

- 91 Hybrid voltage regulator is high in isolation, efficiency
- 101 Picking the right sample-and-hold amplifier
- 118 'Magic' program optimizes circuit parameters

# Electronics®

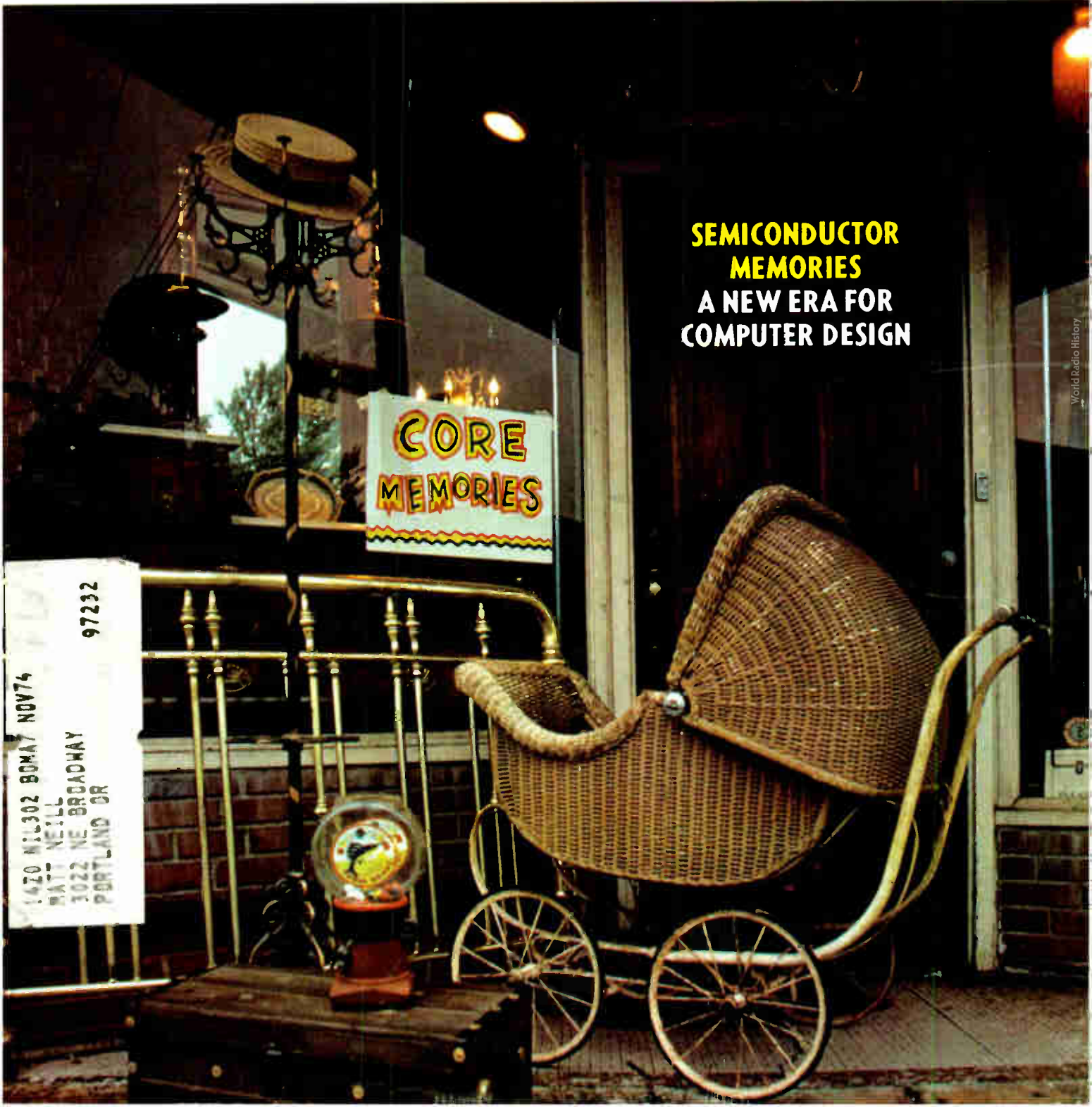

**SEMICONDUCTOR  
MEMORIES**  
A NEW ERA FOR  
COMPUTER DESIGN

# Can a DIVA Disc System really maximize my mini and save me a cool million?



It sure can. Say you own or use one or more of the mini-computers George is sitting on. You can select, according to your particular needs, any one of eight standard mini-maximizer disc systems. George happens to be contemplating a mass memory system with a capacity of approximately 1 gigabyte.

#### **That's a lot of data storage capacity.**

But you might be thinking smaller: 7.5 million bytes, or somewhere in between. We can make you both happy. DIVA makes a disc system that will let you or George segment and store your number-crunching, time-consuming calculations and make short shrift of them. These systems are high-performance units: 624 K bytes/sec transfer, 32-msec avg access, 11 sec stop that cut: running costs to a few bucks/hr.

#### **That's maximizing your mini.**

Now, about the cool million. You don't need a mini for this calculation. DIVA's top-of-the-line disc system with 8 spindles tags out at \$111,900. Add the cost of your mini. Subtract the total from \$1 to \$4 million: the cost of a comparable maxi.

#### **That's saving a cool million, or more.**

Obviously, there's more to mini-maximizing than is written here. Options like IBM compatible formatting, an exclusive DIVA feature, and pseudo-sectoring for efficient disc use. Features like overlap seek and removable packs. The rest is in our free brochure. Send for your copy. Read the specs on all the systems. Talk with George Roessler about costs or any unanswered questions on software, training, application, etc.

Then maximize your mini. She's got a lot of potential. DIVA, Inc. 607 Industrial Way West/Eatontown, N. J. 07724/ Phone: 201-544-9000 TWX 710-722-6645.



Mini maximizer systems

Circle 900 on reader service card

World Radio History

# When you're number one you'd better deliver.

## The 18 GHz Autohet Counter. Right Now.



Autohet isn't just a fast-talking operation. We can deliver. Take a look at the figures: Our automated heterodyning unit allows the correct frequency to be displayed (20 Hz to 18 GHz) in a fraction of a second. What could have taken you five minutes to determine, now appears in milliseconds without requiring you to interpret the gate time or the decimal point. And your result is infinitely easier to read. Readout appears in 11 digits instead of the 6 or 8 you've been used to.

### We deliver FM tolerance.

Because we chose to automate the heterodyne method instead of the transfer oscillator approach, the Autohet counter can measure

correctly in the presence of large amounts of frequency modulation, and take 10 MHz peak-to-peak deviation at any modulation frequency, in the worst case. And in the best case, it's over 130 MHz deviation.

Nobody else can approach our FM performance and our two-week delivery, but that's what you'd expect from a company that's been the industry leader as long as we have.

We can save you more than time. We can save you almost \$2,000 compared to a manual counter with heterodyne converters. And we're cheaper than automatic transfer oscillator counters.

Interested in a counter this fast, this reasonable? Then give a quick collect call to Bob Mangold at (408) 244-7975.



3130 Alfred Street,  
Santa Clara, Ca. 95050

**Others measure by us.**

# the BEST costs LESS



SAYS IT BEST.....COST LESS

## SELF-SCAN® Alphanumeric, single register Panel Displays... under 7¢\* a dot...and the price includes all drive electronics

**ECONOMY**—SELF-SCAN Panel Displays have the lowest cost by any measure...dot, character, panel, or complete assembly. Price quoted in headline includes all panel drive electronics, character generator, bezel with mounting hardware and filter.

**LEGIBILITY**—Display characters are sharply delineated. No pincushioning, fuzzing or loss of focus.

**BRIGHTNESS**—Achieved by orange red colored dots intense enough to stand out brighter and sharper yet subtle enough to prevent possible eyestrain during long viewing periods.

**VISIBILITY**—Assured from 12 feet or 25 feet depending on character size .120° viewing angle means high visibility.

**BETTER PACKAGING**—1.34" max. depth without memory, 1.96" max. depth with memory permits installation in small space areas. SELF-SCAN Panel Displays can be mounted singly or in combinations.

*Call or write Burroughs Corporation, Electronic Components Division, P.O. Box 1226, Plainfield, New Jersey 07061. Phone (201) 757-3400. A Burroughs sales engineer will stop by your office to back our claims with hard facts and figures.*

\*Based on SSD 0132-0030 one thousand piece price.

See us at Wescon Booths #1622-1626

World Radio History

# Burroughs



Circle 2 on reader service card

## 39 Electronics review

COMPUTERS: Motorola introduces Inn-Scan system, 39  
Tek 31 acts like a minicomputer, 40  
Micro Millie makes a debut, 40  
COMMERCIAL ELECTRONICS: Skyjackers promote X-ray scanners, 41  
Crime pays for boom in security systems, 41  
ECONOMICS: Phase 4 produces long-term uncertainty, 42  
MEDICAL ELECTRONICS: Heart monitor, alarm warn of attack, 43  
INDEX OF ACTIVITY: 44  
MILITARY ELECTRONICS: Tacfire to be produced by '75, costs soar, 44  
NEWS BRIEFS: 47  
COMPANIES: Rockwell reorganizes Microelectronics division, 48

## 55 Electronics International

GREAT BRITAIN: BBC designs slow memory for TV subtitles, 55  
AROUND THE WORLD, 55

## 61 Probing the News

COMMUNICATIONS: From omens to messengers, 61  
GOVERNMENT ELECTRONICS: NOAA fills bags with electronics, 64  
TRADE ASSOCIATIONS: The other CIA—a bark and a bite, 66  
CONSUMER ELECTRONICS: Pay TV—will it get four stars? 71

## 75 Technical Articles

SPECIAL REPORT: Semiconductors take over data-storage roles, 75  
POWER SUPPLY: Series-shunt voltage regulator solves problems, 91  
DESIGNER'S CASEBOOK: Sampling regulator controls motor speed, 97  
Digital transient suppressor eliminates logic errors, 99  
COMPONENTS: Choosing a sample-and-hold amplifier, 101  
ENGINEER'S NOTEBOOK: Adding automatic erasure to scopes, 105  
Design chart identifies intermodulation products, 106

## 111 New Products

IN THE SPOTLIGHT: Test-system modularity saves costs, 111  
COMMUNICATIONS: Switch control is all-digital, 112  
INSTRUMENTS: Counter-timer can reach 1 GHz, 115  
DATA HANDLING: Magic: the designer's wand, 118  
PACKAGING & PRODUCTION: Pc-board drill saves time, 120

## Departments

Publisher's letter, 4  
Readers comment, 6  
40 years ago, 8  
People, 14  
Meetings, 30  
Electronics newsletter, 35  
Washington newsletter, 51  
Washington commentary, 52  
International newsletter, 57  
Engineer's newsletter, 108  
New literature, 123  
New books, 124

## Highlights

### The cover: Semiconductors antiquating cores, 75

Nearly every new computer, controller, and calculator either has a semiconductor memory these days or offers one as an option. This widening popularity is due partly to falling prices and partly to the fact that an equipment manufacturer can use chips to build his own memory systems—a near impossibility with cores. Cover photograph is by Art Director Fred Sklenar.

### Omens of the gods become messengers of men, 61

Meteors and lightning, which once signified the anger of gods toward men, nowadays help men communicate with each other. A large utility has built a system that bounces 100-millisecond-long bursts of data off tiny meteorite trails, and a university interested in vlf communications is operating a transmitter for research into lightning-generated "whistlers."

### Hybridization improves the regulator species, 91

The high input-output current isolation of the shunt regulator is combined with the high efficiency of the series regulator in a new series-shunt type of power supply.

### Choosing the right sample-and-hold amplifier, 101

High-speed data-acquisition systems make perhaps the heaviest demands on the sample-and-hold amplifier. But understanding its specifications in terms of its operation will help the engineer choose wisely from the wide range of models now available, whatever the application.

### And in the next issue . . .

The first chopper-stabilized IC op amp . . . thick films make better microwave devices . . . design for a low-noise switching regulator.

EDITOR-IN-CHIEF: Kemp Anderson

EXECUTIVE EDITOR: Samuel Weber

MANAGING EDITORS: Lawrence Curran, *News*;  
Arthur Erikson, *International*

SENIOR EDITORS: John Johnsrud,  
H. Thomas Maguire, Laurence Altman  
Ray Connolly

ART DIRECTOR: Fred Sklenar

ASSOCIATE EDITORS: John N. Kessler,  
Howard Wolff, Gerald M. Walker

DEPARTMENT EDITORS

*Aerospace*: William F. Arnold  
*Circuit Design*: Lucinda Mattera  
*Communications & Microwave*:  
Lyman J. Hardeman

*Computers*: Wallace B. Riley  
*Consumer*: Gerald M. Walker  
*Industrial*: Alfred Rosenblatt  
*Instrumentation*: Michael J. Riezenman  
*Military*: Ray Connolly

*New Products*: H. Thomas Maguire  
*Packaging & Production*: Stephen E. Grossman  
*Solid State*: Laurence Altman  
*Special Issues*: Harry R. Karp

COPY EDITORS: Margaret Eastman,  
Everett C. Terry

ASSISTANT EDITOR: Marilyn Offenheiser

ART: Charles D. Ciatto, *Associate Director*  
Patricia Cybulski, *Assistant Director*

PRODUCTION EDITOR: Arthur C. Miller

EDITORIAL SECRETARIES: Janet Annunziata,  
Julie Gorgoglione, Penny Roberts

FIELD EDITORS

*Boston*: Gail Farrell  
*Los Angeles*: Paul Franson (Mgr.)  
*Midwest*: Larry Armstrong (Mgr.)  
*New York*: Alfred Rosenblatt (Mgr.)  
*San Francisco*: George Sideris (Mgr.),  
Judith Curtis  
*Washington*: Ray Connolly (Mgr.),  
William F. Arnold  
*Frankfurt*: John Gosch  
*London*: Michael Payne  
*Paris*: Arthur Erikson  
*Tokyo*: Charles Cohen

McGRAW-HILL WORLD NEWS

*Director*: Walter A. Stanbury  
*Bonn*: Robert Ingersoll;  
*Brussels*: James Smith;  
*London*: Marvin Petal;  
*Milan*: Peter Hoffmann, Andrew Heath;  
*Moscow*: Axel Krause;  
*Paris*: Michael Johnson, Richard Shepherd;  
*Stockholm*: Robert Skole;  
*Tokyo*: Mike Mealey

PUBLISHER: Dan McMillan

ADVERTISING SALES MANAGER: Pierre J. Braudé

ADVERTISING SALES SERVICE MANAGER:  
Wallis Clarke

BUSINESS MANAGER: Stephen R. Weiss

CIRCULATION MANAGER: George F. Werner

MARKETING SERVICES MANAGER:  
Tomlinson Howland

Like many evolutionary turns in electronics, the switch from core memories to semiconductor memories was slow to start, but then ended up looking like an overnight turnabout. As Wally Riley, our Computers Editor, points out in the special report starting on page 75: "Semiconductor technology, long heralded for tomorrow's memories, has suddenly become the technology of today."

The vast majority of new computer models, large and small, comes with these memories. What's more, from peripherals, such as remote terminals where they scored their first success, to controllers, the solid-state units are appearing in increasing number.

And this success story comes in the face of a host of obstacles—shortages, design difficulties, and lack of standardization. The key: a quantum jump in the price/performance ratio, a jump that has put the semiconductor memory into the "affordable" range. Our 16-page report on the state of the art in semiconductor memories details just where they stand today, how they got there and—most important—what's ahead in the application of these memories.

**Weather**—measuring it, forecasting it, even using it—is the subject of two of the Probing the News stories in this issue.

On page 61, you'll find a report on how communications engineers are harnessing shooting stars and the broadband very-low-frequency emissions generated by lightning to set up links that have some advantages over more conventional approaches. For one, meteor-burst links offer the potential of blackout-

free polar communications. For another, they hold out the promise of low-cost transmissions of simple data from sites that are hard to get to by monitoring personnel. In fact, that is the reason the Bonneville Power Administration, which needs to keep track of the rainfall and stream levels in its vast watershed in Oregon and Washington, turned to meteor-trail transmission links.

Though the idea has been around for decades, meteor-burst links are only now becoming practical—because it was found that messages could be bounced off the trails of micrometeorites, which are far more numerous than the large, visible, shooting stars—so much so as to offset their very brief duration. And, in a bit of a switch, the military is becoming interested in the same kind of system that private-enterprise Bonneville is pioneering.

**The other** Probing the News story (see page 64) deals with the wide range of electronic gear that the National Oceanic and Atmospheric Administration wants to buy and use in its programs to gather and analyze data on the world's weather.

Satellites, of course, are a mainstay of NOAA's work, and a speed-up of launchings is in the works. But the agency is also relying on new sensors, automated weather stations, and the digital communications systems to lash them all together. All in all, the agency has an ambitious program, one which should do its bit for the economic climate of equipment suppliers.



August 2, 1973 Volume 46, Number 16

91,700 copies of this issue printed

Published every other Thursday by McGraw-Hill, Inc. Founder James H. McGraw 1860-1948. Publication office 1221 Avenue of the Americas, N.Y., N.Y. 10020; second class postage paid at New York, N.Y. and additional mailing offices.

Executive, editorial, circulation and advertising addresses: Electronics, McGraw-Hill Building, 1221 Avenue of the Americas, New York, N.Y. 10020. Telephone (212) 997-1221. Teletype TWX N.Y. 710-581-5234. Cable address: MCGRAW HILL N.Y.

Subscriptions limited to persons with active, professional, functional responsibility in electronics technology. Publisher reserves the right to reject non-qualified requests. No subscriptions accepted without complete identification of subscriber name, title, or job function, company or organization, including product manufactured or services performed. Subscription rates: qualified subscribers in the United States and possessions, Canada, and Mexico \$8.00 one year, \$12.00 two years, \$16.00 three years; all other countries \$25.00 per year, except Japan \$50.00 per year and Brazil \$40.00 per year, including air freight. Limited quota of subscriptions available at higher-than-basic rate for persons outside of field served, as follows: U.S. and possessions and Canada, \$25.00 one year; all other countries \$50.00. Single copies: United States and possessions and Canada, \$1.00; all other countries, \$1.75.

Officers of the McGraw-Hill Publications Company: John R. Emery, President; J. Elton Tuohig, Executive Vice President-Administration; Gene W. Simpson, Group Publisher-Vice President; Senior Vice Presidents: Ralph Blackburn, Circulation; John B. Hoglund, Controller; David G. Jensen, Manufacturing; Gordon L. Jones, Marketing; Jerome D. Luntz, Planning & Development.

Officers of the Corporation: Shelton Fisher, President; Wallace F. Traendly, Group President; McGraw-Hill Publications Company and McGraw-Hill Information Systems Company; John J. Cooke, Senior Vice President and Secretary; Ralph J. Webb, Treasurer.

Title registered in U.S. Patent Office; Copyright ©1973 by McGraw-Hill, Inc. All rights reserved. The contents of this publication may not be reproduced either in whole or in part without the consent of copyright owner.

Subscribers: The publisher, upon written request to our New York office from any subscriber, agrees to refund that part of the subscription price applying to copies not yet mailed. Please send change of address notices or complaints to Fulfillment Manager, subscription orders to Circulation Manager, Electronics, at address below. Change of address notices should provide old as well as new address, including postal zip code number. If possible, attach address label from recent issue. Allow one month for change to become effective.

Postmaster: Please send form 3579 to Fulfillment Manager, Electronics, P.O. Box 430, Hightstown, N.J. 08520.

**If you want high voltage,  
programmable power supplies  
that don't depend on delicate  
low voltage transistors  
to stabilize high voltage,  
look into**

**KEPCO**

**BHK**

**Hybrid power supplies  
that control voltage to 2000 volts  
linearly and directly with rugged,  
forgiving vacuum tubes!**

**BHK** power supplies are one of several high voltage designs by Kepco that combine modern I-C and transistor small signal processing (for stability and accuracy) with hard-vacuum, high-voltage pass tubes (for reliability and linearity). The result is a happy partnership with each part of the power supply operating in a favorable environment.

BHK offer 0-500 volts at 0-400 milliamperes, 0-1000 volts at 0-200 milliamperes and 0-2000 volts at 0-100 milliamperes with multiturn voltage and current controls, full metering and automatic crossover voltage/current mode lights.

Ask your Kepco man for details about the Kepco high voltage Hybrids. If you don't know who he is, call (212) 461-7000 collect, or write Dept. AM-14 and we will be glad to direct you to the most exciting power supplies on the scene.

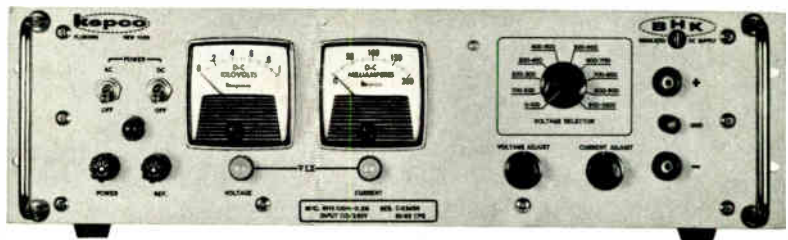

**KEPCO®**

KEPCO, INC. • 131-38 SANFORD AVENUE • FLUSHING, N.Y. 11352 • (212) 461-7000 • TWX #710-582-2631 • Cable: KEPCOPOWER NEWYORK

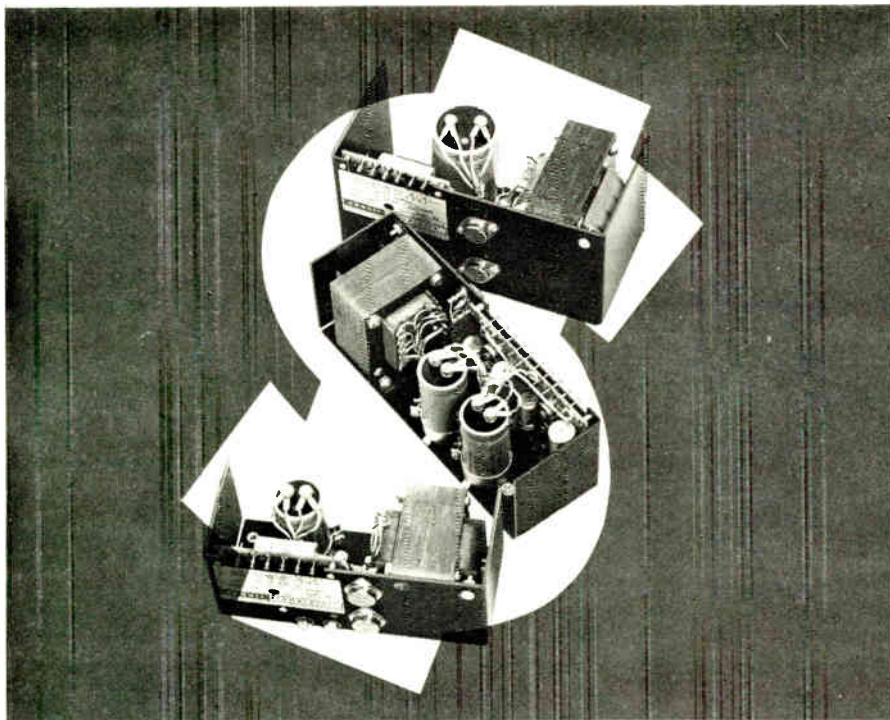

## Start Getting Your Money\$worth Out of Power Modules





Now, you can really start getting your moneysworth out of power modules with Abbott's new LOW COST series. Designed to give you 100,000 hours of trouble-free operation (that's 11½ years), these reliable units meet the needs of OEM engineers. Their purchase price is about \$7 per year of service. The model LC series feature:

- 47-420 Hz Input Frequency
- 0.1% Regulation
- +50°C. Ambient Operation
- Single and Dual Outputs
- 1 Day Stock Delivery

These units provide more quality per dollar compared to similar items on the market. See table below for prices on some of our LC models. Many other LC models are listed in our catalog.

If analyzing the many similar power supplies on the market is confusing; if you are concerned about the long-term reliability of those units, then decide on an Abbott power supply for your system. Your best buy in OEM power modules is ABBOTT.

Abbott also manufactures 3,000 other models of power supplies with output voltages from 5 to 740 VDC and with output currents from 2 milliamps to 20 amps. They are all listed with prices in the new Abbott Catalog with various inputs:

60  to DC  
 400  to DC  
 28 VDC to DC  
 28 VDC to 400   
 12-24 VDC to 60 

5V @ 6 Amps	5V @ 10 Amps	12V @ 10 Amps	15V @ 4 Amps	28V @ 1 Amp	±12V @ 1.2 Amps	±15V @ 4 Amps
LC5T6	LC5T10	LC12T10	LC15T4	LC28T1	LLC12T1.2	LLC15T4
\$72	\$81	\$99	\$81	\$72	\$99	\$135

Please see pages 686 to 699 of your 1972-73 EEM (ELECTRONIC ENGINEERS MASTER Catalog) for complete information on Abbott modules.

Send for our new 56 page FREE catalog.

**abbott transistor**

**LABORATORIES, INCORPORATED**  
 general offices eastern office  
 5200 W. Jefferson Blvd./Los Angeles 90016 (213) 936-8185 Telex: 69-1398  
 1224 Anderson Ave./Fort Lee, N.J. 07024 (201) 224-6900 Telex: 13-5332

H. Orlo Hoadley  
 Rochester, N.Y.

## Readers comment

### The engineer's calculator

To the Editor: Aren't you approaching the subject of the use of small calculators by engineers from the wrong end [*Electronics*, March 29, p. 92]? It's nice to write an algorithm for a particular problem that will be usable on a lot of different calculators, but the detailed operation of calculators differs so much that it is difficult to tell what machines can use a given procedure.

It would be better to describe the features of specific machines and explain just how well they are or are not adapted to calculations that engineers do. For instance, many small calculators store constants, but a constant is stored and used in at least five different ways. Machines using at least two of these ways will not find a reciprocal by the method that was earlier described in your magazine.

Most of the 8-digit calculators lop off any digits beyond seven places to the right of the decimal point, which means that an operator can lose a lot of his significant figures if he is not careful to avoid partial answers that are orders of magnitude smaller than one. In addition, a calculator for engineers should be evaluated on how well it can handle these problems:

- Calculate the resultant of parallel resistors
- Calculate the sum of squares
- If it does not have a direct square-root key, calculate a square root by the successive-approximation method described in the cited article
- Evaluate a second- or third-order power series

The last three of these cannot be done completely on a first-level calculator without entering any variable more than once or having to re-enter an intermediate result later through the keyboard. This takes a second-level machine—one that has a separate memory register, as well as the stored-constant feature. With one exception—the High-Priced machine with 35 keys—the small calculators are not made to accommodate the needs of engineers.



# TRW LVA diode... the sharpest knee below 10 Volts.

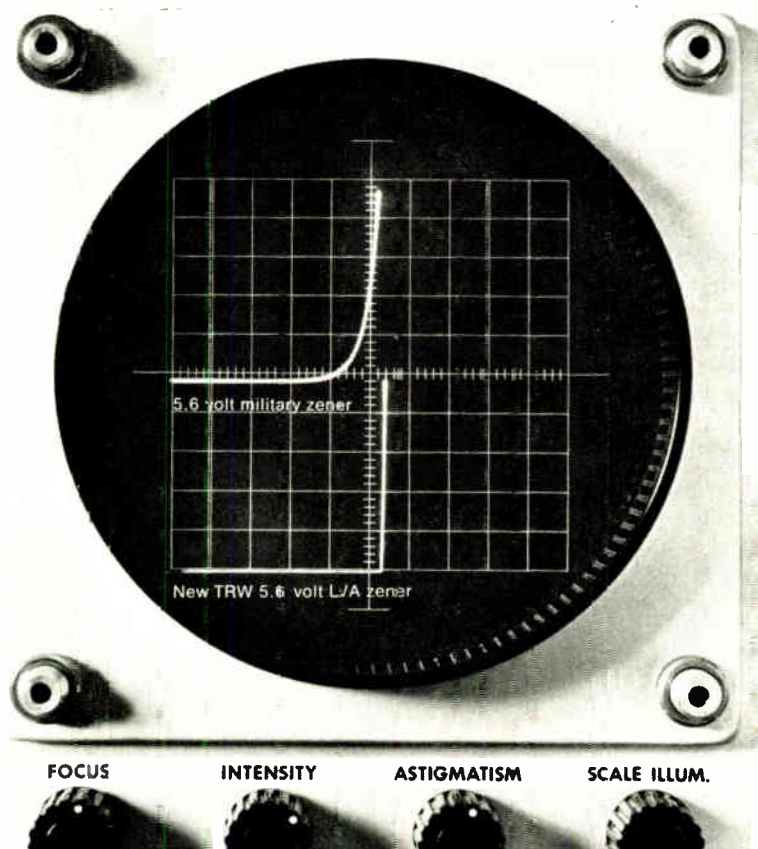

## The current saver.

No other zener can approach TRW's LVA performance below 10 volts. Available for operation down to 4.3 volts, TRW LVA diodes minimize power consumption in portable-battery operated equipment. They're also ideal for instrumentation, where, as reference elements, they draw as little as 50  $\mu$  Amps.

TRW LVA's are available in various package configurations, including passivated chip form for hybrid-

compatible packages. If you have a need for a low current voltage regulator or any other product that demands low current consumption, you should check out TRW LVA zeners. When it comes to current, they're really misers!

For product information and applications assistance write TRW Semiconductors, an Electronic Component Division of TRW Inc., 14520 Aviation Boulevard, Lawndale, California 90260. Phone (213) 679-4561.

These products are available through the following authorized distributors:

Almo Electronics  
Bell Industries  
Cramer Electronics Inc.  
De Mambro Electronics

Eastern Radio Corp.  
Electronics Marketing Corp.  
Elmar Electronics Inc.  
Hall-Mark Electronics Corp.

Harvey-Michigan Inc.  
Liberty Electronics  
Powell Electronics  
Pytronics

Semiconductor Concepts Inc.  
Summit Distributor  
R. V. Weatherford Co.  
Westates Electronics Corp.

## TRW SEMICONDUCTORS

Cut package count . . . Simplify board layout . . .  
Reduce equipment size . . . with

# DIP MULTI-COMP<sup>®</sup> RESISTOR-CAPACITOR NETWORKS



(Metonet<sup>®</sup> Film Resistors, Monolythic<sup>®</sup> Ceramic Capacitors)

## STANDARDIZED DESIGNS\* FOR BETTER AVAILABILITY, BETTER PRICES

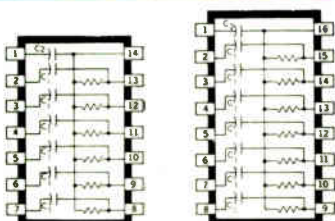

R (Ω)			C <sub>1</sub>
100	470	2000	100pF
150	500	2200	330pF
200	680	3300	0.01μF
220	1000	4700	C <sub>2</sub>
330	1500	6800	0.05μF

### BYPASSED PULL-UP AND R-C COUPLING NETWORKS

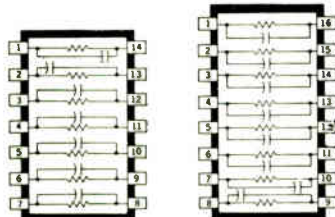

R (Ω)			C
100	470	2000	1000pF
150	500	2200	3300pF
200	680	3300	0.01μF
220	1000	4700	
330	1500	6800	

### SPEED-UP NETWORKS

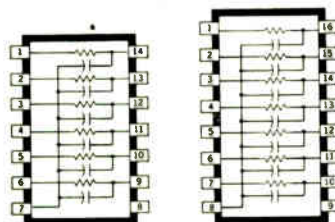

R (Ω)			C (pF)
100	470	2000	
150	500	2200	100
200	680	3300	330
220	1000	4700	
330	1500	6800	

### ACTIVE TERMINATOR NETWORKS

\* OTHER PACKAGES, CIRCUIT CONFIGURATIONS, AND RATINGS AVAILABLE ON SPECIAL ORDER

**Sprague puts more passive component families into dual in-line packages than any other manufacturer:**

- TANTALUM CAPACITORS
- CERAMIC CAPACITORS
- TANTALUM-CERAMIC NETWORKS
- RESISTOR-CAPACITOR NETWORKS
- PULSE TRANSFORMERS
- TOROIDAL INDUCTORS
- HYBRID CIRCUITS
- TAPPED DELAY LINES
- SPECIAL COMPONENT COMBINATIONS
- THICK-FILM RESISTOR NETWORKS
- THIN-FILM RESISTOR NETWORKS
- ION-IMPLANTED RESISTOR NETWORKS

For more information on Sprague DIP components, write or call Ed Geissler, Manager, Specialty Components Marketing, Sprague Electric Co., 35 Marshall St., North Adams, Mass. 01247. Tel. 413/664-4411.

THE BROAD-LINE PRODUCER OF ELECTRONIC PARTS



## 40 years ago

From the pages of Electronics, August 1933

The "Code of Fair Competition for the Radio Industry," drawn up and submitted by the Radio Manufacturers Association, is a carefully composed document and should serve as an effective influence for stabilizing the radio business and creating more jobs—which latter is the primary purpose of the NIRA administration.

All in all, the Code work was well done, under most difficult conditions of pressure, trade cross-currents and counter-proposals, and summer heat.

But engineers will detect several points of injustice in the Radio Code. Engineers, for example, are excluded from the limiting hours of labor. As intellectual workers, engineers might take pride in this distinction, were it not for certain manufacturers who drive their engineers to continuous overtime at starvation wages and then drop them without notice.

The clause specifying that no new radio tubes shall be introduced for the next year has a certain justification, as things stand in radio today; but any such principle of technical "stand-still" is unsound, and its extension will prove ultimately destructive. Another novel economic principle offered in the tube chapter provides that sales below cost of production, if made to meet competition, are not to be regarded as selling below cost!

High-power sound systems and wide-screen projectors developed for the very large movie houses, have now made possible a new entertainment device, the outdoor automobile movie. The first of these "drive-in theaters" occupies a seven-acre field near Camden, N.J., and the idea is expected to spread widely next season for roadside entertainment, much as the golf-course craze three years ago. Visitors drive their cars right into the enclosure, and on cool evenings or during light rain can hear perfectly even with all windows closed. Whole families, with infirm elders, can be transported boldly, with minimum effort.

Until recently, if you wanted broadband RF power, you had to settle for bulky tube-type power amplifiers. No more. Starting at the top, we developed a full line of all-solid-state Class A power amplifiers, covering the frequency spectrum of 100 kHz to 560 MHz, with power outputs ranging from 300 milliwatts to over 100 watts. And we're still climbing.

Driven by any signal generator, frequency synthesizer or sweeper, these compact, portable amplifiers are versatile sources of power for general laboratory work, RFI/EMI testing, signal distribution, RF transmission, laser modulation, data transmission, NMR, ENDOR, ultrasonics and more.

Completely broadband and un-

tuned, our highly linear units will amplify inputs of AM, FM, SSB, TV and pulse modulations with minimum distortion. Although all power amplifiers deliver their rated power output to a matched load, only ENI power amplifiers will deliver their rated power to any load regardless of match.

We also designed our amplifiers to be unconditionally stable and failsafe—you need never fear damage or oscillation due to severe load conditions (including open or short circuit loads).

ENI instrumentation amplifiers come complete with an integral AC power supply and an RF out-

put meter. Ruggedized amplifiers capable of operating under severe environmental conditions are available.

To find out more about our RF power amplifiers write: ENI, 3000 Winton Road South, Rochester, New York 14623. Call 716-473-6900. TELEX 97-8283 ENI ROC.

**RF Amplifiers.  
We started at the top.  
Then worked our  
way up.**

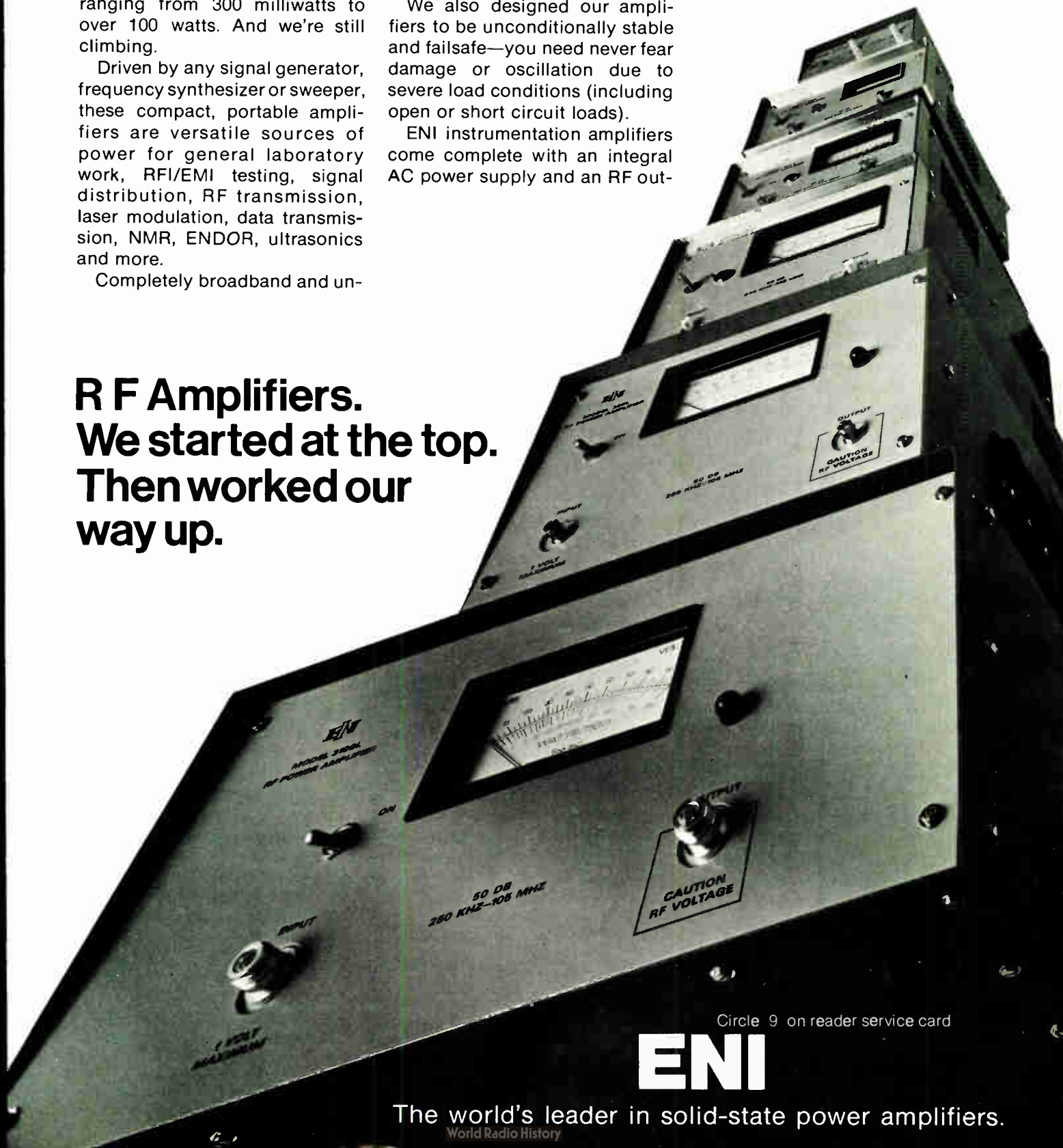

Circle 9 on reader service card

**ENI**

The world's leader in solid-state power amplifiers.

World Radio History

# WE CALL THE 840 THE LOADED NOVA.

## IT'S TOO BIG AND HAIRY TO BE A MINICOMPUTER.

By minicomputer standards, our new Nova 840 is big and hairy and costs a lot of money.

But, in terms of combined hardware/software performance, minicomputer standards just don't apply to the 840.

### BIG HARDWARE

We loaded the 840 with a brand new Memory Management and Protection Unit that turns it into something far more than a minicomputer. MMPU lets the 840 grow to 128K 16-bit words (256K bytes) of main memory, and, most important, lets it take advantage of all the hairy software we've developed.

The 840 also comes with a whole list of peripherals and high-performance options, including a superfast new Floating Point Unit that handles single and double precision arithmetic at speeds that match most big computers.

### HAIRY SOFTWARE

But hardware is only the vehicle. What makes the 840 a different kind of machine is software: the most powerful software available with any

computer at anywhere near its price. Proven software can deliver today.

It has a Real-time Disc Operating System that supervises the whole system; our new Fortran 5, that produces globally optimized, fast-executing code that's as efficient as machine language; Batch; remote job entry software; timesharing BASIC; and Extended Algol.

Dual Operations on the 840 lets you run any two major software streams concurrently and with complete security: multi-terminal timesharing BASIC along with remote job entry, or a real-time control application while you're doing prototype development in Algol.

### THE PROOF

With all that hardware/software muscle, the 840 has embarrassed a lot of far bigger computers in price/performance benchmark comparisons.

For instance, there was the XDS Sigma 7 that was 40% faster running an independently conducted Fortran

benchmark. And then got wiped out by the 840's more-than 10-to-1 price advantage.

Or the DECsystem-1050 that cost eight times more than the 840. And was actually 7% slower running the benchmark.

If you think those benchmarks are too good to be true, just call us. We'd love the chance to give you a lot more details on the benchmarks and how Data General software makes that kind of price/performance possible.

### THE PAYOFF

We know that Data General isn't the only minicomputer company with a big hairy machine.

We also know that the 840 is, capability-for-capability, feature-for-feature, consistently less expensive than the competition.

And we know we can deliver the 840 faster than the competition can deliver their machines: 90 days after you call us with an order. (617) 485-9100.



**DATA GENERAL**  
Southboro, Massachusetts 01772

# If You're Resp

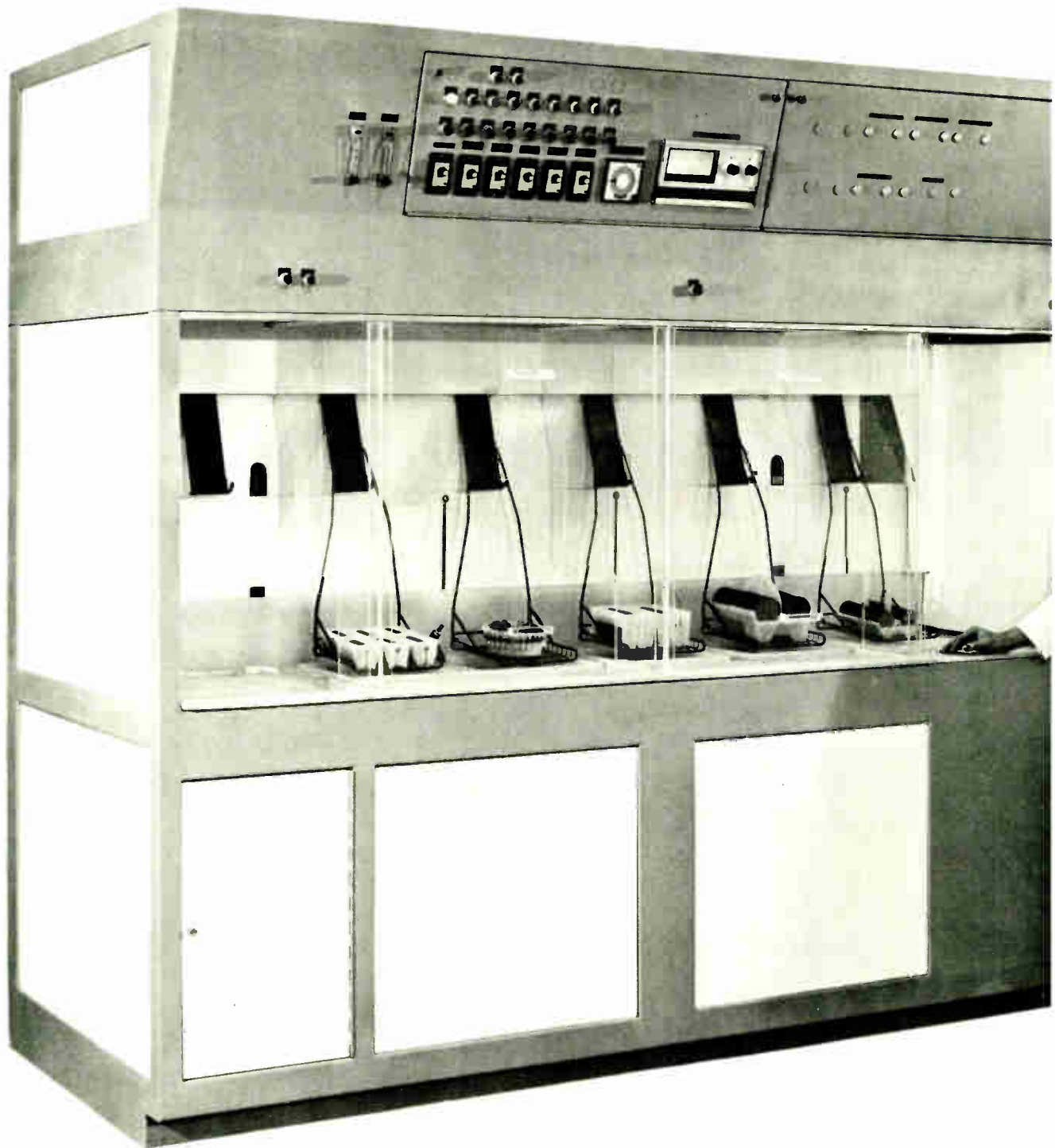

MESA APR-1000—The Now Idea in Chemicals for Electronics

# onsible... you should know about

## MESA™

APR-1000 is the first in a new series of automatic equipment from Allied Chemical. It's designed to save you money and reduce pollution.

APR-1000 is versatile. It removes photoresist from silicon wafers prior to metallization and strips photoresist from chrome masks. It cleans silicon wafers, chrome masks and glass plates.

Because it's totally automatic, you can count on greater reproducibility. With automatic wafer boat transfer and "steady-state" conditions during stripping, you get identical wafer-to-wafer processing. And through-put is high with APR-1000—up to 1800 2-inch or 900 3-inch wafers per hour, depending on wafer boat configuration.

There are other advantages to using MESA equipment: minimum chemical and water requirements, adjustable cycle time, adjustable spray and vapor times, automatic chemical replenishment, adjustable stripper composition, self-contained clean air system in the last two stages, a chemical exhaust system which ties into existing plant systems, resistivity meter to verify thoroughness of rinsing, and drying accomplished without use of flammable solvents.

For more information, on MESA APR-1000, call your local Allied Chemical Sales Office.



P. O. Box 1087R Morristown, N. J. 07960



Specialty  
Chemicals  
Division

# RCL

## SWITCH ENGINEERING HANDBOOK



AN EASY-TO-READ  
NEWLY EXPANDED  
TECHNICAL CATALOG OF  
INDUSTRY'S MOST  
COMPLETE SELECTION  
OF

# MINIATURE ROTARY SWITCHES

INCLUDING MILLIMETER  
CONVERSION DRAWINGS OF  
EVERY RCL SWITCH!

# RCL

General Sales Office  
RCL ELECTRONICS, INC.  
700 South 21st Street  
Irvington, New Jersey 07111

## People

An engineer works  
his way to the top

From an engineer on the bench in 1945 to president of the company just last month—this is the enviable achievement in the career of Winfield E. Fromm, the new head of Cutler-Hammer's AIL division, Deer Park, N.Y. Fromm moves up after spending the last five years as executive vice president, directing AIL's R&D and manufacturing efforts in such things as reconnaissance, electronic counter-measures, radar, air-traffic control and all-weather landing systems. Along the way, Fromm also managed to be the co-inventor of stripline, the well-known rf transmission medium. In short, he's been involved with just about all of the technical areas that mark AIL as one of the foremost high-technology electronics operations in the nation.

Today, his prime concerns are to promote the long-term growth of AIL, which employs some 3,200 people and in 1972 hit \$99 million in sales. His goal is 10% to 15% growth per year. And he also wants to optimize the "people resources" at his company—"to match people to the jobs best suited for them."

Fromm intends to keep AIL in the areas of high technology in which it excels. Classified reconnaissance and countermeasures programs continue to be well funded, he points out. And the prospects look good for both civil and military applications of such things as AIL's scanning-beam landing and air-traffic-control systems. He's also looking to apply AIL's expertise to new business areas that are "not in the consumer field" and to expand the relatively new Ailtech subsidiary, which specializes in instrumentation.

In his spare time, the tall, 55-year-old executive is heavily involved in managing a 500-acre cattle farm he owns in Virginia's Shenandoah Valley. He raises about 115 head of black angus cattle and approaches this business in the same planned and orderly way he does things at AIL. He is also vice chairman the Board of Trustees of



**From the top.** AIL's Fromm looks for growth in high-technology electronics.

Dowling College, a small but growing liberal arts school out near the main AIL headquarters on New York's Long Island, and he's active in the area's United Fund.

But despite these responsibilities, Fromm's office is always open to the people who work for him. Through these contacts, and through the small, informal discussion groups he's instituting, he hopes he'll "maintain as much contact with the people as I can."

TRW Systems' Harter  
resists commercial lure

There's a temptation in the aerospace industry to apply high technology to commercial ventures, but George A. Harter isn't yielding to the temptation. Harter, the new vice president and general manager of TRW Systems group's Electronic Systems division in Redondo Beach, Calif., is confident that the Government and the military will continue



**TRW's Harter:** a viable Federal market.



## Reduce Custom Power Electronics Time and Cost

With a handful of Powercube's new Cirkitblock™ modules and a few clip leads, you can quickly synthesize a virtually infinite variety of power control circuits and power supplies.

Cirkitblock modules have demonstrated capability to meet most design needs and are packaged within a 1" x 1" x 2" basic building block so you can assemble power circuits and supplies of any complexity to any form factor you need in building block fashion.

Design time to operable prototype can be reduced by more than half because conventional breadboarding is eliminated. Your quickly assembled "breadboard" of Cirkitblock modules becomes your operable prototype.

Cirkitblock modules use space technology, but are specified and priced for industrial applications. They can substantially reduce the "as installed" power electronics cost in instruments, calculators, computer peripherals, process control equipment, and communications gear.



Original Powercube Module®

Cirkitblock functional modules not only save design time and money; they're also a lot of fun to work with. Circle reader service number to learn more about Powercube's Cirkitblock functional modules.

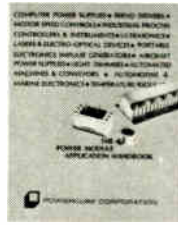

**New! Application Handbook.**  
Write on your company letterhead to obtain your copy.

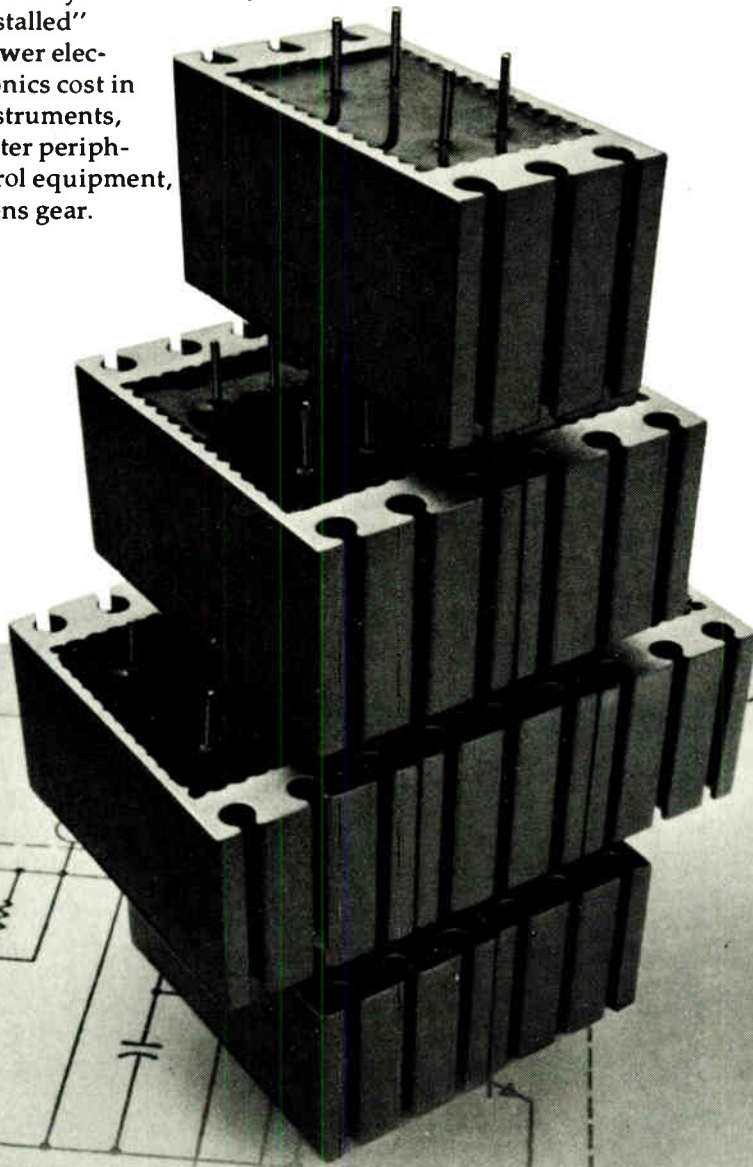

# POWERCUBE CORPORATION

214 CALVARY STREET, WALTHAM, MASS. 02154 (617) 891-1830

SUBSIDIARY OF UNITRODE CORPORATION

# New

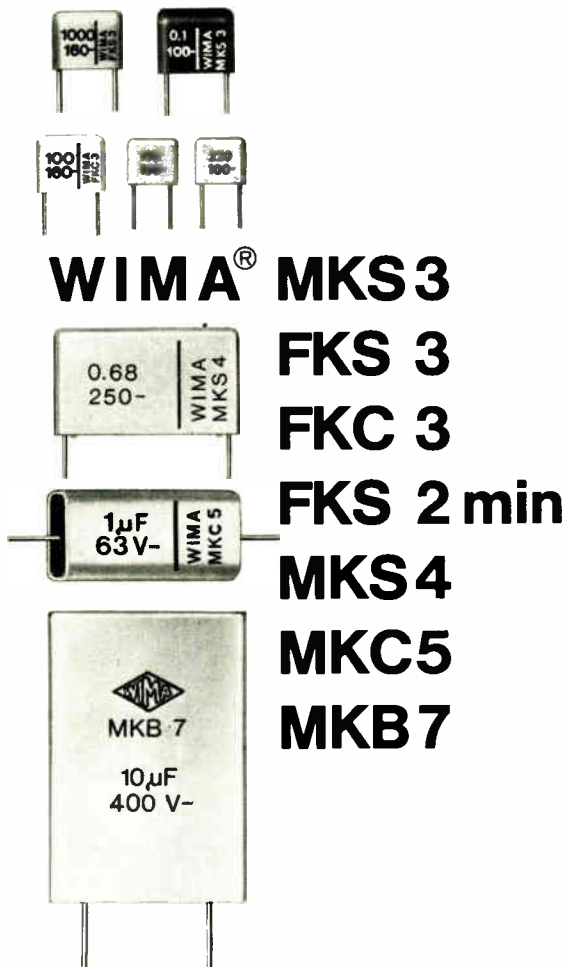

## Capacitors for electronic equipment and for stringent requirements



***Metalized-Miniature types - Polyester/polycarbonate dielectric.***

***The newly developed capacitors are the answer to improving the reliability of your equipment. Please send for the latest technical catalogue***

**WILHELM WESTERMANN** Spezialfabrik für Kondensatoren  
 Augusta-Anlage 56 · P. O. Box 2345 · D-68 Mannheim 1  
 Fed. Rep. of Germany · Tel.: (621) 40 80 12

### People

as viable markets for TRW's advanced technology.

Harter also serves as president of Colorado Electronics Inc., a subsidiary established by TRW in Colorado Springs in 1970 to give the division a low-cost, high-volume manufacturing facility.

That firm is now building a quantity of decoders for home pay TV for Optical Systems Inc. But, says Harter, "that type of commercial work is more of a fill-in, to give us a stable base. The facility was really set up for low-cost military equipment such as modems. We do a lot of development work here in Redondo Beach, and the Colorado plant gives us a good chance to do the follow-on." The plant now has about 150 employees, expected to double within a year.

**Mainstay.** The biggest part of Harter's division is in supplying aerospace electronic systems, such as radio transmitters and receivers and high-speed analog-to-digital converters, particularly to U.S. space and defense agencies and other TRW systems groups. This is an area he knows well, since he was manager of the Space Vehicles division, which makes unmanned satellites.

Harter's new group is also involved in advanced technology, with a good deal of work in data handling and microelectronics. His division's large microelectronics facility is fast developing expertise and capability for the future.

**Triple diffused.** One of the areas the company is working in is triple-diffused bipolar LSI. "We're the only one pushing hard in this technology, which gives high speed and low power, but we're trying to bring another firm up to speed to provide a second source."

Along with the microelectronics, the division will expand its activities in areas other than space.

He expects to spend a lot of time trying to apply the division's large technology base to practical systems applications, mostly with Government and military business opportunities. Says he, "We feel there are still plenty of applications for us to pursue there."

# hp MEASUREMENT NEWS

innovations from Hewlett-Packard

AUGUST, 1973

## in this issue

The computer in the weather station

Let us test one of your microwave devices

Super-sensitive microwave counter



## New answer machines for pockets or desktops

Polar-rectangular coordinate conversions, factorials, or metric conversions—now you can do them all in the palm of your hand... or at your desk.

Hewlett-Packard announces a new scientific calculator, available in both pocket and desktop versions—plus a price reduction for the popular HP-35. All three have solid-state memories similar to those used in computers and are designed for use in science, engineering, surveying, navigation, statistics, and mathematics.

The 9-ounce HP-45 is the first scientific pocket calculator with an addressable memory register system with *nine* storage locations, providing greater computational power, speed and flexibility. Besides the usual logarithmic and trigonometric functions, the HP-45 operates in

(Continued on page 3)

# HP computer system speeds weather forecasts

All forecasting begins with the basic source data, such as wind speed and direction measured by this weather balloon.

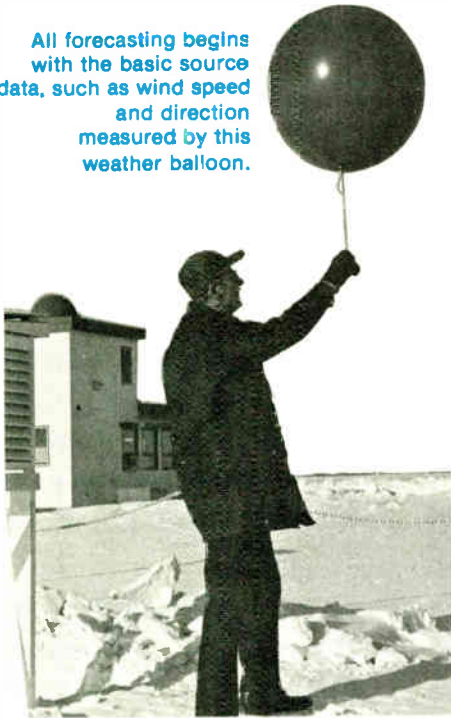

Making rapid detailed weather forecasts requires gathering and analyzing thousands of pieces of meteorological data from hundreds of reporting stations. At Prairie Weather Central, the main forecasting station for central Canada, all this is done by an HP 2120 disc

operating system in one-tenth of the time it took previously.

Approximately 250 weather stations in Canada and the northern U.S. send information hourly. Prairie Weather Central also receives information from Montreal, Moscow and Washington. Data includes barometric pressure, temperature, dew point, moisture, wind speed and direction, and the ceiling (height of the lowest cloud). This information is automatically summarized into reports which meteorologists use to prepare weather maps and forecasts for 3, 6 and 12-hour periods, plus the usual one-day, two-day and weekly forecasts.

Perhaps your own organization is trying to make sense out of vast quantities of rapidly-changing data. If so, consider an HP 2120 disc operating system that runs reliably around the clock.

To forecast how you can use a 2120 system, check E on the HP Reply Card.

## New booklet tells how to select scope probes

With the increased bandwidths in modern oscilloscopes, one probe cannot be used for all measurements. HP's new application note, "Probing in Perspective," helps you select the best probe for most common oscilloscope measurement situations. Major topics include:

- How to select the most accurate scope/probe for a particular measurement.
- How to quickly evaluate a given scope/probe in a particular situation.
- How to estimate errors caused by the probe.

For your free copy, check U on the HP Reply Card.

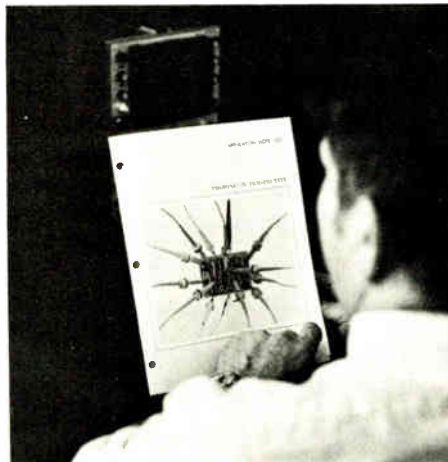

This 12-page booklet helps you realize the full accuracy of your scope.

## Two-pen recorder offers speed, convenience

High acceleration means quick response to small input changes; high slewing speed enables the 7046 to respond to large, fast signal changes.

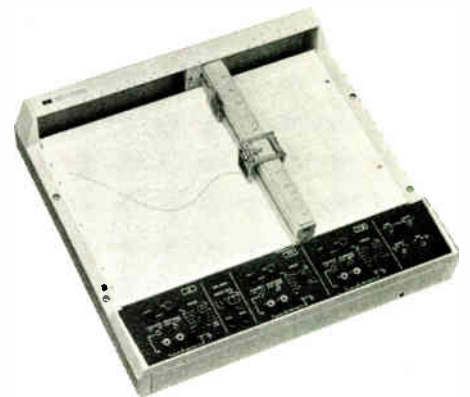

You can plot two signals at once with HP's 7046 high-speed two-pen x-y recorder. Acceleration of the y axis is  $> 2,500 \text{ in/sec}^2$  (6.3 meters/sec<sup>2</sup>); and on each x axis,  $1,500 \text{ in/sec}^2$  (3.9 meters/sec<sup>2</sup>). The y axis pens go from 0 to 30 in/sec (76 cm/sec) in less than 15 milliseconds. Even at these fast speeds, accuracy is  $\pm 0.2\%$  of full scale and overshoot is  $< 1\%$  of full scale.

The recorder uses standard 11 by 17 in. or European A3 size paper. HP's flat, visible-ink, disposable pens trace as close as 0.05 in. (1.2 mm). When you notice the ink supply is low, merely detach the old cartridge pen and snap in a new one. It's quick, convenient and clean; and you can use two different ink colors to distinguish the traces.

Input ranges from 0.5 mV/in. to 10 V/in. Input resistance is 1 M $\Omega$  on all ranges. And metric calibration is available at no extra cost.

OEM discounts are available. For more information, check N on the HP Reply Card.

# Let HP show you how easy microwave testing can be

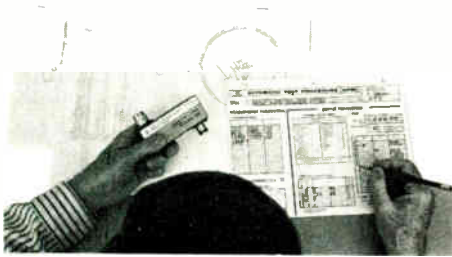

Here are a few of the output charts from testing a bandpass filter.

HP has developed a new software concept for making microwave measurements with automatic network analyzers. The results are increased system utilization, reduced measurement time, no programming, and increased system availability—hence, lower operating costs.

The easy-to-use “automatic test procedure” form becomes the system front panel. In less than an hour, you can learn how to make

tests and specify the output required for most microwave devices. Select up to 10 measurements at as many as 101 frequencies. You obtain 28 different output parameters and have a choice of printing, plotting or storing them on cassettes. Data can then be compared to specifications. It takes no more than 10 minutes to fill in the ATP form, even for complex devices.

The best way to learn more is to have your HP systems field engineer show you how easy it is to fill in the automatic test procedure for one of your devices. He can send the ATP and the device to one of our demo centers where we will test it to the ATP and quickly return it to you with the specified data.

*Check R on the HP Reply Card for more information or to have your field engineer contact you.*

(Continued from page 1)

degrees, radians or grads. Three metric/U.S. conversions are built-in, thereby serving the conventions of all nations and all disciplines—cm/in., kg/lb., and liter/gal.

The tiny HP-45 with 12-digit LED display contains many functions

The new HP-45 scientific pocket calculator



rarely found even on large machines: n factorial, percentage and % difference, mean and standard deviation,  $x^2$  and  $10^x$ , and polar-rectangular coordinate conversions. It's easily the most powerful scientific calculator of this size or price.

If you prefer a desktop calculator, the new HP-46 performs the same functions with an added plus: you can have a digital display, alphanumeric printer, or both. The printer provides a red and black listing of your calculations (just like an adding machine) at a speed of 2.5 lines/sec.

What about the handheld wonder that started it all? Over 75,000 HP-35 pocket calculators are currently used throughout the world. This economy of scale means it now costs less to perform logarithms, exponential and trigonometric functions in the palm of your hand.

*Let us know which calculator appeals to you; check A or B on the HP Reply Card for more information.*

## New data analysis system uses calculator

Now, you can have automatic data acquisition, reduction and analysis at a fraction of the computerized system price. HP's new 3050A automatic data acquisition system scans up to 100 channels; measures dc, ac and ohms at up to 5 readings/sec; then calculates the results on-line or off-line.

Basically the system is a scanner, multimeter, and a calculator. The HP 9820A programmable calculator handles data logging while simultaneously performing algebraic calculations such as transducer linearization or statistical analysis. With a scanner coupled to a digital multimeter, the 3050A system measures:

- dc in 5 ranges from 100 mV to 200 V with 1  $\mu$  V resolution.
- ac in 4 ranges from 1 V to 200 V with 10  $\mu$  V resolution over the frequency range, 20 Hz to 250 Hz.
- resistance from 100  $\Omega$  to 10 M  $\Omega$  with 1 milliohm resolution.

The system is ideal for measuring multipoint physical parameters and testing printed circuit boards. You can run 100% device testing at significantly less cost.

*Learn more about reducing data reduction costs. Check F on the HP Reply Card.*



# Low-cost power supplies for testing ICs

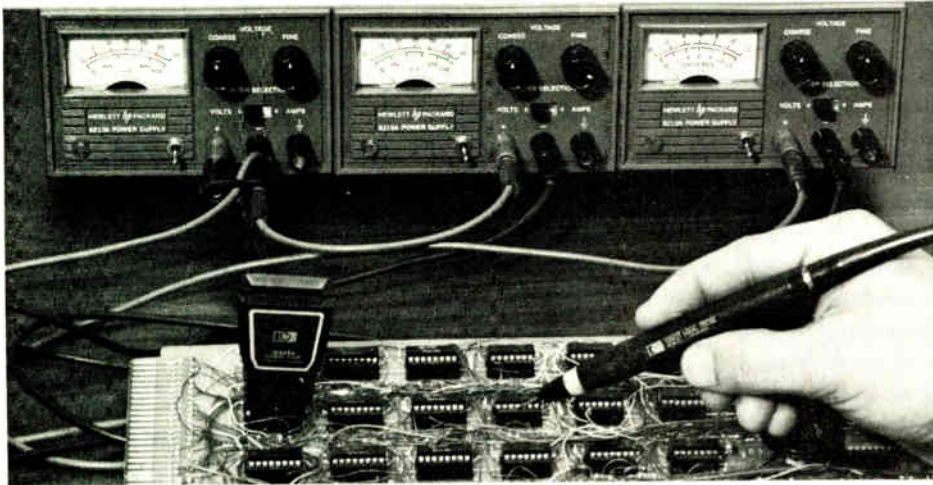

These supplies are packaged in molded impact-resistance cases that can be stacked vertically or rack-mounted in groups of three, as shown here.

At home in the lab, at school, or in the repair shop, these handy dc supplies are ideal for powering digital and linear IC circuits. Models 6213A (0 to 10V at 1A) and 6215A (0 to 25V at 0.4A) feature built-in short circuit protection, separate coarse and fine voltage controls, and switchable panel meter. Regulation is 4 mV (load or line), and

ripple and noise is 200  $\mu$  V rms/1 mV peak-to-peak.

Eight models in this series of 10W bench supplies cover output ratings of 0 to 10V, 0 to 25V, 0 to 50V, and 0 to 100V.

For more information, check M on the HP Reply Card.

## A new signal generator for avionics testing

HP's 8640B AM/FM signal generator (450 kHz to 550 MHz) is ideal for stringent testing of narrow-channel, crystal-controlled receivers because it delivers spectrally pure,



Output stability of the 8640B is better than  $5 \times 10^{-8}$  hr. Answers appear on a 6-digit LED display.

accurate signals with crystal stability. To meet both the general and specialized needs of the aviation industry, the new 8640B opt. 004 NAV/COM signal generator has been developed for testing ILS and VOR equipment as well as the regular aircraft communications receivers.

Specific additional features of the avionics version include: demodulated output for precise AM settings; one-dB stepped output attenuation for the best possible demodulated output linearity; and an amplitude-modulated system optimized to provide the flat response, low phase shift and constant group delay required for accurate VOR and ILS testing. The 8640B can also simulate 75-MHz marker beacon signals.

For more information, check Q on the HP Reply Card.

## New current source tests semiconductors fast

Now, you can test semiconductors and other current-controlled devices faster with HP's new 6140A digital current source. Here's how:

Many automatic test systems for current-sensitive devices use a programmable voltage source in series with a large resistor to approximate a current source. For the required accuracy, you must program a voltage, monitor the output current with a DVM, send an error signal back to the computer, then repeat the procedure until the current is within acceptable limits. Each iteration takes tens of milliseconds, and the entire procedure must be repeated every few seconds as thermal disturbances change the value of the series resistance.

The 6140A replaces this awkward, expensive "program, measure, adjust" procedure by providing a programmable dc current with 1  $\mu$  A accuracy from -16 to +16 mA and 10  $\mu$  A accuracy from -160 to +160 mA at load voltages up to 100V. You don't need a DVM to monitor the output current of the source, and all current level changes are 99.9% complete within 300  $\mu$  s.

For current details, check L on the HP Reply Card.

The 6140A has an active guard circuit to minimize leakage and a programmable voltage limit to protect the unit under test.

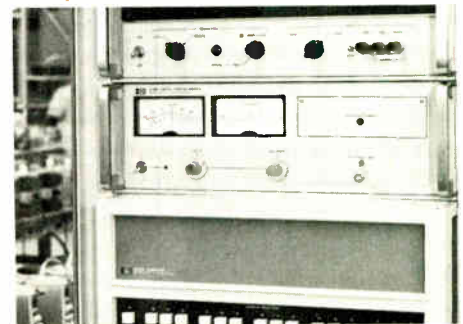

## Fast new low-frequency "snap-on" counter

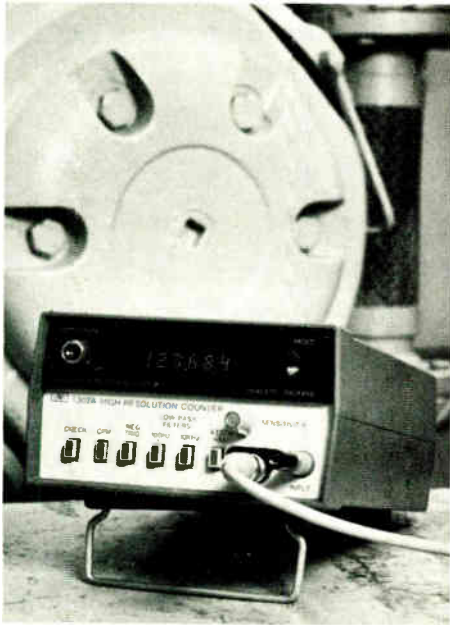

No need to set gate times or make adjustments—the new 5307A counter rapidly measures low frequency events.

The latest module for HP's "snap-together" counters measures low frequency from 5 Hz to 2 MHz with high speed and resolution. A "counts-per-minute" mode reads rpm from 50 to  $1 \times 10^7$ . The new 5307A unit resolves rpm to 0.001 or frequency to 0.0001 Hz in less than a second—that's 10,000 times faster than a conventional counter. Sensitivity is 10 mV (high enough for low-level transducers).

Use the 5307A to calibrate audio frequency and other LF signals, to check mobile radio equipment or Touch-Tone telephones, and to measure line frequency and relay trip settings in the utilities area. The 5307A can operate unattended over its entire specified range with automatic range selection.

Besides this new module, the 5300 series includes 10-MHz, 50-MHz and 525-MHz counters and counter/timers, and a 5-digit multimeter. All are compatible with a 6-digit display, a battery pack and a d/a converter that will give high-resolution plots on an analog recorder.

For more information, check J on the HP Reply Card.

## Plug-ins expand measurement capability of HP 180 scopes



The 184A fast-writing storage scope with 1805A and 1825A plug-ins is the ideal combination for capturing elusive transients.

Compact, plug-in instruments add versatility to HP's 180 oscilloscope line. Measurement capabilities include real time to 100 MHz, sampling to 18 GHz, time domain reflectometry, spectrum analysis and swept frequency testing.

For conventional use, select the economical, bright 180C/D or large-screen 182C scope. If you are plagued by dim traces, try storage—either the medium-speed 181A/AR

or the high-speed 184A/B that writes up to 400 cm/ $\mu$ s.

The 184A is ideal for low rep rate signals and transients yet has variable persistence to eliminate flicker. Add an 1805A vertical amplifier and you get a 100 MHz bandwidth, independent trigger selection, 5 mV deflection factor, and cascading to 50 MHz for 250  $\mu$ V/div deflection factor. The vertical amplifier also adds  $\pm 200$  divisions of offset on each channel.

Insert the 1825A time base and delay generator, and you have 5 ns/div sweep speeds, highly stable triggering to 150 MHz,  $\frac{3}{4}\%$  differential delay accuracy, and trigger holdoff for maintaining calibration on complex waveforms.

Check C on the HP Reply Card for more information.

## Universal bridge bridges the gap between accuracy and economy

Need to test components more accurately? HP's new universal bridge measures resistance, capacitance and inductance to an accuracy of 0.2%, as well as dissipation and

The 4265A universal bridge provides an accurate means of testing component specs.



quality factors to 5% accuracy. The measuring frequency is 1 kHz; other frequencies (50 Hz to 10 kHz) can be obtained with an external oscillator. Results appear on a four-digit display.

An ideal aid for circuit designers, component manufacturers, radio/tv service, and educational institutions, the 4265A universal bridge checks:

- inductance—from 0.1  $\mu$ H to 1111H
- capacitance—from 0.1 pF to 1111F
- resistance—from 0.1 m $\Omega$  to 1.111M $\Omega$
- dissipation factor (for parallel L or series C)—from 1 to 10.

To learn more, check G on the HP Reply Card.

## Get laboratory quality in a portable scope

Model 1710A is a portable 150-MHz oscilloscope that's well-suited for bench applications as well as field work. Quality is evident throughout the scope; for example, gold-plated printed circuit boards provide long life and better conductivity. Careful design of the vertical amplifier results in excellent pulse response, free from excessive perturbations.

Two features—bright scan mode and selectable input impedance—are particularly useful for servicing high-speed computer or communications equipment. The bright scan mode increases writing speed over a calibrated reduced scan display. You can use it to measure fast rise-time, low duty-cycle pulses where you need sharp resolution and an extra bright display.

Selectable input impedance provides a high Z input of  $1\text{ M}\Omega/12\text{ pF}$



The 1710A scope is fast enough to test ECL, as shown here.

or, at the flip of a switch,  $50\ \Omega$  input. This convenient internal  $50\ \Omega$  termination is compensated to match the scope's input capacitance, thereby eliminating reflections that might cause measurement error.

To learn more, check D on the HP Reply Card.

## More capability in microwave spectrum analyzers

New versions of two HP spectrum analyzers offer noteworthy performance improvements. Model 8554B (1250 MHz tuning section) now has:

- Narrow 100 Hz resolution (vs. 300 Hz previously) that facilitates modulation analysis in VHF/UHF communications.
- 50 dB of RF input attenuation (vs. 20 dB) for greater measurement range.

New HP spectrum analyzer products let you analyze UHF and microwave signals with higher precision.



- Lower frequency limit of 100 kHz (vs. 500 kHz) yet the spectrum analyzer is still protected against overload.

Model 8445B, automatic preselector (1.8 to 18 GHz) for the HP 8555A, 18 GHz tuning section has these new advantages:

- 20 dB more rejection of unwanted signals (out-of-band, image, spurious and multiple responses).
- 2 dB less insertion loss.
- Flatter frequency response, typically 1 dB (vs. 3 dB previously). These combine to improve overall measurement accuracy. The 8445B also has an optional LED display of frequency.

These two new units, along with the rest of the HP spectrum analyzer family, can perform virtually every frequency-domain measurement you might need, from 20 Hz to 40 GHz.

For more information, check P on the HP Reply Card.

## New ultra-sensitive microwave counter

HP's 5340A microwave counter is the first to count signals as small as  $-30\text{ dBm}$  (10 Hz to 500 MHz),  $-35\text{ dBm}$  (500 MHz to 10 GHz), and  $-25\text{ dBm}$  (10 to 18 GHz). That's many times the sensitivity of other microwave counters, yet it's rugged enough to take  $+30\text{ dBm}$  inputs.

The 5340A counter is easy to use: apply your signal to a  $50\ \Omega$  connector, then measurement is entirely automatic. Results appear on an 8-digit display with the decimal point automatically positioned and the unit notation specified as kHz, MHz, or GHz. You can select resolution from 1 Hz to 1 MHz. The dynamic range is 42 dB wide ( $-35\text{ dBm}$  to  $+7\text{ dBm}$ ) and VSWR, low ( $< 2:1$  from dc to 10 GHz and  $< 3:1$  from 10 to 18 GHz). If you need higher input impedance, a second input, 10 Hz to 250 MHz with  $1\text{ M}\Omega$  impedance, can be used.

The 5340A is well suited to nearly every microwave application: measuring carrier frequency, receiver alignment, calibrating frequency-measuring devices and signal generators, ECM carrier identification, automatic testing of VCOs, tracking sweep generators, or to aid microwave communications systems. System interface is easy with the new ASCII bus programming and digital output.

Delivery has improved considerably.

For more information, check K on the HP Reply Card.

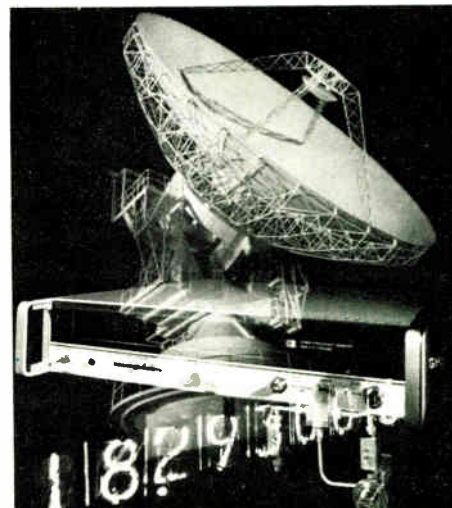

Shown here with a satellite communications antenna, the 5340A microwave counter is ideal for measuring carrier frequencies.



# Plot graphics directly from your time-share terminal

With HP's digital graphic plotter, your time-share system can draw graphs from numbers or algebraic equations. Using data directly from the terminal, the 7200A plotter charts, scales and fits curves—leaving you free to program another problem. The source language can be any EIA type: ALGOL, BASIC, COBOL, FORTRAN, etc. Graph size is adjustable up to 11 by 17 in. (28 by 43 cm).

Engineers, scientists, businessmen, and educators will find the 7200A an impressive time-saver. Instead of struggling with massive printouts or

formulating dull tables of figures, simply pick up a completed graph and insert it in your report. Your graph can be points, curves, circles, straight lines, bars, ellipses, or pie-shaped—whatever format you want. It saves the reader's time, too; a graphic solution is easier to understand, easier to interpret.

*Utility routines are available. For details, check O on the HP Reply Card.*



The 7200A draws graphs from standard EIA ASCII inputs without special software.

## HEWLETT-PACKARD COMPONENT NEWS

### New low-cost LED display for commercial use

HP's new low-cost solid-state display is really something to see. A new optical magnification technique converts 8 discrete LED chips into 7 uniformly-intense bars plus a decimal point. Wide viewing angle and bright red numerals offer excellent readability. Designed for commercial applications, the 5082-7730 series offers a large 0.3 in. (0.8 cm) character with right or left-hand decimal points.

These displays are available for immediate delivery from HP and our franchised distributors.

*Take a closer look; check H on the HP Reply Card.*

The 5082-7730 and 5082-7731 displays come in a standard DIP package for easy socket and PC board mounting.

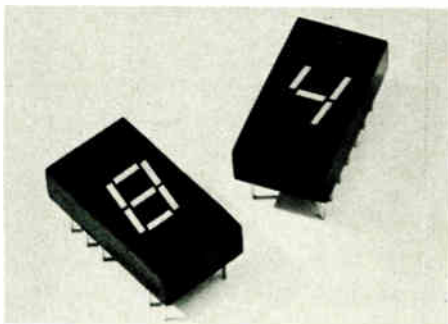

### New beam lead diodes for mixer and detectors



HP's high-performance beam lead Schottky diode for hybrid circuits.

Two new beam lead Schottky diodes have been designed for mixer/detector applications. Use the 5082-2768 diode for X-band, and the 5082-2769 device for Ku-band. Both series have uniform RF characteristics and low noise. Maximum noise figure for the 5082-2768 at 9.375 GHz is 6.5 dB; for the 5082-2769 at 16 GHz, 7.5 dB. Either device can be mounted in a stripline or microstrip circuit by welding, thermocompression, or ultrasonic bonding.

*For specifications, check I on the HP Reply Card.*

### Send for our new RF components catalog

Hewlett-Packard's wide variety of high-frequency components for control and conversion of RF and microwave signals are now described in our new microwave components catalog. Types of devices featured are:

- Switches and switching modules
- Absorptive modulators
- Limiters
- Mixers/detectors
- Step-recover diode modules
- Coaxial switches
- Step attenuators

*For your free catalog, check T on the HP Reply Card.*



Equipment and systems designers will be interested in this new high-frequency components catalog.

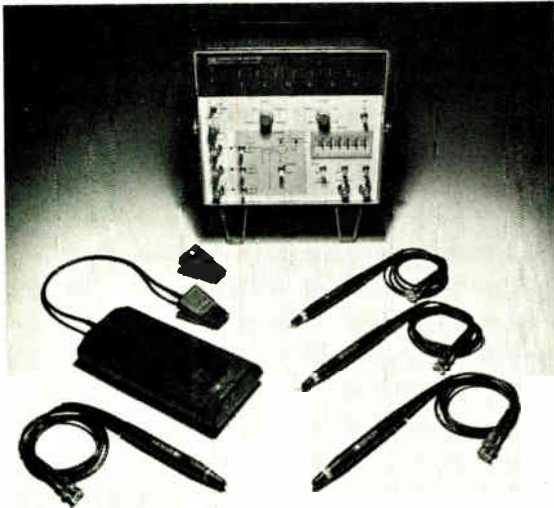

## Digital solutions to digital problems— HP has the tools to match your needs

From handheld probes to a sophisticated logic analyzer, HP's logic test family handles most troubleshooting problems.

Whether you're looking for a single bad IC or debugging the lab prototype of a new digital system, HP offers a complete line of instruments for your logic troubleshooting needs. These easy-to-use test tools detect malfunctions quickly, efficiently and *in circuit*.

To detect a single-shot or intermittent error on one of several circuit nodes, start with the 10529A logic comparator. It automatically compares the suspect IC with a good reference IC, then indicates which pins are faulty. Once a failure has been located, use the logic probe to examine pulse activity. Merely touch the node with the probe tip, and read the band of light. A bright light indicates a logic high; no light, a logic low; blinking light, a pulse

train; and a dim light, open circuits of voltages between the high and low thresholds.

There are three probes—one for each major logic family. Model 10525T checks TTL/DTL circuits; the 10525H checks HTL, HiNil, MOS, relay and discrete-component circuits; and the 10525E is fast enough to test ECL.

For stimulus-response testing, team the 10526T logic pulser with a probe or the 10528A logic clip. The pulser injects reset, shift and clock signals directly into flip-flops, counters and decoders; the probe or clip monitors the effect. Use the pulser and probe on the same node to detect shorts to ground or the power supply. Or use the pulser and clip to view response at several

outputs—e.g., when testing sequential circuits.

To see bit streams digitally displayed, step up to the new 5000A logic analyzer that shows logic states vs. time. It analyzes long digital sequences and captures single-shot data streams. Unique delay and storage features let you view bit patterns both *before* and *after* the trigger event.

Techniques for using these instruments are described in a new booklet, *Digital Logic Troubleshooting*. These cost-effective tools are the logical choice for your production and field service testing.

For a free copy, check S on the HP Reply Card.

HEWLETT  PACKARD

Sales, service and support in 172 centers in 65 countries.

East—W 120 Century Road, Paramus, N.J. 07652,  
Ph. (201) 265-5000.  
South—P.O. Box 2834, Atlanta, Ga. 30328,  
Ph. (404) 436-6181.  
Midwest—5500 Howard Street, Skokie, Ill. 60076  
Ph. (312) 677-0400.  
West—3939 Lankershim Boulevard, North  
Hollywood, Calif. 91604, Ph. (213) 877-1282.  
Europe—Post Office Box 85, CH-1217 Meyrin 2,  
Geneva, Switzerland, Ph. (022) 41 54 00.  
Canada—275 Hymus Boulevard, Pointe Claire,  
Quebec, Canada, Ph. (518) 561-6520.  
Japan—Yokogawa-Hewlett-Packard, 1-59-1,  
Yoyogi, Shibuya-ku, Tokyo, 151.

# Boost memory speed and capacity to new heights.

## PROMs to 15nS, ROMs to 4096 bits.

We hear you talking: you want to design a more powerful machine. With faster access times, more memory and more kinds of memory in less space. With programming tricks that let your customers abbreviate instructions and play games between several processors and memories. To get that kind of machine power, you want to be able to mix and match all kinds of speeds, densities, and organizations to maximize your system. In fact, what you really want is the broadest possible line of fast and dense PROMs and ROMs, with top reliability and lowest cost, preferably from one source for convenience and compatibility.

Now you've got it, from Signetics.

In our PROMs alone, look at the tremendous design possibilities. You're seeing here, for the first time, the brand new 15nS 10139. It's ECL compatible, the only one in the world. That ought to fascinate all you large main frame builders. Now, go over to TTL and Schottky TTL and you'll see six more PROMs. Fast ones, from 25nS to 40nS, in organizations from 32 x 8 to 256 and either tri-state or open collector. Which should turn on you fellows who work with all those peripherals.

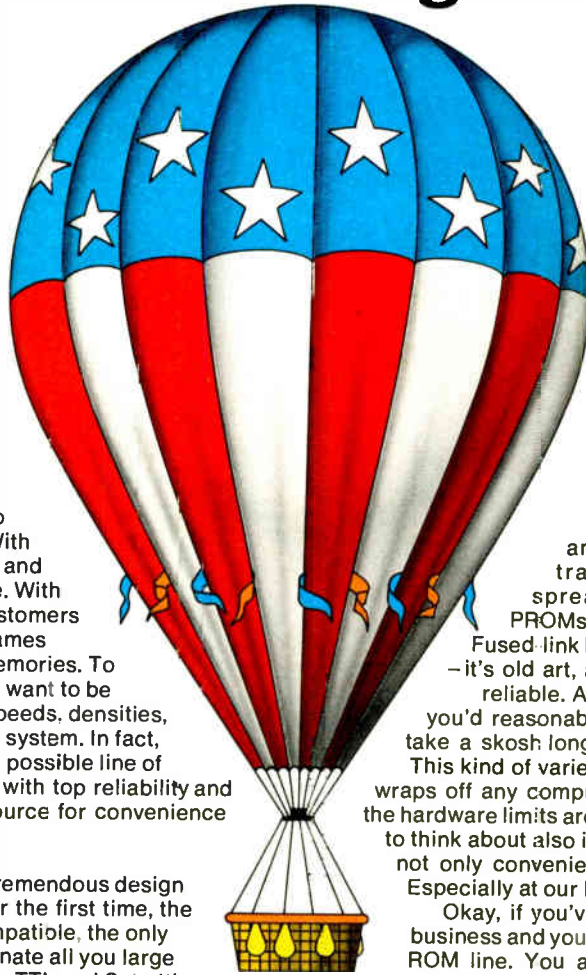

In ROMs, when large production runs and few patterns make them a good tradeoff, Signetics gives you a wide spread, with speeds comparable to our PROMs, and densities even higher.

Fused-link PROM construction is used throughout – it's old art, at Signetics, and proven to be utterly reliable. And you can get PROMs in any pattern you'd reasonably want, without delay. ROM patterns take a skosh longer.

This kind of variety and performance ought to take the wraps off any computer designer's imagination, because the hardware limits are essentially wiped out. What you want to think about also is that when you field program you get not only convenience and flexibility, but cost savings. Especially at our low prices. So, think PROMs.

Okay, if you've read this far, you're in the memory business and you need more information on the PROM/ROM line. You also deserve a reward, we think, for professional diligence. We're happy to provide you both . . . an armload of backup data plus a FREE sample of any unprogrammed PROM or random pattern ROM listed in the chart. Simply do the obvious things with the coupon below. And we'll do the rest.

PROMs			
Device Organization	Typical Access Time	Device #	Type
32 x 8	15nS	10139	New unique. ECL 10K
32 x 8	25nS	82S23	Schottky TTL open collector
32 x 8	25nS	82S123	Schottky TTL (tri-state)
32 x 8	35nS	8223	TTL open collector
256 x 4	40nS	82S26	Schottky TTL open collector
256 x 4	40nS	82S29	Schottky TTL (tri-state)
ROMs			
256 x 8	35nS	8204	Schottky TTL (tri-state)
512 x 8	35nS	8205	Schottky TTL (tri-state)
1024 x 4	50nS	8228	Schottky TTL, totem pole

Attach this coupon to company letterhead and send to:

Signetics – PROM/ROM 811 East Arques Avenue Sunnyvale, California 94086		
About PROMs and ROMs, please send me your handbook, applications memos, ROM programmer brochure, and a list of your distributors. Also, send me one (1) free sample unit of the # _____ listed in the table.		
Name	Title	
Company		
Address		
City	State	Zip
<small>Signetics Corporation. A subsidiary of Corning Glass Works.</small>		

# signetics

# Growing with the

**Amphenol's new telephone connector system saves space, saves time, saves material.**

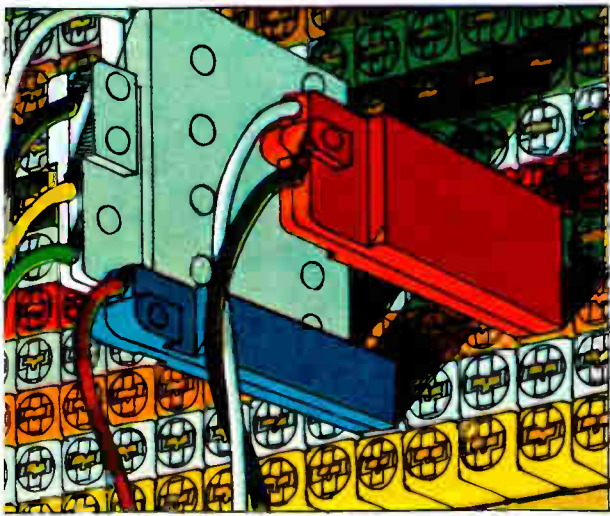

It's called Circuit Concentration Bay (CCB) and was first used to alleviate the problem of overcrowded distributing frames in a major Colorado telephone company central office. More than five miles of cable were actually eliminated in this installation. Floor space requirements were reduced by 80 per cent.

As more and more phone companies gain experience with CCB, it is also becoming clear that the savings in labor are at least as great as the space savings. Instead of the tedious, time-consuming job of hand soldering each connection, the craftsman uses color-coded miniature patchcords to complete circuits in about one-twentieth the time. And circuit interruptions found in normal distributing frames are virtually eliminated.

The savings in space, materials and labor due to Amphenol's CCB system are adding up to tremendous cost reductions and improved service for phone companies across the country.

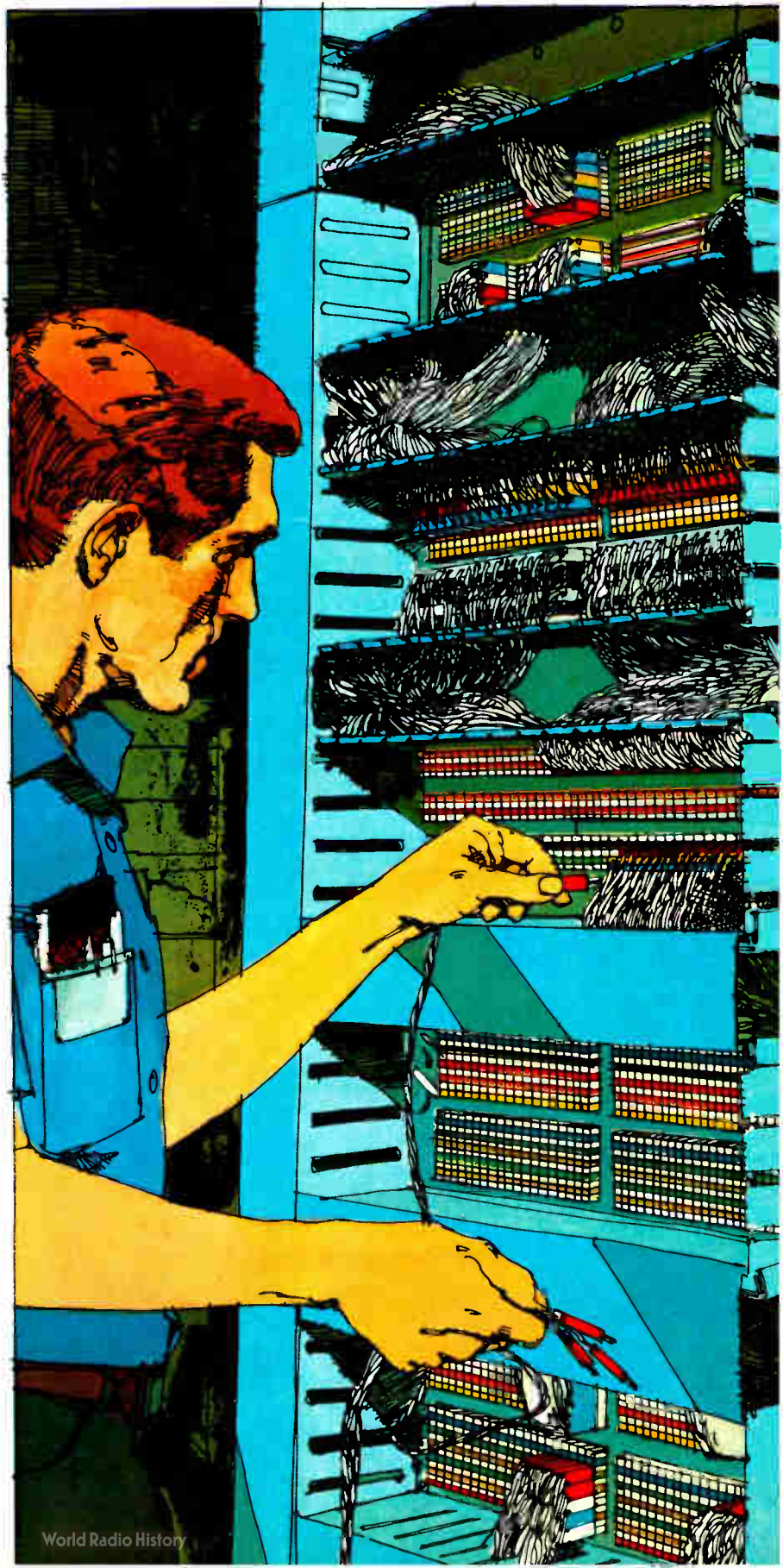

# new electronics

**Amphenol connectors help a mini-computer control a 70,000 vehicle intersection.**



A sophisticated traffic control computer was installed last year to tame an unusually busy intersection in Campbell, California.

Environmental problems are tough because the controller is located right at the intersection. It must remain unaffected by temperature variations between 0 and 120°F, and by voltage variations of plus or minus 10 per cent. It must perform faithfully for years to come.

That's why Amphenol's 5015 series connectors were selected. Our "Old Vet" has a service record in tough environmental conditions that no one can match. Some "Old Vets" are in service after over 30 years on the job.

That's important to Campbell, California because their traffic controller has a lot of work ahead of it.

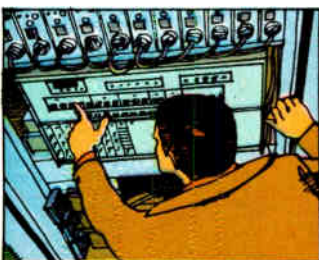

**Amphenol digital turns-counting dials help load a ship by computer.**

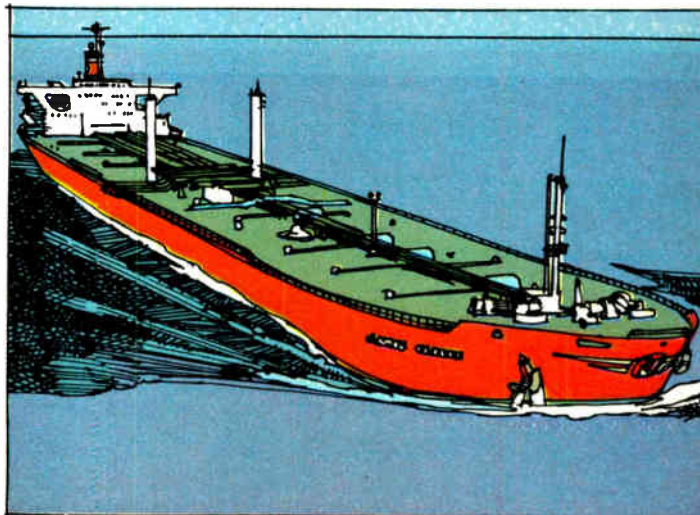

Unless a ship's cargo is distributed just right, stresses can cause extensive hull damage. So proper load distribution is critical. That's why one of the world's largest shipbuilders

has developed an electronic cargo distribution computer. It presents cargo placement and hull stress information continuously.



The Swedish manufacturer selected Amphenol dials for this computer because they're so easy to read. A magnifying window significantly enlarges the numerals and vernier scale, and digital readout is angled to the perpendicular for easy viewing from all positions.

Easy readability of the computer input devices is essential because a misread digit, when fed into the computer, could cause a disastrous error in loading.

**BUNKER RAMO AMPHENOL**

For more information, contact these manufacturing/sales facilities. United States: Amphenol Sales Division, 2875 S. 25th Av., Broadview, Il. 60153 Canada: Amphenol Canada Ltd., 44 Metropolitan Rd., Scarborough, Ont. Great Britain: Amphenol Ltd., Thanet Way, Tankerton, Whitstable, Kent, England West Germany: Amphenol-Tuchel Electronics GmbH, 8024 Deisenhofen bei Munchen, West Germany France: Usine Metallurgique Doloise, 92a98 Avenue de Gray, 39100—Dole, France Australia: Amphenol Tyrec Pty. Ltd., 10-16 Charles St., Redfern, N.S.W. 2016, Australia India: Amphetronix Ltd., 105 Bhosari Industrial Area, Box 1, Poona 26, India Japan: Daichi Denshi Kogyo K.K., 20, 3-Chome, Yoyogi, Shibuya-ku, Tokyo, Japan 151

# 30 A & 40 A Electrically Isolated TRIACS

- 50V to 600V ( $V_{DRM}$ )
- 30A & 40A ( $I_{TRMS}$ )
- Center-gate geometry has improved critical & commutating  $dv/dt$  rating and  $di/dt$  characteristics.
- Void-free glass passivated Di-Mesa chip construction for maximum operational reliability.
- Improved package is hermetically sealed; has extra heavy leads extending to end of header terminals, Molybdenum on both sides of chip for MTI current spreader and to relieve shear forces between chip and substrate for improved thermal characteristics.



WRITE FOR FREE CATALOG



## HUTSON INDUSTRIES

BOX 34235 • 2019 W. VALLEY VIEW, DALLAS, TEX. 75234 (214) 241-3511 TWX 910-860-5537

Distributed by:

In Canada: WEBER-SEMAD ELECTRONICS, Downsview, Ont. 416/635-9880

Vice-President, European Operations:

30 Rue Pierre Semard, Yerres, 91 France Tel: Paris 925-8258 • TELEX 21-311

Distributed in Europe by:

Belgium: C. N. ROOD S.A. Brussels 02-352135 ■ Denmark: E. V. JOHANSEN A/S, Copenhagen (01)\* 295622 ■ Norway: INTELCO, Box 158, 47 2 207451, Sentrum, Oslo ■ Spain: BELPORT, Madrid 234.62.62 ■ Sweden: ELEKTROFLEX, Sundryberg 08-28-9290 ■ Switzerland: D. LEITGEB, Oubendorf 051 85 9666 ■ UK, CLAUDE LYONS, LTD, Hoddeston, Hertfordshire (09924) 67161

Circle 144 on reader service card

# OPEN-LINE REED RELAYS

Quality Engineered at Low Cost  
Broad Line . . . From Distributor Stock

An exceptionally high quality line of Form A and Form C open frame reed relays — with up to 6 contacts (Form A) and 4 contacts (Form C) per relay! Available in standard coil voltages 5 to 48 VDC . . . Capable of switching up to 1/2 amp, 250 VDC (Form A) or 1/4 amp, 28 VDC (Form C). Only .350" high by 1.125" long, with terminals on .1" or .15" grid spacing. Electrostatic and electromagnetic shielding optional. Top performance at low cost . . . Tailored to fit your cost/environmental requirements.

Phone, wire or write.

## ELEC-TROL, INC.

26477 N. Golden Valley Road  
Saugus, California 91350  
(213) 788-7292  
TWX 910-336-1556

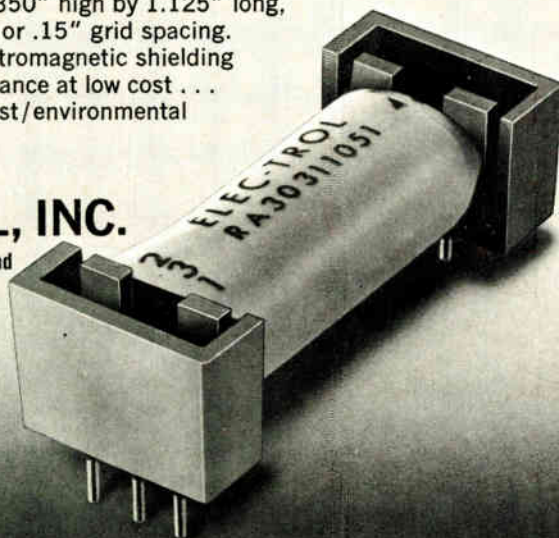

1973-74  
eem  
VOL. TWO

## Meetings

**Preparation and Properties of Electronic Materials:** AIME, Stardust, Las Vegas, Aug. 26-29.

**European Microwave Conference:** IEEE, IEE, Brussels University, Belgium, Sept. 4-7.

**Western Electronic Show & Convention (Wescon):** Wema, Civic Auditorium and Brooks Hall, San Francisco, Sept. 11-14.

**Indian Electronics Trade Fair:** Trade Development Authority, Taj Mahal Inter-Continental, Bombay, Sept. 15-17.

**Third European Solid-State Device Research Conference:** IEEE et al., Munich Technical University, West Germany, Sept. 18-21.

**International Conference on Engineering in the Ocean Environment:** IEEE, Washington Plaza, Seattle, Sept. 25-28.

**International Exhibition of Industrial Electronics (Elettronica 2):** Turin, Italy, Sept. 29-Oct. 8.

**National Electronics Conference:** IEEE, Regency Hyatt O'Hare Hotel, Chicago, Oct. 8-10.

**Electronic and Aerospace Systems Convention (Eascon):** IEEE, Sheraton, Washington, Oct. 8-10.

**Optical Society of America Annual Meeting:** OSA, Holiday Inn—Downtown, Rochester, N.Y., Oct. 9-12.

**International Telemetry Conference/USA:** ITC, Sheraton Northeast, Washington, D.C., Oct. 9-11.

**Canadian Computer Show and Conference:** CIPS, Exhibition Park, Toronto, Oct. 16-18.

**American Society for Information Science Annual Meeting:** ASIS, Hilton, Los Angeles, Oct. 21-25.

**Connector Symposium:** Connector Study Group, Cherry Hill Inn, Cherry Hill, N.J., Oct. 24-25.

# The first at this price!

$\pm 1\mu\text{V}$  resolution / 5 full functions / 26 ranges  
Lead-compensated ohms



For immediate information on Systron-Donner's new Model 7205 5½-digit Multimeter, call us collect on our *Quick Reaction* line: (415) 682-6471. Or you may contact your Scientific Devices office or S-D Concord Instruments Division, 10 Systron Drive, Concord, CA 94518. *Europe:* Systron-Donner GmbH, Munich, W. Germany; Systron-Donner Ltd., Leamington Spa, U.K.; Systron-Donner S.A., Paris (Le Port Marly) France. *Australia:* Systron-Donner Pty. Ltd. Melbourne.

SYSTRON  DONNER

**Fixed resistor  
difference  
is visible to  
the naked eye.**



**If you're really  
serious about cost,  
be serious about quality.**

Paying the lowest price for fixed resistors doesn't mean they're costing you less. Split an A-B resistor apart and discover the difference between Allen-Bradley and all the others. Our exclusive hot molding process forms the elements into an integral structure. Physically strong. With a densely packed, uniform resistance track. Note

how the leads are firmly and thoroughly imbedded to reduce circuit noise. Hot molding is just one way we have engineered more quality into our resistors. Consistent A-B quality that can lower your installed costs and put more reliability into your products. If you think all resistors are the same, read "7 ways to tell the difference in

fixed resistors." See your A-B electronics distributor, or write Allen-Bradley Electronics Division, 1201 South Second Street, Milwaukee, Wisconsin 53204. Export: Bloomfield, New Jersey 07003. Canada: Allen-Bradley Canada Limited, Cambridge, Ontario. United Kingdom: Jarrow, County Durham NE32 3EN.





## Coast firms promise microprocessors

Western Digital Corp., Newport Beach, Calif., will introduce an 8-bit n-channel silicon-gate microprocessor central processing unit before the end of this year. **The company claims that the two-chip CPU will be faster than announced microprocessors and nearly as fast as present minicomputers.**

Western Digital will also introduce a companion 8,192-bit p-channel read-only memory within 30 days, plus an interface block called ASTRO (asynchronous/synchronous transmitter/receiver) before the end of this year, and 8- and 16-bit n-channel ROMs next year.

In other microprocessor developments, **Motorola's version, also an 8-bit n-channel silicon-gate part, will be introduced in the first quarter of 1974,** and Rockwell Microelectronics is developing a fast 8-bit version of its 4-bit parallel-processing system.

## Crime pays for boom in security systems

Spending in the private sector to protect property and prevent crime may equal the funds allocated to police forces by the early 1980s, states a report about to be released by Quantum Science Corp., Palo Alto, Calif. The report contends that **crime against property will be impossible to curtail by public police departments alone and predicts that private industry, supported by an armory of electronic security systems, will fill the vacuum.**

Entitled "Security Systems Industry—Electronics to the Rescue," the analysis pegs the present market for all equipment and guard services at \$4 billion and predicts a steady growth to \$10 billion by 1980. **The fastest-growing segment of the market will be home security,** thanks partly to the greater availability of two-way cable-television installations after 1977—the year in which all CATV operations must be capable of two-way transmission, according to a Federal Communications Commission mandate. In addition, the availability of low-cost mini-computers for on-site control of security sensors and alarms will spread security into more and more homes, says Quantum.

## Signetics' D-MOST claims speed, capacitance marks

Signetics Corp. claims speed and capacitance records for analog switching transistors developed with the firm's D-MOST ion-implantation process [*Electronics*, March 29, p.34]. **These devices, which switch in 300 to 400 picoseconds, pass 1-GHz signals.** Maximum switching rates have not been determined, but measurements have been made to 20 MHz, the limit of Signetics' test equipment. Another feature of the n-channel enhancement-mode field-effect transistors is a threshold of 1.5 volts, allowing direct control of switching by transistor-transistor logic.

**Parasitic capacitances, which causes unwanted switching transients, are only 2 picofarads on the input, 1 pF at output, and 0.13 pF reverse.** The on resistance is 40 ohms. Two types will be available in September at \$1.30 each in lots of 1,000. One model switches  $\pm 10$  v, and the other, which has a gate-protection diode, handles  $\pm 4$ -v signals. **Two new D-MOST amplifier transistors are also going into production.** One has a noise figure of 3.2 dB at 1.5 GHz and is priced at \$4.75 in quantities of

1,000. The other is a uhf transistor, which will be sold for 35 cents each in quantity.

## **Low-priced mini solves big problems**

**Interdata Corp., Oceanport, N. J., will introduce the industry's first 32-bit minicomputer in mid-September.** Dubbed the Mega-mini, the machine will have a base price of less than \$10,000 for the central processing unit with 16,384 bits of core memory, expandable to 256,000 bits. **The 32-bit architecture provides direct addressability of 16 megabytes,** which enables the machine to tackle applications that require large data bases and large programs that formerly could only be handled by much larger and more expensive machines, says the company.

## **Grumman test gear adapts to many Navy aircraft**

The Navy's goal of reducing the amount of flight-line gear needed to check out the complex electronics systems aboard its many types of aircraft has received another shot in the arm. **Grumman Aerospace Corp., Bethpage, N.Y., is going into pilot production of a unit for checking weapons-release systems aboard the F-14 and F-4 fighters, A-6 and A-7 attack planes, and the S-3 anti-submarine patrol craft.** Grumman's AN/AWM-67 weapons-release test set integrates analog, hybrid, and custom C/MOS chips to yield a solid-state package of under 40 pounds that one man can handle. The new unit replaces the Navy's ARM-34 and ARM-51 sets and the need to resort, in some cases, to manual test methods, says Grumman. **In production, the AN/AWM-67 could be priced below \$40,000.**

## **Some Chevy Vegas to get electronic fuel injection**

Chevrolet has announced that it will build a "limited edition" of the four-cylinder Vega using an electronic fuel-injection system supplied by Bendix Corp., Detroit. This will be the first time in 20 years that an American production-line car has been equipped with EFI and marks, Bendix comments, "a growing acceptance of electronic fuel injection" for fuel economy and emission control.

Chevy states that these Vega engines, designed in cooperation with Cosworth Engineering in England, will meet 1974 emission-control requirements without any add-on hardware and will deliver 87% more power than standard Vega four-cylinder engines. "Limited edition," in Detroit terms, usually means at least 5,000 units, and if Vega follows the usual auto-industry script, there will be a substantial increase the following year.

## **Addenda**

**Motorola Semiconductor's rumored MECL 20K logic will have 700-picosecond propagation delay—like the MECL IV prematurely disclosed three years ago—but "it certainly won't be a 1974 product,"** says a top official. . . . Also at Motorola, C-MOS production is starting at the East Kilbride, Scotland, plant for the Common Market, and Motorola has dropped both development of new p-channel parts and the AMS 6002 1,024-bit RAM. . . . **Both Hughes Aircraft Co. and Motorola Semiconductor have developed low-voltage, field-effect liquid-crystal displays that operate at 3 volts. Motorola plans to begin producing in quantity this fall with large-scale production slated for 1974.**

# PIN diode "Micro Pills"

**A CURE FOR STRIPLINE AND MICROSTRIP HEADACHES**



**RUGGED, HERMETICALLY SEALED PIN DIODES ALSO PROVIDE CONTINUOUS RELIEF FROM MICROWAVE CHIP PROBLEMS.**

They're immune to shock, dirt, moisture, scratches and other handling hazards, because they're voidless, metallurgically bonded and fused-in-glass for optimum reliability. Though small enough to use like ordinary chips, Unitrode "Micro Pills" can dissipate 15 watts of average power and 60 kilowatts of peak power. And they can withstand thermal cycling from  $-195^{\circ}\text{C}$  to  $+300^{\circ}\text{C}$  without permanent degradation. Carrier lifetimes exceeding 2.5  $\mu\text{sec}$  assures low distortion performance.

They're ideal for stripline and microstrip applications. Used as switches, duplexers, phase shifters, attenuators, amplitude modulators, or receiver protectors, they operate

as a variable resistance controlled by a self-generated or externally applied bias circuit. The unique construction allows remarkable assembly flexibility, withstanding temperatures up to  $400^{\circ}\text{C}$  when soldering or brazing "Micro Pill" PIN diodes to various circuit media. They're as low as \$4.00 each in 10K quantities. Switch to UM7900 series "Micro Pills" and feel better all day long. For free samples, call or write Howard Kaepfle at (617) 925-0404 collect, Unitrode Corporation, Dept. 13 Y 580 Pleasant St., Watertown, Mass. 02172. For the name of your local Unitrode representative, dial (800) 645-9200 toll free or in New York State (516) 294-0990 collect.

Check listing below for your nearest Unitrode distributor.

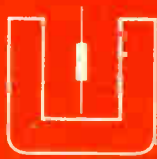

## UNITRODE

Unitrode Franchised Distributors: ARIZ., Phoenix, KIERULFF (602) 276-7331; CAL., Los Angeles, KIERULFF (213) 646-5311; FLO. Alt., KIERULFF (407) 946-6292; San Diego, KIERULFF (714) 278-2112; CANADA, Toronto, SCHWEBER (416) 523-2471; ONT., Mississauga, KIERULFF (905) 343-7090; FLA., Hollywood, SCHWEBER (305) 927-0511; GA., Atlanta, SCHWEBER (404) 449-9170; ILL., Elk Grove, SCHWEBER (712) 593-2742; MD., Rockville, SCHWEBER (301) 881-2570; Baltimore, TECHNICO (301) 828-6416; MASS., Waltham, SCHWEBER (617) 890-9484; MICH., Troy, SCHWEBER (313) 583-9242; N.J., Somerset, SCHWEBER (201) 469-0108; N.M., Albuquerque, KIERULFF (505) 272-3555; N.Y., Rochester, SCHWEBER (716) 326-4180; Westbury, SCHWEBER (516) 334-7474; N.C., Raleigh, SCHWEBER (919) 832-8880; OHIO, Beachwood, SCHWEBER (216) 464-2790; TEX., Garland, KIERULFF (214) 272-2471; Dallas, HAMILTON-AMNET (214) 638-2850; Houston, HAMILTON-AMNET (713) 525-4461; Houston, LENERT (713) 225-1465; WYOM., Salt Lake City, ALTA ELECTRONICS (801) 486-3227; WASH., Seattle, KIERULFF (206) 763-1530.

See EEM Section 4000 and EEOG Semiconductors Section for more complete product listing.

# GE boosted profits for an OEM by helping design a better product

Technical Labs, Inc., Chamblee, Georgia was about to start production of electronic power controllers. There were some problems, however, but their local components distributor saw that some good SCR application assistance might solve them.

He called on General Electric. Our Electronic Components Sales Department salesman visited Technical Labs. They familiarized him with the controller and the problems. Then he called Ralph Locher, a GE SCR application engineer in Auburn, N. Y.

It was discovered that under the original design the controller would be overstressed. Its life would be short, possibly resulting in expensive recalls and replacements. So our engineers came up with a new design for them. One that increased the product's life considerably.

Technical Labs used the new design. They got a long-lasting controller — and a successful, profitable product for the marketplace.

GE has found that going this far to help a customer makes the soundest business sense. It's the way we get good customers. And the way we're keeping them.

**GE won't leave you alone.**

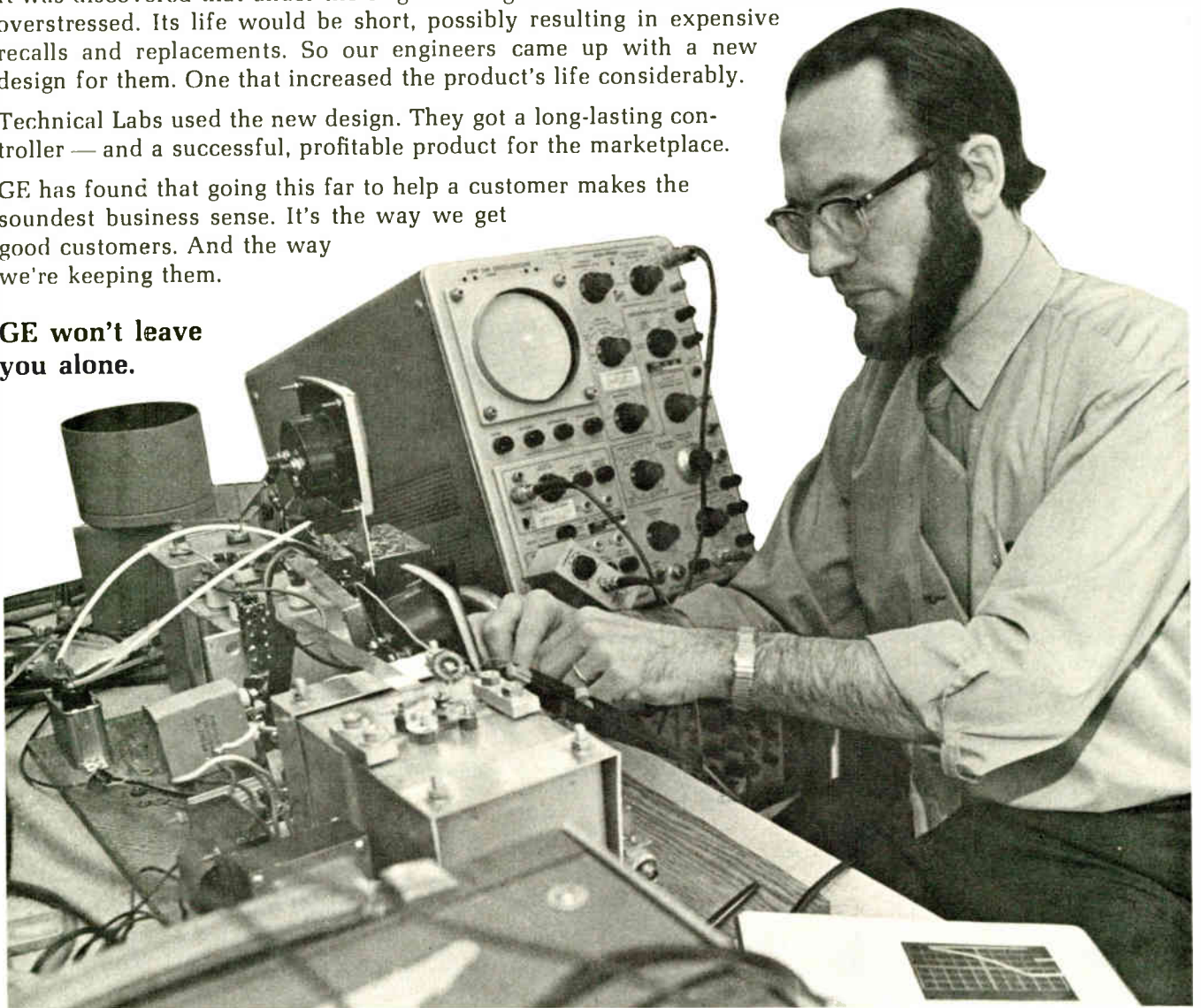

**GENERAL**  **ELECTRIC**

## Motorola system automates hotel-management details to Holiday Inn specifications

Inn-Scan, being installed by motel chain, handles bills, reservations, housekeeping

A new computerized management system for motels and hotels may change the tradition of actually handling reservations, guest accounting, housekeeping, and registrations. The Inn-Scan 400 system, developed in cooperation with the Holiday Inns motel chain, is the first product to emerge from Motorola's new venture activity under Steven Levy, former head of the company's Semiconductor Products division.

To Kemmons Wilson, chairman of the board of Holiday Inns, the minicomputer-based motel system "gives precise push-button control over a range of key innkeeping activities, and will both help reduce operating costs and aid in building guest satisfaction." Unlike other computer-based reservation systems, Inn-Scan also accommodates internal hotel operations.

**Moving in.** The first unit has been installed and fully tested at the 468-room, high-rise Holiday Inn in Hollywood, Calif. Other installations have been made in Holiday Inns in Las Vegas, Nev., and Los Angeles. Motorola will install 14 other systems this year, mostly at Holiday Inns, although one will be at the new 979-room O'Hare International Towers, near Chicago.

Inn-Scan is a fairly conventional minicomputer-based EDP system with CRT terminals for primary entry and display, disk storage, and a printer for receipts and written reports. The Maidaid small terminals

are used by the maids to report housekeeping status. These are coupled to room telephones via acoustic couplers. The guest-accounting module uses point-of-sale terminals placed in restaurants and bars for immediate entry of charges.

The Inn-Scan 400 has four separate modules so that motels can choose the functions required and add capability later, as needed. The modules are: guest registration and room control, housekeeping control, guest-charge-accounting control, and two-year reservation control.

The system, which Motorola says provides economy for motels of more than 100 rooms, uses a Digital Equipment Corp. PDP-11/05 minicomputer, common to all systems. Peripherals and software depend on

the motel's requirements. Typical peripheral equipment includes cathode-ray-tube terminals, printers, and disk storage. Motorola builds the CRT and Maidaid units.

**Software is the key.** Levy says the Inn-Scan system will be a multimillion-dollar-a-year business, commensurate with a similar dollar investment. The cost to a motel depends on the system chosen, but Levy says, "There is no difficulty in selling it to the larger motels." He adds that he considers the software, which was developed with much help from Holiday Inns, to be the most significant part of the system. "We didn't want to generate a new set of software for each group; fortunately, the industry shares common needs." Part of the require-

### Other new Motorola ventures surface

When Motorola organized its new-ventures program under Steven Levy over a year ago, there was speculation about the activities it would pursue. A number of projects have surfaced, including the Inn-Scan, which is the first in a series of dedicated-computer systems for specialized applications.

Other activities include Motorola Tele-programs Inc., in Schuyler Park, Ill., which makes training films. Started as an offshoot of the now-dormant electronic video-recording program, its biggest activity is making films for training law-enforcement officers; this is understandable in view of Motorola's long involvement in making Law Enforcement Assistance Administration money available for education. The group, also making films for education and health care, will do about \$1 million in sales its first year. This figure, though small in a \$1 billion corporation, is significant as the first venture into non-electronic products of what has been billed as the largest all-electronics company in the U.S.

The other new operation, now being incorporated, is Motorola Scalatron, also near Chicago, which will make a musical instrument similar to an organ but capable of playing any musical scale that has ever been used. The \$6,000 instrument is designed mostly for music schools and advanced music departments.

Among other activities, the new-ventures laboratory is also working on a new type of digitally addressed display—one that Levy insists is not for flat-screen TV.

ment was for equipment and software that could be used with a minimum of training by people already working in motels.

Motorola is also working on other dedicated computer-based systems for other applications in what it calls its Rifle program. Hospitals are obvious choices because of similarities to motels and hotels in much of their operation. But Levy says the market for such systems won't be limited to only lodging-type applications. □

### Computers

## Tek 31 acts like a minicomputer

A new programable calculator that can swap data with a computer-graphics terminal is making even less distinct the thin line between programable calculators and minicomputers. The calculator, introduced this month, processes data set up on the terminal, and it can also display processed data as graphs on the terminal.

The Tek 31 calculator was developed by the Information Display Products division of Tektronix Inc., Beaverton, Ore., and marks the firm's reentry into the calculator market. Tektronix tried to breach that market in 1971 by purchasing Cintra, a Sunnyvale, Calif., manufacturer of scientific and statistical calculators. Tektronix hoped at the time that the Cintra machines could compete against the more popular Wang Laboratories and Hewlett-Packard calculators, but then withdrew from the market to develop calculators more in tune with its established product lines.

The Tek 31 is programed through its keyboard in a natural-language format. The keyboard encodes in Ascii (American standard code for information interchange), allowing the calculator to talk to terminals. The code also permits plain English instructions to be worked into the programs, then printed out on the calculator. The alphanumeric

printer, an option, supplements a conventional digital display. Programs may be put into a tape cartridge, kept on magnetic strips, or stored on plug-in read-only memory cards.

The basic processor—15 MOS arrays—contains 74 registers and directly addresses up to 8,192 memory locations in random-access memory chips. The memory options allow part of the RAM capacity to be used for read-only memory and for up to 1,000 registers. A minimum system costs \$2,850 and rents for \$150 a month. With options, the price mounts to more than \$5,000. A smaller version, the Tek 21, which has a 512-word memory capacity and 10 registers, has a base price of \$1,850.

**Poor-man's terminal.** Tektronic expects the calculator-terminal com-

bination to become popular as a sort of poor-man's intelligent terminal. Many laboratories already buy both types of equipment, but few can afford terminals with built-in minicomputers, explains Dwain Quandt, recently named calculator sales manager. He expects the calculator to be used off line until plotting, number-crunching by a time-shared computer, or other special assistance is required. The calculator cannot be used interactively with a computer, however; the operator must relay the calculator's output to the computer via the terminal's keyboard.

Although designed for engineering, scientific, and statistical applications, the Tek 31 is also expected to find markets as a business machine and in instrumentation systems. □

## Westinghouse designs a thoroughly modern Micro Millie

Several years ago, the Westinghouse Co. developed its small Millie computer, a versatile little machine that became the data processor for several military systems. Now, the Defense and Electronics Systems Center has taken the same basic architecture, shrunk the size through new circuit-assembly techniques, and produced a hand-sized computer called Micro Millie, which is only one-fourth as large, but can perform the same functions as its larger sister.

Less than 6 inches square, the 8-pound aerospace digital computer

was funded by Westinghouse, but may be destined for future use aboard missiles and aircraft. It is also a candidate for digital fly-by-wire avionics systems, says George Shapiro, manager of computer and data systems at the Baltimore, Md., center. The price is about \$30,000, depending on quantity.

**Millie's specs.** Micro Millie's measurements include a memory of 64,512 16-bit words, add execution time of 3 microseconds, memory time of 1/μs, and a requirement for about 18 watts of power. Her other vital statistics include TTL for the processor, plus bipolar ROMs and n-channel RAMs for the memory. However, the unit can interconnect with any kind of memory—from plated-wire to solid-state.

A new computer design and a new assembly technique called multichip hybrid packaging (MHP) made Micro Millie possible. "The basic machine architecture is designed around sym-

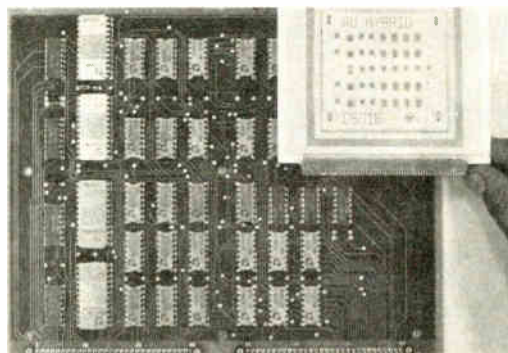

**Compare.** Micro Millie's circuit replaces pc board.

metry to take advantage of LSI," explains James R. Hudson, manager of the computer-development section. There are only 70 ICs in the basic processor for Micro Millie and its predecessor. The ICs for both are mounted on two cards. Moreover, the devices are in the same relative positions on the cards, and the two computers are pin-for-pin compatible.

Multichip hybrid packages are Westinghouse's intermediate step between printed-circuit boards and full-scale LSI. Catalog MSI and LSI devices from a variety of vendors are directly bonded to alumina substrates to create the smaller MHP function cards. "The individual cards make up the machine's enclosure," Hudson says, and there are no expensive custom-made chips. The computer is conductively cooled through heat sinks.

MHI production is now about 1,000 a month, but it will rise to about 3,000 as soon as the center phases out its pc-board production line and replaces it with the new assembly approach. The company is finding economies in the new technique because the chips are cheaper, weigh less, and are more reliable than discrettes. But the new process requires new equipment, and retraining of workers is slow. □

## Commercial electronics

### Skyjackers promote X-ray scanners

The everpresent skyjacking threat is impelling the major airlines to full-scale installation of portable X-ray scanning equipment in the larger airports [*Electronics*, Sept. 25, 1972, p. 32]. Most installations will be fully operational this autumn, in accordance with a Federal Aviation Administration mandate issued last January requiring the use of such inspection systems. The growing market is now pegged at over \$5 million and may double within a year.

Companies fighting to carve out



**Baggage scanner.** Low level X-ray scanners for inspecting baggage won't fog film.

market shares include American Science and Engineering Inc., Astrophysics Research Corp., Baird Atomic Inc., Philips Broadcast Equipment Corp., Philips Electronic Instruments, Teltron Corp., Westinghouse Electric Corp., and Bendix Aerospace Systems division. Supplier of storage tubes to many of these companies is Princeton Electronic Products Inc., New Brunswick, N.J. President S. R. Hofstein reports healthy sales of his PEP 400 image-storage system, the first to allow long viewing times, while using fast low-level X-ray pulses.

U.S. airlines use the portable systems, which, under the 0.5 milliroentgen Federal standard, won't fog camera film in carry-on baggage, they say. Among the major domestic carriers using or about to use them are:

- American Airlines, which is installing "a significant number of units" by August, at a cost of about \$1 million.
- Eastern, with 24 units to be installed over the next several months at a cost of about \$750,000.
- Delta, with 15 units in 12 cities, completion by October for about \$700,000.
- Pan American, already operational last year (details withheld for security reasons).
- TWA, 16 units in 14 cities, to be

installed for about \$1 million.

- United, with 29 units in 15 locations, August installation, also for \$1 million. □

## Solid state

### Fast RAMs enter 4,096-bit race

One of the hottest product-development scrambles ever to hit the semiconductor industry—the 4,096-bit random-access memory—is getting hotter every day. Close on the heels of Intel's 600-nanosecond, n-channel RAM [*Electronics*, July 19, p. 29], will be a Texas Instruments entry, a silicon-gate n-channel product sporting a 300-ns access time, scheduled for the first week in September. And two new RAMs are about to make the scene, a 225-ns device from Western Digital Corp., Newport Beach, Calif., expected in about one month, and an even faster one from Signetics Corp.—a tri-state device capable of 190-ns speed if a two-phase clock is used, or 300 ns if the standard single-phase 10-volt clock is preferred.

Meanwhile, a Mostek unit [*Electronics*, July 5, p. 25] and an entry, jointly developed by Motorola and

AMI, all n-channel silicon-gate products like the others, are due for introduction in the fourth quarter of this year. All will be fully TTL compatible on inputs, outputs, and clocks, and all appear to have settled on the TI pinouts.

TI's RAM is alone in using a single-transistor-cell design—a configuration that when optimized could result in greater packing density for a given performance level.

Generally, a single transistor cell gets its memory from a charge stored in a large single capacitor located across each transistor. In most arrangements, an entire row of cells with their capacitors is connected to a single readout bus. During the ready cycle, a cell's charge is dumped onto the readout bus; because the capacitance of the cell is not large compared to the capacitance of the bus line during operation, signal loss is experienced.

Key to TI's ability to go the single-transistor route—most of the other RAMs, with the exception of Mostek's, but including both the Intel and MIL units already available, are three-transistor-cell configurations—is a sensitive sense amplifier capable of detecting the lower logic swings (200 millivolts) associated with one-transistor designs. Along with the RAM's 300-ns maximum access time is a read-and-write time of 470-ns minimum. Power per chip is typically 400 mw, with standby at 2 mw. □

---

## Economics

---

### Phase 4 produces uncertainty, unease

Uncertain and uneasy, but in most cases unconcerned and undaunted—these are the sentiments of U.S. electronics manufacturers as they take their first look at the Nixon Administration's Phase 4 economic controls.

Expressions of uncertainty and unease come largely from company officials in the capital, while executives at corporate headquarters scat-

tered across the country seemed generally unconcerned, except for the freeze on profits.

The uneasiness in Washington stems principally from the program's expected long-term effect on the economy, while industry officials elsewhere take a less pessimistic, more immediate, view of the controls. Part of the uncertainty in the capital appears to reflect the White House's own presentation of the Phase 4 program, delivered July 18 with a notable absence of the optimism that had marked earlier efforts to restrain inflation. "We should not despair of our plight," remarked the President in his Phase 4 message.

**Slowdown.** Evidence of a decline in the Gross National Product for the second straight month, plus tighter credit and rising interest rates, has some Washington-based advisers to electronics manufacturers concerned about economic prospects for the next 12 to 18 months. The industries' managers in other parts of the country, however, are more immediately concerned about Phase 4's restrictions on higher profits by eliminating any

### Phase 4 rules for industry

- Q. Can prices be increased?
  - A. Yes, but only to the extent that costs increase. There can be no additional markups for profit, as in Phase 2.
- Q. Are there limitations on profits?
  - A. Yes, the same as in Phase 3, they can be no higher than the best two fiscal years ended since Aug. 15, 1968.
- Q. Must cost increases be justified?
  - A. Yes. Only cost increases above the average costs in the last quarter of 1972 may be passed on.
- Q. Is there a new base price on which to compute increases?
  - A. Yes. It is the average price prevailing during the last quarter of 1972.
- Q. Must there be prenotification of price increases?
  - A. Yes. It will be much the same as in Phase 2, unless that requirement is suspended. The Government is entitled to the right of reexamination of justification. The Phase 2 requirement for companies with \$100 million or more in annual sales called for 30 days' notice of an increase, with approval required.
- Q. Are there exceptions to the rule of prenotification?
  - A. Yes. As in Phase 2, exceptions will be made for "gross hardship or inequity," although that rule is likely to be subject to more liberal interpretation.
- Q. How must financial data be reported to the Government?
  - A. Quarterly reports are required for all companies with annual sales of \$50 million or more. Those under that figure must file annually, unless exempted.

markup on higher costs that are passed along.

For the long term, one corporate counsellor in the capital says, "I have told my management that there is a lot of skepticism about the new controls. We have some [plant] expansions in progress, but these are already funded, so we're not worried about them, unless the price of tooling and instruments goes up. What I am principally concerned about is Phase 4 slowing down [the industrial sector of] the economy when it had begun to slow down on its own. With mortgage money drying up, for example, that means a slowdown in housing. That, plus rising food costs, could impact sales of consumer electronics, which have begun to flatten out already. A slowdown there means later slowdowns in other areas like components. It's the old 'domino-theory' effect."

Another management representative of a major consumer manufacturer generally concurred and added, "I certainly don't want to talk about a recession, but we have to at least consider that threat. Frankly, I don't see how these new price controls can be administered.



The Government doesn't have the manpower" assigned to do the job.

Shorter-term limitations on price hikes dominates the thinking of manufacturers outside the capital. But the consensus of companies speaking for the record is one of unconcern about Phase 4. "The only limitations I can see are the limits on increasing profits or an increase in cost," comments Dennis K. Wilson, controller at Beckman Instruments Inc., Palo Alto, Calif., maker of medical-research instruments. Beckman may be pinched by a "decrease in flexibility to change prices" under Phase 4, including "some additional red tape," but Wilson believes that the over-all effects of Phase 4 will be "minimal."

Hewlett-Packard Co. also in Palo Alto, expects "no effect from Phase 4 at all," says one official who contends that, on average, the instrument-makers prices are lower now than a year ago. And one California-based computer maker sees Phase 4 as "a continuation of where we have been"—a condition that is unlikely to affect product prices, although it could hamper hiring in a market where the company is "concerned about our salary levels and being competitive."

Digital Equipment Corp.'s "only concern is the profit-margin freeze," says Edward Schwartz, general counsel for the Maynard, Mass., computer maker. But DEC foresees "areas where suppliers will up prices, and there will be pressure to pass these along." Schwartz believes these will be balanced out by competitive price pressures in the marketplace. Although overseas sales are not covered by Phase 4, DEC says leverage on prices there stems from devaluation.

The instability of the dollar in foreign markets is of concern to some manufacturers dealing abroad. Electronic Arrays Inc., Mountain View, Calif., views that problem as a potential influence on overseas business in such sectors as the price of precious metals. But Robert Graham, general manager for the manufacturer of solid-state components and systems, says, "We don't look for any particular impact

on our business because in the semiconductor industry prices tend to drop," rather than rise. □

## Medical electronics

### Heart monitor, alarm warn of attack

When a patient complains of fatigue or depression, a doctor may suspect heart trouble. However, the electrocardiograms made at the doctor's office may not show the abnormalities in heart pattern that usually precede heart attacks.

Two instruments that may help save a patient's life are being tried out at the Center for Sudden Death, a research facility of Stanford University Hospital, Palo Alto, Calif. One instrument captures 24 hours of heartbeats on magnetic tape for detailed analysis, and the other, an audio alarm, warns a person of a possibly imminent heart attack.

Dr. Donald Harrison, head of cardiology at Stanford Hospital, hopes to use the instruments in combination with new drugs that have been developed to prevent arrhythmia, the type of heart attack that often follows premonitory signs. The alarm and the drugs could be carried by patients so that emergency medication could be taken immediately.

**Taping it.** In experiments, researchers at the center have been using a portable EKG recorder supplied by Avionics Biomedical Instrumentation division of Del Mar Engineering Laboratories, Los Angeles. About the size of a cigar box, it allows the patient being checked for heart disease to go through a full day's activities while his EKG waveforms are tape-recorded.

The practicality of such recorders has been limited by the time needed to analyze the tapes with conventional instruments. To speed up the process, Stanford is programming a Digital Equipment Corp. PDP-12 minicomputer to perform the analysis and print out details of abnormal patterns. The center has also com-

missioned Avionics Biomedical Instrumentation to develop a high-speed scanner that will run the tape at 60 times its normal speed and print out graphs of heart rates and abnormalities, including counts of premature beats, for each hour of the recording.

The alarm system that Stanford has been testing is a miniature analog computer made by Vida Medical Systems Inc. (formerly Cardiodynamics Inc.) of Dublin, Calif. It can be set to detect when the heart goes faster or slower than a patient's normal range and to count the number of abnormal waveforms in a given time. Abnormal patterns are detected by storing and comparing successive waveforms, says Richard Beck, Vida's president. If the norms, which are set by potentiometers for each patient, are exceeded, the unit generates an alarm.

**A case for alarm.** When the patient hears the alarm, he telephones his doctor and holds the loudspeaker on the unit to the phone. This transmits the heart waveforms to an EKG machine, equipped with a phone coupler, in the doctor's office. The doctor advises the patient on emergency procedures as he

**Heart record.** Dr. Donald Harrison, of Stanford University Medical Center, attaches electrodes so that tape recorder can monitor heart action during a 10-hour period.

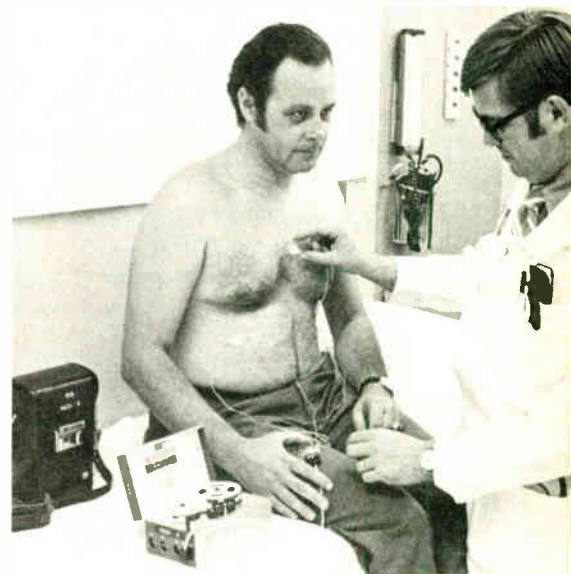

## Electronics review

closely watches the EKG trace.

Mary Ann Austin, the medical technician who operates the instruments at the Stanford Center, recalls that Vida's instrument frequently sounded false alarms during early field trials, making patients apprehensive. The problem was traced to loosening of the EKG electrodes connecting the computer to the wearer's skin, but the problem appears to be solved by a flexible electrode designed at Vida.

Beck says he is now satisfied with the instrument's performance, and Vida began producing a discrete-component version in April. Several of these have been shipped to doctors and clinics, and a hybrid-IC design is being developed. The present alarm is about the size of a transistor radio. □

## Military electronics

### Tacfire production target is now 1975

Tacfire, the U.S. Army's automated artillery fire-direction system, being developed by the Data Systems division of Litton Industries, now appears likely to go into limited production in February 1975, two years later than the April 1973 date the Army and Litton had been shooting for. The original target production date was set for late 1970, but that was discarded soon after the contract was signed in December 1967.

The cost of the program, first set at \$122 million under a total-procurement package, will be \$77.4 million higher at \$199.4 million. But both schedule and cost have been affected by changes in Army requirements, advances in technology, stretchout of the program, and, as Thomas M. O'Donnell, vice president for business development at Litton puts it, "We were a little optimistic when we took the job." Full-scale production is now scheduled to begin in May 1977. During this and preceding limited production, about 150 equivalent systems will be produced, nearly the number originally

scheduled, although there have been many changes in configuration. Production will last 45 months.

**Under fire.** Like many recent military programs, Tacfire has been under fire, but O'Donnell doesn't see any major problems ahead, even though he expects testing to turn up more correctable bugs, especially in the complex software. "We think the program is on track now. The Army needs more time to test and check it out." He says that an Army committee evaluated the system and program last fall and decided "it's

the way to go, but don't rush it."

Part of the problem is understandable in that Tacfire is a major undertaking. Although the Army now has Fadat computers that calculate ballistics, manual operation is necessary for other computations, communications, and record-keeping. Tacfire eliminates manual operation, and forward observers send data through small-burst-transmission digital terminals operating over conventional Army wire or radio.

Observers' data, plus information

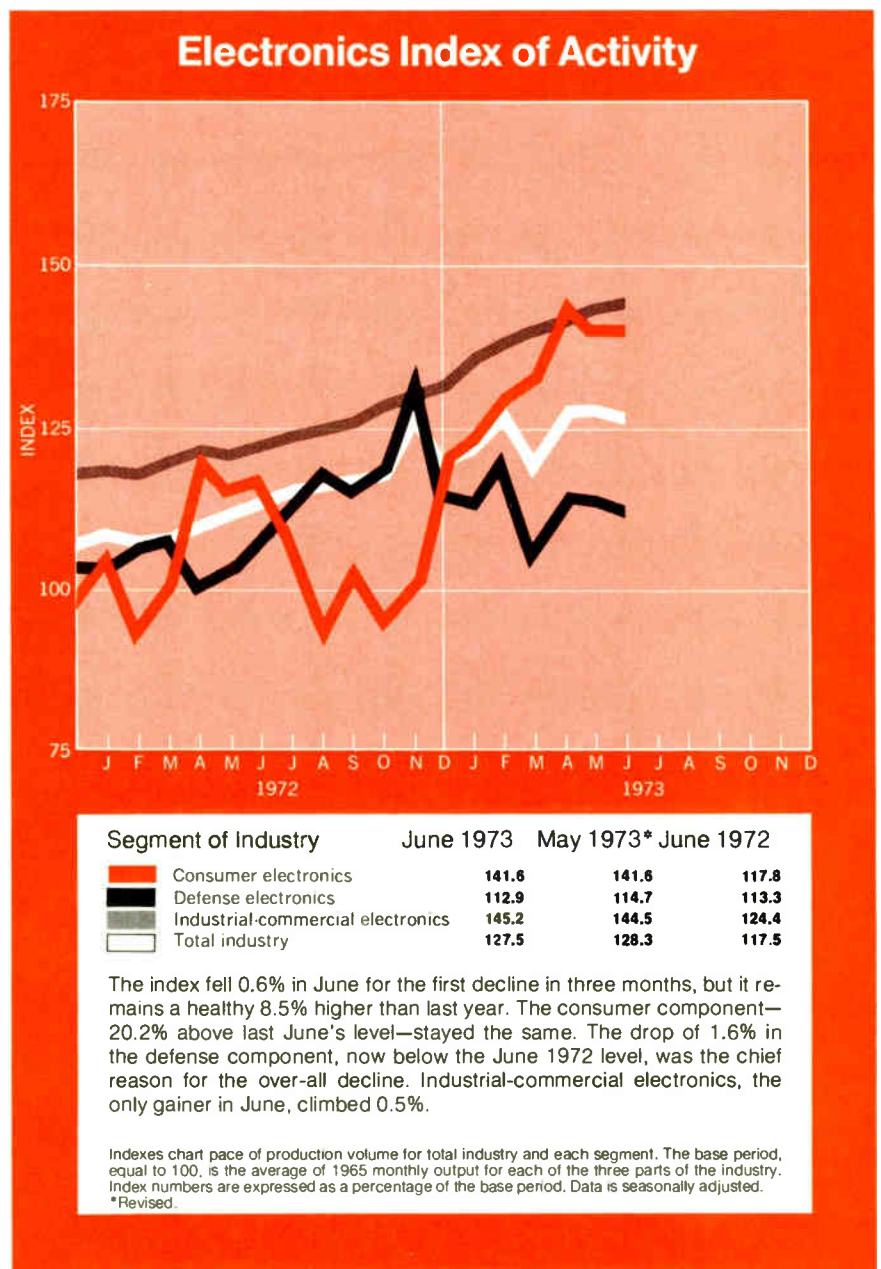

# Believe it or not, this is a complete data acquisition system

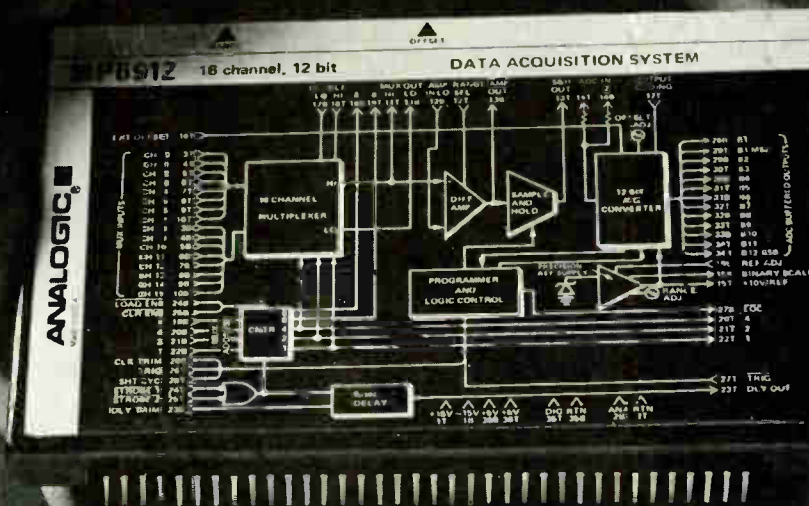

Not a module, a system. All of the circuits for a 16-channel multiplexer with buffer amplifier, fast sample and hold, 12-bit A-D converter, and programming/control/timing logic are in there. Yet the package is only 0.375 inches thin for mounting on standard minicomputer big boards with 0.5-inch spacing.

Look how the MP6912 solves the old problems: First, being an integrated, shielded package, it is relatively immune to wiring parasitics, thermally generated voltage changes, noise pickup (as from a core memory), and other dangers inherent in interconnected modules. Second, it is less expensive, \$695, than the modules it replaces, even before the cost of interconnecting them. Third, it provides significantly better accuracy, stability, linearity, and dynamic response than modules. Fourth, it does all of these things with a throughput of 100KHz, as fast as any system on the market today.

Best of all, the MP6912 takes the problems of designing, building, and testing a data acquisition system out of your plant and into ours—the most experienced data conversion company in the industry. Send for our very complete 16-page system designer's guide on the MP6912, which includes applications, timing diagrams, set-up and calibration procedures, and a lot of other helpful information. Analogic Corporation, Wakefield, Mass. 01880.

Northeast, 617-235-2330, 203-966-2580, 315-446-0220, 201-652-7055, 212-947-0379  
 Mid Atlantic, 215-272-1444, 703-790-5666  
 Midwest, 412-892-2953, 216-267-0445, 313-434-7500, 313-892-2500, 913-362-0919, 314-895-4100, 312-283-0713, 414-476-1500  
 South, 713-785-0581, 214-620-1551, 305-894-4401, 919-227-3639, 205-534-9771, 305-775-3411, 813-867-7820  
 West, 303-744-3301, 505-523-0601, 602-946-4215, 505-296-8303, 714-540-7160, 408-374-5220, 206-762-7664, 503-646-6064  
 Canada, 613-836-4411, 604-688-2619, 416-444-9111, 514-861-1375

**ANALOGIC** ■

Circle 45 on reader service card

# SCIENCE/SCOPE

A Phoenix missile, launched at a record range of 110 nautical miles by a U.S. Navy F-14A Tomcat fighter, recently scored a hit against a supersonic target drone with its radar cross section augmented to make it appear as large as an enemy bomber, during tests at Pacific Missile Range, Pt. Mugu, Calif. The high point of the missile's trajectory was over 100,000 feet. No other known air-to-air missile has ever flown so far and so high and intercepted its target. The F-14A's AWG-9 weapon control system began tracking the target, which had an on-off blinking noise jammer, at extremely long range. Hughes builds both the Phoenix missile and the AWG-9 system.

A new management tool for improving performance and lowering total life cycle costs of complex hardware systems, developed by Hughes, is called CREDIT (for Cost Reduction Early Decision Information Techniques). Using advanced statistical techniques and mathematical models to link initial basic causes to probable future failures, it enables management to achieve a specified reliability at lowest possible cost. CREDIT makes it possible to evaluate tradeoffs among specific modifications in design and manufacturing that will return predictable major reductions in field maintenance and total life cycle costs.

A 50-percent reduction in the size of airborne computers has been realized by using the full wafer T<sup>2</sup>L bipolar high-speed LSI circuits now being manufactured by Hughes. Two of the 1½-inch-diameter wafers form 80 percent of the arithmetic and control function of a high speed digital computer. The new multilayer pad relocation technique adds four insulation and metallization layers on top of the basic silicon wafer and makes functional interconnections by means of a logic routing mask and a computer-generated pad relocation mask which locates the desired cells. The results are reduced manufacturing cost, higher yields, and greater reliability.

A contract for seven Audio Distribution Systems for the U.S. Air Force's AWACS (Airborne Warning and Control System) was recently awarded by Boeing to Hughes, who also furnished options for up to 100 production systems. Using advanced electronic devices, including MOS/LSI technology, ADS is extremely lightweight, requires low power, permits modular growth, minimizes aircraft interconnection wiring, and effectively eliminates crosstalk between channels.

Hughes needs systems engineers with strong systems theory and applied mathematics background, plus experience in design and analysis of weapon and surveillance systems, to apply modern analysis techniques to conceptual system design, algorithm design, modeling and simulation, and performance analysis. MS or PhD and U.S. citizenship required. Please send your resume to: Mr. Jack Tenney, Hughes Aircraft Co., P.O. Box 3310, Fullerton, CA 92634. An equal opportunity M/F employer.

Microelectronic modules for digital electronic watches are now being produced in quantity by Hughes and are being sold to name-brand watch manufacturers and other merchandising companies. Digital watches, which display time in digital readout form, have no moving parts: no hands, dial, gears, spring, balance wheel, or motor. They use a CMOS chip to transform the unvarying vibration frequency of a tiny quartz crystal into a signal that lights the numerical display, showing hour, minute, date, and second, and are accurate to within 3 minutes a year (15 sec. a month average).

Creating a new world with electronics

**HUGHES**

HUGHES AIRCRAFT COMPANY

## Electronics review

from many other sources about weather, targets, and positions, is processed in real time by a digital center at battalion level, with large-scale presentation of data to fire-

control officers, who then provide hard copies of firing instructions to batteries. The system is designed for accuracy within 5 meters. The system is also interconnected with divi-

### News briefs

#### ITT to become common carrier

Specialized common carriers including MCI Corp. and Datran, which have been worrying about competition from AT&T, now find themselves threatened by ITT, which has joined Trans-continental Pipe Line Co. to form a subsidiary called United States Transmission Systems Inc. The new company has filed with the Federal Communications Commission for permission to build a 4,000-mile, \$25 million microwave network from New York to Houston, to be operational by 1975. ITT's carefully researched debut in this area may give the others some grief—the subsidiary is pegging its initial offering of analog service to small and medium-size bulk users, and unlike some carriers, the company has no problem of raising capital. And although the Federal Communications Act prohibits international common carriers from becoming domestic common carriers, ITT insists that USTS is a separate company and not an international carrier.

#### Videoplayer market to surge

Despite the recent bankruptcy of Cartridge Television Inc. [*Electronics*, July 19, p. 44] the videoplayer industry is showing signs of strong growth, says research firm Creative Strategies Inc., Palo Alto, Calif. CSI expects total worldwide sales of videoplayer hardware, software, and support to increase from \$79 million in 1972 to more than \$445 million in 1977 at a compound annual rate of 41.1%.

#### Thor/Delta rocket gets power boost

RCA and McDonnell Douglas have agreed to boost the payload capacity of the Thor/Delta launch rocket for RCA's proposed domestic communications satellites. The augmented thrust will enable the rocket to place a 2,000-pound payload into orbit instead of 1,550 pounds specified for standard versions. This is the first time private industry has set design changes in a launcher and paid for them.

#### DEC buys RCA computer facility

The Digital Equipment Co. has announced an agreement with RCA to purchase the former RCA computer facility in Marlborough, Mass. for an undisclosed sum. The purchase includes 700,000 sq.ft. of manufacturing and office space on 173 acres. The deal will probably be completed in early fall.

#### Color TV sales continue to rise

The U.S. is continuing its switch from monochrome to color television, and imports of both foreign and domestic-label models account for a significant share of the market, according to the Electronic Industries Association, Washington, D.C. Total TV sales to dealers gained 1.5% in the first half of this year with demand for color sets jumping 18.5% and monochrome sales declining 14.3%. Further, imports of large-screen color receivers and other entertainment electronics in May registered 225% higher over a one-year period.

#### U.S. exploits electronic potential

Spurred by the increased potential of U.S. electronics that results from the dollar devaluation, the Commerce Department is lining up components and equipment manufacturers to exhibit in trade shows in Japan and Germany. Both of the week-long exhibitions in Tokyo and Frankfurt begin Nov. 12. The former highlights high-technology components and the latter, automation equipment and systems.

# Production Equipment? Call Hughes (714) 757-1200...



Ext. 258  
Microcircuit welders, bonders and soldering equipment (RS 232)



Ext. 393  
Wire terminating and harness laying systems (RS 234)



Ext. 393  
N/C positioning tables and systems (RS 235)



Ext. 393  
Numerical control systems (RS 233)



Ext. 392  
Industrial automation systems (RS 238)



(213)  
670-9040,  
Ext. 6661  
Wiring analysis systems: FACT®  
Flexible Automatic Circuit  
Testers (RS 236)

Telephone the extension numbers shown for immediate information. For product literature, circle reader service (RS) numbers, or write Sales Mgr., 2020 Oceanside Blvd., Oceanside, CA 92054.

## HUGHES

HUGHES AIRCRAFT COMPANY

### Industrial Electronic Products

sion communication headquarters.

**Schedule and funding.** Along with earlier contract modifications, the program has been restructured to provide cooperative find, fix, and test time through February 1974, then a year of independent tests by the Army before initial limited-rate production. Litton has been funded at \$47.1 million for the work that has been completed, plus up to an additional \$9.9 million for the extended test and development.

Part of the new work will be add-

ing memory capability. Early estimates were low, and changes in technology made new approaches practical. The system uses tape, drum, and core memory, with that order in the hierarchy attributable to the high cost of core, vis-à-vis drum and tape in 1967. Low costs and sizes of present core memory permits physically replacing half of the 32,768 words of memory in each computer used with new mass core memory units of 131,072 words. The RCA drums will also be expanded

from 192 to 256 tracks of 1,024 bits each. The drums may eventually be completely replaced by mass core when the systems go into limited production.

Other technological improvements include upgrading the thermal high-speed line printer and increasing communications and power capabilities. Later on, Litton looks for a multicolor light-emitting-diode display to replace the present 4-by-4-ft digital plotter and large cathode-ray-tube display. □

## Rockwell reorganizes Microelectronics division as sales grow and products diversify

With Rockwell Microelectronics headed for a \$100 million year in 1974, it became apparent that both size and differing types of products made a division of products desirable. As a result, the former organization has been split into two microelectronics divisions—one for MOS LSI devices, headed by Charles V. Kovac, and the other for equipment, headed by Harold L. Edge. The two divisions, of roughly equal size, have their own engineering, manufacturing, marketing, and financial functions, and each will have separate facilities in Mexico, Curacao, and Southeast Asia.

Edge and Kovac, both with the title of vice president and general manager, report to R.S. (Sam) Carlson, who continues as president of the microelectronics divisions, based in Anaheim, Calif. Carlson says that the group was reorganized because of rising sales and to enhance Rockwell's posture in emerging markets.

**Challenge.** Both Edge and Kovac have challenges and opportunities ahead. Although Rockwell from early days has been a leader in MOS LSI in both military and commercial applications, it has never been accepted as part of the clubby semiconductor industry. That doesn't seem to bother Kovac, who was marketing vice president for Rockwell Microelectronics before it was split. Rockwell has made its money on relatively conventional p-channel MOS, although the present process is a refined low-voltage one, com-

pared to the early version.

Others in the industry have touted new and more dramatic technologies. Rockwell has, instead, tried to get into a position to leapfrog into new technologies, such as liquid-crystal displays, silicon-on-sapphire, bubble memories, charge-coupled devices, MNOS, and C-MOS, now in development for watches and calculators. Commercial bubble memories, for example, are moving from Rockwell's Electronics Research division to commercial memory systems and are scheduled for evaluation in April 1974.

Kovac was instrumental in focusing Rockwell's MOS activities to major custom programs, rather than the standard-products marketplace, and, although the company is trying to get into a better position to serve smaller users with such products as programmable microprocessors, he expects this custom policy to continue. However, he predicts that Rockwell will become important in memory and other computer products with such parts as SOS read-only memories, SOS random-access memories and random logic. His division now has a capacity of 500,000 complex MOS devices per month, which will double by the end of the year and again next year.

While Kovac makes the MOS, Edge has the responsibility for end-products and some intermediate ones. Not surprisingly, the emphasis is on products using Rockwell MOS, but at least one assembly, a computer for knitting machines made by another

Rockwell group, doesn't use any MOS. Although the division's consumer calculators sold through mass merchandisers are its best-known products, it also makes other products, including Skid-trol computers and other Rockwell parts. In fact, Edge is responsible for the company's technology-transfer program. This program will likely increase as a result of Rockwell's recent merger with the other Rockwell, Rockwell Manufacturing Co. which makes meters, valves, and industrial tools.

Edge, former vice president of business operations for the Microelectronics division, is still sorting out his markets for the future. Among them will be calculators—including electronic slide rules—watches, and data-communications and automotive products.

The watches, will be for the mass market, with under-\$50 retail prices, using C-MOS and liquid-crystal displays. These products are also Edge's responsibility because of the calculator products he builds with liquid crystals. The calculators are now being produced at a rate of about 40,000 to 50,000 per month, and output is expected to rise to 75,000 or 80,000 this fall.

Kovac and Edge will work closely. As Kovac puts it, "Part of what we're doing will define Harold's products." And Edge adds, "We're defining new products, both on customer demand and the characteristics we can expect from Charlie's products." □

# the New **BUSS**<sup>®</sup> **SNAP-LOCK** Rear Panel Mounted **FUSEHOLDERS**

It's a "SNAP"  
to install....

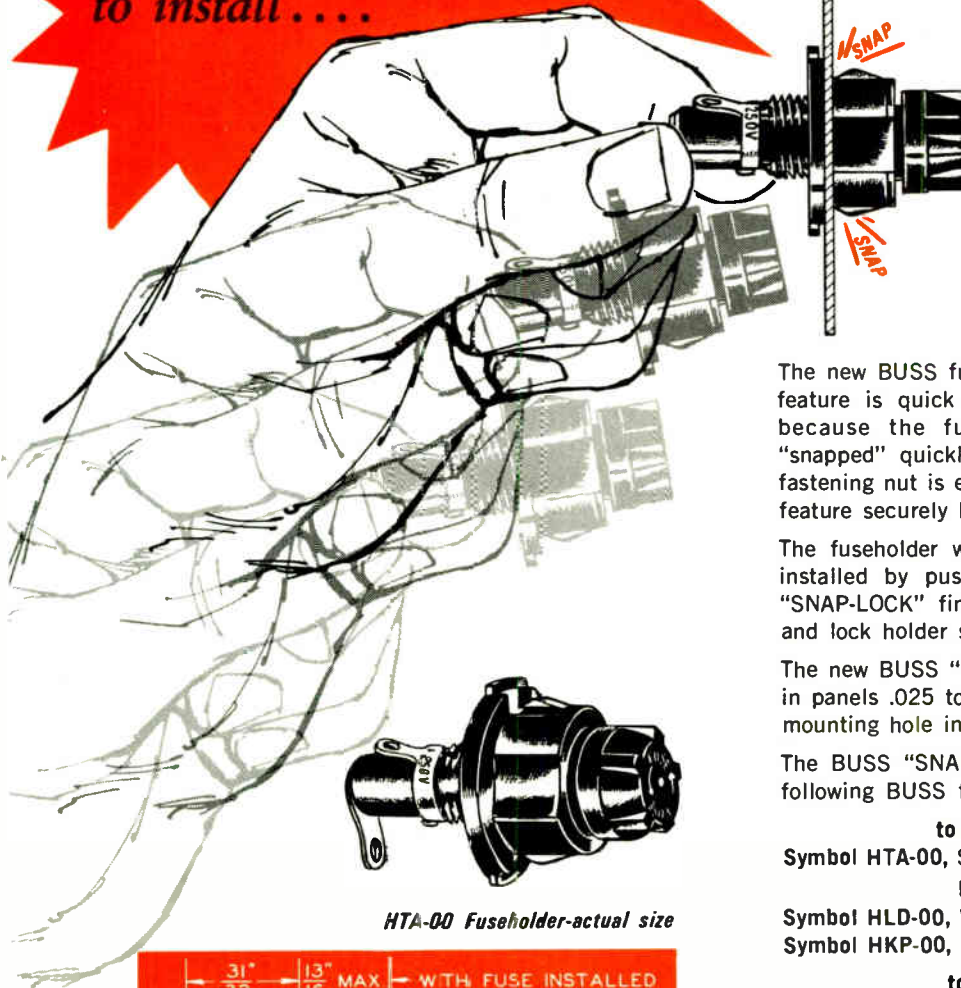

HTA-00 Fuseholder-actual size

Easy...  
Quick...  
Time Saving...

The new BUSS fuseholder with special "SNAP-LOCK" feature is quick and easy to install. It saves time because the fuseholder can be pre-wired and "snapped" quickly into place from rear of panel. A fastening nut is eliminated because the "SNAP-LOCK" feature securely holds the fuseholder in place.

The fuseholder with "SNAP-LOCK" feature is simply installed by pushing it into panel from rear side. "SNAP-LOCK" fingers engage edge of hole in panel and lock holder securely in place.

The new BUSS "SNAP-LOCK" fuseholder can be used in panels .025 to .085 inch thick. (See recommended mounting hole in dimensions below).

The BUSS "SNAP-LOCK" feature is available on the following BUSS fuseholders:

to take 1/4x1 1/4 inch fuses:

Symbol HTA-00, Space Saver, extends just 1 in. behind panel.

Symbol HLD-00, Visual Indicating Fuseholder.

Symbol HKP-00, Standard Fuseholder.

to take 1/4x1 inch fuses:

Symbol HJM-00, Standard Fuseholder.

All are available with quick connect terminals, if so desired.

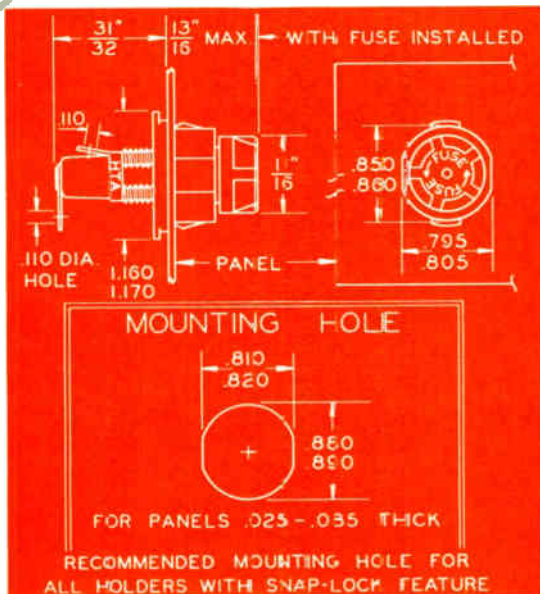

Dimensions of HTA-00 holder.

When tooling up for mounting get latest blueprint.

Also fits 1/2 in. knock-out in electrical boxes

BUSSMANN MFG. DIVISION

McGraw-Edison Company  
St. Louis, Mo. 63107  
Makers of a full line of Electric Fuses

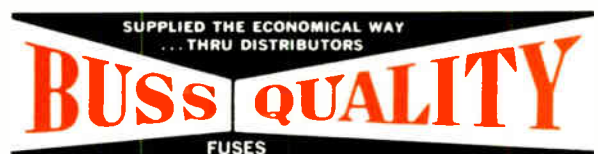

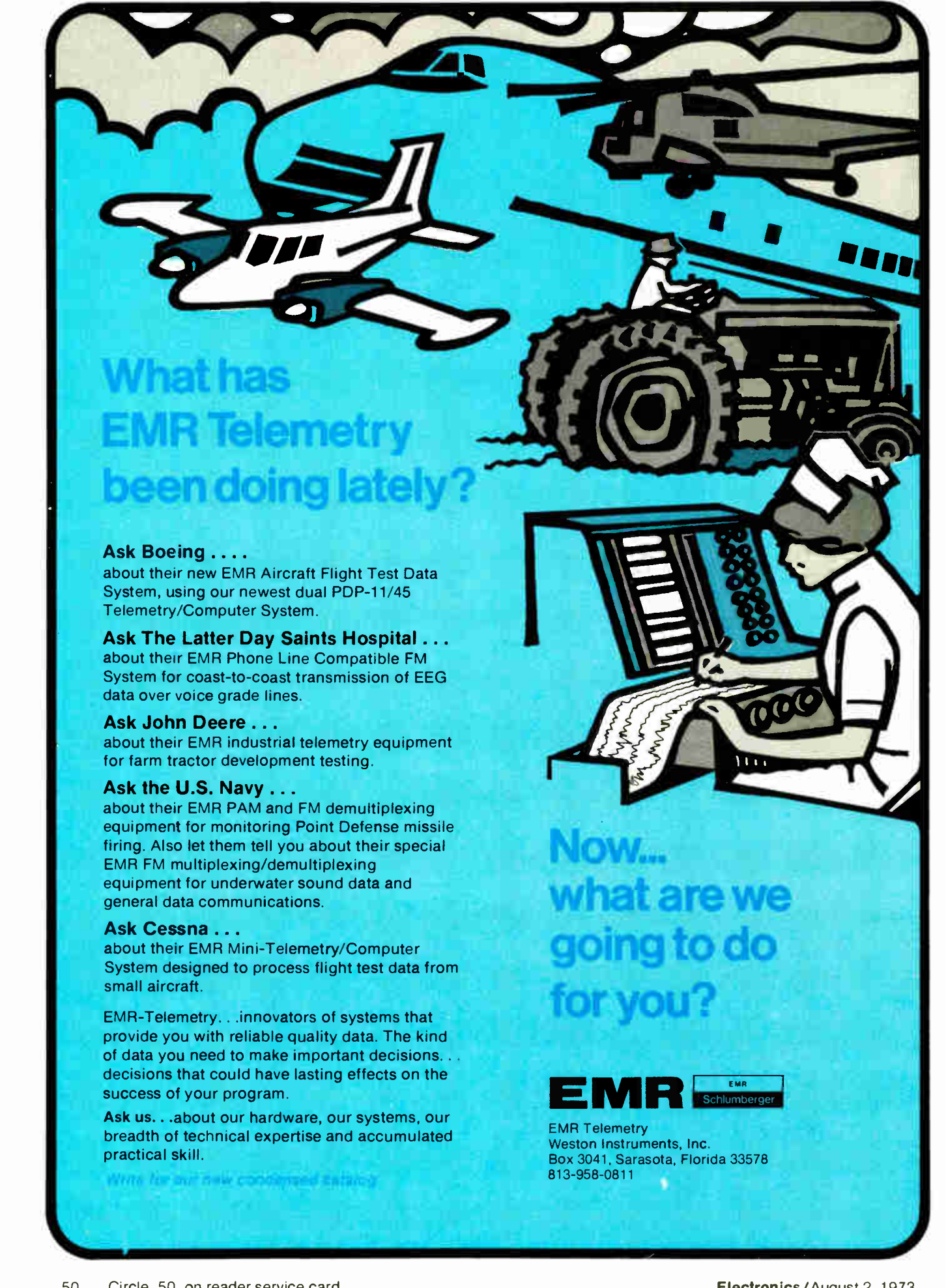

## What has EMR Telemetry been doing lately?

### Ask Boeing . . .

about their new EMR Aircraft Flight Test Data System, using our newest dual PDP-11/45 Telemetry/Computer System.

### Ask The Latter Day Saints Hospital . . .

about their EMR Phone Line Compatible FM System for coast-to-coast transmission of EEG data over voice grade lines.

### Ask John Deere . . .

about their EMR industrial telemetry equipment for farm tractor development testing.

### Ask the U.S. Navy . . .

about their EMR PAM and FM demultiplexing equipment for monitoring Point Defense missile firing. Also let them tell you about their special EMR FM multiplexing/demultiplexing equipment for underwater sound data and general data communications.

### Ask Cessna . . .

about their EMR Mini-Telemetry/Computer System designed to process flight test data from small aircraft.

EMR-Telemetry . . . innovators of systems that provide you with reliable quality data. The kind of data you need to make important decisions. . . decisions that could have lasting effects on the success of your program.

Ask us . . . about our hardware, our systems, our breadth of technical expertise and accumulated practical skill.

*Write for our new condensed catalog*

## Now... what are we going to do for you?

**EMR** EMR  
Schlumberger

EMR Telemetry  
Weston Instruments, Inc.  
Box 3041, Sarasota, Florida 33578  
813-958-0811



## NOAA to issue bids for another type of data buoy

In a tacit admission that the **environmental data buoys aren't performing up to snuff**, the National Oceanic and Atmospheric Administration expects to issue requests for proposals soon for a new prototype buoy that "will take advantage of the lessons we've learned about what components work and what don't," says one official. Company responses would be expected 30 days after issuance of the RFP for the \$1.5 to \$2 million program, due for service in 1975. Expected to bid are the same companies as made the experimental buoys—General Dynamics, Lockheed Missiles & Space, Magnavox, Westinghouse, and maybe GE.

**Specifications may be relaxed on the new buoy so "we can get numbers more acceptable to the practicing meteorologist than the researcher,"** says the official. Some research-oriented instruments work well, but others, like those for wind direction, don't. Another NOAA official comments that "all those lovely components work well in an air-conditioned laboratory, but just don't out there" on the salty rolling sea. He says **the reliability problem involves the sensors, interface, computers and software, and the telemetry.**

## New airport surface radar to be developed for DOT

Looking for better ways to monitor airport ground traffic, the Department of Transportation is readying a request for proposal for the design and development of **an improved airport surface detection equipment radar and may later buy 20 to 30 of them for larger airports.** The radars, which have a very large bandwidth and are used by air-traffic controllers to watch airplanes moving on runways, require much more complex technology than airborne radars. **DOT also will ask the contractor to develop ways to digitize the radar returns.** R&D contract cost is unknown, but two previous developments cost under \$450,000. Radar manufacturers include Cutler Hammer's AIL division, which built the FAA's current 24-gigahertz models at 12 sites, Texas Instruments, which developed a special 14-GHZ unit for Los Angeles airport, and the UK's Decca, maker of a 35-GHZ airport surface movement indicator.

## Solar cells using less silicon may create new markets

If a new technique for producing solar cells more cheaply works out, a recently formed company may have a strong edge in tapping the potential markets for terrestrial power obtained from the sun's energy. That's the gamble being taken by Solarex Corp. president, Joseph Lindmayer, who is leaving his position as head of Communications Satellite Corp.'s physics laboratory where he designed the notably efficient "violet cell" [*Electronics*, May 22, 1972, p. 30]. Lindmayer believes that, **by building cells using less silicon for specialized applications, he can lower prices by nine tenths** and end the "nonsense" that solar power costs too much [*Electronics*, July 19, p. 40]. For instance, a panel a third of a square foot for powering a small yacht would cost about \$50, Lindmayer avers.

## FAA approves Systron Donner fluidic sensors

Systron-Donner Inc., Concord, Calif., predicts **a worldwide market of about \$10 million for its fluidic rate sensors** over the next few years, following FAA approval of their use in autopilots for Boeing 727 and 737 jetliners. The company also eyes additional sales in military and general aviation. The rate sensors, which directly replace conventional rate gyroscopes, detect the relative motion of fluid inside a ring.

# Either our drives outdrive their drives or your money back.

## Plus interest.

Chances are we'll never have to pay off because our drives are the best you can buy. And we know it. We design them ourselves and build them to exceed the most demanding requirements in the industry today.

**SERIES 6000 MAGNETIC TAPE UNITS.** Tape speed 12.5 to 45 ips. Reel size 10.5 or 8.5 inches. Seven or nine track, half inch tape. High speed (200 ips) fast forward and rewind. All standard densities. Industry compatible interface. Simple design with few moving parts. File protect. Self seating reel hold down hubs. Controlled dynamic braking. Automatic multi-level read thresholds. Channel-by-channel electronic deskewing.

**SERIES 8000 CARTRIDGE DISC SYSTEMS.** 100 and 200 tracks-per-inch. 25 or 50 and 50 or 100 million bits storage capacities. Single and dual drives. IBM 5440 removable disc cartridge. Access time 10 milliseconds track to track. Data error during read or write less than  $1 \text{ in } 10^{12}$ . Disc rotation 1500 or 2400 rpm. MTBF 5000 hours. Simple design with few moving parts.

Only 8.75 inches high including power supply. Positive optical head positioning.  Try us. See if you can get your money back. Write for details, or ask for a call from

one of our salesmen.  
Microdata Corporation.  
17481 Red Hill Avenue.  
Irvine, California 92705.  
(714) 540-6730.



from the bold guys at

# Microdata™

## BBC designs slow memory for TV subtitles

**What do you do** when you want to access randomly only a few digital data addresses in a relatively small memory, and you don't care if it takes a second or so? That's what faced engineers at the British Broadcasting Corp. as they searched for ways to store prepared subtitle material—such as players' names, an event-winner's time, or a combination of such details—for superimposing on a TV screen.

Paper or magnetic tape won't give fast enough access. On the other hand, an off-the-shelf disk store will give faster access and more capacity than needed, adding up to a premium cost for unwanted performance. The answer, by the Engineering Designs Department of the BBC, is a memory built around a sheet of magnetic-tape material stretched over a phonograph turntable. Its builders claim that its cost is about half that of the cheapest suitable disk system on the market.

**Turntable.** The magnetic sheet is stretched across a circular frame, like the head of a drum, and then the frame is mounted on a standard Garrard 401 turntable rotating at 78 rpm, with the oxide on the sheet facing downwards towards the turntable. A single, fixed radial arm above the diaphragm carries a single read/write head moved radially by a stepping motor. The head is in permanent contact with the sheet, thus maintaining the head-to-oxide clearance at the tape thickness, about 0.5 mil.

There are 16 head positions and, therefore, 16 diaphragm tracks. Each track is divided into 16 segments, providing the 256 separate storage spaces. Sixteen equally spaced holes drilled around the turntable mark segment divisions. A light-emitting diode and a photocell detect a passing hole for location.

A segment holds about 400 bits altogether, including start, finish, and line-feed characters, as well as

the 256 character bits. Bit-transfer rate is constant at 8,192 bits per second, so packing density varies according to distance of the track from the center, and is between 250 and 400 bits per inch. The diaphragm is 12 in. in diameter.

Maurice Whatton, who is in charge of the project, says that one

problem that has arisen is wear of the diaphragm where it's in contact with the head. Dislodged particles piled up under the head and pushed it away from the oxide. However, this wear has been cut by rounding the head to the shape of a blunt bullet. Servicing internals have been pushed out to 100 hours. □

### Around the world

#### Zinc sulphide for display with memory

Zinc sulphide phosphors can do more than just fluoresce—they can also act as a photoconductor to add memory capability and higher brightness to electroluminescent displays. A team headed by Chuji Suzuki at Sharp Corp.'s Central Research Lab is now developing a series of displays that incorporate these advances. A layer of thin-film zinc sulphide phosphor doped with manganese is sandwiched between two layers of dielectric yttrium oxide that prevents flow of direct current through the phosphor. The dielectric layers are in turn sandwiched between two conducting electrodes. With this configuration, it is possible to produce a latent image, and then read out the image with an electrical pulse.

When a potential of 200 volts or so is connected across the electrodes in the dark and then disconnected, a charge will remain on the two electrodes, since the panel is essentially a capacitor. When the panel is illuminated, light-induced polarization takes place in the phosphor material, building up a charge across the phosphor opposite in sign to that across the two electrodes. This charge polarization in the phosphor constitutes the latent image, which can be erased by illuminating the panel.

This procedure is not too practical, and in practice it is only necessary that the light used for writing be considerably brighter than ambient light, and that readout occur soon after writing. In prototype operation, readout is performed by a voltage pulse of a polarity that adds to the polarization field in the phosphor. A polarization of -60 V can produce an order of magnitude greater output than from an unpolarized panel for the same reading pulse. One of the most interesting aspects of this panel is that the internal polarization reverses polarity during readout. Thus, a succession of readout pulses of alternating polarity can give a continuous high-brightness display.

#### Photoetched RAM has 1-mil cells

In developing high-bit-density dynamic semiconductor memories by conventional photoetching methods, Siemens AG has apparently pulled ahead of its competitors. Using n-channel silicon-gate MOS technology, researchers at the company's Munich laboratories have fabricated single-transistor random-access memory cells with a storage density of 1,600 bits per square millimeter. This cell size of 1 square mil, according to Siemens, compares with 1.5 to 2 square mils for experimental devices made by photoetching methods at other companies.

K.U. Stein, who heads the research project, believes that the 1-square-mil cells, together with a new Siemens-designed sense/refresh amplifier, which is built on gated flip-flop principles, could well be the basis for a 16-kilobit RAM integrated on a single chip. The current state of the art in dynamic RAM design is 4,096-bit arrays, with at least one company having already built an 8,192-bit MOS RAM device [*Electronics*, March 1, p. 38].

# Here are two of the world's best oscilloscopes.

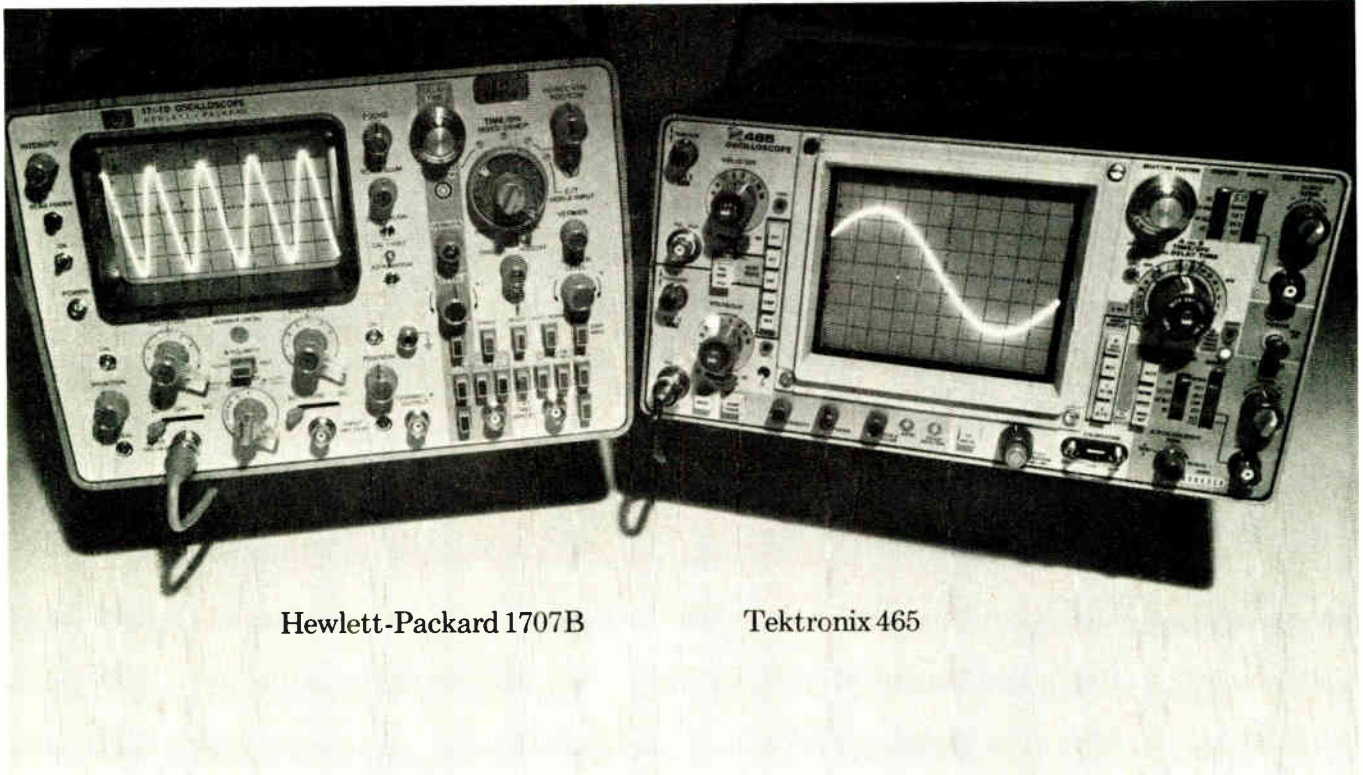

Hewlett-Packard 1707B

Tektronix 465

## Here's why you shouldn't own either one.

You can lease one for as little as \$45 per month.

We can give you immediate delivery on either the Hewlett-Packard 1707B or the Tektronix 465, in quantity.

The Hewlett-Packard scope lease is \$45 per month for 36 months.

The Tektronix 465 is \$50 per month for 36 months.

Anyway you choose, leasing is the best thing that ever happened to a tight capital equipment budget.

You pay for your scope as you use it ... and you pay for it out of the profits it generates.

Call your closest Instant Inventory Center and ask us about short term rentals, delivery, and other lease terms for scopes or any other electronic equipment you need, up to and including minicomputers.



Anaheim, California (714) 879-0561

Dallas, Texas (214) 661-8082

Fort Lauderdale, Florida (305) 771-3500

Gaithersburg, Maryland (301) 948-0620

Lexington, Massachusetts (617) 861-0667

Mountain View, California (415) 968-8845

Oakland, New Jersey (201) 337-3757

Rexdale (Toronto) Ont., Canada (416) 677-7513

Rosemont, Illinois (312) 671-2464

## Rental Electronics, Inc.

A **PEPSICO** leasing company.

## It looks like another good year for Japan

**Industrial, commercial, and government electronics production in Japan will grow 25% during current fiscal year**, which began April 1, according to a forecast by the Electronic Industries Association of Japan. Pacing this growth, with a 27% increase, will be computers and related equipment, which at \$2.1 billion is roughly two thirds of the total market of \$3.13 billion. Tops in growth rate, though, will be fixed-station multiplex communication equipment, which will grow 37% to \$160 million, with growth being credited to export sales and sales to regional governments and other public organizations. Also growing at a rapid rate will be radar, with an increase of 30% to \$97 million, with increased sales coming from airport and marine applications. Measuring and test equipment and industrial process-control equipment, will rise 20% to \$247 million with increased sales fueled by capital investment. **In the export sector, Japan still has a fairly large order backlog, and the EIA-J expects renewed growth**, despite the large revaluation of the yen, because of the good reputation of Japanese products.

## Electronic unit shifts the gears of hydraulic transmissions

**An electronic controller for vehicular automatic transmissions—a direct replacement for a conventional hydraulic control system**—has been developed by the British auto-parts maker Associated Engineering Ltd. The complex hydraulic valve block that does all change-point determination and gear-change actuation in an automatic gearbox is replaced by a much simpler hydraulic block that operates under control of an electronic change-point selector inside the car. The advantage claimed for electronic programming is that change-point determination is much more flexible in any given car, and it's much easier to adapt a basic gearbox design to different cars. Thus, gear changing is better related to circumstances, and the changes themselves are smoother.

**Developmental units are being tried in Germany by Volkswagen on its own automatic gearbox and by BMW using a Borg-Warner gearbox.** AE says one British car maker is also interested. Developmental versions contain two breadboards measuring 4 by 5 inches and are densely packed with TTL packs and op amps. Timing is by monostables. Economic viability depends on reducing the breadboards to LSI circuits, which in turn depends on large-volume orders.

## Philips plans video cassette machine with editing features

Philips Gloeilampenfabrieken is about to hit the market with a new **video cassette recorder featuring electronic editing, sound-dubbing, and stop-motion picture reproduction.** The recorder, which will have its public debut at next month's radio and TV show in West Berlin—from August 31 to September 9—and go to market right after that event, is designed for semi-professional and scientific application and will sell for about 7,500 deutschmarks (about \$3,200) on the German market. The equipment provides for video input terminals to which TV cameras and slide or film scanning devices can be connected. Output signals can be fed either to monitors or color-TV receivers. **Electronic editing is possible in two forms:** "assemble," in which a new recording can be added to an existing one, or "insert," which allows replacing certain scenes in an existing program, both without picture breakup.

## Sweden considers data recorders on every car

A Swedish royal commission studying highway traffic questions has suggested that every auto in Sweden be equipped with an electronic recording device to be used to form the basis for road and traffic fees. The suggestion was among ideas on creating fairer levies for highway construction and maintenance. With the electronic device, **cars could be taxed according to the distance driven, and it could be programed to charge higher fees for in-city or rush-hour driving.**

The nation's highway and traffic institute has developed such a device, for testing purposes. However, a complete system would require placement of generators at the roadside to signal the device that the car were in a certain area during a certain time. A central system would control the roadside signal generators, to account for time changes, seasonal traffic changes, or holidays. The test unit that the institute built records time and speed on a punched tape, which was selected instead of a magnetic tape to allow visual checking, if necessary. Boerje Thunberg, research director of the institute, says that they were aiming for a device that could be mass-produced for a couple hundred kronor—(100 kronor equals \$25). **One extra advantage of the "black box" would be that it could be programed to record speed-limit violations.**

## A single-tube color camera for industrial use

Small British specialist television company Electrocraft Instruments Ltd. of Haslemere, Surrey, has developed a single-tube PAL color camera and is building a first production batch of 12 instruments. The company believes that the initial price of \$3,500 plus lens makes it the cheapest color camera anywhere. The first cameras built will use an RCA tube with integral optical color filters, but the company hopes to substitute a standard high-quality fiber-optic vidicon fitted with its own optical-filter module and cut the price further.

**The head unit, which contains only the tube, coils, and head amplifier, measures no more than 10 inches long, without lens, and 3.5 in. square.** All the rest of the electronics is rack mounted. Small head-unit size is important, Electrocraft says, because the market is primarily industrial where space is tight—for instance, **inspection of inaccessible space inside machines where color information is helpful.** The company engineers say that construction is otherwise conventional except that they had to design and make their own tube coils because they could find no standard ones that provided adequate color uniformity.

**Another single-tube color camera is being developed at the Central Research Laboratories of EMI Ltd.** It's likely to use a novel method of coding the colors onto the carriers.

## Remote-control TV set has built-in timer

The West German TV-set maker Nordmende KG is coming out with color receivers featuring an ultrasonic remote-control unit that **automatically turns on a desired program at preselected times up to two hours in advance.** For that job, the unit incorporates a timer, which also automatically turns off the set at preselected times. In addition to these functions, the unit, like others, handles station selection and control of color saturation, volume and brightness. Gallium-arsenide diodes on the set indicate the operating status of individual functions. At the heart of the remote-control unit is an MOS LSI circuit which integrates about 500 transistors on a 4-square-millimeter chip.

# World's biggest MOS ROM

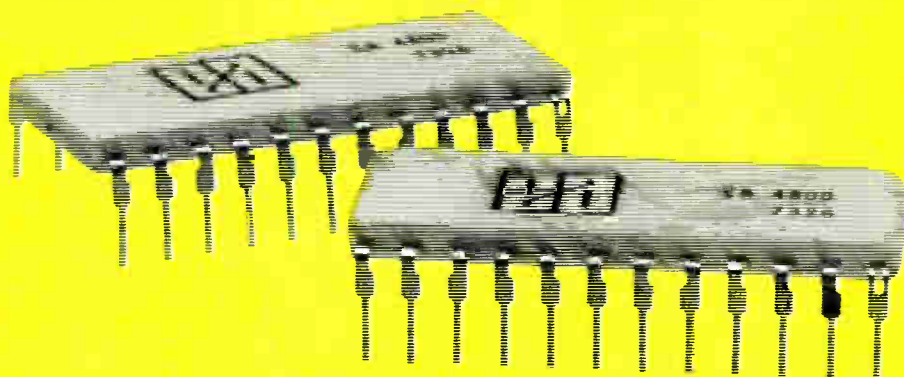

**Stores 16,384 bits at lowest cost per bit ever**

The EA4800 P-channel read-only memory has twice the storage capacity of any other ROM on the market. Using it, you can program calculators, minicomputers, data terminals and similar equipment at the lowest cost per bit ever achieved.

And you will find it very simple to use.

No clocks are required—operation is static.

No address decoding is

required—it's on the chip.

No input pull-up resistors are required for connection to TTL—they're on the chip.

You have your choice of 2048 x 8 or 4096 x 4 organization. You can OR-wire the outputs to expand the memory, and you need only two supplies: +5v and -12v.

The ROM has a maximum access time of 1.2  $\mu$ sec and a low power dissipation of .032 mW per bit. It comes in a

24-pin metal ceramic or silicone-molded DIP.

Price is \$28 in 100-piece quantities in a silicone package.

We can make a mask and deliver the first good ROMs to you in 6 to 8 weeks.

Contact Electronic Arrays, Inc., 501 Ellis Street, Mountain View, California 94040. Phone (415) 964-4321.

**electronic arrays** 

Circle 59 on reader service card

# Look what 5 volts can get you.

These five DPMs use the same 5VDC supply that powers the digital logic in your system.

This simplifies your design and improves reliability. It saves space, saves money, and reduces the amount of heat that's generated. And, because there's no line-power voltage near the DPM, internally generated noise is virtually eliminated.

So you get more reliable readings.

And here's what else you can get for 5 volts. BCD outputs. Overvoltage, polarity, and status indication. Automatic zero correction and programmable decimal points. Aluminum cases that install in a snap.

Each meter is given a seven-day burn-in before shipping. And we're shipping right now.

Our 5 volt DPMs are a whole new class of digital panel meters—a whole new way of thinking. Because now you can think of the DPM as a component, just like any other component in your system.

Take a look below. You'll find a meter that solves your particular problem. Then give us a call. Order a sample.

**A low-cost 3½ digit DPM for OEM applications.** An advance in price/performance capabilities for 3½ digit DPMs. LED display. Bipolar, single-ended input. Full scale range of 0 to ±199.9mV. 0.05% ±1 digit accuracy. Automatic zero and polarity. Normal mode rejection of 40dB at 60Hz or 50Hz. Common mode rejection of 60dB at ±200mV. Fully-latched DTL/TTL compatible outputs and control interface signals. Optional ratiometric input. Only ¾" deep. **\$89 in 100's. AD2010.**

**A high-performance 4½ digit DPM for systems applications.** Capable of performing precision measurements of floating differential voltages in noisy environments. LED display. Full scale range of 0 to ±1.9999V. 0.01% ±1 digit accuracy. Automatic zero and polarity. Normal mode rejection of 60dB at 60Hz or 50Hz. Common mode rejection of 120dB at ±300V. Optically-isolated analog section. Fully-latched DTL/TTL compatible BCD outputs and control interface signals. **\$199 in 100's. AD2004.**

**A simple, reliable 3½ digit DPM for high-visibility display applications.** Incandescent display. Bipolar, single-ended input. Full scale range of 0 to ±199.9mV. 0.05% ±1 digit accuracy. **\$89 in 100's. AD2001.**

**A high-performance 3½ digit DPM for systems applications.** The kind of performance you need for complex system interfacing and data processing. Incandescent display. True differential instrumentation amplifier input. Full scale range of 0 to ±199.9mV. 0.05% ±1 digit accuracy. Automatic zero and polarity. Normal mode rejection of 40dB at 60Hz or 50Hz. Common mode rejection of 80dB at ±2.5V. Fully-latched DTL/TTL compatible BCD outputs and control interface signals. **\$99 in 100's. AD2003.**

**A low-cost 2½ digit replacement for analog meters.** Incandescent display. Unipolar, single-ended input. Full scale range of 0 to +1.99V. 0.5% ±1 digit accuracy. Optional: variable reading rates, BCD outputs, and control signals. **\$59 in 100's. AD2002.**

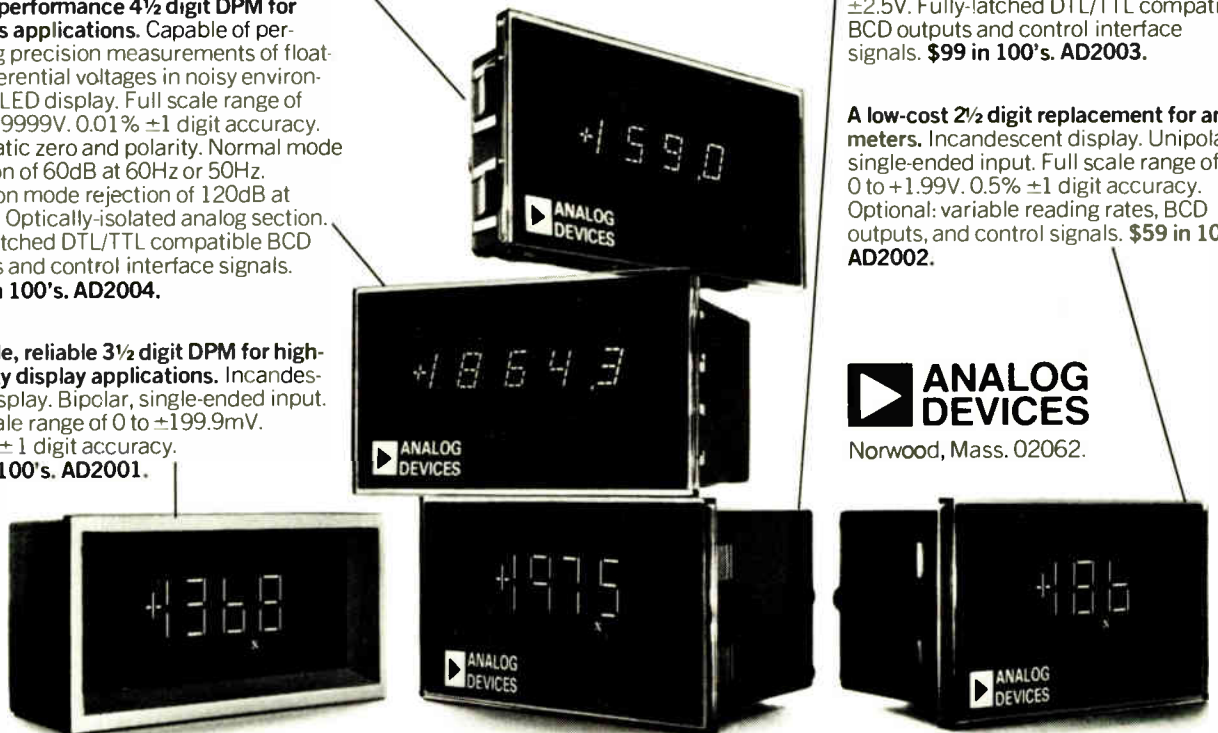

**ANALOG DEVICES**  
Norwood, Mass. 02062.

## Call 617-329-4700

for everything you need to know about 5 volt DC-powered DPMs.



# Probing the news

Analysis of technology and business developments

## From omens to messengers

A hydromet network and a military system will extract blackout-free transmission from meteors, and an Antarctic station is exploring the uses of whistlers

by George Sideris, San Francisco bureau manager

**Mere omens** to the ancients, meteors and lightning in modern times have long promised new modes of practical communications. And at last, though a generation of radio engineers has grown gray and skeptical awaiting the fulfillment of that promise, three groups are well on the way to exploiting the potential of meteor trails and whistler paths.

Bonneville Power Administration will install a hydromet (hydro-meteorological telemetry) meteor-burst network that avoids the channel-capacity problems of early networks by transmitting only a little data at a time. Boeing Electronics Co. has a new military system that is expected to rekindle interest in the use of meteor-burst links for blackout-free polar communications. It cuts message delays to minutes, from the hours that the military found intolerable. And Stanford University has put into year-around operation in the Antarctic the first transmitter designed specifically for research into whistlers—slang for broadband emissions from the magnetosphere.

If tests of data transmissions to Canada are successful, it would mean the first regular use of whistlers for communications.

**Cool savings.** The Stanford station shows that long-range vlf stations can be built cheaply—only \$50,000 compared with \$100 million for the Navy's stations—when they are built on the mile-high platform for antennas provided by the polar ice cap. The university is also considering a meteor-burst link, to connect two stations 800 miles apart. The alternative, over-the-horizon scatter propagation, is subject to losses caused by the ice cap.

One reason that early systems for exploiting meteor-bursts gave poor results is that they did not make full use of the fact that electrons in space can act like natural radio relay stations. Long messages were transmitted by reflecting the signals from the dense trails of large meteorites. But such trails, though they last several seconds, do not occur very often, and long transmission delays resulted.

The Bonneville and Boeing systems rely mainly on the more numerous "underdense" trails of tiny meteorites. These trails last only a fraction of a second and don't reflect signals—they reradiate when stimulated by uhf pulses.

Bonneville allows for the brevity of the underdense trails by lim-

iting message duration to 100 milliseconds. The messages are simply readings of stream levels and precipitation, plus date, time, and station number, sent several times a day in a 27-digit format at 2,000 pulses a second.

**Burst system.** Boeing avoids the long delays by boosting the system power-bandwidth to increase data rates as well as sky coverage and penetration. The system uses the very short trails created by the great number of tiny particles that burn up at an altitude of about 100 kilometers. Operating under computer control, the system accumulates messages in brief bursts. This approach allows rates up to 100 words per minute per channel to be sustained and cuts delay to about 3

**Data via meteor trails.** This is the Bonneville Power Administration's hydro-meteorological telemetry network—or hydromet—that will use meteorite trails to transmit bursts of data.

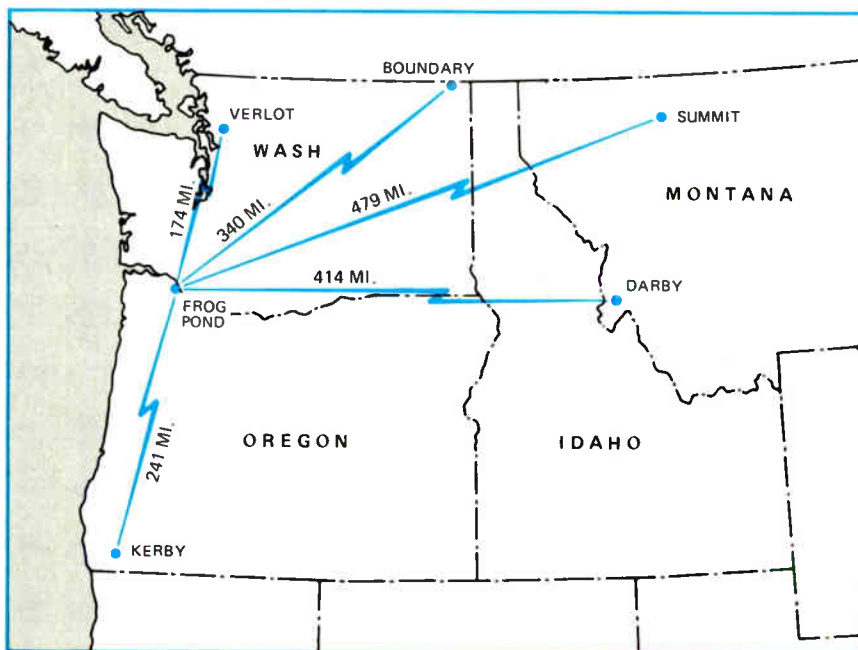

## Probing the news

minutes, according to Ray Leader, Boeing program manager.

**Hydromet.** Five hydromet stations, placed at the far corners of Bonneville's huge watershed in the Northwest, are scheduled to go into operation in 1975. Hops up to 479 miles long will be made with 100-watt transmitters. The master interrogating station will be the prototype used in field tests, refurbished with a rotating antenna so that it can be aimed at all the points in the sky at which the remote stations are aimed.

To acquire data, the master interrogates at 40.01 megahertz. When the remote receives the signal, indicating a trail has been found, it sends the data at 41.01 MHz. At the winter low in meteor activity, about six messages can be sent daily by each station. In the summer, the average would approach 300.

"We'd be happy to get two readings a day from these stations," says D.J. Marihart, head of Bonneville's communications section. "It sure beats sending personnel to take readings, and we cannot afford to run microwave relays so far out." Marihart estimates each station will cost \$7,000 to \$8,000, or the same as conventional stations.

The man who built Bonneville's field-test system, D.N. Match, associate professor of the electronics research laboratory at Montana State University, says hydromet is an ideal application for meteor-burst networks because of the small volumes of data sent. "Hindsight shows the early networks failed because attempts were made to transmit too much data in a short time. The arrival times have to be flexible," Match points out.

**Delay cutter.** Boeing will probably be Bonneville's supplier because Marihart has not yet located another company still active in meteor-burst development. Boeing has hung on in the market since 1959, working mainly on experimental military systems. The military, says Boeing's Leader, likes the meteor-burst idea because the mode provides secure communications immune to polar blackouts. However, long message delays damped mili-

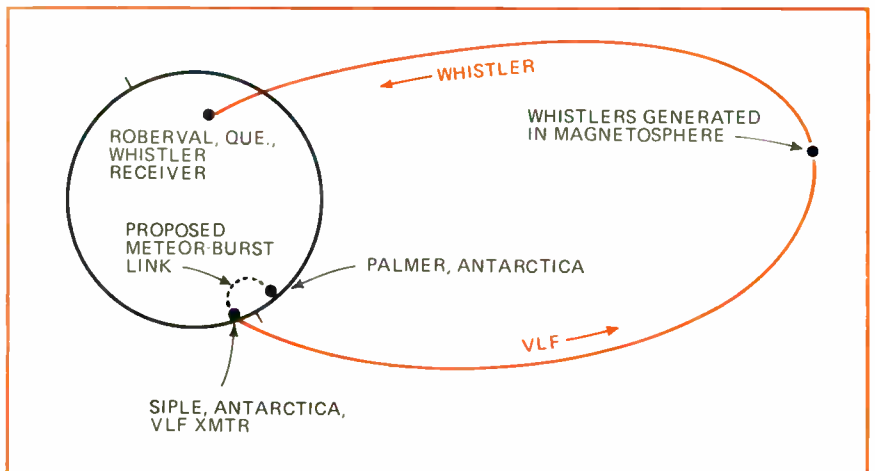

**Whistlers while they work.** Stanford is operating, for the first time, a year-round whistler transmitting station in the Antarctic. Also being considered is a meteor-burst link.

tary plans for operational use.

Boeing's new high-speed systems are undergoing prototype field tests. The computer-controlled masters operate at higher power—500 to 2,000 w—than Bonneville's, and can transmit to the meteor-burst range limit of 1,200 miles. Beyond that range, two stations cannot see the same point because of the earth's curvature. One version provides random-access to many remote units, another polls sequentially. The remote units operate at 100 to 300 watts, and system frequencies range from 40 to 60 MHz.

Leader estimates the masters would cost \$25,000 to \$100,000 in production, depending on message rates and network size. Remote units are small solid-state transceivers that should cost well under \$5,000.

**Whistlers.** As for whistlers, Stanford's station is the first vlf transmitter designed to explore whistler and ionospheric phenomena with a full mix of vlf frequencies and modulation modes. The project chief, Professor R.A. Helliwell of Stanford's radiosciences laboratory in Palo Alto, Calif., has used Navy vlf stations in the past, but those have characteristics fixed by communications requirements. Work on the new station started in 1969, and full-time operation began this February. The receiver is at the conjugate point, Roberval, Que., Canada. Whistlers, broadband vlf emissions generated by lightning, can also be generated artificially by propagating vlf signals along a magnetic line of force to the magnetosphere, where

the signals cause electrons to oscillate, amplify, and emit vlf radiation at varying frequencies. The whistlers descend to earth along other lines of force, in the process precipitating electrons into the ionosphere. Stanford scientists hope to precipitate enough electrons to create false auroras for the study of polar communications problems.

The Siple station in Antarctica is an ideal location for this work because the lines of force end nearby. Also, the 6,000-foot-thick ice cap makes huge antenna towers and powerful transmitters unnecessary. John Katsufakis, the senior research engineer, explains that the ice is a good dielectric. The station operates at 100 kilowatts prime power and 27 kilovolts potential, a fraction of what the big Navy stations need. Also, the ice broadband the antenna. Bandwidth is 2 kilohertz across the vlf range.

Although the radiated power is only 2 to 8 kilowatts, Katsufakis says the results of propagation tests are "beautiful." The immediate goal is to allow the scientists at Siple to let those at Roberval know immediately the triggering parameters. Stanford has been using the Navy communications network.

Another possibility is communicating with satellites on the blind side of the earth. Three satellites have picked up signals while on the same meridian as the station, a demonstration that transworld satellite relays could be made over vlf stations. Katsufakis believes a few hundred watts would be enough to trigger whistlers. □

# Circuit protection —with resistors



Where your circuits require resistors with built-in fault protection, TRW may have a solution. Specifically:

**IRC Type PW.** Wirewound power resistor, 2-50 watts. Inorganically constructed. Use as a standard power resistor. Or use as a *fusible* resistor. Highly effective where you need a versatile, low-cost power resistor, or specific fusing characteristics.

**IRC Type BWF.** Economical 2-watt wirewound resistor in the familiar 1-watt size molded jacket. For years an industry standard for high-volume, automated assembly application. Now available with fusible flameproof feature for hazard applications up to 1000 X overload or 1000 V.

**IRC Type PGR.** Ceramic-insulated, semi-precision film resistor, 1-5 watts. Famous Metal Glaze™ construction—rugged and stable. A low-cost, universally applicable

flameproof resistor in ranges up to 100K ohms—far beyond wirewound resistor capability.

**Complete resistor choice.** Remember, TRW/IRC offers a total resistor capability—wirewound, carbon comp., metal film, functions.

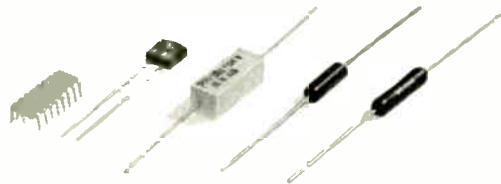

For technical data, flameproof specifications or specific application needs, contact your local TRW sales representative. Or write TRW/IRC Resistors, an Electronic Components Division of TRW, Inc., Greenway Rd., Boone, N.C. 28607. (704) 264-8861.

**TRW<sup>®</sup> IRC RESISTORS**

Government electronics

# NOAA fills packages with electronics

Weather satellites play big role in planning, but sensors, automated manned stations, and digital links wait in the wings

by William F. Arnold, Aerospace Editor

Although the ITOS-E weather satellite was lost during launch July 16 when the second-stage rocket failed and dropped the spacecraft in the sea, the National Oceanic and Atmospheric Administration is readying plans to hurry other satellites into operation to back up two already in orbit. The launch of ITOS-F has been moved up to around Nov. 1, and ITOS-G could go up sooner than next summer.

Moreover, NASA, which procures and launches spacecraft for NOAA, says that the contract for the next three in the series, H, I, and J, should be let before the end of the year, although it has not been decided if it will be a sole-source award to RCA Corp., the series builder. The \$9 million polar orbiting spacecraft use infrared scanning and high-resolution radiometers to watch the weather day and night. If the Office of Management and Budget would release the money already approved by Congress, NASA also would begin contracting for the new-generation TIROS-N program, slated to cost under \$50 million.

**Coming up.** But weather satellites are only part of NOAA's weather-and-environmental monitoring, although an important part. The diversified agency plans or has in prototype a bundle of electronic packages to automate and digitize weather monitoring and forecasting. These programs include new sensors, automated manned weather stations, automated unmanned stations, and the digital communications to interconnect them with ever-watchful satellites.

Two programs best focus NOAA's increasing use of electronics in environmental monitoring:

- Automation of Field Operations and Services (AFOS), a two-phase program that will digitally interconnect 300 weather service offices. Given funding approval, the National Weather Service would begin in fiscal 1975 the four-year first phase to automate 70 larger weather centers for "several tens of millions of dollars," says deputy weather service director Richard Hallgren. E-Systems Inc., Garland, Texas, has been given a 10-month, \$638,000 contract to develop a prototype station. Soon to be decided is how much automation to bring to the second-phase improvement of 230 smaller weather stations. The program also should prod sensor development, Hallgren adds.

- Geostationary Operational Envi-

ronmental Satellite (GOES) program, which will be kicked off this year with the launch of the first of two Synchronous Meteorological Satellites (SMS). After these two prototypes are launched, the agency may exercise its options with Philco-Ford for more, says Clifford A. Spohn, head of NOAA's National Environmental Satellite Service. Procurement for a follow-on GOES series could begin in 1977, he adds. The GOES program has pushed his budget from about \$30 million a year to almost \$55 million annually, Spohn says. Besides its international implications (see "Hands across the sea," p. 65), the program will spur development and procurement of a series of remote monitoring packages, including data buoys, since

**Network.** The Geostationary Environmental Satellite (GOES) will relay data from a network of sensors to an analysis center and interpreted forecasts from there to local weather stations.

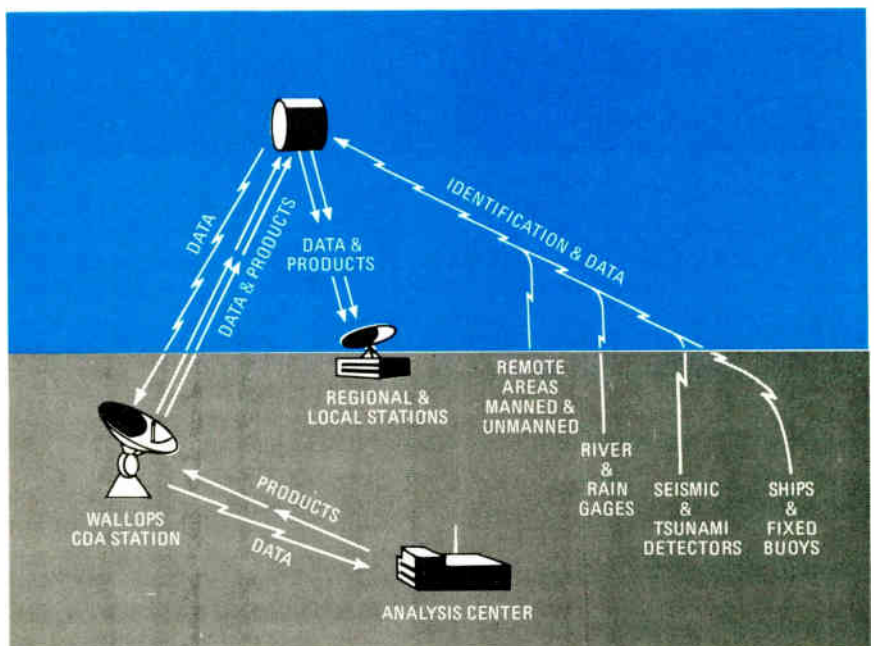

GOES will be able to handle 40,000 platforms every six hours.

In fact, NOAA would like to buy about 10,000 remote platforms during the next 10 years, says Jack H. Pueruer, program manager for the GOES data-collection system. NOAA has ordered from Magnavox' Communications and Industrial Electronics division, Fort Wayne, Ind., 93 production units of a prototype weatherproof pressure-encased platform developed by the company. Each platform costs \$4,000 to \$5,600, depending on lot size, he says. NOAA will release competitive bids late in the current fiscal year for more.

**Conversion.** To be placed on remote towers or buoys, the battery-operated units, basically radio sets, convert the sensing data to digital signals for broadcast to satellites over one of 150 possible channels at 100 bits per second. Components include decoders, frequency synthesizers, and phase-shift-key modulators and transmitters. The agency is working to make its data compatible with Earth Resources Technology Satellite (ERTS) and TIROS-N data-collection systems.

The GOES satellites (the SMS after launch) will "become major early-warning satellites for U.S. weather stations" from their 23,000-mile perch over the Western Hemisphere, Spohn says. The scanning satellite features a 16-inch aperture telescope providing half-mile resolution plus a sophisticated infrared scanning capability for spotting hurricanes and other bad weather. The uhf transponder aboard the SMS will query the remote platforms, such as buoys, rain gages, seismographs, and those on moving ships.

On the ground, the AFOS program will do for the weather forecaster what the FAA's automation program did for the air-traffic controller—"It will automate the communications and the response time, but it won't automate the forecasting," explains John Lovkay, AFOS program manager. Thus, it would free the forecaster from tedious paperwork and give him more precise information.

Key to the program is the prototype automated station being developed by E-Systems for eventual use in the 52 Weather Service forecast offices, four national weather

## Hands across the sea

This fall, representatives of the U.S., USSR, and the European Space Research Organization will meet with the Japanese in Tokyo to further coordinate frequency and coding formats for an international exchange of satellite-derived weather information. The plan, part of the global atmospheric-research program, would become operational in 1976.

Key to the plan is a worldwide belt of five weather satellites, of which the U.S. would use the two GOES spacecraft, and each of the other three participants would build and launch its own. An important part would be played by the multinational network of weather sensors in weather stations, at unmanned remote sites, on buoys, and on moving ships.

Besides the considerable problems of agreeing on how and in what form to exchange the weather data among the participants, a ticklish diplomatic issue will be how to get them to cooperate without anyone appearing to run the show, says Richard Hallgren, deputy director of the National Weather Service. He suggests that those attending the meeting might appoint a coordinating official who would work closely with representatives of the four participants.

centers, and the 14 river-forecast centers. Teletypes and facsimile maps will be replaced by a controller's console with four television screens, one for the forecaster to use as a scratchpad and the other three as reference screens that can call up information from the computer. Once he has assembled his weather map, the forecaster would push a button and the map would be sent quickly over digital circuits to the network. The station's three teletypewriter and two facsimile circuits will be reduced to one voice circuit with a 40-to-1 increase in capacity, says Donald M. Hanson, chief, systems, plans, and design division.

**Mini base.** Designed to use off-the-shelf hardware, the prototype station is built around a Data General minicomputer with 32,768 words of storage for the network's information to drive the displays. The digitized weather maps will be displayed on a scan-converter system made by Econograph, part of Hughes Aircraft Co. The map system includes a "Vernier kind of zoom lens," Lovkay says. Read-only memories will allow the forecaster to "kick up any fonts or symbols," he adds. In production, the stations will cost from \$200,000 to \$500,000 each, depending on complexity, Hallgren says. Lovkay describes the system as a store-and-forward loop with some 60-odd nodes on it.

Second-stage automation for the 230 smaller manned weather posts is in final discussion. The National Weather Service aims to begin pro-

curing production hardware in fiscal 1976, Hallgren says. Two or three packages of greater or lesser automation may evolve and be used with CRTs, or teletypewriters, and other combinations, depending upon need, he explains. Development funds for this fiscal year are still caught in the congressional mill.

Other AFOS-related programs include automated unmanned weather stations and the upper-air monitoring programs, Lovkay says. The service has developed a prototype station that could supersede a production unit, of which the service has 65 systems on order. Production parts are made by SDM Corp., Woburn, Mass., Airtronics, Washington, D.C., Bendix Corp., and Vitro Corp. of America. The prototype tower features a General Electric Portamobile radio that transmits the digitally converted sensing information when queried either by radio or telephone landlines. Lovkay says that the tower could be powered by battery.

The next-generation upper-air sounding system will use 98 Data General Nova 1200 minicomputers at selected sites to further automate telemetry data from high-altitude-balloon sensor packages. The system will incorporate differential Omega navigation to track the balloons and accurately determine high-altitude wind speeds. Hazeltine Corp., Greenlawn, N.Y., has made a prototype switched antenna and Scientific-Atlanta Corp., Atlanta, Ga., a receiver. □

Trade associations

# The other CIA—a bark and a bite

Year-old Computer Industry Association has become an IBM-watcher that's quick to do battle or tell its side of an antitrust suit

by Alfred Rosenblatt, New York bureau manager

"They have been the single strong voice heard against a background of squeaks," says the executive secretary of the Computer Industry Association about IBM and its decades-long domination of the computer marketplace. But in the year since CIA's formation in Encino, Calif., by eight manufacturers—mainly of peripheral equipment—those squeaks appear to be consolidating into a sharper bark that commands more attention each day.

CIA's objective is to make the public, business, and Government aware of the basic difficulties faced by smaller companies competing against IBM with its domination of the marketplace, says Trude Taylor, president of Electronic Memories and Magnetics Corp., Hawthorne, Calif., and one of the CIA founders.

**Fears failures.** And, adds Dan L. McGurk, the ex-president of Xerox Data Systems who got CIA rolling in July 1972 [*Electronics*, June 7, p. 14], if IBM continues its domination, "American technological leadership of the computer industry would disappear" as competitors fail and IBM continues to do much of its technical development at branches overseas. Accordingly, CIA is a more than interested observer of the various antitrust suits against IBM, and the organization has been in the forefront of efforts to obtain some relief—whether by regulation, market-share restriction, divestiture, or restructuring—from what the association regards as IBM's stranglehold.

So far, CIA has proved itself a gutsy and growing association unafraid of tangling with IBM, either in the courts or in print, and of providing the computer industry with what A. G. W. (Jack) Biddle, CIA's execu-

tive secretary, calls "a strong second voice." Membership in the association—styled as a nonprofit group of manufacturers and users of data-processing equipment and services—has climbed to 19 corporate and six individual members. Corporate dues, based on sales volume, range from a minimum of \$1,000 per year to a maximum of \$50,000. The maximum is set, Biddle says, so that no organization will be able to dominate the others. However, adds Biddle, "We still have not gotten the industry to stand behind us by joining CIA. Their attitude is 'let Jack do it,' but we need them all."

**Legal impact.** CIA has also begun to make an impact on the legal and legislative front. Perhaps most dramatic was its successful court appeal to make available to the public the

documents, including IBM's own internal memoranda, filed in the Telex Corp. antitrust suit against IBM. CIA has, in fact, set itself up to supply to the public and the press, at just about the cost of reproducing the material, these and other documents related to antitrust litigation against IBM [see "Price list"].

**Capital staff.** Another important aspect of CIA's legal effort in its first year was the establishment of a full-time legal staff in Washington, D.C., headed by Jack Pearce, a lawyer experienced in antitrust matters. Pearce's post in Washington is calculated to give Government leaders ready access, not only to a non-IBM point of view on computer-industry matters, but one that will reflect the viewpoints of CIA members. This effort is similar, for example, to that

## Price list

The Computer Industry Association is keeping an up-to-date file of the documents being introduced in the Telex, Greyhound, and Department of Justice antitrust suits against IBM. Copies of the documents are available for a nominal fee. But because court records are so voluminous, those "nominal" fees can quickly add up. For example, all of the trial transcripts and exhibits of the Telex vs IBM case, some 22,829 pages, are available for \$5,075. Or the 16,000-plus pages of the daily transcripts alone are priced at \$1,450.

For the more thrifty, minutes of IBM's internal management review committee, dating from 1968 to 1972—a total of 3,052 pages—are available for \$695. And there's also a 1,696-page selection of "significant motions and filings" in the Telex case for only \$390.

In addition, more limited items are available. IBM's trial brief costs \$100, while Telex's brief is a mere \$35. Telex's proposed findings of fact relating to its antitrust claims go for \$60, while IBM's comparable papers are pegged at \$120. Documents relating to the Government's suit, which is only now getting a good start, are available in much lower-priced segments. And the association is providing selected pages at 20 to 25 cents per page.

Perhaps the best buy for the money is CIA's monthly newsletter, "On-Line," at only \$6 per year. These plus other items can be ordered by writing to the CIA care of Kekst & Co., 450 Park Ave., New York, N.Y. 10022, or CIA, 16255 Ventura Blvd., Encino, Calif. 91316.

only recently inaugurated by the larger and much older IEEE.

CIA's efforts in Washington have already proved fruitful, Biddle claims. He contends that the association, by its presentation of facts, has helped to prevent a "soft" pre-trial settlement of the Department of Justice's antitrust suit to break up IBM. By helping to force a trial, "we have made it much more likely that underlying, persistent problems of the data-processing industry will be solved," Biddle says.

**To the Hill.** In addition, CIA officers have given testimony in favor of two pending bills in Congress, the Antitrust Procedures and Penalties Act, sponsored by Sen. John A. Tunney (D., Calif.), and the Industrial Reorganization Act of Sen. Philip A. Hart (D., Mich.).

Perhaps most eyebrow-raising of all is "On Line," a monthly, straight-talking newsletter published by CIA that endeavors to keep on top of the antitrust litigation involving IBM, as well as to report to and educate its readers on the implications of congressional efforts in antitrust matters and the computer industry. The newsletter also seems to try to harass IBM.

Included in recent issues were such notes and articles as "Telex Looks Like the Winner" (this while the trial was in progress); "Your Turn in the Barrel?" (which made the point that if IBM fears its market position is threatened, the offending firms will be dealt with as were the plug-compatible-peripherals manufacturers); and "Is IBM Above the Law?" (outlining the alleged refusal by IBM to make documents available to the Government as the Federal court had ordered).

**Revelations.** In addition, "On Line" has been publishing excerpts from IBM's own internal documents that have come to public attention during the various litigations. (In the past four years, IBM has been challenged in 13 antitrust suits, by CIA's count.) Included among these revelations, for example, is an IBM Quarterly Product-Line Assessment, dated August 1971, which rated the competitive strengths of most of the company's own mainframe computer, tape, and disk-storage systems as "deficient." "Even if you're not in the computer business, this

stuff can get pretty funny," comments one reader.

CIA claims that circulation of its newsletter has reached 1,300 readers, including congressmen, editors and reporters of newspapers, magazines and news services, and the senior management of companies involved in the computer and data-processing industries, plus the financial community.

But IBM is not CIA's only concern.

It hopes to become a regular trade organization for the computer industry, not merely a get-IBM group, says Biddle. Eventually, CIA should address such problems as foreign trade, taxes, and lobbying, recommends James L. Pyle, assistant to the president at California Computer Products Inc., Anaheim, Calif., another founding company. Pyle looks forward to an expansion of membership in CIA, including

## CMOS/LSI SUBSYSTEMS CAN HELP YOU IMPROVE PRODUCT PERFORMANCE AND SLASH PRODUCTION COSTS.



### WE CAN HELP, TOO.

That's our business—helping our customers extend their design and manufacturing capabilities to include the most advanced semiconductor technologies.

Whether your product can be improved through the application of CMOS/LSI subsystems, the high precision of Bipolar linear circuits — or a combination of both — our people have the proven knowledge and access to the industry's most advanced processing equipment. This combination of skills and facilities just might enable us to help reduce your system costs.

Our customers choose to work with us because of the harmony and mutual integrity which characterize the close working relationship we feel is essential to doing a proper job.

We've helped develop some of the industry's most sophisticated integrated circuits for high-volume production, including High-Density CMOS (CMOS utilizing two separate layers of interconnect) and precision Bipolar ICs incorporating high-value thin-film resistors.

If you feel your products might benefit from the application of these advanced techniques, you should know more about us. Give us a call or drop us a line today. Call, write, or circle reader service number 245 today. If we can't help, we'll say so.

### MICRO POWER SYSTEMS

3100 Alfred Street, Santa Clara, CA 95050 Phone (408) 247-5350 TWX: 910-338-0154

TECHNICAL REPRESENTATIVES IN EUROPE AND THE FAR EAST

# JACKS, PINS & TERMINALS

SHIPMENTS FROM STOCK

TEFLON/MICRO MINI/SUB MINI/STANDARD/  
PRINTED CIRCUIT/BRASS SOLDER

Hundreds of  
configurations  
in stock

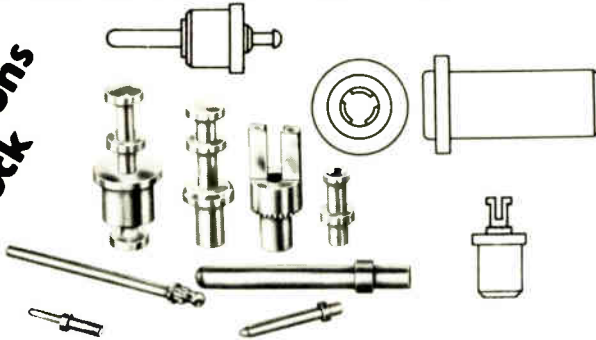

WE PRECISION-MANUFACTURE AND PLATE TO MIL SPEC  
IN GOLD, SILVER, TIN, SOLDER, AND OTHERS TO ORDER.  
FREE CATALOG AVAILABLE.

**CONCORD ELECTRONICS CORPORATION**

37 GREAT JONES STREET, NEW YORK, N.Y. 10012  
(212) 777-6571 TWX 710-581-4930

Circle 68 on reader service card

## Fight Brownouts with TOPAZ LINE REGULATORS

- No Distortion • Most Efficient
- Lowest Cost • Smallest Size



500 VA to 24 kVA

Priced from \$290.

### SPECIFICATIONS:

**Input:** 85 to 125V sine wave  
**Output:** 117 V sine wave  
**Operating Frequency:** 47 to 63 Hz  
**Response:** Less than 1 cycle  
**Efficiency:** 98%  
**Audible Noise:** Typically 2 dB

**TOPAZ**  
ELECTRONICS

SOLUTIONS TO  
POWER PROBLEMS

3855 Ruffin Road, San Diego, CA 92123 Phone (714) 279-0831 TWX (910) 335-1526

## Probing the news

users, as well as big companies.

Would IBM be accepted? Larry Goshorn, president of General Automation Inc., Anaheim, hopes it would be if the company applied. "Why not have a continuing dialog with them—a meaningful interchange, rather than meeting them in court every few years?" he asks.

**Not joining.** As for IBM itself, the company declines comment on the activities of CIA. And as for joining, a spokesman notes that IBM is already a member of the Computer and Business Equipment Manufacturers Association (CBEMA) a broad-based industry group, and "we don't see any benefit of joining another group at this time."

Biddle concedes that CBEMA does represent CIA's constituency, but he points out that it takes no position on competition. □

## The lineup

Don't look for IBM's name, but here's a list of the companies that have joined the Computer Industry Association as of July 6.

Advanced Memory Systems: memories and components  
Amdahl Corp.: mainframes  
Applied Magnetics Corp.: magnetic heads, disk files, cores  
California Computer Products: graphic systems, disk drives  
Cambridge Memories: memories  
Computer Machinery Corp.: key-to-disk systems  
Cullinane Corp.: programs  
Electronic Memories & Magnetics: core, semicon, disk  
Foresight Systems: software  
General Automation: minis  
Informatics Inc.: software products and services  
Information Magnetics Corp.: magnetic heads and components  
Intel Corp.: leasing, peripherals  
Logicon Corp.: consulting, peripherals  
Memory Technology: memories  
Storage Technology Corp.: tape, disk drives; semiconductor memories  
Telex Corp.: disk drives, printers, tape systems  
Xytex: tape library systems  
Randolph Computer: leasing





## Sangamo Recorders. For people who need 32 channels of data. And people who don't.

When you tackle a job that calls for 32 channel recording, you've pretty well got to come to us. We make the Sabre V, the only IRIG all-band portable tape recorder on the market with up to 32 channels on one-inch tape.

But not all jobs need the Sabre V, and we want you to depend on Sangamo anyway. So we also offer the Sabre III, Sabre IV and the Sangamo/Tandberg TIR 100 - newest addition to our line.

Sabre III gives you lab quality and total bandwidth convertibility in a compact all-band portable.

Sabre IV is our laboratory model that's setting new standards of accuracy in recording and reproduction.

Both Sabre III and IV let you process data up to 2.0 MHz in the direct mode, 500 KHz in the FM mode, and with full

serial and parallel PCM capability. They feature total bandwidth convertibility, too.

The Sangamo-Tandberg TIR 100 does almost everything you'd expect a \$16,000 recorder to do but costs under \$4,500. It features four channels including one for voice or data recording, a built-in CRT monitor and a portable size smaller than a cubic foot.

That's four Sangamo recorders in all. One of them is bound to do the best possible job on your data recording job—whatever it is.

For more information, write:

Sangamo Electric Company, Data Systems,  
P.O. Box 3347, Springfield, Illinois 62714.  
Or call (217) 544-6411/Telex 406-421.

**SANGAMO RECORDERS**  
THE INNOVATORS IN TAPE INSTRUMENTATION

# COUNTERSCAN SYSTEMS INTRODUCES TWO STATE OF THE ART PRODUCTS

## A Sophisticated Multiple Conductor WIRE ANALYZER



Bench model shown.  
Larger units are floor consoles.

Designed Exclusively For:  
**High Density Backplane Testing**  
**High Density Cable Testing**  
**Multiple Circuit Wire Verification**

Now for the first time, you can get a wire checker that has followed the state of the art. Once programmed, all you need to do to test different cables, harnesses, backplanes, PW boards, etc., is to press a program select button. No mess with putting on reels of tape, cards, or hooking up other peripheral equipment. This machine is completely self contained and even includes a built-in special purpose computer. Programs are stored in electrically reprogrammable MOS LSI ROM's, and the first program is supplied FREE with the machine. The program content can consist of anything of your choosing. Machine capacities available from 240 points to 384,000 points, in 240 point increments.

Super sophisticated electronic circuitry utilizes CMOS technology almost exclusively. The high density switching is accomplished entirely by CMOS LSI bi-directional switches. Advanced packaging techniques reduce the select/deselect switching component volume by 87%. Choice of various test frequencies and test voltages is continuously available and is part of the program. Any pin connection to the device under test may be used as an input or output. An innovative cable attached keyboard/display unit contains all controls for machine operation. Prices for the basic models range from \$3840.00 complete for the 240 point unit and up. Price includes a printer, mating connectors, programming, and a spare parts kit.

## A High Density 480 Channel MULTIPLEXER



A giant multiplexer/demultiplexer is now introduced to satisfy all high density switching and selecting requirements. This innovative and extremely sophisticated unit utilizes the very latest in switch technology. State of the art solid state LSI-CMOS switches are used throughout. The physically compact unit has a tremendous capacity of 480 channels that may be used both as a Multiplexer and Demultiplexer. Each channel is fully bi-directional and capable of passing plus or minus 12 VDC and 12 V peak AC to greater than one megahertz. The small size of the plug-in-able unit is made possible by one high density wire wrap panel and the utilization of the very new LSI-CMOS switches.

The LSI-CMOS integrated circuits support the Multiplexer design better than any other solid state devices in existence. The CMOS-LSI circuitry permits extremely low power consumption, high reliability, are fully bi-directional, extremely compact unit configuration, and uses electronics that represents the threshold of a new and coming technology. A nine bit parallel straight binary code supplies the address to all channels. Full address decoding with latching selects and maintains switch closures until a reset is desired. Interfacing and supporting components contained on the relatively small size wire wrap panel are all state of the art devices and includes a miniature high density data connector that contains 488 contacts and a miniature edge connector that terminates all 22 wires of a flat cable simultaneously with no preparation.

Prices for the Multiplexers start at \$1800.00 for a quantity of one.

**COUNTERSCAN SYSTEMS P.O. BOX 536 PHONE 402-773-3875 SUTTON, NE 68979**

Circle 131 on reader service card

Circle 132 on reader service card

**New NDP 1255-8**  
 from **NATIONAL ELECTRONICS**  
 featuring

**Gas Discharge Display Panel**

- Large Character (.3")
- Edge Connector Plug In
- Multiplexed • Low Cost



**NATIONAL ELECTRONICS**  
 a varian division  
 geneva, illinois 60134 (312) 232-4300

Presenting  
 in your  
 corner:  
**THE  
 ELECTRONICS  
 BOXER!**

Why mess around when you can have the **ELECTRONICS BOXER** clean up your copies—keep them in top condition.

And, it's easy and inexpensive to keep the **ELECTRONICS BOXER** in your corner. Just complete the coupon and mail! Your order will be processed immediately, postpaid.



**ELECTRONICS BOXER**

**Jesse Jones Box Corporation**  
 2250 E. Butler St., Philadelphia, Pa. 19137

Please send me:  boxes @ \$4.25 each;  
 3 boxes @ \$12.00;  6 boxes @ \$22.00

My check or money order is enclosed.

Name \_\_\_\_\_

Address \_\_\_\_\_

City \_\_\_\_\_ State \_\_\_\_\_ Zip \_\_\_\_\_

Consumer electronics

# Will viewers give ★★★★★ to pay television?

Cable operators fret over equipment limitations  
and watch Sterling's proposed New York installation

by Gerald Walker, Consumer Electronics Editor

Put two or more cable television operators in a room these days, and the first thing they'll talk about is pay TV. Every major cable operator and most small ones have started thinking about how to set up a play-for-pay system for home video viewers.

In fact, programing has already begun in California, Pennsylvania, and Virginia, but the first entry into a big, tough market will undoubtedly be Sterling Manhattan Cable's proposed installation this fall in New York City. The financially troubled cable operator and Home Box Office Inc., both subsidiaries of Sterling Communications, which is controlled by Time Inc., will attempt to sell special sporting events and almost-new movies for a flat monthly subscription to 58,000 regular CATV customers. A charge of around \$10 per home will be levied

on top of the \$6 monthly fee already collected for the cable service.

A new group of entrepreneurs is pushing hard to sell packaged deals similar to the one announced for Manhattan. Arrangements include programs and picture-jamming or scrambling equipment designed to keep the pay shows secure until purchased. Besides Time Inc.'s Home Box Office, well-financed companies are vying to provide the complete pay-TV packages. Among them are Trans-World Communications, New York, out of Columbia Pictures; Warner Cable Corp., part of Warner Pictures and also connected to a cable operator; Home Theatre Network, Los Angeles; Optical Systems Corp., Los Angeles, an early entry, with a leased-channel concept; Theatrevision Inc., New York; and K'Son Corp., Orange, Calif. In addition, such cable-hardware sup-

**Keeping track.** A basic problem in pay TV is ordering and billing. K'Son Corp. believes its subscriber order concentrator will do the job for cable operators' pay TV systems.



intel delivers  
n-channel.

1K MOS  
RAM

WITH...

# AP Test Clip 22

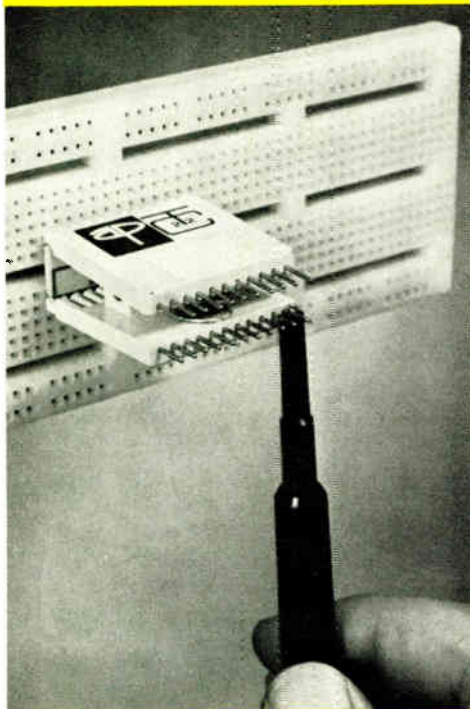

A P 923705

HOW DOES THAT GRAB YOU?

DOESN'T HURT A BYTE!



A P PRODUCTS ARE UNCONDITIONALLY GUARANTEED TO MEET OR EXCEED OUR PUBLISHED SPECIFICATIONS

the  
AP always  
perfect  
products  
company

**AP PRODUCTS INCORPORATED**

72 CORWIN DRIVE • PAINESVILLE, OHIO 44077  
(216) 357-5597

## Probing the news

pliers as Jerrold Electronics, Horsham, Pa.; Oak Industries, Inc., Crystal Lake, Ill.; and Magnavox Co. CATV division, Manlius, N.Y., are offering scramblers and converters with pay-TV capability.

**Memories.** Yet with all this heavy commitment to what is an undetermined, but presumably huge market, cable men can remember the flop pay TV suffered in a prior West Coast outing of over-the-air telecasting. And to provide a sense of déjà vu, the television-broadcasting interests have already begun another campaign to halt, or at least minimize, pay TV. A group called Committee to Protect the Public from Paying for What It Now Gets Free on TV has been formed by the National Association of Broadcasters.

Thus, with the program promoters waving enticing brochures on one side and the broadcasters tuning up their propaganda machine on the other, cable-TV operators in the middle are wondering if the risk is worth the investment. Their decisions involve technical, as well as marketing, problems.

One problem is the unavoidable necessity of managing premium services over one-way cable networks. Because no two-way systems are fully operational, it means that viewers have to order their pay shows through a variety of admittedly "Mickey Mouse" procedures. Consumers have to subscribe by the month, buy "tickets" to disable the set-top jamming devices, or telephone orders for the cable operator to unscramble the picture remotely.

The key is that the pay-TV channel must be jammed or scrambled unless and until the viewer decides to purchase the program.

**Quick entry.** Methods to make the most of one-way limitations are mainly stopgap measures to get operators into pay TV soon enough to start making returns that can finance the more expensive two-way approach. K'Son, for example, has developed a subscriber-order concentrator for per-program pay TV. With this system, the subscriber telephones a special number, which puts him on line with the order con-

centrator. Then he dials a code to identify himself and another code for the program desired. Taking calls at about one every 2 seconds, the concentrator converts the data to digital signals and feeds a mini-computer that unscrambles the pay-TV channel for each order.

Another approach being tried by Magnavox CATV division with TelePrompTer in San Bernardino, Calif., features a two-way data-collecting device installed outside of subscribers' homes. In this setup, a central processor controls the procedure, including the picture-sound scrambling. Programs are ordered through a set-top terminal. But the key to the plan is the IDEM (interactive data-exchange module), which collects records of programs that have been viewed from groups of 32 homes. IDEM stores the billing data until it is collected by service personnel from units mounted on telephone poles.

Service personnel physically collect the information monthly by using standard audio-tape-cassette recorders. The system is two-way between the IDEM and subscribers, but one-way between the central processor and the data module. The modules store the scrambling code as well as maintain a record of all pay-TV transactions. Also, because of the split function between the IDEM and the subscriber's set-top converter, the converter can be simpler and less expensive than one that only does the unscrambling.

**Two-way street.** Ideally, two-way cable is the way to go. A two-way system enables each set owner to order individual shows via an at-home terminal designed to send coded information back to the operator's head-end by the same cable connection that carries the program.

The economics of pay TV for the home are still somewhat hazy. Besides installation of the hardware, which is estimated to cost from \$150 to \$250 per subscriber, operators must consider the investment in cleaning up picture quality.

"The question we all face," says the vice president of a major systems operator, "is, can we afford to wait for two-way? And before we answer that one, we have to decide if we can afford the investment on one-way pay TV." □

# HIGHEST SPEED

80 nsec max! Intel's new 2105 n-channel silicon gate memory is the fastest 1K MOS RAM *available* today! Cycle time is only 180 nsec, while standby power is 80  $\mu$ W/bit. Other speed selections are also available. Compared to equivalent bipolar memories, the 2105 offers less than half the cost per bit and consumes less than one-eighth the power. It beats core hands-down on both cost and performance.

Organized 1024 words by 1-bit, the 2105 provides easy interfacing with on-chip decoding, TTL levels for addresses, write-enable and data-in signals. OR-tie capability is provided for ease of expansion.

Planar refresh allows all 1024 memory cells to be refreshed at once and a "hidden refresh" feature eliminates memory busy signals.

To help you cut your design time to a minimum, Intel has available a 2105 pre-production memory board, the IN-36. It is available with timing and control on one 8" x 10" board in sizes up to 4K words by 9-bits. Cycle time is 300 nsec; access is 150 nsec.

To simplify interface and minimize package count, ask about Intel's 3210 and 3211 TTL and ECL drivers coming soon. Each device contains 4 address drivers and 1 clock driver designed specifically for Intel's n-channel RAMs.

The 2105 and IN-36 are products of Intel's n-channel silicon gate technology. They're available at any Intel distributors. Intel Corporation, 3065 Bowers Avenue, Santa Clara, California 95051, (408) 246-7501.

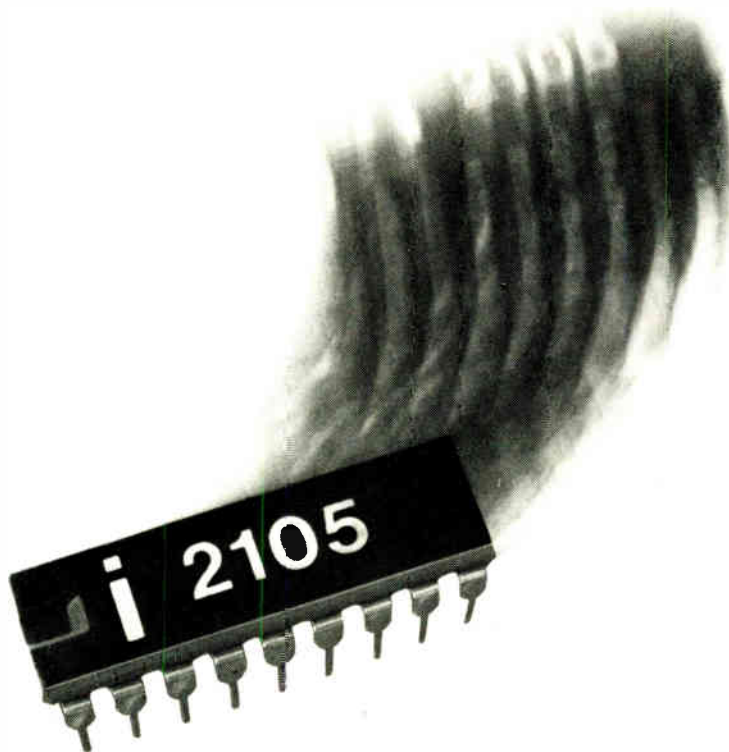

intel delivers  
n-channel.

# The logics of Xerox.

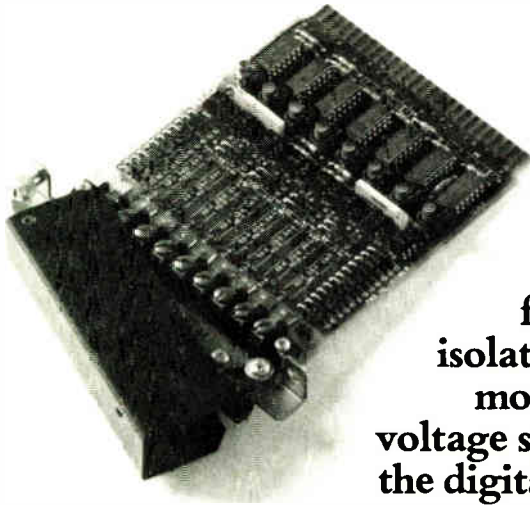

**The Industrial Interface:** A new series for industry. Its photo-optically coupled isolators provide up to 1500 volts of common mode rejection. This helps prevent noise or voltage spikes on the output lines from affecting the digital system.

**The J-Series:** A complete family of low-cost, high-performance logic, function and analog modules. Available in DTL or TTL boards, which are pin-for-pin compatible. Use DTL for systems requiring minimum power consumption. TTL for circuits up to 20 MHz.

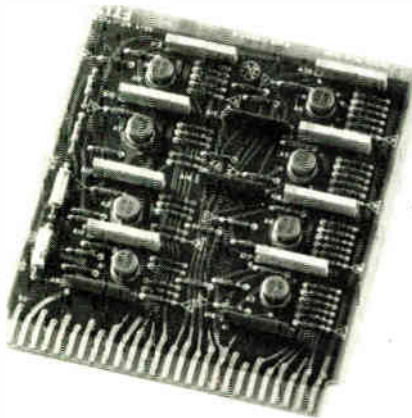
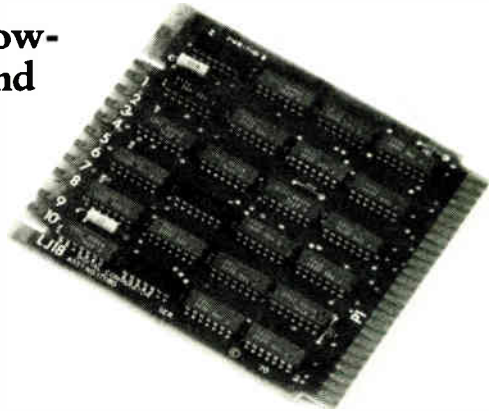

**The T-Series:** Natural logic lets the designer directly implement his equations without converting to NAND/NOR logic. Diode gates help provide a very high noise rejection of 1.5 volts. Facilitates high fan-out gates and clock frequencies up to 10 MHz. This series includes over 140 standard modules.

All modules and supporting hardware are available "off-the-shelf" for immediate delivery.

Just another way of helping you remember we're Xerox, the duplicating, computer systems, telecommunications, micrographics, education, copier company.

And to think you knew us when.

**XEROX**

For further information write: Xerox Corporation, Dept. A3-73, 701 South Aviation Blvd., El Segundo, California 90245. Or call (213) 679-4511.  
XEROX\* is a trademark of XEROX CORPORATION.

# Special report: Semiconductor memories are taking over data-storage applications

---

Despite shortages, difficulties in design, and lack of standardization, advantages of semiconductors have earned their use by manufacturers as storage for new computers, controllers, and calculators on the market

---

by Wallace B. Riley, *Computers Editor*

□ Semiconductor technology, long heralded for tomorrow's memories, has suddenly become the memory technology of today. Nearly every new computer model—regardless of size—now comes with a semiconductor memory or a choice between semiconductors and cores. The technology first proved its worth in remote terminals, and it has spread to all kinds of computer peripheral equipment and controllers; and now it has made possible the common calculator priced at less than \$100.

And the end is not yet. Despite many difficulties, semiconductor manufacturers are breaking through new technological barriers every day—in reducing size, increasing capacity, enhancing speed, improving reliability, and decreasing costs.

One of the many reasons for the wide acceptance of semiconductors is the rapidly increasing ratio of price to performance—bringing a host of memory-dependent electronic gear into the “affordable” range. Decreasing costs of semiconductor memories have also led to many variations in the way relatively inexpensive computers and peripherals are being used.

“There’s no such thing as a ridiculous demand in this business,” commented Dino Sirakides, vice president for product planning and engineering, of Monroe Calculator Corp., Orange, N.J., a few minutes after wishing for a fast nonvolatile read-mostly memory. “Only two years ago, the \$100 pocket calculator was ridiculous—now it’s expensive.”

One advantage of semiconductors is that the equipment manufacturer can build his own memory system from the ground up—something he couldn’t do with core memories, in part because of the large mechanical-assembly problem associated with cores. “Nobody ever

even bothered to build a system starting with pre-assembled core planes,” says Herb Thaler, engineering manager at Adar Associates, manufacturer of memory-test equipment in Cambridge, Mass. “But it’s easy to put a good-sized semiconductor memory—say 4,096 by 12 bits—on one printed-circuit board.”

However, the manufacturer must think several times before offering a semiconductor memory to revise a system made with a core memory that is selling well and operating satisfactorily. He could impact his own standard product.

Although the revised machine could have a memory-access time perhaps one-third that of the old machine, with a correspondingly better price-performance ratio, the manufacturer would suddenly find all his old customers demanding that he replace the old core memories on their installed machines with new semiconductor memories—leaving him with a warehouse full of unsalable second-hand core memories.

The trick is to win new customers and upgrade existing installations by incorporating the semiconductor memory in entirely new machines. If necessary, the manufacturer can sell returned machines on the second-hand market or refurbish them and sell them as nearly new.

But before he switches to semiconductors, the manufacturer must be sure that he can get deliveries on time for the semiconductors that will give him the performance he wants at a price he wants to pay. Burgeoning demand, coupled with most semiconductor manufacturers’ limited plant capacity and scarcity of certain semiconductor materials, have stretched lead times enormously, so that only favored customers can be assured of timely deliveries.

## I. What's available.

All semiconductor memories can be divided into two classes in any of four different and independent ways, resulting in a theoretical classification into 16 different types. These divisions are between dynamic and static circuits, bipolar and MOS technology, read-write and read-only memories, and random-access and serial-access memories. (The distinction between the third and fourth divisions is important—see “Down memory lane,” p. 77.) Because the four divisions are independent, there are theoretically  $2^4 = 16$  different types of memories, but not all of them are purchasable or even practical.

For example, dynamic bipolar memories are impractical because bipolar circuits do not have the intrinsic capacitance that dynamic circuits utilize. And a dynamic read-only memory is a contradiction in terms, while a read-only serial-access memory is a little difficult to visualize. Thus, only about eight of the 16 theoretical types are realistic.

All semiconductor memories share a universal organization. The storage cells are arranged in a square or rectangular matrix, as shown in Fig. 1, with dimensions X and Y. When reading or writing data in the matrix, an address of X + Y bits is required.

The decoded X-address portion identifies one of  $2^X$  lines across the matrix with an associated driver circuit, while the decoded Y-address portion similarly identifies one of  $2^Y$  buses or pairs of buses, usually with associated driving, sensing, and multiplexing circuits. In dynamic memories, refresh amplifiers are also associated with the Y-address, as described below.

During any cycle, the X-address activates all the cells along the X line, transferring the data in all cells to the corresponding Y buses. The Y-address multiplexes the data from one of these buses to the output, or, during a write operation, multiplexes input data onto one bus, replacing whatever was in the addressed cell previously. Data on the other  $2^Y - 1$  buses returns to the cell.

Since only one bit is accessible at a time in any individual semiconductor storage array, and since most systems operate with several bits—often from 4 to 64—in parallel, the required number of bits must be obtained by driving a corresponding number of semiconductor arrays in parallel.

Usually, there is one array per package, but occasionally a hybrid package may contain several arrays, or in custom designs, an array may occupy part of a chip along with other logic. Address decoders, multiplexers, and, sometimes, sense amplifiers are on the same semiconductor chip with the storage array, as distinguished from ferrite-core memories, in which these electronic components are never intrinsic with the storage arrays.

A major user of hybrid packages is IBM Corp., Armonk, N.Y., which developed its own packaging system some 10 years ago in connection with its System 360 computers. That pattern has evolved into today's monolithic logic and memory chips, still usually mounted

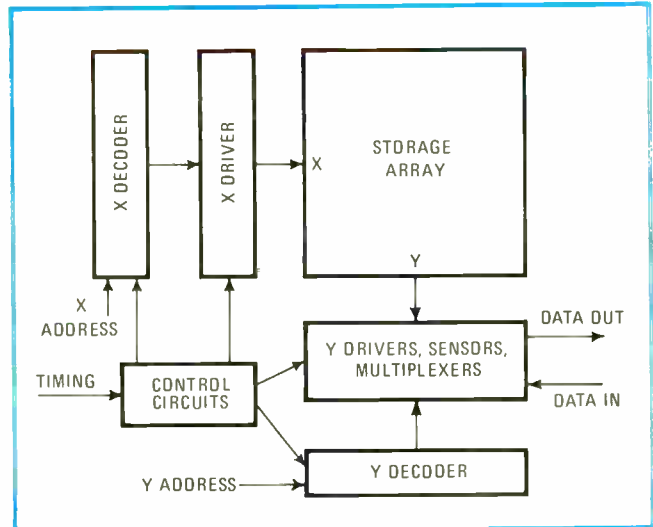

**1. Matrix.** All semiconductor memories have this basic organization on each chip. The X and Y addresses are supplied simultaneously while the timing is one or several external signals.

two on a ceramic substrate, and often with two substrates “piggybacked” on a single set of pins. IBM uses this package almost exclusively for all memory and logic circuits—an exception being a dual 480-bit shift register used in its model 129 buffered keypunch, which IBM purchases from an outside vendor in standard dual in-line packages.

This package is used today, other than in IBM equipment, only by Semiconductor Electronic Memories Inc., Phoenix, Ariz. part of Electronic Memories and Magnetics Corp., Los Angeles, under an IBM license.

One observer regrets that the industry has not made greater use of the IBM package. “It’s definitely superior,” he says. “You get good yield, high density, high reliability—much better than wire bonding and other techniques that are standard elsewhere in the industry.”

### Dynamic and static circuits

One of the four divisions is between dynamic and static circuits. A static memory in any technology consists of an array of binary cells that can be set individually to either of two states, in which they remain so long as the power stays on. (Ferrite-core memories are static; they have the additional advantage that, if proper precautions have been taken, their cells retain their states after power is shut off.) Static semiconductor memories usually consist of arrays of latches or flip-flops with suitable means for addressing individual flip-

DYNAMIC READ WRITE MEMORIES — TRADEOFFS				
	p-MOS	Slow n-MOS	Fast n-MOS	Bipolar
Number of bits	1,024 – 2,048	4,096	1,024	1,024
Access time (ns)	150 – 300	300	85 – 120	50
Power dissipation (mW/bit)	0.2	0.1	0.25	0.5
Average price cents/bit large quantity	0.4	1.0	25	25 – 50



flops. Because one side or the other of every flip-flop in an array is always conducting, the array continuously dissipates power.

A dynamic memory is an array of cells whose contents tend to decay over a period of time ranging from milliseconds to seconds, depending on the technology and on the temperature and other environmental conditions. Therefore, whether in use or not, the cells must be refreshed often enough to assure that the integrity of the stored data is maintained. This refreshing, with the associated timing signals and extra power supplies, represents a distinct disadvantage to the use of dynamic memories, but the disadvantage is far outweighed by their higher attainable speeds and by their lower total power dissipation (they dissipate energy only when reading, writing, or refreshing and may stand by for long periods between cycles).

The most common form of dynamic memory stores data in the form of a charge on a leaky capacitance. Transistors associated with the individual cells and with the array detect the state of the charge on the capacitance, control its restoration during refresh, and impose or remove charge in the course of storing new data. Various types of dynamic cells are shown in Fig. 2.

### **Bipolar and MOS**

Another division is between bipolar and metal-oxide-semiconductor (MOS) technology (Fig. 3). Generally, bipolar ICs have high speed and low density and are expensive, while MOS ICs exhibit the opposite characteristics. A typical bipolar memory is a static array of flip-flops with an access time of 50 nanoseconds or less. These arrays generally dissipate moderately high amounts of power—around 500 milliwatts per chip.

The manufacture of bipolar circuits of all types involves five to seven masking steps to print the circuit patterns, as opposed to three for MOS, so that bipolar memories are quite expensive. Their cost can be justified only when the fast access time of the circuits is required by the system in which they are used.

Until relatively recently, bipolar storage cells could be laid out in arrays with only limited density, because area-consuming isolation barriers were required between storage cells. This meant that a chip with a given number of storage cells had to be fairly large. Furthermore, since the cost of an integrated circuit is roughly proportional to its area, and since the yield of an IC process rises sharply as the chip area decreases, this again contributes to the cost of bipolar memory arrays—over and above the cost of the extra masking steps.

A second closely related effect was that only a limited number of cells could be included on a chip of reasonable size. But over the last two years, Fairchild Camera and Instrument Co., Raytheon Co., Motorola Inc., and others have introduced passive-isolation methods that eliminated the previously conventional active p-type diffusions between storage cells, allowing a substantial saving in area. These new methods permit a maximum of 1,024 bits to be placed on one chip, overcoming the density limitation that previously kept bipolar technology out of the running for computer-mainframe memories.

Dynamic bipolar memories are impractical. But an

### **Down memory lane**

Many engineers needlessly confuse the division between read-write and read-only memories with the division between random-access and serial-access memories. They often refer to read-only memories by the acronym ROM, while a random-access memory is dubbed RAM. The similar acronyms make it easy to fall into the trap of referring to ROMs and RAMs as if the functional division were between them.

On the contrary, most read-write memories and practically all read-only memories have random access; whereas the first common read-write semiconductor memories were serial-access shift registers. Small and slow, they were used primarily for refresh buffers in CRT displays, and they're still widely used in such applications. Furthermore, one of the most promising future prospects in semiconductor memories—arrays of charge-coupled devices—is a serial-access read-write technology.

This article maintains the correct distinction throughout.

MOS memory can be either static or dynamic; most of the memories in use are the latter. Because a dynamic MOS storage cell that is not actually cycling conducts no current other than leakage current, its power dissipation is very small. MOS circuits are simple to manufacture and are therefore inexpensive. Furthermore, since the transistors can be made very small, the arrays can be dense. Because the gate of an MOS transistor is insulated from the rest of the device, it forms a capacitance that is an intrinsic part of the circuit, which contributes importantly to the density of the arrays. (In the few cases where a particularly large capacitance is needed, it can be easily obtained by slightly widening or lengthening a conducting path in the circuit.)

This capacitance is the reason for the principal disadvantage of MOS technology—its slow speed. Come what may, the capacitance has to be charged and discharged during every memory cycle. This has limited the most widely used MOS circuits to access times of 300 to 500 nanoseconds. However, recent improvements in technology indicate that this can be brought down to 100 ns or less, so that MOS is beginning to impinge on the high-speed territory formerly reserved for bipolar technology. But, even with roughly the same access times, bipolar storage cells have a much shorter total cycle time, so that they retain that important advantage.

### **Addressing and transfer**

The third division of semiconductor memories distinguishes between read-write and read-only memories. Read-write memories are the ones usually needed for computer main memories, but there are a few special exceptions. Read-only memories are repositories for unchanging information, such as control sequences for processing units, tables of constants, translators between codes, and the like. Occasionally, ROMs store programs similar to those usually kept in the main memory, but which never need be purposely altered; in the ROM, they are protected from accidental alteration. Both

read-write and read-only memories can be implemented with either bipolar or MOS technology, and read-write memories can be either static or dynamic.

## Random and serial access

The fourth division is between random-access and serial-access memories (see "Down memory lane," p. 77). In a true random-access memory, the time required to read or write data in any particular location is essentially the same for all locations. For a reasonable performance level, computer main memories must employ random access.

But in a serial-access memory, typified by a shift register, data is accessible only in a fixed order, beginning at a prescribed point. Data in an arbitrary location is not available until all the data ahead of that location has been read. No computers of reasonable size with serial-access main memories have been built in more than 20 years—then the available technologies were, for example, magnetic drums and mercury-filled acoustic delay lines.

However, serial-access memories—for some kinds of peripheral equipment, for example—are still an important part of the semiconductor-memory industry. Cambridge Memories Inc., Concord, Mass., was an early maker of such memories, and still produces them with

two to 32 chips of 128 bits each in modules that permit expansion to as much as 16,384 bits (four of the largest modules).

## N-MOS challenges p-MOS

Historically, there have been two kinds of MOS technology, referred to as p-channel and n-channel—or, for short, p-MOS and n-MOS. They are essentially identical, except for the doping of the semiconductor materials used in their fabrication and the polarity of the signals and of the supply voltages they use. However, p-MOS got the upper hand early in development because it was simpler to manufacture and had better yield.

As a result, the major growth in MOS memories—and for that matter in all semiconductor memories—has been with p-channel. It became practical on a large scale late in 1970 with the introduction by Intel Corp., Santa Clara, Calif., of the type 1103, a dynamic p-MOS read-write random-access chip with a capacity of 1,024 bits, organized 1,024 by 1. (Addressing any location on the chip produces exactly 1 bit.) Address decoding is on the chip, so that only a 10-bit address must be supplied by the system that uses it. Practically every semiconductor manufacturer is now a second source for the 1103. Two competitors, the Advanced Memory Systems type 6002 and Fairchild's 3534, are p-MOS memories that, like the 1103, are 1,024-bit dynamic read-write random-access arrays but are not pin-compatible with it or with each other. Mostek Inc., Carrollton, Texas, and

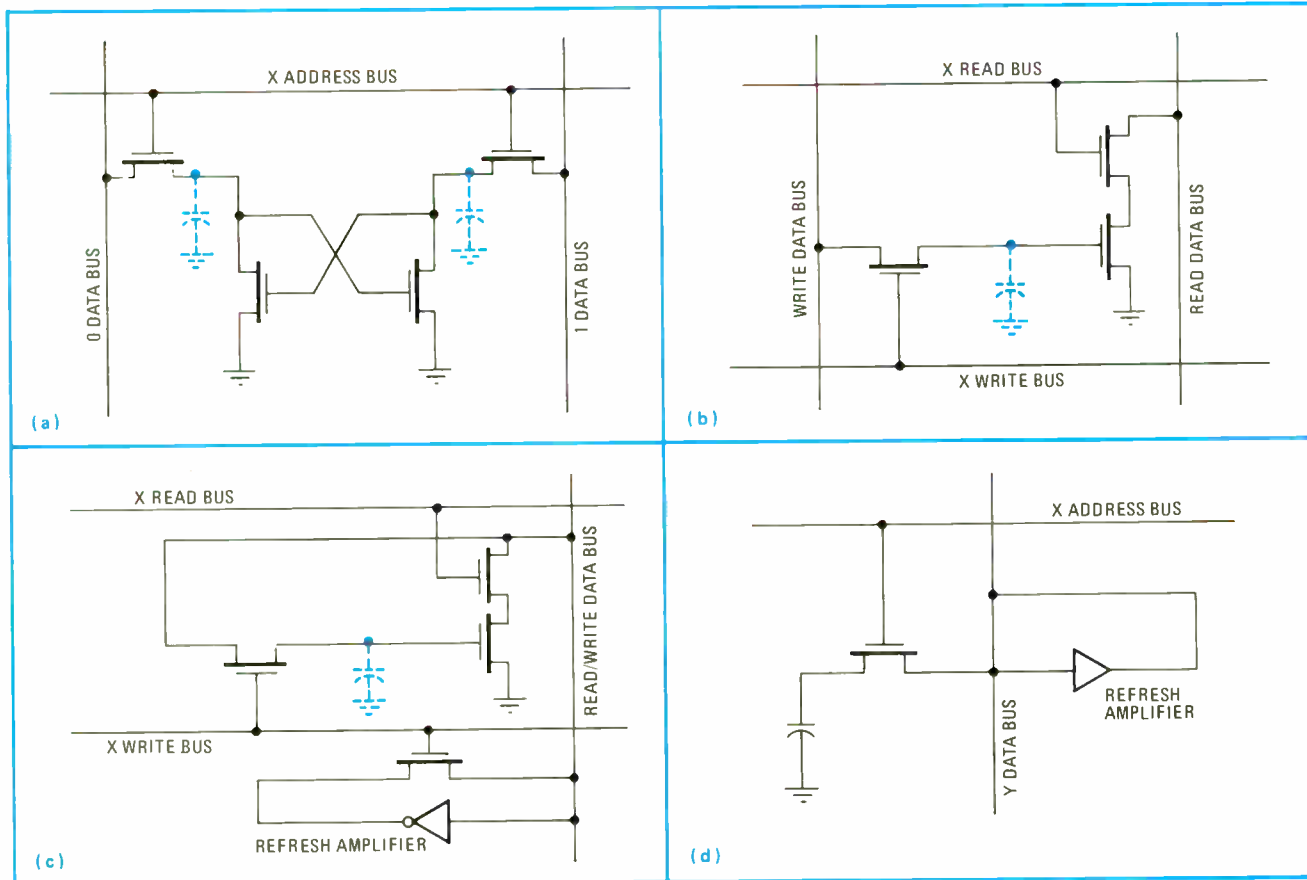

**2. Dynamic circuits.** These four designs are typical of those available, but are not all-inclusive. The four-transistor flip-flop without load resistors (a) is used in the AMS 6002, while the Intel 1103 uses the three-transistor four-bus cell (b). The three-transistor three-bus cell (c) is slightly more compact but rather slow. Mostek Inc. has proposed the one-transistor two-bus cell (d).

National Semiconductor Corp., Santa Clara, Calif., also make their own versions of 1,024-bit p-MOS memories.

In recent years, ways to overcome the early difficulties with n-channel MOS have been developed, notably through the use of a silicon gate on the MOS transistor in place of the traditional metal gate. N-carriers are more mobile than p-carriers, and parasitic effects are less pronounced in n-channel arrays; these factors contribute to higher speed and higher density with n-channel than could be dreamed of with p-channel.

N-MOS also has simpler power requirements and is easier to make compatible with transistor-transistor logic. Compatibility is simplified because both kinds of circuits are referenced to ground with a positive-going signal—approximately 3 volts for TTL and 5 to 15 V for n-MOS, depending on the details of the particular design. On the other hand, p-MOS is referenced to a positive voltage with a negative-going signal, which must be inverted to work with TTL.

“All our next-generation circuits will be n-channel,” predicts B.D. “Bud” Broeker Jr., section manager for memory systems at the Semiconductor Products division of Motorola Inc., Phoenix, Ariz. “In addition to the power-supply advantages, n-channel has speed and density advantages—although not both at the same time. The fact that n-MOS transistors can be made smaller permits high-density arrays to be fabricated, but these same small transistors also have limited current drive, which limits the speed. The small transistors also have lower capacitances, which would tend to speed up the circuits, but this factor is overshadowed by the current requirements.”

Thus, although p-MOS has been the most widely used semiconductor memory technology, n-MOS is making a fair bid to replace it. However, a device designer can't take advantage of both speed and density with n-MOS. He can use storage cells of about the same size as those in p-MOS and achieve speeds nearly as great as those of bipolar, or he can settle for speeds in the same range as those of p-MOS devices and get four times the density, and therefore four times as many storage cells on a chip of conventional size. Or he can throw both high speed and high density out the window and get a static array that is easy to use in a system.

Honeywell Information Systems, Billerica, Mass.,

which worked closely with Intel in developing the 1103 and related products, has forged ahead with its own design for a 2,048-bit dynamic p-MOS memory. Honeywell has no semiconductor manufacturing facilities of its own, so it is negotiating with other vendors to produce the memory.

Meanwhile, Intel, which has been talking for a couple of years about a 4,096-bit n-MOS device, made a formal announcement of the part's availability only a month ago. Microsystems International Ltd., Toronto, Canada, has its own version of a 4,096-bit unit [*Electronics*, Dec. 18, 1972, p. 97]; and Electronic Arrays Inc., Mountain View, Calif., is producing a 1,024-bit n-MOS memory [*Electronics*, March 27, 1972, p. 136]—so far in limited quantities.

### Reliability considerations

Interconnections are the bugaboo of reliability, and reducing the number of interconnections is one of the pressures toward increased large-scale intergration—including increased numbers of bits per chip in semiconductor memories.

In memories, as in all LSI, the larger the area of the chip, the smaller is the yield; a plot of the function is approximately an inverse exponential. But, for a given storage-cell design, reducing the area of the chip and therefore the cell area, requires a tightening of tolerances, which also reduces the yield. A curve of yield plotted against the reciprocal of density (cells per unit area) has a shape similar to that of the logarithm function. Where the two curves cross for a given technology represents the optimum chip area and density for that technology.

“For most designs,” says Brian Croxon, section head, MOS main memory, at Honeywell, “the cell area in the 1,024- and 2,048-bit memories is the same. The larger memories, therefore, are laid out on larger chips, whose area determines the yield. But in the 4,096-bit designs, the cells are made smaller so that density is the ruling factor—particularly since the individual cells are less than half the size of the cells in the 2,048-bit memories and the chips are actually smaller than those of the latter capacity.”

This illustrates the kind of tradeoff that system designers are taking into account. At the present time, for example, the announced 4,096-bit designs are quite slow—Hugh deVries, vice president for engineering at Monolithic Systems Inc., Englewood, Colo., mentions access times of 800 ns or more, which is acceptable to no one. “The 1103 has an access time of 300 ns or so,” he says, “and the 4,096-bit units won't sell until they run at that speed or better.”

### Three read-only variations

The information stored in a ROM is generally considered fixed and invariable, but that is not always true. Read-only memories can be further classified as “write-never,” “write-once,” and “write-sometimes” memories or more technically, read-only, programable-read-only, and reprogrammable-read-only memories—or ROMs, PROMs, and RePROMs. Another term for the third version is the “read-mostly memory,” or RMM—a term not widely favored, perhaps because the acronym can't be

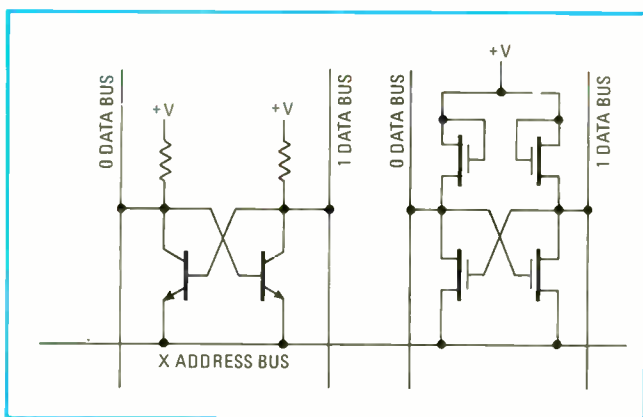

**3. Bipolar versus MOS.** These are the two basic forms of static memory cells. Sometimes the load transistor gates of the MOS version (right) are connected to clock lines or other external signals.

pronounced. But then RMMs aren't widely used, either.

Semiconductor read-only memories are actually the descendants of a long line of read-only memories using non-semiconductor technologies [*Electronics*, March 16, 1970, p. 112]. But within semiconductor technology, the classic read-only memory is the mask-programmable type—the truly read-only or “write-never” memory, the contents of which are defined during the manufacturing process. The memory is an array of diodes, or of bipolar or MOS transistors, with certain interconnections omitted so that the corresponding components in the array are inactive. These interconnections are specified in one of the masks that control one of the deposition or photoetching steps during manufacture. If all the interconnections were left in, the memory would contain all 1s, but omitting some of the interconnections stores 0s at those points. (The logical definitions may be inverted if desired, so that the raw array would contain all 0s, and omitting interconnections would store 1s.)

Obviously, the cost of generating a mask to specify the contents of such a memory limits its economical use to systems in which large quantities of identical ROMs are required and in which changes in the stored data are seldom or never required. For small quantities of read-only data, the programmable ROM is more suitable.

Programmable read-only memories also come in three types, of which the most widely used is the fusible-link type. These are diode arrays in which one connection to each diode is made of an easily melted material—nichrome or polycrystalline silicone. In programming the array, currents large enough to melt the links, but which won't damage the diodes, are directed into the array in such a way as to melt selected links and thus to disconnect the corresponding diodes from the array, thereby establishing 1s or 0s at selected locations. After programming, the currents that pass through the diodes in normal operation are too small to affect the fusible link.

Invented at Harris Semiconductor, Melbourne, Fla., fusible-link PROMs are available with up to 2,048 bits per chip from perhaps a dozen suppliers, and Intersil Inc., Cupertino, Calif., is promising a 4,096-bit PROM by year-end.

### Restored 1s

Fusible nichrome links are subject to certain disadvantages, which discourage some system designers from using them. For one thing, the programming, although simple, takes time—several hundred milliseconds per fused location, or 10 minutes or so to program one large array. For another, under certain conditions the nichrome link, which is supposed to have melted completely away, has been known to “grow back,” restoring a 1 to a location that should contain a programmed 0. The mechanism by which this growing back takes place is not well understood. Fusible silicon links do not grow back, and can be programmed much more quickly.

Intersil has developed an alternative form of PROM—the blown-diode array. It consists of an array of conventional bipolar transistors in which the base-collector junctions are short-circuited to ground through the

base-emitter junctions. To program the memory, high voltages are applied to selected base-emitter junctions to destroy them, removing the short-circuits and thus inserting the other junctions into the circuit.

Only two kinds of reprogrammable ROMs are available. One is an Intel product, using its Famos (for floating avalanche-injection MOS) technology [*Electronics*, May 10, 1971, p. 91]. In Famos, an array of more or less conventional p-channel MOS transistors is used, except that the gate of each transistor is not connected, but rather left electrically floating, buried in a layer of silicon dioxide. A high negative voltage applied across the source and drain of the transistor sets up an avalanche that removes positive carriers from the buried gate. When the voltage is removed, an excess of negative carriers remains in the gate with nowhere to go. They therefore open a conducting channel in the n-type substrate. Exposing the chip to ultraviolet radiation establishes a photocurrent that discharges the floating gate.

Because the Famos technology is constrained by the same speed limitations as conventional MOS, it isn't fast enough for use in mainframes or high-performance peripheral equipment. But it is used in substantial volume in such applications as customized point-of-sale terminals and digital process controllers, and it is a top favorite as a more or less permanent memory for microcomputers.

The other rePROM suffers as much from the controversial history of its maker as anything else, although neither does it offer the most attractive cost and reliability figures. It's the read-mostly memory made by Energy Conversion Devices Inc., Troy, Mich., from a combination of amorphous semiconductor devices made in-house and a diode array supplied by Intel [*Electronics*, Sept. 28, 1970, p. 56]. The founder and president of Energy Conversion Devices is Stanford Ovshinsky, who is a genius at generating headlines. His predictions of the ultimate supremacy of amorphous semiconductors have been startling. His company apparently manages to make and sell enough amorphous semiconductor devices to stay in business, but not many people in the computer industry seem to use them.

REPROMs made by metal-nitride-oxide semiconductor

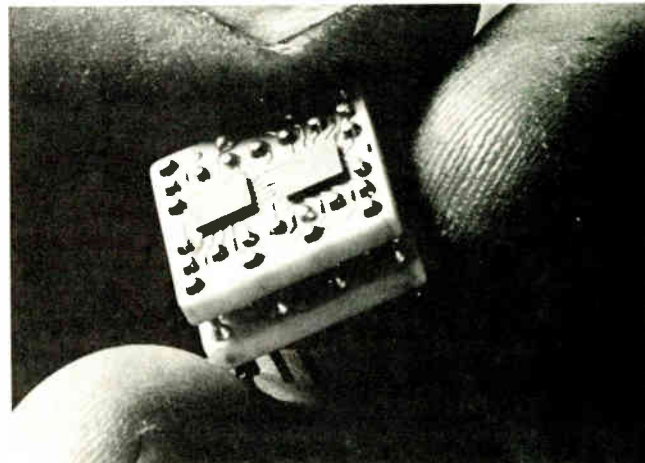

**IBM hybrid.** Two 128-cell bipolar chips are mounted on a ceramic substrate; the second substrate holds two more chips.

(MNOS) technology have been proposed. In this technology, a layer of silicon nitride on top of the oxide but under the metal traps a charge that is brought in by applying a high-voltage pulse of typically  $\pm 28$  v for one second. The trapped charge represents stored data that remains unchanged in the absence of power. The MNOS memory thus is nonvolatile. Experiments at Litton Systems, Woodland Hills, Calif., have shown that the data can remain without degradation for three years or longer [*Electronics*, July 5, 1971, p. 53] if cycled only occasionally. However, IBM research indicates that the distinction between a 1 and a 0 in an MNOS memory tends to disappear after the memory has been cycled a few thousand times.

## II. Who's using them?

Semiconductor memories are showing up today in all classes of computers and computer-related equipment—big computers, add-on memories, little computers, peripheral devices (more properly, their controllers), remote terminals, and electronic calculators.

In big computers, the bellwether user is, as in so many other areas, IBM. Although IBM was not the first to announce a computer with a semiconductor memory, it was almost the first. But in its position as a sort of Big Daddy to the computer industry, the announcement—after years of waiting—had the effect of giving a certificate of validity to the technology.

Today IBM uses semiconductor memories in its System 7 process-control computer and in the recently announced System 3 model 15, as well as across its entire line of System 370 computers—six models, not counting the model 195, which is a sort of bridge between the older System 360 and the 370 at the high end of both lines. At the top and the bottom, in models 168, 158, 125, and 115, IBM uses n-MOS. In the middle, bipolar technology is used in models 145 and 135 and in the System 7. (The dual 480-bit shift register mentioned previously is a p-MOS circuit—probably IBM's only use of p-MOS except in one experimental 8,192-bit chip [*Electronics*, March 1, p. 38] and in research on charge-coupled devices.) Some peripheral devices also have semiconductor memories.

The limited speed of MOS is compensated for in the large machines by including a high-speed buffer, or cache, memory, which is so organized that for the majority of operations, the large MOS array appears to operate with the speed of the small bipolar memory. Benjamin Agusta, manager of exploratory memory and computer science at IBM's laboratory in Essex Junction, Vt., says that unassisted MOS is fast enough for the small machines, while those in the middle need more speed than can be obtained with MOS. Yet for the mid-size, the expense and complication of using the cache can't be justified—so the computers use bipolar arrays. But an IBM-watcher says the company's developing capability in MOS manufacturing wasn't ready in 1970, when the model 145 was, whereas IBM's bipolar line was up to speed with cache memories for the larger 360s and with logic circuits for all the 360s and 370s—leading to a choice of bipolar circuits for the 370/145.

IBM now uses a 128-bit bipolar chip in the System 7

and in the basic versions of the 370/145; additional memory to extend the capability of the 145 comes in bipolar 1,024-bit chips. IBM's other bipolar-memory machine, the 370/135, uses 256-bit chips and was also recently extended to larger sizes with 1,024-bit chips.

In MOS, all IBM computers currently use 2,048-bit chips, while the two largest machines, the 158 and 168, contain cache memories made with the same 256-bit chips that are used in the 135—with somewhat different performance specifications, however.

IBM regards access times at the chip level as confidential and quotes only cycle times at the system level. The company also keeps confidential both the details of storage-cell design and the reasons for not disclosing these details.

Among the other large mainframe-computer makers, Burroughs and Honeywell are out in front in their use of semiconductor memories, Univac has made the switch in two computers, and Control Data Corp. in one. Burroughs uses Intel 1103s in its B1700 and B3700 machines, while Honeywell uses a similar part in its new 6025 large computer. Herbert Stopper, director of engineering, says Burroughs may—pending favorable availability and price conditions—start putting semiconductor memories in its large B6700 machines, as well as its small B700s, which both now rely on ferrite cores.

Univac, which has been promoting plated-wire memories since 1966, last March announced its first computer with a semiconductor memory, the 9480; then, in May, it announced that semiconductor memories would also be available for the Univac 9700, which had been introduced in late 1971. Both memories, as-

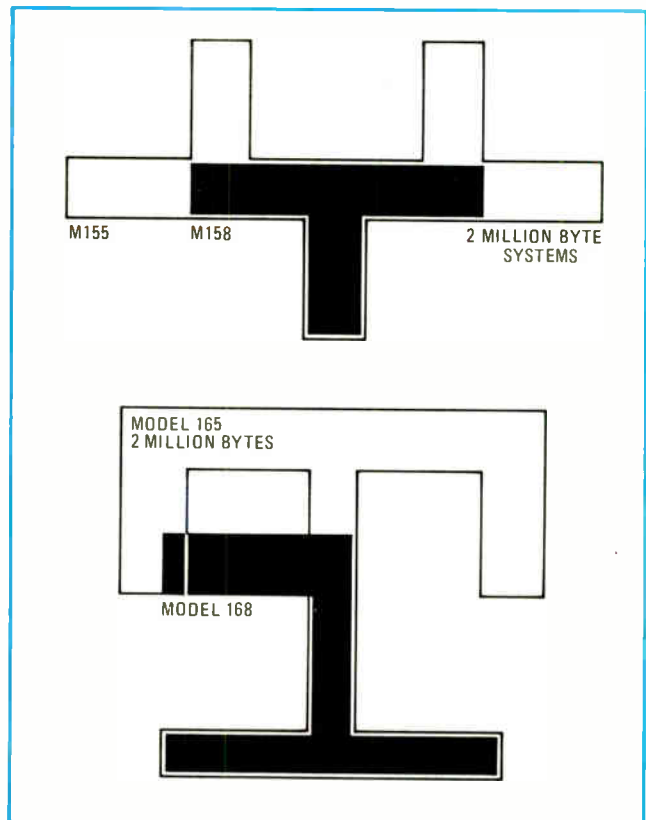

**Shrinkage.** IBM 370/158 and 168 with MOS memory require less floor space (black) than do the 370/155 and 165 with cores.

sembled from Intel 1103s, are essentially identical. Significantly, both computers are part of the series that had plated-wire memories.

"Semiconductor costs have now dropped below those of plated wire for machines of the size of the 9480 and 9700," says Arthur Schneider, director, storage development, at Univac's development center, Roseville, Minn. "Plated wire is still more economical for smaller machines, while ferrite cores are best for very large memories." But Schneider admits that the relative costs of the two technologies are illustrated by the fact that Univac uses vendor-supplied semiconductor memories in place of plated wires that it can make in its own plant.

### Semiconductor memories as add-ons

The bulk of the add-on memory business is with users of IBM's System 360 and System 370 computers. Plenty of System 360 computers are still in place, although IBM isn't building new 360s any more. Every old 360 is a prime target for the add-on memory maker; however, some semiconductor memory houses aim for the add-on business at the high end of the System 370 line. Memory Technology Inc., Sudbury, Mass., for example, builds add-ons for the models 155 and 165, which had core memories but which are now discontinued. MTI puts 16,000 bytes on one printed-circuit board and plugs 32 of these boards into a module that thus contains half a megabyte. Two modules fit into one frame; two frames (two megabytes) replace the entire standard memory that comes with the 370/155, yet take up only half the space of one megabyte of IBM standard core memory. This entire structure is based on the use of 2,048-bit p-channel MOS memories offering 300-ns access at the chip level. This is slow, but since the whole memory has to match the 800-ns access time of the original core array, there is plenty of time to spare.

Storage Technology Corp., Louisville, Colo., sells to the same market. "But we find that IBM's announcement of the models 158 and 168—the MOS-memory systems with virtual memory that replaced the 155 and 165—cut the bottom out of our market," says Eric Ringkjob, director of advanced development.

"We could sell semiconductor memories to replace the cores," he adds, "but it's hard to replace semiconductors with semiconductors, even with a price advantage." Ringkjob expresses no interest in add-ons for the small systems, models 135 and 125. "They'd involve only small amounts of memory per machine, which would have to be on small cards plugged into the machine directly, rather than mounted in an external frame connected by cable," he says.

Both MTI and STC expect to go after the add-on market for the hitherto untouched 370/145, which IBM supplies with a bipolar memory. They figure they can meet the IBM specification at a lower price with 1,024-bit n-channel MOS memories when they become available; designs using samples are already under way at both companies.

A whole new market opens up for minicomputers when they are designed with semiconductor memories.

They can achieve new levels of compactness, and they can economically incorporate smaller memories because semiconductor arrays pay off in smaller sizes than minimum core arrays.

"Basically, the minicomputer designer has two choices," says Jerome Larkin, MOS marketing manager at National Semiconductor Corp. "If he's building a slow machine, he can stay with cores or use p-channel MOS, and when they become available, he can switch to the 4,096-bit n-channel MOS memories. On the other hand, for a fast machine, he can use a circuit like the Intel 1103-1, which is simply a selected 1103 with higher-than-average speed, or Advanced Memories' 6002, or even a combination of cores and bipolar arrays—all while looking forward to fast 1,024-bit n-MOS."

Prime Computer Corp. puts 8,192 words of 16 bits each on a single printed-circuit board, using 1,024-bit p-MOS memories. "We're waiting for the 4,096-bit n-MOS to show up," says John William Poduska, Prime's engineering vice president. "Our machines are designed so that the new board with four times the memory capacity can be plugged right into the existing socket in place of the old board. It'll make a phenomenal improvement in our cost." The computer design allows for the different power supplies the new memory will require. The only difference will be a small change in the current delivered by the supplies already in use.

Burroughs uses 1,024-bit static p-MOS memories in its L8000 business minicomputer, which is the modern equivalent of the accounting machine. "They're slow," Stopper says, "but in that application they don't need to be fast. However, they do need to be easy to use. The statics have input and output levels close to those of the TTL circuits elsewhere in the machine and don't need a lot of fancy timing pulses."

Interdata's latest minicomputers use semiconductor memories in modules of 4,096 words by 16 bits. Access time at the module level is 180 ns; by factoring in the propagation time through a memory controller and the system's ability to overlap cycles in any two of up to

TYPICAL USERS			
Who	Where	What	
IBM	370/115, 125	n MOS	
	370/135, 145	Bipolar	
	370/158, 168	n-MOS, Bipolar buffer	
	System 3/15	n-MOS	
	System 7	Bipolar	
	Burroughs	B1700	p MOS
		B3700	p-MOS
L-8000		p-MOS	
Honeywell	6025	p-MOS	
Univac	9480	p-MOS	
	9700	p-MOS	
Prime	3 models	p-MOS	
Interdata	80, 85	p-MOS (AMS 6002)	
Victor Comptometer	Calculators	p-MOS standard & custom	
Monroe	Calculators	p-MOS standard & custom	

eight modules, the average access time at the controller (what the processor sees) is 215 ns. "These are pretty tough specifications," says Louis D. Pezzi, manager of memory development. "The 1103 can't meet them, and at the time our design was frozen, the 1103-1 wasn't defined yet, nor had anyone begun seriously talking about n-channel circuits. That left us, at that time, with the AMS 6002—which, we found, had another advantage. Its standby power dissipation for our maximum memory configuration of over 65,000 bytes is only 2½ watts—an order of magnitude less than that of the 1103."

Interdata's use of read-only memories illustrates how several technologies can be combined to obtain a desired result. "During development of our machine, we rely on programable read-only memories," says Pezzi. "By the time the first few machines are shipped, the contents of the PROM's are pretty well stabilized, but a few months of field experience inevitably generates several engineering changes, so we stay with PROMs at first. But when the changes die down, we switch to mask-programmed bipolar read-only memories—except in a few special cases for unusual applications, where a customer requires a special instruction set. There we continue to use the PROM."

### Terminals and peripheral equipment

Remote terminals, which provided the first obvious market for semiconductor memories, gave the first big boost to dynamic MOS read-write memory technology, and they remain a major application today. Many terminals have CRT displays that use read-write memories of up to 4,096 8-bit bytes as refresh buffers. They also need ROMs as character generators, which translate the code used to transmit information over the communications lines into raster or beam-deflection information for the CRT displays.

Shift registers are still widely used. They are nearly direct replacements for the magnetostrictive delay lines used in some older terminals. But RAMs, both static and dynamic, are being considered for some models now,

particularly for control functions, rather than refresh buffers.

For example, the Delta 5000 remote terminal, introduced in 1970 by Delta Systems Inc., Cornwells Heights, Pa., used 1,024-bit p-MOS shift registers for the local memory, plus a quad-80-bit p-MOS shift register for a line buffer, which is driven directly by the keyboard. In Delta's terminal, the shift registers replaced small core memories. "Shift registers were the only semiconductor memories available at the time," says Ronald S. Harmon, director of engineering, "except for 256-bit random-access memories, which cost far too much for our use." Even then, says Harmon, Delta Data was paying 1 cent a bit for the shift register—a price that has now dropped to less than 0.4 cent. "It's still the most economical," Harmon says, "although the price seems to have leveled off. We'll probably switch to random-access memories in our next product, which will be announced late this year."

Delta Data already uses random-access memories in its Multiterm unit, which is a cluster of terminals around a local processor. Multiterm stores its data in a 4,096-byte (8-bit) buffer and its instructions in a 65,536-bit read-only memory. The system also has a 16-byte scratchpad memory. The data buffer is assembled from 1,024-bit n-MOS static arrays—"Dynamic support logic is uneconomical here," says Harmon. Fusible-link PROMs are used in the read-only memory, in preference to mask-programmed ROMs, which would be much too expensive in the volume Delta Data would use.

### In the controller

Other peripheral devices attached directly to the computer also use semiconductor arrays for data buffers. These are, strictly speaking, in the peripheral controllers, rather than in the devices themselves. The more complex controllers for magnetic-tape drives and magnetic-disk-storage units are controlled by microprograms, which require read-only memories—again semiconductor arrays.

In the smaller peripheral units, the usual choice for memory is the static-MOS array. Until recently, these have been available only in 256-bit packages, but 1,024-bit versions have been showing up lately. These are easy to use in a design because they require only one power supply, and, although they tend to be slow, speed is usually not a requirement in small machines. Static memories dissipate more power per bit than dynamic ones, but again, because the capacities are small, the total power dissipated by the memory is low enough not to be a problem.

Storage Technology's use of control memories to store microprograms in its tape-control units illustrates the tradeoffs in cost and flexibility that can be obtained with semiconductor memories.

"We design a single control unit to work with any one of a number of different models of the IBM 370," says STC's Ringkjob. "Supposedly, the interfaces for these computers are identical, but they never turn out that way. As a result, we have to trim the design of our controllers to fit the computer they'll be used with."

Like Interdata's Pezzi, Ringkjob recognizes the need to allow for inevitable engineering changes. But with



**Tester.** Computest "Venture" semiconductor-memory tester includes storage file, scope, error display, and keyboard (left).

the interface trimming as an added requirement, Ringjob chooses read-write memory as the initial medium for storing the control program, altering it as needed until the engineering-change activity dies down. Then the read-write memories are changed to mask-programmed read-only memories. Unlike Interdata, STC uses programmable ROMs only when a particular customer has special requirements.

### Semiconductor memories in calculators

A substantial amount of semiconductor memory—both read-only and read-write—is produced, in terms of bits per month, for the burgeoning electronic-calculator industry. But unlike the memories used elsewhere, most calculator memories are custom designs, made economical by the large unit volume of calculator sales—typically in six figures for a major manufacturer.

Victor Comptometer Corp., Chicago, Ill., for example, relies exclusively on its own designs for its semiconductor memories, which are produced for it by vendors. The vendors (prime source is Rockwell Microelectronics Corp., Anaheim, Calif.) work closely with Victor, but the bulk of the functional design is done in Chicago, and the bulk of the semiconductor chip design in Anaheim. Rockwell uses its own round 42-pin package in Victor machines, instead of the dual in-line package that is standard elsewhere in the semiconductor industry.

Likewise, Monroe Calculator, Orange, N.J., a division of Litton Industries, uses many custom chips with some standard parts, especially in the larger machines. Like Victor, Monroe obtains many of its custom chips from Rockwell, but also uses circuits from General Instrument Co., Hicksville, N.Y., Texas Instruments, Dallas, and American Microsystems Inc., Santa Clara, Calif. Standard parts come mostly from National Semiconductor and from Electronic Arrays. "Some of our cus-

tom-chip vendors ask us to provide them with functional diagrams from which they make the mask layouts; others ask only for detailed specifications and do the functional design themselves," says Monroe's Sirakides.

### Hybrid design

Since the object is to reduce the cost of assembly by reducing the number of packages, Victor does all its own design, with minimum package partitioning as a prime objective. "We often combine read-only and read-write memory in the same package, along with calculator logic," says Daniel J. Siwy, director of product engineering. Another characteristic rarely found in standard memories is the capability to obtain more than 1 bit—usually 4—in a single access. This is easy in the large custom packages made for calculators because pin limitations are not a problem. "The more you put on one chip, the less you have to worry about interconnections," points out Roy Phelan, president of the Victor Comptometer research center in Des Plaines, Ill., a Chicago suburb.

Reliability of the logic and memory proper is also extremely important as a function of temperature specification and life expectancy. "We specify the ambient temperature to be 0° to 40°C," says John Tulio, a product engineer at Victor, "but inside the machine, the temperature can get as much as 20°C hotter—if, for example, the power is left on when the machine is covered, or if the machine is left setting on a desk next to a window with the hot sun beating down on it." Another reliability factor is the imposition of high-voltage spikes anywhere on the machine, as when a person touches it after walking across a rug. Such discharges can easily reach 30,000 volts and 15 millijoules, Tulio says, and they shouldn't damage the circuits—although they could alter data that may be stored in the memory at that moment.

### What calculators don't need

Within these constraints, therefore, a number of semiconductor memory technologies don't interest officials at Victor Comptometer. One of these is bipolar technology (too expensive, has unnecessary speed), and another is static circuits. Curiously, the higher power dissipation of static circuits doesn't bother the designers of terminals because the memories are small enough that the total dissipation is tolerable. Nor does it bother Sirakides at Monroe Calculator, who says that the dissipation is compensated for by the single power supply and by the space made available by the absence of refresh logic. But it does bother the people at Victor because their packaging is very tight.

Among the standard parts that Monroe uses are 1,024-bit p-MOS memories, with a 2,048-bit chip here and there, and Sirakides says there's some interest in n-MOS, both the 1,024- and 4,096-bit sizes. These read-write random-access memories are important in the more sophisticated Monroe calculators because the keyboards include a number of blank keys that the customer can specify for his own functions through use of a magnetic program card. This customizes the machine for, as Sirakides says, "bushels of applications," with the

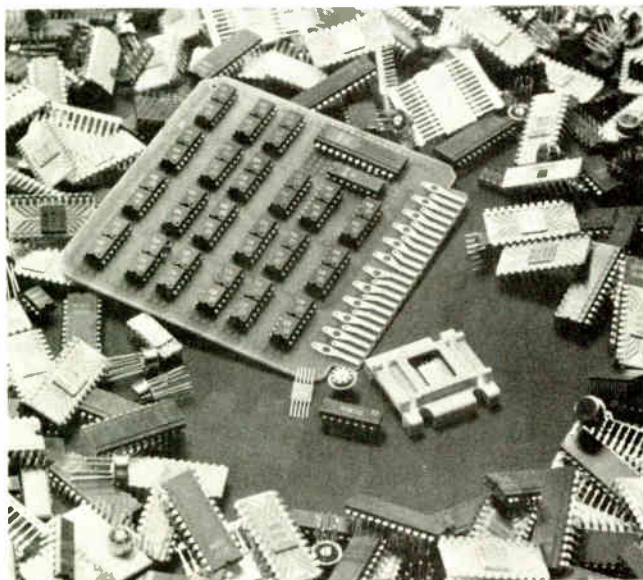

**Complete memory.** Card from CRT terminal contains 43,008-bit main memory, 192-bit shift register, and character generator.



minor disadvantage that the programmed functions disappear in the event of a power failure or if someone pulls the plug out of the wall. But so long as the plug stays in, the programs stay in place—power remains on in the memory—even when the machine is turned off.

“Programable read-only memories would be impractical in this application,” says Sirakides, “because their maximum size is 2,048 bits, and the programs they would contain are very complex.” However, Monroe does use RePROMs in some of its top-of-the-line machines, which it sells only in very small numbers. Until recently, discrete-diode matrixes were used in these machines; now Monroe is beginning to put in arrays of Famos memories. This substitution makes a big difference to Monroe in terms of the labor in making a program board and installing changes and corrections. All the programming is now done with an ultraviolet lamp and some electronic signals, instead of adding and removing diodes.

Monroe also uses mask-programed read-only memories in its smaller machines—the ones that sell for a few hundred dollars and move in large volume. These too have customer-specified keys, but the customer's choices are more limited. Monroe maintains a list of the functions that customers may order and installs keys with the proper labels, plus read-only memories that provide the functions ordered.

### Microcomputers

An important application for semiconductor memories is in the burgeoning microcomputer field—in fact, some producers of the processor chip sets have stated their main reason for offering the microprocessor is to stimulate the memory market.

In a microcomputer, typically one or a few chips contain all the arithmetic and logical functions, plus a modicum of control logic. Most of the control, however, is microprogramed, and the microprogram is kept in a separate read-only memory. Other read-only or read-write memories contain the user's program—usually read-only, because these microprocessors are more likely to be dedicated than general-purpose. Shift registers or other interface chips connect the memories and processors with input-output equipment.

The importance of memories in the microcomputer market is borne out by an Intel estimate that every dollar's worth of microprocessor sales is accompanied by \$10 worth of memory and peripheral sales—mostly MOS. This sweet outlook is soured somewhat by the loss in bipolar logic sales to the applications where the microcomputers replace hard-wired controls—but it is emphasized that the MOS *memory* replaces bipolar *logic*.

## III. What's behind the choice?

When a designer decides to cast off the old familiar ferrite-core stacks and switch to semiconductors, the most important consideration in choice of memory technology is high performance and low cost. “That's been the big selling point of today's p-MOS arrays such as the 1103 and equivalent memories,” says Thomas A. Longo, general manager of the digital products group in the Fairchild Semiconductor division. “The new dy-

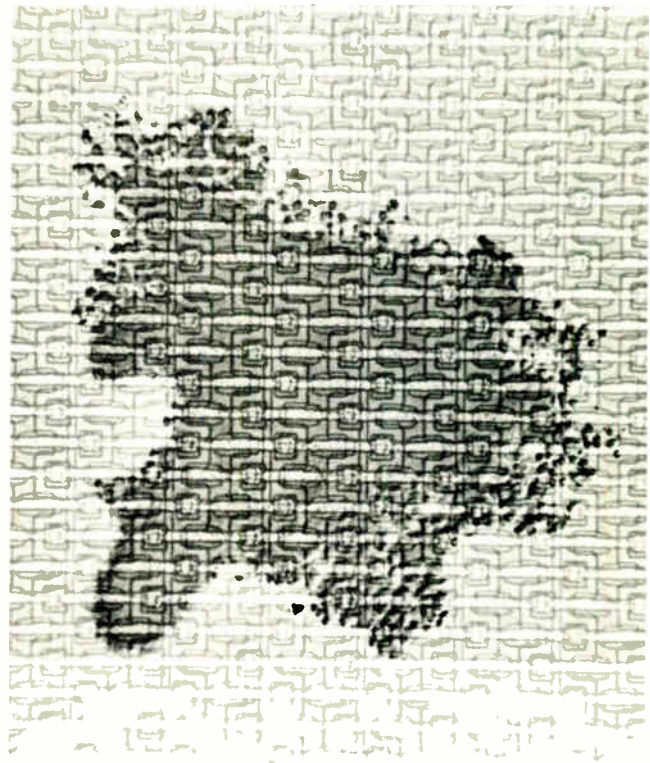

**Biggie.** In this composite photo from IBM, an amoeba is shown against part of an 8,192-bit experimental p-channel memory.

amic n-MOS memories aren't here yet and won't be a significant factor for another six to 12 months.” Their principal advantage will be in performance, Longo believes. N-channel devices are available now, of course, but they're all static and quite slow. When the touted 4,096-bit dynamic n-MOS arrays become available—not before the end of 1973, Longo predicts—they'll be attractive to the user only to the extent that they reduce costs, rather than through their capacity *per se*.

### Simplicity pays

Close behind the cost and performance characteristics comes ease of designing into a system. For some users, in fact, simplicity is more important than cost, particularly where high speed is critical. Says Ramon Alonso, president of Adar Associates, “Right now we're buying minicomputers as subassemblies for our own equipment, installing them complete as an OEM purchase. Eventually, as our business volume increases, we'll probably want to build our own memories and buy only the processors on an OEM basis. But at first, we'll want to minimize the engineering effort required to use them in our system. We don't have the manpower to make a major project out of it. So simplicity will be an important consideration—we may be willing to pay extra to get simplicity.” Alonso adds that the new microcomputers look very attractive—and simple—for his application.

Some of the factors that affect ease of use in a design are compatibility with TTL circuits, direct input and output (without the need for bit drivers or sense amplifiers outside of the memory package itself), the number and amplitude of timing pulses, and the number and wattage of power supplies required. The power-supply watt-

age itself reflects the amount of power dissipated by the circuits; if this is too high, the system will get hot, and the reliability may be adversely affected.

Internally, the classic MOS circuit always has worked with much larger power-supply voltages and wider signal swings than TTL. Users always find it a nuisance to have to include level-conversion circuits in their designs—at the expense of space, power dissipation, wiring, and just plain dollars. Sometimes, conversion circuits have been worked into the basic integrated-circuit chip along with the rest of the MOS circuit—usually a memory—but they take up space on the chip and therefore cost extra components to obtain a desired memory capacity. Low-level MOS circuits have been designed to work directly with TTL [*Electronics*, Apr. 13, 1970, p. 118] but they usually are considerably slower than the high-level circuits.

Timing requirements can be a lot more difficult to overcome. The worst possible timing requires a clock swing between positive and negative levels in multiple overlapped phases. This is particularly bad when the source of the clock pulses must be a TTL circuit. It's considerably simpler when the clock signals can work between ground and some voltage, either positive or negative, and when the memory works with only one clock pulse. The simplest MOS design requires no external timing at all; it may be a pure static circuit or a quasi-static circuit that generates its own timing pulses right on the chip—sometimes with an external reference pulse.

#### Starting from scratch

Although the user could easily design and build his own semiconductor memory system, some semiconductor houses try to discourage such initiative. They proclaim that they have the know-how to assemble a memory system to meet a user's specifications with a lot less strain and pain than the user who starts with a bucketful of ICs.

Building memories is a major part of the business of Advanced Memory Systems, which also sells the 6002. Signetics Memory Systems Inc., a subsidiary of Signetics Corp. (itself part of Corning Glass Works) and Monolithic Systems Inc., Englewood, Colo., are also in this business, but they do not make ICs.

### IV. What have been the problems?

Users of any new technology always encounter unexpected problems with it, and users of semiconductor memories have been no exception. They have encountered design difficulties, power-supply problems, poorer reliability than desirable, and lack of speed. Furthermore, in less technical areas, there have been problems in testing and deliveries.

But the difficulty that makers and users alike seem to mention first is timing—particularly a specification about two overlapping pulses in the Intel 1103 (Fig. 4). These are the precharge and chip-enable lines; chip enable (sometimes abbreviated to cenable) must turn on

before precharge turns off, but precharge must turn off in about 30 nanoseconds. If it turns off in less than 25 ns, stored 1s may eventually turn to 0s; if it turns off after more than 50 ns, stored 0s may turn to 1s.

Curiously, there are two schools of thought about these overlapped pulses. One group says the tight tolerance makes the 1103 difficult to use in many applications; the other says it's a tough, but solvable, problem.

Among those against 1103s are George Vashel, manager, MOS products, and Bob Dwyer, manager, MOS marketing, of Signetics Corp., who denounce the circuit as being a "primitive design." Eric Jackson, vice president for engineering at Memory Technology Inc., says the timing problem makes the 1103 unsuitable for large arrays, such as those MTI makes for adding to the IBM System 370; he also claims it dissipates too much power. Furthermore, he claims that the improvements that Intel made later to the circuit aren't worth very much. "The basic stew isn't right," says Jackson, "and adding more oregano doesn't help it."

Motorola's Bud Broecker says the critical overlap makes the 1103 "a terrible part for the user—but the 1103 is widely used because, for a long time, it was the only game in town." Another choice is the Advanced Memory Systems 6002, which many users have chosen instead of the 1103, perhaps because of its timing. But Broecker points out that the 6002 also is difficult to use. It requires, for example, a special high-level driver, and its normal output is a current only one-seventh that of the 1103.

Herbert Stopper, director of engineering at Burroughs, feels that the complicated controls and extensive testing that the 1103 requires could be vastly simplified if the timing could be relaxed. Interdata's Pezzi, who chose the AMS 6002, says the 1103 is too slow, regardless of the timing problem. The more recently defined 1103-1, with higher speed, wasn't available at the time he made his decision. Finally, John W. Lalley, manager, product sales, at the Computest Corp., Cherry Hill, N.J., points out that the critical timing makes the 1103 difficult to test, but that the 6002 is also difficult to test because of the number of accurately timed input signals that it needs.

But is the 1103 really such a lamentable component? Hardly—its wide use belies the critics' reservations. One industry expert points out that the overlapped timing was a problem once, but it has been licked. "That's why the 1103 has been so successful," he says. "The only people who said it was a serious problem were Intel's competitors and novice designers." This spokesman cites well-known design tricks for avoiding the problem—such as driving both cenable and precharge from gates in the same package and controlling the turn-off of precharge directly from the turn-on of cenable.

Brian Croxon, of Honeywell, describes how the overlap problem was bypassed in the 2,048-bit p-MOS memory that Honeywell has developed as a successor to the 1103 and its ilk. "We put latches on the chip and used three separate clock pulses to turn them on and off—as opposed to calling for overlapped pulses from outside. This represents a balance between circuit requirements and system balance," he says, pointing out

that Intel took similar steps in modifying the 1103 into the 1103A, which no longer has such critical timing.

And after Computest's Lalley mentioned the difficulty of testing the 1103, he went on to say, "People who complain about the timing in the 1103 didn't work with cores."

Users also sometimes run afoul of what seem to be slip-ups on the part of device designers. Sometimes these slip-ups seem to result when device designers try to be system designers and get in over their heads. But more often, and more accurately, they're cases of, as Honeywell's Croxon puts it, "Semiconductor manufacturers (who) made what they wanted to make and could make—and only later reacted to the user's needs."

One difficulty comes from the pin limitations of standard packages. The familiar dual in-line package has either 14 or 16 pins in the standard width—300 mils between the two rows of pins—and a great deal of production equipment is geared to this package. But the Intel 1103 comes in an 18-pin package, also 300 mils wide—close to the limit that can be achieved in this width. Circuits with more connections imply larger chips inside the package, which require more room for the connections between the pads on the chips and the pins that join the chip to the outside world, and therefore, wider packages.

Thus, the production people would like to stay with simpler circuits in smaller packages. But smaller packages mean more packages, more interconnections, more replacements and repairs, and a bigger power supply. The result is a tendency to larger packages, which satisfy the reliability people and the cost accountants.

Sometimes a compromise is necessary. The AMS 6002, for example, comes in a 22-pin package 400 mils wide—one of the factors that make it incompatible with the 1103. Two of these pins are unused, but the 22-pin size is the next-larger standard configuration above 18 pins. A version of the 6002 connects the clock and chip-select inputs together, eliminating two pins—one for the signal and one for a power supply—so that the new version can fit in an 1103-type package. But the compatibility increases the power dissipation and requires the memory to be enabled during refresh, putting the 6002 in essentially the same performance class as the 1103.

### Packaging ROMs

A packaging problem of a different sort shows up with ROMs, particularly those with multiple outputs that are usable as look-up tables or as logic truth tables. In such an application, the memory is easier to use if the number of outputs is approximately the same as the number of inputs. But the manufacturer, constrained by pin limitations on standard packages, may find packaging easier if the number of outputs and inputs differ substantially.

Bud Broeker describes an approach that will be used in future Motorola designs to keep the system designer happy. New dynamic circuits will require only one external clock, and all other timing signals will be generated internally. He cites refresh techniques that restore the charge in the storage cell automatically, without stopping the system.

Two such designs are found in the Advanced

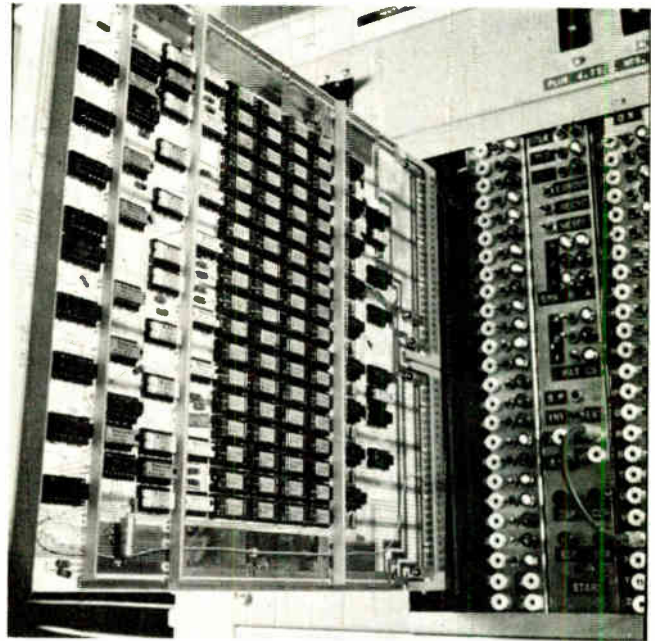

**Extended for maintenance.** In the Burroughs B-1700, the memory proper is the dark array at center, surrounded by support circuitry.

Memory Systems 7001 and in the Electronic Arrays 1500, both of which are 1,024-bit n-channel dynamic memories. The AMS 7001 uses a charge pump, which takes advantage of free states within the semiconductor material to provide a continuous current that keeps the cells refreshed. To the user, the memory appears to be static, but it uses much less power than a static memory.

At the cost of lengthening the cycle, the EA 1500 adds a refresh pulse to every read cycle, but that pulse refreshes every cell in the array, not just a single row. Alternatively, the whole array can be refreshed with a single pulse 60 nanoseconds wide within a special 400-ns interval inserted into the succession of cycles once every 2 milliseconds.

One of the major obstacles to the acceptance of semiconductor memories has been the volatility of stored data—its disappearance when power is turned off, accidentally or on purpose. In some quarters, loss of data is still an obstacle, but usually, it's no longer crucial.

The threat of data loss has been overcome by power-supply and information-storage backups. Power-supply backups are batteries with sufficient capacity to keep the memory going for at least a few minutes and, in some cases, for hours. Information-storage backups include magnetic-disk files and similar equipment, with corresponding checkpoints in the software so that after a power outage, any program in process can be resumed with little difficulty by reloading from the disk unit and restarting at the most recent checkpoint.

### Testing, testing

To design a system around a set of specifications for a major component and then to learn that the component isn't available or doesn't meet the specs used in the design of the system is an exercise in futility. This seems obvious, yet it is a continuing problem and will probably continue to be a problem. Data General Corp., after all, learned this lesson the hard way in 1970 when it

announced its Supernova SC minicomputer. Supernova SC was to have had a semiconductor memory of Intel 1103s, then brand new. But before the first delivery, Data General had to switch to bipolar memories to obtain the necessary speed, and all Supernova SCs to date have been made with bipolar memories.

Not long ago, semiconductor-memory designers were using some rather obscure techniques to maintain pin-to-pin compatibility with a desired prior product while improving performance over that of the other product. One of these design gimmicks was to arrange the rows in an array of 1,024-bits or larger, but out of sequence. Under certain conditions, such a rearrangement could minimize complexity in an address decoder, for example, or otherwise simplify the interior design of the memory array without affecting performance. However, any arrangement is likely to be sensitive to certain patterns of stored data because adjacent cells sometimes interact with one another. Some sophisticated users soon found that their testing was definitely affected by the rearrangement.

If, as is typical, a 1,024-bit array consists of 32 rows of 32 bits each, one might assume that the cells in the first row would have the address numbers 0 through 31; in the second row 32 through 63; and so on, to addresses 992 through 1,023 in the 32nd row. In such an array, testing for pattern sensitivity would require checking the effect of repeatedly inverting a bit in a particular cell numbered  $x$  on the bits stored in cells  $X - 1$ ,  $X + 1$ ,  $X - 32$ , and  $X + 32$ . This test would require  $4 \times 1,024$  cycles times the number of inversions of each bit—with part of the sequence omitted for cells along the edges of the array.

But if the cells aren't sequentially numbered, there are only two ways to check for pattern sensitivity: test for the interaction between each cell and every other cell in the array, requiring  $(1,024)^2$  cycles times the number of inversions, or use a map of the array to set up the test sequence. Such a map is inconvenient because it's likely to be different for every manufacturer.

"We see a trend in the semiconductor industry toward putting the cells back into proper sequence," says Ramon Alonso of Adar Associates, "in order to make things simpler for both the user and the maker of test equipment." But the problem of adjacent interaction isn't the only one. When two successive accesses to non-adjacent addresses are made, the quick transition in the decoder can sometimes result in a race—a change of two or more variables, supposedly simultaneously, but actually slightly displaced in time. This produces a spurious output, at least momentarily—and a momentary output may be sufficient to trigger a flip-flop, thus rendering itself officially correct. "The possibility of races in the decoder makes chip maps still desirable," Alonso continues. George Vashel of Signetics agrees. "Memory users ask for chip maps more often now than they used to," he notes.

Pattern sensitivity is only part of the problem; testing also has to take into account voltage and current levels, timing, and other parameters. "Semiconductor memo-

ries are really analog devices," says Alonso, "especially when you push them to their limit." Although a chip full of flip-flops for logic applications is a truly digital device, he points out that a large array of storage cells, dumping charge from one capacitance to another and sending signals down a long transmission line connecting 64 cells, operates nearly like class A circuits. "They only look digital from the outside," he says.

Memory systems present another level of testing difficulty. Semiconductor chips can be tested at various levels—in the wafer, in the package, and so on up to the user's test of incoming orders—and all of these tests, except for engineering evaluation, can be on a pass-fail basis. But assume that memory packages that pass incoming inspection have a remaining probability of failure of 1%, and suppose 100 of these chips are put on one board. Then the probability that each chip is good is 0.99, and the probability that the board is good is  $(0.99)^{100} = 0.366$ —that is, almost two out of three assembled boards are bad! And that assumes that the board itself is good and that the chips are all properly inserted in the board without bent leads or other difficulties. But one can't throw out the whole board at this level. The problem arises again at higher levels in the system—a rack full of boards or an entire memory system. This calls for an entirely different strategy of testing than was used at the chip level.

At the lowest technical level are problems with delivery of semiconductor memories—particularly when deliveries fall behind what the manufacturer has promised or has led the customer to expect. "Many people who hoped that 4,096-bit n-MOS memories were going to be available and who designed equipment to use them are having to retrench to the 2,048-bit size because the big ones aren't being delivered," says Signetics' Vashel. "Of course, this entails a redesign." He hastens to add that the 4,096-bit memory will eventually be the industry's workhorse, much as the 1,024-bit p-MOS size is now—"but not before the middle of 1974."

Jerome Larkin, of National Semiconductor Corp., is equally pessimistic about the 1,024-bit bipolar memories. "They're supposedly on the market," he says, "but just try to buy them in quantity. It's hard enough to get the old 256-bit bipolar memories."

## V. Benefits from new technology

Of the many variations and improvements on present semiconductor memory technology, n-channel MOS memories in slow 4,096-bit and fast 1,024-bit sizes will be available first. Both of these, when they become available in quantity, will be accepted more quickly than was the 1103—if possible. For most users, the 1103, the first of the widely used semiconductor memory parts, represented a departure from established technology, and users had to convince themselves of its reliability and that its sources could produce it continuously. They won't have to go through quite the same process again because the new parts represent improvements on familiar technology rather than a departure from it.

Nevertheless, these memories won't appear overnight in all sorts of products. "We see them being picked up

fairly quickly in peripheral equipment,” says Ed Gelbach, vice president and director of marketing at Intel, “followed by their use in mainframes in the next cycle of product announcements.”

One problem at the moment is a proliferation of designs, much as there was—and still is—a proliferation of 1,024-bit p-MOS designs, with the 1103 out in front in popularity. In 4,096-bit read-write memories, there’s one slow p-MOS version, which is actually four 1103s on a chip (“a disaster,” sniffs one observer), a relatively slow n-MOS version that requires a single external clock, a faster three-clock n-MOS design, and a happy medium that needs two clocks.

But the proliferation doesn’t bother Burroughs Corp.’s Herb Stopper. “We could use whatever comes along,” he says—“1,024-bit n-channel circuits for speed, and 4,096-bit n-channel circuits where speed is less important than low cost.” Because of the convenient interconnections of the 4,096-bit design—notably TTL levels and the single power supply—it’ll be desirable for small machines, such as terminals. “But its speed isn’t much better than that of ferrite cores,” says Interdata’s Lou Pezzi, “so it won’t be used in main memories. It may be cheaper than cores for mass memories by 1975.”

But whether the 4,096-bit chips become attractive for main memories or not, they’re sure to change the shape of the industry. Meanwhile, system sizes continue to grow, offering a place eventually for even larger sizes. Douglas Powell, manager, computer industry marketing at Motorola, predicts that the 4,096-bit size will be common by the end of 1973, and foresees an 8,192-bit size in 18 to 24 months—perhaps like the previously mentioned IBM design, described at last winter’s International Solid State Circuits Conference, which has already been made experimentally in sufficient quantities to build a small but substantial memory module that has passed strenuous system tests. Eventually, Powell expects devices having as many as 16,384 bits—both larger and more densely packed than today’s chips.

From the established p-MOS technology and the ad-

vantages of n-MOS, it is only a short step to a logical combination of the two, or complementary MOS (C-MOS). This technology offers very low power dissipation because the n-MOS and p-MOS transistors can be put in series. And since both of them can never be on at the same time, the circuit draws very little current. A static C-MOS cell dissipates perhaps 1% as much power as a dynamic n-MOS cell.

### C-MOS goes industrial

C-MOS was originally developed for military applications because of this low power dissipation. But the technology has also become attractive for industrial use because the series connection of the two types of transistors multiplies their nonlinearities and thus reduces their noise sensitivity.

“Now silicon-gate C-MOS is available,” says Marshall Cox, president of Intersil. “Like all silicon-gate circuits, it has better performance and higher density than metal-gate circuits.” A flip-flop made in C-MOS with n-MOS transistors for switching and p-MOS transistors for pullup or load resistances is relatively fast. Thus, Intersil’s new 256-bit static C-MOS memory and its soon-to-come 1,024-bit version both have 300-ns access times. Furthermore, with its low power, it runs cool. But, like all static circuits, the cells are large and thus the memories are expensive.

Meanwhile, in the high-performance area, today’s fast 1,024-bit bipolar arrays—meaning TTL—may have to yield soon to 1,024-bit emitter-coupled-logic circuits configured as memories. Both Intersil and Motorola are pursuing this tack. “We’ll probably announce a static memory with access time of less than 50 ns later this year,” says Cox.

Motorola hasn’t tipped its hand, but Bud Broeker pointed out that with a 50-ns ECL (which Motorola calls MECL) memory running four times as fast as any n-MOS memory, addition of error-correcting codes and logic is possible with an access time penalty of only about 20 ns—against 60 to 70 ns through other technologies.

These codes are useful in large arrays because they replace parity bits in individual bytes in storage, and they correct single and sometimes double errors that originate in storage, thereby increasing the reliability of stored data and—although system manufacturers wouldn’t care to confirm this—permitting the use of a certain proportion of marginal circuits in the memory, increasing the yield and cutting the cost.

Charge-coupled-device technology has a high potential for memories. However, although one or two CCD products are on the market now (for imaging), they’re a long way from large-scale applications in memories—in terms of both the state of technological development and computer architectures that can use them. CCD are essentially large shift registers, like their magnetic cousin, the bubble memory, but they’re very easy and inexpensive to make by conventional semiconductor technology.

CCDs, like shift registers, suffer in performance next to random-access memories. Says Herb Stopper of Burroughs, “If a CCD memory becomes available at 90% of the cost of a random-access memory, then it won’t be used. But if it comes out at 25% of the cost, then people

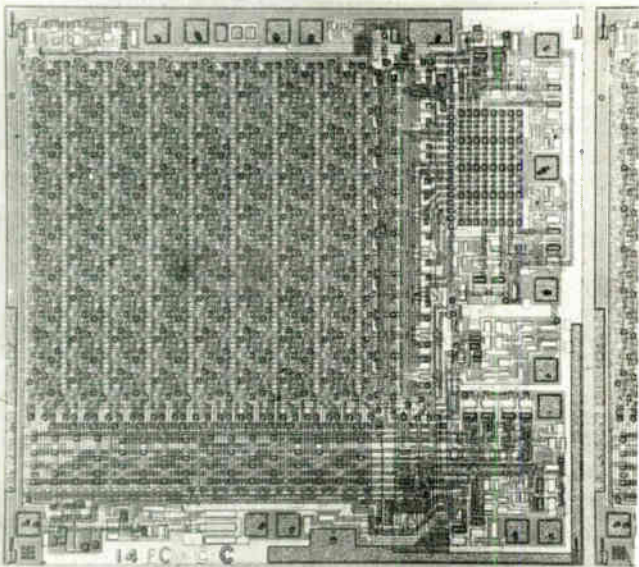

**Old standby.** This standard 256-bit bipolar memory, available from several makers, is now yielding to 1,024-bit parts.

will put up with serial access in some applications in order to benefit from the low price." Similar comments, of course, apply to the bubble memory.

One form of semiconductor memory that may turn out to be the most practical and economic application of CCDs is the large array of shift registers, sometimes called a "silicon disk." In computer systems it may displace today's rotating magnetic disks for storage. In fact, the silicon disk made with dynamic MOS shift registers may become common in large computer installations by the time CCDs become commercially practical.

The silicon disk is functionally a large shift register through which stored data is circulated and retrieved, as required, through one or more ports. Like the magnetic disk that it promises to replace, the silicon disk can store very large quantities of data and disgorge it at high speeds. The only cost is delaying for a brief interval the start of a data transfer while awaiting the arrival of the beginning of the desired block of data at the readout point. But unlike the magnetic disk, which takes 4 to 100 milliseconds, in the silicon disk this interval won't last more than a few hundred microseconds. Furthermore, the shift registers in the silicon disk can stand by while propagating their stored data only at the minimum rate necessary to keep the data refreshed. This standby rate can be a couple of orders of magnitude less than the data-transfer rate, offering a substantial reduction in power dissipation. Moreover, shift registers can change more or less instantaneously from one speed to the other—a trick the mechanical rotating disk can't match.

One silicon disk has already been introduced, but market conditions caused it to be withdrawn. Advanced Memory Systems announced its semiconductor storage unit, or SSU, three years ago [*Electronics*, Feb. 16, 1970, p. 43]. The SSU contained 2 million to 128 million bytes, with an average access time of 131  $\mu$ s and a data-transfer rate of 16 bytes in parallel per microsecond.

However, Jerry Larkin of National Semiconductor (who was with AMS when the SSU was announced) insists the SSU is still a viable concept and will be back. "It

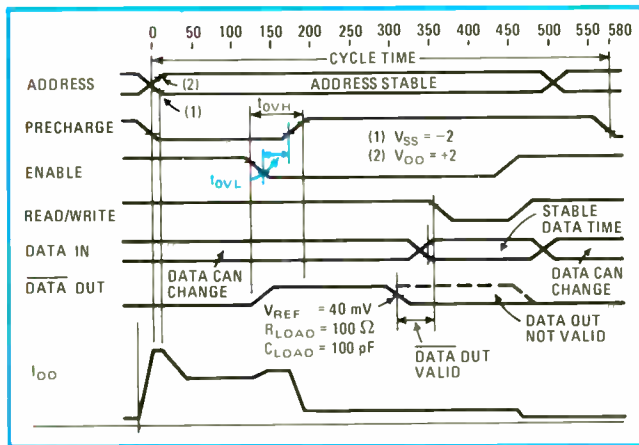

**4. Critical timing.** In the basic version of Intel's 1103 memory, chip-enable must begin before precharge ends; but it has a "window" no more than about 30 nanoseconds wide in which to begin.

should sell for around 0.1 cent a bit," says Larkin, "compared to 0.01 cent a bit for electromechanical rotating memories; its better performance justifies the higher price." Prime's Bill Poduska agrees: "When they can store one full track of a conventional magnetic disk on a single chip—something in the neighborhood of 65,000 bits—silicon disks will come back. It may be in MOS or CCD or bubbles, but the instant speed-change capability and the access times one-fourth to one-tenth those of disks will sell them. And don't forget that silicon disks won't waste any space with synchronizing bits, and they never suffer head crashes the way magnetic disks do."

One of the major advantages of semiconductor memory is that it is distributable throughout a system in modules of almost arbitrarily small size. Distributed memory is not feasible with cores, which are economical only in large stacks—the larger the better. Although no computer with a truly distributed memory has been announced yet, the advent of such a memory becomes more and more probable as semiconductor memories become more and more familiar. Up to now, semiconductor memories have been somewhat questionable, and they have needed a well-known and reliable technology to fall back on; only cores were available.

Herb Stopper hints that Burroughs may be thinking about a distributed memory in a future machine, which, however, is not likely to be announced in the near future. An interim step that Burroughs or another company could take first may be the consolidated memory. In a distributed memory, a small memory would be packaged adjacent to a section of logic in a processor—on the same printed-circuit card, and possibly even on the same chip, as in electronic calculators. With such close connections, no sense amplifiers would be necessary; the memory could talk directly to the logic.

In a consolidated memory, a separate array of substantial size would be packaged in a box adjacent to a logic subsystem. The organization and operation of the memory would be similar to that of conventional arrays, but the memory would be close enough to the logic that conventional cabling between the two could be omitted. Cabling, of course, would be required to permit data to be transmitted between consolidated memory arrays within a system and between peripheral equipment and the arrays.

A distributed memory would probably be made of bipolar circuits, but the consolidated memory could consist of either bipolar or MOS ICs. In either form, the combined package would improve performance and reduce costs.

## Summing up

What's next in semiconductor memories? The outlook, in some ways, is somewhat schizophrenic. Dino Sirakides, of Monroe Calculator, perhaps offers the best summation: "There are lots of things we'd like to see; but, in view of the several different kinds of noncompatible memories on the market today, one thing we'd ask is for the vendors to stop making breakthroughs and start making parts—and zero in on standards." □

Reprints are available at \$3 each. Write to Electronics Reprint Dept., P.O. Box 669, Hightstown, N.J. Copyright 1973 by Electronics, a McGraw-Hill publication.

# Hybrid approach to regulation solves power-supply problems

Series-shunt voltage regulator combines series-regulator efficiency with the high output-to-input isolation characteristic of shunt units; technique proves successful for -15-volt source in secure radio system

by Jerry B. Denker and David A. Johnson, *Cincinnati Electronics Corp., Cincinnati, Ohio*

□ A hybrid series-shunt regulator has been built to combine the high output-to-input current isolation characteristic of the shunt regulator with the high efficiency of the series regulator. Tests indicate that the hybrid maintains more than 30 dB greater isolation than a series-only regulator, and it achieves some 85% efficiency for a range from less than 10% of load to full load.

Shunt regulators, with their inherently high isolation, are commonly used in critical applications where the prime source must be protected against changes in load. Such a regulator, however, is very inefficient, especially in systems with wide load variations, because the power into the regulator is constant and the regulator dissipates more power when the load is reduced. Therefore, series regulators are generally used to achieve high efficiency in systems that can tolerate poor isolation.

However, high electrical isolation between the outputs of multiple voltage regulators and the unregulated direct-current power source is sometimes required. Without the isolation, large current transients can occur at the regulated outputs (Fig. 1).

In designing secure radio-communications systems, for example, current variations on the prime power source caused by poorly isolated supplies for crypto-

graphic equipment might be transferred to the voltage regulator supplying the radio-frequency transmitter. As a result, the encrypting equipment could inadvertently modulate the rf output, which could compromise the encryption system. Moreover, in all applications for power supply systems, it is generally desirable to maintain high isolation between voltage-regulator outputs and the prime source simply to reduce the over-all electromagnetic-interference level in the source.

## Regulator characteristics

Both shunt and series regulators control the output to the load in the same way—by causing a voltage drop ( $E_D$  in Fig. 2), which is varied automatically to subtract exactly the required voltage from the raw unregulated source to maintain a constant voltage on the load.

The shunt regulator causes a current flow through the pass resistor (Fig. 2a) to drop the voltage. When not ex-

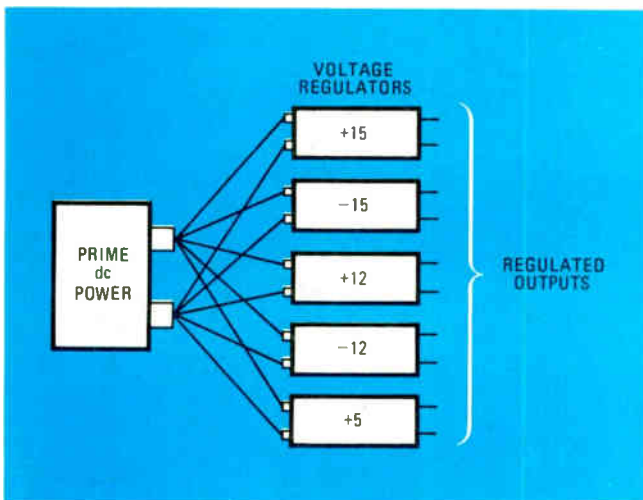

**1. Isolation needed.** To prevent large current transients from contaminating the prime dc power source in a large electronic system, each voltage regulator in the system must be designed so that transients on its output do not bounce back to its input.

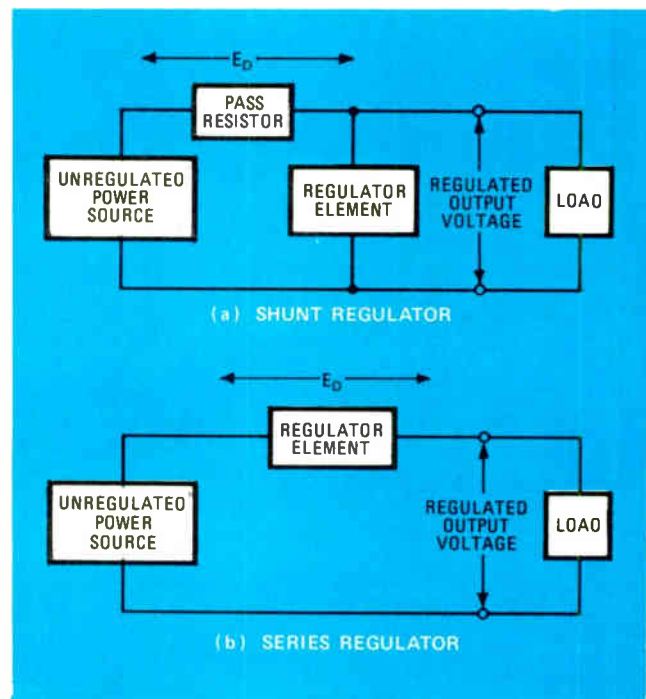

**2. Regulator basics.** The shunt regulator (a) responds to load changes by varying the current flowing in its regulating element. The series regulator (b), however, simply draws less current from the prime source when load power is reduced.

ternally loaded, a shunt regulator conducts the maximum current needed to establish the voltage drop,  $E_D$ . When a shunt regulator is loaded at the output, current through the regulator element is reduced by an amount equal to the load current so that the total current through the shunt regulator remains constant so long as there is a constant voltage source.

Such a design dissipates the maximum amount of internal power when its output terminals are open and unloaded. When fully loaded externally, the current through the regulator element is reduced to a minimum. Dissipation in the pass resistor is constant, irrespective of loading.

A series regulator (Fig. 2b) functions in much the same way, except that the regulator element takes the voltage drop directly across its own terminals, instead of through a pass resistor. Thus, when a series regulator is not loaded, only enough current to keep it active flows through the regulator element, so that its power dissipation is quite small. Then as load-current requirements increase, the power dissipated in the regulator increases proportionately.

The sensing parameter commonly used for both types of regulators is the voltage across the load. This information is then fed back to control the current through the regulator element. By combining the series and shunt regulator elements and using a proper selection of feedback information, a hybrid regulator is capable of efficient operation for a wide variation of loads and with high output-to-input isolation. In such a series-shunt configuration, the series arm is programmed to limit the unregulated source input current to a value slightly greater than is required by the load.

For a hybrid series-shunt regulator that has been designed for a secure military mobile radio, control signals

indicating load changes were derived from the radio's mode-control switch. Thus, the load current requirements for the regulator are predetermined by known demands on that regulator for each operating mode.

### Series-shunt hybrid

A block diagram of the combined series-shunt regulator is shown in Fig. 3. To maintain a constant output voltage across the load, a feedback element in the shunt regulator senses the output voltage and varies conduction of the shunt element accordingly. As shown, the basic components of the shunt arm are a voltage reference, a voltage sampler, a comparator amplifier, and a driven shunt element.

The comparator amplifier compares the reference voltage on one input to a sample of the output voltage on the other input. The resulting amplified error signal drives the shunt element, which conducts to the degree necessary to maintain the output voltage at the level established by the voltage sampler.

When a series regulator element (controlled-current source) is inserted into the series arm of the regulator to supply current to both the driven shunt element and the load, the result is a highly efficient regulator that can be programmed for any given load.

Here's how the regulator controls the current: For a given load, a control signal establishes a reference voltage on one input of the series arm comparator amplifier (Fig. 3). Then a current sampler establishes a voltage, which is directly proportional to the power-source current, on the other input of the comparator. The resulting amplified error signal drives the series-regulator element, which conducts to the degree necessary to maintain a constant current from the power source at the level established by the external control signal. To

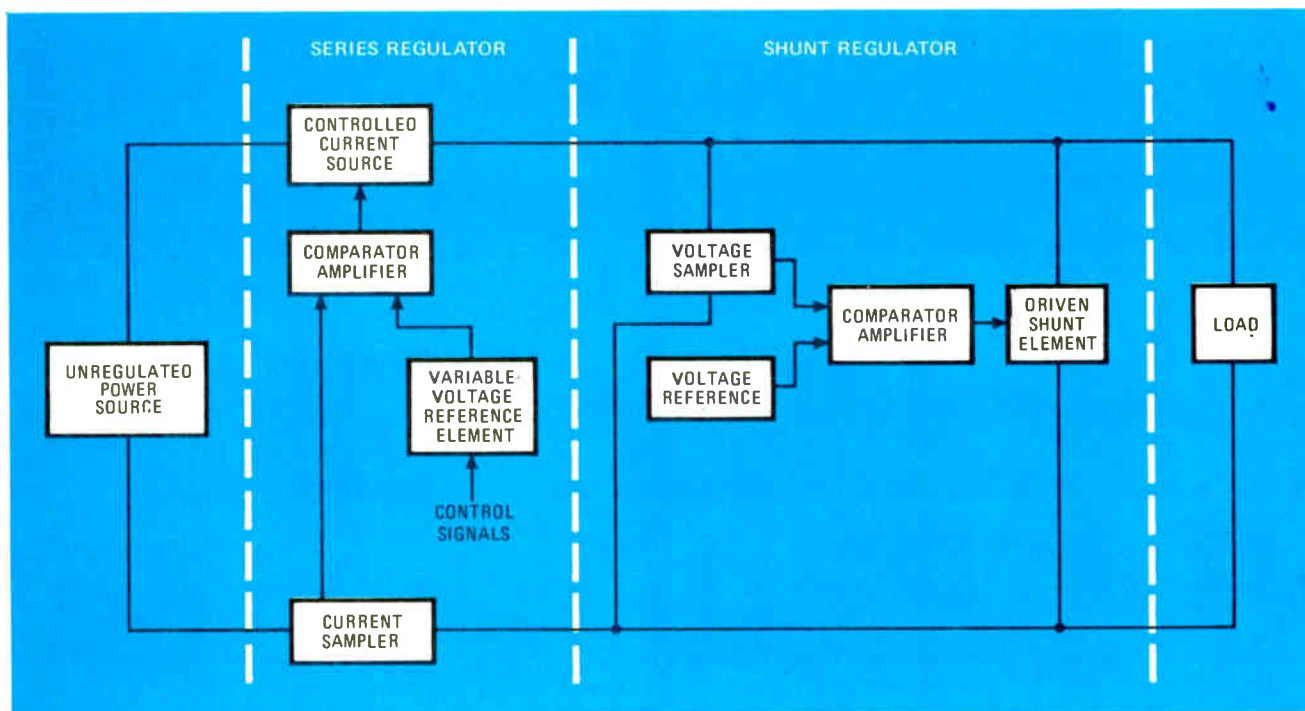

**3. Series-shunt hybrid.** Combining the series and shunt regulator elements provides a hybrid regulator capable of operating over a wide load variation, with both the high output-to-input isolation of the shunt unit and the high efficiency of the series unit.





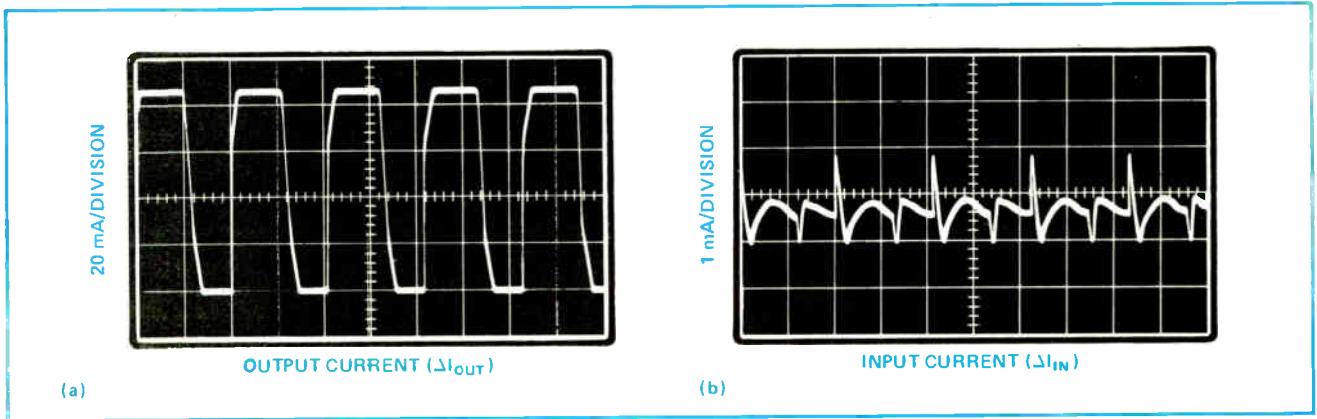

**6. Isolated.** The ratio of the current at the output (above) to the input (below) of the hybrid regulator shows that isolation of greater than 30 dB is achieved. Isolation of high-frequency components can be further improved by adding a capacitor across the output.

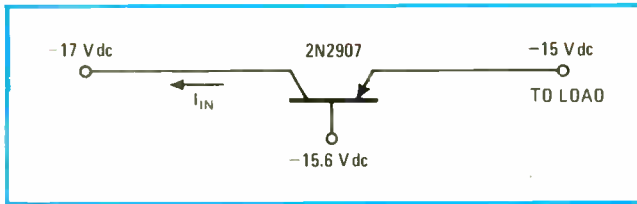

**7. Series-check circuit.** For comparison with the hybrid regulator, a simple series regulator has been constructed and isolation data taken. No noticeable output-to-input isolation is observed, since virtually all of the current variations caused by the load are transferred back to the prime dc power source.

rent through the series regulator. As indicated above, this series current is controlled by the series-element drive level at the output of  $Z_1$ .

### Isolation tests

Tests were also performed to obtain a quantitative measure for the improvement in isolation achieved in using the series-shunt regulator. In these tests, a 2N2907 transistor was driven by a 10-kHz square wave to alternately switch a 166-ohm resistor in and out of the load circuit (Fig. 5). For a regulated output of -15 volts, such load-switching action produces a load-current variation of approximately 86mA at the regulator output.

The control-signal input for the series-shunt regulator was set at -3 volts to allow approximately 200 mA current to pass through the regulator's series arm. The resulting output and input current waveforms for the load-

ed regulator are shown in Fig. 6a and 6b, respectively.

From Fig. 6, the output-to-input isolation for the series-shunt regulator, including all frequency components, is:

$$20 \log(\Delta I_{out}/\Delta I_{in}) = 20 \log(86/1.8) = 33.6 \text{ dB}$$

For comparison, a simple series voltage-regulator circuit (Fig. 7) was constructed and tested with the same switched load. The resulting output and input current waveforms show that there is no isolation whatsoever.

The isolation in the series-shunt regulator can further be improved by placing a capacitor across the output of the series-shunt test circuit, thus removing the high-frequency switching components.

The ability of the regulator output to respond rapidly to load change is limited by the response time of its feedback-control circuitry, and during this response time, the output voltage will decrease. To prevent such voltage fallout, the shunt-regulator control signal is applied for a certain length of time before the regulator load is allowed to change. This permits the regulator to be idling at the higher current, and when the load is increased, the response time is negligible.

The hybrid regulator system has built-in short-circuit protection that the power source input current is limited to the maximum series-element load current for a given load selection. Such a design also lends itself to hybrid integrated-circuit design, especially for low-current applications. For high-current requirements, the shunt and series elements would be discrete devices. □

HYBRID REGULATOR TEST RESULTS							
CONTROL SIGNAL				INPUT CURRENT @ -17 V dc	LOAD CURRENT @ -15 V dc	LOAD	EFFICIENCY
#1	#2	#3	#4				
Gnd	Gnd	Gnd	Gnd	410 mA	400 mA	38 Ω	86%
-15 V	Gnd	Gnd	Gnd	360 mA	350 mA	43 Ω	86%
Gnd	-15 V	Gnd	Gnd	260 mA	250 mA	62 Ω	85%
Gnd	Gnd	-15 V	Gnd	90 mA	85 mA	175 Ω	84%
Gnd	Gnd	Gnd	-15 V	30 mA	28 mA	600 Ω	82%

# Caught in the old cassette vs. 1/2"-drive, price vs. performance crunch?

With a choice like that you pay the price no matter what you do.

So we've come up with the first real alternative you've ever had.

The "Scotch" Brand Data Cartridge.

It's a unique approach to digital tape storage that's priced like a cassette but performs like a 1/2"-compatible drive.

It operates at speeds up to 90 ips, starts/stops with accelerations up to 2000 in/sec<sup>2</sup> and offers transfer rates up to 48,000 bps.

It uses 1/4" tape and records at up to 3200 frpi, so it stores up to 5.5 million bits of data per track on 1 to 4 tracks.

It needs only a single point drive and no external tape guidance, so tape can never cinch, spill, stretch or break and each cartridge has a life expectancy in excess of 5000 passes.

Because the "Scotch" Data Cartridge functions as its own transport, tape handling is fast, accurate and precise at all



times. It's ideal for: Word processors and terminals. Point-of-sale data capture and computer data entry. Minicomputer I/O and paper tape replacement.

And if you need more information, you've got a choice there, too.

Just contact any of the major peripheral manufacturers or Data Products, 3M Company, 300 South Lewis Road, Camarillo, Calif. 93010. Telephone:

(805) 482-1911. TWX:  
910-336-1676.



**We've been there.  
And brought the answers back.**

**3M**  
COMPANY

Meet our new series of  
high-frequency problem solvers . . .

# High-Performance VHF/UHF FET Family

Remember the U310? Some people call it the SuperFET. We introduced it a year ago: worst-case 75Ω input match VSWR of 1.25:1. Figure of merit  $2.35 \times 10^9$  typical. Third order intercept point of +29 dBm.

Now we've extended the U310 technology to produce an entire family of high-performance N-channel junction FETs. They're ideal for VHF/UHF applications such as the two circuits shown below:

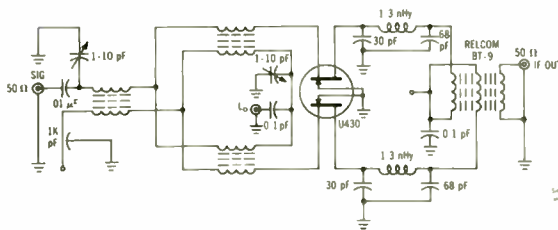

Single-balanced active mixer — 100 dB dynamic range,  
+2.5 dB conversion gain, +32 dBm intercept point, 50-250 MHz.

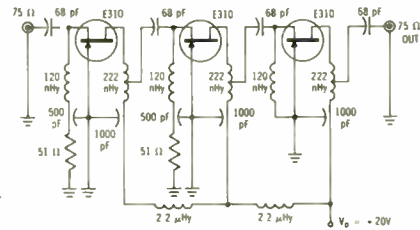

Wideband amplifier — 225 MHz center frequency,  
1 dB bandwidth of 50 MHz, 24 dB gain.

U310 family characteristics include:

- High power gain (common gate) — 16 dB at 100 MHz, 11 dB at 450 MHz.
- Noise figure = 3 dB typical at 450 MHz.
- High transconductance = 10,000 to 20,000  $\mu\text{mhos}$ .

Select the right FET for your application from this array:

Type	Package	Feature	Applications	Price (1k units)
E308	Epoxy TO-106	$V_{GS} = -1.0$ to $-6.0$ V $I_{DS} = 12$ to $60$ mA	High-frequency, small signal VHF or UHF source followers, amplifiers, mixers, or oscillators.	\$ 0.57
U308	Metal TO-52			\$ 3.70
E309	Epoxy TO-106	$V_{GS} = -1.0$ to $-4.0$ V $I_{DS} = 12$ to $30$ mA		\$ 0.75
U309	Metal TO-52			\$ 4.45
E310	Epoxy TO-106	$V_{GS} = -2.0$ to $-6.0$ V $I_{DS} = 24$ to $60$ mA		\$ 0.75
U310	Metal TO-52			\$ 4.45
U310 family dual FETs have $V_{GS}$ , $I_{DS}$ , and $g$ parameters matched to 10% Packages designed for easy insertion into printed circuit boards				
E430 Dual	Epoxy Si-105	$V_{GS} = -1.0$ to $-4.0$ V $I_{DS} = 12$ to $30$ mA $g = 10$ to $20$ mmhos	VHF/UHF balanced mixers and cascode amplifiers	\$ 1.70
U430 Dual	Metal TO-99			\$ 9.95
E431 Dual	Epoxy Si-105	$V_{GS} = -2.0$ to $-6.0$ V $I_{DS} = 24$ to $60$ mA $g = 10$ to $20$ mmhos		\$ 1.70
U431 Dual	Metal TO-99			\$ 9.95

Get the complete story on this advanced high-frequency FET family.  
For application notes and technical information

## write for data

Applications Engineering: (408) 246-8000 Ext. 802



**Siliconix incorporated**

2201 Laurelwood Road, Santa Clara, California 95054

## Sampling regulator controls motor speed

by Philip Dempster  
Este Instruments, Inc., Richmond, Calif.

A permanent-magnet dc motor can serve as its own tachometer for speed control, allowing considerable cost savings to be realized over an expensive motor-tachometer unit. Sampling is employed in the motor-speed regulator shown to eliminate the errors and uncertainties introduced by the motor's armature and brush resistances. Motor speed can vary over a 20:1 range.

During positive half cycles of the input, the transformer's secondary voltage drives transistor  $Q_1$  through diode  $D_1$ . During negative half cycles of the input, this drive power is removed, and the motor's back emf is compared to reference voltage  $V_R$ . Any resulting error

signal is applied to the inverting input of amplifier  $A_1$ .

For a portion of each negative half cycle, transistor  $Q_2$  is switched off by the transformer's secondary voltage, causing field-effect transistor  $Q_3$  to conduct. The amplified error signal at the output of  $A_1$  can then be transferred to capacitor  $C_1$ , where it is stored until the following sampling period. During the next positive half cycle of the input, this stored error signal is amplified again (by amplifier  $A_2$ ) and then applied to the motor to correct any speed error that may exist.

Diode  $D_2$  decouples the motor from the drive circuitry during each sampling period to prevent errors from being introduced in the sampled voltage. Two RC filters—one formed by resistor  $R_1$  and capacitor  $C_1$ , and the other by resistor  $R_2$  and capacitor  $C_2$ —are intended to reduce brush transients. The  $R_1C_1$  filter has the longer time constant of the two and is located after FET  $Q_3$  to avoid degrading the recovery time of amplifier  $A_2$ .

Resistor  $R_3$  controls the gain in the feedback loop. Its value should be chosen to provide the highest possible gain while preserving good loop stability. □

**Motor-speed control.** Sampling regulator circuit permits motor speed to be varied over 20:1 range. For portion of negative half cycle of the input, the motor's drive power is removed so that the motor's back emf can be compared to reference voltage  $V_R$ . Any resulting error is stored across capacitor  $C_1$  until the next positive half cycle of the input. The error voltage is then applied to the motor for speed correction.

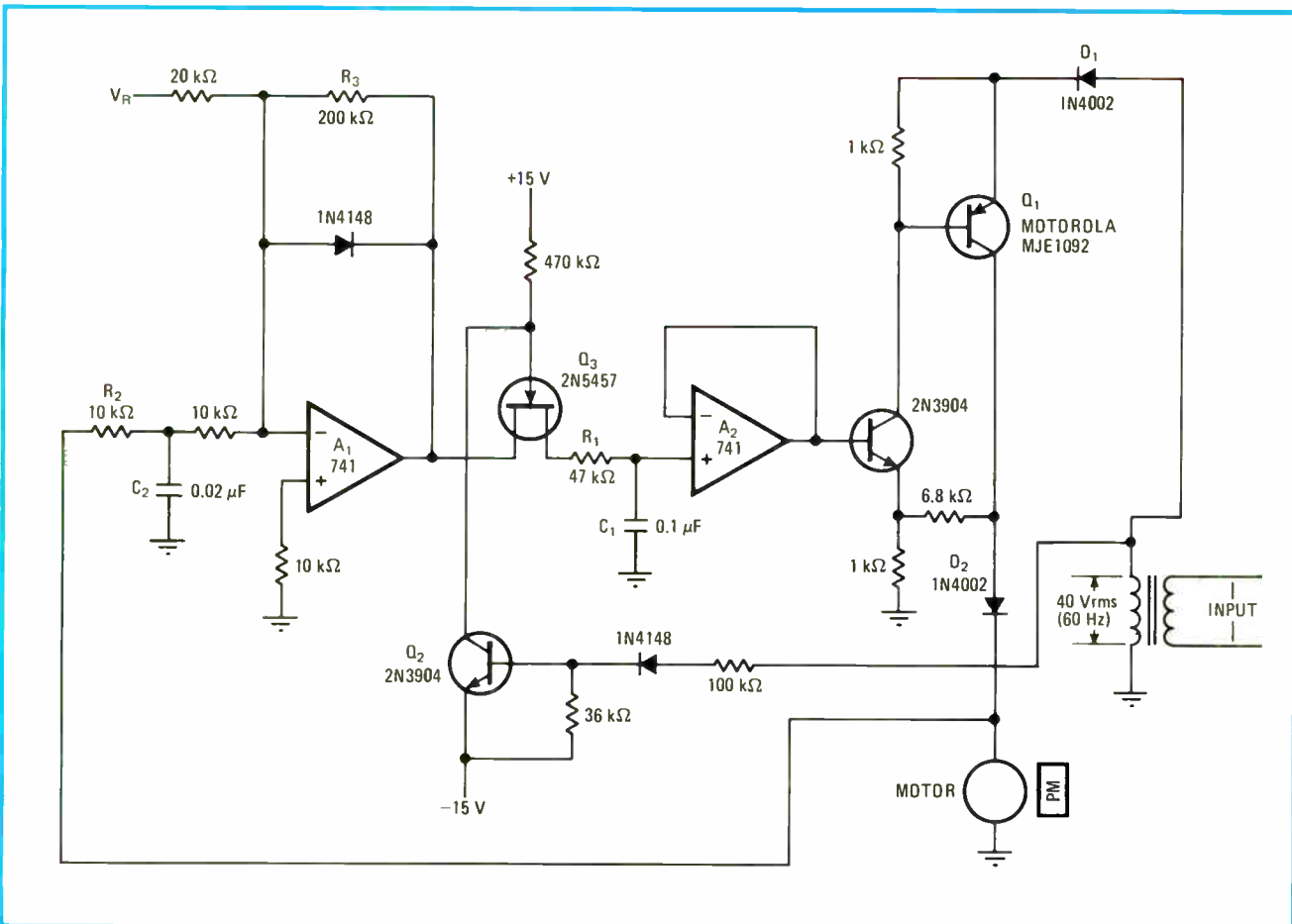

# Digital transient suppressor eliminates logic errors

by Christopher Strangio  
Villanova University, Villanova, Pa.

In digital systems, switching transients occur most often when there is a transition from logic 0 to logic 1 or from logic 1 to logic 0. These transients can introduce errors if their amplitude is large enough to exceed the logic 0 maximum voltage or the logic 1 minimum voltage. Errors are particularly likely to occur at mechanical-to-electrical couplings, as in switches and relays.

The simple digital circuit in the diagram can eliminate these unwanted transients. Initially, the input is low, and the latch and the two monostable multivibrators, MM<sub>1</sub> and MM<sub>2</sub>, are reset. On the first positive-going edge at the input, gate G<sub>1</sub> is enabled, triggering MM<sub>1</sub> and making its Q output go high. This sets the latch so that gate G<sub>1</sub> becomes inhibited and the output goes high. Since gate G<sub>2</sub> is also inhibited after MM<sub>1</sub> is triggered, the input is now blocked both from the latch and from the two monostables. After the first positive-going edge, then, any positive-going transients at the input will have no effect on the output.

The period of monostable MM<sub>1</sub> determines how long positive input transients are prevented from affecting

the state of the output. This period should be adjusted to be slightly greater than the longest possible turn-on transient. When the Q output of MM<sub>1</sub> goes low at the end of the timing period, the next negative-going input transition enables gate G<sub>2</sub>, triggering monostable MM<sub>2</sub> and resetting the latch so that the output goes low.

As long as the input remains high, the latch stays set and the output will continue to be high. The first negative-going edge at the input enables gate G<sub>2</sub>, causing the Q output of monostable MM<sub>2</sub> to go high. This resets the latch so that gate G<sub>2</sub> becomes inhibited and the output goes low. Since gate G<sub>1</sub> also becomes inhibited once MM<sub>2</sub> triggers, the input is again blocked. All negative-going transients will now be prevented from changing the output logic state.

The period of monostable MM<sub>2</sub> establishes the length of time negative transients at the input are stopped from reaching the output. The monostable timing period should be slightly greater than the longest possible turn-off transient. The output will remain low after the timing cycle of MM<sub>2</sub> is complete, provided that the input remains low.

With the components shown, this digital transient suppressor will be triggered by transients as short as 85 nanoseconds. The circuit can be adjusted to block transients that are between 100 ns and 2 seconds wide, occurring after the initial leading or trailing edge at the input. Voltage excursions below 0 volts are handled by the clamping diodes found in most TTL packages; excursions above 5.5 v may be clipped with a zener. □

**Transient suppressor.** Both positive-going and negative-going logic transients are prevented from causing output errors by this digital suppressor circuit. Timing period of monostable MM<sub>1</sub> fixes the maximum width of positive transients that will be blocked, while the period of monostable MM<sub>2</sub> determines the maximum width of negative transients. The timing diagram shows waveforms for several key circuit points.

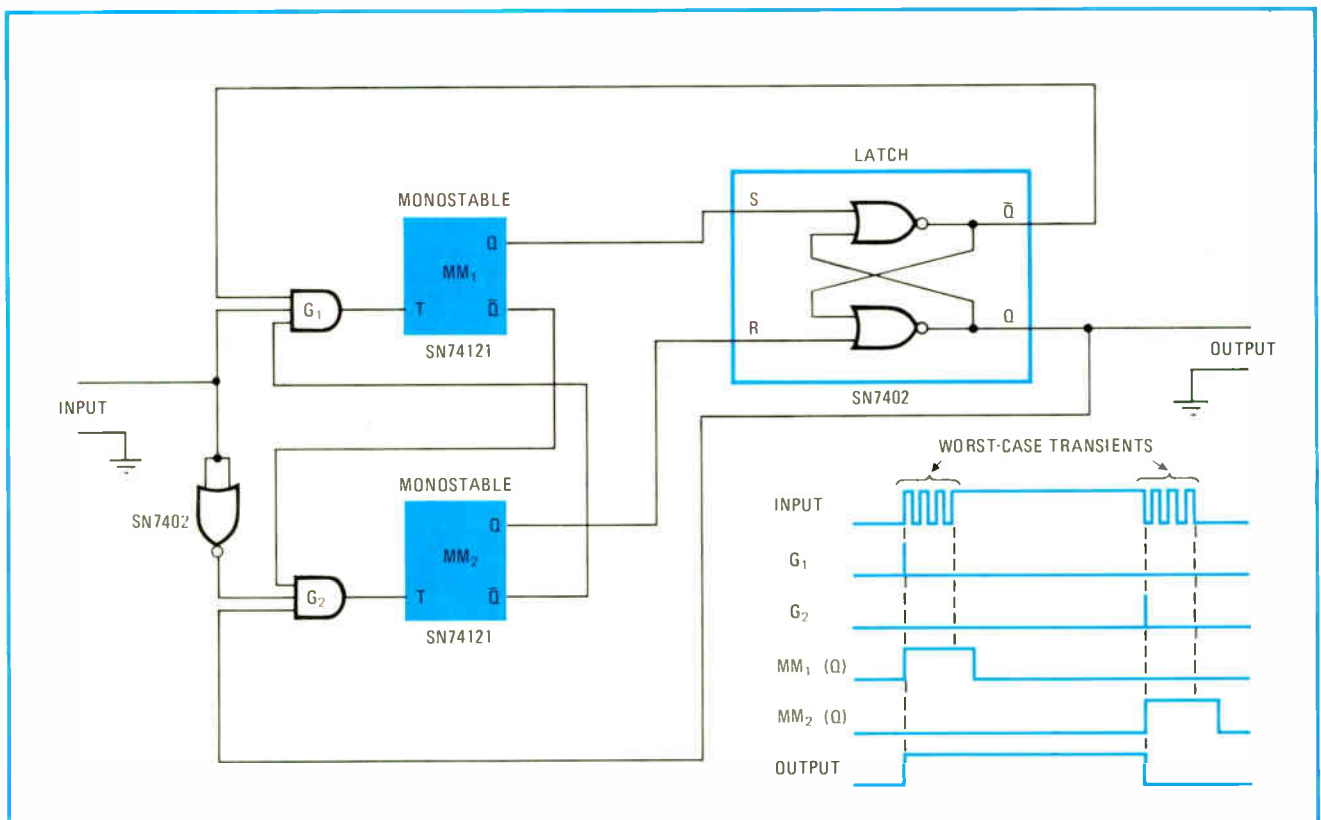

# Counter and decoder/driver produces staircase voltage

by Donald F. Dekold  
Santa Fe Community College, Gainesville, Fla.

Generating staircase voltage waveforms is easy if some of the newer TTL MSI devices are used. Only two IC packages are needed—a decade counter and a 1-of-10 decoder/driver. Up to 10 distinct staircase voltage steps can be generated, and the steps can be made quite large, up to 65 volts dc, before exceeding the output breakdown limitations of the decoder/driver. The circuit is useful as a building block in a curve tracer or a low-resolution analog-to-digital converter, and in control applications requiring the sequential stepping of voltages.

Resistive voltage division is employed (only one output of 10 is on at a time), rather than op-amp summing techniques. This allows the steps to be generated at a rather faster rate than would be possible with an op amp, which is hampered by its slew-rate limitations.

The step levels need not advance with equal increments (or decrements), but can be programmed by selecting the proper resistors in the voltage divider network. However, loading effects must be considered when designing for the output levels wanted.

The circuit in the diagram generates a seven-level staircase output, increasing from 2 to 14 v dc in 2-v increments. The eighth negative clock transition produces a logic low at the corresponding decoder/driver output,  $\bar{Q}_7$ , which resets the counter to zero via the transistor stage. (Without this reset transistor, the counter would automatically reset to zero at the end of the 10th clock cycle.) On the first count, the generator's output is taken from the decoder/driver's  $\bar{Q}_0$  output and is 2 v dc, a typical value for the decoder/driver when it is sinking a 5-milliampere current.

The generator may accept clock frequencies as high as 10 kilohertz, but the transition-time transients that will occur between each output step make the capacitor shown necessary. Although the capacitor provides smoother step transitions, it limits the maximum operating frequency. □

Designer's casebook is a regular feature in Electronics. We invite readers to submit original and unpublished circuit ideas and solutions to design problems. Explain briefly but thoroughly the circuit's operating principle and purpose. We'll pay \$50 for each item published.

**Two-package stepper.** Staircase output generated by decade counter and 1-of-10 decoder/driver can have up to 10 voltage steps, each step being as large as 65 volts. The resistor voltage divider network scales the outputs of the decoder/driver to the desired step sizes. Clock frequencies can be as fast as 10 kilohertz. The capacitor smooths the output transients that may occur at the clock transitions.

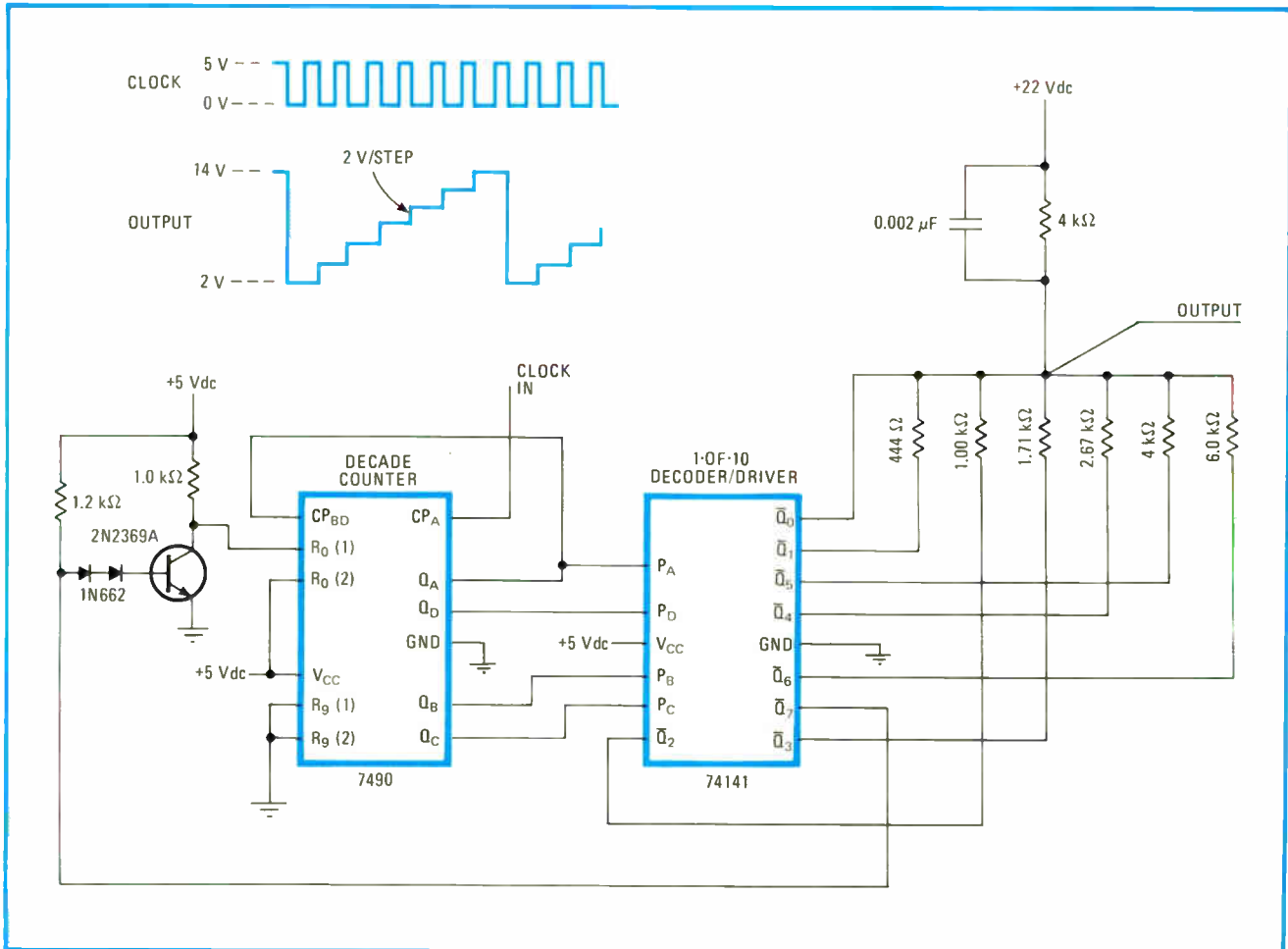



10 MHz to 18 GHz

## MCL is now a leader in solving your high power r-f and microwave testing problems.

Many customers remember us for the "extras" engineered and built into our microwave cavities, e.g., our potted anode bypass assembly.

But some may not be aware that MCL currently offers one of the industry's largest and most diverse power oscillator, amplifier and systems lines.

The same extra margin of reliability and performance customers have learned to expect from our cavities is also a feature of our instrumentation products.

For a recommended solution to your high power testing problem—without obligation—write us today. MCL, Inc., 10 North Beach Avenue, La Grange, Illinois 60525. Or call (312) 354-4350.



See us in EEM-Vol. 1 pp. 551-566

Circle 100 on reader service card



**\* New low cost synthesizer does the phase noise, spurious, stability and reliability job better anywhere you use a signal generator.**

- Low cost,
- Excellent overall phase noise performance
- Widest frequency coverage per dollar, 1 to 160 MHz
- Low spurious content, -70dB to -100dB
- BCD programmable TTL positive true logic
- ALC gives better than  $\pm 1$  dB flatness
- Modular design simplifies special applications
- Stability to 2 parts in  $10^7/24$  hours
- Switching speed is less than 1 millisecond

Use the Model 6160 for communications as a local oscillator, stable incremental tunable synthesizer; for microwave sources, as a radar frequency control, and as a programmable test and NMR source.

Arrange a demonstration today. Call Fluke, P.O. Box 7428, Seattle, Wa 98133. In Europe, address Fluke Nederland (B.V.), P.O. Box 5053, Tilburg, The Netherlands. In the U.K., address Fluke International Corp., Garnett Close, Watford, WD2 4TT.

**FLUKE**

"See us at WESCON '73"

Circle 133 on reader service card

World Radio History

## The Brush 222 battery operated portable recorder.

The Brush 222 is a self-contained 2 channel recorder. It comes complete with signal conditioners, internal battery supply and charger.

The battery supply gives you up to 12 hours of continuous operation. There's pressurized ink writing and linearity guaranteed to 99½%.

Write Gould Inc., Instrument Systems Division, 3631 Perkins Avenue, Cleveland, Ohio 44114. Or Kouterveldstraat Z/N, B 1920 Diegem, Belgium.



**GOULD**

Circle 142 on reader service card



# Choosing a sample-and-hold amplifier is not as simple as it used to be

Sample-and-hold modules, which are particularly useful in high-speed data acquisition systems, are now available in unprecedented variety; a grasp of how they work makes it easier to pick the right one for a given job

by Walter Patstone and Craig Dunbar, *Teledyne Philbrick, Dedham, Mass.*

□ As a naturally analog world goes steadily digital, the sample-and-hold amplifiers that often accompany analog-to-digital converters also increase in variety. The modules now available range from general-purpose units to high-speed, high-accuracy versions and cost anywhere from \$40 to \$400. Unless their characteristics are understood, it's no longer simple to select the right sample-and-hold for a given application.

Functionally, every sample-and-hold amplifier tracks an analog signal and, when directed by an external digital command, freezes its output at the instantaneous value of the input. But the individual parameters of this performance vary in importance with the particular application.

And the applications are numerous. Sample-and-hold amplifiers are particularly useful where fast-changing

signals must be multiplexed in data acquisition systems or where momentary signals must be captured and held. They are frequently used in sampled-data systems to decrease system aperture time with a-d converters, and in display systems to provide smooth, glitch-free outputs from d-a converters. Other applications include pulse stretching, data distribution to multiple readouts, peak and valley following, and ratio-measurement of time-averaged variables.

## The basic circuits

Probably the simplest form of sample-and-hold amplifier is the capacitor-switch combination shown in Fig. 1. With this circuit, the hold command is given when the switch is thrown from position S to position H. But though the circuit works effectively with very slowly

**Experience.** Authors Walter Patstone (foreground) and Craig S. Dunbar have been working together at Teledyne Philbrick for the past four years on the application of circuit modules. One result of their study of applications problems is the model 4853 sample-and-hold amplifier.



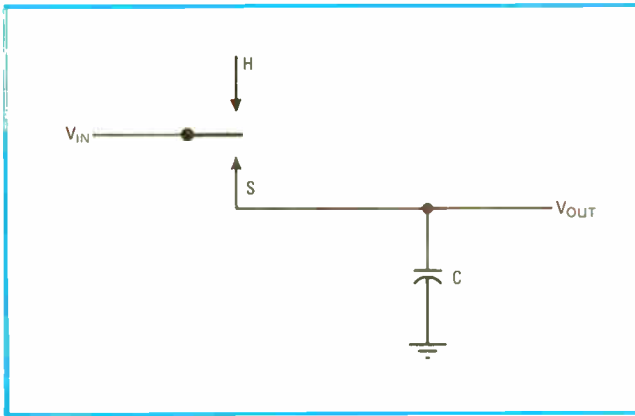

**1. Simplest.** If speed and circuit loading are not too important, a capacitor and a switch make an effective sample-and-hold circuit.

changing signals, it causes too much source and output loading to be of much practical use.

Most practical modular sample-and-holds are designed for noninverting unity-gain operation, but important new inverting designs are now available. In both types, the control inputs are normally operated at standard logic levels and are usually TTL-compatible. Typically logic 1 is the sample command and logic 0 is the hold command.

The basic noninverting sample-and-hold amplifier consists of a resistor, a switch, a capacitor, and an op amp (Fig. 2a). When the switch is closed, the capacitor charges (or discharges) exponentially to the input voltage just as in the simple capacitor example. The output of the operational amplifier follows the capacitor voltage precisely. Again, when the switch is opened, the capacitor holds the instantaneous value of the input voltage. The advantage of the op-amp follower in this circuit is that, once the charge is acquired and the switch is opened, output loading will not discharge the capacitor.

In such a circuit, a FET switch would most probably be used, and the op amp would have a FET input. However, the storage capacitor still loads the input sources, and this loading, if  $R$  is too low, may make the source oscillate or overload it. When the source is overloaded at acquisition time, recovery time normally is long.

Increasing  $R$  to prevent these problems will slow the response time, and instead, a buffer amplifier can be added in front of the capacitor (Fig. 2b). Here the input is isolated from the holding capacitor, and the buffer amplifier provides the capacitor charging current.

This circuit is pretty fast, but since the amplifiers work independently, a summation of errors results. Consequently, if low-frequency tracking accuracy is more important than speed, the feedback loop can be closed around both amplifiers, forcing both to track as one amplifier (Fig. 2c).

The other basic type of sample-and-hold amplifier—the inverting, or integrating, circuit—is shown in Fig. 3. Because the capacitor is in the feedback loop, the input is isolated, and the FET switch operates at ground potential, minimizing leakage current and switching time, while the amplifier is not bothered by a common-mode signal. Although this type of circuit does not require a buffer amplifier to charge the capacitor or isolate the in-

put, its input impedance is significantly lower than in the buffered noninverting types. Therefore, the signal source must have a reasonable drive capability and a low output impedance. No problem will arise, however, if an op amp is used as a preamp.

The modification of the inverting sample-and-hold amplifier shown in Fig. 3b places an inverting buffer amplifier in front of the switch but within the feedback loop. Since the inverting input is floating, high-input impedance is provided. If a FET buffer is used, the current required to drive the circuit will be in the picoampere range. However, the addition of the input buffer introduces common-mode error, and additional non-linearity error, besides reducing speed.

## The parameters

In selecting the proper sample-and-hold for a given application, certain specifications are more critical than others. The nomenclature for these is not yet standardized, but the following discussion is based on terms generally accepted in the industry.

*Aperture time* is the apparent time elapsed between the hold command and the effective opening of the hold switch (Fig. 4a). As the diagram shows, the error caused by the aperture time increases both with the aperture time itself and with the rate of change of the input signal. In actual practice, properly designed FET switching circuits can keep the aperture time, or turn-off time, down to a few nanoseconds.

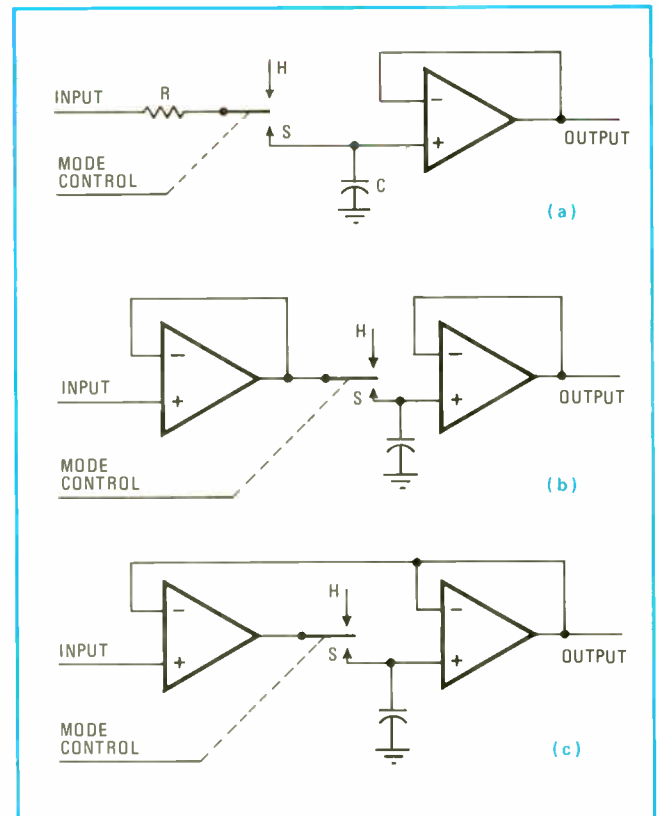

**2. Noninverting circuit.** Basic circuit (a) overcomes the capacitor-switch circuit's sensitivity to output loading. Source loading, however, remains a problem unless an input buffer amplifier is added (b). Putting a feedback loop around both amplifiers improves low-frequency performance but slows the system (c).

Aperture time, by itself, is not a problem for most applications; it may be regarded as a timing delay. Therefore, to the extent that it is repeatable, it may be compensated for by advancing the control timing. Typical values of aperture time for high-performance sample-and-hold range from 5 to 40 nanoseconds.

*Aperture-time uncertainty* is the term for the repeatability of the aperture time. It can also be thought of as the uncertainty in the sample-to-hold transition time, or the difference between the maximum and the minimum aperture times experienced with a particular amplifier. This parameter is a major factor in determining the maximum signal frequency which can be accurately sampled. Commercially available sample-and-hold amplifiers with maximum aperture uncertainty times of  $\pm 1$  nanosecond will permit the sampling of 16-kilohertz signals to a 12-bit (.01%) accuracy.

In digitizing a continuously varying audio or video signal the aperture uncertainty time must be low to minimize jitter and the noise it causes on the reconstructed signal. Note, too, that in this application the delay identified with aperture time is usually unimportant, and no delay compensation is necessary.

*Acquisition time* is the length of time that elapses between the sample command and the precise instant at which the output voltage is tracking the input voltage to within a specified accuracy (Fig. 4b). For the switch-capacitor circuit, acquisition time depends on the charging current available from the driving source current. When

the switch is closed, the capacitor charges or discharges exponentially with a time constant that is a function of the source impedance and hold capacitance.

The worst-case acquisition time occurs when the sample-and-hold circuit must change full scale. Therefore, specifications are normally written in terms of a full-scale voltage step, and the specified accuracy is usually stated as a fraction of a percent of full scale, for example 0.01% or 0.1%. Acquisition time in simple circuits consists primarily of time constants; in more sophisticated designs, amplifier slew rate and settling time have to be included.

One problem that occurs even in the simplest sample-and-circuit hold is the presence of voltage spikes associated with switching transients. These spikes are not only annoying in themselves but also constitute a major source of circuit error. When the capacitor is switched from sample to hold, some charge is transferred to the holding capacitor due to the inter-electrode capacitance of the switch. This charge, translated into an error voltage, is called the *hold jump voltage* by some manufacturers and the *sample-to-hold offset* by others. In packaged circuits, it's usually possible to trim out the jump voltage, but necessary to live with the spikes.

Related specifications are the *sample offset voltage* (the error voltage encountered in the sample mode, which is basically due to the offset voltage of the internal op amp) and the *hold offset voltage* (the error voltage encountered in the hold mode and composed of the

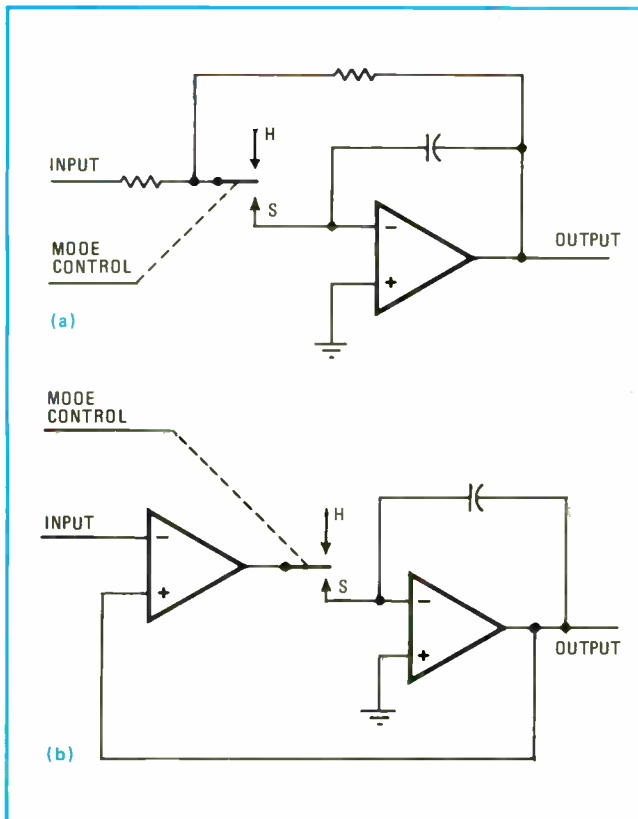

**3. Inverting circuit.** When a capacitor is inserted in the feedback loop, the inverter effectively isolates the input and minimizes the switching time (a). This approach is used in Teledyne Philbrick's 4853 sample-and-hold amplifier. Input impedance is low, however, unless an input buffer amplifier is added (b).

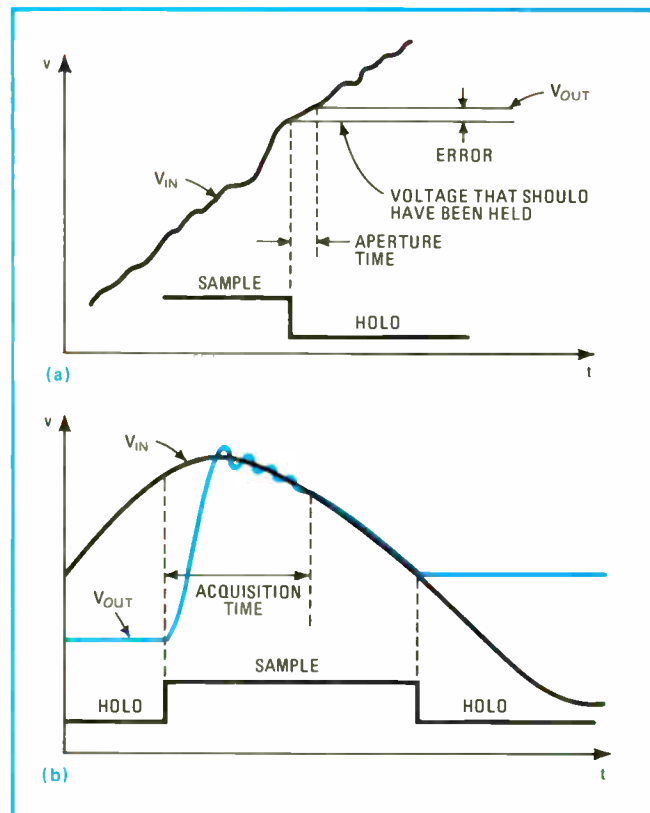

**4. Definitions.** Aperture time is the delay between the arrival of the hold command and the actual opening of the switch (a). Acquisition time is the length of time that will elapse before the amplifier starts tracking the input signal to within some specified accuracy after it has been commanded to do so (b).

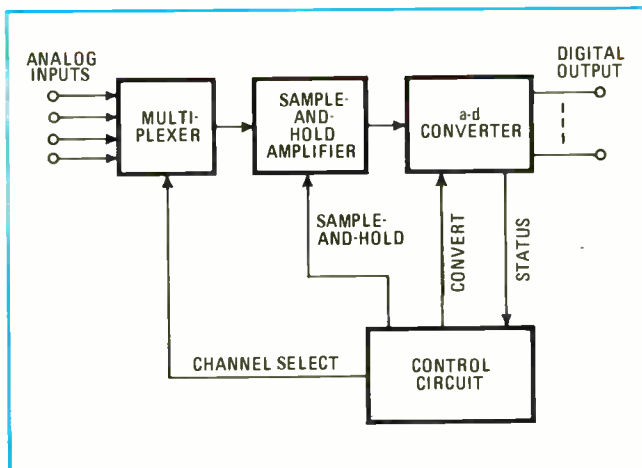

**5. Working within the system.** By providing a constant input voltage to the a-d converter while the multiplexer is switching channels, the sample-and-hold circuit eases the converter's speed constraints.

hold jump voltage and the sample offset voltage). These three voltages are not major sources of error in most applications because all are trimmable to zero. For driving an a-d converter, it is normally sufficient to trim only the hold offset to zero.

During hold, a small part of the input signal feeds through the capacitance of the switch to the output. This *feedthrough*, which is usually a function of the level and frequency of the input signal, can be thought of as the input-output transfer function of the sample-and-hold amplifier while in the hold mode. Ideally, feedthrough should be zero.

If a data acquisition system contained an ideal sample-and-hold amplifier, the basic limitation on its throughput (or rate of transmission of data) would be the conversion speed of its a-d converter, because the multiplexer could be switching to another channel during the conversion. However, many commercially available sample-and-hold amplifiers demonstrate such high feedthrough that switching the multiplexer during the conversion period would give rise to intolerable errors. Some modules therefore use a clamping network to limit feedthrough to  $\pm 1$  millivolt maximum for a  $\pm 20$ -v input step. This permits increased throughput for 12-bit data acquisition systems.

### Decay rate

Also while in the hold mode, a typical sample-and-hold amplifier will exhibit a decay of its output voltage over a period of time. This relatively constant output drift, termed the *decay rate*, is usually specified in microvolts per second. For the simple switch-capacitor circuit, it is caused by leakage currents through both the switch and the hold capacitor. In more complex circuits, it should be noted that the decay can be either positive or negative, depending on the polarity of the buffer amplifier bias current. Further, it is usually sensitive to temperature—with FET buffers, at any rate, the bias current doubles for each  $10^\circ\text{C}$  rise in ambient temperature.

The importance of the decay rate depends on the length of the hold time and the desired accuracy. In high-speed applications the hold periods are seldom longer than 100 microseconds, so decay rate errors are



**6. Fast and accurate.** Philbrick's 4853 is suitable for use with 12-bit converters at speeds up to 20 kHz. Input voltage range is  $\pm 10$  V, input impedance is  $2\text{ k}\Omega$ , and aperture time uncertainty is  $\pm 1$  ns.

unimportant even when the decay rate is as high as 1 microvolt per microsecond.

Perhaps the most difficult and sophisticated application for a sample-and-hold amplifier is in a very-high-speed data acquisition system, like the one outlined by the simplified block diagram of Fig. 5. The sample-and-hold circuitry maintains a constant input to the a-d converter during the conversion period while the multiplexer is seeking the next channel to be converted. After the first conversion is complete the sample-and-hold amplifier samples the next input, and the cycle is repeated. Sampling can be synchronized with the other system components, or it can be performed asynchronously.

In such a system, nearly all parameters are important except decay rate—that is, acquisition time, aperture time, aperture uncertainty time, bandwidth and feedthrough must all be considered in the designer's error budget because they all can affect the throughput data rate. The feedthrough is especially critical in multiplexed systems.

Note that the designer of a data acquisition system frequently has a choice of approaches for handling a known throughput rate. For example, many applications allow the use of a sample-and-hold amplifier with a moderate-speed a-d converter as an alternative to a very-high-speed a-d converter. Use of the moderate-speed combination often results in significant cost savings.

In the fast system, decay rate is not very important because the signal is usually not held for any significant length of time. The opposite is true of slow applications, where the most important parameter would be decay rate and all others would be of minor consequence.

One example of such a slow application is the mechanical test system measuring deformation in a titanium aircraft forging that is being subjected to a constantly increasing load. At predetermined points in time the sample-and-hold freezes the transducer signal so that it can be read out and displayed. Here the decay rate should be low enough to keep the reading within the desired accuracy right to the end of the maximum hold period. □

## Adding automatic erasure to storage oscilloscopes

by T. Richardson and Alan R. Freeman  
Indiana University, School of Medicine, Indianapolis, Ind.

When you are inspecting a slow event in detail with a storage oscilloscope, it's often convenient to have the trace automatically erased at the end of each sweep. As a matter of fact, automatic erasure is now a standard feature on the later models of many storage scopes. But a model with only manual erasure can frequently be modified without much trouble to include this desirable feature.

The circuit diagram shows a simple and inexpensive way to add automatic erasure to the popular model 564B Tektronix storage oscilloscope. With this modification, the scope's screen is automatically erased at the end of each sweep. Single-sweep information of slow events can then be easily observed without mechanically clearing the screen. The circuit is stable and costs less than \$10 to build.

The model 564B scope is particularly easy to modify because its manual erasure is accomplished by grounding a single charged capacitor. The modification circuit samples the scope's horizontal sawtooth at one of the CRT horizontal-deflection plates. This potential triggers

a one-shot that then closes two transistor switches, each one in parallel with an existing erase switch. A toggle switch in series with the transistor switches allows the automatic erasure to be overridden so that the advantages of the manual erasure can be retained.

In greater detail, the sawtooth potential at the left horizontal plate is sampled. The voltage divider made up of resistors  $R_1$ ,  $R_2$ , and  $R_3$  establishes a potential offset, placing the wiper of  $R_2$  at 5.5 volts. When the sawtooth drops to around 80 v, potentiometer  $R_2$  permits this triggering point to be adjusted through the last 2 centimeters (on the screen) of the sweep.

Diode  $D_1$  protects transistor  $Q_1$  from large reverse potentials. Since  $Q_1$ 's base terminal is isolated by the  $R_1R_2R_3$  resistor network,  $Q_1$ 's base voltage varies only between 6 and 5 v, changing potential as the one-shot is triggered at the end of the sweep. When the base of  $Q_1$  shifts from 5 to 6 v, this device turns on. The base of  $Q_1$ , therefore, varies by  $\pm 0.5$  v from a nominal voltage of 5.5 v, which is the power-supply potential determined by resistors  $R_4$  and  $R_5$ .

Transistors  $Q_1$  and  $Q_2$  make up the one-shot. The collector current of  $Q_1$  forward-biases the base of transistor  $Q_2$ , turning  $Q_2$  on and decreasing  $Q_2$ 's collector resistance so that the potential of point H (the model 564B junction of  $R_{305}$  and  $R_{313}$ ) drops from about 12 v to zero.

Capacitor  $C_1$  discharges through the base of transistor  $Q_1$  and holds both  $Q_1$  and  $Q_2$  on long enough for  $Q_2$  to trigger the erase cycle of the upper beam of the

**Scope modification.** For under \$10, simple circuit adds automatic erasure to Tektronix model 564B storage scope. The modification allows slow events to be observed conveniently with a single sweep. Photo shows actual installation, including a front-panel mode selection switch.

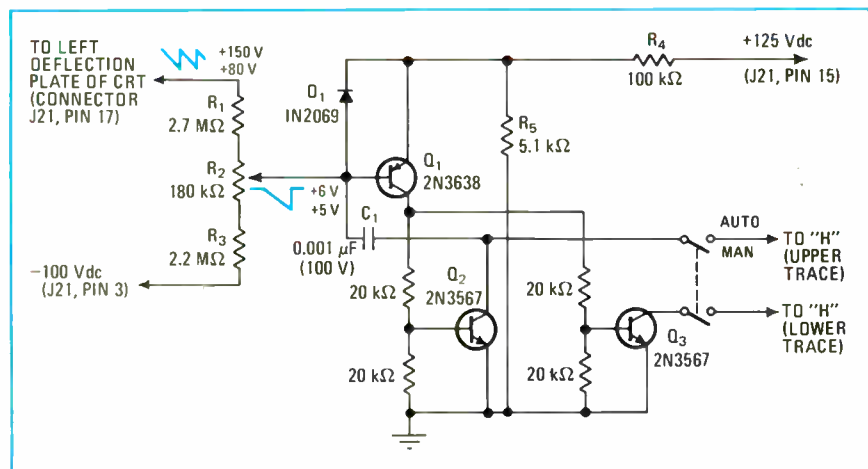
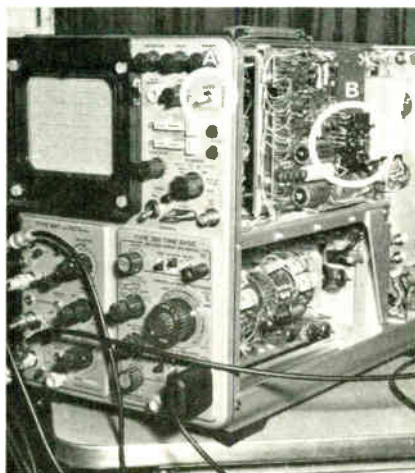

scope. In the same manner, transistor Q<sub>3</sub>, which is also in the collector loop of transistor Q<sub>1</sub>, triggers the erase cycle of the scope's lower trace.

The scope can be switched between automatic and manual erasure modes with the double-pole double-throw toggle switch. Once the circuit is installed and the scope has warmed up for 15 to 20 minutes, potentiometer R<sub>2</sub> can be adjusted to have erasure occur at the desired point on the scope face.

The modification circuit allows the model 564B to operate with automatic erasure at sweep speeds as fast as 50 milliseconds per centimeter. It may be necessary to reduce the scope's erase-cycle duration slightly to display the first centimeter of the overall sweep setting. However, the erase cycle should not be made so short

that the screen's background is brightened (a condition that may vary with age).

The nominal supply voltage of 5.5 v derived by resistors R<sub>4</sub> and R<sub>5</sub> is not a critical value. The resistance tolerances of R<sub>4</sub> and R<sub>5</sub>, therefore, are also not critical, provided that potentiometer R<sub>2</sub> can be adjusted to trigger transistor Q<sub>1</sub> properly and Q<sub>1</sub>'s collector-emitter breakdown voltage is not exceeded.

The photo shows an actual installation of the modification circuit. The mode-selection switch is mounted on the front panel, and the rest of the circuitry is located inside the scope. □

Engineer's Notebook is a regular feature in Electronics. We invite readers to submit original design shortcuts, calculation aids, measurement and test techniques, and other ideas for saving engineering time or cost. We'll pay \$50 for each item published.

## Design chart identifies intermodulation products

by Helmut Lobenstein  
General Electric Company, Aircraft Equipment Div., Utica, N.Y.

Frequency conversion in receiving, transmitting, or synthesizer systems frequently causes undesirable in-band mixing products to be produced. A rapid and handy design aid—the often-forgotten mixer intermodulation chart—can help the designer predict which of these unwanted frequency components will be troublesome to his system.

This type of chart is generated by considering what frequency products are created by mixing an rf input at frequency  $\alpha$  with a local oscillator (LO) signal at frequency  $\omega$ , producing an i-f output at frequency  $\beta$ :

$$\beta = | \pm n\omega \pm m\alpha |$$

where m is the harmonic number of the rf input frequency and n is the harmonic number of the LO frequency. This equation can be rewritten as:

$$\beta/\omega = | (\pm m\alpha/\omega) \pm n |$$

which has the form of a linear equation (for instance,  $y = mx + b$ ), permitting straight lines to represent any desired harmonic number.

The chart is easy to use. Suppose an rf input of 8–9 gigahertz is to be mixed with an LO frequency of 10.5 GHz, producing an i-f output of 2.5–1.5 GHz. To find the intermodulation products that can be expected, first tabulate the data:

$\alpha$	$\omega$	$\beta$	$\alpha/\omega$	$\beta/\omega$
8-9	10.5	2.5-1.5	0.762 0.857	0.238 0.143

On the chart, the frequency ratios of  $\alpha/\omega = 0.762$  and  $\beta/\omega = 0.238$  intersect the  $\alpha = \omega - \beta$  line, as they should, since this is the desired down conversion. Any other lines that cross the  $\omega - \beta$  line within the range plotted will produce an in-band mixing product. In this case, the product:

$$\alpha = (3\omega + \beta)/4$$

which is the fourth harmonic of the rf input minus the third LO harmonic, is produced. The other product produced is:

$$\alpha = (4\omega + \beta)/5$$

which is the fifth harmonic of the rf input minus the fourth LO harmonic. The higher the harmonic number of the mixing product, the lower is its power level. There are several ways to determine this level<sup>1</sup>.

The choice of a mixer significantly influences the harmonics that occur. A simple single-diode mixer, for example, will produce all the harmonic mixing products. But a single-balanced mixer will suppress one of its in-

TABLE 1  
INTERMODULATION PRODUCTS FOR SINGLE-BALANCED MIXER

Local oscillator harmonic (n $\omega$ ) \diagdown Signal harmonic (ma)		Signal harmonic (ma)				
		1	2	3	4	5
1	a	$\omega \pm a$	$2\omega \pm a$	$3\omega \pm a$	$4\omega \pm a$	$5\omega \pm a$
2						
3	3a	$3a \pm \omega$	$3a \pm 2\omega$	$3a \pm 3\omega$	$4\omega \pm 5a$	$5\omega \pm 3a$
4						
5	5a	$5a \pm \omega$	$5a \pm 2\omega$	$5a \pm 3\omega$	$5a \pm 4\omega$	$5a \pm 5\omega$

TABLE 2  
INTERMODULATION PRODUCTS FOR FULL-WAVE DOUBLE-BALANCED MIXER

Local oscillator harmonic (n $\omega$ ) \diagdown Signal harmonic (ma)		Signal harmonic (ma)				
		1	2	3	4	5
1	a	$\omega \pm a$	—	$3\omega \pm a$	—	$5\omega \pm a$
2						
3	3a	$3a \pm \omega$	—	$3\omega \pm 3a$	—	$5\omega \pm 3a$
4						
5	5a	$5a \pm \omega$	—	$5a \pm 3\omega$	—	$5\omega \pm 5a$

put signals and its even-order harmonics, while a double-balanced mixer will suppress both input signals and all of their even-order harmonics. Tables 1 and 2 indicate the intermodulation products generated by these latter two types of mixers, assuming perfect mixer balance.

For the example given here, the spurious mixing

products should be more than 80 decibels below the desired output whenever a double-balanced mixer, which is properly matched for impedance<sup>2</sup>, is to be used in the system. □

**REFERENCES**

1. James W. Steiner, "RFI due to Intermodulation Products," IEEE Transactions on Electromagnetic Compatibility, January, 1964
2. Peter Will, "Reactive Loads: the Big Mixer Menace," Microwaves, April, 1971.

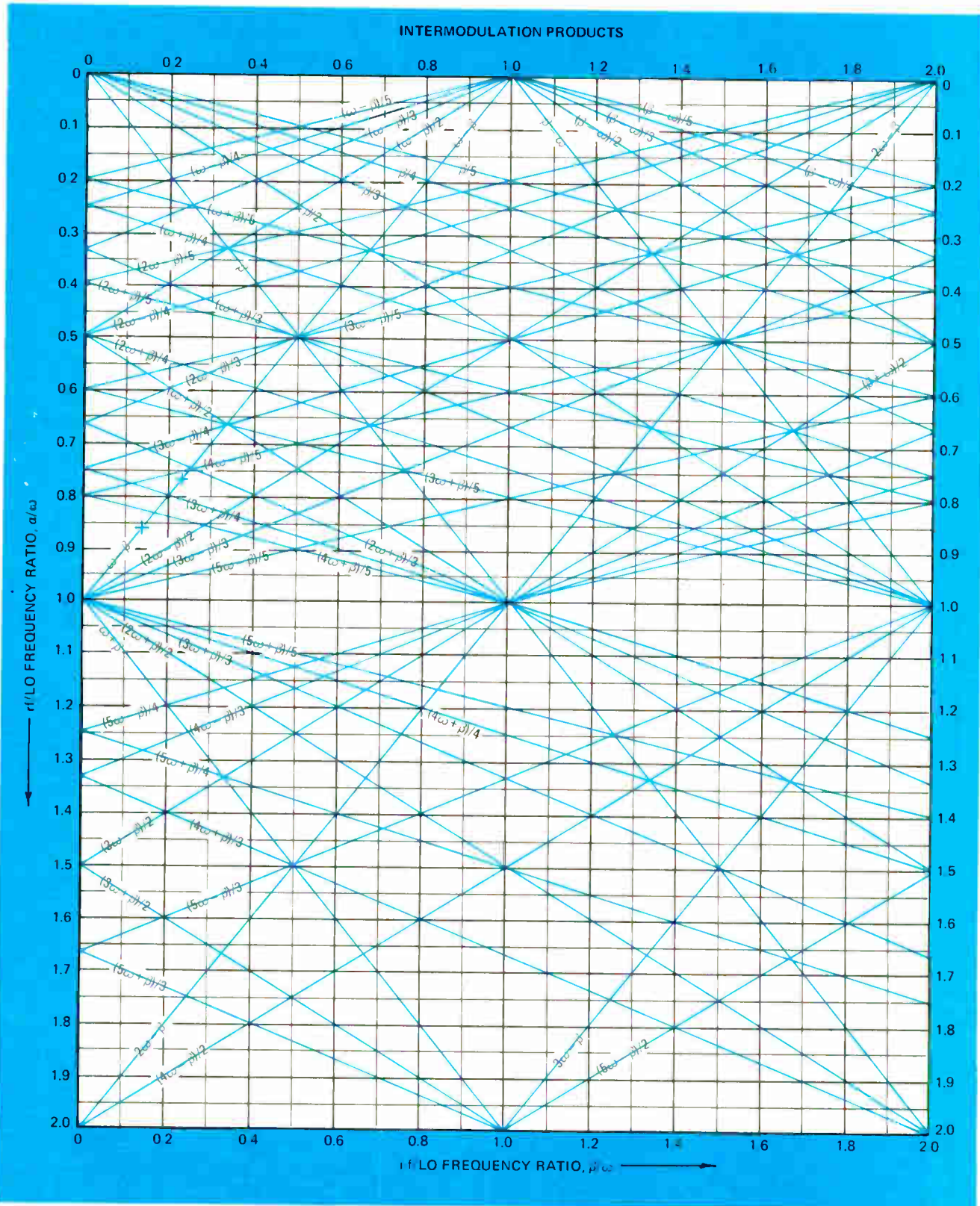

## **Brave new world of faceless test instruments**

Test instruments can always be recognized by their knobs, dials, meters, and digital readouts, right? Wrong. Users of big automatic test systems, like the large General Radio units, are **talking to their instruments through computers and saving money** because one computer can serve many instruments automatically, faster and better than people can, and can increase accuracy and throughput besides. Xincom's Pintofile will do the same thing for small-scale test facilities.

## **Sony engineers get their feet wet at the retail end**

American engineers may like to know how one successful Japanese manufacturer breaks in new members of its technical staff. Sony assigns beginning engineers to retail outlets selling Sony products, so that they get first-hand knowledge of what end users demand in consumer products, as well as which products are well or badly received and why. Sony feels that it gets **more innovative product development from engineers who don't have to rely solely on sales managers for user feedback.** What do you think?

## **Surface-wave filter covers a wide band**

Specialists in radar systems shouldn't forget that surface-acoustic-wave devices offer an attractive means of **obtaining wideband lightweight rf and microwave filters at a low cost.** The Air Force's Cambridge Research Laboratories, Bedford, Mass., for example, has built a bank of 21 filters spaced 5.3 megahertz apart, with center frequencies of 520 to 650 MHz. The filter bank, on a 2-by-0.9-centimeter lithium tantalate substrate, makes building a comb generator a simple job, for it does away with the usual mix of conventional frequency multiplier and mixer circuits.

## **New addition to the decade counter's uses**

With a little imagination, you can turn the ordinary decade counter into a very versatile component. Besides its primary function of counting logic pulses, the decade counter can perform frequency division, provide a time delay, or generate pulses. Still another application is generating waveforms economically—**an example is the staircase generator** on page 99. This circuit, which consists of a decade counter and a 1-of-10 decoder/driver, employs a simple resistor voltage divider for scaling step size; up to 10 steps are possible.

## **Designers can win transferable scholarships**

Here's a chance to beat the high cost of sending your kids to college. Motorola is holding a design contest, and the prizes are scholarships that the winners can keep or transfer to their children or anyone else they like. **Grand prize is \$2,500.**

The only restrictions on a proposed project are that it **cost less than \$100 and contain at least two Motorola parts.** The company will supply the parts free to candidates who reach the semifinals. Also, so that veteran design engineers won't be competing against technicians and students, there are two entrants' categories, professional and nonprofessional. The contest closes Dec. 31, 1973. For further details, contact Bob Field, Motorola Semiconductor Design-In, P.O. Box 2953, Phoenix, Ariz. 85036.



**ASSURE  
PRECISE  
OUTPUT  
CONTROL**  
for  
**EVERY  
APPLICATION**

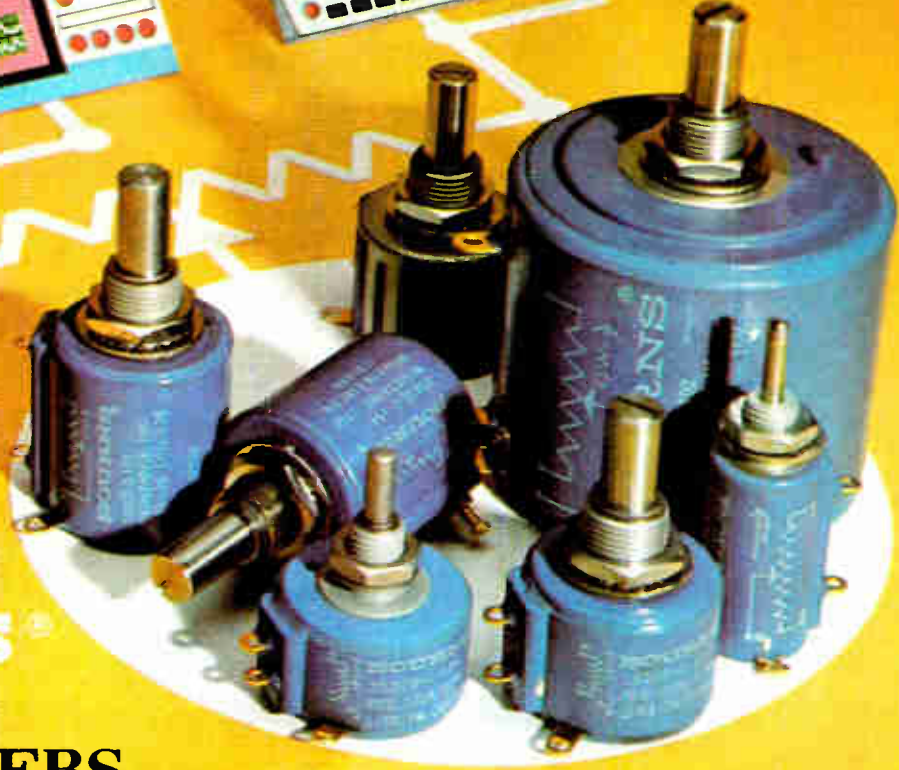

**SPECIFY  
BOURNS®  
PRECISION  
POTENTIOMETERS**

10, 5, 3, and Single Turns

1<sup>1</sup>/<sub>16</sub>" • 1<sup>1</sup>/<sub>8</sub>" • 1<sup>1</sup>/<sub>4</sub>" • 3<sup>1</sup>/<sub>4</sub>" • 1<sup>1</sup>/<sub>2</sub>" Diameters

Less than 0.5% Return Rate

Wirewound and Nonwirewound Types

Exclusive SILVERWELD™  
Termination

Competitive Pricing

Bourns matchless precision potentiometers are stocked in-depth at your local Bourns Distributor. Contact the one nearest you for price and fast delivery.



**BOURNS, INC., TRIMPOT PRODUCTS DIVISION • 1200 COLUMBIA AVE., RIVERSIDE, CALIF. 92507**

Circle 109 on reader service card

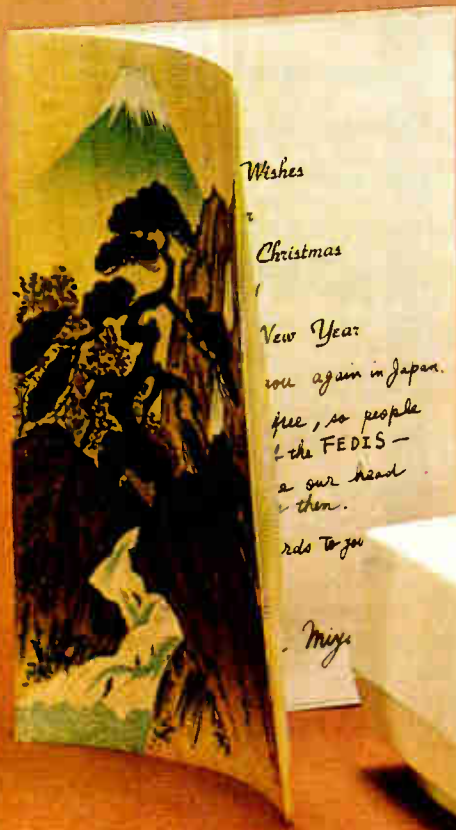

# 三宅様 どうも有難うございました

"Thank You, Mr. Shin Miyake."

We at Macrodata want to thank you for your thoughtful note saying:

"The mask was error free, so people recognized the efficiency of the FEDIS-CADIS system. I hope our head people will decide to buy them ..."

Yes, that is the point of our FEDIS/CADIS MD-170 LSI Design System — it offers the LSI designer the quickest, most direct, most reliable method of producing error-free masks by single iteration design.

As you discovered, Mr. Miyake, in only 3 weeks it was possible to proceed from your preliminary composite drawing of the master LSI circuit for your digital clock to the final error-free artwork. And you accomplished all this on our FEDIS system with which you had no previous experience.

Others are also finding that the Macrodata MD-170 and the new more powerful MD-170B with the interactive graphic features are buying them calendar time, reducing their LSI design costs, eliminating subtle errors, and increasing yields. To those who want to learn more about this remarkable LSI design system, we are offering free copies of our FEDIS/CADIS brochure.

## Macrodata



**Macrodata Corporation**, 6203 Variel Avenue, Woodland Hills, California 91364, Phone: (213) 887-5550, Telex: 65-1345  
Sales Offices: Northern California Area Tel. (408) 735-9560 • Southwestern Area Tel. (213) 644-3611 • West/Central Area — Denver Tel. (303) 934-5505 • Scottsdale Tel. (602) 947-7841 • Albuquerque Tel. (505) 299-7558 • Dallas Tel. (214) 231-2573 • Houston Tel. (713) 621-0040 • Minneapolis Area Tel. (615) 636-1770 • Chicago Area Tel. (312) 455-5100 • Cleveland Area Tel. (216) 461-8333 • New York and New England Area Tel. (914) 962-7797 • Southeast Area Tel. (205) 883-0140 • International: West Germany — Munich Tel. (0811) 34 56 00 Telex: (841) 521-5969 • Milan, Italy Tel. 871-988/899-248 Telex: (843) 34314 • Sweden and Norway — Stockholm Tel. (08) 87 03 45 • Switzerland and Austria — Bern Tel. (031) 22 44 81 Telex: (845) 33172 • Tel Aviv, Israel Tel. 25 55 69 • Tokyo, Japan Tel. (03) 985-5266 Telex: (781) 272-2171 • Buckinghamshire, England Tel. High Wycombe (0494) 36 3 81 Telex: (851)837236

Circle 114 on reader service card

World Radio History

Instruments

## Counter-timer can reach 1 GHz

Basic unit counts to 100 MHz; optional prescalers used to reach higher levels

Action in counters for the new 900-megahertz land-mobile communications band is heating up with a new 1-gigahertz entry from Newport Laboratories [see also *Electronics*, July 19, p. 137]. The instrument is based on a lower-frequency counter, and an optional internal prescaler enables it to reach the 1-gigahertz range. Designated the model 700, it has timing capability as well.

The basic counter, at \$775, is a 100-MHz unit with a seven-digit Sperry planar display and an oven-stabilized time base with a maximum drift of less than 1 part in 10<sup>8</sup> per day. Options include 9 digits (\$35), high-stability time base of 3 parts in 10<sup>9</sup> per day (\$125), and prescalers (available for counting to 512 MHz (\$295) or 1-gigahertz (\$595)). A special low-level 512-MHz prescaler with a sensitivity of 10 millivolts is priced at \$395.

Standard functions include binary-coded-decimal output and remote programming of function. An unusual feature is the use of an integrated-circuit read-only memory for programming instead of the conventional multisection rotary switch. The ROM also permits automatic

display and programming of decimal points and annunciator units.

The prescaler option plugs into a socket in the mainframe, so it can be added to the basic unit in the field. Only one solder connection is required, to a BNC connector already on the panel, and no calibration is necessary. The prescalers use Plessey high-frequency emitter-coupled-logic circuits. All ICs plug into sockets for ease of servicing.

The unit is organized into three channels, the main input (dc to 100 MHz), a dc-to-10-MHz channel, and the high-frequency channel. The basic channels are high-impedance (1 megohm) with 100 mv rms sensitivity to 100 MHz. A 50-ohm input and 100-mv sensitivity are standard for the higher-frequency input.

The counter is 3.5 inches high by 11 in. wide by 17 in. deep. It operates on 115 or 230 volts, 50 to 400 Hz, at 35 watts.

Newport Laboratories Inc., 630 East Young St., Santa Ana, Calif. 92705 [351]

ties) uses a small fluorescent lamp.

The 4½-digit unit requires only 20 milliwatts for the MOS and 1 mW for the display (830 microamperes at ±12 volts). The transmissive model requires 26 mA at 115 v ac or 13 mA from 230 v ac. The digits are 0.65 inch high, and the unit operates with standard TTL inputs at a rate up to 500 kilohertz.

Digilin Inc., 1007 Air Way, Glendale, Calif. 91201 [352]

## Programmable pulse generator built for automatic testing

A fully programmable pulse generator with rise times of less than 3 nanoseconds, ±10-volt pulse amplitudes, and 50-megahertz pulse frequencies is designed for automatic test equipment. Called the model 1501A, the instrument can link with parallel, Ascii, or serial-by-16-bit programming, and each of these



modes may have either a binary or BCD input, and either positive or negative true logic. The standard model is provided with parallel programming and BCD inputs. Price for this unit is \$3,500, or \$4,500 with front-panel controls.

E-H Research Laboratories Inc., 515 Eleventh St., Oakland, Calif. 94604 [353]

## Liquid-crystal event counter offers low-power circuitry

Aimed at replacing electromechanical devices, a new Digilin event counter that uses liquid-crystal displays offers solid-state reliability and the wearout performance of immobile parts. The counter is priced at \$52 each in quantities of 100 for a version with reflective display. And its low-power MOS and liquid-crystal circuitry can operate for months from a small battery in case of power failure. A transmissive display version (\$68 in similar quan-



## Phase-angle voltmeter covers 30 Hz to 300 kHz

A phase-angle voltmeter, which makes precision measurements over the range from 30 hertz to 300 kilohertz, is designated the PAV-4 series. Each of the three mainframes offered accepts a range of fixed-frequency and variable-frequency plug-ins. An infinite choice of fixed-frequency filters is available in the

scription of wire-wrapping technology as applied to electronics and telecommunications. It includes charts of coilite bits and sleeves, sections on terminal spacing, and tool specifications. Circle 421 on reader service card.

**D-a converters.** A data sheet is available from Computer Labs, 1109 S. Chapman St., Greensboro, N.C. 27403, on fast-settling d-a converters. [422]

**Proximity switches.** Namco Controls, 170 E. 131st St., Cleveland, Ohio 44108. The series EE940 and series EE950 rf inductive proximity switches with fail-safe features are the subject of an eight-page brochure. [423]

**Spray etcher.** A two-page leaflet describes a 20-inch conveyerized spray etcher for printed-circuit-board production, manufactured by Chemcut Corp., 500 Science Park, State College, Pa. 16801. [424]

**Power supply.** Spellman High Voltage Electronics Corp., 1930 Adee Ave., Bronx, N.Y. 10469. A six-page catalog, number 7300, provides information on the company's line of high-voltage power supplies, including solid-state, regulated, unregulated, rack-mounted, miniature, modular, and series-regulated high-voltage types. [425]

**Logic cards.** The Tenor Co., 17020 W. Rogers Dr., New Berlin, Wis. 53151, has issued bulletin 700A, which describes solid-state logic cards and systems. The publication also gives information on mounting hardware and applications of the logic cards. [426]

**Product catalog.** The Hickok Electrical Instrument Co., 10514 Dupont Ave., Cleveland, Ohio 44108. A product-selection guide and catalog describes and illustrates the company's product line, which includes multimeters, oscilloscopes, and industrial card-readers. [427]

## A BETTER MOUSETRAP, WE BUY IT.

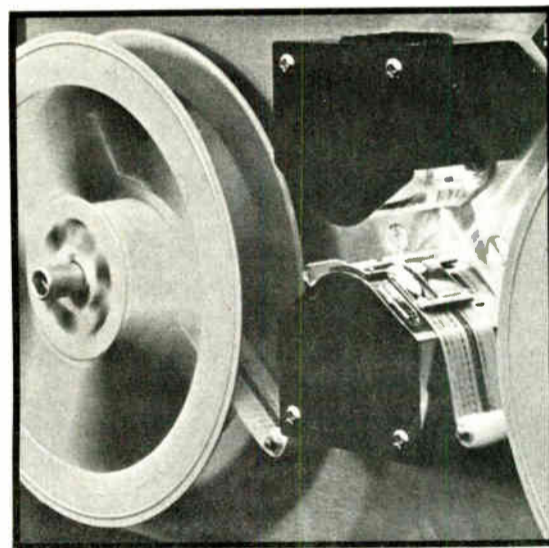

The computer controlled drilling machine is the newest and most precise way of ensuring that each hole in each printed circuit board is perfect. Like just about everything else in our five individual plants, it's the latest thing on the market. And like everything else in our plants, it's there to give you the best and most reliable printed circuit boards you can buy. We spend a lot of time and effort hunting up all the little things that add quality and reliability to our manufacturing processes. What it means to you is crack quality control, maximum reliability and on-time delivery. Whether your order is a single prototype or a production run of gold, solder mask over bare copper circuits. In plated through two-sided, or multi-layer boards. People have said we build a better mousetrap. Maybe that's because we buy a better mousetrap. Whenever we find it.



• 3475 Edward Avenue, Santa Clara, California 95052 • (408) 249-0464  
Manufacturing facilities located in Santa Clara, Stockton and Santa Ana.

Circle 123 on reader service card

Why mess around when you can have the ELECTRONICS BOXER clean up your copies—keep them in top condition.

And, it's easy and

inexpensive to keep the ELECTRONICS BOXER in your corner. Just complete the coupon and mail. Your order will be processed immediately, postpaid.

**ELECTRONICS BOXER**  
**Jesse Jones Box Corporation**  
 2250 E. Butler St., Philadelphia, Pa. 19137  
 Please send me:  boxes @ \$4.25 each;  
 3 boxes @ \$12.00;  6 boxes @ \$22.00  
 My check or money order is enclosed.  
 Name \_\_\_\_\_  
 Address \_\_\_\_\_  
 City \_\_\_\_\_ State \_\_\_\_\_ Zip \_\_\_\_\_

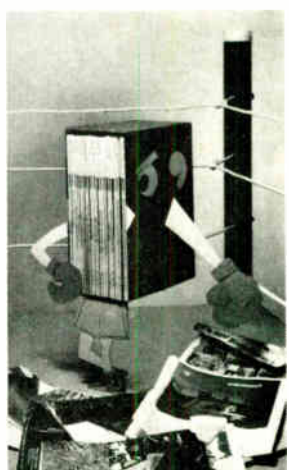

**A message from Kodak  
to a certain engineer/scientist  
who is very active  
in photosensor devices**

Though much too busy to be job-hunting, you are aware that now would be a good point in your career to move to an environment where technique is well developed for turning science into technology that society wants.

In the decade or more since taking your Ph.D. in solid-state physics or electrical engineering, you have built up sufficient experience in materials research and device development—and in the management thereof, with all the people problems and interface problems—to lead a sizable effort in the study and development of devices complementary to our proprietary technology in information recording.

If you exist and are ethically available, we sure want to meet you. The position is no minor one, and there is opportunity to grow even further.

**But don't hesitate to raise your hand** if 1) your experience is more in utilization of solid-state devices than in creating new ones, 2) you haven't been at it more than five years, 3) you have managed only a small number of engineers. You may still be the candidate who will lead another group at the Kodak Research Laboratories that is charged with the responsibility for bringing innovative imaging technologies somewhat closer to commercial fruition.

Please communicate with Dr. D. B. Glass  
Business and Technical Personnel, Kodak  
Rochester, N. Y. 14650.



An equal-opportunity employer m/f



**EMPLOYMENT  
OPPORTUNITIES**

Send New Ads to:

Electronics  
Class. Adv. Dept.  
P.O. Box 900, N.Y., N.Y. 10020

**POSITION VACANT**

**Electronics Shop Supervisor**—This position requires thorough familiarity with theory and practice of analog and digital scientific electronics equipment, circuitry, interfacing, etc. It entails both design and building, as well as maintenance of existing equipment. The supervisor is assisted in this task by two electronics engineers. Salary according to qualifications. Submit curriculum vitae, names of three references, salary requirements to James Franck Institute, University of Chicago, 5640 South Ellis Avenue, Chicago, Illinois 60637 (telephone 312; 753-8216).

**INFRARED VIEWERS & PARTS**

TYPE 6929 INFRARED IMAGE TUBE...  
Late-date monovoltage Image Converter  
Features high resolution & single input of  
12,000 vdc. Self-focusing 1.36" dia by 2.33"  
long. Good Mfr's seconds. Normal price  
\$170.00. New Surplus... **ONLY \$74.95 ppd.**

FOR:  
•Crime Detection •Laser Study •Research

**MINIATURE HIGH-VOLTAGE POWER SUPPLY**  
Solid state power supply for 6929 tube & 9902 Metascope. Input 1.34 vdc (IRM IR  
battery) Output 12,000 vdc. Size 1.0" dia x 2.5" long. 1st Quality. List \$350.00.  
BRAND NEW... **ONLY \$14.95 ppd.**

**COMBINATION OFFER: 6929 Tube & Power Supply... \$99.95 ppd.**

**COMPLETE METASCOPE INFRARED VIEWERS**  
Model 9902 Late-date Viewer utilizing 6929 tube. Military version of and identical to  
5500C Metascope. Complete with light source. Ready to use. Current list \$675.00.  
Like-New Surplus... **\$225.00 ppd.**

**McNEAL ELECTRIC & EQUIPMENT CO.**  
4736 Olive St. St. Louis, Mo. 63108

**HELP!**

**Q. How do I reply to a box number ad?**

**A.** Address an envelope with the box number indicated in the ad, c/o Electronics, Class. Adv. Dept., P.O. Box 900, NY, NY 10020

**Q. Whom do I contact or call to re-new my classified ad or make corrections?**

CLASSIFIED ADVERTISING  
**SEARCHLIGHT SECTION**  
BUSINESS OPPORTUNITIES  
USED OR SURPLUS EQUIPMENT

**IMMEDIATE DELIVERY**  
Minis & Peripherals  
**DEC—HIS**  
**SEL—HP—NOVA**  
Card, Printer, Tape, Disk  
**TELETYPES**  
**33, 35, 37**  
For Sale/Rent  
**617/261-1100**  
Send For **FREE Price List**  
**AMERICAN USED COMPUTER CORP.**  
P.O. Box 68, Kenmore Sta., Boston, MA 02215

CIRCLE 951 ON READER SERVICE CARD  
**DIVERSAL NAMEPLATE CO.**  
P.O. Box 2337  
San Antonio, Texas 78206  
stock anodized nameplates

**FORWARD** **FAST**  
**OFF** **MONITOR** **SLOW**  
**REVERSE** **AUTOMATIC**

catalog on request  
CIRCLE 952 ON READER SERVICE CARD

**FREE CATALOG TOOLS**  
**HARD-TO-FIND PRECISION TOOLS**  
Lists more than 1700 items—pliers, tweezers, wire strippers, vacuum systems, relay tools, optical equipment, tool kits and cases. Also includes four pages of useful "Tool Tips" to aid in tool selection.  
**TENSEN TOOLS**  
4117 N. 44th Street, Phoenix, AZ 85018

CIRCLE 953 ON READER SERVICE CARD  
**RADAR SYSTEMS GROUND AND AIRBORNE AUTOMATIC TRACKING ANTENNA SYSTEMS NIKE AJAX NIKE HERCULES M-33 MSO-1A MPS-19 MPS-9 SCR 584 TPS-10 TPS-28 FAA-ASR-2 AIRBORNE SYSTEMS APN-84 APN-102 APS-20 APS-27 APS-45 DPN-19 DIGITAL COMPUTERS IBM 650 IBM 704**  
LARGEST INVENTORY OF RADAR AND MICROWAVE EQUIPMENT IN THE WORLD  
**RADIO RESEARCH INSTRUMENT CO.**  
3 QUINCY ST., NORWALK, CONN. 06850 (703) 853-2600

CIRCLE 954 ON READER SERVICE CARD  
**free catalog**  
**POTTING APPLICATORS**  
MANUAL OR AIR OPERATED  
2½cc 6cc 12cc 30cc  
FOR POTTING, ENCAPSULATING ETC.  
**PHILIP FISHMAN CO., INC.**  
7 CAMERON ST. WELLESLEY, MASS. 02181

CIRCLE 956 ON READER SERVICE CARD  
**FREE ALARM CATALOG**

**USING ACTIVE FILTERS  
OR PASSIVE FILTERS ?**

**Are size, shape or weight considerations important? Special mechanical configurations offered—Hermetically sealed or encapsulations for pcb installations**

**Low, high, band pass and reject designs—Butterworth, Chebishev, Bessel or elliptic response characteristics—wide range of source and load impedances**

**Low frequency actives, stable toroidal LC's, RC twin-T's**

**No EXTERNAL components required**

**Unbiased recommendations on active or passive filter selections for maximum economy**

**White instruments, incorporated**

PHONE AREA 512/892-0752 • P.O. Box 698 AUSTIN TEXAS 78767

Circle 124 on reader service card



**YOU'RE WHISTLING IN THE DARK...**

if you think that heart disease and stroke hit only the other fellow's family.

**GIVE ... so more will live**  
**HEART FUND**

Contributed by the Publisher

**New books**

**Compatibility and Testing of Electronic Components**, by C.E. Jowett, Halsted Press, a division of John Wiley & Sons Inc., 345 pp., \$19.75

Microelectronics has spawned a whole slew of competing fabrication techniques in its short lifetime, and the process engineer is often hard put to choose from the various materials and processes. This book can help because its scope is quite broad, covering a myriad of thin- and thick-film topics.

But it is not aimed at the beginner. He would be better served by reading "Thick Film Hybrid Microelectronic Technology" by Hamer and Biggers [*Electronics*, Dec. 4, 1972, p. 156].

Jowett has several decades of experience in the reliability of the fabrication processes in these fast changing technologies. In the thin-film area, he covers the use of tantalum, failure modes in thin-film circuits, and vacuum deposition of thin-film organic layers. Thick-film topics include the screening and firing of crossover dielectrics and adhesion of conductive and resistive inks. Another chapter surveys the bonding of chips to substrates. Especially interesting is a chapter dealing with infrared radiation as a technique for reliability screening.

Jowett questions the validity of certain environmental tests in his chapter on "The Purpose of Testing." He points out, for example, that salt spray just isn't the all-purpose accelerated corrosion test many think it is. Jowett contends that there is seldom a direct relationship between resistance to salt spray and resistance to corrosion in other environments—even marine atmospheres. But he says the test is satisfactory in evaluating the porosity of protective coatings.

Although there a number of books which describe the techniques of microelectronics with more and better illustrations, few of their authors are as successful as Jowett in developing capsule synopses of both processes and materials and placing them in prospective.

Stephen E. Grossman,  
Packaging & Production Editor

## New products

### Instruments

# Counter-timer can reach 1 GHz

Basic unit counts to 100 MHz; optional prescalers used to reach higher levels

Action in counters for the new 900-megahertz land-mobile communications band is heating up with a new 1-gigahertz entry from Newport Laboratories [see also *Electronics*, July 19, p. 137]. The instrument is based on a lower-frequency counter, and an optional internal prescaler enables it to reach the 1-gigahertz range. Designated the model 700, it has timing capability as well.

The basic counter, at \$775, is a 100-MHz unit with a seven-digit Sperry planar display and an oven-stabilized time base with a maximum drift of less than 1 part in  $10^8$  per day. Options include 9 digits (\$35), high-stability time base of 3 parts in  $10^9$  per day (\$125), and prescalers capable of counting to 512 MHz (\$295) or 1-gigahertz (\$595). A special low-level 512-MHz prescaler with a sensitivity of 10 millivolts is priced at \$395.

Standard functions include binary-coded-decimal output and remote programming of function. An unusual feature is the use of an integrated-circuit read-only memory for programming instead of the conventional multisection rotary switch. The ROM also permits automatic

display and programming of decimal points and annunciator units.

The prescaler option plugs into a socket in the mainframe, so it can be added to the basic unit in the field. Only one solder connection is required, to a BNC connector already on the panel, and no calibration is necessary. The prescalers use Plessey high-frequency emitter-coupled-logic circuits. All ICs plug into sockets for ease of servicing.

The unit is organized into three channels, the main input (dc to 100 MHz), a dc-to-10-MHz channel, and the high-frequency channel. The basic channels are high-impedance (1 megohm) with 100 mV rms sensitivity to 100 MHz. A 50-ohm input and 100-mV sensitivity are standard for the higher-frequency input.

The counter is 3.5 inches high by 11 in. wide by 17 in. deep. It operates on 115 or 230 volts, 50 to 400 Hz, at 35 watts.

Newport Laboratories Inc., 630 East Young St., Santa Ana, Calif. 92705 [351]

## Liquid-crystal event counter offers low-power circuitry

Aimed at replacing electromechanical devices, a new Digilin event counter that uses liquid-crystal displays offers solid-state reliability and the wearout performance of immobile parts. The counter is priced at \$52 each in quantities of 100 for a version with reflective display. And its low-power MOS and liquid-crystal circuitry can operate for months from a small battery in case of power failure. A transmissive display version (\$68 in similar quan-

ties) uses a small fluorescent lamp.

The 4½-digit unit requires only 20 milliwatts for the MOS and 1 mW for the display (830 microamperes at  $\pm 12$  volts). The transmissive model requires 26 mA at 115 v ac or 13 mA from 230 v ac. The digits are 0.65 inch high, and the unit operates with standard TTL inputs at a rate up to 500 kilohertz.

Digilin Inc., 1007 Air Way, Glendale, Calif. 91201 [352]

## Programmable pulse generator built for automatic testing

A fully programmable pulse generator with rise times of less than 3 nanoseconds,  $\pm 10$ -volt pulse amplitudes, and 50-megahertz pulse frequencies is designed for automatic test equipment. Called the model 1501A, the instrument can link with parallel, Ascii, or serial-by-16-bit programming, and each of these



modes may have either a binary or BCD input, and either positive or negative true logic. The standard model is provided with parallel programming and BCD inputs. Price for this unit is \$3,500, or \$4,500 with front-panel controls.

E-H Research Laboratories Inc., 515 Eleventh St., Oakland, Calif. 94604 [353]

## Phase-angle voltmeter covers 30 Hz to 300 kHz

A phase-angle voltmeter, which makes precision measurements over the range from 30 hertz to 300 kilohertz, is designated the PAV-4 series. Each of the three mainframes offered accepts a range of fixed-frequency and variable-frequency plug-ins. An infinite choice of fixed-frequency filters is available in the



Overall analog  
dynamic range: 132 db

Automatic/  
programmable  
gains to 1024

## NEW APPROACH TO LOW LEVEL DATA ACQUISITION

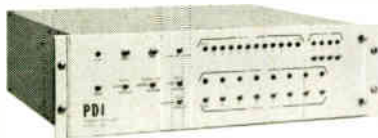

Phoenix Data's new 8000 Series

Phoenix Data's floating point 8000 Series data acquisition system features adaptability to virtually any analog input signal currently in use—offering automatic or programmed gain selection with 11 binary ranges from  $\pm 10$  millivolts to  $\pm 10.24$  volts full scale. The data word (12 binary bits) is combined with the range data (4 binary bits) for a 16 bit output word in the automatic ranging mode. The system will resolve input changes of 5 microvolts on the  $\pm 10$  millivolt range for an overall analog dynamic range of 132 db.

### FEATURES:

- ADC resolution of 12 binary bits.
- 11 binary gain ranges.
- $\pm 10$  mv to  $\pm 10.24$ V input ranges.
- Solid state MOSFET multiplexing.
- Thruput rates from 1 to 20 KHZ.
- Auto or programmable gains.
- Up to 128 channels per chassis.
- System accuracy of .05% of reading.
- System T.C.:  $0.001\% \text{FSR} \pm 1 \mu \text{volt RTI}/^\circ\text{C}$ .

If it's stability, accuracy, speed, or all-around quality you need in Data Conversion, contact Phoenix Data now!



## PHOENIX DATA, INC.

3384 West Osborn Road  
Phoenix, Arizona 85017

Ph. (602) 278-8528. TWX 910-951-1364

## New products

range of from 30 Hz to 10 kHz; the variable-frequency filters cover the ranges of from 300 Hz to 10 kHz and

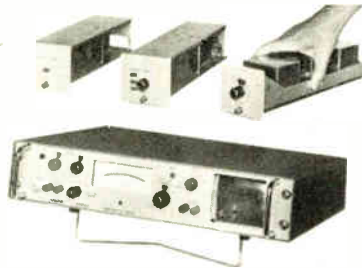

from 10 kHz to 300 kHz. Price starts at \$950 without plug-ins.

Singer Instrumentation, 3211 S. LaCienega Blvd., Los Angeles, Calif. 90016 [354]

## Function generator

is priced at \$250

The model 400 function generator features a range of 0.02 to 2 megahertz, a dial accuracy to within  $\pm 2\%$  of full scale, and a price of \$250. It

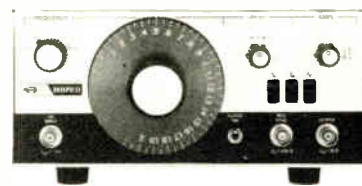

provides a 1,000-to-1 frequency modulation, plus sine, square, and triangle waveforms with sine distortion less than 1%. It is dc offset-variable from  $-10$  to  $+10$  v open circuit. The instrument will be available in September.

Systron Donner Corp., Datapulse Division, 10150 W. Jefferson Blvd., Culver City, Calif. 90230 [355]

## Strip-chart recorder

prints every 2 seconds

A strip-chart recorder, equipped for battery operation, prints every two seconds with a chart-speed accuracy that is within 0.1%. The multipoint recorder traces one to six points in different colors. It operates from batteries of 12 to 30 volts and is protected against inversed polarity, while a voltage regulator and com-

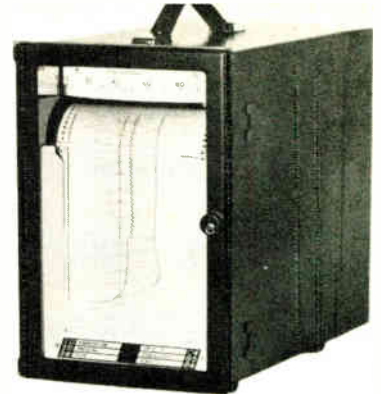

parator circuitry are provided for automatic shutoff if the battery voltage supply is inadequate. Price is about \$1,000 for a single-channel unit; six-channel instruments range from \$1,600 to \$2,000.

Elnik Instruments Inc., 410 Garibaldi Ave., Lodi, N.J. 07644 [357]

## Frequency synthesizer

spans 1 hertz to 12 MHz

Covering the range from 1 hertz to 13 megahertz, a frequency synthesizer is designated the model 1028. A special feature of the instrument is circuitry that uses no mixing processes; instead, the output frequencies are obtained by dividing down from a basic precision oscillator, so that the numerous spurious signals normally found in synthesizer circuits are not generated in the instrument. Price is \$1,800 without attenuator and \$2,200 with attenuator.

Pacific Measurements Inc., 940 Industrial Ave., Palo Alto, Calif. 94303 [356]

## Optical signal generator

provides constant power

An optical signal generator provides a power stabilization capability with a short-term stability of within 2% over the entire range from 0 to 1 milliwatt. Designated the model 3071H, the instrument accepts internal keying frequency and external digital or analog input to operate its laser in either its keyed or a-m

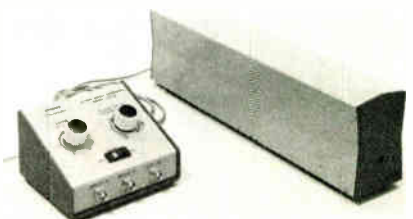

mode. Price of the unit is \$1,500. Hughes Aircraft Co., Box 90515, Los Angeles, Calif. 90009 [358]

X-Y lab recorder offers 7 time sweeps

Featuring disposable fiber pens, the model 715 X-Y recorder is available with a plug-in seven-speed time-base generator that operates on ei-

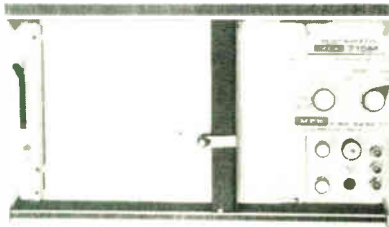

ther the X or the Y axis. The instrument has guarded and shielded differential inputs, constant 1-megohm input impedance, and buffered follow-up potentiometers for noise immunity. Price is \$180.

MFE Corp., Keewaydin Dr., Salem, N.H. 03079 [359]

Counter-timer measures up to 50 megahertz

Priced at \$575, the model 1608 counter-timer uses MOS LSI and bipolar devices, and features two input channels. Channel A provides frequency, totalize, and rpm measurements up to 50 megahertz, and channel B provides period and multiple period capabilities up to 2



megahertz. Time interval and ratio are a combination of both channels. Input operating range is from 50 mV through 1 V rms and 10 V rms, with a non-damaging input of 100 V rms.

Eldorado Electrodatabox Corp., 935 Detroit Ave., Concord, Calif. 94518 [360]

# Bonds are for making retirement easier.

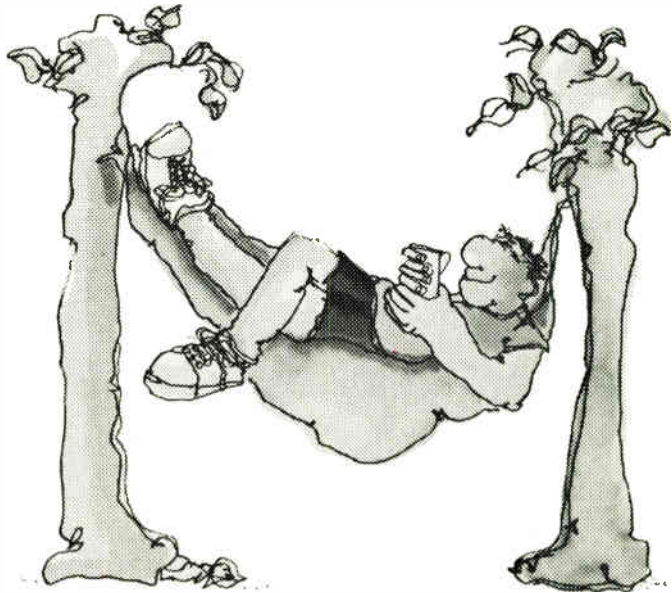

U.S. Savings Bonds can help you keep a firm grip on your future.

Join the Payroll Savings Plan where you work, right now.

Get a start on your nest egg and make sure there'll be some glitter in your golden years.



## Take stock in America.

Buy U. S. Savings Bonds

Now E Bonds pay 5½% interest when held to maturity of 5 years, 10 months (4% the first year). Bonds are replaced if lost, stolen, or destroyed. When needed they can be cashed at your bank. Interest is not subject to state or local income taxes, and federal tax may be deferred until redemption.



The U. S. Government does not pay for this advertisement. It is presented as a public service in cooperation with The Department of the Treasury and The Advertising Council.

Data handling

## Magic: the designer's wand

Revised circuit analysis and optimization program broadens its capabilities

These days, designers of circuit-analysis computer programs are keeping the user in mind—making computer-aided design as convenient as possible. Staying in tune with the times is Magic (Modern Analytical Generator of Improved Circuits), a circuit-analysis and optimization program. First released about two years ago, Magic has been continually updated with features that extend its scope and increase its speed.

Magic operates in the frequency domain over the entire spectrum from near dc to the microwave region, on both conventional ladder networks and linear microwave circuits. The program can quickly analyze a circuit for design verification or optimize it for design improvement. In its optimization-computation mode, Magic automatically adjusts the values of circuit elements to obtain the best-fit circuit response to one or more curves

specified by the user. Moreover, Magic is conversational; it accepts free-format inputs, and all key-word instructions relate to physical parameters.

One of the program's new features is an improved search scheme that efficiently deals with networks having a wide spread in variable element size. Magic can also now handle multiple feedback loops, junctions involving any number of circuit branches, and up to four different types of active devices. In addition, error functions can be more complex than the usual "least-square" approximation and can have any order error up to 20th power. Two other new features are Monte Carlo analysis and ac worst-case analysis.

Additional Magic capabilities include sensitivity analysis, transmission-line analysis, and S-parameter transistor representation. Furthermore, the program eliminates the need to do device modeling, permitting the user to work directly with measured device parameters or from a data sheet. As with many programs, output results can be in either tabulated or graphic form.

Magic is available on a time-shared basis through University Computing Co., Dallas, Texas, or in-house versions can be leased for \$2,500 a month. Circuits containing up to 500 nodes can be analyzed for

any frequency-domain response in less than 2 seconds. And optimizing a common single-transistor amplifier for gain typically consumes approximately 20 seconds of computer time. For a Monte Carlo analysis, Magic usually needs less than a quarter of a second per frequency per variable. The computer time required depends on the problem being solved and the user solving the problem.

Typical Magic printouts are shown for both a Monte Carlo analysis and a sensitivity analysis of a one-transistor 500-megahertz amplifier.

Scientific System Technology Inc., 603 Business Parkway, Richardson, Texas 75080 [361]

## Terminal accesses a variety of computers

The Spacer batch terminal, which comprises a minicomputer coupled through a communications-control module, can access a variety of computers, including IBM, CDC, GE, ICL, Univac, and XDS types. The minicomputer, called the Pacer 100, also provides hybrid-computation, graphics, and data-acquisition compatibility. Spacer is programmed to link with most mainframe computers by emulating the manufacturers' equivalent terminals. Selection by the operator of the terminal to be emulated is accomplished by loading from the system's library. Hardwiring and cumbersome patchboards are eliminated.

Electronic Associates Inc., West Long Branch, N.J. 07764 [363]

## Tape head provides erase-before-write

Featuring an all-metal face, a precision read-write-erase cassette head meets ANSI and ECMA standards and provides an erase-before-write capability. The erase feature is achieved by adding a second gap, spaced 0.030 inch from the read-write gap. The primary application

```

STAT DETECTED ( DIRECT )
% TOLERANCE = 5.00
MONTE CARLO ANALYSIS FOR UNIFORM DISTRIBUTION OF VARIABLE ELEMENTS.

```

FREQ	MEAN	SIGMA	DIFFER	
			1-SIGMA	1-SIGMA
500.0	-0.3903	.50133	-2.8090	-8.9716
625.0	-9.5365	.31299	-6.6463	-10.134
750.0	-0.4723	.13923	-0.5926	-10.491
			-0.3341	-0.6106
			-0.0577	-8.8870

```

SENSITIVITY DETECTED ( DIRECT )
FREQUENCY NORMALIZED SENS WITH RESPECT TO EACH VARIABLE ELEMENT
(NOTE: DRITS ARE %%; SENS LESS THAN .001 ARE SET TO ZERO)

```

FREQ	1-SIGMA	2-SIGMA	3-SIGMA	4-SIGMA	5-SIGMA
500.0	-.3016-01	.9413-01	1.310	.2107	.8776-01
625.0	-.7130-01	.6250-02	-.5510-01	.5710	-.2002
750.0	-.2150-01	-.3076-01	-.4330-01	-.7300-01	-.3092
	-.2167-01				-.1000



of the product is to erase with a wider track prior to writing new data. This allows the interchangeability of cassettes with a lower error rate. Two models are

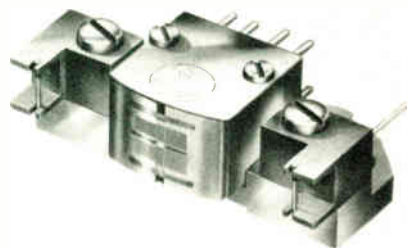

available: the single-channel AMCH-11-RWE and the dual-channel AMCH-21-RWE.

American Magnetics, 2424 Carson St., Torrance, Calif. 90501 [364]

### Buffer stores computer data for teleprinter

Data from a computer processor can be received by a slower teleprinter that is linked to the model 1300A storage unit. Data characters arriving at the buffer are stored in the electronic memory until read out by the printer, so that the buffer provides an on-line link between parts of a data system operating at different speeds. The buffer may also be used for temporary data storage with editing retransmission equipment. Price is \$1,595.

Plantronics, 385 Reed St., Santa Clara, Calif. 95050 [365]

### Optical reader scans 350 characters a second

An optical page and document reader, the model 170, is for applications in data communications. It

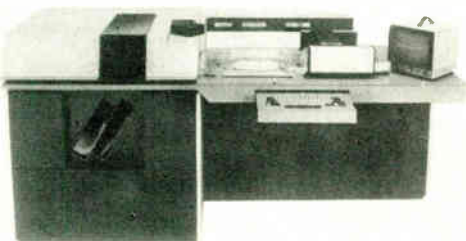

provides low-cost conversion of typewritten text and data to computer language, eliminating the need for double keyboarding. The unit scans documents at the rate of 350 characters per second, and accuracy is said to be less than one error in 500,000 characters. The unit can handle all types of printout.

Compuscan Inc., 900 Huyler St., Teterboro, N.J. 07608 [366]

### Tape drive reads, writes to 20 inches per second

With a read-write speed to 20 in./s, the model 172 digital cassette tape drive is specifically for use in low-cost, medium-performance data storage systems such as point-of-sale terminals, key-to-tape systems, and data-terminal storage. Search and

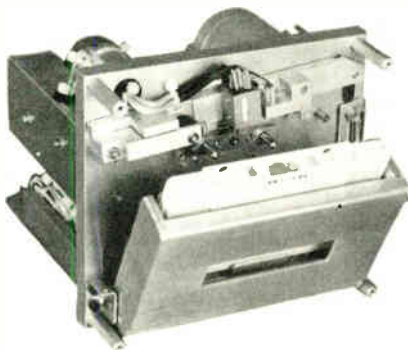

block read-write speeds are specified to 40 in./s, and wind speeds to 120 in./s. All three speeds have forward-reverse capability. Price is \$285 in 500-lots; a model with several extras, such as reel and capstan servo amplifiers, is priced at \$555 in the same quantity.

Dicom Industries, 715 N. Pastoria Ave., Sunnyvale, Calif. 94086 [367]

### Read-write display terminal built for dedicated systems

The model ASR208A1 serial display controller is a pollable read-write terminal with protected format, compressed transmission, and full error-detection capabilities. It is designed for OEM and end-user data inquiry and entry applications in



multi-terminal dedicated-line systems, and is RS232-compatible at up to 9,600 baud asynchronous. The unit displays up to 1,920 cursor-addressable characters in an 80-character-by-24-line format. Price is \$1,990, with OEM discounts available.

Ann Arbor Terminals Inc., 6107 Jackson Rd., Ann Arbor, Mich. 48103 [368]

### Add-on memory can be shared by two computers

An add-on memory system, part of the line of Expandacore-11 units, allows two PDP-11 minicomputers to share it. The memory also features a dual-port interface with two Unibus interconnections. The interconnections permit two PDP-11 processors or peripheral controllers to access a single memory directly. The self-powered memory is expandable in either 8,000- or 16,000-word modules from a minimum of 8,000 16-bit words up to 144,000 words.

Cambridge Memories Inc., 696 Virginia Rd., Concord, Mass. 01742 [369]

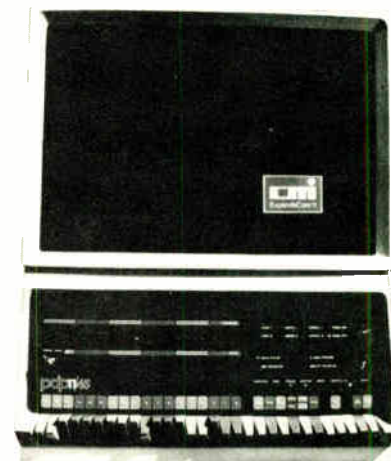

Packaging &amp; production

## Pc-board drill saves time

---

Chuck permits size change in 2 seconds; dynamic brake boosts throughput by 30%

---

Manufacturers of printed-circuit boards know all too well the labor burden entailed in changing from one drill size to another during a drilling operation. Removing and replacing a drill in a key- or collet-type chuck may require as much as a minute. Most quick-change chucks have another drawback. They limit the board stack height to 3/16 inch. But a new quick-change chuck called the Chagemaster Powerquill, manufactured by the Power Tool division, Rockwell International, enables an operator to change a drill in as little as 2 seconds. If this chuck is teamed with a dynamic brake that can bring a drill, whirling at 54,000 rpm, to a dead stop in 9 seconds, drilling throughput rises by 30%.

It now becomes faster to change drills than to change stacks of boards. And doing away with removal and replacement of stacks reduces the likelihood that hole centers will end up off true position. When four to six drill sizes are required in a board, it has been common to leave a bit in place, rather than tolerate the 45-to-60-second change time, and drill one stack after another. But each time a stack is removed and replaced, positioning errors may occur.

The new chuck differs from many



competing types in that it employs a positive drive, whereas most other quick-change systems employ centrifugal clutches, which by their nature confine the operating speed range to that necessary to hold the drill in place.

"Another problem with traditional quick-change chucks has been that they have usually had a common shank diameter and a short flute," says J.E. Frank, president of the Chicago Circuit Board Drilling Co., Palos Heights, Ill. Frank, who helped develop the new quick-change chuck, points out that the short-fluted drills can pass through no more than three 1/16-in. laminates. But standard bits are used in the Chagemaster Powerquill. They have a shank diameter that is the same as the flute diameter and will drill through four to five 1/16-inch laminates.

The heart of the quick-change drill system is a pneumatic-release tool-holder that handles straight-shank drills ranging in size from 0.013 in. (#80) to 0.250 in. A collet is used with all diameters through 3/16 in. The drill is locked into a holder and preset to depth on a bench. The operator merely presses a button to engage a pneumatic release, removes one drill, and inserts another.

The Chagemaster Powerquill is used in conjunction with a high-frequency 3/4-horsepower drive, which permits the operator to select a speed between 5,400 and 54,000 rpm. No-load to full-load speed varies no more than 5%.

Power Tool Division, Rockwell International, 3715 Blue River Rd., Racine, Wis. 53401 [391]

---

LED cartridges offer 180° viewing, low power

For light-emitting-diode applications, the TT-450 series cartridges are for jackfields that require long indicator life, low power demand, and integrated-circuit compatibility. The cartridges provide 180° of viewing and have current-limiting resistors built in. The cartridges are

patching-system components and have applications in telephone apparatus, switchboards, radio and television broadcast, and military

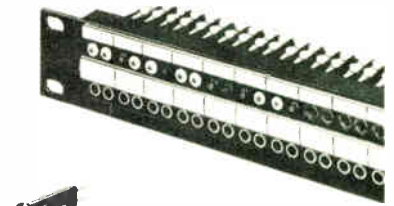

and ground-support equipment that require high-quality miniaturized patching systems. Standard voltages are 6, 24, and 48 v dc. Price is \$3.50. Switchcraft Inc., 5555 N. Elston Ave., Chicago, Ill. 60630 [395]

---

Circuit-board drill has 30 accessories

A new drill in the Mini-Drill line is called the Mini-Drill Jr. and comes with 30 accessories in a kit. The unit is a prototype and production hand tool and is said to cut printed-circuit-board production time by up to 30%, since it can be used to remove bridges, drill out closed up holes or

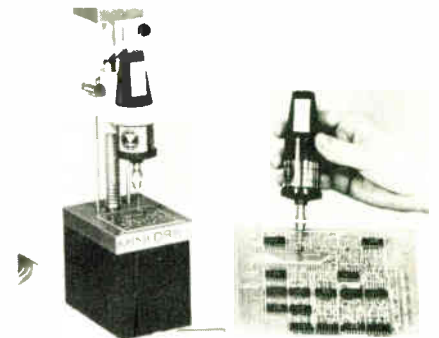

cut sections, with the milling heads supplied. Price is \$149.95.

Micro Electronic Systems Inc., 8 Kevin Dr., Danbury, Conn. 06810 [396]

---

28-pin connector pair inserts without strong force

A 28-pin high-density pin-and-socket connector pair has a contact configuration that has been designed to provide good contact and good current-carrying capacity with-

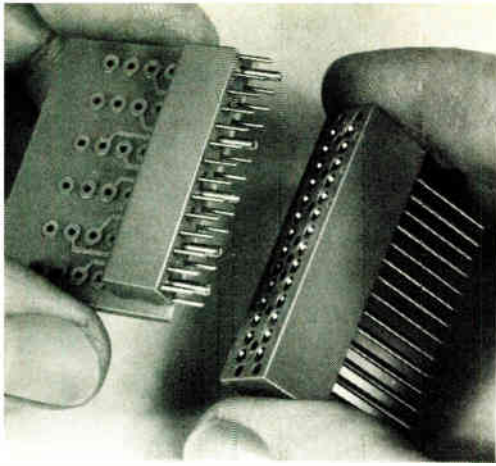

out high insertion forces. The connector, designated the 127 series, has contacts on 0.100-in. centers. The plugs have molded-in pin contacts with dip solder terminations, and they use rivets for positive attachment to pc boards. The connectors are rated at 3 amperes.

Amphenol Industrial Division, Bunker Ramo Corp., 1830 S. 54th Ave., Chicago, Ill. 60650 [393]

### Metered dispenser is for range of viscous materials

The 1000D electron pneumatic dispenser features 0.1-second pulses with  $\pm 1\%$  repeatability. Solid-state, precision control, and modular ac-



cessories allow the system to be tailored to dispense most anaerobic adhesives, epoxies, solder pastes, lubricants, and other viscous materials, from 1-cc syringes up to 12-ounce cartridges. Evaluation kits for two-part epoxy-mixing and loading systems are available, as well as five temperature solder-paste ranges. Price of the basic unit is \$195.

Electron Fusion Devices, 977 Waterman Ave., E. Providence, R.I. 02914 [397]

### Plate connector accepts Naval-standard pc modules

A plate-type connector for input-output applications accepts Naval Standard Hardware Program

printed-circuit modules. The connector is available in 1-, 2-, 3-, 4-, or 5-row sets, each with 20 contact positions. The 40 contacts per row are centered on a 0.100-inch grid; tails are 0.025 inch square for wire-

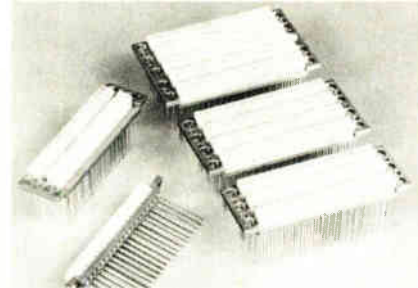

wrapping. The connector will also accept any standard male blade connector in the same grid pattern. Typical price for a lot of 100 is \$4.50 per row of 40 contacts. Delivery is from stock.

National Connector, 5901 S. Country Rd. 18, Minneapolis, Minnesota 55436 [398]

### Wafer-abrading machine handles 300 parts per hour

Designated the SWAM, a wafer-abrading machine removes oxides and evenly textures semiconductor slices. Production rates of better than 300 parts per hour can be achieved on 3-inch wafers. The unit transports the wafers on a 7-inch-wide endless belt under the reciprocating nozzle of an S.S. White model H airbrasive unit. The belt speed, nozzle, traverse speed, nozzle tip distance, air pressure, and flow of abrasive are all adjustable.

Crystal Mark Inc., 1613 W. Burbank Blvd., Burbank, Calif. 91506 [399]



# Bare bones recorders

Now, for the first time, you can buy an O.E.M. configuration recorder at the low O.E.M. price.

These are complete recorders. Included is precision high speed galvanometer (d.c. to 150 Hz) amplifier, power supply, and two paper speeds.

Save up to 50%... no fancy panels or cases... just the "barebones" of features, performance and quality.



A DIVISION OF ATLAN-TOL INDUSTRIES, INC.  
ATLAN-TOL INDUSTRIAL PARK  
WEST WARWICK, RHODE ISLAND 02893  
(401) 828-7010

\$286! One Channel

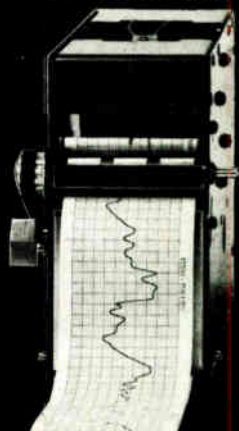

\$575! Two Channel

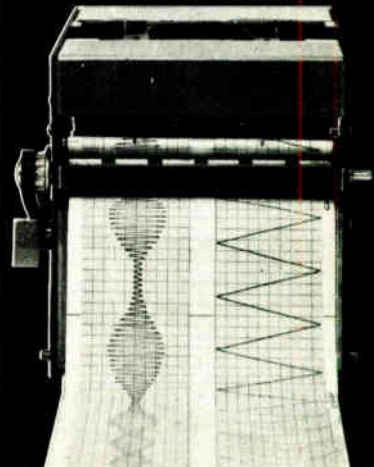

**A message from Kodak  
to a certain engineer/scientist  
who is very active  
in photosensor devices**

Though much too busy to be job-hunting, you are aware that now would be a good point in your career to move to an environment where technique is well developed for turning science into technology that society wants.

In the decade or more since taking your Ph.D. in solid-state physics or electrical engineering, you have built up sufficient experience in materials research and device development—and in the management thereof, with all the people problems and interface problems—to lead a sizable effort in the study and development of devices complementary to our proprietary technology in information recording.

If you exist and are ethically available, we sure want to meet you. The position is no minor one, and there is opportunity to grow even further.

**But don't hesitate to raise your hand** if 1) your experience is more in utilization of solid-state devices than in creating new ones, 2) you haven't been at it more than five years, 3) you have managed only a small number of engineers. You may still be the candidate who will lead another group at the Kodak Research Laboratories that is charged with the responsibility for bringing innovative imaging technologies somewhat closer to commercial fruition.

**Please communicate with Dr. D. B. Glass  
Business and Technical Personnel, Kodak  
Rochester, N. Y. 14650.**



An equal-opportunity employer m/f

CLASSIFIED ADVERTISING  
**SEARCHLIGHT SECTION**  
BUSINESS OPPORTUNITIES  
USED OR SURPLUS EQUIPMENT

**IMMEDIATE DELIVERY**  
**Minis & Peripherals**  
**DEC—HIS**  
**SEL—HP—NOVA**  
**Card, Printer, Tape, Disk**  
**TELETYPES**  
**33, 35, 37**  
For Sale/Rent  
**617/261-1100**  
*Send For FREE Price List*  
**AMERICAN USED COMPUTER CORP.**  
P.O. Box 68, Kenmore Sta., Boston, MA 02215

CIRCLE 951 DN READER SERVICE CARD  
**DIVERSAL NAMEPLATE CO.**  
**P.O. Box 2337**  
**San Antonio, Texas 78206**  
**stock anodized nameplates**

FORWARD		FAST
OFF	MONITOR	SLOW
REVERSE		AUTOMATIC

*catalog on request*  
CIRCLE 952 DN READER SERVICE CARD

**FREE CATALOG TOOLS**  
**HARD-TO-FIND PRECISION TOOLS**  
Lists more than 1700 items—pliers, tweezers, wire strippers, vacuum systems, relay tools, optical equipment, tool kits and cases. Also includes four pages of useful "Tool Tips" to aid in tool selection.  
**TENSEN TOOLS**  
4117 N. 44th Street, Phoenix, Ariz. 85018

CIRCLE 953 DN READER SERVICE CARD

**RADAR SYSTEMS GROUND AND AIRBORNE AUTOMATIC TRACKING ANTENNA SYSTEMS. NIKE AJAX NIKE HERCULES M-33 MSQ-1A MPS-19 MPS-9 SCR 584 TPS-1D TPS-2B FAA-ASR-2 AIRBORNE SYSTEMS APN-84 APN-107 APS-20 APS-27 APS-45 DPN-19 DIGITAL COMPUTERS IBM 650 IBM 704**  
LARGEST INVENTORY OF RADAR AND MICROWAVE EQUIPMENT IN THE WORLD  
**RADIO RESEARCH INSTRUMENT CO.**  
3 QUINCY ST., NORWALK, CONN. 06850 (703) 853-2600

CIRCLE 954 DN READER SERVICE CARD

**free catalog**  
**POTTING APPLICATORS**  
**MANUAL OR AIR OPERATED**  
2 1/2cc 6cc 12cc 30cc  
FOR POTTING, ENCAPSULATING ETC.  
**PHILIP FISHMAN CO., INC.**  
7 CAMERON ST. WELLESLEY, MASS. 02181

CIRCLE 956 DN READER SERVICE CARD

**FREE ALARM CATALOG**  
Full line of professional burglar and fire alarm systems and supplies. 80 pages, 400 items. Off-the-shelf delivery, quantity prices.  
**mountain west alarm**  
4215 n. 16th st., phoenix, az. 85016

CIRCLE 957 DN READER SERVICE CARD

**EMPLOYMENT OPPORTUNITIES**  
Send New Ads to:  
Electronics  
Class. Adv. Dept.  
P.O. Box 900, N.Y., N.Y. 10020

**POSITION VACANT**

**Electronics Shop Supervisor—This position** requires thorough familiarity with theory and practice of analog and digital scientific electronics equipment, circuitry, interfacing, etc. It entails both design and building, as well as maintenance of existing equipment. The supervisor is assisted in this task by two electronics engineers. Salary according to qualifications. Submit curriculum vitae, names of three references, salary requirements to James Franck Institute, University of Chicago, 5640 South Ellis Avenue, Chicago, Illinois 60637 (telephone 312; 753-8216).

**ZIP CODE  
MOVES THE MAIL**

**INFRARED VIEWERS & PARTS**  
TYPE 6929 INFRARED IMAGE TUBE...  
Late-date monovoltage Image Converter. Features high resolution & single input of 12,000 vdc. Self-focusing. 1.36" dia. by 2.33" long. Good Mfrs' seconds. Normal price \$170.00. New Surplus... **ONLY \$29.95 ppd.**  
FOR:  
•Crime Detection •Laser Study •Research  
**MINIATURE HIGH-VOLTAGE POWER SUPPLY**  
Solid state power supply for 6929 tube & 9902 Metascope. Input 1.34 vdc (RM-1R battery). Output 12,000 vdc. Size 1.0" dia. x 2.5" long. 1st-Quality. List \$350.00. **BRAND NEW... ONLY \$74.95 ppd.**  
**COMBINATION OFFER: 6929 Tube & Power Supply... \$99.95 ppd.**  
**COMPLETE METASCOPE INFRARED VIEWERS**  
Model 9902. Late-date Viewer utilizing 6929 tube. Military version of and identical to 5500C Metascope. Complete with light source. Ready to use. Current list \$675.00. **Like-New Surplus... \$225.00 ppd.**  
**McNEAL ELECTRIC & EQUIPMENT CO.**  
4736 Olive St. St. Louis, Mo. 63108

**HELP!**

- Q. How do I reply to a box number ad?**  
**A.** Address an envelope with the box number indicated in the ad, c/o Electronics, Class. Adv. Dept., P.O. Box 900, NY, NY 10020
- Q. Whom do I contact or call to re-new my classified ad or make corrections?**  
**A.** Write Electronics, Class. Adv. Dept., P.O. Box 900, NY, NY 10020 or call: (212) 997-6585 or 6586. Give full company name, size of ad, & date or dates it is scheduled to appear.

## New literature

**Wire wrapping.** A catalog from OK Machine and Tool Corp., 3455 Conner St., Bronx, N.Y., provides a description of wire-wrapping technology as applied to electronics and telecommunications. It includes charts of coltite bits and sleeves, sections on terminal spacing, and tool specifications. Circle 421 on reader service card.

**D-a converters.** A data sheet is available from Computer Labs, 1109 S. Chapman St., Greensboro, N.C. 27403, on fast-settling d-a converters. [422]

**Proximity switches.** Namco Controls, 170 E. 131st St., Cleveland, Ohio 44108. The series EE940 and series EE950 rf inductive proximity switches with fail-safe features are the subject of an eight-page brochure. [423]

**Spray etcher.** A two-page leaflet describes a 20-inch conveyORIZED spray etcher for printed-circuit-board production, manufactured by Chemcut Corp., 500 Science Park, State College, Pa. 16801. [424]

**Power supply.** Spellman High Voltage Electronics Corp., 1930 Adee Ave., Bronx, N.Y. 10469. A six-page catalog, number 7300, provides information on the company's line of high-voltage power supplies, including solid-state, regulated, unregulated, rack-mounted, miniature, modular, and series-regulated high-voltage types. [425]

**Logic cards.** The Tenor Co., 17020 W. Rogers Dr., New Berlin, Wis. 53151, has issued bulletin 700A, which describes solid-state logic cards and systems. The publication also gives information on mounting hardware and applications of the logic cards. [426]

**Product catalog.** The Hickok Electrical Instrument Co., 10514 Dupont Ave., Cleveland, Ohio 44108. A product-selection guide and catalog describes and illustrates the company's product line, which includes multimeters, oscilloscopes, and industrial card-readers. [427]

# IF THEY BUILD A BETTER MOUSETRAP, WE BUY IT.

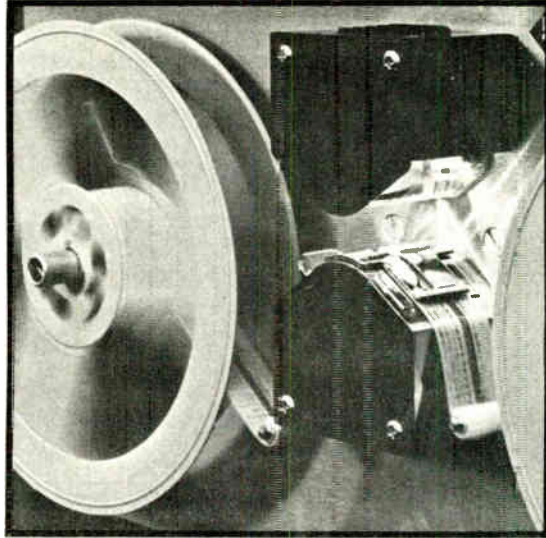

The computer controlled drilling machine is the newest and most precise way of ensuring that each hole in each printed circuit board is perfect. Like just about everything else in our five individual plants, it's the latest thing on the market. And like everything else in our plants, it's there to give you the best and most reliable printed circuit boards you can buy. We spend a lot of time and effort hunting up all the little things that add quality and reliability to our manufacturing processes. What it means to you is crack quality control, maximum reliability and on-time delivery. Whether your order is a single prototype or a production run of gold, solder mask over bare copper circuits, in plated through two-sided, or multi-layer boards. People have said we build a better mousetrap. Maybe that's because we buy a better mousetrap. Whenever we find it.



• 3475 Edward Avenue, Santa Clara, California 95052 • (408) 249-0464  
Manufacturing facilities located in Santa Clara, Stockton and Santa Ana.

Circle 123 on reader service card

Why mess around when you can have the **ELECTRONICS BOXER** clean up your copies—keep them in top condition.

And, it's easy and

**ELECTRONICS BOXER** in your corner. Just complete the coupon and mail. Your order will be processed immediately, postpaid.

### ELECTRONICS BOXER

Jesse Jones Box Corporation

2250 E. Butler St., Philadelphia, Pa. 19137

Please send me:  boxes @ \$4.25 each;  
 3 boxes @ \$12.00;  6 boxes @ \$22.00

My check or money order is enclosed.

Name \_\_\_\_\_

Address \_\_\_\_\_

City \_\_\_\_\_ State \_\_\_\_\_ Zip \_\_\_\_\_

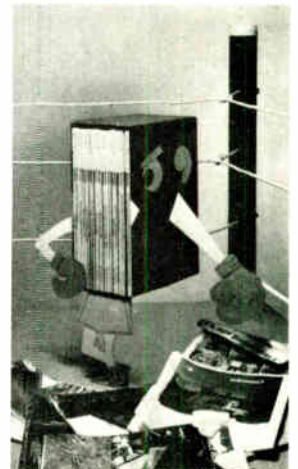

# USING ACTIVE FILTERS OR PASSIVE FILTERS ?

**Are size, shape or weight considerations important?  
Special mechanical configurations offered—Hermetically sealed or encapsulations for pcb installations**

**Low, high, band pass and reject designs—Butterworth, Chebishev, Bessel or elliptic response characteristics—wide range of source and load impedances**

**Low frequency actives, stable toroidal LC's, RC twin-T's**

**No EXTERNAL components required**

**Unbiased recommendations on active or passive filter selections for maximum economy**

**White**

**instruments, incorporated**

**PHONE AREA 512/892-0752 • P.O. Box 698 AUSTIN TEXAS 78767**

Circle 124 on reader service card



**YOU'RE WHISTLING IN THE DARK...**

if you think that heart disease and stroke  
hit only the other fellow's family.

**GIVE... so more will live  
HEART FUND**



*Contributed by the Publisher*

## New books

**Compatibility and Testing of Electronic Components**, by C.E. Jowett, Halsted Press, a division of John Wiley & Sons Inc., 345 pp., \$19.75

Microelectronics has spawned a whole slew of competing fabrication techniques in its short lifetime, and the process engineer is often hard put to choose from the various materials and processes. This book can help because its scope is quite broad, covering a myriad of thin- and thick-film topics.

But it is not aimed at the beginner. He would be better served by reading "Thick Film Hybrid Micro-electronic Technology" by Hamer and Biggers [*Electronics*, Dec. 4, 1972, p. 156].

Jowett has several decades of experience in the reliability of the fabrication processes in these fast changing technologies. In the thin-film area, he covers the use of tantalum, failure modes in thin-film circuits, and vacuum deposition of thin-film organic layers. Thick-film topics include the screening and firing of crossover dielectrics and adhesion of conductive and resistive inks. Another chapter surveys the bonding of chips to substrates. Especially interesting is a chapter dealing with infrared radiation as a technique for reliability screening.

Jowett questions the validity of certain environmental tests in his chapter on "The Purpose of Testing." He points out, for example, that salt spray just isn't the all-purpose accelerated corrosion test many think it is. Jowett contends that there is seldom a direct relationship between resistance to salt spray and resistance to corrosion in other environments—even marine atmospheres. But he says the test is satisfactory in evaluating the porosity of protective coatings.

Although there are a number of books which describe the techniques of microelectronics with more and better illustrations, few of their authors are as successful as Jowett in developing capsule synopses of both processes and materials and placing them in perspective.

Stephen E. Grossman,  
Packaging & Production Editor

<b>Abbott Transistor Labs Inc.</b> Technical Adv. Agency	6	<b>Macrodata Company</b> JMR Advertising	114
<b>Allen-Bradley Company</b> Hoffman, York, Baker & Johnson, Inc.	34	<b>M C L, Inc.</b> Carr Liggett Advertising, Inc.	100
<b>‡ Allied Chemical Corporation</b> (Specialty Chemical Division) E. S. Fuller, Inc.	12-13	<b>‡ Microdata Corporation</b> James Brunton Advertising	54
<b>■ Amphenol Components Group— Bunker Ramo Corp.</b> Marsteller, Inc.	28-29	<b>Micro Power Systems</b> Associated Ad Ventures, Inc.	67
<b>■ Analog Devices Inc.</b> Schneider Parker Guy Inc.	60	<b>■ 3M Company—Mincor Division</b> D'Arcy-MacManus & Masius, Inc.	95
<b>Analogic Corporation</b> Grover and Erickson Inc.	45	<b>Motorola Semiconductor Products, Inc.</b> E. B. Lane & Associates, Inc.	32-33
<b>AP Products Incorporated</b> H. J. Venaleck Advertising	72	<b>National Electronics</b> Lea Advertising	70
<b>Astro-Med</b> Michael London Associates	121	<b>• Phillips N. V. Pll/T &amp; M Division</b> Marsteller International S. A.	56
<b>‡ Bourns, Inc.</b> Marlborough Assoc., Inc.	109	<b>Phoenix Data</b> Craig Miller Advertising	116
<b>Burroughs Corp.</b> Conti Advertising Agency Inc.	2	<b>■ Powercube Corporation, Div. of Unitrode</b> Advertising Assistance, Inc.	15
<b>■ Busmann Mfg. Division of McGraw-Edison Co.</b> Henderson Advertising Company	49	<b>• Raytheon Microwave &amp; Power Tube Division</b> Provandie Eastwood & Lombardi, Inc.	54
<b>CamperRent International Systems, Inc.</b> Recreational Marketing Associates	148	<b>■ RCL Electronics, Inc.</b> Monvay Advertising Agency	14
<b>■ Clairax Corporation</b> Black-Russell-Morris	4th Cover	<b>‡ Rental Electronics, Inc.</b> Humphrey Browning MacDougall, Inc.	56
<b>■ Concord Electronics Corp.</b> Sound Advertising	68	<b>• Rohde &amp; Schwarz</b>	1E
<b>Counterscan Systems</b>	70	<b>Sangamo Electric Company</b> Winius-Brandon Company	69
<b>Data General Corporation</b> The Advertising Group	10-11	<b>Schauer Manufacturing Corp.</b> Noian, Keeler & Sites	126
<b>Divis, Inc.</b> Halloff & Caine	2nd Cover	<b>Signetics Corp., Sub. of Corning Glass Works</b> Hall Butler B at network, Inc.	27
<b>EIP Labs</b> Dailey & Associates Advertising	1	<b>Siliconix</b> Robertson West, Inc.	96
<b>Elec-Trol, Inc.</b> S. Michelson Advertising	30	<b>■ Sprague Electric Company</b> Harry P. Bridge Company	8
<b>Electronic Arrays, Inc.</b> Regis McKenna, Inc.	59	<b>Standard Memories, Inc.</b> Hall & McKenzie	53
<b>■ Electronic Navigation Industries</b> Hart Conway Co., Inc.	9	<b>■ Systron Donner Concord Instruments</b> Bonfield Associates	31
<b>Emr-Telemetry</b> Carol Marketing Associates	50	<b>Thermalloy</b> Warren-Guild	126
<b>• English Electric Valve Co. Ltd.</b> The London Advertising Partnership	6E-7E	<b>■ Topaz Electronics</b> Mesa Copy	68
<b>Fluke Manufacturing Co., John</b> Bonfield Associates	100	<b>TRW/IRC Resistors</b> Gray & Rogers, Inc.	63
<b>■ General Electric Electronic Components</b> Robert S. Cragin, Inc.	38	<b>TRW Electronics, Semiconductor Division</b> The Bowes Company	7
<b>• General Radio</b> Grad Associates	5E	<b>■ Unitrode Corporation</b> Impact Advertising	37
<b>• Golden Gate Enterprises</b> Ad-Ventures	9E-12E	<b>Webtek Corporation</b> J. R. Bloomer Company	125
<b>■ Gould, Inc./Instruments Systems Div.</b> Carr Liggett Adv., Inc.	100	<b>White Instruments, Inc.</b> Wilson & Associates, The Art Studio, A Division of Graphic Studios	124
<b>■ Hewlett-Packard, Electronics Products Group</b> Corporate Marketing Communications	17-26	<b>Wima, Westermann</b>	16
<b>Hughes Aircraft Company</b> Foote, Cone & Belding	46-47	<b>Xerox</b> Needham, Harper & Steers Advertising, Inc.	74
<b>Hutson Industries</b> Warren-Guild	30		
<b>Intel Corporation</b> Regis McKenna, Inc.	71,73		
<b>Interdata</b> Shaw Elliott, Inc.	110		
<b>■ Kepco Incorporated</b> Weiss Advertising	5		
<b>■ Lambda Electronics Corporation</b> Michel Cather, Inc.	3rd Cover		
<b>Lika Corporation</b> Moorhead Marketing	123		

### Classified & Employment Advertising

<b>EQUIPMENT (Used or Surplus New) For Sale</b>	
American Used Computer Corp. ....	122
Diversal Nameplate Co. ....	122
Fishman, Philip Co., Inc. ....	122
Jensen Tools ....	122
Kodak ....	122
Mountain West Alarm ....	122
Radio Research Instrument Co. ....	122

• For more information on complete product line see advertisement in the latest Electronics Buyer's Guide  
 • Advertisers in Electronics International only  
 ‡ Advertisers in Electronics domestic edition only

**TRY SOME  
FREE SAMPLES  
OF BY-BUK  
PROFESSIONAL  
QUALITY  
ELECTRONIC  
CIRCUITRY  
DRAFTING  
AIDS.**

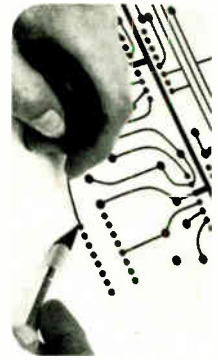

It's our way of proving that artwork layout accuracy can be accomplished in seconds with By-Buk pressure sensitive drafting aids.

We'll also send you our catalog featuring thousands of ideas in individually die cut artwork patterns and conductor line tapes to connect them with.

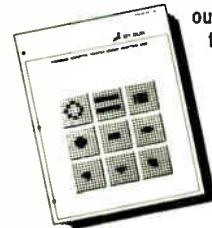

**WEBTEK  
CORPORATION**

4326 W. Pico Blvd., Los Angeles, CA 90019  
(213) 937-3511

Circle 125 on reader service card

# RENT FUN

Great family adventure in the only one-way camper rentals (also 2-ways). Pick us up in most major cities and, if you wish drop off in another. Our modern campers feature full conveniences, sleep 4—enjoy one for about the price of a station wagon rental.

800-228-9696

TOLL FREE



CamperRent International System, Inc.  
3100 East Oakland Park Boulevard  
Fort Lauderdale, Florida 33308

Please send me information on CamperRent

Name \_\_\_\_\_

Address \_\_\_\_\_

City \_\_\_\_\_ State \_\_\_\_\_

Zip \_\_\_\_\_ Phone \_\_\_\_\_

# NEW SHORTER CASE! SCHAUER 1-WATT ZENERS

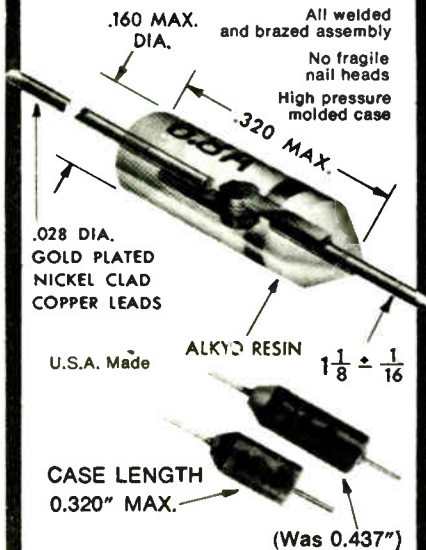

**SAME LOW PRICES FOR  
1% TOLERANCE ZENERS  
ANY VOLTAGE  
FROM 2.0 TO 18.0**

Quantity	Price Each
1-99	\$1.07
100-499	.97
500-999	.91
1000-4999	.86
5000 up	.82

**IMMEDIATE SHIPMENT**  
Send for rating data and  
20%, 10%, 5% and 2%  
tolerance prices.

Semiconductor Division

## SCHAUER

MANUFACTURING CORP.

4514 Alpine Ave., Cincinnati, Ohio 45242  
Telephone 513/791-3030

### Advertising Sales Staff

**Pierre J. Braudé** [212] 997-3485  
Advertising Sales Manager

**Atlanta, Ga. 30309:** Joseph Lane  
100 Colony Square, 1175 Peachtree St., N.E.  
[404] 892-2868

**Boston, Mass. 02116:** James R. Pierce  
607 Boylston St. [617] 262-1160

**Chicago, Ill. 60611:**  
645 North Michigan Avenue  
Robert W. Bartlett (312) 751-3739  
Paul L. Reiss (312) 751-3738

**Cleveland, Ohio 44113:** William J. Boyle  
[716] 586-5040

**Dallas, Texas 75201:** Charles G. Hubbard  
2001 Bryant Tower, Suite 1070  
[214] 742-1747

**Denver, Colo. 80202:** Harry B. Doyle, Jr.  
Tower Bldg., 1700 Broadway  
[303] 266-3863

**Detroit, Michigan 48202:** Robert W. Bartlett  
1400 Fisher Bldg.  
[313] 873-7410

**Houston, Texas 77002:** Charles G. Hubbard  
2270 Humble Bldg. [713] CA 4-8381

**Los Angeles, Calif. 90010:** Robert J. Rielly  
Bradley K. Jones, 3200 Wilshire Blvd., South Tower  
[213] 487-1160

**New York, N.Y. 10020**  
1221 Avenue of the Americas  
Warren H. Gardner [212] 997-3617  
Michael J. Stoller [212] 997-3616

**Philadelphia, Pa. 19102:** Warren H. Gardner  
Three Parkway, [212] 997-3617

**Pittsburgh, Pa. 15222:** Warren H. Gardner  
4 Gateway Center, [212] 997-3617

**Rochester, N.Y. 14534:** William J. Boyle  
9 Greylock Ridge, Pittsford, N.Y.  
[716] 586-5040

**San Francisco, Calif. 94111:** Don Farris  
Robert J. Rielly, 425 Battery Street,  
[415] 362-4600

**Paris:** Alain Offergeld  
17 Rue-Georges Bizet, 75 Paris 16, France  
Tel: 720-73-01

**Geneva:** Alain Offergeld  
1 rue du Temple, Geneva, Switzerland  
Tel: 32-35-63

**United Kingdom:** Keith Mantle  
Tel: 01-493-1451, 34 Dover Street, London W1

**Milan:** Robert Saidel  
1 via Baracchini Phone 86-90-656

**Brussels:** Alain Offergeld  
23 Chaussee de Wavre  
Brussels 1040, Belgium  
Tel: 13-73-95

**Stockholm:** Brian Bowes  
Office 17, Kontor-Center AB, Hagagarten 29,  
113 47 Stockholm. Tel: 24 72 00

**Frankfurt/Main:** Fntz Krusebecker  
Liebigstrasse 27c  
Phone 72 01 81

**Tokyo:** Tatum Katagiri, McGraw-Hill  
Publications Overseas Corporation,  
Kasumigaseki Building 2-5, 3-chome,  
Kasumigaseki, Chiyoda-Ku, Tokyo, Japan  
[581] 9811

**Osaka:** Ryji Kobayashi, McGraw-Hill  
Publications Overseas Corporation, Kondo  
Bldg., 163, Umegae-cho Kita-ku [362] 8771

**Australasia:** Warren E. Ball, IPO Box 5106,  
Tokyo, Japan

### Business Department

**Stephen R. Weiss, Manager**  
[212] 997-2044

**Thomas M. Egan,**  
Production Manager [212] 997-3140

**Carol Gallagher**  
Assistant Production Manager [212] 997-2045

**Dorothy Carter,** Contracts and Billings  
[212] 997-2908

**Frances Vallone,** Reader Service Manager  
[212] 997-6057

### Electronics Buyers' Guide

**George F. Werner,** Associate Publisher  
[212] 997-3139

**Regina Hera,** Directory Manager  
[212] 997-2544

# MAKES MICA OBSOLETE!

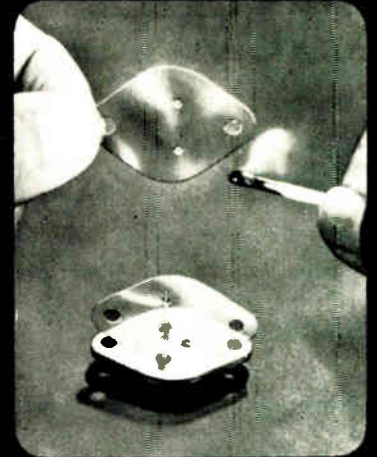

## NEW! THERMA-FILM WASHERS

### THERMA-FILM

is a newly developed insulating material that makes mica obsolete. Just check these advantages:

- WON'T CHIP, CRACK, PEEL OR BREAK
- 7,000 VOLTS/MIL DIELECTRIC STRENGTH
- TEMPERATURE RANGE -269°C to +400°C
- THERMAL RESISTANCE OF 0.6°C/watt
- PRICED THE SAME AS MICA
- REDUCES REJECTS AND IMPROVES RELIABILITY OF YOUR EQUIPMENT



Write for  
**FREE**  
Catalog

## Thermalloy

P. O. Box 34829  
2021 W. Valley View  
Dallas, Texas 75234  
Phone: 214/243-4321  
TWX: 910/860-5542



Do you face  
a make or buy  
decision on  
power supplies?

# BUY LAMBDA'S LT SERIES 25 MODELS, 3 PACKAGE SIZES, ALL 5-YEAR GUARANTEED.

Line regulation: 0.02%; Load regulation: 0.15%;  
Ripple and noise: 1.5 mV RMS;  
Temp. coef.: 0.01%/°C; AC input: 105-132Vac.

### LTS-CA SINGLE OUTPUT MODELS

4<sup>29</sup>/<sub>32</sub>" x 4<sup>15</sup>/<sub>16</sub>" x 9<sup>5</sup>/<sub>16</sub>"

MODEL	FIXED VOLT. RANGE VDC	MAX. AMPS AT AMBIENT OF:			PRICE	
		40 C	50 C	60 C		
LTS-CA-5-OV*	5±1%	7.0	6.5	5.8	4.8	\$80
LTS-CA-6	6±1%	6.6	6.2	5.5	4.6	80
LTS-CA-12	12±1%	4.4	4.1	3.8	3.2	80
LTS-CA-15	15±1%	4.0	3.7	3.4	3.1	80
LTS-CA-20	20±1%	3.1	2.9	2.7	2.4	80
LTS-CA-24	24±1%	2.6	2.4	2.2	2.0	80
LTS-CA-28	28±1%	2.2	2.2	2.0	1.8	80

\*Includes fixed overvoltage protection at 6.8V±10%

### LTS-DC SINGLE OUTPUT MODELS

4<sup>29</sup>/<sub>32</sub>" x 7<sup>1</sup>/<sub>2</sub>" x 10<sup>1</sup>/<sub>2</sub>"

MODEL	FIXED VOLT. RANGE VDC	MAX. AMPS AT AMBIENT OF:			PRICE
		40 C	50 C	60 C	
LTS-DC-5-OV*	5±1%	17.0	14.5	12.0	\$150
LTS-DC-6	6±1%	16.0	14.0	12.0	150
LTS-DC-12	12±1%	11.0	9.7	8.6	150
LTS-DC-15	15±1%	10.0	8.8	7.7	150
LTS-DC-20	20±1%	8.0	7.1	6.0	150
LTS-DC-24	24±1%	7.1	6.4	5.4	150
LTS-DC-28	28±1%	6.0	6.0	5.0	150

\*Includes fixed overvoltage protection at 6.8V±10%

### LTD-CA DUAL OUTPUT MODELS

4<sup>29</sup>/<sub>32</sub>" x 4<sup>15</sup>/<sub>16</sub>" x 9<sup>5</sup>/<sub>16</sub>"

MODEL	FIXED VOLT. RANGE VDC	MAX. AMPS AT AMBIENT OF:			PRICE	
		40 C	50 C	60 C		
LTD-CA-152	±15±1%	2.0	1.8	1.7	1.5	\$110
LTD-CA-122	±12±1%	2.0	1.8	1.7	1.5	110

### LTS-DB SINGLE OUTPUT MODELS

4<sup>29</sup>/<sub>32</sub>" x 7<sup>1</sup>/<sub>2</sub>" x 10<sup>1</sup>/<sub>2</sub>"

MODEL	FIXED VOLT. RANGE VDC	MAX. AMPS AT AMBIENT OF:			PRICE
		40 C	50 C	60 C	
LTS-DB-5-OV*	5±1%	12.0	10.8	9.0	\$130
LTS-DB-6	6±1%	11.0	9.9	8.2	130
LTS-DB-12	12±1%	7.6	6.7	5.7	130
LTS-DB-15	15±1%	7.2	6.4	5.4	130
LTS-DB-20	20±1%	6.0	5.3	4.5	130
LTS-DB-24	24±1%	5.5	4.9	4.1	130
LTS-DB-28	28±1%	4.0	4.0	3.7	130

\*Includes fixed overvoltage protection at 6.8V±10%

### LTD-DB DUAL OUTPUT MODELS

4<sup>29</sup>/<sub>32</sub>" x 7<sup>1</sup>/<sub>2</sub>" x 10<sup>1</sup>/<sub>2</sub>"

MODEL	FIXED VOLT. RANGE VDC	MAX. AMPS AT AMBIENT OF:			PRICE
		40 C	50 C	60 C	
LTD-DB-152	±15±1%	3.8	3.2	2.6	\$160
LTD-DB-122	±12±1%	4.0	3.4	2.8	160

## 1-DAY DELIVERY



\$80

LTS-CA-5-OV  
5V, 7A

\$130

LTS-DB-5-OV  
5V, 12A

\$150

LTS-DC-5-OV  
5V, 17A

**LAMBDA**  
ELECTRONICS CORP.

A Veraco Company

MELVILLE, NEW YORK 11746 515 Broad Hollow Road Tel. 516-694-4200  
 ARLINGTON HEIGHTS, ILL. 60005 2420 East Oakton St., Unit Q Tel. 312-593-2550  
 NORTH HOLLYWOOD, CALIF. 91605 7315 Varna Ave. Tel. 213-875-2744  
 MONTREAL, QUEBEC 100C Hymus Blvd., Pointe Claire, Quebec 730 Tel. 514-697-6520  
 PORTSMOUTH, HANTS, ENG. Marshlands Road, Farlington Tel. Cosham 73221  
 VERSAILLES, FRANCE 64a 70 rue des Chantiers 78004 Tel. 950-2224

Send for free  
LAMBDA POWER SUPPLY  
APPLICATION HANDBOOK  
& CATALOG



Circle 901 on reader service card

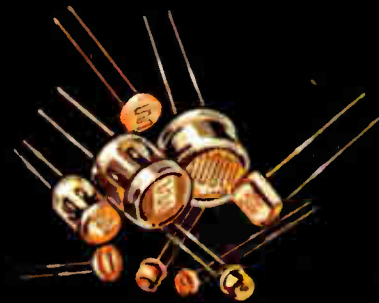
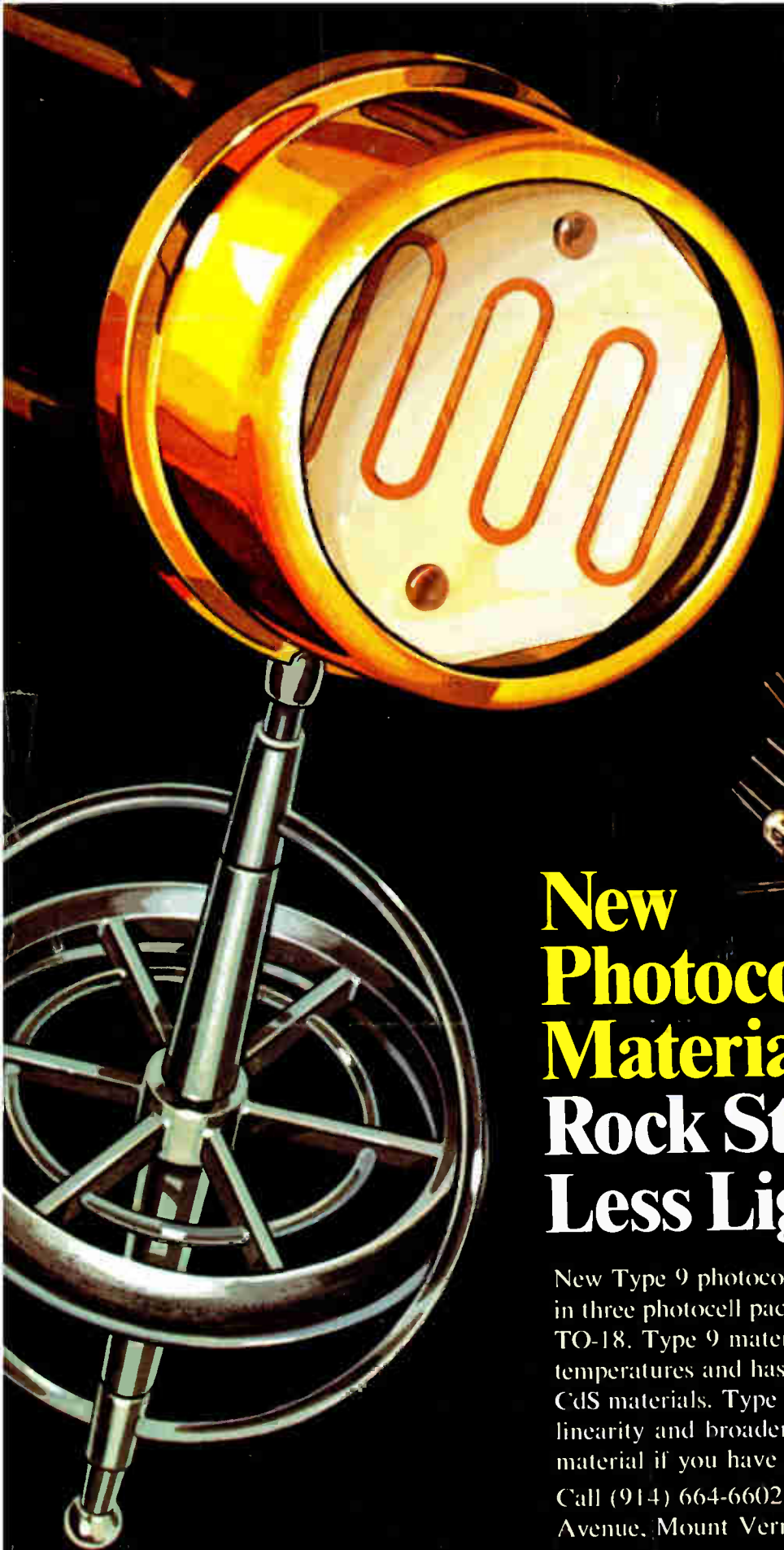

# New Photoconductive Material Rock Stable... Less Light Memory

New Type 9 photoconductive material is now available in three photocell packages from Clairex — TO-5, TO-8, TO-18. Type 9 material is more stable at high temperatures and has less light memory than normal CdS materials. Type 9 material also has improved linearity and broader spectral response. Try Type 9 material if you have photocell stability problems.

Call (914) 664-6602 or write Clairex<sup>®</sup>, 560 South Third Avenue, Mount Vernon, New York 10550.

## CLAIREX ELECTRONICS

A DIVISION OF CLAIREX CORPORATION

Circle 902 on reader service card