

- 94 How Japan's EEs are challenging U.S. technology
- 102 Transferred-electron devices move into microwave systems
- 109 Eliminating op amp errors with automatic zero correction

Electronics®

INTEGRATION
BRINGS A
NEW
GENERATION
OF
TRANSDUCERS



1420 N.1302 BOMAT NOV74
MATT NEILL
3022 NE BROADWAY
PORTLAND OR 97232

14 NEW Lowest Cost Spectrum Analyzers

From Sub-Audio to Microwave

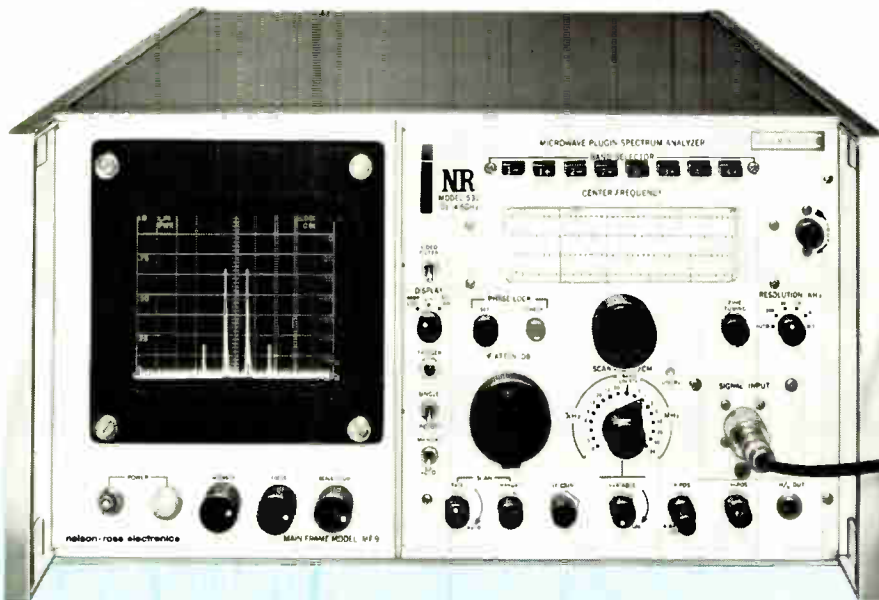

Nelson Ross Spectrum Analyzer Model 531

10 MHz to 4.5 GHz
Dispersion 0-1 GHz
Phase locked 1 KHz resolution
Price: \$3,050

Nelson Ross, the specialist in Spectrum Analyzers, has the **Biggest Selection, Most Versatile Specifications and Proven Reliability . . . All This For The Lowest Prices.**

Now you can select a Spectrum Analyzer from 0.5 Hz to 6.5 GHz which is just right for your application. And, with Nelson Ross you'll save 50% or more by not paying for unnecessary extras that you'll probably never use.

The versatile Spectrum Analyzers illustrated here are typical of 14 complete analyzers and more than 30 plug-in analyzers available from Nelson Ross.

The complete instruments include the new MF-9 Calibrated Display Main Frame which provides bright, long persistence

8x10cm readouts, adjustable scale illumination and camera mount facility.

Our plug-in analyzers come in 3 complete series: • for the Tektronix "540/550 letter" series scopes • for the Tektronix 560 series scopes • for the HP 140/141 series scopes and the Nelson Ross MF-9 Display Main Frame.

Compare specifications, quality, ease of use and price. We're sure you'll join the thousands who have been selecting Nelson Ross Spectrum Analyzers for more than a decade.

Call, write or circle the Reader Service Number to get your new Nelson Ross Spectrum Analyzer Catalog. Then you can compare and save.

Typical Plug-In Spectrum Analyzers for Nelson Ross MF-9 Display Main Frame or HP 140/141 series scopes.

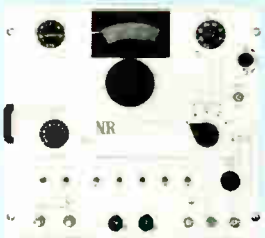

Sub-Audio: Model PSA-036
0.5 Hz - 2 KHz
0.5 Hz Resolution
Plug-In: \$1,200
With MF-9: \$2,200

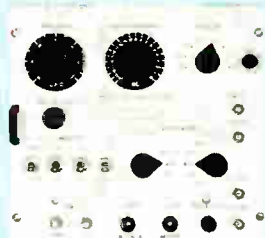

Broadband: Model PSA-235
1 KHz - 25 MHz
200 Hz Resolution
Plug-In: \$1,700
With MF-9: \$2,700

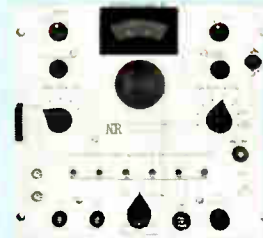

Audio: Model PSA-031
10 Hz - 20 KHz
10 Hz Resolution
Plug-In: \$ 850
With MF-9: \$1,850



RF-TV: Model CATV
1 MHz - 300 MHz
Plug-In: \$1,500
With MF-9: \$2,500

Typical of more than 25 Plug-In Analyzers for use with Tektronix scopes.



For "540/550 letter" series
SSB Narrow-Band RF
Model PSA-201
0.6 - 36 MHz
10 Hz Resolution
\$1,675



For 560 Series
Ultrasonic
Model PSA-023
0.15 - 500 KHz
150 Hz Resolution
\$850

nelson • ross electronics

A DIVISION OF POLARAD ELECTRONICS CORP.
5 Delaware Drive
Lake Success, New York 11040
516 - 328-1100 • TWX: 510 - 223-0414

Circle 900 on reader service card

from the **HAMILTON** tradition of fine watchmaking...



Hamilton metal science

...a new name for advanced technology of metals

You knew us as Hamilton Precision Metals. Now, know us as Hamilton Metal Science. A name that better reflects the scope of our business and our products. A new name that more clearly embodies our present and planned products, processes and critical technologies. Our new triangular logo signifies our multifaceted operation: metals processing, parts fabrication, advanced products. The logo's delta symbol, meaning change, reflects our determination to be even more responsive to customer needs. The red growth bar describes the forward thrust of Hamilton—today and in the future.



A new name for precision strip and foil
Ultrathin foil to 0.000070". Precision strip and wire. In the size, quality, dimensional tolerance, surface finish you require. Absolutely to specifications. From specialty melting through precision rolling, we deliver a wide range of precision products you can rely on. Tight production controls assure material integrity.

More on
metals processing?

Circle No. 241

 Hamilton metal science

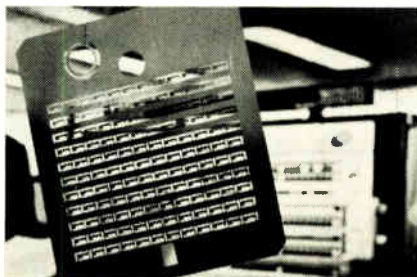

A new name for photoformed parts
Photoforming responds to the expanding need for critical tolerance parts: everything from magnetic recording head laminations to TV tube and solar cell grids to high-speed printer tapes. This advanced chemical-etching process assures low-cost parts within your strict design limitations. Dimensional stability and fast delivery is guaranteed.

More
Photoforming details?

Circle No. 242

 Hamilton metal science



A new name for precision components
Hamilton expertise is expanding swiftly in metals processing, parts manufacturing, magnetic material manufacturing and testing, and functional engineering to supply subassemblies, devices and finished components. Single-source, in-house solutions to components and device assembly problems lift many burdens from customers, result in cost savings and improved product quality.

New literature!

Circle No. 243

 Hamilton metal science

a division of HMW Industries, Inc., P.O. Box 1707, Lancaster, Pa. 17604

39 Electronics Review

PATENTS: Supreme Court says software can't be patented, 39
INTEGRATED ELECTRONICS: Semiconductor inductance device, 40
DISPLAYS: Smectic LC used at Bell Labs, 41
DISPLAYS: IBM lab turns to tungsten, 41
INSTRUMENTATION: Scope features built-in multiplier, 42
COMMUNICATIONS: Private TV gains momentum, 44
AUTOMOTIVE ELECTRONICS: RCA's BITE tests Army vehicles, 44
COMMERCIAL ELECTRONICS: Investigations stir BART's pot, 47
INDEX OF ACTIVITY: 47
OPTOELECTRONICS: NBS light-speed test opens frequencies, 49
SPACE ELECTRONICS: Last Apollo to carry new experiments, 50
NEWS BRIEFS: 50

63 Electronics International

WEST GERMANY: Nixdorf buys first U.S. subsidiary, 63
WEST GERMANY: Boron implanting improves CCD memory, 63

69 Probing the News

MANUFACTURING: A new offshore explosion, 69
AVIONICS: Computerized en-route ATC abroad, 74
AEROSPACE: Digital fly-by-wire nears launch, 76
PEOPLE: Dan Noble's past is link to the future, 80

83 Technical Articles

INSTRUMENTATION: Integration brings low-cost transducers, 83
DESIGNER'S CASEBOOK: Staircase generator resists drift, 90
Binary division produces harmonic frequencies, 91
Four-ampere power supply costs just \$13 to build, 91
SPECIAL REPORT: Can trying harder put Japan's EEs ahead of U.S.? 94
SOLID STATE: Transferred-electron devices used more in systems, 102
CIRCUIT DESIGN: Dynamic zero-correction suppresses error, 109
ENGINEER'S NOTEBOOK: Evaluating power loss in microcircuits, 111
Guidelines for design of front panels, 112
Light-emitting diode doubles as sensor, 113

117 New Products

IN THE SPOTLIGHT: A-d converter resolves 16 bits in 8 μ s, 117
INSTRUMENTS: 80-MHz counter costs only \$325, 119
SUBASSEMBLIES: Photoelectric control devices use LEDs, 125
SEMICONDUCTORS: Two-color LED lamps aimed at consumer jobs, 130
PACKAGING & PRODUCTION: Interconnections reduced by half, 139
MATERIALS: 148

Departments

Publisher's letter, 4
Readers comment, 6
40 years ago, 8
People, 14
Meetings, 30
Electronics newsletter, 35
Washington newsletter, 57
Washington commentary, 58
International newsletter, 65
Engineer's newsletter, 115
New literature, 152
New books, 156

Highlights

Where the new offshore labor markets are, 69

Malaysia and Portugal are already providing electronic-component manufacturers with low-cost labor. Hong Kong, an older offshore labor source, is suffering from the rising wages typical of economies with nearly full employment.

The first IC-style transducer, 83

Fabricating transducers in the form of hybrid ICs not only brings them into line with the other components of an electronic system—it radically simplifies calibration and testing. High accuracy becomes practical at low cost.

Japanese EEs are bidding to be No. 1, 94

The continued success of their electronic products has bred in Japanese EEs a self-confidence that now aims to originate, not imitate. They rely on a team approach to problems, but as team members work more interdependently than is usual in the West.

Transferred-electron devices go commercial, 102

Now that practical TE oscillators and amplifiers have arrived, they demand—and in this article get—an evaluation of their merits in relation to other microwave components.

And in the next issue . . .

Electronics' nation-by-nation forecast of the European market . . . optimizing a memory system with the 4-kilobit RAM.

The cover

Pressure gage is upstaged by National Semiconductor's integrated-circuit approach to transducer fabrication.

EDITOR-IN-CHIEF: Kemp Anderson

EXECUTIVE EDITOR: Samuel Weber

MANAGING EDITORS: Lawrence Curran, *News*;
Arthur Erikson, *International*

SENIOR EDITORS: John Johnsrud,
H. Thomas Maguire, Laurence Altman

ART DIRECTOR: Fred Sklenar

ASSOCIATE EDITORS: Richard Gundlach,
John N. Kessler, Howard Wolff

DEPARTMENT EDITORS

Aerospace: William F. Arnold
Circuit Design: Lucinda Mattera
Communications & Microwave:

Lyman J. Hardeman

Computers: Wallace B. Riley

Consumer: Gerald M. Walker

Industrial: Alfred Rosenblatt

Instrumentation: Michael J. Riezenman

Military: Ray Connolly

New Products: H. Thomas Maguire

Packaging & Production: Stephen E. Grossman

Solid State: Laurence Altman

Special Issues: Harry R. Karp

COPY EDITORS: Margaret Eastman,
Everett C. Terry

ASSISTANT EDITOR: Marilyn Offenheiser

ART: Charles D. Ciatto, *Associate Director*

PRODUCTION EDITORS:
Patricia Cybulski, Arthur C. Miller

EDITORIAL SECRETARIES: Janet Annunziata,
Julie Gorgogione, Penny Roberts

FIELD EDITORS

Boston: James Brinton (Mgr.), Gail Farrell

Los Angeles: Paul Franson (Mgr.)

Midwest: Larry Armstrong (Mgr.)

New York: Alfred Rosenblatt (Mgr.)

San Francisco: Stephen Wm. Fields (Mgr.),

Judith Curtis

Washington: Ray Connolly (Mgr.),

William F. Arnold

Frankfurt: John Gosch

London: Michael Payne

Paris: Arthur Erikson

Tokyo: Charles Cohen

McGRAW-HILL WORLD NEWS

Director: Walter A. Stanbury

Bonn: Robert Ingersoll;

Brussels: James Smith;

London: Marvin Petal;

Milan: Peter Hoffmann, Andrew Heath;

Moscow: Axel Krause;

Paris: Stewart Toy, Michael Johnson;

Stockholm: Robert Skole;

Tokyo: Mike Mealey

PUBLISHER: Dan McMillan

ADVERTISING SALES MANAGER: Pierre J. Braudé

ADVERTISING SALES SERVICE MANAGER:
Wallis Clarke

BUSINESS MANAGER: Stephen R. Weiss

CIRCULATION MANAGER: George F. Werner

MARKETING SERVICES MANAGER:
Tomlinson Howland

An interesting contrast—the eagerness on the part of industry to develop new offshore manufacturing capabilities while it continues to mine new applications for technology in the nation's capital—is reflected in our Probing the News section this issue.

Our Washington bureau manager, Ray Connolly, has plumbed the intense State Department and industrial interest in setting up new competitive operations from Malaysia to Portugal (see p. 69), while Bill Arnold, our Aerospace Editor, tracked what may become NASA's biggest spinoff of space technology—digital fly-by-wire flight control systems for aircraft (see p. 76).

Turned on by the machinations of international trade, Connolly finds that multinationalism is making anachronisms of references to “an American corporation.” After reporting the story, he concludes: “In a very real sense, electronics companies are leading in the development of ‘world corporations.’”

One interesting angle he turned up on the Malaysian side of the story is that “old traders, like the Europeans and Japanese, are setting up joint ventures with the Malaysians there, while the American operations are wholly owned. Conceivably, that could be politically troublesome in the future.”

In his look ahead at digital fly-by-wire systems, Arnold found that “digital, rather than analog, is where it's going to be, even for light planes—eventually.” Though NASA's effort, like those of the military, is keyed to high-performance aircraft, the space agency “is looking at the digital systems for general aviation, too,” he says. “Since fly-by-wire will

eventually give a manufacturer the option of either increasing payload or building a lighter and therefore less expensive plane, NASA is now funding research on similar innovations for small planes.”

Determination by Japanese engineers to be innovators in technology comes through loud and clear in the article (see p. 94) profiling their career attitudes. As staffers Charlie Cohen and Jerry Walker point out, Japanese EEs have a lot going for them, particularly in job security.

An environment in which periodic layoffs are unknown has bred some tough competitors. For one thing, the Japanese engineer can take risks without fear of being fired. It also provides opportunity for long-range projects, though engineers told our reporting team that Japanese management is certainly not prone to draw out R&D efforts.

Nevertheless, despite the pressures, there is a remarkable orderliness about the Japanese EE's job, stemming in part from the nation's orderly society. A striking example of this characteristic occurred when Cohen and Walker were due to interview three engineers at Fujitsu Ltd. One of the three arrived an hour late, explaining that his commuter train was delayed. Smilingly, he produced a slip of paper punched to show when the train actually arrived. This slip is handed out by the station master to show the employees' bosses that the railroad had made them late to work.



December 4, 1972 Volume 45, Number 25
89,864 copies of this issue printed

Published every other Monday by McGraw-Hill, Inc. Founder: James H. McGraw 1860-1948. Publication office 1221 Avenue of the Americas, N.Y., N.Y. 10020; second class postage paid at New York, N.Y., and additional mailing offices.

Executive, editorial, circulation and advertising addresses: Electronics, McGraw-Hill Building, 1221 Avenue of the Americas, New York, N.Y. 10020 Telephone (212) 997-1221. Teletype TWX N.Y. 710-581-5234. Cable address MCGRAWHILL N.Y.

Subscriptions limited to persons with active, professional, functional responsibility in electronics technology. Publisher reserves the right to reject non-qualified requests. No subscriptions accepted without complete identification of subscriber, including name, title, or job function, company or organization, including product manufactured or services performed. Subscription rates: qualified subscribers in the United States and possessions, Canada, and Mexico \$8.00 one year, \$12.00 two years, \$16.00 three years; all other countries \$25.00 one year except Japan \$50.00 per year including air freight. Limited quota of subscriptions available at higher-than-basic rate for persons outside of field served, as follows: U.S. and possessions and Canada, \$25.00 one year; all other countries \$50.00. Single copies: United States and possessions and Canada, \$1.00; all other countries, \$1.75

Officers of the McGraw-Hill Publications Company: John R. Emery, President; J. Elton Tuohy, Senior Vice President; S. Donald B. Gridley, Group Vice President; Vice Presidents: Ralph Blackburn, Circulation; John R. Callahan, Editorial; John B. Hoglund, Controller; David G. Jensen, Manufacturing; Jerome D. Luntz, Planning & Development; Joseph C. Page, Marketing.

Officers of the Corporation: Shelton Fisher, President, Wallace F. Trendly, Group President, McGraw-Hill Publications Company; John J. Cooke, Senior Vice President and Secretary; Ralph J. Webb, Treasurer. Title registered in U.S. Patent Office; Copyright 1972 by McGraw-Hill, Inc. All rights reserved. The contents of this publication may not be reproduced either in whole or in part without the consent of copyright owner.

Subscribers: The publisher, upon written request to our New York office from any subscriber, agrees to refund that part of the subscription price applying to copies not yet mailed. Please send change of address notices or complaints to Fulfillment Manager; subscription orders to Circulation Manager, Electronics, at address below. Change of address notices should provide old as well as new address, including postal zip code number. If possible, attach address label from recent issue. Allow one month for change to become effective.

Postmaster: Please send form 3579 to Fulfillment Manager, Electronics, P.O. Box 430, Hightstown, N.J. 08520.

4 filters in 1

Model 3202 offers two independent low-pass or high-pass channels or single channel band-pass or band-reject from 20 Hz to 2 MHz.

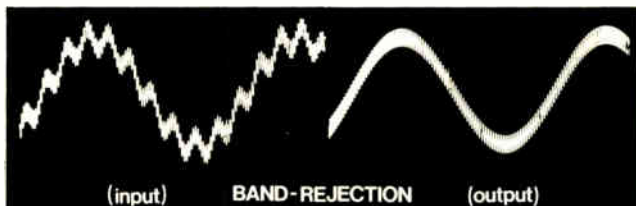
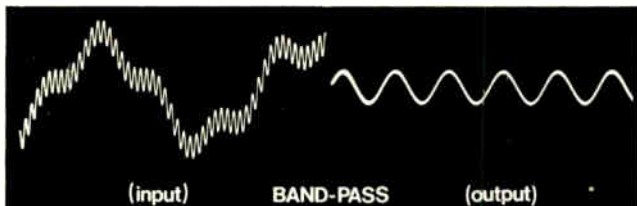
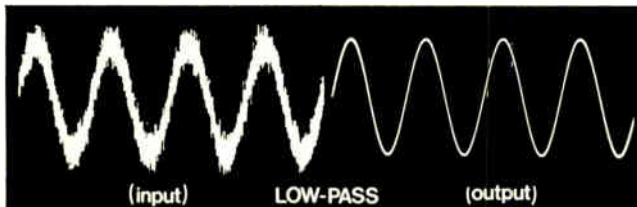

For only \$795, Model 3202 provides the flexibility essential for complex frequency or time domain measurements.

FUNCTIONS: Low-pass — direct coupled with low drift.
High-pass — upper 3 dB at 10 MHz. Band-pass — continuously variable. Band-rejection — variable broad band or sharp null.

TWO RESPONSE CHARACTERISTICS: (1) Fourth-order Butterworth or (2) simple R-C (transient free)

ZERO-dB INSERTION LOSS: All-silicon amplifiers provide unity gain passband response. 24 dB per octave slopes per channel extend to at least 80 dB.

90-dB DYNAMIC RANGE: Low hum and noise (less than 100 microvolts) eliminate costly preamplifiers.

For fast action, call the Wavemakers at: (617) 491-3211
TWX: 710-320-6583, Krohn-Hite Corporation,
580 Massachusetts Ave., Cambridge, Mass. 02139, U.S.A.

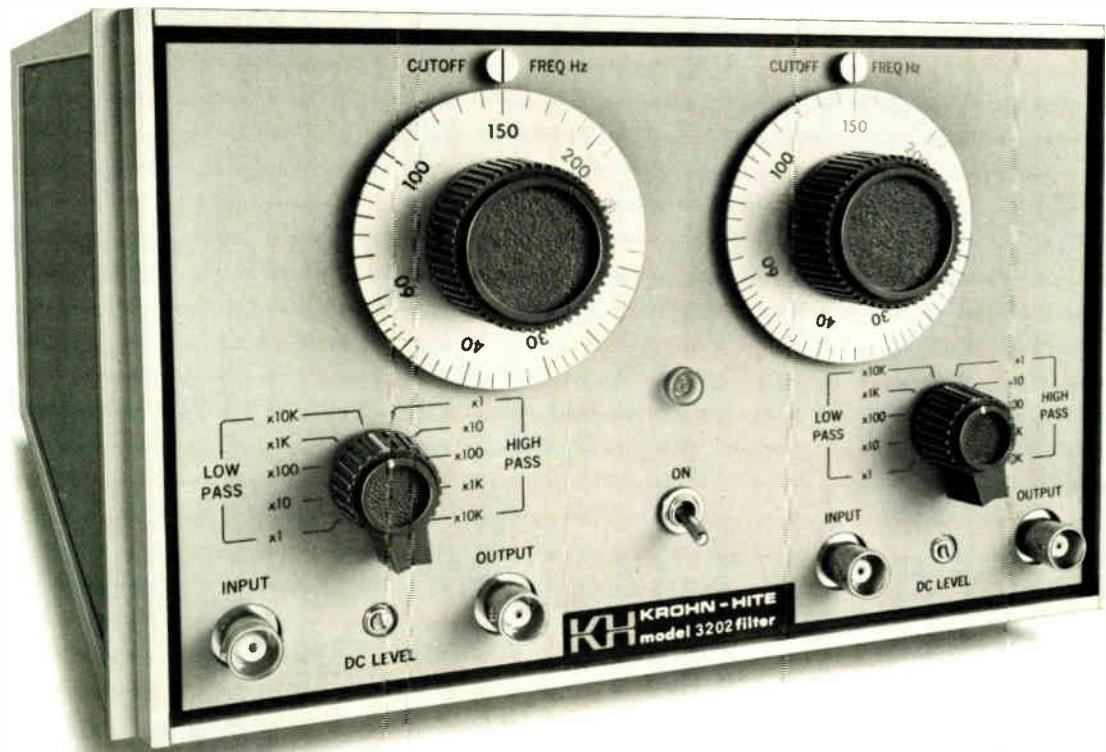

KH KROHN-HITE CORPORATION

OVERSEAS SALES OFFICES: AUSTRIA, Universal Elektronik Import; AUSTRALIA, Warburton Franki Limited; BELGIUM, C. N. Rood s.a.; DENMARK, SC Metric A/S; ENGLAND, Allied International Limited; FINLAND, Into O/Y; FRANCE, Radio Equipments Antares; GERMANY, Nucletron Vertriebs GMBH; HOLLAND, C. N. Rood n.v.; INDIA, Bali International Agencies; ISRAEL, R. D. T. Electronics Engineering, Ltd.; ITALY, Sistrrel s.p.a.; JAPAN, Shoshin Shoji Kaisha, Ltd.; NEW ZEALAND, Warburton Franki, Ltd.; SOUTH AFRICA, Protea Physical; SPAIN, Rema Leo Haag, S.A.; SWEDEN, Teleinstrument; SWITZERLAND, Megex Zurich GMBH.



**Our
lightweight
portable
isn't much of a
financial
burden, either.
\$995.**



\$995 for Dual trace, Delaying Sweep and Portability.

- 14 lbs (you don't have to pretend it's light — it really is light.)
- Lowest cost delaying sweep
- Push button Controls
- 10 MHz
- Full auto triggering

Where else can you get all this in a portable for \$995.

Write for all the Details —

DUMONT OSCILLOSCOPE
LABORATORIES INC.
40 Fairfield Pl., West Caldwell, N.J. 07006
(201) 575-8666; TWX (710) 734-4308

DUMONT
OSCILLOSCOPE LABORATORIES, INC.

6 Circle 6 on reader service card

Readers comment

Engineer's notebook errata

To the Editor: I'd like to point out a few minor corrections for my Engineer's notebook, "Single time measurement determines capacitor R and L" [Oct. 9, p.119]. The by-line should have shown that I am employed at the Charles Stark (not Stack) Draper Laboratory.

In Fig. 1, the bottom node of the capacitor-equivalent circuit should be grounded, and in Fig. 2, the scope trace should reflect a vertical sensitivity of 200 millivolts/centimeter and a horizontal sensitivity of 20 nanoseconds/cm.

Carlo Venditti

Charles Stark Draper Laboratory
MIT

Cambridge, Mass.

Scott overlooked

To the Editor: We were quite surprised that in your article on noise monitoring, "Noise-monitoring laws create orders" [Oct. 23, p.72], H. H. Scott Inc. was not mentioned as one of the country's leading suppliers of sound-level meters.

We have been supplying moderate-cost, high-value sound-level meters to industry and government for the past 26 years, and we are the second largest domestic manufacturer.

E. G. Dyett Jr.

General manager
Scott Instrument division
Eastern Air Devices Inc.,
Maynard, Mass.

Nanofarad idea misses print

To the Editor: I observe in your "Readers comment" in the issue of Aug. 28 [p.6] that the original proposal for using the nanofarad designation to eliminate leading and trailing zeroes was made May 8 of this year. The thought has occurred before. I proposed it in March 1960 in a letter to the editor of a competing publication.

Although the editor indicated to me an intention to publish an expansion of thoughts along this line, I don't believe he ever did.

Robert L. Forgacs
Instrumentation Section
Ford Motor Co.
Dearborn, Mich.

4 Quadrant Magnetic Analog Multiplier DC x AC = AC Output



#MCM 1351-2

**Product Accuracy
is $\pm 1/2\%$ of all
readings Over Full
Temperature Range
of -55°C to $+125^{\circ}\text{C}$**

- Product accuracy is specified in % of reading for all output analog voltage product points over the full military temperature range instead of % of full scale error giving superior results for small values.
- Linearity, product accuracy, and zero point virtually unaffected by temperature changes.
- All units are hermetically sealed and completely shielded from external electric or magnetic fields.

Specifications Include:

Transfer equation: $E = XY/3$

X & Y input signal ranges:
0 to $\pm 3\text{V}$ Peak

Maximum static and dynamic product error: $1/2\%$ of point or 2 MVRMS, whichever is greater, over entire temperature range

Input impedance: $X = 10\text{K}; Y = 10\text{K}$

Full scale output: 3 VRMS

Minimum load resistance for full scale output: 2000 ohms

Output impedance: Less than 50 ohms

X input bandwidth:
 $\pm 0.5\text{db}$, 0 to 200 hertz

Y input bandwidth:
 $\pm 0.5\text{db}$, 20 hertz to 1000 hertz

DC power: $\pm 15\text{V}$ unless otherwise required @ 20 ma

There is No Substitute
for Reliability



GENERAL MAGNETICS, INC.

135 Bloomfield Avenue
Bloomfield, New Jersey 07003
(201) 743-2700

Circle 7 on reader service card

THE GOOD, THE DENSE & THE SPEEDY.

Whether you need a good, dense static shift register, a good, speedy dynamic shift register or a good title for a low-budget "spaghetti" western, we've got you covered.

Good & Dense.

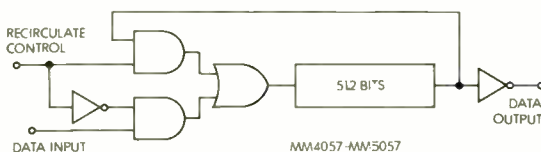

Our new MM4055/MM5055 family is a series of 512-bit silicon gate static shift registers featuring on-chip clock and recirculate logic, 2.2MHz maximum guaranteed operating frequency and TTL compatibility.

The MM4055/MM5055 has a 128 x 4 configuration. The MM4056/MM5056 has 256 x 2. While the MM4057/MM5057 is configured 512 x 1 in an 8-pin mini-dip for extremely high board density.

Good & Speedy.

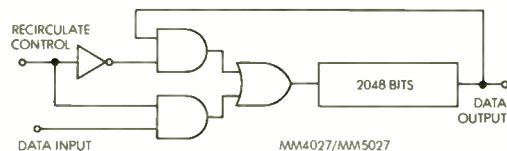

Our new silicon gate dynamic shift register, the MM4027/MM5027, is something else. 6 MHz maximum guaranteed data rate. 2048 x 1 configuration. On-chip recirculate logic. 8-pin mini-dip.

If you prefer, we've also got a 16-pin version (MM4025/MM5025) and a 10-pin version (MM4026/MM5026), both configured 1024 x 2.

We could go on and on. But suffice it to say, if you need some great shift registers, some great shift registers are what we've got.

National Semiconductor Corporation,
2900 Semiconductor Drive,
Santa Clara, California 95051.

Write us today. Better yet, call us
at (408) 732-5000.

NATIONAL

Scottsdale, Ariz. (602) 945 8473 Mountain View, Calif. (415) 961 474C Sherman Oaks, Calif. (213) 783 8272 Miami, Florida (305) 446 8309 Chicago, Illinois (312) 693 2660 Indianapolis, Ind. (317) 255 5822 Lenexa, Kansas (816) 358 8102

Burlington, Mass. (617) 273 1350 Glen Burnie, Md. (301) 760 5220 Farmington, Mich. (313) 477 0400 Englewood Cliffs, N.J. (201) 871 4410 Syracuse, N.Y. (315) 455 5858 Cleveland, Ohio (216) 961 5300 Beaverton, Oregon (503) 643 5445 Dallas, Texas (214) 233-6801

40 years ago

From the pages of *Electronics*, December 1932

Significant to all interested in the electronic field is the official announcement of the entry of another industrial giant into the wider application of electronics, growing out of the consent decree and settlement of the Government's suit against RCA. Amid all the turmoil of readjustment of a complex legal situation again there is given recognition of the expanding importance of the non-radio applications of the tube and amplifier.

Already it is well known that no less than 85 per cent of the entire vast research laboratory of the General Electric Company is devoted to study of electronic processes. And roughly the same proportion applies to the laboratories of the Westinghouse companies. If RCA is to be separated completely from its parent companies and their manifest destiny in the electronic fields, then it was logical that the disinherited offspring be granted authority to proceed energetically along its own paths of non-radio, electronic expansion,—a field to which it has already made many important contributions.

Under the settlement the Radio Corporation obtains rights to manufacture radio transmitters, and continues its own activities in the fields of receiving sets, tubes, musical instruments, television, communication broadcasting and sound pictures. General Electric and Westinghouse may also enter the radio field after 30 months. Licenses in future may be obtained either from the RCA, or from the individual patent owners.

Thus the consent decree can be hailed as ushering in a new day for both radio and the electronic arts. Under its terms uncertainty has been ended, and succeeded by a settled program. Executives and engineers on all sides, freed of legal burdens, can now devote themselves to business development in both radio and its allied domain of electronics.

New impetus is given to the whole industry, and from the new setup independents and "trust" interests will all benefit.

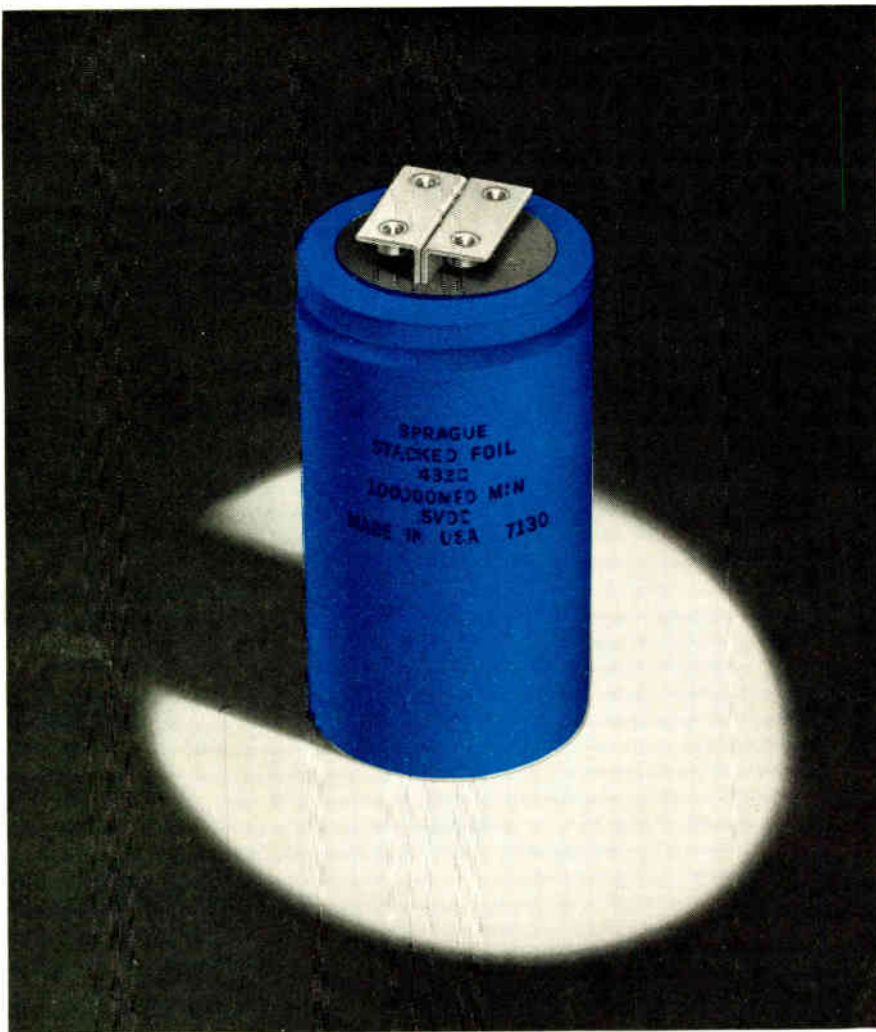

Stacked...with beautiful curves!

(stacked-foil construction with ultra-low impedance, ultra-low ESR, ultra-low inductance)

Revolutionary new Type 432D COMPULYTIC® Aluminum Electrolytic Capacitors offer capacitance values to 100,000 μ F with equivalent series resistance of typically less than 0.001 ohm and inductance of only 1 nH in a 3" x 5 $\frac{1}{8}$ " case. This same capacitor will handle 93 amperes of ripple current at 65 C and 1 kHz.

Impedance limits at 10 kHz are as low as 0.001 ohm with typical values of only half of the specified limits.

Terminals are ideal for use with laminated-bus power distribution systems found in modern EDP equipment, where the low ESR and impedance of Compulytic capacitors help insure continued operation of logic circuits even during momentary power outages.

Sprague Type 432D Capacitors are available in nine voltage ratings from 5 to 50 volts d-c, and are designed for operation over the temperature range from -40 to +85 C.

For complete technical data, write for Engineering Bulletin 3443 to: Technical Literature Service, Sprague Electric Co., 35 Marshall St., North Adams, Mass. 01247.







THE BROAD-LINE PRODUCER OF ELECTRONIC PARTS

8 Circle 8 on reader service card

Electronics/December 4, 1972

GENERAL  ELECTRIC

OPTOELECTRONIC COUPLER LINEUP

			
<p>H10 SERIES COUPLERS</p> <ul style="list-style-type: none"> • 3 hermetically packaged models offer choice of SSL-Photo-transistor, SSL-Photo-darlington and SSL-light sensitive SCR 	<p>H11 SERIES COUPLERS</p> <ul style="list-style-type: none"> • 6 models offer interchangeability with popular industry types • H11A1 and H11B1 offer 50% and 500% min current transfer ratios respectively • 2,500V isolation 	<p>H13 SERIES INTERRUPTER MODULES</p> <ul style="list-style-type: none"> • 4 models offer "no contact" switching for use with shaft encoders, counters, position sensing, keyboards and limit switch application 	<p>H15 SERIES COUPLERS</p> <ul style="list-style-type: none"> • 4000V isolation • 4 low cost models for pulse transformer replacement, SCR and TRIAC triggering • Solid State reliability at low cost

OUR NO. 1 GOAL:
TO MAKE
GENERAL ELECTRIC
YOUR BEST BUY



**AVAILABLE NOW FROM
YOUR AUTHORIZED
GENERAL ELECTRIC
DISTRIBUTOR**

Circle 9 on reader service card

National's 118: Some good news. Some bad news.

If you only have a few National 118's in stock, you're in luck!
Send us one and we'll send you two of our AMD 118's.
(Put one back in stock and put the other into test.)
Two to a customer, please. We're excited, not crazy.

Circle Bingo card #205

The National 118 is a good product.

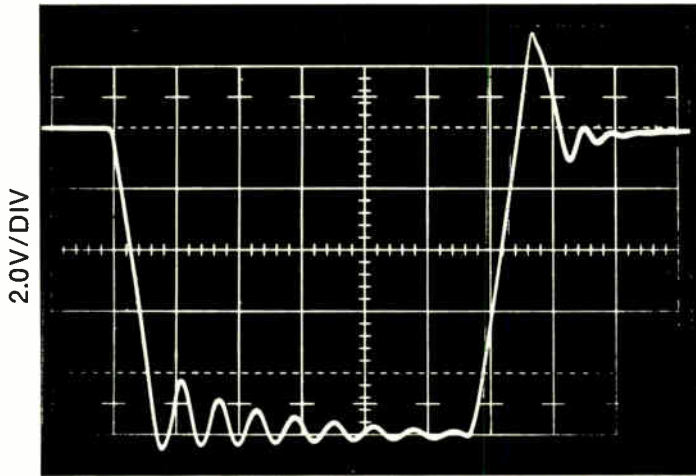

0.2µs/DIV

It's a high speed linear op amp that does magical things in A to D converters, active filters, sample and hold circuits and wide band applications.

It comes in three temperature grades with these super specs: Slew rate, 70 volts per micro-second! Input offset voltage, 2mV. Input bias current, 120nA. Offset current, 6nA. Voltage gain, 200K.

It's internally compensated. If you want to add external compensation, you can double bandwidth and slew rate.

It's a good product.

But AMD's 118 is a great product.

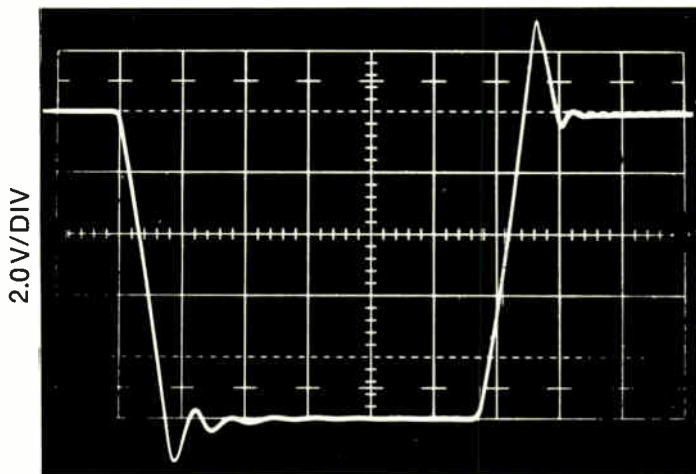

0.2µs/DIV

Significantly better. It has all those specs and something more. It's more stable. Its phase margin is 35° with less than 2db overshoot. And there's no oscillation.

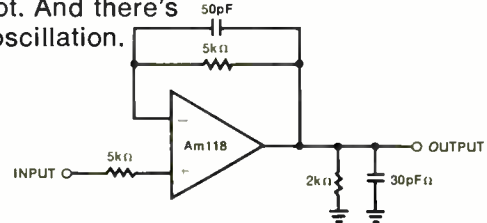

Both scope pictures were made using this voltage follower, slew rate test circuit.

Did you know we're going to be the sixth largest integrated circuits company in the United States by 1975? Do you know how? One product at a time.



Advanced Micro Devices

(We're going to be #6)

Distributed nationally by Hamilton/Avnet and Cramer Electronics. Telephone 800-538-7904 toll free, or in California 408-732-2400, and ask for Shel Schumaker. In Los Angeles, Steve Zelencik or Russ Almand at 213-360-2102. In Mid-America, Chuck Keough at 312-297-4115. In the eastern United States, Steve Marks or Bill Seifert at 516-676-4500. In the Northern California area, Dave Haun at 415-967-7031. 901 Thompson Place, Sunnyvale, California 94086/TWX 910-339-9280/TLX 346306.

HAMMOND DID AWAY WITH ALL THIS JAZZ...

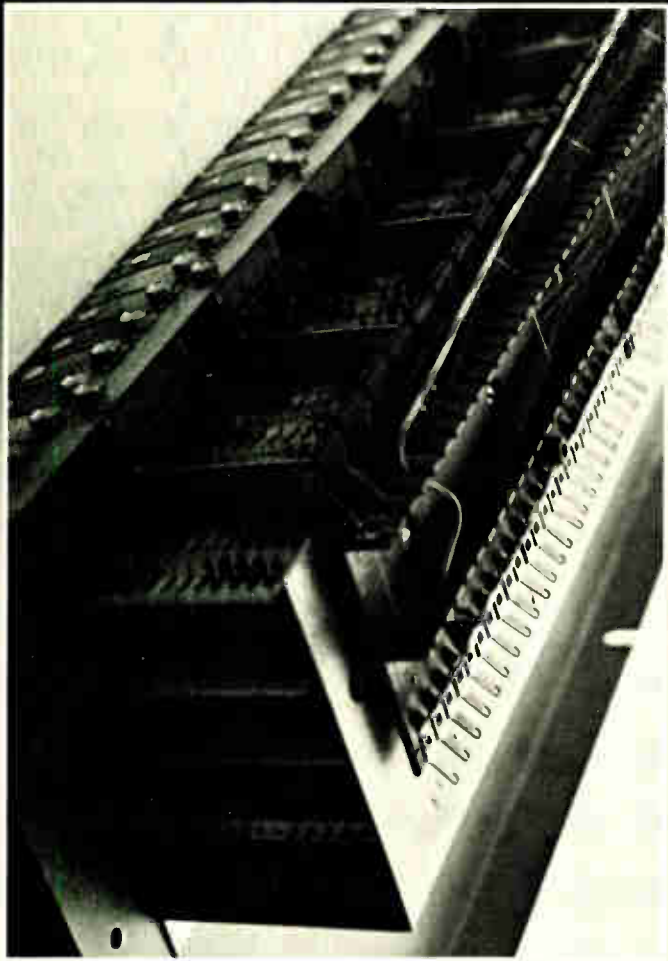

IN FAVOR OF A SIMPLER TUNE...

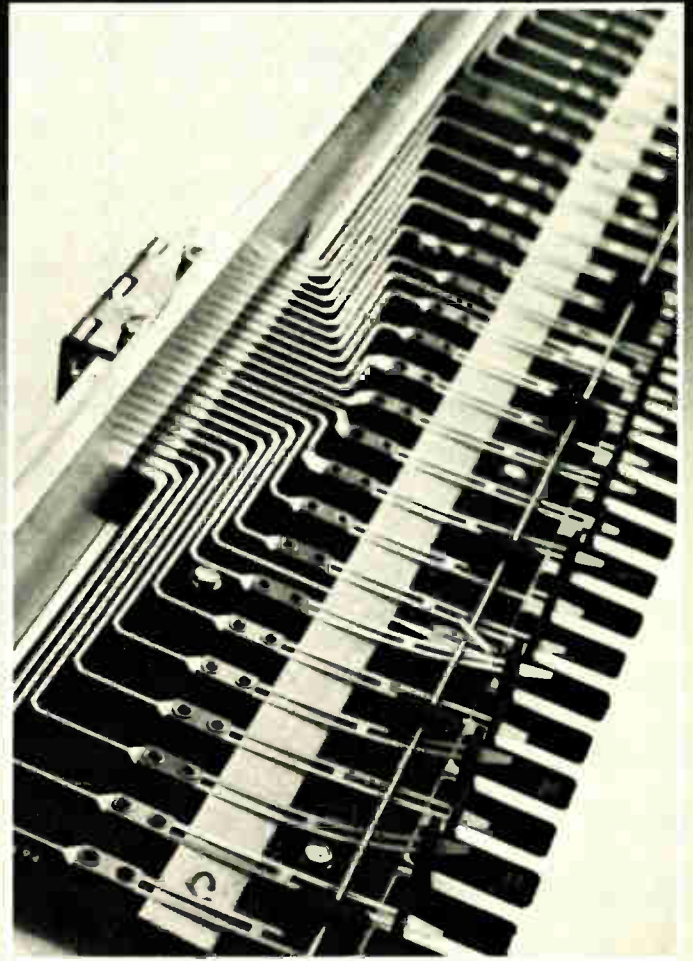

HAMMOND ORGAN CO. offered MOSTEK a challenge. They wanted to know if we could participate in a program that would attack their space/cost problem, effect dual savings, and yield an improved product that stayed competitive. Not a unique request or need, but at first brush it was obvious the state-of-the-art held no ready solution. But we knew MOS had the potential to solve

their problem, and we enthusiastically accepted their challenge. Our solution met all design and cost parameters. Following initial acceptance, Hammond ordered four different circuits for their Phoenix, Regent and Concorde models. Reliability of the chips in this very cost-sensitive consumer product is evident by Hammond's latest request to MOSTEK: develop a fifth

circuit for use in new models scheduled for 1973.

MOSTEK'S design allowed HAMMOND to greatly simplify their key switches from multi-contact to single contact types, as shown in the dramatic, actual comparison photos above.

HAMMOND'S other unique requirements demanded new design techniques; such circuitry had never been

THANKS TO THIS GREAT LITTLE NUMBER!



successfully manufactured in MOS before. Precise resistor networks so necessary for close harmonic control were a must, and a major breakthrough was made in this area. Using series and/or parallel combinations of single resistor geometry, matched and close tolerance networks, MOSTEK was able to meet HAMMOND'S requirements in significant fashion: the finished design

put 34 networks on a single chip! Coupled with proven technology, this unique technique has opened the doors to new solutions for other industries and a multitude of applications. What are the implications for your product? Call or drop us a line: we're ready to go to work on *your* challenge!

REGIONAL SALES OFFICES:

Western: 11222 La Cienega Blvd., Inglewood, Calif. 90304 (213) 649-2888; **Eastern:** 60 Turner Street, Waltham, Mass. 02154 (617) 899-9107; **Central:** 8180 Brecksville Rd., Brecksville, Ohio 44141 (216) 526-6747. **INTERNATIONAL: Europe:** MOSTEK GmbH, 7 Stuttgart 80, Breitwiesenstrasse 19, West Germany (Telex-7255792 MK D) **Japan:** System Marketing Inc., 4 Floor, Mimasu Bldg., 3-14-4 Uchikanda, Chiyoda-ku, Tokyo, Japan (Telex-0222-5276 SMITOK) **Far East:** Imai Marketing Assoc., Inc., 525 W. Remington Dr., #108, Sunnyvale, Calif. 94087 (Telex-35-7453) **Hong Kong:** Astec Components Ltd., Golden Crown Court, Flat "C" 5th Floor, 70 Nathan Rd., Kowloon, Hong Kong (Telex-HX4899) **Mid East:** Racom Electronic, 60 Pinkas St., Tel Aviv, Israel (Telex-33-808 RACEL) **Canada:** Cantronics Inc., 4252 Braille Ave., Montreal, Quebec (TWX-610-421-3324)

MOSTEK

MOSTEK Corporation
1215 West Crosby Road
Carrollton, Texas 75006
(214) 242-0444

© Copyright 1972 by
MOSTEK Corporation

Circle 13 on reader service card

seph's pursuit of the future—he spends almost half his time teaching it at the University of Minnesota—evolves naturally out of his work. Consider some of his current projects: self-repairable systems, micro- and macroprogramming, and LSI's impact. It's quite possible that all of these will help make the computer the commonplace tool of the future that Joseph is helping to build.

The Univac scientist agrees that major changes must be made first. "But," he points out, "the technology is available now. It will just take three to five years to convince users." For example, there is what Joseph calls "polysystem architecture." With this concept, microprogrammed modules are pieced together to do the jobs of varying complexity. Joseph expects such architecture to appeal particularly to the consumer market.

With so many computers in use, what about the communications problem? "Dedicated buffers—of say, eight to 16k—would take over some tasks of central processors," says Joseph. "This would permit us to have networks with fast serial busses." And that's only one way. "Technology will reduce the communications problem," says Joseph, speaking with the confidence of a man whose work in computers goes back to the Nike-Zeus and Nike-X days at Univac.

Interestingly, Joseph points out, with computers doing so much of the time-consuming everyday work man now must do for himself, he'll have more time to select options of all sorts—in his choice of professions, lifestyle, or recreation. With all these options, he'll need more input to make intelligent decisions. And where will that input come from? Why, from computers—where else?

But unexpectedly for a futurist and past president of the Minnesota chapter of the World Future Society, the crewcut scientist has a nice sense of the past. Joseph carries in his wallet a picture of his house—a splendid old Victorian mansion. As for how many rooms it has, Joseph replies: "Just say 'more than 25'—that sounds better."

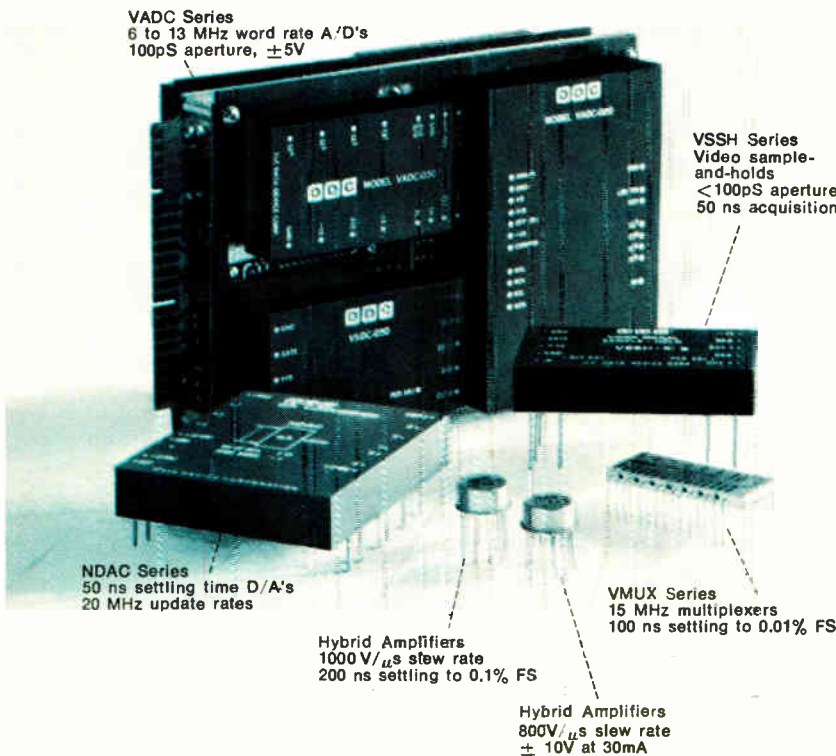
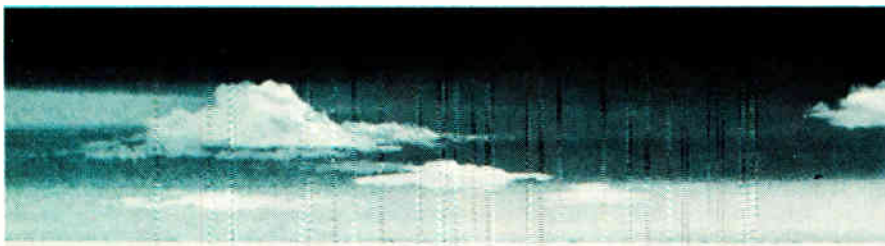

When the going gets tough, the tough get going.

That's what established us as a leader in high speed sophisticated data conversion equipment: A/D, D/A converters, multiplexers, sample-and-hold modules, wideband amplifiers. Each product's been specifically designed to satisfy some of the most critical interface requirements you'll run up against. Be it speed, accuracy, size or reliability. Whether your application involves TV digitizing or head-up displays . . . large-screen displays or moving target indicators . . . traffic control or numerical control . . . fire control or pollution control . . . We've solved the tough ones.

Don't forget—we've also solved the easy ones. Write or call our application engineers for our complete data conversion and signal interface catalog.



ILC DATA DEVICE CORPORATION

100 TEC STREET, HICKSVILLE, N. Y. 11801 • PHONE: (516) 433-5330

APPLICATION CENTERS

Long Beach, Calif. (213) 597-5744	Washington, D. C. (703) 821-2300	Bruxelles, Belgium (Tel.) 62.01.59
--------------------------------------	-------------------------------------	---------------------------------------

hp MEASUREMENT NEWS

innovations from Hewlett-Packard

DECEMBER edition

in this issue

New calculator-based network analyzers

Quick and quiet digital plotter

The "portables" get a lift

A new standard in AM/FM generators

HP's solid-state successor to the time-proven 608 signal generator.

For more than 20 years, the HP 608 series VHF signal generators have generally been recognized as the standard of the industry. Now, we introduce a solid-state VHF generator series with wider frequency coverage (450 kHz to 550 MHz), increased modulation capability (FM as well as AM), better stability, and impressive spectral purity.

The 8640 generators deliver low-noise signals that, until now, could be attained only with vacuum-tube generators. Non-harmonic and sub-harmonic outputs are down more than 100 dB and noise is less than -130 dB/Hz at 20 kHz offset from the carrier. Extremely clean

(continued on page 4)

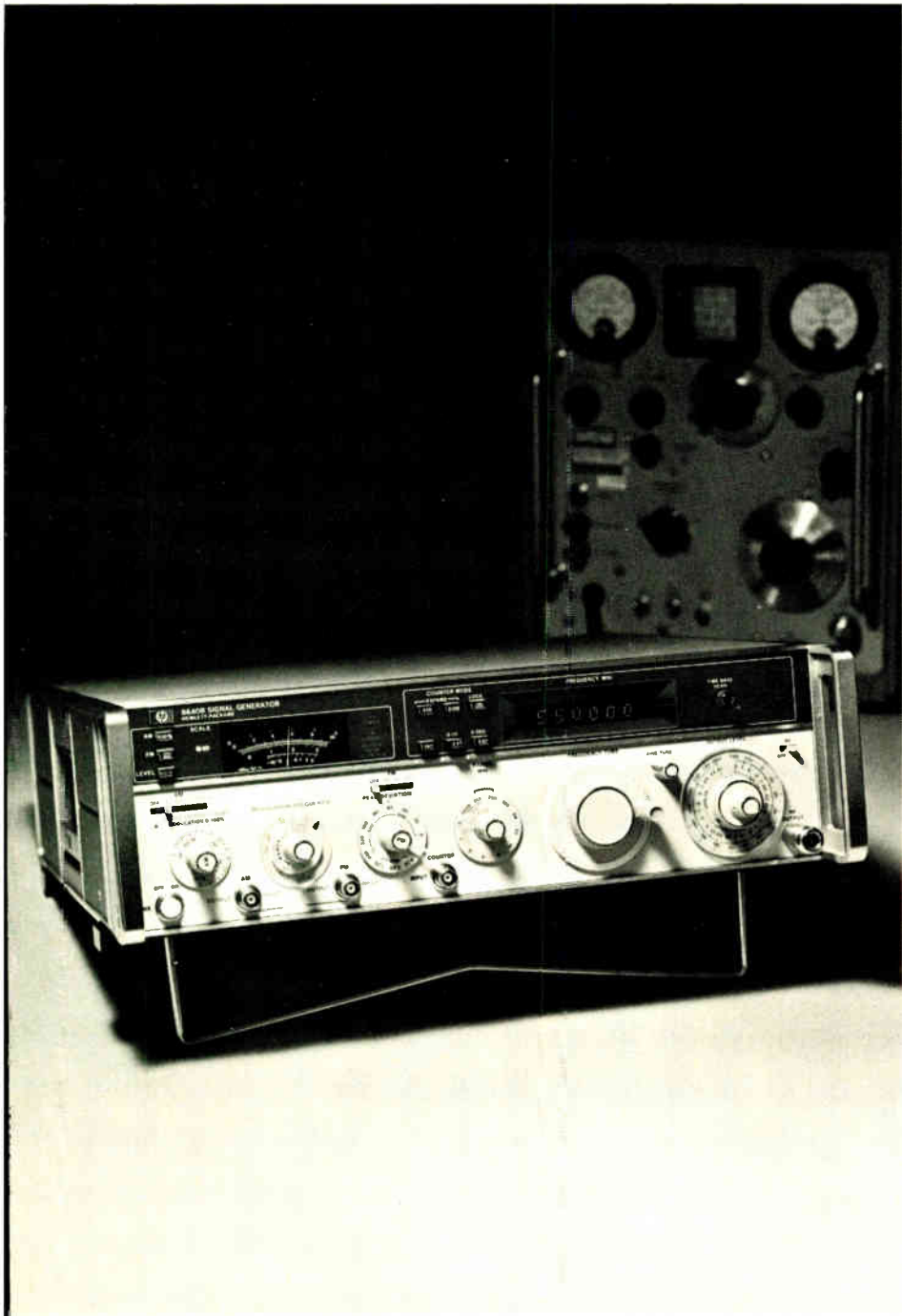

New OEM computer discounts reflect lower memory costs



Optional Writable Control Store lets you microprogram a 2100A computer to specific applications.

Prices for the HP 2100A computer have been reduced by \$2,000 for each 8K of core memory. Likewise, HP has increased its discount rate to original equipment manufacturers.

You save dollars without losing any capability. The expandable 2100A minicomputer holds up to 32K of memory in a 12-inch (30.48 cm) mainframe. Standard equipment includes 80 powerful instructions, hardware multiply/divide, memory protection, automatic restart after a power failure, unlimited levels of indirect addressing, and 14 I/O channels. With HP's proven software and a wide selection of peripherals, OEMs can tailor the 2100A to virtually any configuration.

For details on the 2100A computer and OEM discounts, check B on the HP Reply Card.

Now, distribute frequency without distortion

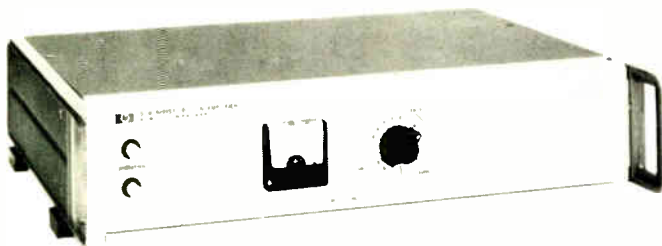

The 5087A is the first distribution amplifier to accept single 5 MHz input and distribute 0.1, 5 and 10 MHz outputs

For isolated, undistorted multiple outputs from atomic or crystal frequency standards, try the 12-channel 5087A distribution amplifier. Three input channels accept 10 MHz, 5 MHz, 1 MHz or 100 kHz in any combination. You can select the number of outputs for each channel, up to a total of 12 outputs. Each output level is adjustable from 0 to 3 V rms.

The distribution amplifier boasts of excellent short-circuit isolation (< 0.1% amplitude change);

exceptional phase stability (< 0.1 ns/°C for 5 and 10 MHz); low noise; and -60 dB crosstalk. Amplitude stability is ± 0.5 dB, 0° to 50°C. In the event of an ac power failure, the distribution amplifier switches over to standby dc.

Price: \$1500 for the standard configuration.

Several options are available. For details, check H on the HP Reply Card.

New features, low prices for HP portables



All 1700B scopes have a new color-coded front panel for easier operation.

HP's popular 1700 series portables now incorporate lower prices with a number of product improvements. New features incorporated in all 1700B delayed sweep models include:

- Mixed sweep, external trigger input for the delayed sweep, and calibrated delay. (These three features formerly were optional.)
- HF reject for delayed sweep provides better low frequency delayed time base triggering.
- Line sync for the main sweep.
- Slower decade of sweep for the main time base (0.5, 1 and 2 sec/div.), particularly useful when viewing transduced, bio-medical or natural phenomena.

You get laboratory quality with the convenience of mobility. All 1700B portables have internal battery power and rugged construction for reliable operation at even the most remote field station. Prices for these new portables:

1700B (35 MHz)	\$1475
1701B (35 MHz, delayed sweep)	\$1550
1702A (35 MHz, storage)	\$2375
1703A (35 MHz, storage, delayed sweep)	\$2725
1706B (75 MHz)	\$1500
1707B (75 MHz, delayed sweep)	\$1575
1710A (150 MHz, delayed sweep)	\$2300

For specifications, check A on the HP Reply Card.

Choose independent or tracking power outputs

Three new solutions to your network analysis problems

You don't have to run diagnostics; the HP calculator executes network analysis self-calibration programs to maintain system accuracy.

Two versatile lab supplies each house two identical 50W regulated power supplies. A convenient front panel switch lets you select either independent or tracking operation. In the tracking mode, the right supply tracks the left within $.2\% \pm 2 \text{ mV}$. Tracking mode is especially useful for powering operational amplifiers, push-pull stages, deflection systems, or any application where plus and minus voltages must track with insignificant error. The independent mode lets you operate the two supplies individually, in auto-parallel or in auto series.

Each side of the dual supply can be operated as a constant voltage or constant current source, and each has its own crowbar for overvoltage protection. In the tracking mode, an overvoltage condition in either supply trips both crowbars.

Output ratings for the 6227B (each side) are 0—25 V at 0—2 A; or the 6228B (each side), 0—50 V at 0—1 A. Price: \$495.

For specifications, check J on the HP Reply Card.

HP 6227B dual-output power supply.

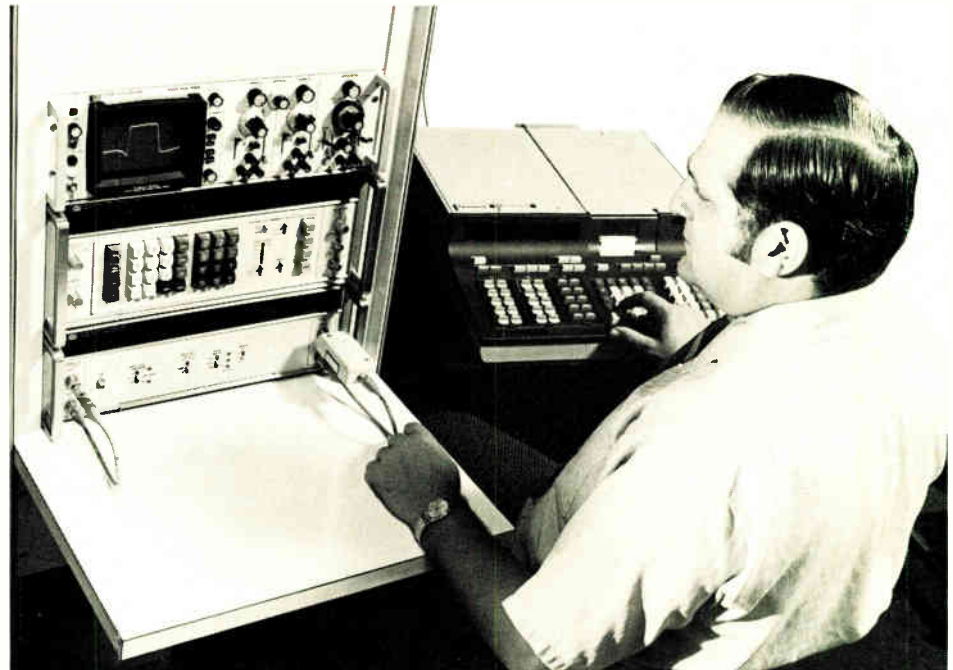

What happens when you combine a network analyzer with a calculator? You get automatic testing of gain, phase and group delay.

Designed primarily for the production line and R & D lab, HP's new 3040A, 3041A and 3042A network analyzers measure gain with 0.01 dB resolution, phase with 0.01° resolution, and delay with 20 choices of split frequencies (or an unlimited number under calculator control). Point-by-point, swept and differential measurements can be made.

The 3040A is a manual network analyzer with a frequency synthesizer as the source and a two-channel selective tracking detector. With the synthesizer as a stable, accurate frequency standard, all measurements are precise. Use the 3040A to characterize narrow-band devices with extremely high Q.

The semi-automatic 3041A is controlled by a marked card programmer via the new ASCII interface bus. The card programmer adds limit testing capability. Simply mark the test on a card, then run it.

The 3042A runs under control of an HP 9820 programmable calculator. An ideal manufacturing and research tool, this automatic network analyzer can be operated manually or programmed by magnetic cards. The ASCII bus simplifies programming and interfacing. The calculator handles simple decision-making and performs high-level statistical manipulation of test data.

Prices range from \$6,900 to \$22,900.

For network analyzer information, check C on the HP Reply Card.

Electronic measurement: books on why and how

Whether you are an electronics student or highly experienced engineer, two new books by HP authors dispel the haze surrounding electronic instrumentation. Both books are available from McGraw-Hill.

The *Basic Electronic Instrument Handbook*—edited by HP's Clyde F. Coombs, Jr.—is the first text to bridge the gap between academic knowledge and a realistic working situation (where you struggle to interpret a complex instruction manual). Content ranges from basic electronic theory to specific measurement problems and solutions. An 832-page general reference for the practicing engineer or technician, it's also a valuable guide for non-electronic people involved in instrument selection and purchasing. Price: \$28.50

Because "science and technology are so intertwined with measurement as to be totally inseparable from it," Dr. Bernard M. Oliver, HP R&D Vice-President, and John M. Cage of HP Laboratories co-edited *Electronic Measurement and Instrumentation* from contributions by 35 authorities. This 720-page book discusses the role of measurement, many measurement techniques, the theories behind them, their inherent limitations, and the preferred instrumentation. This definitive text for graduate EE students, engineers and physicists is part of the McGraw-Hill Inter-University Electronic Series. Price: \$29.50. Check R or S on the HP Reply Card and we'll have the publisher send you more information.

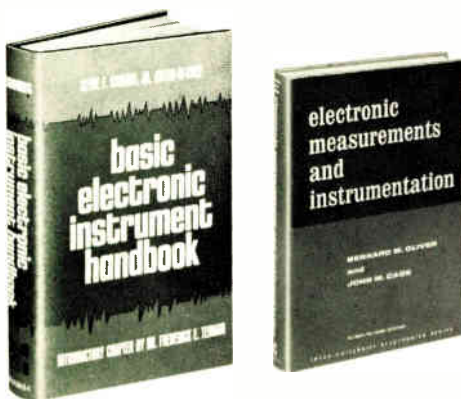

Fast, low-cost plotter for minicomputer



This quiet 11 by 17 in. (28 by 43 cm) graphic plotter draws as fast as a computer thinks.

Need a plotter that can keep up with your computer? The 7210A graphic plotter processes up to 20 coordinate pairs per second and draws symbols at the rate of 5 per second. A high-acceleration mechanism accelerates the pen to 10 in./sec. (25.4 cm/sec) in less than 12 milliseconds. Even at these fast speeds, the plotter is virtually silent.

Our secret is a built-in micro-processor that accepts pen position data in either binary or BCD codes—in other words, directly from the computer or a terminal. There's no complex software, nor do you tie up any valuable core storage.

The finished drawing has smooth arcs and circles. Because of the micro-processor, the computer doesn't calculate intermediate points. The resulting graph is free of the "stair-step" pattern typically found in most incremental plotters.

Installation is easy. If you own an HP computer, your plotter can start drawing five minutes after it arrives. Price: \$3400.

For the complete plotter picture, check M on the HP Reply Card.

New pulse generator for ECL circuit tests

ECL (emitter-coupled logic) is the coming high-speed IC logic, particularly in the computer and communications industries. Now, there's another versatile laboratory pulse generator that handles general IC testing yet is fast enough to test modern ECL chips.

Two output connectors deliver simultaneous, complementary signals—ideal for driving differential inputs. Repetition rate ranges from 10 Hz to 200 MHz, so the 8008A pulse generator satisfies TTL requirements as well as ECL. The maximum 200 MHz rate satisfies the most advanced designs, while the manual and low frequencies are used for stepping through logic states. And you can vary pulse transition times from ≤ 1.2 ns to 2.5 ns with an optional risetime converter.

Price: \$2700.

For more information, check N on the HP Reply Card.

(Continued from page 1)

signals are vital for such rigorous receiver tests as adjacent-channel selectivity.

Whether you choose model 8640A with slide-rule tuning dial or model 8640B with six-digit LED display, you really get three generators in one: a stable CW source, a fully-calibrated FM generator, and a high-performance AM generator. Both cover 450 kHz to 550 MHz with power output from +19 to -145 dBm.

The economical 8640A is ideal for design labs, production testing, and field maintenance applications. Frequency accuracy is better than 0.5%, and drift is less than 10 ppm/10 min. (after two hour warmup).

The 8640B has a built-in phase-lock synchronizer to achieve output stability better than 5×10^{-8} /hour. Even when the 8640B is locked, spectral purity and precision FM of the unlocked mode is preserved. A built-in counter measures external signals to 550 MHz.

The 8640A costs \$3100; 8640B, \$4450.

For more on these new AM/FM generators, check P on the HP Reply Card.

New automatic system delivers accurate RF signal analysis

New two-channel recorder sets new standards for sensitivity and trace

Any two-channel oscillographic recorder offers the versatility of plotting two events at once, but HP's new 7402A recorder lets you select and vary the sensitivity according to your requirements. A choice of three preamplifiers plug into the mainframe for sensitivities of: $1\mu\text{ v/div.}$ with differential, floated and guarded input; 1 mv/div. with differential, balanced to ground input; and 20 mv/div. with single-ended input.

Because the 50 mm chart width is 25% wider than other comparably priced recorders, the writing resolution is 25% better. After two months of continuous use, HP's new stainless steel pens with carbide tips had no measurable pen fatigue.

Select chart speeds from 1 to 125 mm/sec. Frequency response is $\pm 2\%$ of full scale from dc to 40 Hz, and rise time is 7.0 to 7.5 ms. A complete working system starts at \$1740.

To learn more about the new two-channel recorder, check L on the HP Reply Card.

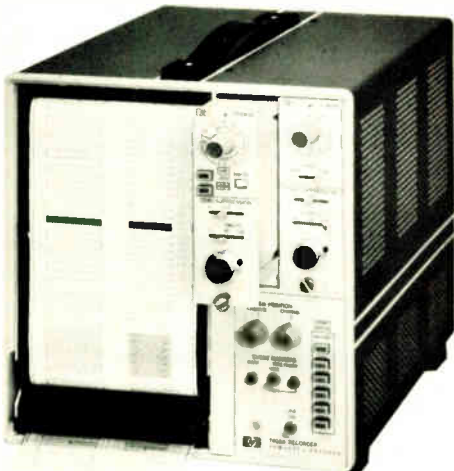

Preamplifier modules easily slip into the 7402A recorder mainframe.



Shown here testing a UHF component, the HP 8580B serves as a cost-effective production test station.

Knowing signal power at critical frequencies is essential for communications system operators; for agencies that manage the radio spectrum; and for manufacturers who design, build and maintain RF systems.

Now, HP's 8580B spectrum analyzer performs frequency-selective signal strength measurements automatically, from RF through microwave. This new system measures signal characteristics in a congested environment to aid in spectrum management or in the control of communications systems. The 8580B also characterizes signal sources and frequency translators as well as linear networks—which means you can test mixer, modulators, oscillators and receiver front-ends.

Wide frequency coverage, 10 kHz to 18 GHz, is automatic. Multiple inputs measure signals from several sources. Frequency accuracy is better than 3 parts in 10^7 at 18 GHz. The receiver can tune in increments as small as 5 Hz, with analyzing bandwidths as narrow as 10 Hz. Measurement range is +30 to -130 dBm.

Automatic operation, combined with an easy-to-use keyboard and control panel, means your operator won't require extensive training. Or let the system run unattended, with HP software doing the work.

Prices start at \$96,400.

To learn more, check O on the HP Reply Card.

New HP automatic system for communication equipment tests

Fast, easy diagnostic testing: simply use a probe to contact internal test points, then follow the instructions on the 9540 system display.

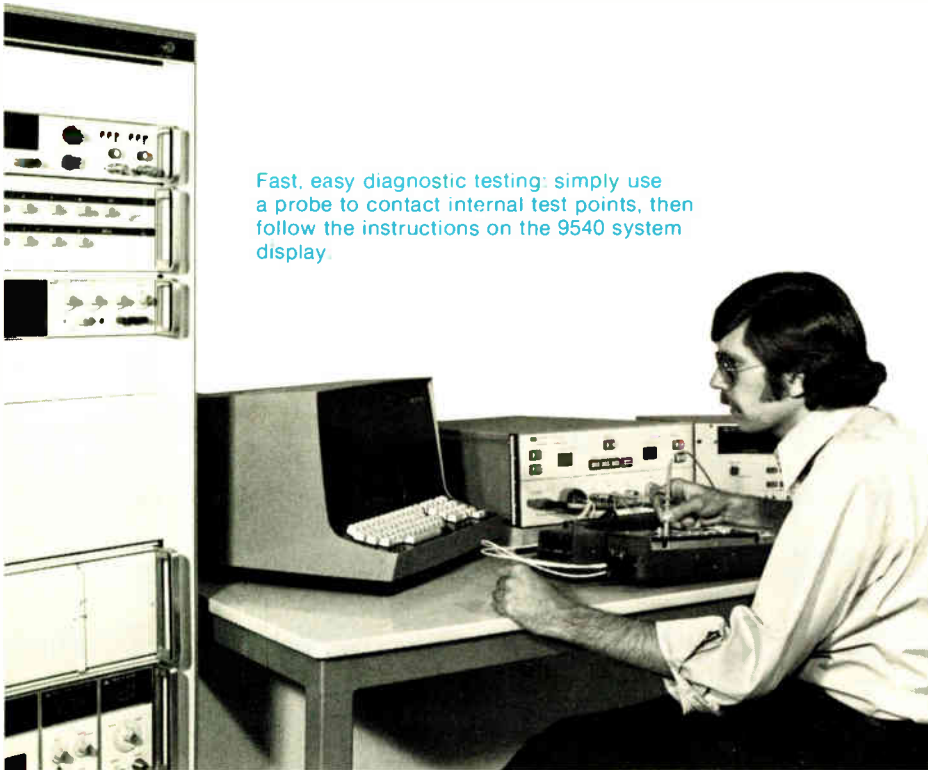

Now, you can test a typical transceiver to EIA standards for land mobile communications equipment in about three minutes—that's 5 to 10 times faster than equivalent manual testing.

The 9540 automatic test system performs many common tests for the production and maintenance of AM and FM mobile transceivers. Capability includes distortion, deviation, power, frequency, stability, SINAD, and sensitivity. Special software routines let you measure FM deviation and distortion without using extra instruments. You can test radio equipment operating on any frequency from 10 MHz to 1000 MHz at transmitter powers up to 100 W (1 KW maximum is optional).

The computer runs tests and analyzes data from a test station located up to 20 feet away. For streamlined, fast troubleshooting, a dual-connector RF test head at the test station interfaces the

transceiver and system. The test head contains RF switches, RF mixer and RF detector. Two sets of connectors let one transceiver warm up while the other is being tested, or they may be used for input and output when testing modules. A high-speed DVM and timer/counter are used as A/D and frequency-to-digital converters, respectively.

HP supplies typical test listings to help technicians and engineers write their own tests using the HP ATS BASIC language. Operating instructions appear on the system display; an average operator can run the system merely by pushing a button.

Select the economical 9540B paper tape system or the 9540D disc memory system with files for 2.4 million words. Prices start at about \$100K.

For more on computerized transceiver testing, check Q on the HP Reply Card.

New multiprogrammer for automatic test/control

Put your minicomputer to work in automatic test and control systems with HP's 6940A/6941A multiprogrammer. This low-cost system building-block provides a bidirectional data link between a single computer I/O channel and up to 240 individually addressable, plug-in card slots, each with a 12-bit I/O capability.

In automatic test applications, the multiprogrammer can provide stimuli for a device under test and instantly collect responses from that device. A wide range of plug-in cards lets you program analog outputs (V, R and I), output digital words, close contacts, monitor digital lines, and sense status changes.

The modular nature of the multiprogrammer permits flexible system development. You start with a master unit (6940A) and 1 to 15 plug-in I/O cards. As system needs increase, simply add extender mainframes (6941A) and plug-in cards.

The 6940A master unit costs \$1500; the 6941A extender, \$900. I/O cards cost \$75 to \$430 each. *For more on the multiprogrammer, check K on the HP Reply Card.*

Run HP's multiprogrammer under computer control, or operate it manually from the front panel switch register.



The lowest noise yet for HF transistors

The lowest guaranteed noise figure ever offered in a microwave transistor is here—and it's priced below all other low-noise transistors on the market. The new 35870 series small signal NPN device boasts a guaranteed *maximum* noise figure of 2.3 dB at 2 GHz and 3.3 dB at 4 GHz. *Typical* noise figures are lower, of course: 2.0 dB at 2 GHz and 3.0 dB at 4 GHz.

The new transistor has plenty of gain, too: typically 14.8 dB at 2 GHz, 9.6 dB at 4 GHz, and 6.4 dB at 6 GHz (f_{max} is 14 GHz).

Price: only \$90 each in 100+ quantities.
For details, check D on the HP Reply Card.

HP's new low-noise microwave transistors come in a rugged metal-ceramic package.

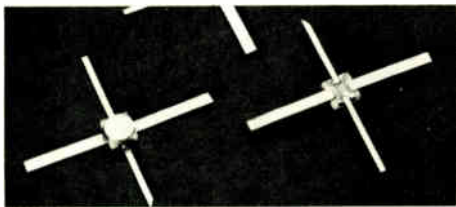

New low-cost beam-lead Schottky diode

High-level detection, switching, gating, A/D conversions, sampling and wave shaping are only a few applications for HP's new beam-lead equivalent of our 5082-2800 Schottky diode.

With fast switching, this device is ideal for applications that require large numbers of high frequency diodes or as replacements for P-N junction diodes.

Breakdown voltage is 70 V; reverse leakage current, 200 nA; capacitance, 2 pF; and carrier lifetime, 100 pico-seconds. At UHF frequencies, the diode has 95% rectification efficiency. Priced at 99¢ in small quantities.

To learn more, check F on the HP Reply Card.

New packaging protects PIN diodes

Three new 100 MHz to 12 GHz PIN diodes are available in hermetically-sealed stripline packages which pass MIL specs for a variety of environmental tests. The 5082-3140 device is for general applications from VHF through X band. Model 5082-3170 has similar characteristics but is reverse polarity. Both handle 30 W of power; dissipation is 2.5 W.

The fast-switching 5082-3141 device is also useful where low bias current is needed for maximum attenuation. Switching time is 5 ns. Power handling ability is 13 W; dissipation is 1 W. Isolation is > 20 dB for all three devices.

Prices: \$25 each in quantities of 1-9, and \$21.50 each for 10-99. Delivery is from stock.
For hermetic diode details, check G on the HP Reply Card.

The HP 5082-3140 hermetic stripline diode.

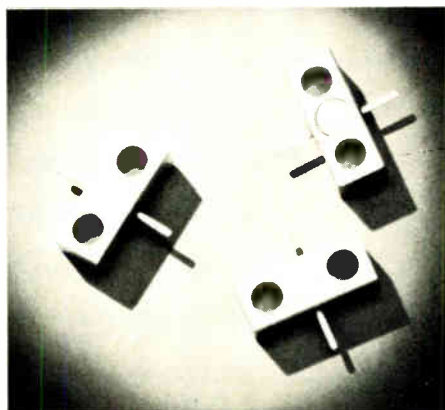

New microwave stripline Schottky diodes

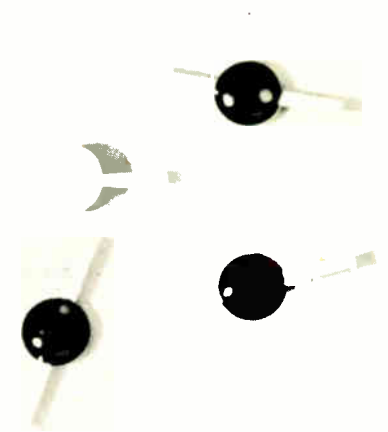

These low-noise stripline diodes are only 0.1 inch (2.5 mm) in diameter.

For economically-priced microwave mixer Schottky diodes, consider four new low-noise devices from HP. In the 1-4 GHz range, the 5082-2213 diode has a maximum noise figure of 6.0 dB and a VSWR of 15:1. The lower-priced 5082-2215 model has a typical NF of 6.5 dB and a maximum VSWR of 2:1.

From 4 to 12 GHz, the 5082-2217 diode has a maximum NF of 6.5 dB and a VSWR of 1.5:1. The lower-priced 5082-2219 series has a typical NF of 7.0 dB with a VSWR of 2:1.

Uniformity of RF characteristics is assured so that you can replace these components in the field without circuit adjustment. Typical applications include telecommunications receivers, microwave synthesizers, ECM and radar front ends.

In quantities of 1 to 9, the 5082-2213 costs \$8.25 each; 5082-2215, \$6.00; 5082-2217, \$12.50; and 5082-2219, \$9.00.

For more information, check E on the HP Reply Card.

Universal counters offer higher sensitivity and faster time interval measurements



Whether you compare accuracy, price, versatility or performance, HP counters stack up better.

HP universal counters/timers measure frequency, ratio, period, multiple period, time intervals, and totalize with one significant difference—these do it better than any comparably-priced counter. Measure the frequency of CW or burst signals, 50 to 550 MHz with better accuracy and high sensitivity (to 15 mV). As for stability, the aging rate is as low as 5×10^{-10} /day. Now, these HP counters have FCC approval.

For time interval measurement, only HP offers averaging down to 150 ps, with resolution to 100 ps—that's 1000 times better than conventional techniques. You can also get a built-in DVM for setting

trigger levels digitally. That's far more accurate and faster than using an oscilloscope, and the DVM technique works at high frequencies where the scope markers tend to blur. Because these counters have hysteresis compensation, you don't have to reset levels when switching from positive to negative inputs. Hysteresis compensation simplifies setup and reduces errors.

Be assured that HP counters also have better system capability. All front panel controls can be operated remotely and economically. A built-in three-range integrating DVM and counter can easily be programmed into your system.

With a choice of six models, select the universal counter that fits both your performance needs and your not-so-universal budget. Prices range from \$995 to \$2195. A new book explains it all. For your copy, check 1 on the HP Reply Card.



Send for our informative booklet on easier ways to make frequency and time interval measurements.



Measurement, Analysis, Computation

East—W 120 Century Road, Paramus, N.J. 07652.
Ph. (201) 265-5000.
South—P.O. Box 2834, Atlanta, Ga. 30328.
Ph. (404) 436-6181.
Midwest—5500 Howard Street, Skokie, Ill. 60076
Ph. (312) 677-0400.
West—3939 Lankershim Boulevard, North
Hollywood, Calif. 91604. Ph. (213) 877-1282.
Europe—Post Office Box 85, CH-1217 Meyrin 2,
Geneva, Switzerland. Ph. (022) 41 54 00.
Canada—275 Hymus Boulevard, Pointe Claire,
Quebec, Canada. Ph. (518) 561-6520.
Japan—Yokogawa-Hewlett-Packard, 1-59-1,
Yoyogi, Shibuya-ku, Tokyo, 151.

If you're working in computer peripherals, you want **Semiconductors For Communication Systems**...If you're working in data Modems, you want **Semiconductors For Communication Systems**...If you're working in aircraft/military radio, you want **Semiconductors For Communication Systems**...If you're working in active filters, you want **Semiconductors For Communication Systems**...If you're working in serial/parallel converters, you want **Semiconductors For Communication Systems**...If you're working in land/mobile radio, you want **Semiconductors For Communication Systems**...If you're working in audio power devices, you want **Semiconductors For Communication Systems**...If you're working in phase-locked loops, you want **Semiconductors For Communication Systems**...If you're working in synchronous/asynchronous transmission, you want **Semiconductors For Communication Systems**...If you're working in twisted pair drivers/receivers, you want **Semiconductors For Communication Systems**...If you're working in mixers, you want **Semiconductors For Communication Systems**...If you're working in control logic, you want **Semiconductors For Communication Systems**...If you're working in telephone crosspoint, you want **Semiconductors For Communication Systems**...If you're working in MATV, you want **Semiconductors For**

SEMICONDUCTORS FOR COMMUNICATION SYSTEMS

MOTOROLA Semiconductors

you want **Semiconductors For**
 in IF amplifiers/detectors, you
 working in low-noise preamps,
Semiconductors For Communication
 ing in control logic, you want
 ing in small-signal audio, you
 re working in single-sideband
Semiconductors For Communication
Semiconductors For Communication Systems...
 ing in marine radio, you want
 rking in D-A/A-D converters,
 're working in data interface
Semiconductors For Communication
 , you want **Semiconductors**
 in receiver oscillators, you
 rking in receiver front ends
 , you want **Semiconductors**
 working in CATV, you want
Semiconductors For Communication Systems...

Write on your company
 letterhead. Box 20912,
 Phoenix, Arizona 85036

If you're working in communications...

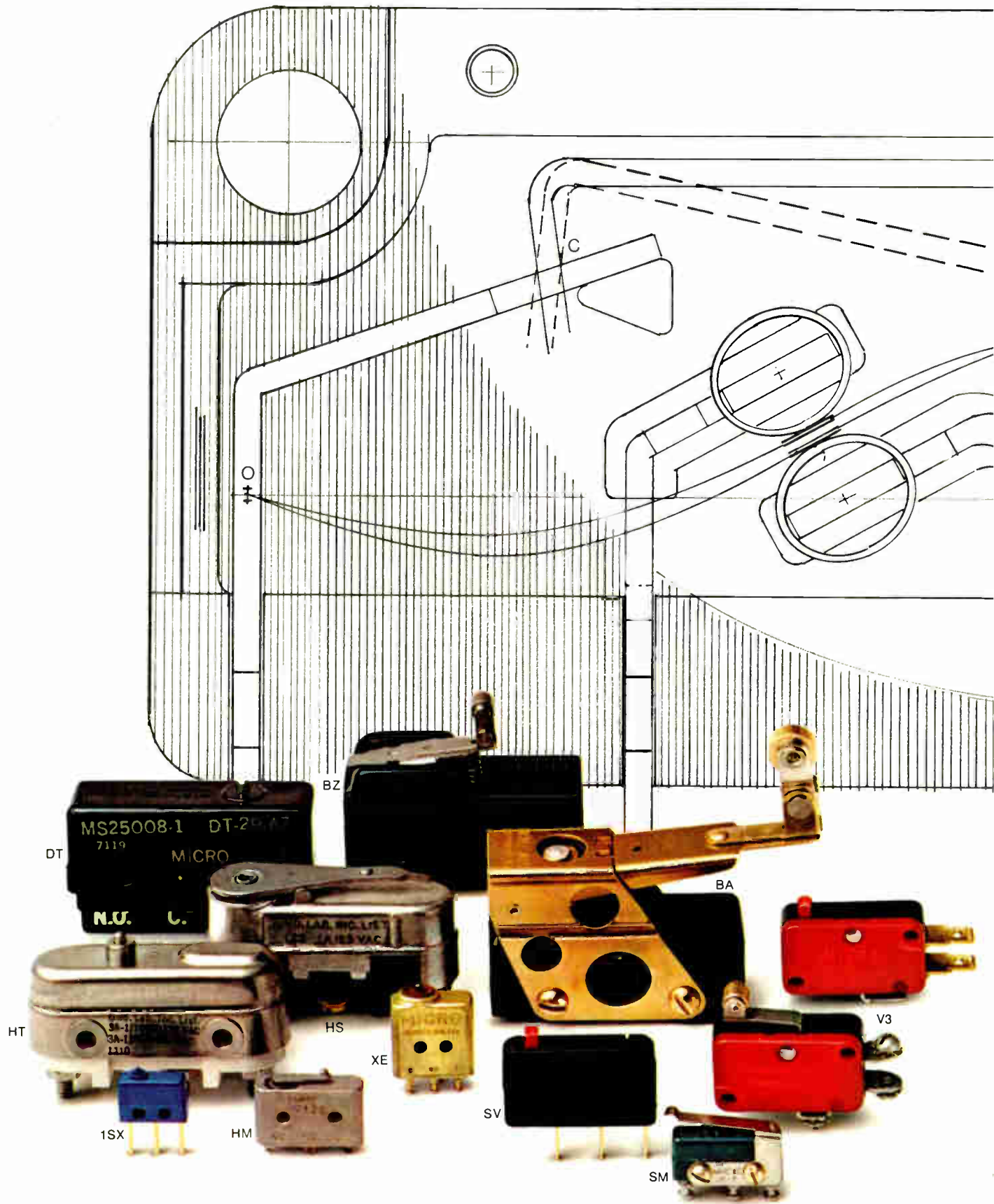

MICRO SWITCH products are available worldwide through Honeywell International.

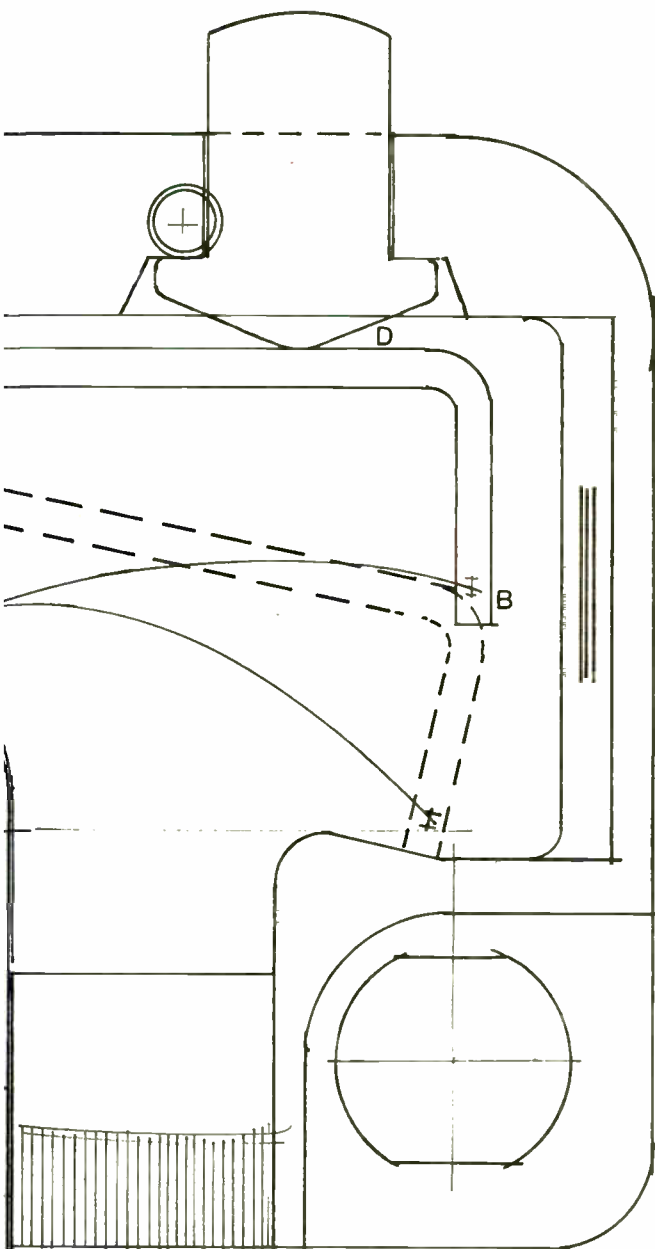

We're big in basics.

We invented the basic switch. So it's no wonder we offer more of them than anyone else in the world.

THE WAVE OF THE FUTURE.

The SV is our newest basic. It uses a revolutionary spring concept to provide reliability unique to a miniature snap-action switch.

BACK TO THE BASICS.

When space and weight are critical, a snap-action subminiature such as the SM (up to 10 amps AC) or the smaller 1SX (up to 7 amps AC) more than likely will be perfect. When cost is also critical, the small, versatile V3 (up to 15 amps AC) is ideal.

For maximum dependability and repeatability, there are our thousands of standard-size switches. The BZ and BA are among the most popular (up to 20 amps AC).

DOWN TO THE SPECIFICS.

For special situations, we have special basics. The DT (DPDT) and the HT, a high-temperature basic, (up to +1000° F) are good examples. SE and XE are small

switches offering environmental protection (MIL-S-8805). While HM and HS offer true hermetic

sealing (MIL-S-8805).

Actually, these are only a few members of our basic family. To meet the rest, contact your MICRO SWITCH Branch Office or Authorized Distributor (Yellow Pages, "Switches, Electric"). Or write for our complete literature.

MICRO SWITCH makes your ideas work.

MICRO SWITCH

FREEPORT, ILLINOIS 61032
A DIVISION OF HONEYWELL

Which of these General Electric lamps can help you most?

New Green Glow Lamp!

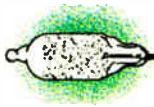

Actual Size

Finally, a broad spectrum bright green glow lamp from General Electric, that gives you greater design flexibility than ever before. It emits green and blue light with suitable color filters. It is called G2B.

What's more, the G2B is directly interchangeable electrically and physically with our high-brightness C2A red/orange/yellow glow lamp.

So you can use the G2B alone for 120 volt green indicator service. Or together with the C2A to emphasize multiple functions with color. For example: for safe/unsafe functions, dual state indications and to show multiple operations in up to 5 colors.

And remember. Both the G2B and C2A save you money because of their low cost, small size and rugged construction.

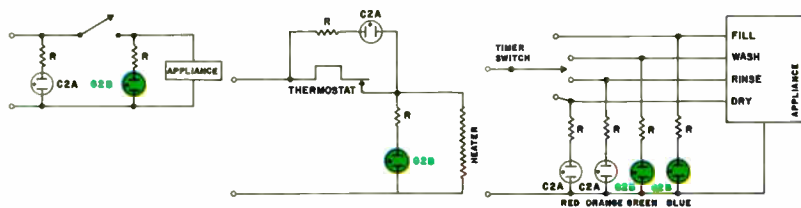

New Sub-Miniature Wedge Base Lamp.

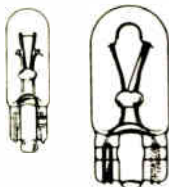

If space for indicator lights is your problem, this new GE T-1 $\frac{3}{4}$ size all-glass wedge-base lamp is your solution. It measures less than $\frac{1}{4}$ " in diameter.

The filament is always positioned

in the same relation to the base. It won't freeze in the socket, which virtually ends corrosion problems. And like its big brother — the T-3 $\frac{1}{4}$ wedge base lamp — it features a simplified socket design.

Three Potent Infrared Solid State Lamps (LEDs).



Get more than twice the useful output of other GE solid state lamps with GE SSL-54, SSL-55B and SSL-55C.

The increased energy concentrated in a narrow 20° cone allows you to use less sensitive detectors. Or to operate the lamps at lower current. Or to space lamps and detectors

farther apart.

All are excellent matches for GE photodetectors and can be used in many photoelectric applications. They're also particularly useful in applications demanding an infrared source capable of withstanding severe shock and vibration.

To get free technical information on any or all of these lamps, just write: General Electric Company, Miniature Lamp Products Department, Inquiry Bureau, Nela Park, Cleveland, Ohio 44112.

GENERAL  **ELECTRIC**

Meetings

USNC/URSI Meeting: URSI, IEEE, Williamsburg Conference Center and College of William & Mary, Williamsburg, Va., Dec. 12-15.

Business and Equipment Exposition: NRMA, New York Hilton, New York, Jan. 7-10.

Aerospace Sciences Meeting: AIAA, Sheraton-Park, Washington, Jan. 10-12.

International Solid State Circuits Conference: IEEE, Marriott, Philadelphia, Feb. 14-16.

Aerospace and Electronic Systems (Wincon): IEEE, Sheraton-U. of Pa., Philadelphia, Feb. 13-15.

IEEE International Convention (Intercon): IEEE, Coliseum and New York Hilton, March 26-29.

Southwestern IEEE Conference and Exhibition (Swieecoco): IEEE, Houston, Texas, April 4-6.

International Symposium on Circuit Theory: IEEE, Four Seasons Sheraton, Toronto, Canada, April 9-11.

International Magnetics Conference (Intermag): IEEE, Washington Hilton, Washington, D.C., April 24-27.

Carnahan Conference on Electronic Crime Countermeasures: IEEE, U. of Kentucky, Carnahan House, U. of Kentucky, Lexington, Ky., April 25-27.

Electron Device Techniques Conference: IEEE, United Engineering Center, New York, May 1-2.

Naecon: IEEE, Sheraton, Dayton, Ohio, May 14-16.

International Symposium: SID, Statler-Hilton, New York, May 15-17.

Measurement and Test Instrument Conference: IEEE, Skyline Hotel, Ottawa, Ont., Canada, May 15-17.

Conference on Laser Engineering and Applications: IEEE, OSA, Hilton, Washington, D.C., May 30-June 1.

Fluke problem solvers

A new AC calibration system with wide range, superb stability, high accuracy and complete programmability.



Here's the best ac calibration system you've ever seen. It's designed to give you state-of-the-art performance in the cal lab, in the factory or in automatic test systems.

The new system consists of the Model 5200A AC Calibrator and the Model 5205A Precision Power Amplifier.

Covering a frequency range of 10 Hz. to 1.2 MHz, the Model 5200A output is from 100 microvolts to 120 volts at current levels up to 50 milliamperes. Mid-band accuracy is ± 0.02 percent. Short term amplitude stability is ± 10 ppm. Six month stability, ± 0.01 percent. Working with the 5200A, the Model 5205A provides output voltages from 100 volts to 1200 volts at current levels up to 200 milliamperes. Combined 5200A/5205A amplitude accuracy is ± 0.03 percent.

The 5205A can also be used as a stand-alone amplifier providing programmable gains of X10 and X100 for frequencies from dc to 120 kHz. Output amplitudes from 1 millivolt to 1700 volts peak are offered for a wide variety of waveforms including pulses, sawtooths and triangles. All functions are remotely programmable with standard TTL logic levels. Uniquely, the 5205A can be programmed by both the 5200A and another control source so that it can be time-shared in an automatic system to perform a multitude of functions.

Price of the Model 5200A AC Calibrator is \$3,995. The Model 5205A sells for \$2,495.

To arrange a demonstration or get more details just dial 800-428-0361 for the location of your nearest Fluke sales office. Call it free anywhere in the contiguous United States.

Fluke, P.O. Box 7426, Seattle, Washington 98133. Phone (206) 774-2211.
TWX: 910-449-2650 / In Europe, address Fluke Nederland (N.V.), P.O. Box 5053, Tilburg,
Holland. Phone (04250) 70130. Telex: 884-55237. In the U.K., address Fluke
International Corp. Garbutt Close, Watford, WD2, 4TT. Phone, Watford, 33066. Telex: 934583.



Circle 31 on reader service card

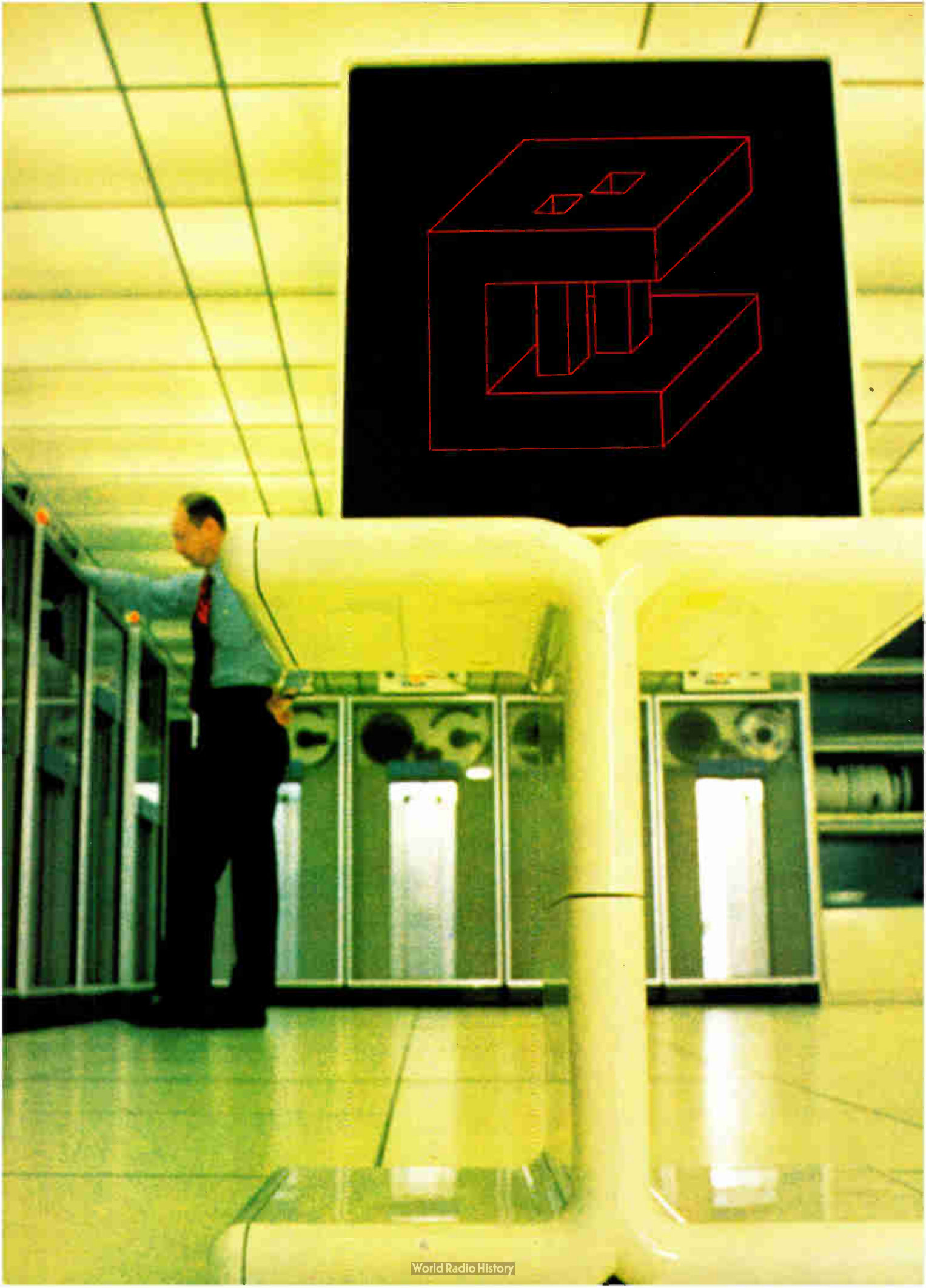

You've got the kind of an organization that demands instant, high-impact, full spectrum visual communication.

We've got Digivue.

INVENTORY STATUS

CUST NO	PART NO	QTY	TYPE	SHIP VIA
09731	46200	100	JB	AIRFREIGHT
08252	46200	150	JB	AIRFREIGHT
16723	20094	2000	DJ	RAIL
20412	27498	15	P	SPECIAL
23674	72667	55	KD	AIRFREIGHT
40750	20095	98	T	REA
54621	64298	87	PL	AIRFREIGHT
54687	37110	5	T	HAND CARRY
54687	63319	600	P	SPECIAL
54687	74472	1000	AB	REA
86446	63380	60	J	AIRFREIGHT
86500	72674	1	QV	UPS
46636	73378	35	BZ	HANDCARRY
46636	46200	100	JB	AIRFREIGHT
46636	20095	50	T	REA

a



b

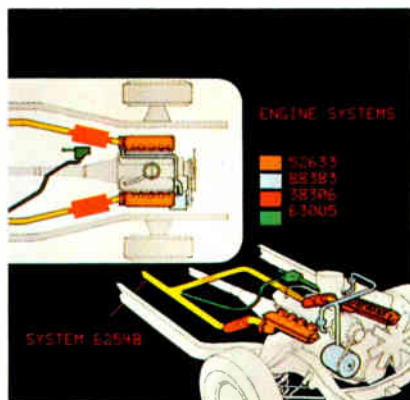

c

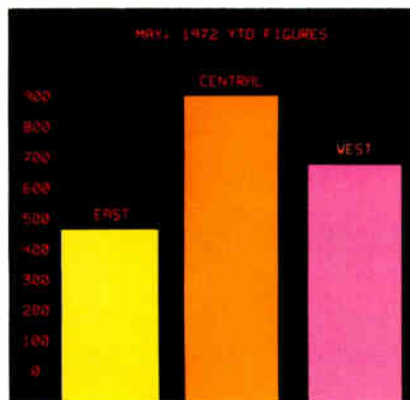

d

Communicate. That's the watchword for the Seventies. And that's just what Digivue® Display/Memory units do—with impact, immediacy and memorability.

Digivue Display/Memory units deliver computer-generated alphanumeric or graphic information at microsecond speeds. And a Digivue Display/Memory unit is a digital plasma display device—the space age display system that's a technological giant step beyond the cathode ray tube.

Inherent memory, selective write/erase, drift-free images, rear-projection capability, design adaptability, hard copy printout potential—that's Digivue.

Digivue Display/Memory units are now available in three different sizes: A 256 x 80 addressable line panel at a resolution of 33 lines per inch; a 256 x 512 addressable line panel at a resolution of 50 lines per inch; and a 512 x 512 addressable line panel at a resolution of 60 lines per inch that offers an active display area for up to 4,000 characters.

If you need fast, multi-purpose visual communication with impact—in a business, school, hospital, transportation center—we've got what you need. Digivue Display/Memory units.

Call or write: Jon Klotz, Marketing Manager
Electro/Optical Display
Business Operations C,
Owens-Illinois, Inc.,
P.O. Box 1035, Toledo, Ohio 43601
(419) 242-6543.

Communication with Digivue units begins at a data processing center like the one pictured on the opposite page, where computer-generated information is directly addressed to Digivue units at various locations.

a/A Digivue unit in a shipping department relays the day's orders by catalog number, type, quantity and method of shipment. Digivue's inherent memory allows instant retrieval of this information without refresh requirements at any time.

b/A Digivue unit on the desk of a financial vice president transmits a twelve-month cost projection. Terminal manufacturers note: Digivue's slim panel depth allows for high-styled consoles and attractive, unobtrusive placement in an almost limitless variety of situations and locations.

c/Digivue units help a sales training class with assembly techniques for a new product line. Because Digivue panels are transparent, rear-projected graphics in every color of the rainbow deliver high-impact visuals no CRT system can even come close to.

d/With the help of a Digivue unit, a busy executive secretary prepares information for an important meeting—utilizing a combination of rear-projected graphics and computer-generated alphanumerics.

Owens-Illinois

Circle 33 on reader service card

World Radio History

Digivue is a registered trademark of Owens-Illinois, Inc.

Display/Memory Units

DIGIVUE

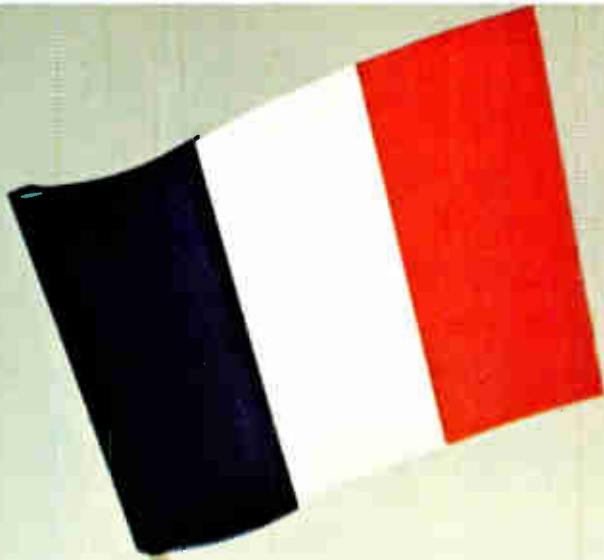

Voilà

Amphenol brings you a whole new line of fans. Etri, from France. A complete, established line of axial fans. With solid design advantages that make them the most widely accepted fan in Europe. Built to last longer by design.



Ball Bearings, Not Bushings

Ball bearing shaft assembly is designed to reduce the friction that wears out conventional bushing-design fans before their time has come.

Aluminum Frame, Not Plastic

Non-deforming aluminum body designed to conduct and dissipate motor heat, protecting bearings and sensitive motor parts from premature burn-out and wear-out.

A Lightweight Rotor, Not a Heavy One

Designed to place less stress on the bearing assembly. Laminations and windings are stationary. Fan blades are lightweight self-extinguishing plastic or aluminum alloy.

Standard models can handle almost any job be it an industrial, military, or space application. Customized designs take over where the standard line leaves off. We welcome special ventilation problems.

Etri is not new. Etri backed by Amphenol is new. It's one of the first products from our Alliance Marketing Service. Amphenol's AMS selects the best components on a world-wide

basis and brings them to you. You get a broader component selection and increased design options. For more information, contact: Alliance Marketing Service, Amphenol Sales Division, 2875 South 25th Avenue, Broadview, Illinois 60153. (312) 345-4260.

Circle 34 on reader service card



AMPHENOL

Dielectric isolation used in power ICs

Dielectric isolation, the IC technique that was used only recently to build the first commercial C-MOS logic devices, **is now making its way into the world of power ICs.** In fact, the developers at RCA's Solid State Technology Center in Somerville, N.J., have worked out a unique way of dielectrically isolating silicon wafers by inserting a silicon-dioxide layer between them and then forming the various circuit elements by diffusion. **The technique already has been used to build a power chip consisting of three transistors and six resistors.** And the transistors' base voltages, V_{CBO} , of 450 to 500 v are far in excess of anything attainable by conventional monolithic junction-isolation techniques.

In contrast to the problems encountered building power ICs by conventional methods, **RCA's dielectrically isolated devices achieve high reliability by using silicon-nitride layers over the junctions.** Field electrodes, which are kept at collector potential, are then used to prevent surface-ion buildup, as well as to prevent induced channels from occurring beneath the interconnections, a condition that could cause reduced voltage capability. The silicon-nitride overcoat also prevents the migration of ionic contaminants into the passivating film, preventing another cause of device failure in power chips.

National using Planox for p-channel part

National Semiconductor has joined the short list of manufacturers offering parts made with the Planox process, a technique designed to increase the density and speed of MOS devices and developed in Italy at Società Generale Semiconduttori [*Electronics*, Dec. 20, 1971, p. 44]. In this country, Standard Microsystems of Hauppauge, N.Y., also makes the devices.

In production at National is a 2,048-bit p-channel shift register that operates at 6 megahertz, faster than the 2 to 4 MHz common with standard p-channel construction. However, a typical n-channel device built with National's Planox would have speeds around 100 nanoseconds; standard n-channel would be in the 150-ns range.

New engineer jobs opening in CATV

A Department of Commerce report released late last month has predicted a need for from **35,000 to 62,000 new technical and engineering personnel in the cable television industry within the next five years.** According to a survey of cable operators, CATV construction firms, and cable equipment manufacturers, there are now 2,000 unfilled technical and engineering positions in this industry. The study concludes that, though these are ballpark estimates, there is clear need for the Government to initiate training programs to bring technical people into CATV.

Printed-circuit TWTs promise cost cuts

A radically new approach to traveling-wave-tube design—the use of printed-circuit technology—could lead to impressive cost reductions. Allen W. Scott, manager of advanced development at Varian Associates' TWT division, predicts that eventually **production units made by printed-circuit technology will sell for under \$100, less than one-fifth the cost of conventional tubes with the same performance.** Applications range from phased-array radars to microwave relay transmitters.

All tube elements, including the beam-forming electrodes, the mi-

crowave interaction structure, the collector, and all electrical and microwave connections are printed on a pair of ceramic sheets. The sheets themselves form the vacuum envelope of the tube.

The printed-circuit technique is useful at frequencies to X-band, according to Varian. **A 22-watt L-band tube has been tested with a 25% bandwidth and an over-all efficiency of 28%**, which is comparable to conventional tube performance. Gain at 22-w output is 10 decibels. The pc tube measures approximately 8 by 2½ by 2½ inches, including focusing magnets.

Printed-circuit TWTs, says Scott, can produce average or cw power from 500 w at 1 GHz to 30 w at 10 GHz. Pulsed power of 10 kW at 1 GHz and 100 w at 10 GHz is attainable. The L-band unit has been built, but production plans aren't yet firm. The other parts are still in the design phase.

Advanced ATC start planned for FY 1975

The Federal Aviation Administration plans to begin research and development of the advanced air traffic management system, an automated air traffic control network for post-1985, with a fiscal 1975 expenditure of \$17.2 million. **The total system is expected to cost \$350 million.** The Department of Transportation will suggest development concepts to the FAA by the end of fiscal 1973, and will base its recommendations on studies by Boeing and North American Rockwell's Autonetics, as well as a recently awarded one-year automation study to TRW Inc.

U.S. firms may get boost from Colombian ATC buy

Avionics manufacturers interested in cracking the tough Latin American market are watching closely an impending award by the Colombian government for a \$35 million air-traffic-control system. Should a team of U.S. companies led by Page Communications Inc., a subsidiary of Northrop, beat out the other qualified bidder, Thomson-CSF of France, **that victory could give U.S. firms a big foot-in-the-door toward other major Latin American avionics contracts** because of an interest in system commonality.

The U.S. team hopes it may have an edge, since the Federal Aviation Administration advised the Colombian government on the specifications. The contract is expected to be awarded early next year, and a U.S. win would be the first big harvest from the joint FAA-Commerce Department and Export-Import Bank program to raise U.S. avionics sales south of the border [*Electronics*, Feb. 14, p. 94].

Addenda

In the name of international cooperation, but mainly to share costs, the National Aeronautics and Space Administration and the European Space Research Organization are considering joining forces on two future satellite programs. **The agency and ESRO are working on the possibility of cooperating on part of the proposed 1978 Pioneer/Venus orbiter.** . . . William C. Hittinger, vice president and general manager of RCA's Solid State division, is being promoted to executive vice president in charge of consumer and solid state.

match this



an 8K mini with cassette and software for \$3,950*

An operating system—including the GRI-99, 8K word computer; the GRISSETTE II, a full duplex read-write cassette system; interface *and* software.

Now, with the GRISSETTE II cassette system as a low-cost peripheral for the GRI-99 computer, a truly economical cassette-base operating system is a reality.

The unique GRISSETTE II cassette system is the logical, low-cost, high-performance replacement for paper tape.

It is simple, uncomplicated and provides up to one million characters on a single cassette. Coupled with a keyboard entry device, source programs can be edited, assembled, modified and re-assembled.

GRISSETTE II can be used to load object programs as well as diagnostics. Data can be recorded or entered conveniently and efficiently. With an optional Auto Loader, programs can be loaded and started automatically, activated by a single computer console switch.

*OEM quantity price

The GRI-99 computer is a Direct Function Processor utilizing our original Universal Bus System. It is unequalled for ease of programming and exhibits unusually simple operating characteristics. Software development costs are the lowest in the industry. Debugging of software and hardware are also big dollar savers.

The results: You get your total system operating faster at lower cost. With GRI equipment you save when you buy . . . you save when you use it.

Write GRI Computer Corporation
320 Needham Street, Newton, Ma. 02164
Phone: (617) 969-0800. Cable: GRICOMP

Go ahead and match.

gri
GRI Computer
CORPORATION

Why we think the Brush 222 is your best choice in a 2-channel battery-run portable recorder.

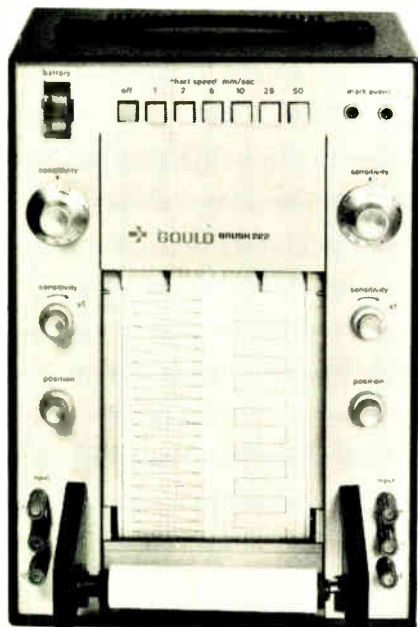

ACCURACY. With the 222, you get linearity guaranteed to 99.5% with our Metrisite® servo loop feedback system. Of course, there are other recorders just as accurate. We know that. Because we make most of them.

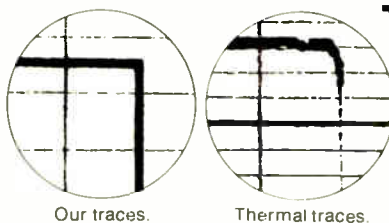
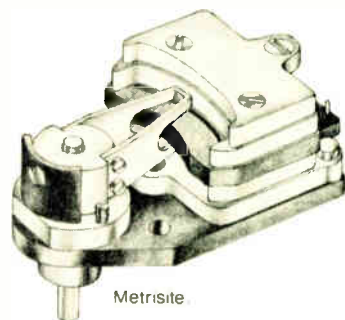

THE CLEANEST TRACES. When you say hello to your 222, you say good-bye to smudging, smearing, skipping and puddling traces. The reason: pressurized inking that forces a crisp, clean trace not just onto, but into the paper.

REAL PORTABILITY. You don't have to be King Kong to take the 222 exactly where you need it. It's completely self-contained and weighs just 25 pounds.

SOLID FEATURES, NOT FRILLS. Like: built-in preamps that give you measurement range from 1mV per division to 500V full scale without recalibration. Pushbutton-controlled chart speeds. Two event channels. An ink supply that lasts a year. And a no-mess disposable ink cartridge, so your fingers never look like part of a Rorschach test.

LONG-LIFE BATTERIES. The internal battery supply gives you 12 hours of continuous operation. Up to 6,000 hours of total operating life. And complete rechargability in just 16 hours. Just plug the 222 into an ac or dc outlet overnight and you're ready to go in the morning.

We think you may want to know more about the 222 and our other recorders. So, write us. Gould Inc., Instrument Systems Division, 3631 Perkins Avenue, Cleveland, Ohio 44113 or Rue Van Boeckel 38, Brussels 1140, Belgium.

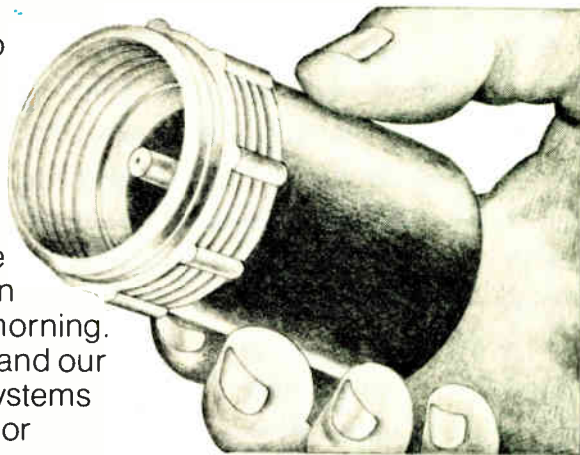

A year's supply of ink.

BRUSH INSTRUMENTS

 **GOULD**

Electronics/December 4, 1972

Software patent hot potato winds up in Congress' lap

Supreme Court action ruling out patents on ideas leaves question of whether those already granted are invalid

The 94th Congress of the United States, due to convene in January, looms as the court of last resort for proponents of computer software patents. Ironically, that was the judgment of the U.S. Supreme Court in its Nov. 20 ruling that computer programs derive from ideas that are mathematical formulas and that "one may not patent an idea."

The 6-0 decision was clouded by

what some lawyers on both sides of the patent issue called "a bad case" for a Supreme Court precedent. It involved a petition for a writ of *certiorari* by acting Commissioner of Patents Robert Gottschalk, which sought to overturn an earlier judgment by the Court of Customs and Patent Appeals supporting the attempt of two Bell Laboratories employees, Garry R. Benson and Arthur C. Tabbot, to patent a digital computer software program. Already known as the Gottschalk-Benson decision, the new ruling was written by long-sitting Associate Justice William O. Douglas, generally regarded as the Supreme Court's most liberal member. Asso-

ciate Justices Potter Stewart, Harry Blackmun, and Lewis Powell did not participate in the case.

Justice Douglas's opinion reversing the lower court action conceded that the high court was overwhelmed by the technological complexities of the issue, as well as by the tight budget of a Patent Office physically unable to cope with software patent claims. Thus the court bucked the issue to Congress.

"If these programs are to be patentable," Douglas wrote, "considerable problems are raised which only committees of Congress can manage, for broad powers of investigation are needed, including hearings which canvass the wide variety

Software, hardware people see it all ways

The software industry is split on the patentability issue. This is reflected by Dick H. Brandon of Brandon Applied Systems, New York, who clearly prefers the laws of copyright and trade secrets to protect his software programs. "The Supreme Court decision was correct," he declares. "I've never felt that software should be patented. There is no merit in it. A set of instructions to run a computer is no more patentable than a set of instructions you give a clerk to run an adding machine." Besides, he adds, patent law requires full disclosure; common law covering trade secrets doesn't.

Brandon's view that "we've lived all these years without patenting programs" is supported by the Supreme Court's citation of the 1966 report of the President's Commission on the Patent System. "The creation of programs," the commis-

sion observed, "has undergone substantial and satisfactory growth in the absence of patent protection" and with coverage by copyright.

Varying degrees of industry indifference to the judgment are reflected in Brandon's belief that Gottschalk-Benson's effect on computer hardware makers would be "none," as well as the view of software patent holder Martin Goetz of Applied Data Research that the court's judgment "won't significantly hurt the industry" built up around software.

Computer manufacturers have subdued the champagne-cork pop while privately toasting their successful opposition in the supreme test. "It can hardly be called the final judgment," cautions one computer company counsel in the capital. "Mister Justice Douglas copped out and just lobbed the ball up to the Hill." What Congress will sooner

or later have to face is the question most computer makers believe the court dodged. That question, in the court's decision, "is whether a [computer program] method described and claimed is a 'process' within the meaning of the Patent Act." The act provides that "whoever invents or discovers any new and useful process . . . or any new and useful improvement thereof, may obtain a patent therefor. . . ."

Where the Douglas opinion for a unanimous court is alleged to have dodged the ultimate issue is its warning that: "We do not hold that no process patent could ever qualify if it did not meet the requirements of our prior precedents. It is said that the decision precludes a patent for any program servicing a computer. We do not so hold."

Thus there is still caution in the manufacturing community and a ray of hope for software patents.

of views which those operating in this field entertain." Those views, Douglas observed, came largely in the form of 16 *amicus curiae* briefs—an uncommonly large number—filed in the case. Most came from computer hardware manufacturers opposed to software patents, which they say could constrain new technology and increase hardware costs by requiring insurance to protect programs that come with systems.

Action unlikely. The Court's unanimous call for "considered action by the Congress" is likely to go unheeded except perfunctorily. This is the conclusion of patent experts in the capital's legal community, who note realistically that computer industry hardware lobbyists who oppose patents are far better organized and more effective on Capitol Hill than the much smaller software industry, where views are divided. Moreover, says one Federal observer of the congressional process, "there are much bigger fish to fry next year—like tax reform and Government health insurance. They make better headlines than patents on computer programs."

Still up in the air is the issue of whether or not the 100 or more patents issued earlier on software programs will be vacated because of

Gottschalk-Benson. No one is sure. In the opinion of patent attorney and software specialist Michael Rackman, "I'm sure the law won't crystallize without many more cases." Rackman is one of a number of computer industry lawyers who believe Gottschalk-Benson was, for the Supreme Court, "the worst possible case—or the best possible case from the point of view of the Patent Office"—on which to base the precedent-setting decision.

Gottschalk-Benson, he points out, "deals purely with a mathematical process, and this clouds the court's thinking." Rackman contends that "a better case" would have been Prater and Wei [*Electronics*, Sept. 1, 1969, p. 37]. There, Mobil Oil Co. received a patent on a computer program for seismographic analysis designed to locate oil deposits. Where Prater and Wei had "the end result of telling you where the oil is" and presumably better met the test of a patentable process, Rackman points out that Gottschalk-Benson "involves translating from one number system to another, a purely mathematical manipulation. The court has evidently decided on the basis of this one case that all programming is mathematical and therefore not patentable." □

Integrated electronics

Japanese build semiconductor inductance device featuring stable, high-Q values

Many attempts have been made to simulate inductance in semiconductor devices by using thermal effects, the Hall effect, or exploiting impedance relationships in reactance diodes. None has produced a practical product that can be substituted for a conventional inductance because it has been impossible to build devices with both high Q values and temperature stability. Now a team at Mitsumi Electric Co. in Japan has produced a semiconductor inductance device that makes stable high-Q inductance available in integrated form.

The new device, which the developers call SemiconL, relies on the principles of negative impedance conversion and gyration to simulate inductive effects. The gyrator is a nonreciprocal two-port network whose input impedance is proportional to its load admittance. Thus a gyrator produces the characteristics of an inductor when a capacitor is connected to its output. A negative impedance converter produces at its output terminals the negative reciprocal of any impedance placed at its output. The combined action of gyrator and con-

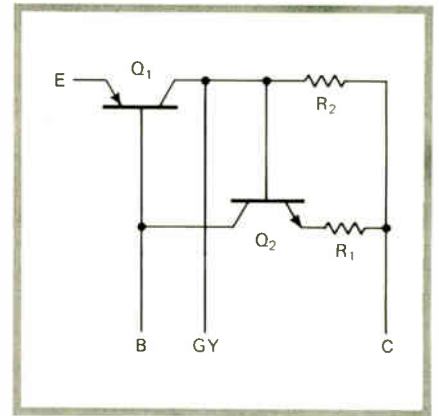

Inductance. Japanese have built semiconductor inductance device, the SemiconL.

verter in the SemiconL produces both high inductance and high negative resistance simultaneously, affording a number of unique circuit applications, including filters, oscillators, and amplifiers.

Because the SemiconL does not generate magnetic fields as coils do, they are not adversely affected by them either. And since the SemiconL has negative resistance, it can achieve higher values of loaded Q than do coils. Also, with the proper connection, the SemiconL is capable of providing gain; inductance variation can be achieved by both current and voltage control. On the negative side, the device requires a bias supply and its dynamic operating range is limited by linearity requirements.

The device is fabricated by conventional bipolar monolithic processes on a silicon planar chip 0.15 millimeter thick and 0.6 mm square. It can simulate inductances from 1 microhenry to 5 henries with a loaded Q value of 50 to 100 at frequencies up to 15 megahertz. Temperature coefficient is 400 ppm/°C. Developmental individually packaged SemiconLs have been produced at Mitsumi's development center.

In addition, the simulated inductances have been included in two other hybrid circuit packages, the LVI 15-D2, a 3.58-MHz color subcarrier coilless trap and automatic resolution control circuit, and the LMIO 2-D2, an a-m intermediate frequency amplifier detector operating at 455 kHz.

The development is being described this week at the International Electron Devices Meeting in Washington by Takeo Miyata, Ryokichi Watanabe, and Seiya Hamada. □

Displays

Smectic LC used at Bell Labs . . .

Bell Laboratories' engineers have taken advantage of two drawbacks of so-called smectic liquid crystals to improve on an earlier display system by making it selectively erasable. Both models use the heat of an infrared laser beam to inscribe a liquid crystal with information that is then projected onto a viewing screen [*Electronics*, Oct. 23, p. 32]. But instead of the cholesteric LC of the first system, Bell is now using smectic LC material. That type has until now defied successful application, according to Frederic J. Kahn of the Solid State Device laboratory in Murray Hill, N.J.

Compared with cholesteric LCs, smectic material has a much more highly ordered molecular structure, one that is quite sluggish and does not respond to an electric field. But like the cholesteric material, it does respond to the laser's heat—rising in temperature so that it enters an isotropic state which, as it cools down with the removal of the laser beam, settles into a polycrystalline-

like state that scatters light strongly. This is the storage state.

When information is written in them, the smectic and cholesteric materials behave similarly. But whereas an ac field placed across the cholesteric crystal will erase it completely, the field has no such effect on the smectic. With its sluggish molecular structure, the smectic LC is only affected by a field applied at the same time that the material is being scanned, and reheated, by the laser. The locally heated material is then erased in what Kahn calls a "field-assisted thermal erase" mode. Typically, the writing beam is transferred to an erasing beam when a 35-volt field at 1.5 kilohertz is applied across the LC.

Resolution obtained in demonstrating the feasibility of the technique was 50 lines per millimeter over a 3-by-3-centimeter area, according to Kahn. Contrast is about 10:1. Addressing speed with the X-Y deflected laser beam has been about 10^4 picture elements per second for less than 20 milliwatts of 1.06-micrometer yttrium-aluminum-garnet laser power. Newer material Kahn is working with requires only about 4 milliwatts.

Hot stuff. Overall, Kahn says alphanumeric or graphic data can be written with higher resolution on the smectic material. A disadvantage is that it remains in a liquid crystal state only above room temperature—from 35°C to 75°C, compared with 0°C to 60°C for cholesteric material. However, Kahn points out that smectic materials are

relatively early in their development, and it's "only a matter of time" before room-temperature smectic materials are developed. □

. . . as IBM lab turns to tungsten

But if smectic liquid crystals represent one of the newest display materials, the thin-film incandescent display developed at the IBM Thomas J. Watson Research Center, Yorktown Heights, N.Y., touches on one of the oldest materials of the electronic age—tungsten filaments. IBM engineers there have fabricated a three-character, 5-by-7-dot matrix display that uses 20-by-20-mil dots of thin films of tungsten. Fred Hochberg, manager of the group working on the devices, asserts that the photolithographic techniques used to batch-fabricate whole arrays of characters could mean a display cheaper than what's available.

Hochberg's displays are fabricated on a ceramic substrate covered with a thick layer of glass. Holes produced in the laminate are filled with metal to form the element support posts. A thin layer of refractory metal is then deposited on the glass, and the metal and glass are etched to produce a field of free-standing microfilaments. Strung between the support posts of the IBM devices are flat metal films, not the metal helixes of other tiny incandescent display devices such as Numat-

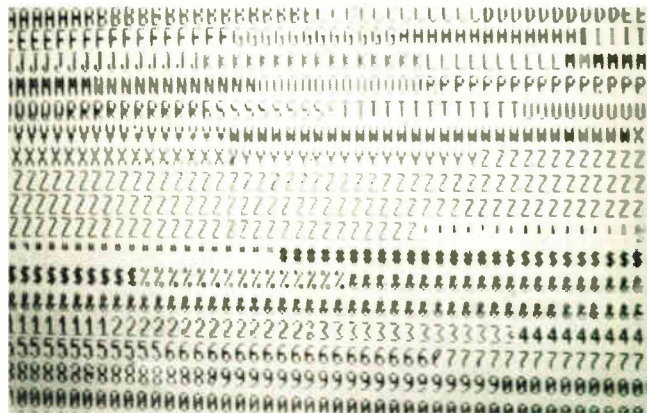
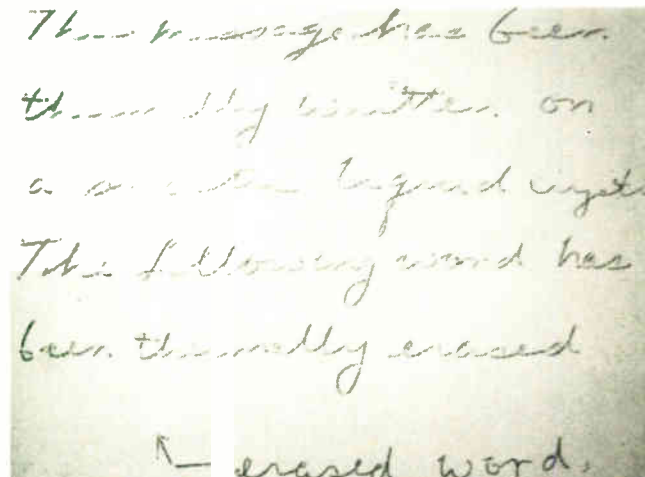

Now you see it. Erasable display using smectic liquid crystals (at left) shows missing word. Sample characters are above.

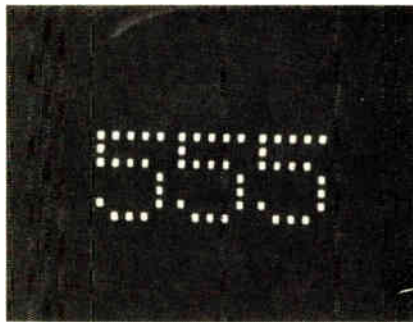
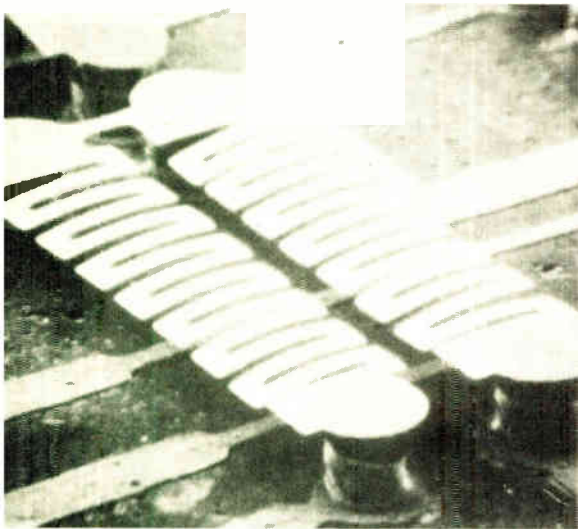

Bright dot. Thin-film tungsten serpentine form a lighted dot whose incandescent area, diminished by cooling losses at each fastened end, is 20 mils square. Work at IBM results in display shown above. Efficiency is said to be better than that of most light-emitting diodes; device operates at 1,200°C.

rons or Pinlites. And the film is in an evacuated glass envelope.

The efficiency of the device, operating at 1,200°C, is better than that of most light-emitting diodes, he says. And if operated at higher temperature, the tungsten's efficiency improves markedly. The color of the device, described by Hochberg as "pleasing," is a straw yellow. Despite the hot temperature at which the filament operates, the low mass involved reportedly causes the substrate to heat up by less than 50°C. This is low enough to allow semiconductor driver chips to be mounted inside the display package. About 10 milliwatts are used for each dot. Normally, no more than 20 dots per digit are lighted, for a consumption of 200 milliwatts per digit. They can be driven by TTL.

A paper describing the displays will be given in Washington at the International Electron Devices Meeting, Dec. 4-6. □

Instrumentation

Scope features built-in multiplier

Spurred by in-house needs, Philips Gloeilampenfabrieken in the Netherlands has developed an oscilloscope with a built-in multiplication function, a feature that permits the product of two input signals to be

displayed on the instrument's screen.

Apparently the first of its kind, the instrument does away with the need for complex bench setups consisting of such devices as multipliers, attenuators, dc balancing controls, a power supply, and input and output networks that must be hooked together for signal-product determination on an oscilloscope. With the Philips instrument, that job is done simply by connecting to it the two signal inputs, and with the flick of a few switches, the product can be read. The signal can be displayed simultaneously with either one of the original signals.

The signal-multiplication feature extends over a bandwidth of 30 megahertz, attributable to the use of high-speed monolithic ICs, custom-designed by Philips. The scope comes in two versions, the PM 3252 and the PM 3253. When not in a multiplier mode, the former is a standard 60-MHz, dual-trace, general-purpose laboratory instrument. The latter, also a 60-MHz instrument, employs a storage-type cathode-ray tube.

Systems designers are finding that the need to be able to multiply two parameters and display the result for analysis and comparison is growing. For example, with the new Philips scope, current and voltage can be multiplied to display power directly. The product of two physical parameters—for instance, force times displacement and torque

times angular velocity—can be measured directly. There are a host of other applications, such as in semiconductor development work for transient power measurements, in professional recorder work for tape-recorder head adjustments, and in component design for high-accuracy phase and dynamic phase-change measurements.

Quick, accurate. In phase alignments, for example, the product of the two signals that are out of phase has a dc component directly related to the phase difference. Measuring this component with the scope is a quick and accurate way to determine phase. Furthermore, the phase variation can be displayed as a function of time, and this permits dynamic phase measurements.

The instrument's storage version can be particularly useful in applications where the product of single-shot events needs to be investigated, as in destructive tests of semiconductor devices and materials. It should also be suitable for determining gas-discharge characteristics in components.

The development of the new scopes, says Jacques Wouters, a Philips product engineer, was triggered by the many requests from Philips departments for an instrument with a multiplying function. They were all clamoring for it—the computer people, the semiconductor makers and the recorder designers, explains Wouters.

"And with our expertise in designing high-speed thin-film ICs for counters and other instruments, we were able to produce a multiplier scope with a bandwidth such as ours."

Both instrument versions are compact portable types with 5-inch display tubes that have useful display areas of eight by 10 divisions. For the PM 3252, these divisions are 1 centimeter each; for the PM 3253, 9 millimeters.

The input sensitivity for both scopes is 2 millivolts over the entire 60-MHz bandwidth and 200 microvolts over a reduced bandwidth of 5 MHz. The instruments incorporate a drift-compensation network for both Y amplifiers. This network

TEKTRONIX
committed to
technical excellence

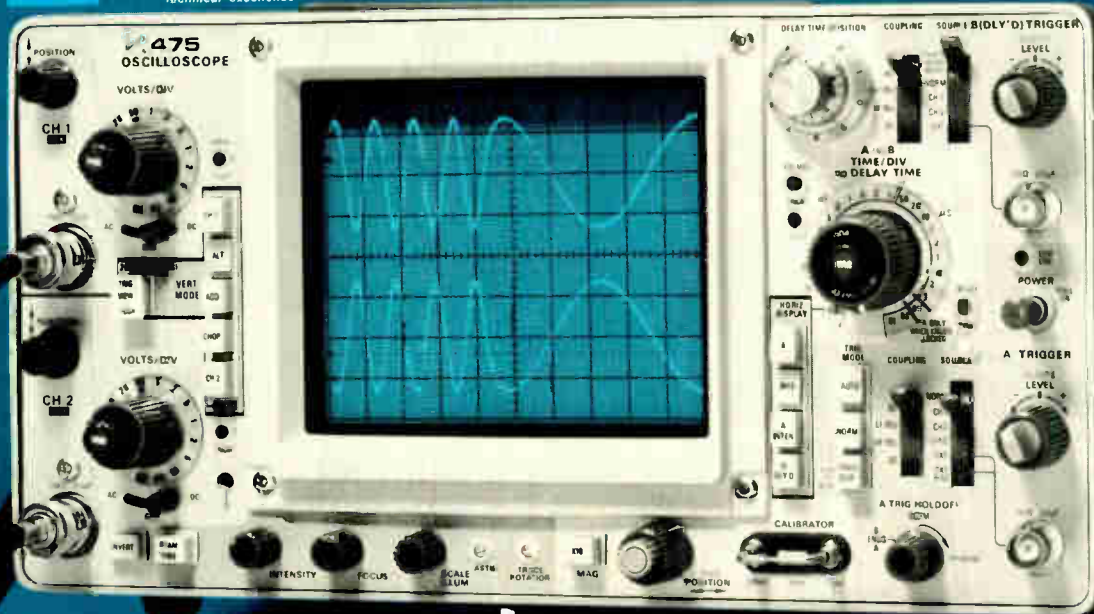

NEW

value leaders = higher bandwidths + lower prices
faster sweep speeds + new operation conveniences + better sensitivities

The **NEW** dual-trace **TEKTRONIX 475** and **465 Oscilloscopes** supersede the world's most traveled and widely used general-purpose oscilloscopes . . . the **TEKTRONIX 453A** and **454A**. They have significantly more bandwidth, twice the sweep speed, a bright 25% larger (full 8 x 10 cm) display and additional user conveniences. And all of this in a shorter, thinner, lighter and much lower-priced package.

The **200 MHz TEKTRONIX 475 Oscilloscope** at 2 mV/div and 1 ns/div sweep speed contains the highest gain bandwidth and sweep speed now available in a general-purpose portable oscilloscope and for only \$2500. Add to this many user conveniences including: push-button trigger view, knob-skirt sensitivity readout, ground reference button on the probe tip, simple to interpret vertical and horizontal mode push buttons and many more . . .

The new **TEKTRONIX 465** with 100 MHz at 5 mV/div and 5 ns/div sweep speed has all of the same user conveniences and service features as the 475 and is an outstanding price/performance package for only \$1725.

This outstanding performance and versatility with **TEKTRONIX** quality and laboratory accuracy makes these not only the finest field scopes available but also top contenders for use by development and design engineers. Optional DC or battery operation gives you a portable scope ready to travel and ready to make measurements at remote locations.

For complete information or to arrange a demonstration, contact any **TEKTRONIX** Field Office. Our offices are located in or near major cities and industrial centers — world wide. If you prefer, write Tektronix, Inc., P.O. Box 500, Beaverton, Oregon 97005. In Europe, write Tektronix Ltd., P.O. Box 36, St. Peter Port, Guernsey, C.I., U.K.



200 MHz @ 2 mV \$2500

value leaders



100 MHz @ 5 mV \$1725

U.S. Sales Prices FOB Beaverton, Oregon

For a demonstration circle 42 on reader service card

Circle 43 on reader service card 43

eliminates dc drift, an important feature in the multiplier mode.

Both versions will go to market in Europe and the United States around March of next year, but sample units will be shown to prospective customers in late December. The price for the PM 3252, the standard unit, will be about \$2,000; the PM 3253, the storage-CRT version, will sell for about \$3,800. □

Communications

Private television gains momentum

With impetus provided by a series of approvals by the Federal Communications Commission, a new telecommunications medium has been created that makes possible a limited-access institutional service. Called the multipoint distribution service (MDS), it is a metropolitan microwave common-carrier system on which anyone may purchase time. Range is about 25 miles.

Construction permits have been granted for MDS systems in Houston, Washington, Chicago, Minneapolis, Dayton, Philadelphia, and Pittsburgh. Several of the systems are expected to go into operation by the end of the first quarter of 1973.

The new service is directed toward such users as hotels and motels for movie distribution, retail store chains, hospitals, and universities. Don Franco, president of Microband Corp. of America, predicts that the new industry will produce revenues exceeding \$300 million and employ more than 2,000 people directly by 1976. Microband, a New York City firm, bases its forecast on the fact that it holds three of the construction permits and has applications in 33 metropolitan areas that represent 34% of the U.S. population. Franco also projects a \$27 million cumulative equipment cost by 1976.

Varian Associates, of Palo Alto, Calif., is presently the only manufacturer of microwave transmitters and receivers that have been type-

accepted, but several other suppliers are known to be developing equipment.

MDS operates in the band from 2,150 to 2,162 megahertz, using omni-directional transmitting antennas with effective radiated powers of 100 watts (approximately 10 W of transmitter power goes into the antenna). The receiver antenna is a directional horn or parabolic dish reflector, with size depending on its distance from the transmitter site. A receiver down-converter processes the incoming signal into a lower-frequency carrier compatible with standard television receivers. The entire system (transmitter and the microwave portions of the receiver) is owned by the common carrier and leased by the user.

The applicants have not detailed the tariffs that will be imposed on users—an omission that must be corrected before operational licenses are approved. However, applications for construction permits have contained tentative tariff plans. Following such guidelines, over-all income for the carrier will be derived from three charges: a per-hour charge ranging from \$75 to \$250 for transmitter use, a monthly receiver rent of \$25 to \$50, and a receiver installation fee of several hundred dollars. □

Automotive electronics

RCA's BITE tests Army vehicles

Maintenance is one of the costliest parts of any system, even on a vehicle as simple as a Jeep. Now RCA's Aerospace Systems division in Burlington, Mass., has developed a concept for testing motor vehicles aimed at cutting needless preventive maintenance and at offsetting repairs of nonexistent faults.

It's called BITE for built-in test equipment, and uses multiple transducers, spotted at critical points within a vehicle's engine and chassis to point out genuine trouble—often before it becomes troublesome.

Newton A. Teixeira, manager for systems projects in RCA's automatic test equipment program and management office, says that about nine out of 10 potential faults give some kind of warning before any real damage is done.

But in contrast with its name, BITE isn't all that built-in. To cut cost, there is a complex cable harness connecting about 50 sensors of various types to a large multipin jack on the vehicle dash. The rest consists of a hand-held Vehicle Test Meter and a Vehicle Readiness Unit.

The VTM is largely a switch network. But with human engineering in mind, there is a go/no-go lamp panel for such parameters as battery voltage; air, fuel, and oil filters installed; oil and coolant levels; power-steering pressure; filter clogging; and water in oil or fuel. Thus a motor pool driver can climb into his truck in the morning, rotate a single switch, and get a good idea as to whether he should drive away. By contrast, the system on the Volkswagen does 18 tests to BITE's 43.

But the VTM can perform far more complex tasks. It not only checks the BITE sensors and cabling, but also reads out parameters like oil pressure, manifold vacuum, battery voltage, dwell angle, fuel pressure, and many more, with the numbers appearing in engineering units on a 3½-digit plasma display.

The VRU makes many of the same tests in straight drive-it or fix-it fashion, but with a bit more electronic sophistication than the VTM. The mechanic again plugs into the sensor system at the dashboard jack; using a thumbwheel switch, he can successively check about 30 items.

The VRU's electronics package lies on two printed-circuit boards. Teixeira says they should adapt to large-scale integration if quantity justifies the cost. Aside from about 15 op amps and limiters, and about 12 comparators, circuitry is predominantly digital.

Each test—including consideration of several other parameters—is run automatically, and if a flaw is sensed, a flip-flop latches and a red or yellow light flashes on.

RCA has instrumented a Jeep and

Our compact, portable lab grade recorder.

7 speed equalization without plug-ins.

Autoload. Hinged back cuts maintenance time in half.

Find out how.

Find out how Bell & Howell's rugged CPR-4010 instrumentation recorder/reproducer was designed so maintenance in remote, out-of-the-way places means far less downtime. Compare the CPR-4010's IRIG performance, ease of operation, and application versatility with its competition. Check out our automatic tape threading, 7-speed transport, and 7-speed direct and FM all electrically switchable electronics. Send us the coupon and we'll send you complete information about the CPR-4010, plus a free Buyer's Check List for

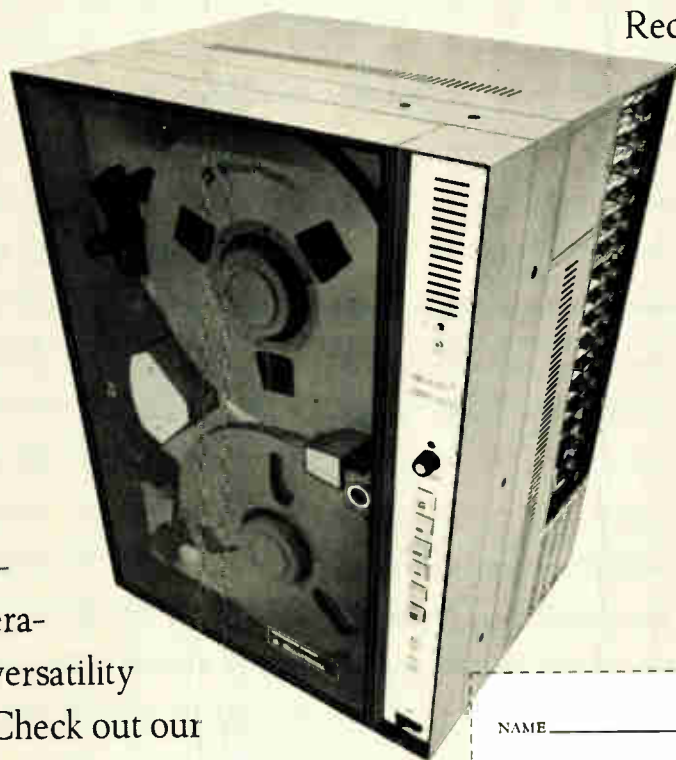

Recorders that will let you compare ours with your current equipment, or theirs. To receive more information about the CPR-4010 and a FREE buyer's check list, write: Bell & Howell.

CEC/INSTRUMENTS DIVISION

360 Sierra Madre Villa, Pasadena, California 91109



BELL & HOWELL

NAME _____

TITLE _____

COMPANY _____

ADDRESS _____

CITY _____ STATE _____ ZIP _____

CPR-4010

© COPYRIGHT 1972 BELL & HOWELL

Circle 45 on reader service card

Dialight sees a need:

(**Need:** A large $\frac{5}{8}$ " high LED readout at a low \$4.95* price.)

See Dialight.

Each digit in this bezel assembly contains a Dialight light-emitting diode, decoder/driver, and resistor network that produces a bright, highly visible readout that can be easily installed in a panel. The readout display is supplied with discrete gallium phosphide or gallium arsenide phosphide diodes arranged in a seven-segment format. These generate a bright, highly legible red character (0.625 inch

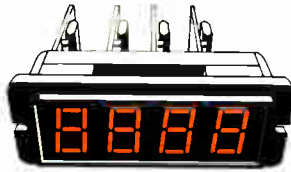

high—the largest size character in the industry) with the lowest power consumption for a character of this size. Ideal for mounting on a control panel, or in a digital clock, meter, credit-card verifier, TV channel indicator, or hospital room status-board indicator. The contrast ratio between the illuminated and non-illuminated segments is further enhanced by a one-piece red nonglare window.



Dialight is a company that looks for needs...and develops solutions. That's how we developed the industry's broadest line of LED light sources, indicator lights and readouts. No other company offers you one-stop shopping in LED visual displays. And no one has more experience in the visual display field. Dialight can help you do more with LEDs than anyone else because we have done more with them. Talk to the specialists at Dialight first. You won't have to talk to anyone else.

Here are a few products in this family: **1.** Multidigit readout assembly in 0.205" character height **2.** Status display module with 6 LEDs with adjustable light cells **3.** LED readout in character height 0.625" **4.** Alphanumeric display complete with code generator/driver character height 0.300" **5.** 5 x 7 dot matrix alphanumeric display in character height 0.300" **6.** Hexadecimal display with logic character height 0.270" **7.** Single digit LED readout module in 0.125" character height. **8.** Numeric display with integral TTL MSI circuit chip with counter character height 0.270" **9.** Single digit LED readout module in 0.270" character height (MAN 1 equiv.). *1000 lot quantity for 730-1003

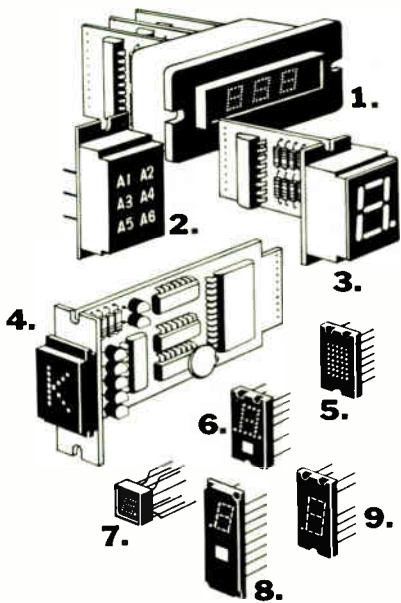

Please send data on your LED readouts.

NAME _____
 TITLE _____
 COMPANY _____
 ADDRESS _____
 CITY _____ STATE _____

DIALIGHT

Dialight Corporation, A North American Philips Company
 60 Stewart Avenue, Brooklyn, N.Y. 11237 (212) 497-7600

Circle 49 on reader service card

Electronics review

practice, the transmitting instruments may not have to be precise.

Employing six klystrons and five different kinds of 50- to 300-milliwatt cw lasers, three of them 8 meters long, the experiment made a "ferocious, hideous-looking scheme" that "filled a whole lab room," Evenson remarks. Two recent developments made the experiment work; a very-high-frequency 3.39-micrometer helium-neon laser that was methane stabilized and a tungsten point-contact cat-whisker diode.

The experiment, based on the relation between frequency and

wavelength of modulated laser light, was to obtain frequency and wavelength measurements and multiply them to derive the speed of light. The wavelength measurement was obtained by an interferometric comparison between the stabilized 3.39 μ m laser and a krypton lamp, whose emission serves as the standard reference.

After the year-long project, Evenson says, the next step will be to redefine the krypton wavelength standard for measuring the speed of light and "fix it so the speed of light may never have to be measured again." The new speed of light is

Electronics Index of Activity

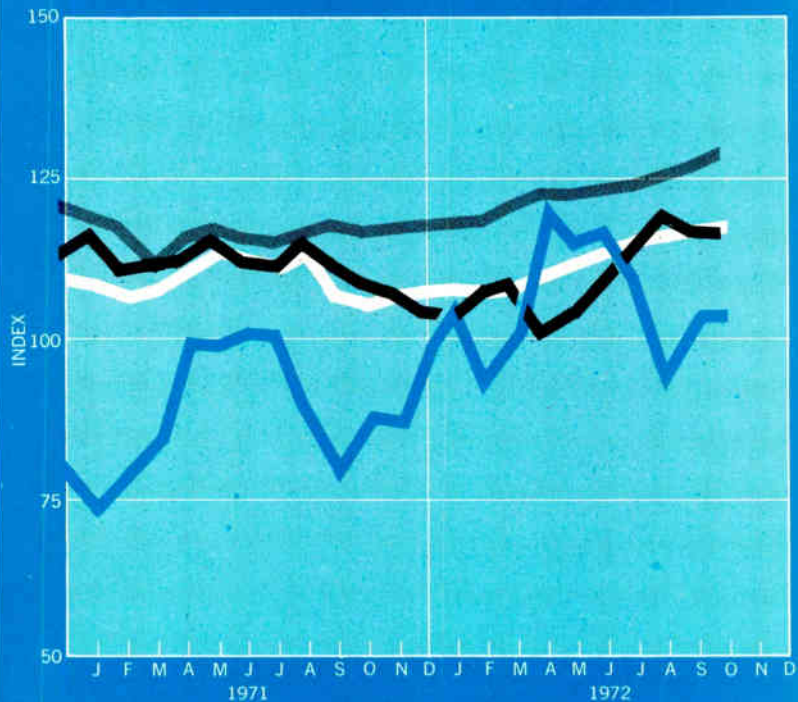

Segment of Industry	Oct. '72	Sept. '72*	Oct. '71
Consumer electronics	104.3	104.3	87.9
Defense electronics	116.9	117.1	108.2
Industrial-commercial electronics	129.8	127.4	117.7
Total industry	118.7	118.1	109.7

The index rebounded slightly in September from August's decline by inching upward 0.7%, leaving it 9.4% above its year-ago level. Once again, consumer electronics was the month's high gainer, up 1.8%. However, it was 2.3% below its corresponding 1971 month. Defense, unchanged on a month-to-month basis, was 14.3% ahead of its September 1971 performance, its biggest year-to-year gain of 1972. Industrial-commercial rose 1.4% for the month.

Indexes chart pace of production volume for total industry and each segment. The base period, equal to 100, is the average of 1965 monthly output for each of the three parts of the industry. Index numbers are expressed as a percentage of the base period. Data is seasonally adjusted.
 * Revised.

Electronics review

calculated to be 299,792.4562 kilometers per second ± 1.1 meters per second, or 186,282.3960 miles per second ± 3.6 feet per second. The old standard was 299,792.5 kilometers per second. \square

Space electronics

Last Apollo to carry new experiments

The scheduled Dec. 6 Apollo 17 launch lowers the curtain on America's \$25 billion man-on-the-moon program with an ambitious lineup of electronic experiments. Originally planned for Apollo launches 18, 19, and 20 before dwindling public interest and declining Federal commitment killed the missions several years ago, the experiments were rushed aboard 17 to gather important scientific information about the moon.

A significant experiment is the lunar sounder, which will perform while the command module orbits the moon. Based on synthetic-aperture (side-looking) radar developed for the Air Force by the University of Michigan's Willow Run laboratories, the sounder will gather topographic and structural data about the moon's surface down to a depth of 1 kilometer. Along with data from special cameras and a laser altimeter, sounder information also will help scientists chart a gravity profile that depicts the moon's surface.

Also, experience with sounder operation and data analysis will aid design of future instruments for surface or near-surface water detection on Mars, geological mapping on Mars and Venus, and topside sounding of Jupiter. The sounder has three major parts: the radar, an optical recorder, and two antennas, a hf retractable dipole, and a vhf Yagi.

Three transceivers at 5, 15, and 150 megahertz will send a series of chirped pulses, to be reflected back from the moon's surface and re-

corded by the optical recorder. The three frequencies are used "to see three different depths into the moon," explains Leon J. Kosofsky, program engineer with NASA's Apollo Orbital Experiments office in Washington.

The sounder "is a big investment in payload" and takes up room occupied on previous missions by a subsatellite and other gear, he says. Subcontractor RCA built the radar, Goodyear Aerospace the recorder, and Spar Aerospace the antennas for prime contractor North American Rockwell. \square

Among the other experiments is a far-ultraviolet spectrometer, which will fly in lunar orbit for the first time aboard Apollo 17. The instrument, operating in imaging and spectrographic modes, will detect such constituents of the lunar atmosphere as oxygen, xenon, and krypton, plus pick up far-ultraviolet solar radiation reflected from the moon's surface, as well as from galactic sources. John Hopkins University's Applied Physics Laboratory supplied the instrumentation for a scientific team that is led by that school. \square

News briefs

ITT eyes people movers

ITT is trying its hand at rapid transit. It is building a prototype car that uses linear motor magnets to float above a magnetized rail. The car will be controlled by three ITT 1650 computers that interrogate each other. If one disagrees, the car stops. "The idea," says a spokesman, "is to have several cars fan out in a neighborhood to pick up passengers, then join at a central location, proceed to the destination, and fan out again to drop off passengers." ITT says it can build its system for about a quarter the cost of San Francisco's beleaguered \$1.4 billion BART (see p. 47).

Space Shuttle simulation

NASA's Manned Spacecraft Center, Houston, has ordered a \$925,000 computer system from Systems Engineering Laboratories, Ft. Lauderdale, Fla., to simulate the environmental dynamics of the Space Shuttle's developing vehicle-control and guidance systems. SEL will use dual Systems 86 real-time computers with 96,000 words of core memory. One processor will simulate vehicle dynamics and environment; the other will simulate spacecraft guidance functions and digital flight control systems.

Scout car procurement

Built-in test and diagnostic systems could become common on Army vehicles ranging from Jeeps to tanks if a recent scout car/reconnaissance vehicle RFP is indicative. The Ford Motor Co. and Lockheed are competing for a potential \$100 million contract, with the winner to be decided after a fly-off next spring.

While the basic concepts are widely different, both companies include a complex set of sensors, interconnecting cable harness, and a test-equipment-access jack. Their testing approach resembles the one used in RCA's instrumentation for maintenance of a Jeep and a truck for the Army (see p. 44).

Amorphous alterable ROM

Researchers at Iowa State University say they've built an electrically alterable read-only memory that could be an alternative to MNOS devices [*Electronics*, Oct. 23, p. 65]. Using 256-bit amorphous semiconductors from Energy Conversion Devices, Troy, Mich., the workers at the Iowa EE department lab in Ames have put together a TTL-driven, electrically alterable ROM with an access time of 70 nanoseconds and a cycle time of 125 ns for use in a terminal multiplexer.

Prof. A. E. Pohm says that no failures have been observed after about 1,000 hours of operation.

**When it comes to
card memories...**



WE'RE

When it comes to everything-on-one card memories, ours is the only game in town. We're the firstest with the mostest in the field of random access coincident current memories that are completely contained on a single printed circuit card. Each card contains all the required logic, drive and sense circuitry. In 18 mil wide temperature core. And now also with high-speed semiconductor memories, for high speed telemetry and data communications applications. And large capacity mainframe

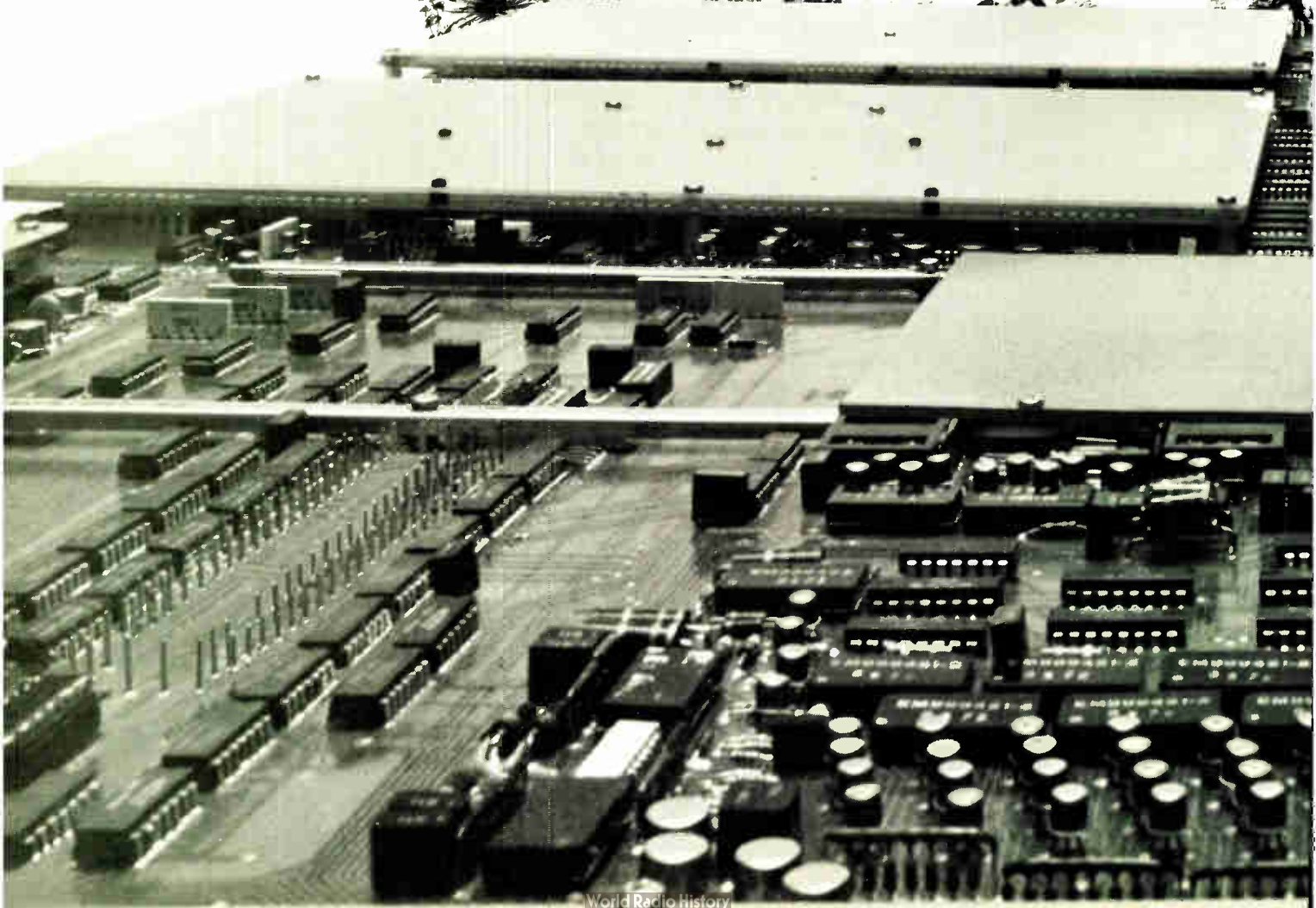

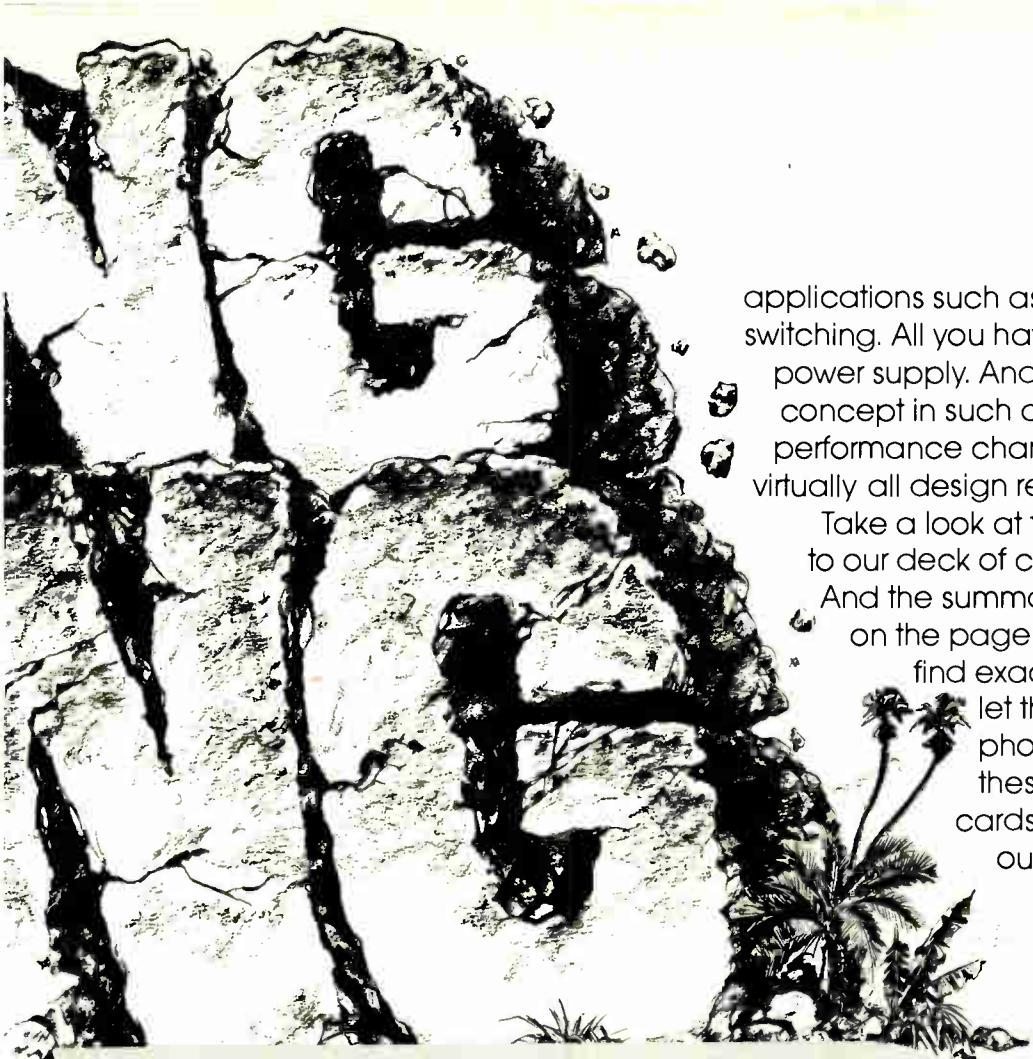

applications such as telephone switching. All you have to add is a DC power supply. And we offer this off-the-shelf concept in such a wide range of size and performance characteristics that it covers virtually all design requirements.

Take a look at the two latest additions to our deck of cards on the next page. And the summary of all our cards on the page after that. But if you don't find exactly what you want, don't let that stop you. Just pick up the phone or write. Because even as these pages go to press, new cards are being added to our deck.

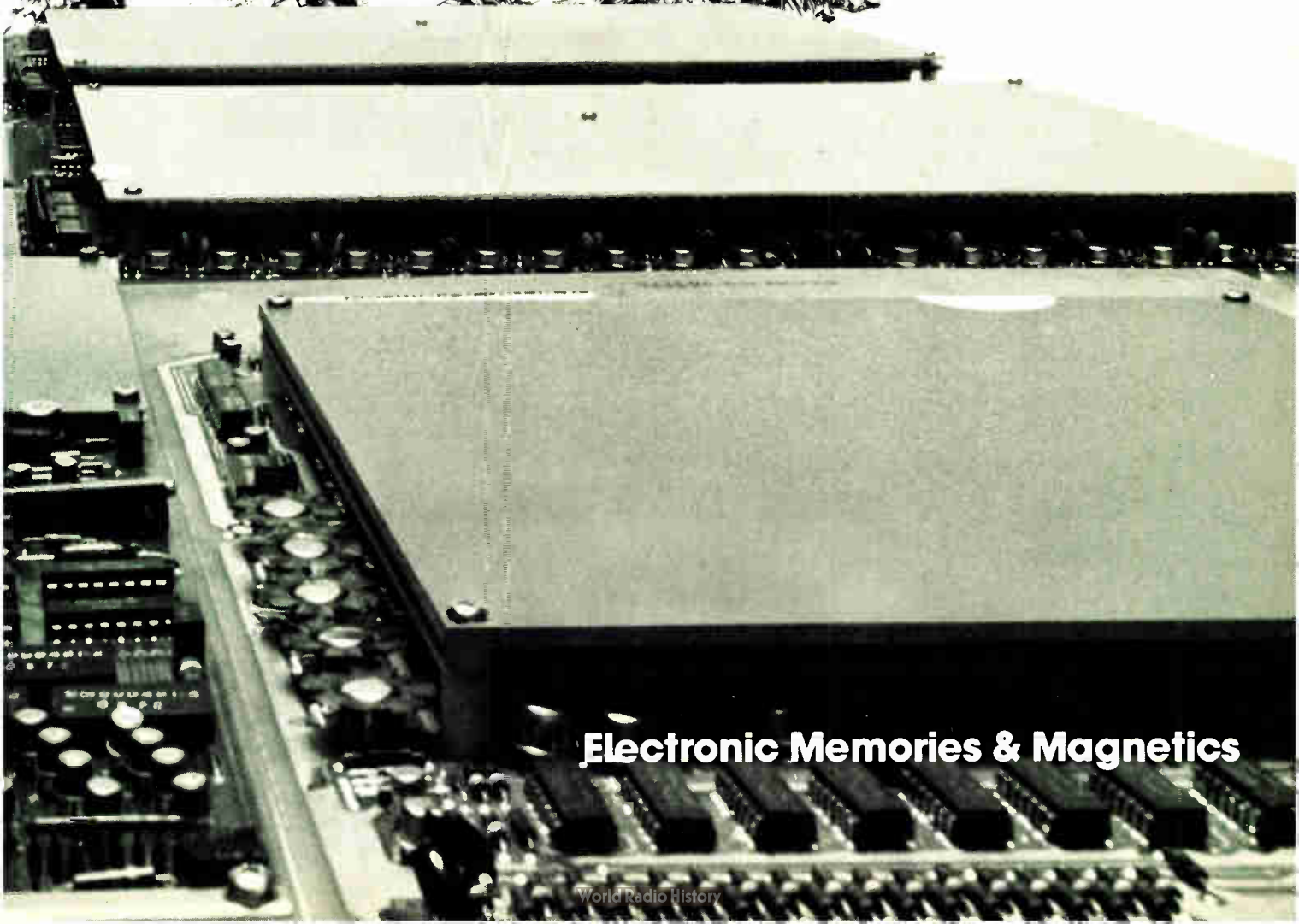

Electronic Memories & Magnetics

WITH 2 EXTRA ADDED



Circle 54 on reader service card

ATTRACTIONS!

High capacity card that works from a plus five power supply 8Kx18 Our new 8Kx18 Micromemory 2000 series gives you a large capacity configuration that operates from plus five volts input only. This low cost card comes with edge connections that allow the memory to

be treated just like a logic circuit. The Micromemory 2000 series is also available in a 4Kx9 and many other configurations. All sizes are plug compatible.

Ultra high speed semiconductor RAM We call it our new Micram. It uses 512 bit semiconductor modules. Cycle time is as fast as 180 nanoseconds. For real-time asynchronous machines, telemetry and data communications applications, this high speed card offers added flexibility to the system designer. It is virtually plug compatible with our Micromemory 3000 cards which offer you 650 ns. cycle time.

In addition, there's our Micromemory 6000 series for large mass memories. It's a multiple board module with a 16K sense and a basic PCBA size of 12.75" x 15.4". Outline width of a 16Kx40 group is only 1.7". Low drive cores are used for low power input.



Electronic Memories & Magnetics

Take a long look at our table of specs. Then give us a chance to bring a smile to your face with price and delivery quotes. And if the all-in-one card memory you need isn't shown below, write to us anyway. Just keep those cards coming, folks. We do.

	MICROMEMORY 2000	MICROMEMORY 3000	MICROMEMORY 6000	DOUBLE CAPACITY MICROMEMORY 2000	MICROGRAM
Configuration	4,096x9	8,192x18	16Kx40	8Kx18	8Kx20
Alterable to:	—	16,384x9	32Kx20	—	16Kx10
Full Cycle Time	1.0 μ s	650ns	1.2 μ sec	1.0 μ s	200ns
Access Time	400ns	300ns	500ns	400ns	200ns
Modes	R/R, C/W, R/M/W	R/R, C/W, R/M/W	R/R, C/W, R/M/W	R/R, C/W, R/M/W	R/W
Byte Control	—	X	X	—	X
Data Save	X	X	X	X	—
Required Voltages	+5V	\pm 15V, +5V	+15V, +5V	+5V	+5V
# of PCBA's	1	1	1 control card + 1 per 16Kx40	1	1
PCB Size	11 $\frac{3}{4}$ x 15"	11 $\frac{3}{4}$ x 15.4"	12 $\frac{3}{4}$ x 15.4"	11 $\frac{3}{4}$ x 15.4"	11 $\frac{3}{4}$ x 15.4"
Allowable PCB Spacing	1"	1"	1"	1"	1"
Expansion in a single chassis to:	16,384x9 8,192x18	65,536x9 32,768x18 16,384x36	65,536x160 131,072x80 262,144x40	8,192x18 16,384x18 8,192x36	—
Extended Address to:	32,768x9	65,536x18	524,288x40	65,536x18	65Kx20
In increments of:	4,096x9	16,384x9 8,192x18	16,384x40 32,768x20	8,192x18	4Kx20 8Kx10
Stack	3W, 3D	3W, 3D	3W, 3D	3W, 3D	—
TTL Compatible	X	X	X	X	X



**If you're not dealing
with Electronic Memories,
you're not playing
with a full deck.**

Electronic Memories & Magnetics

12621 Chadron Avenue · Hawthorne, California 90250 · Phone (213) 644-9881

**The 95415: 1024x1 bit. ECL.
45ns access time at 0.5mW per bit.**

For designers of very high speed ECL systems, here's a 1024-bit RAM that can operate at speeds compatible with those of their system's logic. The 95415 features 15ns chip select time, full ECL compatibility, emitter follower outputs for ease of memory expansion, and *decreasing* power dissipation with rising temperature.

Because the 95415 is static, it's simple to use and requires no peripheral electronics. And because of its functional density, designers can save significant costs by reducing package count, circuit board number and size, number of connections and by increasing system reliability.

This fastest of all 1K RAMs is available now in limited quantity - in 16-pin hermetic DIP - from your friendly Fairchild distributor. The cost: \$109 (1-24) or \$100 (25-99).

New Applications

The isoplanar process introduces very high speed operation at near MOS densities, opening up exciting new applications such as:

- Fast writable control store for microprogramming, adding flexibility and eliminating the need for fixed ROMs.
- Large high-speed scratchpad to make multi-processing more feasible.
- Simulation of long high-speed shift registers.
- Improvements of buffer or cache memory performance by increasing capacity without any power or size trade-off.
- Building cost-effective high-speed mainframe memories.

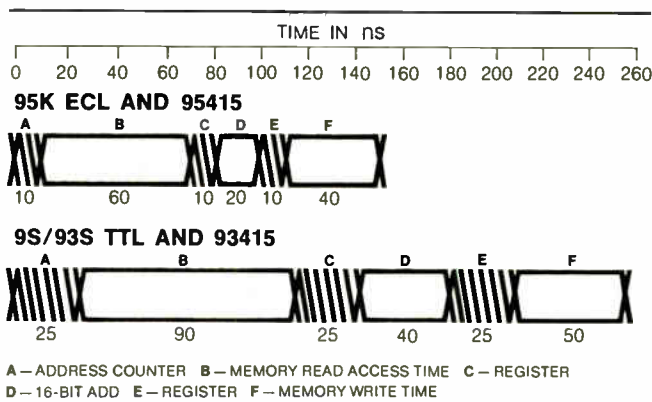

COMPARISON OF ECL AND SCHOTTKY TTL READ-MODIFY-WRITE SYSTEM PERFORMANCE

Note that the ECL system is 105ns faster than the Schottky TTL design. In practice, ECL is even faster because of superior high frequency interconnection characteristics. And use of more complex multiphase clocking can give still better performance.

In the above ECL system, 95K Series MSI functions are used with the 95415 ECL memory. For even faster speed (at increased package count and power) use our 95410, the fastest 256 RAM available.

Isoplanar Memory Line-up

DEVICE	TYPE	ORGAN- IZATION	TYPICAL ACCESS TIME(ns)	TYP. CHIP SELECT TIME(ns)	POWER (mW/bit)	INPUT LOADING
93410	TTL	256 X 1	45	25	1.8	0.50 U.L.
93410A	TTL	256 X 1	35	20	1.8	0.50 U.L.
93415	TTL	1024 X 1	60	30	0.5	0.25 U.L.
95410	ECL	256 X 1	25	7	1.8	50KΩ Typ.
95415	ECL	1024 X 1	45	15	0.5	60KΩ Typ.

Whatever your memory needs, you could well find the answer among these devices. Call your Fairchild distributor or the factory for prices and availabilities.



This announcement is neither an offer to sell nor a solicitation of an offer to buy any of these securities.
The offering is made only by the prospectus.

November 17, 1972



425,000 Shares

Solid State Scientific, Inc.

Common Stock
(\$.40 Par Value)

Price \$17.25 per Share

*Copies of the prospectus may be obtained from the undersigned and others
only in States in which such a prospectus may be legally distributed.*

R. W. Pressprich & Co.
Incorporated

ABD Securities Corporation

Allen & Company
Incorporated

Clark, Dodge & Co.
Incorporated

Dominick & Dominick,
Incorporated

Robert Fleming
Incorporated

Hayden Stone Inc.

Hill Samuel Securities
Corporation

Kleinwort, Benson
Incorporated

L. F. Rothschild & Co.

F. S. Smithers & Co., Inc.

Suez American Corporation

Thomson & McKinnon Auchincloss Inc.

C. E. Unterberg, Towbin Co.

G. H. Walker & Co.
Incorporated

Wood, Struthers & Winthrop Inc.

Kjobenhavns Handelsbank

Estabrook & Co., Inc.

Jefferies & Company, Inc.

New York Securities Co.
Incorporated

Roosevelt & Son
Incorporated

Weis, Voisin & Co., Inc.

Implanting of boron ions improves CCD memory elements

Charge-coupled devices, circuit developers have found, hold out promise for use in shift registers based on MOS technology [*Electronics*, March 15, 1971, p.31]. Such iterative arrangements of MOS storage elements could prove especially suitable for large-scale memory circuits because of the high degree of integration achievable with them.

There is one problem with CCDs, however. The coupling losses incurred during the transfer of charges from one element to another can lead to errors in the information stored. The answer has been to employ expensive manufacturing methods. But with a new ion implantation technique devised at Siemens AG's research laboratories in Munich, it is now possible to inexpensively fabricate CCD memory arrays in which charges are transferred with negligible loss.

To understand how coupling losses come about, consider a row of basic CCD elements. The devices are arranged as a string of closely spaced MOS capacitors which, in their simplest form, consist of a gate-metal electrode, an isolation layer—the gate oxide—and a homogeneous semiconductor substrate. The charges representing the information are transferred, or coupled, between the electrodes of adjacent elements by way of electric fringing fields.

Barriers. Crucial to the efficiency of the charge-transfer process are the potential barriers that exist in the gaps between the electrodes. These barriers are usually so high, however, that only part of the charges can get across them. This, then, is the cause for the transfer losses. They can be kept to a minimum only if extremely narrow gap widths are used between the electrodes.

To overcome the coupling losses, the new Siemens technique, worked

out by researchers K.U. Stein, Karl Goser, and Ulrich Ablassmeier, uses an additional step in the ion implantation process. In this step, boron ions are implanted into the gap area between the elements. These ions, in effect, lower the potential barrier, adjusting it to a value that insures virtually complete charge transfer. The boron ions build up a counter potential that acts to reduce the potential barriers.

Siemens researchers say that investigations carried out on experimental charge-coupled-device memories with up to 150 elements have shown coupling losses to be less than 0.5%. This level translates into a transfer efficiency of 99.8%. □

West Germany

Nixdorf buys first U.S. subsidiary

Takeovers of German companies by American firms have been reported frequently in recent years. But when a German firm buys into an American company, it's unusual—especially if the acquisition is in the highly competitive U.S. computer field.

Such an acquisition has just been agreed on. The buyer: Heinz Nixdorf, head of West Germany's Nixdorf Computer AG. The object: the computer division of Victor Computometer Corp., Chicago, the company that has been the sole distributor of Nixdorf data processing equipment on the U.S. and Canadian markets since 1968. The takeover of the division, for which Nixdorf is paying \$10 million, takes effect at the end of December.

That Heinz Nixdorf, the 47-year-old president of the Westphalian firm, should move so boldly into the

hotly contested American computer market means that he is either an optimist, the maker of a wanted product, or a sharp business operator. Actually, Nixdorf is all three.

Start. Regarded in European computer circles as a tough entrepreneur and as one of the most active managers in German electronics, Nixdorf started out in the data processing field in 1952, when he was a physics student. That year, he set up shop in the Westphalian town of Paderborn. He aimed his first product, an electronic calculating machine, at a gap in the market that he thought needed to be filled, and he hit the target dead center. A few years later he followed up with an electronic tabletop adding machine, called the Wanderer Conti, which was distributed by the German office machine maker Wanderer Werke. In 1965, Nixdorf started to make calculators under his own name. Small computers and terminals have become his forte.

By deliberately thinking small in computers, Nixdorf has hit on a way to cut a big swath in world markets. Since 1967, his worldwide sales have mushroomed from about 3,700 machines to 29,000 now. Sales volume is expected to be around \$128 million this year, up from \$107 million in 1971. The more than 20 subsidiaries and service organizations in Europe, Asia, Africa, Australia, and North America are expected to do nearly \$30 million worth of business this year, 50% more than in 1971.

Unlike many other German electronics firms, which tend to shy away from what they think is a too-tough U.S. market, Nixdorf has moved vigorously into it. So far, about 1,000 systems have been installed there. And only recently a large-sized order—for no fewer than 1,000 systems—came in from the Commercial Credit Corp., a subsidiary of the Control Data Corp. □

Cincinnati Milacron now offers you the bare minimum

It's called the Strippable CIP. The new CIP/2002 is the minimum hardware framework from which you can build your own minicomputer.

You get only the basic components you need to build your own dedicated system. The CIP/2002 can save OEM users considerable cost because all but the most essential hardware has been stripped away. Only the control board, two data boards, and the frame remain. This allows the system builder to use the power of the minicomputer creatively. Incorporating and adapting the unit to your needs is vastly simplified. Best of all, the variety of options lets you pick just those you need. You don't pay for "frills" you don't need. And the price is very low as a result.



Send today for our free idea booklet entitled "Minicomputers And Their Applications" and get full details on how the Strippable CIP can save you money. Write or call (513) 494-5444, MINICOMPUTERS Cincinnati Milacron, Process Controls Division, Lebanon, Ohio 45036.

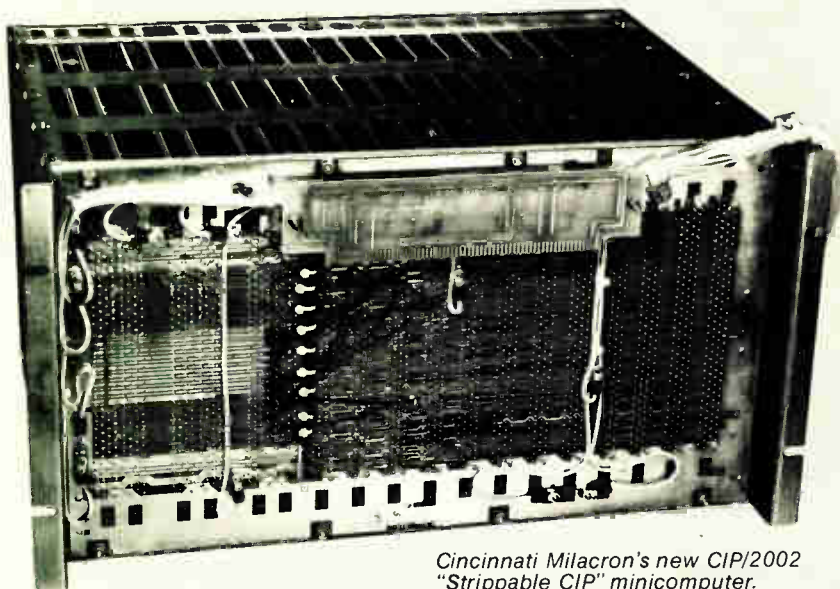

*Cincinnati Milacron's new CIP/2002
"Strippable CIP" minicomputer.*

minicomputers



Machine Tools
Process Controls
Chemicals
Plastics
Plastics Processing Machinery
Abrasives

Sweden looks abroad for Viggen missile

A sharp cutback in funds has hit development of an air-to-air missile for the fighter version of Sweden's Viggen aircraft. So far, about \$2 million has been appropriated, of which almost half has been spent. An additional \$7 million, covering some initial production, was scheduled for the next five fiscal years, but will be cut out. The Swedish Air Force, forced now to turn to foreign-developed missiles, **has to decide whether the missiles will be purchased abroad or made in Sweden under license.** A spokesman for the defense staff says: "Of course, this does not mean we automatically turn to the United States. We have acquired missiles from various nations, with several from France." Total value of missiles in the program will amount to some \$20 million, once the fighter version of the Viggen is produced in the late 1970s.

Siemens markets Hall-effect switching IC

Siemens AG is about to go to market with an integrated Hall-effect switch **featuring a built-in power supply and incorporating circuitry for the Hall generator, amplifier, Schmitt trigger, output stage, and voltage stabilizer.** Designated S059, the new IC is claimed to be less critical to operating voltage changes and less temperature-dependent than other magnetically controllable, contactless IC switches. The operating voltage is selectable between 4.5 and 30 volts. Two output transistors with a maximum output current of 20 milliamperes are turned on with a magnetic field of 600 gauss to generate an output pulse lasting about 100 microseconds. The output is TTL-compatible. Housed in a package measuring 10 by 6 by 2 millimeters, the S059 is **suitable for direct mounting into the keys of desk calculator and electric typewriter keyboards.** Other applications for the device are in touch-control panels for elevators and machine tools. Deliveries of the IC should get under way by January.

Vehicle-location system in Britain uses laser

The nodding laser technique, devised by Marconi Co. for centralized monitoring of the progress of buses [*Electronics*, Oct. 27, 1969, p. 204], **will start its first full-scale trial in mid-January. Then Bristol Omnibus Co. will start to use it for monitoring 40 single-deck buses on four routes in the center of Bristol.** Each bus is equipped with a roof-mounted, side-pointing, low-power helium-neon laser, which scans roadside marker plates as the bus passes. The plates are covered from top to bottom with strips of reflecting material in two widths. Photodiodes on the bus pick up a digital code unique to each beacon location. The stored code is transmitted by vhf radio link to a central control room, on command from the central PDP-8E computer. A Tektronix display **will show the whole city center with all bus positions, or each route separately with its individual buses.** This initial scheme, with about 900 marker plates, has cost about \$300,000, provided partly by the government, which is interested in wider use.

Sweden to build computer-controlled submarines

The Swedish government has given final approval for an order for three submarines of a new type—they feature a high degree of computer control and can operate with 18 men, **about half the number of crewmen used in other subs of similar size.** The submarines, each with

displacement of 980 tons, will be built by Kockums Shipyard, Malmoe, Sweden, at a total cost of about \$53 million. Of this sum, **about \$28 million will be spent for weaponry and control equipment.** Shipboard computers will control weapons, navigation, and engines, as well as keep tabs on the operation of the various systems. The subs will be armed with wire-controlled and target-seeking torpedoes, and can be used for minelaying.

British open second transatlantic earth station

The new satellite ground terminal that just started operating at the British Post Office's earth station at Goonhilly, Cornwall, adds two telephony transmit carriers and 11 telephony receive carriers to the two outgoing and eight incoming carriers of the existing transatlantic terminal. Two further incoming carriers, out of the presently planned 22, will be brought into use by year-end. Both terminals will also handle a television channel. **The new antenna eventually should obviate the need to shunt some British transatlantic traffic via Continental earth stations.** By the end of next year, the terminal will be fitted with a frequency-division, multiple-access system. Then, the permanent channel links to lightly used earth stations will be replaced by temporary links that can be connected on demand, thus improving efficiency of channel usage.

Japan's Sanyo drops price of eight-digit calculator

Sanyo Electric Co. takes honors as the first major Japanese electronics manufacturer to come out with very-low-price calculator for those users who want the standard eight digits. With single-chip logic and dry-cell power supply, the \$66 calculator can do the standard four functions, chain multiplication and division, and constant multiplication and division. **It features a floating decimal point with underflow that retains the most significant digits on the fluorescent display.** Sanyo says it will sell the calculator in both consumer electronics and stationery stores.

Thailand upgrades phone network

A four-year program to convert the Telephone Organization of Thailand to automatic switching equipment with new and expanded trunk routes is getting off the ground with its first \$37 million in the form of a 20-year loan from the International Bank for Reconstruction and Development. Estimated cost of the total program by TOT, the government-operated telephone service, will be \$102.8 million on completion.

In the plan's first phase, the Bangkok metropolitan area will get approximately 88,000 lines of automatic switching equipment, convert more than half of its 161,000 exchange lines to automatic switching equipment, and add three new exchanges and associated subscriber and junction line equipment. The 37,000 lines in the provinces will be expanded by another 43,000, plus associated hardware, including conversion of small manual exchanges to automatic switches of higher capacity.

Equipment financed by the World Bank loan from Washington will be **through international competitive bidding, except for extension of certain exchanges.** For these, "compatibility is essential," says the bank, and hardware will be bought from original suppliers.

- Q.1 Who just slashed RTV adhesive/sealant prices?**
Q.2 Is there an easy way to improve TV reception?
Q.3 How can I cut prototype mold costs by 25%?
Q.4 What's a practical way to protect delicate parts from shock?

A1 GE did. By as much as 12%. Which means you can now use one-part RTV silicone engineering grade adhesive/sealants without paying a premium. So why compromise? Specify GE RTV-102 (white), 103 (black), 108 (clear) or 109 (metallic). And you'll meet industry, government, UL and food-grade requirements. Circle Reader Service No. 91.



A3 Use GE RTV-700, the strong, two-part silicone mold-making compound that needs no postbake, cures in 24 hours and has the high tear strength and elongation to reproduce precision parts quickly and accurately. Circle Reader Service No. 92.

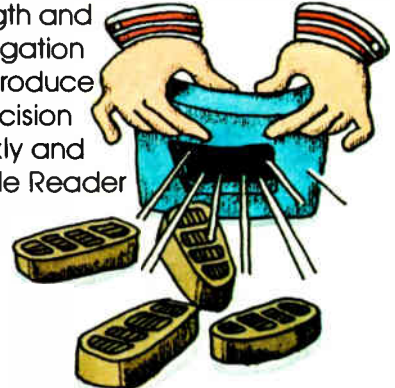

A2 Definitely. With GE Silicone Rubber. It improves TV set performance because its electrical properties are far superior to those of other elastomers. And because it takes less material to do the job with silicone rubber, you save space and weight. Fire resistance? GE Silicone

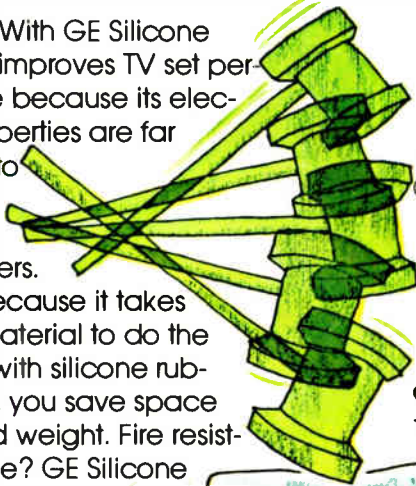

Rubber meets all the latest TV industry safety requirements. It's perfect for wire insulation, corona rings and anode caps. Circle Reader Service No. 93.

A4 With GE RTV-619 Silicone Gel. It cures at room temperature into a clear, resilient, dielectric gel cushion for circuitry and for protecting electronic assemblies. RTV-619 cures without exotherm and can withstand temperatures from -65°C to $+150^{\circ}\text{C}$. Circle Reader Service No. 94.

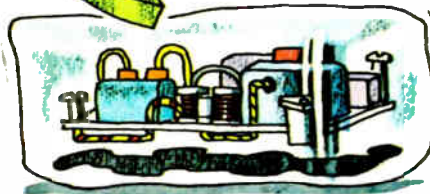

For all the details, write: Section N12383
 Silicone Products Dept., General Electric Co., Waterford, N.Y. 12188.

GENERAL  ELECTRIC

GE silicones.
The answer.

Teradyne's L100 Automatic Circuit Board Test System speaks for itself.

<pre> PASSED GOOD: 43 BAD: 8 </pre>	<pre> FAILED FAILURE COUNTERS (BAD/TOTAL): FTEST 0/36 MTEST 5/83 BTEST 0/1 TTEST 0/2 </pre>
<pre> MT44 D8 THIS TEST PASSED MTEST ON PINS: M LIMIT :+ 500. MV ACTUAL!+ 248. MV </pre>	<pre> TT39 THIS TEST FAILED TIME FROM PIN 18 TO 21 ACTUAL: 00.195 US TMIN: 00.050 US TMAX: 00.190 US </pre>
<pre> FT35 THIS TEST FAILED <ALARMS>S1 FAILING PINS: 20 Z K </pre>	<pre> FT15 THIS TEST FAILED FAILING PINS: S R P N M L J </pre>

If you test circuit boards, you get the message. The L100 doesn't just tell you a bad board is bad. It helps you find out why. And in a fraction of the time you'd usually spend troubleshooting. We'd like to send you a brochureful of reasons why the L100 is the most money-saving system you can buy.

Write: Teradyne
183 Essex Street
Boston, Mass. 02111

In Europe:
Teradyne Europe
S.A., 11 bis, rue
Roquépine,
75 Paris 8^e, France.
Tel. 265 72 62.

TERADYNE





MALAYSIA

New offshore explosion

Low-cost labor, credit, taxes lure world
manufacturers to expand in Malaysia and Portugal



PORTUGAL

by Ray Connolly, Washington bureau manager

Rising wages and dwindling labor pools in the offshore markets developed during the '60s are driving the multinational corporations still further afield in their search for profitability in the '70s. Led by American components companies, electronics firms from the U.S., Europe and Japan are being attracted into countries as diverse as Malaysia and Portugal. And governments anxious to build an economy on something other than agriculture are doing their best to add to the initial attraction of low-cost labor.

Malaysia, for example, has drawn more than 30 electronics manufacturers to its shores since 1966, when Matsushita Electric Co. began to assemble its line of National television receivers at the Batu Tiga industrial estate or park, about 15 miles outside the capital of Kuala Lumpur.

Twelve of those electronics companies are U.S. operations, and indications are that Malaysia has applications to set up assembly and manufacturing plants from as many more American components and communications equipment makers. National Semiconductor became the first U.S. electronics manufacturer to begin producing in Malaysia, just last January.

Jobs and output. Electronics manufacturers operating in Malaysia from other nations—Japan, Britain, Holland, Sweden, the Philippines, Hong Kong, and the nearby Republic of Singapore—brought the 1971 job total in electronics to more than 6,000 workers, according to State Department estimates. Output was more than \$18 million Malaysian dollars, when one Malaysian dollar was worth 37.3 U.S. cents. This year employment and industry output

are both still rising sharply as more assembly-plant operations are being brought into service.

Where Malaysia has widely promoted its drive to develop an electronics capability through its Federal Industrial Development Authority, even to the point of establishing offices in New York City, the growth in Portugal has proceeded almost unnoticed. Starting virtually from scratch in 1964 with a total national output of 23,000 radio receivers, it now has a dozen foreign manufacturers, seven of them from the U.S. The industry's output reached "about \$30 million in 1970," according to a recent State Department estimate, which adds that "production today is believed

to be considerably larger as newly installed plants approach their normal levels of output." In 1972, Portugal will become a net exporter of electronics for the first time, with components shipments to the U.S. in the forefront.

The U.S. is by far the major importer of Portuguese components, which range from ICs to computer memories. Last year, for example, it took \$7.6 million in Portuguese components, more than two-thirds of the \$11.3 million export total, according to that nation's statistics. But of Portugal's \$15.6 million in exports of assembled products, mostly monochrome TV and radio receivers, the U.S. took only 3%. The rest went to Portugal's partners

Labor haven. Workers at the Matsushita plant in Malaysia assemble television sets. Japanese corporations were among the first to set up offshore assembly plants in Malaysia.

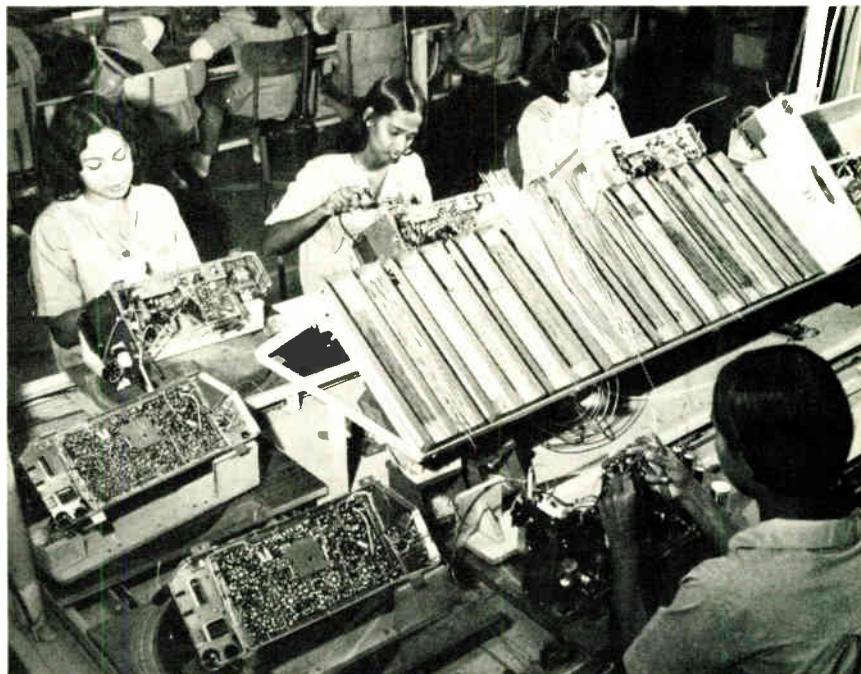

MULTI-CHANNEL GRAPHIC DISPLAY SYSTEMS

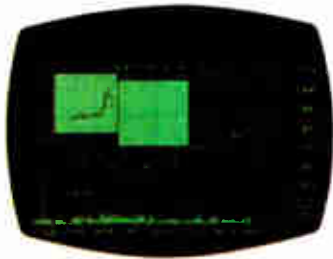

MULTI-TERMINAL SYSTEMS

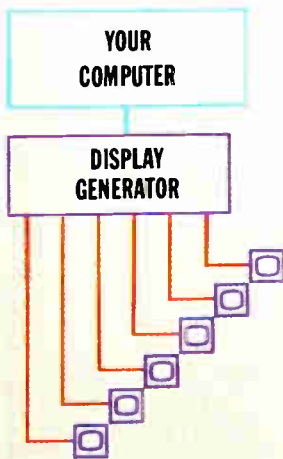

COLOR OR GRAY SCALE DISPLAY

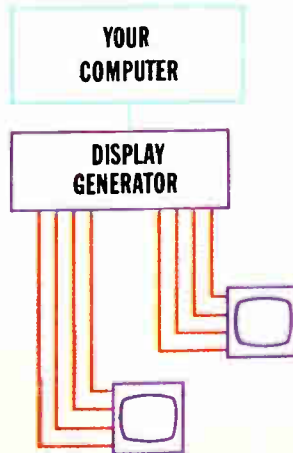

FORM OVERLAY DISPLAY

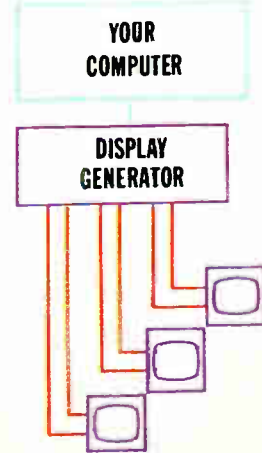

Choose one from column A, two from column B

Or choose all from column C, or...

Because this is a multichannel graphic display system, you can choose most any combination you wish. And like a Chinese dinner, any way you order it, you get an excellent buy.

This system uses a common display generator and a disc memory refresh to drive up to 16 independent, high resolution channels.

For **multiterminal applications**, use each channel to drive a low cost, daylight viewable TV monitor. Cost for a 16 terminal monochrome system, complete with 14" monitors, keyboards, and typical computer interface, works out to just under \$4000/terminal.

If you want **color or gray scale displays**, just combine channels. Two channels give you three colors and black; four channels give you 16 colors plus

black. And for a full color display (4095 levels) use twelve channels. Color can make even the most complex graphics understandable.

You can also use **multiple channels for convenience in editing or data entry**. Put a standard grid or form on one channel, your graph or data on another. Then superimpose the channels on a single display monitor. Because you don't have to regenerate the grid when you change the data, you can have more efficient software.

These systems have all the capability you need for most applications—there are over 1/4 million individually addressable points in the graphic display. You can selectively erase any rectangular area of the screen; write up to 51 lines of 85 alphanumeric characters. And because the displays are disc re-

freshed, the CPU need generate each display only once.

So think of the multichannel display system when you need computer graphics. Call your Data Disc representative for more information, or contact us at 686 West Maude Avenue, Sunnyvale, California 94086: 408 / 732-7330.

And for dessert, have a fortune cookie.



Probing the news

in the European Free Trade Association—West Germany, Britain, Austria, and Sweden.

With statistics showing Portugal's electronics exports in the first five months of 1972 ahead of last year by 25%, the U.S. Consulate at Oporto reports that "further spectacular increases may well take place" since many foreign-owned operations are new and not yet operating at full capacity. One estimate by a U.S. electronics manufacturer is that "Portugal's production of black-and-white televisions could make it the Taiwan of Europe, just as its output of components could turn it into another Mexico or Malaysia" for American industry.

Advantageous location. Malaysia, of course, is still far from becoming a net exporter. It consumed 111 million Malaysian dollars in electronics last year, of which more than \$102 million was imported. Nevertheless, it is experiencing a phenomenal growth rate as American and Japanese manufacturers move in. Be-



Fertile ground. Litronix is among the 12 U.S. electronics manufacturers that have opened up plants in Malaysia, and there are about a dozen more U.S. applications pending approval.

yond the appeal of low wages and tax benefits, Malaysia's geographical position helps—directly north of the Republic of Singapore, where there are 23 large electronics manufacturing operations, 16 of them owned by American companies. Several of the 16 plan on using their Malaysian facilities as "feeders" for operations in Singapore and even Taiwan. One pro-Malaysian source also cites the stability of that country's government as an added advantage to consider in contrast to "the uncertain political status of Taiwan."

U.S. operations in Singapore that could expand into Malaysia—but haven't yet—include: Aircor, Continental Device, Electronic Memories & Magnetics, Fairchild Semiconductor, General Electric, Sperry Rand, and Texas Instruments, reports the U.S. State Department. Even so, the fact that Malaysia already has acquired a dozen U.S.-owned companies since National Semiconductor first began operations in January indicates the country must be doing something right.

Motorola Semiconductor, for example, is setting up in a 100,000-square-foot plant in the new Sungei Way free-trade zone, investing about 15 million Malaysian dollars—about half of that anticipated in new projects by the government, according to the State Department. All told, new electronics plants being set up in Malaysia will generate 6,000 more jobs this year, and that figure is expected to jump an additional 10,000 by the third year of operation, for a total of about 17,000 electronics-oriented jobs.

Government aid. What Malaysia is doing right from the standpoint of manufacturers is the same thing that Portugal is doing right. Portuguese government incentives to industry, according to the Oporto consulate, include: "tariff protection, exemption on duties of imported equipment, tax advantages and credit facilities for certain types of investment." The outlook for the infant electronics industry in Europe's rectangular southwest corner is sufficiently bright for the Oporto Industrial Association to be planning an International Exposition of Electronics and Electronic Products for October 1973.

New offshore growth at a glance

Portugal: had 12 major producers in 1971, including 7 U.S. who will become net exporters in 1972. Electronics output was \$30 million in 1970, and is rising rapidly. In 1971, exports of \$26.9 million included \$11.3 million in components; imports of \$27.8 million included \$19 million in assembled equipment.

Over 5,000 workers, mostly women, average 23–27 cents per hour in components plants, or 33–56 cents per hour in assembly plants. U.S.-owned companies include operations by General Instrument, Advance Ross Electronics, Duluth Scientific, Corning Glass Works (Signetics), Control Data, Applied Magnetics, and International Standard Electric. Largest operation belongs to Philips of the Netherlands; others, all West German, include: Gatag, with Relda and Max Grundig; Walter Preh and Grundig Werke; Ernest Roederstein and Grundig Werke; and Siemens AG.

Malaysia: has 30 major producers, including 12 U.S., and applications for at least a dozen more, mostly U.S. Net importer but growing fast; some new operations sought to feed plants in Republic of Singapore to the south (see below). Output in Malaysian dollars (with U.S. \$1.00 equal to M\$2.75) was \$18 million in 1971 with 14 plants operating. Malaysian exports in 1971 were M\$8.9 million; imports, M\$102.4 million. Consumption hit M\$111.5 million in 1971.

Workers, mostly women, number upwards of 7,000. Semi-skilled workers receive 43–56 Malaysian cents per hour. U.S. operations include: Electronic Arrays, Hewlett-Packard, Intersil, Litronix, Litton Industries, Monsanto, Motorola, Microsystems International, Monolithic Memories, National Semiconductor, Teledyne, and Union Carbide. Joint Japanese/Malaysian ventures include: Clarion Malaysia, Matsushita, Toshiba, Sanyo, Seiko, Sharp, Pension Components, Shinwa Industries, Tamura, and Communico Co. Others: Maltronics (Holland), Roxy (Hong Kong), L M Ericsson (Sweden), Plessey (Britain), Unilite (Singapore), Intron (Philippines), and Robert Bosch (West Germany).

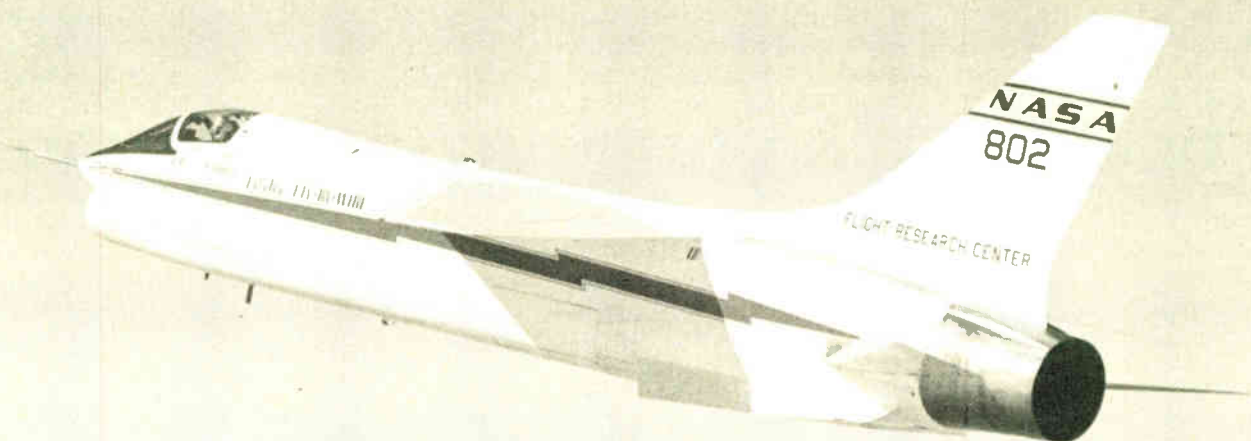

Aerospace

Digital fly-by-wire nears launch

NASA, leading computer flight-control development, targets operational aircraft system for 1978; goal is more efficient systems and lighter planes

by William F. Arnold, Aerospace Editor

Fueled by continuing advances in computers and large-scale-integration technology, Government and industry researchers are developing new digital fly-by-wire (DFBW) flight-control systems. Developers predict that when DFBW systems are ready later this decade, they will lead to cheaper and more responsive flight control in aircraft that, though lighter, will carry the same payloads as previous planes.

Although electronic communications, navigation, and guidance systems already aid pilots, the actual manipulation of a plane hasn't changed much since the Wright brothers: the pilot's stick and rudder move the control surfaces through mechanical connections of wires and pulleys, rods, and hydraulic-assisted devices. DFBW systems would replace the cumbersome mechanical connections with efficient airborne digital computers that direct sensor/servo networks, thereby completing the upcoming digital generation of aircraft avionics

[*Electronics*, Nov. 9, 1970, p. 87].

And aircraft design may even be revolutionized by DFBW, says Peter R. Kurzhals, chief of the Guidance and Control branch of NASA's Office of Aeronautics and Space Technology. He cites a Boeing Co. study for the U. S. Air Force, which shows that a KC-135-size four-engine tanker designed around a DFBW system could carry the same payload if it were 50% smaller, and weighed 250,000 pounds instead of 334,000 pounds.

With computer control, a DFBW system can directly command the control surfaces so that the loads on the aircraft structure are reduced. Reduced loads lead to reduced structural strength and lighter weight, which means that a plane could operate with smaller control surfaces.

In addition to marking a milestone in the first flight aboard a NASA test aircraft this year, DFBW systems have also flown in some specialized craft, such as NASA's

launch vehicles and the Apollo lunar command module, as well as the Concorde supersonic transport which, however, has a mechanical backup. Analog fly-by-wire systems are being developed for operational use, but they generally are seen as stepping stones to the more advantageous digital systems.

Among DFBW system developers, NASA is furthest along with two programs. One is the space shuttle orbiter, for which North American Rockwell is the prime contractor [*Electronics*, Aug. 14, p. 44]. NASA recently chose a triply redundant DFBW control system over the analog/digital hybrid system first proposed. Ronald V. Murad, shuttle avionics chief, says that, since the flight control will be part of the over-all navigation, guidance, and control system, the all-digital system will reduce the number of required computers from nine to five and will provide other advantages.

"Digital has tremendous weight, power, and space savings," Murad

For every electronic protection need
BUSS® has a quality Fuse & Fuseholder



1/4 x 1 1/4 inch
 Time Delay Fuses
 From 1/100 to 30 amps,
MDL MDX
 for 32V, 125V, or 250V

1/4 x 1 1/4 inch
 Normal Blowing Fuses
AGC GLH MTH
 From 1/500 to 30 amps,
 for 32V, 125V, or 250V

Space-Saver Fuseholder for 1/4 x 1 1/4 inch fuses projects only one inch behind panel

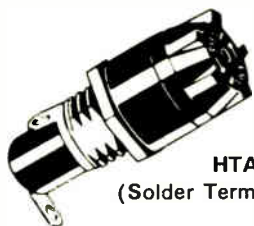

HTA
 (Solder Terminals)



HTA-HH
 (1/4" Quick-Connect
 Terminals)

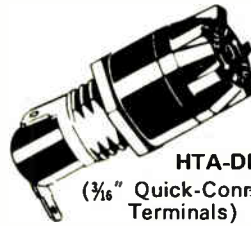

HTA-DD
 (3/16" Quick-Connect
 Terminals)

ALL FUSE HOLDERS HAVE THESE FEATURES IN COMMON

- Rated for 15 amps at 250 volts
- Dielectrically capable of withstanding 1500 volts a.c. between terminals and between terminals and panel
- Bayonet-type knob grips fuse so that fuse is withdrawn when knob is removed; strong compression spring assures good contact
- Made for installation in D-hole to prevent turning in panel
- Terminals are mechanically secured as well as soldered in holder.

The BUSS line of small dimension fuses and mounting hardware covers the complete spectrum of electronic applications. Use the coupon at right to order the complete catalog.

BUSSMANN MFG. DIVISION, McGraw-Edison Co.,
 St. Louis, Mo. 63107

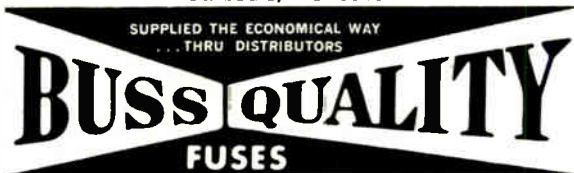

BUSSMANN MFG. DIVISION, McGraw-Edison Co.
 St. Louis, Missouri 63107

Please send me a copy of BUSS Bulletin SFB

NAME _____
 TITLE _____
 COMPANY _____
 ADDRESS _____
 CITY _____ STATE _____ ZIP _____

Probing the news

says. NASA and North American Rockwell are still studying computer requirements, but Murad estimates that each computer will have a storage capacity of 32,000 words, allowing for a 100% margin, a margin level that could drop in time.

The highlight of NASA's second program was the first flight this year of an LTV Aerospace F-8C jet, equipped with a DFBW system and a Sperry triply redundant analog FBW as a backup. The plane has flown nine flights with an Apollo inertial measurement unit (IMU) and lunar-guidance computer (LGC). The estimated \$10 million program aims to prove out DFBW and get Federal Aviation Administration and public acceptance by 1978, in time for the next generation of jet transports.

Sizing the computer. The program is now entering a second phase. Massachusetts Institute of Technology is performing systems engineering for the F-8C system to replace the Apollo hardware, Kurzhals says. This dual-channel system would use an aircraft computer, such as a Singer Kearfott SKC 2000, a Control Data Corp. Alpha, or a Teledyne 43M, having about 32,000 words of memory.

Actual flight control would take only 6,000 words, says NASA assistant branch chief Melvin E. Burke, but "we're sizing the computer to the problem" of additional testing and evaluation functions. A computer contractor will be chosen in the spring.

Pending topside approval, NASA hopes in fiscal year 1974 to begin the development of a full DFBW system with no mechanical or analog backup. It would fly in 1976 aboard a small jet transport the size of a Lockheed S-3A or North American Rockwell Sabreliner. This final flight testing should lead to FAA and public acceptance.

Besides supplying NASA's analog FBW backup, Sperry's Flight Systems division, Phoenix, Ariz., has an in-house DFBW program flying aboard a Convair 990, says Ronald P. Cotfila, head of the Advanced Avionics department. The DFBW experiment uses a Sperry 1819A computer with 16,000 words of memory

to interpret pilot commands to the control-surface servomechanisms, and it has a mechanical backup, he says.

"The future of digital fly-by-wire is very good," Cotfila says. "In our opinion, it's the coming thing. We're developing the computers and systems right now." Sperry also developed the analog FBW system that flew aboard a McDonnell Douglas YF-4E this year as part of an Air Force program.

Honeywell's Aerospace division, St. Petersburg, Fla., is designing the DFBW flight-control system on the space shuttle orbiter for North American Rockwell. NASA is expected to approve North American Rockwell's request that Honeywell be selected to build the orbiter system. Honeywell built the analog FBW-backup systems for the Apollo command modules and lunar excursion modules. Honeywell's Government and Aeronautical Products division, Minneapolis, also has an in-house digital flight-control program, which includes operational laboratory work in DFBW. Along with Lear Siegler Inc., it has parallel phase one study contracts for the Air Force's Digital Tactical concept (Digitac) and C-141 fly-by-wire programs and the Navy's Digital Flight Control Program (Digiflic).

Bendix Corp's Navigation and Control division, Teterboro, N. J., has flown a flight-control system, guided by a digital computer,

aboard a Beech-Hawker 125 business jet [*Electronics*, July 31, p. 18] and has been working on analog FBW systems for the Air Force.

Lear Siegler also is working on DFBW, reports Kenneth C. Kramer, president of the Astronics division, Santa Monica, Calif. The company is proposing a DFBW system for the Navy's Digiflic study, aimed for a multimode LTV A-7 fighter. It will receive a parallel contract with Honeywell when the program gets funded, he says.

Is DFBW going to come? "Absolutely," answers Honeywell's shuttle program manager Walter N. Lundahl. "It's the system of the future. There's no question about it." Others second his assessment. But some add that they don't see DFBW coming right away. "It's going to come, but there's a problem of getting the size and cost of computers down, comments Lear's Kramer. Sperry's Cotfila adds, "It's difficult psychologically to convince the FAA and the general public of the safety." And Honeywell's Lundahl remembers that FBW "has been in the wings for 20 years, but pilots have been reluctant to accept it."

What needs to be done? NASA's Kurzhals asserts that the goals of NASA's program are to prove that DFBW is reliable, adequate to perform functions, and that the "pay-offs are real." So far, pilot acceptance has been favorable, NASA reports. □

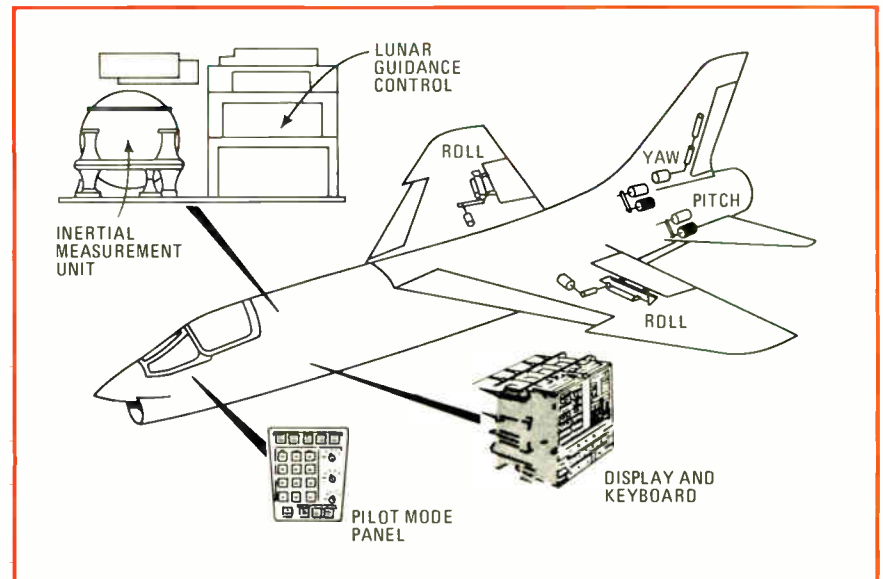

First. Apollo computer and navigation gear replace mechanical links as primary control system in NASA flight-test program.

APPLY TODAY

Suggest a use for the 555 IC timer, and get one FREE to work with.

Think. What could you do with this flexible, low-cost, exceptionally simple-to-use circuit? The first – and only – standard IC timer in production today. That functions interchangeably as a time delay, oscillator, pulse detector or power modulator. With resettable timing from microseconds through one hour.

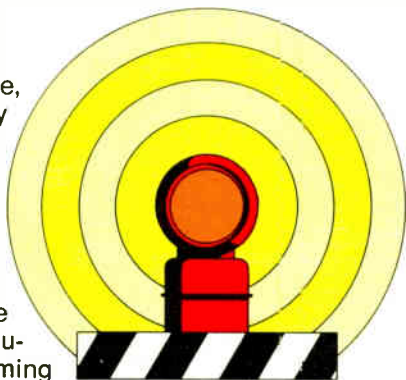

Think. And get much more than a penny for your thoughts. Originate a specific use for the 555, and we'll rush you a timer to experiment with. FREE.

Applications almost limitless. Over the broadest range of industries. This exclusive device easily wires into just about anything made today requiring generation of a frequency or time delay.

Anything. Anywhere.

Anything you can think of for the home. From appliance and cooking timers... to house-light timers, sprinkler system regulation. Or how about security systems, with all their intricate mechanizations? Anything in the automotive line. Like anti-skid braking controls, windshield wiper speed regulators, tachometers. Fuel injection and emission control systems.

Sports: electronic stopwatches. Entertainment: vending and concession machines. Business: office intercoms, time-release locks, teletypes, telephones. Biomedical: stimuli control.

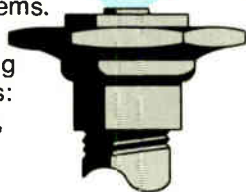

And of course, anything in the electronics/computer fields – right back where it all started.

Specs for the versatile 555 timer include 200mA output drive capability; flexibility in supply voltage 5 to 15 volts; unique temperature stability 0.005% per °C. Free run or latch in adjustable duty cycles, externally triggered.

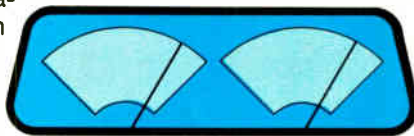

And the incredible ease-in-use (requires only a resistor and capacitor) is matched only by our incredible low cost. The 8-pin dual-inline circuit

comes to you off the shelf from your distributor for only 75¢, from 100-up.



Signetics/Linear
811 East Arques Avenue
Sunnyvale, California 94086

- Attached is my application suggestion for the 555 universal timer. Please send my FREE part immediately.
- Rush me all specs and data for the 555 timer.

Name

Title

Company

Address

City

State

Zip

Telephone

Signetics Corporation, A subsidiary of Corning Glass Works.

signetics
the IC professionals

People

Dan Noble's past is link to the future

Semiconductor pioneer rides herd on Motorola's multidivisional drive to achieve supremacy in the electronic watch component business

by Paul Franson, Los Angeles bureau manager

At the age of 71, Daniel E. Noble, chairman of the Science Advisory Board of Motorola Inc. should have long since retired. But Noble's accomplishments indicate he's not the kind of person who takes to retirement easily.

His most recent project is bearing fruit in the form of Motorola's penetration into the electronic watch market. Motorola's approach is to build a kit consisting of the C-MOS circuit, the quartz crystal, and the electric stepping motor to drive conventional hands [*Electronics*, Jan. 17, p. 29].

Noble expects the watch components to be a significant business at Motorola: "300 million watches are sold each year; if one-third were quartz and the kit cost \$10, that's \$1 billion." Noble's conviction that electronic watches would find a significant market goes back at least nine years. That's when he and Robert Galvin, now Motorola's chairman, discussed the concept of electronic watches with Swiss watchmakers.

When he came back to the States, Noble talked to the head of Motorola's Central Research Laboratories, and decided that Motorola "should get into the watch electronics business when the integrated-circuit divider technology was available. That was before C-MOS," Noble recalls. "But when it came along, we could see that it provided the technology for the micro-ampere-signal processing needed to operate the watch for a year. Then the lab developed the circuitry, and "I decided to provide the coordination required to make the venture a reality." A special group in Phoenix worked on the motor, and Noble

coordinated the efforts of the group in Schaumburg to make the crystal. "Bob Galvin had been along with me in Switzerland, and there was no problem with opposition in the company," says Noble.

But the watch program isn't the only case in which Noble's foresight has paid off for Motorola. Among other things, he:

- founded Motorola's Science Advisory Board
- blazed a corporate trail to Phoenix
- pioneered in fm radio
- started and managed the company's Communications, Semiconductor Products and Government Electronics divisions.

Noble's understanding of the need for the engineer who opts not to go into management to achieve recognition and rewards led to his founding two years ago of the Motorola Science Advisory Board, where the creative working engineer can present his ideas directly to top corporate management.

Decided on Phoenix. In the days after World War II, Noble came to Arizona and staked out a corporate claim for what was to become the site of one of the giants of the semiconductor industry. Here he started and managed the company's Communications, Semiconductor Products, and Government Electronics divisions. "It was the type of area that would attract the creative people I knew would be needed for the solid-state work," he says.

One of the people he hired was a former Harvard professor, C. Lester Hogan, who made the Semiconductor Products division a potent force before becoming chief executive officer of Fairchild Camera & Instrument Corp. At that time,

Noble recalls, "he had no industrial experience, no semiconductor experience, and no business experience. But he learned fast."

Like Hogan, Noble's early years were spent as a professor of mathematics and engineering. And it was during a stint at the University of Connecticut that he developed the first fm two-way radio, which he adapted to establish the first state-police radio system. And it was this interest in communications that led to Motorola's strength in power transistors for automotive radios, inverters for rf amplifiers, and the first practical non-Bell-system uhf mesa transistors.

Prognosticator. Sporting a thin mustache and a bow tie, he still maintains a professorial manner. Noble is a forceful and engaging speaker with a wry sense of humor. Speaking to humanities students at Arizona State University recently,

Corporate guru. Dan Noble keeps Motorola ticking on its electronic watch project and heads the firm's Science Advisory Board.



he admitted, "For years, I have labored under the illusion that I am an expert prognosticator; my father was a prognosticator, also my father's father. My mother was a Methodist."

His self-chosen characterization is apt. Noble has the canny ability to calculate the variable forces at work in the electronics industries—research, development, markets, sociological trends, politics, and government. As a corporate planner, he shares the glory for the achievement by Motorola of \$1 billion in sales this year for the first time. And Noble predicts that IC technology will make possible within five years electronic watches selling for less than \$25 that will be as accurate as \$2,500 watches are today.

But Noble's vision also extends to people. He views the human condition optimistically: "The Industrial Revolution was a revolution in increased productivity due to adapting machines to extend our muscles. Now we're entering a period of extension of creativity due to brain extension with computers and electronics. We may have 25 to 50 years of stumbling as we try to find our way, but that will be followed by a period of creativity unimaginable now."

In his later years, Noble, a devout believer that "A high percentage of the positive forces for good that make life viable have been started by science and engineering," has tried to educate people to recognize the transition to this new era.

Noble's foresight is not restricted to technical creativity, either. He is a painter whose works abound in the lobbies and executive suites of Phoenix, and he has exhibited his paintings and sold successfully. However, he claims no more than an experimental interest. The paintings, including symbols, and even parts familiar to anyone in electronics, suggest both a view of man alienated from his environment and an intellectual sense of humor—perhaps a put-on.

Concerning his own future, Noble still has plenty of projects to work on: "A thing like retirement isn't something I can accept with equanimity, and I expect to keep on working until about 1975 if my health holds up." □

NOW 10 Bits —

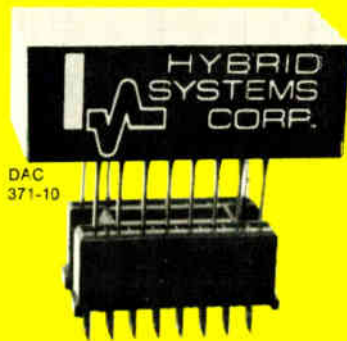

DAC
371-10

D/A Converter
plugs into
a single IC
socket!

\$19.00 in singles

For the first time . . . a miniature 10-bit DAC at low cost. The remarkable ultra-compact DAC 371-10 is a complete current output converter, ready to use — packaged in a 1.4" x 0.6" x 0.48" module. Built-in reference, DTL and TTL compatibility . . . plus all active components are hermetically sealed for extra reliability. Contact us for full details.



HYBRID SYSTEMS CORPORATION

87 Second Ave., Northwest Industrial Park, Burlington, Mass. 01803
Telephone: 617-272-1522 TWX: 710-332-7584

Circle 81 on reader service card

Miniature plug-in power transformers

**Huge in-depth inventory for
immediate off-the-shelf
delivery.**

Sizes from 1 to 24VA

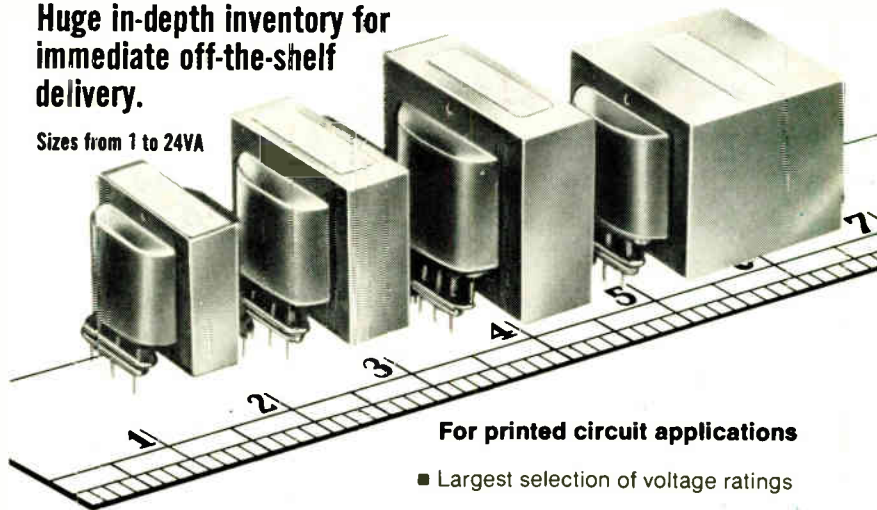

For printed circuit applications

- Largest selection of voltage ratings
- Low cost—no minimum order requirements
- 115 or 115/230V primaries

Send for complete catalog including extensive line of power and voltage regulating transformers.

**Signal
transformer co. inc.**

1 Junius Street, Brooklyn, N.Y. 11212
Tel. (212) 498-5111

Circle 165 on reader service card 81

Quality RFI/EMI
broadband filters...
broad line
availability.



If you're really
serious about cost,
be serious about quality.

Allen-Bradley gives you a choice of forty-two broadband filters in Pi, T and L configurations. These "hermetically" sealed low pass filters are designed to suppress conducted interference on DC and low frequency AC (0 to 400 Hz) power lines. Meet or exceed MIL-F-15733. Available with gold or

tin plating. Request Publication 5418. Call your A-B electronics distributor, or write: Allen-Bradley Electronics Division, 1201 S. Second St., Milwaukee, WI 53204. Export: Bloomfield, N. J. 07003. Canada: Allen-Bradley Canada Limited, Galt, Ontario. United Kingdom: Jarrow, County Durham NE32 3EN.

Voltage Rating		Minimum Insertion Loss (dB)			
-55 C to +85 C	-55 C to +125 C	0.30 MHz	1.0 MHz	10 MHz	1000 MHz
	200 VDC 125 VAC	12 to 34	23 to 65	58 to 80	70 to 80
150 VDC	100 VDC	16 to 52	35 to 80	65 to 80	70 to 80
100 VDC	50 VDC	26 to 63	37 to 80	66 to 30	70 to 80



Actual Size

Circle 82 on reader service card



Allen-Bradley
Milwaukee Wisconsin 53204

Integration brings a generation of low-cost transducers

This pressure transducer uses an all-silicon vacuum reference chamber with a Wheatstone-bridge arrangement of diffused piezoresistors to measure pressures ranging + between 0 and 1 atmosphere

by Arthur R. Zias and William F. J. Hare, *National Semiconductor Corp., Santa Clara, Calif.*

□ Considering that virtually all electronics instrumentation ultimately must interface with the larger mechanical world through one type of transducer or another, it is surprising that these transducers have not long ago benefited from the advances that have been made in integrated-circuit technology. The development lag appears even more surprising when one realizes that transducers have routinely set the price and performance boundaries of most measurement systems.

Although the reasons behind the delay are fairly clear (see box, "Why the lag?"), they have recently lost much of their validity. Hence, a growing supply of transducers is expected to become available in the near future. Standard high-volume IC techniques will be used to build, test, calibrate, and package these transducers. And they

will be priced like ICs. A sample of these good things to come is National Semiconductor's new pressure transducer, the LX1600A.

An all-silicon vacuum chamber

The new transducer, which sells for about \$10 in large quantities, consists essentially of a Wheatstone-bridge arrangement of four piezoresistors diffused into a silicon chip. The silicon chip is actually a 1-mil-thick pressure diaphragm that has been etched out of one wall of a vacuum reference cavity (Fig. 1). The rest of the cavity wall has a thickness of 12 mils.

The Wheatstone bridge consists of four p-doped (boron) regions diffused into the etched chip of n-type silicon. Unlike a conventional metal strain gage, whose

1. Pressure transducer. Hybrid device is contained on a single ceramic substrate, along with array of thick-film signal-processing resistors, mechanical enclosures, and two op amps (a 747 and a 741) that serve as buffer amplifier and output amplifier, respectively.

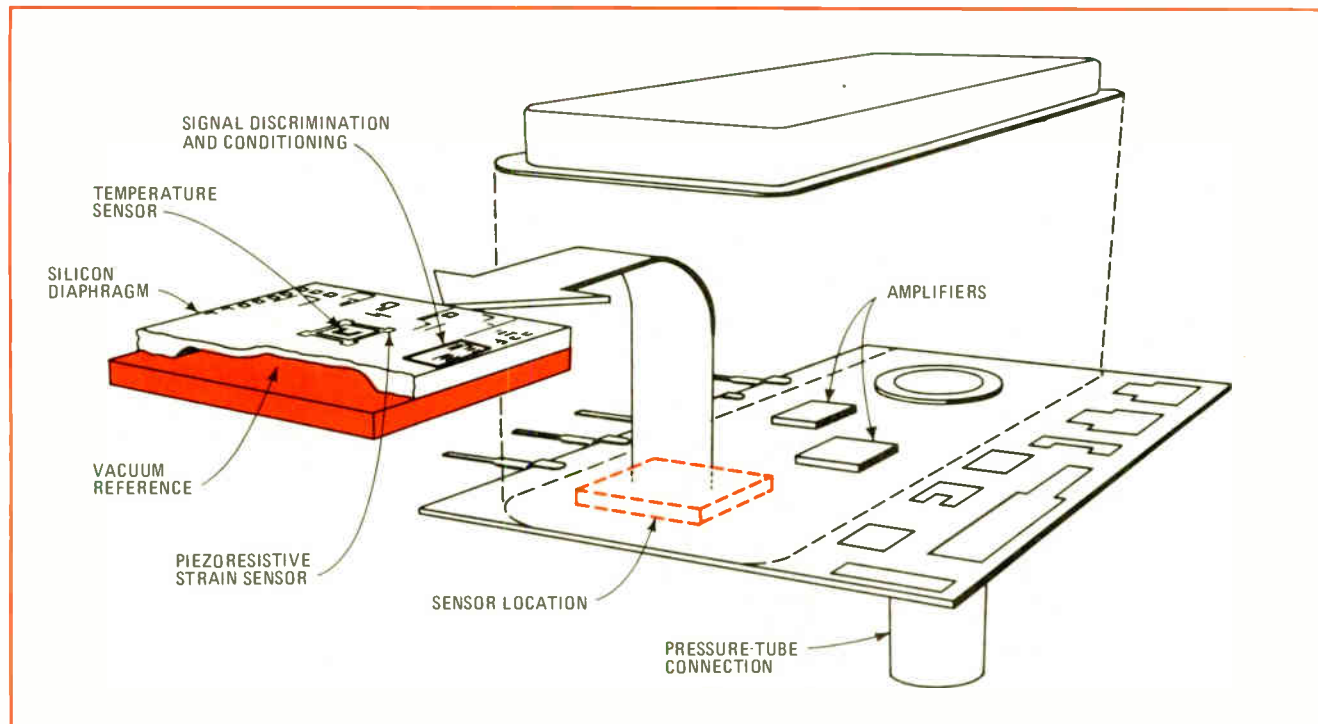

2. Calibration. Characteristic curve for IC pressure transducer is defined from specification of null and full-scale end-points, rather than from best straight line between actual null and full-scale points of each individual unit. This is both good and bad: it makes the transducers completely field-interchangeable, without recalibration, but it also automatically includes errors caused by the initial null and full-scale offsets of each actual transducer.

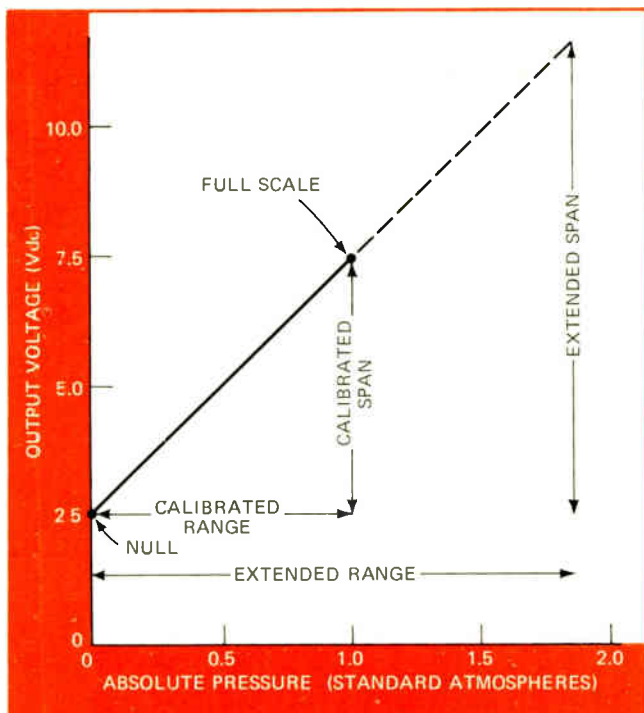

3. Hybrid. Pressure sensor, two op-amp chips, and array of laser-trimmed thick-film resistors are mounted on ceramic substrate.

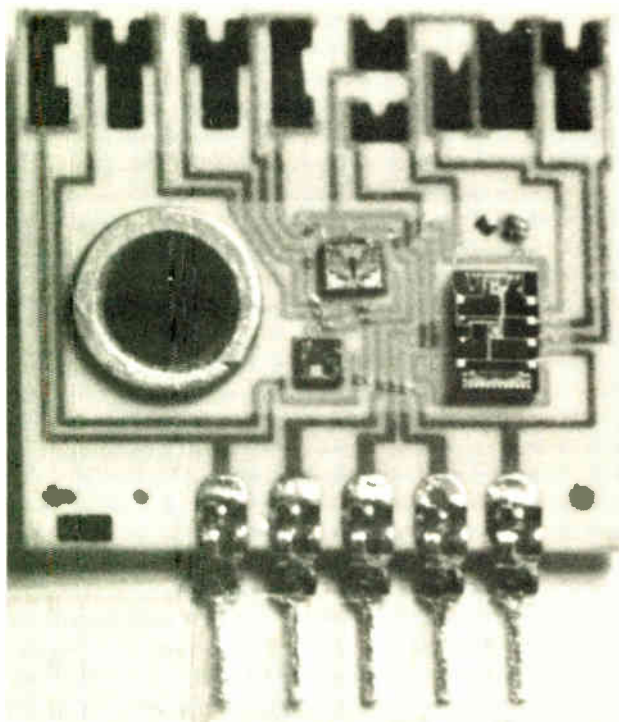

gauge factor, $G = (1/\epsilon) (\Delta R/R)$, is dependent upon distortions of gage geometry, the piezoresistive effect depends on changes in the actual resistivity of the gage material. Thus, for a piezoresistive gage, $G = (1/\epsilon) (\Delta\rho/\rho)$, whereas the metal strain gage has a gauge factor

$$\left(\frac{1}{\epsilon}\right) \frac{\Delta(L/A)}{L/A}, \quad \text{where}$$

$\epsilon = \Delta L/L$ is the strain, $R = \rho L/A$ is the gage resistance, $L =$ length of gage wire, and $A =$ its cross-sectional area.

For p-type materials, such as in the sensor regions of the gage being described, $\rho = 1/\mu_p q p$, where μ_p is the hole mobility, q is the electronic charge, and p is the doping concentration.

This bulk effect is highly sensitive to strain; equivalent gage factors range as high as 140, compared with the 2.5 that is typical for metals. At one time, this was considered the great advantage of piezoresistivity; today it is not. The higher gage factors are obtained at light doping levels that also lead to high temperature sensitivity. Thus, in the LX1600A, a modest gage factor of about 90 is used.

The piezoresistive effect has been explained as the effect of strain on the asymmetric conduction-band energy, relative to the valence-band energy. This results in higher carrier mobility in one direction than in the direction perpendicular to it.

Depending upon crystallographic plane and direction, the differential mobilities in different directions can be of equal magnitudes, but opposite signs, allowing the clever designer to fabricate a device that is internally self-compensating for temperature variations.

For example, in the 1-0-0 plane used in the LX1600A, it is possible to arrange piezoresistors so that $G_{LL} = -G_{LT}$, where the LL subscript denotes the longitudinal direction and LT, the transverse. Then for a particular thermo-expansive error, $(\Delta R/R)_L$, which equals $G_{LL}\epsilon_L + G_{LT}\epsilon_T = G(\epsilon_L - \epsilon_T)$, so that, for a symmetrical structure, such as a circular diaphragm, this particular error is cancelled out.

Automation affects calibration

Since as much as 50% of the cost of a pressure transducer may be attributable to its calibration and testing, the automation or elimination of these procedures must figure heavily in any design for a high-quality, low-cost device.

Paradoxically, to achieve low over-all costs, it pays to aim for an extremely accurate design because testing is more expensive than extra accuracy. In fact, if one wafer were to supply sensors for both a "high-accuracy" transducer, with individual stability testing, and for a "low-cost," sample-tested model, and if assignment to these batches had to be made at the wafer-probe stage, then the most accurate sensors would certainly go to the sample-tested low-cost units.

The performance specs typically called out for transducers tend to be categorized roughly as individual, stability, or nominal parameters. Items in the first group must be 100% tested. These include null and full-scale output voltages and null and FS temperature coefficients. The usual IC parameters, such as junction char-

acteristics and leakage currents, as well as the bridge resistances, can be measured quickly and easily at the wafer stage. Assuming these tests are handled with a computer-controlled microprobe, increased accuracy and lowered costs through early culling are compatible.

The stability characteristics—linearity, hysteretic error and deadband—are by far the most expensive to measure. (Hysteretic errors are ambiguities caused by slight differences in the response of the transducer to increasing and decreasing pressures. The transducer's deadband is the maximum shift in the null characteristic that can be caused by a pressure excursion up to the transducer's rated overpressure limit.) These tests tend to be subtle and time-consuming, and hysteretic error and deadband are so small that they present major instrumentation problems. Worst of all, these parameters require checking, not at the wafer-probe stage, but late in the assembly process. In fact, the IC's absence of linkages and mounting stresses and the single crystal's characteristic freedom from diaphragm hysteresis make these parameters exceedingly hard to measure outside of a specialized lab.

Obviously, the nominal, qualification specs, such as shock, vibration, and electromagnetic interference, affect package requirements and design. But they have little over-all effect on the testing costs of a high-volume item.

Because this tight production control is an economic necessity, and because production and test entail an automaticity uncommon to transducers in general, IC transducers are best calibrated and specified in ways novel to conventional devices. For example, IC units are trimmed and calibrated as they are built. The computer-controlled mass-production routine is arranged so that the specified nominal output is achieved by trimming the null and full-scale end points to a specified tolerance and using a single input-output curve for all units (Fig. 2).

This type of calibration is also a major departure from conventional practice for individually fabricated transducers. It eliminates field calibration and facilitates complete field interchangeability within the spec, but it sacrifices some of the "outer-edge" performance claims that might otherwise be made. In fact, it costs the spec writers 2% in the null voltage and full-scale voltage claims. These are errors that, in individually calibrated units, would disappear in shifts of the "best-straight-line" from unit to unit. That $\pm 2\%$ figure notwithstanding, the device is suitable for a wide variety of fuel-metering, volume- and density-measuring, and anticipatory proportional control applications.

In final calibration, a computer-controlled laser trims a matrix of output resistors deposited on the hybrid ceramic substrate (Fig. 3). The substrate also holds the IC sensor cell, a buffer amplifier (a 747 operating at unity gain), and a 741 operational amplifier that raises the balanced and compensated sensor signal to a nominal full-scale value of 7.5 vdc. The laser trims that voltage to within 2% of FS. It also trims the null to 2.5 vdc $\pm 2\%$ of FS, the null temperature coefficient to 0 ± 1.0 mv/°F, and the full-scale TC to 0 ± 1.5 mv/°F.

Such errors as nonlinearity, deadband, and hysteretic error aren't trimmable; they're slaves to the sensor con-

Why the lag?

Why has the transducer industry allowed so much time to elapse between the development of integrated-circuit technology and its application to the fabrication of mechanical transducers? For force and pressure transducers particularly, a good deal of this lag can be traced to a highly fractionated, low-volume, nonstandard market environment inherited with the old electromechanical tradition. A recent industry compendium, for example, lists (after eliminating duplications) some 75 manufacturers supplying the entire \$2.5 billion IC market, including all categories—linear, digital, MOS, LSI, MSI, and all the rest; but the same source lists some 90 makers of pressure sensors alone. And pressure accounts for much less than half the annual \$320 million transducer market.

Furthermore, since good-quality devices—that is, devices that can make measurements that are reproducible to within approximately 0.1% of full scale—cost from \$150 to \$500, this is plainly a market of short runs. And since the suppliers average less than \$1 million a year, it's also plain that this field, at least, has heretofore offered few occasions for major investments in high-volume, high-quality product innovations. In general, therefore, progress has been a painfully slow evolution from watchmakers' delights, featuring potentiometer wipers and unbonded strain gages, to cemented gages and, recently, deposited and diffused pickoff elements. In all cases, these have been produced singly or in small batches.

They have also been tested and calibrated singly, an important disadvantage, since test and calibration—across the price-range—account for between 30% and 50% of a transducer's over-all cost. In addition, individual calibration adversely affects interchangeability; in many systems, transducers are the only elements that require recalibration of the entire system when they are replaced.

Recently, however, this picture has changed. Automotive, appliance, and certain high-volume industrial requirements have made major investments in high-volume, high-quality force and pressure transducers a good bet, especially for companies with linear IC capabilities already in hand. The result of these efforts will be a growing family of transducers manufactured completely by high-volume IC techniques.

struction. Hysteretic and deadband errors are, however, very much smaller in ICs than in conventional transducers, and since nonlinearity is mainly a function of design, it's very predictable, stable, and reproducible from IC to IC.

Physical construction

The pressure transducer is built on a 165-mil \times 115-mil silicon chip of which a 90- \times 65-mil area is the pressure diaphragm. This leaves more than enough area for temperature-compensating diodes, bridge-balancing resistors, and a zener regulator for the bridge power supply. In fact, there is enough extra room to put the op-amp buffer and output amplifiers on the sensor chip, should this become desirable (Fig. 4).

The vacuum cavity is formed by etching the back side
(continued on page 88)

A brief history of variable-resistance pressure transducers

In the beginning, there was the potentiometric device (A). Its low cost and high-level output signal made it and have kept it popular in simple systems. The pot has several serious problems, however, caused mainly by the need to move its wiper a considerable distance along the resistance element as the input pressure changes.

The problems include high sensitivity to vibration and shock, poor frequency response, short life, and non-linearity errors. Even the best units will typically fail before they complete 100,000 cycles. And despite attempts to minimize nonlinearity—either directly, by putting convolutions in the aneroid capsule, or indirectly, by adding mechanical assemblies to minimize the movement of the sensing element—errors in excess of 3% are the rule, not the exception.

Early methods of coping with the displacement problem centered around the unbonded strain gage (B). This device offered substantial improvements in accuracy, life, frequency response, and even temperature sensitivity. Maximum errors of less than ½% of full scale are common with these devices.

The drawbacks of the unbonded strain gage are two-fold: it is a delicate and expensive transducer that is difficult to build and handle, and it is incapable of providing more than a few tens of millivolts of output signal. Usually, limitations on loading and output level make it necessary to locate a preamplifier close to the transducer, a step that increases the already high cost of the device.

An alternative to the unbonded-gage transducer is the wire, foil, or semiconductor gage bonded directly to the pressure diaphragm (C). Like the unbonded arrangement, this one requires a preamplifier, but its simplicity, and the elimination of such mechanical parts as force rods, flexures, and linkages, results in a much cheaper unit. Frequency response and sensitivity to vibration are also improved.

Accuracy, however, is not. In fact, because of instabilities in gage bonding, inaccuracies in gage location on the pressure diaphragm, and mass-loading of the diaphragm by the gages and cement, the accuracy is not as good as that of the unbonded unit. The gage-cement combination also changes the mechanical properties of the diaphragm and makes it useful only for rather high pressures—those above approximately 100 pounds per square inch.

Another alternative to the unbonded-gage transducer—one that can be used at low pressures—is the bonded-gage assembly employing a force rod that acts on a cantilever beam, to which the gages are cemented (D). Relative movement of gages and beam can be eliminated if the beam is made of silicon and the gages are diffused into it. In both this approach and the preceding one, the development of doped-silicon strain gages with gage factors in excess of 100 (compared with about 2 for metal wires) has made possible the construction of transducers that provide large output signals with a minimum of sensor displacement. Since flat diaphragms are inherently nonlinear, and since the nonlinearity increases with diaphragm movement, this minimization of movement is reflected directly in improved accuracy.

Unfortunately, the sensitivity of a silicon strain gage is directly tied to its temperature sensitivity. Decreasing the doping level increases both. Furthermore, the temperature sensitivity of silicon severely restricts the service-

temperature range of any pressure transducer that employs a silicon sensor.

Gages built around thin metal film overcome the temperature problems of semiconductor devices and offer some other important advantages. In constructing one of these gages (E), a metal strain-gage pattern is vacuum deposited onto an insulated pressure diaphragm. The extremely low mass of the thin film overcomes the problem of diaphragm loading for modest pressure levels.

This approach, which puts the resistance pick-off element in intimate contact with the moving sensing element, enhances accuracy, resistance to shock and vibration, and frequency response. Stability is also very good because of the low temperature coefficient of the thin metal film.

By applying modern thin-film technology to the fabrication of these transducers, manufacturers can include a variety of circuit arrangements, such as balance, trim, and temperature-compensation networks on a single pressure diaphragm. Not counting zero-balance errors, thin-film pressure gages routinely keep their errors in the 0.1% to 0.5% range.

An increasingly popular alternative to the deposited-film transducer is the single-crystal diaphragm with diffused gage regions (F). This construction combines the piezoresistor's high sensitivity with the single-crystal's freedom from hysteresis. It is a definite improvement over units that employ polycrystalline metal diaphragms because, once errors are reduced to about 0.2%, hysteresis becomes a major limitation on further error reduction.

These single-crystal semiconductor gages are expensive. However, such a gage provides a handy silicon slab that can serve as a substrate for amplifiers and other active signal conditioners that can markedly improve the transducer's performance. As a result, silicon-diaphragm units have found their way into air-data computers and other systems where the high cost is justified by the extremely high accuracy they provide.

A further refinement of the silicon-diaphragm transducer is a unit that incorporates a vacuum reference cell within the silicon itself (G). This refinement eliminates the need for pressure-tight seals around the silicon. Since the pressure-tight bonding inevitably introduces extraneous strains into the piezoresistive material, and this strain is temperature-sensitive (because of the different thermal-expansion coefficients of silicon and metal) the self-contained reference cell constitutes a major technological advance. It leads to transducers having specifications that rival those of laboratory standards, and these gages are the ultimate in pressure transduction today.

An important challenge to the transducer industry now is to apply this technology to industrial and consumer needs, such as fuel metering, process control, and barometry. One approach is to combine the silicon-cell concept with existing IC design and fabrication methods. With such a combination, yield economics force a reduction in the size of the silicon sensor to a set of dimensions more characteristic of IC chips.

Similarly, production economics dictate the adoption of standard IC diffusion parameters and test, calibration, and trimming operations. The result (H), which is described in this article, sacrifices some accuracy (maximum error is about 2% over-all) but it is a truly useful, low-cost device that can be produced in large quantities.

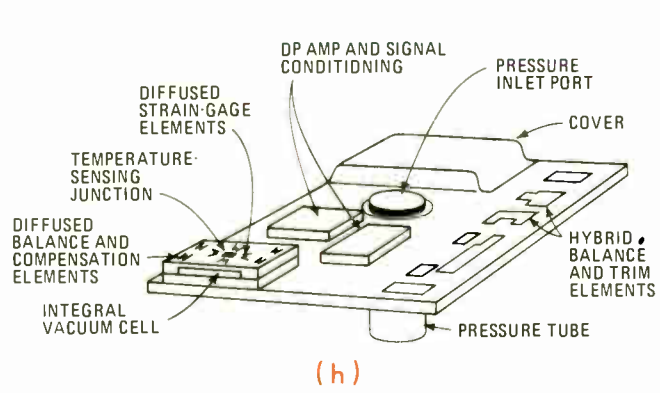
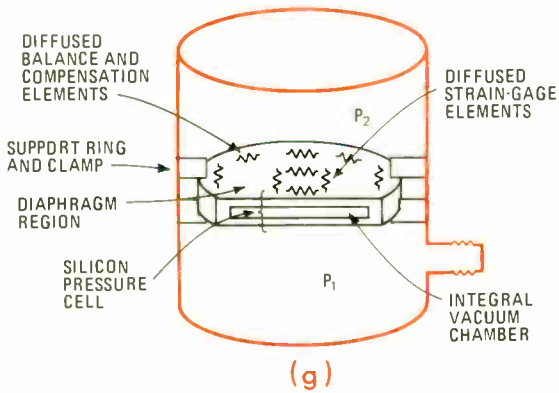
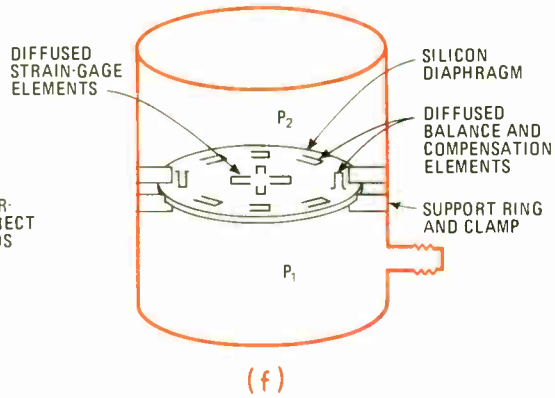
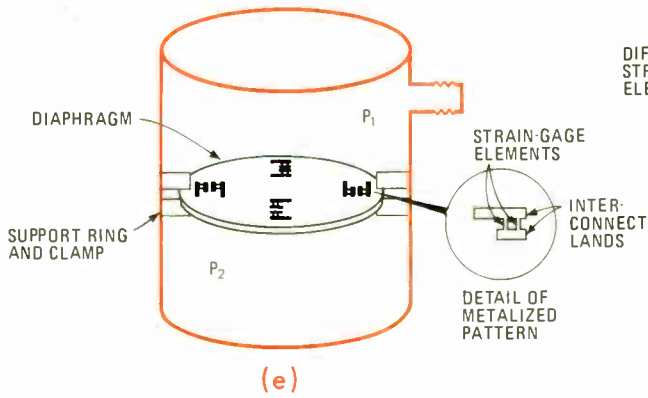
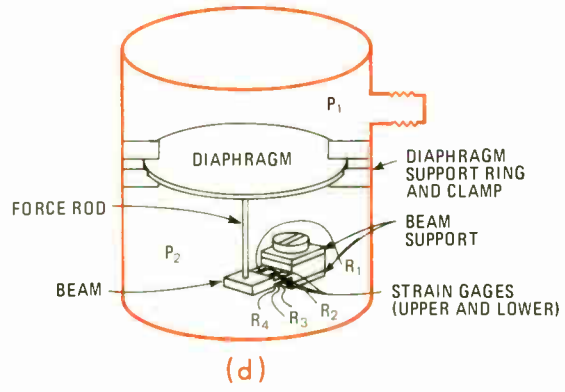
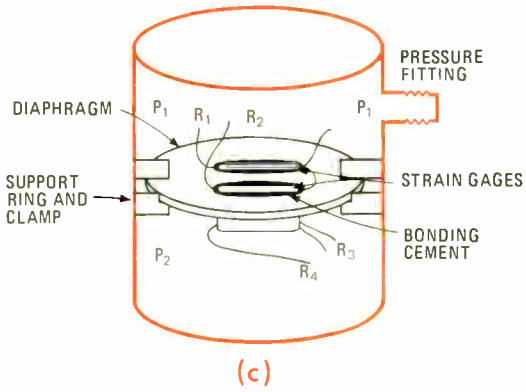
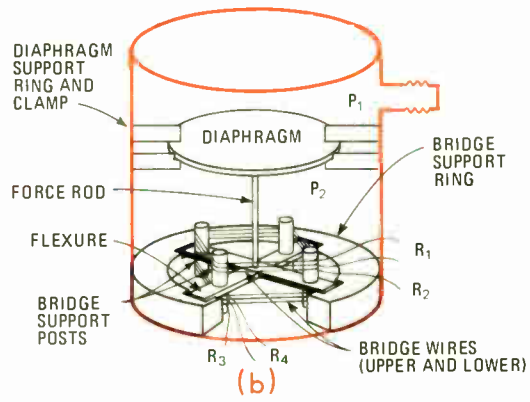
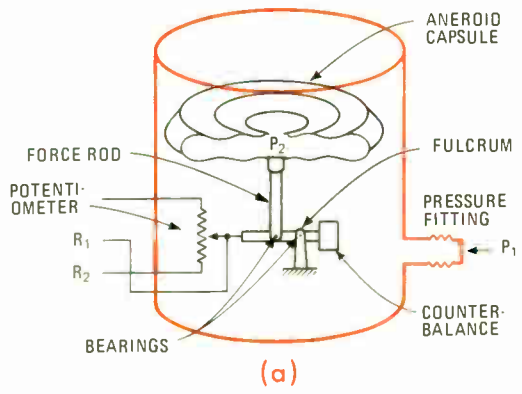

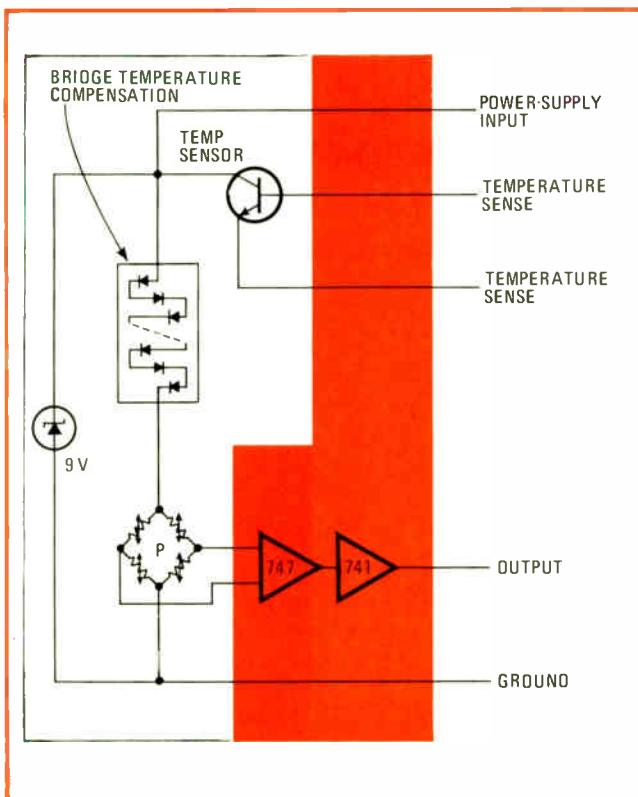

4. Extra real estate. Circuit elements in unshaded area of transducer are incorporated on the sensor chip, which includes the pressure diaphragm and the rest of the essential mechanical structure. As the simplicity of the diagram implies, there is more than enough room on the 165 × 115-mil chip to include the amplifiers.

(continued from page 85)

of the silicon chip to a depth of 11 mils and then bonding it to a backplate of silicon 12 mils thick. Because this process is done under a vacuum, the result is a pressure-tight vacuum reference cell that makes the transducer an absolute pressure sensor. Since the vacuum cell is made entirely of silicon, it is not subject to the temperature-induced errors that can affect a cell made of two or more materials with different temperature coefficients of expansion.

The diaphragm dimensions give the transducer a nominal range of 0 to 1 atmosphere, with the silicon stressed to less than 18% of its rupture point at 1 atm. The transducer can actually be operated at double-range—0 to 2 atm—and will survive excursions to 3 atm without offset or degradation. Power-supply modifications are needed, however, to make good measurements above about 1.9 atm.

The reference-cell vacuum is good enough that the actual lower measuring limit of the transducer is set by op-amp noise, not by the vacuum structure.

It almost looks easy

Except for creation of the cavity, its alignment, and the specification and control of crystallographic orientation, all the fabrication steps and tolerances, from masks to diffusion concentrations, follow existing commercial practice for high-volume linear ICs. But for its pressure reference cell, its crystal orientation, and unique set of masks, the IC chip could be confused with

any product of a familiar IC production line.

The mask-set places an interesting structure—a power-transistor with no ultimate transistor function—in the center of the sensor bridge. This transistor can be used during production test and calibration to raise and to monitor chip temperature. In the course of this service, its β tends to be compromised so that it is of doubtful value as a transistor.

However, the emitter-base junction remains a stable temperature-sensor, and it is not required for any signal-conditioning in the final configuration. Junction access is therefore provided through a pair of leads to give the user a convenient temperature sensor, along with his pressure transducer. Simultaneous measurements of pressure and temperature can thus be made by exploiting the 2.5-mV/°C voltage drop across the emitter-base junction of this internal test feature.

Second-guessing the manufacturer

Despite all its automated fabrication and calibration, the LX1600A still retains a certain amount of flexibility—and a finite chance for the enterprising user to get into trouble. For example, although it's not especially recommended, at least one user is second-guessing the factory laser calibration with further trimming to improve parameters of interest. (Additional trimmables include the null TC for the 0-atmosphere condition over the -40°F range and the 1-atm FS TC over the same temperature range. Static and total error bands, of course, are likely to be compromised thereby.)

Although the transducer will survive 3-atm excursions, at 1.9 atm, the output signal level approaches to within about 0.5 v of the 12.5-vdc nominal power supply, which should be regulated to 1% or better. Raising the power-supply still higher is a possibility, but this compromises linearity slightly. It also increases internal power dissipation, which introduces further errors.

Lowering the power supply below about 11 v starves the internal 9-v zener. Since the zener will regulate a 1% input to 0.1%, if the zener is starved out, it must be replaced by a regulated 0.1% supply. Replacing it with a more accurate supply can buy added accuracy. Recalibration is, of course, then required. A refinement on this is to derive a temperature reading from the internal junction temperature-sensor, and use this to control excitation voltage, through an op amp, thereby compensating for sensitivity changes with temperature. Or, the temperature-sensor output could be amplified and used to compensate for the device's offset TC.

The temperature-sensing junction lends itself to some variation also. The recommended connection provides a dependable 2.5 mV/°C, but against a reverse junction breakdown at 7 to 8 v. On the other hand, the reverse direction has the advantage of ensuring that the junction is always less positive than any point on the bridge. The junction can, with some care, be used in the forward direction; then it provides -2 mV/°C against only 0.6 v in this direction.

Caution is indicated when the junction is operated in the forward direction, since the entire chip substrate is a common collector and there's no isolation other than the operating point to prevent the transistor from compromising the bridge's pressure signal. □

Complete RF Network Analysis with **POLAR DISPLAY**

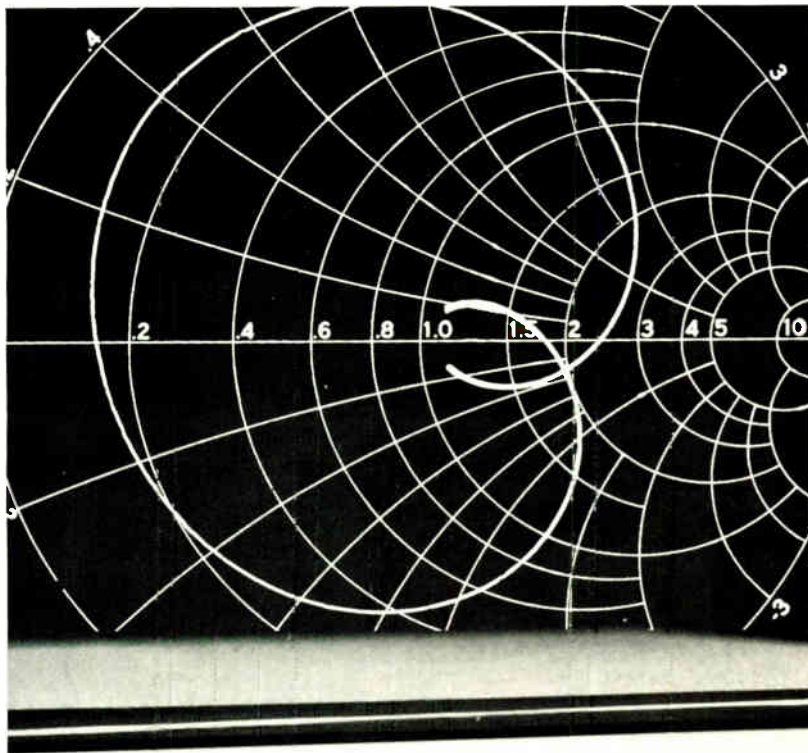

WHEN you need concise measurement data on antennas or rf cables, you'll see the value of polar (Smith-chart) displays of impedance versus frequency.

WHEN you want accurate measurements of structural return loss, you'll appreciate the ability to switch quickly from a rectilinear to a polar display.

WHEN you have to characterize active devices, you'll find invaluable the large 360-degree display with a full 100-dB dynamic range.

WHEN you must compare two unknowns or compare two ports of multiport unknowns such as power splitters or phase shifters, you'll want the speed and simplicity of polar displays of the vector difference.

WHEN you want all this from 400 kHz to 500 MHz with 0.005-dB resolution, you'll want the 7145-dollar 1710 RF Network Analyzer with polar display from General Radio — the GR 1710...

WHEN you need a lot.

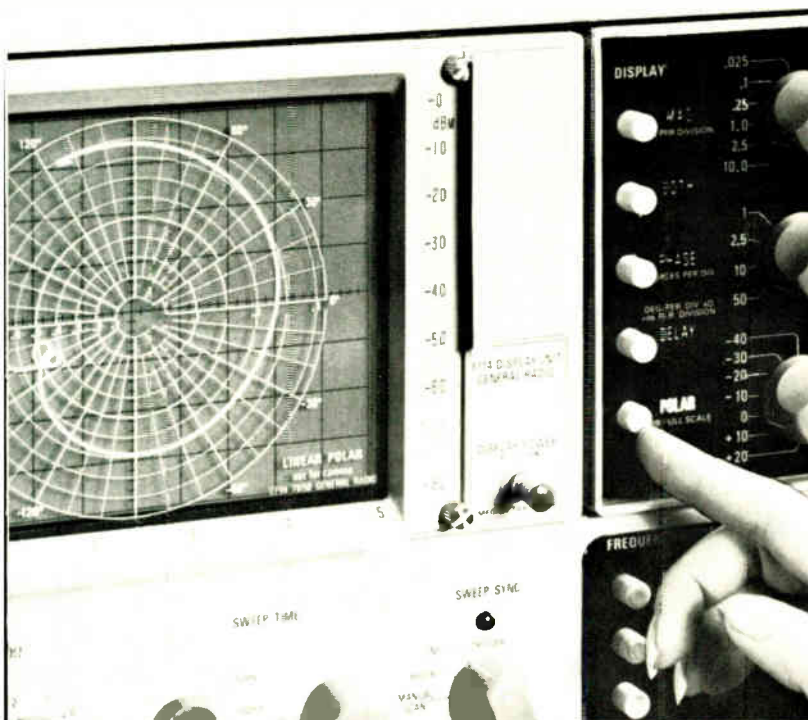

For High-Frequency Measurements



General Radio

NEW YORK (N.Y.) 212-964-2722, (N.J.) 201-791-8990 • BOSTON 617-646-0550
CHICAGO 312-992-0800 • WASHINGTON, D.C. 301-948-7071 • LOS ANGELES 714-540-9830
TORONTO 416-252-3395 • ZURICH (01) 55 24 20

GR COMPANIES • GRASON-STADLER • TIME/OATA • TECHWARE COMPUTING CORP.
GR ASSOCIATE • MICROMETRIC SYSTEMS INC.

Four-ampere power supply costs just \$13 to build

by Joseph Ennis
Automation Industries, Inc., Vitro Laboratories Division, Silver Spring, Md.

The cost of building a regulated power supply can be lowered to around \$13 if a large capacitor is used to store energy at a higher voltage than is necessary. Under normal operating conditions, the supply, which is primarily intended for powering a stereo amplifier, can deliver an output of 4 amperes at 20 volts with load fluctuations down to 18 hertz and with regulation to better than 5%.

A high-value capacitor, one measuring tens of thousands of microfarads, stores charge so that only a small amount of transformer iron is needed to produce the 4-A operating current. The resulting higher-than-required capacitor voltage is then dropped to the desired 20-v level with a transistorized series regulator. Moreover, two inexpensive incandescent lamp bulbs are used for short-circuit protection, rather than a more costly current foldback technique.

With no load at the output, the transformer charges

the capacitor to about 39 v through the diode bridge. The transformer, which has a no-load secondary voltage rating of 28 v ac, can deliver the 4-A operating current but will not deliver this voltage under loading because of its core and copper losses. Although capacitor voltage may drop to around 24 v during peak loading, the series regulator will continue to provide a smooth 20-v output.

A current of more than 4 A could be controlled by the regulator transistor with the appropriate heat sinking, but the heat sink would cost more than the transistor. The heat-sink area is designed to handle only normal worst-case operating conditions and does not allow for any current foldback dissipation.

Instead, this dissipation is provided by two replacement-type automobile lamp bulbs. Besides acting as fuses when there is a short circuit at the output, they reduce the voltage drop across the regulator transistor, thereby decreasing the power it has to dissipate during normal supply operation.

To change the supply's output voltage to 15 v, the 23-v zener is replaced by a 17-v one. If a 5-v supply is needed, a transformer with a secondary voltage lower than 28 v should be selected to reduce the voltage drop that the regulator must handle. A negative-voltage supply can be constructed by substituting complementary transistor types TIP30 and TIP32 for the type TIP29 and TIP31 transistors. □

Economical regulated supply. Parts cost for power supply is pared to absolute minimum by storing energy in 33,000-microfarad capacitor at higher-than-required voltage level. This allows a fairly lossy, and therefore inexpensive, transformer to be used. Incandescent lamp bulbs serve as fuses in case of a short circuit and reduce voltage seen by series-regulator transistor. Output is 20 volts at 4 amperes.

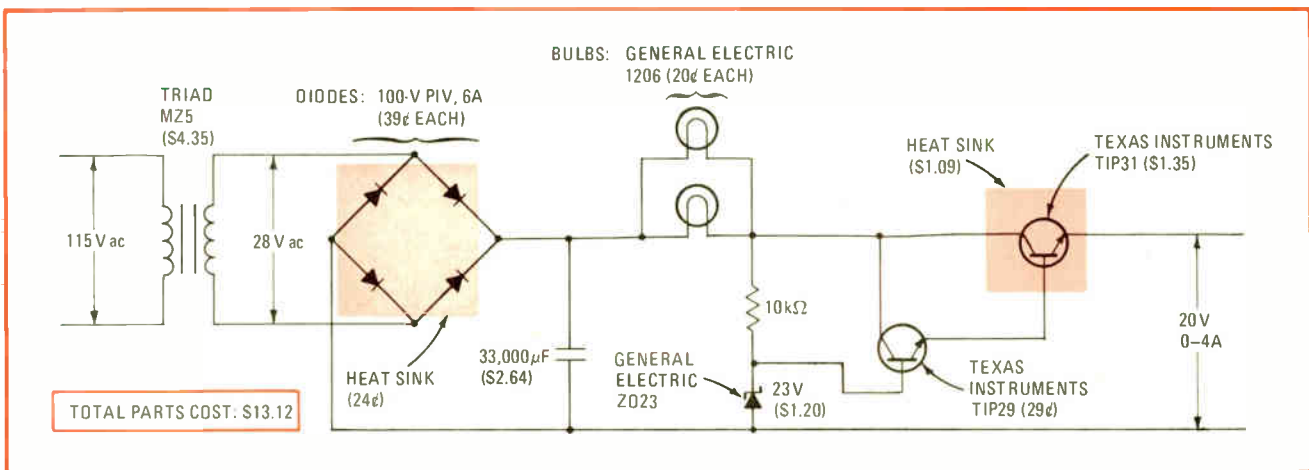

Binary division produces harmonic frequencies

by Donald DeKold
Santa Fe Junior College, Gainesville, Fla.

Harmonically related frequencies—more specifically, a fundamental frequency and its first nine overtones—can be generated with binary division of a blanked pulse

train. The harmonic frequency generator, which consists of a clock pulse generator, a decade counter, and a few NOR gates and flip-flops, produces square-wave outputs at frequencies f_0 through $10f_0$.

The clock frequency must be 2^n times faster than the frequency of the highest harmonic of interest (n is the number of flip-flops used for the binary division). Therefore, to produce the highest harmonic, $10f_0$, in this case, the clock output is simply divided down by 2^n . For all harmonics but the fifth, however, the clock signal must be properly gated before it can be divided.

To understand why this is so, consider what happens

with the ninth harmonic. The uppermost NOR gate passes and inverts the first nine clock pulses to reach it. But the arrival of the tenth pulse coincides with the arrival of a high from the decade counter. Since the counter's output stays high for the full duration of the tenth clock pulse, the gate's output remains low, preventing the tenth pulse from propagating. This tenth-pulse rejection occurs every $2^{10}f_0$ times per second.

Clearly, the gate's output pulse frequency is nine-tenths that of the clock frequency, because one pulse is blanked for every ten delivered. The gate's output waveform may be regarded as the 2^{10} th overtone of $9f_0$, but one that is badly distorted with respect to phase. The nine pulses making up a full period of this waveform are cumulatively advanced in time from their proper locations as they progress through one complete period of the binary overtone of the fundamental.

This phase distortion can be almost eliminated by successively dividing the gate output by two with flip-flops, as shown in the timing diagram. Waveforms A through F illustrate how the blanked space can be made smaller by flip-flop divisions of 2, 4, 8, and 16. Although only $2\frac{1}{2}$ cycles of divided-by-16 waveform F are shown,

the reduction of phase distortion is still evident.

The proper locations of this waveform's transitions—those that a true square wave of frequency $9(2^{10-1})f_0$ would produce if divided in the same way—are denoted by the colored dashed lines. The leftmost switching edge, which exhibits the largest error, is advanced by 18° from the true edge. At any stage of division, the maximum uncertainty in a transition will always be less than the period of the clock frequency.

Harmonic frequencies $6f_0$, $7f_0$, and $8f_0$ are developed in much the same way as $9f_0$. Two clock pulses must be blanked for $8f_0$, three for $7f_0$, and four for $6f_0$. To generate harmonics $5f_0$, $4f_0$, $3f_0$, $2f_0$, and f_0 , binary divisions of harmonics $10f_0$, $8f_0$, and $6f_0$ are performed as indicated.

Complementary-MOS integrated circuits can be used to build this harmonic generator. If RCA's type CD4017A decade counter is chosen, the maximum clock frequency is limited to 5 megahertz. (An unused dual-input NOR gate in RCA's type CD4001A package can be employed as the clock inverter.) □

Designer's casebook is a regular feature in Electronics. We invite readers to submit original and unpublished circuit ideas and solutions to design problems. Explain briefly but thoroughly the circuit's operating principle and purpose. We'll pay \$50 for each item published.

Harmonic generator. Single clock signal can be used to create fundamental frequency f_0 and its first nine harmonics. Clock frequency can be divided directly for tenth and fifth harmonics, but other harmonics must be gated to produce appropriately blanked pulse train. (For instance, one clock pulse out of ten is blanked by top NOR gate for harmonic $9f_0$.) Flip-flops then divide gated outputs.

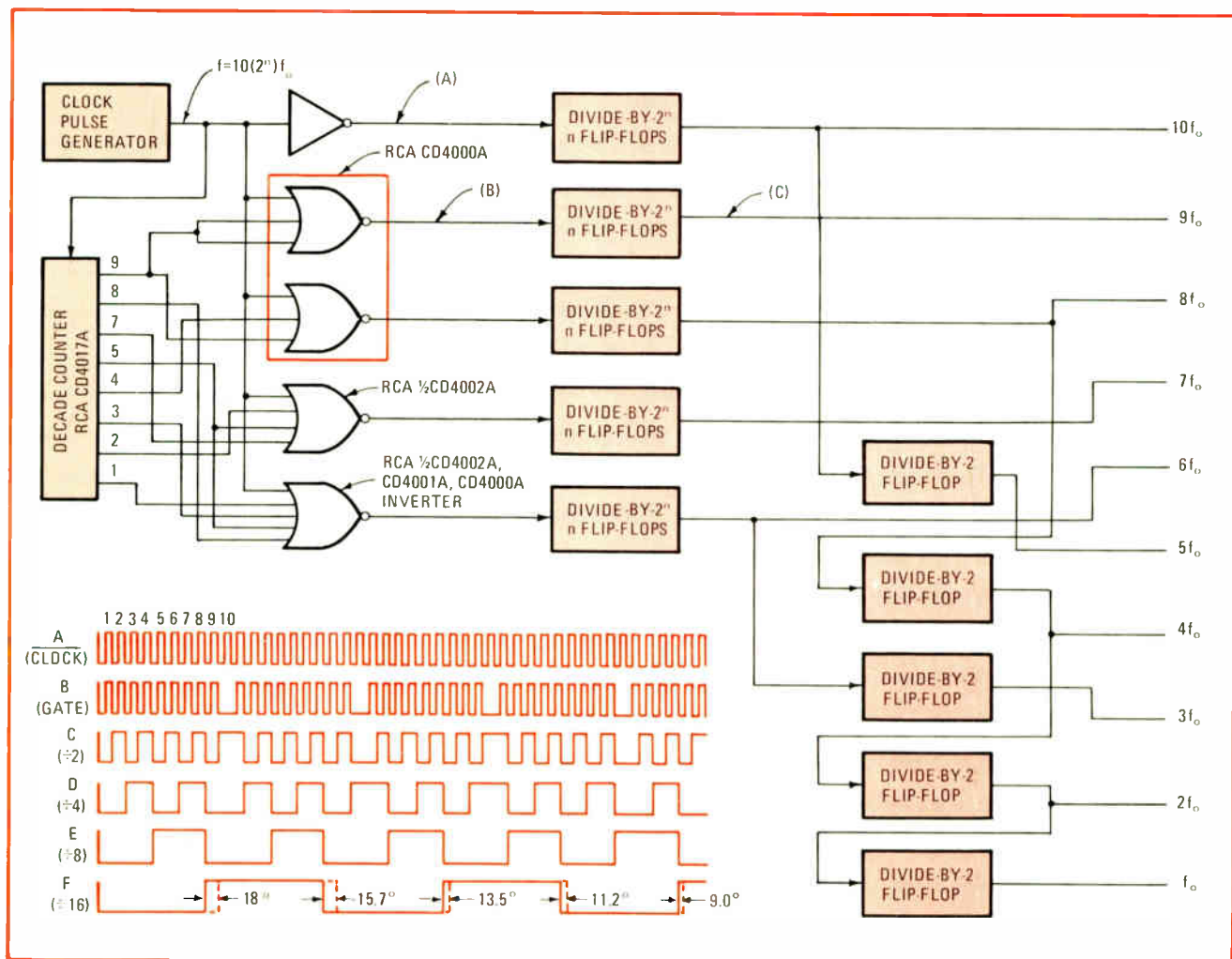

Here's a versatile new IC for
portable or battery-powered instrumentation

150 μ Watts powers Triple Op Amp

The Siliconix L144 is a *low-power* monolithic IC with three complete op amps and a common bias network on the same substrate. The circuit operates over a power supply range of ± 1.5 to ± 15 V, with a supply current set by an external bias resistor. With a ± 1.5 V battery, only $50 \mu\text{A}$ is required for all three op amps!

Other features:

- Internal compensation provides stable operation for any feedback circuit—including capacitive loads > 1000 pF
- 80 dB gain with $20\text{K}\Omega$ load
- Typical slew rate $0.4 \text{ V}/\mu\text{sec}$
- Military or commercial versions available

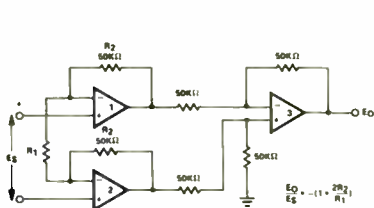

Instrumentation amplifier for high input impedance with differential operation.

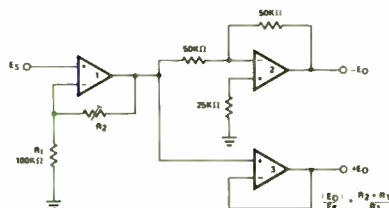

Precision phase splitter with good gain, high input impedance, low output impedance.

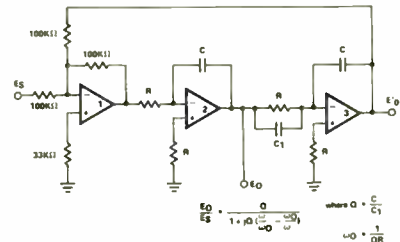

Active filter with high Q and excellent stability.

Applications? Above are three suggestions. There are more: Low-drift sample-and-hold, inverting amplifiers, voltage comparators, and so on. Call us if you have a specific design problem.

write for data

Applications Engineering: (408) 246-8905



Siliconix incorporated

2201 Laurelwood Road, Santa Clara, California 95054

Can trying harder make Japanese electronic engineers ichi-i (No.1)?

After years of being considered inferior to their U. S. counterparts, these confident EEs are making a strong bid to become world leaders instead of merely competent copiers of successful commercial products

by Gerald M. Walker, *Consumer Editor*, and Charles Cohen, *Tokyo bureau manager*.

□ Behind the seemingly endless stream of electronic products flowing into the world market from Japan stands a cadre of dedicated, smart, hard-working engineers. After decades of chasing the technological leadership of the U.S. and Europe, they are ready and able to take their place among the front-runners.

For years, Americans have brushed off Japanese engineers as mere copiers who crowded the front row at technical conferences in order to take pictures of all the slides or else roamed the trade shows to vacuum-clean every booth for spec sheets and samples. As the technological gap between Japan and the United States has narrowed, disdain has changed to respect, and the term "Japanese copy" has lost its derogatory connotations. Now the island nation is determined to catch up and pass the U.S. in all sectors of the electronics industries by producing "Japanese originals."

There's no missing the universal attitude of Japanese EEs—complete confidence. Their intent is clear—to lead the world. Indeed, some are almost irritatingly cocksure of the superiority of Japanese products and the Japanese system. In this respect, self-confidence must be included among the similarities to U.S. engineers, who also see themselves as world leaders.

Contrasted to the economic and social pummeling that U.S. engineers endured during the recession, Japan's EEs are in an enviable position in many ways. They have security, status, and financial commitment by industry to R&D. And when the private sector of the economy falters, as it did during 1970–71, the government moves in to prime the pump by increasing spending for public works, space, and defense.

Similarities, differences, and enigmas

What is the Japanese EE like, and how does he do his job? Interviews with almost 50 engineers representing a cross-section of age, experience, product specialty, and title have revealed some similarities to American EEs, as well as obvious differences. In addition, it's important to recognize that there are aspects of Japanese society—including its engineers—that a Westerner just cannot comprehend.

In addition to the self-confidence he shares with his U.S. counterpart, another similarity is the pleasure derived from solving a problem and seeing the solution in the form of a product. It's hard to find an engineer who doesn't list working on hardware—creating a product—

as a primary job satisfaction throughout his career.

The education of an engineer in Japan is generally much like that in the United States, although there is less emphasis on laboratory work and fewer tests. The first two years are spent on general science, mathematics, and language courses, and the last two on intensive engineering courses (see panel, p. 95).

The differences between Japanese and American EEs show up immediately, once they begin work in industry. Foremost is the aspect of job security. Ask a typical Japanese engineer if he feels that he has job security, and chances are, he'll look bewildered. He doesn't understand the question because he hasn't really thought about it. Rephrase the question to inquire if it's true that, once he enters a company, he will never be fired. He replies, "Yes, this is true."

As Masatomo Imai, an IC designer for Tokyo Shibaura Electric Co. (Toshiba), explains it, "unless you do something evil socially, you will not be laid off."

By the same token, it is not considered "proper" for an engineer to leave a company, comments Takao Hayashi, manager of the Digital Switching System section of the Computer division of Fujitsu Ltd. He adds that things may become more fluid for the younger engineers at some future point, but for most, lifetime employment is the rule.

One of the reasons that job-hopping is virtually unheard of in Japan is that the typical engineer really doesn't gain anything by moving to another company.

Mitsuhiko Yoshikawa, Sharp Corp., feels that Japan's products cannot surge ahead if Japanese EEs are copiers.



If anything, his salary may be decreased, since it is based on longevity, as well as rank and performance. His semiannual bonus, also based on longevity, will certainly be decreased in a switch of companies.

Because of the social attitude about jumping companies, it is also quite likely that an engineer would find it difficult to find employment at a competitor's firm. Toshiaki Irie, manager of microwave transistor engineering, Semiconductor division, Nippon Electric Co., points out that if he were unhappy at NEC, competitor Fujitsu probably wouldn't hire him because the philosophies of the two companies are different.

"Why wouldn't Fujitsu hire a NEC engineer? It's a national trait—and it's unfair," he shrugs.

Alternatives are limited

Another reason that there isn't much company-to-company job-changing is that the electronics industries are dominated by a small number of huge enterprises. This means that there are not that many different employers from which to choose.

Says Tomoo Okada, section chief in the Telephone Switching Engineering department of Fujitsu: "In my case, there are only four companies working in the field. No matter which company I would work for, I'd still be in the same environment. The main customer would be the same. I would still see the same group of engineers at conferences. Unless I would change my field completely, there is no merit in changing companies."

This commitment by employer and employee from graduation to retirement leaves the impression that engineering departments would probably be inflexible prisons. It may seem that the engineer could quietly goof off for 30 or 40 years, knowing that his benevolent big-brother employer would carry him along in the womb of security.

For some reason, neither of these impressions is correct. A look at the engineering career requires a look at the Japanese character. At first, the EE appears to be a highly disciplined worker, a machine that the company clicks on every Monday and doesn't turn off until he leaves for home Friday night.

Strangely, Japanese workers, including EEs, still indulge in what many Americans consider "Mickey Mouse" activities. Many must wear company uniforms—drab, shapeless dust jackets—at work, or else attach the company pin to their lapels. They sing company songs. Every day, they join in five minutes of office-wide calisthenics, usually starting at 3 p.m.

And—horror of horrors—Japanese engineers don't even think twice about joining the company branch of the electrical workers' union and holding membership until they reach the bottom rung of the management ladder. During that time, they're in the same union with the hourly wage-earners, and it doesn't seem to sully their professional pride. (Industry-wide unions, such as the electrical workers or teamsters, don't exist in Japan, yet. Engineers usually belong to the All-Japan Federation of Electric Machine Workers Union, which has some 540,000 members.)

Thus, with the union negotiating his salary and benefits in a company that won't fire him, what provides the incentive? A closer look reveals that it is old-fash-

ioned company loyalty. As Namio Yamaguchi, an engineer in the TV Research Laboratory for Matsushita Electric Industrial Co., declares, "Because home electronics is so competitive, the future of Matsushita is on our shoulders. If we don't develop competitive products, and there are no sales, the future of other people at Matsushita who depend on us is on our shoulders."

Rather than being an automaton, the average Japanese EE feels that the company needs him to survive. *(continued on page 98)*

Education: not so inscrutable

Enrollment in engineering courses has not declined in Japan. In fact, the competition to enter top-ranked schools is as stiff as ever. Entrance examinations are difficult, primarily because the competition is heavy, and the universities prefer to weed out potential failures before they are accepted.

Probably the most influential engineering school among the national institutions is at the University of Tokyo, which sets the pattern for other engineering schools in Japan. For the first two years, most U. of T. engineering students may not see a member of the engineering faculty, for they are enrolled in general courses taught by different faculty members. By the second year, the student begins basic engineering courses, and in the third and fourth years, the curriculum is completely devoted to engineering.

By the fourth year, the embryonic engineer is hard at work on his graduation thesis. The Japanese school year begins in April, so that the summer vacation falls within the year. As a result, the U. of T. engineering faculty "encourages" fourth-year students to work for a month during the summer vacation. (At one time, it was required.) This month in the fourth year is usually the first taste of actual engineering working conditions that the EE student receives. Students usually make short weekly reports on their jobs and final reports at the end of the month. (Quite often, these summer jobs lead to permanent employment with the same company after graduation.)

Even though graduate work is not common in Japan, the U. of T. has 170 applicants for its 43 openings in the master's program for 1972, reports Sogo Okamura, professor of electronic engineering. Of these, only 31 were accepted. Graduate students normally conduct projects at one of the 14 research institutes in the university.

Like their U.S. counterparts, Japanese engineering departments are concerned about cramming the maximum practical lab work into the limited time available, while providing all the engineering basics possible. Also as in the U.S., the Japanese schools have added computer-science courses, although these courses may not be taught by the engineering department.

While interest in engineering is high among students now, Prof. Okamura is concerned about the future. He recently visited the United States and learned firsthand about the decline in students, as well as the disillusionment among working EEs about their engineering careers.

"Sometimes, U.S. problems reach Japan three or four years later," he observes. "We should be preparing for this situation now."

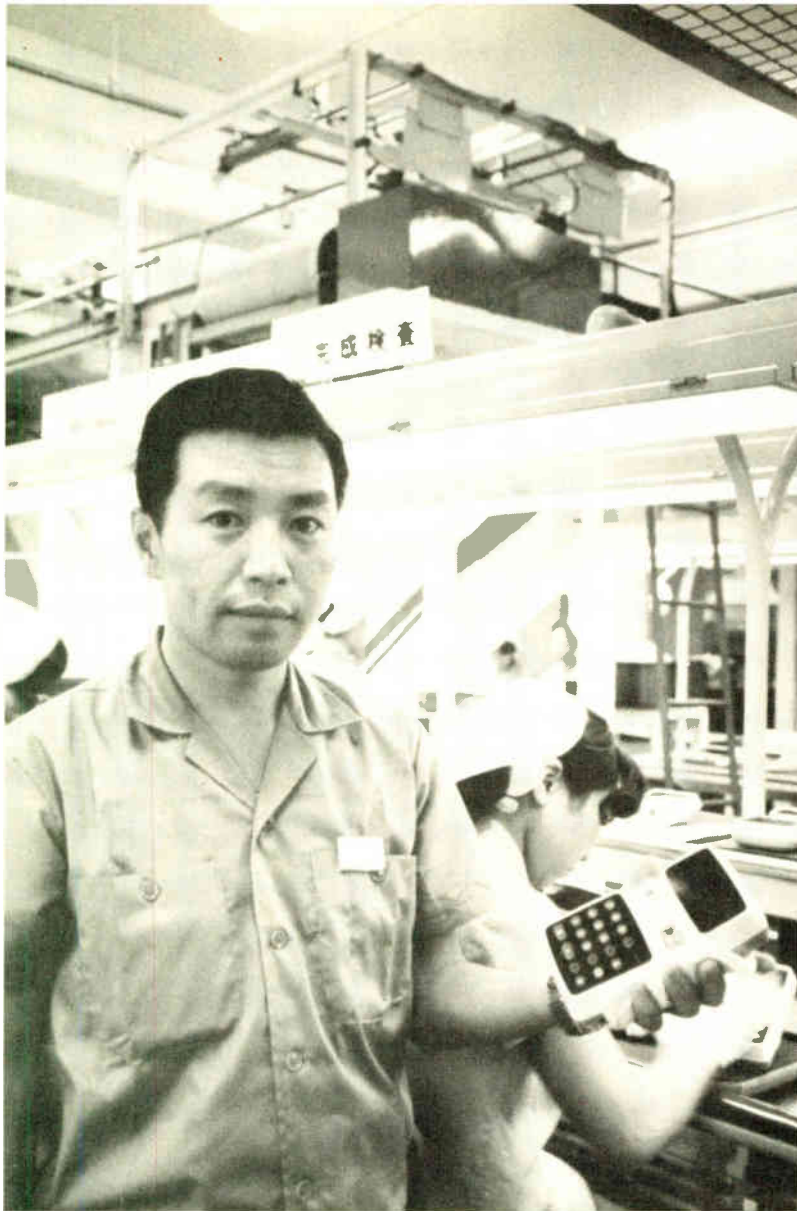

Inside a Japanese EE department

Hiroataka Sasaki, chief engineer, third engineering section of the Electronic Desk Calculator department at Matsushita Communications Industrial Co., is under the gun to design products in the company's late bid to get into the calculator business. But he's happy in his work because he is at last in the center of the action, working on an important project.

At 38, he has been with the parent company, Matsushita Electric Industrial Co., for 15 years. He started in the radio-manufacturing end of the firm in test systems, then moved to designing nuclear test equipment in the research and development center. When Matsushita got out of the nuclear field five years ago, Sasaki was offered an opening at the industrial products subsidiary, which meant relocating from Osaka to Yokohama. Since moving, he has worked on an analog-to-digital converter, then an X-Y plotter. Both of these projects were successful.

But Sasaki was interested in getting into what he saw to be Matsushita's mainstream—mass-produced products. With the encouragement of a friend and colleague he met while at the central laboratory, he managed to switch to the hectic activity in the calculator department, also in Yokohama.

In the two years since he moved, his design team has been responsible for five new models, and it has four more in the works. He heads a section of eight engineers and technicians. Following Sasaki through a typical day provides an excellent example of what happens inside a Japanese engineering department. What the outsider is not readily able to see is the subtle interaction that takes place in the engineering team.

Mainstream. Feeling that his move two years ago to calculator design put him in the center of action at Matsushita, Sasaki begins his busy day conferring with general manager Akira Harada (left) about sales acceptance of his product designs. Pains are taken in Japanese companies to make engineers aware of the end-products they manufacture, and EEs tend to feel personally responsible for the success or failure of their products. Based on a lifetime devoted to a single company, the commitment is to the employer first; personal recognition, second. This philosophy is at work in the engineering team that Sasaki heads (top right). He disputes the U.S. contention that Japanese teams are usually overloaded with engineers. His team of four EEs and four technicians has developed five calculator models. There are four engineering sections within the calculator department, three responsible for a group of complete designs. The fourth section is a pool used to help out any of the other three, as needed.

Sasaki's immediate supervisor, Sadamichi Someda (right), senior development manager, is also a personal friend who helped him move to calculators. Their relationship is easygoing, marked by good humor and mutual respect. Far from being a regimented cog in the design machine, Sasaki has leeway to thrash out differences of opinion with his boss and his junior associates. Although the parent company has a components division with one of the world's most diversified product lines and a semiconductor subsidiary, Sasaki and his team call in outside salesmen to obtain additional information. Below, he discusses batteries with a General Electric salesman. Sasaki began a search for improved batteries because, faced with the same pressure from consumerism as in the U.S., he and other Japanese engineers now must stress product reliability, along with cost and performance. Perhaps Sasaki's ambitions are well summarized by a sign hanging in the plant that reads, "Gather all of your strength for promoting the development of products that are commercially attractive." His satisfaction with the product is apparent.

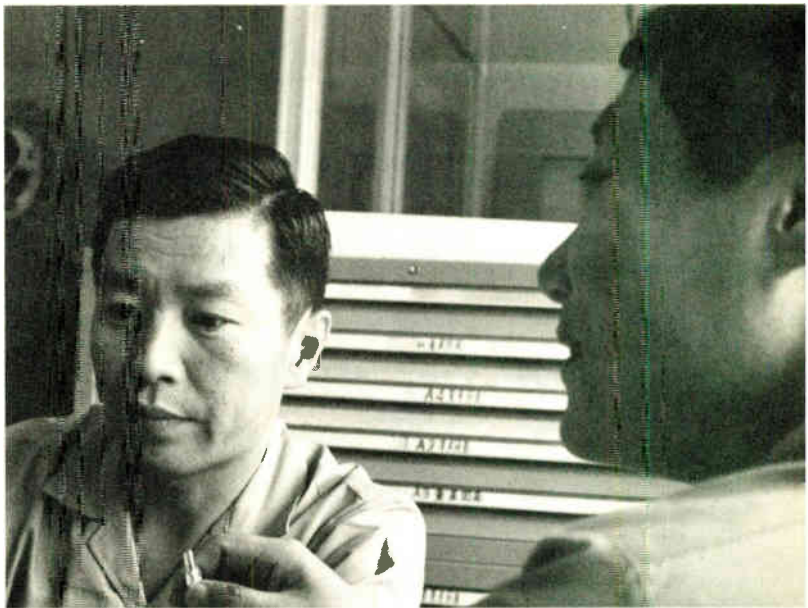

(continued from page 95)

The security implicit in every job actually encourages action. "It is very important in research and development, because in research, there is no guarantee of success. You are able to take chances on the assumption that you will not be fired, instead of playing it safe to keep your job," explains Ken-ichi Mori of Toshiba Research and Development Center. He adds that he and his boss originally spent six months to hammer out the philosophy of the department. The fact that there was no visible output during that time didn't bother anyone.

NEC's Irie adds that the system permits long-range programs, during which the engineer does not have to worry about being laid off or diverted by a change in managers. One drawback of this system, on the other hand, is that it's difficult to form quickly an engineering team with specific expertise for a new product. For one thing, since it is virtually impossible to lure a specific top engineer from another company, an engineering department must build the teams around what's available inside the company. (The first small signs of American-style head-hunters have been seen in Japan. They have been recruiting EEs on a gradual basis to man the increasing number of joint U.S. ventures.)

Although Japanese EEs can't or won't move from company to company, there is a considerable amount of movement within the giant electronics companies. For example, one Matsushita engineer is on his fourth completely different assignment in 15 years for the company (see p. 96). This mobility even extends to subsidiaries and joint ventures for the large parent firms.

Such companies as Toshiba carry out formal procedures to keep EEs moving laterally through the various divisions, as well as upward on the promotion ladder. At Toshiba, every engineer fills out a questionnaire once a year to indicate what he has done during the year, if he is happy with his assignment, and if he wants to move. This report, along with the immediate superior's report on performance, goes to the department head for review. If necessary, there is a conference with the department head about changing jobs. All the data concerning job satisfaction is sifted to make reassignments as easy as possible. Other companies are not quite as formal in this procedure.

In some respects, moving within the company is similar to looking for a job in another company—that is, the individual engineer can look around, find an activity that he would like to join, and then negotiate with the heads of his present and desired sections to get the new assignment. The art is to make the move without offending his present boss or embarrassing the new boss by creating an unpleasant situation. Everyone's feelings must be considered.

Salary structures differ

Salary comparisons are difficult to make between the U.S. and Japan. For one thing, the Japanese engineer gets a pension from the company at retirement, which is usually at age 55 or 60. (There is much discussion now about extending retirement into the 60s.) The EE may receive one lump sum or a lump sum plus a monthly payment thereafter. The lump sum is supplied entirely by the company, but the monthly payments may be ei-



Shigeo Shima, Sony Corp., contends that Japanese engineers have made innovations by doing the unexpected.

ther wholly company-funded or participatory by both company and employee.

Japanese EEs also get semiannual bonuses, which can make their actual annual salaries equivalent to about 18 months of base pay. Many companies do vary bonuses according to business results, mainly for the upper-echelon officials. The bonus for the vast majority is a component of annual wages.

Estimates of comparable salaries vary

One engineering manager asserts that the Japanese engineer's pay amounts to roughly \$3,000 as a beginner, including bonuses. Another estimates the salary for a department chief in a large company is \$13,300 to \$16,700; a few earn up to \$20,000 a year.

The high cost of living in Japan certainly does not jibe with the lower salaries there. Housing in such industrial centers as Tokyo, Osaka, and Yokohama is astronomically expensive. Apartment rents in Tokyo even shock New Yorkers accustomed to paying \$100 or more per room. Because of the acute shortage of livable space, some unions provide loans to engineers to buy homes, and some companies provide housing. (The unions also pay maternity costs, and some sponsor vacation spas for engineers and their families.)

Most food is priced as high as it is in the U.S. Automobiles, TV sets, and clothing are priced only slightly below American levels because of the taxes included: gasoline is priced much higher than it is in the U.S. The only bargain besides telephone rates, by comparison, is public transportation, which is clean, efficient, and convenient for most Japanese workers.

Part of the reason for the high prices, besides inflation typical of industrialized nations, is the unusually burdensome distribution and retailing system of the country, which adds costs to every product.

Nor can a bright engineer achieve economic independence in Japan by starting his own company. There is a nearly total lack of venture capital in the economy. As a consequence, small electronics companies built around

specialized products or sharp, creative engineering teams are practically nonexistent. Some Japan EEs feel that this situation restricts progress because such flexible, high-technology companies can theoretically vitalize the industry and usually advance the state of the art. For a Japanese manufacturer to accomplish the fast reactions typical of electronics firms that have been nurtured by venture capital in the U.S., it must surmount a lot of inertia and pay heavily in overhead. This lack of venture capital for brash new firms is unlikely to change much in the near future.

Educational development differs

Another noticeable difference between the Japanese and American EE concerns advanced education. Hardly a U.S. engineer has not felt the pressure to get an advanced degree to keep up to date and improve his career prospects. That pressure is not exerted in Japan. Very few engineers continue schooling for masters' degrees or doctorates. There are no night schools for post-graduate programs, nor do companies make much effort to encourage more degrees. Sometimes a research lab may tap a certain individual to take a master's degree or doctorate, equating the program to a job assignment. Sony Corp., for one, assigns some EEs to the U.S. and Europe to advance their education.

The entire procedure for keeping abreast of technology appears to be uncoordinated in Japan. Company training programs are few, technical conferences tend to be superficial, and formal outside courses are unavailable. Ask EEs how they keep on top of what's new, and they say, "Read the literature."

This informal approach tends to work, but the reason appears to be buried in the subtle interplay that takes place in the Japanese engineering team. Practically everyone belongs to a team; some members work on a specific design problem, while others appear to be contributing nothing—they're off in a corner reading the literature, immersing themselves in the technology related to the design problem. Then the readers rejoin the workers, and the design jells, somehow, through the exchange of information between the two. This description of the procedure is oversimplified, but it typifies the team approach.

On this subject, an American engineer who has ob-

Toshiaki Irie, Nippon Electric Co., points out that engineers find it difficult to job-hop in Japan because companies frown on it.



Satoshi Shimada, Sony Corp., expects the need to develop pollution control will show true worth of engineers.

served these teams for nine years points out, "It may not be possible to convey in English what goes on inside the Japanese engineering department because there's an organizational chemistry incomprehensible to an American." The key seems to be that the division of labor does not cause friction, nor are the EEs overly concerned with individual glory for a design if the team can achieve the desired goal. Essentially, the Japanese EE does not take an ego trip with his work. He doesn't mind borrowing others' ideas, adapting bits and pieces from other designs, licensing patents, and mixing it all together into a new application. This readiness to adapt other ideas has led to the cliché about Japanese copies.

Adaptations pay off

The issue of copying is particularly sensitive to Shigeo Shima, director of the Sony Research Center. Sony takes pride in its innovations and has the reputation of achieving results by going in unexpected directions. This philosophy has also produced its share of bombs, but on the whole, doing the unexpected, as Shima characterizes it, has worked.

He points to the development of the in-line-gun TV picture tube and the all-solid-state television chassis as two contributions launched on the Japanese industry's desire to "do something different." Sony's first two versions of the tubes were failures, but seven years of effort have produced what is today promoted as the Trinitron tube.

The solid-state chassis was an outgrowth of experience gained in developing the transistorized radio. And behind the radio is a story that Shima relates with obvious relish. He recalls that in 1952, when the head of the company that was to become Sony visited the U.S. to complete arrangements to obtain a license to manufacture the then-new transistor, its developers asked the visiting Japanese what he intended to do with it. They were astonished when he said he planned to build inexpensive radios. The rest is history.

Shima himself went through a replay of this story 12

years ago, when he visited the semiconductor division of a U.S. company that also produces television receivers. There he asked engineers what progress they had made in applying transistors to TV. They weren't aware of any such applications.

Shima next posed the same question to the company's TV manufacturing division and got the same reaction—bafflement. He concludes, "We did the seemingly absurd thing in Japan. Now the transistorized TV receiver is in use around the world. Now it is obvious to all sides." Hitachi Ltd. is credited with pushing the Japanese TV industry to all-solid-state color sets when it converted its entire line, including large-screen models, in one swoop.

A circuit-theory expert at the Sony Research Center, Dr. Jun Numata, adds that the Japanese camera is a good example of developing another country's ideas. "You may say the Japanese camera is a copy of the German's, but Japan has developed it to a standard of excellence that has made it first in the world. The basic principle is not Japanese, but at what point are subsequent innovations not copies? It's hard to define."

Agreeing, Mitsuhiko Yoshikawa, of Sharp Corp.'s advanced development and planning center, states, "It won't be possible to forge ahead as copiers. It is neces-

sary to do original work—to create our own technology—in order to sell to the outside world."

The art of catching up

"Because we started late," comments Muraji Yoshida, a Mitsubishi Electric Corp. communications-equipment engineer, "we were forced to follow the U.S. lead, and that makes sense when you have to catch up."

Seiichi Nasu, also a Mitsubishi communications engineer, adds, "We have used early U.S. work as a foundation for original work. When you are behind, the most efficient way to catch up is to learn from the leader."

Now neither feels he is copying. Speaking for his colleagues, Kohichi Kondoh, who designs advanced radar at Mitsubishi, concludes, "We have to do our own work. I don't feel I am copying, and one proof is that in my field of radar, there are no technical agreements."

If originality is an economic advantage in terms of designing and marketing products overseas, there is also social advantage now. Like the U.S., Japan is now beginning to concentrate on pollution control. This is an area, says Satoshi Shimada, project manager of Sony's advanced television systems, in which the U.S. and Japan are starting at an even point. "So—the future can accurately judge whether Japanese engineers have the ability to produce new things. It will be interesting to see who will come up with the best (pollution-control) system first," Shimada observes.

With self-confidence, company support, hard work, incentive, and the unique chemistry of the team approach, the Japanese EE is a formidable figure. In the past, these ingredients have helped the electronics industry to catch up to the U.S. Today, ask EEs if they are going to lead the world. "Yes." The firm reply is accompanied by a polite smile.

A subtle sense of this attitude even crept into a Japanese science-fiction movie of a few years back. The plot involves the exploration of Planet X. The Japanese astronauts find life and quickly report that the people of Planet X are a superior race in all respects. The movie continues to emphasize this technological superiority, yet about midway through the last reel, the leader of the superior planet informs the astronauts, "We have copied your space ship." The Japanese apparently feel the need to be number one in the galaxy too. □



Toshio Hiraguri, Fujitsu Ltd., comments that EEs don't feel pressure from Japanese companies to get advanced degrees.

Masatomo Imai, Toshiba, states that unless an engineer does something evil socially, he will not be fired.



Ken-ichi Mori, Toshiba, believes that job security is important to a researcher, permitting him to take chances.

S-D puts the accuracy back into high speed DVMs



FILTER FOR EMERGENCY ONLY

Make 30 accurate readings a second... even with noisy inputs

Most "high speed" digital voltmeters come to a screeching halt when they have to measure noisy signals. That's because most DVM's offer absolutely no noise rejection without using input filters—and even the best designed filter will limit a DVM to two or three readings a second.

Now Systron-Donner has done something to put the accuracy back into the high speed DVM. We designed our new fully-guarded 5-digit Model 7110 around Dual Slope Integration, the only reliable measuring technique that provides built-in noise rejection without the need for filters. As a result the 7110 will make 30 readings a second and give the right answer every time, even in the presence of unwanted noise and ripple. Yes, there's a filter, too, but you'll only need it for extremely noisy signals.

Built-in noise rejection is only one feature that makes the 7110 an outstanding lab or system meter. Five dc voltage and five dc ratio ranges are standard

with all-range autoranging from ± 1 microvolt to ± 1100 volts. Both ac voltage and 4-wire resistance measurements can be added and, for system use, a variety of fully isolated digital output and remote programming options are available.

We also added some little things, like a light that tells if you've selected an optional function that isn't installed. (There's also circuitry that withstands overloads up to 1000 volts even if you mis-program all controls and inputs. And to protect your investment we designed the 7110 so that every option can be installed at any time by simply adding plug-in cards.

Model 7110 is priced from \$1,695 including 100 mV full scale and ratio ranges. Ask your local Scientific Devices office for technical data or contact: Concord Instruments Division, 888 Galindo St., Concord, CA 94520. Phone (415) 682-6161.

SYSTRON  DONNER

Another S-D instrument first! Electronic counters/Digital voltmeters/Pulse generators/Data generators/Time code generators/Sweep generators/Spectrum analyzers/Digital panel meters/Digital clocks/Signal generators/Oscillators/Laboratory magnets/Precision power supplies/Analog & analog-hybrid computers/Data acquisition systems.

Transferred-electron devices take on more roles in microwave systems

Improved materials and better heat sinks have helped transferred-electron devices overcome unwanted thermal effects; TE oscillators and amplifiers now rival avalanche diodes and tubes in low-noise or medium-power applications

by Bertrand E. Berson, *RCA, David Sarnoff Research Center, Princeton, N.J.*

□ Transferred-electron oscillators and amplifiers have now become practical for use in commercial microwave systems. They are already serving as transmitters in beacons, radars, transponders, radio and data links, and automotive radars and speed sensors. They provide sources for intrusion alarms, identification tags, pumps, sweepers, and fuzes. And they can be found in fixed and tuned local oscillators for radio communications test equipment and receivers, or as amplifiers for satellite communications systems.

But competition is tough. Other solid-state devices, such as Impatt and Trapatt diodes (see "Operational distinctions"), are pressuring the transferred-electron oscillators and amplifiers in many of these applications, especially where high power is needed. In addition, gallium-arsenide FETs are moving up in frequency, and offer extremely low noise, with increasing power outputs. Moreover, in the realm of moderately high-powered systems, the traveling-wave tube still rules, while the klystron dominates in systems requiring many hundreds of watts of microwave power.

Indeed it is often difficult for the system designer to decide which is the best microwave device for his needs, more especially as new techniques continue to change the relative levels of performance of the various devices. But getting a handle on the state of the art of transferred-electron devices and how they compare with the others should go far in clarifying a complex situation (see Table 1).

The greatest advantage a transferred-electron diode has over Impatt and Trapatt diodes is its ability to operate over a wide band with less noise and lower operating voltages at equivalent frequencies. This makes the transferred-electron oscillator especially attractive as a local oscillator from C band through K band. On the debit side, the TEO is presently being outperformed in terms of power and efficiency by Impatts and Trapatts, which are therefore more suitable for use as transmitters in many systems. (In some systems, though, the better noise performance of the TEO makes it competitive.) TEOs also require a III-V compound material system, such as gallium arsenide or indium phosphide, materials that are more difficult to work than the silicon used in Trapatts and some Impatts.

Compared to tubes, the TEO, being a solid-state device, operates at a lower temperature without requiring a vacuum, factors that contribute to longer life. A num-

ber of manufacturers are now quoting MTBFs of well over 100,000 hours for continuous-wave TE devices. Moreover, a TEO needs lower biasing voltages and a less complex power supply than do the other solid-state devices and the big tubes. This is particularly important in battery-operated systems such as hand-held radars and automotive applications, where TEOs have gained a strong foothold.

As for the transferred-electron amplifier, its principal strengths are its bandwidth and voltage gain. Both are greater than in avalanche amplifiers. These assets, plus the TEA's ability to operate with good linearity, wide dynamic range, and low noise, are making the device an important new contender for the job of boosting transmission signals in microwave communication links.

In short, each kind of device has its place—TEAs and TEOs in applications where low noise is most vital, avalanche diodes where noise can be tolerated, and tubes for exceptionally high powers.

Yet recent advances in transferred-electron technology may soon change this order. Better gallium-arsenide material is resulting in more efficient, higher-power TE oscillators and amplifiers. Methods of reducing temperature degradation of performance, long a problem

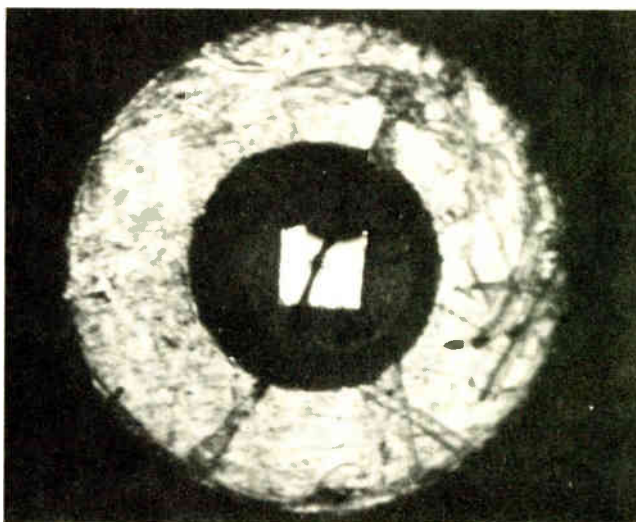

1. Start here. This bare transferred-electron device is the heart of new microwave oscillators and amplifiers that are finding their way into microwave systems ranging from communications to fuzes and intrusion alarms. (Photograph courtesy S.Y. Narayan.)

with TEOS, are at last being demonstrated in the form of new heat-sinking technology. New material systems, such as indium phosphide, are being developed that should further boost performance of both oscillators and amplifiers. With these advances, new data as a basis for comparison will need to be consulted before selecting the proper device for a system.

Material concerns

Key to the growth of transferred-electron technology is the gallium-arsenide material that goes into most of the devices. Indeed, it was the development reliable methods of growing GaAs that got transferred-electron devices into the commercial realm. By now all commercial devices use epitaxially grown material, that is, single crystal layers grown on a single crystal substrate. This method yields material with far better uniformity than the old bulk material method.

This improved uniformity results mainly from the low temperature needed to prepare epitaxial material—700°–900°C, as compared with 1,238°C or higher for bulk material. In addition, epitaxial material, because of its positive temperature coefficient of resistance, is not susceptible to thermal runaway as is bulk material. Moreover, the device thickness in epitaxial material can be finely controlled during growth, whereas bulk material requires abrasive or chemical thinning to achieve the final active layer thickness—often 10 micrometers or less.

Recently a new fabrication process has been developed, in which heat sinks are plated onto the devices before the wafer is separated into chips, and then chip and heat sink are bonded directly into packages. This process is cheaper than adding the heat sink after packaging, since chip and heat sink can be batch-processed and high yields result from reduced operator skill requirements. Moreover, the integral heat sink makes handling easier during the wafer thinning process because it provides a surface to grip on. Figure 1 shows a device with heat sink bonded directly into a standard varactor package.

Taking the heat off

Since it's the high, uneven temperature of the device during operation that limits its performance, much of today's device fabrication is directed toward reducing thermal effects. Figure 2 shows the theoretical relationship of the variation in ratio of peak electron velocity to valley electron velocity with temperature, and compares it with experimental data.

To obtain these sets of data, some devices were uniformly heated, and others were operated at power levels high enough to cause uneven internal heating. For the case of uniform heating, the experimental results are in reasonable agreement with the calculations. However, for self-heating, where the heating comes from operating a device at high average powers, the peak-to-valley ratio of the velocity curve drops significantly when compared to the curve for uniform heating. Unfortunately, this ratio drop is accompanied by a drop in efficiency: in a sample uniformly heated at 350°K, the efficiency drops approximately 10%, whereas in a sample that is self-heated at the same temperature,

TABLE 1:
STATE OF THE ART COMPARISON OF
TRANSFERRED-ELECTRON OSCILLATORS AND AMPLIFIERS
WITH OTHER TYPES OF MICROWAVE DEVICES

TE oscillators compared with:	Strengths	Weaknesses
Impatt diodes	Lower noise. Higher pulsed power. Higher pulsed efficiency. Lower bias voltage.	Lower cw efficiency and power.
Trapatt diodes	Lower noise. Higher duty cycle operation. Higher frequency operation. Lower bias voltage.	Lower pulsed power and efficiency. Less temperature-stable. Si vs GaAs.
Transistors	Higher frequency operation. Higher pulsed power. Less complicated structure.	No cw L and S band devices. Si vs GaAs.
Tubes	Longer life, more reliable. Equivalent noise performance. Lower bias voltage. Simpler power supplies.	Lower power and efficiency. Less temperature-stable.
Baritt diodes	Higher power efficiency.	Si vs GaAs
TE amplifiers compared with:	Strengths	Weaknesses
Impatt amplifiers	Greater bandwidth. (Higher voltage gain-bandwidth product.) More linear. Lower noise. Wider dynamic range.	Lower cw efficiency and power.
Trapatt amplifiers	Much greater bandwidth. (Much higher voltage gain-bandwidth product.) Much more linear. Much lower noise. Much wider dynamic range. Higher frequency operation.	Much lower pulsed power and efficiency. No UHF or L-band operation. Si vs GaAs
Transistor amplifiers	Greater bandwidth. (Higher voltage gain-bandwidth product.) Higher power in C, X and Ku bands.	Two-terminal device. Si vs GaAs.
Tubes	Longer life. More reliable low bias voltages. Simpler power supplies.	Less power and efficiency. Less temperature-stable.
Baritt diodes	Greater bandwidth. (Higher voltage gain-bandwidth product.) Higher power and efficiency.	Si vs GaAs.

2. Self-heating hurts. External uniform heating of a transferred-electron device does not lower its efficiency as sharply as does self-heating due to device operation. The drop in efficiency is related to the decrease in the ratio of peak electron velocity to valley electron velocity. The lower the ratio, the poorer the efficiency.

the efficiency drops approximately 65%. This drop in device efficiency arises from the temperature gradient (and thus resistivity gradient) which self-heating causes to occur across the sample.

One way to compensate for the inefficiency caused by self-heating is to superimpose a correcting doping gradient on the normal doping profile, so that at high temperatures the resistivity gradient is decreased. Losses from rising temperature can also be minimized by reducing the device diameter. Figure 3 shows the temperature gradient across a 10-micrometer sample as a function of diameter for several types of heat sinks. Clearly, for all types, the smaller the diameter, the smaller the temperature gradient across the device. Again, the integral-heat-sink technique is ideal for reduced diameters because it permits better wafer handling in production.

Using the best thermal-spreading material will also

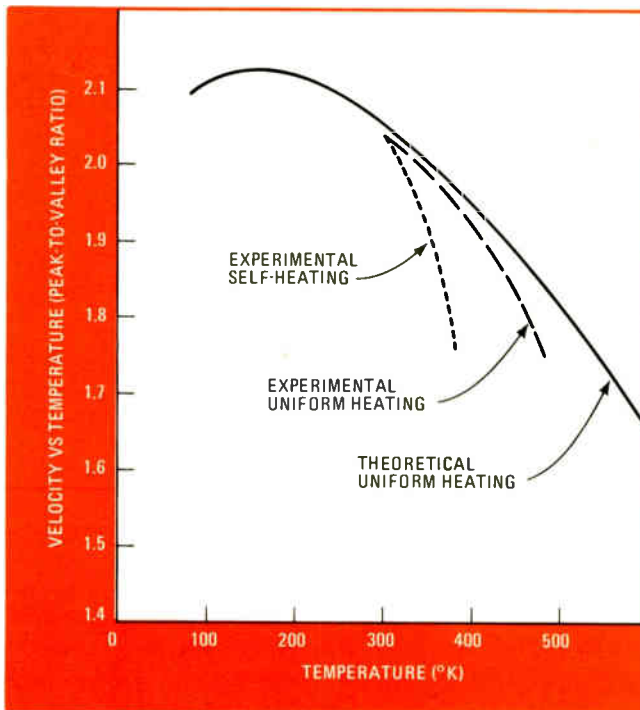

Operational distinctions

Transferred-electron devices (like Gunn diodes and LSAs) and avalanche diodes (Impatts and Trapatts) fall into the same general microwave category. Called direct conversion devices, they all convert dc energy directly into rf energy. But they do the converting very differently.

Even their structures are different. Transferred-electron devices are bulk devices made of only one type of doped material (n-type), while Impatts and Trapatts are conventional diodes based on pn or metal-semiconductor junctions.

In operation, a transferred-electron device relies on an electron's ability to shift from a state of high mobility into one of low mobility in such materials as gallium arsenide or indium phosphide. When a dc bias field above a certain threshold value is applied to a sandwich of GaAs (such as the n⁺n-n⁺ structure shown in the figure), the mobility of the electron devices decreases, and a space charge develops very rapidly in the n⁻ drift region.

This drift region can be thought of as a region of high-field space-charge domains traveling from the n⁺ (cathode) region on the left to the n⁺ (anode) region on the right.

In contrast, the conventional Impatt (an acronym for impact avalanche transit time) diode is a p⁺n junction on an n⁺ substrate, in which the active drift region is the n region shown in the figure. Here rf power is developed when a dc bias greater than threshold is applied to the junction. Electron-hole pairs are created (that is, they avalanche) at the junction, and the electrons then drift through the n region. Present devices are primarily fabricated from silicon and gallium arsenide. Recently, silicon double-drift avalanche diodes have been developed in which a second complementary drift region is added to the structure, and they produce still higher power at higher frequencies.

In the Trapatt mode (an acronym for trapped-plasma avalanche transit time), the avalanche zone moves through the drift region, creating a trapped-plasma effect.

The same device can be operated as an Impatt at relatively low current and as a Trapatt at higher currents and lower frequencies. Present devices use silicon as the semiconductor material.

Transferred-electron devices can also be operated in different modes—Gunn, quenched-domain, delayed-domain, and LSA. The simplest and best-known of these is the mode characterized by J.B. Gunn of IBM, in which space-charge domains travel across the sample from cathode to anode. When the circuit is used to control domain nucleation and extinction, quenched- and delayed-domain modes result. These can give higher power outputs and efficiency than the Gunn mode.

The LSA or a limited space-charge-accumulation mode of operation results in still higher power outputs. Invented by John Copeland of Bell Labs, LSA operation occurs when the drift region is made much thicker for a given frequency than in the Gunn-type or circuit-controlled TE device. In this mode, no domains are present; the entire sample is in the negative-resistance regime, and thus able to generate power.

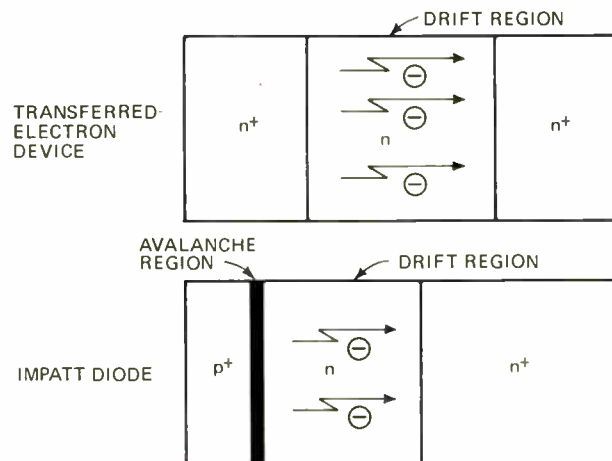

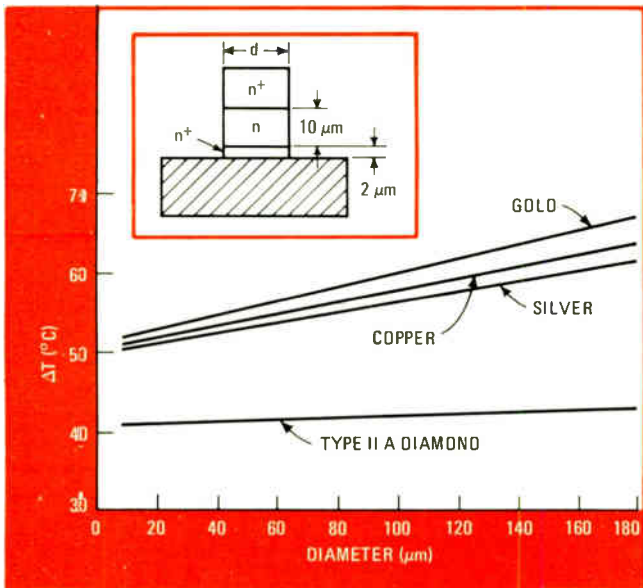

3. Diamonds forever. The best heat-sink material is Type IIA diamond. Other heat-sink materials are shown for comparison, however, since processing difficulties can wipe out diamond's advantages. Also emphasized is the effect of device diameter—the smaller the diameter, the less the change in temperature.

help in dealing with temperature gradients. Improvement is seen when the heat-sinking material goes from gold to copper to silver to Type IIA diamond. Also possible is double heat-sinking, which cuts the gradient across the device by a factor of two, and boosts efficiency by a factor of 25% to 50%.

TEO performance

Better GaAs and more advanced temperature-compensating techniques are adding up to TEOs with higher performance. Figure 4 displays the best results achieved with TEOs.

The best pulse efficiencies reported to date are from RCA—32% in L band and 28% in X band. Others have reported pulse efficiency in the 20% to 25% range. Since the quality of the GaAs material to a large extent determines the efficiency of a transferred-electron device, these improved ratings imply that good material is widely available.

For continuous-wave devices, efficiencies of 14% in X band have been achieved at RCA. Others have achieved efficiencies greater than 10% in X and Ku band, a marked improvement over the 1% to 2% of only a few years ago. This indicates improvements in materials as well as in heat-sinking techniques. This level of efficiency in cw devices is particularly important because it means that TEOs will make ideal local oscillators in a great many of today's microwave systems, and could challenge Impatt for dominance of high-power systems.

Noise ratings have also been improved. In some commercial devices, a-m noise in two sidebands at 100-hertz bandwidth is greater than 140 decibels down at a point 5 kilohertz from the carrier, and fm noise is 1 Hz rms in a 100-Hz bandwidth 100 kHz from the carrier for a cavity with a Q of about 3,500. Such figures indicate that today's solid-state devices have noise specifications comparable to those of a typical reflex klystron.

Recently even better results have been recorded. For example, fm noise of 8 Hz in a 1-kHz bandwidth, 2 kHz from the carrier, has been obtained for TE devices with a Q of 500—a threefold improvement over the best previously reported results. On this point, too, Table 1 summarizes the relative positions of TEOs and competitive devices.

Improvements in frequency stability with temperature, a key performance factor in many systems applications, are shown in Table 2. Best reported stability is seven parts in 10^7 at X band, exhibited by a device mounted in a high-Q cylindrical cavity operating in the TE_{011} mode.

It should be pointed out that, although the high-Q cavity improves stability, it also reduces bandwidth and must be restricted to fixed tuned circuits. But stabilities of one part of 10^5 are available for TE devices from L band through X band with simple wideband coaxial cavities. This means that suitable stable TE microwave sources are now available for most data links in use today.

A particularly significant result is the temperature stability of three parts in 10^6 reported recently for a Cayuga Associates limited space-charge-accumulation TE device. This previously unpublished result is especially important because the poor temperature stability of LSA devices, typically one part in 10^3 , has restricted their general use in commercial systems.

TEA performance

Great strides have been made in building transferred-electron amplifiers, as Table 3 indicates. It tabulates the performance of TEAs in various frequency bands. Amplifiers are available that cover all of C band and X band, and new devices extend coverage to the 8–16 gigahertz range. Experimental devices have exhibited the negative resistance required for amplification over an

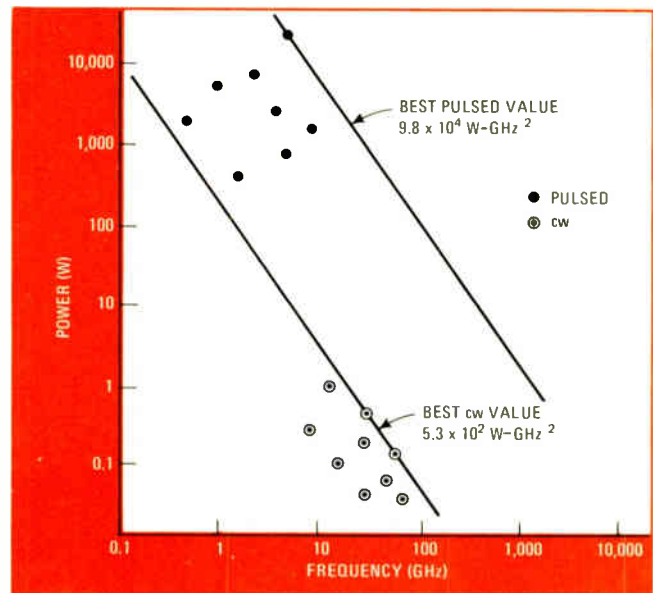

4. More power to them. Performance of a microwave source is rated by the product of its power and frequency squared (Pf^2). This figure of merit has increased by orders of magnitude in the last two years. Present TE oscillators have achieved as much as 100,000 $W-GHz^2$ for pulsed devices, and 530 $W-GHz^2$ for cw operation.

TABLE 2: FREQUENCY STABILITY WITH TEMPERATURE OF TRANSFERRED-ELECTRON OSCILLATORS

Frequency (GHz)	Temperature range (°C)	Frequency variation (Hz/Hz/°C)	Power variation (dB)	Remarks	Company
1.4	-55 to +150	$+1.2 \times 10^{-5}$	5.0	Uncompensated coaxial cavity, pulsed operation.	RCA
5.6	-60 to +80	-8×10^{-5}	2.0	Compensated coaxial cavity, pulsed operation.	RCA
7.8	+20 to +110	$+7 \times 10^{-6}$	0.3	Waveguide stabilized with loading, cw operation.	Oxford Univ.
9.0	-40 to +80	3×10^{-6}	-	Cavity stabilized, <1-dB loss in power, cw operation.	Litton
11.0	+25 to +55	-7×10^{-7}	-	Waveguide was stabilized with high QTE ₀₁₁ cavity, cw operation.	Fujitsu
9.8	-45 to +80	-1.1×10^{-5}	-	Low Q gold-plated Invar coaxial cavity, output power decoupled 6 dB, cw operation.	Plessey and Univ. of Sheffield
10.0	100	3×10^{-6}	-	Pulsed LSA oscillator.	Cayuga Associates
10.5	-40 to +90	4.2×10^{-5}	3.0	Unstabilized waveguide cavity, pulsed operation.	RCA
18.6	-	1.2×10^{-6}	-	Used as self-oscillating up converter.	Nippon

octave of frequency, and with improvement in circuitry, commercial multi-stage amplifiers covering such bands will soon be possible. With multi-stage amplifiers, moreover, gains of more than 20 dB are available at C and X band, with a voltage gain-bandwidth product of greater than 100 GHz.

High-powered TEAs are also becoming a reality throughout the microwave spectrum. Pulsed amplifiers have been fabricated that deliver 2 watts in C band. Continuous-wave amplifiers can deliver 2 w in C band and greater than 0.5 w in X band. Efficiencies are as high as 5% cw and 6% pulsed.

The noise figure is fairly low as well, averaging 15 dB in C and X band and 16 dB in Ku band. Recently RCA devices have shown noise figures of 13 dB in C and X band, while amplifiers developed in England have

shown noise figures of 18 dB in Ka band (34 GHz). Taken together with the excellent phase and gain linearity associated with these devices, these performance figures have finally made the transferred-electron amplifier a strong competitor of the old TWT in low- and medium-power applications.

To tackle the temperature-stability problem, techniques are being developed in which individual stage gains are kept low, while operation is maintained in the center of the frequency band. Under these conditions reasonably good stability can be expected. Over wide bands, on the other hand, high-gain amplifiers will require an oven to maintain temperature stability and uniformity.

Great progress has also been made in TEA circuit and package techniques. A typical schematic of a reflection-

TABLE 3: PERFORMANCE OF REFLECTION-TYPE TRANSFERRED-ELECTRON AMPLIFIERS

Instantaneous bandwidth (GHz)	Small-signal gain (dB)	Saturated power output (W)	Efficiency (%)
4.5 - 8.0	8	1	3
4.5 - 6.9	20	1.9	1
4.0 - 8.0	7.5	0.1	2
5.5 - 6.5	3.0	2.0 (pulsed)	6
7.8 - 11.8	25	0.4	1
8 - 12	6	0.6	2.5
9 - 15	6	0.1	2
14.5 - 16.5	8.0	0.12	2

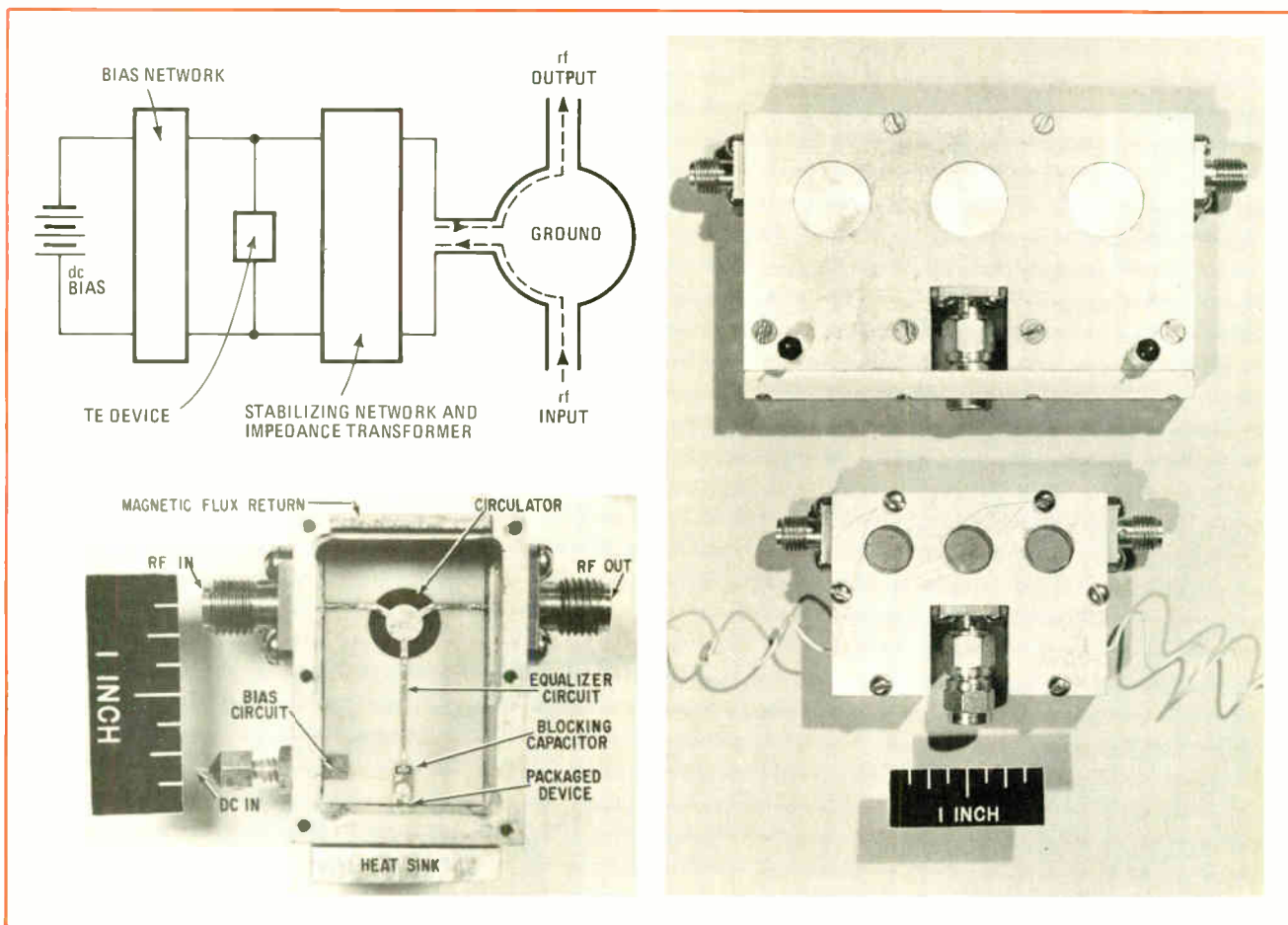

5. Transmitting microwaves. TE devices are packaged as complete transmission circuits, including bias and stabilizing networks, plus circulator to decouple input and output. Amplifier schematic shown in (a) also includes dc bias source, which could be a simple battery. Completed circuit is shown in (b) and commercial package in (c). (Photographs courtesy R. Paglione, B.S. Perlman and L.C. Upadhyayula.)

type TEA is shown in Fig. 5a. Needed along with the TE device itself are: a bias network to supply the drive field; a stabilizing network and impedance transformer to provide the proper matching between the device and the cavity; and a circulator to separate the rf input from the rf output.

Previously this circuit was built up from discrete component and then packaged, a process that often made for reduced performance and bulky layouts. Now a technique has been devised to build the entire circuit on an integral substrate (Fig. 5b) in much the same manner as is used to build a conventional hybrid circuit. As a result, an integral amplifier component can now be obtained which has low parasitics and minimum area, and can be batched-processed for cost savings. A finished package is shown in Fig. 5c.

Another type of TE amplifier that has recently been developed is built on the same principles as the conventional traveling-wave amplifier. The traveling-wave TE device shown in the schematic in Fig. 6 is divided into three regions: the input coupling region, the output coupling region, and the amplification region. In the amplification region a growing space-charge wave amplifies the input signal, where the gain is proportional to the length of the sample. Since the gain occurs only in the direction of the space-charge wave, the device has unilateral gain, and no circulator is required.

A problem area is the input couplers which, being lossy, reduce gain and also increase the noise of the devices. A remedy involves building a FET-like input coupler which can provide input gain.

This first of the traveling-wave amplifiers had gains as high as 18 dB in pulsed operation over the range of 1 to 4 GHz. Cw devices use a small ratio of material thicknesses to provide stability. Recently, continuous gain from 7.2 to 15.3 GHz has been demonstrated at RCA.

Traveling-wave TE amplifiers, however, are low-power devices—a problem which can be alleviated by adding a negative-resistance amplifier to the output of the devices. Work toward this end is presently under way at RCA.

The switch to LSA

For unusually high power, the LSA type of transferred-electron device is much more suitable than the Gunn type. Indeed, the highest power ever obtained from microwave solid-state oscillators has been obtained working with harmonics in the LSA mode—6 kW at 1.75 GHz with 14.6% efficiency, and 2 kW at 7 GHz with 4.1% efficiency. In this mode the device is operated in a low-Q circuit to achieve a multi-frequency non-sinusoidal waveform. Although Copeland of Bell Labs, who invented the LSA mode, worked primarily with sinusoidal waveforms, he points out that harmonics could

**TABLE 4:
PERFORMANCE OF INDIUM PHOSPHIDE OSCILLATORS**

Frequency (GHz)	Saturated power output (W)	Efficiency (%)
7.5	1.9 (pulsed)	10
15.0	0.5 (pulsed)	20
17.3	0.2 (cw)	8.6
22	0.2 (cw)	10.0
26.7	0.09 (cw)	6

increase LSA efficiency. Efficiencies remain high even in the presence of material nonuniformities: 10% for a 60% doping gradient. And since low-Q circuits are used, tuning is relatively easy.

Three levels improve on two

In 1970 a TEO effect was proposed with materials that would have a more complicated electron transfer than the gallium-arsenide systems. Candidates for these materials are indium phosphide, indium arsenide phosphide, and indium gallium antimonide. Of these, indium phosphide is the most advanced experimentally.

The advantage such oscillators would have over GaAs systems would be a higher peak-to-valley ratio. Furthermore, such materials would tend to inhibit domain growth—a plague of all TE devices, since domains reduce efficiency and lead to breakdown phenomena. Domain growth would be inhibited in such materials because the three levels prohibit interactions that cause electrons to follow field fluctuations. This would also result in LSA-like modes and stable amplifiers.

Indium-phosphide devices have been developed in laboratories in England for several years. While the question of whether indium phosphide is a three-level oscillator is still the subject of debate, the experimental results have been very encouraging (see Table 4). The

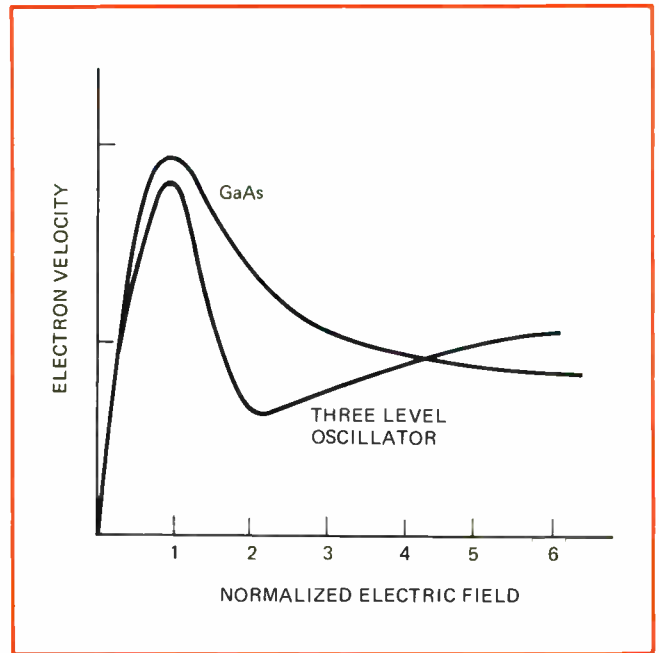

7. Three levels are better than two. The ratio of peak electron velocity to valley electron velocity in three-level material systems may be higher than in present two-level material systems such as gallium arsenide. The result should be more efficient devices.

efficiencies obtained in Ku and Ka bands are better than those obtained with gallium arsenide in the same frequency bands. When indium-phosphide TEAs were used as reflection-type amplifiers at 33 GHz, a noise figure of 7.5 dB was achieved, the lowest ever for a TEA. □

BIBLIOGRAPHY

- Special Issue on Semiconductor Bulk-Effect and Transit Time Devices, IEEE Trans. Electron Devices, January 1966, Vol. ED-13, No. 1.
- Second Special Issue on Semiconductor Bulk-Effect and Transit Time Devices, IEEE Trans. Electron Devices, September 1967, Vol. ED-14, No. 9.
- S. M. Sze, "Physics of Semiconductor Devices," Wiley Interscience, New York, 1969.
- H. A. Watson (ed.), "Microwave Semiconductor Devices and their Circuit Application," McGraw-Hill Book Co., New York, 1969.
- J. E. Carroll, "Hot Electron Microwave Generators," Edward Arnold Ltd., London, 1970.
- Special Issue on Microwave Semiconductors, IEEE Trans. on Microwave Theory and Techniques, Vol. MTT-19, No. 8, August 1971.
- W. D. Hershberger (ed.), "Topics in Solid-State and Quantum Electronics," Wiley, Chichester, Sussex, England, 1972.
- L. F. Eastman (ed.) "Gallium Arsenide Microwave Bulk and Transit-Time Devices," Artech House, Dedham, Mass., 1972.

6. Fellow traveler. Resembling the traveling-wave tube is the construction of the traveling-wave TEA—an input, an amplifying, and an output section. Amplifying section is an elongated segment of GaAs material, which permits growing space-charged waves to amplify the input signal. Techniques to eliminate traveling domains include dielectric loading of amplifying section, low ratio of sample thickness to sample width, and use of low-doped material.

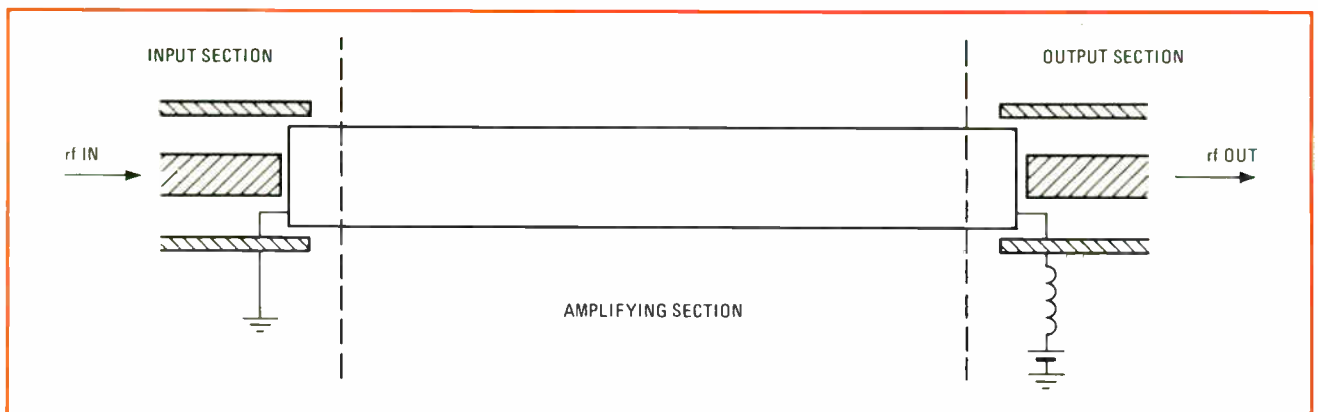

Dynamic zero-correction method suppresses offset error in op amps

In data-acquisition systems, the offset voltage and offset voltage temperature drift of a FET-input op amp can be held to only a few microvolts by a sample-and-hold correction technique

by Richard C. Jaeger and George A. Hellwarth, IBM General Systems Division, Boca Raton, Fla.

□ Although today's monolithic FET-input operational amplifier offers the advantages of high input impedance, large open-loop gain, fast slew rate, and low input-bias current, it often has a high initial offset voltage that drifts with time and with changing temperature.

However, certain dynamic zero-correction techniques can drive the initial offset voltage to zero and reduce the effect of initial offset current when the amplifier is used for signal conditioning in a multiplexed or sampled data-acquisition system. One such scheme keeps the amplifier's input voltage to only a few microvolts and its offset voltage temperature drift to merely a few hundredths of a microvolt per degree Celsius.

This method overcomes the shortcomings of previous dynamic zero-correction techniques. One method, for example, controls drift by inserting a dc correction signal into the amplifier's input with a periodically operated switch or modulator, an auxiliary ac-coupled amplifier, and a demodulator switch and filter. This scheme is not only expensive, but it produces carrier-frequency noise from the switches and recovers slowly from an overload condition.

Recent methods require switches operating synchro-

nously between the cycles of a multiplexer or an analog-to-digital converter so that the switches and demodulation filter become a measure-and-hold circuit. After measuring the magnitude of the input offset voltage (with the amplifier input, shorted by a switch), the circuit holds the correction voltage inserted at the amplifier input. This technique is sometimes hampered by errors in the sample-and-hold circuit and by feedback instability during the correction cycle.

Zeroing out offset error

In the improved zero-correction scheme (Fig. 1), the amplifier is also driven by a multiplexer, and the offset voltage is dynamically eliminated between multiplexer cycles. A set of switches, which are synchronously linked to the multiplexer timing control, change the amplifier's operating mode to eliminate offset error. MOSFETs are usually used as the switches because of their operating speed and predictable switching action.

Zero correction is implemented by disconnecting and grounding both inputs of amplifier A_1 , allowing the forward gain of the over-all amplifier to generate a large output voltage that is fed back to the input of interstage

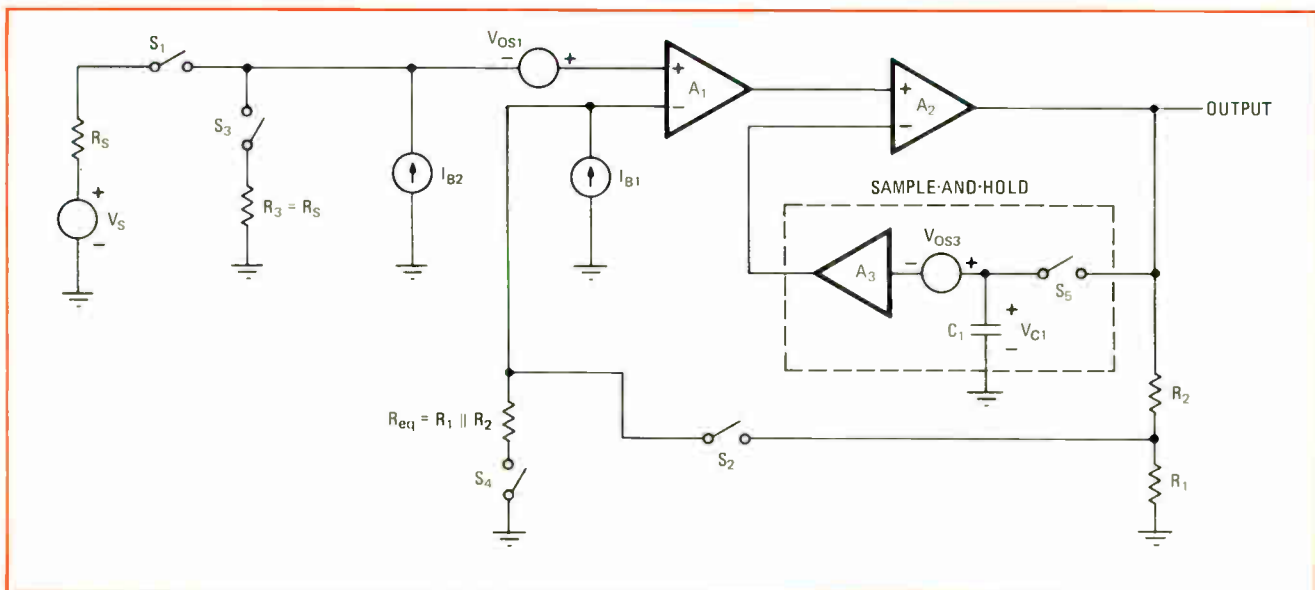

1. Dynamic zero-correction. Offset voltage of over-all amplifier is held to a few microvolts by inserting correction voltage at input of amplifier A_2 . By applying correction voltage at interstage between A_1 and A_2 , errors due to sample-and-hold inaccuracies can be minimized. Sample-and-hold circuit stores correction voltage while over-all amplifier has its feedback loop open and is disconnected from source.

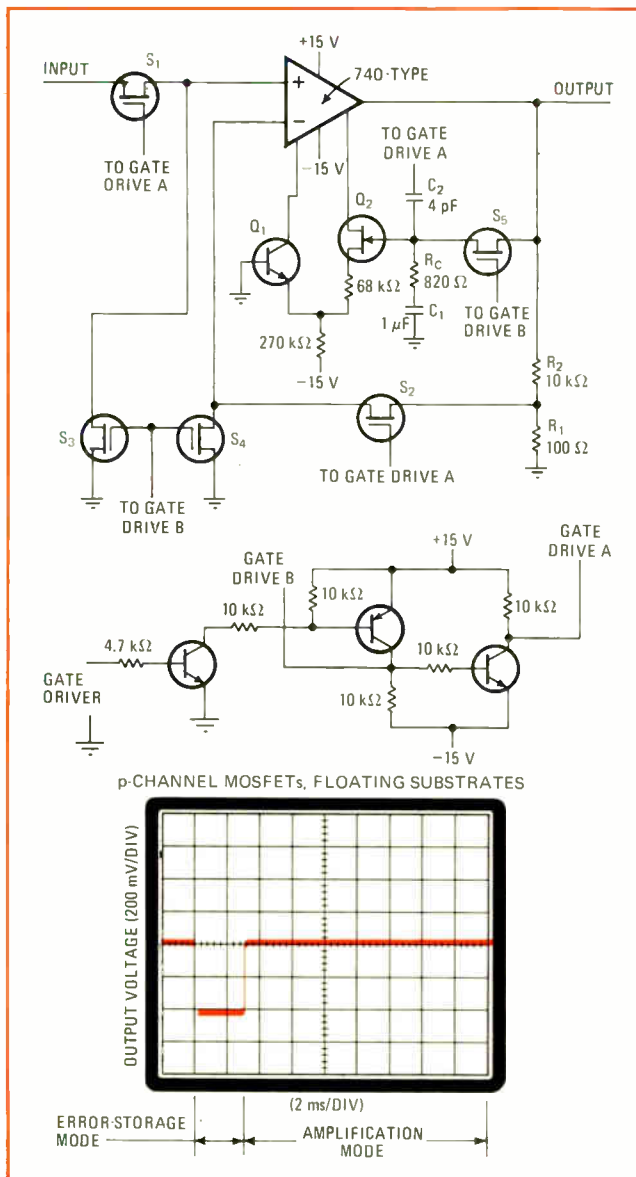

2. Practical circuit. Zero-correction scheme for popular 740-type op amp employs MOSFET switches to cyclé op amp between error storage and amplification modes. Sample-and-hold circuit, which is composed of switch S_5 , transistors Q_1 and Q_2 , and capacitor C_1 , inserts correction current, rather than correction voltage, into an intermediate stage of op amp. Scope trace shows op-amp output.

amplifier A_2 . The feedback voltage is sampled and held while amplifier A_1 is returned to normal operation by reconnecting its input to the signal source.

The over-all amplifier is cycled between two modes of operation—amplification and error storage. The error storage cycle begins when switches S_1 and S_2 are opened and switches S_3 , S_4 , and S_5 are closed. This causes A_1 to amplify its own offset voltage and the sampling circuit to derive the correction voltage.

Opening switches S_3 , S_4 , and S_5 and closing switches S_1 and S_2 start the amplification cycle by driving A_1 with the input-signal source and closing the over-all amplifier's normal feedback loop. The correction voltage remains applied to amplifier A_2 so that A_1 's offset is reduced by an amount determined by A_2 's gain.

The zero-corrected amplifier offset, therefore, can be

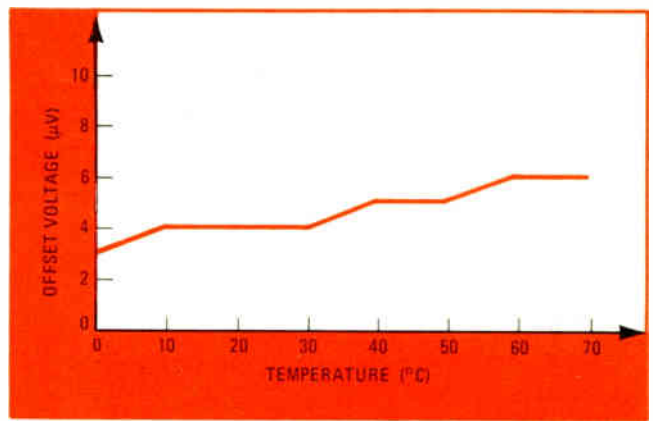

3. Almost-zero drift. Offset voltage of zero-corrected 740-type op amp is initially $3 \mu\text{V}$ and has temperature drift of under $0.05 \mu\text{V}/^\circ\text{C}$.

expressed in terms of A_1 's offset and A_2 's gain:

$$V_{OS} = V_{OS1}/(1 + G_{A2})$$

where V_{OS1} is the equivalent amplifier input offset voltage without correction, and G_{A2} is the open-loop gain of A_2 . The correction voltage stored on capacitor C_1 is:

$$V_{C1} = G_{A1}G_{A2}V_{OS1}/(1 + G_{A2}) + V_{OS3}$$

where V_{OS3} is the offset voltage of unity-gain amplifier A_3 , and G_{A1} is the open-loop gain of amplifier A_1 .

Because the correction voltage is applied after the first stage of the over-all amplifier, the effect of errors caused by sample-and-hold inaccuracies is significantly reduced. Resistor R_{eq} is made equal to the parallel combination of resistors R_1 and R_2 to correct for the error caused by bias current I_{B1} , which flows through these resistors during normal amplifier operation. Similarly, the error due to bias current I_{B2} is compensated for by resistor R_3 , which has the same value as resistor R_S .

Getting practical

Figure 2 shows a practical zero-correction scheme for the popular FET-input 740-type op amp. The components are numbered to correspond with the labels of Fig. 1. Amplifiers A_1 and A_2 of Fig. 1 become the op-amp's input and output stages, respectively.

The sample-and-hold circuit, which is formed by switch S_5 , transistors Q_1 and Q_2 , and capacitor C_1 , injects a correction-signal current, instead of a correction-signal voltage as shown in Fig. 1, into the interstage offset adjustment port of the op amp. Resistor R_C is included to stabilize the negative feedback of the correction loop during error storage.

When switch S_3 opens, the correction voltage on capacitor C_1 is disturbed because the circuit's gate-drive signal is coupled through the gate-source capacitance of the MOSFET that is being used as the switch. Capacitor C_2 , which is returned to the gate-drive signal having opposite polarity, neutralizes this error. The scope trace depicts the circuit's output as the op amp cycles between the error-storage mode and the amplification mode, where the source voltage is zero.

A plot (Fig. 3) of offset voltage (referred to the op amp's input) as a function of temperature illustrates the remarkably low drift this zero-correction scheme can attain. The circuit brings the initial offset voltage down to only a few microvolts and holds offset voltage temperature drift to less than $0.05 \mu\text{V}/^\circ\text{C}$. □

Evaluating power dissipation in microcircuit design

by Lyle F. Pittroff
Microcircuit Operations, Helipot Div., Beckman Instruments, Fullerton, Calif.

Converting a circuit from the discrete-component concept into a single miniaturized microcircuit is analogous to the design and development of a larger system. Although specific design problems must be handled on an individual basis, several key areas must be considered early in the game.

This Engineer's notebook covers package-temperature rise, component ratings, and component compatibility; a later notebook will focus on a shortcut technique for estimating the substrate area required for any given circuit. This latter article will also discuss component density and hopefully answer the question, "Will it fit?" when circuit designs have been finalized.

Microcircuits shrink the package size, but package power remains the same, and the power density can be increased significantly. An estimate of the temperature rise in a new microcircuit design can be a critical step in the package-selection process. Two specific areas must be evaluated:

- Substrate/package temperature rise above the ambient or heat-sink maximum operating temperature.
- Individual component/junction temperature rise above the substrate/package temperature.

A simple review of the thermal model for the package and those components dissipating significant power will quickly reveal whether or not the design is in the right ball park for most hybrid-circuit configurations. With the fundamental thermal model shown in the first figure, a steady-state Ohm's law network analogy can be used to evaluate component temperature rise.

For the initial approximation, transistors and diodes dissipating less than 100 milliwatts, resistors, and most ICs are assumed to be operating at the case temperature. It is also assumed that all of the heat generated by internal circuit elements is being conducted away by the case (there is no radiant energy).

Conventional thermal model designations for a hybrid microcircuit are outlined in the second figure. The package temperature rise is a function of the total power dissipation (P_T) of all internal circuit elements:

$$T_R = T_C - T_A = P_T \theta_{CA}$$

where T_R is the temperature rise between two specified points, T_C is the case temperature, T_A is ambient temperature, and θ_{CA} is the thermal resistance from the case to ambient without a heat sink.

As a rule of thumb, the thermal resistance, θ_{CA} , of a package in free air (no forced cooling and minimum pin conduction) causes a temperature rise of about 35°C per watt of power dissipation per square inch of package

area (35°C/w/in.²). For example, the temperature of a circuit dissipating 1 w would rise approximately 35°C above ambient in a 1-inch-square package or 70°C above ambient in half that package area. This general rule is conservative and should prove a safe first approximation for most pc-board applications.

The individual component temperature rise above the substrate temperature is a function of the component's power dissipation and thermal resistance. Although significant temperature rises are usually limited to the larger devices, some typical values of chip thermal resistance for smaller semiconductors are given.

The maximum allowable junction temperature (T_J) for silicon devices depends on the application, and in

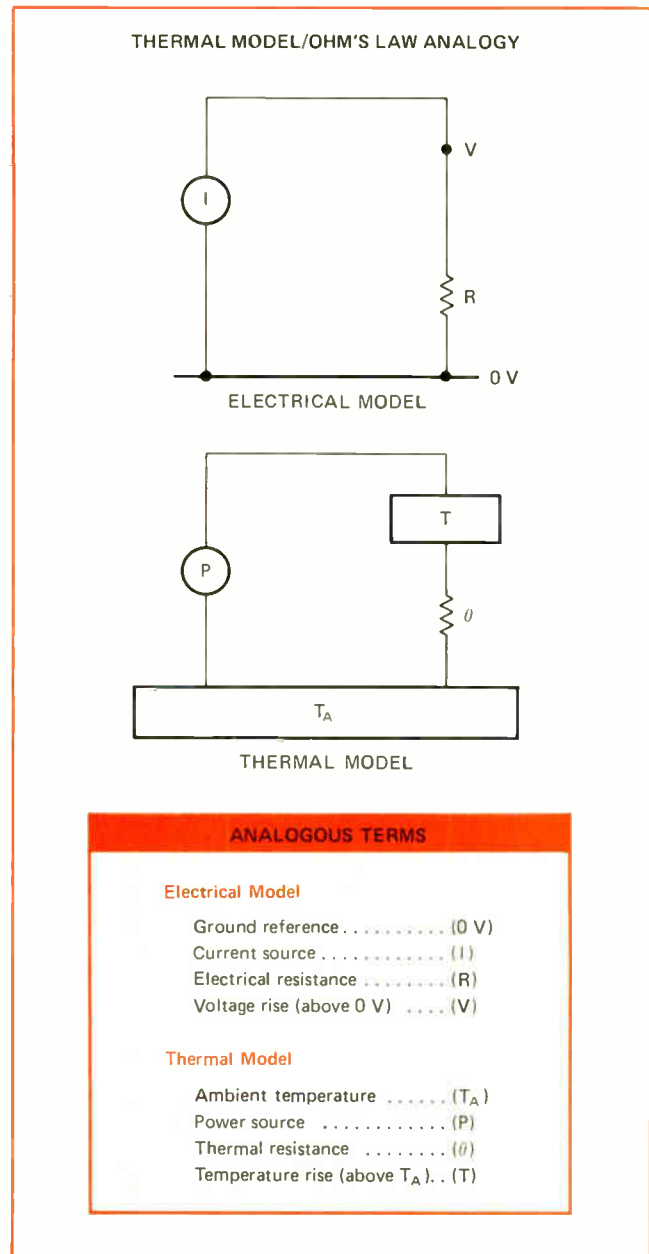

CONVENTIONAL THERMAL MODELS FOR HYBRID MICROCIRCUITS

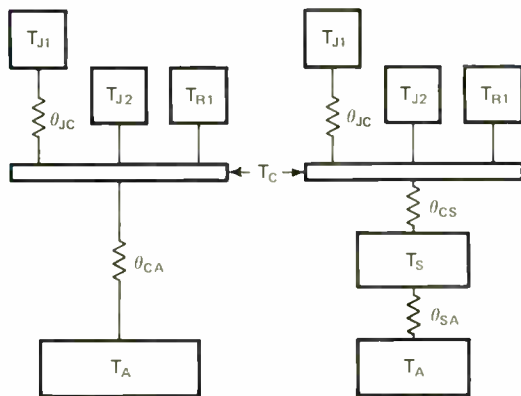

MODEL PARAMETERS

T_A	= Ambient temperature
T_S	= Heat sink temperature
T_C	= Case temperature
T_{J1}	= Q_1 junction temperature (power device)
T_{J2}	= Q_2 junction temperature (small signal device)
T_{R1}	= Resistor R_1 temperature
θ_{JC}	= Thermal resistance from power die junction to case
θ_{CA}	= Thermal resistance from case to ambient (no heat sink)
θ_{CS}	= Thermal resistance from case to heat sink
θ_{SA}	= Thermal resistance from heat sink to ambient
T_R	= Temperature rise between two specified points

TYPICAL SEMICONDUCTOR CHIP THERMAL RESISTANCE

Category	Typical Device Types	Typical θ_{JC}
Small signal	2N2484, 2N2605	150° C/W
Low power	2N2219, 2N2905	60° C/W
Medium power	2N3724, 2N4030, 2N2194	44° C/W

some cases, it is limited by system specifications. The seat-of-the-pants rule is to never allow a junction to exceed 200°C in general utility applications. High-reliability applications often further limit T_{J1} to 150°C or 175°C.

Component compatibility is yet another design consideration that must not be overlooked in building hybrid microcircuits. Realistically, it is sometimes more economical or better design practice to leave certain devices in discrete form outside of the microcircuit package. Large capacitors, for instance, as well as large power transistors and diodes, large inductive devices, and special parts head the list of discretes requiring individual attention.

To judge component compatibility, usually both performance and packaging objectives must be surveyed in the context of the over-all system. Each application imposes its own unique combination of economical, electrical, mechanical, and environmental circumstances.

Even conductors and crossovers are sometimes subject to the considerations of component compatibility. Fine-line screening techniques permit very narrow line widths to be realized, but Ohm's law still prevails and halving the line width doubles the line resistance between two points. Consequently, the layout of high-current paths and low-impedance lines may require special attention. □

Guidelines for design of front panels

by Roy Udolf and Irving Gilbert
Litcom Division of Litton Systems Inc., Melville, N. Y.

Laying out a display/control panel so that an operator can function efficiently with little training requires more than just making sure that everything fits. In fact, many future problems can be avoided by spending time early in the project to plan the interface between internal components and front-panel controls and displays. Not only must the panel layout assure a good man/machine interface, but often the location of certain controls and displays determines the layout of many critical internal components.

The following guidelines can't cover all the considerations involved in designing effective control/display panels, but they should help the designer with this aspect of the project early in the design phase. Later, he can make mock-ups of the proposed man/machine interfaces for prototype use to detect any previously unpredicted problems.

General considerations

- A panel must be designed so that it can be used effectively by a large number of different operators. There is no such person as the "average operator."
- Stereotyped symbols, such as red = danger/stop; green = O.K./go, should be used to minimize training time with the panel. Such common stereotypes should never be reversed.

Organizing controls and readouts

- Similarity of size, shape, or color, as well as proximity of location, may be employed to group related controls and/or readouts.
- Bracketing and framing of similar control functions may be effectively used to organize complex panels.
- Related controls and readouts should be grouped together, with the readouts above or to the left of the controls to eliminate interference from the operator's hands (since most operators will be right-handed).

Labeling and letter size

- A lettering-size gradient in increments of 25% should supplement the use of similarity and proximity to assist the operator in organizing and subordinating display and control functions.

- Clutter, unnecessary labeling, and abbreviations should be avoided to eliminate operator confusion due to sensory overload.
- Labels need to be large enough for comfortable viewing under ambient illumination at a normal operating distance. This should never be less than 20 inches.
- Unless the panel is to be viewed from below, labels should be consistently placed above the devices to which they refer to eliminate hand interference and ambiguity of reference.

Operator's field of view

- Limitations of the operator's field of view must be considered. When the operator focuses on a fixed object, he has maximum acuity within $\pm 1^\circ$ of his center of vision, he can no longer see reds and greens at $\pm 20^\circ$, and he loses both blue and yellow at $\pm 40^\circ$. If readings are necessary beyond these limits, the operator's head must be free to turn.
- Important color displays that must be placed beyond these limits of the fields of view require either flashing or auditory signals to gain attention. Auditory signals are frequently the better solution, since flashing lights

tend to be assigned different meanings from steady-state lights in many systems.

- Intermittently illuminated devices require refresh rates well above the viewer's critical flicker frequency for approximately 95% of the operator population to view comfortably. This critical frequency is a function of the display brightness, size, and duty cycle.

Operating environments

- The effects of the operating environment must be considered, both for its direct degradation of human performance (such as visual degradation under acceleration or anoxia) and the restricting effects of protective clothing and equipment. Operation in the dark mandates red illumination of displays and precludes the use of color coding.
- Controls for equipment requiring operation in a darkened environment may be shape-coded (up to about 15 properly selected shapes may be used) and also size-coded (up to three sizes, differing from each other in increments of no less than 50%).
- Point displays of lights in a darkened room require some back-lighting. □

Light-emitting diode doubles as sensor

by Thomas T. Yen
Slatham Instruments Inc., Oxnard, Calif.

A seldom recognized property of many light-emitting diodes is that, in addition to emitting light when forward-biased, they can also detect light when reverse-

biased. This emitter/sensor property in a single device leads to several potential applications.

One of the more intriguing possibilities is an automatic brightness control for a LED display panel. By momentarily reverse-biasing one of the LED elements (a decimal point, for example), the emitter-come-sensor could be made to detect the ambient-light intensity, and then the intensity level of the display could be adjusted accordingly.

In another application, the emitter/sensor could serve as a simple transceiver, to be placed at points on a digital communications bus. A data link capable of two-way communications can be constructed simply by using fiber optics and a single device at each end.

Such applications require a switching circuit similar to the one shown. When the input is high, Q_1 conducts, and a forward bias current flows through D_1 , which emits photons. The photocurrent is given by:

$$I \approx \frac{V_z}{R_1} - \frac{V_1 - V_2}{R_2}$$

When the input is low, Q_1 turns off, D_1 becomes a sensor with a reverse bias of $V_1 - V_2$, and the light current through R_2 develops a voltage at the output.

Initial tests show that both infrared (gallium arsenide) and red (gallium arsenide phosphide) LEDs respond to light from a small incandescent source. Once a diode is selected, it should be tested further to determine the exact switching speed and sensitivity characteristics. Several LEDs have been tested, including the Hewlett-Packard Co. 5082-4107 (GaAs) and 5082-4440 (GaAsP) and Daimetric's DLD-32 and DLD-33, both red-LED GaAsP types. □

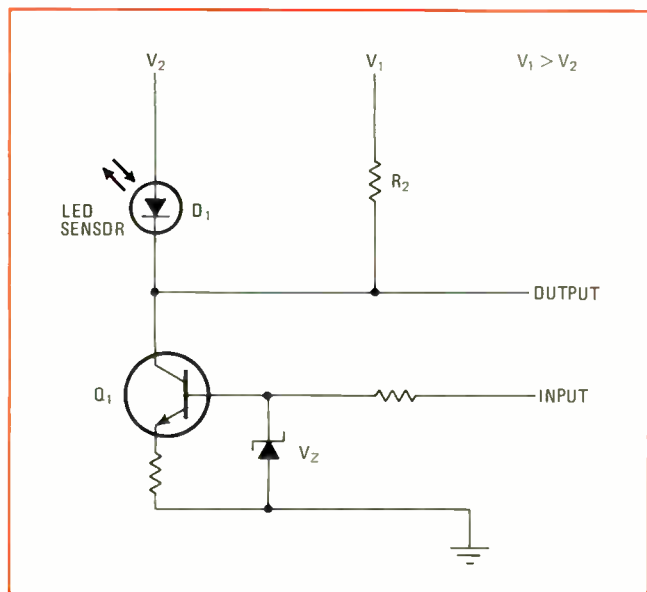

LED Switch. A few components can be added to enable the conventional LED to double as a photodetector.

Engineer's Notebook is a regular feature in Electronics. We invite readers to submit original design applications and measurement ideas. We'll pay \$50 for each item published.

OUR ANGLE: Low Cost D/S and S/D Modules

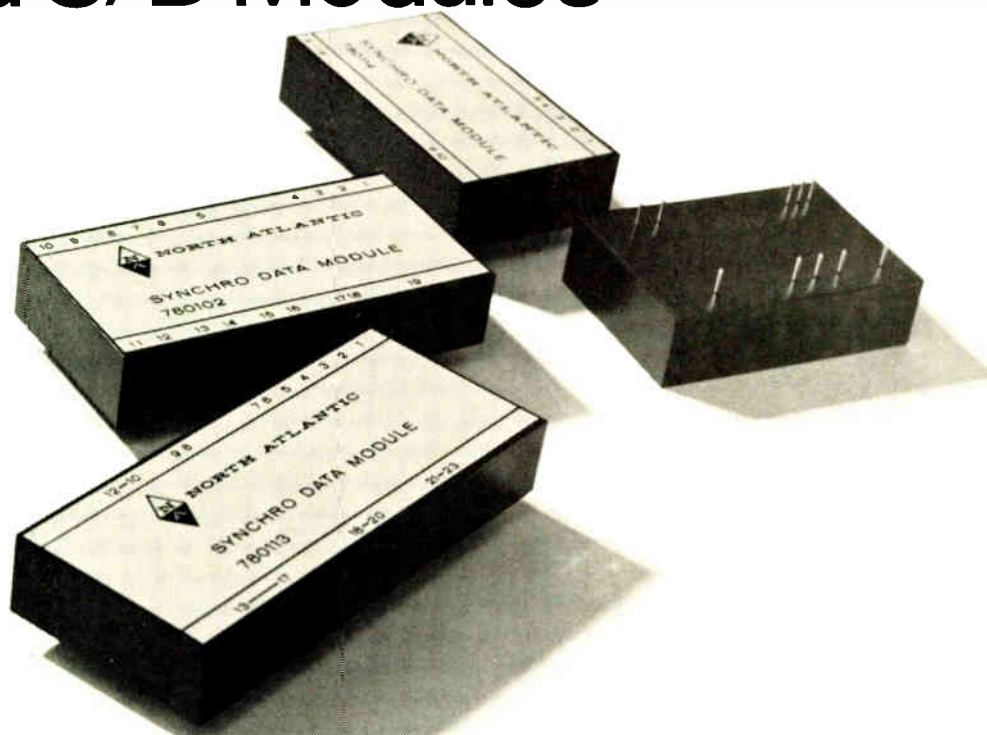

TYPICAL S/D MODULE SETS		
FUNCTION	LINE-LINE	FREQUENCY
S/D or R/D	11.8V	400Hz
R/D	26V	400Hz
S/D or R/D	90V	400Hz
S/D	90V	60Hz

TYPICAL D/S MODULE SETS		
FUNCTION	LINE-LINE	FREQUENCY
D/S or D/R	11.8V	400Hz
D/R	26V	400Hz
D/S or D/R	90V	400Hz
D/S	90V	60Hz

How does a choice of 14-bit resolution, 60 or 400 Hz data frequency, high accuracy, 11.8V to 90V line-line voltages and all kinds of self-protection circuitry look from your angle?

North Atlantic's Series 780 is available now. Only 5 modules make up a complete S/D or D/S converter, and any set nests in an area less than 21 square inches.

S/D specifications include 3 minutes \pm 0.9LSB accuracy, and continuous tracking with low velocity errors. D/S specifications include 4 minute accuracy, 1.25 VA output and 25 μ sec settling time.

Key performance specifications for both converters include 14-bit (0.22°) resolution over 360°, 0-70°C operation and 4000°/sec data rates. Both units are DTL and TTL compatible.

To shrink your prototype schedule, we offer an interconnecting PC board. Or, if you plan to integrate a converter directly onto your own PC cards, we can supply proven mylar artwork.

Any set of modules — \$650. Order a set today. North Atlantic sales engineering representatives are located throughout the free world.



NORTH ATLANTIC industries, inc.

200 Terminal Drive, Plainview, New York 11803 Phone (516) 681-8600
California District Office: 13418 Wyandotte Street, N. Hollywood, CA 91605; Phone (213) 982-0442

Engineer's newsletter

New ROMs ease logic design

Designers who have been using bipolar read-only memories to perform control-logic functions will be pleased to hear that more and more sophisticated ROMs are becoming available, both electrically programmable and mask-programmable. **And to make matters even better, 2,048-bit programmable ROMs are now appearing.** The first was introduced recently by Harris Semiconductor, and other semiconductor makers are not far behind. One big advantage in using ROMs is the saving in board space, meaning that fewer packages are needed to perform the logic.

With the programmable ROMs, **the user needn't carry a large inventory because he is able to use the same basic unit for many programs.** And many new universal programmers, such as the Spectrum Dynamics model, are already available to simplify programming.

Adhesive is quick, withstands high temperatures

If you need an adhesive that sets up fast and withstands temperatures to 475°F, then Eastman's 910 MHT may be the one. Applying adhesives prior to high-temperature encapsulation often results in subsequent bond failures. **However, 910 MHT, a member of the cyanoacrylate adhesive family, sets up in seconds and withstands the temperatures encountered in curing processes.**

For example, the adhesive solved a problem that American Aerospace Controls Inc., Farmingdale, N.Y., encountered when securing magnetic components to a pc board. With previous cyanoacrylate adhesives, the bias magnets shifted before the encapsulation step. But with the Eastman product's fast setup, the magnets stayed in place. No shifting occurred during curing of the encapsulant material. For further information contact Emerson & Cuming Inc., Canton, Mass.

Components here in beam-lead packages . . .

Designers of uhf equipment should welcome the appearance of many conventional components in beam-lead packages at prices they can afford. **They will now have the opportunity to specify the devices for high-volume applications.**

An example is Hewlett-Packard's new beam-lead Schottky diode, which the company says is the beamed version of its old 5082-2800 Schottky diode. **The nice feature of the new device is that small quantities are available at less than \$1 each.** The part is aimed at such applications as high-level detection, switching, gating, and logarithmic and a-d conversion. Also look for beam-lead power devices. Suppliers now feel they can use beams with powers of 1 W and above.

. . . as multiple devices share single package

Users of discrete semiconductors have been talking about the increased availability of packages containing such multiple discrete devices as duals, quad transistors, Darlingtons, double emitters, and diode arrays. **The key is that the technique offers big savings in device costs, assembly costs, and board space.** The packages also contain a design bonus: individual devices can be matched for a particular device parameter. Perhaps the most complex of these multiple discretely are the quad transistors and dual field-effect transistors. The latter have become popular for applications where FET inputs have to be matched. Suppliers do the matching, designers get the benefits.

You get more out of memories from Microsystems International...

RAMs

"do for one. Their MF 1101 1024 bit MOS RAM is the guts of my mainframe program. It's a big job and every week several thousand 1101s are delivered from Microsystems. They fill small memory systems too with MF 1101s. They're the 256 bit MOS RAMs. For my money they're number one when it comes to MOS RAMs."

PROMs

"I'm involved with ultra high speed microprocessors and I mean I can't do anything that isn't the best. I've been using Microsystems' MD 6200, the 256 x 4 bit Bipolar ROM. It has a 35 ns access time so I get pretty well what I want, you know. When I get into specialized displays I've been specifying the MF 7107 4092 bit ROM—it's a 64 x 9 x 7 MOS character generator. It makes the difference, really I've seen yet. Sure I'll go on using them."

PROMs

"My program requirements are constantly changing and our systems have a 2048 bit MOS PROM, the MF 7601. It's electrically programmable and does a first class job at low cost. For prototyping we use their light erasable reprogrammable PROM, the MF 1701. And for very high speeds their 256 x 4 bit Bipolar MD 6300 PROM is about the best damn buy you can get! We fill our sockets with them..."

MOS & Bipolar Memories from the performance leader



microsystems international limited, box 3529 station c, ottawa, canada — montreal, ottawa, toronto, brussels, stuttgart, london, palo alto, philadelphia

For further information—call or write your nearest Microsystems sales office or distributor.

USA — MICROSYSTEMS INTERNATIONAL SALES OFFICES: CALIFORNIA — Palo Alto, (415)493 0848 Santa Ana, (714)979 6522 ILLINOIS — Schaumburg, (312)894 7660 MINNESOTA — New Hope, (612)944 1802 NEW HAMPSHIRE — Nashua, (603)762 8288 PENNSYLVANIA — Philadelphia, Huntingdon Valley, (215)W17-6541 2

SALES REPRESENTATIVES: ARIZONA — Scottsdale, Barnhill Live Inc. (602)947 841 CALIFORNIA — Los Altos WW Posey (415)948 7771 Santa Ana, Rical Associates, (714)557 6543 COLORADO — Denver, Barnhill Live Inc. (303)944 9505 CONNECTICUT — New Canaan — Stan Pogue Inc. (203)966 4848 FLORIDA — Indialantic, Tech Rep Associates, (813)723 9140 Largo, Tech Rep Associates, (813) 595 2834 GEORGIA — Chamblee, Tech Rep Associates, (404)929 8739 ILLINOIS — Chicago, L Tru Inc., (312)266 1568 INDIANA — Indianapolis, R. E. Marquart & Associates, (317)254 2947 MARYLAND — Baltimore, L. P. Kilmann Co. (301)752 8756 MASSACHUSETTS — Norwood, John Patrick Inc. (617)762 3164 MISSOURI — Kansas, Florence & Miller Inc. (913)723 5210 NEW YORK — Cicero, Advanced Components Inc. (315)694 2671 New York, ABC Electronic Sales (516)747 6610 North White Plains, ABC Electronic Sales (914)946 3001 2 NEW JERSEY — Tenafly, ABC Electronic Sales (201)268 2354 OHIO — Columbus, Tom Mulligan & Associates, (614)457 2247 NEW MEXICO — Albuquerque, Barnhill Live Inc. (505)299 7638 PENNSYLVANIA — Philadelphia, ABC Electronic Sales (215)917 5641 TEXAS — Addison, Campbell Sales, (214)239 9196 UTAH — Salt Lake City, Barnhill Live Inc. (801)487 1327 WASHINGTON — Seattle, Carlyle Technical Sales, (206)62 4290

DISTRIBUTORS: ARIZONA — Phoenix, Kieruff Electronics, (602)273 7331 CALIFORNIA — Carson, Hi-Rd, (213)537 6500 Los Angeles, Wilcox, (213)685 9625 Menlo Park, BHI Electronics, (415)323 9431 San Carlos, Sterling Electronics, (415)992 2254 San Diego, Kieruff Electronics, (619)278 2112 COLORADO — Denver, Kieruff Electronics, (303)342 7600 FLORIDA — Clearwater, Southland Electronics Inc. (813) 448 4814 LONG ISLAND — Freeport, Mirago Electronics Inc., (516)548 4444 Farmingdale, Arrow Electronics, (516)694 6800 Plainview, Newark Electronics, (516)822 8444 MARYLAND — Baltimore, Arrow Electronics, (410)747 3200 MASSACHUSETTS — Boston, De Vito Electronics, (617)787 1200 Dedham, Gerber Electronics, (617)329 2400 Watertown, Sterling Electronics, (617)926 9720 NEW JERSEY — Haddonville, Mid Atlantic, (609)428 8285 NEW YORK — Rochester, Simco Electronics, (716)328 3230 NEW MEXICO — Albuquerque, Kieruff Electronics, (505)247 1055 TEXAS — Dallas, Semiconductor Specialists Inc., (214)358 6211 WASHINGTON — Seattle, Kieruff Electronics, (206)763 1568

CANADA — MICROSYSTEMS INTERNATIONAL SALES OFFICES: ONTARIO — Ottawa, (613)828 9191 Toronto, (416)279-1358 QUEBEC — Montreal, (514)875 2814

DISTRIBUTORS: BRITISH COLUMBIA — Vancouver, RAE Industrial Electronics Ltd., (604)687 2621 ONTARIO — Malton, Semiconductor Specialists (Canada) Ltd. (416)578 7444 QUEBEC — Montreal, Citeo Electronics Limited, (514)735 5511

New products

Converter resolves 16 bits in 8 μ s

Analog-to-digital unit is made out of 11 basic building blocks; special comparator has gain of 12,000 and fast settling time

by Stephen Wm. Fields, San Francisco bureau manager

When the subject of a 16-bit analog-to-digital converter is brought up, the discussion of how to use it turns out to be almost as important as the one on how to build it. Intech Inc., of Santa Clara, Calif., has built a fast a-d converter and is putting together material on how to use it.

Gil Marosi, designer of the model A-856 modular unit, points out that building a 16-bit device, especially a fast one, poses some peculiar problems. Since the A-856 has a conversion time of only 8 microseconds, each bit must be resolved in 0.5 μ s. And the converter has an input signal range from -10 volts to +10 V, which means that it can resolve one bit as 305 μ V.

Linearity error of the converter is specified at 0.001%, and a full-scale accuracy is within 0.0015%. Temperature drift is no more than ± 7 parts per million/ $^{\circ}$ C. Long-term stability is to within ± 30 ppm per month; and short-term, ± 5 ppm.

Fast. The A-856 employs a successive-approximation technique. "And with this method," says Marosi, "the worst case occurs when the input (after being converted from a voltage somewhere between -10 and +10 V to a unipolar current of from 0 to 32 milliamps) is exactly 16 mA, and it is balanced against the most-significant-bit (MSB) current, which is also 16 mA. Between the moment the MSB current is off (no signal), and when it is switched on and balanced against the input current, only 0.5 μ s is allowed for settling the MSB current, the comparator, and any logic delays."

This restraint is combined with the fact that the wideband noise of the A-856 must be kept at about 100 μ V peak to peak, or in any case, it is

not to exceed half a bit or 120 μ V pk-pk for the total result to be meaningful, Marosi adds. "When an instrument of such a complexity is designed, some means must be found for the performance capabilities of any part of the blocks to be measured and monitored," he says.

It's one thing to design a 16-bit a-d converter, but it's another thing to design one that can be manufactured. Intech approached the problem by splitting the system into 11 basic modules (see diagram).

This modular approach reduces the problem of a cumulative error in the finished product. For instance, if all of the components were first assembled into the final product before the device was calibrated, the chances are that, if it could be done at all, it would take many hours of hand-tweaking. But with the modular approach, each module is assembled, tested, and brought to specifications. Therefore, only minor hand-tweaking is required.

"One of the most important building blocks in any a-d (and especially in a 16-bit a-d) is the com-

parator," Marosi points out. In the A-856, "it has to be able to determine within a half-bit or less if the input current is exactly balanced by the output current of the 16-bit DAC, and it must be able to do this at any step in the sequence."

The comparator is also required to amplify a half-bit signal of 0.25 μ A into a 1-kilohm resistor—0.25 mV—to a 3-v swing at the output, suitable for driving a TTL or DTL load; thus it must have a gain of 12,000, and, as Marosi puts it, it's not too easy to find a comparator that has a voltage gain of 12,000, settling time of less than 0.35 μ s to 0.25 mV, input bias current of less than 100 nA, and a voltage-offset drift of less than 20 μ V/ $^{\circ}$ C. Since this was not to be found in any integrated-circuit comparator on the market, Marosi turned to discrete and designed one from scratch.

The A-856 which requires ± 15 V and +5 V, comes on a printed-circuit card measuring 4 by 5 inches by 1 in. high. It is priced at \$1,300.

Intech Inc., 1220 Coleman Ave., Santa Clara, Calif. 95050 [338]

Modular way. Standard parts were used wherever possible to keep down cost of 16-bit a-d converter. The 12-bit DAC, for example, is a commercial hybrid device.

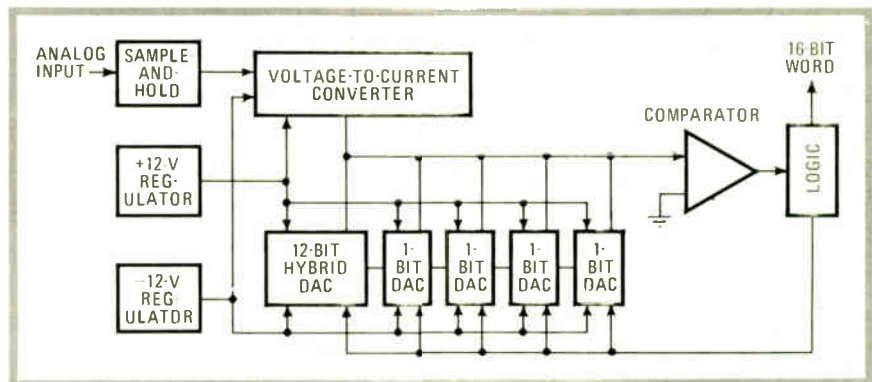

For those of you who wanted a complete digital signal analyzer for less than \$30,000:



1923/11 Time Series Analyzer (TSA)

It's the Time/Data 1923/11—the newest in a long line of hard-working digital TSAs. Aside from the price, there are some other reasons why you'll like this system. One of them is our TSL—a Time Series Language that gives you a lot of analytical capability without a programmer for an operator. Anyone can learn it in a couple of hours. And anti-obsolescence is built in. You can add to the 1923/11, block-by-block, and develop any capability you want. Versatile, too. Hang on a peripheral or two and you'll

get report-ready copy, analog plots or whatever. With the 1923/11 you're not stuck with something that's just built our way. We'll rig and deliver it so it works your way and with your operators. Like to see the system in action? We'll bring it to your place for a free demonstration. Then we'll deliver one in 90 days.

For complete data and the demonstration, contact any GR or Time/Data office. Do it now, before the demo line gets too long.

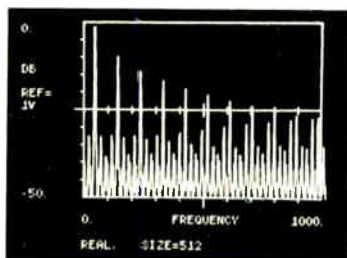

One example of the report-ready copy you get with this system.



Time/Data

A GR Company

1050 East Meadow Circle
Palo Alto, California 94303
(415) 327-8322

Instruments

80-MHz counter costs only \$325

5-digit unit automatically handles wide range of input-voltage levels

There was a time when a frequency counter was a major investment—and a backbreaking piece of equipment to move around. Just how much progress has been made in the last 10 years is illustrated by Ballan-



tine's latest counter—the 5725A.

It spans from 5 hertz to more than 80 megahertz, weighs only four pounds, costs only \$325 (less in OEM quantities), and is so simple to operate that controls are practically nonexistent.

The counter's input sensitivity is 75 millivolts rms up to 40 MHz, decreasing to 120 mV rms at 80 MHz. Maximum input voltage is 240 volts rms up to 1 kilohertz, decreasing to 10 V rms at 10 MHz and above. The FET input circuit has so large a dynamic range that the input sensitivity control seldom needs adjustment. For this reason, the usual front-panel knob has been replaced by a screwdriver adjustment.

While not a super-precision laboratory instrument, the 5725A does contain a crystal-controlled 1-MHz reference source with an aging rate of less than two parts per million per month and a temperature sensitivity of less than five parts in $10^7/^{\circ}\text{C}$ from 0°C to 40°C . A ceramic trimmer capacitor is provided for tuning the crystal to a 1-MHz frequency standard.

In addition to performing as a straightforward five-digit frequency counter, the 5725A can operate as an event counter and as a frequency ratiometer. In its event-counting mode, the counter's gate is opened and closed by a pair of front-panel pushbuttons. The display is stored when the gate is closed, so if it is reopened without being reset, the count will continue to accumulate from where it left off.

When used as a ratiometer, the counter will display a ratio F_1/F_2 , where F_1 is any frequency between 5 Hz and 80 MHz applied to the front-panel connector, and F_2 is any frequency between approximately 10 kHz and 2 MHz applied to a rear-panel connector.

Power consumption is 10 watts. Ballantine Laboratories Inc., P.O. Box 97, Boonton, N. J. 07005 [351]

Precision digital voltmeter is completely self-balancing

Combining modern a-d conversion techniques with classical potentiometric and differential measurement methods, a self-balancing digital voltmeter keeps its maximum error below $\pm(0.0015\%$ of reading + 0.001% of range). The model 2760 has five standard ranges—0.1 to 1,000 vdc—plus an optional 10-mV dc range and other optional ranges for resistance, ac voltage, and ac and dc current. The 5-digit instrument provides 60% over-range on most ranges.

Leeds and Northrup Co., North Wales, Pa. 19454 [352]

Microwave stabilizer tunes over 1 to 40 gigahertz

A microwave synchronizer-stabilizer, model 251, is a solid-state source covering 1 to 18 GHz with no holes and with frequency stability of one part in 10^8 per second (10^7 per day). The unit, which can impart crystal stability to any type of voltage-tunable microwave source, is continuously tunable from 1 to 40

GHz. A built-in rf mixer covers 1 to 18 GHz, and two plug-in mixers cover 18 to 26.5 GHz and 26.5 to 40 GHz respectively. Price for the basic 251 is \$2,900. The mixers are \$400 and \$500 additional.

Sage Laboratories Inc., 3 Huron Dr., Natick, Mass. [354]

Digital ohmmeter reads low resistance within 0.02%

The model SP 3789 digital ohmmeter measures resistance below 200 ohms with a maximum error of $\pm(0.02\% + 1$ digit). Four ranges cover values from 10 microhms to



200 ohms. Measurements are displayed on a $4\frac{1}{2}$ -digit light-emitting-diode readout, and operation may be in a single- or continuous-measurement mode. Ac noise rejection is better than 80 dB at 60 Hz. Test leads may have resistance to 5 ohms with no effect on accuracy.

Electro Scientific Industries Inc., 13900 N.W. Science Park Dr., Portland, Ore. 97229 [353]

Generator delivers variable output pulses to 30 kV

A nominal rise time of 6 nanoseconds is a feature of the model PG-030 high-voltage pulse generator. The unit delivers variable output pulses to 30 kilovolts and offers negligible time jitter and total trigger-

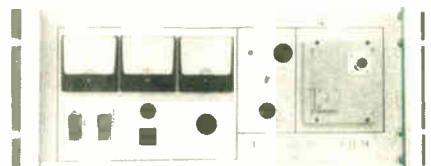



Augat says: Take a hard look at circuits cast in iron.

Think about it. In the electronics industry — which thrives on change — something as difficult to change as the PC board is practically taken for granted.

Ironic. Especially since there's an alternative that gives you all the flexibility that PC boards lack. With Augat's dual-in-line plug-in panels you can make component and wiring changes in minutes. In bread-boarding, prototyping, production.

Augat saves you time and money. There's no waiting for artwork and fabrication, as with PC boards. No need for inventories of logic cards. What's more, the Augat panel gives you up to three times the packaging density of planar

printed circuit boards, with greater reliability.

All of which means that your product gains an important competitive edge simply by switching to Augat panels.

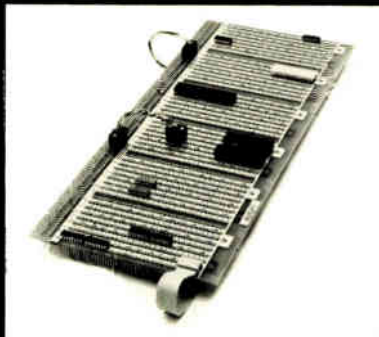

And now you probably understand why we're delivering thousands of these boards every week. We'll be happy to tell you more. Call us today at (617) 222-2202. Or write for our I.C. catalog showing our complete product line in panels and accessory equipment. Augat Inc., 33 Perry Avenue, Attleboro, Massachusetts 02703. Our representation and distribution is nationwide and international.

Plug into Augat® instead.

Circle 120 on reader service card

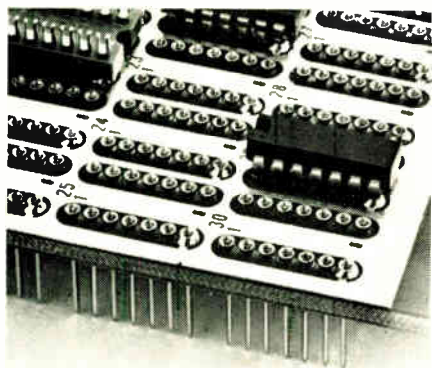

All plug-in panels are not the same.

It's one thing to want plug-in flexibility in your circuit. It's another to get flexibility plus all the other things you'd like in a dependable point-to-point system.

Like easier IC insertion. Precision-machined contacts. Tighter contact retention. Greater reliability (we'll prove it). Unique tapered entry sockets (patent pending). Lower profile. Plus the versatility to accept 14, 16, 18, 24, 28, 36 or 40 pin IC's in a choice of panel sizes.

And we offer virtually any panel you'll need, in any number of patterns, plane-mounted or edge-connected, off the shelf or custom.

We'll also give you single-source supply for sockets, enclosures and accessories—even automatic wire wrapping whenever you need it.

The Augat way? It's a better way. Call us at (617) 222-2202. Or write for our catalog. Augat Inc., 30 Perry Ave., Attleboro, Mass. 02703. Our representation and distribution is nationwide and international.

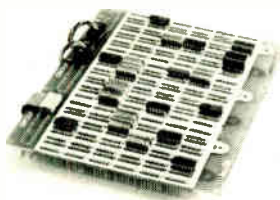

Plug into Augat' instead.

Circle 121 on reader service card

New products

to-output delay of less than 100 nanoseconds. Output pulse widths from 5 ns to 10 microseconds are available by using auxiliary plug-in pulse-forming networks. The PG-030 is used in light-modulation and laser-control applications, especially in driving Kerr electro-optical shutters.

Kappa Scientific Corp., P.O. Box 30585, Santa Barbara, Calif. 93105 [355]

Plotter handles two signals with 1.3-mm pen separation

Using flat visible-ink cartridges, the model 7046A X-Y plotter handles two signals at one time with a pen separation of 0.05 inch or 1.3 millimeters. Acceleration on the Y axis

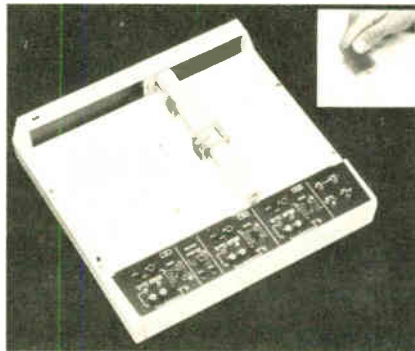

exceeds 2,500 in./s² and on each X axis it is 1,500 in./s². Slewing speed is 30 in./s. and overshoot is less than 1% full-scale. The unit writes traces with separation of 0.05 inch, and input ranges are from 0.5 mv/in. to 10 V/in., with continuous vernier settings between ranges. Input resistance is 1 megohm on all ranges. Price is \$2,650.

Hewlett-Packard Co., 1501 Page Mill Rd., Palo Alto, Calif. 94304 [356]

Counter-timer measures intermittent pulses

A counter-timer updates its display only if a pulse is available for measurement, as shown by a gate indicator. This indicator, in conjunction with the trigger level, simplifies setup and permits single-pulse sampling. Frequency range is from

0 to 50 megahertz, and the unit measures periods from 100 nanoseconds to 99,999 seconds, elapsed time, and totalizing to 99,999



events. Price is \$350.

Bartronics, 10507 S.E. 30th St., Bellevue, Wash. 98004 [357]

Sweepers with Impatt diodes cover 32 to 90 GHz

Millimeter-wave sweep generators covering 32 to 90 gigahertz use Impatt diodes as sources. The diodes are mounted in cavities separated from the power supply by diode-protecting circuits. The power supply can be used with each of five different sources in the line. The models 44056H and 44056H-001 cover 32 to 40 GHz, the former with a bandwidth of 5 GHz and the latter



with one of 8 GHz, both putting out 5 milliwatts. The model 44066H covers 40 to 60 GHz; the model 44016H, 50 to 75 GHz; and the model 44076, 60 to 90 GHz. Price is \$1,000 for the power supply, and \$1,500 to \$3,275 each for the sources.

Hughes Aircraft Co., P.O. Box 90515, Los Angeles, Calif. 90009 [358]

Bit-error tester also checks clock slippage

The model 7191 bit-error test set measures and displays bit errors of the type produced by digital mag-

RHG for IF Amplifiers

LOGARITHMIC IF AMPS

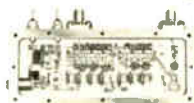

MATCHED IF AMPS



IC HYBRID IF AMPS



CATALOG IF AMPS



CUSTOM IF AMPS



LIMITING IF AMPS



LINEAR IF AMPS



LOW INTERMOD IF AMPS



Over the years the industry has come to depend upon RHG for a steady stream of innovations and improvements in its various product lines.

This year is no exception, and in the IF Amplifier line alone RHG is offering:

- A new line with "IF output only" at \$295.00
- A new line of Hybrid IC Lin & Log IF Amps
- A new line of constant phase shift limiters
- A new line of IC preamps in <1 cubic inch
- A new line of highly accurate & super stable log amps
- 33 new features/improvements/reduced prices

WRITE FOR DETAILED TECHNICAL DESCRIPTION AND LISTING OF STANDARD MODELS.

RHG

**RHG ELECTRONICS
LABORATORY · INC**

94 MILBAR BOULEVARD ■ FARMINGDALE
NEW YORK 11735 ■ (516) 694-3100 ■ TWX 510-224-6493

for Reliability, Innovation and Service

New products

netic-tape recorder-reproducers, modems, rf link equipment, bit synchronizers, and other transmission and storage devices. Clock slippage caused by synchronization circuits operating under adverse data conditions can also be measured. Internal bit rates are adjust-

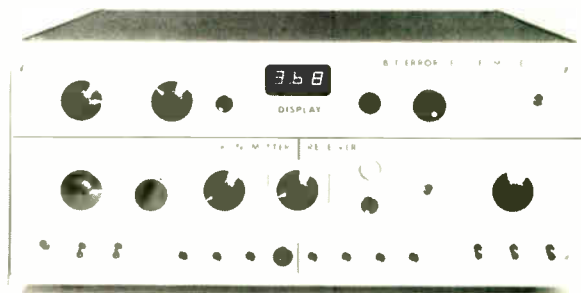

able from 1 bit per second to 5 megabits/s, or an external clock may be used for operation to 10 megabits/s. Price of the model 7191 is under \$3,000, and delivery time is 60 days. The tester is available in desktop and rack-mount versions.

Coded Communications Corp., P.O. Box 767, 533 Stevens Ave., Solana Beach, Calif. 92075 [359]

Rf current probes measure

from 1 kHz to 1 GHz

A series of rf current probes covers the range from 1 kHz to 1 GHz. The probes have a split, two-piece structure, enabling them to be clamped around a conductor. This eliminates the need to break the conductor to feed it through the probe window. Diameters of the windows range from a maximum of 4 inches to 3/4 inch. Available models have rf current ratings to 1 A, maximum power current to 350 A, and pulse current to 500 A.

Singer Instrumentation, 3211 S. La Cienega Blvd., Los Angeles, Calif. 90016 [360]



The Uncomputers.

An unabashed attempt to uncomplicate mathematics.



Until today, everybody who needed a computer to help with his job was faced with a far greater decision than a simple choice of hardware. He literally had to go back to school to learn a whole new language. Indeed a science. Just to be able to translate his job (which he knew well in the first place) into something computers and programmers could understand.

This is utter nonsense. So we decided to bring out a kind of computer that works from the job up instead of from computerese down. What follows is a glossary of the terms that guided us and can help you understand what the Uncomputers are all about.

Unlearn.

This is what you do with Fortran and Cobol and all the other ungainly languages you need for ordinary computers.

Uncomputerese.

This is the language we use. It's made up of algebra, trigonometry, basic arithmetic and common sense.

Unbudgeted.

When you bring out a computer everybody can use, you have to be sure everybody can afford it. Uncomputers are for sale for around \$3,000 and lease rates start at under \$20 a week.

Unlimited.

We didn't forget anything. With the Uncomputers over 4,000 steps of programming

and up to 522 complete arithmetic registers, symbolic logic, sub-routines, and capability for up to 22 simultaneous equations fit into a space no bigger than the corner of a desktop.

Unessential.

With the Uncomputers you don't need a lot of extra-cost extras either. The basic unit creates, debugs, and updates its own magnetic program cards. You will however be able to get a lot of pretty advanced peripherals if you really need them.

Uninformed.

If you have a computer everybody can use and everybody can afford, the next thing is to be sure everybody can get to see it at least. And try it at most. We went for most. Just call your local man from Monroe, and we'll let you try one in your office for a week free of charge and obligation.

Monroe.
The Calculator
Company.

The road to hell is paved with good intentions.



Rise/Fall Times from Ins; Propagation Delays as low as 800ps; CTL; Schottky TTL; ECL. Promises. Promises. High speed logic is full of them—idealized switching time specs, developed under ideal load and environmental conditions in the manufacturers' labs.

But in this not-so-perfect world, how will the devices perform when stressed to your particular circuit conditions? What happens to all your plans when a 2ns circuit slows down to 2.5 or 3.0ns? Let's face it, if those few hundred picoseconds didn't make a difference, you wouldn't have used those sophisticated high-speed devices in the first place.

Now you can test these critical parameters with the Time Machine, Fairchild Systems' revolutionary, on-the-spot Real Time add-on to our Sentry Test Systems. We characterize what you want to know about TTL, Schottky, CTL and ECL device switching time parameters. Automatically, with picosecond accuracy and repeatability that only a digital approach can guarantee while precisely simulating the actual device environment. Rise times, fall times, propagation delays, all in a single pass—with just one insertion—regardless of test complexity. Up to 100,000

times measurements per second...a fantastic improvement over anything else operational today.

And because the Time Machine is a Sentry add-on, you can perform functional, time parametric and D.C. parametric measurements all in a single test without moving from one test head to another.

Developed out of a decade of leadership in advanced semiconductor testing systems, the Time Machine uses our

own digital techniques for Real Time dynamic measurements. It's available integrated into factory shipments of new Sentry Systems—or retro-fit to existing systems in the field.

Today's super-fast designs have slammed shut the gap between optimum device capability and the demands your designs make on that capability. It's no longer academic whether or not logic delivers the tightest switching time specs touted in data sheets. You've got to make dead certain that every part is TIME-characterized within your circuit use conditions. Before all hell breaks loose.

FAIRCHILD Fairchild Systems
3500 Deer Creek Road
Palo Alto, California, 94302

Send us complete data and specs on the new Time Machine option for high speed logic testing.
 Include complete material on the Sentry series.
 Please have your rep call us for a personal fill-in.

Name _____
Title _____
Company _____
Street _____
City _____ State _____
Zip _____ Telephone _____

Fairchild Systems

Fairchild Systems Technology, a division of Fairchild Camera & Instrument Corporation

Subassemblies

Photoelectric units use LEDs

Complete line of controls built for high-ambient-light, other industrial conditions

One of the first complete lines of photoelectric controls using solid-state light sources has been introduced by General Electric Co.

The Mod-U-Ray line, with light-emitting diodes as light sources, complements the family of incandescent-lamp devices produced by GE. Use of the LED devices, which emit a modulated infrared beam, provides operation under wider voltage variations, extreme ambient light, and higher temperatures—from -25°F to 122°F for amplifiers and -50°F to 160°F for heads. Because there is no filament, the LED-based device can better withstand shock and vibration, and the range of controls has been doubled in some cases.

The new line includes two self-contained reflex controls, one with a 25-foot range, the other with a 60-foot range, and both available with plug-in options; a 400-foot-range transmitted-light control; micro-miniature heads with a range of four feet; miniature heads with a range of 60 feet; right-angle min-

iatures with a range of 36 feet; and two coaxial scanners with ranges of 20 and 40 feet. An amplifier designed for indoor or outdoor use is available for all heads.

Applications include area protection with invisible barriers of light, high-ambient-light locations, applications where lamp burnout cannot be tolerated, and conventional industrial tasks such as detecting, counting, flow control, and sorting.

General Electric Co., Drive Systems Product Dept., Waynesboro, Va. [383]

Analog divider features high untrimmed accuracy

Optimized for one-quadrant division, the model 4290 analog divider is specified for 0.5% maximum error, without external trimming, for a 100:1 range of denominator values from 100 millivolts to 10 volts. Drift is specified at $.02\%/^{\circ}\text{C}$. With external trimming, either the range can be extended to 1,000:1 without affecting accuracy, or accuracy can be improved to within 0.1% over the 100:1 range. Two-quadrant operation is possible with one added op amp. Small signal bandwidth is 100 kilohertz for a 10-v denominator, 50 kHz for a 0.1-v denominator. Price in 1-9 quantities is \$175.

Burr-Brown Research Corp. International Airport Industrial Park, Tucson, Ariz. 85706 [385].

A-d converters operate on system dc power

Designated the "Bare Bones" line, a series of analog-to-digital converters is designed to operate as system components, using the dc power supplies in radar, data-communications equipment and other systems. The eight models in the line offer 6-, 7-, and 8-bit resolution at a 10-megahertz encoding rate; 6-, 7-, 8-, and 9-bit resolution at 5 MHz; and 10-bit resolution at 3 MHz. Three input ranges are offered as no-cost options: 0 to 2.048 volts, -1.024 v to $+1.024\text{ v}$, and 0 to

-2.048 v . The units measure 7 by 8 by 9 inches.

Computer Labs Inc., 1109 S. Chapman St. Greensboro, N.C. 27403 [386]

Transistor-switching supplies offer 9 voltages

A series of transistor-switching power supplies offers nine commonly used voltage outputs. The 62600 series provides output ratings from 4 volts at 40 amperes to 28 v at 10.7 A. All units deliver full rated

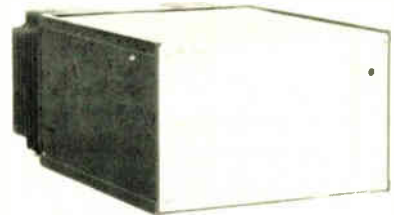

power up to 50°C with linear derating by 50% at 71°C . All models are specified to 0.1% line or load regulation, 20 mv rms, 60-mv peak-to-peak ripple and noise, and 3- μs transmit response following a halving or doubling of load. Price is \$395.

Hewlett-Packard Co., 1501 Page Mill Rd., Palo Alto, Calif. 94304 [384]

Cold-cathode flat display is compatible with MOS

A series of flat-panel cold-cathode displays is designated the CD-1201 Decapac. The 12-digit display features a cathode construction that eliminates gaps between the seven segments of the numerical display. A decimal point is provided in each

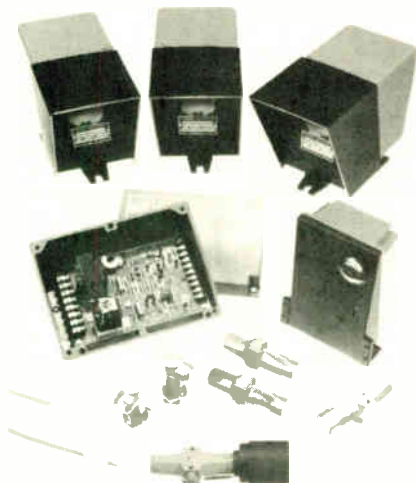
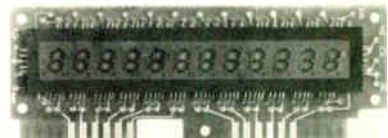

New products

digit position. The display, which is MOS-compatible, is also available in sample quantities in eight-digit and 20-digit versions. Units offering digits in virtually any multiple of four will also be available.

International Electronics Corp., Melville, N.Y. 11746 [387]

Three-digit liquid-crystal readout draws 10 μ A

Aimed at applications where power consumption must be low, a line of liquid-crystal displays includes a three-digit model that operates on 10 microamperes at 30 volts to 40 v and from 20 hertz to 10 kilohertz. The displays are driven by standard



C-MOS ICs that are available from several makers. The line also includes three-and-a-half-digit and four-digit models, with a decimal point between each digit. The price for the three-unit readout, as an evaluation model, is \$50. Discounts are available above 10,000 units. Delivery is from stock.

Radionics Laboratory Inc., Box 211, Kingston, N.J. 08528 [388]

LED and decoder/driver are separately replaceable

Based on a plug-in installation and maintenance approach, the L-100 series of readout assemblies allows rapid parts interchange and repair. One feature of the design is that the readout elements and the drivers are separately replaceable. They are mounted in dual in-line packages, and the entire assembly plugs into a printed-circuit-card edge connector, which serves as a supporting base and an electrical interface. Readouts are mounted on 0.6-inch centers, and the decoder/drivers take up the

Where to get Schmitt

Teledyne Semiconductor Distributors

Alabama:

Powell Electronics
Huntsville (205) 539-2731

Arizona:

Dalis Electronic Supply
Phoenix (602) 258-8151
Inland Electronic Supply
Tucson (602) 624-4402
Intermark Electronics
Tempe (602) 968-3484

California:

Bell Electronic Corp.
Menlo Park (415) 323-9431
Hollywood Radio
Hollywood (213) 466-3181
Intermark Electronics
San Carlos (415) 592-1641
Intermark Electronics
San Diego (714) 279-5200
Intermark Electronics
Santa Ana (714) 540-1322
Intermark Electronics
Van Nuys (213) 782-0362
Kierulff Electronics Co., Inc.
San Diego (714) 278-2112
Milo of California
Los Angeles (213) 478-9854
Milo of California
San Diego (714) 232-8951
Semiconductor Concepts
Woodland Hills (213) 884-4560
Wesco Electronics
Los Angeles (213) 685-9533
Wesco Electronics
Palo Alto (415) 968-3475
Westates Electronics Corp.
Chatsworth (213) 341-4411

Colorado:

Intermark Electronics
Denver (303) 936-8284
Kierulff Electronics Co., Inc.
Denver (303) 825-7033

Florida:

Cramer/E. W., Inc.
Hollywood (305) 923-8181
Cramer/E. W., Inc.
Orlando (305) 894-1511
Powell Gulf Electronics
Miami Springs (305) 885-8761
Powell Electronics
Orlando (305) 423-8586

Illinois:

Kierulff Electronics Co., Inc.
Rosemont (312) 678-8560
Lakeland
Elk Grove Village (312) 595-1000

Kansas:

Milo Connector Center
Kansas City (913) 287-2100

Maryland:

Arrow Electronics
Baltimore (301) 247-5200
Milgray Electronics, Inc.
Hyattsville (301) 864-1111
Pytronic Industries
Savage (301) 792-7000
Technico, Incorporated
Baltimore (301) 828-6416

Massachusetts:

DeMambro Electronics
Boston (617) 787-1200
Future Electronics Corp.
Framingham (617) 879-0860
Milgray Electronics
Burlington (617) 272-6800

Michigan:

Northland Electronics
Farmington (313) 477-3200

Minnesota:

Electro Com Corporation
Minneapolis (612) 788-8601
Industrial Components
Minneapolis (612) 927-9991

Missouri:

Hall-Mark Electronics Corp.
St. Louis (314) 521-3800

New Jersey:

Milgray Delaware Valley
Cherry Hill (609) 424-1300

New Mexico:

Century Electronics
Albuquerque (505) 265-7837
Kierulff Electronics Co., Inc.
Albuquerque (505) 247-1055

New York:

Lafayette Industrial Electronics
New Hyde Park, L.I. (516) 488-6600
Milgray Electronics
Freeport (516) 546-6000
Semiconductor Concepts
Hauppauge, L.I. (516) 273-1234
Summit Distributor, Inc.
Buffalo (716) 884-3450

Ohio:

Arrow Electronics
Cleveland (216) 464-2000
Arrow Electronics
Dayton (513) 253-9176
Electronic Marketing Corp.
Columbus (614) 299-4161
Milgray Electronics
Cleveland (216) 881-8800

Pennsylvania:

Arrow Electronics
Folcroft (215) 534-3200
Powell Electronics
Philadelphia (215) 724-1900

Texas:

Hall-Mark Electronics Corp.
Houston (713) 781-6100
Lenert Co., Inc.
Houston (713) 225-1465
Solid State Electronics
Dallas (214) 352-2601
Solid State Electronics
Houston (713) 785-5205

Washington:

Intermark Electronics
Seattle (206) 767-3160
Kierulff Electronics Co., Inc.
Seattle (206) 763-1550

Canada:

Future Electronics
Montreal, Quebec (514) 735-5775
R.A.E. Industrial Electronics Ltd.
Vancouver, B.C. (604) 687-2621

Schmitt, the name that made the trigger famous, now makes HiNIL universal.

Schmitt is Teledyne's new HiNIL 367, noise-proof line receiver. It's the new way to go for a universal input-port to logic blocks. In industrial applications, for example, most inputs are either a switch or a relay closure. They usually cause contact bounce. But the most amazing thing about the 367 is that it has a truth table that simply eliminates contact bounce by definition.

And by the way, the noise immunity of the 367 is more than enough to handle any long lines between the logic and input. It has a 5.0 volt worst-case noise immunity and an additional 2.5 volt dead-zone Schmitt Trigger margin.

Because the 367 is a Schmitt Trigger, it holds that 2.5 volt noise immunity even during logic transition. Slow-down

capacitors, as you all know, do not provide true noise immunity during switching. But, with the 367 in there, you can use those slow-down capacitors at the rate of 4msec/uFd and achieve a high guaranteed noise immunity too.

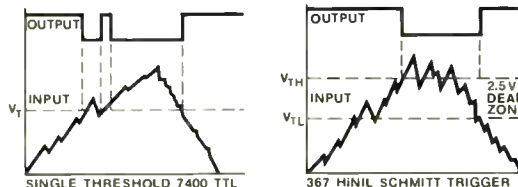

For fussy people, we put an inhibit pin on the 367 that allows information to be accepted only at times of low noise.

The new Quad Schmitt 367 is available now at \$2.98 in 100 up quantities. Order now or get in line.

the challenger

TELEDYNE SEMICONDUCTOR

1300 Terra Bella Avenue Mountain View, California 94040 (415) 968-9241 TWX: 910-379-6494 Telex: 34-8416

3½-digit DPMs:



**Ours.
Theirs.**



**When we talk about reliability,
we put our money where our mouth is.**

With a full one-year warranty!

At first glance, our Model 36 looks about the same as most other 3½-digit DPMs (it even fits in the same panel cutout as the AN2532). But that's where the similarity ends:

RELIABILITY: In plain language, ours works better and keeps on working longer than theirs. To back up this promise, our Model 36 comes with something you don't get with theirs: a *full service, one year warranty covering parts and labor!*

PRICE: Our Model 36 sells for less than \$100 in 100-piece quantities, and gives you a lot more for your money.

PERFORMANCE: Ours outperforms theirs. Check our Model 36 specs and features: 0.05% accuracy, 50 ppm/°C stability, 7-segment Sperry non-blinking planar display. Small size, 2.0" H x 3.5" W x 2.8" D. Lower power drain, less than 3.5 watts. Ultra-high input impedance, > 1000 megohms. Standard models include autopolarity, automatic blanking and programmable decimal point at no extra cost.

DELIVERY: Ours can be delivered to meet your production schedules. Why wait for theirs?

WANT MORE REASONS TO BUY OURS? That's easy—just drop us a line or give us a call.

GRALEX
INDUSTRIES

DIVISION OF GENERAL MICROWAVE CORP.
155 MARINE ST., FARMINGDALE, N. Y. • 516-694-3607

Circle 128 on reader service card

World Radio History

New products

same space on the rear of the board. Maximum height is less than 1½ in., and up to 18 digits are available in

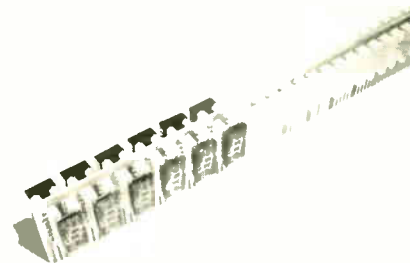

one continuous strip. Price is \$9.75 per digit in 1,000-digit quantities. Luminetics Corp., 1150 N.W. 70th St., Fort Lauderdale, Fla. 33309 [389]

Converter's output settling time is 25 nanoseconds

A digital-to-analog converter designated the DAC-GI 10 B provides an output settling time of 25 nanoseconds to within 0.1% of its final value. That speed allows an update word rate of 50 megahertz. Full-scale output is ±2.5 milliamperes with a maximum voltage compliance of ±1.2 volts. Input digital word length is 10 bits. Over-all accuracy is to within ±0.05% with a temperature coefficient of ±30 ppm/°C, and operating range is from 0°C to 70°C. Price of the unit, which contains input buffer logic, electronic switches, ladder network, and precision voltage reference source, is \$149.

Datel Systems Inc., 1020 Turnpike St., Canton, Mass. [390]



Electronics/December 4, 1972

It took us years to develop the best stereo microscope.

Now give us a few minutes to prove it.

Let us compare our StereoStar/ZOOM to any stereoscopic microscope in your lab.

Our microscope offers high resolution, larger fields of view, greater working distance. We have as wide a magnification range as you're likely to need: a full 6 to 1 zoom range with magnifications from 3.5 X through 210 X. The zoom control knob is coupled—so that it's conveniently located on both sides, for either left or right-hand operation. And the entire head is easily rotatable through 360°.

135 years of optical excellence went into the AO StereoStar/ZOOM. Let us compare it to any stereo microscope in your lab. After all, if it's worth your money, it's worth your time.

Call your AO Representative. Or write for our convincing 24-page brochure.



**AMERICAN OPTICAL
CORPORATION**

SCIENTIFIC INSTRUMENT DIVISION • BUFFALO, N. Y. 14215

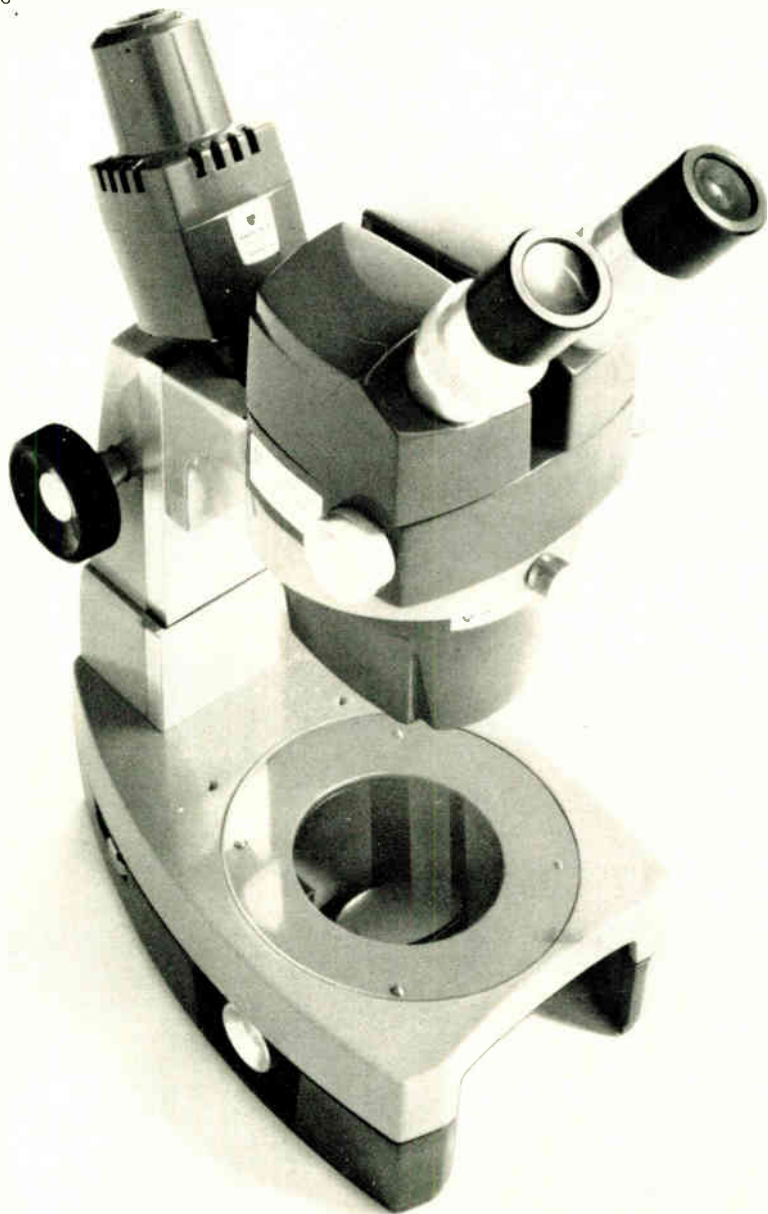

Semiconductors

LEDs aimed at consumer jobs

Two-color lamps designed as condition indicators in autos, audio gear, planes

In many consumer applications, including autos and audio gear, the analog panel meter has been replaced by an "idiot lamp." But while the lamp can indicate a faulty condition, it can't indicate a changing condition or, for that matter, from which direction a change is taking place. A new type of lamp from Monsanto solves this problem.

Basically, the lamp consists of two light-emitting-diode chips inverted in parallel in a single clear diffused-epoxy header. Different color combinations of red, green, and yellow chips may be ordered. With two red chips, such as the model MV 5094, the lamp will operate on ac or dc. But with one green, such as the model MV 5491, added to the red, the color of the display depends on the net direction of current through the device. If a dc signal flows in one direction, the red lamp lights up. If the current is equal from both directions (a net of zero) all lamps will remain unlit; and if the flow is in the other direction, the green lamp is lit.

At forward current of 20 milliamperes, the red-emitting chip has a brightness of about 1.5 millicandelas; the green and yellow, 0.5 millicandela. In an application where brightness must be matched, lamps can be operated at 20 mA in both directions. Several diodes can be added in series to accomplish the match.

In a car, the single lamp could be used as a battery charge/discharge indicator, and it would provide considerably more information than the present red warning light. In audio equipment, the two-color LED lamp could be employed as a tuning indicator. In aircraft, another property

of the two-color lamp could be employed—a third state. A single two-color LED is either red or green, depending on the direction of current flow, but if an ac signal is applied, the display looks like two light sources, red and green, placed side-by-side in one package.

The two-color lamps are available in all combinations of red, green, and yellow. In quantities of 1,000, the red/red is priced at 99 cents.

Monsanto Commercial Products Co., Electronic Special Products Division, 10131 Bubb Rd., Cupertino, Calif. 95014 [411]

1,024-bit RAM provides 45-nanosecond access time

Expanding its family of memories made with the Isoplanar process, Fairchild is marketing an emitter-coupled-logic 1,024-bit random-access memory that offers an access time of 45 nanoseconds. The fully decoded high-speed memory, designated the 95415, is available in evaluation quantities. Earlier Isoplanar products, including the 93410, a transistor-transistor-logic 256-bit RAM, and the 95410, an ECL 256-bit RAM, are now available in production quantities.

The 95415, organized as 1,024 words by 1 bit, can be used with Fairchild's ECL 95K series and ECL 10K series circuits, allowing construction of large memories that operate at the same speed as their associated logic circuitry. The 95415, which dissipates 0.5 mw per bit, is designed for use in high-speed buffer, controller, and main storage elements or in add-on memory units. It is priced at \$109 each for 1 to 24, \$100 each for 25 to 99.

Fairchild Camera and Instrument Corp., Semiconductor Components Group, 464 Ellis St., Mountain View, Calif. 94040 [412]

One-chip MOS clock circuit is microprogrammable

A one-chip programable MOS clock circuit is designed for a variety of time-keeping operations. The model

MK 5017 P has several read-only memories that can be programed through the gate mask for applications including household clocks, industrial timers, and elapsed-time indicators. Features include a four- or six-digit display, and circuitry that will drive luminescent-anode seven-segment display tubes directly, eliminating the need for driver transistors. Either 50- or 60-hertz frequencies from standard power lines may be used, or crystal control from the company's univer-

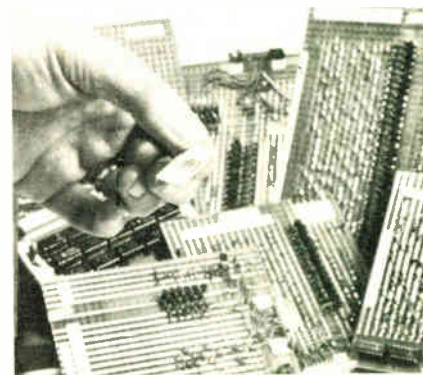

sal time-base circuit. The circuit includes 24-hour alarm with immediate reset. Alarm tone is generated on-chip. Price is \$10 in quantities.

Mostek Corp., 1215 West Crosby Rd., Carrollton, Texas 75006 [413]

Low-priced generator chip produces five waveforms

Depending on the package-pin selected, a low-cost monolithic generator circuit can supply a sine, square, triangular, sawtooth, or pulse waveform output. External timing networks determine the circuit's operating frequency, which can range from less than 0.001 hertz to more than 1 megahertz. Outboarded resistors can also vary the duty cycle of the pulse output. Frequency modulation and sweeping can be accomplished by an external voltage, and the frequency can be programed digitally through external RC networks. The model 8038 is available in both commercial and military versions, with a maximum temperature drift of either 50 or

This filter contact



eliminates electromagnetic pollution.

Amphenol has met the challenge of placing fragile components—ceramic and ferrite—in the rugged mechanical environment of an electrical connector. And we've done it without disturbing the electrical and mechanical integrity of the individual components.

Our stress-isolated filter contact eliminates the possibility of failure due to vibration, physical abuse and thermo/transient shock.

The proof is in its five-year record on many major military and industrial programs.

We'd like to discuss your specific filter connector requirements and show you how this filter contact can help eliminate electromagnetic pollution.

Send for our new catalog which tells much more. Circle the reader service card. Or call your local Amphenol salesman. Amphenol Sales Division, 2875 S. 25th Avenue, Broadview, Illinois 60153.

Send for this catalog!



AMPHENOL

Circle 131 on reader service card

Finally!
A filter so precise,
filter characteristics
for every setting
are printed
on top.

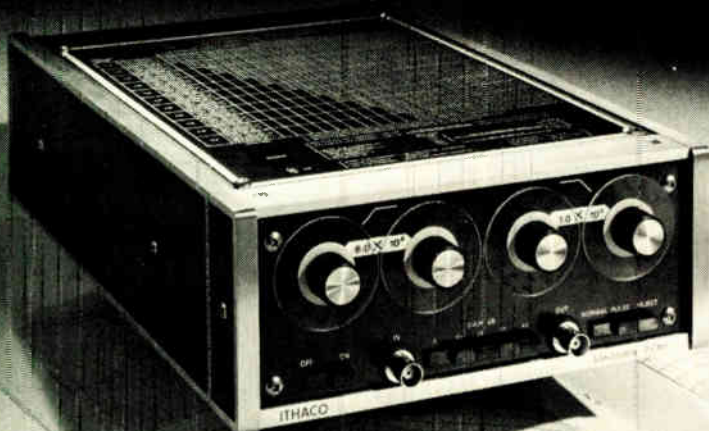

We've built a variable electronic filter that's so precise, it has enabled us to print the cutoff frequencies, center frequency, bandwidth, noise bandwidth and filter gain, for every setting, *on top of the instrument*. Besides being the easiest-to-use filters on the market, our 4200 series filters are twice as accurate, have less than half the self-noise, and provide 10 dB greater outband rejection than any other filters. Frequency coverage is .01 Hz to 1 MHz. Built-in selectable post-filter gain and remote preamplifiers are optional. A Butterworth response is used in the NORMAL mode and a Bessel response in the PULSE mode (transient response is superior to conventional "RC" or "Low Q" modes of other filters).

The price? \$695.

For complete specifications and your free copies of our variable electronic filter application notes, write to: Ithaco, Inc., Box 818-7R, Ithaca, New York 14850. For immediate response, call Don Chandler at 607-272-7640 or TWX 510-255-9307.

ITHACO

New products

100 ppm/°C. Price ranges from \$2.50 to \$18 for 100 pieces, and delivery is from stock.

Intersil Inc., 10900 N. Tantau Ave., Cupertino, Calif. 95014 [414]

MOS LSI circuit set
 is designed for calculators

An MOS LSI calculator-circuit set is complex enough for business applications and is inexpensive enough (\$32.50 each in 100-lots) to be used in consumer units. The calculating logic, the clock, and much of the interface circuitry of a 12-digit, four-

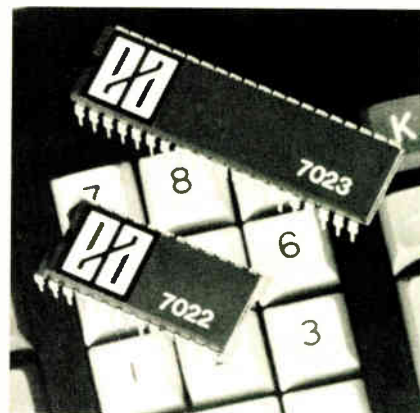

function calculator with memory are included in two MOS circuits: the 7022 in a 28-lead DIP and the 7023 in a 40-lead DIP. The two packages, which make up the S-129 set, contain an arithmetic-algebraic processor with 12-digit entry and display capacity, accumulator memory, keyboard-scanning and display-logic control, internal clock generator, and power-on clearing circuitry. Delivery is from stock.

Electronic Arrays Inc., 501 Ellis St., Mt. View, Calif. 94040 [415]

Light-emitting diodes
 fit incandescent sockets

A series of light-emitting-diode lamps can be interchanged with incandescent lamps, specifically T-1 and T-1¼ types. No circuit or receptacle changes are required. This is made possible by incorporating re-

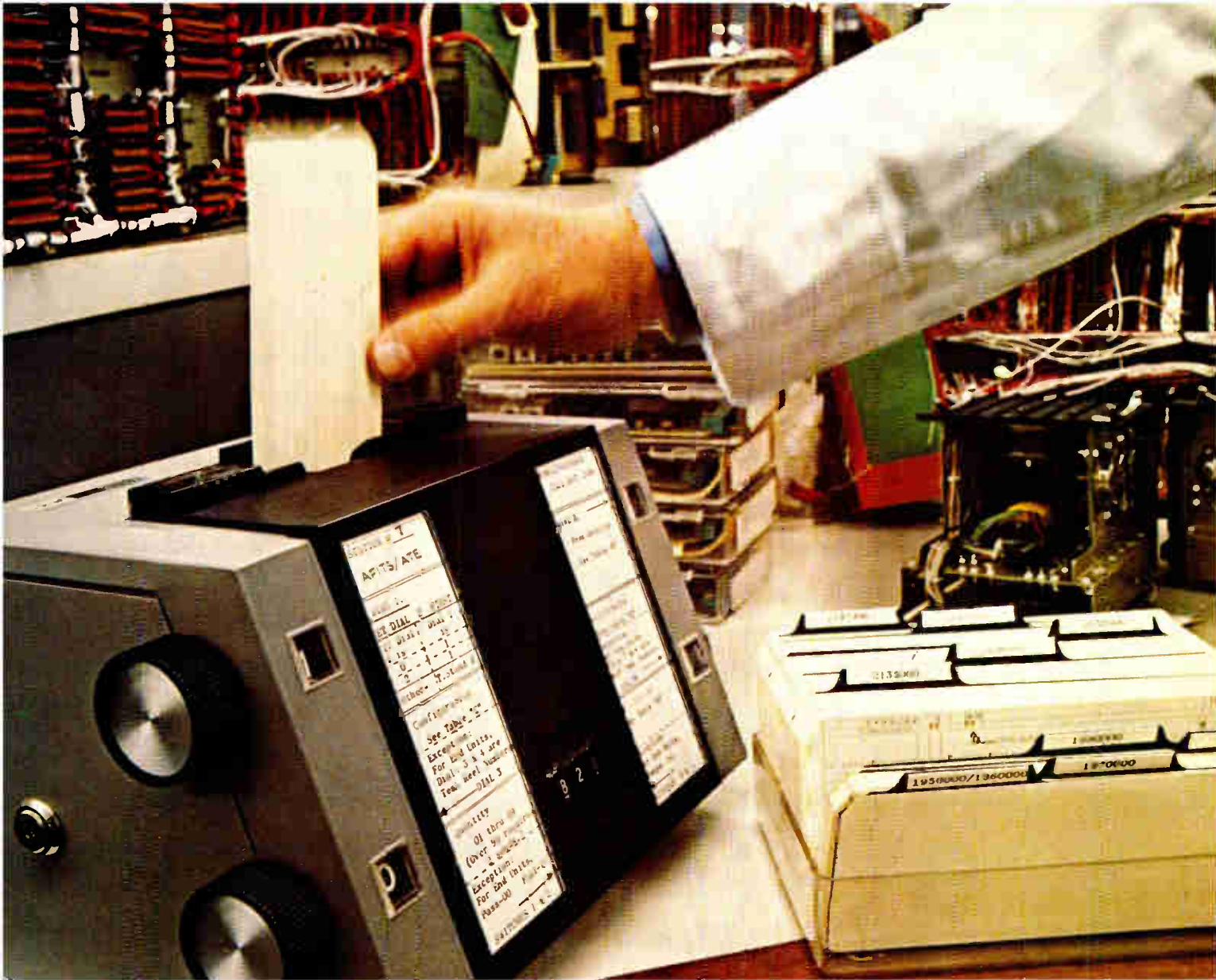

IBM System/7 installed at Bendix to speed production reporting.

Until recently, production control reporting at a Bendix Corporation plant at Teterboro, N.J. was a 4-day process. It took that long to ascertain the status of some 10,000 electronic subassemblies moving through the shop.

Now, with the use of an IBM System/7 computer, a complete report on all of the previous day's activities is ready at the start of each working day. This simplifies and streamlines the flow of materials and the assignment of job priorities.

The plant, part of the Navigation and Control Division of Bendix, produces components used in the PB-100 Flight Guidance System which Bendix manufactures for the McDonnell Douglas DC-10 aircraft.

All changes in location and status of

the subassemblies are entered at fourteen IBM 2796 Data Entry Units on the shop floor. The units are controlled by the System/7, which edits the data input for accuracy. The data is then transmitted to an IBM System/370 Model 155 at a nearby Bendix plant, which updates production records and compares actual performance with planned schedules. Items not following schedules are singled out for immediate attention and corrective action.

Full information on the System/7 is available through your IBM representative or local office. Or write IBM Data Processing Division, Department 807-E, 1133 Westchester Ave., White Plains, N.Y. 10604.

IBM



World Radio History

Miniature switches from Raytheon?

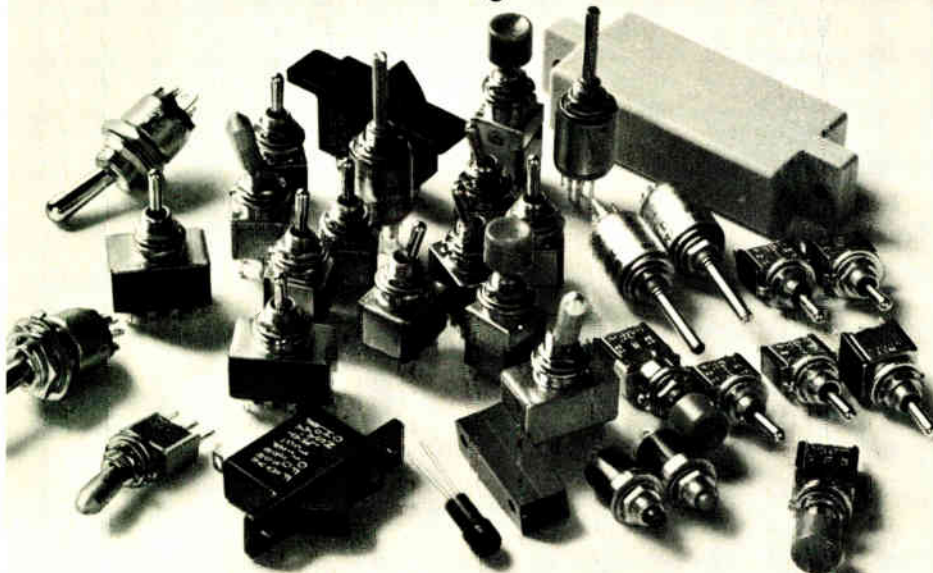

Now that's a switch.

When Raytheon creates a brand new line of miniature panel switches and lights, you can be sure of high quality. But there's more. Our new Rayswitch line includes all the popular rotary, toggle, push-button, proximity and rocker type designs.

There's a Raytheon switch perfect for your panel, whether the application is anything from advanced test equipment to computer peripherals. So next application, switch to Rayswitch. Just call your Raytheon representative. For a copy of our catalogue, write Raytheon Company, Distributor Products Operation, Fourth Avenue, Burlington, Mass. 01803.

RAYTHEON

New products

sisters within the lamp body. Resistor type may be specified within limits, enabling the circuit engineer to provide the proper device current

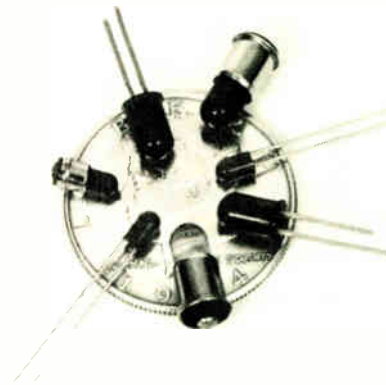

for a given circuit voltage. A variety of bases and lens colors is available. Lamps Inc., 19220 S. Normandie Ave., Torrance, Calif. 90502 [416]

PROMs let microcomputer assemble programs for itself

A set of four PROMs, which enables an MCS-4 microcomputer prototype to assemble programs for itself, plugs into the prototyping board and performs all the functions of a Fortran IV assembler, eliminating the need for a general-purpose computer. The units translate symbolic assembly language

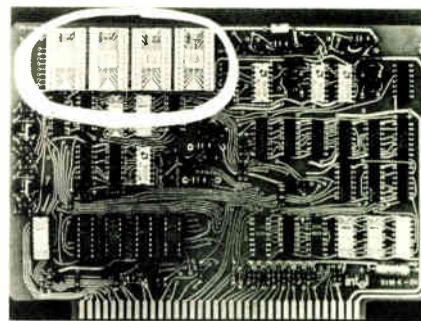

into bit patterns suitable for entry into the microcomputer-control PROMs. The assembler accepts input source text from a teletypewriter on each of two required passes. On the first pass, a name table and source listing are created. On the second pass, the source text is reread, and teletypewriter punched tape is generated for programing the control

Circle 134 on reader service card

SPEED YOUR HOLIDAY MAIL



What the industry taught us about minicomputer software.

You name it, we got it.

You can't get no for an answer.

Ask for any software package these days and everybody claims to have it. What they really mean is they may have something they can adapt or piece together or disguise or — most likely — start working on fast.

And next year sometime

Free for the asking.

The biggest come-on of all. Not only do they claim to have all this wonderful software, but they're willing to give it away.

Problem is, what they're willing to give you for nothing is probably priced just about right. And by the time you add development costs for about 7K words at \$15 a word — just to make it work — it's anything but free.



Introducing the Interdata family of Operating Systems.

Here's a whole family of minicomputer software packages that's different.

The Interdata RTOS, for example, is the most comprehensive minicomputer Real-Time Operating System available today. It has a dynamic core allocation system with 16 priority levels, supports a full range of peripherals and is field-proven.

Our RTEXX is a multi-programming real-time executive system which gives you high throughput with low overhead. DOS is particularly easy to use for program development, supports file handling on a disc and can operate in either batch or interactive mode. BOSS is perfectly matched to small systems, and supports many devices such as disc, tape or cassette.

And there's plenty of basic software as well as high level language programs such as Interactive FORTRAN and FORTRAN IV. They've all been proved on the Interdata New Series family of minicomputers. They all can be expanded or modified to match your configuration. And they're all backed by the Interdata warranty to make sure you're satisfied.

What you need is what you get.
And that's what's
so different.

INTERDATA

2 Crescent Place, Oceanport, New Jersey 07757. (201) 229-4040. Boston — (617) 890-0557.
Chicago — (312) 437-5120. Dallas — (214) 238-9656. Denver — (303) 758-0474. Detroit —
(313) 356-5515. Houston — (713) 783-1830. Los Angeles — (213) 640-0451. Palo Alto —
(415) 969-1180. Washington — (703) 525-4806. Toronto — (416) 678-1500. United Kingdom —
Uxbridge 52441. Sydney — NSW 439-4155. West Germany — 0811/160031. Tokyo — 270-7711.



Circle 135 on reader service card



Rx
*Cassette Fixes
Relief*

Avoid distress by specifying computer-grade heads for your cassette drive. HDC cassette heads are designed and manufactured to the same high standards as their industry-endorsed big brothers. With cassette heads, as with all HDC heads, we have seen no reason to compromise. Remember, HDC is the pioneer of shieldless heads.

**COMPUTER GRADE
DUAL GAP
WRITE/READ
NO EXTERNAL
CROSSFEED
SHIELD
DUAL OR
SINGLE TRACK**



HAMILTON DIGITAL CONTROLS, inc.
2118 Beechgrove Place, Utica, N.Y. 13501

New products

PROMs. Price is \$365 for the set of four.

Intel Corp., 3065 Bowers Ave., Santa Clara, Calif. [419]

Display driver delivers
breakdown voltage of 160 V

Breakdown voltages of 160 v are provided by the model monoDRV-01 high voltage display driver. The device is designed to drive the cathode segments of such high-voltage

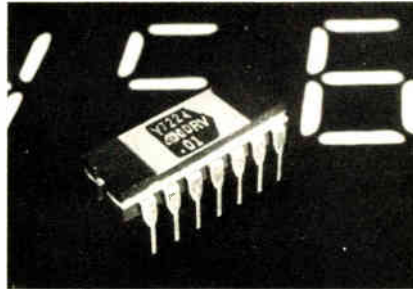

gas-discharge displays as Panaplex and Sperry numerical devices. Input levels are compatible with MOS logic, and circuitry is provided for dc restoration when used in ac-coupled multiplexed operation. Price for quantities of 1 to 24 is \$3.95; for 25 to 99, it is \$3.35.

Precision Monolithics Inc., 1500 Space Park Dr., Santa Clara, Calif. 95050 [418]

Digital clock is built
on a single MOS chip

A complete digital clock on a single chip is called the MM5314 series. The chip contains the counting, decoding and multiplexing circuitry required for a four- or six-digit clock, and it operates from an 11- to 19-volt supply. P-channel enhancement-mode low-threshold process is used, and operation is from a half-wave-rectified 50- or 60-hertz input, which is then shaped and divided by either 50 or 60. Three other counter stages complete the division to 12 or 24 hours. Price ranges from \$14.25 to \$16.50 in 100-lots, depending on packaging.

National Semiconductor Corp., 2900 Semiconductor Dr., Santa Clara, Calif. 95051



**OUTSTANDING
THERMAL ENDURANCE
RUNS IN THIS FAMILY:**

**ELECTRICAL
TEMP-R-TAPE
OF KAPTON.**

Temp-R-Tape® of Kapton* is now available in a complete "family" of tapes—all offering outstanding thermal endurance, retaining their excellent mechanical and electrical properties over an operating range from -100F to +500F. Available in thicknesses from .001 to .0045" with electric strengths up to 10,000 volts... with a choice of pressure-sensitive silicone adhesive on one or both sides, or thermosetting acrylic adhesive, or a flame retardant adhesive... and in ¼", ½", ¾", 1", 1½", and 2" widths, with special widths slit to order.

Find your CHR distributor in the Yellow Pages under "Tapes, Industrial" or in industrial directories. Or write for details and sample. The Connecticut Hard Rubber Company, New Haven, Connecticut 06509.

CHR

a HITCO company



*T.M. of DuPont

"SOMETIMES WE NEED ONE PRINT, SOMETIMES 5000."



**Call in Kodak.
We've got the answers.**

From the smallest, single-detail revision to vast orders requiring thousands of prints of one drawing, Kodak's photoreproduction methods can help get the job done for you faster, and at lower cost.

Whether your drawings are full size or on microfilm, whether you use diazo or offset, we'll show you how to make your distribution prints the easy way. With Kodak's help.

We'll even send a Kodak sales representative to help you choose the best plan for your particular needs.

To set the wheels in motion, just mail in the coupon. We'll take it from there.

Please send me complete details on Kodak's many procedures for drawing reproduction.

Name _____

Position _____

Company _____

Address _____

City _____ State _____ Zip _____

Eastman Kodak Company
Business Systems Markets Division
Dept. DP898, Rochester, N. Y. 14650

**ENGINEERING DATA
SYSTEMS**



Carpenter uniformity lets you control your controlled-expansion alloys. Which is the way it should be.

First, you get greater control of your product by having a wider range of alloys to select from. Low expansion. High expansion. Glass and ceramic sealing—including Carpenter's exclusive Kovar®.

Next, you control fabrication costs. Each of these Carpenter alloys has been made specifically to provide optimum (and we mean optimum) fabricating qualities for a single process: stamping, deep drawing, or photo-etching . . . you tell us which one you use.

Finally, and most important, you get to keep control over your Carpenter controlled-expansion alloys, order after order. Because we use all *our* control and technology to make them consistently uniform time after time. And uniformity is a Carpenter tradition.

Let Carpenter uniformity put you in control . . . for consistent trouble-free production and lower fabricating costs. Just call your nearest Carpenter Service Center, today. They're in the yellow pages. Or, write Carpenter Steel Division, Carpenter Technology Corporation, Reading, Pa. 19603. *European Office: Emmastraat 38, Amsterdam-Z, The Netherlands.*

CARTECH CARPENTER
TECHNOLOGY
CARPENTER STEEL DIVISION

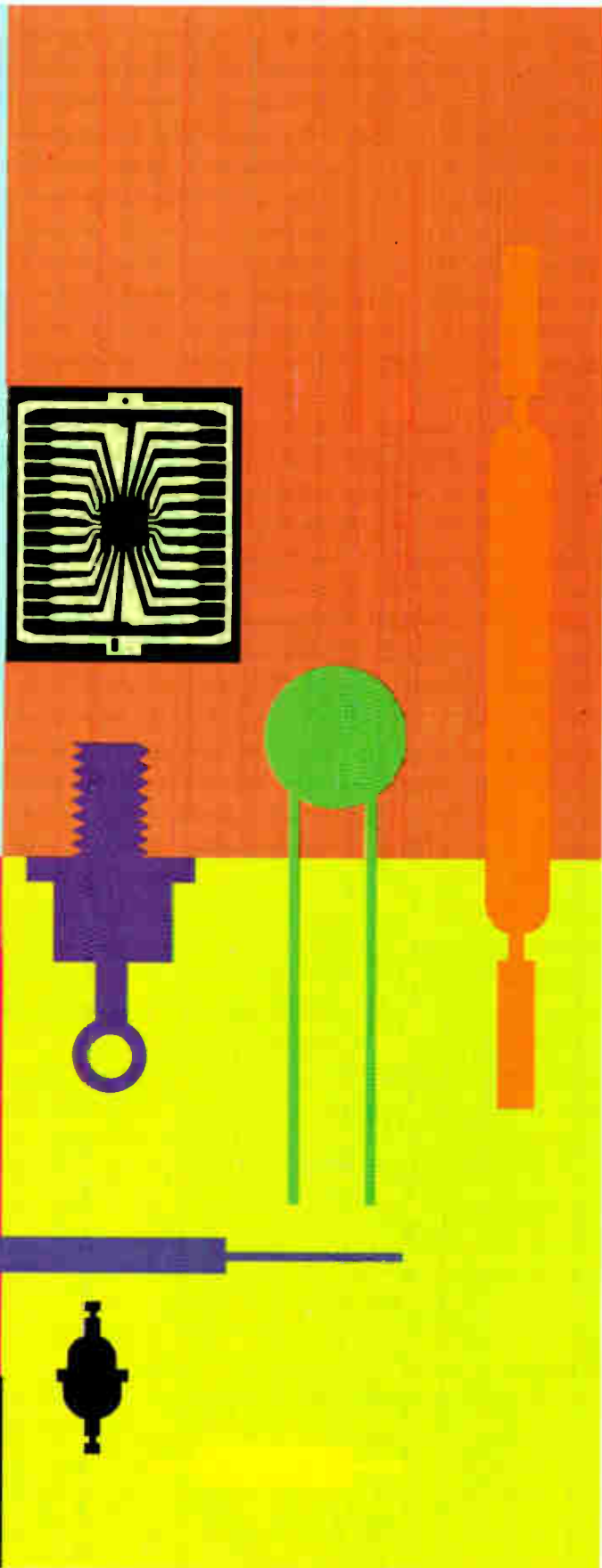

Packaging & production

Interconnections reduced by half

On 2-layer board, pressfit back-panel system gets double duty from wire-wrap

Connectors are easier to design with these days because many of the new entries offer the user the convenience of standard units with the features of a custom line. Belonging to this new breed, Elco's pressfit back-panel connecting system promises to reduce costs significantly by slashing the number of wire-wrapped interconnections by 50% to 75%. Elco is introducing at the same time a novel three-dimensional multi-tier card-edge connector that doubles contact density for a fixed area.

The new pressfit connecting system is literally based on the square peg in a round hole. Square contact posts that are suitable for wire-wrapping are pressed into round plated-through holes in either a single- or multi-layer board. The pressfit provides ample mechanical support, and each post makes electrical contact with only the desired board plane. Soldering is unnecessary.

With the pressfit system, the same board can be used to carry either power and ground planes or a number of different supply voltages. Earlier systems required separate boards because each contact post had to be soldered to its plated-through hole. Moreover, the pressfit system allows changes and additions to be easily implemented.

Once the posts are installed, insulated connector housings are placed over them so that the final assemblies appear to be conventional wire-wrap card-edge connectors. These modular insulated housings are provided for any number of even contacts. The new system is available for immediate installation. Cost is typically 5 to 7 cents per con-

tact, depending on the number of board layers and the number of plated-through holes.

The other new card-edge connector, the multi-tier design for hybrid microelectronic packaging, increases contact density by giving height to a second level of contacts. The first unit employing this concept has 80 contacts on a 0.3-inch grid by 2-in. length; contact spacing is 0.025 in.

The two main levels in the receptacle use short and long (lower and upper) contacts. In each level, adjacent contacts are 0.1 in. apart, one row at each side, with the rows and levels being offset by 0.05 in. The contact tails are in four offset rows, with a spacing of 0.075 in. between rows and 0.1 in. between contacts.

The multi-tier contact will be released by January.

Elco Corp., Willow Grove Div., Willow Grove, Pa. 19090 [391]

Leadless IC receptacle uses base-metal contacts

It performs as well as gold-plated versions, says Burndy Corporation of a leadless integrated-circuit receptacle that employs tin contacts. Unlike conventional pin-type receptacles, the new unit, called Hypoint, uses chisel-pointed contacts that penetrate the solder pads on the substrate, making a gas-tight connection.

Leonard H. Feldberg of Burndy's Advanced Development division, says that the contact force of 175 grams minimum that is developed in the receptacle insures a gas-tight, low-resistance contact of 2 milliohms or better. "The technique is a carryover from wrapping wire around posts," he adds. "We examined the wire-to-post contact and learned that high force would insure that the brittle oxide formed on the tin would crack, separate, and enable fresh metal to establish a re-

liable, low-resistance connection."

Burndy says that the IC package can be removed and replaced 40 times or more without appreciable loss in contact resistance. A test probe can reach each contact at the side of the package for troubleshooting purposes.

The receptacle is available in 24-, 28-, and 40-contact versions.

Burndy Corp., Norwalk, Conn. 06852 [392]

DIP strips accommodate jumbo IC packages

A family of dual in-line strip connectors, to be used in pairs, provides sockets for 24-, 28-, and 40-lead packages recently introduced by semiconductor manufacturers. Contact spacings are on 0.100-in. cen-

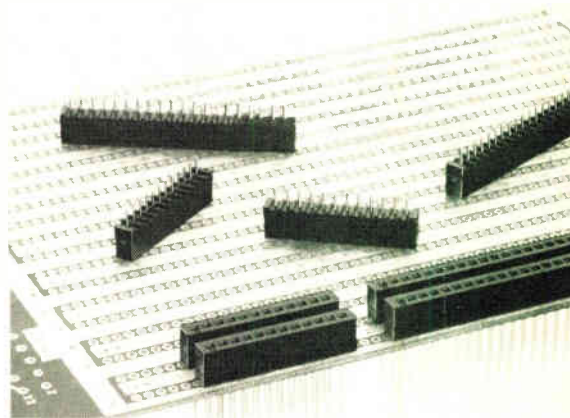

ters, and strip pairs are positioned according to package width. The 2300 and 3000 series have wire-wrapped and DIP solder leads respectively, and both series have phosphor bronze contacts plated with gold or bright tin. Price in 1,000-lots ranges from 35 cents to 40 cents.

Stanford Applied Engineering Inc., Advanced Packaging, 2165 S. Grand Ave., Santa Ana, Calif. 92705 [393]

Circuit board serves also as heat dissipator

Developed for power supplies used in plating rectifiers, welders, computer equipment, and other appli-

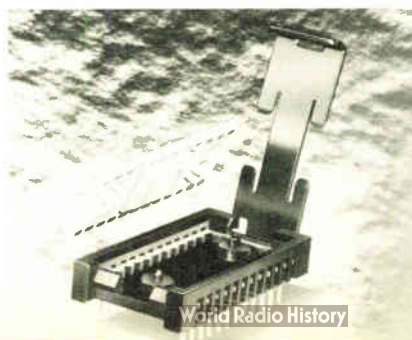

A new read/write memory system with ROM capability— by TOKO

Let TOKO bridge the gap between law-performance 0.5 penny per bit memory and 3 pennies per bit memory. TOKO's new NDRO memory system, HS-600E, offers high performance—300NS access time and 600NS cycle time—and electrically alterable ROM capability. TOKO's plated wire memories, assure simplified computer architecture.

Basic module size:

- 4K word by 9 bits
- 4K word by 18 bits
- 8K word by 9 bits
- 8K word by 18 bits

8K x 18 configuration consists of five plug-in boards: two memory stack boards, two bit electronics boards and one word electronics and control board. Each board 13" x 8.7" in size.

Various memory systems, stacks, pulse transformers, and delay lines are also available.

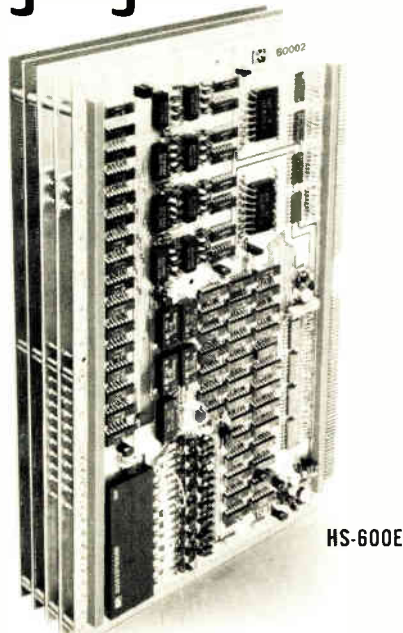

Head Office: 1-17-1 chome, Higashi Yuki-ya, Ohta-ku, Tokyo, Japan
 New York: Toko New York Inc. 350 117th Avenue, New York, N.Y. 10001 U.S.A. Tel: 565-3767 Los Angeles: Toko, Inc. Los Angeles
 Liaison Office: 1830 West Olympic Blvd., Los Angeles, 90006 U.S.A. Tel: 330-0417 (Telex) Toko Elektronik GmbH: D-85310 D-1
 Konstanz 72 A.C. Fran. Tel: 11 284111



For further information, just call or write:

TOKO, INC.

Circle 140 on reader service card

New products

ations, a new printed-circuit board is also heat dissipator and structural member. The single-sided metal-core circuit board is made possible by a coating called Insultek which has high dielectric strength and high electrical surface resistance and at the same time displays high thermal conductivity.

Insultek is applied to one side of an aluminum substrate that has an epoxy layer with copper foil overlay laminated to its opposite side. The foil receives a photoresist image and the circuit is then etched. The components are mounted to the back of the board, with leads extending through the insulated holes to the circuit side, putting the components in intimate contact with the Insultek finish.

International Electronic Research Corp., 135 West Magnolia Blvd., Burbank, Calif. [341]

Packaging system for ECL has third voltage plane

Designed for emitter-coupled logic, a high-density packaging system offers a third voltage plane, in addition to the ground and V_{CC} planes. The added plane allows the boards to control impedance of transmission paths while maintaining maximum logic power efficiency. This is accomplished by terminating long lines with a resistive load equal to the characteristic impedance of the lines—to the -2.0-volt plane. The series, designated 8136-ECL1, is available in multiples of 30 DIP patterns up to 180 patterns. Price for a 30-pattern panel ranges from \$40 to

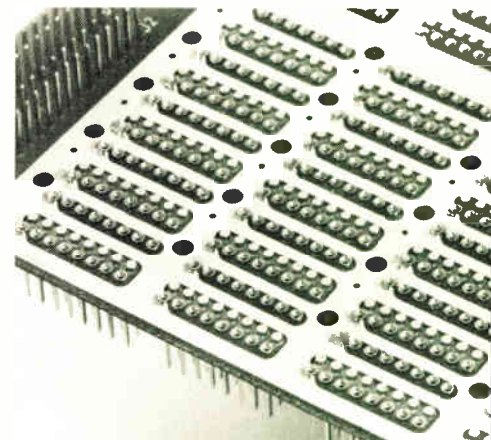

30 A & 40 A Electrically Isolated TRIACS

- 50V to 600V (V_{DROM})
- 30A & 40A ($I_{T(RMS)}$)
- Center-gate geometry has improved critical & commutating dv/dt rating and di/dt characteristics.
- Void-free glass passivated Di-Mesa chip construction for maximum operational reliability.
- Improved package is hermetically sealed; has extra heavy leads extending to end of header terminals, Molybdenum on both sides of chip for MT1 current spreader and to relieve shear forces between chip and substrate for improved thermal characteristics.



WRITE FOR FREE CATALOG



HUTSON INDUSTRIES

BOX 34235 • 2019 W. VALLEY VIEW, DALLAS, TEX. 75234 (214) 241-3511 TWX 910-860-5537

Distributed by:

ALTA-LAND ELECTRONICS, INC., Salt Lake City, Utah. 801/486-7727 ■ BODELLE CO., INC., Chicago, Ill. 312/468-1016. Detroit, Mi. 313/273-6920 ■ THOR ELECTRONICS, Elizabeth, N. J., 201/354-2420 ■ In Canada: WEBER-SEMAD ELECTRONICS, Downsview, Ont. 416/635-9880.

Vice-President, European Operations:

30 Rue Pierre Semard, Yerres, 91 France Tel: Paris 925-8258 • TELEX 21-311

Distributed in Europe by:

Belgium: C. N. ROOD S.A. Brussels 02-352135 ■ Denmark: E. V. JOHANSEN A/S, Copenhagen (01)* 295622
 ■ Holland: RODELCO, Den Haag 647808 ■ Norway: EINTLCO, Oslo ■ Spain: BELPORT, Madrid 234.62.62
 ■ Sweden: ELEKTROFLEX, Sundbyerg 08-29 50 40 ■ Switzerland: D. LEITGEB, Dubendorf 051 85 2201 ■ UK, CLAUDE LYONS, LTD, Hoddeston, Hertfordshire (09924) 67161

140 Circle 166 on reader service card

Electronics/December 4, 1972

Raytheon plus Telefunken.

A whole new world of quality CRT's.

In the past, you've had a pretty slim choice in high quality CRT's from any single source. Now things are different. You can order any Telefunken CRT directly from Raytheon. In fact, considering Raytheon and Telefunken together, there is no broader line of high quality CRT's available.

This is a great marriage of U.S. and European technology. The outstanding Telefunken line plus the equally outstanding Raytheon line. Both sold and serviced exclusively by Raytheon's nationwide support organization.

The total Telefunken electrostatic deflection CRT line is available, every size and shape. You can now get the very best performance —



brightness, deflection sensitivity, post-deflection magnification, spot size, resolution — in very flat faced CRT's. You can also get a full line of accessories such as shields, sockets, anode caps, special graticules and a complete range of phosphors.

Samples can be delivered immediately, and you can expect rapid turnaround on production orders.

Commercial and military instrumentation, medical electronics, or whatever your field — Raytheon has the CRT's. For further information, specifications or applications assistance write or call us today. Raytheon Company, Industrial Components Operation, 465 Centre Street, Quincy, Massachusetts 02169. Telephone (617) 479-5300.

RAYTHEON

Circle 141 on reader service card

api PYROMETERS:

Quality comes in a wide choice

Quality: full cold junction and copper error compensation for 2% standard accuracy, 1% optional; mirror scales on most models.

Choices: analog: eight sizes from 2¼" to 6"; panel, bezel and lens mounting; contemporary styling with 5 case colors; rectangular, edgewise and portable case models; special ranges. Digital indicators with thermocouple and RTD inputs.

Performance: backed by 25 years of application experience, plus complete line of companion thermocouples, probes and accessories.

Fast delivery from your distributor: write for bulletins or phone (617) 890-2000. LFE Corporation, 1601 Trapelo Road, Waltham, Massachusetts 02154.



Process Control Division

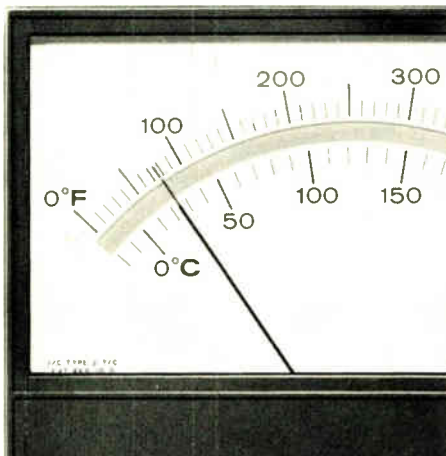
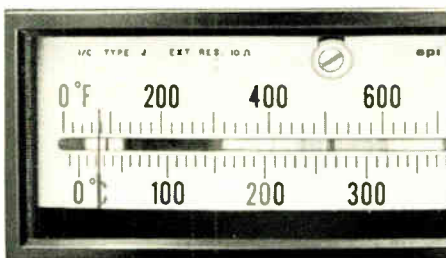

Circle 142 on reader service card

Introducing the expensive dual-trace scope that doesn't cost a lot.

The B&K Precision Model 1470.

The compact 5-inch solid-state 1470 is specially designed to meet 80% of all industrial scope applications.

It has DC to 10 MHz bandwidth with 10 mV/cm sensitivity. Sixteen triggered-sweep speeds range from 1 μsec/cm to 0.2 sec/cm. Triggers on input signals as low as 5mV.

Sound good? Our prices become even more remarkable once you see our specs.

Call your B&K distributor. Or write Dynascan Corporation.

In stock at your parts distributor.



Product of
Dynascan Corporation
1801 West Belle Plaine Avenue, Chicago, Illinois 60613

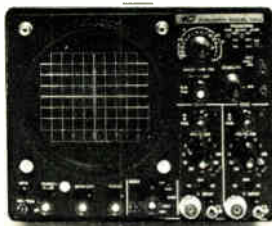

\$499⁹⁵

142 Circle 200 on reader service card

New products

\$80 depending on style and quantity.

Augat Inc., 33 Perry Ave., Attleboro, Mass. 02703 [396]

Terminal block built for close-stacked boards

A right-angle terminal block for printed-circuit boards, designated the GBPN, places the external connections at right angles to the board.

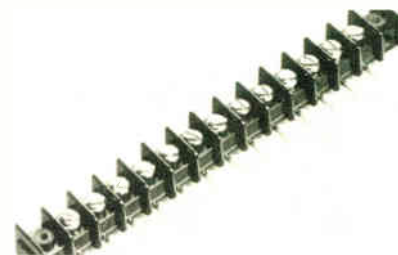

This speeds the connection of external leads, or permits closer stacking of the boards, or both. The internal terminals of the blocks are bright tin-plated pins, 0.062 in. in diameter. Price of the GBPN as a six-pole block is 93 cents in 1,000 pieces, or \$1.07 with mounting holes.

Curtis Development and Manufacturing Co. Inc., 3266 N. 33rd St., Milwaukee, Wis. 53216 [394]

24-lead dual in-line package has alumina base

A 24-lead DIP for MOS and micro-circuit packaging is designed to provide the advantages of ceramic technology at prices comparable to those of less efficient materials. The body of the SP-2298 is specially processed alumina, molded with an

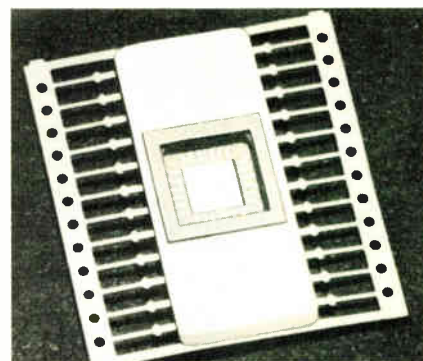

Electronics/December 4, 1972



How Deionized Water Aids Quality Control In Making Printed Circuit Boards

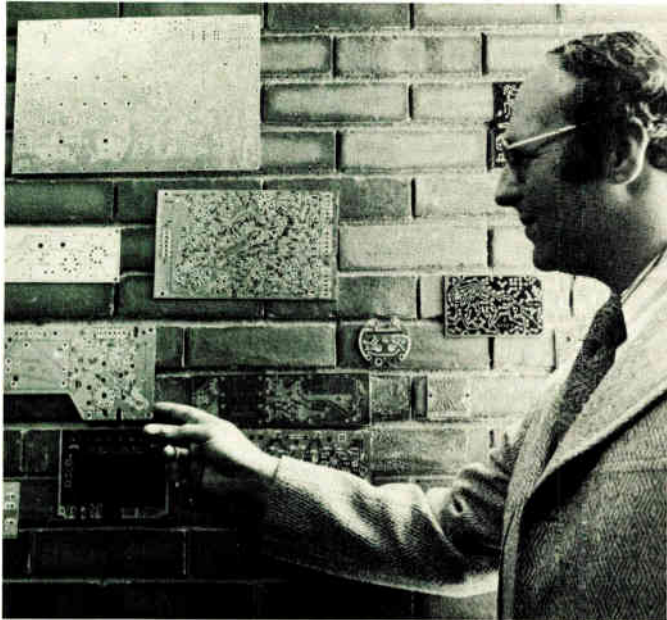

Some of the many printed circuit boards made by Poncher Industries, Inc., Cary, Illinois—shown by President Charles Poncher. Very high quality water is a production "must."

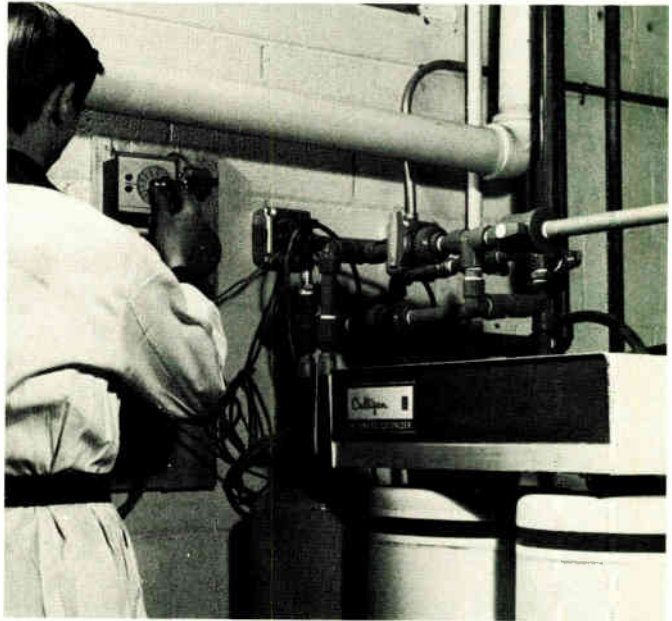

To provide water for plating solutions and ultra-clean rinsing of circuit boards—the treatment system includes a Culligan deionizer, activated carbon filter and deionizer exchange tank.

Rejects stay low and quality stays high at Poncher Industries, Inc., Illinois manufacturer of sophisticated printed circuit boards for commercial and consumer applications. A key supplier to such blue chip electronics makers as Zenith, Motorola, Stewart-Warner, Seeburg, Oak Electro-Netics and others, Poncher stresses perfection in every step of manufacture.

"Our job is to make sure the printed circuit board is as reliable as we can make it," says Mr. Poncher.

"This, of course, includes using the cleanest water possible in plating solutions and in rinsing tanks. The only answer to the contamination problem is deionized water."

The deionizer chosen was Culligan's Model DA.

The high-quality deionized water provided is used for rinsing at critical points in the cleaning, sensitization and electroplating processes. General Manager Andy Walsh emphasizes—

"I knew from long experience with printed circuit manufacturing that deionized water is vital, so we ordered the deionizer right from the start. It has proved to be a wise decision."

For detailed information and additional case histories, write to Will Sanders for our 4-page Job Report No. 137—or call your local Culligan Man for a consultation.

Culligan USA, One Culligan Parkway, Northbrook, Illinois 60062.

CUSTOMER: Poncher Industries, Inc., Cary, Illinois

PROBLEM: Need for high quality water for plating and rinsing circuit boards

SOLUTION: Deionized water

EQUIPMENT: Culligan Model DA Deionizer, Activated Carbon Filter, Deionizer Exchange Service

BRIDGE RECTIFIERS



IBR

**SILICON
AVALANCHE
INTEGRATED
BRIDGE
RECTIFIERS**



■ 10A and 25A (I_o) ■ 100V, 200V, 400V, 600V (V_{RM}) ■ 250V, 450V, 650V min. avalanche Voltages ■ Fast recovery time series ■ Low thermal impedance ($Z_{\theta JC}$) allows operation at full rated load to 100°C, T_c ■ Electrically insulated case ■ Three mounting options: press-fit, stud mount, TO-3 outline mounting flange ■ \$2.50 ea., (10A, 200V, TO-3 mounting flange in 1000 qty.)

EBR

**EPOXY
BRIDGE
RECTIFIERS**

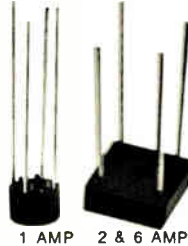

■ 1A, 2A, 6A (I_o) ■ 100V, 200V, 400V, 600V (V_{RM}) ■ Controlled avalanche series (250V, 450V, 650V min) ■ Fast recovery time series (200 ns, t_{rr}) ■ Minimum size and maximum mounting ease result in substantial space and cost economies ■ 91¢ ea. (1A, 200V, controlled avalanche in 1000 qty.)

Design us in; we'll stay there
WRITE FOR NEW CATALOG
(Also Cataloged in EEM & REM)



VARO

VARO SEMICONDUCTOR, INC.

P.O. BOX 676, 1000 N. SHILOH, GARLAND, TEX. 75040, 214/272-4551, TWX 910-860-5178

Distributed by:

ALLIED ELECTRONICS, Chicago, Ill. 312/421-2400. **THE ALTAIR CO.**, Richardson, Tex. 214/231-5166. **BELL ELECTRONICS**, Menlo Park, Cal. 415/323-9431. **BLUFF CITY DIST. CO.**, Memphis, Tenn. 901/725-9500. **BRIDGEFIELD SUPPLY**, Twinsburg, Ohio 216/425-4209. **CRAMER ELECTRONICS**, Nationwide; Newton, Mass. 617/969-7700; Rochester, N. Y. 716/275-0300. **ELECTRONIC PARTS CO.**, Denver, Colo. 303/266-3755. **FARWEST, INC.** Bellevue, Wash. 206/747-1515. **MERQUIP ELECTRONICS**, Skokie, Ill. 312/965-7500. **MERRILL ELECTRONICS**, Chicago, Ill. 312/286-2525. **MILGRAY ELECTRONICS**, Freeport, N. Y. 516/546-6000. **WESTATES ELECTRONICS**, Chatsworth, Calif. 213/341-4411.

In Canada:

ELECTRO SONIC, Toronto, Ont. 416/924-9301. **R. A. E. IND. ELECTRONICS**, Vancouver, B. C. 604/687-2621. **WESTERN RADIO SUPPLY**, Hamilton, Ont. 416/528-0151.

Circle 144 on reader service card

New products

F15-61T lead frame to provide a thermally conductive, hermetic unit. Over-all dimensions are 0.5 by 1.25 inches. The chip cavity, 0.101 in. deep, has an F15-61T seal ring.

Sealox Division, National Beryllia Corp., Haskell, N.J. 07420 [395]

Matrix board programmers permit modular assembly

A tongue-and-groove configuration on miniature solderless matrix boards, called Mini-Boards, permits lock-in modular assembly in any number of groupings. Each module, 1.47 inch square by 27/32 in. thick, has 100 program holes on 0.100-inch centers. Shorting or diode-holding pins are used in connecting selected junctions of the internal two-deck matrix. The modules assemble on aluminum framing rails to form a panel containing a large number of units.

Programming Devices Division, Sealectro Corp., 225 Hoyt St., Mamaroneck, N.Y. 10543 [397]

Receptacles are designed for ac-dc power converters

A line of receptacles is designed for ac-dc power converters and/or battery-charger connections in a variety of equipment, including TV receivers, radios, the cassette-type recorder/players, and hand-held calculators. The Power Jax receptacles have integrally molded jack housings that interlock all internal parts to prevent shifting and short-

Now staggered fingers let you pour the power to IC's and hybrids safely

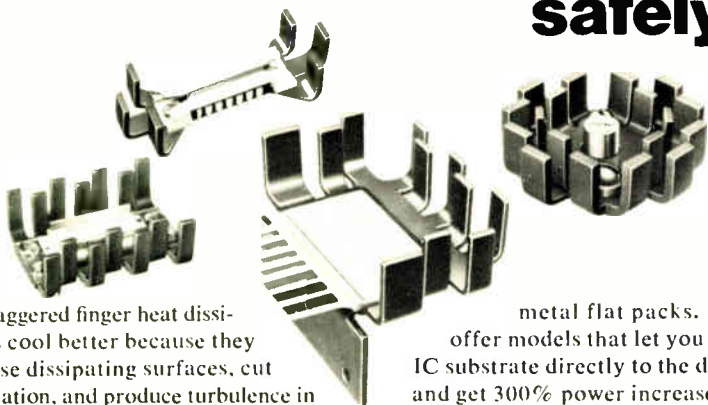

Our staggered finger heat dissipators cool better because they increase dissipating surfaces, cut re-radiation, and produce turbulence in forced air, and now they're available for IC's and microcircuits in special packages as well as standard. TO's, DIP's, .500" and .650" wide ceramics, 1"-square sealed

metal flat packs. We even offer models that let you pot your IC substrate directly to the dissipator and get 300% power increases easily. Ask for our new catalog. IERC, 135 W. Magnolia Blvd., Burbank, Calif. 91502, a subsidiary of Dynamics Corporation of America.

IERC



Heat Sinks



Bestsellers

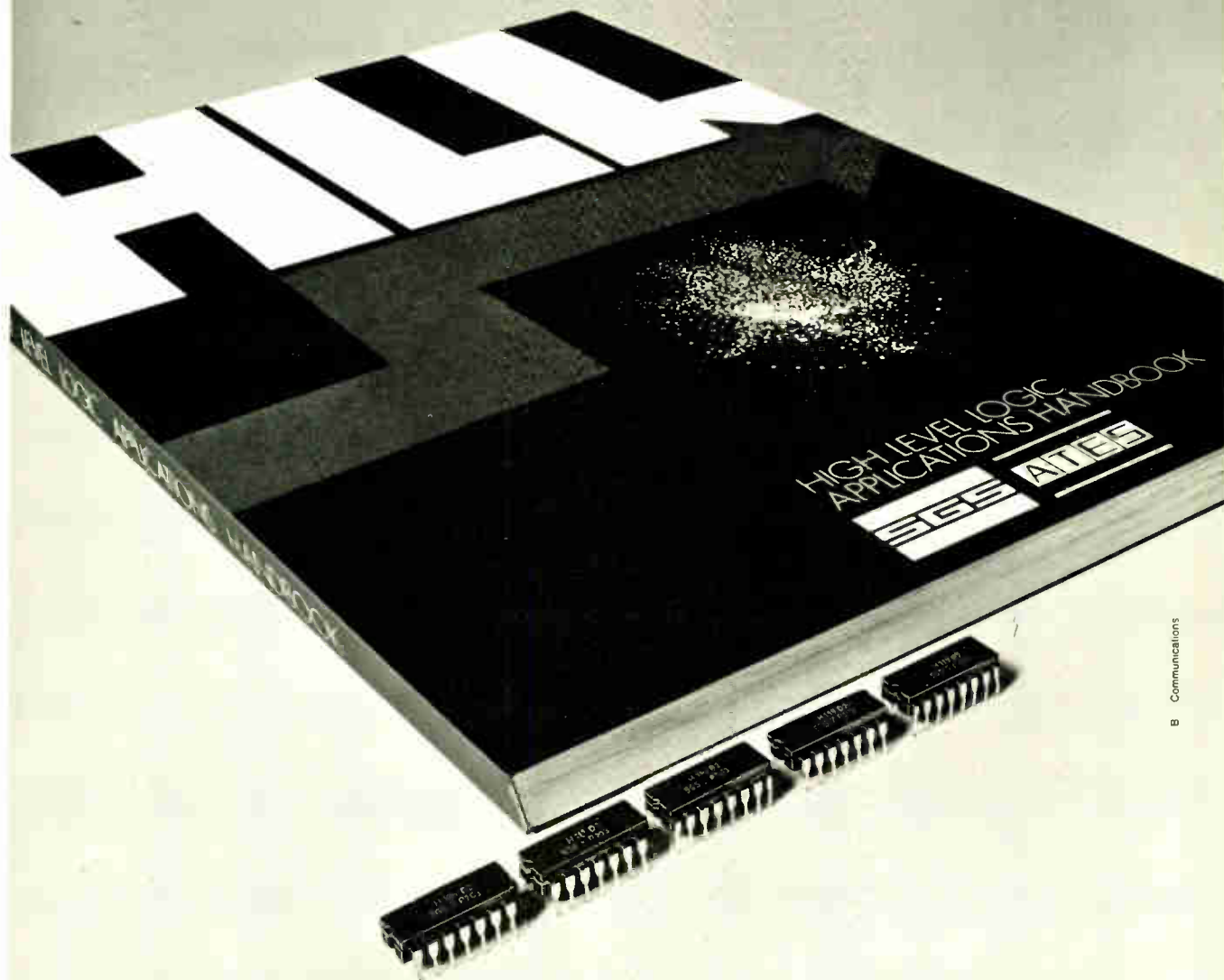

B Communications

6 additions to our High Level Logic family (five new circuits and a book)

SGS/ATES' High Level Logic elements, the H 100 series, feature the widest supply voltage range in the market — 10.8V to 20V — allowing them to work efficiently even with poorly stabilized supplies.

This, in combination with noise immunity as high as 5V at $V_{CC} = 15V$, and 25 (worst case) fan-out, make them the logical, space and cost-saving alternative to electromechanical components in high noise environments.

Design information and applications are provided in the SGS/ATES High Level Logic Applications Handbook, available at US \$ 3.00.
Order your copy now.

The complete H - 100 series from SGS/ATES (* new type):

- H 102 Quad 2-input gate
- H 103 Triple 3-input gate
- H 104 Exp. dual 4-input gate
- * H 105 Exp. dual 2-wide 2-input AND-OR inverter
- H 109 Exp. dual 4-input AND power gate
- H 110 Dual JK flip-flop with separate preset
- H 111 Dual JK flip-flop with separate preset and clear
- * H 112 Hex inverter (open collector)
- H 113 High to low level quad converter
- H 114 Low to high level quad converter
- * H 115 Hex inverter with strobe (open collector)
- H 117 One shot multivibrator
- * H 118 Hex inverter with active pull-up
- * H 119 Hex inverter with strobe active pull-up
- H 122 Quad 2-input gate with passive pull-up
- H 124 Quad 4-input gate with passive pull-up
- H 156 4-bit binary counter
- H 157 Decade counter
- H 158 BCD to decimal decoder and driver



Italy: Via C. Olivetti 1, 20041 Agrate Br., tel.: 039-65341
USA: 435 Newtonville Ave., Newtonville, Mass. 02160, tel.: 617-9691610
UK: Planar House, Wotton Street, Aylesbury, Bucks, tel.: 0296-5977
France: 58, rue du Dessous des Berges, Paris 13e, tel.: 5895223
Germany: 809 Wasserburg/Inn, Post Box 1249, tel.: 08071-721
Sweden: Postbox, 19501 Märsta, tel.: 0760-40120
Singapore: Lorong 4 and 6, Taa Payoh, Singapore 12, tel.: 531411



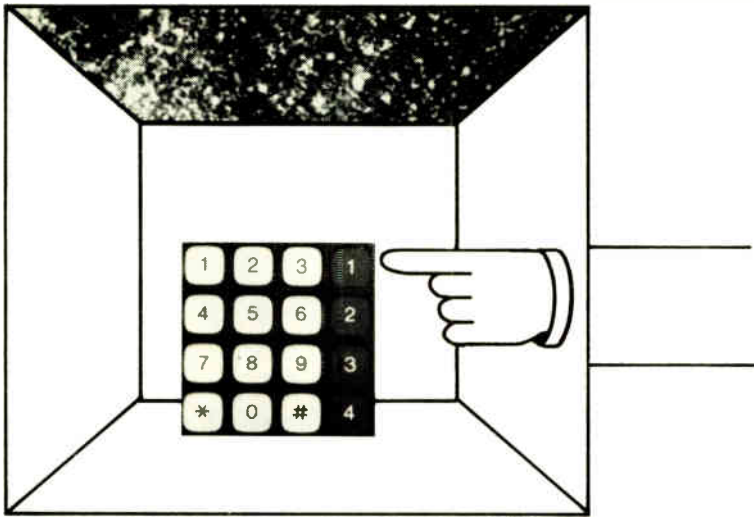

The Chomerics EF Keyboard

(It's the keyboard of tomorrow.)

And most of the key parts are missing. All the moving parts, and most of the expensive ones. Instead, the EF switches with a single piece of highly conductive rubber. It's fail-proof, less than 3/16" thick, and comes in any configuration you want to dream up. For a price you won't believe.

Pretty soon everybody will be trying to make keyboards like the EF. Meanwhile you'll have to come to us.

CHOMERICS 77 Dragon Court, Woburn, MA 01801 (617) 935-4850
Circle 146 on reader service card

Electronics... 40-50% lower basic production costs in Trinidad & Tobago

Whether you're a manufacturer or a contractor, savings like these mean plenty in today's ultra-tight competition.

And in 10-year-old Trinidad & Tobago there are solid reasons for them. Workers who want to work. English-speaking to eliminate language barriers. Familiar corporate names like Sylvania, Westinghouse and General Telephone & Electronics. Sophisticated products like memory core assemblies and high speed coil windings. Government-subsidized training, tax holidays and other incentives.

All this in the most industrialized country in the whole Caribbean.

We'd like you to have two reports: 1) A businessman's guide to profit opportunities in Trinidad & Tobago. 2) A 15-point fact sheet for makers of electronic and electrical products like yourself. Send for them before a competitor beats you to it.



Production workers at Telecomm, IDC sponsored electronics industry.

Trinidad & Tobago Industrial Development Corp.
400 Madison Avenue, New York, N.Y. 10017
Tel: (212) PL 5-9360 • Clyde S. Namsco, U.S. Director

Send me your 2 folders on Trinidad & Tobago

Name _____
Title _____
Company _____
Address _____
Telephone _____
Product Line _____

New products

ing of parts. The two-conductor units have shunted center conductors that allow automatic switching to internal dc power when the external power plug is removed. Price of the units is \$1 each.

Switchcraft Inc., 5555 N. Elston Ave., Chicago, Ill. 60630 [398]

Assembly system automates seven production functions

A numerically controlled assembly system provides near-automated production in seven assembly applications: printed-circuit boards up to 15 in. by 15 in., cordwood-module pc boards, point-to-point soldering, harness lay-in wiring, wire-wrapping, mechanical assemblies, and component interconnection. The system delivers, sequentially or by

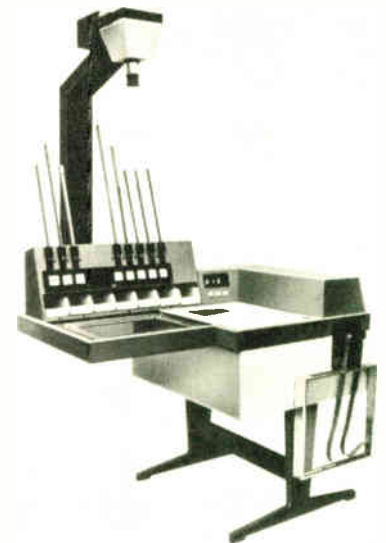

random access, parts, components, or wires to the operator, or else directs the operator to the correct part by lighting bins mounted on the system console. Simultaneously, an overhead projector flashes an arrow or dot to indicate the exact insertion location, the assembly or interconnection site, soldering point, or wiring route and termination point. Two models of the N system are available: the 75 N priced at \$11,150; and the 150 N, \$14,500.

Ragen Precision Industries Inc., 9 Porete Ave., N. Arlington, N.J. 07032 [399]

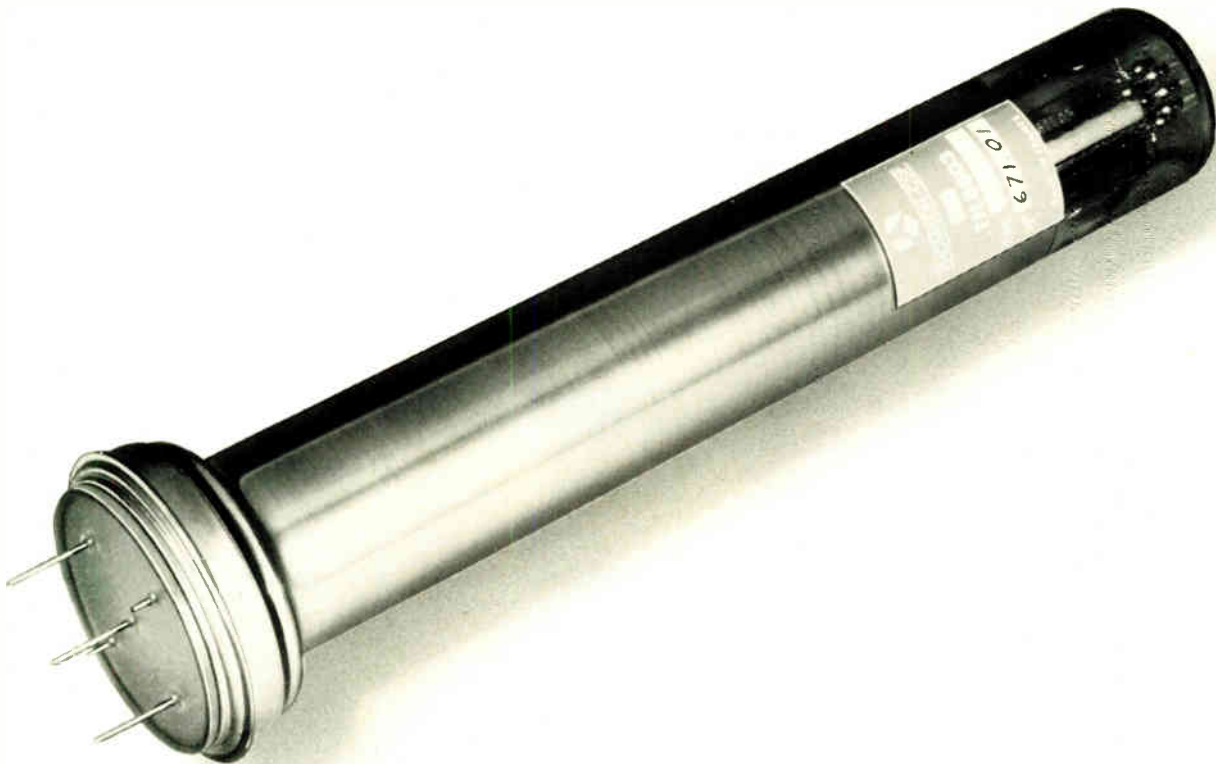

We proudly present our new high resolution storage tube...

Over 4000 lines resolution, with the same long storage and fast erase features of our mini tubes.

Our TH 8803 storage tube is a single ended design in a two inch diameter Vidicon configuration that provides a limiting resolution performance of 4300 TV lines per diameter. It can store 16 millions of bits, in the digital form or the equivalent in the full TV gray-scale image form, for more than 20 minutes under continuous readout scanning operation.

A unique feature of the TH 8803 is its fast erasing capability by means of a special gun design*. Two TV frames are sufficient to erase the whole surface down to the noise level of a good amplifier. Because the display function is separated from the storage system, the user can selectively edit the stored image or, if he is interested in blow-up, zoom-in on any portion of the image.

The two-inch diameter structured silicon target of the TH 8803 permits a resolution of 2700 TV lines at 50 % modulation level. It also permits operation with standard Vidicon hardware, and low voltage levels.

The high performance level reached makes the TH 8803 ideal for a number of applications such as buffer memory, high density data storage and retrieval, bandwidth compression or expansion, scan conversion, etc.

For more information about this tube and our entire line of storage and display tubes, please circle the appropriate number on the Reader Service Card, or contact us directly.

* Thomson-CSF patent.



THOMSON-CSF

THOMSON-CSF ELECTRON TUBES, INC. / 50 ROCKEFELLER PLAZA / NEW YORK, N.Y. 10020 TEL. (212) 489-0400

France - THOMSON-CSF Groupement Tubes Electroniques / 8, rue Chasseloup-Laubat / 75015 PARIS / Tél. 566.70.04

Germany - THOMSON-CSF Elektronenröhren GmbH / Am Leonhardsbrunn 10 / 6 FRANKFURT/MAIN / Tel. 70 20 99

Italy - THOMSON-CSF Tubi Elettronici SRL / Viale degli Ammiragli 71 / ROMA / Tel. 63 80 143

Japan - THOMSON-CSF JAPAN K.K. / Kyosho Building / 1-9-3 Hirakawa-cho / Chiyoda-ku / TOKYO / T 102 / Tel. 03 264-6341

Sweden - THOMSON-CSF Elektronrör AB / Box 27080 / S 10251 STOCKHOLM 27 / Tel. 08/22 58 15

United Kingdom - THOMSON-CSF Electronic Tubes Ltd / Bilton House, Uxbridge Road, Ealing / LONDON W5 2TT / Tel. 01-579 1857 / Telex: 25 659

1652

NEW DISPLAY TECHNIQUES

Random access, electron beam charge writing, reading, and selective erase, on a silicon wafer mini-memory.

XYZ image plotting

- Computer gray scale images
- Computer graphics
- Animated graphic image sequences
- Analog waveforms (ECG, flow)
- Sonar, Radar video displays

Line-scanned image formation

- Line-at-a-time slow scan
- Ultrasonics, radiographic, densitometer, IR scan
- TV video frame storage
- X-ray imaging (reduced dosage)
- LLLTV video integration above noise
- In-process product inspection
- Image motion detection
- Video file library retrieval

Read-outs

- 525 to 2047 lines TV raster read-out
- Slow-scan read-out to hard copy, etc.
- 100:1 Electronic Zoom

Resolution—2000 to 3000 TV lines and up. 30 to 100 MHz bandwidth

All possible with our electronic scan converter custom chassis, plus interface electronics. What are your requirements/

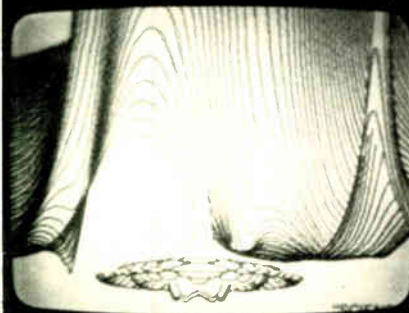

Write or Call: Ames Giordano, Pres.



Graphic and Video Scan Converter Display Systems

American DataCom

1275 Bloomfield Ave.
Bldg. 27 Fairfield, N.J. 07006
201-575-0116

New products/materials

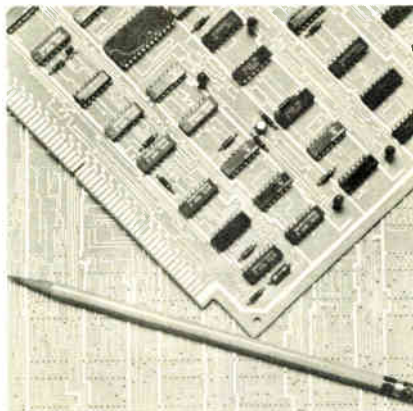

A copper-clad laminate called Cim-clad is a printed-circuit-board material for computer and communications applications and for use in hostile environments. The material is based on an epoxy resin reinforced by a fiberglass mat. It is said to combine the advantages of polyester-based laminates with those of general-purpose and flame-retardant glass-cloth-reinforced epoxy laminates. The laminate is particularly suitable for high-volume applications, where punched holes and blanked contours afford large cost-savings over drilled holes and routed shapes.

Cincinnati Milacron, Molded Plastics Div., Cincinnati, Ohio 45209 [476]

A casting epoxy system called Tra-Cast 3012 is an almost water-white epoxy resin material for casting and encapsulating applications. The 100% solids system contains no solvents, has good flowability, and can be mixed and handled at room temperature. It is particularly suited for small-mass casting and embedding where clarity and good impact strength are required. The material adheres to itself and to metals, ceramics, glass, and many plastics.

Tra-Con Inc., Resin Systems Div., 55 North St., Medford, Mass. 02155 [477]

An acid dip for immersion cleaning, brightening, and protecting solder and other tin-lead alloys is called Enplate Ad-483. The liquid is designed to clean and brighten solder plate on printed-circuit boards which has become darkened or tarnished due to etching operations or after long periods of storage. The

HIGH-FREQUENCY OP AMP SOLUTIONS

FROM



1GHz UNITY GAIN FREQUENCY
GAIN — BANDWIDTH

300MHz CLOSED LOOP
BANDWIDTH

1000V/μS SLEWING
RATE

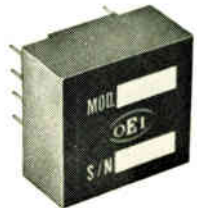

MODEL 9816 is available in a standard 1.125" sq. X 0.5" high module.

Price: \$36. each in quantities of 1, 2.



FOR THE SAME SPECS IN A SMALLER MODULE, ask about MODEL 9491A: 1.0" sq. X 0.31" high. Price: \$36. each in quantities of 1, 2.

For line driving, video, and pulse applications, our MODEL 9804 in the larger module and MODEL 9412 in the smaller module feature:

±10V at ±200mA output

±250V/μS

500MHz gain — bandwidth

Price: \$30. each in quantities of 1, 2.

Optical Electronics, Inc., manufactures a complete line of Op Amps, analog function modules, and 3-D displays.



OPTICAL ELECTRONICS INC.

P. O. Box 11140 • TUCSON, ARIZ. 85706
Phone (602) 624-8358 TWX (910) 952-1283



A place for everything and everything in its place.

Airco doping gases are predictable. (We invented doping gases.) They let you lay down what you want to lay down—where you want to lay it. Because they're the purest you can buy: silane, arsine, diborane, phosphine. Information? Contact your Airco rep or Hank Grieco. 575 Mountain Avenue, Murray Hill, New Jersey 07974. Phone: 201-464-8100. Then let the chips fall where they may.

AIRCO
Industrial Gases

Circle 149 on reader service card

WHO'S Carrier System will operate with LVDT, strain gage, or variable reluctance transducers?

Where?

$$\frac{\text{Signal}}{\text{Noise}} = -120 \text{ db.}$$

When?

Noise level = 1,000 volts rms.

Why?

Because you need data even though the noise and data frequencies coincide.

How?

With Natel's System N. Write for our catalog describing System N and other Natel products. Better yet, call Jim Naster now: (213) 882-9620.

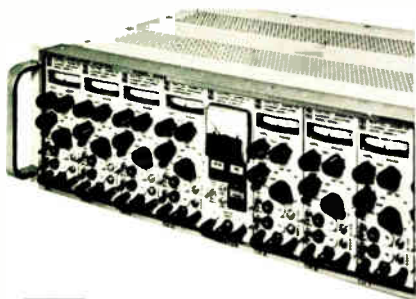

Natel Engineering Co.
A NATEL COMPANY

8944 Mason Avenue
Canoga Park, Ca. 91306
Phone: (213) 882-9620

New products/materials

material is supplied ready to use, and is workable from room temperature to 120°F for 30 to 60 seconds, depending on the processing rate desired.

Ethone Inc., Box 1900, New Haven, Conn. 06508 [478]

Extra-large copper-clad laminates for stripline phased-array-antenna designs measure 24 by 60 inches in thickness, with ½-ounce, 1-ounce, or 2-ounce copper. Reinforced cross-linked polystyrene or polyphenylene oxide is available with controlled dielectric constant values of 2.62 and 2.55, and dissipation factors of 0.001 and 0.0016, respectively.

Custom Materials Inc., Alpha Industrial Park, Chelmsford, Mass. 01824 [479]

Passivation glass enhances the maximum voltage of high-voltage transistors and other devices. Designated IP810, the glass is designed both to passivate the junctions and to enhance the voltage of devices requiring operating temperatures up to 150°C. The glass is also applicable to any mesa device, and can be applied directly. Metalization is applied through windows etched in the glass by photolithographic techniques. Price is as low as 10 to 15 cents per wafer.

Innotech, 181 Main St., Norwalk, Conn. 06851 [480]

Two clear, optically pure epoxy resin systems are designed for embedding, encapsulating and ruggedizing optoelectronic devices. One cures at room temperature within a few hours, and the other requires a brief cure at between 110° and 150°C. Both have optical transparency between 3,000 angstroms and 2.6 microns.

Marblette Epoxy Systems, 166 Chapel St., New Haven, Conn. 06513 [339]

Packaged in aerosol containers, a cleaner for electronic assemblies, called SC-800, also lubricates and prevents destructive corrosive action. The price for a 6-ounce container is \$3.95, and they are available in cartons of 12.

Starnetics Co., P.O. Box 9308, North Hollywood, Calif. 91609 [340]

New AO II-80 Illuminator sheds intense, "cold" light on your subject.



This is the illuminator with 1001 uses. You can use it to provide bright, shadowless light for microscopy. To equally illuminate samples under stereo comparison microscopes. To illuminate miniature components under assembly. Illuminate hazardous areas. And in many other applications.

The AO II-80 uses a quartz iodine light source. Fan-cooled lamp has 50- to 500-hr. life. A 4-level switch controls settings. Unit weighs only 4¾ lbs.

The flexible two-branch gooseneck light guides transmit intense cold light—measure 24". (Other light guides also available.)

**AO II-80 Illuminator
price: only \$129.50
Gooseneck Light Guide
(shown) \$75.00**

 **AMERICAN OPTICAL
CORPORATION**
Fiber Optics • Southbridge, Massachusetts 01550



1973: The Year of the Advertiser

Beginning January 1, Electronics is dropping all bleed charges! And there'll be no full-run rate increase in 1973. Actually, Electronics hasn't had a rate increase since January, 1970. While in the same period, circulation is up nearly 10% and will continue to rise in 1973.

What does this mean to you?

- You can now reach an Electronics reader at nearly 10% less than you paid in 1970. You save!
- If you use bleed, you save an additional 15% on the cost of a full page ad. 25% savings in all!
- Free bleed allows you to be even more creative by using the additional 29% area available!

Why are we setting a precedent by lowering your advertising costs? Because we want 1973 to be the year of the advertiser. How can we do this? By

giving you an extra return on your investment. And, speaking of investments, leading advertisers have already increased our ad revenue by 22% over last year.

What else does Electronics give you? Only the most authoritative editorial in the technical publishing business, delivering the most involved readers in your markets.

Electronics is THE SOURCE for advertiser benefits in 1973—the year of the advertiser. Because Electronics saves ad dollars!

Electronics 
THE SOURCE. 

MONOLITHIC CRYSTAL FILTERS

THE STATE OF THE ART

The Truth About Monolithics . . .



Truth is stronger than fiction. It's also said to be the greatest gimmick in advertising. That's what this series of ads is about — the truth about monolithic crystal filters. If you want the truth about the best filter for your application, talk to us. We've been making monolithic crystal filters longer than anyone else — and we've made more of them. We know what can't be done as well as what can.

Standard Substitute . . .



When is a conventional crystal filter unconventional? When it's a monolithic designed to be completely interchangeable with its conventional counterpart — and to be 10 to 50% less expensive. If you're still using conventional crystal filters and aren't ready to redesign your equipment check with us. The next best thing to designing your new radio around a monolithic crystal filter is plugging a monolithic into your old one. It may be just what the doctor ordered to keep the patient alive and well a little longer.

Short Course . . .



Whether you're now using integrated crystal filters or just thinking about it, you'd probably like to know more about them. We're offering a limited number of reprints of an up-to-date survey article including specification guidelines. A copy is yours for the asking. Just drop us a note on your letterhead.

Like more information on monolithics? Drop us a line or call us.

Pi

Piezo Technology Inc.
2400 Diversified Way
Orlando, Florida 32804
305-425-1574

The Standard in monolithic
crystal filters.

New literature

Resistors. Eltec Instruments Inc., Central Industrial Park, Daytona Beach, Fla. 32014, has published an eight-page catalog featuring the company's line of semiconductive-glass high-megohm resistors. Information on design, specifications, values, and applications is provided. Circle 421 on reader service card

Electron tubes. A 100-page guide to electron tubes and semiconductors is available from United-Page Inc., 481 Getty Ave., Paterson, N.J. Products include cathode-ray and receiving tubes, rectifiers, diodes, zeners, transistors, and FETs. [422]

SCRs. An SCR folder available from Unitrode Corp., 580 Pleasant St., Watertown, Mass., contains information on circuit applications, product specifications, and design ideas. More than 16 types of SCRs are featured. [423]

Rf inductors. An eight-page data sheet provides information on environmental characteristics, dimensions, and specifications of shielded rf inductors for computer and communications applications. The data sheet is available from Nytronics Inc., Orange St., Darlington, S.C. 29532 [424]

Optics. A range of laser optics is described in a technical catalog that is being offered by Coherent Radiation, 3210 Porter Dr., Palo Alto, Calif. [425]

Modems. Bell-compatible data modems manufactured by Intertel Inc., 6 Vine Brook Park, Burlington, Mass., for end-users of data-communications systems, are described in three four-page brochures. [426]

IC packaging. An eight-page technical brochure from Augat Inc., 33 Perry Ave., Attleboro, Mass., describes the company's Dead-or-Alive IC interconnection packaging system. Schematics, diagrams, and specifications are given. [427]

Test consoles. Bulletin SRT-13 from Singer Instrumentation, 3211 S. La Cienega Blvd., Los Angeles, Calif.

Xecon PolaStrip® is the most advanced elastomer stripgasketing material you can use in electronic packaging and products today. Brings you shielding effectiveness at microwave frequencies without compromising your miniaturization trend and reliability goals. Top compression deflection and recovery. Many cross-sections in stock. Write for free Design Guide. Metex Corporation, 970 New Durham Road, Edison, N.J. 08817. West Coast: Cal-Metex Corporation, Inglewood, California 90301.

**METEX
CORPORATION**

How to shield your designs from EMI.

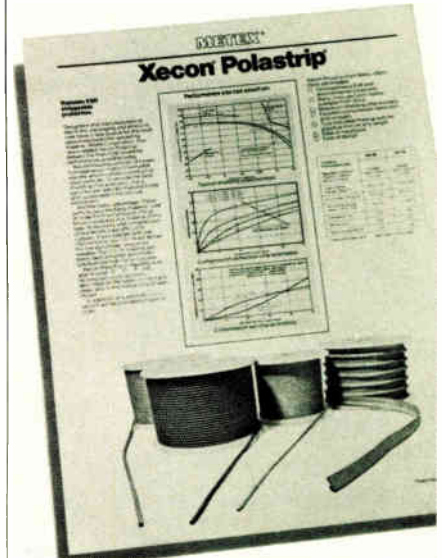

Circle 171 on reader service card

High performance double balanced mixer

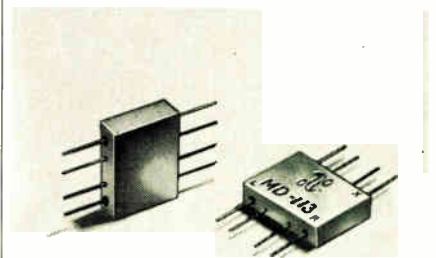

This flatpack double-balanced mixer with bandwidth of 10 to 1000 MHz has typical mixer noise figure less than 7 db and LO-RF Isolation better than 30 db at 1 GHz. Third order intercept is typically +20 dbm. Used as frequency converter, phase detector, pulse modulator and as voltage/current variable attenuator. Price \$29. **ANZAC Electronics, 39 Green Street, Waltham, Mass. 02154 Tel. (617) 899-1900.**

Every single thing about our new fine tuner is fine. Even the price.



Precise fine tuning has always been a problem. Until now. Raytheon's new Microvernier control knob utilizes the principle of harmonic drive to provide a new, low-cost method of obtaining high-resolution tuning or precise zero setting.

The patented performance-proven Microvernier control knob is more economical. Because it's gearless. Yet its zero-backlash performance is precise enough to meet the most sophisticated electronic standards. It features both 40:1 and 1:1 tuning ratios. And it's available now in three sizes to keep all your fine tuning under control. Write Raytheon Company, Fourth Avenue, Burlington, Massachusetts 01803.



Circle 153 on reader service card

A CAMBION® Double "QQ" Product Line

As often as you want, too. The design of the jack and the materials from which it is produced give it the strength to be cycled more than 50,000 times (we've done it) without appreciable change in contact resistance.

And we didn't just do it once "in the lab."

We have tens of millions of these jacks out, in use by customers. ID's range from .016" to .080". And are available in different shapes and types for mounting components, patching, plugging, or whatever you have in mind.

All CAMBION cage connectors are standard, immediate delivery items. You can have them fast in whatever number you want. That's the CAMBION Double "QQ" approach, the quality stands up as the quantity goes on. Ask for a sales engineer or a catalog. Cambridge Thermionic Corporation, 445 Concord Avenue, Cambridge, Mass. 02138. In Los Angeles, 8703 La Tijera Blvd. 90045.

This cage jack was built for recycling!



Standardize on

CAMBION®
the guaranteed electronic components

Circle 172 on readerservice card

NEW Heathkit 2½ Digit DMM

only 79^{95*}



A compact, solid-state multimeter with digital readout — at a fantastic kit-form price. The new Heathkit IM-1202 has four overlapping ranges to measure voltages from 10 mV to 1000 V on DC (either polarity), 10 mV to 700 V rms on AC, 10 uA to 2.5A on AC or DC current. Five resistance ranges measure from 1 ohm to 2.5 megohms. Front panel polarity switch reverses inputs without changing leads. 6 lbs.

NEW Heathkit 30 MHz Counter

only 169^{95*}



The Heathkit IB-1100 gives 1 Hz to over 30 MHz counting on a full 5-digit readout with 8-digit capability. The lighted overrange indicator makes misreading virtually impossible. Stable time-base circuitry assures accuracy better than ±3 ppm from 22° to 37° C. Diode protected J-FET gives improved triggering over 100 mV to 150 V input range. Solid-state circuitry mounts on one large board for easy assembly. 6 lbs.

Send for FREE '73 Catalog

HEATH COMPANY, Dept. 53-12
Benton Harbor, Michigan 49022



- Please send FREE Heathkit Catalog.
- Enclosed is \$ _____, plus shipping.

Please send model(s) _____

Name _____

Address _____

City _____ State _____ Zip _____

Prices & specifications subject to change without notice.

*Mail order prices; F.O.B. factory. TE-275

Circle 173 on reader service card 153

MORE!

new

V-PAC* POWER SOURCES

for

- Op amps
- Line receivers
- Comparators



Now, use standard +5v source to power your linear IC's. Simplify design, reduce system volume, eliminate extra power supplies, reduce manufacturing costs, with V-PAC power sources.

Operate from 7 to as many as 35 of these types from a single V-PAC source: 709, 741, 710, 711, 720.

Less than a third cubic inch, standard DIP pin configuration, V-PAC sources can be mounted on half-inch center cards with other components.

TYPE:	VA 12-12	VA 15-15	VA 12-6
VOLTAGES:	+12 -12	+15 -15	+12 -6

Write or call for full specifications.

WEST:	EAST:
213-843-5200	513-761-5432
214-233-4489	201-992-2505
505-298-1875	803-288-4450
312-654-8645	416-743-9130
415-593-2189	617-272-7655
206-747-9424	305-941-5514



Reliability, Inc.

5325 Glenmont, Houston, Texas
77036 • 713-666-3261

Europe and the Far East: TISCO (TI Supply Co.)

TWX: 910-881-1739 *TM, Reliability, Inc.

New literature

90016, describes 12 manual and automated systems for production testing of synchro and resolver components. [428]

Panel meter. California Instruments Co., 5150 Convoy St., San Diego, Calif. 92111. Operating information and specifications of the series 8330 digital panel meters are provided in a four-page brochure. [429]

Attenuators. An attenuator and audio-products catalog that provides 16 pages of information, including applications, charts, tables, and a selection guide, is being offered by Shalco Inc., P.O. Box 1089, Smithfield, N.C. 27577 [430]

COS/MOS ICs. RCA Solid State Division, Route 202, Somerville, N.J., has published a revised eight-page catalog describing COS/MOS digital integrated circuits. The catalog contains logic diagrams with terminal designations and data charts for 52 circuits. [431]

Computer. Digital Equipment Corp., 146 Main St., Maynard, Mass. 01754. A 16-page brochure outlines the features and applications of the Timeshared-8 computer system. The brochure discusses hardware, software, and support features, as well as a variety of applications. [432]

Code converter. A data sheet from Plantronics Inc., 385 Reed St., Santa Clara, Calif., describes the model 703 code converter, designed to change 5-level Baudot characters to 8-level ASCII. [433]

Switches. A 72-page catalog published by Cherry Electrical Products Corp., 3600 Sunset Ave., Waukegan, Ill., describes the company's line of keyboards and switches. [434]

Magnetic shielding. Ad-Vance Magnetics Inc., 226 E. 7th St., Rochester, Ind. A 16-page catalog discusses magnetic shielding. Technical data is given on use of ductile foils, sheet stock, tape data protectors, and various components for fabrication. [435]

NEW SHORTER CASE! SCHAUER 1-WATT ZENERS

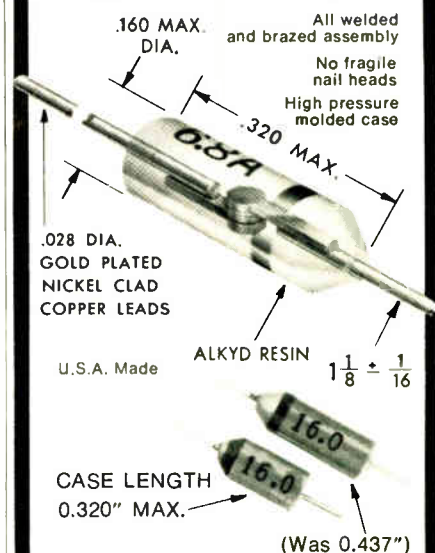

**SAME LOW PRICES FOR
1% TOLERANCE ZENERS
ANY VOLTAGE
FROM 2.0 TO 18.0**

Quantity	Price Each
1-99	\$1.07
100-499	.97
500-999	.91
1000-4999	.86
5000 up	.82

IMMEDIATE SHIPMENT

Send for rating data and 20%, 10%, 5% and 2% tolerance prices.

Semiconductor Division

SCHAUER

MANUFACTURING CORP.

4514 Alpine Ave., Cincinnati, Ohio 45242
Telephone 513/791-3030



**Everything you need
to know about power
supplies is right here
in this little box.**

**Only \$94.00
complete**

The equivalent of 25 cubic feet of catalogs sits right on your desk in this little 4" x 6" box.

The most complete Power Supply Catalog File available anywhere... 6667 current catalog pages have been collected and organized on microfiche cards — 98 pages per card. Every major source of power is listed, indexed and easy to find.

This little box costs only \$94.00 and can save you hundreds of dollars in space, time and effort.

Never before available: This is the first microfiche series from the Electronics Catalog Retrieval System. The microfiche cards fit any

standard reader and there is space in the box for up-dated information.

Special introductory offer: If you don't already have a standard microfiche reader, you can order the new Kodak Ektalite 120 *with your*

purchase of the Power Supply Catalog File at the special low introductory price of \$85.00 (delivery included).

The Ektalite 120 is a desktop reader weighing less than five pounds. It's compact, noiseless, easy-to-use. All you do is feed in the microfiche from left to right, and manipulate the control knob to locate the image you want.



**Mc
Graw
Hill** **Electronics
Catalog Retrieval
System**

...and these other
NEW BOOKS
of special interest from McGraw-Hill



New books

An expanded new edition of a classic guide

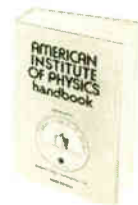

AMERICAN INSTITUTE OF PHYSICS HANDBOOK

New 3rd Edition
Dwight E. Gray,
Coordinating Editor,
2,200 pp., hundreds
of tables, \$49.50

This revised 3rd Edition gives you:

- Rewritten material on viscosity of gases and liquids
- New treatment of architectural acoustics
- Thermometer tables recomputed based on 1968 changes in International Practical Temperature Scale
- Entire *Electricity and Magnetism* section revised
- New subsections on radio, astronomy, radiometry, nonlinear optical coefficients, and far infrared
- New sub-section on atomic transition probabilities
- New information on energy band structure of metals and conductors . . . and much more.

9 big sections provide a comprehensive guide to—

- Mechanics • Acoustics • Heat • Electricity and Magnetism • Optics • Atomic and Molecular Physics • Nuclear Physics • Solid-State Physics • Mathematics Bibliography; SI Units

A practical, how-to guide to the design of multichannel communication systems



COMMUNICATION SYSTEMS DESIGN:

Line-of-Sight and Tropo-Scatter Systems
By Philip F. Panter
589 pp., \$19.50

This new single-source reference brings together the latest technical information and practical applications essential to the design of multichannel communication systems, both analog and digital. It gives you the necessary mathematical background and a wealth of how-to-do-it examples. Although the book focuses on line-of-sight and tropo-scatter systems, its coverage can also be applied to the design of other communication systems.

Special features include . . .

- distribution functions in design of LOS systems
- intermodulation noise in single and multicarrier FM
- antenna systems used in microwave communication
- how to predict path loss
- formulas and methods for calculation of transmission loss over terrestrial paths

How to use the computer to design semiconductor devices



SEMICONDUCTOR DEVICE MODELLING FOR COMPUTER-AIDED DESIGN

Edited by
Gerald J. Herskowitz
and Ronald B. Schilling
360 pages, \$16.50

This book provides insight, step-by-step guidance, and specific techniques on how to design semiconductor devices or circuits using these devices. It enables you to simulate actual device and/or circuit performance without the need for costly and time-consuming redesign.

Special features include:

- model development using a combination of approximation and numerical techniques
- two-dimensional analysis of the field effect transistor
- acquisition of data and reduction methods for d.c. and transient behavior of devices in large-signal operations

First unified view of the complex interrelations of activities that comprise human communication



HUMAN COMMUNICATION: A UNIFIED VIEW

Edited by
Dr. Edward E. David, Jr.
and Dr. Peter B. Denes
458 pp., \$25.00

Written by 15 noted specialists, this book gives you an overview of the many levels of activity involved in human communication and discusses the nature of the events at each level. By discussing important aspects of the physical, physiological, linguistic, and psychological events in communication between humans, this book brings concepts from different specialties into a cohesive whole.

Special features:

- Discusses numerous aspects of human communication formerly available only in reports and technical papers
- Makes available for the first time in book form the contributions of outstanding experts in the field.

Thick Film Hybrid Microcircuit Technology, Donald W. Hamer and James V. Biggers, Wiley-Interscience, a division of John Wiley & Sons Inc., 424 pp., \$19.15.

Authors Hamer and Biggers have based this clear, concise presentation of the technology of thick film on material developed and tested in a series of five-day seminars begun three years ago. While the book makes no demands on the reader's specialized knowledge of chemistry, physics, or metallurgy, it includes an ample bibliography.

The opening section of the book provides an interesting and unusual historical perspective of the technological events leading up to the current interest in hybrids. It goes on to cover thick-film printing, screen printing, trimming, bonding, packaging, and sealing. The authors state the merits and problems of the various fabrication techniques. Excellent photographs and line drawings contribute to the clarity of presentation.

Two chapters are of particular interest: chapter three, "The economic rationale for thick-film hybrids," explains the economies realized by hybrids, compared with discrete components. Chapter 13, "The economics of thick-film hybrid microcircuit production," outlines the costs of fabricating a model circuit for production runs of 25, 1000, and 50,000 units. To round out the IC world, Appendix I examines monolithic ICs and thin-film integrated circuits. Appendix II lists the manufacturers and journals in the field of thick-film technology.

Some 500 companies are now into thick-film technology, and every day, industries are examining the role hybrids may play in their growth.

On the debit side, this publication makes no attempt to explore circuit applications of hybrids, an important topic.

Nonetheless, this book should serve as a valuable reference to those experienced in hybrid technology. It also provides an excellent introduction for the newcomer.

Steve Grossman,
Packaging & Production Editor

McGraw-Hill Book Company
1221 Avenue of the Americas,
New York, N.Y. 10020

Send me the book(s) checked for 10 days on approval. After 10 days I will remit in full plus tax, postage, and handling, or return book(s) without obligation. Offer good only in U.S. and order subject to acceptance by McGraw-Hill.

Name _____

Address _____

City _____

State _____

Zip _____

- (01485X) **American Institute of Physics Handbook—NEW 3rd Edition**
- (484368) **Communication Systems Design**
- (283966) **Semiconductor Device Modeling for Computer-Aided Design**
- (154465) **Human Communication: A Unified View**

23-L-124

Modular, controllable system for infrared solder fusing

Self-cleaning non-focussed heaters provide uniform, full width heat distribution — no windows or reflectors to clean.

Proven control system with automatic stabilization — no interaction between zones — no false turn-ons — wider operating ranges. All components conservatively rated.

More versatile — new modular design provides a broader range of optional features, enabling a buyer to tailor the machine to his needs.

Faster — Belt travels up to 20 ft./min., fuses up to 4800 sq. ft. (double sided circuit boards) per hour — more than twice as fast as our competitors.

15" machine with pump fed fluxer
\$7900

24" machine with pump fed fluxer
\$8940



RESEARCH INC

BOX 24064 MINNEAPOLIS, MINNESOTA USA 55424
Circle 176 on reader service card

X-Y PLOTAMATIC RECORDERS

OEM RACK PORTABLE



Value Priced From **\$750**

- PAD/LOAD* Paper Handling
- 8½ in. x 11 in. and 11 in. x 17 in.
- Electronic Overdrive Protection
- Differential Guarded and Shielded Signal Inputs
- Disposable Fibre Cartridge Pens (Capillary Pen optional)
- Sealed Follow-Up Potentiometers buffered for noise immunity
- I/C Circuit Design
- Time Base Generator (optional)

MFE CORPORATION

Keowaydin Drive Salem, M.H. 03079 TEL (603) 893-1921 TELEX 947477 TWX 710-366-1887

Circle 157 on reader service card

COMPRESSED VIDEO

- Starts with a standard CCTV camera
- Ends on the screen of a standard CCTV monitor
- Uses "dial up" voice grade telephone circuits in the middle
- Is a highly flexible alternative to facsimile or the Picture Phone

The CVI 200 series Video Converters provide for single frame TV picture transmission over audio bandwidth circuits. Options include multiple image storage, hard copy, computer I/O, and color.

Video instruments for data acquisition, processing, transmission, and display.

cvi

Colorado Video, Inc.
Box 928 Boulder, Colorado 80302
(303) 444-3972

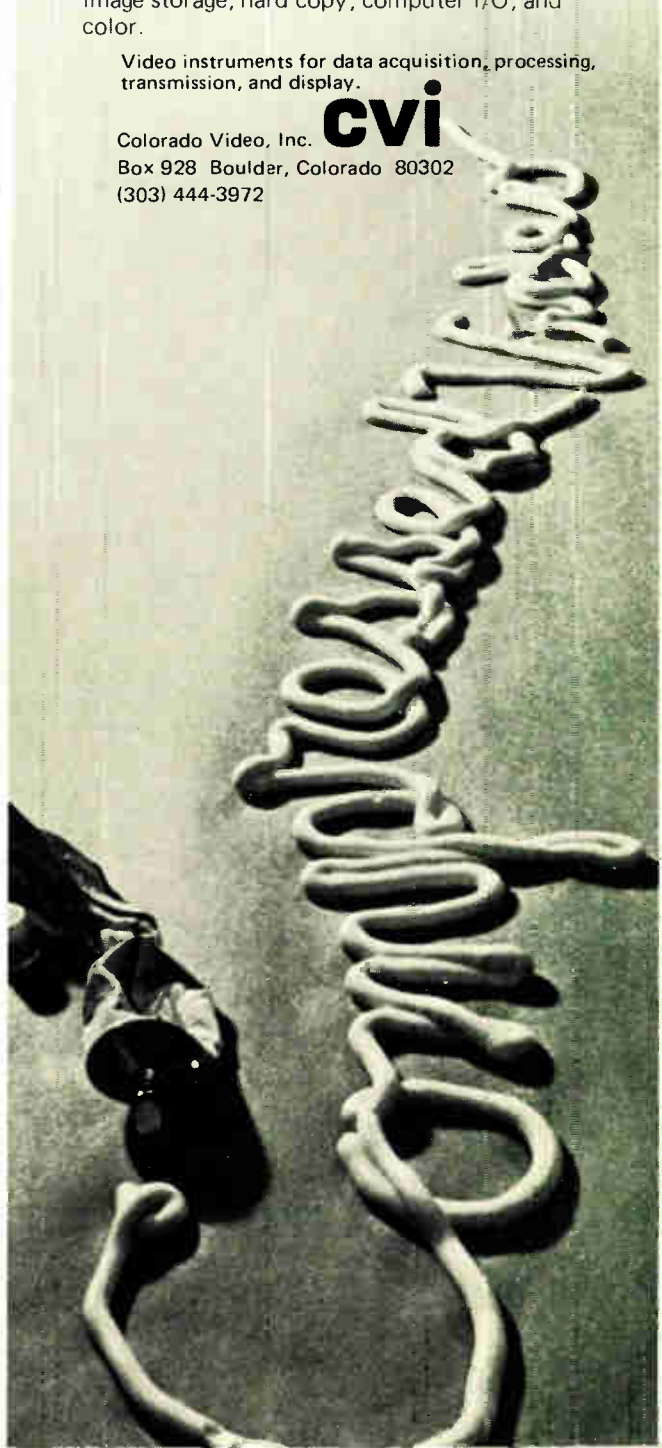

Circle 177 on reader service card

157



The new
BIG ONE
from McGraw-Hill...

Be up on this
powerful new cost-saver



**MOS/LSI
DESIGN AND
APPLICATION**
By
**William N. Carr
and Jack P. Mize**

320 pp., \$18.50

Today anyone working in such a rapidly advancing field as MOS/LSI integrated circuits needs a practical, unified treatment of the entire subject. This working guide not only puts you in close touch with the current state of the art, but gives you the fundamental concepts to enable you to analyze any future technology advances. It also alerts you to economic trends and how they will affect future systems designing.

With this 100% practical reference, you'll understand *exactly* what goes on inside the integrated MOS/LSI package and have right at your fingertips the application circuitry for use with these same circuits.

In case you missed it—the perfect companion volume to MOS/LSI



This practical volume — the first to explore the entire family of TTL integrated circuits — guides engineers, computer designers, systems analysts, and managers to the best uses of these devices.

**DESIGNING WITH TTL
INTEGRATED CIRCUITS**

Prepared by the *IC Applications Staff of Texas Instruments Incorporated*

322 pp., \$18.50

McGraw-Hill Book Company

1221 Avenue of the Americas,
New York, N.Y. 10020

Send me: **MOS/LSI Design and Application (010081)** **Designing with TTL Integrated Circuits (063745)** for 10 days on approval. After 10 days I will remit in full plus tax, postage, and handling, or return book(s) without obligation. Offer good only in U.S. and order subject to acceptance by McGraw-Hill.

Name _____

Address _____

City _____

State _____

Zip _____

23-L-124

Advertising Sales Staff

Pierre J. Braudé [212] 997-3485
Advertising Sales Manager

Atlanta, Ga. 30309: Joseph Lane
100 Colony Square, 1175 Peachtree St., N.E.
[404] 892-2868

Boston, Mass. 02116: James R. Pierce
607 Boylston St. [617] 262-1160

Chicago, Ill. 60611:
645 North Michigan Avenue
Robert W. Bartlett (312) 751-3739
Paul L. Reiss (312) 751-3738

Cleveland, Ohio 44113: William J. Boyle
[716] 586-5040

Denver, Colo. 80202: Harry B. Doyle, Jr.
Tower Bldg., 1700 Broadway
[303] 266-3863

Detroit, Michigan 48226: Robert W. Bartlett
2600 Penobscot Building
[313] 962-1793

Houston, Texas 77002: Charles G. Hubbard
2270 Humble Bldg. [713] CA 4-8381

Los Angeles, Calif. 90010: Robert J. Rielly
Bradley K. Jones, 3200 Wilshire Blvd., South Tower
[213] 487-1160

New York, N.Y. 10020
1221 Avenue of the Americas
Warren H. Gardner [212] 997-3617
Michael J. Stoller [212] 997-3616

Philadelphia, Pa. 19103: Warren H. Gardner
6 Penn Center Plaza,
[215] 971-3617

Pittsburgh, Pa. 15222: Warren H. Gardner
4 Gateway Center, [212-971-3617

Rochester, N.Y. 14534: William J. Boyle
9 Greylock Ridge, Pittsford, N.Y.
[716] 586-5040

San Francisco, Calif. 94111: Don Farris
Robert J. Rielly, 425 Battery Street,
[415] 362-4600

Paris: Alain Offergeld
17 Rue-Georges Bizet, 75 Paris 16, France
Tel: 720-73-01

Geneva: Alain Offergeld
1 rue du Temple, Geneva, Switzerland
Tel: 32-35-63

United Kingdom: Keith Mantle
Tel: 01-493-1451, 34 Dover Street, London W1

Milan: Robert Saidel
1 via Baracchini Phone 86-90-656

Brussels: Alain Offergeld
23 Chaussee de Wavre
Brussels 1040, Belgium
Tel: 13-65-03

Stockholm: Brian Bowes
Office 17, Kontor-Center AB, Hagagarten 29,
113 47 Stockholm. Tel: 24 72 00

Frankfurt/Main: Fritz Krusebecker
Liebigstrasse 27c
Phone 72 01 81

Tokyo: Masaru Wakeshima, McGraw-Hill
Publications Overseas Corporation,
Kasumigaseki Building 2-5, 3-chome,
Kasumigaseki, Chiyoda-Ku, Tokyo, Japan
[581] 9811

Osaka: Ryji Kobayashi, McGraw-Hill
Publications Overseas Corporation, Kondo
Bldg., 163, Umegae-cho Kita-ku [362] 8771

Australasia: Warren E. Ball, IPO Box 5106,
Tokyo, Japan

Business Department

Stephen R. Weiss, Manager
[212] 997-2044

Thomas M. Egan,
Production Manager [212] 997-3140

Carol Gallagher
Assistant Production Manager [212] 997-2045

Dorothy Carter, Contracts and Billings
[212] 997-2908

Frances Vallone, Reader Service Manager
[212] 997-6057

Electronics Buyers' Guide

George F. Werner, Associate Publisher
[212] 997-3139

Regina Hera, Directory Manager
[212] 997-2544

No other conductive elastomer can shield your electronic products against EMI as effectively as Xecon®, the whole line. Xecon gasketing is made with silver deposits on a stable, lightweight substrate in a silicone matrix. Temperature range for sustained operation is -60°C to 200°C. Xecon protection is available: as die cut waveguide and connector gaskets; in sheets; and custom molded and vulcanized to your own specs. Write for free EMI Handbook today. Metex Corp., 970 New Durham Road, Edison, N.J. 08817. West Coast: Cal-Metex Corporation, Inglewood, Calif. 90301.



**Help
stamp out
EMI.**

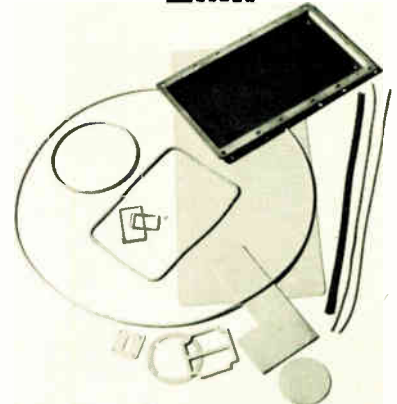

Circle 212 on reader service card

**High dynamic range
amplifier**

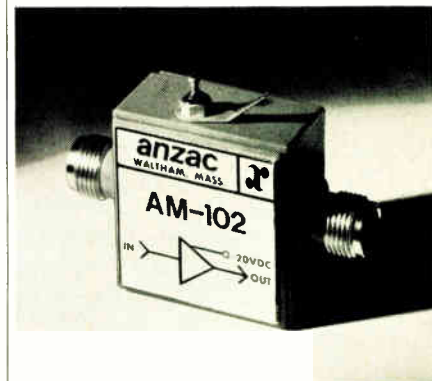

Low distortion and 10 db gain are provided by ANZAC Model AM-102 amplifiers over the 10 to 300 MHz range. Proprietary circuitry provides good gain stabilization, low intermodulation distortion (+27 dbm 3rd order intercept) and flat frequency response (to ± 0.8 db). Price \$69. ANZAC Electronics, 39 Green Street, Waltham, Mass. 02154 Tel. (617) 899-1900.

Circle 178 on reader service card

158 Circle 158 on reader service card

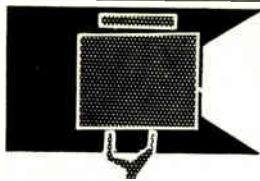

SEARCHLIGHT SECTION

• CLASSIFIED ADVERTISING • BUSINESS OPPORTUNITIES
• USED OR SURPLUS EQUIPMENT

AUTOTRACK MOUNT



AUTOTRACK SCR-584 RADARS

360 degree azimuth, 210 degree elevation sweep with better than 1 mil accuracy. Missile velocity acceleration and slewing rates. Amphidyne and servo control. Will handle up to 20 ft dish. Supplied complete with control chassis. **ALSO** in stock 10 cm, van mounted radar system. Comical scan PPI 6 ft dish. Ideal for S band telemetry, weather, balloon trk, missile trk, rocket trk, ECM range. Write for complete data, 600 pg. instr. bk. avail. at \$25 ea.

PATH LOSS MEAS. FACILITY

Mfg. REF. For establishing max. xmsn paths for tropo and microwave links. 2 heli-hut vans. Covers 1-2.5ghz bands. 20 to 120 watts CW output.

MOD IV HIGH RESOLUTION TRACKER

Instrumentation radar, freq. 8.5-9.6 GHz, Pwr: 250 KW, .1 mil tracking accuracy. 6' Fresnel lens antenna with 4 horn monopulse feed. Tracking range 50 or 200 miles. Formerly used as range safety radar at Cape Kennedy.

MIT MODEL 9 PULSER 1 MW—HARD TUBE

Output 25kv 40 amp., 30kv 40 amp. max. Duty cy. .002 to 2 microsec. Also 5 to 5 microsec. and 1 to 5 microsec. Uses 6C21. Input 115v 60 cycle AC. Mfg. GE. Complete with driver and high voltage power supply. Ref. MIT Rad. Lab. Series, Vol 5, p. 152.

2 MEGAWATT PULSER

Output 30 kv at 70 amp. Duty cycle .001. Rep. rates, 1 microsec. 600 pps. 1 or 2 msec. 300 pps. Uses 5948 hydrogen thyratron. Input 120/208 VAC 60 cycle. Mfr. GE. Complete with high voltage power supply.

17 MEGAWATT LINE PULSER

Output 17KV at 1000 Amps. Rep. rate 150-2000 PPS. 2.5 Microsec. Kexer tube 5948 thyratron. Pwr. 208V, 3Ph, 60HZ, 38KVA.

HV POWER SUPPLIES

5KV @ 1 Amp, 20KV @ 1.3 Amps, 35KV @ 1.5 Amps, 28KV, 70MA; 12KV @ 800MA, 18KV @ 2.25 Amps, 17.5KV @ 1.8 Amps.

Radio-Research Instrument Co. INC.

3 Quincy St., Norwalk, Conn. 06850 • 203-853-2600

CIRCLE 951 ON READER SERVICE CARD

RECON DRONE CONTROL RADARS

X Band systems autotrack and search complete with plotting boards. Fully mobile van mounted. Gives PPI, slant range, altitude data. Ground to air control links and beacons also in stock. AN/MPQ-29 & AN/UPW-1

PARAMETRIC AMPLIFIER

Collins type. 2.3 Ghz, 30 Mhz band width, 1.7 DB noise figure. 20 DB gain, 5 way power splitter output.

SPARE PARTS IN STOCK

Nike Ajax, Nike Hercules, M-33, MPS-19, TPS-1D, TPS-10D, FPS-6, SPS-8, SCR 584, HIPAR

RADAR & RF PKGS.

34ghz 40kw Pulse RI pkg
24ghz 40kw Pulse bomb toss system
16ghz 130 kw Pulse B-58 search radar system
X BAND AUTOTRACK 250KW PULSE M-33
compl w / plot boards
X BAND AUTOTRACK 50KW PULSE B-47
fire control complete

C BAND HEIGHT FINDER

AN/FPS-26 5 megawatt output
AN/TPS-37, 1 megawatt output.

C BAND 1 MEGAWATT AUTOTRACK

10ft dish mortar locator MPQ-21
C BAND 285KW PULSE Search AN / SPS-5 / 10
S BAND 1 MEGAWATT COHERENT AN / FPS 18
S BAND 1 MEGAWATT PULSE NIKE ACQ.
I. BAND 1 MEGAWATT PULSE AN / UPS-1
I. BAND 500KW PULSE AN / TPS-1D / I
I. BAND 5 to 20KW PULSE
400mhz 1KW CW AN / FPS-23
225mhz 1 MEGAWATT PULSE AN / TPS 28
2-30mhz 100KW PULSE
CW .950-5ghz 150 WATTS
CW 1.5mhz-10.5ghz 5 WATTS

AN / GPG-1 SKYSWEEP TRACKER

3 cm. auto tracking radar system. Comp pkg w / indicator sys. Full target acquisition & auto tracking. Input 115v 60 cy. new. In stock for immed. del. Entire sys. 6' x 3' x 10'. Ideal for infrared tracker, drone tracker, missile tracker, R & D.

CATV-COLOR

MICROWAVE LINKS

Ratheon type KTR-1000. Fullcolor bandwidth as well as studio audio. Rack mounted. Complete trans-receiv racks in stock.



HUNDREDS MORE IN STOCK
LARGEST RADAR
INVENTORY
IN WORLD.
WRITE
FOR
CATALOG
ON YOUR
LETTERHEAD

FREE BROCHURE

Up Your Own Organization! A complete guide on how to start and finance your own business. Free brochure. Entrepreneur Press, Dept. B-31, Drawer 2759, Santa Clara, Calif. 95051.

Somebody—

Somewhere

needs your idle equipment! Reach that buyer quickly and economically thru the

“SEARCHLIGHT SECTION”

The meeting place of
Used Equipment Buyers and Sellers



EMPLOYMENT OPPORTUNITIES

Manufacturer of sophisticated tape recorders for aerospace and commercial applications has immediate openings for Electronic Engineers with the qualifications listed below:

SR. ELECTRONIC CIRCUIT

DESIGN ENGINEER

Space Craft Electronics

- B.S.E.E. Required
- 5-7 Years experience in design of space-craft electronics
- Analog and digital experience necessary

SR. ELECTRONICS CIRCUIT

DESIGN ENGINEER

- B.S.E.E. Required, M.S. desirable
- 5 Years experience minimum
- Capable of logic design using State-of-the-Art speeds
- Capable of servo analysis and synthesis-active filters
- Information theory background desirable

Mail resumes including salary history to:

LEACH CORPORATION,

Controls Div.

717 North Coney Ave., Azusa, Cal. 91702

An Equal Opportunity Employer

U.S. Citizen

FREE CATALOG

HARD-TO-FIND PRECISION TOOLS

Lists more than 1700 items—pliers, tweezers, wire strippers, vacuum systems, relay tools, optical equipment, tool kits and cases. Also includes four pages of useful "Tool Tips" to aid in tool selection.



JENSEN TOOLS
4117 N. 44th Street, Phoenix, Ariz. 85018

CIRCLE 952 ON READER SERVICE CARD

FLASH STRIPPER For shielded wire braid



Weld groundlead and/or strip braid in one fast operation.

Submit sample w re. Ask for data sheets.

EWALD Instruments Corporation

Rt. 7E Kent, Ct. 06757 - Tel (203) 927-3278

CIRCLE 953 ON READER SERVICE CARD

free catalog

POTTING APPLICATORS MANUAL AND DISPOSABLE

6cc 12cc 30cc

FOR POTTING, ENCAPSULATING, AND SEALING OF MINIATURE COMPONENTS

PHILIP FISHMAN COMPANY
7 CAMERON ST., WELLESLEY B1, MASSACHUSETTS

CIRCLE 954 ON READER SERVICE CARD

Advanced Micro Devices Keye/Donna/Pearlstein	10-11	General Electric Co., Semiconductor Products Department Advertising & Sales Promotion Syracuse Operation	9	Owens-Illinois Inc. - Digivue Howard Swink Advertising	32-33
Advanced Micro Devices Keye/Donna/Pearlstein	14E	General Magnetics McCarthy/Scelba/DeBiasi Adv. Agcy. Inc.	6	Philips Elcoma	2E, 23E-24E
Airco Industrial Products, Division of Airco, Inc. Gimbel, Hammond, Farrell & Walsh, Inc.	149	General Radio Co. GRAD Associates	89	Philips N. V. PH/T & M Division Marsteller International S. A.	64
Allen-Bradley Company Hoffman, York, Baker & Johnson, Inc.	82	Gould, Inc./Instrument Systems Div. Carr Liggett Adv., Inc.	38	Piezo Technology, Inc. Shattuck/Roether Advertising, Inc.	152
Allen-Bradley Hoffman York, Inc.	19E	Gralex Industries Division of General Microwave Corp. Industrial Marketing Associates	128	Power/Mate Corporation Spectrum Marketing Associates	161
American DataCom	148	Grayhill, Incorporated Carr Liggett Advertising, Inc.	162	R. W. Pressprich & Co. Incorporated The Wittleder Company, Inc.	62
American Optical Corp., Fiber Optics Fuller & Smith & Ross, Inc.	150	GRI Computer Allied Advertising Agency, Inc.	38	Raytheon Company, Industrial Components Operation Provandie Eastwood & Lombardi, Inc.	141
American Optical Corporation, Scientific Instrument Div. Fuller & Smith & Ross, Inc.	129	Hamilton Digital Controls, Inc. Graystone and Ramsey, Inc.	136	Raytheon Company, Microwave & Power Tube Div. Distributor Products Provandie Eastwood & Lombardi, Inc.	134, 153
Amphenol Alliance Marketing Service, Bunker Ramo Corp. Marsteller, Inc.	34	Hamilton Metal Science Beaumont, Heller & Sperling, Inc.	1	RCA Electronic Components Al Paul Letton Company, Inc.	62
Amphenol Canada Division, Bunker Ramo Corp. Marsteller, Inc.	131	Heath/Schlumberger Scientific Instruments Advance Advertising Services	153	RCA Solid State Division Al Paul Letton Company, Inc.	161
Anzac Electronics Robert J. Allen Marketing & Public Relations	152, 158	Hewlett-Packard, Electronics Products Group Corporate Marketing Communications	17-26	Reliability, Inc. Marketing Services Management	154
Augat Creamer, Trowbridge, Case & Basford, Inc.	120-121	Hughes Aircraft Company Foote, Cone & Belding	46-47	Research, Inc. Gordon Rosholt & Company Advertising	157
Bayer AG. Roston, Kremer and Stawer	10E-11E	Hutson Industries Warren-Guild	140	RHG Electronics Laboratory, Inc. Samuel H. Goldstein	122
Bell & Howell—Electronics & Instruments Group Boylhart, Lovett & Dean	45	Hybrid Systems Corp. Susan E. Schur	81	Rohde & Schwarz	1E
Bussmann Mfg. Division of McGraw Edison Co. Henderson Advertising Company	77	IBM Data Processing Division Geer, DuBois & Co., Inc.	133	Schauer Manufacturing Corp. Nolan, Keelor & Stites	154
Cambridge Thermionic Corporation Chirurg & Cairns, Inc.	153	ILC Data Device Corporation Marchin Weltman Advertising, Inc.	16	Schneider R. T. Intermedia	15E
Carpenter Technology Corp. Beaumont, Heller & Sperling, Inc.	138	Interdata Shaw Elliott, Inc.	135	Sescom Perez Publicite	7E
Centralab Electronics, Div. of Globe Union, Inc. The Brady Co.	73	International Electronic Research Corporation Van Der Boom, McCarron, Inc., Advertising	144	SGS - ATEs STUDIO B Communications	145
Chometrics, Inc. Van Christo Associates, Inc.	146	Ithaco, Inc. Hart Conway Co. Inc.	132	Signal Transformer Co. Tobias Associates, Inc.	81
† Cincinnati Milacron, Process Controls Division David K. Burnap Advertising	64	Krohn-Hite Corporation Impact Advertising Inc.	5	Signetics Corp., Sub. of Coming Glass Works Hall Butler Blatherwick, Inc.	79
Colorado Video, Inc. O'Connell-Columb, Inc. Creative Business Communications	157	Lambda Electronics Corporation Michel Cather, Inc.	3rd Cover	Siliconix Robertson West, Inc.	93
The Connecticut Hard Rubber Company Cohar Associates	136	LFE Corporation, Process Control Division Culver Advertising Inc.	142	Souriau & Cie Arane Publicite	9E
Culligan U S A Alex T. Franz, Inc.	143	• LTT Publibel	21E	Sprague Electric Company Harry P. Bridge Company	8
Dale Electronics, Inc., A Sub. of The Lionel Corporation Swanson, Sinkey, Ellis, Inc. Advertising	4th Cover	McGraw-Hill Book Company	156, 158	Systron Donner Concord Instruments Bonfield Associates	101, 162
DATA DISC, INC. Hal Lawrence, Inc.	70	• E. Merck, Darmstadt Macona	17E	Tektronix, Inc. Dawson, Inc.	43
Dialight Corporation Michel-Cather, Inc.	48-49	Metex Mohr & Co., Inc.	152, 158	Teledyne Semiconductor Regis McKenna, Inc.	126-127
Dumont Oscilloscope Laboratories, Inc. Barbetta Miller Advertising, Inc.	6	• MFE Corporation Scott Advertising, Inc.	157, 161	Teradyne, Inc. Quinn & Johnson, Inc.	68
Dynascan Corporation (Industrial Products Division) Albert Jay Rosenthal & Company Advertising	142	Microfiche	154 A-B, 155	Thomson CSF Bazaine Publicite	147
Eastman Kodak Company, Business Systems Markets Div. J. Walter Thompson Co.	137	Microsystems International Ltd. Media Advertising Ltd.	116	Time Data Paul Pease Advertising, Inc.	118
Electronic Arrays, Inc. Regis McKenna, Inc.	15	• Micro Switch Division of Honeywell N. W. Ayer & Son, Inc.	28-29	Toko, Inc. Hakuhodo, Inc.	140
Electronic Memories, Inc. Gumpetz, Bentley, Fried, Scott	51-56	Microwave Semiconductor Corp. Paul Eilman & Assoc.	2	Trinidad & Tobago Industrial Development Corp. Development Counsellors International, Ltd.	146
Electronic Navigation Industries Hart Conway Co., Inc.	14	Monroe, The Calculator Company Division of Litton Industries Baker & Hartel Inc.	123	Union Carbide Corp., Linde Division Young & Rubicam, Inc.	59
Fairchild Semiconductor, Inc. Carson/Roberts, Inc. Adv., Division of Ogilvy & Mather, Inc.	60-61	Mostek Corporation Kaufman Advertising, Inc.	12-13	VARO SEMICONDUCTOR, INC. Warren-Guild	144
Fairchild Systems Technology Hall Butler Blatherwick, Inc.	124	Motorola Semiconductor Products, Inc. E. B. Lane & Associates, Inc.	27	Victoreen Instrument Division Dix & Eaton, Inc.	162
Fluke Manufacturing Co., John Bonfield Associates	31	Natel Electronics Graphic Image Associates	150		
General Electric Co., Miniature Lamp Div. Carr Liggett Advertising, Inc.	30	• National Semiconductor Corp. Chiat/Day, Inc. Advertising	7		
General Electric Company (Plastic Dept. Silicone Products Dept.) Ross Roy of New York, Inc.	67	Nelson Ross Electronics, Div. Polarad Electronics McCarthy-Scelba-DeBiasi Advertising Agency, Inc.	2nd Cover		
		North Atlantic Industries, Inc. Diversified Corporate Services, Inc.	114		
		• Ohmic Promoazur	5E		
		Optical Electronics Craig Miller Advertising	148		
		• Oscilloquartz SA, Neuchatel M. R. Hofer Werbeagentur BSR/EAAA Bern	12E, 23E		

Classified & Employment Advertising

F. J. Eberle, Manager 212-971-2557

EQUIPMENT (Used or Surplus New) For Sale	
Ewald Instruments Corp.	159
Phillip Fishman Co.	159
Leach Corp.	159
Radio Research Instruments Co.	159

• For more information on complete product line see advertisement in the latest Electronics Buyer's Guide
 * Advertisers in Electronics International
 † Advertisers in Electronics domestic edition

OEM DIGITAL PRINTER ACCESSORY

FOR MFE STRIP CHART RECORDERS

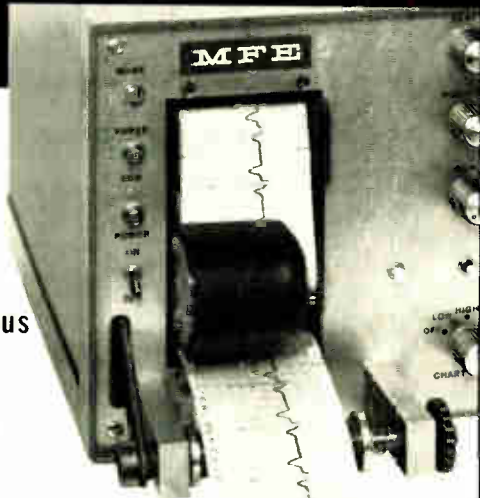

VALUE
PRICED AT
\$300

DEM Discounts
Available

Simultaneous
Digital
Printing
and Analog
Recording

MFE

CORPORATION

Keewaydin Drive, Salem, N.H. 03079 • TEL. (603) 891-1921 • TELEX 947472 • TWX 710 366 1887

Circle 179 on reader service card

POWER SUPPLY HANDBOOK

YOUR'S

FREE

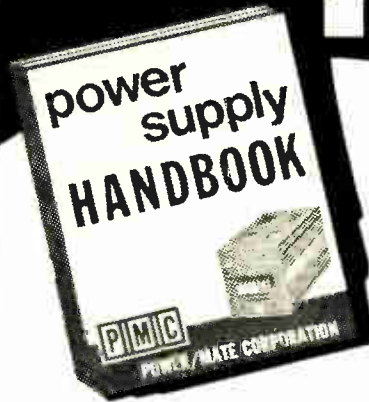

A complete
reference of
definitions, prin-
ples of operation,
load connections
and performance
measurements.

A working tool for
the Engineer. Yours
for the asking . . .
and its FREE from
Power/Mate.

SEND FOR YOUR FREE COPY

P/M/C

POWER/MATE CORP.

514 S. RIVER STREET HACKENSACK N.J. 07601
Phone (201) 343-6294 TWX (710) 990-5023

Circle 180 on reader service card

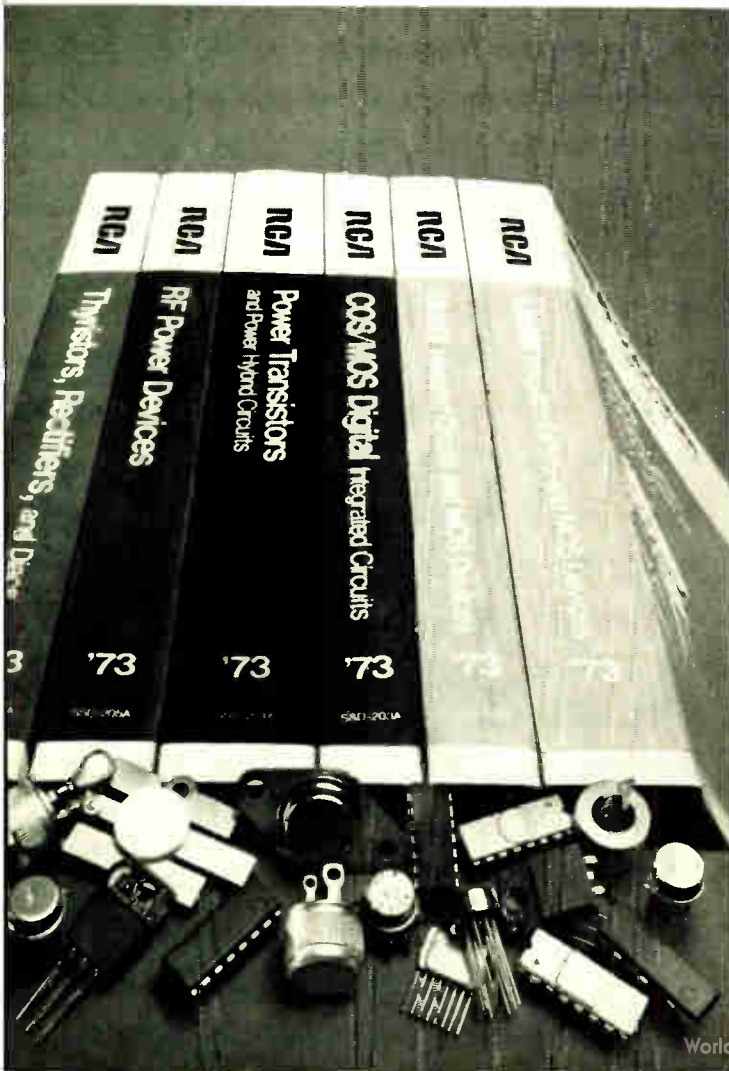

It's time to order your 1973 RCA Solid State Databooks

Complete, up-to-the-minute data for RCA's IC's and discrete devices.

Get off to a fast start in 1973 with timely, comprehensive data from RCA, the company that specializes in complete, accurate data on all of its solid state devices.

The 1972 DATABOOKS have been used in thousands of plants in the United States and around the world. And even more plants will be reached in 1973. This is your chance to be one of the new recipients.

The new DATABOOKS cover a great range of your requirements because RCA has some of the broadest lines in the industry: linear and COS/MOS ICs, MOS-FETs, power transistors, power hybrids, RF and microwave devices, thyristors, rectifiers, and diacs.

25% new or revised material. Complete commercial product data. Complete, current application notes. Easier-to-use quick-reference guides. New, comprehensive subject index. Cross-reference index of developmental to commercial type numbers.

Six 1973 DATABOOKS for only \$10 (optional list price: \$12), with monthly new products newsletter. See coupon for details. Send the coupon along with your check or money order (payable to RCA Corporation) or your company purchase order. Or call your RCA distributor. If the coupon is missing, write RCA, Solid State Division, Section 70L-4 Box 3200, Somerville, N. J. 08876.

RCA Corporation
Solid State Division
Section 70L-4 Box 3200
Somerville, New Jersey 08876

- Rush me the six 1973 DATABOOKS and put my name on newsletter mailing list. My cost, only \$10. Offer good only until December 31, 1972.
- Rush me prices for individual DATABOOKS and updating service.

NAME/TITLE _____

COMPANY _____

ADDRESS _____

CITY/STATE/ZIP _____

I enclose payment by: Check Money Order Purchase Order

Offer good only in U.S. and Canada. Direct other inquiries to RCA sales offices or distributors.

Circle 161 on reader service card

\$ 239



First automatic counter-totalizer at that price.

* AGC * Autoranging to 200 KHz * 5 digits standard, 2 optional * Leading zero suppression * 25 mV sensitivity * 5 high stability oscillator options * Rechargeable battery option * BCD conversion optional

For details or a demo of Model 6202, contact your local Scientific Devices office or Systron-Donner at 10 Systron Drive, Concord, CA 94518. Phone (415) 682-6161. Europe: Munich, W. Germany; Leamington Spa, U.K.

SYSTRON  DONNER

Circle 162 on reader service card

\$ 350



Measure 103.807 Hz automatically in 1 sec.

* AGC * Autoranging to 2 MHz in 1 sec. * Automatic frequency readings to 0.001 Hz in 1 sec. * 6 digits standard, 2 optional * 25 mV sensitivity * Leading zero suppression * 5 high stability oscillator options * Rechargeable battery option

For Model 6220 literature, contact your local Scientific Devices office or Systron-Donner at 10 Systron Drive, Concord, CA 94518. Phone (415) 682-6161. Europe: Munich, W. Germany; Leamington Spa, U.K.

SYSTRON  DONNER

162 Circle 181 on reader service card

Eliminate relay failures.

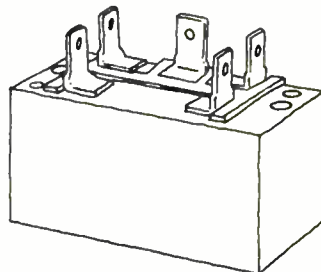

Use Grayhill's Solid State Relays.

Grayhill Solid State Relays eliminate coil and contact sticking and burn outs because there literally are no moving parts.

Grayhill Relays are protected against transients, surges and inductive "kicks" by design—incorporating exclusive, built-in guardian circuits.

Optional features include: zero voltage crossover; logic circuit compatibility; and transformer (or LED) isolated input and output circuits.

For our latest Engineering Catalog or engineering assistance write or phone: Grayhill, Inc., 523 Hillgrove Ave., La Grange, Illinois 60525. (312) 354-1040.



Circle 182 on reader service card

Compare Mini-Mox to whatever film resistor you're using now.

Our Miniature Metal Oxide Resistors Can Give You up to 10,000 Megs and 5000 Volts in 1/10th the Space.

Compared to metal film resistors our tiny Mini-Mox can give you greater power handling capability and substantially better resistance to size or voltage to size ratios.

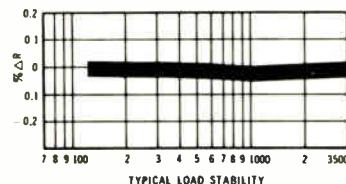
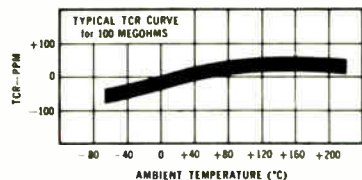

Mini-Mox outstrips conventional carbon film in every category: 100 ppm TCR; voltage to size ratio; stability; power handling capability; initial tolerance and reliability, particularly under extreme environmental conditions.

Model	Resistance	Rating @70°C	Max. Oper. Volts	Length Inches	Diameter Inches
MOX-400	1-2500 megs	.25W	1000V	.420	.130
MOX-750	1-5000 megs	.50W	2000V	.790	.130
MOX-1125	1-10,000 megs	1.00W	5000V	1.175	.130

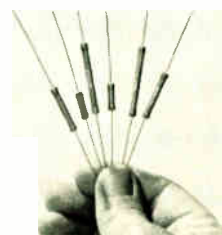

For detailed specifications on Mini-Mox send for this technical bulletin. Victoreen Instrument Div. of VLN Corp., 10101 Woodland Avenue, Cleveland, Ohio 44104. Telephone: 216/795-8200.



DMA 684

Expertise in high voltage

Circle 183 on reader service card

Do you face a make or buy decision on power supplies?

BUY LAMBDA LX SERIES

Now 47 models in 8 package sizes...
single, dual & triple outputs.

new single and dual output models in "EE" package



NEW "EE" PACKAGE
SINGLE OUTPUT
LXS-EE-5-OV

\$425

5 VOLTS 45 AMPS
(with O.V.)

NEW "EE" PACKAGE
DUAL OUTPUT
LXD-EE-152

\$435

±15 TO ±12 VOLTS 12.5 AMPS

all listed in Underwriters'
Recognized Components Index*

all designed to meet MIL
environmental specifications

all in stock for 1-day delivery

all guaranteed 5 years

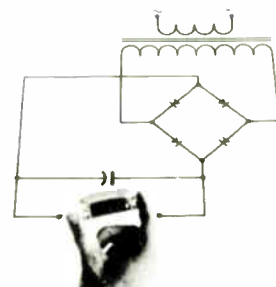

**WHETHER
YOU MAKE
OR BUY...**

**LAMBDA
ELECTRONICS CORP.**

A  Company

*LX-EE models presently undergoing qualifying tests.

MELVILLE, NEW YORK 11746 515 Broad Hollow Road Tel. 516-694-4200 ARLINGTON HEIGHTS, (CHICAGO) ILL. 60005 2420 East Oakton St., Unit Q Tel. 312-593-2550
NORTH HOLLYWOOD, CALIF. 91605 7316 Varno Ave. Tel. 213-875-2744 MONTREAL, QUEBEC 100C Hymus Blvd., Pointe-Claire, Quebec-730 Tel. 514-697-6520

Circle 901 on reader service card

Odd Jobs Wanted

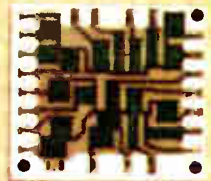

Highly respected company with reputation for fast handling of special resistance projects seeks challenging assignments in thick film. Completely equipped to design and/or produce special circuitry inside DIP and SIP packages. Laser trimming facilities for high volume needs. Also special capabilities for non-standard configurations, hybrids and high power requirements. Custom substrate preparation, including LED metalization, a specialty. References furnished. Contact your Dale Representative or call 402-564-3131.

Dale Electronics, Inc., Box 609,
Columbus, Nebraska 68601.
In Canada: Dale Electronics
Canada, Ltd. A subsidiary of
The Lionel Corporation.

