

Computer-aided C/MOS logic design and analysis 85

The job market for EEs: recovery or relocation? 98

Special report: the lively world of active filters 104

Electronics



Repackaging upgrades a minicomputer



1420 N. 302 80th Ave
WATT NEILL
3022 NE BROADWAY
PORTLAND OR 97232

MOS TECHNOLOGY INC.'S NEW HI-SPEED ROMS

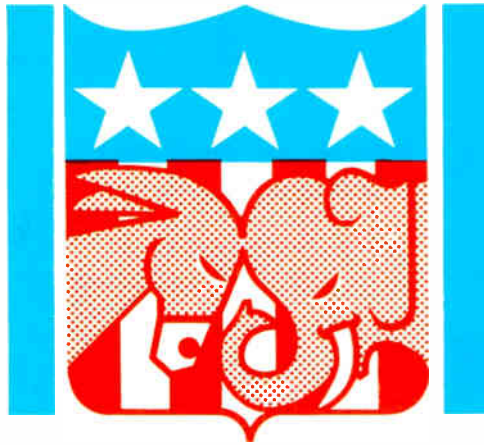

TWO SLIGHTLY DIFFERENT ORGANIZATIONS

THE MCS 2017
7x9x64
4032 BITS

THE MCS 2020
7x10x32
2240 BITS

BOTH WORKING TO SERVE YOU AS THE ROM OUTPUT CHARACTER GENERATOR

Both Fully Qualified With:

- 440 NS ACCESS TIME
- 200 MW MAXIMUM POWER
- "WIRE-OR" CAPABILITY
- FULL ADDRESS DECODING
- DUAL-IN-LINE PACKAGING
- SILICON NITRIDE PROCESS

*one of them's got exactly what
you want...take it and run!*

We've Turned
A Technology
Into A Company



MOS TECHNOLOGY, INC.

VALLEY FORGE INDUSTRIAL PARK, VALLEY FORGE, PENNA. 19401
215-668-7950 • TWX: 510-668-0833

A Proud Affiliate of Allen-Robbins Co.

EASTERN REGIONAL OFFICE

Regional Sales Director — Mr. William Whitehead, MOS TECHNOLOGY, INCORPORATED, 88 Sunnyside Blvd., Suite 307, Plainville, New York 11803 • Phone: (516) 822-4240 • Alabama, Florida, Georgia, N. Carolina, S. Carolina, Tennessee, Mississippi — Cuirve Aerospace Associates, P.O. Box 1424, Huntsville, Alabama 35807 • Phone: (205) 536-5650 • 2907 McCoy Road, P.O. Box 13229, Orlando, Florida 32809 • Phone: (305) 855-0843 • P.O. Box 5588, Greensboro, North Carolina 27403 • Phone: (919) 273-3040 • New England States — Victor Associates, 179 Union Ave., Framingham, Massachusetts 01701 • Phone: (617) 879-5710 • Northern New Jersey, New York (Westchester County, Long Island) — Falk Baker Associates, 383 Franklin Avenue, Putney, New Jersey 07110 • Phone: (201) 661-2430 • E. Pennsylvania, Southern New Jersey — Rivco, P.O. Box 338, King of Prussia, Pennsylvania 19406 • Phone: (215) 265-5211 • Delaware, Maryland, Washington, D.C., Virginia, West Virginia — Bernard

White & Company, Inc., 7 Church Lane, Baltimore, Maryland 21208 • Phone: (301) 484-5600.

CENTRAL REGIONAL OFFICE

Regional Sales Director — Mr. Alan Mattal, MOS TECHNOLOGY, INCORPORATED, 10400 W. Higgins Rd., Suite 631, Rosemont, Illinois 60018 • Phone: (312) 298-2035 • TWX: 910-233-4595 • Indiana, Indiana, Wisconsin — I-TEC, Incorporated, 5808 West Higgins Rd., Chicago, Illinois 60630 • Phone: (312) 286-1500 • Ohio, Kentucky, W. Pennsylvania — McShane, Inc., P.O. Box 523, 123 W. Washington, Medina, Ohio 44256 • Phone: (216) 725-4568 • Michigan — R. C. Merchant & Co., 18411 W. McNichols Road, Detroit, Michigan 48219 • Phone: (313) 535-6000 • Missouri, Kansas, Nebraska, Iowa — Harlan J. Westler & Assoc., Inc., 2050 Woodson Road, St. Louis, Missouri 63114 • Phone: (314) 428-3934 • Texas, Oklahoma, Arkansas, Louisiana — Norvel Associates, 10210 Monroe Drive, Dallas, Texas 75220 • Phone: (214) 357-6451

WESTERN REGIONAL OFFICE

Regional Sales Director — Mr. Jack Turk, MOS TECHNOLOGY, INCORPORATED, 2172 Dupont Drive, Pallo Bldg., Suite 221, Newport Beach, California 92660 • Phone: (714) 833-1600 • Arizona, New Mexico — Toward Engineering Assoc., P.O. Box 15268, Arcadia Station, Phoenix, Arizona 85018 • Phone: (602) 955-3193 • California, Nevada — Berland & Zoolian, Inc., 7340 Florence Avenue, Suite 205, Downey, California 90241 • Phone: (213) 927-4406 • Hunter Associates, 1208 Fox Plaza, San Francisco, California 94102 • Phone: (415) 628-8576 • Colorado, Utah, Wyoming — R. C. Enterprises, 1107 South Pearl Street, Denver, Colorado 80210 • Phone: (303) 744-2464 • Washington, Oregon, Idaho, Montana — J. A. Tudor & Assoc., Inc., 2605 Western Avenue, Seattle, Washington 98121 • Phone: (206) 682-7444.

INTERNATIONAL SALES REPRESENTATIVES

Argentina — T. R. C. Electronica, S.A.C.I., Cangallo 2450, Buenos Aires, Argentina • Phone: 88-4044/79/76.

Mr. M. Lissin • England, Wales, Scotland, Ireland — Impectron Limited, Impectron House, 21-31 King Street, London W3 3LX, England • Phone: 01-992-5388 • France — Bureau de Liaison, 113 Rue de L'Université, Paris Ville, France • Phone: 551.9920 • Germany, Netherlands — International Micro Electronics, Inc., Arabellahaus 1838, Arabellastr. 5, 8000 Munich 81, Germany • Phone: 92-021 • India — Electronic Enterprises, 46 Karan Building, New Charni Road, Bombay 4, India • Phone: 375375 • Israel — Eastronics, Ltd., 75 Haifa Road, P.O. Box 21029, Tel-Aviv, Israel • Phone: 38352 • Italy — Special-Ind. Corporation, Piazza Spoltorno, 20159 Milano, Italy • Phone: 632-435 • Japan, Hong Kong, Korea, Taiwan — Takachio Kohel Company Ltd., 1-7, Chome Kohjimachi, Chiyoda-Ku, Tokyo 102, Japan • Phone: 263-3211 • Sweden, Denmark, Finland, Norway — Thru F. Forsberg, Forshagatan 58, P.O. Box 79, Farsta 1, Sweden • Phone: 647070 • Switzerland — Ernst M. Egli, Ingenieur-Bureau Ag, Willikonstrasse 295, Zurich (CH 8053), Switzerland • Phone: 53.38.11.

Can you imagine what the signal source of the future will be like?

Will it have excellent frequency accuracy and stability?

Better amplitude characteristics?

Systems capability with inexpensive interfacing and software you can handle yourself?

And how about a reasonable price tag?

Well, the new Hewlett Packard 3320A and 3320B Frequency Synthesizers give you all this—plus a lot more!

Both instruments give you frequency accuracy and stability measured in a few parts per million per year. That's a thousand times better than any RC oscillator.

They both give you the signal purity of a good RC oscillator—a new feature for a frequency synthesizer.

The 3320B offers you amplitude accuracy, resolution and frequency response measured in a few hundredths dB over a 100-dB attenuation range. So it is both a frequency standard and a very precise level generator.

The 3320A and 3320B have optional remote control and the 3320B can even be controlled directly from most tape readers or card readers (like the new HP 3260A Marked Card Programmer).

And to top it off, the 3320 has the widest frequency range of any test oscillator, programmable oscillator or

low cost frequency synthesizer on today's market, 0.01 Hz to 13 MHz.

How about the price tag?

The 3320A, priced at \$1900, and the 3320B at \$2400 give you two great buys in signal sources—both today and in the future.

We call the 3320 "the new price/performance benchmark for precision signal sources." *Electronics* magazine called it a "pacesetter." You'll call it "a steal."

For further information on the 3320A/B, contact your local HP field engineer. Or write Hewlett-Packard, Palo Alto, California 94304. In Europe: 1217 Meyrin-Geneva, Switzerland.

HEWLETT  PACKARD

SIGNAL SOURCES

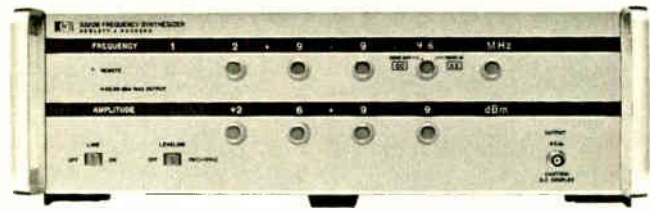

091/18

**... at \$1900,
It's a Steal!**



How good is the 3469B? Compared to what?—We compared it to all the competitive DMM's we could find up to \$1000, and found it equals or exceeds the performance

of every 3-digit DMM available.

Make your own comparison. If you want the most capable 3-digit DMM on the market, without paying a lot of money, get HP's 3469B.

Priced at \$595, order from your local HP field engineer. Or, write Hewlett-Packard, Palo Alto, California 94304. In Europe, 1217 Meyrin-Geneva, Switzerland.

If you're a comparison shopper... Here's a 4-in-1 DMM that beats them all.

100X More Sensitive
Than Most (1 mV F.S.
to 500 V F.S.)

100X More Bandwidth
Than Most
(2 Hz. to 10 MHz.)

100X More Sensitive
Than Most (1Ω F.S. to
10 MΩ F.S.) Unique
Lead-Resistance
Compensation.

3X Sampling Rate of
Most (S.R. = 15/sec.)

100X More Sensitive
Than Most (1 μA F.S. to
100 mA F.S.)

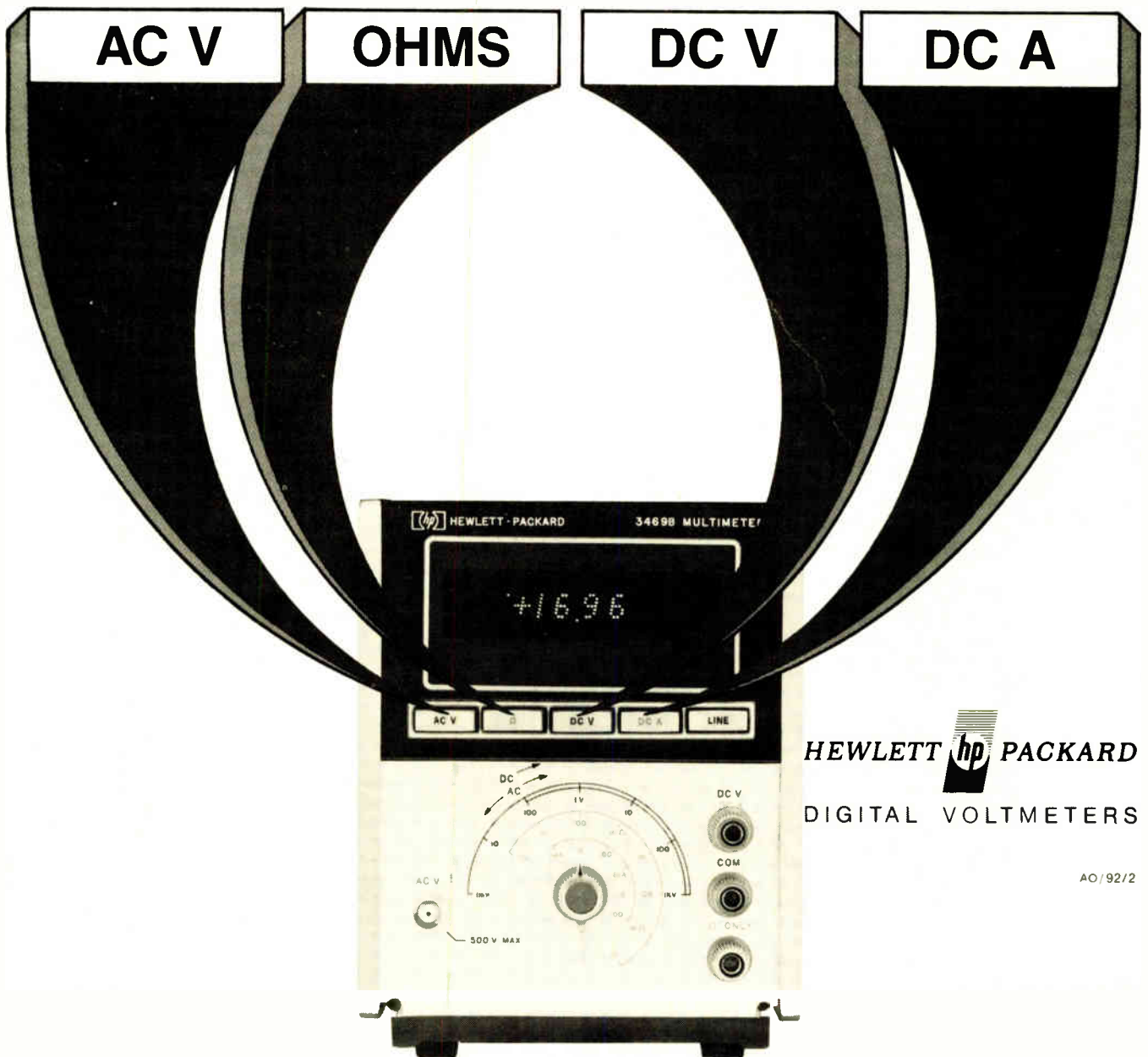

HEWLETT **hp** PACKARD
DIGITAL VOLTMETERS

AO/92/2

33 Electronics Review

COMMUNICATIONS: Electronic switching goes long distance, 33
COMPUTERS: Powerful processor runs No. 4, 34
DISPLAYS, Storage CRT boosts contrast, 34
INDEX OF ACTIVITY: 35
COMMUNICATIONS: Bell's DUV test links Boston, N.Y., 35
CONSUMER ELECTRONICS: Amplifier gives equal hearing, 36
CONSUMER ELECTRONICS: Digital ICs think for TV tuners, 38
COMPANIES: Going to Japan? Try me, says Sony, 38
COMMERCIAL ELECTRONICS: Crystals step up to bar, 40
MILITARY ELECTRONICS: SALT doesn't halt ABM R&D, 42
COMMUNICATIONS: DEC introduces four systems, 44
FOR THE RECORD: 44

69 Probing the News

PROCESSING: Ion Implantation coming of age, 69
TRANSPORTATION: Transpo boosts ground electronics, 73
PRODUCTION: Easing the switch to electronics, 75
INDUSTRIAL ELECTRONICS: Auto electronics picks up speed, 76

81 Technical Articles

PACKAGING: Repackaging a minicomputer cuts costs, 81
SOLID STATE: Computer enables design of C/MOS logic, 85
DESIGNER'S CASEBOOK: Diode and op amp make thermostat, 90
Logic system checks out analog-to-digital converter, 91
Double-duty multivibrator gives complementary outputs, 92
INSTRUMENTS: Multiplexing cuts cost of digital conversion, 94
YOU AND YOUR CAREER: EEs are finding jobs again, but . . . 98
CIRCUIT DESIGN: Active filters get more of the action, 104
ENGINEER'S NOTEBOOK: Extending the life of recording heads, 111
Charts calculate tradeoffs in pc edge connector costs, 113

119 New Products

IN THE SPOTLIGHT: Supply offers stable 400-Hz power, 119; Chip comparator keeps pace with ECL, 123
COMPONENTS: Low-cost d-a converters settle fast, 125
INSTRUMENTS: Synthesizer has low phase-noise, 129
DATA HANDLING: 2-k MOS RAM goes to market, 133
SUBASSEMBLIES: Photodiodes built for op-amp coupling, 136
SEMICONDUCTORS: ROM uses only 100 μ W per bit, 138

55 Electronics International

WEST GERMANY: A core-semiconductor memory, 55
FRANCE: TV makers anticipate sales rise, 55
FRANCE: Honeywell-Bull's new chairman, 57

Departments

Publisher's letter, 4
Readers comment, 6
40 years ago, 8
People, 14
Meetings, 24
Electronics newsletter, 29
Washington newsletter, 51
Washington commentary, 52
International newsletter, 59
Engineer's newsletter, 116
New literature, 140

Highlights

Ion Implantation pays off, 69

Demand for ion-implanted MOS LSI chips is accelerating because the precision of the process improves device density, yields, and accuracy.

Repackaging upgrades a minicomputer, 81

Modifying the memory, power supply, and back panel improves reliability and compactness at lower price by using existing, proven technology.

EEs find jobs again, but choices are limited, 98

Companies are gradually increasing their engineering staffs, but they are shopping carefully. Openings in non-electronics industries increase as more companies adopt electronics techniques.

Charts show tradeoffs in pc connector costs, 113

Costs are compared with various desired performance criteria for cantilever and bellows-type connector designs.

Novel design offers stable 400-Hz power, 119

Rotating generator employs magnetizable poles with variable spacing to provide constant-frequency output accurate to within 0.01%.

And in the next issue. . . .

Low-cost plastic optical components . . .
Special report on industrial telemetry . . .
CDI—another high-density semiconductor process.

The cover

Designer ponders possible new configurations of minicomputer modules that can save money.

Electronics

EDITOR-IN-CHIEF: Kemp Anderson

EXECUTIVE EDITOR: Samuel Weber

MANAGING EDITORS: Lawrence Curran, *News*;
Arthur Erikson, *International*

SENIOR EDITORS: John Johnsrud,
H. Thomas Maguire, Stephen E. Scrupski

ART DIRECTOR: Fred Sklenar

ASSOCIATE EDITORS: Richard Gundlach,
John N. Kessler, Howard Wolff

DEPARTMENT EDITORS

Aerospace: William F. Arnold
Circuit Design: Lucinda Mattera
Communications & Microwave:

Lyman J. Hardeman
Computers: Wallace B. Riley
Consumer: Gerald M. Walker

Industrial: Alfred Rosenblatt
Instrumentation: Michael J. Riezenman
Military: Ray Connolly

New Products: H. Thomas Maguire
Packaging & Production:
Stephen E. Scrupski

Solid State: Laurence Altman
Special Issues: Harry R. Karp

COPY EDITORS: Margaret Eastman,
Everett C. Terry

ASSISTANT EDITOR: Marilyn Offenheiser

ART: Charles D. Ciatto, *Associate Director*

PRODUCTION EDITORS:
Patricia Cybulski, Arthur C. Miller

EDITORIAL SECRETARIES: Vickie Green,
Nancy Baldasare, Julie Gorgoglione

FIELD EDITORS

Boston: James Brinton (Mgr.), Gail Farrell
Dallas: Larry Armstrong (Mgr.)

Los Angeles: Paul Franson (Mgr.)

New York: Alfred Rosenblatt (Mgr.)

San Francisco: Stephen Wm. Fields (Mgr.),
Roberta Schwartz

Washington: Ray Connolly (Mgr.),
William F. Arnold

Frankfurt: John Gosch

London: Michael Payne

Paris: Arthur Erikson

Tokyo: Charles Cohen

McGRAW-HILL WORLD NEWS

Director: Walter A. Stanbury; *Atlanta*: Stan
Fisher; *Chicago*: Mike Sheldrick; *Cleveland*:
Arthur Zimmerman; *Detroit*: James Wargo;

Houston: Robert E. Lee; *Los Angeles*: Michael
Murphy; *Gerald Parkinson*; *San Francisco*:
Margaret Drossel; *Seattle*: Ray Bloomberg;

Washington: James Canan, Herbert W.

Cheshire, Seth Payne, Warren Burkett, William
D. Hickman; *Bonn*: Robert Ingersoll; *Brussels*:
James Smith; *London*: Marvin Petal; *Milan*:
Peter Hoffmann, Andrew Heath; *Moscow*: Axel
Krause; *Paris*: Stewart Toy, Michael Johnson;

Stockholm: Robert Skole; *Tokyo*: Mike Mealey

PUBLISHER: Dan McMillan

ADVERTISING SALES MANAGER: Pierre J. Braudé

ADVERTISING SALES SERVICE MANAGER:
Wallis Clarke

BUSINESS MANAGER: Stephen R. Weiss

CIRCULATION MANAGER: George F. Werner

RESEARCH MANAGER: David Strassler

MARKETING SERVICES MANAGER:
Tomlinson Howland

Publisher's letter

With emerging signs of an economic upturn, we sent Jerry Walker, who doubles as careers editor and consumer editor, to take another look at a subject dear to the hearts of our readers—employment for EEs. In previous stories on this subject, you'll recall, Jerry discovered a great deal of disenchantment among EEs about their careers, particularly among those who had been laid off or dislocated due to cutbacks in Government programs. He also reported a growing militancy among EEs, and predicted a greater role in career security matters by such staid old institutions as the IEEE.

Now that things are picking up, however, Jerry wondered if that is changing again, and, with the help of our bureaus, talked to engineers, personnel directors, college placement specialists, and other watchers of the employment situation. The result is his story on page 98, which shows that while there are now more jobs available, those who offer them are more selective, and many are likely to be outside the traditional marketplace for EEs.

We're relying on you, though, to help us write a sequel to Jerry's article. The questionnaire on page 103 is designed to find out from our readers a variety of things: first, are hard times really over for EEs? Second, what kind of difficulties were experienced by EEs in finding or keeping jobs, and third, is dissatisfaction with electronics as a career being sustained? Help us tell your story—your comments and experiences are welcomed.

It's becoming a cliché to talk about how quickly technology moves in electronics, but we keep getting re-

mindings that it's true. An example is the story on ion implantation on p. 69, for which Dallas bureau manager Larry Armstrong served as anchor man. Just two years ago we reported that only two principal U. S. companies had any significant experience with implantation techniques—Hughes Aircraft Co. and Mostek Corp. Now the list includes just about every major semiconductor manufacturer in this country, Europe, and Japan.

And while Accelerators Inc. dominated implantation equipment sales two years ago, it's getting serious competition from Extron Corp. and Ortec Inc. Semiconductor makers are driving dopants into everything from C/MOS watch circuits to Impatt diodes with ion accelerators to get finer geometries and better performance.

A good indicator of the breadth of interest in implantation comes from Armstrong, who says that Accelerators Inc. has a clean room dedicated to customer use and it's booked solid for months to come by semiconductor suppliers, who are sending their own people to the Austin, Texas, facility to get first-hand experience with the technique.

Armstrong reports, "The semiconductor people come in and use the facility for a day at a time, or so, and not even Accelerators Inc. people know what these potential equipment customers are doing with their wafers." That's a sure sign that implantation can give device makers a competitive edge that they're not about to compromise.



June 19, 1972 Volume 45, Number 13
89,926 copies of this issue printed

Published every other Monday by McGraw-Hill Inc. Founder James H. McGraw 1860-1948. Publication office 1221 Avenue of the Americas, N.Y. N.Y. 10020. Second class postage paid at New York, N.Y. and additional mailing offices.

Executive editorial circulation name title or job function company or organization including product manufactured or services performed. Subscription rates: qualified subscribers in the United States and possessions and Canada \$8.00 one year, \$12.00 two years, \$16.00 three years; all other countries \$25.00 one year except Japan \$50.00 per year including air freight. Limited quota of subscriptions available at higher-than-basic rate for persons outside of field served as follows: U.S. and possessions and Canada, \$25.00 one year, all other countries \$50.00. Single copies: United States and possessions and Canada \$1.00; all other countries \$1.75.

Subscriptions limited to persons with active professional functional responsibility in electronics technology. Publisher reserves the right to reject non-qualified requests. No subscriptions accepted without complete identification of subscriber name title or job function company or organization including product manufactured or services performed. Subscription rates: qualified subscribers in the United States and possessions and Canada \$8.00 one year, \$12.00 two years, \$16.00 three years; all other countries \$25.00 one year except Japan \$50.00 per year including air freight. Limited quota of subscriptions available at higher-than-basic rate for persons outside of field served as follows: U.S. and possessions and Canada, \$25.00 one year, all other countries \$50.00. Single copies: United States and possessions and Canada \$1.00; all other countries \$1.75.

Officers of the McGraw-Hill Publications Company: John R. Emery, President; J. Elton Tuohig, Senior Vice President—Services; Donald B. Gridley, Group Vice President; Vice Presidents: Ralph Blackburn, Circulation; John R. Callahan, Editorial; John B. Hoglund, Controller; David G. Jensen, Manufacturing; Jerome D. Luntz, Planning & Development; Joseph C. Page, Marketing.

Officers of the Corporation: Shelton Fisher, President; Joseph H. Allen, President Publications and Business Services Group; John J. Cooke, Senior Vice President and Secretary; Ralph J. Webb, Treasurer.

Title registered in U.S. Patent Office. Copyright 1972 by McGraw-Hill, Inc. All rights reserved. The contents of this publication may not be reproduced either in whole or in part without the consent of copyright owner.

Subscribers: The publisher upon written request to our New York office from any subscriber agrees to refund that part of the subscription price applying to copies not yet mailed. Please send change of address notices or complaints to Fulfillment Manager, subscription orders to Circulation Manager, Electronics, at address below. Change of address notices should provide old as well as new address, including postal zip code number if possible, attach address label from recent issue. Allow one month for change to become effective.

Postmaster: Please send form 3579 to Fulfillment Manager, Electronics, P.O. Box 430, Hightstown, N.J. 08520.

The filter that stands by itself.

Model 3550 multifunction filter has no competition. For just \$590, this instrument provides band-pass, band-reject, low-pass or high-pass operation — instantly selected by a single front panel switch. The 3550 minimizes circuit loading with high input impedance and overcomes load sensitivity with low output impedance. Cut-off frequency is continuously adjustable from 2Hz to 200kHz — covering the entire

audio range and well beyond. Model 3550 also offers a choice of Butterworth response or Low Q for transient-free performance. Its features like these that leave all other filters without a leg to stand on. For fast action, call The Wavemakers at (617) 491-3211, TWX 710-320-6583 Krohn-Hite Corporation, 580 Mass. Ave., Cambridge, Mass. 02139.



KH KROHN-HITE CORPORATION

OVERSEAS SALES OFFICES: AUSTRIA, Universal Elektronik Import; AUSTRALIA, Warburton O'Donnell Limited; BELGIUM, C. N. Rood s. a.; DENMARK, SC Metric A/S; ENGLAND, Allied International Limited; FINLAND, INTO O/Y; FRANCE, Antares; GERMANY, Nucletron Vertriebs-GMBH; HOLLAND, C. N. Rood n. v.; INDIA, Bali International Agencies; ISRAEL, R.D.T. Electronics Engineering, Ltd.; ITALY, Vianello S.P.A.; JAPAN, Shoshin Shoji Kaisha, Ltd.; NEW ZEALAND, H.M.Z. Ltd.; SOUTH AFRICA, Protea Physical; SPAIN, Rema Leo Haag, S.A.; SWEDEN, Teleinstrument; SWITZERLAND, Megax Zurich GMBH.

NEW



The first portable that isn't a test of your manhood.



Our new 2100 dual-channel field scope weighs 14 pounds. Or about half of what most other "portable" field scopes weigh. Know what that means? It means that you no longer have to lug around a scope that weighs a ton. Trying to look as if it was "nothing."

Ours really is a featherweight. And best of all, it's a featherweight with heavyweight features.

To begin with, it has a big 4-inch screen. It can shoot 100 nanosecond pulses. It has 10 MHz bandwidth. It features delayed sweep. And has color-coded, push button controls. Not to mention a tuning fork that works like the ones in fine watches.

What's more, you get Dumont's FULL AUTO triggering (that gives you a constant triggered presentation, and lets you select a trigger level only within the signal amplitude) as well as AND/gate logic (for external triggering of as many as 4 simultaneous inputs).

The cost for this 14-pound, 5000-MTBF wonder? \$995.

Which isn't exactly a burden either. Why not write us for all the information.

DUMONT OSCILLOSCOPE LABORATORIES INC.
40 Fairfield Pl., West Caldwell, N.J. 07006
(201) 575-8666; TWX (710) 734-4308

DUMONT
OSCILLOSCOPE LABORATORIES INC.

Readers comment

Optimum sampling

To the Editor: In Arthur G. Stephenson's "Digitizing multiple rf signals requires an optimum sampling time" [*Electronics*, March 27, p.106], there is an error in the discussion of aperture time which may mislead your readers.

The author states that a seven-bit converter requires a 1-nanosecond aperture time to keep error to one bit for a 100-megahertz signal. The general equation for frequency vs aperture is:

$$f_{\max} = 1/[2n(2\pi)t_a] \text{ Hz}$$

Thus, for $t_a = 1 \text{ ns} = 10^{-9}$, and $n = 7$

$$f_{\max} = 128 \times 6.28 \times 10^{-9} = 1.2 \text{ MHz}$$

Michael Neidich
President, Intems Inc.
Mineola, N. Y.

■ Mr. Stephenson replies: Mr. Neidich's question relative to aperture time in my article can only be addressed by deriving the expression we used to find peak aperture error.

The error resulting from a finite aperture time when sampling a sinusoidal carrier (as in radio communications) has been defined for an equal weighting model (as shown below) by T. Stephens.

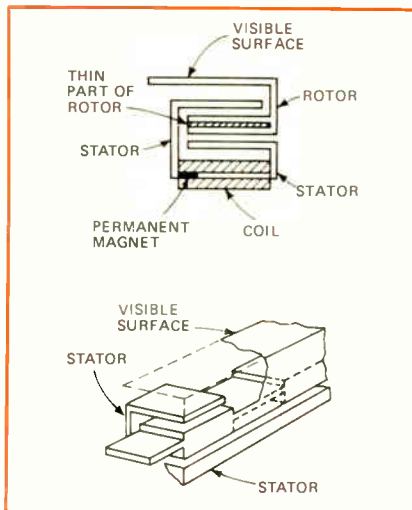

If $e_i(t)$ represents the voltage during aperture time, as shown in the figure, $e_i T = \sin(\omega t + \theta)$. The output voltage, $e_o(T)$, may be

$$e_o(T) = \frac{1}{T} \int_{-T/2}^{T/2} \sin(\omega t + \theta) dt$$

$$= \frac{1}{\omega T} \left[\cos\left(\frac{\omega T}{2} + \theta\right) - \cos\left(\frac{\omega T}{2} - \theta\right) \right]$$

The aperture error, E , is

$$\begin{aligned} & e_i(0) - e_o(T) \\ & = \text{Actual voltage at sample time } (ts) - \text{voltage averaged over the aperture time} \\ & = \sin \theta \\ & - \frac{1}{\omega T} \cos\left(\frac{\omega T}{2} + \theta\right) \\ & + \frac{1}{\omega T} \cos\left(\frac{\omega T}{2} - \theta\right) \\ & = \sin \theta \left[1 - \frac{2}{\omega T} \sin \frac{\omega T}{2} \right] \\ & = \sin \theta \left[1 - \frac{\sin \omega T/2}{\omega T/2} \right] \end{aligned}$$

Thus the peak aperture error

$$\left[1 - \frac{\sin \omega T/2}{\omega T/2} \right] \text{ (assuming the}$$

sine wave amplitude is normalized to 1.0).

My article stated that "a seven-bit analog-to-digital converter with an aperture time of 1 ns can digitize a 100-MHz carrier with an error less than one quantization level." This statement may be substantiated by using the relationship derived above for peak aperture error.

A 1-ns aperture time is $1/10F$, when F is 100 MHz. Therefore, ωT is $(1/10)F$ or 36° . Solving for peak aperture error, using an aperture angle of 36° (or 0.2π radians), yields a peak error of 0.016.

In order to keep the error less than one quantization level, a six-bit or 64-level analog-to-digital converter can theoretically be used. (In a 64-level system, the quantization step sizes are $1/64$ or 0.0156.) For a practical system, a seven-bit or 128-level configuration has been postulated as the basis for a design. ($1/128 = 0.0078$ per quantization step).

The Great Escape

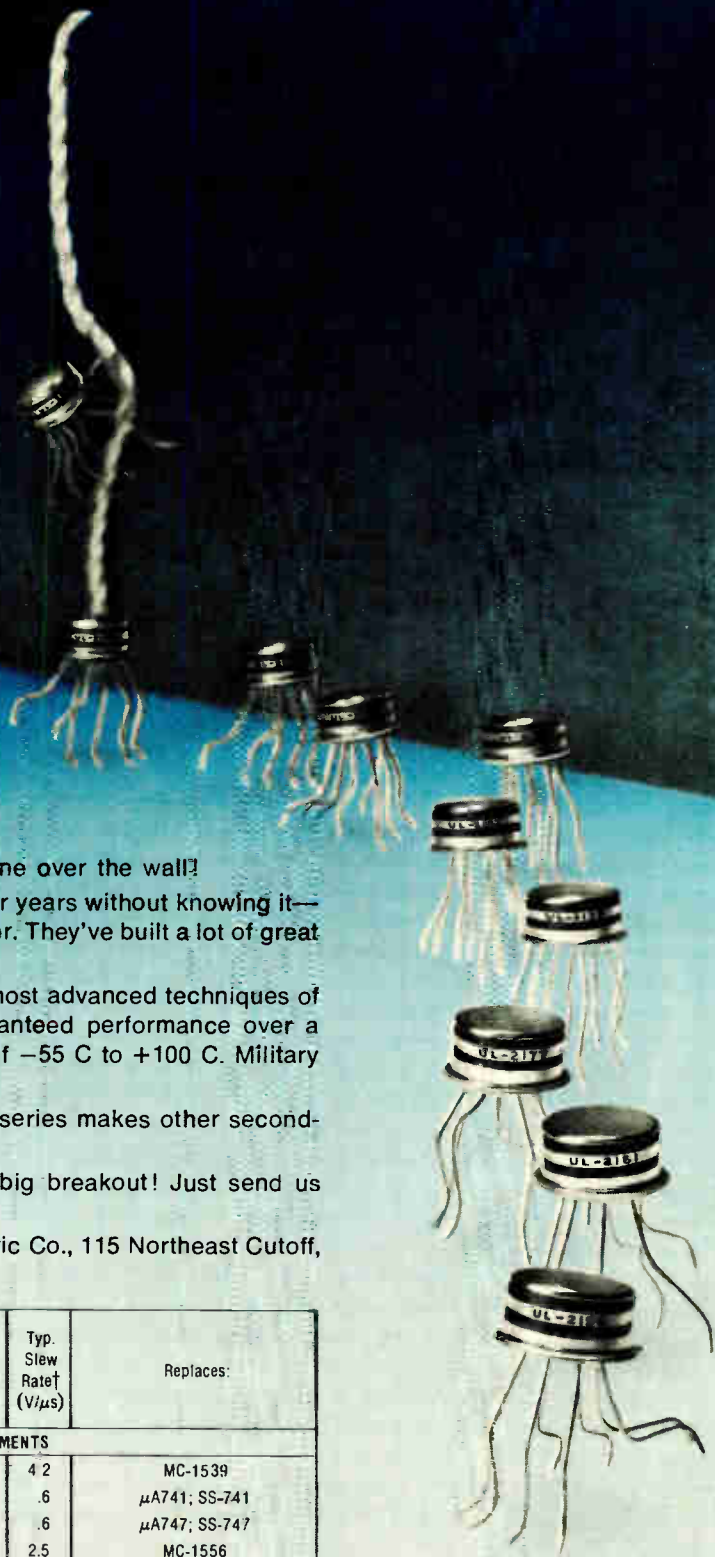

Sprague's monolithic op amps have gone over the wall!

You probably have been buying them for years without knowing it—under some other manufacturer's part number. They've built a lot of great reputations:

Sprague has done it by combining the most advanced techniques of processing and control. The result is guaranteed performance over a broadened commercial temperature range of -55 C to $+100\text{ C}$. Military versions operate to $+125\text{ C}$.

The same technology that made these series makes other second-source and proprietary designs as well.

Ask how you can share in Sprague's big breakout! Just send us your requirements!

Semiconductor Division, Sprague Electric Co., 115 Northeast Cutoff, Worcester, Mass. 01606. Tel. 617-853-5000.

Sprague Series ULS		Max. Input Offset Voltage† (mV)	Max. Input Bias Current† (nA)	Max. Input Offset Current† (nA)	Min. Gain† (dB)	Typ. Slew Rate† (V/ μ s)	Replaces:
Internally Compensated	Require External Compensation						
IMPROVED PIN-FOR-PIN REPLACEMENTS							
—	2139	3	500	60	94	4.2	MC-1539
2151	—	2	50	5	94	.6	μ A741; SS-741
2157*	—	2	50	5	94	.6	μ A747; SS-747
2156	—	4	15	2	100	2.5	MC-1556
—	2158	2	50	5	94	.6	μ A748; SS-748
UNIQUE SPRAGUE DESIGNS							
2171	2172	2	15	7	94	1.5	Similar to MC-1556, SN-52771/SN-52770
2173	2174	2	3	1.5	100	.3	Similar to SG-118/LM-108, SG-108
2175	2176	2	3	1.5	100	1.5	Similar to MC-1556, SN-52771/SN-52770
2177	2178	2	.6	.3	100	.3	Similar to SG-118A/LM-108A, SG-108A

*Dual $\ddagger T_a = 25^\circ\text{C}$



Analog Products for Signal Processing



HOT
WORK
HERE.

AND
HERE.

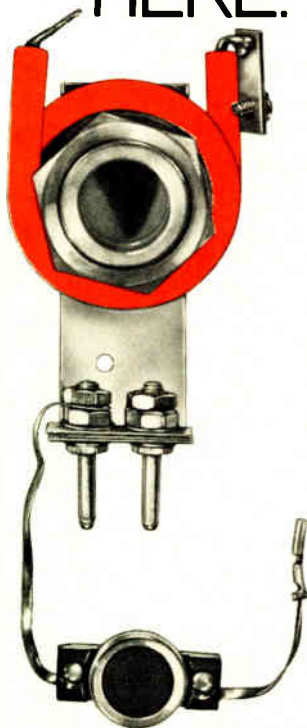

That's why Trigoneter components employ the heat resistance of Plenco 349 Black.

Trigoneter, Inc., Frankfort, Ky., manufactures components for electrical appliances and equipment that bear some of the best known names in industry.

Consider Trigoneter's little Snap-Action Thermostat, a safety temperature limiting device for electric coffee makers, battery chargers and a variety of other applications where temperature control is required. Screw injection-molded in part of our Plenco 349 Black, a high heat-resisting grade phenolic, well over a million of these thermostats are in use today.

Plenco 349 Phenolic is also specified for this company's Universal Mini-Plug Range Receptacle, used exclusively on electric ranges. The heating element plugs into the receptacle, which is designed to accept the heating elements of various manufacturers for ease of replacement.

"Both receptacle and thermostat meet rigid UL and CSA standards," reports Trigoneter, adding: "The ability of your Plenco 349 material to stand higher temperatures has enhanced the life of our devices."

Just one of many such reports we receive at Plenco. Let's get together and see how Plenco can help put your own situation under control.

PLENCO
THERMOSET PLASTICS

PLASTICS ENGINEERING COMPANY
SHEBOYGAN, WIS. 53081

Through Plenco research... a wide range of ready-made or custom-formulated phenolic, melamine, epoxy and alkyd thermoset molding compounds, and industrial resins.

40 years ago

From the pages of *Electronics*, June 1932

Prior to opening the Chicago display, licensees of the Radio Corp. of America were given opportunity to see a preliminary demonstration of cathode-ray television reception. The transmitter was in the Empire State Building where Mr. Sarnoff addressed the assembled lookers-in on 24th Street. While this apparatus represents the nearest approach to commercial models it is still far from the stage where it can be offered the public. Those who have played with television were favorably impressed with the quality of pictures received; those who had done nothing with such experiment thought the pictures needed to be vastly improved.

Many of radio's present ills may be traced to past excesses of production. Uncontrolled optimism—or ambition—followed by open-scale operations by hundreds of loft artists contributing nothing.

Each succeeding drop in price made more remote the legitimate manufacturer's chance of profit, and so increased in direct ratio the opportunity for the gyp manufacturer. Each wave of advertising stressing low prices, educated the public to believe cheapness was more important than fidelity, long life, or freedom from service cost. There are more than half a hundred of this opportunist gentry operating in New York City. Their overhead is nil, their technical equipment consists in soldering irons, and they contribute nothing to research.

The radio set in the modern family automobile is a great joy, but the idea might be carried further to give speeding motorists roadway instructions, traffic cautions, and even advertising reminders.

If automobile radio sets were tuned to a fixed short-wave, then all along the roadway, local antennas could be used to deliver appropriate messages to motor-car drivers. For example, upon approaching a dangerous curve, the car would pass through a zone of ether vibrations counseling in clear ringing tones: "Slow down for bad curves ahead."

GE DESIGNED THESE TRIACS FOR YOU

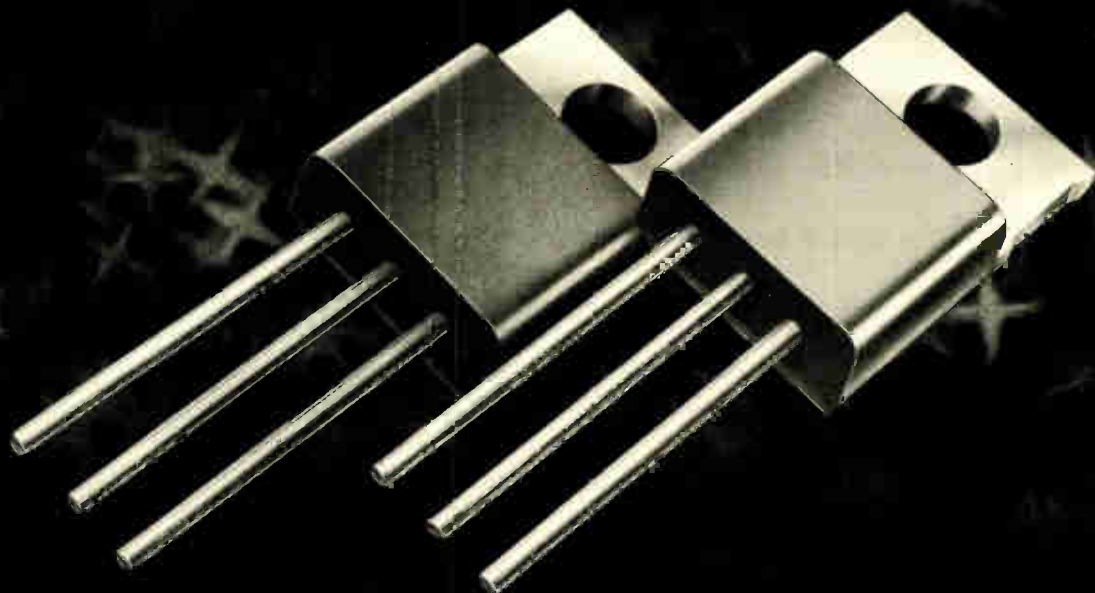

GE originated the triac in 1963 and now offers new standards of performance and reliability. Silicone encapsulated SC141 and SC146 triacs, up to 500 volts, and 6 and 10 amps respectively, feature the new proprietary **POWER-GLAS™** passivation process which creates a void free bond between the silicon chip and the matched glass. This results in low "off-state" currents of typically $10\mu\text{A}$. The SC141 and SC146, like all GE triacs, have inherent immunity from transient voltage damage and improved commutating dv/dt . Additionally these rugged packages incorporate a stress-free assembly system, which offers you torque limit-free tab mounting and easily formed round leads. For your convenience, GE offers 6 standard lead configurations. These features make the SC141 and SC146 your best value in 6 and 10 amp triacs.

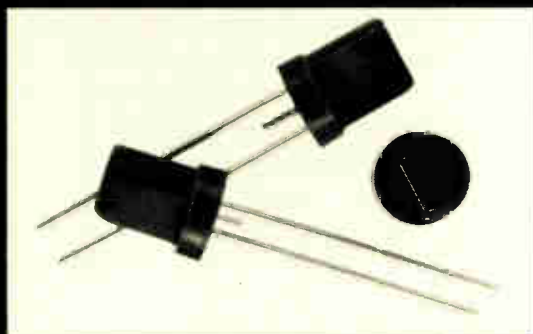

Another GE creative design, the ST4 asymmetrical trigger, is an ideal trigger for light dimmer applications. It features performance comparable to triggering circuits using at least 3 additional passive components and greatly reduces hysteresis effects by means of a single RC time constant. At 46¢ each in 1,000 unit level, it is truly an economical companion to GE **POWER-GLAS™** passivated triacs.

GENERAL  **ELECTRIC**

Interested in seeing how GE triacs and triggers can help you design? For free SC141B and ST4 samples write on company letterhead to GE Semiconductor Products Department, Electronics Park, Bldg. #7, Mail Drop 49, Syracuse, New York 13201.

The Am685

Made for high-speed analog-to-digital converters, data acquisition systems, optical isolators, VCO's and line drivers and receivers. It has 0.5mV input sensitivity, 2mV maximum offset voltage, complementary ECL outputs and a built-in latch. The 7.5ns propagation delay and 2ns acquisition time permit data processing to be performed up to 100 MHz.

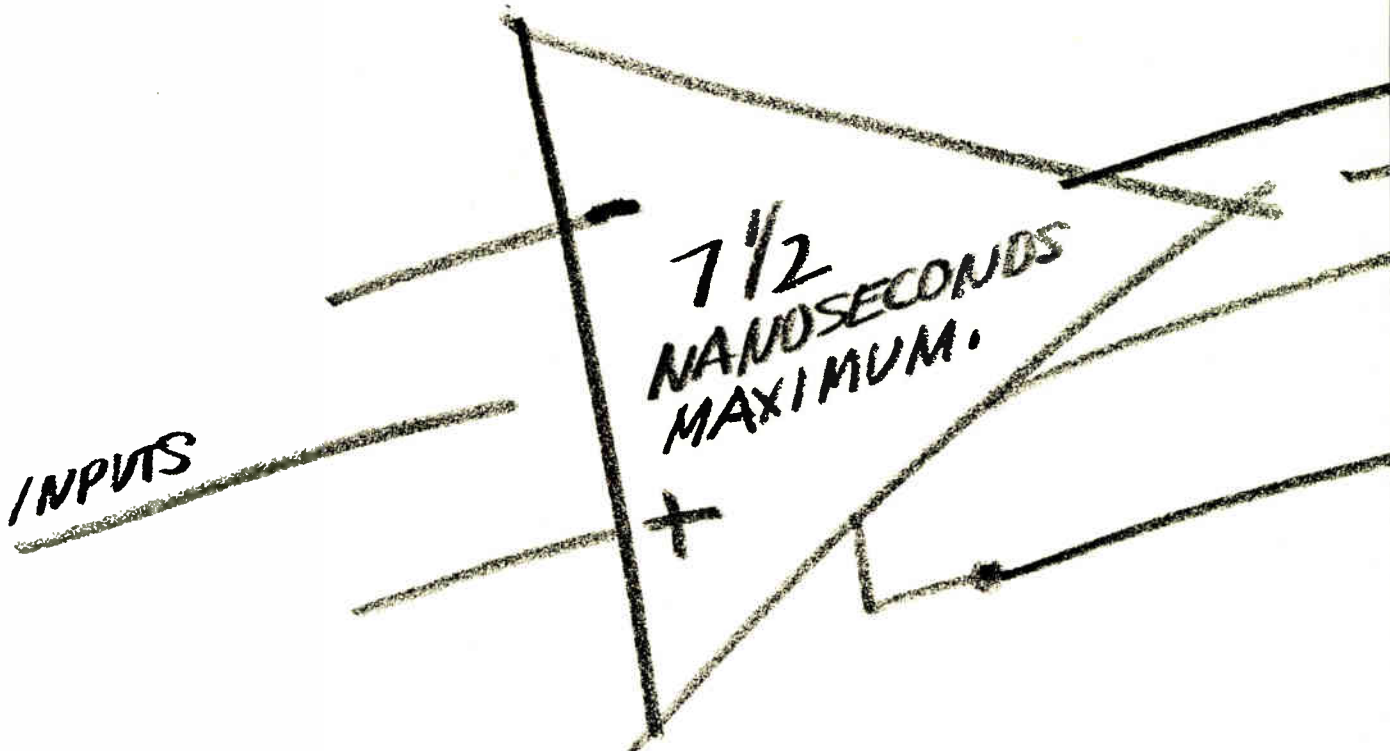

Test conditions: $V_{in} = 100\text{mV}$ step, 5mV overdrive.

The world's fastest comparator.
Propagation delay of 7.5 nanoseconds
maximum at 25° C.

9.5 nanoseconds maximum over
temperature range.

OUTPUTS

LATCH ENABLE

Who's #1 in comparators?
We are.

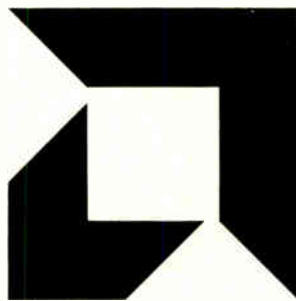

Advanced Micro Devices, Inc.

Distributed nationally by Hamilton/Avnet and Cramer Electronics. Telephone 800-538-7904 toll free, or in California 408-732-2400, and ask for Shel Schumaker. In Los Angeles, Steve Zelencik or Russ Almand at 213-360-2102. In Mid-America, Chuck Keough at 312-297-4115. In the eastern United States, Steve Marks or Bill Seifert at 516-676-4500. In the Northern California area, Dave Haun at 415-967-7031. 901 Thompson Place, Sunnyvale, California 94086/TWX 910-339-9280/TLX 346306.

Circle 11 on reader service card



STRAIGHT TALK

Our New Model 20 Programmable Calculator. Latest In the Series 9800.

It speaks and understands English. It speaks and understands Algebra. It really understands your problems. It was designed for instant programming right at your desk. The Model 20 will take you from concept to final solution of your problems

faster than any other system on the market.

Incredibly Natural Language.

You'll quickly grasp the operating concepts of the Model 20, because it uses a natural but powerful language that lets you work with algebraic symbols, formulas, and English language instructions. And, if you already know how to program, you'll

appreciate features that once were exclusive to languages like FORTRAN or BASIC: Enter and Format statements, function subroutines, and callable subroutines with parameter passing.

Talk out a problem with your Model 20. Key in your problem exactly as you would write it on paper. Press EXECUTE and there's your answer. It's deceptively simple.

With the Model 20 you always know where you stand. Its alphanumeric display and printer give you operating instructions, show your formula as you key it in, and



completely label your input and output data.

Easy To Get Along With.

One of the nicest things about the Model 20 is that it doesn't bite. If you make a mistake, your display not only tells you there's an error—but precisely what and where the error is. Then it's a simple matter to insert, delete, or replace anything from one symbol to an entire line with just a few quick strokes on the editing keys. It adds up to this: You don't have to be an expert to operate the Model 20. Because of its error detecting and correcting techniques,

the Model 20 is the fastest and easiest programmable calculator available.

A Word About Power.

What really counts is not that our calculator will solve up to 36 simultaneous equations, but what you can do with that power. With the Model 20 you'll spend less time getting answers and more time building ideas. Another thing. Our keyboard is modular. So if you don't like our setup, you can build your own.

The Model 20 can be plugged into our hardworking Series 9800 Peripherals: X-Y Plotter, Type-

writer, and Card Reader, to name a few. An added plus—it interfaces with test instruments. The basic unit, including our built-in alphanumeric display and printer is \$5,475, with immediate delivery.

For more information or a "hands-on" demonstration, write: Hewlett-Packard, P.O. Box 301, Loveland, Colorado 80537. In Europe: 1217 Meyrin-Geneva, Switzerland.

C092/2

HEWLETT  PACKARD

CALCULATOR PRODUCTS

For literature, circle 218 on reader service card
For demonstration, circle 219 on reader service card

More power to you!

AND BANDWIDTH TOO . . .

Our Model 406L is an ultra-wideband RF power amplifier whose wide range of frequency coverage and power output provides the user with the ultimate in flexibility and versatility in a laboratory instrument. Easily mated with a wide variety of signal sources, this completely solid state unit amplifies AM, FM, SSB, TV pulse and other complex modulation with minimum distortion.

Constant forward power is continuously available regardless of the output load impedance match, making the 406L ideal for driving highly reactive loads.

Unconditional stability and instantaneous failsafe provisions in the unit provide absolute protection from damage due to transients and overloads. Complete with power supplies and output meter, this low cost instrument provides over 5 watts of power from 100 KHz to over 250MHz. . . and there's no tuning.

Applications include:

- RFI/EMI testing
- Laser modulation
- Communication systems
- Ultrasonics
- Laboratory instrumentation
- Spectroscopy

For complete information write or call

Electronic Navigation Industries,
3000 Winton Road South,
Rochester, New York 14623.
(716) 473-6900

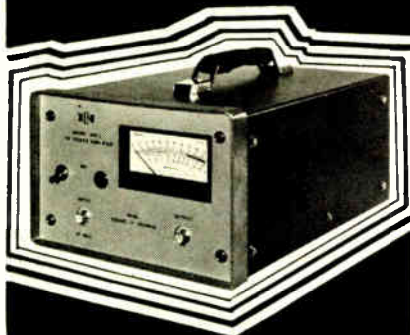

EN ELECTRONIC
NAVIGATION
INDUSTRIES

People

British CATV firm expands U.S. beachhead

The British are coming. This time they're tackling U.S. cable TV competition. The company is Rediffusion Inc., Saugus, Mass., part of the United Kingdom communications giant with worldwide operations in CATV and television broadcasting.

Heading the invasion force is an American, Robert E. Weissman, recently appointed executive vice president of the firm. At 32, Weissman has had experience in broadcast engineering, cable R&D, and communications equipment manufacturing. He is also familiar with finance, another important ingredient for surviving in the capital-intensive CATV business.

Weissman feels that Rediffusion has a good future in this country because of its wide financial and product base, established elsewhere in the world. The firm intends to market cable hardware, including head-end equipment, line amplifiers, and eventually, home terminals. In addition, the company has a stake in cable system operation designed around a switching center approach, called Dial-A-Program, that is quite different from the branched trunking systems set up in the U.S. [*Electronics*, May 8, p. 91]. Though not likely to be accepted for entire cable

installations, Dial-A-Program, Weissman contends, could be used for two-way television by smaller entities, such as universities and hospitals.

"Now that the FCC freeze on expansion is over, cable operators will be investing again, so the United States will be the growth market in CATV. The difference today is that the operators have technical expertise, and manufacturers have to be ready to meet their demands, rather than dictate to them," Weissman observes.

Commenting on the growth of cable, Weissman says, "CATV can't profit on providing only entertainment. It needs new sources of income from new services. So manufacturers have no choice but to get into R&D to advance these new services. But the trick is not to be three steps ahead of the market in technology. You stay one step ahead to make profits."

Benson: new job is like '48 over again

"With a new organization, there are no precedents, no straitjackets. We make our own organization to accomplish what has to be done," observes K. Blair Benson, long-time CBS engineer who has just become director of audio and video engineering for Goldmark Communications Corp., a new firm in Stamford, Conn.

Goldmark Communications is the brainchild of Peter Goldmark, who retired as president of CBS Laboratories this year and started his own firm in preference to accepting a cushy job as a kind of all-purpose guru to CBS. Goldmark Communications is more of a systems development firm—specializing in advanced communications—than a hardware manufacturer, so Benson's role as engineering director is quite different from his last job as vice president in charge of Electronic Video Recording technical development work.

When CBS phased out EVR in this country, Benson moved over to the



Weissman: Leading the British to U.S.

Carter Semiconductor wants you to know about its quality... You'll be impressed!

Quality and reliability go together like Carter and Semiconductors. We judge a products reliability by its long-term performance to spec. You can judge Carter by its performance to your critical needs, whether it be on-time delivery or design.

Try us and be impressed!

We can deliver whatever you need when you need it. Linear IC's, TO-92 Metal can transistors, epoxy transistors, germanium diodes, silicon diodes and rectifiers.

Our pledge to you is quality devices, reliability of operation and fast and efficient service and delivery.

Be impressed! Write or call today for our catalog of products.



CARTER SEMICONDUCTOR, INC.

Sioux Falls - 381 Allen St., Sioux Falls, S.D. 57103 (605) 454-9141
Main Office & Eastern Region - 8001 Junction Turnpike, Germantown, N.Y. 11791 (819) 364-2244
Western Region - (415) 941-7268 Midwest Region - (312) 287-8418

Circle 15 on reader service card

It's your lead



...when you deal with MICRO-i®

A winning combination often depends on the selection of the right lead. You can make that selection when you specify MICRO-i.

Choose your leads from standard .100 inch grid styles of gold plated beryllium copper ribbon for welding; tin coated for standard applications; plated pads for reflow soldering or wire bonding; and leads that are internally bonded to withstand high temperature processing . . . or one that's just right for your circuit design.

MICRO-i inductors are inherently self-shielding, moisture resistant and have negligible core saturation effects within rated current values. These miniature inductors are available in four basic sizes from .100 to .250 inch square. Their profile is a scant .065 or .075 inches with "L" values from .015 μ H to 1.0 mH.

Perhaps your unique requirements demand special materials and configuration; a miniature discrete transformer or a tuned resonant circuit. Special designs, values or tolerances can be matched to your needs.

Find out exactly how Delevan can transform its MICRO-i to fit your application and make your next selection a winner. Phone or write.

Delevan
Division



AMERICAN
PRECISION
INDUSTRIES INC.

270 QUAKER RD. / EAST AURORA, N. Y. 14052
TELEPHONE 716/652-3800 TELEEX 091-293

OTHER DIVISIONS OF AMERICAN PRECISION INDUSTRIES INC.
BASCO • OUSTEX • MOELLER INSTRUMENT CO. • OXFORD CORP.

MICRO-i is covered
by U. S. Patent
No. 3,493,909.

People

small new firm to start from scratch. He intends to hire a staff of 15 to 20 engineers, basically for research and development, since the firm will not manufacture what it designs.

Among the projects framed by Peter Goldmark is what he calls the Rural Society, in which communications will replace transportation. People will live in rural settings, and the outside world will come to them over television linked to various communications systems. A subsidiary of Warner Communications Inc., Goldmark's new company has a natural interest in cable TV, but is concentrating on future cable appli-



Benson: Recapturing excitement of '40s.

cations for new services. Benson will begin by looking at magnetic recording devices, both video and audio; new forms of television origination equipment; and digital methods of information transmission.

Another early project for the new department will be study of video storage and retrieval systems.

"The biggest challenge for us will be developing a means of accommodating these widely different types of equipment into an economical communications system."

A veteran of CBS broadcast engineering going all the way back to 1948, he adds, "it's just like the early days of television here, the feeling of newness one has when breaking ground."

Here's enough
to put you onto
flat flexible
cable...

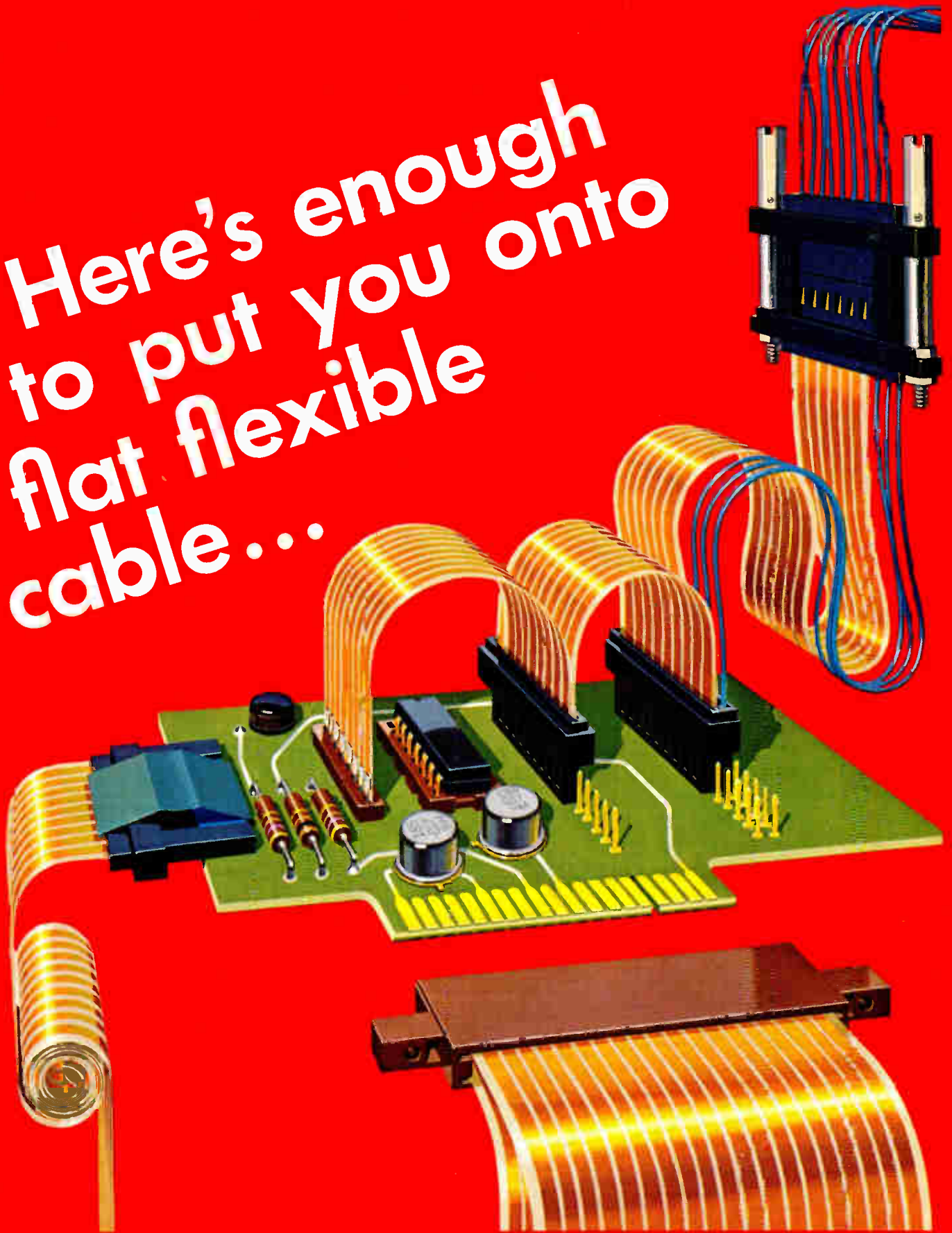

...Your widest choice of the most connectable connectors

Soup to nuts. Or more specifically: cable-to-cable, cable-to-round wire, cable-to-post, cable-to-strip receptacle, cable-to-board. You can go anywhere you want with flat flexible cable, with the AMP family of connectors. They're just what you need to take advantage of the savings in weight and space, and the opportunities for eliminating wiring errors and reducing costs which flat flexible cable can bring you.

These connectors are designed specifically for flat cable, with exceptionally low profile. After all, it makes sense to put a slim connector on slim cable. And they all use an exclusive insulation displacement crimp termination method, which makes connections quickly, reliably and economically.

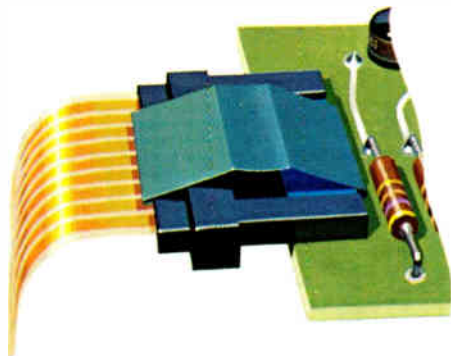

Two-piece cable to board

Another way to go from cable to board. A spring retention catch holds the mating sections firmly together.

Circle 102

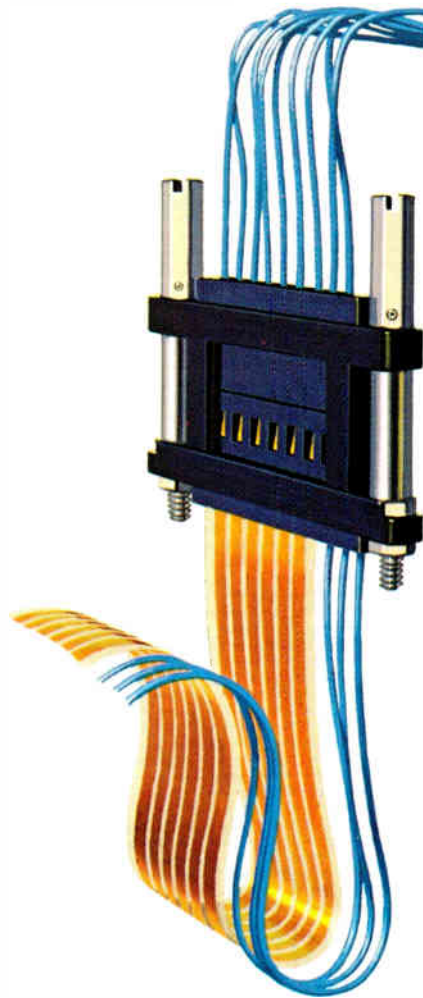

Round wire to cable

The transition from round wire to flat cable is easy, because interchangeable A-MP contacts are available to handle both kinds of conductor, and fit into the same connector housing. You can mix wire and flat cable on the same half of the connector. And naturally, you can link cable to cable whenever you need.

Circle 101

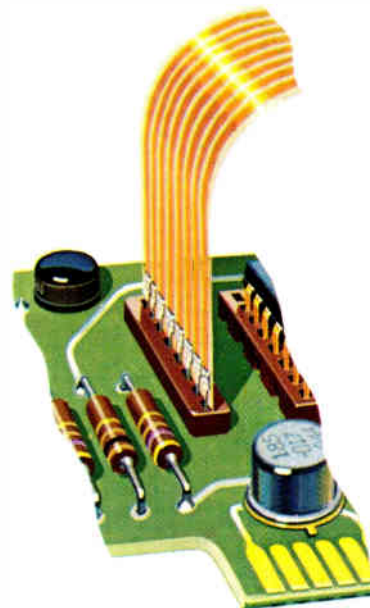

Cable to strip receptacle

This is easy. You don't even need a connector housing. A-MP contacts, after attachment to the cable, go directly into an A-MP strip receptacle of the same type used for DIP packages.

Circle 103

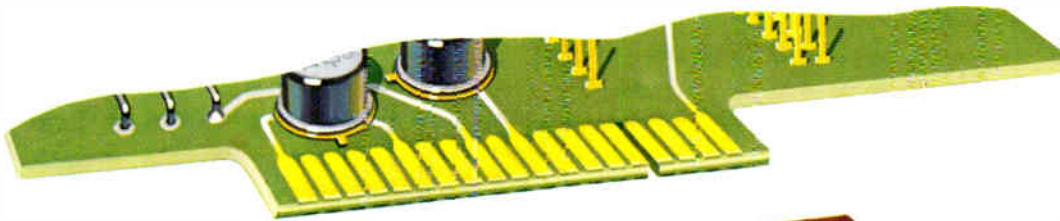

One-piece cable to board

This is the newest in our flat flex line . . . a one piece double row edge connector, which mates directly with bifurcated contact pads on single or double sided printed circuit boards. It can be supplied with or without mounting ears for fastening to the p/c board or rack.

Circle 104

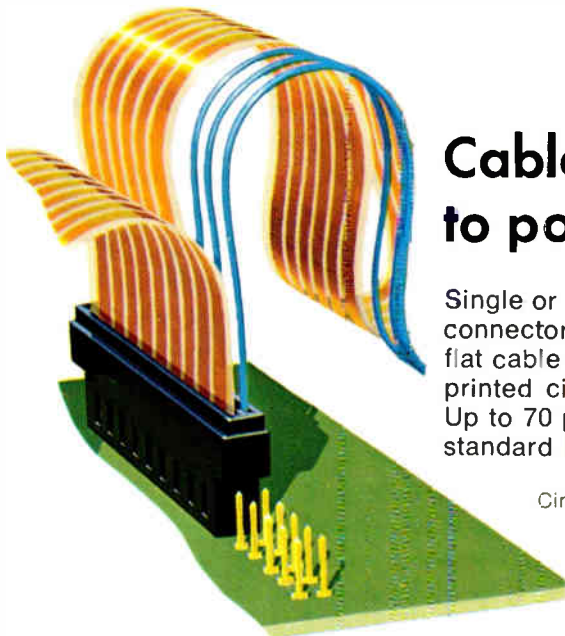
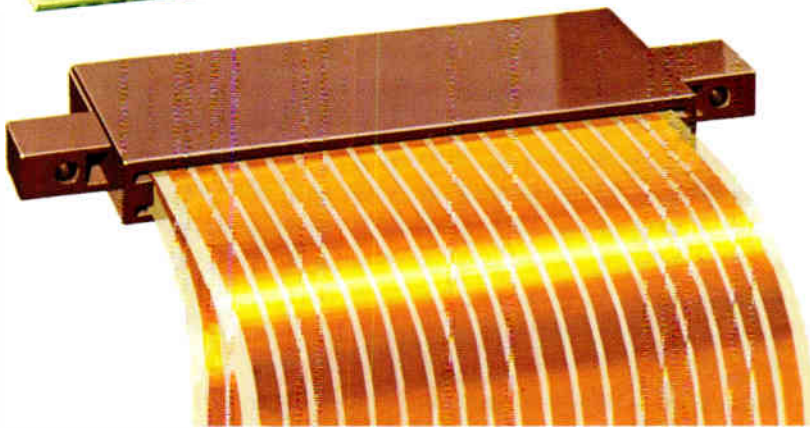

Cable to post

Single or double row connectors let you plug flat cable to posts on printed circuit boards. Up to 70 positions in standard housings.

Circle 105

The fast, reliable way to terminate flat cable.

No stripping, no costly cable preparation is needed. Just cut cable to length and use an AMP-O-MATIC machine especially designed to handle flat cable. Our insulation displacement crimp method is shown in the drawing. The ears on the contact penetrate insulation on both sides of the conductor, then fold over to grip and force the insulated conductor up into the wire barrel, where insulation displacing lances make positive four-point contact with the conductor. The machine has the capability of terminating at the rate of 2 per second.

Circle 107

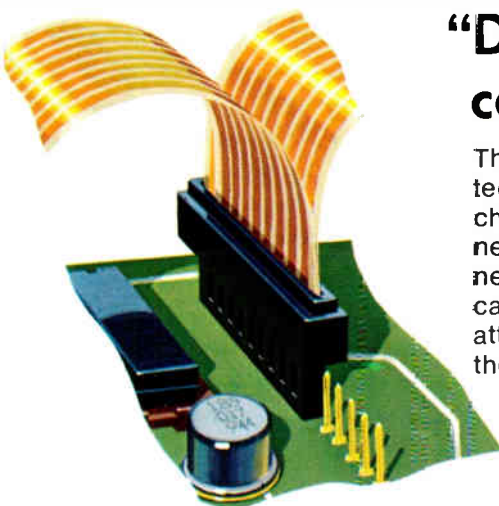

“Daisy Chain” connections

The AMP termination technique allows daisy chain or branch connections without any need for cutting the cable. Just machine-attach contacts across the width of the cable, fold cable back on itself and insert in the connector housing.

Circle 106



Thinking flexible etched cable? Think AMP. Our capabilities are unique. And complete.

Imaginative design is our specialty. We like to tackle . . . and solve . . . knotty problems like the cable illustrated here. We can control impedance from 50 to 125 ohms. Build a shield plane on one side of the circuit. Create performance values you've been reaching for but never before attained.

Long lengths. We can manufacture continuous lengths of cable, with repeat patterns up to 50 feet long. Widths to 22 inches.

Reliable termination. Our insulation displacement crimp technique assures interface with proved environmental stability, with the cost savings of automated application.

New economy. AMP solderless interconnection method lets us use lower temperature insulating film, eliminates costly complications.

Complete capability. We can supply you etched cable with all connectors assembled, ready to plug into your equipment. Let's start thinking together. For a consultation, write or call **AMP Incorporated, Industrial Division, Harrisburg, Pa. 17105.**

AMP
INCORPORATED

Manufacturing and direct sales facilities worldwide: Barcelona, Brussels, Buenos Aires, Frankfurt, London, Mexico City, Paris, Puerto Rico, Sao Paulo, s'Hertogenbosch (Holland), Sydney, Stockholm, Tokyo, Toronto, Turin, Vienna.

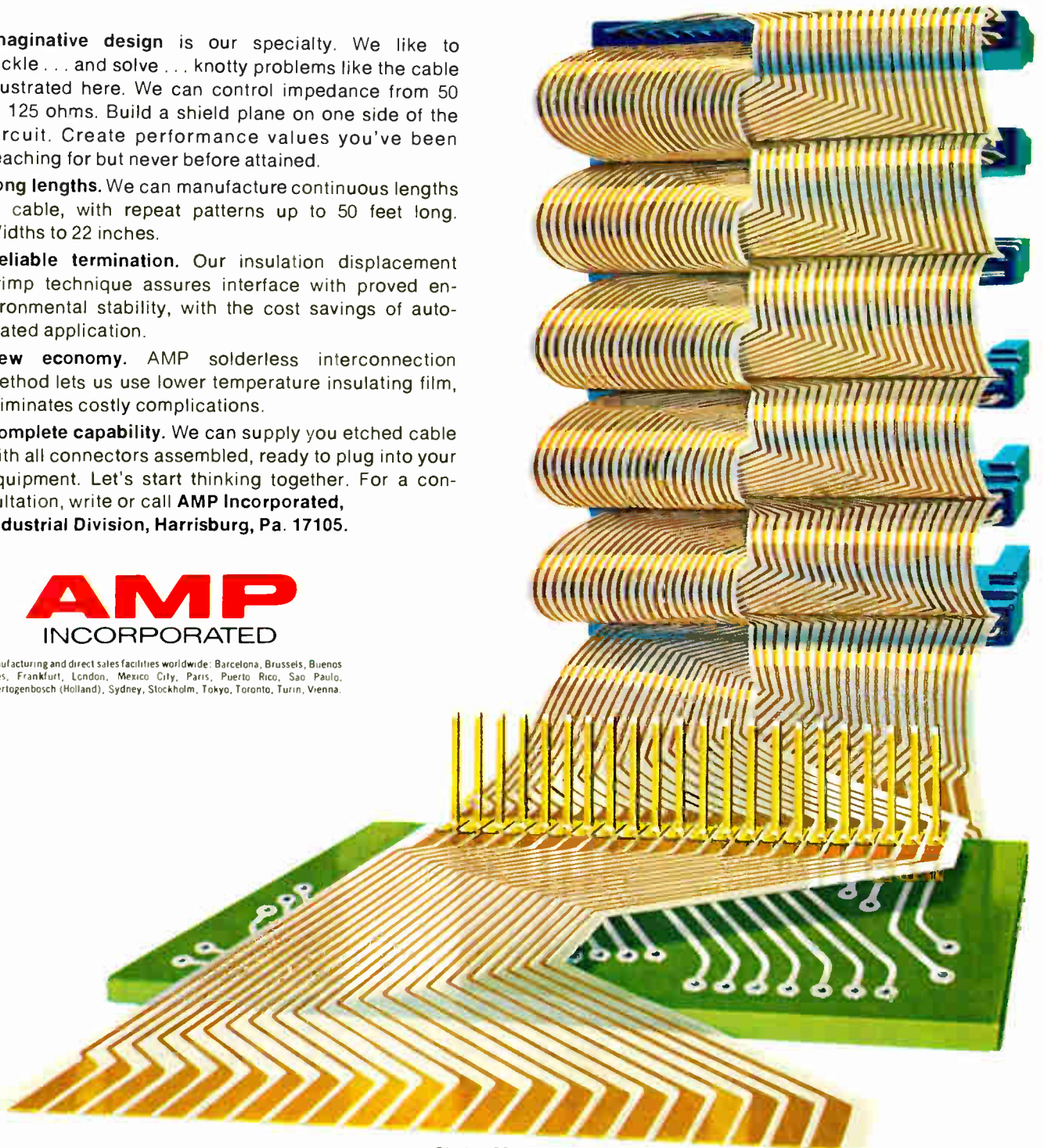

Circle 108

We solve all kinds of electronic problems.

It's as easy as a, b, c, d, e, f, g, h, i.

Many people think of Engelhard only in relation to the specific product with which they are familiar. However, we're involved in all sorts of products for the electronics industry. Interested... just check the a, b, c's listed here.

a. CONTACT MATERIALS

Why do we produce so many different types of electrical contacts? Because you have so many different needs. So chances are whatever an application calls for, we make them. You can use them with confidence, because you can rely on Engelhard's engineering and manufacturing facilities and our expertise and knowledge of special powder metallurgy processes. ECON-O-TAPE® cuts contact costs, too. Continuous form reduces labor. Use only as much contact material as needed, where it is needed.

b. THERMOMETALS*

We handle many varieties of THERMOMETALS. Roll them into almost any thickness. Form them into almost any shape. Plate, braze or weld them. Why? To give you exactly what you need. That's why there are so many different thermostatic bimetals being made at Engelhard. In thousands of different configurations, for as many applications. There are several manufacturers of thermostatic bimetals, but only one source of THERMOMETALS.

c. CLAD STRIPS

We have a method to help you solve your stamping and drawn parts problems—efficiently, economically and permanently. ECON-O-CLAD® metal strips save you time and money. They're continuously clad and metallurgically bonded with

an intimate heat dissipation capability.

d. THICK & THIN FILM MATERIALS

What kind of products does Engelhard have for the industry? Good ones. And plenty of them. Metal powders. Single element or formulated metallo-organic solutions for thin films. Thick film inks, Au and Au-Pt, for high conductivity and excellent adhesion to substrates, acknowledged to be the best in the industry. And an experienced team of specialists to help you with your specific applications. Engelhard covers the field.

e. GAS PURIFICATION SYSTEMS

Need ultra pure hydrogen? Engelhard's HPD purifiers provide hydrogen with impurity levels below the limits of detection. Systems can be supplied for flows from 100 cc/min to large in-plant systems complete with on-site hydrogen generation. Also available: systems for purification of industrial gases (argon, helium, nitrogen, oxygen, etc.) and in-plant nitrogen generators.

f. QUARTZ PRODUCTS

A subsidiary of Engelhard, Amersil, Inc. supplies quartz tubing for diffusion that lasts 20-30% longer. It's OHF-ST tubing, a practically water-free stabilized tubing with greater resistance to devitrification plus increased temperature resistance. When your plans call for fused quartz or fused silica, we have what you need. In forms that are highly pure, non-contaminating and resistant to acid and thermal shock. In a variety of forms and sizes. Transparent, opaque or in combinations of each.

g. PLATINUM CLAD WIRE

We have developed a platinum clad wire that provides surface characteristics of pure platinum

and physical properties of the base metal core. And we make it available in sizes down to .001" diameter. Platinum cladding of various weights are offered on cores of molybdenum, tungsten, nichrome, nickel, steel, etc. High purity gold and aluminum 1% silicon wire in sizes ranging down to .001" diameter are available from us for many of your bonding operations. Our wire is specifically designed to meet your requirements.

h. PLATING PRODUCTS & ANODES

Engelhard has precious metal plating products for virtually every industrial, commercial, and military application. And the technology, field service and competitive attitude to assure total customer satisfaction. Electroplating solutions include: gold, both cyanide and non-cyanide, rhodium, platinum, palladium and silver. Brighteners and replenishers are available for each of the above. A variety of osmium, iridium, rhodium, platinum, palladium, ruthenium, gold and silver salts used in the preparation of electroplating baths are supplied. Anodes for silver plating are available in rod, flat sheet, corrugated sheet, ball, hollow and rectangular.

i. HIGH PURITY BRAZING METALS

Vacuum processing used during manufacture of ULTRA-VAC† Brazing Alloys mechanically removes gaseous and volatile elements. It is now possible to obtain closer control of trace elements than formerly available through V. T. G. or commercial grades of the same composition.

Ask Engelhard about solving your electronics problems effectively and economically. We've written a new brochure on the subject. Write for it today.

†Trademark applied for



ENGELHARD INDUSTRIES DIVISION
ENGELHARD MINERALS & CHEMICALS CORPORATION
430 MOUNTAIN AVE. MURRAY HILL NEW JERSEY 07974

An Equal Opportunity Employer



We make more minicomputers than all the other minimakers put together.

We've been making more minis every week,
every month, every year since 1963. And that was
the year we invented the minicomputer.

To find out why you should join the gang that
buys Digital, write Digital Equipment
Corporation, Maynard, Mass. 01754.
(617) 897-5111. European headquarters: 81, route
de l'Aire, 1211 Geneva 26. Tel.: 42 79 50.

If you're not buying from Digital, you're paying
too much for too little.

digital

Finally!
A filter so precise
we've been able to tabulate
filter characteristics
for every setting.



We've built a variable electronic filter that's so precise, it has enabled us to print the cutoff frequencies, center frequency, bandwidth, noise bandwidth and filter gain, for every setting, *on top of the instrument*. Besides being the easiest-to-use filters on the market, our 4200 series filters are twice as accurate, have less than half the self noise, and provide 10 dB greater outband rejection than any other filters. Frequency coverage is .01 Hz to 1 MHz. Built-in selectable post-filter gain and remote preamplifiers are optional. A Butterworth response is used in the NORMAL mode and a Bessel response in the PULSE mode (transient response is superior to conventional "RC" or "Low Q" modes of other filters).

The price? \$695.

For complete specifications and your free copy of application note 1AN-101 write to: Ithaco, Inc., Box 818-7, Ithaca, New York 14850. If your need is immediate, call Don Chandler at 607-272-7640.

ITHACO

Meetings

International Data Processing Conf.: DPMA, New York Hilton, June 27-30.

International Symposium on Electromagnetic Compatibility: IEEE, Arlington Park Towers, Chicago, July 18-20.

Joint Automatic Control Conf.: AIAA, IEEE, et al., Stanford University, Palo Alto, Calif., Aug. 16-18.

Western Electronic Show & Convention (Wescon): WEMA, Convention Center, Los Angeles, Sept. 19-22.

Engineering in Medicine and Biology: IEEE, Americana, Bal Harbour, Fla., Oct. 1-5.

International Symposium on Remote Sensing of Environment: U. of Michigan, Willow Run Labs, Ann Arbor, Oct. 2-6.

U.S.A. & Japan Computer Conf.: AFIPS, IPSJ, Tokyo, Oct. 3-5.

Ultrasonics Symposium: IEEE, Statler Hilton, Boston, Oct. 4-6.

National Electronics Conf.: NEC, Regency Hyatt O'Hare, Chicago, Oct. 9-11.

International Conference on Cybernetics and Society: IEEE, Sheraton, Washington, D.C. Oct. 9-12.

Conference on Display Devices: IEEE, United Engineering Center, New York, Oct. 11-12.

Eascon: IEEE, Marriott Twin Bridges, Washington, D.C., Oct. 16-18.

The Business Equipment Show: McCormick Place, Chicago, Oct. 16-20.

International Conference on Computer Communications: IEEE, ACM, Hilton, Washington, D.C., Oct. 24-26.

Nerem: IEEE, Nov. 1-3, John B. Hynes Civic Auditorium, Boston, Nov. 1-3.



NEW VALOX[®] 310-SE0 THERMOPLASTIC POLYESTER RESIN IS OUT.

IN ZERO SECONDS.

With no sacrifice of dimensional stability, toughness, heat resistance or moldability.

In UL flame tests, unreinforced VALOX 310-SE0 thermoplastic polyester surpassed the highest UL self-extinguishing ratings, SE-0 and Group 1. It flamed out in zero seconds. As a quarter second of film proves.* But that's not all.

It's unlike SE polypropylene because it doesn't sacrifice heat resistance or toughness. It's unlike SE nylon because it has higher dimensional stability and much lower water absorption. It's unlike any acetal because no acetal is self-extinguishing. And unlike competitive thermoplastic polyesters, it's unreinforced for greater ductility and lower cost.

What's more, VALOX has built-in lubricity, unsurpassed solvent resistance, and it usually molds faster than nylon, acetal or polypropylene. At lower temperatures. And in the same molds.

In short, new VALOX 310-SE0, like other VALOX grades, including a glass-reinforced UL SE-0 grade, is a balanced thermoplastic. For complete details, write Section 148, Plastics Dept., General Electric Co., One Plastics Ave., Pittsfield, Mass. 01201.

Leader in Engineering Plastics
LEXAN[®] NORYL[®] GENAL[®] PHENOLICS VALOX[®]

GENERAL  ELECTRIC

*Unedited film. Photographed at 24 frames per second with an Arriflex 35mm camera and a 90mm Macro-Kilar lens.

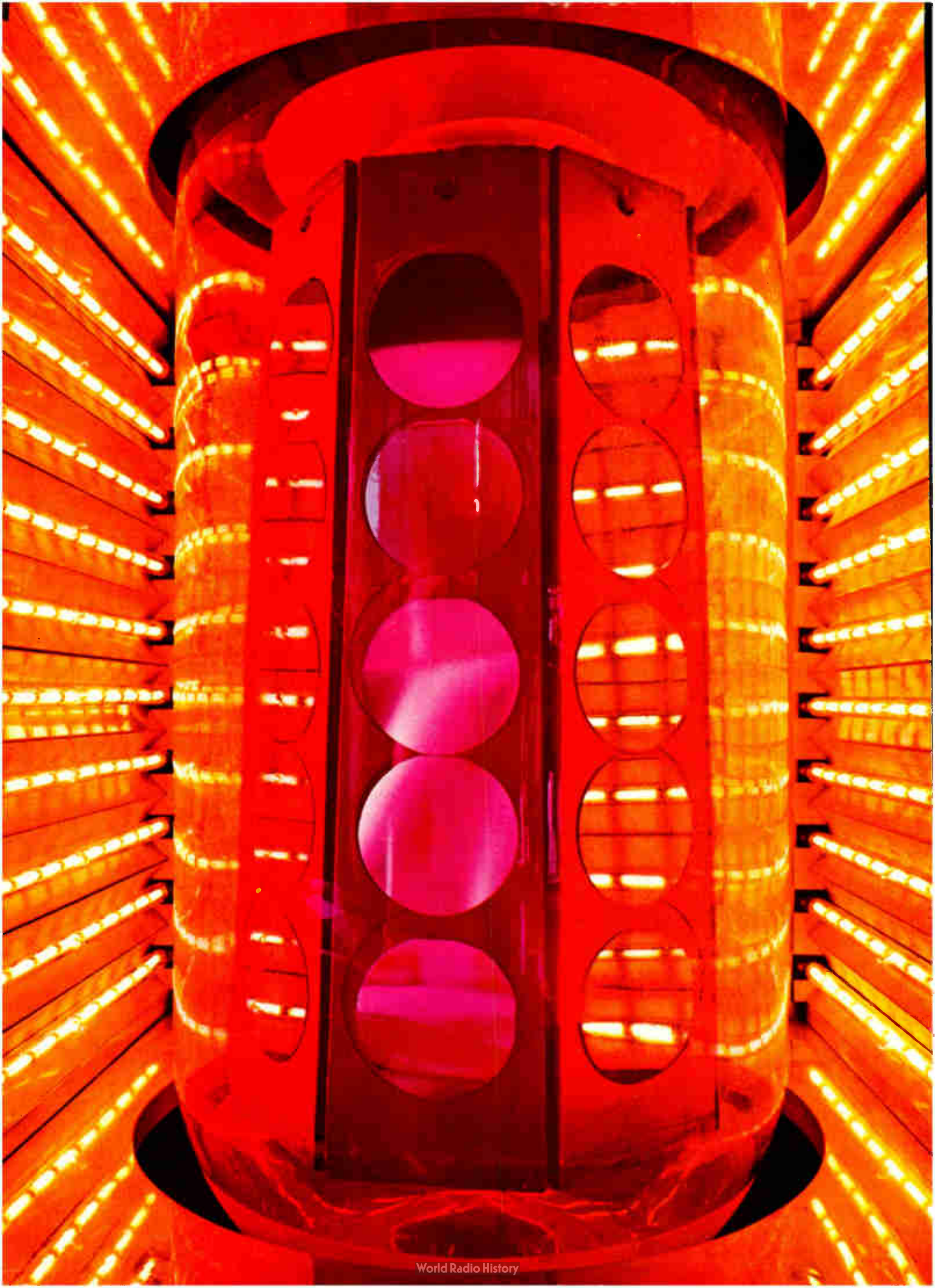

Radiant heating lets you run a CVD Reactor not a radio station.

A Radio-Frequency Reactor uses a lot of valuable room. And RFI can whack out sensitive lab instruments.

The new AMH-704 Mini-Reactor™ for the lab. It's one-third the size of an RF Heated Reactor. Costs a lot less, too. And doesn't use an RF generator. It has all the advantages of a big, expensive production reactor. With none of the big, expensive disadvantages.

The Mini processes four 2" or one 3" wafer at a time. Silicon epitaxy, refractory metals, dielectric films, all the way up to and through Tungsten and Alumina. You get incredible control and repeatability for the most advanced thin film depositions.

The reason is the radiant energy source built into the reactor. With radiant-heated systems, you adjust temperature electronically. And thermocouple control assures $\pm 3^\circ\text{C}$ precision from 400° to 1200°C .

Radiant Energy Heating.* The first major breakthrough in 15 years for chemical vapor deposition systems. And Applied Materials is applying it to a whole new generation of equipment:

The new AMC-740 ISOMAX for greater throughput. Up to forty 2" or eighteen 3" wafers at a time. With incredible uniformity. Better than twice the throughput of any available reactor.

The new AMN-730 Nitrox™ Reactor for greater flexibility; profiles temperature electronically so you can deposit multi-layer structures in a single run, without opening the reactor. That counts when you're processing SiO_2 , Si_3N_4 , Al_2O_3 , polysilicon, dielectric films or refractory metals.

Call Joe Nava at (408) 738-0600 for immediate requirements. Or for a complete literature pack on any of our units, write to: Applied Materials Technology, Inc., 2999 San Ysidro Way, Santa Clara, California 95051.



applied materials
radiant heating

*Applied Materials Technology, Inc. U.S. Patent No. 3,623,712

You can assemble our SMA connectors



in less time than it takes to shave.

Five minutes. That's all it takes to assemble our SMA connectors for subminiature coax cables. A significant savings in production time.

You get your Amphenol SMA connectors factory preassembled, thus keeping loose parts at a minimum. And by using an inexpensive tool kit to prepare the cable, putting them all together is a snap. Parts loss is virtually eliminated.

Amphenol set the trend by making its SMA connectors of high-strength, heat-treated beryllium copper material, which is three times stronger than stainless steel. These superior connectors are, of course, completely intermatable and interchange-

able with existing stainless steel designs. Amphenol was the first source qualified for MIL-C-39012 SMA connectors.

Available in a wide variety of flexible and semi-rigid cable connectors; receptacles for strip-line, MIC packages, and numerous other microwave components. And if you need SMA specials or complete cable assemblies, come to the world's largest manufacturer of coaxial connectors.

See your authorized Amphenol distributor or write Amphenol RF Division, Bunker Ramo Corporation, 33 East Franklin Street, Danbury, Connecticut 06810.

**BUNKER
RAMO** **AMPHENOL**

Electronics newsletter

Intel to acquire watch business. . .

Intel Inc., the Santa Clara, Calif., semiconductor maker, is expanding into the electronic watch business. An agreement in principle has been reached with Microma Universal Inc. of Mountain View, Calif., for Microma to become a wholly owned subsidiary of Intel.

For Microma, the deal would mean access to a sophisticated semiconductor processing operation [*Electronics*, May 22 p. 59]; as for Intel, says a spokesman for the company, "We believe the watch business is a very good one to be in."

. . . as Benrus puts Motorola C/MOS into quartz watch

The Benrus Corp. is introducing a \$99 quartz crystal wrist watch using Motorola C/MOS circuitry. **The price is significant: Timex, which owns a big chunk of the low-priced-timepiece market, has a similar watch selling for \$125.** What's more, Benrus also will build a model for women—until now, the size of the components has virtually precluded manufacture of a smaller women's version.

Electronics for the watch, which will have a conventional readout, was developed by the Benrus Technipower division working with Motorola's Watch group. The movement is provided by the Benrus Watch division. About the women's model, Benrus president Victor Kiam says: "We used clever design with our C/MOS circuitry. **In addition, we use a true stepping motor so that you can actually see the sweep second hand tick off every second.**"

Wiles resigns from TRW to go into rep business

Q. T. Wiles, vice president and group executive at TRW Electronic Components divisions (ECD), Los Angeles, has resigned to become an independent manufacturers' representative, handling TRW/ECD products initially, and serving the Southwest from a California base. **"I wanted to be my own chief executive," Wiles says of the change, "and the time to bite the bullet was just as good now as any other time."** He stresses, however, that he didn't "go looking for another job."

J. S. Webb, executive vice president of TRW Inc. and Wiles' predecessor in the TRW/ECD post, has stepped back in to run the operation temporarily. He says Wiles has promised to make the transition as smooth as possible, helping with special projects when needed, "but he's a lame duck, and people in this business don't stay lame ducks very long." Webb maintains he's set no target date to choose Wiles' successor but says he has three "prime candidates" in **George Hart, Karl Heller, and James Jensen, each of whom heads a TRW/ECD operating division.**

Terminal offers both real-time, remote batching

The classic distinction between on-line real-time computer terminals and remote-batch terminals is about to become less distinct as Incoterm Corp. **prepares to bring out a terminal that combines both functions.** The Natick, Mass., firm already manufactures a comparatively sophisticated cathode-ray tube terminal with a controller that has substantial processing capability.

Incoterm's new combination terminal will be based on its present "smart" terminal, but will have additional peripherals attached to it so that it can function in one-line real-time, remote-batch, or stand-alone mode.

Westinghouse and Radiant end pact

Radiant Energy Systems of Newbury Park, Calif., and Westinghouse have terminated the agreement under which Radiant was to have developed and built electron-beam mask-making and wafer-exposure equipment designed by Westinghouse. Radiant had acquired the agreement from its parent company, Hugel Industries. Harry Moore, Radiant's president, says, "Nothing was ever built under that agreement. Our work is substantially different from Westinghouse's, and we feel that there's nothing they can contribute to us."

The work at Radiant is continuing with about half of the company's engineering concentrating on the electron-beam work. The Air Force has purchased a mask-making system, and an electron-projection system for direct exposure of semiconductor wafers has been sold to an overseas firm, but not yet delivered.

IBM to market cash dispenser

IBM, as predicted earlier this year, has announced a cash-dispensing machine for banks [*Electronics*, March 2, p. 65]. **It issues currency in \$5, \$10, and \$20 denominations, charging withdrawals to a customer's account through an on-line link with the bank's computer.** The dispenser identifies the customer by a magnetically striped credit card and a personal identification number that he enters from a keyboard.

IBM will manufacture the new machine in its plant in Greenock, Scotland, where it also manufactures such equipment as data communications gear and key-entry machines. **But it has not announced the machine in Europe and doesn't plan to market it there.**

The dispenser, priced at \$17,000, is available for purchase only. This is a departure from usual practice because IBM rents almost everything it makes, offering equipment for sale only because it was required to do so by court decree. **Although IBM usually prices its equipment near the top, the price range of similar equipment already on the market is \$12,000 to \$50,000.**

Addenda

Look for another major development in August in the trend toward lower cost for more performance in digital panel meters. Analogic Corp. of Wakefield, Mass., **will bring out a low-cost 3-digit DPM that will sell for \$40 each in lots of a thousand (\$45 in lots of a hundred).** And, unlike some competitive 2½-digit units, it will have a completely floating analog input. . . . **The U.S. Customs Bureau has broadened its proceedings against Japan** so that it may assess countervailing duties on shipments of consumer TV receivers, radios, phonographs, tape players, and tape recorders if their export to the U.S. is supported by "rebates, refunds, bounties, or grants" to Japanese manufacturers by their government. Now included are TV receiver parts, color picture tubes, resistors, transformers (deflection components), and tuners for receivers with integrated circuits. . . . Seven large computers worth \$70 million will be acquired by the Atomic Energy Commission for its seven major laboratories. Four AEC installations—Oak Ridge, Savannah River, Argonne, and the Stanford linear accelerator—will get four IBM machines. Labs at Brookhaven and Los Alamos will get Control Data Corp. machines, as will a combined installation for the Lawrence-Livermore Radiation Labs.



PDP-8. PDP-11. For OEM's

These are the most popular minicomputers in the world. They are available in a wide range of configurations for OEM's.

With prices as low as \$25k in quantities of 50. We make sure they have the features, performance and support that make PDP-11 and PDP-8 the most popular, most successful minicomputers.

Without price but complete right computer. We've been working up with some of the toughest OEM's around. And getting away with their business.

who hate to spend money.

When they want to buy a computer, they want the right one. At the right price. From the right company. Come and see us.

GRI Computer Corporation
320 Needham Street, Newton, Mass. 02164
(617) 969-0800



nuts

No other minicomputer manufacturer has had the guts to say it, so let us be the first: the actual cost of a minicomputer is *meaningless* when compared to the ultimate investment you *have* to make in interfacing it to your system, debugging the software and, finally, getting the system to perform the job it was designed for.

That's the REAL COST of the minicomputer you buy.

GRI's Functional Minicomputers* can easily compete with theirs on hardware cost. It's in the post-purchase operations where GRI computers' simplicity and ease of systems integration helps you to save, and save big.

We can do it because GRI computers are organized *functionally* for amazingly easy interfacing and unmatched programming and use simplicity.

* Patented

In truth, there is nothing else around that can do the job as quickly, efficiently and as inexpensively as our Functional Computers.

Don't take our word for it. Make us prove it. You owe it to yourself to find out about our Direct Function Minicomputers. Send for our new book and find out what all the shouting is going to be about.

Write to: GRI Computer Corporation
320 Needham Street, Newton, Mass. 02164
Phone: (617) 969-0800. Cable: GRICOMP

Go ahead and crack a nut.

gri
GRI Computer
CORPORATION

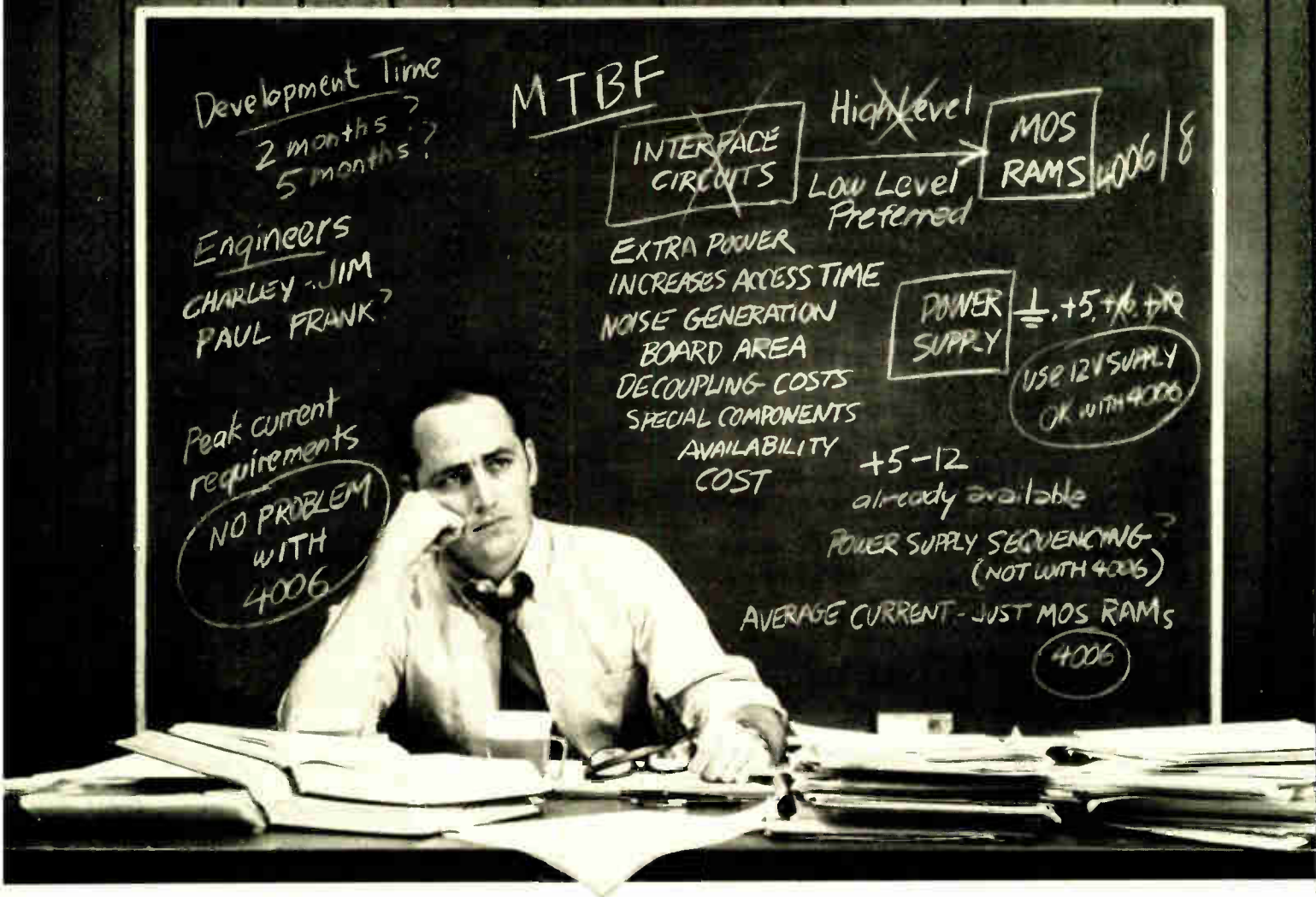

Looking for semiconductor memory components that fit your system?

Our 1024-bit MOS RAM checks out. Try it in for size.

If you're designing memory systems for such applications as computers, peripherals, office machines or terminals you're concerned about a number of critical items. Look at that cluttered blackboard for a starter! So which RAM to choose? We've got some ideas that will help you make up your mind. Read on . . . and see how our 1024-bit MOS RAM, the MK 4006 P, checks out against your system requirements.

System Design / Manpower / Cost. Our ion implanted 4006 is TTL compatible. No need for input interface circuits. No clocks. Simple timing, which means fewer design/engineering hours, fewer debugging hours, and smaller engineering charges on your budget.

Development Time. By using our RAM, you'll reduce your engineering time . . . get your system into the

marketplace more quickly. This means a lot — not only to your marketing people but to your customers as well.

Manufacturing Costs / PCB Factors. With our 4006 you'll need less PC Board area (because you don't need those interface circuits or clock drivers). Your layout people will appreciate the easy, uncritical layout made possible by the 4006. And major benefits for manufacturing include reductions to one board instead of two and double-sided boards instead of the more costly three-layer ones. Plus, our 16-pin package means you can use standard insertion equipment.

System Reliability. When you design-in the 4006 you need fewer components, fewer PC Board interconnects — thus fewer chances for problems. And to assure the high reliability of every circuit, we test each 1024-bit RAM at temperature.

At MOSTEK volume manufacturing backs our product — we're currently shipping to over 17 volume customers.

End of checklist? Not really. We invite you to check around. Find out who's buying 1024-bit MOS RAMs and who's shipping them in quantity. (You might be surprised at where the action is.) Then call your nearest MOSTEK sales office, representative or distributor. *We'll help you make up your mind — while we take a load off it.*



1215 West Crosby Road
Carrollton, Texas 75006
(214) 242-0444

Regional Sales Offices: West: 11222 La Cienega Boulevard, Inglewood, Calif. 90304 (213) 649-2600 East: 60 Turner Street, Waltham, Mass. 02154 (617) 899-9107 Midwest/Southeast: 315 S. W. Avenue, Jackson, Michigan 49203 (517) 787-0508.

International: MOSTEK GmbH, 7 Stuttgart 80, Waldburgstrasse 79 West Germany 0711-731305, System Marketing Inc., Center News Bldg., 1-3-11 Sotokanda, Chiyoda-ku, Tokyo, Japan, W. G. Booth Pty., Ltd., 39 Church Street, Hawthorn, Victoria 3122, Australia

Copyright 1972 by MOSTEK Corporation

Electronic switching goes long distance with all-digital No. 4

Bell's new ESS boasts five times more trunks than crossbar system it is due to replace in 1976

Electronic switching, until now limited to local service, is moving into the long-distance regime with a switching system more powerful than the crossbar switch it replaces. It provides better speed, reliability, and repairability than even the latest local electronic switching systems.

The first toll electronic switching system, dubbed No. 4 ESS, is scheduled for installation in Chicago in 1976—Bell Laboratories engineers already are working with prototypes of No. 4.

Described at the International Switching Symposium in Cambridge, Mass., in two papers by Bell Labs personnel, the system's specifications are impressive. Moreover, it's the first Bell System switch designed to operate in an all-digital environment: digitized messages, digitally addressed, are switched from input to output by diode-transistor matrices under control of a digital computer.

Five times. The No. 4 ESS will handle 107,000 trunks and/or service circuits and 350,000 call attempts per hour. That's more than five times the trunk capacity and three times the call attempts possible with the more costly No. 4A ESS crossbar electromechanical system it would replace—which is, at the moment, the largest switching arrangement Bell has that is capable of handling long-distance calls.

Goals of the No. 4 development program include lower administrative costs than are possible with present switches, faster and less costly maintenance, and more flexibility than the earlier ESS—including extremely important self-test and repair capability.

Because of its reliance on solid-state technology, computer-aided design, batch-process production methods, and computer-assisted checkout, the new switching system is expected to offer capabilities exceeding projected demand at a competitive price and in a smaller package than today's crossbar switching can offer.

Initially, the system will have to handle and log messages, even though it is designed for the digital message environment Bell envisions for the future. Thus, so-called voice-

band interface units will convert incoming analog signals to pulse-code-modulated bit streams. Time-slot interchange units fit these into appropriate locations in a time-division-multiplexed bit stream, and from there the solid-state switch shunts the appropriate call to the appropriate output terminal. Incoming bit streams are handled in reverse fashion if they are addressed to local trunks, and the voice-band interface converts the digital information handled by the new switching system back to its original analog format.

As the T1 PCM local-carrier and T2 toll-carrier systems are phased in, No. 4 will be found at the center of webs of T-type carrier lines, transferring messages among them. And since T1 is digital, the voice interface units characterizing early

Big switch. Bell System's new electronic switching system, No. 4 ESS, will go into service in Chicago in 1974. It will be the first ESS for long-distance switching.



No. 4 installations would be phased out with reduced costs, something that the Bell System finds tempting.

Learning. Bell Labs spokesmen freely built on their experience with No. 1 ESS.

Early models—introduced in 1964—used a fixed magnetic-card memory and software that sometimes made the No. 1 ESS act like a spiteful child.

If its call capacity were exceeded, it sometimes would break all connections rather than merely give a busy signal. No. 4 ESS benefits from software revisions and new memory formats evolved for No. 1. In one instance, the core memory of the new system has cycle time of 1.4 microseconds.

Also, the memory is alterable—unlike the magnetic cards—allowing nearly real-time program changes to fit new conditions. The No. 4 has a backup memory, on disk and tape drives, providing redundancy at many levels. For example, if one core bank were to go bad, the control program software of the computer would switch to a back-up unit and signal for replacement of the troubled module. If both core banks were to go bad, the system could call for repair and afterward quickly reload core from disk storage.

No reeds. The base capacity of the switching matrix also appears to be a result of some painful experience with the No. 1 ESS. Instead of using electromechanical reed relays, No. 4 uses more reliable solid-state switches. In addition to that obvious advantage, the matrix is not only large to begin with (in each time-slot interchange is an 8-by-8 cross-point matrix, and in the time-multiplex switch itself is a 256-by-256 crosspoint matrix), but is time-shared to yield the equivalent of 128 such systems, a Bell spokesman claims.

The switching matrices of the earlier ESS could overload. Calls could come in and find no available route through the switching matrix. This often led to trunks having to operate at only about 60% of their rated capacity.

No. 4 can increase trunk loading

to about 90%—a factor that should help lower trunk costs significantly for the Bell System. □

Computers

Powerful processor runs No. 4 ESS

When Bell Laboratories told the story of its solid state No. 4 electronic switching system at the International Switching Symposium, it also had a message about the brain inside No. 4 ESS: the 1A computer. One of the machine's designers calls the 1A about as powerful a processor—within the limits of its special-purpose design—as the largest of the general-purpose computers available today.

It is eight times faster than the processor used in the 1964-vintage No. 1 ESS because of its twin core memories—32,768 words with cycle time of 1.4 microseconds each—beam-lead, diode-clamped transistor-transistor logic, and its more powerful instruction set.

The 1A's ICs have a 4- to 5-nanosecond gate propagation delay, and power dissipation is about 6 milliwatts per gate. The ICs are assembled on beam-lead chips about 45 mils on a side. A collector-diffusion isolation technique keeps device size small and increases packing density. However, at about 10 NAND gates each, the chips aren't considered more than medium-scale integration by Bell Labs.

Standard. With the goal of keeping costs down, Bell Labs has standardized the design rules for the ICs and their ceramic substrates so that computer-aided design can be used for layout, routing, logic verification, partitioning, and documentation. The computer also generates magnetic tape to guide art-work generators, both for IC masks and ceramic substrates. These substrates are laid out to size; no photo reduction is required.

Up to 52 chips are laid down on the 3-by-4-inch ceramic substrates. A thin-film design, sometimes with

more than 1,000 bridge-like cross-overs, is used for interconnection; the back of the ceramic is plated with a solid conductive ground plane, using laser-drilled plated holes for vias. The conductive back plane, by turning each hybrid circuit into a strip transmission line component with tightly controlled impedance characteristics, is said to cut crosstalk, ringing, and other undesirable effects.

The hybrids are placed on 80-pin plug modules, and it is out of such modules that the computer and, indeed, nearly all of No. 4 ESS is assembled. Nearly every part of the system is plugged together to speed installation time and ease maintenance. □

Displays

Storage CRT boosts contrast

Many potential users of CRT terminals have shied away because of the need for complex refresh circuits to keep the information available for long periods; flicker is another deterrent for some. The large 11-inch screen storage tube eliminated both problems, but added one of its own: poor contrast. However, Tektronix Inc., Beaverton, Ore., has managed to increase contrast by a factor of four over existing storage CRT terminals.

The reason for the shift to direct-view storage tubes was that they eliminated the need for external memory circuits and they provided a high information density with good resolution and without flicker and drift. But they could only be used in subdued lighting environments.

Roger Frankland, a development engineer at Tektronix, claims that a new flood-gun design now permits direct view storage displays to be used in office environments where the ambient lighting is as high as 100 foot-candles, enabling the user to view the display without shielding the screen or squinting. Frank-

Electronics Index of Activity

June 19, 1972

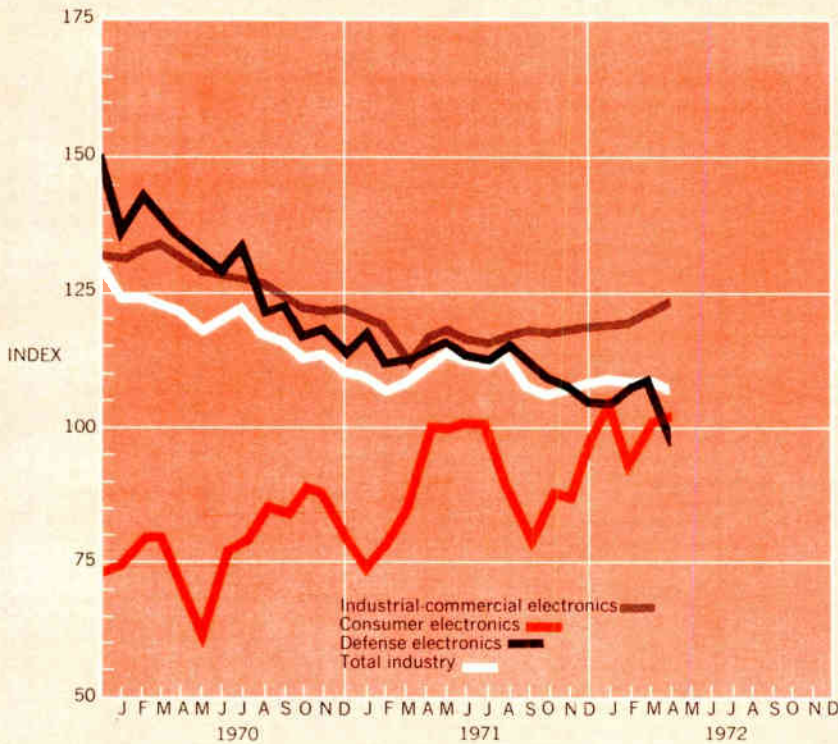

Segment of Industry	April '72	March '72*	April '71
Consumer electronics	102.9	101.7	100.7
Defense electronics	99.7	104.3	113.3
Industrial-commercial electronics	123.6	121.9	117.8
Total industry	107.4	109.1	112.3

Because of a miscalculation, the Index of Activity for April as it appears in the June 5 issue of *Electronics* (p. 44) is incorrect. The corrected index is at the left.

The error was made in the defense component of the index. The actual drop from March's 104.3 was 4.6 points to 99.7. This left the total industry total at 107.4, a decline of 1.7 points from the March result of 109.1.

Indexes chart pace of production volume for total industry and each segment. The base period, equal to 100, is the average of 1965 monthly output for each of the three parts of the industry. Index numbers are expressed as a percentage of the base period. Data is seasonally adjusted.
* Revised.

land described the technique at the meeting of the Society for Information Display in San Francisco last week.

The direct-view storage display employs two electron guns. One is for writing the information on the screen for the first time and the other—the flood gun—supplies the electrons required to keep the display lighted for viewing over an extended period.

To make a brighter display, it would seem that if more electrons were provided by the flood gun, the phosphors would be excited more, and a brighter display would result. But Frankland says that the increased electron flow simply causes more space-charge spreading, and the added electrons are wasted—they hit parts of the tube where they do no good.

The solution was to increase the energy of the electrons, as well as the number of electrons.

Frankland's theory is that if the electrons are emitted at higher energy levels, the space-charge spreading of the electron bundle won't be enough to impair the image.

As the Tektronix engineer puts it, "We've developed a more efficient system in which we don't waste electrons."

The increased electron energy (voltage) combined with the increased electron density (current) meant that the internal tube parts would be subjected to substantially more abuse.

But, without giving any specifics, Frankland says that the new Tektronix storage tube doesn't age any faster than its predecessors.

The new-flood-gun design has doubled the contrast of the tube from 0.1 to 0.2 (contrast is measured on a scale of from zero to one), and when an ambient light filter that matches the green output of the dis-

play is added the contrast goes from 0.2 to 0.46. A display employing the new tube along with the filter, the model 613, will be available this fall. □

Communications

Bell's DUV test links N.Y., Boston

Eight months ago AT&T told the world that it would meet demands for digital service with a technique that permits data signals to "hitch-hike" on existing microwave radio systems. The new development, called DUV for data under voice, would use the lower end of baseband frequencies that are currently being utilized [*Electronics*, Oct. 25, 1971, p.34].

And that was about all that Bell

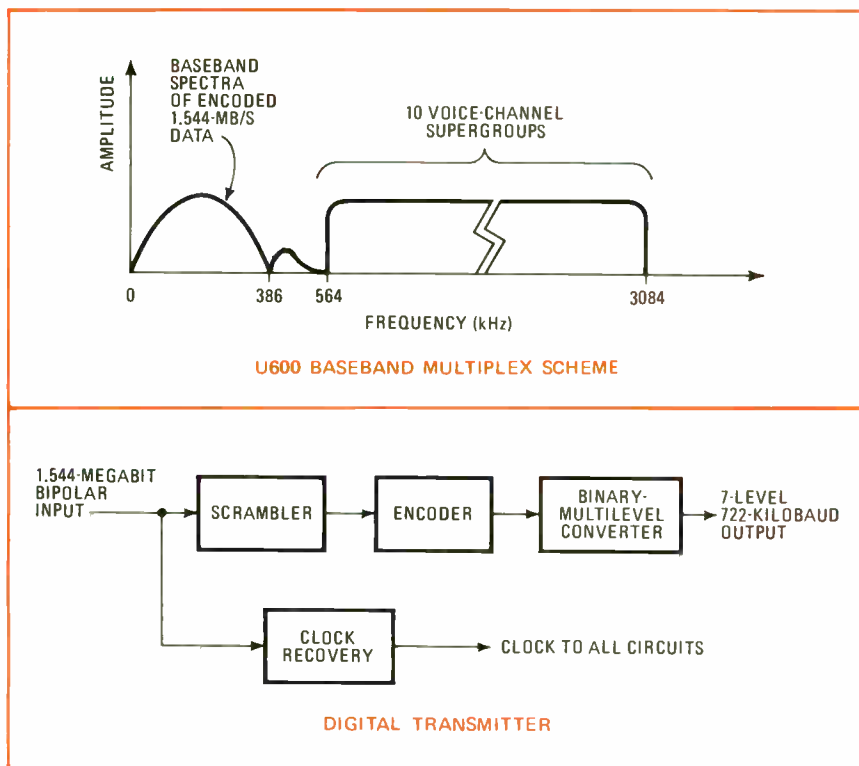

Out in the open. AT&T has released details of its digital under voice (DUV) data system.

had to say about the technology.

Now, details of the proposed nationwide service for 1974 have surfaced. At the same time, K.L. Seastrand of Bell Laboratories in North Andover, Mass., says that preliminary field data from a test DUV link between New York and Boston indicates "performance consistent with that anticipated."

Flying. DUV is described by Seastrand and his fellow researchers in a paper to be given June 19 at the International Communications Convention in Philadelphia. The technique allows a 1.544 megabit/second data stream to be inserted into a portion of the baseband spectrum between 0 and 564 hertz (see spectrum drawing above). Both U600 and L600 standard multiplexing systems will accommodate the digital signal. "Straightforward field modifications of the L600 multiplex will make its baseband look like the U600 scheme," says Seastrand, "making the bottom half-megahertz available for data transmission."

Also, he adds, a 64- or 308-kilohertz pilot synchronizing signal will be moved to 512 kHz.

A digital transmitter will translate

the 1.544-Mbit bipolar, 50% duty cycle input into a seven-level, 772-kilobaud output (see block diagram). Key to the transmitter's operation is the encoder and binary multilevel converter. The encoder first digitally divides the 1.544-Mbit/s binary signal into two data streams at 0.772 bit/s each.

These two lines are then processed into a single seven-level output with nulls in its frequency spectrum at 0 and 386 Hz.

The output is then passed through a low-pass filter and multiplexed with the voice channels to frequency-modulate a microwave carrier channel.

A digital receiver at the other end of the communications link decodes the seven-level signal back to the bipolar 1.544-Mbit/s data stream. The receiver functional blocks are fundamentally the inverse of the digital transmitter. In addition, circuitry is provided to monitor error performance and provide control information.

A fully developed radio route in the 4- and 6-GHz bands consists of 16 microwave channels. Thus, by combining up to 16 1.544-Mbps

lines in a single radio hop, a 24-Mbit/s digital capacity per route can be achieved. □

Consumer electronics

Amplifier gives equal hearing

Confusion among audiophiles over what type of four-channel sound systems to buy has engendered a new breed of audio amplifier, a unit that helps remove the sound buff's greatest fear—obsolescence.

Fisher Radio, Long Island City, N.Y., has put together a line of amplifiers designed to combine or "strap" the outputs of the four amplifier channels in pairs. As a consequence, full-rated power (20 to 20,000 hertz) is used all the time in both the two-channel or four-channel mode. To make it easier to go four-channel, there's a switch on the front panel to convert the amplifiers back and forth.

The 304, 404, and 504 models have built-in quad sound decoders (CBS's SQ matrix system), putting Fisher in the CBS/Columbia Records camp in the competition of matrix versus four discrete channels. Because of the effort to build an amplifier that straddles two- and four-channel sound, the front panel is a jungle of controls, including a switch to cut in the SQ decoder. The higher-priced 404 and 504 have "joystick" master balance controls to "center" the listener inside the four speakers.

Heavy. Another result of putting a foot in each sound mode is a larger amplifier than two-channel units—measuring 21½ by 6-⅞ by 16-⅞ inches. New models are also heavier than older styles, ranging from 39 to 43 pounds. The power transformer alone weighs a hefty 15 lbs. However, Fisher engineers say that follow-on models will reduce both the size and weight by shrinking the transformer.

The new line includes application of MOSFET phase-locked loop ICs for tuning and has pushbutton controls



THE TEKTRONIX S-3260 AUTOMATED TEST SYSTEM

...the result of years of systems experience...

THE S-3260 WILL TEST:

- MOS and Bipolar Shift Registers
- Random Access Memories
- Read-Only Memories
- MOS and Bipolar Random Logic Arrays
- Circuit Boards
- Modules
- Subsystems

S-3260 FEATURES:

- **Advanced Test Fixturing**—Nanosecond Response Characteristics
- **128 Active Pins**—64 Input, 64 Output
- **Functional Tests**—20-MHz Data Rate; Force, Compare, Mask and Store @ 20 MHz; Individual Drive and Compare Levels at Each Pin; Programmable Loads.
- **Parametric (DC) Tests**—Functional Preconditioning, Differential Voltage Measurements; Kelvin Connections; Force V, Measure I; Force I, Measure V.
- **Dynamic (Timing) Tests**—One Shot Time Measurements; Functional Preconditioning; Dual, Strobed Comparators; Active or Passive Loads.
- **Go-No-Go or Analytical Tests**
- **Interactive Program Writing**
- **Device-Oriented Source Language**
- **Graphical Test Result Displays**
- **Data Logging and Data Reduction with Computer Graphics Displays**
- **Optional Hard Copy Output**
- **Modify Tests and Data Logging Options at Run Time**

Your TEKTRONIX Field Engineer can arrange a discussion with a Systems Specialist. Call him or write Tektronix, Inc., P. O. Box 500-A, Beaverton, Oregon 97005.



A-m stereo may get trial run

If the Federal Communications Commission gives the go-ahead, a New York metropolitan area radio station will test transmission of a-m stereo sound. By adding a special modulator to be supplied by Electrospace Corp., Westbury, N.Y., station WWDJ will be able to broadcast any stereo recordings in a format compatible with present a-m receivers.

Though a-m stereo is an old idea, it's never been tried. That's why any expansion of this approach to other broadcasters will probably need FCC permission. Present rules do not ban a-m stereo; however, neither do they recognize it.

According to Arnold M. Wolf, president of Electrospace, a broadcaster with a complete fm stereo studio and an a-m studio can equip his a-m side for stereo for about \$20,000. And a listener would need two radios, one tuned slightly above the frequency and one slightly below. However, Wolf foresees a new market for a-m radios, should the stereo idea take hold. Such a radio would have two i-f strips and two audio channels.

for fm muting, a-m Dynamic Noise Limiter (DNL), and high and low filters, as well as loudness contour and the SQ decoder. Retail prices range from \$299.95 to \$499.95.

Reflecting the note of caution sounded by consumers, Fisher president Don Harper explains that the new series "will provide a sensible bridge between stereo and four-channel sound. They will not become obsolete, whatever happens to four-channel." □

Digital ICs think for TV tuners

Though varactor TV tuners do away with the wear-prone contacts of mechanical detent versions, they still need mechanical switches for selection of preset voltages on varactor diodes, broadcasting bands, and channel indicators. What's more the search-type tuners providing swept voltage on varactor diodes have suffered from errors caused by audio carrier signals or instability in weak signal areas.

Now two Japanese companies have simultaneously developed digital ICs—bipolar and MOS—to eliminate these drawbacks and make varactor tuners more reliable. The designs, revealed at the IEEE Chicago Spring Conference on Broadcast and Television Receivers, are the work of Matsushita and

Tokyo Shibaura Electric Co. (Toshiba).

The Matsushita system uses binary numbers corresponding to channel numbers. Selection of preset voltages on varactor diodes is made by a corresponding binary-coded signal which is stored in "binary memory" and applied to a "decoder" circuit. The terminal selected is connected to a potentiometer which applies a preset voltage on the varactor diodes, previously tuned at the desired channel.

One circuit, MK8014, has a clock pulse generator and an up-down binary counter. Remote channel selection can be done without use of moving parts such as motors or rotary switches, Yoichi Sakamoto and Eisuke Ichinohe of Matsushita report. The bipolar decoder circuit, MK8030, selects the proper voltage on the varactor diodes and switches on the channel indicating lights.

Tuner. Using two other newly developed MOS LSI circuits based on the concept, Matsushita has developed a varactor tuner with a keyboard channel selector that displays the tuned channel on a two-tube Nixie readout. Pushing a numeric selection feeds an encoder, where it is binary-coded and stored in an eight-bit shift register. This output is processed like binary memory output of the bipolar version.

The similar development by Toshiba uses two ICs—one p-channel MOS LSI in a 20-pin dual in-line package for channel selection and

one bipolar IC for voltage selection. This system features forward and backward shift capability, direct channel access by pushbuttons, and remote control capability.

With the MOS circuit, T-3119, the user can set a specific number in a cyclic channel selection. So if the tuner is to cycle between channels 2,4, and 7, the user can ground channel 8 and limit the sweep of the selector.

On the bipolar circuit, T-2126, transmission drift due to current error is experimentally 5 millivolts per 30°C maximum at 15 volts. According to Toshiba engineers Shinichi Makino, Koichiro Sakuma, and Hisao Tajiri, maximum slope is the tangent to local oscillator frequency versus control voltages, which should be within automatic fine-tuning range. □

Companies

Going to Japan? Try me, says Sony

In a move that's bound to make points in Washington, Sony Corp. has offered to market U.S.-made products in Japan. And one day after advertising the plan in this country, interest by several types of American manufacturers was running high, according to Osamu Mabuchi, who heads Sony's new America-Export-to-Japan division in New York.

Actually, the idea for this venture came some three years ago under Akio Morita, then president of Sony America and now president of the parent company. Since then, Sony has done a small amount of marketing for U.S. companies in Japan, but other projects have prevented any serious expansion of the effort.

Now, says Mabuchi, all the stops are out, and Sony will be ready to try its hand at just about any consumer hard goods product from audio equipment to refrigerators to washing machines. The only products that it would hesitate to sell are clothing and consumer electronics in

Bell & Howell & Heads You Win

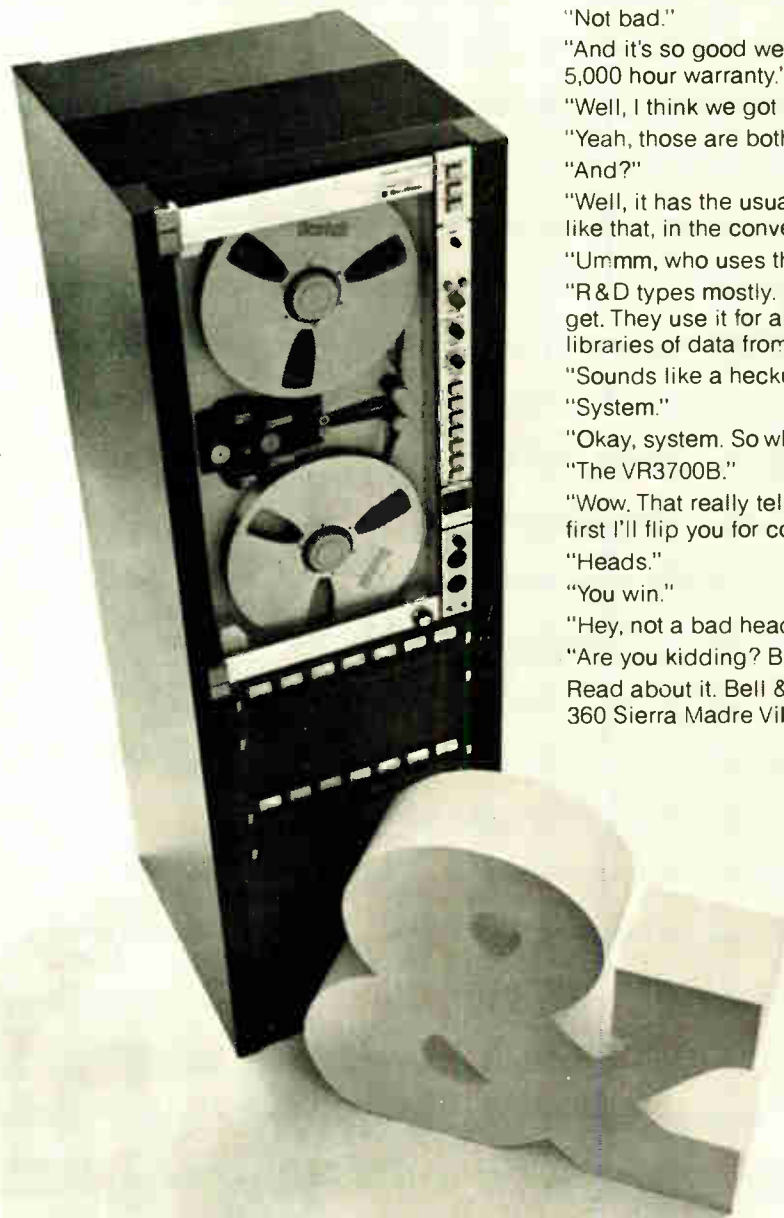

"Wow! We've done it! A super headed recorder/reproducer like nothing nobody's ever seen!"

This from one of our brighter back room boys as he charged into our office.

"Take a look guys. 2MHz performance at 60 ips. Realize what that means? Perfect recording with half the tape. And at about \$200 a reel, that's a cash register full of saved bucks."

"Not bad."

"And it's so good we've given the record head a whompin' 5,000 hour warranty."

"Well, I think we got something to work with. Anything else?"

"Yeah, those are both industry firsts from Bell & Howell."

"And?"

"Well, it has the usual 14 channels. 15/16 to 240 ips and stuff like that, in the conventional format."

"Ummm, who uses the thing?"

"R&D types mostly. It's about as sophisticated as you can get. They use it for aircraft tests. Cars. To pull down whole libraries of data from field recorders. That sort of thing."

"Sounds like a heckuva machine."

"System."

"Okay, system. So what do you call the super headed system?"

"The VR3700B."

"Wow. That really tells it like it is. Okay, we'll do an ad. But first I'll flip you for coffee. Call it."

"Heads."

"You win."

"Hey, not a bad headline for the..."

"Are you kidding? Beat it. Sheez, can you imagine."

Read about it. Bell & Howell, CEC/Instruments Division, 360 Sierra Madre Villa, Pasadena, California 91109.

CEC/INSTRUMENTS DIVISION



BELL & HOWELL

1%

AMERICAN MADE

Tolerance **SCHAUER** 1-Watt **ZENERS**

Immediate Shipment Low Prices

ANY voltage from 2.0 to 18.0

Quantity	Price each
1-99	\$1.07
100-499	.97
500-999	.91
1000-4999	.86
5000 up	.82



Write for complete rating data and other tolerance prices.

Buy the kit- Save a lot



Kit contains a 51-piece assortment of SCHAUER 1% tolerance 1-watt zeners covering the voltage range of 2.7 to 16.0. Three diodes of each voltage packaged in reusable poly bags. Stored in a handy file box. Contact your distributor or order direct.

A \$54.57 value for
ONLY **\$24⁵⁰**

Semiconductor Division
SCHAUER
Manufacturing Corp.

4514 Alpine Ave. Cincinnati, Ohio 45242
Telephone: 513/791-3030

Electronics review

direct competition with Sony's line in Japan. While that doesn't allow much leeway for consumer electronics, Mabuchi insists that the door is open to electronic products that complement Sony's.

The financial arrangements will

vary with each company, generally including some form of exclusive representation agreement for Sony. Besides providing a ready-made selling force, the Japanese firm will consult with American manufacturers on technical features, such as

Liquid crystal lights up the bar with display advertising whiskies

The next time you stop in at your friendly neighborhood tavern, there's a fair chance one of the latest innovations in electronics technology—liquid-crystal displays—will be adding to the glow.

For while most engineers have been considering liquid crystals for delineating digits in such things as watches, panel meters, and calculators [*Electronics*, May 8 p. 73], at least one group has applied them to cartoon-like advertising displays. And one of the first customers is Calvert Distillers Co., which is using them for animated back-of-the-bar displays promoting three brands of its whiskies.

Ashley-Butler Inc., a New York firm specializing in advertising displays for use inside stores, developed the new liquid-crystal units. Initially, the company sponsored the development effort jointly with RCA's Solid State Products division, Somerville, N.J. But last year, when RCA went through some reorganization following the demise of its computer operation, it discontinued work on the large-size liquid-crystal display [*Electronics*, Jan. 3, p. 29]. Ashley-Butler undertook the further development of the displays, at the same time acquiring some RCA engineers who had been working on the project.

The displays are square, measuring eight inches on a side, making them the largest liquid-crystal displays in production, asserts an Ashley-Butler spokesman. In addition to the displays for Calvert, the company is also developing them for Bufferin, the U.S. Navy's recruiting program, American Express Co., and Sears, Roebuck.

The displays rely on ordinary nematic liquid-crystal material placed between pairs of transparent conductive electronics and two

pieces of glass. As many as 40 different shapes can be turned on in up to 100 different combinations, according to Sandor Caplan, an ex-RCA man and now vice president, technical operations, at Ashley-Butler's plant in Somerville.

The sequences are controlled electromechanically by a rotating drum that resembles those found in music boxes. As the drum rotates, the patterns are connected sequentially via conductors brought down to the bottom of the display to a 35-volt ac liquid-crystal material firing signal. This voltage causes the liquid-crystal material to scatter light streaming in from behind the display and produce the desired messages and patterns.

The electronics is quite simple, Caplan points out, consisting of little more than a 40-volt transformer and an ac motor to turn the drum. Price of the displays starts at \$30 each in minimum quantities of 1,000. The price decreases for larger orders. Ashley-Butler, gearing up to produce more than 125,000 displays per year, guarantees them for at least one year of operation.

And off in the company's development laboratory is a larger ad display measuring 12 inches on a side, as well as a digital clock display being worked on for Bulova Watch Co. and displays incorporating patterns of dots that can reproduce the half-tone quality of a photograph. □



Solitron

DEVICES, INC.

1177 BLUE HERON BLVD.
RIVIERA BEACH, FLORIDA
(305) 848-4311
TWX: (510) 952-7610

SAN DIEGO, CALIF.
8808 Balboa Ave.
CMOS, PMOS Circuits
Diodes, Rectifiers, &
Zeners
FET & Dual FET
Transistors
High Voltage Assemblies
Linear & Monolithic IC's

RIVIERA BEACH, FLA.
1177 Blue Heron Blvd.
Hi-Rel Power Transistors
SI & Ge. Power
Transistors
Hi-Rel Power Hybrids
PNP-NPN Industrial
Transistors

PORT SALERNO, FLA.
Cove Road
Microwave Connectors
Plaxial (R) Cable
Precision RF Coaxial

JUPITER, FLA.
1440 W. Indiantown Rd.
Microwave Stripline
Components
Microwave Diodes
RF and Microwave
Transistors
HF Rel Power
Transistors

TAPPAN, N.Y.
256 Oak Tree Road
Diodes & Rectifiers
Ferrite & Ferrite Devices
High Voltage Assemblies
Power Rectifiers
Thick Film
Hybrid Circuits

KENT, ENGLAND
Tubbs Hill House
London Road,
Sevenoaks
Solidev, Ltd.
Full line of
Solitron devices

BEN BARAQ, ISRAEL
51 Hayarkon Street
AEL Israel, Ltd.
Full line of
Solitron devices

TOKYO 105, JAPAN
Rm. No. 21,
Kyodo Bldg.
No. 4-10, 2 Chome
Migashi Shinbashi
Minato-ku
Full line of
Solitron devices

FOR COMPLETE INFORMATION,
PRICES AND ENGINEERING
APPLICATIONS ASSISTANCE,
WRITE TODAY OR DIAL
TOLL-FREE 1-800-327-3243.

Solitron's new fast switching* series of high voltage, high current, silicon power transistors are triple diffused planar devices delivering up to 10 Amps at 450 Volts. Features include switching power ability to 4.5 KW and thermal resistance (θ_{JC}) = 0.8° C/Watt maximum. The combination of fast switching and high power capabilities make these transistors ideal for high frequency converters, inverters, series regulators, relay drivers, and power supplies. Packaged in a standard TO-3, this new series also is available in the isolated TO-61 and TO-63 cases.

* $t_r = 0.15 \mu\text{sec}$
 $t_f = 0.15 \mu\text{sec}$
 $t_s = 1.5 \mu\text{sec}$
($I_C = 5.0A, I_{B1} = I_{B2} = 1.0A$)

SDT 350-3 and-5
SDT 400-3 and-5
SDT 450-3 and-5



**FASTER
THAN
LIGHTNING**
SOLITRON'S NEW
FAST SWITCHING
450V, 10A
POWER TRANSISTORS

At Last!

Answers to the four most important questions about digital panel meters —

1 — Are line transients causing your panel meters to flip?

Data Technology's special transformer power supply blocks out line pulses up to 400 volts peak-to-peak!

2 — Is instability masking the accuracy of your equipment?

Data Technology's 100 pico amp input bias current assures accurate readings, even when "behind-the-panel" temperatures rise.

3 — Need a better looking, more readable panel meter to give your equipment a competitive edge?

Data Technology has user-preferred Sperry displays in the "standard" size case for best visibility and first-class appearance.

4 — Looking for relief from profit-robbing failures?

High quality components, superior workmanship, and wide-safety-margin designs combine to cut service and repair costs.

Compare our new 4000 series digital panel meters with what you've been buying.

Discover how many of your problems we've solved!

Data Technology Corporation



2700 So. Fairview Road, Santa Ana, Calif. 92704
Phone: (714) 546-7160



Electronics review

line voltage changes, and other product modifications to help capture the Japanese consumer.

Mabuchi states that the attraction to an American company is Sony's track record in marketing innovations, such as its successes with six-transistor radios and small-screen color TV sets. Both products paddled against the marketing stream but

won consumer acceptance eventually, Mabuchi adds.

A secondary, but important result of this plan is the aura of cooperativeness that Sony can gain in Washington, where U.S.-Japanese trade relations are strained. "We've enjoyed good business in America," says Mabuchi. "Now we want to reciprocate to our mutual benefit." □

Military electronics

Arms-limitation treaty tangled in politics but antiballistic-missile R&D goes on

"Change usually starts at the top for us and then it trickles down from there." That's how one senior Defense Department systems planner explained the expressed confidence among low-level electronics subcontractors for the Army's Safeguard ABM system that the U.S.-Soviet Strategic Arms Limitation Treaty would not seriously threaten their contracts.

At the Pentagon, in Congress, and among the top contractors, like Bell Laboratories and Western Electric Co., there is less certainty about the longer term. As a Bell spokesman put it, "so far we don't know what the agreement will mean to our work."

Politics. Other contractors and Government officials concur that some domestic political issues surrounding the ABM treaty—notably its call for a national Capitol-area site as one of two—will have to be resolved in the Senate ratification before the technology can be finally determined. Other possible impediments include a Senate upset with reports that the two-site ABM system called for may end up costing as much as the \$8 billion proposed for the pre-treaty four-site system. Also, Defense Secretary Melvin Laird has suggested that military support for SALT may be conditioned on Congressional approval of funds for other major programs.

Specifically cited are North American Rockwell's B-1 strategic bomber and the Navy's new missile-

launching submarine Trident—the program originally called ULMS and now being explored by General Dynamics Corp.—as well as a Pentagon desire to proceed with a new class of undersea cruise-launched missile submarines. As the UCLM boats would launch missiles on an aircraft-like cruise trajectory—instead of a ballistic course—they would not be subject to the initial treaty limitations. The Soviet Union has an inventory of such boats.

Though these issues would prolong the debate, no one seriously questions eventual approval of the treaty. "These things are important but they are still secondary," explains one staff man on the Democratic side. "The treaty is overriding and everyone of course knows that it's a motherhood document. You can't afford to oppose it."

Generally, electronics contractors are expected to benefit more than any other technology from the treaty: limitation to two sites is expected to escalate R&D to upgrade them to the maximum permissible limits. A case in point is the 5-year prototype program for the Site Defense System, formerly called Hard-site, under a \$382 million contract to McDonnell Douglas Astronautics Co., Huntington Beach, Calif.

Paid. The company got its first five-month increment of \$10 million four months ago followed by the recent \$168.3 million award to Martin-Marietta's Orlando, Fla., operation for development of a Sprint II

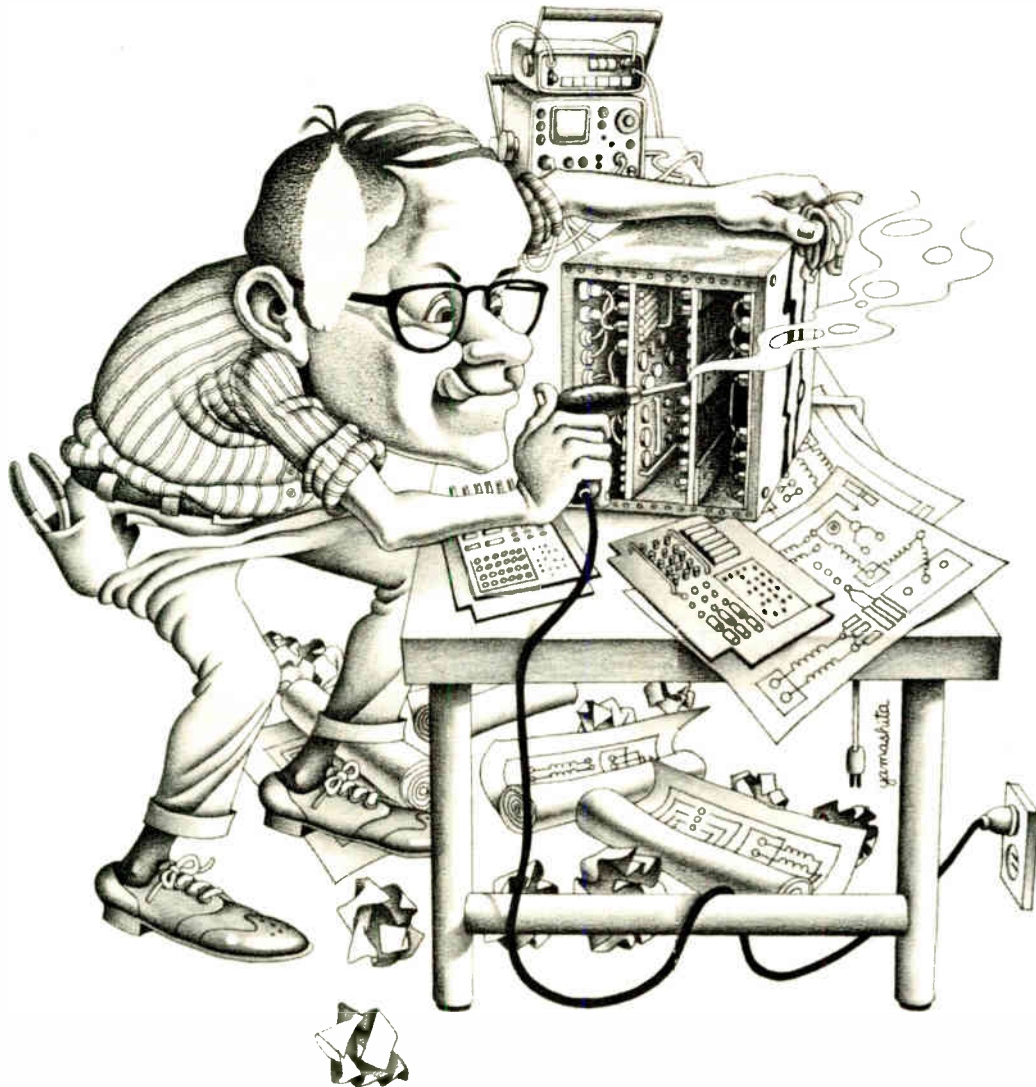

**Before you build your own logic tester,
try ours for six weeks.
And see how yours should work.**

We know what you're going through. You need a computerized logic tester that is efficient, flexible, easy to program and simple to operate for production testing of digital logic cards.

But before you go to the trouble of designing your own tester, take us up on our offer. You'll find we've already built the features you need into our CAPABLE Tester.

HERE'S HOW OUR OFFER WORKS. For \$600.00 you get CAPABLE for 6 weeks. We'll help you write a program for one of your digital logic cards and teach you how to use CAPABLE.

Then you will see how easy it is to program CAPABLE for all of your digital cards. And how it not only functionally tests cards, but performs component level fault isolation in just seconds.

And how it provides more uniform and more positive testing even with greatly decreased test time. Most importantly, you can evaluate in your own operation the overall production savings and increased productivity

that our computerized tester will give you. To learn more about CAPABLE write today for full details. We'll give you something to shoot for.

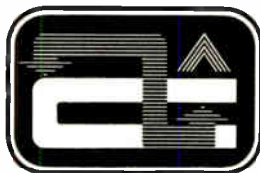

COMPUTER AUTOMATION, INC.
895 West 16th Street • Newport Beach, California
92660 • Phone (714) 642-9630 • TWX 910-596-1377

IS4 ST DP main switch

Household equipment TV - Programming

- 4 A/250 V/AC
(140 A peak current).
Approved by UTE, SEMKO,
DEMKO, FEMKO, CSA, UL, etc.
- 10 A/AC for special applications
 - DP with a change over
 - Unlimited possibilities
 (several switches for programming,
with or without locking system).
- **NEW**: Central mounting possible.

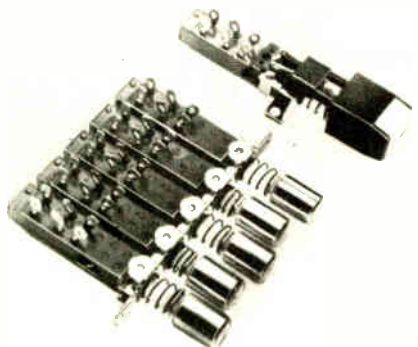

- Manufactured by ISOSTAT in :
England, France, Germany,
Hong-Kong, Italy, Japan, Spain
and, under licence, in USA and USSR.

In north and central America :

CENTRALAB 5757 North Green Bay Av.
MILWAUKEE WISCONSIN 53201
Tel. (414) 228 1200 Telex 026 650 GLOBE-UNION
for other countries, refer to :



LIPA & ISOSTAT G.B. Ltd 6 Mandeville Place
LONDON W.1. ENGLAND Tel. (01) 935 04 81 ou 88 23
Telex 261 772 LIPOSTAT LONDON

or :

ISOSTAT 67, rue Anne-Marie Colombier
93 - BAGNOLET FRANCE Tél. 858 41 80 +
Télex 22189 LIPOSTA BAGNT

pub. 99ed

missile. With systems engineering and technical assistance from Brown-Teledyne, Huntsville, Ala., the SDS total effort is expected to run to \$700-\$800 million, says a Safeguard official.

Location of a Capitol-area site—with the Army reported to prefer the large acreage at Fort Belvoir, Va., for the 100-missile complex—could lead to upgrading of the GE-developed perimeter acquisition radar (PAR), since the treaty limits the number of radars to six on a side of the Capitol, but not the number of faces per radar.

Communications

DEC introduces four systems

About a year after its establishment, the Digital Equipment Corp. data communications group has forged the sharp opening wedge of its attack on a mushrooming market with the introduction of four PDP-11-based data communications systems, the 11D20 series. Latest in the series is the 11D23 front-end processor [*Electronics*, June 5, p. 36] for IBM series 360 and 370 computers, which puts DEC in competition with IBM's own 3705 front-end processor in the IBM plug-compatible market. DEC also sees itself competing with such other firms as Interdata, Data General, and GTE Sylvania in data communications.

While DEC has sold into this market for years, the advent of the new generation of PDP-8s and -11s gave it a broad line of gear especially suited to communications applications.

The major force, says Don Alusic, marketing manager, is the PDP-11—with its modular instruction set and byte-manipulative capabilities. To go up against IBM, one must do more than compete on price. "In addition to offering the PDP-11's architecture and software," says Alusic, "we are offering 'tools' which IBM cannot, or does not, offer. These usually are in the form of software

modules and peripheral devices, which the buyer can assemble to perform his communications tasks at a cost about half that of comparable IBM equipment, and with greater flexibility. The PDP-11 is a general-purpose computer, and IBM's interfacing boxes are not."

An example of this is the remote terminal equipment, where DEC's group already offers a range of interfacing for a variety of terminals—interface hardware and software that allow automatic dialing, synchronous or asynchronous communication over single or multiple lines, and so on. IBM offers this on a custom basis and at an average of about twice the DEC price.

The 11D20 series encompasses, besides the 11D23, the 11D20 communications system base; the 11D21, which includes the 11D20 plus hardware and software to emulate the IBM 2780 Model 1 data transmission terminal and the 11D26 remote-batch terminal. □

For the record

B-1 computer. Kearfott division of the Singer Co. has won a \$2 million contract from the Boeing Co. to supply seven SKC-2000 airborne computer sets for the B-1 bomber's central avionics control subsystem. Two identical units will fly in each B-1 to handle navigation, weapons delivery, and display data management.

Ready. Raytheon is ready to throw its V-ATE capability behind a 1,024-bit bipolar RAM. Presently sampling, Raytheon promises a production line of several thousand units next month. Pilot-line units have access time of 35 nanoseconds maximum, typically 29-31 ns; 50% more die per wafer than typical oxide isolation parts; and a speed-power product of 10 picojoules.

TI technique. TI, on the other hand, instead of going the way of Raytheon's V-ATE, Motorola's VIP, or Fairchild's Isoplanar [*Electronics*, June 5, p. 41], is using compose masking for bipolar memory chips. This involves a single nitride mask for all critical diffusions. □

THE 1024-BIT TTL RAM IS HERE



Our new 93415 RAM: 1024 x 1 bit. TTL. 60 ns access time at 0.5 mW/bit. And Isoplanar did it.

The 93415 RAM is the most complex monolithic bipolar read/write memory ever made.

This self-contained subsystem also features 30ns chip select access time, open collector (expandable) output, static TTL operation and decreasing power dissipation with rising temperature. Available now in prototype

quantities in 16-pin hermetic DIP. What this means to designers of high-speed digital systems is that for the first time they have available a major TTL memory building block that can operate at speeds compatible with those of their systems' logic. Because it's static, the 93415 is simple to use, requires no complicated

peripheral electronics. And because of its functional density and capability, the 93415 gives the designer a fine opportunity to realize significant cost savings by 1) reducing package count, 2) reducing circuit board number and size, 3) reducing number of connections, 4) increasing system reliability.

Functional diagram of the 93415 TTL RAM

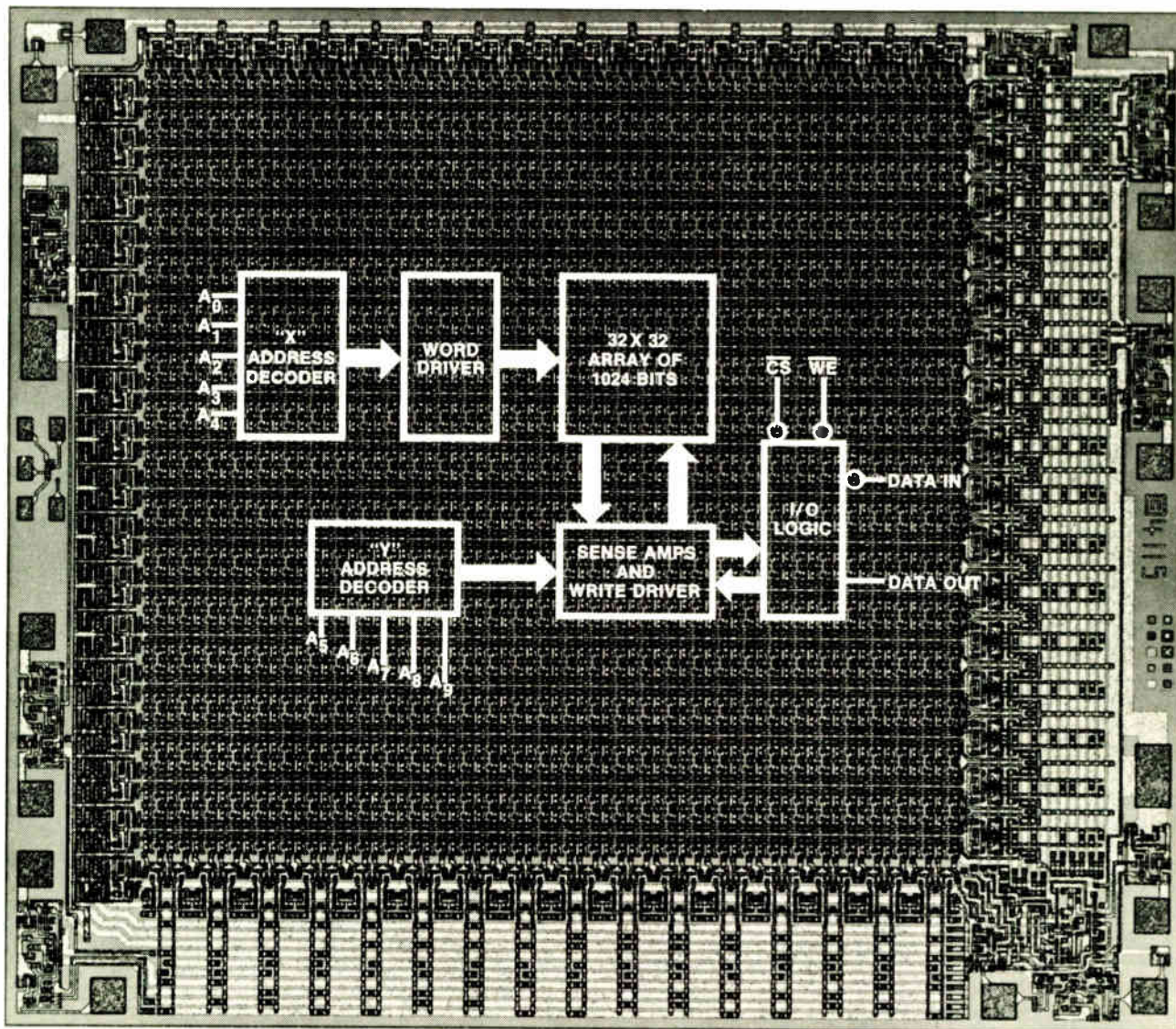

Significant Memory Applications

Some of the more exciting applications of 93415 are: as a fast writable control store for micro-programming, eliminating many present needs for fixed ROMs; as a large high-speed scratchpad to make multiprocessing more feasible; for simulation of long high-speed shift registers; for improvement of buffer or cache memory performance by increasing capacity without any power or size trade-off; and obviously for building cost-effective high-speed main-frame memories.

Isoplanar did it. Again

Our 93415 is the most recent, and most important, product of our isoplanar technology. Isoplanar proved itself last year with the successful introduction, and volume production, of our 93410 256-bit TTL RAM and our 95410, world's first 256-bit ECL RAM.

The introduction of the 93415, another industry first, is just one more demonstration of what isoplanar can do. Soon, isoplanar will do it again, with even more complex TTL and ECL memories.

What is Isoplanar? It's a bipolar fabrication process that replaces conventional planar P+ isolation diffusion with an insulating oxide. Result: High density. High yield. Low cost. Improved speed/power performance (from lower parasitic capacitance). Improved reliability (from planar surface). Isoplanar is the designer's assurance of proven reproducibility and deliverability.

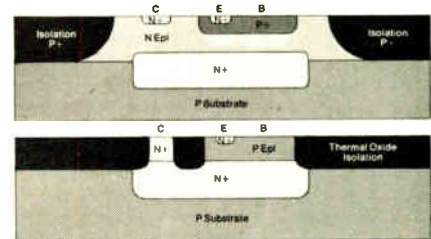

No space is required between base and collector regions and isolation in isoplanar bi-polar (bottom) compared to conventional planar bi-polar (top).

Fairchild Bipolar Memories

BIPOLAR READ/WRITE MEMORY APPLICATIONS SUMMARY					
ORGANIZATION	REGISTERS SYSTEM SPEED 5-30ns	SCRATCHPAD SYSTEM SPEED 15-60ns	CONTROL SYSTEM SPEED 20-70ns	BUFFER SYSTEM SPEED 50-80ns	MAIN SYSTEM SPEED > 75ns
8 x 1	(TTL) 9338, 93S39* (ECL) 9539*				
16 x 1		(TTL) 93407, 93433 (ECL) 95401			
16 x 4			(TTL) 93403 (ECL) 95400		
256 x 1				(TTL) 93410‡ (ECL) 95410‡	
1024 x 1				(TTL) 93415‡ (ECL) 95415‡*	

*IN DEVELOPMENT ‡ISOPPLANAR DEVICES.

Availability

Some 93415 RAMs are already out in the field in evaluation quantities. Prototype quantities are available now from your friendly Fairchild distributor at the following prices:

1-24 25-99 100-999

\$87.50 \$80.50 \$70.00

Volume shipments available during 4th quarter.

**MADE IN
FAIRCHILD**



another 1st from AMS

a 2048 bit RAM with TTL
compatible
inputs

You're really the winner. Why? Because your system . . . with AMS devices . . . comes out ahead. And when *your* system wins, everyone else's is second best.

AMS' new 2048 bit 6003 does in '72 what our 1024 bit MOS RAMs did in '70 . . . it sets a new industry standard for a TTL compatible RAM. In performance, reliability, price and delivery, it's way out front; first in its class. Our specifications (see right) are production characteristics and not once-in-a-lifetime laboratory curiosities. We guarantee them.

In the race to develop and prove the advantages of a 2048 RAM, you've heard plenty of performance claims. Mostly, it's been chalk talk. The AMS 6003; it's real, it's now, and it's inventoried nationwide for immediate response to delivery schedules. To us, that's part of being first.

Can the competition catch up? Maybe, but remember there's only room for one in the winner's circle. If your design is competing for the top spot, stick with a winner. Specify the AMS 6003, the industry's first competition proven 2048 bit RAM.

AMS STOCKING DISTRIBUTORS

Alabama:
Powell Electronics
Huntsville
(205) 539-2731

Arizona:
R. V. Weatherford Co.
Phoenix
(602) 772-2144

California:
R. V. Weatherford Co.
Anaheim
(714) 147-0891
Clermont
(913) 849-3451
Pomona
(714) 621-1261
San Diego
(714) 278-7400

Powell Electronics
Mt. View
(415) 964-0870
Palo Alto
(415) 371-5373

Colorado:
R. V. Weatherford Co.
Denver
(303) 427-3736

Florida:
Powell Electronics
Miami
(305) 885-8761
Orlando
(805) 423-8586

Maryland:
Powell Electronics
Beltville
(301) 947-4010
Massachusetts:
Anito Electronics
Cambridge
(617) 868-3170

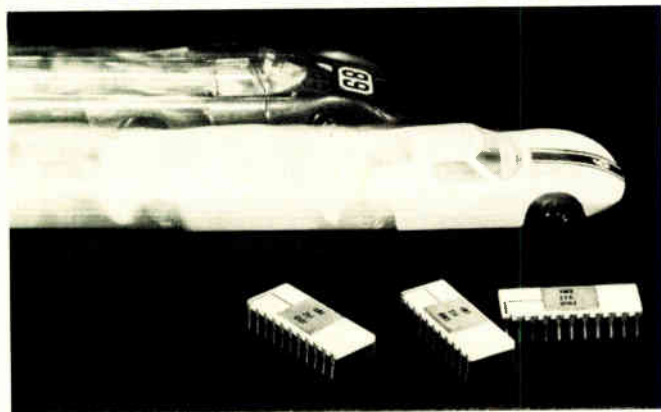
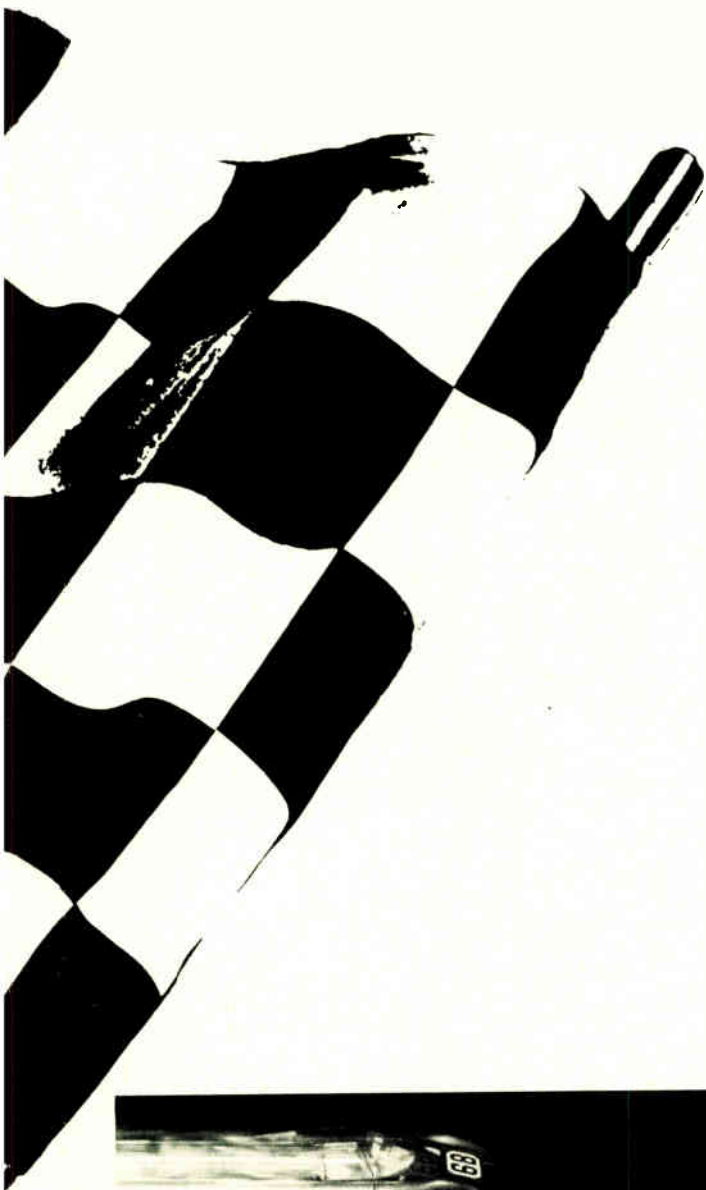

the 6003 from **AMS**

- Low Power Dissipation: 80 μ w/bit operating 20 μ w/bit standby.
- Address and Chip Select Registers On the Chip.
- Data Output Latch Incorporated Into the Circuit.
- Access Time: 360 ns
- Cycle Time: 595 ns
- TTL-compatible Address and Control Inputs.
- Operating Temperature Range: 0°C to 70°C.
- High Yield Aluminum-Gate P-Channel Process.
- Standard 22-Pin Ceramic DIP.

Advanced Memory Systems, Inc.
1276 Hammerwood Avenue,
Sunnyvale, California 94086

Our name is our business.
We build advanced memories.

AMS INTERNATIONAL SALES OFFICES

New Mexico:
R. V. Weatherford Co.
Albuquerque
(505) 265-5671

Pennsylvania:
Powell Electronics
Philadelphia
(215) 724-1900

Texas:
R. V. Weatherford Co.
Richardson
(214) 231-6951
(214) 231-7141
(214) 231-7142

Washington:
R. V. Weatherford Co.
Seattle
(206) 762-4200

Munzig International, Inc.:
Los Angeles
(213) 382-8435

England:
London Slough 34003

France:
Paris
686.14.73

Holland:
Amsterdam
45 68 24

Japan:
Tokyo
503-4751

Sweden:
Stockholm
766 33 94

Switzerland:
Geneva
(022) 35 84 14

West Germany:
Munich
0811/630667

AMS DOMESTIC SALES OFFICES

California:
Encino
(213) 986-3895

Sunnyvale:
(408) 734-4330

Massachusetts:
Randolph
(617) 828-2181

Pennsylvania:
Blue Bell
(215) 643-5422

AMS manufacturers' representatives are located throughout the United States. Consult your local telephone directory for the one nearest you.

Circle 49 on reader service card

Off the Shelf

RCA RF Tubes/Cavities
for VHF/UHF Translator/ Transposer
Service world-wide.

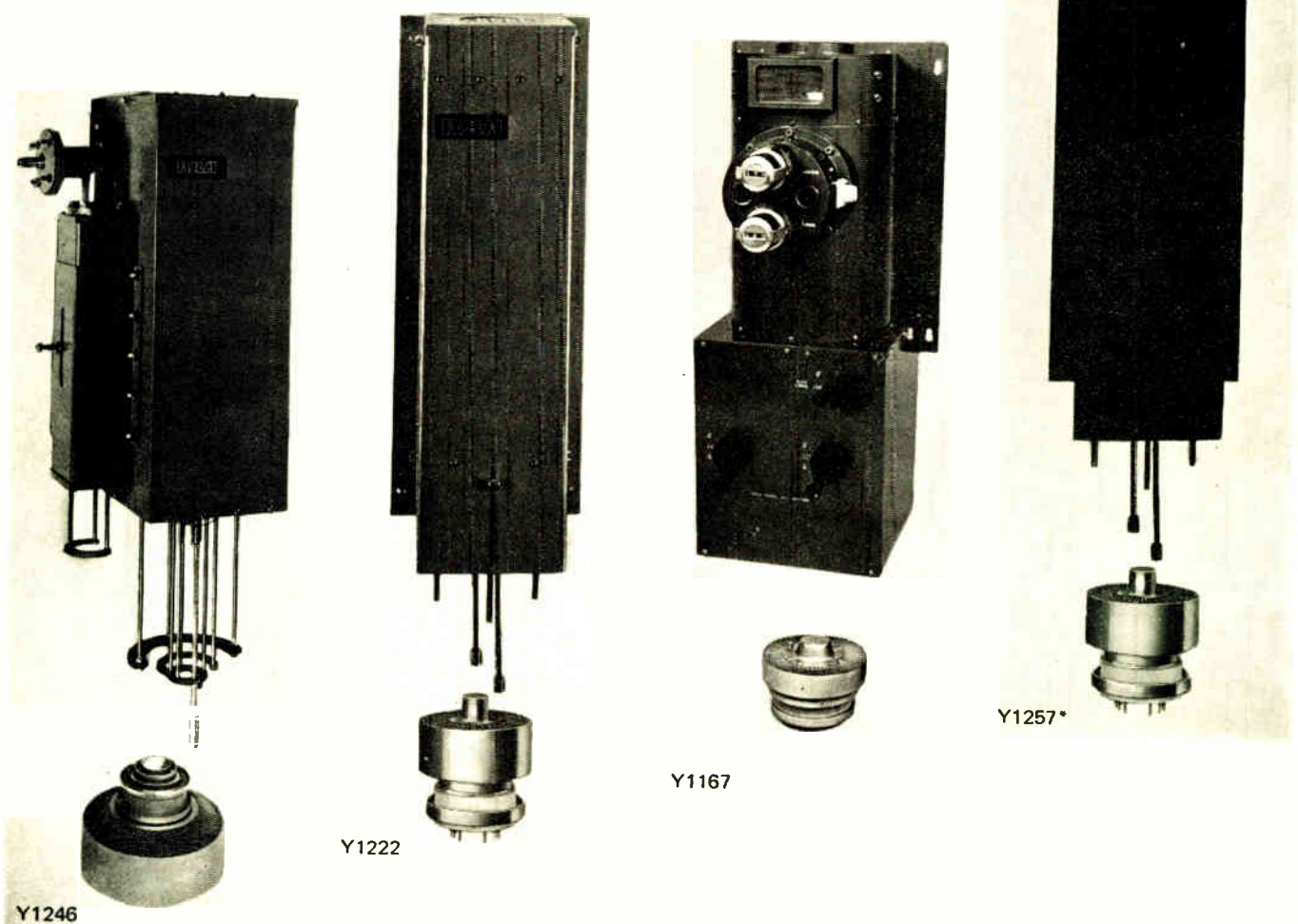

From 100 W to 1 kW. For VHF and UHF. That's RCA's range of RF tubes and cavities for translator/transposer service — world-wide!

From RCA the leading U.S. supplier of these combinations, you get as much as a 4-to-1 savings in plate dissipation. All the audio/visual RF circuitry is provided in each tube/cavity combination, and it can be tuned to any band now allocated to TV service anywhere in the world.

Ask your RCA Representative about the attractive costs and special advantages of RCA tube/cavity combinations. For more information, write: RCA, Power Tube Marketing, Section 70F-19/ZR7, Lancaster, Pa. 17064. International: RCA, 2-4 rue du Lièvre, 1227 Geneva, Switzerland, or Sunbury-on-Thames, U.K., or P.O. Box 112, Hong Kong. In Canada: RCA Limited, Ste. Anne de Bellevue 810, Quebec.

Tube/- Cavity	Peak of Sync	Gain (Typ.)	Linearity (Typ.)
8122/Y1222	100 W VHF	15 dB	-52 dB
8792/Y1167	1 kW VHF	12 dB	-50 dB
4628/Y1246	1 kW UHF	12 dB	-52 dB
8226/Y1257*	100 W UHF	12 dB	-52 dB

*Objective

Pentagon acts to hold down Army SAM-D costs . . .

IBM and IT&T have been named by the Army to look over the shoulder of prime contractor Raytheon Co. "to control the costs of SAM-D," the newest missile system for air defense. The Army's Chief of R&D selected the team after deputy defense secretary Kenneth Rush stipulated it as one of five conditions attached to approval of SAM-D engineering development. **At mid-June, total SAM-D costs were estimated at \$5.2 billion—including procurement of \$3.9 billion and RDT&E of \$1.2 billion.** Those figures are up 33% and 48%, respectively, from Army estimates of one and two years ago.

Secretary Rush called for **"reducing procurement and operating costs" by examination of possible changes in systems specifications, design, and alternate solutions.** He also ordered an independent study of SAM-D performance amid tactical and electronic countermeasures.

. . . as Army gets hit on FAADS overrun

The Forward Area Air Defense System—the Army's low-altitude counterpart to SAM-D—is being charged on Capitol Hill with a **\$377.6 million cost overrun and a radar that suffers from "six major deficiencies,"** according to a classified General Accounting Office staff study. Unclassified portions of the study are being used by Rep. Les Aspin (D., Wis.) in an attack on the Army system comprising Philco-Ford's Chaparral missile, GE's Vulcan Gatling gun, and Sanders Associates' Forward Area Alerting Radar. Aspin, who dubbed the radar "a botched-up disaster," says its **cost has "skyrocketed" to \$114.1 million from a \$41 million estimate** and that Army officials told him acceptance of the radar has slipped at least until September from last January "because of additional technical foulups." The House Appropriations Committee has disclosed that the Army has deployed the system without the radar.

Supreme Court boosts CATV equipment market

An increase in the cable television broadcast equipment market will result from the early June ruling of the Supreme Court, predicts an Electronic Industries Association executive. In a five-to-four decision, the court upheld the **Federal Communications Commission's right to require CATV systems to originate "a significant share" of their programs,** instead of rebroadcasting old films and commercial series, and retransmitting commercial signals. Cablecasters' own estimates of **per-station outlays for portable and studio broadcast equipment run from \$1 million to as low as \$30,000,** depending on equipment quality.

Addenda

Canada has joined the U.S. triservice tactical communications system known as Tri-Tac, while Australia mulls over signing the project formerly known as Mallard [*Electronics*, June 5, p.57]. . . . **Army Electronics Command, director of Tri-Tac, has made equal awards of \$2.97 million** to GTE Sylvania Electronic Systems and ITT Defense Communications to build two AN/TTC-39 (V) prototype switches. . . . Litton Industries Data Systems division took a long step **toward qualifying its AN/GYK-12 artillery tactical fire direction computer (known as Tac-fire) as an Army tactical standard** with its selection for use in the Sylvania Tri-Tac switch; Burroughs Defense Systems, Paoli, Pa., has the processor for the ITT prototype.

Growth and manpower in electronics (Pt. II)

At a time when the electronic industries are struggling to find new sources of growth, their management seems comforted that most economic indicators are moving upward. But no comfort can be derived from the latest membership survey of the Aerospace Industries Association of America, according to which engineering and scientific jobs in aerospace will suffer a further drop of 5.7% for the year. "By December 1972," AIAA reports, "it is estimated that 150,000 scientists and engineers will be employed, compared to the 1967 peak of 235,000." Thus does the erosion of a major segment of the nation's technology base continue in a difficult election year.

The changing customer

Aerospace is, of course, a significant consumer of electronics; it is unquestionably the most demanding customer for hardware that advances the state of the art. So the forecast of a continuing decline in aerospace jobs across the board is disturbing, if not unexpected, news to electronics industries looking for ways to increase their own declining share of the Gross National Product.

One of the electronics industries' strengths, of course, is that they are not as directly dependent as aerospace on the Federal customer and the vagaries of congressional treatment of White House budgets. Yet it should not be forgotten that 1967—the peak year for aerospace—was also the year when U.S. electronics production peaked out at just under 3% of the GNP. That percentage share has been declining ever since 1967, and, as Texas Instruments' chief executive Mark Shepherd Jr. pointed out not long ago to his peers in the Electronic Industries Association, the U.S. electronics production in 1972 "will realize a lower percentage share of the GNP than a decade earlier."

Increasing the share

There are ways to reverse this course. Beyond the obvious expansion of applications for communications and data processing, the ways are too often defined simply and glibly as "new markets" that will come as the cost of technology declines in the decade ahead. But just because electronics will cost less, TI's Shepherd sees "markets much larger than the value of the electronic hardware." For him, therefore, the message is simple: "Deal in total problem solutions, not merely in electronic hardware."

For some, that recommendation is reminiscent of the aerospace siren song of the '60s; it was called Systems Engineering. But it is evi-

dent that Shepherd is not selling a panacea. "What is emerging as the critical shortage of this era is skill in matching knowledge to needs. In this sense we do have a technological shortage—of the new technology that will be the foundation of the so-called 'knowledge-based industries.' These industries will rely on combinations of technology, hardware, software, automation, capital intensity, complex systems capability, and information management. The ability to combine these ingredients is, in itself, a challenging new technology."

Who will put these ingredients together? "It won't be engineers with aerospace experience, at least not in our company," contends another company president who concurs with Shepherd's estimate of the challenge. "I can't be on the record with this because it might be construed as discriminatory," he explains in a request for anonymity, "but aerospace background is bad for our business" (making commercial and consumer electronics). With a good many managers privately expressing similar views, who do they believe will put together the "knowledge-based industries" of tomorrow? Their answer: today's students.

Will the engineers be there?

For an industry anxious to return to a period of growth, that answer suggests electronics executives should look sharply at what is happening today in graduate engineering schools—the source of tomorrow's inventive labor. The National Science Foundation has concluded such a look and found that in 2,579 university departments granting the Ph.D., graduate engineering enrollment in 1971 dropped 5.7% on top of 1.7% decline the year before. On a more dramatic, if less catastrophic, scale, the engineering dean of a Washington-based university last year bemoaned the prospect of closing his undergraduate department altogether for lack of applications even while his school was noting a record number of applications for what one official called "the human sciences of law and medicine."

Management in any industry often finds itself so overwhelmed by the present that it postpones looking at the future. But if electronics is to expand its technology base and resume its growth curve with less dependence on aerospace; if it believes its engineering manpower tool is neither inexhaustible nor interchangeable within different segments of the industry, then it must take some thoughtful looks beyond the next P&L statement and determine its best source of knowledge. —Ray Connolly



Hot off the press.

Teledyne's new FET Fact Finder

From the company with the broadest line of FETs, comes the most comprehensive FET data book ever. Its 164 pages present a big section of applications and complete characteristic curves on every FET we make. It also contains detailed min/max parameters on every device. It's the most complete JFET data manual ever compiled.

Get yours now from your local Teledyne Semiconductor sales office or representative.

Quick,
have a salesman bring me a new FET data book.

Name _____ Title _____

Company _____

Address _____

 **TELEDYNE SEMICONDUCTOR**

1300 Terra Bella Avenue Mountain View, California 94040 (415) 968-9241 TWX: 910-379-6494 Telex: 34-8416

For more than 10 years, THOMSON-CSF has been a leading manufacturer of ultra reliable triodes and tetrodes including their associated tunable cavities for use in VHF and UHF translators.

The most comprehensive line of tubes/cavities for class A operation from 10 watts to 2 kW for any TV band up to 1,000 MHz are available off the shelf.

Furthermore, the THOMSON-CSF family of TV translator tubes/cavities features highest gain and lowest

intermodulation product performance available and their ruggedized metal-ceramic construction assures high MTBF translator equipment operation.

These outstanding translator tubes/cavities are supported by the world-wide THOMSON-CSF sales and service organization. For more information about these translator products and other power tubes manufactured by THOMSON-CSF contact the sales office nearest you.



THOMSON-CSF

THOMSON-CSF ELECTRON TUBES, INC.
50 ROCKEFELLER PLAZA / NEW YORK, N.Y. 10020
(212) 489-0400

France - THOMSON-CSF Groupement Tubes Electroniques / 8, rue Chasseloup-Laubat
75 PARIS 15^e / Tel. 568.70.04
Germany - THOMSON-CSF Elektronenrohren GmbH / Am Leonhardsbrunn 10
6 FRANKFURT/Main / Tel. 70.20.99.
Italy - THOMSON-CSF Tubi Elettronici SRL / Viale degli Ammiragli 71 / ROMA
Tel. 63 80 143
Sweden - THOMSON-CSF Elektronrör AB / Box 27080 / S 10 251 STOCKHOLM 27
Tel. 08/22 58 15
United Kingdom - THOMSON-CSF Electronic Tubes Ltd / Bilton House, Uxbridge Road,
Ealing / LONDON W5 2TT / Tel. 01-579 1857
Japan - THOMSON-CSF Japan / Kyosho Building / 1-3-10, Hirakawa-Cho / Chiyoda-Ku
TOKYO 〒 102 / Tel. (03) 264-6341

Our TV translator tubes/cavities
have proven performance.
Millions of hours of successful operation all over the world.

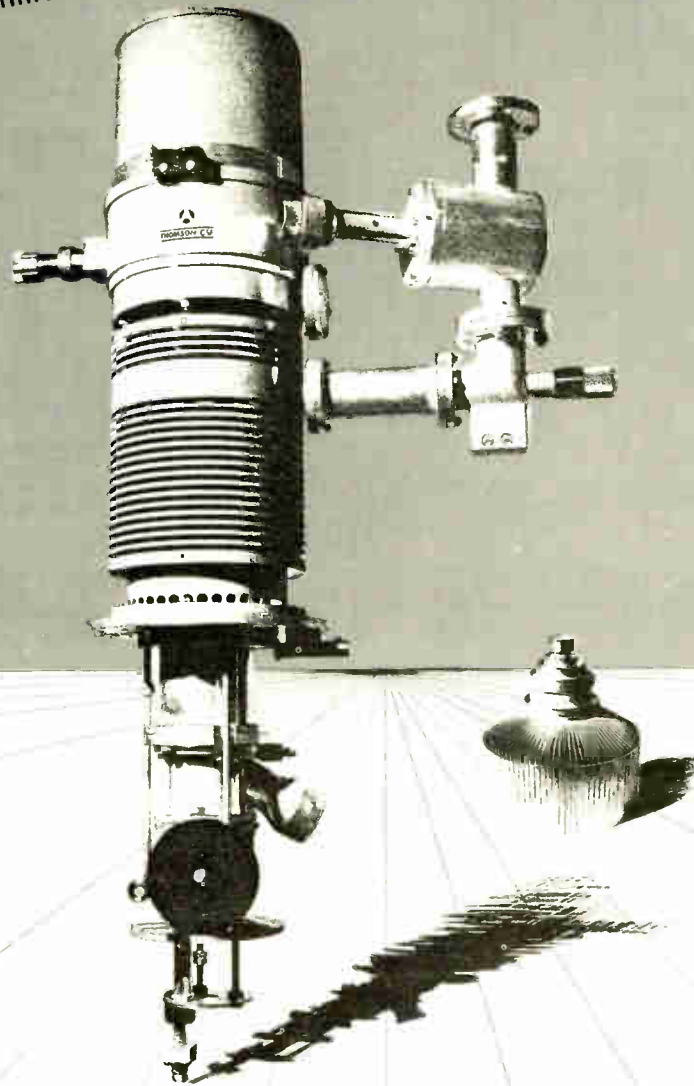

Core, semiconductor combined on one memory structure by Philips

A new hybrid memory, combining core and semiconductor technology in one structure, has been built at the Philips Research Laboratories in Hamburg, Germany. Not only does the structure have the density of cores and the small size of semiconductors, but it also promises considerably lower prices per bit.

The potential of the so-called integrated magnetic memory (IMM) as a random-access memory device could be enormous.

While as fast as an MOS element, it is structurally much simpler and therefore easier to fabricate. Besides, unlike an MOS device, the IMM is nonvolatile.

Like a core. The new device resembles a flat-rolled ferrite minicore. Deposited on a silicon chip, this core encloses a pair of thin-film aluminum conductors sandwiched between silicon-dioxide insulating layers. With the core material providing an uninterrupted magnetic path around the conductors, the device operates in a closed-flux mode.

At its present state of development, the IMM has an area of only 0.01 square millimeter, small enough to provide an information-packing density of 10,000 bits per square centimeter, or 65,000 bits per square inch. The element's switching time is about 100 nanoseconds. Current MOS memories switch in 100 to 300 nanoseconds, depending on size.

Also, with IMMs, higher device yields should be possible than can now be obtained with semiconductor memories because the substrate need not have crystal perfection, and also because sputtering instead of the more critical diffusion techniques is used in element fabrication. Higher device yield is, of course, the key to lower costs per bit in memory manufacture.

So far, the Hamburg researchers

have developed four-by-four-bit arrays with hundreds of such arrays contained on one chip.

The next step in the development, says Jan Verweel, project leader, is to fabricate larger arrays and to integrate them with semiconductor drive and address circuitry on the same wafer. □

France

TV makers see sales in wind

European consumer electronics manufacturers who market in France showed off their products in Paris early this month in an atmosphere of anticipation. The reason:

a shakeup in the French radio-TV monopoly that could mean better programming and, therefore, more sales.

Not only has the director of the monopoly resigned, but parliament is investigating allegations of crookedness against TV personalities. Also, France's two channels probably will start independent programming by fall, and on Dec. 31 a third (all-color) network will go on the air.

Even with programming in its present state—reminiscent of American TV 10 to 20 years ago—color receiver sales are beginning to mount. Manufacturers are confident they will sell 420,000 color sets this year, more than double the 1970 figure of 205,000. The addition of the third network and the expected structural changes at ORTF, which runs things,

Easing the way in the Soviet

While the U.S. computer show staged by 28 companies in Moscow at the end of last month didn't exactly set a record for orders—the total isn't expected to reach a million dollars—it did serve as an indicator that doors to sales in Russia are opening.

One of the more significant developments was announcement of a new Russian-language magazine, *American Firms Offer*, designed to afford American computer makers and other electronics firms direct advertising access to Soviet ministries, enterprises, research centers, and foreign trade organizations. Published by Vneshtorgreklama, a government advertising agency, the new magazine will accept only technical advertising at \$300 per page. Intem is the official U.S. representative of all state advertising groups. The magazine is due to appear in a few weeks.

Shown. At the Moscow computer show, Control Data Corp.'s standout exhibit was its 3300 system, a medium-scale general-purpose layout. CDC reported receiving serious inquiries also about its 6200 system from the Soviet National Weather Service and from the oil ministry.



Manufacturer Saves 31 Minutes Per Man Hour with **CABLE-SCAN™ Harness System***

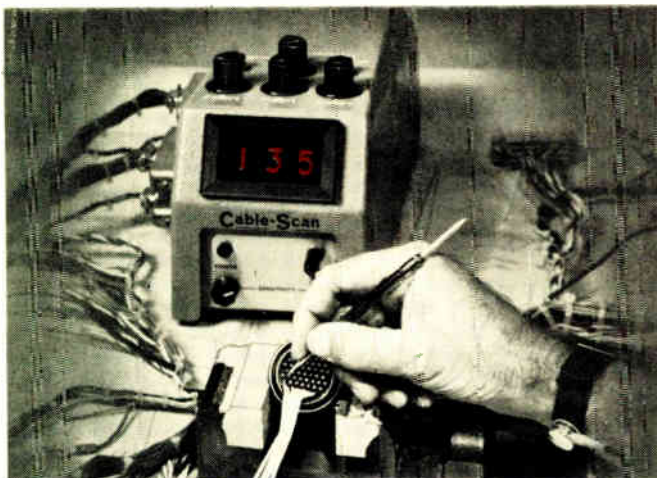

1 Quickly locate termination point by touching connector pin

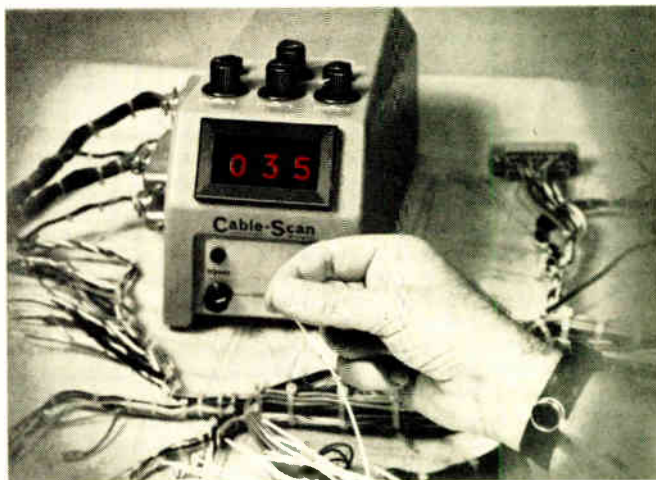

2 Instantly identify any wire by touch

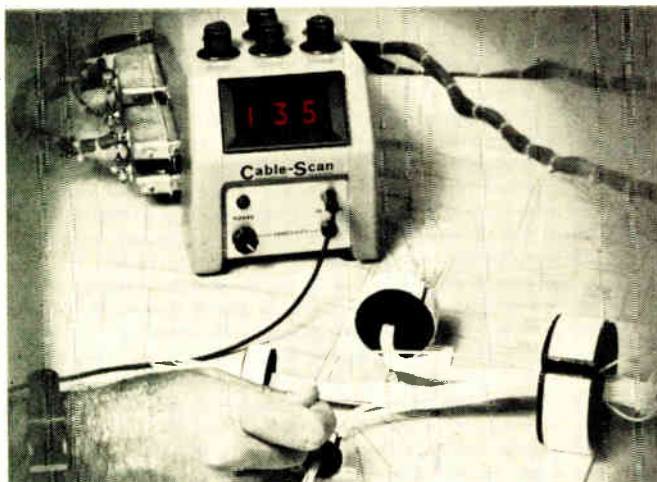

3 Route wire to proper destination



4 Complete installation and get immediate verification of proper termination

Until recently the only way wires could be selected and routed to make harnesses and cable assemblies was by traditional methods such as color coding, wire tagging, preprinted wire or some other equally slow tedious and expensive method of identification. Now Thomas & Betts Corporation offers a totally new system which combines instant identification and testing at the point of fabrication in 1/5th the time of any present method. Since everything is verified while the job is in process costly rework is eliminated. By touching the end of any wire the operator introduces a low level signal through the finger tips to each circuit. This causes the numerical readout of the wire identity. Cable-Scan Inc., 145 E. Emerson Ave., Orange, California 92665

*Documented Case Histories

Cable-Scan Inc.

Subsidiary of Thomas & Betts Corporation



will likely keep the curve up.

Brightness. Other consumer products are moving well in France, led in growth pace by tape recorders. Industry figures show 1972 sales projections of 900,000 tape recorders, 200,000 more than in 1971. Radio sales are expected to top 4 million sets in France, half a million more than last year. And record players are tabbed for about 1 million units in France this year, compared with 920,000 last year.

The Paris show, Salon International Radio, Television Electro-acoustique, attracted 140 exhibitors, strongly dominated by the French, who had 66 booths. Japan was second with 16, and Italy was third with 13.

A survey of exhibitors showed that the 110° TV tube will arrive in large quantities in France in the fall. And the increasing use of ICs in sets accounts for the main technological transformation.

On the commercial side, the French firm Pizon Bros. is expecting its line of small-screen sets to pick up gradually, as French families start adding second sets. Only about 2% of French homes now have two television sets.

But probably the most unexpected commercial development to emerge at the show is the arrival in France of the Rubin 61-centimeter-screen color TV from the Soviet Union. The French import house Comix is stocking 1,500 Rubins, to be marketed in France as the Ruby, beginning in September. If the Ruby goes over well, smaller sets from Russia will be added to the line. France is the first Western market that the Soviet television makers will try to tap.

"We will have a wholesale price 30% to 40% under the price of French manufacturers," says a French Comix official. "We think this set will go very strongly." The Rubin is a 10-module set that is about 50% transistorized. It has a 625-line system, so it is not equipped to receive French network Number One. But within the next two or three years Number One will switch from its current 819-line system to 625 lines. □

Brulé collects reward for success with chairmanship of Honeywell-Bull

If the survival of the Franco-American computer partnership Honeywell-Bull can be traced to any single factor, it would be the influence of energetic Jean-Pierre Brulé. At the age of 42, Brulé has just been rewarded by advancing to the chairmanship of the Honeywell-Bull board—an early arrival indeed in the country that invented gray eminence.

Brulé says there may be other major presidents and chairmen of his age in France, "but I can't think of any." He became chief executive officer (he already was, and remains, president) at the end of May, replacing Henri Desbruères, 65, an acknowledged supersalesman and former president of Air France and Snecma, the aircraft engine maker.

Honeywell-Bull is now beginning to reap the benefits of fundamental management changes that young Brulé introduced in 1968—just a year after he joined what was then Bull-General Electric. Honeywell-Bull's consolidated net profit in 1971, the first year it was made public, was \$15.5 million on revenue of \$348 million.

"It's not IBM yet," says Brulé with a grin, "but we're improving fast." Like most computer makers, Honeywell-Bull can't help using IBM as a yardstick. In any talk with officials of the Paris-based company, including Brulé, performance is repeatedly measured against the industry giant. But Brulé has an even better reason for comparing his company to IBM. He worked there for 12 years, abandoning a promising career in 1967, when he was deputy director of manufacturing for IBM's World Trade Corp. in New York.

GE picked him out of the IBM labyrinth and brought him back to Paris in 1967 to make him deputy general manager of the struggling Bull-GE operation. Remembering those early days and his decision to leave IBM, Brulé says he was attracted by the "belief that there was a great strength in Bull that was not being used by GE."

"My impression was that the right chemical reaction had not taken

place since the 1964 merger," he says. "In fact, there were probably no two companies less suited to work together. One was very French, the other very American. Integration had not been achieved—even language abilities on both sides were weak."

So Brulé set out to exploit the engineering knowhow of the Bull office-machine company—a move welcomed by the French staff, which had felt neglected and defensive because of GE's total dominance in hardware conception for three years. Brulé headed a team that developed the "mission concept" in computer building, assigning development, manufacturing, and marketing responsibility to specific plants.

When Honeywell bought control of GE's computer operations in 1970—and with it 66% of the French subsidiary—one of Brulé's first concerns was to maintain the mission idea he had helped create. Honeywell quickly agreed with him.

Today Honeywell-Bull accounts for 36% of the revenue and personnel of Honeywell Information Systems. Asked how much of the profit it contributes, Brulé retreats: "Let's just say we're proud of our contribution, and we expect to increase it." □



New from Helipot: the lowest trimmer profile in the business.

SHOWN ACTUAL SIZE

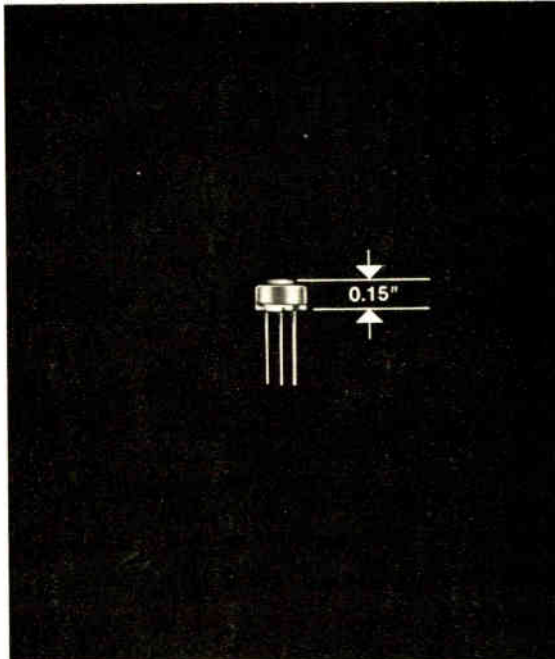

You can't do better than our Series 82 Trimmers for small size and low cost . . . and, of course, Helipot dependability. These $\frac{1}{4}$ " single-turn, general-purpose cermet models have the lowest profile in the industry with a proven cermet resistance element that can be set to any voltage ratio within 0.05% of full scale. Sealed metal housings, solid stops, and essentially infinite resolution. They'll save you space—they'll save you money. (Our prices start at \$1.40 list.) Two good reasons to write for specs and prices today.

Beckman INSTRUMENTS, INC.

HELIPOT DIVISION

2500 Harber Blvd., Fullerton, Calif. 92634

HELPING SCIENCE AND INDUSTRY IMPROVE THE QUALITY OF LIFE

Symphonie satellite delayed a year

The launch of the Franco-German communications satellite Symphonie is being delayed at least a year as rocket design teams try to correct faults that led to the failure of the last test firing in November [*Electronics*, International Newsletter, Nov. 22, 1971]. **A new report on the abortive launch of the four-stage Europa 2 vehicle says complete re-design of several major components must be carried out.** The report singles out a Marconi guidance computer as "unfit for flight" because it is an untested prototype. Also criticized are "serious design errors" in the integration of the guidance and telemetry systems. "The sensitivity of the guidance system and sequencer to external interference must be greatly reduced," says the report, issued by the European space vehicle launcher development organization, ELDO. **At least two more tests of Europa 2 are considered essential before Symphonie can be orbited. The new target date is sometime in 1974.**

Large-diameter fiber shows low transmission loss

Researchers at Southampton University are obtaining good enough pulse transmission performance in relatively large-diameter, multi-mode, glass-type fiber media to suggest that they may challenge small diameter, single-mode fibers in operational systems. Using liquid-core fiber of 50 micrometers internal diameter in 200-meter lengths, the researchers have measured **transmission losses of only 10 decibels per kilometer at 1.08 micrometers wavelength and 15 dB per km at 0.9 micrometers.**

The 0.9-micrometer wavelength is within the range of gallium-aluminum-arsenide lasers, the most likely signal source. **Usable bandwidth is estimated at 100 megahertz**, probably sufficient to be operationally useful and much greater than had been expected of a multimode fiber. Single-mode fibers, with solid cores, will probably achieve 1 gigahertz.

The researchers won't say what the materials are until the combination is patented, except that the liquid is an easily obtainable substituted hydrocarbon. Its long-term stability still has to be checked. Because liquid-core fibers would probably be difficult to use in practice—for instance, no leak could be tolerated—the researchers will try to find a solid equivalent.

Leading Norwegian consumer products firms to merge

Merger plans have been announced by Tandberg Radiofabrikk AS and AS Radionette, Norway's two leading manufacturers of TV sets, radio receivers, tape recorders, and loudspeakers. The merger will strengthen competitiveness abroad, Vebjoern Tandberg explained on Norwegian TV, especially in manufacture of color sets. **The move is called a merger, but because fast-growing Tandberg's share of the combine is evaluated at 81% it looks more like a Tandberg takeover.**

Radionette has not been making much money in recent years, and there have been lots of rumors that it would soon have to lay off employees. Difficulties arose a few years ago after Radionette moved into new production quarters that turned out not to be adequate for its original plans. At the same time, Norway's state broadcasting company was to switch to color TV transmission. This switch, however, was delayed for two years by the national assembly.

Fandberg, on the other hand, is a bustling enterprise with sales of nearly \$30 million last year. The firm's switch to color production has been a success with, among others, a single order from Britain for 15,000 sets. And its tape recorders have earned a reputation for high quality, especially in the lucrative U.S. market.

Japanese push liquid crystal panel development

Three Japanese firms are cooperating in a three-year project to develop a prototype 20-by-20-inch liquid crystal matrix panel capable of displaying up to 600 alphanumeric characters. Its repertoire would include the English alphabet, Arabic numerals, and the Japanese kana characters. The estimated cost of the project is \$1.6 million. An agency of the Ministry of International Trade and Industry will put up half the funds, **since the government feels that there is a pressing need for a low-power, large area, flat panel for computer and other data display.**

Hitachi Ltd. will develop peripheral circuits and handle overall system assembly, Asahi Glass Co. will work on the actual glass panel, and Dai-Nippon Toryo Co. will supply the liquid crystal material to be used. Initially, they will make a 6-by-6-inch experimental panel displaying 40 characters. **None of the technology or know-how will become property of the government,** but companies are expected to return a percentage of the funds received if they are successful in their development. **Even if the project fails, they will not owe the government anything but a report on how they failed.**

Mullard looks to U.S. military for IR detector sales

Mullard Ltd., is about to make a push to sell infrared detectors to American companies making night-viewing systems for the U.S. military. **Mullard engineers say their latest cadmium-mercury-telluride single devices and arrays will meet U.S. military specs "easily".** The best sales prospects are for arrays of chips mounted on substrates of an undisclosed ceramic material.

Mullard's chips are typically 150 by 50 micrometers divided into three squares, the center one active and the outer ones evaporated over to form contacts. Spacing between chips is about 10 micrometers. A five-element array is in production development for a Hawker Siddeley military reconnaissance system. Experimental arrays with 10 and 30 elements have been built. **The goal is 200 or more elements, each of which will produce one line of a TV raster** so that only one mechanical horizontal scan is necessary to produce a complete picture frame. The main development problems are producing sufficient chips of identical performance and mounting the array so that each chip is cooled equally by the liquid nitrogen coolant.

Gas array panel tested for TV display in Japan

Add gas-filled array panels to the devices being developed in Japan for use as television panel displays. Researchers at the Technical Research Laboratories of NHK, Japan's broadcasting system, have developed circuits that **permit Burroughs panels that were originally developed for numerical displays to be used to display television signal.** Because of its elongated shape the panel was used vertically to display the full height of a TV picture but only about one-quarter of its width. **With a maximum brightness of about 15 foot lamberts, the device exhibits a contrast ratio of about 25 to 1.**

Who's into back planes? You are. Cinch is.

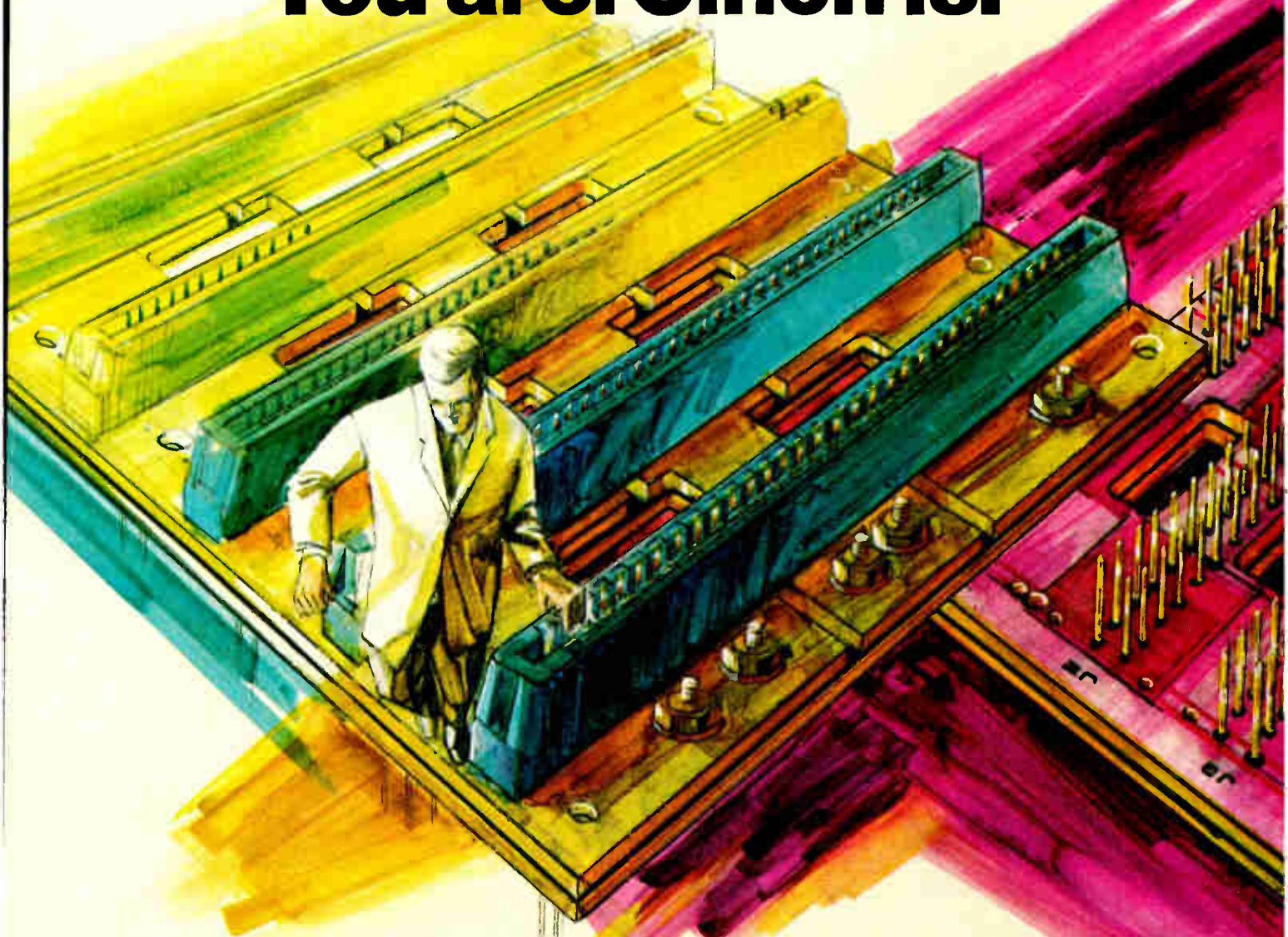

For high density packaging, back plane connector systems are the way to go, especially in producing computers and peripherals.

Cinch can tell you all about back plane connector systems . . . because we wrote the book on them (Our Catalog C-164). Cinch back plane connector systems offer seven important efficiency and economy features:

1. *Replaceable buss bars that permit removal and replacement of individual bussing contacts.*
2. *Easily replaceable individual voltage plane and ground plane contacts.*
3. *Preloaded cantilevered or tuning fork contacts on .100", .125", .150" or .200" centers.*
4. *Uniform contact alignment and closely con-*

trolled insertion forces through simultaneous insertion of entire contact rows.

5. *Selectively gold-plated contacts to reduce costs.*
6. *Precision monoblock or modular connector bodies.*
7. *Specially designed molded styrofoam carriers that eliminate damage in transit.*

If you're into back planes already, you've probably talked to Cinch. If you're not into them yet, you ought to talk to us. Call us at (312) 439-8800, and we'll fly out to see you. Incidentally the book—Catalog C-164—is free, from your Cinch sales office or Cinch Connectors, an Operation of TRW Electronic Components, 1501 Morse Avenue, Elk Grove Village, Illinois 60007.

C-7200

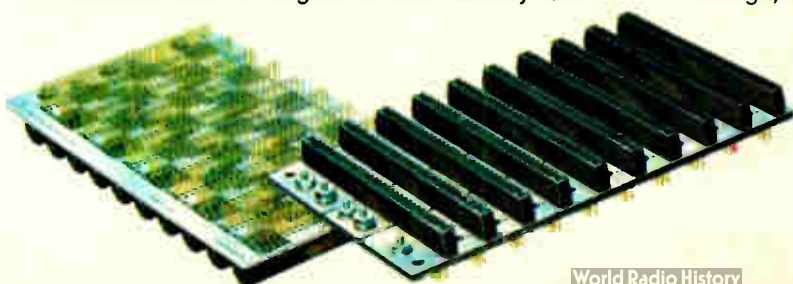

TRW
CINCH CONNECTORS

Circle 61 on reader service card

HOW MANY SPECIALTY GAS MANUFACTURERS DO YOU KNOW THAT HAVE SEVEN DISTRIBUTION POINTS IN WYOMING?

Just one, right? Linde. And we've got 526 others located throughout the rest of the country. Plus five plants in key geographic locations. One near you, so you'll always save on delivery charges. To find out a lot more about Linde Specialty Gases and services, write us for a free copy of the 108-page "Linde Specialty Gas" catalog. Union Carbide Corporation, Linde Division, Dept. LJB, 270 Park Ave., N.Y., N.Y. 10017.

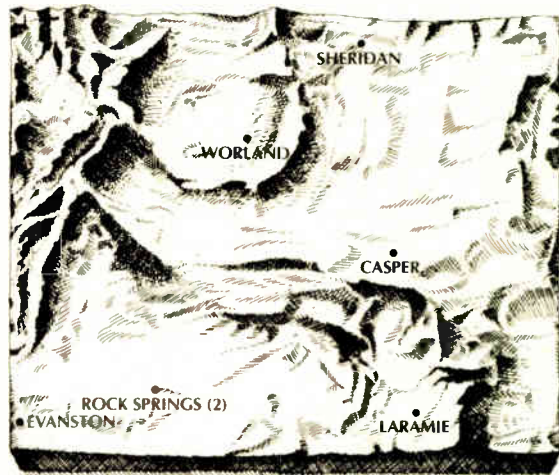

Linde is a registered trademark of the Union Carbide Corporation.

NEW!

THE MITE™ LIGHTWEIGHT HEAT GUN

working in tight areas. And because it's so easy to use, operators can work with less fatigue.

The new MITE Heat Gun offers three easily interchangeable nozzles for a full range of production applications.

*Reg. Trade Name of DuPont

Here's the newest member of our complete line of flameless heat tools — long famous for their rugged dependability.

Extra-lightweight, ultra-compact in design, drawing only 5.4 amps, the MITE Heat Gun brings new dimensions of performance to medium-duty heat-shrink applications. Perfect balance combines with a total weight of only two pounds to provide optimum control. Compactness makes it a wizard when

Well balanced

High Impact housing



Three interchangeable heat range nozzles

Recessed switch for easy operation and maximum safety

Convenient Hanging Loop

Rugged, Anodized, Air Cooled Barrel

Safety Light — Easy to use... indicates unit is "on".

One hand control — Three-way switch operated with simple finger movement.



ONLY \$34.95

INCLUDING THE SHRINK-TUBE ADAPTER!

MASTER

Racine, Wisconsin 53403 Phone: 414/633-7791

Here are the first LED display Panel Meters priced

Under \$100.



Introducing from DigiTec — two all new DPM's — 3 digit unipolar and 3½ digit bipolar digital panel meters, priced under \$100 in production quantities. These instruments have many unique features such as solid-state LED displays, self-contained power supplies and optional BCD. The design reflects our many years of experience in providing OEM equipment. For example: range, scaling and decimal point are all programmable. In addition, the input filter is programmable to satisfy variable reading times and normal mode rejection.

Let United Systems consult with you in selecting the most suitable DPM for your application. Contact the factory or your local representative for a demonstration or evaluation unit.

Call or write United Systems Corporation, 918 Woodley Road, P. O. Box 458, Dayton, Ohio 45401 (513) 254-6251, TWX (810) 459-1728.

DIGITEC
UNITED SYSTEMS CORPORATION
subsidiary of **Monsanto**

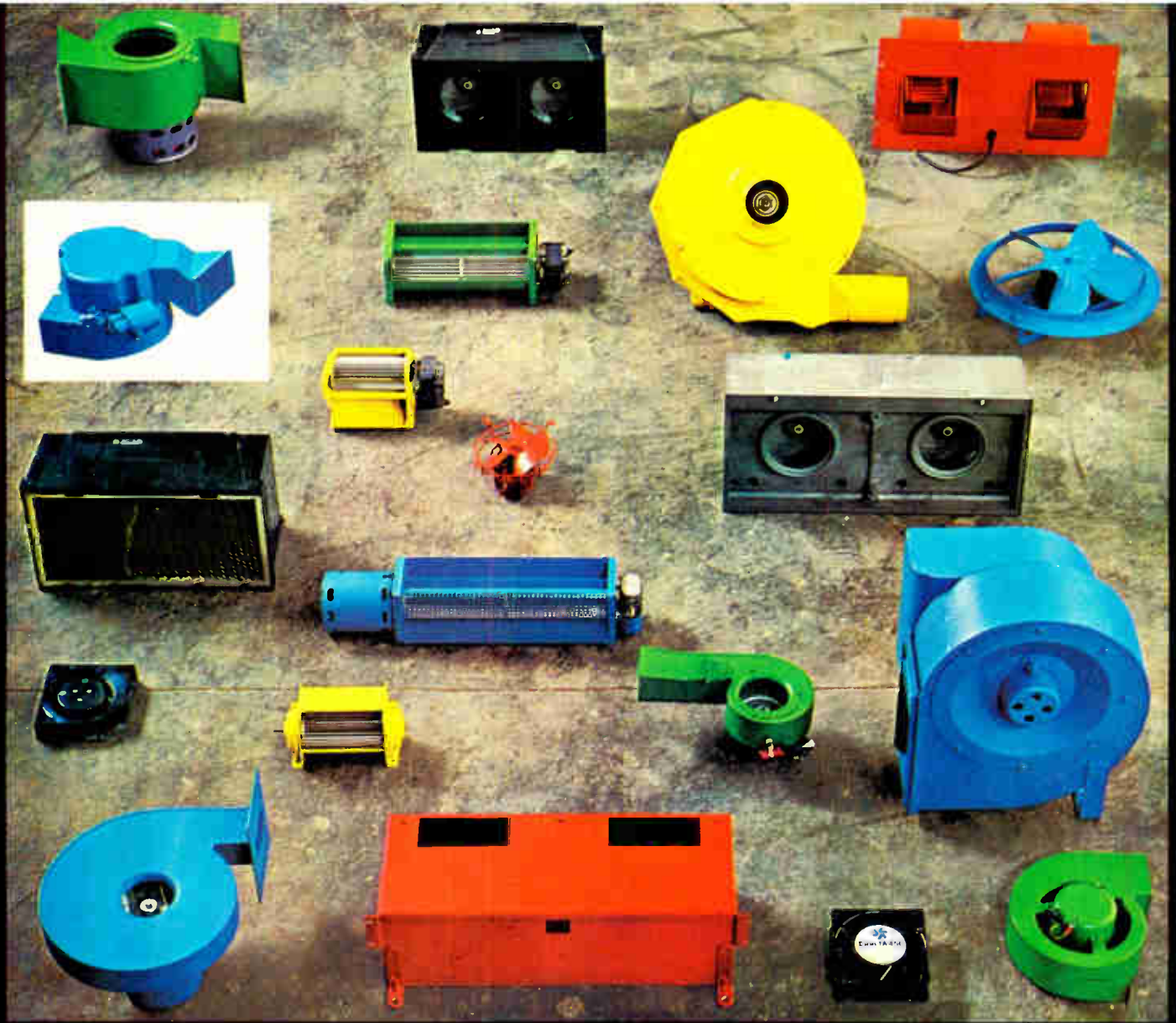

**This one
does a job
for your
competitor.
It might
not be
for you.**

Torin

Torin Flexibility

Problem: Late in the development stage of a new product, one of our computer customers discovered an unforeseen contamination problem that could only be corrected by an air supply. No space allowance had been made for a blower unit. Air flow and pressure requirements that required a good sized centrifugal impeller presented further difficulty. Space tolerances were tight and rigid.

Solution: Our engineers used a specially-designed motor with an end bell that, in order to fit, had to meet a critical limitation within 20 thousandths of an inch. To save space the motor was set into the inlet end of the centrifugal wheel. The forward-curved inlet duct was given special configuration to get around hardware already existing within the computer. Although the wheel housing was originally conceived in sheet metal, experimentation revealed that plastic would not only reduce costs considerably, but would also allow better scroll development. Design to prototype was accomplished within three weeks. 90,000 units are now in actual use, only 50 have proved less than satisfactory.

Your competitor's air-moving problems are his. Yours are yours. And both are firmly dictated by optimum product performance. Often we can produce exactly what you require through modifications of existing units. But if custom design is called for we can turn that out too. More than 500,000 square feet of modern production space results in competitive pricing and realistic deliveries.

You see here just one example of our flexible problem-solving experience. There's so much more to the Torin story. Get it first hand from one of our twenty Technical Sales Representatives. Or, write or phone for our tells-it-all booklet.

Torin Corporation

United States: Torrington, Conn.
Vernon, Conn.
Riverside, Calif. (Elgin III)

Canada: Oakville, Ont.

England: Swanton, Wilts.

Belgium: Nazareth.

Australia: Sydney.

Circle 65 on reader service card

There were a lot of excuses why no one was offering a true, 10-MHz, LSI Test System...

then along came Macrodata!

"Remember last year, when 1 and 2-MHz test systems were standard, and Macrodata introduced a low-cost, 5-MHz, LSI Tester — the MD-100? Then you won't be surprised to learn that Macrodata has done it again! Now, take a look at the new MD-104 LSI Test System.

"It's the first, true, 10-MHz, LSI test system to offer all these benefits: (1) a high quality, built-in paper tape reader usually found only on higher priced machines; (2) a 10-MHz rep rate that allows the user to test bipolar memories on-line at system operational speeds; (3) a speed that allows the testing of ECL memories; (4) a direct and immediate display of failure conditions, allowing call-up of the exact error condition in both address and data; (5) a 10-MHz rep rate that doubles user throughput as he works with the large bipolar memories coming on the market; (6) a standard, random-access control memory of 64 words by 24 bits wide — expandable to 128 words; (7) an improved instruction set

and enhanced subroutine and loop capability, including automatic refresh for dynamic memories; and (8) a GALPAT II test routine capability that is faster than Macrodata's original GALPAT.

"The new MD-104 is compatible with the MD-100 and can use existing personality cards for testing all the most popular RAM's, ROM's, shift registers, and UAR/T at rates up to 5 MHz. Also, the new MD-104 cards will allow the user to test the faster bipolars up to 10 MHz. As a bonus, an option for testing random logics will also be made available.

"With all that going for it, you'd expect a high price tag. But not from Macrodata! Prices start at only \$24,950, including the built-in paper tape reader and basic firmware.

"And that boys and girls, is Chapter Five of the Macrodata Story — another exciting chapter in their march to leadership. For your copy of the new MD-104 brochure, use the reader service card; and if you're ready to do business now, just call us directly."



Chapter Five. The Macrodata Story.



Macrodata Company, 20440 Corisco Street, Chatsworth, California 91311, Phone: (213) 882-8880, Telex: 65-1345

Sales Offices: Los Angeles Area Tel. (213) 245-9404 · San Diego Area Tel. (714) 232-2017 · Northern California Area Tel. (408) 244-1505 · Philadelphia Area Tel. (609) 228-1325 · New England Tel. (617) 862-5700 · Southeast Area Tel. (205) 883-0140 · **Foreign:** Munich, West Germany Tel. 34 56 00 Telex: 841-521-5969 · Milan, Italy Tel. 871-988 - 899-248 Telex: (843) 34314 · Tokyo, Japan Tel. 03 985 5266 Telex: (781) 272-2171

Press here to save on lighted pushbutton switches.



**buys all
the switch
you need.**

Oak's Series 300 gives you good looks and a small price-tag in lighted pushbutton switches. Plenty of switching performance for most jobs, without paying a premium. Even the Series 300 Split-Legend/4 Lamp Switch is less than \$1.60 (normal latch, 2P2T, glass alkyd insulation, no engraving, less lamps.)

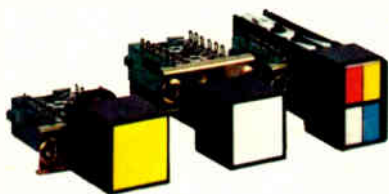

Three versions with switching up to 4P2T.

Choose from single, dual, or four lamp display as well as non-lighted type. One to twelve station, momentary, interlock, alternate action, or any combination available on the same switch bank. Lockout feature available for all types. Power Module 3A125VAC. Lighted indicators are identical in size and appearance, but without switching.



Built to take it.

Series 300 is built for reliable performance and long life. Applications galore — bank terminals, calculators, and copy equipment.

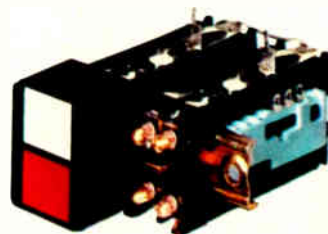

Modular design.

Single-legend/single-lamp, split-legend/4-lamp, and single-legend/redundant lamp switches have snap-on lamp holders. Plus replaceable legend plates, lens caps, and button assemblies. Front-panel relamping, too, without special tools on all types.

Gang them up by the dozen.

Order up to 12 switching stations on a single channel, any switching mix, with convenient panel-mounting studs. Color selection: white, lunar white, yellow, amber, orange, red, green, blue. Choose silk-screened, hot-stamped, or engraved-and-filled legends. Split-legend switches can be specified with any two, three, or four colors on insertable legend plates.

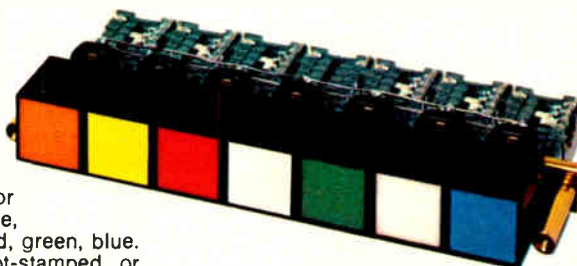

Write for our Series 300 Brochure

OAK Industries Inc.

SWITCH DIVISION/CRYSTAL LAKE, ILLINOIS 60014
TELEPHONE: 615-459-5000 ■ TWX: 910-634-3353 ■ TELEX: 72-2447

100% ac testing of consumer ICs

Is it really necessary? Is it practical? Is it available?

Sample testing of TV and radio parts is no way to ensure a good night's sleep. Ideally, both makers and users of consumer ICs should test every device for ac characteristics.

But 100% ac testing sounds expensive, so what do people do? They compromise.

They tighten up on AQL specs.

They make dc correlations instead of true ac tests.

If the return rate climbs, or if bad parts show up in the finished product, they shout a little louder at the vendor or the inspector or the QC manager.

There's a better way.

Our J263 will automatically test for every ac spec from stereo channel separation to chroma demodulation angle to video i-f gain. And it will do it so fast that 100% testing is economically practical.

On an IC production line, the J263 will even wafer probe, and it will multiplex to as many as seven stations.

In incoming inspection, the J263 will datalog chapter

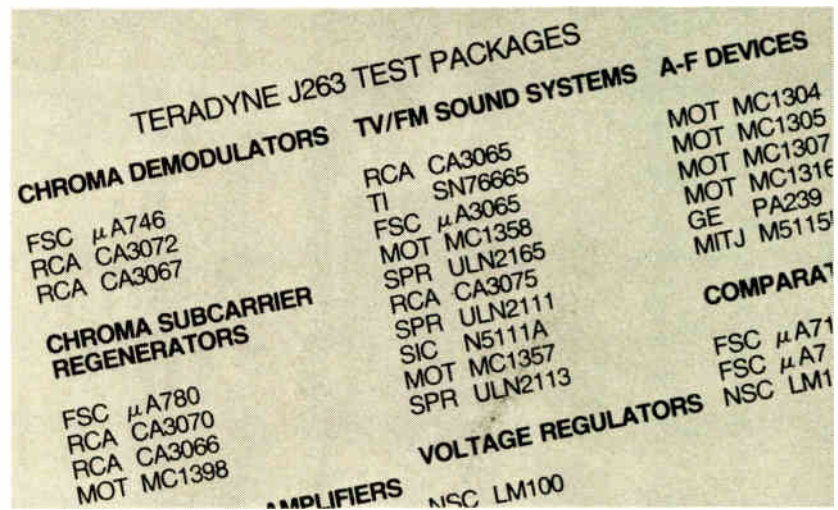

and verse on all your suppliers, so you'll know who's shipping you what.

Backing up the J263 is a long list of test packages. They include the applications hardware and software for just about any consumer IC on the market. All the tests have already been worked out with the key producers and users, so you start off with a thoroughly proven, debugged installation.

If the alternatives to 100% ac testing are getting you down, tell us to rush you a J263 brochure. It illustrates again that in testing, the best solution is always an honest one.

Write: Teradyne, 183 Essex St., Boston, Mass. 02111.

TERADYNE



Ion implantation coming of age

Once limited to MOS gate alignment and threshold control, the process is in use for bipolar and microwave devices, and for radiation hardening

by Larry Armstrong, Dallas bureau manager

Although many device engineers still consider ion implantation an infant technology, it's an infant fast maturing into a precocious youngster. Semiconductor manufacturers are discovering that it can be used for more than just tailoring voltage thresholds and achieving self-aligned gates in MOS arrays [*Electronics*, May 25, 1970, p. 125].

A raft of new applications is going into production at a large number of companies here and abroad. Customers are beginning to ask specifically for ion-implanted devices, and industry experts foresee the day when, as higher beam voltages and currents become available, ion implantation will become commonplace even in bipolar production.

Manufacturers use specially designed particle accelerators to break up elements into ions, sort them out by mass, and fire them into a target with energies from 40 kilo-electronvolts to more than 300 keV. Improving on thermal diffusion, this technique allows faster semiconductor doping at temperatures of hundreds of degrees instead of thousands. Moreover, for low-threshold devices and those requiring non-Gaussian profiles, it permits tailoring of junction depth and ion-density—it minimizes the internal spread of dopants under the contact areas of a device that occurs with thermal diffusion and makes the area under a gate a precise thickness. The result is lower capacitance for high speed,

low-power operation, high density, and reduced crosstalk and switching noise.

Writing by beam. Moving into production fast are p-channel devices having depletion loads with larger and more accurate implanted resistors. Implant techniques are also being used for microwave and radiation-hardened devices and for ion deposition prior to thermal diffusion in bipolar devices. Since the ion beam can be deflected electronically, further development of focusing and control mechanisms should allow complex patterns to be "written" without a mask. Sony Corp., for example, may be the first company to use microbeams; it has ordered a machine designed to deliver ion beams a micron in diameter or less. The implant technique is becoming so precise, it makes diffusion look like "scattering ions to the breeze," say some manufacturers.

Moreover, bringing ion-implanted devices out of R&D and into production will eventually turn out to be easier than it is with diffusion-processed circuits, believes Mostek Corp. vice president Robert Palmer. Mostek, with perhaps more production experience than anyone else in the industry—it has made more than 200,000 implanted wafers—has combined n- and p-channel techniques with depletion loads for improved speed/power products [*Electronics*, March 13, p. 26].

But as with all new, hot technologies, some companies may be committing more dollars to the tech-

Ion control. Wafers for watches are implanted automatically with precise control of penetration and depth at Motorola's Semiconductor Products Div., Phoenix, Ariz.

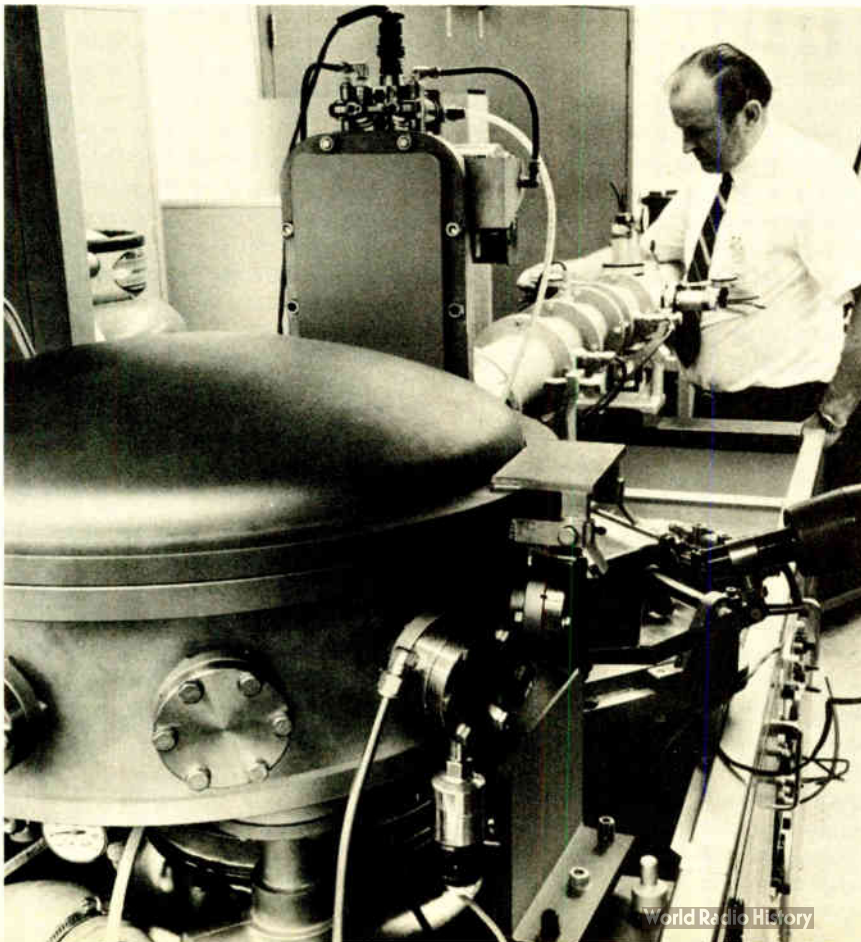

nique than the result justifies, contends Donald Trotter, director of R&D at American Micro-systems Inc., Santa Clara, Calif. But he agrees with Palmer that ion implantation enables a manufacturer to react to process changes faster than he could with furnaces—to determine threshold adjustments for the next run, for example, only two wafers need be implanted. Trotter adds, however, that while this is good for small runs in R&D, “there is a logistics problem in doing this in the factory.” But with threshold adjustment, “we can get a better yield on a tighter spec,” he says, such as ± 150 millivolts.

Advantages. The same attributes that make ion implantation increasingly popular on MOS LSI lines for obtaining low threshold voltages, higher device reproducibility and yields, and higher switching speeds also make possible small geometries and narrower patterns—it can produce channels as narrow as 0.5 micrometer. C/MOS III, recently introduced by Hughes [*Electronics*, June 5, p. 35], combines other techniques with ion implantation to yield devices with three times the density of conventional C/MOS.

Similarly, implanted resistors require not only much less chip real estate than diffused resistors, but can be made very accurately—in the 10–100-ohm-per-square range for bias and load, says Hans Dill, manager of solid-state-device research at Hughes Aircraft Microelectronics Products division, Newport Beach, Calif. Hughes, a pioneer in ion implantation, uses it for resistors of up to 10 megohms, and for others with 99% accuracy for a 9-bit digital-to-analog converter in its entertainment system for the DC-10 jetliner. For such resistors, Hughes takes advantage of radiation damage to the semiconductor's lattice structure that is caused by ion implantation. Normally annealed out, this reduces electron mobility and results in less pinchoff and higher temperature stability, Dill explains.

Sprague Electric Co., North Adams, Mass., also implants resistors, at present only on some proprietary items. But semicon-

ductor R&D manager Kenneth Manchester predicts that 14- to 16-bit converters on a chip are in the offing. “Though many other techniques must be developed first,” Manchester says, “commercial production of such devices is probably about three years away.”

Masks used. By implanting through a mask, manufacturers have obtained very narrow gates in MOS, bipolar, and microwave devices, permitting very-high-frequency operation. Varactors and pin diodes can be implanted accurately for a desired profile—for example, to give the proper capacitance-versus-voltage characteristic for linear tuning, says Hughes' Dill. With ion implantation, his company has developed a new type of MOS microwave switch that can handle up to a watt but doesn't need continuous drive, as pin switches do (see p. 38).

Implantation techniques are also ideal for Impatt diodes for microwave applications, adds George Foyt, an assistant group leader in solid-state-device research at MIT's Lincoln Laboratory, Lexington,

Mass. With such processes, it is possible, says Foyt, to get much shallower junctions in gallium arsenide. And because the junction is nearer the surface, it can be placed nearer the heat sink, making the thermal resistance between the junction and the sink very low. Implantation could pave the way for Impatts with increased power and fewer defects.

Imaging devices requiring large p-n junctions of uniform surface are photodetectors and semiconductors addressed with electron beams. Foyt uses protons to bombard gallium arsenide to form isolation rings around avalanche diodes and photodiodes on the wafer, a technique that he says may be adaptable to other combinations of semiconductor material and ions. The lab also implants heavy ions, such as antimony, into indium antimonide and lead telluride to achieve much higher impedance, making such diodes better suited to imaging applications. Impedance runs about 20 megohms at zero bias and 77 K, compared with about 2 megohms without implantation.

Over in Munich, the Institute fuer

Three who make accelerators

Three domestic companies marketing accelerators designed specifically for ion implantation offer a good barometer of activity in this area. Challenging Accelerators Inc. are newcomers Ortec Inc., Oak Ridge, Tenn., and Extrion Corp., Peabody, Mass., both of which moved into the field within the past year with—as Ortec product manager George H. Thoeming puts it—“production machines that can do device development.” Both have backlogs.

Accelerators Inc., Austin, Texas, with well over 50 machines in the field, maintains the edge in sales, however. Its current backlog for its fully automated production equipment, already delivered to Mostek and Hewlett-Packard, includes orders from Mostek, TRW, Telefunken, General Motors, General Electric, Sony, Westinghouse, and others. Ortec's entry is a 150-keV machine that can implant from 100 to 200 wafers per hour at 50 microamperes, typical specs for the industry. Ortec counts IBM among its customers, with three machines, AMI with two, and Fairchild's Diode division, which has one. Extrion offers three standard machines: a 150-keV model for boron and phosphorus doping, a 200-keV machine that can also accommodate arsenic, and a 400-keV model aimed more at the R&D market. Extrion buyers include Raytheon, GTE Labs, National, Fairchild, and Solitron. The Extrion equipment differs in that it uses a 90° analyzing magnet structure instead of the customary straightline approach; it requires less shielding and eases the cleaning process when changing from dopant to dopant, claims marketing manager Eli M. Young.

It is still an expensive technology, though. These accelerators cost from \$60,000 to \$100,000, and even more for higher-voltage R&D machines. “Everything is a little bit customized,” Extrion's Young says, because of the fast, continual change in production techniques. President of Accelerators Inc., Norman A. Bostrum, adds: “People really can't ignore the possibility of using other dopants, so they always buy more than they really need. Sooner or later we're going to have to sell in the \$25,000 to \$30,000 range to compete with diffusion furnaces.”



864

Sperry displays have more eye appeal!

Panel meters, DVM's, instruments, calculators, computers, business machines and other equipment have more "buy appeal" with advanced Sperry displays† because they have more eye appeal where it really counts — right on the face of your product. These are the unique displays which produce continuous characters, with no irritating gaps or breaks between segments. Sperry displays are also better looking because character shape was determined by human factors engineering — with full consideration given to aspect ratio and form factors.

Sperry displays are brighter, sharper and easier to read than tube-type displays and the much publicized LED's. They have no screens, filaments or "off" numbers to impair readability. In fact, they're so much better looking that it is impossible to show the difference on the printed page. You have to see the actual display to fully appreciate their excellent appearance.

Compare them side-by-side with any other display. You'll find Sperry beats them all.

Sperry displays also come in colors — attractive, easy to read orange or red. Not always true of other types. And Sperry beauty is also more than skin deep. There's the wider viewing angle, low power consumption and proven reliability, not to overlook the cost — \$1.00** per digit in large OEM quantities for either the 1/2" or 1/3" display.

See for yourself.

Find out how great Sperry displays can look on your product. Check the reader service card for sample 1/3" and 1/2" self adhesive, printed display strips and complete technical information, or phone or write: Sperry Information Displays Division, Post Office 3573, Scottsdale, Arizona 85257. Telephone (602) 947-8371.



Sperry 1/2" Sperry 1/3" Nixie 1/2" LED 1/4"

COMPARE THE BRIGHT, NO GAP APPEARANCE OF SPERRY DISPLAYS WITH ANY OTHER DISPLAY.

SPERRY
INFORMATION DISPLAYS

It's a whole new ball game in displays!

 **SPERRY RAND**

Circle 71 on reader service card

World Radio History

†Patent Pending
*NIXIE is the registered trademark of the Burroughs Corporation.
** Price is \$2.30 in 5,000 digit quantity.

Probing the news

Technische Elektronik implants phosphor in gallium arsenide to produce diodes operating in the infrared range, and uses aluminum for diodes operating in the visible region. Otherwise, most U.S. manufacturers are working on silicon. Texas Instruments, in Dallas, Tex., for example, has developed an ion-

implanted silicon infrared sensor.

Resistant to radiation. A major use of ion implantation may be in radiation hardening: "We're making the best radiation-hardened devices in the industry," claims Hughes' Dill. The firm's p-channel devices can withstand 10^7 rads of gamma radiation and 10^{15} of neutrons, with a threshold shift of less than 2 volts. Hughes is currently working with the Naval Research

Laboratory on radiation-hardened n-channel devices.

In bipolar production, the use of ion implantation is now limited to deposition before diffusion. "As a replacement for pre-deposition diffusion, ion implantation gives us better control of the amount of dopant, so we get a better yield on the product," explains Albert Y.C. Yu, manager of device research at Fairchild Semiconductor Corp., Mountain View, Calif. In bipolar devices, this process can be used for the transistor base or emitter and for high value resistors. A problem with ion implantation, Yu says, is that it is only good for shallow diffusions of a micrometer or so—"if you need deeper regions, then you have to go to the diffusion furnace." But by implanting the exact amount of dopant, and then driving it in to the required depth with the furnace, "you still get the precise control you need for high yields with the implantation process," he says.

Japan's interests. The Japanese are also pushing to get the combined ion deposition and thermal diffusion process into early production. They are working, as well, on the more conventional use of ion implantation for gate self-alignment and threshold control in MOS LSI, including enhancement-depletion devices. Hitachi Ltd. is scheduled to start implantation soon for deposition prior to diffusion; its aim is to control dopant surface density more precisely for better control of bipolar transistor current gain. Toshiba will follow suit next year with production of bipolar transistors and also junction FETS.

Sprague's Manchester calls this "enhanced diffusion," but adds that really to capitalize on implantation in bipolar work, accelerators with beam voltages in the high kilo- or even mega-electronvolt range are needed. Another limitation is current. Dopant strength varies directly with amperage, and thus is proportional to throughput. "I would like to see the accelerator makers come up with machines to deliver a milliampere with boron, and then, especially for research applications, a 500-mA machine," says Manchester. "As it is, we're a long way from burning holes in wafers with today's equipment." □

WHAT'S OURS IS YOURS. FREE FOR 30 DAYS.

STATE-OF-THE-ART ELECTRONICS: Long life, high noise immunity, high accuracy with LED's, photo-transistors and fiber optics in all our readers. $7\frac{1}{2}$ " reels shown.

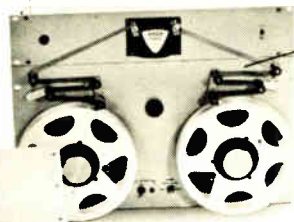

SPEED: Stop-on-character up to 750 ch/s (8000 Series) or up to 300 ch/s (9000 Series) and no overshoot. $10\frac{1}{2}$ " reels shown.

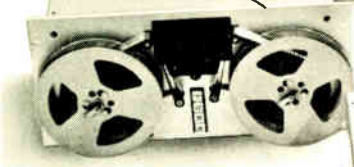

GENTLE TAPE HANDLING: Noiseless, fully-proportional reel servos and sprocket drive. $5\frac{1}{4}$ " reels shown.



HIGH RELIABILITY: Only one moving part (the sprocket drive) MTBF over 10,000 hours.

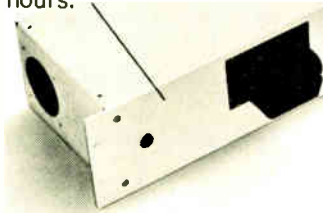

ERROR-FREE TAPE READING: Self-cleaning heads read all standard tapes up to 60% transmissivity.

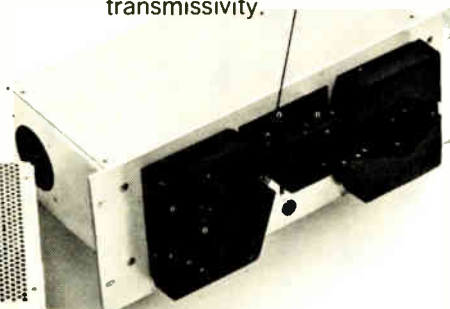

MINI-READERS: Reads bidirectionally at 300 ch/s speed.



Call and we'll lend you what you need. Free for 30 days.

Electronic Engineering Company of California, Santa Ana, Ca. 92701. (714) 547-5651.



EECO OEM readers: could you ask for more?

Transportation

Transpo boosts ground electronics

Aerospace companies come down to earth with automated prototype mass transportation included in exhibits at national exposition

by William F. Arnold, Aerospace Editor

The nation's aerospace companies, faced with lagging military and commercial markets, have turned their systems expertise to the promising market of automated mass land transportation. They exhibited their ground vehicles along with builders of earthbound transportation at Transpo '72, the nine-day all-transportation extravaganza sponsored by the U. S. Department of Transportation.

Transpo was on the right track, in the judgment of most of the manufacturers represented, including electronics firms, which expect to contribute liberally to the controls that these new systems will need.

And if the number of companies developing surface vehicles and their electronic control systems is a criterion of the future market, the outlook is bright. Experimental or development models of computer-controlled or high-speed ground transit vehicles were exhibited by the Boeing Co., Seattle, Wash.; LTV Aerospace Corp., Dallas, Texas; Grumman Aerospace Corp., Bethpage, N.Y.; and Rohr Industries Inc., Chula Vista, Calif.

Dashing vehicles. Ford took the only prototype of its proposed guideway vehicle to Transpo. Bendix Corp., Southfield, Mich., exhibited its Dashaveyor, also a guideway vehicle. Transportation Technology Inc., an affiliate of the Otis Elevator Co., Denver, Colo., demonstrated its electrically propelled air-cushioned vehicle. General Motors showed the basic element of its modular vehicle that can accommodate additional sections to construct cars, trucks, buses or railroad-type passenger cars.

Electrically propelled guideway

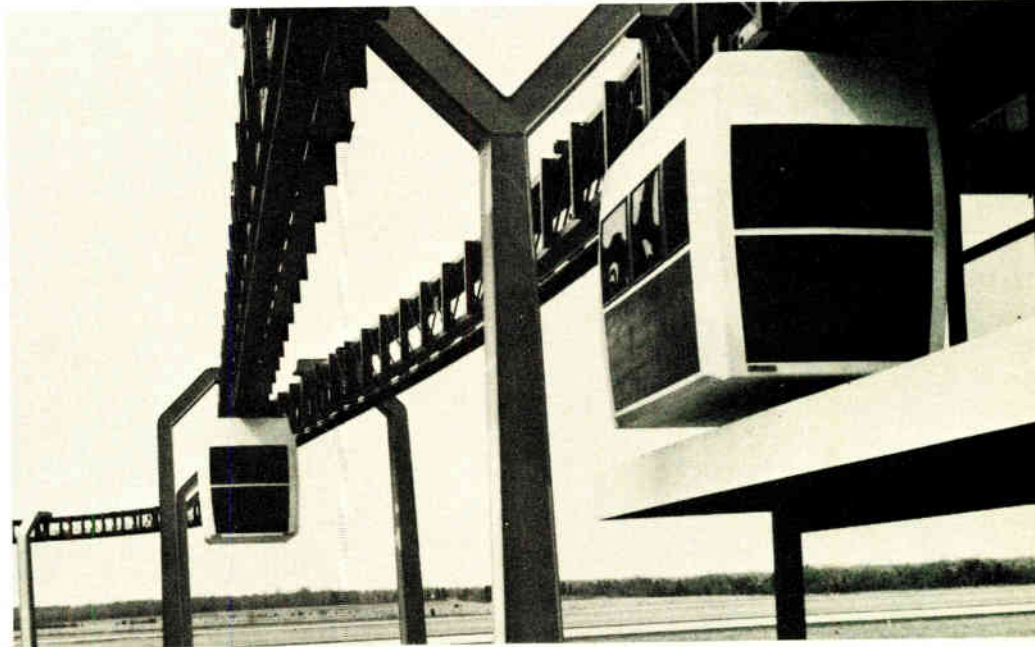

People mover. Push-button-controlled vehicles such as these were designed by Rohr Industries for use in high-density areas like airports, shopping centers, and downtown areas.

vehicles were also exhibited by Wabco Monorail division of American Standard Inc., New York City; North American Monorail Corp., Utica N.Y.; and Unitran Corp., a subsidiary of Pollution Controls Industries Inc., Torrance, Calif. Also exhibiting ground transportation systems were the German companies Krauss-Maffei AG and Messerschmitt-Bolkow-Blohm GmbH, as well as several French companies and the French national railroad: Société National Chemin de Fer.

In addition to the major developers of ground transportation systems, Transpo attracted electronic systems suppliers. General Railway Signal Co., a unit of General Signal Corp., Rochester, N.Y., was there. It supplies the command and control system for the Monocab people

mover, and the company has a contract for the automatic system to control the trains of the Metro Rapid Transit System in Washington, D.C. Another exhibitor was Westinghouse Electric Corp., Pittsburgh, Pa., which has built a people mover for Tampa's International Airport and is now supplying the computerized communications, controls, and propulsion system for San Francisco's Bay Area Rapid Transit System.

In the air. In the rush to get back to the land, air-oriented systems were not forgotten. Goodyear Aerospace Corp., Akron, Ohio, demonstrated the Staran associative array processor, built for the Air Force, which is being tested by the Federal Aviation Administration as an automatic collision predictor for air traf-

Probing the news

fic controllers. Sperry Rand's Univac division, Blue Bell, Pa., showed off its ARTS (Advanced Radar Terminal System), which is being installed at 62 of the FAA's busiest airport control centers. Univac and Lockheed Electronics Co., Plainfield, N.J. displayed their competing automated radar beacon systems, one of which the FAA is expected to select shortly for medium-size airports [*Electronics*, Jan. 31, p.41]

Vying for a vast potential market, McDonnell Douglas Corp., St. Louis, Mo., and RCA, New York City, exhibited their respective EROS and Secant airborne collision avoidance systems. Westinghouse also highlighted an air traffic control system.

Raytheon Co., Lexington, Mass., exhibited plan-view displays and computer displays for its air traffic control system and a new ground-control approach landing system, AN/TPN-19, built for the Air Force. Raytheon, along with Avco Corp. and Massachusetts Institute of Technology, Cambridge, Mass., is studying the feasibility of a magnetically-powered high-speed mass-transit vehicle.

Elsewhere. Concurrent with Transpo, DOT sponsored an International Congress of Transportation Conferences in Washington. There were six meetings, co-sponsored by 19 organizations, including the Institute of Electrical and Electronics Engineers.

The conferences discussed problems and plans for air cargo, air transportation, vehicle and highway safety, effects of transportation on the environment, and experimental safety vehicles.

In a session on short-takeoff-and-landing (STOL) aircraft, Robert B. McIntyre, of De Havilland Aircraft of Canada Ltd., predicted that this approach could reduce airport traffic density 20%. By profitably carrying short runs, STOLs, which will need new avionics and landing guidance systems, could relieve some pressure on conventional airports by landing at STOLports," he said.

Agreeing, Daniel S. Klein, special



Airy predictions. When the Staran associative processor is tied in with air traffic control radar, it can predict aircraft paths and determine if any aircraft are on collision courses.

assistant for project development of Eastern Air Lines Inc., said that "the most critical part" of introducing STOLs is the "cost of landing sites and plane operating costs." He said STOLs also have a future in areas such as the Southeast, where "the cost of new ground transportation is not feasible." The Northeast corridor air market is potentially big market for STOLcraft, he added.

The Electric Boat division of General Dynamics Corp. envisions a major electronics market under the sea for a fleet of large submarine tankers. These submersibles will need inertial guidance, top sounding, side-looking sonar, obstacle-avoidance sonar, long-range doppler sonar, and precision depth-recorder systems to enable tankers loaded with oil to navigate under the polar ice from Alaska to the At-

lantic Ocean, a spokesman pointed out.

The show, with in excess of 500 exhibits by more than 350 companies, organizations, and Government agencies, gave buyers and visitors more than enough to look at and ask questions about.

Transpo drew praise, as well as an estimated 1.5 million visitors. Litton Industries' managing director, Barney Oldfield, said that the "concentration-of-total-technology concept of the show" gave Litton an unusual opportunity to display the full spectrum of the variety of its endeavors.

"We are pleasantly surprised at the turnout," says John H. Sidebottom, Raytheon vice president. "It's three times more successful than we had predicted," declares Otis marketing manager, Paul A. Putziger. □

Production

Easing the switch to electronics

A California company teaches new technology to oldline auto aftermarket manufacturers who buy its hybrid circuit production line equipment

by Paul Franson, Los Angeles bureau manager

It's one thing just to supply production equipment for electronic parts—but Radiant Energy Systems, a Newbury Park, Calif., company, also designs the products the equipment makes, makes them, and trains its customers' personnel so they can take over themselves later on. The product is components—principally hybrid voltage regulators—for automobile electronic gear sold in the automobile aftermarket.

This in-depth approach was triggered when RES completed deliveries under its contract with Delco Electronics last summer. Having supplied Delco with the second of two fully automated production lines for regulators and radio parts, RES president A. Harry Moore decided to look for new, smaller customers in the oldline electromechanical companies who supply the auto aftermarket. They need to shortcut the usually tortuous route taken by companies entering electronics, and Moore felt RES had the personnel to help them, as well as experience in large assembly lines and knowledge of hybrid circuits. In effect, the firm is offering a total package of product design, assembly line, and employee training.

The hybrid lines RES has developed can be designed for different volume requirements—from simple, two-operator lines to semi-automated production, all the way up to the fully automated line. Most users, however, need more flexibility and smaller quantities than the big production lines like Delco's offer. At least three different voltage regulators can be expected to be in demand, plus many other future hybrid electronics assemblies. Even

the big auto makers may find it desirable to have considerable flexibility. Typical lines can produce up to one million hybrids per year on a single shift basis, yet can be reprogramed in a few hours.

A small two-operator line may consist of a resistor-trim and preliminary-test station and a die-attach station, each with its own operator, with other stations they share for component soldering and wire-bonding. This kind of setup is good for about 250,000 devices per year. Three more operators bring the annual production up to about 500,000 parts. The small lines might cost \$250,000 and produce 400 parts per hour, compared to the over \$1 million for the two Delco systems with an output of 3,600 parts per hour. The Delco systems use flip-chips, but the smaller companies usually stick to wire-bonding systems.

Getting on line. For these companies, Radiant designs a product electrically and mechanically, procures all piece parts, and manufactures the assembly in its in-house facility. While this is moving forward, the company plans an assembly line for the customer and begins training his personnel. In this way, the customer can get a lead of six to eight months on his competitors, using the RES-supplied parts while getting his own operation on-stream.

A typical customer has had RES produce about 30,000 parts, and it expects to take over as production nears 50,000 units. Even after the company takes over, RES can continue to supply products for some time to avoid delays caused by start-up problems. At present, Moore says that RES is designing or supplying parts for three U.S. and two Eu-

ropean firms, and has delivered assembly equipment to one of them.

The components RES designs must withstand the difficult automobile environment—widely fluctuating supply voltages and temperatures, transient spikes, spray, and strong-armed mechanics. For this reason, the company negotiates with semiconductor houses for special parts such as custom linear ICs.

Originally, RES was founded to make electron-beam mask equipment, an activity it is continuing. But when the firm was acquired by Hugel Industries in Sunnyvale, Calif., it took over Hugel's automated assembly line work because the personnel and facilities at Newbury Park seemed better suited to that activity. Hugel later shifted other semiconductor scribe and assembly equipment production facilities to the company, and Moore came with that operation.

What else? Aside from the business in the automotive industry, RES is also pursuing such fields as relay and control manufacture. To expand its capabilities, which include ultrasonic and thermocompression wire bonders, ribbon bonders, die bonders and separation equipment, the company has taken over distribution of assembly equipment made by Nordex Inc., in Danbury, Conn., and by Forslund Engineering in Petaluma, Calif. And as a side benefit, though a large one, the company's discussions with a calculator company (Logic Data of Chicago) about setting up an automated assembly line led to a large contract to assemble calculators. Sticking to his principles, however, Moore adds, "We may well transfer the whole line to the customer in the future." □

Industrial electronics

Auto electronics picks up speed

Car makers are forced to try solid-state controls to meet the stringent standards set by legislation; discrete components will lead the trend

by Alfred Rosenblatt, New York bureau manager

The auto industry has had the potential for becoming a major customer for electronics for several years. But now the ground is shaking, and it looks as if the market volcano will begin to erupt, with discrete and hybrid components making the early penetration. A number of signs indicate that 1973 is the breakthrough year.

The word from Chrysler last month was that the solid-state ignition system, offered this year as a \$35 option on the company's V-8 cars, will be standard equipment in all 1973 Chrysler cars and trucks—that's roughly 2 million units, a dramatic jump from the 300,000 units installed in 1972 models. At General Motors, a spokesman says that the "unitized" ignition system, available this year as an option in top-of-the line Buicks and Pontiacs, will be offered in several additional General Motors models in 1973. Industry insiders say GM will install electronic ignition systems as standard equipment in the 1973 Vegas.

Ford speaks. And even Ford Motor Co., stung in 1969 by a faultily designed electronic voltage regulator, is pushing ahead. Model year 1974 should see Ford introduce an electronic ignition system, predicts one industry observer—and shipments of these must, of course, begin in 1973. The auto companies seem finally to have taken up the predictions regarding the booming growth of the auto electronics market that have emanated mostly from semiconductor houses scrambling for new business. Said Ford chairman Henry Ford II at Transpo '72 in Washington, D.C., last month, "The growth in electronics in automobiles will be tremendous."

But Ken Stone, manager of market forecasting, TRW Electronic Components divisions, Los Angeles, Calif., is a lot more specific. He, too, feels that 1973 will be the year auto electronics takes off: "We're already seeing an increase in the electronic parts we sell: wires, cables, pc boards—in fact, all types of discrete components." Robert Hood, manager of automotive products at Fairchild's Semiconductor division, Mountain View, Calif., says, "The market [for auto electronics] is so large, you're rapidly going to move into a capacity-limited situation. The auto electronics industry could absorb possibly as much as 50% of the total semiconductor plant capacity today."

Emphasizing this point is Paul Thomas, a marketing manager at RCA Solid State Products division, Somerville, N.J., who landed the power transistor contract for Chrysler's ignition. "Other new product development areas may suffer because engineers are working to supply a new socket in the volume required," he asserts.

Fairchild's Hood stands by last year's prediction of a \$1 billion auto electronics market [*Electronics*, May 10, 1971, p.105]. Only he pushes up the date this will happen to as early as 1977, instead of by decade's end. By 1976, the market could hit \$500 million, forecasts Phil Pasho, marketing manager for consumer micro-electronics at Fairchild.

Electronics abroad. In France, Motorola SPD, a dominant factor in European production and sales of semiconductor products for cars, forecasts the 1972 market at about \$25 million—quadrupling to about \$100 million within five years.

In West Germany, auto electronics sales last year amounted to about \$10 million, according to Siemens AG, Munich, and Texas Instruments Deutschland GmbH. For 1972 and the two following years, the companies expect a 20% to 30% annual increase in sales. The big upturn, they feel, will be for 1975 vehicles, when clean-exhaust standards are expected to be in force, not only in the U.S., but also in Germany. Texas Instruments' Siegfried Mack, marketing manager for consumer products in Germany, predicts a \$40 million market in 1975. Siemens AG's Oskar Perescenyi, a market researcher, pegs 1976 sales at \$47 million, with integrated circuits accounting for 25% to 30% of the total.

Federally set standards for emission control and safety, as well as those mandated by states such as California, virtually dictate the use of electronics by next year. And despite auto company hopes, the Federal Environmental Protection Agency seems adamant—by virtue of its recent threats against Ford for not meeting pollution testing requirements—in its decision not to postpone the 1975 implementation deadline.

Only with electronics for such devices as voltage regulators, ignition systems, and fuel controls, can the specified auto emission levels for 50,000 miles of operating life be maintained. Likewise, safety requirements will be met in part by a device such as a seat-belt interlock, which will prevent an engine from starting until the belts have been fastened and the doors locked. This will find its way into cars during 1973 for the 1974 model year. Growth is predicted for additional

38% OFF

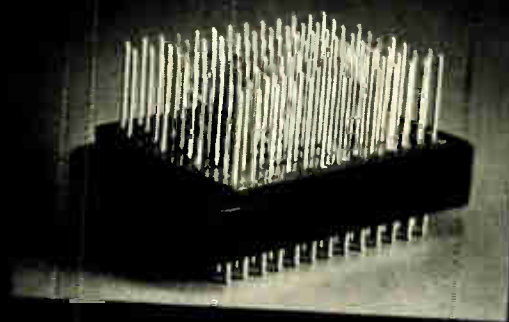

This isn't a discount sale on rack and panel connectors and it's not just a way of getting rid of old inventory.

It's just a plain and simple fact that you can save money by using our P108 rack and panel connector.

And as an even bigger advantage, the savings come on your end of the line, not ours.

You can save on installation cost, because the P108 comes completely assembled. All you need is someone to snap it into place.

In one installation, using fifty-four of our 104-pin P108 connectors, the customer was able to reduce assembly time by 18.6 hours using a combination of automatic and semiautomatic wire wrapping techniques.

This resulted in a 38% reduction in overall assembly labor.

He also got an extra measure of assured reliability, because on any GTE Sylvania connector everything is made by GTE Sylvania — from plastic body to gold-plated contacts.

The standard P108 connector comes with 104 pins. We also have a 50-pin version.

On the 50-pin version, your savings will be a little bit less than on the 104-pin design.

Sorry about that. In any event, why not contact Marv Gustafson at 814-723-2000. He'll tell you all about the P108 and our complete custom facility. GTE Sylvania, Precision Materials Group, Parts Division, Warren, Penn. 16365.

GTE SYLVANIA

Circle 77 on reader service card

The Elegant Transformer Kits

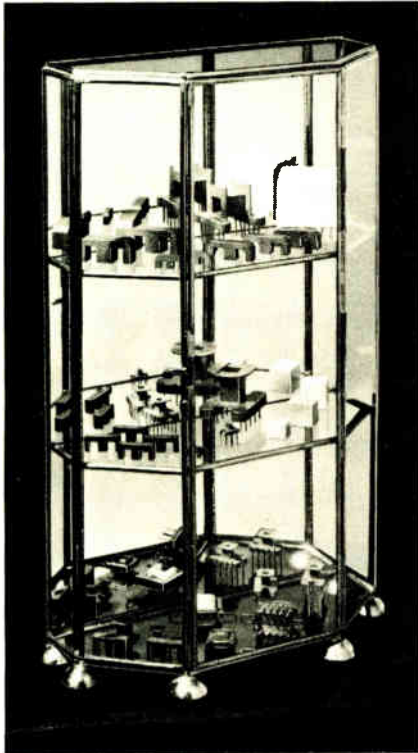

Select from 157 kits. To find the exact match for your needs. Plus ready-made economies. With ferrite cores. Steel frames. Cases. And bobbin/coil forms that pin precisely into standard printed-circuit grid patterns.

Six materials: fluorocarbon, nylon, glass-reinforced nylon, DAP, polyester and epoxy. For stability at temperature ranges from 105 to 200 C.

The complete collection expresses the craftsmanship you expect from EPC as an EAI component company. Look to EPC also for custom-molded parts. Or to EAI for thick-film audio amps. Capacitors. Custom coils. Solenoids. Active filters. Analog/digital converters and other special function modules. Plus a growing list of other elegantly crafted etceteras.



EPC

Electrical Plastics Corporation
500 Long Branch Avenue
Long Branch, New Jersey 07740
Tel. (201) 870-9500

A Subsidiary of Electronic Associates, Inc.

Probing the news

safety features, such as adaptive braking, already offered by Bendix Corp., Automotive Control Systems group, South Bend, Ind., and Kelsey-Hayes Co., Romulus, Mich., on several cars and trucks, as their prices come down.

Legal designs. And because of the number of European and Japanese cars exported to the U.S., EPA requirements will affect not only the 10 to 12 million cars, trucks, and buses manufactured annually in the U.S., but the 25 million automotive vehicles produced overseas.

For example, Joseph Lucas Ltd., Britain's largest supplier of electrical equipment to car makers, is now starting to make electronic systems for cars, producing electronic voltage regulators, electronic ignition systems, electronic cruise controls, and anti-skid brakes. Mullard Ltd. is interested in developing electronic subsystems for car equipment, but won't commit itself to production.

Which way to go? The depth of electronics penetration into the automotive market will, of course, depend on the cost/reliability factor. For example, Chrysler did not choose a glamor technology such as LSI arrays of metal-oxide semiconductor circuits for its electronic ignition system. Nor did it choose hybrid circuitry. Rather, Chrysler chose discrete active and passive components attached to an ordinary printed-circuit board—the kind that's been around for years.

Chrysler's choice bears watching. It means that companies like RCA, which expects its power transistor sales for vehicles to double to \$16.1 million in 1973, and TRW with divisions producing discrete resistors, capacitors, and transistors, will certainly benefit in the short term. Further off are the LSI-based logic and control circuits favored by companies such as Fairchild. Such advanced devices will undoubtedly find their places in automotive electronics during the late 1970s. By 1980, it is forecast that vehicles will contain as much as \$100 worth of electronics.

Delco Electronics division's solid-state ignition system—a hybrid design—and Essex International Inc.'s

boasted "first LSI array to go in any car anywhere in the world" represent further stages of electronics development. But as far as electronic technology is concerned, all three systems involve touches of everything that will be introduced into automobiles during the next decade and even beyond. And each represents distinct efforts to meet the same difficult criteria of the automobile market: extremely reliable operation under a wide range of temperature, vibration, and other environmental conditions, as well as low cost.

Chrysler is emphatic about not choosing integrated circuitry now. "The 'modern-wonders-of-technology' approach costs lots of money and takes time," declares Earl W. Meyer, assistant chief engineer, engine-electrical, in Detroit. "Besides we prefer to know that millions of the devices we're using have already been used."

Reliability and cost are also uppermost in the minds of auto executives at General Motors. But at its Delco Electronics division, Kokomo, Ind., hybrid thick-film circuitry is the technology of choice for solid-state voltage regulator and ignition systems. Delco prints resistors and conductive pads on a ceramic substrate and attaches active monolithic semiconductor chips. Bipolar silicon devices are used with the regulator, for example, including a flip-chip that contains logic and control circuitry and a Darlington-pair output chip, reports Frank S. Stein, chief engineer for solid-state products.

Security in LSI. But while Chrysler moves ahead smartly with discretes, and GM strives to bring down the cost of hybrids, Essex International readies a security system built around its own MOS LSI array.

Robert E. Valk, vice president and general manager of the Wire Assembly division, Detroit, says the system is slated to be offered as an option on a 1973-model car. The auto company participated with Essex in a "joint engineering effort."

Thus, in the auto industry, electronics technology moves along toward a rich destiny. Time alone will test the impact of legislation, and experience will ultimately tell the reliability story. □

If your aluminum packages leak, you didn't buy RCA hermeticity—in steel.

Aluminum Package—TO-3, soldered, preformed eyelets
Thermal Cycling Test Conditions—16 W, ΔT case=90°C
(40°C to 130°C)
Typical Performance (cycles to failure)—3 K
Typical Requirements (cycles)—25K

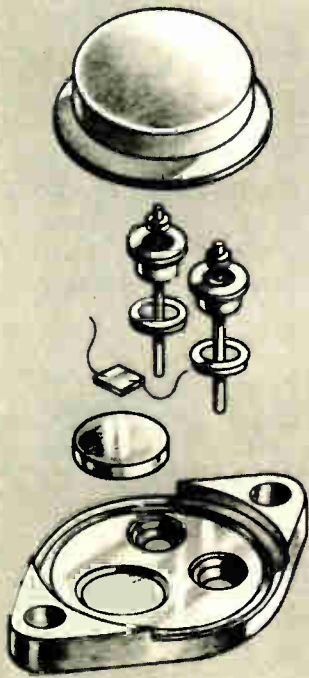

Steel package—TO-3, glass-to-stem, compression seal
Thermal Cycling Test Conditions—16 W, ΔT case=90°C
(40°C to 130°C)
Typical Performance (cycles)—50 K (Test terminated; no failures.)
Typical Requirements (cycles)—25K



The case for RCA in popular TO-3 transistors is steel...rated from -65°C to +200°C.

The aluminum package can have an inherent weakness in the solder bond between the eyelets and the aluminum header. Under temperature cycling, fractures develop at this interface, destroying the device's hermeticity.

The RCA steel package, with

its glass-to-stem high compression seal, welded cap, and controlled solder process, offers you at least an order of magnitude improvement over aluminum in terms of hermeticity, reliability, and long-term, trouble-free performance.

Ask for RCA's Reliability Report ST6071, or conduct your own tests. Write: RCA Solid State, Section 70F-19 UTL31, P. O. Box 3200,

Somerville, N.J. 08876. International: RCA, Sunbury-on-Thames, U. K., or Fuji Building, 7-4 Kasumigaseki, 3-Chome, Chiyoda-Ku, Tokyo, Japan. In Canada: RCA Limited, Ste. Anne de Bellevue 810, Quebec.

RCA Solid State
 products that make products pay off

Why the best high frequency transistors cost less than the second best.



It doesn't happen often. But in the case of microwave transistors, you don't have to trade off performance to get the lowest price. That's because we've combined advances in silicon semiconductor technology with efficient mass-production. The result to date has been:

The workhorse: HP 21.

This small signal transistor is the backbone of any RF/microwave amplifier design. It has a 12 dB gain at 2 GHz (useable to 5 GHz), a noise figure of 4.2 dB at 2 GHz and a price of only \$19 each in small quantities. So you won't be making tradeoffs in your design.

Really low noise.

The HP 22, a significant new high frequency device, has a maximum

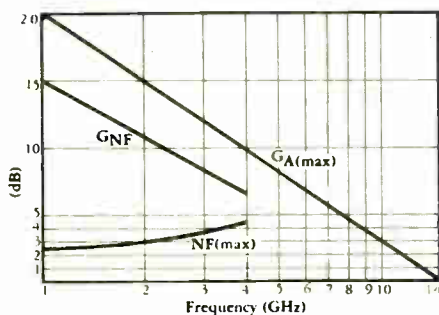

guaranteed noise figure of 4.5 dB at 4 GHz with 6.5 dB gain when biased for optimum NF (10 V, 5 mA). With 3 dB more gain across the band than the HP 21, the HP 22 is useable to 8 GHz

in its stripline packages. All for just \$75 each. No other transistor can make that statement.

More power out.

That's the function of the new HP 11. It fills the power gap between the HP 21 and high power devices. As a preamp

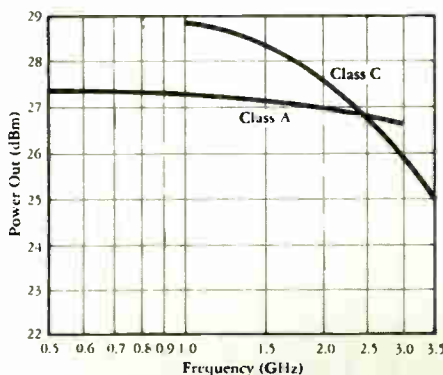

output or linear driver, it offers low distortion from 2 to 4 GHz. Yet it costs the same as the small signal HP 21.

The low price of success.

You've seen the kind of performance our transistors offer. Now let's get down to the cost factor.

Quantity	HP 21	HP 22	HP 11
1-99	\$19	\$75	\$19
100+	15	65	15

(Domestic USA prices for stripline packages.)

Can you afford not to use them?

Firm delivery and great reliability.

We can deliver most orders from stock.

And you can count on device reliability. Our proven manufacturing process not only provides excellent parameter stability from batch to batch but insures healthy devices. Like 10 million hours MTBF for the HP 21.

An HP field engineer is nearby to answer your questions and handle your orders promptly. Why not give him a call for complete information about our transistors. Or write Hewlett-Packard, Palo Alto, California 94304. Europe: 1217 Meyrin-Geneva, Switzerland.

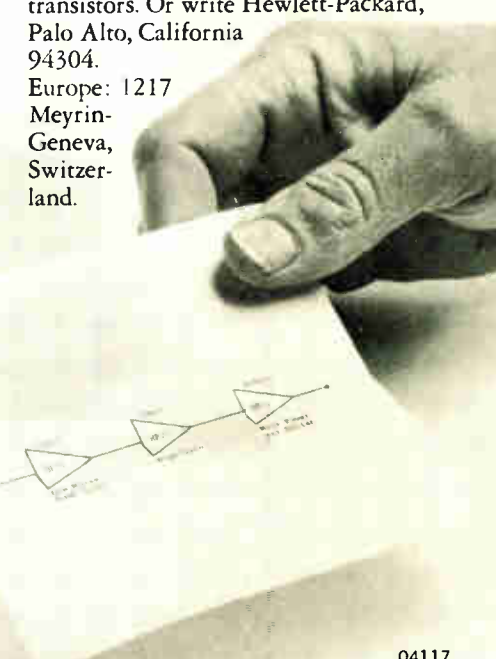

HP transistors: a small price to pay for performance.

HEWLETT  PACKARD
COMPONENTS

Circle 80 on reader service card

Repackaging a minicomputer upgrades performance, cuts cost

Modifying the memory, power supply, and back panel improves reliability and compactness at lower price without using new and untried technology

by James E.D. Austin, Bruce J. Loughlin, and Jonel D. Sutton, *Data General Corp., Southboro, Mass.*

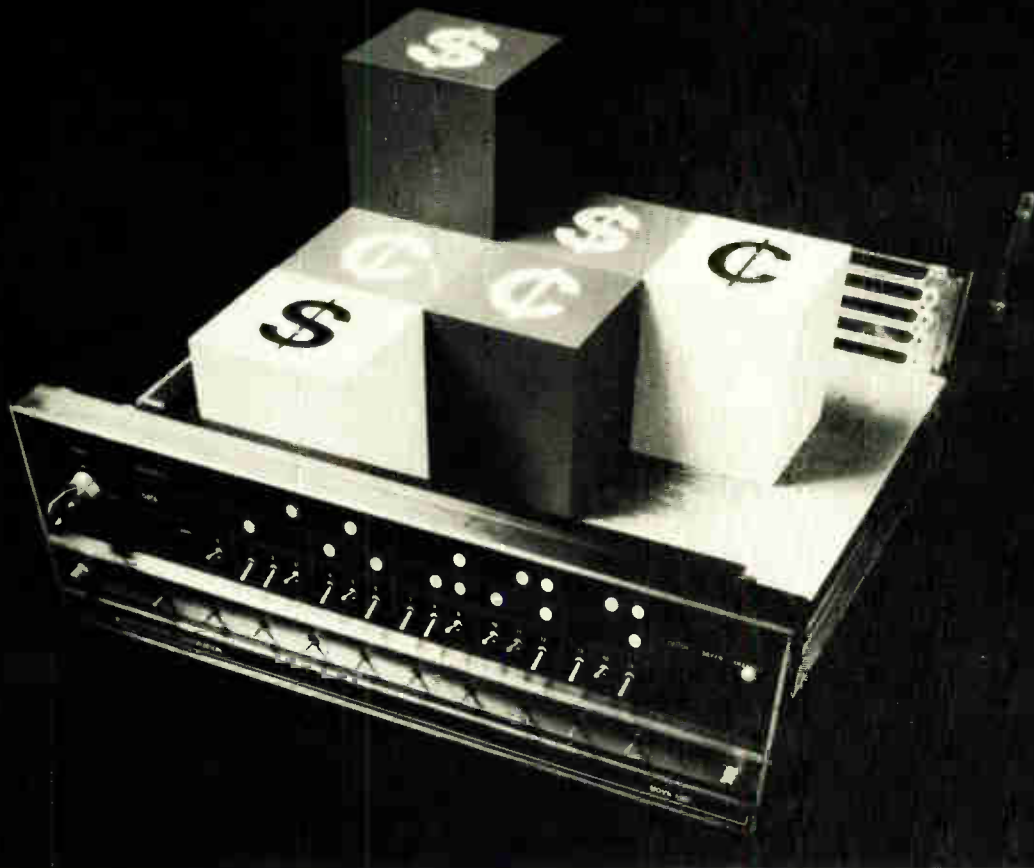

□ To improve its price-performance ratio, a new model in a minicomputer family need not rely on exotic new technology that rides the leading edge of the state-of-the-art. A less glamorous method has been used to upgrade a minicomputer—circuitry of proven reliability and off-the-shelf components were combined with improvements in assembly and test of subassemblies.

For the Nova family, design engineers concentrated on three sections—memory, power supply, and back panel. The memory price was reduced by about 25%, and the mainframe price was reduced by about 20%.

The same basic power-supply design was used for two model sizes—one accommodating four pc boards, and the other accommodating 10. The size of the supply was reduced enough for it to be combined with the back-

panel assembly, thereby also reducing the number of connections required. But the most significant changes were made in the memory, where capacity was doubled on the same 15-inch-square printed-circuit board.

Memory is the most costly portion of a minicomputer, accounting for over half the purchase price. For example, a 12,288-word memory in a Nova 1200 system accounts for \$8,100 of the \$10,500 purchase price. Thus, an important design goal was to add memory capacity without increasing the price, and even to reduce it, if possible.

Previous 16-bit by 1-, 2-, and 4-kiloword memories were all mounted on 15-inch-square printed-circuit boards. One restriction on the new memory design was that it had to be interchangeable with the earlier memo-

ries. Thus, the 8,192-word boards had to operate with the same allowable variation of power supply voltage (14 to 16 volts), and be pin-to-pin compatible on the 15-inch pc board. However, because of the inherently longer sense wires in the 8-kiloword memory and inductive effects of the greater number of cores with the higher zero-disturb voltage (voltage induced in trying to switch cores to the zero state that are already in that state), the ability to deliver sufficient drive current at the low end of this range was marginal. Drive current was increased by reducing the termination resistance and adding extra cooling capacity for the cores.

The effect of termination resistance can be seen from the relationship of factors that determine core memory read and write currents:

$$I_{\text{read}} = I_{\text{write}} = \frac{V_{\text{mem}} - V_{\text{sat}} - V_{\text{diode}}}{R_{\text{wire}} + R_{\text{term}}}$$

where V_{mem} is memory power-supply voltage, V_{sat} is the voltage drop at saturation in the integrated X and Y drivers, R_{wire} is resistance of the memory wire, and R_{term} is the value of current-determining resistor that terminates the drive lines. The equation shows that the margins on the memory voltage translate into margins on read and write currents, and any desired currents

1. Memory expansion. New memory board, laid on top of older memory board, has more space for actual memory plane because of elimination of entire row of dual in-line sense amplifiers. Memory plane itself is only slightly larger than new board.

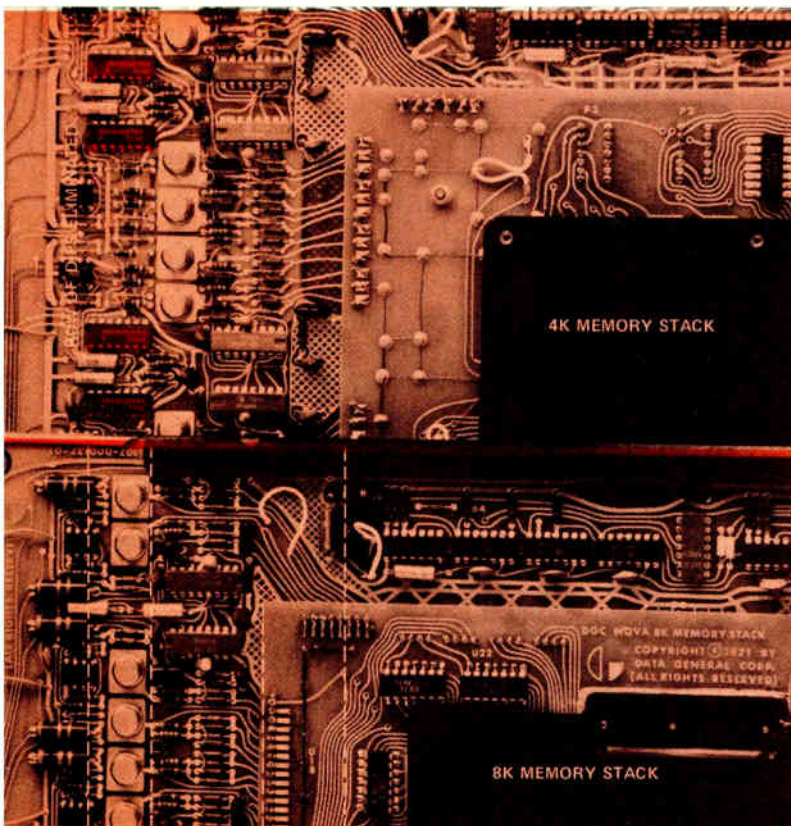

BOARD SPACE SAVED BY ELIMINATING DIPS EXTRA WIDTH OF 8K BOARD

can be obtained by varying R_{term} .

Current, however, cannot be increased unless the heat generated in the inhibit wire and in the cores is considered. Still other thermal problems were associated with the objective of doubling the memory capacity on the same-size circuit board.

Cooling the cores

Heat generation was first reduced by increasing the size of the inhibit wire from 43 gauge to 41. Heat generated in the wire and cores is dissipated by an arrangement normally used in high-density airborne computers, which have a substrate conduct the heat to another plate, where it is dissipated. A silicone compound holds the cores in place and provides a heat-conduction path to an aluminum substrate beneath the core stack.

The mounting feet on the Nova cover plate contact the silicone and provide a good heat path to the cover, which is placed in the forced-air stream. These steps reduce the operating temperature rise from 14°C above ambient in the 4-kiloword memory to only 5°C above ambient in the 8-kiloword memory. With this temperature rise, the cores could use higher read currents.

Doubling the size of a memory within the confines of the same-size board was made possible first of all by reducing the number of components (Fig. 1). Quad multiplexers and flip-flops supplanted the dual units, cutting in half the corresponding number of circuit packages.

The old sense amplifiers were replaced by units that assert low—that is, signal the logical 1 at a low voltage in the memory buffer output register. In the earlier memory, amplifiers asserted high, but the new sense amplifiers eliminated an entire row of packages that had been required for conversion from high to low assertion. This step alone saved about 11 square inches.

The core array itself was compressed by changing the geometry for the core layout. In the 4-kiloword board, the cores, with 18 mils outside diameter, were arranged in a box pattern (Fig. 2a) with 18-mil center spacings. The array was 6½ inches long by 6 inches wide. If the same pattern had been retained in the 8-kiloword memory, the length would have been 13 inches, and the stack would have had to be folded to fit on a board.

Herringbone pattern used

The folded stack was rejected for several reasons: it would have cost more than a flat stack; it would have been more difficult to maintain and troubleshoot; and it would have involved a long inhibit wire that would have aggravated thermal problems. Instead, the planar format was preserved by using a double-herringbone core pattern (Fig. 2b), along with the larger inhibit wire (when the first memory was designed, the vendors were not experienced at stringing 18-mil cores, and they did not want to commit themselves to using a heavy wire.)

In the herringbone, the cores are placed 10 mils apart in one direction, and the rows are 19 mils apart in the other. This configuration nearly halved the width of the memory array, bringing it within the allotted space on the board. It also held the inhibit wire to a length not much greater than it is in the 4-kiloword memory, helping to reduce the heat rise in the wire.

A major consideration in the new design was that

there were two models—a basic four-slot design to accommodate four pc boards and a 10-slot version, which holds 10 boards containing more memory and special input/output circuitry. The four-slot version accepts two memory boards, a control-processor, and an I/O board. A decision was made to use the same basic power-supply design for both models. The single design thus had to be compact enough to fit in the smaller minicomputer, and the other version had to supply enough power for the larger memory.

Earlier computers had the power supply mounted on the chassis (Fig. 3). This design could have been used for the new models, but the goal was to reduce the number of interconnections and connectors. The power supply could also have been placed on its own 15-inch board and plugged into the back panel, but this would have set severe height restrictions on the components to allow adequate clearance between boards and would also have increased the number of assemblies. Although smaller storage capacitors could have been used, a greater number would have been required, thus increasing component count and cost, and extra connectors would also have been needed on the back panel for the power-supply board.

Instead, the power supply was built directly on the back panel. The integrated assembly can be wave-soldered and tested independently and then fed into the assembly line. Interconnections between power supply and back panel were thus eliminated, and the subassembly count was reduced by one.

Circuit duplicated

The basic circuit of the earlier power supply was duplicated in the new approach—it had handled the power requirements of seven 15-inch boards and had already been proven reliable in operation, with a failure rate of 28.28 failures per million hours.

The component count and volume of the four-slot model's power supply, which delivers 175 watts, had to be reduced. Board area was cut in half by eliminating the series regulator. The negative voltage formerly provided by the regulator was generated elsewhere in the power supply by a secondary winding that was added to the switching coil of the +15-v regulator choke.

Thus, the series regulator was replaced by three small components—the secondary winding, a capacitor, and a diode. However, elimination of the regulator raised a problem: it also meant elimination of the rectifiers that had generated the voltage for the front panel lamps.

Fortunately, the reduced load on the new four-slot computer's power supply permitted it also to take on the lamp load. The reduced power demand also meant that smaller T-package transistors (plastic units with molded-in metal bases) could replace larger TO-3 types. This resulted in significant savings—0.1 square inch per device versus 2.25 square inches with the TO-3s.

Integrating the back panel and power supply allowed the storage capacitors to be mounted perpendicular to the vertical back panel and parallel to the bottom of the chassis. This permitted longer, narrower capacitors to be used, saving additional space on the back panel. Further space gains were made because the reduced power requirements allowed 31,000-microfarad capacitors to

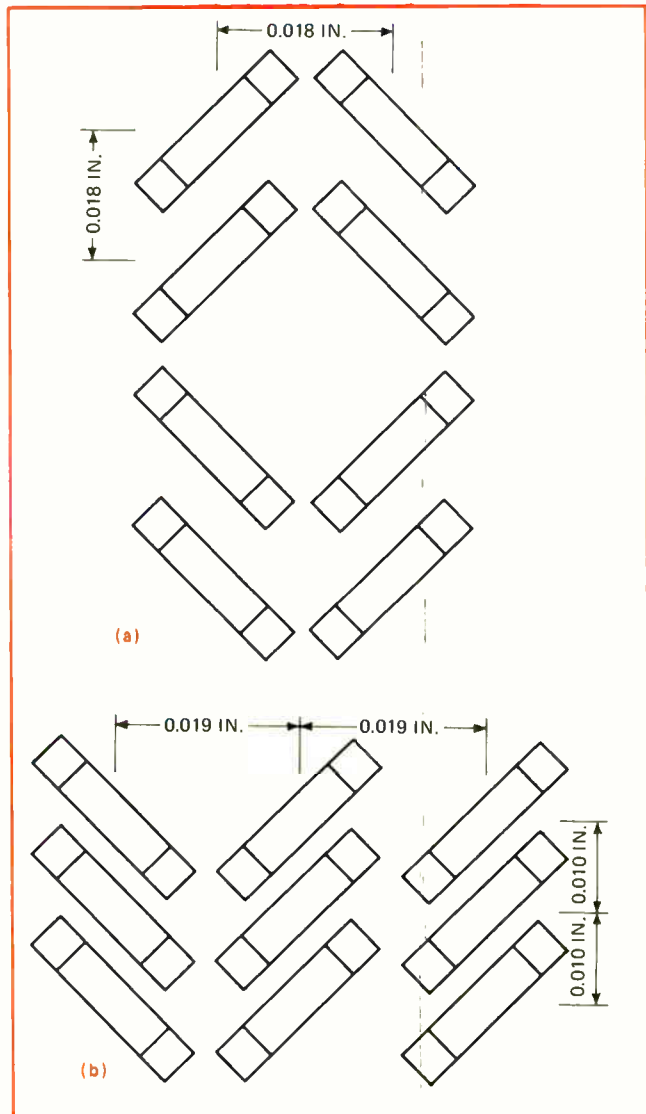

2. Patterns. Box pattern (a) that had been used for magnetic core layout in previous memories required 18 mils between cores. To double the memory capacity on a board of the same size, a herring-bone pattern (b) was used to pack the cores more closely together.

be used in place of the 48,000- μ F devices.

Although the rating of the 10-slot computer's power supply was 240 w—about 30% higher than that of the four-slot model—minor revisions allowed much of the same circuitry and many of the same components to serve in both power supplies. For instance, in the larger power supply, the current in the +5-v switching regulator nearly doubled to 20 A, producing a 2-v drop across the switching transistor and raising power dissipation in the transistor. To accommodate the increased current, a 0.05-ohm resistor, placed in series with the switching transistor, absorbed about half of the voltage and power, and thereby also lowered the transistor's running temperature by 15°C.

Surges damped

An unusual design approach was applied to safeguard the switching transistor against the effects of power surges. Standard practice dictates a decrease in switching time to limit power. This practice, however,

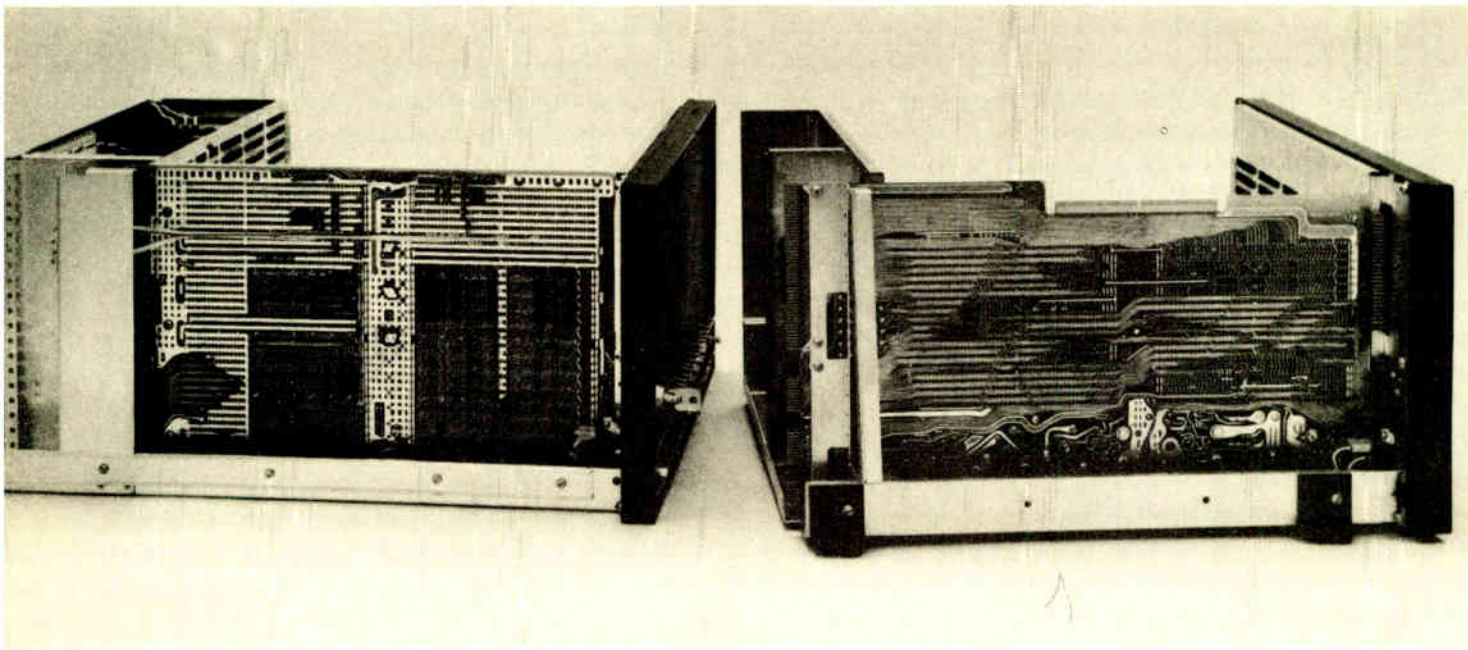

3. Move it over. Power supply in old computer (left) was at rear of cabinet, and mounted on base plate, making a separate subassembly. In new version, power supply is mounted on back panel (actually located on the side of the computer). It thus uses etched conductors of back panel and is soldered in one step. Note that filter capacitors can be much taller than in the old version because they now lie horizontally.

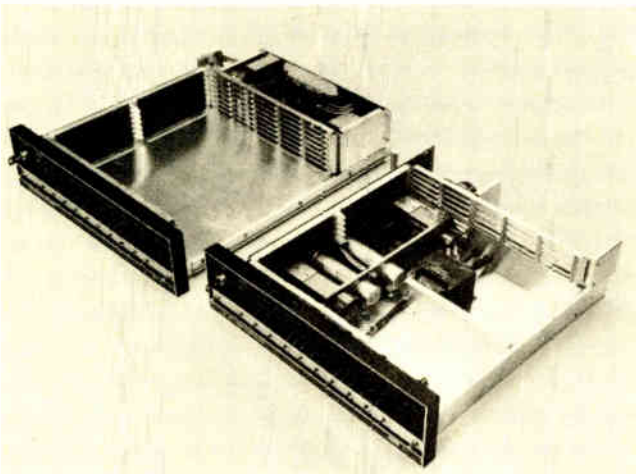

4. Back-panel wiring. Etched conductors of new 10-slot version (right) carry signals to peripherals, which plug into edge pads on left of back panel. On older units (left), connections for peripherals were made by wire-wrapping. Heavier etched conductors for power supply wiring are evident on lower portion of new back panel. Note also that front panel plugs to back panel with edge connectors.

tends to enlarge the current spike produced in the commutating diode as it recovers, since the same charge must be removed from the diode in a shorter time.

In the new design, transistor switching time is increased, spreading the pulse over a longer interval. Although this increases the power during transition, the boost is more than compensated by the lower I^2R losses from reducing the current peak. At the same time, current surges are reduced to levels within the switching transistor's operating limits.

The back panel permits use of etched conductors, rather than wire-wrapping for I/O connections (Fig. 4). These conductors increase convenience and reliability,

as well as reduce cost and eliminate manufacturing steps. In the older design, two 50-pin connectors, requiring much splicing and general cable work, carried the 47 separate signals from wire-wrapped pins on the back panel to the peripheral equipment.

In the new machines, I/O signals are brought to the rear of the I/O connector as etched conductors terminating in a 100-pin connector. Space on the back panel for the conductors is obtained by eliminating three of the former seven pc boards in the smaller computers, and seven of the former 17 in the larger machines. Manufacturing costs are reduced because the entire board can be wave-soldered in one step, and no wire-wrapping is required. In both re-engineered computers, enough space was made available next to the I/O fingers to hold several other connectors. These can be wire-wrapped to the appropriate pins on the back panel if additional special interfaces are required. The Teletype connection was also simplified by eliminating an edge connector and plugging the cable directly to back-panel wire-wrapping pins.

As a result of the redesign, the price of the 8-kiloword memory is about 25% less than the combined prices of two previous 4-kiloword memory boards. Previously, two 4-kiloword memory boards cost \$2,700 each, and thus two would cost \$5,400. The repackaged 8-kiloword assembly costs the user \$4,100, at a net saving of \$1,300 for each 8-kiloword increment used. The price of a Nova 1200 with a 12-kiloword memory thus was reduced from \$10,850 with three 4-kiloword boards to \$9,550 with one new 8-kiloword and a 4-kiloword unit; a 16-kiloword Nova 1200 was reduced from \$13,550 with four 4-kiloword memories to \$10,950 with two 8-kiloword boards. The effect of combining the back panel and power supply was to reduce the prices of both the smaller 1210 and the larger 1220 by 20% and 17%, respectively, below those of their predecessors. □

Computer helps design of complementary MOS logic

Accurate characterization of MOSFET current-voltage curve permits computer modeling of silicon-gate C/MOS logic circuits; switching performance of both combinational and sequential logic circuitry can be predicted or analyzed

by James Foltz and Fuad Musa, *Motorola Semiconductor Products Inc., Phoenix, Ariz.*

□ Complementary metal-oxide-semiconductor logic circuitry is being more widely used as the demand increases for digital systems that operate at low power levels and from low supply voltages. C/MOS satisfies these requirements with its extremely low dynamic power dissipation and its essentially zero quiescent power consumption. Moreover, silicon-gate C/MOS can operate from very low supply voltages—as little as 1 volt, thereby further reducing power requirements.

Complementary logic structures, however, can become quite complex, making the use of computer-aided analysis essential, since the basic C/MOS logic element, the inverter, requires two devices—an n-channel and a p-channel MOS field-effect transistor. To use the computer, a practical model of the silicon-gate MOSFET is needed that satisfies C/MOS requirements.

The model must be suitable for both transient analysis and determining the effect of MOS device parameters, especially threshold voltage, on circuit performance. As threshold voltage becomes smaller, operating speed can be increased, but possibly at the price of higher power consumption.

The MOSFET model

Because of its simplicity and accuracy, the low-frequency large-signal equivalent circuit of the MOSFET (Fig. 1) provides a good basis for developing the appropriate equations for C/MOS computer analysis. Through Sceptre, a general-purpose computer program, and MOSFET current and voltage relationships, this equivalent circuit can be used to predict C/MOS switching speed, power dissipation, and the effect of threshold voltage on transient response and power-speed product.

The MOSFET model is a four-terminal device consisting of drain-source current generator I_{DS} and five capacitors that represent the device's gate-source C_{GS} , gate-drain C_{GD} , gate-substrate C_{GB} , drain-substrate C_{DB} , and source-substrate C_{SB} capacitances. For an n-channel MOSFET, current flows from the drain terminal to the source terminal; for a p-channel transistor, current flows from source to drain.

Model capacitors C_{DB} and C_{SB} represent junction capacitances and can be evaluated readily by conventional methods. However, since C_{GS} , C_{GD} , and C_{GB} are MOS gate-oxide capacitances, they are functions of processing parameters and device geometry, as well as MOSFET terminal voltages. Although the sum of these

latter capacitances is constant, their individual values vary with biasing conditions and also depend on the direction of current flow between drain and source terminals. Detailed descriptions of how to evaluate MOS capacitances are available.^{1,2,3,4}

This model does not account for any source or drain series resistances because the effect of these resistances can be neglected, due to the extremely low current developed by the MOSFET at silicon-gate C/MOS operating voltage levels. (Peak current is about 100 microamperes, while drain-source voltage approximately equals the 1.5-v gate-source voltage).

Characterizing the model

In the linear region, the current generator, I_{DS} , can be written as:^{5,6,7}

$$I_{DS} = B_o[(V_G - V_o - V_D/2)V_D - (V_G - V_o - V_S/2)V_S - (2/3)K_o(|V_D + 2\phi_F|^{3/2} - |V_S + 2\phi_F|^{3/2})] \quad (1)$$

where all voltages are referenced to substrate potential:

$$B_o = Z\mu C_o/L$$

$$V_o = \phi_{MS} - Q_{SS}/C_o + 2\phi_F$$

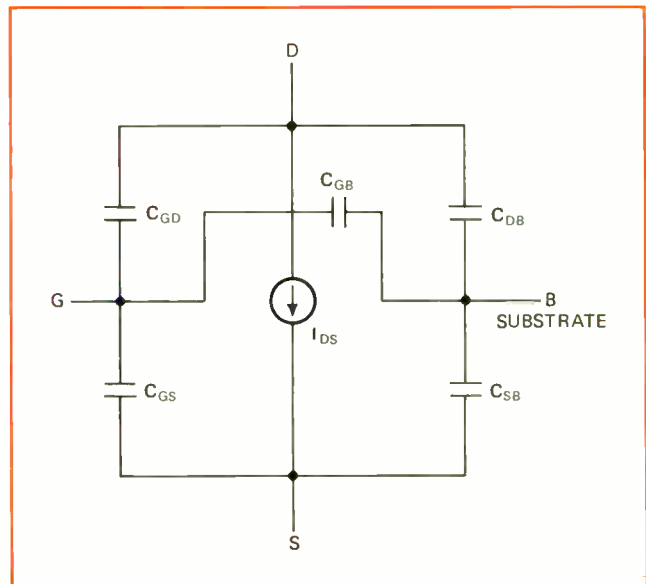

1. **MOSFET model.** Low-frequency large-signal equivalent circuit of MOSFET serves as model for complementary MOS logic. Equation for current generator, I_{DS} , represents model's current-voltage characteristic, which can be applied to C/MOS design or analysis. Current flows from drain to source for n-channel device.

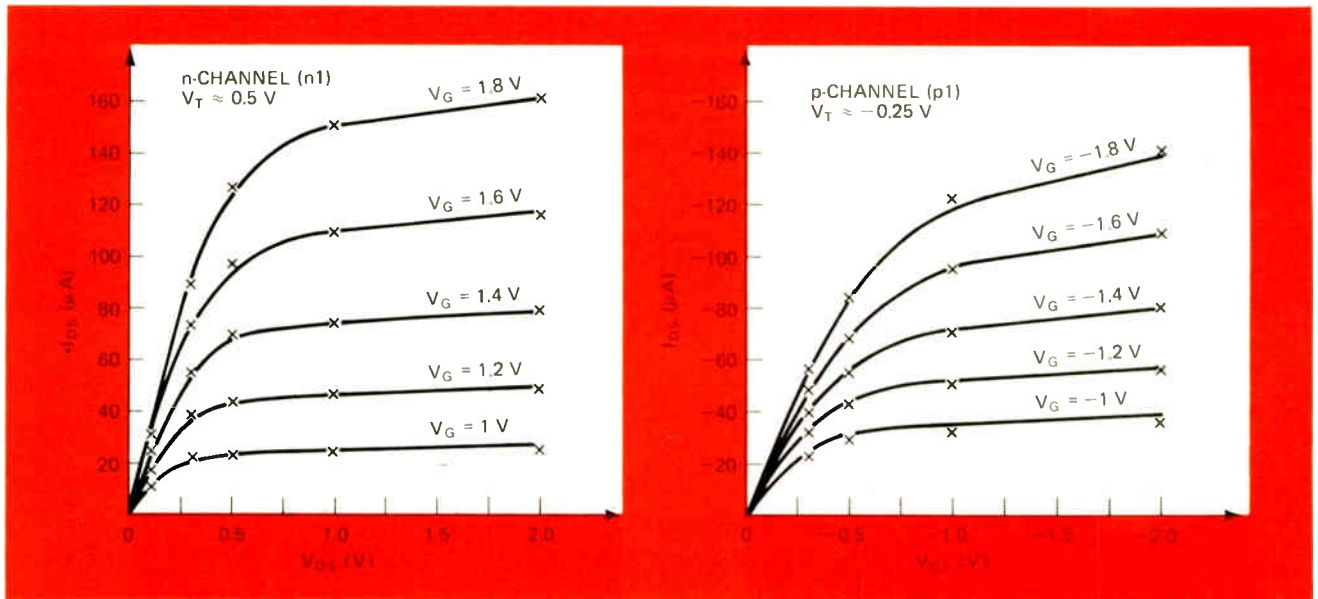

OPTIMIZED PARAMETERS

Device type	B_0 (A/V^2)	V_0 (V)	N_D (cm^{-3})	X_0 (microns)	Q_{SS}/C_0 (V)	L (microns)	V_T (V)
n1	2.85×10^{-4}	-0.57	4.3×10^{15}	0.117	0.27	3.9	0.48
p1	-1.4×10^{-4}	0.24	1.1×10^{15}	0.115	0.30	5.2	-0.25
n2	8.9×10^{-4}	-0.68	1.12×10^{16}	0.122	0.24	20.0	1.20
p2	-3.49×10^{-4}	0.14	4.72×10^{15}	0.122	0.33	25.0	-1.0

2. Mathematical versus practical. Device parameters needed to compute model current, I_{DS} , are noted in table for small (n1 and p1) and large (n2 and p2) transistors. Parameters are mathematically optimized to approximate the current-voltage characteristics of real devices. I-V curves for n1 and p1 MOSFETs embody the comparison of predicted results (solid lines) with measured data (test points).

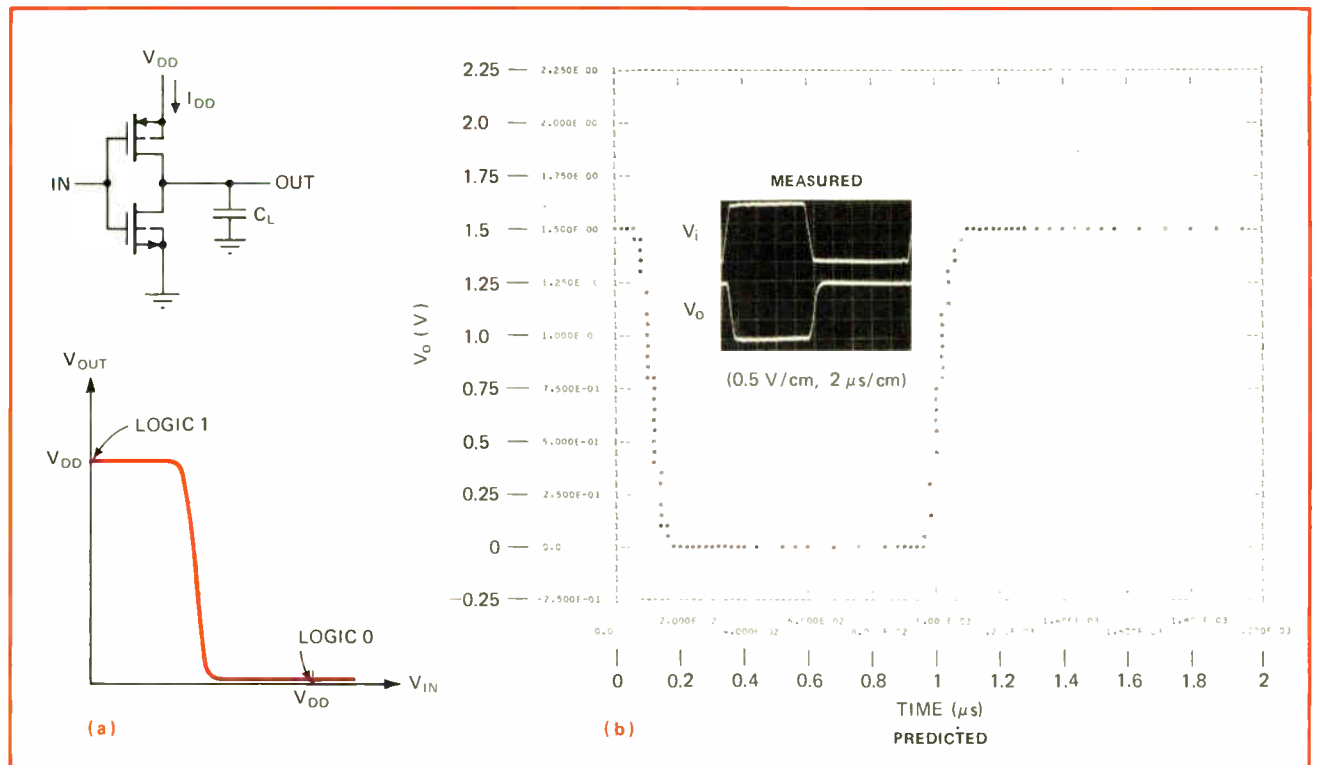

$$K_o = (2\epsilon_o\epsilon_s e N_D)^{1/2} / C_o$$

V_G is the gate voltage, V_D the drain voltage, V_S the source voltage, Z the channel width, L the channel length, μ the inversion layer mobility, C_o the gate-oxide capacitance per unit area, ϵ_o the permittivity of free space, ϵ_s the relative dielectric constant of silicon, N_D the substrate impurity concentration, ϕ_{MS} the metal semiconductor work function difference, Q_{SS} the fixed positive charge at the silicon/silicon-oxide interface, ϕ_F the Fermi substrate potential, and e the electron charge.

In the saturation region, V_{DSAT} replaces V_D in Eq. 1 and is defined by:⁵

$$V_{DSAT} = V_G - V_o \pm (K_o^2 / 2 [1 - (1 \pm 4(V_G - V_o + 2\phi_F) / K_o^2)^{1/2}]^{1/2} \quad (2)$$

(In Eq. 2, where a choice is indicated, the sign is + for n-channel and - for p-channel.) To simplify computations, the channel conductance in the linear region, g_{ds} , can be regarded as a linear function of V_G , provided that $V_S = 0$ and V_D is much less than $2\phi_F$:

$$g_{ds} = \left. \frac{dI_{DS}}{dV_D} \right|_{V_D = \text{constant}} = B_o(V_G - V_T)$$

where threshold voltage V_T is:

$$V_T = V_o + K_o(2\phi_F)^{1/2}$$

When channel conductance g_{ds} is plotted against gate voltage V_G for an actual MOS device, the value of variable B_o (slope) becomes smaller with increasing gate voltages. This is due to reduced surface mobility and to the series source resistance, which lowers the gate-source voltage below the applied gate voltage. For all silicon-gate MOSFETs, variable B_o can be approximated by a constant when V_G is less than or equal to 2 v.

Modeling C/MOS logic

A computer-aided technique can be developed to optimize the values of Q_{SS} , V_o , oxide thickness X_o , channel length L , and impurity concentration N_D so that the current-voltage relationships calculated with Eqs. 1 and 2 closely approximate those measured for practical silicon-gate C/MOS devices.

The table in Fig. 2 lists the most important optimized parameters for two pairs of n-channel and p-channel MOSFETs. The upper two sets of values, n1 and p1, are for small transistors, while the lower two, n2 and p2, are for large transistors. Both the predicted (with the model's equations) and the actual (from existing transistors) current-voltage characteristics of devices n1 and p1 also appear in Fig. 2. The differences between the predicted and the measured curves are small.

The basic element of the C/MOS logic family is the inverter, which is shown in Fig. 3a along with its transfer characteristic. Figure 3b shows the inverter's predicted and measured switching performance. The printout reflects the computed switching speed, based on the optimized parameters of transistors n1 and p1. And the oscilloscope trace displays the switching action of a circuit

3. C/MOS logic inverter. Basic C/MOS logic element is inverter (a) comprising p-enhancement MOSFET (top) and n-enhancement MOSFET (bottom). Voltage transfer function shows transition from logic 1 to logic 0. Computer plot (b) of output voltage versus time projects inverter switching performance using n1 and p1 parameters. Scope display is for inverter built with n1 and p1 MOSFETs.

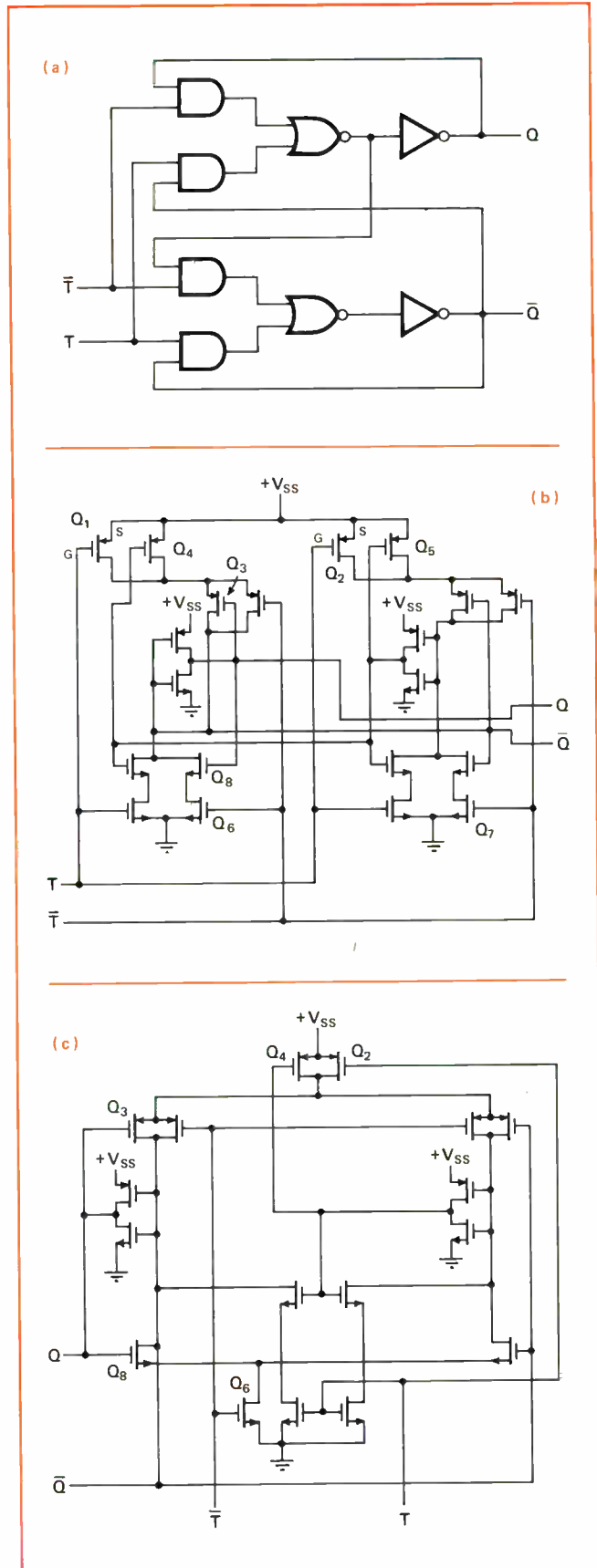

4. Minimizing device count. Flip-flop (a) requires 20 MOSFETs, as shown in (b). But three transistors are redundant and can be removed—one between either Q_1 or Q_2 , another between Q_4 or Q_5 , and the third between Q_6 or Q_7 . Final flip-flop (c) uses 17 MOSFETs.

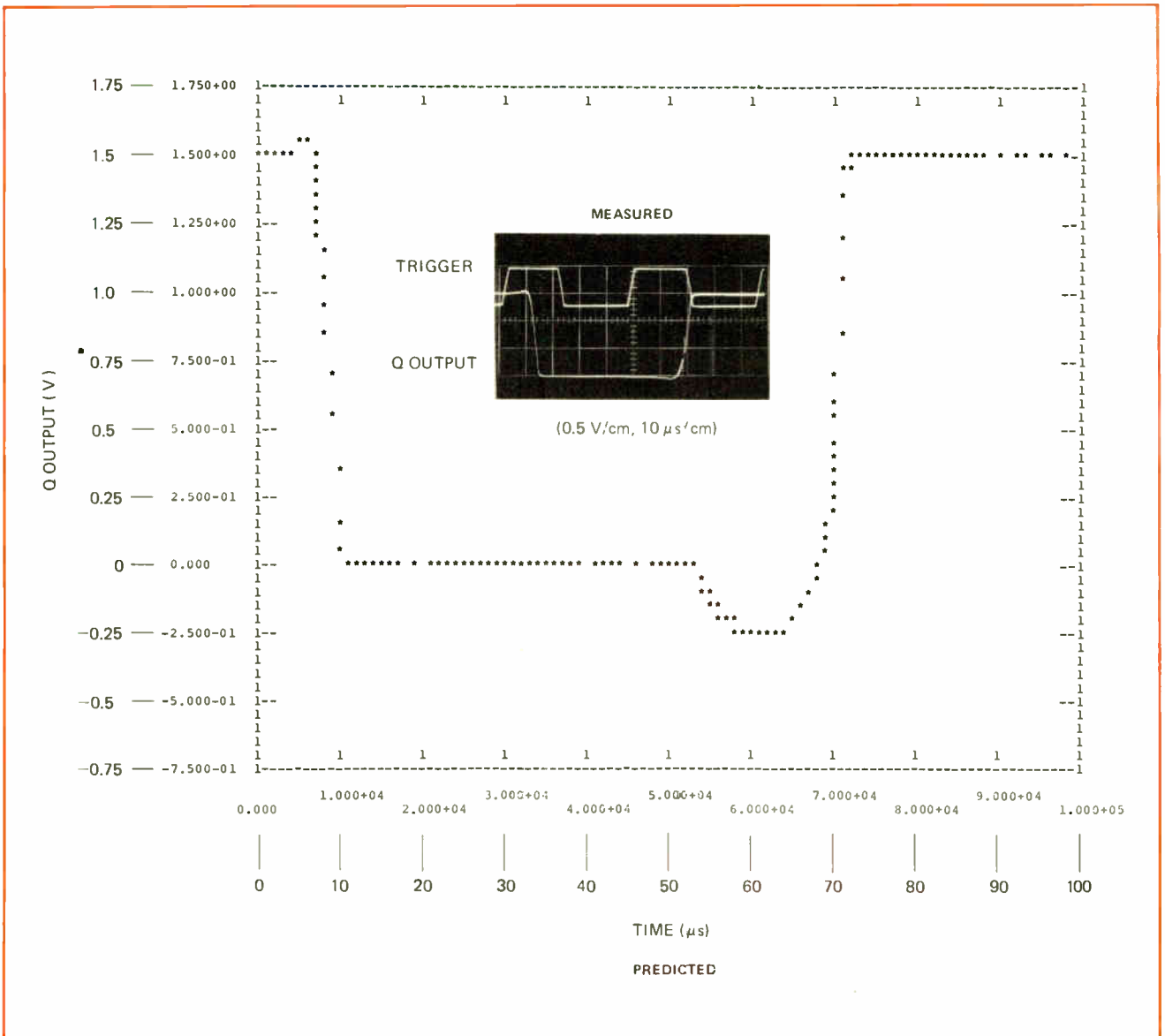

5a. Flip-flop Q output. Predicted switching performance is plotted by computer for Q output of toggle flip-flop that is simulated with n2 and p2 parameters of Fig. 2. Oscilloscope trace displays same Q output for actual flip-flop built with practical n2 and p2 MOSFETs.

built with actual n1 and p1 transistors. Each switching waveform is the voltage across load capacitor C_L (2 picofarads) when the inverter is operated from a 1.5-v dc supply and is driven by a 1.5-v input having 100-nanosecond rise and fall times.

Power-speed product

One of the most important performance parameters of any switching circuit is its power-speed product; power consumption and operating speed are directly proportional to each other. Here, the C/MOS inverter has the advantage of dissipating power only during its transition, when charging or discharging its load and internal capacitances. However, I^2R power may be dissipated if both MOSFETs conduct simultaneously during transition, when the supply voltage and the input signal amplitude exceed the sum of the n- and p-channel threshold voltages. Dissipated power then becomes a function of input rise and fall times and increases with slower signals. Therefore, the C/MOS inverter's power-

speed product, which is defined as $V_{DD}I_{DD}/\text{frequency}$, may not necessarily be constant with frequency if the input signal is sinusoidal or has varying rise and fall times. The MOSFET model can be used to predict the power-speed product by employing a function subroutine in conjunction with Sceptre⁸ to calculate the average inverter current drain, I_{DD} .

For example, if an inverter's sum of threshold voltages is about half a 1.5-v supply, its power-speed product goes up by a factor of four when input rise and fall times are increased from about 0.1 microsecond to around 5 μs . The power-speed product for an inverter having a sum of threshold voltages that is greater than the supply does not change with slower inputs.

Sequential logic circuits

In addition to combinational logic, sequential C/MOS logic circuit performance can also be predicted with the MOSFET equivalent circuit. Sequential circuits can be considered as interconnected combinational logic

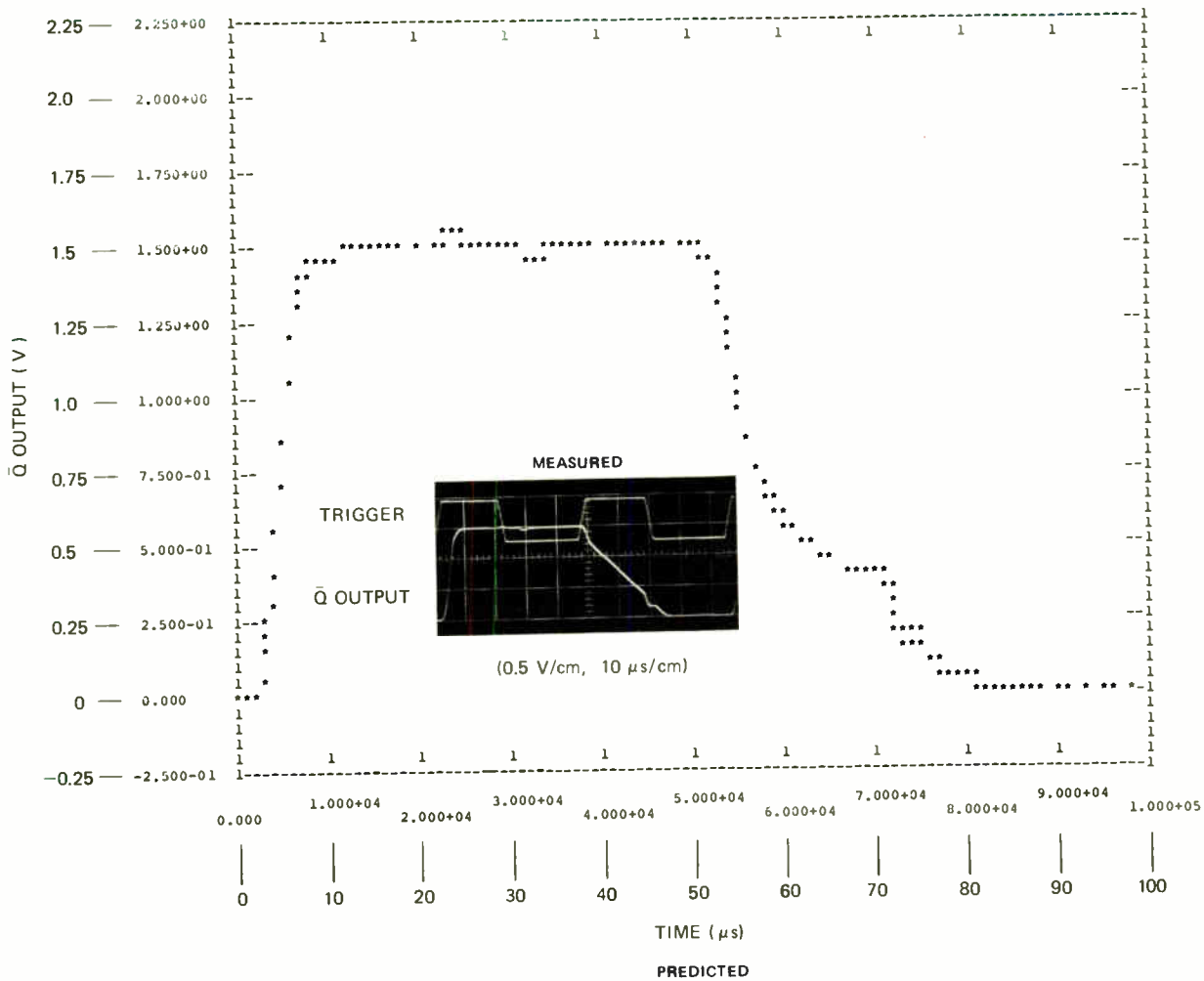

5b. Flip-flop \bar{Q} output. Computer predicts switching action of flip-flop \bar{Q} output by plotting output voltage versus time. Again, device parameters of n2 and p2 MOSFETs are used to simulate flip-flop. Switching performance of practical flip-flop is shown by scope trace.

blocks, like gates and inverters, with appropriate feedback. A toggle (type T) flip-flop, for example, can be implemented with the blocks noted in Fig. 4a.

In this form, the flip-flop requires 20 transistors, as indicated in Fig. 4b. A closer inspection, however, reveals that a few transistors serve the same functional purpose.

P-enhancement transistors Q_1 and Q_2 , for instance, have identical bias conditions; their gates and sources are common. One of these transistors can be eliminated when the drains of the two have been tied together. This is possible, since their common drains will be buffered from the logic output node by transistor Q_3 .

The same reasoning applies to transistors Q_4 and Q_5 , since their drains are also common, once Q_1 and Q_2 are tied together. Moreover, transistors Q_6 and Q_7 have an identical biasing arrangement, allowing one of them to be eliminated after connection of their drains, which will be buffered from the output by transistor Q_8 . In all, three devices are redundant and may be removed. The final flip-flop, Fig. 4c, requires 17 transistors.

The MOSFET model can be employed to predict the switching performance of the toggle flip-flop, as was done for the inverter. The parameters of MOSFETs n2 and p2 can be used for computation, and actual n2 and p2 transistors can be used to breadboard the flip-flop.

Both the predicted and measured Q and \bar{Q} output forms are noted in Fig. 5, when each output drives a 7-pF load. The longest part of the switching cycle, about 20 μ s, is the fall time of the \bar{Q} output, Fig. 5b. □

REFERENCES

1. C.T. Sah, "Characteristics of the Metal-Oxide-Semiconductor Transistor," *IEEE Transactions on Electron Devices*, ED-11, July, 1964, pp. 324-345.
2. C.T. Sah, H.C. Pao, "The Effects of Fixed Bulk Charge on the Characteristics of Metal-Oxide-Semiconductor Transistors," *IEEE Transactions on Electron Devices*, ED-13, April, 1966, pp. 393-409.
3. Paul Nygaard, "An investigation of Voltage-Variable Gate-Oxide Capacitance," Motorola Inc., Internal Communications, 1971.
4. William Lattin, "MOS Voltage-Variable Capacitance Study," Motorola Inc., Internal Communications, 1972.
5. A.S. Grove, "Physics and Technology of Semiconductor Devices," Wiley, 1967.
6. D. Frohman-Bentchkowsky, A.S. Grove, "Conductance of MOS transistors in Saturation," *IEEE Transactions on Electron Devices*, ED-16, January, 1969, pp. 108-113.
7. Robert H. Crawford, "MOSFET in Circuit Design," McGraw-Hill, 1967.
8. Paul Nygaard, "Sceptre Subprogram Library," Motorola Inc., Internal Communications, 1970.

Diode plus low-cost op amp makes accurate thermostat

by Robert Koss
Adac Inc., Colchester, Vt.

Employing a silicon diode as the temperature-sensing element allows an inexpensive operational amplifier to control temperature to a variation of less than 0.05°C . A type 1N4148 diode, for instance, has a typical temperature coefficient of -2 millivolts/ $^{\circ}\text{C}$.

The resistance bridge in the diagram sets the temperature that is sensed by diode D_1 and that is maintained by the heater element, resistor R_1 .

When temperature is too low, control voltage V_1 goes negative, limiting the op amp's output to 12–14 volts. Transistor Q_1 conducts and provides the necessary

heater current. When temperature is too high, diode D_2 prevents amplifier output voltage from going negative, and transistor Q_1 turns off. Average current then is always positive and is controlled by the amplifier to compensate for changes in temperature.

Transistor Q_2 and resistor R_2 prevent the heater current from exceeding a specified limit. (For this circuit, maximum heater current is 375 mA.) If the voltage drop across resistor R_2 equals Q_2 's 0.6-V base-emitter voltage, transistor Q_2 turns on, shorting the amplifier's current-limited output to ground, thus turning off transistor Q_1 .

The stability of the control loop depends on several thermal time constants that are not easy to calculate. Computations can be reduced a little by using a relatively large time constant in the feed-forward direction for R_3C_1 and keeping the remaining thermal lags as small as possible. Sense diode D_1 should make good thermal contact with the object to be temperature-controlled. It should also be thermally insulated from changes in external conditions. □

Inexpensive thermostat. Tight temperature coefficient of silicon diode permits low-cost op amp to be used for controlling temperature to within 0.05°C . Resistance bridge sets temperature of heater containing sense diode D_1 . For low temperatures, amplifier turns on transistor Q_1 , which supplies heater current. For high temperatures, amplifier output remains positive because of diode D_2 , but Q_1 stops conducting.

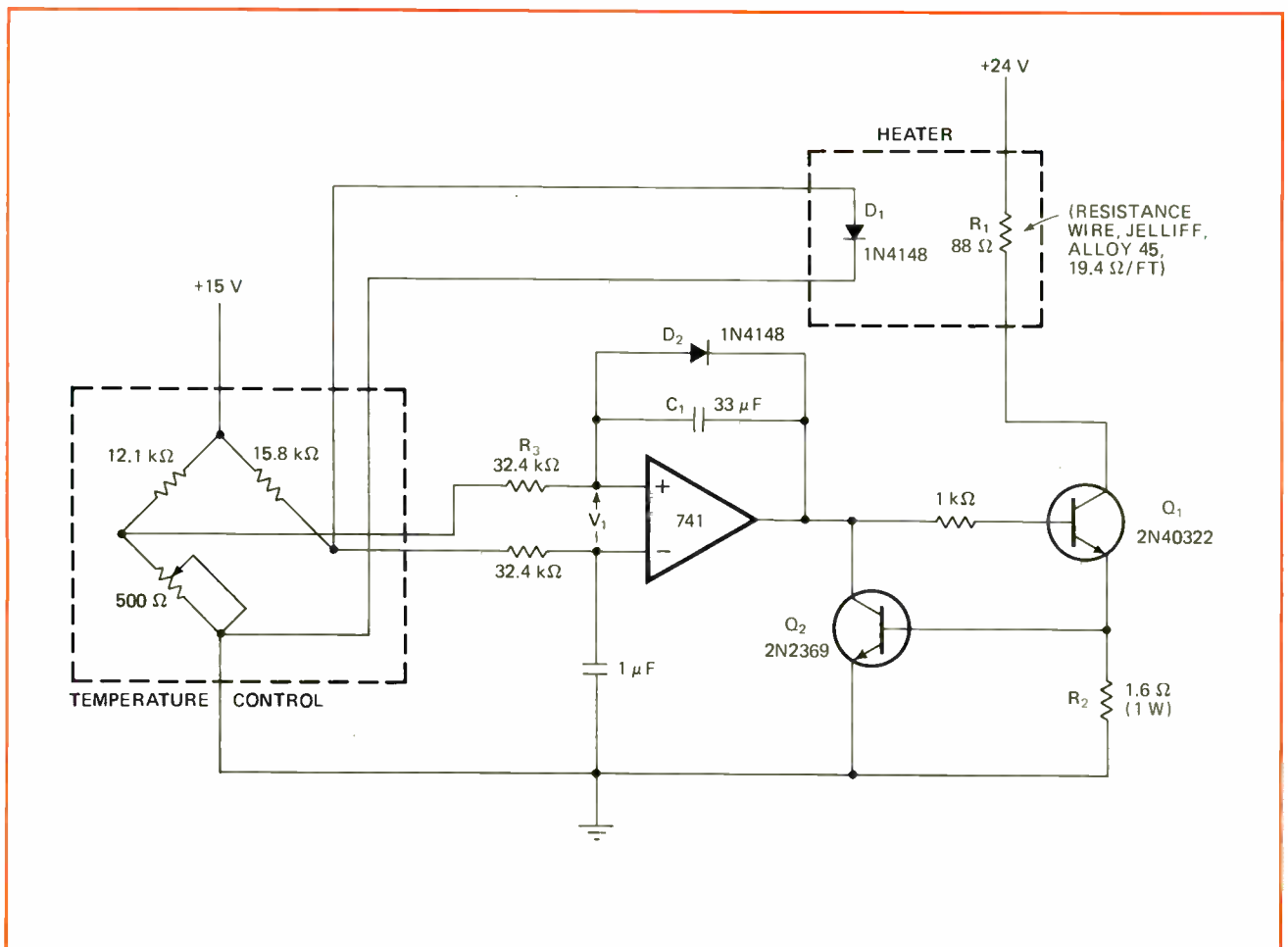

Logic system checks out analog-to-digital converter

by Charles J. Huber
Westinghouse Electric Corp., Systems Development Div., Baltimore, Md.

Testing the conversion accuracy of an analog-to-digital converter need not be a laborious and time-consuming task. The test configuration shown can reduce the job to a go/no-go operation without undue expense (approximately \$36 for integrated circuits plus the cost of a digital-to-analog converter).

This test system produces a 12-bit digital ramp that is converted (by the d-a converter) to a 4,096-step analog ramp. The analog ramp is applied to the a-d converter under test, and the resulting output from the 10-bit a-d converter is compared to the 10 most significant bits of the 12-bit digital ramp.

An input clock is applied simultaneously to a one-shot delay network and to a ripple-through counter consisting of three four-bit binary counters. The delayed clock becomes the input for six four-bit buffer latches. These accept and delay all 12 of the bit outputs from the counter to remove glitches from the digital ramp. The delayed clock now acts as the basic time reference.

Verifying converter accuracy. A-d converter test system generates 12-bit digital ramp with ripple-through binary counter. Buffer latches smooth out any ramp glitches. D-a converter then develops analog input for a-d converter using only 10 most significant ramp bits. Exclusive-OR gates compare a-d output with ramp. Errors pass to another buffer for comparison with appropriately delayed clock.

The 10 most significant bits from the latches drive both a d-a converter and a comparator formed by three quad exclusive-OR gates. These gates compare the bits of the digital ramp to the output bits of the a-d converter, on an individual basis. The analog output of the d-a converter corresponds to the input digital code within $\pm\frac{1}{2}$ the least significant bit.

The delayed clock pulse also passes through another one-shot delay network before reaching a sample circuit, which strobes a second set of buffer latches. For zero error at the buffer outputs, the minimum strobe delay equals the a-d conversion time. An interpolating voltage applied to the d-a permits continuous voltage control of the a-d output over the $\frac{1}{8}$ -bit range.

The test system can accurately determine conversion times of 2 microseconds for successive-approximation and variable-reference a-d converters. Additionally, the nature and position of other conversion errors can be determined by relating displayed error pulses to the digital ramp. For example, small areas of the ramp can be investigated by making constants of the 10 most significant bits of the digital input and using the eleventh and twelfth bits as variable controls.

More system flexibility can be obtained by using an up/down counter to eliminate the d-a converter's slew time when the count changes from 111 . . . 1 to 000 . . . 0. Replacing the counter with a pseudo-random generator allows testing for all input changes. □

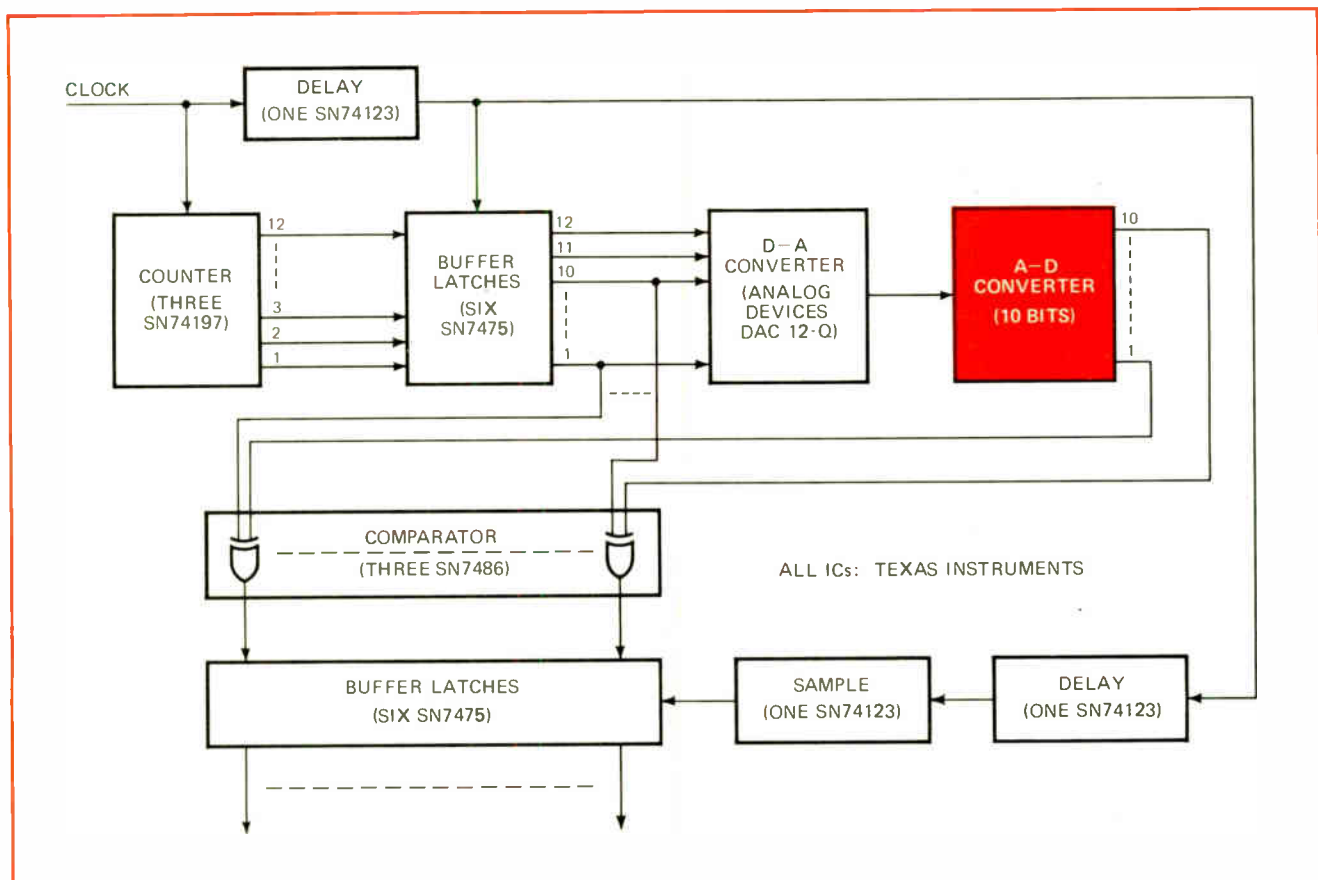

Double-duty multivibrator gives complementary outputs

by Edward Beach
National Radio Institute, McGraw-Hill Inc., Washington, D.C.

Depending on its input signal period, a pulse generator operates as a one-shot or as a synchronous astable multivibrator. In either mode, the circuit provides complementary outputs. An ordinary grounding pushbutton switch can serve as the input device.

Gates G_1 and G_2 form a simple latch that prevents the circuit from operating in the absence of an input (high). When the input goes low, the latch changes state, allowing gate G_1 to act as an inverter. Gates G_1 , G_3 , and G_4 are the pulse-generating portion of the circuit.

If the input remains low for less than three generator time constants, single complementary pulses are produced by gates G_1 and G_4 . The leading edge of each output pulse coincides (neglecting gate delays) with the leading edge of each input pulse. The trailing edge of the output pulse (again, neglecting gate delays) resets the latch and disables the generator.

When the input signal remains low for longer than

three time constants, at least two complete output pulses with a period equal to approximately three generator time constants are produced. In this case, the pulses begin and end synchronously. The first output pulse coincides with the leading edge of the input, and the last pulse is a full-width pulse, no matter when the input is removed.

Resistor R can range in value from 330 ohms to 1.5 kilohms, while capacitor C can be some value between 0.001 microfarad and 1,000 μF . For example, when $R = 1,000$ ohms and $C = 100 \mu\text{F}$, the circuit will produce either a 100-millisecond pulse or a 100-ms pulse train with a repetition rate of about 3 pulses per second.

For critical timing applications, a nonpolarized capacitor should be used when C is a high value; for less-critical applications, an ordinary electrolytic or tantalum capacitor will suffice. Since the reverse capacitor voltage is only about -0.7 volts, an inexpensive capacitor can be used.

The circuit can also function as an inexpensive transistor-transistor-logic clock simply by replacing gates G_1 , G_3 , and G_4 with half a type 7404 circuit. In addition, gate G_2 could be eliminated and an inverted version of the input signal applied directly to gate G_1 , but this could shorten the last pulse in the pulse train. □

Designer's casebook is a regular feature in Electronics. We invite readers to submit original and unpublished circuit ideas and solutions to design problems. Explain briefly but thoroughly the circuit's operating principle and purpose. We'll pay \$50 for each item published.

Manual pulser. Pushbutton-operated pulse generator functions either as a monostable or astable multivibrator. Low input signal enables G_1 - G_2 latch so that G_1 becomes an inverter. Gates G_1 , G_3 , and G_4 then generate complementary output pulses. When input is low for less than three RC time constants, circuit is a one-shot; when input period exceeds $3RC$, circuit is a synchronous astable multivibrator.

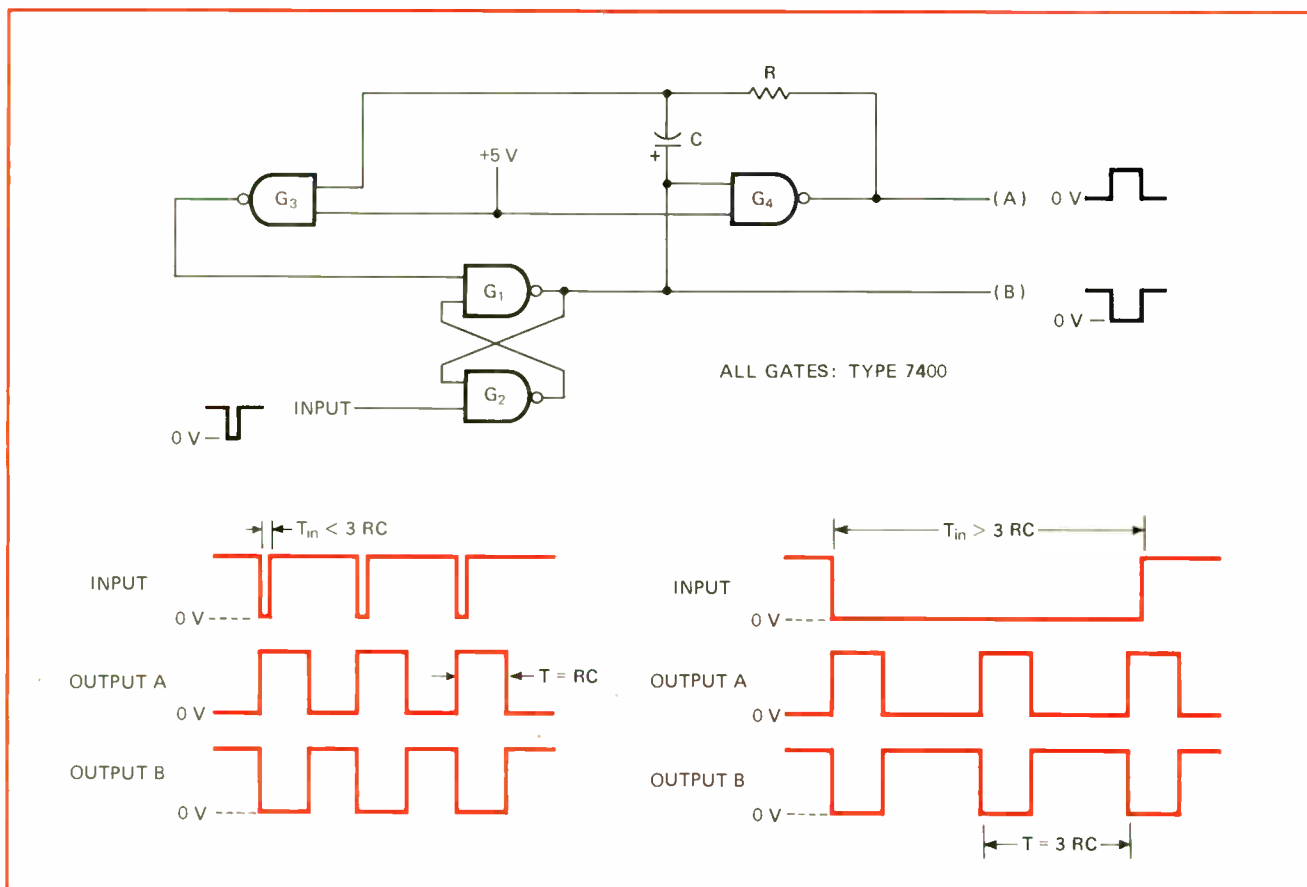

Evolution and the function generator

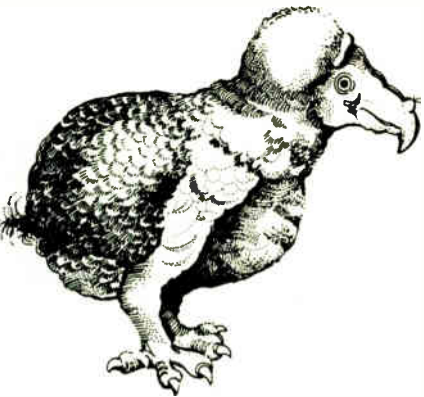

Lessons from the Dodo

IEC, in building its high-quality, low-cost Series 30 Function Generator, learned from the mistakes of others. (Yes, the industry has had its Dodos.) We knew that only a strong, highly reliable unit would survive, so we developed our compact, hard-working 0.3Hz-3Mhz Series 30 accordingly.

Performance and quality are built into the unit right from the beginning. Interstate Electronics Corporation's independent QC lab puts every Series 30 semiconductor through a rigorous performance test before production acceptance. Then, after Unit Testing, Calibration, Burn-In, and Stress Cycling, each instrument ticketed for shipment has to pass QC's computerized Assurance Test before it goes to our customer.

Monkeying with Ontogeny

The Unit Test is the first evaluation to identify and correct operative problems in the working instrument. Each of Series 30's versatile outputs, including variable Width Pulse, Sweep Sawtooth, Adjustable D-C Level, and Sine, Square, and Triangle waveforms are scrutinized for pure, consistent performance up to 20V p-p. In addition, our direct-reading Sweep Limit, 40-db Calibrated Attenuator, and other controls are handled for "feel" as well as accuracy.

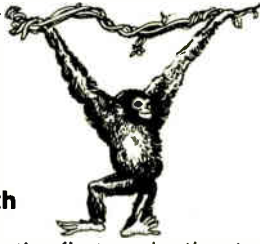

During Calibration, Trigger, Gate, Burst, and Sweep Modes are given full play. By such critical inspections, we learn more about the instruments we make, and the product species as a whole is improved.

IEC actually over-calibrates to reach an exceptional quality of performance. While we spec a respectable 0.3% sine distortion, our generators typically achieve 0.18%.

Loss of the Sixth Toe

As part of the stress Cycle, we developed a "Shake 'n Bake" test that jolted and jarred Series 30 prototypes, then operated them in a 70°C. heat chamber. We still burn-in each Series 30 generator, but after extensive Unit Tests without a vibration failure, the "shake" cycle was declared obsolete.



Mutation Elimination

We don't produce to MIL-SPECS, but our procedures are amazingly close to it. During four in-process inspections, a QC team checks everything from each solder joint to screw mounts, rejecting the slightest imperfections. We expect each Series 30 unit to evolve exactly as specified, with absolutely no mutations.

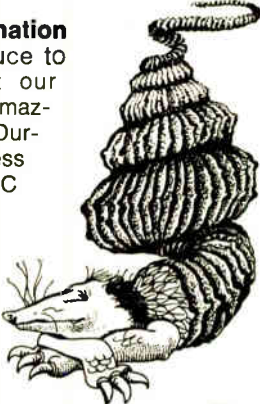

Survival of the Fittest

After calibration, the Series 30 generator undergoes a minimum 120-hour "mileage" test. We turn each instrument on and off at irregular intervals during this stress cycling to simulate real-world strain, and our exclusive Output Limit Indicator glows to confirm that the Generator is operating under stress.

Following this, all instruments are processed by a final automated lab system. At this point the Function Generator *must* continue to perform precisely, with an exacting degree of conformity and predictability. Only by surpassing the highest standards of the species does the Series 30 survive in the field, and enjoy the lowest return in the industry.

We're ready to back up our claims. Go ahead . . . call John Norburg, collect, at (714) 772-2811, and ask for a demo!

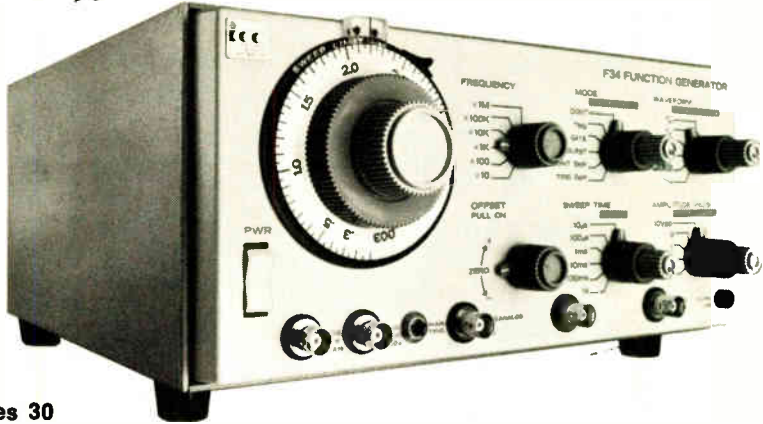

F34 . . . \$495

5 Other Models available in Series 30 From \$295 to \$695



IEC INTERSTATE ELECTRONICS CORPORATION

a subsidiary of A-T-O Inc.
Dept. 7000, Box 3117, Anaheim, Calif. 92803.
TWX 714-776-0280 TELEX 655443 & 655419

Circle 93 on reader service card

Multiplexing technique cuts cost of digital-to-resolver/synchro conversion

By taking loading errors into account, a new method raises the accuracy of multiplexed d-r and d-s converters; it helps synchros and resolvers exploit their high reliability to compete better with shaft angle encoders

by Frederick G. Roberts, *North Atlantic Industries Inc., Plainview, N.Y.*

□ The spread of digital techniques into the industrial—as distinct from the accounting—world has created a superabundance of analog-to-digital and digital-to-analog converters. Less obvious, but just as important, has been the parallel expansion in the devices that interface a digital computer to any mechanical shafts and mechanisms it controls.

Through most of the 1960s, it appeared that shaft angle encoders would ultimately supplant analog resolver and synchro transducers and their associated electronics as the most popular way to convert shaft angles into digital form, and vice versa. (In converting digital words into shaft angles, the encoders control servos that apply mechanical power to the shafts.) But since shaft angle encoders never attained the reliability of analog transducers, the advent of low-cost digital and linear integrated circuits has once again tipped the balance in favor of the older devices.

Now a cost-saving method for multiplexing several mechanical channels promises to make synchros and resolvers even more attractive in the future.

Multiplexed d-r and d-s converters

Multi-axis machine tools, materials handling equipment, automated production lines, and automatic test equipment are examples of computer operation in which one digital data source controls several channels of mechanical operation. In such applications, an arrangement like that shown in Fig. 1 is typically used to update a multiplexed array of digital-to-resolver or digital-to-synchro converters. Because of the relative slowness of numerically controlled machine tools and other mechanical equipment, speed is less crucial than it often is in conventional d-a converter multiplexing—in multiplexed cathode-ray tube displays, for example.

Very high accuracy is another parameter that distinguishes this group of converters from more conventional a-d and d-a equipment. Whereas 12-bit digital-to-voltage converters are only now becoming available on a commercial scale, mechanical shaft position has been monitored and controlled at the 14- to 16-bit level for many years. Because they work on transformer principles, the resolver and synchro transducers are highly accurate devices. And because these transformer principles can be incorporated in the design of digital-to-resolver (d-r) and digital-to-synchro (d-s) converters, conversion accuracy can be made to depend upon the

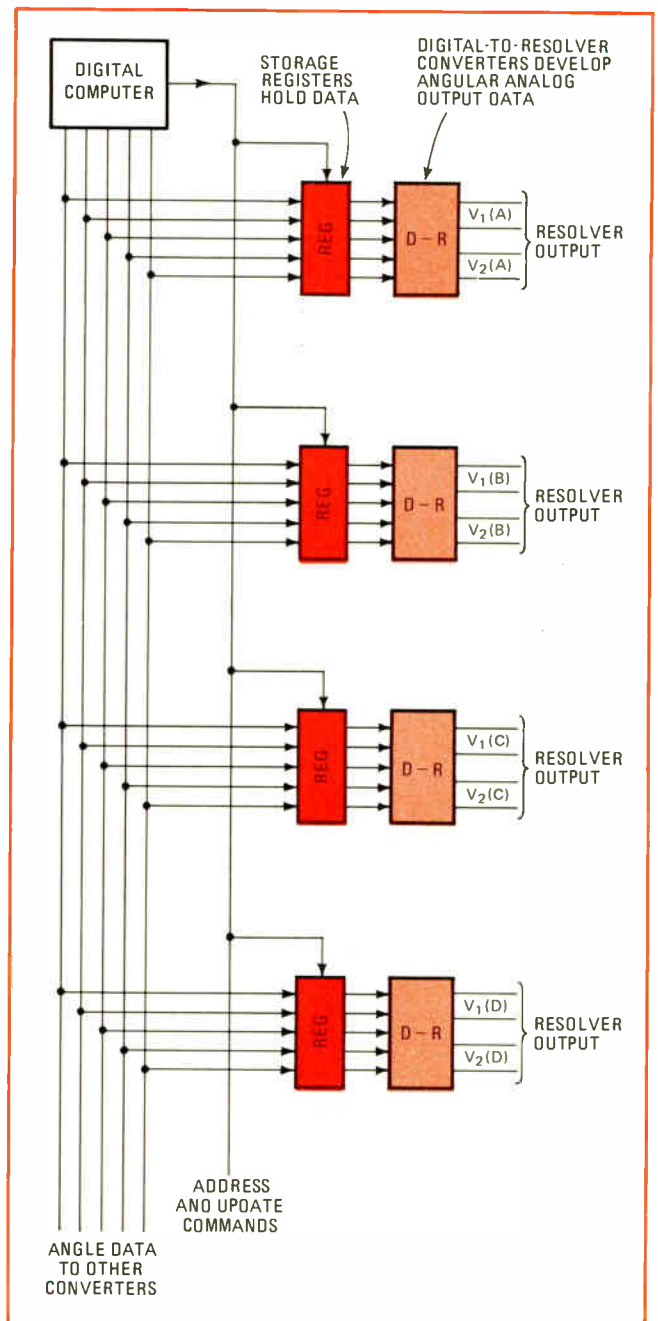

1. **Expensive.** Multiplexed array of precision digital-to-resolver (d-r) converters can be very costly at accuracies beyond about 12 bits.

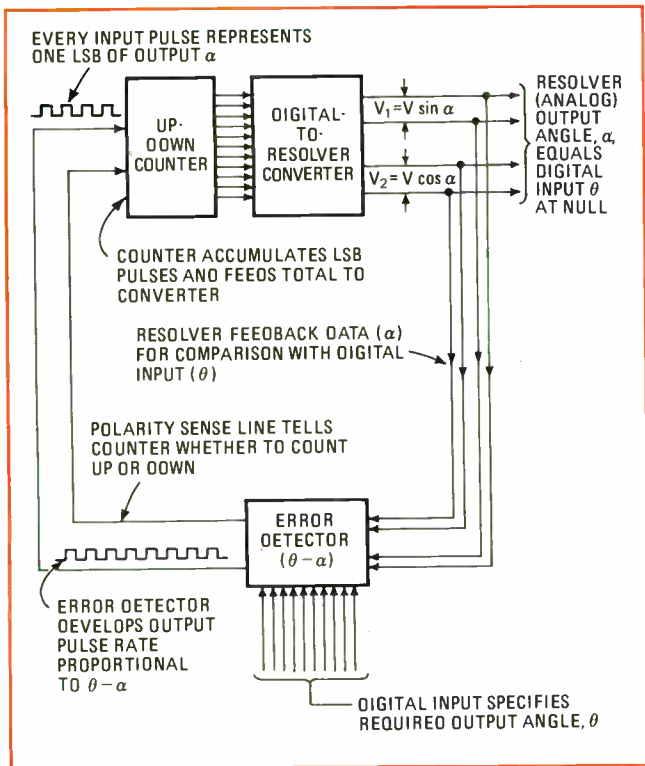

2. High accuracy from low. Precision error detector in feedback loop provides high performance from inexpensive converter. Scheme becomes really economical when many converters share one error detector (see Fig. 3).

stability of a transformer turns ratio (which is immune to temperature, aging, and so on), instead of upon the stability of resistor networks, reference sources, and other much weaker links.

Unfortunately, a precision transformer divider is much more costly than its resistance-divider counterpart, so d-s and d-r converters with accuracies beyond about 12 bits also cost more than comparable 12-bit digital-to-voltage converters. Accordingly, the multi-

plexed array of d-r converters illustrated in Fig. 1 can be quite expensive.

How can this cost be cut down? An effective method is to substitute an array of low-accuracy, low-cost d-r converters for the expensive ones shown in Fig. 1, and then increase their effective accuracy by allowing them to time-share a precision error-correcting feedback loop. Besides permitting low-cost d-r converters to be operated at high accuracy in multi-channel installations, this approach automatically takes output loading into account, ensuring that high accuracy is maintained regardless of load variations.

Null out the error

In this feedback control system, the digital information specifying a desired output angle, θ , is fed into an error detector, which compares it with the actual output angle, α , of the d-r converter. Any difference between these angles causes the error detector to change the input to the converter until the error is nulled. To understand the details of this system's operation, consider the block diagram of Fig. 2, in which only one converter is included for simplicity's sake.

Assume that the d-r converter has been set initially at 40° (because of a 40° count held in the up-down counter), and that the digital computer has commanded it to reset to 42° . The new data is fed to the error detector, which looks for a difference between it and the actual d-r output. The net result of the 2° difference is a rapid train of output pulses from the error detector, which causes the up-down counter to readjust the accumulated angular total of least-significant-bit counts towards 42° . The error detector design includes a polarity detector (for counter up-down sensing) and a voltage-to-frequency converter as the source of counter updating pulses, so that the clock rate drops as the final 42° count is accumulated and the converter output approaches the desired angle. This prevents instabilities in the error-correcting loop.

In this system the accuracy of the resolver output

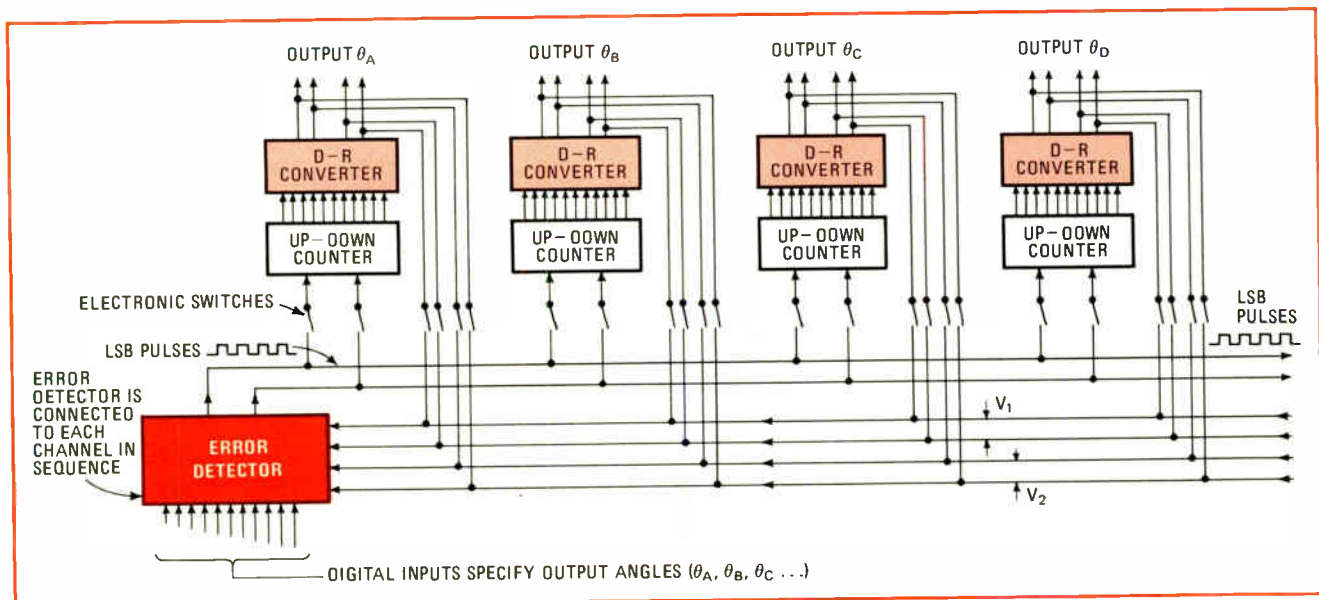

3. Economical. High-resolution, low-accuracy digital-to-resolver (or synchro) converters used in the feedback scheme cost about one third as much as the high-accuracy transducers employed in the open-loop system illustrated in Fig. 1.

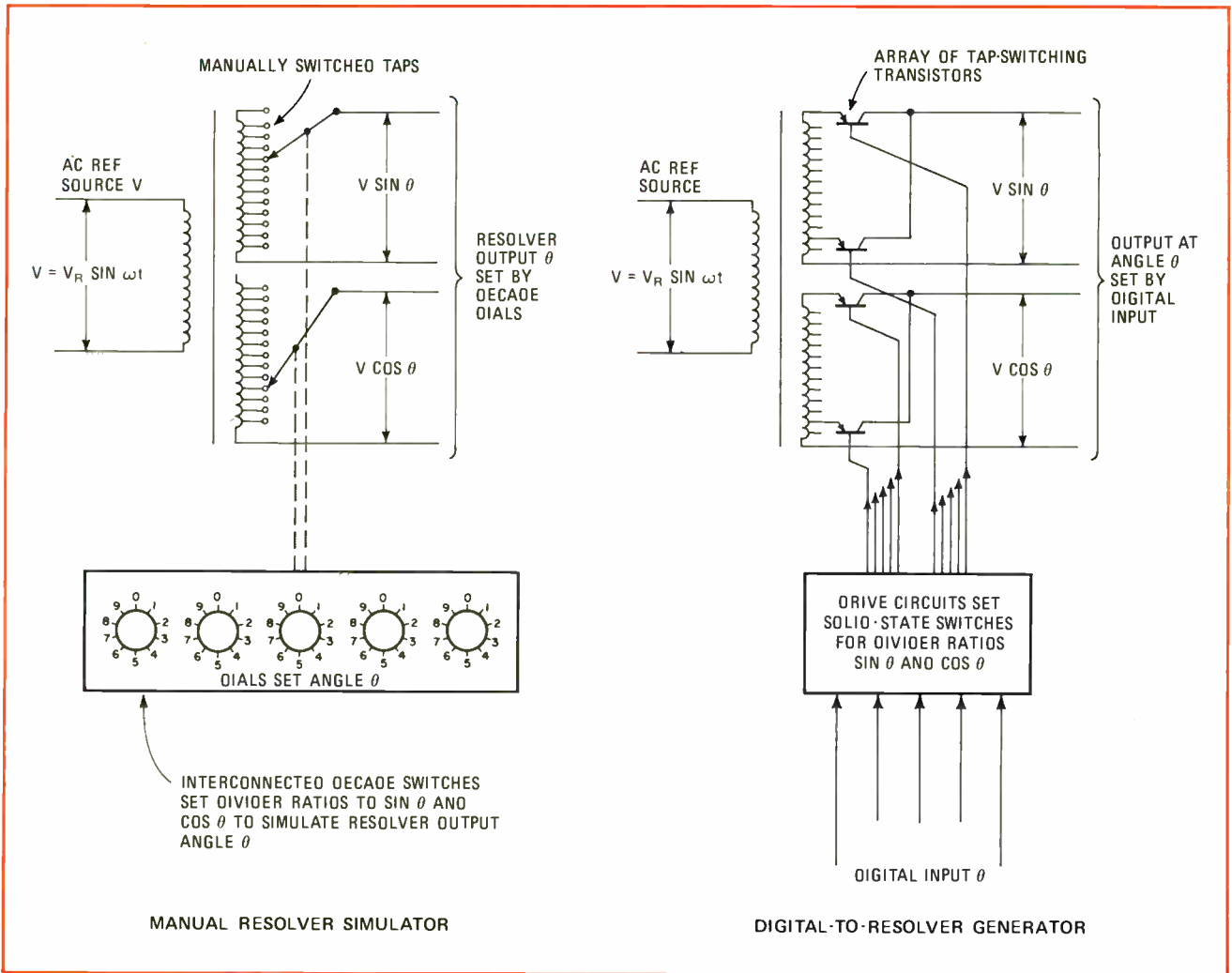

4. How the converter works. Digital-to-resolver converter is simply an automated version of a manual resolver simulator. In both cases, four-wire resolver-type output format is produced by selecting transformer taps instead of rotating a shaft.

data depends upon the accuracy of the error detector, rather than the d-r converter's accuracy. Thus, inexpensive converters can be used to build a highly accurate system. The only important requirements for the converters are that their outputs be strictly monotonic functions of their inputs, and that they have sufficient resolution to be set accurately to the desired angle.

The cost savings implied by these requirements are substantial. A d-r converter with 16 bits of resolution and commensurate accuracy might cost about \$3,000, including power supplies. A comparable unit with 16 bits of resolution and only 12- or 14-bit accuracy might cost about \$1,000. The point is that accuracy gets very expensive beyond a certain point, whereas resolution can be added at little extra cost. (Note that the validity of this point depends on the assumption that monotonicity is readily achieved in the converter design. Thus, while it is clearly applicable to transformer-type d-r and d-s converters, it does not necessarily apply to d-a and a-d converters.)

Multiplexing the loop

The complete low-cost multiplexed system is illustrated in Fig. 3. The digital inputs include both address (not shown) and angle data for each channel. The error

detector is connected in sequence to each converter in turn by an array of electronic switches controlled by the address inputs. Simultaneously with each fresh connection, the digital input to the error detector is updated in accordance with the desired output for that particular channel.

Once a given d-r converter has been updated to a particular angle, the error detector is switched to the next converter, wrapping its loop around the converter and monitoring the updating process until the up-down counter register receives whatever total of least-significant-bit pulses is required to set the output to the desired new angle. Once a null is reached—that is, the output angle coincides with input angle—the error detector signals the computer to connect it to the next channel.

Inside the converter

One way to look at a d-r converter is as a device that simulates a resolver's electrical behavior but not its mechanical behavior. That is, it produces not shaft angles but resolver-format outputs in response to digital commands. Since a resolver is a transformer whose primary-secondary couplings are modified by shaft ratio in sine and cosine fashion, it is simple, at least in principle, to build a non-automatic resolver simulator out of a pair

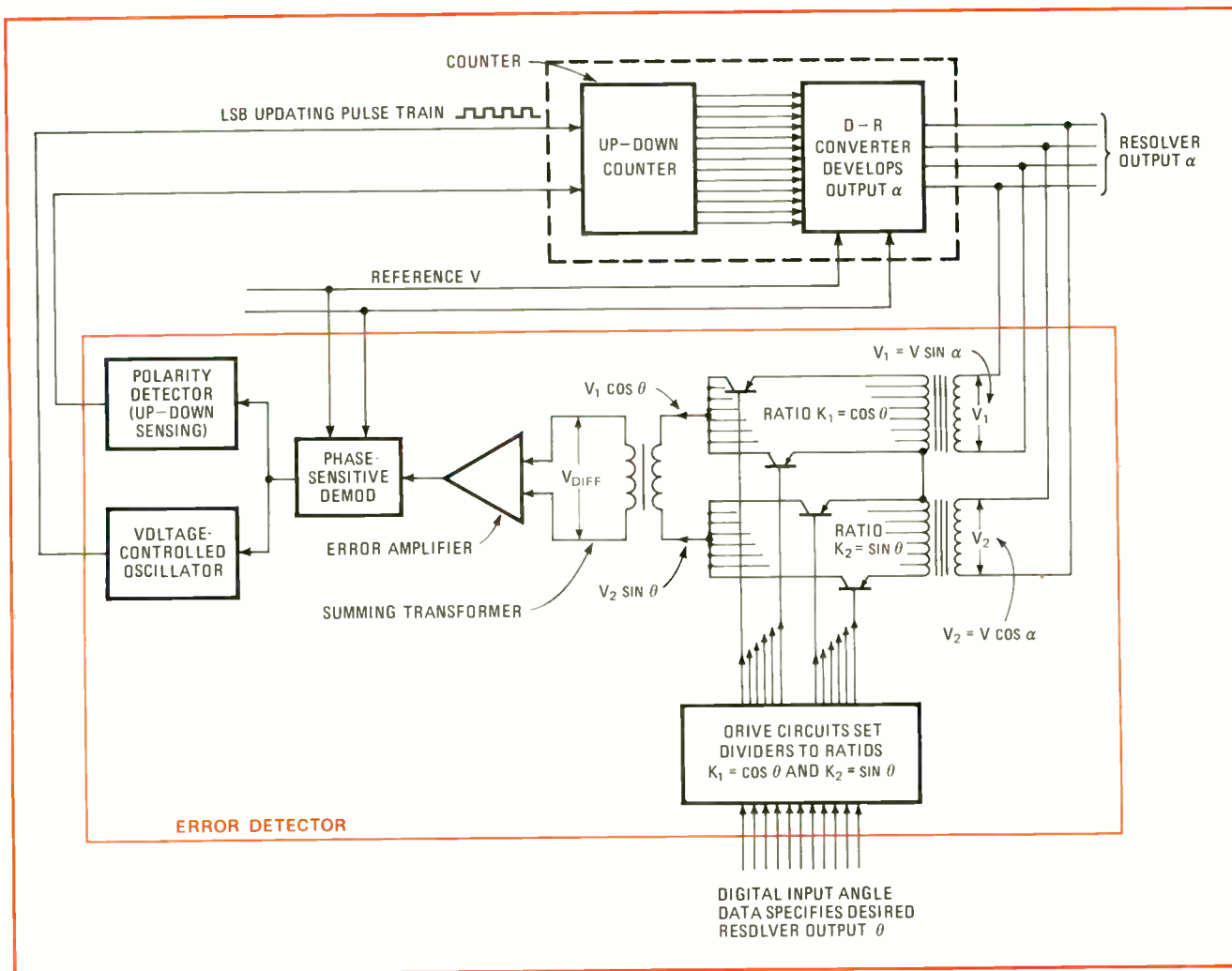

5. Inside the error detector. Heart of the detector is a resolver-to-digital converter which, operating in conjunction with the error amplifier, finds the difference between a digital signal and an analog signal in one easy step.

of manually switched transformer dividers. (Transformers are used both for high accuracy and for the low output impedance that is required.) As Fig. 4 shows, the dividers have taps that are adjusted according to the sine and cosine of the angle set up on the decade dials.

A d-r converter is an automated version of the manual resolver simulator, with solid-state switching circuits replacing the ganged mechanical switches. The d-r converter usually includes logic circuits that translate digital computer commands into the drive voltage that will operate the digitally selected transistor switches. Once more, the use of transformers instead of resistor networks maximizes accuracy and stability, while providing very low output impedance.

How the error detector works

Fortunately, it is not hard to develop a pulse rate proportional to the difference between a digitally specified angle and its analog counterpart in a four-wire resolver format. The circuitry is quite straightforward, being a rearrangement of the circuitry in a conventional r/s-d converter. The converter is built around a d-r/s unit to which an error amplifier, a phase-sensitive demodulator, and a voltage-controlled oscillator are added.

The closed-loop arrangement is shown in some detail

in Fig. 5 with the converter circuitry rearranged for the error-detection function. Resolver output from the multiplexed d-r converter feeds into the error detector's digitally switched dividers in which the digital input data establishes ratios $K_1 = \cos \theta$ and $K_2 = \sin \theta$. Since input resolver data is itself in the form of variable amplitude carrier voltages, $V_1 = V \sin \alpha$ and $V_2 = V \cos \alpha$, the output from the two dividers becomes $V \sin \alpha \cos \theta$ and $V \cos \alpha \sin \theta$. The summing transformer presents the difference between these values— $\frac{1}{2} V \sin (\theta - \alpha)$ —to the error amplifier. The amplifier's demodulated output then feeds the voltage-controlled oscillator which develops a clock pulse rate proportional to the difference between θ and α . The polarity of the demodulated output determines whether the counter should count up or down.

The result of all of this is a train of pulses that changes the accumulated count in the up-down counter, in least-significant-bit increments, causing the converter's output to home in on the digitally specified value.

Since the technology already exists for both low-cost but high-resolution d-r converters and for the angular error detector, this new arrangement affords appreciable cost savings in high-accuracy, multi-channel interfacing systems. □

EES are finding jobs again, but their choices are limited

Companies are gradually increasing their engineering staffs again, but they are shopping carefully; opportunities in non-traditional industries increase as more companies adopt electronics techniques

by Gerald M. Walker, *Consumer Editor*

□ The employment outlook for electrical engineers, which now appears to be better than it was only three months ago, is beginning to reflect changes more basic to EE careers than mere sales ups and downs. Today, there is evidence across the country that technical jobs are coming back—though this increase in hiring is by no means a boom.

Several of these new opportunities have been created by the development of new products. New markets, in turn, have created jobs outside of electronics industries—while opportunities in R&D have been limited severely. Because openings are poorly distributed, many EEs have migrated to other occupations, frequently suffering under-employment in the process.

Colleges have experienced fewer recruiting visits, but are placing more EEs at higher salaries than they did last year (Fig. 1). And the shrinking freshman classes have even raised the specter of a future shortage of EEs.

Despite these signs of change, a good deal of ambiguity persists among engineers concerning what to do about job security—stand pat and wait for a better day, or become activists (Fig. 2). A symptom of this feeling is the heavy vote in favor of having the IEEE take on career-related activities. While the IEEE membership's mandate would appear to have been a sign of militancy, it has actually a rather conservative gesture, compared to other alternatives. There has been no rush to organize a separate and perhaps tougher professional association than the tortoise-paced IEEE can provide.

Neither has there been a rush by engineers and scientists to join labor unions. On the whole, these professionals seem to be prepared to wait out the employment storm or shift job disciplines and, at the same time, take limited steps to head off future job crises.

What is "normal?"

The pattern of hiring is bearing out what some EEs were predicting more than a year ago: the engineer's career has been altered fundamentally by the economic downturn, in part because industry has changed the employment ground rules. Gone are the days of loading up engineering staffs at the drop of a new product. The hiring pace is now cautious—perhaps a sign of a maturing industry. So, while most members of the engineering fraternity two years ago were fretting about a return to the "normal" days of the mid-1960s, close observers now feel that today is normal, and the '60s were abnor-

mal; that is, the "gypsy" engineer is a relic of the past.

"The picture is not as bleak as we had thought. Placement officials have tended to think of the inflated opportunities of the '60s as normal. But maybe today is more nearly normal," comments Richard Stewart, director of the Purdue University Placement Service. "Placement is not as bad for engineers as for liberal arts graduates; however, when recruiting drops for engineers, it's news, so we lose perspective."

Other placement officials echo this thought, though the statistics to back up their observations have not been completed. Ms. Steinun Kroman, UCLA's director of engineering and science placement, for instance, feels that the trend is upward, even in the aerospace firms, and that EEs appear to be in better shape for jobs than other engineers.

And the trends at work in the industry have also affected engineering schools. The most direct impact has been a decline in engineering enrollments. The supply-and-demand imbalance, which has become commonplace in electronics, appears to be widening again as jobs pick up and university enrollments dip. This situation implies an engineer shortage within four years.

The Fall Enrollments Survey conducted by the Engineering Manpower Commission of the Engineers Joint Council has reported a 7.6% decline below the 1970 level in full-time EE bachelor candidates—led by a whopping 18% drop in the freshman class [*Electronics*, Feb. 28, p.42].

Dr. Joseph Rowe, of the University of Michigan Engineering School, speaks for many of his academic colleagues when he predicts that there will be a shortage of engineers in the 1975–1980 period. However, the solution to the periodic oscillations in the engineering population still remains beyond the control of the engineering schools, he adds.

The new hiring pattern is reflected in university placement. Most schools report fewer recruiting visits, but more jobs in the callers' brief cases. For example, Purdue University reports the number of companies recruiting dropped in the 1971–1972 season to 450 from 560 last year.

There was less shopping and more hiring this year, reports Purdue's Stewart. Purdue graduates 170 BSEEs this month, and 190 companies made recruiting calls specifically for EEs. The choice of jobs is better than these numbers indicate because well over half of the

bachelor-degree graduates will either go on for post-graduate work or go into the armed forces.

At Stanford University, William Whitsett, assistant director of career planning and placement, notes that demand for communications and microwave circuit design is "a little stronger." EEs interested in MOS ICs also have good opportunities, but in computers and instruments "there is not too much around," he adds.

While he has not collected the numbers yet, Alvah K. Borman, assistant dean of cooperative education and director of graduate placement at Northeastern University in Boston, says, "Things seem to be improving. It's a little better than last year, but nowhere near 1969." He points out that recruiters are looking for new graduates that can go into the plant. However, R&D hasn't picked up. "In general, people are looking for plant, sales, and applications engineers." Northeastern expects this year to graduate about 190 in electronics and 29 in power systems.

Hiring increases

More companies are beginning to beef up their engineering staffs, though the increases are not uniform. Superspecialists continue to have difficulty finding jobs, while engineers flexible in their career goals are getting a choice. This trend is particularly apparent in the June graduates—those with relatively open-ended objectives are receiving three or four offers in many cases; some of those with narrowly defined aims have been graduated without accepting jobs.

However, Ikor Inc., Burlington, Mass., is having trouble finding engineers with experience in high-power

Keeping up with inflation

Professional engineers received earnings increases during the past two years amounting to 11%, according to the latest *Professional Engineers Income and Salary Survey*, conducted by the National Society of Professional Engineers. Median income of the NSPE members polled for 1971 was \$18,210. The salary increase corresponds to the increase in the cost of living for the same period.

Other survey findings:

- 90% earned at least \$12,590 last year.
- 10% earned at least \$29,830 in 1971.
- Median earnings for self-employed engineers was \$26,100, \$17,630 for salaried employees.
- Engineers in the East earned more than those in other regions.
- Engineers in the Midwest earned the least.
- Those working for the Federal Government and for public utilities showed the highest gains during the two-year period.

Copies of the full report, *Professional Engineers Income and Salary Survey*, cost \$7 (\$3.50 for NSPE members) from NSPE Headquarters, 2029 K St., N.W., Washington, D.C. 20006.

microwave technology. The firm, which wants to hire four to eight new people, has extended its search to California to fill this quota.

While most firms have reported gradual increases in personnel, National Semiconductor Corp., Santa Clara, Calif., is adding professionals at a furious pace—approx-

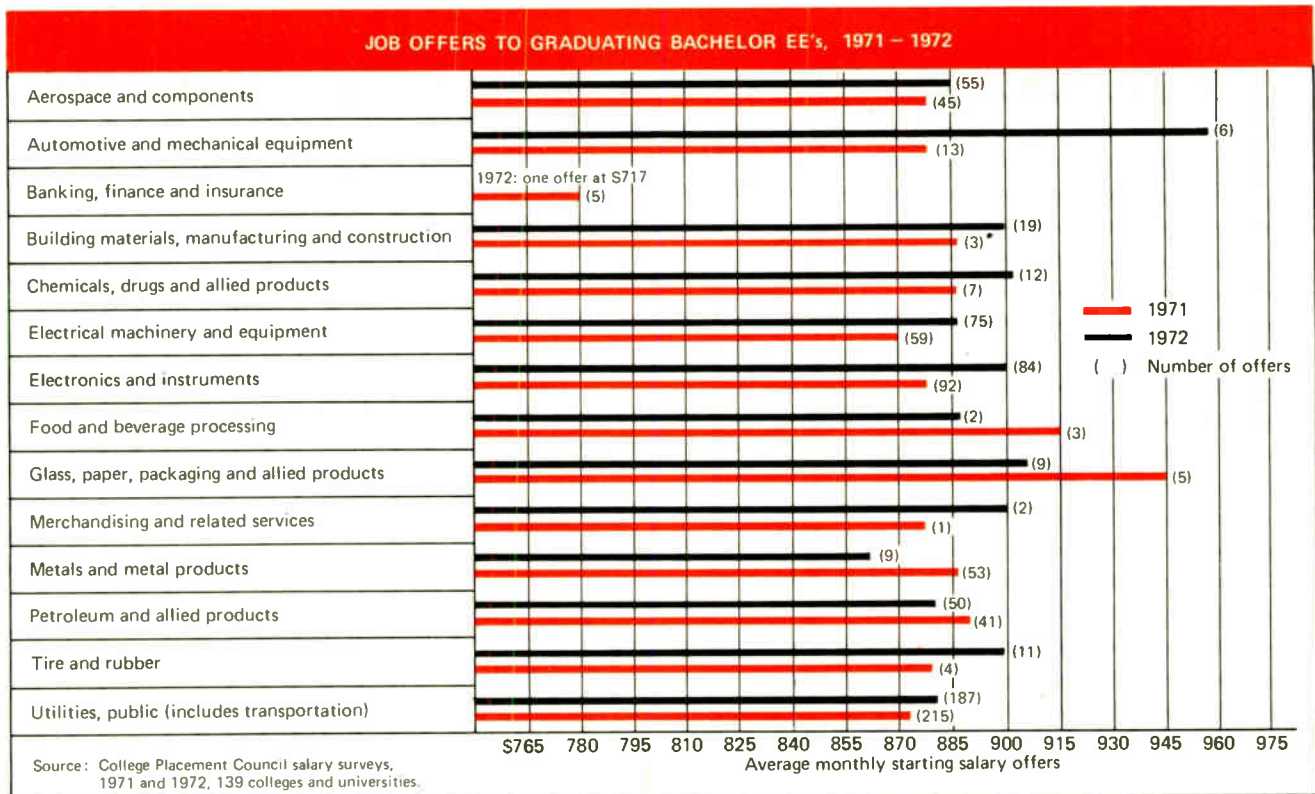

1. Where the jobs are. This comparison of job offers to EEs by industry and salary for 1971 and 1972 was developed from a survey of 139 representative colleges and universities conducted by the College Placement Council, Bethlehem, Pa. The complete report, *Men's Salary Survey*, covers all types of engineers, plus masters' offers. The graph above also shows the number of offers to EEs at the 139 schools.

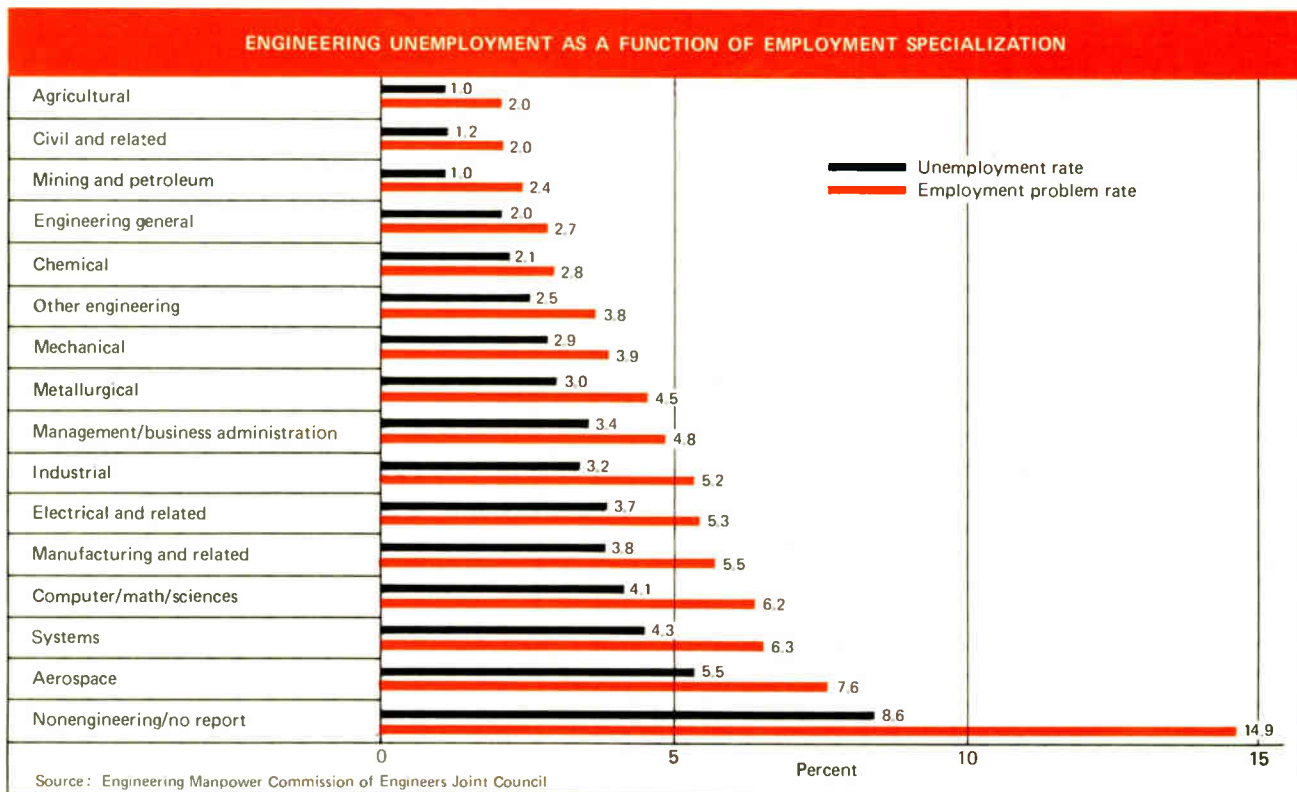

2. Not good, not bad. Electrical engineers were neither the worst nor the best off in employment during 1970, as this graph from the Engineers Joint Council indicates. "Employment problems rate" is defined as engineers working at jobs not related to engineering.

imately 20 a month, most of them EEs. "People are being hired at beginning levels all the way through the intermediate levels," says National's personnel director Joseph Malone. Forty new college graduates will be added in June, about 75% with technical degrees.

Another San Francisco area firm, Philco-Ford Corp., Palo Alto, plans to hire 25 new engineering graduates this June, including 15 EEs. This number is below that of 1967 and 1968, but up slightly from last year. Philco-Ford is bringing in EEs interested in rf, microwave, and analog and digital circuit design.

Employment has improved in Southern California, too. Donald McRell, industrial relations manager for the Electronics Systems division of TRW Inc., Redondo Beach, Calif., comments, "We're no longer short of work—we're short of people." Last year the picture was completely negative, with layoffs the rule. But this year, the TRW division expects a total of 150 engineers to be hired. "We're under pressure to get people in here in a hurry," McRell reveals.

The biggest requirement is in communications, mainly for less experienced and intermediate engineers. The impetus for this flurry of hiring is the winning by TRW of a number of new Government contracts. Reminiscent of the old roller coaster hiring pattern, McRell is attempting to rehire engineers that had been laid off previously. "We've had good experience with people who've left us coming back. A large number were quick to come back," he says.

In the Boston area, General Radio Co. predicts that hiring this year will be increased to near the boom levels of 1968 and 1969. Sprague Electric Co., North Adams, Mass., on the other hand, is doing no hiring

during its struggle to get back into the black in sales.

Digital Equipment Corp., Maynard, Mass., falls between these two with a moderate amount of hiring. DEC manager of personnel administration and planning, Gradon A. Thayer, says that it's more difficult now to find good engineers, but the Northeast has not pulled out of the job slump completely.

New products hold key

It's clear now that increases in sales do not automatically trigger job openings for engineers. New technology and new products create the jobs. It's also clear that even when new products are in the works, companies are more cautious in staffing engineers to bring the product to market than they were in the mid-1960s. "Close to the vest" is the name of the game.

During the lean period of Government spending, Ikor, for instance, undertook in-house R&D which has now paid off in new products and new jobs. Says Joseph Proud, vice president of research, "We had to be practical, not philanthropic. But the practical motives led us to keep the highly qualified engineers and suffer the salary burden until it paid off. Everyone tries harder during the dry period to make things work."

Another example of how new products create new jobs is RCA's Consumer Electronics division, Indianapolis, Ind. Most consumer electronics companies have had vigorous sales, yet for the most part, not much increase in engineering staffs. At RCA, however, development of a new magnetic video-tape-recording system for home use has reached the point at which more engineers are required to get the product into production and on the market. Since last January, RCA has hired

about 12 engineers with three to five years of experience and will probably add a few more.

In effect, the consumer group has created a fourth support staff within engineering, thanks to the development of the new home VTR. As a consequence, total engineering personnel in the division, which is divided into color TV, black-and-white TV, audio, and VTR groups, is again equal to the numbers employed in 1968-1969.

General Electric Co. expects to hire about as many new graduates this year as last. The makeup of the hiring is a good indication of where the new-product action has been, for in 1971, the giant manufacturer added 330 engineers—20% for the industrial group; 35% for the generators and power group; 10% for consumer; and 5% each for aircraft, components and materials, and major appliances.

EES migrate

Finally, the crossover of EEs into other non-traditional jobs, noticeable at the beginning of this decade, has become an established trend. Demand for EEs has followed the greater use of electronics in processing plants, hospitals, textile mills, and other non-electronic enterprises. The College Placement Council found that at 139 selected schools, offers to bachelor-degree EEs as of March 1971 numbered 196 for aerospace, electrical, and electronics firms, and 444 were from non-traditional employers such as automotive, chemical, construction, metals, and petroleum companies.

This year in March, the Council reported 214 BSEE offers from the traditional sources and 308 from industries off the usual track. These figures do not include hiring by various public agencies nor medical institutions. Nevertheless, outside electronics employers continue to dominate the job market. UCLA's Ms. Kroman reports that activity—still down from the high level of previous years—has picked up for EEs in utilities.

Northeastern's Borman also observes that companies not involved in electronics and aerospace are becoming increasingly important employers of EEs. Concurring, an official of another East Coast engineering school remarks, "In most cases, these non-traditional firms want engineers more interested in making things work than in design. They are also interested in engineers who can interface between non-technical people."

Medical electronics calls

This is certainly the case in medical electronics. A gradually increasing number of electrical engineers who want to apply their technical skills to helping people or who prefer not to enter industry are choosing bioengineering. Several universities have set up some form of engineering-medical education. Lately, emphasis has been on working directly in hospital patient care with physicians, rather than doing research projects in laboratories, although it was through the research projects that many EEs found their openings on hospital staffs.

While a certain amount of idealism helps propel engineers into medical work, it's a rigorous—often discouraging—way to make a living. The pay is no attraction, since most hospital administrators still conceive of engineers as technicians, rather than professionals. Medical

staffs have also been slow to admit the need for trained engineers to recommend, evaluate, and maintain the increasingly complex equipment now in clinical use.

But as one leading observer in this field has stated, the medical profession has only dipped its toe into electronics—demand for more engineers is bound to follow. Says Seymour Ben-Zvi, director of the Scientific and Medical Instrumentation Center for Downstate Medical Center in New York, "To be realistic, medicine is in the infant stage—actually the neo-natal state—in technology. There are inescapable frustrations for engineering in dealing with doctors and with equipment manufacturers. Once rapport is established, there is satisfaction in seeing things work, in being of service."

Starting from scratch in 1961, Downstate now has five full-time engineers on the staff, and for a hospital, that's rapid action. Massachusetts General Hospital in Boston employs 11 EEs, not counting those in its Laboratory for Computer Science, which has 15 program analysts, three operators, and four engineers. And EE employment is increasing at the hospital. A spokesman points out, "For many of these people, design work that improves equipment performance by 10% to 20% is not thrilling, but the applications are a lot more interesting. They derive pleasure from seeing people being helped." Massachusetts General has EEs working on pacemakers, cardiac monitors and related sensors, and advanced projects involving nuclear instrumentation.

Engineers faring better overseas

The job crisis that has gripped U.S. engineers apparently has not occurred elsewhere in quite the same way. Observers in France, England, West Germany, and Japan report that employment has remained steady, de-

Looking for work

There are a few publications that engineers may find helpful in seeking employment. These include:

- *College Placement Annual*. This is a directory of positions customarily made available to college graduates by principal employers. It is available through college placement offices and libraries.

- *Index of Opportunities for Engineers*. This is an encyclopedia of engineering employers, published by Resource Publications Inc., Hightstown Rd., Princeton Junction, N.J. 08550, and comes in 10 volumes, arranged by region, at \$2.00 each or \$9.95 for the set.

- *Technical Career Index*. A manual by James L. Lubin, professor at the Newark College of Engineering, this index gives information on 450 companies as of 1969. It costs \$5.00 from Padric Publishing Co., Box 393, Bernardsville, N.J. 07924.

- *Job Hunting Guide and Employment Source Directory*. These two directories list executive search consultants, newspapers, and employment agencies. The price of each volume is \$3.50, or the two are \$5.95. Order from the Employment Management Assn., P.O. Box 385, Weston, Mass. 02193.

Though not in the placement business as such, the Engineers Joint Council, 345 E. 47th St., New York City, has published numerous surveys on employment. An order bulletin is available from the council.

spite economic ups and downs. In general, the comparatively small impact that defense and aerospace spending has on the electronics industries of these countries has made the difference in damping large fluctuations in hiring and firing.

In France, for example, "there's under-employment, and there's bad employment, but there's no great problem of unemployment," says Maurice Ponte, president of the country's Electrical-Electronic Engineering Professional Society, and one of Europe's leading engineers. At the Ministry of Labor, figures for 1971 indicated that on a monthly average, 5.4% of unemployed EEs seeking jobs did not find them; however, there's no indication in these figures how many took jobs that make only marginal use of their engineering training. "A lot of young engineers have trouble finding the right kind of job," Ponte points out.

There is a problem among the older engineers that the government has taken steps to change. Since late last year, employers have had a payroll tax of 0.8% to help finance a retraining program for managers and workers whose skills are obsolete. About 1,500 engineers a year take "recycling" courses in electronics and computer techniques at the Ecole Supérieure d'Electricités, the University of Paris school of electrical and electronics engineering. Courses usually last two weeks and range from "introductory electronics" to "applications of computers in industrial processes."

Britons keep jobs

Across the Channel, British engineers are not suffering as much as blue-collar workers during the country's economic hard times. The most qualified engineers have remained employed, except when a development project has been curtailed, which is rare in England, or when a large operation has been closed down entirely, as happened with the termination of IC operations at GEC Semiconductors Ltd., Witham.

Older EEs unemployed in Great Britain, though small in number, have had difficulty, and many leave engineering as a result. Of the staff laid off at the GEC Semiconductors closing, two engineers have become school teachers, and another applied for more than 50 jobs before landing a position lower than the one he had left.

Young graduates, on the other hand, are moving easily into non-traditional activities, report career advisers.

"They've been conditioned not to expect too much these last two years," comments one university adviser. "New science graduates these days understand what only arts majors understood in the old days—that their university doesn't necessarily train them for jobs."

West Germany's engineers have also weathered an economic slump that caused layoffs of assembly workers. "What firms have practiced," says an official of the association of German engineers in Düsseldorf, "can be termed a stock-piling policy—a policy whereby firms hold on to engineers during a bad period, even if it proves somewhat unprofitable." The reason is that it costs less to keep a qualified man when times are bad than to hire and train a new EE for the job when business picks up again.

Another indication of the stable job situation for engineers in Germany is that the number of scientists and engineers going to the U.S. has dropped considerably—as much as 70% below the 1968 figure, government authorities report. Some engineers have even returned to Germany from America in the belief that the opportunities are improving faster in Europe than in the U.S.

Even in Japan, which has had a trying time since the so-called Nixon Shocks put the economy into a turmoil, engineers have not suffered. As a rule, Japanese companies do not lay off engineers when there's a downturn. Larger companies may cut back in the number of graduating engineers recruited, but this merely means that small or less-attractive companies that have a hard time interesting engineers during boom times have a better chance of hiring people.

Japanese engineers probably have more job security than either U.S. or European EEs, but their system may not always work favorably. Though the axe rarely falls, when it does, a laid-off Japanese engineer is in a precarious position because there is much less job mobility in Japan. By the same token, job-hopping is frowned upon and may cause hard feelings on all sides. Therefore, engineers often leave their initial places of employment to engage in special studies at a university or find some other excuse to spend several months on some neutral ground before moving to a new employer. □

Unemployed, underemployed, over-employed: Where have you been? Where are you going?

Seldom has the career picture for EEs been as muddled as it has been in the last few years. From a period of high employment, rising salaries, and peak status, EEs now find themselves in a topsy-turvy world.

To get a handle on what has happened and is happening along the job front, we've prepared the questionnaire (p. 103) for you to report your employment status and level of job satisfaction. There is also room for your written comments. Deadline for returns is July 10, 1972. Soon thereafter, the editors of *Electronics* will analyze your reports and present results in an article so that readers can compare their employment—or unemployment—situations. Identities of respondents

will be kept strictly confidential.

To submit your questionnaire, clip this form, fill in your replies, and mail before July 10 to:

Editor, Code J
Electronics
1221 Ave. of the Americas
New York, N. Y. 10020

Note that the questionnaire is divided into two sections—one for those currently employed and one for those unemployed. Questions concerning both groups precede and follow the special group sections.

Job status questionnaire _____

1. Are you presently employed? _____ or unemployed? _____

(If employed, continue with questions 2 through 12.)

(If unemployed, skip to questions 13 through 20.)

2. How long have you been at your present position? Years _____

3. What's your salary now? \$8,000 to \$10,999 _____
\$11,000 to \$13,999 _____, \$14,000 to \$16,999 _____
\$17,000 to \$19,999 _____, \$20,000 to \$24,000 _____
\$25,000 to \$29,999 _____, \$30,000 or above _____

4. Did you get a pay increase since the end of the wage-price freeze? Yes _____ No _____ If so, what percentage? _____

5. Were there personnel cutbacks in your department in 1971? Yes _____ No _____ In 1972? Yes _____ No _____ If so, have you been forced to work longer hours to make up for reduced personnel? Yes _____ No _____

6. Are you satisfied with your position? Completely satisfied _____, Moderately satisfied _____, Moderately dissatisfied _____, Completely dissatisfied _____

Comment: _____

7. Do you feel underemployed in your present position? Yes _____ No _____

Reasons: _____

8. What would you prefer to be doing professionally? _____

9. Though an employed engineer, have you been laid off or transferred in a consolidation at any time during the last two years? Laid off _____ Transferred _____

10. Did you change jobs of your own accord during the last two years? Yes _____ No _____

Reasons: _____

11. If laid off, how long did it take to find another position? 1-3 months _____, 4-6 months _____, 7-9 months _____, 10-12 months _____, over a year _____

12. If laid off and rehired:

How was your salary affected?

Higher _____ Lower _____ Same _____

How was your level of responsibility affected?

Higher _____ Lower _____ Same _____

Compared to your last job, how is your current technical assignment, the same _____ related _____ completely different _____

(Please skip to question 21.)

13. If unemployed, how long have you been out of work? 1-3 months _____, 4-6 months _____, 7-9 months _____, 9-12 months _____, over a year _____

14. How many job interviews have you had since being laid off? Number _____

15. Are you willing to relocate? Yes _____ No _____

16. Have you sought employment in non-electronic industries? Yes _____ No _____ If so, what types of companies? _____

17. Have you sought employment outside engineering? Yes _____ No _____ If so, what other job types? _____

18. Have you taken non-engineering graduate courses in order to convert to another type of profession? Yes _____ No _____ If so, what courses? _____

19. Have you done part-time or free-lance projects while unemployed? Yes _____ No _____

20. Has your attitude toward technology and the engineering career changed as a result of being unemployed? Yes _____ No _____

Comment: _____

For both employed and unemployed engineers:

21. Do you feel that the engineer has been treated fairly during the downturn in the economy and the cut-back in Government spending? Yes _____ No _____ No opinion _____

Comment: _____

22. Are efforts by state and national agencies to find jobs for unemployed engineers adequate? Yes _____ No _____ No opinion _____

Comment: _____

Title and function _____

Highest degree _____ Age _____

Total years in engineering _____

Your company's (or former company's) main products _____

City _____ State _____

(To be counted, returns must be received by July 10.)

SPECIAL REPORT

Active filters get more of the action

Built around the new, better, cheaper IC op amps, active filters are beginning to move in on passive filters; their advantages include flat passbands with sharp corners, inherent isolation, and easy tuning

by Lucinda Mattera, *Circuit Design Editor*

□ For all practical purposes, an active filter is just an RC network tacked on to an operational amplifier—or amplifiers—and its price and performance depend essentially on those of the op amp. Recently IC op amps have improved so much on both counts that active filters have started challenging passive filters at the lower end of the frequency spectrum. In fact, the very lowest end is by now all theirs.

A great many are being built in-house. They are relatively straightforward to design, because they can be easily handled in mathematical terms and lend themselves to computer-aided design. But with the manufacturers of active filters busily cutting prices and introducing standard products that can be customized by the buyer, the make-or-buy decision is becoming more difficult than it was a year ago.

Presently, communications applications in telephone equipment and various military programs are making heaviest use of active filters. They are also being exploited in some areas of data acquisition, notably telemetry, medical research, oceanography and the monitoring of geophysical phenomena. But much larger and practically untapped markets exist in process control, data acquisition, computer terminals, and modems. Other potential markets include pager systems, petrochemistry, and instrumentation.

From this listing, it's clear that active filters perform the same functions as passive filters, providing either low-pass, high-pass, bandpass or band-reject (notch) outputs. Their response characteristics are also identical, since they can realize a Butterworth, Chebyshev, Bessel, Gaussian or Cauer (elliptic) response. As a result, deciding which type of filter will do the better job boils down to the traditional design tradeoff between cost and performance.

Two frequency breakpoints—100 hertz and 20 kilohertz—can be used as soft guidelines for the decision. Active filters should be considered only if they are to operate at very low frequencies or in the audio region—say, from 0.001 Hz to 20 kHz. Above 20 kHz, the passive filter costs less than the active and provides comparable or better performance. Below 100 Hz, passive performance is quite sloppy, so that the active filter is the more practical choice almost regardless of cost. From 100 Hz to 20 kHz, however, the active filter's cost does not really

change, while the passive filter's steadily drops, making the performance the deciding factor in this region.

Over the audio range and below, the active filter has a flat constant-amplitude passband and sharp corner frequencies. Moreover, even when operating at frequencies below 10 Hz, it provides reasonably high values of Q, allowing good selectivity to be obtained. In contrast, the vlf passive filter requires very high inductance values so that the inductors are physically large and cannot provide the Q needed for good selectivity.

Above 20 kHz, the op amp is the limiting factor. Its gain-bandwidth product determines the highest frequencies at which the filter can work. The output power level of most low-cost general-purpose IC op amps begins to roll off at about 20 kHz, attenuating the filter output voltage. But op amps with gain-bandwidth products large enough to sustain filter operation above 20 kHz are expensive, costing \$5–\$10 instead of \$1.

Comparing active and passive

In general, it's the component parts of the active filter that contribute most to its cost—the IC op amps cost nearly a dollar each, whereas resistors and capacitors get only a few cents apiece. With the passive filter, on the other hand, the design time needed to produce desired performance is the expensive element.

This can be inferred from a comparison of active versus passive performance:

- The behavior of practical inductors is very nonlinear at low frequencies, especially with respect to temperature coefficient. But because even low-cost general-purpose op amps offer dependable temperature performance, the active filter can achieve a corner frequency as tight as 100 parts per million per °C without too much difficulty.
- Obtaining a frequency accuracy within only 5% can be troublesome with the passive filter, but is easy with the active.
- Getting sharp corner frequencies, which are inherent in the active filter, requires many inductors and capacitors in the passive-filter. This makes the passive bigger than the active for the same skirt selectivity.
- The active filter can supply a controlled gain over its entire operating frequency range. The passive filter always attenuates a signal.

- Additionally, the active filter is easily tuned to the desired operating frequency with a resistor, while the passive must be tuned with an inductor and/or capacitor.

- Impedance matching at either the active filter's input or its output is unnecessary because its op amp provides it with inherent isolation in the form of a high input impedance and a low output impedance. For the passive filter, impedance matching can prolong design time inordinately, and proper termination may even involve active devices (an emitter-follower or an op amp) at each end.

- Realizing higher-order filter functions is a simple matter of cascading active-filter sections, each of which provides at least a second-order filter function. This is a marked improvement on implementing higher-order functions with the passive filter, which requires the addition of inductors and capacitors that make the design more complex and interaction problems more acute.

Mathematically, in fact, the active-filter section can be treated as a second-order transfer function that is synthesized as a pole pair rather than a low-pass or high-pass filter section. This makes the active filter easy to manipulate on paper or to design with the aid of a computer without special complicated programs.

Other cost considerations

Admittedly, the passive filter operates without being tied to a power supply, while the active cannot. Op-amp power supplies are common to so many applications, however, that the addition they make to the price is usually very reasonable.

And even so, there are situations in which active filters are more cost-effective than are passive. Several active filters, for instance, can fit on one printed-circuit board, while at least one board is usually needed for each passive filter. The cost of associated hardware like pc boards, connectors, and cables could be substantial enough to tip the balance toward active filters.

Moreover, active filters often help lower production costs. When housed in small IC-compatible packages they can save assembly time, and are adaptable to existing automatic production machinery, like insertion and wire-wrapping equipment.

Today's practical active filter is one that uses an active device to synthesize inductance. There are four basic types.

1. Non-inverting. Positive-feedback active filter (low-pass, in this case) maintains zero phase shift between input and output. This least-used filter circuit minimizes component count.

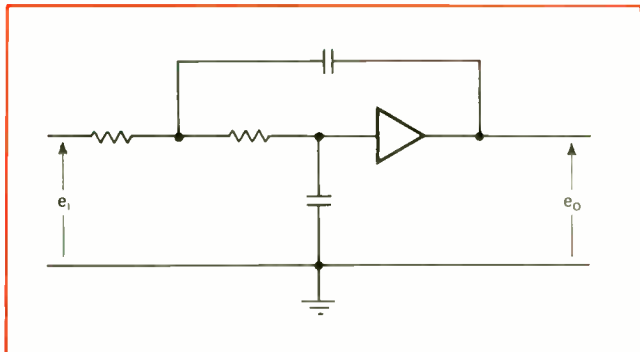

Data acquisition: promising

Although computer-controlled data acquisition systems are popular, only a few contain analog-to-digital converters that use filters to precondition incoming analog signals for improved data analysis accuracy. The filters that are used, however, are generally active, since much of the data being collected occurs at frequencies of 20 hertz or below.

Only rather specialized data gathering systems—for example, systems for special automobile testing, offshore drilling operations, and checking bridge construction—presently employ filters. For the most part, process control, where a good deal of data acquisition is done in the noisy environment of industrial machinery, remains a holdout against filtering.

Manufacturers selling data acquisition systems with prefiltering include: Digital Equipment Corp., Maynard, Mass.; Data General Corp., Southboro, Mass.; and Analogic Corp., Wakefield, Mass. Another company, Datel Systems Inc., Canton, Mass., will be introducing a prefiltered multiplexing system at the Wescon show.

The least used—the positive-feedback filter (Fig. 1)—is also the only one to employ a noninverting op amp. This filter, which is also known as the voltage-controlled voltage source, usually requires the fewest resistors and capacitors and is easily tunable over a wide frequency range. It is the only practical active filter circuit that offers zero phase shift without needing a second amplifier for signal inversion.

The other three circuits incorporate negative feedback, using the op amp in its inverting mode. For these, the output signal is out of phase with the input by 180°. Common names for the three are multiple-feedback, state-variable, and biquad active filters.

Negative-feedback filters

The multiple-feedback active filter (Fig. 2), which is the most widely used, consists of a single op amp and an associated RC network. As a bandpass filter, it offers constant-gain-and-bandwidth performance that does not change as the filter's center frequency is shifted. Two variations of this filter—the bridged-T and the twin-T active filters—have only one feedback path. But they are less popular than the multiple-feedback ver-

2. Most popular. Multiple-feedback filter has two or more negative-feedback paths. Here a bandpass function is realized. The shifting of center frequency does not affect filter's gain and bandwidth.

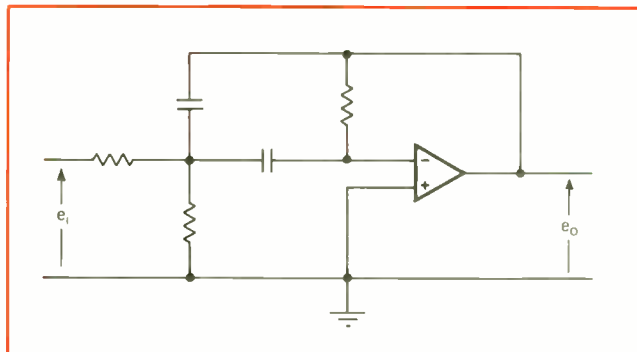

SPECIAL REPORT

sion, because they need more passive components and have higher output impedances.

Both the state-variable (Fig. 3) and biquad (Fig. 4) active filters realize a transfer function through the analog computing technique of integrating and summing. The former is based on general state-variable theory, while the latter is a modified state-variable filter that involves quadratic equations.

Simultaneous low-pass, high-pass, and bandpass outputs are available from the state-variable filter. The biquad filter provides simultaneous low-pass and bandpass functions, but requires an additional amplifier to realize a high-pass output. This choice of output function is why these circuits are often referred to as universal active filters or active resonators [*Electronics*, "Active resonators save steps in designing active filters," April 24, p.106].

Both these types of filter require two or three op amps each, in addition to the necessary resistors and capacitors, making them rather more expensive than the multiple-feedback filter. In exchange for this higher cost, however, they do offer a choice of output functions and simpler design procedures. Also, they are relatively insensitive to passive-component tolerances. The Q, gain, and operating frequency of the two can be independently adjusted with resistors.

Better temperature stability can be obtained from the state-variable and biquad filters than from the multiple-feedback filter, but op-amp quality must be better; the multiple-feedback filter is not as sensitive to amplifier performance. On the other hand, since the gain-bandwidth product of cascaded amplifiers is smaller than the gain-bandwidth product of a single amplifier, the upper frequency limit of the state-variable and biquad filters tends to be lower than that of the multiple-feedback filter circuit.

As for the relative merits of the biquad and the state-variable filters, the former is usually the better for a low-pass or bandpass function, and the latter better for

3. Versatile. State-variable filter requires three op amps to supply high-pass, low-pass, and bandpass outputs at same time. Operating frequency, gain, and Q are independently adjustable. Also, circuit is not sensitive to passive-component tolerances.

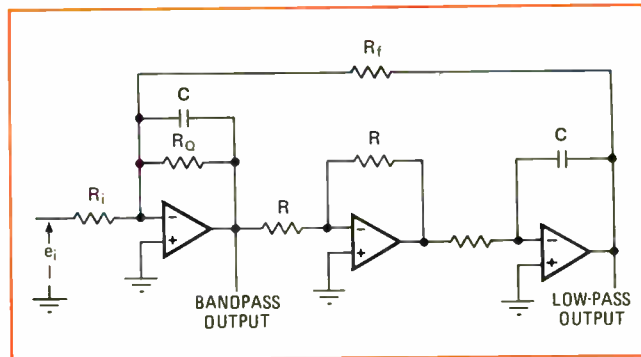
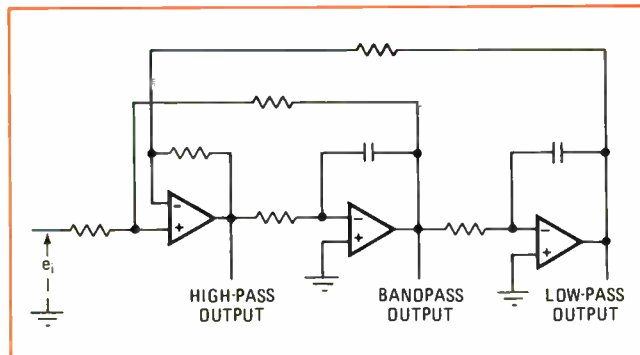

4. Modification. Biquad active filter offers most advantages of state-variable circuit, but cannot produce a high-pass function without additional amplifier. R_i sets gain, R_o sets Q, and R_f sets frequency.

a high-pass function. But the values of the resistors and capacitors in a biquad may be so high that their temperature coefficients become inadequate. In that case, the state-variable filter is to be preferred, since its performance parameters are set by component ratios and it can make use of low resistor and capacitor values, with their better temperature coefficients. For example, the Q of the state-variable is determined by a resistance ratio, not a single resistor value as with the biquad.

Deciding to make or buy

As a rule, active-filter users build their own circuits if they have the necessary design experience, and if they use filters in large quantities. Active filter suppliers find their main customers are among those users who lack design know-how, or who have particularly stringent performance requirements.

In contrast to the ones built in-house on pc boards, purchased active filters are always plug-in modules that are housed in IC-compatible packages. These ready-made units are either modular encapsulated assemblies (Fig. 5) of packaged discrete-type components or precision hybrid circuits (Fig. 6) that contain chip amplifiers, chip and/or discrete capacitors, and thick-film and/or thin-film resistors. They are usually negative-feedback filter circuits of the three types discussed above, and can range in price from about \$26 for a single standard unit to a few hundred dollars for a single special unit.

Only about four years ago, the market for active filters seemed to have a bright future. But many potentially large markets have remained relatively unpenetrated because of widespread in-house design, the firm establishment of passive filters, and the lack of filtering in many data gathering applications. Nevertheless, active filter sales are expected to be close to \$10 million for 1972, climbing to \$19 million by 1975.

While the current market is growing at the rate of 10% to 15% per year, usage of active filters is probably growing much faster since many more filters seem to be being built in-house than are being sold by filter manufacturers. To attract more sales, some filter suppliers are hoping to launch the same kind of customer-education campaign that was extremely successful for the op amp. That goal should be helped along by the declining prices of recent and upcoming new filter products.

Because most filters are custom items, their manufacturer is primarily in the business of selling engineering

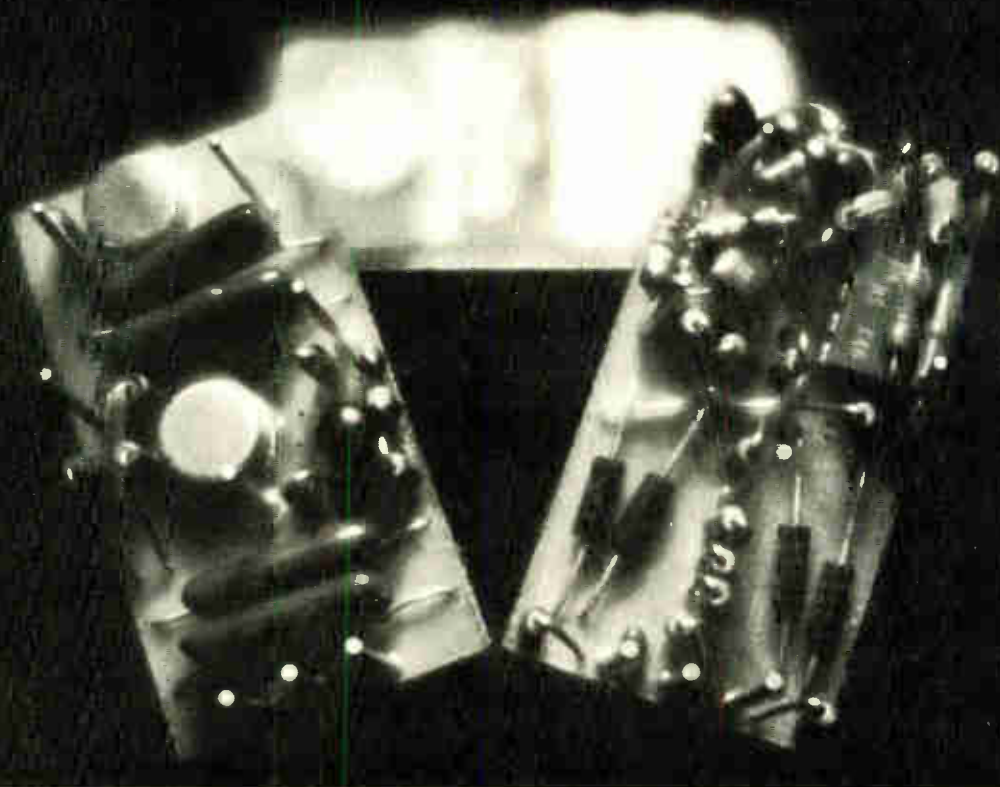

5. Off-the-shelf. Modular-type filters manufactured by Frequency Devices are assembled from discrete amplifiers, resistors, and capacitors. Several vendors supply similar filters in both standard and custom models, as either factory-tuned or customer-tuned circuits.

services. Filter makers who do supply standard filters attribute only about 30% of their sales to them.

Several companies are offering the universal active filter as a standard product, but its reception has been mixed. Some users say that its principal feature, its variability, is useless since filter needs are usually specialized. The filter's data sheet is said to be difficult to understand, and tuning it to desired specifications may not be easy. Tuning can be further complicated when several of the devices are cascaded, because their tuned component values generally differ from resonator to resonator. Finally, the universal filter is expensive because it contains more than one op amp.

However, as one supplier points out, this filter can be used as a basic building block by the manufacturer to realize a whole line of filters, without harming the filter's tuning versatility. The manufacturer can choose the filter function he wants and then encapsulate. Eventually, therefore, the universal filter will cost the manufacturer less to make—and his customer less to buy.

Filter makers stress lower pricing

One of the oldest suppliers of modular-type active filters, Burr-Brown Research Corp., Tucson, Ariz., is keenly aware of the need for a low-cost ready-made unit. This month, the company is introducing its series ATF76 filters that are about half as expensive as its earlier units and are intended to be priced about 10% below competing lines. The new filters are fixed-tuned units that employ IC op amps instead of discrete transistors. Single-unit prices begin at \$29 for a two-pole low-pass Butterworth filter.

Ron Gadway, product marketing engineer, data conversion products, sums up the filter maker's biggest problem, "Our competition is really the customer him-

self. If we can't give him what he wants for his price, he'll build it himself." Burr-Brown expects to expand its standard line with a state-variable filter before the end of this year, and to add a voltage-tunable filter shortly afterwards.

Another manufacturer of modular-type filters is Frequency Devices Inc. of Haverhill, Mass. This small company has an interesting way of keeping parts cost low. Alan Schutz, director of engineering, explains, "We buy capacitors with tolerances of $\pm 20\%$, but know their actual values to within $\pm 0.5\%$. Resistor values are then easy to determine with a simple computer program."

A recently introduced family of tunable active filters

6. Chips and films. Hybrid active filters tend to be customized circuits of thick- and thin-film resistors, chip capacitors, and chip amplifiers. Pictured is digitally tunable bandpass filter made by Sprague Electric for the military. Molded tantalum capacitors (on left and right sides) are sometimes used to furnish required capacitance.

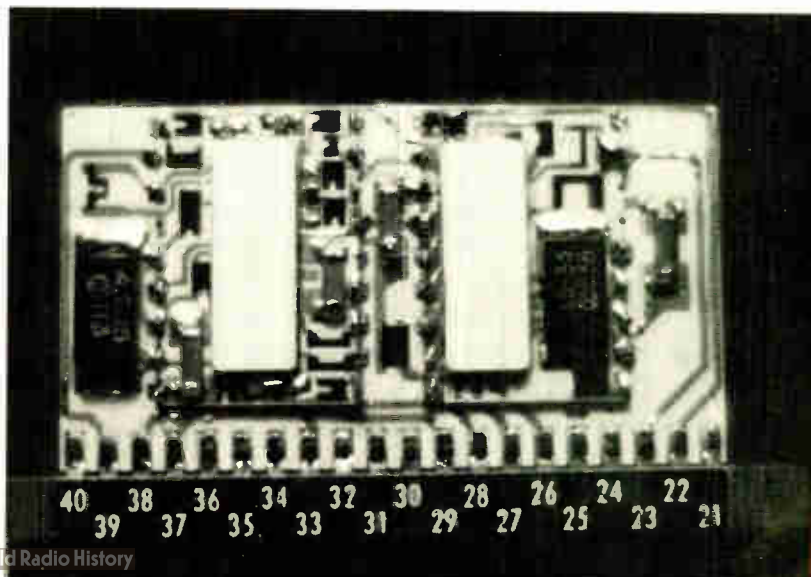

SPECIAL REPORT

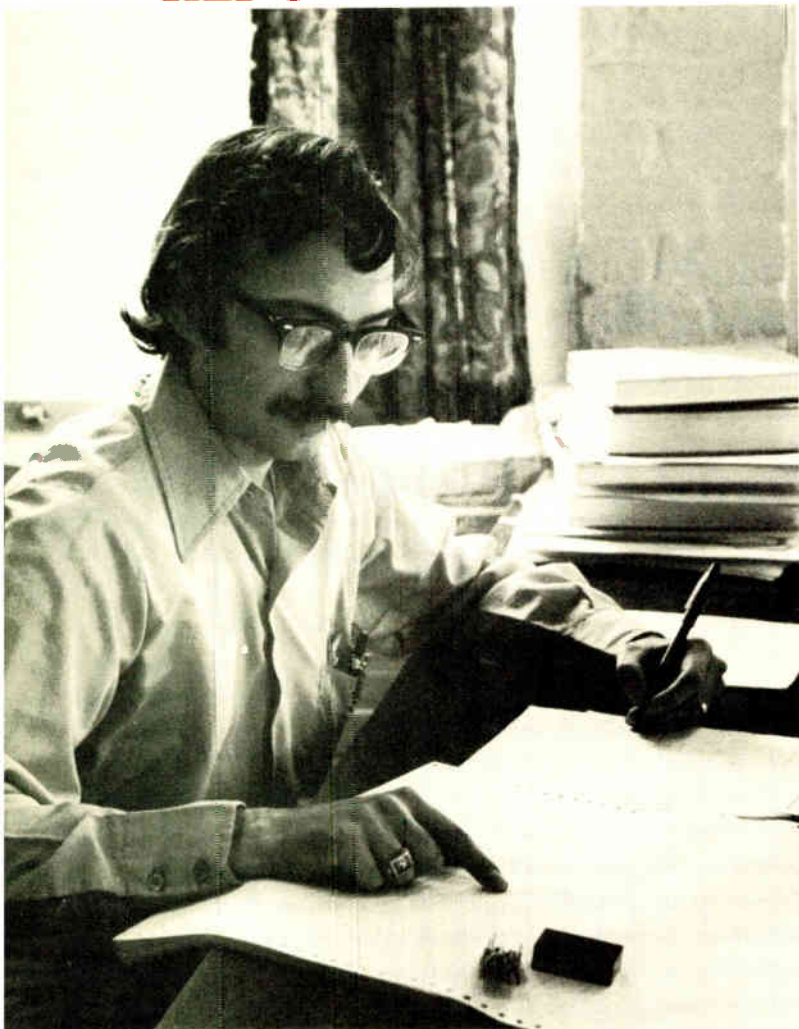

7. **Module maker.** Alan Schutz of Frequency Devices thinks that suppliers must teach customers how to select and use active filters.

from Frequency Devices frees the customer from the difficult and time-consuming job of capacitor trimming. The capacitors are inside the package, and tuning is accomplished with outboarded resistors. Frequency Devices is one of the few companies with a standard series of voltage-tunable active filters. Tuning ranges for these extend down to 0.01 Hz and up to 50 kHz. Single-unit pricing starts at \$210.

Manufacturers that make hybrid active filters do so, for the most part, as a byproduct of their other hybrid business. A well-known supplier of hybrid circuits for several years is the Semiconductor division of Sprague Electric Co., in Worcester, Mass. Eugene Donovan, operations manager, hybrid circuits, points out, "Anybody who depends on filters totally is going to have a difficult time. At Sprague, we build hybrids and can serve several markets with the same technology, because the components used in our converter products can also be used in our filters."

In an attempt to break hybrid filters out of the



8. **Hybrid maker.** Active filter suppliers must also service other markets to survive, asserts Eugene Donovan, Sprague Electric.



9. **Instrument maker.** Variable active filters can be used as design aid to find filter needed, observes Ernest Lutfy, Krohn-Hite Corp.

predominantly custom market, Sprague intends to introduce a second line of standard filters in the next month or so. The filters will be tunable, using external resistors to control Q, frequency and gain. Both band-pass and notch functions will be available for frequencies of 30 Hz to 10 kHz. Pricing is not yet firm.

Motorola Semiconductor, Phoenix, Ariz., is aiming particularly for penetration of the modem area with active hybrid filters. But, observes Don Kessner, manager of systems, industrial applications, "because of cost, the hybrid active filter will probably never replace the pc-board active filter used in those modems where space is not critical." Only when the "so-called all-MOS data modem" becomes practical does he feel that a high-volume special market may develop for the inexpensive hybrid filter. Intended for low-speed operation, this modem would comprise two packaged circuits—a digital MOS chip and an analog front-end conditioner for the chip. The analog portion could be a hybrid filter.

Kinetic Technology of Santa Clara, Calif., which re-

covered from bankruptcy officially this last December, is selling both modular and thick-film hybrid active filters. The company's standard hybrid filters are state-variable circuits that provide a variety of response characteristics, from Butterworth to elliptic. The least expensive filter in this family sells for \$26 singly, dropping to less than \$5 in quantities over 10,000. It includes an extra op amp.

Fred Glynn, Western regional sales manager, offers a bit of customer advice. "If frequency accuracy within 1% is acceptable," he says, "the customer can use inexpensive 1% resistors to tune our filters without difficult trimming. If his accuracy requirement is tighter, we suggest that he use a less expensive filter [of ours] and tune it with a fixed resistor and a trimmer potentiometer."

For completeness' sake, the instrument type of active filter (Fig. 10) should also be mentioned. It can provide a number of filtering functions over a wide frequency range. The user selects the functions he wants (low-pass, high-pass, or a combination of these) and then dials the frequency he wants.

Krohn-Hite Corp., Cambridge, Mass., manufactures a series of these variable active filters. The company's instruments can perform low-pass, high-pass, band-pass and band-reject filtering from 0.001 Hz to 3 MHz. Prices range from \$450 to \$2,075 for frequency accuracies of $\pm 2\%$ to $\pm 10\%$.

"Because our instruments are tunable and can be operated over a wide frequency range, they are sometimes used as a design aid to help pinpoint the fixed-frequency filter that will be needed," notes Ernest Lutfy, sales manager. Medical researchers are also using the variable filter, for example, to test the frequency response of the ear, or to listen to the heartbeat of a fetus while filtering out unwanted signals from its expectant mother.

Users justify building in-house

In-house active filter design is done by companies who can spread engineering costs over a number of products. "We seldom buy outside because it's just too expensive," says Farouk Al-Nasser, a principal scientist at the test instrument division of Honeywell Inc., in Denver, Colo., who is involved in designing data storage systems. But he cautions that learning how to design active filters may take as long as two to three years, because existing literature does not cover practical considerations for the op amp. Most filter theory still treats the op amp as an ideal element having infinite gain and perfect isolation.

Many modem manufacturers have a staff of active filter design specialists. One of these is Paradyne Corp. of Clearwater, Fla. "The cost of active filters depends on who designs them," says Tom Saliga, senior engineer. "Using only one op amp, we can build a [multiple-feedback] filter with four to five poles for around \$1 to \$1.50."

Paradyne even standardizes its active filter designs to some extent to realize additional cost savings. Most of the filters the company incorporates in its modems use the same two values of capacitance, enabling Paradyne to buy capacitors in very large volume.

Specializing in pc-board modems (Fig. 11), Intertel



10. Variable active filter. When filter frequency must be continuously varied, an instrument-type filter can be used. Corner frequencies and filter function can be selected from front panel.

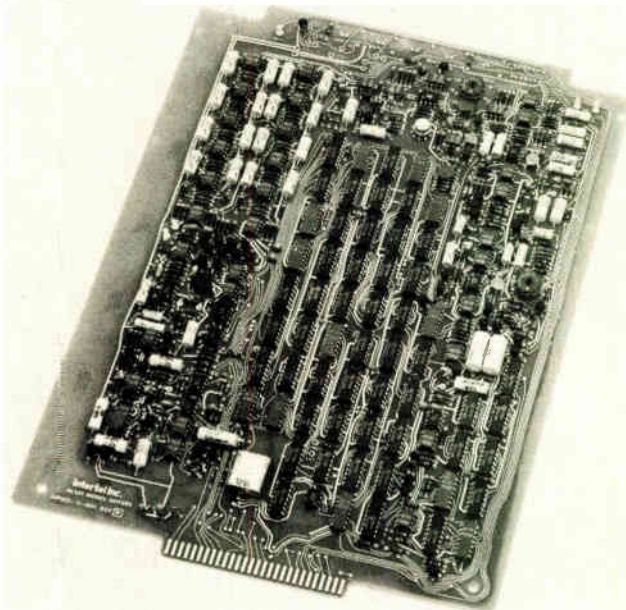

11. Tight fit. Intertel Inc. employs narrow-band active filters to eliminate noisy sidebands in receiver portion of pc-board 201-type modem. Complete modem measures only 9.5 by 12.9 inches.

Inc. in Burlington, Mass., uses active filters exclusively to keep its modems as small as possible. "We need very special filters and prefer designing our own," says George Harlem, marketing coordinator. "Nobody else can build them as cheaply as we can, and nothing that we could buy is equivalent in terms of performance."

Many designers actively prefer active filtering to passive. Jerry Holsinger, Intertel president, explains why: "In a sense, passive filter design is a black art. Active filter design is really a totally new concept in which the general-purpose building block is not a physical component, but simply a second-order transfer function." He's referring to the fact that an active filter can be completely described by its pole-zero plot, which always contains a pole pair, permitting the filter to be easily manipulated mathematically.

One designer, John DeFalco, who is a lead engineer at Honeywell Information Systems in Billerica, Mass., personalizes his preference for active filters. "Passive filter design is just a matter of looking up data in tables and charts—it's a lot more fun designing an active filter," he says. □

OUR ANGLE: High Speed Accurate and Automatic Angle Position Indicators

WHAT'S YOUR ANGLE?



MODEL 545/100

If you're converting synchro/resolver data to digital format, you need both speed *and* accuracy to keep pace with today's data explosion. Only one converter meets both these requirements without compromise. And for under \$4K. . . . North Atlantic's Model 545/100.

The solid-state Model 545/100 converts both resolver and synchro data with 0.01° accuracy and resolution. And continuously digitizes input angle data at $20,000^\circ$ per second in the face of real-life noise, harmonics and quadrature levels. BCD output is available at the rear connector. Conversion can be stopped by a data freeze command. If multiplexed signals are your bag, acquisition time is less than 30 ms.

Options? Other models offer many options, including 0.001° resolution with 10 arc-second accuracy; data frequencies from 60Hz to 2.4kHz, binary output, small size.

No matter what your conversion problem, if you require ultra-fast, ultra-accurate tracking, contact your North Atlantic sales engineering representative today. He'll show you a better angle.

NORTH ATLANTIC
industries, inc.

200 TERMINAL DRIVE, PLAINVIEW, NEW YORK 11803
cable: noatlantic / twx: 510-221-1879 / phone: (516) 681-8600

Extending the life of digital recording heads

by Greg J. Ehalt and M. J. Grundtner
Nortronics Co., Minneapolis, Minn.

High-speed digital tape transports with tape speeds of 100 to 250 inches per second and rapid start-stop operation wear out conventional channel digital recording heads much too fast. Generally made of aluminum with Mumetal cores, these heads remain usable for only about 2,000 hours. Their surface imperfections also tend to accelerate tape wear, and the signal dropout that results from deposits of wear debris is very troublesome in digital computer applications.

Worse still, today's high-density data storage systems make it necessary to minimize the space between head and tape in order to maximize resolution. In commercial systems (except those designed for air-film support), this has meant living with continuous sliding contact between tape and head—and with the concomitant problems of excessive maintenance, a short and unpredictable life, and inaccurate data storage.

Analysis of tape microstructure and of worn computer heads has shown that wear is essentially caused by abrasion. Magnet tape is like superfine emery cloth, the abrasive particles on its surface being 5 to 10 micro-inches in diameter. When these come in contact with the recorder head surface, they either cut into it, removing chips from it like a machine tool, or make shallow furrows that may cause fatigue, localized corrosion and microfracture. The rate of wear depends on the amount of contact between tape and head surface, which in turn depends partly on the degree of aerodynamic lift (air bearing action) as the tape passes over the head and

partly on the action of the individual magnetic particles, as affected by binder and tape resilience, particle angularity, and surface plasticity.

Consequently, any factor that reduces abrasion by magnetic particles will enhance head life. For instance, surface chemical reactions producing thin organic or oxide films on the head surface can buffer the contact between magnetic particles on the tape surface and the metal face of the head—but these films are regrettably not controllable, and their origins poorly understood. Again, as the abrasive medium and the material being abraded approach each other in hardness, wear rate becomes negligible, and surface cutting no longer occurs.

With all these factors in mind, Nortronics investigated numerous materials for digital head coatings. The equation used for abrasive wear was $V = KWL/3H$, where V = volume of material being removed, W = load, L = distance slid, H = indentation hardness of the softer material, and K = wear coefficient.

Several approaches were evaluated (Table 1) in terms of gap erosion, core material cost, ease of manufacturing, core efficiencies, differential wear rates, head life, crosstalk rejection, and basic wear capability.

Twelve of the hard-coat materials tested were charted (Table 2) in terms of application method, porosity, obtainable finish after grinding and lapping, and tape wear. An aluminum oxide alloy applied by plasma torch was selected for development of a LifeTime Ceramic (LTC) head, because it had low porosity, good hardness and surface finish, and caused no apparent tape wear after 10,000 passes of dynamic testing.

The design adopted achieves long life by contouring or relieving the face of the Mumetal magnetic core to within 0.010 in. of the gap on either side. The non-magnetic ceramic coating is then applied to the face of the head to fill in the relieved areas, and the head is re-contoured to the desired shape. The LTC coating is significantly harder and more wear-resistant than the core

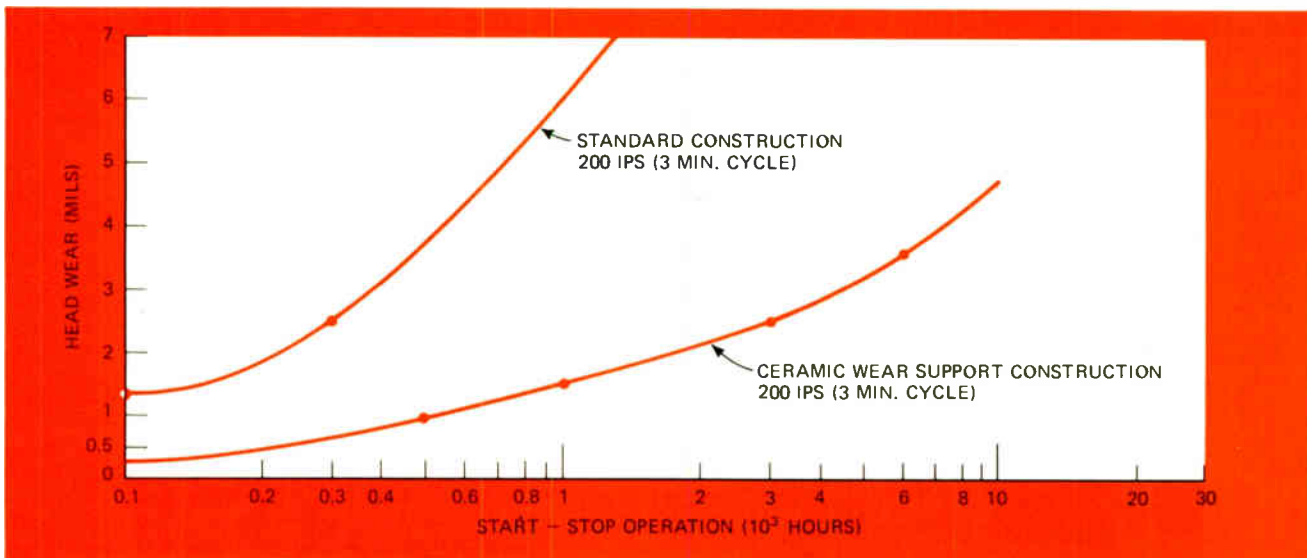

HARD-COAT MATERIALS AND PROCESSES

Material	Application method	Porosity	Finish (µin. AA)		Tape wear at 200 ips
			After grinding with 400 grit wheel	After lapping	
Aluminum oxide (Union Carbide type LA 1 or equiv.)	Detonation gun	5 - 6 %	10 - 12	1 - 2	Pores fill with foreign matter and start tape wear.
Tungsten carbide (Union Carbide type LW 1 or equiv.)	Detonation gun	4 - 5 %	12 - 15	2 - 3	Pores fill with foreign matter and start tape wear.
Tungsten carbide (Union Carbide type LW 4 or equiv.)	Detonation gun	½ - 1 %	4 - 5	1 - 2	Small wear after 10,000 tape passes.
Tungsten carbide (Union Carbide type LW 5 or equiv.)	Detonation gun	2 - 3 %	10 - 12	1 - 2	Small wear after 10,000 tape passes.
Aluminum oxide (Coors type Rokide A or equiv.)	Oxyacetylene torch	15 - 20 %	45 - 50	30 - 35	Too rough for use.
Chrome oxide (Coors type Rokide C or equiv.)	Oxyacetylene torch	15 - 20 %	45 - 50	30 - 35	Too rough for use.
Chrome oxide (Metco type 106 NS or equiv.)	Plasma torch	10 - 15 %	40 - 45	25 - 30	Too rough for use.
Chrome oxide (Union Carbide type LC 4 or equiv.)	Plasma torch	2 - 3 %	10 - 14	1 - 2	Small wear after 10,000 tape passes.
Tungsten carbide (Union Carbide type LW 10 or equiv.)	Plasma torch	6 - 8 %	10 - 15	2 - 3	Slight marking of tape, probably due to porosity.
Tungsten carbide (Metco type 72 F or equiv.)	Plasma torch	10 - 12 %	10 - 15	6 - 8	Slight marking of tape, probably due to porosity.
Hard chrome	Electrolytic plating	None apparent	2 - 3 (80 grit wheel)	1 - 2	No apparent wear after 10,000 tape passes.

Design approach	Gap erosion	Core material costs	Ease of head manufacture	Core efficiencies at frequencies of		Differential wear rates	Head life	Crosstalk rejection	Basic material hardness (assume Mumetal = 1)
				300 kHz ∇	300 kHz ∇				
Nortronics hard coat process	Good	Low	Low	Good	Average	Good	Good	Good, shields exposed	10
Ferrite cores Mumetal or aluminum spacers	Poor	Medium	Medium	Average	Good	Poor	Average	Average, shields wear below ferrite	6
Ferrite cores and nonmagnetic ferrite spacers	Poor	High	High	Average	Good	Good	Good	Average, shields recessed below spacer	7
Alfenol cores Alfesil cores Sendust cores	Good	High	High	Average	Average	Average	Average	Good	3
Alfenol tipped cores Alfesil-tipped cores Sendust-tipped cores	Good	High	High	Average	Average	Average	Average	Good	3
Chrome-plated over Mumetal cores	Good	Low	High	Good	Average	Good	Good	Good	8

it surrounds. Because of the differential wear rate, the height of the core relative to the ceramic rapidly stabilizes at the level of the ceramic surface. With an adequate tape wrap and tension, the tape bridges the core area at the gap, riding primarily on the hard ceramic surface. This provides a design whereby the actual head wear—the pole pieces at the gap—is almost entirely determined by the nonmagnetic surface of the head.

The average digital drive becomes obsolete before it

wears out—it has an operational life of perhaps 10 to 15 years. Yet a conventional all-metal digital head lasts only two or three years. LTC not only should extend head life ten times, but does not require any changes in core or shield structure, so that electrical performance remains unchanged. And for greater efficiency under limiting conditions, the gap depth of an LTC head may be reduced without shortening its life. Just as important, it eliminates expensive field maintenance. □

Charts calculate tradeoffs in pc edge connector costs

by Robert R. Marker,
Cinch Connectors, Elk Grove Village, Ill.

The cost of a printed-circuit edge connector is based primarily on the insulator and contact material, the number and type of contact, and the amount of gold plating used. These factors can be related to a standard reference connector, and percentage changes in cost for each option can be estimated.

The charts are based on actual cost figures developed over a long period of time, but care must be exercised in their use for cost estimating because other factors, such as the quantity and delivery time required, can have equal or greater impact on the price. The charts indicate, however, the possible economies in trading off cost for performance on several aspects of connector design.

All comparisons are made relative to an arbitrarily chosen reference connector commonly in use: a 22-position, dual-readout edge connector with diallyl phthalate insulator and wire-wrapping terminals, plus bellows-type contacts of phosphor bronze, grade A material, plated with 30 microinches of gold over the entire contact surface.

Cantilever contacts would decrease the connector cost, since such contacts are made in comb-like form and the carrier strip allows simultaneous loading of all contacts into the insulator. However, the cantilever contact will withstand fewer insertions and withdrawals (typically 50 cycles, versus the bellows contact's 100 cycles, if both have 30 microinches of gold). The bellows contact's longer engagement surface, more gentle en-

trance angle, and lower spring force all combine to give it a longer life.

Vibration will also be more critical, since cantilever contacts typically withstand up to 500 cycles per second of sinusoidal vibration, while the bellows type takes up to 2,000 cps. Figure 1 shows the relative costs of cantilever contacts versus bellows contacts. For example, the 22-contact reference connector will cost about 7% less with cantilever contacts.

Increasing the gold-plating thickness will increase contact life. Bellows-type contacts must be plated equally over the entire surface, but cantilever contacts can be selectively plated. Figure 2 shows relative costs of contacts that are barrel-plated (the bellows contacts) and selectively plated (cantilever contacts). The cost figures apply only to differences in gold thicknesses and do not cover the economies of simultaneous insertion of cantilever contacts. Thus, the chart indicates that to increase the life of the bellows contact from 100 to 500 cycles by applying 50 microinches of gold, rather than 30, would increase the cost by 16%. On the other hand, use of a cantilever contact selectively plated with 100 microinches to provide 500-cycle life would decrease plating costs to about 86% of the cost of the reference connector.

Contact material comparisons are shown in Fig. 3. Phosphor bronze costs about a third as much as beryllium copper, but is not recommended for use above 105°C, since it has a tendency toward stress relaxation. Beryllium copper can approach 150°C before encountering similar problems. Thus, from Fig. 3, using beryllium copper for the 22-contact connector will result in about a 7% increase in connector cost.

Another important factor in edge-connector performance and cost is the insulator material. The insulator must provide retention of the contact and electrical separation of the circuits under a variety of environmental conditions. Thermosetting compounds (diallyl phthalate and glass-reinforced or general-purpose phenolic) offer stability at high temperatures, but are relatively expensive, and can be difficult to mold and brittle in thinner wall sections. Thermoplastics (such as glass-reinforced nylon type 6/6, polycarbonate, and modified PPO—polyphenylene oxide) also can be used, but each has advantages and drawbacks.

Polycarbonate is stable and strong, but degrades when subjected to the chlorinated hydrocarbon cleaning solvents commonly used as flux removers. Nylon type 6/6 is resistant to these solvents but is hygroscopic, causing dimensional and electrical instability in moist

TABLE 1
MOLDED INSULATOR COSTS

Material	Relative Cost
Diallyl phthalate	100 %
Glass phenolic	93 %
General-purpose phenolic	59 %
Polycarbonate	58 %
Nylon 6/6	53.5 %
Modified PPO	53 %
Nylon 12	49 %
Celanex 917	36 %

TABLE 2
INSULATOR MATERIAL PERFORMANCE
 (96 HOURS AT 90/95% RELATIVE HUMIDITY AT 40°C)

INSULATION RESISTANCE (MEGOHMS)

Material	Before	During	30 min. after
Diallyl phthalate	20 x 10 ⁶	20 x 10 ⁶	20 x 10 ⁶
Glass phenolic	10 x 10 ⁶	1.5 x 10 ⁵	2.5 x 10 ⁵
G.P. phenolic	10 x 10 ⁶	150	1000
Polycarbonate	20 x 10 ⁶	20 x 10 ⁶	20 x 10 ⁶
Modified PPO	20 x 10 ⁶	2.3 x 10 ⁵	5 x 10 ⁶
Nylon 6/6	20 x 10 ⁶	9.8	1000
Celanex 917	20 x 10 ⁶	5 x 10 ⁶	15 x 10 ⁶
Nylon 612	20 x 10 ⁶	1 x 10 ⁶	4 x 10 ⁶

VOLTAGE BREAKDOWN (VOLTS RMS)

Material	Before	During	30 min. after
Polycarbonate	3144	2925	3125
Modified PPO	3075	2638	3006
Nylon 6/6	3000	2370	2410
Celanex 917	3183	3119	3160
Nylon 612	3244	3094	3150

(Thermosets not tested, but higher voltage breakdowns)

DIMENSIONAL STABILITY

Material	Length - before	Length - after
Polycarbonate	4.740	4.741
Modified PPO	4.741	4.741
Nylon 6/6	4.727	4.744
Celanex 917	4.730	4.732
Nylon 612	4.736	4.739

(Thermosets unaffected)

atmospheres. Glass-reinforced modified PPO is also susceptible to cleaning solvents, but is easily molded to close tolerances. New thermoplastic compounds, such as Celanex 917 and glass-reinforced nylon 612, are inexpensive to mold and are not subject to many of the disadvantages of other thermoplastics. Thus they can often be used in place of thermosetting compounds at considerable savings in cost.

Relative costs for molded insulators using various materials are based on molding in screw injection presses (see Table 1). Since processing time is a significant part of the insulator cost, these figures provide a much more accurate comparison than material costs alone would.

As an example, suppose the cost of the 22-position reference connector is known. For similar quantities and delivery times, assume that the engineer wants to estimate the cost of a connector that has the same number of contacts but uses polycarbonate insulation and cantilever contacts of phosphor bronze, selectively plated with 50 microinches of gold.

The cost-savings factor for polycarbonate insulation is 58%; for cantilever contacts, 93% (7% savings); for 50 microinches of selectively plated gold, 81%. Thus the cost of this connector would be (0.58)x(0.93)x(0.81), or about 44%, of the reference connector, according to the simple multiplication. However, the actual cost probably would not be precisely 44% of the reference cost—it would be safer to say around half the cost of the reference connector. □

Engineer's Notebook is a regular feature in Electronics. We invite readers to submit original design, applications, and measurement ideas. We'll pay \$50 for each item published.

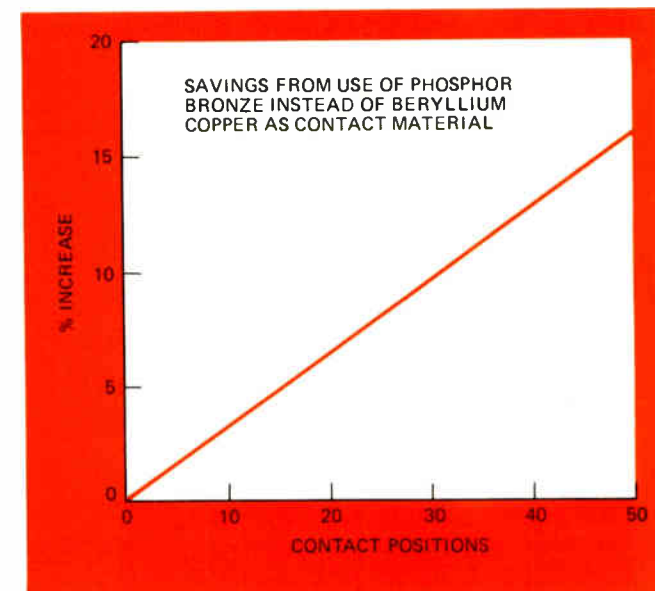
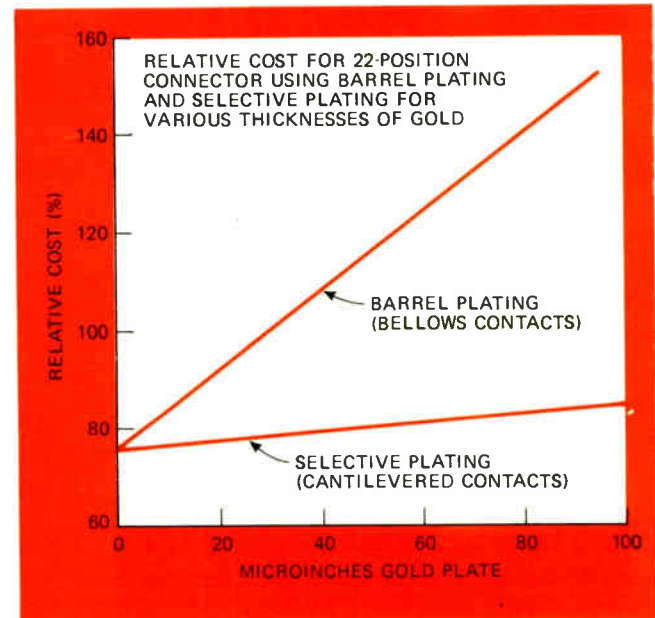
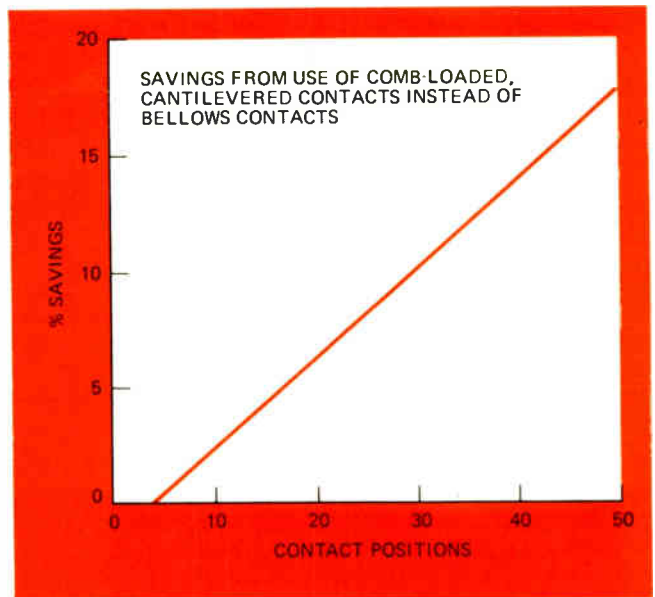

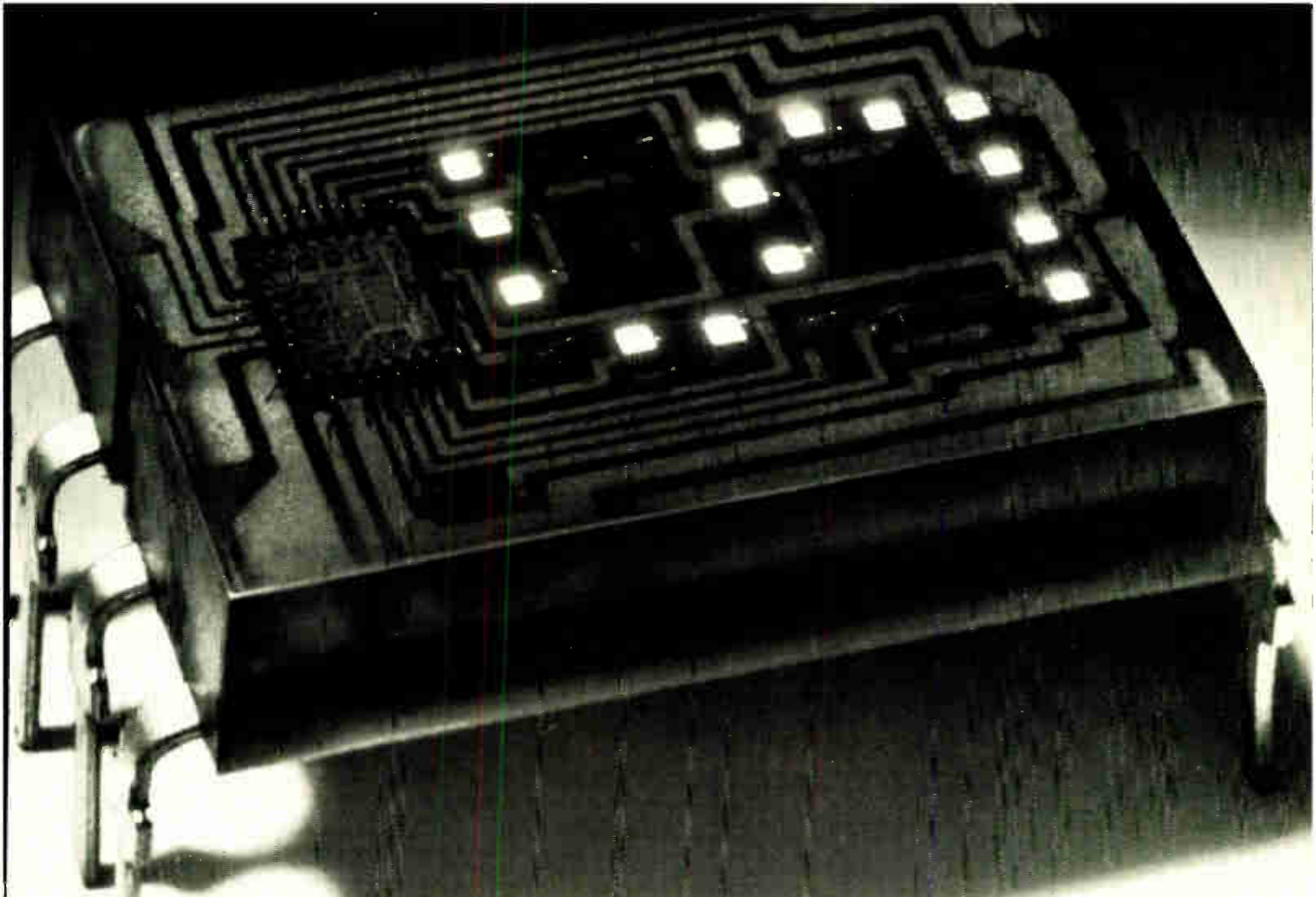

We built in the decoder/driver so you don't have to.

Not only the decoder/driver but the memory too! Now available for *immediate* delivery is the HP 5082-7300 series solid state display.

It's completely TTL compatible. All you do is address it directly with four-line BCD input. The on-board IC allows for either the storage of input data or real-time display. You save design time, space and money, and get a completely reliable integrated display system.

A bright .290 inch high, shaped character gives

excellent readability over a wide viewing angle in a compact .600 inch by .400 inch package.

So why wait? For *immediate* delivery on the HP 5082-7300 call your local HP sales office, or Hewlett-Packard, Palo Alto, Calif. 94304. In Europe: 1217 Meyrin-Geneva, Switzerland.

HEWLETT  PACKARD

COMPONENTS

Circle 115 on reader service card

01202A

Reliability is everybody's bag

Don't toss out your reliability files if you're switching over from military to commercial or consumer designing. One of the major conclusions at a session on plastic-encapsulated semiconductors at the 1972 Reliability Physics Symposium in Las Vegas, as reported in the Reliability Analysis Center's newsletter, was "**Reliability requirements of industrial and consumer markets frequently approach those of the military, and thus require greater management attention to component quality assurance.**"

The viewpoint was extended even further by Gilbert Waite, advanced manufacturing development section head, Honeywell Information Systems, Billerica, Mass., at a session at the Electronic Components Conference in Washington, D.C. He observed, "There are cases, for example in automobile and telephone equipment, where reliability does approach the military's—but from the high side." Waite's position is that **volume production requires designed-in component reliability, rather than tested-in reliability**, as is often the case when making components under military specifications.

TV transmission by cable gains another supporter

Another top industry expert has endorsed the proposal made last year by Motorola chairman Robert Galvin that **all television signals be carried by cable, thus setting free valuable spectrum space** for mobile and marine communications. Robert Adler, Zenith research and development head, spoke up at the recent Electronic Industries Association meeting, "Electronics 1985," in Chicago.

We wouldn't bet on such a conversion actually being made soon, but even if it isn't, we do recommend that you take it as an indication of a large potential market in two-way broadband communications equipment for home use.

Active filters gain popularity

Use of active filters is increasing rapidly, say their manufacturers. More engineers, they say, now recognize the advantages of active filters. In the past year, prices of standard units have dropped by approximately half. Look for a new generation of active filters with voltage tuning rather than resistance tuning, and also expect **digitally programmed active filters that will use digital-to-analog converters to set the frequencies**. One specialist sees fully integrated active filters arriving in three to five years; such units will comprise thin-film resistors on top of monolithic active structures, as is now being done for d-a converters.

Addenda

Here are a couple of new specialized slide rules that could be useful in your work: American Electronics Laboratories Inc. has one for communications systems that **determines fundamental relationships between the receiver parameters and transmitter power, antenna gain, and frequency**. Write to AEL, Dept. CC/1123, P.O. Box 552, Lansdale, Pa. 19446 . . . Or, if you are designing with or using thermocouples for temperature measurement, you'll probably be able to use a new **thermocouple-temperature slide rule that gives voltages from various material pairs**. A letter to Hoskins Manufacturing Co., 4445 Lawton Ave., Detroit, Mich., 48208, will get you one.





16 NEW MULTIPLES

FROM THE POWER HOUSE

Dual and Triple Output OEM Power Supplies

The most economical power/cost ratios in the power supply industry are now available in 16 new *multiple* output power supplies. These new units are specifically designed for computer, peripheral and instrument applications.

The same high quality components, low manufacturing costs, proven engineering design, reliability and economy incorporated in our highly successful single output OEM Series are here now in our new multiple output series and that means *multiple* satisfaction! We do it better for less, that's why Powertec is the leader in the OEM business. **EXCLUSIVE FEATURES:** Reliability • Economy • Proven Engineering Design • Low Manufacturing Costs • High Quality Components.

	MODEL NUMBER	OUTPUT POWER			100 PIECE ** PRICE
		OUTPUT #1	OUTPUT #2	OUTPUT #3	
2K - DUAL OUTPUT	2K15D-1.3	+12V, 1.5A or +15V, 1.3A	-12V, 1.5A or -15V, 1.3A	NA	\$37.00
	*2K5D-3.0	5V, 3.0A or 6V, 2.5A	5V, 3.0A or 6V, 2.5A	NA	
Depth — 2.50	*2K5, 15D	5V, 3.0A or 6V, 2.5A	12V, 1.5A or 15V, 1.3A	NA	
Width — 7.87	*2K5, 24D	5V, 3.0A or 6V, 2.5A	18V, 1.0A or 20V, 1.0A or 24V, 1.0A	NA	
Height — 4.00					
2L - DUAL OUTPUT	2L15D-2.8	+12V, 3.0A or +15V, 2.8A	-12V, 3.0A or -15V, 2.8A	NA	\$65.00
	*2L5D-6.0	5V, 6.0A or 6V, 5.0A	5V, 6.0A or 6V, 5.0A	NA	
Depth — 2.75	*2L5, 15D	5V, 6.0A or 6V, 5.0A	12V, 3.0A or 15V, 2.8A	NA	
Width — 9.38	*2L5, 24D	5V, 6.0A or 6V, 5.0A	18V, 2.3A or 20V, 2.3A or 24V, 2.3A	NA	
Height — 4.88					
2R - TRIPLE OUTPUT	2R-70T	+12V, 1.5A or +15V, 1.3A	-12V, 1.5A or -15V, 1.3A	5V, 6.0A or 6V, 5.0A	\$69.00
	*2R-72T	5V, 3.0A or 6V, 2.5A	12V, 1.5A or 15V, 1.3A	5V, 6.0A or 6V, 5.0A	
Depth — 2.87	*2R-74T	5V, 3.0A or 6V, 2.5A	18V, 1.0A or 20V, 1.0A or 24V, 1.0A	5V, 6.0A or 6V, 5.0A	
Width — 11.00	*2R-76T	12V, 1.5A or 15V, 1.3A	18V, 1.0A or 20V, 1.0A or 24V, 1.0A	5V, 6.0A or 6V, 5.0A	
Height — 4.88					
2S - TRIPLE OUTPUT	2S-140T	+12V, 3.0A or +15V, 2.8A	-12V, 3.0A or -15V, 2.8A	5V, 12A or 6V, 8.0A	\$119.00
	*2S-142T	5V, 6.0A or 6V, 5.0A	12V, 3.0A or 15V, 2.8A	5V, 12A or 6V, 8.0A	
Depth — 4.00	*2S-144T	5V, 6.0A or 6V, 5.0A	18V, 2.8A or 20V, 2.3A or 24V, 2.3A	5V, 12A or 6V, 8.0A	
Width — 15.00	*2S-146T	12V, 3.0A or 15V, 2.8A	18V, 2.8A or 20V, 2.3A or 24V, 2.3A	5V, 12A or 6V, 8.0A	
Height — 4.88					

All outputs are floating, can be connected in any common configuration unless otherwise noted. Other voltages and currents available, consult factory for price and delivery.

*NON-STOCKED ** For quantities other than 100, contact factory.

SPECIFICATIONS: INPUT: 115VAC \pm 10V, 47-63 Hz • REGULATION: Line \pm .25%, Load \pm .25% • RIPPLE: 1mv RMS 5 & 15V • RESPONSE: 50 μ sec typical • TEMPERATURE: 0°C to 40°C derated to 71°C • O.L. PROTECTION: Current limit/foldback • Optional OVP available. **DELIVERY:** stocked models within 24 hours, 30 days for others.

Incidentally, if you don't see your exact model on the chart, we'll build an OEM *multiple* from stocked subassemblies in any voltage/current combination. Give us a call and we'll be glad to quote within 24 hours. Stay within the same size and power rating, and the price won't change.

POWERTEC INC. an Airtronics Subsidiary

9168 DeSoto Ave., Chatsworth, California 91311 • (213) 882-0004 • TWX (910) 494-2092

POWERTEC

onward & upward

1/2 BILLION BITS OF MOS MEMORY

Microsystems International — first year of MF1103 production!

Our first MF1103s came out of the tubes in June, 1971. After twelve months of steadily accelerating production, we've shipped more than 500 million bits of this popular memory.

We'll ship more in the future. Much more — by several orders of magnitude.

Why? Because the market is there, growing rapidly — and we have the know-how to make the product. Selected to suit your specific requirements, with access times ranging from 300 ns to 150 ns and cycle times from 580 ns to 340 ns. Quality assured by the most extensive diagnostic and testing resources available. We have the production capacity — housed in a \$30 million facility, backed up by our MF1103 experience — twelve months of it.

Also in high volume production are MF1101A/1101A1 — 256 bit fully decoded RAM; MF1301 — 2048 bit ROM and MF1601/2, 1701/2 — 2048 bit pROM. Our shift register portfolio includes the dynamic 1024 bit MF1402A family, dynamic dual 100 bit MF1406 family, static dual 128 bit MF7104 and static dual 100 bit MF7105. For D/A conversion there is the MF7108 — 10 bit SPDT switch.

Whatever your memory requirements, contact Microsystems International — we ship immediately.

silicon gate MOS LSI from the performance leader

microsystems international limited box 3529 station c ottawa, canada — montreal ottawa, toronto, brussels, stuttgart london, palo alto, philadelphia.

For further information — call or write your nearest Microsystems sales office or distributor.

U.S.A. MICROSYSTEMS INTERNATIONAL SALES OFFICES:

CALIFORNIA — Palo Alto, Phone 415—493—0848 ILLINOIS — Schaumburg, Phone 312—894—7660 PENNSYLVANIA — Philadelphia, Huntingdon Valley, Phone WI 7-5641 2

SALES REPRESENTATIVES: ARIZONA — Scottsdale, Erskine Associates, Phone 602—263—7654 CALIFORNIA — Los Altos, W W Posey, Phone 415—948—7771 Santa Ana, Rical Associates, Phone 714—557—6543 CONNECTICUT — New Canaan, Stan Pierce Inc., Phone 203—966—4630 FLORIDA — Indiantonic, Tech—Rep Associates, Phone 305—723—9140 Largo, Tech—Rep Associates, Phone 813—595—2834 GEORGIA — Chamblee, Tech—Rep Associates, Phone 404—939—8339 ILLINOIS — Itasca, Lou Bacher & Associates, Phone 312—773—1810 INDIANA — Indianapolis, R E Marquart & Associates, Phone 317—253—3997 MARYLAND — Baltimore, L H Kolman Co., Phone 301—732—8766 MASSACHUSETTS — Norwood, Stan Pierce Inc., Phone 617—762—3164 MISSOURI — St. Louis, Pem Sales Co., Phone 314—427—7200 NEW YORK — Cicero, Advanced Components Inc., Phone 315—699—2671 New York, ABC Electronics Sales, Phone 516—747—6610 OHIO — Columbus, Tom Mulligan & Associates, Phone 614—457—2242 PENNSYLVANIA — Philadelphia, ABC Electronics Sales, Phone 215—464—2275 TEXAS — Addison, Campion Sales, Phone 214—239—9196

DISTRIBUTORS: ARIZONA — Phoenix, Kierulff Electronics, Phone 602—273—7331 CALIFORNIA — Gardena, Santa Monica Bell, Phone 213—321—5802 Los Angeles, Wesco, Phone 213—685—9525 Menlo Park, Bell Electronics, Phone 415—323—9431 San Carlos, Sterling Electronics, Phone 415—592—2353 San Diego, Kierulff Electronics, Phone 714—278—2112 COLORADO — Denver, Kierulff Electronics, Phone 303—343—7090 LONG ISLAND — Freeport, Milgray Electronics Inc., Phone 516—346—6000 MARYLAND — Baltimore, Arrow Electronics Inc., Phone 301—247—5200 MASSACHUSETTS — Dedham, Gerber Electronics, Phone 617—329—2400 Watertown, Sterling Electronics, Phone 617—926—9720 MINNESOTA — Minneapolis, Hall Mark Electronics Corp., Phone 612—925—2944 NEW YORK — Buffalo, Genesee Radio & Parts Co. Inc., Phone 716—873—9661 Rochester, Simcona Electronics, Phone 716—328—3230 NEW MEXICO — Albuquerque, Kierulff Electronics, Phone 505—247—1055 TEXAS — Dallas, Semiconductor Specialists Inc., Phone 214—356—5211 WASHINGTON — Seattle, Kierulff Electronics, Phone 206—763—1550

CANADA — MICROSYSTEMS INTERNATIONAL SALES OFFICES: ONTARIO — Ottawa, Phone 613—828—9191, Toronto, Phone 416—279—1358 QUEBEC — Montreal, Phone 514—875—2814

SALES REPRESENTATIVES: BRITISH COLUMBIA — Vancouver, A W. Bieue, Phone 604—685—7914

DISTRIBUTORS: BRITISH COLUMBIA — Vancouver, R A E Industrial Electronics Ltd., Phone 604—687—2621 ONTARIO — Malton, Semiconductor Specialists (Canada) Ltd., Phone 416—678—1444 QUEBEC — Montreal, Cesco Electronics Limited, Phone 514—735—5511

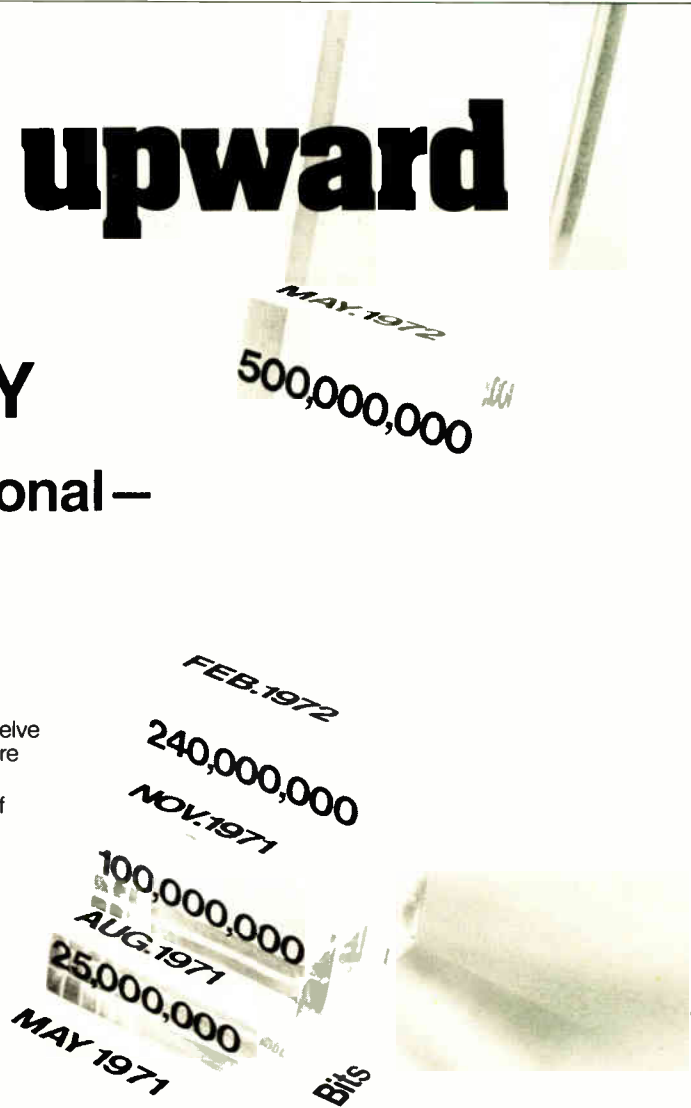

MF1103 MF1103-1 1024 bit MOS RAM



New products

Supply offers stable 400-Hz power

Novel design challenges conventional generators; magnetizable poles with variable spacing yield constant-frequency output to within 0.01%.

by Lyman J. Hardeman, Communications & Microwave Editor

In the matured field of rotating power generators, innovative designs are seldom encountered. An exception is a unit invented by John F. Roesel, Jr., president of Precise Power Corp., Bradenton, Fla.

This constant-frequency generator achieves an output frequency accurate to within less than 0.01%. According to Roesel, it "combines the frequency-stability advantage of a solid-state generator with the high reliability and lower price of a rotating machine."

In conventional alternating-current generators, a voltage is induced in conductors when they are made to move in a magnetic field. The size of this voltage is determined by the rate of change of flux linkages in the output winding; the magnetic flux field is derived from either a fixed permanent magnet or wound field poles.

Existing permanent-magnet generators have limited voltage regulator capability, though they are a

relatively lightweight and economical approach to some applications. While better voltage regulation is achieved with the wound field rotor machine, it comes at the expense of decreased reliability and increased weight, size, and cost. For both types of generator, however, their fixed-pole configuration results in an output frequency which is directly proportional to rotor speed and, therefore, to variations in the speed of the prime mover.

To circumvent this problem, the Precise Power generator incorporates a continuous layer of magnetizable material around the rotor periphery (see drawing). Constant-frequency operation is maintained by electronically controlling the position, spacing and number of field poles. Thus, output frequency is established, not by prime mover speed, but by a standard oscillator synchronizer.

In the write circuit, a quartz-crystal oscillator synchronizes an in-

verter that drives a resonant circuit composed of a tuning capacitor and the inductance of the exciter coil. A voltage feed back loop controls the writing flux density, and hence the output regulation, to within 1%.

Efficiency of the generator is typically that of a permanent-magnet generator except for the writing electronics. Normally, this power drain is about 50 watts for a 1-kVA generator, resulting in an efficiency of 65% to 70%. Efficiency increases with units operating at higher power levels.

Transients isolation. The constant-frequency generator is compared with conventional 400-Hz sources in the table. As shown, solid-state generators provide the only other alternative for applications requiring high frequency stabilization and voltage regulation. However, the new rotating generator costs less, is more reliable, and provides complete isolation from voltage transients on its input, ac-

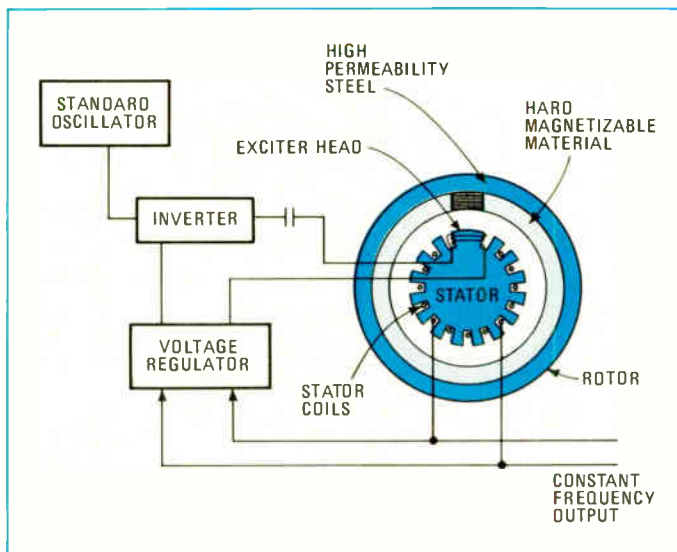

1 KVA - 60 TO 400 Hz FREQUENCY CONVERTERS					
	IMPMG	SMPMG	SMWFRG	SSC	CFG
Frequency stability	2.5 %	0.1 %	0.1 %	< 0.01 %	< 0.01 %
Voltage regulation @ unity power factor	8 %	8 %	2.4 %	< 1 %	< 1 %
Weight (pounds)	100	250	300	100	95
Volume (cubic in.)	2,000	4,000	4,200	2,000	1,600
Reliability	Excellent	Good	Fair	Fair	Good
Efficiency	70 %	60 %	55 %	75 %	65 %
Price	\$900	\$2,000	\$2,500	\$3,500	\$1,800

IMPMG - Induction motor/permanent magnet generator
 SMPMG - Synchronous motor/permanent magnet generator
 SMWFRG - Synchronous motor/wound field rotor generator
 SSC - Solid state converter
 CFG - Constant frequency generator



WHAT'S WRONG WITH THIS PICTURE?

Nothing. Because everything was made with HYSOL MH 17 epoxy molding powders. A NEW HYSOL epoxy transfer molding powder that's better than anything you can use for encapsulation.

Better because it's moisture resistant. It has excellent moldability, low moisture permeability, salt-spray resistance, temperature cycling resistance . . . just about everything you need to encapsulate semiconductors. And it's been proven by major manufacturers to be superior. You couldn't ask for more except maybe excellent lead adhesion, low thermal expansion or elevated temperature stability. And MH 17 has that, too.

There's nothing wrong with this picture. With MH 17, your picture could look just like it.

D DEXTER HYSOL DIVISION • THE DEXTER CORPORATION
 OLEAN, NEW YORK / LOS ANGELES and PITTSBURG, CALIFORNIA
 TORONTO / LONDON / MUNICH / TOKYO / MEXICO CITY

New products

According to Precise Power Corp. engineers.

David Taylor, marketing vice president of Precise Power, says the combined annual market for both solid-state and conventional rotary 400-Hz converters from 500 VA to 100 kVA is about \$100 million, and should remain fairly constant for the next five years. This includes large shipboard systems as well as smaller installations that provide power for production equipment using 400-Hz inputs. "Our constant-frequency generator should significantly impact this market," says Taylor. "In addition, we think the generator will penetrate other markets, such as isolation generators for

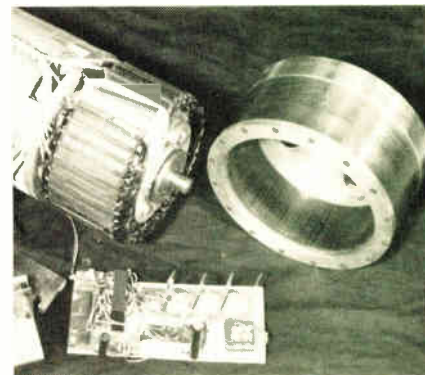

Constant frequency. A 2.5-kVA 60-to-400-kHz converter uses a magnetizable drum (right). A single "write" head (left) displaces output windings on stator. Frequency-controlling electronics are shown in foreground.

continuous power systems, and as a three-phase regulated supply for rectification and use in large-computer dc supplies."

Model 1400A, a 60- to 400-Hz unit with a 1-kVA rating, will be available within 90 days and will be priced at about \$2,000. This model can be wired for a 60-Hz input of either 230-v single-phase or 220/440-v three-phase.

Various electronic drives are available to give frequency stability to within 0.0001% to 0.1%. Voltage regulation error is typically less than $\pm 1\%$. Total harmonic distortion is less than 3%, and generator efficiency is greater than 70%.

Units with 5, 10, and 30 kVA and higher ratings will follow.

Precise Power Corp., P.O. Box 1905, Bradenton, Fla. 33502 [338]

Now... Power Linear Integrated Circuits from your digital supply

Datel Systems offers a new series of modular DC-DC converters designed for point of load applications.

Major advantages of using the Datel DC-DC converters over conventional line operated DC power supplies include: safe voltage power distribution; noise immunity through power supply isolation; optimized circuit performance; minimum size; floating outputs; higher efficiency and low heat rise.

Designed for small size (1.5" x 2" x 0.4" to 2" x 2" x 0.4"), they are fully encapsulated and feature dual-in-line pinning compatibility, .100" grid pin spacing which permits direct plug-in to printed circuit boards or any standard dual-in-line connector strip.

Features

- Choice of Inputs .. 5VDC, 12 VDC, 28VDC
- Choice of Outputs .. ± 12 VDC, ± 15 VDC, ± 18 VDC
- Low Profile Package 0.4" High
- Low Output Noise 1mv RMS Max.
- Output Current .. ± 25 ma and ± 100 ma

BLOCK DIAGRAM

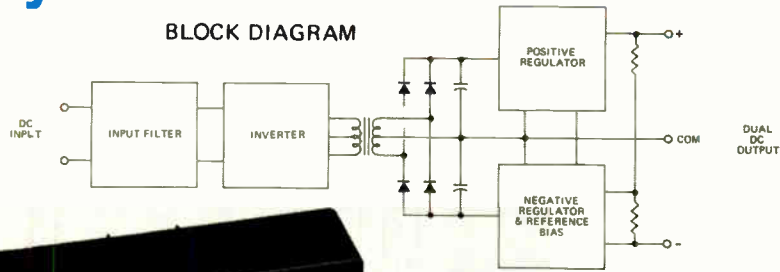

\$3900 and up

and for new free 50-page catalog for A/D D/A converters.

DATEL SYSTEMS, INC.

1020 TURNPIKE STREET, CANTON, MASS. 02021 / TEL. (617) 828-6395 TWX 710-348-0135

Circle 121 on reader service card



YOU'RE WHISTLING IN THE DARK...

if you think that heart disease and stroke hit only the other fellow's family.

**GIVE... so more will live
HEART FUND**



Contributed by the Publisher

BROWNOUTS

... cause voltage drops to 8%

GR regulators handle drops up to 20% and provide voltage outputs constant to 0.5%.

... can occur anytime

GR regulators are ready anytime; automatic, reliable, with a two-year warranty.

... affect any line voltage

GR regulators handle any ac line voltage; 115, 230, or 460 V; 50 to 60 or 400 Hz.

... affect any load

GR regulators handle any load; outputs to 19.7 kVA/phase with no added noise or distortion.

... can cost thousands

GR regulators start at \$390.

... can start now

GR regulators can be delivered now; over 100 stock models plus units built to your specs.

If you can't tolerate computer goofs, poor process control, inaccurate instrumentation, overheated motors, cool heaters, or other assorted equipment aberrations, invest in a General Radio Variac® automatic line-voltage regulator.

NEW YORK (N.Y.) 212 664-2722 (N.J.) 201 791-6990 BOSTON 617 646-0550 CHICAGO 312 962-0800 WASHINGTON, D.C. 301 981-5333 LOS ANGELES 714 540-8630 TORONTO 416 252-3395 ZURICH (01) 55 24 20

for Line-Voltage Control



General Radio

CONCORD, MA 01742

BOURNS LOW COST FAMILY

OF INDUSTRIAL *TRIMPOT*[®]
POTENTIOMETERS

49^{*}¢

OFF THE SHELF AS LOW AS

POWER: ½ WATT (or better) AT 70°C.

TEMPCO: AS LOW AS 100PPM/°C OVER TEMPERATURE RANGE OF -55° TO +125°C AND -55° TO +150°C.

Bourns **LOW-COST FAMILY** was designed specifically to fill the requirements of cost-conscious industrial users — so *were the prices!* Imagine how they reduce on large production-run quantities. As a bonus, you get Bourns TRIMPOT potentiometer quality, reliability and performance.

AVAILABILITY

All models shown are stocked in depth **RIGHT NOW**, so delivery is off-the-shelf from the factory or your local Bourns distributor.

Complete data on all models of the **LOW-COST FAMILY** is available upon request. Just write, or call, your local Bourns Sales office, representative, or distributor.

*1000-piece price Model 3389, U.S. dollars, F.O.B., U.S.A.

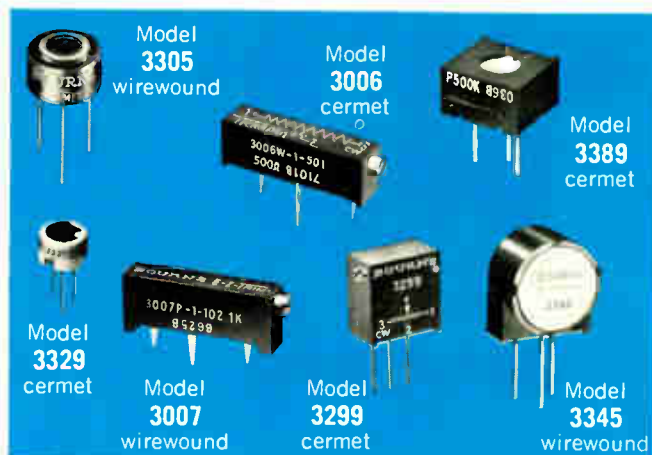

BOURNS, INC., TRIMPOT PRODUCTS DIVISION • 1200 COLUMBIA AVE., RIVERSIDE, CALIF. 92507

Chip comparator keeps pace with ECL

Monolithic linear circuit holds propagation delay to 7.5 nanoseconds, built-in latch makes unit ideal for sample-and-hold applications

by Stephen Wm. Fields, San Francisco Bureau manager

At a time when high-speed digital circuits employing Schottky, TTL or emitter-coupled-logic technology are the rule rather than the exception, it's a wonder that there hasn't been a high-speed monolithic comparator circuit to interface digital and analog equipment.

Now there is one, developed by Advanced Micro Devices Inc., Sunnyvale, Calif., and designated the model AM685.

Len Brown, linear product marketing manager at AMD, says, "The AM685 boasts a 7.5-nanosecond maximum guaranteed propagation delay—that makes it the world's fastest comparator. The device was developed for those designers who require millivolt accuracies at nanosecond speeds, such as in very fast analog-to-digital converters; for those needing detection capability of low-level logic signals in the presence of heavy noise; and for other high-spec work, such as in data-acquisition systems, optical isolators, sense amplifiers, and sample-and-hold circuits." The device can also be used as a line driver or a line receiver.

The sample-and-hold application is a natural for the AM685 because it has a built-in latch that, says Brown, performs the function of a sample-and-hold circuit, allowing short input signals to be detected and held for further processing by other circuits. "The AM685 is a three-stage device. It only takes 2 ns for a signal to get to the second stage, and this is the stage with the latch; so we can work with a 5-millivolt signal and lock it up easily in 2 ns," Brown adds.

With almost every type of integrated circuit, there is a certain

amount of "specsmanship" in rating new devices. But with comparators, there is a standard measurement—a 100 mV signal is applied to the circuit to set it one way, and a 5-mV "over-drive" signal is applied over the threshold; then, the time it takes the device to react to a certain level is measured.

With the AM685, this time is a guaranteed maximum of only 7.5 ns—at least twice as fast as anything else available on the market to date, AMD says.

All this means faster, more accurate systems, adds Brown. "For example, in a-d's, the 685's resolution spec of 0.5 mV and its response down to 3 mV makes it five times more accurate than anything else available." Other features of the AM685 include ECL-level outputs capable of driving 50-ohm lines, input offset voltage of 2.0 microvolts maximum, input offset current of 1 microampere, and an input bias current of 10 μ A. Also significant is the fact that, unlike other comparators, the 685 has no hysteresis.

Latch aperture time is 0.4 ns, typical, and common-mode rejection ratio is 80 dB minimum, with a com-

mon-mode voltage range of ± 3.3 v minimum.

Performance of the AM685 is based on a high-speed linear process developed at AMD. The process, employing a combination of advanced npn bipolar transistors and Schottky diodes, makes possible the short 7.5-ns propagation delay without sacrificing the close matching characteristics of the device's input and output sections. Brown says that the AM685's close-matching has usually been found only in "slow, high-performance linears." And he adds, "The AMD process developments will be used for other high-speed comparators, as well as for a family of soon-to-be-announced high-speed amplifiers."

The process is capable of producing transistors with F_T of greater than 1 GHz.

The AM685 is available either in the -30°C to $+85^\circ\text{C}$ range or the 55°C to $+125^\circ\text{C}$ range. The shorter-range part in a TO-100 can in quantities of 100, is priced at \$8.95 each; the full-range part is \$20. Delivery is from stock.

Advanced Micro Devices Inc., 901 Thompson Place, Sunnyvale, Calif. 94086 [339]

Swift sampler. With a maximum delay of 7.5 nanoseconds, the AM685 replaces complex circuitry in analog-to-digital converters, optical isolators, and other applications.

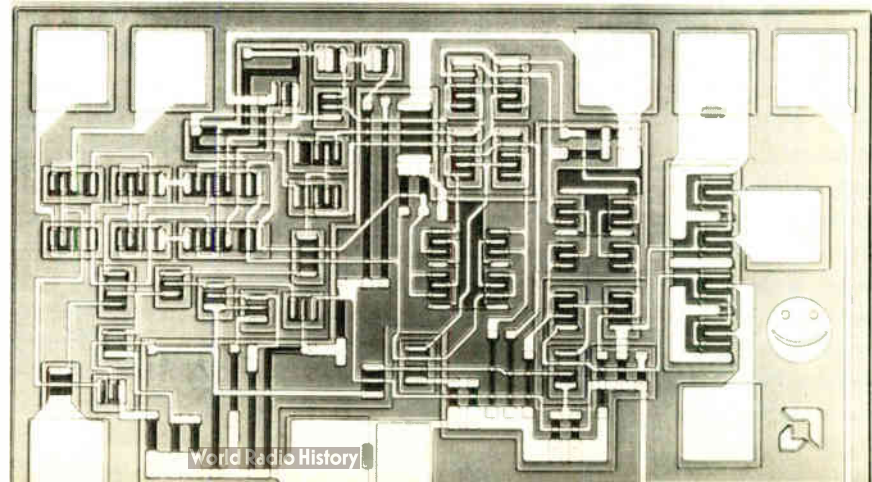

Free! The industry-wide fixed resistor cross-reference nobody (except you) wanted us to publish.



This handy chart is the first comprehensive cross-reference in the resistor industry. It tells you at a glance who makes what types of fixed resistors and what all their competitors' equivalent part numbers are. Covers every popular resistor type and every major manufacturer. See why nobody (except us) wanted you to have it?

Why "except us"? Because only TRW makes every popular type of fixed resistor. We have no reason to push one type over another. You can get exactly what you want—from a single source—TRW. It's like 22 companies rolled into one.

To make it even easier, we've prepared another chart for you—one that lists the complete electrical and physical characteristics of all popular resistor types and their relative prices. See exactly what the trade-offs are. Match your design as precisely as though you were using custom parts.

To get either or both of these unique aids, fill in the attached coupon and mail it today to TRW Fixed Resistors, an Operation of TRW Electronic Components. Or contact your local TRW Distributor.

TRW Fixed Resistors/Distributor Marketing
P. O. Box 12867
Philadelphia, Penn. 19108 (Phone 215/923-8230)

Sounds like a good idea.

Please send me a free copy of your fixed resistor profile and cross-reference charts.

Name _____

Company _____

Address _____

City _____

State _____

Zip _____

TRW
IRC FIXED RESISTORS

New products

Components

D-a converters settle fast

Multiplier units providing 8- to 12-bit resolution take only 1.5 microseconds

Selling for as little as \$99 in single-unit quantities, a new series of multiplying digital-to-analog converters provides resolutions of 8, 10, or 12 bits. For either a digital or analog input change, the units settle to within $\pm 0.01\%$ of full scale in only 1.5 microseconds.

Series DAC-MV modules can operate as conventional d-a converters or perform four-quadrant multiplication to form the product of two inputs—a variable analog reference and a digital word of up to 12 bits. The analog input is passed through a weighted network, under the influence of the digital input word. When the digital input is zero, the analog output is zero, regardless of the amplitude of the analog input. Typical applications include digitally scaling analog signals, vector generation for computer analysis, automatic ac calibration, digital phase shifting, and data normalization.

Input coding can be straight binary, binary-coded-decimal, offset binary or two's complement. The analog input can vary from -5 to $+5$ volts over the frequency range of dc to 200 kilohertz; its source current must be 1 milliampere. The full-scale analog output is 5 mA and can be either unipolar (0 to 10 v) or

bipolar (± 5 v). Through external strapping, four-, two-, or single-quadrant multiplication can be realized.

For all the full-scale converters, accuracy is to $\pm 0.01\%$, with a linearity of within $\pm \frac{1}{2}$ the least-significant bit and a temperature coefficient of ± 30 parts per million per $^{\circ}\text{C}$. Small-quantity prices range from \$99 for an eight-bit unit to \$139 for a 12-bit unit.

Datel Systems Inc., 1020 Turnpike St., Canton, Mass. 02021 [341]

Switch combines three pilot lights and one switch function

An enclosed switch, called the Lever Lite III, combines the functions of three pilot lights and one switch into

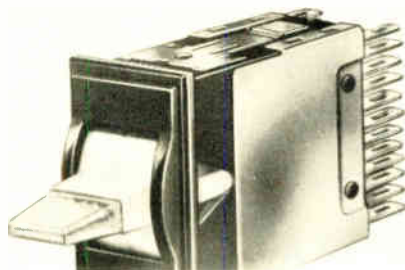

one unit. The tri-purpose device also combines three separate colors with a multiplicity of switching circuits, so that the switch uses one-color or multiple-color illumination or is nonilluminated. The unit is designed for single-hole, front-of-panel installation and removal, and relamping is done from the front.

Switchcraft Inc., 5555 North Elston Ave., Chicago, Ill. 60630 [347]

Temperature-sensitive reed switch resets automatically

A switch assembly measuring $\frac{1}{4}$ -inch in diameter opens to break a circuit when a predetermined ambient temperature is reached. The assembly consists of a reed switch, surrounded by two annular permanent magnets and a shunt. The only moving parts are the reeds of the switch, rated to operate at least 50 million times. A magnetic field actuates the switch, and the tempera-

ture-sensitive element is a material that acts as a shunt between magnets. At temperatures below its Curie point, the ferromagnetic shunt completes a magnetic path that keeps the switch closed. As the Curie point is reached, the high reluctance inhibits the passage of flux and the switch opens.

Hamlin Inc., Lake Mills, Wis., 53551 [343]

Card-edge connector needs no soldering

A card-edge connector, model 6317, requires no soldering. The connectors are press-fitted into plated-through holes on printed-circuit-board back panels. The result is a strong mechanical connection, as well as a gas-tight electrical connection. The contacts are connected to the wiring on the pc back panel and have solderless-wrap tails so wire-wrapping can handle any additional

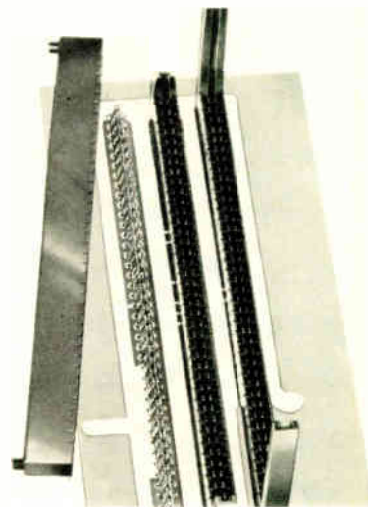

connections that cannot be done by printed wiring. Contact resistance is 7 milliohms between pc card and the back panel and $0.5\text{ m}\Omega$ between contact and panel.

Elco Corp., Willow Grove, Pa. 19090 [395]

Bandpass filters offer center range from 1 Hz to 10 kHz

Active bandpass filters model 1000 have been added to a series offering center frequency and selectivity fac-





CARD FILES

from the originator of card packaging systems



- ◆ Nylon guides with integral mounting feet
- ◆ Precision card/connector alignment
- ◆ Easy assembly — snap-on card guides
- ◆ Extruded aluminum mounting bars
- ◆ Rugged, lightweight construction

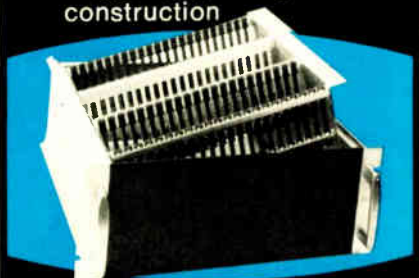

Configurations are virtually unlimited — files, kits, drawers — both vertical and horizontal, as well as fully wired systems. Also, Scanbe P.C. card file systems provide for any card/connector combination and any card spacing with single and multi row designs. Contact Scanbe for quality card file systems.



SCANBE MANUFACTURING CORP.
"The Packaging People"
3445 Fletcher Avenue
El Monte, California 91731
Telephone (213) 579-2300

New products

tory-adjusted to users' specifications. Center frequencies are available over the range of from 1 hertz to 10 kilohertz, and Q values offered are 2, 5, 10, 20, and 50. The devices are capable of operating with power



supplies from +5 volts dc to ± 18 v dc and exhibit high input impedance, coupled with low output impedance. Price is lower than \$15 per pole pair in production quantities.

Ferritronics Ltd., 222 Newkirk Rd., Richmond Hill, Ont., Canada [346]

million per year and $+1$ ppm/ $^{\circ}$ C, with frequency response exhibiting a maximum rise time of 10 nanoseconds. The attenuator is available in various styles, and packaging sizes vary according to attenuator configuration. A typical size is 0.820 by 0.520 by 0.150 inch for a Pi device and 1.190 by 0.520 by 0.245 inch for an O attenuator. Typical prices are from \$2.34 in 100-lots.

Vishay Resistor Products, Div. of Vishay Intertechnology Inc., 63 Lincoln Highway, Malvern, Pa. [348]

Illuminated pushbutton switches are rated at 5 A

Illuminated pushbutton switches that are about the size of a matchbook are rated at 5 amperes, 125 volts ac and 28 v dc. They are used in computers, calculators, accounting and office machines, and electronic measuring instruments. The units are available with either maintained or momentary contacts. The two-pole double-throw devices, for

Ten transformers mount on single circuit board

Ten multiple-pulse transformers can be mounted on a single printed-circuit board. Models 4253-1004 and 4253-1005 allow each or all of the units to be tailored for circuit applications—either as drivers or isolation units in computer memory systems. Operating temperature range is from 0 to 70 $^{\circ}$ C, and dielectric strength is 250 volts rms. Pulse inductance is 6 millihenries, and ET constant is minimum of 0.5 volt-microsecond. The units, with 28 printed circuit leads, measure 0.300 by 0.320 by 2.0 inches.

Bourns Pacific Magnetics Corp., 28151 Highway 74, Romoland, Calif. 92380 [345]

Prepackaged attenuators use bulk metal-film resistors

A line of prepackaged attenuators incorporates stable bulk metal-film resistors. The units have a time-and-temperature stability of 25 parts per

single-hole mounting, feature positive detent action and an electrically independent lamp circuit. When necessary, the incandescent lamps, in 6, 14, or 28 volts, can be replaced from the front panel by removing the operator cap. Price ranges from \$2.08 to \$4.95 depending on quantity.

Specialty Products Div., Cutler-Hammer Inc., 4201 N. 27th St., Milwaukee, Wis. [349]

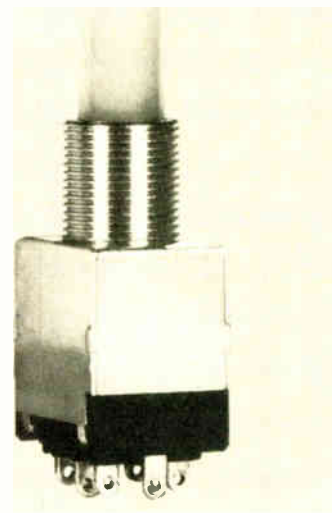

For all types of 1/4 x 1 1/4" fuses and fuseholders:

BUSS YOUR ONE SOURCE

Normal Blowing Fuses

AGC GLH MTH
From 1/500 to 30
amps, for 32V, 125V,
or 250V

Time Delay Fuses

MDL MDX
From 1/100 to 30 amps,
for 32V, 125V, or 250V

Visual Indicating Fuse

GBA (Red Indicating
Pin)
From 3/4 to 5 amps,
125V



Space-Saver
—projects only one
inch behind panel

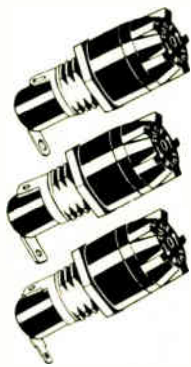

HTA (Solder
Terminals)
HTA-HH (1/4"
Quick-Connect
Terminals)
HTA-DD (3/16"
Quick-Connect
Terminals)

HKP (Solder Terminals) **HKP-HH** (1/4" Quick-Connect Terminals)
The Fuseholder for All-Purpose Applications

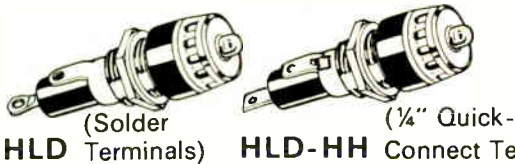

HLD (Solder Terminals) **HLD-HH** (1/4" Quick-Connect Terminals)
Visual Indicating Fuseholder

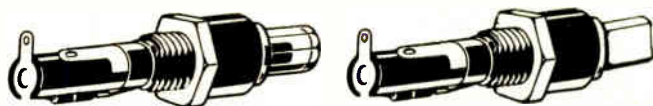

HKL (Octagon Knob) **HKL-X** (Flat-Sided Knob)
Lamp Indicating Fuseholder

FUSEHOLDERS

All Have These Features in Common • Rated for 15 amps at 250 volts • Dielectrically capable of withstanding 1500 volts a.c. between terminals and between terminals and panel • Bayonet-type knob grips fuse so that fuse is withdrawn when knob is removed; strong compression spring assures good contact • Made for installation in D-hole to prevent turning in panel • Terminals are mechanically secured as well as soldered in holder

This is only a sampling — use the coupon below to get a full description of the complete BUSS line of fuses and mounting hardware.

BUSSMANN MFG. DIVISION, McGraw-Edison Co.
St. Louis, Missouri 63107 E 672

Please send me a copy of BUSS Eullet'n SFB

Name _____

Title _____

Company _____

Address _____

City _____ State _____ Zip _____



New. 8-channel recorder with preamps in a single box.

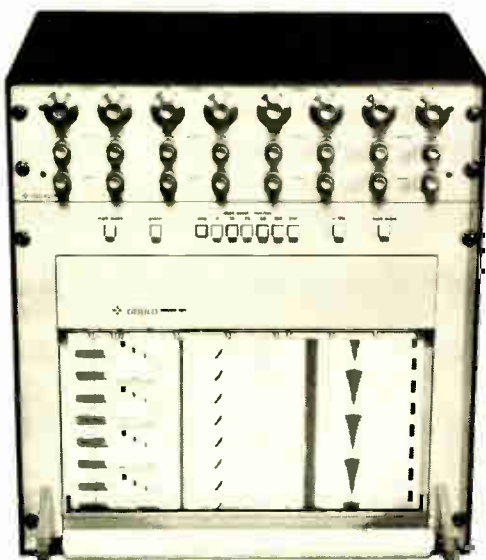

It's the Brush 481. For about \$1000 less than the same components bought separately.

It gives you Brush quality. And Brush innovations. For example: pressurized inking system that writes dry and eliminates smudging, puddling and priming. And Metrisite® non-contact servo-loop feedback device that guarantees 99.5% linearity.

You also get 12 pushbutton chart speeds, from 0.05 to 200mm/second. 40 Hz full scale frequency response. And the built-in preamps provide a measurement range of 1mV/div to 500 V d-c full scale. With differential, balanced and floating inputs and high common mode rejection.

Finally, you get your choice of either a compact portable or rack mounted version—and accessories like chart take-up reel and Z-folder.

The only thing missing: the problems of separate preamps.

You'll certainly want more information. So contact Gould Inc., Instrument Systems Division, 3631 Perkins Avenue, Cleveland, Ohio 44114. Or Rue Van Boeckel 38, Brussels 1140 Belgium.

BRUSH INSTRUMENTS

 **GOULD**

Instruments

Synthesizer has low phase-noise

160-MHz unit is remotely programable; basic model built for external control

Frequency synthesizers are well known for their extremely high frequency stability and resolution. On the other hand, their noise performance—phase noise, in particular—is not usually considered to be a



strong point. For this reason, General Radio considers its model 1061 a significant addition to the frequency-source market.

The basic instrument, priced at \$4,700, spans the range from 400 kHz to 160 MHz, with a resolution of 10 kHz (5 digits). Its signal-to-phase-noise ratio is greater than 60 dB for a noise bandwidth extending from 0.5 Hz to 15 kHz on both sides of the center frequency. The signal-to-amplitude-noise ratio is greater than 80 dB for the same noise bandwidth.

Non-harmonically related spurious frequencies are more than 80 dB below the fundamental frequency, while harmonically related signals are at least 30 dB down. Output power level is adjustable from 0 dBm to +20 dBm (into a 50-ohm load) and will remain level to within 1 dB across the full frequency range.

Reflecting the increasing trend toward automated instrumentation, the basic version of the 1061 is controlled entirely by external signals and has no front-panel controls. This improves the unit's reliability and keeps its cost to a minimum.

Front-panel controls are available as an option at a cost of \$350. Frequency control of the basic synthesizer is by a TTL-compatible binary-coded-decimal signal. Output power is controlled by a continuously adjustable dc voltage.

The basic synthesizer contains no reference oscillator. If an internal frequency standard is required, two options are available: an oscillator with a maximum frequency drift of two parts per million per month, selling at \$190; and a unit with a maximum drift of one part per billion per day, priced at \$470.

Other options include resolution to within 0.1 Hz (10 digits), phase-modulation capability, and a continuously variable frequency mode, which effectively converts the synthesizer into a sweeper because it allows the frequency to be controlled by an external sawtooth waveform.

The 1061 requires 75 watts of prime power at either 115 or 230 volts $\pm 15\%$ at any frequency from 45 to 500 Hz. It fits into a standard 19-inch rack and weighs 50 pounds. Height is 5.22 inches and depth is 22.88 in. Operating temperature range is 0 to +50°C.

General Radio Co., 300 Baker Avenue, Concord, Mass. 01742 [351]

Low-priced panel meter aimed at industrial jobs

The \$35–\$50 analog meter market is the target of Analog Devices Inc. in fielding a 2½-digit panel meter that will sell for \$50 in OEM lots of 100 and up. The user gets a choice of green, red, blue or amber displays. The digital meter, designated the AD2002, uses seven-segment incandescent RCA Numitrons for readout.

With the 2002, there is no fancy back-panel connector and no need for digitally processed data. Analog inputs of 0 to 1.99 volts can be soldered directly to back-panel connections. The decimal point is fixed by simply disconnecting unwanted points on the back panel.

Despite its simplicity, Analog says, the meter is accurate to within

0.5% of reading ± 1 digit. Powered by 5 volts dc, the instrument uses a staircase/counter technique for converting analog signals to digital form.

Thomas Mealey, product marketing manager, expects the meter to sell into pure readout applications, including temperature and other industrial indicators, and into medical and scientific instruments which often need only 2½-digit resolution but have a requirement for unambiguous readouts.

The meter will sell for \$75 each for 1 to 9. For digital interfacing, a BCD option is offered for \$5 in OEM lots.

Analog Devices Inc., Rte. 1 Industrial Park, P.O. Box 280, Norwood, Mass. 02062 [352]

Function generator offers range of 10^{-4} Hz to 11 MHz

A broadband function generator with a frequency range from 0.0001 hertz to 11 megahertz is designated the model 7056. The unit provides voltage-controlled amplitude, frequency, offset, and phase modulation. In the amplitude-modulation mode, the 7056 can vary the modulation from zero through 100%. The unit is also a source of sine, square, triangle, ramp, pulse, and synchronous waveforms, continuous, single-shot, or burst. Phase-lock operation permits the unit to be locked to an external frequency, and the relative phase of the 7056 output to be varied through 360° with respect to the signal locked into. Price is \$995.

Exact Electronics Inc., 455 S.E. 2nd Ave., Hillsboro, Ore. 97123 [353]

Digital panel meters have plug-in LED readouts

A line of digital panel meters, the model 1295 series, offers a single MOS LSI plug-in chip, replacing as many as 16 standard 14-pin transistor-transistor logic packages. In addition, the unit has plug-in light-emitting-diode readouts. Other features include a single printed-circuit

Bond instead of bolt

Eastman 910* adhesive speeds assembly line operations, eliminates parts inventories. Joins fast, strong, economically.



For details, call or write:
Eastman Chemical Products, Inc.
Kingsport, Tenn. 37662



Circle 130 on reader service card

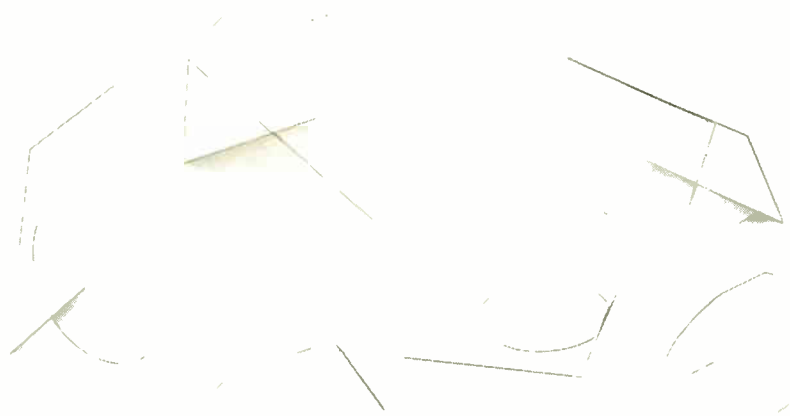

Now your sapphire substrates cost you less. A lot less.

Go ahead with your plans for SOS and hybrid IC work and forget the budget. Meet all your thin film and epitaxial requirements and win your purchasing department's approval. Get the circuit isolation only sapphire substrates provide and make a better product.

A lot of new things are possible now that your sapphire substrates cost you down to 50% less than you thought they would.

That's right — polished, single crystal, pure sapphire substrates in any size you need for about half the cost of yesterday's price. Plus all popular orientations like 1102 for SOS and C axis for hybrid IC's. Plus the finest sapphire substrate quality you can get. Anywhere.

How do we do it? Very intelligently. Call Frank Reed, Marketing Manager, and find how we can do it for you. For less.

NYCO saphikon division 16 Hickory Drive • Waltham, Mass. 02154 • (617) 890-2400

130 Circle 149 on reader service card

New products

board for all analog-to-digital and digital circuitry, power consumption of about 2½ watts, fixed or remote programmed decimal points, and easily changeable range. The unit is designed to function in severe environments, and input versus readout-slope change is easily achieved.

The model 1295 is a full bipolar

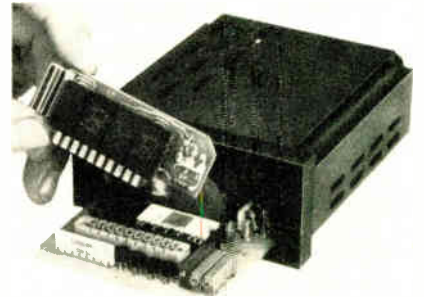

3½-digit unit; the 1296 is a limited 3½-digit unit; and the 1297 is a full bipolar 2½-digit unit. Accuracy for the 3½-digit DPM is to within $\pm 0.1\%$ ± 1 digit and for the 2½-digit unit, it is $\pm 0.5\%$ ± 1 digit. Price for the meters is less than \$100 in OEM quantities.

Weston Instruments Inc., 614 Frelinghuysen Ave., Newark, N.J. 07114 [357]

Oscilloscope delivers dc to 10-MHz bandwidth

The dual-channel model 2100 portable oscilloscope has a bandwidth from dc to 10 megahertz, sensitivity of 10 millivolts per division, and a maximum sweep speed of 50 nanoseconds per division. The unit also provides a delayed sweep capability, along with pushbutton front panel controls and functional color groupings. The unit is designed with integrated circuits, thereby eliminating variable components. The model 2100 has full auto-triggering in addition to AND-gate logic for external triggering of as many as four simultaneous inputs. Price of the unit is \$995.

Dumont Oscilloscope Laboratories Inc., West Caldwell, N.J. 07006 [358]

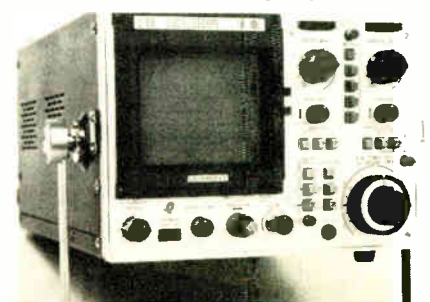



The PDP-11 family grows on. The rugged one: PDP-11R20

Some computer problems are plain impossible to bring to the computer. PDP-11R20 goes to them.

Goes where there are bad things like 5G shocks, 500Hz vibration, 55°C temperatures, 95% relative humidity, severe EMI, 30% voltage swings, 10% frequency transients. Even if the power source fails completely, the PDP-11R20 processor will resume when the power does — from just where it left off. You won't lose data.

Then there are convenience features: Peripheral connections are MIL type — quick and reliable. The computer will operate in any attitude — at weird angles, even upside down if it comes to that.

Aside from these and other protective features, the 11R20 is the same high-performance 16-bit computer as the PDP-11/20 and possesses the most powerful mini-computer architecture in the world. Like core memory expandable to 124K words, built-in multi line and level priority interrupt, 8 general purpose registers, over 400 instructions, direct memory access, automatic power fail and restart.

It goes on and on. So if you happen to have an ocean going ship, or a tank, or just an ordinary van, take PDP-11R20 to where the control or processing problems are. It will not only survive the environment, it will keep processing in the environment for a long time.

But first, send for the complete story. Digital Equipment Corporation, Main St., Maynard, Mass. 01754. (617) 897-5111. European Headquarters: 81, route de l'Aire, 1211 Geneva 26 Tel.: 427950

digital

Circle 131 on reader service card

In the grand tradition of the paper clip:

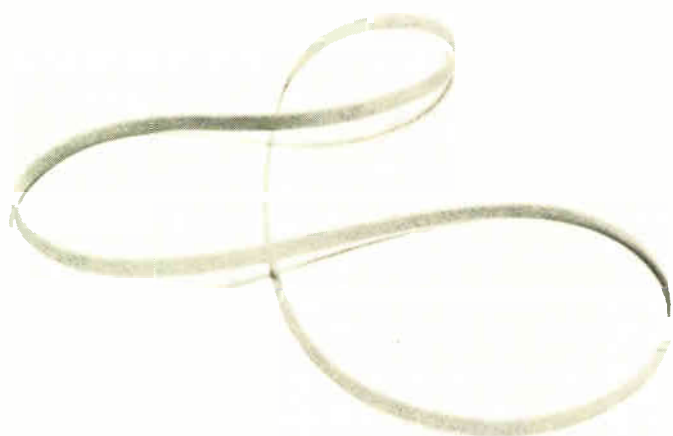

The 3M drive band. A new concept in tape handling.

Based on an entirely different, elegantly simple drive technique, the new 1/4" Scotch® Brand Data Cartridge combines reel-to-reel performance with cassette convenience and price.

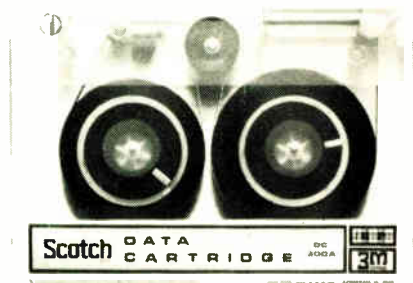

The Data Cartridge functions as its own transport and needs to be driven at only a single point.

With our new technique, tape is handled — not just driven — in the Data Cartridge.

The drive band travels

around three tension rollers and is wrapped partially around the tape on both hubs, making "rolling" contact with the tape. Tape wear is extremely low since the tape oxide touches nothing else except the head. Compliance in the band provides controlled tape tension at all times. No machine operation can cinch, spill, stretch or break the tape.

A single external motor powers the drive band through contact

with extended hubs on one of the tension rollers. Tape motion is easily controlled by starting, stopping or reversing this motor.

Since no external guidance is required, tape/head alignment is simplified and a variety of head and data configurations may be used with consistently high data reliability.

The Data Cartridge starts and stops within 25 ms at any operating speed, shuttles at up to 180 ips, stores up to 8 times as much data as the 0.150" cassette and has an expected lifetime in excess of 5000 passes.

Add to this a cost comparable to cassettes and only one quarter that of 1/2" compatible tape decks, and you have a breakthrough in digital tape handling for any application.

Need more data? Simple.

Contact Data Products, 3M Company, 300 S. Lewis Road, Camarillo, California 93010, Tel. (805) 482-1911, TWX 910-336-1676.

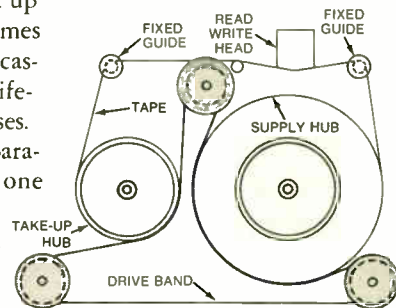

Data Products **3M** COMPANY

Data handling

2-k MOS RAM goes to market

TTL-compatible memory with 590-nanosecond cycle time sells for a cent a bit

What started out as a custom-designed project for Honeywell Inc. has become an off-the-shelf product for semiconductor makers. Last year, Honeywell funded development of a 2,048-bit random-access MOS memory. Several companies received funds, but it appears that only Advanced Memory Systems Inc., Sunnyvale, Calif., and Signetics Corp., also of Sunnyvale, have delivered the devices and are supplying Honeywell's initial production demands. A third company, National Semiconductor Corp., Santa Clara, Calif., which developed the part with in-house funds, is also supplying Honeywell.

But now that Honeywell seems to be getting enough devices, AMS will sell the part on the open market. Applications include use in calculators, test equipment, smart terminals, small- and medium-size computer memories, and in an add-on memory system for the IBM 370 series.

The AMS 6003 is a 2,048-word-by-1-bit MOS dynamic random-access memory that has a maximum access time of 360 nanoseconds and a cycle time of 590 ns. Inputs are TTL-compatible, thereby eliminating the need for level shifters, and the output current is a hefty (by MOS standards) 2 milliamperes, so that there is no need for a sense amplifier to get TTL-level outputs—all that must be added is a resistor. The original Honeywell specification called for an output current of 600 microamperes. AMS had the idea to boost this to 2 mA, accomplished by using a huge output transistor on the chip.

The 6003 has a built-in data latch—the output stays valid throughout the complete cycle—and

therefore there is no need for an external latch to make sure the data is stored in the device when it is strobed. The latch requires that the address be valid for only 80 ns, then the line can go high for the rest of the 510 ns in the cycle.

The part employs a standard high-threshold MOS process—one that AMS has been using for several years. This, says Mel Phelps, marketing manager, "is one reason that the part yields well; another is that it is not a very big chip—it measures approximately 150 by 170 mils." A special circuit is used in a feedback network to get TTL levels from the high-threshold part.

The AMS 6003 is available from stock for 1¢ per bit—\$20.48—in quantities of 250.

Advanced Memory Systems Inc., 1276 Hammerwood Ave., Sunnyvale, Calif. 94086 [361]

Low-cost computer built for process, simulation systems

Users of small process control systems or digital simulation systems often have to pay about \$2,500 for the minicomputer needed in the system. The Micro II computer from Garrett Manufacturing Ltd. is aimed at precisely those kinds of applications, and with a price of \$1,550 in single quantities; the price drops by \$250 in quantities of 100 or more.

The basic processor comes with 256 words of 8-bit bipolar semiconductor memory, which is expandable to 2,048 words and can include a mixture of random-access and read-only devices. Although it's a small memory, officials at the company, a subsidiary of the Garrett Corp., say it's sufficient to handle a variety of applications. Among them are controlling the processing of printed-circuit boards. This could include control of both the etching-time sequencing and hole-drilling.

Another use might be in digital system simulation. Company engineers point out that because the inputs and outputs are brought out to

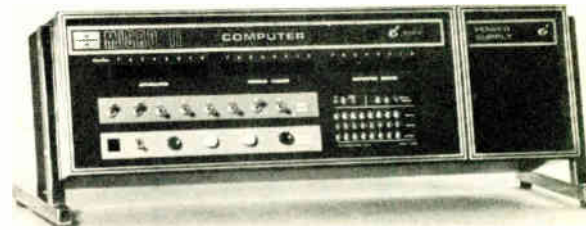

the Micro II's front panel, the processor can be used to breadboard a digital circuit, using the front panel jacks to patch the circuit into the processor, check it out, and finalize the circuit schematic. This feature is already catching on in digital training courses at universities.

The general-purpose parallel machine executes any instruction in some 500 nanoseconds, and the instruction set totals 16. Programs can be loaded by means of front-panel switches, or through peripheral devices such as paper tape units, a cassette recorder or keyboard. Use of a standard rear-connector permits coupling the cassette recorder to the processor for memory loading. In all, up to seven different input or output devices can be addressed.

The Micro II is offered as either a stand-alone processor or in a 19-inch-wide rack-mounted version for original equipment manufacturers. Delivery time is approximately eight weeks.

Garrett Manufacturing Ltd., 255 Attwell Dr., Rexdale, Ontario, Canada [362]

Transmission controller is IBM 360/370 compatible

A transmission control unit called the model 270X is a plug-for-plug front-end compatible unit for IBM 360/370 mainframe computers. The unit includes a model 55 dual processor with two banks of 8,192-byte modular core memory, 32 general-purpose registers, hardware multiply/divide and floating point, list processing, automatic I/O, and a special instruction set for data com-

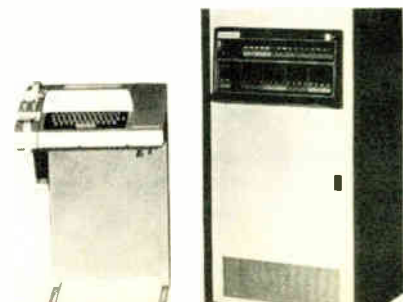

ENGINEERS WHO KNOW ZENER DIODES SPEC DICKSON

That's because Dickson has earned a reputation for excellence in voltage regulating (Zener) and reference (TC) diodes. Since Dickson has always been a specialist in Zeners, engineers expect the best and they get it . . . from a hi-rel military unit to low-cost industrial devices. Give us a try! Write, today, for our 6-page Zener Selection Guide.

"The Specialists"



"Where Quality Makes The Difference"



DICKSON
ELECTRONICS CORPORATION
PHONE (602) 947 2231 TWX 910 950-1292 TELEX 667 406
P.O. BOX 1390 • SCOTTSDALE, ARIZONA 85252

Circle 134 on reader service card

A new read/write memory system with ROM capability— by TOKO

Let TOKO bridge the gap between law-performance 0.5 penny per bit memory and 3 pennies per bit memory. TOKO's new NDRO memory system, HS-600E, offers high performance—300NS access time and 600NS cycle time—and electrically alterable ROM capability. TOKO's plated wire memories, assure simplified computer architecture.

Basic module size:

- 4K word by 9 bits
- 4K word by 18 bits
- 8K word by 9 bits
- 8K word by 18 bits

8K x 18 configuration consists of five plug-in boards: two memory stack boards, two bit electronics boards and one word electronics and control board. Each board 13" x 8.7" in size.

Various memory systems, stacks, pulse transformers, and delay lines are also available.

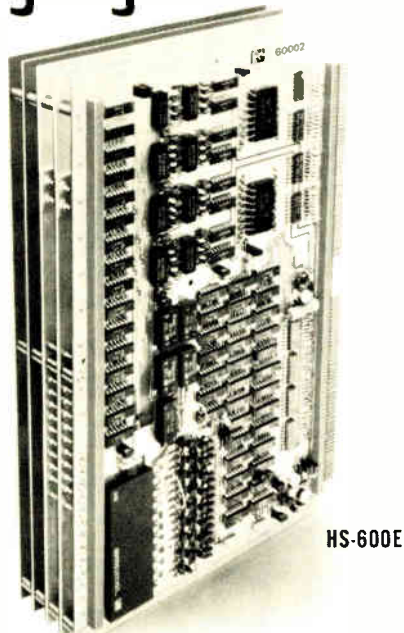

HS-600E

Head Office: 1-1-1 Chome, Higashi-Yuki-ya, Ohta-ku, Tokyo, Japan
New York: Toko New York Inc. 150 E 4th St., New York, N.Y. 10001 U.S.A. Tel: 565-1767, Lo. Angeles: Toko, Inc. Los Angeles
London Office: 18-20 W. 1. Plymouth Blvd., Lo. Angeles, 90 01 1-1
U.S.A. Tel: 380 0417 (Das. Ador.) Toko Elektronik GmbH: 4-D 100 1
Laytonstrasse 77, W. Germany, 1. D 11 641 11



For further information, just call or write:

TOKO, INC.

New products

munications and I/O requirements. Also featured are power-fail protection with auto restart, console typewriter, universal real-time clock module, and expansion chassis. Price of the 270X is \$49,000. It is expandable in memory, line terminations, and other options.

Interdata, 2 Crescent Place, Oceanport, N.J. 07757 [365]

Tape transport offers crystal-controlled timing

A tape transport with crystal-controlled timing throughout also features three automatic clipping level changes and marginal skew check. The model 9000 is available in tape speeds from 12½ to 37½ inches per second, nine-track 800 characters per inch, and seven-track dual density. In addition to overwrite, other features are: front-accessible test panel with additional checkout controls, selectable addressing, and light-emitting-diode indicators. Price is \$2,500 in quantity.

Kennedy Co., 540 West Woodbury Rd., Altadena, Calif. 91001 [366]

Card-to-tape converter reads 40 cards per minute

A card-to-punched-tape converter called the model 40 CTP is aimed at numerical control, input systems for



digital computers, communications, automatic testing, and specialized data processing applications. The unit punches 72 characters per sec-

ond and reads 40 cards per minute. It measures 22 by 22 by 24 inches, and test results have shown 30 errors per 50 million character conversions. Price is \$6,500.

Datatec Corp., 6119 Jessamine St., Houston, Texas 77036 [368]

Magnetic tape data terminal provides automatic rewind

An optional automatic rewind feature is offered for the model 4210 magnetic tape data terminal. This feature allows the user to place the 4210 in an unattended answer mode and to receive data at speeds of up to 240 characters per second during a 24-hour period. Once the data batch has been received, the 4210 automatically rewinds the magnetic tape at 400 characters per second to the beginning of the transmission, turns on its associated printer, and reproduces the data via hard copy at speeds of up to 150 words per minute. When the data has been printed, the unit switches itself back to the unattended mode to begin the cycle again.

Teletype Corp., 5555 Touhy Ave., Skokie, Ill. 60076 [367]

Tape transport is for OEM digital applications

A high-precision digital cassette tape transport is aimed specifically at OEM applications. The basic CT100A is a single-capstan transport and can include all the control electronics, read/write amplifiers, servo electronics, tape beginning and end sensors and logic, high-speed search, and file-protect circuitry. Double-capstan models with and without electronics are also available. Start/stop time is 20 milliseconds, recording density is up to 1,600 bits per inch, and tape speed is from 4 to 12 inches per second. The unit is configured with a minimum of moving parts—there are no clutches, springs or pulleys, and the capstan motor is a brushless type.

Electronic Associates Inc., West Long Branch, N.J. 07764 [369]

SOLITRON

silicon power rectifier assemblies

to meet all your requirements

Conservatively rated @ 25 amps., using latest thick film technology for maximum thermal efficiency resulting in low θ_{j-c} characteristics.

Features: PIV—50 to 600 volts
25 amps. I_o @ T_c 75°C.

J527 SERIES
COMMON CATHODE, ANODE OR DOUBLER

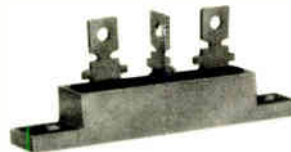

H768 3-PHASE
BRIDGE SERIES

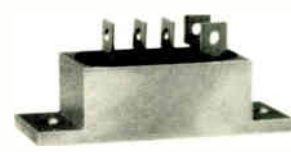

G775-U BRIDGE SERIES DESIGNED
TO MEET UL REQUIREMENTS



J775 BRIDGE SERIES

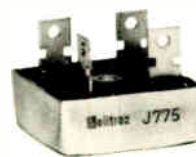

10 AMP. BHC SERIES



Features: VRM 100-600 V
10 amps. I_o @ T_c 65°C.

Write or call for full technical information:

EAST

Florida, Orlando
Hallmark Electronics
(305) 855-4020
Maryland, Baltimore
Radio Electric Service
(301) 823-0070
Savage
Pytronics, Inc.
(301) 792-7000
Massachusetts, Boston
DeMambo Electronics
(617) 787-1200
Nedham Heights
Kierulff/Schley
(617) 449-3600
New Jersey, Pennsauken
Resco (609) 662-4000
New York, Binghamton
Federal (607) 748-8211

Hauppauge
Semiconductor Concepts
(516) 273-1234
Hicksville
Kierulff/FJR
(516) 433-5530
Pennsylvania, Trevose
Hallmark (215) 355-7300

MIDWEST

Colorado, Denver
Intermark Electronics
(303) 936-8284
Kierulff (303) 343-7090
Illinois,
Elk Grove Village
Lakeland (312) 595-1000
Ohio, Dayton
Kierulff (513) 278-9411
Kettering
Arrow (513) 253-9176

Texas, Dallas
Component Spec.
(214) 357-4576
Houston
Component Spec.
(713) 772-5127

WEST

Arizona, Phoenix
Kierulff (602) 273-7331
California, Culver City
Avnet (213) 836-7200
JSH Elec. (213) 837-0177
Los Angeles
Kierulff (213) 685-5511
Menlo Park
Bell (415) 323-9431
San Carlos
Intermark Electronics
(415) 592-1641

San Diego
Intermark Electronics
(213) 782-0362
Washington, Bellevue
Farwest (206) 747-1515

Seattle
Intermark Electronics
(206) 767-3160
Kierulff (206) 763-1550

CANADA

Quebec, Montreal
Prelco Electronics, Ltd.
(514) 389-8051

 **solitron devices, inc.**

256 Oak Tree Road, Tappan, N. Y. 10983 (914) 359-5050 • TWX 710-576-2654

Subassemblies

Photodiodes give wide light range

Silicon devices designed for coupling to op amps in photometers, radiometers

For manufacturers of light-measuring instruments who are shifting from photomultiplier tubes to solid-state combinations, prime considerations include low light levels and wide light-level ranges. To help achieve these goals, United Detector Technology has developed a new line of p-i-n silicon photodiodes called the DP series.

The devices are aimed particularly at makers of photometers, radiometers, and densitometers.

For photomultiplier replacement, the photodiodes are used in the photovoltaic mode rather than the conventional biased arrangement. For biased applications, the photodiode is usually chosen for minimum dark leakage current and minimum capacitance to produce minimum noise, offset voltage and response time.

But, says Paul H. Wendland, president of UDT, this is not an optimum arrangement for photodiodes, which are current generators rather than variable resistors—it's better to use them with inverting-mode operational amplifiers, basically current-to-voltage converters [*Electronics*, May 24, 1971, p. 50]. In this hookup, the diode is placed in the feedback loop, and maximum zero-bias impedance is the most desirable characteristic to get low noise and wide range. The DP series has been specifically designed for this property, Wendland says, without sacrificing wide spectral coverage and dynamic range.

The PIN-3DP, for example, has a typical zero-bias impedance of 300 megohms. Coupled with an op amp that has a low-noise field-effect-transistor input, the PIN-3DP can detect light levels from 10^{-13} watts to

10^{-3} w—a 10-decade range—with a linearity that is within 1%. Housed in a TO-18 package, it has an active area of 0.03 square centimeter and sells for \$6.20 in quantities of 100.

Another in the new line, the PIN-10DP, with a BNC connector, has an active area of 1 square centimeter, impedance of $2\text{ M}\Omega$, and a price tag of \$33.15. Units are available in TO-5 and TO-8 packages, as well as in the TO-18 type.

United Detector Technology Inc., 1732 21st., Santa Monica, Calif. 90404 [381]

Active notch filters offer stability, high Q

A line of active notch filter modules for printed-circuit-board-mounting offers a variety of notch frequencies in the audio range. Q is set with an external resistor over a range of 8 to 100, without affecting tuning or gain. Minimum attenuation at the notch frequency is 40 decibels; a dc offset capability is included. Input impedance is 1 megohm; output impedance from the emitter-follower circuit is less than 2 ohms. Frequency stability is 25 ppm/°C. Applications include rejection filters for line frequencies such as 50, 60, 100, 120, and 400 hertz, particularly in instruments that handle low signal levels.

A.P. Circuit Corp., 865 West End Ave., New York, N.Y. 10025 [382]

Converter provides stable 2-wire digital transmission

A voltage-to-frequency converter permits 2-wire transmission of digital data and can be used with strain gages, thermocouples, load cells, voltage or current sources, phase detectors, and medical instrumentation transducers. It is also suited for control or monitoring servo and phase-locked loops, synchronous speed control, and arithmetic operations. The model 4701 features linearity to within 0.01%. Output waveform is a train of DTL/TTL-compatible 30-microsecond pulses.

Price of the converter is \$59. Teledyne Philbrick, Allied Dr. at Rte. 128, Dedham, Mass. 02026 [387]

Range of active filters is 0.001 Hz to 50 kHz

The series 700 active filters covering 0.001 Hz to 50 kHz are unity-gain, noninverting types. Models include 2-, 4-, and 6-pole versions, low-pass,

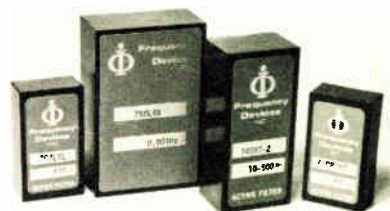

high-pass, or bandpass, with Butterworth, Bessel, and Tchebyscheff transfer functions. Also included are 4-pole low-pass filters externally tunable (with resistors) up to a 500:1 ratio in the range of 1 hertz to 50 kilohertz. Insertion loss is 0.02 decibel, and cutoff frequency accuracy is to within 2%. Other specifications are a 1-ohm output impedance and output drift to $\pm 20\ \mu\text{V}/^\circ\text{C}$. Price in 100-lots is from \$25.

Frequency Devices Inc., 25 Locust St., Haverhill, Mass. 01830 [385]

Counter-display modules have from 2 to 6 digits

A series of modules includes a decade counter, latch, decoder driver, and readout for each digit. Models

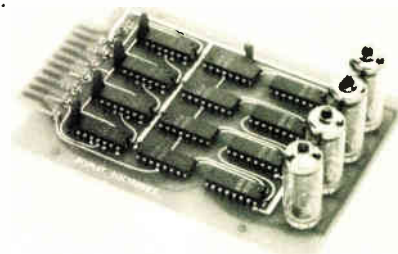

in the series CM are available with from two to six digits, and the integrated circuits are 7400 series transistor-transistor logic. Minimum counting rate is typically 18 megahertz, and the modules operate over

MONOLITHIC
CRYSTAL FILTERS

THE
STATE
OF THE
ART

Bicycle Built For Two

 Tandem bikes are a current fad. Tandem monolithics are more than a fad — they're the state of the art. And for good reason. If you need four-pole performance, or better, you probably need a tandem monolithic crystal filter. Like to know more? Talk with us. We make monolithics and tandem monolithics — more of them than anyone else — and we'll be glad to discuss which is best for your application.

Who Gets Your Business

 Many companies know a little bit about making a lot of things. We know a lot about making just one thing — monolithic crystal filters. The fact that we are the only specialists in the field is a reassuring point for you. Especially when you need assistance and technical know-how in solving filtering problems.

Standard Versus Custom Models

 In the horse-and-buggy days of electronics (year-before-last) all crystal filters were custom models — expensive and uncertain in price, performance and delivery. We've changed all that with a wide, wide selection of standard models. Twenty-one new models at 21.4 MHz. Over twenty-five models at 10.7 MHz. All available from stock. Plus many others, all using our proven monolithic technology. Standard models save time, save money, and you know what you're going to get. When you do need custom filters, we can help. From writing specifications to delivering on time.

Like more information on monolithics? Drop us a line or call us.

Pi

Piezo Technology Inc.

2400 Diversified Way
Orlando, Florida 32804
305-425-1574

The standard in monolithic
crystal filters.

New products

a temperature range from 0 to 70°C. Lamp test and zero blanking functions are provided. A 5-volt dc power supply is required for logic and readout. Price of the four-digit module is \$79.

Display Electronics, P.O. Box 1044, Littleton, Colorado 80120 [388]

A-d converter comes in modular form

A dual-slope integrating analog-to-digital converter in modular form is available in either 17-bit binary-coded-decimal output or 14-bit binary output. The devices feature accuracy to within 0.01%. 40 millise-



conds of total conversion time, automatic error correction, high noise rejection, and measurement at the rate of 25 samples per second. Analog input range is ± 10 volts full scale, and overload capability is ± 100 v maximum. Single unit price is \$259.

Analog Devices Inc., Rte. 1 Industrial Park, P.O. Box 280, Norwood, Mass. 02062 [389]

A-d module converts

8 bits in 2 microseconds

The model ADC 540WB general-purpose analog-to-digital converter has a maximum sample rate of 500,000 samples per second. The unit converts eight bits in under 2 microseconds, and is used in conjunction with successive-approximation logic. Settling time is 100 nanoseconds. Accuracy versus temperature specification is 50 parts per million per degree centigrade, and linearity vs temperature is 20 ppm/°C. Price is \$195.

Hybrid Systems Corp., 95 Terrace Hall Ave., Burlington, Mass. 01803 [390]

\$125



it's so easy to take . . .

You can replace your thermopile with a SBN PYROELECTRIC DETECTOR.

- **BROADBAND RESPONSE**— UV to microwaves
- **HIGH SENSITIVITY**— > to 125 V/W
- **FAST RESPONSE**— better than 5ns
- **NO CRYOGENICS**— operates from -40°C to 90°C
- **RUGGED AND NONHYGROSCOPIC**

This package includes a sensing element plus an integral FET and fits a standard 9 pin miniature tube socket. Available from stock for only \$125.00.

Call us at 216/248-7400 with your IR detection and measurement problems.



HARSHAW

THE HARSHAW CHEMICAL COMPANY
DIVISION OF KEWANEE OIL COMPANY

Crystal & Electronic Products Department
6801 Cochran Road • Solon, Ohio 44139
(216) 248-7400

Semiconductors

ROM uses only 100 μ W per bit

C/MOS memory designed
as low-power replacement
for p-channel 1101 type

Complementary metal-oxide semiconductor devices seem to be finding wide interest as low-power replacements for existing bipolar logic and p-MOS memory circuitry. National Semiconductor has announced a line of C/MOS pin-equivalents for low-power transistor-transistor logic. Solitron will shortly announce a similar line, and meanwhile has also developed a replacement for the popular p-channel 1101A 256-bit static read-only memory with a new feature—it can maintain data storage indefinitely by using a small battery if main power fails.

The new CM4111 is a plug-in replacement for the 1101A, but has much lower power drain—typically less than 100 microwatts per bit instead of 10 milliwatts. It's also a little faster than the 1101A with a 500-nanosecond access time.

The requirement for only one power supply voltage led Solitron to add a feature. The extra power terminal required by the 1101A has been used as a separate connection for the storage array so that it can be driven during a power failure—the drain is in picoamperes.

The CM4111, packaged in a 16-pin DIP, is priced at about \$14 in small quantities—between the 1101A and the faster 1101A-1.

Solitron Devices Inc., P.O. Box 1416, San Diego, California 92111 [411]

FET-input op amp
has low input bias

A new monolithic field-effect-transistor-input operational amplifier is being offered by Intersil Inc., Cu-

pertino, California.

The device, called the 8007, requires an input bias current of only 2 picoamperes and has a slew rate of 6 volts per microsecond. Input impedance is 10^{12} ohms, and the unit is internally compensated.

Jack Gifford, director of analog products, comments, "For the first time, we're offering the designer a monolithic op amp that competes favorably with the big complex modules and yet is no bigger than, and pin-compatible with, the 741 op amp." The 8007, packaged in a low-profile 8-pin, TO-99 case, is a pin-for-pin replacement for the 101A, 709, 740, and 741 op amps.

A special version, the 8007A, offers input bias current of 1 pA maximum at 25°C. The 8007A has its case electrically isolated from the chip, permitting the designer to operate the case at any potential.

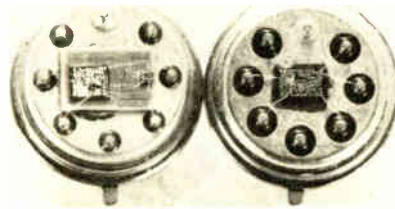

Also, leakage paths between pins are minimized, since the case intercepts the current flow. This is the key to operating the device at 1-pA bias. The 8007 is priced at \$5 each in quantities of 100.

Intersil Inc., 10900 North Tantau Ave., Cupertino, Calif. [412]

Dual Darlingtons are
rated up to 30 watts

Dual Darlingtons featuring power ratings as high as 30 watts are designed for wave-bridge applications such as stepper-motor drivers and converters in print-hammer and



other solenoid drivers. Other features include a BV_{CEO} up to 100 volts, minimum current gain at 5 amperes up to 2,000, with a saturation voltage as low as 1.5 volts at 5A, turn-on time up to 0.5 microsecond and turnoff time up to 2 μ s. U2T101 series monolithic power Darlington chips are used in the units, and high speed rectifiers are included for inductive load current commutation. Prices in 100-lots are \$10 for the 30-watt PIC500, \$6.50 for the 20-w PIC501, and \$4.90 for the 20-w PIC502.

Unitrode Corp., 580 Pleasant St., Watertown, Mass. 02172 [417]

AND/OR biphas pairs are
aimed at digital applications

A triple AND/OR biphas pair using C/MOS technology is intended for use in digital equipment where low power dissipation, low package count, and high noise immunity are primary design requirements. The model CD4037A can be used for data coding and decoding in split-phase communications systems; disk, drum, and tape digital recording systems; plated-wire and core memory systems; or as a high-to-low logic level converter. Features include microwatt quiescent power dissipation, high noise immunity, and large fanout capability. Price ranges from \$3.60 to \$8.16 in 100-lots, depending on packaging.

RCA, Solid State Div., Rte 202 Somerville, N.J. 08876 [420]

Op amp's input offset
voltage is 0.7 mV

Series 2157 dual operational amplifiers are designed as direct plug-in replacements for type μ A747 op amps. The units feature a high common-mode input voltage range, and an input offset voltage of typically 0.7 millivolt. Input offset current is typically 2 nanoamperes, input bias input resistance 3 megohms, and open loop voltage gain 250 volts per millivolt. Also offered are offset null

NEW CATALOG RELEASE
from CENTRON ENGINEERING, INC.

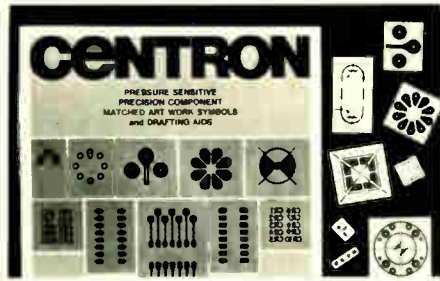

This new 16-page catalog with over 3,500 new items, includes CENTRON'S pressure sensitive artwork symbols and drafting aids plus a complete assortment of pre-cut reference designation letters and numbers of various sizes, related drafting words, schematic and logic symbols, new connector fingers, and fillets.

Send now for this **FREE** catalog, #105, and sample.



Circle 152 on reader service card

SAN-E
DIGITAL TAPE HEADS

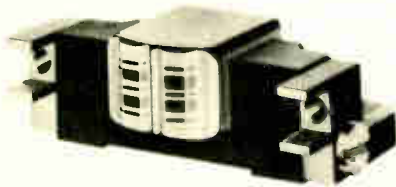

MSD-2/MSD-2F DUAL GAP HEADS
(read after write) for 2-ch. cassette format

DIGITAL & MAGNETIC CARD HEADS

- MSW-2F. digital write head
- MS-TR3/TW3 3 ch. read/write head
- MS-C9 9-ch. read head
- MS-TR7/TW7 7-ch. read/write head
- MS-TR9/TW9 9-ch. read/write head
- MS-TR12/TW12 12-ch. read/write head

AUDIO TAPE HEADS

- MS-8 8track-2channel stereo head
- MS-8C 8track-2channel rec./playback & erase head
- MS-84 8track-4channel stereo head
- MSP-44 4track-4channel for auto reverse stereo cassette head

SAN-E DENKI COMPANY, LIMITED
1101 MINAMI KAWAHORICHO TENNOJI-KU, OSAKA, JAPAN
PHONES: OSAKA 779 1591 CABLE: SANMAGNETICS
TELEX: J63765 JCCINC

Circle 153 on reader service card

New products

capability and input and output protection. Operating temperature range is from -55°C to $+100^{\circ}\text{C}$, and versions are available for military

SPRAGUE
ULS-2157H

ULS-2157K

and aerospace temperature requirements. Price varies from \$2.68 to \$6.59, depending on quantity, packaging, and temperature range.

Sprague Electric Co., 35 Marshall St., North Adams, Mass. [418]

IC links TTL clocks with MOS systems

A clock driver, the MHP401, is designed to link saturated logic to the capacitive loading imposed by metal-oxide semiconductor systems. The unit is capable of sourcing and sinking the large peak currents necessary to achieve high clock rates, and a hybrid approach is used to



provide high current switching transistors and other associated components in a single package. While driving a 500-picofarad load and operating from +5- and -12-volt power supplies, the unit delivers clock pulses at rates of up to 5 megahertz. Price in quantities of 100 is \$3.90.

Motorola Semiconductor Products Inc, P.O. Box 20912, Phoenix, Ariz. 85036 [419]

**SUE:
THE FIRST
GIRL
MINICOMPUTER**

**[She loves to
make a scene.]**

For system users with a requirement for generating displays, our gal minicomputer becomes Scintillating SUE, the star of your show business. She'll give you a thruput of 80 million bits per second. Lets you intermix core and semiconductor memories as needed in the same system. And her wide bandwidth Infibus lets you update her whenever technology moves ahead a step or two. From Sailor SUE, for shipboard systems, to Sagacious SUE for elephantine memory, SUE leaves the neuter minicomputers far behind. She's the modular minicomputer. Call SUE at (213) 722-6810, or write: 6201 E. Randolph Street, Los Angeles, California 90040.

Lockheed Electronics

Data Products Division
A Subsidiary of Lockheed Aircraft Corporation



Circle 139 on reader service card 139

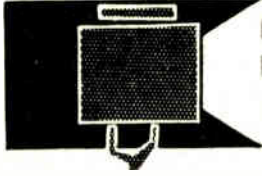

SEARCHLIGHT SECTION

- CLASSIFIED ADVERTISING • BUSINESS OPPORTUNITIES
- USED OR SURPLUS EQUIPMENT

HP 1208B XY DISPLAY SCOPES (New w variable persistence storage (HP price \$1195 w storage) **NOW \$650**

HP 80 (Mosley) Strip Chart Recorder Variable speed and level **\$450**

Large inventory of test equipment and transducers on hand—Let us know what your requirements are

LABORATORY EQUIPMENT SALES & SERVICE
415 Rainier Ave. N. Renton Wa 98055
Phone 206.228.2000

CIRCLE 953 ON READER SERVICE CARD

RADAR SYSTEMS GROUND AND AIRBORNE. AUTOMATIC TRACKING ANTENNA SYSTEMS. NIKE AJAX. NIKE HERCULES. M-33. MSO-1A. MPS-19. MPS-9. SCR 584. TPS-1D. TPS-28. FAA-ASR-2. AIRBORNE SYSTEMS. APN-84. APN-102. APS-20. APS-27. APS-45. DPN-19. DIGITAL COMPUTERS. IBM 450. IBM 704.

LARGEST INVENTORY OF RADAR AND MICROWAVE EQUIPMENT IN THE WORLD.
RADIO RESEARCH INSTRUMENT CO.
3 QUINCY ST., NORWALK, CONN. 06850 (203) 853-2600

CIRCLE 951 ON READER SERVICE CARD

free catalog

**POTTING APPLICATORS
MANUAL AND DISPOSABLE**

6cc 12cc 30cc

FOR POTTING, ENCAPSULATING, AND SEALING OF MINIATURE COMPONENTS

PHILIP FISHMAN COMPANY
7 CAMERON ST., WELLESLEY 81, MASSACHUSETTS

CIRCLE 952 ON READER SERVICE CARD



**EMPLOYMENT
OPPORTUNITIES**

ITALIAN INDUSTRY (MILAN)

Seeks experienced Chemist of Laboratory. Excellent knowledge concerning phenolic, epoxy and melamine resins as well as production of industrial laminates for printed circuits and multilayers. Please write:

Casella T-157
SPI
20100 Milan (Italy)

POSITION VACANT

Scientific Equipment Repairman—Medical Instrument Repairman—Electronics Technician—Tuskegee Institute, an independent university, requires services of a vigorous and responsible repairman of scientific instruments. He will organize and operate maintenance service for instruments used in biology, chemistry, veterinary medicine, agricultural science, etc. Most problems are electronic. Minimum of 2 years training and 4 years experience required. Salary open. Equal opportunity. Write J. G. Tryon, C/O School of Engineering, Tuskegee Institute, Alabama 36088.

Don't forget the

BOX NUMBER

. . . when answering the classified advertisements in this magazine. It's our only means of identifying the advertisement you are answering.

New literature

Software package. An illustrated 12-page brochure from Rapidata Inc., 20 New Dutch Lane, Fairfield, N.J., describes the features of Recal II, a computerized package for performing ac, dc, and transient analysis on linear and nonlinear circuits. Circle 421 on reader service card.

Clock/calendar. Chrono-log Corp., 2583 West Chester Pike, Broomall, Pa. 19008. An applications note discusses the advantages of using a real-time programable clock/calendar for reading time and date into a computer memory under program control. Functions discussed include job identification, accounting, control, machine language identification, and the timing of iterative loops. [422]

Terminals. A 48-page catalog of press-fit Teflon terminals and circuit hardware is available from Seal-electro Corp., Mamaroneck, N.Y. 10543. It provides detailed listings and technical information on a line of feed-throughs, stand-offs, plungers, jacks, probes, and other devices in miniature and microminiature sizes. [423]

Instrumentation. RF Communications Inc., 1680 University Ave., Rochester, N.Y. 14610, is offering a condensed catalog covering a line of frequency synthesizers, stable signal generators, broadband and tunable power amplifiers, modular amplifiers, and a variety of accessories. [424]

Relays. A 12-page catalog is available from C.P. Clare & Co., 3101 Pratt Ave., Chicago, Ill., offering a designer's reference guide to the standard plug-in general-purpose relay. Included are photos, dimensional drawings, and schematics, as well as terminal and socket information. [425]

Switching. A product bulletin describes a line of heavy current-switching power modules featuring snap-action operation. Bulletin E-584 is available from Switchcraft Inc., 5555 No. Elston Ave., Chicago, Ill. 60630. [426]

**Somebody—
Somewhere**

needs your idle equipment! Reach that buyer quickly and economically thru the

"SEARCHLIGHT SECTION"

**The meeting place of
Used Equipment Buyers and Sellers**

Send new ads to:

**ELECTRONICS
P.O. Box 900, N.Y., N.Y. 10020**

High-Accuracy

Phase Meters

0.5 Hz to 2 MHz

Digital or meter readouts

As low as \$885



930 E. Meadow Dr. Palo Alto, Ca. 94303
(415) 321-7428

Circle 154 on reader service card

NEW CATALOG RELEASE

from **CIRCUIT-STIK, INC.**

"INSTANT CIRCUIT BOARDS"



A new 4-page catalog supplement from CIRCUIT-STIK, INC., will introduce you to over 100 new compact patterns. As with all CIRCUIT-STIK subelements, these new compact patterns are specially coated with a pressure sensitive adhesive backing. Their "instant" application eliminates artwork, photowork, drilling, screening, and etching for all circuit board proto-types or limited production runs.

This **FREE 4 page supplement, #501-A**, with a sample may be ordered from:

circuit-stik

24015 GARNIER STREET P.O. BOX 3396 TORRANCE CALIFORNIA 90510
U.S. PATENT 3,538,389 & other Patents Pending

New literature

Microwave diodes. Alpha Industries Inc., 20 Sylvan Rd., Woburn, Mass. 01801. A guide to microwave diodes describes more than 1,000 styles in 70 pages. Included are technical data, applications, test and burnout information, and facilities capabilities. [427]

Integrated circuits. A 12-page catalog has been published by Precision Monolithics Inc., 1500 Space Park Dr., Santa Clara, Calif. 95050, describing a line of high-performance linear integrated circuits. These include digital-to-analog converters, comparators, and operational amplifiers. [428]

Power supply. Powertec Inc., 9168 DeSoto Ave., Chatsworth, Calif. 91311, has available a catalog detailing a line of standard OEM dc power supplies with complete specifications, prices, and delivery schedules. [429]

Quartz boats. A bulletin from Electronic Slicing & Dicing Inc., 45 Osgood St., Methuen, Mass. 01844, shows various quartz diffusion boat configurations, including slotted, baffled and slotted, and double-rod baffled types. [430]

Video instruments. A short-form catalog listing 27 video instruments is offered by Colorado Video Inc., Box 928, Boulder, Colo. 80302. Among them are data display devices, video analyzers, a video disk recorder, special effects, and image enhancers. [431]

Resistors. RCL Electronics Inc., 700 S. 21st St., Irvington, N.J. 07111. An engineering handbook on precision and power wirewound resistors also includes basic information on specialty items, such as chip resistors, high-temperature resistance probes, and shunt resistors. [432]

Communications equipment. General Electric Co., Data Communication Products Dept., Section P, P.O. Box 4197, Lynchburg, Va. 24502, has published a 10-page brochure on DigiNet data communications equipment. [433]

SUE: THE FIRST GIRL MINICOMPUTER

**Never underestimate
the power of a woman.**

Don't be misled by the fact that our SUE is a lady. When it comes to a competitive situation, SUE is more than a match for any of the neuter computers.

Her wide bandwidth Infibus gives her a thruput of 80 million bits per second. That's the kind of power we mean when we talk about Super SUE for big, complex systems. Or SUE the Savant for high-powered research and scientific applications. Or Synergistic SUE for controlling a large number of elements in a single system. If you haven't met SUE, you don't know how modular a minicomputer can be. Call her at (213) 722-6810, or write: 6201 E. Randolph Street, Los Angeles, California 90040 for an introduction.

Lockheed Electronics

Data Products Division
A Subsidiary of Lockheed Aircraft Corporation

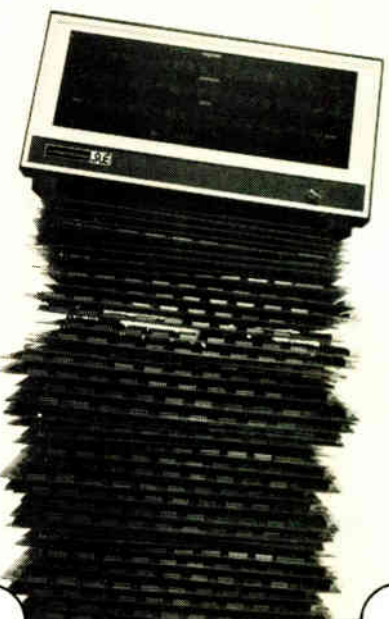

Circle 155 on reader service card

Circle 141 on reader service card 141

Electronics advertisers

June 19, 1972

Advanced Memory Systems Writing Unlimited	48-49	Fairchild Semiconductor, Inc. Carson/Roberts, Inc. Adv., Division of Ogilvy & Mather, Inc.	45-47	Plastics Engineering Company Kuttner & Kuttner, Inc.	8
Advanced Micro Devices Keye Donna Pearlstein	57	General Electric Company, Plastics Dept. Ross Roy of New York, Inc.	25	Powerlec, Inc. Warren C. Wilson & Associates	117
Advanced Micro Devices Keye Donna Pearlstein	10-11	General Electric Co., Semiconductor Products Department Advertising & Sales Promotion Syracuse Operation	9	RCA Electronic Components Al Paul Lefton Company	50
AEG Telefunken Werbeagentur	58	General Radio Co. GRAD Associates	121	RCA Electronic Components Al Paul Lefton Company, Inc.	35E
AEI Semiconductors Limited MCR Advertising Limited	20E	Gould, Inc./Instrument Systems Div. Carr Liggett Adv., Inc.	128	RCA Ltd. Marsteller Ltd.	4E-5E
AMP, Incorporated Atkin-Kynett Co., Inc.	17-20	GRI Computer Allied Advertising Agency, Inc.	31	RCA Solid State Division Al Paul Lefton Company, Inc.	79
Amphenol RF Division, Bunker Ramo Corporation Marsteller, Inc.	28	GTE Sylvania Parts Division Doyle Dane Bernbach Inc.	77	Rohde & Schwarz	1E
APM-Hexseal The Sommer Agency, Inc.	144	Guardian Electric Mfg. Co. Kolb/Tookey and Associates Inc.	3rd cover	San-E-Denk Company Limited Daipro, Incorporated	139
Applied Materials Technology Hall Butler Blathernick, Inc.	26-27	Harshaw Chemical Company Industry Advertising Company	137	Scanbe Manufacturing Corp. Warren C. Wilson & Associates	126
Beckman Instruments, Inc., Hellipot Div. N. W. Ayer/Jorgensen/MacDonald, Inc.	58	Heath/Schlumberger Scientific Instruments Advance Advertising Services	144	Schauer Manufacturing Corp. Noian, Keeler & Stites	40
Bell & Howell - Electronics & Instruments Group Coordinated Communications, Inc.	39	Hewlett-Packard Dorland Advertising Ltd.	15E-18E	Schneider R. T. Partner Conseil	25E
Birch Stolec Ltd. Derek R. Miller Advertising Limited	13E	Hewlett-Packard Richardson, Seigle, Rolfs & McCoy, Inc.	115	Silec Electronique Pema	36E
Bourns, Inc. Marlborough Assoc., Inc.	122	Hewlett-Packard Tallant/Yates Advertising, Inc.	12-13	Sodeco Thomas Stocker	8E
Burndy Electra Publicis	23E	Hewlett-Packard Tallant/Yates Advertising, Inc.	1-2	Soltron Devices, Inc. Tobias Associates, Inc.	135
Bussman Mfg. Division of McGraw Edison Co. Henderson Advertising Company	127	Hewlett-Packard Richardson, Seigle, Rolfs & McCoy, Inc.	80	Soltron Devices, Inc., Transistor Division Haselmire Pearson Advertising, Inc.	41
Canon Amsterdam	26E	Hysol Div., The Dexter Corp. Stahika, Falier & Klenk, Inc.	120	Sperry Information Displays Division N. A. Winter Advertising Agency	71
Carter Semiconductor RAMA Adv.	15	Interstate Electronics Corporation Chris Art Studio, Inc.	93	Sprague Electric Company Harry P. Bridge Company	7
Centron Engineering Haaga Advertising	139	Isostat Gead	44	Tektronix, Inc. Dawson, Inc.	37
C. I. I. Interplans-Publi Action	24E	Ithaco Inc. Hart Conway Co., Inc.	24	Teledyne Relays S. Michelson Advertising	61
Cinch Connectors, Operation of TRW Electronic Components Stral Advertising Company, Inc.	61	ITT Cannon Electric GmbH Werbeagentur	2E-3E	Teledyne Semiconductor Regis McKenna, Inc.	53
Circuit-Stik, Inc. Haaga Advertising	141	Krohn-Hite Corporation Impact Advertising Inc.	5	TERADYNE, Inc. QUINN & JOHNSON, INC.	68
Computer Automation Cochrane Chase & Company, Inc.	43	Lockheed Electronics Company McCann-Erickson Inc.	139, 141, 143	Thomas & Betts Company McCarthy, Scelba, DeBiasi Advertising Agency, Inc.	56
Dale Electronics, Inc., A Sub. of The Lionel Corporation Swanson, Sinkey, Ellis, Inc. Advertising	4th cover	LTT Publibel	29E	Thomson CSF Bazaine Publicite	54
Data Technology Corp. James Bischof & Associates Advertising/Communication	42	Macrodata Company JMR Advertising	66	Thompson CSF/ALLCO Bazaine Publicite	27E
Datel Systems, Inc. John Donlan Advertising	121	Master Appliance Klau-Van Pietersom-Dunlap, Inc.	63	Toko, Inc. Hakuhodo, Inc.	134
Delevan Division, American Precision Industries, Inc. Comstock Advertising, Inc.	16	3M COMPANY - Mincom Division D'Arcy-MacManus-Intermarco, Inc.	132	Torin Corporation Viscom International Inc	65
Dickson Electronics Corporation N. A. Winter Advertising Agency	134	Microsystems International Ltd. Media Advertising Ltd.	118	TRW, Electronic Components Division The Bowes Company	124
Digital Equipment Corporation Creamer, Trowbridge, Case & Basford, Inc.	131, 22-23	MOS Technology, Inc. Henry S. Goodsett Advertising, Inc.	2nd cover	Tyco, Saphikon Division Robwood Associates, Inc.	130
Dumont Oscilloscope Laboratories, Inc. Barbetta Miller Advertising, Inc.	6	Mostek Corporation Continental Communications Incorporated	32	Union Carbide Corp., Linde Division Young & Rubicam, Inc.	62
Dytech Corp.	32E	Motorola Semiconductor Products, Inc. E. B. Lane & Associates, Inc.	31E	United Systems Corp. Advertising & Merchandising, Inc.	64
Eastman Chemical Products, Inc., Industrial Chemicals J. Walter Thompson Company	130	National Semiconductors Ltd. Knox Advertising Ltd.	144	V/O Technomashexport V/O Vneshtorgreklama	28E
Electronics Associates, Inc. Gerald Clarke, Inc.	78	North Atlantic Industries, Inc. Helme Associates, Inc.	110	Wiltron Company Frank Burkhard Company	141
Electronic Engineering Company of California, Electronic Products Div. R & H Marketing Communications	72	Oak Industries, Inc., Switch Division Buchen Advertising, Inc.	67		
Electronic Navigation Industries Hart Conway Co., Inc.	14	Philips ELA Marsteller International S. A.	6E-7E		
Engelhard Industries Keyes, Martin & Company	27	Philips Gad Elcoma Tag-Intermarco delaMar	11E, 21E, 33E		
		Philips N. V. Pkt/T & M Division Marsteller International S. A.	56		
		Piezo Technology, Inc. Shattuck/Roether Advertising, Inc.	137		

Classified & Employment Advertising

F. J. Eberle, Manager 212-971-2557

EQUIPMENT (Used or Surplus New) For Sale	
Philip Fishman Company	140
Laboratory Equipment Sales & Services	140
Radio Research Instrument Company	140
SPI	140

For more information on complete product line see advertisement in the latest Electronics Buyer's Guide
 * Advertisers in Electronics International
 † Advertisers in Electronics domestic edition



Photo: ©Neill

Miss Raquel Welch

Learn the seven warning signals of cancer. You'll be in good company.

1. Unusual bleeding or discharge.
2. A lump or thickening in the breast or elsewhere.
3. A sore that does not heal.
4. Change in bowel or bladder habits.
5. Hoarseness or cough.
6. Indigestion or difficulty in swallowing.
7. Change in size or color of a wart or mole.

If a signal lasts longer than two weeks, see your doctor without delay.

And be sure to have a health checkup once a year, no matter how well you may feel.

Fight Cancer with a checkup and a check

American Cancer Society

Advertising Sales Staff

Pierre J. Braudé [212] 971-3485
Advertising Sales Manager

Atlanta, Ga. 30309: Joseph Lane
100 Colony Square, 1175 Peachtree St., N.E.
[404] 892-2868

Boston, Mass. 02116: James R. Pierce
607 Boylston St. [617] 262-1160

Chicago, Ill. 60611: Robert W. Bartlett
Kenneth E. Nicklas, 645 North Michigan
Avenue, [312] MO 4-5800

Cleveland, Ohio 44113: William J. Boyle
[716] 586-5040

Dallas, Texas 75201: Richard P. Poole
1340 Republic National Bank Building
[214] RI 7-9721

Denver, Colo. 80202: Harry B. Doyle, Jr.
Tower Bldg., 1700 Broadway
[303] 266-3863

Detroit, Michigan 48226: Robert W. Bartlett
2600 Penobscot Building
[313] 962-1793

Houston, Texas 77002: Richard P. Poole
2270 Humble Bldg. [713] CA 4-8381

Los Angeles, Calif. 90010: Robert J. Rielly
Bradley K. Jones, 3200 Wilshire Blvd. South Tower
[213] 487-1160

New York, N.Y. 10020
1221 Avenue of the Americas
Warren H. Gardner [212] 997-3617
Michael J. Stoller [212] 997-3616

Philadelphia, Pa. 19103: Warren H. Gardner
6 Penn Center Plaza,
[212] 971-3617

Pittsburgh, Pa. 15222: Warren H. Gardner
4 Gateway Center, [212-971-3617

Rochester, N.Y. 14534: William J. Boyle
9 Greylock Ridge, Pittsford, N.Y.
[716] 586-5040

San Francisco, Calif. 94111: Don Farris
Robert J. Rielly, 425 Battery Street
[415] 362-4600

Paris: Alain Offergeld
17 Rue-Georges Bizet, 75 Paris 16, France
Tel: 720-73-01

Geneva: Alain Offergeld
1 rue du Temple, Geneva, Switzerland
Tel: 32-35-63

United Kingdom: Keith Mantle
Tel: 01-493-1451, 34 Dover Street, London W1

Milan: Robert Sidel
1 via Baracchini Phone 86-90-656

Brussels: Alain Offergeld
23 Chaussee de Wavre
Brussels 1040, Belgium
Tel: 13-65-03

Stockholm: Brian Bowes
Office 17, Kontor-Center AB, Hagagarten 29,
113 47 Stockholm Tel 24 72 00

Frankfurt/Main: Fritz Krusebecker
Liebigstrasse 27c
Phone 72 01 81

Tokyo: Masaru Wakeshima, McGraw-Hill
Publications Overseas Corporation,
Kasumigaseki Building 2-5, 3-chome,
Kasumigaseki, Chiyoda-Ku, Tokyo, Japan
[581] 9811

Osaka: Ryji Kobayashi, McGraw-Hill
Publications Overseas Corporation, Kondo
Bldg., 163, Umegae-cho Kita-ku [362] 8771

Australasia: Warren E. Ball, IPO Box 5106,
Tokyo, Japan

Business Department

Stephen R. Weiss, Manager
[212] 997-2044

Thomas M. Egan,
Production Manager [212] 997-3140

Carol Gallagher
Assistant Production Manager [212] 997-2045

Dorothy Carter, Contracts and Billings
[212] 997-2908

Frances Vallone, Reader Service Manager
[212] 997-6057

Electronics Buyers' Guide

George F. Werner, Associate Publisher
[212] 997-3139

Regina Hera, Directory Manager
[212] 997-2544

SUE: THE FIRST GIRL MINICOMPUTER

**She's
no fortune hunter.**

Our gal SUE is a Sweet-heart when it comes to price. Because you pay for exactly what you get. No more. Say you need a 4K computer. SUE's price, complete, would run \$4,295. If you needed a hundred of them, SUE's price would drop to less than \$2,600 a unit.

And SUE has modularity that the neuter computers can't touch. Her Infibus has plugs for up to 24 cards. So she can be whatever kind of minicomputer you need. Want to generate displays? Use the combination of cards that make her Scintillating SUE. A big memory? Sagacious SUE. And a hundred or so more. For her vital statistics, call SUE at (213) 722-6810. Or write to 6201 E. Randolph St., Los Angeles, California 90040.

Lockheed Electronics

Data Products Division
A Subsidiary of Lockheed Aircraft Corporation



Your old counter and
\$365*

gets you to
600



The new Heath/Schlumberger SM-114A Scaler extends the useful range of any counter with more than 100 kHz capability. Three pushbutton-selected ranges allow division of input frequency by 1, 10 and 100. The ÷ 1 range provides for direct transmission of frequencies from 10 MHz to 100 MHz with a gain of 17 dB; ÷ 10 and ÷ 100 ranges will scale frequencies between 40 MHz and 600 MHz.

Output voltage and impedance matches all counters. The new SM-114A features a 50 ohm output impedance with 50 mV rms sensitivity and an output of 1 V P-P into a 50 ohm load. The input is protected to 5 V rms and has a VSWR of 2:1 up to 2 V rms. The 1 V P-P output will drive virtually every counter on the market, and with only 50 mV required from the signal source.

Simple to use. Unlike many other frequency scalars, the Heath/Schlumberger SM-114A has no sensitivity adjustment or input attenuator. Just connect the input and output signals with standard BNC-type cables and select the dividing range. Scale frequency into the UHF region at low cost.

Order the SM-114A now.

Assembled SM-114A, 8 lbs. \$365.00*

SM-114A SPECIFICATIONS — INPUT — Frequency Range: ÷ 1 — Sine or square wave: 10 MHz to 100 MHz. ÷ 10 — Sine wave: 40 MHz to 600 MHz (typical 15 MHz to 600 MHz). Square wave: 10 MHz — 600 MHz. ÷ 100 — Sine wave: 40 MHz to 600 MHz (typical 15 MHz to 600 MHz). Square wave: 10 MHz — 600 MHz. **Amplitude:** Minimum — 50 mV RMS. Maximum — 2.0 V RMS (to maintain 2:1 VSWR) protected to 5 V RMS. **Impedance:** 50 Ω with less than 2:1 VSWR from 10 MHz to 600 MHz and less than 2 V RMS input voltage, AC coupled. **OUTPUT — Amplitude:** 1 V P-P. **Impedance:** 50 Ω, AC coupled. **POWER REQUIREMENTS —** 120 V, 50/60 Hz, 7 watts. May be changed to 240 V with internal switch and change of fuse. **DIMENSIONS —** 9 1/4" deep, 6 3/4" wide, 2 1/4" high.

**Count Frequency
 To 80 MHz For
 As Little As \$350.***



For counting capability into the high frequency region at modest cost, check out the Heath/Schlumberger 80 MHz frequency counters:

Our SM-105A provides 10 Hz to over 80 MHz range, 5-digit LED readout, 100 mV rms input sensitivity and time base stability of ±10 ppm... for just **\$350.***

Our SM-104A counter provides the same range and readout as the SM-105A, but has a research-grade TCXO time base guaranteed stable to 1 part in 10⁶ per year and 5 digits of TTL-compatible BCD output... for only **\$500.***

HEATH Schlumberger	
HEATH/SCHLUMBERGER SCIENTIFIC INSTRUMENTS	
Dept. 531-283 Benton Harbor, Michigan 49022	
<input type="checkbox"/> Please send additional information on the SM-114A Scaler. <input type="checkbox"/> Please send latest Scientific Instruments catalog, which includes SM-104A & SM-105A information.	
Name _____	
Title _____	
Company/Institution _____	
City _____ State _____ Zip _____	
*Mail order prices; F.O.B. Benton Harbor, Michigan Prices and specifications subject to change without notice. EK-338	

144 Circle 144 on reader service card

A kitfull of lighting solutions free

Complimentary contents: wide assortment of different shape and colored silicone filters that snap on over incandescent lamps. Can withstand in excess of 500 °F for over 1,000 hours. Ideal for lighted push-button switches and indicators, control diagram boards, dashboards, etc. Detailed catalog and a number of "unexpected" design application histories. Write:

APM-HEXSEAL
 DIVISION OF APM CORPORATION
 44 HONECK ST ENGLEWOOD, N.J 07631



Circle 156 on reader service card

TO-18 MINIATURE PHOTOCELLS
 offer increased flexibility/control

NSL-312 and NSL-412 series of Photoconductive Cells deliver 7 photocell resistance ranges using either Cadmium Selenide or Cadmium Sulphide material. They come in 2 physical configurations: hermetically sealed TO-18 package; moisture resistant, plastic encapsulated unit. This affords you a designer's choice of 28 standard photocells to meet your particular requirements. Package, price and electrical parameters are all within your control.

Check National's similar CdS and CdSe standard Photocell packages in 1/4", TO-5, TO-8 and 1" configurations.

Other NSL Photoelectric Devices: Silicon Phototransistors, Photo Diodes, Photodetector Arrays, Lamp Modules.

Contact us about your applications. Technical literature on request.

NATIONAL SEMICONDUCTORS LIMITED

331 Cornelia St., Plattsburgh, N.Y. 12901, (518) 561-3160
 West Coast: Call TREPCO (213) 641-7411
 2150 Ward St., Montreal 378, Que., (514) 744-5507

Circle 157 on reader service card

Do you have this No. 1 reference in the Solenoid Industry?

This free book lists more kinds of solenoids... with more spec info than any other solenoid reference file.

It's all you'd expect from No. 1 in the industry: Everything you need to know to spec a solenoid. Packaged in an easy-to-use 44-page manual/catalog covering the most complete line of solenoids available *anywhere*. Plus, "How to Select a Solenoid" section, pull/stroke graphs and schematic drawings of Guardian Solenoids in every imaginable shape and size to meet virtually any electro-mechanical requirement.

And it's yours for the asking from your Guardian Angel



Box-Frame Solenoids



Tubular Solenoids

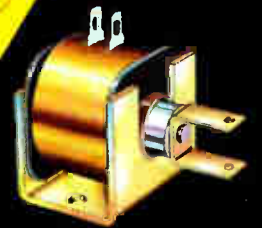

U-Frame Solenoids



Laminated Solenoids



LATE NEWS!
 Virtually all Guardian Solenoids are now **RECOGNIZED UNDER THE COMPONENT PROGRAM OF UNDERWRITERS' LABORATORIES, INC.**



GUARDIAN®

GUARDIAN ELECTRIC MANUFACTURING CO. • 1550 W. Carroll Ave., Chicago, Illinois 60607

In a hurry? Call your Guardian Distributor.

Circle 901 on reader service card

Odd Jobs Wanted

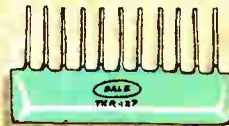
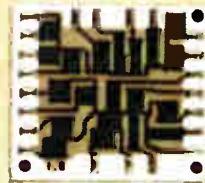
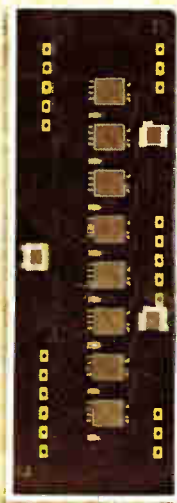

Highly respected company with reputation for fast handling of special resistance projects seeks challenging assignments in thick film. Completely equipped to design and/or produce special circuitry inside DIP and SIP packages. Laser trimming facilities for high volume needs. Also special capabilities for non-standard configurations, hybrids and high power requirements. Custom substrate preparation, including LED metalization, a specialty. References furnished. Contact your Dale Representative or call 402-564-3131.

Dale Electronics, Inc., Box 609,
Columbus, Nebraska 68601.
In Canada: Dale Electronics
Canada, Ltd. A subsidiary of
The Lionel Corporation.

