

Forecast of equipment and components markets 63

Correcting distortion in precision displays 70

Urban mass transit programs pick up speed 81

Electronics®



When will the storm subside?

428 408956 4487 FEB71
 0372 WK00 0106
 BASIC COMM ELEC
 050 X00
 4M EXVT 0000
 JAN 15 1971

The 6 advantages offered by SGS

SGS is the largest European producer of MOS devices

- SGS can deliver large quantities of MOS elements in the shortest time.
- SGS designs and produces MOS devices on customer request.
- SGS designs MOS fast, using computer aid (CAD).
- SGS produces MOS devices by the most advanced technology: high threshold voltage, P-channel; low threshold voltage silicon gate;
- SGS produces MOS elements with high reliability.
- SGS sells MOS elements at really competitive prices.

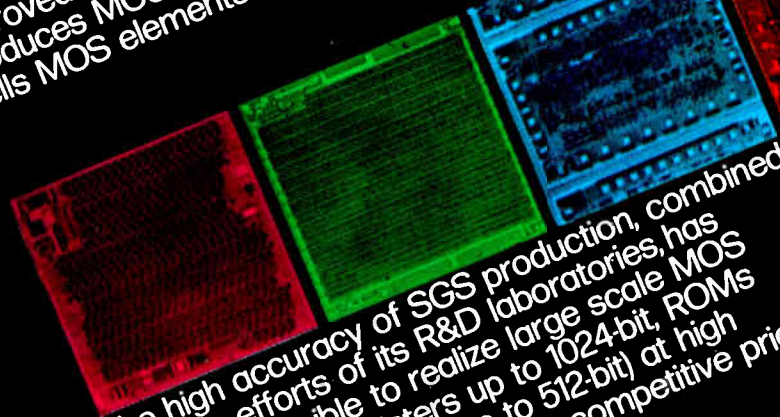

Above: SGS Clean Room facilities
 Above from the left: microphotographs of 35 times Dual 512 bit shift register, 1024 bit 4 phase shift register, MOS-51 custom circuit, 2048bit dynamic ROM
 Left: Low cost, high quality SGS package for LSI elements

The high accuracy of SGS production, combined with the efforts of its R&D laboratories, has made it possible to realize large scale MOS devices (shift registers up to 1024-bit, ROMs up to 2048-bit, RAMs up to 512-bit) at high quality levels and extremely competitive prices.

- Availability
- Price
- Quality
- Range
- Assistance
- Design on request

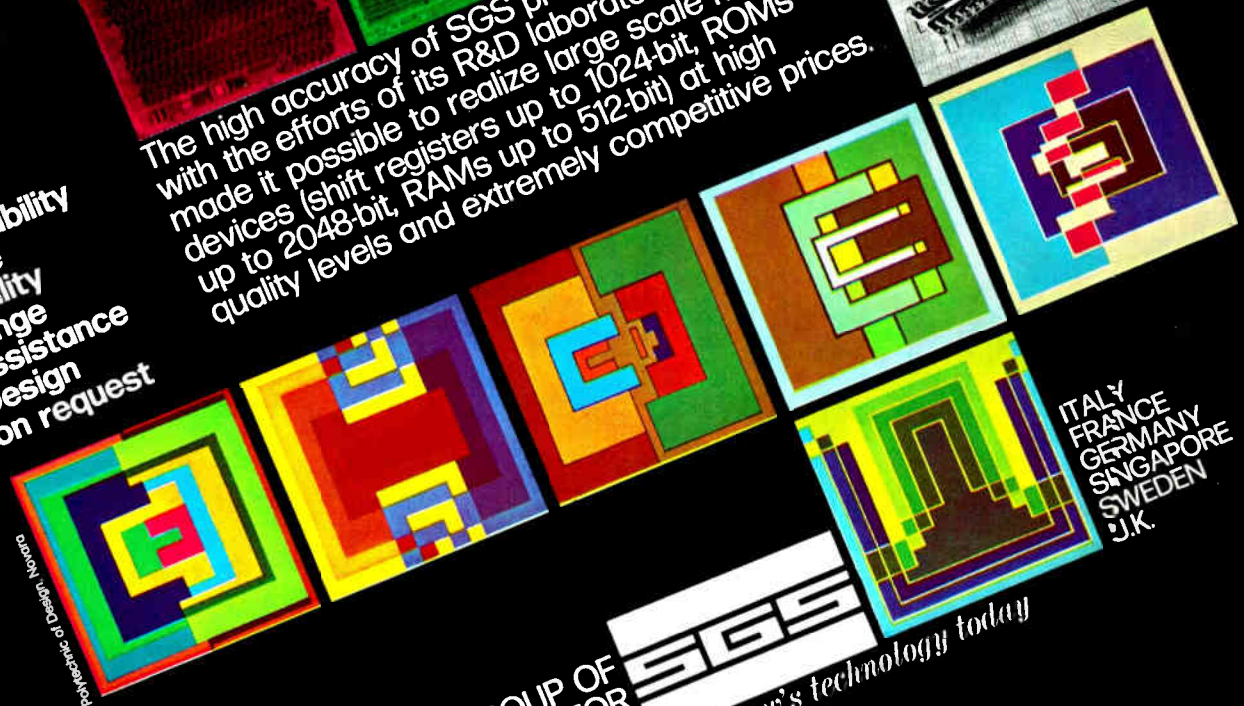

Photographic Design Monitor

- ITALY
- FRANCE
- GERMANY
- SINGAPORE
- SWEDEN
- J.K.

SGS
 SGS GROUP OF SEMICONDUCTOR COMPANIES
 tomorrow's technology today

These amplifiers make your test equipment—and your budget—look good.

Hewlett-Packard's new wideband RF amplifiers improve the sensitivity of your scopes, spectrum analyzers, counters, network analyzers — anywhere you need low-noise, high-gain amplification.

As a result of HP's hybrid thin-film microcircuit technology, these amplifiers bring you superior perform-

ance and high reliability at low cost.

The table below gives frequency ranges, prices and performance of the six basic configurations. Dual channel versions of the preamps can also be supplied to improve the performance of 2-channel instrumentation.

They're ready for delivery now. A call to your HP field engineer will

bring you the details of how these amplifiers can help enhance the test equipment you're using now. Or write to Hewlett-Packard, Palo Alto, California 94304; Europe: 1217 Meyrin-Geneva, Switzerland.

HEWLETT  PACKARD

04021A

HEWLETT-PACKARD 8447 SERIES LAB AMPLIFIERS

| | HP 8447A Preamp | HP 8447B Preamp | HP 8447C Pwr. Amp. | HP 8447D Preamp | HP 8447E Pwr. Amp. | HP 8447F Preamp/Pwr. Amp |
|--|--------------------|--|-----------------------|--------------------|-----------------------|-----------------------------|
| Frequency Range | 0.1-400 MHz | 0.4-1.3 GHz | 30-300 MHz | 0.1-1300 MHz | 0.1-1300 MHz | 0.1-1300 MHz |
| Nominal Gain | 20 dB | 22 dB | 30 dB | 26 dB | 22 dB | 48 dB |
| Gain Flatness | ±0.5 dB | ±1 dB | ±1 dB | ±1.5 dB | ±1.5 dB | ±3 dB |
| Noise Figure | <5 dB | <5 dB to 1.0 GHz <6 dB, 1.0-1.3 GHz | <11 dB | <8 dB | <11 dB | <8 dB |
| Output Power @ 1 dB Gain Compression | >+7 dBm | >-3 dBm | >+17 dBm | >+7 dBm | >+14 dBm | >+14 dBm |
| Price | \$550 | \$600 | \$450 | \$650 | \$700 | \$1175 |

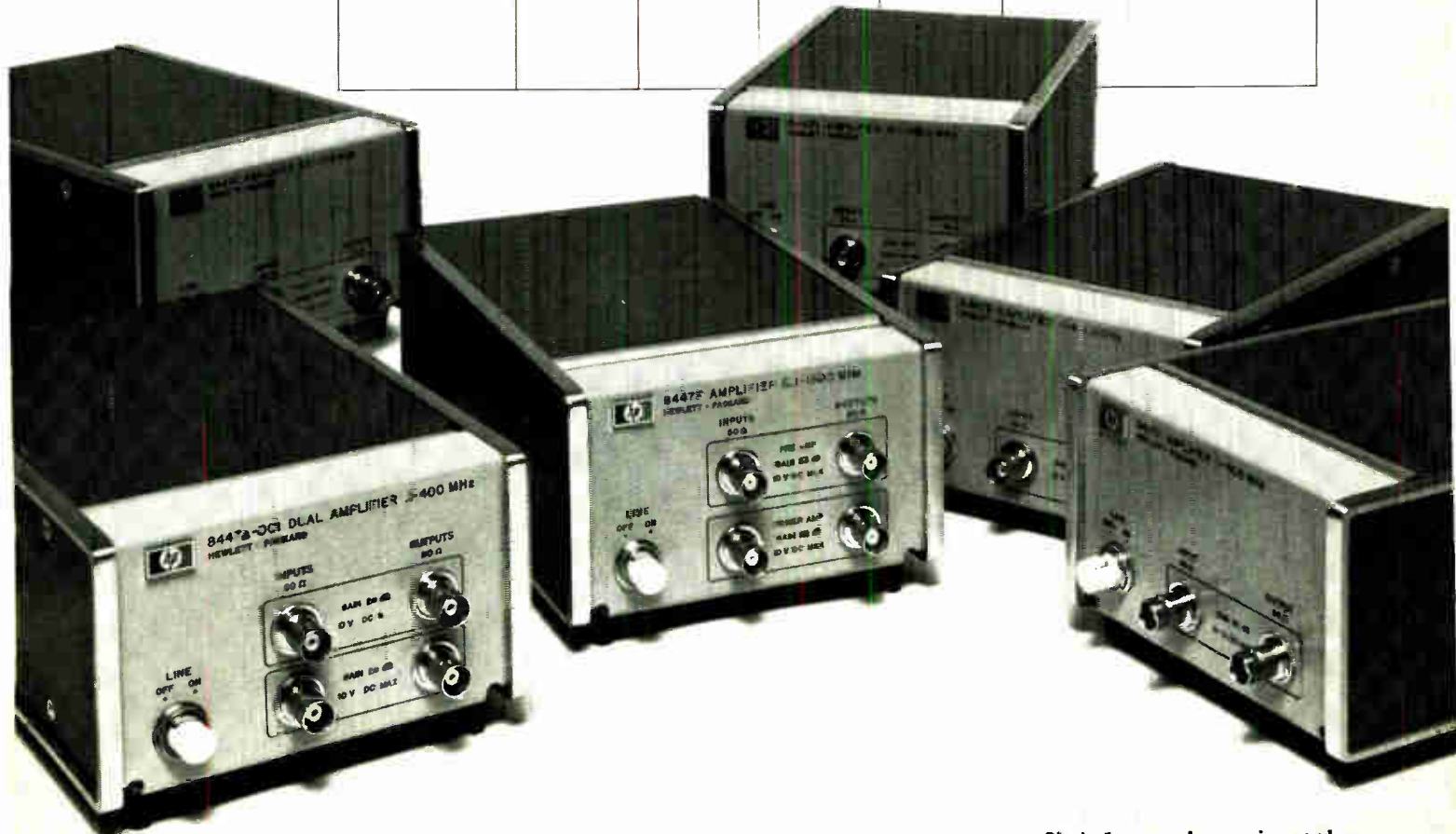

← Circle 900 on reader service card

Circle 1 on reader service card

Electronics

EDITOR-IN-CHIEF: Kemp Anderson

EXECUTIVE EDITOR: Samuel Weber

MANAGING EDITORS: Robert Henkel, News;
Arthur Erikson, International

SENIOR EDITORS: H. Thomas Maguire,
Stephen E. Scrupski

ASSOCIATE EDITORS: William Bucci, Richard
Gundlach, John Johnsrud, Howard Wolff

DEPARTMENT EDITORS

Communications & Microwave: Leon M. Magill;
Computers: Wallace B. Riley; Consumer:
Gerald M. Walker; Industrial Electronics:
Alfred Rosenblatt; Instrumentation: Owen Doyle;
Military/Aerospace: Herman Lowenhar;
New Products: H. Thomas Maguire (Mgr.),
William P. O'Brien; Packaging
& Production: Stephen E. Scrupski;
Solid State: Laurence Altman

COPY EDITORS: William S. Weiss, Chief;
Margaret Eastman

ART: Fred Sklenar, Director
Charles D. Ciatto, Assistant Director

PRODUCTION EDITORS: Susan Hurlburt,
Arthur C. Miller

EDITORIAL SECRETARIES: Claire Goodlin,
Vickie Green, Terri O'Neil,
Bernice Pawlak

FIELD EDITORS

Boston: James Brinton (Mgr.), Gail Farrell;
Dallas: Paul Franson (Mgr.);
Los Angeles: Lawrence Curran (Mgr.);
New York: Peter Schuyten (Mgr.); San
Francisco: Stephen Wm. Fields (Mgr.),
Marilyn Howey; Washington: Ray Connolly
(Mgr.), Jim Hardcastle, Larry Armstrong;
Frankfurt: John Gosch; London: Michael
Payne; Paris: Arthur Erikson; Tokyo:
Charles Cohen

McGraw-Hill World News

Director: Walter A. Stanbury; Atlanta: Stan
Fisher; Chicago: Mike Sheldrick; Cleveland:
Arthur Zimmerman; Dallas: Marvin Reid;
Detroit: James Wargo; Los Angeles: Michael
Murphy; San Francisco: Margaret Drossel,
Tyler Marshall; Seattle: Ray Bloomberg;
Washington: Charles Gardner, James Canan,
Herbert W. Cheshire, Seth Payne, Warren
Burkett, William D. Hickman; Bonn: Robert F.
Ingersoll; Brussels: James Smith; London:
Marvin Petal; Milan: Jack Star; Moscow:
Axel Krause; Paris: Robert E. Farrell, Stewart
Toy; Tokyo: Mike Mealey

PUBLISHER: Dan McMillan

ASSISTANT TO THE PUBLISHER: Wallace C.
Carmichael

PLANNING & DEVELOPMENT MANAGER:
Donald Christiansen

ADVERTISING SALES MANAGER: Pierre Braudé

CIRCULATION MANAGER: George F. Werner

RESEARCH MANAGER: David Strassler

PROMOTION MANAGER: Tomlinson Howland

ADVERTISING SALES SERVICE MANAGER:
Wallis Clarke

About this issue

The New Year seems a fitting time to tell you, the reader, how much we value your thoughts about the world of electronics. Our Readers Comment department is really your section, and is open for business all year round.

Ringing out the old year and ringing in the new is not the work of a moment at *Electronics*. In fact we have invested a full two man-years in wrapping up 1970 and finding what's in the technological cards for 1971. The result: the U.S. market report starting on page 35.

Although we do the exhaustive job annually, it has become an industry perennial, growing each year to keep step with the changes in electronics. And it has become a valuable industry standard. Often, as our team of reporters and editors moved around the country contacting electronics engineers and executives, they ran across the same testimonial. One man summed it up: "Why ask me? I rely on your figures."

That comment well illustrates why so many electronics officials find the report so useful. By sampling a cross-section of each industry segment, hitting all the leading companies along the way, we build up the kind of total picture that many in the field just can not develop for themselves.

Among all the report's conclusions about 1971, one stands out. This year, more than ever before, electronics men, from engineers to company presidents, need to know what the new year will bring. It's no understatement that in 1971 jobs are at stake.

Speaking of jobs, it may be of interest to explain how we did ours in putting together the market report. Coverage was two-pronged: qualitative and quantitative. It was up to the editorial staff to describe

in words and the research staff to describe in numbers the dimensions of the market. The numerical description evolved out of questionnaires mailed to the sales or marketing managers at more than 2,250 companies and their divisions, subsidiaries and branch facilities.

For the story in words, the editorial staff, both New York-based department editors, and our field bureaus—Boston, Washington, Los Angeles, Dallas, San Francisco, and New York—went out to interview the engineers and the company executives whose decisions will markedly affect the course of the coming year. New York editors, on swings to the Mid-West, the South, and the West Coast, used their specialized expertise to pull out the fine-grained details of industry trends. Field men winged in to New York to apply their wide grasp of an area's industries and problems to the final writing job. In all, enough words were filed to fill a healthy-sized novel. But we're only a magazine, so it all had to be condensed to delineate the main trends and outline the total picture. Still some fascinating detail, amounting to more than half again as much as is printed, had to end up on the cutting room floor.

January 4, 1971 Volume 44, Number 1
91,565 copies of this issue printed

Published every other Monday by McGraw-Hill, Inc. Founder: James H. McGraw 1860-1948. Publication office 330 West 42nd, N.Y., N.Y. 10036; second class postage paid at New York, N.Y., and additional mailing offices. Executive, editorial, circulation and advertising addresses: Electronics, McGraw-Hill Building, 330 W. 42nd Street, New York, N.Y. 10036. Telephone (212) 971-3333. Teletype TWX N.Y. 710-581-4235. Cable address: MCGRAW HILL N.Y.

Subscriptions limited to persons with active, professional, functional responsibility in electronics technology. Publisher reserves the right to reject non-qualified requests. No subscriptions accepted without complete identification of subscriber name, title, or job function, company or organization, including product manufactured or services performed. Subscription rates: qualified subscribers in the United States and possessions and Canada, \$8.00 one year, \$12.00 two years, \$16.00 three years; all other countries \$25.00 one year. Limited quota of subscriptions available at higher-than-basic rate for persons outside of field served, as follows: U.S. and possessions and Canada, \$25.00 one year; all other countries \$50.00. Air freight service to Japan \$60.00 one year, including prepaid postage. Single copies: United States and possessions and Canada, \$1.00; all other countries, \$1.75.

Officers of the McGraw-Hill Publications Company: John R. Emery, President; J. Elton Tuohis, Senior Vice President—Services; Donald B. Gridley, Group Vice President—Services; Ralph Blackburn, Circulation; John R. Callahan, Editorial; William P. Giglio, Administration; David G. Jensen, Manufacturing; Jerome D. Luntz, Planning & Development; Joseph C. Page, Marketing; Robert M. Wilhelm, Finance.

Officers of the Corporation: Shelton Fisher, President; Joseph H. Allen, Group Vice President—Publications and Business Services; John J. Cooke, Senior Vice President and Secretary; Gordon W. McKinley, Vice President and Treasurer.

Title registered in U.S. Patent Office; © Copyright 1971 by McGraw-Hill, Inc. All rights reserved. The contents of this publication may not be reproduced either in whole or in part without the consent of copyright owner. Subscribers: The publisher, upon written request to our New York office from any subscriber, agrees to refund that part of the subscription price applying to copies not yet mailed. Please send change of address notices or complaints to Fulfillment Manager; subscription orders to Circulation Manager, Electronics at address below. Change of address notices should provide old as well as new address, including postal zip code number. If possible, attach address label from recent issue. Allow one month for change to become effective.

Postmaster: Please send form 3579 to Fulfillment Manager, Electronics, P.O. Box 430, Hightstown, N.J. 08520.

...like more capacitance in aluminum 'lytics?

Get **SPRAGUE Type 36D** **POWERLYTIC®** **CAPACITORS**



INFORMATION RETRIEVAL NO. 209

- Large cylindrical electrolytic capacitors for use in digital computer power supplies, industrial control equipment, energy storage applications, etc
- Low impedance construction
- Largest case (3" dia. x 8 7/8" high) provides 650,000 μ F at 3 volts!
- Can be operated at +85 C
- Tapped No. 10-32 terminals simplify filter bank assembly
- Available with or without outer plastic insulating sleeves
- Request Engineering Bulletin 3431C

4SC-9153R2

...want high volume efficiency in tubular 'lytics?

Use **SPRAGUE Type 39D** **POWERLYTIC®** **CAPACITORS**

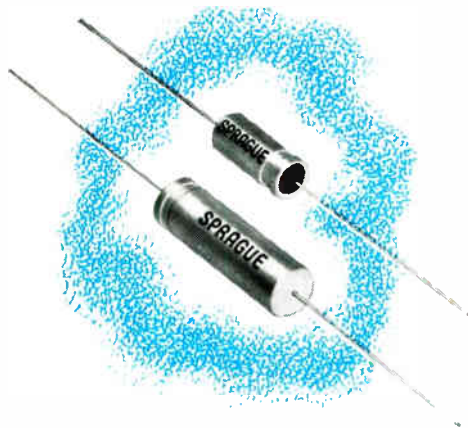

INFORMATION RETRIEVAL NO. 210

- Provide maximum capacitance in smaller cases with axial leads
- No internal riveted or pressure connections
- Welds at critical anode and cathode terminals
- Molded end covers
- Life expectancy of 10 years or more in normal service
- Very low effective series resistance and leakage current
- Request Engineering Bulletin 3415

4SC-9154R2

For Engineering Bulletins as noted above, write to:
Technical Literature Service, Sprague Electric Co., 35
Marshall Street, North Adams, Massachusetts 01247.



Sprague' and '®' are registered trademarks of the Sprague Electric Co.

THE BROAD-LINE PRODUCER OF ELECTRONIC PARTS



there's a reason why AEL rewards its electronic scientists

They're special people. Very special, because we know that the answer to your problem lies within them. Over the years, our scientists in the field of electronics have been tested and proven right, over and over again.

When it came to problems in Electronic Warfare . . . they solved them. When it came to problems in Communications . . . they solved them. When it came to problems in CATV . . . they solved them. And now they're solving the most complex problems when it comes to whole systems. Sure, we reward our electronic scientists at AEL, but don't you think they deserve it? They're working on the solution to your problem right now.



*Leading the way
with creative electronics.*

AMERICAN ELECTRONIC LABORATORIES, INC.
P.O. Box 552 • Lansdale, Pa. 19446 • (215) 822-2929 • TWX: 510-661-4976 • Cable: AMERLAB

Readers comment

How to communicate

To the Editor: Your observations on the crisis in the IEEE [Nov. 9, 1970, p. 105] focuses on the problem of inadequate communications which leaves the IEEE leadership ignorant of the membership's wishes. I understand that some organizations have successfully applied, under similar circumstances, the following recent discoveries: the concept of feedback; the membership meeting, and the questionnaire.

Seriously, it is not a joke that the main supporters of our society are expected to stay content on the leash at the age of 50 while 15-year-old school children demand and obtain participation in the government of their small world? It's a leash that is held by utility executives, college deans, and research directors, who often don't know the climate in which an industrial engineer works, and consequently do not always understand what his needs are.

According to several surveys, an overwhelming majority of EEs feel that the membership should be polled on the direction in which our society should be steered, and the majority decision should be executed. Most of us gave our sons for this concept.

Max J. Schindler
Boonton, N.J.

Getting it straight

To the Editor: Several errors cropped up in the final version of my Designer's casebook [Oct. 12, 1970, p. 100].

The constant 0.4 in the first equation is the forward diode drop of the unijunction emitter and not a recovery time. R_4 is not for temperature compensation, but is necessary for reliable oscillation. R_5 does not provide negative feedback, but sets the center frequency of the oscillator. The reference to R_6 in the last sentence should be to R_4 .

L.G. Smeins
Ball Brothers Research Corp.
Boulder, Colo.

BUSS

QUALITY

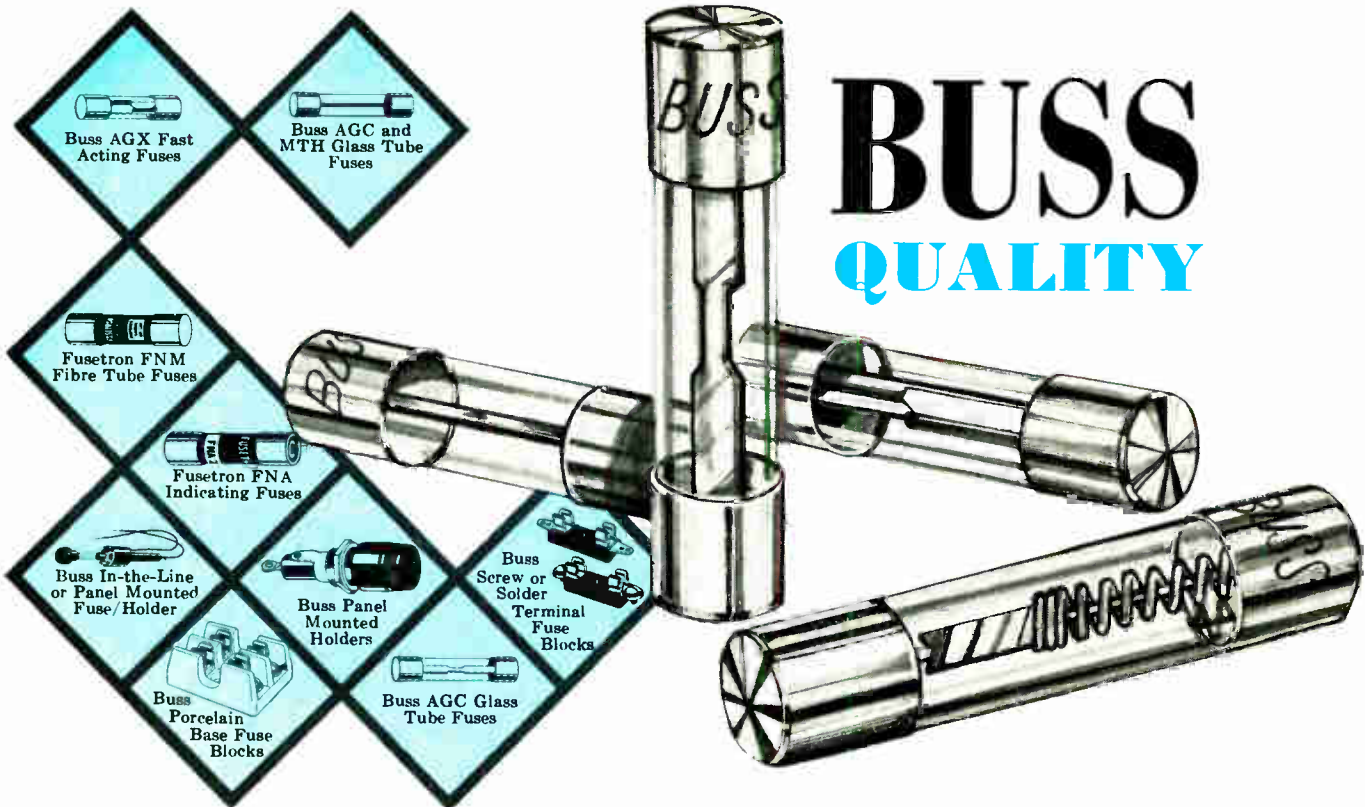

SMALL DIMENSION

FUSES and FUSEHOLDERS

FOR THE PROTECTION OF ALL TYPES OF
ELECTRONIC & ELECTRICAL CIRCUITS & DEVICES

The complete BUSS line of fuses includes dual-element "slow-blowing," single-element "quick-acting" and signal or visual indicating types . . . in sizes from 1/500 amp. up—plus a companion line of fuse clips, blocks and holders.

Only a representative listing is shown here of the thousands of different types and sizes of fuses and holders available from BUSS.

All standard items are easily obtained through your BUSS distributor.

When special fuses, fuse clips, fuse blocks or fuseholders are required, our staff of fuse engineers is at your service to help in selecting or designing the fuse or fuse mounting best suited to your requirements.

For detailed information on the complete BUSS line write for BUSS bulletin SFB.

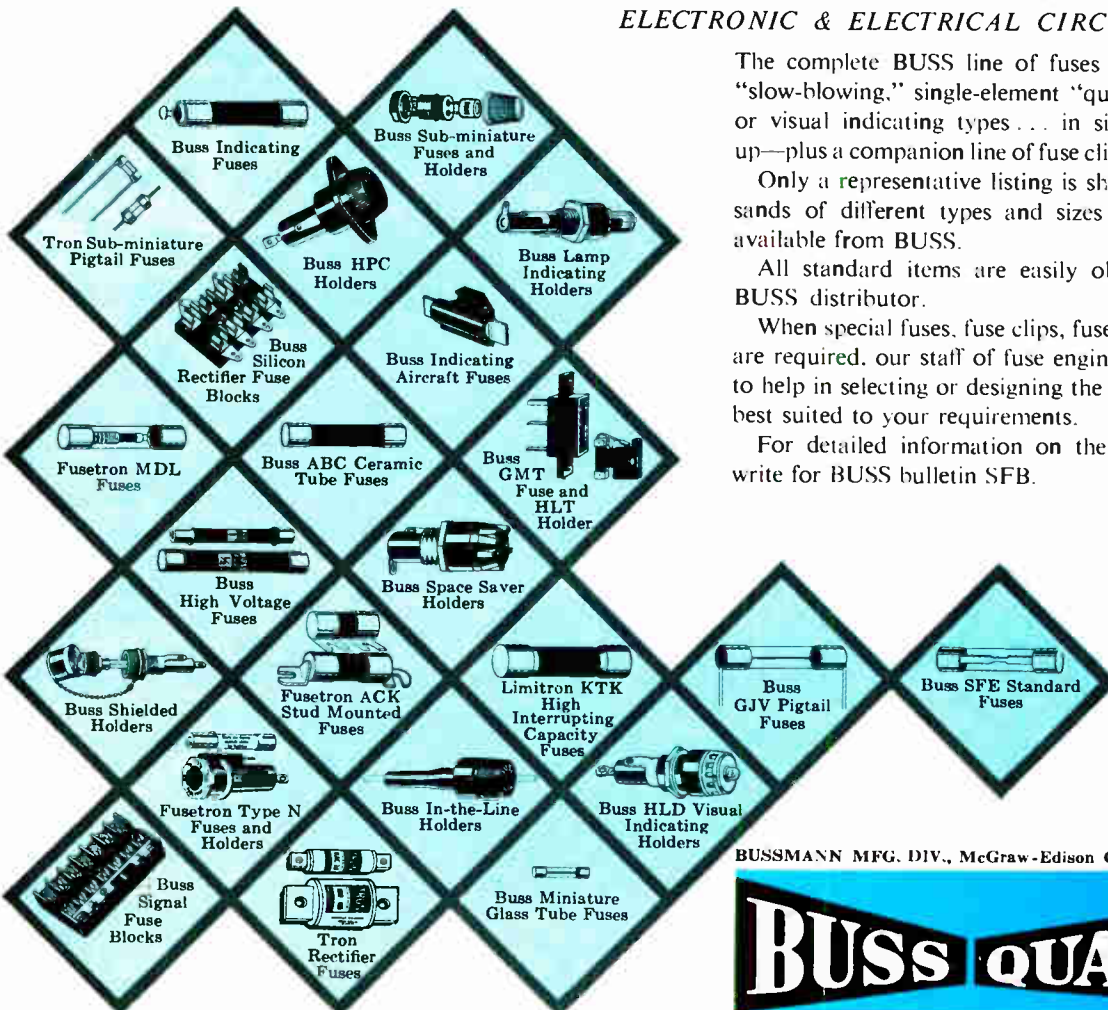

BUSSMANN MFG. DIV., McGraw-Edison Co., ST. LOUIS, MO. 63107



Our passive components can be obtained from a well-stocked industrial distributor right near you, for even faster delivery. Isn't it time you investigated our innovative people and products? Write Airco Speer Electronics, Bradford, Pennsylvania 16701.

We do.

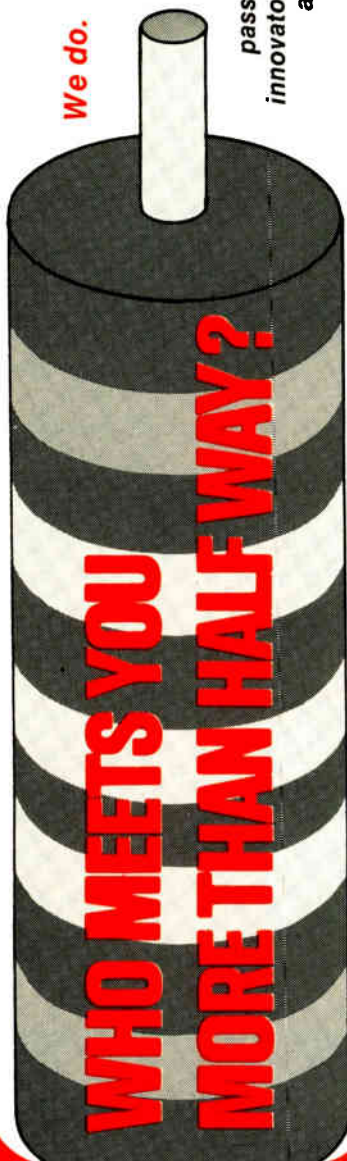

The
passive
innovators
at
AIRCO Speer Electronics

Who's who in electronics

To be profitable we can't be aloof from commercialism. We have to get down into the market and be alive." That's the word from Robert W. Cochran, named the first director of marketing for professional products at CBS Laboratories. The product department, in Stamford, Conn., is making a significant turn toward selling that is much more common for a rough-and-tumble commodity than an R&D center.

Cochran, a 20-year veteran of broadcasting industry sales at General Electric, is responsible for shaping a rather loose confederation of professional products sales into a disciplined marketing organization. The goal is to make this department, which now represents only a fraction of income compared to the big government and industrial research contracts, an active contributor to the laboratories' profits. The 46-year-old Cochran confidently predicts that in five years his organization will account for 50% of total income.

The task is complicated by the product mix, consisting of four diverse groups, each with a different market and price structure. The sole unifying thread, Cochran says, is that each will get a new distribution plan.

In the broadcast group, which represents 40% to 45% of professional product sales (mostly in video image enhancers and audio controls) worldwide distributors will become the first line to TV, radio, and recording studios. The only direct OEM sales will be to firms building complete broadcast systems.

The second group, education systems, is responsible for sales of the AVS 10 audio visual cartridges for use in CBS-developed players. Here the primary thrust will be toward education software developers who, in turn, will sell a teaching package to schools. A similar approach will be used for diazo microduplicating. The fourth is Vidifont.

A physics major from Bucknell University, Lewisburg, Pa., Coch-

ran feels that marketing takes more than reputation these days. "Somebody has to stomp on the grapes," he says.

There's nothing new about engineers wanting to rent instruments, says Charles Buffiou, vice president for marketing at Tektronix Inc. Going back to his days as a field engineer for Tek in the 1950s, Buffiou says even then customers would ask him if they could rent an oscilloscope for a month or so. In those days Buffiou could offer only sympathy. But if he were out there now, he could offer a lot more: Tektronix has become one of the first big instrument makers to offer a rental program.

As the top domestic marketing man in the Beaverton, Ore., firm, Buffiou is responsible for implementing the program and watching its progress. Although the 41-year-old officer doesn't expect rentals to account for any significant share of Tek's business, he feels the program's value lies in giving his field engineers a lot more flexibility in dealing with customers. "We need an additional term of sales to fill out the array of tools the field engineer needs to do his job," he says. And Buffiou should know what Tek salesmen need: after joining the company in 1956, he worked his way up the sales ladder from a field engineering job in Kansas City to a vice presidential chair at Beaverton in 1969.

Buffiou says Tek's decision to rent was based strictly on demand.

A rental house, he says, "can put together a package that includes oscilloscopes along with instruments we don't carry." What's more, says Buffiou, Tek salesmen won't concentrate on trying to rent equipment, as the rental firms do.

In effect, Buffiou sees renting as another way to sell a scope. He claims it's a convenient way for customer to evaluate an instrument. Furthermore, the program will keep Tek's name in front of engineers who are interested in renting today because they can't afford to buy.

Meetings

Calendar

Optics in Microelectronics, Optical Society of America, Stardust Hotel, Las Vegas, Jan. 25-26.

Winter Convention on Aerospace and Electronic Systems (WINCON), IEEE; Biltmore Hotel, Los Angeles, Feb. 9-11.

International Solid State Circuits Conference, IEEE; Sheraton Hotel, University of Pennsylvania, Feb. 17-19.

International Convention & Exhibition, IEEE; Coliseum and New York Hilton Hotel, New York, March 22-25.

Reliability Physics Symposium, IEEE; Stardust Hotel, Las Vegas, March 31-April 2.

European Semiconductor Device Research Conference, IEEE, DPG (German physical society), NTG (German communications society); Munich, March 30-April 2.

USNC/URSI IEEE Spring Meeting, Statler Hilton Hotel, Washington, April 8-10.

National Telemetry Conference, IEEE; Washington Hilton Hotel, April 12-15.

International Magnetics Conference (Intermag), IEEE; Denver Hilton, Denver, Colo., April 13-16.

Conference & Exposition on Electronics in Medicine, Electronics/Management Center, Medical World News, Modern Hospital, Postgraduate Medicine; Sheraton-Boston Hotel and the John B. Hines Civic Auditorium, April 13-15.

Relay Conference, College of Engineering, Oklahoma State University Extension, National Association of Relay Manufacturers; Stillwater, Okla., April 27-28.

Southwestern IEEE Conference and Exhibition, Houston, Texas, April 25-May 2.

International Microwave Symposium, IEEE; Marriott Twin Bridges Motor Hotel, Washington, May 16-20.

Call for papers

Computer Society Conference, IEEE; Sheraton-Boston Hotel, Boston, Sept. 22-24. April 30 is deadline for submission of papers to 1971 IEEE Computer Conference, P.O. Box 245, Prudential Station, Boston, Mass. 02199.

In the United States there are two more possibilities how to make the coming decades your most successful ones.

1st possibility

To record measured values by means of Kienzle* Digital Printers

Kienzle* Digital Printers offer considerable advantages. Parallel input, incorporated read-out unit for BCD outputs or 1-out-of-10 information. Kienzle* Digital Printers are available as tape printers or with motor-returned carriage and, upon request, also with card and tape punching units.

2nd possibility

To represent Kienzle* Digital Printers in the United States

Kienzle* Digital Printers are a novelty on the U. S. market. For the distribution of our instruments we are looking for representatives who are well introduced, who know the market and who can provide technical service.

Come to see us at the IEEE-show Stand 3737/3838

You can see the Kienzle* Digital Printers on our stand at the IEEE-show and we can also discuss with you the possibility of cooperation. In any case you should write to us and ask for detailed information.

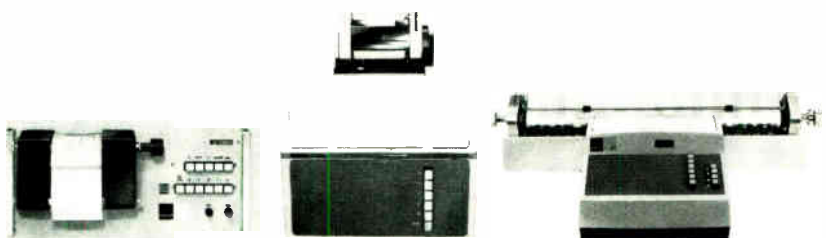

* pronounced Kinsler by the way

**Kienzle Apparate GmbH · 7730 Villingen/West Germany
Postfach 1640 · Telex 07-92838**

A brief word about P.C. connector

No one connector supplier offers the variety of printed circuit types and configurations that AMP does. This fact translates in benefits to you of 1) greater design freedom, 2) selection of your own degree of reliability, and 3) a total termination capability that can fit the largest or smallest of your production needs. These benefits are what we call AMP **Economation**.

All three types of wiring techniques

We offer a choice of wiring techniques for crimp snap-in, point-to-point, and solder termination.

Crimp — AMP pioneered the *crimp snap-in* contact featuring the advantage of selective random wiring and partially filled housings. We still have the broadest selection for this type of application.

Point-to-Point — Our connectors for point-to-point wiring include both the A-MP **TERMI-POINT**★ clip-type and the wrap-type with .025 square posts. AMP terminating tooling includes manual, semi-automatic, and completely automatic X-Y wiring machines.

Solder—Most of our mother/daughter connector types and many of our board-to-wire connectors are available in solder tab or eyelet styles.

Biggest variety of contact types and plating

Because of your need to suit a variety of design parameters, AMP offers bifurcated contacts, leaf type, cantilever and

Connectors for point-to-point wiring

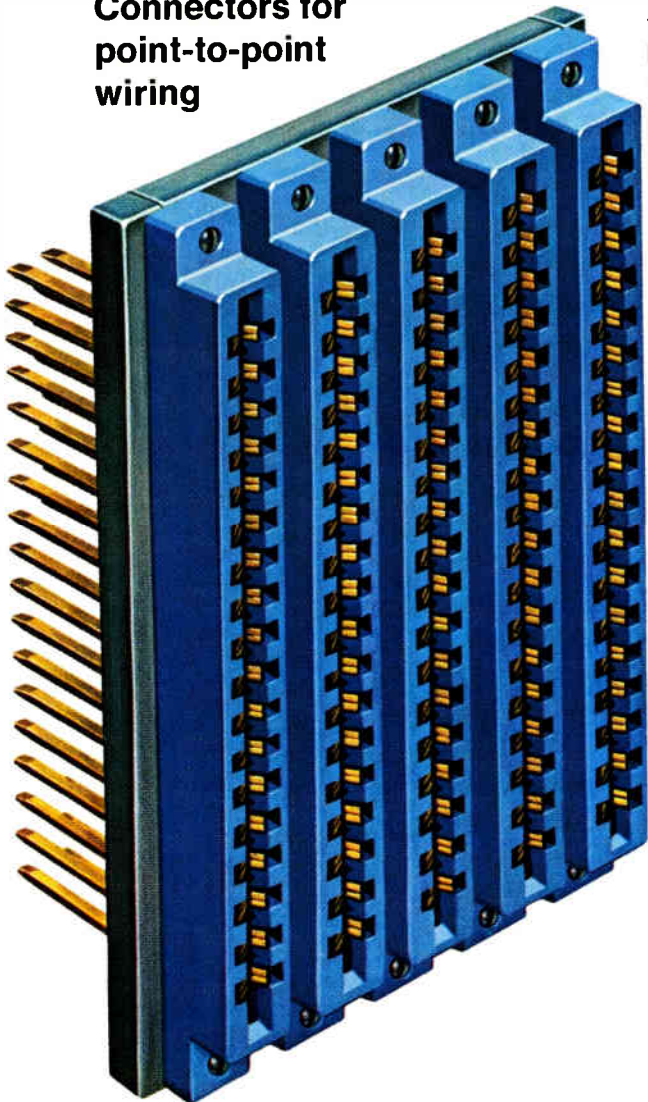

Random wiring with crimp snap-in contacts

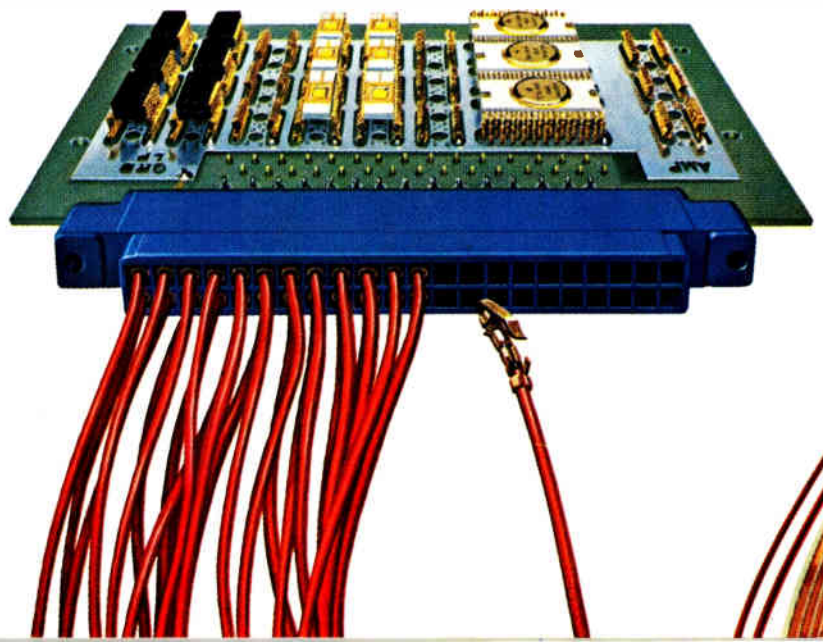

the world's broadest line...AMP

fork type. These contacts are available in a variety of platings to accommodate different degrees of reliability and economy.

Center line spacing and positions

Our commercial printed circuit connectors cover grid and staggered center-to-center spacings of .050 to .156 and positions variations—from 3 to 50 dual. The sheer variety of our P.C. connector types covers practically all your requirements. Our engineering staff will work with you on custom designs.

Variety of housing materials

Our plastic technology gives you a broad choice of housing

materials in thermosetting and thermoplastic materials.

Flexible Flat Cable

AMP has the most reliable and quickest method for mechanically attaching contacts to flat cable—automatically by machine. And AMP contacts can even be applied in the middle of the cable, or anywhere in between. Housings are available for cable-to-board or cable-to-cable applications. Round wire can also be used in combination with flat cable.

Substrate Connectors

AMP has a variety of designs for connecting various styles of substrates including zero-force and high density connectors for MSI and LSI circuitry. Talk to us about your requirements.

We'd like to enlarge upon this brief description of our P.C. line in person, or in printed form in our new printed circuit connector catalog. For more words and some fast action write: **AMP Incorporated, Industrial Division, Harrisburg, Pa. 17105**

AMP
INCORPORATED

Mother/Daughter applications

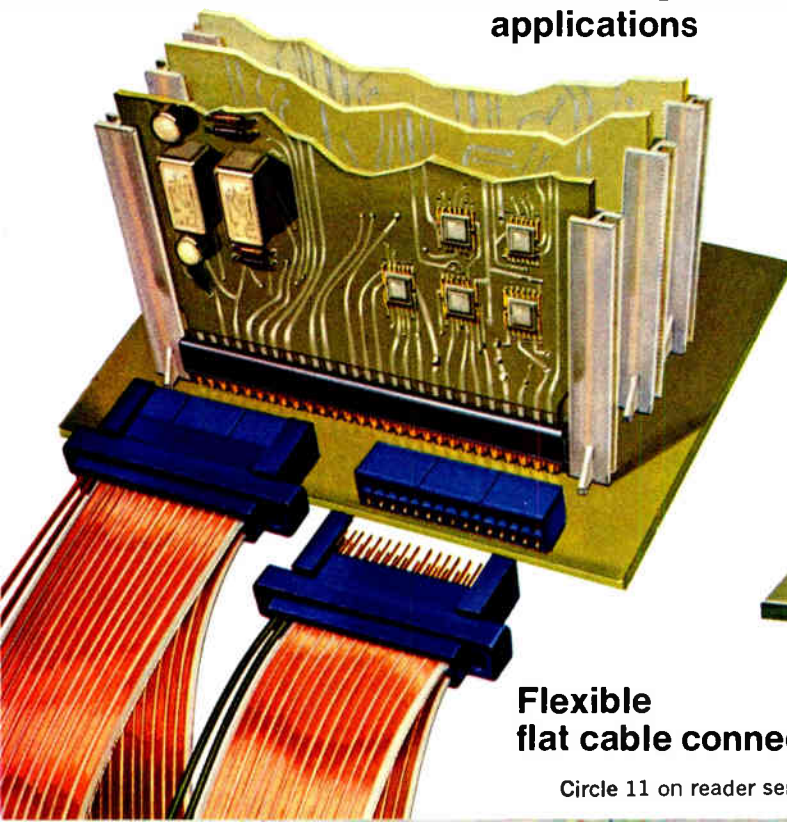

Flexible flat cable connectors

Zero-force entry and withdrawal connectors

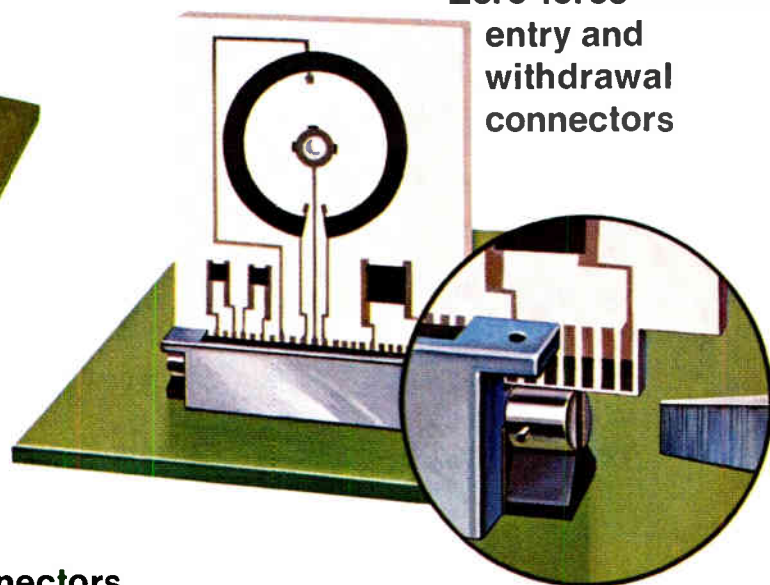

Circle 11 on reader service card

*Trademark of AMP Incorporated



Studying the true structure of a facet of crystal.

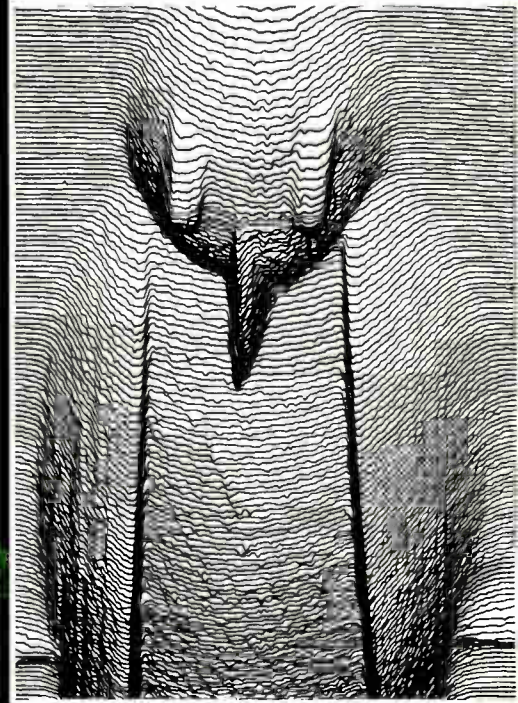

We prove that appearances are deceiving.

All the objects pictured here may look one way on the surface.

But the intricate traces tell you what they are really like.

These miniature topographical maps are produced by the Gould Micro-Topographer, a totally new instrument that measures and records surface geometry in three dimen-

sions. It can map any surface up to 2" x 2" square, magnify horizontal characteristics 200 times and vertical characteristics from 10 to 100,000 times.

Presentation is made on an X-Y plotter, system accuracy is 1.0 percent, and a wide range of probes accommodate materials



Proof that a commemorative coin is authentic.



Measuring deposit on the substrate material in an integrated circuit.



Checking surface geometry of valve section to ensure proper seating.

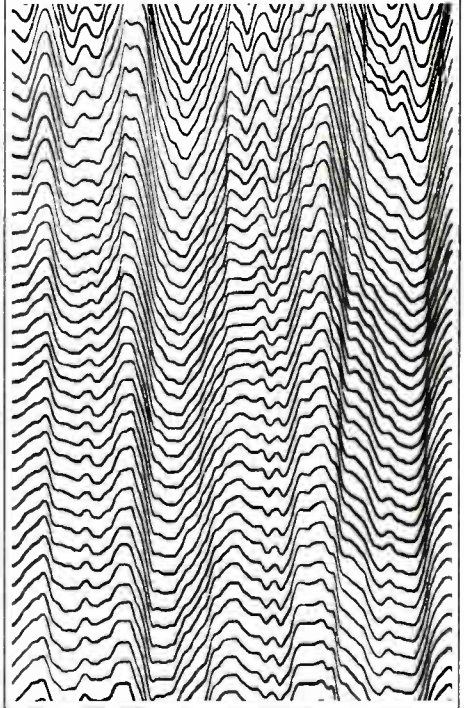
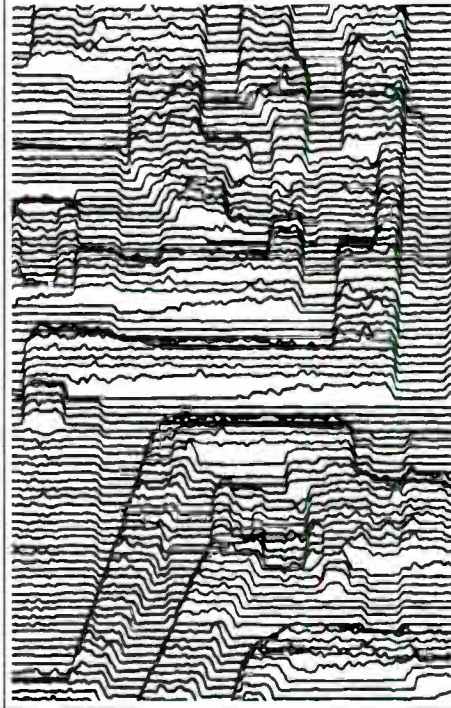

with diverse surface and hardness characteristics.

The Gould Micro-Topographer features rugged, functional cabinetry and solid state electronics. Which means this versatile new system may be used in normal shop environments with minimum temperature and vibration isolation.

The Gould Micro-Topographer. It adds a whole new perspective to surface measurement. And is one more example of how Gould's Instrumentation Group puts hard-to-get information into easy-to-use form. Gould Inc., 8550 West Bryn Mawr Avenue, Chicago, Illinois 60631.

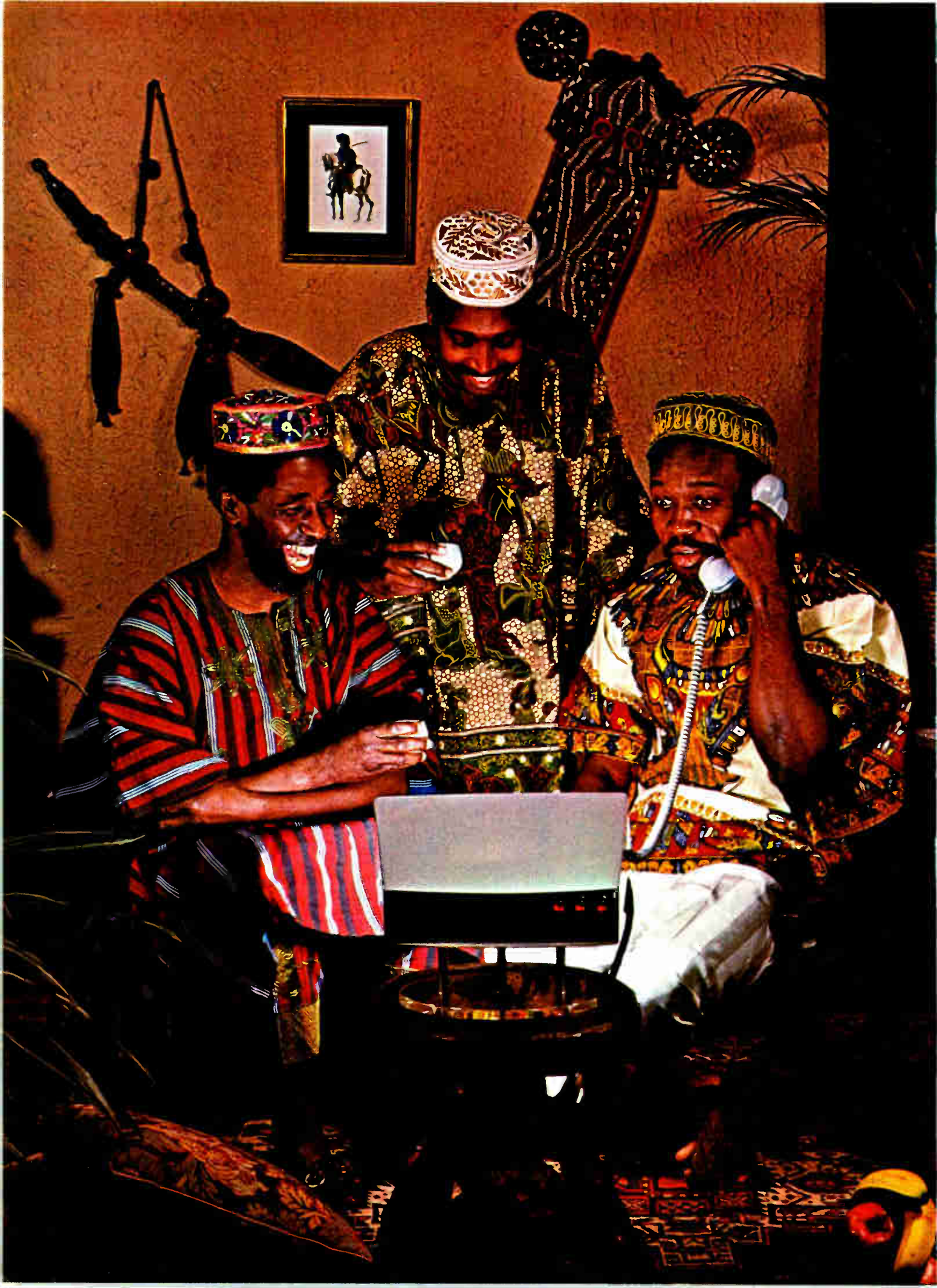

By 1979, French pictures will be seen live in Cameroon.

In the decade ahead, electronics will be bringing the nations of the world closer together. Socially. Economically. Maybe even politically.

Right now the countries of Western Europe are collaborating on a high-capacity communications satellite system to handle television, air traffic and picturephone networks all over Europe, Africa and the Middle East.

So, by the end of this decade, nations that not too long ago used drums for communications will have picturephone service. Major sports events, such as the 24 hours of LeMans, will be beamed live to such obscure countries as Cameroon, Dahomey, Togo and Tanzania. While Sundays in Swaziland will be spent watching live bullfights from Spain.

Fact is, two-thirds of all electronics production and consumption will be outside the United States.

Who are the master minds masterminding these international changes?
Our readers.

Among them, more than 10,000 subscribers in 110 countries outside the United States. From Australia to Zambia. The very men who are spreading the electronics market to every corner of the world.

Every two weeks, Electronics presents them with a complete, up-to-the-minute picture of the state of the technology. Including a special international section spotlighting the latest electronic innovations as compiled by our editors in Russia and Japan, as well as Europe.

So if you'd like to be included in the world's electronics market tomorrow, speak to the men who are working on it today.

Electronics, a McGraw-Hill market-directed publication.

Our readers are changing the world.



Announcing a new panel savings plan.

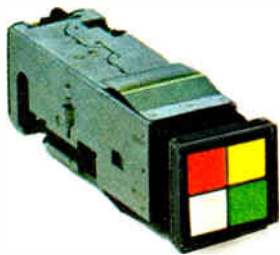

Big dividends from small pushbuttons.

It doesn't take much to reduce the size of your control panels and cabinet fronts.

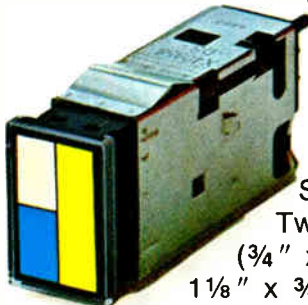

All it takes is compact miniature pushbuttons.

Like the new MICRO SWITCH illuminated DS.

Two sizes are available ($\frac{3}{4}$ " x $\frac{3}{4}$ " for our 1-unit and $1\frac{1}{8}$ " x $\frac{3}{4}$ " for our $1\frac{1}{2}$ -unit).

And both can be matrix mounted on $\frac{3}{4}$ " or $1\frac{1}{8}$ " centers. So there's no need for spacers or barriers.

A long-term investment.

A rugged metal housing encloses each switch and protects against the bumps and bangs of military and commercial use.

The housing also helps provide our DS pushbuttons with exceptional RFI attenuation capability. Incorporated into the housing are welded skirts that assure positive metal-to-metal grounding between the switch and adjacent units. And also between the switch and our rigid, box-girder matrix frame.

Your choice of options.

Pick the mounting that best fits your application. Either individually mounted switches (meet the requirements of MIL-S-22885) or custom matrix configurations featuring plug-in switches that are best for remote stations or indicating functions.

You can have up to four lamps in every switch. And either one, two, three or four-way split section screens. (The $1\frac{1}{2}$ -unit provides more than one-third additional legend area.) Full guards are available for single-unit switches.

Then save even more space by combining both 1-unit and $1\frac{1}{2}$ -unit switches in the same matrix. A single frame will handle up to sixteen 1-unit switches or up to ten $1\frac{1}{2}$ -units.

Who can participate in the plan.

MICRO SWITCH DS pushbuttons meet both commercial and military requirements. So they can be used in almost any panel from power plant control to tactical ground support equipment.

For more information, call your MICRO SWITCH Branch Office or Distributor (in the Yellow Pages under "Switches, Electric"). He'll show you how little it takes to participate in our savings plan.

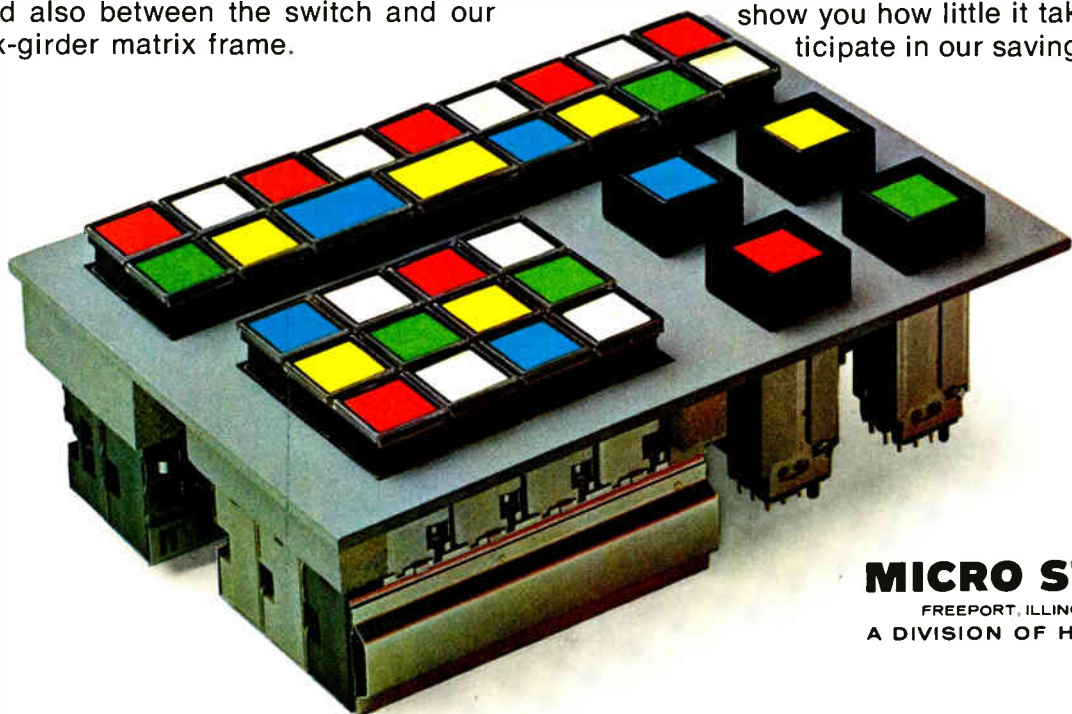

MICRO SWITCH

FREEPORT, ILLINOIS 61032
A DIVISION OF HONEYWELL

Electronics Newsletter

January 4, 1971

Hughes wins patent for silicon gate

Hughes Aircraft Co. has received a patent for the silicon gate MOS process—but the Hughes MOS division in Newport Beach, Calif., itself may not immediately exploit the process extensively. The patent, entitled “insulated-gate field effect transistor with semiconductor gate electrode,” was awarded to Hans G. Dill, manager of the Solid State Research Laboratory, which is linked to the Hughes Research Laboratories in Malibu. Dill filed in October 1966.

MOS division manager Jack Hirshon says the company already is spreading the word around the semiconductor industry and asking users of the silicon gate process if they want licenses. They risk patent infringement charges if they aren't licensed. Hirshon says the patent “covers the use of a semiconductor gate as the diffusion mask for forming MOS transistors”—essentially every application of the silicon gate to date.

But Hughes could have a fight on its hands. According to one silicon gate manufacturer in the San Francisco area, Bell Labs and Philco-Ford also have patents on the basic process—Bell through its general research, Philco via its takeover of General Micro-electronics. To add a bit more spice to the stew, a licensing agreement with Bell usually contains a general cross-licensing clause—including silicon gate or any other process. The conflict is reminiscent of the Texas Instruments-Fairchild scuffle over the basic IC patent finally resolved in favor of Fairchild.

The Hughes division kept the development under wraps while Intel Corp. and then Fairchild Semiconductor and now a host of other companies announced silicon gate MOS products. But based on experience with both silicon gate and ion-implanted devices they have made, Hughes' officials favor the latter over the silicon gate because Hirshon says it delivers lower parasitic capacitance due to overlap and closer threshold adjustment, as well as permitting implantation of linear resistors.

Intel to introduce programmable MOS memory chip

The Intel Corp. is about to announce an MOS read-only memory with a difference—it will be programmable. The only programmable memories on the market now are bipolar devices in which a connecting link is either fused, blown, or grown. But the Intel ROM—a 2,048-bit unit—makes use of trapped charges under the gate region to form 1's and 0's. Also, unlike the bipolars, the Intel device can be reprogrammed with a simple black box. The Mountain View, Calif., company also is planning to sell a programmer so users can program blanks or reprogram existing patterns themselves.

Also traveling down read-only memory lane is Monolithic Memories Inc. of Santa Clara, Calif. The company soon will introduce a 2,048-bit bipolar ROM with an MOS-like price tag of below a penny a bit in high volume. The memory is packaged in a standard 16-pin dual-in-line package (MOS 2,048-bit memories require 22 or 24 pins). Power dissipation is only 0.2 milliwatt per bit, while access time is only 45 nanoseconds.

TI production woes delay calculator

Canon's pocket calculator, which was to be selling in the U.S. last month, is being delayed because production of its thermal print head by Texas Instruments is two months behind schedule. The calculator, called

Electronics Newsletter

Pocketronic [*Electronics*, April 27, 1970, p. 54], is designed around three MOS circuits and can add, subtract, multiply, and divide; it was to sell for less than \$400.

TI's James W. Clifton, manager of display products, says he expects to catch up during the second quarter. The print head, which is used with thermally sensitive paper to provide hard copy readout, is a silicon array of small dots that can be heated in various combinations to form numbers and other characters. Clifton attributes the delay to the fast turnaround time initially scheduled for the project: 15 months from laboratory to the large-scale production required by the Japanese firm.

The Canon calculator also uses three of TI's MOS/LSI circuits. Apparently, there is no problem in delivering these circuits.

NASA computer eyes chromosomes for birth defects

Latest spinoff from space technology for society's benefit—karyotyping—results from NASA-sponsored research at Jet Propulsion Laboratory (JPL). Using the same IBM 360/44 computer that enhanced photographs radioed from the moon and Mars, JPL researchers are scanning slides of human chromosomes to prepare an individual's karyotype, or chromosomal fingerprint. Karyotyping can successfully reveal some hereditary disorders, including certain forms of mental retardation and diseases that show up later in life.

Presently, costly manual processes largely limit karyotyping to confirming diagnoses. The JPL system could permit screening of large population groups, such as marriage license applicants. For the shorter term, officials say, karyotyping will permit screening to determine if radiation, drugs, industrial chemicals, and other environmental poisons cause chromosome damage.

JPL researchers hope to refine their system to a point where karyotyping can be done in hospitals and clinical laboratories with one of the new 16-bit word, 8-kilobit-core minicomputers. The system, with digital input from a scanning microscope and camera, could be marketed commercially for as little as \$50,000, the group estimates.

TI to stop making Ge microwave transistors

Texas Instruments is phasing out production of germanium microwave transistors. Though germanium has a theoretical three-to-one advantage over silicon in frequency capability, silicon material technology has moved far beyond that of germanium. The reason: silicon's greater versatility has justified greater development expenditures. TI has found that major customers no longer are buying germanium microwave transistors, so the company will stop accepting new orders, probably in mid-1971, though it will maintain stocks of some devices.

Addenda

Hewlett-Packard is about to introduce a computer with a semiconductor memory. Though no one at the company will confirm it, observers believe that the memory will be a combination of MOS and bipolar devices. . . . Defense Secretary Laird says the fiscal 1972 budget will present "a new defense strategy of realistic deterrents" based on "strategic, fiscal, manpower, and political realities." The budget, which Laird hinted will go to Congress about Feb. 8, will request 4% to 5% raises for military and civilian employees—boosting manpower costs to about 52% of the Pentagon's spending total.

COMES WITH EVERY GE
COMPUTER GRADE CAPACITOR

Extensive research and development

Research at General Electric is directed toward one basic philosophy: to give every customer the most reliable product at a reasonable price. Toward this end, our capacitor research staff in Irmo, S.C., working with their colleagues in the GE Research and Development Center and the Material Supply Operation in upstate New York, have contributed unique innovations in electronic capacitor development.

An outstanding example is the GE 86F computer grade capacitor. Advanced foil technology produces an exceptionally reliable product with useful service life in excess of 10 years when operated within rated conditions. GE 86F 500 computer grade capacitors offer the highest capacitance available per case size — up to 540,000 microfarads at 5 volts. This can mean up to a 30 percent reduction in the number of units required, or a significant reduction in assembly size, when you specify GE computer-grade capacitors. In addition, you gain a unit with high ripple current capability, low ESR, and a long shelf life.

High-capacitance units are available in nine case sizes — diameters $1\frac{3}{8}$ " to 3" with lengths up to $8\frac{5}{8}$ " — for operation up to 100VDC.

Choose from other standard ratings of computer grade capacitors for operation up to 450VDC (370,000uf maximum at 5VDC) . . . or let General Electric special-design a computer grade capacitor to fit your application.

Call your GE Electronics Distributor or GE EESO District Sales Manager or write Section 43038, General Electric Company, 1 River Road, Schenectady, N. Y. 12305.
Electronic Capacitor & Battery Dept., Irmo, S. C.

GENERAL ELECTRIC



Don't get stuck with a near-perfect signal source.

Get the source that's best for you. Varian Solid State has them all, solid-state and thermionic: Gunn-effect oscillators from 6 to 60 GHz delivering up to 200 mW.

Impatt oscillators up to one watt in X band, 750 mW in Ku band. Reflex and multi-cavity klystrons delivering efficiencies to 20%, frequencies all the way up to 220 GHz and power to 200 watts CW. BWOs, either standard or miniature, operating into Ka band. And you get prompt delivery with no red tape because you get them all from one place, the Solid State Division, Varian's signal-source specialists.

Your man from Varian is the perfect one to talk to for up-to-date, unbiased assistance. With a complete product line to back him up, he has no reason to sell you anything less than you need. See him at more than 30 Varian Electron Tube and Device Group Sales Offices throughout the world. Or call him



varian
solid state division

at our Solid State Division, 611 Hansen Way,
Palo Alto, California. (415) 326-4000.

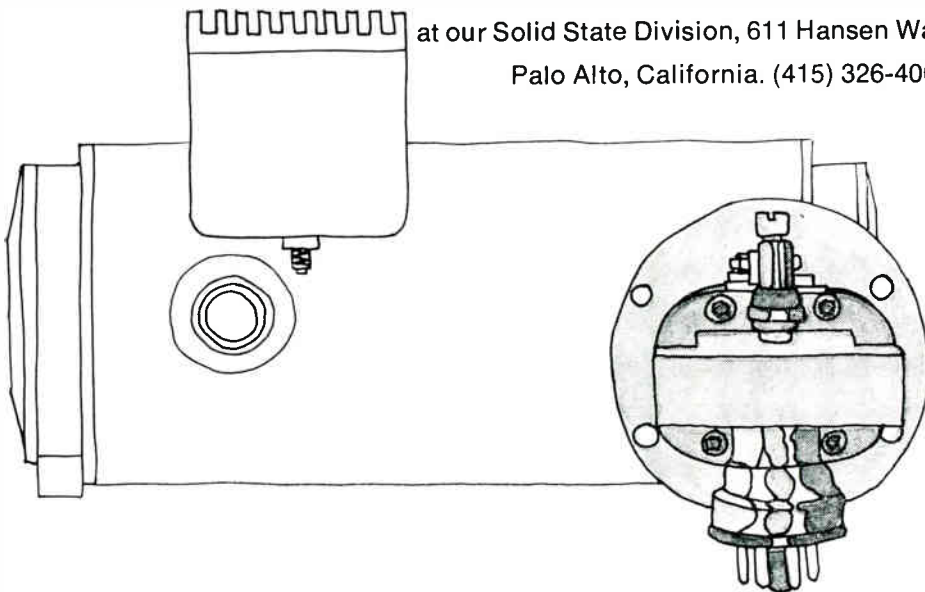

Fairchild joins the automated gang bonders

Unibond plastic packaging line is latest attempt by a semiconductor industry giant to cut costs of processing

The thrust now for semiconductor makers in their efforts to cut the cost of integrated circuits is in automated packaging and bonding. They realize that innovations in circuitry alone can't do the job—and they also know that 70% of fabrication labor is in the bonding operation.

Fairchild Semiconductor has developed a technique it calls Unibond. The system employs a controlled-collapse bump method (something like IBM's solid logic technology modules) and a beam-lead-like approach to connecting the chip to a lead frame. Fairchild's technique also shows similarities, particularly in concept, to General Electric's Multibond [*Electronics*, Dec. 7, 1970, p. 33] and Motorola's spider bonding [*Electronics*, Sept. 16, 1968, p. 58].

In the works for about two years, the system will go on-line within six months. It will be phased in for new products, and the Mountain View, Calif., company says it will bring out 30 linear and 70 digital circuits during the first quarter alone. The next step after Unibond will be automated wafer preparation.

Unibond begins by plating 5-mil-diameter bumps on the bonding pads of a chip. This process, which

produces a two-layer bump, is applied to all of the chips at once on a whole wafer before it is scribed. The two layers guarantee that, when the chip and its lead frame are passed through a furnace, the bump will collapse only as far as desired. The wafer is scribed and the chips are placed in a 10-cavity jig, which vibrates the chips into position in a corner of the cavity. Then a stamped lead frame is placed on top of the face-up chips.

This lead frame is a circular

metal stamping, with straight metal "beams" radiating from the chip. A weighted strip is placed on top of the lead frame and the whole assembly—jig, chips, lead frame, and weights—are passed through a furnace on a moving belt.

Controlled collapse of the bumps permits a certain amount of misalignment between chip and lead frame. When the bumps melt, the capillary attraction of the molten liquid tends to pull the frame into position.

When the devices come out of

Stepping along. The Fairchild Unibond process begins with bumps plated on the chips, below left. Then the internal lead frame is bonded to the chip, right. The bottom picture shows the circuits encapsulated with their plastic "pills" and bonded to lead frame. In final step ICs are dual in-line packaged.

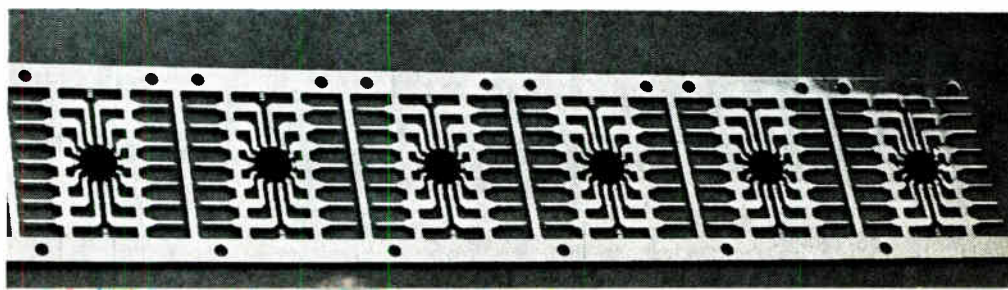
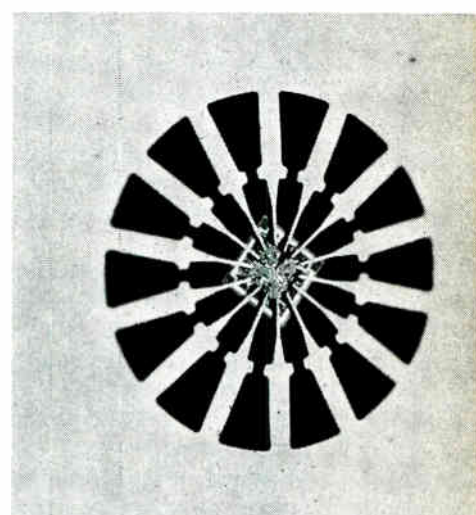
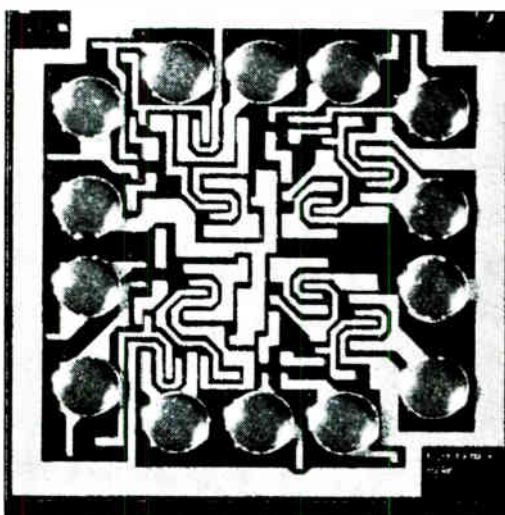

the furnace, a plastic "pill" package is molded around them. In this configuration—a very small plastic pill with metal leads radiating from it—the device is almost complete. "At this point," says William L. Lehner, vice president for packaging technology and equipment development, "we have a salable product. It can be used as is or in hybrid integrated circuits." Or it can go on to the final steps of the Unibond system.

If the pill package is placed on a tinned dual in-line package lead frame and passed through a furnace again for reflow soldering, all the pill's leads become bonded to the lead frame and the device is ready for standard DIP plastic encapsulation.

Fairchild says Unibond offers other advantages besides the elimination of costly and error-prone wire bonding. For one, the finished package can dissipate 25% more heat than a standard plastic DIP. This is because the beams are bigger than the 1-mil-diameter wire that is normally used, Lehner explains, so they can carry more current. He adds that "Unibond is about 50 times faster than manual wire bonding for a 14- or 16-pin DIP."

The other advantage is inherent in the dual plastic system. Lehner says that the plastic for the pill can be tailored to protect the chip, while the plastic for the DIP can be tailored to resist degradation caused by outside conditions. "We have a system that will meet all of the mil specs, including salt spray," he says.

There are basic differences between the Fairchild system and the Motorola and GE approaches. For one thing, Unibond requires a moving belt furnace; the others don't. Also, neither Fairchild nor Motorola can produce a package like GE's Minimod, which is shipped to customers on sprocketed reels for automatic insertion.

Motorola ultrasonically bonds a stamped aluminum lead frame to the chip pads. Separate chips are fed into the handler; gross placement is manual, while final align-

ment is automatic. The lead frame then is welded to a conventional dip frame.

GE thermally compresses bonds of copper leads to gold bumps laid over aluminum pads. The leads are formed by etching, rather than stamping, the lead frame from a copper strip laminated to a 35-mm Kapton plastic sprocketed film strip. The frame then can be reflow-soldered to any lead frame except aluminum—which makes soldering difficult and also might corrode. But the big difference is that GE doesn't separate chips before bonding—wax holds the chips together for automatic positioning after the wafer is sawed.

Computer-aided design

Software provides fast, accurate proof

A computer software package has been put together to permit an engineer to make a proof of computer-generated artwork before committing it to film. What's more, it eliminates the waiting time involved when a paper proof must be drawn by the same x-y plotter that would make the film. The proof is more accurate than the x-y plotter version, because it copies exactly the small inaccuracies inherent in exposing a film.

The software is a product of Automation Technology Inc., a Champaign, Ill., spinoff of the University of Illinois' Illiac 4 project.

The software's data input is a reel of magnetic tape or other medium containing the information that drives the x-y plotter; it translates this information into another tape that can drive a Clevite electrostatic printer [*Electronics*, April 28, 1969, p. 121] or it can drive the printer directly. The pattern that appears on the printer's output is an exact replica of what would appear on the film.

An example of the kind of error the program can catch with its exact-copy capability is shown in the drawings. A program may call for a wide conductor path to be drawn perpendicular to another path, turning to run parallel and simultaneously becoming narrower, as shown below left. When exposed on film, the narrowing of the path is achieved by reducing the aperture of the light source, which may result in too small a space between conductor paths (center drawing)—a spacing that, perhaps, could be bridged by solder in a later production stage.

Running the original tape on a plotter and drawing the pattern on paper would take just as long as exposing the film, and it wouldn't show the aperture-change error, because the pattern would be drawn as a single line without width (right drawing). Translating the original tape to a form that would draw the path with width by drawing both sides would take twice as long as the one-pass line drawing or the film exposure. For a large plotter (six feet square)

Fast print. Software program permits engineer to see proof of artwork, showing conductor paths with width before going to film.

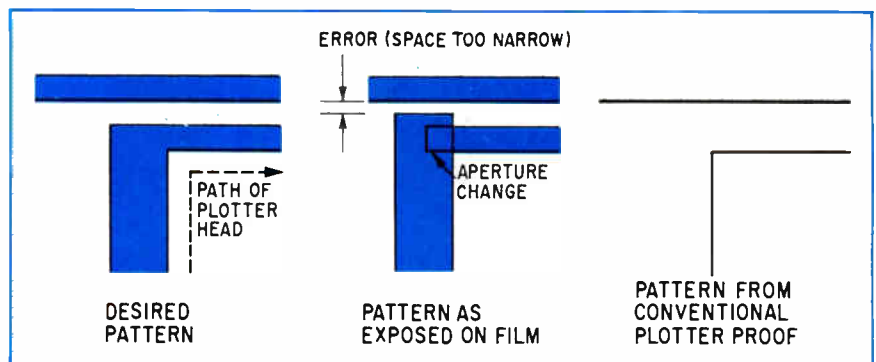

Electronics Index of Activity

Jan. 4, 1971

After October's drop, the first in three months, the index resumed its upward trend in November, rising 3.7 points to 117.8 over last month's revised 114.1. Nevertheless, the overall index is still 13.6 points off last year's figure of 131.4. This month's only gainer was defense, which rose 7.9 points to 125.4, the largest month-to-month increase since January 1969. The rise was due to the military's habit of disbursing unevenly. The biggest loser was consumer electronics, down 1.5 points to 88.4.

Industrial-commercial activity edged downward by a mere 0.9, to 122.1. This sector is 9.8 points below last year

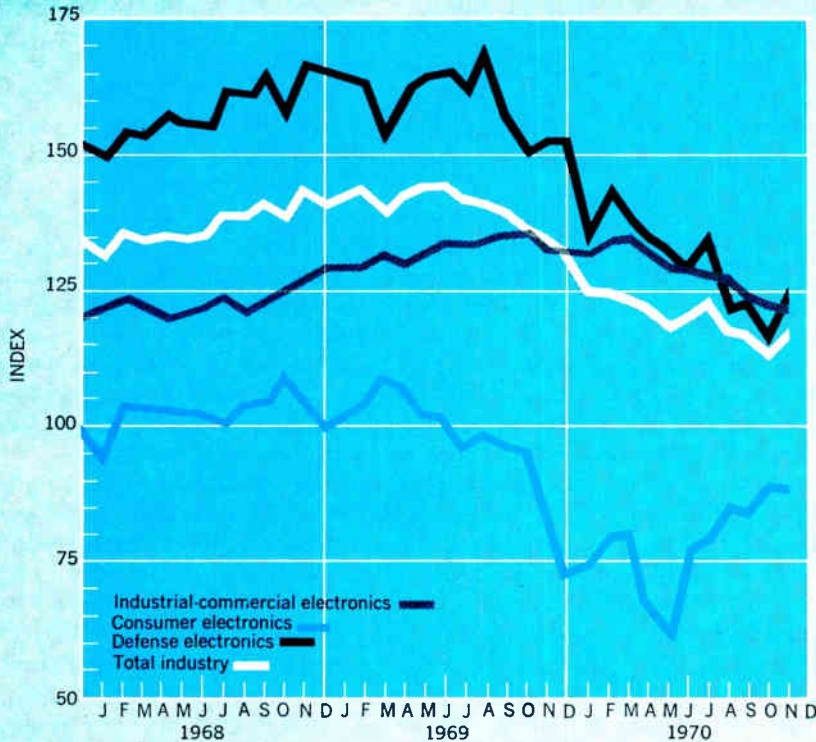

| Segment of Industry | Nov. '70 | Oct. '70* | Nov. '69 |
|-----------------------------------|----------|-----------|----------|
| Consumer electronics | 88.4 | 89.9 | 73.7 |
| Defense electronics | 125.4 | 117.5 | 149.8 |
| Industrial-commercial electronics | 122.1 | 123.0 | 131.9 |
| Total industry | 117.8 | 114.1 | 131.4 |

Indexes chart pace of production volume for total industry and each segment. The base period, equal to 100, is the average of 1965 monthly output for each of the three parts of the industry. Index numbers are expressed as a percentage of the base period. Data is seasonally adjusted.
* Revised.

drawing a complex pattern, this could take several hours. Using the Clevite printer, Automation Technology's program, on the other hand, produces a proof in a few seconds—and it draws the path with width; the printer has a row of 600 styluses that, when selectively charged, control the deposition of dark toner on the printer's paper.

The software is available in three versions, two in assembly language for machines such as the Honeywell or Digital Equipment mini-computers, and one in Fortran for larger computers such as IBM's 360 or 370 models. The Fortran version generally can be used on any computer that has a Fortran compiler; the assembly-language programs can be easily converted to versions for other computers. The program could also be used with small variations for other makers of electrostatic printers.

Garber Scientific Instrument Co., one manufacturer of equipment with which the Automation Technology program and the Clevite printer might be used, also offers an accessory unit called Quick Look—a cathode-ray tube display on which a plot may be previewed.

Military electronics.

USAF pushes A-X to regain close air support role

As the Army struggles for approval of its AH-56 Cheyenne helicopter gunship, the Air Force is pushing to recapture responsibility for close air support for ground troops. The new Air Force weapon is its low and slow A-X aircraft; prototypes will be built by Fairchild Hiller and Northrop Corp. for the first competitive fly-off under Defense Secretary Melvin Laird's "fly-

before-buy" policy instituted for the military.

Whichever design wins, avionics on the new twin-engine jet will be minimal and off the shelf, say top Air Force officials. Most likely, the hardware will consist of communications, navigation, laser target designator, and laser receivers, although the aircraft will have the space and power to accept new sensors being developed that might be ready for use when and if a production decision is made by 1975.

Fairchild Hiller and Northrop, working with awards of \$41.2 million and \$28.9 million, respectively, will build two prototypes each for the competition, which is scheduled 26 months from now. Though Cessna Aircraft challenged the selection on the ground that its \$28.3 million bid for a modified A-37 jet was lowest of the six received, industry sources contend that low

bid challenges are applicable more to production than design contracts, where performance carries heavy weight.

In any event, the two A-X competitors believe the challenge from Lockheed's Cheyenne and its competitors [*Electronics*, Dec. 7, 1970, p. 51]—Sikorsky's S-67 ASW helicopter and Bell's modified Huey-cobra—is even greater. A somewhat lesser threat is represented by Britain's Hawker-Siddeley AV-8 Harrier VTOL now being acquired by the Marines.

Compared with Fairchild Hiller's \$41.2 million version for its more complex A-X award, the Army is spending \$130 million this year to salvage the Lockheed Cheyenne. That program encountered problems with technology, costs, and Congress in the last two years of its five-year history. Nevertheless, Deputy Defense Secretary David Packard is expected to proceed with all three programs before deciding whether one or all the aircraft are required for close air support. Congress, however, is pushing for a single aircraft for the mission without preference for a fixed or rotary wing. Rep. George Mahon's (D., Tex.) appropriations committee has told the Pentagon to provide an evaluation early this year to expedite the close-ground-support decision.

Integrated electronics

D/MOS promises speed, easy fabrication

Just when standard p-channel MOS integrated circuits are beginning to gain wide acceptance in production volumes, and when three other MOS technologies—n-channel, complementary, and silicon gate—are vying for future acceptance, it would seem a bad time for a company to pursue still another MOS technology. But researchers at the Signetics Corp. feel that their new process, called D/MOS for double-diffused MOS [*Electronics*, Dec. 7, 1970, p. 25], is worth the effort because it will offer MOS circuits

at the higher performing bipolar speeds, and will simplify fabrication. Equally important, D/MOS technology also can be applied to discrete devices. Microwave transistors, with F_{max} values as high as 10 gigahertz, already have been made in the lab.

With D/MOS both depletion and enhancement mode devices can be made. In terms of circuit speed, D/MOS is five times faster than standard n-channel circuits and even greater than that for p-channel units. The key to the speed is in the channel length—the region between the source and drain that is under the gate. Generally, the longer this length, the longer the transfer times and the slower the circuit. With regular p- or n-channel techniques, this length is limited by photolithographic capabilities—that is, by the masks. This is also true with silicon gate techniques, where a polycrystalline layer acts as the mask.

But with D/MOS, the channel length is determined by the difference in length between the p and n+ diffusions—the longer the n+ diffusion takes, the longer the channel. So by carefully choosing diffusion times, the channel length can be kept short and the device is fast.

According to Joseph Kocsis, manager of high-frequency and microwave integrated circuits at Signetics, D/MOS combines three techniques that together offer several attractions. These include relaxed processing tolerances in both masking and diffusion, high-voltage breakdown control independent of

channel length, and maximum transconductance that's determined by the scattering-limited velocity of silicon.

The device is fabricated on n-type epitaxial silicon by a double-diffusion of p- and n-type dopants through the same oxide opening at the source side, and a single diffusion at the drain side. The p-type channel doping determines threshold voltage. The gate metal performs two device functions: modulation of carrier concentration in the channel and elimination of curvature effects which usually limit breakdown voltage.

The location of the drain and the width of the gate metal overlay are chosen for voltage control independently from the channel length, which is determined by the diffusion schedule at the source opening. Using the high-breakdown-voltage control techniques, a D/MOS device has been made with a V_{DS} of 300 volts with an F_{max} greater than 1 gigahertz.

The device's high-speed performance results from the fact that the n-type carriers travel from source to drain at the scattering-limited velocity of silicon. The carriers are modulated during the transit time through the short channel. The remaining transit time occurs through a high-field drain depletion region, which is designed for short transit-time, low feedback capacitance, and also for adequate breakdown voltage.

For channel lengths from 0.4 to 2 microns, threshold voltages have been obtained from $-4V$ to $+2V$. maximum available gain is about

Strata. Signetics says its D/MOS will yield bipolar speeds. A discrete microwave device may be available next year, though the company says it has no marketing plans yet.

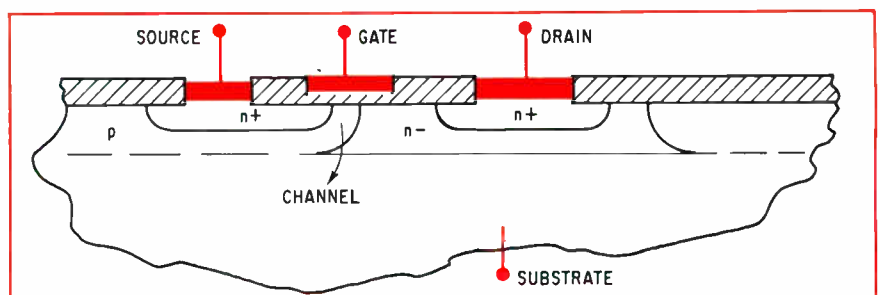

new tektronix 7514 with write thru...

a significant advance in storage oscilloscopes

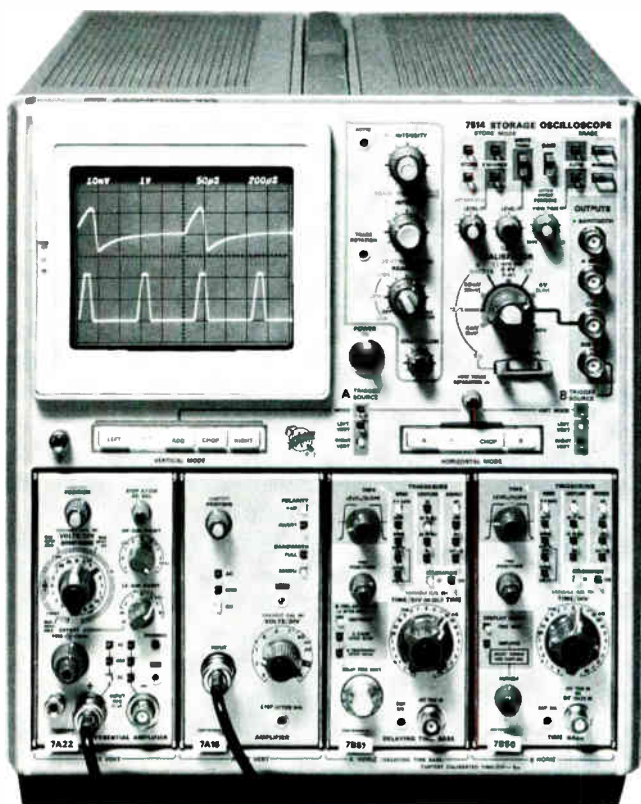

WRITE THRU allows simultaneous stored and conventional displays in the same area of the CRT . . . ideal for precise comparison of waveforms. Store a waveform, switch to **WRITE THRU** and the stored waveform then becomes a reference for all subsequent ones. Storage oscilloscopes are frequently used in the non-store mode, but until now, their usefulness has been limited due to a lack of trace brightness. Not so with the 90-MHz 7514! The 7514 has a conventional writing speed of $450 \text{ cm}/\mu\text{s}$, faster than any other storage oscilloscope. Set the focus control only once, and a new **auto-focus** circuit will take over, so that additional manual focusing is not required with changes in intensity.

The NEW 7514 uses rugged, bistable, split-screen storage which has a **high-burn resistance**. An auto-erase system with variable viewing time allows automatic erasure of either half of the screen after pre-selected view time. The extensive use of push-button controls make the 7514 very **easy to use**.

Numerous plug-ins covering a wide performance spectrum are available, including the NEW 7D13 DIGITAL MULTIMETER, which measures voltage, current, resistance and temperature; and the NEW 7D14 500-MHz DIGITAL COUNTER. With vertical and horizontal mode switching in the mainframe, simultaneous measurements can be made by up to four plug-ins having widely different features.

For measurement ease, CRT Readout, which is exclusive to Tektronix, labels the CRT with time and frequency; volts, ohms, temperature (C), and amps; invert and uncal symbols.

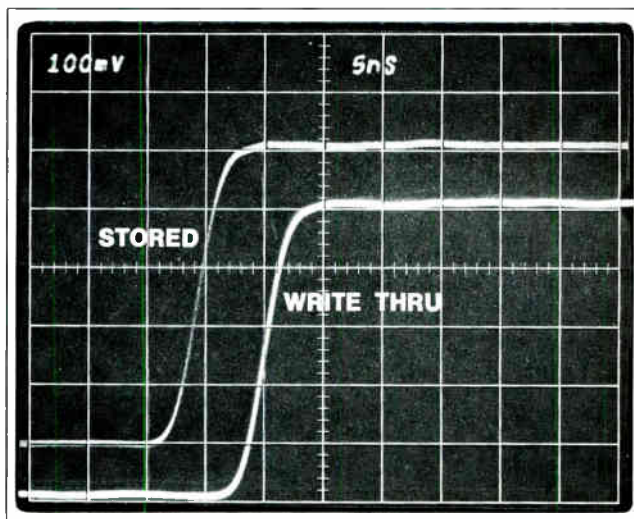

Call your nearby Tektronix field engineer for a demonstration. Prices of instruments shown: 7514 Storage Oscilloscope \$3200, 7A16 Amplifier \$600, 7A22 Differential \$500, 7B50 Time Base \$450, 7B51 Delaying Time Base \$510.

U.S. Sales Prices FOB Beaverton, Oregon

Available in U.S. through the Tektronix lease plan



TEKTRONIX®

committed to
technical excellence

5 GHz with a noise figure of 5 decibels at 1 GHz.

Kocsis says that microwave characterization of a D/MOS device's S-parameters "shows the device will be interchangeable with many microwave bipolar transistors. Self-alignment techniques for the gate result in lower parasitics and improved microwave performance. And D/MOS is directly compatible with TTL circuits—it will yield a new form of high-speed integrated circuit with 5 V-or-less supply voltages."

Kocsis emphasizes that D/MOS performance has been achieved with noncritical processing steps and should offer very high yield. "This factor could lead to a significant price reduction in microwave components as well as in high-performance integrated circuits," he says.

Electro-optics

Photochromics working into hardware

After years of promise, photochromic materials, which change color in response to light, and cathodochromic, which respond to an electron beam, are finally starting to appear in working displays. First came the Corning Glass Works graphic display system [*Electronics*, April 13, 1970, p. 45], and Optel Corp.'s storage oscilloscope and data terminal, which offer high visibility in bright ambience and very long storage periods [*Electronics*, Nov. 23, 1970, p. 33].

Now comes a document storage system that Carson Laboratories of Bristol, Conn., is preparing to deliver to the Army Missile Command. Using a crystal of photochromic alkali halide material only 2 inches square by 0.1-inch thick, the Carson system uses Bragg angle holography to store the information on 1,000 8½-by-11-inch pages. To refer to any page, the user simply dials the page address into the system; he can then view an image of that page through an eyepiece.

Moreover, this data storage density is only the beginning, according to Arthur Carson, president of the company. "Potentially," he says, "the same size of crystal can store a couple of million pages. We haven't yet had the chance to explore the full capability."

RCA, meanwhile, has concentrated its efforts on cathodochromic display tubes, in the belief that this area will give maximum rewards in the shortest time. Using sodalite powder as the target in a cathode ray tube, Istvan Gorog and his coworkers at RCA Laboratories have built a storage display tube with essentially infinite storage time, 10-to-1 contrast ratio, and less than 2 seconds thermal erasure time. The RCA group has also retrofitted a standard CRT with a cathodochromic target to give a long persistence reflective display.

Further down the road are the R&D laboratories to which materials suppliers are selling photochromic materials in various formulations and forms. National Lead Co., through its crystal products division, offers single crystals, sintered compacts, and powders or calcium and strontium titanates. The company is even experimenting with a photochromic paper for strip-chart recording. American Cyanamid Co. and Litton Industries' Airtron division both offer sodalite, an aluminosilicate with halogen and sodium ions. Others—largely in-house laboratories—are making the alkali halides.

Avionics

S-3A equipment nears test date

With delivery of the first subsystem components to prime contractor Lockheed Aircraft's Integration Test Facility early this year, the Navy will move toward third-quarter flight tests of avionics for its carrier-based S-3A antisubmarine aircraft—though the first tests will be aboard a P-3C land-based antisub plane. The Naval Air Systems Command (Navair) says

software development schedules call for program-tape deliveries timed to allow a systematic check-out and integration of the avionics to begin about a year before the first S-3 flight, and more than 18 months before the first full avionics system flight. Equipment integration and ground testing, say officials, should guarantee successful debugging of what is shaping up as the most complex avionics package for the military inventory.

Elements of the 3,000-lb. package make up a system that "is functionally and generically very closely related to the A-New avionics system of the land-based P-3C," says Navair's Capt. Fred H. Baughman. Further, the four-man plane also will have the All-weather Carrier Landing System.

Secure communications can be maintained between the plane and other ships using uhf and hf voice and data links. With the plane's Univac processor getting regular updates from the ship, direct computer-to-computer communications also will be possible. Heart of the avionics is the Univac variation on its UYK-7 [*Electronics*, Sept. 29, 1969, p. 61] plus the multichannel acoustic processor to handle data from the plane's sensors, and an auxiliary memory made up of drums and a digital tape recorder.

The S-3 sensor package will include the SSQ-53 direction finding are ranging sonobuoy and the SSQ-50 command-activated sonobuoy, though the latter is still under development. In addition to a broadband passive countermeasures system, the S-3 will carry the ASQ-81 magnetic anomaly detector, which is similar to the one on the P-3C, as well as the new ASP-116 radar. Both the radar and the MAD system are being built by Texas Instruments and will be two of the few items going directly to Lockheed as Government-furnished equipment. Completing the ASW sensor package are forward-looking infrared and camera systems.

Navigation is keyed to the doppler inertial system. "A very tight, state-of-the-art, long-range point-to-point accuracy is specified," says



Bell & Howell & Jon Wells & The Simple Folk

Some people asked our guys how come we didn't turn out a recorder/reproducer that simple folk could use. At a simple price. Something that was production line oriented for a bunch of industries across the board.

We bounced that problem to Jon Wells who just recently came up with the remarkable, hi-rel VR3700B series.

Back Jon came with a little number called the VR3500. Although it's not as esoteric as the B model, it does have a lot of its features.

He used a modular concept with functions being grouped according to use. Linear IC's to get the bulk down. And large cards so any trouble shooting that needed to be done could be done fast.

Transport and electronics are set up so they can be easily repaired or modified. There's a closed loop tape path so you get real accuracy. Bi-directional speeds for versatility. A fail-safe phase lock DC capstan drive so you won't lose a smidgen of information. And very gentle tape handling.

As far as time base error and dynamic skew and flutter, they're fantastically low.

And so's the price.

Another thing. You don't have to be an engineer to run it. The how-to's are decal'd right on the equipment.

That's the VR3500. An industrial recorder/reproducer. Brand new. And ready.

For all the specs, write its father, Jon Wells, Bell & Howell, Instruments Division, 360 Sierra Madre Villa, Pasadena, California 91109.

INSTRUMENTS DIVISION

 **BELL & HOWELL**

Circle 27 on reader service card

Baughman, "as well as the ability to stabilize the system in a tactical situation to a drift rate of a few yards per minute. The attitude heading reference system provides navigational backup. "Another element of the navigation, and one that frankly will be difficult to implement," says the project officer, is the sonobuoy reference system. This completely passive, bearings-only location system will eliminate the need to overfly and visually sight sonobuoys in the water—"something which we have always had to do in ASW."

Lasers

**Nd/YAG diode-pumped
at room temperature**

In the book of lasers, 1970 is going down as the year of the room-temperature device. First Bell Laboratories announced continuous operation of a GaAs injection laser [*Electronics*, Aug. 31, 1970, p. 37]. Now Texas Instruments in Dallas has achieved continuous room-temperature operation of a neodymium-doped YAG unit using an array of light-emitting gallium arsenide phosphide diodes as the pump source. This is the first time lasing thresholds could be achieved at room temperature with diode-pumped YAG rods. TI previously achieved YAG operation with a diode pump [*Electronics*, April 28, 1969, p. 40] but both the diode array and the laser rod had to be cooled.

In the past, Nd/YAG lasers were pumped with tungsten lamps, but these were relatively poor sources of pumping power. They emitted over the entire spectrum, and since the YAG rod could absorb energy within only narrow fixed bands, much of the tungsten energy was wasted, or worse still, turned into heat which can cause expansion and instability problems in the YAG rod. GaAsP diodes, on the other hand, have narrow spectral emission—only a few hundred angstroms—which can be matched to the YAG's absorption band by

changing the bandgap of the GaAs system with the right amount of phosphor doping. Thus, a much greater fraction of available pumping energy can be delivered to the YAG rod with a GaAsP system for a given pump power input than with a tungsten lamp.

TI's array is made up of 64 diodes emitting at 8,000 Å, one of the YAG laser's major absorption bands. Previous work with the cooled system indicated that an extremely densely packed array would be required to supply enough energy to the YAG rod to achieve the lasing threshold at room temperature, when diode efficiency goes down and lasing threshold goes up. To reach this density, the diodes were put on 28-mil centers. Individual diodes are 18 mils in diameter, and are constructed with elliptical dome surfaces to reduce energy losses resulting from internal reflection with the diodes themselves.

An important factor in diode pumping is the method of coupling the pumping energy to the laser rod. TI worked with direct coupling, putting the linear array as close to the rod as possible. However, Bell Labs, which also has been very active in diode-pumped Nd/YAG, has also developed a semi-elliptical cavity in which the diode array is at one focus and the YAG rod at the other. This arrangement focuses the energy on the laser rod. Although efforts are still in the early laboratory stage, both TI and Bell Labs feel that present diode-pumped YAG performances can be extrapolated to the level of 100 to 500 milliwatts with an overall system efficiency (electrical power into pump to optical power out of the laser) of better than 0.5%. This would be good enough to make the YAG a strong contender as a compact optical source.

For the record

Bad news. Tektronix is planning a large layoff—first in its history—this year, says Charles Buffiou, vice president for marketing. Exact

numbers haven't been set, but Tek wants to cut its production capability by 15%. Technical and marketing staffers won't be affected. "We don't believe we can fire engineers or salesmen just because business is bad," explains Buffiou.

On line. A new message-switching computer center devoted exclusively to handling Mailgram traffic has been dedicated by Western Union and the Postal Service. Consisting of three Univac 418-11 central processors, the Mahwah, N.J., facility will handle switching for the 20,000-messages a week.

Present Mailgram service is a joint venture. The message is typed on a teletypewriter, including the name, address, and zip code of the recipient. The computer switches the message to the post office nearest the destination. At the post office, the Mailgram is printed out, stuffed into a special envelope, and delivered as first-class mail.

Even brightness. A new laser deflector operating at 70 megahertz is the second product developed by the acousto-optic group of the Zenith Radio Corp. of Chicago. The D-70R will have a resolution of 400 spots and a light output that is almost constant over the entire deflection range. It's designed to project TV pictures.

Big gun. A 36-kilowatt electron beam gun developed by Westinghouse Electric from welders will be field tested in New Mexico next year by the Bureau of Mines as "potentially safer, cheaper way to dig mines and tunnels." Funds for the project come from the Pentagon.

Entrepreneurs. Robert Widler and David Talbert, developers of Fairchild's 709 operational amplifier and more recently designers of the LM108 op amp and LM109 voltage regulator at National Semiconductor, are believed ready to form their own linear IC design company. Replacing Widler at National is Robert Dopkin; George Rutland replaces Talbert.

Φ-LINE POWER DARLINGTONS

integrated switching
circuits
cost you less...

and make your work a lot easier.

Unitrode's new industrial 10 Amp silicon planar NPN Darlington transistors offer you the advantages of a monolithic two transistor circuit for less than the price of comparable discrete devices. They're ideal for high gain switching applications such as print hammer drivers, solenoid, servo and lamp drivers and for amplifying applications such as motor controls and linear amplifiers. They're available in two hermetically sealed metal packages — a lead-mounted TO-33 (U2T101) and a chassis-mounted TO-66 (U2T201). Both utilize overlay (multiple emitter) techniques on driver and output transistors. Saturation voltage is 1.5V max. @ 5A and current gain is 2000 min @ 5A. Collector-Emitter voltage ratings are available up to 150 volts. U2T201 has a power dissipation rating of 25W @ a case temperature of 100°C. For whatever Darlington application you have, Unitrode Φ-Line Darlington are more efficient and less expensive than any other method of performing the function. Why not make us prove it? (U2T101 is \$2.75 ea. in lots of 100.)

For fast action, call sales engineering collect at (617) 926-0404
Unitrode Corporation,
Dept. 1C, 580 Pleasant St., Watertown, Mass. 02172

Free samples on request.

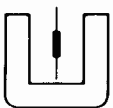

UNITRODE quality takes the worry out of paying less.

What makes ours the world's best MOS?

Unique features. Like PSG passivation, cerdip, MOSAB.

Things that make Philco® MOS the most reliable on the market.

First, our PSG passivation. We apply a unique phosphosilicate glass over the entire surface of the chip—not just over the metallization. This produces the most trouble-free MOS you can buy.

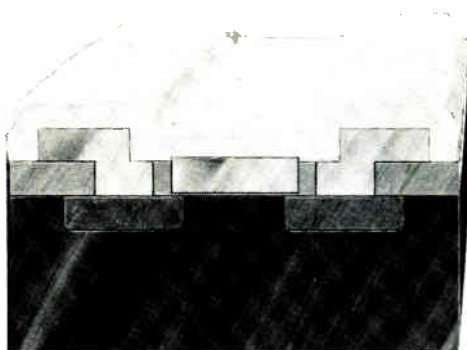

All-over PSG passivation

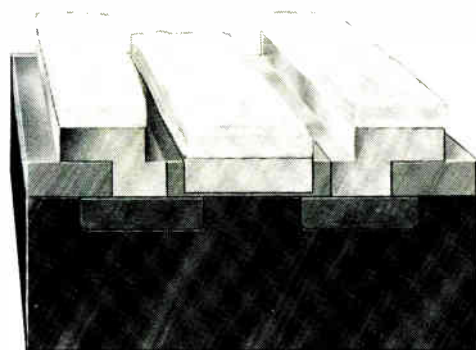

Passivation over metal only

Our special PSG process ends surface ion migration and eliminates field inversion voltage effects—the “Fahrenheit freakout” that can cause all sorts of logic errors when chip temperatures rise. It also prevents corrosion, scratched metallization, and bridging of metal lines by stray conductive particles.

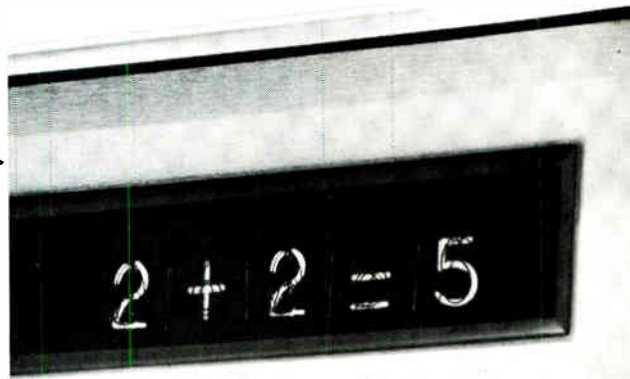

Sealing cerdip at 550° C

And PSG's high-temperature capability lets us give you MOS in cerdip—the low-cost hermetic packaging that meets all the environmental requirements of MIL Standard 883.

Then there's our patented MOSAB input device. It ensures permanent over-voltage protection at every input on every circuit. In conventional MOS circuits the voltage limit increases each time there's a transient surge, as shown on the curve tracer. Until eventually there's no over-voltage protection left.

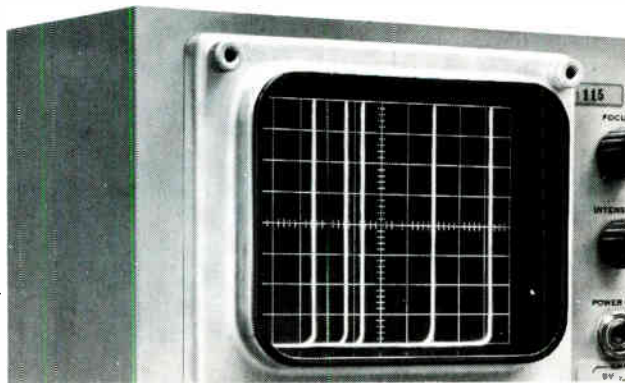

These all add up to yields that are double the industry average . . . from a plant that can make up to a million perfect chips a week. And that means top reliability at attractive prices. See for yourself. Write Philco-Ford Corporation, Microelectronics Division, MOS Marketing, Blue Bell, Pa. 19422. (215) 646-9100.

Or call our nearest sales office: Los Angeles, Calif., (213) 641-8105 • Palo Alto, Calif., (415) 321-8740 • Melrose Park, Ill., (312) 345-1000 • Burlington, Mass., (617) 272-1600 • Dearborn, Mich., (313) 323-3797 • Union, N.J., (201) 686-7512 • Syracuse, N.Y., (315) 422-3154 • Dayton, Ohio, (513) 223-1832 • Don Mills, Ontario, (416) 444-2541.

PHILCO 

The better idea people in MOS.

Everybody is talking about monolithic memories, now you're going to hear about Monolithic Memories.

We're making semiconductor memory systems that can put your computer, big or small, ahead in the price/performance race with the next guy . . . or the big guy.

Monolithic Memories makes high performance, low cost memories and we're introducing four all at once now that we've put thousands in stock.

Consider . . .

Monolithic Memory Planes. High performance RAM subsystems. Specifically, the

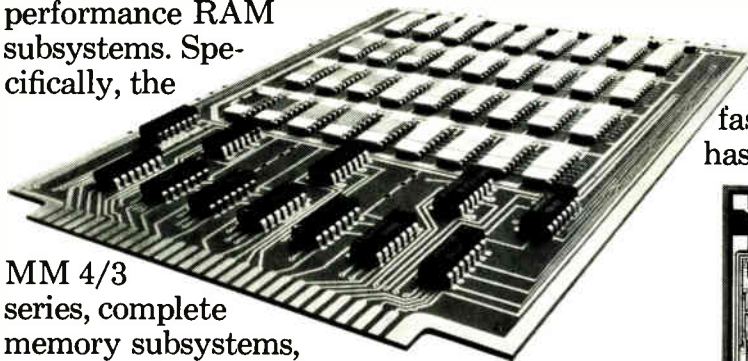

MM 4/3 series, complete memory subsystems, fully tested and ready for plug-in. Available off the shelf as 512 or 1024 words in any bit configuration you want with an access time of 120 nsec (nondestructive readout) and cycle time of 100 nsec.

But, if your choice is component, consider . . .

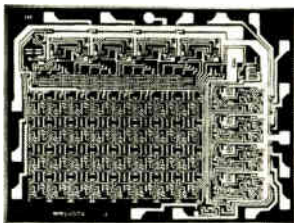

Random Access Memories. Bi-polar RAM's built with the lowest power dissipation available and completely TTL/DTL compatible.

Specifically, the world's fastest 64 bit RAM, the MM5500. Several other companies make it, but only Monolithic Memories guarantees 50 nsec and ± 10 per cent VCC

supply variation over the full mil temperature range.

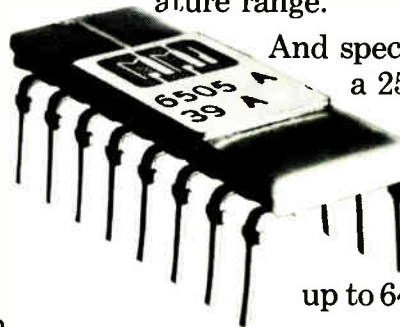

And specifically, the MM6505, a 256 Bit RAM with an access time of 100 nsec (decoder to memory output). Its decoder driver, MM6504, can handle up to 64 packages, (16K bits).

Consider . . .

Read Only Memories. A 30 nsec access time makes our MM5200 the fastest 1024 Bit ROM on the market. It also has a ± 10 per cent VCC range guarantee and a low, low power dissipation of .35 mw/bit. Guaranteed fast turn-around on custom requirements.

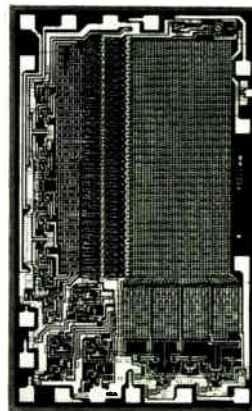

Now you know why everyone is talking about Monolithic Memories. We build semiconductor memories to compete spec and price-wise with cores and any other memory product you're using. If you haven't found the memory system you need, give us a call . . . we might be announcing it next month. Write or call for data sheets.

Monolithic Memories

Monolithic Memories, Inc. 1165 East Arques Avenue
Sunnyvale, California 94086 Telephone: (408) 739-3535 TWX: 910 339-9229

Washington Newsletter

January 4, 1971

**Comsat plans
a second
domestic system . . .**

Communications Satellite Corp. is trying to persuade the three major broadcast networks—ABC, CBS, and NBC—as well as news services, publishers, and “everyone else we can get to listen,” to sign on as customers for a second domestic satellite system. The system would be independent of the two-satellite system already planned for AT&T’s use, and would have to be proposed to the Federal Communications Commission before the March deadline. Broadcasters are noncommittal about the idea, pending the decision on their own private satellite study recently received from Page Communications Engineers, the Washington-based subsidiary of Northrop Corp.

Is Comsat worried about Hughes Aircraft’s latest domestic satellite proposal? Company officials deny it, noting that their 24 transponder satellites offer twice the capacity of the Hughes system, which, with 8 of 12 channels used by GT&E, could serve only a limited number of small subscribers. However, Comsat may find AT&T, its principal customer, upset by the fact it is soliciting business from companies that AT&T now counts among its customers.

**. . . as Hughes files
for system
to serve GT&E**

Hughes Aircraft’s proposed two-satellite system calls for synchronous orbiting of two modified versions of the Hughes HS-333 satellite that’s currently under contract with Telesat Canada for use in the Canadian domestic satellite system. The 6-foot-diameter, spin-stabilized satellites, each with a 5-foot-diameter, parabolic reflector antenna, would be at 100° and 103° west longitude, with a slot for a future third satellite at 97°. The narrow separation would permit use of fixed antennas to receive signals from either satellite, and so would help hold CATV receive-only ground station costs down to \$110,000. Each of the 12 broadband transponders would accommodate a color TV channel using orthogonal linear polarizations for receive and transmit, and operating in the 6- and 4-GHz bands. Hughes plans its first satellite launch 19 months after FCC approval, with initial CATV service within a month of launch, and fully backed-up service within 24 months.

**Foster pushes
R&D initiative
options . . .**

Industry will find several hundred millions of dollars in new programs in the fiscal 1972 \$7-billion Defense Department budget for research and development. Dr. John S. Foster Jr., Director of Defense Research and Engineering, calls them “initiatives,” and defines three types of programs: those achievable “with existing or near-term technology,” those offering “a giant step rather than an evolution,” and those that “leapfrog” the whole approach to a problem. His itemized shopping list has cleared through his own department and awaits approval of Secretaries Laird and Packard before going to the Office of Management and Budget and lastly to President Nixon.

Aides state that the “initiatives” projects will be aimed at increasing defense capabilities by 10-20% or more, with expensive improvements in present hardware. Friends say Foster is fed up with going to Congress to defend the same old weapons systems for needing another shot of money to achieve their original performance goals or to upgrade their performance by a few percentage points.

Washington Newsletter

... as Navy talks of major changes in strategic concepts

Military research chiefs indicate they are doing some fundamental rethinking of defense problems that could lead to major changes in electronics for command and control and for antisubmarine warfare. Dr. Alan Berman, director of research at the Naval Research Laboratory, for one, ponders what will happen after our missiles prove out. For instance, he postulates, it would be unnecessary to risk multi-million-dollar airplanes against \$200,000 bridges that could be replaced overnight. Or suppose one or two missiles were mounted on a ship 60 feet long with a draft of 8 feet. "That is so shallow you can't even torpedo it," he observes.

This sort of conceptual planning shows up more and more as the military attempts to use limited research and development funds to make what is known as "a qualitative difference in military capabilities." The Russian naval threat, Berman thinks, exists as it does today because the measure-counter-measure strategy of the past indicates that the U. S. Navy would continue to have the same character for another 15 to 20 years. This is no longer a certainty, as Navy planners move closer to beaching at least half the fleet as too expensive to operate. Changing the character of the U.S. fleet would threaten the Soviets with a very rapid fleet obsolescence.

LEAA loses out as FBI takes over Project Search

International Business Machines Corp. appears the sole beneficiary of FBI Director J. Edgar Hoover's successful ploy to have the only criminal information data bank in the nation. In the new fiscal year, which begins July 1, Hoover will take over Project Search [*Electronics*, April 27, 1970, p. 115] from the Justice Department's Law Enforcement Assistance Administration and incorporate it into his National Crime Information Center. Though Attorney General John Mitchell says the transfer is part of an economy move, police sources say its origin lies in Hoover's jealousy of the successful Search program, and attendant publicity received by the growing LEAA. IBM supplies System 360 hardware to the FBI for the NCIC, while Search employs a Burroughs B-5500 at Michigan state police headquarters.

Though IBM's system will expand as a result, the Burroughs installation is likely to continue in place for use solely by Michigan. Terminal requirements, mostly teleprinters, are unlikely to change. Money for the expanded FBI system, reportedly some \$1.3 million, will come out of the fiscal 1972 budget, leading industry sources to question where the projected savings will come from.

Congress to weigh medical device rules

Electronic medical device manufacturers should be readying their position for Congressional hearings on medical device legislation, since Reps. Paul Rogers (D.-Fla.) and Seymour Halpern (R.-N.Y.) both intend to introduce modified versions of their 1970 bills sometime this month. Industry has indicated its willingness to work with Rogers, who, as the second-ranking and most active Democrat on the House subcommittee on public health and welfare, has the seniority to bring his bill to fruition.

More substantive than Halpern's, Rogers' bill incorporates recommendations from last year's report of the HEW Special Committee on Medical Devices, called the Cooper report. But the hearings required by the relatively new medical device field will probably be extensive, so that the passage of any regulatory legislation this year is unlikely.

Electronics industries sales to hit \$25.14 billion, a 2% increase over 1970

The Los Angeles aerospace engineer taking an order for pizza and the Boston radar designer repairing a roof off Route 128 have one thing in common with every engineer and manager in the electronics industries: they all want to know what's ahead in 1971. To give them the picture, Electronics' editors spent three months interviewing executives at hundreds of companies. The industries finished 1970 with sales nearly 4% below expectations, about even with 1969's level at \$24.64 billion. Though the economy is poised for a rebound and many electronics markets are expected to turn up in the second half, the real impact of any upturn will not assert itself until 1972. The two-year-old sales plateau will continue in 1971; business will increase by 2%—not enough to offset inflation. Increases of more than 7% in both the industrial/commercial and the consumer markets will make up for the 5% drop in Federal spending.

Huge Federal budget deficits and shifting national priorities spell continued trouble for most military and space projects. In the semiconductor industry, price cutting will continue and even expand as companies line up for a tough battle in 1971—this sector's second nongrowth year in a row. The computer industry, surprised by an 8% dip in 1970, expects improved capital spending to resume its growth curve. In all, the industries may have seen the worst in 1970, and while 1971 won't cause any shouts of joy, business will remain steady, giving companies the opportunity to spend the development money needed to lay the groundwork for the higher sales anticipated in 1972.

| | 1970 | 1971 | 1974 |
|---------------------------------------|-----------------|-----------------|-----------------|
| ELECTRONICS INDUSTRIES, TOTAL* | 24,641.0 | 25,143.1 | 32,266.6 |
| Federal | 10,628.0 | 10,063.0 | 12,540.0 |
| Industrial/Commercial | 9,417.5 | 10,178.1 | 13,673.3 |
| Consumer | 3,895.5 | 4,202.0 | 5,303.3 |
| Replacement Components | 700.0 | 700.0 | 750.0 |

*U.S. factory sales in millions of dollars by calendar year

Index

- 36 Solid state
- 39 Computers
- 43 Packaging & production
- 44 Components
- 46 Consumer
- 49 Communications
- 52 Instruments
- 55 Military
- 58 Industrial
- 59 Space
- 60 Federal

Solid state

- Continuing sharp decline in discretess sector will more than offset the growth in sales of ICs
- It's going to be a design-in year for silicon gate as sales of MOS will break the \$100 million mark
- Digital bipolar price war will continue, while Schottky TTL makes inroads in ECL territory

□ By the middle of last year it became apparent the semiconductor industry wasn't going to achieve the growth it had anticipated for 1970. A bad third quarter dashed any hopes of a turnaround, and the year ended with the industry off by 2% to 4%. Though *Electronics* foresees a 2.7% gain in 1971, many in the industry are expecting a flat year at best, with some looking for another 2% to 4% decline.

Compounding the semiconductor industry's woes in 1970 was the almost universal overestimation of the size of the markets. "We were all overly optimistic in the amount of depression that we saw and the time we thought it would take us to get out of it," says Reed Neddermeyer, director of marketing for discrete devices at Fairchild.

With the tough battle for business expected to continue this year, many in the industry believe the demise of Sylvania Electric Products' Semiconductor division last fall was just the beginning of the shakeout. And with the big production overcapacities existing in most product areas, it comes as no surprise that few, if any, companies are spending any money in 1971 on expanding production. "I'm not spending a nickel on expansion," says National Semiconductor Corp.'s president, Charles Sporek, "but I am spending it on developing new products."

One veteran market observer estimates: the semiconductor market in 1970 "will come in at \$1.293 billion," down 2% from the \$1.318 billion in 1969 sales. The observer—Gene Selven, director of discrete and integrated circuit product marketing at Fairchild's Semiconductor division in Mountain View, Calif.—now sees 1971 sales hitting \$1.264 billion, down \$29 million from last year. *Electronics* is forecasting a \$35 million increase, but statisticians call these variations "insignificant," particularly when the uncertainties regarding the general economy in 1971 are considered.

The flat outlook for 1971 is 'due to the continuing sharp decline in the discrete device business. From \$905 million in 1969, discretess slipped to \$788 million in 1970, and Selven predicts they'll fall even further to \$700 million in 1971—too great a decline for the growing IC markets to overcome. In the IC areas last year, sales of digital bipolar circuits totaled between \$280 million and \$289 million, down from the \$320 million makers had expected to sell. This year's picture won't be any better, with estimated drops ranging from \$3 million to \$13 million. The price wars in both the bipolar and discrete sectors last year are expected to rage through 1971, though some companies expect to see some order restored in the volatile TTL logic price area by the end of the year. But price

erosion has now begun to infect the linear IC market, which did have an increase, though disappointing, in 1970, up to \$82-84 million from \$72 million in 1969. However, linear IC sales this year will increase up to \$90-95 million, major makers predict.

The one bright spot in the market is the MOS business. It exploded in 1970, but with not quite as big a bang as some predicted. Estimates for last year's sales range from \$52 million to \$70 million. Several major suppliers figure it will go up 50% in 1971 to the \$100-110 million area. Fairchild's Selven is more conservative, figuring it will hit \$88 million, still a 70% increase over the \$52 million he estimates for last year.

One of the major reasons for lower bipolar IC sales is the price war. Prices on transistor-transistor logic are still falling, and although some kind of stabilization is hoped for in the latter part of the year, few marketeers are willing to stake their product lines on that premise. The profit picture is even darker. The TTL price war is continuing apace: prices in some cases are down to 15 cents a gate. Sylvania's Semiconductor division of course, was the major casualty last year, but more are expected to fall in 1971, says National's Don Valentine, marketing vice president.

Andrew A. Procassini, vice president and director of marketing for Fairchild's Semiconductor division, Mountain View, Calif., also sees a TTL shakeout in the wind. "Sylvania was just the beginning. We will see some small companies going out of business in 1971 and we will see some being taken over for captive, in-house use." However, unlike Valentine, Procassini feels that the TTL pricing war is over, having finally bottomed out. Further, he feels the market will pick up in the second half of '71.

If there's a silver lining at all, it's because with such low prices, many systems houses are replacing mechanical designs and discretess with TTL. "This way, when things pick up, there will be more users of TTL," says National's Valentine. But even when business starts picking up steam TTL prices will stabilize at 16 to 20 cents per gate, Valentine feels.

Another trend, though it may not have much impact on '71 profits, is Schottky-clamped TTL ICs. Texas Instruments, Dallas, at the high end of its 54/74 line is offering a family of Schottky-clamped TTL devices that offer a 3-nanosecond typical gate propagation delay and 20 milliwatt-per-gate power dissipation.

"There's a speed-power product improvement of two to three times for Schottky TTL over ECL," points out Glen R. Madland, president of Integrated Circuit Engineering, the Phoenix, Ariz., consulting firm. "Our opinion is that ECL will become less important than

many had thought including us," he says. "TTL will grow very substantially in 1971, in spite of the price cutting, because of Schottky TTL," says Madland. He thinks TTL shipments could hit \$200 million, this year, up from about \$120 million in 1970.

ECL will grow, too, and possibly then because some major computer manufacturers are already committed to it for large machines. Madland expects RCA, Control Data Corp., and possibly others to announce commercial computers that use ECL this year. The ICE president expects ECL sales to grow from about \$40 million last year to about \$60 million in 1971—a 50% gain. But the onset of Schottky TTL could flatten even this year's ECL growth curve significantly, Madland feels.

Last year's linear IC sales were both a disappointment and a surprise to most makers, who were coming off a bad 1969, even though 1970 sales were up 14% from 1969's \$72 million. As late as midyear, companies like National were revising their earlier estimates of an \$82 million market in 1970 to \$93 million.

Richard Abraham, director of ICs at Motorola Semiconductor, maintains that the technological trends in linear circuits will center on consumer applications, especially television sets. "The power handling capabilities of linear devices will be increased, and we'll see higher power regulators and amplifier circuits," he predicts.

Nor is Abraham alone. Mike Scott, Fairchild's linear marketing manager, also sees a trend to high-performance monolithic amplifiers for TV and communications applications in '71, although he feels that of the two, TV is the stronger. According to Scott, even though total cost of ICs for a TV is only \$20, volume sales will allow people who can build multifunction ICs to replace the discrete circuits to make money.

However, the linear market is by no means safe from price wars. Signetics' Art Fury, marketing manager for linear ICs, among others, says that he is expecting—in fact experiencing—price attrition in standard linear products. Fury further predicts that in the latter part of this year, many makers will be leaving the linear sector.

Fairchild's Scott feels that the important trend in linear ICs this year will be production methods and product turn-around, rather than technology. The company that can react quickly to a market need in 1971 will get the orders, he feels.

Fairchild expects to introduce 36 new products by next June. One will be a new, very low power

(about 1 microwatt) operational amplifier which has very low bias current and drain.

Not quite as bullish as others, National's Valentine feels that while linear ICs will grow in '71, "the growth won't be dramatic." The TV companies can't be forced to use a circuit, he says. Fury too, has his reservations about the growth of monolithic linear ICs. "This year will see an increase in the use of discrete hybrid linear ICs—consumer subsections including i-f strips, audio amplifiers and preamplifiers, speed controls for tape decks, and color TV circuits."

This year also will witness the introduction of Schottky-barrier linear ICs, one of which was recently brought out by Fairchild.

The MOS market didn't turn out as bullish as had been predicted for 1970, says Warren Wheeler, senior vice president of American Micro-systems Inc., Santa Clara, Calif. AMI, generally conceded the top spot in MOS business, was looking for MOS sales to quadruple in 1970, "but now we realize that the market was a little softer," says Wheeler. "I set the '71 MOS market at between \$100 and \$120 million," he asserts.

Francis Krch, MOS marketing manager at Hughes Aircraft Co.'s MOS division, Newport Beach, Calif., predicts that 60% of the MOS circuits actually shipped in '71 will be storage devices, with shift registers and ROMs taking the lion's share. Random access memories, on the other hand, says Krch, "are coming on slower than expected because core prices keep coming down."

Perhaps uppermost in the minds of many MOS marketers is the possibility of a price war in 1971. Although his view may be largely a case of semantics, Jack M. Hirshon, manager of Hughes' MOS operation, does not foresee drastic price erosions or a price war this year. What he does see is "orderly price reductions caused by competition; but people should be able to manufacture and profit [in MOS] at current selling prices." This is fine for established MOS houses, Hirshon continues, but it may be tough on new companies. "The start-ups are walking cold into declining prices, and unless they have a unique product—not just shift registers and memories—they'll be spilling more ink than they could ever forecast."

Jerry Crowley, manager of Signetics' MOS department, sees MOS experiencing "a flat first half in '71." Crowley, as do others in the industry, bases his opinion on events in the data processing market. "If EDP swings up in February, then the second

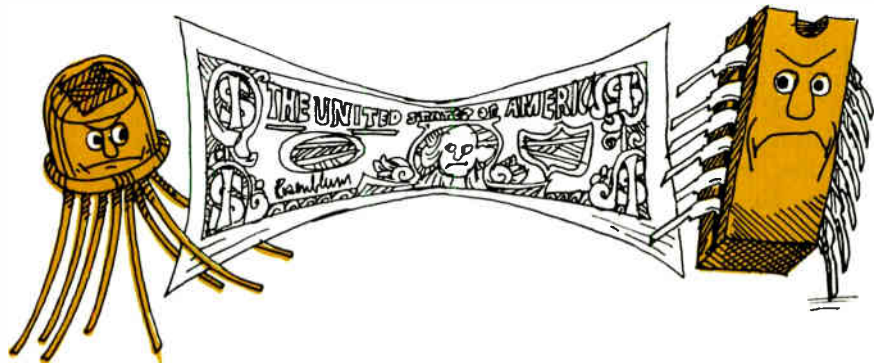

half of '71 could be dramatic for MOS; semiconductors lag the rest of the electronics economy by about six months." Crowley, unlike Hirshon, is quite certain there will be a price war in MOS during the first half of the year. "The big people will be using price leverage to kill the little guy—it will be an extremely aggressive situation."

There's little doubt that while standard p-channel MOS devices will account for the bulk of sales in '71, the rest of the MOS market has everyone watching. Competing in this arena are a wide variety of MOS technologies including silicon gate, complementary, n-channel, ion-implanted, and double-diffused MOS.

How will sales break down? George Rigg, MOS marketing manager at Signetics, estimates the total MOS market at \$115 million, spread out as follows: standard p-channel devices, including (100), (111) and nitride circuits 70%, silicon gate 25%, and the rest—C/MOS, n-channel, ion implant, etc.—5%. But eventually, "silicon gate will emerge as the significant MOS technology," says Rigg. "It's the coming thing."

The generally accepted leader in silicon gate work right now is the Intel Corp., Mountain View, Calif., but other firms are coming on strong. These include AMI, National, Intersil, Signetics, Fairchild, TI, and Motorola. The bellwether product right now in Intel's silicon gate family is its 1103, a 1,024-bit random access memory. Many of these firms have plans to second-source the Intel product line this year. For example, Hank Blume, director of MOS processing at Intersil, is looking for replacement business in '71—mostly in Intel's direction. He expects the industry to follow Intel's lead in silicon gate this year, largely because the technology "allows high speed and lower power consumption which is particularly important for long registers." However, Blume, like many others, sees '71 as the "design-in year" for silicon gate.

Although Hughes' Hirshon strongly espouses the merits of his ion-implanted MOS devices, he admits silicon gate is in his "bag of tricks. We're using it in high-voltage structures in R&D," he notes. Hirshon still favors I/MOS over silicon gate. "We can implant linear resistors in devices, which can't be done with silicon gate," he asserts. But ultimately, Hirshon expects his people to combine elements of I/MOS and silicon gate to produce such devices as high-voltage tetrode arrays to work as drivers at levels above 150 volts; conventional MOS now cuts off at 70 V.

Nor is AMI putting all of its eggs into one basket. The firm will be making both silicon gate and ion-implanted MOS devices by the second quarter.

Complementary MOS, with both n and p channels on the same chip, also is being touted as a fast-growing technology, thanks to its low power dissipation and higher speeds. It was pioneered by RCA's Electronic Components division, now the Solid State division, Somerville, N.J. C/MOS, says William Hittinger, an RCA vice president and division general manager, has immediate applications in industrial timing and controls, computer peripherals, data multiplexers, electronic clocks and counters, automotive electronics, military and aerospace programs, as well as extremely low-power memory systems. And while

RCA may have been first in C/MOS, other firms are coming on strong. Motorola's Richard Abraham feels C/MOS will play a much more important role in new system designs because of its inherent advantages—so much so that it will compete with bipolar devices. And another Motorola source says that "the division hopes to do to RCA in complementary MOS what TI did to Sylvania in TTL circuits some years back," when TI stole the TTL banner from Sylvania, which was first with its SUHL product line.

Another technology coming in '71 is n-channel MOS. The big feature here is its high speed and its direct compatibility with TTL (p-channel requires polarity correction). Among the products available in '71 will be Cogar Corp.'s 1,024-bit dynamic shift register and Intersil's n-channel silicon gate 256-bit RAM. Intersil later in the year will introduce a 1,024-bit dynamic shift register similar to Cogar's.

For a new MOS technology that'll rival bipolar devices in speed Signetics is turning to double diffused MOS. David Kleitman, the company's R&D director, says the D/MOS process offers very high-speed operation and can be used as both logic elements and as discrete microwave transistors. "With the discrete devices," says Kleitman, "we've seen F_t values of up to 10 gigahertz, as fast as any existing logic element."

"Up to our ears in transistors"—that's how one Fairchild marketing manager sees the state of the discrete semiconductor business. And he's not alone. Most manufacturers of discretely are wallowing in inventory built up by expected heavy sales that didn't materialize in 1970. "Last year was a disappointing year," says Ben A. Jacoby, manager of solid state power at RCA's Solid State division. "We were geared for a 1970 market based on a very good 1969."

The discrete business dropped by about 20% last year—from about \$75 million a month to \$60 million, estimates Fairchild's Procassini. However, he feels that business will pick up slightly by the end of 1971 to make this year a flat year at best for the discrete business. Another manufacturer's spokesman doesn't see a pickup at all; he predicts 1971 will be the mirror image of 1970 in unit sales, but price erosion will drop off 15% of overall dollar sales.

At Motorola, Patrick D. Lynch, vice president and director of operations for discrete products, is projecting an industry wide sales downturn of about 3% this year. "It appears that germanium devices will take the main brunt of the decline," says Lynch, "while thyristors, optoelectronics, certain silicon transistors, and zener diodes are among the discrete products that will continue to grow."

Reinhard E. Rist, RCA's manager of thyristor and rectifier sales, puts the 1971 thyristor market alone at about \$65 million. "Presently," says Rist, "SCRs account for 83% of the market, but during the next decade triacs will take over at least 50% of the total thyristor market."

While discretely generally present a bleak picture, there are some definite growth areas for 1971. "Power devices, for example, are expected to grow in 1971 and so are thyristors," says Fairchild's Neddermeyer. "Low-frequency power will grow in '71," he says,

because increasing IC business takes over some areas from small-signal transistors but not from the power end. "ICs are actually a help to the power transistor business," he asserts.

As military spending goes, so goes microwave. Backing up the old truism this year is the military airborne radar market, which should be, as it was last year, "a bummer," says one device maker. However, there are bright spots in the microwave semiconductor outlook for 1971 despite the generally declining military market. These include hardware for electronic counter-measures, expendable devices, and high-power sources, such as Impatt diodes.

Spending on electronic countermeasures this year will be rising sharply. "There was twice as much ECM business in 1970 as in 1969, and the trend for 1971 is in the same direction," says Richard T. DiBona, group vice president at Microwave Associates Inc., Burlington, Mass. At the same time, he notes, his company's airborne radar business has dropped by half. In ECM, he sees "more new systems coming, more follow-on work, and more prototype production work."

If 1971 looks like an up year for ECM, it also bodes well for manufacturer of inexpensive expendable devices—those used only once for such things as chaff augmentation and mini-jammers. Martin Schilling, vice president of R&D for Raytheon, feels there is a good "prospect of a market for lightweight, active solid state devices, which, emitting at microwave frequencies, would act as chaff augmentation."

To date, commercial microwave business has been a disappointment for most microwave companies; in fact, it has suffered as much as government business, many in the industry say. One microwave product manager estimates that the civilian sector is running as much as 20% below what he expected, and it may drop another 5% to 10% in 1971. Cable television "got bogged down, nobody took collision avoidance that seriously; I don't foresee any major upswing for at least two years," he predicts.

However, there should be some moves in the commercial market, notes Mike Crowley, manager of

applied research at HP Associates division of Hewlett-Packard Co., Palo Alto, Calif. "High-power C- and X-band silicon Impatts will make a major technological impact in '71," he says. "We're counting on it." Crowley sees routine continuous wave outputs in the 1- to 3-watt range. "Commercial applications should begin to be felt this year with such applications including 10.5-gigahertz radar and burglar alarms."

Consumer products will be largely responsible for the projected growth in the optoelectronics market this year. Overall sales should grow by \$6 million over 1970 to \$41 million this year. Ian McCrae, marketing manager for Texas Instruments' Optoelectronics division, speaks for many when he predicts a 10% increase in consumer sales in '71. "The big market will be in camera exposure control. Now that silicon is coming down in cost," McCrae adds, "silicon sensors will rapidly replace cadmium sulfide or selenium in these applications. This is a high-volume market—for Polaroids and Instamatics—and could run as high as 10 million units alone in 1971."

One obstacle to market growth notes Howard Borden, director of display research at American Microsystems, is "the integration of LEDs into the IC logic circuits." The power needed to drive LEDs, he feels, is too high for MOS and this tends to rule out the small calculator market. He foresees the elimination of the bipolar driving buffer between the MOS logic and the LED display "but it won't happen in 1971."

Aside from the consumer applications, TI's McCrae sees a decline in 1971 in military sales of optoelectronics, if for no other reason than the general decline of military spending. Further, the computer segment will be flat at best, since the card and tape reader markets are already saturated, he says.

Jack McDowell, marketing manager for Fairchild's Microwave and Optoelectronics division says the optoelectronics market should reach \$45 million at best, but he's only looking for \$43 million. He breaks it down as: \$30 million for silicon sensors, \$2 million for isolators, and \$11 million for emitters. Emitters break down into silicon infrared, \$2 million, LEDs, \$9 million, and solid state displays, \$3 million. □

Computers

- Sales during 1971 to swing back upward again, propelled by new machines announced last year
- Minicomputers and mini-based systems will keep growing both in flexibility and in popularity
- Semiconductor memories finally get IBM blessing, but core arrays still dominate market with ease

□ Last year, every large mainframe house, except one, and most minicomputer makers greeted the new decade with new machines—but all the same, 1970 was a bad year. This year, given a general economic recovery, the introductions should pay off and help turn EDP sales upward once more.

In 1970, not only did the aerospace market dry up for lack of funds, but other potential buyers either

delayed orders because of tight money, or decided to wait and look over the new lines of computers they knew were on the way. Frederick G. Withington of the Arthur D. Little Co. estimates the year's drop at 18% to 27% from 1969's sales of \$5.5 billion, and projects 1970 sales at between \$4 and \$4.5 billion. A little less pessimistically, Richard E. Hall, group vice president for marketing at the Amphenol components

group, Bunker-Ramo Corp., expects a 10% fall from 1969 levels. Others, including *Electronics*, feel that 8% is more like it.

But in 1971, Hall figures that large mainframe sales will be 10% higher than 1970—given that general economic recovery. “Capital outlay should loosen in the second quarter of 1971,” hopes another spokesman, “and this should release the orders delayed by 1970’s tight money. If the economy cooperates at all, we could be on our way back to a 20% yearly growth rate by 1972.”

Large systems must account for most of any sales upswing, and selling is still going to be a matter of keeping up with IBM. Unlike the 360s, IBM’s System 370 computers are evolutionary rather than revolutionary. Users of present 360s can convert to 370s with minimal software revamping—and gain some performance in the bargain. Thus, it appears that the company largely aims to keep a tight hold on its present customer base.

Nonetheless, IBM’s introduction of the System 3 Model 6 and System 7 computers, by adding the pre-processor front ends its line lacked, should make it a more potent competitor. Backing this is the acceptance of the System 3 Model 10 in 1970; in addition, more than \$500 million in 370 business has been booked already for 1971 delivery. As ever, IBM’s is the game to beat.

RCA, for instance, which already had decent bookings for the 45 and 46 models of its Spectra 70 line, responded to IBM’s 370 announcement in September with four new computers; the models 2, 3, 6, and 7 are aimed at holes in IBM’s product line. Some feel that RCA may have boxed itself in by interleaving the performance of its models between those of IBM.

Univac, Control Data, and Xerox Data Systems all have new machines aimed at the scientific computer market, and though this can account for up to 30% of computer dollars in a good year, money in aerospace was so tight that all three firms fared poorly last year.

Of the three, Univac’s new 1110 seems most significant. CDC merely unveiled a list of specifications for its long-expected STAR computer last November. While XDS’s Sigma 9 has a high-volume input-output processor it has little in the way of startling technology.

Univac’s 1110, the largest machine introduced by that firm, uses multiprocessor architecture. It also has a plated wire main memory, like the same firm’s 9000 series.

Industry insiders note that Univac’s plated wire costs about \$1.90 a byte and its 1.5 microsecond core about 23 cents a byte while IBM’s semiconductor memory runs about \$1 a byte and its 2- μ s core costs 50 cents a byte, not counting the semiconductor cache memory in front of it. So it’s felt that if Univac can combine core and wire in a canny way, it can beat IBM in a price/performance memory race.

In October Burroughs chimed in with its 700 series, a group of three machines which upgrades its older 500 series. All are multiprocessors and, like RCA’s, feature virtual memory.

And that leaves Honeywell Information Systems as

the only major company not to have introduced a large mainframe in 1970.

Although most industry observers, and HIS spokesmen also, don’t think HIS will cut into IBM’s market share in 1971, many are betting on the firm to increase its share over the long haul. HIS spokesmen admit that the merger hurt 1970 sales. From the announcement of intent in late May to consummation at the end of September, GE salesmen fought a holding action and gained little new business. Even so, the combined gross for the two firms is claimed to show no decline from 1969 figures.

Jerome Kantor, director of product marketing, figures that the time spent in merger and reorganization was far from wasted; meanwhile the competition exposed its new wares, enabling HIS to target its forthcoming introductions for maximum competitive impact.

The main thrust is to be in the high end of HIS’s line; in the first quarter of 1971, the firm expects to introduce from two to five large mainframes, making the 600 series of computers, formerly belonging to GE competition for the IBM 370.

Kantor does say, however that the new models will feature the “efficient data base management, the combination of local and remote batch processing, plus time sharing, and multiprocessor/multiprogramming architecture,” which characterized GE’s original 600 series. Though these are the very features that gave GE and its customers so many headaches in the past, Kantor says the bugs are out, and that new technology is going to make the machines “aggressively competitive.”

The Digital Equipment Corp., largest of the minicomputer makers, is hoping for a 35% to 40% increase in sales for this segment of the computer market in 1971. Depressed by the economy, the dollar volume of sales for these 12- and 16-bit machines still managed to stay even or move ahead a bit in 1970—to nearly \$150 million. And depending on the economy in 1971, manufacturers see a potential \$200 million market. This figure is based on delivery of up to 6,000 minicomputer systems, a growing number containing more than one processor.

“IBM’s new minimachines won’t have any significant competitive impact on our market this year,” says DEC’s Nicholas Mazzaresse, vice president for small computers. “IBM is selling to a different group of people—mostly those who need preprocessors for IBM’s larger machines, and who fear to get out from under IBM’s wing.” IBM is said to have projected a market of up to 3,000 system 3s, all to be delivered between the third quarters of 1970 and 1971. And although the system seems to be selling fairly well, it is said to be lagging behind IBM’s goal. Some firms, especially Data General and DEC, even expect to begin cutting into the lower section of IBM’s markets with multiprocessor systems and computer networks based on their existing product lines.

Despite the hope of new markets, the minicomputer field is undergoing the expected shakeout, but at a slower pace than anticipated. “Corporations always take a long time to die,” says one observer, “but one



sign of imminent death is creating a large backlog by extensive price cutting.

Minicomputer market-share predictions remain about the same as those made in mid-1970 [*Electronics*, July 20, 1970, p. 105]. DEC should retain from 50% to 70% of the market, while HIS (through what used to be the Honeywell Computer Control division), Varian Data Machines, and Hewlett-Packard will each account for 7% or 8% of the total. Data General claims it left 1970 with a 10% share.

Technology as glamorous as that coming from the large-machine houses is being used in many of the small computers. Data General's Supernova SC is billed as the only minicomputer so far with an IC main memory, and machines with variable architectures are emerging from the unified busing concepts of GRI Computer Corp., DEC, and Modular Computer Systems Inc.

DEC also is investigating Schottky-clamped transistor-transistor logic for an ultra-high-speed version of its PDP-11's processor module—due sometime before mid-1971 [*Electronics*, Dec. 7, 1970, p. 25]. Roger Cady, engineering manager for the PDP-11 line, feels that Schottky TTL offers much of the speed of emitter-coupled logic, without ECL's interfacing and power problems. While the semiconductors for the module haven't been picked yet, the module already has a place in DEC's market plan. It not only is to be offered as a speed-up option for existing PDP-11s, but also will form the high speed "brains" of the forthcoming Basic Time Sharing System (BTSS), to be built around the PDP-11.

Scheduled for introduction in the first half of 1971, the BTSS is aimed at the in-house time-sharing market. It's to be capable of handling up to 16 users, and should sell for \$40,000 to \$50,000 in its simplest form, says DEC's Mazzaresse.

But as the competition broadens, the system profit picture is changing. With the decline in semi-conductor and memory prices, the central processor contributes less to total system profit. "The average system, including peripherals, now costs \$35,000 to \$40,000," says DEC's Cady, "and the CPU is only 5% to 10% of the total. Thus much of the profit is going to have to come from peripheral equipment unless we decide to overprice computers, and we can't."

Accordingly, DEC announced a new line of home-brewed peripherals last year, ranging from IBM-compatible tape decks to a new hard-copy input/output device, called the DECwriter, that is expected to

challenge teletypewriters [*Electronics*, Nov. 23, 1970, p. 26]. They're designed to match the price/performance ratios of minicomputers, says Mazzaresse, adding "they are relatively inexpensive, but sturdy enough to last."

Competitor Data General agrees with DEC. "The peripherals available for use with minicomputers today are only scaled-down versions of those developed for large machines," says A. Z. Kluchman, director of marketing for the company. He feels that this often results in flimsy construction and high maintenance. Data General also is embarked on an in-house peripheral equipment program with tape and disk drives due to appear by perhaps the second or third quarter of 1971.

The expensiveness of IBM's peripherals enabled independents to sell similar equipment for large machines at lower prices, and thus do fairly well despite a recessive 1970. But while IBM may not lower prices drastically, for fear of courting antitrust action, it does tend to up performance without an equivalent rise in price. "The last few magnetic disk drives from IBM showed successively declining profit margins," says Lloyd C. Hubbard, president of Tracor Data Systems. Similarly, in late 1970 IBM moved to drop so-called "extra use charges" on its largest-selling multiple-spindle disk drives, thus again competing on a price level, but subtly.

Also meaningful for peripheral makers is IBM's 370/145, with its built-in control for a disk drive, a technique that could be used with other peripherals, too. Tracor's Hubbard expects other 370s to have internal controllers, too, so that the market for plug-to-plug compatible peripherals could fade.

In off-line peripherals, the market for key-to-tape and key-to-disk equipment could reach \$50 million this year, says an industry source. Originally one-for-one substitutes for keypunches, they now replace 16 keypunch machines in 60% to 80% of installations. Usually the keyboard stations feed a minicomputer which stores the data on tape or disk.

Even single-station key-to-tape or -disk could reach \$300 million a year by 1975, according to Quantum Science Corp. And by then the cluster installations should be good for \$480 million.

Computer-output microfilm (COM) hasn't grown the way its backers hoped. At the end of 1969, about 400 systems had been installed, according to one estimate, and some of last year's optimistic projections called for the number to double in 1970. It didn't,

though it did rise by about 60%, claims Charles Askanas, president of Quantor Inc. "We expect to pass the 1,000 mark before the end of 1971," he maintains, "and between 350 and 375 systems will sell this year."

The noncaptive (non-IBM) memory system market, which has been growing at about twice as fast as the computer hardware market, will continue its faster pace in 1971. Magnetic cores essentially made up the entire 1970 market of about \$65 million, but semiconductor memories will start showing up in quantity in 1971, at about \$10 million, some people estimate. Despite the start of the surge in semiconductor random access memories (RAMs), cores are expected to continue to grow in 1971 to about \$70 million, and to peak out at about \$100 million only in 1975, according to a company that is making an exhaustive study of this market. By then, semiconductor memories are expected to climb to the \$50 million area—or about a third of the noncaptive market.

Though batch-fabricated semiconductor memories—ballyhooed for the past three years as the latest contender for the memory throne—are finally coming on strong, cores are clearly the choice for large memories, in the 100 million-bit area, and are still competing strongly in the 10 million-bit range. And in trying to sell their semiconductor memory chips, many firms fail to realize they're shooting at a moving target when it comes to core pricing. There's lots more engineers can do to cut core costs, says Eugene E. Prince, vice president and general manager of Ampex Corp.'s Computer Products division in Culver City, Calif. Ampex will be introducing new core memories this month, "and we have several in development aimed at further cutting costs," Prince adds.

One core market that didn't exist 18 months ago is in large capacity, on-line systems that are plug-to-plug replacements for IBM's large core store (LCS-2361) units used in the IBM 360/50, 65, 67, and 75.

Ampex started the ball rolling in mid-1969 when it shipped its first extended core memory (ECM) system; it has already installed 30 of the 10 million-bit systems, and will ship more than \$16 million worth this year alone. It now has orders for more than 24 of the \$289,000 units and is producing them at the rate of two a week. Other independent suppliers entering this IBM memory replacement business are Data Products Corp., which got started in early 1970, and Fabri-Tek Inc., which entered six months ago.

About \$120 million to \$150 million worth of the large core memories were installed by the end of 1970, Ampex's Prince estimates, about 20% of them last year. He estimates that at least \$40 million to \$45 million more will be installed in 1971. Ampex is also expanding its ECM line by developing systems for the smaller models in the 360 line.

The embryonic semiconductor memory, however, received its biggest boost to date in 1970, when IBM introduced the System 370/145 with a mainframe IC memory. "IBM's use of semiconductor main memory made it intellectually respectable and not just a wild idea," says Data General's Kluchman.

Semiconductor RAMs are in the "very early stages of development," says Earl Gregory, vice president and director of marketing at Electronic Arrays Inc., Mountain View, Calif. The market will be "fairly small" in 1971, he believes, "between \$3 million and \$5 million—and probably closer to \$3 million," and adds that design activity will be "huge." Gregory maintains that semiconductor memory producers "overestimated their ability to move systems people," and also underestimated the testing and manufacturing problems. "The industry is just now demonstrating that it can make RAMs," he says, but testing is "still a problem."

While semiconductor memories will finally make a respectable showing in 1971, there are several problems not yet solved, particularly in the areas of volatility and standardization.

The question of volatility is controversial. Says one systems house: The fact that a semiconductor memory can lose information if power fails or if there is a loss of dc voltage to the cell can be a severe restriction. Says Ampex's Prince: "I don't expect the volatility problem to be licked in 1971, but when it is, watch semiconductor memories go."

But volatility is not a problem in most applications, protests Donald D. Winstead, vice president of marketing, Semiconductor Electronic Memories Inc., Phoenix. Most users reload their core memories every morning in any event, he says. In March, SEMI will be introducing a new product in its bipolar hybrid line that will require such low standby power that it can hold data in memories up to 4K by 16 bits for 10 to 12 hours with a single battery.

Semiconductor memory technology is diverse and badly in need of standardization, says one systems house. It cites the many process technologies now being offered, the varied threshold voltages, and the differing packaging schemes. Compatibility between manufacturers is essential so that customers can pick second sources, but this is not likely to happen in 1971.

And where does plated wire fit into the memory picture? For years touted as the successor to cores, it has not yet found major applications. It still has several proponents though, and is finding limited acceptance. Univac has used its own plated wire as the mainframe memory in its 9000 series for four years, and late in 1970 introduced its big 1110 system with a plated-wire mainframe memory. But many companies that spent money on plated-wire development finally dropped it.

The difficulty with plated wire has been continuing process problems, which prevented makers from ever achieving their yield or cost objectives. Process repeatability has also been a problem. But one new company, formed in Denver solely to develop and sell plated-wire memories, says it has solved these problems and will be shipping this year earlier than anticipated. Nemonic Data Systems, Inc. has a \$300,000 backlog and has better than \$1 million in bids outstanding, all commercial, states its president, Robert A. Fillingham. Right now, the biggest problem is that "we need more people in the plated-wire business"—to sell the idea of wire memories and act as second sources. □

Packaging & production

- No upturn is in sight until the second half, with an overall sales gain of 10% at best for 1971
- Automation on production lines will increase, and prices for ceramic LSI packages will decline
- DIPs are making greater inroads everywhere, but progress of beam leads is still lagging

□ When new equipment orders start sagging, as they did in 1970, so does the packaging and production equipment end of the business. That's just what happened last year, when packaging and production gear sales were running typically 5% to 10% below the 1969 level. In fact, orders for some product lines such as IC packages, still are dropping. If there is an upturn in business this year in these areas, most companies believe it won't happen until the second half. So the best that this segment of electronics can hope for in 1971 is perhaps a 5% to 10% increase over what was a slow 1970.

The trend in 1971 will be toward more automated packaging and production techniques, as well as lower-priced packages. Ahead are cheaper, ceramic housings for large-scale integrated circuits, for example. Another development will be greater proliferation of the dual in-line package for passive as well as active components because of the DIP's adaptability to automatic insertion techniques and its standard lead spacing. This year also will see connectors for flat cable that give reliable connections to the conductors, and fast turnaround with computers for partitioning logic on circuit boards and for generating interconnection patterns.

Other trends emerging in 1971 include more use of additive printed circuitry for fewer processing steps; dry film photoresist for printed circuit boards with narrow lines; wire-wrapped, socketed IC boards for faster turnaround on low-volume production runs, and positive photoresists for higher IC yields.

During 1970, there was a persistent shortage of ceramic DIPs with up to 40 leads for LSI circuits [*Electronics*, March 30, 1970, p. 123]. At year's end, package suppliers had just about caught up with the demand—thanks partly to the slump in the IC market. By the end of 1971, according to Don Mooney, customer service representative for Coors Porcelain Co., Golden, Colo., the situation will be reversed, with supply exceeding demand. He doesn't see price of the package (typically over \$1 for a 40-lead unit) dropping by more than 15%. However, Gary Hillman, general manager of Mitronics Inc., Murray Hill, N.J., feels the ceramic package market will become extremely price competitive: he expects price reductions of up to 50% within the next 18 months.

Not all the action in IC packages will be in ceramic DIPs, however. Last year, American Micro-systems Inc., Santa Clara, Calif., developed a 40-lead edge-mount ceramic package (a single-layer ceramic substrate that plugs into an edge connector); at 55 cents, the company said it would be 50% cheaper than DIPs

because it eliminated the lead frame [*Electronics*, Oct. 12, 1970, p. 48]. Lyle Irwin, senior project engineer at AMI, estimates the company will ship about 2 million devices in edge-mount packages in 1971, about 20% of the total production for all their 40-lead circuits.

Sensing the cost-consciousness of profit-pinched original equipment manufacturers, AMI is also working on a plastic version of the edge-mount connector for introduction 1971; this unit will be priced at about 20 cents.

One scheme that promises to further automate IC packaging is a copper lead frame on a sprocketed 35-mm strip of Kapton polyimide plastic film. It was introduced by General Electric's Integrated Circuits Products department, Syracuse, N.Y., in December.

The lead frame, which is formed by etching a continuous copper strip laminated to the Kapton, can be used in several configurations. The chip could be attached to the lead frame and then could be encapsulated. Alternatively, the lead frame could serve as an intermediate fan-out stage bonded to a Kovar frame for conventional dual in-line packages, or the chip could be cut out of the strip and shipped as a "beam-leaded" chip, with copper beams that are much easier to handle than conventional units with gold beams.

In the plastic-encapsulated version, which GE calls the Mini-Mod, a user would buy the devices on reels for automatic positioning and bonding onto his circuit boards.

GE says it will introduce one circuit a month in the Mini-Mod package during 1971. The company says it will ship about 1 million Mini-Mods during 1971, and adds that usage could go as high as 10 million circuits in 1973.

Many industry observers feel that high prices for beam-lead devices are slowing acceptance. For example, Mepco Inc., a maker of hybrid circuits in Morristown, N.J., took a look at beam-leaded devices and decided against tooling up for them now. According to Michael Snyder, Mepco's manager of hybrid circuit design, circuits built with beam leads would have been more expensive than wire-bonded units, notwithstanding the beam lead's increased yield and lower assembly costs.

The cheapest way to make connections to a chip, under Section 807 tariff regulations, is to "wire-bond in the Orient," says Robert Simko, director of the Maptek forecasting service at Quantum Sciences Corp., New York. Due to its flexibility and the heavy investment in existing equipment, wire bonding will not be

strongly challenged through 1974, according to a semiconductor device package and material study just completed by Quantum Sciences.

The printed circuit sector, a packaging industry bellwether, had a poor 1970, and 1971 probably will not bring it back fully to the solid 1969 levels. According to James Swiggett, president of the Photocircuits division, Kollmorgen Corp., Glen Cove, N.Y., independent suppliers' printed circuit business dropped about 33% during the first three quarters of 1970. He estimates that 35% to 40% of all printed circuits made in the U.S. are made by independents; 60% to 65% are produced in-house. For 1971, he sees an increase of 25% at best; only 5% at worst.

A better year, however, is in store for makers of flexible flat cable. They believe that the exigencies of business are making many equipment manufacturers take a closer look at their operations. Now they're more receptive to flat cable as a significant factor in cost savings—all connections can be made simultaneously and little time is lost in tracing wire paths at each end of a cable. C.H. Carter, sales manager for electronics markets at 3M's Electro Products division, St. Paul, Minn., is bullish on the flat cable market for 1971, projecting "a sales increase of over 30% despite the unsettled national economy."

There's not much reason for optimism in the production equipment market in 1971. Many companies have been holding back investments in capital equipment because of tight money.

For example, Bernard Toomey, manager of the electronics division at Markem Corp., Keene, N.H. cites his firm's experience with its new high-speed component identifier-marker. The system handles up to 50,000 components an hour, compared with 10,000 an hour in the previous model. One potential customer, he said, was impressed and could have used as many as 15 of the units, but just didn't have the money to buy them.

Hal Skurnick, product manager for electronics with the S.S. White division of Pennwalt Corp., manufacturers of thick-film resistor trimmers, is typical of equipment producers when he says that he's looking more toward Europe for a growth market. He says the foreign market accounted for 25% of his sales of resistor trimmers in 1970 and "at the rate it's growing it may even outpace the U.S. in three years."

On the other hand the slow sales of capital equipment have helped sellers of fabrication services, such as wire-wrapping, who filled the vacuum when many companies refused to invest in their own equipment.

Connector manufacturers, too, are offering services such as wire-wrapping back-panel assemblies of their connectors, or supplying a program tape to control the customer's wrapping machine. This wasn't done just two or three years ago. Lou Roberts, marketing services manager at Elco Corp., Willow Grove, Pa., says the connector manufacturer no longer considers himself in the component business, but rather in the packaging system business. □

Components

- Even with moderate rebound in second half, sales will barely top depressed 1970 levels
- Communications, consumer electronics, and appliance markets should provide upward push
- Demand will rise for hybrid resistor networks, electrolytic aluminum capacitors

□ Buffeted by military cutbacks, customer inventory reduction, and overseas competition, component manufacturers had an unexpectedly stormy 1970. Capacitor sales were more than 5% below what they'd predicted, while connectors and resistors were down 18% and 19% respectively.

Because of current market conditions and because they were so wrong in their forecasts for 1970, manufacturers are hesitant about 1971. Most see no significant improvement in sales during the first half, and feel the situation could deteriorate further. A moderate rebound during the second half is considered likely, but the net result would be total component sales just overtaking depressed 1970 sales. Quantum Science Corp., the market research firm, forecasts a 4.8% increase in capacitors shipped during 1971 and 3.8% rise in the number of resistors shipped.

The slow pace of recovery is partly the result of last year's overoptimistic forecasts. Says Kenneth Stone,

manager of the electronics market development department at TRW Inc.: "The data processing industry forecast 15% to 20% growth for 1970. When it got only 2% growth, excess inventories created problems for us and for other component suppliers. The industry severely cut back its component purchases to bring inventories into line. This correction is still going on."

But a more important factor is the lag in the computer industry's response to economic conditions. When times are good, computer makers operate with order backlogs of several months, so they are insulated from the immediate effects of an economic downturn. Now that the recession has stretched out, major computer companies are maintaining much smaller inventories of components.

Compensating to a degree for this lethargic market is the communications field. Western Electric Co., the Bell System's manufacturing arm, expects to increase its purchases from outside suppliers by 10%, and, while

it is difficult to estimate the total spent on outside electronics annually, the company appears to have bought between \$500 million and \$540 million in 1970, and is expected to buy between \$550 million and \$600 million in 1971.

There are signs, too, that a resurgence in consumer electronics is under way. Sales of color TV are on the rise. And Carroll G. Killen, vice president for sales and corporate marketing at Sprague Electric Co., says this rise has already been reflected in an increased demand for resistors and capacitors. The appliance industry, too, according to Wayne Etter, vice president of the capacitor-distributor group at P.R. Mallory & Co., Inc., should improve in 1971 with a national rise in housing starts. "This should also have a favorable effect on sales to the telephone and communications industries," Etter adds.

Finally, technological trends will boost sales for some components, though at the same time depress others. Shipments of large aluminum electrolytic capacitors should rise with the increased production of digital systems. Hybrid thick-film resistor networks, because of their compactness, will be favored over other resistor types. Dual in-line packaging will be used increasingly for many types of components because it lends itself to automatic assembly. On the other hand, the increasing functional density of ICs will lessen the demand for ceramic disk decoupling capacitors in digital systems.

Of all the market segments, sales of military components are likely to remain the poorest. But no component house with a large investment in precision fabrication gear and test systems for high-reliability manufacturing is willing to discount military business entirely. "Mepco won't get out of the hi-rel business," says Edward Klein, a North American Philips vice president who includes Mepco Inc. in his industrial group. While the high reliability military market won't get up to its pace of three years ago, Klein expects it to be stronger than it has been recently.

Quantum Science Corp. forecasts a stable, if not slightly declining, pattern of sales for capacitors in military-aerospace applications, with most of the units going into R&D equipment. The same is true for resistors, says Robert Simko of Quantum. He sees military-aerospace resistors dropping from their 1970 sales level of \$120 million to \$118 million in 1971 and to \$112 million by 1974.

But component manufacturers have taken steps to reduce their dependence on government orders, principally by turning to the industrial segment, which includes computers, peripheral equipment, data communications, industrial control and instrumentation. Stone of TRW Inc. looks at it this way: "In the long run, industrial electronics is the major growth area. It represented 27.7% of the pie in 1969, and that figure will be 29.7% this year. During the last five years, sales have been growing at a 5% average annual rate, including a 6% drop in 1970. In 1971, industrial electronics will grow 6%."

For this sort of reason, Burndy Corp., the high reliability military connector manufacturer, is shifting strongly toward the industrial market, and has set up

a new group to sell to the computer, peripheral equipment, machine tool, data transmission, and commercial avionics manufacturers. The company has adapted some of its basic military connectors by using less expensive finishes on the metal parts, manufacturing to looser tolerances, and eliminating some of the reliability testing; it has also designed entirely new connectors for commercial applications.

Although the benefits will be slow in reaching component manufacturers because of the built-in lag in the industrial segment, the potential is there. To tap it, component manufacturers have to learn to anticipate users' needs for the components that go with IC-laden digital systems. Edward Geissler, manager of computer components marketing at Sprague, has put much thought into this strategy. "We used to sit back and develop materials, hoping the customer would find a use for them. Now we are accepting the fact that active components are setting the pace and that the trends in logic forms for specific applications determine what passive components will be needed."

In Sprague's view, capacitors in digital systems have a mixed future. Decoupling capacitors are needed—usually ceramic disk types—but, as the number of functions per IC package goes up with the advent of MSI and LSI, the number of decoupling capacitors per system goes down. "People are using as many disk decoupling capacitors as they ever will," Geissler says.

On the other hand, demand for aluminum electrolytic capacitors will go up. These are used in the power supplies for digital systems, and as production of the systems increases, so will the demand for this type of capacitor. Thus aluminum electrolytics, overall, will grow from \$92.3 million in 1970 to \$96.7 million in '71 to \$107 million in '74.

Many companies have adopted the dual in-line package approach, which was originally developed for monolithic IC packaging. There is, in fact, something of a DIP revolution in progress, with film resistor networks, capacitors, toroidal inductors, trimmers, and reed relays being adapted to this type of packaging.

Despite the stiff competition from overseas manufacturers, which includes many U.S. subsidiaries, the consumer segment of the component market is not being abandoned in America. As in the industrial segment, hybrid circuits seem to be the answer. Sprague, for example, is building hybrids for an all-hybrid color TV set that RCA will assemble the same way, and will introduce as a top-of-the-line model in 1972. Other TV makers reportedly will do the same.

Harry Nieders, marketing manager at Mallory, sees an additional benefit to component producers: hybrids will make it possible to sell advanced technology to makers of consumer electronics. Components such as tantalum capacitors, which have been avoided because of their cost, are economical in the unpackaged form compatible with hybridization—the package, after all, is what adds to the cost and increases the chances for failures once the chips are cut and tested. Nieders sees sizeable orders for such unpackaged components within two or three years.

In the consumer market, and in the industrial market as well, most manufacturers who hope to compete with components imported from low-cost-labor areas are stepping up mechanization, by investing heavily in capital equipment. "An important factor in our optimism for 1971 is our belief that manufacturers who have sufficient capital for labor-saving manufacturing devices should have an advantage in the highly competitive marketplace," Etter of Mallory says. Mallory's 1970 capital expenditures totaled about \$6.7 million, compared to virtually nothing in 1969.

How adaptable various components are to automatic manufacture will therefore affect the mix of devices produced by U.S. companies. Sprague's Killen sees ceramic and aluminum electrolytic capacitors, for instance, as big items because of the relatively little labor required to make them.

Among other components, some are even now in a growth situation. Robert Carroll, general sales manager for Hi-C Inc., reports that his company recorded a 10% increase in sales in 1970, and finds growing interest in relays packaged in TO-5 cans. The outlook is bullish for solid state relays as well. Richard G. Fisk, director of marketing for Ohmite Manufacturing Co., believes that sales of solid state relays will total a half million dollars this year for his company alone.

Connector sales fell far short of the \$396 million mark set for them for 1970, realizing only \$326 million. The decline in military spending hit coaxial connectors hard, and will continue to do so this year, though the recovery in industrial markets should be big enough to guarantee a slight overall gain from 1970's

\$27 million to \$29 million. Similarly, cylindrical connectors, used extensively in aircraft, have suffered from the slack in military aircraft production, but should recover somewhat this year with jumbo jet production. Most other types of connectors are industrially oriented and should benefit from the improvement in computer and telephone industries.

Printed circuit connectors, however, exceeded expectations. Instead of the \$57.2 million predicted at the beginning of 1970, PC connectors totaled up \$2.3 million more than that. And growth should be even better in 1971, with sales climbing to almost \$65 million. John Ensley, a market researcher for Amp Inc, attributes this growth to the acceptance of modular approaches like Motorola's Quasar line by home entertainment manufacturers; the more modules there are in a system, the more connectors they need.

Solid state alphanumeric displays are already impinging on their electron tube equivalents, such as the familiar glow-discharge tube. These came in far below expectations in 1970, with sales of \$9.3 million instead of the expected \$13 million. A growth of 9% is anticipated for 1971.

While the major cause of the low display-tube sales is the general economic situation, the rising popularity of solid state alphanumeric devices is a contributing factor, since probably three-quarters of those currently sold are replacing an older type of component in existing applications. However, this situation is expected to be reversed within two years, when designs that exploit the properties of solid state displays will account for three-quarters of display sales. □

Consumer

- After a down 1970, sales should fare no worse this year, but they won't exceed even 1969 levels
- Slow market puts brakes on introduction of new designs in TV sets, radios, and phonographs
- Calculator sales to bounce ahead once more; automation gains ground among office machines

□ This is the year that most consumer electronics companies wish would just go away quietly. Except for whatever cold comfort can be obtained from the projection that 1971 will be no worse than 1970 and perhaps will get back to 1969 levels, marketing bosses look upon the coming 12 months much the same way football coaches view tie ball games.

The outlook for 1972 and 1973 is much better, based on the expectation of a comeback in the nation's economy and the marketability of new products promised then. Yet this belief does not relieve the apathy with which the consumer firms are greeting the current year. The lack of optimism is indicated by:

- Uncertainty over consumer spending in 1971. Economists' predictions are contradictory. On the one hand, unemployment is too high to be conducive to a spending spree in the near future; on the other, expenditures for consumer goods and services are expected to rise more than 7% in 1971, a slightly-

better-than-average gain for this type of spending.

- Caution in introducing technical innovations. A good sign of market malaise is the slowing of design changes in television, radio, phonographs, and automobiles this year. Though these manufacturers traditionally are reluctant to reveal competitive selling features in advance, there is little evidence that they will have any to hide this year.

- A poor showing in 1970. With a couple of exceptions, consumer electronics' position declined last year, despite an upturn in the fourth quarter. This record has added to uneasiness about 1971. Last year was budgeted to be as much as 10%-20% better than it turned out in some segments, causing considerable belt tightening internally.

- Possible impact of Federal legislation. Consumer-oriented bills with some impact on electronics are reaching Congress—and their chances of passage are improving (See panel, p. 47). Some provisions, such

as new fire safety requirements in TV sets, might lead to engineering changes in home electronics. They will certainly add more paperwork to satisfy bureaucratic regulations. Should the proposals be enacted, manufacturers are not sure how much the new regulations will add to production costs, but they are certain that expensive materials and wire will be specified in more products than in the past.

▪ Continued impact of Japanese competition. Though action against dumping gained headway last year, U.S. manufacturers expect to compete with the Japanese through marketing rather than legal channels. U.S. companies will start more offshore plants, despite howls from domestic parts makers, and an emphasis on big TV screens and phono consoles will seek to counterbalance the Japanese advantage in small units. According to one research firm, Japan's competitive advantage will wane in the next five years. With its domestic wages climbing, Japanese consumer electronics firms are going in for more automation and offshore plants of their own.

This adds up to a stand-pat year. *Electronics'* consensus projects a \$4.2 billion total market, up by a meager 7.9% from 1970's estimated \$3.9 billion. However, there are bright spots: top-of-the-line stereo components and consumer-aimed electronic calculators. If it were 1972, the list also would include cameras, four-channel stereo, automotive pollution-control electronics, and auto tape cassette players.

If it were 1975, by far the brightest spot would be home video players. So far there has been more talk than sales of video player/recorders, though the CBS-Motorola combine has begun delivering industrial/institutional EVR. A paper blizzard has blown up just to disseminate information to marketers, educators, and investors. No announcement of a new entry is complete without mention that by 1980 the home video player market in the U.S. will be worth \$1.25 billion a year, including \$700 million for hardware. But these figures are speculative at best, since they are not based on any experience.

Compared to the hectic state of video playback gear, conditions in the \$2 billion color television arena are relatively placid. Estimates for U.S. factory sales of color sets in 1971 range from 5.3 to 5.6 million units, while 4.6 million monochrome receivers are expected to be sold. Both projections are roughly the same as 1970 estimates. The Japanese will increase their share of the low-priced market, unless actions against dumping cause a cut in imports.

Price increases announced for some color models late last year are likely to be reported on other lines—and they may stick. Sales growth for the big 25-inch sets should be satisfactory, although they may succeed at the expense of some 23-in. models. According to William E. Boss, vice president marketing for Sylvania Entertainment Products, Batavia, N.Y., the 23-in. group most likely will become the low end of the big-screen line, which indicates price breaks.

Technical innovations will be sparse, reflecting the wait-and-see attitude of the industry in the current business climate. Integrated circuits will continue to be a selling point, with more devices in chassis for

Consumer protection laws and where they stand

An election-year Congress keyed to the vote-getting potential of consumer issues proposed five bills last year that could have some impact on electronics. And those that were unpassed after the lame-duck session of 1970 probably will be reintroduced this year. If and when this legislation passes, the impact will be felt on engineers, under pressure to design with potential Federal scrutiny, and on marketing to absorb inevitable increases in costs. There will also be an impact on quality control paperwork.

Here's a status summary prepared with the help of the EIA Consumer Electronics Group:

▪ Warranties and guarantees: Regulates the wording of guarantees and the performance of manufacturers. It passed the Senate in July after a minor amendment to the definition of "consumer product." It was not passed in the House.

▪ Class action: Consumers would be permitted to bring class actions against manufacturers if the Attorney General or the FTC successfully completed an action against an offending party or if the class of consumers is injured by an "unfair consumer practice." But the consumer group must inform the FTC 90 days prior to taking action, giving the FTC time to act first. Buried in Senate and House committees.

▪ Consumer product testing: A proposed Federal test center. No action in either branch.

▪ Department of Consumer Affairs: Would set up a Council of Consumer Advisers, an independent consumer protection agency, and a Consumer Advisory Committee for promoting consumer interests within Government. It passed the Senate and was buried in a House committee. In the House version the Consumer Protection Agency would perform more substantive functions, such as representing consumer interests before Federal agencies and courts, handling consumer complaints, making information available to consumers (including product test results prepared by Federal agencies) and continuing to work with the National Commission on Product Safety.

▪ Consumer Product Safety Commission: Set up a permanent "watchdog" group, recommended by the National Commission on Product Safety. There was insufficient time for action last session in either body.

i-f amplifiers and fine tuning. Tuning systems will be simplified, with varactor diodes appearing in more models.

Though technical innovations in TV will be fewer, the audio portion of consumer electronics is enthusiastic about a number of sales-making ideas. It's an important market: total world sales of phonographs and high-fidelity equipment will amount to just about \$2 billion, of which the United States share will be about \$580 million and Japan around \$530 million.

The economic downturn apparently has not hurt hi-fi components. In fact, consumer interest is prompting high-priced add-ons, such as lab scopes for monitoring sound quality, Dolby-effect and attenuator filters for tape players, slide switch control of frequencies, and digital electronic tuning. The Altec Lansing division of LTV Ling Altec Inc., Anaheim,



Calif., is offering a tuning device that eliminates differences in room acoustics and sells for more than \$700, including installation by factory technicians.

The sales potential of four-channel stereo has the audio manufacturers rubbing their palms. Due to begin moving this year, quad sound will be firmly entrenched next year, both for recordings and broadcast. Complementing this trend will be a return to hi-fi components, away from compacts and consoles.

The reason for this pickup, says Herbert Horowitz, president of Empire Scientific, a turntable and speaker company in New York, is that "the public is getting infected with the audiophile's desire for higher and higher quality."

U.S. radio manufacturers are pinning their hopes on high-end sales again this year. More extensive use of integrated circuits will permit enough room in cabinets for combinations such as AM/FM radio, digital clock, and mini stereo speakers.

The electronics picture in cameras is a little out of focus. Mark Sewl, vice president of the Camera division of Polaroid Corp., Cambridge, Mass., points out that electronic controls have taken over shutter mechanisms on all Polaroid color cameras, even the low-priced models. Polaroid is "looking seriously at" optoelectronic devices for indicator functions, but does not expect to introduce them this year.

By contrast, Ian McCrae, marketing manager for optoelectronics at Texas Instruments, Dallas, is highly enthusiastic about the prospect for more electronics in cameras in 1971. He predicts that exposure controls with silicon devices will replace selenium types in 10% of cameras this year, and that light-emitting diodes for exposure indicators will be designed into cameras for 1972.

The potential of the automotive electronics sector

has been left at the curb, year after disappointing year, awaiting the big sales potential in Detroit. Entertainment systems (about \$690 million worth) and voltage regulators appear to be the only big sellers this year, with antiskid devices optional on high-priced models.

Emission control devices are closer to acceptance, primarily because of Government legislation. Though the auto companies are unhappy about Government deadlines, electronics suppliers will benefit by the pressure, because as one Detroit engineer points out, "Drivers will buy entertainment systems, but they have to be forced to pay for pollution control and safety devices."

None can offer an accurate guess on how much emission control will cost the auto buyer or what it will be worth to electronics manufacturers.

A question just beginning to intrigue auto electronics firms is the Japanese position in this potentially lucrative market. So far, they have been content to dominate the entertainment market, but some sources feel the Japanese may get interested in supplying subassemblies for emission control systems. Beyond that point, it's not clear. Says the chief engineer for an automotive electronics firm: "Japanese in the OEM market—we're scared to death of it."

Commercial electronics: high hopes

Though their 1970 performance appears to have been less disappointing than that of the consumer sector, commercial electronic sales did not escape the general downturn in the economy. How the coming 12 months shape up also depends on which way business spending goes, but manufacturers have high hopes for 1972 in point-of-sale terminals, electronics

for education, and brokerage house data systems.

The market for electronic calculators has opened up spectacularly, thanks to MOS/LSI circuits. Needless to say, the Japanese have been very strong here, capturing 70% of domestic unit sales last year and about half of the \$241 million retail sales. Sharp, Cannon, and Seiko are using American-made LSI circuits, but Japanese suppliers will make inroads here with their own calculator circuits this year. Electronic calculators should take another big jump this year, on top of the 62% rise last year. However, more companies—domestic and foreign—will be vying for a slice of the pie. The next big push, expected by next Christmas, will be toward consumer sales in eight-digit minicalculators selling at \$100. Because of the uncertain nature of consumer acceptance, sales predictions this year also are uncertain. However, U.S. companies are determined to recapture a larger share of the calculator market from the Japanese.

The picture is murky for office copiers and duplicators, because of uncertainty about business spending in general. According to the Business Equipment Manufacturers Association, the office copier-duplicator market, including supplies, has exceeded the billion-dollar mark and should increase by slightly more than 10% this year. High speed copier-duplicators probably will show more growth in percentage than slow-speed document copiers, says BEMA.

Technically, the trend in high-volume, high-speed machines will be to minimize operator participation via automatic controls. "Fast or slow will no longer be as important as the number of operator functions eliminated by automatic controls," says William F. Souders, vice president of marketing for the Business Products group of Xerox Corp., Rochester, N.Y. This trend was firmly set by Xerox last year, he adds, with introduction of a duplicator with the capability for five size reduction modes by pushbutton control and a machine with automatic two-side copying. This trend means more electronic devices such as solid state timers and discrete components for size reduction circuits.

Another aspect of commercial electronics that depends on the state of the economy is brokerage data handling. The stock market was hit hard last

year and some brokerage houses collapsed or merged. Despite this trend, Weir Sargeant, vice president of marketing for Ultronic Systems Corp., New York, a part of General Telephone & Electronics' new Information Systems Inc., predicts that brokerage data handling will spring back from a decline last year to a 14% increase in 1971.

Many brokerage firms, he says, have in-house computer centers that they can no longer afford. This group of firms is ripe for time-shared systems, which fits in nicely with Ultronic's plans, he notes. The trend this year will be to provide systems that automate both the front-office stock quote routine and the back-office customer service paperwork.

If data handling is the best way to make money on the stock market, teaching may be the best way to make money in the education field. This was the conclusion of one engineer who last year got out of trying to sell teaching aids to budget-blitzed state education departments and went back to the classroom. His assessment was that electronics companies have greatly overestimated the size of the education field and are now hurting from a combination of taxpayer revolts against increased school budgets and teacher demands for higher pay.

Where does this leave electronics in education? Not as bad off as might appear, says Walter J. Coari, vice president of marketing for Chester Electronic Systems, Chester, Conn., a leader in dial access study systems. He sees an encouraging trend: disillusionment with film projection teaching aids in favor of video tape, and telephone-to-computer information access in the classroom. "Right now, this is not a fabulous business," he concedes, "but in the long run it will grow because of the need to handle more students with fewer teachers. This means more electronic aids, including at-home study systems."

Still another electronic market adversely affected by economic decline is the new family of retail store cash registers. The hardware is available and the data handling systems are ready. But they probably will remain poised on the brink this year as department stores wait for sales to improve. Like most of the consumer/commercial market, the policy is to maintain a low profile until more money becomes available, hopefully in the second half of 1971. □

Communications

- Microwave carriers to challenge AT&T's hold on the booming market for data transmission
- Independent telephone companies expect to slice off 10% of the \$400 million PBX market
- Cable television companies are looking forward to 1971 sales of \$90.2 million, a gain of 5%

□ Offsetting the softness in the military/government sector of the market, industrial and commercial communications gear should ring up sales of \$1.979 billion, nearly 3.9% over last year. Thanks to this upward movement, the entire communications market

will make a slight advance to just under \$3 billion, a 0.6% increase over 1970.

Confidence in the steady growth on the commercial side is partly attributable to strength in the data transmission area. "Despite the economy, data trans-



mission needs just refuse to stop growing," notes one official of a medium-sized independent telephone company. "And as data grow, so grows the associated hardware—microwave front ends, and antennas, modems, cable terminals, and the like."

Other solid areas include the private branch exchanges (PBX), where the independents are mounting a formidable challenge to the telephone companies; general purpose facsimile equipment, where manufacturers can expect industry rental figures to double from \$12 million to \$24 million; land mobile radio, which recently got a boost from an FCC ruling on the use of uhf TV spectrum space; and cable television, which is expected to reach the six million-subscriber level this year.

The Bell System still leads the data transmission parade. A source there estimates that data traffic grew 35% in the last year and, with 175,000 data sets in operation, accounted for 3% of Bell's total revenues. Revenues for 1971, according to this same source, should jump to 5% of the total.

The special common carriers—Microwave Communications of America and Data Transmission Co.—while continuing to look forward to 1971 as their first big year, complain of Bell's tactics in the scramble to line up customers. Kenneth Cox, a Micom vice president and former FCC commissioner, says, "Bell is being anticompetitive by advertising and planning its own digital system while opposing Micom's application for similar service."

Datran is counting on receiving FCC approval of its construction permits in early 1971—so much so that it is already starting on a prototype system. To this end, it plans to spend \$7 million, much of it this year, on systems integration, in addition to the more than \$1 million already spent on market research and system simulation. Contracts for prototypes have been awarded to Collins Radio for microwave modulation

and long haul microwave hardware, to Raytheon for local distribution equipment, and to Martin-Marietta for switching equipment. When the system integration study is complete, contracts totaling more than \$350 million will be let for the overall system.

Microwave Communications Inc.'s Chicago-St. Louis data network should turn on in May, provided, of course, that FCC approval comes in February as expected. An MCI spokesman says that more than 300 channels, both narrow and broad band, have already been leased.

Not to be forgotten in the expanding competition is Western Union, which is already offering several new services. Says John E. Cox, an assistant vice president at the company's Mahwah, N.J., facility, "We're planning on a 15% growth in our present traffic this year." For openers there's Datacom—a three-point time-division-multiplexed, low-speed system linking 45 cities—that Western Union claims will provide the user with an estimated 80% savings over switched service. Datacom will also function as a test bed for the company's asymmetric service—that is, 4,800 bits per second in one direction and 70 to 110 bits per second in the other.

The carrier's other 1971 plans include startup of a nationwide service trial of a 2,400 bits-per-second service on an all-digital system, and construction of digital, 20 megabit-per-second service, dubbed Overbuild because it will share equipment with the company's present analog service. Planned to link New York, Philadelphia, Baltimore, Washington, Pittsburgh, Cleveland, Detroit, Indianapolis, Cincinnati, Chicago, and St. Louis, Overbuild will use 30-megahertz channels in the 6-gigahertz band over microwave radio, and employ frequency diversity. Later, Western Union expects to switch to space diversity and orthogonal polarization to double channel capacity.

Rounding out the data transmission picture are

private microwave systems, which are expected to grow in 1971 at a rate of 15% over 1970. An FCC decision on a Bell offering could indirectly spur the growth of these systems. If the commission decides that users of Bell's Telpak microwave channels can sublet them, Bell says it will have to raise Telpak rates. "In that event," suggests Charles Eaton, general manager of General Electric's Telecommunications Products division in Lynchburg, Va., "more large companies will think seriously about investing in private systems of their own."

The modem market, which can only benefit from all this increased traffic, should make a strong comeback this year after a relatively disappointing 1970. According to some industry sources, it could even reach the \$100 million mark. GE's Eaton, for example, forecasts a 30% growth curve for most communications devices, in particular, modems and multiplexers.

The main problem for the modem manufacturers at this point appears to be Bell's introduction of its 300-baud 113A originate-only data set—and even Bell admits it. Virgil Vaughn Jr., engineering director for data communications at AT&T, says: "By the end of 1971, we hope to have tens of thousands of 113As leased. This will give the manufacturers of low speed modems a hard time, making it difficult for them to compete." Against critics who accuse Bell of marketing a loss leader, Vaughn says that AT&T is not subsidizing the 113A, pointing out that the FCC requires cost support information before approving a tariff.

Loss leader or no, the 113A's low lease price is hurting the independents to the point where many are rethinking their market strategy. Rather than build interconnection modems which compete directly with the 113A, several manufacturers are looking to the OEM market in 1971, and some are even experimenting with monolithic modems on a single MOS chip.

One such firm is Penril Data Communications in Rockville, Md., which is presently marketing a monolithic modem that operates at 1,200 bits per second and is aimed at OEMs. Company sources believe the device should play a big part in the \$10 million low- and medium-speed modem market forseen for 1971. Modex Corp. in Costa Mesa, Calif., is another firm that expects big things from the single chip modem market. Its 1,200-baud modem chip can be mounted on a single pc board and, together with power supply, will fit under a telephone. Modex expects to price the device at around \$200 and to sell 20,000 this year.

Another sore point among Bell's competitors is the data access arrangement (DAA)—the black box that must interface any non-Bell modem with the Bell System. These manufacturers insist that Bell has been making the DAA increasingly difficult to obtain by classifying it as an "interim" device, which in effect means that each user must file for it under a special tariff. Even if the device is stocked by the local telephone company, this filing takes time—60 days in New York, for instance. But according to William Quirk, AT&T marketing director for data communications, these charges aren't accurate. "There is a relatively

small demand for the DAA, and we're well stocked. Besides, it normally takes months to get a computer installed, so if the customer places his DAA order early, there will be no problem."

While the PBX, or private branch exchange, market is not expected to increase radically in dollar volume this year (the generally anticipated growth figure is about 10%, to \$400 million), what will grow radically are the inroads into Bell territory. This year the independents expect to seize 10% of the total dollar market, leaving Bell with 90%. The highest volume in PBX sales will come from the small (under 100 lines) systems, like those going into motels and hotels. "A full 20% of the total unit PBX market will be for hotel-motel units," estimates K.C. Thompers, marketing manager for North Electric Co. in Galion, Ohio. One reason given by Thompers for the increasing inroad on Bell's market is the independents' introduction of a wider variety of PBXs.

According to sources at Stromberg-Carlson Corp., the hotel-motel market should have been even bigger in 1970—perhaps as high as 30%—except that the tight money market has delayed large construction, in some cases indefinitely. However, the institutional market, especially hospitals, will take up much of the slack. Hospital administrators, more cost conscious than ever, have taken to buying PBXs, instead of leasing them, which means they are turning more and more to the independent manufacturers. Other buyers of private systems include schools, the railroads and the trucking industry.

All types of larger switching systems—stepped, crossbar, and ESS, as well as store and forward—will also see higher production levels in 1971. Conservative estimates place the growth figure at around 10%, while optimists say that sales could rise as much as 30%, to nearly \$250 million. Bell, for one, plans to install 100 new No. 1 ESS offices in 1971, raising the total to 245 (No. 1 ESS has a capacity of more than 65,000 lines). 1971 will also see the installation of several No. 2 ESS systems, which have a capacity of up to 15,000 lines, in rural and suburban areas. Suppliers hurt by military cutbacks are finding a haven in message switching, particularly of the store-and-forward variety. Among them is ITT Defense Communications, Nutley, N.J., which developed and is now upgrading an interface adapter for the Programed Airline Reservation System.

Compared with switching systems, general-purpose facsimile machines are a much newer and smaller market segment—and are also expected to sell faster. This year they should double sales, which is in line with their 100% to 150% annual growth of the past four years. An estimated 15,000 to 20,000 machines are presently under lease, at fees varying from \$40 per month for a single-speed receiver to \$75 per month for an acoustically coupled transceiver. On the basis of an average rental of \$50 per month, or \$600 per year, the industry will grow from the 1970 figure of \$12 million to \$24 million in 1971.

Though four- and six-minute machines currently hold sway in the marketplace, three-minute machines, due for introduction early this year, and dual-speed

machines will capture the lion's share of the facsimile market during 1971.

The high-speed facsimile market will also climb, but only about 5% to 10%. Limited in applications, these machines are used primarily to transmit large volumes of graphic data, such as weather maps and fingerprints, waybills and invoices for the transportation industry.

In the land mobile radio market, also, growth will not be spectacular. Though a recent FCC ruling buoyed the market by allocating up to two TV channels in the lower uhf range (channels 14-21) in ten cities for land mobile use, a source at the Electronic Industries Association's Industrial Products division says, "Opening up one to two channels in the 10 cities instead of the six we asked for everywhere can hardly be considered a bonanza for the land mobile people—it's just a little relief, that's all."

Nevertheless, Edward J. Hart, vice president of commercial communication systems at RCA's Government and Commercial Systems division, forecasts an upturn in land mobile equipment sales of \$50 million in 1971, over and above the 1970 figure of \$300 million.

A good portion of the new land mobile space will be allocated in the public safety area; canned message systems are currently being demonstrated by a number of manufacturers to municipal police departments. An RCA system, for example, which got a tryout with the New York City Police Department, uses differential phase shift (phase reversal of a 600-hertz tone in the 150-MHz band) operating over regular police channels.

While most new systems will be of the voice or canned message variety, hard copy digital units—teleprinters and facsimile units—will continue to be used on an experimental basis only. Says one source at the FCC, which must approve special licenses for such experiments, "It's beginning to appear that such teleprinter systems use too much time. In fact, this market appears to be slowing down, partly because of recent tests by the Milwaukee Police Department under a

Law Enforcement Assistance Agency grant. The teleprinters didn't really do a thing to help the police; the printouts were both slow and hard to read. And, this year I think we'll see facsimile following the same path the teleprinter did in 1970."

Picturephone installations, according to AT&T, will jump from around 100 operational sets in 1970 to close to 3,000 in various cities including Chicago, Pittsburgh, Washington, New York, Los Angeles, and Cincinnati. However, with the exception of a Pittsburgh-Chicago link, all service will be intracity. The anticipated growth in Picturephone service is backed up by Western Electric production claims this year of about 500 sets per month. This contrasts with 1970's total output of about 500 sets.

While commercial Picturephone service is still a Bell-only offering, Stromberg-Carlson is starting to make some slight inroads with its Vistaphone videotelephone. Four preproduction Vistaphone units, with their antimony trisulphide silicon target cameras, have already been installed for private use by the Mid-Continent Telephone Co., in Elyria, Ohio, and if tests there are successful, Vistaphone may go into commercial service by the end of this year.

Finally, cable television, although still held back by legal problems, is expected to make significant gains in 1971. In terms of subscribers, the CATV industry expects to pick up another 700,000 homes, states John Lady, director of research for the National Cable Television Association in Washington, "a figure which will take us over the six million mark." Currently, the average CATV system has about 2,000 subscribers. If, however, as expected, the FCC in 1971 loosens its restrictions on the industry, including the ban on importation of distant signals, the industry will see the beginning of 5,000- to 10,000-subscriber systems, say most informed sources. In terms of hardware, including head end and line equipment, TV set converters and microwave gear, CATV equipment makers are looking for nearly \$90.2 million in sales in 1971, a gain of above 5% over last year's figure. □

Instruments

- With European sales offsetting a flat year at home, overall sales volume should rise by 6%
- Communications test gear will continue to sell; computer-controlled systems will finally take off
- Growth of medical electronics equipment will continue to outpace gains in the other markets

□ Hurt by a miserable year at home, instrument houses in 1970 were grateful for soaring overseas sales that helped some of them break even overall. Again in 1971, they're looking to Europe—where they sell more than 30% of their instruments—this time for the boost needed to offset an expected flat year stateside and to raise overall sales by 6%. The instrument manufacturers' predictions, however, hinge on an improvement in the U.S. economy that's expected around midsummer. Without it, not only will domestic

instrument sales continue to sag, but European sales also will begin to dry up in the last part of the year, industry observers say.

Meanwhile, instrument makers feel that last year's strong sectors—communications test gear in particular—will remain robust in 1971. And sales of computer controlled test systems finally should begin to show some of the strength predicted but not realized in 1970—if customers, as expected, loosen up their capital outlays in the third quarter. On the other hand,

general purpose benchtop instruments will continue to sell poorly, particularly the high-priced units.

More low-priced lines will be introduced in 1971, and to cut inventories, prices on some existing items will be slashed. The search for new markets will intensify, with the focus on the industrial field. But any large moves into new markets are unlikely during 1971—manufacturers only now are beginning to explore what products and marketing approaches will be demanded by new areas.

Worldwide sales of U.S.-made instruments and test systems are expected to total over \$1 billion in 1971. About \$360 to \$400 million is expected from European sales, if the European instrument market continues to grow by better than 20%. It's a big "if." Some industry observers feel a slowdown is inevitable; they predict that the growth rate will drop to between 10% and 15% this year. Even if they're wrong and Europe does hold up, few instrument houses will see their overall sales climb back to 1969 levels. For many companies, European sales already represent a sizable percentage of their business. Two of the biggest—Tektronix Inc., Beaverton, Ore., and Hewlett-Packard Co., Palo Alto, Calif.—sell 40% of their instruments overseas. Dana Laboratories, Inc., Irvine, Calif. sells between 20% and 25% of its instruments to Europe, and Systron-Donner Corp., Concord, Calif., 20%.

Even if the U.S. instrument market does pick up, its complexion will be changed. No longer will instrument makers be able to count on large-volume government orders. "We used to have customers who'd be building, say, six avionics consoles," says James Cunningham, Systron-Donner's marketing director. "So they'd buy half a dozen digital voltmeters and half a dozen counters, and so on. And they'd want the latest hardware for their console.

Instrument makers thus will have to rely on one- and two-unit orders from their traditional customers while they search for new markets. The big prospect is the industrial sector; almost every instrument house is talking about applying technology to industrial problems. One marketing chief says that industrial sales represent a potential 30% of the total instrument market, three times his estimate of the current percentage.

Some companies already are moving in the industrial market. Tektronix last year introduced a line of machine control tools, while at Monsanto Electronic Instruments in West Caldwell, N.J., marketing manager Theodore Brandt has one man looking into industrial opportunities full time. The John Fluke Manufacturing Co. of Seattle, Wash., is introducing a line of digital-to-analog converters aimed at the process control industry. Hewlett-Packard isn't sitting still, either: the first of its 1971 products aimed at this market will be the 1700 series of service oscilloscopes, scheduled for introduction this month.

Sales of programable test gear—an index of the number of test systems sold—didn't increase in 1970. At Dana Labs, Alan Kest, marketing manager, reports that there hasn't been any "drastic change" in the proportion of programable voltmeters sold. Sys-

tron-Donner's Cunningham agrees that programability hasn't been a big selling point.

Integrated-circuit test systems account for a large percentage of the computer-controlled testers sold. For the most part, the IC systems did poorly in 1970. Fairchild Systems Technology, for example, sold, at most, three of its new Sentry 400 systems. Its Boston-based rival, Teradyne Inc., took orders for only six of the new Slot machines, says vice president Alex D'Arbeloff. With the semiconductor industry waging a price war, business isn't expected to get better in 1971. The total market for '71 is placed at between only \$50 million and \$60 million.

But systems makers still will be active in preparing for the time when large-scale integrated circuits go into volume production. Teradyne has just introduced a dynamic-test station, and for 1971 it plans to put its own minicomputer into its Slot machine tester, replacing the PDP-8L now used. Fairchild Systems, says marketing manager Carl Steffens, soon will build into its LSI test system, the Sentry, the capability to test MOS/LSI. The market for LSI testers eventually is expected to go to well over \$75 million; for 1971 it could reach \$12 million.

To keep sales of benchtop instruments up in 1971, manufacturers will have to keep prices down. "There seems to be a loosening of capital funds for the under-\$500 and under-\$1,000 types of instruments," says Julian Silverman, president of Eastern Instrumentation, a Philadelphia sales representative firm, which handles the lines of several instrument houses. "Conversely," he adds, "higher-priced instruments have been hit hard."

One of the hardest hit has been digital voltmeters. "The bottom just dropped out of that market," com-



ments Art Stephens, project manager at Simpson Electric Co. in Chicago. However, the market for DVMS is still substantial—over \$20 million for 1971.

Brimming with health is the market for 3½-digit multimeters. "We haven't been able to keep up on our orders," says Charles Sunderland, digital product manager at Triplett Electrical Instrument Co., Bluffton, Ohio. Estimates now are that the digital multimeter market will hit the \$4 million mark in 1971.

Digital panel meters have not held up as well. Prices leveled off in 1970 at around \$120 each, too high to trigger off large-volume orders from original equipment makers. The market for 1971, says Triplett's Sunderland, is around \$8 million, considerably below the estimate of a couple of years ago.

The market for counters showed softness in 1970, partly due to a saturation that was evident even before 1970. "The number of people making counters is growing a lot faster than the market itself," says Monsanto's Brandt. The counter market in 1971 is likely to remain at about \$50 million.

Frequency synthesizers also showed little growth in 1970, and most likely won't go over the \$12 million mark this year. However, price reductions substantial enough to make synthesizers competitive with oscillators would change the picture. Monsanto's Brandt estimates that a 1-megahertz synthesizer that would sell for \$3,000 would send the market up 30%-35%.

Oscilloscopes were poor sellers in 1970. H-P, it's estimated, found its scope business off by 5%, while Tek scope sales dropped by an estimated 20%. Both companies are predicting slow but steady sales increases this year. Tek is far out in front of H-P; Tek's scope sales total is estimated at close to \$100 million, while H-P's is around \$25 million.

Tek will be counting heavily on customer acceptance of its 7000 series. Some industry observers expect the 7000's price to come down in 1971. "They introduced a real Cadillac scope at a time when customers really didn't need that sort of thing," says one. "I think they've got a real problem there." Tek's vice president for marketing, Charles Buffiou, replies: "When we developed the 7000 series, we intended to introduce the top of the line first. If you introduce the simple versions first, you run into compatibility problems, and never get into the complex versions."

Indications are that Tek will continue to introduce lower-priced units to its 7000 lineup in 1971 in an attempt to boost sales. H-P's plans this year include a plug-in for its 183 that will boost frequency response to 500 MHz, making the 183 the fastest scope available.

As for trends in the oscilloscope area, much of the activity will center around the medium-priced units that go for \$500 to \$1,500. A handful of smaller U.S. companies already are competing. H-P, with its 1700, and Tektronix, with its line of Telequipment scopes from a U.K. subsidiary, will be moving in. Competition can be expected from Japan: Panasonic will be pushing its line of under-\$1,500 scopes this year, as will Kikusui Electronics Corp. The size of the market for these scopes is indicated by Reginald Alexander, a sales manager for Marubeni-Iida (America) Inc., which represents Kikusui: "We estimate a

market of \$5 million alone in 1971 for 10-MHz scopes with 10-millivolt sensitivity," he reports.

Another emerging trend will be an increase in the number of low-priced instruments available. Engineers increasingly are looking for an instrument that does a specific job, says Monsanto's Brandt, and are de-emphasizing the importance of buying multiple capabilities in a single unit. As a result Brandt expects to see more instruments with fewer ranges or lower resolution.

One of the first low-priced products to hit the market in 1971 will be a line of high-performance frequency counters from Dana selling for between \$1,000 and \$1,500. "Before the year is out", predicts marketing manager Kest, "Dana will have counters at an even lower price." Under-\$1,500 counters started showing up in 1970, but most high-performance units still sell for \$2,000 and up.

All of the low-priced counters and DVMS won't be new models. In both markets there's the distinct possibility that price wars will flare up during 1971. Counter and DVM sales have been disappointing, so inventories are high.

Solid state displays will show up in more instruments. Monsanto already has started using light-emitting diode modules. A major instrument house is readying its first LED instrument, a DVM, for the IEEE show in March. Even inexpensive instruments may start using LEDs in 1971. Jack Stengenga, digital instrument marketing manager at Weston, says prices are almost low enough to make LEDs feasible in panel meters and other inexpensive lines.

Instrument rental firms should continue to grow this year. Once shrugged off by instrument makers as an insignificant part of their business, rentals have gained a toehold during the slump. The total volume of rental business was about \$8 million in 1970, and should go over \$10 million in '71.

The instrument makers themselves are showing increased respect for the renters. Both Systron-Donner's Cunningham and Dana's Kest say that some of their biggest customers are rental companies. Other makers actually are climbing on the rental bandwagon. Tektronix started a rental program at the end of last year, and chances are good that other larger makers will follow suit in '71.

Medical electronics: a healthy year

Though they fell below expectations, sales of medical electronics gear still are outpacing the instrumentation market generally. Last year the overall state of the economy dampened the market, and sales reached \$650 million, according to the Department of Health, Education and Welfare. This relative slowdown is expected to continue through most of 1971, but sales are expected to grow to \$710 million. These figures include long-established items such as X-ray equipment and newer products including hospital information systems, patient monitoring systems, and automated laboratory gear.

Patient monitoring equipment sales are expected to grow between 15% and 30% during 1971, reaching

between \$25 and \$30 million, says Dean Morton, general manager of Hewlett-Packard Co.'s Medical Electronics division in Waltham, Mass. And the automated lab gear market will approach the \$100 million mark this year as it continues to grow by around 20%.

Monitoring systems are selling, simply because few hospitals have them and most want them. But two other factors will boost sales in 1971. First, monitoring systems are finding new applications. Originally developed to keep tabs on cardiac patients, they're now starting to watch over fetuses, newborns, and patients coming out of surgery.

In addition, monitoring systems will get a new look in 1971. Abbott Medical Electronics Co., Chicago, and Westinghouse Electric Corp.'s Medical Systems department in Cheverley, Md., have recently introduced computer-controlled systems.

At least two other companies are also expected to introduce computer-controlled monitoring systems before the year-end. These new systems will feature digital displays, digital signal processing to cut down on cable requirements, and software capabilities to allow the systems to supply diagnostic information.

One trend that seems to have run its course in monitoring is the turnover in competition. The 1960s saw many companies get into and get out of the business.

Now the market has settled down with about half a dozen companies doing most of the business, and no new faces expected in 1971.

The market for automated lab gear also is dominated by just a few firms. One is Technicon Corp. of Tarrytown, N.Y., whose overall sales jumped from \$78 million in 1969 to over \$100 million last year—a growth of 28%. For 1971 the company is expecting about the same percentage jump. Growth rates and predictions at the other automated-lab houses are about the same.

Economy moves plus an increasing number of potential customers are boosting the market for automated lab gear. Though only large hospitals can afford to buy this automated gear, the number of these hospitals is on the rise, while the small-hospital population is decreasing.

The possibility of Federal controls in the biomedical area is remote in 1971. Congress reportedly has assigned a low priority to the area, and little has come of the report submitted last year by the Presidential Commission on Medical Device Safety. For the record, manufacturers claim that they'd welcome Government imposed standards, but in private, many admit that living with any kind of controls would boost their costs—and therefore prices. □

Military

- Electronics spending to drop 4% to 6% on top of last year's 6% to 7% decrease
- RDT&E expected to hold steady even though procurement will be reduced by at least 6%
- ULMS program for Navy will lead American defense strategy seaward for the seventies

□ The Defense Department will be spending \$360 million to \$600 million less in 1971 for electronics, a drop of 4% to 7% on top of 1970's 6% to 7% decline, for a two-year total reduction of more than \$1 billion. Factor in inflation and it's clear that companies chasing Pentagon dollars will have to do more of what they did last year—chop overhead to keep costs in line or buy into a contract to keep the operation going.

The hardest pinched sector will be procurement, with estimates for 1971 running \$185 million to \$500 million below 1970 levels. With a \$300 million dip as a consensus figure, money spent on electronics procurement in 1971 will drop by a hefty 6%.

Research, development, test, and evaluation (RDT&E) money has been fairly steady, largely because neither Congress nor the Administration wants to cut it back too heavily and reduce the options on future defense systems.

Looking at the overall defense picture this year, the Electronic Industries Association predicts \$69 billion in appropriations—an average of estimates from 19 prime contractor members. While budget request projections are in the \$74 billion to \$75 billion range—the first rise since President Nixon took office—the 92nd Congress is expected to seek economies equal to

the \$6 billion-plus reduction that cut this year's spending level to less than \$67 billion, making the EIA figure pretty accurate. On the premise that about 15.5% of defense money is spent on electronics, the big figure for electronics firms should be \$10.2 billion.

The thinking of the nation's political and business leaders shows a fundamental dichotomy. The big-budget advocates feel that to turn the economy upward before the 1972 election, money should be poured into the defense sector, which already has the plant, the people, and the knowhow. They point out that, even with the industry already toeing the mark, it would take 18 months for a big-budget decision by the White House to spread through all levels of the economy. Arrayed against the defense-spending backers are the "relevance" people, who insist that Pentagon hardware money should be diverted toward so-called social markets—environment and education.

The upshot: industry managers see no increase in actual procurement over the \$19 billion in the current House money bill. R&D funding may go up, but industry sources don't believe it will result in many jobs. Citing that \$19 billion figure, one industry expert says the Pentagon "will be lucky to hold the line in fiscal 1972." And if President Nixon asks for more,

"There is such a split between the Administration and the Democratic majority in Congress now, that even the committee chairman would have trouble holding the line—and they should get the credit for it if they do," he asserts. In fact, some insiders feel that \$19 billion is too high. The EIA's fiscal 1972 procurement average is \$17.7 billion (falling between a high of \$19.7 billion and a low of \$14.1 billion), with electronic content averaging 23.4% (high 27%, low 12.5%). Add to this programmed economic pressures—such as pay raises—that are forcing a move away from tactical options toward upgrading strategic systems.

If there is a possible bright spot in the military electronics picture it's in RDT&E. The electronics portion of the Defense Department's RDT&E budget was estimated at \$2.48 billion to \$2.76 billion in 1970. Though there's no genuine consensus on where it's going this year, some feel there will be a slight increase, perhaps \$40 million. Still others foresee a drop amounting to \$75 million to \$140 million. Estimates of electronics RDT&E for 1971 range from \$2.4 billion to \$2.6 billion. Finally, one government economist expects some growth, but stresses that it will be current dollar terms—in other words, inflated dollars.

If 1971 spending is shrouded in uncertainty, there seems to be less mystery about the direction of defense strategy. It's going to sea—and it's happening in four ways: accelerated development activity for the Undersea Long-range Missile System (ULMS); planned expansion of the Navy's nuclear-powered attack carrier fleet; development of the F-14 air-superiority fighter as its chief armament; and development of the Aegis system as the fleet's shield.

In an urgent push to bring the first subs into operation by 1978, ULMS funding will be tripled in the budget request, from \$44 million to around \$130 million. Procurements under the \$15 billion program will extend into the 1980s. Lockheed is conducting design studies on the 6,000-mile-range missiles.

ULMS, says one DOD official, will require "a great deal of instrumentation that's not in inventory now." An example, he says, is sonar and precise navigation and stabilization gear to guide ULMS boats around the uncharted seamounts on the ocean floor.

The debate over another program in the RDT&E area—the Safeguard antiballistic missile system—is still going on. As a result, the Air Force and Army spent millions of dollars on alternative systems, though Congress has killed the Air Force's Hard Point. Officially, the Army says it will need the Hard Site system if the Soviets increase the accuracy and the number of warheads on their medium range SS-11 missiles. Such a conversion, defense officials say, would make SS-11s a major threat to silo-based Minuteman missiles that could be countered only by a low-cost, dedicated missile defense system.

The Army will spend \$58 million on Hard Site through June 30 and will probably spend somewhat more during fiscal 1972.

Spending for missile electronics, which runs to approximately 45% of a system's production cost, could rise by \$250 million in 1971. Whether or not total outlays in this market expand to meet the \$1.4

billion to \$1.5 billion forecast depends on a number of factors. Among them is a possible new one: the overseas threat. It's more economic than military, defense officials point out, as the Pentagon explores the potential of offshore procurements.

The most recent example is the Army's decision to test the mobile, all-weather, ground-to-air French air defense missile known as Crotale [*Electronics*, Dec. 21, 1970, p. 39], produced by Thomson-CSF and Engins Matra.

Crotale is an immediate threat to such U.S. defense systems as the Chapparral-Vulcan combination produced by Philco-Ford and General Electric. For the longer term, industry sources suggest a series of successful Crotale tests early this year could lead to review of such other air defense systems as the Improved Hawk and the SAM-D. Both are Raytheon programs.

Aircraft production, which slipped 25% from fiscal 1970 to fiscal 1971, is expected to drop again in fiscal 1972 as several major avionics-laden programs are phased out. Among them are the F-111, the A-7E, and the F-4, plus Lockheed's ill-starred C-5A.

Production of the General Dynamics F-111s will all but halve by the end of the year; only 38 will be made, all of them F-111Fs with a reduced avionics package consisting primarily of an IBM AN/AYK-6 computer and inertial navigator by Autonetics. The six F-111Fs scheduled for production in 1972 will be the last of the controversial breed.

This also will be the last year of full 120-per-year production of LTV Aerospace Corp.'s A-7E, although production of the A-7D will not peak until it hits 110 a year in 1972. Both include avionics packages worth at least \$1.25 million.

Despite the award to Boeing of the Airborne Warning and Control System contract, no decision has been made on the large, rotodome-housed radar. Hughes and Westinghouse are the finalists in this competition. Selection of the winner entails a competitive flyoff, probably in 1972. The AWACS aircraft, Boeing 707-320s, will have a flyaway cost of over \$20 million each; nearly \$10 million will be avionics, much of it peripheral to the large and costly radar.

In terms of electronics, AWACS is the largest Air Force program still funded from RDT&E accounts, although the service is certain to push for production money in fiscal 1972 now that the Congress has finally approved the \$87 million total requested for this year. It gives AWACS substantial funds to carry it until a new appropriation is passed. After years of Pentagon indecision, Air Force sources now feel that AWACS represents one of their most solid programs.

As for the B-1, though North American has a \$1.3 billion contract for two static models and five flight versions of this successor to the B-52, funding this year is a mere \$75 million. Even assuming that the B-1 will survive continued Congressional scrutiny, its first scheduled flight is more than seven years off—and avionics purchases have been put off for at least six years.

The Army's AH-56 Cheyenne gunship, a controversial Lockheed program, currently has R&D funds

for \$17.6 million, and the service is expected to ask for significantly more in order to develop the helicopter for the part of tank-buster in future land warfare. Similarly, the Army is expected to want an increase in its \$17 million budget for developing advanced helicopters for various roles ranging from observation to heavy lift.

The Navy will proceed with its RDT&E helicopter program also in 1971, devoting most of its attention to the shipborne LAMPS system for antisubmarine search, detection, and destruction. Congress is urging the Navy to employ a helicopter already in the military inventory for this purpose, and though the service is still pushing for a new bird, it may have to settle simply for a new avionics and weapons package. At any rate, the \$13.5 million which the service asked for last year was cut by nearly \$10 million by Congress, and now the Navy plans to ask for at least as much new money again.

To provide the muscle for the increased aircraft carrier emphasis, Grumman's F-14 will be ticketed for \$274 million in development funds. The F-14, armed with its Hughes-made Phoenix missile systems and AWG-9 fire-control system, can use the early-warning capability of GE's AN/APS-111, flying on the carrier-based E-2A and E-2B, to spot and destroy targets that are several hundred miles from the task force. However, it cannot intercept missiles that have already been launched.

The missile-defense role will be handled by Aegis, now in R&D at RCA under a \$253 million, multiyear contract. Aegis will use General Dynamics' Standard missile, which is gradually replacing the Terriers and Tartars, to destroy incoming missiles 100 miles away.

Current studies in Congress are aimed at the functional overlap of the F-14 and the Air Force air-superiority entry, McDonnell Douglas' F-15. Funding for the F-15 will be \$370 million this year. Although all of the avionics systems have been cut back somewhat, at least \$3.5 million of the airplane's estimated \$15 million-plus flyaway price will be for avionics.

The Navy's new carrier-based antisubmarine warfare aircraft, the S-3A, has been kept in RDT&E status, pending further development of its avionics subsystem. Still, its budget has received an add-on of \$58 million this year. The airplane will have a flyaway cost of over \$16 million, \$8 million of which is for avionics, primarily the A-New ASW system.

For commercial avionics suppliers, the financial woes of the airlines are a source of real worry. While there will be little effect on firm 1971 contracts to buy airplanes (some 65 DC-10s, L-1011s, and 747s), there is bound to be a sharp cutback in optional purchases. These typically amount to 30% to 50% of the firm orders, meaning a 28% drop in overall orders—\$25 million in potential avionics business lost.

One sufferer is McDonnell Douglas' collision avoidance system. McDonnell had hoped to get the airlines to commit themselves to purchase at least 500 of the time-frequency systems, so that it could start production. Now, says a McDonnell spokesman, "the money just isn't there." And no one expects a turnaround for at least another 18 months. A possible gainer from

the resultant delay in implementing the time-frequency system is RCA, whose Secant system will be tested by the Navy starting this summer.

As for the supersonic transport, the battle over SST funding has avionics makers worried over the threat to a 15-year production run of 500 planes. A major victim would be Sperry Rand's Flight Systems division, which would get \$500 million of the craft's \$600 million avionics total.

In satellites, despite fierce opposition by European governments that favor L-band aeronautical services craft, the Federal Aviation Administration is expected to gain White House approval this year for its hybrid Aerosat plan. The satellite, which would be launched by Comsat Corp. in 1973, would carry operational vhf transponders and experimental L-band transponders,

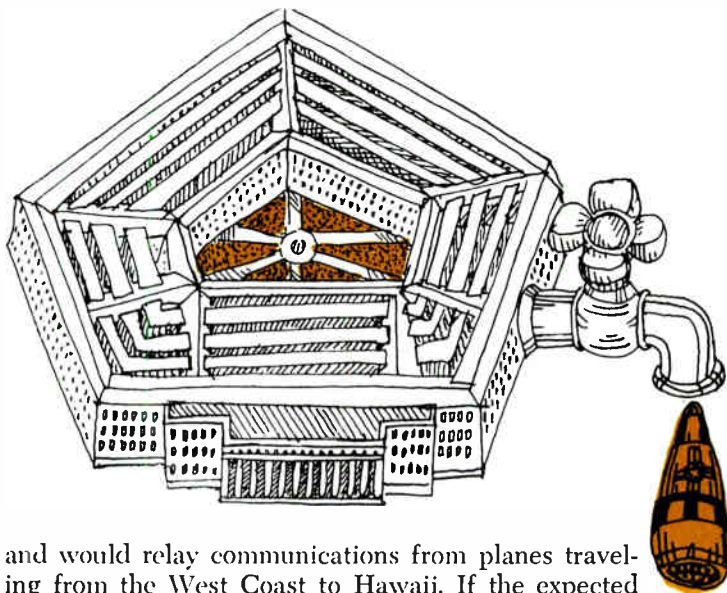

and would relay communications from planes traveling from the West Coast to Hawaii. If the expected approval is gained, Comsat will let contracts for the development of the satellites this year. The airlines and the FAA would split the \$6.7 million annual cost of the vhf channels, while the \$7.8 million uhf costs would come out of the FAA's budget.

The Pentagon's electronics and communications category, which accounted for industry sales of about \$990 million to \$1.1 billion in 1970, will also dip in 1971, according to most estimates. Sales here will run between \$840 million to \$865 million in 1971—a decrease of anywhere from 15% on \$150 million to 23% on \$28 million.

Satcom plans to spend about \$40 million in fiscal 1971, about 100% more than in the previous fiscal year. Of that figure, \$7 million is for R&D. A large part of that will go for 29 communications subsystems—modulators, multipliers, multiplexers, and all the allied equipment needed to modulate signals all the way from i-f to the user. Bandwidth is 50 megahertz, but will be increased to 500 MHz. Contracts are to be rebid, with Philco, Radio Engineering Labs, Page, and Stelma competing.

AACOMS (Army Area Communication System) will use \$20 million to \$30 million over the next three years to go digital, with 10% to 15% to be spent this year. Sixty bids have been solicited for the terminal. □

Industrial

- Increased use of minicomputers should spark a market acceleration in the second half of 1971
- Process control systems outlook is mediocre as steel, petrochemicals, and chemicals stagnate
- Machine tool sales decline throws wet blanket on prospects for direct numerical control gear

□ The industrial automation equipment business is starting 1971 in a holding pattern at the \$1.2 billion annual rate reached back in 1969. Sales moved upward only slightly during 1970, and most companies see a flat first half of 1971. But optimists are confident of an acceleration in business this year—most likely in the second half.

One factor expected to spark the turnaround is a marked increase in the use of minicomputers. In market projections for process control and numerical control, as well as for automated manufacturing and parts handling, minicomputers figure prominently in systems that offer better control for less money.

There are a few other bright spots, too. The electric utilities "are going absolutely wild" trying to add capacity and avoid a repetition of last year's urban brownouts, one controls maker says. Manufacturers of controls for gas turbine generators are sure to benefit. And plastics processing may provide new business this year. The industry has never been able to buy a process control system in a single package. Now General Electric Co., New York, hopes to capture a healthy share of this market—estimated at \$25 million—with its Plasti-Matic control system.

But the overall picture in process control was gray at the turn of the year—business was better than might be expected in the context of the economic slowdown, but some segments still were hurting badly. "Steel is dead," says an official of a company selling motor controls for steel processing. His company's sales to rolling mills in the primary metals industry, for example, were down to about \$15 million in 1970, about one-third of the peak reached in 1967 and '68, and he sees little improvement in 1971. But automation of steelmaking facilities, such as basic oxygen furnaces, will get increased attention as manufacturers try to increase productivity.

Sales to the petrochemical and chemical companies are just about holding at early-1970 levels, and some modernization projects have been delayed or stretched.

All in all, minicomputer prospects still represent the brightest spot in the industrial electronics outlook. By 1975, it's predicted, the minicomputer market will reach \$1.5 billion, and about 30% of the machines will be used in some form of on-line process control and parts manufacturing. Some minicomputer makers and users anticipate significant steps in this direction during 1971, especially since low-priced machines are proliferating in the market.

As a result of lower costs for computers and instruments, prices for process control systems have dropped dramatically. According to one official at

Honeywell Inc.'s Industrial division, Fort Washington, Pa., a typical system, costing \$250,000 in 1960 and about \$100,000 in 1965, would cost \$30,000 to \$50,000 today.

What's more, the process engineer's approach to computers is maturing as the machines become less costly and more available. "The engineers have learned more about their processes and are concentrating on increased efficiency, rather than on computer control for the sake of computer control," says Gail Loper, manager of product development in the Digital Systems division of the Foxboro Co., Foxboro, Mass. "They're content to control only a part of their process, and are realistic about the payback they expect," he notes.

"**Process engineers no longer feel they have to control the world,**" says another supplier of controls. With today's minicomputers, industrial processes can be automated in segments. Frank Mears of Mobil Oil Co., New York, cites one example in the petrochemical process field: more on-line use of minicomputer-controlled gas chromatographs.

Prices for process control instruments are expected to move downward in 1971. Last fall, GE announced a 30% price reduction on a line of redesigned electronic instruments; they're down to the \$400 level of pneumatic instruments designed for the same jobs. Other makers are likely to follow this price trend, as well as the move to make instruments smaller and more compatible with digital control.

Machine tool sales, sliding at an even sharper rate than the general economy, have pulled sales of numerical control equipment down with them. Most predictions are that any upturn won't come until late in the second quarter of 1971—at best. One industry consultant pegs 1970's numerical control shipments—new and retrofit—at \$65 million, a discouraging performance after the more than \$90 million rung up in 1969. If and when the economic upturn comes, direct numerical control systems (DN/C) are expected to surge, outpacing the conventional tape-controlled equipment.

Almost half of the numerically controlled metal-working systems exhibited at the Machine Tool Show last fall were DN/C systems, says Arthur Klaben of Theta Technology Corp., a market research firm in Wethersfield, Conn. And many firms are marketing retrofit kits for tape-operated DN/C machines. Peter Senkiw, president of Applied Data Systems in Dayton, Ohio, adds this observation: "Although they may not have funds at the moment, many machine tool users are doing their homework and are preparing to

implement direct N/C as soon as they can.”

In DN/C systems, programs stored in a mini-computer replace the numerical control tape and reader, eliminating a source of errors. And it's easier to change a computer program than to substitute a control tape. Also, each machine tool can be tied into a real-time management information system.

Programmable controllers—another step toward the computer-controlled factory—will make a significant impact on manufacturing techniques in 1971. These controllers are designed to replace relays and solid state logic modules in regulating machine sequence and timing cycles on assembly lines. Operation of the controllers can be changed by replacing a read-only memory or reprogramming a read-and-write memory—

rewiring of the controller is not a requirement.

Evaluation of programmable controllers was fairly widespread during 1970. Acceptance has been “fantastic,” says a spokesman for Modicon Inc., Dedham, Mass., a manufacturer of the devices. They have been tried out on transfer lines in the automotive industry, on chemical and plastic batch-processing lines, on automated cranes, and on materials handling and weighing systems.

“There are \$400 million worth of potential applications for programmable controllers each year,” asserts Donald E. Chace, product manager for controllers at Digital Equipment Corp. Maynard, Mass. He predicts that up to \$10 million of programmable controllers will be sold in 1971. □

Space

- NASA is pushing hard for shuttle effort, but Congress questions 'relevance' of the program
- Agency also turning toward navigation aids, microwave ILS, and CAT detection equipment
- ATS, High-Energy Observatory, Grand Tour could absorb some slack left by Apollo cutback

□ The team that crowned a decade of space triumphs with the lunar landing in 1969 is hardly a team anymore in this second space decade. With NASA constantly being told to “stretch out” or “wait till next year,” morale sagged in 1970 about as fast as the Russian space program grew. The fair-haired boys of the 1960s simply were yesterday's heroes to a nation whose priorities were changing. And anxious electronics firms, shutting down plants and seeing their own teams breaking up, also find the 1971 business outlook grim.

The big question now, with the manned lunar program winding down, is what will take the place of Apollo as the big-ticket item in NASA's budget. If NASA has its way, it will be the space shuttle.

But even the most optimistic aerospace companies have their doubts. They don't think the White House and Congress will let NASA begin detailed design work on a \$6 billion to \$9 billion space program when “relevance” and “human needs” are the in words on Capitol Hill. Many in industry and NASA alike believe the slack left by Apollo's decline will not be taken up this year. As a result, the space agency's budget probably will decrease from the \$3.2 billion appropriated in fiscal 1971—a seven-year low—to between \$2.7 billion and \$3.1 billion for fiscal 1972. Since roughly one-third of NASA spending goes for electronics purchases, the industry likely will see its space market, which dropped to about \$1.2 billion in calendar 1970, dip under \$1 billion in 1971.

Such a budget certainly won't be enough to get all the new unmanned programs going, either. But to hear some NASA program managers tell it, several new opportunities could start knocking for business-starved electronics subcontractors in fiscal 1972. NASA would like to get going on the Grand Tour

planet fly-by program and the High Energy Astronomy Observatory, and start moving into final design on the Viking Martian orbiter/lander. These unmanned programs would represent quite a chunk of money in fiscal 1972, and once they move into the hardware stage, their total runout cost would exceed \$2 billion over the next few years.

New program starts in the next year or two will be the key to the rest of the decade's space budgets. With the long-lead-time programs, what happens or doesn't happen could establish that space, for the entire decade, will not be a growth market for electronics companies—even with a base as low as this year's.

A budget this low would mean that space shuttle efforts would be stretched out for another year while contractors are asked to come up with alternate (e.g. cheaper) shuttle concepts. This, in turn, would mean that the \$3 billion to \$4 billion space station program and its \$500 million payload would not fly until the 1980s, if ever.

Meanwhile, studies continue over a broad front on the reusable two-stage space shuttle, being designed for a useful life of 100 flights.

North American Rockwell Corp., El Segundo, Calif., and McDonnell Douglas Corp., St. Louis, are working on Phase B preliminary design contracts, while Chrysler Aerospace, Detroit, is doing a concept formulation study of a bell-shaped one-shot-to-orbit vehicle. Grumman Corp.'s Aerospace division, Bethpage, N.Y., and Lockheed Aircraft Corp., Burbank, Calif., are studying a one-shot version with drop tanks.

All is not black, though, for the electronics firms. While NASA's space program may be declining, the requirements of relevance and human needs are permitting the agency to build its aeronautics role. Only recently, NASA's Office of Applied Research and Tech-

nology (OART) was reorganized to place more emphasis on aeronautics. And, at least for the time being, much of NASA's aeronautical effort will be channeled into avionics.

The slack left by the decline of manned space flight also may be accompanied by increases in the NASA Office of Space Science and Applications. Sometime this year General Electric Co. will begin bending metal and building electronics systems for its Earth Resources Technology Satellites, spacecraft that will be equipped with a wide range of sensors, among them RCA's TV sensors and Hughes Aircraft's multispectral scanners. Thus, the peak costs for the \$50 million ERTS program should come during fiscal 1971-1972.

Also scheduled to reach their peak this year are the Applications Technology Satellites F and G. Fairchild Hiller Corp., Germantown, Md., which won the contract after protesting the initial award to GE, will begin work on the \$50 million program this year with peak spending in fiscal 1973 and 1974. ATS-F will fly in 1973, while ATS-C will wait until 1975.

NASA is proposing to begin its High-Energy Astronomy Observatory program this year, aimed at launching the six-ton spacecraft in 1974, 1975, 1976, and 1978. The program is the "major thrust of our physics and astronomy program," an OSSA official says. He notes, however, that Congress may well knock down the \$100 million to \$200 million program, which is now in the preliminary design stage at Grumman Aerospace Corp. and TRW Inc.'s Systems Group.

A second ambitious space program scheduled to begin this year is the Grand Tour, which would provide fly-bys of Jupiter, Saturn, Uranus, Neptune, and Pluto by two craft. Yet the \$950 million costs of the program during its 10-year life may lead to delays or even cancellations by the White House or Congress. OSSA sources say the program, which would require development of advanced LSI devices with eight-to-10-year lifetimes, would require \$30 million to \$50 million during its first year alone.

A final decision NASA must make this year is whether to go ahead with its Viking Martian orbiter/lander. Two years ago, NASA slipped the program by two years, so "if we're going to do it in 1975, we've got to get big money in it this year," an OSSA spokesman says. The Martin Marietta Corp., New York, is ready to gear up for detailed design work on Viking this year; it would cost \$30 to \$40 million in fiscal 1972 money and much more the following fiscal year. Total cost would be \$700 to \$850 million.

On the research front, NASA's Office of Applied Research and Technology plans to begin flight tests of a helium neon laser communications system aboard an RB-57 to see "what the atmosphere does to laser beams up and down. Nobody has ever really done this before," says one OART engineer. OART officials also are excited about work under way with thin-film bubble memories built of yttrium indium garnet deposited on a gadolinium gallium garnet substrate. The North American Rockwell development promises to be lower in cost than orthoferite bubble memories. □

Federal

- Two bright spots for nondefense spending are urban mass transportation, air traffic control
- Law enforcement agency bankroll will swell to \$600 million from last year's \$480 million
- New, businesslike Postal Service will receive a 10% to 20% increase in its funding for R&D

□ From the point of view of Government spending, it makes little difference whether 1971 is measured with a conventional Gregorian or fiscal calendar: the outlook for the six months beginning now is not as good as the Administration had hoped. For fiscal 1971, which ends June 30, the most optimistic forecasts for Federal electronics spending see no more than a stabilizing effect in areas outside defense and space. And with sharp cuts in procurement of tactical hardware continuing as the Administration tries to put a lid on the Southeast Asian war, the gains predicted in federally funded civilian sectors cannot take up the slack. White House fears of a \$15 billion to \$20 billion fiscal 1972 budget deficit, piled atop the larger loss forecast for the current year, are leading to wholesale slashes in many Federal programs. Yet two transportation efforts with a high percentage of electronics spending are expected to buck the trend.

Supporting those exceptions—urban mass transit and air traffic control—is the Department of Transportation

legislation signed last year by the President.

On the air traffic control front, the Airport and Airways Development Act says that at least \$250 million a year will be authorized for acquisition of computers, radars, and instrument landing systems needed to un-snarl the nation's air traffic during the 1970s. And since money for equipment will come out of a trust fund stocked by an airline ticket tax, little trouble is expected in obtaining appropriations.

The \$250 million floor represents a \$60 million gain over the \$190 million appropriated this fiscal year for ATC facilities and equipment. And most of the big money will go into increasing automation at terminals and en route air traffic control centers, FAA officials say. Much of the money that is left, they add, will go into a competitive purchase of 40 more medium-density instrument landing systems.

The \$60 million increase, however, will not go as far as would be expected, FAA sources warn. In fact, due to tight budgets, en route and terminal control

centers didn't get all their equipment.

In the 22 en route centers, IBM's computers will have to be modified to generate the alphanumeric tags that identify planes. This feature, which was proposed for the en route displays in the early 1960s, was stripped from the system because of tight money. The FAA also plans to begin work on adding conflict prediction and resolution capabilities to the en route centers after July 1. IBM is a likely candidate.

Also in the FAA's plans for fiscal 1972 is the addition of primary radar tracking to its Automated Radar Terminal System (ARTS). Univac is developing the primary tracking capability with its own funds under an informal agreement with the FAA. The feature is expected to add \$10 million to \$12 million to the \$35 million cost of the 64 ARTS installations.

The FAA also hopes to buy 20 ARTS 2 systems from Univac after June 30, at an estimated cost of \$4 million. Designed for lower-density airports, ARTS 2 lacks ARTS 3's radar tracking.

Meanwhile, the FAA is plugging hard for vast increases in its \$46 million R&D budget. FAA sources note that just keeping the doors open at the agency's Atlantic City, N.J., R&D center costs \$25 million. Combined with the FAA's \$6 million tab for the newly acquired Transportation Systems Center formerly occupied by NASA, only \$15 million remains for actual R&D expenditures on automating terminal and en route centers, and developing badly needed ATC aids.

As a result, Gustav Lundquist, the FAA's associate administrator for development, plans to ask Congress for \$150 million R&D funds for fiscal 1972, the bulk of which would be spent on electronics efforts. Airline sources point out, however, that in making budgetary estimates, fact must be separated from fancy. They predict that if the FAA asked for \$150 million, it will get between \$110 million and \$120 million.

While the FAA will be the largest electronics buyer in the Government outside of NASA and the Pentagon this year, a sister agency in the Department of Transportation—the Urban Mass Transportation Administration—is beginning a growth spiral that someday will put it in the FAA's league. The agency's growth is the result of legislation giving it \$800 million a year.

At present, most UMTA money is spent on conventional rail and bus systems, with only a small amount for electronics. But as UMTA's research team develops more sophisticated hardware to meet the cities' needs, more will be spent on computer traffic control and subway command and control.

Robert Hemmes, the electrical engineer who runs UMTA's development efforts, points out that his agency will spend \$13.1 million in fiscal 1971 and \$20 million in fiscal 1972, building one or two pilot systems designed for use in urban cores.

Other pilot projects with large electronics potential scheduled for competitive 1971 awards are: the computer-controlled dial-a-bus, a dynamically routed system that would permit users to get door-to-door bus service by telephoning a dispatcher; an electronic signal device that would allow buses to slip through traffic lights by changing them from red to green; an automated bus fare collection system; an onboard data

recorder that would store maintenance information for buses, and advanced monitoring and communications units for rail systems.

Outside of DOT and the FAA, Government electronics spending plans for 1971 fall off sharply. One average estimate of outlays in fiscal 1972 puts spending at about \$654 million for the combined efforts of the Departments of Health, Education, and Welfare; Housing and Urban Development; Interior; Justice; and the Commerce Department with its Environmental Sciences Services Administration. The Electronic Industries Association's requirements committee, which put together the estimates, admits that "the figures are very soft," indicating industry's own lack of intelligence in these comparatively small and relatively unexplored Federal markets.

What's more, some departments and their subordinate agencies maintain no records for their expenditures on technology. Much of the money goes to industry and the academic community under R&D grants; another large chunk is spent on demonstration programs for state and local governments, which usually must come up with matching funds. Industry finds it hard to track expenditures in the latter category.

Among the largest in percentage of electronics is the Justice Department's Law Enforcement Assistance Administration (LEAA) with its present bankroll of \$480 million. This is expected to rise sharply in the new fiscal year—although not double again, as it did last year. Present estimates run between \$600 million and \$660 million. But LEAA, apart from its effort to develop a standard police transceiver, spends most of its money in block grants to the states—some \$340 million—where the tendency is to spend it for either more police and police training, or patrol vehicles and nightsticks. This fiscal year, for example, LEAA will lay out \$26 million for planning—including some systems analysis studies which can be contracted to high-technology companies; \$7.5 million for R&D;

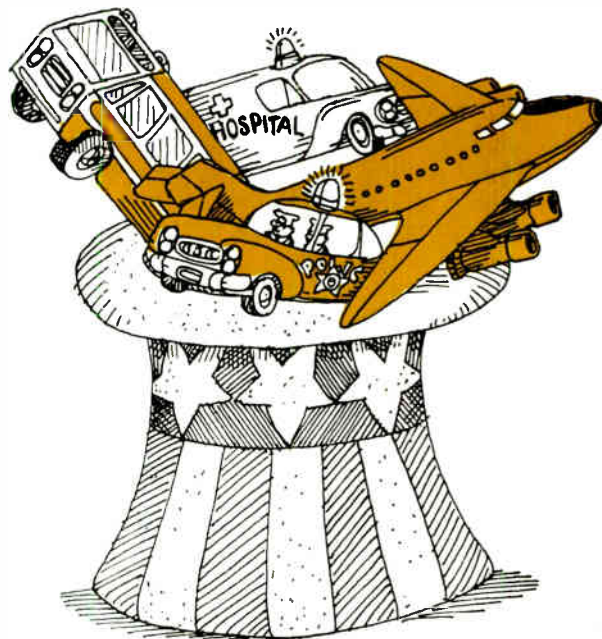

and \$8 million equally divided between technical assistance to state and local jurisdictions and its computerized criminal justice information and statistics programs. This \$41.5 million total, a bit less than 10% of the LEAA appropriation, is where electronics companies are likely to find most of their contract money.

At the sprawling Department of Health, Education, and Welfare, whose nearly \$60 billion budget is second only to the Defense Department's, an official admits with some embarrassment, "I don't think anyone really knows what we spend on electronics altogether. HEW doesn't keep records that way." At lower levels, however—notably in the Office of Education and the National Institutes of Health—better estimates are available. Education, for example, spends about \$250 million of its \$3.5 billion budget on electronics.

Yet only a very small amount of this sum comes from the research and development budget of the Education Office. That budget, in turn, amounts to less than half the total estimated electronics expenditure.

Of the remainder of funds designated "electronics," an estimated \$100 million goes to local jurisdictions for discretionary purchase of conventional hardware.

Another \$50 million to \$60 million filters through organizations such as the 20 regional laboratories established and funded by HEW. One of these, the Far West Laboratory, is funding a four-year, three-step program to study and design a computerized educational research information network.

On the medical side, HEW's National Institutes of Health are expected to offer a better growth market than education. Yet this could be overshadowed by a substantial Nixon Administration commitment to broader public health services, including perhaps a form of national health insurance. However, complaints persist in NIH that the Administration "has no plan to speak of," as one ranking staff chief puts it.

Funding for biomedical instrumentation is expected to progress at an unchanged pace in 1971 with the Institute of Environmental Health Sciences and Heart and Lung Institute spending \$24 million to \$30 million, plus an estimated \$1.7 billion throughout HEW for collaborative R&D with outside organizations. But, again, most R&D money will continue to flow to university medical schools and nonprofit research groups.

Though the Environmental Science Services Administration (ESSA) and the National Bureau of Standards (NBS) are the prime areas of electronics interest within the Commerce Department, no significant changes in activity affecting industry are forecast for 1971. ESSA's R&D funds will rise almost \$5.4 million to nearly \$29.7 million.

Typical of the modest and widely dispersed ESSA R&D programs is its satellite sensor effort, raised this year to \$1.1 million via a \$117,000 increase in funds. ESSA will fund studies of, and experiments in, atmospheric effects on microwave transmission.

On the procurement side, ESSA's big procurement spending for electronics falls into two satellite programs. First is \$3 million for initial funding of the F and G models of the improved Tiros system (I-TOS) to be launched in 1972 and 1973, respectively, follow-

Stamp of money

It's not exactly a government agency, but then again it's not a private firm. No matter what you call it, though, the recently reorganized U.S. Postal Service promises to become a solid electronics market in the years ahead. Because the service lagged in developing new systems before it was reorganized last year, little of the \$10 billion it is authorized to borrow will go toward purchases of off-the-shelf electronic systems this year.

But the service's board of governors, which shows strong signs of acting like the businesslike group it is supposed to be, probably will approve a 10% to 20% increase in the service's \$63 million research and engineering budget for the fiscal year beginning in July. Much of the money is expected to be spent on computers, optical readers, and other devices.

Toward the end of the year, IBM and Recognition Equipment Inc. of Dallas will deliver prototypes of advanced OCR readers that will undergo field tests in early 1972. If the machines test out, orders may begin to roll in. Meanwhile, the Post Office is asking industry for proposals on bar-code readers.

On a smaller scale, teams of postal industrial engineers are now studying the 125 largest post offices to determine what small steps can be taken to increase efficiency. Harold Faught, Assistant Postmaster General for Research and Engineering, says the Postal Service is studying many small-scale systems—some of them electronic—to improve the flow of mail through postal facilities in the short term. Also under development are sophisticated vending machines that can automate over-the-counter operations.

ing NASA's upcoming launch of RCA's Tiros-M. I-TOS models A through E already are fully funded. The F and G models will require an additional \$4.2 million a year for a total cost of \$11 million. Second on ESSA's list is a \$1.2 million increment of the \$5.3 million planned for the first geostationary operational environmental satellite (GOES-A), the ESSA follow-on in 1975 to NASA's synchronous meteorological satellites.

The electronics potential from two new organizations, the Environmental Protection Agency (EPA) and the National Oceanographic and Atmospheric Administration (NOAA) is small.

EPA Director William Ruckelshaus, a former Justice Department staffer, heads a far more popular body although he is in the embarrassing position of spending more in 1971 than the Administration wants. Congress plans to give him \$275 million for the National Air Pollution Control Administration (NAPCA) that EPA took over from HEW: the figure is far more than the \$106 million Nixon request. Similarly, the Federal Water Quality Administration (FWQA) which EPA inherited from the Interior Department, will get most of the \$1 billion appropriated for waste treatment; the administration sought only \$50 million. □

Reprints of the 1971 U.S. markets report, combined with the 1971 European report, are available at \$5 each. Write to Electronics Reprint Department, P.O. Box 606, Hightstown, N.J.
© Copyright 1971, Electronics®, A McGraw-Hill Publication.

Industrial and Commercial Markets

| | (millions of dollars) | | |
|--|-----------------------|-----------------|-----------------|
| | 1970 | 1971 | 1974 |
| INDUSTRIAL AND COMMERCIAL TOTAL | 9,417.5 | 10,178.1 | 13,673.3 |
| Test and measuring instruments, total | 716.2 | 759.0 | 1,012.9 |
| Spectrum Analyzers, below | | | |
| microwave frequencies | 12.9 | 13.3 | 21.7 |
| Frequency synthesizers | 10.2 | 11.7 | 20.8 |
| Function generators | 4.8 | 6.0 | 11.5 |
| Signal generators | 19.7 | 20.5 | 25.3 |
| Sweep generators, below | | | |
| microwave frequencies | 7.6 | 8.3 | 11.7 |
| Pulse Generators, below | | | |
| microwave frequencies | 10.8 | 12.0 | 16.9 |
| Oscillators, below microwave frequencies | 20.4 | 21.3 | 26.1 |
| Waveform Analyzers & Distortion Meters | 5.3 | 5.9 | 8.4 |
| Counters, time and frequency | 29.6 | 31.0 | 40.2 |
| Timers, electronic | 72.3 | 75.7 | 90.0 |
| Panel Meters, total | 45.9 | 47.4 | 51.9 |
| Analog | 40.8 | 41.5 | 40.0 |
| Digital | 5.1 | 5.9 | 11.9 |
| Noise Measuring Equipment, below microwave frequencies | 12.1 | 13.8 | 17.0 |
| Frequency Measuring Instruments, except counters | 13.2 | 14.3 | 16.8 |
| Analog Voltmeters, Ammeters & Multimeters electronic below microwave frequencies | 10.3 | 9.7 | 7.8 |
| Digital Voltmeters & Volt meters, total | 28.1 | 29.2 | 46.6 |
| 3½ digit | 6.4 | 6.9 | 15.1 |
| 4½ digit and above | 21.7 | 22.3 | 31.5 |
| Power Meters, below microwave frequencies | 6.1 | 6.7 | 10.2 |
| Impedance Measuring Equipment, below microwave frequencies | 13.9 | 14.7 | 18.0 |
| Calibrators and Standards active & passive | 13.8 | 15.1 | 20.9 |
| Oscilloscopes, main frame only | 110.3 | 112.8 | 140.8 |
| Oscilloscope Accessories and Plug-ins | 23.6 | 26.2 | 37.9 |
| Recording Instruments, digital & analog, total | 70.1 | 74.0 | 96.4 |
| Magnetic Tape | 41.7 | 43.0 | 52.4 |
| Strip Chart | 23.3 | 25.2 | 34.8 |
| X-Y | 5.1 | 5.8 | 9.2 |
| Component Testers (capacitor, transistor, tube, integrated electronics, etc.) | 29.7 | 32.3 | 54.8 |
| Power Supplies, lab type | 56.4 | 60.2 | 79.6 |
| Amplifiers, lab type | 6.3 | 6.8 | 10.2 |

| | | | |
|---|--------------|--------------|--------------|
| Microwave measuring equipment, total | 82.8 | 90.1 | 131.4 |
| Microwave phase measuring equipment | 6.0 | 6.7 | 10.8 |
| Microwave impedance measuring equipment | 13.2 | 14.1 | 19.4 |
| Microwave power measuring equipment | 4.4 | 4.9 | 7.8 |
| Spectrum analyzers | 17.3 | 19.2 | 25.7 |
| Frequency measuring and analysis | 9.4 | 10.3 | 14.2 |
| Microwave noise measuring equipment | 5.5 | 6.4 | 10.5 |
| Signal generators | 15.7 | 16.2 | 23.0 |
| Sweep generators | 8.4 | 9.1 | 14.6 |
| Field intensity meters and test receivers | 2.9 | 3.2 | 5.4 |
| Medical equipment, total | 374.5 | 411.5 | 544.8 |
| Diagnostic Equipment, total | 249.4 | 273.6 | 354.1 |
| X-Ray, Fluoroscopic Equipment | 191.0 | 208.0 | 267.0 |
| Electroencephalographs | 8.3 | 9.5 | 10.8 |
| Electrocardiographs | 19.1 | 21.7 | 26.1 |
| Ultrasonic Equipment | 6.1 | 7.1 | 10.7 |
| Radioactive Tracer Equipment | 13.2 | 14.7 | 22.6 |
| Electron Microscopes | 11.7 | 12.6 | 16.9 |
| Patient Monitoring Systems | 23.6 | 27.4 | 40.5 |
| Prosthetic Equipment, total | 66.9 | 70.7 | 97.0 |
| Hearing Aids | 52.1 | 54.0 | 71.2 |
| Pacemakers | 14.8 | 16.7 | 25.8 |
| Therapeutic Equipment, total | 34.6 | 39.8 | 53.2 |
| X-Ray Equipment, Therapeutic | 22.5 | 25.1 | 30.4 |
| Ultrasonic Equipment | 5.4 | 6.6 | 9.7 |
| Diathermy, shortwave & microwave | 3.7 | 4.2 | 6.1 |
| Defibrillators | 3.0 | 3.9 | 7.0 |
| Nuclear instruments & equipment, total | 207.3 | 218.5 | 309.7 |
| Pulse analysis instrumentation | 19.3 | 21.2 | 25.3 |
| Power Supplies for Nuclear Equipment | 10.1 | 10.8 | 18.2 |
| Personal Dosimeters | 2.6 | 2.8 | 4.1 |
| Radiation Monitoring Portable | | | |
| Survey Instruments | 4.1 | 4.7 | 6.2 |
| Radiation Monitoring Fixed Position | 4.7 | 5.3 | 8.2 |
| Detectors (all, separate unit or part of system), total | 9.2 | 10.0 | 15.6 |
| Solid state (Semiconductors, scintillation crystals, and organic phosphors) | 4.9 | 5.4 | 7.3 |
| Tubes (Geiger gas ilcw, BF ₃) | 3.3 | 3.5 | 6.1 |
| Ionization Chambers | 1.0 | 1.1 | 2.2 |
| Reactor Controls | 23.0 | 24.1 | 31.4 |
| Nuclear gauging and processing | 78.1 | 82.0 | 112.0 |
| Nuclear Instruments & Equipment, other | 56.2 | 57.6 | 88.7 |

| | 1970 | 1971 | 1974 |
|---|----------------|----------------|----------------|
| Computers & related equipment, total | 4,754.4 | 5,285.2 | 7,029.3 |
| Digital Computers, except process control | 3,490.0 | 3,885.0 | 4,925.0 |
| Analog Computers, except process control | 58.7 | 64.8 | 81.0 |
| Hybrid Computers, except process control | 42.5 | 46.0 | 74.8 |
| Input-Output Equipment, total | 505.6 | 560.7 | 838.2 |
| Electromechanical Devices, total | 287.5 | 316.9 | 421.8 |
| Card Readers | 78.3 | 83.4 | 105.9 |
| Readers, paper tape | 39.2 | 42.7 | 49.8 |
| Card punches | 105.4 | 108.0 | 130.1 |
| Impact Printers | 31.5 | 40.6 | 67.4 |
| Keyboards | 22.8 | 28.3 | 48.6 |
| Electromechanical readout devices, other | 10.3 | 13.9 | 20.0 |
| Electronic Devices, total | 218.1 | 243.8 | 416.4 |
| Digital Displays | 30.5 | 34.4 | 53.7 |
| CRT Displays | 46.2 | 53.3 | 82.5 |
| Non-impact printers | 10.1 | 14.5 | 29.8 |
| Audio output equipment | 2.3 | 4.9 | 10.4 |
| Character recognition equipment (optical, magnetic, etc.) | 129.0 | 136.7 | 240.0 |
| Mass Storage Memories, total | 319.3 | 345.9 | 511.0 |
| Core Memories | 48.7 | 56.3 | 69.8 |
| Magnetic Tape Machinery | 73.0 | 78.6 | 110.0 |
| Magnetic Drum Memories | 39.2 | 43.7 | 53.2 |
| Magnetic Disc Drives | 158.4 | 167.3 | 278.0 |
| Remote Terminal Equipment, total | 300.5 | 332.6 | 485.3 |
| Terminals | 183.0 | 204.6 | 285.0 |
| Couplers | 117.5 | 128.0 | 200.3 |
| Electronic desk calculators | 37.8 | 50.2 | 114.0 |

| | | | |
|---|----------------|----------------|----------------|
| Communications equipment, total | 1,905.8 | 1,979.4 | 2,633.0 |
| Radio, total | 559.3 | 569.3 | 745.9 |
| Airborne including ground links | 149.3 | 141.0 | 202.5 |
| Land Mobile | 216.1 | 225.4 | 256.0 |
| Marine Radio | 24.7 | 26.1 | 35.3 |
| Microwave Relay | 113.4 | 117.6 | 168.0 |
| Amateur Equipment | 21.6 | 23.2 | 37.7 |
| Citizens Band Equipment | 34.2 | 36.0 | 45.3 |
| Navigation, total | 161.9 | 173.4 | 288.1 |
| Radar | 98.2 | 105.8 | 180.0 |
| Other navigational aids (Sonar, Loran VDR) | 63.7 | 67.6 | 108.1 |
| Terminal & Switching | 240.0 | 247.3 | 299.0 |
| Carrier Current | 26.8 | 29.9 | 44.7 |
| Intercom | 101.3 | 106.7 | 119.6 |
| Commercial Sound & P.A. | 223.8 | 227.6 | 206.0 |
| A-M Station Equipment | 16.5 | 17.8 | 21.7 |
| F-M Station Equipment | 15.9 | 17.5 | 24.0 |
| TV Station Equipment | 138.9 | 142.8 | 162.4 |
| Facsimile | 39.6 | 44.3 | 76.5 |
| Telemetry | 211.5 | 215.0 | 256.0 |
| Modems | 83.7 | 97.6 | 205.4 |
| CATV Equipment | 86.6 | 90.2 | 185.4 |
| Lasers & equipment, total | 68.1 | 74.8 | 136.9 |
| Gas Lasers | 43.6 | 47.0 | 80.0 |
| Solid State Lasers, incl. Ruby Lasers | 3.9 | 4.5 | 6.4 |
| Semiconductor Lasers | 6.0 | 7.3 | 20.2 |
| Liquid Lasers | 3.1 | 3.4 | 7.7 |
| Laser Power Supplies | 5.6 | 6.4 | 9.9 |
| Auxiliary laser equipment, incl. nonlinear crystals | 5.9 | 6.2 | 3.7 |
| Closed circuit television equipment, total | 77.3 | 81.9 | 142.7 |
| Industrial CCTV | 37.2 | 39.5 | 66.0 |
| Educational CCTV | 27.1 | 28.2 | 55.4 |
| Theater CCTV | 4.4 | 5.1 | 10.5 |
| Medical CCTV | 8.6 | 9.1 | 17.8 |
| Dictating devices (for business) | 107.3 | 108.0 | 125.0 |

| | | | |
|--|----------------|----------------|----------------|
| Power supplies, OEM type | 84.6 | 86.3 | 119.0 |
| Industrial operations electronic equipment, total | 1,122.0 | 1,173.5 | 1,613.0 |
| Motor Speed Controls | 61.4 | 62.5 | 82.5 |
| Welding Controls | 25.3 | 26.0 | 32.3 |
| Power Supplies (complete equipment) | 132.7 | 135.3 | 170.0 |
| Photoelectric gauges and controls | 20.5 | 22.1 | 35.3 |
| Cryogenic Equipment | 68.4 | 70.3 | 97.4 |
| Ultrasonic Cleaning Equipment | 19.2 | 20.4 | 28.7 |
| Ultrasonic Testing Equipment | 24.3 | 26.5 | 40.8 |
| Infrared inspection and gauging equipment | 44.8 | 46.3 | 61.0 |
| X-Ray inspection and gauging equipment | 35.3 | 37.9 | 48.8 |
| Process Control Computer Systems, total | 341.5 | 352.6 | 468.6 |
| Process Control Computer Systems, analog | 91.8 | 96.9 | 144.0 |
| Process Control Computer Systems, digital | 248.3 | 253.7 | 320.5 |
| Process Control Computer Systems, hybrid | 1.4 | 2.0 | 4.1 |
| Peripheral Equipment | 85.1 | 92.7 | 133.7 |
| Converters, A to D | 26.0 | 28.4 | 43.8 |
| Converters, D to A | 21.2 | 23.0 | 28.7 |
| Production data-gathering systems | 13.2 | 15.0 | 27.4 |
| Process control operator consoles, complete | 24.7 | 26.3 | 33.8 |
| Machine Tool Controls, total | 81.1 | 86.0 | 101.0 |
| Point-to-Point Control Systems | 45.6 | 48.3 | 70.6 |
| Continuous Contouring Systems | 35.5 | 37.7 | 59.5 |
| Electronic controllers and programmers | 49.0 | 53.2 | 75.8 |
| Electric actuators and solenoid valves | 50.4 | 52.3 | 63.4 |
| Indicators, Industrial | 8.7 | 10.1 | 15.1 |
| Recorders, Industrial | 64.3 | 66.7 | 84.3 |
| Pollution Monitoring Systems (data gathering portion) | 10.1 | 12.6 | 23.7 |

U.S. Markets 1971 Forecast

Market estimates represent U.S. factory sales and are based on an *Electronics* survey. In certain cases, product categories have been added, deleted, or redefined; these market totals are not directly comparable to those of previous years.

Federal Electronics

| (millions of dollars) | 1970 | 1971 | 1974 |
|---|---------------|---------------|---------------|
| FEDERAL ELECTRONICS, TOTAL | 10,628 | 10,063 | 12,540 |
| Department of Defense, electronics portion, total | 9,245 | 8,885 | 11,125 |
| Procurement, total | 4,670 | 4,485 | 6,000 |
| Communications | 1,010 | 965 | 1,325 |
| Aircraft | 1,325 | 1,200 | 1,775 |
| Missiles | 1,385 | 1,405 | 1,810 |
| Mobile and ordnance | 365 | 345 | 415 |
| Ships | 585 | 570 | 675 |
| Research, development, test and evaluation | 2,475 | 2,400 | 2,800 |
| Operations and Maintenance | 2,100 | 2,000 | 2,325 |
| NASA, electronics portion | 1,200 | 985 | 1,110 |
| FAA, electronics portion | 116 | 125 | 225 |
| AEC, electronics portion | 68 | 68 | 80 |

Consumer Electronics

| (millions of dollars) | 1970 | 1971 | 1974 |
|--|----------------|----------------|----------------|
| CONSUMER ELECTRONICS, TOTAL | 3,895.5 | 4,202.0 | 5,303.3 |
| Television receivers, total | 1,992.0 | 2,241.2 | 3,038.0 |
| Monochrome TV | 408.0 | 401.2 | 348.0 |
| Color TV | 1,584.0 | 1,840.0 | 2,690.0 |
| Radios, total | 543.0 | 585.0 | 687.0 |
| Home A-M and F-M radios | 263.0 | 270.0 | 315.0 |
| Automobile A-M and F-M radios | 280.0 | 315.0 | 372.0 |
| Tape recorders and players, total | 551.9 | 557.9 | 663.5 |
| Automobile cassette players | 23.7 | 29.0 | 74.0 |
| Automobile 4-track and 8-track players | 98.4 | 82.3 | 55.8 |
| Home/office cartridge players/recorders | 187.5 | 195.2 | 225.0 |
| Open reel tape recorders | 84.3 | 80.6 | 62.7 |
| Recording tape (non-industrial) | 158.0 | 170.8 | 246.0 |
| Home Video players/recorders | 7.8 | 9.0 | 24.5 |
| Hi-fi audio components (amplifiers, receivers, speakers, tuners) | 158.4 | 162.5 | 192.3 |
| Phonographs | 425.0 | 418.3 | 385.0 |
| Electronic organs | 101.0 | 103.0 | 112.0 |
| Guitar amplifiers | 35.4 | 37.6 | 44.3 |
| Kits | 59.0 | 62.4 | 78.5 |
| Garage door openers (control devices only) | 14.1 | 15.3 | 40.0 |
| Automotive electronics | 7.9 | 9.8 | 38.2 |

COMPONENTS

(millions of dollars)

| | 1970 | 1971 | 1974 |
|---|----------------|----------------|----------------|
| COMPONENTS, total | 4,567.0 | 4,731.6 | 5,952.5 |
| Antennas & antenna hardware, total | 407.5 | 413.8 | 526.0 |
| Capacitors, total | 434.3 | 459.7 | 541.1 |
| Paper Capacitors | 56.3 | 59.4 | 65.3 |
| Film Capacitors | 71.4 | 77.6 | 99.5 |
| Electrolytic Capacitors, total | 191.1 | 199.0 | 229.4 |
| Aluminum | 92.3 | 96.7 | 107.0 |
| Tantalum | 98.8 | 102.3 | 122.4 |
| Mica Capacitors | 22.1 | 23.4 | 23.0 |
| Glass & Vitreous Enamel Capacitors | 9.4 | 9.0 | 8.0 |
| Ceramic Capacitors | 62.7 | 68.3 | 87.2 |
| Variable Capacitors | 21.3 | 23.0 | 28.7 |
| Connectors, total | 326.1 | 344.1 | 464.2 |
| Coaxial Connectors, standard size | 27.1 | 29.0 | 38.5 |
| Coaxial Connectors, miniature | 17.2 | 18.4 | 25.8 |
| Cylindrical Connectors | 93.6 | 96.2 | 139.7 |
| Rack and Panel Connectors | 76.7 | 78.9 | 98.9 |
| Special Purpose & Fused Connectors | 49.3 | 52.8 | 69.8 |
| Printed Circuit Connectors, total | 59.5 | 64.9 | 87.1 |
| Card Insertion types | 27.6 | 29.0 | 30.9 |
| Two-Piece type (metal to metal) | 19.8 | 22.7 | 29.0 |
| Plate Module type | 12.1 | 13.2 | 19.2 |
| Dual in line packaged sockets | 3.2 | 3.9 | 5.0 |
| Delay lines | 17.3 | 19.7 | 27.4 |
| Electromechanical devices, total | 540.1 | 558.1 | 743.3 |
| Encoders & Decoders | 39.5 | 43.0 | 77.8 |
| Fractional Horsepower Motors | 384.0 | 391.4 | 502.3 |
| Motor generators | 16.1 | 17.0 | 21.2 |
| Resolvers | 8.8 | 9.2 | 12.4 |
| Servo Motors | 30.3 | 31.4 | 41.5 |
| Solenoids | 21.7 | 23.0 | 37.7 |
| Stepper Motors, all types | 19.2 | 23.5 | 32.0 |
| Synchros | 20.5 | 19.6 | 18.4 |
| Electron tubes, total | 1,212.7 | 1,221.9 | 1,402.0 |
| Receiving Tubes | 187.5 | 173.0 | 136.0 |
| Power and Special Purpose Tubes, total | 347.0 | 347.9 | 373.6 |
| High-Vacuum Tubes | 56.7 | 55.6 | 51.0 |
| Gas and Vapor Tubes | 20.1 | 19.0 | 18.8 |
| Klystrons | 35.3 | 36.2 | 34.2 |
| Magnetrons | 34.9 | 32.8 | 30.7 |
| TWT's including backward wave types | 60.3 | 59.1 | 57.7 |
| Light-Sensing Tubes | 38.2 | 39.1 | 48.6 |
| Image-Sensing Tubes (Including TV Camera Tubes) | 33.6 | 34.7 | 42.3 |
| Storage Tubes | 18.1 | 17.7 | 21.5 |
| Light-Emitting Tubes | 20.3 | 21.8 | 28.7 |
| Silicone-Diode Array Tubes | 0.6 | 0.8 | 2.8 |
| Display Tubes, except cathode ray | 9.3 | 10.1 | 14.2 |
| Cathode Ray Tubes, except TV | 19.6 | 21.0 | 25.6 |
| TV Picture Tubes, black-and-white | 71.2 | 70.0 | 67.4 |
| TV Picture Tubes, color | 607.0 | 631.0 | 825.0 |

| | 1970 | 1971 | 1974 |
|---|----------------|----------------|----------------|
| Ferrite devices, total | 312.7 | 319.0 | 409.5 |
| Computer Cores | 21.0 | 22.3 | 39.0 |
| Transformers & Chokes, except TV | 209.2 | 211.0 | 262.4 |
| TV Ferrite Components, including yokes, flybacks | 70.4 | 72.7 | 90.3 |
| Coils | 12.1 | 13.0 | 17.8 |
| Filters, electronic, total | 75.5 | 85.8 | 119.5 |
| Passive Filters | 41.4 | 43.8 | 56.0 |
| Crystal Filters | 27.0 | 31.3 | 40.2 |
| Active Filters | 7.1 | 10.7 | 23.3 |
| Loudspeakers | 110.7 | 112.4 | 133.0 |
| Magnetic recording mediums, total | 211.4 | 228.9 | 336.4 |
| Audio Tape | 63.6 | 67.4 | 105.0 |
| Instrument Tape | 37.4 | 39.0 | 52.7 |
| Video Tape | 35.6 | 39.2 | 51.5 |
| Computer Tape | 74.8 | 83.3 | 127.2 |
| Printed circuits, total | 273.8 | 295.6 | 415.0 |
| Single-layer Boards | 103.5 | 107.2 | 126.3 |
| Two-layer Boards | 110.3 | 121.0 | 151.7 |
| Multilayer Boards | 60.0 | 67.4 | 137.0 |
| Quartz crystal (including mounts and ovens) | 49.6 | 53.0 | 68.2 |
| Resistors, total | 340.7 | 358.8 | 414.8 |
| Fixed Resistors, Total | 190.2 | 195.1 | 216.3 |
| Composition Resistors, fixed | 72.4 | 74.0 | 75.3 |
| Deposited Carbon Resistors, fixed | 17.1 | 16.7 | 14.7 |
| Metal Film Resistors, fixed | 48.7 | 50.3 | 61.3 |
| Wirewound Resistors, fixed | 52.0 | 54.1 | 65.0 |
| Potentiometers, Total | 137.1 | 140.8 | 168.0 |
| Wirewound Potentiometers | 55.6 | 57.2 | 71.3 |
| Non-Wirewound Potentiometers | 81.5 | 83.6 | 94.7 |
| Other Resistors (including varistors and thermistors) | 21.4 | 23.0 | 32.0 |
| Relays, total | 246.6 | 260.7 | 352.0 |
| Solid-State Relays | 17.1 | 20.4 | 43.2 |
| Electromagnetic Relays, Total | 101.6 | 109.9 | 141.0 |
| Contact Meter Relays | 5.1 | 5.3 | 4.9 |
| Crystal Can Relays | 26.5 | 27.8 | 31.4 |
| Dry Reed Relays | 23.0 | 25.4 | 40.8 |
| Mercury Wetted Relays | 14.3 | 15.7 | 23.0 |
| Resonant Reed Relays | 1.6 | 2.1 | 4.1 |
| Telephone Type Relays | 27.0 | 28.7 | 30.4 |
| Thermal Relays | 4.1 | 4.9 | 6.4 |
| Other Relays | 127.9 | 130.4 | 167.8 |
| Semiconductors, total | 1,266.1 | 1,301.2 | 1,723.5 |
| Discrete, conventional devices, total | 492.5 | 471.2 | 383.3 |
| Transistors, total | 364.2 | 353.4 | 291.3 |
| Transistors, silicon, bipolar, total | 270.1 | 260.3 | 212.5 |
| Small signal (less than 1 watt power dissipation) | 191.4 | 186.5 | 157.8 |
| Power (1 watt dissipation or more) | 78.7 | 73.8 | 54.7 |
| Transistors, germanium bipolar | 68.9 | 64.2 | 29.3 |
| Transistors, field effect | 18.7 | 21.6 | 36.8 |
| Transistors, unijunction | 6.5 | 7.3 | 12.7 |
| Diodes, total | 128.3 | 117.8 | 92.0 |
| Germanium diodes | 24.0 | 20.2 | 9.3 |

| Semiconductors continued | 1970 | 1971 | 1974 |
|---|--------------|--------------|--------------|
| Silicon diodes | 104.3 | 97.6 | 87.7 |
| Discrete, special devices, total | 185.9 | 193.3 | 252.4 |
| Thyristors (SCR's 4 layer diodes, etc.) | 64.7 | 69.6 | 89.8 |
| Tunnel diodes | 4.9 | 4.7 | 4.3 |
| Microwave diodes | 19.6 | 21.2 | 39.7 |
| Varactor diodes | 9.1 | 9.6 | 15.2 |
| Zener diodes | 54.2 | 56.1 | 63.0 |
| Microwave transistors | 8.1 | 9.2 | 21.8 |
| Multiple devices (duals, diode arrays) | 25.3 | 22.9 | 18.6 |
| Monolithic Integrated Circuits, total | 431.7 | 470.4 | 848.0 |
| Linear IC's, total | 83.7 | 91.4 | 180.0 |
| Operational amplifier type | 33.7 | 37.4 | 63.0 |
| Other | 50.0 | 54.0 | 117.0 |
| Digital IC's, total | 348.0 | 379.0 | 668.0 |
| MOS, total | 68.0 | 102.0 | 360.0 |
| Small scale integration (less than 12 gates) | 12.0 | 22.0 | 60.0 |
| Medium scale integration (12 to 100 gates) | 18.0 | 30.0 | 80.0 |
| Large scale integration (100 gates or more) | 38.0 | 50.0 | 220.0 |
| Bipolar, total | 280.0 | 277.0 | 308.0 |
| Small scale integration (less than 12 gates) | 232.5 | 230.0 | 238.0 |
| Medium scale integration (12 to 100 gates) | 47.5 | 47.0 | 70.0 |
| Optoelectronic devices | 35.9 | 41.7 | 79.7 |
| Photovoltaic (solar) cells | 6.3 | 7.8 | 10.4 |
| Photoconductive cells | 9.3 | 10.6 | 16.5 |
| Light emitting diodes | 2.9 | 5.0 | 9.3 |
| Photodiodes | 5.2 | 6.1 | 11.0 |
| Phototransistors | 7.0 | 7.8 | 16.2 |
| Special optoelectronic devices (isolators, switches) | 2.1 | 2.8 | 6.3 |
| Bar Segment Devices (incandescent & electroluminescent) | 1.9 | 2.3 | 4.1 |
| Light-Emitting diode displays | 1.2 | 2.1 | 5.9 |
| Rectifiers, Solid State | 120.1 | 124.6 | 160.1 |
| Rectifiers, silicon | 93.4 | 97.6 | 122.8 |
| Rectifiers, selenium and copper oxide | 12.0 | 11.4 | 10.3 |
| Rectifier assemblies | 14.7 | 15.6 | 27.0 |
| Switches, mechanically actuated, total | 188.5 | 208.8 | 292.7 |
| Coaxial Switches | 7.8 | 8.6 | 12.8 |
| Pressure Switches | 19.7 | 21.0 | 26.3 |
| Pushbutton Switches | 31.4 | 35.8 | 57.2 |
| Rotary Switches | 33.1 | 36.0 | 52.8 |
| Snap-Action Switches | 50.5 | 56.8 | 73.7 |
| Thumbwheel | 6.3 | 7.6 | 10.4 |
| Toggle, mercury, knife, misc. | 26.6 | 28.0 | 37.6 |
| Stepping Switches | 13.1 | 15.0 | 21.9 |
| Transducers, total | 101.0 | 106.4 | 143.9 |
| Pressure Transducers | 30.5 | 32.1 | 40.8 |
| Position Transducers | 28.4 | 30.2 | 41.4 |
| Strain Transducers | 29.6 | 31.0 | 46.5 |
| Acceleration Transducers | 12.5 | 13.1 | 15.2 |
| Wire & Cable, total | 356.8 | 371.4 | 440.0 |
| Coaxial Cable | 71.4 | 73.3 | 86.7 |
| Flat and Flexible Printed Circuit Cable | 32.3 | 35.2 | 48.8 |
| Hook-up Wire | 154.3 | 158.6 | 160.5 |
| Magnet Wire | 98.8 | 104.3 | 144.0 |

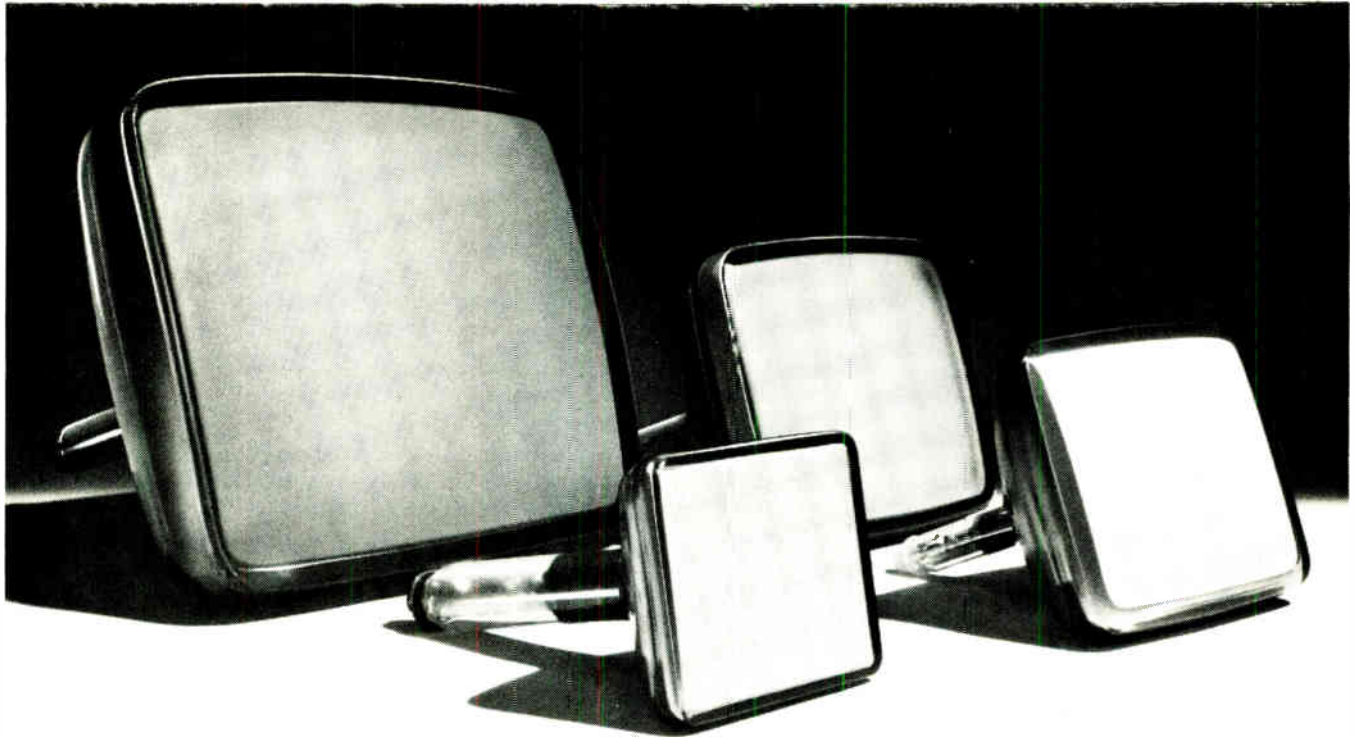

Eyes For Your Information Display System

You see . . . you have a choice of sixteen Hitachi Display Tubes for Computer Readout and Data Display Terminals. 5 inch to 14 inch Cathode Ray Tubes with four types of phosphor screens (P4, P7, P31, P39). Compare them with any other make on the market and you will find them to possess highly stabilized, high performance characteristics.

Naturally.

They were researched and developed based on accumulated technology since 1910 . . .

CHARACTERISTICS

| | | Conventional Resolution Displays | | | | | High Resolution Displays | | | | | | | | | | |
|--------------------------|--|----------------------------------|---------------|---------------|---------------|---------------|--------------------------|---------------|---------------|---------------|---------------|---------------|---------------|---------------|---------------|---------------|---------------|
| | | 5.5 | 7.5 | 9 | 12 | 14 | 5 | 5.5 | 7 | 7.5 | 9 | | 10 | 14 | | | |
| | | 140MB- | 190CB- | 9AGP- | 310DGB- | 340CB- | 130AMB- | 140ZB- | 170AB- | 190DB- | 230AJB- | 230AKB- | 270AB | 340TB- | 340UB- | 340WB- | 340XB- |
| Deflection Angles (rleg) | | 70 | 90 | 90 | 90 | 90 | 70 | 90 | 70 | 90 | 90 | 90 | 70 | 90 | 90 | 90 | 90 |
| Neck Dia. mm (inch) | | 20.0 (0.787) | 20.0 (0.787) | 20.0 (0.787) | 20.0 (0.787) | 20.0 (0.787) | 28.6 (1.125) | 28.6 (1.125) | 36.5 (1.437) | 28.6 (1.125) | 28.6 (1.125) | 28.6 (1.125) | 36.5 (1.437) | 28.6 (1.125) | 28.6 (1.125) | 28.6 (1.125) | 28.6 (1.125) |
| | | P4 | | | | | P39 | | | | | | | | | | |
| Resolution | Line Width "A" (at the center) mm (inch) | 0.15 (0.0058) | 0.18 (0.0071) | 0.21 (0.0082) | 0.22 (0.0086) | 0.21 (0.0083) | 0.09 (0.0035) | 0.08 (0.0031) | 0.20 (0.0079) | 0.09 (0.0035) | 0.07 (0.0027) | 0.11 (0.0043) | 0.14 (0.0055) | 0.10 (0.0040) | 0.12 (0.0047) | 0.12 (0.0047) | 0.13 (0.0051) |
| | "B" (at the edge) mm (inch) | 0.16 (0.0062) | 0.19 (0.0074) | 0.26 (0.0102) | 0.26 (0.0102) | 0.23 (0.0092) | 0.11 (0.0043) | 0.12 (0.0047) | 0.22 (0.0088) | 0.12 (0.0047) | 0.14 (0.0055) | 0.14 (0.0055) | 0.19 (0.0076) | 0.14 (0.0055) | 0.14 (0.0055) | 0.14 (0.0055) | 0.15 (0.0059) |



Hitachi America, Ltd. Chicago Office (Electronics Department): 111 East Wacker Drive, Chicago, Illinois 60601, U.S.A. Tel: (312) 644-6565
Hitachi, Ltd. 1 Berlin 31, Kurfürstendamm 102, Deutschland
 Tel: 8864011; 8864012; West Berlin

Designer's casebook

Battery discharge triggers alarm and shuts off supply

By Dean Jeutter

Drexel University, Philadelphia, Pa.

A circuit with two Schmitt triggers will activate an alarm when a battery runs down, and then will shut down a voltage regulator powered by the battery. The warning can assure swift replacement of the battery, while the shutdown prevents erratic operation of systems such as telemetry transmitters and industrial radio controls.

The two triggers are formed by transistors $Q_1 - Q_2$ and $Q_3 - Q_4$. As long as the battery is adequately charged, the second trigger circuit keeps the collector-emitter voltage of Q_5 at about 0.25 volt dc and Q_5 conducts hard. In this state the conventional voltage regulator formed by Q_6 and Q_7 can power the load.

Diodes D_1 and D_4 keep the trigger operating points nearly the same, while zener D_2 assures a stable operating voltage for Q_2 and Q_3 .

The trigger point of $Q_1 - Q_2$ is set between -6

and -14 volts dc by adjusting potentiometer R_1 . At this point in the battery-discharge curve, Q_2 cuts off. This causes Q_1 to conduct and sound the alarm. The annunciator is a relatively new device that requires only 3 milliamperes at 6 V dc for a full 80-decibel tone output.

As the battery voltage decreases further, the voltage drops across R_2 and D_3 account for the lower trigger voltage presented to the $Q_3 - Q_4$ switch. At this second cutoff point, the voltage regulator is shut down. When $Q_3 - Q_4$ switches, Q_5 is cut off, removing battery voltage from the regulator.

The 10-kilohm R_2 makes the second trigger point about 0.50-v lower than the first. R_2 may be varied to change the voltage difference and increase or decrease the time ($t_2 - t_1$) on the discharge curve. This will determine the time between alarm and shutdown. To minimize trigger-point interaction, the two Schmitt triggers are isolated by diode D_3 .

With a 15-v battery supply, potentiometer R_2 allows the regular output to be adjusted between -6 and -11 V dc. Regulation is 1%. The entire circuit drains only 25 milliamperes from a fully charged battery, and even with both triggers actuated, the current demand is only 4 mA—low enough to keep the alarm sounding for quite a while.

Early warning. When battery voltage drops to point A on the discharge curve, Q_2 switches on Q_1 , activating the alarm. The battery continues to discharge and when point B is reached Q_3 and Q_4 switch, thus cutting off Q_5 and shutting down the voltage regulator section. R_1 and R_2 set the trigger points; R_3 adjusts the regulator output.

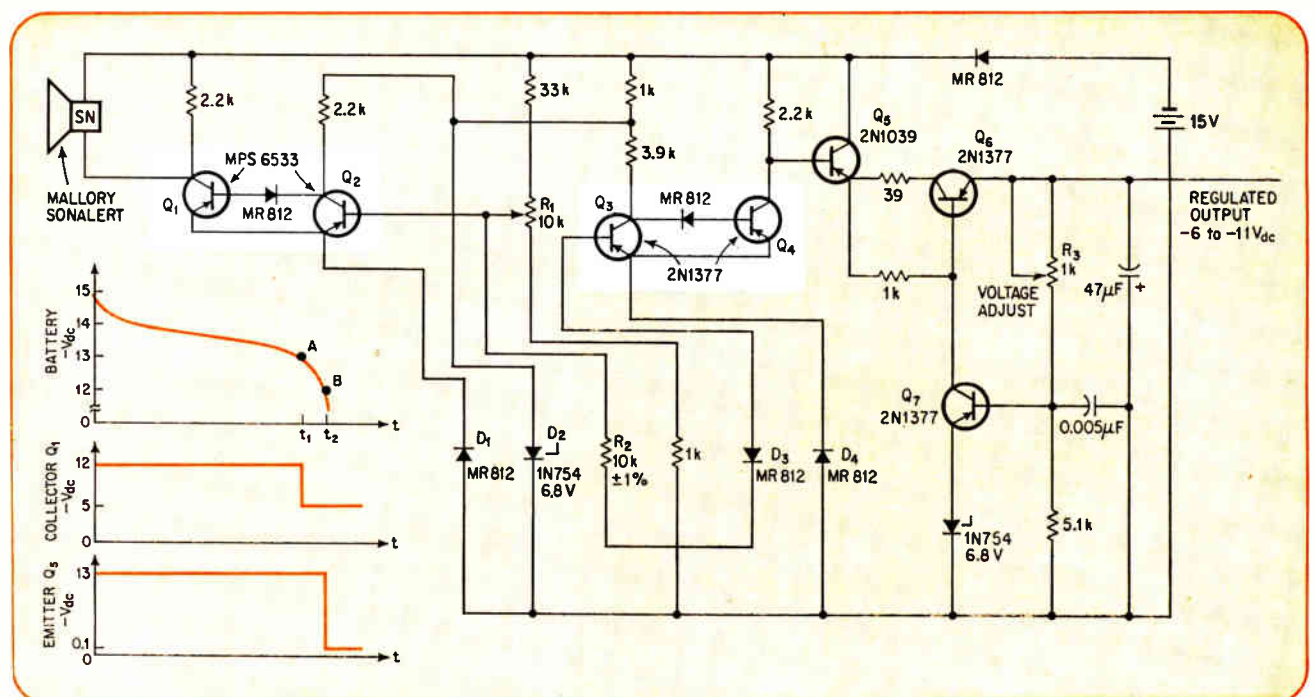

Simple photocell circuit measures pulsed laser power

By George Bowman and T. Koryu Ishii
Marquette University, Milwaukee, Wis.

For measuring a pulsed laser's output power, simple circuits using a photovoltaic cell and a voltmeter are impractical because of their low sensitivities and large time constants. Moreover, most pulsed laser outputs are too short to be properly captured and recorded by this type of circuit. A transistor and a switch added to the basic circuit provide a meter indication that's easy to read and, if necessary, the circuit is easy to calibrate.

The design hinges on charging a capacitor to a voltage determined by the intensity of the laser beam striking a photocell. The amount of charge on the capacitor is proportional to the laser's power output.

Initially, the circuit's ganged three-position switch is set to "Measure" and S_1 to "On." When no light strikes the photocell, its resistance is much higher than that of R_1 . When a light pulse does strike the cell, its resistance drops, abruptly increasing the voltage across R_1 . As a result, a current pulse flows through the emitter-base junction of Q_1 , charging the capacitor. As soon as the pulse passes, the photo-

cell's resistance returns to its starting value, trapping the charge on the capacitor.

When S_2 is set to "readout," the capacitor discharges through R_2 and the transistor, which now functions as an amplifier. The meter pointer deflects to some maximum value, which represents the laser power, then slowly returns to its initial point.

The time constant of R_2 and C should be greater than 350 seconds; R_2 can be adjusted so that the light doesn't cause the meter to read off scale.

Since the maximum deflection is a measure of the power in the light pulse, it's often convenient to prepare a calibration curve for the circuit by plotting maximum deflection against the input voltage to the laser. For precision measurements, the circuit must be calibrated with a lumen meter or a calorimeter.

The photocell is in a sealed chassis, behind a diffuser, usually a piece of frosted glass. The first shields it from ambient light, and the second attenuates the incoming beam. However, light leakage is inherent in the system. To compensate for it, S_1 is set at "On," S_2 at "Measure," and R_1 is adjusted until the meter deflection is closest to zero. Next, S_2 is switched to "Off" to remove stray voltage from C , and then turned back to "Measure," and the circuit is ready.

Diode D_1 and resistor R_3 provides temperature compensation; R_3 also limits the meter current.

Designer's casebook is a regular feature in Electronics. Readers are invited to submit novel circuit ideas and solutions to design problems. Descriptions should be brief. We'll pay \$50 for each item published.

A light measure. With S_1 closed and S_2 set to "Measure," the laser pulse is fired at photocell. The cell's resistance drops, causing capacitor C to charge to a voltage proportional to beam power. S_2 is then set to "Readout," which allows C to discharge through the transistor amplifier and the meter.

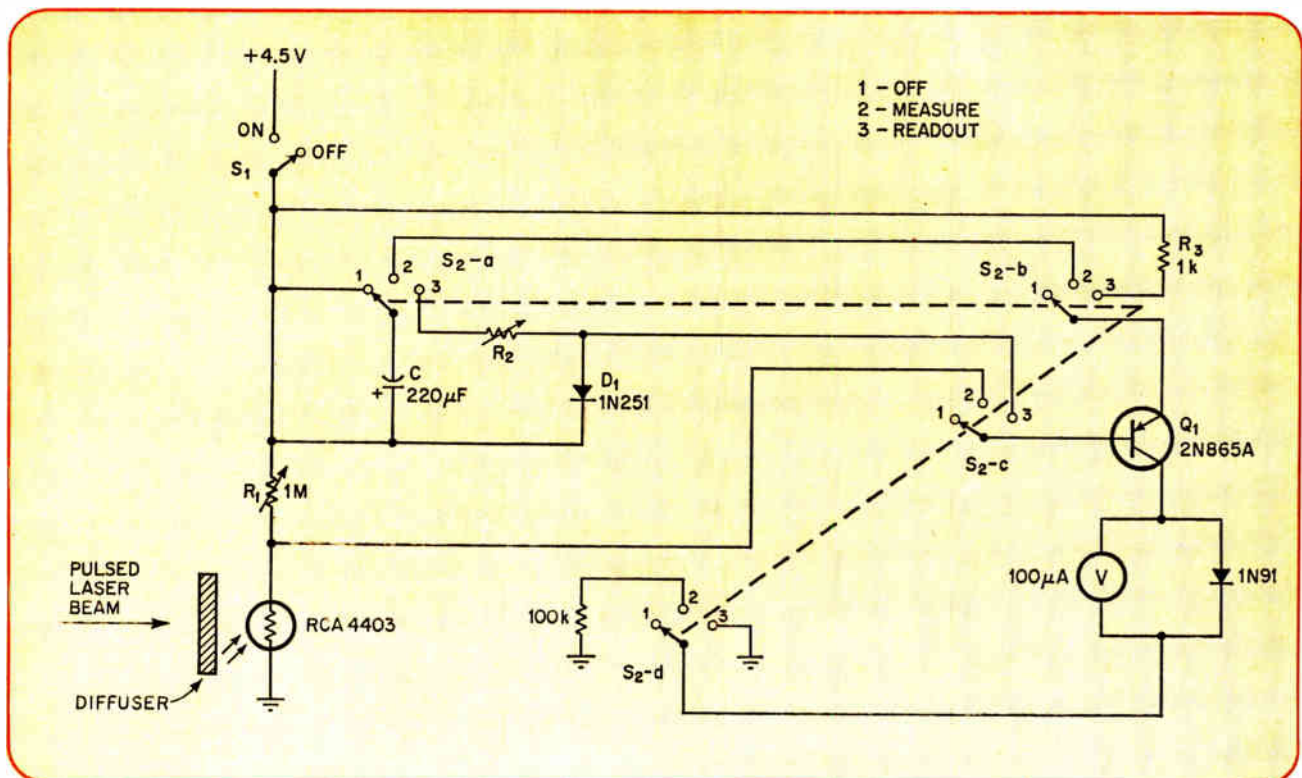

IC op amps straighten out CRT graphic displays

Designed into a simplified, absolute value circuit, today's op amps provide an inexpensive solution to the twin problems of pincushion distortion and blurred focus that plague precision CRTs

By J. L. Divilbiss, *Coordinated Science Laboratory, U. of Illinois, Urbana*, and Sergio Franco, *U. of Toronto*

□ Imposing the spherical geometry of a scanning beam on to the flat or nearly flat face of a high resolution cathode ray tube is like trying to knock a round peg into a square hole. But instead of a simple peg-and-hole mismatch, the result is pincushion distortion of the CRT image, and focus blur at the edges of each matrix dot.

The distortion takes the form of a bowing or tilting of the information display toward the outer edges of the image, and makes accurate analysis of graphic data impossible unless there is some provision for correction. Worse still, the greater the need for accuracy of tube display analysis, the higher the tube resolution—typically a 4,096-by-4,096-point matrix—and the greater the distortion. Information displayed on a flat-faced CRT with 40° deflection is bowed about 1.6% and, with 90° deflection, about 9.4%. For some purposes such conditions demand nearly 100% distortion and focus correction.

Pincushion distortion may be overcome, and focus corrected, in various ways; however, until the development of inexpensive integrated circuit operational amplifiers it's been difficult to accomplish both goals economically.

In many applications the problem of distortion can be solved with a specially shaped deflection yoke, or with a pincushion correction coil mounted ahead of the deflection yoke. But this approach is impractical for high resolution systems because tampering with the deflecting field invariably blurs the spots and increases their diameters.

A better solution is to generate correction signals equal to the distortion current ahead of the deflection amplifiers, as indicated in Fig. 1. Just a few years ago it would have been complex and expensive to generate these correction functions. But the IC op amp approach diagrammed in Fig. 2 now allows it to be done at modest cost with a single four-inch-square printed circuit card, which corrects both for distortion and for focus. This type of card is now in use in a high precision flying spot scanner for computer analysis of graphic data at the Coordinated Science Laboratory at the University of Illinois.

Assuming that the electron beam is "bent" in a very short distance compared to the total beam length on the flat-faced CRT, the following polynomials set

the ground rules for the correction circuit, Fig. 3.

$$X = k_1 I_x [1 + k_2 (kI_x^2 + I_y^2)]$$

$$Y = k_1 I_y [1 + k_2 (I_x^2 + I_y^2)]$$

Correction signals then are:

$$X_{\text{corr}} = kx (x^2 + y^2)$$

$$Y_{\text{corr}} = ky (x^2 + y^2)$$

The focus correction current is $I_{\text{focus}} = I_{\text{static}} + k(x^2 + y^2)$ where I_{static} is the current required to focus the beam at the screen center. This similarity between the pincushion and focus corrections is why the same circuit can handle both the tasks detailed in Fig. 3.

The **input signals** for the correction circuit are taken from 12-bit, digital-to-analog converters (DACs) that have an output range of 0 to -8.19 volts. Simple precision resistor dividers make this range symmetrical around zero, as the correction function requires. In addition, it is possible to calibrate the circuit with inexpensive, digital voltmeters because this 12-bit DAC arrangement avoids outputs with fractional voltage.

The "rectify" circuits, which generate the absolute magnitudes of the offset signals, are based on a design for an improved absolute value circuit pro-

1. Correction. Both pincushion distortion (depicted in color) and focus can be corrected with this circuit for graphic display on cathode ray tubes.

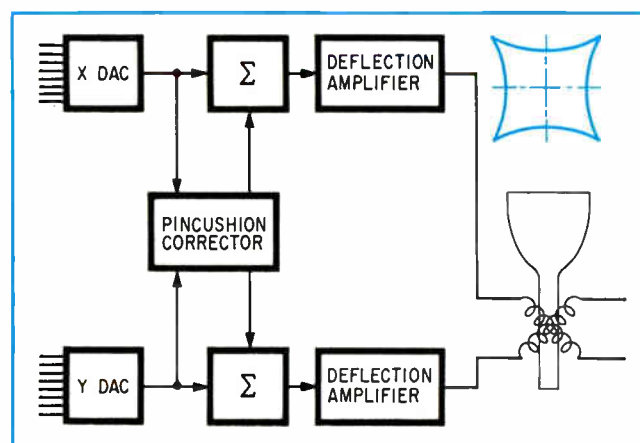

Figuring transconductance

A simple and inexpensive way of obtaining signal multiplications is to use the transconductance of a pair of matched transistors with their emitters tied together. This application in fact is one key to the fast response and small size of the pincushion correction circuit.

The transconductance of a transistor may be found by differentiating the fundamental equation which relates the collector current I_c and base-emitter voltage drop V_{BE} namely:

$$\frac{dI_C}{dV_{BE}} = \frac{d}{dV_{BE}} I_S \exp \frac{qV_{BE}}{kT} = \frac{q}{kT} I_C,$$

where I_S is the saturation current, q the electron charge, k Boltzman's constant, and T the absolute temperature.

To apply the transconductance principle, suppose the two transistors are initially balanced, i.e., with $V_{B1} = V_{B2}$. Then the current I_E applied to the emitters will divide equally between the two transistors, so that their transconductances are:

$$\frac{dI_{C1}}{dV_{BE1}} = \frac{dI_{C2}}{dV_{BE2}} = \frac{q}{kT} \cdot \frac{(I_E)}{2}.$$

If the two transistors are unbalanced by applying a differential input signal dV between B_1 and B_2 , so that $V_{B1} = V_{B2} + dV$, the result is $dV_{BE1} - dV_{BE2} = dV$. Then, according to the transconductance equations, the two collector currents will vary by the amount

$$dI_{C1} = \frac{q}{2kT} \cdot I_E \cdot dV_{BE1} \text{ and}$$

$$dI_{C2} = q \cdot KE \cdot dV_{BE2}, \text{ respectively.}$$

If $dI_C = dI_{C1} - dI_{C2}$, then

$$dI_C = \frac{q}{2kT} \cdot I_E \cdot dV.$$

For small signals, the differentials may be replaced by small, finite increments to get

$$I_C = \frac{q}{2kT} \cdot I_E \cdot V,$$

so that the differential output current is proportional to the product of the common emitter current and the differential input voltage. The proportionality constant, at room temperature, is approximately equal to 19 V^{-1} .

posed by M.A. Smither². In a technique that has now become commonplace in op amp applications, Smither achieved a highly accurate, absolute value circuit with only a single pair of matched resistors, where conventional³ versions need several matched or trimmed resistors paired for similar accuracy. This circuit uses a $\mu A739$ IC, which actually provides two op amps in a single dual in-line package.

The "multiply" circuits in Fig. 2 generate an output proportional to the product of their two inputs, using the principle of the variable transconductance of matched transistor pairs that is now widely employed in analog function generation for simplicity, fast response, small size, and low cost (see "Figuring transconductance" above.) The emitter currents to the matched pairs are supplied by operational amplifiers connected as current generators. For proper operation, it follows from op amp theory that the

resistors of the external network must satisfy:

$$\frac{R_4}{R_6} = \frac{R_3}{R_6 + R_7},$$

as shown for the X channel current generator, Fig. 3. Then the current driven from the load is given by

$$i_L = \frac{R_3}{R_4} \cdot \frac{X}{R_6}$$

Since the multipliers Q_2 and Q_4 have an input in common, they are driven in parallel by the same current generator. Resistors R_{14} and R_{15} , introduced to compensate for mismatches, between the base-emitter voltage drops of the two pairs, allow the current supplied by Q_5 to split into equal parts. Q_5 makes up for the weak pulldown capability of the $\mu A739$.

Though there are five adjustment pots in this circuit, the adjustment procedure is fairly straightforward.

2. No more bowing. Shown in greater detail, the correction circuit has three outputs for the X and the Y channel and focus.

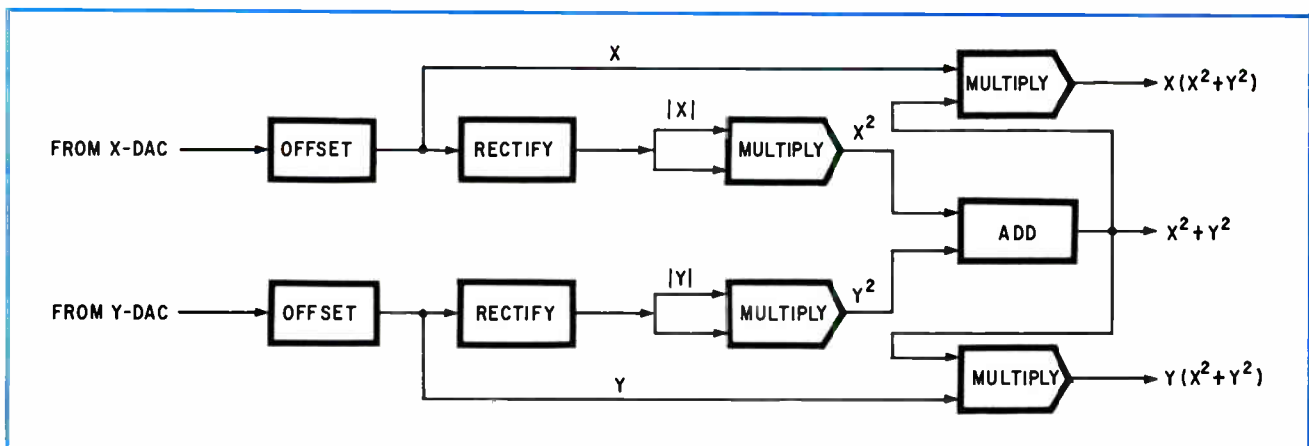

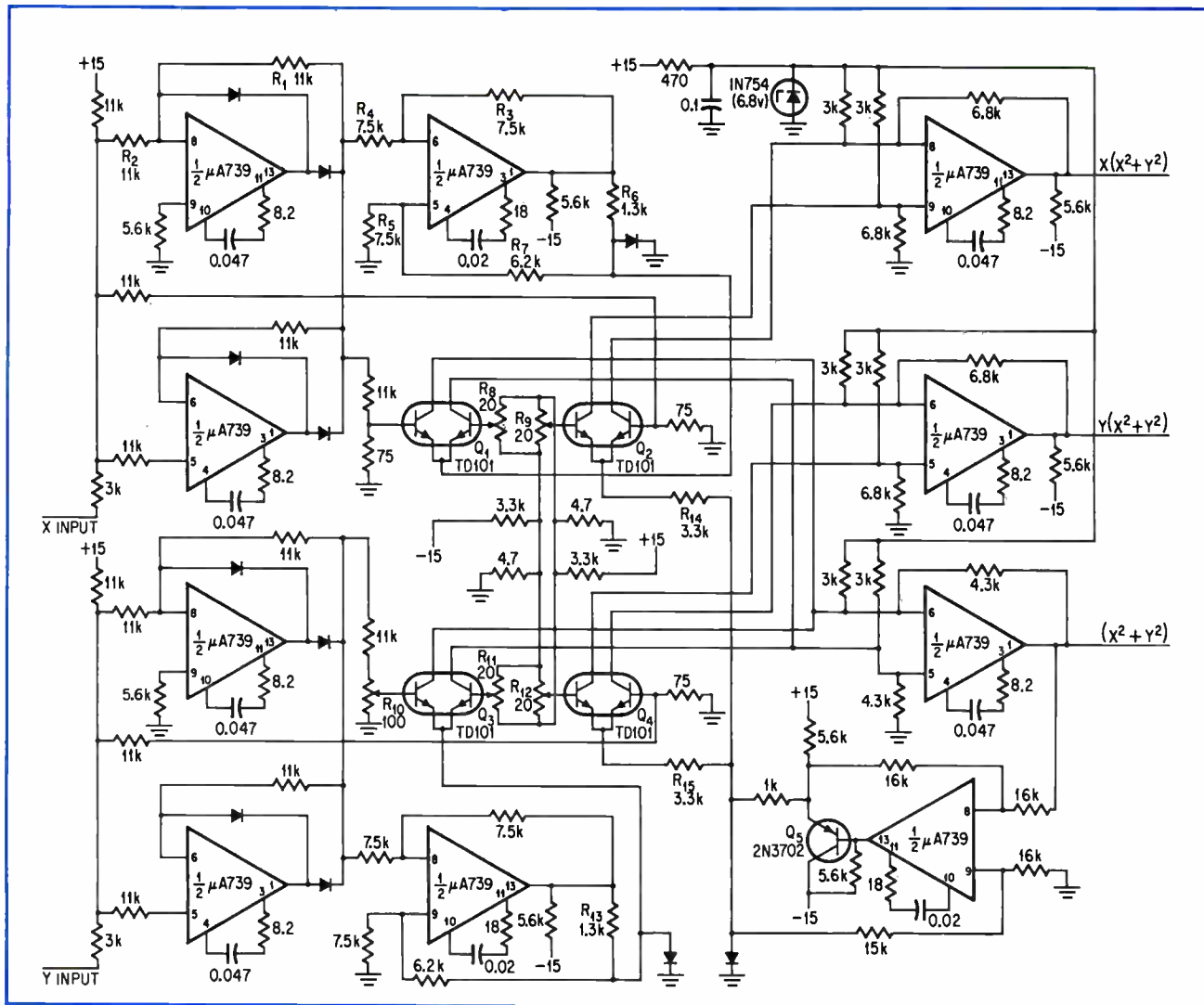

3. The big picture. An advantage of the $\mu A739$ integrated circuit used in this diagram is that it has two op amps in one package, shown here divided into X and Y input. Q1, 2, 3, and 4 are matched transistors employing transconductance to obtain signal multiplications. The entire circuit can be put on a four-inch-square printed circuit board.

ward. Each of the four 20-ohm pots (R_8 , R_9 , R_{11} , and R_{12}) compensates for the difference in base-emitter drops of a particular transistor pair, while R_{10} compensates for possible mismatches between the transconductance of Q_1 and Q_3 and between R_8 and R_{13} . In a more general sense, the circuit described here generates output proportional to $(X^2 + KY^2)$, and R_{10} allows K to be set to unity. For systems in which the X and Y deflection properties are not identical, a value of K other than unity may provide better correction.

The accuracy of the completed circuit depends primarily on the care with which various resistors and transistors are matched. For example, R_1 and R_2 should be matched to insure unity gain in the absolute value circuit. In this application, matching resistors to 0.1% and base-emitter drops to about 2 millivolts added only slightly to the labor of assembling a board. The result is 0.5% of full scale accuracy, which is more than adequate for deflection systems. Circuit

speed is limited by the slew rates of the op amps, so that full scale transitions with the $\mu A739$ require about 12 microseconds.

There is another scheme for correcting pincushion distortion of alphanumeric display on CRTs⁴, but it doesn't work for graphics. There are just too many lines to handle in a precision CRT based on a 4,096-by-4,096 dot matrix. With this other approach, for example, a diagonal line across the screen would have discontinuity notches resembling an erratic flight of stairs unless all address bits were used to remove the steps. □

References

1. J.J. Devilbiss, "Illiac 3 Scanner Analog Circuits", Department of Computer Science Report No. 320, University of Illinois, Urbana, Ill., April 1969.
2. M.A. Smither, "Improved Absolute-Value Circuit", EEE, March 1969, p. 124.
3. "Handbook of Operational Amplifier Applications", Burr-Brown Research Corporation, 1969, p. 42.
4. J.W. Wolf and J.H. Williams, "On the beam for sharp CRT character displays," Electronics, Sept. 29, 1969, p. 108.

Linear actuators: Positioning systems that offer high speed, high resolution and positional accuracy within mils.

The drive system in a pm loud-speaker is a familiar example of the linear actuator principle. It consists of a coil mounted in the annular gap of a permanent magnet assembly. When you introduce a current, the coil moves with force proportional to the product of the current and the magnetic field.

Your particular application may require the coil to move a precise amount, apply a precise force or simply advance to a specific position. Coil travel can be several inches or a few thousandths of an inch depending on your need. Positional accuracy within mils is possible when high resolution sensing equipment is used.

The magnetic circuit. 3 basic types.

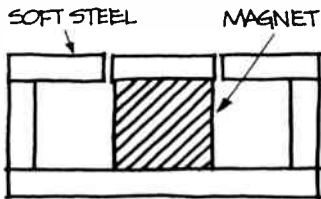

FIG. 1

Figure 1 shows the magnetic circuit with highest efficiency. The magnet forms the center pole with a soft steel plate on the gap end. Leakage is 1.5 to 1.8. Operating density of the

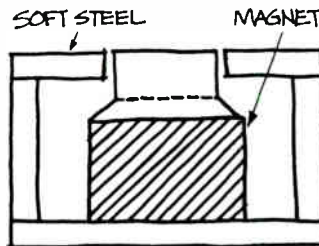

FIG. 2

magnet controls gap density. Magnet length determines coil excursion.

Greater gap density for a given gap size is possible when you design the type of circuit in figure 2. The soft steel center pole operates near magnetic saturation, which may be 50% greater than the magnet B_d in figure 1. Leakage in the figure 2 circuit is 1.8 to 2.2. Short center pole length establishes coil excursion in this type of circuit.

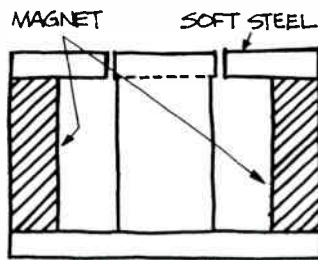

FIG. 3

The circuit in figure 3 provides long coil excursion, high gap density —

or both. Leakage ranges from approximately 2.5 to 3.0. Magnetic saturation of the center pole sets gap density.

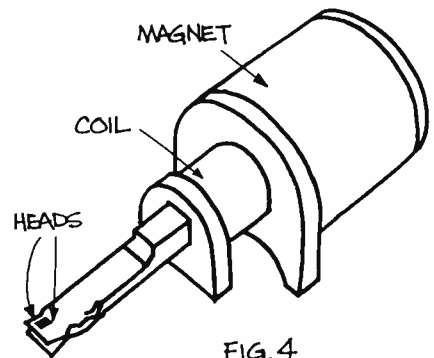

FIG. 4

The unit in figure 4 is an application of the magnetic circuit in figure 3 above. It positions magnetic heads in computer disk drive systems. Both electrical and optical position sensing are employed to achieve extremely high resolution.

We offer design assistance.

If your design problem concerns high speed or high resolution linear motion, you can get the magnetic circuit information you need at Indiana General. Our engineers are always ready to work with you. Just write Indiana General, Magnet Products, Valparaiso, Indiana 46383.

indiana general 

a division of Electronic Memories & Magnetics Corporation

New

HARD COPY UNIT



4601 HARD COPY UNIT with T4002 GCT

Permanent copies from the Tektronix T4002 Graphic Computer Terminal and . . .

This New Hard Copy Unit produces copies *directly* from Tektronix Storage CRT's. Operation is easy. At the push of a button or upon programmed command, your computer outputs are permanently recorded on reproducible copies. In just 18 seconds a high resolution copy of even complex displays is ready for use.

Now, information from your computer is quickly copied for distribution to management and office personnel. These copies are ideal for portfolios and permanent records—and serve as a quick, inexpensive method to keep business clients and associates informed with current information.

COPY COST is less than 8 cents per 8.5 x 11-inch copy, depending upon usage.

When people who have a need to know can't come to see the computer display, send them a copy. With the 4601 Hard Copy Unit you'll have a quick, easy, low-cost way to record and send information when and where it's needed.

For additional information, contact your Tektronix Field Engineer or Application Engineer; or write to Tektronix, Inc., P. O. Box 500, Beaverton, Oregon 97005.

4601 Hard Copy Unit \$3750
T4002 Graphic Computer Terminal, less interface \$8800

Available in U.S. through the Tektronix lease plan
U.S. Sales Price FOB Beaverton, Oregon



. . . the T4005 Graphic Display

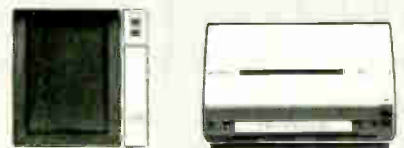

. . . the 611 Storage Display Unit



TEKTRONIX®

committed to
technical excellence

Fairchild fights back

With a poor 1970 behind it, semiconductor firm hopes group reorganizations, stronger MOS position, new plants, and faster turnaround will pay off this year

by Stephen Wm. Fields, San Francisco bureau manager

Favorite gossip topic along "silicon gulch"—the nickname given the San Francisco Peninsula because of the concentration of semiconductor makers—traditionally has been Fairchild Semiconductor, partly because it spawned the local industry and partly because of its business ups and downs. But seldom has the buzzing been so loud as it has since its parent company, Fairchild Camera & Instrument Corp., confirmed a 30% drop in work force and a \$15 million loss in the first nine months.

Despite its problems—and some of them are formidable—Fairchild Semiconductor is moving into the new year on a brighter note with a huge investment program in facilities and technology nearly completed. The big question now is not so much whether the company is in trouble, but what president C. Lester Hogan and his team are doing to straighten it out.

Most industry watchers automatically assume that the company's big loss came primarily from its semiconductor division. However, this division, along with the much smaller microwave and optoelectronics division, accounted for only a third of the company's nine-month pretax loss. Offsetting part of the division's losses were royalty payments. If these monies are disregarded, the losses from semiconductor operations become a larger portion of the overall total, just how much Fairchild officials won't say, but maintain it is "nowhere near most of the total."

Like nearly all semiconductor houses, Fairchild was hit hard in last year's recession atmosphere. The price wars, the weakness of

the discrete device market, and the sharply reduced buying of some of the big computer makers have hurt Fairchild particularly. And in one of the few 1970 growth markets, MOS, Fairchild found itself struggling to catch up.

But bad timing hurt most. Under Fairchild's rebuilding program, 1970 was the peak year for spending huge sums of money—just when the bottom was falling out of the market.

Looking back now, Hogan maintains, "I could have been profitable in 1970 if I hadn't finished what I had started. But it wouldn't have been best in the long run." Since 1968 he has spent about \$50 mil-

lion in capital investments, the total for 1970 alone was about \$24 million. But this money bought a new MOS wafer fabrication facility; a TO-92 automated plastic transistor assembly line [*Electronics*, Sept. 28, 1970, p. 37]; Unibond, an automated plastic packaging system for dual in-line ICs [see p. 21]; and the Wiesbaden, Germany, plant, which is now coming on stream [*Electronics*, Dec. 7, 1970, p. 111].

Hogan also has continued to make changes as problems cropped up in last year's down market. Recently, he set up task forces to move technology out of the central R&D labs and into production: the division expects to introduce 70

Hogan's watchword: production

When Les Hogan arrived at Fairchild from Motorola Semiconductor in 1968, he took over a company that had what he called "an antiquated non-competitive facility" [*Electronics*, Aug. 19, 1968, p. 45]. The problems he faced were immense: a complete lack of inventory control, poor production, little or no MOS capability, and no coordination between production and research and development.

"When they [previous management] moved R&D away from the main plant, they might as well have moved it to Hawaii," one ex-Fairchild manager says. At the time, central R&D was spending an estimated \$1 million a month, even though "all of the short-range R&D—the work leading to new products—was being carried out in the factory," another ex-Fairchild manager notes. The R&D lab, five miles distant, was "becoming a university and hobby shop," he recalls grimly.

Before Hogan took over, Fairchild's R&D lab was known as one of the finest in the industry—even Hogan admitted it when he came aboard. But Fairchild had the poorest production reputation: most customers' orders were late in delivery. So an important part of Hogan's rescue operation was to invest money in improving and expanding the division's production lines.

Unfortunately, he points out, the rebuilding process is like putting together a machine—you can't use it until the last bolt is in place. "Toward the middle of 1969, I was beginning to get frustrated," he admits. "We were making progress but the progress wasn't obvious. Now our facility is second to none in the world and we have people that are second to none in the world."

NEW FULLY AUTOMATED SHOCK TEST SYSTEM



**(MEETS MIL. STD. 883 AND
COMPARABLE IN-HOUSE SPECS.)**

This new Blue M system meets Mil. Std. 883, Method 1011, Conditions A to D and comparable commercial specs automatically . . . avoids the expense and human error inherent in manual operation.

It consists of two Blue M VERSA-WHIRL Constant Temperature Baths. One has a range from ambient to +204°C., the other 0°C. down to -75°C. Baskets of test specimens are automatically transferred from one to the other. Dwell time in each bath and number of cycles are adjustable. Baths operate continuously, for constant processing. System automatically shuts off after predetermined number of cycles with baskets poised for unloading as illustrated. System can be operated manually if desired.

Baths proper — easily the finest of their kind ever built — feature solid-state digital setpoint time proportioning control providing virtual straight-line performance. This and uniquely efficient liquid circulation system affords uniformity and control of $\pm 0.25^\circ\text{C}$. throughout both ranges.

For information on this advanced system, other VERSA-WHIRL Baths, and other Thermal Cycling and Shock Test Chambers, write: Blue M Engineering Company, A Division of Blue M Electric Company; Corporate Headquarters, Blue Island, Illinois 60406.



Probing the news

new digital and 30 new linear ICs in the first quarter alone. Fairchild also is putting more engineering efforts into standard digital bipolar circuits and is changing the emphasis here from custom to standard circuits. And it has combined the 30 product groups into eight profit centers in an attempt to respond more quickly to customers' needs.

One of Hogan's major efforts has been to establish Fairchild as a power in MOS. The four wafer fabrication areas on stream when he came to the company were designed for bipolar work, where cleanliness requirements are less stringent than for MOS. So last year Fairchild built two new fabrication plants, which are now on line. One is for silicon gate MOS. The other is for standard p-channel devices and contains about 60 diffusion tubes. "This is extremely large," notes one competitor. "They should be capable of shipping about \$40 million a year worth of products."

However, delays in shipments may continue for a while, mainly because the division's testing capacity still isn't up to its wafer fabrication capability. By March, however, four more high-speed test stations will have been added.

"The mainstream of our MOS business for 1971 and into 1972 will be custom circuits," reports Gene Blanchette, vice president and director of the company's MOS and memory operation. About 80% of Fairchild's MOS effort is in custom circuits. The division has introduced some standard MOS products, such as shift registers and read-only and random access memories, but Blanchette says that "production volume orders for the RAMs won't develop until 1972. Shift registers are just starting to pick up now and we are delivering to selected customers."

Fairchild shipped about \$150,000 worth of MOS circuits in January 1970, says Hogan. "In December 1970, we shipped \$1 million," he adds. Blanchette expects Fairchild to sell \$15 to \$20 million of MOS devices in 1971, a figure which he says would make the company first in MOS among the "big three" semi-

conductor manufacturers (over Texas Instruments and Motorola) and possibly fourth in overall MOS production.

Fairchild says it also has a back-up of new MOS technology that it can bring on stream when needed. To help get new MOS—as well as bipolar—devices into production, the advanced product development groups have been rearranged so that they're directed by operations or marketing officers. For example, a new nitride silicon gate process is now under the control of production and is being installed in the new MOS fabrication laboratory. The C/MOS process is under the wing of a task force that is getting it into production.

To get around the lack of coordination between the research and development effort and the production side, product-related R&D has been moved back to Mountain View. "We have set up task forces," explains James Early, director of R&D, "for getting technology out of R&D and into production. They carry the ideas over and work on the R&D production interface. Central R&D at Palo Alto now is concerned with the broadly applicable technology that it is hard to find a home for in a single product group."

As for its bipolar digital IC work, Fairchild is waiting for its custom contracts to run out. "We haven't had as many new products as we should have had," says Wilfred Corrigan, division vice president and general manager. This is partly because custom work has represented 70% of Fairchild's digital efforts. "We were heavy in custom digital—in designing the 25 or so circuit types that were required for each big machine," says Corrigan. "The problems are that we can't get any standard products out of this and much of our engineering effort has been tied up."

Fairchild is winding up most of these contracts now, and in the first quarter, he says, "the ratio will switch—to 75% standard and 25% custom. We're changing the ratio because we've overemphasized the custom area and the EDP business [the main source of Fairchild's custom business] is down."

The lack of new linear ICs repre-

Short circuits.

Now you can bypass slowdowns in printed circuit design.

Do your design problems include tape slippage and lack of dimensional stability on master layouts, numerous design changes, and other annoyances that hamper efficient printed circuit design?

If so, we believe that reproducing your taped master on KODAGRAPH ESTAR Base Film is the answer. For more information, contact your Kodak Technical Sales Representative, or write: Eastman Kodak Company, Business Systems Markets Division, Department DP506, Rochester, New York 14650.

DRAWING REPRODUCTION SYSTEMS BY KODAK

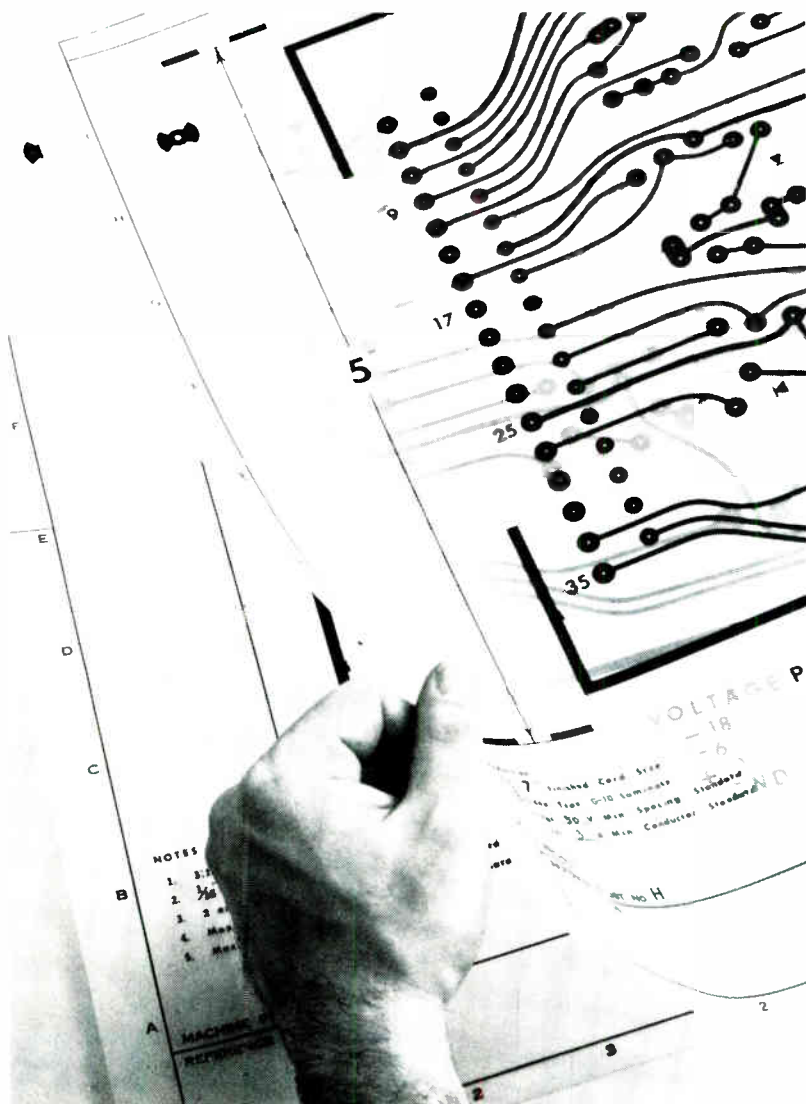

Kodak

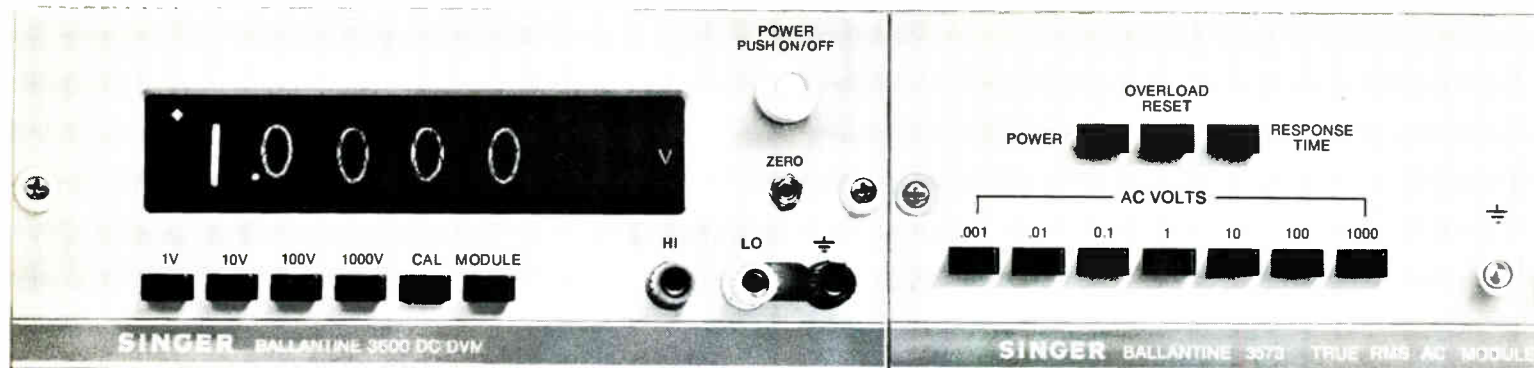

if you didn't buy SINGER'S New True RMS DVM...

And were measuring signals like this...

Your present average responding DVM would give you errors like this...

But with Singer's 3573 you get accuracy like this!

| | | |
|--|------------|--------------|
|  | 10% | 0.05% |
|  | 3% | 0.05% |
|  | 4% | 0.05% |
|  | 10% | 0.05% |

Only a True RMS DVM can accurately measure non-sinusoidal waveforms, and only the Singer Model 3573 is true from 10 Hz to 11 MHz. It's true from an astonishing 1 mV full scale (and that means 100 nanovolt resolution) to 1000 volts full scale. It's also true to an accuracy of $\pm 0.05\%$ of reading, $\pm 0.05\%$ of full scale at mid band.

And coupled to this great AC capability you can also make DC measurements with an accuracy of $\pm 0.01\%$ of reading and $\pm 0.01\%$ of full scale, using the Model 3600.

We have prepared a paper explaining the significance of True RMS, Average, and Peak Responses which we will send to you upon request.

The Singer Company
Electronic Products Division
250 Crossways Park Drive
Woodbury, New York 11797
Telephone: (516) 921-9400
Telex: 961-468

SINGER INSTRUMENTATION

sented a different problem. "We've had a lot of new circuits in the works, but our problem has been coordination," says Corrigan. But now one location serves the entire linear operation. "We've re-formed the group and concentrated it," he notes. "We've cut a lot of people, but it's a more efficient operation."

The profit-center idea is another managerial change that Fairchild hopes will produce strong results in 1971. Under that reorganization, 30 products groups were combined into eight separate operations—MOS, MSI/LSI, digital, transistors, diodes, linear ICs, high-volume digital (TTL), and hybrids.

The overall goal is to make it easier for a customer to get what he wants. For example, in the linear group the engineering was scattered over several buildings. Michael Scott, linear IC product marketing manager, says that "when a product moved from one building to another, it was always logged into inventory after each step." Thus, it could take upwards of 10 to 15 weeks to get a product out the door. But now that linear is all together and functioning as a small, separate "company," Scott says, "we've turned around on a new product in nine days from concept to shipping. The frustration is being eliminated."

The linear group is now making money, he adds, "and we're looking to increase profits by turning our assets over faster." By the end of January, Scott expects to be able to turn around on unexpected orders in three weeks. This swifter turnaround time is not just for the customer's benefit—Scott points out that with a 10-week cycle even a tiny process accident like a mislabeled etching solution bottle would go unnoticed until most of the lot was ruined.

So for Fairchild Semiconductor, 1970 was a frenetic year of adding plant and equipment, reorganizing operations, and cutting back to get in line with declining business. The company has done a lot, but more remains to be done. As Corrigan puts it, "We've still got a lot of changes to make. We have the products and we have the capacity. We have to stabilize the people," he adds. □

Probing the news

Computers

Off-track bets go legal —via computer system

If successful, New York's new revenue-raising scheme could catch on, opening a big market for EDP gear

by Alfred Rosenblatt, *Industrial Electronics* editor

The new look in horse parlors substitutes a roomful of telephone operators for bookies, touts, blackboards, and clouds of cigarette smoke. Beginning on Jan. 11 in New York City, the first government-run off-track betting enterprise in the U.S. is putting its money—\$9 million, to start—on data processing equipment.

If the system proves successful, particularly as a money-earner for New York's depleted tax coffers, it could open up a new and very lucrative market for companies like Computer Sciences Corp., Los Angeles, which directed the overall design. Already, interested civic delegations from New York's Nassau and Rensselaer counties, and from the states of Illinois, Massachusetts, and California, have visited the offices of the New York City Off-Track Betting Corp. to look over the system.

Engineers in New York City's Bureau of the Budget had been studying the possibilities of off-track betting since 1954, says Harry J. Harmatz, the Betting Corp.'s computer system manager. But when the State Legislature finally gave the go-ahead, the revenue-hungry city fathers rushed to get the horse parlor into operation. Computer Sciences received a contract on Aug. 10 and delivered all software and the initial hardware by Nov. 15—"a complete miracle," Harmatz says, since such a project usually takes four or five times as long.

Such a short deadline was met by "making maximum use of existing hardware," says Wayne B.

Swift, Computer Sciences' director for the project. "We're not straining the technology anywhere," he notes. Existing software was used wherever possible, both to get the system on line quickly and to facilitate moving to a larger network in the future using similar but more powerful computers.

The heart of the off-track betting system is a central processing facility with two leased IBM 360/50 computers and peripheral equipment for communicating with branch offices and with racetracks. In addition, PDP-8 computers, each serving 20 betting terminals, will be located in the central office. Communication links between branches and central office will be 1,200-baud leased lines.

Betting terminals will be located in branch offices around the city, and bettors will be able to walk up to a window and place their wagers with an operator, who will punch in the required information. Each terminal consists of a ticket-printing machine and a keyboard data entry and display terminal. An automatic ticket reader addition is planned for the spring.

Major subcontracts thus far include \$2.6 million for 1,000 ticket-printers from DI/AN Controls Inc., Dorchester, Mass., and \$2 million for 1,150 keyboard data entry and cathode ray tube display terminals to Wyle Laboratories, El Segundo, Calif. Deliveries are to be spread over two years. The 150 extra data terminals will be used to accept bets phoned in by regular customers who have deposited money on account. For starters, the telephone



Tolerance
SCHAUER
1-Watt
ZENERS

Immediate Shipment
Low Prices

ANY voltage from 2.0 to 18.0

| Quantity | Price each |
|-----------|------------|
| 1-99 | \$1.07 |
| 100-499 | .97 |
| 500-999 | .91 |
| 1000-4999 | .86 |
| 5000 up | .82 |

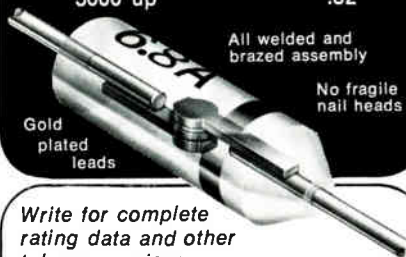

Write for complete
rating data and other
tolerance prices.

**Buy the kit—
Save
a lot**



Kit contains a 51-piece assortment of SCHAUER 1% tolerance 1-watt zeners covering the voltage range of 2.7 to 16.0. Three diodes of each voltage packaged in reusable poly bags. Stored in a handy file box. Contact your distributor or order direct.

A \$54.57 value for
ONLY \$24⁵⁰

Semiconductor Division
SCHAUER
Manufacturing Corp.

4514 Alpine Ave. Cincinnati, Ohio 45242
Telephone: 513/791-3030

betting room will have 70 terminals.

Initially, the system will have five branch offices located at Grand Central Station and in other parts of the city. Plans are to expand gradually, adding about five to 10 branches each month with a total of 50 window terminals. As new branch offices come on stream, more PDP-8s will be added as needed. By opening day, all the IBM equipment will be installed, ready to handle the maximum 1,150 terminals, though it will be some time before this capability actually will be used.

All betting computations, transactions, and reporting are handled by the central computers, which can absorb 300,000 bets an hour. Peripheral equipment includes disk drum and tape storage devices, a two-million-byte large-scale core memory, and dual IBM 2703 transmission controllers, all working under standard IBM operating programs—Multiprogramming with a Fixed Number of Tasks (MFT) and Basic Telecommunications Access Method (BTAM).

The IBM computers don't interface directly with the ticket issuing terminals. Such an arrangement would have caused unacceptable transmission delays because of the time needed to format and transmit all messages to the terminals for display and printout. Instead the PDP-8 minicomputers, made by the Digital Equipment Corp., Maynard, Mass., are used as concentrators and preprocessors, relieving the central computers of formatting chores and acting as store-and-forward buffers that keep track of betting transactions in progress. Thus, the minicomputers make operation of the larger machines possible, says Edwin Brenman, the Betting Corp.'s director of data services. "If we didn't have a minicomputer, we'd have to invent one."

Bets placed in branch offices or phoned in are punched into terminals. Then data is transmitted to the minicomputers. Under the BTAM program, the two 360s, through the 2703 controllers, query the PDP-8s on the amount wagered, the track identity, and the race and horse numbers. As they receive and store this information, the 360s (one can act as a backup for the other

in case of failure) assign a number to the data that identifies its location in the store and indicates the time the bet was made. This number, designed to make it almost impossible to counterfeit winning tickets, then is printed on the betting ticket at the branch office and issued to the customer. Once a winning ticket is cashed at the branch office, information on the bet is erased from the store.

Up to 64 characters describing a bet can be entered at the keyboard terminal in a fully buffered mode. As many as eight bets may be made on a single ticket; combination, daily doubles, and quinella betting can be accommodated. After a bet is punched in and transmitted to the central office, the minicomputer serving that terminal checks its 8,000-word store to see that the horse actually is entered in the specified race. Then the bet is displayed on the terminals' CRT exactly as it will appear on the ticket to be issued. Following this verification, the operator activates the printer. The setup can handle four such transactions per minute, the Betting Corp. expects.

The reader/printer to be added this spring to each terminal is being developed by DI/AN. When the bet is placed, the ticket-issuing unit prints a four-digit, 16-character bar code on the ticket, representing its identifying number. The reader/printer reads the code and prints the payoff on a winning ticket.

Betting at the terminals closes at least a half-hour before each race to allow betting information to be transmitted by the 360 to the individual race tracks, where it is used to adjust parimutuel odds.

Although no one really knows how much money the new betting system will handle, Betting Corp.'s Samuels says the figure may climb as high as \$1 to \$1.5 billion annually in three to five years. Under the present arrangement, 10% of this amount would be shared by the city and state. With more bets representing more revenue, the political sun could continue to shine on expansion of the betting system. "And if it goes in New York, I don't think there's any question that it will go elsewhere," says Computer Sciences' Swift. □

Government electronics

Mass transit market: promising

Though money for 'dial-a-ride' and 'people-mover' programs is limited now, market for systems with high electronics content could go over \$1 billion

by Jim Hardcastle, Washington bureau

By Washington standards, the Urban Mass Transportation Administration's \$33 million research and development budget isn't a lot of money. But the promise of a \$1 billion-a-year market with a large electronics content is making the Department of Transportation agency's R&D activities highly attractive to electronics companies. "It seems like I'm spending half my time briefing industry marketing men on what we'll be doing here," says Robert Hemmes, the agency's R&D director.

While the R&D budget is modest, legislation signed last year guarantees \$800 to \$900 million a year in Federal aid to help local governments build operational transportation systems. And since the local communities building the systems will have to pick up 30% of their cost, a \$1 billion-plus market is developing. At first, grants from the 1970 Urban Mass Transportation Act will go toward conventional rail and bus transit systems. But five to 10 years from now, the sophisticated systems being developed and tested with research funds will be getting the heavy Federal aid.

The electronics content of the mass transit systems envisioned is impressive. Required will be digital land mobile transmitters and receivers, computers and new software, inexpensive mobile terminals that use either teleprinters or cathode ray tube displays, and voice response units capable of handling large numbers of calls into central computers. Also needed—for computer-controlled driverless systems—will be sensors and telemetry for gathering and transmitting infor-

mation on velocity, location, and distance from other cars.

Right now, the mass transit agency's limited R&D budget allows it to develop and test very few new systems under real-world conditions—a necessity to determine public acceptance and operating costs. "With a \$30 million budget, I can only get one demonstration system built per year," says Hemmes. "Next [fiscal] year, I think I can get \$50 million. With that I can get two demonstrations."

If Hemmes can, in fact, buck the downward trend in Federal research budgets and get his \$50 million, work is expected to begin on two novel mass transportation ideas [*Electronics*, Dec. 21, 1970, p. 40]. Agency officials are readying a demonstration of "dial-a-ride," a demand-responsive vehicular system that would fill the gap in public transportation between taxicabs and buses. And they're negotiating with several manufacturers for construction of a demonstration "people-mover" system designed to serve congested downtown areas.

In the dial-a-ride system, a user would call a central number and talk to a dispatcher, who would punch the user's destination into a computer terminal. The computer would determine which of a fleet of small buses could most easily pick up the user and would also estimate the time of arrival. Then it would flash a radio signal to the chosen bus, telling the driver where to make the pickup; the directions would appear in the bus either in teletype printout or on a cathode ray tube.

Designed to serve outlying areas

with moderate population densities or to fill gaps in downtown areas during off hours, dial-a-ride "is very much like a taxi except that it costs less," says Joseph Silien, dial-a-ride program manager. "The savings comes from the fact that several people will be sharing the vehicle," he notes.

The first test will begin in Haddonfield, N.J., some time before midyear, Silien says. But since its goal is to determine "whether people will respond and whether they like it or don't like it," he says, the Haddonfield system will be manually controlled to keep the hardware investment down.

A computer-controlled system probably will be tested in Rochester, N.Y. where the Genesee Valley Regional Transit Authority is negotiating a contract with the Washington agency for a dial-a-ride system. The Rochester program is scheduled to begin in August with a fleet of 10 small buses, which would be expanded to about 20. Routing and scheduling probably would be handled by an IBM 360/40, using an algorithm developed by the Massachusetts Institute of Technology's Urban Systems Laboratory under a \$1.3 million agency grant. The Rochester test should determine whether or not computer routing and scheduling is more expensive than manual dispatching.

As the Urban Mass Transportation Administration prepares for its dial-a-ride demonstration, groundwork also is being laid for testing a people-mover system at the University of West Virginia to connect three sub-campuses at Morgantown. There, the agency plans to

Kinomat culture that counts



automatic machines for electronic and electromechanical components

Machines for winding and precise finishing of the most different types of **electric coils**. Capping, spotwelding and soldering machines for contact leads, lacquering and grinding machines, for the production of **resistors**. Winding, rimming, spot and ultrasonic welding machines for the production of **electrolytic capacitors**. Tinning pots, tinning machines, lamination stacking machines, rotating tables for precision assembly processes, taping devices etc., for the production of **components**.



KINOMAT
CINEMATISMI
AUTOMATISMI

Head office: 20021 BARANZATE DI BOLLATE
(Milano) ITALIA Via Monte Bernina, 22
phone: 9903020/9901820
cable: KINOMAT-BOLLATE
telex: KINOMAT 34565

Please send us, without any engagement for us, technical information concerning
your machine for: _____

ADDRESS TO: _____

el

Probing the news

call for six to 30 driverless passenger cars, guided by rails or mono-rails, that can travel as regularly scheduled trains during peak traffic and as demand-responsive vehicles during lulls.

Several companies are bidding in the competition for the Morgantown system, which will be funded out of the \$20 million the transit agency plans to request for new systems programs in fiscal 1972. "We want to get this system rolling in earnest by October 1972," says Dr. Wilhelm Riathel, new systems program manager. However, none of the firms bidding on the demonstration project "are really offering what we want," he adds. "They still lack the flexibility we are seeking."

According to a Johns Hopkins Applied Physics Laboratory study funded by the agency, command and control systems are among the weakest links in the systems proposed. In order to sense velocities and locations of vehicles as close as 30 to 40 feet apart, "you really have to have fine-grained resolution," says Dr. W. H. Avery, study director at APL. "Any one of these cars can throw a wheel or something. And the collision you could have would make the pile-ups on the San Diego Freeway look like kiddy-car crashes."

Hardware costs must also be reduced. "Present calculations indicate that a computer-controlled system would be more expensive by a factor of three or four," Avery says.

Some of the systems proposed by companies would ride on overhead monorails, others on concrete guideways or on cushions of air. Headways would range from 1.6 to 60 seconds, cruising speeds from about 15 to 45 miles per hour, and passenger capacity from five to 12 people. Among the companies proposing the people-mover systems are Westinghouse Electric Corp., Pittsburgh; Varo Inc., Garland, Texas; Transportation Technology Inc., Madison Heights, Mich.; Dashaveyor Co., Los Angeles; Sky-Kar Corp., Fort Worth, Texas; and Alden Self-Transit System Corp., Bedford, Mass.

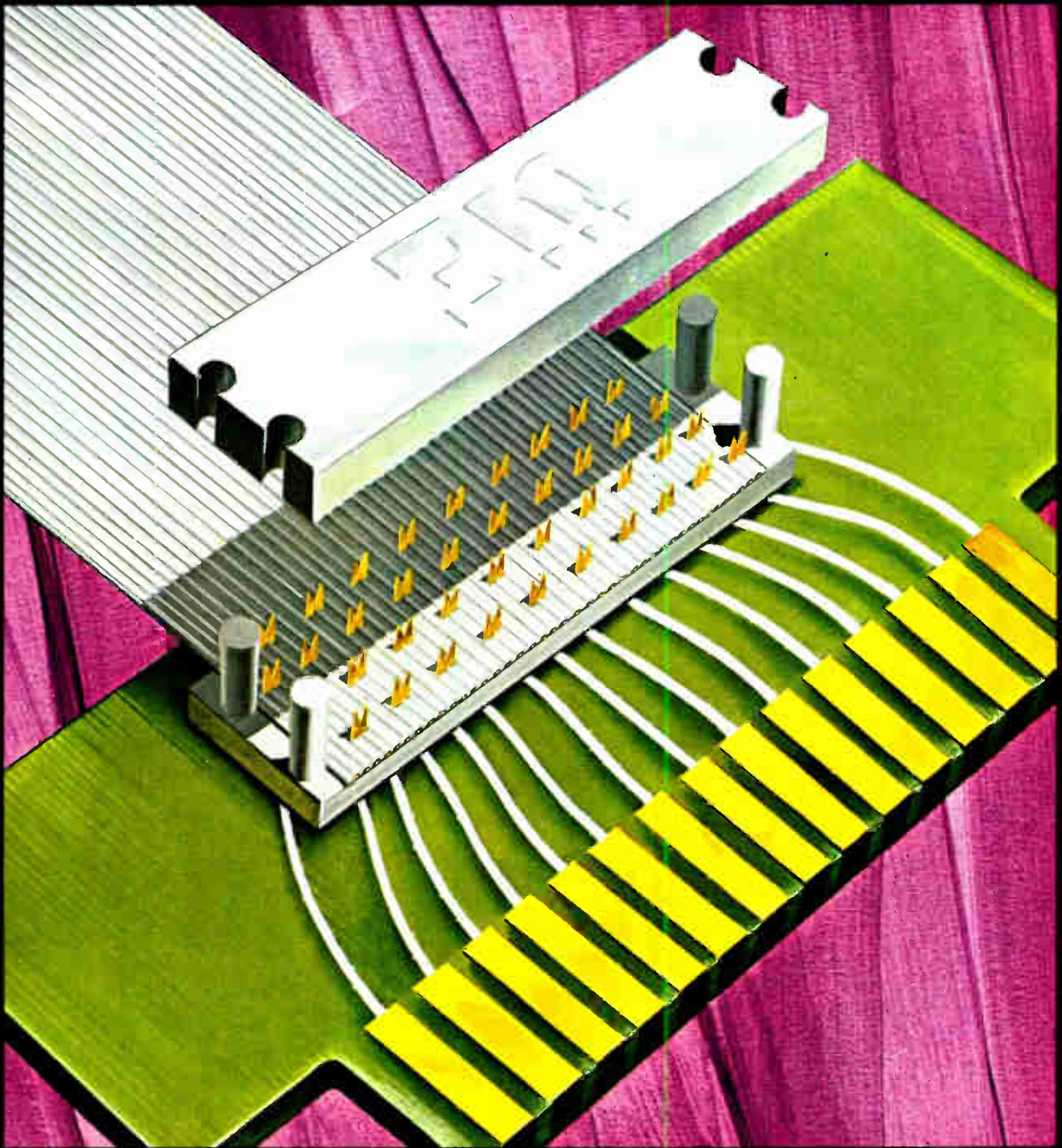

3M's Flat Cable and Connectors... your systems approach to circuitry.

Speed and dependability are yours for your circuitry system assemblies. 3M's "Scotchflex" Flat Cable and Connector Systems provide fast simultaneous circuitry transitions.

"Scotchflex" Flat Cable and Connector Systems win on every count • No stripping or soldering • Reduce wiring errors • Permit easy trouble-shooting •

Provide predictable electrical characteristics • Speed production. • Transitions available for printed circuit board, dual in-line plug, WWP and PCB edge card. For complete information, write: Dept. EAH-1, 3M Company, 3M Center, St. Paul, Minn. 55101.

"SCOTCHFLEX" IS A REGISTERED TRADEMARK OF 3M CO.

3M
COMPANY

BRAND-REX PRESENTS

BUCK ROGERS

IN THE 25th CENTURY

TRAPPED IN ORBIT AROUND MARS, DR. HUER HASTENED TO COMPLETE HIS NEW DEFENSE SYSTEM TO WARD OFF THE BAND OF ATTACKING TIGER MEN...



IF I CAN GET THIS CENTRAL CONTROL SYSTEM RIGGED IN TIME IT WILL SET UP AN INVISIBLE BARRIER AROUND OUR SPACE SHIP THAT EVEN THE TIGER MEN CAN'T PENETRATE... BUT I'M STUMPED. WHERE WILL WE GET ALL THE SPECIALIZED WIRE WE NEED TO WRAP THIS COMPUTER'S BACK PANEL?

THIS LOOKS LIKE A JOB FOR **BRAND-REX** WIRE. IT'S TOUGH STUFF. LUCKILY SPACE SCOUT SHIPS ALWAYS CARRY AN AMPLE SUPPLY.

INCREDIBLE, BUCK. THERE ARE 11 DIFFERENT KINDS OF **BRAND-REX** BACK PANEL WIRES HERE! AND LOOK AT ALL THE COLORS!

SOMETHING FOR EVERY OCCASION, DOC. HERE'S THE **KYNAR** WIRE WE NEED.

SHORTLY...

THE INVISIBLE SHIELD IS WORKING!

LOOKS LIKE **BRAND-REX'S** BACK PANEL WIRE IS THE REAL HERO OF THIS TALE. AND NO WONDER. **BRAND-REX** OFFERS MORE DIFFERENT WAYS TO WRAP A BACK PANEL THAN ANYONE ELSE IN THE UNIVERSE.

SO REMEMBER, EARTHFOLKS: THE NAME **BRAND-REX** MEANS WIRE AND CABLE THAT'S WAY AHEAD OF ITS TIME. TODAY PRACTICALLY EVERY MAJOR PROCESSING UNIT AND ITS PERIPHERAL EQUIPMENT USE AT LEAST ONE KIND OF **BRAND-REX** BACK PANEL WIRE. WHY NOT SEND FOR THE NEW **BRAND-REX** SPECIFICATION BR-212D AND GET A FULL COLOR BUCK ROGERS WIRE WRAP® WALL CHART FREE! JUST WRITE TO:

BRAND-REX DIVISION
AMERICAN ENKA CORP., WILLIMANTIC, CONN. 06226
THE PLANET EARTH

BRAND-REX, WAY AHEAD IN WIRE AND CABLE

Programmable supplies 'adapt' to automatic systems

Digitally controlled sources need little interfacing; current-limiting feature allows dynamic-load tests

The digitally controlled power supplies being introduced by John Fluke Manufacturing Co. don't look like plug-in modules—though in a sense, they are. According to Fluke engineers, the new units fit into almost any automatic system without interface circuitry. The supplies, because of their versatility, do their own interfacing. Each supply has wide output-current and output-voltage ranges, is immune to noise, can be made to accept almost any input format, and has bias and reference supplies built in. Furthermore, the maximum output-current level, as well as the reference signal to a supply's digital-to-analog converter, are programmable.

Four units make up the new line. The 4210A and the 4250A use 8-4-2-1 binary-coded decimal inputs, while the 4216A and the 4265A need 14-bit binary signals. Fluke can modify these units to work with other formats.

The low-power 4210A and the 4216A—each priced at \$995—deliver up to 100 milliamperes. The respective ranges are 0 to ± 10 volts and 0 to ± 16.383 V. For both models, outputs are programmable in 1-mV steps. Accuracy is $\pm (0.01\%$ programed value + 100 microvolts). Both can sink 50 mA, and settle in 30 microseconds.

The 4250A and the 4265A—priced

at \$1,195—deliver up to 1 ampere. Both can sink 0.5 A and have a settling time of 100 μ s. The 4250A's output ranges are 0 to + 10 V in 1-mV steps, and 0 to ± 50 in 10-mV steps. Ranges for the 4265A are 0 to ± 16.383 V in 1-mV steps and 0 to ± 65.532 V in 4-mV steps.

Since their range-changing circuits are solid state—not mechanical—the supplies switch ranges quickly (under 100 μ s).

Maximum ripple and noise levels are extremely low. For example, the 4250A, operating at its 50-V range, has a ripple level no higher than 3 mV rms and a noise level no higher than 10 mV peak-to-peak.

"We feel that the greatest application is going to be in automatic systems for testing almost anything," says Fluke product manager Phillip Gaberich.

Each supply is basically a ladder network for converting digital inputs into an analog signal. The input comes into the ladder either directly or through an isolation circuit. Isolation—a \$200 option on the low-power units and \$400 on the high-power models—is intended for applications where input noise is high enough to distort the output. The isolation circuit breaks an incoming word into two segments, and then sends them serially via transformers to a register and on to the ladder.

The supplies all come with a 10-V internal source for their ladders. An external-reference capability is a \$200 option. It allows a supply to be a programmable ac, as well as dc, source. Amplitude range for the external reference is 0

to ± 14.5 V, and the frequency range goes up to 100 kilohertz.

The external reference can act as a programmable attenuator for the supply. And, if the reference comes from a sine wave generator set to a fixed amplitude, it allows the

At work. Supply at top of rack delivers up to 50 volts. The two (side by side) below the computer put out 10 V each.



Whatever your load moving problem . . . Ledex has the answer!

FORCE OR TORQUE



STROKE

If you need fast, direct rotary motion, pick from eight basic *Ledex rotary solenoids*. Available with rotary strokes from 25° to 95° and up to 117 lb. in. of torque.

Whether it's rotary or linear motion, a lot of wallop at the beginning, in the middle or at the end of the stroke, or if it's fast response you're after . . . Ledex has the answer to your load moving problem.

If your application calls for a short or medium length stroke, consider *Ledex push or pull solenoids*. Seven sizes . . . with flat face plungers for short strokes to .060 inch or conical face plungers for

strokes to .390 inch. Force to 85 pounds. Response time less than 10 milliseconds.

For long stroke linear applications . . . *Ledex long stroke, straight pull solenoids*. Four sizes . . . strokes to .750 inch, force outputs to 20 pounds.

To give you quick starts on your prototypes, small runs you need in a hurry or critical spurs, Ledex stocks over 300 solenoid models. If none of these fit your exact requirements, our willing and experienced engineering staff works with you to come up with a custom solution.

Write today for an up-to-date set of Ledex Solenoid Catalogs . . . Rotary, Push/Pull, Straight Pull . . . with specifications and application information.

Specialists in remote actuation



LEDEX INC.

123 Webster Street, Dayton, Ohio 45401, phone (513) 224-9891

New products

supply to be directly programmed to deliver rms voltage values.

This option also turns a supply into a multiplier, since a supply's output is always the product of the input and the reference.

For systems that demand the same stimulus over and over, each supply has the standby-command feature. A one-bit signal can clear a supply's output to 0 and then order the programmed command for the desired stimulus to be stored in the supply's memory. When the standby signal is withdrawn, the stored command is again applied.

Programmable current limiting is a \$200 option for the high-power supplies. With it, one of two current ranges—100 mA or 1 A—can be selected. For the 100-mA range, the output limit can be changed in 10-mA steps. For the other range, the steps are 100-mA high.

Fluke engineers are waiting for customer feedback before they start listing the uses of this option. However, Gaberich has one in mind already—checking the regulation of signal sources. "Connect the output terminals of the power supply being tested to the output terminals of the 4250A [or 4256A]," he explains. "Then you program the voltage of the 4250 to near 0, and program a current limit of 100 mA. The power supply under test will pump current back into the 4250A at a constant 100-mA level; you can vary voltage output of the supply under test and it will always force 100 mA. In other words it [the 4250A] is kind of a dynamic load. And if you want to change loads on the supply under test, all you have to do is program a different current limit."

The other option is a front panel display. Here a string of light-emitting diodes shows the input word in either BCD or binary format. Price for this option is \$150 for the low-power models and \$200 for the high-power units.

Fluke is taking orders for its supplies now. Deliveries will begin in April for the low-power supplies, and in June for the other two.

John Fluke Manufacturing Co. Inc., P.O. Box 7428, Seattle, Wash. [338]

MOS . . .

we make a

big

production

out of it

Currently playing, MTS: 1001—Dynamic Dual 100 Bit Shift Register 1002—Static Dual 32 Bit Shift Register. MCS: 1002—Seven Segment Decoder/Driver: 1004—2240 Bit ROM (64 X 5 X 7 Character Generator). Currently in rehearsal . . . the spectacular low voltage POM and RAM show scheduled to open early '71 with 2560 X 1, 2048 X 1, 1024 X 2, 512 X 4, 256 X 8, 256 X 9, 256 X 10, 2240 (64 X 5 X 7), 2240 (64 X 7 X 5) in the line of ROMs along with two other powerful, low voltage headliners: A 256 bit static RAM and a 1024 bit RAM. In the supporting cast: The Dynamic Triple 56 Bit, Dynamic 512 Bit and 1024 Bit Shift Registers. All of them moving fast under less power at competitive prices . . . and that's just the standard stuff . . . you ought to see our custom jobs!

WE'VE TURNED
A TECHNOLOGY
INTO A COMPANY



MOS TECHNOLOGY, INC.

VALLEY FORGE INDUSTRIAL PARK, VALLEY FORGE, PENNA. 19081 • 215-566-7950

A Proud Affiliate of Alien-Bradley Co.

EASTERN REGION

Mr. Bill Whitehead, Sales Director, MOS Technology Inc., 88 Sunnyside Blvd., Suite 307, Plainview, N. Y. 11803 • 516-822-4240 • REPRESENTATIVES—MicFael Scott Co., Inc., 20 Walnut St., Wellesley Hills, Mass. 02181 • 617-235-0102 • Ossmann Component Sales Corp., 280 Metro Park, Rochester, N. Y. 14623 • 716-442-3920 • Bob Jackson, Mfr.'s Rep., P.O. Box 17484, Charlotte, N. C. 28211 • 704-366-6678 • Falk-Baker Associates, 382 Franklin Ave., Nutley, N. J. 07110 • 201-661-2430 • Currie Aerospace Associates, Inc., P.O. Box 13229, Orlando, Fla. 32809 • 305-855-0843 • C. H. Newson & Associates, Inc., 711 Bethlehem Pike, Philadelphia, Pa. 19118 • 215-248-3377.

CENTRAL REGION

Mr. Al Mattal, Sales Director, MOS Technology Inc., 10400 W. Higgins Rd., Suite 631, Rosemont, Ill. 60018 • 312-298-2035 • REPRESENTATIVES—Norvell Associates, P.O. Box 20279, Dallas, Texas 75220 • 214-357-6451 • John Grey Associates, 3957 Denley Ave., Suite 206, Schiller Park, Ill. 60176 • 312-671-3258 • Hastings Inc., 249 Winding Way, Dayton, Ohio 45429 • 513-771-5674 • Special Electronic Sales, 8053 Bloomington Freeway, Bloomington, Minn. 55420 • 612-884-4317 • Harlan J. Weiser & Associates, Inc., 2050 Woodson Pk., St. Louis, Mo. 63114 • 314-428-3934 • R. C. Merchant & Co., Inc., 18411 W. McNichols, Detroit, Mich. 48219 • 313-535-6000.

WESTERN REGION

Mr. Jack Turk, Sales Director, MOS Technology Inc., 2172 Dupont Dr. (Patio Bldg.) Suite 221, Newport Beach, Calif. 92660 • 714-833-1600 • REPRESENTATIVES—Hunter Associates, 1208 Fox Plaza, San Francisco, Calif. 94102 • 415-626-8576 • W. B. Knight Co., Inc., P.O. Box 400, 112 Glasgow Ave., Inglewood, Calif. 90301 • 213-678-4711 • J. A. Tudor & Associates, Inc., 2605 Western Ave., Seattle, Wash. 98121 • 206-682-7444 • Checkmate Sales, P.O. Box 22411, Denver, Colo. 80222 • 303-771-4920 • Toward Engineering Associates, Inc., P.O. Box 15268, Arcadia Station, Phoenix, Ariz. 85018 • 602-955-3193.



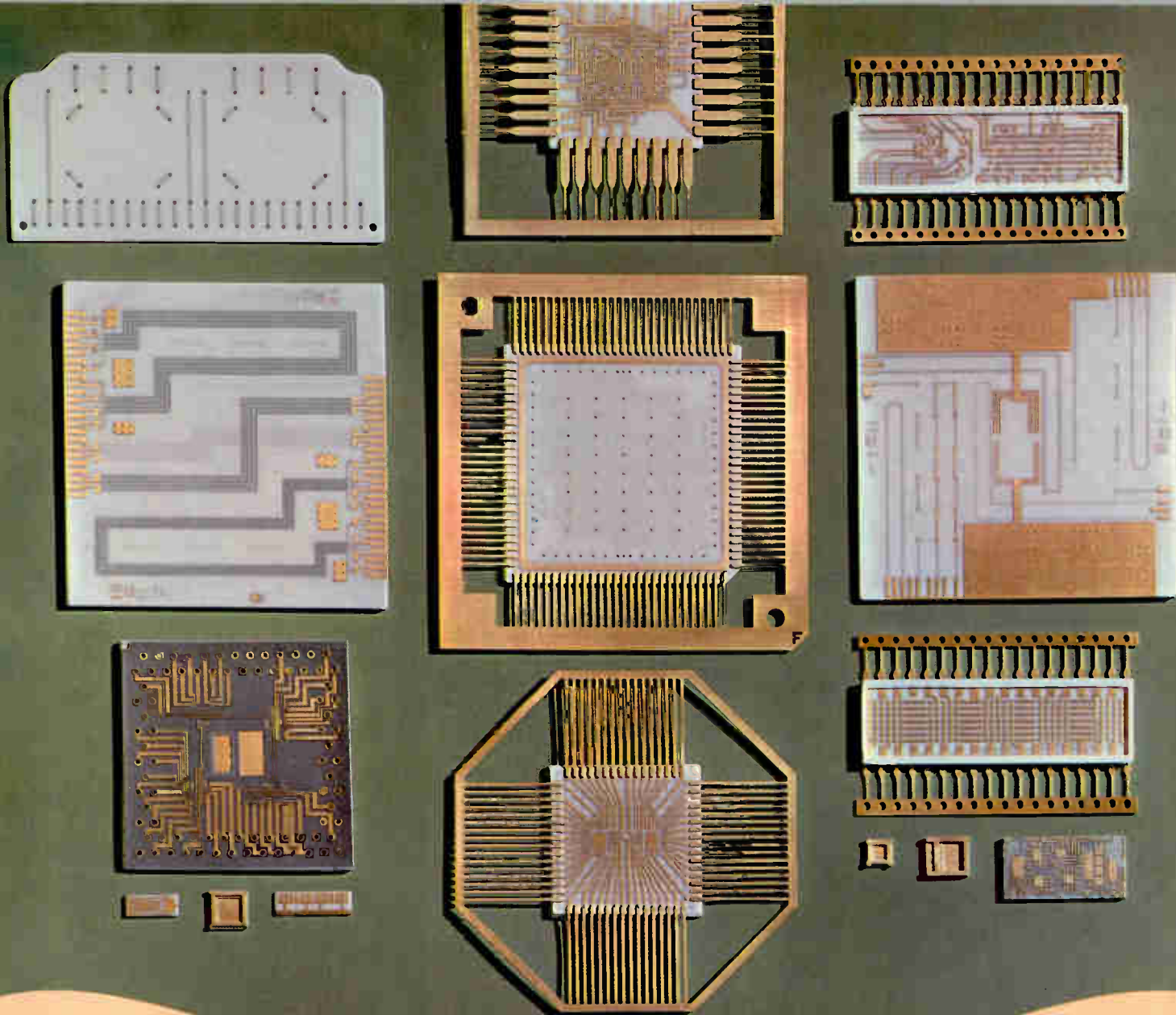

Illustration approximately actual size.

MULTI-LAYER

AlSiMag[®] Composite Substrates

Tremendous advances continue in these custom made, monolithic multilayered structures of electrically conductive patterns separated and insulated by planes of high-alumina ceramic (no glass). Prototypes frequently are the stepping stones to major ad-

vances. By getting together with people to see what we can work out, dramatic progress continues to be made. Best designs have evolved through head to head conversations. A folder giving present design parameters will be sent on request.

CONSIDER FOR:

- MULTI-CHIP CIRCUITS
(Both Bi-polar and MOS)
Chip Attachment may be Flip Chip or Beam Lead.
- CHIP CARRIERS
- LIGHT EMITTING DIODE ARRAYS
Can be made in any number of layers.
- COMPLEX THIN FILM, THICK FILM, or ETCH BACK CIRCUITS
(Standard buried conductor paths permit you to customize the top layer.)

CODE IDENT. NO. 70371

PHONE 615/265-3411 • CHATTANOOGA, TENNESSEE 37405, U.S.A. A SUBSIDIARY OF

American Lava Corporation

3M
COMPANY

For service, contact American Lava representatives in Offices of Minnesota Mining and Manufacturing Company in these cities (see your local telephone directory): Boston: Needham Heights, Mass. • Chagrin Falls, O. • Chicago: Elmhurst, Ill. • Dallas, Tex. • Indianapolis, Ind. • Laurens, S. C. • Los Angeles, Calif. • Metropolitan New York: West Caldwell, N. J. • Up-State New York and Canada: Phoenix, N. Y. • Orange, Conn. • Philadelphia, Penn. • St. Louis: Lee's Summit, Mo. • Salem, Va. • S. San Francisco, Calif. • Tempe, Ariz. • International: c/o American Lava Corporation, Chattanooga, Tenn. 37405, U.S.A., TELEX 558432

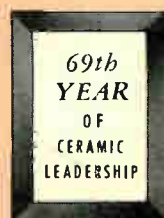

New products

Instruments

H-P offers service scope

Portable unit comes in sealed chassis; bandwidth is 35 MHz

Oscilloscopes for repairmen are quite different from those found in design laboratories. Service people want a rugged instrument that's

easy to carry and can run off a battery. Engineers at Hewlett-Packard Co. say their new—and first for H-P—field service oscilloscopes meet these criteria.

There are two models: The 1701A, with sweep delay and a \$1,850 price tag, and the 1700A, without sweep delay and with a \$1,680 ticket. Each weighs 24 pounds, measures approximately 15 by 12 by 7½ inches, and has a display area of 6 by 10 centimeters.

Each scope is a dual-channel unit with a 35-megahertz bandwidth. Vertical sensitivity is 10 millivolts per cm. Maximum sweep is 0.1 microsecond per cm.

Either line power or a battery

can drive the scopes. An 8-lb battery pack, which fits into the chassis, is a \$200 option. The pack runs for six hours and requires a 14-hour recharge period.

The prime application, particularly for the 1701A with its sweep delay, will be servicing digital equipment, says product line manager Chuck Donaldson. H-P marketing men, he points out, broke the service market down according to integrated-circuit type when planning the 1700 line. "We want the 1700A and the 1701A to handle TTL and anything slower," he says. A bandwidth broader than 35 MHz isn't needed, even for this high-speed logic, says Donaldson, be-

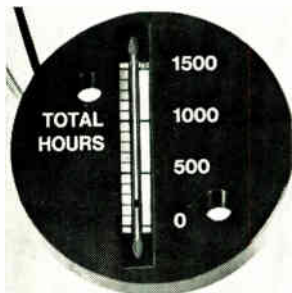

Elapsed time indicator model 930 has broad application potential because no external power source is required. It is powered by an internal mercury battery of hearing-aid size. Heart of the unit is the mercury coulometer in which a visible gap travels along a mercury-filled capillary tube according to total flow of electric current. Curtis Instruments Inc., Mt. Kisco, N.Y. [361]

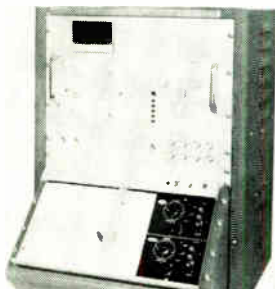

Frequency response analyzer model 103 is for measuring, analyzing, and recording the frequency, amplitude ratio, and phase relationship of test signals for a variety of equipment. Applications include R&D, production testing, and maintenance of machine tool controls, and aircraft flight control. Industrial Measurements & Controls, N. Thomas St., Pomona, Calif. [362]

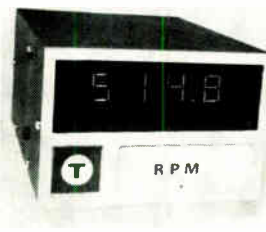

Digital tachometer displays rpm or any other rate information. Display is a highly visible, seven-segment digital readout that can be viewed in direct sunlight. Input frequencies from 0 Hz to 20,000 Hz, sinusoidal, square, pulse, and triangular waveshapes can be accommodated. Voltage can range from 10 mV to 30 V rms. Technical Products Corp., Box 521, Cape Girardeau, Mo. [363]



Multimeter model mn 124 is a 4-digit unit that provides up to 2,500 points of measuring capability in a compact package suitable for bench or rack mounting. Display consists of four decimal tubes with stored display as well as polarity and function indicators. Unit has 17 ranges. Accuracy is 0.001 to 0.01% depending on range. Dixon Inc., Grand Junction, Colo. [364]

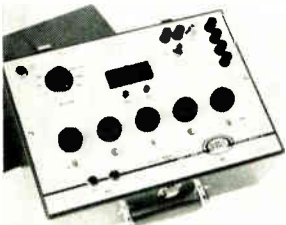

Portable Kelvin bridge model 72-439 eliminates interpolation of slidewire readings. It offers five-dial in-line readout from 0.5 microhm to 1,111 ohms in seven ranges, with accuracy of $\pm(0.03\%$ of reading ± 0.03 microhm). The built-in solid state detector has a sensitivity of 1 μ V per division. James G. Biddle Co., Plymouth Meeting, Pa. 19462 [365]

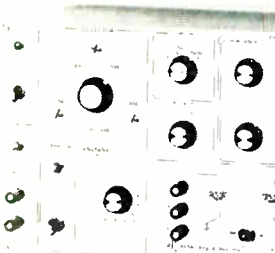

Semiconductor curve tracer model BCT-4A is for use in conjunction with any existing X-Y oscilloscope. It displays several dynamic characteristic curves of semiconductors in the common emitter configuration. Operating conditions provided include: collector voltages up to 250 V, collector current to 3A. Beta Engineering and Development, Box 2004, Hartford, Conn. [366]

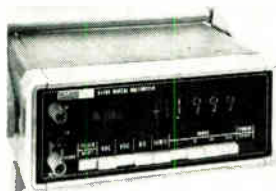

Digital multimeter model 8110A, through the use of matched high-quality wirewound resistors, polystyrene capacitors and an extremely stable reference amplifier, achieves a dc accuracy of $\pm(0.01\%$ of input $\pm 0.01\%$ of range) for 90 days and is within $\pm(0.01\%$ of input $\pm 0.02\%$ of range) after six months. Price is \$850. John Fluke Mfg. Co., Box 7428, Seattle, Wash. [367]

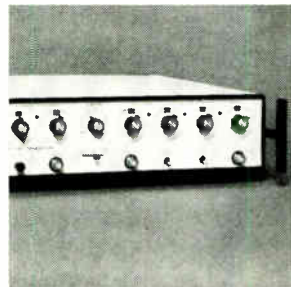

Programmable waveform generator model 605 can receive commands from any digital source and produce a wide assortment of rapidly changing waveforms. The compact, 3½-in.-high unit has a frequency range from 0.001 Hz to 1.1 MHz (usable to 0.0001 Hz). Frequency accuracy is $\pm 1\%$ of setting plus 1 digit at 0.001 Hz to 100 kHz. Exact Electronics Inc., Box 160, Hillsboro, Ore. [368]

CORONA-FREE 30 kv High Voltage Connectors



Shielded Tri-Coupler
MODEL 3732

Shielded Coupler
MODEL 3731

Bulkhead Receptacle
MODEL 3730

Cable Plug
MODEL 3733

Ideal for use in X-ray, radar, laser, RF, pulse, power, and other military/industrial applications. ■ Rated 30 kv continuous unmated ■ up to 10,000 ft. and 90% humidity ■ molded of high dielectric epoxy resin ■ couplers are fully shielded for greater safety and reduction of electrostatic collection of dust ■ bulkhead receptacle includes corona ball, plus "O" ring for hermetic sealing.



POMONA ELECTRONICS CO., INC.

1500 East Ninth Street, Pomona, California 91766 • (714) 623-3463

Circle 115 on reader service card



GAS RADAR GS-1

DX Gas Rader (Gas Detector) to safe guard you against Gas Danger which cost you life.

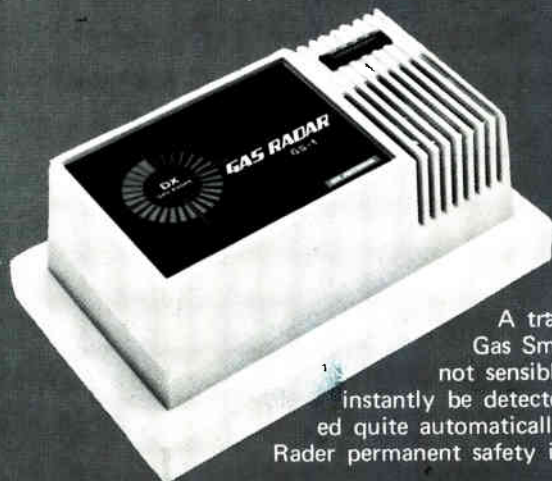

A trace of leakage Gas Smoke or Fume not sensible to you can instantly be detected and alarmed quite automatically by DX Gas Rader permanent safety in your home.

Highest sensitivity realized by DX Electronic level Gas Rader, Model GS-1, Negligibly Low Cost of Performance.

Quick response to present. The Growth of Danger to Uncontrollable magnitude. Extreme ease of Preparation.

Distributor
Sun Worldwide Corp.
80-60 Lefferts Blvd.
P.O. Box F,
Kew Gardens, N.Y. 11415



DX ANTENNA CO., LTD.
MANUFACTURERS, EXPORTERS
CABLE DXANTENNA KOBE, JAPAN

DX ANTENNA

90 Circle 90 on reader service card

New products

cause "customers are interested in measuring time delay rather than rise time."

H-P engineers designed the scopes for field work. Each comes in a sealed chassis, to prevent dust and moisture contamination. Because heat dissipation is low—about 18 watts when running off a battery—no vents or fans are needed.

Besides its own battery pack, any other dc supply over the range of 11.5 volts to 36 V can serve as the power source. In their ac mode, the scopes run off a 115-V or a 230-V line that can fluctuate by as much as 20%. Line frequency can run between 48 and 440 hertz.

Donaldson predicts that dc power will be a popular source for his scopes—but not because they'll be going to a lot of remote areas. "You can almost always find a place to plug a scope in," he says. Rather, Donaldson expects many servicemen to stay away from line voltage in an attempt to isolate the oscilloscope from the sources connected to the system under test.

The service scopes themselves are easy to service, or at least to calibrate. Less than 50 adjustments are necessary to completely calibrate either unit. "A trained technician can do the job in under an hour," says Donaldson.

Much of the credit for the new scopes' performance goes to their power supply and their cathode ray tube.

The supply is built around a dc-to-dc converter that's 87% efficient. Battery voltage goes right to the converter, which generates the dc levels needed in various parts of the scope. When running off line power, the scope routes its ac input through an isolation transformer to a rectifier-regulator, and on to the converter.

The new CRT allows the big display area to fit into a small box. The tube is only 14 inches long, but has a vertical deflection factor of 1.5 v and a horizontal factor of 3.5 v.

Delivery time for the two oscilloscopes is eight weeks.

Hewlett-Packard Co., 1501 Page Mill Road, Palo Alto, Calif. [369]

Why just hope for laminate consistency?
Call on the Lint-Pickers!



You hope your copper-clad laminates will be consistently perfect and perfectly consistent. And what you hope for, you get, from the "Lint-Pickers".

UOP Norplex is called that, you know, because we're the finicky-est folks in the laminating business. Our clean rooms, with precisely controlled temperatures and humidity, add to Norplex product dependability.

Special quality-control equipment, much of it designed by Norplex, helps assure reliable high-volume production. And assures the uniform quality that is guaranteed to meet

or exceed NEMA and MIL-P specifications. Also, our new, modern plant at Franklin, Indiana, is now adding extra capacity to turn out and speed your orders.

Most important, though, are Norplex's skilled technicians and workers, proud of their products, proud to be called "Lint-Pickers"

UOP Norplex is a division of Universal Oil Products Company, a half-billion dollar company busy making life better through research and product innovation world-wide.

Write for our latest catalog. It's designed to help engineers select the right laminates for every need.

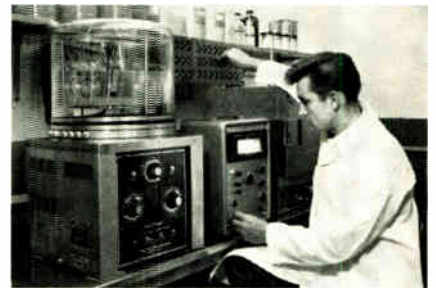

Volume and surface resistivity testing of copper-clad laminates. Exterior control unit, designed by Norplex, gives fast, reliable readout.

Main Office and Plant
Norplex Drive
LaCrosse, Wisconsin 54601
608/784-6070

 **NORPLEX**
LAMINATED PLASTICS

Franklin Office and Plant
P.O. Box 185—Route 31 North
Franklin Industrial Park
Franklin, Indiana 46131
317/736-6106

Semiconductors

Counter does many jobs

Versatile IC designed to help user reduce stock and simplify circuitry

One way for integrated circuit users to keep the lid on inventories is to stock flexible, multifunction devices. That's what Fairchild

Semiconductor has in mind in marketing the 9305 variable-modulo counter. The device combines the functions of a decade counter, a divide-by-12 counter, and a binary counter in a monolithic chip.

The 9305 also offers other operational modes. It performs division and counting in 10 binary modes without external logic—it can divide or count by 2, 4, 5, 6, 7, 8, 10, 12, 14, and 16. It can function as a 50% duty-cycle frequency divider in five of these modes—8, 10, 12, 14, and 16. And by adding two NAND gates, it can count or divide by 11, 13, and 15. No other MSI device on the market can do all of these, says Hank Smith, a product mar-

keting manager at Fairchild. "Besides helping our customers to keep their inventories down," he says, "the 9305 also can help them simplify their designs."

The 9305 consists of four R-S master/slave flip-flops separated into two functional units. When programmed as a three-stage counter (using the second, third, and fourth flip-flops), the device provides synchronous binary count modulus of 5, 6, 7 or 8. The first flip-flop, a single toggle stage, can operate in the modulo 2 mode or can be combined with the other three stages to provide modulus 10, 12, 14, or 16. The four-stage configuration also can be used to achieve a 50% duty

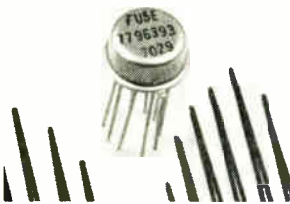

Double balanced modulator/demodulator μ A796 features high carrier suppression. The linear IC is a low-cost monolithic design with precisely matched transistor components at the inputs and outputs. Chief uses are in transmitters and receivers and as fast differentiators in computer input/output systems. Fairchild Semiconductor, 313 Fairchild Dr., Mountain View, Calif. [436]



Germanium pnp alloy, high power transistors are identified as the JAN 2N456B-457B-458B series and JAN 2N1021A-1022A series. They are packaged in a JEDEC TO-3 case. Typical specifications are: multiple gain selections from 1 to 10 amperes; V_{CE} (sst) as low as 0.5 V; V_{CE0} up to 120 V; and V_{CEX} up to 120 V. Solitron Devices Inc., Riviera Beach, Fla. 33404 [440]

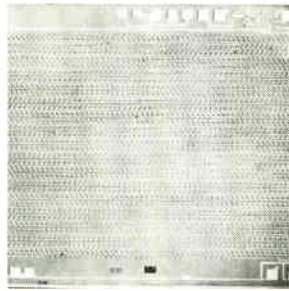

MOS/LSI 1024-bit dynamic shift register operates up to 1 MHz with a 25 pF load. Data is shifted through the register by a 4-phase clock system. Timing signals are externally generated. The register interfaces with standard MOS input and output levels, and can be serially coupled to form higher orders. Price (100 lots) is \$20. Collins Radio Co., Newport Beach, Calif. [437]

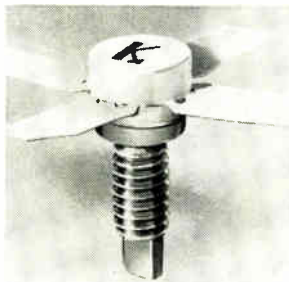

Ruggedized transistors 3TX850 and 3TX851 are for fm and cw requirements at 28 V operation up to 1 GHz, where load mismatch capability is required. Units are specified at 5.2 dB power gain at 1 and 2.5 W, respectively. Both devices are packaged in a 1/4-inch ceramic strip-line with all leads isolated from the case. Kertron Inc., Riviera Beach, Fla. [441]



Glass microwave varactors GC-1760 are abrupt junction silicon devices that offer extremely high Q and high tuning ratios and are oxide passivated for stability at high temperatures. Q's over 1,000 are standard as are capacitance values from 5.6 to 39 pF. The series can be custom designed to meet tailored circuit needs. GHZ Devices Inc., Kennedy Dr., No. Chelmsford, Mass. [438]

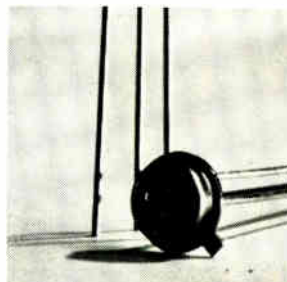

Industrial SCRs in the ID100-104 series feature hermetically sealed TO-18 JEDEC metal can packaging at prices competitive with plastic devices. Voltage ratings range from 30 V for the ID100 to 200 V for the ID104, with continuous dc forward current ratings of 500 mA at 100°C case. Prices start at 45 cents in 1,000 lots. Unitrode Corp., Pleasant St., Watertown, Mass. [442]

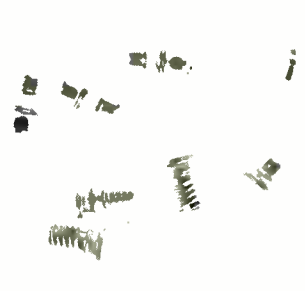

Silicon step recovery diodes are designed for use in high performance frequency multiplier circuits from L band to Ku band. Types A4S 360, A4S 370, and A4S 375 are optimized for efficiency and power output at S, C and X bands, respectively. Typical is the A4S375 which is capable of 300 mW output (x4) at 13.3 GHz. Aertech Industries, Sunnyvale, Calif. [439]



Junction FET switch/drivers are for use with ± 15 -V power supplies. Line includes the DG151A series of 2-channel spst and dpst units for the military temperature range, the DG151B similar series for the industrial range, the DG161A single channel spdt and dpdt units for military use, and the DG161B. Siliconix Inc., Laurelwood Rd., Santa Clara, Calif. [443]

Spec for spec, every one of the 28 designs in our new family of high-performance A/D and D/A converter modules is the best in its class. Each provides an optimum combination of stability, linearity, accuracy, and speed. Several are unique. Yet every one is priced to compete with *ordinary* converters. *How do we do it?*

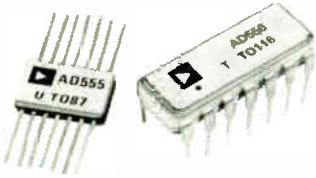

secret ingredients

It's simple, really. We start out way ahead, with *fourth-generation* IC quad switches—our exclusive μ DAC™ quads, which incorporate circuit and processing innovations that make high-performance 16-bit conversion a practical reality at practical prices . . . and superb 8-to-12-bit conversion a snap.

The **current quads** have a unique type of internal reference compensation (another headache gone!) and proportional junction geometry, for minimum intrinsic V^{BE} errors.

The **voltage quads** are optimized by dielectric isolation of all critical junctions for minimum resistance and resistance mismatch. These quads give us conversion linearity to within 0.01% without tweaking or trimming!

Then we complement the near ideal performance of μ DAC switches with μ DAC ultra-stable thin-film resistance networks . . . laser-trimmed for virtually perfect linearity. (And how does a T.C. of 1PPM/°C sound?) And since we designed μ DAC networks for optimum compatibility with μ DAC quads, the rest is all downhill.

These years-ahead "secret ingredients" were designed and built in our new "outer-limits" fourth generation IC engineering and

production facility. They gave us an unfair advantage over all other manufacturers of converters. Now that the secrets are out, of course, they'll be playing catch-up ball. (Don't wait for them.)

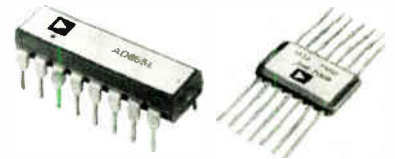

more secret ingredients

FIVE REPRESENTATIVE DESIGNS

DAC-16QM

16-bit D/A Converter (also 14-bit DAC-16QM) Linear within 0.0008%! From ordinary $\pm 15V$ op amp supplies — no need for 100 volt current-source supplies. Gain T.C. is 1ppm/°C. Completely universal — up to 14 possible codes.

DAC-12M

Multiplying 12-bit D/A (also 8-bit DAC-8M) Four-quadrant multiplier; accepts one digital and one or two analog (bipolar or unipolar) inputs; output is their product. Accuracy, $\pm 0.024\%$.

ADC-12QM

12-bit A/D Converter (also 8-bit & 10-bit designs) Relative Accuracy, 0.0125%; differential linearity, $\pm \frac{1}{2}$ LSB; T.C. of linearity, ± 3 ppm/°C; T.C. of reading ± 5 ppm/°C. Output: serial/parallel; binary, BCD; TTL;

DAC-12QM

12-bit D/A Converter (also 8-bit & 10-bit designs) Output: 0 to 5 or 10VDC (or $\pm 5, \pm 10V$) @ 10mA; 50V/ μ sec slew rate; Linearity & F.S. Accuracy, $\pm \frac{1}{2}$ LSB each; T.C., ± 7 ppm/°C.

DAC-12QS

12-bit D/A Converter (also 8-bit & 10-bit designs) Same performance as DAC-12QM, but without input storage register.

SIZES: 2" x 2" x 0.4" or 2" x 2" x 0.36" or 2" x 4" x 0.4", as shown below.



Write today for the complete "data package" on all the converter products of: ANALOG DEVICES, INC., 221 Fifth Street, Cambridge, Mass. 02142.

For immediate delivery from stock, or other prompt, personal assistance, call: Dick Ferrero at (617) 332-2131 or (617) 969-3661; TWX: (710) 335-6472.

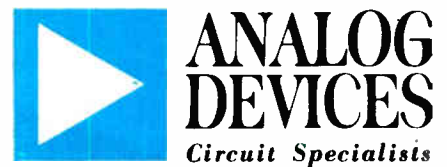

We use Secret Ingredients
...in 28 new D/A & A/D Converters

Attention Data Systems OEM's:
Secret Ingredients for Sale. In Stock. Call for Evaluation Units & Quotes.

®



die cast
ZINC ALLOY



molded
PLASTICS



Coil Bobbins
Gears & Pinions

GET THIS
SAMPLE KIT

OF GRC TINY
PLASTIC
MOLDINGS

Gries' special methods and Value Engineering are combined to give highest functional value. Imaginative engineering ideas are turned into precise, uniform tiny parts. You save every step of the way . . . basic part through final assembly.

NO SIZE TOO SMALL!
MAXIMUM SIZE FOR PLASTIC MOLDINGS: 1 3/4", .05 oz.

Write today on company letterhead for your kit.

Gries Reproducer Co.

Division of Coats & Clark Inc.

151 Beechwood Ave., New Rochelle, N.Y. 10802
(914) 633-8600

Circle 116 on reader service card

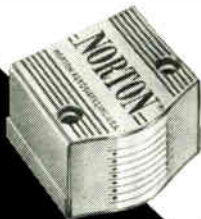

NORTON®
MAGNETIC
HEADS

MULTITRACK
ERASE
RECORD
PLAY

Send now for complete technical literature.

NORTON

ASSOCIATES, INC.

10 Di Tomas Court, Copiague, N.Y. 11726
Phone: 516 598-1600

New products

cycle at the output. For functions in modulo 11, 13, or 15, the 9305 requires only two additional NAND gates or one gate and an inverter. These design combinations provide controllable four-bit modulus with an output duty cycle of nearly 50%.

Thanks to its high-speed counting capability (typically 26 megahertz) the 9305 is ideal for multi-stage counting operations when programmed for modulus of 10, 12, 14 or 16. Multistage dividers with large odd or even divide ratios can be designed using two or more 9205s and only very little additional logic. With only one ripple delay per four bits, the 9305 operates much faster than conventional ripple counters which have a built-in delay for every bit. The unit also can be used in designing TV sync generators, one-of-10 sequencers, rate multipliers, and many other multistage counting functions.

Smith says that in TV applications, the 9305 can be used for both the horizontal and vertical drives. "By using three 9305s," says Smith, "we can produce the 625 lines needed for European circuits or the 525 needed for American sets. And all of the decoding logic is included in the three packages."

The 9305 is available from Fairchild distributors in a 14-pin dual in-line package, and is priced at \$3.45 in quantities of 100.

Fairchild Semiconductor Inc., 313 Fairchild Drive, Mountain View, Calif. 94040 [444]

Low-cost bipolar encoder aimed at keyboard market

Many of the new keyboard encoders are metal oxide semiconductor types. But a low-cost bipolar monolithic encoder is Harris Semiconductor's entry into this lucrative market. Housed in a dual in-line package, the encoder will be priced at under \$5 and will be able to handle up to 16 keys, sufficient for small calculators. For larger keyboards with up to 256 keys, only two encoders are necessary. They can be wired for any of the popular

codes, including the 7-bit ASCII and the 8-bit EBCDIC.

According to Harris, the encoder will provide exceptional flexibility in shifting from one code to another without time-consuming keyboard modifications. Adaptation is achieved by using the truth tables supplied. These tell the user how to hook up the encoder inputs.

Called the HD-0165, the bipolar encoder contains a 16 x 5 matrix and 13 gates. The 24-pin dual in-line package has 16 inputs, four binary outputs, a two-key rollover detection output, a strobe output, and two input power pins. When a key is depressed, a binary four-bit code is generated (an eight-bit code for two encoders) together with a strobe level. The outputs are compatible with diode-transistor and transistor-transistor logic levels; the HD-0165 is not compatible with p-channel MOS. Since the output is a straight binary code, parity must be provided by external circuitry. The encoder inputs are compatible with all closure-type keys, as well as other types that provide +5 volt signal, pulsed or steady state. Total propagation time through the matrix is 115 nanoseconds, so input pulses must be at least that long.

The encoder operates from a +5 volt power supply and draws 51.5 milliamperes maximum when one key is depressed and 80 mA max when all 16 keys are held down. The voltage out corresponding to a binary 0 is 0.4 v; it's 2.4 v for a binary 1.

To develop a complete encoder, the HD-0165 requires only a 3 millisecond one-shot for timing and a four-bit latch to accumulate data until it's ready for processing.

"Cost is the strong point of the encoder," says David Uimari, applications manager, "since it will compete with discretes and hybrids." The HD-0165 is priced at \$4.60 each in quantities of 100 and higher. "Discretes cost more than \$6," adds Uimari. Deliveries begin this month.

Harris Semiconductor, division of Harris-Intertype Corp., Melbourne, Fla., 32901 [445]

Announcing . . .
a new 1971 Third Edition
of the most complete and authoritative science reference ever published!



" . . . a boon for scientists, engineers, technicians . . . the information is accurate, checked by the best specialists in each field."
 THE KIPLINGER BOOK LETTER

" . . . the most comprehensive source of information for the physical and natural sciences, and for their applications in technology."
 New York Public Library, NEW TECHNICAL BOOKS

" . . . a first class tool without substitute . . . It is the book for the specialist looking for information outside his specialty."
 SCIENTIFIC AMERICAN

McGraw-Hill is proud to announce this major new revision of America's most authoritative and widely-used science reference — the *only* multi-volume reference that provides comprehensive coverage of every scientific and engineering discipline.

An indispensable working tool that will save you hours of work and research, the *McGraw-Hill Encyclopedia of Science and Technology* gives you instant access to the basic theories, concepts, and procedures, and to the latest developments in your own and related fields. Whatever the question that comes up on the job, you'll get a clear, *authoritative* answer at the turn of a page. You'll find it invaluable in reviewing fundamental principles and procedures before starting a new assignment . . . and as a lightning-fast way of acquiring basic concepts and procedures whenever an assignment leads you outside your own area of specialization.

When it was first published in 1960, the *McGraw-Hill Encyclopedia of Science and Technology* won instant acceptance by engineers, scientists, and technicians all across the country. And now, to keep pace with the explosive growth in scientific and technical knowledge, our editors have undertaken a monumental revision and expansion of this landmark work—

- Every single article has been scrutinized for completeness and clarity and to make sure it reflects the latest developments in the field. As a result of this detailed study, *66% of the encyclopedia has been extensively revised.*
- The text has been expanded by nearly 1,000,000 words

The McGraw-Hill

ENCYCLOPEDIA of SCIENCE & TECHNOLOGY

- Completely revised and re-illustrated
- Greatly expanded
- New, larger, easier-to-use format
- Brought right up to date throughout

to cover the extraordinary recent growth in such sciences as electronics, space travel, ecology, oceanography, conservation, geophysics, and hundreds of others. A full 8% of the text consists of entirely new articles on subjects not included in previous editions.

- All illustrations have been carefully reviewed and redrawn where necessary, and *thousands of new illustrations have been added.*
- To maintain its leadership as the foremost science reference in print, *every bibliography has been updated*, except in rare cases where a thorough search revealed no significant new material on the subject since the previous edition.
- The *Index* volume, uniformly praised as a model of "The Perfect Index," contains nearly *20,000 more citations* than the previous edition. In addition, a *Topical Index* lists all the articles under 100 specific fields.
- A handy *Readers' Guide* shows how to make maximum use of the encyclopedia and find any information you need quickly and easily.
- A handsome, new, *larger format* provides room for more text and illustrations . . . makes the volumes even more attractive and handier to use than before.

In short, no effort has been spared to bring this brand new Third Edition right *up-to-the-minute* in every scientific discipline . . . to maintain its acknowledged reputation as the most *authoritative* reference of its kind . . . to make it even more *useful* than the universally praised first and second editions.

SEND FOR FREE ILLUSTRATED PROSPECTUS

Presents the Entire Span of Today's Scientific, Engineering, and Technical Knowledge in 15 Volumes

- 12,000 photographs, drawings, maps, charts, and diagrams —9,000 of them in *two colors* to increase clarity
- 72 pages in *full color*
- 7,600 articles, ranging from concise definitions to extensive book-length treatments
- 10,800 pages—more than 7,400,000 words
- *Readers' Guide* showing how to use the encyclopedia and find any information quickly and easily
- *Index* volume with 120,000-entry comprehensive index and valuable *Topical Index*
- Unique *cross-reference system* of 40,000 citations
- Prepared by more than 2,500 specialists in every field
- Annual *Yearbook* service available for subscribers keeps the encyclopedia always up-to-date

McGraw-Hill Book Company

330 West 42nd Street • New York, N.Y. 10036

Please send me, without obligation, your free, full-color prospectus describing in detail the new 1971 Third Edition of the *McGraw-Hill Encyclopedia of Science and Technology.*

Name _____

Firm _____

Address _____

City _____

State _____ Zip _____

**AVAILABLE UNDER CONVENIENT PAYMENT
 PLAN AT NO ADDITIONAL COST**

50-E-1

This Brush Multipoint recorder is 16 times faster than conventional multipoints. And you can change its mode by turning a dial.

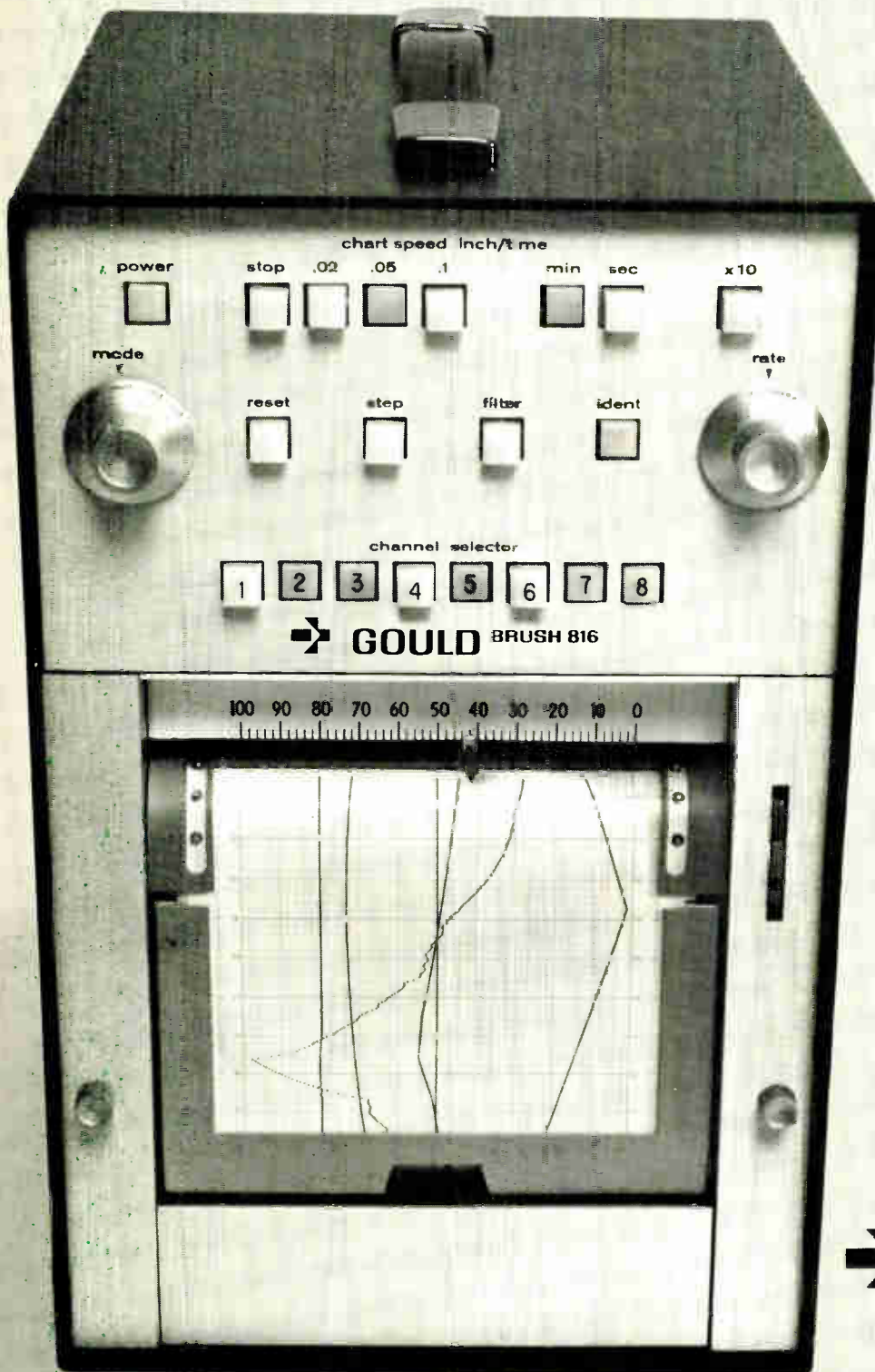

High speed. And exceptional versatility.

These are two big reasons why the Brush 816 Multipoint Recorder goes right to the head of its class.

It scans and displays up to 8 channels of data 16 times faster than conventional multipoints. And that means maximum information at lowest cost per channel.

The dial at upper left gives you fingertip selection of operating mode; *multipoint* sampling, *intensified* sampling (for channels of high dynamic content), or *continuous* single channel recording. Presentation is rectilinear on a 4½" grid while traces are clear and easy-to-read. Paper is stack-to-stack Z-folded and tucks neatly into a catch drawer below the writing table. And there's a pushbutton choice of 12 chart speeds.

The 816 adapts to a wide range of data sources and handles both high and low level inputs. A series of optional signal conditioners provides almost unlimited input flexibility.

Typical applications include: temperature dispersion vs. flow; pressure distribution within a vessel; structural stress analysis; dye dilution studies; chemical analysis; patient monitoring; machine or automotive dynamics. And many more.

At first chance, take a good look at the Brush 816 Multipoint Recorder. You'll get so much more . . . but you won't pay more to get it. Write: Brush Division, Gould Inc., 3631 Perkins Avenue, Cleveland, Ohio 44114, or Rue Van Boeckel 38, Brussels 1140 Belgium.

 **GOULD BRUSH**

Packaging and production

Bonder shields beam leads

Compliant tape technique distributes force evenly, minimizing deformation

The closer the beams on beam-leaded semiconductor chips, the more difficult it is to control deformation of the beams during bond-

ing to the substrate. To solve such problems, Western Electric developed a method called compliant beam lead bonding. Now, J. and A. Keller Machine Co. Inc., a builder of custom machinery, is using the technique in a standard product.

In this type of bonding, a compliant tape (aluminum in Keller's bonder) is inserted between the bonding head and the beams. The bonding head has an indentation in its tip to allow for chip height while pressing over the leads. As it comes down, the head deforms the aluminum around the beam leads, transmitting force to the beams evenly to make the bonds. To facilitate bonding, the substrate is

heated during the process.

The Keller bonder, designated the KCB-1000, features semiautomatic dice pickup, dice reject, and bonding cycle. One button engages or disengages the vacuum pickup and other parts of the cycle.

The bonder's optical gear provides a superimposed image of the substrate and the device through a horizontal microscope with 10X through 40X magnification and a prism-type beam splitter that reflects in-line vertical views of the device and the substrate.

The micromanipulator for positioning the chip under the microscope has 10:1 ratio for easy use. Bonding pressure is variable up to

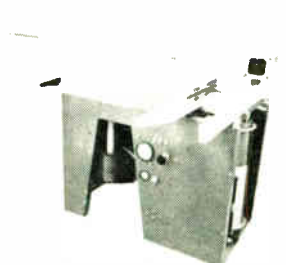

Automatic laminating press model LP1114-ID, originally designed for the high-volume production of laminated cards, is used to apply a plastic cover to pc boards in high-density packaging where problems of weight and space are acute. The 11 x 14 in. press plates are easily handled after minimal on-the-job training. Harco Industries Inc., 10802 N. 21st Ave., Phoenix 85029 [421]

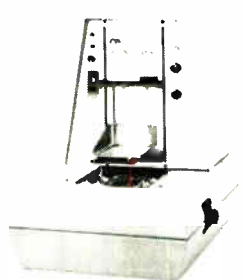

Automatic solder dipper model 1900, for ceramic substrates, has a wave type solder pot for dross-free drippings. Cartridge loading enables production rates up to 8,000/h. Substrates are soldered uniformly because of the dross-free solder surface, precise control of immersion time and uniform withdrawal rate. Mechanization Associates, S. Whisman Rd., Mtn. View, Calif. [422]

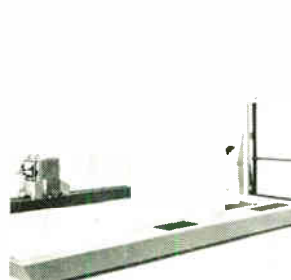

High-precision microphotography camera, called Dekacon III Magnum, has a 400 X artwork capacity for 200+ mil chips, and features a large 80 x 90 in. copyboard. It is especially suitable for producing high-density LSI circuits. Working lines of 5 microns are provided over image areas of 2 x 2 and 3 x 3 inches. HLC Mfg. Co., 739 Davisville Rd., Willow Grove, Pa. 19090 [423]

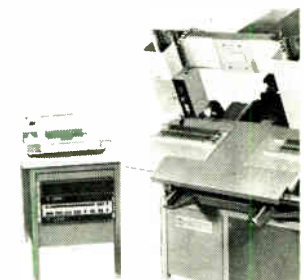

Semiautomatic wire termination system 6954/6964 offers a choice of options in control, design, and wiring methods. Options include: direct computer control or numerical control, single or dual head, and use of any type of termination head. System is rated to wrap from 24 to 30 AWG wires up to 400 wires/h/head. Universal Instruments Corp., Box 375, Syracuse, N.Y. [424]

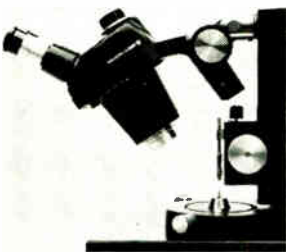

Designed to save clogged capillaries, the model 100 unplunger is an essential companion machine for fine wire thermocompression bonders. In operation, the capillary is removed from the bonder and installed point up in the capillary chuck. A micropositioner aids alignment beneath a tungsten probe with precise vertical travel. Kurt Mfg. Inc., P.O. Box 1579, Oceanside, Calif. [425]

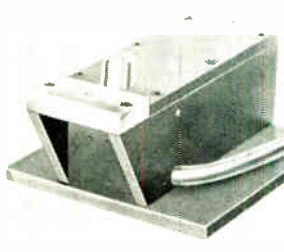

The Com-Prep 838 electronic component lead preparer is electrically operated to cut component leads to adjustable lengths by simply inserting components through dieplates. As the component reaches its full insertion point, a cutter is electrically activated to cut the leads automatically and with repetitive uniformity. Epping Machine Inc., 681 Main St., Belleville, N.J. [426]

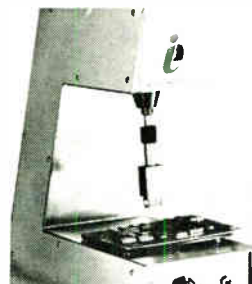

Automatic instrument model ACE-700 extracts preformed multi-head TO-5, TO-18, 14- and 16-lead dual in-line IC modules from single and double-sided, and multilayer pc boards. As the component is removed, the extractor removes molten solder from the lead holes, permitting direct replacement of the defective IC module. Enfield Industries Inc., Box 225, Flourtown, Pa. [427]

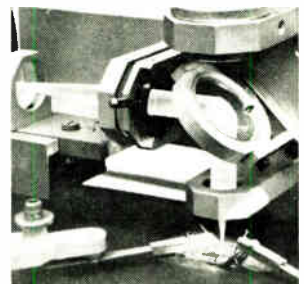

Laser trimmer model 110A is suitable for thick and thin films, as well as for scribing and cutting uses. Utilizing a Xenon laser, it takes advantage of high peak power, short duration pulses in the blue-green spectral region to perform hitherto difficult operations. It may be triggered manually or by comparator output. TRW Instruments, 139 Illinois St., El Segundo, Calif. [428]

Save Cost Enjoy Quality with TOKO INC.

Announcing a new cost saving plan on PCB assembly with transformed Dual-In-Line PULSE TRANSFORMERS and DELAY LINES by thick film approach.

Offering a wide range of custom-designed features which meet your requirements.

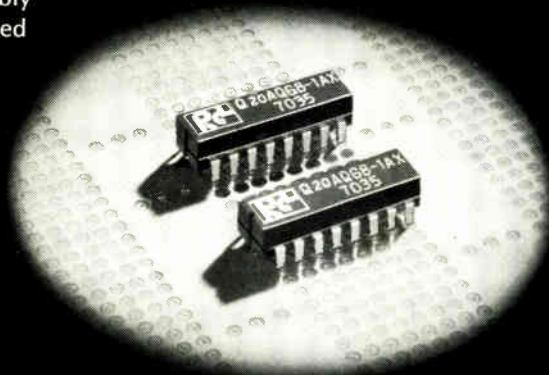

For further information, just call or write



TOKO, INC.

Head Office: 1-17, 2-chome, Higashi-Yukigaya, Ohta-ku, Tokyo, Japan

New York: **Toko New York Inc.**

350 Fifth Avenue, New York, N.Y. 10001 U.S.A. Tel: 565-3767

Los Angeles: **Toko, Inc. Los Angeles Liaison Office**

1830 West Olympic Blvd., Los Angeles, 90006 Cal. U.S.A. Tel: 380-0417

Düsseldorf: **Toko, Inc. Europe Liaison Office**

4 Düsseldorf, Kölner Straße 246, Düsseldorf, W. Germany Tel: 78-7064

Circle 117 on reader service card

WIRE WOUND RESISTOR

SILICON INSULATED SMALL SIZE,
HIGH STABILITY, LOW T.C.R., LOW PRICE.

| TOL | PRICE 100 Pz. US \$ | TOL | PRICE 100 Pz. US \$ |
|------|---------------------------|------|---------------------------|
| 5% | 6,00 | 5% | 10,00 |
| 2% | 8,00 | 2% | 12,00 |
| 1% | 10,00 | 1% | 15,00 |
| 0,5% | 12,00 | 0,5% | 18,00 |
| 0,2% | 20,00 | 0,2% | 22,00 |

1 W or 5%
0,2 W at 0,2%
100 Δ Max.
0,1 Δ Min.

2 W at 5%
1 W at 0,2%
250 Δ Max.
0,1 Δ Min.

Price F.O.B. Mexico City
5 Free samples for anybody who writes on Co. letter.
Call or write L. Michel Kun Pres.

SPECIAL T.C.R. AVAILABLE.
We also make:
All types of wire wound, ceramics and fiber glass from $\frac{1}{2}$ W to 1 000 W.
Metal oxide resistors from $\frac{1}{2}$ W to 10W. Down to 1%.
Thick film circuitry, passive and active.
Load resistor assembly up to 20 Mega watts.
Edge wound, punched grid etc. etc.

LEMEX, S.A. - San Esteban No. 23 - MEXICO 16, D.F.
MEXICO CITY TEL. 561-30-00

98 Circle 98 on reader service card

New products



Safeguard. Compliant tape in head protects beam leads during bonding.

about 50 pounds, while tip temperature can be controlled up to about 300°C. Time cycle is variable to 10 seconds. The unit requires a vacuum of 14 inches of mercury. The bonding tip turret has eight bonding tips, and the tape is automatically indexed after every bond cycle so that a new compliant frame is ready for the next bond.

The operator first sets the machine for the desired bonding temperature, time cycle, and bonding pressure. Then he manually loads a substrate onto the vacuum chuck at the front of the main carriage, and shifts the carriage to bring the dice dish into position under the optical system.

The lighting is automatically adjusted at each position of the carriage. After aligning the chip and the compliant window frame, the operator presses the die pickup button, and examines the die for proper alignment in the compliant window frame. If alignment is not proper, he can reject the chip back to the dice dish surface for realignment. He shifts the carriage to the rear position, bringing the substrate chuck under the optical system. After aligning the chip and substrate, the operator presses the bond button.

Price of the bonder will be in the \$10,000 range.

Electronics Division, J. and A. Keller Machine Co., Inc., P.O. Box 103, Buffalo, N.Y. 14217 [429]

THIS SPACE CONTRIBUTED BY THE PUBLISHER

LISTEN TO YOUR BODY.



If something's going wrong, it'll tell you.

1. Change in bowel or bladder habits.
2. A sore that does not heal.
3. Unusual bleeding or discharge.
4. Thickening or lump in breast or elsewhere.
5. Indigestion or difficulty in swallowing.
6. Obvious change in wart or mole.
7. Nagging cough or hoarseness.

If you have a warning signal, see your doctor. If it's a false alarm, he'll tell you. If it isn't, you can give him time to help. Don't be afraid. It's what you don't know that can hurt you.

American Cancer Society

Our Reconstituted Mica Capacitors Are Tested Harder

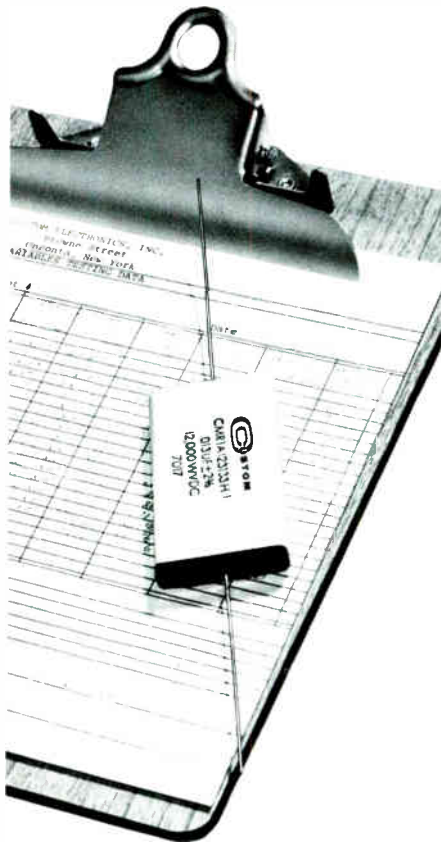

You get higher capacitor reliability for less

Because Custom Electronics, Inc. is the reconstituted mica capacitor maker who precisely grades the dielectric material before it reaches production, other manufacturers' final mistakes are never started at Custom. The result is fewer production rejects, and lower job quotes for Custom Electronics' customers. Add this grading system to Custom Electronics' rather fanatical Quality Control efforts throughout the production process, and it becomes clear why our client list reads like the who's who of high voltage electronics.

If your high voltage capacitor needs are RELIABILITY and IMMEDIATE SERVICE write or call Custom Electronics, Inc., Browne St., Oneonta, N.Y. 13820. Phone 607-432-3880.



CUSTOM ELECTRONICS, Inc.

New products

Press performs multiple flat-cable connections

One of the advantages of flat cable is the ease with which it can be used for multiple connections. Capitalizing on this, 3M Company is marketing a lightweight assembly press, in either a hand-operated or pneumatic-cylinder version, for use with the company's Scotchflex flat-cable connectors.

In operating the press, the connector cover is placed on the base plate, the cable laid on top of it, and the connector body on top of the cable. A locator plate aligns all three. As the press is lowered, it forces the connector's insulation-stripping U-shaped contacts through the insulation, and the conductor is forced between the jaws of the U. Since the wires are wedged between the contact legs, a high pressure is maintained.

Wires as small as 30-gage on 50-mil centers can be handled, and simultaneous connections of up to 50 conductors can be made. Since 3M estimates that one connector could be applied to a cable in less than a minute, a 50-conductor cable operation translates into about 3,000 connections an hour.

Interchangeable locator plates provide positive positioning for any of 3M's connectors. The plates can also be rotated to allow the cable to run across them, for insertion of connectors at points along the run.

Price of the manual press, the 3440, is \$62.50; the pneumatic version, the 3445, sells for \$80. Locator plates cost \$12 each.

3M Co., Electro-Products division, St. Paul, Minn. 55101 [430]

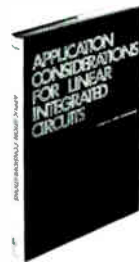
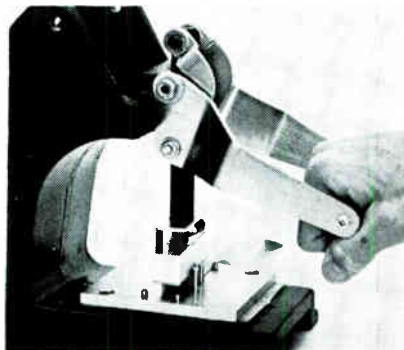

3 from Wiley-Interscience

APPLICATION CONSIDERATIONS FOR LINEAR INTEGRATED CIRCUITS

Edited by JERRY EIMBINDER, *Editor of EEE Magazine*

"Innumerable circuit applications with key design tips make this a useful volume for the working engineer involved in linear integrated circuits."—*Design Engineering*

Application Considerations for Linear Integrated Circuits covers the latest design techniques in biasing, compensating and incorporating linear integrated circuits into systems and equipment. Each of the twenty chapters is written by a nationally recognized authority in his respective field. Topics include guidelines for the selection of optimum integrated circuits for specific applications, "specmanship," and various rules and design techniques for using operational-amplifier integrated circuits.

1970 337 pages \$16.50

DIFFERENTIAL AMPLIFIERS

By LAWRENCE J. GIACOLETTO, *Michigan State University*

The author provides a basis for analyzing the performance of differential amplifiers. The design of differential amplifiers using electron tubes, bipolar transistors, field-effect transistors and integrated circuits is explained and supported with numerical calculations interspersed with practical data. Performance considerations embrace unsymmetrical operation, thermal effects, large-signal and multi-stage operations, evaluation of limiting performance, and techniques for measurement of both conventional and conversion amplifications. Noise and stability are also discussed.

1970 236 pages \$12.50

NONLINEAR NETWORKS AND SYSTEMS

By RICHARD CLAY, *Consulting Engineer*

Nonlinear Networks and Systems presents a new approach to the study of physical networks. The book's first chapter summarizes the relevant results of graph theory and thus lays the foundation for study of the structure of the network and the consequences of its particular configuration. Subsequent chapters deal with the properties of network elements and give some new methods for deriving network equations. Nonlinear system analysis is developed first as a logical extension of linear analysis and then treated independently by modern methods.

January 352 pages (approx.) \$13.95 (tent.)

wiley

WILEY-INTERSCIENCE

a division of JOHN WILEY & SONS, Inc.
605 Third Avenue, New York, N. Y. 10016

In Canada:

22 Worcester Road, Rexdale, Ontario

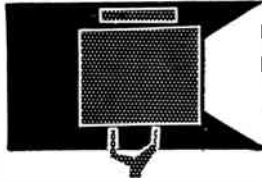

SEARCHLIGHT SECTION

• CLASSIFIED ADVERTISING • BUSINESS OPPORTUNITIES
• USED OR SURPLUS EQUIPMENT

AUTOTRACK MOUNT

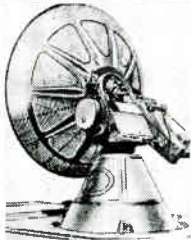

360 degree azimuth, 210 degree elevation sweep with better than 1 mil. accuracy. Missile velocity acceleration and slewing rates. Ampidyne and servo control. Will handle up to 20 ft. dish. Supplied complete with control chassis. In stock—immediate delivery. Used world over by NASA, USAF, MP-61-B. Type SCR-584. Ideal satellite tracking. Large spare parts inventory for back-up.

ANTI-AIRCRAFT GUN MOUNT

Will handle 6,000 lbs. rapid slew through 360° azimuth, 180° elevation. Mobile.

COUNTERMEASURES SYSTEM

Covers L-band, S-band, X-band, all radars. Tacan, UHF drone control, VHF drone control, Communications band. All housed in shelter.

FIBERGLASS RADOME Will handle 20 foot antennas. Easily erected & shipped. \$4800.

B-58 BOMBER ELECTRONICS

Ku band search radar, Ku doppler radar, Ku altimeter, all jamming countermeasures.

PULSE MODULATORS

MIT MODEL 9 PULSER 1 MW—HARD TUBE
Output 25kv 40 amp., 30kv 40 amp. max. Duty cy. .002, .25 to 2 microsec. Also 5 to 5 microsec. and 1 to .5 microsec. Uses 6CEL. Input 115v 60 cycle AC. Mfg. GE. Complete with driver and high voltage power supply. Ref: MIT Rad. Lab. Series, Vol. 5, p. 152.

2 MEGAWATT PULSER

Output 30 kv at 70 amp. Duty cycle .001. Rep. rates. 1 microsec. 600 pps. 1 or 2 msec. 300 pps. Uses 5948 hydrogen thyratron. Input 120/208 VAC 60 cycle. Mfr. GE. Complete with high voltage power supply.

SCR 584 AUTOTRACK RADARS

Our 584s in like new condition ready to go, and in stock for immediate delivery. Ideal for telemetry research and development, missile tracking, satellite tracking. Fully Desc. MIT Rad. Lab. Series, Vol. 1, pps. 207-210, 228, 284-286. Comp. Inst. Bk available \$25.00 each.

HUNDREDS MORE IN STOCK
LARGEST RADAR
INVENTORY
IN WORLD.
WRITE
FOR
CATALOG
ON YOUR
LETTERHEAD

AUTOMATIC TRACKING SYSTEM

Sci. Atl. Mod. 3101-J70 Antenna Pedestal. AZ-EL 15 deg. Per second rated speed. 23 inch dia. bearing. Complete w/control console & mag. amplifiers. Also in stock complete Clo-track resolving system for 200-400 MHz telemetry band including 12' square quad. Helix. All part of Atlas missile instrumentation system.

MICROWAVE SYSTEMS

SPARE PARTS IN STOCK

Nike Ajax, Nike Hercules, M-33, MPS-19, TPS-ID, TPS-10D, FPS-6 SP88, SCR-584, MPQ-18. From Largest Inventory in World

KU BAND RF HEAD

16.5 GHz. 50 KW, .001 duty cycle, 45 Watts avg. compl. w/5C22 modulator compl. recv. Mfr. Emerson Electric.

L BAND RF PKG

20 KW peak 990 to 1040 MC. Pulse width .7 to 1.2 micro sec. Rep. rate 180 to 420 pps. Input 115 vac

MICROWAVE LINKS

C BAND Phileo CLR6, CLR7, CLR9. Radar video link. Motorola MHR-4.

X BAND FIRE CONTROL SYSTEM

MD-4, A5, APG, 32 system. 50 KW Autotrack, complete system, all cables etc., incl. gun turret if desired.

AN/GMD-1B RAWIN RADAR

L-Band Radiosonde Tracking System. Complete, new cond. in stock for immed. del. AN/GMD-2 computer mfg. Gen'l Mills also in stock.

500 KW L BAND RADAR

500 kw 1220-1359 mac. 160 NAUTICAL mile search range P.R.I. and A scopes. MITL thyratron mod 5J26 magnetron. Complete system.

C BAND AUTOTRACK

1 Megawatt 10 ft. Parabola. Sperry.

AN/GPG-1 SKYSWEEP TRACKER

3 cm. auto. tracking radar system. Comp. pkg. w/indicator sys. Full target acquisition & auto. tracking. Input 115v 60 cy. new. In stock for immed. del. Entire sys. 6' x 3' x 10'. Ideal for infrared tracker, drone tracker, missile tracker, R & D

INDICATOR CONSOLES

AN/SPA-4A, PPI 10", range to 300 mi. VI-1 PPI 12". Range to 200 mi. VI-1 RHI 12" to 200 mi. 60K ft. FPS-6 RIII. FPS-8 PPI. CPS-6B PPI. plus many more.

Radio-Research Instrument Co.

45 W. 45th St., New York, N.Y. 10036 ■ 212-586-4691

CIRCLE 960 ON READER SERVICE CARD

"SEARCHLIGHT"

IS

OPPORTUNITY ADVERTISING

- to help you get what you want.
- to help you sell what you no longer need.

Take Advantage of it—For Every Business Want

"Think SEARCHLIGHT First"

New literature

Dc power supplies. Kearfott division of Singer-General Precision Inc., Little Falls, N.J., has issued brochure L69-0870 giving details about 16 different dc power supplies.

Circle 446 on reader service card.

Optoelectronic fault indicator. Texas Instruments Inc., P.O. Box 5012, M/S 308, Dallas 75222. Application report CA-153 discusses the use of visible light-emitting diodes, instead of an oscilloscope or meter, to show the logical state of an IC output. [447]

Power supplies. Keithley Instruments Inc., 28775 Aurora Rd., Cleveland, Ohio 44139. Volume 18, No. 5 of Engineering Notes covers a complete line of high-voltage power supplies. [448]

Carrier amplifiers. Rosemount Plug-In Inc., P.O. Box 107, Nashville, Tenn. 37202. A four-page data sheet describes standard, solid state 6- and 20-kHz carrier amplifier systems. [449]

Cassette tape drive. Ampex Corp., 401 Broadway, Redwood City, Calif. 94063. Description and revised specifications of the model TMC digital cassette tape drive are contained in data sheet C-135. [450]

Miniature rotary switches. RCL Electronics Inc., 700 S. 21st St., Irvington, N.J. 07111, has available the 1971 edition of its miniature rotary switch catalog. [451]

Bidirectional counter-display. Anocut Engineering Co., 2375 Estes Ave., Elk Grove Village, Ill. 60007, offers a technical bulletin on a low-cost bidirectional counter-display for applications requiring readout of up to seven digits, plus polarity. [452]

J-FET catalog. Unisem Corp., P.O. Box 11569, Philadelphia, Pa. 19116. A new type of monolithic dual J-FET is the feature of a short-form catalog. [453]

Differential operational amplifiers. Analog Devices Inc., 221 Fifth St., Cambridge, Mass. 02142. A data sheet gives specifications, performance curves, operating principles, and applications of model 184 high-stability, low-drift, low-offset, differential operational amplifiers. [454]

Audio response system. Cognitronics Corp., 333 N. Bedford Rd., Mt. Kisco, N.Y. 10549, offers a data sheet describing a multiplexed audio response system for computer information retrieval by voice output. [455]

Glass-ceramic capacitors. Corning Glass Works, Corning, N.Y. 14830. Two-page illustrated data sheet CCA-1.06 describes a new line of three semi-precision glass-ceramic capacitors. [456]

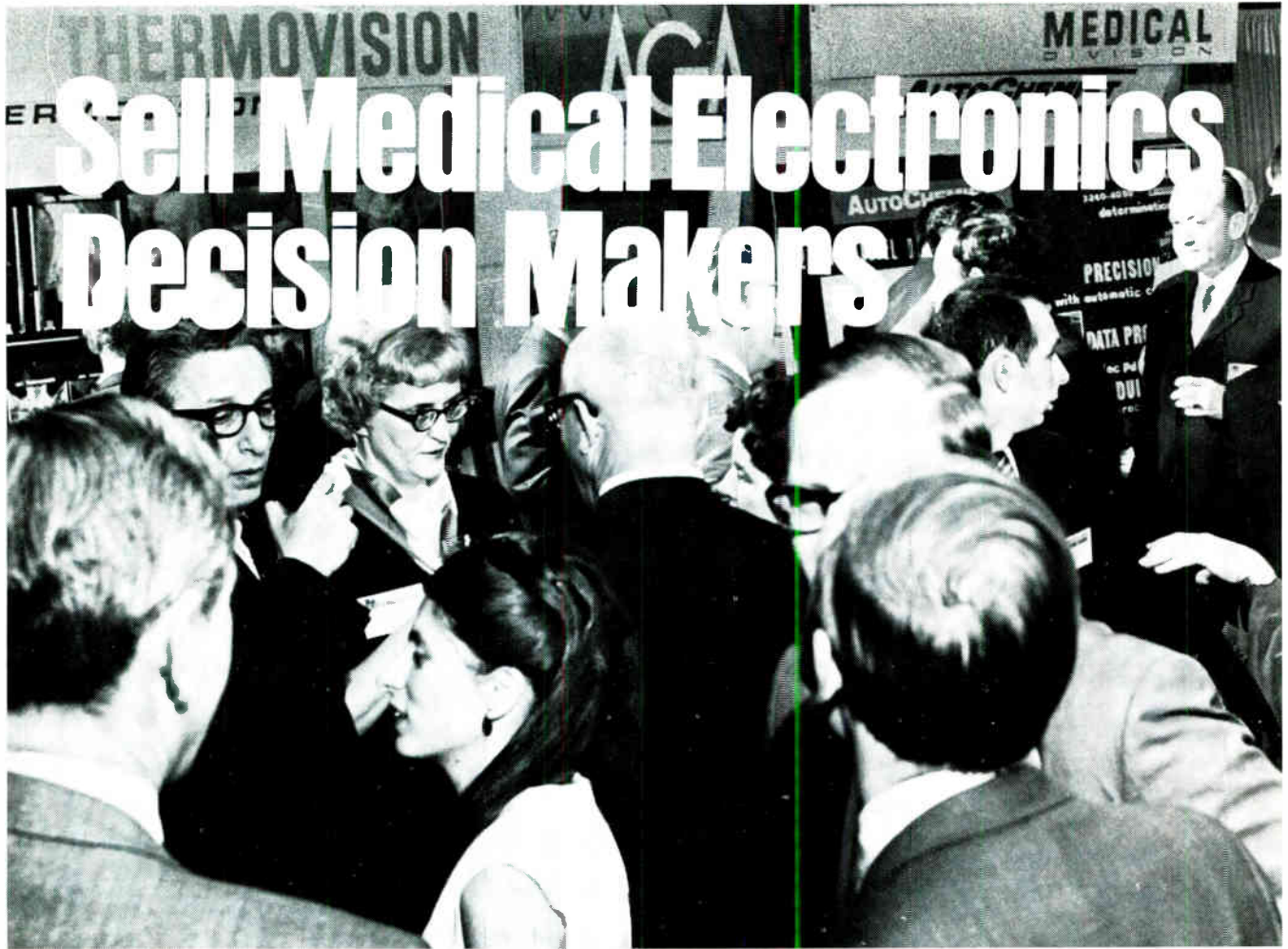

Sell Medical Electronics Decision Makers

The ELECTRONICS IN MEDICINE Conference & Exposition is different. Unlike every other medical show, it concentrates solely on medical electronics. It brings together only the manufacturers of medical electronics gear and the buyers and specifiers of such equipment—physicians, hospital administrators, biomedical engineers, educators, researchers and system design engineers.

Effective Sponsorship

ELECTRONICS IN MEDICINE is co-sponsored by Medical World News, Modern Hospital, Postgraduate Medicine and Electronics. The combined know-how and circulation of these major publications assure exhibitors of a highly qualified national audience.

On-Target Conference

A carefully crafted series of sessions, designed to attract only buyers and specifiers of medical electronics equipment and services, will be created by the editors of the co-sponsoring publications in conjunction with Dr. John Truxal, Institute Professor, Polytechnic Institute of Brooklyn. Dr. Truxal has long been concerned with the inter-play of engineering with biology and medicine and chaired a committee of the National Academy of Engineering on that topic.

Aggressive Promotion

The conference and show will be broadly promoted by the co-sponsoring publications, which have a combined

circulation of 400,000. A massive direct mail campaign and public relations campaign will be undertaken. Full page ads, well in advance of the event, will appear in all magazines. Direct mailers will repeatedly find buyers and specifiers wherever they work—hospital, private or group practice, clinic, research lab, and university.

Exhibitors Sell

The 3rd National Conference & Exposition on ELECTRONICS IN MEDICINE will enable you to find and sell new customers, expose current customers to your new products, create impressive lists of new, valuable contacts and create significant penetration of this burgeoning multi \$million market.

Reserve Your Booths Today

There is no premium on corner or upfront booths. Excellent locations, at no extra cost, will go to those firms which act promptly.



3rd National Conference & Exposition on Electronics in Medicine

Sheraton Boston Hotel / John B. Hynes Civic Auditorium
April 13-15, 1971

For space reservations, information:

Steve Miller, Exhibit Manager, National Expositions Company, Inc., 14 West 40th Street, New York, N. Y. 10018 • 212/564-8714.

QUICK

One of these dependable,

OPERATING

easy-to-install Simmons fasteners

FASTENERS

may be exactly what you need

FOR

to solve your fastening problem.

ELECTRONICS

Standard Simmons panel fasteners, latches, pressure hinges, hole plugs and other devices have proved themselves in thousands of varied electronics applications. Most are immediately available from stock in various sizes and capacities, and all can be adapted to your special needs. Quickly. Economically.



Write for this 36-page catalog. Complete data on Simmons' quality quick-operating fasteners.

SIMMONS

FASTENER CORPORATION

1745 North Broadway, Albany, New York 12201

MINI-Q-LOCK — quick-operating fastener for miniaturized electronics applications where space and weight limitations are important. ▼

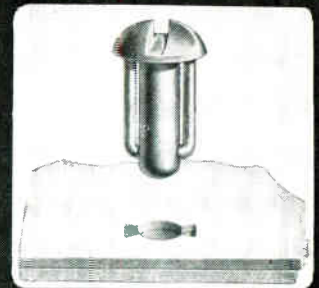
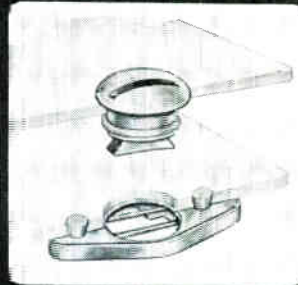

SPRING-LOCK — one-piece blind rivet for removable panels and control covers; self-adjusts to various panel thicknesses. Locks, unlocks with a ¼-turn.

QUICK-LOCK — for removable panels and access doors; locks or opens with a 90° turn. Works with curved sheets or slightly misaligned holes. ▼

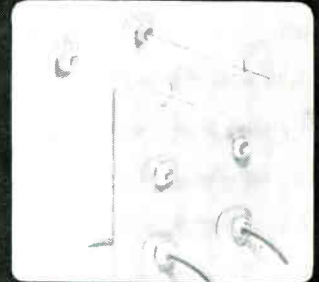
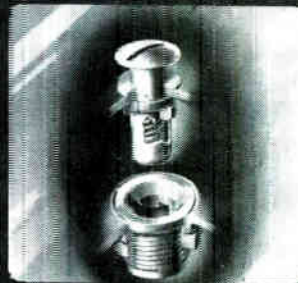

HOLE PLUGS (plastic) permit fast, secure, snap-in installation in round, square or unusual-shaped holes. Not affected by climate or temperature.

LINK-LOCK — ideal for latching where heavy locking pressure is required. High impact resistance. Available in medium and heavy duty. ▼

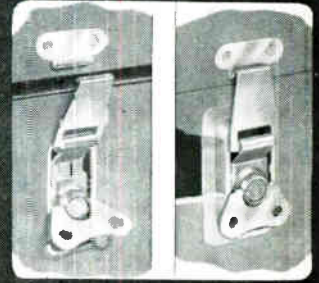
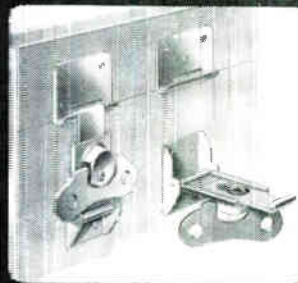

RECESSED LINK-LOCK — minimum protrusion, pressure-tight seal. Can be bonded with adhesive or riveted to any sheet, sandwich material or plywood.

HINGE-LOCK — rugged pressure hinge provides strong seal on hinge line of gasketed cases. (Matched hardware with Link-Lock fasteners) ▼

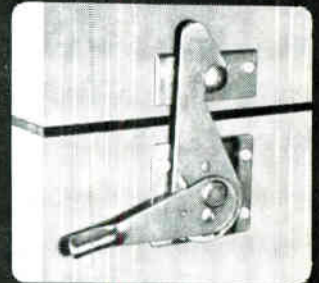
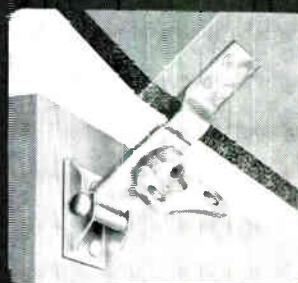

HOOK-LOCK — springless, positive-locking latch lies flat on mounting surface; high closing pressure and load-carrying capacity. Impact and shock-proof.

International Newsletter

January 4, 1971

Saab-Scania tightens grip on Scandinavian computer market . . .

Saab-Scania AB rang out its first year of operation with a rash of computer orders from Scandinavian nations. Among them: the first application of a Saab machine for industrial process control. The company's computers generally are marketed for administrative and scientific jobs. The machine, a model D22, will be used to control a rolling mill in Finland's largest steel company, Rautaruukki Oy. The D22, with a memory cycle of 1.6 microseconds, and a main memory capacity of 16,384 to 262,144 words by 24 bits, won out over an IBM 370/145 for the Finnish job.

At the same time, Saab-Scania got orders for two other computers from Norwegian purchasers and two from Swedish buyers. The orders for the five computers are worth about \$4 million. Saab-Scania now has seven computers in Norway and about 10 in Finland.

. . . and strengthens position in military market

Saab-Scania AB also landed a \$36 million production contract for air-to-ground missiles for the Viggen supersonic attack aircraft. The supersonic missile, designated the 05 A, is radio-controlled by the pilot after firing. It will be produced on a new production line. The missile also can be mounted on the Saab 105, the subsonic combination trainer-attack aircraft built by Saab-Scania and used by the Swedish Air Force. The Swedes are trying to sell this plane to Switzerland, and since the air-to-ground missile is in production, projected lower prices for the 05 A could be a sales point in the Swiss competition.

German retailers to tie into EDP net

Large-scale time sharing is about to be made available to one of West Germany's biggest business segments. The 400,000-member West German retailers' association and Datev GmbH, a data processing organization set up for tax consultants, have signed an agreement whereby retailers can be hooked up to Datev's computer center.

The scheme calls for installation of low-rental terminal equipment that will connect small- and medium-sized retail outlets to Datev's computer center in Nuernberg. The center will handle retailers' cost, wage, and earnings calculations, and disposition and status of goods available. It will also be used for market research and analysis. The association estimates that within five years, at least half of its members, or about 200,000 retailers, will be tied in.

Plessey buys Italian components maker

In line with its belief that non-American electronics firms must internationalize to succeed, England's Plessey Co. has purchased the Italian components firm, Arco Societa per l'Industria Elettrotecnica SpA of Milan. The purchase follows Plessey's 1969 acquisition of Alloys Unlimited Inc., Melville, N.Y. The English electronics firm paid about \$5 million for the assets of the Italian company, which employs 800 people and specializes in wound components and capacitors.

Plessey's spokesmen say they'll develop more manufacturing capacity in Continental Europe, particularly in Italy. Plessey now has telecommunications-related operations in five continents, and electronics plants in the U.S., Australia, South Africa, Portugal, Malta, and Barbados, the last three being core memory assembly facilities.

International Newsletter

H-P Japanese venture to design and build its own minicomputer

Unable to obtain approval from Japan's Ministry of International Trade and Industry for domestic fabrication or import of Hewlett-Packard's minicomputer, Yokogawa Hewlett-Packard, a joint-venture company, is designing and building its own minicomputer. Starting next April, the company expects to ship about 30 units a month—half to be used in measuring systems teamed up with other YHP instruments. The remainder likely will go as OEM gear to other instrument manufacturers that do not have their own computer, and a few will be sold by themselves for scientific and technical applications.

Actually, 20 to 30 H-P minicomputers have been imported into Japan, but MITI has allowed them to come in only as a small part of a large system. Minicomputers may be freed from import restrictions in another 18 months or so, but YHP feels it needs a computer now to support sales of its measurements systems.

MOS phono cartridge on market by midyear

A hi-fi phonograph containing the new MOS strain-gauge pickup cartridge developed by Thomas-Brandt's Sescosem subsidiary [*Electronics*, March 16, 1970, p. 63] may be on the market by midyear. What's more, a strain-gauge microphone may be on the market even sooner, and the French company is adapting the technology for medical instruments and other devices using pressure sensors.

The phono cartridge will drop Sescosem's original layout of two MOSFETs deposited on tiny silicon bars parallel and connected to the needle shaft. Instead, it will have two FETs placed directly on the needle shaft. Sescosem at first aimed to develop a low-cost cartridge for medium-quality record players, but results were so good that the unit will be used on top-of-the-line sets. Available initially only in a complete hi-fi system, the cartridge later will sell as a separate component, with a target price of around \$20.

Polish shakeup bodes well for electronics sector

The civil violence in Poland, touched off by drastic hikes in consumer prices, has forced the new government in Warsaw to modify economic strategies—and the electronics sector should be favorably affected. Edward Gierek, who replaced Wladyslaw Gomulka as Communist Party leader, already has announced that prices for television sets and other consumer electronics equipment will be reduced sharply. What's more, a two-year price stop will apply to most other goods.

To correct the economic troubles that have plagued the Warsaw regime for years, the new government has made it clear it would accelerate industrialization and step up cooperation and trade relations not only with East Bloc countries but with the West as well. The recent West German-Polish treaty on economic and technical cooperation should significantly further Poland's goals. The five-year treaty calls for a phased liberalization of trade and, of significance to electronics companies, it will facilitate issue of licenses and cooperation in production.

Both nations already are exchanging electronics production knowhow, although on a relatively small scale. Of note are the agreements West Germany's AEG-Telefunken and Grundig Werke GmbH have made with Polish firms regarding tape recorder and phonographic equipment production. In the most recent move, the German-Belgian firm Agfa-Gevaert signed an agreement with the Polish firm Polimex whereby a magnetic tape cassette plant will be put up at Gorzow.

Tiny transmitter brings telemetry down to earth

Swedish system can be used to transmit and receive medical or work-study data over a 1,600-foot range

Thanks to space projects, telemetry of physiological data has certainly gotten off the ground. Yet ground-based telemetry of such data—from a heart patient to his doctor, for example—has not taken off. One of the biggest problems has been to make the transmitter small enough to be carried easily, while at the same time providing enough power for proper range and stability.

Now a small Swedish company, Medinik AB, is producing what it considers the best all-around compromise of transmitter size, transmission range, power consumption, and stability. The Medinik unit—which can be used for electrocardiograms, electroencephalograms and electromyograms—consists of a palm-sized transmitter weighing about 2 ounces and a cigar-box sized receiver that can be hooked up to many different recording and display devices.

The Swedish gymnastics and athletics university is using the device and credits it with helping champion swimmer Gunnar Larsson train for the Olympics. Another Swedish application is in studying the heart and muscles of trotting horses.

But by far the biggest market is in health and work-study applications. For medical applications, the

Medinik system is expected to find increasing use by doctors, who want heart attack patients to get up and start walking around several days after the attack. And Sven Rundberg, owner of Medinik, feels that an increasingly large market will be for ergometrics—studying optimum muscle output for time and motion studies, as well as for tool or machine design.

The Medinik transmitter has a range of about 1,600 feet. It has a crystal-controlled oscillator that transmits at 223.45 megahertz, with a drift of only ± 1.5 kilohertz. Because of its crystal control and negligible drift, there is no need for constant adjustment of the receiver, which requires only an on-off switch.

The receiver can pick up four signals, and the operator, by switching channels, can pick out the one signal he wants for study. A single superheterodyne with crystal controlled oscillator, the receiver uses two MOS FETs—one in the rf amplifier and the other in the mixer.

Since the crystal oscillator is directly modulated, the Medinik transmitter does not require a sub-carrier oscillator and modulator, which reduces size and cuts power consumption. The system also eliminates problems with subcarrier oscillators. Two ICs are used in the modulator in the transmitter.

One unusual design element in the transmitter is its small loop antenna, which gives a circular radiation pattern. Other biotelemetry transmitters usually use a thread or rod antenna.

A multichannel system can be made up by combining two or more receiver/transmitter sets with different crystals. In Sweden, frequency allocation regulations limit the total to 11 channels.

Honeywell AB of Sweden is handling marketing of the Medinik system. Honeywell offers it as an "extra" in its Accudata system for intensive patient care. However, since Medinik can be used with other recording or display units, it is being marketed for use with other systems.

West Germany

Sorting ceramic components like cracked glassware

Any experienced shopper for china-ware knows that lightly tapping a glass will tell him whether it has cracks or similar defects. That's also the way a new AEG-Telefunken test instrument judges the quality of ceramic components—like isolators, switch segments, and base plates—used in electronics equipment. The new tester is based on the different damping characteristics that good and defective ceramic components exhibit when subject to an impact force.

What prompted AEG-Telefunken to develop its new tester are the cumbersome and time-consuming methods used for ceramic components testing. One such method involves dipping components into a red fluorescent liquid, which, when washed off the surface, stays in any hairline cracks. This is obviously a

slow procedure. In another method, the sound of a component dropping onto a metal plate is evaluated by ear—a rather unreliable method.

Yet another way of evaluating sounds produced by an impact force is to analyze the spectral combination of sound waves. But AEG-Telefunken designers rejected this approach because of the many electronic filters it would need. Besides, the spectral combination is affected by a body's shape. Damping characteristics, on the other hand, are largely independent of shape.

Their tester's sound evaluation is based on a process of integrating the area under the curve described by the peaks of the detected sound wave oscillations and on a comparative evaluation of that area. In a typical test, the component is dropped onto a steel plate from a height of between 0.5 and 1 inch, sufficient distance to cause the component to resonate at its natural frequency, yet small enough for it not to crack or break. The sound waves it produces are picked up by a microphone, and its output is applied to a high-pass filter designed to exclude all audio frequencies below 5 kilohertz or so, and to prevent extraneous noise in the vicinity from affecting the tester.

An amplifier boosts the filter output by 30 to 60 decibels depending on the particular type of ceramic component being tested. The amplified signals are then applied to a parallel circuit with a rectifier in one branch and a Schmitt-trigger/monostable-multivibrator combination in the other branch. This circuit combination is kicked into operation by the very first voltage peak that arrives at the Schmitt-trigger input, and produces a constant level output for as long as the vibrations last. The multivibrator output and the rectifier amplifier output are applied to a diode-based digital switch.

Gated by the multivibrator output, the digital switch passes the rectified sound voltage signals to an integrator circuit. This circuit's time constant is such that the integrator's final voltage value is

reached during the time that a good component vibrates at its particular resonant frequency. The digital switch initiates the integration process, terminates it, and discharges the integrator to its zero value.

Following the integrator is a comparator with a preset threshold voltage. If the integrator output exceeds this voltage, the component is rated as good, and a green lamp lights up. If not, a red lamp goes on. For automatic sorting, the comparator output operates upon an electromagnet which, in turn, actuates a wiper-like mechanism on the steel plate. The wiper pushes good components off the plate to one side, while bad ones are pushed off to the other.

Developed by Helmut Schunk of the company's speech analysis and synthesis laboratories at Ulm, the tester is now being introduced at AEG-Telefunken's ceramic components producing subsidiaries. Its cost: about \$140.

France

Localized epitaxial growth for wristwatch, space MOS

Standard diffusion methods of chip doping were not good enough for researchers at France's Sescosem, who wanted to develop 5-megahertz MOS circuits for space applications and wristwatch frequency-divider circuits running off 1.3-volt batteries. Sescosem therefore turned to localized epitaxial growth. The results: a new electronic wristwatch frequency divider that apparently performs as well as similar MOS circuits announced this fall by RCA and Motorola, plus a pair of complementary MOS circuits for space that challenge RCA circuits made by diffusion.

Sescosem's goal was an impurity level of no higher than 10^{16} boron atoms per cubic centimeter. Diffusion would have given them 10^{17} , unless they had resorted to RCA's complex technique of continuing to heat a chip after the diffusion gas cutoff, in order to burn off excess

boron atoms. "That method is difficult", says Jean Grosvalet, research director of Sescosem's Corbeville development laboratory. "The time and temperature have got to be precise, and even then the results are hard to reproduce."

Actually, Sescosem began its epitaxial MOS drive in 1967, under contract from the French space agency, and developed one circuit by late 1968. But inability to localize epitaxial doping meant the circuit had to be made from two chips, one with n and one with p characteristics, connected by gold wires. The circuit required an input of 9 V and consumed 15 microwatts, for 12 MOS devices. Sescosem has now mastered localized growth and can make complementary MOS circuits containing up to 200 devices on a single chip, needing only $5 \mu\text{W}$ of power.

To form p and n channels in an n-type silicon chip, technicians open windows in the chip's oxide layer by means of conventional masking methods. They then put the chip in an epitaxial chamber at $1,000^\circ \text{C}$ in the presence of hydrochloric acid and hydrogen, which dig 0.1 micron-deep holes in the silicon.

By using epitaxial growth, they deposit p-type silicon in the holes at $1,100^\circ \text{C}$ in the presence of silicon tetrachloride, hydrogen and about 1% hydrochloric acid. The acid prevents silicon from forming on top of the oxide layer or between it and the silicon chip. Otherwise, silicon polycrystals 15 to 30 microns thick tend to form. Such crystals, when the oxide surface is polished, may be driven into the chip and form dozens of unwanted p areas.

The polishing is essential after the channels are grown, because the holes tend to have a convex bottom that causes the epitaxially grown areas to protrude above the oxide surface. Metalization for gate electrodes and interconnections is put on in the normal way.

The French firm has developed a laboratory model frequency divider encased in 24 packages with eight MOS elements per package. It

divides the 8,192-hertz time base frequency of a quartz crystal to 2 Hz.

The wristwatch circuit problem is being put to a computer-aided-design library of complementary MOS devices at the company's Saint-Egreve plant. The goal is a 200-device circuit that divides the quartz frequency to 1 Hz, consumes a maximum of 1 μ W, and requires at most 2.6 V, and possibly 1.3 V. The firm expects to have its watch circuit on the market by June, at a price of under \$20.

Francois Houdart, commercial director of Sescosem-Corbeville, believes the market for electronic watches will reach 1 million units a year in the near future. Switzerland's Omega marketed one this year, using a hybrid bipolar IC. It sells in France for \$1,800, but Houdart believes electronic watches will be available in 1972 for around \$200.

On the high-frequency side, Sescosem has used its localized epitaxial technique to develop prototypes for two complementary MOS circuits: a double inverter and a double switch. If run at 4 V, they work at 1.25 MHz with dynamic consumption of 0.15 μ W per kilohertz, while at 8 V they operate at 8 MHz, consuming 0.6 μ W per KHz. That beats competing RCA circuits, which operate at 9 V and 2 MHz, says Sescosem, crediting its own higher frequencies to the lower concentration of impurities possible with epitaxial growth.

Sescosem is also developing a double flip flop quad nand circuit for portable military transmitter-receivers, and hopes to market this circuit and the two space circuits, all with aerospace reliability characteristics, by the end of this year.

Japan

How to recognize a 100-yen coin, new or old

How can a booth phone be made to tell 100-yen coins from slugs? In pushing plans to modernize its pay phone network to take 100-yen

pieces, Japan's telephone company is aiming at completely unassisted long distance dialing. The trouble is the public's temptation to use slugs will be greater than with present pay phones designed for suburban use, in which the caller can insert up to six or ten 10-yen coins that are automatically collected as charges mount.

The Nippon Telegraph and Telephone Public Corp. have therefore come up with a coin recognition scheme, which should be applicable to other types of coin collection mechanisms like vending machines, and perhaps also to some industrial uses.

Although the suburban phones can be used to call any place in the country, they become impractical for long distances. Each message unit costs 10 yen, and time in each message unit decreases with distance. Between Japan's two largest cities, Tokyo and Osaka, a caller can only speak five seconds per unit—compared with a minute or two between adjacent cities. Thus on a long distance toll call the six or ten coins are soon depleted, and more coins have to be fed to the phone at an impracticably fast rate.

NTT's plans are for new booth phone that will take up to 10 10-yen coins and nine 100-yen coins for collection during the call as needed. The problem of rejecting slugs in favor of 100-yen coins is compounded by the varied types of coins in circulation and by the method of collection. Japan started using 100-yen coins in 1957 but in 1967 switched from silver alloy to a nickel alloy, though without changing the weight and size. The most likely slug is the copper-alloy 10-yen coin, which, when filed down slightly, resembles the old 100-yen coin more closely than the new 100-yen coin resembles the old.

As for the method of collection, electrical or magnetic ways of checking coins in motion down a feed chute tend to be unreliable. Methods of checking coins after they are collected, depending on, say, the sound of the coin bouncing against some fixed object, are dif-

ficult to implement. NTT's solution is to measure the change in impedance in coils on both sides of the coin as the coin rests against a stop before collection.

Coils for checking coins are wound on 14-mm-diameter pot cores and arranged on either side of the coin slot. A frequency of 20 kilohertz was selected because it provides good measurement sensitivity and does not generate interference in the telephone line. At 20 kHz, a new 100-yen coin gives the coils a resistive component of about 138 ohms and inductive reactance of 584 ohms. For an old 100-yen coin, the resistance is 74 ohms and the inductive reactance 470 ohms. The impedance difference is more than 15%.

The tough job is to weed out 10-yen and five-yen coins, which are a trifle smaller than the old 100-yen piece. The 10-yen coin pushes the impedance of the coils about 2% below the value for the old 100-yen coin, while the five-yen coin raises the impedance about 2% above that of the 100-yen coin.

This small impedance variation can be detected, though, by a bridge circuit. Measurements on an input signal by at least 60 decibels when an old 100-yen coin is between the coils and the bridge balanced for the average coin. The attenuation of falls to 50 dB or less, giving a margin of at least 10dB to make recognition possible.

The output of the bridge is fed through a 20-kHz filter to an amplifier, and then the output of the amplifier is returned to the input of the bridge to form an oscillator circuit. The output of the amplifier is also connected to an amplitude discriminator circuit. Amplifier gain is chosen so that if circuit attenuation is less than 60 dB no oscillation will occur. Local feedback around the oscillator is used to assure stable performance in this mode: the amplitude-sensitive circuit need only discriminate between the presence or absence of a signal.

The bridge is equipped with three sets of balancing impedance and two switches. Initially the impedance in the standard arm bal-

ances the bridge with no coin between the coils. When a coin falls into the slot between the coils, the bridge becomes unbalanced and the first switch is operated to replace the first impedance with the second. If the coin between the coils is a new 100-yen piece, the bridge again becomes balanced and the coin is accepted. If the bridge is still unbalanced, the second switch is operated to bring the third impedance into the circuit. If the coin between the coils is an old 100-yen piece, the bridge again becomes balanced and the coin is accepted. If the bridge is still unbalanced the coin is rejected.

Great Britain

ICs run vehicle tachometer and speedometer

In Britain's automobile industry, electronic devices are driving ahead slowly but surely. A new bus to be made next fall by British Leyland Motor Corp. will have an electronic speedometer and tachometer, both built around an integrated circuit. The tachometer alone will be standard equipment in the new Jaguar V-12 sports car due for introduction later this year, the first time a British production car has sported an IC-based instrument. Both instruments are the first of a family now being developed by Smiths Industries, Ltd., of Witney, Oxfordshire.

The tachometer is the basic instrument. It's been available for about a year as a \$40 accessory for power boats, driven by capacitive pulses derived from the spark plug leads. It will soon be on sale in England at about \$35 as a car accessory, driven from the contact breaker in the distributor and adjustable for four, six, or eight cylinders. Because the Jaguar will use a new Joseph Lucas breakerless electronic ignition system, the counter is driven from an oscillator which is part of the ignition switching circuitry.

Smiths plans even more car engine instruments, including a

diesel engine model driven by a simple sine wave generator—the diesel, of course, has no ignition timing system. The IC is identical in all versions; only the input filter differs according to drive.

The speedometer is basically a tachometer driven from a sine wave generator mounted on the gearbox or final drive output shaft. However, because it has to incorporate the odometer, the instrument is complex and its chip contains about four times as many components as needed on the tachometer. Costing four or five times as much as mechanical speedometers, it is only commercially practical where its use allows some compensating saving. For instance, the Leyland bus has its gearbox at the rear so that a mechanical speedometer needs a very long drive cable.

Brian Shepherd, chief engineer of Smiths Electronics division, reckons it will be three to four years before a combined electronic speedometer and odometer appears on ordinary cars as original equipment, though Smiths is working on a design now. Shepherd points out, however, that the electronic speedometer should last much longer—the odometer on the bus has a life expectation of 250,000 miles.

Shepherd's team designed the chips, then called for manufacturing tenders. Texas Instruments Ltd. won the tachometer chip contract. Shepherd preferred this approach rather than the usual one of inviting IC makers to design a chip to specification. "I believe it was easier for us to learn chip design than for TI, for instance, to grasp all the problems of using electronics in automobiles. We could also be sure that we got value for money, because we knew exactly what was on the chip," Shepherd says.

The tachometer chip starts with a Schmitt trigger to sharpen the edges of the input, followed by a monostable vibrator putting out pulses which open a current switch. The current pulses pass from the chip to a moving coil meter which integrated them and displays a

mean value. The monostable circuitry is claimed to provide pulse width accurate to 1% regardless of temperature and supply line variations at 80% duty cycle. This is achieved by close component matching.

The current switch's function is to pass a current pulse of precise amplitude during the exact period defined by the monostable circuit. The current is defined by a differential amplifier switch and a tail resistor and is routed to the meter through a Darlington amplifier. By feeding current to the meter rather than voltage, Shepherd dispenses with thermistors to compensate for temperature effects on the meter.

To vary the input so it will accommodate different meters, the tail resistor is changed. The full-scale reading, or engine revolution range, is selected by varying the time constants of the monostable circuit. The supply voltage is controlled by a shunt stabilizer on the chip, which deals with the spikes and voltage variations that are unavoidable in automobiles.

The chip measures 0.04 inch square and all the processes are compatible with transistor-transistor logic. There are 12 transistors, eight diodes and 17 resistors. The tachometer IC is in an eight-lead dual in-line plastic pack.

The speedometer IC, though, is in a 14-lead ceramic dual in-line pack. The extra leads are required by the odometer function and some extra facilities built into the instrument, which include the ability to work with two different preselected rear-axle ratios, and a low-speed trip switch. In the bus application this will be used to ensure that the driver cannot open the doors until speed drops below, say, 2 miles per hour.

This chip, which will be made by Plessey Co., measured 0.065 by 0.07 inch. The odometer function is obtained by five flip flops and some extra gating which divide the tachometer pulses by 22 and by 30 to provide the two axle ratios used on the bus. The speedometer switches ratios when the driver switches axle ratios.

Photocells ain't what they used to be...



they're a heck of a lot better

Photocells are doing jobs today that they couldn't have done ten—five—
or even two years ago. There have been that many improvements!

HIGHER STABILITY
MORE UNIFORM RESPONSE TO COLOR TEMPERATURE
HIGHER SPEED RESPONSE
WIDER VARIETY OF PACKAGES AND SIZES
INCREASED EFFICIENCY
HIGHER LINEARITIES

Let us show you: how the "light touch in automation and control" can help
solve your problems. Call (914) 664-6622 or write Clairex,® 560 South
Third Avenue, Mount Vernon, New York 10550.

CLAIREX ELECTRONICS

A DIVISION OF CLAIREX CORPORATION

Circle 109 on reader service card

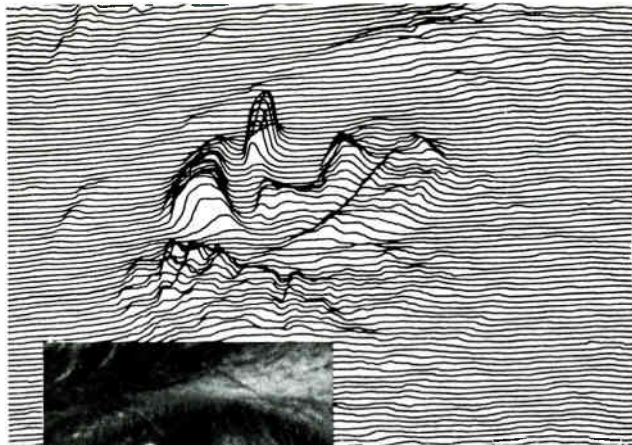

How Can You Sort Useful Information from 100 Million Bits Per Second?

Today the television camera is an extremely versatile data acquisition tool. It can give you around 100 million bits of information per second — spatial dimensions, brightness, color, time — with a wide range of sensitivities. Not all of what the camera sees is usable, however.

How can you extract the exact, useful data you need from this source?

Colorado Video has the Model 321 Video Analyser specifically designed to help you pinpoint the data you want and eliminate the redundant or useless bits.

The 321 can be used on a "stand-alone" basis as a laboratory instrument for such applications as image analysis and camera-to-hard-copy interfacing. Or, the 321 can provide input to your computer for a variety of analysis functions. It can also be controlled by the computer.

The 321 now is being used for such diverse operations as automatic instrument calibration via computer, cancer cell analysis and measuring changes in the diameter of human veins.

Find out what the Colorado Video Model 321 Video Analyser can do for you. Write or call for information. Price: \$2500.



COLORADO VIDEO,
INCORPORATED

CVI

P.O. Box 928, Boulder, Colorado 80302. Phone (303) 444-3972
Video Data Acquisition • Processing • Display • Transmission

NEW ALTERNATE ACTION PUSH BUTTON SWITCHES

(Push-On, Push-Off)
...the Reliable Ones by Grayhill

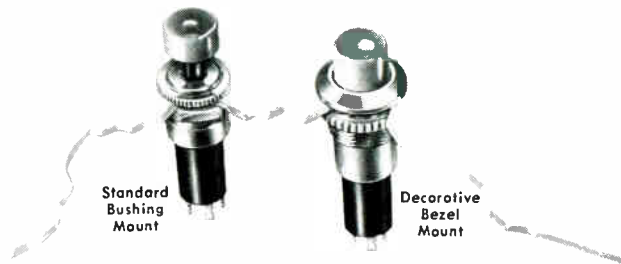

250,000 operations — WITHOUT A MISS.

- SPDT, SPST
- 1/4 Amp., 115 VAC resistive
- Totally enclosed
- Space saving - .937" behind panel
- Momentary action counterpart available

For your Grayhill Engineering Catalog offering complete technical data — contact



523 Hillgrove Avenue
LaGrange, Illinois 60525
Area Code 312, Phone 354-1040

... the Difference Between Excellent and Adequate

Circle 118 on reader service card

The power supply you plan to build is built!



OTHER MODELS 3 to 50 V available

It's on the shelf, ready for immediate delivery from Electrostatics. With specs proven in service. Low cost. Brief specs on our Model 200:

- 5V 15A DC Power Supply
- Input 105-125V, 47-420 Hz
- Regulation: Line 0.01%
Load 0.1%
- Ripple: 500 μ V max.
- Temp: -20 to +71°C
- Foldback current limiting
- Size: 5.5" W x 5" H x 10.8" L

(\$114 with overvoltage protection)

For full information call Robert McCartney, Manager of Application Engineering, (714) 279-1414. Or circle the number below for our latest data sheet.

Electrostatics, inc.

7718 Clairemont Mesa Blvd., San Diego, California 92111

DLPT 111

Electronics advertisers

January 4, 1971

| | |
|---|--------------|
| Airco Speer Electronic Components Hazard Adv. Co. Inc. | 8 |
| American Electronic Laboratories Inc. Ernest William Greenfield Inc. | 6 |
| American Lava Corporation, Sub. of Minnesota Mining & Mfg. Co. Designers Inc. | 88 |
| AMP Incorporated Aitkin Kynett Co. Inc. | 10, 11 |
| Analog Devices Inc. ADS | 93 |
| Augat Inc. Horton Church & Goff Inc. | 3rd Cover |
| Bell & Howell Electronics & Instruments Group | |
| Coordinated Communications Inc. | 27 |
| Blue M Electric Company South Suburban Advertising Brand Rex | 76 |
| Creamer, Trowbridge, Case & Basford Inc. | 84 |
| Bryans Ltd. C. P. Wakefield Ltd. | 10E, 11E |
| Bussmann Mfg. Division of McGraw Edison Company Henderson Advertising Company | 7 |
| Clairex Corporation Michel Cather Inc. | D-1 |
| Colorado Video Inc. Tallant/Yates Adv. Inc. | D-2 |
| Custom Electronics Inc. Laux Advertising Inc. | 99 |
| DX Antenna Company Ltd. Sanko Sha Advertising Agency, Co. Ltd. | 90 |
| Eastman Kodak Company, Business Systems Markets Div. J. Walter Thompson Co. | 77 |
| Electrostatics The Phillips Agency of California Inc. | D-2 |
| Electronics Ries Cappiello Colwell Inc. Electronic in Medicine Conference | 14-15 101 |
| Federal Scientific Corp. Zam & Kirshner Inc. | 17E |
| Fluoroware Colle & McVoy Adv. Agency Inc. | D-4 |
| G. E. Bradley Ltd. Hyde and Partners Ltd. | 18E |
| General Electric Co., Capacitor and Battery Department Robert S. Cragin Inc. | 19 |
| Gould Inc. Brush Instruments Carr Liggett Adv. Inc. | 96 |
| Gould Inc. Corporate Division Carr Liggett Advertising Inc. | 12-13 |
| Grayhill Incorporated Carr Liggett Advertising Inc. | D-2 |
| Gries Reproducer Company Harold Marshall Advertising | 94 |
| Hewlett Packard Company Lennen & Newell Inc. Hitachi Ltd. Dentsu Advertising | 1 67 |
| Indiana General Corporation Electronics Div. The Griswold & Eshleman Company | 73 |
| John Wiley & Sons Ed McLean & Co., Inc. | 99 |
| Kienzle Apparate GMBH Fahrenson + Fehse Kinomat Brouch Publicita | 9 82 |
| Ledex Inc. Yeck & Yeck Incorporated Lemex S. A. | 86 98 |

| | |
|---|------------------|
| McGraw-Hill Book Company Micro Switch Division of Honeywell N. W. Ayer and Son Inc. | 95 16 |
| 3M Electro Products Division Batten, Barton Durstine & Osborn Inc. | 83 |
| Monolithic Memories Regis McKenna Inc. Mos Technology Inc. Henry S. Goodsett Advertising Inc. | 32 87 |
| Norton Associates Inc. J. J. Coppo Company | 94 |
| Olympus Optical Co. Ltd. | 16E |
| Philco Ford Company, Microelectronics Division The Aitkin-Kynett Company Inc. | 30-31 |
| Philips Gad Elcoma Media International | 12E, 13E 20E |
| Philips N. V. Pit/Tmi Division Marsteller International S. A. | 20E |
| Plessey Components Rumrill Hoyt Inc. Pomona Electronics Company Buxton Advertising Agency | 2E 90 |
| RCA Electronic Components Al Paul Lefton Company | 4th Cover 19E |
| Reliance Controls Bond Publicity Services Ltd. | 19E |
| Schauer Manufacturing Corp. Nolan, Keelor & Stites | 80 14E |
| Serel Termont Technique SGS Scuola Di Design Di Novara | 14E 2nd Cover |
| Simmons Fastener Corporation Fred Wittner Company Singer Company, Ballantine Operation Technical Industrial and Scientific Marketing Inc. | 102 78 |
| S. P. Elettronica Studio Sergio Rosata Sprague Electric Company Harry P. Bridge Company | 9E 5 |
| Tadiran Israel Electronics Industries Ltd. Pelled Advertising & Public Relations Ltd. | D-4 25, 74 |
| Tektronix Inc. Dawson Inc. Thomson CSF Electron Tubes Inc. Mohr & Co. Inc. Toko Incorporated Hakuodo Inc. | 2 98 |
| Unitrode Corporation Impact Advertising Inc. Universal Oil Products Norplex Div. Campbell Mithun Inc. | 29 91 |
| Varian Associates Eimac Division Jack Herrick Adv. Inc. | 20 |

Classified & Employment Advertising

F.J. Eberle, Manager 212-971-2557

EQUIPMENT (Used or Surplus New) For Sale
Radio Research Instrument Co. 100

For more information on complete product line see advertisement in the latest Electronics Buyer's Guide
Advertisers in Electronics International

Advertising Sales Staff

Pierre J. Braudé [212] 971-3485
Advertising Sales Manager

Atlanta, Ga. 30309: Charlton H. Calhoun, III
1375 Peachtree St., N.E.
[404] 892-2868

Boston, Mass. 02116: William S. Hodgkinson,
James R. Pierce, 6072 Boylston St.
[617] 262-1160

Chicago, Ill. 60611: Ralph Hanning,
Kenneth E. Nicklas, 645 North Michigan
Avenue, [312] MO 4-5800

Cleveland, Ohio 44113: William J. Boyle,
[716] 586-5040

Dallas, Texas 75201: Richard P. Poole,
1800 Republic National Bank Tower,
[214] RI 7-9721

Detroit, Michigan 48226: Ralph Hanning,
2600 Penobscot Building
[313] 962-1793

Houston, Texas 77002: Richard P. Poole,
2270 Humble Bldg. [713] CA 4-8381

Minneapolis, Minn. 55402: Kenneth E. Nicklas,
1104 Northstar Center [612] 332-7425

New York, N.Y. 10036
500 Fifth Avenue
Warren H. Gardner [212] 971-3617
Michael J. Stoller [212] 971-3616

Philadelphia, Pa. 19103:
Jeffrey M. Preston
6 Penn Center Plaza,
[215] LO 8-6161

Pittsburgh, Pa. 15222: Jeffrey M. Preston,
4 Gateway Center, [412] 391-1314

Rochester, N.Y. 14534: William J. Boyle,
9 Grevlock Ridge, Pittsford, N.Y.
[716] 586-5040

St. Louis, Mo. 63105: Kenneth E. Nicklas,
The Clayton Tower, 7751 Carondelet Ave.
[314] PA 5-7285

Denver, Colo. 80202: Richard W. Carpenter
Tower Bldg., 1700 Broadway
[303] 266-3863

Los Angeles, Calif. 90017: Robert J. Rielly,
Bradley K. Jones, 1125 W. 6th St.,
[213] HU 2-5450

San Francisco, Calif. 94111: Don Farris,
Richard R. Butera, 425 Battery Street,
[415] 362-4600

Paris: Alain Offergeld
17 Rue-Georges Bizet, 75 Paris 16, France
Tel 727 33 42, 727 33 60

Geneva: Alain Offergeld
1 rue du Temple

United Kingdom and Scandinavia
London: Keith Mantle, Tel: Hyde Park 1451
34 Dover Street, London W1

Milan: Robert Saidel, Roberto Laureri Jr.
1 via Baracchini Phone 86-90-656

Brussels: Denis Jacob
22 Chaussee de Wavre
Brussels 1040, Belgium

Frankfurt/Main: Fritz Krusebecker
Elsa-Brandstroem Str. 2
Phone 72 01 81

Tokyo: Paul Y. Ishii, McGraw-Hill
Publications Overseas Corporation,
Kasumigaseki Building 2-5, 3-chome,
Kasumigaseki, Chiyoda-Ku, Tokyo, Japan
[581] 9811

Osaka: Akihiko Kamesaka, McGraw-Hill
Publications Overseas Corporation, Kondo
Bldg., 163, Umegae-cho Kita-ku [362] 8771

Australasia: Warren E. Ball, IPO Box 5106,
Tokyo, Japan

Business Department

Stephen R. Weiss, Manager
[212] 971-2044

Thomas M. Egan,
Production Manager [212] 971-3140

Dorothy Carmesin, Contracts and Billings
[212] 971-2908

Frances Vallone, Reader Service Manager
[212] 971-6057

Electronics Buyers' Guide

George F. Warner, Associate Publisher
[212] 971-3139

Regina Hera, Directory Manager
[212] 971-2544

ELECTRONICS OUT OF STONE



Primitive Art? Magic? No.

We use the most modern and advanced equipment to produce electronic components from quartz. Tadiran manufactures CR-type crystals (as well as crystals in TO-5 cases), crystal filters and crystal discriminators.

Our quartz crystal products are manufactured to meet U.S.

Military Specifications —

proof of their high quality and reliability.



TADIRAN
ISRAEL ELECTRONICS INDUSTRIES LTD.

3, HASHALOM ROAD, TEL AVIV ISRAEL

Circle 120 on reader service card

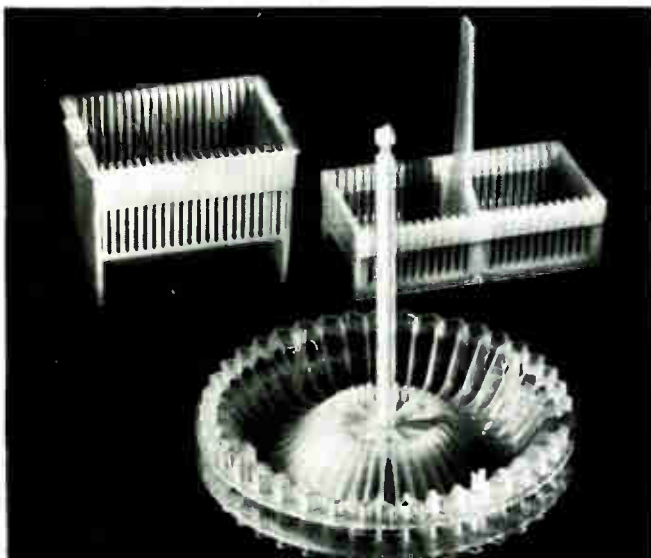

Easy etching!

Here's the ideal way to handle masks, wafers, and substrates in process.

Fluoroware is precision-molded from Teflon® FEP — virtually inert in strong acids, bases, and solvents. Useable at extreme temperatures. Write for our new 32-page catalog showing hundreds of designs, shapes, and sizes.

*DuPont trademark



FLUOROWARE®

CHASKA, MINNESOTA 55318 • PHONE (612) 448-3131

D 4 Circle 112 on reader service card



YOU'RE
WHISTLING
IN THE
DARK . . .

. . . if you think that heart disease and stroke hit only the other fellow's family. No one is immune. Protect the hearts you love. For authoritative information, ask your Heart Association. For medical advice see your doctor. To safeguard your family . . .

GIVE...
so more will live
**HEART
FUND**



Contributed by the Publisher

Electronics | January 4, 1971

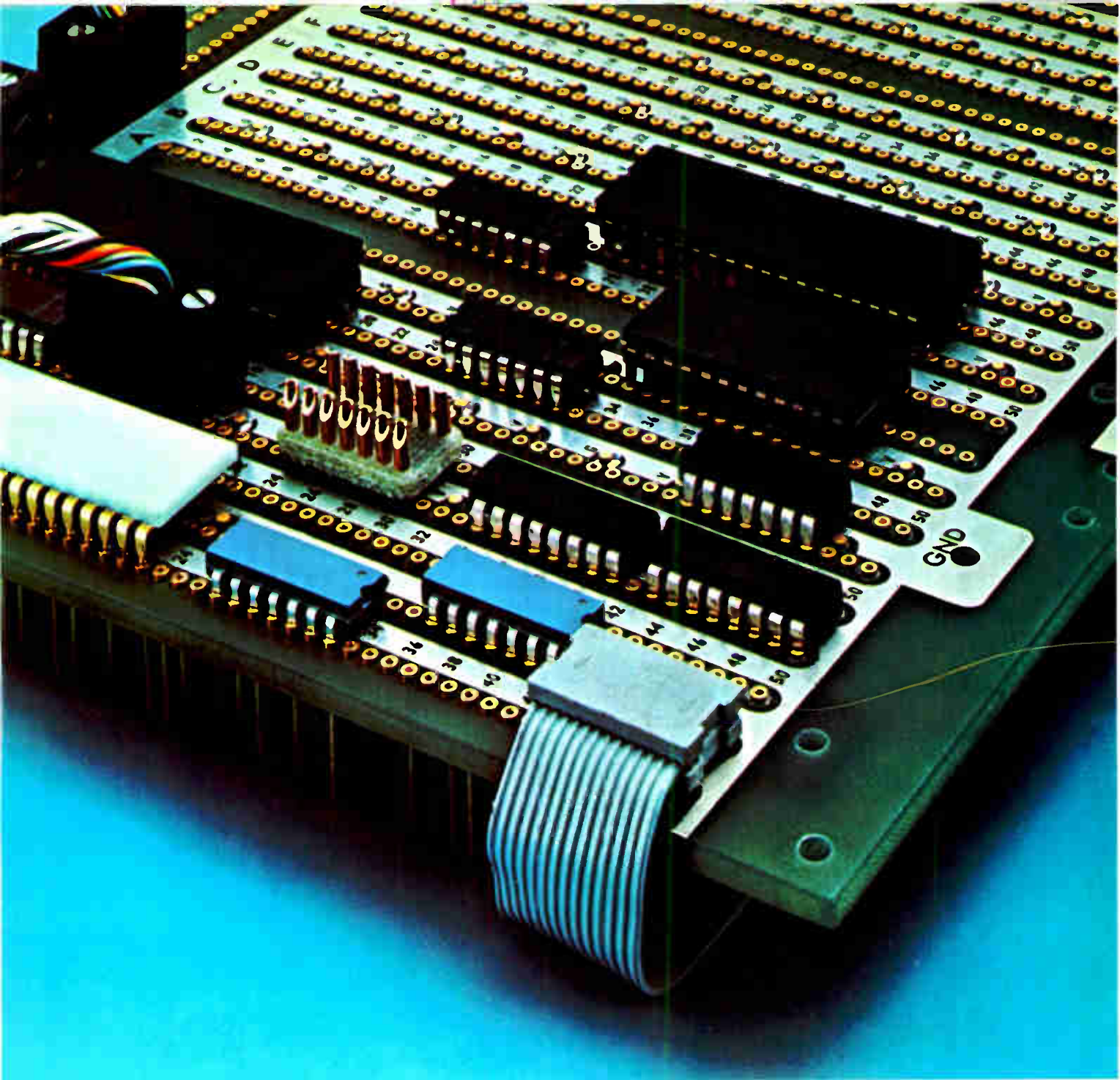

Plug in anything

Let Augat's new universal board provide complete flexibility in IC packaging and prototyping.

You can plug in any dual-in-line IC including popular 14, 16, 24 or 36 packages. The rows of contacts also accommodate our adaptor plugs for interposing discrete components and plugs for I-O connections and interfacing. Board also accepts Augat's new 14-pin, flat cable plug with unique patented design permitting fast assembly without stripping the wire. Plugs directly into IC socket pattern.

Universal board is available in modules of 9 rows with 50 contacts to a row up to 6 modules. Additional pins

are tied in to power and ground planes are strategically located . . . easily accessible. No interference with IC patterns. Like all Augat panels, board is available automatically wrapped to your specifications.

Why be restricted in your packaging and prototyping? Let Augat open the door to greater flexibility.

Call us, (617) 222-2202, or write for our complete IC folder. Augat Inc.
30 Perry Ave. Attleboro, Mass. 02703.

AUGAT
INC.

Cut the Size of Your Power Supply in Half with Fast, High-Voltage Transistors from RCA.

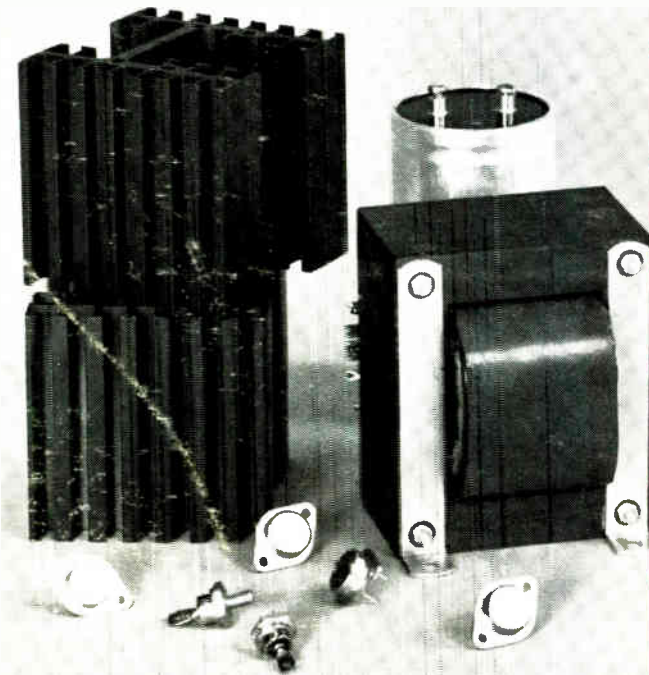

Conventional 5 V, 25 A Supply

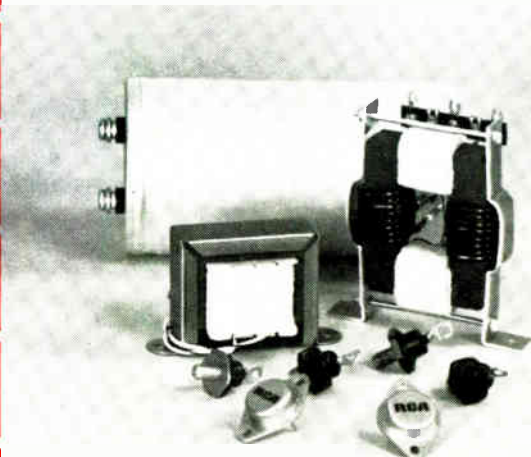

New 5 V, 50 A Supply

RCA

For details and application note, write: RCA, Commercial Engineering, Section 70A-4/UT14, Harrison, N.J. 07029

Circle 902 on reader service card