

- Cashing in on point-of-sale terminals 52
- CAD program features optimization 58
- Flux feedback boosts phased array accuracy 77

# Electronics®

DIAMOND-SCRIBED WAFER

**Giving diode chips  
an even break**

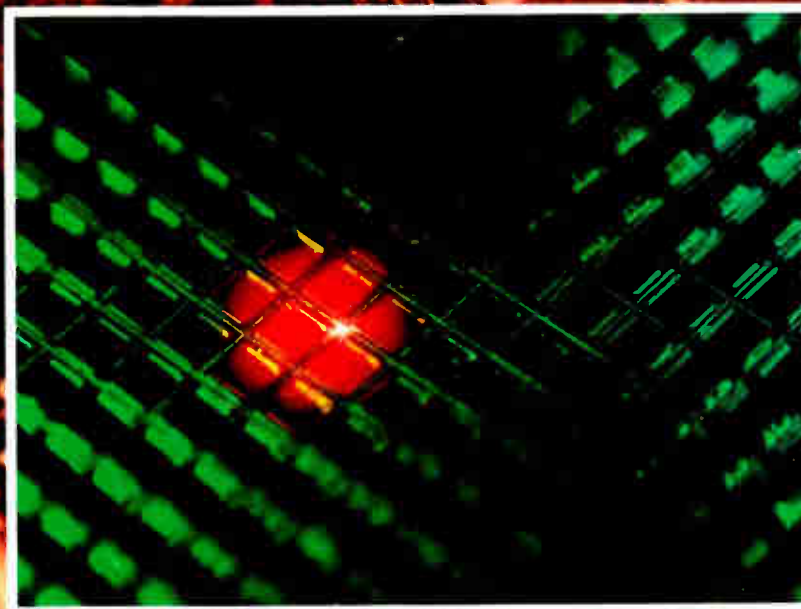

LASER-SCRIBED WAFER

!420 K55956 44RA7 FEB71  
 R KISSLER  
 BASIC COMM ELEC  
 BOX 956  
 MOSES LAKE WA  
 98837

# Suppose you wanted an Automatic RLC Bridge

that could measure up to 2 M $\Omega$  resistance, 2000 H inductance, and 0.2 F capacitance, plus equivalent series resistance and leakage current. A bridge with 5-digit resolution for reactance and resistive readouts, automatic decimal point and units of measurement; a 20-measurements-per-second capa-

bility; 120-Hz and 1-kHz test frequencies; 5-terminal connections to preserve a basic 0.1% accuracy; a built-in 0 to 3-V bias or external bias to 600 V; optional remote programmability and data output.

And prices that start at \$4,450. (in U.S.A.)

## Where could you possibly find such a bridge?



1683 Automatic RLC Bridge by



**General Radio**

Concord, Mass. 01742 Europe: Postfach 124, CH 8034 Zurich, Switzerland

ATLANTA 404 633-6183 / BOSTON 617 646 0950 / CHICAGO 312 992-0800 / CLEVELAND 216 886-0150  
DALLAS 214 637-2240 / LOS ANGELES 714 540 9830 / NEW YORK (N.Y.) 212 964-2722 (N.J.) 201 943-3140  
PHILADELPHIA 215 646-8030 / SAN FRANCISCO 415 948 8233 / SEATTLE 206 747-9190 / SYRACUSE 315 454-9323  
WASHINGTON, D.C. 301 881 5333 / TORONTO 416 252-3395 / ZURICH (051) 47 70 20

Circle 900 on reader service card

# The sweeper with the "think ahead" design

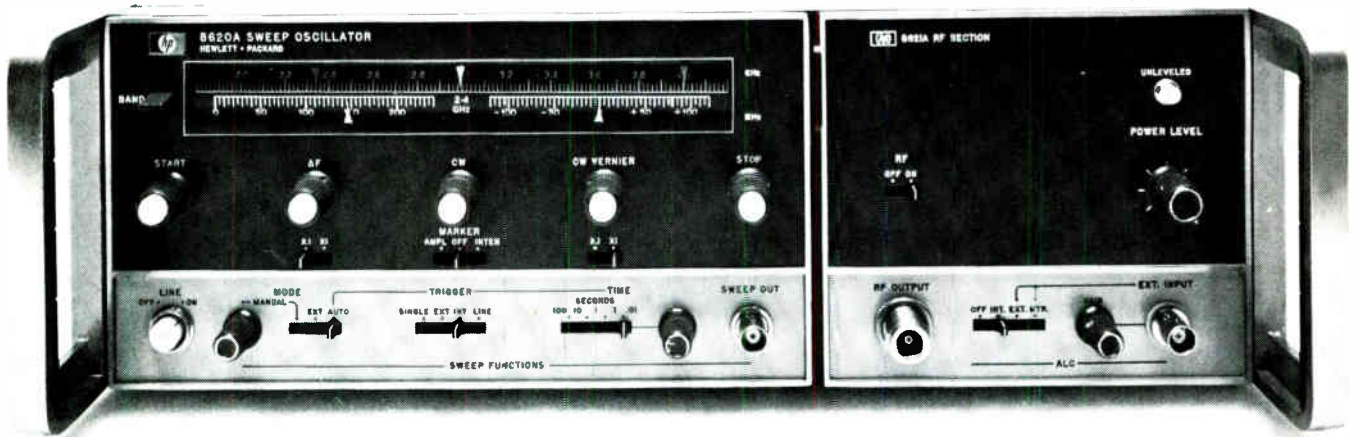

# It's here right now. HP's new multiband solid-state sweeper.

Take a look at the front panel and see how unique it really is. Functions are divided up the way you use them: frequency functions around the dial, sweep functions below. You can select frequency band simply by pressing a lever that rotates the dial. This gives multi-octave output from a single RF connector. The plug-in drawer holds the thin-film micro-circuit RF modules.

HP's new 8620A Microwave Sweep

Oscillator gives you exceptional tuning linearity, low noise, low residual FM and high power output along with multiband performance, compact size, programmability, and HP instrument compatibility. In fact, all the performance features you expect in a sweeper are built into this new instrument.

Not only is the 8620A an economical bench sweeper, but its "think ahead" design lets it grow into a sophisticated

multi-octave sweeper system for far less money than you'd expect. A demonstration? Just call your local HP field engineer. Or write to Hewlett-Packard, Palo Alto, California 94304; Europe: 1217 Meyrin-Geneva, Switzerland.

04022

HEWLETT  PACKARD

SWEEP OSCILLATORS

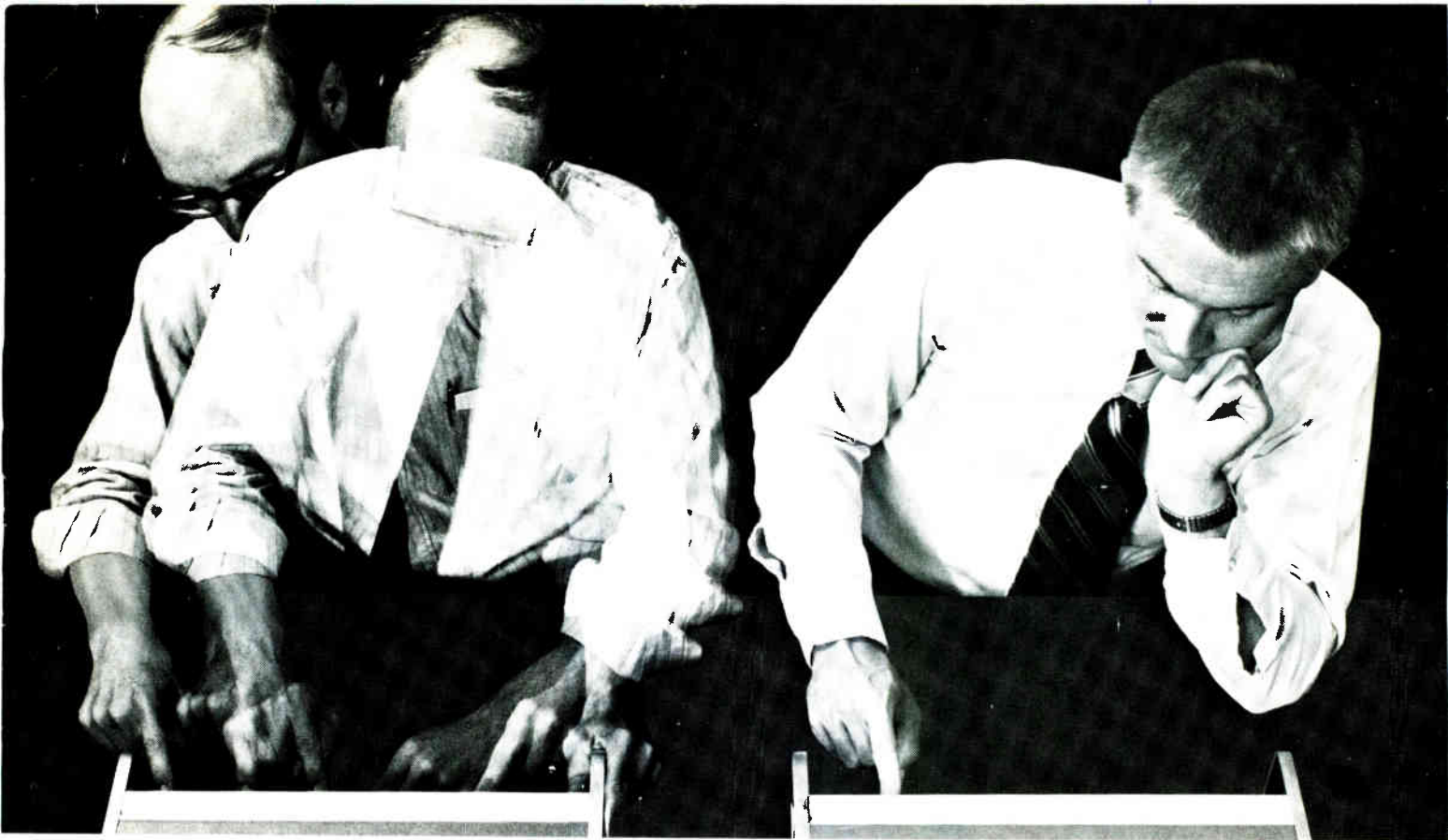

**A good bench DVM  
is fast  
and accurate ...**

**A great bench DVM  
is fast, accurate,  
and easy to use!**

HP's 3480 is a great bench DVM. Simple, foolproof controls and full, five-decade autoranging reduce operating effort and errors. Fast response time and low noise make millivolt adjustments easy. And high noise rejection makes the last digit fully useable.

Low injected noise will not disturb the circuit under test. And constant  $>10^{10} \Omega$  input resistance on the lower three voltage ranges reduces loading errors.

The digital readout display is presented in standard format for easy reading, easy understanding; i.e., +143.17 mV—not backwards, or inside out. Other convenience features include a sampling-rate indicator and a manual trigger for quick one-shot samples.

Options and plug-ins are available to give you combinations of five DC ranges, five true-RMS AC ranges, and six ohms ranges. And you pay for only the capabilities you want. Prices begin at \$1500 for five ranges of fully autoranging DC.

For further information, contact your local HP field engineer, or write to Hewlett-Packard, Palo Alto, California 94304. In Europe: 1217 Meyrin-Geneva, Switzerland.



HEWLETT  PACKARD

DIGITAL VOLTMETERS

090/45

---

## 31 Electronics Review

**AVIONICS:** Copter-mounted radar could go into Awacs  
**COMPUTER-AIDED DESIGN:** Changes made in automated chip design system  
**DISPLAYS:** Cathodochromic tube holds display permanently  
**ELECTRO-OPTICS:** Light pipes may be answer to moving data through aircraft  
**MEDICAL ELECTRONICS:** EIA conference told hospital equipment has distressingly high failure rates  
**SOLID STATE:** High-power pulses from LSA diodes  
**CONSUMER ELECTRONICS:** Government lines up attack on Japanese imports  
**SATELLITES:** ATS-5 millimeter-wave experiments show good results  
**COMPUTERS:** Univac announces new machine  
**MEMORIES:** Ampex introduces semiconductor systems ahead of schedule  
**COMMUNICATIONS:** There's a Prairie Star in the future  
**FOR THE RECORD**

---

## 51 Articles

**COMMERCIAL ELECTRONICS:** Computerized terminals ring up sales in cash register territory  
**CIRCUIT DESIGN:** Program refines circuit from rough design data  
**CIRCUIT DESIGN:** Designer's casebook  
**PRODUCTION:** Diamond scribes start to give way to laser machines, slurry saws, new etch methods  
**MILITARY ELECTRONICS:** Flux monitoring boosts accuracy of phased array radar systems

---

## 83 Probing the News

**COMMERCIAL ELECTRONICS:** U.S. firms gird for calculator battle  
**GOVERNMENT ELECTRONICS:** Budget shortages stall ARTS 3 implementation  
**COMMUNICATIONS:** AT&T's petition raises eyebrows  
**ADVANCED TECHNOLOGY:** Surface waves pick up speed  
**CONSUMER ELECTRONICS:** Synthesizers tune up for market push

---

## 99 New Products

**IN THE SPOTLIGHT:** IR scanner detects microcircuit flaws; Spectrum analyzer rides wide ranges  
**COMPONENTS:** Sonic cells do counting jobs; Transducer measures load without breaking connection  
**SUBASSEMBLIES:** Op amp draws 1 pA current  
**MICROWAVE:** Solid state power limiter; Load leveler carries power, controls signals on one cable  
**DATA HANDLING:** An analog minicomputer; Foldover cuts size of plug-in core stack  
**SEMICONDUCTORS:** MOS shift registers have third output state

---

## 129 Electronics International

**JAPAN:** Big computer is fallout of government's large-scale project  
**WEST GERMANY:** Electronica reflects trends in instrumentation, components; On mask-wafer aligning  
**GREAT BRITAIN:** Magnetic printer gives 30 lines per minute; Minicomputers at Rolls-Royce  
**JAPAN:** Auto dashboard TV shows all the dials

---

4 About this issue  
6 Readers comment  
14 Who's who in electronics  
20 Meetings  
25 Electronics Newsletter  
41 Washington Newsletter  
124 Technical abstracts  
126 New literature  
PB1 Personal Business  
127 International Newsletter

EDITOR-IN-CHIEF: Kemp Anderson

EXECUTIVE EDITOR: Samuel Weber

MANAGING EDITORS: Robert Henkel, *News*;  
Arthur Erikson, *International*

SENIOR EDITORS: H. Thomas Maguire,  
Stephen E. Scrupski

ASSOCIATE EDITORS: William Buccì, Richard  
Gundlach, John Johnsrud, Howard Wolff

#### DEPARTMENT EDITORS

**Communications & Microwave:** Leon M. Magill;  
**Components:** George F. Watson; **Computers:**  
Wallace B. Riley; **Consumer:** Gerald M. Walker;  
**Industrial Electronics:** Alfred Rosenblatt;  
**Instrumentation:** Owen Doyle; **Military/**  
**Aerospace:** Herman Lowenhar; **New**  
**Products:** H. Thomas Maguire (Mgr.),  
William P. O'Brien, George Weiss; **Packaging**  
**& Production:** Stephen E. Scrupski;  
**Solid State:** Laurence Altman

**COPY EDITORS:** William S. Weiss, *Chief*;  
Margaret Eastman

**ART:** Fred Sklenar, *Director*  
Charles D. Ciatto, *Assistant Director*

**PRODUCTION EDITORS:** Susan Hurlburt,  
Arthur C. Miller

**EDITORIAL SECRETARIES:** Claire Goodlin,  
Vickie Green, Terri O'Neil,  
Bernice Pawlak

#### FIELD EDITORS

**Boston:** James Brinton (Mgr.), Gail Farrell;  
**Los Angeles:** Lawrence Curran (Mgr.);  
**New York:** Peter Schuyten (Mgr.); **San**  
**Francisco:** Stephen Wm. Fields (Mgr.),  
Marilyn Howey; **Washington:** Ray Connolly  
(Mgr.), Jim Hardcastle, Lois Vermillion;  
**Frankfurt:** John Gosch; **London:** Michael  
Payne; **Paris:** Arthur Erikson; **Tokyo:**  
Charles Cohen

#### McGRAW-HILL WORLD NEWS

**Director:** Walter A. Stanbury; **Atlanta:** Stan  
Fisher; **Chicago:** Robert E. Lee; **Cleveland:**  
Arthur Zimmerman; **Dallas:** Marvin Reid;  
**Detroit:** James Wargo; **Los Angeles:** Michael  
Murphy; **San Francisco:** Margaret Drossel,  
Tyler Marshall; **Seattle:** Ray Bloomberg;  
**Washington:** Charles Gardner, James Canan,  
Herbert W. Cheshire, Seth Payne, Warren  
Burkett, William D. Hickman; **Bonn:** Robert F.  
Ingersoll; **Brussels:** James Smith; **London:**  
Marvin Petal; **Milan:** Jack Star; **Moscow:**  
Axel Krause; **Paris:** Robert E. Farrell, Stewart  
Toy; **Tokyo:** Mike Mealey

PUBLISHER: Dan McMillan

ASSISTANT TO THE PUBLISHER: Wallace C.  
Carmichael

PLANNING & DEVELOPMENT MANAGER:  
Donald Christiansen

ADVERTISING SALES MANAGER: Pierre Braudé

CIRCULATION MANAGER: George F. Werner

RESEARCH MANAGER: David Strassler

PROMOTION MANAGER: Tomlinson Howland

ADVERTISING SALES SERVICE MANAGER:  
Wallis Clarke

**L**aser and diamonds conjure up some of the fabled qualities of irresistible forces and immovable objects. And as in the undecidable riddle, the two are pitted against each other in a not-yet-decided contest—scribing semiconductor wafers. This issue's cover reflects the laser's challenge to diamonds in the tricky job of cutting chips apart (see p. 70). The photomicrographs, courtesy of Motorola, one of the first firms to use laser scribing, show the edges of two different chips, placed face to face. The top chip, scribed by diamond, has microcracks that can propagate and ruin the chip. The bottom chip, scribed by laser beam, is cleanly broken. The inset shows the way a laser beam moves across a wafer.

In sending the photos to *Electronics*, Irwin R. Carroll, supervisor of technical communications, wryly commented on the difficulties encountered—not in using the technique, but in photographing it. Motorola's team took 56 color photos of an actual laser beam at work on a wafer. But in the end, a photo of a simulated set-up, which showed the technique best, had to be used. Said Carroll: "We found the fascination of laser scribing is very hard to capture on film."

**O**ur outpost in Japan, the hotbed of electronic calculator production (see *Probing the News*, p. 83), is manned by old Japan hand Charles L. Cohen, who has been there for 15 years, half of them spent with McGraw-Hill. An electronics engineer, Cohen attended

the University of Tokyo, and his grasp of the language has been a priceless asset for *Electronics*: he regularly scoops the competition.

Take electronic calculators as an example. Having followed the field from the beginning, he knew the significance of a tiny experimental electronic calculator that he spotted in the development labs of Hayakawa, now Sharp, way back in October 1968. He fired off the first story about the first machine seriously aimed at using LSI to open consumer markets for calculators. Then, thanks to his linguistic edge, he talked the company into giving *Electronics* a photo of the machine's circuits. He has been on top of the subject since then, too, and put together a minutely detailed 5,000-word report, which formed the basis for the *Probing the News*.

The American side of the picture was supplied by Lawrence Curran and Stephen Wm. Fields, managers of *Electronics*' Los Angeles and San Francisco bureaus, respectively, and New York-based consumer electronics editor Gerald Walker. Walker, in covering the Business Equipment Manufacturers Assn. show earlier this month, came across a potential new market for electronics—calculator surveillance. "The mini models are now small enough to walk off with," he says. "So exhibitors put them under bubbles, chained them down like post office pens, insisted on signing out units before letting you handle them, or else hired professional guards to stand over the mini displays. Next year: closed circuit TV."

November 23, 1970 Volume No. 43, Number  
24—91,525 copies of this issue printed

Published every other Monday by McGraw-Hill, Inc.  
Founder: James H. McGraw 1860-1948. Publication office  
330 West 42nd, N.Y., N.Y. 10036; second class postage  
paid at New York, N.Y. and additional mailing offices.  
Executive, editorial, circulation and advertising ad-  
dresses: *Electronics*, McGraw-Hill Building, 330 W. 42nd  
Street, New York, N.Y. 10036. Telephone (212) 971-3333.  
Teletype TWX N.Y. 710-581-4235. Cable address:  
MCGRAWHILL N.Y.

Subscriptions limited to persons with active, profes-  
sional, functional responsibility in electronics technol-  
ogy. Publisher reserves the right to reject non-qualified  
requests. No subscriptions accepted without complete  
identification of subscriber name, title, or job function,  
company or organization, including product manufac-  
tured or services performed. Subscription rates: qual-  
ified subscribers in the United States and possessions  
and Canada, \$8.00 one year, \$12.00 two years, \$16.00  
three years; all other countries \$25.00 one year. Lim-  
ited quota of subscriptions available at higher-than-  
basic rate for persons outside of field served, as fol-  
lows: U.S. and possessions and Canada, \$25.00 one  
year; all other countries \$50.00. Air freight service to  
Japan \$60.00 one year, including prepaid postage. Single  
copies: United States and possessions and Canada,  
\$1.00; all other countries, \$1.75

Officers of the McGraw-Hill Publications Company:  
John R. Emerv, President; J. Elton Tuohis, Senior Vice  
President—Services; Donald B. Gridley, Group Vice  
President; Vice Presidents: Ralph Blackburn, Circula-  
tion; John R. Callahan, Editorial; William P. Giglio,  
Administration; David G. Jensen, Manufacturing; Jerome  
D. Luntz, Planning & Development; Joseph C. Page,  
Marketing; Robert M. Wilhelm, Finance.  
Officers of the Corporation: Shelton Fisher, President;  
Joseph H. Allen, Group Vice President—Publications  
and Business Services; John J. Cooke, Senior Vice Presi-  
dent and Secretary; Gordon W. McKinley, Vice President  
and Treasurer.

Title © registered in U.S. Patent Office; © Copyright  
1970 by McGraw-Hill, Inc. All rights reserved. The con-  
tents of this publication may not be reproduced either in  
whole or in part without the consent of copyright owner.

Subscribers: The publisher, upon written request to  
our New York office from any subscriber, agrees to re-  
fund that part of the subscription price applying to copies  
not yet mailed. Please send change of address notices or  
complaints to Fulfillment Manager; subscription orders  
to Circulation Manager. *Electronics* at address below.  
Change of address notices should provide old as well as  
new address, including postal zip code number. If pos-  
sible, attach address label from recent issue. Allow one  
month for change to become effective.

Postmaster: Please send form 3579 to Fulfillment Man-  
ager. *Electronics*, P.O. Box 430, Hightstown, N.J. 08520.

# PETP FILM CAPACITORS

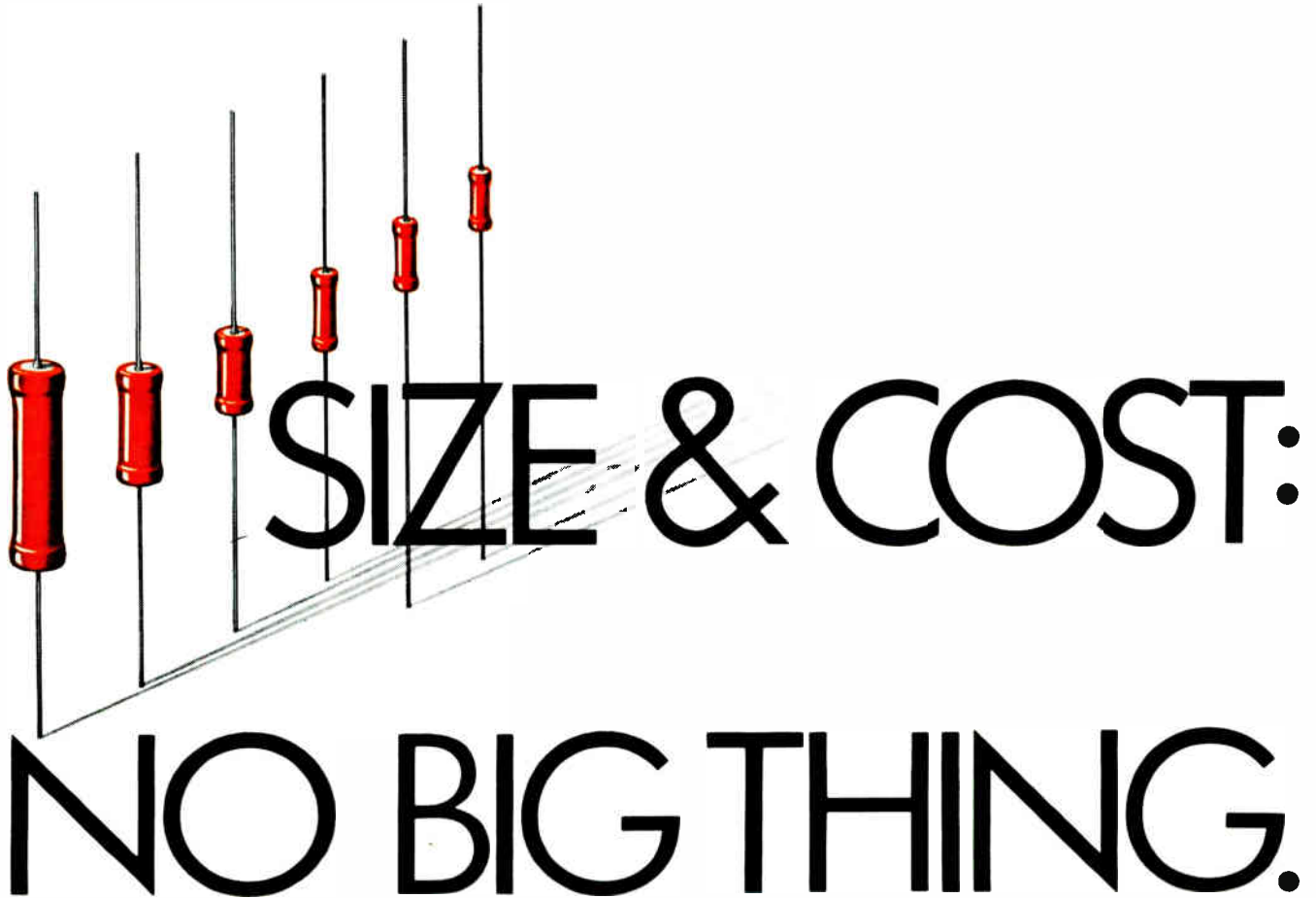

EASIER THAN EVER TO FIT  
YOUR BOARD & BUDGET.

BROAD LINE GETS BROADER.  
8 LOWER CAPACITANCE VALUES  
(100 pF thru 390 pF @ 200 V).

Type 192P Pacer® Polyester Film Capacitors are mass-produced to beat the space/cost squeeze in commercial and industrial applications. Extended-foil PETP film sections with metal end caps provide best possible non-inductive construction. End caps also act as moisture barriers. Ideal for automatic insertion on printed wiring boards. Expanded line includes capacitance values from 100 pF to .47  $\mu$ F. Voltage range, 80 to 600vdc. Write for Bulletin 2066C.

Technical Literature Service  
Sprague Electric Company  
35 Marshall Street  
North Adams, Mass. 01247



**THE BROAD-LINE PRODUCER OF ELECTRONIC PARTS**

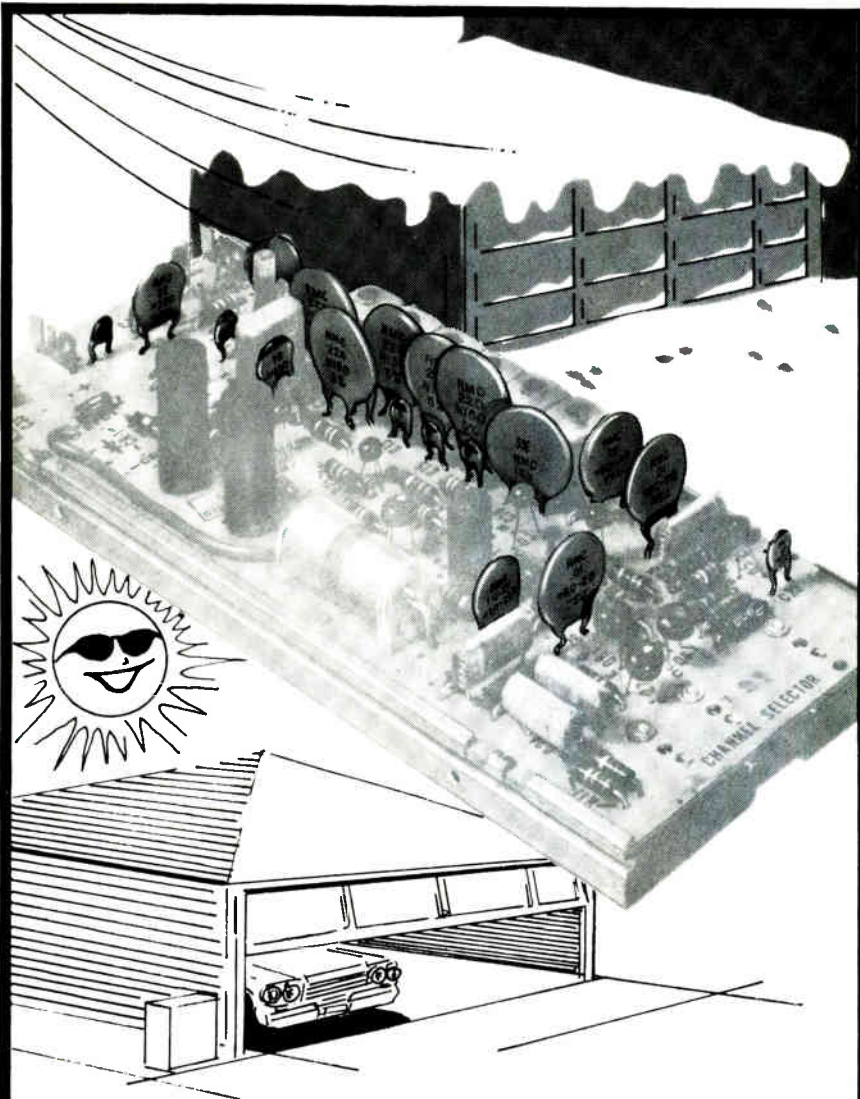

# RMC DISCAPS FOR TEMPERATURE SENSITIVE APPLICATIONS

Perma-Power, a division of Chamberlain Mfg. Corp., a leading manufacturer of radio controlled garage door openers, specifies RMC DISCAPS to assure reliability under extreme environmental conditions.

RMC produces a full range of DISCAPS for temperature sensitive circuitry or applications requiring exact temperature compensation. Frequency and temperature stable types, as well as units of predictable variability, are available.

DISCAPS are produced to the highest standard of quality and may be specified with complete confidence.

If your application requires special physical or electrical characteristics, contact RMC's Engineering Department.

Write today on your company letterhead  
for your copy of the complete RMC catalog.

DISCAP  
CERAMIC  
CAPACITORS



**RADIO MATERIALS COMPANY**  
A DIVISION OF P. R. MALLORY & CO., INC.  
GENERAL OFFICE: 4242 W. Bryn Mawr Ave., Chicago 46, Ill.  
Two RMC Plants Devoted Exclusively to Ceramic Capacitors  
FACTORIES AT CHICAGO, ILL. AND ATTICA, IND.

## Readers comment

### Leakage lament

To the Editor: We read with interest, and some consternation, the article on MOS commutators by Dale Mrazek of National Semiconductor [June 8, p. 82]. I would like to point out an error that your readers should be aware of.

There is no difference in leakage between (100) crystal orientation and (111) crystal orientation. Whether a device is specified at 125°C or at 85°C is purely a function of circuit design, power dissipation, and the willingness of the supplier to make tests at 125°C.

The box at the bottom of page 85 states: "Finally, silicon cut along the (100) plane is much cleaner electrically than (111) silicon. Leakage is very low in (100) devices." It's also stated that "while any silicon device's leakage rises rapidly with temperature, only MOSFETs made with the (100) silicon are specified at operating temperatures to 125°C."

Intel Corp.'s 1406/7 is an extremely high-speed, low-power, low-leakage, dual 100-bit shift register which is specified over the temperature range of -55°C to +125°C. The 1406/7 is built on (111) material and can be compared with the 406/7 of Mr. Mrazek's firm, built on (100) material.

Since minimum operating frequency in a dynamic shift register is a direct function of junction leakage, it is an excellent test of our two processes. Although the Intel device has two or three orders of magnitude lower junction leakage, this low leakage is process oriented and in no way is a function of crystal structure.

Robert F. Graham  
Intel Corp.  
Mountain View, Calif.

■ *Mr. Mrazek replies: Mr. Graham is comparing apples and oranges. The article was about analog commutators, not shift registers.*

*At the time the article was written, there were no other analog commutator ICs with the high-temperature specifications cited in the article. To my knowledge, there are*



# Actual Size!



**Fully automatic: DC to 3 GHz - \$2,295.**

**S-D's new 6053 counter:**

Automatic operation, plus a new low sensitivity, high input impedance 200 MHz amplifier add up to one thing—a new high in counter performance. By automatic operation, we mean just that. All you do is hook up to either the BNC or "N" type connector and push the range button. It's really simpler than using an ordinary frequency meter!

**Other key features and specs:** 3½" half rack configuration. Resolves 3 GHz to 0.1 Hz. Remote programmable BCD recorder output. 10 mV rms on 200 MHz input. Choice of 7 or 9 full digits.

The \$2,295 price comes out to only 77¢ per MHz! For that, why settle for 500 MHz, when the new S-D 6053 goes right up to 3 GHz?

Ask your local Scientific Devices office for complete data or a demonstration or contact: Concord Instruments Division, 888 Galindo St., Concord, CA 94520. Phone: (415) 682-6161. TWX: 910-481-9479.

SYSTRON  DONNER

**Another S-D instrument first!** Electronic counters/Digital voltmeters/Pulse generators/Data generators/Time code generators/Sweep generators/Spectrum analyzers/Digital panel meters/Digital clocks/Signal generators/Oscillators/Laboratory magnets/Precision power supplies/Analog & analog-hybrid computers/Data acquisition systems.

# WE'VE GOT A BETTER WAY TO MAKE PRINTED CIRCUITS!

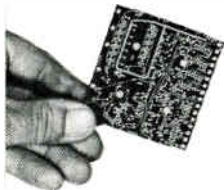

To avoid the necessity of a multi-layer circuit board for a process computer, we produced this high-density dual-inline double-sided board with a 6 mil line width and 8 mil line spacing. Ask us . . . we've got a better way to make printed circuits!

This 3-layer circuit board was designed to be as economical as most double-sided circuit boards . . . for the Control Data 7600 Computer. Ask us . . . we've got a better way to make printed circuits!

Not all multi-layer circuit boards are small. Although some of our circuits measure a fraction of an inch, double-sided circuit board produced for a memory system measures 18" x 22". Ask us . . . we've got a better way to make printed circuits!



APOLLO

Our circuit boards were on Apollo, LEM, and sets. experiment. Sequential laminating, extra-fine line width and spacing, plated slots and edges.



GEMINI

Again, top reliability was required and delivery on-time was made to the customer.

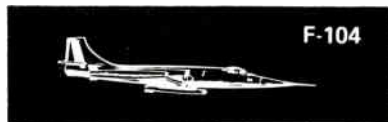

F-104

Developed new technique to produce circuit boards with more reliable plated-thru holes.



C5

We introduced circuit boards that had the highest density circuitry ever used before on a production basis.

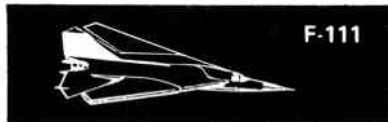

F-111

New industry technique was used to produce multilayer circuit boards with an internal heat sink.

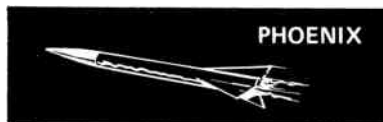

PHOENIX

Required new techniques for manufacturing heat sinks and insulation by chemical milling.



707

Reliable circuit boards in high volume at low cost were produced for this project.



POSEIDON

Developed new technology for sequential laminating multi-layer circuit boards with aluminum backbone.



**This design and production experience can work for you . . . CALL US NOW.**

**CONTROL DATA  
CORPORATION**

CONTROL DATA CORPORATION  
CIRCUITS DIVISION  
7800 COMPUTER AVENUE  
MINNEAPOLIS, MINN. 55435  
PHONE: (612) 927 5681

## Readers comment

still no other analog commutator ICs with comparable specifications commercially available.

Leakage is relevant to operating temperature because leakage rises rapidly with temperature, making 125°C operation impractical if low-temperature leakage is high. Such devices have to be screened for high-temperature performance.

Leakage is related to the process as follows: the (100) process has low fault concentration and gives low-resistivity silicon if properly performed. It has a low switching threshold (−2 volts vs. −4 V for (111) silicon). Smaller devices can be built with smaller functions for a given  $R_{on}$ , also curbing leakage.

Low-threshold logic MOS devices are starting to become available in (111) silicon with the silicon gate and ion implantation processes, but such products were not commercially available at the time the article was written. To my knowledge, analog commutators made by these processes—against the normal (111) process—are not now available or cannot be even compared.

Finally, dynamic shift registers must be compared under different operating conditions than commutators. I also wonder why Mr. Graham chose to compare one of our old shift register designs with one of his company's newest.

### Amplifier power

To the Editor: There was a gross error in the specification of our model 300P wideband power amplifier [Oct. 12, p. 153]. The amplifier that is pictured and described is in fact a 3-watt unit that sells for \$450. The description erroneously states that this unit can provide over 30 W of power output. We can provide over 30 W of Class A power over the described frequency band using two of our model 320L amplifiers and a set of our hybrid combiners, models PM12-2 and PM40-2. This combination, however, sells for \$4,955, and not \$450.

L.M. Salmen  
Electronic Navigation  
Industries Inc.  
Rochester, N.Y.

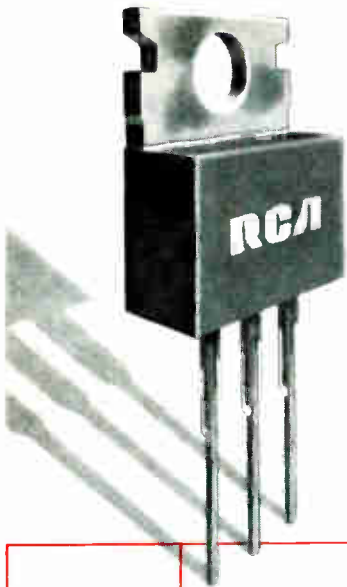

# FOUR FOR FREE!

RCA offers you four plastic power transistors without charge.

| RCA Type  | Package       | $V_{CER}$ (sus)<br>V | $h_{FE}$ | I<br>C<br>A | V<br>CE<br>V |
|---|---------------|----------------------|----------|-------------|--------------|
| <b><math>f_T=0.8</math> MHz min; <math>P_T=100</math> W max</b> |               |                      |          |             |              |
| 2N5034  | TO-3 equiv.   | 45                   | 20-80    | 4           | 4            |
| 2N5035  | Straight lead | 45                   | 20-80    | 4           | 4            |
| 2N5036  | TO-3 equiv.   | 60                   | 20-80    | 5           | 4            |
| 2N5037  | Straight lead | 60                   | 20-80    | 5           | 4            |
| <b><math>f_T=0.8</math> MHz min; <math>P_T=36</math> W max</b>  |               |                      |          |             |              |
| 2N5293  | TO-66 equiv.  | 75                   | 30-120   | 0.5         | 4            |
| 2N5294  | Straight lead | 75                   | 30-120   | 0.5         | 4            |
| 2N5295  | TO-66 equiv.  | 50                   | 30-120   | 1           | 4            |
| 2N5296  | Straight lead | 50                   | 30-120   | 1           | 4            |
| 2N5297  | TO-66 equiv.  | 70                   | 20-80    | 1.5         | 4            |
| 2N5298  | Straight lead | 70                   | 20-80    | 1.5         | 4            |
| <b><math>f_T=0.8</math> MHz min; <math>P_T=50</math> W max</b>  |               |                      |          |             |              |
| 2N5490  | Straight lead | 50                   | 20-100   | 2           | 4            |
| 2N5491  | TO-66 equiv.  | 50                   | 20-100   | 2           | 4            |
| 2N5492  | Straight lead | 65                   | 20-100   | 2.5         | 4            |
| 2N5493  | TO-66 equiv.  | 65                   | 20-100   | 2.5         | 4            |
| 2N5494  | Straight lead | 50                   | 20-100   | 3           | 4            |
| 2N5495  | TO-66 equiv.  | 50                   | 20-100   | 3           | 4            |
| 2N5496  | Straight lead | 80                   | 20-100   | 3.5         | 4            |
| 2N5497  | TO-66 equiv.  | 80                   | 20-100   | 3.5         | 4            |

Why? Because RCA has produced millions of plastic power transistors for automotive and audio applications, production techniques are proven, reliability is established, and prices are lower than hermetic counterparts. We're confident that you will design RCA plastic power into your circuits — once you've tried them!

Review the chart and select any four. They're ideal for applications such as voltage regulators, switching regulators, linear regulators, pulse amplifiers, linear amplifiers, power switching, solenoid relays, and many others.

Next, contact your *RCA Industrial Solid-State Distributor*; he is your source for the four free samples. This offer is good in the U.S.A., and expires December 31, 1970.

RCA | Electronic Components | Harrison, N.J. 07029



# National m popular devi Signetics and put together.

What do we mean by popular?  
We mean popular: National makes all the bipolar digitals, linears, hybrids, transistors and J-FETS most companies use most of the time. And we make them in all the popular packages.

Who determines our line? Our customers. Primarily systems designers. Guys with common needs and custom needs. We fill the common needs with the devices we all know and love. And, we find a way to turn custom problems

into more common solutions. Which means we wind up with most of the devices you're most likely to put on your own parts list.

Which makes us the logical first stop when you've got a new list of parts to buy.

Or, if you already have a good first source, give us a shot at seconds.

When you use National **National.** as a second source, you don't have to shop around for a third source.

# Makes more choices than TI, Fairchild

| Bipolar Digital Circuits |                     |           | Linear       |                                |            | Hybrids      | Discrete Devices  |
|--------------------------|---------------------|-----------|--------------|--------------------------------|------------|--------------|-------------------|
| TTL                      | MSI                 | DTL       | Amplifiers   | Comparators<br>&<br>Sense Amps | Regulators | SH2001(FSC)  | Jan TX types      |
| 54N (T.I.)               | Popular 7400 (T.I.) | 830 (Mot) | 703 (FSC)    | 710 (FSC)                      | 723 (FSC)  | SH2002 (FSC) | Industrial (T.I.) |
| 74N (T.I.)               | Popular 9300 (FSC)  | 930 (FSC) | 709 (FSC)    | 711 (FSC)                      |            | SH2200 (FSC) | (Consumer (Mot))  |
| 54LN (T.I.)              | Popular 8200 (Sig)  |           | 741 (FSC)    | SN5520 Series (T.I.)           |            |              | J-Fets (Mot)      |
| 74LN (T.I.)              |                     |           | 747 (FSC)    | SN7520 Series (T.I.)           |            |              |                   |
| 74H (T.I.)               |                     |           | 748 (FSC)    |                                |            |              |                   |
| 54J (T.I.)               |                     |           | CA3028 (RCA) |                                |            |              |                   |
| 54L (T.I.)               |                     |           |              |                                |            |              |                   |

**To be a good second source, you  
have to be a good first source.**

**Tektronix**

# PLUG-IN

*measurement flexibility*



Mainframes  
available  
with or without  
Rugged Bistable  
Storage

**The Dual Plug-In Feature** of the 560-Series Oscilloscopes allows conventional Y-T or X-Y displays with either single-trace or multi-trace units. The 564B MOD 121N (pictured above) provides stored displays at constant brightness independent of signal repetition rates. Seven-inch rackmounts are available in this family of valued performers.

561B ..... \$595

564B MOD 121N ... \$1,250

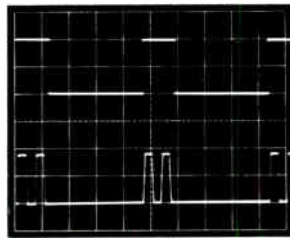
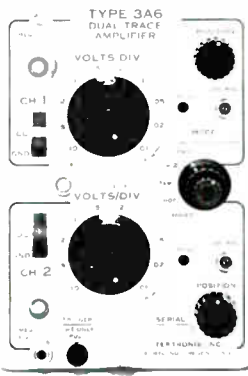

### MULTI-TRACE

Compare time related pulse trains using this DC to 10 MHz, 35-ns risetime plug-in with deflection factors from 10 mV/div to 10 V/div.

**Type 3A6 . . . . . \$550**

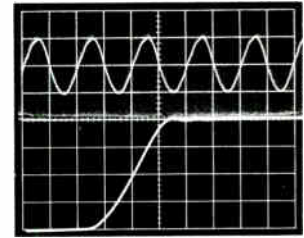
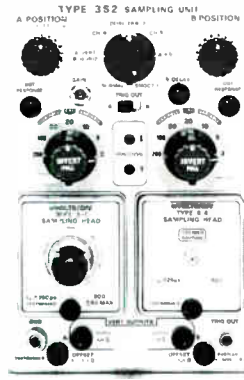

### SAMPLING

Extend your measurement capabilities to 14 GHz with 25-ps risetime, internal triggering, dual-trace and interchangeable heads.

**Type 3S2 . . . . . \$950**

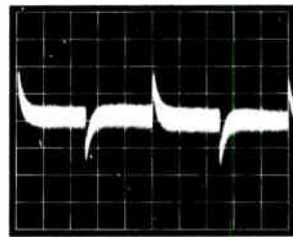
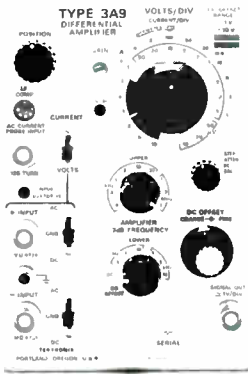

### DIFFERENTIAL

Make differential measurements from DC to 1 MHz with 10- $\mu$ V/div deflection factor and 100,000:1 common-mode rejection ratio.

**Type 3A9 . . . . . \$525**

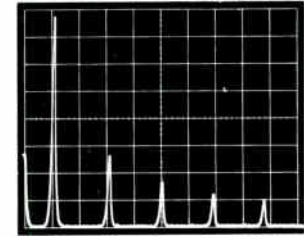

### SPECTRUM ANALYSIS

Analyze the frequency spectrum from 50 Hz to 1 MHz with calibrated dispersion and calibrated deflection factors.

**Type 3L5 . . . . . \$1125**

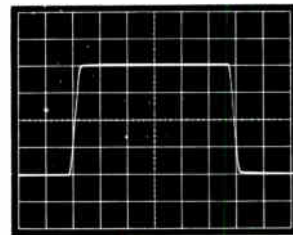
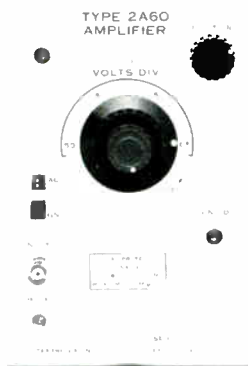

### SINGLE-TRACE

Perform single-trace measurements from DC to 1 MHz at deflection factors from 50 mV to 50 V/div with this low-cost plug-in.

**Type 2A60 . . . . . \$140**

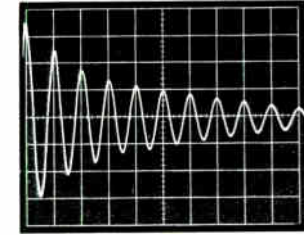
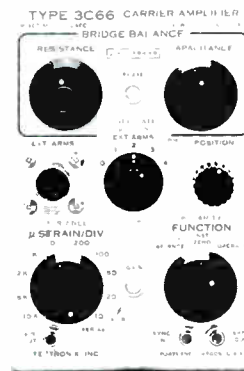

### CARRIER AMPLIFIER

Measure force, acceleration, strain and displacement in applications such as stress analysis, vibration studies and fatigue tests.

**Type 3C66 . . . . . \$495**

The Tektronix 560-Series Oscilloscopes have a complete selection of plug-ins, permitting you to adapt your measurement capabilities to meet your changing measurement needs. More than 25 plug-in units are available covering single channel, multi-trace, differential, sampling, spectrum analysis and other special purpose applications. Adapting your measurement capability to meet your changing measurement needs is assured.

For detailed specifications contact your local Tektronix Field Engineer or write: Tektronix, Inc., P.O. Box 500, Beaverton, Oregon 97005.

These instruments are available through our new Leasing Plan.

U.S. Sales Prices FOB Beaverton, Oregon



**Tektronix, Inc.**

*committed to progress in waveform measurement*

# FREE Engineering Handbook on Electromagnetic Delay Lines



**We've reserved  
a copy  
for your desk . . .**

Terms . . . engineering definitions . . . how to specify delay lines . . . characteristics of various types . . . specifications . . . they're all included in this concise, easy-to-read handbook . . . yours for the asking.

**LUMPED CONSTANT . . .  
DISTRIBUTED CONSTANT  
. . . VARIABLE**

**all three types are covered  
in this reference  
handbook.**

# RCL

**RCL ELECTRONICS, Inc.,**

General Sales Office:

Seven Hundred  
South Twenty First Street  
Irvington, New Jersey 07111

## Who's who in electronics



Larse

**Being a program manager** at Lockheed Missiles & Space Co., which George Larse was, is a "lot like running a small business," which he does. After 19 years with Lockheed, Larse formed his own company about a year ago. And based on the company's performance to date, he must be given high grades in running a small business. The Larse Corp., founded with the intention of bringing MOS/LSI technology to industrial applications, already is on the market with its first product—a compact, complex signal processor called the data communicator [*Electronics*, June 22, p. 135].

The tough job—selling the device—is still ahead. But Larse is confident that the communicator will find its way into a large number of data acquisition, alarm, tone interrogation, and supervisory control systems.

The communicator's key components are two MOS circuits; one has 1,500 transistors and scans, encodes, and transmits 16 inputs to a 3,500-transistor chip that decodes and demultiplexes them.

Turning out such complicated integrated circuits in a year hinged on cooperation, says Larse. "Circuit and logic designers worked hand in hand with MOS designers." This, he claims, cut down on the chance of errors creeping in when logic designs were converted into MOS layouts. In companies much larger than his 20-man firm, states Larse, the logic men and the MOS

men are usually in two separate departments, and rarely get to talk directly to one another. In a big company, he claims, it would have taken at least two years to build these chips.

Plans now are to concentrate on the communicator in 1971. "We're an OEM supplier," insists Larse. "We're not in the systems business." But he says his company eventually will go after the end-user business.

**Last spring** Deputy Secretary of Defense David Packard wrote the Pentagon's top brass that he was "concerned about the management of telecommunications within the Department of Defense." To make the system more efficient, Packard concluded, its management had to be strengthened. The best way to get such a job done, in his opinion, was to give a man the authority and responsibility required for the job and turn him loose.

From this came the creation of the post of Assistant to the Secretary of Defense for Telecommunications and, in late summer, the appointment to it of Louis A. deRosa, Philco-Ford's corporate vice president for engineering and research.

**With his new** assignment, deRosa becomes executive agent for the National Communications System, the Pentagon's designation for all Federal communications networks from the Defense Communications Agency down to the smallest government system. His principal role, however, will be to develop, coordinate, and then recommend DOD telecommunications policy to the secretary.

Though still assembling the information he needs, deRosa already envisions improving the integration of military communications systems as well as upgrading their level of redundancy to guarantee a network that would remain operational after attack. This view is reflected in the Pentagon's recent disclosure of its plan to contract for analysis of a minimum essential emergency com-



These are  
reference  
standards.



This is  
the new Fluke  
working standard.

The new Fluke 730A DC Transfer Standard, a rugged 20 pound, battery powered instrument, takes the fuss out of calibration.

Of course you'll continue to use your standard cell bank as a basic reference. But you'll be time and money ahead if you use the Fluke 730A as your "working standard" and avoid standard cell problems such as temperature sensitivity, length of settling time, and overload. The truly portable Fluke 730A features low temperature coefficient, full accuracy in minutes, overload protection, and quick and easy calibration to your reference standard.

The Fluke 730A consists of four identical independent reference supplies. Output terminals provide individual outputs, the mean output of up to four references and the series output of up to four references. Specific reference voltage outputs available are 1.000, (1.018 +  $\Delta$ V), (1.019 +  $\Delta$ V), 10.000 and  $\Delta$ V Volts. The Model 730A may be used as a 1 volt or 10 volt standard, or as an "electronic standard cell."

Transfer accuracy is 2 ppm. Stability is 10 ppm/month for individual references. Only 3½" high, the 730A can be used on the bench or in a rack. Guarded outputs give you freedom from noise in high accuracy floating measurements.

Price is \$1995.

For the full story see your Fluke sales engineer or contact us directly.



Fluke, Box 742E, Seattle, Washington 98133. Phone: (206) 774-2211. Telex: 910-449-2853/  
In Europe, address Fluke Nederland N.V., P.O. Box 5053, Tilburg, Holland.  
Phone: (04250) 70130. Telex: 634-EJ237/ In the U. K., address Fluke International Corp.,  
Garnett Close, Watford, WC2 4TT. Phone: Watford, 27769. Telex: 9345E3

# Pick your Alpha gaussmeter--- NMR or Hall Effect

Alpha's complete line includes seven models ranging from inexpensive Hall Effect units to a direct digital readout Nuclear Magnetic Resonance instrument for highly precise measurements.

If your need is for **measurement accuracies of 10 ppm**, Alpha's Model 3093 will meet it in an integral control/display unit housing a 5" CRT resonance display and a seven digit readout. Range is from approximately 1,500 gauss to a maximum of 18,000 gauss. A single proton sample and a single probe, which is usable at any desired distance, serve for the entire range. Price is only \$4975. Another



NMR Gaussmeter  
Model 3093

**NMR unit**, Model 675, is available for \$685.

Alpha offers a complete selection of **Hall Effect instruments** which combine accuracy, wide range, and low cost. Alpha's Model 3102 provides direct digital readings of 0-100,000 gauss to an accuracy of .1% for a price of \$950.



Hall Effect Gaussmeter  
Model 3102

At **minimum cost**, Alpha's Model 3104 is a general purpose gaussmeter with 2% accuracy. A taut band, knife-edge, mirror-scale meter supplies direct reading from 0-30,000 gauss in six ranges. Cost is \$295.

Other Alpha gaussmeters include Model 3100 for **precision field plotting and calibration** at \$1495; Model 3101 for **DC differential measurements** at \$895; and Model 3103 **field-to-analog voltage transducer** at \$625.

Hall Effect Gaussmeter  
Model 3100

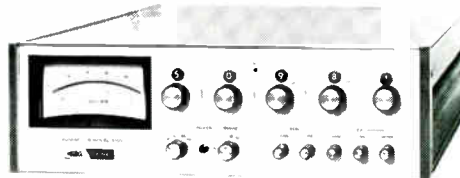

Write today for full information and specifications.

**Alpha**, subsidiary of Systron Donner Corporation  
P. O. Box 2044, Oakland, California 94604  
Phone (415) 635-2700

ALPHA  
SUBSIDIARY

SYSTRON  DONNER

## Who's who in electronics

munications network, which will eventually form the basis for an overall system employing extra low to super high frequencies.

"**First the Russians** came, then the Germans. But when the Russians arrived for a second time, I figured it was time to get out of Estonia for good." Rein Narma's decision during World War 2 to escape his native land is now bearing fruit for the General Instrument Corp., in the form of an MOS operation that finally turned profitable in August.

The 47-year-old Narma has been vice president of GI's Semiconductor Products group since last March. He went there after working his way up from chief engineer at Ampex Professional Products Co. to vice president and general manager of Ampex's video operations. "At Ampex," says Narma, "I was a customer of GI. But the same criteria apply whether you make end equipment or components—you have to be pride and quality competitive."

**Narma says** that GI's technical problems were buried under management problems. "There was a degree of anarchy; there was a lack of direction. Paper work for a particular operation didn't match what was actually being done." He adds that the MOS department was over-staffed—"yet I couldn't find the single person who was responsible for wafer quality control, for example." So his first task was to cut his payroll from 1,300 to 900. It must have worked, because his semiconductor group will ship twice as much in November as it did in March.

The new vice president didn't wave a magic wand. He simply pounded home to foremen and managers his basic management philosophy: discipline and commitment. And he told them that they would meet their commitments or leave. Now, says Narma, wafer preparation is up 50%, probe yields are up, wire bonding volume has increased, and he expects product shipments to increase by about 20% a month.

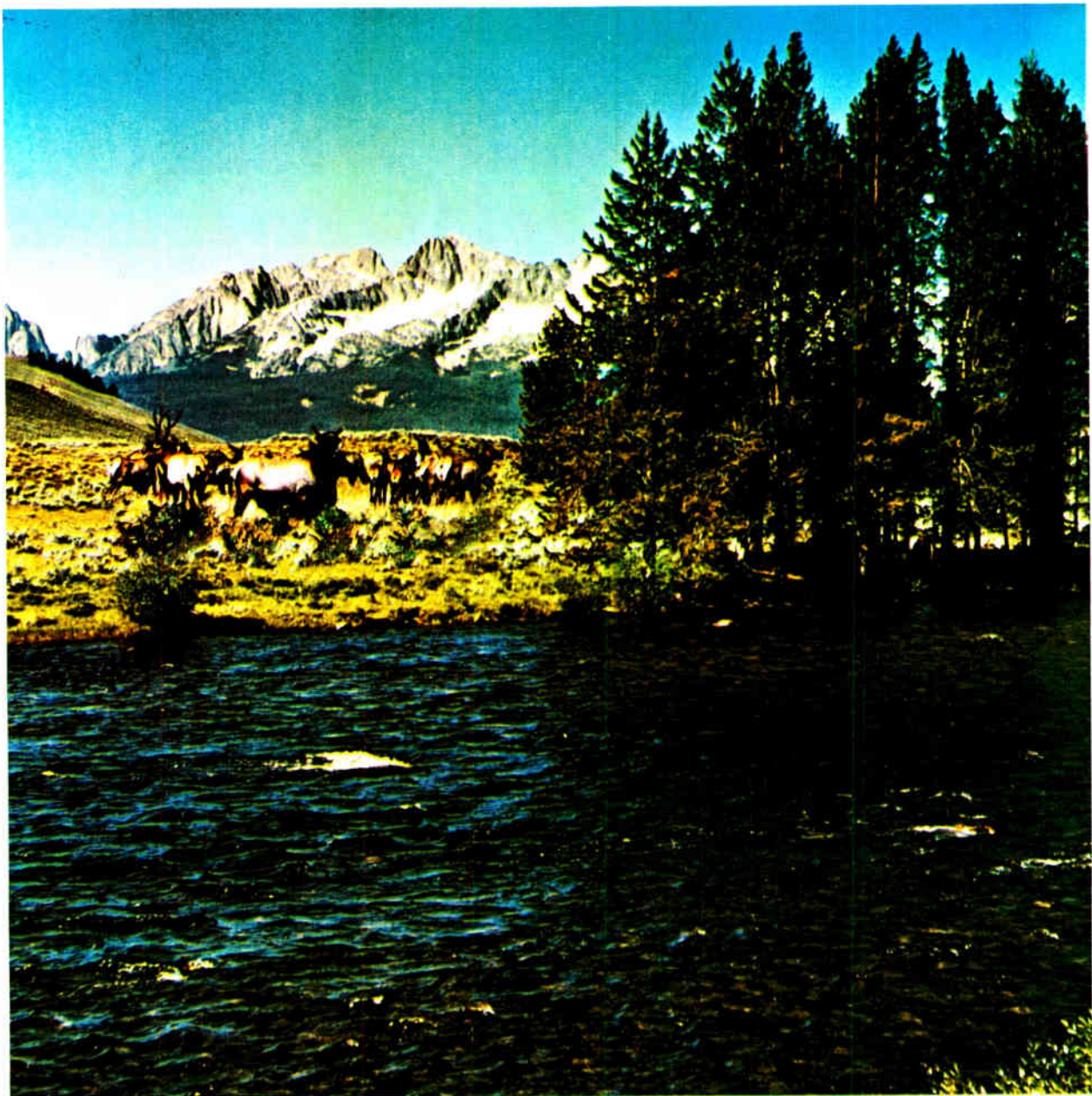

## Rare Species, We Breed. Common Ones, We Manufacture.

We mass-produce metal oxide semiconductors — commonly called MOS. The basic material for MOS devices is silicon, the earth's most common element. The rarer element, germanium, gave life to the transistor two decades ago. Nowadays, we breed millions of new transistors every day on paper-thin wafers of silicon, in our plants located in elk-rich Idaho and around the world.

Right now, AMI/MOS devices are working in computers, peripherals, data communications systems and hundreds of specialized products.

The chances are good that a new breed of MOS devices from AMI can put you ahead of your competition, even if your product is not normally thought of as "electronic" in nature. So hop a jet to our Pocatello, Idaho plant or to our Santa Clara

headquarters — where MOS is in season all year round — and see firsthand what microscopic chips of silicon might do for you.

### American Micro-systems, Inc.

3800 Homestead Road, Santa Clara, Calif. 95051 Phone: (408) 246-0330



THE LEADING  
MOS COMPANY,  
WITH FACILITIES IN  
CALIFORNIA, MEXICO  
IDAHO & KOREA

# Three reasons why we're increasingly reluctant to sell you connectors:

We know that there are several hundred thousand different problems, some of them yours, that can be solved by the right connector.

So we make several hundred thousand different connectors.

And that used to make us very proud.

Not now.

Now it makes us worry.

Because the interrelationships of components, connectors, terminations, substrates, circuitry, modules and sub-modules have become so super-complex that connectors—even our several hundred thousand connectors—aren't enough to solve your problems.

You need more. Considerably more.

You need complete electro-mechanical packaging systems, systems that attack your put-it-together problems on a total, integrated basis.

Like the three systems shown here.

Variboard<sup>T.M.</sup>

Variframe<sup>T.M.</sup>

Variplate<sup>T.M.</sup>

With the Variboard system we can do virtually anything you want, using single- or double-sided circuit boards as the base. Components can be mounted on connectors or directly to the boards. Connectors can be mounted in plated-through or unplated holes. Wired and printed circuits can be mixed. And boards can be mounted on mother boards, using our card-edge connectors.

The Variframe system provides what phenolic boards lack: the strength and rigidity to serve as structural members. Variframe mounting frames do the structural work, providing convenient mounting for board-edge and rack and panel connectors.

The Variplate system is the most widely used metal-plate back panel interconnection system. The Variplate

metal plate serves as a structural member; can provide bussing and voltage and ground planes; accommodates individual components and connectors in any configuration. And it is perfectly suited for automatic wire-wrapping termination.

Please don't get the idea you can just pick up the phone and say, "Hey, Elco, send me a system." There are several hundred decisions to be made, some of them quite basic.

But we're prepared to help you make those decisions, quickly and surely. Matter of fact, we can take you from design through selection of connectors, plates, frames, and boards—and even make all the necessary interconnections; manually, semi-automatically, or fully automatically. And we've done it in six weeks.

Six weeks.

That's not very long. But we can do it. And that's the way we want to do it. Because when you use us not as connector-makers but as connector-systems-makers, you use us best.

To get started using us right

away call the nearest Elco number, (215) 659-7000 for the Willow Grove Division, (814) 643-0700 for the Huntingdon Division, or (213) 675-3311 for the Pacific Division.

If you're enjoying a lull between packaging panics right now, send for our new Total Packaging Service brochure. It'll give you a head start on the future. Write (or TWX) us at Elco, Willow Grove Division, Willow Grove, Pa. 19090. TWX: 510-665-5573. Elco, Huntingdon Division, Huntingdon, Pa. 16652. TWX: 510-691-3117. Elco, Pacific Division, 2200 Park Place, El Segundo, California 90245. TWX: 910-325-6602.



# Variboard™, Variframe™, Variplate™

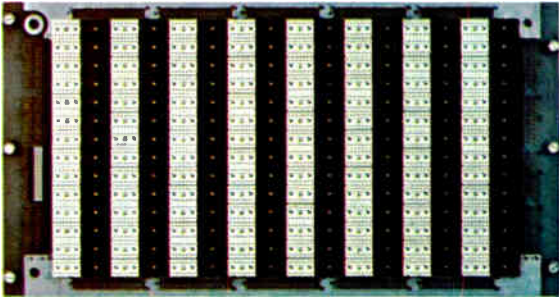

The versatile electronic packaging system: mount components directly, mount connectors (particularly our Mojo™ modular connectors) in plated-through holes eliminating wiring, mount connectors in non-plated holes and wire them. Your choice in any combination.

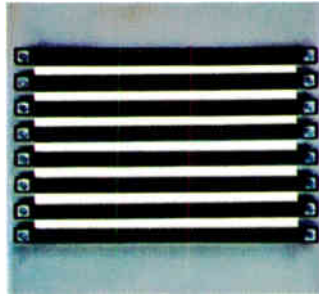

The convenient, economical way to structural strength for any size p.c. board. Use p.c. card edge connectors (metal to metal), p.c. connectors, and rack and panel connectors. Get as complicated as you want.

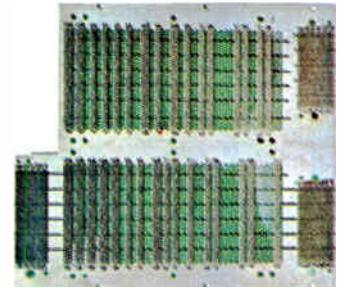

The most widely used metal-plate back panel interconnection system. It's a structural member. Can provide bussing and voltage and ground planes, accommodates components and connectors in any configuration, and is perfect for automatic wire wrapping on our Gardner-Denver machines.

## ELCO Electromechanical Packaging Systems

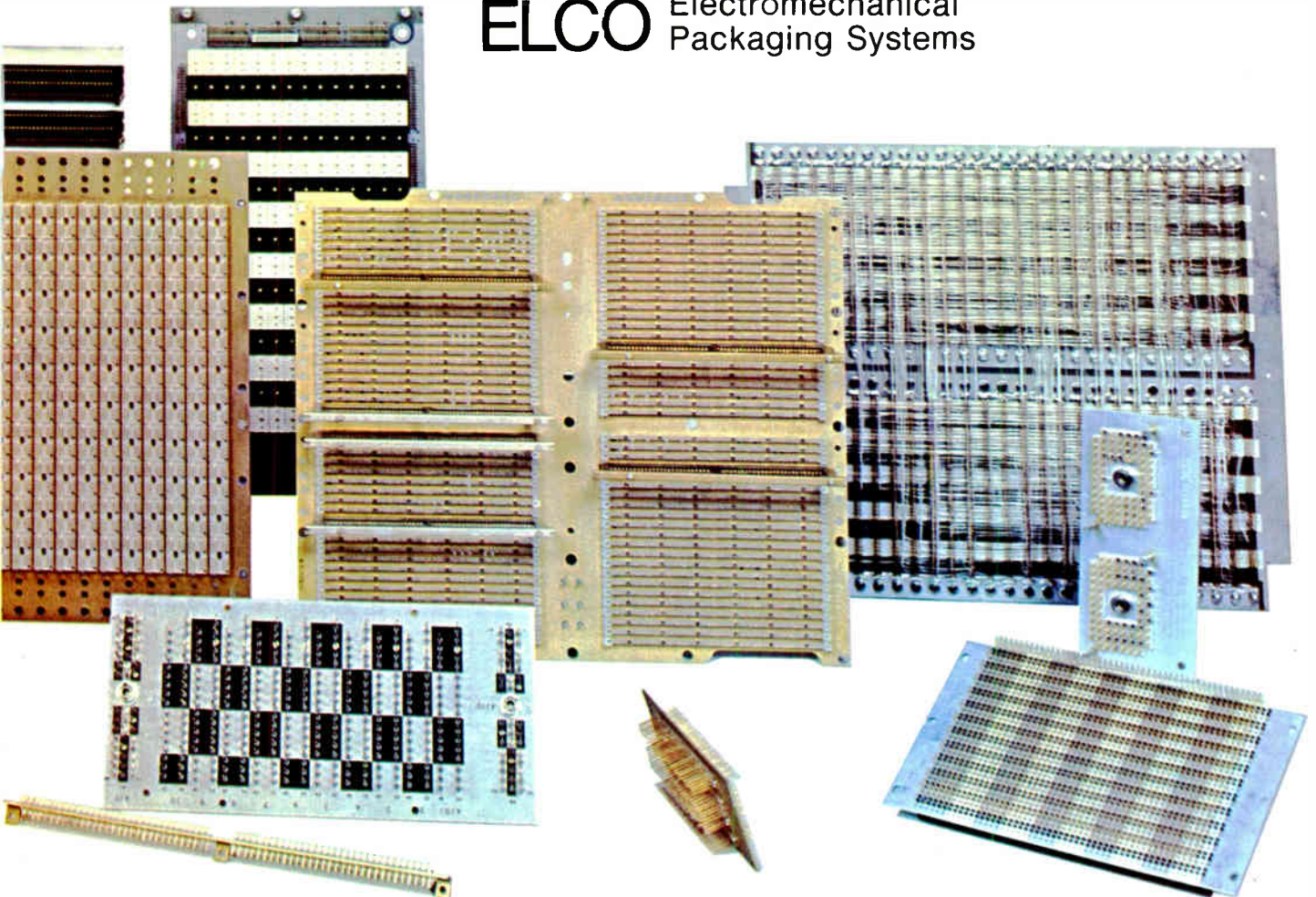

**NOW**  
**HIGH-PERFORMANCE SCRs**  
**TO MEET THE**  
**CRITICAL NEEDS OF ...**

- Power Inverters
- A.C. Motor Variable Speed Drives
- Induction Heaters
- Pulse Width Modulators



**NATIONAL<sup>®</sup>**  
**DISC PACKAGED**  
**REGENERATIVE GATE\* SCRs**  
 provide these plus factors. ...

- + Voltages to 1000 V
- +  $dv/dt$  to 500 V/ $\mu$  sec.
- + Turn-off time to 15  $\mu$  sec.
- +  $di/dt$  to 800 A/ $\mu$  sec.
- + Low power gate drive
- + Operation to 20 KHz, with low switching losses
- + 175 and 380 amperes RMS
- + Also available in stud packages to 470 amperes RMS

\* A NATIONAL<sup>®</sup> exclusive.  
 Patent No. 3,486,088

We welcome requests for detailed data and application assistance. Contact ...

**NATIONAL ELECTRONICS, INC.**  
 a varian subsidiary

Geneva, Ill. 60134, phone 312-232-4300

## Meetings

### Calendar

**Conference on Display Devices, IEEE;** United Engineering Center Auditorium, New York, Dec. 2-3.

**Conference on Vehicular Technology, IEEE;** Statler-Hilton Hotel, Washington, Dec. 2-4.

**National Electronics Conference, IEEE;** Conrad Hilton Hotel, Chicago, Dec. 7-9.

**International Symposium on Circuit Theory, IEEE;** Sheraton Biltmore Hotel, Atlanta, Ga., Dec. 14-16.

**Reliability Symposium, IEEE;** Sheraton Park Hotel, Washington, Jan. 12-14.

**Optics in Microelectronics, Optical Society of America, Stardust Hotel, Las Vegas, Jan. 25-26.**

**International Solid State Circuit Conference, IEEE;** Sheraton Hotel, University of Pennsylvania, Feb. 17-19.

**International Convention & Exhibition, IEEE;** Coliseum and New York Hilton Hotel, New York, March 22-25.

**Reliability Physics Symposium, IEEE;** Stardust Hotel, Las Vegas, March 31-April 2.

**European Semiconductor Device Research Conference, IEEE, DPG (German physical society), NTG (German communications society);** Munich, March 30-April 2.

**National Telemetry Conference, IEEE;** Washington Hilton Hotel, April 12-15.

### Call for papers

**International Symposium on Remote Sensing of Environment, University of Michigan; Ann Arbor, May 17-21, 1971. December 15 is deadline for submission of summaries to the Center for Remote Sensing Information and Analysis, Willow Run Laboratories, P.O. Box 618, Ann Arbor, Mich. 48107, attn: Jerald J. Cook.**

**IEEE Spring Meeting, Statler Hilton Hotel, Washington, April 8-10. Jan. 25 is deadline for submission of abstracts to Dr. John V. Evans, Secretary USNC/URSI, Lincoln Laboratory, M.I.T. Lexington Mass. 02173.**

**European Microwave Conference, IEE;** Stockholm, Sweden, Aug. 23-28. March 1 is deadline for submission of summaries to 1971 European Microwave Conference, Fack 23, 104 50, Stockholm 80, Sweden.



**Behind this counter are 40 million hours of reliability data.**

**That's only one reason it's the world's best seller.**

Only the 5245's have over 40 million hours of operating data behind them — data which is computerized so HP can keep track of the performance of the 20,000 5245's now in use around the world. In addition, they all get torture-tested up to 160° F to make sure they'll operate under the most severe conditions.

The 5245's adapt easily to your needs. 14 plug-ins go from dc to 18 GHz and perform a great variety of functions. You can even order a long-term time-base stability of  $< 5 \times 10^{-10}$  — good enough to use as a precision frequency standard.

That's why, in the long run, buying the best all-around counter on the market

— the 5245 — will save you money. Downtime and servicing are minimal. But you can get parts and service around the world. No wonder these counters are the only choice for many leasing companies.

Prove it to yourself. Call your local HP field engineer and find out why these are the most accurate, flexible and economical counters you can get. Anywhere.

Or write Hewlett-Packard, Palo Alto, California 94304; Europe: 1217 Meyrin-Geneva, Switzerland.

HEWLETT  PACKARD  
ELECTRONIC COUNTERS

# Fight noise pollution





# with this quiet family.

Hot Molding with Allen-Bradley's exclusive technique, gives these composition variable resistors an unusually low noise level. And importantly, this low noise level actually decreases in use. Under tremendous heat and pressure the resistance track is molded into place. A solid element with a large cross-section is produced.

This important Allen-Bradley difference means better short-time overload capacity and a long operating life. Control is smooth, resolution almost infinite. These variable resistors are ideal for high frequency circuits. Why should you trust the performance of

your designs or your reputation to anything less than Allen-Bradley quality? Use the most thoroughly "field tested" (over 20 years) variable resistors available today. Quantity stocks of popular types J, G, W and GD available for immediate delivery from your appointed A-B industrial electronics distributor.

For information write: Marketing Department, Electronics Division, Allen-Bradley Co., 1201 South Second Street, Milwaukee, Wisconsin 53204. Export office: 1293 Broad Street, Bloomfield, N. J. 07003, U.S.A. In Canada: Allen-Bradley, Canada Ltd., 135 Dundas Street, Galt, Ontario.

## SPECIFICATIONS

|  | TYPE J—<br>STYLE RV4   | TYPE K   | TYPE G—<br>STYLE RV6  | TYPE L                           | TYPE W   | TYPE GD   |
|--|--|--|---|----------------------------------|--|---|
| CASE DIMENSIONS  | 5/8" deep x 1-5/32" dia. (single section)  | 5/8" deep x 1-5/32" dia. (single section)                          | 15/32" deep x 1/2" dia.                                       | 15/32" deep x 1/2" dia.          | 15/32" deep x 1/2" dia.                        | 35/64" deep x 1/2" dia.   |
| POWER at + 70°C  | 2.25 W   | 3 W  | 0.5 W   | 0.8 W                            | 0.5 W  | 0.5 W   |
| TEMPERATURE RANGE  | -55°C to +120°C  | -55°C to +150°C  | -55°C to +120°C   | -55°C to +150°C                  | -55°C to +120°C                                | -55°C to +120°C   |
| RESISTANCE RANGE (Tolerances: ±10 and 20%)                               | 50 ohms to 5.0 megs  | 50 ohms to 5.0 megs  | 100 ohms to 5.0 megs  | 100 ohms to 5.0 megs             | 100 ohms to 5.0 megs                           | 100 ohms to 5.0 megs  |
| TAPERS   | Linear (U), Modified Linear (S), Clockwise Modified Log (A), Counter-Clockwise Modified Log (B), Clockwise Exact Log (DB). (Special tapers available from factory) |  |   |                                  |  |   |
| FEATURES (Many electrical and mechanical options available from factory) | Single, dual, and triple versions available. Long rotational life. Ideal for attenuator applications. Snap switches can be attached to single and dual.            | Single, dual, and triple versions available. Long rotational life. | Miniature size. Immersion-proof. SPST switch can be attached. | Miniature size. Immersion-proof. | Commercial version of type G. Immersion-proof. | DUAL section version of type G. Ideal for attenuator applications. Immersion-proof. |

## ALLEN-BRADLEY

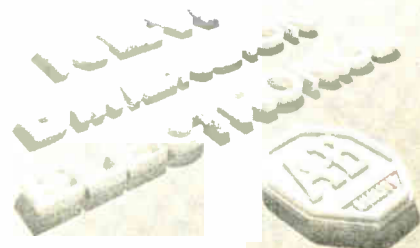
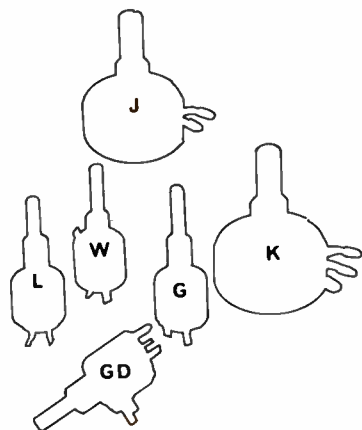

Need a fast, accurate solution to an IC problem? E-H Research Laboratories, Inc. teams up with Iwatsu Electric Company, Ltd. to offer you the ideal test instrumentation.

E-H breaks through with the **E-H 129 pulser** which is capable of driving the fastest digital logic circuits. Until this compact, all solid-state instrument came along, no practical commercial pulse generator offered repetition frequency capability beyond 200 MHz. The E-H 129 offers 500 MHz, 2-volt pulses with less than 500 ps risetime and such extras as baseline offset, pulse-top/baseline inversion function, and synchronous gating.

And the ideal mate for this instrument is the **Iwatsu 5009B sampling scope** which allows you to observe and control the waveforms you generate. The Iwatsu 5009B with 18GHz bandwidth lets you evaluate fast circuits with high accuracy—in fact, direct measurements on 100 ps edges with less than 2% display error. Features include less than 20 ps risetime, sensitivity from 10mV/cm, dual-trace performance with seven operating modes, separate miniature sampling heads, big CRT and triggering to full bandwidth for extra convenience.

If these two instruments can't solve your problems, E-H can offer you E-H and Iwatsu instrumentation that can. Contact an E-H representative and get a fast solution. Today.

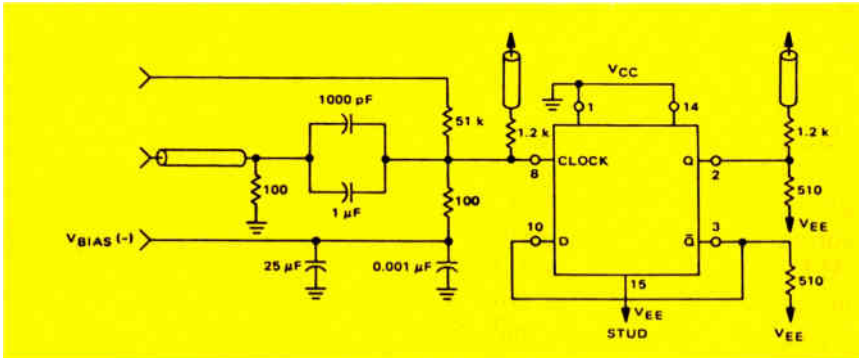

E-H  
the  
fast  
solution



**E-H** E-H RESEARCH LABORATORIES, INC.

515 Eleventh Street • Box 1289, Oakland, California 94604 • Phone: (415) 834-3030 • TWX 910-366-7258  
 In Europe: E-H Research Laboratories (Ned) N.V., Box 1018, Eindhoven, The Netherlands, Telex 51116  
 In Japan: Iwatsu Electric Company, Ltd., 7-41, 1-Chome Kugayama Suginami-Ku, Tokyo 167, Japan

---

# Electronics Newsletter

---

November 23, 1970

## Zenith's pay TV may go on the air

Zenith Radio, which manufactures equipment approved by the FCC for telecasting pay-as-you-go programs, is negotiating for what may become the first operational pay TV station. Though Zenith's Phonevision system for encoding and decoding video signals for subscription users has government approval, each channel broadcasting with the system also must obtain a green light from the FCC. Zenith is discussing purchase of the construction permit for Chicago's channel 38, owned by the Chicago Federation of Labor.

## Depletion-load MOS RAM economizes on real estate

The first MOS memory designed to take advantage of depletion-load techniques now is in production at the Mostek Corp. The 1,024-bit random access memory not only has a 300-nanosecond access time but, more importantly, is small, occupying the area formerly needed by a 256-bit RAM. Use of ion-implanted depletion loads means less space is needed for metalization, channel area, and power distribution: only a single +5-volt supply is needed, making the device not just threshold compatible, but power-supply compatible with TTL devices.

Taking advantage of the depletion load's saving in real estate, Mostek designers have squeezed in an internal clock and full decoding, and put the chip in a standard 16-pin package. The only competitive device, a 1,024-bit MOS RAM from Intel in an 18-pin package, requires additional power supply voltage, some external components to make it compatible with TTL, and an external clock.

## Hughes to double ion-implant capacity

An ion-implantation machine being phased into operation at Hughes Aircraft Co.'s MOS division in Newport Beach, Calif., may be a fair-sized step toward eliminating the low-throughput drawback [*Electronics*, May 25, p. 125]. The 150,000-volt machine will handle 40 2-inch-diameter wafers at a time, compared to 20 for the division's initial laboratory unit. When it begins to operate 15 hours a day, minimum throughput will be 2,000 wafers a week. Division manager Jack Hirshon says the doubled capacity of the new machine means that "ion implantation is no longer a laboratory process; it's a production tool."

## TI maps campaign in display market

Texas Instruments has organized a display device branch within its Optoelectronics department to pursue development and marketing of solid state displays, including liquid crystal devices. The operation will be headed by James W. Clifton.

At the same time, TI was forced to lay off 1,800 employees in Dallas. The reduction came on the heels of a 1,210-worker cut announced last month. The latest layoff also brought an end to the reduced work week arrangement inaugurated to avert mass layoffs.

## NRMEC to sell chips for big calculators

North American Rockwell Microelectronics Co. has designs on a larger share of the calculator chip business [see p. 83]. Almost all its production now goes to the Sharp Corp. of Japan. NRMEC has designed four basic chips that "have the flexibility required for application to end products

---

# Electronics Newsletter

---

requiring calculation functions all the way up to programable calculators," says Charles Kovac, vice president for marketing. These chips would interface with keyboards that have 65-key capacity and "displays known to be used in this class of machine," Kovac adds.

## DEC to market hard-copy printer

It's likely that Digital Equipment Corp. is preparing to challenge the Teletype Corp.'s dominance of the computer keyboard/hard copy I/O market. The medium is DEC's new Decwriter, which would cost about \$1,000 more than the most commonly used teletypewriter—but, at 30 characters per second, would be three times faster.

Moreover, the Decwriter uses LSI—a first for DEC—for decoding in its 2,240-bit read-only memory. The next-largest chip in the machine is a 7400 series quad flip-flop. DEC estimates that its Decwriter will have a mean time before failure of 30 million characters.

## LSI testers feature speed and economy

LSI testers capable of working faster than 100 megabits a second—five to 20 times faster than anything now commercially available—will be announced in early 1971 by Tau-Tron Inc. of Lowell, Mass. The new testers gain a cost advantage, too, from their maximum-length shift-register pattern generator: a single 16-bit shift register with feedback connections can spew out more than 65,000 test words without repeating itself. This, it's claimed, makes the machine both faster than systems using computer-generated test patterns, and far less costly than those storing patterns in a memory. In addition, the systems will use Tau-Tron's proprietary Univer tunnel diode logic, which is capable of microwave frequency clock rates, to enable it to outspeed testers using ROM storage.

Because of the savings in memory cost, and the need for only minimal computer supervision, the large DFE-7P production test system will be priced at about a third to a half the cost of many production testers—\$80,000 to \$100,000. A \$5,000 unit, the DFE-3P, will be aimed at end-user testing, and will be manually operated.

## Honeywell unveils four time sharers

Honeywell Information Systems has announced four low-rental, time-sharing systems. Renting from \$2,995 to \$7,815 monthly, the new 1600 series is aimed at competing systems now pegged at \$10,000 to \$18,000 a month. The 1600s can handle up to 960 subscribers, 64 of them simultaneously; each would have access to programs including Basic, Fortran IV, DAP-16, Solve, Teach, Edit, and, in three of the four models, Cobol.

## Addenda

At least one well-placed computer industry insider expects IBM to be giving the same boost to MOS memories as it gave to bipolar versions with its 370/145 machine [*Electronics*, Oct. 12, p. 125]. MOS memories are expected to be in two machines coming next year to round out the lower end of the 370's price/performance spectrum. . . . Control Data Corp. and the major French and British computer makers, CIE and International Computer Ltd., have formed an R&D subsidiary in the first step toward cutting into IBM's two-thirds share of the European market. . . . GE has moved into the plastics industry with a control system for temperatures and machine sequences that monitors operations.

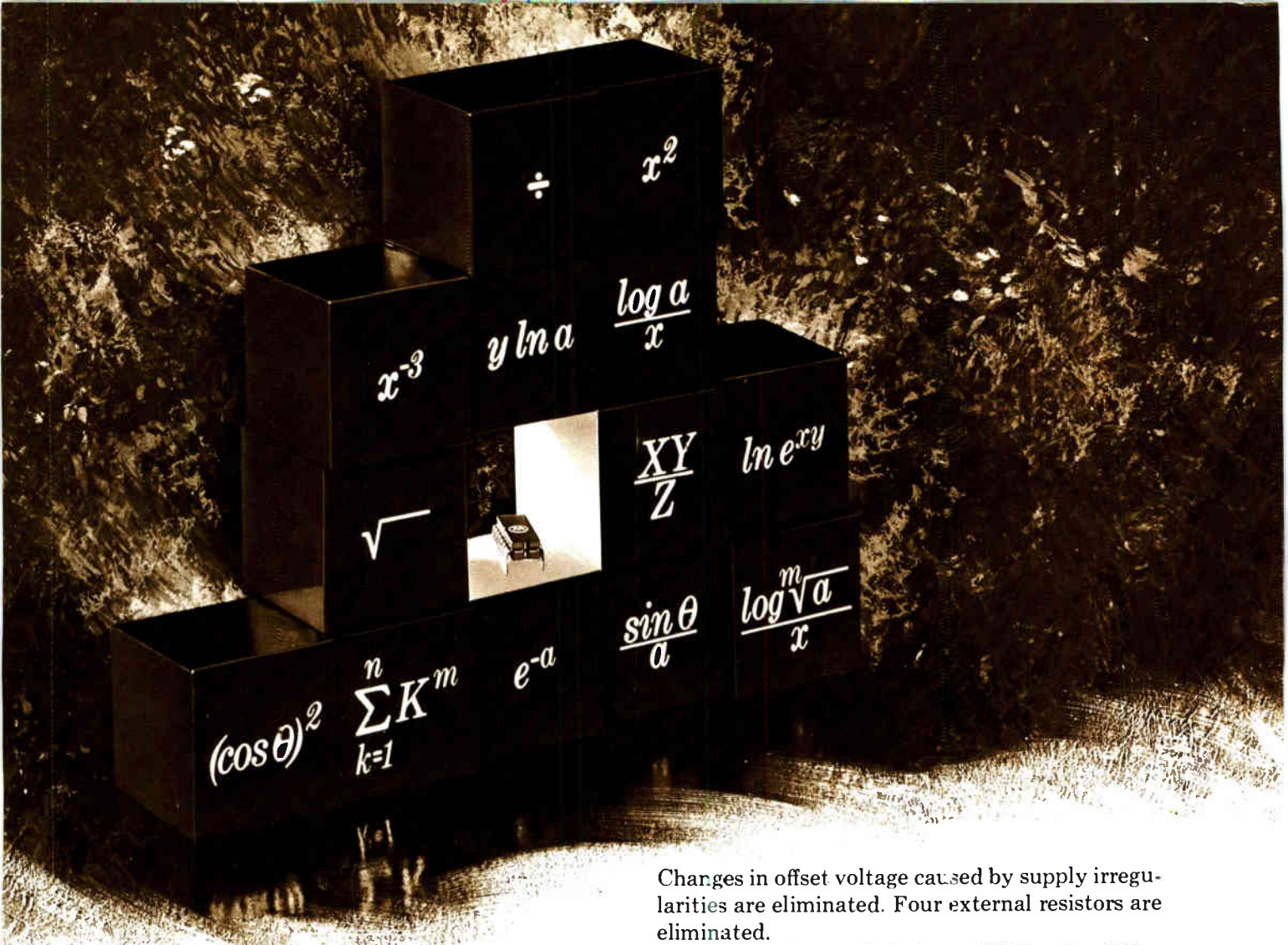

## Second generation IC "Multiplier Plus"

### Plus What?... Plus built-in voltage regulator and current converter

Motorola's new MC1594/1494 introduces the second generation of monolithic IC four-quadrant multipliers based on the variable transconductance principle. The "multiplier plus" is easier to use than the familiar industry standard MC1595/1495, and it offers a new high level of performance.

#### "Plus" features for cost reduction

The built-in current and voltage regulator eliminates the effects of power supply fluctuation and reduces the number of external components required. It regulates all current sources on the monolithic chip, effectively immunizing the multiplier to supply voltage fluctuations. It also provides two (+4.3 V) regulated voltages to bias the offset adjust potentiometers. Interaction among the pots during adjustment is eliminated.

Changes in offset voltage caused by supply irregularities are eliminated. Four external resistors are eliminated.

At the other end of the multiplier the differential current converter provides a single-ended output current referenced to ground.

#### "Plus" features for Improved Performance

Linearity of 0.5% max (X or Y) for the MC1594 sets a new standard of excellence, and the MC1494 offers a fine 1.0% max error (X or Y). The "multiplier plus" is easier for the designer to use because it handles input and output voltages of  $\pm 10$  V with  $\pm 15$  V supplies. And power supply sensitivity is also significantly improved.

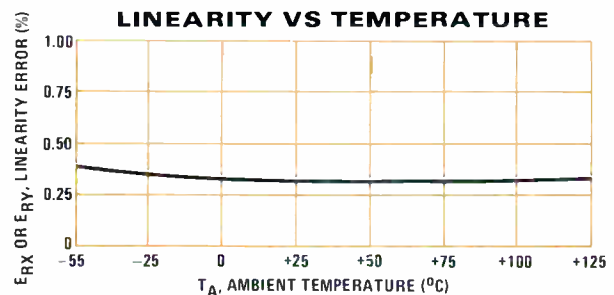

Please turn page for circuit information



**MOTOROLA LINEAR**

— serving a greater range of analog designs!

# Here Is The Second Generation Monolithic IC Multiplier Motorola's MC1594/1494 "Multiplier Plus"

**BLOCK DIAGRAM**

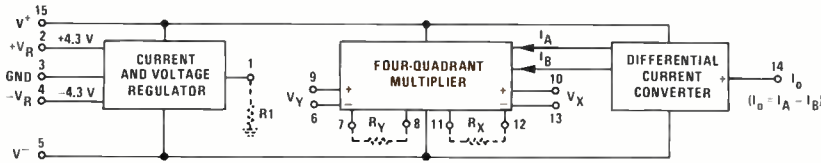

**COMPLETE CIRCUIT SCHEMATIC**

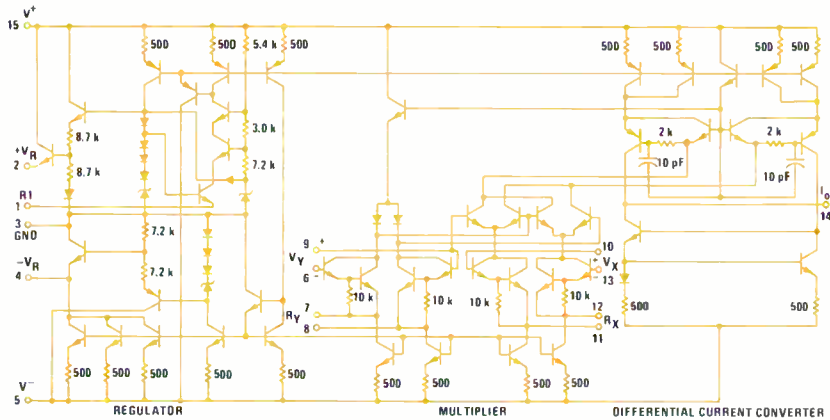

**TYPICAL MULTIPLIER CONNECTION**

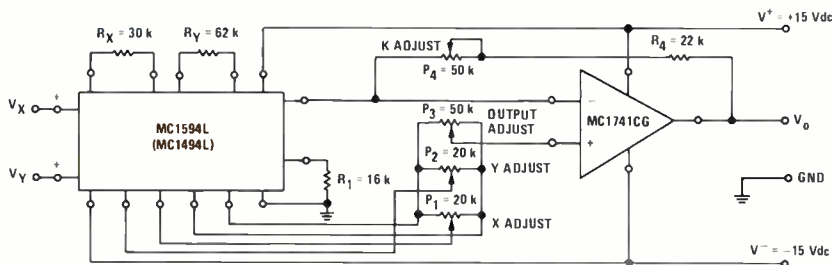

## Check these performance features

- Excellent linearity  
0.5% max (X or Y) — MC1594L  
1.0% max (X or Y) — MC1494L
- Wide input voltage range —  $\pm 10$  V
- $\pm 15$  V supply operation
- Single ended output referenced to ground
- Improved offset adjust circuitry
- Adjustable scale factor
- Power supply sensitivity — 30 mV/V (typ)

## Learn all about the "Multiplier Plus" right away

The MC1594L and MC1494L are available now from your nearest Motorola distributor at 100-up prices of \$12.00 - MC1594 and \$8.00 - MC1494. Both devices are in the 16-pin ceramic dual in-line package. For a 14-page applications-specifications data sheet, circle the reader service number or write Motorola Semiconductor Products Inc., P.O. Box 20912, Phoenix, Arizona 85036.

Circle No. 250

The circuitry shown external to Motorola products is for illustrative purposes only, and Motorola does not assume any responsibility for its use or warrant its performance or that it is free from patent infringement.

## "Multiplier Plus" Special Introductory Offer

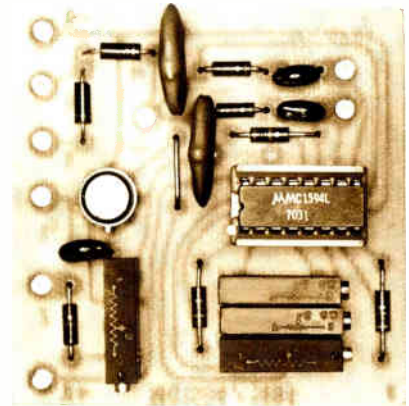

Complete MC1594 or MC1494 Evaluation and Experiment Kit DC and AC applications — All you need to build it for Multiply • Square • Divide • Square Root • Balanced Modulator • Amplitude Modulator • Phase Detector • Frequency Doubler.

40% Off total 1-up price of all components and hardware!

MCK1594 Kit . . . This \$38.45 value only \$23.10

MCK1494 Kit . . . A \$32.45 value at only \$19.50 (substitute MC1494L multiplier)

## Parts list MCK1594 and MCK1494

| Quantity | Part Description                     |
|----------|--------------------------------------|
| 1        | MC1594L or MC1494L                   |
| 1        | MC1741CG op amp                      |
| 2        | 1N5241B Zener Diodes                 |
| 2        | 510 ohm, 1/4 W, 20% carbon resistors |
| 1        | 16K, 1/4 W, 5% film resistor         |
| 1        | 22K, 1/4 W, 5% film resistor         |
| 1        | 30K, 1/4 W, 5% film resistor         |
| 1        | 62K, 1/4 W, 5% film resistor         |
| 2        | 20K, 15 turn cermet potentiometers   |
| 2        | 50K, 15 turn cermet potentiometers   |
| 2        | 0.1 $\mu$ F ceramic disc capacitors  |
| 3        | 10pF ceramic disc capacitors         |
| 1        | 16-pin dual in-line socket           |
| 1        | PC board                             |
| 10       | terminals                            |

Also contains complete "How To Do It" construction note and data sheet with applications information.

Specify by MCK1594 or MCK1494 — state quantity — enclose check (P.O. is OK for order over \$20.00) — offer expires May 20, 1971 — limit, 5 (five) kits. Send order to Motorola Semiconductor Products Inc., P.O. Box 20912, Phoenix, Arizona 85036.



**MOTOROLA LINEAR**

— serving a greater range of analog designs!

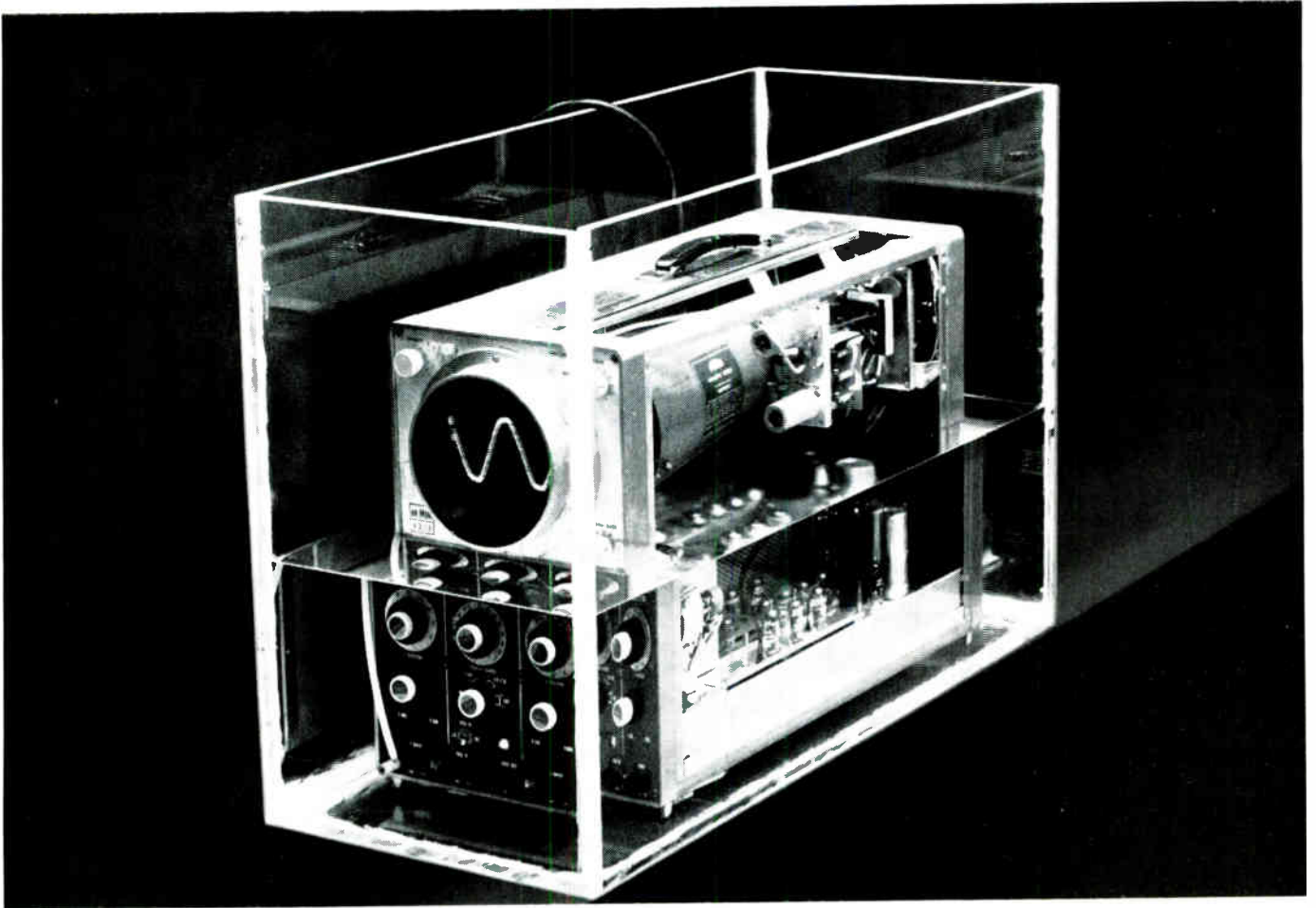

**This oscilloscope is alive and well in a bath of FREON<sup>®</sup> TF cleaning agent.**

## That's compatibility.

If this FREON fluorocarbon cleaning agent won't damage the wide variety of materials used in a sensitive oscilloscope, that's compatibility. In fact, FREON cleaning agents are compatible with most materials of construction used in the electronics and aerospace industries.

If your product has to be cleaned thoroughly, safely and efficiently, there are five more reasons why you should be using FREON solvents:

**1. Low Boiling Point (under 120°F).** Ideal for low-

temperature vapor degreasing. Cooling time eliminated. No damage to heat-sensitive parts. Low heat passage to work environment.

**2. Complete Wetting and Penetration.** High density combined with low surface tension lifts soils and floats away trapped contaminants.

**3. Chemically Pure and Stable.** No need for acid acceptance and scratch tests. No inhibitors needed. Parts dry residue-free.

**4. Lower Overall Cleaning Costs.** FREON is recoverable for reuse indefinitely. Power requirements low in vapor degreasing. Fewer production rejects. Save labor by cleaning complete assembly instead of separate parts.

**5. Safe.** Nonflammable, non-explosive, low in toxicity.

If you have a cleaning problem or are looking for an improved cleaning system, write today to Du Pont Company, Room 8826-H, Wilmington, Delaware 19898.



**FREON**  
Cleaning Agents

# NEW

# LOW-COST, SOLID STATE AC RELAYS

To Turn on:

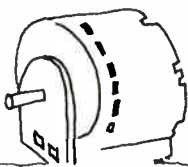

MOTORS



SOLENOIDS



LIGHTS



HEATERS

etc.

ETC.

Choose from 70 new SPST Solid State Relays

**SERIES 601 FEATURES:**

- Amazingly low cost
- 1 - 10 AMPS at 140 V RMS or 280 V RMS
- Drive directly from TTL logic
- Total isolation between control and load circuits (4-Terminal Network)
- All solid state (NO REEDS)
- Zero voltage switching available to minimize RFI
- Transient protected on input and output
- PC board or screw terminal mounted

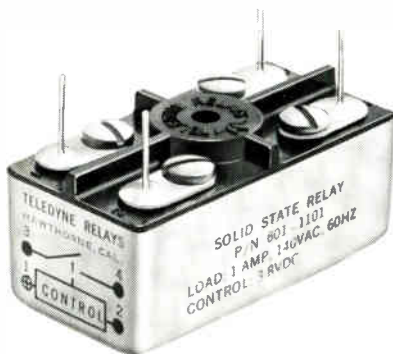

**PART NUMBERING (Economy Line)**

| INPUT (CONTROL) VOLTAGE RANGE | OUTPUT VOLTAGE RATING | OUTPUT (LOAD) CURRENT RATING & PART NUMBERS |          |          |          |          |
|-------------------------------|-----------------------|---|----------|----------|----------|----------|
|                               |                       | 1 AMP                                       | 3 AMP    | 5 AMP    | 7 AMP    | 10 AMP   |
| 3-10 VDC                      | 140 VAC               | 601-1001                                    | 601-1002 | 601-1003 | 601-1004 | 601-1005 |
|                               | 280 VAC               | 601-1006                                    | 601-1007 | 601-1008 | 601-1009 | 601-1010 |
| 6-32 VDC                      | 140 VAC               | 601-1011                                    | 601-1012 | 601-1013 | 601-1014 | 601-1015 |
|                               | 280 VAC               | 601-1016                                    | 601-1017 | 601-1018 | 601-1019 | 601-1020 |
| 15-45 VDC                     | 140 VAC               | 601-1021                                    | 601-1022 | 601-1023 | 601-1024 | 601-1025 |
|                               | 280 VAC               | 601-1026                                    | 601-1027 | 601-1028 | 601-1029 | 601-1030 |
| 20-75 VDC                     | 140 VAC               | 601-1031                                    | 601-1032 | 601-1033 | 601-1034 | 601-1035 |
|                               | 280 VAC               | 601-1036                                    | 601-1037 | 601-1038 | 601-1039 | 601-1040 |

NOTE: Add "P" to P/N for printed circuit (pin) mounting only.

**ECONOMY LINE PRICE / QUANTITY (Typical)**

| LOAD<br>Amps @ 140 VAC | QUANTITY |           |             |
|------------------------|----------|-----------|-------------|
|                        | 10 - 24  | 100 - 249 | 1000 - 2499 |
| 1                      | \$12.20  | \$ 8.75   | \$ 6.65     |
| 3                      | 13.50    | 9.70      | 7.35        |
| 5                      | 15.30    | 10.60     | 8.10        |
| 7                      | 16.60    | 11.55     | 8.80        |
| 10                     | 18.45    | 12.80     | 9.75        |

**PART NUMBERING (Zero Voltage Turn-On)**

| INPUT (CONTROL) VOLTAGE RANGE | OUTPUT VOLTAGE RATING | OUTPUT (LOAD) CURRENT RATING & PART NUMBERS |          |          |          |          |
|-------------------------------|-----------------------|---|----------|----------|----------|----------|
|                               |                       | 1 AMP                                       | 3 AMP    | 5 AMP    | 7 AMP    | 10 AMP   |
| 3-8 VDC                       | 140 VAC               | 601-1101                                    | 601-1102 | 601-1103 | 601-1104 | 601-1105 |
|                               | 280 VAC               | 601-1106                                    | 601-1107 | 601-1108 | 601-1109 | 601-1110 |
| 7-85 VDC                      | 140 VAC               | 601-1111                                    | 601-1112 | 601-1113 | 601-1114 | 601-1115 |
|                               | 280 VAC               | 601-1116                                    | 601-1117 | 601-1118 | 601-1119 | 601-1120 |
| 90-280 VAC                    | 140 VAC               | 601-1121                                    | 601-1122 | 601-1123 | 601-1124 | 601-1125 |
|                               | 280 VAC               | 601-1126                                    | 601-1127 | 601-1128 | 601-1129 | 601-1130 |

**ZERO VOLTAGE TURN-ON LINE PRICE / QUANTITY (Typical)**

| LOAD<br>Amps @ 140 VAC | QUANTITY |           |             |
|------------------------|----------|-----------|-------------|
|                        | 10 - 24  | 100 - 249 | 1000 - 2499 |
| 1                      | \$21.60  | \$15.00   | \$11.40     |
| 3                      | 22.95    | 15.94     | 12.11       |
| 5                      | 24.30    | 16.88     | 12.83       |
| 7                      | 25.65    | 17.81     | 13.55       |
| 10                     | 27.45    | 19.06     | 14.50       |

For complete information on quantity prices and delivery, call your nearest Teledyne Relay Distributor — or us.



**TELEDYNE RELAYS**

3155 West El Segundo Boulevard, Hawthorne, California 90250 • Telephone (213) 679-2205



# Copter-borne radar could function as part of Awacs

L-band system possesses data-remoting capability, spots cluttered targets at long range

That versatile skyhook, the helicopter, is being used experimentally by the Air Force as a tactical radar platform. But scientists at the Rome Air Development Center aren't interested in merely enhancing long-range target detection by getting radar above trees, out from behind hills, and up where the earth's curvature is less of a barrier.

Their system, teaming a Bell UH-1 helicopter and a Westinghouse L-band radar, combines remarkable performance with a data-remoting capability. It may prove to be the prototype of a battlefield surveillance and control system—a sort of Airborne Warning and Control System (Awacs) in miniature that could in fact be used as a gap filler for Awacs. However, Awacs is a strategic system.

The most prominent feature of the radar is a 2.5-by-12-foot corporate-fed planar array of printed circuit dipoles. When not in use, it is stowed between the chopper's landing skids. The nine-rpm antenna radiates a modified cosecant-squared beam with vertical coverage of about 20°. There are no adverse aerodynamic effects from antenna drag because the rotor downwash creates a cocoon of dead air just below the helicopter.



Hanging in. Radar antenna—a corporate-fed planar array of pc dipoles—for system with data-remoting capability stows between copter's skids.

The radar is designed to detect low-flying craft in the presence of ground clutter. It uses a coherent moving target processing indicator with four-pulse cancellation to achieve subclutter visibility of 50 decibels over a dynamic range of more than 60 dB. Signal processing is digital, with the acceptance velocities hard-wire programed and with the pulse-repetition-frequency swept to eliminate blind speeds. The receiver, which has a -120-dB sensitivity, automatically compensates for the helicopter's forward velocity by shifting its coherent oscillator proportionately. The transmitter is built around a Raytheon cross-field amplifier, and puts out 100 kilowatts peak and 2.5 kW average.

The radar owes much of its performance to its mount, a dynamic antivibration isolator, which uses springs and dampers to "tune out"

specific oscillatory disturbances. Motorola's AN/TRC-92 microwave relay terminal, with dual antennas mounted on the helicopter, transmits radar video through a manually tracked data link to a ground-based command post. There it is processed and displayed on a cathode ray tube display, General Electric's computer-driven Mirage 2 system.

In 18 months of tests, the 1,500-pound feasibility model has regularly detected, from an altitude of 5,000 feet, bombers and helicopters flying 50 miles away at treetop heights. Ultimately, the Air Force hopes to develop both an automatically tracked data link and an upgraded version of this prototype, one with range performance to 200 miles and a velocity resolution of at least three knots. Resolution of that magnitude would enable the radar to detect moving vehicles in

dense jungle clutter at a range of up to 30 miles.

Although the RFP has not yet been issued, USAF scientists hope to have an upgraded radar flying on a Sikorsky HH-53 helicopter in a year. The HH-53 carries a bigger payload and will also permit the antenna to be mounted on the aircraft's centerline. The present helicopter requires off-center mounting, limiting speed to about 30 knots.

And while all these improvements could push the radar's cost above \$1 million, to say nothing of the added cost of the data link and a navigation system to convert targets to aim points, the overall system would still be economical for real-time battle field surveillance and as a complement for Awacs.

### Computer-aided design

#### Collins makes changes in data-entry approach

It's been a little more than a year since Collins Radio Co. unveiled its design automation system for MOS/LSI [*Electronics*, Sept. 1, 1969, p. 33; Oct. 13, 1969, p. 82]. But it's been a sobering year for the company. Only 11 customers

have turned to the design automation and fabrication system since the first of the year, and only 23 chips from outside customers have been put through some portions of the system, in which the customer accepts most of the design responsibility, in that time. Yet the system can handle 100 designs a month, and only 60 days are required from Collins' reception of the customer's logic equations to his receipt of finished hardware.

However, George Grondin, assistant division engineer in the Solid-state Devices division there, says he isn't discouraged. He thinks he knows some of the reasons why the concept hasn't been more widely accepted. And Collins is altering its original thinking to fit what he's been learning in his travels.

**One reason** is that customers probably aren't quite ready to accept the design responsibility themselves. "They're accustomed to breadboarding and prototypes," Grondin says, and breadboards are eliminated in the Collins system; the customer gets such things as computer-generated printouts of his logic cell placement, a printer plot of that placement, and a summary of the capacitance of each node in a chip design.

"Some of the customers are a little bit frightened of doing the design themselves," Grondin notes, "but ultimately it's inevitable that they'll be doing both chip and cell design because we'll be limited by the size of our own circuit design team." For now, though, Collins is ready to relax its initial stance and do the design at its Newport Beach, Calif., facility for customers who want to provide device specifications.

**Another obstacle** to wider acceptance of the system is the distance between most customers and the Collins data entry centers, located in Boston, Cedar Rapids, Dallas, Los Angeles, Newport Beach itself, and Toronto. Grondin feels this can be solved partly by mailing data back and forth between the customer and Collins, or by having the customer translate his basic logic information into taped data that can be sent by phone line to the nearest data entry center. Collins would still promise a complete design translation into device geometry in 30 days and fabrication in another 30 days.

There were bugs in the original system that had to be worked out, with one of the worst being a cell-placement algorithm that produced

### Stocking the shelf

Collins Radio is about to move into the off-the-shelf MOS/LSI market. Moreover, it will make the almost unheard of move of publishing expected yields in relation to die size. The line, developed and produced by Collins' automated system, includes a family of read-only memories that can store up to 2,560 bits organized in 256 eight-, nine-, or ten-bit words, or in 512 four- or five-bit words. The memories include a storage matrix, decoding, and dc output storage register. Expansion capability in either the word or the bit size permits up to eight ROMs to be combined into a memory system of up to 4,096 words of any bit length. The low-threshold p-chan-

nel MOS is compatible with TTL and DTL. Price per device, after, a one-time mask charge of \$1,000, is \$58 in quantities of 1 to 24, and \$32 for 100 to 999.

Another large standard product (6,000 transistor functions on the chip) is a 1,024-bit four-phase dynamic shift register. The high-threshold circuit dissipates 225 milliwatts and operates to 1 MHz.

A third family of devices includes read-write storage arrays of up to 256 bits organized as 64 four-bit words. These arrays, which do not include decoding and driving, have access times as low as 40 to 100 nanoseconds, and dissipate less than 1 milliwatt per bit.

Collins has also published prices for processing custom LSI, permitting an engineer to determine design, development and production costs for custom chips. Typical figures for the process through mask making are about \$9,000 for a 120-mil die, and about \$4,200 for production of 10 wafers of this size, which yield about 325 good devices through assembly, packaging, and testing. The price list also specifies expected yields from each step in the process. The 120-mil-square die, for example, is figured to have a 35% wafer sort yield, a 77% scribe-break-sort-in-spec yield, and a 73% assembly-packaging-testing yield.

some extremely large chips. Viatron Computer Systems Corp. was Collins' first customer, and went away unhappy when some of the nine chips Collins was asked to make turned out to be 300 mils square or more. Collins later satisfactorily delivered some read-only memories to the now-beleaguered Viatron. And the algorithm has been changed.

Collins engineers have by now done 81 custom chip designs for Collins systems using the system. Grondin reports that the average time for logic equation to finished device on these designs was just 15 days.

Collins is also breaking out portions of the design automation and fabrication service that will be made available separately, including use of computer programs for logic simulation and device layout, automated production of photo tooling that's 10 times final device size, automated production of the 1:1 step and repeat image, and wafer fabrication. What's more, the firm has taken the unprecedented step of listing wafer scribe, break, sort and inspection yields in relation to die size, plus assembly, packaging and test yields.

---

### Displays

---

#### Cathodochromics offer permanent storage

Because storage oscilloscopes make it possible to compare waveforms recorded hours apart, they're handy instruments for anyone involved in circuit design, drift measurement, and transducer monitoring. But they don't store traces indefinitely—the maximum is about eight hours, and most models fall far short of that value. Moreover, the stored image disappears when the power is cut off.

That's why engineers at the Optel Corp., a small Princeton, N.J., firm formed by a group of ex-RCA men, are enthusiastic about the cathodochromic materials they are using in their new display equipment. Cathodochromic materials



**Staying power.** Cathodochromic display stores image even when disconnected.

darken when exposed to an electron beam, and remain dark until deliberately erased by the application of heat, a process that takes about 2 seconds. A display that uses the material as the target in its cathode ray tube will therefore store a pattern indefinitely.

In addition, the cathodochromic tube offers greater contrast (5:1 ratio) and visibility in very bright ambient light, says Zoltan J. Kiss, the company's president. This stems from the fact that the screen is viewed by reflected light. Optel is marketing its line of cathodochromic Reflexicon storage displays at less than \$4,000 each—somewhat more than conventional phosphor-CRT oscilloscopes with storage capability, which cost \$700 to \$3,000, depending on performance.

Optel also offers two other items of cathodochromic equipment. One is a variable-persistence display, in which the trace lasts for a time inversely proportional to the ambient light, or until it is erased rapidly by the controlled application of light or heat. Like the storage unit, it can display alphanumeric, graphic, and pictorial information from computers, data banks, facsimile systems, and other sources. In addition, they both can perform signal processing, such as integration, directly on the display.

But the star of the Optel catalog is a cathodochromic data terminal for time-sharing and information retrieval systems. Besides providing both hard and soft copy, it has a viewing screen on which the image from the cathodochromic tube is projected and an electrostatic copier that reproduces the

stored image on paper on demand. The terminal also contains a tape unit, a buffer memory, and logic so that programs can be written and edited off line. The display tube is operated in conjunction with a graphics generator. The simplicity of the cathodochromic technique—no local memory or repetitive updating are needed—helps to keep the price under \$10,000.

Optel won't reveal what cathodochromic materials it is using. The company, however, is actively developing materials with an eye to obtaining faster erasure, wider gray scale, and full-color images.

---

### Electro-optics

---

#### IBM looks to light pipes to move airplane data

Convinced that there is a practical limit to how much cable can be threaded through an aircraft to transfer data, IBM has turned to optics for a solution. And in the process, the computer giant is generating speculation that it plans to grind out more optical solutions to data problems in the years ahead.

IBM engineers say that their yet-to-be-announced light interface technology system has little to offer in present airborne environments, where 1-megahertz data channels are about all that are needed. But they are convinced that later in the decade, 10 to 15 MHz channels will be needed to service increasingly sophisticated airborne computers and displays. When this happens, they say, the in-house development holds the edge over conventional systems in terms of both costs and performance since there is no need to do multiple-channel parallel transfers.

**The system** consists of a photo-emitting gallium aluminum arsenide diode that serves as a transmitter, a length of fiber-optic pipe that serves as the communications medium, and a silicon photodetector that functions as a receiver. It can transmit digital or analog signals. With present equipment, an

## Electronics review

IBM source says, "25 MHz over 50 feet is no problem. The diodes we use are the only limiting factor."

One of the greatest advantages claimed for the system is that it is completely electrically isolated from the system it interconnects, and so eliminates the need for extensive tests for point failures that could wipe out whole systems. Just as importantly, an IBM source says, it cannot be affected by rf interference and therefore doesn't require shielding. Only at high radiation levels does the glass fiber begin to discolor and attenuate the signal, the source says.

"The advantages of the technology are there," the source says. "The problem is convincing people that the need for such a radical departure exists."

### Medical electronics

#### Device makers charged with poor performance

Only two of the eight modules in a new piece of solid state medical measurement gear—the power supply and oscilloscope—came close to meeting performance requirements at Toronto's Hospital for Sick Children. The other modules, says Dr. A. M. Albisser of the hospital's medical engineering department, "failed at the rate of one every three to five days." These include components to measure pressure, temperature, pulse, respira-

tion, electrocardiogram, and rate meters.

"Besides component failures," Albisser told an Electronic Industries Association conference on medical devices, "the design proved to be technically incompetent." In particular, he said, "non-linearity, drift, and instability on the electrical side and poor design on the mechanical side are some of the outstanding shortcomings." None of the more than 150 silent industry registrants seemed surprised by the Canadian's conclusion that "we are greatly disappointed by this equipment."

The hospital's criticism of medical electronic equipment manufacturers was characteristic of the day-long Washington meeting sponsored by EIA's Health Care Electronics section. Contrasted with the new hardware, Albisser said, some of the hospital's older equipment—Sanborn instruments purchased from 1951 to 1955 and including electrocardiogram; electroencephalogram; Carrier, ac-dc differential, and strain gage amplifiers as well as chart recorders—"have proven to be very reliable and easy to repair using readily available parts." The Toronto hospital's five-year-old medical engineering unit has improved reliability in some of this gear by replacing parts such as tubes and capacitors with military-industrial components.

Remarks by Albisser and other medical electronics users clearly indicated pressure for more and

better information exchange, improved hospital training programs in equipment use and maintenance, as well as the need to develop national device standards for industry. In one question-and-answer session, manufacturers were told that a quarter of the hazards associated with equipment were traceable to the maker. Yet, Dr. Theodore Cooper of the National Heart and Lung Institute reiterated figures gathered by New York State University's Downstate Medical Center that 40% of incoming equipment reviewed from 1966 to 1968 was defective—it either did not meet manufacturers' specifications, or the basic design and construction was unsafe.

Dr. Cooper, who headed a special commission which recommended in September steps to be taken to insure device safety, told the EIA group that current proposals for regulating devices are drawn from precedents set by drug regulations of the Food and Drug Administration, and that these "are not viable in the device field." Cooper said his study group believes that "present and potential hazards, and the need for reliability and effectiveness of devices necessitates specific legislation."

Apart from Federal regulation, however, manufacturers were advised to broaden their communications lines with medicine and to note that many of their devices used in emergency situations need to be made as simple as possible.

### Medical market

An estimated breakdown of the medical electronics market now and in 1975 was presented to the EIA symposium by Howard Fagin of the Department of Health, Education, and Welfare. Figures are in millions of dollars:

|                          | 1970  | 1975  |
|--------------------------|-------|-------|
| Medical EDP              | \$250 | \$600 |
| Diagnostic               | 193   | 315.8 |
| Clinical                 | 90    | 200   |
| Therapeutic              | 61    | 107.9 |
| X-ray tubes, accessories | 28    | 35    |
| Patient monitoring       | 28    | 64    |

### Solid state

#### Practical small radar two steps closer

Attempts to build radars inexpensive and compact enough for use in small boats and planes have been largely unsuccessful. The reason: there have been no suitable solid state components capable of operating reliably at frequencies high enough to make these radars practical.

That's why two recent seemingly

unrelated developments in solid state technology have excited radar people. One is the acoustic surface-wave delay line processor [*Electronics*, May 25, p. 45, and p. 93, this issue], which could greatly shrink the size and cost of a radar's signal processing circuits. The other is the high-power pulses—2 kilowatts and up—that are now available from limited space-charge (LSA) diodes.

Lester Eastman of Cayuga Associates, manufacturer of LSA power sources, says his firm has routinely been able to build 2-kw diodes in C band at 10% efficiency. And although the duty cycle is low, Eastman feels that there is sufficient power for short-range radars and electronic beacons. Performance of the Cayuga devices at higher frequencies is also good: X-band diodes provide 600 W of pulsed power and Ku-band diodes (high radar frequencies,) 150 W.

Eastman attributes this good LSA performance to the high quality of Cayuga's gallium arsenide, a claim many companies working in this material would find hard to make. In fact, he feels the problems with GaAs have been overstated. True, strict material requirements are imposed on the LSA diode (it's an overgrown Gunn diode, with a very large active region.) But Eastman points out, "We have hundreds of high-performing wafers." He says high yields result from Cayuga's ability to maintain chip variation to below 5%, and in some cases as low as 2%.

---

## Consumer electronics

---

### Government lining up against Japanese imports

A legal counterattack on consumer electronics imports from Japan that are hurting U. S. manufacturers is in full swing in Washington.

On one front, the Tariff Commission has ruled that radio and television tuners dumped by Japan have harmed domestic industry—the first tariff decision against Japanese consumer electronics. The

commission also focused attention on electronics during a special investigation of the impact of imports on U. S. industry. Four EIA divisions and several companies lined up to testify at the hearings. EIA-Japan also made a statement.

While not united, EIA's Consumer Electronics Group, the Solid State Products division, the world trade committee of the Parts division, and the imports committee of the Tube division, all supporting strict enforcement of U. S. dumping laws. The Japanese argued that increasing American sentiment favoring protectionism in general and the dumping laws in particular are no longer relevant or beneficial to mutual trade.

**It may be** several weeks before the commission draws up a report. However, its conclusions may not actually lead to imposition of quotas on imports, which would take domestic manufacturers with offshore facilities off the hook. If the hearing strategy attributed to the government works out, the investigation should pressure the Japanese into self-imposed regulation and, in some cases, changes in Japan's own import restrictions. World trade observers in Washington view the investigation as a campaign primarily designed to protect U. S. textile interests. Electronics, in effect, is riding the textile coattails.

Meanwhile, on a second front, the Treasury Department is to rule next week on charges that Japanese color and monochrome television receivers have been dumped in this country. Should this decision go against the Japanese, the Tariff Commission then would decide if the dumping has in fact injured U. S. industry. As in the tuner case, the commission must make its ruling before tariff rates can be exacted.

It's the payment issue that has brought merchants J. C. Penney and Sears & Roebuck, who import sets that they sell under house names, into the dumping case. Both retailers have claimed that any increase on imports will force up prices of their sets and thus injure

the U. S. consumer. And arguments on behalf of consumers have been carrying a lot of weight lately in Washington.

---

## Satellites

---

### High reliability claimed for mm-wave tests

Many supporters of millimeter-wave satellite communications have been turned on by NASA reports of high reliability with experimental transmissions at 15 and 31 gigahertz. These frequencies would also dramatically increase data flow and use smaller and presumably less costly ground stations.

Summing up a year's experiments with NASA's ailing Applications Technology Satellite 5, Goddard Space Flight Center states, "The overall impression is that reliability will not be a limiting factor in the use of 15 and 31 GHz." In more detail, Louis Ippolito, a member of Goddard's ATS-5 team, reports that messages relayed over ATS-5's 31-GHz uplink and its 15-GHz downlink were blacked out only 0.02% of the time during a total of 140 hours of rain at a Rosman, N. C., ground station. "That's not bad," he says, in view of predictions that outages caused by rainfall were expected to be the principal problem with the millimeter band.

**Ippolito adds** that work with ground stations a few kilometers apart at Ohio State University may well provide a means of further reducing outages caused by rainfall. Experiments with two stations separated by only 3.4 km revealed that hundredfold improvements in reliability can be achieved by switching to a nearby station during storms, he says.

As with most experiments, however, new questions were raised and old ones remained unanswered. One new question posed by the ATS-5 experiment is why the ratio between fading at 15 and 31 GHz varies as wildly as it does. "It may vary quite drastically within a storm or remain quite constant,"

Ippolito says. He is looking to further data from ATS-5 and future communications satellites that will describe the fading phenomena and help obviate the problem.

---

### Computers

---

#### Univac joins

#### new-machine list

In the past five months, five of the so-called Big Eight computer makers have introduced new medium and large machines. And just as the parade begins to grow monotonous, a sixth—Sperry Rand's Univac division—has come along with its entry and the professed intention of shaking up the ballgame.

The new 1110 computer is the largest in Univac's old-line 1100 series, of which the most recent and successful have been the 1108 and the somewhat smaller 1106. (A multiprocessing, "fail-safe" version of the last, comprising two 1106s back to back, was announced along with the 1110.)

In competitive terms, the 1110 embodies features that set it apart from many of the machines already announced by IBM, RCA, National Cash Register, Xerox Data Systems, and Burroughs. For openers, its throughput makes it the biggest of any of them. It has a 98,304-word main memory, expandable in 32,768-word increments to a maximum of 262,144 words, which is entirely plated wire, something Univac has used since 1966 but never in a machine of this size. Read access time for a 36-bit word is 320 nanoseconds; write is 520. With the exception of IBM's 370/155 and 165 cache memories, these speeds are higher than anything else available.

The 1110 achieves its high performance level through the fast memory cycles and pipeline processing. Normally, it would take about 1.2 microseconds to process most instructions, but the processor, called a command/arithmetic unit (CAU) can start a new instruction every 300 nanoseconds. As many as four instructions can

be in the works at one time. Further, most other machines are byte-oriented, working with eight bits at a time. Univac's word length is 36 bits, but it can chop this up into six 6-bit characters.

The basic 1110 contains two independent CAUs, which at times may demand data from the same memory module simultaneously. To minimize interference, the memory modules are therefore built up from 8,000-word submodules which are independently accessible. Neither CAU has to waste time on input-output operations; a separate input-output access unit, or IOAU, handles all such work. Another plus is the number of channels available for input-output—up to 24 per IOAU, and four IOAUs per system if the customer wants them. The basic 1110 is two CAUs and one IOAU.

Along with the plated wire memory, Univac offers modules of extended core storage with a cycle time of 1.5 microseconds from a minimum of 262,144 up to 1 million words. The plated wire addresses run from about 1 million down to a minimum of 786,432; the core from 1 million up to 2 million addresses. This means the whole memory available to the CAU is in a single array, all addressable in the same way, with some of it a bit slower than the rest.

---

### Memories

---

#### Ampex unveils semiconductor memories

As recently as August, the Ampex Computer Products division had suggested that its first semiconductor memory systems wouldn't bow until mid-1971. But in one of the surprise announcements at the Fall Joint Computer Conference in Houston, Ampex took the wraps off its three systems.

Ampex' Robert Pryciak concedes that IBM's announcement of the 370/145 computer with an all-semiconductor memory [*Electronics*, Oct. 12, p. 125] probably prompted Ampex to announce its semiconduc-

tor memory systems earlier than was originally planned. Pryciak is product manager of core and semiconductor products in the Computer Products division.

The new systems are the ASM (for Ampex semiconductor memory) 10, 20, and 30. The first two are MOS systems; the ASM-30 uses bipolar storage chips, and is the fastest of the three. It has a read-modify-write cycle time of 400 nanoseconds in a 1,024-word by nine-bit system that uses a +5-volt power supply and consumes just 35 watts.

The bipolar storage chips are made by Fairchild Semiconductor and are essentially the same as those Fairchild is supplying for the giant Illiac 4 computer, but not as fast: the Illiac 4 units read-modify-write cycle is less than 100 ns. Ampex felt the relaxed speed specifications would be well suited to the requirements of minicomputer manufacturers. Read time is 300 ns, and write time is 250 ns, but Pryciak says these are conservative specifications. Each card will contain 36 chips of 256 bits by one word.

The MOS-fabricated ASM-20 is 100 ns slower than the bipolar ASM-30, with a 500-ns read-modify-write cycle and 400-ns read and write cycles. It's also organized as 1,024 words by nine bits on one card, but is expandable on the same card to 4,096 words by nine bits. It also uses 36 256-bit, one-word storage chips, but these MOS components are supplied by Intel Corp. Pryciak says that the ASM-20's speed is 30% faster than the memory in the IBM 370/145.

In addition to the minicomputer memory application Pryciak feels the ASM-20 can be used as a fast cache memory to work with bulk core storage units. It's also a natural address-protection memory for a core system Ampex is developing to replace high-speed mainframe memories equivalent to the IBM 300 models 68, 87, and 75.

The ASM-10 is a slower MOS system developed initially for a geophysical system peripheral device made by Mandrel Industries

# NEW

## 3 - PLUG - IN OSCILLOSCOPE

- 60-MHz Bandwidth
- Dual-Trace, 5 mV/div
- 5 ns/div Sweep Rate
- 2% Accuracy
- 8 x 10 cm Display
- Solid State

**\$2325** COMPLETE WITH PLUG-INS

The TEKTRONIX 7503 THREE-PLUG-IN OSCILLOSCOPE offers *more* measurement capability per dollar than any other quality oscilloscope.

**Easier to use.** An exclusive peak-to-peak auto-triggering mode provides a triggered sweep throughout the 360° range of the level/slope control. The front panel is uncluttered, lighted push-button switches are extensively used to conserve space. Controls are conveniently related to function through the use of a color-keyed front panel.

**Seventeen plug-ins** covering a wide performance spectrum are available to solve virtually all of your measurement problems. Some of the features offered are: dual-trace, differential comparator, 10- $\mu$ V differential, sampling, current amplifier, a New Digital Multimeter and a New Digital Counter. Plug-ins can be chosen to give the 7503 delaying sweep and 90-MHz bandwidth.

**Faster measurements.** Auto Scale-Factor Readout is exclusive to Tektronix! It labels the CRT with time and frequency; volts, ohms, temperature (C), and amps; invert and uncal symbols; and automatically corrects for 10X probes and magnifiers. Readout is required when using the 7D13 Digital Multimeter and the 7D14 Digital Counter plug-ins. It can be ordered initially or as a conversion kit, which is easily installed. Either case, the cost is only an additional \$400.

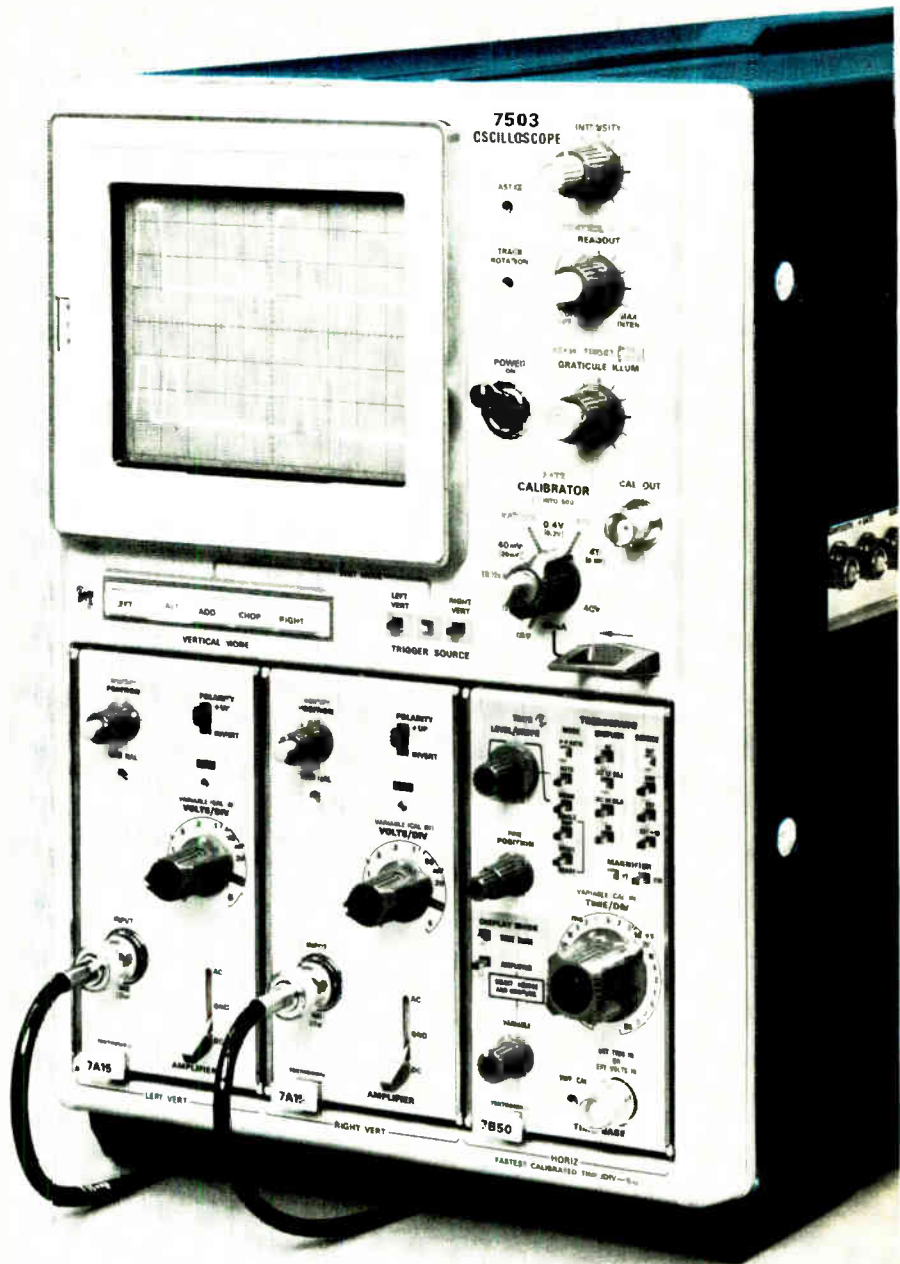

**TEKTRONIX®**

committed to  
technical excellence

For a demonstration of the New Tektronix 7503 Oscilloscope, contact your local Tektronix Field Engineer or write: Tektronix, Inc., P.O. Box 500, Beaverton, Oregon 97005.

|   |        |
|---|--------|
| 7503 Oscilloscope without readout, Option 1 ..... | \$1375 |
| 7A15 Single-Trace Amplifier .....                 | \$ 250 |
| 7B50 Time Base .....                              | \$ 450 |
| 7503 Cscilloscope with readout .....              | \$1775 |

U.S. Sales Prices FOB Beaverton, Oregon  
Available in U.S. through the Tektronix lease plan

---

## Electronics review

---

Inc., an Ampex subsidiary in Houston. Also supplied by Intel, it has 512 words by nine bits on one card made up of 18 256-bit-by-one-word random access memory components. Read-modify-write time is 2.8 microseconds, read time is 2  $\mu$ sec, and write time is 1.4  $\mu$ sec. It's expected to have peripheral equipment applications, and is expandable to 1,024 words by nine bits on one card.

---

## Communications

---

### Prairie Star shines fitfully over Pentagon

The Pentagon is moving to coordinate the three services tactical communications with some of the technology and staff salvaged from the Army's controversial project Mallard [*Electronics*, Oct. 12, p. 67]. The long-range, limited goal of developing a single tactical trunking and switching system is known as Prairie Star by the Army, which hopes to act as executive agent.

Though Prairie Star still requires Deputy Defense Secretary David Packard's approval, Louis deRosa is already using his office as the new DOD telecommunications chief to coordinate the effort. Prior to DOD approval and justification of Prairie Star to Congress for an appropriation, the Pentagon hopes to carry the program with the \$5 million plus remaining in Mallard.

**As a broadband**, multichannel system limited to switching and trunking functions, Prairie Star will permit each of the military services to evolve its own compatible terminal gear and loops—a compromise intended to stifle much of the rivalry that arises in triservice programs. Army sources also say that deRosa proposes to put Prairie Star under a special command—which would expand his telecommunications empire—or assign this function to the Defense Communications Agency, over which deRosa has firmer control. Yet the former Philco-Ford executive, still unfamiliar with the complex protocols of the Federal bureaucracy, may have

compromised some options by tacking an estimated \$20 billion price tag on the new system prior to final approval by the Pentagon and, more importantly, Congress. The dollar figure, recently attributed to deRosa, was called "a vast overstatement" and "a misrepresentation" by a spokesman for the Pentagon's top management. "Neither Mallard nor Prairie Star has been conceived with a budget anywhere near that figure," it was said. "That's a misrepresentation of what might be the cost of a total communications package, including all terminals and end use equipment that the services themselves will buy."

At any rate, the digital system's evolution is expected to have two phases. The first will explore existing mobile tactical switching units, including the Army AN/TTC-25 developed by North Electric, the AN/TTC-31 developed by Sylvania Electronic Systems for the Marines, and the AN/TTC-30 funded by the Air Force through Rome Air Development Center and contractor RCA. Outputs from such switches could be time-division-multiplexed and fed into microwave trunks. Since most terminals and loop hardware would be analog at the start, modems are expected to be a big ticket item in the first phase.

Speculation is that deRosa, in an effort to exercise his new authority, may want to dump plans for a triservice switch competition between the Army's TTC-25 and the Marines' TTC-31 and instead draft a new switch specification embodying the best characteristics of both.

The second phase, the best description of Prairie Star, would convert the hybrid system into a pure digital communications package, beginning in the mid-70s.

---

### For the record

---

**Find the enemy.** A 27-pound backpack that provides military forward observers with a precise fix on their own and target loca-

tions is now being evaluated at the Johns Hopkins Applied Physics Laboratory prior to Marine Corps field tests. Built by Honeywell's Aerospace division with Naval Air Systems Command funds, the H-445 Navsat locator determines fixes with the aid of a remote master station, which compares the doppler shift of the Navy Navigational Satellite system's 400- and 150-megahertz signals at two locations—its own and the backpack's.

The Honeywell division also is pushing a 5-pound strapdown guidance system for use either as an inertial sensor assembly or, with a small, low-cost computer, as a navigation and guidance system. Called the H-478, the new package is aimed at the Navy's air combat maneuvering range program.

**Another computer.** Not to be left out, Xerox Data Systems has announced the latest and largest member of its computer family, the Sigma 9, along with a new operating system, dubbed XOS, and a 1,500-line-per-minute printer. The Sigma 9 has a 131,072-word core memory, expandable to 524,288 32-bit words. Its cycle time is 900 nanoseconds per 4-byte transfer in each memory bank, and there are eight banks in the minimum system configuration.

**Belt tightening.** Hazeltine Corp. of Little Neck, N.Y., and its subsidiary, Wheeler Laboratories of Smithtown, N.Y., have laid off more than 700 employees. The layoff at Wheeler, about two-thirds of the staff, will leave about 20 employees. These Hazeltine will absorb in early 1971, when Wheeler apparently will cease to exist.

A Hazeltine spokesman denied that Wheeler Labs would close, but did confirm the layoff without giving the total of those affected. The spokesman added that it would not affect Hazeltine's capability in both defense and nondefense business.

**Vote snarl.** Insufficient voter and poll-worker education seems to be giving computerized balloting a black eye by causing Detroit's



# how to get a \$400 frequency counter for \$199<sup>95\*</sup>

much publicized delays in the Nov. 3 general election. Some voters folded, spindled, and/or mutilated their ballots while waiting to enter the booth. Others punched their cards incorrectly, or didn't use enough force to remove the chad.

**Tester.** Possibly the most versatile LSI tester to date is being built by Xintel Corp., in Chatsworth, Calif. The Spectrum 1 will do functional and parametric testing, with a 5-megahertz functional test frequency, on any LSI device—bipolar, p- or n-channel MOS, or complementary MOS—and will be available in versions that can test devices with eight to 64 pins. At \$150,000, the 40-pin version costs \$50,000 to \$150,000 less than most testers.

In the Xintel approach, no pin is dedicated as an input or output pin, and any pin can be designated to transmit or receive a signal. Essentially, Xintel has built a voltage-forcing and current-measuring capability, or a current-forcing and voltage-measuring capability into each pin, and the user can have the software tag any pin's output with a given parameter.

The \$150,000, 40-pin system includes a Data General Nova computer with 8,192 words of core memory and a 65,000-word disk, a high-speed reader, teletype, and all software. Xintel is quoting delivery 120 days after an order is received.

**Quick bite.** A point-of-sale terminal system tailored for fast-food shops has been introduced by Honeywell Information Systems. Called the TraCom (Transaction Communicator), the system is designed to handle the cash-only transactions and relatively small range choices that differentiate the hamburger stand from the retail store.

Clerks enter customer orders on a nine-to-40 key menu keyboard, which is controlled by Honeywell's II-112 minicomputer and its 4,000-word core memory. The system selects preset prices from the memory, prints out individual item prices on a sales slip, adds the tax, and calculates the total.



## ...build the new Heathkit® IB-101

- Accurate counting, 1 Hz to over 15 MHz
- Automatic trigger level for wide range input without adjustment
- Five digit readout with Hz/kHz ranges & overrange indicators give eight digit capability
- High Z input
- Computer-type integrated circuitry eliminates divider chain adjustment

The latest Heath breakthrough in low cost, high quality instrumentation. New IB-101 counts from 1 Hz to over 15 MHz; advanced integrated circuitry eliminates blinking readout & divider chain adjustment.

Overrange indicator & Hz/kHz switch give the IB-101 8-digit capability. Set the range switch to kHz & the display reads out to the nearest kHz... push the range switch to Hz and read down to the last Hz. Overrange & Hz/kHz indicators light up to give error-free measurement & correct range at all times. Automatic decimal locator eliminates interpolation & figuring.

Exclusive Heath-designed input circuit uses a dual-gate, diode-protected MOSFET... provides proper triggering without adjustment from less than 100 mV to over 200 V. Input Z is 1 megohm shunted by less than 20 pF to minimize circuit loading & error. Other features include sockets for all 26 IC's & 5 display tubes... 120/240 V AC operation & convenient handle/tilt stand.

Compare the new Heathkit IB-101... then order yours. **Kit IB-101, 7 lbs... \$199.95\***

**IB-101 SPECIFICATIONS:** Frequency Range: 1 Hz to greater than 15 MHz. Accuracy:  $\pm 1$  count  $\pm$  time base stability. Gate Times: 1 millisecond or 1 second with automatic reset. **INPUT CHARACTERISTICS** — Sensitivity: 1 Hz to 1 MHz, less than 100 mV rms. 1 MHz to 15 MHz, less than 250 mV rms, after 30 minutes warmup. Trigger Level: Automatic. Impedance: 1 Megohm shunted by less than 20 pF. Maximum Input: 200 V rms, DC — 1 kHz. Derate at 48 V per frequency decade. **TIME BASE:** Frequency: 1 MHz, crystal controlled. Aging Rate: Less than 1 PPM/month after 30 days. Temperature: Less than  $\pm 2$  parts in  $10^7$ /degree C. 20 to 35 degrees C after 30 minutes warmup.  $\pm .002\%$  from 0 to 50 degrees C. **GENERAL:** Readout: 5 digits plus overrange. Temperature Range: Storage; —55 to 80 degrees C. Operating; 0 to 50 degrees C. Power Requirements: 105-125 or 210-250 V AC, 50/60 Hz, 8 watts. Cabinet Dimensions: 8 1/4" W x 3 1/4" H x 9" D not including handle. Net Weight: 4 1/2 lbs.

HEATH COMPANY, Dept. 520-28  
Benton Harbor, Michigan 49022



a Schlumberger company

Enclosed is \$ \_\_\_\_\_, plus shipping.

Please send model (s) \_\_\_\_\_

Please send FREE Heathkit Catalog.  Please send Credit Application.

Name \_\_\_\_\_

Address \_\_\_\_\_

City \_\_\_\_\_

State \_\_\_\_\_

Zip \_\_\_\_\_

\*Mail order prices; F.O.B. factory. Prices & specifications subject to change without notice. TE-232

# Now...12,000 trims per hour

High-volume model added to S.S. White resistor trimming line

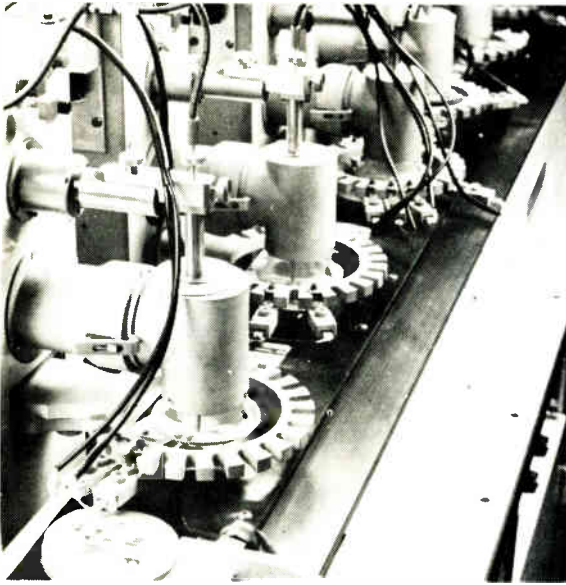

Seven trimming stations make seven simultaneous trims every 2 seconds.

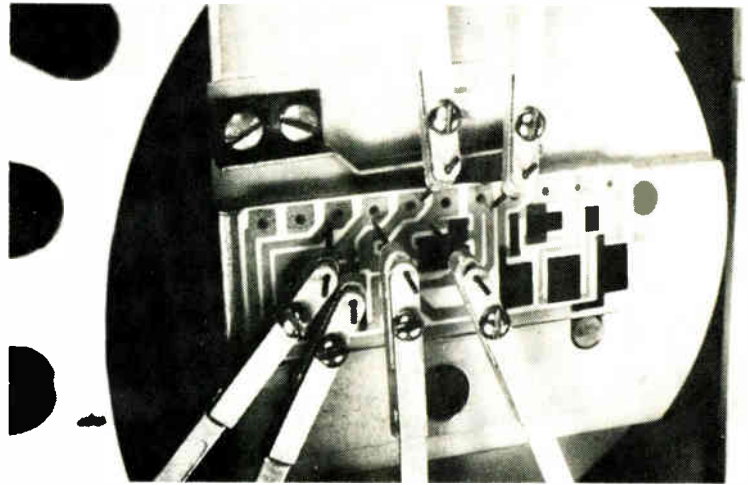

After the trim, probes flash data to memory bank for referral to accept/reject station.

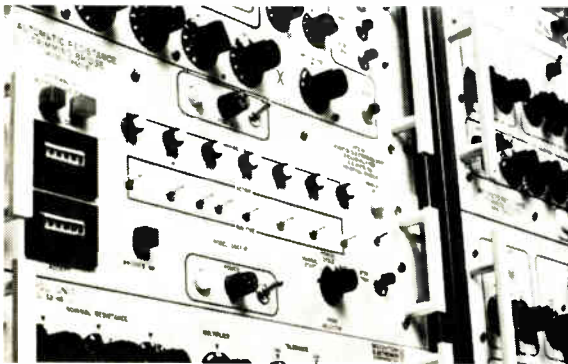

Trim parameters are dialed on separate console. Memory bank and bridges control and monitor the entire cycle.

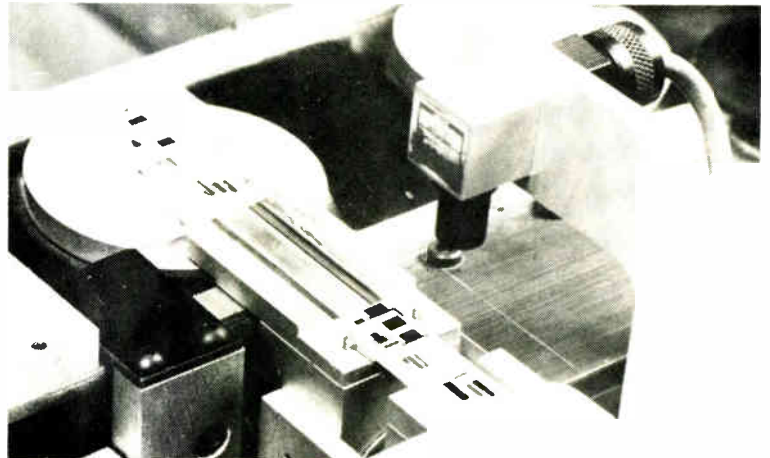

Nests accept any number of different size substrates. They are automatically rotated to accomplish trimming in either X or Y direction.

The latest addition to S.S. White's family of resistor trimming systems is the high-volume, seven-station Model AT-707. It has the capacity to trim more than 12,000 individual hybrid thick-film resistors per hour... seven simultaneous trims every 2 seconds!... at 1/2 of 1% accuracy.

The Model AT-707 automatically loads, positions, trims, monitors, inspects, and accepts or rejects the substrates. Trimming method is the proven S. S. White Airbrasive® concept, which is heatless, shockless, accurate, and does not alter the substrate.

*Complete range of resistor trimming systems.* The S. S. White family of resistor trimming systems provides you with a complete range of capability, from breadboarding to high-volume, high-accuracy production, both resistor and capacitor trimming.

For example, if you're in the prototype stage there's our Model LAT-100. Low-cost (how about \$5,950 for an easy investment?), capable of under 1% trimming accuracy, it is ideal for low-volume or experimental work.

A number of models are available for intermediate production requirements. The manually loaded Model AT-701A will produce up to 600 trims per

hour, depending on the dexterity of the operator. Addition of a rotary table (Model AT-701AR) will lift this output to more than 1,000 per hour. Accuracy of 1/2 of 1%... or better... is obtainable.

Model AT-704A puts you into big-time production... 4,000 trims per hour. It's rotary fed and trims four resistors simultaneously.

*All this and more.* Call Hal Skurnick (212-661-3320) and ask for a demonstration. If you would rather see a gorgeous movie on the AT-707, he can arrange that too. While you're at it, ask him about such elegant and sophisticated add-ons as our two-speed trim system for both high speed and high accuracy. If your needs are trimming active voltage circuits, he has answers for that too. Capacitor trimming? Easy. Whatever your trimming needs, S. S. White... who pioneered these methods... has a system for you. Just pick up your phone.

Call or write: S. S. White Industrial Products Division, Pennwalt Corporation, Dept. R, 201 East 42nd Street, New York, N.Y. 10017 (212-661-3320)

**PENWALT™**

**S.S. WHITE**

INDUSTRIAL PRODUCTS

---

# Washington Newsletter

---

November 23, 1970

## DOD sets February for first meeting on tactical research

The Defense Department's new Tactical Research Advisory Committee, called Tacrac, will get together for the first time in a three-day classified symposium about the middle of February, say officials. The meeting, scheduled to be held at Ft. Rucker, Ala., is **designed to attack the tactical systems problems encountered in Southeast Asia and help the U.S. achieve a hardware capability that will be new to potential enemies.** "Much of what we had in inventory was exposed in Vietnam," explains one official.

Limited to some 200 of DOD's top managers, military field force commanders, and industry scientists and engineers, **the Tacrac sessions will be closed to marketing personnel to prevent them from turning into product promotion meetings.** However, industry intelligence gathering is a foregone conclusion. Says one Pentagon official: "That's what we want, but it will be a two-way street. We've got the problems; we'll be asking for guidance on solutions—real solutions that can be in the field in no more than a couple of years." **Pressure to use existing technologies, plus the fact that more Tacrac meetings will be scheduled after February, suggests that DOD is concerned that its inventory of tactical tricks is low indeed.**

## USAF study shows shift to applied R&D in Russia . . .

There's been a fundamental change in the research priorities in Russia in recent months, says a Rand Corp. analysis for the U.S. Air Force, "with emphasis now to be placed on industrial problems and applications." **Defense R&D officials see an ironic parallel with the U.S. policy evolving under President Nixon's new science adviser, Edward E. David, formerly of Bell Laboratories [*Electronics*, Oct. 26, p. 22].** The Soviet shift, however, is defined as the resolution of several years of controversy in Russian scientific circles and not necessarily related to U.S. programs. But it is believed to represent "a downgrading of concern for basic research," says Rand's Simon Kassel.

## . . . but Soviet EDP seen unhurt

Increasing application of Soviet computers in industrial automation is likely to leave Russia's pursuit of EDP technology largely unaffected by R&D cuts in other areas, the Rand analysis concludes. **A meeting of the USSR Academy of Sciences put capital investment in automation at the top of a list detailing national economic needs by 1990.** V. M. Glushkov, director of the Institute of Cybernetics in the Ukraine, described display screens, a high degree of integration, extended miniaturization, and specialized processors as 1970-75 needs. Computer requirements for 1975 and beyond were said to be optoelectronics, laser elements, external disk memories with a capacity of  $10^{14}$  bytes, and voice input/output.

## Navy attributes slip in ECD memories to production woes

Navy engineers are speculating that production problems with Energy Conversion Devices Inc.'s read-mostly memories [*Electronics*, Sept. 28, p. 56] are leading to delays in deliveries to the Naval Avionics Facility in Indianapolis. The 256-bit devices, on order since this spring for evaluation by NAFL, have yet to be delivered. Navy sources there say that ECD is probably holding up the order while it works out production problems with the chalcogenous glass film that is the basis of the device.

---

# Washington Newsletter

---

## SST fund fight nears Senate vote

Backers of the supersonic transport are still predicting that the SST appropriations bill will pass the Senate, but even their voices are sounding grim as the vote nears. At stake is the fiscal 1971 money which is to put two prototype planes, packing \$10 million in Sperry Rand Flight Systems division avionics and controls, into production. If the \$290 million bill is killed or significantly reduced, the SST could be shelved indefinitely.

Lobbying has picked up in intensity as budget cutters and environmentalists combine forces to block the project. But as it stands today, even prime contractor Boeing is not enthusiastic about the SST's chances of clearing the Senate. Supporters argue that they may pick up votes based on the merits of the SST now that the elections are over. But opponents contended that some "lame ducks," who will be finishing Senatorial careers during the present post-election session, will turn against the Administration-backed proposal.

## David Israel moving from DOD to FAA as planning chief

Federal Aviation Administration officials are counting on a top Pentagon engineer to add direction to air traffic control system planning. Tapped to become the FAA's top system planner is David Israel, deputy director for engineering with the Defense Communication Planning Group, the top-secret Pentagon agency responsible for developing devices to sense enemy troops. He will become director of the FAA's Systems Engineering Management Staff, a think-tank operation that will plan the growth of the nation's air traffic control system [*Electronics*, Aug. 17, p. 59]. Both the airlines and the electronics people are hoping that Israel can stand up to powerful FAA bureaucrats and force the development of a system that meets the needs of the 1970s.

## FAA study casts shadow on ARTS buy

Recent cost/benefit studies may be used as justification to delay or cut back on purchases of the Automated Radar Terminal Systems [see p. 87]. The Federal Aviation Administration has wrapped the results of the studies, apparently ordered by the White House Office of Management and Budget, in secrecy, but word of their existence has leaked out through airline and Congressional sources. If, as suspected, the studies cast a doubt on the cost effectiveness of ARTS 3 systems in medium-density airports, the FAA may cut back on its purchase of 30 Univac systems scheduled to be made in May.

Both Congressional and industry sources say that cost effectiveness is not really at issue in the ARTS decision now before FAA officials. They say that enormous White House pressure is being exerted to keep down costs and the \$50 million ARTS system offers a huge target to budgetary axe-wielders. Systems 1 through 34, which will be plugged into high-density airports, would not be affected by the decision.

## Addenda

Declining defense procurement dollars are spelled out in the Pentagon's new ranking of top contractors for fiscal 1970. Lockheed, General Electric and General Dynamics led the list with awards of more than \$1 billion each, but their combined total was down \$873 million from the year before . . . R&D contracting also fell in a companion DOD ranking, which was led by Lockheed (\$562 million), Western Electric (\$369 million), and Grumman (\$346 million), which improved overall with its Navy F-14 fighter awards.

# THE MOS DRIVER

# \$545



515 11th Street • Box 1289, Oakland, Calif. 94604 • (415) 834-3030

Dear Sir:

I want you boys from E-H Research Laboratories to prove I'm not just seeing things. Here is my purchase order. I have a \_\_\_\_\_ phase problem, so please send me \_\_\_\_\_ Model G720 MOS Drivers for only \$545 each. I understand I can use your unique Model G720 as a clock driver or a data driver. And if my problem is 2 phase, 4 phase, or more, I can purchase several and just stack them up. I believe the Model G720 MOS Driver from your new GENERATION 70™ line of low-cost, high-performance instruments offers an Output of -30 to +12 Volts and has Remote Current Injectors with Rep Rates to 10 MHz and Delay and Width to 200 ms. Apparently other features include no adjustments, non-selected parts, one-year guarantee and 5-day free trial. I'll believe it when I see it.

|               |                       |
|---------------|-----------------------|
| Name _____    | Title _____           |
| Company _____ |                       |
| Address _____ | Telephone _____       |
| City _____    | State _____ Zip _____ |



If you don't want to cut up your magazine, just a purchase order to E-H or to an E-H Representative will do.

# What's the prognosis for Medical Electronics?

**DOCTORS, HOSPITAL ADMINISTRATORS, AND ENGINEERS CAN FIND OUT BY ATTENDING THE**

3rd National Conference & Exposition on Electronics in Medicine

April 13-14-15, 1971/Sheraton-Boston/Boston, Massachusetts

Presented by Electronics/Management Center

in association with McGraw-Hill Publications

Electronics/Medical World News

Modern Hospital/Postgraduate Medicine

- What's available in patient-monitoring equipment and what's needed?
- What can computers do in medical record keeping and data analyses that they couldn't do before?
- How safe is medical electronics equipment — from the standpoints of both patient and operator?
- How stringent are major test equipment requirements of the clinical laboratory?
- What are the most effective techniques now in use in multiphasic screening?
- What are the key problems in hospital electronic equipment buying and maintenance?
- How will the Cooper Committee report affect new device control legislation?

These questions will be fully explored at a series of unique workshop sessions during the three-day 3rd National Conference on Electronics in Medicine to be held in Boston next April.

The 1971 meeting will include 50 per cent more topics and speakers than the previous conference. Morning sessions will feature speakers who have been selected for their expertise as well as for the articulate manner in which they convey their knowledge to a professional gathering such as this.

The enthusiasm of the '70 conferees for the afternoon panel/workshops has won a repeat performance — this time with topical discussions and specialists who will lead the workshops. They'll attack problems from all sides, then invite attendees to become active participants in the sessions. Conferees will have a chance to join at least two of the six workshop sessions.

An important adjunct to the technical program will be an exposition of new hardware (and software) in the medical electronics field.

## **SPEAKERS:**

Dr. John Knowles, General Director  
The Massachusetts General Hospital  
Boston, Mass.: Feature address

Dr. Donald M. MacArthur, former  
Deputy Director (Research & Technology)  
Department of Defense  
Topic: Hospital of the future

Dr. H. Fernandez-Moran  
The University of Chicago  
Topic: Information storage

Dr. Charles Edwards, Commissioner  
Food and Drug Administration  
Topic: FDA's role in medical device legislation

William Goodrich, General Counsel, FDA  
Topic: Evaluating present and proposed regulatory practices

Professor Oliver Schroeder, Director  
Law-Medicine Center  
Case Western Reserve University  
Topic: Medicolegal aspects of electronics in medicine

Dr. Arthur C. Beall, Jr.  
Baylor University, College of Medicine  
Topic: Device legislation: Another look

Dr. Cesar A. Caceres  
Professor and Chairman  
Department of Clinical Engineering  
The George Washington University Medical Center  
Topic: Cardiac screening

Dr. Octo Barnett  
Director, Laboratory of Computer Science  
The Massachusetts General Hospital  
Topic: Hospital automation

Dr. John B. Henry, Professor and Director,  
Dept. of Pathology  
State University of New York  
Upstate Medical Center  
Topic: Multiphasic screening

Dr. Julius Korein  
Dept. of Neurology  
New York University Medical Center  
Topic: The computer and the medical record

Dr. Max Harry Weil  
Associate Professor of Medicine  
Presbyterian Hospital, Los Angeles  
Topic: Patient monitoring

Dr. Joel Nobel, Director of Research  
Emergency Care Research Institute  
Philadelphia  
Topic: Evaluating equipment

Dr. Dwight E. Harken  
Chief, Thoracic Surgery  
Peter Bent Brigham Hospital  
Topic: Periontogenic diseases

Dr. William A. Spencer, Director  
Texas Institute for Rehabilitation and Research  
Topic: Electronic prosthetic devices

Dr. Allen Wolfe  
Barnes Engineering Company  
Stamford, Conn.  
Topic: Thermography

Dr. Aida S. Khalafalla  
Senior Principal Research Scientist  
Honeywell  
Topic: Plethysmography

Mr. Roger S. Powell  
National Heart & Lung Institute, NIH  
Topic: Electrical energy systems for  
artificial hearts

### EXHIBITS:

New medical electronics instrumentation and support equipment will be featured in the exposition that accompanies the technical program. Many manufacturers will display equipment that can be demonstrated or operated on site in the exhibit hall (John B. Hynes Civic Auditorium, adjacent to the Sheraton-Boston).

Among those companies which plan to display their most advanced equipment are American Tele-

phone and Telegraph Co., Bio-Optronics, Biotronics, Birtcher Corp., Civil Systems, Coulter Electronics, DeVilbiss, Dyonics, Goodman Brothers, Graphic Controls, Honeywell Inc., Humetrics, Intec, Isotopes (Teledyne), Macro Service, Mechanics for Electronics, Mediquip Corp., Medical Information Technology Inc., Motorola, Raytheon, Sanders Associates, Sloan Technology Corp., Princeton Fluidics, T & T Technical, and Technicon.

Exhibits will provide an important opportunity for attendees to see first hand (and in some cases even operate) the latest equipment and instrumentation designed specifically for medical applications.

### WORK SESSIONS:

*Patient monitoring:* Leader, Dr. Howard Hochberg; Roche Medical Electronics; A discussion of routine and critical problems in patient monitoring, including available instrumentation and equipment needed to provide improved monitoring.

*Computers in medicine:* Leader, Dr. William E. Chapman, Palo Alto Medical Research Foundation. What the computer can and can't do in medical record-keeping, data analysis, and medical history taking.

*Safety clinic:* Leader, Allan F. Pacela, chief research scientist, Beckman Instruments. A forum at which doctors and engineers will be able to exchange views on what is available and what is needed to improve the safety of medical electronic equipment from the standpoint of both patients and operators.

*Laboratory automation:* Leader, Dr. Hugo C. Pribor, Director, Institute of Laboratory Medicine, Perth Amboy. A discussion of the major test equipment requirements of the clinical laboratory, with a critical evaluation of present and future needs.

*Multiphasic screening:* Leader, Dr. Allen Pryor, Latter Day Saints Hospital. What are the most efficient techniques now in use and how can they be improved? This session will probe the question.

*Impact of electronics instrumentation in hospitals:* Leader, A. Allen Weintraub, Administrator, St. Vincent Infirmary, Little Rock. Key problems center on selecting and organizing electronics equipment in the hospital to get maximum immediate benefit.

### REGISTER NOW—SAVE \$35!

Advance registration fee: \$165  
Registration at conference: \$200  
(includes all sessions, exhibits,  
luncheons, reception and a digest  
of technical papers when published).  
Mail registration form and make  
checks payable to:  
Donald Christiansen  
Conference Chairman  
Electronics in Medicine P-30  
330 West 42nd St.,  
New York, New York 10036  
A block of rooms is being held at  
the Sheraton-Boston Hotel for  
registrants. Make your reservations directly  
with the hotel, identifying yourself  
as a Conference attendee.



Advance Registration Form  
3rd National Conference & Exposition  
on Electronics in Medicine  
April 13-14-15, 1971

Name \_\_\_\_\_ Title \_\_\_\_\_

Address \_\_\_\_\_

City \_\_\_\_\_ State \_\_\_\_\_ Zip \_\_\_\_\_

Hospital or Company affiliation \_\_\_\_\_

Please be sure check is enclosed

01—Electronics

# EXPAND YOUR SPECTRUM ANALYZER CAPABILITY...

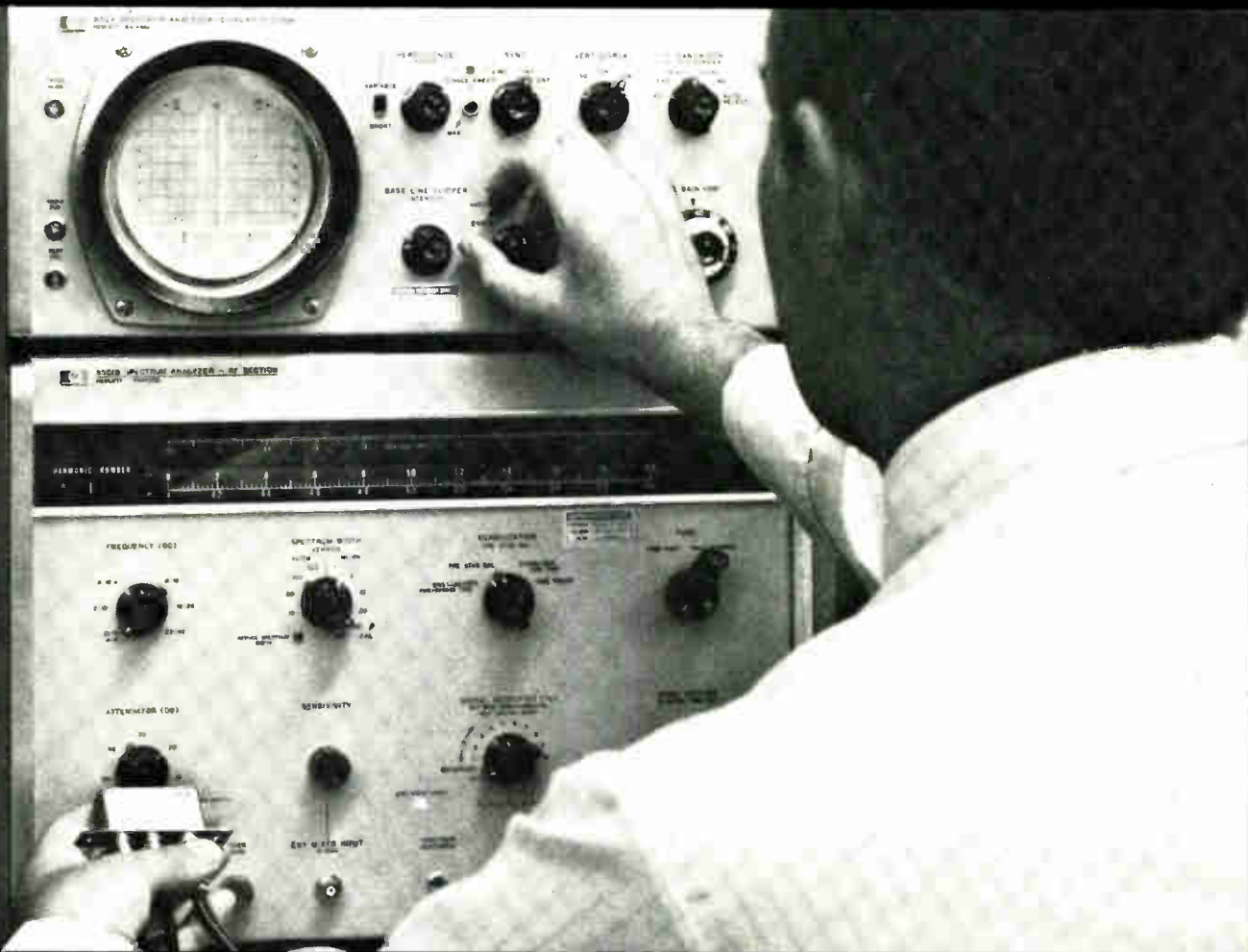

## ...AT ONLY 2.5% OF ITS COST!

Expand it with:

- Increased Sensitivity . . . 6 dB
- Reduction of Internal Spurs
- Flat Response down to 200 kHz (not 10.1 MHz)
- Flat Response up to 2 GHz (not 1.8 GHz)
- 15 db Less LO Signal at the Input Port
- 20 dB More Input Before Burn-out

Now, all these things are economically possible with RELCOM's M1F double-balanced mixer . . . designed for use on analyzers with a 2 to 4 GHz LO and a 2 GHz IF. Just a small investment will give your instrument expanded capability to make more critical measurements.

For a better idea of what this mixer can do for your analyzer, compare the following spectrum analyzer photographs.



A major consideration in spectrum analysis is whether the response is real, or is internally generated. Spurious frequency components generated in the first mixer of the 8551B/851B are shown below. Where there are really only four  $-20$  dBm input signals at 250, 350, 470, and 550 MHz, other spurious signals are present in the display.

The 8551B/851B is unspecified below 10 MHz. The numbered (in MHz) responses are  $-50$  dBm calibrating signal inputs. Notice the low frequency response roll-off. The responses labeled "S" are internally generated spurious signals. The rise at the left of the picture shows the desensitization due to the LO feed-thru to the 2 GHz IF of the spectrum analyzer.

The dynamic range and sensitivity of the 8551B/851B is limited by the noise figure of the instrument. Shown below is a 600 MHz input signal at  $-20$  dBm and a 500 MHz input signal at about  $-80$  dBm. The settings on the analyzer are as follows: Horizontal scale 30 MHz/cm, vertical scale 10 dB/cm and IF bandwidth 10 kHz. Can you see the 500 MHz signal?

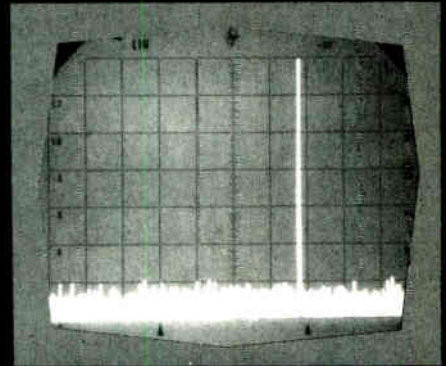
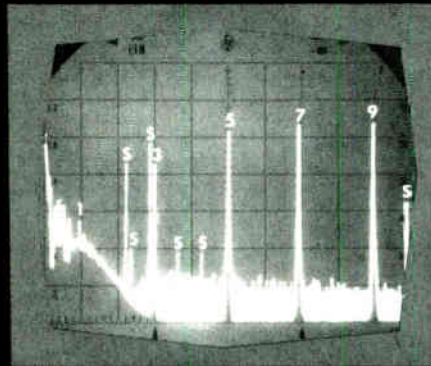
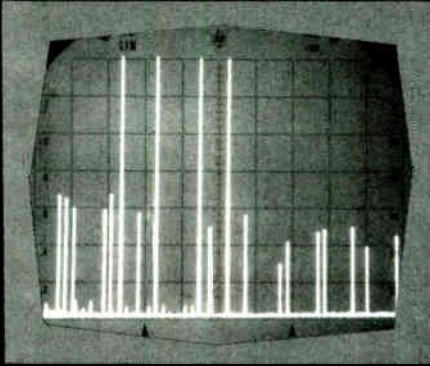

B  
E  
F  
O  
R  
E

B  
E  
F  
O  
R  
E

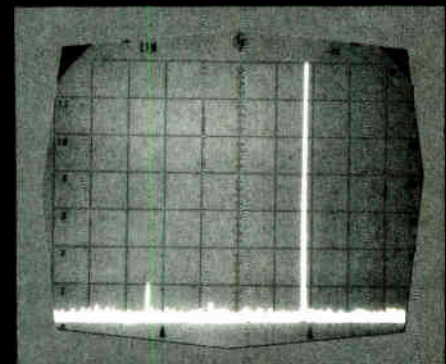
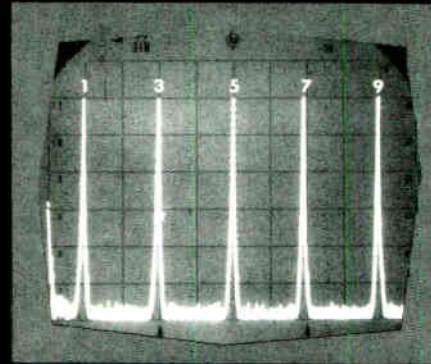
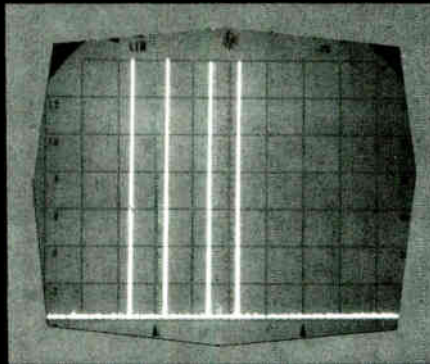

A  
F  
T  
E  
R

A  
F  
T  
E  
R

With the same input signals and spectrum analyzer settings as above, substitution of the Relcom Model M1F Double-Balanced Mixer for the first mixer (single-diode) in the spectrum analyzer eliminates the confusing intermodulation products. The vertical scale is 10 dB/cm.

Substitution of the Relcom Model M1F Double-Balanced Mixer for the first analyzer mixer under the same conditions as above provides: (1) a flat frequency response in the 200 kHz to 10 MHz range, (2) increased gain and less noise for more dynamic range, (3) a drastic reduction in internally generated spurious signals, and (4) a reduction in the desensitization due to the LO feed-thru.

Substitution of the Relcom Model M1F Double-Balanced Mixer for the first spectrum analyzer mixer reveals the presence of the low-level 500 MHz signal. Reduction of the spectrum analyzer IF gain provides the same reference amplitude for the 600 MHz input. The M1F provides about 6 dB improvement in the spectrum analyzer noise figure.

Same advantages apply in the 1.8 to 4.2 GHz range. Buy a Model M1F now, and see its remarkable value for yourself. We'll include applications data with delivery. If you're not completely satisfied, just return the mixer within two weeks for a full refund. Act today! Delivery from stock. Price, \$275 each.

# RELCOM



# By 1979, your wife will be computer-aided.

Running a household is getting as complicated as running a business. So, by the end of this decade, your household will have something business couldn't do without — the computer.

Although no larger than a personal TV, your home computer will help your wife plan and cook meals. It'll automatically activate the laundry cycle, balance the checkbook and do the shopping. In addition, your computer will be able to check your child's homework or take you on in a game of chess.

Best of all, your computer will be able to converse with other computers. So you can order tickets to the theatre or Sunday's double header from your kitchen table. Even make airplane and hotel reservations for an entire vacation.

But a home computer will be just one of the home-electronic breakthroughs you'll see in the decade ahead.

The fact is, products of electronics technology will be doing more in our lives tomorrow than electricity does for us today.

Our daily newspapers will be automatically printed in our living rooms. Home diagnostic centers will keep watch on our health. Automated highways will do the driving.

Who are the master minds masterminding these changes?

Our readers.

Among them the engineers who'll be adapting more and more electronic innovations for home use.

Every two weeks, Electronics presents its readers with a complete up-to-the-minute picture of the state of the technology. Plus all the fast-changing developments in their particular fields of interest. Industry-wide and world-wide.

Whether you're a reader or an advertiser, Electronics can help make you part of the future.

Electronics, a McGraw-Hill market directed publication.

**Our readers are changing the world.**



# Signetics

## SILICON GATE MOS

### Super Speed Dynamic Shift Registers

2506—3MHz Dual 100-bit

2507—3MHz Dual 100-bit

2504—10MHz Single 1024

2503—10MHz Dual 512

2502—10MHz Quad 256

2505—5MHz Single 512 with logic

2512—5MHz Single 1024 with logic

### Fully Decoded Random Access Memories

2501—256-bit Static

2508—1024-bit Dynamic

### Tri-State Output Static Shift Registers

2509—3MHz Dual 50-bit with logic

2510—3MHz Dual 100-bit with logic

2511—3MHz Dual 200-bit with logic

### High Speed Read Only Memories

2513—64x7x5 Character Generator

2514—512x5 Static ROM



Signetics begins the new 2500 Series in Silicon Gate MOS. Characterized, in production. The most devices and lowest costs in the field. Available now. Call or write Signetics Corporation for lit-packs: 811 E. Arques Avenue, Sunnyvale, California 94086. (408) 739-7700.

A subsidiary of Corning Glass Works.



# Article Highlights

---

**Computer terminals  
ring up sales in  
cash register sector  
page 52**

The familiar retail store cash register's days are numbered, thanks to the growing use of electronic point-of-sale equipment. The electronic registers, using magnetic or optical reading devices, absorb coded data from sales tags, clear credit, calculate charges, record sales, and update inventory. They fit in neatly with sophisticated management information systems, providing retailers with better control over their merchandise. And customers can expect faster service with fewer errors.

**Program refines  
circuit from rough  
design data  
page 58**

Circuit designers have yet another important tool to work with: the Match computer program. Other computer-aided design programs just perform analysis functions. But with Match, the designer need only supply a description of desired frequency-selective characteristics, a circuit configuration, and ballpark component values. The program then juggles these values until the device's response is optimized.

**Diamond scribes start  
to give way to  
newer techniques  
page 70**



In the highly competitive semiconductor industry, 70% to 85% yields in the important scribe-and-break stage of production just aren't good enough. So the manufacturers are starting to turn from the venerable diamond scribe and toward newer etching and cutting methods that promise chip yields of 95% or better. Among these

are laser scribes, wafer cutters that use slurry or slurry in combination with metal bands, and even new variations of the old etch scribing process.

**Flux monitoring  
boosts accuracy  
of phased arrays  
page 77**

Permeability changes in the ferrite phase shifters of phased-array radars degrade beam-pointing accuracy and increase system losses. Flux feedback, a new concept in phase-shifter driver control, monitors flux buildup in the ferrite core and feeds back this data to the driver, neatly overcoming temperature, aging, and component tolerance effects.

---

## Coming

**High-frequency ICs**

Instruments that measure high frequencies, such as time and frequency counters, require extremely fast circuitry. To meet this challenge, a variation of emitter-to-emitter-coupled logic is being put to work in a new family of input gates, counters, and other high-speed circuits.

# Computerized terminals ring up sales in cash register territory

Electronic point-of-sale terminals plus computerized record-keeping promise to increase retailers' control of merchandise and speed customer service; but market acceptance probably will be slow

By Alfred Rosenblatt, *Industrial electronics editor*, and Gerald M. Walker, *Consumer editor*

□ Electronic point-of-sale equipment is marking the familiar retail store cash register for obsolescence. The payoff to the store manager will be better information about the merchandise he inventories and sells. For the manufacturers, the switchover could mean sales ranging from \$1 million each from the 300 or so major chain-stores in the U.S. to \$25,000 for setting up a single independent retailer. And for the customer, the new generation of registers promises faster service with fewer errors.

But as rosy as the long-term picture seems, the next two years will see painfully slow acceptance from profit-pinchd retailers, a direct clash between optical and magnetic approaches to data input, and stiff competition among the various point-of-sale systems to gain an early, decisive upper hand.

Point-of-sale registers are in effect data terminals and so quite different from conventional types. Whether stand-alone units or controlled by computer, they read coded data from sales tags, clear credit, identify operators, calculate charges, record sales, update inventory, and even test for entry mistakes. Despite their array of functions, learning to use them takes as little as 15 minutes.

Such electronic units are not merely one-for-one replacements for electromechanical cash registers. Rather they are part of sophisticated management information systems, designed to give the retailer more data about incoming and outgoing merchandise, cash flow, and inventory on the rack than he's ever had before. But though this is the key feature of the new terminals, it may also be the hardest concept to sell, because it involves marketing more than just a cash box topped by a sales slip printer and a bell.

Almost a dozen companies, both large and small, have developed terminals and data handling systems to go with them. They include Sweda division of Litton Industries, Orange, N.J.; Olivetti Corp of America, New York; Pitney-Bowes Alpex, Stamford, Conn.; Friden division of the Singer Corp., San Leandro, Calif.; American Regitel, San Carlos, Calif.; Transaction Systems, Inc., Palo Alto, Calif.; Inventory Management Systems, Los Angeles, Calif.; Totalisator division of General Instrument Corp., Towson, Md.; and the giant in registers, National Cash Register, Dayton, Ohio.

All the new terminals boast the latest in integrated

circuits, and some are using medium-scale integration for shift register and counting functions and LSI for memory functions. Bipolar ICs and MOS technology are favored, although discrete components still find their way into some proprietary circuit designs.

Probably the first electronic register to reach the market, American Totalisator's Uni-Tote, has run the gamut from relays for stepping functions back in the early '60s, through transistors and logic cards, to MOS/MSI today for gating, counting, multiplexing and mass storage. Like all terminal producers, Uni-Tote depends most on standard devices from the big three semiconductor suppliers, rather than costlier custom designs. "There's nothing fancy inside," says George Groth, director of engineering. "We don't have a leg up on the technology, but we have kept up with it."

But it's not just their increased complexity that makes an electronic terminal cost \$500-\$1,000 more than an electromechanical cash register. A sizable additional cost is software because, as John Kerin of Singer Information Systems, a New York retail systems consulting firm, points out, "Once the retailer commits himself to the new electronics, he must have the software to benefit from the data collected."

**A critical element** at the point of sale is the tag a retailer attaches to his merchandise (see Fig. 1). For more than 15 years, these tags have combined machine-readable punched holes with alphanumeric characters for the customer to read. But the terminals' automatic readers require either optically or magnetically encoded tags—and machines to produce them. The result is an encoder/reader conflict between the optical approach led by NCR and the magnetic favored by most of the other terminal manufacturers.

Confident of its long-time acceptance by retail merchants, NCR put its cash register leadership on the line when it recently announced the 280 Retail System, built around an optical wand reader that picks up white, black and green bars on the tag (*Electronics*, Sept. 28, p. 37). The total system hinges on the unique tag, which stores 10 characters per inch. Critics say that NCR is risking too much in asking retailers to limit themselves to a new tag type and, more importantly, to an encoder selling for \$10,340. (Pitney-Bowes Alpex has also revealed plans to market an optical reader, which will use only black and white bars, but has declared all design details con-

fidential so far. Tag density may be less than NCR's.

Magnetic encoders, in contrast, would cost the retailer in the region of \$500 to \$1,000, that is, if he chooses to make his own tags instead of hiring a service. Furthermore, magnetic code supporters point out, while a magnetic tag can be de-magnetized and thereby destroyed, an optical tag can be altered without destroying the code. So, they claim, a damaged optical tag might be used intentionally or unintentionally, while a damaged magnetic tag would simply not be processed. Magnetic encoding followers also claim that acceptance by credit card and airline users is strongly in their favor. In addition, magnetic tags accommodate more coded information per inch and can be overprinted with alphanumeric information without impairing the coded strip.

**In defense of the NCR approach,** Carl F. Rench, vice president for corporate product development, points out that optical materials cost less than magnetic. In addition, they permit simpler tag-reading circuits in the terminal because the code can be read accurately at any angle or speed at which the clerk may pass the read head over the tag. He adds that other, far less expensive encoders will be introduced in a couple of years for use by retailers or by merchandise manufacturers when packaging goods for retail stores. According to Rench, they will be available for \$1,000 and handle a variety of tag styles. At this price optical encoders would be no more expensive than magnetic.

"The encoder cost for a system is not the critical element," he argues. "We can prove by case studies that, of all the costs of a retail program, optical encoding will be less important to the retailer than concern with the total system."

The need for considering the total data environment is stressed by many in retailing. "The point of sale is only one of the places where retailers require fast and accurate data," asserts New York retail industry consultant Ethel Langtry. "Data-capture devices are needed at each crossing point to check in goods delivered at the receiving dock, goods transferred from one store to another, and goods returned to the store by a customer. Devices are also needed to track goods transferred from the receiving dock to departments within the store, and to file away information about goods that have been ordered and will soon be received."

To allow the same tag to serve all data points, each of these data-capturing devices should apply the same reading technique as the one used at the point of sale. And this, of course, raises the stakes in the upcoming optical versus magnetic battle.

In the meantime, though, devices have been developed that "read" print-punch tickets into terminals. An Olivetti TC 601, point-of-sale terminal, which is keeping track of merchandise returns at one of Alexander's New York stores, is fitted with a module that reads such tickets with a fiber-optic hole reader. Another device, developed for on-site reading of print-punch tags, is a hand-held "gun" from Information Machines and Ricca Data Systems, Los Angeles. This could be used to take inventory by reading tags still attached to the merchandise.

Manufacturers have taken two basic approaches to point-of-sale terminal design: stand-alone and computer-controlled. The stand-alone terminal has enough logic and memory to control the transaction and store data independently of other equipment. The controlled terminal, on the other hand, has much less logic and

1. **Minding the store.** In the retail store, point-of-sale terminals complement ticketing machines at the incoming end and report to the store's main computer system to produce management reports. In the Olivetti system, pictured here, data regarding sales transactions at up to 128 terminals are stored by a Vector 5000 minicomputer, then forwarded along a high speed communications line to the main computer.

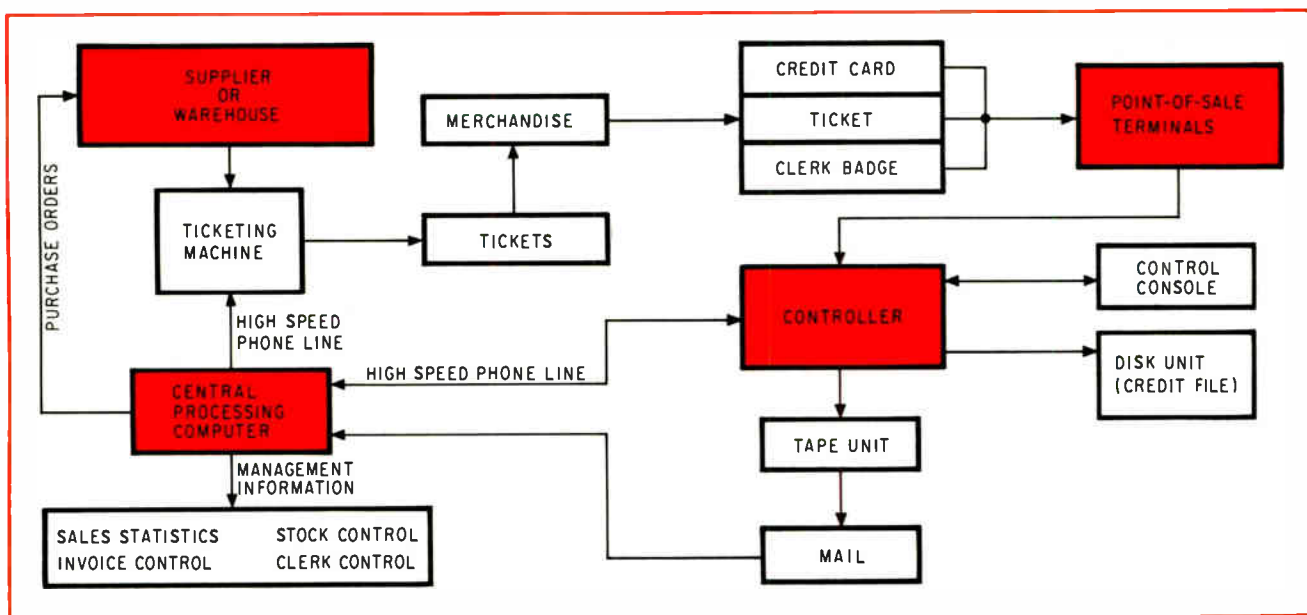

## Problems with success

The retailers' success during recent years is spurring merchants to consider the new generation of terminal equipment.

As a skillful merchandiser, the retailer must keep track of the items in his inventory, know what his customers are buying and replenish stocks as they become depleted. This is done in a variety of ways. One of the most common is to read the coded punched tickets that were pioneered almost 20 years ago by Kimball Systems division of Litton Industries, and are also supplied by Dennison Manufacturing. Generally, the ticket is torn off when the merchandise is purchased. At the end of the day, the tickets are fed into an automatic reading machine which reads and stores the information for entry into a computer processing system.

Other techniques rely on the sales clerk to key in for each item a multi-digit coded number—referred to as a stock keeping unit or SKU. In the case of a shirt, for example, an SKU would completely specify the style, color and size. In addition, the clerk must key in his own department and identification numbers and the item's price. So many numbers are required that a clerk must often make more than one pass over the register keys. This all takes time and keeps customers waiting—something retail store managers don't like to do. Also, the clerks, many of whom are part-timers and relatively inexperienced, make mistakes that cost the stores money and invalidate any serious attempt at inventory control.

With 1,500 retail stores to worry about, eliminating the human errors is one of the prime reasons the Singer Co. ordered its subsidiary division, Friden, to develop a point-of-sales terminal, says Singer president Donald F. Kircher. After successful field tests this June, Singer decided to install Friden's Modular Data Transmitting System terminal in all of its stores by the end of next year. With this system, up to 70,000 characters of data, stored on a continuous tape loop within each terminal, are sent over phone lines at the end of each business day to one of several regional data processing centers.

memory, and must be guided by a computer, either a special purpose type or a minicomputer that can perform various data processing chores as well.

**Which type of terminal is most suitable** for a given application depends on several factors. A chain operation of small stores, each with only a cash register or two, might find it too expensive to tie widely separated units to a central controller, and so decide on stand-alone units. A large department store, however, might prefer centrally controlled terminals. It would be relatively easy to wire them together and, with logic and memory invested in a small programmable computer, the system would have a great deal of flexibility.

Whichever type of terminal is selected, it must perform the functions diagramed in Fig. 2. The control unit at the center of the drawing controls such things as the cash drawer, a price display, a series

of instruction displays which lead the clerk through a sales transaction, and a printer which types out the customer's receipts and may also record each sale on paper tape.

Inputs to the control unit are from a keyboard containing both functional and numerical keys, and an automatic information reader, which reads price tags, credit cards, and identification badges. Terminals also usually emit an audible signal to tell the clerk the information has been scanned correctly.

**Storage of sales data** is done by the control equipment in controlled terminals and by magnetic tape in stand-alone units. For example, one version of Information Machines' Registron terminal stores data on an inexpensive, built-in tape cassette, which is removed at the end of the day and sent to the central processor.

In concept, this method of transmitting sales data is hardly different from the one used with conventional cash registers, such as the NCR class 52 and 53 machines and the Sweda 1983, which store data on punched paper tape or optically scannable journal tapes. (In fact, to bridge the gap between the present cash register and the coming electronic terminal, Sweda has even evolved a hybrid device—an automatic magnetic tag reader that would store data on optical character or punched paper tape and could be retrofitted to Sweda electromechanical cash registers.)

However, it's also possible to transmit the cassette data electronically over common carrier lines, through a Dataphone or an acoustic coupler. Friden's Modular Data Transmission System (MDTS) terminal, for instance, stores data in a \$650 Individual Store and Forward module on a continuous tape loop, which is polled at the end of the day by a computer at the data processing center.

Still another stand-alone terminal, NCR's model 280, though it has enough circuitry to make it virtually a minicomputer, cannot store the sales data. Instead, a separate magnetic tape data collector, the NCR 723, stores information from as many as 48 terminals. Data accumulated on the tape are then transmitted periodically to a central processing computer.

Because the shape of the market is still fuzzy, point-of-sale equipment is being developed with both stand-alone and computer-controlled capability in the same unit. So at present there is not much of a battle over which approach is superior.

Jesse Lentini, product manager for Olivetti in New York, claims that computer control has the better long-range potential because the programs and hardware can grow with the store while stand-alone registers may solve today's needs, but not tomorrow's.

The problem, he observes, is that retailers have been afraid to go to purely computer-controlled systems for fear that breakdowns will cause chaos. As a consequence, electronic registers have to be able to operate purely as cash boxes. Also, extra controllers are needed as back up during downtime. These redundancies cost money, however, and may not be necessary when retailer confidence in electronic systems grows.



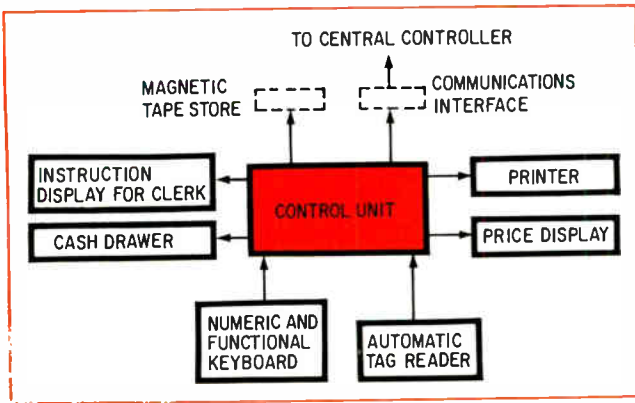

**2. Terminal case.** Every point-of-sale terminal requires a central control unit to operate the devices shown here. It's more complex as a stand-alone register and less complex when centrally controlled.

"When the retailer realizes that he is paying extra for redundancy that he is not using, he will cut it out," comments Lentini. It may be five years before this confidence grows, however, and when that happens, it will be possible to eliminate power supplies and computing circuits at the register and controller.

Ninety percent of the circuits in the Olivetti TC 601 computer-controlled terminal are integrated circuits, both DTL and TTL. It includes 14-lead shift registers, NAND and NOR gates, and flip-flop memories. The greatest density on any one chip is a circuit with 24 flip-flops. Olivetti's controller is built around a mini-computer, the company's Vector 5000, which can run up to 128 remote point-of-sale terminals brought through four multiplexers in groups of 32. The mini-computer also acts as a data collector and concentrator, interfacing with communication lines to a store's main data processing computer.

Other companies that tie terminals to a central controller include Sweda, which links 16 terminals to a controller, Pitney-Bowes Apex, and American Regitel, using a Data General Nova. Also, one version of the Friden point-of-sale system has terminals tied to the company's System 10 general business processor.

Besides scanning the terminals and controlling their sequential operations, says consultant Richard Shaffer of Gambit Management Strategies, the controller may perform such tasks as:

- accumulating and storing the day's sales and tax receipt totals by department, sales person, and time of day;
- storing and updating credit and inventory information on disk or tape files;
- retrieving information from the files in answer to requests at the point-of-sale terminals;
- detecting and correcting transmission errors in data received from the remote terminals.

It is, of course, possible to bypass the controller and tie terminals from many stores directly to a general purpose computer—as General Electric and J.C. Penney did when they attempted to set up on-line operation with their Tradar system. A dual installation of

big, expensive GE 415's would have controlled over 1,500 terminals and produced the retailer's management reports at the end of the day. Because of excessive computer cost, the number of terminals had to be large to make the system economical. But after investing some \$10 million, Penney called off the program for undisclosed reasons.

Observers believe the cancellation was prompted by overly complex software and internal politics rather than a failure of the hardware. Whatever the reasons, the Tradar demise has made other retailers a little gun shy toward on-line systems. And, except for checking credit-card customers or keeping a running inventory on high-priced items such as furniture and television sets, many consider on-line systems unnecessary.

**An unusual approach to terminals** is being taken by two-year-old Transaction Systems Inc. Engineers there have developed a hand-held magnetic sensing head that reads not only price tags and identification badges but also instructions about the type of transaction taking place. These instructions—specifying such things as whether a sale is "charge," "cash," or "COD,"—are magnetically encoded function strips, which are mounted on the terminal and virtually replace the keyboard. The result is that the usual box-like structure containing the keyboard, dollar display and sales slip printer is eliminated, and the terminal is almost entirely flat on top.

The terminal consists of two parts: an upper control unit, which includes a printer, and a cable-connected logic unit under the counter. Although the terminal operates as a stand-alone unit, it must store data in a central collector.

Key to the operation of the system are, of course, quarter-inch-wide magnetically encoded strips. When used as tags, these strips are coded with price and inventory control numbers, have a human-readable item description, and are produced by a punched-card-driven tag maker also built by the company. Some 20 to 30 characters can be encoded on a price tag, and the wand can read up to 400 of them per second.

The encoding technique is still a secret, as well as the techniques used for interpretation. The sorts of problems they solve are various. The system resembles a magnetic tape transport whose head is never aligned properly and whose speed is erratic. And the transport never knows when a message will come,

**3. Wand waving.** By scanning magnetic encoded function strips with a reader wand, the clerk using Transaction Systems terminal enters subroutines controlling memory functions. Strip has alphanumeric overprinting.





4. **Optical reading.** The NCR 785 reader picks up optically encoded series of white, black, and green bands containing 10 characters per inch. It's connected to a 280 point-of-sale stand-alone register. Instructions above keyboard tell clerk how to enter information.

nor its amplitude or length. The resolution of the data varies because the distance from the wand to the tape varies, and the data have to be capable of being received backwards, at different speeds, or incompletely.

According to Transaction Systems Vice President Alan Jensen, the function strips offer an important advantage: because the instructions on the strips act as subroutines, the terminals can do more program steps. This means that a terminal can be moved from store to store or department to department without reprogramming—only the strips need changing, which makes the terminal circuitry simpler.

**Though relatively simple in design,** the Transaction register employs four types of circuits—bipolar ICs, bipolar MSI for shift register and counters, MOS/LSI memories, and a few proprietary discrete circuits. Jensen explains that the company used discrete circuits for reading magnetic data from its double gap ring wand head only because it did not want to take development time to go the integrated circuit route. However, he says the application is ideal for MOS ICs.

Transaction also has a proprietary magnetic memory to perform the read-write function when the terminal is in the stand-alone mode. "Some totals such as cash in the box must be protected locally in event of a power failure," Jensen reveals, "yet this total is changing all the time. This read-write memory had to be nonvolatile so we chose a magnetic one. Then to simplify production and avoid using two different tech-

nologies in the same terminal, we also employed our own design of magnetic read-only memory rather than a semiconductor type."

The Transaction register makes nine tests for error on every scanned item before accepting the data into the system. Besides tests for parity, amplitude, and number of bits, which most terminals perform routinely on digital input, this unit also evaluates the analog waveform at six points. In other words, the read circuit is capable of handling digital and analog incoming information. If it's accepted, the register sounds a beep signal to the clerk, and if unacceptable, nothing happens. This forces the clerk to repeat scans until he hears the beep.

As a double check, the terminal has a program of the sequence for entering information, and will simply ignore all signals until the clerk follows instructions.

Although manufacturers agree that large scale purchases are still a couple of years distant for point-of-sale terminals, some of the nation's largest retailers have begun testing systems.

Montgomery Ward, for example, is testing one system from NCR and another from Friden. Sears, Roebuck and Co. is testing two systems from Sweda and Friden. And J.C. Penney Co., which recently terminated the Tradar terminal system, is nevertheless still interested in point-of-sale electronics.

So is the Singer Co. Past the trial period, Singer is already installing MDTS terminals from its Friden division at each of its more than 1,500 retail stores around the country. When completed, Singer claims its system will be the largest remote batch processing system in the world.

**Other smaller retail organizations** are already installing the new terminals. Bullock's is installing terminals built by American Regitel in Los Angeles. New York-based Bloomingdale's has been testing some Sales Point Information Computing Equipment (SPICE) terminals developed by Pitney-Bowes Apex, at its store in Stamford, Conn., and is considering converting the entire store to them. Pitney-Bowes Apex is already installing them at the 20 stores in the Barker discount chain of the Franklin department stores. Olivetti says it has orders for four systems in Europe, including 24 terminals at the duty-free shop in Frankfurt's International Airport. Under minicomputer control, the system will calculate the exchange rate and make change in 22 currencies. And Clover stores, a new mass merchandising chain that belongs to Philadelphia's prestigious Strawbridge and Clothier department store, will be installing Friden's point-of-sale terminals when it opens its first outlet early next year.

Information Machines, another firm specifically organized to develop a point-of-sale terminal, says it has some 40 orders, mostly for test in back-office work from stores around the country.

To the retailer, the great number of companies trying to sell point-of-sale systems represents a striking change from the NCR-dominated market of a few years ago. "Every guy who ever worked for the phone company and has a garage seems to be developing a point-of-sale system," says the data processing manager



5. Store's store. Friden's Modular Data Transmission System (MDTS) terminal uses a continuous tape loop in a \$650 module for daily transactions to the data processing center for updating inventory, recording charge purchases, and initiating reorders.



6. Things Italiano. The Olivetti TC 601 terminal, shown here, reads magnetic code merchandise tags. Terminal is part of storewide inventory control and sales data collection system controlled by minicomputer. It can also be used as a stand-alone register.

of a large New York City department store chain.

His attitude is understandable. For the last 85 years, National Cash Register has had the register business almost to itself. More than 90% of the estimated three million cash registers installed around the world are NCR machines. It was only in the early 1960s that Sweda, a Swedish company since acquired by Litton Industries, began to compete in any meaningful sense. (Sweda now estimates its share of the worldwide market may be as high as 15%).

**Because of the need** to develop new software systems and the conservative bent of most retailers, many feel it will take at least two years before many new terminals are sold. Most will probably go into new stores or through a particular department in a store chain, says Harry Spaulding of Technical Resources Inc., a retail-industry consultant based in Atlanta. Hardly anyone will decide to replace the registers they already have, especially when the machines are so well built that most retailers expect them to last forever, he points out.

While retailers are handling the new systems gingerly, the 20,000-member National Retail Merchants Assn. has set up standards task groups to draw up specifications for point-of-sale equipment before sales pick up steam. Standards groups in its Information Systems division have been working for a year studying the needs of users and expect to have a workable set of specifications in about 18 months. Two task groups already at work have divided the

study into merchandise tagging and customer identification.

Though some manufacturers fear that the committee will specify requirements that have not yet been invented, Irving I. Solomon, vice president of the division, insists that his groups will come up with practical guides. To make sure of this, he has dismissed 28 members of his committee for blue skying.

"We don't want to end up with monster equipment, oversized and expensive," he declares. "We want the most economical system starting with the lowest common denominator. All additional features for more complex applications will be extra cost options to bigger retailers."

"We want to delineate our requirements for at least the next five years. And we want every electronics company that's interested to be able to show us what they have," Solomon states.

The task groups are retail-oriented executives, though 5 to 8 percent are also engineers. When their work is further along, equipment manufacturers will be invited to join the discussions.

Other groups will soon be looking at requirements in warehousing, distribution, personnel, and internal and external communications. And Solomon wants to coordinate the NRMA work with that of other retail trade associations interested in devising electronic specifications.

But, one manufacturer warns, between now and the arrival of the NRMA specs, a lot can happen. □

# Program refines circuit from rough design data

Instead of just analyzing a frequency-selective circuit, Match program enables the computer to juggle component values until the response of the device has been optimized

By Harry B. Lee, Philip Carvey, Ralph Grabowski, and David Evans, *Applicon Inc., Burlington, Mass.*

□ Adjusting component values till a frequency-selective circuit gives the desired response is a job a computer could do. And the newly available Match program teaches computers how to do it, providing an automated cut-and-try approach that zeroes in directly on the solution, unlike circuit analysis programs.

All the input the engineer has to provide is a description of the desired loss or phase characteristic as a function of frequency, a circuit configuration, and ballpark component values. He may also set upper and lower limits to these values, to ensure that the computer delivers a set of realistic circuit elements.

The program takes it from there, systematically varying the components to minimize an error measure, a quantity derived from the difference between the circuit's desired and actual characteristics at several frequencies. It stops when the error measure is within bounds set up by the user.

Either loss or phase characteristics can be optimized, each of them either in relative or in absolute terms. There's also a linear phase option. This range of options is useful for solving many problems including synthesis, loss and delay equalization, broadband matching, correction for parasitics, and device modeling.

**Match is applicable** to a wide range of circuits, including active and passive filters, feedback amplifiers, equalizers and matching networks. A unique feature of the program enables the engineer to enter empirical frequency response data directly, ensuring that the behavior of critical devices, such as transistors, is accurately represented within the computer.

Figure 1 is an example of how Match can be applied as a synthesis tool. Here, all the components are arbitrarily assigned unit values, which Match progressively revises till they produce a loss characteristic almost exactly like the one desired.

Each of Match's optimization options is best suited to a particular class of applications. The absolute loss option, for example, attempts to make the losses of the actual and desired frequency responses agree at a specified set of frequencies. It tends to average out ripple and ignore minor peaks in the response. The relative loss option attempts to make the shapes of the actual and desired curves agree. In the process, one curve may be displaced from the other by a fixed amount of loss, but this can be made up with an extra

gain stage that has a flat response. Therefore, where gain is the dominant consideration, the absolute loss option should be used, and where frequency selectivity is important, the relative loss option should be used.

Similarly, the absolute and relative phase options match either the actual phase values or the shapes of the phase response curves. In the absolute phase option, the curves will generally agree well across the band, but the phase relationships between frequencies may not be preserved. The relative phase option preserves these phase relationships but there may be an extra, fixed phase shift added to all frequencies.

The linear phase option seeks a phase characteristic that is as linear as possible, regardless of absolute phase shift or group delay. In the process, it can significantly change the values of absolute phase shift and group delays.

The procedure for optimizing a circuit characteristic hinges on:

- First, establishing a single error quantity to measure the difference between actual and desired performance.
- Second, minimizing this error quantity by systematically varying the circuit parameters.

In order to derive the error measure, the user must first describe his desired loss or phase characteristic with tabular data and enter the data into the computer. The table for the desired characteristic can be entered with the teleprinter or be derived from an existing circuit already analyzed and stored in the computer memory. The second method is particularly useful when correcting a circuit for parasitic effects. (When optimizing loss, the program ignores phase and vice versa.)

The number of frequencies at which Match is called upon to perform a fit is important. Too many test frequencies result in slow convergence, while too few may not produce a good fit across the band. A good rule is to set the number somewhere between  $N$  and  $2N$ , where  $N$  is the number of variable parameters.

At this point, Match is ready to construct the error measure. It does this by calculating the differences between the actual and the desired performance characteristics at the set of test frequencies specified by the user. It then multiplies each discrepancy by a weighting function, and raises each of the weighted discrepancies to an even power,  $q$ . Finally, it sums

them—and this sum is the error measure for the curve.

Note that with this procedure, the error will be zero only if the agreement is exact at all test frequencies, and will be positive if agreement is anywhere inexact. It cannot be negative, since all discrepancies are raised to an even power before the final summing operation.

The error measure is defined as

$$\sum_{i=1}^n \left\{ |w(f_i)| \times [P(f_i) - P_o(f_i)] \right\}^q$$

where

$f_1, f_2 \dots f_n$  = the frequencies at which a fit is desired.

$P(f_i)$  = the actual performance at frequency  $f_i$ .

$P_o(f_i)$  = the objective performance at frequency  $f_i$ .

$w(f_i)$  = a factor that weights the error at frequency  $f_i$ .

$q$  = an even, non-zero integer.

Normally, the program sets all error weights to unity, but it can also be instructed to increase the weights for those frequencies at which errors would have greater significance.

For example, in a transmission line, a 0.1-dB ripple in the pass band may be as undesirable as 5-dB error in the stop band, and if so, the weights should be chosen so that both errors contribute the same amount to the error measure. This is done by assigning weights of 50 to passband errors and unity to stop-band errors.

**Unless otherwise instructed,** the program sets the exponent  $q$  to two, thus giving a least squares fit. However, there still may remain some large individual errors. A larger exponent emphasizes the large errors, and would result in a better match, but with large values for  $q$ , more computer time is used.

Once the program has determined the error measure for a particular set of component values, it proceeds to minimize it by automatically adjusting the component values. To do so, it uses a proprietary version of the Fletcher-Powell algorithm,<sup>1</sup> an efficient method of speeding the rate of convergence by assuring that each iteration reduces the error. This algorithm operates effectively on a time-shared computer.

For its first pass, a decision must be made on how much to change the parameter values, and unless instructed otherwise, Match arbitrarily changes the parameter values by 20% of the allowed range. After the first step Match evaluates the results, and sets the size of the next step with its adaptive features.

Match allows the user to specify groups of components whose values will be held constant relative to each other during the optimization procedure. Such capability is useful in imposing constraints for obtaining symmetry, antisymmetry, constant resistance image impedances, all-pass transfer ratios and fixed attenuation poles.

It's important to realize that, if too many circuit elements are varied, the result is slow convergence, while too few variables may result in a poor fit between the actual and desired response. In this case, doubling the number of variables more than doubles the solution time. It's thus best to start by varying only a few elements and then increase the number

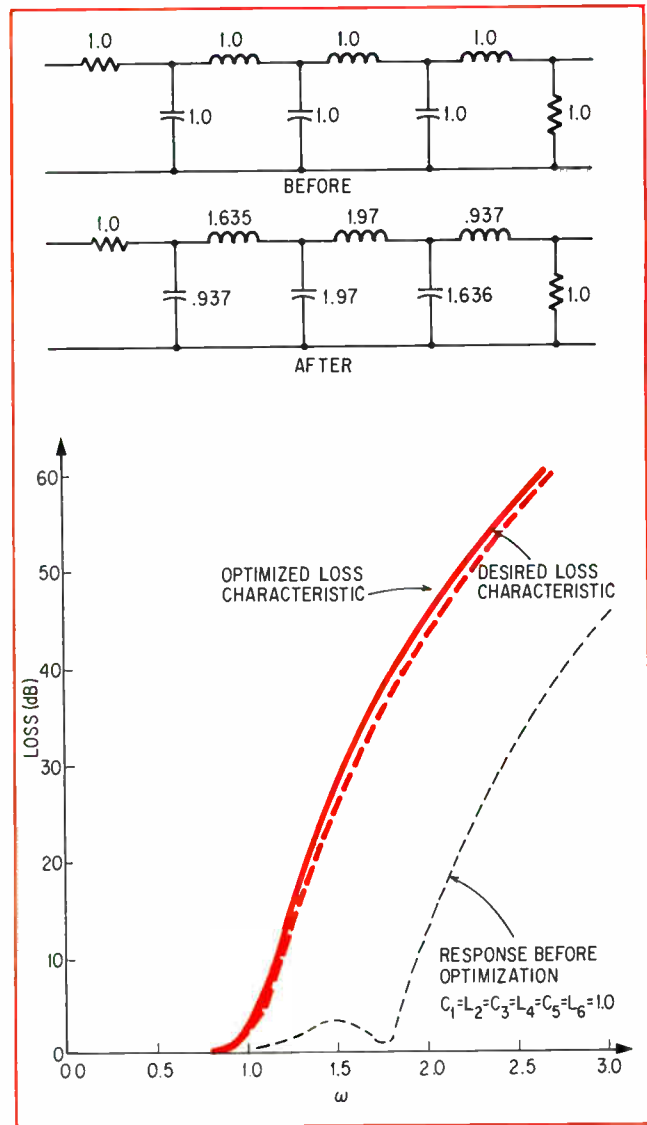

1. Match game. Optimization feature of Match can adjust unit-valued circuit elements in upper circuit to values necessary to meet desired loss characteristic.

if it appears the resultant fit is not good enough.

The variable elements chosen should be the ones to which the error measure is most sensitive. Often this is evident by inspection but if it isn't, error sensitivities can first be calculated with the program and the results used as a basis for choosing the variable elements.

The program sets the minimum and maximum values of the elements at half and twice the nominal values, respectively. But the user is free to expand or contract the range of variation for any element.

A geometrical representation aids understanding of the minimization procedure. If there are two variable parameters,  $X_1$  and  $X_2$ , with minimum and maximum values assigned to each, then the allowed range for the two parameters can be represented as an area in the  $X_1$ - $X_2$  plane, as in Fig. 3. For a three-parameter situation, the allowed range would be represented by

## What Match does

Match is an interactive frequency domain analysis and optimization program for lumped-constant, linear circuits. It's available nationwide through such time-sharing services as Com-Share Inc., P.O. Box 1588, Ann Arbor, Mich.; Applied Logic Corp., P.O. Box 124, One Palmer Square, Princeton, N.J.; and Multicomp Inc., 36 Washington Street, Wellesley Hills, Mass.

Beyond automatic variation of parameters to improve the circuit design and optimization the program's innovative features include:

- Exact group delay and sensitivity calculations
- Acceptance of empirical data
- Simulations and component tracking
- Frequency and impedance scaling
- Smith and expanded Smith Chart plotting
- Acceptance of tables for entering rational function data
- Analysis of large cascade circuits
- Calculation of any transfer ratio of the circuit
- Calculation of any Z, Y, G, H, ABCD, or scattering parameter
- Free-format input command language

a solid that was rectangular in its shape.

The minimum error measure could appear within this allowed space in a number of places, either at some internal point or on a boundary. There may even be more than one local minimum. The Fletcher-Powell algorithm used by Match finds one of the local minima. Thus in cases where the error measure has a single minimum within the allowed space, Match finds the absolute (or global) minimum. In cases where the error measure has several local minima, Match finds one of them. In any case, Match always improves circuit performance in that it reduces the error.

The minimization procedure works as follows: first the error measure is evaluated, and any data the user has requested are typed out. If the termination conditions are satisfied, the program stops. If not, the parameter values of the circuit are changed to reduce the error and the steps are repeated. In most applications, fewer than 50 iterations are needed to produce a good approximate minimum.

**The three conditions for termination are:** either arrival at a preset maximum number of iterations, or satisfaction of one or other of the two convergence criteria, or user intervention by means of a signal from the teletype.

The number of iterations that the program performs is controlled by the user. The adaptive nature of the Fletcher-Powell algorithm makes it desirable to iterate at least  $N$  times, where  $N$  is the number of variable parameters.

Match offers two convergence criteria—convergence of the error measure and convergence of the selected parameter values. If the error measure changes rapidly as the circuit parameters are varied, then the error convergence criterion is probably preferable. Here the user would instruct the program to stop if the percentage change in error is less than a small value,

**2. Step-by-step.** Optimization begins with two responses—desired and actual (A). Program takes discrepancies between them at specified test frequencies (B), multiplies each by weighting function (C), and raises each to some even power  $q$  (D). It then sums all of these to form an error measure, a single quantity that describes how closely desired and actual characteristics agree.

Program then acts to reduce error.

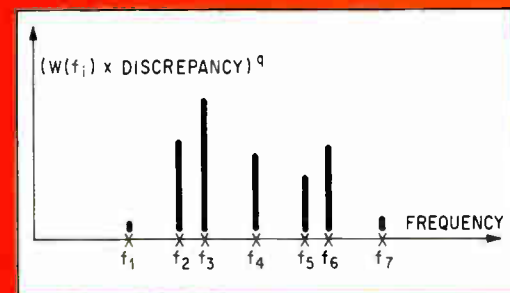
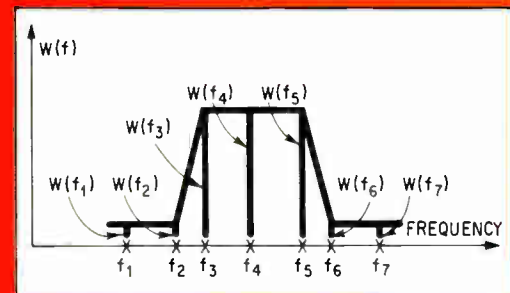
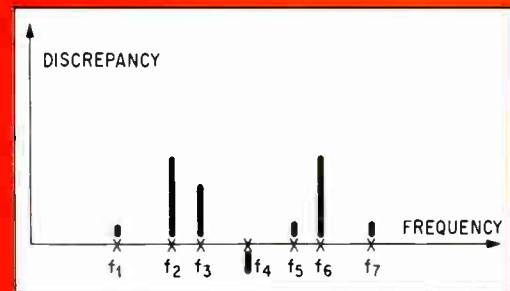
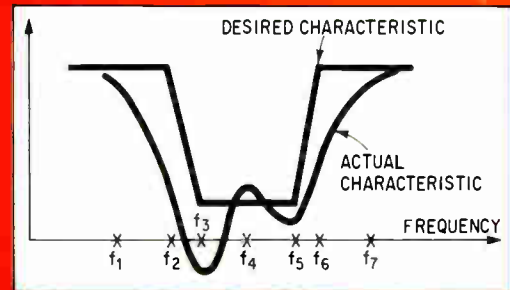

$c_e$  for each of  $m_e$  consecutive steps. But if the error changes slowly as the circuit parameters are varied, then the parameter convergence criterion is useful. Here the program stops if the maximum percentage change in all parameter values is less than  $c_p$  for each of  $m_p$  consecutive steps. This is particularly useful when a broad error minimum is found and further iterations do not change the parameter values very much.

**The final step** is to check the results to make sure that too wide spacing of frequency points has not resulted in unwanted narrow peaks where the actual characteristic deviates from the desired characteristic. In Fig. 4, for example, the fit is good at all test frequencies, but unacceptable bulges show up at the ends of the pass band. To trim up the response, the program can be run again with extra frequencies added at these points.

3. At a minimum. In area representing the allowed range of two typical parameter values  $X_1$  and  $X_2$ , minimum values of error measure may occur on the edge of the allowed area (A), at an interior point (B), or there may be several local minima with one absolute minimum (C). In the last case, the program will find only one of the local minima, which may not be the absolute minimum.

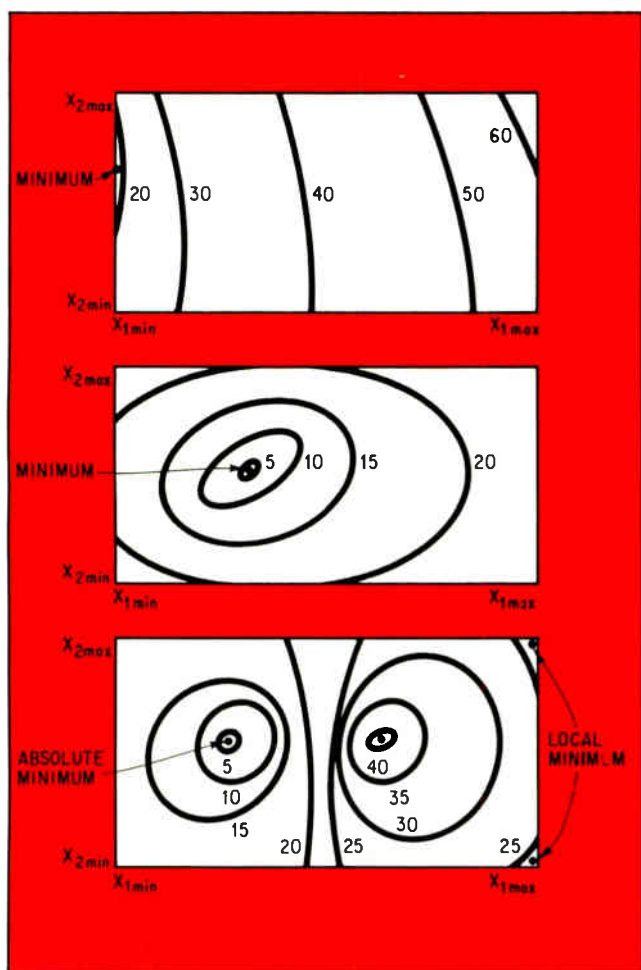

As an example of the use of optimization, consider a seventh-order Cauer low-pass filter designed with Match at Stanford Research Institute. Because it was a spacecraft application, size and weight restrictions required inductors with a Q of 15 at 1 kHz. Figure 5 shows the circuit with its initial values.

The first command sets the resistance units to kilohms (RUNIT 3) and capacitance units to nanofarads (CUNIT -9), while the inductance units are taken to be henries, since no other instructions are given:

```
COMMAND? SET RUNIT 3 CUNIT -9
```

The next set of commands describes the circuit as a cascade of L sections (EL) with the series branch described first, and then the shunt branch. Parallel combinations are denoted by P. Each section is numbered (S1, S2, etc.).

```
COMMAND? CA S1 EL RS 8.2, C1 22.164
```

```
COMMAND? CA S2 EL C2 P L2 1.1048 1.3306, C3 31.956
```

```
COMMAND? CA S3 EL C4 P L4 5.2799 1.1690, C5 30.121
```

```
COMMAND? CA S4 EL C6 P L6 3.6995 1.1621, C7 P RL 19.893 8.2
```

The next command establishes two sets of frequencies, one in the pass band and one in the stop band. The passband frequencies step up linearly between 25 and 1,250 Hz, with 12.5 Hz increments. The stop-band frequencies step up logarithmically between 1,100 and 10,000 Hz, with each frequency larger than the previous one by a factor of 1.03.

```
COMMAND? SET BPASS LIN 25 1260 12.5 BSTOP LOG 1100 10000 1.03
```

The next command is to store the lossless response (gain from port 1 to 2, G21) in the passband in a table called TPASS and the stopband response in BSTOP:

```
COMMAND? SAVE G21 IN TPASS ON BPASS NOW G21 IN TSTOP ON BSTOP NOW
```

The next command tells Match to plot all curves using the same scale (SET ONE SC 1) and to store the complete lossless problem description (FILE EM):

```
COMMAND? SET ONESC 1 FILE EM
```

The Qs of all the inductors are then set to 15, measured at 1,000 Hz:

```
COMMAND? SET Q:GL15 QF:GL 1000
```

Then the computer is instructed to plot, in the band-pass region, both the lossless response (saved in TPASS) as determined from a filter handbook and the response of the filter with the finite Q (L OF G21). Note that G21 now becomes the response with losses. The computer print-out is shown in Fig. 6.

```
COMMAND? PLOT L OF G21 AND L OF TPASS ON BPASS NOW
```

The same is done for the bandstop region, as in Fig. 6.

```
COMMAND? PLOT L OF STOP AND L OF G21 ON BSTOP NOW
```

Now the user instructs the computer to get back to the original, infinite Q design, previously filed (FILE EM) in preparation for the optimization procedure.

```
COMMAND? READ EM
```

In Fig. 7, note that the user has identified 11 frequencies at which the program will be instructed to

perform the match. The 11 frequencies then are entered.

```
COMMAND? SET BGOAL 11
? 10 310 600 840 1025 1150 1225 1250 2160 3000
10000
```

Next the specification characteristic which will be matched is entered as that of the original infinite Q circuit.

```
COMMAND? SAVE G21 IN TGOAL ON BGOAL NOW
```

Error weights then are entered, with passband errors, between 0 and 1,250 Hz, weighted 80 times, and with the stopband errors weighted as one.

```
COMMAND? SET ERRWGT R 4 0 80 1250 80 2160
1 10000 1
```

A set of auxiliary variables called user parameters (PAR) are then defined. Capacitors  $C_1$ ,  $C_3$ ,  $C_5$ , and  $C_7$ , and  $R_1$ , are each normalized to themselves (a value of 1 for each gives the original values in Fig. 5). The combinations of  $C_2-L_2$ ,  $C_4-L_4$ , and  $C_6-L_6$  are to be controlled in impedance, so that each capacitor is multiplied and each inductance is divided by the same

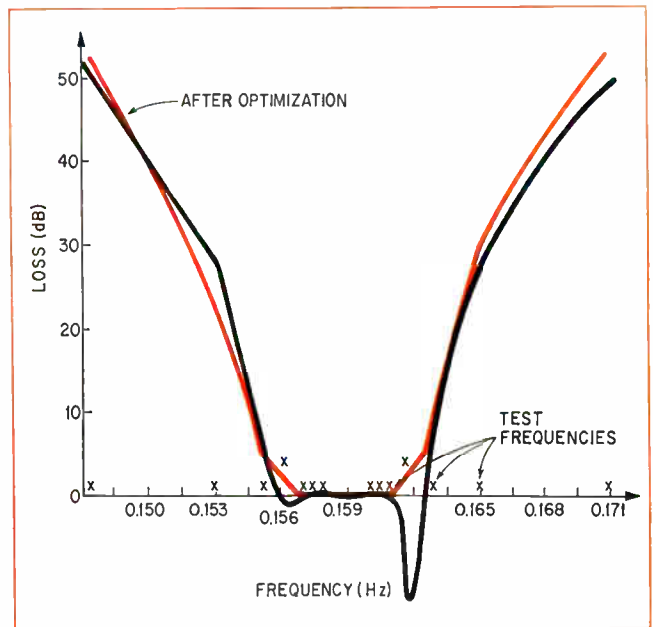

## Putting optimization to work

Optimization, in addition to its utility as a synthesis tool, can also be applied to the correction of parasitics, phase equalization and modeling of two-terminal devices.

Parasitics often cause a filter constructed from handbook information to degrade from the handbook designs. But if the designer can estimate the parasitics, optimization can help him adjust the nominal component values to yield a closer approximation of the handbook response.

The circuit of Fig. A is a low-pass filter taken directly from a handbook. When parasitic losses in the inductors are included, the response is degraded. However, optimization with the circuit parameters shown restores the desired behavior almost perfectly.

Many systems require phase equalization, since they distort the phase characteristics of the signals which they transmit. A common procedure consists of placing one or more all-pass sections in cascade with the system shown in Fig. B. The parameters of the all-pass sections then are adjusted so as to make the phase of the aggregate system equal to some desired phase characteristic.

For example, the circuit to the left of the dashed line is a fifth-order Chebyshev filter taken directly from a handbook. The sections to the right of the dashed line are phase equalization sections; the element values of the sections were first computed by hand, and then the element values of the equalizing section were adjusted by Match to make the phase as linear as possible. The resultant element values are shown, with the associated delay characteristic.

Still another use is in device modeling, where the program can calculate the equivalent circuit parameters that most closely match the measured device characteristics. One such example is shown in Fig. c, where a microwave diode's equivalent circuit is adjusted to match the measured values of the real and imaginary parts of its input admittance.

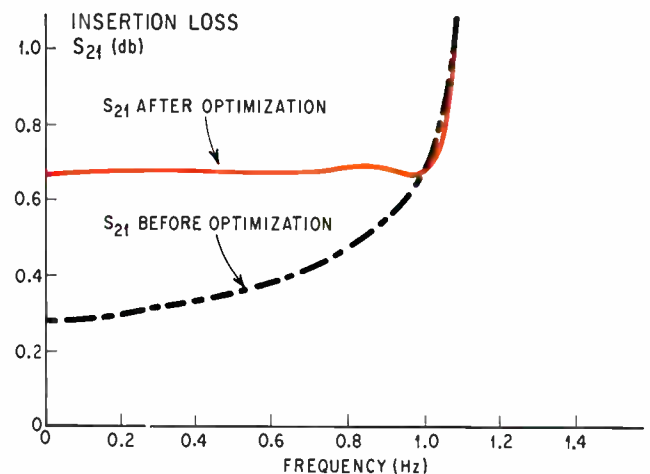
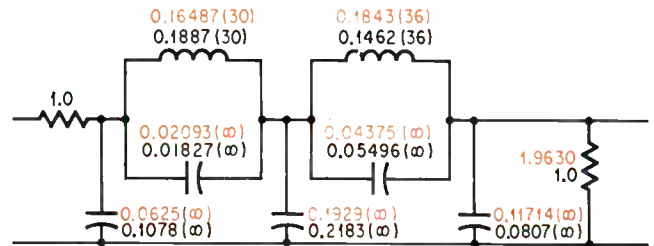

A. Accounting for parasitics. Chebyshev filter design was taken from handbook, but because of parasitics its response is degraded. Accounting for the dissipation and with the optimization option, circuit elements are adjusted to new values, shown in color.



4. Final check. After optimization run, bulges in the fit between actual and desired characteristics which sometimes appear between the selected test frequencies can be eliminated. This is done by running through optimization procedure with added frequencies at points of anomaly to bring them into line.

5. Practical example. Seventh-order Cauer low-pass filter designed with Match at Stanford Research Institute. Initial values of the circuit elements before the optimization procedure are shown.

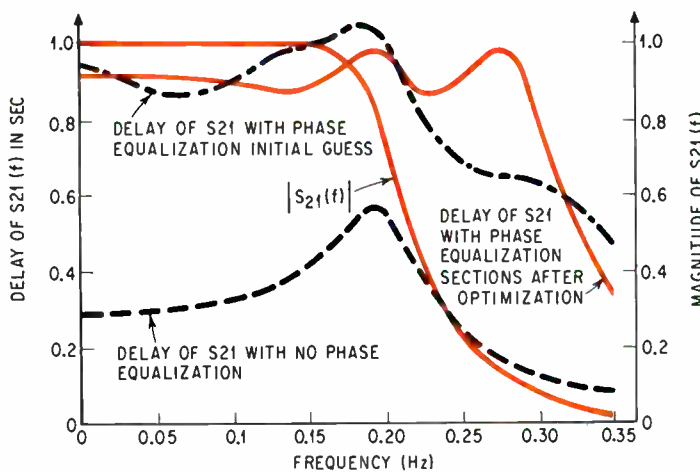
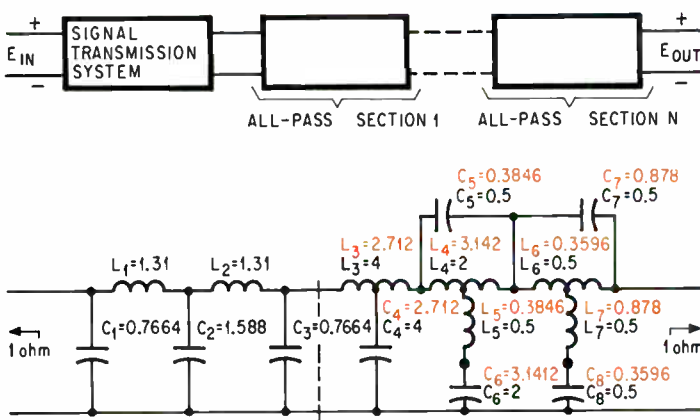
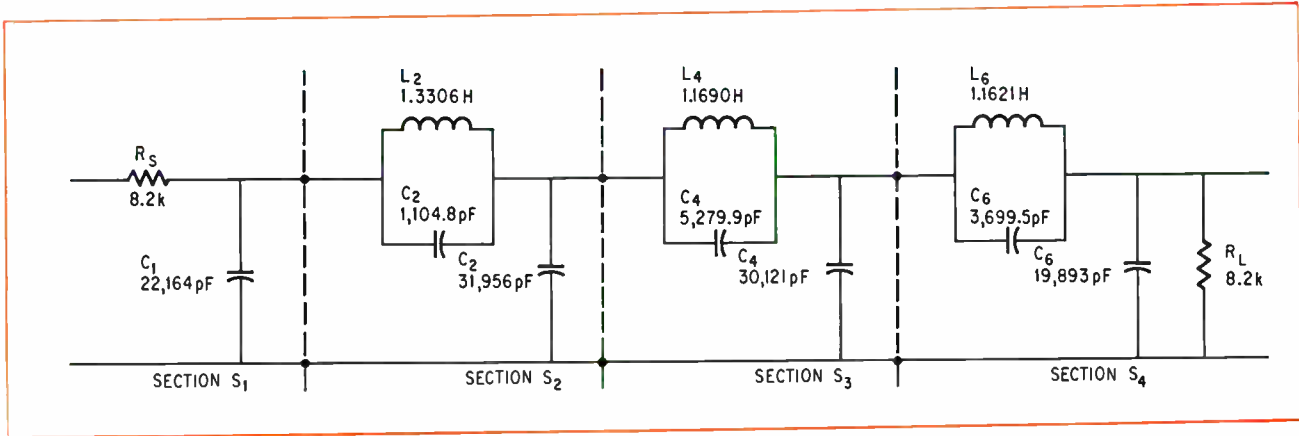

B. Phase correction. The Chebyshev filter to left of dashed line is connected to all-pass network with values calculated by hand for first try. Optimization option adjusts all-pass section's element values, shown in color, to give a flatter delay characteristic in the passband.

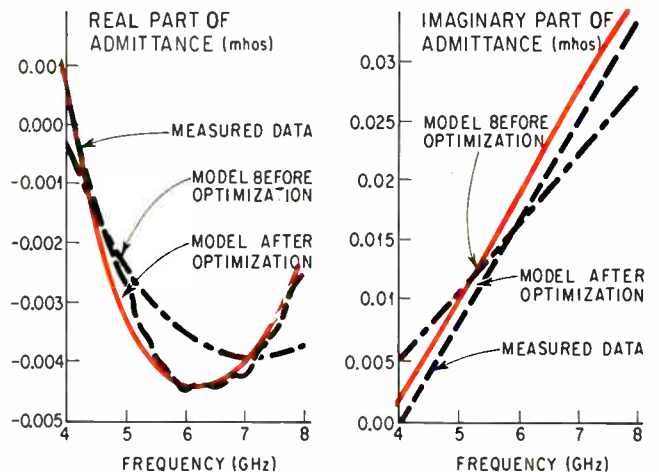
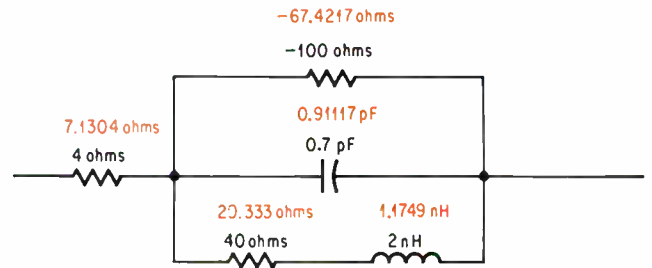

C. Device model. Equivalent circuit of microwave diode is shown with approximate values before optimization. Match readjusts the element values, shown in color, so that the equivalent circuit more nearly corresponds to the actual measured admittance of the diode.

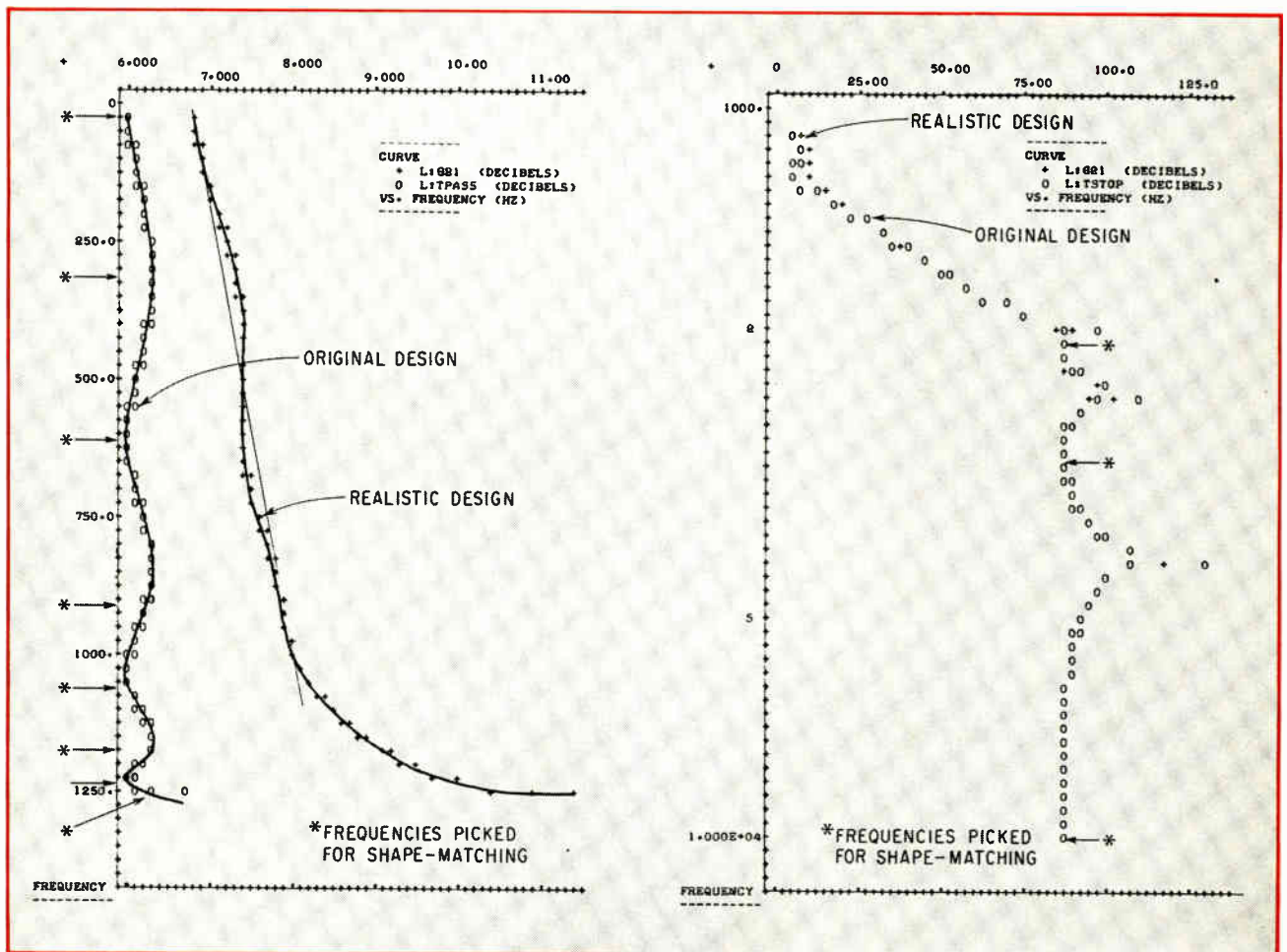

6. Before optimization. Passband and stop-band response of filter in Fig. 5 are plotted by the computer. Response with handbook-selected, infinite-Q parts and response with inductor Qs of 15 at 1 kHz are plotted. The frequencies chosen for matching are marked by asterisks:

amount. This keeps the attenuation poles fixed.

```

COMMAND? PAR PC1 MULT 1 C1 PC3 MULT 1 C3
PC5 MULT 1 C5 ?PC7 MULT 1 C7 PRL MULT 1
RL PZ2 MULT 1 C2 DIV 1 L2
COMMAND? PZ4 MULT 1 C4 DIV 1 L4 PZ6 MULT 1
C6 DIV 1 L6

```

The command for variation of the eight user parameters is then defined, but not yet executed:

```

COMMAND? SET G VARY 8 PC1 PC3 PC5 PC7 PRL
PZ2 PZ4 PZ6

```

Next, the circuit elements are set with finite Q and the normalization frequency is set to 1,250 Hz (this is the frequency at which the gain will be matched for this attenuation-shape optimization problem):

```

COMMAND? SET Q:GL 15 QF:GL 1000 NF 1250

```

The attenuation shape option then is called out for the BGOAL frequencies:

```

COMMAND? MATCH RLOSS OF G21 TO TGOAL
ON BGOAL

```

The first command to vary parameters is to vary the user parameter for the load resistance (this will be a first try, varying only the load resistor):

```

COMMAND? VARY 1 PRL

```

Then an automatic stop criterion is entered if the

error is under 1% for two passes:

```

COMMAND? STOP IF ERRC UNDER 1 PC FOR 2

```

The user parameter boundaries then are fixed.

```

COMMAND? SET MIN:CP .01 MAX:CP 100

```

The computer then is commanded to go ahead and vary the load resistor:

```

COMMAND? COFOR 1 NOW

```

After running through the optimization routine, the computer prints out the results for the error weight.

```

INITIAL ERROR = 367859.1

```

```

PRL = 1.000000

```

```

AFTER 1 ITERATIONS ERROR = 38558.66

```

```

PRL = 100.0000

```

Note that the error has been reduced by an order of magnitude with just one iteration, which involved changing the user parameter PRL from 1 to 100, the maximum value.

The computer now is instructed to vary all the user parameters in 50 iterations typing out results after every fourth iteration:

```

COMMAND? VARY G VARY TYPE NONE EVERY 4 GO
FOR 50 NOW

```

However, after only 20 iterations, the automatic

**ERROR FUNCTION:**  $[(\text{DESIRED}-\text{ACTUAL}); \times \text{WEIGHT}_i]^2$

|    | FREQUENCY (HZ) | ABS ERROR (DECIBELS) | ERROR TERM |
|----|----------------|----------------------|------------|
| 1  | 10.000         | .00010227            | 6.6944E-05 |
| 2  | 310.00         | -.00022097           | .00031248  |
| 3  | 600.00         | .00020917            | .00028001  |
| 4  | 840.00         | -.00023696           | .00035935  |
| 5  | 1025.0         | .00023557            | .00035515  |
| 6  | 1150.0         | -.00025979           | .00043194  |
| 7  | 1225.0         | .00023998            | .00036859  |
| 8  | 1250.0         | 0                    | 0          |
| 9  | 2160.0         | .32715               | .10703     |
| 10 | 3000.0         | .018550              | .00034412  |
| 11 | 10000.         | -.0083517            | 6.9750E-05 |

**ERROR FUNCTION = .10961813**

**ERROR FUNCTION DERIVATIVES:**

| WRT | DERIVATIVE |
|-----|------------|
| PC1 | -.076463   |
| PC3 | -.093354   |
| PC5 | -.10727    |
| PC7 | -.98146    |
| PRL | 8.0057E-05 |
| PZ2 | .058564    |
| PZ4 | -.078568   |
| PZ6 | 1.1926     |

7. Table of errors. Computer prints out results of optimization run, listing test frequencies, absolute errors, and weighted errors (error term). Error function is sum of weighted errors. Also tabulated are error function derivatives, describing the slope of the variation curve for each parameter, which are useful in further tuning the circuit.

stop is actuated. Note that the error has been reduced by more than six orders of magnitude.

```
INITIAL ERROR = 38558.66
AFTER 4 ITERATIONS ERROR = 19626.63
AFTER 8 ITERATIONS ERROR = 3095.860
AFTER 12 ITERATIONS ERROR = 110.3644
AFTER 16 ITERATIONS ERROR = .5410678
ITERATION CONVERGED.
AFTER 20 ITERATIONS ERROR = .1096181
```

The computer then is commanded to list all the errors at each selected frequency (BGOAL), as in Fig. 7.

COMMAND? LIST ERRS

Both the absolute error and the weighted error are tabulated (recall that errors in the pass band were judged to be 80 times more important than those in the stop band). The error terms are summed to form the error function, .10961813, which is the number that Match tries to reduce. Note in Fig. 8 that the error is zero at the normalization frequency, 1,250 Hz. In addition, there is a plot of gradient information for each user parameter; this information is useful in further tuning the circuit on the bench.

After this, the computer is instructed to plot the results of the optimization in the pass band, as in Fig. 8:

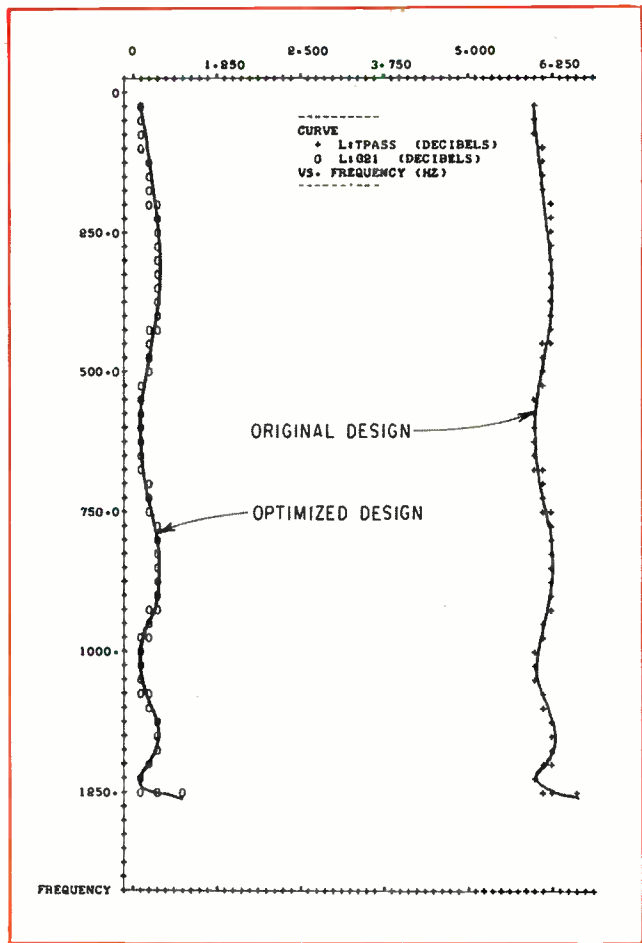

8. Close enough? Results of optimization run show that shape of optimized design closely parallels desired characteristic, differing only by additive constant. The program's relative loss option was used here, since response shape was judged more important than absolute loss.

COMMAND? PLOT L OF TPASS AND L OF G21 ON BPASS NOW

Finally, the user parameters are converted back to actual component values:

COMMAND? UPDAT GP LIST VAL:GC VAL:GL RL VAL:GC

```
C1 =12.416 NF
C2 =.94282 NF
C3 =23.201 NF
C4 =3.7473 NF
C5 =21.024 NF
C6 =2.3357 NF
C7 =13.456 NF
```

VAL:GL

```
L2 =1.5592 H
L4 =1.6471 H
L6 =1.8407 H
RL =752.42 K OHM
```

**Reference:**

1. R. Fletcher, M.J.D. Powell, "A Rapidly Convergent Descent Method for Minimization", The Computer Journal, 1963, pp. 163-168.

# Designer's casebook

## Wired OR circuit simplifies binary number comparison

By Louis E. Frenzel Jr.  
Silver Spring, Maryland

Comparing two multibit binary numbers in a wired OR circuit is both simpler and less expensive than the more common approach of using several exclusive NOR circuits and a NAND gate. The simpler version offers up to a 50% reduction in package count, while the fewer number of gates used improves speed.

The wired OR circuit is basically equivalent to available four-bit medium-scale integrated comparators, but substantially less expensive. A pair of quad two-input NAND gates, such as the 946 (DTL) or the 7401 (TTL), can replace a single package four-bit MSI com-

parator circuit at less than one-third of its cost.

The circuit operation can be seen by analyzing the related Boolean equations to compare two four-bit numbers, A and B.

$$\text{Equality} = E = (A_1B_1 + \bar{A}_1\bar{B}_1) (A_2B_2 + \bar{A}_2\bar{B}_2) (A_3B_3 + \bar{A}_3\bar{B}_3) (A_4B_4 + \bar{A}_4\bar{B}_4)$$

Complementing both sides of the equation, then reducing it with DeMorgan's theorem yields:

$$\bar{E} = \overline{(A_1B_1 + \bar{A}_1\bar{B}_1) (A_2B_2 + \bar{A}_2\bar{B}_2) (A_3B_3 + \bar{A}_3\bar{B}_3) (A_4B_4 + \bar{A}_4\bar{B}_4)}$$

Since  $AB + \bar{A}\bar{B} = \bar{A}B + A\bar{B}$ , the equation becomes:

$$\bar{E} = \bar{A}_1B_1 + A_1\bar{B}_1 + \bar{A}_2B_2 + A_2\bar{B}_2 + \bar{A}_3B_3 + A_3\bar{B}_3 + \bar{A}_4B_4 + A_4\bar{B}_4$$

Again, complementing both sides of the equation expresses the output of the wired OR circuit:

$$E = \overline{\bar{A}_1B_1 + A_1\bar{B}_1 + \bar{A}_2B_2 + A_2\bar{B}_2 + \bar{A}_3B_3 + A_3\bar{B}_3 + \bar{A}_4B_4 + A_4\bar{B}_4}$$

Logically better. Commonly used circuit (left) requires substantially more gates to compare two multibit binary numbers than does the wired OR circuit (right). Latter configuration is faster than the exclusive NOR approach and can be constructed of two quad two-input gates, such as the 946 (DTL) or the 7401 (TTL).

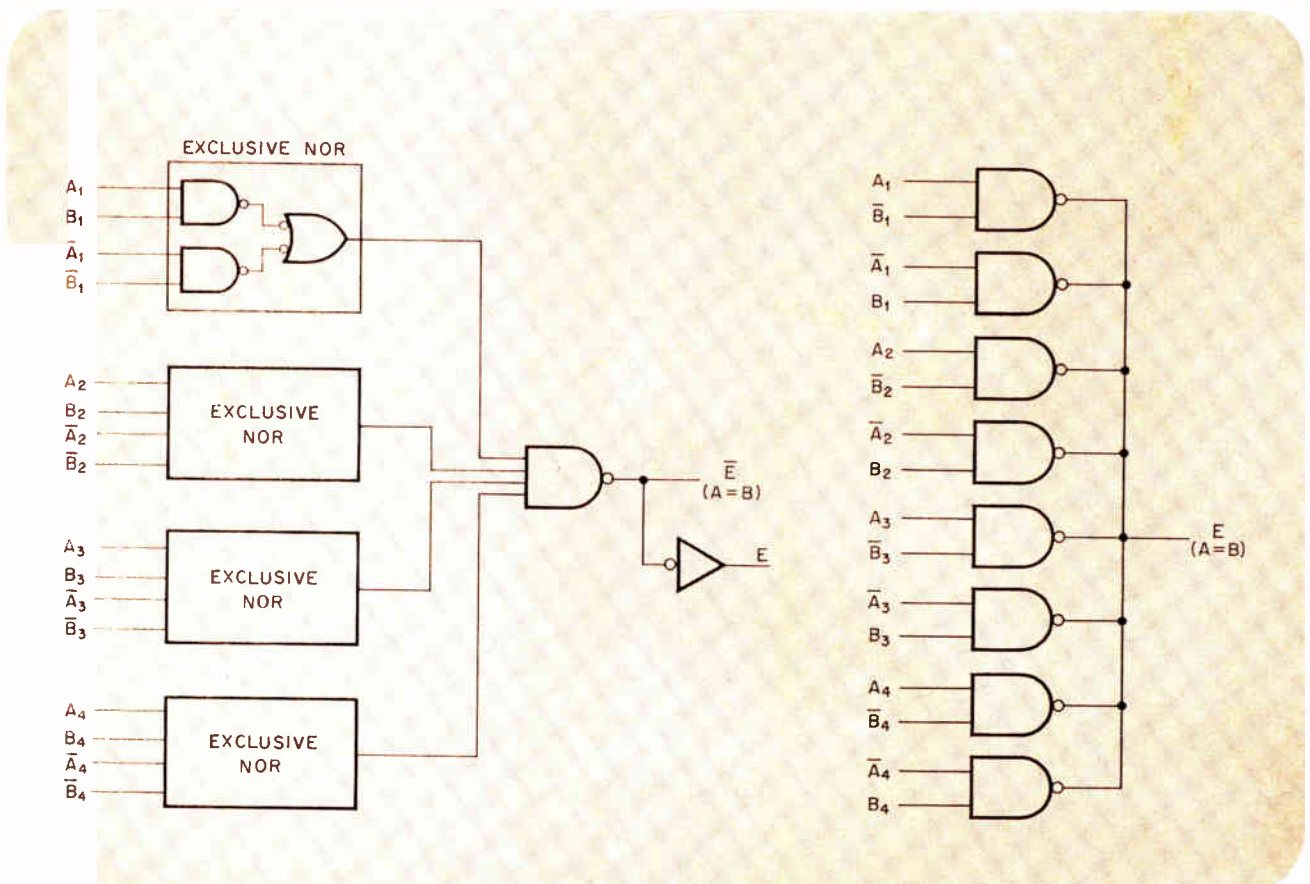

# IC limiter preserves phase over 50-dB dynamic range

By Roland J. Turner  
 RCA Missile and Surface Radar division, Moorestown, N.J.

Operation of frequency- and phase-modulated systems will be impaired by any phase shift in the processing circuitry. For example, serious errors will occur if the phase shift in the limiter circuit used with composite video, or zero crossing detectors changed with either the amplitude or frequency of the incoming signal. In addition, double-sideband systems generally require accurate phase references that must be sup-

plied in quadrature for both the modulation and demodulation sections. The limiter circuit provides symmetrical complementary outputs that are in phase quadrature with the input signal over 50-dB dynamic range. Using two inexpensive ICs the limiter generates a 15-V peak-to-peak signal that lags the input signal by 90°, and remains in quadrature within  $\pm 0.5^\circ$ .

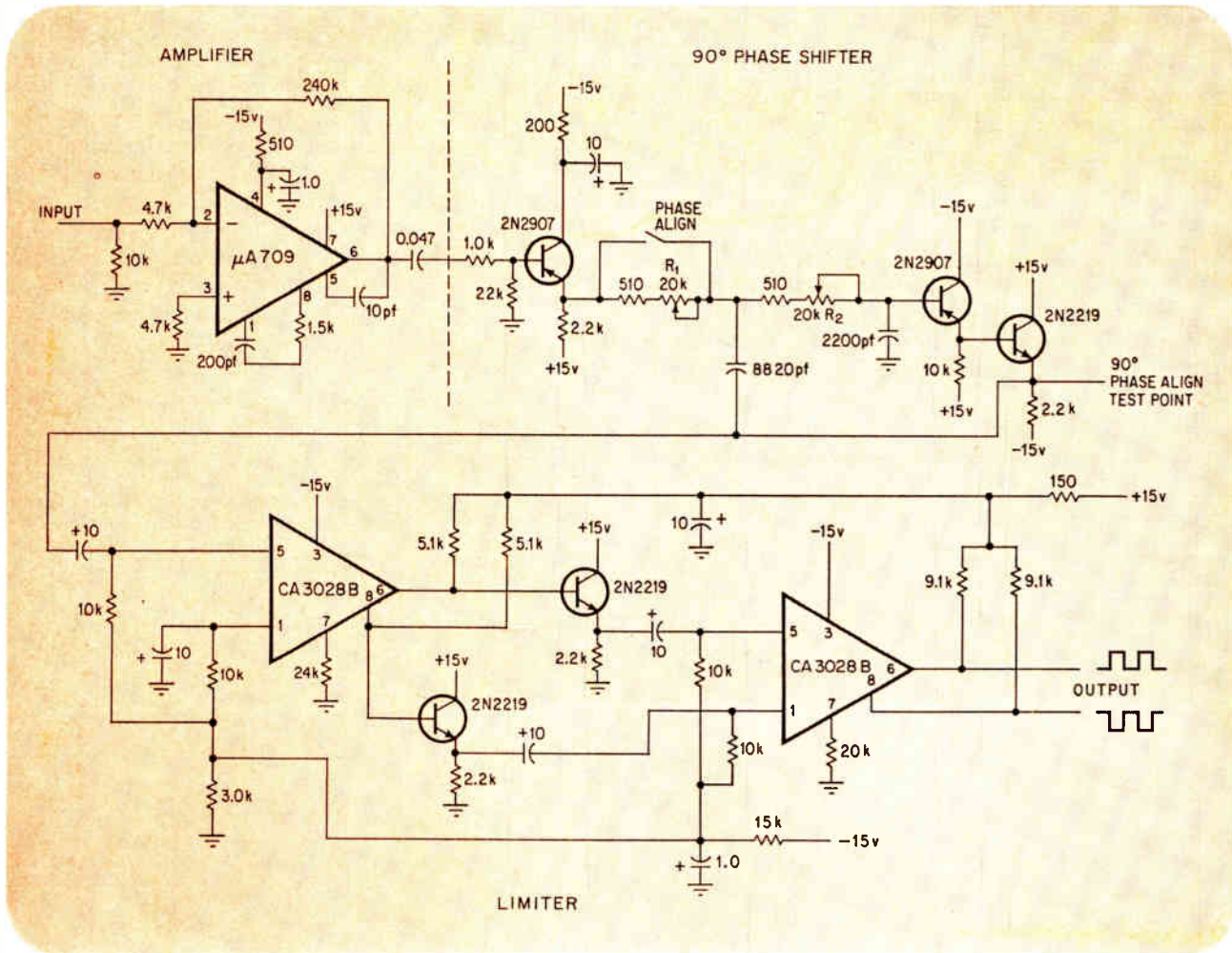

plied in quadrature for both the modulation and demodulation sections.

Two inexpensive integrated circuits can be used to build a circuit that provides two limited complementary outputs (each in phase quadrature with the input signal) that track the phase to the input signal to within  $\pm 0.5^\circ$ . The circuit is insensitive to changes in input signal amplitude from 0.5 to 100 millivolts peak-to-peak and provides a limited output swing of 15 volts peak-to-peak between 2 and 60 kilohertz.

This circuit, in addition to limiting the signal with little phase error, provides a quadrature phase shift essential in operating a conventional phase

detector. It also provides complementary output signals required to drive MOSFET switches in a balanced phase detector. Moreover, its symmetrical outputs prevent generation of unwanted dc and video pedestals in the phase-detector output.

The complete circuit comprises an operational amplifier, a 90° phase shifter, and the limiter. Although the amplifier design is straightforward, the method used to obtain the 90° phase shift isn't.

The phase shifter stage employs an active low-pass filter with a Chebyshev response. This provides a 90° phase shift at the corner frequency where the amplitude response is unity, a feature unattainable

with a two-pole resistive-capacitive passive network. Adjustment of  $R_1$  and  $R_2$  yields a  $90^\circ$  phase shift for any corner frequency between 2 and 60 kHz.

The limiter uses two RCA CA3028B differential amplifiers. To achieve symmetrical limiting over a wide dynamic range the dc path from pins 1 and 5

must be equal and must return to the same bias supply. The limiter stages must be driven from a low source resistance, such as an emitter follower. Lower phase distortion also is obtained if the CA3028Bs are operated from a 1.0- to 1.25-milliamperere current source.

## Optoelectronic switch monitors line power

By James van Zee,  
Harvard University, Cambridge, Mass.

A simple optoelectronic switch can be used to detect a power-supply failure and relay the message to a digital shut-down circuit. The switch's low-level logic circuit is completely isolated from the power mains by optical coupling. What's more, it's inexpensive—total parts for the circuit shown cost about \$7—and is easily adapted to monitor any ac or dc supply. This version plugs into 110-volt or 220-volt ac lines, depending on the size of series resistor  $R_1$ .

When line power is normal, the diode rectifier and capacitor  $C_1$  provide the minimum current of about 200 microamperes required to keep the light-emitting diode lit. In turn, the LED holds phototransistor  $Q_1$

in saturation, so that the output is a logical 1. If the line voltage goes down,  $Q_1$  switches off; the output pair  $Q_2$ - $Q_3$  drops the output level to logical 0 (ground), setting flip-flops in a shut-down circuit.

Response to a power failure typically is within 2 milliseconds, fast enough for shutdown. The circuit is insensitive to normal zero crossings of the ac voltage. The capacitor,  $C_1$ , supplies enough current to let the LED keep  $Q_1$  on during these few milliseconds.

However, response time varies somewhat with the dc current gain of  $Q_1$ . A device with a more tightly specified current gain than the switch shown should be used in applications where operating temperature will vary widely. Also, shutdown logic, such as some TTL circuits, may ring if the output transitions are not shaped. Capacitor  $C_2$  prevents this.

The large series resistance allows use of inexpensive, low-voltage diodes in the input circuit. Total circuit power consumption is about 50 milliwatts.

Designer's casebook is a regular feature in Electronics. Readers are invited to submit novel circuit ideas and solutions to design problems. Descriptions should be brief. We'll pay \$50 for each item published.

**Optoelectronic plug.** Low-level logic monitors power failures through phototransistor  $Q_1$ . As long as line power is normal, the light-emitting diode saturates  $Q_1$ , which holds the output at logical 1. A power failure turns off the optoelectronic switch, causing the output to drop to the logical 0 level.

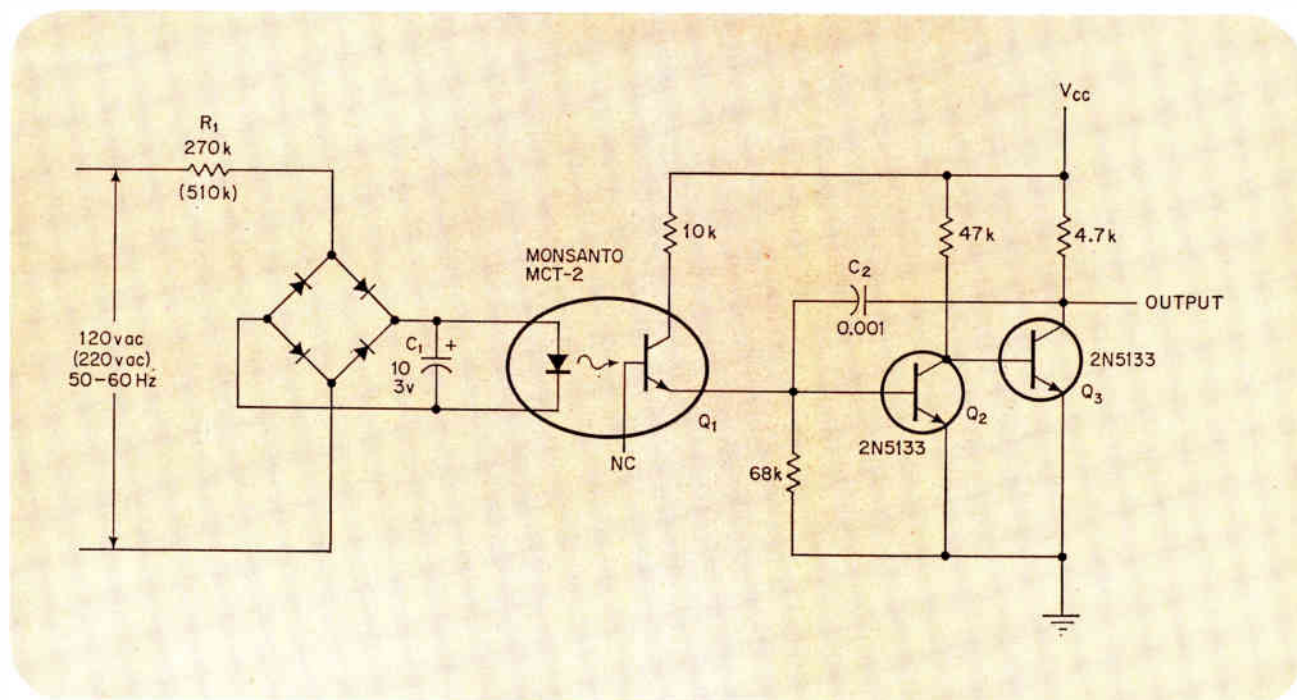

# Philips dual beam 3231 at Teradyne...

**"Its simplicity  
simplifies our work."**

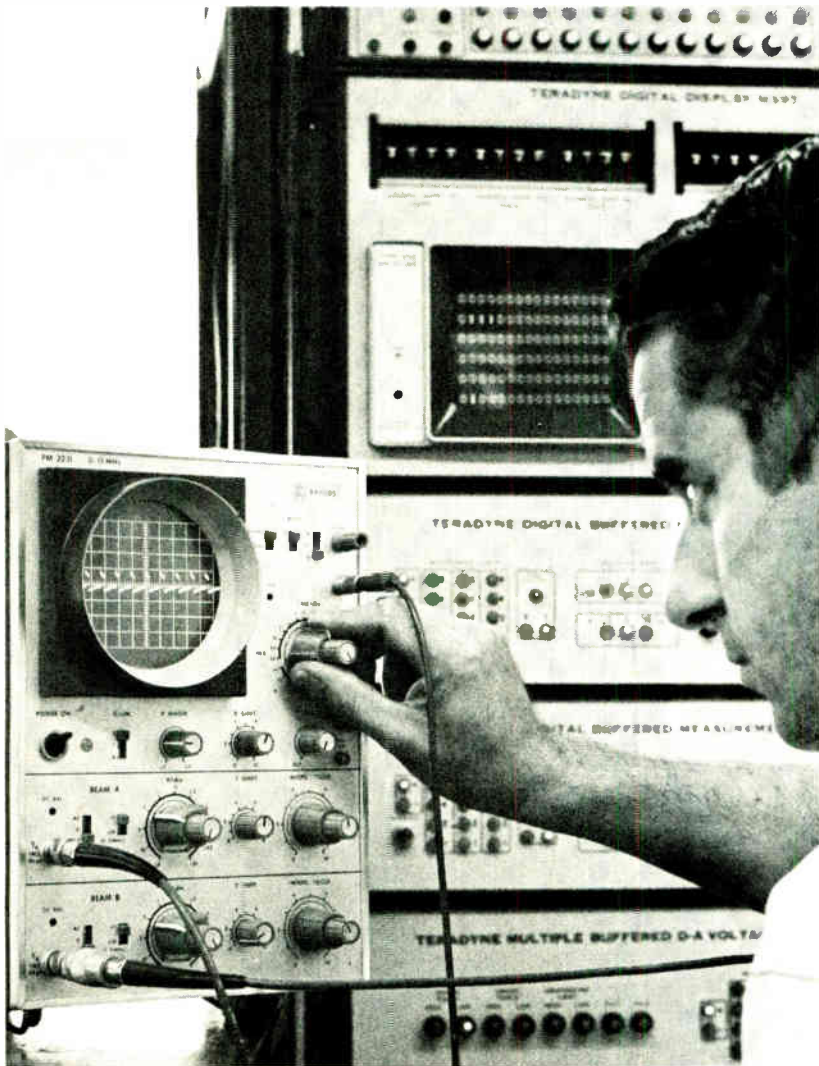

## International Search for Scope for The SLOT Machine

Teradyne's international scope search for an *industrial* scope to final check The SLOT Machine proved the Philips 3231 15 MHz/10mV (5MHz/1mV) dual beam scope the "easiest to own, the easiest to work, and with the best rise-time per dollar."

## Teradyne's SLOT Machine's one week test

Teradyne's systems for sequential logic testing see a week or more of stringent checkout before shipping to manufacturers who use them for high-speed production-line tests of complex IC's. Teradyne has to assure that leading edges of logic pulses are fast and straight but not so fast as to cause crosstalk and oscillations in the system.

## T1... T2, T3

Because its high speed response (together with simple delay line to catch a leading edge) spots overshoots and crosstalk, and because the dual beam function makes logic chain comparisons a cinch, Philips PM 3231 does daily engineering duty for every SLOT Machine that Teradyne ships. What can Philips do for you in logic testing — in pre-shipment test, research or in production? Teradyne liked our industrial no-tricky-business approach. Perhaps you will too — give us a call and see: 914-664-4500. Ask for Dick Rude, National Sales Manager, Test & Measuring Equipment.

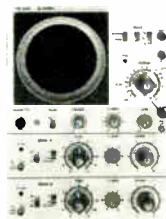

PM 3231  
15 MHz/10mV  
Two gun crt

**\$1050**

**PHILIPS  
ELECTRONIC  
INSTRUMENTS**

750 S FULTON AVE. MT. VERNON, N.Y. 10550  
A DIVISION OF PEPI, INC.



Best friend? The diamond scribe, still the most widely used tool for separating semiconductor chips, is starting to give way to other machines. Scribe-and-break yields typically are 70% to 90%. Chief problem, say most users, is that microcracks radiate out and down from the half-mil-deep scribe line, reaching into the active areas of a die, possibly causing further fracture and failure later in temperature cycling.

# Diamond scribes start to give way to laser machines, slurry saws, new etch methods

Semiconductor manufacturers explore new wafer-cutting techniques in effort to achieve nearly perfect chip yields in the critical scribe-and-break stage

By Lawrence Curran, *Los Angeles bureau manager*

□ To boost chip yields to the 95%-or-better range in the critical scribe-and-break stage of production, semiconductor manufacturers are beginning to explore new wafer-cutting techniques. As a result, diamond scribes are starting to lose their near-monopoly to laser scribes, slurry cutters, wire-and-slurry saws, and new variations of the etch-cutting process.

The venerable diamond scribe offers yields that range between 70% and 90%, but the highly competitive semiconductor firms feel they must shoot for better percentages. This is especially important in the scribe-and-break stage. The manufacturers have invested most of their time and money in the wafer by the time it's broken up into individual chips; rejects hurt more than they do earlier in production.

Laser techniques have been getting plenty of attention since Motorola's Semiconductor Products division conferred production status on laser scribing of silicon wafers on a high-volume zener diode line [*Electronics*, Oct. 12, p. 34]. And other large firms are sure to follow. Officials at Quantronix Corp., Smithville, N.Y., who sold Motorola their first production laser scribe, report that Texas Instruments, Signetics Corp., and RCA are all evaluating the technique. And North American Rockwell Microelectronics Co. has been laser scribing beam-lead MOS/LSI wafers on a medium-volume production line for some months [*Electronics*, Aug. 31, p. 37] using an in-house-built machine. Western Electric also is evaluating a laser system at its Allentown, Pa. facility.

But laser scribing probably won't become universal. The high initial cost of the equipment (\$55,000 for the Quantronix model 601 Laserscribe) will hold most of the smaller semiconductor houses to the diamond



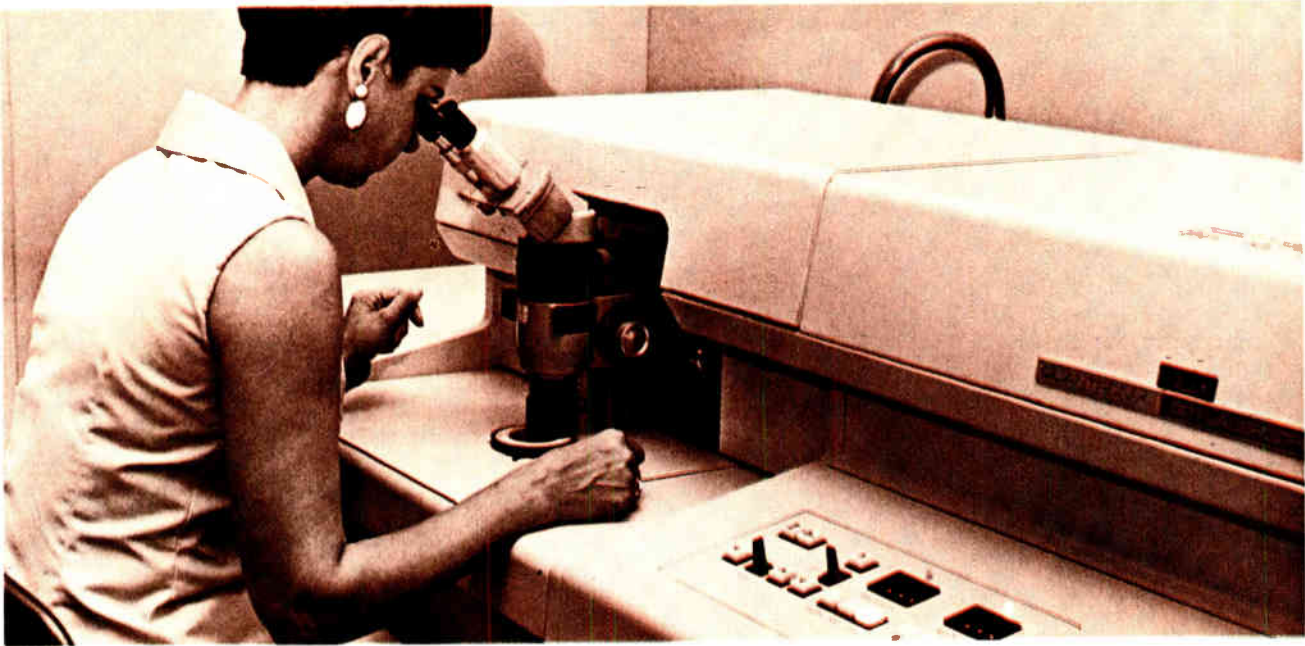

**Zap and snap.** The laser scriber, Quantronix Corp.'s 601, cuts a one-to-two-mil-deep line that users say gives them a cleaner break than does the diamond scriber; yields in the scribe-and-break operation are 95%. Quantronix machine costs \$55,000, compared with about \$4,000 to \$8,000 for diamond scribers. But Motorola's Semiconductor Products division is replacing all four diamond scribers on its zener diode production line with one of the Quantronix machines, figuring to offset higher price with increased yields.

tool. And lasers won't work for some semiconductor houses because their wafers are too thick, or because they're looking for a one-step chip-separation technique to replace the two-step scribe-and-break operation still required with laser dicers.

What's more, diamond scribing may have a good deal more yield potential; in fact, carefully controlled experiments have resulted in 98% to 100% yields (see panel, p. 72). And manufacturers of diamond equipment are critical of lasers. Frank L. Christensen, president of Tempres Industries Inc., in Los Gatos, Calif., the leading supplier of diamond scribers, says: "We have explored lasers, and my view is that although they have a greater depth of penetration and maybe a higher yield than diamond scribers, it's still a process of scribe and break," implying that the better laser scribing yields might be compromised in the breaking operation. Christensen also maintains laser kerfs, or cuts, are wider than the typical diamond cuts, wasting silicon, and that the laser can cause heat damage to devices.

**Motorola's contention** is that it might be able to pay for its Quantronix laser scriber in a year or less because of higher yields. Christensen points out, though, that both Motorola and National Semiconductor Corp. in Santa Clara, Calif., are getting clean-cut chips "with edges that look like they've been sawed" using a Tempres diamond scriber.

However, Christensen isn't beating the drums for diamond scribing, either. "Neither lasers nor diamonds are the answer," he asserts. His emphasis on the breaking operation suggest Tempres may have a one-step chip-separation technique already under development.

The Quantronix Model 601 Laserscribe appears to have overcome most of the criticism usually leveled at laser scribing of silicon wafers. Critics frequently cited the high cost of the equipment, splattering of silicon over active areas, undue heating of areas adjacent to the kerf, and inability to control its depth and width. These drawbacks were common in early attempts to put together in the lab individual, commercially available components, including the lasers themselves, X-Y positioning tables, and optics.

Motorola's Semiconductor Products division evaluated the Quantronix approach for well over a year before deciding to buy. The machine went to work on the zener diode production line last July, and eventually will replace all four diamond scribers on that line, says Ronald L. Roberts, manager of material processing for zener diodes. He says the Quantronix machine is being used on one shift, scribing about 2 mils deep into an 8-mil-thick wafer on dice ranging from 25 to 150 mils square.

The model 601 Laserscribe uses a high-intensity laser beam to vaporize a narrow kerf in the wafer surface. The kerf is formed by overlapping pulses of radiation from a neodymium-doped YAC laser. Control is by an acousto-optical Q switch that permits from 1,000 to 8,000 pulses per second to strike almost on top of each other. At a table speed of 2 inches per second, the zone affected by each short pulse is only 2 mils. The Q-switched laser, 4-by-4-inch precision two-axis table, viewing and focusing optics, electronic subsystems, auxiliary cooling and vacuum equipment all are housed in an enclosed cabinet.

Roberts reports that Motorola improved yields in the scribe-and-break steps from the 70% to 90%

## The case for diamond scribing

At least one independent observer feels diamond scribing still has plenty of life left. Experiments conducted by Samuel M. Polcari, a senior scientist at the former NASA Electronic Research Center in Cambridge, Mass., before he transferred to its successor, the Transportation Systems Center, have achieved scribe-and-break yields of 98% to 100% using conventional diamond scribing machinery. Polcari's conclusion: there's little wrong with the basic diamond scribing process; the trouble stems from careless use of it.

Polcari feels that much of the yield loss at the scribe-and-break stage is due to a lack of care and poor knowledge of critical scribing parameters. Production engineers scribe wafers almost as if they were scratching window glass prior to breaking it, paying little attention to the silicon crystal structure. Polcari feels attention to a few simple rules for scribing could improve typical 70% to 90% yields to near 100%.

Polcari reviewed as many aspects of the scribing process as he could, but imposed two limitations. First, he used only commercially available equipment: a Tempress Industries Inc. machine and diamond tools from the American Coldset Corp. Second, he maintained a standard 1-mil scribe depth despite variations in wafer thickness from 8.4 mils to 9.9 mils.

Working within these boundaries, Polcari varied the angle between wafer and scribing tool, the shape of the tool itself, its rate of travel, its exerted force, and its direction of travel relative to the wafer's lattice structure. Eventually, with the proper mix of values, he repeatedly obtained 98%-100% yields with sharp cleavage lines and little, if any, dust or chipping.

He started with a brief look at the advantages of "heel" scribing over cutting with the "toe" of the tool. The business end of such tools are truncated pyramids (see sketch). In toe scribing, one of the pyramid's sharp edges moves through the surface of a wafer like the prow of a ship. In heel scribing, a blunt surface is the leading section. Polcari found that heel scribing is less critical in terms of tool force and other variables, and also observed that it produced less fragmentation and substrate damage for a given set of conditions than did toe scribing.

**Orientation of the wafer** during scribing also is important. In scribing lines at right angles to the (110) orientation flat on the wafer, there's little difference in whether the tool moves toward or away from the flat. But scribing parallel to the flat, along the (110) planes, is critical. The scribe should move across the wafer so that it first intersects the bases and then the apexes of the small triangles formed by the intersecting (111) lattice planes. Regardless of tool depth, tool angle, downward force, geometry, or scribe speed, movement along the direction pointed by these triangles invariably results in cleaner, less fragmented die edges and less debris at separation.

Scribing speed also has a great effect on chip yield. With Polcari's scriber moving at 14 inches per minute originally, the tool skipped and bounced near the rim of the wafer, damaging many peripheral chips. Increased tool force only caused excessive substrate damage, but Polcari found that slowing the scribe's speed to about 7 inches per minute resulted in well-scribed lines from rim to rim, and dramatically increased chip

yield near the edges of the semiconductor wafer.

The angle the shank of the scribe makes with a line normal to the surface of the wafer also was found to be important. All other parameters being equal, the optimum angle using the tools available to Polcari came out at 36° to 38°. Though Polcari tried larger angles up to about 44°, these led to fragmentation and substrate damage.

**Too much tool force** also damaged the substrate. Polcari experimented with forces from one to 40 grams. A range of 6.5 to 15 grams resulted in the highest yields, especially at small scribe angles. The typical user would probably obtain optimal results at 36° tool angle and 6.5 to 10 grams tool force.

Though Polcari had only a few tool geometries to choose from, he tried each and noted a difference in performance. The smaller the theta angle (see sketch) of the flat surface on each edge of the tool tip, the less force is dissipated laterally along the scribe line. As theta dropped from 60° to 33°, greater numbers of good scribe lines occurred over wider ranges of tool forces and scribing angles. And as Polcari's work progressed, he noted that a characteristic of good scribe lines was a series of minute hash marks, pointing in a direction opposite to that of tool travel.

Polcari notes that his figures are only a starting point, not cast in concrete. But the serious production engineer should be able to increase yield fairly quickly by employing Polcari's approach. During experiments, Polcari recommends that the normal illumination used to examine scribe lines should be supplemented by dark-field illumination, too—it is far better at showing up substrate damage.

Polcari feels that his techniques should be completely adaptable to production situations. "One current reason for low yields is that the scribing process is left up to production line personnel; a good scribe line is subjective matter in most plants. But this doesn't have to be the case; now that these experiments are over we can replace subjectivity with engineering data." Nor does Polcari expect careful diamond scribing to add much machine downtime or maintenance—"even in our experimental setup, less than ideal, we could just about set it and forget it. With normal care, there's little to get out of whack."

The Polcari report is NASA Technical Note TN D-5811 and is available at \$3.00 from the Clearing House for Federal Scientific and Technical Information, Springfield, Va. 22151

—James Brinton

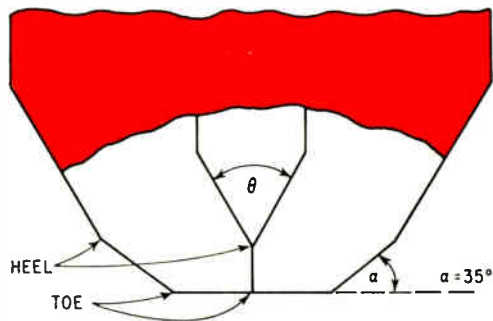

**Slurry flurry.** Lasers won't work for everyone. A multibladed saw can dice several wafers at once using metal bands and an abrasive slurry, poured over wafers as bands reciprocate. Chips are held in place by a wax, which is later dissolved, leaving chips with clean, square edges. This cutter is used at Motorola for wafers holding forward-reference devices (diodes), for which two wafers are bonded together to form junctions too thick for diamond scribing.

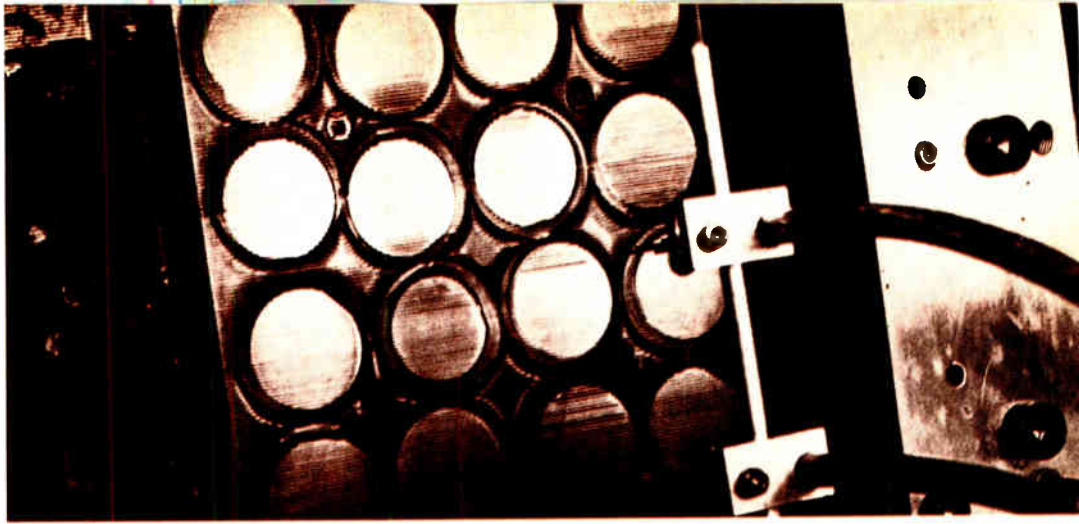

level achievable with a diamond scriber to 95% or better with the laser. Motorola still breaks the zener wafers apart manually (an operator rubs a stylus over the wafer, which is mounted on a flexible pad). This step, more than laser scribing, is responsible for the remaining 5% yield loss, he says. Roberts hopes to further improve yields by mechanizing the breaking operation using commercially available equipment in which the operator pushes a roller across the wafer as it is held on a flexible belt. With equal pressure imparted to all parts of the wafer all the time during each movement of the roller, fewer dice should be damaged.

The 2-mil-deep, 1-mil-wide laser kerf "puts us well past all of the active areas on an 8-mil-thick zener diode wafer," Roberts points out. But with diamond scribers, he says, "the scratch is significantly less than 2 mils deep and it can generate microcracks into the active areas that could become reliability risks under temperature cycling."

**The laser's cutting speed**—a steady 2 ips against the diamond scriber's 1 ips—is another advantage Roberts cites. Quantronix specifies the 601's maximum speed as 2 ips. Further, says Roberts, "the fact that the laser cuts the wafer 'on the way back' increases its throughput compared to a diamond scriber." The diamond unit's cut is in one direction in a given axis, then it indexes to the next scribe line to make that cut in the same direction. The laser cuts one line in one direction, indexes to the next line, and cuts it in the opposite direction, more than doubling throughput considering the laser's greater speed.

Roberts cites a further advantage of the laser scriber: its beam cuts through oxides and metal on a wafer while the diamond won't cut through oxide. The oxide must be removed in one of the normal etching steps prior to diamond scribing. This doesn't necessarily entail an extra step, however; the process is usually geared for it.

Roberts believes—as does Quantronix president Richard T. Daly—that the 601 Laserscribe is the first machine on the market designed from the start to scribe silicon wafers. "It's the only major breakthrough I've seen in wafer dicing in 11 years," Roberts maintains.

Roberts and Quantronix officials both acknowledge that silicon splatter is still a slight problem in laser

scribers. Roberts says the vacuum system included in the Quantronix machine can carry away 80% to 90% of the vaporized silicon. Motorola eliminates the remaining vaporized residue by a quick dip in de-ionized water. This extra step is "more than overshadowed by better yields," Roberts says. And Motorola is working to automate the water rinse.

**The fact that Motorola** is replacing all four diamond scribers with the laser dicer in a high-volume device line suggests the economics of the laser will win out in the long run. Indeed, Quantronix officials estimate annual operating costs of the 601 Laserscribe operating on two shifts will be \$45,000; they claim the same costs for a diamond scriber are \$182,150, with \$150,000 of that attributed to a 5% yield loss processing 120,000 wafers valued at \$25 each. The yield loss for the laser unit is estimated at 0.5% for the same number of wafers at the same value, or only \$15,000. Motorola hasn't had the machine long enough to verify those figures, but Roberts has no quarrel with Quantronix's economics.

Quantronix's Daly says control of the kerf's width and depth isn't particularly difficult. "If you use a good 10X lens," he explains, "the kerf will always be about 1 mil wide, and the kerf depth is controlled by table movement. We're actually controlling the number of overlapping pulses that strike a given spot on the wafer." Specified kerf depth for the 601 is 1 mil at 2 ips, with greater depths possible at slower speeds.

Engineers at North American Rockwell Microelectronics Co. also like laser scribing, although, unlike Motorola, they're not using it in high-volume production. Another difference is that NRMEC, in Anaheim, Calif., put its unit together piecemeal. A YAG laser, precision X-Y table, optics and controls were bought individually—to scribe MOS/LSI wafers bearing beam-lead chips.

NRMEC selected the laser technique because beam-lead chips can't be diamond scribed and broken—the beams would be cut off. And NRMEC engineers didn't want to incur the extra masking step required before etching the dice apart from the back, and also felt back-etching lowers yields if the etchant spreads, so they're laser scribing about 9 mils through from the back of a 10-mil-thick wafer.

The work is being done on chips up to 180 by 216

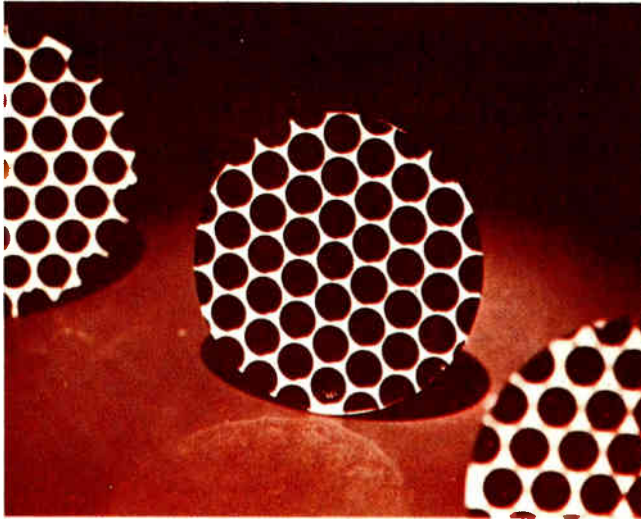

**Framed etchings.** The etch method, is done by spraying a wax resist through a metal mask on the p-n junction wafer. After etching, the resist is removed, giving a "gentle" separation.

mils at speeds well under half an inch per second; throughput isn't a big concern at NRMEC: the chips are so large that yield is the dominant consideration.

After laser scribing, the dice are conventionally broken using hand rollers. The scribed wafer is placed on a thin plastic sheet before breaking. After the roller separates the dice, the plastic sheet is placed in what appears to be an embroidery hoop, and put on a heated plate to make the plastic more flexible. As the hoop is brought down over the plate, the plastic is evenly stretched in all directions, pulling the dice far enough apart so that they can be easily picked up by the vacuum tool of a beam-lead bonder. The plastic expander is an NRMEC design, but commercially available die matrix expanders are also being evaluated.

**Singing the praises of the slurry** approach to chip dicing is R. Bruce MacLeod, manager of market development for Taft-Peirce Manufacturing Co. The firm's Mark III dicing machine, often called the slurry saw by users, has been on the market for three years. It was jointly developed by Taft-Peirce and IBM, which wanted it to cut smooth edges on chips to facilitate automatic handling. IBM licensed Taft-Peirce to sell the machine after using it in house for about five years.

Here's how the process works. First, a wafer is mounted on a thermoplastic holder with a wax such as glycol phthalate (the wax also is cut through with the silicon). Next the wafer is aligned with a kerf-line pattern contained in an optical comparator. Once aligned, the wafer is moved to the slurry saw, where a pin arrangement for accepting the transfer fixture assures that the kerf lines remain aligned.

The transfer fixture is clamped to the dicer's indexing fixture, which is moved toward the spindle holding the 4-inch-diameter "cutter" blades. As many as 20 blades are spaced to conform to the die dimensions. The cutter head is enclosed in a housing, and

slicing begins when nozzles feed a slurry, usually silicon carbide, to the heads. Rotating at 9,000 revolutions per minute, the blades hurl the slurry at the kerf areas on the wafer; the cutter blades never touch the wafer, only the slurry does. It cuts completely through the wafer and wax, leaving a kerf about 4.5 mils wide. Then the fixture that holds the wafer is indexed 90° in preparation for the Y-axis cuts.

Taft-Peirce officials say a 2-inch-diameter wafer can be cut in about 2 minutes, but separation time, including alignment, runs to about 4½ minutes. After cutting, the remaining wax is dissolved with acetone, while the chips fall into a basket for cleaning.

Taft-Peirce officials are quick to note that the Mark III applies no force or heat to the wafer to disturb devices mechanically or electrically; yields range anywhere from 98% to 100%; the machine can cut through multilayer devices on a wafer, and it works well on gold-plated devices. George Sederback, Taft-Peirce staff engineer, says diamond scribes tend to tear gold metalization, not always getting through to the silicon.

Y.S. Kim, manager of semiconductor operations at Semiconductor Electronic Memories Inc. in Phoenix, says his firm chose the slurry saw because there was no effective alternative to process SEMI's 20-mil-thick wafers that also would eliminate the usual breaking operation and yield smooth chip edges for automatic handling.

**Kim says the 20-mil thickness** of the wafers, bearing bipolar IC memory elements, was selected to minimize diffusion warpage and handling breakage. "A diamond scriber will allow you to break an 8-mil-wafer without too much trouble," he notes, "but to get to that thickness, we'd have to lap the back of the wafer down from 20 mils, which could introduce breakage in handling." Further, SEMI uses a soft ball-solder joint to mount dice to substrates, and Kim points out that the conventional roll-type breaking that follows the scribe would damage the balls.

"We did a lot of information research on diamond, laser, wire saw, and slurry saw scribing when we started the company," Kim reports. The diamond method was ruled out because of the thick wafers and solder balls, and wire saws were vetoed "because too many of them would have been required to give us the speed we need. Besides we didn't find any reliable equipment." Lasers don't cut deep enough to handle SEMI's wafers, Kim says, "so we had little choice but the slurry saw. There's quite some engineering in the machine," he notes.

David Mealer, SEMI's manager of metalization points out that SEMI's highly automated production flow requires "a clean, straight edge on the dice rather than the crystallographic bevel cut" produced by diamond scribes and etch separation. A bevel edge allows chips to ride up over each other in the automatic equipment that's used to orient and visually inspect the dice, but with flat edges, the chips butt firmly against each other.

Before the dice go into SEMI's sorter they're picked up by a magnetic loading device; dice are marked with magnetic ink for loading into the sorter if they're

good or for immediate discarding if they're bad.

Among the slurry saw's disadvantages are the cost of the comparator, which can run to \$12,000 above the \$20,000 price of the saw itself. Another drawback is the wide kerf, and a few mils on each side of the kerf have to be provided, stretching the distance between active areas to 8 to 10 mils. This reduces the number of dice SEMI can get from a 2¼-in. wafer by 5% to 10%, but Kim points out that the kerf area isn't a total loss—it contains test devices and metalization test patterns that can be probe-checked to check processing before chip separation.

Taft-Peirce is most enthusiastic about the slurry saw's ability to cut through multilayer devices. The company says RCA is using the machine in its Somerville, N.J., facility to cut through 100-mil-thick multilayer diodes. Electronic Control Corp., in Euless, Texas, is slurry sawing 4-mil-thick silicon-controlled rectifier chips.

Other Taft-Peirce customers include the Delco Radio division of General Motors Corp. in Kokomo, Ind.; IBM in Fishkill, N.Y., and Cogar Corp. in Wappingers Falls, N.Y. Cogar spokesmen say the slurry saw offers faster cycle time and lower cost than laser scribes. They've also added a new wrinkle to the Taft-Peirce machine: a diamond blade is used instead of stainless steel, and the diamond does the cutting instead of just guiding the slurry as the steel blades do. They say this yields a 3-mil kerf, it's faster than metal and slurry, and produces far less chipping at the kerf edge.

**Another chip-separation technique**, similar in principle to the slurry saw, employs wire bands or blades combined with an abrasive slurry to completely cut through wafers. Both single-wire cutters and multiple-bladed machines are in use at Motorola on different device lines.

The single-wire/slurry cutter dices dielectrically isolated ICs. Motorola engineers say diamond scribes can't be used on these devices because the wafer is largely made of amorphous, polycrystalline silicon, which doesn't fracture neatly. The wire is fed from one spool to another on the machine, moving back and forth to cut completely through the wafer, which is then indexed for the next cut. Here the wafer also is held on the table fixture with a wax or cement that is dissolved after dicing is completed.

The multiple-band/slurry machine is best suited to forward-reference devices because it can cut many wafers simultaneously and because in these devices junctions often are bonded together in wafer form before they are cut apart. This creates a fairly thick wafer—about 14 mils—that must be cut completely through to maintain the integrity of the devices, again ruling out the conventional diamond-scribing-and-breaking procedure.

Beam-lead device makers, of course, also have to look beyond diamond scribing to maintain their beam structures. Bell Laboratories revived one of the oldest chip-separation techniques when it pioneered beam leads and etched them apart from the back of the wafer, imparting a 54° bevel to the chip edges (the angle cut results from the silicon's crystal structure).



**Semiconductor sawmill.** A slurry saw called the Mark III dicing machine by the maker, Taft-Peirce Manufacturing Co., uses up to 20 blades running at 9,000 rpm to hurl a slurry at the kerf area. Disadvantages are that only one wafer at a time can be cut, and a wide (usually 4.5 mils) kerf area is required. The big advantage: slurry cuts completely through thick wafer—up to 20 mils thick—delivering chip-separation yields as high as 98%.

Etch separation in this manner requires an extra masking step.

Etch separation was used for years before Bell Labs chose it for beam-lead circuits, and it's still employed for certain other semiconductor devices, such as high-voltage rectifiers. One spokesman says that because the junction meets the die surface, "we want to introduce the fewest discontinuities possible, and chemical etching with a round die still seems to be the best way to do it."

In the process, a wax resist is sprayed through a metal mask onto the p-n junction wafer. Etching strips away all the silicon but the circular dice, and the resist is removed from the dice. □

# You can display one advantage of our new 5120-Bit ROM.

## It's a 7x9 font.

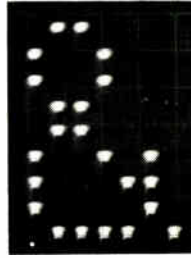

Oscilloscope trace

Characters in a 7 by 9 vertical scan font. CRT and other advanced types of scanning displays can now generate clear and readable characters, of high resolution, using advanced, standard MOS/LSI.

The EA4001 is only the first of many patterns capable of being programmed from the new EA4000 high performance, Read Only Memory—the highest density ROM available today. It is organized as 512 words, 10-Bits/word providing 5120 bits of memory. Complete decoding is done on the chip through an address holding register that allows sampling and timing control of the input data.

Its high speed capability—500 ns access time—makes logic function generation and micro programming applications a snap. Look-up-

table jobs can be accomplished with high accuracy and low cost per bit. It's easy to use. No clocks are required; it consumes only .06 mW/bit and one output resistor makes it bipolar compatible. Because it's an EA product, it's guaranteed reliable—and available.

The EA4001 is on your EA distributor's shelf now. \$40 in 100 lot quantities.

For custom patterns using the EA4000 ROM, call or write your local EA Representative or

Electronic Arrays, Inc., 501 Ellis Street, Mountain View, California 94040. Telephone (415) 964-4321

# Flux monitoring boosts accuracy of phased array radar systems

By sensing flux buildup in ferrite core, feedback technique yields precise phase control while automatically compensating for changes in system operating parameters

By Hunter C. Goodrich and Robert C. Tomsic, *RCA Missile and Surface Radar division, Moorestown, N.J.*

□ Phased array radars may use many thousands of ferrite phase shifters that are highly sensitive to thermal effects and other operational parameter changes that can degrade radar performance. A new ferrite phase shifter control system design makes temperature tolerances less critical, and in the process minimizes the effects of component aging, power supply fluctuation, and other parameter changes. The technique is called "flux feedback"<sup>1</sup>: the amount of magnetic flux induced in the phase shifter is monitored and the driver pulse is turned off when the desired flux level is reached.

Instead of putting preset amounts of energy into the cores, as in conventional systems, RCA's flux-feedback technique precisely controls phase shift by precisely controlling flux build up, flux being proportional to phase. This neatly circumvents the phase shifter's change in permeability with temperature. Temperature range of any given phase shifter is increased threefold: The ferrite core typically can tolerate temperature swings of 75°C instead of only 25°C, yet achieve the same accuracy.

What's more, because the technique senses the flux in the core and feeds back this information to the driver, any change in the components in the driver/phase-shifter loop is automatically compensated for. And substantial savings can be effected because wider tolerances allow use of less-critical components and circuits. Since a four-faced radar for hemispherical coverage may have 16,000 radiators, each with its own phase shifter and control channel, even a small cost-per-channel saving can become a large sum. The flux-feedback approach is a very simple and effective way to achieve the stringent requirements that are typically imposed on the driver/phase-shifter combination:

Control of remanent flux levels to an accuracy of 1% to 2% despite thermally induced ferrite permeability changes of possibly 40%; temperature effects on other components; circuit aging; and power-supply fluctuations caused by the simultaneous turn on of thousands of high current drivers.

In examining the characteristics of the components, it's interesting to note that although a radar's beam-steering computer generates digital phase-shift commands for each ferrite shifter, the shifters themselves are analog devices. This applies to multibit shifters,

whose several cores are digitally proportioned in length, with appropriate cores being driven to saturation, as well as to the more widely used analog shifters, whose flux is set directly to the desired value.

In analog flux phase shifters a reference point serves to establish a reference insertion phase from which the desired differential phase shifts are generated by driver command. The remanent point on the hysteresis loop is commonly used as a reference point (point  $B_{rt}$  or  $B_{rr}$  in Fig. 1). It's reached by applying a saturating RESET pulse whose magnetizing force is several times the coercive force of the ferrite core element. Depending on the type of core used, this requires driving 5 to 20 amperes through a single-turn control winding. A SET voltage pulse, of opposite polarity to the RESET pulse, when applied to the element control winding, will drive the magnetic flux along the hysteresis loop (Fig. 1).

Following completion of the SET pulse, the magnetic flux falls back slightly, leaving a change of flux,  $\Delta\phi_r$ , approximately proportional to the area (integrated volts  $\times$  time) of the SET pulse. The flux level therefore can be controlled by cutting off the SET drive current at the proper moment. Typical driv-

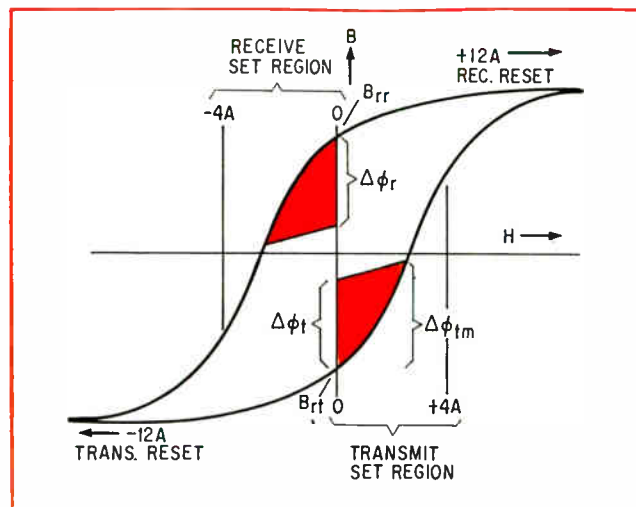

1. Flux control. Hysteresis loop of a typical ferrite material. The magnitude and direction of the induced flux must be established separately for both transmission and reception.

## Phase shifter driver types

### Variable-amplitude circuit:

A fixed-width pulse, whose amplitude is proportional to the desired flux level, is applied to the core control winding.

**Advantages:** The requirement for variable-pulsewidth circuits is entirely eliminated.

**Disadvantages:** No inherent compensation for component aging and control-lead losses, or for unit-to-unit variation in phase-shifter characteristics. Very sensitive to supply voltage changes. Inefficient at low flux settings: linear output stage dissipates most of the driver power.

### Variable-width circuit:

A fixed-amplitude pulse, whose width is proportional to the desired flux level, is applied to the core control winding.

**Advantages:** More efficient than variable-amplitude type. Driver need not be linear. Less control circuitry: where many drivers receive the same command, a common variable-width gate can be used.

**Disadvantages:** No inherent compensation for component aging and control-lead losses, or for unit-to-unit variation in phase-shifter characteristics. Sensitive to supply voltage changes. Requires precise pulse-amplitude regulation.

### Multiple-bit circuit:

Uses several cores, whose lengths are digitally proportioned. Each requires a separate bi-directional driver. Each core is always saturated in either the positive or negative direction.

**Advantages:** Current level into each core is uncritical, provided it exceeds the core's saturating level. Direct digital control eliminates need for d-a converters. Insensitive to supply-voltage changes.

**Disadvantages:** Cost of the additional amplifiers and cores usually exceeds the cost of the control circuitry used with other driver types. Further, a typical phase-setting command requires several cores to be set in their most temperature-sensitive direction.

### Flux-feedback variable-width circuit:

A pulse is applied to the core control winding. Flux buildup is monitored and compared with the command level. The pulse is cut off when that level has been reached.

**Advantages:** Highest efficiency of any type. Virtually eliminates inaccuracy due to changes in amplifiers and cores, as well as errors caused by supply-voltage changes and control-lead losses.

**Disadvantages:** Requires accurate RC integrator components for precise timing.

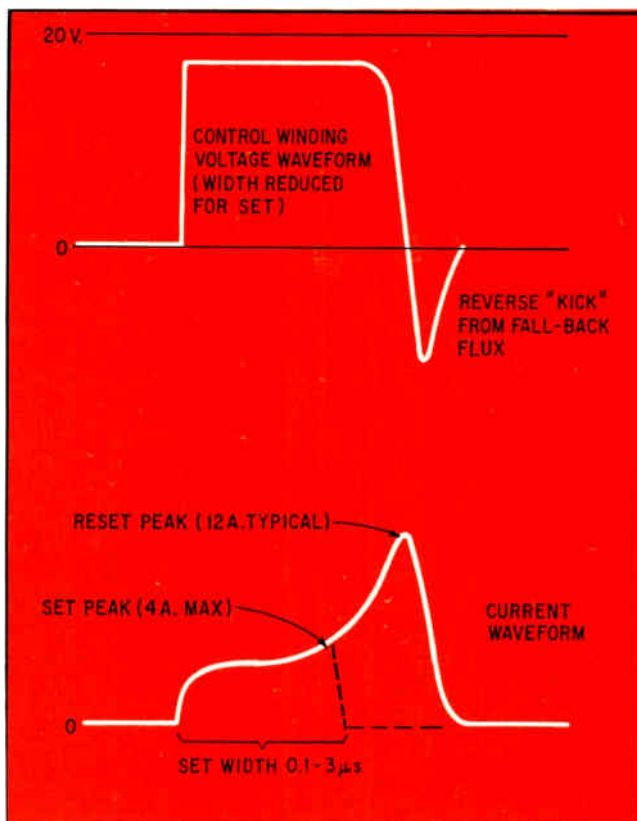

2. Steep rise. A phase-shifter driver must supply hefty currents with a very short rise time. With the flux-feedback design approach, sensitivity to power-supply falloff as thousands of drivers switch on is minimized.

er waveforms are shown in Fig. 2.

Most ferrite phase shifters are non-reciprocal: for a given direction of microwave energy flow, there is a corresponding direction of ferrite magnetization in which the flux-vs.-phase-shift characteristic is most linear and temperature stable. This preferred magnetization direction occurs when the magnetizing current is applied in a direction opposite to that in which the microwave energy will flow. Since, in an array, transmit and receive energies flow in opposite directions, a well-designed phase-shifter driver will provide pairs of RESET and SET pulses which flow, alternately, in opposite directions.

The driver pulse sequence is illustrated in Fig. 3. For transmission the ferrite core is reset in direction B and then set in direction A. After transmission the core is reset in direction A and set in direction B for receive. Thus the hysteresis loop is traversed during each complete TRANSMIT-RECEIVE cycle. To permit close-range radar operation, the RESET-SET cycle time is held to no more than 10 microseconds.

The block diagram of the flux-feedback circuit shown in Fig. 4 includes drivers for a pair of core-magnetizing windings, sensing circuitry to monitor flux buildup in the cores, and a means of cutting off the buildup when it has reached the desired level.

Two identical gated amplifiers are used for bi-directional core magnetization: Each drives a single-turn control winding. When winding A is driven, winding B acts as a flux monitor and vice versa. Amplifier A provides the transmit SET pulse and the receive RESET pulse, amplifier B provides the transmit RESET pulse and the receive SET pulse. The



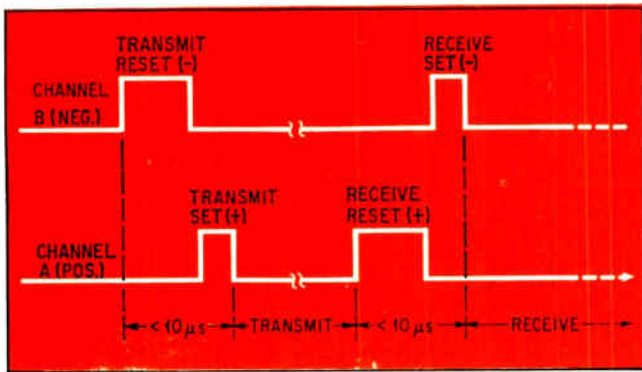

3. Switched on. Driver gate cycle lasts no more than 10  $\mu s$ , clears initial phase setting, and establishes a new one.

analog command voltage is applied through a differential amplifier to cancel any lead pickup in the analog distribution network. (Digital commands can also be used if a d-a converter is included with each driver.) A single RC integrator and IC comparator are used to control the pulse duration of whichever amplifier is providing the SET pulse. A diode couples the voltage induced in the undriven winding to the integrator.

The integrator output is a negative-going voltage ramp whose level is proportional to the change in flux,  $\Delta\phi_{tm}$ , established up to that moment. This ramp is applied to an IC comparator which also receives a negative analog command voltage indicating the desired flux level. As soon as  $\Delta\phi_{tm}$  matches the commanded level the comparator changes state, cutting off the gated driver amplifier. At the conclusion of the drive pulse the flux level assumes the new remanent level,  $\Delta\phi_t$ . This level differs from the cut-off level  $\Delta\phi_{tm}$  by the amount of the fallback flux,  $\Delta\phi_f = \Delta\phi_{tm} - \Delta\phi_t$ , a small difference that is due to the imperfect squareness of the material's B-H loop, and is readily compensated for in the selection of the command voltage scale factor.

The RESET pulse width is also controlled by an IC comparator. This comparator monitors the voltage across a very small (approximately 60 milliohm) output current sampling resistor  $R_s$ . This voltage is compared in the RESET comparator to a preset level and the active driver is cut off when the voltage begins to exceed that preset level. Reset pulse width control is preferable to a fixed RESET pulse area because, on average, it produces a large power saving. Without such control the RESET pulse must be made wide enough to reach the RESET flux level under a worst-case condition. However, if the previous SET pulse has left the core partially magnetized in the new reset direction, a fixed-area RESET pulse will drive the core into needlessly hard saturation, wasting power. Controlling the RESET pulse width reduces average driver power by about 50% and cuts the worst case dissipation by 4 to 1.

A schematic diagram of the flux-driver circuit is shown in Fig. 5. This circuit has yielded excellent results in both discrete component and hybrid-integrated forms. So far, 128 hybrid drivers have been

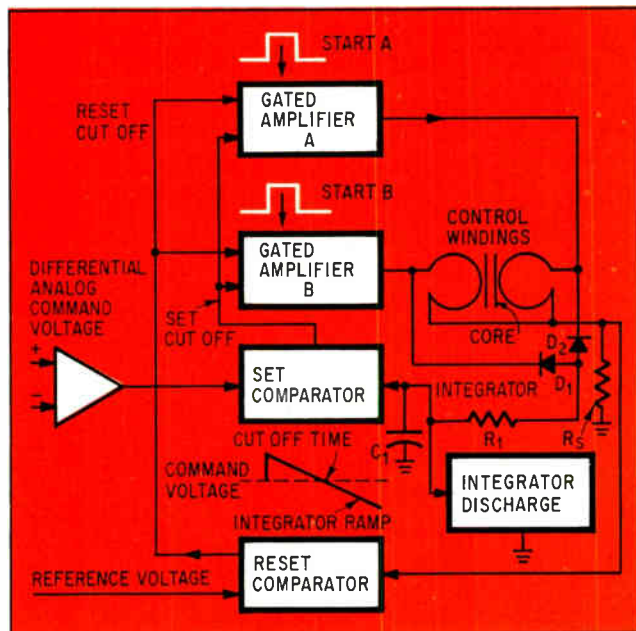

4. Dual roles. Control windings A and B alternately serve as magnetizing and sensing windings. The integrator monitors flux buildup for the comparator.

## Why all the fuss?

Phase-setting accuracy is critical because even small errors can severely affect antenna gain and sidelobe levels. In fact, every doubling of phase errors quadruples antenna gain losses. Directivity lost from the main beam appears as increased sidelobe gain. Still, some people wonder why a phase-setting accuracy of two or three degrees is important, considering that the typical phase-shifter design uses five-bit quantization and thus is inherently limited to increments of  $11.25^\circ$ .

Actually, quantization does not, in practice, materially affect antenna gain or limit beam pointing accuracy. In an array comprising at a minimum hundreds of radiators, rounding off a 10-bit calculation to five bits sharply reduces the maximum quantization error. The reason: since approximately the same number of phase shifters will be set above as are set below the precise value desired, the average will be quite close to that value. Beam-pointing error will approximately equal the quantization divided by the number of elements in the array. For example, a 1,125 element array would have an average beam pointing error of  $0.01^\circ$ . In contrast errors not due to quantization typically are proportional to the desired phase setting. These cannot be counted on to average out, and sharply affect both pointing accuracy and sidelobe level.

A second quantization effect, spurious sidelobes which may occur at specific beam-point-angles when less than five-bit quantization is used, can also be sharply and easily reduced. Simply adding the same, arbitrarily selected phase shift to all the phase shifters, and varying that value on a pulse-to-pulse basis, will distribute such sidelobes through all the potential beam positions. As a result, the spurious sidelobe levels at a given beam position will be reduced by approximately the square root of the number of pulses integrated in the receiver.

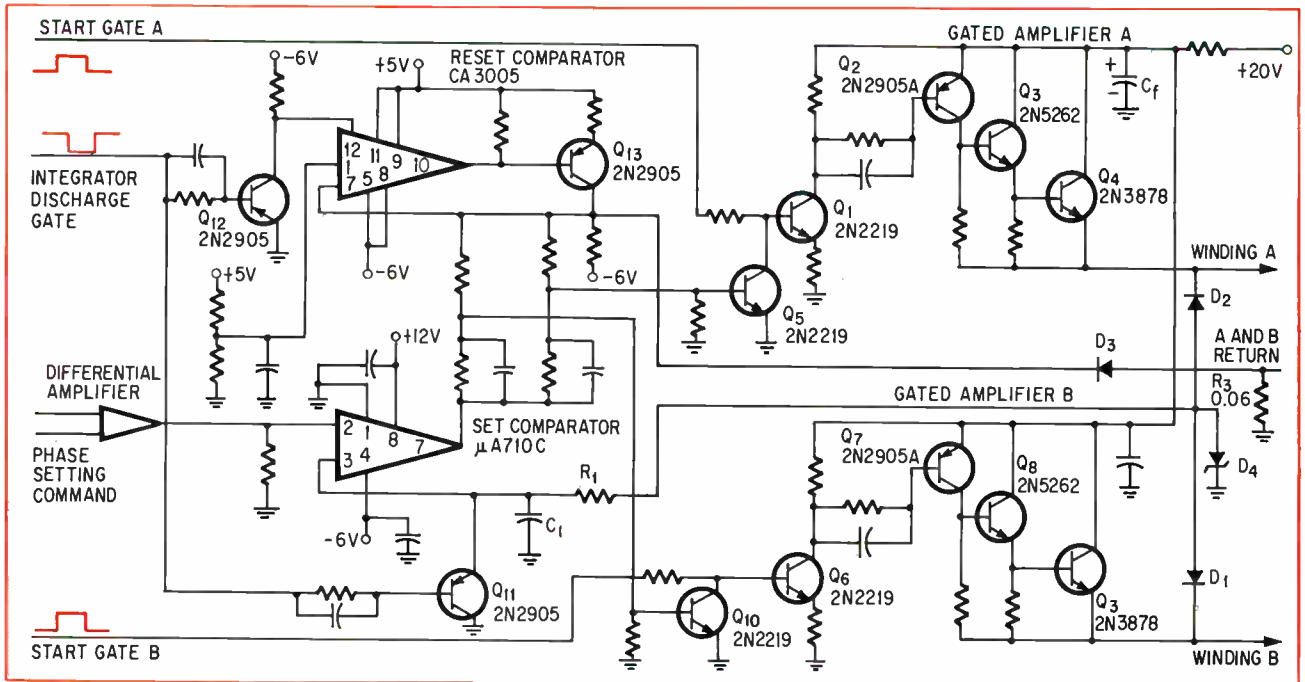

5. Compare, then decide. A typical flux feedback phase shifter driver uses IC comparators with 0.05% accuracy. It is the most efficient type, and the most economical way to achieve high accuracy. It virtually eliminates errors due to supply voltage changes, component aging and tolerances, and temperature effects.

constructed and used in a working subsection of a full array. Parts of the circuit also are being monolithically integrated on a bipolar chip. In the hybrid version, the control circuitry is placed in one module, and gating amplifiers are placed in separate but similar modules, as shown in Fig. 6. The amplifiers can supply a 12-A RESET pulse with a 0.1  $\mu$ s rise time, and, when delivering their approximately 5-A SET pulses, can be cut off in 0.1  $\mu$ s.

The gating amplifiers (Fig. 5) are turned on at the correct time by the START GATE pulses A and B, which are distributed in parallel to all drivers. The start gates keep the gated amplifier on until the output of the appropriate set or reset comparator turns on either shorting gate,  $Q_5$  or  $Q_{10}$ , to effectively ground the amplifier input. Transistor  $Q_{11}$  acts as a gate to discharge the integrator capacitor  $C_1$  in advance of the SET pulse. The transistor is kept on during the RESET pulse to prevent the set comparator from turning off the RESET drive pulses.  $Q_{13}$  latches the reset comparator to prevent its switching state again as the current in  $R_s$  falls off. For the set comparator, the slight change in integrator voltage resulting from the integration of the fallback-flux overshoot voltage performs a similar function. While Fig. 5 shows two different types of comparators the most recent designs use dual-comparators in a single IC package.

With the flux-feedback approach, the phase-setting accuracy is independent of most of the driver amplifier characteristics, but it does require prompt response to a cut off command to prevent excess flux buildup in the core and resultant phase errors. A fixed overshoot can be readily compensated, but variations must be minimized. This has been accomplished by

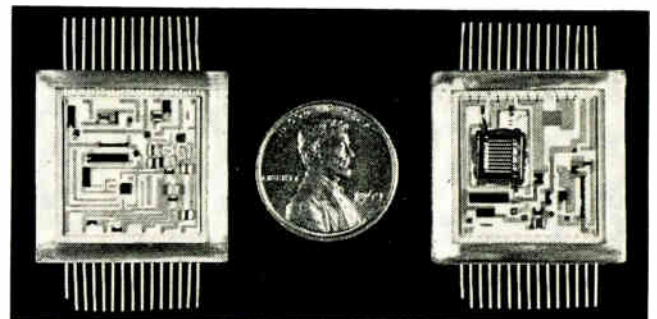

6. Squeeze play. Hybrid flux feedback drivers, with control and amplifier circuits in separate modules.

using relatively high-frequency transistors and by keeping them slightly out of saturation so they can be cut off promptly. Efficiency is high because the amplifiers are essentially either fully on or cut off.

In automated tests at 16 phase-command levels made on 128 hybrid-integrated driver/phase-shifter combinations, linearity errors were less than 2.5° rms and the average variation of phase shift with temperature from 0 to 70°C was 1.5°. The change in phase shift due to  $\pm 5\%$  supply-voltage variations was  $\pm 0.9^\circ$ . By contrast, temperature-induced errors alone with uncompensated variable-width and variable-amplitude drivers over a 70°C range can be on the order of 20°: other errors are similarly larger. □

#### References

1. U.S. Patent 3,510,675 issued to D.A. Johnson, R.J. Tomsic, and H.C. Goodrich, assignors to RCA Corp.



# **DEFENCE**

## **WITHIN THE ERIE ORBIT ...**

Throughout the free world in airborne armaments, guidance, communications and navigational systems, there are more types and quantities of Erie components and assemblies than we can possibly enumerate.

An important addition to this range is the broad band filtering specifically developed for the protection of armament systems from electromagnetic R.F. interference in the HAWKER SIDDELEY "HARRIER" VTOL JET in service with the R.A.F. The filtering for this aircraft was custom designed by our Erie England engineering and manufacturing groups. Similar and equally important filtering against RFI is accomplished by our North American facilities for numerous USA type aircraft. Just another example of the filter devices used the world over in aircraft, spacecraft, ships, land vehicles and static installations. Would you like to find out why? We will gladly send you a brochure. Write to Sales Engineering Dept., Erie Technological Products, Inc., 644 West 12th Street, Erie, Pa. 16512.



Erie Technological

**ERIE**

**TECHNOLOGICAL**

**PRODUCTS, INC.**



Erie, Pennsylvania

# Dual-Gate MOSFETs

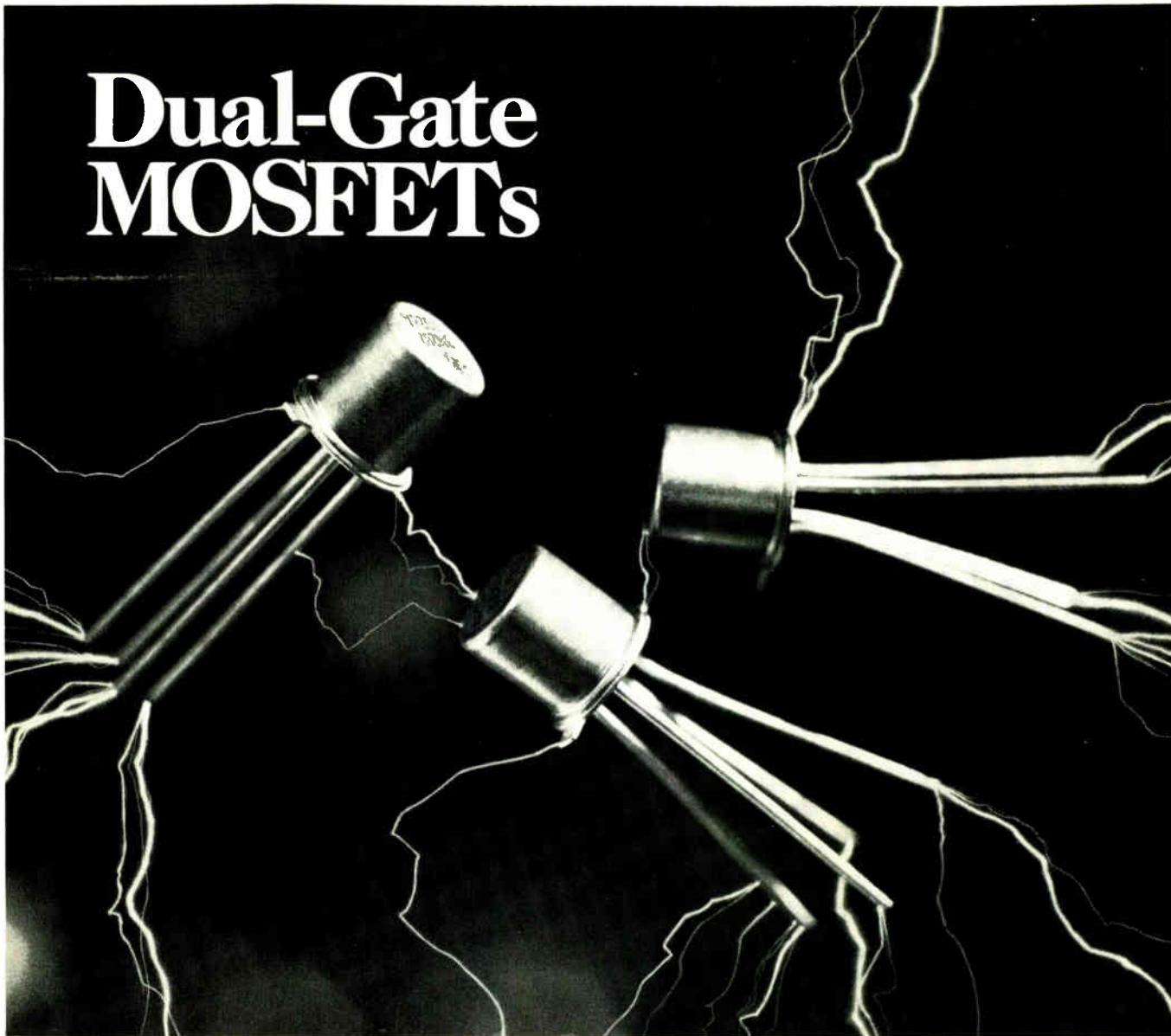

## Safe from costly transient voltages

Transient voltages during assembly may damage up to 30% of the MOS transistors you use.

Not any more.

Now, TI builds MOSFETs with monolithic, back-to-back diode protection that's designed to block out troublesome transients.

And, they eliminate time-consuming precautionary assembly steps. That means lower production costs, fewer wasted devices.

The 3N201, 3N202 and 3N203 dual-gate MOSFETs, with inte-

grated diode protection, have wide application in VHF and FM RF amplifiers, IF amplifiers, mixers and demodulators.

You can expect better system performance because of these unique TI MOSFET advantages: 10 db higher output impedance; low feedback capacitance of 0.03 pF maximum; and a typical low noise figure of 2.8 db.

All together, these characteristics add up to the performance you want at considerably lower cost.

Priced below comparable devices and in a different league compared to intricate tube 'n socket technology, these MOSFET prices are set to your advantage: 3N201, \$1.00; 3N202, 95¢; 3N203, 90¢ (500-999).

All three are available now from TI stock or authorized distributors. Ask for the new data sheet and application reports. Write: Texas Instruments Incorporated, PO Box 5012, MS 308, Dallas, Texas 75222.



**TEXAS INSTRUMENTS**  
INCORPORATED

## U.S. firms gird for calculator battle

American companies seek to loosen Japanese grip on \$241 million market; MOS/LSI arrays should help offset lower labor and assembly costs abroad

**Despite memories** of how the Japanese took a U.S. development—the transistor—and used it to lock up the radio industry, U.S. calculator companies have been watching history repeat itself in their industry. In a rich market that's growing at a 60%-or-greater clip, the Japanese are using American-developed MOS/LSI technology to grab the lion's share of U.S. calculator sales. But there are growing signs that American firms will fight back harder and more effectively than they did over radios.

Time is running out, however. The Japanese already hold as much as 70% of domestic sales by unit, and they're continuing to increase their share. "The Japanese have the momentum," says Charles Kovac, vice president of marketing, North American Rockwell Microelectronics Co. (NRMCO). Total Japanese shipments last year hit 441,000 electronic calculators.

To maintain this momentum, the Japanese have been striving to develop additional features for their calculators and to find new ways to cut costs. These efforts are paying off at both the high and low ends of their product lines: unit prices are falling fast, and the Japanese have started selling in the U.S. the more complex programmable calculators. By far the most important Japanese decision, which has blown the entire market open, was to design MOS/LSI into calculators, thereby reaping substantially lower assembly costs from the higher integration levels.

Ironically, the Japanese came to the U.S. to buy these circuits, which now account for much of the U.S. production of MOS devices. But even more ironically, the Japanese move has given U.S. cal-

culator makers an important new weapon; by reducing the electronics in a calculator to just a few packages, "we've removed the advantage of having the labor done outside the U.S.," points out Earl Gregory, vice president of marketing for Electronic Arrays Inc. Because of this, he expects a strong U.S. effort to build calculators involving both new companies and those firms traditionally associated with electromechanical calculators. A growing number of U.S. firms are designing their own units and using Japanese machines to temporarily fill in their product lines.

**Presently, only a handful** of U.S. firms are challenging the onslaught—certainly less than 10. More than 20 Japanese firms are building calculators, ranging from pocket-size units for business use to electronically programmable units for science and engineering use.

What U.S. electronic calculator

makers have been lacking is a total commitment to the business, believes NRMCO's Kovac. Most U.S. firms are making or marketing electronic calculators only to complement a line of other business machines; calculators haven't been their primary concern, he says. But this may be changing. In the past, traditional calculator makers such as Burroughs, Remington Rand, and Monroe, were going abroad, mainly to Japan, to have their electronic calculators built. "We're now seeing the beginnings of a reversal of this trend," says Electronic Arrays' Gregory. These same companies are seriously considering doing more of their own manufacturing, he says. Electronic Arrays is selling a six-chip "calculator set" [*Electronics*, July 20, p. 122] to several new U.S. companies that Gregory feels will be serious contenders in the electronic calculator business. And Gregory says his

### Hand in hand

The dynamic growth of the electronic calculator market is providing the major impetus for the upward swing in MOS sales. Half of this year's worldwide MOS output—forecasts range from \$60 million to \$80 million—will go into calculators, says Texas Instruments' Dave Roop, TI's MOS marketing manager. He predicts MOS sales in 1971 will double, and calculators will still account for half the output. Roop estimates next year's sales at between \$120 million and \$150 million, meaning that \$60 million to \$75 million would go into calculators.

Like many MOS circuit makers, the Dallas company is working to

reduce the number of chips for a calculator set. Roop says that designing and building a one or two chip calculator next year "will be a snap."

This would make possible a calculator selling at \$200 retail. Even more dramatic, TI is designing an MOS chip which would contain all the electronics for a calculator that would sell for \$99—truly a potential high volume consumer product. And TI is thinking "very strongly" of selling this bigger, custom chip in 1971, he notes. If TI can get the price of this one chip down to between \$15 and \$25, then a \$99 electronic calculator will be possible, Roop says.—Robert Henkel

# NEW ANALOG/DIGITAL DIGITAL/ANALOG AND DIGITAL PANEL METER CATALOG



## YOURS FOR THE ASKING.

Dur new 16-page publication covering the most complete line of analog/digital/analog conversion, signal conditioning and digital display products in the industry. It includes basic specifications and descriptive data on the entire line of Analogic products and capabilities, including:

- Digital Panel Meters
- Modupac™ A/D and D/A Conversion Modules
- Circuit Card A/D and D/A Conversion Units
- Complete A/D Conversion Systems
- Complete D/A Conversion Systems

Write for our catalog; we designed it for your use. For immediate engineering information or assistance on your instrumentation or systems problem please phone Dick Tassone, (617) 246-0300.

ANALOGIC CORPORATION  
AUDUBON ROAD  
WAKEFIELD, MASS. 01880  
TEL: (617) 246-0300

**ANALOGIC** ■  
...The Digitizers

### Probing the news

firm also may provide complete calculators to be marketed under the customer's name.

American Calculator in Dallas is introducing a unit using Electronic Arrays' chips. It employs eight Monsanto gallium arsenide phosphide light emitting diodes in its display and is designed to sell for \$350 to \$465. The company also expects to have a smaller unit out by mid-1971 that will sell for about \$200, competing with Sharp and Canon units—and is hoping to open up the calculator market to consumers next year.

Another U.S. company, Fairchild Camera and Instrument, also is expected to announce next year a pocket calculator in the \$200 range.

Two U.S. companies that are switching from mechanical to electronic units are SCM, which has just introduced a three-chip MOS/LSI machine selling at \$495, and Victor Calculator Co., which is test marketing a five-chip unit that can add, subtract, multiply, and divide and includes a memory. It sells for \$695. Victor gambled on the state of the art in MOS ICs back in 1967 but couldn't bring out the calculator it had announced because General Micro-electronics Inc., the IC supplier, couldn't make the switch from prototype to production.

"The way to beat the Japanese is in marketing," claims Edmund Burke, vice president of American Calculator. "We deal directly with sales reps who get 10% instead of 40% as dealers do," he notes, adding: "The reason the U.S. firms can't keep up with the Japanese on price is that outmoded sales organizations run up costs and run down profits."

Just how successful U.S. calculator makers will be in turning back the Japanese invasion depends largely on the ability of U.S. semiconductor manufacturers to maintain a lead in MOS/LSI technology, Gregory believes. "Today that LSI technology is centered in the U.S. The Japanese are aggressive about getting that ability, but U.S. companies won't be sitting still in MOS/LSI either. You have to have the knowhow to bring out new func-

tions, and that knowhow isn't automatically transferred with technical assistance agreements," he declares.

Currently, Japanese companies such as Canon, Sharp, and Seiko are buying large quantities of LSI for their calculators from NRMCO, Texas Instruments, and Intersil.

Sales of calculators in the U.S. this year are expected to hit \$241 million at the retail level, a 62% rise over 1969 despite current business conditions. And "there's absolutely no sign of a shakeout," says one U.S. manufacturer. "On the contrary," he says, "at least three new units are being introduced each month." The big push now by most makers is to get their lowest-priced units down to the \$100-\$200 level—low enough to attract the potentially vast consumer market.

While Japanese imports account for 65% to 70% of retail unit sales, they account for only half of dollar sales. But the Japanese hope to raise this total by introducing the more expensive memory-type calculators. Factory shipments to the U.S. from Japan amounted to \$35.65 million in 1969, or 112,000 units. Through the first nine months of 1970, these figures rose to \$55.89 million and 220,000 units. Total Japanese shipments were 441,000 units, worth \$146.4 million in 1969. By the first half of 1970, factory shipments equaled all those of 1969, totaling 519,000 units worth \$142 million.

In 1971 Japan's total factory shipments are expected to reach 2.75 million calculators valued at \$661 million—up 1.5 million units over 1970 shipments which are estimated to be valued at \$330 million. And it expects shipments to the U.S. to increase by 477,000 units and \$100 million, reaching 810,000 units valued at \$184.5 million in 1971.

This kind of a steamroller is hard to stop, and some U.S. manufacturers feel government action is needed. "If we get fair play, we can beat anybody," says Edward Lesnick, product planning director at Wang Laboratories Inc. "This means that either the U.S. raises tariff barriers against the Japanese or that the Japanese drop their



The "foremost-in-film-capacitors" people  
did it again...another first from Dearborn!

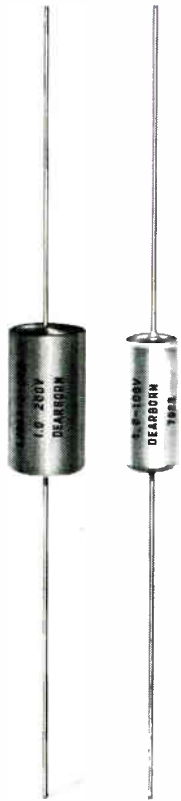

# -65 C to +150 C OPERATION WITHOUT VOLTAGE DERATING

NEW! DELTAFILM® 'LJ'  
METALIZED POLYSULFONE  
FILM CAPACITORS.  
OUTSTANDING.

Extended operating temperature range lets you use these new capacitors in applications where film capacitors could not previously qualify. Capacitance/voltage parameters equal to or better than those of metalized polycarbonate capacitors. Extended life expectancy. Improved electrical characteristics. Voltage range from 60 to 200 VDC. Available in hermetically-sealed metal cases as well as wrap-and-fill epoxy end seal construction.

For complete technical information write to:  
Dearborn Electronics, Inc.  
Box 530, Orlando, Fla. 32802

**Dearborn Electronics, Inc.**  
(a subsidiary of the Sprague Electric Company)

FOREMOST IN FILM CAPACITORS



Mini. Division manager Tadashi Sasaki says eight digits is enough for an electronic "soroban", the Japanese name for abacus. The small Sharp calculator is designed to serve as a portable unit for addition, subtraction, multiplication, and division. Price is kept low to facilitate mass production and to eventually get one into every home and then into the hands of students.

Originally, display units used in Japanese calculators employed cold cathode gas glow, which required high voltage drive and consumed much higher power than the calculator circuits. Sharp pioneered the use of vacuum tube displays with multiple anodes coated with fluorescent coating. Nippon Electric and Matsushita Electronics Corp. are working on multiple-digit glow display tubes.

Many companies in Japan are working on light-emitting diode displays, but so far none have come out with commercial units, as has American Calculator. And several companies are exploring liquid crystal displays —Busicom, Seiko, and Matsushita are among the most advanced. Busicom claims it will market a liquid crystal display calculator next year, and Seiko says it also will offer one next year.

**Japanese calculator makers** generally have favored displays rather than printouts since the former are cheaper and easier to get on the market. Sharp's line of display calculators, for example, starts off at \$277 and goes up to units with 16 digits and two memories selling for \$875. But their least-expensive printout unit, with 16 digits and one memory, sells for \$639.

Printout models also present something of a technological problem, and manufacturers don't agree on the best solutions. Norelco, for example, uses a nine-position scan with seven printing point needles while Canon uses electrosensitive paper and "burns" in the numbers on its new \$950 units. And Seiko, Hermes, and Tashiba also have mechanical printouts. □

*Contributors to this report included Stephen Wm. Fields in San Francisco, Charles Cohen in Tokyo, Larry Curran in Los Angeles, and Gerald M. Walker in New York.*

## Probing the news

### Government electronics

# Budget shortages stall ARTS 3 implementation

Hamstrung by lack of funds, FAA may be forced to delay air traffic control systems further

By Jim Hardcastle, *Washington bureau*

**America's only hope** of reducing air traffic congestion near airports within this decade is being delivered four years late and with only about half of its planned performance intact. And because of money and planning problems in the Federal Aviation Administration, the Automated Radar Terminal System (ARTS) will not get its first operational test until early next year at Chicago's O'Hare airport. The capabilities of the ARTS 3 package to be installed at the nation's busiest airport are much reduced from the original concept and the same will be true of the 63 remaining systems planned for other U. S. terminals. In fact, some installations could slip another year if the White House maintains its constraints on Federal spending.

Built by Sperry Rand's Univac division under a \$50 million turn-

key contract, ARTS 3 will display aircraft identity, altitude, and ground speed on a scope, alongside radar blips. The system should make life considerably easier for harried controllers, says John C. Mercer, chief of the FAA's Air Traffic Control Development division. But Mercer feels that ARTS' promise lies in keeping the growing number of airplanes apart in crowded terminal control areas. And since ARTS has been constructed in a modular fashion, many features, such as tracking of primary radar, automated metering and spacing of aircraft, collision prediction, and intermittent positive control, can be added to the system to handle the air traffic that the FAA expects will double over the next decade.

This same modularity permits ARTS hardware to be fashioned

**Checkout.** Univac engineer tests ARTS 3 scope at company's St. Paul, Minn., plant where system is being debugged for operational use in Chicago.

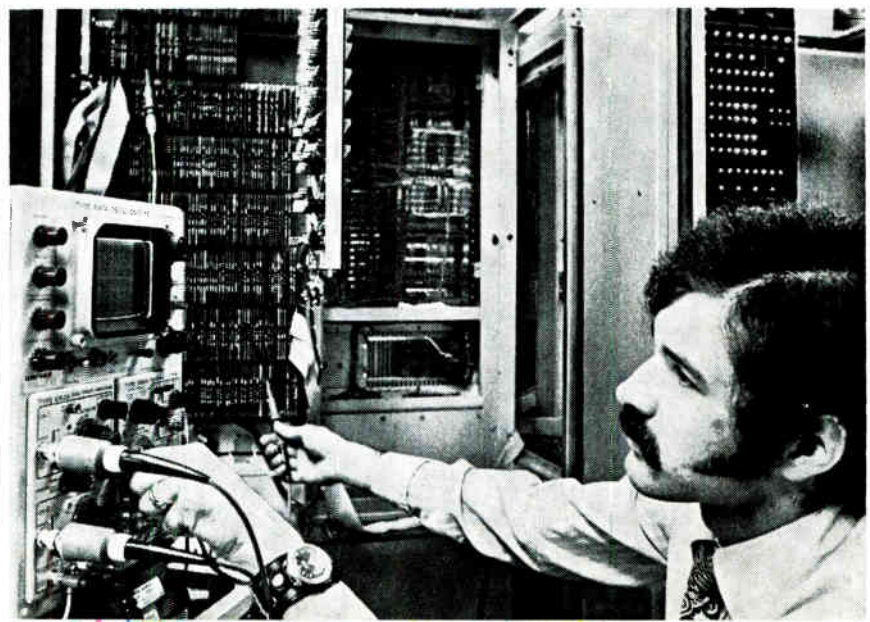

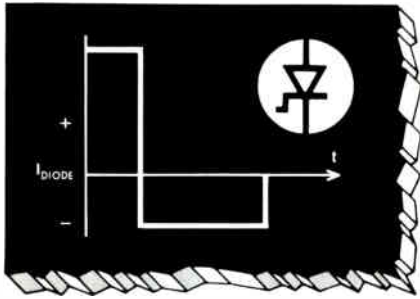

# PULSE SNAP DIODE

**Problem:** You need to sharpen a high amplitude pulse to picosecond speeds.

**Solution:** The Siliconix PSD. Here's a typical application, a pulse sharpener:

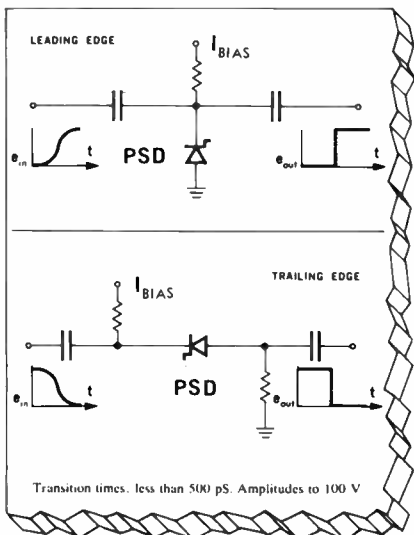

Use the PSD for pulse squaring, delaying, area limiting and other applications, too.

Write for instant data and applications information.

**Siliconix**  
incorporated

2201 Laurelwood Rd. • Santa Clara, Calif. 95054  
(408) 246-8000 Ext. 201 • TWX: 910-338-0227  
In Europe: Siliconix Limited, Saunders Way, Sketty, Swansea, Great Britain

## Probing the news

into a scaled-down version called ARTS 2 or into huge configurations such as in Chicago, Mercer says, where eight 16-kilobyte memory modules, four input-output processors, four central processors, two data acquisition systems, and 20 displays eventually will be installed. The ARTS 2 version, for smaller airports, shares almost all ARTS 3's features except radar tracking. Instead, alphanumeric tags move along with the blips, but if the tag loses its blip during quick maneuvers, the two must be matched manually by the controller, Mercer explains. A prototype ARTS 2 system is being tested at the Knoxville, Tenn., air traffic control center.

Airline sources agree with Mercer's claims for ARTS 3 but they note that ARTS is already four years late. And since they have already invested \$40 million to \$50 million in airborne transponders needed to make the system work, they are increasingly annoyed by implementation delays caused mainly by the FAA's continuing difficulty in finding funds.

The funding problem dates back to ARTS' earliest days, just after it was first proposed in 1962 by a Presidential air traffic control committee. Though originally the same

hardware used in the en-route air traffic control system was slated for ARTS, the expense, size, and difference in requirements dictated the design of new hardware. And much valuable time was lost.

As a result, a contract was awarded to Univac in 1963 for prototype ARTS 1 hardware, which has been operating in Atlanta since 1966. A later version, ARTS 1A later was installed in New York's central air traffic control center, with many sophisticated features, such as primary radar tracking, not found in ARTS 3 because of cost. It is still working there and "a generation of controllers has been trained there that wouldn't know how to do the job without it," Mercer says.

Several more years were lost as the FAA checked out the prototype and searched for funds to finance production of the system. Technical problems were encountered but none have led to major delays, Mercer says. Most, he adds, "were of a production engineering variety," with one notable exception. That exception concerned Texas Instruments' display, which at first failed to register primary and secondary radar blips and was hard pressed to write characters during the system's dead time. Both problems were worked out but, TI grumbled, largely because modification cost was subtracted from the profits it expected from fixed price

## The art of ARTS

Data displayed on the ARTS 3 scopes are acquired by beacon interrogator radars from transponders aboard commercial aircraft. The replies to the radars come in the form of coded pulse trains, trigger signals, and antenna azimuth, which are fed into a beacon video digitizer built by Burroughs Corp. It isolates the replies, correlates them from successive interrogations, and detects target range and azimuth. A Burroughs primary radar digitizer performs a similar function, but its output is not tracked by the ARTS computer in present configurations.

The output of the digitizer flows into a computer module with a 750-nanosecond cycle time that tracks the aircraft, while another module associates the track with flight plan data it receives from en-route control centers. Once the track is matched with flight plans, the second module generates alphanumeric characters and transmits them to a Texas Instruments display subsystem.

There, the sensor video is converted from its range and azimuth format into a tv-type rectilinear scan before it is displayed. Meanwhile, alphanumeric characters generated by the processing module are changed into tv signals, which are mixed with the sensor signals from the converter. Finally, the resulting composite is presented on a bright, 945-line display that does not require the dark environment normally associated with radar displays.

If you have problems to solve, these days you need all the help you can get. That's where we come in. We make tools that extend your capabilities. And once you have our tools we give you all the support you need to use them efficiently.

We make three different calculating systems and a time-sharing mini-computer. The one thing they all share is versatility. For instance any calculator we make is capable of doing very sophisticated scientific work but it will also work for a business man, to accommodate the merger of science and business. A lot of things come up during the technical man's day that have to do with dollars and cents.

Every system we make has the added versatility that it can be programmed and will keep records in numeric or graphic

form. The important thing is you can have as little or as much as you want. When you want it.

We had to think of everything. Because you never know what you'll be thinking of.

For information on any Wang system, call Mr. Courtney collect (617) 851-7211. Wang Laboratories, Inc., Dept. E-11, 836 North Street, Tewksbury, Massachusetts 01876.

# Thinking tools.



# WANG

# NEW AUTO-POLARITY FET V-O-M SPEEDS TESTING

You've probably imagined the convenience and time-saving you'd enjoy if you could just clip one of the V-O-M leads to ground or to the chassis, and have your meter always read upscale regardless of the polarity of any other terminal you touched.

No need to imagine it any more . . . you can see it and try it right now at your Triplet distributor. Called the Triplet Model 602, it's probably the most convenient V-O-M ever built. Its convenience goes well beyond the auto-polarity feature, though . . . to AC and DC measurements from 10 mV to 1000 V in 8 ranges at 11 megohms DC and 10 megohms AC input resistance . . . AC and DC from 0.02 to 1000 mA in 4 ranges . . . resistances from 0.2 ohms to 1000 megohms in 6 ranges. And with an accuracy of 3% on voltage measurements, and a rugged suspension-type meter movement, the Model 602 has what it takes to make your job easier.

This great new V-O-M is only **\$100** suggested USA user net. For more information, or for a free, no-obligation demonstration, call your local Triplet distributor or your Triplet sales representative. Triplet Corporation, Bluffton, Ohio 45817.



*The World's most complete line of V-O-M's . . . choose the one that's just right for you.*

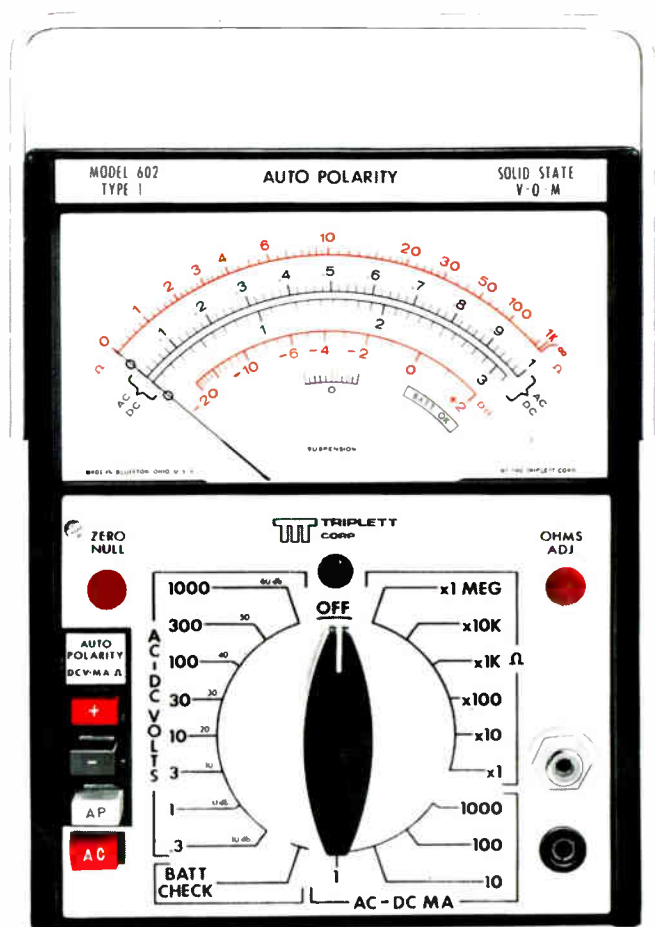

1. Auto Polarity . . . convenient and time-saving; creates memory and suppressed scale.
2. High sensitivity (.3V AC and DC) at constant 11 megohms input resistance.
3. Simplified scale with only 2 arcs for 24 AC/DC ranges.

contract with Univac. One source close to the program observes that TI's complaints stemmed from the fact that it underestimated the development work it would have to perform to adapt its displays to an airport environment.

Tight budgets, however, have caused delays right from the first. Because of the lack of funds, the FAA waited until February 1969 to award a contract to Univac to build 62 units for airport use and another two for training and experimental purposes. The contract was cut up into three buys, the second of which has just been completed. In each case, the FAA has had to scramble for funds to meet its obligations.

**Funds for the first buy** of 12 systems were obtained after FAA reprogrammed \$8.5 million allocated for building a sophisticated ARTS 1A system in Chicago for use in the ARTS 3 program. Again, only through reprogramming \$18 million—or nearly 10% of the FAA's facilities and equipment account—was the agency able to complete its second buy of 23 systems. And this still leaves the FAA's accounts flat for the purchase of systems 36 through 64; these must be paid for in May.

Norman Edwards, the FAA official charged with implementing the system, says that he has no idea at this point where the money will come from. He claims that two options for raising the funds exist—either another reprogramming, which could cut deeply into the plans for more conventional air traffic control equipment, or a supplemental appropriation. But air traffic control circles are filled with speculation that the Office of Management & Budget of the White House has cut out funds for ARTS in the FAA's supplemental request. In addition, OMB is asking the FAA to justify ARTS 3 systems 35 through 64 through cost benefit studies, a move that could delay their installation for another year.

"It's criminal to cast a shadow on this program this late in the game," says one top airline source. He believes, however, that one way or another the FAA will find the money, even if it means another six months delay in the program. □

## Probing the news

### Communications

# AT&T's petition raises eyebrows

Bid for FCC's Johnson to sit out Bell decisions seen as move to balk competitors with court appeals

By Ray Connolly, *Washington bureau manager*

**AT&T's petition** of FCC commissioner Nicholas Johnson to disqualify himself "from further participation in matters before the Federal Communications Commission involving any companies in the Bell System," initially came as only a mild surprise to communications professionals in and out of government. To them, AT&T's charge that a recent Johnson speech "demonstrated deep-seated bias and prejudice against the Bell System" at first seemed an uncharacteristic fit of pique on the part of the giant carrier. On close reading, however, the petition suggests to a growing number of observers that Bell is carefully building a case for possible future court appeals of unfavorable FCC decisions, a plan that one commission staffer feels "could become a serious drag on industry expansion."

The expansion hinges on a variety of pending FCC judgments on data communications, domestic satellites, and special-service common carriers with their microwave networks—notably those involving Microwave Communications of America Inc. and its affiliates, and University Computing's subsidiary, Data Transmission Co. (Datran). As one attorney puts it, "AT&T can appeal any decision it doesn't like to the courts. By prolonging litigation, it can hamstring potential competitors like Datran and Micom while building up its own services in these markets. No matter what the final outcome, Bell wins by buying time and everyone else loses."

Speculation about AT&T's real

intentions centers about that part of its petition citing a recent U. S. Court of Appeals decision in a suit involving former Federal Trade Commission chairman Paul Rand Dixon. In this case, concerning Cinderella Career and Finishing Schools Inc. and the FTC, the court said commissioners have no "license to prejudge cases or to make speeches which give the appearance that the case has been prejudged." The AT&T petition concludes that "because of a speech made by the then chairman Dixon, while an appeal from an examiner's decision was pending before the FTC, and despite the fact that Mr. Dixon's vote was not necessary for a majority, the court in the case set

*Cat's-paw. Is AT&T using Johnson?*

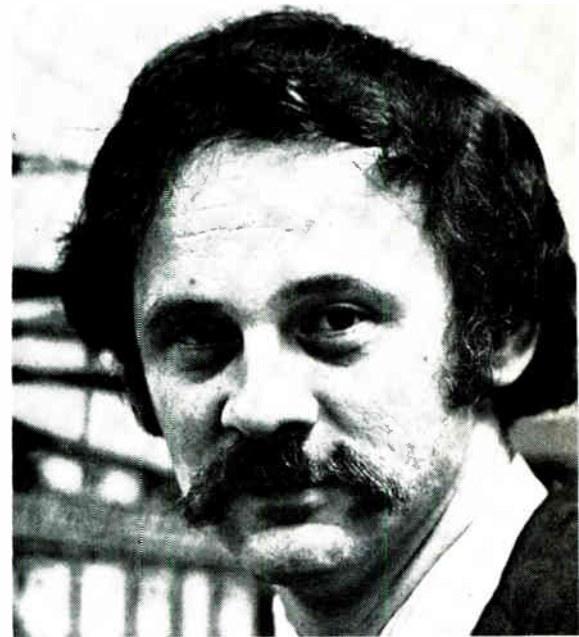

# What price real estate?

Complete HF Receive Antenna capability only 50 metres in diameter

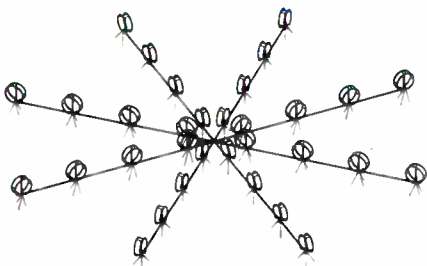

One metre diameter loops 4 metres apart form a broad-band directional receiving array covering 2-32 MHz, with optimum beam characteristics for both long and short range communication.

Rosette configurations of linear arrays provide complete azimuth coverage, in a number of overlapping high gain beams all available simultaneously. Rosette Loop Systems replace vast Rhombic or Log-periodic antenna farms, and require less than one hundredth of the real estate.

Aperiodic Loop Systems are ideal for applications in areas of restricted space or when quick set up is important, and are small enough to mount on a roof or conceal just below ground level.

Aperiodic Loop Systems are currently in use around the world by numerous Military and Governmental Agencies. Send for detailed Antenna Brochure:

## Hermes Electronics Limited

P.O. Box 1005  
Dartmouth  
Nova Scotia  
Canada  
Telex: 014-422744  
TWX 610-271-1973  
Telephone 902466-7491

## Washington

Apartment 315  
2020 F Street N.W.  
Washington  
D.C. 20006  
U.S.A.  
Telephone 202 296-2978  
TWX 710-822-1106

aside the commission's order and remanded the case to the commission for a new decision without the participation of Mr. Dixon."

By substituting Nicholas Johnson for Paul Rand Dixon and the FCC for the FTC, some Washington legal counsels experienced in communications proceedings divine a Machiavellian method beneath AT&T's obvious outrage at Johnson's apparent bias. "If Johnson disqualifies himself in every decision affecting Bell," says one attorney unwilling to be named, "then he is no longer an effective commissioner and should resign. There aren't many FCC rulings—except broadcast license renewals—that don't affect Bell."

What did Nick Johnson say to arouse such an impassioned petition by the normally dispassionate AT&T? The young FCC commissioner did indeed give a speech—a speech virtually unnoticed by most press prior to AT&T's disqualification petition—in which he charged that "there are three basic areas where I believe the Bell System has not served its own interests—what I will call financial operations, promotion of service, and technological improvements."

Titled "Why I Am a Conservative, or for Whom Does Bell Toil," the address before a Chicago communications group proved once again that Johnson is a quick-witted gadfly with an ability to turn a clever phrase. "You all recall the Telephone Company," the commissioner began lightly. "You have to recall the telephone company. You lose your dime on the first try." Though his audience was amused, AT&T clearly was not. Nevertheless, it took nine days for the eruption at AT&T to explode into the nation's business media. That Johnson's speech received little initial notice is attributed to his reputation as an outspoken maverick—one whose pronouncements begin to strike editors' ears as variations on a repetitious theme and thereby begin a steady progression from the front pages through the women's section on their way to burial among the obituaries.

In Chicago, however, Johnson was sounding a different theme. As he put it, "I used to talk and write

about the public interest in telephone matters a lot: lower rates, more flexible services, optimal rates of technological growth and plant expansion, and so forth. Well, I've stopped," he said, because "it's not working. It's kind of like falling in love by yourself. It's a beautiful trip, but it's kind of lonely." Thus, he said, "I've decided to talk about Bell's interests" because "at least you're not talking to yourself."

That someone was indeed listening was quickly demonstrated by AT&T's disqualification petition as well as its six-page rebuttal in an internal management newsletter that says Johnson's charges are "without merit and factually unsupported." And from there the newsletter undertakes a point-by-point rebuttal of the commissioner's charges that AT&T financing programs were shortsighted and costly; that it failed to exploit Federal tax opportunities for accelerated depreciation; that it should spin off Western Electric for the benefit of shareholders; that its electronic switching system will be "obsolete technology" when installed; that Bell is not meeting and has not met the needs of data communications users; that "Bell had to make a crash effort to catch up" in the TD-2 microwave radio relay system because "competitors had jumped in ahead."

AT&T's strong reaction to the Johnson charges has been termed overreaction by some FCC insiders, a number of whom see it as part of the larger appeals plan. Others believe AT&T merely wanted to get on the record in opposition to public criticism of its actions. Whatever the reason, FCC chairman Dean Burch says the dispute will be considered by the full commission—though there is little it can do except rap Johnson's knuckles with a censure of sorts, considered an unlikely action. Getting Johnson off the commission would require extraordinary action, but impeachment by Congress isn't likely. Johnson himself initially said he was considering the disqualification petition "most seriously." Nevertheless, this is hardly a guarantee that Nicholas Johnson will be any less outspoken in the future. □

Advanced technology

# Surface waves pick up speed

Despite funding slowdown, surface wave acoustic technology is moving toward inexpensive, high-performance devices for signal processing

By Richard Gundlach, *Associate editor*

**Despite a buildup** of interest over the past two years in surface wave acoustics, the sheer complexity of this young technology, coupled with the current lack of funding, has slowed progress. But several late-breaking developments have given this technology a dramatic push.

Designers, closely following the field because of the promise of components far smaller than those now used for high-speed signal processing [*Electronics*, Jan. 19, p. 110], are excited over several recent events: research that will lead to real-time, electronically programmable signal processing of arbitrary waveforms; development of simpler experimental devices with significantly improved performance; and a technique for simplifying fabrication.

While this work has moved surface wave acoustics closer to the applications stage, much engineering remains to be done before devices hit the market. How soon this happens depends largely on whether enough funding is committed.

**Perhaps the most significant** of the new developments is a parametric convolution technique recently demonstrated by Stanford University's Microwave Laboratory. "Devices using this technique would be able to correlate arbitrary functions whereas previous surface wave devices only processed fixed functions," says J. H. Collins of Edinburgh University, one of the pioneers in the field. The convolution technique can be used for correlation, time conversion, pulse compression, Fourier transformation, and variable delay. The Stanford approach works either in bulk

or surface wave devices for correlation of biphase coded waveforms, either for direct spread spectrum communications or arbitrary linear fm (Chirp) radar systems. And it eliminates the multiple-tap matched filter delay lines now required for handling complex fixed codes.

Signal processing can be accomplished simply by adding two electrodes to the middle of a surface wave delay line; the electrodes form a capacitive plate, one on top and one on the bottom of the piezoelectric substrate. A big advantage: electrode geometry doesn't depend on the signals' modulation characteristics.

Experiments on parametric convolution techniques initially were done at microwave frequencies using bulk waves in lithium niobate, then with surface waves. Later, H. J. Shaw, associate director of Stanford's Microwave Laboratory, described parametric acoustic interactions where the reference signal is time-reversed and correlation is performed, permitting processing gain and allowing signals to

be recovered from noise. In the Stanford experiment, insertion loss was about 45 decibels, and dynamic range was 65 dB. The time-bandwidth product was 75. Although these figures were not optimized for performance, they are comparable to existing devices. Stanford now is working on a correlator that uses this technique.

A disadvantage of parametric configurations is that electrodes must be spaced many wavelengths apart so that the substrate doesn't break, even though the acoustic wave penetrates only about a half wavelength into the material. But another recent development—burying a transducer within the piezoelectric material—allows the material to be used more efficiently, thus minimizing insertion loss. This technique ultimately should lead to devices with insertion losses of less than 20 dB.

But materials and processing problems remain a major stumbling block in achieving this performance. Lithium niobate has the best properties but it's very difficult to deposit thin films of this

Momentum. Time-reversing the reference signal in the surface wave device allows correlation without the need for special multiple-tapped delay lines.

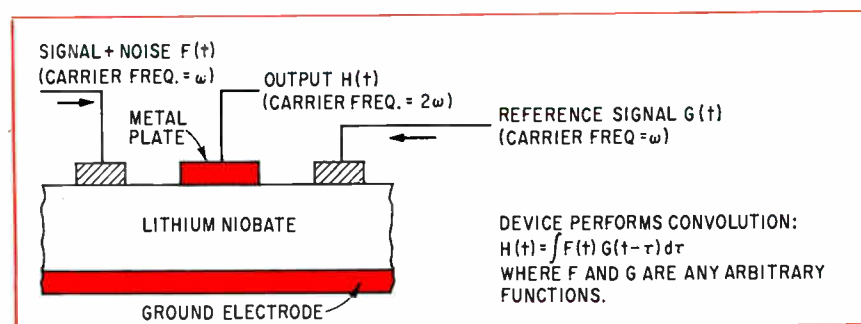

# Indianapolis is only a day away...

Indianapolis . . . where you  
and your product are within 24 hours  
by truck of more major cities than any other  
place in the United States. Your prime buyers and  
suppliers are, at most, only a day away via seven inter-  
state freeways that circle the city.

Twelve U.S. highways are linked to the Interstate 465  
urban loop to form a transportation network unparalleled  
in the nation. And an abundance of planned plant sites and  
developments adjacent to the 465 loop put you within 30  
minutes of any part of the city.

## FROM...

**CHICAGO ST. LOUIS DETROIT**  
**CINCINNATI LOUISVILLE**  
**LEXINGTON KNOXVILLE NASHVILLE**  
**COLUMBUS CLEVELAND TOLEDO**  
**Dayton SOUTH BEND FORT WAYNE**  
**CHARLESTON Gary MILWAUKEE**  
**MADISON GRAND RAPIDS**

For information, for assistance on sites  
and buildings, for computerized site  
selection, write John Hardy, Area  
Development Director, Dept. DA 240 or  
call 317 635-6868.

**INDIANAPOLIS  
POWER &  
LIGHT**

Indianapolis, Indiana 46206

## Probing the news

material. Sputtered zinc oxide, a familiar technology for microwave bulk transducers, and the newer vapor-deposited single-crystal aluminum nitride look promising, but they're difficult to deposit in 20 micron-deep thicknesses, needed for vhf operation.

The Autonetics division of North American Rockwell Corp., however, has grown single-crystal aluminum nitride films on single-crystal sapphire, a significant achievement since the AlN exhibits strong piezoelectric coupling, and its surface wave velocity is very close to that of the sapphire substrate. Furthermore, the dispersion of surface waves propagating in the material is low. With the Autonetics technique, transducers operating in the low-gigahertz region can be made by conventional photolithography instead of by expensive electron microscopy.

Surface wave amplifiers have also taken a step forward, thanks to three new developments that have both lowered cost and improved performance. Stanford has built a monolithic composite device that uses a thin layer of silicone oxide to separate an indium antimonide layer from lithium niobate. This configuration reduces the fabrication cost. Electronic gain at 220 megahertz was about 25 dB with a drift voltage slightly greater than 25 kilovolts. Terminal gain was about 7 dB with a delay-bandwidth product of several hundred.

A new type of separated medium amplifier that uses an accumulation layer on silicon substrates provides the lowest noise figure—5 dB—of any surface wave amplifier. MIT's Lincoln Laboratory is experimenting with this device.

Still another type amplifier, a three-terminal device that uses the acoustoelectric properties of gallium arsenide is unique in that it doesn't need interdigital transducers to launch the acoustic waves. In the Hughes Research Laboratory device, rf signals across the input terminals generate an acoustic wave that travels down the GaAs to the output terminals. [*Electronics*, Nov. 9, p. 25]. □





## Bell & Howell & Recording & How

It's done with oscillographs. We have a bunch, but let's talk about these two. They can handle on-line or off-line test and measurement of any physical happening you might have in mind. From pulse flutters during surgery to whether or not you're refining that crude the same way today as last year.

The one on the bottom is the 5-134. It does everything but talk. It writes to 25,000 Hz. (But with all that speed, it has a data accuracy to  $\pm 1/2\%$ .) And can flip into any one of 10 different servo-controlled speeds.

It's modular, of course, with special refinements. Like the timer, servo control board and galvo all plug in. Individual input connectors as standard. An extremely quiet operation. That type of thing.

Here's a couple more exclusives. You don't have to write out timing line rates. With us, that's taken care of automatically. With a timing ID marked on the edge of the paper. Not only that, the rate can be manually selected or can be automatically synced with paper speed.

And it's got a "jog" feature that allows you to move the paper short distances for initial set up—one hold-down button for on/off.

The smaller box is the 5-135. It weighs in at 35 pounds (a real portable) as compared to the other's 50 pounds. Both boxes share pretty much the same components. It's just that the 5-135 has broader application by more industries across the board because it's not quite so fancy (9 channels versus the 5-134's 18, for instance). Even though it's smaller, it doesn't skimp on performance. It has the largest range of input power options of anybody going. And all that at a lot less money. Not bad, huh?

And one more thing. Just in case you're building a system, we've got a range of other new goodies to complement these graphs: 1-172 amplifier, 8-114 bridge excitation/signal conditioner and the 23-111 paper processor.

If anything here piques your curiosity, you can get the full package of specs by writing Bell & Howell, Instruments Division, 360 Sierra Madre Villa, Pasadena, California 91109.

INSTRUMENTS DIVISION

 **BELL & HOWELL**

© Copyright 1970 Bell & Howell

Consumer electronics

# Synthesizers tune up for market push

Electronic music-maker companies use standard ICs to reduce size and cost of units slated for homes, rock bands, and schools

By Gerald M. Walker, *Consumer editor*

**Sales of the hit record**, "Switched-on Bach," are switching on the sales potential of what could become an important market—electronic music synthesizers. The trend is away from the bulky, expensive Moog-type units, whose size and pricetags have restricted them largely to studio work and sales of only \$5 million a year, toward smaller, portable, real-time synthesizers that may have a chance of cracking the \$135 million electronic instruments market.

Semiconductor houses could benefit strongly from what promises to be fierce competition to make the synthesizer standard equipment in homes, rock bands, and high school music departments. The new units rely on bipolar and MOS integrated circuits to achieve the size and price reductions needed to fuel the sales takeoff.

All synthesizers have three basic parts—sound sources, sound modifiers, and controllers. The sound

sources include a noise generator, oscillators, and an input for an external source. The sound modifiers include voltage-controlled filters and amplifiers, and their associated contour generators. The controllers include manual slides, a keyboard, and foot pedals.

Size and simplicity separate the new concert synthesizers from their expensive big brothers. In the large units, complex programing is required to patch together and modify sounds. The output is a tape recording which may be processed several times before the music is ready to be performed. By contrast the playable synthesizers are real-time devices that have to be easy to program. They require either built-in amplifiers and speakers or an output to both.

**To offer the live performer** rapid control and styling while keeping prices down, the portable-unit designers have pared the instrument to its bare essentials and have gone all out for printed circuits and encapsulated voltage-controlled oscillators. And whereas the first wave of custom-made synthesizers defined the musical needs of an instrument and popularized the electronic sound, the second generation is boasting better musical stability thanks to closer electronic tolerances. Reliability is an essential feature for an instrument to be played live under severe performance conditions.

The first small synthesizer to reach production this year was the Putney VSC3, a British-designed instrument distributed in the U.S. by Ionic Industries Inc. The Putney weighs 20 pounds and sells for \$1,395; an optional keyboard is

priced at \$595. It has three oscillators, an envelope shaper that gives sound resonance, a bandpass filter, input and output amplifiers, and special-effects controls. But its main features are a plug patch-board to set up the musical combinations, and a joystick with which the performer can vary any two control parameters simultaneously.

The best-known name in synthesizers, Moog Inc., is entering the competition with a player appropriately named Mini Moog and priced at \$1,195.

The classroom, on the other hand, is the only target for the Electrocomp, sold for \$999, together with a \$325 manual controller, by Electronic Music Labs Inc. Organized by three engineers, the company landed a contract from the Connecticut Department of Education to design and build a synthesizer for music instruction.

**Another unit** for both education and live performance is due by year's end from Tonus Inc., another relatively new firm. Its ARP 2600 portable music synthesizer is carried in separate keyboard and electronic module sections, selling together for about \$1,400.

Aimed at the would-be composer with no musical aptitude is the simplified Muse synthesizer. It offers the capability to program a simple chord by slide switches through all of its mathematical variations thanks to a 31-bit shift register and timer that control the selected melody. It's due from Triadex Inc. by Christmas for about \$300 and is the first of what's called a "home entertainment computer" line. □

**Making the scene.** First of the small synthesizers will be the British Putney.

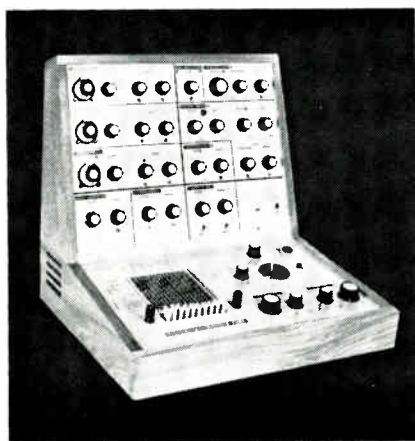

# Two new photorecording papers from Kodak

**Kodak Linagraph Direct Print Papers, Types 1895 and 2022, could be your only choice when...**

- you're faced with some laboratory recording, some field recording
- wet processing is impossible
- you need data instantly, and it must last indefinitely
- your recorders are direct-print

Now, if there's an event happening almost anywhere, you can get a high-quality tangible record. With new Kodak *Linagraph* 1895 (standard base) and 2022 (extra-thin base) Papers, you get readable traces the instant you expose to room light... crisp, dark traces a minute later. And the image is extremely stable.

No-heat, no-wet process *Linagraph* 1895 and 2022 Papers are designed for use with direct-writing cameras and oscillograph records equipped with high-intensity tungsten, xenon, or mercury-vapor light sources. They produce high-contrast images that are easy to read, reproduce well on most office copiers.

This paper is one of many products designed by Kodak scientists and engineers to solve data-recording needs through photography. The materials and technology to meet your specific requirements are probably available right off the Kodak shelf. Want more information? Just mail the coupon or call our photographic specialists at (716) 325-2000, Ext. 5114.

Department 412L  
EASTMAN KODAK COMPANY  
Rochester, N. Y. 14650

- Send information on *Kodak Linagraph* 1895 and 2022 Papers.
- Send new "Kodak Products for Instrumentation" catalog.
- Have representative call.

Name \_\_\_\_\_

Position \_\_\_\_\_

Firm Name \_\_\_\_\_

Address \_\_\_\_\_

City \_\_\_\_\_

State \_\_\_\_\_

Zip \_\_\_\_\_

11-48

**Kodak**

# What makes ours the world's best MOS? MOSAB. Input protection that stays where we put it.

Every MOS manufacturer builds over-voltage protective devices into his input circuits. But conventional devices are all subject to "diode walkout" as shown on the curve tracer. With each successive surge, the "zener" voltage increases . . . until eventually it exceeds the circuit breakdown voltage. And that means complete failure.

Our patented MOSAB (MOS Avalanche Breakdown) device is different. It clamps over-voltage protection at a value well below the danger point. And it doesn't walk away on you . . . regardless of how many over-voltage surges come along.

Philco® MOS has other built-in protection too. We apply a unique PSG passivation material over the entire chip—not just over the metallization. This gives you

MOS that's completely passivated . . . electrically stabilized, and protected all over against ion migration and scratched metallization. Try our trouble-free MOS with the input protection that's permanent. Write Philco-Ford Corporation, Microelectronics Division, MOS Marketing, Blue Bell, Pa. 19422. Call (215) 646-9100 or your nearest sales office.

Los Angeles, Calif., (213) 641-8105 • Palo Alto, Calif., (415) 321-8740 • Melrose Park, Ill., (312) 345-1000 • Burlington, Mass., (617) 272-1600 • Dearborn, Mich., (313) 323-3797 • Union, N.J., (201) 686-7512 • Syracuse, N.Y., (315) 422-3154 • Dayton, Ohio, (513) 223-1832 • Don Mills, Ontario, (416) 444-2541.

**PHILCO** 

The better idea people in MOS.

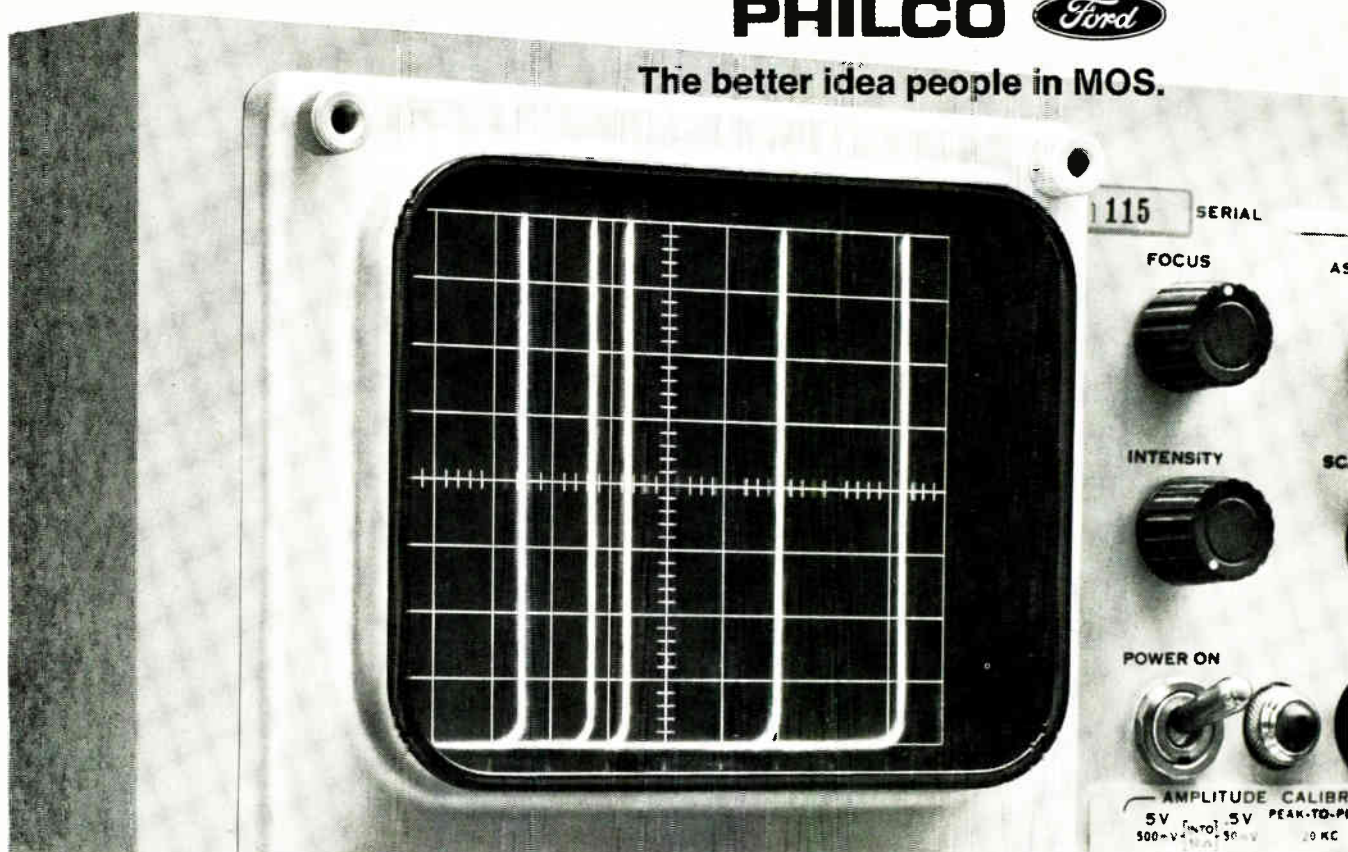

# IR scanner detects flaws in microcircuits

CRT display reveals design and process defects when devices are operated under load

**When the heat's on**, integrated circuits and other components often do not live up to expectations. Devices which check out during the manufacturing process sometimes fail in the circuit because defects in design, fabrication, or packaging were not detected earlier.

An optical scanning device, called a microscanner, has been developed by Barnes Engineering Co. for detecting small flaws in microcircuits by evaluating their thermal characteristics under electrical loads and temperature changes. The RM-50 combines the features of a high-sensitivity, real-time infrared camera with the characteristics of an infrared microscope to produce highly magnified thermal images of microcircuits in the time it takes to scan the frame of a cathode ray tube. The microscanner automates the tedious task of taking spot temperature measurements with a mechanically operated microscope. In fact, the system is 2,000 times faster than infrared microscopes and produces a variety of displays previously unattainable, according to the designer, Donald Fisher.

Applications are expected to include circuit design, and fabrication of integrated circuits and other components. By obtaining a thermogram of a printed circuit board layout or breadboard of a network,



**Hot spots on display.** Red areas show where current flow is overheating a thin-film hybrid amplifier when test voltages are applied. To get color thermograms on the CRT screen, a converter is required.

the designer can quickly determine where large areas of heat are being generated by current distribution. During fabrication and packaging of ICs, quality-control engineers can detect flaws in processing operations, such as etching or plating, by examining sample thermograms taken from batches off the production line.

A typical test with the microscanner involves raising the temperature of the device in a transient manner and noting the thermal response as the target area is scanned. Fisher contends that breaks or shorts can be visually recognized by the thermal pattern

more quickly and more easily than with conventional microscope techniques. "When a temperature transient is applied to the device, and there is a break somewhere in the circuit, you should observe some kind of discontinuity in the display pattern," he notes.

Thermal images are displayed in black and white and shades of gray which are converted to discrete temperature values. In addition, three dimensional isometric displays also may be generated on the CRT. What's more, single-line scans can be extracted from the picture. A digital readout on the screen indicates the temperature

# Varo High Voltage Silicon Rectifiers carry your big loads

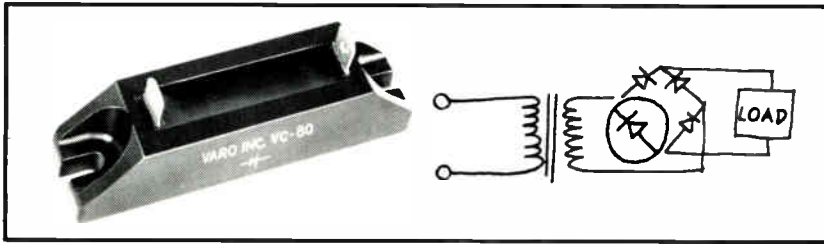

Our new VC Series rectifiers may be tiny (3" long, 3/4" high, 3/4" wide), but they're plenty tough enough to stand up under high voltage, high power conditions.

They have voltage ratings of from 2 KV to 8 KV, current ratings of 1 to 2 amps, and they're available with an optional 300 nanoseconds recovery time.

Varo VC Series rectifiers are made to handle the biggest jobs. Like X-ray power supplies, radio and radar transmitters, and things like the new microwave oven power supplies.

And they'll handle most of the new high voltage, high power system demands that'll be coming along in the future, too.

The new VC Series from Varo. It's the kind of thing we know you've come to expect from us.

**\$4.18** EACH

VC-80 (8,000 Volts—1 Amp).  
1,000 quantity



SEMICONDUCTOR DIVISION, 1000 N. SHILOH ROAD, GARLAND, TEXAS 75040 (214) 272-4551

Circle 140 on reader service card

## New products

extremes of the device under test. An electronic zoom provides up to 3X magnification with any of the lenses used in the system for close-ups of small areas. An accessory converter can be added to produce color thermograms for quick identity of hotspots.

Mirrors driven by torque motors move the image in front of the infrared detector's field of view. The object is placed under the microscope, aligned and focused through the visible channel. As soon as the infrared objective is indexed, the thermal image appears on the CRT screen. A beam-splitter allows the operator to see the screen at the same time it is being photographed by a built-in photorecorder, without obstructing the operator's view.

The 40X objective lens produces a spatial resolution of 0.001 inch, permitting detection of temperature variations smaller than 0.1°C. For higher resolutions, a 100X objective lens provides a field of view of 0.025 x 0.025 inch with a spatial resolution of 0.0004 inch and a working distance of 0.3 inch. To examine large objects, there is an objective lens which supplies a field of view 2.5° across with a spatial resolution of 0.7 milliradian. This objective can be focused from 30 inches to infinity.

An absolute radiation reference is supplied in the infrared channel by a chopper that continuously interrupts the detector field of view. This reference permits the operator to use the microscanner as a fixed-point or position-programmed radiation thermometer. Here the torque-driven scanning mirrors are positioned and programmed by externally supplied dc voltages. Thus, the instrument can automatically inspect a series of critical points on the object and a computer can make accept-reject decisions.

The price for the basic unit is \$20,000. The system is available with four basic objective lenses: 100X, 40X, 10X, and a variable 3X or less. The infrared microscanner will be available for delivery in January.

Barnes Engineering Co., 44 Commerce Rd., Stamford, Conn. 06902 [338]

# TIGHT-WAD

## BREADBOARD DESIGNER

*The ELite 2 is stingy with your money - with your time  
When it comes to advanced circuit design*

This dynamic lab in a box will enable you to design, layout, test and construct (and re-use) all IC and discrete components circuitry (LIS, MSI, MOS) **WITHOUT SOLDERING, SPECIAL TOOLS, PLUGS OR PATCH CORDS.**

**PLUS THESE BUILT-IN FEATURES:**

- Wide range function generator — sine, square, triangle
- Wide range pulse generator—bi-polar outputs
- 3 monitored power supplies — floating, stable, short circuit proof
- 12 data display lamps — high input impedance ± turn-on thresholds
- All breadboard interconnections with solid #22 gauge hook up wire
- Desk top convenience: 6 inches high, 17 1/2 inches wide, 12 inches deep.
- **ORDER ONE TODAY**

*Write or call for complete specifications catalog*

**PRICE**  
**\$1,300**  
**COMPLETE**



# ELi

## EL Instruments Incorporated

61 First Street  
Derby, Conn. 06418

Phone:  
203/735-8774

**BRAND-REX PRESENTS**  
**BUCK ROGERS**  
 IN THE 25th CENTURY

WILMA, DR HUER AND I WERE JUST LEAVING NEPTUNE WHERE WE'D HELPED TIE IN A NEW NETWORK OF PERIPHERAL EQUIPMENT WITH THE MASSIVE NEPTUNIAN COMPUTER CONTROL CENTER.



THANK YOU BUCK ROGERS, FOR PUTTING US WISE TO **BRAND-REX** WIRE AND CABLE. OUR COMPUTER SYSTEMS COULD NEVER HAVE FUNCTIONED WITHOUT THEM.

IF **BRAND-REX** IS ALREADY SUPPLYING THE 10 BIGGEST CENTRAL PROCESSING UNIT MANUFACTURERS IN THE UNIVERSE, IT STANDS TO REASON THEY'LL HAVE THE PRODUCTS COMPATIBLE WITH YOUR NEEDS. GOOD-BYE FOR NOW.



WE'RE OFF TO MERCURY TO DO ANOTHER CRITICAL HOOK-UP JOB WITH **BRAND-REX** WIRE AND CABLE.



SHORTLY AT THE PLANET MERCURY'S NEW COMPUTER CONTROL CENTER...

BUT DR. HUER, THIS MERCUREAN SYSTEM IS ENTIRELY DIFFERENT FROM THE ONE WE JUST WORKED ON FOR NEPTUNE.

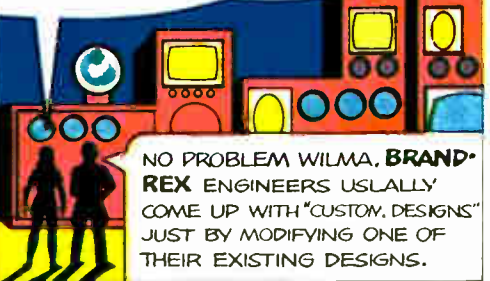

NO PROBLEM WILMA, **BRAND-REX** ENGINEERS USUALLY COME UP WITH "CUSTOM" DESIGNS JUST BY MODIFYING ONE OF THEIR EXISTING DESIGNS.

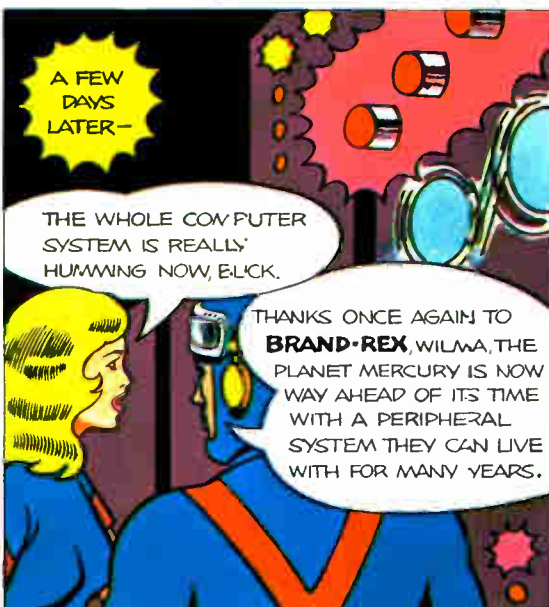

A FEW DAYS LATER—

THE WHOLE COMPUTER SYSTEM IS REALLY HUMMING NOW, BLCK.

THANKS ONCE AGAIN TO **BRAND-REX**, WILMA, THE PLANET MERCURY IS NOW WAY AHEAD OF ITS TIME WITH A PERIPHERAL SYSTEM THEY CAN LIVE WITH FOR MANY YEARS.

SAY EARTHFOKLS: DID YOU KNOW THAT **BRAND-REX** ENGINEERS TURN OUT AS MANY AS 3,000 NEW CABLE DESIGNS IN A YEAR? NO WONDER THEY HAVE MORE ULL APPROVALS ON COMPUTER WIRE AND CABLE THAN ANYONE ELSE. THEY'RE USED TO WORKING HAND-IN-GLOVE WITH THE BIGGEST NAMES IN THE INDUSTRY SO THEY JUST NATURALLY OFFER THE MOST COMPATIBLE DESIGNS FOR PERIPHERALS AVAILABLE. TAKE MY ADVICE AND WRITE FOR THE **BRAND-REX** CATALOG ON BUSINESS MACHINE WIRE AND CABLE TODAY.



**BRAND-REX DIVISION** AMERICAN ENKA CORP.  
 WILLIMANTIC, CONN., 06226, PHONE 203 423-7771.

**BRAND-REX, WAY AHEAD IN WIRE AND CABLE**

Instruments

# Analyzer rides wide ranges

Input amplitudes can vary by 100 dB; scans go to 10 GHz

The large display tube in AIL's 707 spectrum analyzer doesn't just enlarge the same old signals—it displays more information, because of the instrument's high dynamic range and large scan width.

For example, over its range of 10 megahertz to 12.4 gigahertz, the 707 can display amplitudes as much as 100 decibels apart. As a result, it can simultaneously display a kilowatt in-band signal and milliwatt sidebands.

And since the scan width is adjustable between 10 kilohertz and 10 GHz, the 707 can simultaneously sweep S, C, and X bands when set to its widest scan—a capability needed in electromagnetic interference and surveillance work.

Another feature is the analyzer's high sensitivity. The value varies, according to the frequency range, from -100 dB referred to 1 milliwatt at 5.4 GHz and above, to -115 dBm in the 1.8-4.0 GHz range. This high sensitivity is the result of low spurious response. For inputs with frequencies over 1.8 GHz, the noise level is 80 dB below a 0 dBm input. For lower frequencies, the noise is 80 dB below at -20 dBm.

These specs are partly the result of AIL engineers' knowledge of what's available in components, says Francis Edden, engineering head of AIL's microwave division. The 707 has no custom-made parts, he points out. The components, including solid state oscillators and yig filters, are off-the-shelf.

"One of the points we worked the hardest at," recalls Edden,



"was getting good filtering. In the 707, we have filters with bandwidths of 1 kilohertz, 10 kHz, 100 kHz, and 1 MHz with shape factors of about 10 to 1 from 3 dB to 80 dB. In order to have good presentation, these are the kinds of shape factors you need."

Not only is the spurious level low but so also is the 707's reradiation level. Regardless of input level, it will put back into the input source a signal level no higher than a few microwatts. Some other analyzers, says Edden, generate signals in the milliwatt range.

The low noise level is due also, says Edden, to the instrument's built-in preselector. Before reaching this tuned amplifier, an input passes through an adjustable 60-dB attenuator to a switch. For signals under 2 GHz, the switch sends the input through a converter whose fixed frequency output (2.2 GHz) goes to the preselector. Higher frequency inputs go directly from the attenuator to the preselector, which in these cases is swept. But whatever the input frequency, the preselector's output is mixed with a swept signal coming from a voltage-controlled oscillator. Out of the mixer comes a 200-MHz i-f signal which is filtered and con-

verted to 21.4 MHz. This signal goes through a 100-dB logarithmic amplifier to the display.

AIL has a number of applications in mind for the 707. Its large display can be fitted with an accept-reject grid, making the analyzer useful in production testing.

In doppler-effect systems and in test setups for oscillators, the 707's ability to resolve frequencies that are close to one another is useful. Peak resolution is 1 kHz, so, for example, the 707 can display two signals that differ by 60 dB and are less than 10 kHz apart.

Nor is the 707 limited to jobs under 12.4 GHz. Working with a mixer, which AIL will be offering for "a few hundred dollars," and an ordinary microwave oscillator, it can have a range up to 40 GHz.

Besides its cathode ray tube, the 707 has a digital readout which shows the center frequency to a resolution of 1 MHz. This display is made of light-emitting diodes.

A convenience feature is the automatic phase locking which allows the analyzer to be tuned by just a single dial. It's not necessary to peak a meter or balance any circuit after switching ranges.

When not analyzing spectra, the 707 is an oscilloscope. The instrument's specified scan rates run from 1 second per cm to 1 ms/cm. For scans faster than 3 ms/cm however, the circuitry can no longer keep pace. So the unit switches itself into the time domain and works like a standard oscilloscope.

The 707 comes in a single package—12½ by 17 by 20 inches. It weighs 65 pounds, and draws 200 watts. The price is \$10,900 and delivery time is 3 months.

AIL, a division of Cutler-Hammer, 815 Broad Hollow Road, Farmingdale, N.Y. 11735 [339]



# About MIL-temp-range, clockless, TTL-loving RAM's, ROM's, and other MOS improbabilities.

There are any number of people making MOS devices these days.

But not so many people using them.

And we know why.

Almost all MOS devices are power hungry.

Most of them don't get along easily with DTL and TTL.

And almost every one carries a 65°C or 85°C maximum-temperature limitation around its neck.

That's why ours are so improbable.

They all interface directly with worst-case DTL and TTL levels.

They all operate over the full

-55°C to 125°C MIL spec range.

And the RAM's use about half the power that most of the others require.

Our new off-the-shelf 256 x 1 RAM, for instance.

It's fast (<1 μsec access time); low power (1 mw/bit); and it interfaces with DTL and TTL without pull-up or pull-down resistors. Our special field-inversion protection keeps those specs stable at 125°C and at circuit voltages well in excess of -20 volts.

That's not a "someday we'll do it if you pay for the tooling" promise. Our stock list already includes 64 x

4 and 256 x 1 RAM's; 1024-bit, 2048-bit, 3072-bit, and 4096-bit ROM's; and a new 2240-bit character generator; not one of which has a clock or needs a clock driver. More—like a 1024 x 1 RAM—are on the way.

What's your pleasure? Call and tell us what you want and you'll have one in 72 hours. Write, and we'll have data in the next mail.

Special problem? Ask for our MOS problem-solver, John Kitzrow.

Unisem Corporation  
P.O. Box 11569  
Philadelphia, Pennsylvania 19116  
Telephone: (215) 355-5000.

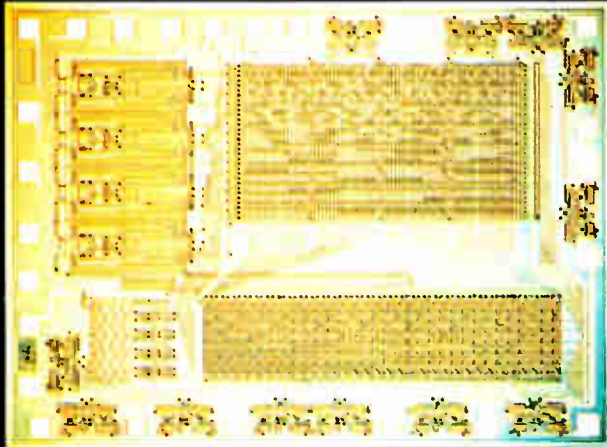

UA2540/3540 2240-bit character generator

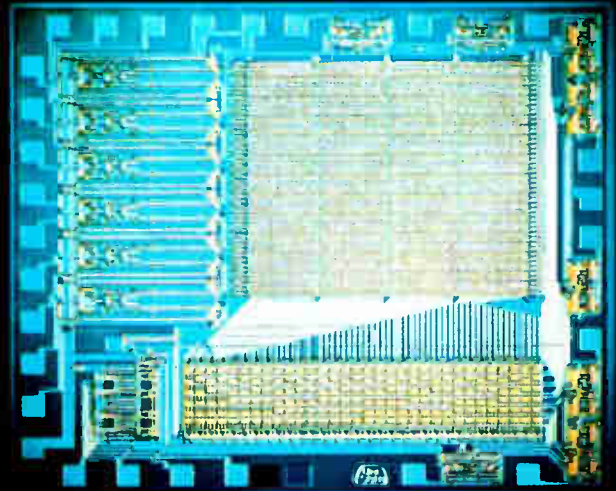

UA2572/3572 3072-bit ROM

UA2548/3548 2048-bit ROM

UA2556/3556 256 x 1 RAM

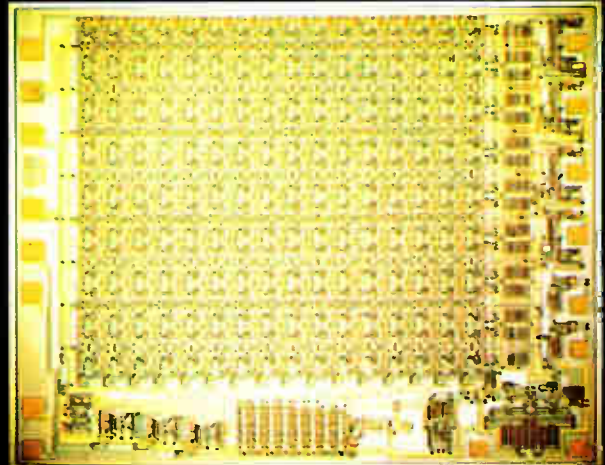
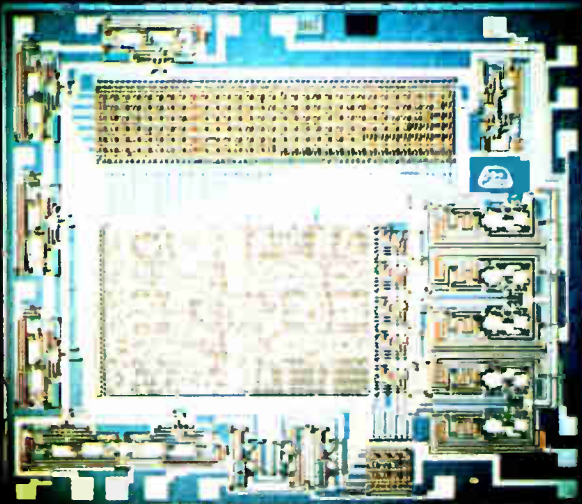

**Unisem**  
TREVOSE, PENNSYLVANIA 13047

**U  
A.**  
SUBSIDIARY OF UNITED AIRCRAFT CORPORATION

## New products

### Components

# Sonic cells do counting jobs

## Transducers challenge optical units for card sensing, production-line tallies

Photocells are widely used in such applications as punched-card counting and production counting of items moving along a conveyor

belt. But photocells are sensitive to changes in light intensity, and can become fouled with dust, requiring wipers or air blowers to keep them clean. These are some of the limitations that engineers at the Instrumentation division of Gulston Industries feel they've overcome with the MTR-4500 sonic sensor cell series.

The devices are completely interchangeable ultrasonic receivers and transmitters. In a typical installation, the receiver and transmitter are mounted on opposite sides of a channel through which the card passes, reflecting the transmitted signal back to the receiver. John Hayer, manager of the Instrumentation division, says that if 10 volts

peak to peak are put into the system, the output will be an easily detectable 3 volts. That 3-v signal drops to the microvolt range when a card interrupts the beam, "so only a level detector is needed to provide a signal for the user's counting technique," Hayer points out.

Six entries in the MTR-4500 series have been designed, with operating frequencies ranging from 16 to 200 kilohertz; 40-kHz and 200-kHz units are available now as off-the-shelf transducers that can be used in the transmitter/receiver arrangement for counting applications. The Gulston transducers require only 5 to 10 milliwatts of power, versus



Plastic-cased capacitors type KM9 are for use as filters for power supplies used in electrostatic copiers and precipitators. Units are available in voltage ratings from 1,000 to 12,500 V. They meet humidity requirements of EIA specification RS-164, with 500 hours exposure at 95% relative humidity and + 40°C temperature. Film Capacitors Inc., 100 Eighth St., Passaic, N.J. [341]



Two-electrode surge arresters series CG are for the protection of telecommunications lines and solid state circuitry. Response to transients is rapid. Life is guaranteed for 50 discharges under maximum load conditions, with 200 discharges being typical. Units feature low-voltage operation and high peak current capabilities. Signalite, 1933 Heck Ave., Neptune, N.J. 07753 [345]

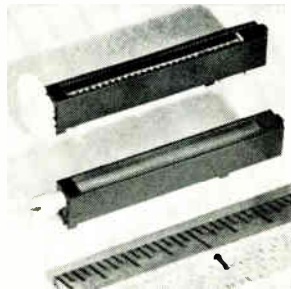

Preset carbon potentiometers offer nominal resistances from 1 kilohm to 2.2 megohms. The 20-turn trimmers dissipate up to 1/8 W at 70°C. Tolerance on nominal resistance value is ±20% and repeatability is 0.1%. Units are available for immediate delivery at 41 cents each in 5,000 lots and 33 cents in 25,000 lots. Amperex Electronic Corp., 35 Hoffman Ave., Hauppauge, N.Y. [342]

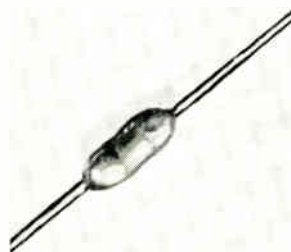

Epoxy roll-coated chokes are designed to meet requirements of MIL-C-15305D. Thirteen models are available in an inductance range from 0.10 μH to 1 μH (± 10% tolerance). Self-resonant frequencies range from 680 MHz on the 0.10 μH model to 240 MHz on the 1 μH model. Over-all length including leads is 2.955 inches minimum. Dale Electronics Inc., Columbus, Neb. [346]

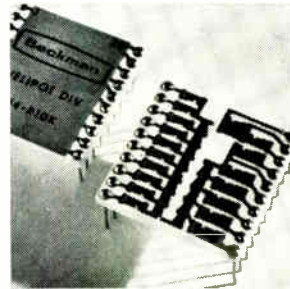

Ladder network model 814 is a 14-bit binary unit designed for use in digital to analog conversion applications. Units feature tracking to 1 ppm/°C, settling time to 100 ns, maximum output voltage ratio errors as low as 33 ppm, and specified output accuracies over -20° to +80°C operating temperature range. Beckman Instruments Inc., 2500 Harbor Blvd., Fullerton, Calif. [343]



Printed-circuit board connector series 225 is available with 6 through 43 contact positions in both eyelet and dip-solder termination styles. Contact center-to-center spacing is 0.156 inch. Units utilize an economical bifurcated bellows-type contact that permits a high number of board insertions and withdrawals without damage. Bunker-Ramo Corp., 1830 S. 54th Ave., Chicago [347]



Significant contact noise reduction combined with 250 Hz repetitive switching is offered in the type HGJ mercury relay. Typically, noise voltage is reduced from 100 μV using an industry standard relay to 10 μV at 4 ms after coil energization, with 10 kHz system bandwidth. The relay is rated for 10 billion operations. C.P. Clare & Co., 3101 Pratt Blvd., Chicago 60645 [344]

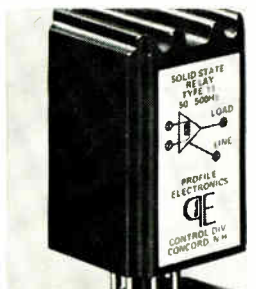

Solid state relays type 11 are 8-ampere devices that are essentially full wave power switches for controlling ac loads. Because they conduct over the full 360° of the cycle, they can be used for either resistive or inductive loads without derating. When the input is removed they will deenergize the load when the voltage crosses zero. Profile Electronics Inc., Concord, N.H. [348]

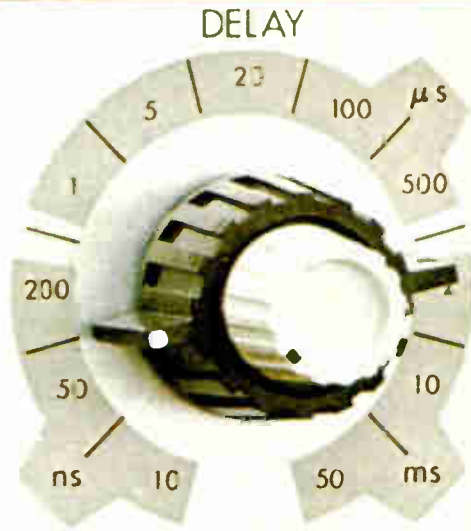
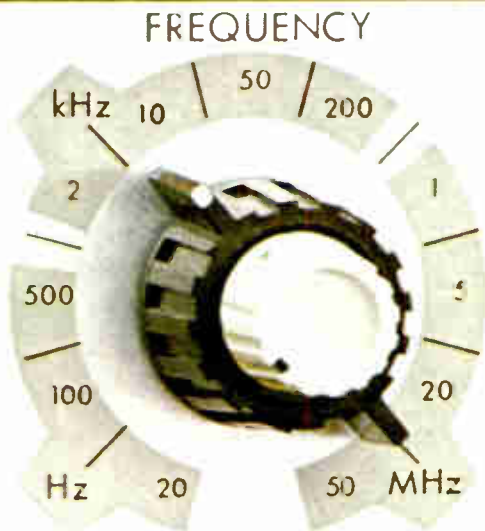

INT



SGL CYCLE

EXTERNAL

DRIVE



TRIG

OUTPUT



TERM



GENERATION 70

model G 710 PULSE GENERATOR

\$395

Dear Sir:

You boys from E-H Research Laboratories talk big. Now, prove it. Here is my purchase order. Please ship me \_\_\_\_\_ Model G710 50 MHz pulsers for only \$395 each. I understand the E-H Model G710 pulser from your new GENERATION 70™ line offers dual outputs with amplitude to 5V into 50 ohms, rise and fall times of 5ns, duty factor greater than 50%, external triggering and waveform distortion less than 5% peak-to-peak. I want a 5-Day Free Trial and a One-Year Guarantee.

Name \_\_\_\_\_ Title \_\_\_\_\_

Company \_\_\_\_\_

Address \_\_\_\_\_ Telephone \_\_\_\_\_

City \_\_\_\_\_ State \_\_\_\_\_ Zip \_\_\_\_\_

515 11th Street • Box 1239, Oakland, California 94604 • (415) 834-3030

If you don't want to cut up your magazine, just a purchase order to E-H or to an E-H Representative will do.



# aer·o·ne·tics (â'r'ə-nê'tiks)n.

1. Having to do with electronic metering and measuring. 2. The design and manufacture of metering and measuring devices to equal or exceed all known industrial, scientific or military requirements. 3. The ability to adapt principles proven by the aviation/aerospace industry to satisfy similar electronic instrumentation requirements.

*AERONETICS Division has the engineering creativity and manufacturing flexibility to satisfy your electronic metering and measuring needs. Send us your requirements and specifications.*

**AERONETICS**  
a division of AAR CORP.  
2100 Touhy Avenue  
Elk Grove Village, Illinois 60007  
PHONE: (312) 593-6700  
TELEX: 253594 / CABLE: AIRNAVCOM



Circle 141 on reader service card

## Where reliability really counts!

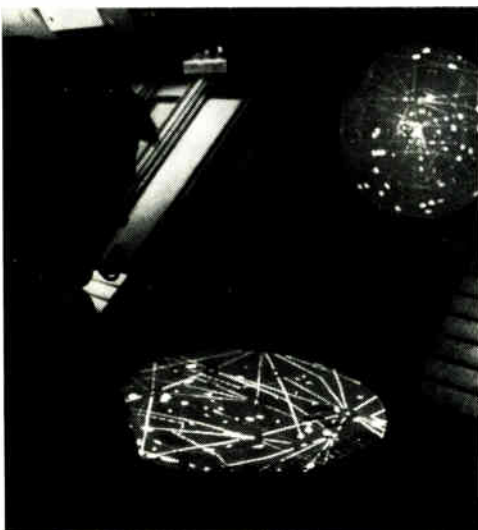

The reliability of Zenith Flat-Face Metal CRTs is demonstrated by their extensive use in enroute air traffic control centers and airports. When safety depends on reliability, Zenith is specified! Shouldn't you take advantage of Zenith CRT quality in your application? Write for details.



**ZENITH RADIO CORPORATION**  
THE RAULAND DIVISION  
5614 W. JARVIS AVE. • CHICAGO, ILL. 60648 • 312-647-8000

106 Circle 106 on reader service card

## New products

several watts for light sources, and they have projected lifetimes of 50 years, compared to about 5,000 hours for light sources.

The transmitted beam can be focused, making the units useful in hole-sensing applications such as punched-card or tape reading.

Instrumentation Division, Gulton Industries Inc., 1644 Whittier Ave., Costa Mesa, Calif. 92627 [349]

## Transducer senses load without cutting connection

Flux-sensitive resistors play the key role in a small transducer designed for power measurements. About three inches on a side, the device gauges load dissipation without disconnection of any leads. Instead, the wire carrying current to the load passes through a hole in the transducer while the load voltage is being sensed. The result is a dc signal proportional to the load.

Designated the 404 and made by American Aerospace Controls Inc., the device is aimed at such jobs as monitoring motors and computer power supplies and checking power systems in aircraft.

In effect, the device measures power by multiplying load current by load voltage. Bordering the transducer hole is a split magnetic core. In its air gap is a bridge with flux-sensitive resistors in two of its arms. When current flows through the wire in the hole, a magnetic field appears in the core, unbalancing the bridge by changing the resistance of the two flux-sensitive arms. With the load voltage exciting the bridge, the magnitude of the transducer's output signal—an ac signal—depends on both the load voltage and the field strength. This procedure makes the bridge output proportional to the product of load voltage and load current.

This unbalance signal passes through a rectifier and a filter before being made available at the transducer's output terminals.

In small quantities, the 404 sells for \$250 each.

American Aerospace Controls Inc., Farmingdale, N.Y. 11735 [350]

Electronics | November 23, 1970

# Honeywell Computers may be applied liberally.

If you're looking for a general-purpose computer that really is general purpose, you ought to know about Honeywell computers. Like the H316 computer below, and other members of the Series 16 family. Then there's the Series 32 family. And the H112 minicomputer. They're being used in all sorts of applications.

On off-shore oil rigs, they're helping keep free-floating ships directly over the drill.

In supermarkets, they're speeding checkouts and maintaining total inventory control.

In airline systems, they're concentrating data to cut back on expensive telephone line lease costs.

In hospitals, they're providing on-line, real-time access to both in-hospital communication systems and remote data facilities.

And if that isn't enough, try these: Space capsule simulation. Antenna control. Numerical control.

Remote manipulator control. Industrial control. Weather reconnaissance. Weather forecasting. Patient monitoring. Navigation. Target tracking. Fire control. Seismic studies. Travel reservations. Medical research. Credit verification. River traffic control. Communications. Graphic data conversion . . . Whew.

Now that's what general-purpose computers are all about.

Get more information about Honeywell computers and the uses they're being put to. Write for our Control Applications Kit. So you can consider the alternative: Honeywell, Computer Control Division, Framingham, Massachusetts 01701.

## The Other Computer Company: **Honeywell**

Circle 107 on reader service card

HONEYWELL INTERNATIONAL—Sales and Service offices in all principal cities of the world. Manufacturing in Australia, Canada, Finland, France, Germany, Japan, Mexico, Netherlands, Spain, Taiwan, U.K. and U.S.A.

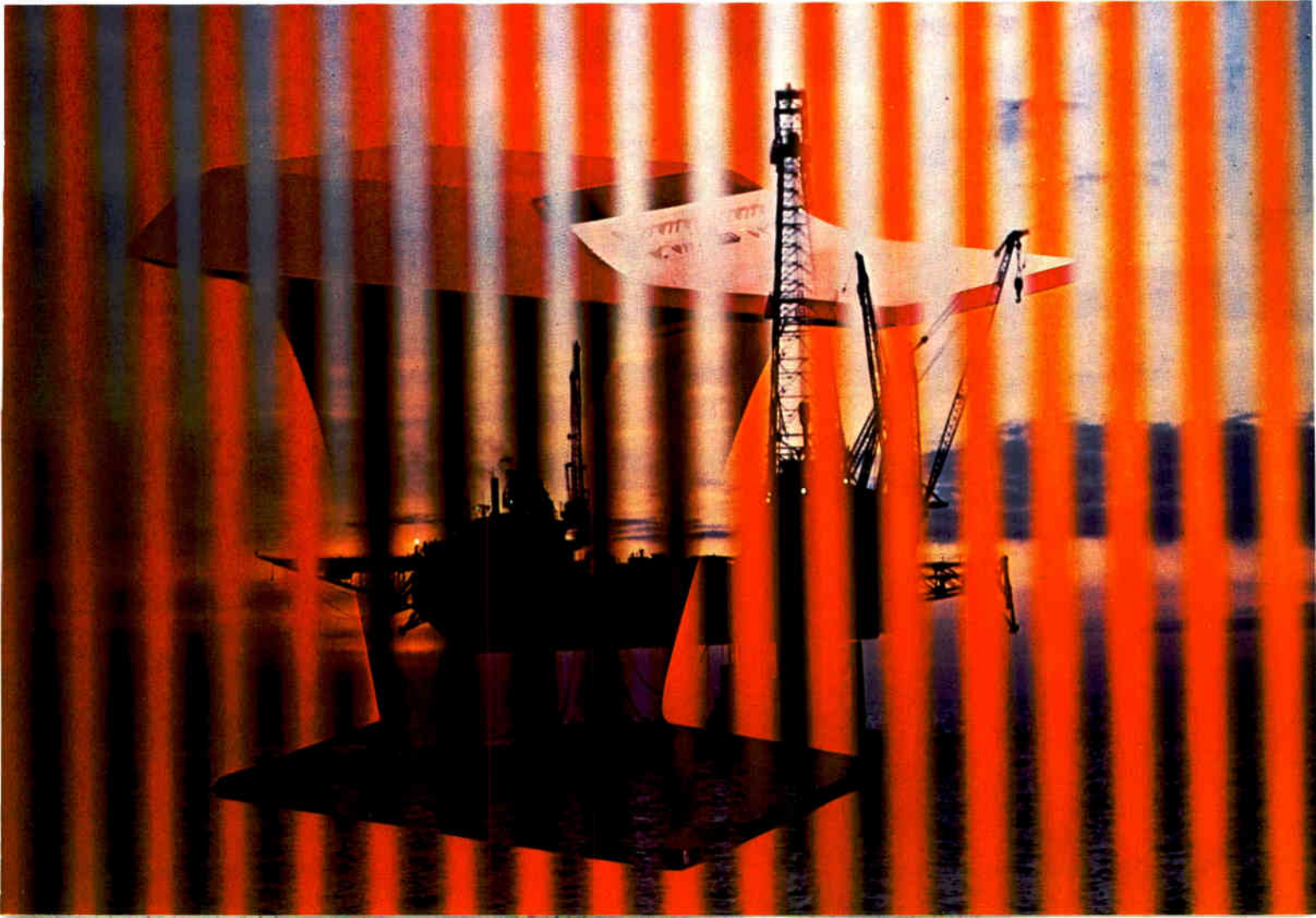

**SOLID  
STATE  
DIGITAL DISPLAYS  
THAT LET  
YOU  
LIGHT UP  
FOR LESS**



The MOD Line now has winning numbers. Digits to turn you on. Today the men from MOD can deliver gallium arsenide phosphide displays, brightly lit red digits

with easy-to-read character set, solid state reliability, and full IC compatibility. Low power requirements and easy readability of the 1/8-inch characters are ideal for portable or desk-top instruments and calculators. Price, packaging, flexibility, availability. Fairchild MOD has it all.

**PRICE IS A BREAKTHROUGH**... \$5.80 per digit in quantities of 1,000 for the FND 10 single digit. Comparable competitive devices sell for over \$7.00 a digit. We are ready (and anxious) now to give firm price and delivery quotes on large quantities. Small quantities cost is a competitive \$12.00 per digit.

**PACKAGING IS SUPERIOR**... Easiest-to-apply packages in the industry fit either sockets or PC boards. Plug-in modules retrofit into old designs or give maximum flexibility in new concepts. Custom packaging as well.

**APPLICATION IS FLEXIBLE**...

Three series from which to choose. FND 10... discrete, single-digit modules available now. Coming soon, the FND 20... six- or ten-character arrays in a single, plug-in

package. Or FND 30... multiple-digit arrays in plug-in package, complete with full multiplexing logic, input data storage, and decode/drive functions... a logic/display package that can hasten product introduction by months.

**AVAILABILITY IS NOW**... The MOD Line distributors listed below have FND 10 displays on the shelf. Call the office nearest you and pick some winning numbers.



- SCHWEBER ELECTRONICS (516) 334-7474 (617) 891-8484
- (416) 925-2471 (305) 927-0511 (301) 427-4977 (205) 539-2756 (216) 464-2970
- HAMILTON/AVNET SALES (213) 870-7171 (415) 961-7000
- (713) 526-4661 (602) 272-2601 (714) 279-2421 (206) 624-5930
- (303) 433-8551 (503) 255-8550
- COMPUTER COMPONENTS CORP (214) 239-0271
- SEMICONDUCTOR SPECIALISTS, INC. (312) 279-1000
- (313) 255-0300 (513) 278-9455 (412) 781-8120 (317) 243-8271
- (612) 866-3434 (314) 423-6500
- FAIRCHILD MOD WESTERN AND CENTRAL SALES REGION (415) 962-3363
- FAIRCHILD MOD EASTERN SALES REGION (617) 272-8150

**THE MOD LINE**



MICROWAVE AND OPTOELECTRONICS  
A DIVISION OF FAIRCHILD CAMERA AND INSTRUMENT CORPORATION  
2557 Charleston Road, Mountain View, California 94040

## New products

### Subassemblies

# Op amp draws 1 pA current

Two others in family of hybrids offer fast slew rate, settling time

Circuit designers have been battling the low-input impedance requirements of monolithic operational amplifiers for years. To

satisfy requirements, a pair of matched field-effect transistors were usually placed around the monolithic circuit. But Bell and Howell is now marketing a hybrid operational amplifier at \$13—about the price the engineer must pay for the components alone, according to Ian Isdale, sales manager for the Control Products Division.

In addition to this C-118 FET input differential operational amplifier, Bell and Howell is offering the F-318 hybrid op amp which Isdale says has the lowest input bias current—one picoamp maximum—on the market, and the C-238 op amp which offers fast settling time and slew rate in a TO-8 can.

“Generally, when a person considers the cost of an amplifier he thinks only of how much the components cost him,” says Isdale, “but what about the assembly time and the yield?” After buying the FETs and the monolithic amplifier, he points out, designers may put the thing together and still find it doesn’t meet their specifications; now they can buy the device outside and, if it doesn’t meet the spec, it goes back to the manufacturer.

The 118 operates with an open loop gain of 100 decibels, a common mode rejection ratio of 80 dB, and a 5-pA input bias current.

The F-318 hybrid op amp is initially being offered in a 14-pin

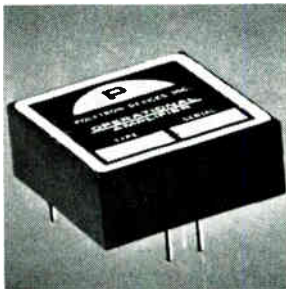

Differential operational amplifier P209-9 is designed for control, computer and instrumentation applications. It exhibits a common mode rejection ratio of typically 1.5 million and voltage gain of 1.5 million. Dc resistance between inputs is  $10^{12}$  ohms with an input capacitance of 4 pF. Gain-bandwidth product is 2 MHz. Polytron Devices Inc., 844 E. 25th St., Paterson, N.J. [381]



Frequency to dc converter model 421 is built to meet full military specifications. It features a wide temperature range from  $-65^{\circ}$  to  $+165^{\circ}$ F. Utilizing integrated circuits, the unit occupies only 3.5 cubic inches. Applications include ground and flight flow measurement, tachometry and frequency measurement. Waugh Controls Corp., 7621 Hayvenhurst Ave., Van Nuys, Calif. 91406 [382]

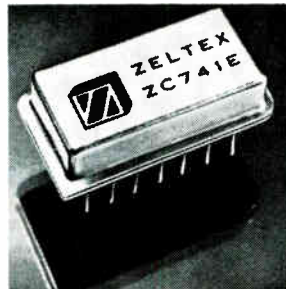

Operational amplifiers ZC741E and ZC801E are hermetically sealed and come in 14-pin dual in-line packages. Each is capable of achieving over 500 selectable gain and circuit configurations by simply interconnecting amplifier leads. The programmable gain range is 0.004 to 250. Gain-bandwidth product is 4 MHz. Zeltex Inc., 1000 Chalamar Rd., Concord, Calif. 94520 [383]

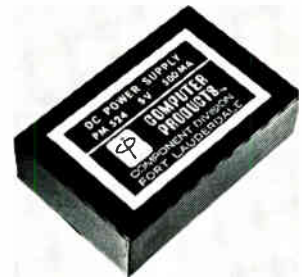

Potted module dc supply PM524 is designed to provide power for IC logic gates. Output is 5 V dc at 500 mA. Unit operates from  $115 \pm 10$  V ac, 50 to 400 Hz. Line regulation is  $\pm 0.05\%$  maximum; ripple and noise, less than 1 mV rms; temperature coefficient, 0.02%/°C; and operating range,  $-25^{\circ}$  to  $71^{\circ}$ C. Computer Products Inc., Box 23849, Fort Lauderdale, Fla. [384]



FET operational amplifier 1957 features an output voltage range of  $\pm 100$  V at 10 mA. It has a unity gain frequency of 1 MHz and a guaranteed minimum output of 200 V peak to peak at 20 kHz. It has a minimum of 60 dB of common mode rejection at an input of 40 V pk-pk. Price is under \$40 in production lots. Melcor Electronics Corp., 1750 New Highway, Farmingdale, N.Y. [385]



Modular analog-to-digital converter ADC-10H is a successive approximation unit that derives its low cost from the marriage of hybrid and monolithic technologies. The low profile (0.4 in.) module measures 2 x 4 in. The 0.020-in. gold-plated pins are spaced on a 0.100-in. grid. Price (1-9) is \$225. Analog Devices Inc., Pastoriza Div., Elliot St., Newton Upper Falls, Mass. [386]

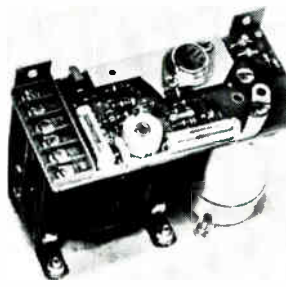

Regulated power supplies in the X-L series are for application or integrated circuits and for most peripheral computer type products. Line and load regulation are 0.25%  $\pm$  10 mV. Rms ripple is 1 mV max. Temperature coefficient is 0.03%/°C. Ambient temperature at full rating is  $-20$  to  $+55^{\circ}$ C. Price (100 and up) is \$37.50 each. X-L Electronics, Rte. 53, Mt. Tabor, N.J. [387]

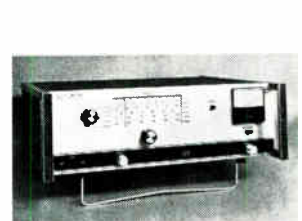

Power amplifier RF-815 is tunable within six band-switched ranges, from 10 to 500 MHz. It provides up to 8W of rf power into a 50-ohm load. It provides more than 35 dB of gain over its frequency range. The 3-dB rf bandwidth is 1.5 MHz at the low end of the range, increasing to 5 MHz wide at 500 MHz. RF Communications Inc., 1680 University Ave., Rochester, N.Y. [388]

# DIGITAL TV



CVI video sampling instruments allow your computer to "look" at practically anything. High accuracy bandwidth compression of conventional television signals opens new doors to data processing in research and industrial applications. Let us tell you about some of our unique video devices.

COLORADO VIDEO, INCORPORATED  
P.O. Box 928 • Boulder, Colo. 80302 • Phone (303) 444-3972

# cv

Video Data Acquisition • Processing • Display • Transmission

Circle 142 on reader service card

## MICO

**NEW MODEL 885  
SEVEN RATIO  
WIDE-RANGE ENGRAVER**

NO. 885

FOR LONG AND  
MULTI-LINE WORK

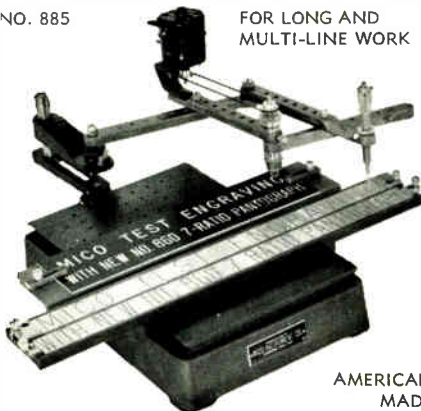

AMERICAN  
MADE

- A time-saver for large plate work
- Engravers letters 1/32" to 3" high using standard masters.
- Seven pantograph ratios—from 1:5:1 to 6:1.
- Choice of 3-ball-bearing spindle assemblies for 1/8", 3/16" or taper-shank cutters.
- HSS, COBALT and Solid Carbide Cutters.
- Single and multi-line copy carriers for holding blanks 3/4" to 3 1/2" high.
- Accommodates Mico standard accessories.

Send for bulletins and prices

**MICO INSTRUMENT CO.**

77 Trowbridge St. Cambridge, Mass. 02138

110

Circle 110 on reader service card

## New Micro-Miniature Form C Reed Relays

Only  
.290 00!

- The First FORM C Micro-Min. Relay Available!
- Measures .435 x .290 OD, only 0.03 cu. in.!
- Min. Overall Length with Bent Leads .600
- High Speed 100 microsec. Operate Time (ex. Bounce)
- Stock Voltages 3, 6, 12 and 24
- Leads or Pins. Also Available with Form A.

Special voltages, resistances, electrostatic and/or magnetic shields available. Write for new Bulletin MR-9.2.



**COTO-COIL COMPANY, INC.**  
Pavilion Avenue, Providence, R. I. 02905  
Tel: (401) 941-3355

Circle 182 on reader service card

## New products

dual in-line package with a case measurement of 0.775 by 0.450 by 0.175 inch—a slightly larger body size than is standard, but compatible with existing DIP sockets.

"We intend to come out with more hybrid circuits in a DIP," says Isdale, "because of the large number of requests we're getting, especially for automated assembly of printed circuit boards." The new DIP package offers internally trimmed, 1-millivolt offset voltage and also a trim pin to null the offset voltage further. Another significant feature of the new device is its compatibility with the familiar 741 DIP monolithic amplifier.

The 318 should be especially useful in log amplifiers or log ratio modules where the logarithm of extremely small currents, in the 100-pA range, must be computed. The op amp is also useful in sample-and-hold or timing applications where very long holding times are necessary.

The C-238 is a FET input wide-band differential amplifier with a 20-milliamp output capability. Its dynamic characteristics—a slew rate of 60 volts/microsecond and a settling time of 2  $\mu$ sec to an accuracy of 0.01%—make it particularly suited for wideband drivers and buffers, fast integrators and comparators, and digital-to-analog converters.

Other characteristics include open loop gain of 100 dB, CMRR of 90 dB, input bias current of 5 pA, and typical thermal drift of 25  $\mu$ V/ $^{\circ}$ C. The amplifier can be ordered in a military version that meets Mil-Spec temperatures.

The C-238 is priced at about \$50 in quantities of 1 to 9. The F-318 is priced typically at \$25 in the same quantities.

Control Products Division, Bell and Howell, Bridgeport, Conn. [389]

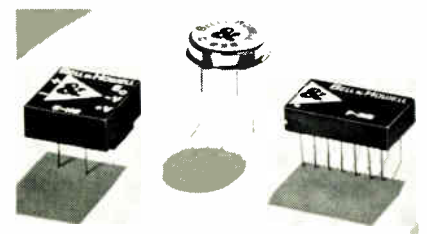

Electronics | November 23, 1970





## Look at Acopian's new mini-module dc power supplies

Look at their size. Single output models (there are duals, too) are as small as 2.32" x 1.82" x 1.00". And they can all be soldered directly into printed circuit boards.

Look at their performance. Load and line regulation is 0.02 to 0.1% depending on the model selected. Ripple is only 0.5 mv RMS. And Acopian's long experience in power supply technology assures high reliability.

Look at the choice of outputs. There are 58 different single output modules ranging from 1 to 28 volts, 40 ma to 500 ma. Duals are available in 406 different combinations

of voltages. And these are true dual power supplies, with like or different outputs in each section that are electrically independent of each other. Perfect for powering operational amplifiers. Or for unbalanced loads.

| Acopian mini-module power supplies      |                                |           |
|---|--------------------------------|-----------|
|   | Singles                        | Duals     |
| Output Voltages (vdc):                  | 1 to 28                        | 1 to 28   |
| Output Currents (ma):                   | 40 to 500                      | 40 to 250 |
| Line and Load Regulation:               | .02 to 0.1% depending on model |           |
| Ripple                                  | 0.5 mv RMS                     |           |
| Ambient Temperature (without derating): | 0 to 55°C                      |           |
| Polarity:                               | outputs floating and isolated  |           |

Look at their price. Single output models start at \$39, duals at \$58.

For a look at all the facts, write or call Acopian Corp., Easton, Pa. 18042. And just like Acopian's other 82,000 power supplies, every mini-module is shipped with a tag that looks like this . . .



## New products

### Microwave

# Radar limiter is solid state

High-power device aimed at replacing TR tubes uses ferrites, diodes

The move toward replacement of high-power vacuum tubes by solid state devices is continuing. The latest example is a limiter, com-

prised of ferrites and diodes, that was developed to protect high-power radar receivers from burn-out caused by transmitter power reflected from the antenna. The unit is a replacement for transmit-receive tubes.

Reliability is the key feature of the solid state limiter introduced by the Solid State division of Varian Associates. The device has a design life exceeding 20,000 hours, or 10 times that of existing TR tubes. The life expectancy of the TR tube is shorter since it contains gas that is consumed during operation.

In TR tube operation, transmitter power reflected from the radar an-

tenna causes the gas to ionize, detuning the tube circuit and reflecting the power away from the receiver. The Varian limiter provides the same protection. The ferrite section, consisting of a series of rods, provides about 15 decibels of high-power isolation. The diode section, containing two specially developed p-i-n devices, reduces the spike and flat leakage power sufficiently to provide reliable receiver protection.

The first of a family of limiters that will cover S, C, X, and Ku bands is the VFX-9500. It is designed to operate in any 5% bandwidth from 8.5 to 10.0 gigahertz and can withstand peak powers of 10 kilowatts



Spst switch model M415, for service in subminiature cable systems, covers the 50-MHz to 18-GHz range with over 45-dB isolation from 4 to 18 GHz and over 30-dB isolation from 50 MHz to 4 GHz, 2.5 dB maximum insertion loss, 2 W cw and 75 W peak power. Price is \$198. Somerset Radiation Laboratory Inc., 2060 N. 14th St., Arlington, Va. 22216 [401]

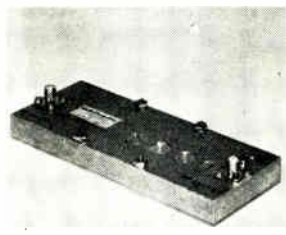

Transistor amplifier model HFW-4 (TX)-50200 is designed for low-level rf signal applications. Lumped and distributed circuit elements are combined to effectively cover the range from 500 to 2,000 MHz in a single unit. Noise figure is less than 6.5 dB. Gain is greater than 25 dB; gain flatness,  $\pm 1.25$  dB. Applied Research Inc., 76 South Bayles Ave., Port Washington, N.Y. [402]



Backward-wave-oscillator control assembly WJ-1168 supplies power to and controls the frequency of any standard BWO covering a band in the frequency range from 0.95 to 18 GHz. It can be provided with several circuit options as required in final use, including digital control capability, and phase detector input. Watkins-Johnson Co., 3333 Hillview Ave., Palo Alto, Calif. [403]

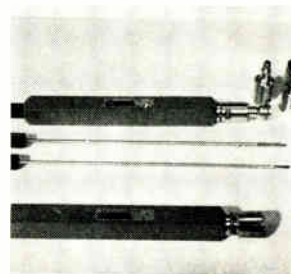

Fixed precision terminations are offered in two styles. The 8707 features interchangeable connector adapter sets, while the 3120 has permanently attached connectors. They are based on an element made from a microwave-absorbent material. Typical element SWR is less than 1.05 from 3 to 6 GHz and less than 1.03 from 6 to 18 GHz. Alford Mfg. Co., Winchester, Mass. [404]

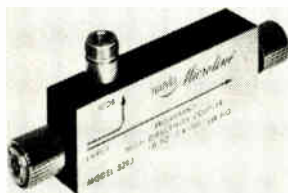

High directivity 10-dB couplers models 3293 and 5293 are precision instruments designed for broadband reflectometer applications in the 1 to 12.4 GHz frequency range. The broad frequency coverage permits one coupler to replace several without deteriorating performance. Price of the 3293 is \$625; the 5293 costs \$675. Narda Microwave Corp., Plainview, N.Y. [405]



Eight microwave signal sources, featuring high reliability and low a-m and fm noise, are for telecommunications, troposcatter, radar and instrumentation use. They cover 850 MHz to 3 GHz with output power to 1 W. Desired frequency stability can be selected from  $\pm 0.05\%$  to 0.000001% from  $-20^\circ$  to  $+60^\circ\text{C}$ . Aertech Industries, 825 Stewart Dr., Sunnysvale, Calif. [406]

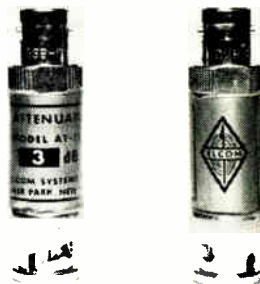

The AT-75 type 75-ohm coax attenuators have an internal construction that uses low cost resistive elements to achieve high-frequency operation. Accuracy is  $\pm 1/2$  dB from dc to 1 GHz and  $\pm 1$  dB to 1.5 GHz, with a VSWR of 1.2:1. Units can dissipate  $1/2$  W cw or 500 W peak power over an operating range of  $-25^\circ$  to  $+85^\circ\text{C}$ . Elcom Systems Inc., Deer Park, N.Y. [407]

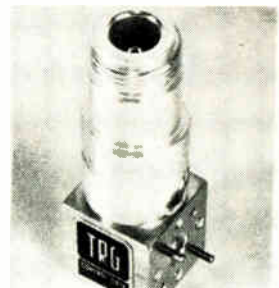

Waveguide-mounted, millimeter mixers having i-f bandwidths up to 4 GHz with i-f frequencies up to 8 GHz are available. Series 960 block type mixers consist of a Schottky barrier diode integrally mounted in the waveguide, and are available in each waveguide size from 26.5 to 220 GHz. Price of the W960 is \$1,395. Control Data Corp., Border St., East Boston, Mass. [408]

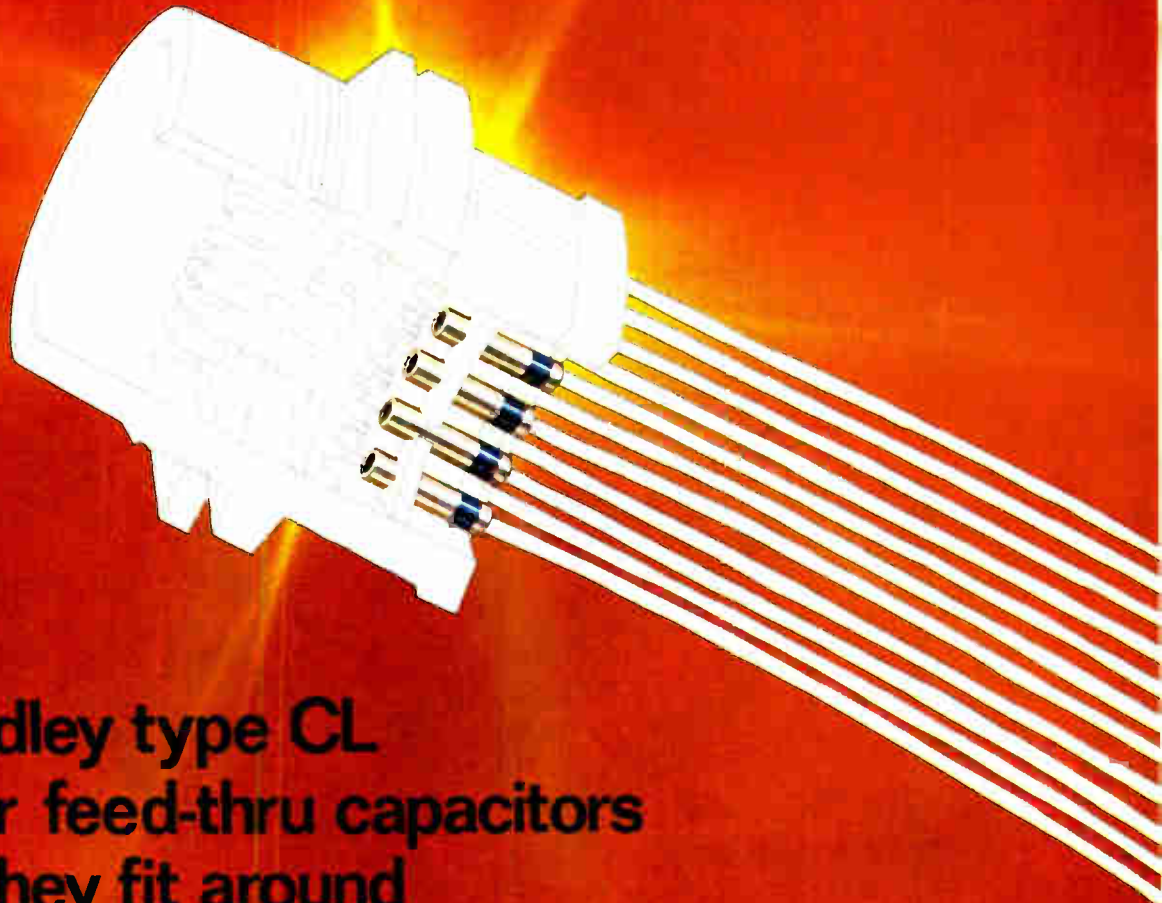

## Allen-Bradley type CL multi-layer feed-thru capacitors so small they fit around the head of a pin.

**VOLUMETRIC EFFICIENCY.** Big words that explain why Allen-Bradley type CL feed-thru capacitors are so small. Our unique multi-layer concept shaves size to a minimum, without affecting performance. It took Allen-Bradley to get filter capacitors down to their fighting weight. Now rolled capacitors are no longer a design alternative.

Concentric layers of proprietary Allen-Bradley ceramic and noble metal electrodes are fired together for unmatched protection against moisture and contamination. Rugged. Non-polar. With lower inductance and far less noise.

Voltages to 200 WVDC. Temperatures to 125°C. Capacities to 1.0  $\mu$ F. High dielectric strength and reliability.

Several styles and sizes are available through your appointed A-B industrial electronic distributors. For further information write: Marketing Department, Electronics Division, Allen-Bradley Co., 1201 South Second Street, Milwaukee,

Wisconsin 53204. Export office: 1293 Broad Street, Bloomfield, N.J. 07003 U.S.A. In Canada: Allen-Bradley Canada Ltd., 135 Dundas St., Galt, Ontario.

### ALLEN-BRADLEY



# The \$98 keyboard.



**It's all solid state. From keys to connectors. MOS encoded. Assembled. Ready to plug in.**

For just \$98 in production quantities, you get the most advanced keyboard on the market. It's all solid state and includes the world's first application of an integrated circuit as a keyboard switching element. And now, it's also MOS encoded.

Solid state eliminates mechanical linkages, electromechanical parts, moving contacts and all the other moving parts that normally wear out.

MOS adds a new degree of flexibility in providing up to four codes per key. In addition, it reduces discrete components by a factor of nearly one hundred.

The result of all this is increased operating life for the keyboard as well as reduction in main-

tenance. And costly service calls to remote locations are practically eliminated.

Installation of our SSK is quick and simple. Just plug it in. Our keyboard readily adapts to your equipment without a lot of special interface circuitry.

And with our \$98 unmechanical marvel you also enjoy the benefits of our quality assurance personnel. Each keyboard is carefully watched over from start to finish. This includes raw material inspections at our suppliers as well as stringent life tests in the advanced test laboratory at MICRO SWITCH.

Let's get together and discuss keyboard prices or the many other parts of the business you consider important. Technology. Compatibility. Reliability. Delivery. They're all important to us. Call or write us and see.

## **MICRO SWITCH**

FREEPORT, ILLINOIS 61032

A DIVISION OF HONEYWELL



A single pair of wires, or a leased telephone line, can carry the audio signals for a complete control system.

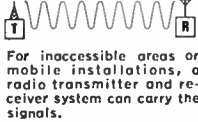

For inaccessible areas or mobile installations, a radio transmitter and receiver system can carry the signals.

## REMOTE CONTROL SWITCHING WITH AUDIO SIGNALS

(actual size)

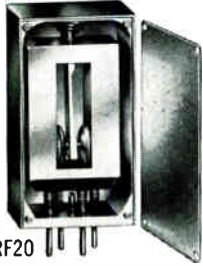

MODEL RF20  
contactless resonant reed encoder/decoder  
.395 x .620 x 1.100

An audio tone can be generated by an electronic oscillator or resonant reed encoder circuit, then transmitted by wire or radio. The tone activates a resonant reed relay to perform a control function.

Bramco reeds permit over 100 selective control frequencies within the 67 to 3000 Hz. spectrum. This is assured by: (1) the narrow response band-width of about 1% for decoders and (2) the high accuracy of Bramco reed encoders (1/10 of 1% of design frequency).

A big advantage of reeds in control switching is that they are ideally suited for simultaneous and sequential coded tone systems. The actual number of control functions possible in such a system is virtually unlimited. For example, over 3300 individual control functions are possible with only 16 frequencies coded sequentially in groups of three.

Compared to other types of tone filters, resonant reeds are small and inexpensive. They give more control functions per spectrum, per size, per dollar.

If you work with controls that select, command, regulate, or indicate, you should know how it can be done with audio signals. We custom design and stock a broad line of encoder/decoder components and modules. Bramco also custom designs LC filters from 0 to 200 KHz.

For literature write Bramco Controls Division, Ledex Inc., College and South Streets, Piqua, Ohio, or call 513-773-8271.



BRAMCO CONTROLS DIVISION  
LEDEX INC.

College and South Streets, Piqua, Ohio 45356

## New products

and average levels of 50 watts. Maximum voltage standing wave ratio is 1.5:1 and insertion loss is less than 1.0 dB.

The VFX-9500 is priced at \$750 in small quantities, and about \$500 each for quantities over 100.

Varian Associates, Solid State Division, 611 Hansen Way, Palo Alto, Calif. 94303 [409]

## Load leveler carries power, control signals on one cable

In most microwave systems, some type of feedback from the load to the source is needed to maintain the load voltage level. The usual configuration requires an extra cable to close the loop. A system developed at Instruments for Industry Inc. utilizes the power cable as a two-way street.

By restricting the power signal to higher frequencies, the system, which has both a source and a load module, can use the lower frequencies for transmitting the control signal generated at the load. Because the power and control signals use the same coaxial cable, the technique can be used where distortion caused by another cable would be unacceptable.

The source output travels through a high-pass filter in the source module and through the coaxial cable to the load. The load module, located between the transmission line and load, samples the power, detects it, and passes it through a low-pass filter and back to the source module, along the same coaxial cable that carries the power to the load. At the source, this low-frequency signal passes through a second low-pass filter and is applied to a voltage-controlled attenuator.

The load levelers are designed for a 50-ohm coaxial cable, but will work into reactive and mismatched resistive loads. Each module measures 3 1/4 x 1 1/4 x 1 1/2 inches, and can be built to the purchaser's specifications for less than \$1,000 for the pair.

Instruments for Industry Inc., 151 Toledo St., Farmingdale, N.Y. 11735 [410]

## DIALCO SUBMINIATURE INDICATOR LIGHTS

Here are 4 out of 4000

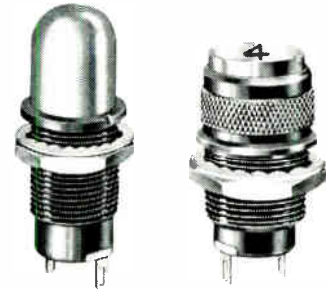

SHOWN ACTUAL SIZE

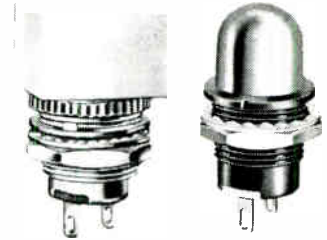

Designed to meet requirements of MIL-L-3661B and MIL-L-6723.

Sizes for mounting in 1/32", 1/2" or 1/32" clearance hole.

Incandescent for 1.35 to 28V and neon for 105-125V AC-DC or 110-125V AC.

Patented built-in current limiting resistor (U.S. Patent No. 2,421,321).

Wide selection of lens shapes and colors.

Both hot-stamped or engraved legends.

Available off-the-shelf for prompt delivery.

Send for free catalog



SAMPLES ON REQUEST—AT ONCE  
NO CHARGE

Dialight Corporation, 60 Stewart Ave., Brooklyn, N. Y. 11237. (212) 497-7600



## What's the good word at Brand-Rex?

**Ak·zo·na** (ăk zō'nä) **1.** A new American corporation made up of Brand-Rex Company (wire and cable), American Enka Company (nylon, polyester, rayon yarns and fibers), International Salt Company (one of the world's largest salt producers), and Organon Incorporated (ethical drugs)—combined 1969 sales, \$332 million. *Brand-Rex, formerly a division of American Enka, will retain its identity as a separate company and be headed by Harry Wasiele, Jr. as president.* **2.** A new American corporation that will “*provide the foundation for a broader base of operations with greater access to sources of capital... be less dependent on seasonal and cyclical factors... and enable a sound growth.*”

**Akzona**  
INCORPORATED, ASHEVILLE, N. C.

**3.** A new American corporation affiliated with a worldwide industrial complex which has over 5,000 persons in research and development; and, as part of that complex, is in an excellent position to benefit from a vast reservoir of technology in plastics and other areas. **4.** A new American corporation with headquarters in Asheville, N.C.; with 13,000 employees; with the name Akzona Incorporated replacing American Enka Corporation and International Salt Company on the New York Stock Exchange.



## New products

### Data handling

# Now an analog minicomputer

Thick-film hybrid circuits increase component density, minimize power dissipation

The mini trend in digital data processing is spreading into the analog computer field. Electronic Associates Inc. has developed a

110-pound machine, measuring 33 by 22 by 13 inches and called the Miniac, that is designed around the extensive use of thick-film hybrid technology. Though essentially an analog machine, it has a small digital section.

Besides contributing to miniaturization through high packing density, the thick-film circuits result in low power dissipation and improved reliability, EAI says.

The Miniac was built primarily for educational applications such as the simulation of physical and chemical phenomena, but the company foresees its use also in process control, biomedical engineering, data reduction, and monitoring

shock and vibration tests.

Because of a patch panel that simplifies programing, the machine doesn't require a programmer to do more than patch from the output of the functional blocks to the inputs. Since a block's function is determined by pushing a selector button on the front panel, a single block on the panel can be changed from summing amplifier to integrator to multiplier to divider by merely depressing the correct function button in the control section.

Most other analog computers have different function blocks on the panel to indicate integrators, amplifiers, multipliers, etc. But only those familiar with the machines



Portable multiple copy terminal model 1010B is for computer time-sharing applications. It measures 14 x 19 x 6 in. and weighs 20 lb. In addition to a low price of \$2,100, other features include an integral acoustic coupler, a reliable impact printing mechanism that prints 4 copies, and internal storage of fan-folded paper. Computer Devices Inc., 10 Sonar Dr., Woburn, Mass. [421]

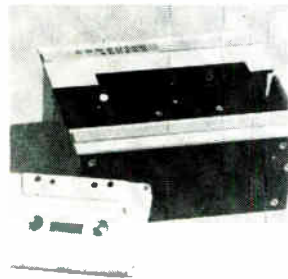

Cassette tape transport model 250 is for digital recording applications. The 4.5 x 6 x 2.5 in. unit, with recording and retrieval rate of 1,000 8-bit characters per second, costs \$525 in evaluation quantities and \$250 in OEM lots. The unit has a read/write capability in both incremental and continuous operation. Computer Access Systems, 3050 W. Clarendon Ave., Phoenix [422]

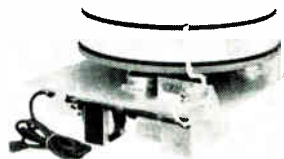

Head-per-track disk memory systems for small scale computers offer a choice from a wide range of storage capacities, performance levels and random data access time, so that optimum cost/performance ratio can be achieved for any specific computer system application. Unit prices start at \$3,300. Engineered Data Peripherals Corp., 1701 Colorado Ave., Santa Monica, Calif. [423]

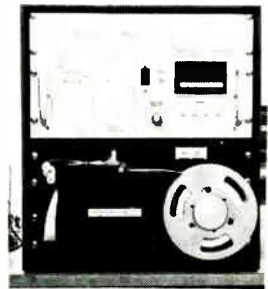

Data logger 220 accepts up to 4 channels of 0-200 mV analog signals. Analog signals are converted to digital, multiplexed with time-of-day, and recorded in 8-level ASCII code on paper tape. Applications are in laboratory data collection and monitoring, as well as in field measurements. Accuracy is  $\pm 0.05\%$ . Digital Products Corp., 6950 N.W. 12th Ave., Ft. Lauderdale, Fla. [424]



Model DM-312 disk drive and DC-314 disk storage control unit offer IBM users twice the access speed and immediate savings of up to 18% as direct plug-to-plug replacements for the IBM 2312 disk drive and 2314 control unit. The disk files will also be available for OEMs. The system is self-monitoring. Ampex Corp., 9937 W. Jefferson Blvd., Culver City, Calif. 90230 [425]

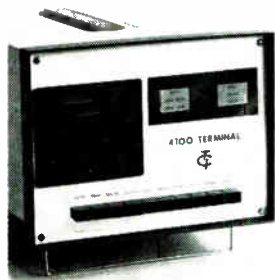

Communications terminal 4100 is compatible with both RS-232B and Teletype equipment. It is a cassette magnetic tape terminal incorporating both low-speed incremental and high-speed asynchronous interfaces. Speeds to 1,200 bits/second can be selected. The basic terminal is priced at \$1,650. Technical Concepts Inc., 580 Jefferson Rd., Rochester, N.Y. [426]

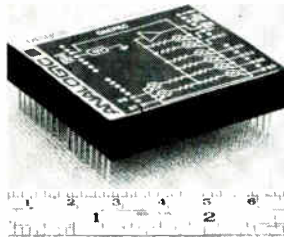

Dacpac MP1808 is a high-speed, 8-bit digital-to-analog converter available in either BCD decimal format or several variations of binary. Settling time to  $\pm 0.1\%$  full scale accuracy is 5  $\mu$ s, with a temperature coefficient of 100 ppm/ $^{\circ}$ C. Output slow rate is 10 V/ $\mu$ s, with 20 mA current capability internally short-circuit protected. Analogic, Audubon Rd., Wakefield, Mass. [427]

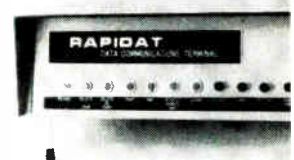

General purpose data communications terminal interfaces with and buffers data between a high-speed data set and a Teletype ASR-33, ASR-35 or an IBM Selectric typewriter. It is designed to operate up to 2400 baud in a network of terminals controlled by a central computer. It stores up to 10,000 characters. Rapidat, 17815 Kings Park Lane, Houston, Texas 77058 [428]

# Save Cost Enjoy Quality with TOKO INC.

Announcing a new cost saving plan on PCB assembly with transfermolded Dual-In-Line PULSE TRANSFORMERS and DELAY LINES by thick film approach.

Offering a wide range of custom-designed features which meet your requirements.

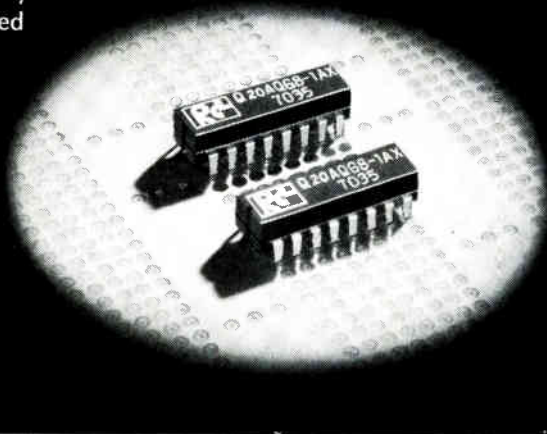

For further information, just call or write



**TOKO, INC.**

Head Office: 1-17, 2-chome, Higashi-Yukigaya, Ohta-ku, Tokyo, Japan

New York: **Toko New York Inc.**

350 Fifth Avenue, New York, N.Y. 10001 U.S.A. Tel: 565-3767

Los Angeles: **Toko, Inc. Los Angeles Liaison Office**

1830 West Olympic Blvd., Los Angeles, 90006 Cal. U.S.A. Tel: 380-0417

Düsseldorf: **Toko, Inc. Europe Liaison Office**

4 Düsseldorf, Kölner Straße 246, Düsseldorf, W. Germany Tel: 78-7064

Circle 118 on reader service card

CLASSIFIED ADVERTISING  
**SEARCHLIGHT SECTION**  
BUSINESS OPPORTUNITIES  
USED OR SURPLUS EQUIPMENT

RADAR SYSTEMS GROUND AND AIRBORNE. AUTOMATIC TRACKING ANTENNA SYSTEMS. NIKE AJAX. NIKE HERCULES. M-33. MSQ-1A. MPS-19. MPS-9. SCR 584. TPS-1D. TPS-28. FRA-ASR-2. AIRBORNE SYSTEMS. APN-04. APN-102. APS-20. APS-27. APS-45. DPN-19. DIGITAL COMPUTERS. IBM 650. IBM 704.

LARGEST INVENTORY OF RADAR AND MICROWAVE EQUIPMENT IN THE WORLD.  
**RADIO RESEARCH INSTRUMENT CO.**  
45 WEST 45TH ST. N. Y. 10036 212-JU 6-4691

CIRCLE 966 ON READER SERVICE CARD

**free catalog**  
**POTTING APPLICATORS**  
MANUAL AND DISPOSABLE  
6cc 12cc 30cc  
FOR POTTING, ENCAPSULATING, AND SEALING OF MINIATURE COMPONENTS  
PHILIP FISHMAN COMPANY  
7 CAMERON ST., WELLESLEY 81, MASSACHUSETTS  
CIRCLE 967 ON READER SERVICE CARD

ADDRESS BOX NO. REPLIES TO: Box No. Classified Adv. Dept. of this publication. Send to office nearest you.  
NEW YORK, N. Y. 10036: P. O. Box 12  
CHICAGO, ILL. 60611: 645 N. Michigan Ave.  
SAN FRANCISCO, Cal. 94111: 425 Battery St.

### BUSINESS OPPORTUNITY

Electronic Components Required. An Australian distributor of Electronic components seeks suppliers. Send details. BO-2915, Electronics.

# Your Heart Fund Fights

HEART ATTACK  
STROKE  
HIGH BLOOD PRESSURE  
INBORN HEART DEFECTS

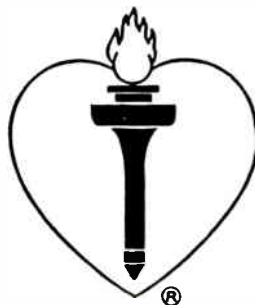

## New products

can patch the correct functions without first referring to a manual. To program a multiply function on the Miniac, wires are connected to the input and output of the block and the function switch labeled Multiplier beneath the program panel is depressed. If the Divider function for the block is depressed, the symbol then becomes a divider.

The program panel is divided into fields, each of which contains a fixed number of amplifiers. The panel can be modularly expanded to include up to four fields containing a total of 27 amplifiers. There are nine integrators in the machine, enabling the operator to program three third-order nonlinear differential equations, one ninth-order equation etc.

The Miniac is believed to be the first analog computer to incorporate thick-film hybrid technology. The nonlinear circuits are built with IC field effect transistor amplifiers.

The computer runs on 50 and 60 hertz, at 115 or 230 volts. The price ranges from \$5,000 to \$10,000, depending on the number of fields desired.

Electronic Associates, Inc., West Long Branch, N.J. 07740 [429]

## Foldover cuts size of plug-in core stack for minicomputers

Minicomputer manufacturers appear to be settling on a fairly standard memory size—4,096 words by 18 or 16 bits. Until recently, off-the-shelf memories weren't available in this configuration; memory users had to pay substantial development costs for a storage unit to fit their machines. Now core memory suppliers are building standard modules for inventory.

The Electronic Memories division of Electronic Memories and Magnetics Corp. has unveiled a standard 4,096-word by 18-bit planar magnetics module designed specifically to fit minicomputers. The core stack will use either 18- or 20-mil-diameter cores; the 20-mil version will sell for \$1,000 in sample quantities, and for \$500 in



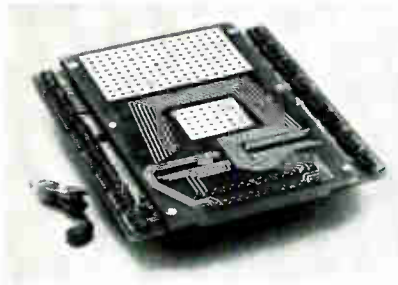

quantities of 100. The 18-mil unit will be priced slightly higher, but with a cycle time of 700 nanoseconds, the 18-mil version also is faster than the 850-ns 20-mil stack.

Electronic Memories engineers say the EM2220, as a standard product, will save users the usual \$4,000 to \$10,000 design costs for a custom stack. They believe it offers more storage in a smaller size than any other core stack available. At 6 inches by 6½ inches by ¾ inch it's about half the size of most competitive planar magnetic modules. It's also slightly smaller than an Ampex unit, which, however, offers word and bit variations from 1,024 by 6 bits to 4,096 words by 18 bits in several steps [*Electronics*, Nov. 9, p. 119].

Dale Sutton, Electronic Memories' product manager for commercial magnetics, says the EM2220's small size was achieved primarily by mounting cores on two boards, then folding one over the other so that the cover becomes an active part of the stack. The folded-stack design isn't the first of its kind but is new in a standard product.

Because it's a plug-in "component," the stack doesn't require an edge connector, which also contributes to its size reduction, as do core spacings smaller than standard ones, Sutton points out.

Barry Pfeil, product engineer for planar products, says that the EM2220 "allows us to fit virtually every minicomputer configuration we've seen."

The 3-wire, 3-D design uses two-diode-per-line decoding.

Sample quantities are available from stock; volume quantities will require 30 to 45 days.

Electronic Memories Division, Electronic Memories and Magnetics Corp., 12621 Chadron Ave., Hawthorne, Calif. [430]

the new Bausch & Lomb StereoZoom 7 Coaxial Illuminator (Patented)

## You're looking at a major advancement in microelectronics cost reduction and quality assurance

Now—speedily, surely—you can examine reflective micro-objects for the first time as they really are. Full color definition. Without flare, glare, shadowy ambiguity. With image quality comparable to the best monobjective microscope... and in 3-D.

One-step visual quality control is now possible, for example, in assembling microelectronics. And quality assurance checking of multi-layer elements is swift and conclusive. Results: significant time and cost reductions.

New, unique, vertical illumination is the reason. The Bausch & Lomb StereoZoom 7 Coaxial Illuminator supplies uniform-intensity, full-aperture, on-axis illumination to both sides of the optical system. Better than ring lighting. Better than ordinary vertical and incident light systems.

But words can only hint. See it for yourself. Ask for Catalog 31-2368 and a demonstration of the Bausch & Lomb StereoZoom 7 Microscope with Coaxial Illumination... now.

**BAUSCH & LOMB** 

SCIENTIFIC INSTRUMENT DIVISION

61435 Bausch St. Rochester, N. Y. 14602



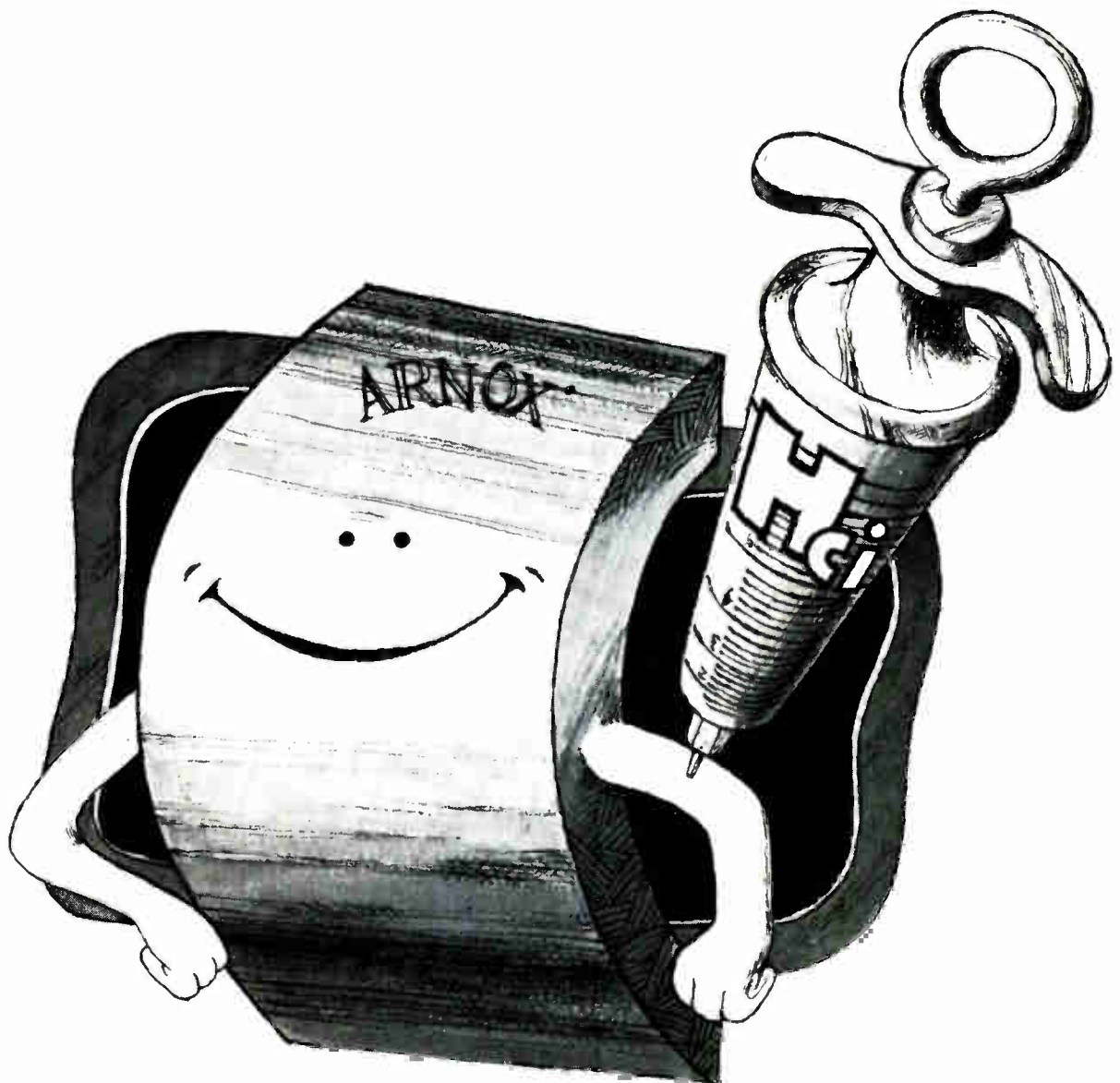

## Demagnetization resistance.

**It's high in Arnox®...the low-cost, lightweight ferrite for permanent magnets.**

Here's the economical solution to your search for a permanent magnet with just the right properties. One grade of Arnox has very high demagnetization resistance over a wide range of temperatures plus a high energy product—an ideal combination for DC motor arcs. Another grade has maximum demagnetization resistance at cold temperatures for electron-beam focusing. Other grades meet other needs.

The point is, you can order Arnox magnets

for motor arcs, loudspeakers, separators, magnetos, you-name-it, with high, higher, or highest demagnetization resistance *and* with any of a variety of energy products. And Arnox ferrite is almost always the lowest priced permanent magnet per pound. Weighs less than metallics. Readily available, too, since it's made from non-strategic material.

Ask about Arnox. We'll send the facts when you call or write.

 **ARNOLD**  
SPECIALISTS IN MAGNETIC MATERIALS

## New products

### Semiconductors

# MOS registers have 3 states

Units for data-bus systems can go into high-impedance, off-line output condition

One of the most important aspects of semiconductor design is system characterization—matching the device to the system. This was the

primary design aim in a new family of silicon-gate metal oxide semiconductors, developed by Signetics Corp., that include three static shift registers: a dual 50-bit unit, a dual 100 and a dual 200. They were built with bus-organized computer and peripheral systems in mind, so their principal feature is three-state operation.

George Rigg, formerly a systems engineer and now MOS product manager at Signetics, says they are the first three-state MOS products on the market. National Semiconductor Corp. has announced a line of bipolar three-state devices [*Electronics*, Oct. 12, p. 157].

Like the National units, the new

MOS devices have three output conditions. The logic 0 output is +5 volts at 500 ohms maximum; the logic 1 state is -5 V at 500  $\Omega$  maximum; and the third, or off-line, state for bus-oriented systems is a high-impedance state, 1 M $\Omega$  with a maximum leakage current of 10 microamperes. The third level permits circuits to be connected on a bus without the danger of short-circuiting the supply voltage to ground when one circuit on the bus is on and another is off.

Unlike the conventional shift register, in which the output is taken from the center of two series-connected transistors, the gate leads from each of the two output

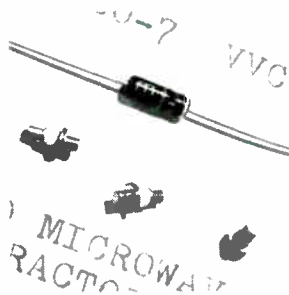

Silicon varactors series E700 are available in the ceramic pill package, having a  $f_{max}$  in excess of 100 GHz, and a working voltage of 60 V. These tuning varactors are made from 1 pF to 22 pF, and provide full octave tuning capability. Applications include afc and fm. Prices start at \$7.80 in 100 lots. Eastron Corp., 25 Locust St., Haverhill, Mass. 01830 [436]

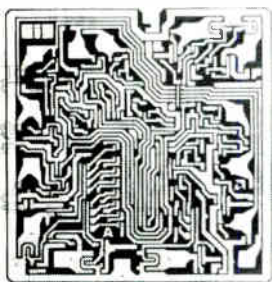

High-speed encoder type 9318 is an MSI circuit that encodes eight active low-input signals to a 3-bit binary code giving priority to the most significant input. Its speed advantages are useful to designers of priority interrupt systems, code conversion units, keyboard encoders and various types of converters. Advanced Micro Devices Inc., 901 Thompson Pl., Sunnyvale, Calif. [440]

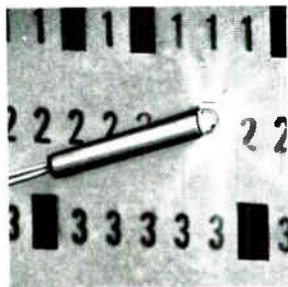

Oxide-passivated, silicon photo-transistor STPT40 with fast-switching times (1.5  $\mu$ s typical rise time, 5  $\mu$ s fall time), allows rapid reading for character recognition, tape and card readout, photo switching, differentiative detection and symmetry control. Collector-emitter breakdown voltage is rated to 50 V minimum. Sensor Technology Inc., Gerald Ave., Van Nuys, Calif. [437]

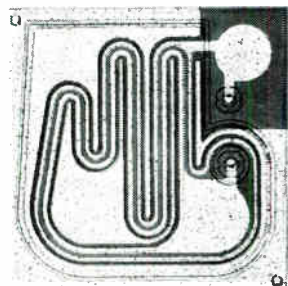

Three MOSFETs, designated 3N201, 3N202, and 3N203, provide designers an improved output impedance for communications amplifiers. They offer a typical 10-kilohm output impedance, making circuit performance independent of transistor-to-transistor variations. They feature a typical 12,000  $\mu$ mhos gain. Texas Instruments Inc., P.O. Box 5012, M/S 308, Dallas, Texas [441]



Four small-signal, metal-packaged transistors provide turn-on switching speeds of 300 ns and turn-off times of 1  $\mu$ s, operating from high voltages. All deliver a maximum collector current of 100 mA and a minimum gain of 40 from 1 mA to 50 mA. Prices (1-99 lots) range from \$9.75 to \$12.75. Fairchild Semiconductor, 313 Fairchild Dr., Mountain View, Calif. [438]

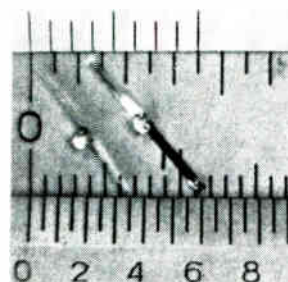

Two low-noise, silicon, Schottky barrier mixer diodes feature hermetically sealed packages approximately 0.040 in. long, having gold-plated ribbon leads suitable for welding or solder. The SMR-32B is rated at 5.5 dB maximum noise figure at 3GHz; and the SMR-33B is 6.5 dB at 9 GHz. California Eastern Laboratories, 1540 Gilbreth Rd., Burlingame, Calif. [442]

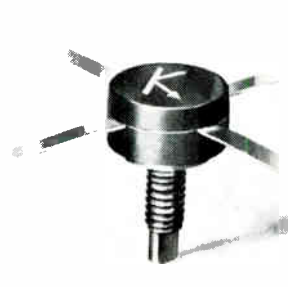

Communications transistor family is characterized for fm and cw operation up to 175 MHz with power outputs reaching 25 watts for 12-volt operation. Power gains of 8 dB for the 4-watt 3TX601, 5 dB for the 13-watt 3TX602, and 4 dB for the 25-watt 3TX603 are specified. The devices are available from stock. Kertron Inc., 7516 Central Industrial Dr., Riviera Beach, Fla. 33404 [439]

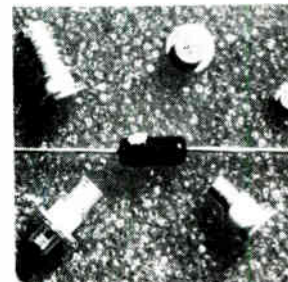

P-i-n microwave switching diodes series GC-4000 consist of 12 basic types available in six different styles. Featuring fast transition speed with voltage breakdown as high as 750 V, the series also offers low combinations of resistance and capacitance as well as complete passivation for high reliability and stability. GHZ Devices, Kennedy Dr., North Chelmsford, Mass. 01863 [443]

# TAKE

12 SMALL LAMPS

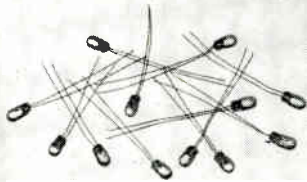

# MOUNT

ON A CIRCUIT BOARD

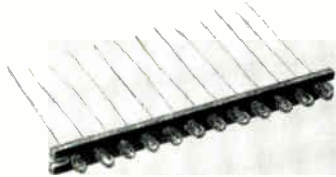

# MOLD

A NUMBERED BEZEL

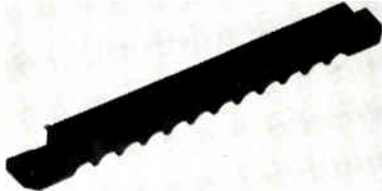

# RESULT

A LIGHT MODULE TO  
MONITOR TWELVE  
COMPUTER CIRCUITS\*

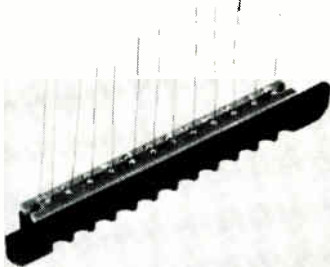

\*Can be made for a lesser number down to one

We can help you refine your small lamp application. Write, describing the requirement. Tung-Sol Division, Wagner Electric Corporation, 630 W. Mt. Pleasant Avenue, Livingston, N.J. 07039. TWX: 710-994-4865. Phone: (201) 992-1100; (212) 732-5426.

# TUNG-SOL®

WHERE BIG THINGS ARE  
DONE WITH SMALL LAMPS

© Reg. T.M. Wagner Electric Corporation

## New products

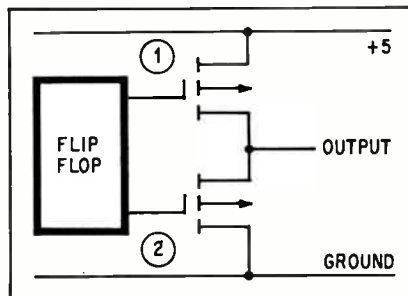

Third state. When flip-flop outputs 1 and 2 are both off, the device goes into a very-high-impedance state.

transistors in the Signetics tri-state register are connected to a flip-flop. When this has both of its gates off, the output of the shift register is a very high impedance, which puts the device in its third or off-line state.

The maximum operating frequency of the devices is 3 megahertz, and all of the inputs are compatible with transistor-transistor logic: 0.3 V maximum for logic 0, and 3.4 V minimum for logic 1.

Another significant feature, says Rigg, is that the clock is also TTL-compatible. And, although the registers are static devices that require four-phase clocking, they need only one external input. The other three are generated internally on the chip.

Prices for the shift registers in TO-100 cans and in quantities of 100 are \$3 each for the dual 50-bit, \$4 for the dual 100, and \$5 for the dual 200. Sample quantities are available now, and quantity orders can be shipped after the first of the new year.

In its family of silicon-gate MOS products, Signetics will also include dynamic shift registers and read-only memories. In the random-access memory field, the first products will be a 256-bit static device and a 1024-bit dynamic unit.

"All will be TTL-compatible," says Rigg, "and all will be fast devices—the edge in this market is speed." The 1024-bit dynamic RAM will have an access time of 300 nanoseconds and a cycle time of 500 nanoseconds.

Signetics Corp., 811 East Arques Ave., Sunnyvale, Calif. 94084 [444]

# Are you going to sit on the sidelines all your life?

What are you doing about what's wrong with our community? You. Not the fellow next to you. You.

Don't kid yourself. You know what the problems are. You read the papers. You listen to the gossip. Now get off the sidelines and into the game.

One way is to spend some time with one of our United Way agencies. Learn something of the new methods being used, the new programs under way. And the new money that's urgently needed.

That's the catch. For if you do let yourself become really informed, it'll cost you. You'll pledge more to the United Way than you've ever done before. You'll give your Fair Share.

If you don't do it, it won't get done.



advertising contributed  
for the public good

You can really know what geometry lurks beyond the linear profile. You can record spatial relationships based on length, breadth, height and depth scanning of surfaces, even on soft materials. No longer is there a need to rely on arithmetical averages or linear cross sectional profiles. Surfaces up to 2" square can be examined for profile, roughness, arithmetical average and waviness. A precision diamond stylus repetitively scans the sur-

face to be measured and transmits signals for hard copy print out in 3-D macro topograph. Magnification can be stepped from 5X to 200X on the X-Y plane, and from 10X to 100,000X in the Z axis.

Gould, Inc.  
Gaging & Control Division, 4601  
Arden Drive, El Monte, California  
91731 (213) 442-7755



The Gould Micro-Topographer™ 200 recording (below) of a micro electronic circuit illustrates the potential of this analytical tool for micro surface geometry.

## Now you can study hidden micro surface patterns in 3-D

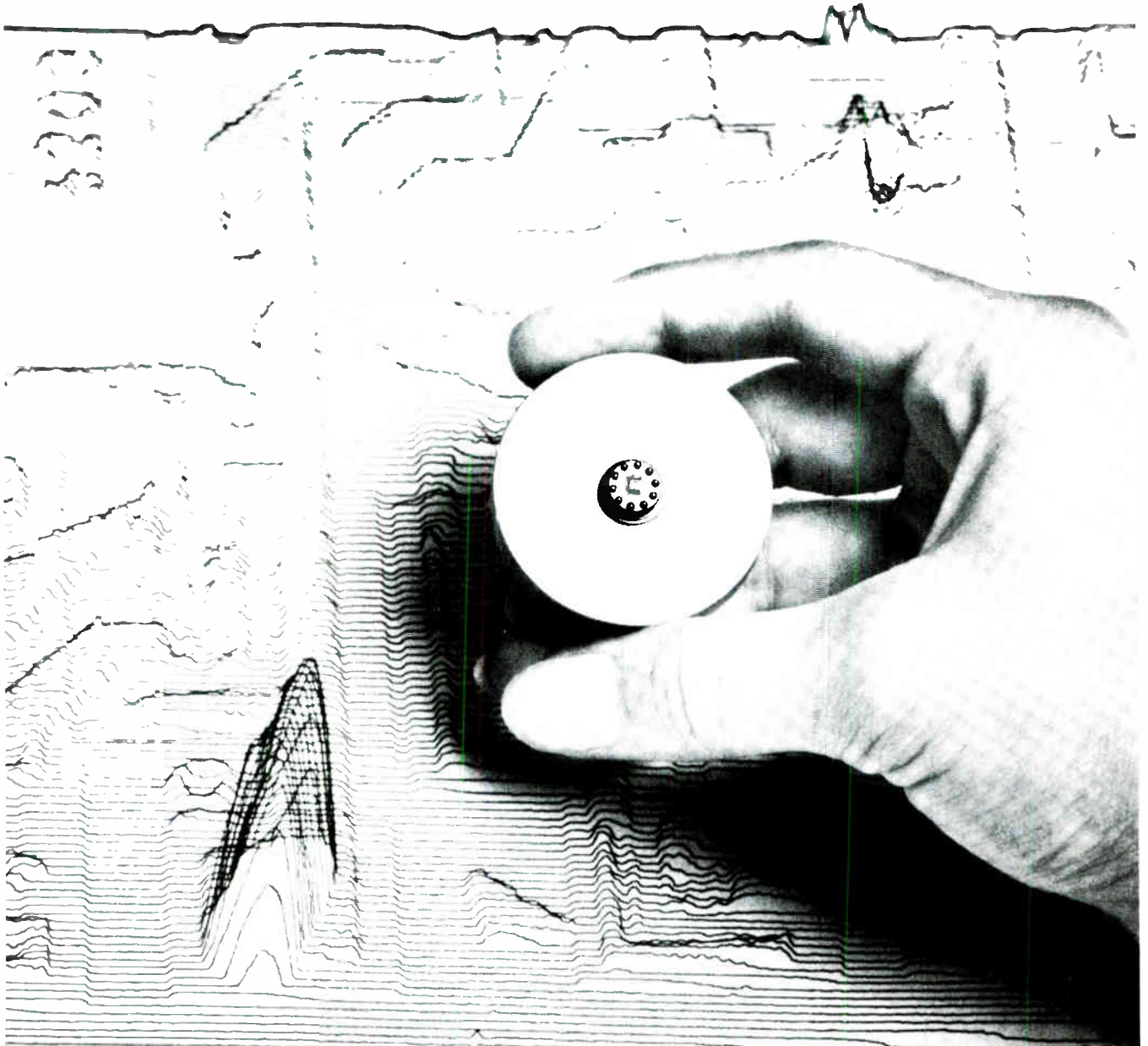

## If you can't stand the heat ...

stay out of the kitchen!



Here are components that stand the heat . . . and the cold ( $-55^{\circ}\text{C}$  to  $+125^{\circ}\text{C}$ ) without voltage derating. The dissipation curve is as flat as a pancake . . . and the other specs are out of this world. Maybe your recipe calls for

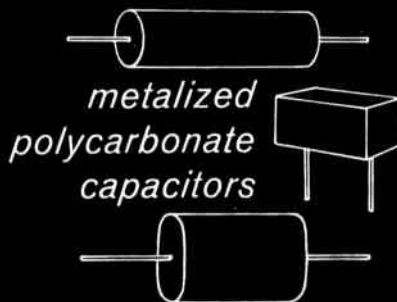

Try Standard's PC2-E (Rectangular Epoxy) and PC2-W (Wrap and Fill).

Send for Catalog and complete details.

**Standard**  
CONDENSER CORPORATION

Dept: E-11

1065 West Addison Street  
Chicago, Illinois 60613 • (312) 327-5440

124 Circle 124 on reader service card

## Technical Abstracts

### Blast vs radiation

Approaches to system hardening  
R.A. Poll  
Systems, Science and Software  
La Jolla, Calif.

Since a typical aircraft reaches its blast-overpressure limit in environments of relatively low neutron fluence and gamma-ray intensity, it's wasteful to harden the avionics against higher radiation levels. The author therefore calculates, on the basis of yield data, the thermal and overpressure levels that will be encountered in various exo- and endo-atmospheric environments, with weapon yields of from 10 kilotons to one megaton. From this he estimates the corresponding neutron and prompt gamma environments, and in effect specifies the limits outside which further hardening is pointless.

Hardening approaches against both environments are suggested, and their cost estimated. Against the lower neutron fluences—less than  $10^{10}$  neutrons/cm<sup>2</sup>—circuits should be capable of tolerating at least 1-2% voltage and current variation and be built with transistors whose  $f_c$  is at least  $10^6$  hertz. Above that but below  $10^{13}$  n/cm<sup>2</sup>, higher  $f_c$  and circuit tolerances are required.

With a still higher fluences level, the designer must provide additional gain and feedback, reduced fanout, increased base drive, etc. He must also take advantage of short-term annealing effects, where possible allowing the system time partially to heal itself before reapplying the full electrical stress of operation.

Against both the prompt and the total gamma doses, the designer should use radiation-hardened ICs or circumvention techniques to protect computer memories, and circuits that will not latch up. Man can be an invaluable part of the hardening system, especially where circumvention requires mode switching, memory transfer, etc. Electromagnetic pulse (EMP) effects are also briefly discussed.

Presented at the IEEE Annual Conference on Nuclear and Space Radiation Effects, La Jolla, Calif., July 21.

## The Material of Unlimited Uses...



## SOLDERING "UNSOLDERABLES"

...is but one of the thousands of uses for advanced low-melting-temperature alloys such as Cerroalloy® 35. Cerroalloy 35 melts between 238° and 260° F., and can be used with ordinary soldering techniques. When soldered with this versatile alloy, "toughies" such as glass-to-metal, ceramic-to-metal and metal-to-metal seals stay tight even in a deep vacuum. Other Cerro® Alloys, including specials made to your individual specs, are perfect for joining ultra-delicate parts like integrated circuits which cannot be heat-sunk during soldering. Low-temperature soldering as cool as 117° F. can also be accomplished with certain Cerro Alloys.

For detailed information contact Cerro Alloy Dept., Cerro Copper & Brass Company, Bellefonte, Pa. 16823 . . . (814) 355-4712.

In Europe, contact Mining & Chemical Products Ltd., Alperton, Wembley, Middlesex, England.

**CERRO®**

Circle 144 on reader service card

Here's the solution...

# Philips' miniature Plumbicon\*

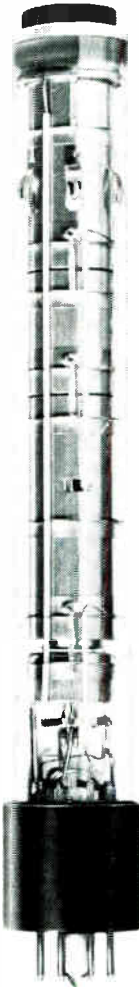

(actual size)

...now what's your problem?

We'll tell you the truth. It took a lot of imagination to build this TV camera tube.

With a diameter of just 5/8", it's just about half the size of Philips' famous Plumbicon tube preferred all over the world for its speed of response, resolution and sensitivity.

Yet the performance of the mini-Plumbicon is comparable to that of its big brother.

Now it's your turn.

What could a half-sized Plumbicon mean to you?

A whole new range of miniature broadcast cameras?

A solution to a tricky CCTV application . . . maybe industrial . . .

or military . . . or even in space? A new medical monitoring

concept, perhaps? Or something to simplify outside broadcasting reportage?

Maybe it's the key to a new idea for a data transmission

link . . . or the heart of an intelligence or security system.

What about colour microscopy?

But as we said it's your turn.

**\* Registered trademark of N.V. Philips' Gloeilampenfabrieken for TV camera tubes.**

N.V. Philips' Gloeilampenfabrieken – Eindhoven, the Netherlands

Manufactured, distributed and sold in the U.S. by

Amperex Electronic Corporation, Electro-Optical Devices Division, Slatersville R.I.



electronic components  
and materials

# PHILIPS

## Our Reconstituted Mica Capacitors Are Tested Harder



## You get higher capacitor reliability for less

Because Custom Electronics, Inc. is the reconstituted mica capacitor maker who precisely grades the dielectric material before it reaches production, other manufacturers' final mistakes are never started at Custom. The result is fewer production rejects, and lower job quotes for Custom Electronics' customers. Add this grading system to Custom Electronics' rather fanatical Quality Control efforts throughout the production process, and it becomes clear why our client list reads like the who's who of high voltage electronics.

If your high voltage capacitor needs are RELIABILITY and IMMEDIATE SERVICE write or call Custom Electronics, Inc., Browne St., Oneonta, N.Y. 13820. Phone 607-432-3880.



**CUSTOM ELECTRONICS, Inc.**

## New Literature

**Operational amplifier.** Torque Systems Inc., 225 Crescent St., Waltham, Mass. 02154, has issued a data sheet on the PA-131, a high-speed, 60-watt class B op amp for driving CRT sweeps. Circle 446 on reader service card.

**Timing unit.** Timing Systems Inc., Marblehead, Mass. 01945, has published a data sheet on the 915 Nanoclock, a high-resolution timing unit which operates from an external 1-MHz reference frequency, and provides an array of isolated timing references and digital time-of-day display. [447]

**Residual gas analyzers.** Varian, Vacuum Division, 611 Hansen Way, Palo Alto, Calif. 94303, has issued a brochure discussing Quad 1100/1110 residual gas analyzers [448]

**Subminiature switches.** Beltone Electronics Corp., 4201 W. Victoria, Chicago 60646, has issued a technical brochure on a series of subminiature switches that use the patented no-bound mercury all-position element. [449]

**Fused quartz and silica.** Amersil Inc., 685 Ramsey Ave., Hillside, N.J. 07205, has prepared an extensive technical brochure covering optical fused quartz and fused silica. [450]

**Nickel-cadmium batteries.** General Electric Co., 1 River Rd., Schenectady, N.Y. 12305, offers bulletin GEZ-4881 on its line of sealed nickel-cadmium rechargeable batteries. [451]

**Incremental/synchronous recorders.** Incor Corp., P.O. Box 156, Feasterville, Pa. 19047. A full line of IBM compatible, synchronous and incremental magnetic tape units is described and illustrated in a four-page brochure. [452]

**Data entry keyboards.** Cherry Electrical Products Corp., 3600 Sunset Ave., Waukegan, Ill. 60085, has published an information file that includes complete information on specifying and ordering electronic data entry keyboards. [453]

**Temperature control systems.** RFL Industries Inc., Boonton, N.J. 07005. Temperature control systems for single or multichannel applications are covered in a four-page brochure. [454]

**Rf interference filters.** Electro Cube Inc., 1710 S. DelMar Ave., San Gabriel, Calif. 91776. A four-page brochure outlines rf interference filters and capabilities for design and manufacture of filters to customer requirements. [455]

**Microwave capacitors.** Johanson Mfg. Corp., 400 Rockaway Valley Rd., Boonton, N.J. 07005, has available a product brochure featuring eight new microwave variable capacitors. [456]

**Synchron<sup>®</sup> motors**  
**help money**  
**make**   
**money** 



In the vending business, a would-be customer with dollar bills and no coins might just as well be flat broke. Unless there's a bill changer around. Like this one made by Rowe International.

Feed it a dollar bill and, presto! Instant alchemy. That useless paper is turned into spendable change.

The acceptance of the bill provides a signal which is transformed into multiple pulses in a Hansen-actuated electromechanical pulse chopper. Impulses are then sent to a memory unit and the payoff is actuated. The major reason why Hansen motors are specified:

"Dependability."  
Contact your Hansen man and find out how Hansen dependability can help you.



**HANSEN**  
Manufacturing Company, Inc.  
Princeton, Indiana 47570



**HANSEN REPRESENTATIVES: CAREY & ASSOCIATES,** Houston and Dallas, Texas; **R. S. HOPKINS CO.,** Sherman Oaks, Calif.; **MELCHIOR ASSOCIATES, INC.,** San Carlos, Calif.; **THE FROMM CO.,** River Forest, Ill.; **JOHN ORR ASSOCIATES,** Grand Rapids, Mich.; **H. C. JOHNSON AGENCY, INC.,** Rochester, N.Y.; **WINSLOW ELECTRIC CO.,** Essex, Conn., Villanova, Pa., and Teaneck, N.J.  
**EXPORT DEPARTMENT: 2200 Shames Drive, Westbury, N.Y. 11590**



NOVEMBER 1970

**Consumerism**

Where the buyer stands

**Travel & Sports**

Getting away on skis  
— in Western Canada

**Investments**

Better broker relations

**Home**

How to clean the air  
inside your home

**Healthy, Wealthy and Wise**

## Gifts for Kids: Greenery That Stays Green

This may be the year to put some planning into Christmas for the kids. A gift that goes beyond the usual melange of toys might brighten the eyes of a youngster in the family—by the time he's 20, that is.

It could be a share of stock, a bond, a \$100 bill or something more elaborate. The "planned gift" is worth looking into if you have a sizable amount in mind.

A trust, for instance, gives you a lot of leeway for projects such as college financing. Say that your child will enter college in 10 years. You're in the 32% top tax bracket—the \$20,000 to \$24,000 taxable income range. You establish a 10-year trust for the child and put in enough securities to pay, say, \$500 a year in dividends or interest.

Ten years from now, the \$500-a-year at 5% compounded quarterly comes to about \$6,640 in the child's account, and he gets the income tax free. You save \$160 a year in taxes since you have split away \$500 of taxable income. For you to save the same \$6,640 over 10 years—after taxes—would take a third more in income-producing investments. And the beauty of it is that in 10 years you can return the trust property to your own account.

If you want to avoid a formal trust, consider setting up a simple

custodian account. It's a streamlined approach. Assuming you're giving securities, you go to a broker's office and register the gift items in your name—or in someone else's—as "custodian for the benefit" of the youngster. As custodian, you can sell the original securities, reinvest the proceeds, and invest the annual income as you see fit.

**Personal Business**

is a new McGraw-Hill editorial feature devoted entirely to your personal interests.

You still save taxes by splitting off family income into the child's low tax bracket. There are, though, two possible drawbacks: When the child reaches 21, the property becomes his; and if you are personally named as custodian and die before the child is 21, the property is part of your estate for tax purposes.

But note: You can name a family member as custodian.

**Banks, too.** There is also, of course, the simple savings account for a child. If you bank \$1 today at 5% compounded quarterly, it builds to \$1.64 in 10 years—and doubles in 13 years.

A bank will work out a savings schedule for anybody who wants to plan something sizable, such as

college financing. For example, for a five-year old, you need to put \$68 a month into a 5% quarterly compounded account to have a \$15,000 kitty when the child enters college at age 18. He can then draw out \$2,041 in eight equal semiannual installments during four college years (the pay-out totaling \$16,328). A similar account with the same payout for a child of 10 takes \$127 a month for eight years.

Another idea is to start a child on the road to his own life insurance program, beginning at a low premium. You ease things for him in later years. Straight life costs about \$8 a year per \$1,000 at age 5, around \$9 at age 10, and \$10 at age 15—assuming at least \$10,000 in coverage. This jumps to \$16 at age 30 when your child, maybe as a young parent, might need to buy.

You can get some added values by attaching options to a child's life policy. Simple example: Say that you buy a \$10,000 policy for a boy aged 10 for \$90 a year. Adding an option charge of \$9 a year will give the boy the right to buy more coverage at option dates in the future, regardless of his state of health. Under a typical plan, his possible coverage is \$70,000.

Christmas gifts for the children in your family can mark the start of long-range gift planning that's

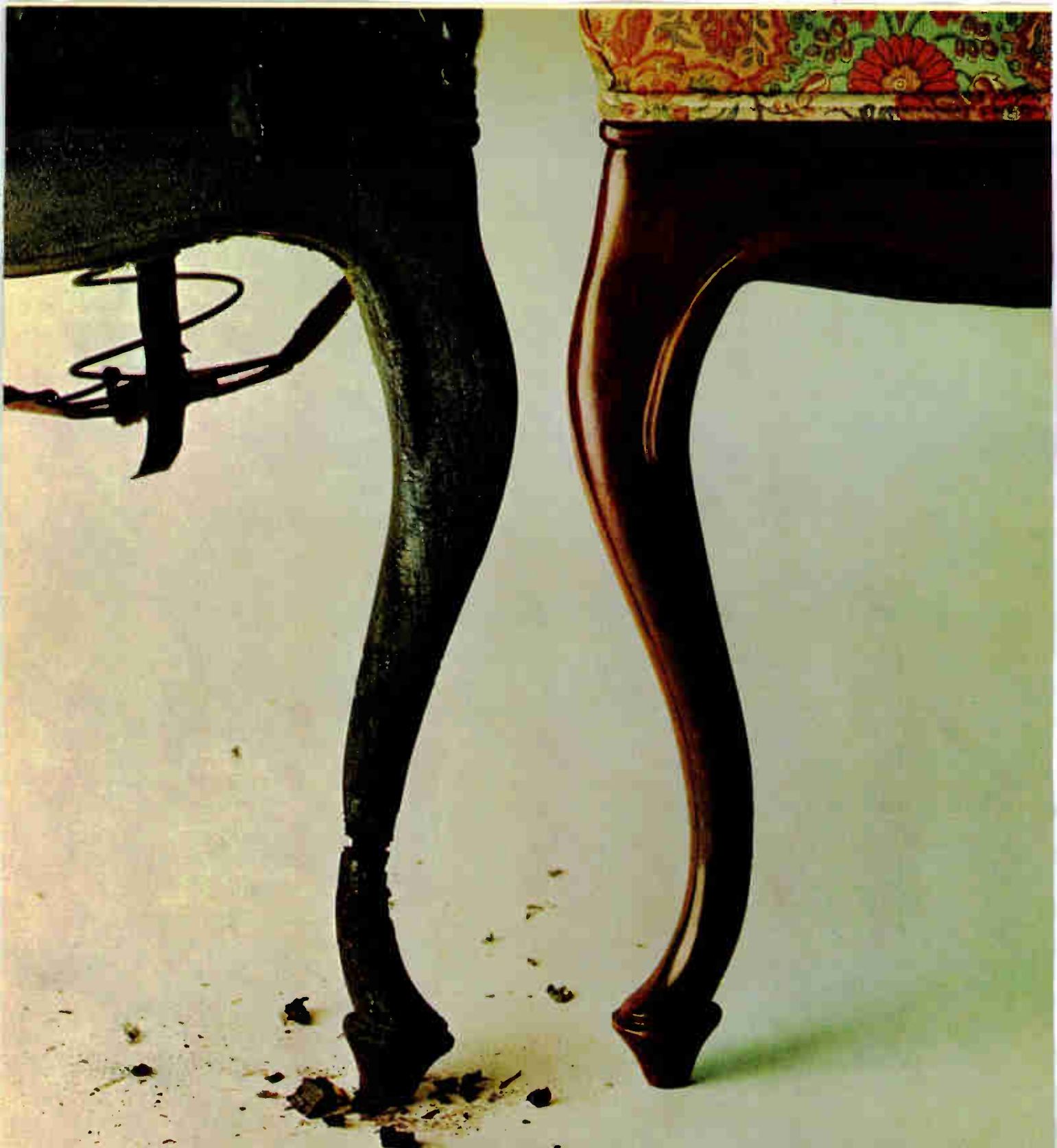

**As inflation boosts the cost of replacing your home and possessions, we boost the amount your Homeowners insurance pays, automatically.**

In just a few years, inflation can increase the cost of replacing your home and its possessions by thousands of dollars. If it does, we automatically increase the amount your Homeowners insurance will pay. It's one less thing for you to worry about. We protect you from loss by fire, tornado, burglary, vandalism and more, at low rates. We're the world's largest home insurer, for some very good reasons. (Current policyholders: if your coverage hasn't been updated with this new feature, call your State Farm agent.) **State Farm is all you need to know about insurance.**



tied in with saving estate taxes. If you give \$60,000 to your children (the amount of a married couple's lifetime gift tax exemption), and your taxable estate turns out to be more than \$100,000, your family will save at least \$15,000 in taxes.

But this kind of giving takes professional advice—as well as big money.

## CONSUMERISM

### Faulty goods: Where the buyer stands

In the next few weeks, you will probably be spending as much as at any time of the year—on Christmas presents for young and old, fancy foods and beverages, winter sports gear, clothing, and more. A prime question: What are your legal rights if you get stuck with defective, inferior, or even dangerous merchandise?

Of course, a telephoned complaint to a reliable retailer may bring quick satisfaction. To the less cooperative maker or seller of defective goods, a letter from a lawyer may be the answer. Finally, you may have to go to court—or at least begin the process with a settlement in mind. But with consumerism such a hot issue now, you'll find that:

- Manufacturers and retailers both realize that they are more closely under scrutiny than they have ever been.

- Consumers are getting a break as never before when faulty product cases go before juries, or pre-trial settlements are reached by lawyers.

Take some cases. Look at the "implied warranty." Let's say you buy a home movie projector and discover that it won't work properly. You have a legal right to return it for refund or replacement—even without a printed guarantee. You automatically have a warranty implied from the transaction. It says that the product is of average salable quality. So if the seller balks, you're justified in having your lawyer write a letter or even sue if he deems it wise.

The express warranty poses a harder case. Say that you buy a home workshop machine tool at a fixed price with the understanding that it will have a specific attachment. You take delivery and find it missing.

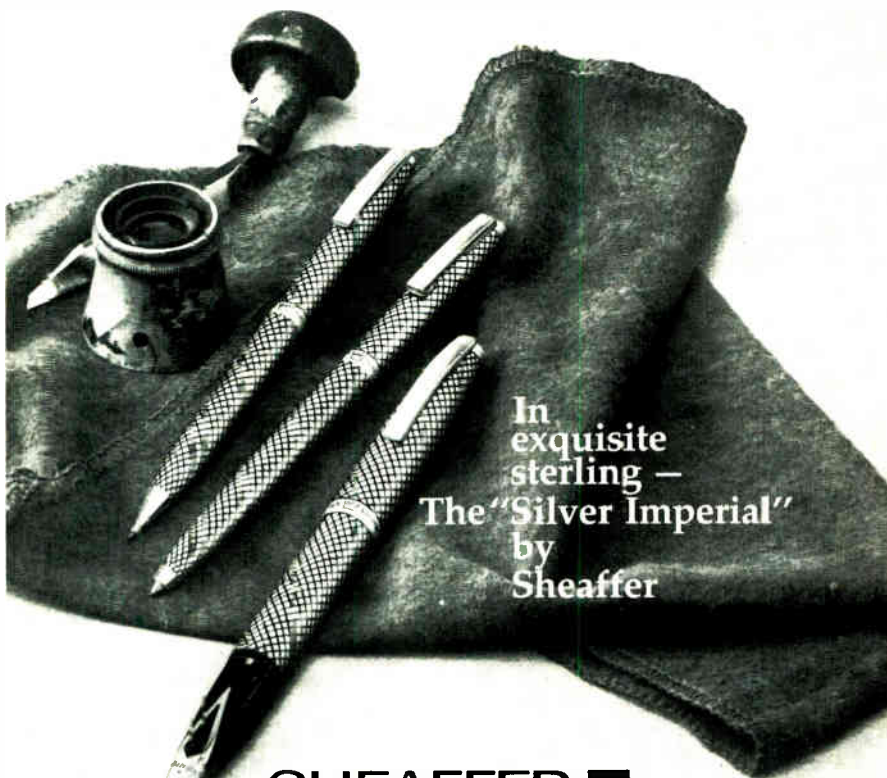

In exquisite sterling —  
The "Silver Imperial"  
by Sheaffer

**SHEAFFER**   
still the proud craftsmen

W. A. SHEAFFER PEN COMPANY, A  COMPANY, FORT MADISON, IOWA 52627



**DIGITAL CALENDAR CLOCK**  
**IN SLVER ALUMINUM CASE OR 24 KT. GOLD PLATED**

The most handsome and functional accessory ever to grace a desk or table! Gives time, day and date automatically! Illuminated numerals contemporary design, precision electric motor. Accurate to a minute a year! We'll ship air mail to you or your gift list for holiday delivery. 3½" x 4" x 3½". Designed for years of dependable service!

|   |  |
|---|--|
| <p>Please rush _____ CASLON<br/>DIGITAL CALENDAR CLOCKS<br/>checked below. I am enclosing<br/>payment of _____</p> <p>QTY _____</p> <p>_____ Satin aluminum ..... \$32 air p.p.d.<br/>_____ Black aluminum ..... \$34 air p.p.d.<br/>_____ 24 kt. gold plated ..... \$75 air p.p.d.</p> <p><input type="checkbox"/> Ship to the names enclosed.</p> <p>THESE QUALITY CLOCKS ARE<br/>FULLY GUARANTEED FOR 13<br/>MONTHS. 15 DAY RETURN PRIV-<br/>ILEGE, OF COURSE.</p> | <p>NAME _____</p> <p>ADDRESS _____</p> <p>CITY _____ ZIP _____</p> <p style="text-align: center;">(California residents add sales tax)</p> <p style="text-align: center;"><b>FUTURE FINDERS</b></p> <p style="text-align: center;">6000 SUNSET BOULEVARD<br/>HOLLYWOOD, CALIFORNIA 90028</p> |
|---|--|

To protect yourself in this case, you must have an express warranty—usually a guarantee on paper. But it can be based also on the seller's verbal or advertised promise. To prove that such a promise has been made, you must produce evidence: a notation on a sales slip, a newspaper ad, or a witness. With it, your lawyer may be able to swing a settlement.

You also need an express warranty if the product is guaranteed for a specific span of time. It means little if a so-called guarantee says "good for the reasonable life of the product," or "guaranteed for a reasonable period of home use." The question is, what does "reasonable" mean? For any high-ticket item, you're wise to get a specific time-guarantee—and on paper.

**Injury.** When somebody in the family is hurt or made ill by a product, the law is heavily on your side. Example: Say a transformer for an electric train is faulty and, as a result, your child is seriously injured. You might sue the retailer and get damages on the basis of implied warranty. But to win, you might need to show some negligence on the retailer's part. So, a better bet—especially since a transformer is a standard assembled item—is probably to sue the maker. Your case would be based on negligence in production, a claim that could well be inferred from the circumstances, and one that you needn't prove.

What about poor repair service? Aside from legal action, your best bet may be a letter to the president of the company. Often, though, it comes down to picking your retailer with considerable care in the first place. Today, many people are relying less on printed warranties and are buying where they have charge accounts—and promptly returning products that don't work properly before they even receive the bill.

---

## TRAVEL AND SPORTS

### Getting Away on Skis —in Western Canada

If you're tired of crowding at the tow—and that's the bane of skiers from New England to California—you might try the ski resorts of western Canada. They've been discov-

ered, but they're not yet mobbed. Book now and you can ski even at Christmastime in some locations.

Canadian Pacific's famous Banff Springs Lodge, 80 mi. west of Calgary, Alberta, will be open all winter. And 200 mi. to the north, Canadian National's newer Jasper Park Lodge will stay open until mid-April. Besides these top resorts, there are other first-rate but smaller hotels along the spine of the Canadian Rockies: for instance, the new Mt. Royal and the Voyager at Banff. And there are new motels at both Banff and Jasper. At Banff Springs Lodge and Jasper Park Lodge, you'll find good food, entertainment, bars, and all services, down to fracture specialists.

But the big lure is uncrowded skiing on dry powder slopes. Mt. Norquay (6,900 ft.) with its nine runs, is only 3 mi. from Banff. And at Lake Louise, 35 mi. away by bus, three mountain faces are linked by lifts—you can ski 7½ mi. from valley to valley, without climbing.

At Jasper's Marmot Basin, there are 13 runs, including a seven-miler from the top of 8,557-ft. Marmot mountain. Snow machines keep a few slopes packed for skiers who can't handle the powder. And if you tire of the runs, there's skating, motor sledding, curling, and snowshoeing.

**Grouse Mountain.** Vancouver, a city of about 1-million in the mild coastal lowland of British Columbia, is takeoff point for Grouse Mountain (3,900 ft.), just 6 mi. from downtown. Grouse has 10 runs, with a tramway and a variety of lifts. Stay in Vancouver at hotels such as the Bayshore Inn, Georgia, and Vancouver, and dine at Hy's Encore or La Colombe, or atop the mountain at the Grouse Nest. You can relax at Oil Can Harry's discotheque.

Seventy miles away (by car or train) there's Whistler Mountain (4,280 ft.) which has wide open slopes and the longest vertical drop in North America that's served by lifts. At nearby Alta Lake, Cheakamus Inn and Ski Boot Lodge have comfortable if not deluxe accommodations.

The third big ski region in western Canada—the most remote—is the interior mountain section of British Columbia. You can stay at such towns as Kimberley, Penticton, and Kamloops, and go by car to some excellent and well equipped local ski areas. In this area, helicopter skiing

is catching on among experienced skiers.

Bugaboo Peak, for instance, is an area where lifts are unknown. At Bugaboo, you first must prove to lodge and helicopter proprietor Hans Gmoser that you're expert. Then for upwards of \$400 a week you get room, meals, and helicopter service. Each morning, a copter picks up the skiers at the bottom of a run, flies to another peak, then repeats the process until evening. For details, write to Hans Gmoser, Canadian Mountain Holidays, Box 583, Banff, Alberta.

---

## INVESTMENTS

### Better Broker Relations: A Two-Way Street

One of the more popular sports this year has been cuss-your-broker. And many people who have taken a beating in the stock market may have good reason to cast a dim eye on the "registered rep." But an investor might also want to examine his broker relations—and remember that the relationship is a two-way street.

This is a smart proposition even if you use a broker only occasionally for advice and information. And it makes lots of sense if you're fearful of your performance in the market in the months ahead. A key point: It's not always the registered rep who is neglectful of an account. Just as often it can be the investor.

This also holds for whipping up unneeded activity, or "churning". Some investors help churn their own accounts.

Those most likely to demand unneeded action and suffer as a result are people who persist in jumping from broker to broker, and those who have little experience in the market. For these, one point is essential: Take time to fix a clearcut view of your investment objectives. Then let your broker know what they are.

**Changing goals.** Some who have been in the market for years—and who believe they have a clear notion of their aims—will fail to keep their brokers up to date on changing goals caused perhaps by a death, marriage, or such.

Other investors confuse their brokers. "A blue-chip man will get restive

# Most Americans are only happy 4 days a year.

There's Christmas. And New Year's Eve.  
And a birthday. And maybe an anniversary.

With a little luck, maybe you got a raise this year.  
Or maybe your wife has a baby. If so, that makes  
five days a year. Out of 365?

*Americans, There Is No Law  
Against Being Happy.*

Look, we are sorry to preach  
to you. But if there's one thing we do  
know about, it's being happy. We ab-  
solutely positively know that a man  
who puts on an After-Six tuxedo and  
takes his wife to a fancy place is go-  
ing to be happy. (Or at least happier.)  
An After-Six makes the dinner bet-  
ter, the night more romantic, the play  
funnier, and the lady you are with  
lovelier.

Please, friends—be happy.

**after**  
**Six** Adventures in formal and normal wear.

1290 AVE. OF THE AMERICAS, N.Y.C.  
22ND & MARKET STS., PHILA., PA.





See this and other contemporary and traditional Alma Designer Series at your Alma dealer; for his name and address, write Alma Desk Company, Dept. PB2, P. O. Box 271, High Point, N. C. 27261.

# Cut travel costs

Do you travel on business? Then TraveLodge has special rates for you. Pre-set and guaranteed. Just fill in the coupon below. Clip it to your letterhead and send it to Director of Sales, TraveLodge, Box 308 PB-1, El Cajon, California 92022. You'll have your TLC card by return mail. Use it. You'll save your company money. You can save trouble for yourself, too, by calling (800) 255-3050.

One toll-free number for more than 450 TraveLodges across the continent.

# here.



and want to take a flyer or two," says the manager of a carriage trade brokerage. "After a while the rep won't know where his client wants to go." For this breed, one piece of advice is to set aside perhaps 10 or 15 percent for speculation — and make sure the broker understands this. It's a case of client-broker communications.

**Paperwork.** In a general yearend review, let your registered rep know what you're reading in the way of market information. Investment letters are often a menace, and an open exchange with the broker may pay off. If you lack this kind of confidence in your broker, then maybe you need a new man.

Top pros insist that an investor has a basic responsibility that can't be delegated: knowing what's going on. The theme is pushed hard. Says an executive in a leading brokerage: "If you have \$10,000 or more in a mixed portfolio, and can't spend some time studying the market each week, you shouldn't have an account with a broker."

What you need, he adds, is a portfolio manager — or a mutual fund.

Some added suggestions for the investor: (1) Meet with the registered rep every month to fix instructions — if your account is at all active. (2) Give the broker any needed "open order" (to buy or sell at a specified price), plus an itinerary, before extended business trips or vacations. (3) Acquaint your wife with your plans.

**Duties.** Besides executing orders, a good broker will keep you informed, and he'll look upon this as a vital part of his job. He will even phone a client overseas if something happens to shake the account.

"He should do this without instructions," says a brokerage partner.

As for churning (which you can spot yourself by comparing your dollar performance over, say, six months, with what you would have done with no trades), some brokerage executives, in effect, say caveat emptor. Some admit that firms often find it hard to police their own men.

If a yearend review puts you to seeking a new broker, remember that picking the firm isn't too hard. Despite recent brokerage failures, you are safe with a known, established house. The real problem is picking a registered rep. The branch manager or partner will suggest a man — but nobody can screen him for you.

# Georgia, the unspoiled.

America, there's still a part of you left the way you were meant to be: Clean. Green. New. And full of promise. This is Georgia, the unspoiled—with the right balance of industry and environment, and a proper respect for both.

Offering those who believe in—and practice—private free enterprise, a unique package of industrial advantages. Advantages in land, sea, air, water, and quality of life. From time to time, we'll be showing you what the advantages of Georgia, the unspoiled, could mean to you. Your family. Your

company. And your company's profits. In the meantime, the Fantus Company has put all the profit potential facts together for you. Just send us the coupon. And we'll send you the way things are in Georgia.



Air you can breathe. Yet carries tons of cargo from the nation's third busiest airport.



Water you can drink. Yet an abundant supply for industry.



Land to raise children on. Yet plenty of room for industry, growth.



A sea fit to swim in. Yet handles cargo through two deepwater ports.



Gleaming beaches and deepwater frontage plant sites.



A father and son sharing the joys of major league sports.



People. Trained for you free. Prepared to work hard for an honest wage.



Fresh and salt water fishing.



A highway system serving the distribution center of the Southeast.



Exciting nightlife, unspoiled by garish neon signs.



A place where a great symphony plays.

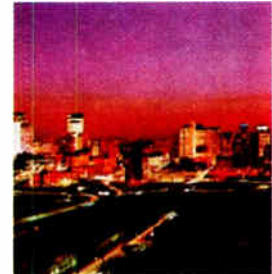

And tall, unspoiled cities.



A computerized system to select industrial sites.



Georgia Department of Industry & Trade, Industry Division,  
P.O. Box 38097, Dept. MH-1, Atlanta, Georgia 30334  
Send free information on:  Fantus Cost Studies,  
 other industrial data,  travel attractions.

name \_\_\_\_\_ title \_\_\_\_\_  
company \_\_\_\_\_  
address \_\_\_\_\_  
state \_\_\_\_\_ zip \_\_\_\_\_

The Fantus Company has prepared for Georgia, locational cost analyses for 31 SIC industries. They show in detail, the profit potential for a Georgia operation. And they're free.

# Firestone's new "asymmetrical" Town & Country: The first important improvement in winter-tire design in over 20 years!

**What's so much better about it?  
Better starting. Better steering.  
Better stopping. Better traction.**

## Why an "asymmetrical" design?

Take a good look at the tread of this wide, new Town & Country\* tire. You'll see three different designs: A. The outside shoulder. B. The center. C. The inside shoulder. This unusual engineering lets the new Town & Country charge through deep snow and dig through slush and mud. The remarkable wide-tread design also greatly increases tire mileage and gives you much finer handling when you're on dry roads.

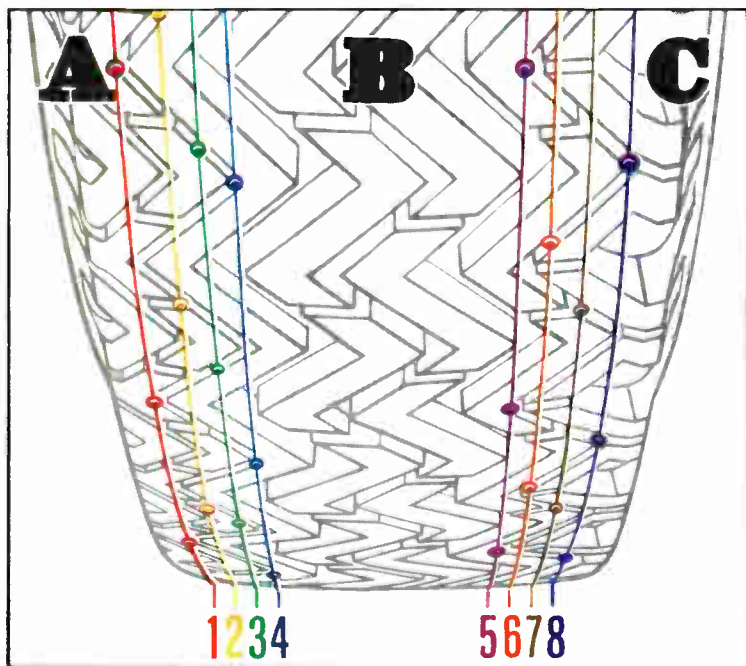

## The "asymmetrical" design gives you 8 rows of studs instead of only 6.

This wider, new Town & Country tread permits the placement of 112 ice-gripping studs instead of only 84, in eight rows instead of only six. That's why this new tire can give more secure footing on ice, whether you use four or just the usual two on the rear.

## Put this new tire on all four wheels!

The "asymmetrical" design allows you to put this new tire on all four wheels. Why do it? The National Safety Council strongly recommends studded tires (where local laws permit) on all four wheels because on most cars the majority of your braking power





**Even at only 12 mph you can stop much quicker on ice! Tests show:**

1. With new "asymmetrical" Town & Country studded tires on both front and rear, car stops in only 44 ft.

2. With new "asymmetrical" Town & Country studded tires on rear only, car stops in 56 ft.

3. With traditional design studded winter tires on rear only, car needs 65 ft. to stop.

As speeds increase, the difference in stopping distances will be even greater.

and steering control comes from the front wheels. What does this mean to you? Shorter stopping distance on ice and greater control on icy curves.

**Longer mileage at turnpike speeds.**

This new Town & Country has a special new "flat contour" tread design for a quieter ride, longer mileage and better handling even at turnpike speeds, whether you're on wet or dry roads.

**You go through ice, mud, or snow or we pay the tow!**

Firestone's new "asymmetrical" Town & Country will get you there and get you back and let you start, steer and stop better than any other winter tire we've ever made. Another pleasant surprise is that when you ask for the new Town & Country at your local Firestone dealer or store you'll find that it sells for no more than you'd expect to pay for any fine winter tire.

**The finest winter tire you can buy:**

It's designed for maximum control by permitting the use of studded winter tires on all 4 wheels.



Tests prove that 4 studded "asymmetrical" tires can stop up to 32% better on ice than 2 traditional design studded winter tires.

The new "asymmetrical" Town & Country tire provides positive handling, long wear, and a smooth, quiet ride on any road, wet or dry, even at turnpike speeds.

(All comparisons relate to the previous Firestone Town & Country tire.)

**Firestone**  
The Mileage Specialist.

**If we can move a 2,400 pound, stuffed polar bear from Spokane to Boise without ruffling his fur, then we can move your new V.P. and his family without ruffling theirs!**



Actually, we've moved this big bruiser a couple of times. And everywhere he goes, his enormous glass showcase goes.

He's over 12 feet tall, has a 94-inch waist and 69-inch neck—the largest polar bear ever to be killed.

And every time he arrived, he arrived intact and on time!

We'll be just as careful with that new V. P. you've got to get into town. And if he happens to own a stuffed polar bear, well, we'll know just how to move it!

## How to Clear the Air Inside Your Home

You can't do much about air pollution in the streets except protest. But at home—in an apartment, townhouse, or close-in suburb—you may want to make the air as fit for breathing as possible.

In a house, central air purifiers are attached to the air-duct system in the basement. An electrostatic precipitator removes 75% to 90% of the dirt, pollen, and smoke. It will filter the air in your home four to six times an hour (Carrier Corp., General Electric, Chrysler Air Temp; \$400 for up to 10 rooms).

Portable room air purifiers can be plugged into a socket, are under one sq. ft. in size, and make very little noise (Puritron Corp., \$30 to \$45). Double-duty units humidify the air and collect dirt. One type goes in the duct system (Carrier, \$100). The other is a room humidifier to which effective air-filtering gear can be attached (Presto Industries, \$60 up).

Standard air conditioners do a reasonable job in hot weather. They filter out some of the dirt, but aren't designed for purification.

**Noise.** As for noise pollution, the recommended home remedy—if you're really serious—is soundproofing. You can get a remarkable result if you spend enough money.

To soundproof a room, the best way is to install parallel inner walls about 6 in. from the existing walls, with acoustical materials in between. Cost is about \$2 per sq. ft. if you hire a skilled man, but half that or less if you do the job yourself. Windows need the same treatment, and the best material is Thermopane which is two ¼-in. panes with a 2-in. to 4-in. space between. Figure on high cost here: \$125 a window. To save on this item, consider wooden shutters.

Doors should be weatherstripped, and acoustical ceiling tiles installed at a cost of 50¢ per sq. ft.

Total tab: Soundproofing a bedroom effectively will run \$500 to \$1,000. If the job is done properly, it can eliminate 75% to 80% of all outside noise.

## The Tender Touch

Automatic/Remote Tuning with  
**KENWOOD KR-7070**  
FM/AM Stereo Receiver

300 Watts • 3 FET • 4 IC • XTAL Filter • \$549.95



**KENWOOD**, 15711 S. Broadway, Gardena, California 90247

For the KENWOOD DEALER nearest you call FREE: 800-553-9550 (In Iowa call collect, 319-242-1867)

## NEWEST, MOST ADVANCED POCKET SYSTEM! Best features of older systems, plus improvements. Helps you end "forgetting," slip-ups... get more done... keep full tax and expense records.

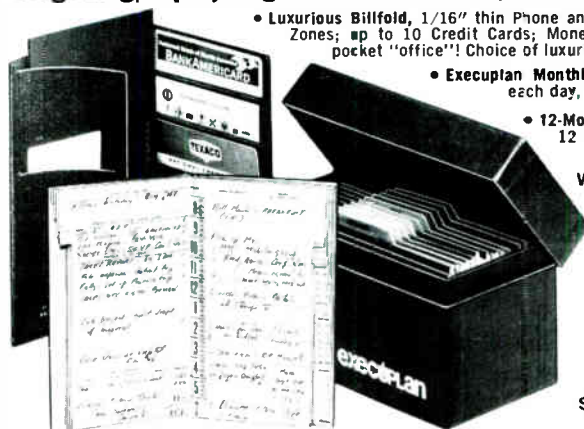

- Luxurious Billfold, 1/16" thin Phone and Address Book; Area Codes; Time Zones; up to 10 Credit Cards; Money, Checks, Tickets, Papers... your pocket "office"! Choice of luxurious leathers.
- Execuplan Monthly Planner-Diary, with 2 pages for each day, expense record; speed-indexed.
- 12-Month File Box, sturdy, indexed, holds 12 Planner-Diaries, full year's record.

We who manage The Publishers Guild, a 50-year old company, developed EXECUPLAN for our own staff use. We improved it by test and trial—found we had "a better mousetrap". Demand has soared. This organized, handy ½" "office" slips into your pocket, relieves worry, won't let you forget appointments, calls, decisions or deductible expense. Can save you 10 to 50 times its cost! Satisfaction guaranteed, 30 day free trial!

## execuplan

Users worldwide praise it as "absolutely indispensable." Adapts to your needs, works perfectly. Enjoy using the system with all latest improvements. May be charged to Diners Club, American Express, Master Charge. Sign coupon, give number.

**FREE BONUS**—Only Execuplan offers this Day-Planner Desk Pad. Keeps visible on your desk notes, schedule, etc. Supplements your Pocket System—no other desk system needed. Exclusive!

Execuplan, The Publishers Guild  
315 Park Ave. South, NYC 10010

EXECUPLAN, Dept. PB-11, 315 Park Ave. S., NYC 10010  
(Show leather choice, color, quantity ordered)

|                                   | Price   |
|-----------------------------------|---------|
| Morocco Calf, Black               | \$15.95 |
| Ostrich Calf, Black               | 16.95   |
| Water Buffalo, Black              | 17.95   |
| Pin Seal Goat, Black              | 19.95   |
| 12-Month Refill and File Box Only | 8.95    |

Check or MO enclosed for \$ \_\_\_\_\_ (NY, NYC add Sales Tax). We pay shipping. Begin with month of \_\_\_\_\_

Name \_\_\_\_\_

Address \_\_\_\_\_

City \_\_\_\_\_ State \_\_\_\_\_ Zip \_\_\_\_\_

Charge  Diners  Am. Exp.  Master Charge \_\_\_\_\_ Account Number \_\_\_\_\_

Signature \_\_\_\_\_

**IBM  
introduces  
all-monolithic  
technology,  
memory and logic.  
And a new  
computer that  
makes the most  
of it:**

**System/370  
Model 145.**

**You might call it a new era of computers,  
or a new generation, or a technological breakthrough.  
But what really counts is what it means to you.**

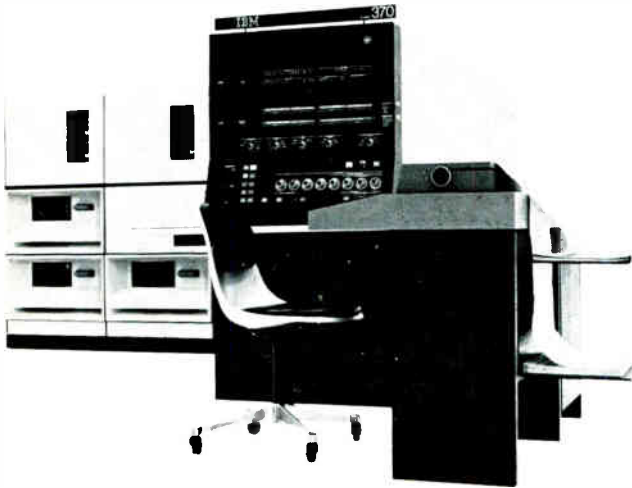

**The hottest concept in computer technology**

System/370 Model 145 is the first general-purpose business computer with 100% monolithic circuitry. Including main storage.

The use of this technology with its very high circuit density cuts main storage space in half.

Monolithic technology also speeds up the computing process. And improves reliability as well.

**New advancements in speed**

Model 145 is 3 to 5 times faster than System/360 Model 40. 5 to 11 times faster than System/360 Model 30.

And that's another reason it's the natural system to move up to if you're a Model 30 or 40 user.

**Features, features, features**

Like the other computers in the System/370 line, Model 145 is newly engineered inside and out. It's loaded with features.

Like four selector channels. So you can run more jobs and get more work done in the same time.

Like reloadable control storage. So you can have features like block multiplexing, 1400 and 7010

compatibility, and DOS emulation at no extra charge.

Like our new low-cost, high-speed disk facility (the 2319) that holds 87 million characters. And attaches directly to the system without the need for a separate control unit.

**System/370: IBM's computer line for the '70s**

With System/370, whatever you've got to get out gets out a lot faster.

With any model, you can get our new high-speed printer (the 3211). It fires out numbers and letters at the rate of 2000 lines a minute. Faster than you can blink.

With any model, you can also get our new high-speed disk facility (the 3330). It can hold up to 3½ times more information than our current files. 800 million characters in all. And it can send it into your computer up to 2½ times faster. At a rate of 806 thousand characters per second.

We think it's the best file around.

**Revolutionary new product line**

But perhaps the most amazing thing of all is that we've been able to make System/370 this advanced while still making it compatible with System/360.

And you also know with IBM you have the support of the most complete program library in the world. As well as the support of our Systems Engineering and Education services.

We've used a lot of words to describe System/370 Model 145. Like 100% monolithic circuitry. Like faster speeds. Increased performance. New features. Greater reliability.

These words aren't empty chatter.

Everything we've said is backed up by hard facts.

Our products change. But our philosophy doesn't. We want you to get the most out of your computer system.

**System/370. The performance computers for the seventies.**

**IBM®**



### In Jogging: Easy Does It

There's no question that a daily routine of jogging will ward off heart attacks and strokes. But the specialists have been sounding a warning note to men over 40 who are out of condition. Pushing too hard can mean serious trouble. Says Harvard's Dr. Warren Guild, a sports medicine specialist:

- A man should see his doctor before starting on any rigorous jogging routine. Especially, don't be ashamed (as many men are) to reveal shortness of breath or mild chest pains. Trouble can't be buried.
- Do-it-yourself jogging stints—with no supervision at all—are often dangerous. They can fell a man who is out of shape.

People who carry around extra poundage—or, of course, those who rarely exercise—must be particularly careful. For such a person, working up to 30 minutes of daily jogging should take four to six months—not four to six weeks. First, says Dr. Guild, simply walk briskly several times a week for two weeks. Follow this with a 30-minute routine of slow jogging interspersed with ample walking. Then gradually work up to 30 minutes of daily jogging. Too many men, says Guild, have been moving much too fast on this.

### Save a dollar here— a dollar there

Is your mutual fund down? A new study by the 20th Century Fund—*Mutual Funds and Other Institutional Investors*—says, in effect, that the funds never really did better than the market as a whole....The report (McGraw-Hill, \$7.95) finds that if you had invested equally in every issue on the NYSE over the last 10 years, you'd have fared better than if you had put the cash into funds. One conclusion: The primary function of the funds in the future will be to provide the small investor with a quick, cheap, easy way to diversify his investment.

If your retirement plans call for a fixed income and you want to get away from paying income taxes quarterly, note that the Treasury has ruled that starting next year you can have cash automatically deducted from an annuity—like salary withholding....**Your estate:** The speed-up in payment of estate and gift taxes that's been in the financial page headlines is only the visible part of an iceberg. Top estate planners warn that more meaningful changes are coming in the next few years (maybe by 1971). Anybody who wants to cope with estate planning ought to get next to a good adviser—and by and large, it's best to start with a tax lawyer.

### A fast scan: the seasonal scene

Dan Jenkins' book on college football, *Saturday's America*, has an old-time stadium buff sounding off about the passion and the razzle-dazzle that overcome everybody at 2 p.m. on a Saturday in the fall; it goes way back to Knute Rockne's Four Horsemen (1924) and takes in such latter day names as Joe Namath (pre-Broadway) and O.J. Simpson. You'll like it (Little, Brown, \$5.95) . . . **Winter sports:** Anyone off to Europe to ski this winter should check Abby Rand's *A Ski Guide to Europe: the Fabulous Forty*. It's a lively look at the top resorts in France, Germany, Italy, Switzerland; it's practical trip-planning stuff (Award House, \$10).

**Food and drink:** What with damp and chill in the air, try Cappuccino as fixed at the delightful Caffè Greco in Rome's Via Condotti: Stir 2 cups steaming hot water and 1 cup dry instant coffee cream; mix in 4 cups strong, steaming coffee (emphasis on strong), ¼ cup sugar, ¼ tsp nutmeg—then pour into warm cups and garnish with chocolate curls....Caffè Greco's man will put into hot black coffee a dash of Cointreau—on an exceptionally chilly day....**Bookings:** An outfit called Reservations World will speed your hotel bookings. For domestic hotels, you get two-hour service; foreign, 72 hours; over 20,000 hotels are in this set-up, from the Drake in Chicago to Mexico City's Camino Real (Reservations World, 1 Park Ave., New York).

# Speed-A-Gift. For the client in your life.

Or anyone on your gift list. A quick, unique and convenient way to send beautiful, fresh flowers, arranged in a handsome gift, almost anywhere. Through Florists' Transworld Delivery.

The wide range of prices and the dozen lasting gifts mean there's something for everyone in Speed-A-Gift. Depending on the gifts you select, most are usually available from less than \$3.50 to \$30.\* And most FTD florists accept major credit cards or welcome your charge application.

There's no shopping. No wrapping. No mailing expense. Just tear out this page and hand it to your secretary. Have her pick the gifts by number, call your nearby FTD florist, and tell him to send them the FTD way.

Then you can be just as sure as if you delivered them yourself.

- SG-14 cup and saucer.
- SG-15 pitcher and bowl.
- SG-16 condiment set.
- SG-17 cups and caddy.
- SG-18 cocktail hibachi.
- SG-19 cheese board set.
- SG-20 silver sugar scuttle.
- SG-21 cannon stein.
- SG-22 crystal compote.
- SG-23 jewelry chest.
- SG-24 chip 'n dip.
- SG-25 picture clock.

**Speed-A-Gift**  
DELIVERY SERVICE



Send it the  
FTD way.



\*As an independent businessman, each FTD Member Florist sets his own prices.

Wide open spaces can be very tempting for plant sites. The only trouble is they're usually in the middle of nowhere. So you can easily wind up using some of that open space for warehouses.

Now take Massachusetts. Not only is it right in the middle of everywhere, it has plenty of every kind of transportation. And best of all it all works.

Massport is a good example. A brand-new public container terminal rising on the Charlestown side of the Mystic River and capable of handling up to 30 large containers an hour as well as bulk shipments is indicative of a new spirit to match the needs of the 70's. So is a new labor contract which allowed

a complete modernization of work rules and insures Massport of one of the most stable waterfront labor forces in the U.S. All this has led to new service to the rest of the world and along the coast.

Of course transportation isn't everything. And it isn't in Massachusetts. Our labor force is adaptable, productive and stable. The area is a cultural oasis. The unique quality environment aids business and people to prosper.

This is Massachusetts. Where everything works for you.

Send for our new fact book. We'll send you the works.

# Once they lure you there, how do you get your products out?



Massachusetts Department of Commerce & Development  
100 Cambridge Street  
Boston, Massachusetts 02202

Name

Title

Company

Street

City  State  Zip

**MASSACHUSETTS**  
*Where everything works for you.*

MGH-11





---

# International Newsletter

---

November 23, 1970

## **IBM pushes for wider access to Japan's patents**

IBM's strong desire to improve its patent position in communications technology appears to be behind the tough license-renewal conditions it has laid down to Japanese computer companies. The 10-year licenses under basic IBM patents expire at the end of December. Until now Japanese companies have been required to make their own patents available to IBM on a royalty basis. But in the upcoming negotiations, IBM is asking them also to make available patents which they hold jointly and to take the responsibility for settling any problems that result. And problems undoubtedly will result, because it is against Japanese law for one joint patent holder to issue a license without the consent of the other joint holders. Significantly, IBM also wants to change the field covered by the agreements from just data processing to all information handling systems. The patents to which IBM wants access appear to be mainly those held jointly with the Nippon Telegraph and Telephone Public Corp. (NTT). Thus this tactic is another facet of the strategy that last July led IBM to press NTT for a cross-licensing agreement.

## **French company buys medical electronics arm of Westinghouse**

Westinghouse will sell its medical electronics division to the French firm, Cie. Generale de Radiologie, making this Thomson-Brandt subsidiary one of the world's top three medical electronics companies, along with Germany's Siemens and Philips of the Netherlands. Terms have not been fixed, but Westinghouse is expected to own 25% of CGR.

CGR makes X-ray and thermography equipment, electronic patient monitoring devices, and such items as heart pacemakers and artificial kidneys. Its sales last year were \$72 million. The Westinghouse division, located in Baltimore and Washington, makes X-ray equipment and electronic devices that monitor chemical parameters in the human bloodstream. Its 1969 sales were \$36 million. CGR plans to manufacture some of its products for the U.S. market in the former Westinghouse plants.

## **Swedish consumer agency passes on color TV sets**

A Swedish government color TV test has turned out to be a manufacturer's dream—and will brighten Christmas for makers and dealers. Out of the sets from 17 different makers which the state consumer agency tested, all except one made in Hungary received a grading of "good" or "acceptable" for operational reliability and repair costs. This test was undertaken in response to the makers' outcry over the result of a similar evaluation made last year; it showed so many sets to be unacceptable that color TV sales, which had been booming, dropped to near zero.

However, one point stressed by the consumer agency that ran the tests may delay a return of the color sales boom. The agency said it pays to wait before buying because quality has been constantly improving, purchase and repair costs have been dropping, and there is no reason to believe this trend won't continue.

## **Computer-controlled express train tested in Germany**

West Germany's government-run railways are speeding up their pace of train service automation. What the state rail agency calls the world's first remote-controlled and computer-guided high-speed train has just been tried out on a small stretch between Hanover and Hamburg. Traveling at speeds of up to 120 miles per hour, the locomotive responded to sig-

---

# International Newsletter

---

nals received from a computer center in Hanover. The signals were coupled between loops along the rails and on the locomotive.

In another automation program, all stations along a 60-mile stretch between Hanover and Bremen have been tied to the Hanover computer center. Working with data automatically registered along a train's route, the computer transmits teletypewriter instructions to local personnel, telling them how trains should be switched for optimum routing through stations. The next step in this program will be to put all train switching gear at one station under direct computer control.

## Europeans assess electronic device X-ray threat

Are X-ray emissions from electronic devices a health hazard? Doctors, engineers and public health officials from 22 countries met in Toulouse, France, earlier this month to take a long look at the problem. Their conclusion: laboratory instruments and professional equipment, such as electron microscopes, transmitting and rectifying tubes, thyatrons, klystrons and magnetrons, emit X rays in such minute quantities and are already so well shielded that people working near them run virtually no health risks.

Color television sets, object of controversy in the U.S., also got a relatively clean bill of health. Conference delegates agreed that viewers run no risks whatsoever if they keep 2 inches or more away from the set. At less than 2 inches some sets on the market emit more than the 0.5 roentgens of radiation per hour that conference doctors considered dangerous. For this reason, TV repairmen do run some risk, but delegates generally felt that repairmen, wary of the 25,000-volt power supply of the shunt regulator tubes that emit the X-rays, tend to keep a respectful distance in any case.

## French hold back 110° color sets

France's color TV firms have agreed to postpone launching sets with 110° picture tubes and, when they eventually introduce them, to do so simultaneously, for fear of jolting the already sluggish French color market. No date has yet been set, but it's likely the new sets will be launched just after the 1971 Christmas selling season. Sets with 110° tubes have been marketed in Germany, "but they are not doing so well," says Jacques Fayard, head of Thomson-Brandt consumer product division.

Because of the 819-line picture of France's first TV channel, special high-power scanning transistors have to be used and they both cost more and create major heat dissipation problems. Sets with 110° tubes will thus cost at least \$50 more than present sets, figures Fayard. "It's going to be a shock to people who have been waiting for color prices to come down to see them go up again."

## West Germans build satellite terminal for 10-GHz trials

As part of its drive to open new frequencies for future communications networks, West Germany's post office has ordered an experimental satellite ground station that will operate at 10 gigahertz and above. It's to be built near Frankfurt by AEG-Telefunken under a \$1 million post office contract, and the experiments will be conducted in conjunction with Sirio, an Italian satellite scheduled for a 1972 launching. Areas to be investigated are the propagation and transmission characteristics of signals in the 10- to 20-GHz range, and their eventual use in a European television distribution system.

## Hitachi set to go with a new computer

Top-of-the-line unit, to offer performance between IBM 155 and 165, benefits from fallout of large-scale project

**Hitachi Ltd.** has finally received permission from the Ministry of International Trade and Industry to build commercial computers using techniques it developed for the ministry's large-scale computer project. The company's first step after the go-ahead was to announce the Hitac 8700 computer—which everybody knew it was working on. First deliveries are scheduled for the first half of 1972 and the company will take orders next year.

The new computer's performance, about three times better than its top-of-the-line 8500, is between that of IBM's models 155 and 165. Hitachi chose this performance level to compete with IBM, which plans to produce the model 155 in Japan. Another performance benchmark for the new Hitachi computer is that it is roughly as powerful as the recently displayed Nippon Electric model 700 computer [*Electronics*, Oct. 12, p. 167], billed as Japan's biggest commercial computer, but the tradeoffs in the two computers are quite different.

Hitachi says the new computer's high speed is due to the LSI hybrid arrays and the high-density packaging scheme it developed for the large-scale computer and a buffer memory developed specially for the 8700. However, the new computer is only about one-third as fast as

the large-scale machine because it employs a somewhat slower main memory, uses a simplified configuration with serial operations in some of the places where the large-scale computer uses parallel operations, and omits look-ahead control. Nippon Electric's 700, by contrast, uses look-ahead control and a faster memory, but has no buffer.

Hitachi's LSI hybrid arrays feature emitter-coupled logic IC chips bonded face down onto a ceramic substrate with two layers of wiring. Average delay per gate is only 1.1 nanoseconds. Sixteen types of arrays are fabricated from five basic chips. For the two-layer wiring, the inner conductor is made of deposited and etched aluminum 2.5 microns thick. A 4.5-micron glass insulating layer is sputtered on, and about 200 through-holes are opened for interconnections. Then pedestals about 8 microns high are made and another aluminum layer deposited, with some metal going over the pedestals to form a surface for ultrasonic chip bonding.

The Hitac 8700 is designed for operation with up to four central processors. The main memory has a maximum capacity of eight megabytes, with a cycle time of 0.9 microsecond per eight bytes. This is same capacity as, but somewhat slower speed than, the large-scale computer. Two- or four-way interleaving is available. The buffer has a cycle time of 210  $\mu$ s; its capacity is 16 kilobytes.

**For almost limitless memory** capacity, the computer uses the virtual memory scheme employed on the large-scale computer. One page

is 4 kilobytes, one segment is 64 pages, and total address space is 16 kilosegments. Program or data dynamic relocation in page units is possible. Sixteen associative registers are available to convert logical addresses to physical addresses.

### West Germany

#### Electronica reflects trend toward instrument packages

The trend toward computerized instrument systems, which started in the U.S. several years ago, now is clearly discernible in Europe. Plenty of evidence to that effect surfaced at Electronica this month. No longer are European manufacturers thinking only in terms of single instruments—voltmeters, analyzers, and signal generators—designed for a specific function.

"Many customers want a complete system that automatically gathers, measures, and processes data, documenting the test result," says Manfred Pribsch, division sales manager at Rohde and Schwarz, the big West German test and communications equipment maker. "They just state their problems and let the instrument people come up with a package solution."

Electronica was picked as the debut vehicle for a perfect example of the systems engineering trend in instrumentation: a computer-controlled semiconductor components tester. Built by Rohde and Schwarz, the ATS 2540 can measure and evaluate the parameters of

practically any semiconductor component on the market today: linear and digital hybrid or monolithic ICs; MSI and LSI devices; discrete components, from simple diodes and transistors to more complex thyristors; printed circuit boards; and other substances.

The automatic test system is priced at \$54,000 for the simplest configuration and runs up to roughly five times that for the most complex version. It's intended for both makers and users of components, but is also suitable for small-scale testing in research and development labs.

The system's versatility and modular construction sets it apart from most others built so far, Priebsch says. Adding appropriate plug-in modules adapts the ATS to test different components. For example, in its most basic version, the system can perform logic function tests on digital ICs. In these tests the shortest measuring time is 100 microseconds per function, giving 10,000 function tests a second.

By adding modules, the system can determine dc parameters, such as offset voltages and currents in operational amplifiers or input currents and output voltages of linear and digital ICs. Other modules adapt the equipment for pulse-type measurements—rise, fall, and propagation delay time, for example—while still others allow testing for signal-to-noise characteristics, frequency response, distortion, and input and output impedances.

For versatility, the system can be programmed and controlled either by its built-in computer or by punched tape. Under tape control, the sequence and combination of tests is stored on eight-hole tape.

In one-time programming, the data on the tape is put into a core memory before being applied to the control unit. The core memory is expandable to handle 20 programs and has a cycle time of 10  $\mu$ s per word.

In computerized operation the built-in Honeywell 311 computer, which stores all required programs,

takes over system control. At the same time, it evaluates the test results and provides documentation for error analysis.

### Spinning glass plate ends alignment blurs

Blurriness is one of the hazards of mask-to-wafer alignment in integrated circuits production. To counteract it, researchers at the Boeblingen laboratories at the International Business Machines Corp. in West Germany have developed a new focusing method.

Its basis is a rotating glass plate that focuses the aligner's microscope onto the object planes of the mask and the wafer alternately. In this way, sharp images of both mask and wafer are obtained, and alignment errors virtually eliminated. The method was described at the Fourth International Congress on Microelectronics held at Munich earlier this month.

Aligning the mask on the wafer is one of the most critical phases of photolithographic processes used in IC production. During alignment, the wafer and mask have to be separated by at least 20 microns, so that the wafer can be moved without the physical contact that could damage the mask's emulsion.

For proper alignment, mask and wafer have to be viewed simultaneously, but since they are located in two different planes—and separated by a distance larger than the microscope's depth of field—the observer can only see more or less blurred images.

In the new method, however, says its developer Guenter Makosch, a glass plate, which is coplanar with the microscope's lenses, rotates in the space between the lens system and the wafer-mask combination. The glass plate is oblong and its axis of rotation offset from the microscope's optical axis. Thus, the plate alternately covers and uncovers the wafer and mask images. When the plate is over the mask and the wafer, the wafer's image is sharp. A quarter-turn later, the image of the mask

### The tables turn at Electronica

Electronica 70, the big electronics show held in Munich early this month, was, as predicted, the biggest and best attended Electronica ever staged. Nearly 1,500 firms from around the world—50% more than two years ago—exhibited their wares either directly or indirectly, and drew more than 40,000 visitors, a jump of 25%, to the Bavarian capital.

But Electronica presented quite a different view of the European industry scene this year. Gone was the optimism that prevailed among components people two years ago, when manufacturers were wallowing in big order backlogs and users were complaining about component shortages. This time it was the manufacturers' turn to complain.

**At the stands** and during after-hours shop talks, the recurrent theme was the worldwide pressure on prices. The pronounced price erosion this year has caused many firms to suffer losses. For some types of integrated circuits, prices have plummeted 60% and more in a few months time. Some standard TTL circuits of medium complexity now are selling for 35 pfennigs, or 10 cents, a gate. "This year," says an official of a large American components firm in Germany, "has been the worst yet. Not even the big houses are making much of a profit these days."

The crisis may well last for most of next year. Some people even predict that it may continue into 1972. As a result, even though the volume of semiconductor consumption in Europe will rise at a respectable rate next year, the market value will go up only moderately—no more than 12% or so—according to most observers.

Many firms already have cut back investments. F.E. Jones, chairman of Mullard in Great Britain, says freely: "It will be difficult to stay in this business without losing £1 million a year." Ralph Bennett, product planning manager of Fairchild Halbletter GmbH adds: "Some companies may be forced to change the nature of their business."

is sharp. In effect, the glass plate changes optical path length.

Besides eliminating blurriness, the method has several other advantages, such as allowing compensation for the different image contrasts. Usually, the contrast of the black-and-white mask is much greater than that of the wafer. In the Makosch method, however, the contrast levels can be made the same if the proper duration for each image is chosen by picking a plate with the right long-to-short-side ratio.

The method also allows observing the wafer structures through the much denser fields and line patterns of the mask. Still another plus is that the compensation system, which consists essentially only of the glass plate and its drive mechanism, can be built as a simple attachment into any IC-production microscope used today.

In testing the method at the Boeblingen laboratories, Makosch used an ordinary glass plate 750 microns thick and measuring about 4 centimeters on one side and 2 cm on the other. Makosch says that generally the image quality improves with increasing distance between the mask and the wafer. For good images he recommends a mask-to-wafer distance of greater than 100 microns. Such distances, however, put stringent requirements on the mechanical alignment and guidance systems for the masks. But these, Makosch says, can be met without too much difficulty. Tests with mask-wafer separations greater than 300 microns show little alignment error.

### Great Britain

#### Drum helps magnetic printer puts out 30 lines per second

Some years ago Standard Telecommunication Laboratories, an ITT subsidiary, devised a magnetic printer, called the Ferrodot, which printed letters with minute ferrite particles and eliminated mechanical components except for a revolving drum. It would print 5,000 to 10,

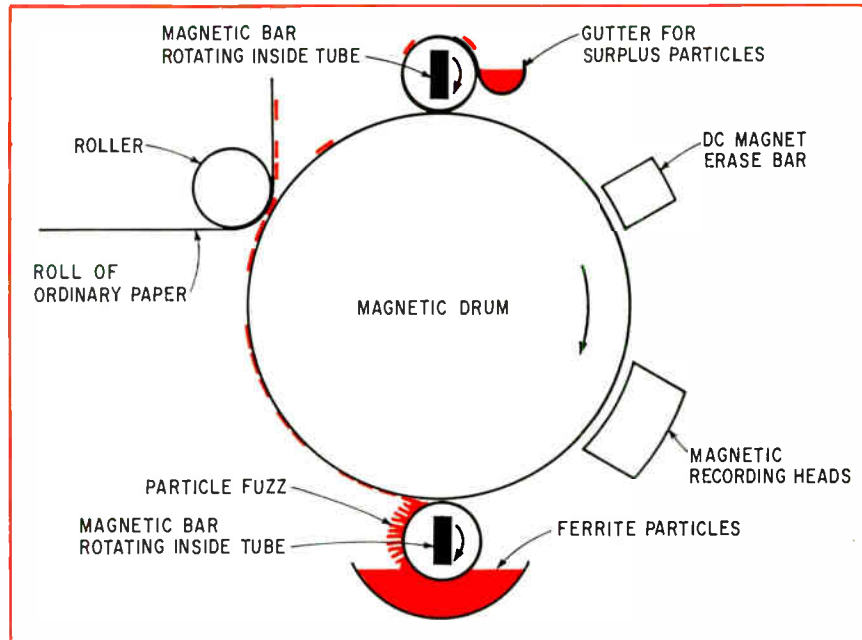

000 characters per second, but no one wanted that kind of speed.

Now ITT-Creed of Brighton has rescued the basic idea and used it in a production prototype machine that can print at 30 lines per second, using the 132-characters-per-line standard. That's comparable to the fastest mechanical printer available, but is cheaper, quieter and more reliable than mechanical systems, the company says.

The basis of the Creed Ferrodot is a horizontal revolving drum, 8.5 inches long and 1.5 inches in diameter, which has a nickel-cobalt alloy high-remanence magnetic surface. A line of recording heads runs along its length. The head tips have a .0065-inch center spacing, giving a density of about 160 per inch. When two adjacent tips are energized, a point on the drum surface between them is magnetized. Ten adjacent tips, corresponding to nine magnetized points, define the width of a character. Height is defined by 15 successive energizations.

The magnetized points pick up any resin-coated ferrous oxalate particles from a trough beneath the drum. The particles are raised by a magnet revolving in a tube under the drum. As the magnet revolves, the particles creep around the outside of the tube until they are taken off by the attraction of

the drum surface. A similar system on top of the drum lifts off any particles remaining after printing. When ordinary paper is rolled against the drum, the resin sticks to it, and the particles are fixed by melting the resin.

If copies are required, the erase bar is switched off and the pattern on the drum rolls around again. But a machine designed to provide copies would have to have the drum circumference equivalent to the size of an ordinary page or buffer storage inputs. In fact, the big snag with the ITT-Creed machine compared to percussive printers is that it prints only one copy at a time. However, Gibson Stirling, technical director of ITT-Creed, does not think the lack of duplicates is a serious drawback. "We have a repertoire of 138 characters, double that of ordinary line printers, as well as quietness, cheapness and reliability," he says.

#### Minicomputers assist Concorde engine program

Thanks to its minicomputer assistants, a second-generation computer at Rolls-Royce is churning out 50% more work than it did in its prime, when it was running alone. The computer complex is

helping the company's Bristol Engine division, in cooperation with SNECMA of France, build the engine for the Anglo-French Concorde commercial jetliner. The division is nearly through implementing the computer scheme—called AMOS—in its plant at Bristol.

The main services provided to the division's 2,700 engineers are: number-crunching for designers, program writing for numerical control machine tools, monitoring of engines on test and quick analysis of test results, and on-line computation for automatic drafting machines. All processing is done in a single English Electric KDF-9 central processor unit which has been at the works for several years.

**The point of AMOS** is to get maximum use of this CPU, and later out of another similar machine. To do this, six Digital Equipment Corp. PDP-8 and one PDP-11 computers have been added to collect information for the KDF-9. The PDP-11 handles real time analysis of engine vibration data taken from analog mag tape, and forwards it for full analysis in the KDF-9.

The DEC computers and 40 teletypes communicate with the KDF-9 through a PDP-10 and a hardwired interface built by Rolls-Royce engineers. The PDP-10 takes all inputs, files them in a data bank of 100-million characters, organizes them, with backing data and programs, into a queue for entry into the KDF-9 and turns the ASCII code of the DEC computers into KDF-9 code. On the way out it reverses the processes. The KDF-9 is thus relieved of nearly all internal housekeeping. The approach also does away with any need for the ordinary input-output unit of the KDF-9, considered not very good by Rolls-Royce men.

In the test bed installation, six beds feed their outputs to three data collection units, each of which has two 12-bit parallel data transmitters and one eight-bit receiver. All six outputs go to a PDP-8 which monitors up to 772 parameters for each engine and feeds back print-out data to strip printers in the

data collection units. The data from all six engines that have to be analyzed in the KDF-9 then pass to a second PDP-8 which edits them for transmission.

The test bed sites are about one mile from the PDP-8 installation and precautions were necessary to cope with the difference in earth potentials over that distance, particularly as electric motors driving air compressors at the test beds raised the local earth potential high above the computer site potentials. Complete electrical isolation has been obtained by including a physical break of a few thousandths of an inch in the data links.

The gap is bridged by gallium arsenide opto-electronic couplers, which Rolls-Royce built from Plessey GaAs infra-red emitters and detectors. Each coupler is followed by a Schmitt trigger to restore the waveform. Rolls-Royce men say they give an isolation of about 1.6 kilovolts and so far have shown test lives of 150,000 hours without degradation.

---

### Japan

---

#### Auto dashboard tv shows all the dials

Nippon Denso Co. opened a window on automotive displays of the future at the Seventeenth Tokyo Motor Show, which ended a week ago. Its Electronic Graphic Scope, with a 13-inch color TV tube, groups together all the displays on a car's dashboard—from the speedometer to the radio dial—and also provides warnings for a number of functions not now available. And, to make doubly sure that the driver does not miss the visual warnings, audio warnings are programmed to break into the radio receiver loudspeaker circuit.

The EGS is designed as a universal display unit. The prototype unit can be switched to provide rear-view vision, and, when the car is not in motion, ordinary television shows can be displayed.

Denso engineers are still investigating whether color tubes are

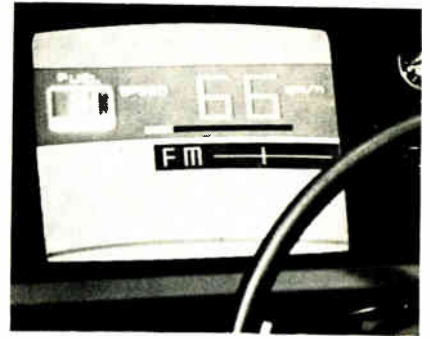

On the beam: All the dials a driver needs show up on the color TV screen.

reliable enough and last long enough for automotive use—but do not think this use is unrealistic, since cathode ray tubes are routinely used in aircraft and ship radars. They also point out that they are not tied to color tubes—they might consider liquid crystals, light emitting diodes, or other types of displays.

In general, the ordinary displays are formed by a character generator, and the alarm displays by signals recorded on a video tape. Because of the complexity of presenting numbers, many of the displays at present are analog bars, but MSI or LSI character generators would be an inexpensive route to more figures.

Below a numerical speed read-out, is an analog bar speed display that gives the same information. A long bar near the top of the display indicates headlights are on, and change of color to red indicates high beams. Shorter yellow bars to the left and right show that blinkers are in use. For hazard blinkers, red bars appear simultaneously on both sides. Brakes, too, are bars—pink for the hand brake and red for the foot brake—but fuel level is shown by an emptying gas pump. Letters show whether the radio is on a-m or fm, and an analog bar is the dial.

Eventually, Denso engineers plan to add numbers to the radio dial, and they could easily add such other indications as tachometer reading, transmission speed range, and time. Another possibility is simple alarm displays from the pattern generator.



Photo: O'Neill

Miss Raquel Welch

Learn the seven warning signals of cancer. You'll be in good company.

1. Unusual bleeding or discharge.
2. A lump or thickening in the breast or elsewhere.
3. A sore that does not heal.
4. Change in bowel or bladder habits.
5. Hoarseness or cough.
6. Indigestion or difficulty in swallowing.
7. Change in size or color of a wart or mole.

If a signal lasts longer than two weeks, see your doctor without delay.

And be sure to have a health checkup once a year, no matter how well you may feel.

**Fight Cancer with a checkup and a check**

American Cancer Society

## Advertising Sales Staff

**Pierre J. Braude** [212] 971-3485  
Advertising Sales Manager

**Atlanta, Ga. 30309:** Charlton H. Calhoun, III  
1375 Peachtree St., N.E.  
[404] 892-2868

**Boston, Mass. 02116:** William S. Hodgkinson  
607 Boylston St.  
[617] 262-1160

**Chicago, Ill. 60611:** Ralph Hanning,  
Kenneth E. Nicklas, 645 North Michigan  
Avenue, [312] MO 4-5800

**Cleveland, Ohio 44113:** William J. Boyle,  
[716] 586-5040

**Dallas, Texas 75201:** Richard P. Poole,  
1800 Republic National Bank Tower,  
[214] RI 7-9721

**Detroit, Michigan 48226:** Ralph Hanning,  
2600 Penobscot Building  
[313] 962-1793

**Houston, Texas 77002:** Richard P. Poole,  
2270 Humble Bldg. [713] CA 4-8381

**Minneapolis, Minn. 55402:** Kenneth E. Nicklas,  
1104 Northstar Center [612] 332-7425

**New York, N.Y. 10036**  
500 Fifth Avenue  
**James R. Pierce** [212] 971-3615  
**Warren H. Gardner** [212] 971-3617  
**Michael J. Stoller** [212] 971-3616

**Philadelphia, Pa. 19103:**  
**Jeffrey M. Preston**  
6 Penn Center Plaza,  
[215] LO 8-6161

**Pittsburgh, Pa. 15222:** Jeffrey M. Preston,  
4 Gateway Center, [412] 391-1314

**Rochester, N.Y. 14534:** William J. Boyle,  
9 Greylock Ridge, Pittsford, N.Y.  
[716] 586-5040

**St. Louis, Mo. 63105:** Kenneth E. Nicklas,  
The Clayton Tower, 7751 Carondelet Ave.  
[314] PA 5-7285

**James T. Hauptli** [415] DO 2-4600  
Western Advertising Sales Manager

**Denver, Colo. 80202:** Richard W. Carpenter  
Tower Bldg., 1700 Broadway  
[303] 266-3863

**Los Angeles, Calif. 90017:** Robert J. Rielly,  
Bradley K. Jones, 1125 W. 6th St.,  
[213] HU 2-5450

**San Francisco, Calif. 94111:** Don Farris,  
James T. Hauptli, 425 Battery Street.  
[415] 362-4600

**Paris:** Denis Jacob  
17 Rue-Georges Bizet, 75 Paris 16, France  
Tel 727 33 42, 727 33 60

**Geneva:** Denis Jacob  
1 rue du Temple

**United Kingdom and Scandinavia**  
**London:** Keith Mantle, Tel: Hyde Park 1451  
34 Dover Street, London W1

**Milan:** Robert Saidel, Roberto Laureri Jr.  
1 via Baracchini Phone 86-90-656

**Brussels:** Denis Jacob  
22 Chaussee de Wavre  
Brussels 1040, Belgium

**Frankfurt/Main:** Fritz Krusebecker  
Elsa-Brandstroem Str. 2  
Phone 72 01 81

**Tokyo:** Masaru Wakeshima, McGraw-Hill  
Publications Overseas Corporation,  
Kasumigaseki Building 2-5, 3-chome,  
Kasumigaseki, Chiyoda-Ku, Tokyo, Japan  
[581] 9811

**Osaka:** Akihiko Kamesaka, McGraw-Hill  
Publications Overseas Corporation, Kondo  
Bldg., 163, Umegae-cho Kita-ku [362] 8771

**Australasia:** Warren E. Ball, IPO Box 5106,  
Tokyo, Japan

## Business Department

**Stephen R. Weiss, Manager**  
[212] 971-2044

**Thomas M. Egan,**  
Production Manager [212] 971-3140

**Dorothy Carmesin,** Contracts and Billings  
[212] 971-2908

**Frances Vallone,** Reader Service Manager  
[212] 971-6057

## Electronics Buyers' Guide

**George F. Werner,** Associate Publisher  
[212] 971-3139

**Regina Hera,** Directory Manager  
[212] 971-2544

# There is a difference in Heath Dynamics' Quartz Crystal Filters!

Heath Dynamics specializes in the design and manufacture of the highest quality Quartz Crystal Filters and Discriminators for the Communications Industry.

Our facility is completely new, inside and out, fully staffed and equipped with the most modern mechanical and electronic test measuring devices.

We employ the assistance of one of the largest time sharing computers available.

Heath Dynamics' area of specialization includes the manufacture of miniature and sub-miniature filters in the range of 10 thru 32 Mhz. Bandwidths may be from .025% thru .35% in the smallest packages and may range up to 2.0% in the larger ones.

*We manufacture direct replacement filters for all the current monolithic designs using our half lattice configuration which yield lower insertion loss, lower ripple and greater ultimate rejection. Yet our filters cost less and faster delivery is guaranteed!*

All Heath Dynamics' crystal filters designed and manufactured to your particular specifications meet Mil F. 18327.

In short, we want your business and we'll act like it. Do us both a favor and send us your print or specification for a quote. If you have any questions just write or call us... we're here to serve you.



**heath  
dynamics, inc.**

6050 n. 52nd avenue  
glendale, arizona 85301  
(602) 934-5234

subsidiary of  
Heath International, Inc., Richmond, Mich.

# Electronics advertisers

November 23, 1970

|  |             |   |              |  |            |
|--|-------------|---|--------------|--|------------|
| <b>Acopian Corporation</b>                                   | 111         | <b>General Instrument Microelectronics</b>                        | 40E          | <b>Relcom</b>  | 46, 47     |
| Mort Barish Associates                                       |             | Michael Lawler & Borradaile Ltd.                                  |              | <b>RMC</b>   |            |
| <b>AEG Telefunken</b>  | D4          | <b>General Radio Company</b>                                      | 2nd Cover    | <b>Rohde &amp; Schwarz</b>   | 43E        |
| Werbeagentur   |             | Grad Associates   |              |  |            |
| <b>AEI Semiconductors Limited</b>                            | 9E          | <b>Georgia Department of Industry &amp; Trade</b>                 | PB7          |  |            |
| MCR Advertising Limited                                      |             | Cargil Wilson and Acree Inc.                                      |              | <b>Schlumberger Ltd. EMD</b>   | 5E         |
| <b>Aero Mayflower Transit Company</b>                        | PB10        | <b>Gould Inc.</b>   |              | T. B. Browne Ltd.  |            |
| Caldwell Van Riper Inc.                                      |             | <b>Gaging &amp; Control Division</b>                              | 123          | <b>Schlumberger SIS</b>  | 6E         |
| <b>Aeronetics Div. of AAR Corp.</b>                          | 106         | Swain, Mealer & Emerson Inc.                                      |              | T. B. Browne Ltd.  |            |
| Robert L. Cohn Inc. Advertising                              |             |   |              | <b>Schneider R. T.</b>   | 36E        |
| <b>After Six Inc.</b>  | PB5         |   |              | Noirclerc Publicite  |            |
| Gilbert Advertising Inc.                                     |             |   |              | <b>S. E. Laboratories Ltd.</b>   | 21E        |
| <b>Alco Electronics Products Inc.</b>                        | D3-D4       | <b>Hansen Manufacturing Company</b>                               | 126          | Graphis Publicity Ltd.   |            |
| Marketronics Advertising                                     |             | Keller Crescent Company   |              | <b>Sercel</b>  | 22E, 35E   |
| <b>Allen Bradley Company</b>                                 | 22, 23, 113 | <b>Heath Company Sub of Schlumberger Ltd.</b>                     | 39           | Termonet Technique   |            |
| Hoffman-York Inc.  |             | Advance Advertising Services                                      |              | <b>Sfernice</b>  | 20E        |
| <b>Alma Desk Company</b>                                     | PB6         | <b>Heath Dynamics Inc.</b>  | D1           | Publicitor   |            |
| Bennett Advertising Inc.                                     |             | Ira Morton Advertising  |              | <b>SGS</b>   | 26E        |
| <b>American Enka Company</b>                                 | 116         | <b>Hermes Electronics Limited</b>                                 | 92           | Scuola Di Design Di Novara   |            |
| Doremus & Company  |             | Design Group  |              | <b>Signetics Corp. Sub of Corning Glass Works</b>  | 50         |
| <b>American Microsystems</b>                                 | 17          | <b>Hewlett Packard, Loveland Division</b>                         | 2            | Hall Butler Blatherwick Inc.   |            |
| Jordan Advertising   |             | Tallant/Yates Advertising   |              | <b>Silec Electronique</b>  | 18E, 19E   |
| <b>Analog Corporation</b>                                    | 84          | <b>Hewlett Packard Company</b>                                    | 1, 21        | Promotion Vente Publicite  |            |
| Allied Advertising Agency Inc.                               |             | Lennet & Newell Inc.  |              | <b>Siliconix Inc.</b>  | 88         |
| <b>Arnold Engineering Company</b>                            | 120         | <b>Hitachi Metals Ltd.</b>  | D3           | Robertson West Inc.  |            |
| Brand Advertising Inc.                                       |             | Asia Advertising Agency Inc.                                      |              | <b>Sogie</b>   | 10E        |
| <b>Ates Componenti Elettronici, S. P. A.</b>                 | 31E         | <b>Honeywell Computer Control Division</b>                        | 107          | Etudes et Creations Publicitaire   |            |
| Publicitas   |             | Cremer, Trowbridge, Case & Basford Inc.                           |              | <b>Solartron Electronics Group Ltd.</b>  | 7E         |
|  |             |   |              | T. B. Browne Ltd.  |            |
|  |             |   |              | <b>S. P. Elettronica</b>   | 15E        |
| <b>Bausch &amp; Lomb Incorporated</b>                        | 119         | <b>IBM DP Division</b>  | PB12-13      | Studio Sergio Rosata   |            |
| Wolff Associates Inc.  |             | Marsteller Inc. Advertising                                       |              | <b>Sprague Electric Company</b>  | 5          |
| <b>Bell &amp; Howell Electronics &amp; Instruments Group</b> | 95          | I. E. R.  | 44E          | Harry P. Bridge Company  |            |
| Coordinated Communications Inc.                              |             | PEMA  |              | <b>Standard Condenser Corporation</b>  | 124        |
| <b>Boonton Electronics Corporation</b>                       | 85          | <b>Indianapolis Power &amp; Light</b>                             | 94           | R. N. Johnson Advertising  |            |
| The Creative Group   |             | Ruben, Montgomery & Associates Inc.                               |              | <b>State Farm Insurance Company</b>  | PB2        |
| <b>Brand Rex</b>   | 101         |   |              | Needham, Harper and Steers Inc.  |            |
| Cremer, Trowbridge, Case & Basford Inc.                      |             |   |              | <b>Systron Donner Corporation</b>  | 7, 16      |
|  |             |   |              | Bonfield Associates Inc.   |            |
|  |             | <b>Kenwood Electronics</b>  | PB11         |  |            |
| <b>Cerro Copper &amp; Brass Company</b>                      | 124         | Albert Frank Guenther Law Inc.                                    |              | <b>Tektronix Incorporated</b>  | 12, 13, 37 |
| Sykes Advertising Inc.                                       |             |   |              | Dawson Incorporated  |            |
| <b>Colorado Video Inc.</b>                                   | 110         | <b>Lambda Electronics Corporation</b>                             | 3rd Cover    | <b>Teledyne Relays Company</b>   | 30         |
| Tallant Yates Advertising Inc.                               |             | Michel Cather Inc.  |              | S. Michelson Advertising   |            |
| <b>Communication Associates Inc.</b>                         | 38E         | <b>Ledex Inc. Branco Controls Division</b>                        | 115          | <b>Texas Instruments Incorporated Components Group</b>   | 82         |
| Beecher Associates Inc.                                      |             | Yeck and Yeck Inc.  |              | Albert Frank-Guenther Law Inc.   |            |
| <b>Control Data Corporation</b>                              |             | <b>LIT</b>  | 32E, 33E     | <b>Toko Inc.</b>   | 118        |
| Printed Circuits Operation                                   | 8           | Publibel  |              | Hakuhodo Inc.  |            |
| Midwest Advertising Services Inc.                            |             |   |              | <b>Trave Lodge International</b>   | PB6        |
| <b>Cosmic Optical Co. Ltd.</b>                               | 28E         | <b>Massachusetts Department of Commerce &amp; Development</b>     | PB16         | Dailey & Associates Advertising  |            |
| Matsushita Inc.  |             | Chirurg & Cairns Inc.   |              | <b>Triplett Electrical Instrument Company</b>  | 90         |
| <b>Coto Coil Company Incorporated</b>                        | 110         | <b>Mico Instrument Company</b>                                    | 110          | Byer and Bowman Advertising  |            |
| Williams Company The   |             | <b>Micro Switch Division of Honeywell</b>                         | 114          | <b>Tung-Sol Division of Wagner Electric Corporation</b>  | 122        |
| <b>Custom Electronics Inc.</b>                               | 126         | N. W. Ayer and Son Inc.   |              | Winius Brandon Company   |            |
| Laux Advertising Inc.  |             | <b>Monsanto Company</b>   | 17E          |  |            |
|  |             | Michel Cather   |              | <b>Unisem Subsidiary of United Aircraft Corporation</b>  | 103        |
| <b>Dearborn Electronics Inc., Sprague Electric Co., Div.</b> | 86          | <b>Motorola Semiconductor Products Inc.</b>                       | 27, 28       | Schaefer Advertising Inc.  |            |
| Harry P. Bridge Company                                      |             | Lane & Wampler Advertising Inc.                                   |              |  |            |
| <b>Dialight Corporation</b>                                  | 115         |   |              | <b>Valvo GmbH</b>  | 24E, 25E   |
| Michel Cather Inc.   |             | <b>National Electronics Inc., Subsidiary of Varian Associates</b> | 20           | Intermarco GmbH  |            |
| <b>DuPont de Nemours &amp; Company, Freon Division</b>       | 29          | Connor-Sager Associates Inc.                                      |              | <b>Varo Inc.</b>   | 100        |
| N. W. Ayer & Son Inc.  |             | <b>National Semiconductor Corporation</b>                         | 10, 11       | Tracy-Locke Incorporated   |            |
|  |             | Chiat Day Inc. Advertising  |              |  |            |
| <b>Eastman Kodak Company</b>                                 |             |   |              | <b>Wang Laboratories</b>   | 89         |
| <b>PCIM Market Development</b>                               | 97          | <b>Philco Ford Company</b>  |              | Chirurg Cairns Inc. Advertising  |            |
| Rumrill Hoyt Incorporated                                    |             | <b>Microelectronics Division</b>                                  | 98           | <b>W. A. Scheaffer Pen Company, A Tectron Company</b>  | PB3        |
| <b>E-H Research Labs Inc.</b>                                | 24, 43, 105 | The Aitkin Kynett Company Inc.                                    |              | Sperry-Boom Inc.   |            |
| Steedman, Cooper and Busse Advertising                       |             | <b>Philips Electronics Instruments</b>                            | 69           | <b>Weston Schlumberger</b>   | 37E        |
| <b>Elco Corporation</b>                                      | 18, 19      | Marsteller Inc.   |              | <b>White, S. S. Industrial Products, Penwalt Corp.</b>   | 40         |
| Schaefer Advertising Inc.                                    |             | <b>Philips Eindhoven Nederland</b>                                | 69           | W. L. Towne Company Inc.   |            |
| <b>Electronics</b>   | 48-49       | <b>Philips Electrologica Office Machine Division</b>              | 29E          |  |            |
| Ries Cappiello Colwell Inc.                                  |             | Media International   |              | <b>Zenith Radio Corporation</b>  | 106        |
| <b>Electronics Arrays Inc.</b>                               | 76          | <b>Phillips Gad Elcoma</b>  | 125          | Mills, Fife & MacDonald Inc.   |            |
| Regis McKenna Inc.   |             | Media International   |              |  |            |
| <b>Electronics in Medicine Conference</b>                    | 44-45       | <b>Philips N. V. Pit / Tmi Division</b>                           | 2E           |  |            |
| EL Instruments Inc.  | 100         | Marsteller International S. A.                                    |              |  |            |
| Froehlich Advertising Services                               |             | <b>Plessey Ltd. Automation &amp; Transmission</b>                 | 41E          |  |            |
| <b>Erie Technological Products Company Inc.</b>              | 81          | Rumrill Hoyt Inc.   |              |  |            |
| Walker, Schmidt & Mackall Inc.                               |             | <b>Plessey Components</b>   | 23E          |  |            |
| <b>Execuplan Div. of Publishers Guild</b>                    | PB11        | Rumrill Hoyt Inc.   |              |  |            |
| Equity Advertising Inc.                                      |             | <b>Polymotor S. A.</b>  | 39E          |  |            |
|  |             | George Hynes & Partners Ltd.                                      |              |  |            |
| <b>Fairchild Microwaves and Optoelectronics</b>              | 108         |   |              | <b>Classified &amp; Employment Advertising</b>   |            |
| Robert Ebey Company Inc.                                     |             | <b>Radio Materials Company, P. R. Malory and Company</b>          | 6            | F.J. Eberle, Manager 212-971-2557  |            |
| <b>Ferisol</b>   | 8E          | M. M. Fisher Associates Inc.                                      |              |  |            |
| Agence Domenach  |             | <b>RCA Electronic Components</b>                                  | 9, 4th Cover | <b>EQUIPMENT (Used or Surplus New) For Sale</b>  |            |
| <b>Firestone Tire &amp; Rubber Company</b>                   | PB8-9       | Al Paul Lefton Company  |              | Phillip Fishman Co. .... 118   |            |
| J. Walter Thompson   |             | <b>RCL Electronics Inc.</b>                                       | 14           | Radio Research Instrument Co. .... 118   |            |
| <b>Florists Transworld Delivery</b>                          | PB15        | Morvay Advertising Agency   |              |  |            |
| Post Keyes Gardner Inc.                                      |             |   |              | <b>For more information on complete product line see advertisement in the latest Electronics Buyer's Guide</b> |            |
| <b>Fluke Manufacturing Co. John Bonfield Associates</b>      | 15          |   |              | <b>Advertisers in Electronics International</b>  |            |
| <b>Fluoroware</b>  | D4          |   |              |  |            |
| Colle & McVoy Adv. Agency Inc.                               |             |   |              |  |            |
| <b>Future Finders</b>  | PB3         |   |              |  |            |
| Hassett Levin Inc.   |             |   |              |  |            |



# THINK DIGITAL



**NEON READOUT DRIVER MODULE**

USES ELFIN\* 7-SEGMENT DISPLAY TUBE

Factory assembled Elfin readout modules with built-in decoder-drivers are ready to plug into your systems. Choice of decoder-drivers or with memory, counter, Model DM-17G-721

**13.62**  
IN 500 LOTS

**ALCO**  
LAWRENCE, MASS.

\* Manufactured Under a License By Burroughs Corp.

Circle 146 on reader service card

# THINK DIGITAL

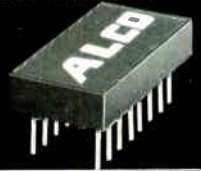

**HYBRID DECODER DRIVERS**

BCD-to-7 output decoder/power drivers with counters & memories for Alco & other segmented displays. Hybrid design allows either high voltage or high current output. 1000 lot prices as low as 8.76 each.

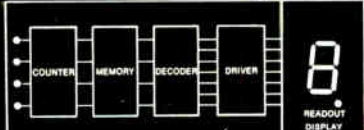

**ALCO** ELECTRONIC PRODUCTS, LAWRENCE, MASS.

Circle 147 on reader service card

## E=2(C+EDP)X

Last year, Electronics magazine contained twice as much information on computers and electronic data processing as the next leading electronic publication.

If the cover of this magazine has your name and address on it, there is no better formula for keeping yourself abreast of the industry's technology.

This time next week, you can start putting our product into your product

# Maybe Sooner

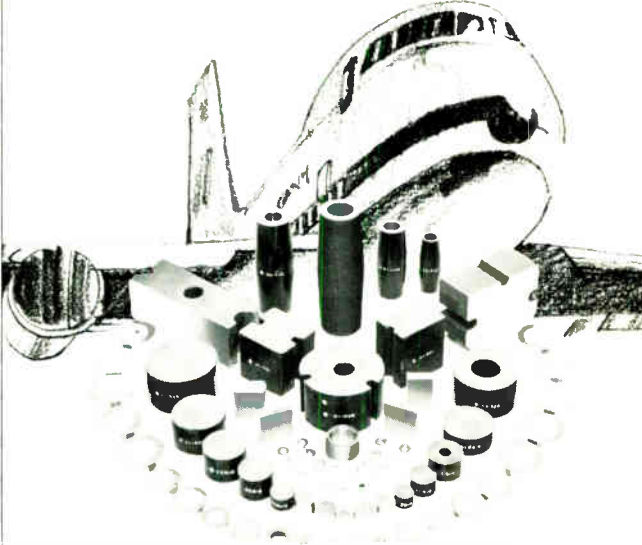

## Our product is Hitachi Cast Magnets

When we say we deliver, we mean it. By fast, efficient air transportation to anywhere in the world. We'll have Hitachi Cast Magnets at your factory within one week.

Here's what you'll get.

Cast magnets designed and finished to close tolerances featuring high coercive force and big energy product plus magnetic field uniformity and stability. Magnets that can be cast in the most intricate shapes. High quality magnets that are widely used in sophisticated communications hardware, meters, generators, motors, magnetos and other equipment.

At Hitachi Metals, cast magnet production is integrated, and backed by years of experience. A long tradition of quality workmanship is coupled with the latest computer-backed technology for precision mass production.

Take a look at the properties of six typical Hitachi Cast Magnets.

| Type                | Residual Induction (Br) gauss | Coercive Force (Hc) oersteds | Energy Product (BxH) max. x 10 <sup>-6</sup> |
|---------------------|-------------------------------|------------------------------|--|
| HI-MAG (ALNICO-5-7) | 13,000-14,500                 | 700-750                      | 6.8-8.2                                      |
| YCM-8B (ALNICO-8)   | 8,800-9,600                   | 1,380-1,500                  | 4.8-5.5                                      |
| YCM-8C (ALNICO-8)   | 7,400-8,700                   | 1,600-1,750                  | 4.5-6.0                                      |
| YCM-8D (ALNICO-8)   | 7,500-8,300                   | 1,700-1,850                  | 5.5-6.5                                      |
| YCM-8E (ALNICO-8)   | 7,500-8,500                   | 2,000-2,150                  | 5.5-7.0                                      |
| YCM-9B (ALNICO-9)   | 10,000-11,500                 | 1,400-1,700                  | 9.0-11.0                                     |

Interested? Please write for full information.



**HITACHI**  
Hitachi Metals, Ltd.

Head Office: Chiyoda Bldg., Marunouchi, Tokyo, Japan

### Hitachi Metals America, Ltd.

New York (Head Office): Magnet Materials Sect., 437 Madison Ave.,

New York, N.Y. 10022, U.S.A. Tel. 212-758-5255

Chicago: 2200E, Devon Ave., Des Plaines, Ill. 60018, U.S.A.

Tel. (312) 299-0031

Detroit: Suite 375, 24300 Southfield Road, Southfield, Michigan 48075,

U.S.A. Tel. (313) 354-4425

## Equipments and Systems

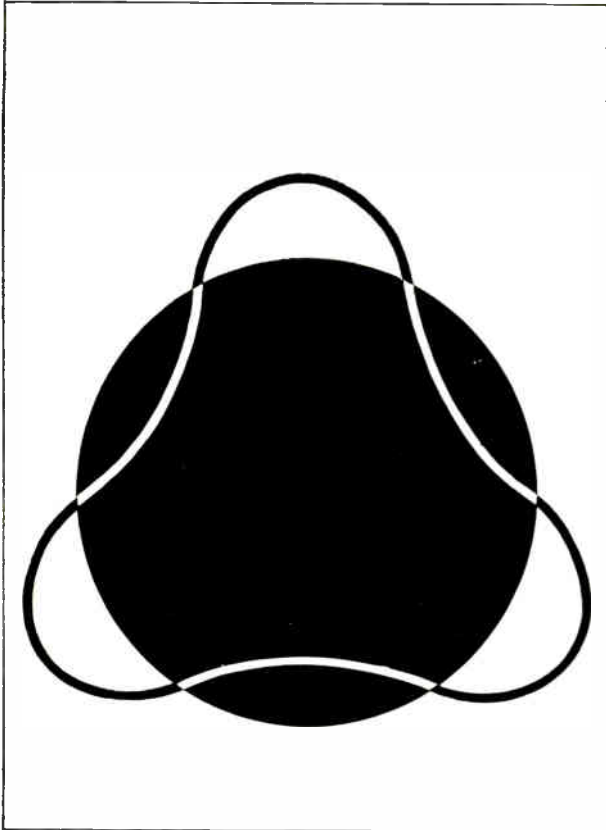

922.833

bearing the  
**TELEFUNKEN** trademark  
are symbols of  
progress in the World

We manufacture and supply: Broadcasting and television transmitters · Communications transmitters · Maritime transmitters and transceivers · Professional receivers and direction finders · Radars · Radiotelephone sets and systems · Telecommunications equipment and cables · Data processing systems

Write for comprehensive documentation

ALLGEMEINE ELEKTRICITÄTS-GESELLSCHAFT  
AEG-TELEFUNKEN  
Export Department  
79 Ulm · Elisabethenstraße 3  
Germany



AEG-TELEFUNKEN

D 4 Circle 136 on reader service card

## ROCKER SWITCH

U/L AVAILABLE

Low-cost rocker switch has high current in 1/2" case. 100,000 on-off operations. Low-silhouette rocker. U/L approved. Choice of SPST on-off @ 85¢ ea., SPDT on-on @ 95¢ ea.



**ALCOSWITCH®** 10A @ 125 VAC.  
DIV. OF ALCO ELECTRONIC PRODUCTS, INC., LAWRENCE, MASS.

Circle 148 on reader service card

## TOGGLE SWITCH MINIATURES

Higher ratings, longer life 250,000 operations. Metal construction, high impact insulation allows use under wide range of environmental conditions. U/L approved. SPDT, DPDT. 1/4" or 1/2" bushings.

10A @ 125 VAC



**ALCOSWITCH®** CYLINDRICAL CASE  
DIV. OF ALCO ELECTRONIC PRODUCTS, INC., LAWRENCE, MASS.

Circle 149 on reader service card

**FREE!**  
HOW TO HANDLE  
WAFERS, CHIPS,  
SUBSTRATES,  
MASKS

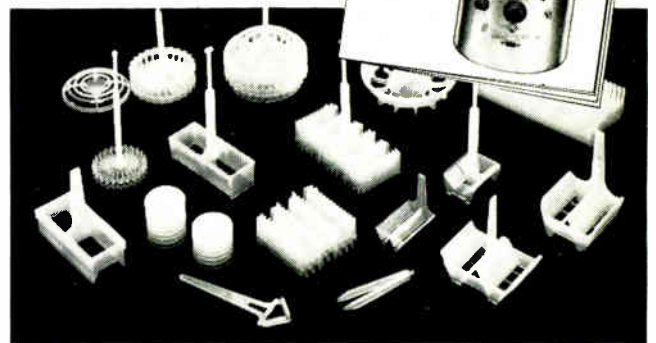
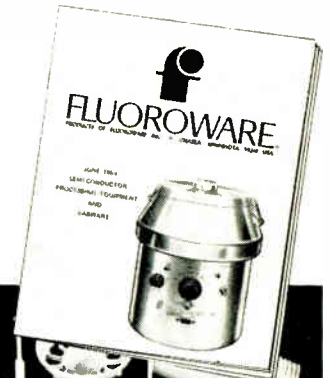

FEP Teflon\* precision-molded into baskets, carriers, and trays — perfect for processing and handling semiconductor materials. The FEP material is virtually inert and useable at extreme temperatures. Hundreds of types, designs and sizes.

Write for 28-page catalog containing complete specifications and technical data.

\*DuPont Trademark

**FLUOROWARE.**

Chaska, Minnesota 55318 • Phone 612-448-3131

Circle 150 on reader service card

# High efficiency, 2% regulation

## Lambda LW series a new concept in low-cost power supplies

Designed to power transistor circuitry, lights, motors, solenoids and relays. Convection cooled—no blowers.

### LW Series modular and full-rack models

| PACKAGE D<br>4 1/16" x 7 1/2" x 9 3/8"  | Model   | Voltage Range | Max. Current (Amps) at Ambient of: <sup>(1)</sup> |      |      |      | Price <sup>(2)</sup> |
|---|---------|---------------|---|------|------|------|----------------------|
|   |         |               | 40°C  | 50°C | 60°C | 71°C |                      |
|  | LW-D-10 | 10±5%         | 27  | 25   | 23   | 17   | \$250                |
|   | LW-D-12 | 12±5%         | 26.5  | 20   | 13.7 | 8.8  | 250                  |
|   | LW-D-15 | 15±5%         | 22.5  | 20   | 13.7 | 8.8  | 250                  |
|   | LW-D-18 | 18±5%         | 19  | 18.3 | 13.7 | 8.8  | 250                  |
|   | LW-D-20 | 20±5%         | 17.5  | 16.7 | 13.7 | 8.8  | 250                  |
|   | LW-D-24 | 24±5%         | 14.7  | 14   | 13.2 | 8.8  | 250                  |
|   | LW-D-28 | 28±5%         | 12.5  | 12   | 11.1 | 7.7  | 250                  |
|   | LW-D-48 | 48±5%         | 7.6   | 7.3  | 6.8  | 6.2  | 250                  |

| PACKAGE E<br>4 1/16" x 7 1/2" x 11 3/4"   | Model      | Voltage Range | Max. Current (Amps) at Ambient of: <sup>(1)</sup> |      |      |      | Price <sup>(2)</sup> |
|---|------------|---------------|---|------|------|------|----------------------|
|   |            |               | 40°C  | 50°C | 60°C | 71°C |                      |
|  | LW-E-3-P-3 | 2.8-3.8       | 55  | 52   | 49   | 45   | \$270                |
|   | LW-E-4     | 4±5%          | 53  | 50   | 47   | 43   | 270                  |
|   | LW-E-4-P-5 | 4.5±5%        | 49  | 46   | 43   | 40   | 270                  |
|   | LW-E-5     | 5±5%          | 45  | 42   | 40   | 37   | 270                  |
|   | LW-E-6     | 6±5%          | 39  | 37   | 35   | 32   | 270                  |

| PACKAGE EE<br>4 1/16" x 7 1/2" x 16 1/2"  | Model    | Voltage Range | Max. Current (Amps) at Ambient of: <sup>(1)</sup> |      |      |      | Price <sup>(2)</sup> |
|---|----------|---------------|---|------|------|------|----------------------|
|   |          |               | 40°C  | 50°C | 60°C | 71°C |                      |
|  | LW-EE-5  | 5±5%          | 91  | 87   | 82   | 62   | \$400                |
|   | LW-EE-6  | 6±5%          | 78  | 75   | 70   | 54   | 400                  |
|   | LW-EE-10 | 10±5%         | 51  | 48   | 45   | 35   | 350                  |
|   | LW-EE-12 | 12±5%         | 42  | 40   | 37   | 28   | 350                  |
|   | LW-EE-15 | 15±5%         | 35  | 33   | 31   | 24   | 350                  |
|   | LW-EE-18 | 18±5%         | 33  | 32   | 30   | 23   | 350                  |
|   | LW-EE-20 | 20±5%         | 31  | 30   | 28   | 22   | 350                  |
|   | LW-EE-24 | 24±5%         | 26  | 25   | 23   | 17   | 350                  |
|   | LW-EE-28 | 28±5%         | 22  | 21   | 20   | 15   | 350                  |
|   | LW-EE-48 | 48±5%         | 13  | 13   | 12   | 9    | 350                  |

| PACKAGE G<br>5 3/16" x 19" x 16 1/2"  | Model   | Voltage Range | Max. Current (Amps) at Ambient of: <sup>(1)</sup> |      |      |      | Price <sup>(2)</sup> |
|---|---------|---------------|---|------|------|------|----------------------|
|   |         |               | 40°C  | 50°C | 60°C | 71°C |                      |
|  | LW-G-5  | 5±5%          | 150   | 146  | 135  | 123  | \$675                |
|   | LW-G-6  | 6±5%          | 128   | 123  | 115  | 105  | 675                  |
|   | LW-G-10 | 10±5%         | 88  | 85   | 79   | 72   | 675                  |
|   | LW-G-12 | 12±5%         | 75  | 72   | 67   | 61   | 675                  |
|   | LW-G-15 | 15±5%         | 60  | 57   | 53   | 49   | 675                  |
|   | LWG-24  | 24±5%         | 48  | 46   | 42   | 39   | 675                  |
|   | LWG-28  | 28±5%         | 39  | 37   | 34   | 32   | 675                  |
|   | LWG-48  | 48±5%         | 24  | 23   | 21   | 19   | 675                  |

Package G models are only available without meters. For chassis slides, add suffix ".CS" to the model number and \$60 to the price. NOTES: (1) Current rating is from zero to I max. Current rating applies over entire output voltage range. Current rating applies for input voltage 105-132 vac 57-63 Hz.

(2) Prices are USA list prices only, FOB Melville, N.Y.; North Hollywood, Calif.; Montreal, Canada. All prices and specifications are subject to change without notice.

#### Efficiency

greater than 50%, with unique SCR circuitry

#### Convection cooled

no external heat sinking or forced air required

#### Regulation

line 2%, for line variations from 105-132 Vac load 2%, 20% load to full load or full load to 20% load; or 2%, full load to no load with a 20% preload, throughout voltage adjust range

#### Low ripple

300 mV RMS or 2% of output voltage, whichever is greater

#### AC input voltage

105-132 Vac, 57-63 Hz

#### Temperature coefficient

(.03% + 0.5 mV)/°C

#### Ambient temperature range

0°C to +71°C, operating  
-55°C to +85°C, storage

#### Thermally protected and short-circuit proof

current limiting circuit and self-resetting thermostats protect supplies

#### Remote programming

200 ohms/v nominal, or volt/volt

#### Remote sensing

#### Complete serviceability

all components replaceable

#### 5 year guarantee includes material and labor

Write for complete Lambda Catalog!

 **LAMBDA  
ELECTRONICS CORP.**

A  Company

Lambda's Distributor Division maintains a total inventory of over 10,000 power supply units located in Los Angeles, Montreal and New York for 1-day delivery—5 year guarantee.

515 Broad Hollow Road, Melville, Long Island, New York 11746 • Tel. 516-694-4200 • TWX 510-224-6484

# Cut the Size of Your Power Supply in Half with Fast, High-Voltage Transistors from RCA.

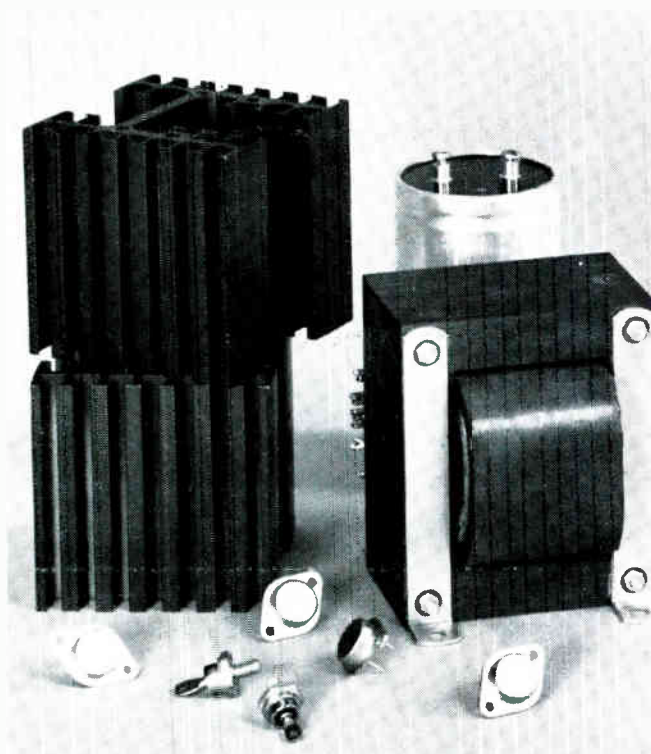

Conventional 5 V, 25 A Supply

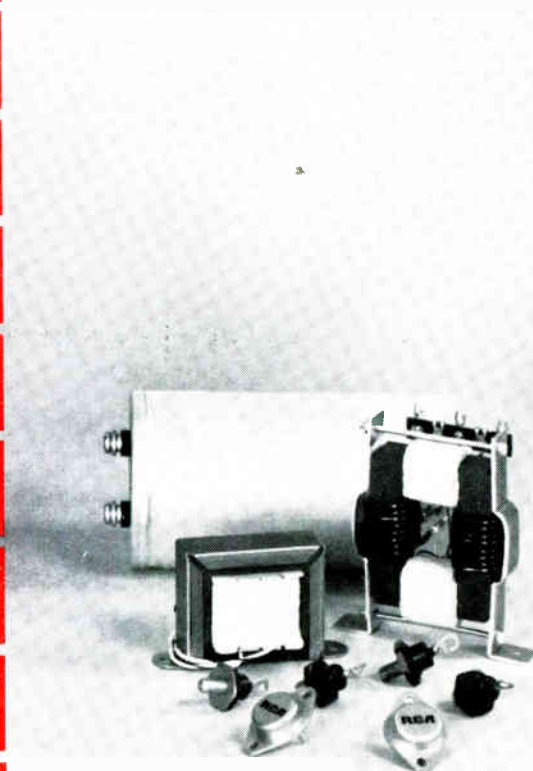

New 5 V, 50 A Supply

# RCA

For details and application note, write: RCA, Commercial Engineering, Section 70K-23/UT14, Harrison, N.J. 07029

Circle 902 on reader service card