

Amorphous semiconductors: jury still out 56

\$1.00 A McGraw-Hill Publication

Designing low-noise bipolar amplifiers 82

September 28, 1970

The big gamble in home video recorders 89

Electronics®

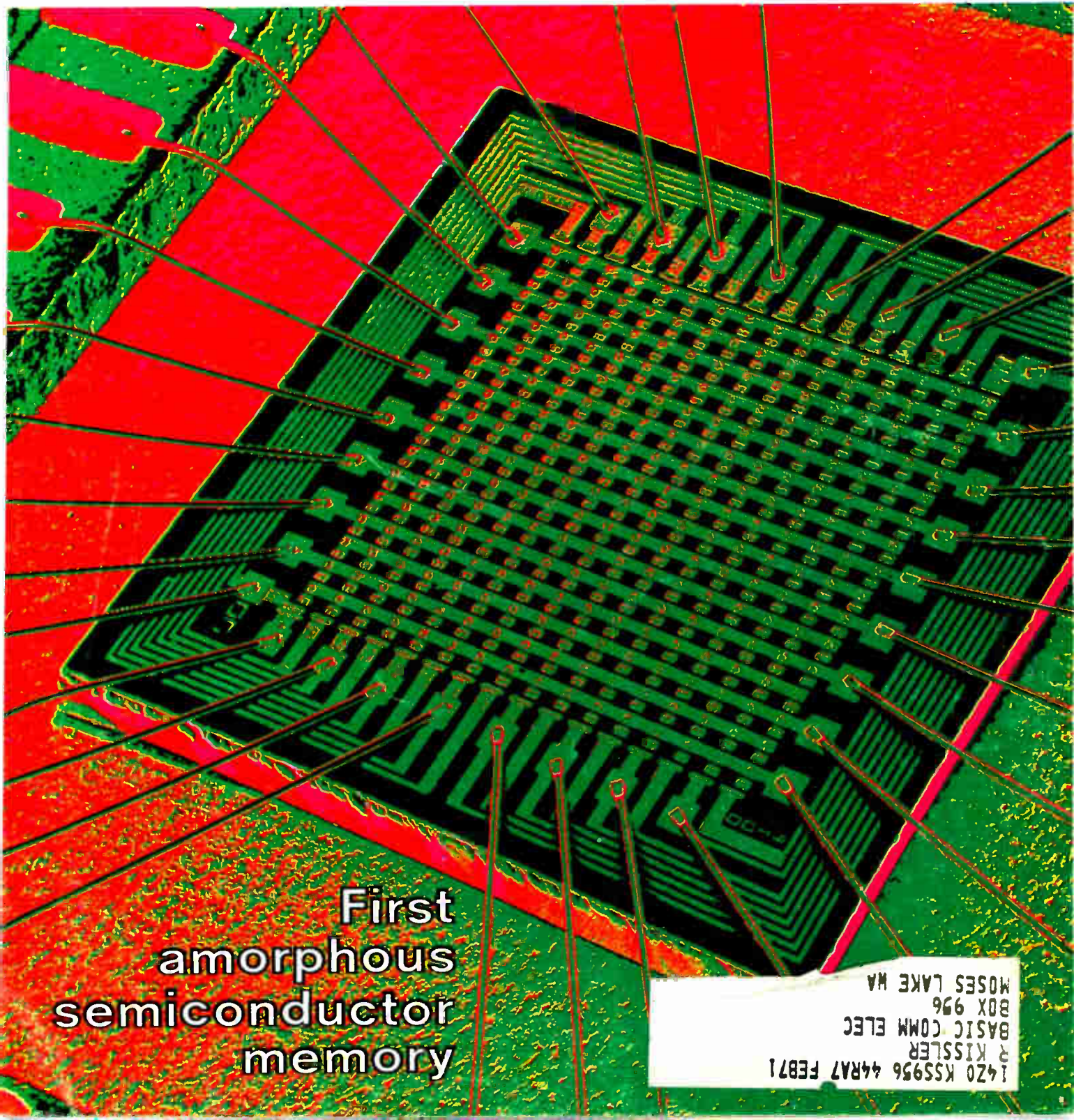

First
amorphous
semiconductor
memory

1420 KSS956 44RA7 FEB71
R KISSLER
BASIC COMM ELEC
BOX 996
MOSES LAKE WA

Suppose you wanted an Automatic RLC Bridge

that could measure up to 2 M Ω resistance, 2000 H inductance, and 0.2 F capacitance, plus equivalent series resistance and leakage current. A bridge with 5-digit resolution for reactance and resistive readouts, automatic decimal point and units of measurement; a 20-measurements-per-second capa-

bility; 120-Hz and 1-kHz test frequencies; 5-terminal connections to preserve a basic 0.1% accuracy; a built-in 0 to 3-V bias or external bias to 600 V; optional remote programmability and data output.

And prices that start at \$4,450. (in U.S.A.)

Where could you possibly find such a bridge?



1683 Automatic RLC Bridge by



General Radio

Concord, Mass. 01742 Europe: Postfach 124, CH 8034 Zurich, Switzerland

ATLANTA 404 633 6183 / BOSTON 617 646 0550 / CHICAGO 312 992 0800 / CLEVELAND 216 886 0150
DALLAS 214 637 2240 / LOS ANGELES 714 540 9830 / NEW YORK (N.Y.) 212 964 2722 IN J.I. 201 943-3140
PHILADELPHIA 215 646 8030 / SAN FRANCISCO 415 948 8233 / SEATTLE 206 747-9190 / SYRACUSE 315 454-9323
WASHINGTON, D.C. 301 881 5333 / TORONTO 416 252 3395 / ZURICH (051) 47 70 20

Circle 900 on reader service card

You can load up on X-Y recorders.

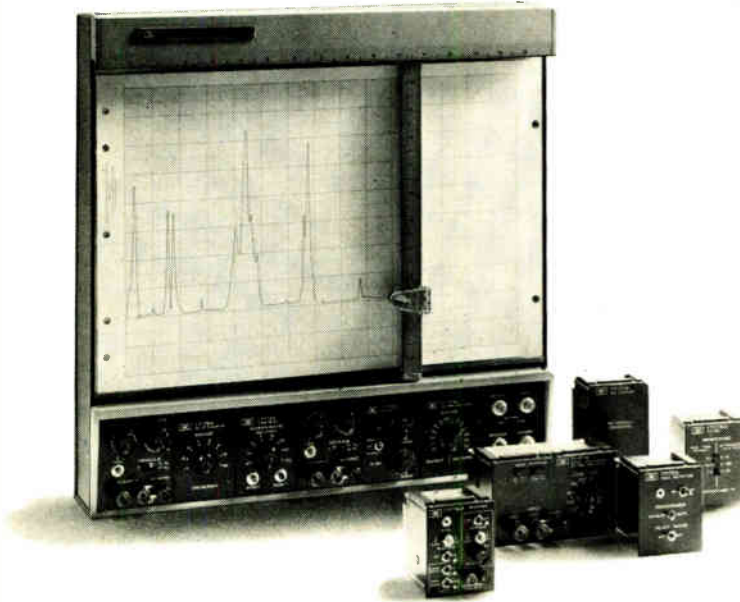

Or get an X-Y recorder you load up.

The world's first plug-in X-Y recorders let you buy modules, not mainframes, when you want to change applications. So you can order a single workhorse instrument to handle any analog and almost any digital job you have in mind. With the best dynamic performance on the market.

There are eight plug-ins for Hewlett-Packard's 7034A and 7004B X-Y's. You can use two plug-ins per axis. Besides taking care of all the routine tasks, they'll let you plot X-T, Y-T, single channel and discrete analog data. Extract signals superimposed on steady-state DC. Record AC from 5 Hz to 100 kHz. Plot two channels independently. And handle high-speed point plotting, too. You can specify the capability you want now and add to it later.

Dynamic performance is state-of-the-art. There's acceleration of better than 1500 in/sec² and slewing speed of 30 in/sec to catch all the transients that most recorders miss. Guarded circuits eliminate the effects of common mode voltages, and IC construction keeps your recorder running perfectly day after day. Autogrip electrostatic paper hold-down and mess-free disposable

ink pens are standard.

The 8½" x 11" 7034A costs just \$1295 and the 11" x 17" 7004B is only \$100 more. Modules start at \$25. To lighten your load in X-Y recording, call your local HP field engineer. Or write to Hewlett-Packard, Palo Alto, California 94304; Europe: 1217 Meyrin-Geneva, Switzerland.

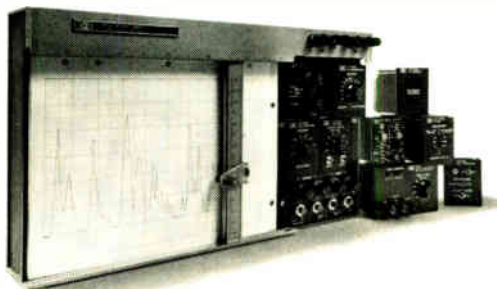

HEWLETT  PACKARD

GRAPHIC RECORDERS

11904

How to improve your test equipment without blowing your budget.

Simply use Hewlett-Packard's new family of high-performance, wideband general-purpose power amplifiers and preamps. These low cost RF amplifiers improve the sensitivity of your scopes, spectrum analyzers, counters, network analyzers — anywhere you need low-noise, high-gain amplification. These amplifiers are the result of

HP's hybrid thin-film microcircuit technology.

The table below gives frequency ranges, prices and performance of the six basic configurations. Dual channel versions of the preamps can also be supplied to improve the performance of 2-channel instrumentation.

They're ready for delivery now.

A call to your HP field engineer will bring you the details of how these amplifiers can help enhance the test equipment you're using now. Or write to Hewlett-Packard, Palo Alto, California 94304; Europe: 1217 Meyrin-Geneva, Switzerland.

HEWLETT  PACKARD

04021

HEWLETT-PACKARD 8447 SERIES LAB AMPLIFIERS

	HP 8447A Preamp	HP 8447B Preamp	HP 8447C Pwr. Amp.	HP 8447D Preamp	HP 8447E Pwr. Amp.	HP 8447F Preamp/Pwr. Amp.
Frequency Range	0.1-400 MHz	0.4-1.3 GHz	30-300 MHz	0.1-1300 MHz	0.1-1300 MHz	0.1-1300 MHz
Nominal Gain	20 dB	22 dB	30 dB	23 dB	22 dB	45 dB
Gain Flatness	± 0.5 dB	± 1 dB	± 1 dB	± 1.5 dB	± 1.5 dB	± 3 dB
Noise Figure	< 5 dB	< 5 dB to 1.0 GHz < 6 dB, 1.0-1.3 GHz	< 10 dB	< 8 dB	< 10 dB	< 8 dB
Output Power (@ 1 dB Gain Compression)	> +7 dBm	> -3 dBm	> +19 dBm	> +7 dBm	> +14 dBm	> +14 dBm
Price	\$550	\$600	\$450	\$700	\$800	\$1225

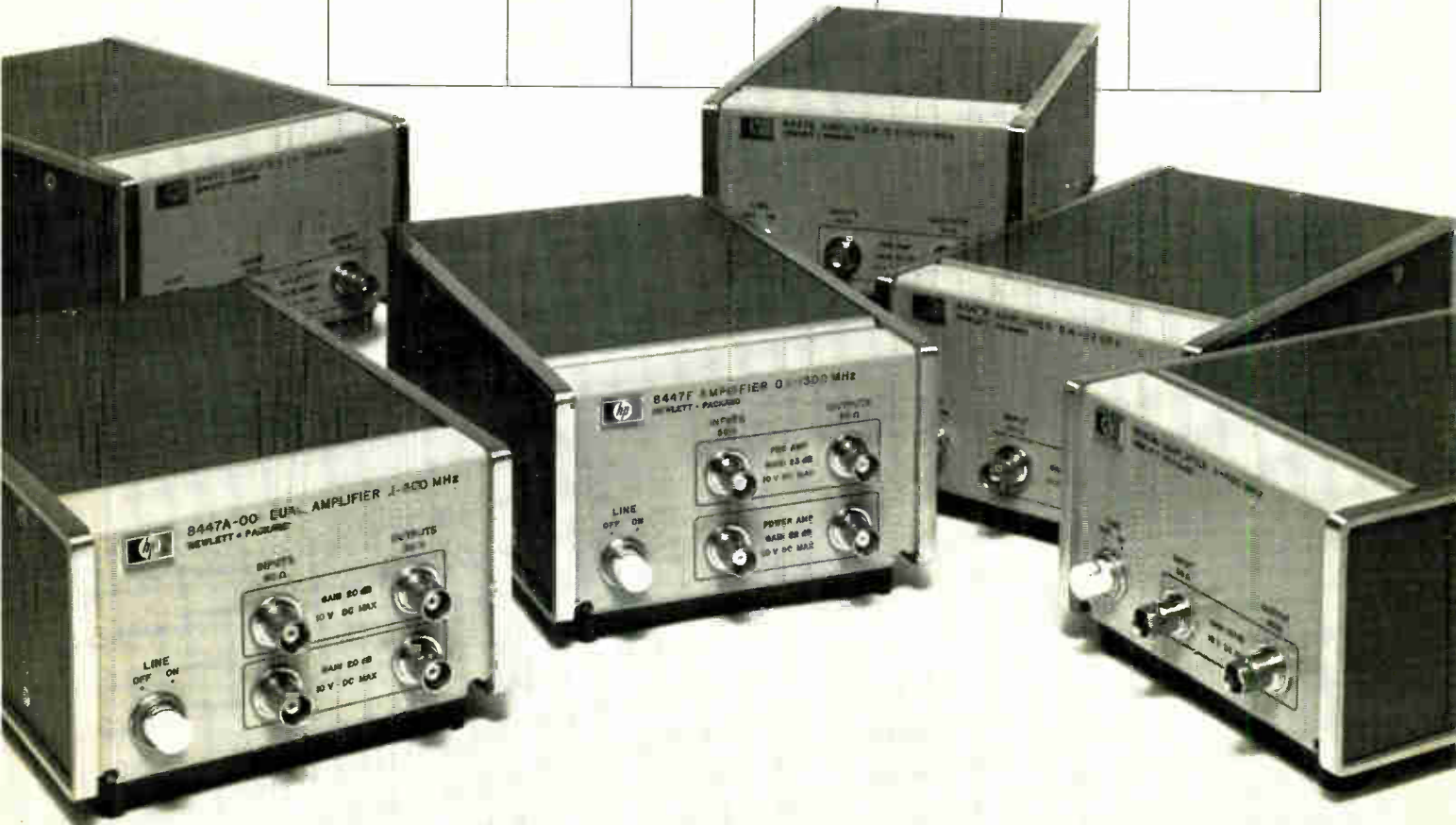

Features

Probing the News

- 85 **Government:** Dean Burch: FCC's pragmatic boss
- 89 **Consumer electronics:** Stakes are high in home video game
- 91 **Military electronics:** Aerospace Corp.'s road widens
- 93 **Instrumentation:** Skyjackings spur detection work

Electronics Review

- 37 **Manufacturing:** Fairchild line churns out transistors
- 37 **Industrial electronics:** NCR's point-of-sale gear
- 38 **Communications:** OTP cuts into FCC's preserve
- 38 **Consumer electronics:** CBS promises better color prints
- 39 **Memories:** Navy looking at Ampex thin film
- 39 **Radar:** CAS offered for ships
- 40 **Companies:** RCA seeks place in IC market
- 41 **Computers:** The Fed moves to eliminate the float
- 41 **Government:** Law and order budget to double
- 42 **Government:** Can fingerprints be sent by satellite?
- 42 **Military electronics:** Crossbow tests miss-distance indicator
- 44 **Electro-optics:** Image intensifier with gyroscope

Electronics International

- 127 **Japan:** Ceramic filters that operate at 30-200 MHz
- 128 **Great Britain:** Implanting ions at production-line rates
- 129 **Japan:** Glass fiber laser; pulses in the avalanche mode
- 130 **Switzerland:** Magnetic properties

New Products

- 97 **In the spotlight**
- 97 **NCR** shifts to cores in Century 300
- 100 **Minicomputer** controls tester
- 105 **Instruments review**
- 105 **IR probe** for hard-to-reach spots
- 106 **Industrial recorder** from Norway
- 109 **Data handling review**
- 109 **Plated wire memory** goes to market
- 113 **Packaging and production review**
- 113 **IC connectors** move in from edge
- 114 **Ellipsometer** gives quick reading
- 117 **Semiconductor review**
- 117 **Darlington** have low V(sat)
- 118 **IC amp** fits any sound system

Articles

- Amorphous semiconductors part 1** 56 **Nonvolatile and reprogrammable, the read-mostly memory is here**
Integrated arrays combine amorphous and crystalline technologies; new memories could help realize the promise of microprogramming
R.G. Neale and D.L. Nelson
Energy Conversion Devices Inc.
Gordon E. Moore, Intel Corp.
- Amorphous semiconductors part 2** 61 **Theory gives shape to amorphous materials**
Before conventional semiconductors can be challenged, problem of how amorphous devices function must be solved; new CFO model helps explain behavior
David Adler
Massachusetts Institute of Technology
- Amorphous semiconductors part 3** 74 **Industry's verdict still a long way from unanimous**
Arrayed against those few companies and research labs that think the new technology will pay off are many more that don't; still others are fence-sitting
- Circuit design** 78 **Designer's casebook**
 - With some discrete aid IC op amp swings 100 V
 - Feedback limits amplifier better than zeners can
 - Monitor teams spare gates and solid state lamps
 - Op amps find values of buried resistors
- 82 **Audio noise: why settle for more?**
Optimizing transistor's collector current yields noise figure far below specified minimum, and it's easily calculated
- 4 **About this issue**
- 6 **Readers Comments**
- 14 **Who's Who in electronics**
- 20 **Meetings**
- 33 **Electronics Newsletter**
- 51 **Washington Newsletter**
- 120 **New Books**
- 121 **Technical Abstracts**
- 122 **New Literature**
- PB-1 **Personal Business**
- 125 **International Newsletter**

Departments

Electronics

EDITOR-IN-CHIEF: Kemp Anderson

EXECUTIVE EDITOR: Samuel Weber

MANAGING EDITORS: Robert Henkel, *News*;
Arthur Erikson, *International*

SENIOR EDITORS: H. Thomas Maguire,
Stephen E. Scrupski

ASSOCIATE EDITORS: William Bucci, Richard
Gundlach, John Johnsrud, Howard Wolff

DEPARTMENT EDITORS

Advanced Technology: Laurence Altman;
Communications & Microwave: Leon M. Magill;
Components: Joseph Mittleman; *Computers*:
Wallace B. Riley; *Consumer*: Gerald M. Walker;
Industrial Electronics: Alfred Rosenblatt;
Instrumentation: Owen Doyle; *Military/*
Aerospace: Herman Lowenhar; *New*
Products: H. Thomas Maguire (Mgr.),
William P. O'Brien, George Weiss; *Packaging*
& Production: Stephen E. Scrupski;
Solid State: George F. Watson

COPY EDITORS: William S. Weiss, *Chief*;
Margaret Eastman, Edward Flinn

ART: Fred Sklenar, *Director*
Charles D. Ciatto, *Assistant Director*

PRODUCTION EDITORS: Susan Hurlburt,
Arthur C. Miller

EDITORIAL SECRETARIES: Barbara
DiBenedetto, Claire Goodlin, Vickie Green,
Terri O'Neill, Bernice Pawlak, Patricia Ritter

FIELD EDITORS

Boston: James Brinton (Mgr.), Gail Farrell;
Los Angeles: Lawrence Curran (Mgr.);
New York: Peter Schuyten (Mgr.); *San*
Francisco: Stephen Wm. Fields (Mgr.),
Marilyn Howey; *Washington*: Ray Connolly
(Mgr.), Jim Hardcastle, Lois Vermillion;
Frankfurt: John Gosch; *London*: Michael
Payne; *Paris*: Arthur Erikson; *Tokyo*:
Charles Cohen

McGRAW-HILL WORLD NEWS

Director: Walter A. Stanbury; *Atlanta*: Fran
Ridgway; *Chicago*: Robert E. Lee; *Cleveland*:
Arthur Zimmerman; *Dallas*: Marvin Reid;
Detroit: James Wargo; *Los Angeles*: Michael
Murphy; *San Francisco*: Margaret Drossel,
Tyler Marshall; *Seattle*: Ray Bloomberg;
Washington: Charles Gardner, James Canan,
Herbert W. Cheshire, Seth Payne, Warren
Burkett, William D. Hickman; *Bonn*: Robert F.
Ingersoll; *Brussels*: James Smith; *London*:
Marvin Petal; *Milan*: Jack Star; *Moscow*:
Axel Krause; *Paris*: Robert E. Farrell, Stewart
Toy; *Tokyo*: Mike Mealey

PUBLISHER: Dan McMillan

ASSISTANT TO THE PUBLISHER: Wallace
Carmichael

PLANNING & DEVELOPMENT MANAGER:
Donald Christiansen

ADVERTISING SALES MANAGER: Pierre Braudé

CIRCULATION MANAGER: George F. Werner

RESEARCH MANAGER: David Strassler

PROMOTION MANAGER: Tomlinson Howland

ADVERTISING SALES SERVICE MANAGER:
Wallis Clarke

About this issue

Amorphous semiconductor research, like the materials themselves, looks somewhat shapeless and unstructured, what with the variety of research projects going on. One thing is crystallizing, though: amorphous semiconductor materials will surely have a place in future electronic products. *Electronics'* editors decided to sort out the status and potential of the work; hence the comprehensive three-part presentation starting with Ovonic devices on page 56.

Since their splash in the press about two years ago, the thin-film Ovonic devices promoted by Energy Conversion Devices Inc. have been searching for the mantle of acceptability. Now, through a connection with Intel Corp., Ovonic devices have earned a considerable degree of respectability. Contributing to the article on the first Ovonic product, a 256-bit read-mostly memory, is Gordon E. Moore, Intel vice president and director. His coauthors are Ronald G. Neale, operations vice president at ECD and formerly with England's Mullard Radio Valve Co. and the Electronic Machine Co., and David L. Nelson, ECD's engineering director and formerly with the Bendix Corp.'s Research Laboratories.

To round out the picture and give an overview of other work, David Adler, associate professor in the Department of Electrical Engineering at MIT, analyzes the somewhat anomalous behavior of amorphous semiconductors (page 61). Then for on-the-spot reporting

(page 74), the magazine's field editors in the U. S., Europe and Japan, plus McGraw-Hill World News men, were sent out digging.

Washington staffer Lois Vermillion found during her research on the role of Dean Burch as chairman of the FCC (page 85) that the former manager of Barry Goldwater's Presidential campaign has quite a temper. While interviewing communications industry managers and legal specialists, as well as sources in Congress, the Pentagon, and, of course, the FCC itself, Mrs. Vermillion heard about rumors that Burch might have a conflict of interest as a result of a reported tie with a communications company.

To pin down the rumors, she put the question to Burch during an interview and got a crackling denial. Later, the chairman wrote a follow-up letter saying, "The more I thought about that question . . . frankly, the madder I got." And, he went on, whoever wanted the question posed should "come in and see me about it because I would sure as hell like to straighten him out about it." But, of course, the question was posed by Mrs. Vermillion on the sound premises that public officials are subject to public accounting and the reporter has a duty to take hard questions directly to the source. In a subsequent letter, Burch, calmer, ended the dialogue by saying "since there apparently is such a rumor, I certainly intend to advert to it at some stage in a public utterance."

September 28, 1970 Volume No. 43, Number 20—89,558 copies of this issue printed

Published every other Monday by McGraw-Hill, Inc. Founder: James H. McGraw 1860-1948. Publication office 330 West 42nd N.Y., N.Y. 10036; second class postage paid at New York, N.Y. and additional mailing offices.

Executive, editorial, circulation and advertising addresses: Electronics, McGraw-Hill Building, 330 W. 42nd Street, New York, N.Y. 10036. Telephone (212) 971-3333. Teletype TWX N. Y. 710-581-4235. Cable address: MCGRAW-HILL L.N.Y.

Subscriptions limited to persons with active, professional, functional responsibility in electronics technology. Publisher reserves the right to reject non-qualified requests. No subscriptions accepted without complete identification of subscriber name, title or job function, company or organization, including product manufactured or services performed. Subscription rates: qualified subscribers in the United States and possessions and Canada, \$8.00 one year, \$12.00 two years, \$16.00 three years; all other countries \$25.00 one year. Limited quota of subscriptions available at higher-than-basic rate for persons outside of field served, as follows: U.S. and possessions and Canada, \$25.00 one year; all other countries \$50.00. Air freight service to Japan \$60.00 one year, including prepaid postage. Single copies: United States and possessions and Canada, \$1.00; all other countries, \$1.75.

Officers of McGraw-Hill Publications Company: Joseph H. Allen, President; John R. Emery, J. Elton

Tuohis, Senior Vice Presidents; Donald B. Gridley, Group Vice President; Vice Presidents: Ralph Blackburn, Circulation; John R. Callahan, Editorial; William P. Giglio, Administration; David G. Jensen, Manufacturing; Jerome D. Luntz, Planning & Development; Joseph C. Page, Marketing; Robert M. Wilhelm, Finance.

Officers of the Corporation: Shelton Fisher, President and Chief Executive Officer; John J. Cooke, Senior Vice President and Secretary; Gordon W. McKinley, Vice President and Treasurer.

Title © registered in U.S. Patent Office. © Copyright 1970 by McGraw-Hill, Inc. All rights reserved. The contents of this publication may not be reproduced either in whole or in part without the consent of copyright owner.

Subscribers: The publisher, upon written request to our New York office from any subscriber, agrees to refund that part of the subscription price applying to copies not yet mailed. Please send change of address notices or complaints to Fulfillment Manager; subscription orders to Circulation Manager. Electronics at address below. Change of address notices should provide old as well as new addresses, including postal zip code number. If possible, attach address label from recent issue. Allow one month for change to become effective.

Postmaster: Please send form 3579 to Fulfillment Manager, Electronics, P.O. Box 430, Hightstown, N.J. 08520.

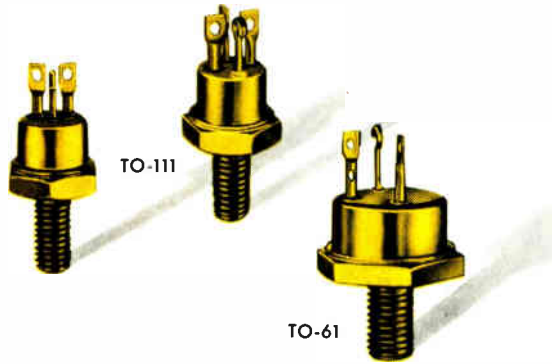

JAN-TX

POWER TRANSISTORS FROM PIRGO

**eight JAN and eight JAN-TX types
available from stock now!**

Type	Case	BV_{CEO} (sus)	h_{FE} @ 1A	V_{CE} (sat)
JAN-TX 2N2812 / JAN 2N2812	TO-61	60	40—120	1.5 @ 10A
JAN-TX 2N2814 / JAN 2N2814	TO-61	80	40—120	1.5 @ 10A
JAN-TX 2N2880 / JAN 2N2880	TO-111	70	40—120	2 @ 5A
JAN-TX 2N3749 / JAN 2N3749*	TO-111	70	40—120	2 @ 5A
JAN-TX 2N3996 / JAN 2N3996*	TO-111	80	40—120	2 @ 5A
JAN-TX 2N3997 / JAN 2N3997*	TO-111	80	80—240	2 @ 5A
JAN-TX 2N3998 / JAN 2N3998	TO-111	80	40—120	2 @ 5A
JAN-TX 2N3999 / JAN 2N3999	TO-111	80	80—240	2 @ 5A

*isolated collector

Get them off-the-shelf
by calling your Sprague semiconductor distributor.
Or call Gil Levy at Pirgo. (516) 694-9880

5P-0100R3



PIRGO ELECTRONICS, INC., 130 CENTRAL AVE., FARMINGDALE, N.Y. 11735
A SPRAGUE ELECTRIC CO. AFFILIATE

High noise immunity runs in our family of IC's . . . *



DTLZ II-family Integrated Circuits with high noise immunity from AEG-TELEFUNKEN

The digital integrated circuits of the DTLZ II-family are designed for *high noise immunity* applications, for instance in industrial electronics.

These are DTLZ (diode transistor logic with zener diodes) silicon monolithic integrated circuits. DTLZ means a modified DTL (diode transistor logic) with zener diodes instead of the normally used voltage dropping diodes. So, a *high noise margin* is reached and also a *small temperature drift*.

Features:

Worst case noise margin 4.0 V at 12 V supply voltage over the full temperature range.

Fan-out of all gates and flip flops 10, power gates 30.

Propagation delay times of gates: $t_{PLH} < 250$ ns, $t_{PHL} < 150$ ns.

Clock frequency of the flip flops: > 1 MHz.

Average power consumption at 50% duty cycle: 35 mW.

Interface elements from 5 V to 12 V and vice versa for compatibility between FP-family and other families are available.

The circuits of the DTLZ II-family are mounted in a plastic dual inline package with 14 pins. They are available for two temperature ranges:

$t_{amb} = 0^{\circ}\text{C} \dots +75^{\circ}\text{C}$ and

$t_{amb} = -20^{\circ}\text{C} \dots +85^{\circ}\text{C}$

For more information write to us or call us for our DTLZ II-catalog.

AEG-TELEFUNKEN CORPORATION**

570 SYLVAN AVENUE
ENGLEWOOD CLIFFS, N.J. 07632
TEL. 201-568-8570

** Formerly:

TELEFUNKEN SALES CORPORATION
GARDEN CITY N.Y.



Semiconductor Devices
from AEG-TELEFUNKEN

Readers comment

Regulators

To the Editor:

In William L. Brown's article on regulated power supplies [July 20, p. 94], the circuits and descriptions are good, but hardly what one is by the first paragraph to expect.

His "series shunt-regulator" is a simple, ordinary series regulator, and the only conclusion he actually arrives at is that upping the gain of the feedback loop—in this case by running an op amp open loop—will increase regulation. His "dynamic shunt resistance" analogy is incorrectly applied here: a large current swing cannot occur in the output of the op amp because it would switch the series regulator on or off; and a few tenths of a milliamper change in the output will create a negligible shunt regulating effect for a zero to 5 ampere supply.

Geoffrey W. Torrence
University of Texas
Austin

■ The author replies: these regulators employ multiple loop feedback, which includes the dynamic shunt path, for which the op amp is closed loop—not open loop. The relative series-shunt action is a function of the frequency response of these paths. Whether the series element in the linear regulator is switched (and it must not be) by the shunt current variations is dependent on frequency, gain, and magnitude. In the switching regulator, the series element is always switching; and the shunt action is isolated from the series action at higher frequencies by the series inductor and 5 microfarad capacitor, making the shunt regulating action much more self evident and simpler to study experimentally.

As part of the original study, the dynamic range of the shunt element was significantly increased by addition of a broad-band power booster stage, and the shunt conductance was kept high, up to many megahertz, with a $\mu\text{A}-715$ op amp. However, even shunt current variations in the low milliamper range, as provided by the low cost op amp

(continued on p. 8)

* See 'Electronics' April 13, 1970
Page 23E

Which 5-digit multimeter is your best buy?



The new S-D 7005 offers five-digit resolution and accuracy. Designed for top performance in actual laboratory use.

Price: \$1,295.

S-D just introduced it.

Prove it to yourself. Ask these questions in evaluating any competitor DVM:

Does the basic DVM include **four dc ranges** from 1 V full scale to 1,000 V full scale?

Can all **optional functions** be added by means of individual cards at any time? (Auto-ranging, AC volts, DC millivolts, ohms, DC current and digital outputs?)

Is the **input impedance** greater than 10,000 megohms or 1 V and 10 V ranges? Is **feedback noise** at the input terminals less than 1 mV? Is full scale **response time** less than 400 millisecs?

Does the unit use **dual slope integration** for max noise immunity at line frequencies? Are **plug-in cards** used for easy maintainability of all measurement circuitry?

Does it have an **annunciator** to remind you what measurement you're making? Are its **digital outputs** compatible with both IC logic and discrete component logic?

The S-D 7005 offers all these features and more for just \$1,295. Request technical data or a demonstration from your local Scientific Devices office or contact: Concord Instruments Division, 888 Galindo St., Concord, California 94520. Phone: (415) 682-6161. TWX: 910-481-9478.

SYSTRON  **DONNER**

Another S-D instrument first! Electronic counters/Digital voltmeters/Pulse generators/Data generators/Time code generators/Sweep generators/Spectrum analyzers/Digital panel meters/Digital clocks/Signal generators/Oscillators/Laboratory magnets/Precision power supplies/Analog & analog-hybrid computers/Data acquisition systems.

heat & serve



That's all it takes with solder preforms from The Indium Corporation of America.

A little heat and our high-purity, low-melting preforms serve your needs exactly... whether you have automated soldering or simply need exact amounts or shapes of solder every time. Our solder preforms—made from Indium, Lead, Tin, Silver, Cadmium, Gallium, Antimony, Bismuth, Copper, Aluminum, Nickel and/or Germanium—are available in any size, weight, shape, composition and tolerance to your specifications. And we deliver. So, call on The Indium Corporation.

We're your low-melting metals gourmet.



INDIUM CORPORATION OF AMERICA

1676 LINCOLN AVE. • UGICA, N.Y. 13503
TELEPHONE 315/797-1633 • TWX 510-242-228E

Readers comment

used to illustrate the article, reduce switching ripple by roughly an order of magnitude. Connecting the op amp as a straight amplifier to increase the loop gain (without shunt action) does not produce such improvement.

On progress

To the Editor:

Bravo Mr. Frank [June 8, p. 4], gradually people seem to be awakening to the tragic dilemma so called progress has driven us into. I would go even one step further than Mr. Frank and not only limit population (how could this be done in those countries that contribute most to the population explosion?) and try to control waste production, but stop progress altogether.

What has progress really brought us? A lot of benefits, no doubt. A longer life span through medical achievements and better hygiene. Now if we could only enjoy all those extra years.

Has anybody ever thought of the effect of a doubling of mankind on the supply of breathing oxygen or about the effect of the added quantities of CO₂ on the climate? All these are side effects of progress. And yet, have not most of us average citizens achieved a standard of living that was unheard of a few hundred years ago? What more could we want? Why not expend some (or most) of our energy to the betterment of our general living conditions and those of our less fortunate neighbors. When are our major political forces going to wake up and, instead of using their influence and their surprising ability to sway people just to elect one or the other candidate, use these talents to motivate producer and consumer to produce less and consume less not so much for economic stability but just to retain the status quo?

If the status quo could be frozen today we could start working on the problems instead of creating new ones with every bit of progress. Hopefully, there are more Frank's: why not join forces?

Claus J. Segebarth
Troisdorf, West Germany



*“If you’re calling Radiation
and **Harris**
answers...*

Don’t hang up!”

RADIATION MICROELECTRONICS HAS CHANGED ITS NAME TO **HARRIS SEMICONDUCTOR**

NEW PLANT:



HARRIS SEMICONDUCTOR . . . a new name and a new IC manufacturing facility with approximately 113,000 sq. ft. of the latest innovations in wafer manufacturing and development.

HARRIS SEMICONDUCTOR, the new name for Radiation Microelectronics, is just in time for the opening of one of the most up-to-date IC manufacturing facilities in the country. Smooth production flow and exacting quality control have been the keynote of its design. To assure environmental integrity there are four completely

isolated modules right in the heart of the building: two for wafer manufacturing and inspection . . . one for engineering development and assembly . . . and the fourth for photo-masking and process development. Each has its own vertical laminar-flow ventilation system which blankets the entire module with super-clean air kept at $72^{\circ} \pm 1^{\circ}\text{F}$ and $45\% \pm 1\%$ rela-

tive humidity. And as added environmental protection, the air is filtered again by the laminar-flow hoods at each individual production station. That assures us of maximum yield for our high-quality chips. And it assures Harris Semiconductor customers that they'll get IC's with the *best price/performance ratio on the market.*



SUPER-CLEAN AIR . . . In vertical laminar-flow hoods designed to provide additional air filtering, wafer photo resist is exposed to ultraviolet light after precise mask alignment.

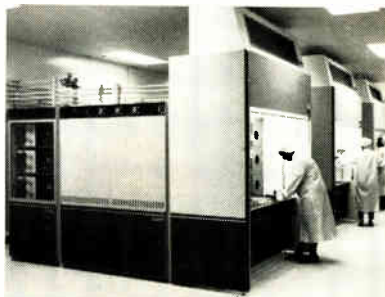

. . . THE LATEST DIFFUSION EQUIPMENT
Six furnace chambers on each of these Brute diffusion systems are regulated within 0.25°C for precise uniformity of wafer diffusion rates.

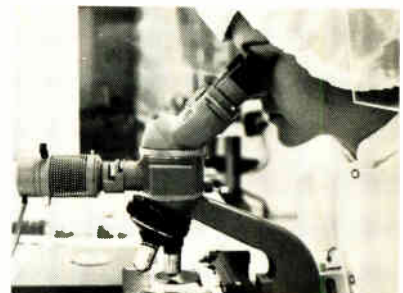

All material moving through the manufacturing process is continually monitored to assure conformance to the rigid standards of high quality Harris Semiconductor has been noted for.

NEW PRODUCTS

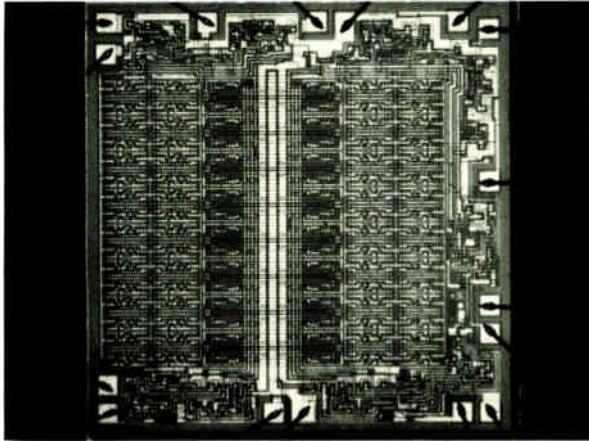

64-BIT BIPOLAR RAM WITH 35ns ACCESS

Using Schottky clamped transistors the Harris RAM-0064 is the first bipolar read/write memory capable of 35ns access times. As a high-speed scratch-pad memory, it provides:

- DTL/TTL compatibility
- Full decoding to 16 words by 4 bits per word
- Uses single 5 volt power supply
- Open collector output for "Wired-Or" expansion
- 16 pin dual in-line package
- 0° to +75°C, \$25.60*
- -55° to +125°C, \$32.00*

*100 to 999 unit price

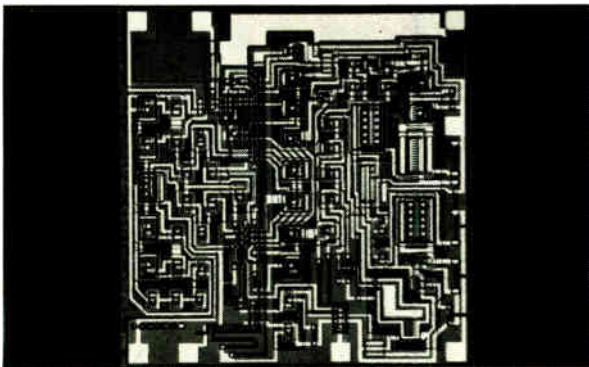

NEW WIDE-BAND, HIGH-IMPEDANCE OP AMP

Harris' new RA-2620 and RA-2625 Wide Band Op Amps have gain bandwidths which are an order of magnitude better than standard op amps on the market today. In addition, they provide:

- Input impedance of 500Megohms
- Slew rate of 35 V/us
- Typical bias and offset currents of 2nA
- Ideal for high-input impedance comparators
- RA-2620 . . . -55° to +125°C, \$17.85*
- RA-2625 . . . 0° to +75°C, \$10.70*

*100 to 999 unit price

And in addition to our recently introduced PROM and 8-bit D/A Converter, watch for these new products soon to be announced:

MEMORIES
256 x 1 PROM
1024 BIPOLAR ROM
16 BIT BIPOLAR RAM
2560 MOS ROM

DIGITAL
9300 STORAGE REGISTER
9301 1/10 DECODER
9304 DUAL ADDER
9309 DUAL 4 INPUT MPX
9312 SINGLE 8 INPUT MPX
9316 HEX COUNTER

LINEAR
6-BIT CURRENT SOURCE
MONOLITHIC LADDER
NETWORKS

IF
HARRIS
ANSWERS
DON'T
HANG
UP!



 **HARRIS
SEMICONDUCTOR**

A DIVISION OF HARRIS-INTERTYPE CORPORATION

Norwalk, Connecticut (203) 853-3646
Lexington, Massachusetts (617) 862-1055 / Frederick, Maryland (301) 662-5400 / Oaklawn, Illinois (312) 423-6010 / Albuquerque, New Mexico (505) 268-3549 / Palo Alto, California (415) 321-2280
Dallas, Texas (214) 231-9031 / Long Beach, California (213) 426-7687 / P. O. Box 37, Melbourne, Florida 32901 (305) 727-5430 / EXPORT SALES, OAGE CORPORATION, STAMFORD, CONNECTICUT

RADIATION MICROELECTRONICS HAS CHANGED ITS NAME TO **HARRIS SEMICONDUCTOR**

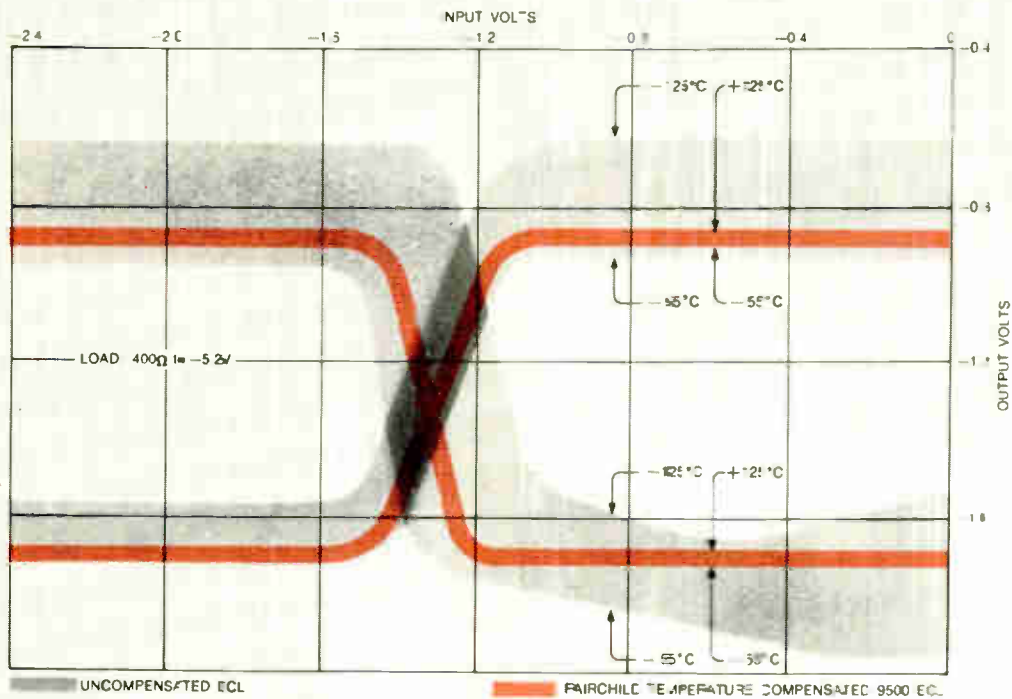

CHANGE IN ECL LOGIC LEVELS WITH TEMPERATURE

EASY TO USE:

Simplified wiring rules. Standard double-sided PC boards. Unterminated lines. Logic levels constant over temperature range.

HIGH SPEED:

2nS gate delay (even faster system speeds with MSI elements).

LOW COST:

Low unit cost for gates and MSI. Low design and manufacturing costs with conventional board assembly and wiring techniques.

Easy ECL.

New 9500 ECL Family.

The temperature compensation in our 2nS ECL makes it so nifty to use.

Until 9500 ECL, emitter coupled logic was the prima donna of the industry: a dazzling performer, but so temperamental to work with. As one of the major ECL manufacturers pointed out, "ECL requires a higher degree of sophistication—in printed-circuit board design, thermal/mechanical design, and in designing to minimize noise. But," he concludes on a melancholy note, "the main problem is in getting people to accept this." The fact is, with the advent of the 9500, people don't *have* to accept these trade-offs any longer.

It's the temperature compensation in our new 9500 ECL that makes it the first low-cost non-saturating high-speed digital IC family that's *easy to use*.

Elaborate system cooling designs are unnecessary because a unique on-chip temperature compensation network maintains logic levels constant over the temperature range. This, in turn, means that noise margins remain constant with temperature. Constant logic levels also reduce the danger, common in other ECLs, that additional time delays may be introduced by driving input transistors into saturation. And finally MSI functions, such as the 9581,

become easy to use, thus reducing system complexity and cost.

Layouts are simplified and PC board manufacturing costs reduced because 9500 can drive up to 8 inches of unterminated line using on-chip input and output pull-down resistors. Standard double-sided PC boards can be used.

In addition, the circuits are stable because these internal resistors maintain the real part of the input impedance positive across the operational frequency range.

If desired, 9500 can drive 50 ohm lines up to 10 feet long.

These 9500 ECL devices — 16-pin, hermetically-sealed, ceramic DIP, 0° to 75°C — are now available from your friendly Fairchild distributor (others to follow shortly):

	1-24	25-99	100-999
9502 Dual 4 I/P OR/NOR Gate	2.95	2.35	2.05
9503 Triple 2 I/P OR/NOR Gate	3.10	2.50	2.15
9504 Quad 2 I/P NOR Gate	3.25	2.60	2.30
9528 Dual D Flip-Flop	9.75	7.80	7.05
9581 One of Eight Multiplexer	24.50	19.50	17.50

Send for data sheets and applications information on the new 9500 Easy ECL Family.

FAIRCHILD
SEMICONDUCTOR

FREE Engineering Handbook on Electromagnetic Delay Lines

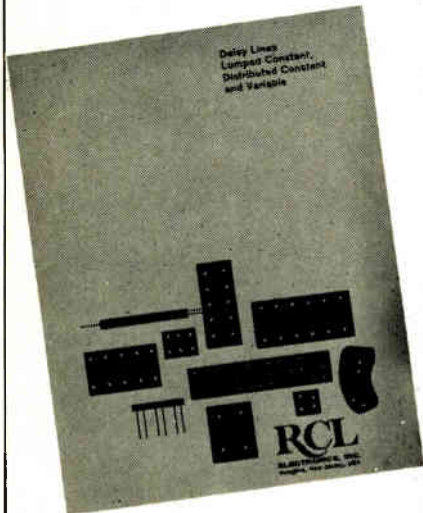

We've reserved
a copy
for your desk . . .

Terms . . . engineering definitions . . . how to specify delay lines . . . characteristics of various types . . . specifications . . . they're all included in this concise, easy-to-read handbook . . . yours for the asking.

**LUMPED CONSTANT ...
DISTRIBUTED CONSTANT
... VARIABLE**
all three types are covered
in this reference
handbook.

RCL

RCL ELECTRONICS, Inc.,

General Sales Office:

Seven Hundred
South Twenty First Street
Irvington, New Jersey 07111

Who's Who in electronics

The recent reorganization at the Signetics Corp., which actually started just before the summer, was aimed at separating the company's product lines and integrating the functions within each line. Now that it's completed, "the company should be in a better position to serve both itself and its customers," explains Jack E. Halter, newly named vice president of products and marketing at the Sunnyvale, Calif. company.

When a company is small, and has a small product line, many functions can be handled by one person. There can be one design engineer, one process engineer, and one marketing man. But as the company grows, responsibility has to be split. This leads to a major difficulty; sometimes the people who design a product know nothing about marketing it, and the marketers know nothing about production. And as each new product type is added to the line, a new group of people is assembled to handle it.

Halter's answer was to set up a vertical product organization with a minimum of interfacing between groups. Each product group—digital, linear, and metal oxide semiconductor—has its own production control people, design engineers, product engineers, process engineers, and a marketing manager. As Halter puts it, "If linears don't sell one month, I only have to talk to one person—the linear marketing manager."

Timing, says Halter, is one of the biggest problems in reorganizing a company. How large does it have to be before the groups are formed? "We may have done it \$10 million too late," he says, which might call for some backtracking. Halter is now working on a scheme whereby each group would operate as a separate company.

Halter, a BSEE graduate of UCLA, has been with Signetics for almost seven years. Starting as a regional manager, he became successively sales manager, product marketing manager, and manager of marketing. He was named vice president of marketing in April, and after Charles C. Harwood was named

president of Signetics [*Electronics*, Sept. 14, p. 52], Halter became vice president of products and marketing.

His new post loads Halter with responsibility for most of the company's operations except R&D and sales. "We've taken sales out," he says. "The OEM sales, distributor sales, and the system-planning people report directly to the president; I've given away sales, but I've picked up manufacturing."

Besides splitting the company into groups, Halter is also faced with tying things together "so that we present a Signetics image." He has formed a product marketing group that does more than its name implies. Things that are common to all groups, like mask preparation and silicon encapsulation, for example, have to be controlled by one single group to allow for proper scheduling and to eliminate unnecessary duplication of equipment. "This way," he says, "every product line is on an equal basis—each has to hold up on its own and if it doesn't, we know where to look."

Few would disagree with the premise that the semiconductor industry is still a long way from maturity, particularly in applying sophisticated management techniques to production problems. It's also no secret that for some time the General Instrument Corp.'s Microelectronics division has been plagued with its share of IC yield troubles. That's where James H. McGarry comes in.

For the last nine months McGarry, GI corporate vice president and general troubleshooter for the parent organization, has been on temporary assignment to the division. His specific task is to maximize IC production, and it will be no mean feat if he pulls it off. For openers, the 57-year-old McGarry has managed, since his arrival at the Hicksville, N.Y., facility, to reduce the turnaround time from raw silicon to packaged IC from the usual six or seven weeks to barely

DATA OUTPUT TIMING DIAGRAMS

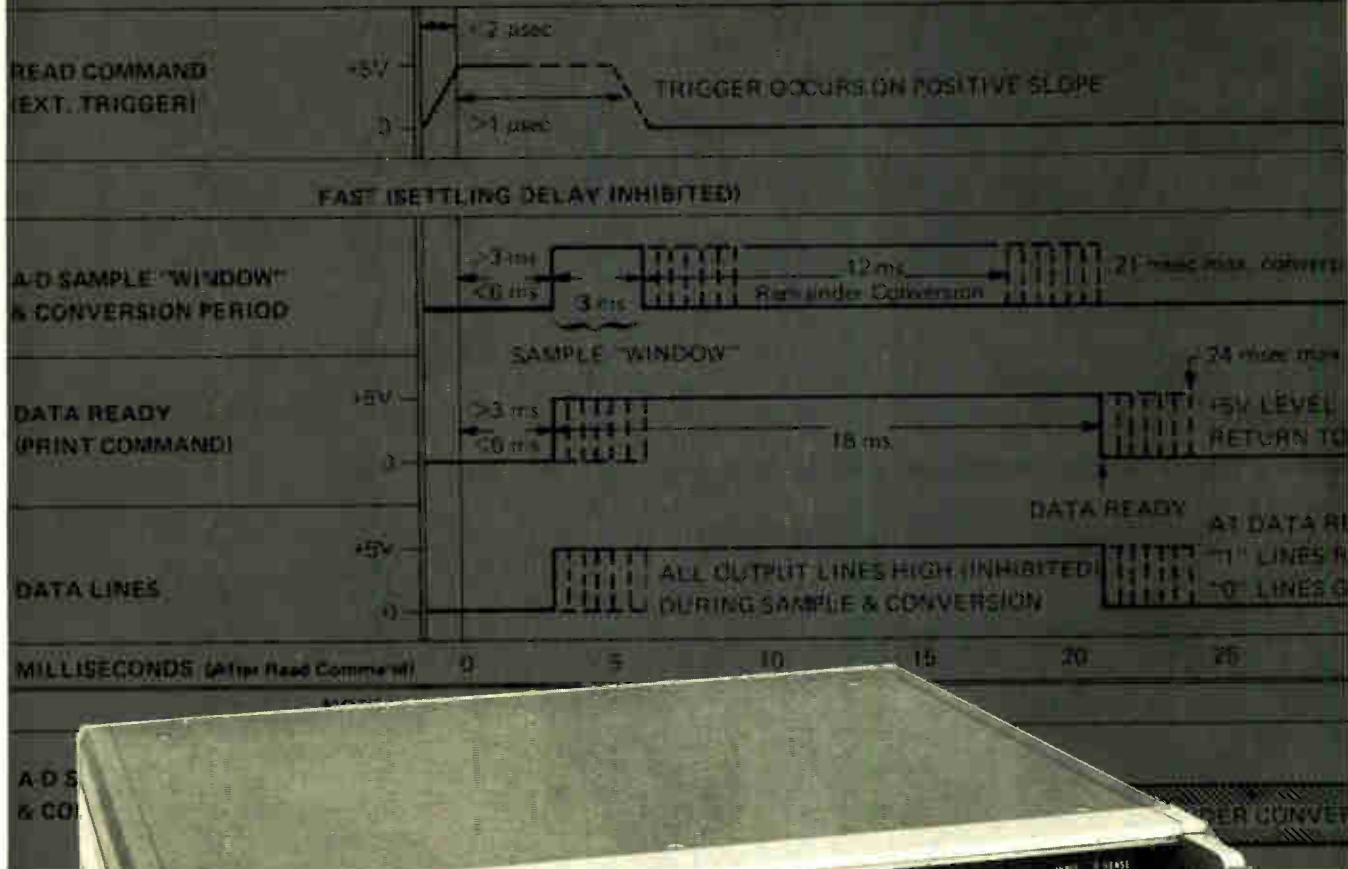

The DVM to beat the system!

Here are 10 reasons why Fluke's 8300A is easy to use, easy to interface, and easy to program. 10 reasons why it's *the* systems digital voltmeter.

1. We blank the data output during conversion and time out to keep random signals out of the system.
2. A "device busy"/"ready" flag inhibits acquisition of readout until data is ready.
3. Programmable, on-call time-outs allow settling of analog options and auto-ranging, then call up a final conversion which is the only reading presented.
4. An automatic overload flag acts independently of the system.
5. Data may be acquired serially so that you can interface directly with an 8, 12 or 16 bit computer.
6. Because the DVM can take large overloads, problems caused by switch timing and large transients are eliminated.
7. Signal input is completely isolated from data out and remote control circuits without use of relays.
8. Fully guarded "box in box" construction gives you totally uncompromised input isolation.
9. DTL-TTL compatability.
10. High accuracy/low price... 0.005% with prices from \$1395.



Fluke, Box 7428, Seattle, Washington 98133. Phone: (206) 774-2211. TWX: 910-449-2850/ In Europe, address Fluke Nederland (N.V.), P. O. Box 5053, Tilburg, Holland. Phone: (04250) 70130. Telex: 884-50237/ In the U.K., address Fluke International Corp., Garnett Close, Watford, WD2 4TT. Phone: Watford, 27769. Telex: 934583.

Sweep 5-2350 MHz with a single instrument



Price. \$2495.00

VS-90 sweep generator packs more range—more convenience—into one compact package. With no extra, plug-in heads needed. Three overlapping bands provide full sweep coverage from: 5-800 MHz; 750-1300 MHz; and 1250-2350 MHz. Each band can be swept to its full width and each has the stability required for narrow band circuit testing. Birdy-by-pass marker provides for up to seven single frequency or harmonic markers. External input takes CW source for variable marker.

Basic Specifications:

FREQUENCY RANGE: 5.0 MHz to 2350 MHz in three overlapping bands.

RF OUTPUT: The RF output is at least 0.75v rms into a 50 ohm load.

FLATNESS: The flatness is ± 0.5 db at maximum sweep width (tested with a CD-51 detector).

HARMONIC DISTORTION AND SPURIOUS AT RATED OUTPUT:

Band ± 1 from 10 MHz to 800 MHz-25 db below fundamental output.

Band ± 2 40 db below fundamental output. Band ± 3 40 db below fundamental output.

Texscan Corporation
2446 N. Shadeland Ave.
Indianapolis, Ind. 46219
AC 317/357-8781

Texscan Limited
Hemel Hempstead,
Hertfordshire, England
Phone: 58558

Texscan

Who's Who in electronics

seven days, and with a corresponding improvement in yields to boot.

In many ways, McGarry traces his success at Microelectronics to his past experience in the IC business—virtually none. "I really don't know anything about the semiconductor business, per se," he asserts. "What I do know is management and production. As such I was able to come in here and start fresh." Before joining GI corporate nearly 18 months ago, McGarry was an ITT vice president in charge of that company's transmission department in Raleigh, N.C., and before that director of operations at ITT's Federal labs.

McGarry has made changes that might seem obvious to management men in other industries, but are unusual in the semiconductor business. For example, he moved executives closer together so that personal contact eliminated a long chain of paperwork. Then he initiated motivation boosting output charts for the girls who do the IC lead bonding. The more competitive environment increased yields by 50%. He did the same thing with manufacturing managers: individual charts show actual production beside projected output.

Wafer handling also came in for scrutiny. Discovering that a wafer is handled by the operators—transferred from one container or one piece of equipment to another—some 70 times, McGarry got together with the factory engineers to develop ways to cut the figure. A typical solution involved a carrier used to hold the wafers when they are inserted in an etching solution. Why couldn't the same carrier be used throughout the processing, McGarry asked. He was told that they were expensive—about \$40 apiece—because they had to be made of Teflon to resist the etching solution. McGarry's solution: carriers of identical design, but of a cheaper plastic for about \$2. Now, after the wafers are etched, the cheaper carrier is inverted over the more expensive one. When the combination is turned upside down, the untouched waters slide gently into the \$2 carrier and continue through the fabrication process.

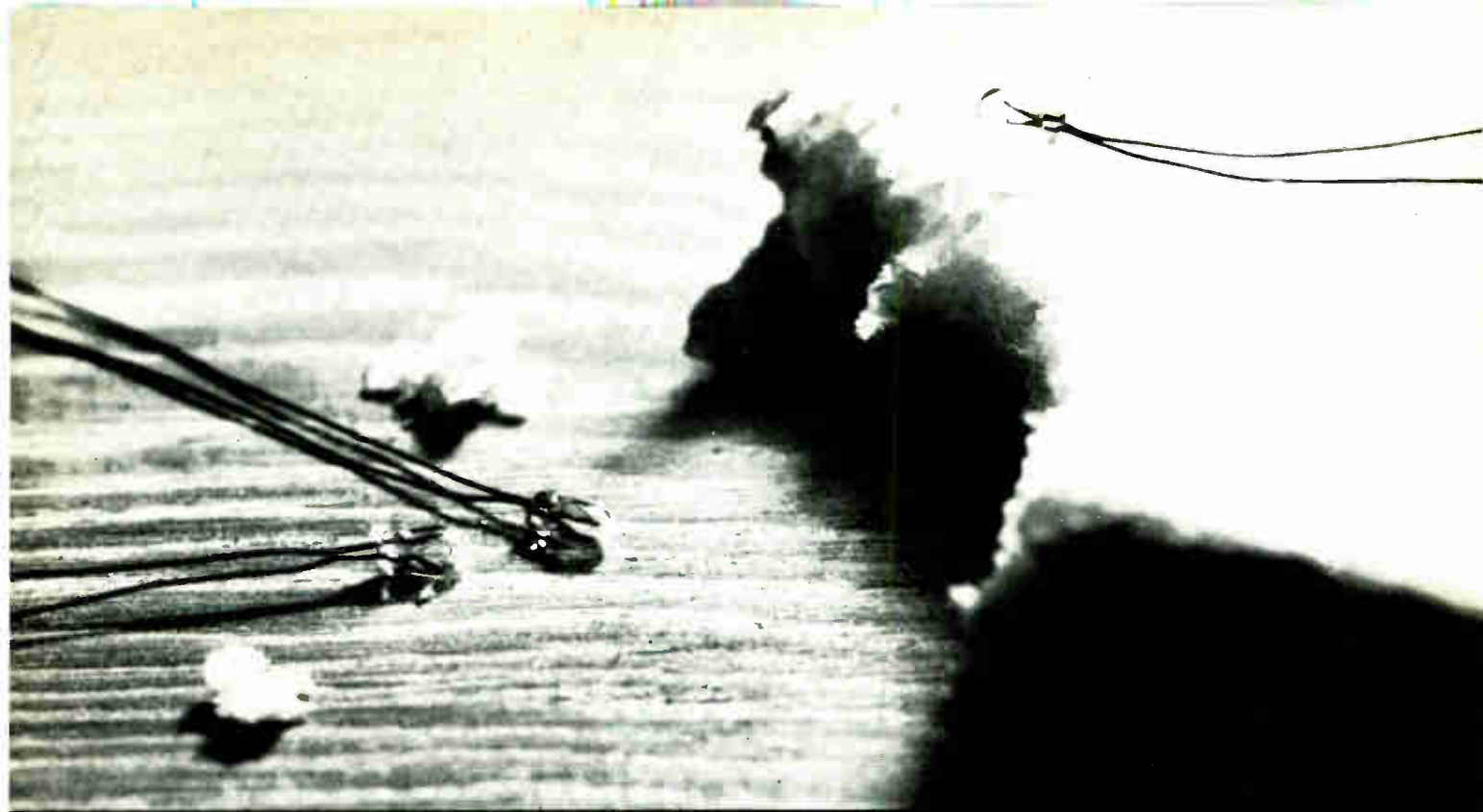

Chicago Miniature's new low current, fine wire lighting bugs need only a fraction of the current normally required for sub-miniature lamps.

These T-1 and T-3/4's have an average current drain of only 8-21 ma., and are specifically designed for applications requiring illumination from low current level circuits.

A new process developed by Chicago Miniature gives our bugs well shaped, stress-free fine wire filaments which result in superior

reliability and life performance.

Their ability to be driven directly from low output integrated circuitry eliminates the need for separate driver circuits. And, all of these lamps are aged for a minimum of 16 hours to insure long lamp life and dependable operation.

For complete information on these low current, fine wire Lighting Bugs, circle the reader service number or write for catalog CMT-3A.

For application assistance contact your Chicago Miniature Sales Representative. For off-the-shelf delivery, contact your local authorized Chicago Miniature Electronic Distributor.



CHICAGO MINIATURE
LAMP WORKS
4433 N. Ravenswood Ave.
Chicago, Illinois 60640
(312) 784-1020

a GENERAL INSTRUMENT company
See us in booth 1214 WESCON

THE LIGHTING BUGS

This bug
feeds on practically
nothing.



**“No one made a
small, quiet, medium-speed
chain printer for \$9500.
So Mohawk did.”**

George C. Hohl, OEM Marketing Director, discusses a new product.

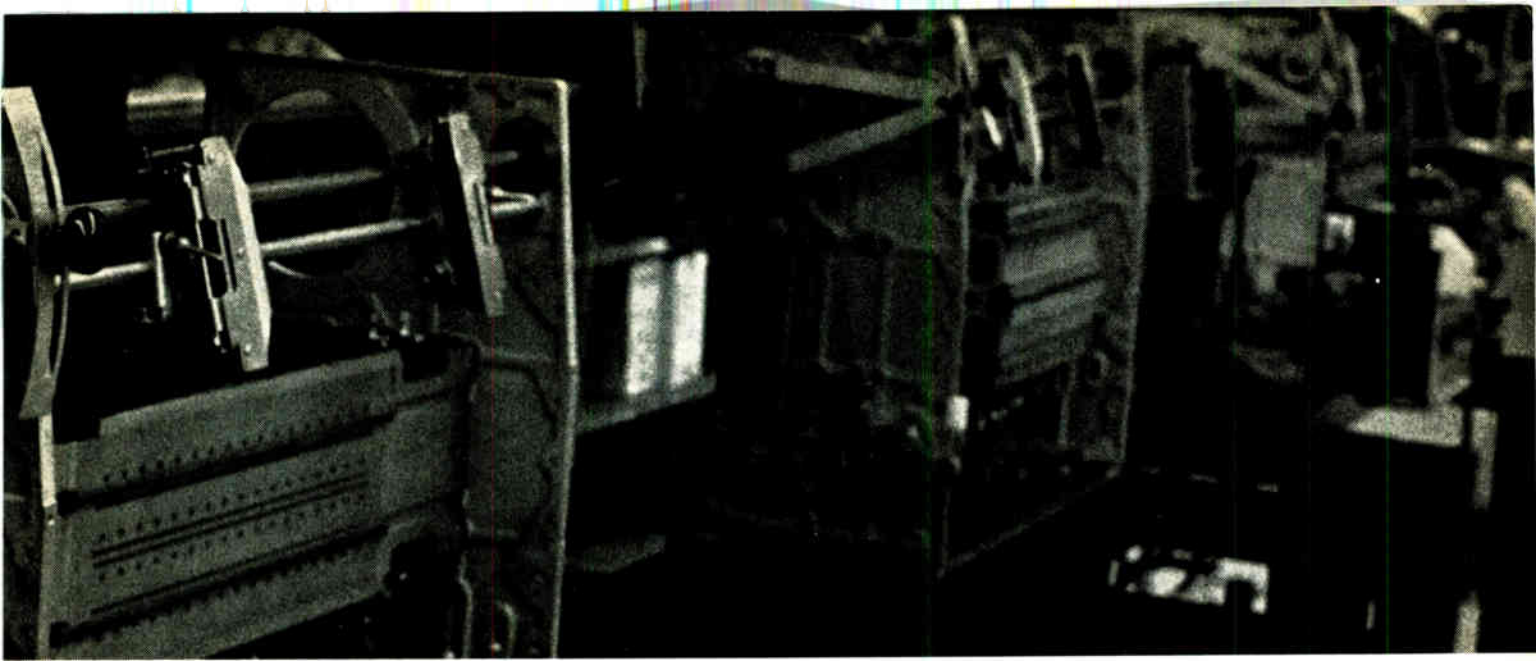

“We saw a gap in the printer field. Either you paid a lot of money to get a lot of speed and sophistication, or you could pay a little and get very little in return. We decided to aim our printer somewhere in between.

“Chain printers are mechanically simpler, easier to maintain, less expensive. Their flat face characters give good print characteristics, too.

“Our design requirements were rough. We wanted 300 lines-per-minute with such niceties as easily changeable fonts, and yet we wanted to sell it for less than \$10K. It had to be small, and yet we couldn't lose accessibility. The design engineers grumbled, but they made it.

“The changeable font cartridge is great—an operator can quickly switch the font chain—and we're offering fonts from 16 to 128 characters.

“We designed a disposable ribbon cartridge to make ribbon

changes quick and clean. Paper handling is enclosed to stay clean, too. And everything that could be modularized, was modularized.

“We considered noise reduction vital—anyone who has worked in a printer room knows why. Well, compared to other printers, you'd hardly know this one was working.

“We're selling the printer for \$9500 in OEM quantities, and some variations cost even less. So you get a lot of performance in a very little printer—for very little money.”

Mohawk Data Sciences Corp.
Herkimer, New York



DIALCO DATALITES[®]

mount as close
as 1/2 inch center
to center



SHOWN ACTUAL SIZE

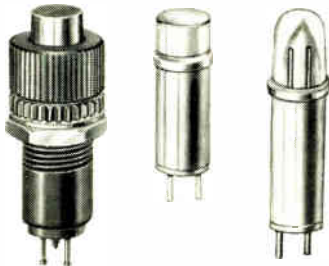

Designed to meet or exceed requirements of MIL-L-3661B.

Replaceable plug-in cartridges: Incandescent for 1.35-120V; neon—high-brightness operation 110-125V AC, and standard brightness operation 105-125V AC-DC.

Wide range of lens shapes, colors and finishes.

Broad selection of positive or negative legends.

Available off-the-shelf for prompt delivery.

Send for free catalog



SAMPLES ON REQUEST—AT ONCE
NO CHARGE

Dialight Corporation, 60 Stewart Ave.,
Brooklyn, N. Y. 11237. (212) 497-7600



Meetings

Optics at stage center

By sheer weight of numbers, if nothing else, the papers on optical gear will demand attention at the International Electron Devices Meeting to be held Oct. 28-30 at the Sheraton-Park Hotel in Washington. Optical topics will range from methods of achieving greater frequency stability in helium-neon gas lasers to the marriage of semiconductor and electron-beam techniques in camera tubes and new combinations of materials for light-emitting diode displays.

No less significant are the papers on integrated circuits. Field effect integrated circuits receive particular attention, with a new symbology appearing—MIS for metal insulator semiconductor, instead of the usual MOS—thus revealing the variety of forms the basic FET IC is assuming. Some evidence of the diversity of research and development going on can be gleaned from the titles: "Silicon Gate Complementary MOS Integrated Circuits," by R.R. Burgess and R.G. Daniels of Motorola; "Dielectric Isolation for MOS ICs," by D.O. Patterson and W.H. White of Radiation Inc., and "The Effective Mobility of MOS Transistors on Insulating Substrates," by E.J. Boleky of RCA.

Bipolar ICs won't be ignored, of course. One of the remarkable trends that will be in evidence at the conference this year will be the adaptation of MOS (or MIS) fabrication techniques to bipolar devices. Witness "Polychystalline Silicon Technology for Bipolar Integrated Circuits," by J.A. Schoeff of Motorola and "The MNOS Bipolar Transistor," by B.A. McDonald of Fairchild Semiconductor.

One of the most critical parts of an IC—the metal used to interconnect circuit elements on the chip—will have a session devoted to it exclusively: "Interconnection Metallurgy," reflecting the concern of manufacturers with existing metallization systems and the search for new ones. Efforts to improve the workhorse aluminum metallization technique will be examined by H.J. Bhatt of the Cogar Corp.

in "Superior Aluminum for Interconnection of Monolithic Integrated Circuits," and by W.R. McMahon of Texas Instruments in "Anodic Processing of Interconnect Systems for Integrated Circuits." An overview will be provided in "The Corrosion Resistance of Several Integrated Circuit Metalization Systems," by J.A. Cunningham, C.R. Fuller, and C.T. Haywood of TI.

Other device types to be covered during the three-day conference include memories, transistors (especially transistor models), crossed-field amplifiers, microwave generators, acoustoelectric devices, traveling wave tubes, and thyristors and diodes.

For further information contact Gerald Sevick, Bell Laboratories, Murray Hill, N.J.

Price conscious

When connector makers and their customers get together Oct. 21 and 22 for their third annual symposium, their sessions will reflect the usual mix of technical topics. But the talk between sessions probably will center on the subject uppermost in the minds of all cost-conscious electronics executives: how to bring costs down while improving performance.

Anticipated attendance at the meeting, to be held at the Cherry Hill Inn in Cherry Hill, N.J., is 500 connector specialists and 40 manufacturers. On the technical side, there will be more than 30 papers in eight major categories. They are military and commercial computer packaging; flexible flat cable; connector test methods and evaluation; rf connector improvements; materials and finishes; standardization; new termination connector techniques; and connector potpourri. Each category will contain three or four papers from manufacturers such as Fairchild Hiller, Texas Instruments, Methode, Bendix, AMP, Phelps Dodge, Burndy, IBMs, ELCO, Microdot, and Burroughs.

For further information contact James Pletcher, AMP Inc., Harrisburg, Pa.

(Continued on p. 22)

We can make anything by photo chemical machining. Not just 2 million color TV masks a year.

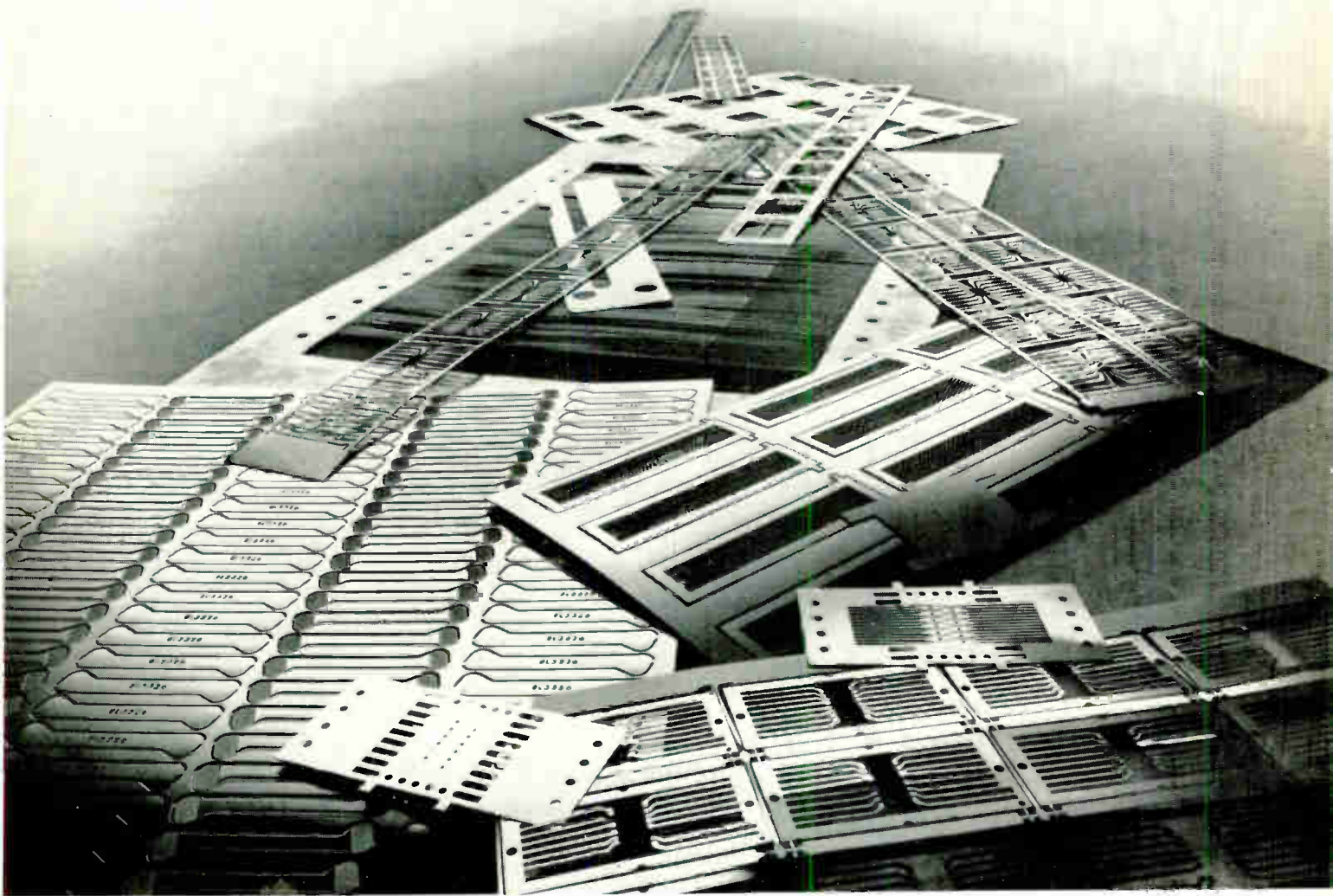

Anyone can handle a run-of-the-mill chemical milling job. But if you're going crazy with frustration, we've got answers not everyone can give you.

Like the time we rescued a whole integrated circuit production line that was shut down because a part kept failing. Our metallurgists found the "insignificant" change in metal grain structure that a metal supplier had introduced.

Or the time somebody needed a metal part that could pass a very nasty bending test. We whipped up a nickel alloy that did the job, though a lot of people on the sidelines said it couldn't be done.

Where do we get the experience? We've been through the mill with a huge, continuous photo chemical machining operation that has turned out millions of aperture masks (500,000 perfectly formed holes per mask).

We make all sorts of other complex things by photo chemical machining. (You see some of them here.) IC lead frames. Display tube numbers. Grids. Heaters. Electric razor cutter heads. Computer card guides.

We start them out in our big artwork shop and end up by plating them with nickel, gold, or silver.

Now we're expanding our photo chemical machining operations with a lot of automatic machinery. So we can handle more work.

If you need something special, come to us. Instead of just milling around.

Send for our brochure. Write to: Marketing Department, Sylvania Precision Materials, Chemical and Metallurgical Division, Towanda, Pa. 18848.

SYLVANIA
GENERAL TELEPHONE & ELECTRONICS

Circle 21 on reader service card

NOW
HIGH-PERFORMANCE SCRs
TO MEET THE
CRITICAL NEEDS OF...

- Power Inverters
- A.C. Motor Variable Speed Drives
- Induction Heaters
- Pulse Width Modulators

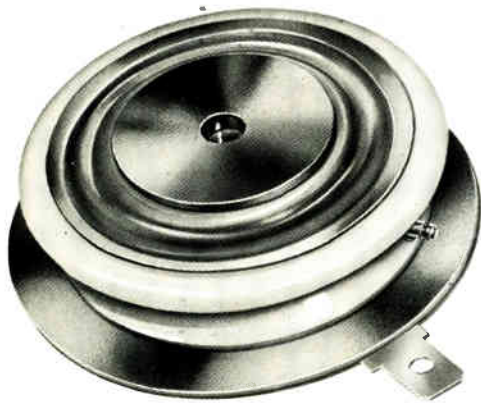

NATIONAL®
DISC PACKAGED
REGENERATIVE GATE* SCRs
provide these plus factors...

- + Voltages to 1000 V
- + dv/dt to 500 V/ μ sec.
- + Turn-off time to 15 μ sec.
- + di/dt to 800 A/ μ sec.
- + Low power gate drive
- + Operation to 20 KHz, with low switching losses
- + 175 and 380 amperes RMS
- + Also available in stud packages to 470 amperes RMS

* A NATIONAL® exclusive.
Patent No. 3,486,088

We welcome requests for detailed data and application assistance. Contact...

NATIONAL ELECTRONICS, INC.

a varian subsidiary

Geneva, Ill. 60134, phone 312-232-4300

Meetings

(Continued from p. 20)

Calendar

Mervin J. Kelly Communications Conference, University of Missouri, IEEE; University of Missouri Library, Rolla, Oct. 5-7.

Industry & General Application Group Annual Meeting, IEEE; La Salle Hotel, Chicago, Oct. 5-8.

Government Microcircuit Applications Conference: GOMAC, Department of Defense, Army, Navy, Air Force, NASA, Department of Commerce, National Bureau of Standards, Post Office Department; U.S. Electronics Command, Fort Monmouth, N.J., Oct. 6-8.

Symposium on Microwave Energy, International Microwave Power Institute, Scheveningen, Holland, Oct. 7-10.

American Society for Information Science Meeting, Sheraton Hotel, Philadelphia, Oct. 11-15.

International Telemetry Conference, Electronic Industries Association, Instrument Society of America; International Foundation for Telemetry; International Hotel, Los Angeles, Oct. 13-15.

Systems Science and Cybernetics Conference, IEEE; Pittsburgh, Oct. 14-16.

CAMAC Instrumentation, European Organization for Nuclear Research; Geneva, Switzerland, Oct. 14-16.

Automatic Support Systems for Advanced Maintainability, IEEE, Aerospace and Electronics System Group; Stouffer's Riverfront Inn, St. Louis, Mo., Oct. 19-21.

Electronic and Aerospace Systems Convention (EASCON), IEEE; Sheraton Park Hotel, Washington, Oct. 26-28.

Annual ISA Conference and Exhibit, Instrument Society of America; Civic Center, Philadelphia, Oct. 26-29.

Western Space Congress, Vandenberg Scientific and Technical Societies Council; Vandenberg Inn, Santa Maria, Calif., Oct. 27-29.

Annual Symposium on Switching and Automata Theory, Switching and Automata Theory Committee of the IEEE; Santa Monica, Calif., Oct. 28-30.

International Electron Devices Meeting, IEEE; Sheraton Park Hotel, Washington, Oct. 28-30

(Continued on p. 24)

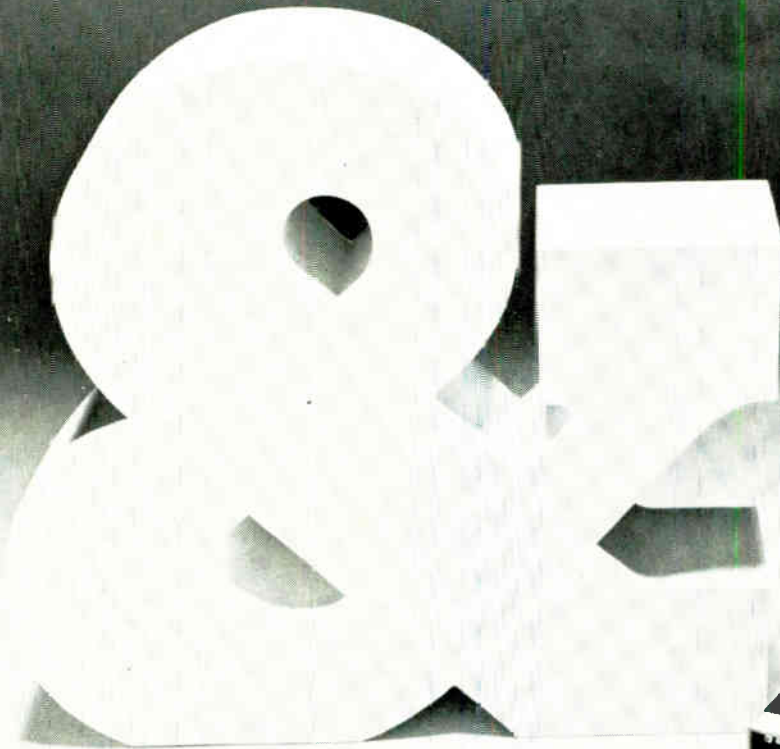

Bell & Howell & Recording & How

It's done with oscillographs. We have a bunch, but let's talk about these two. They can handle on-line or off-line test and measurement of any physical happening you might have in mind. From pulse flutters during surgery to whether or not you're refining that crude the same way today as last year.

The one on the bottom is the 5-134. It does everything but talk. It writes to 25,000 Hz. (But with all that speed, it has a data accuracy to $\pm 1/2\%$.) And can flip into any one of 10 different servo-controlled speeds.

It's modular, of course, with special refinements. Like the timer, servo control board and galvo all plug in. Individual input connectors as standard. An extremely quiet operation. That type of thing.

Here's a couple more exclusives. You don't have to write out timing line rates. With us, that's taken care of automatically. With a timing ID marked on the edge of the paper. Not only that, the rate can be manually selected or can be automatically synced with paper speed.

And it's got a "jog" feature that allows you to move the paper short distances for initial set up—one hold-down button for on/off.

The smaller box is the 5-135. It weighs in at 35 pounds (a real portable) as compared to the other's 50 pounds. Both boxes share pretty much the same components. It's just that the 5-135 has broader application by more industries across the board because it's not quite so fancy (9 channels versus the 5-134's 18, for instance). Even though it's smaller, it doesn't skimp on performance. It has the largest range of input power options of anybody going. And all that at a lot less money. Not bad, huh?

And one more thing. Just in case you're building a system, we've got a range of other new goodies to complement these graphs: 1-172 amplifier, 8-114 bridge excitation/signal conditioner and the 23-111 paper processor.

If anything here piques your curiosity, you can get the full package of specs by writing Bell & Howell, Instruments Division, 360 Sierra Madre Villa, Pasadena, California 91109.

INSTRUMENTS DIVISION



BELL & HOWELL

How would you like to have the best work force in your field?



Drucker

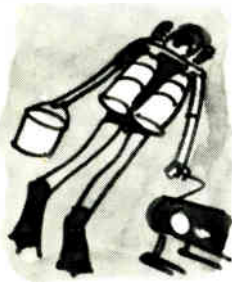

In Florida we can show you how to have profits... performance... productivity!
Here's why Florida can deliver:

- We can out-recruit anyone for skilled labor. We'll show you proof of 10-to-1 superiority in competitive recruitment.
- Our skilled work force is growing faster than in any state in the Southeast.

- We now have in Florida a larger working age population (18-65) than any other Southeastern state.

Florida is a great place to work and live. Won't you let us reveal the hidden profit potential in Florida's remarkable labor picture? Just phone (904) 224-1215 or write in confidence.

Dept. D-4

Please send information about:

- Manufacturing plant
- Headquarters office
- Research
- Warehouse
- Other _____

NAME _____

TITLE _____

COMPANY _____

ADDRESS _____

CITY _____ STATE _____ ZIP _____



Meetings

(Continued from p. 22)

Joint Engineering Management Conference, IEEE; Drake Hotel, Chicago, Oct. 29-30.

Environmental Engineering, George Washington University; Washington, D.C., Nov. 2-4.

Northeast Electronics Research and Engineering Meeting (NEREM), IEEE; Sheraton Boston Hotel and War Memorial Auditorium, Nov 4-6.

Nuclear Science Symposium, IEEE; Statler Hilton Hotel, New York, Nov. 4-6.

Fall Joint Computer Conference, IEEE; Astro Hall, Houston, Nov. 17-19.

Short courses

Computer Graphics in Electronics Design, University of California at Los Angeles; Boelter Hall, Room 2444, Oct. 29-31; \$245 fee.

Computer-Aided Circuit Optimization, University of California at Los Angeles; Boelter Hall, Room 4442, Nov. 2-6; \$310 fee.

Holm Seminar on Electric Contact Phenomena, Illinois Institute of Technology and IIT-Research Institute; Sherman House, Chicago, Nov. 9-12; \$125 fee.

Call for papers

International Federation for Information Processing Congress, Ljubljana, Yugoslavia, Aug. 23-28, 1971.

Nov. 30 is deadline for submission of papers to academician V.M. Glushkov, chairman, IFIP Congress 71 Program Committee, Institute of Cybernetics, Ukrainian Academy of Sciences, Kiev-28, U.S.R.; or professor C.C. Gotlieb, Vice-Chairman, IFIP Congress 71 Program Committee, Institute of Computer Science, University of Toronto, Toronto, Ontario, Canada; or Professor H. Zemanek, vice-chairman, IFIP Congress 71 Program Committee, IBM Laboratory, Vienna, Parkring 10, A-1010 Wien, 1, Austria.

National Telemetry Conference and Exposition, IEEE; Washington Hilton Hotel, April 12-15, 1971. **Dec. 14 is deadline for submission of abstracts to Henry B. Riblet, NTC '71 Technical Program chairman, The Johns Hopkins University, Applied Physics Laboratory, 8621 Georgia Ave., Silver Spring, Md., 20910.**

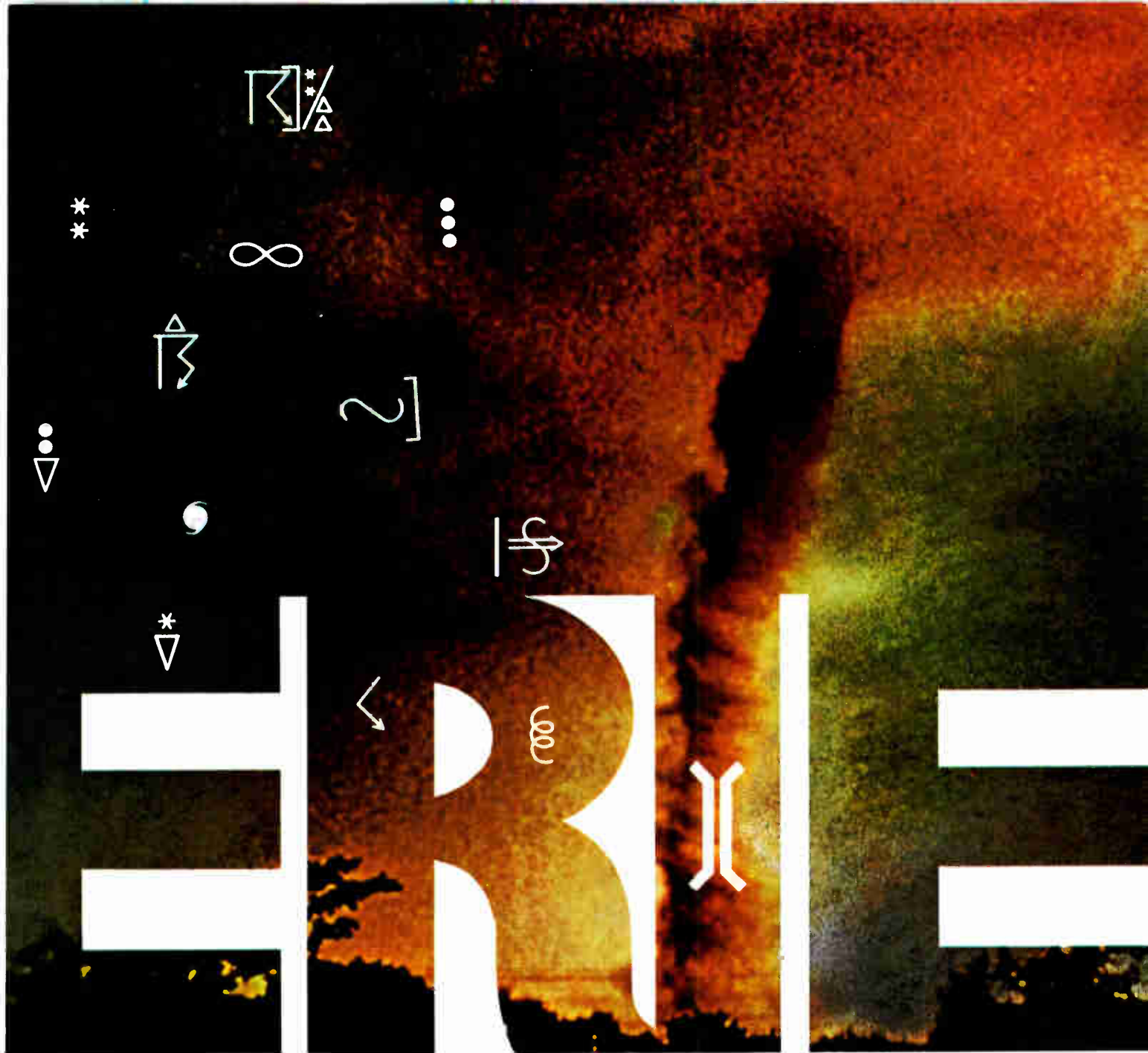

When you're adding a new "twist" to tornado tracking...

Symbolic representation of global weather as plotted by Burroughs ILLIAC IV computer.

bring ERIE in early.

Cyclone off Ceylon. 17-inch snow at Salem. Tropical storm in Trinidad. World-wide weather reports? No, forecasts! Made four days in advance... with the same accuracy as present one-day predictions. That's just one of the superscale jobs possible with the incredible new ILLIAC IV computer designed by the University of Illinois and built by Burroughs Corporation. Unlike conventional computers that process serially, ILLIAC IV utilizes parallel processing... crunching numbers on many matrix problems or differential equations simultaneously, and at super speeds. From the start, ERIE engineers have worked closely with Burroughs to develop the highly-sophisticated resistor/capacitor and resistor modules at the heart of ILLIAC IV. Proof, once again, that it pays to bring ERIE in early.

ERIE TECHNOLOGICAL PRODUCTS, INC.
644 West 12th Street, Erie, Pennsylvania 15512
(814) 453-5611

Circle 25 on reader service card

Worldwide capability

internal connectors

input/output connectors

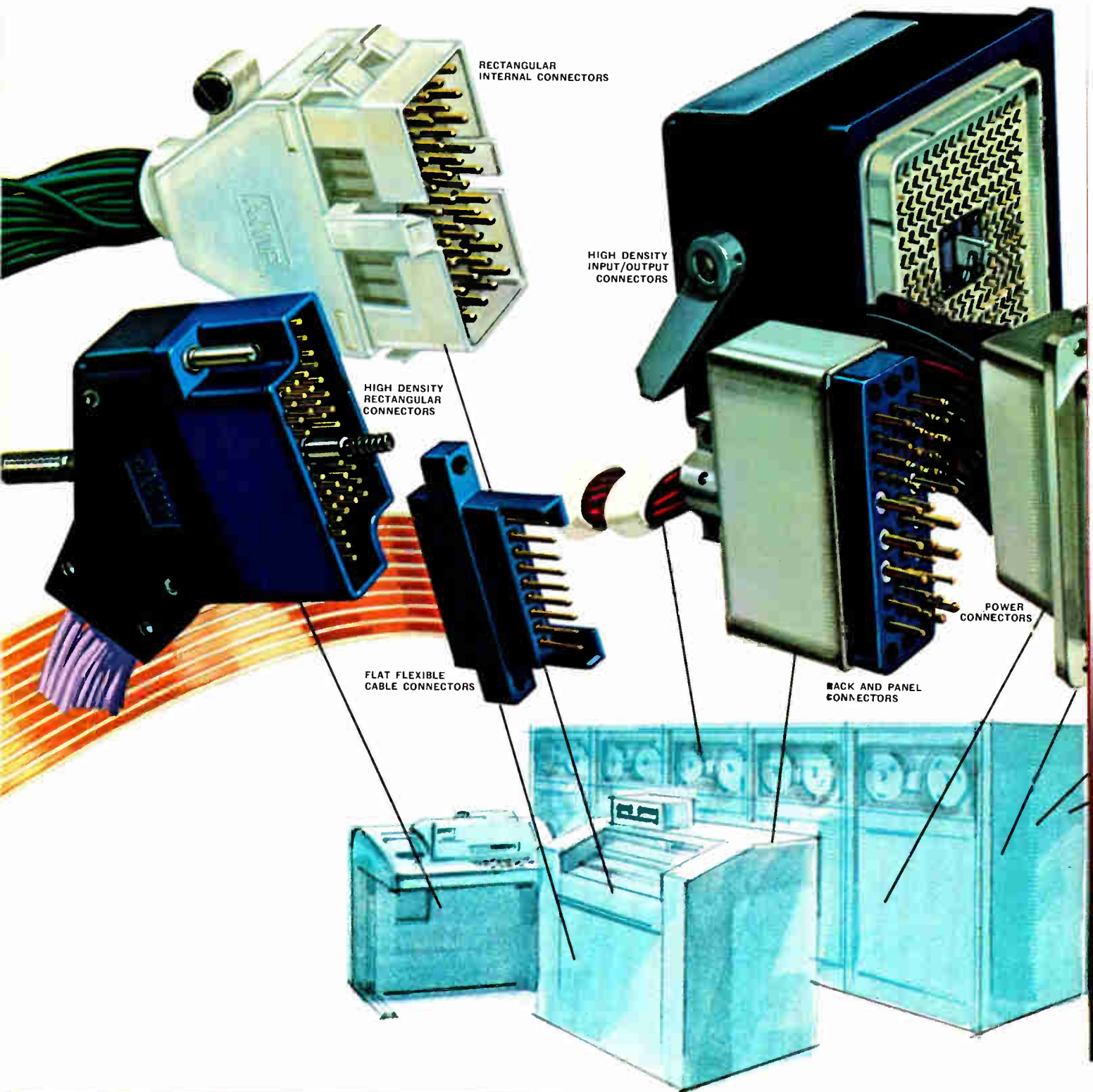

for computers in:

interconnection systems

wired panels

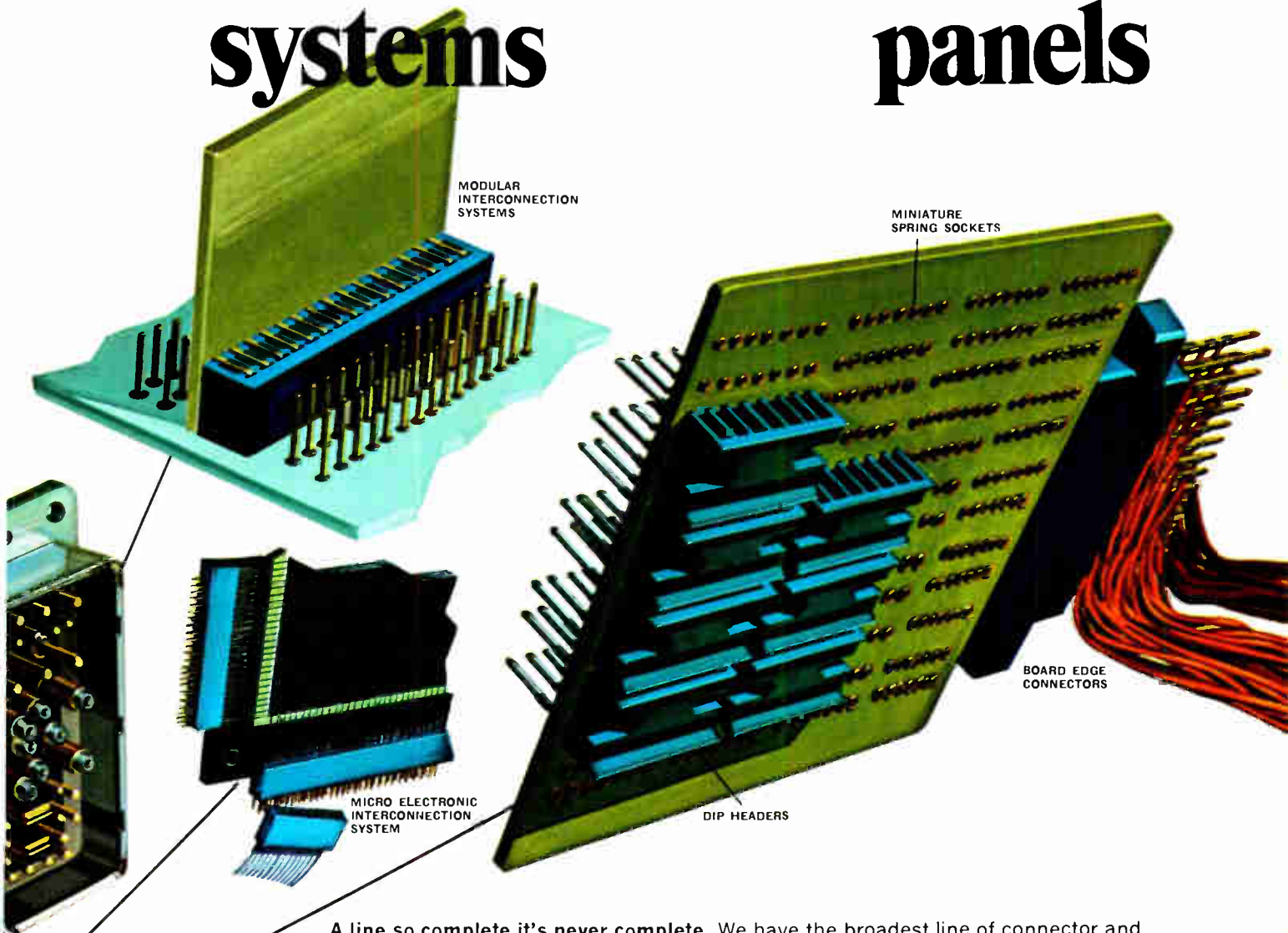

A line so complete it's never complete. We have the broadest line of connector and interconnection techniques for computers and peripheral equipment in the world. And we can design new ones to fit your ever changing needs.

No matter where you are. We're worldwide. In manufacturing, engineering and direct sales representation. And the quality of our products and services never varies.

Some say we're experts. And we think our connectors live up to it. Board-to-board, point-to-point, racked, stacked, panelled or hanging free our connectors are among the most reliable in the world.

How can we do all this and save you money, too? A-MP★ automatic application tooling for use right in your own plant . . . engineered specifically for the A-MP product. This application tooling enables you to realize the lowest total installed cost.

Want more? Write today for complete catalog data on our connector and interconnection products for computers.

INDUSTRIAL PRODUCTS DIVISION, AMP INCORPORATED, HARRISBURG, PA. 17105.

★ Trademark of AMP Incorporated

AMP

INCORPORATED

Circle 29 on reader service card

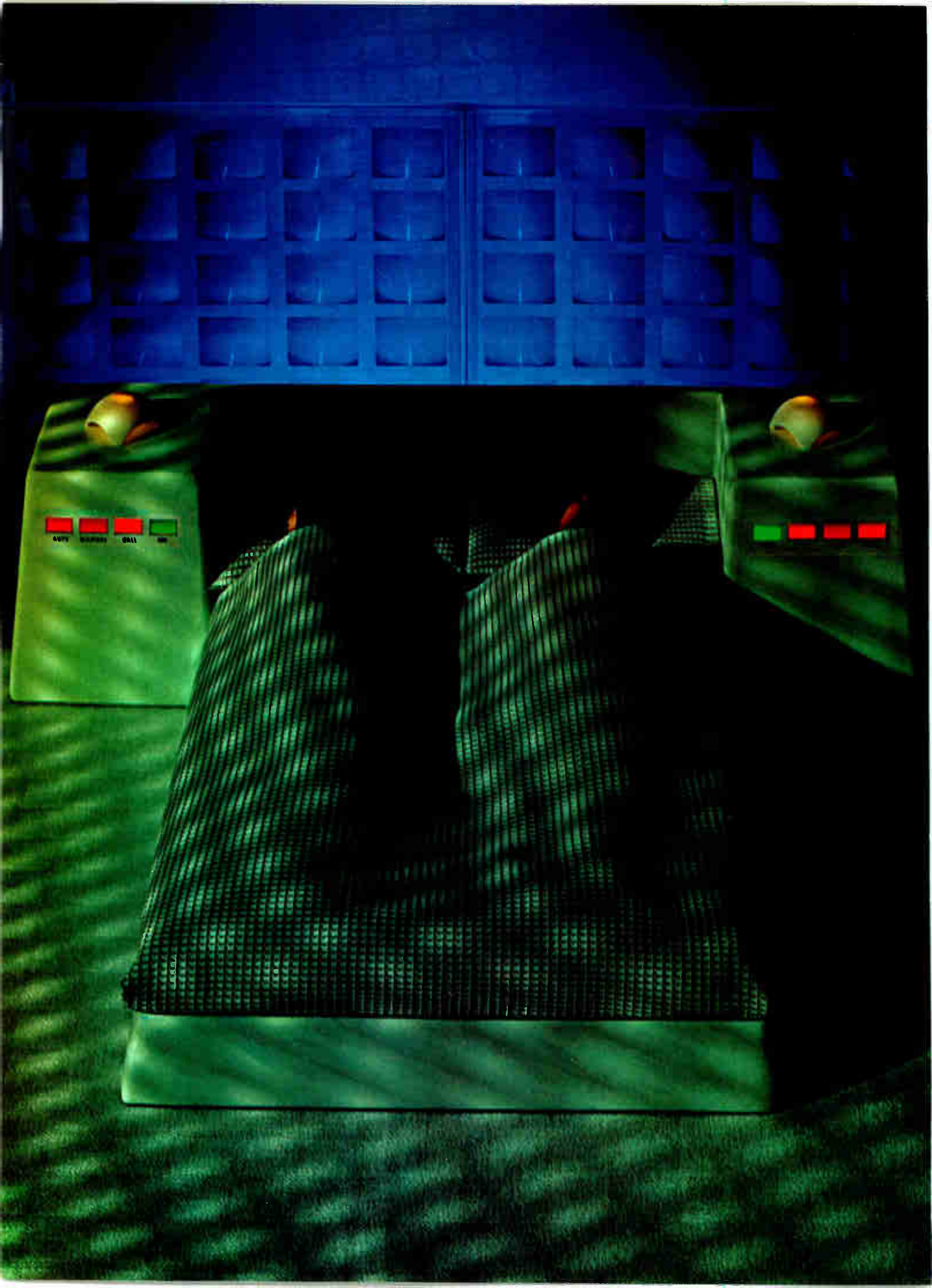

OFF ON CALL

ON OFF

By 1979, your bed will take you to your doctor.

Electronics will be giving your doctor a lot of new tools in the decade ahead. Your bed, for example, may save you from weekly visits to his office.

Part of a remote monitoring system, the bed would contain instruments to keep a regular check on patients with chronic conditions. Cardiac patients, for example, would periodically have the ECG data tapes transmitted to hospital diagnostic centers. These centers, in turn, would process and transmit the data to a terminal right in the doctor's office.

And along with helping patients lead normal lives outside the hospital, these medical-electronic devices will be assisting doctors and nurses inside the hospital; taking care of routine follow-up work such as verifying that prescribed medication has been administered.

The fact is, products of electronics technology will be doing more for our lives tomorrow than electricity does for us today.

Our daily newspapers will be automatically printed in our living rooms. Home computers will cook the food and wash the clothes. Automated highways will do the driving.

Who are the master minds masterminding these changes?

Our readers.

The men who are helping to advance medical care through electronic innovations. (Interested in this fascinating field? We'll be glad to send you a reprint on our Medical Electronics series.)

Every two weeks, Electronics presents its readers with a complete up-to-the-minute picture of the state of technology. Plus all the fast-changing developments in their particular fields of interest. Industry-wide and world-wide.

Readers and advertisers use Electronics for the same reason. It helps keep their business lives healthy.

Electronics, a McGraw-Hill market directed publication.

Our readers are changing the world.

A McGraw-Hill Publication

Electronics

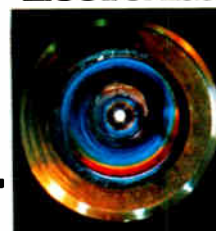

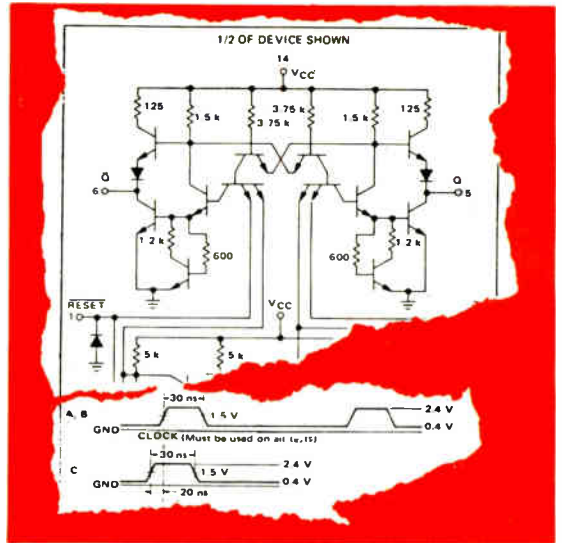
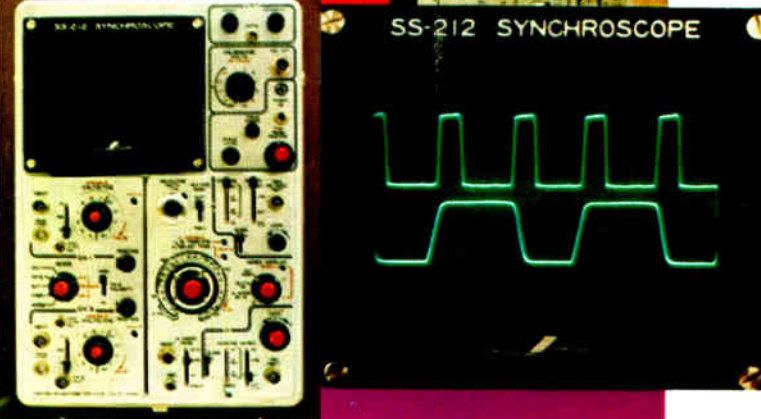

E-H the logical solution

The E-H Research Laboratories, Inc., America's leading designer and manufacturer of pulse generators and other measurement instruments, has teamed up with the Iwatsu Electric Company, Ltd., Japan's foremost manufacturer of oscilloscopes. Together they make an ideal team to solve any of your logic problems.

For example, the **E-H 137 pulser** is an ideal stimulus source offering a source impedance of 50 ohms, fast, ultra-clean, adjustable leading and trailing edge ramps, all the output levels you need for TTL and ECL logic and 100 MHz pulse repetition frequency.

Team this up with the **Iwatsu 212 oscilloscope** and you've got a team that'll perform to your utmost satisfaction for years to come. The Iwatsu 212 is the ideal wide-band scope featuring bandwidth in excess of 200 MHz, with sweep speeds and writing rate to match. One $M\Omega$ input impedance matches directly with the impedance level of circuitry under test. This is the only 200 MHz bandwidth oscilloscope featuring 1ns/cm and delayed sweep in one instrument. Big, bright 6x10 cm display is another feature.

These are only two instruments from a broad line of E-H and Iwatsu instrumentation exclusively available from E-H. So whatever your logic problems are, contact an E-H representative today for the most logical solution.

E-H **E-H RESEARCH LABORATORIES, INC.**

515 Eleventh Street • Box 1289, Oakland, California 94604 • Phone: (415) 834-3030 • TWX 910-366-7258
 In Europe: E-H Research Laboratories (Ned) N.V., Box 1018, Eindhoven, The Netherlands, Telex 51116
 In Japan: Iwatsu Electric Company, Ltd., 7-41, 1-Chome Kugayama Suginami-Ku, Tokyo 167, Japan

Electronics Newsletter

September 28, 1970

Aerojet-General to sell thin film active devices

Aerojet-General, in a radical change in policy, is going to market thin-film ICs. The first device, a three-input NOR gate, is being offered now for evaluation. The firm says it could sell for 25 cents a gate in quantity. The decision may have been triggered by the belief of engineers at the firm's Azusa, Calif., Electronics division that they've gotten around the common problem of thin-film active devices: gate dielectrics that become relatively unstable.

They've developed circuits using cadmium selenide or tellurium semiconductor materials. The circuits use insulated-gate field effect transistors with an aluminum oxide dielectric. Previous efforts at thin film ICs have used the same dielectric, but Aerojet engineers feel they're unique in using electron-beam evaporation of the material in one pump-down of a vacuum system rather than depositing aluminum metal, anodizing it with a plasma, and then etching away unwanted dielectric. The latter method doesn't lend itself to one-step batch fabrication.

Fairchild making pocket calculator

Fairchild may have killed its minicomputer development program, but it's going full steam ahead with a calculator. The Microwave and Optoelectronics division has developed a 1.5-pound pocket calculator slated for introduction in January—shortly after the group moves into its new building. The device, with a nine-digit solid state readout, will be more like a computer than a calculator—it will perform trig functions and have a memory.

As for the decision to drop the mini, a highly placed spokesman for the company says this does not mean Fairchild's policy of "forward integration" has been shelved. Implementation of the policy, aimed at getting Fairchild into the manufacture of subsystems that use its semiconductors, has been shelved "until things pick up," he says.

Second sources look to cut die sizes

A new trend is surfacing in the integrated circuit business: redesign of a prime source's product line by second source manufacturers to cut die sizes. And prime sources—the original circuit designers—are taking a hard look at their existing lines to see how to cut real-estate consumption.

The Integrated Circuit Engineering Corp. in Phoenix, Ariz., reports that it's getting a lot of the overflow redesign efforts the IC manufacturer would rather not do himself. In three cases in the last six months, such redesigns were ordered. For example, a medium-sized semiconductor house asked for redesign of a series 7400 TTL line of medium-scale ICs it supplies as a second source. And another customer wanted to become a second source for Sylvania's SUHL TTL line and asked Integrated Circuit Engineering to redesign for layout efficiency.

Penney seeks credit-check system

Giant retailer J.C. Penney, after terminating its costly Tradar contract with General Electric, is going to request bids from more than 40 companies for a relatively austere credit-authorization system. Tradar was a complete on-line, real-time, point-of-sale transaction system.

The bids, due Sept. 30, are for a hypothetical four-store, 80-cash-register layout. Penney wants to check credit on every charge transaction

Electronics Newsletter

from a negative account file at an in-store or central location. Later, the system could be expanded to use a positive credit-checking file, which would set limits on the amounts of credit.

The GE Tradar system, first tested in one of Penney's stores in 1967, apparently was canceled not for technical reasons, but because Penney changed its mind after a backer of the system shifted to another job. Comments one competitor: "Tradar would have worked, but it was expensive and was based on a pair of obsolete GE 415 computers."

Interface opens way to calculator control

A digital interface that lets users substitute programable calculators like the Wang 700 or Hewlett-Packard 9100 for computers may offer the least costly route yet to digital process control, data acquisition, and similar applications. Month-old IDEA Inc. of Riverdale, Md., offers a single-channel interface at \$2,000; it's expandable to seven channels at \$900 per channel.

The interface includes microprogram boards to instruct the calculators in manipulating incoming data, making possible not just calculation and data logging, but closed-loop process control, too—a province formerly reserved for costly full-blown computers. System price, including a calculator and printer, would be \$8,000 to \$9,000 for one channel.

New firm offers 1,536-bit ROM

What may be the largest bipolar read-only memory available, 1,536 bits, is the first product of a new firm, Kenics Electronics of Largo, Fla. Size of the transistor-transistor-logic device formerly was available only in MOS. Designated the B-100, the 64-word-by-24-bit memory is expected to be used as a high-accuracy lookup table, microprogram store, or tape reader replacement. Access time is about 200 nanoseconds; each of the ROM's 24 outputs can sink 5 milliamperes at 0.5 volt. Low-level address characteristics also match TTL at 0.3 mA.

Kenics, formerly a process-control house, moved into the IC business by acquiring the equipment, and about half the staff, of a Honeywell facility that was moved to Minneapolis.

GE consolidates time-share offices

After spinning off its computer manufacturing operation, GE has now turned its attention to cutting costs at its Information Service division by closing down that division's 17 autonomous time-sharing centers and consolidating them into three major units at Cleveland, Los Angeles, and Teaneck, N.J. GE is hoping to cash in on the savings that come from using large-scale GE-600 machines instead of the smaller GE-200s used in the regional centers, even though a nationwide grid of lines will have to be leased to link regional customers with the consolidated centers.

Addenda

Sylvania officials still are evaluating the market potential of their Soniscan magnetoacoustic bulk memory system [*Electronics*, Aug. 31, p. 33]. Most recently, the company has been sounding out possible joint venture partners. . . . ICV Inc. of New York has working models of a credit-verification system that stores information on a hologram built into the card. The card is blank with the hologram—a tiny circle of transparent material containing a signature specimen and other personal information for identification—in one corner. The card is read by laser projection.



DUAL FETS for DIFF AMPS from Siliconix

Does your diff amp design call for low noise, low distortion, high input Z and wide dynamic range? (1.) Try this long tailed pair arrangement, (2.) use a Siliconix dual and (3.) get the performance below:

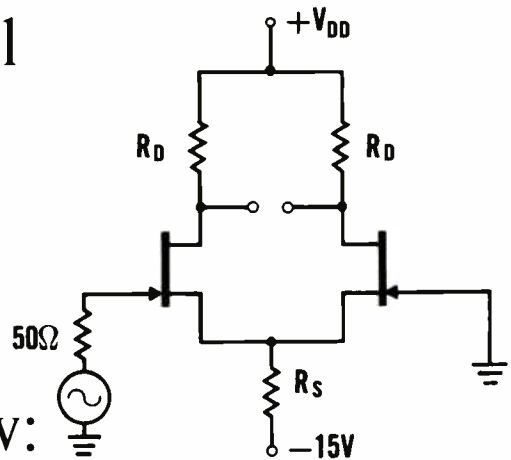

DEVICE TYPE	+V _{DD} (V)	R _D (KΩ)	R _S (KΩ)	VOLTAGE GAIN (dB)	BANDWIDTH 3 dB (MHz)	DIFF V _O (Vp-p)	
						1% THD	2% THD
2N5519	30	60	39	26	0.25	10	13
U235	30	39	20	30	0.6	10	16
U257	20	5.6	3.6	25	6.0	4.5	5.5

Other applications include □ Phase splitters □ Push-pull drivers □ Unbalanced-to-balanced transformation □ Etc. For complete data and applications assistance, write or call any of the offices below.

New York: Sy Levine (516) 796-4680
 New England: Al La Croix (617) 769-3780
 Ft. Worth/Dallas: Charlie Williams (214) 231-8151
 St. Louis: Jim Spicer (314) 291-3616
 Minneapolis: Ed Koelfgen (612) 920-4483
 Southern California: Dave Ferran (213) 420-1307
 Northern California: Chuck Brush (408) 246-8000



Siliconix incorporated

2201 Laurelwood Road • Santa Clara • California 95054
 Telephone (408) 246-8000 Extension 201 • TWX: 910-338-0227
 In Europe: Siliconix Limited, Saunders Way, Sketty, Swansea, Great Britain

CENTIGRID*

The Low Profile .100 Grid Relay

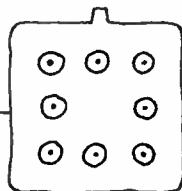

Packaging and Production Engineers please note:

CENTIGRID* Series 112 Relay's 8 leads, spaced on 0.100 centers — all on the periphery of the header — permit direct plug-in convenience on all PC boards. This relay won't be the highest component on the board. It's only .225 high, thereby minimizing board spacing. It's only .370 per side.

Design and Circuit Engineers please note: The CENTIGRID* has the same performance as our TO-5 relays. Coil voltages, in 6 choices, range from 5 to 26.5 VDC.

Using CENTIGRID* Series 112 relays permits compliance to Mil Std. 275B and Mil-P-55110A circuit board specifications without complicated lead spreading.

Space-wise Engineers please note: Ease of installation and inspection makes CENTIGRID* the perfect answer to any packaging density problem.

We're not complacent. We're relay innovators.

- First with the TO-5 Relay.
- First with an internal coil diode.
- First with an internal transistor driver.
- First with an internal op-amp.

And now: CENTIGRID* . . . another big breakthrough from the "little relay people." All the problem-solving low-down is yours for the asking. Simply write or call:



*TM App



TELEDYNE RELAYS

3155 West El Segundo Boulevard, Hawthorne, California 90250 • Telephone (213) 679-2205

Modular assembly turns out hordes of transistors

Fairchild's concept utilizes originally designed die bonders, wire bonders, and molding machines

When Reed Neddermeyer, marketing manager for discrete devices at Fairchild Semiconductor, said, "Fairchild has enough capacity now to supply the world with transistors," [*Electronics*, Aug. 17 p. 75] he was talking about the company's world-wide capability. But now that Fairchild's automated plastic TO-92 transistor line is up and running, it could probably supply the world's needs from one room at the division's Mountain View, Calif., facility.

The line is built around a modular concept where the modules consist of die bonders, wire bonders, and molding machines. Presently, there are five die bonders (each of which feeds five wire bonders), four molding machines, and one computer-controlled tester. All the equipment was either designed by Fairchild and manufactured by an outside vendor, or designed and built by Fairchild divisions—there is no off-the-shelf equipment. In fact, to keep things completely under control, Fairchild bought the Inland Machine Corp., the maker of the molding machine.

Industry watchers have been waiting to see what C. Lester Hogan, Fairchild's president, would do in terms of designing a "better automatic line than Motorola's" since Hogan was the force behind

the Motorola line. And from the looks of it, Fairchild has made improvements in at least two areas. For one, operator decisions have been reduced from about six to three—the operator has to align a die under a spot of light for die bonding, and align the base and emitter pads under spots for wire bonding.

The package was also improved. Instead of mounting the die directly on the collector lead (as Texas Instruments does) or on a pad that is an extension of the collector lead (as Motorola does), Fairchild bends the collector pad

Cutoff. Fairchild puts right-angle bend in collector lead of encapsulated transistors to keep moisture from chip. Up-bonded base, emitter wires also resist moisture.

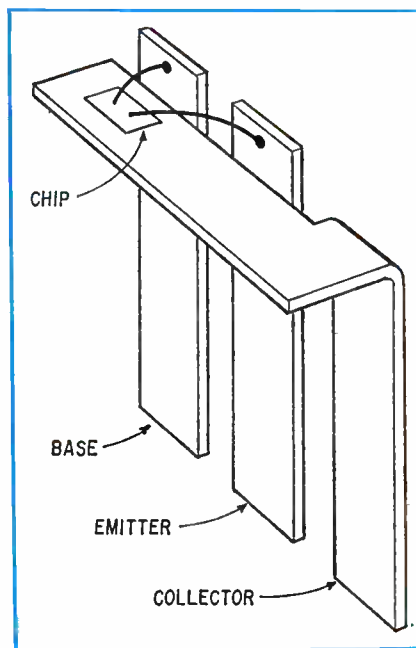

perpendicular to the leads and bonds the chip on the top of the pad. A Fairchild spokesman says that having the collector pad perpendicular to the plane of the base and emitter leads and positioned below the top of the base and emitter posts permits "up-bonding" and lengthens the moisture path.

Upbonding, says Fairchild, eliminates any tendency for the lead wire to short to either the die surface or the collector pad. Secondly, the chance of moisture reaching the chip is reduced. The normal moisture penetration path in a plastic transistor is along the leads. But with the collector pad perpendicular to the plane of the leads, the combined distance (moisture path) from the outside of the package to the die is longer than with either of the other two construction techniques. And moisture doesn't like to go around corners.

Since there are four machines and the frames hold 100 devices, 24,000 devices are churned out each hour. (Plans are to increase the frame size to 200 units each in the near future.) The tester can turn out about 20,000 devices per hour.

Industrial electronics

NCR apt to sharpen point-of-sale battle

National Cash Register's introduction of a point-of-sale information system could spur usually conservative department stores—wary af-

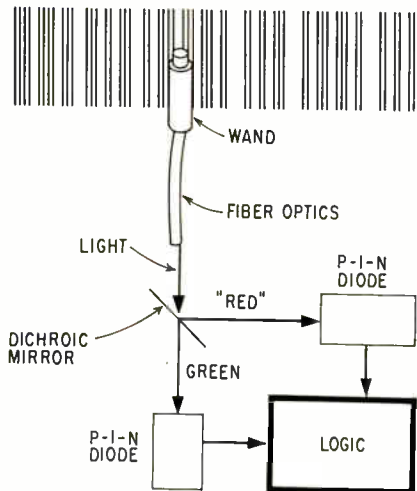

Tricolor. Wand reads black, green white strip. Transition from white to green to black to white yields logical 0; opposite transition a 1. Transitions are carried to terminal via fiberoptic light pipes, dichroic mirror that transmits short wavelengths, reflects long ones.

ter a decade of dissatisfied shopping around—to buy the new generation of electronic cash registers. But the giant NCR, with its vast sales organization, is by no means alone. Retailers will be wooed by a host of other companies scrambling for a share of the annual register market, now estimated at considerably over half a billion dollars.

Other firms selling such equipment include Pitney-Bowes-Alpex, the Singer Co.'s Friden division, Olivetti Corp. of America, Litton's Sweda division, as well as Ricca Data Systems, American Regitel Corp., and American Totalisator, a General Instrument division.

Pass. Salesgirl moves wand over color-coded strip to collect data.



NCR's computer-based system automatically flags sales and merchandising data needed to keep track of inventory. The system reads price tags, credit cards, and identification documents via a hand-held wand, verifying credit, calculating the entire sale, and computing any applicable taxes or discounts. Transaction details are stored on magnetic tape for subsequent computer processing. It's also possible to operate the NCR 280 terminal on a stand-alone basis if the central data collector goes down.

At present NCR is the only manufacturer to use an optically encoded system to read data from price tags; others use magnetically encoded sales tickets. Montgomery Ward has been working with NCR in field tests in its Lima, Ohio, store.

Basic price of the system is about \$25,000, for which the user receives a 280 terminal, the wand, the 723 magnetic tape data-collection unit, and the 747 tag printer. Delivery time is expected to be around nine months.

Communications

OTP's charter erodes FCC's primacy

The Office of Telecommunications Policy has been reorganized. President Nixon has put it at least on an equal footing with the Federal Communications Commission, and has made sure the White House will have a hand in future communications decisions.

He has given OTP new responsibility in areas of communications traditionally within the realm of the FCC—the private frequency spectrum and computer-communications interfaces. OTP has been directed to conduct studies and analyses on “the impact of the convergence of computer and communications technologies,” that will lead to recommendations for action, indications that the long-awaited FCC decision on its computer com-

munications inquiry could be held up until the commission gets OTP input. Nixon has ordered OTP to make sure that Executive branch views get to the FCC.

OTP also has been told to develop “a comprehensive, long-range plan for improved management of all electromagnetic spectrum resources.” Though the White House order notes that the plan will be developed “in cooperation with” the FCC, OTP will be stepping into an area of private spectrum management which has been specifically the province of the Federal Communications Commission.

Consumer electronics

Color TV recorder takes forward step back to film

Color movie reprints for television distribution often lack the intensity of the original, presenting the viewer with faded heroes riding across faded scenery into faded purple sunsets. Now CBS Laboratories has developed a simple means of copying TV signals on film with a laser beam color film recorder to be introduced at next week's Society of Motion Picture and Television Engineers Conference.

Codeveloper Leo Beiser, staff physicist, declares that the new system has “quality so spectacular that there will be no question as to its acceptance by the television networks.” the recorder features an unspectacular arrangement of gas lasers and optics. However, the color combiner and beam deflector are the keys to quality color reproduction.

Prototypes due in about six months will accept any NTSC signal from video tape or directly from a camera and make either 16-millimeter or 35-mm film. The recorder's beam deflector scans a single laser light beam for red, green, and blue after the color combiner reconstructs the three lines coming from red, green, and blue intensity mod-

ulators. Three gas lasers provide the light source.

The result, says Beiser, is perfect registration from one beam rather than the superimposition of three separate color beams via three independent cathode ray tubes.

The system presently in use, the Trinescope process, requires three CRT's, each assigned a color. A beam from the TV signal is split by mirrors to the CRTs which then combine the image optically on film. It's this last stage that causes the registration problem common on color TV movies.

The new CBS approach can also be applied to laser display on large TV screens, but power limitations on the gas types make this possibility uneconomical now. The target for the recorder, on the other hand, will be TV networks here and abroad. The unit records at the standard rate of 24 frames per second, and sound can be tacked on by any means the user chooses, such as magnetic recording track.

"High-quality color was the challenge," Beiser points out. "There has been no good direct color film system available, although the possibility of using lasers has been clear since we started work on the recorder over four years ago."

Memories

Navy airborne processor turns to Ampex thin film

Military airborne computer users are a demanding lot. Not only do they want memories that are incredibly dense, fast, and rugged, but they also want them low in power consumption. Of all the military users, none is more demanding than the Navy's Advanced Airborne Digital Computer program team, which is also asking for prices less than a penny a bit for the mainframe store [*Electronics*, Aug. 3, p. 89].

Industry, however, is standing up to the AADC challenge. The Navy team says a thin-film memory

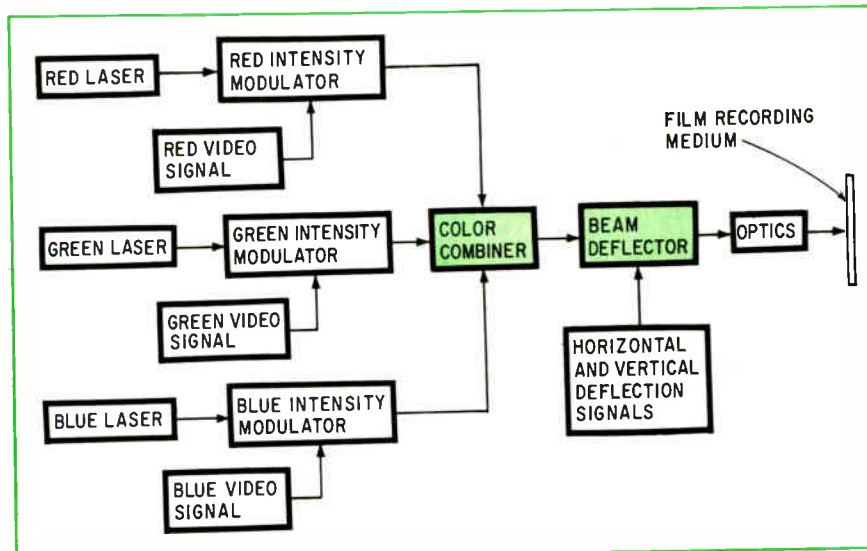

TV premiere. CBS Labs' new laser color film recorder will debut for TV featuring color combiner and beam deflector to make perfect registration.

under development by Ampex Corp. seems to meet both the main-frame and task memory needs of the modular computer, designed to fly on all Navy planes in the 1975 to 1985 time frame.

Called the closed flux memory, the nondestructive readout device is produced by electroplating a layer of copper between two layers of permalloy on an aluminum and epoxy substrate. A photoresist then is applied, and five-mil-wide bit storage lines are formed by etching away parts of the structure, creating a sense-digit line sandwiched between permalloy layers. Another plating step deposits word lines that run perpendicular to the bit storage lines along their easy axes. Finally, a metallic film is plated over the structure; this prevents creep by closing the magnetic flux of the lines.

The memory, akin to plated-wire types in operation, has a read-only time of 100 nanoseconds. Read-write cycle time is 150 ns. While only experimental arrays have been produced, Ampex projects that it can build the memory for half a cent a bit, with 75% to 80% of that figure to go for the unit's electronics, Ampex says.

Because the magnetic flux is contained, the only limitation on density is the resolution of optical masking techniques, which means

that the bit lines could be formed on one-mil centers. However, until smaller integrated circuit and better interconnect techniques are developed, Ampex plans to hold back on the densities. Thus, the 8,192-bit stacks Ampex hopes to build for the Navy will contain 44,000 bits per cubic inch, denser by far than any other memory under consideration for the AADC, but far short of the technology's potential.

An important feature of the arrays is that their 350-milliamper and 20 mA write and drive currents make them directly compatible with integrated circuits. Thus it's possible to build small-task memories that will fit inside a package, says AADC program manager Ronald Entner. Power requirements for the 8k-by-16-bit memory the Navy is looking at are 0.5 watt for the memory array and 19 W for the array plus its TTL electronics.

Radar

Computerized display aimed at ending ship collisions

If collision avoidance systems for ships become a new electronics market, as the Iotron Corp. hopes, then the Bedford, Mass., firm has just gotten a head start with its

new computer and display system.

Such gear is long overdue for ships, says James S. Coolbaugh, Iotron's director of marketing. Statistics compiled since the 1940s by the U.S. Merchant Marine Council and other groups show that about one in three deck officers misinterprets a radar's plan position indicator display (PPI) unless they can confirm their judgment visually—and of course, radar is supposed to help most in fog or darkness.

During maneuvers, radar may even be a hazard, for more than two out of three deck officers draw wrong conclusions from the PPI while accelerating, slowing, or turning. Instead of cutting the number of collisions, therefore, radar is generally admitted to have added a new variety—the “radar-aided collision.”

Iotron's Digiplot console contains two computers and a Monsanto light pen aided display system, the MAN-1. One computer takes digitized data from the onboard radar system's video section, and stores them in dual 100-bit Texas Instruments MOS shift registers. It's capable of retaining range and bearing data on up to 100 targets at a time, along with the amplitude of the radar return. A proprietary circuit discriminates against sea clutter on the basis of target area, its size relative to its range, and whether it appears repeatedly, sweep after radar sweep.

Once this processor has the target data down pat, it hands the computing job to a slightly modified Lockheed MAC-16 computer, which calculates the speed and course of each target. The MAC-16 also runs the display system, showing land masses as dotted outlines and ships as dots with lines stretching away from them to indicate their intended speed and/or course.

“The beauty of the Digiplot is the understandability of the display,” says Coolbaugh. Flipping a switch to the “relative plot” position shows any ships that may be approaching in the form of vector lines pointing to the center of the screen—the operator's ship. If the user wants to work with a so-called

true plot, the 16-inch CRT shows a course and speed vector for his own ship, radiating from the center of the screen, as well as course and speed vectors for other ships. (The normal PPI scope display area just shows dots, does no course and speed computing, and thus requires extra effort to interpret.)

To figure his way out of a possible collision situation, the skipper can punch the “future position” switch, setting it for, say, five or six minutes in the future. This allows the conning officer to spot collisions many minutes ahead of time just by watching for meeting vector lines on the screen. If a collision looks imminent, the conning officer can try out course and speed changes on the MAC-16, see the result on the CRT, and make sure his decision is the right one before giving his orders to the helmsman.

Iotron plans to offer the system for \$30,000, and hopes to find many takers. “With a jumbo tanker expected to run at \$60 million to \$80 million in the near future, \$30,000 is cheap insurance,” says Coolbaugh. And considering the oil spill any collision involving a jumbo tanker makes, and the losses, penalties, and ecological damage that could result, Coolbaugh expects to see the Digiplot a widely used ounce of prevention.

Companies

RCA looks for place in the IC sun

When William C. Hittinger moved from the General Instrument Corp. to head RCA's newly formed Solid State division [*Electronics*, April 13, p. 46], industry insiders wondered if his charter was to make the new division a name to be reckoned with in the integrated circuit business. Now, with six months under his belt, Hittinger has something of an answer: yes and no.

“Sure we have ambitions for a major place in the sun along with

the Fairchild, Texas Instruments, and Motorolas, but not across the board; we'll be sticking with metal-oxide semiconductor, emitter-coupled logic, linear and hybrid ICs, but we'll leave the saturated bipolar market to the others,” Hittinger (pronounced with a hard “g”) says.

The point is, explains the new vice president and division general manager, that for RCA to get into transistor-transistor logic and the rest, it would have to buy its way in with loss leaders, “something we're not about to do.”

Naturally, RCA will continue to emphasize its traditionally strong lines in the semiconductor business—the discrete, especially power, devices. But that's not all. Along with its standard line of MOS products, the division practically pioneered what was once considered a fascinating but limited offshoot of the MOS process—complementary MOS. Now, says Hittinger, C/MOS is a potentially large business that is starting to take off. Furthermore, the division has a group in residence at RCA's labs in Princeton, N.J., working on applying silicon-on-sapphire fabrication techniques to the MOS and C/MOS process.

This concept of a “group in residence” is an innovation with Hittinger, one he feels is particularly vital to the division's future growth. “If we've fallen down in the past, it's because we weren't translating technological knowhow into marketable products. Part of my assignment here is to get a kind of intradivisional interaction going with all parts of RCA.” Currently, a group of circuit engineers from Indianapolis (RCA's television manufacturing arm) is in residence at Somerville, N.J., working on linear ICs for TV sets, while yet another group from Somerville is at the company's Defense Electronics Products division in Moorestown, N.J., developing products for the defense group. The idea, as Hittinger sees it, is for one group of engineers to virtually live at another division with the ultimate

intention of "coming back with a bag full of usable technology."

Another tack being taken by the Hittinger regime toward getting more IC products into the commercial marketplace is to develop, say, a line of linears for RCA TV sets, and then expand the line commercially for customers outside the RCA family.

The solid state division hopes to apply this method to other areas as well. A line of ECL circuits now being developed by solid state for the company's computer operation



Hittinger: "Bringing back a bag of usable technology."

will initially be sold to the Cherry Hill, N.J., facility. Eventually, however, solid state will broaden the line for full-blown commercial exploitation.

Finally, there's the division's line of hybrid power modules, or integrated power systems, as Hittinger calls them. These units will have applications ranging from power outputs for computers, at one end of the spectrum, to handheld power drills for home and industry at the other.

Computers

Federal Reserve net speeds check clearing

Like millions of other consumers, the engineer who pays his rent with a check on the 25th of the month using funds he will not deposit until he gets paid on the first is in for a rude awakening. The Federal Reserve System, whose 12 regional banks serve as a clearinghouse for transfer of funds between member banks, is dramatically upgrading its communications network to eliminate the time lag between checkwriting and final payment.

That time lag, which bankers view as equivalent to a short-term "loan" to their customers, generates a daily volume of millions of dollars in uncollected funds which bankers term "the float." Bankers, naturally, want to eliminate the float. Now they believe they are closer to that goal with the Fed's new network as the start of an all-electronic system for real-time transfer of funds.

The first step taken in upgrading the network is the installation of a Control Data Corp. M-1000 quad store and forward switch at Culpeper, Va., which has already taken over the switching of the Fed's teletypewriter network. By eliminating the 1-to-2-hour queues of the old Western Electric 81-D torn-tape switch, the four M-1000s have already made it possible to guarantee that wire transfers, the primary use of the Fed's teletypewriter network, are received the same day they are sent.

Because of the limited bandwidth of the Fed's telegraph circuits, only large checks are presently cleared by wire; the rest are transferred by ground transportation. But wire transfer traffic is expected to increase by an order of magnitude after the Fed links all of its banks with 2,400-band circuits that will be switched on the Culpeper system by the end of the year.

Bruce Smyth, the chairman of

the Fed subcommittee that runs the network, says the leased circuits will be used to carry high-speed interbank traffic transmitted and received via IBM magnetic tape terminals. As the data rates go up, he notes, the cost of transferring checks by wire goes down. Therefore, he predicts, the Fed will be using faster data speeds to transfer more of the billions of checks written each year by wire.

Meanwhile, he adds, more Federal Reserve banks are drawing up plans for what they call computer-to-computer communications. The term, which Smyth says is a misnomer, means that each Fed bank will eventually install its own computer-controlled switch to distribute traffic to and from street banks—the large member banks that serve the public.

Once street banks, which are presently linked to the Fed network by torn-tape switches, are on-line with the network, it is only a short step to the direct electronic transfer of funds from one bank's computer to another's.

Government

Nixon seen doubling LEAA budget to \$1 billion . . .

Mounting evidence indicates that the Justice Department's Law Enforcement Assistance Administration fiscal 1972 budget could approach \$1 billion—more than double this year's \$480 million—as part of a Nixon Administration shifting of resources from the Defense Department into domestic programs. Between 40% and 60% of LEAA's budget is expected to end up in the electronics industry, through Federal grants to states for such programs as upgrading police communications, computerizing court systems, and in general applying advanced technology in the criminal justice system.

Congress is on a law and order tear that will last until appropriation time next summer, and it can be expected to bless such an ap-

appropriation request from the White House. Many Congressmen are already pushing for a \$1 billion LEAA budget.

LEAA is embarking on a program of workshops across the country aimed at developing the abilities of the states to spend more money wisely. The agency has brought together systems analysts and criminologists from different state agencies, who, with LEAA help, will learn to develop five-year plans for law enforcement in their states and decide the division of resources between nontechnological systems such as community relations and technological systems and evaluate how different approaches can help combat crime.

LEAA sources say initial findings indicate the states will place the most emphasis on communications and equipment upgrading, personnel training, and rehabilitation.

... as LEAA, NASA talk of ATS fingerprint fax

The Law Enforcement Assistance Administration and NASA are negotiating for the use of Applications Technology Satellite 3 to transmit fingerprints from California to the East Coast. Paul K. Wormeli, coordinator of LEAA's Project Search (system for electronic analysis and retrieval of criminal histories) says the two agencies are at the barebones talking stage, but that the cooperative effort looks promising and could be the first step toward a dedicated police satellite. [*Electronics*, April 27, p. 115].

For the initial experiment, LEAA would use one wideband ATS channel to transmit facsimile fingerprints from Mohave, Calif., to the FBI in Washington or the New York State Identification and Intelligence Service. LEAA and NASA are working out the technical details. A 200-line-per-inch resolution—the same as over telephone lines—would be required. But satellite use, says Wormeli, would cut the transmission time to 2 or 3 seconds from the 14 minutes it now takes

over telephone lines for coast-to-coast facsimile.

Wormeli says he has been trying for months to win LEAA over to the idea of using a satellite for Search communications. The project now covers 15 states and, having just completed a successful two-month demonstration, will be expanded to states with high crime rates, beginning in 1971. Wormeli believes the Justice Department agency will be receptive to the idea if the fingerprint satellite experiment "proves to be a cost-effective solution" to several problems encountered with telephone lines. Among these are the buildup of delays caused by using low-speed (100 bands) telephone lines, low quality of reproduction, and the expense of using national land lines.

A decision on the NASA-LEAA venture will be made by the first of the year, LEAA sources say. If the program goes, and proves successful, the agency will consider putting up a satellite for fingerprints, Search, and other police communications.

Military electronics

Crossbow checks out miss-distance indicator

Firearms made the crossbow obsolete. But now engineers at Motorola's Government Electronics division in Scottsdale, Ariz., have resurrected it as a means of testing a training system that indicates missile velocity and miss distance. The system will obviate the need to fire a live missile in training and destroy a target by telling pilots how close their dummy missiles came to a towed target and what the missile's path was, so that the "kill" probability can be determined by a ground computer.

Though the Air Force will be able to use 105-mm howitzer projectiles to simulate missiles, engineers needed something quieter and less expensive. So to test how well they were measuring the angle

between the missile and the radar's boresight, or straight-ahead "view," they fire aluminum arrows from a tripod-mounted crossbow through the radar beam.

The Motorola division is by now working on the second increment of its contract with Elgin Air Force Base for a feasibility demonstration model. Thomas Koehler, project leader, believes that the phase-comparison monopulse radar system will be the first radar scoring apparatus that gives both miss distance and vector data. Acoustic systems are being developed, but Koehler says they can be hampered by noise at supersonic speeds.

Specifically, Motorola's system will make airborne measurements of the elevation and azimuth angle between the target and the missile. It will also note the time the missile passes certain preset fixed ranges from the target. From this information, which is to be telemetered to the ground, a computer will calculate the miss-distance vector at fuzing time of the missile (telemetered separately from the missile), the miss-distance vector at closest range, and the missile-velocity vector. This last is needed to determine how close the missile would have come to the target.

Included in the equipment will be two antennas (one that looks forward from the target and another that looks aft), the transmitter and receiver, and the ground computer complex. The dual-antenna system is expected to be completed by December. To date, the division has built a single-antenna system to prove that angle measurements can be made with it, and that's where the crossbow came in.

The trajectory of the aluminum arrows is consistent enough for the radar to make accurate angle measurements, Koehler says. "If we can measure the electrical phase shift between two points on an antenna in the receive mode," he explains, "we can measure the angle off boresight of the missile."

This is different from the usual goal with this kind of radar, which

A NEW SPECTRUM ANALYZER SYSTEM

The New Tektronix 1401/323 Spectrum Analyzer System is for people who like to travel light.



The 3½ x 8½ x 13-inch 1401 Spectrum Analyzer Module weighs only eight pounds including an internal rechargeable battery pack.

Add a 323 Sony/Tektronix Oscilloscope for a display indicator: Total weight of both? Less than fifteen pounds!

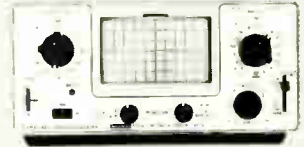

For fifteen pounds, here's some of what you have: A portable, 1-to-500 MHz analyzer with 60-dB dynamic range and up to 500-MHz frequency span—plus a complete DC-to-4 MHz, 10 mV/div, DC powered (AC, too) oscilloscope.

AND FOR PRESENT SCOPE OWNERS: The 1401 Spectrum Analyzer Module is compatible with any oscilloscope with full-screen deflection of 5-volts horizontal (adjustable ±10%) and 1.2-volts vertical.

WEIGHS ONLY 15 LBS.

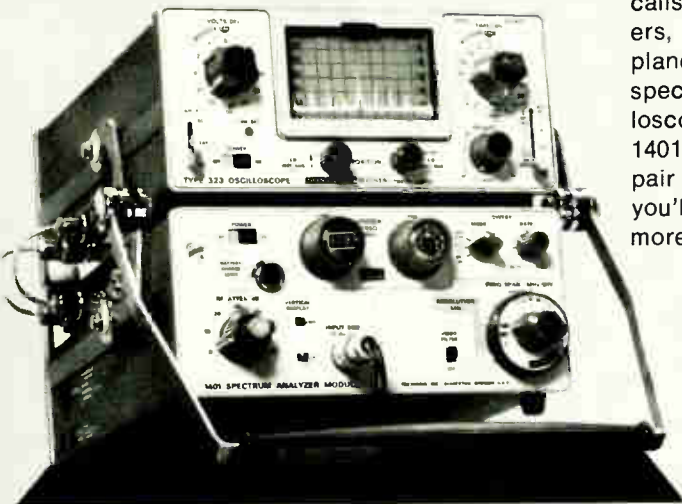

When you make local service calls or field trips, climb towers, are in and out of airplanes and ships, and use spectrum analyzers and oscilloscopes, take along the New 1401 and the 323. With this pair of light-weight performers you'll travel easier and solve more field problems with much less effort.



For additional information contact your local Tektronix Field Engineer or see the 1970 Tektronix catalog supplement.

1401/323P7 Spectrum Analyzer System \$2860
1401 Spectrum Analyzer Module \$1900

U.S. Sales Prices FOB Beaverton, Oregon

Available in U.S. through the Tektronix lease plan



TEKTRONIX®

committed to progress
in waveform measurement

Electronics review

is to get the target into the bore-sight area of the radar.

To determine the angle, they use a receiver that's range-gated for 125 feet and 225 feet from the target. As the missile passes through two imaginary circles around the target at those distances, its elevation and azimuth angles are measured, and the time it passes four points—two preset distances on both sides of the target—is marked. All this information, along with the time the missile was fuzed, is telemetered to the ground computer, which then calculates whether the missile, if it had been a live war-head, would have come close enough to destroy the target.

Electro-optics

Image intensifier holds its ground

Though the Starlight image-intensifying night vision scope provided infantrymen in the Vietnam jungle with a picture of the enemy at night, a tank or helicopter mounting was a different story. In these applications, the platform's vibrations and maneuvering made the scope virtually useless.

Now Mark Systems of Cupertino, Calif., has incorporated a gyroscope and a second-generation image intensifier, a single stage device, into its 2310A Image Intensifier and Stabilized Monocular. Not only is jitter removed, but the 2310A is ready to move into production now, says the Army; other advanced systems are still in the

Hard look. Image-intensifying scope is smaller than Starlight versions and has gyroscope.

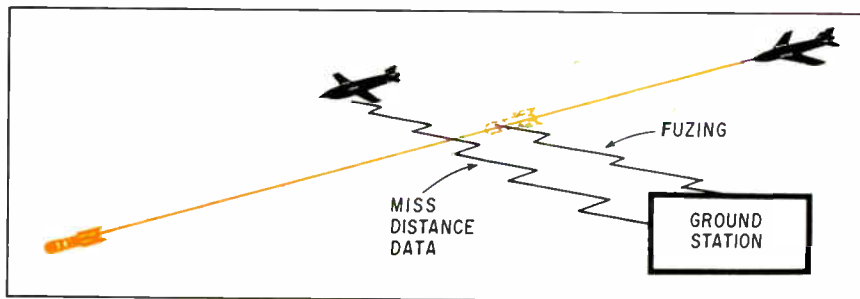
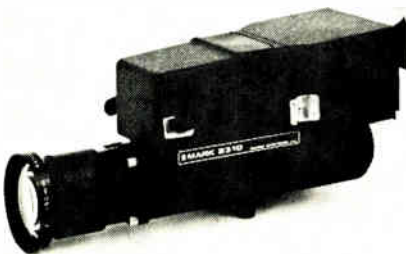

That close. Miss distance and missile fusing data are telemetered to ground over separate links to help calculate kill probability.

development stage. What's more, the intensifier stage itself is about 3 inches long and 3 inches in diameter instead of 8 to 12 inches long and 9 inches in diameter. The entire system, intended for observation and/or recording, weighs 7 pounds and measures 12 by 4.75 by 7 inches.

The micro channel plate device intensifier is classified. All that can be learned is that it is a small solid state component requiring very low power.

The 2310A is basically a lower power (8X) telescope with a 3-inch-long image intensifier inserted in the primary optics. One of the optical elements is mounted on a gyroscope to provide stabilization, which takes out up to 90% of the case motion and is specified as $\pm 5^\circ$ in pitch and yaw. A special magnetic system between the gyro frame and the inner gimbal allows the unit to be panned at 5° per second. Power for the gyro is supplied by six small batteries, for the intensifier itself by two separate batteries.

The conventional approach to stabilizing an optical image, whether it be in a camera or a viewing device, has been to employ servo-driven stabilized mounts for the entire system. For example, World War II cameras had a servo-driven mount and controls that weighed more than 100 pounds and drew more than 100 watts. In the Mark Systems technique, the instrument is permitted to vibrate or oscillate, and a small, internal optical element stabilizes the image. The stabilizing portions of the system weigh only ounces and the power

requirements are a fraction of a watt.

To picture how the system works, think of it as a three-part optical system—a primary objective, which can be thought of as a low-power telescope of magnification m_1 , a stabilizing prism with magnification m_2 , and some secondary optics with magnification m_3 . The prism is affixed to a gyro, so that it maintains an inertia reference. Then, if the system is tipped, a stabilized output requires the input angle of a ray to the third stage to equal the initial tilt angle.

This works out to an equation that states that m_1 must equal $1-1/m_2$ for stabilization. And this is easily achieved. The magnification of the third stage can then be tailored for the desired overall magnification of the system.

For the record

Striplining up. Motorola's Government Electronics division in Scottsdale, Ariz., has followed ITT's Defense Communications Laboratories into the stripline antenna field [*Electronics*, Aug. 31, p. 34]. Motorola has recently announced the development of stripline antennas at L, S, C, X, and Ka band that use a multilayer board sandwich with a proprietary feed-through technique to eliminate the eyelets sometimes used to connect the dipole radiators and the corporate feeds of such antennas. Early stripline antennas, with unbalanced corporate feeds, needed a balun to match impedance to the

Button, Button...

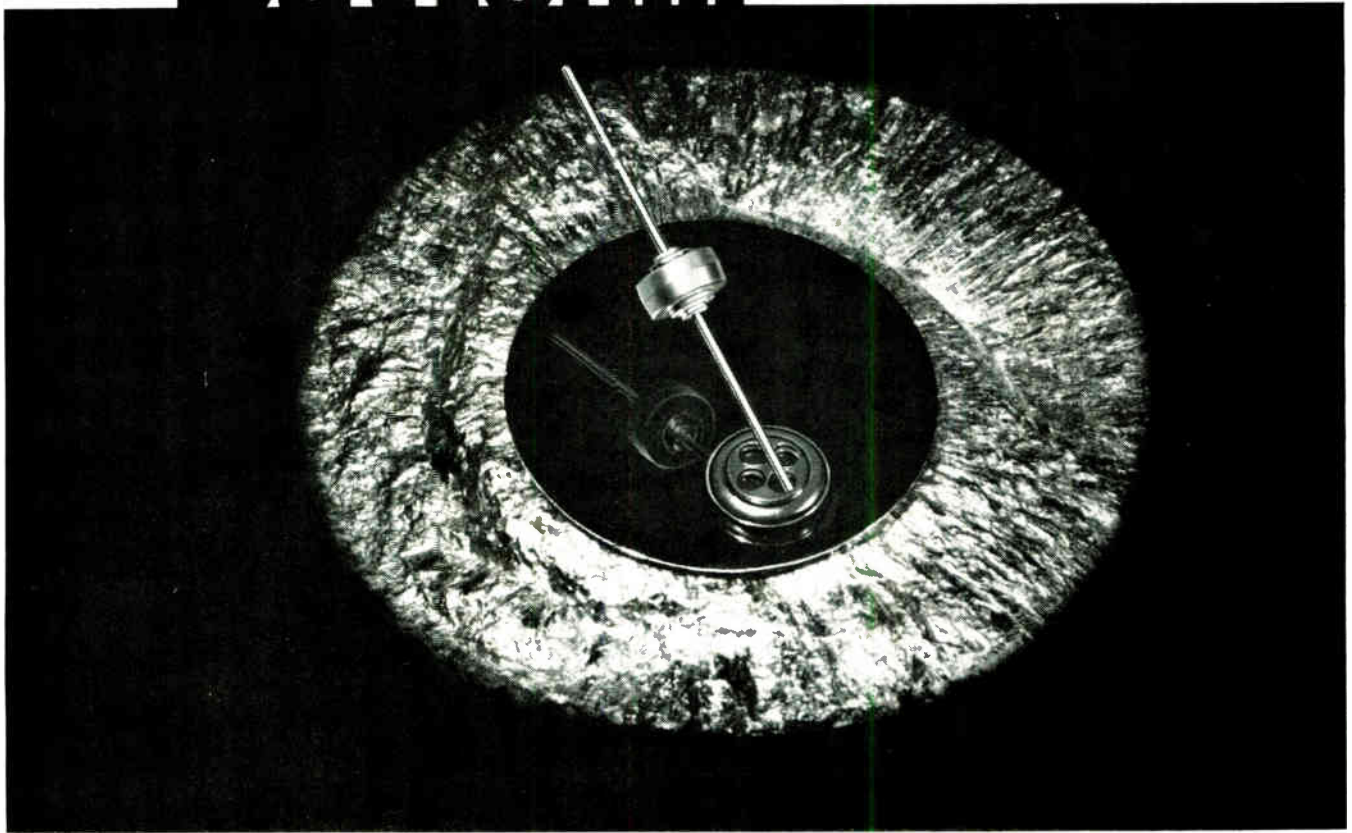

Motorola Rectifiers have it!

... And you get *more amps per dollar* from the world's highest-current lead-mounted rectifier — the new MR751 "Button" Series.

If you're getting hot from looking for rectifier savings in dollars and finding only pennies — cool it! Let the industry's first 6-amp axial-lead rectifier save *real money* in your designs by providing more than twice the amps per dollar plus significant mounting and assembly savings.

But the real big savings is in the initial cost.

Compare these MR751 series prices with those of typical stud-packaged 6-amp counterparts:

RECTIFIER TYPE	100-UP PRICES		DEVICE #
	TYPICAL, 6-A STUD ASP'S	MOTOROLA MR751 SERIES	
$V_r = 100V$	\$.90	\$.45	MR751
$V_r = 200V$	1.25	.49	MR752
$V_r = 400V$	2.00	.62	MR754
$V_r = 600V$	3.75	.90	MR756

Compared to stud rectifiers of similar current rating, the silicon MR751 series devices install faster, easier and take less space. And their new, button-shaped, voidless plastic case provides insulation against accidental shorting or grounding.

The MR751 series rectifiers are available in four working peak reverse voltage ratings up to 600 volts and each features a high 600-ampere inrush current surge capacity for increased capacitive-loaded design latitude.

And if you really want to cool it — with a proper heat sink and mounting — this little "button" will handle up to 26 amperes! This and other outstanding characteristics — like forward voltage drop of 0.9V (max) and reverse current at rated dc voltage of 0.25 mA (max) — make the MR751 series rectifiers a real cool buy.

Buttonhole your nearest Motorola representative and ask for evaluation samples — today! Or, write Motorola Semiconductor Products Inc., Box 20912, Phoenix, Arizona 85036.

 **MOTOROLA POWER**
— where the priceless ingredient is *care!*

THE ULTIMATE ALTERNATE MOS SOURCE



We think our credentials as a primary source for MOS products speak for themselves. Our research and production capabilities in the field result from years of successful experience.

We are also convinced that the same capabilities make us a logical choice for your alternate MOS source. If you already have custom circuit designs, we can take it from there. One of our Hughes specialties is freeing your development funds for greener pastures.

We can start with masks, art work, or device samples of other

manufacturers. We produce wafers, chips, or tested parts.

At Hughes, we have pioneered and refined ion-implant technology. Our overglassing and silicon nitride-silicon oxide passivation techniques are at your service, second to none. We offer complete assembly and testing capabilities.

Specifically, the processes now available from us are these:

P-channel MOS-High V_{TH}
P-channel MOS-Low V_{TH}
Complementary MOS-High V_{TH}
Complementary MOS-Low V_{TH}

Here's an example of Hughes' alternate source capability. Through our technical licensing arrangement with RCA, we can now offer from Hughes the CD 4000 series: HCOS 4000, HCOS 4001, HCOS 4004, HCOS 4007, HCOS 4013, and HCOS 4015.

If all this sounds like some kind of ultimate to you, write us for full technical and pricing information. The address is: Hughes MOS Division, 500 Superior Avenue, Newport Beach, CA 92663.

Electronics review

inherently-balanced dipoles. The feedthroughs that penetrated the topmost stripline board to connect the dipoles to the corporate-feed board, a quarter wavelength below it, often had to double as a baluns as well. Motorola now claims to have dispensed with this arrangement and to have come up with a feedthrough technique that yields a perfectly flush topmost surface.

ITT has a design that also eliminates feedthrough. A 30-by-30 inch monopulse array with a dual-circular polarization capability and made of four modular subarrays has been successfully tested. ITT's design mates dipole elements and balanced corporate feeds on the same sides of stripline boards, so that neither feedthroughs nor baluns are needed. The company has contracts from both the Army and the Navy for perproduction prototypes of X-band arrays.

Raytheon sues Intersil. The Raytheon Co. has filed a plea for \$2 million damages and a permanent injunction against Intersil Inc., its subsidiary the Intersil Memory Corp., and 14 Intersil employees. Among other things, Raytheon charges the men and companies with raiding Raytheon Semiconductor division personnel, specifically men in key integrated circuit marketing, memory design, and processing slots. Raytheon's initial complaint is about 30 pages long and corporate rage shows even through its legal jargon. It accuses the companies, Intersil board chairman Jean Hoerni, and 13 former Raytheon employees of causing "inestimable damage" to Raytheon's stance in the semiconductor memory field, of trading in proprietary information—not just of Raytheon but that of Raytheon's customers—and in some cases of taking what were in effect secret plans for at least two new products, a 64-bit and a 256-bit bipolar memory.

Said Intersil president James Riley, who just moved over from Signetics: "Legal counsel has advised me that, after their initial

pass through the papers, Intersil has committed no wrong."

Comprehension. The Institute of Printed Circuits, looking to the day when punched cards or magnetic tape will replace drawings and printed specifications, is taking steps to make sure that everyone speaks the same language. A committee on computer-aided technology has issued a proposed standard covering formats for descriptive data. It's to be offered for acceptance at next fall's institute meeting after expected trimming at the April conference.

Me too. "What the 'ins' can do, we can do better." That was the RCA theme, referring to IBM, when RCA announced its new line of computers. RCA claimed that the line, the RCA 2, 3, 6, and 7, would make it No. 2 in computers by the late 1970s despite the Honeywell acquisition of General Electric's computer market.

The new line's principal feature is its compatibility with existing RCA Spectra 70s and IBM System 360s. In addition, the machines can emulate both RCA and IBM second-generation machines. And the 3 and 7 have extensive virtual memories, an important feature for time-shared operation [*Electronics*, Sept. 14, p. 34]. This isn't a new idea, having been used previously on certain models of RCA's Spectra 70 and on the GE 645, the IBM 360/67, and several Burroughs machines. GE and IBM have been soft-pedaling their virtual memories because of serious difficulties with software; Burroughs' success with software for its disk and drum systems, including virtual memory, has been legendary. The memories are assembled from standard 131,000-byte modules in capacities that reach over two million bytes in some models. Cycle time is 1,440 nanoseconds for the two little ones and 765 ns for the two big ones.

RCA is particularly proud of its new policy of guaranteed conversion to any of the new machines from an IBM 360/30, 40, or 50.

How did Hughes get a reputation for innovation?

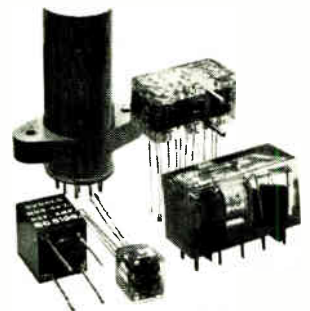
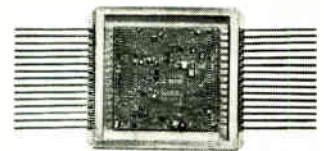

That's how.

A reputation from technical know-how in developing better MOS devices (RS 283), bipolar and hybrid circuits (RS 284), discrete devices and monolithic circuits (RS 282), frequency control devices (RS 285), and special assemblies (RS 286).

HUGHES

HUGHES AIRCRAFT COMPANY
INDUSTRIAL ELECTRONICS GROUP

TRW covers the spectrum 3MHz to 3GHz



...with highest available solid state power

Wherever your application fits—from 3 MHz to 3 GHz—you can do the job with TRW RF power transistors. Broadband, state-of-the-art, and packaged for easy use. Not just output transistors, but a complete family for amplifier chain requirements in each band. Available off-the-shelf, with proven reliability to meet on-line frequency or amplifier/multiplier requirements for commercial and military land, mobile

and aircraft equipment. Backed up by in-depth product lines, packaging capability and applications know-how.

Even above 3GHz, TRW can help you. Our advanced technology provides reliable RF power at all frequencies for amplifier/multiplier design approaches. And if you need custom hybrid modules or MIC's to operate anywhere in the spectrum, we can help you there, too.

For complete information about TRW RF power transistor capability, contact TRW Semiconductor Division, 14520 Aviation Blvd., Lawndale, California 90260. Phone: (213) 679-4561. TWX: 910-325-6206.

TRW®

TRW 100W 1090MHz Hermetic Transistor

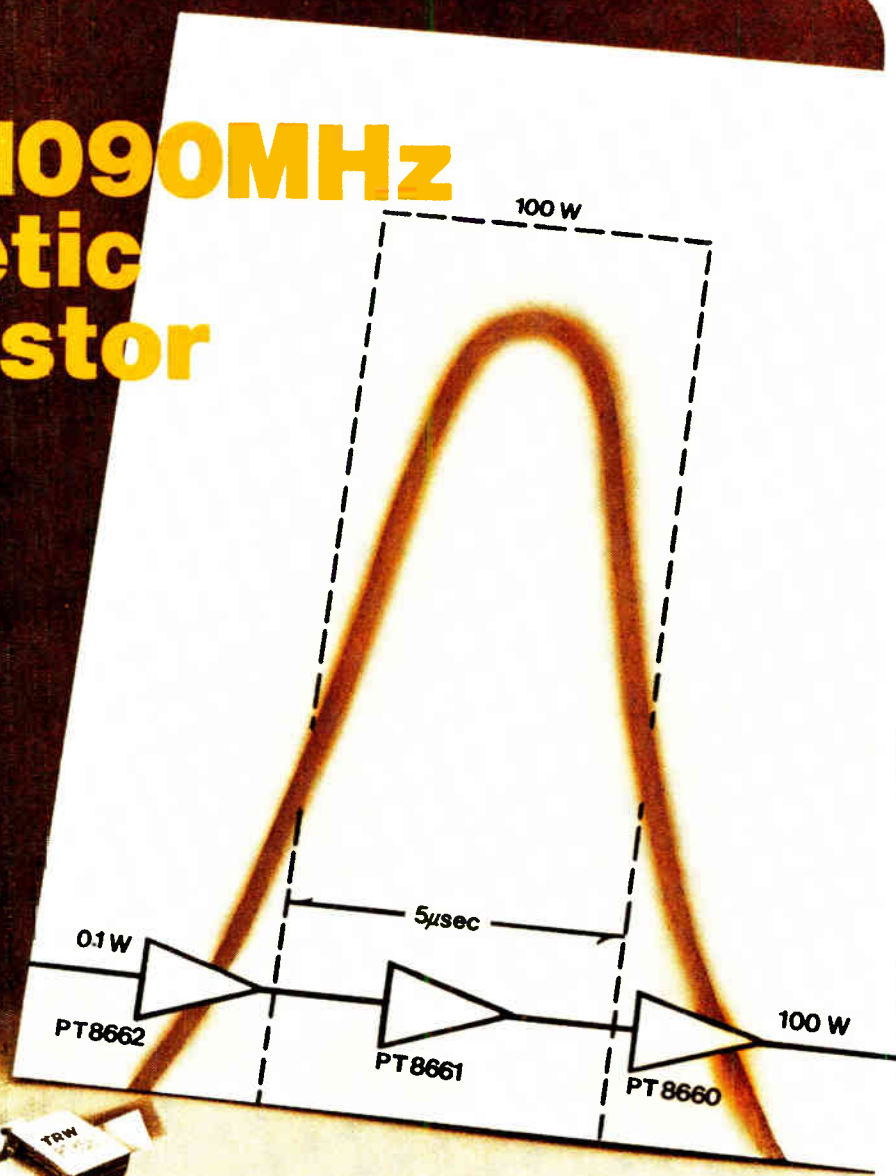

...delivers reliable Pulsed Power for DME, TACAN and IFF

Now you can design all solid state DME, transponders or radar equipment to meet ARINC, military and general aviation requirements. The key is a new TRW family of pulsed power transistors.

The broadband TRW PT8660 provides 100 Watts of peak pulse power with 10dB gain at 1090MHz. Used with companion transistors TRW PT8661 and PT8662, you get 30dB gain in a common base pulsed power

chain. And the PT8660's may be combined to meet even higher pulsed power requirements.

This new transistor family can also provide up to 50 watts of pulsed oscillator power to satisfy the source requirements for these avionics applications. All are packaged in the new HLP (Hermetic—Low Parasitic) package designed for easy use, optimum electrical and thermal characteristics.

For complete information on

this new TRW family of pulse transistors, contact any TRW distributor or TRW Semiconductor Division, 14520 Aviation Boulevard, Lawndale, California 90260. Phone: (213) 679-4561. TWX: 910-325-6206.

Actual Size



TRW®

8" HELIAX

high power without a hanger "HANG-UP"



Faced with carrying a couple of hundred RF kilowatts? Need low, low attenuation? Move up to 8" HELIAX® coaxial cable. Big. Semi-flexible. Continuous lengths to 850 feet. Eliminates connector bullets and complicated hangers. Thermal expansion

and contraction don't faze it. Power capabilities: 300 kw average at 30 MHz; 58 kw at 600 MHz. Use for HF; Tropo; OTH radar; VHF and UHF-TV. Wouldn't you like to know more? Communicate with Andrew.

11-68

 **ANDREW**

CONTACT THE NEAREST ANDREW OFFICE OR ANDREW CORPORATION, 10500 W. 153rd STREET, ORLAND PARK, ILLINOIS 60462
Circle 50 on reader service card

Washington Newsletter

September 28, 1970

One-man rule sought for FCC and other regulatory agencies

A proposed reorganization of the Federal Communications Commission and other independent U.S. regulatory bodies would give FCC chairman Dean Burch [see p. 85] and his counterparts vastly increased authority by effectively substituting one-man rule for the majority voting of a multimember commission. The proposal is contained in an Executive branch reorganization study by a Nixon task force—one of a score named before his election—and may show up in next year's legislative program. Former FCC chairman Newton Minnow confirms the plan, noting that his views were solicited by the Administration. "I think it's a good thing," he says, adding that he proposed comparable changes to President Kennedy. Members of Congress aware of the program are skeptical of its chances but are keeping silent until they see what is proposed.

NASA delays station to save shuttle

The 12-man space station program will slip at least two years as NASA tries to free more of its declining budget for its No. 1 manned space project—the \$7 billion space shuttle. Meanwhile, the space agency is asking North American Rockwell and McDonnell Douglas to rethink their preliminary design studies, which call for about \$500 million in electronics developments for the \$3 billion station.

Many of these restudy areas—the impact of metric tooling in building the craft or the use of on-board nuclear power plants, for example—look like make-work projects designed to hold design teams together long enough for NASA to try rallying Congressional support for the station. To date, NASA's efforts have been aimed at stirring up the scientific community's interest in the station's potential. If this fails, chances are NASA will promote the military surveillance and missile defense uses.

Whitehead cuts back staff at Office of Telecommunications

While still awaiting Senate confirmation, Clay T. Whitehead moved in as director of the Office of Telecommunications Policy and started heads rolling. Facing a Congressional cut of about \$1 million in a \$3.3 million fiscal 1971 budget request, Whitehead is eliminating an estimated 16 to 30 jobs to make space for systems analysts and econometricians.

General Dynamics to compete in race for AADC memory

The Navy is proving it's serious about ferroacoustic memories by looking for a second source. A memory developed by General Dynamics for antisubmarine warfare applications will compete with Sylvania's thin film Soniscan [see page 34] for the mass memory of the Naval Air System Command's Advanced Airborne Digital Computer program. Navy sources disclose that a \$20,000 contract will be awarded to General Dynamics to deliver a memory with 32 data lines, each packing 256 bits, for study.

The firm's approach differs from Sylvania's in that General Dynamics' memory uses strands of plated wire with PZT transducers fixed at the end of each wire instead of using thin film sandwiched between glass plates. Access to a block rivals Sylvania's—between 1.5 and 2.5 microseconds—but total block unload time, 150 nanoseconds, is only half as fast. General Dynamics claims ease of fabrication and an order of magnitude higher output level are offsetting advantages. Storage density is expected to run to 10^{10} bits per cubic foot and the cost, although General Dynamics won't discuss it, to around 0.1 cent a bit.

Washington Newsletter

NASA labs open for down-to-earth research projects

As cutbacks in the space program force layoffs and shutdowns on NASA, the agency is turning from the problems of outer space to those of inner space—such as environmental monitoring and law enforcement [see p. 42]. NASA's agreement with the Interior Department to provide space and equipment at its Mississippi Test Facility to the Bureau of Commercial Fisheries may be followed by others.

The bureau will move in for studies on the location and abundance of ocean fishery resources, and for environmental monitoring. The bureau plans to experiment with aircraft-mounted lasers, low light-level image intensifiers, and other sensing equipment to detect schools of fish and to monitor pollution of the Gulf of Mexico. BCF research will help pin down the remote sensing techniques that will be included on NASA's Earth Resources Technology Satellite and the manned Skylab.

House computers gain with dropping of joint data unit

The House of Representatives' computerization program [*Electronics*, Aug. 31, p. 41] got a boost when the House overturned an amendment to the Legislative Reform Act that would have established a joint committee on data processing. Capitol Hill sources say a joint House-Senate effort would have slowed down the work of the House, delayed issuance of requests for proposals, stalled its two-year specification development program, and given the Senate the opportunity to dominate the design of House computers. The reform bill, which must still clear a House-Senate conference, also provides for electronic voting on the House floor. A Senate computer services subcommittee, headed by Sen. B. Everett Jordan (D., N.C.), has just begun planning a system and, with the outcome of the reform bill vote, the Senate will have to go ahead on its own.

FAA move dooms uhf satellite of NASA/ESRO

The joint NASA/European Space Research Organization plan to fly two uhf satellites for relaying North Atlantic airline communications looks dead. Federal Aviation Administrator John Shaffer, dooming the plan, instead will support a hybrid system that would relay operational vhf and experimental uhf traffic. The first hybrid would be launched by Communications Satellite Corp. over the Pacific in 1973. Uhf vs. vhf is still a controversial issue in Europe, one reason why the Pacific route will be first.

Airlines and FAA will split the \$6.7 million annual cost of the vhf channels, while the \$7.8 million uhf costs will be written off to R&D. Since most satellite costs are in R&D, an identical satellite for relaying North Atlantic communications could be launched by Comsat for \$4.5 million a year, instead of \$30 million for the NASA/ESRO plan.

Addenda

Donn L. Williams, president of North American Rockwell's Autonetics division will lead an Electronic Industries Association study of what the industry will look like in 1985. The study will include social, political, and technological factors that could affect the industry, and predictions about technological developments. . . . The Department of Labor is supporting an American Institute of Aeronautics and Astronautics program to transfer unemployed defense and aerospace engineers and scientists to other industries. The department will fund a pilot project starting in Philadelphia and extending to Boston, Huntsville, Dallas-Fort Worth, and Seattle. Success could push the program into 25 other cities.

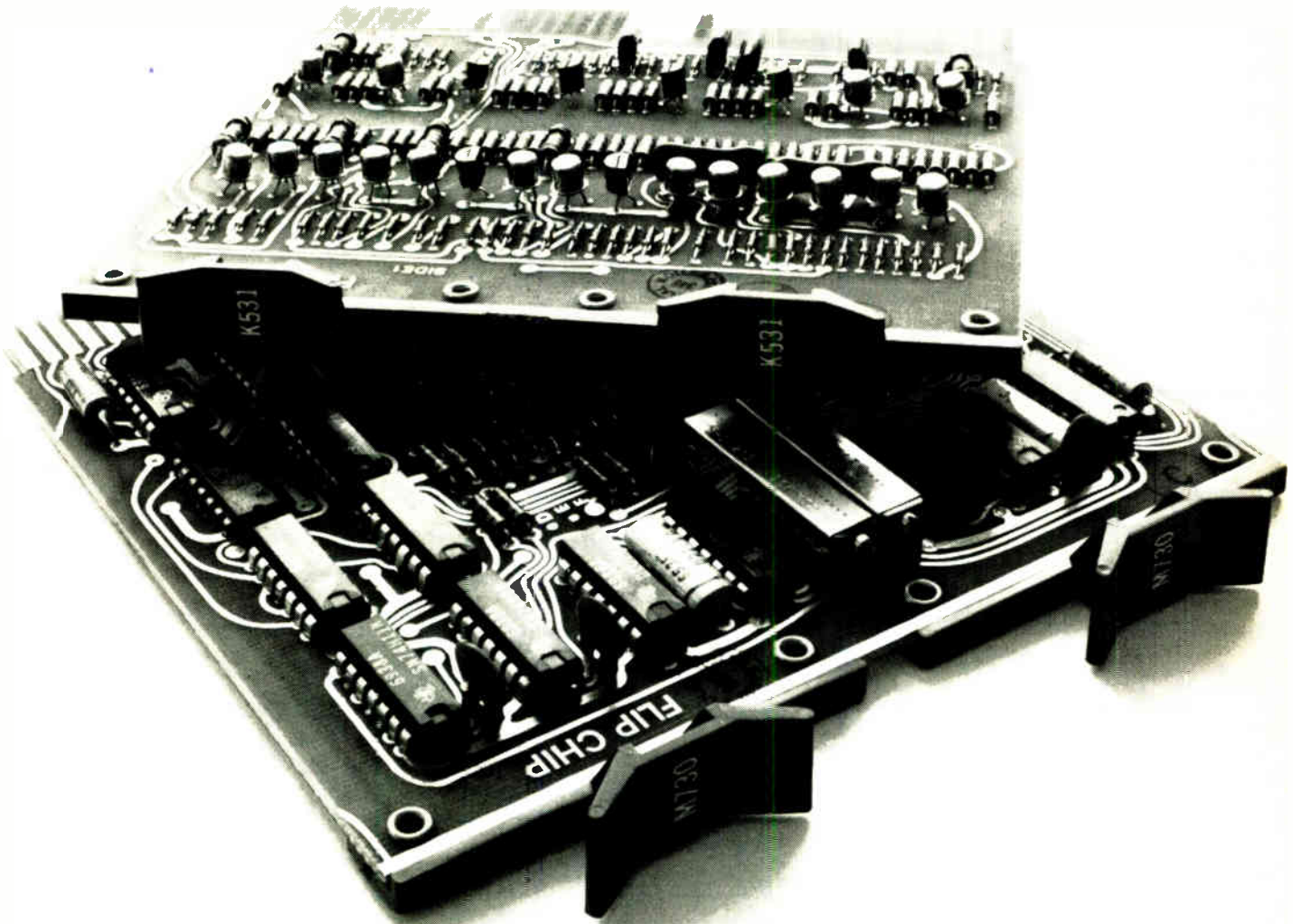

The tortoise and the hare

Sometimes, you want all the speed you can get. Interfacing a computer, for instance. Or building an instrument that measures, or tracks, or controls events that require that speed. Digital offers a full line of hare modules . . . M-series, that fly at 10 MHz.

But sometimes, you want something a lot slower. For general laboratory control, or to replace old-fashioned relays, or to control a machine. Designing them slow means that you can also design them immune from electrical noise. Digital has a full line of tortoise modules as well . . . K-series, that crawl at 100 KHz.

Each series is physically, electrically, and logically compatible. 100 modules in M-series. 70 modules in K-series. Each comes with a full line of hardware, power supplies, plug-in boards, cabinets, racks, and so forth. Each comes with Digital's guarantee. Each comes with the

knowledge that Digital uses them in their own computers and controllers.

Two free books describe them completely—module by module and function by function. Write.

DIGITAL EQUIPMENT CORPORATION, Maynard, Massachusetts. Telephone: (617) 897-5111 / ALABAMA, Huntsville / CALIFORNIA, Anaheim, Los Angeles, and Palo Alto / COLORADO, Denver / CONNECTICUT, New Haven / DISTRICT OF COLUMBIA, Washington (College Park, Md.) / FLORIDA, Cocoa / GEORGIA, Atlanta / ILLINOIS, Chicago / MASSACHUSETTS, Cambridge and Maynard / MICHIGAN, Ann Arbor / MINNESOTA, Minneapolis / MISSOURI, St. Louis / NEW JERSEY, Parsippany and Princeton / NEW MEXICO, Albuquerque / NEW YORK, Centereach (L.I.), New York City, and Rochester / NORTH CAROLINA, Chapel Hill / OHIO, Cleveland and Dayton / PENNSYLVANIA, Philadelphia and Pittsburgh / TENNESSEE, Knoxville / TEXAS, Dallas and Houston / UTAH, Salt Lake City / WASHINGTON, Seattle / AUSTRALIA, Brisbane, Melbourne, Perth, and Sydney / CANADA, Edmonton, Alberta; Carleton Place, Ottawa, Toronto, Ontario, and Montreal Quebec / ENGLAND, London, Manchester, and Reading / FRANCE, Paris / GERMANY, Cologne and Munich / HOLLAND, The Hague / ITALY, Milan / JAPAN, Tokyo / SWEDEN, Stockholm / SWITZERLAND, Geneva.



digital
MODULES • COMPUTERS

10 microvolt sensitivity with a lot of numbers.

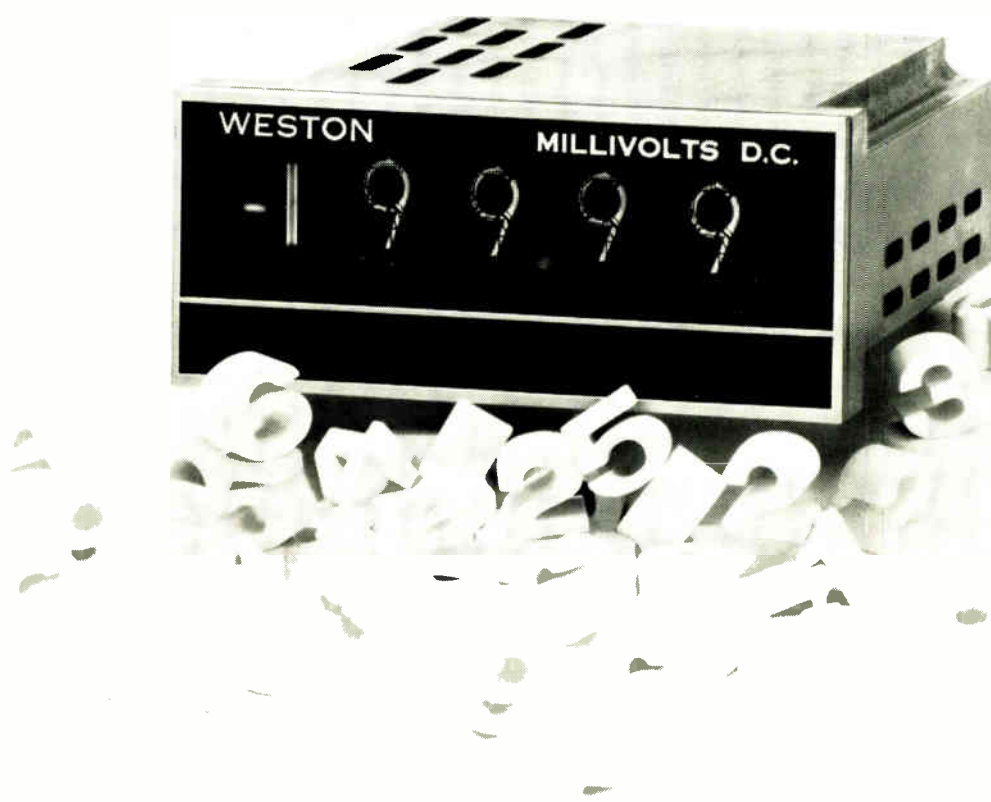

40,000 to be precise.

Our latest bi-polar Model 1294 packs more numbers than any other into industry's smallest package! And it reads them with a sensitivity of *10 microvolts!* The 1294 is a true bi-polar 4½-digit instrument with a display capability of 19999 and out-of-range indication. Its state-of-the-art electronics utilizes T'L logic and unique time-sharing circuitry that cuts power consumption to less than six watts. BCD output is optional. Input impedance is high: 10 meg-

ohms on the 100 millivolt range. Reading rate is 5 per second. Response time is well under one second. Accuracy is .05% of reading, ±1 digit.

Housed in the same 7 sq. in. front-panel-mountable case as our five other DPM's, the 1294 offers all the features that have distinguished this line . . . Weston's patented dual slope* integration, plug-in Nixie** tubes, repairable (non-potted) circuit boards, and ten standard voltage and current ranges.

If you're sensitive about your numbers, Weston Model 1294 provides the ultimate at a reasonable price. See how the 1294 complements industry's broadest DPM line. Write for details from the DPM originators.

WESTON INSTRUMENTS DIVISION,
Weston Instruments, Inc., Newark, N.J.
07114

a Schlumberger company

WESTON®

*U.S. Pat. #3,051,939

**Registered trademark, Burroughs Corp.

Article Highlights

**Read-mostly memory
is nonvolatile
and reprogrammable
page 56**



A new type of semiconductor memory that features the nonvolatility of the read-only memory combined with the flexibility of the random access type has been developed and made available in evaluation quantities. This read-mostly memory exploits the property of amorphous semiconductors that change from an ordered to unordered state with a pulse of energy. The array can be

programed by converting the individual cells to the proper state; the data can be read by measuring the cell's resistance. And since conversion of cells is reversible, reprogramming is achieved by changing state.

**Theory gives shape to
amorphous materials
page 61**

Several amorphous semiconductor devices have been built and are working in laboratories. But before they'll present a real challenge to conventional semiconductor technologies, the problem of learning how amorphous devices function must be solved. Progress in this direction is being advanced by a new model that explains the puzzling behavior of threshold and memory switches.

**Companies split
on future of
amorphous materials
page 74**

Arrayed against the few semiconductor companies, research labs, and Government groups that see a real future for amorphous devices are many firms doubtful that the devices will ever hit the market. In the middle is a substantial group that has adopted a wait-and-see attitude. The picture abroad is somewhat more optimistic, and work is proceeding apace in several countries.

**Audio noise:
Why settle for more?
page 82**

Manufacturers of bipolar transistors often don't specify optimum noise figures, and designers who accept these figures as the best available put up with much more noise than they need to. Now there's a simple way to calculate the optimum collector current; it's used in a complementary two-stage amplifier with a noise figure below 1.5 dB and gain greater than 60 dB at audio frequencies.

Coming

**Semiconductor memory
costs**

Semiconductor memories are just beginning to become attractive from a cost standpoint. But the real cost of a semiconductor memory often remains elusive. The typical cents-per-bit quote for memories can be quite deceptive unless the oft-hidden packaging costs are taken into account.

Nonvolatile and reprogrammable, the read-mostly memory is here

Integrated arrays combine amorphous and crystalline technologies; new memories could help realize promise of microprogramming

By R. G. Neale and D. L. Nelson, *Energy Conversion Devices Inc., Troy, Mich.*
Gordon E. Moore, *Intel Corp., Mountain View, Calif.*

□ Both the read-only and random access varieties of semiconductor memories leave something to be desired in many applications. RAMs' volatility allows data stored to disappear if power fails. On the other hand, ROMs' inflexibility commits them to data that cannot be changed.

A new kind of integrated circuit, the "read-mostly memory," avoids these problems. An integrated array of amorphous and crystalline semiconductor devices available in sample quantities, the RMM can be programmed, read, and reprogrammed repeatedly. And once programmed, the RMM retains data unless it's intentionally altered. The RMM, therefore, doesn't need the data storage on card, tape, or disk required to back up a RAM if power fails. And the same RMM can be used even if the program must be changed; there's no need for the time-consuming and expensive process of making new masks and fabricating a new IC, nor is it necessary to substitute an electrically programmable but fixed type circuit.

Microprogramming—a computer technique in which a programmer can at will change an operational code or sequence—probably will emerge as the most important application for these devices. The great promise of the microprogramming concept has yet to be fully realized—even though the idea originated almost 20 years ago—because of the difficulty and cost of changing the contents of microprogram stores with available memory devices.

Several fertile areas exist where the read-mostly memory's special property of electrically alterable, nonvolatile data storage could be usefully applied:

- ▶ Airborne computers, which often require a different set of data for a particular mission or operational situation.
- ▶ Industrial control systems, in which "canned cycles"—stored instructions—must occasionally be altered for new tooling, instrumentation, or test procedures.
- ▶ General purpose computers in which, even though storage of fixed data is required, it is still desirable to make changes in the data during the design phase.

Physically, the new 256-bit RMM's organization is a 16-by-16 matrix of amorphous semiconductor cells,

which must be isolated from each other by integrated silicon p-n junction diodes, as shown on opposite page, to prevent spurious paths in the array. The 122-by-131-mil chip size gives a packing density comparable to that of bipolar or MOS techniques, and should improve with fabricating experience. The chip is enclosed in a 40-lead ceramic dual in-line package.

Each cell in the memory consists of an Ovonic amorphous semiconductor device and an isolating diode in series on a silicon substrate, as shown opposite. The Ovonic structure itself consists of a film of amorphous semiconductor material between two molybdenum electrodes. Many such cells—series combinations of Ovonic devices and silicon diodes—are arrayed over the silicon chip, with each cell addressable by an x-y grid, as shown on opposite page, below. The cell behaves like a nonvolatile bistable resistor with an on-to-off resistance ratio of about 10^3 .

Without the series diodes, a few adjacent Ovonic devices in the on (low resistance) state might make the Ovonic device being interrogated appear to be on when it's really off. The resistance of the adjacent on cells would shunt the off resistance. With the diodes, however, the back resistance of the diodes added to the on resistance of the adjacent cells prevents this ambiguity.

Despite some superficial resemblances, the amorphous semiconductor memory is quite a different animal from the electrically alterable, fusible type of memory recently introduced by such companies as Radiation Inc., Motorola Semiconductor, and the Solid State Scientific Corp. Although both types can be programmed in the same way, the fusible type's program can't be changed, whereas the amorphous semiconductor RMM can be reprogrammed repeatedly.

Changing the memory cell from a high-resistance (disordered) to a low-resistance (ordered) state and vice versa—that is, programming—is done by applying a pulse of a certain voltage, current, and duration. The cell can then be interrogated, or read, without changing its state by applying a constant current and measuring the voltage to determine whether the Ovonic device is in its high or low resistance state.

What defines a set or a reset pulse is not so much its energy as its energy-time profile. Thus, the SET, RESET, and READ operations for the 256-bit memory array require significantly different drive conditions, with voltages varying from a few volts to 25 V, currents from a few milliamperes to over 100 mA, and pulse widths from nanoseconds to milliseconds.

Typical configurations for SET, RESET, and READ driving are shown on the next page. Preparatory to a SET operation, the critical voltage of the Ovonic memory must first be exceeded and a current of several milliamperes must flow for several milliseconds to ensure stable conversion to the low resistance state. This action is accomplished by bringing a selected y line (connected to the cathode of the memory cell to be set) to ground through a saturated transistor. Simultaneously holding all other y lines at 25 V (the inhibit voltage) reverse biases the other diodes and thus isolates the memory cells. At the same time, a selected x line (connected to the anode of the memory cell to be programmed) is driven by a 5 mA constant current source at 25 V to insure that the amorphous semiconductor is in the ordered state. The drive voltage, however, must not be allowed to increase above 25 V, since a breakdown of the isolation diodes might result.

In the RESET operation, the procedure is similar except that the current source is increased to 200 mA and the pulse width is reduced to 5 μ s. As with the SET operation, the voltage is limited to 25 V.

To read a cell it's merely necessary to apply a fixed current to the cell and measure the voltage drop. A low voltage indicates an on (or SET) cell, and a high voltage indicates an off (RESET) cell.

The circuitry for the READ operation must identify the SET and RESET states of a cell quickly. A typical READ condition is a 2.5 mA constant current applied to the selected x line and a grounded y line. The READ output voltage will then be less than 3 V for a SET memory cell, 5 V for a RESET cell.

The memory cell array's line capacitance and the storage time of the isolation diode determine reading speed. For fast reading, the large capacitance of the y line should be driven by a low-impedance source. The small capacitance of the x line should be driven by a constant current source to forestall excess current through the amorphous memory switch. Such conditions could produce an array access time of about 65 ns. However, the access time for the system would be somewhat longer because of the propagation time of the decoder and driver circuitry.

Of course, the drive circuitry will vary with the particular system. Some applications may not require SET or RESET circuits in the system itself; programming would then be done by external equipment. Also, dropping the 25 V requirement for setting makes the READ circuit relatively easy to implement.

The simplicity and cost of the READ circuit depends

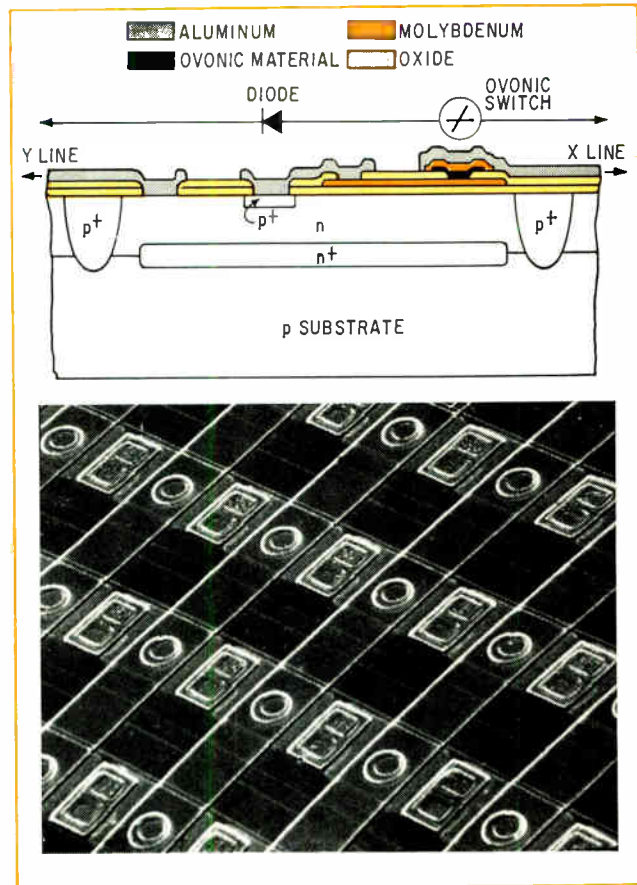

Winning combination. Each read-mostly memory cell contains a thin-film of amorphous semiconductor material deposited on a single-crystal silicon substrate in series with a silicon diode. The metal stripes—the x-address lines—connect the doughnut-shaped Ovonic switches. Running perpendicular to the stripes the y-address lines buried in the silicon connect the figure-eight-shaped silicon diodes. The diagram at top details the cross section of a complete memory cell.

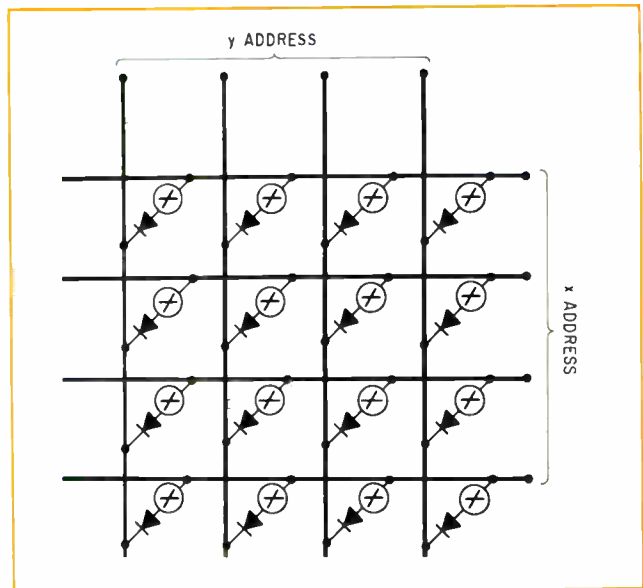

Array. The isolating diodes and Ovonic switches are connected in series across an x- and y-address line. The RMM consists of 256 such combinations.

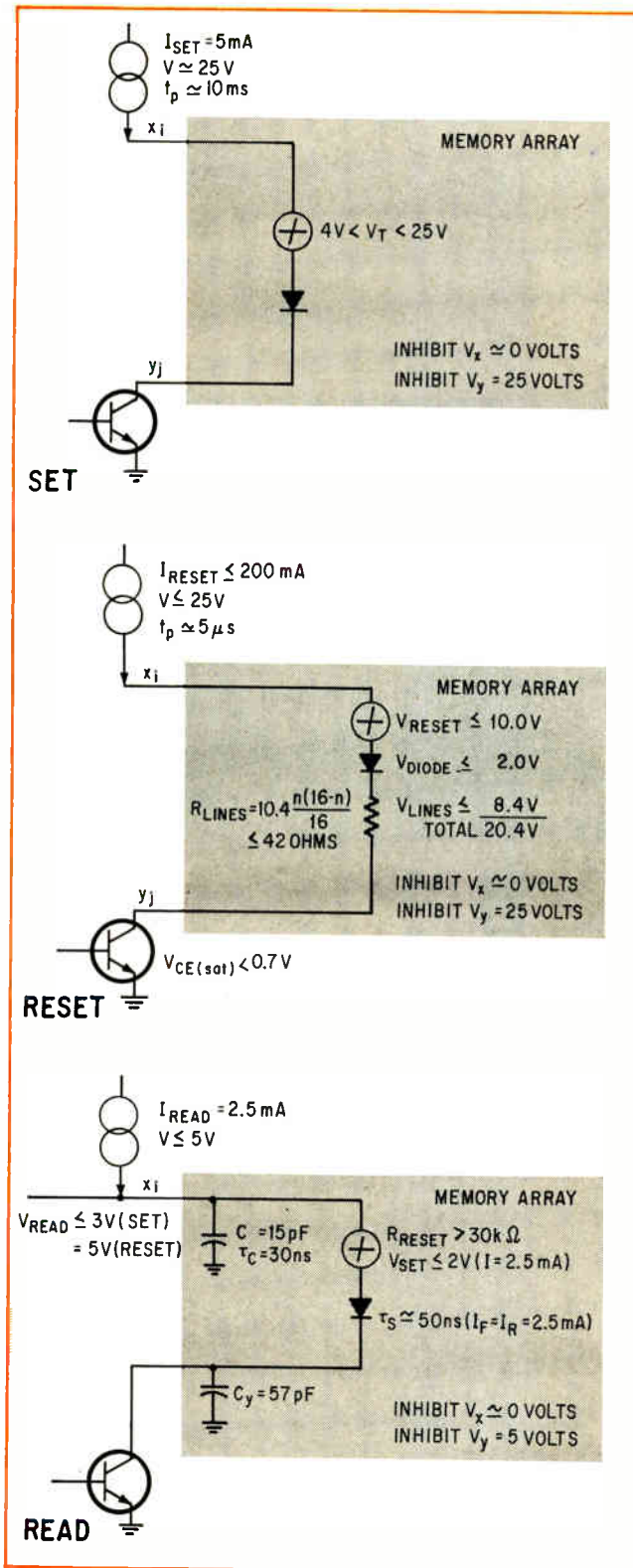

How to read. The operations of SET, RESET, and READ require significantly different values of voltage, current, and pulse duration. Typical conditions are shown in this diagram. The inhibit voltages are for the x and y lines, respectively; n is the number of diodes; V_T is the critical voltage of the amorphous semiconductor; t_p is the pulse duration, and τ_c and τ_s are the time constants affecting READ speed.

on speed requirements: at lower speeds, simple pull-up resistors will suffice, but higher speeds necessitate active pull-up drivers.

One of the knottiest aspects in the RMM development was how to integrate the amorphous-semiconductor memory cells and the silicon substrate containing the isolation diodes. The processing conditions and sequence had to be adjusted to insure compatibility with both types of device.

The problem centered on the aluminum that connects the isolation diodes to the Ovonic devices. This aluminum must be alloyed to the silicon substrate to assure a good contact. However, alloying requires a temperature of about 550°C, which would be too high, since it would also destroy the amorphous semiconductor materials.

This impasse was resolved by depositing and etching the molybdenum film that serves as the lower electrode for the amorphous semiconductor and then alloying or sintering the aluminum to both the silicon diode and the molybdenum. A clear molybdenum surface contact is thus left for the amorphous semiconductor. The aluminum applied over the amorphous semiconductor cell in a subsequent step need not be alloyed, since it doesn't contact the silicon.

As in other p-n junction isolated silicon ICs, the breakdown voltage is an important consideration. The diodes consist of p-type regions of material in n-type channels, as shown on the preceding page. Each of the 16 n-type channels contains 16 diodes. The maximum voltage that appears across the n-type channels must not exceed the breakdown voltage between the n-type channel and p-type isolation channel.

The resistivity of the n-type channel is about 20 Ω per square for the process used (the same process used to make transistor-transistor logic ICs). For a square memory cell (Ovonic device and isolating diode combined), the line resistance for 16 diodes would be 320 Ω . A RESET current of 100 mA passing through the channel develops a voltage drop of 32 V. In the TTL process, however, breakdown voltages usually range from 25 to 30 V, and the channel isolation would fail.

Diffusing a shallow n⁺ region along the channel reduces the channel's resistivity from 20 Ω per square to 3 Ω per square and, hence, the voltage drop across it. Moreover, no extra process step is required as the n⁺ diffusion is needed anyway to establish an ohmic contact between the aluminum and the n-type channel.

In addition, the diode channels have both ends shorted by an aluminum conducting strip around the outside of the array, reducing the effective interconnection resistance to the cells. This places the channel in parallel with the addressing line, reducing their effective resistance. Thus, the channel resistance for a channel of n cells is nR/4 when both ends of the channel are shorted, whereas it would be nR without the short.

Repeatability of SET and RESET cycles was the prime concern at the outset of the RMM development. Large quantities of devices were therefore tested to

Benign disorder

The useful bistable characteristic of amorphous semiconductor material depends on a reversible phase transition between two states of greater and less disorder—high resistance and low resistance. To understand the effect, consider the diagram of a thin film of amorphous semiconductor in a memory system, shown below. (The physics of amorphous-semiconductor switching are explained in detail in the article immediately following.)

To switch a cell to the low resistance state, a voltage exceeding a certain threshold value V_t is applied across the amorphous film. This is an electronic process, not a thermal one, which switches the film and establishes an initial conducting condition that enables electrical energy to be deposited in a confined film channel. A 50-microjoule pulse applied in about 10 milliseconds heats the amorphous material sufficiently to change phase from a disordered or glassy state to a more ordered structure.

The crystallization, or ordering process, is related to the participation of carriers from the valence band—those that form the bonds in the material—in the conduction process. The removal of these carriers from the bonds allows atomic restructuring to take place more easily. Accompanying this change is a drop in resist-

ance of some 3 or 4 orders of magnitude. The sequence of events is called SET process.

The duration of the SET pulse is important. For example, a pulse of only 0.1 ms won't create a permanent change in the amorphous film even though the pulse's amplitude is greater than the critical value V_t . The memory cell will switch to the low resistance state, but when the pulse terminates, the cell reverts to the high resistance state. But with a 10-ms pulse, the cell will remain in its low resistance (or on) state after the pulse is removed. The cell then can be continuously interrogated nondestructively. This is called the READ operation.

To return the cell to its high resistance (RESET) state, the material must be changed back to the disordered state. This is achieved by applying a high current for a short period (approximately 5 microseconds). With about 5 μ J of energy deposited in the cell, the heat generated returns it to the amorphous state, as shown below. The cell cools rapidly, and the disordered, high-resistance state is maintained at room temperature. A typical cell with critical voltage of 15 v is about 1.5 micrometers thick and 5 μ m in diameter; such a cell cools to room temperature in about 1 μ s.

SET—High to low resistance

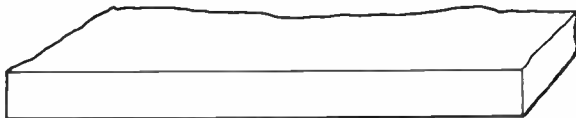

Initial state—high-resistance amorphous material

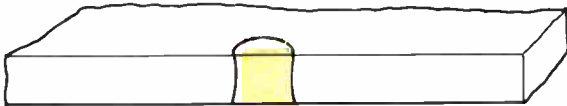

SET pulse is applied. Voltage across the device exceeds threshold and conduction starts in a small confined channel. Material is still amorphous.

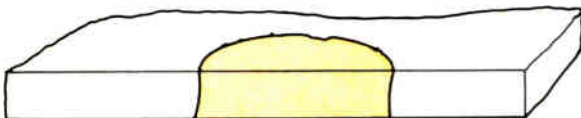

Energy dissipation caused by current flow expands the channel's diameter until it reaches a size related to the SET energy-time profile; material is still amorphous.

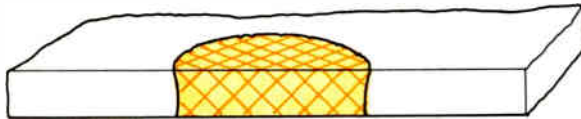

An ordered state with a greatly lower channel resistivity develops and is retained when the current is removed. The material is no longer amorphous.

RESET—Low to high resistance

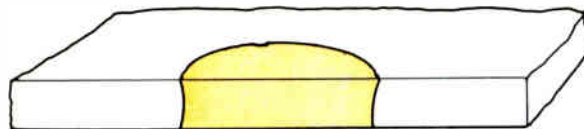

An applied RESET pulse returns the material to the high-resistance amorphous state.



The amorphous state remains when the power applied to the device is removed.

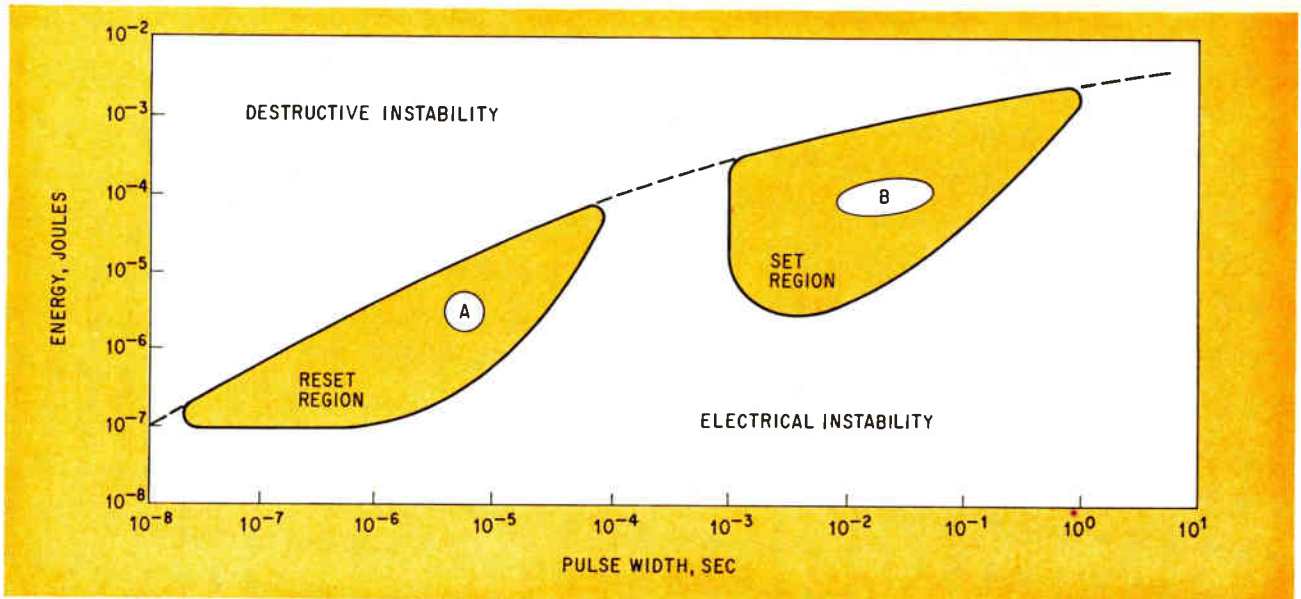

Time and energy. To ensure that the memory is stably SET or RESET without any damage, the energy-time product should fall within the shaded regions. Also an effective SET change of state requires sufficient RESET energy to reconvert the entire volume of material that has been SET. Thus, a cell that has been SET in region B must be RESET in region A

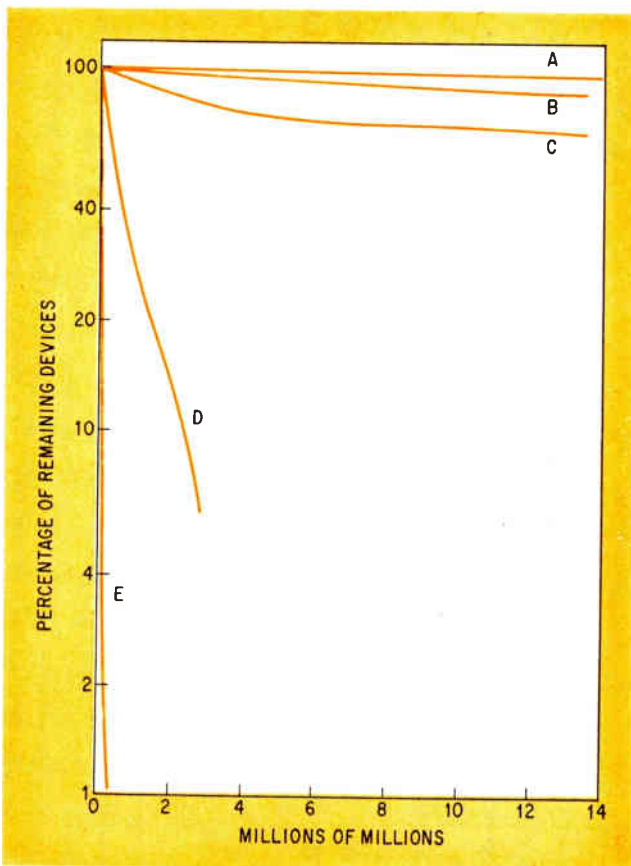

Life cycles. Relatively small changes in the composition of material will affect the operating lifetime of amorphous memory cells. Replacing two atomic % of one constituent in a three-element glass with another shifts the lifetime from the short-lived curve marked E to the long-lived curve marked A.

evaluate the effects of repeated cycling on various switching materials and geometries, and under differing processing and operating conditions. Thousands of test cycles were made.

It was found that the composition of an amorphous semiconductor can dramatically affect the lifetime of the device. The curves shown at left illustrate the effect: the nearly vertical short-lifetime curve (marked E) represents a three-element glass amorphous semiconductor.

The addition of only 2 atomic percent of an additional element shifts the cycle lifetime behavior to the nearly horizontal long-lifetime curve (marked A). The three upper curves represent material compositions that Energy Conversion Devices is studying and optimizing for use in the RMM.

The energy-time combination used for SET and RESET also profoundly affects life expectancy. Certain regions on an energy versus time plot result in effective setting and resetting, as shown above. An energy-time combination that falls below the regions defined by the roughly triangular regions will not produce a stable change in the state of the memory cell, not even after repeated cycling.

Another consideration is the energy-time balance; a cell set with a certain energy within the SET safe area must be reset at a compatible energy in the RESET safe area. Thus, if a cell is set within the ellipse marked B on the energy diagram, then the proper RESET condition should lie within the circle marked A.

The reason for this correspondence requirement is that the area of the converted region in the amorphous semiconductor film depends on the SET energy-time. Thus, as more material is converted to the ordered state, a larger energy is required to achieve a stable reconversion. □

Theory gives shape to amorphous materials

Before conventional semiconductors can be challenged, the problem of how amorphous devices function must be solved; the new CFO model explains hitherto puzzling behavior of threshold and memory switches

By David Adler, *Massachusetts Institute of Technology, Cambridge*

□ The promise of amorphous semiconductor materials won't be realized until their characteristics can be precisely defined and their operation controlled. The problem is that they behave quite differently from crystalline semiconductor materials. And two batches of apparently the same amorphous material could behave quite differently from each other.

The possibilities inherent in amorphous semiconductor technology are enormous. One promising application is memory switching, leading to densities on the order of a million bits per square centimeter. For optically controlled memory switching, amorphous alloys could be developed that would be transparent to red light when switched on and opaque when off. This might be the heart of an easily alterable memory with a capacity as high as 10^{12} bits.

And that's not all. Amorphous technology lends itself to electroluminescent displays; its bistability characteristic can be used as a threshold switch to turn a lamp on and off continuously over a large voltage range. Another possibility is ac thermostat switching, because threshold voltage for conduction decreases sharply with increasing temperature.

But trumpeting these laboratory devices and projections would be premature if the theory behind their operation were still as uncertain as the models for the behavior of those recent casualties, the tunnel diode and the LSA diode. Nevertheless, new models provide the amorphous materials with a firmer theoretical basis that has hitherto been available.

One, called the CFO model after Cohen, Fritzsche, and Ovshinsky, its originators, characterizes the energy band structure and electrical properties that are observed in many amorphous (chalcogenide) glasses, besides accounting for other observations, such as their optical absorption and radiation hardness. Still more recently, two additional models (IIFO and FO) use the CFO model to build a coherent theory of amorphous switching. And although there remain some observations that are as yet recalcitrant, these models, taken as a theoretical foundation, go a long way towards elucidating the elusive properties of the amorphous state of solids.

These properties are best understood in terms of the differences between amorphous and crystalline solids. A crystalline solid is a periodic array of atoms.

The environment of any atom in it is exactly the same as that of any other equivalent atom. But though the environment of an atom in an amorphous solid may be identical with its nearest neighbor's, its second-nearest neighbors may be twisted around. And most likely its tenth-nearest neighbors in the amorphous material will have essentially random orientations. In short, amorphous solids have a high degree of short-range order, but no long-range order.

Another point is that the amorphous state of a given composition generally has higher energy than the corresponding crystalline state; said another way, amorphous solids are metastable. This is not the same as unstable, which refers to materials that readily crystallize. But amorphous solids will in fact crystallize if heated above a critical temperature and slowly cooled (annealed), though they will not readily do so at the temperatures ordinarily associated with crystalline solids. So to avoid crystallization, they must be made by rapid cooling (quenching) from the higher-temperature disordered state.

Early investigators fabricated amorphous material by quenching from the liquid state, and the resulting compounds were generally called glasses. However, an important class of crystalline semiconductors, in-

Subtle. MIT's amorphous chalcogenide film, sandwiched between 200 micron-diameter molybdenum contacts, was sputtered in argon atmosphere.



cluding germanium and silicon, enter an amorphous state only when deposited on a cold substrate directly from the gaseous state. Quenching their liquid form merely turns them from molten to solid metal, which is not a semiconductor. Another kind of amorphous solid can be produced by chemical reactions at temperatures below the diffusion point, where crystallization does not occur. This is the method used to manufacture electrolytic capacitors.

Altogether, no fewer than a dozen methods have been used to produce amorphous materials with widely different properties. Moreover, it is possible that several different types of metastable disordered structures can be formed from a single chemical composition, depending on the exact preparation technique, or perhaps even on pure chance. And, it can seriously be questioned whether only one type of elemental material, say, Ge, yields only one type of amorphous compound. But though such an abundance may be a boon to device designers looking for a particular functional property, it poses a serious problem in characterizing amorphous solids.

In classifying such solids, the criterion is the type of chemical bonding between atoms that is primarily responsible for their cohesive energy. For amorphous semiconductors, two types are important—covalent bonding, in which atoms share electrons, and ionic bonding, in which ions with opposite charges are held together by the Coulomb attraction. The former group can be subdivided into pure elemental materials and mixed systems, making altogether three classes of amorphous material of value to semiconductor technology: the elemental amorphous semiconductors, examples of which are germanium, silicon,

tellurium, sulfur, and boron; the covalent amorphous semiconductors, which encompass such compounds as GeTe, As₂Se₃, and the chalcogenide, arsenide, and boride glasses; and the ionic amorphous semiconductors, compounds such as V₂O₅, Al₂O₃, and the transition-metal oxide glasses.

Once classified, the structure of the material in each class can be identified. The fact that amorphous semiconductors are spatially disordered systems presents a problem in analysis. But other disorders have been handled in the past, and these provide a feel for the disorder effects in amorphous compounds.

A perfect crystal in its ground energy state has perfect order—compositional, positional, and magnetic (spin). Given the position and type of an atom anywhere in the crystal, and the crystal's orientation, the exact position and type of every other atom can be determined, as well as the orientation of any permanent magnetic moments.

However, crystals are never perfect; and their imperfections can be characterized. An impurity represents an imperfection in compositional order; a defect (i.e., a vacancy or an interstitial atom, one which is located between regular lattice sites in a crystalline solid) is an imperfection in positional order; and a reversed spin is an imperfection in magnetic order. And crystals always have surfaces, which cause further positional disorders.

In addition, there are dynamic imperfections, often called elementary excitations. For example, lattice vibrations (phonons) are dynamic imperfections associated with positional disorder, and spin waves (magnons) are dynamic imperfections associated with magnetic disorder. Since elementary excitations often

Then there was Ovshinsky

The surge of interest in amorphous semiconductors excited by the Physical Review Letter published by S. R. Ovshinsky in late 1968 was as much a surprise to active researchers in the field as to the rest of the scientific and engineering community. Why all the fuss? Application of amorphous solids are everywhere. Glass is a venerable example. Electrolytic capacitors that are made of amorphous aluminum oxide or tantalum oxide are familiar to everyone working in electronics. And there are the new developments with xerography, based on the photoconductive properties of amorphous selenium or arsenic triselenide.

Nor could the tumult over Ovshinsky's disclosure have been due to the promise of switching. For amorphous switching had been applied by Ovshinsky himself over 10 years before, and was widely reported in the literature [*Electronics*, Aug. 14, 1959, p. 76]. Since that time variants have been rediscovered by many people. Further, such switching is not unique to amorphous materials, having been found in polycrystalline materials, such as antimony sulfide, nickel oxide, and recently even in single crystals of gallium arsenide, tin sulfide, and magnetic oxides. And switching aside, current-controlled negative resistance was observed in boron as early as 1913.

If this were not enough to dampen enthusiasm for new amorphous phenomena, the final quencher should have been the documented proof from many well known investigators that the switching was the uncontrollable result of such side effects as chemical reduction or sputtering of electrode material into the sample. Besides, early devices were reported to be unreliable, failed early, often could not be reproduced, changed characteristics with time, and melted during operation.

So why the massive rush into an archaic field with useless products? The answer is clear. While amorphous semiconductor materials have been known and used for centuries, only in the last few years has a theory been developed to explain their electrical and optical properties. This work has suggested new and fascinating concepts, which studies of crystalline semiconductors have not even hinted at. Although switching and current-controlled negative resistance have been observed in many materials over the past 50 years, switching, for example, in thin films of certain chalcogenide glasses is a different story entirely. In fact, it's because of their properties and our increased understanding of the basic physics that the probability of commercial applications of amorphous phenomena has increased many times over.

require little or no additional energy, they have important effects at low temperatures.

Then there are situations, like high temperatures, in which complete disorder occurs. A ferromagnet above its Curie temperature has no long-range magnetic order. An alloy above its ordering temperature shows long-range compositional disorder. Any liquid has long-range positional disorders. However, in every case, short-range order persists.

Similarly, all amorphous solids exhibit complete long-range positional disorder. For the elemental amorphous semiconductors, this is the only form of disorder: the position of any atom in amorphous Ge will reveal its identity. The covalent amorphous semiconductors, however, also have compositional disorder, and thus some ambiguity could exist in its chemical formula. For example, As_2Se_3 nominally contains 40% As and 60% Se, but it can be made just as easily with 39% As and 61% Se, or 20% As and 80% Se, or any other proportion. In such compounds, when an atom is finally located, it's not possible to know more than the probabilities of which kind it is.

In any case, the electrical properties of each class can be dealt with once the amorphous crystals have been classified structurally. The basic theory of electrons was applied to solids by Bloch and Wilson some 40 years ago. Bloch showed that, for a perfectly periodic arrangement of atoms, the energy states available to an electron as it moves through a solid are continuously distributed over certain energy ranges, called bands, but are excluded from other energy ranges, called gaps. More important, these states are itinerant, so that every electron is equally likely to be found anywhere in the crystal, rather than being localized around a particular atom, as might have been inferred from atomic physics.

Building on Bloch's conclusions, Wilson showed that a material is an insulator when it has just the right quantity of electrons for all of its energy bands to be exactly full or completely empty, with an energy gap between the highest filled band and the lowest empty band. Other materials, having one band partially filled, are metallic (conductors).

With the Bloch-Wilson theory, only a minimum of computation is needed to predict whether a particular crystal will turn out to be insulating or metallic. More important, the theory cleared up the problem of metal's high conductivity. Previously it had been thought that ion cores, by scattering conducting electrons, should produce a mean free path about as wide as a lattice spacing. Instead, mean free paths of over 100 lattice spacings were commonly observed—the well-known mystery of the unscattered electrons. The Bloch-Wilson theory, however, showed the itinerant nature of the outer electrons to be responsible for the long mean free paths. And this itinerancy follows from the assumption of perfect periodicity.

At first glance it would seem that periodicity is vital in explaining the electrical properties of crystals. Not so. Consider electrical conductivity as a function of temperature, taken through the melting point, which is the temperature at which long-range peri-

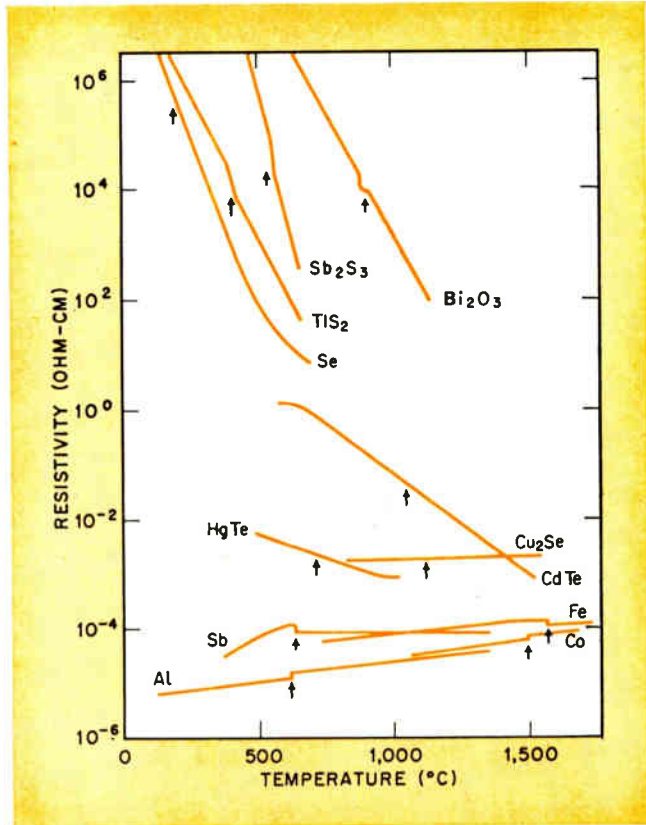

1. Insensitive. Resistivity as a function of temperature for several materials in both the crystalline and liquid states shows insensitivity of material's conductivity to long-range disorder. At the melting point indicated there is almost no change in the observed resistivity, and in a few cases (CdTe and Cu_2Se), where there is no observed density change upon melting, no change at all is observed in the resistivity.

odicity disappears. If periodicity were the controlling factor in electrical conductivity, a sharp drop in conductivity at the melting point would be expected. However, except for several materials whose short-range order changes discontinuously at the melting temperature and leads to a semiconductor-metal transition, almost nothing happens to the electrical conductivity of solids when they melt—metals remain metallic, semiconductors remain semiconducting, and insulators remain insulating.

Typical conductivities of several materials over a range of temperatures are shown in Fig. 1. As seen, small discontinuities may occur at the melting point, but in every case these can be attributed to the discontinuity in material density and not to disorder. Furthermore, in some materials that experience no sharp change in density upon melting, it is impossible to pick out the exact melting temperature.

Clearly, long-range periodicity does not appreciably affect electrical properties. So a promising tack to take in determining the electrical properties of an amorphous material, which exhibits long-range disorder, is to assume perfect short-range order and

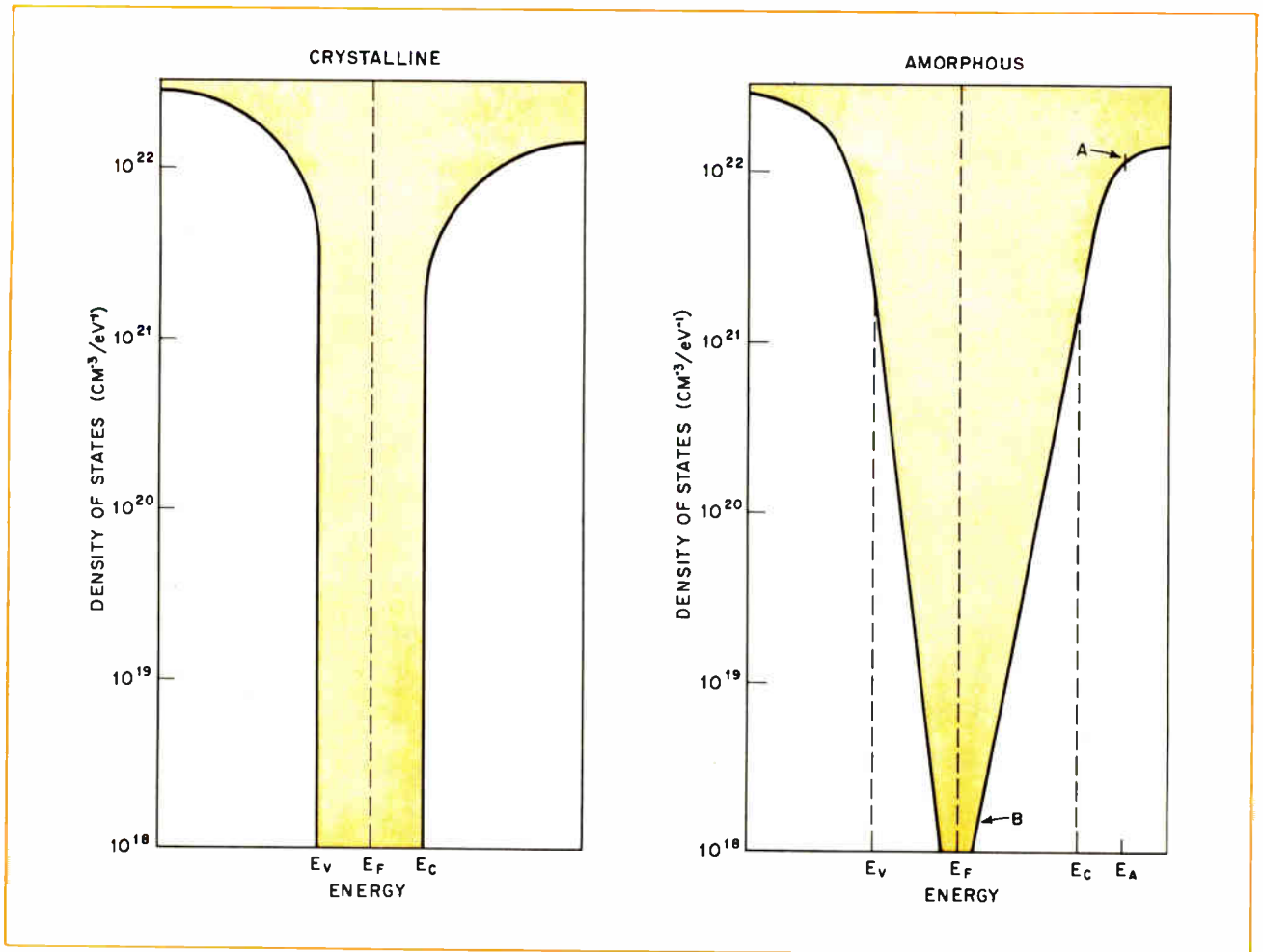

2. Filling the gap. The density-of-states structure for crystalline germanium (left) has an energy band gap bounded by E_C , the conduction-band minimum, and E_V , the valence-band maximum. Also shown is the Fermi energy in the gap. Perturbations occurring near the valence and conduction edges will move some states into the energy gap. This is the condition for amorphous Ge (right); called the band tails, these small density-of-states exist in what previously was the forbidden gap.

then, as with crystalline solids, introduce the effects of long-range disorder. These would include both a perturbation on the band structure and an additional scattering process that could limit the free carriers' mobility (velocity per unit of applied field).

The question, then, is if a material, whether crystalline or amorphous, maintains its short-range order. A liquid is known to possess a great deal of short-range order just above the melting point, where its long-range order is destroyed. X-ray and electron diffraction techniques show that the same is true for amorphous solids. For example, the nearest-neighbor environment of amorphous Ge is the same as in crystalline Ge; each Ge atom is surrounded by the same regular tetrahedron of Ge atoms. Since the band structure of a semiconductor is determined primarily by the nearest-neighbor configuration, the electronic density-of-states for amorphous and crystalline Ge should not be very different.

Now, the density of states $n(E)$ of crystalline Ge are known and are shown in Fig. 2, left. The perturbation induced by the deviations of second and

higher neighbors from the Ge crystal structure will move some of the states up in energy, others down. In the relatively flat portions of the bands, where $n(E)$ is large and essentially independent of the energy, these perturbations will have very little net effect. But near the valence and conduction band edges, they will have a profound effect, since they will move some states into the energy gap—and this, as a first approximation, is what the density-of-state of amorphous Ge might be expected to look like. The plot for amorphous Ge is shown in Fig. 3, right. Small densities of states exist in what previously was the forbidden gap and are called band tails.

This new band configuration makes it possible to describe the conduction properties (electron mobility) of amorphous Ge. Consider a state in the high-density part of the conduction band (point A in the figure). The density-of-states at E_A is of the order of 10^{22} per cubic centimeter per electron-volt. From this value, it can be calculated that the average separation of states within an energy kT (0.025 eV at room temperature) at E_A must be about 10 angstroms. This

means that, assuming all states to be localized and separated from each other by a potential barrier, an electron in one of the states of energy E_A near the negative electrode can tunnel to any other state of equal energy that's within a 10 \AA radius. Since the tunneling distance is so short, the probability is relatively large. Thus, despite the localized nature of the states, the electron can reach a reasonably high velocity when an external field is applied.

However, for an electron in the conduction-band tail, the average separation of states is much greater. For example, at point B, where the density of states is only on the order $10^{18}/\text{cm}^3/\text{eV}$, the average separation between states of energy within kT (at room temperature) would be about 250 \AA . The tunneling probability for this separation is near zero, as is the mobility of an electron placed in such a state. In fact, the only way to obtain conduction once an electron is localized deep in the band tail would be to excite it to a delocalized state higher in the band.

For an electron in a state in the region of intermediate density (10^{20} to $10^{21}/\text{cm}^3/\text{eV}$), there are two possibilities: as the density-of-states decreases, its mobility might either decrease gradually to essentially zero or it might make a sharp transition. Although not final, recent theoretical work indicates the transition is sharp. If so, the energies E_c and E_v , which separate localized from delocalized states in the conduction and valence bands, represent sharp structure only in the mobility. They can be thought of as mobility edges rather than band edges as in crystalline Ge. Similarly, the minimum energy separation between delocalized states in the two bands can be called the mobility gap; it plays the same role as the energy gap plays in crystalline structures.

Such a model can be used to characterize the band structure in elemental amorphous materials. In a material like amorphous Ge, enough electrons are present just to fill the valence band, including the states in the tail, leaving the conduction band empty. Thus, at low temperatures, the Fermi energy is located almost midway between the band tails. However, unlike crystalline Ge the localized states in the band tails are not donor or acceptor states—those below the conduction-band mobility edge are empty and those above the valence-band mobility edge are filled. Furthermore, the material does not degenerate when the Fermi level rises into the conduction-band tail: degeneracy occurs only after the Fermi level crosses the mobility edge, E_c .

Most important, this band model can be used to explain some of the observed but seemingly irreconcilable properties of elemental amorphous semiconductors. For example, the electrical conduction of amorphous Ge is primarily p-type (dominated by holes) but, in sharp contrast to crystalline Ge, its electrical properties are rather insensitive to impurities.

Most probably, the p-type nature of the conduction represents the effects of defects (acceptors) in the amorphous structure. As the defects are removed, say, by annealing away the pores that are produced during vapor deposition, the resistivity of amorphous Ge increases sharply. This would be expected to

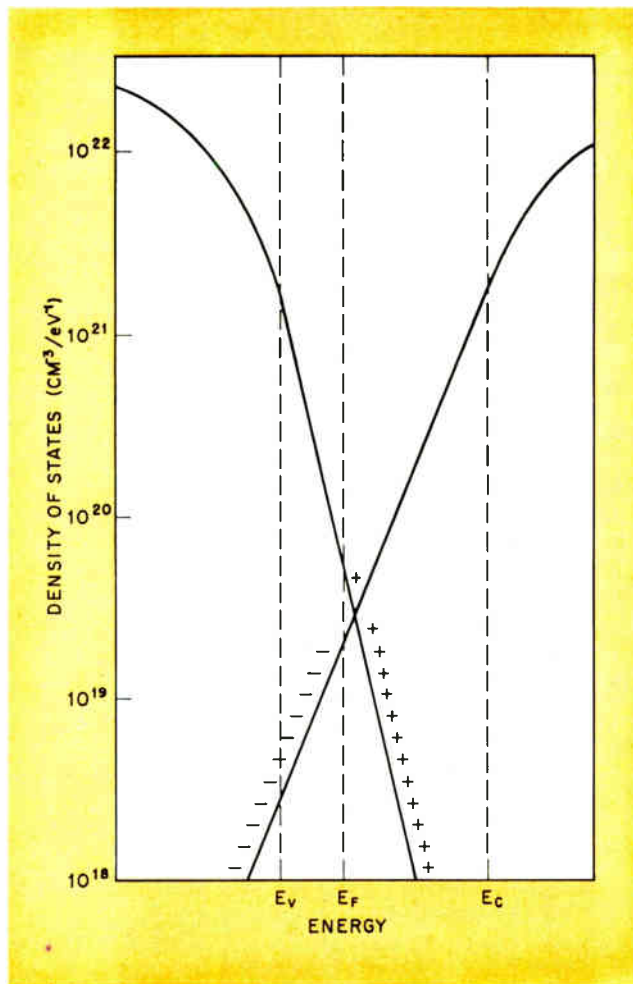

3. New picture. The CFO model for the density-of-states of a chalcogenide glass shows that the valence and conduction bands actually overlap. Even so, states can be distinguished between the valence-band and the conduction-band tails by whether they create positively or negatively charged ions. E_v and E_c represent the mobility edges; E_i is the mobility gap. The Fermi energy E_f is pinned in the gap. Truly a remarkable structure, it nevertheless serves to substantiate the great quantity of seemingly contradictory phenomena that have been observed in these materials.

happen if the acceptor (p-type) levels disappeared—but the conductivity is observed to remain p-type.

The explanation derived from the band model argues that the conduction band is more spread out in energy than the valence band. According to band theory, the higher the energy, the wider the band, all other things being equal. For a material such as Ge, all other things may well be equal, since the valence and conduction bands represent bonding and anti-bonding bands of the same electrons. So the conduction-band tail also is more spread out than the valence-band tail. Since the Fermi energy is midway between the band tails, it must be closer to the valence-band mobility edge than to that of the conduction band. The concentration of free holes, proportional to $\exp [-(E_f -$

The doping riddle

Pure crystalline semiconductors are highly sensitive to small impurity concentrations. For example, a few parts per million of arsenic in zone-refined germanium increase charge transport (conductivity) by a factor of 10^5 . However, charge transport in chalcogenide glasses is virtually independent of impurity concentrations of even a few percent. Conductivity remains small, still given by the standard equation, $\sigma = \sigma_0 \exp(-E_A/kT)$, with the same energy at point A and σ_0 as in the pure material.

It's difficult to figure out what a donor-type impurity might be in a chalcogenide glass with a composition such as arsenic 30%, selenium 18%, germanium 21%, tellurium 31%. Ge has four outer electrons, As has five, Se and Te have six. It could be naively assumed that introduction of, say, iodine atoms, with seven outer electrons, as substitutes for Te, might provide extra electrons which could be easily excited into the conduction band. But the electrical conductivity of $As_{30} Se_{18} Ge_{21} Te_{30} I_1$ is indistinguishable from that of $As_{30} Se_{18} Ge_{21} Te_{31}$.

The explanation: chalcogenide glasses have both positional and compositional disorder. Thus it's probable that, during formation (in the liquid state), each atom seeks out a favorable position—one in which all valence requirements are locally fulfilled. This means that every Ge atom can find a position where it is surrounded by four, tetrahedrally arranged, nearest-neighbors, each sharing one electron with it in a covalent bond. According to the 8-N rule of covalent bonding, the lowest energy state of an As atom is one in which it forms covalent oxide with three nearest neighbors; during glass formation, each As atom can find such an environment.

Similarly, each Se or Te atom can find a position in which it has two nearest neighbors, thus fulfilling its local bonding requirements. Thus, the combination of

positional and compositional disorder makes possible a network structure with no dangling bonds. But these dangling bonds lead to donor and acceptor levels in ordinary crystalline semiconductors. The extra electron contributed by an As impurity at a tetrahedrally coordinated Ge site can be freed from its atom with much less energy than an electron that forms part of a saturated chemical bond. So donors and acceptors may need not exist in chalcogenide glasses.

As for introducing donor levels by substituting I for Te, each I atom during the glass formation can find a position in which all of its valence requirements (one covalent bond) are locally fulfilled and no dangling bonds are produced. The fixed structure of a crystal enables I atoms to fill Te positions. But there is no way to accomplish this in an amorphous solid and it is virtually impossible to obtain ordinary conduction.

Junctions, too

In crystalline semiconductors, contacts can be either ohmic or rectifying, depending on the work functions of the materials in the junction. But it is peculiar (and useful) feature of chalcogenide glasses that contacts are always ohmic. In this sense, metal-chalcogenide glass junctions resemble metal-metal junctions.

Ordinarily, in the case of a negative electrode such as gold, it would be expected that a Schottky barrier as shown in Fig. 4 left, would be set up at E_f and would impede injection of electrons into the semiconductor. But since a chalcogenide glass has an extremely large density of localized states in the gap, the entire position space charge can be accommodated within an estimated 30 Å from the electrode, as indicated in Fig. 4 right. Thus, electrons can now tunnel easily from the metal into the conduction band of the glass, providing the ohmic contacts that are observed.

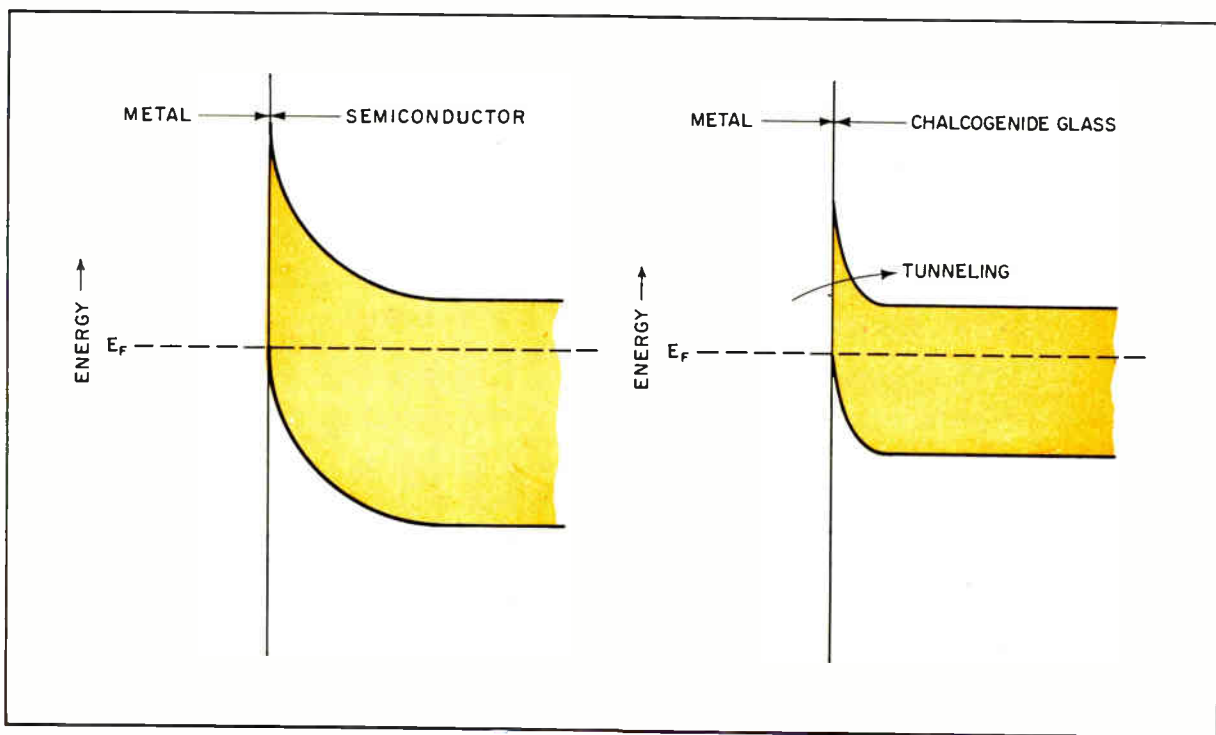

E_v/kT], then exceeds that of free electrons, which is proportional to $\exp [-(E_c - E_F/kT)]$, and conductivity remains p-type.

Even if a donor-type impurity such as arsenic atoms could be substituted for Ge atoms, the extra electrons could be accommodated in the conduction-band tail. This would increase the Fermi energy somewhat, but if $(E_c - E_F) > (E_F - E_v)$, conduction remains p-type.

Characterizing the band structure and electrical properties of amorphous Ge is manageable. Doing the same thing for covalent amorphous semiconductors, of which the chalcogenide glasses are the most common, is much more complex. The trouble is that, while amorphous Ge exhibits only long-range positional disorder, the chalcogenide glasses show compositional disorder as well.

Typical chalcogenide glasses may have almost any composition, for example, $As_{30} Se_{18} Ge_{21} Te_{31}$. Moreover, disorder is directly responsible for the band tails, so that much more extensive tailing can be expected in the chalcogenide glasses. In fact, Cohen, Fritzsche, and Ovshinsky recently suggested in their CFO model that the tailing in chalcogenide glasses is great enough to make the valence and conduction bands overlap—a unique state in semiconductor theory. This band overlap is seen in Fig. 3—the density-of-states of a chalcogenide glass—known as the CFO model.

This unusual situation immediately raises two questions: if the valence and conduction bands overlap, is it still possible to distinguish between the two, or should the two bands be plotted as a single density-of-states representing the sum of the bands? And if states exist in the conduction band with energy lower than some of the valence-band states, shouldn't a repopulation occur to achieve equilibrium?

The answer to the first question is that, despite the overlap, a state in the valence band tail can be distinguished from one in the conduction band tail. A localized state in the valence tail is normally filled, in which case the corresponding atom is neutral; if empty, it must represent a positively charged ion. On the other hand, a localized state in the conduction-band tail ordinarily is empty, and the corresponding atom is neutral; an electron input would create a negatively charged ion. Thus there is a sharp distinction between localized states in the two bands.

CFO's answer to the second question is that indeed a repopulation must occur, in which case the electrons fill the lowest possible energy states at zero temperature. Provided no donor or acceptor states exist, there will be enough electrons to fill the valence band exactly and leave the conduction band empty.

However, electrons in the highest valence-band states may lower their energy by falling into the states at the bottom of the conduction-band tail. This process will continue until the energy of the system is minimized and the Fermi energy then can be drawn above the highest filled states, as shown in Fig. 3. The same process, however, also empties some valence-band states, which therefore represent positively charged traps in the gap. Further, it fills some conduction-band states, which represent negatively charged traps. And most important, equal densities of

positive and negative traps always exist in this model.

This is the essence of the CFO model. It accounts impressively for many experimental results on chalcogenide glasses, including some unusual properties.

For example, it predicts that two types of electronic transport are possible—a bandlike, intrinsic conductivity due to excitation of electrons either above E_c or below E_v in Fig. 3, and a hopping type of conductivity among the localized states in the gap. The former should dominate at high temperatures, the latter at low temperatures. The mechanism underlying low-temperature conduction is not yet clear, but clearly high-temperature transport is the intrinsic process.

On the question of optical absorption, the CFO model accounts nicely for the observation that the absorption edge isn't as sharp as found in most crystalline semiconductors. Instead, the absorption coefficient is exactly what would be expected if large valence and conduction band tails existed, as the CFO model suggests. In this theory the mobility gap can be estimated as on the order of 1 eV.

Thermoelectric effects also can be accounted for. The evidence from Seebeck-effect measurements shows that conductivity is bandlike and always p-type, regardless of the nature of the impurities. The discussion of amorphous Ge indicated that its independence of impurities was easily explained on the assumption that the conduction-band tail is more spread out. The CFO model has a still more successful explanation, because now it's assumed that the Fermi energy is pinned in the gap. But conductivity reveals an inconsistency: Hall-effect measurements, not necessarily trustworthy, indicate an n-type conductivity. This Hall-Seebeck puzzle, which sometimes occurs in crystalline semiconductors, has not yet been resolved.

The fact that amorphous solids are more resistant to radiation than the corresponding crystalline solids also can be explained by the CFO model. Radiation induces large densities of defects in crystalline semiconductors, thus increasing conductivity sharply. However, in amorphous semiconductors, where atoms already are disordered, radiation damage should not be very extensive. Exactly the extent of radiation

Source material. Oscillations result when a pulse (upper trace, $2 \mu\text{sec}/\text{div.}$) is applied to a 1-thick chalcogenide film. Lower trace shows voltage-across film.

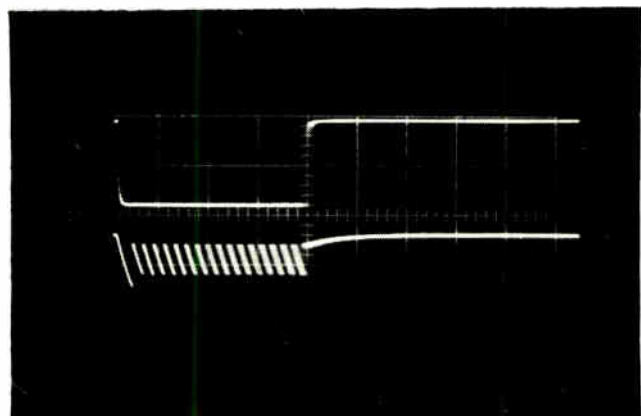

Amorphous switching . . .

Many of the mechanisms that at first glance could be used to explain the switching of amorphous semiconductors in fact do not agree with the observed data. For example, threshold switching very likely is not due to avalanche breakdown, particularly since the mean free path of free carriers is less than 10 Å. With a threshold field of 10^5 V/cm, the carriers can gain only 0.01eV from the field between collisions, and it would appear impossible for these carriers to bridge a 1-eV gap by impact ionization. Thus, no hot-electron effects should be expected in chalcogenide glasses.

Zener breakdown can also be eliminated, either because fields of 10^5 V/cm will not yield a tunneling probability sufficiently large to overcome the recombination rate, or because the large negative resistance region is incompatible with the necessity of maintaining the tunneling rate.

Likewise, switching that depends on a field-induced increase in carrier mobility also can be ruled out. This would be a strong possibility if room temperature conduction were achieved primarily by means of a hopping mechanism, since such a field could bring about exponential mobility rises or even a transition to band-like conductivity. However, in the chalcogenide glasses, band-like conduction predominates at room temperature.

A structural transformation under high-field conditions would also appear to be possible. But this mechanism should be more likely in ionic materials than in primarily covalent compounds like the chalcogenide glasses, and the absence of any thermally induced transition is further evidence against such a model.

Thermal runaway, arising from extremely rapid Joule heating, also has been a frequent explanation. Such a model accounts for the negative resistance region, the pre-switching delay time, and filament formation. There seems to be little question that switching is thermally induced for bulk material and for films thicker than about 8 microns. And thermal runaway has been found to occur for particular compositions and geometries even in thin films. However, although a purely thermal model cannot fully explain the observed switching characteristics, the effects of Joule heating, particularly in the on state, cannot be ignored.

But the most promising method for reconciling the observed phenomena at present is an electronic mechanism of some kind. A large nonohmic region exists before switching in which current rises exponentially with voltage, and thermal effects are negligible. This represents a non-equilibrium electronic effect, strong evidence for an electronic mechanism for switching. Furthermore, the fact that the switching characteristics of thin films of chalcogenide glasses appear to be qualitatively different from those in other materials suggests that a mechanism must be sought which employs the unusual electronic properties of amorphous semiconductors.

The Cohen-Fritzsche-Ovshinsky model offers a useful feature for threshold switching—it requires the material to have essentially equal densities of positive and negative traps. This implies that a non-equilibrium state, in which all traps are filled, is neutral, and thus can support a high conductivity.

Recently, two possible models for threshold switching

have been proposed which make explicit use of the CFO model. Henisch, Fagen, and Ovshinsky (HFO) suggested a double-injection space-charge model, outlined in Fig. 5. Its main feature is the formation of a negative space charge near the cathode, caused by the trapping of electrons emitted from the electrode, and formation of a positive space charge near the anode. These space-charge regions limit the current and act as virtual electrodes, increasing the electric field in the bulk material. Eventually, the two space-charge regions overlap in the center of the film, producing a region in which all positive and negative traps are filled. Since this region is also neutral, it is highly conductive. Consequently, the state initially is unstable, electrons will be accelerated toward the anode, holes toward the cathode, and a highly conductive state formed very rapidly. It is sustained by double injection, provided that a holding voltage greater than the mobility gap is maintained across the film.

Fritzsche and Ovshinsky (FO) suggested a competing mechanism, shown in Fig. 6. They point out that field-induced excess carriers can lead to formation of depletion regions near the electrodes, since the anode and cathode are unable to supply the holes and electrons necessary to maintain the non-equilibrium current. The resulting Schottky barriers grow with increasing voltage,

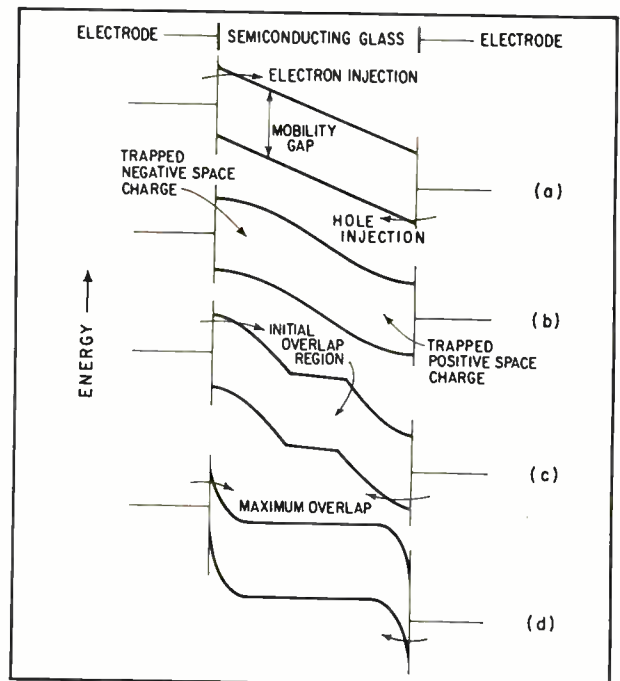

5. Switching model I. The HFO model details threshold switching in chalcogenide glasses in several steps: (a) initial state of low conductivity, immediately after voltage is applied; (b) formation of space charges and space-charge-limited current; (c) unstable situation resulting from overlap of the positive and negative space-charge regions; (d) conducting state, maintained by double injection of electrons and holes.

but the large density of traps in chalcogenide glasses enables the entire depletion region to be accommodated within 30 Å of the electrodes, maintaining ohmic contacts. Trap-limited current proceeds until all traps are filled; then switching occurs rapidly. The resulting on state is stable, provided the voltage that remains across the material exceeds the mobility cap.

Both the HFO and FO models can account for threshold switching, and both may even occur in the same materials at different ambient temperatures. The HFO model is essentially a low-temperature mechanism, while the FO model requires intermediate temperatures, in order to set up the Schottky barriers before threshold. The evidence now points to the fact that the transition between the two models occurs below room temperature. The pre-switching conductivity appears to be bulk limited rather than electrode limited, and the delay time has been shown to be largely independent of polarity reversals, in accordance with the FO model. Both models are consistent with the minimum charge injection observed before switching. As of now, the FO model has the virtue of at least surviving experimental elimination. The exact threshold behavior mechanism may not yet have been clearly determined, but switching can no longer be considered the complete mystery it once was.

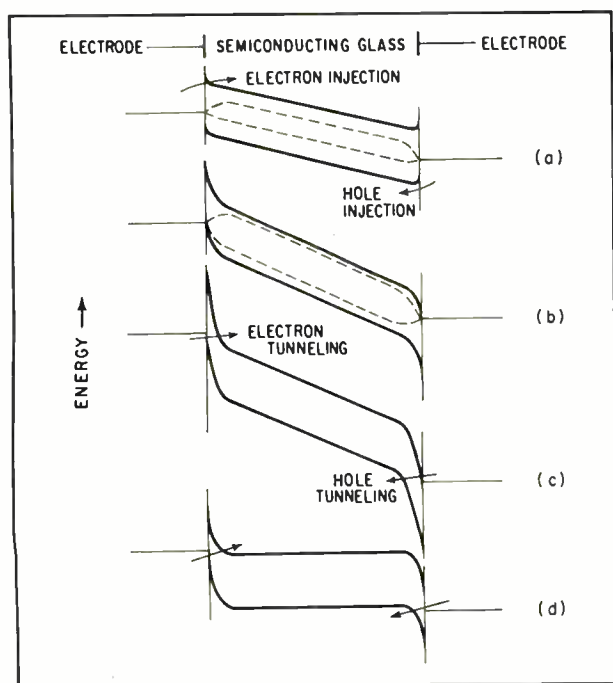

6. Switching model II. The FO model for threshold switching in chalcogenide glasses: (a) initial state of low conductivity, immediately after voltage is applied; (b) formation of Schottky barriers, due to non-equilibrium carrier concentration in the bulk; (c) double-injection state with trap-limited current; (d) conducting state, obtained after all traps are filled.

immunity in chalcogenide glasses was discovered in the course of testing switches. Even when the radiation was intense enough to produce nuclear transmutations and destroy the cables attached to the devices, the switches remained within 10% of their original characteristics.

This phenomenally high radiation resistance is remarkable since it must be true that nuclear transmutations create defects that act as donors; in the band structure of Fig. 3 these are states originating in the valence band (i.e., neutral when occupied) near the conduction band edge.

These donor states, however, fail to produce extrinsic conduction. The explanation, according to the CFO model, is that there are unoccupied states in both the valence and the conduction band tails that are below the donor states in energy. The excess electrons fall into these states at equilibrium, leaving ionized donors behind them. And all that happens is that the Fermi energy shifts slightly to $E_F + \Delta E_F$, which hardly affects the conductivity at all.

In addition to their radiation hardness, the photoconductivity of chalcogenide glasses could make them a versatile semiconductor material. With crystalline semiconductors, when light of an energy larger than the band gap impinges on their surface, intrinsic electron hole pairs are formed, which contribute to conductivity while the light is on. When the light is turned off, a rapid (10^{-8} s) recombination reduces the conductivity to its equilibrium value.

According to the CFO model, the same would be expected of an amorphous semiconductor, provided that the photon energy exceeded the mobility gap. (This principle is the one behind xerography.) This is just what is observed in chalcogenide glasses at room temperature. However, at the temperature of liquid-nitrogen (77°K), Fagen and Fritzsche observed an excess dark conductivity that persisted for hours after the incident light was removed.

Again, this last result is explicable by the CFO model if the mechanisms for recombining photo-excited electrons and holes are taken into consideration. At the moment that a light is turned off there are about 10^{12} per cm^3 free electrons with energy above E_c . These may recombine directly with free holes, which are mobile and are attracted to the free electrons by Coulomb interaction. A second possibility is that the electrons may be trapped in those localized states in the valence and tail that are unoccupied because of photoexcitation. These states are positively charged, and thus will attract free electrons. However, this process should be dominated by direct recombinations and its effect minimized, since the free holes are mobile and the concentrations of photo-excited free and bound holes are the same order of magnitude.

But most significant of all, free electrons may be held by the localized, positively charged traps that exist above the Fermi energy in Fig. 3. Although these traps are immobile, they are present in great numbers—roughly 10^{10} per cm^3 . This is about 10^7 times the concentration of holes below E_F and should result in the predominance of this process over direct recombination, even though its density-of-states cross-

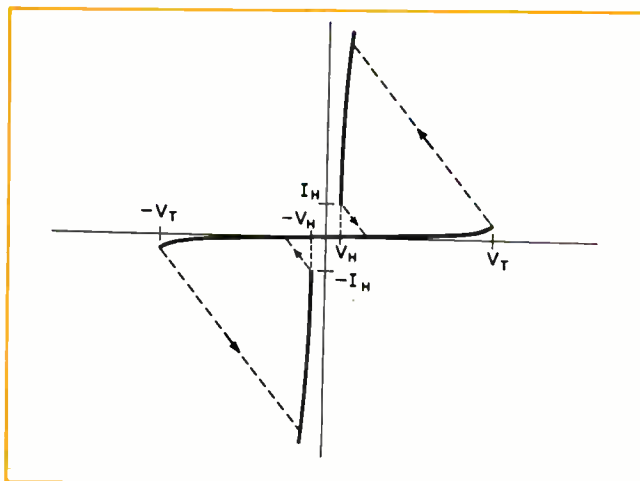

7. Amorphous switch. Current-voltage characteristics of a thin film of a threshold-type chalcogenide glass in series with a current limiting resistance shows the discontinuous nature of the switching. This is typical of all chalcogenide glasses.

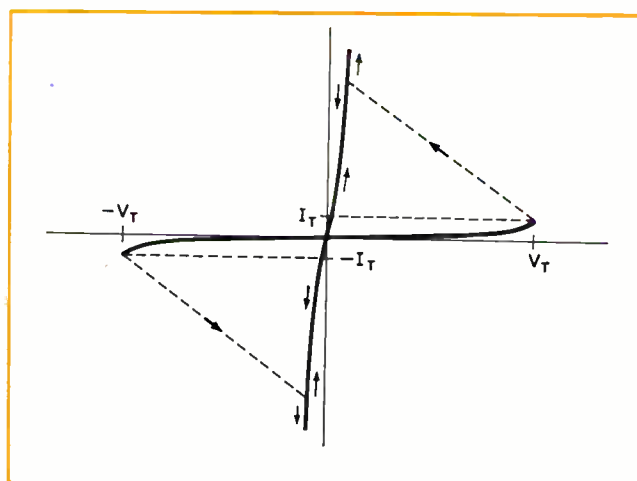

8. Good memory. Current-voltage characteristics of a thin film of chalcogenide glass doped with small percentages of As and Sb show a memory cycle. Although similar to I-V characteristics of threshold-type material, no holding voltage is necessary.

section is lower than that for direct recombination. (Electrons also could be trapped at the neutral sites in the conduction band tail, but they lack Coulomb attraction, and the cross section is negligible.)

In all likelihood, therefore, most free electrons are trapped above the Fermi energy. There they become localized states, and cannot return to their equilibrium positions below E_F without the assistance of atomic vibrations (phonons). At room temperature, the atoms vibrate with sufficient vigor to restore equilibrium in less than 1 millisecond. However, at 77°K , their vibrations are very sluggish and electrons can stay above E_F for hours. Since the electrons are then nearer the conduction band mobility edge, they induce excessive dark conductivity, as observed.

Clearly, any nonequilibrium creation of excess carriers should lead to a similarly long relaxation time at low temperatures. A completely analogous result, in which excess conductivity remained long after the application of voltage pulses, also was observed by Fagen and Fritzsche at 77°K .

If the trapping of electrons above the Fermi energy level is the dominant recombination process, it should be observable in the fluorescent radiation emitted after photoexcitation. Kolomiets investigated the recombination radiation from a chalcogenide glass having a 1.1 eV mobility gap, and found two peaks. One, near 1.1 eV, results from direct combination, but a peak 50 times more intense was observed near 0.67 eV.

The interpretation of this result is far from clear. The CFO model predicts that dominant fluorescence should occur at less than half the gap, rather than at 60% of the gap, as observed by Kolomiets. In chalcogenide glasses, however, E_F would be expected to be nearer E_v than E_c , to explain the p-type conductivity. If so, a third peak should exist near 0.42 eV, representing the trapping of photoexcited free holes below E_F . Since Kolomiets' equipment cut off below 0.60 eV, this peak has not yet been investigated.

Nevertheless the CFO model accounts for many experimental results. Assuredly, an adequate theory and an adequate method of classifying the space of amorphous materials are essential before their unique and revolutionary properties can be fully realized.

One such property, first considered by Ovshinsky, is threshold switching. Exhibited by a large class of chalcogenide glasses, threshold switching is a consequence of a material's I-V characteristics, an example of which is shown in Fig. 7. In the material's off state, the resistance is 1 to 10 megohms at low fields. Above about 10^4 v/cm, current starts to rise exponentially with increasing voltage. The threshold field is of the order of 10^5 v/cm, and is largely independent of thickness. This makes the threshold voltage proportional to thickness and it can be made to vary from 2 V to 300 V. On the other hand, the holding voltage is independent of thickness, and can be varied from 0.5 V to 1.5 V, depending on the glass.

Conduction in the on state occurs along filamentary paths, and its characteristics are independent of polarity. Switching time is of the order of 100 nanoseconds. Between the application of the threshold field and the occurrence of switching, there is a delay that decreases exponentially with voltages above threshold. It can be reduced from about $1\ \mu\text{s}$ to less than 1 ns.

Switching parameters depend on the composition of the material, but some form of switching—threshold or memory—is almost universal in chalcogenide glasses. One property found during differential thermal analysis of good threshold-type material is the absence of any significant thermodynamic phase transition up to 400°C . This may turn out to be the major material requirement. As the temperature increases, the glass appears neither to crystallize nor melt—it just becomes less and less viscous.

Amorphous material also can be made to perform memory switching. Ovshinsky found that if chalcogenide

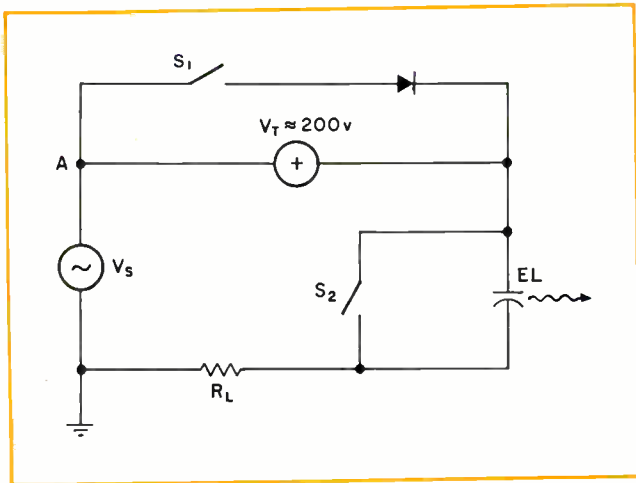

9. Lighting up. A simple circuit can be built that provides bistable control of an electro-luminescent lamp by means of a threshold switch. Perhaps the most promising application of threshold switching, it can provide bistable operation for $100\text{ V} < V_s < 200\text{ V}$.

genide glasses contain small percentages of cross-linking elements, such as As and Sb, which require threefold coordination to fulfill their local valence requirements, their current-voltage characteristics have the sort of memory cycle shown in Fig. 8. Off-hand, these characteristics greatly resemble those of the threshold-type material of Fig. 7, except that no hold voltage is necessary, and the switching is bistable. The device remains on until a rapid current pulse of either polarity is applied.

Material compositions of memory switches are much nearer the edges of the glass-forming region than those of threshold switches. Because of this, differential thermal analyses of bulk memory-type materials reveal very different behavior from that of threshold-type materials. Generally speaking, threshold-type glasses show no thermal transitions, whereas memory-type glasses have at least two. Upon heating, an exothermic (heat-releasing) transition occurs near 300°C , which may be associated with a phase separation and crystallization in the material. Near 400°C , there is an endothermic (heat-absorbing) transition, correlated with melting. A low-resistance state always is obtained when the material is cooled after reaching a point intermediate between the two transitions. Above the second transition, however, fast cooling produces a high-resistance glass, while slow cooling yields a polycrystalline state of low resistance.

These results, taken together with X-ray, electron diffraction, nuclear magnetic resonance, and transport data, suggest a simple mechanism for memory switching. Initial breakdown occurs as in threshold switching, producing a conductivity state that requires a holding voltage for stability. In the course of the breakdown, a rapid phase separation of the positive and negative ions in the conducting filament occurs, and results in a channel of low-resistivity polycrystalline material. After breakdown, ionic motions are much more likely, since many of the covalent bonds

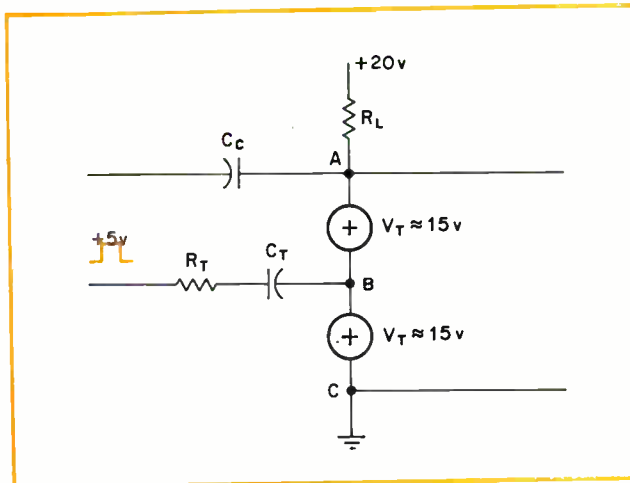

10. Either way. A quasi-three-terminal device using two threshold switches in series can be turned on either by a negative or by a positive pulse, pointing to threshold switching's basic independence of polarity.

responsible for the local atomic positions are broken. A short current pulse returns the material to the off state by first melting it, thanks to a large I^2R Joule heating, and then by quenching it. Since the environment of the filament remains at low temperature, after a short pulse a rapid cooling of the melted material insures glass formation and low conductivity.

In addition, bulk studies of a particular memory material, $\text{Te}_{81}\text{Ge}_{15}\text{As}_4$, have shown that the switching is reversible and does not require significant compositional changes. They also establish that its on state is due to the semimetallic properties of doped, polycrystalline Te. High conductivity therefore is not an artifact of fabrication but a bulk material property.

Clearly, both threshold and memory switching could have a profound effect on semiconductor technology. The most promising application for threshold switching is in electroluminescent displays. A simple circuit, which demonstrates the compatibility of threshold switches with electroluminescent devices, is shown in Fig. 9. Using a switch with a threshold voltage of 200 V, the EL lamp (which acts as a capacitor in the circuit) will be permanently off for source voltages, V_s , below 100 V, while it will be continually on for V_s above 200 V. Therefore, bistable operation is possible for $100\text{ V} < V_s < 200\text{ V}$.

If, for example, $V_s = 100\text{ V}$, and the capacitor is initially uncharged, V_t is never exceeded, and the lamp remains off. When switch S_1 is closed, a charge of $+100\text{ V}$ is placed on the upper capacitor plate. Nothing happens until -100 V appears at point A. This results in -200 V across the threshold switch, which fires and transfers the -100 V to the upper capacitor plate, causing the lamp to glow. As soon as the capacitor is fully charged, the holding current cannot be maintained, and the threshold switch turns off. Again, nothing happens until the voltage at A reaches $+100\text{ V}$, 8 milliseconds later, at which point 200 V appears across the switch and it fires. The lamp

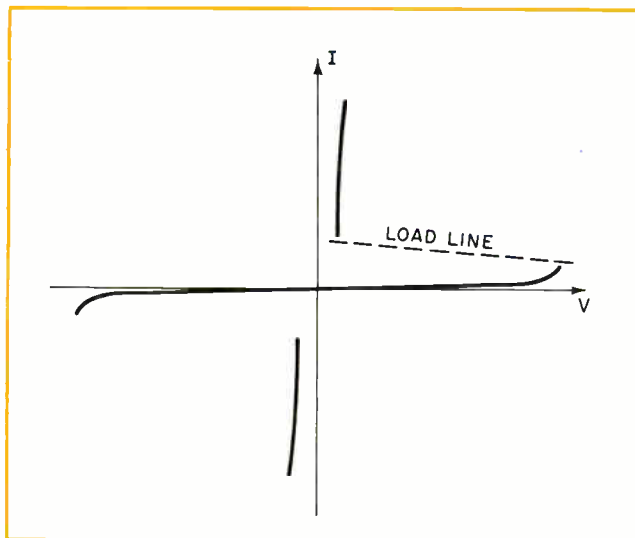

11. Highly unstable for use as a potential high-frequency oscillator, the current-voltage characteristics of a threshold switch in series with a very large load resistance shows lack of any stable state over a range of applied voltages.

then emits light and locks +100 V on the upper plate, restoring the initial conditions. The lamp glows every 8 ms and is continually on. Closing switch S_2 removes the charge from the capacitor, and turns the lamp off.

One of the simplest applications of threshold switching, is as an ac thermostat. Some chalcogenide glass compositions can be prepared in which the threshold voltage for conduction decreases sharply with increasing temperature (a 3% decrease per degree C). Thus if V_0 is the threshold voltage at temperature T_0 , application of a bias voltage equal to V_0 will cause the switch to be on for all temperatures less than T_0 , but off at all higher temperatures.

Another possible use is in high-frequency oscillation. The principle is illustrated in Fig. 11. When the load resistance exceeds 100 kilohms, and the applied voltage is sufficiently high, it is possible that no stable switch state exists. This is because the threshold voltage of the non-conducting state can be exceeded with a bias too small to maintain even the holding voltage of the conducting state. Since the switching time is less than 1 ns, gigahertz oscillations are possible, in principle. However, a device has not yet been successfully operated in this frequency range.

Nor should the use of the threshold switch in logic circuits be overlooked. Although basically only a two-terminal device, many three-terminal circuit applications already have been devised.

As an example, consider the quasi-three-terminal device shown in Fig. 10. With 20 V across two identical switches, 10 V is dissipated across each. Since the threshold voltage is 15 V, neither fires. However, if a positive 5 V pulse is applied at B, 15 V appears across BC, and the lower switch fires. This causes the voltage at B to drop to the holding voltage of 1 V, and leaves 10 V across AB, causing the upper switch also to fire. The output voltage across AC is now

about 2 V. Turn off can be accomplished by applying a negative voltage pulse at A large enough to reduce the current below the hold value. If C_0R_L is large enough, both switches turn off, and output voltage returns to 20 V. An interesting point is that the turn-on pulse could equally well be -5 V, in which case the upper threshold switch would fire first, adding the bonus of switching independent of polarity.

In memory switching, the high packing density and few exterior connections necessary for operation make amorphous semiconductors an ideal medium for bulk computer applications. In addition, their inherent radiation hardness is an important advantage, especially for bulk data storage.

A recent development that uses amorphous memory switching is a 256-bit electronically alterable read-mostly memory, built by Energy Conversion Devices on substrates from Intel Corp. [For a detailed description, see the article immediately preceding.] What's more, there appear to be no obstacles to an expansion of its capabilities to the order of 10^6 bits.

Recent work on optical, as opposed to electrical, switching, has broadened the range of applications of memory switching. Feinleib of ECD has shown the possibility of switching memory-type material both on and off with the same laser. What happens is analogous to field-induced switching: the on state is produced by phase separation under nonequilibrium conditions, in which there are large densities of photo-induced carriers, and the off state by local heating and subsequent quenching. More exciting, however, Feinleib has been able to develop an amorphous alloy that is transparent to red light when off, but opaque when on. This could be the kernel of an easily alterable optical memory and, since a laser beam can be focused within 1 micron diameter, a 10^{12} -bit memory becomes an imminent possibility.

The fact that memory-type material can be switched with a laser beam opens up the possibility of electrostatic printing. The plate produced by laser-induced switching of a memory-type material, as opposed to a xerographic plate, is permanent, and can be used to prepare as many copies as desired. In addition, the master plate can be altered very easily. □

BIBLIOGRAPHY

1. S. R. Ovshinsky, "Reversible Electrical Switching Phenomena in Disordered Structures," *Phys. Rev. Letters* 21, 1450 (1968).
2. M. H. Cohen, H. Fritzsche, and S. R. Ovshinsky, "Simple Band Model for Amorphous Semiconducting Alloys," *Phys. Rev. Letters* 22, 1065 (1969).
3. E. A. Fagen and H. Fritzsche, "Electrical Conductivity of Amorphous Chalcogenide Alloy Films," *J. Non-Crystalline Solids* 2, 170 (1970).
4. B. T. Kolomiets, T. N. Mamontova, and A. A. Babaev, "Radiative Recombination in Vitreous and Single Crystal As_2S_3 and As_2Se_3 ," *J. Non-Crystalline Solids* 4, 289 (1970).
5. H. Fritzsche and S. R. Ovshinsky, "Electronic Conduction in Amorphous Semiconductors and the Physics of Switching Phenomena," *J. Non-Crystalline Solids* 2, 393 (1970).
6. H. K. Henisch, E. A. Fagen, and S. R. Ovshinsky, "A Qualitative Theory of Electrical Switching Processes in Monostable Amorphous Structures," *J. Non-Crystalline Solids* 4, 538 (1970).
7. D. Adler, J. M. Franz, C. R. Hewes, B. P. Kraemer, D. J. Sellayer, and S. D. Senturia, "Transport Properties of a Memory-Type Chalcogenide Glass," *J. Non-Crystalline Solids* 4, 330 (1970).
8. D. L. Nelson, "Ovonic Device Applications," *J. Non-Crystalline Solids* 2, 528 (1970).
9. T. J. Kobylarz, "Several Circuit Applications of Amorphous Semiconductors," *J. Non-Crystalline Solids* 2, 515 (1970).

Tell us the Truth.

Okay, Signetics, they tell me you're prepared to custom-build ROM for all kinds of applications. To tell the truth, here's my ROM application:

- Control
- Micro-programming
- ASCII-ebcdic
- Hollerith to EXCESS-3
- Binary to BCD
- Adder
- Function generator
- Character generator
- Other: _____
- _____
- _____
- _____
- _____
- _____
- _____

Now you tell me the truth, and nothing but, in your data sheets and truth table forms. While you're at it, send details of your off-the-shelf ROM 8224 (ASCII-ebcdic) a TTL 256-bit IC organized as 32 words with 8 bits per word. One more thing: this is my real

name _____
company _____
address _____
city _____
state _____ zip _____

Mail to: Mr. Stan Goodrich, Signetics Corporation, 811 E. Arques Ave., Sunnyvale, Ca. 94086.

Signetics 

Signetics Corporation/811 E. Arques Ave., Sunnyvale, California 94086 (A subsidiary of Corning Glass Works)

Industry's verdict still a long way from unanimous

Arrayed against those few companies and research laboratories that think the new technology will pay off are many that don't, while between are some fence-sitters; overseas firms express considerably more optimism

By Laurence Altman, *Advanced Technology Editor* and George F. Watson, *Solid State Editor*

□ Will amorphous semiconductor technology make it out of the laboratory and into the highly competitive semiconductor market? Those who think so are Energy Conversion Devices in Detroit, Intel Corp. of Mountain View, Calif., and a handful of university and government laboratories. Almost everyone else must be counted as a nay-sayer and there are also a few fence-sitters.

The following interview typifies the last group's attitudes. The subject, who requests that he and his company remain anonymous, is a widely respected man in a high position in a well-known research laboratory.

Q: What do you think of the prospects of amorphous semiconductors?

A: Frankly, I wouldn't give you a nickel for them.

Q: Why not?

A: Because the material is unreproducible, the devices unreliable, and the theory shot full of holes. Besides, no two observations are alike.

Q: Is your laboratory working on them?

A: You bet we are.

Q: Can we print that?

A: No.

But, however much established companies may dislike encouraging a technology whose success could annihilate conventional semiconductors, can they afford to ignore it? The attractions are undeniable:

▶ Unlike crystalline semiconductor materials, raw amorphous glass is dirt cheap. Almost any amorphous glass has switching properties, and none requires the stringent purity of bulk silicon, gallium arsenide and germanium. Films can be made simply by quenching the bulk glass; no expensive p-n junctions, no multiple diffusion layers, no epi-growths, are necessary, since the amorphous material does the switching by itself.

▶ Driving power requirements for amorphous devices are low and independent of polarity, lending great flexibility in addressing schemes. Operation is immune to the effects of radiation, which the political climate makes essential.

▶ Amorphous material, being electro-optic, can be switched between transparent and opaque states, opening up the prospect of 10^{12} -bit storage memories if used with narrow laser beam scanners. Perhaps

most importantly, all the IC techniques built up over the years are directly and naturally applicable to amorphous devices.

Consequently, the companies excited over the prospects for the future of amorphous semiconductors have something to be excited about. And few as they are, their voices are loud. By far the most vocal is Detroit-based Energy Conversion Devices, headed by Stanford Ovshinsky, who is considered the founder of amorphous semiconductor technology, and enthusiasm is heard on both coasts: MIT's Materials Laboratory

The broader view abroad

Unlike their U.S. counterparts, many overseas semiconductor manufacturers are letting a distinct tone of optimism break down their traditional reservations about amorphous semiconductors. In fact, work in the United Kingdom, West Germany, the Soviet Union and Japan is proceeding briskly, although often at variance with the application goals pursued in the U.S.

Perhaps the most extensive device-oriented work is going on at Standard Telecommunication Laboratories Ltd. Cyril Drake, who heads up amorphous semiconductor work there, feels that Europe generally is at least as far along as the U.S. in fundamental understanding of glass semiconductor behavior. And despite the fact that there's no real prospect of production devices appearing in the next year or two, the long-term outlook is optimistic, Drake claims.

Drake's work is exclusively in oxide glasses to provide useful inexpensive memories and switches for telephone and computer applications. Drake has made tens of thousands of devices over a five-year span. The big problem in his work is random variation in the performance of a single device from cycle to cycle, he explains. However, Drake says that he has reduced the separate problem of long-term drift to negligible levels.

At Marconi Co. Ltd., Dennis Bryant, chief of semiconductor physics, says, "We think that active device matrices covering large areas eventually might be made more easily in glass than in silicon, and be very useful for display control." His company has made experimental switch and memory devices which have shown

in the East and Intel on the West Coast.

At ECD they're interested in producing working devices. This has not been easy. For several years, the company could only supply a few samples to interested customers. But by now it is in pilot production of a new read-mostly memory circuit [see p. 56]. And the company's R&D isn't standing still, either. Work is proceeding on improving the capacity and performance of the RMM. And the company is attempting to exploit the properties of amorphous semiconductors in other applications, including an electroluminescent display panel, a computer mass memory, and high-speed computer printout.

A big boost for ECD production efforts in amorphous semiconductors came from Intel Corp. Robert Noyce, president of Intel, feels that Ovshinsky "did the industry a service by bringing amorphous semiconductors to its attention." Intel's endorsement may prove the strongest boost for amorphous technology.

In the joint Intel-ECA RMM venture, Intel is supplying the silicon substrates on which ECD is placing glass films. The silicon chips contain the p-n junctions necessary to electrically isolate the amorphous memories, pointing up the importance of the compatibility of amorphous films with silicon technology, which offers a practical way to address devices.

Noyce notes that "there is no license agreement either way. We feel that it's an intriguing way to

make memories and we're working with ECD".

Noyce is well aware that many in industry attack amorphous materials as unreproducible, the devices as unreliable, and the mechanism of operation as undefined. But Noyce thinks the amorphous switching effect no longer can be dismissed as a mere laboratory curiosity. Says Noyce, "Now I think they [Ovshinsky and his company] understand how and why it [the process] works."

On the other hand, Fairchild Semiconductor, a neighbor and competitor of Intel's, is not so bullish. In fact, Fairchild hasn't changed its low opinion of amorphous devices much, even in light of the recent ECD and Intel collaboration. Says C. Lester Hogan, president of Fairchild: "The effect is there, but I am still skeptical about the time and money necessary to make it into a usable product. It took four years, after having a firm theoretical background, to get a good silicon transistor product. And with Ovonic devices, we're not that far along in understanding them as we were in understanding silicon in 1950. People are being naive," he adds, "if they think that Ovonic devices will soon change the world; it will take \$100 million and at least another five years."

But Fairchild may give it a try. Harry Sello, second in command at the Semiconductor R&D Lab in Palo Alto, says, "We are getting devices and evaluating them. I have looked at diodes to see about their

lifetimes of up to 1 billion cycles. The main development problem is that the temperature in the conducting channel in the glass is very close to its softening temperature.

Amorphous semiconductor work in the USSR has reportedly been proceeding for at least 20 years, considerably longer than in the West. Important research centers are at the Physico-Technical Institute in Leningrad, the N.S. Kurmakov Institute of General and Organic Chemistry, in the Moscow Academy of Sciences, and the Physics of Solids Laboratory of the Lenin State Teachers' Training University in Moscow. A television camera using the photoresistive properties of amorphous semiconductors reportedly has been developed for space applications.

Siemens AG's Munich laboratories has been working on amorphous devices for the past five years. But so far, commitments of manpower and research funds have been relatively modest. Right now, Siemens is not sure whether amorphous devices will ever become a commercial success. "It depends largely on whether the instability problem can be satisfactorily resolved," says Max Guntersdorfer, the Siemens researcher responsible for amorphous device development.

But even if this problem is solved, amorphous semiconductor applications will be rather limited, Guntersdorfer says. "They will never replace conventional germanium or silicon devices, but will be restricted to special applications." For example, they may be used where insensitivity to radiation is a requirement, or in large memory arrays or Xerox-like printing systems, where an array of amorphous elements covering a large area would be charged according to certain

patterns and be used for printing.

Siemens' experimental devices so far include discrete thin and thick film switching elements and thin and thick film memory devices. Next year, the company expects to make radiation-resistant amorphous photoresistors that could be used for space applications.

These devices look attractive to Siemens—provided they can be made at considerably lower cost than the present Ovshinsky elements and can be easily integrated. But availability is difficult to pin down, Guntersdorfer says. "Most likely functionable photoresistors will be ready first," he says.

In Japan, R&D on amorphous semiconductors is proceeding at a healthy pace. Several organizations are active: Hitachi Ltd., Mitsubishi Electric Corp., Matsushita Electric Industrial Co. Ltd., and a large group (by amorphous semiconductor standards) of about 15 people doing research at the Electrotechnical Laboratory of the Ministry of International Trade and Industry.

The largest operation appears to be at Hitachi, which is working on amorphous devices for vidicon targets and optical memories. Amorphous semiconductors show promise for image devices because a large area with uniform characteristics can be made easily. In fact, vidicon targets are close to becoming a product.

Hitachi is not attempting to make switching devices; engineers feel that amorphous semiconductors are not sufficiently reliable in this application.

Matsushita is working on an organic amorphous semiconductor. Organic material, rather than the glasses, was chosen in the belief that there is no point in repeating the work of others, especially when the others do not have a product.

possibilities." But like many people, he adds that the materials problem will continue until the mechanism is understood. "The material is not reproducible—it can't be laid down the same way twice. But if it works, and this is a big if, then it may be good for some memories. But there are other techniques like bubbles and magnetic domains that are contenders as well," he asserts.

The Bell Telephone System is not keen on amorphous semiconductors either. According to W.S. Boyle, executive director, Bell Labs took an early independent look at amorphous materials and decided they probably wouldn't be suited for Bell System devices, where high reliability is mandatory.

Boyle feels there is a misconception on the question of cost. Although amorphous materials would be cheaper because the raw material requirements are lax, the major cost of a device is not in materials, but in processing. For example, the cost of a slice of single-crystal silicon is only one-tenth of the device fabrication cost, he feels, adding that the major cost of amorphous semiconductor devices likely would be in fabrication.

Agreeing with Boyle is A. D. Pearson, materials research scientist at Bell Labs. Long a specialist in amorphous-type materials, Pearson feels that any device whose operation relies on a localized phase change in the material will find reliability problems.

"Building devices is no trouble—you can build one from scratch in half a morning," he says. "The problem is making the device work the same way over and over again. And although there are people at Bell Labs working in the general area of amorphous materials—including the semiconductors—presently there is no hard evidence based on our work to change our earlier opinion that long-term reliability will end up the final crusher on amorphous devices."

The story's about the same at IBM, which has had a research program in amorphous semiconductors for about two years. "We think it's scientifically interesting," says Marshall Nathan, manager of the cooperative phenomena group of the physics department at the Thomas J. Watson Research Center. However, he adds, "we haven't seen any devices." As he sees it, the basic problem is one of stability and repeatability. But Nathan points out that IBM is not confining its research in amorphous semiconductors to just switching, but is looking at a much broader range of properties.

Also on the East Coast, RCA Laboratories in Princeton, N.J., reports it has no device work in progress. But according to one RCA scientist Ben Abeles, RCA has an active interest in the transition metal oxide glasses, such as V_2O_5 , especially for thin film devices. And since RCA is a major supplier of military electronics, it has a natural stake in exploiting the radiation hardness exhibited by amorphous materials.

Some of the best theoretical and early device work in amorphous materials is coming from physicist-oriented university and government-supported laboratories, where the climate is free from the pressures of product development. (This is the basis for the charges leveled against amorphous semiconductors

that they're just a plaything for the physicists.) One such establishment is the MIT Materials Laboratory (Stanford is another), in Cambridge, Mass., which have been in it from the start.

So far most of the MIT work has been with compounds composed of 81% tellurium, 15% germanium, and 4% arsenic. Using both bulk and thin film samples, the group is attempting to apply their observations to experimental devices. For example, MIT researchers have noticed that a current pulse less than a millisecond wide applied to an experimental thin film memory device will be sufficient to cause breakdown, but the device will switch back when the pulse is removed. However, if the pulse is applied for at least one ms, the film remains on even after the pulse is removed. This implies that the chemical bonds that hold the glassy structure are broken during the pulse time; this could help in determining operation.

The MIT amorphous group also is working with a compound composed of $Te_{50}As_{30}Si_{10}Ge_{10}$. And preliminary tests with these films have been made. The group has spent several months perfecting the film (sputtering) technique. In the process they observed an interesting result: although most researchers thought that the material would be best manufactured at the lowest possible fabricating temperature the MIT group found just the opposite—annealing at high temperatures makes it better.

The Government's interest in amorphous devices stems primarily from its radiation resistance property. The high-energy neutron field that blankets wide areas after a nuclear burst destroys solid state devices by dislocating their crystalline structure. The Pentagon, fearing that a series of bursts could destroy most military electronic systems, is actively searching for alternate systems. Military devices using amorphous materials, with their relative immunity to radiation (the atoms already are at random) may provide the ideal solution.

Much of the Army's interest is centered on the Materiel Command's Harry, Diamond Laboratories in Washington. Preliminary work is primarily directed toward exploring operational mechanisms of in-house prototype devices.

One interesting amorphous device under study at the Diamond Labs is one made by hot-pressing non-crystalline gallium arsenide into an amorphous compound. According to Marvin Cohen, a Diamond Labs physicist, these devices provide the uniformity needed to explore switching phenomena. Equally important, he says, "we know just about everything there is to know about GaAs—something that can't be said for the glasses Ovshinsky uses in his devices."

Picatinny Arsenal in Dover, N.J., has maintained a lively interest in amorphous semiconductors, largely because of their radiation resistant properties. Picatinny's work is directed more toward characterizing devices than understanding basic properties.

Inputs for this article came from Electronics' field correspondents Jim Hardcastle in Washington, Gail Farrell in Boston, Stephen Wm. Fields in San Francisco, Charles Cohen in Tokyo, John Gosch in Frankfurt, and Michael Payne in London. Also contributing were McGraw-Hill World News staffers Steve Lowman in Pittsburgh, Tyler Marshall in San Francisco, Marvin Reid in Dallas, and Gerald Parkinson in Los Angeles.

DESIGN WITH THE BEST AVAILABLE RF COMPONENTS

They come in all shapes and sizes: Connector models in three configurations . . . printed circuit models in plastic or hermetically sealed containers and TO-5 packaged units. Packages and specifications for nearly every application you can think of. And a few more we've thought of. Why not review these components for yourself in our new series of short-form catalogs:

MIXERS — This catalog provides basic specifications and packaging information on RELCOM's line of single- and double-balanced mixers, dc to 4 GHz. Application notes describe the mixers' use as modulators, phase detectors, current-controlled attenuators and up-down frequency converters. Typical circuits are shown, along with performance data. Tables of intermodulation harmonics for both standard and high-level mixers are included.

WIDEBAND TRANSFORMERS — An important part of this catalog of balanced and single-ended transformers is a section of "how to" application notes. These notes describe various techniques for constructing a frequency doubler, 180° power divider, power combiner, phase splitter and detector, pulse shaper, sampler and wide-band amplifier. Schematic diagrams are included along with performance specifications and package descriptions. Frequency range for the BT- and T-series transformers is 0.2 to 700 MHz.

REACTIVE HYBRIDS — Relcom hybrids are designed to operate over the 0.5 to 600 MHz frequency range. The catalog offers detailed functional diagrams, specifications

and performance data reflecting the hybrids' operation as signal combiners, power splitters, and power combiners. Equal power output of the hybrid ports insures balanced feeding, making Relcom hybrids ideal for use in systems such as multi-element antenna arrays.

RF SWITCHES — Relcom electronic switches include both SPST and SPDT devices, covering a frequency range of 0.3 to 500 MHz, with nanosecond switching speeds. These switches are significant for their transient-free operation as a result of high isolation between the switching and output ports. In fact, the high-degree of transient-freeness permits operation of the solid-state devices over a very wide frequency range. Complete specifications and extensive performance data are described in the catalog. All catalogs include price information for quantities of one to four units. We'll quote prices for larger quantities on request.

For quality RF-signal processing components you'll want these catalogs in your file for quick reference. They're easy to get. Simply circle our Reader Inquiry Number. Additional information and application details are always available by calling a Relcom Sales Engineer at our Mountain View plant.

RELCOM

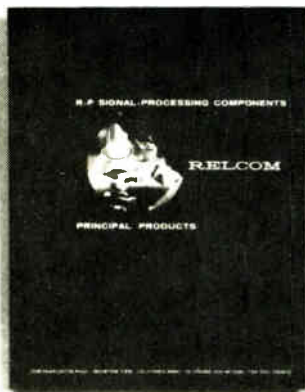

MIXERS

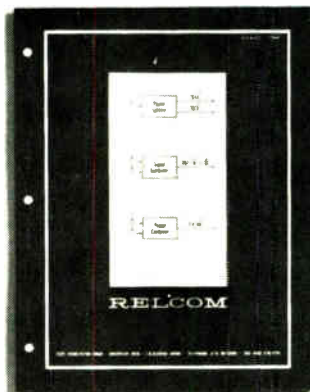

REACTIVE HYBRIDS

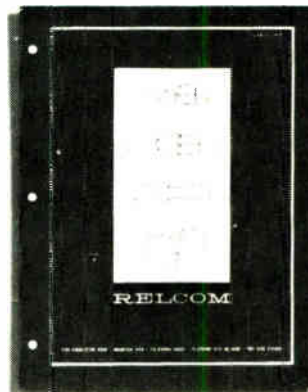

TRANSFORMERS

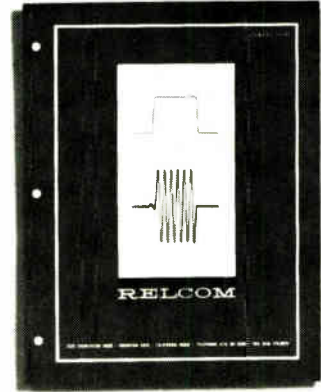

RF SWITCHES

DESIGN WITH RELCOM

2329 Charleston Road ● Mountain View ● California 94040 ● Telephone (415) 961-6265 ● TWX (910) 379-6979

Designer's casebook

Designer's casebook is a regular feature in Electronics. Readers are invited to submit novel circuit ideas and unusual solutions to design problems. Descriptions should be brief. We'll pay \$50 for each item published.

With some discrete aid IC op amp swings 100 V

By Robert P. Patterson

University of Minnesota, Minneapolis

It costs much less to make a hybrid operational amplifier with low-voltage and high-voltage stages than to buy a complete high-voltage op amp. The first stage can be a monolithic op amp.

The design here is a unipolar inverting amplifier with an output swing in closed-loop operation of +100 volts to -10 V. An output between -100 V and +10 V can be obtained by reversing the sec-

ond-stage supply polarities by making Q_1 and Q_3 npn instead of pnp transistors, and by making Q_2 a pnp type.

Q_1 is a dc level shifter. Q_2 and Q_3 form a direct-coupled amplifier with a gain of about 10, determined by $(R_1 + R_2)/R_1$. With the loop open, approximately -13 V is required at the base of Q_2 for zero output. Capacitor C_2 reduces output noise by rolling off the gain of the discrete transistor stage. Offset and drift are determined by the integrated amplifier.

The IC cannot be an internally compensated op amp. Compensation capacitor C_1 must be much larger than normal (30 pF for the LM101A) to prevent oscillation. The additional open-loop gain of 10 could make the total circuit gain roll-off approach or exceed 12 dB per octave, causing instability.

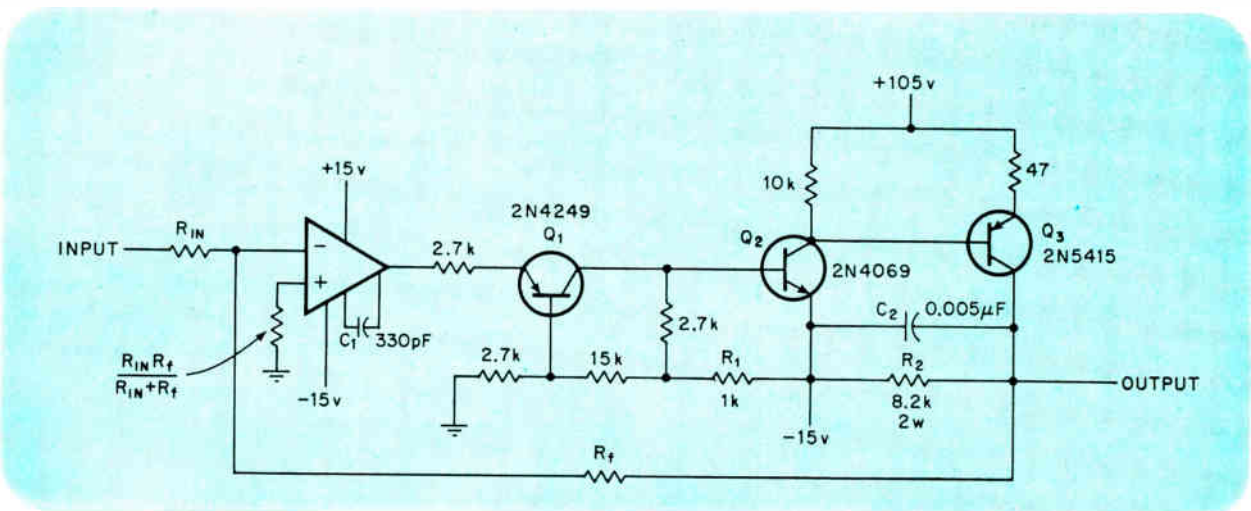

Low in, high out. Low-voltage monolithic amplifier controls high-voltage discrete amplifier, allowing the output to rise to nearly the high-voltage supply. Output swing of this unipolar inverting amplifier is +100 V to -10 V in closed loop operation.

Feedback limits amplifier better than zeners can

By Paul K. Yee

Zeltex Inc., Concord, Calif.

High gain in a feedback loop of an amplifier limits orders of magnitude more sharply than a conventional zener-diode amplifier limiter, since active limiting is unconstrained by the usual component impedance.

Operational amplifier A_1 operates normally when its output, inverted by A_2 , doesn't exceed the limit voltages, $\pm E_L$.

Diodes for amplifiers A_3 and A_4 forestall amplification until the sum voltage at the inverting input of A_1 and A_2 goes above the threshold. Then they amplify open-loop, making their outputs

$$e_3 = -G_3(E_L + e_2) = G_3(E_L + V_{out})$$

for $(E_L - V_{out}) < 0$

$$e_4 = -G_4(-E_L + e_2) = -G_4(-E_L - V_{out})$$

for $(-E_L - V_{out}) > 0$

where G is open-loop gain.

A_1 also inverts; thus, if the output of A_1 drops below $-E_L$, it is driven positive by the added negative feedbacks from A_3 , and if it rises above $+E_L$, the positive output of A_4 drives A_1 negatively.

The limiting slope is defined as $\Delta V_{out}/\Delta e_{in}$, or simply the reciprocal of gain in this case. Low-cost amplifiers can provide a slope of 2×10^{-6} .

Loop stability requires that A_3 and A_4 have gain-bandwidth products at least five times lower than those for A_1 and A_2 .

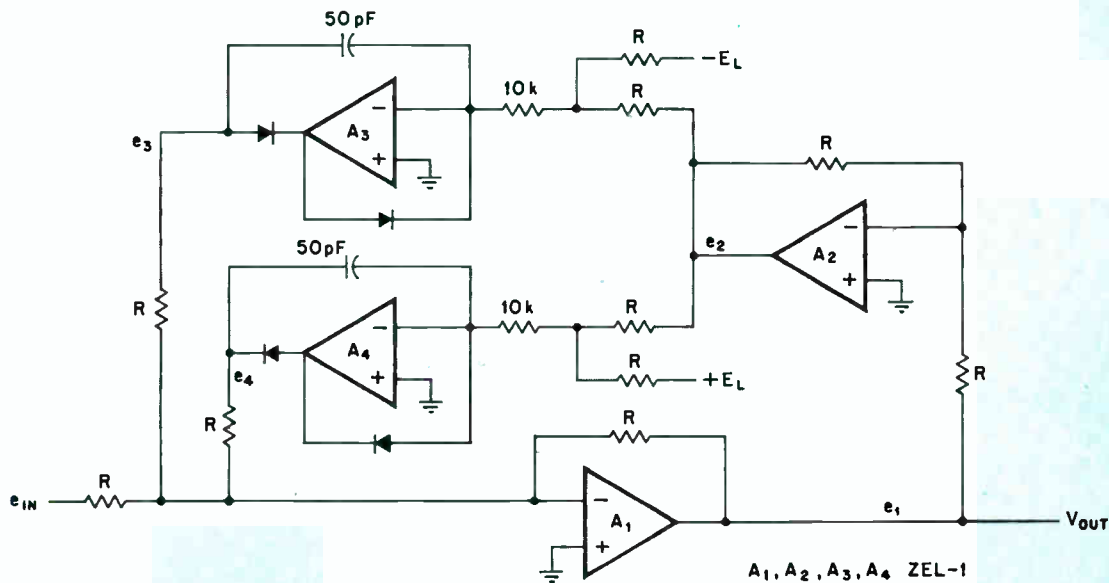

Active limiter. Amplifier A_1 quickly drives its output back within limits by generating high-gain feedback through either A_2 and A_3 or A_2 and A_4 . The gain-bandwidth product of A_3 and A_4 should be at least five times lower than that for A_1 and A_2 for good loop stability.

Monitor teams spare gates and solid state lamps

By T.F. Prosser

PD Labs, Cupertino, Calif.

Usually, extra gates or inverters are available in IC packages on a logic or power-supply card, and red light-emitting diodes are inexpensive now. Together, they can monitor supply voltages cheaply and reliably.

Variable resistor R_1 is set to switch gate G_1 's

output from high (logic one) to low (zero) if the positive supply voltage exceeds a maximum such as 5.5 volts for a 5-volt supply. This switches G_2 from low to high and turns on D_1 . Conversely, R_2 is set to switch G_3 from low to high and turn on D_3 if the positive voltage drops below a minimum, for example 4.5 volts.

If the voltage is neither too high nor too low, gate G_4 has two low inputs and a high output that keeps D_2 lit. In this normal voltage condition, both D_1 and D_3 are off.

Resistors R_3 , R_4 , and R_5 limit the logic one output currents of the gates to a value that is safe for the logic family used. Currents as low as 3 milliamperes will light low-cost diodes such as Monsanto Company's MV50.

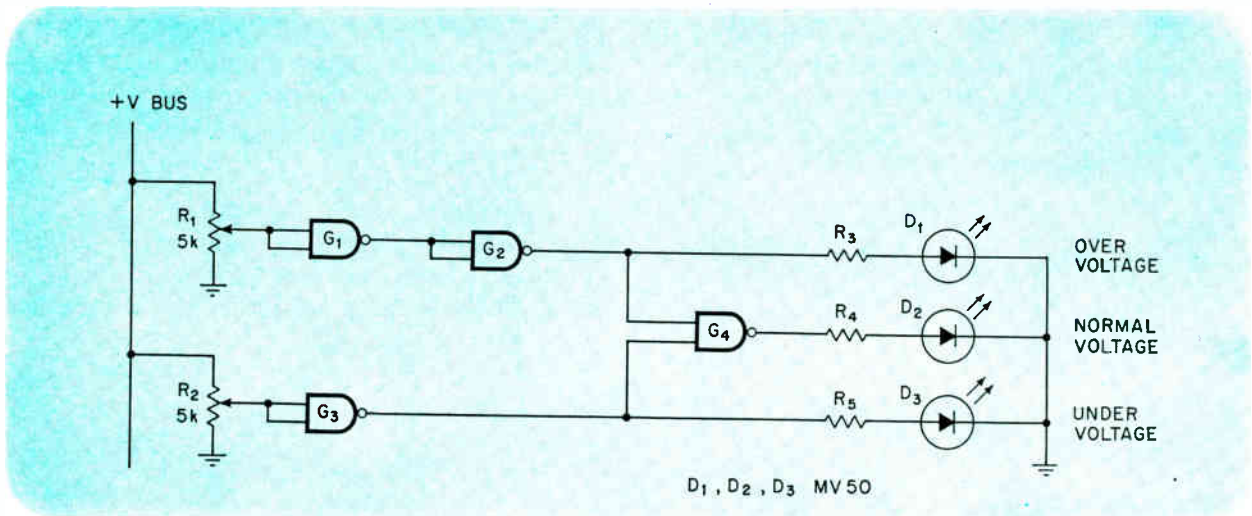

Condition red. Gates G_1 and G_2 sense an over-voltage on the power-supply line and drive a light-emitting diode D_1 on with a logic "one" output from G_2 . If the voltage falls too low, the output of G_3 goes high, and D_3 glows red. Otherwise, only the output of G_4 is high, so only D_3 is lit, when the voltage falls within the limits set by R_1 and R_2 .

Op amps find values of buried resistors

By William J. Travis

Sprague World Trade Corp., Ronse (Renaix), Belgium

One resistor in a "T" attenuator or ladder network must be replaced, but which one? The network has been encapsulated and only the terminals can be probed conveniently. Solving three simultaneous equations for each "T" section will identify the resistor—if the measurements or calculations are without errors.

Or, the value of each resistor can be measured directly by connecting the network and meter to a unity-gain current amplifier, A_1 and A_2 .

Having the resistors in the "Y" connection guarantees that the current from the ohmmeter entering terminal 1 will be the same as that drawn from terminal 2. Moreover, no current flows in resistor R_y , making the voltage across R_y zero and placing node A at ground potential. Therefore, the meter current can represent only the value of R_x .

By transposing the terminals with a selector switch, R_z and then R_y can be measured.

The ohmmeter reading is accurate for currents up to about 0.3 milliamperes for the resistor values shown. The values can be scaled down or up for higher or lower currents. For example, currents to about 3 mA can be measured with R_1 and R_3 at 3 kilohms, R_2 at 1 k Ω , R_4 at 531 ohms, and R_5 at 1.593 k Ω . If desired a multiscale circuit can be pre-

pared on a wafer switch to handle various currents.

Error sources include input bias currents and offset voltages of A_1 and A_2 and common-mode errors of A_2 . Field effect transistor inputs will minimize measurement errors.

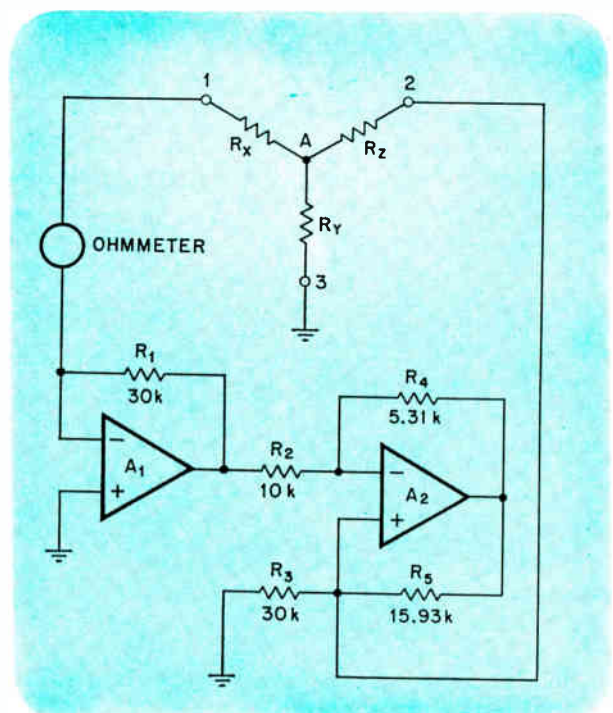

Measuring R_x . Circuit that measures only the current flow between terminal 1 and node A cures problems of finding value of unknown resistance R_x .

Philips PM 3200 scope puts an engineering test on the production bench for Analog Devices

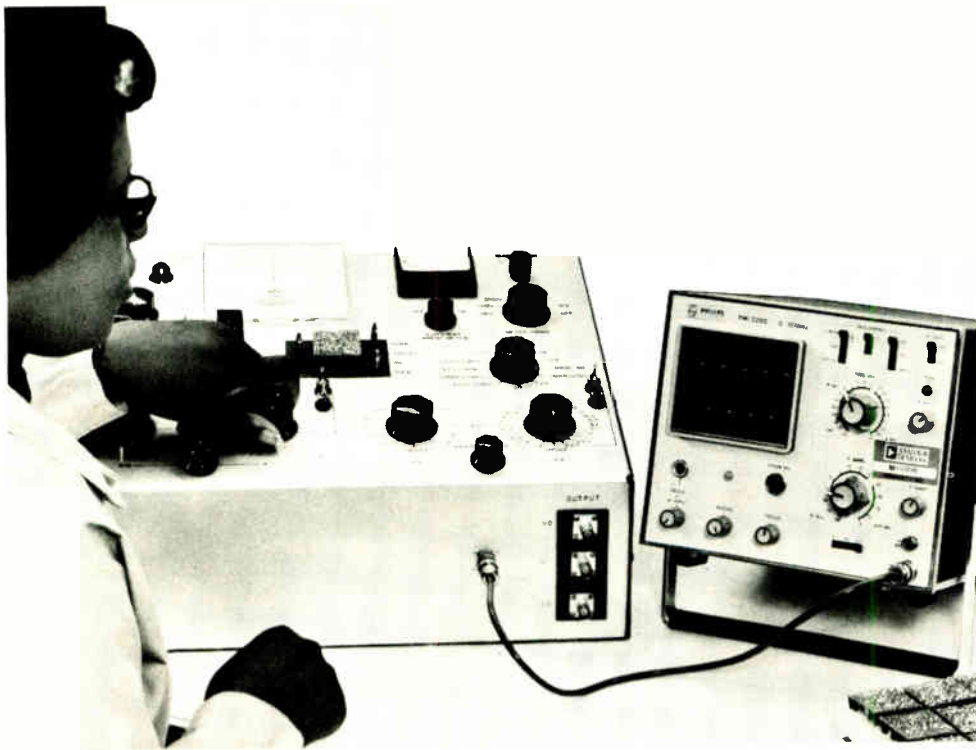

Production Bench Test — Analog Devices

Production Test Manager John Lang added depth to his production test procedures for op amps and multipliers while testing more of them than ever before — and with non-technical personnel. To the list of Analog Devices' 100% tests (which include chopper waveform, offset voltage, common mode ratios) the check for slewing rate, previously an engineering-only examination, has just been made routine.

How does the PM 3200 scope help John Lang perform the impossible?

PM 3200 is simple to use: "Syncs right in . . ." Holds the line . . . "no shift with

line voltage variation . . ."

No set-up problems . . . dc balance has been eliminated; automatic triggering.

PM 3200 . . . takes up only a fraction of the bench space of previous scopes . . . and at a fraction of the cost, too.

What can Philips do for you in production — bench, on-line, simple or complex? Analog Devices liked the way we simplified things while helping to extend their testing capability. Perhaps you would too — give us a call and see: 914-664-4500. Ask for Dick Rude, National Sales Manager, Test and Measuring Equipment.

PM 3200 10MHz 2mV/div \$495

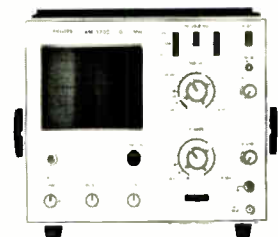

**PHILIPS
ELECTRONIC
INSTRUMENTS**

750 S. FULTON AVE., MT. VERNON, N.Y. 10550
A DIVISION OF PEPI, INC.

Audio noise: Why settle for more?

Optimizing a transistor's collector current yields a noise figure far below the specified minimum; it's easily calculated for amplifier design

By J. A. Roberts* and N. A. Jolly, *University College of Swansea, Great Britain*

□ Most designers settle for much noisier audio amplifiers than necessary. They assume that data sheets on small-signal bipolar transistors specify the best obtainable noise figures.

Most manufacturers, however, do not list the minimum noise figure for their devices—they simply list it at a convenient collector current, usually about 100 microamperes. And the optimum value of this current, so far as noise is concerned, is normally well below 100 μ A. Moreover, manufacturers often fail to specify the other essential design parameter—current gain—at much below 1 milliampere.

Fortunately, ascertaining actual minimum noise figures is straightforward. After selecting a transistor type and a power supply voltage (V_{CC}), and after determining the driving source resistance (R_s), the designer need only

► Calculate the optimum collector current from

$$I_{C \text{ opt}} = \frac{1}{40R_s} (\beta_o)^{1/2}$$

where β_o = dc current gain

► Calculate the minimum noise figure for the optimum collector current from

$$F_{\text{min}} = 1 + \frac{r_{bb'}}{R_s} + \left(\frac{1}{(\beta_o)} \right)^{1/2}$$

where $r_{bb'}$ = intrinsic base spreading resistance.

► Determine the maximum voltage gain from

$$A_{V \text{ max}} \approx 40 V_{CC}$$

If the design requirements cannot be met with the selected device or supply voltage, then either, or both, must be changed.

As these relations are only approximate, adequate safety factors must be allowed. For example, since the dc gain in some transistors drops off sharply as they approach saturation, the collector-to-emitter voltage $V_{CE(\text{sat})}$ in any transistor should be assumed to be at least 1 volt. This means that the maximum gain realizable is $40(V_{CC} - V_{CE(\text{sat})})$. The value of the intrinsic base spreading resistance for small signal transistors usually lies between 60 and 400 ohms.

Typically, these calculations yield a far more flattering picture of a device than does its data sheet. A case in point is a 2N3707 transistor, for which the manufacturer claimed a dc gain of more than 100 and a noise

figure of less than 5 decibels at a collector current of 100 μ A. However, a paper by Faulkner and Harding¹ shows average gains of 250 and 150 at 100 μ A and 1 μ A respectively, and a minimum noise figure of less than 0.5 dB for all six transistors tested.

Once the basic design requirements have been satisfied, remaining amplifier parameters, such as input resistance and capacitance, can be determined from standard design relations. For instance, any of the usual methods of biasing the amplifier can be used, since they do not affect its minimum noise figure.

However, it is unusual to design a single-stage high gain amplifier unless a very narrow bandwidth is required. More commonly a two-stage feedback arrangement is used; choosing a complementary pair permits the use of direct coupling with excellent bias stability, and capacitive coupling is unnecessary.

Two-stage amplifier design is handled in the same manner as single-stage design. The optimum collector current and then the noise figure of the first stage are determined from the source resistance, the intrinsic base spreading resistance and the dc gain of the transistor. For the complementary amplifier and equivalent noise circuit shown on top of p. 83 the first-stage collector current is:

$$I_{C1} = \frac{V_{be2}}{R_3} + I_{B2} \approx \frac{V_{be2}}{R_3}$$

The base current of the second stage, I_{B2} , can be neglected since it is much smaller than V_{be2}/R_3 , where V_{be2} is the base-to-emitter voltage in stage 2 and R_3 is the bias resistor to the collector of the first stage of the amplifier. The criterion for choosing the second-stage collector current for negligible noise contribution is given by Faulkner²

$$\frac{\beta_{o2}}{I_{C2}} \gg \frac{1}{I_{C1}}$$

The transconductance parameters, g_{m1} and g_{m2} , and the base-to-emitter resistance of stage 1, $r_{b'e1}$, are dependent on the respective collector currents:

$$g_m = \frac{qI_C}{KT}$$

where q = the charge on an electron, K = Boltzmann's constant, T = temperature in degrees K, and

* Mr. Roberts is now with Marconi-Elliott Automation.

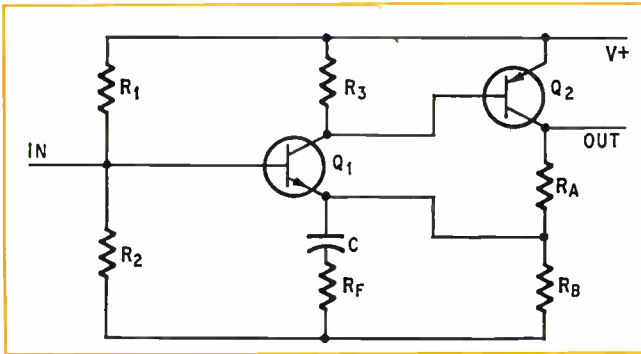

Two stage. Complementary design permits the use of direct coupling between stages without affecting the amplifier's stability. Little change in the noise figure will occur if the parallel combination of R_F and R_B (feedback resistors) is very small compared to R_S and the parallel combination of R_1 and R_2 (bias resistors) is very large.

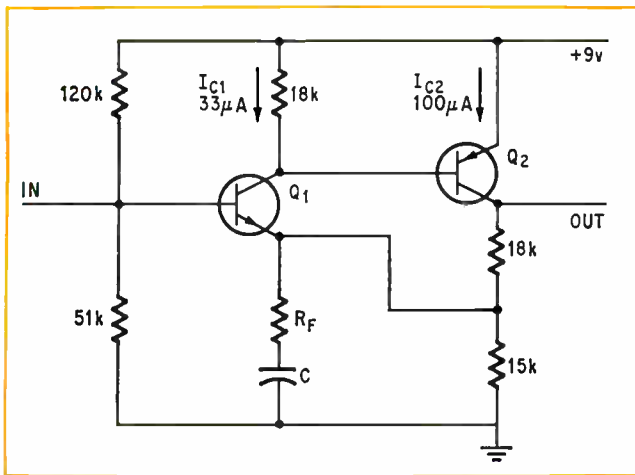
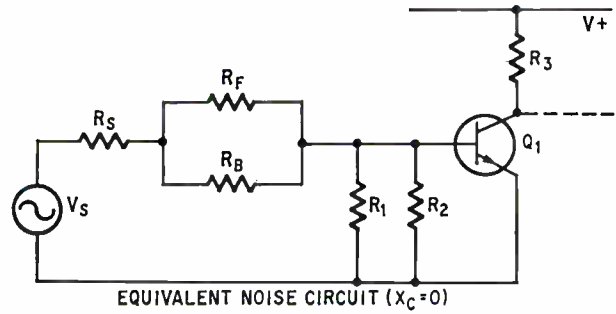

Quiet. This low noise amplifier was designed on the principle that collector current can be optimized for minimum noise. The amplifier's open-loop gain is over 60 dB and $R_F = 0$, and its noise figure is less than 1.5 dB. Increasing R_F to 2 kilohms drops the gain to 20 dB but leaves the noise figure unchanged.

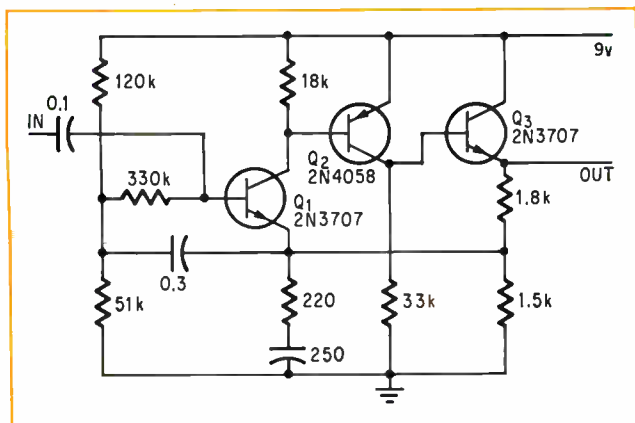

Optimum amp. The use of bootstrapping in the input stage raises the input impedance of the amplifier to several megohms while Q_3 (the emitter follower) lowers the output impedance of the amplifier without affecting the dc stability.

$$r_{b'e} = \frac{\beta}{g_m}$$

where β = ac gain of the transistor.

The maximum possible gain of the complementary two-stage amplifier occurs when the feedback resistance and capacitive reactance from the emitter to ground in stage 1 are both zero. This is the open-loop gain, A_{VOL} , and is given by:

$$\begin{aligned} A_{VOL} &= g_{m1} R_{L1} g_{m2} R_{L2} \\ &= g_{m1} \left(\frac{R_3 \Gamma_{b'e1}}{R_3 + r_{b'e1}} \right) g_{m2} R_A \end{aligned}$$

where R_A is a resistor from the collector of stage 2 to the emitter of stage 1. The closed-loop gain, A_{VCL} , can be found by including the resistors R_F and R_B in the circuit. If $A_{VOL} \gg A_{VCL}$, the closed-loop voltage gain is simply:

$$A_{VCL} = \frac{\frac{R_B R_F}{R_B + R_F} + R_A}{\frac{R_B R_F}{R_B + R_F}}$$

But the introduction of R_F and R_B as well as the bias resistors R_1 and R_2 must now be considered in the noise figure calculation. Little change in F_{min} will occur, however, if:

$$\frac{R_1 R_2}{R_1 + R_2} \gg R_s \gg \frac{R_F R_B}{R_F + R_B}$$

This minimum noise figure approach was applied to the design of a two-stage low-noise audio amplifier, shown at center left. Its open loop gain is greater than 60 dB ($R_F = 0$) and its noise figure is less than 1.5 dB with selected devices. When R_F is increased to 2 kilohms, the voltage gain is reduced to 20 dB without any significant change in the noise figure.

A general purpose design incorporating special matching features is shown at lower left. □

References

1. E.A. Faulkner and D.W. Harding, "Some Measurements on Low Noise Transistors for Audio Frequency Applications," *The Radio and Electronic Engineer*, Proc. IERE, July 1968.
2. E.A. Faulkner, "The Design of Low Noise Audio Frequency Amplifiers," *ibid.*
3. J. Watson, "Semiconductor Circuit Design," chapter 5, Adam Hilger & Van Nostrand-Reinhold, 2nd ed., 1970.

the
world's
most
widely
traveled
oscilloscopes!

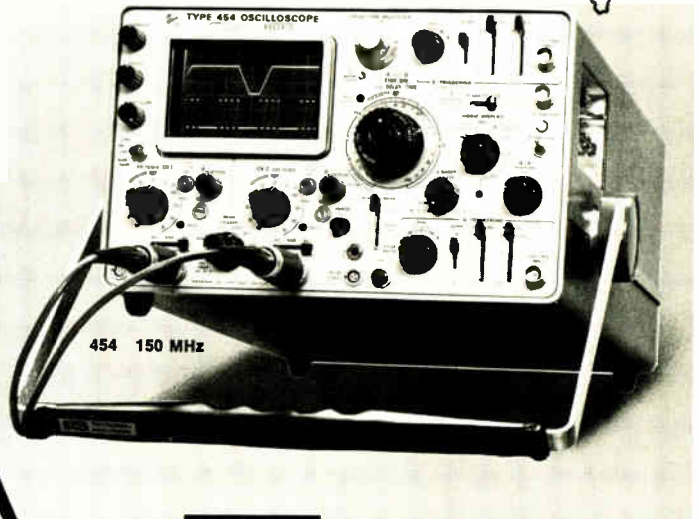
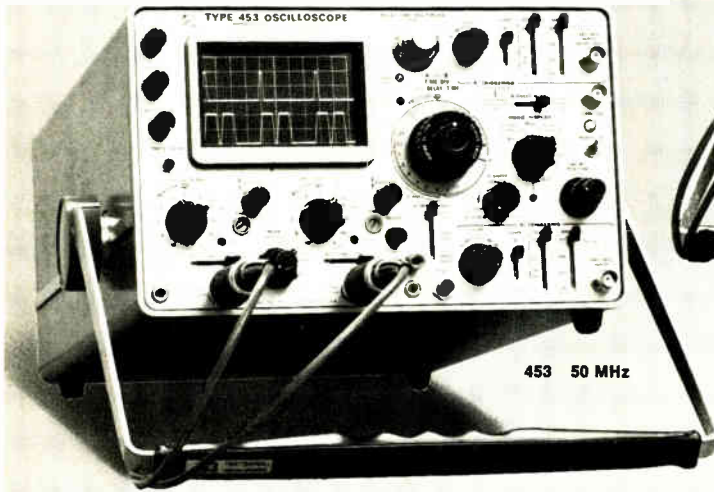

TEKTRONIX®

committed to progress
in waveform measurement

Customer preference has made the Tektronix 453 and 454 the world's most widely traveled oscilloscopes. The reasons are many. Here are just a few!

PORTABILITY: Features which make the going easy include—storage for accessories in a convenient front-panel protective cover; a cover to keep out rain and dust; a vertical handle position makes the carrying easy. The 453 and 454 take rugged trips in stride and arrive ready to work.

PERFORMANCE: With dual channel 1 MΩ inputs, delayed sweep, 5 mV/div, plus many other built-in performance features, you solve problems quickly in the field or in the lab.

OPERATOR EASE: The controls are human engineered to take the guesswork out of triggering, delayed sweep, and other functions—less guesswork means faster measurements.

RUGGEDIZED: Some oscilloscopes are temperamental about severe environments. Not the 453 and 454. Both meet essentially all of the important military environmental specs, without the associated extra cost.

When you make field trips, take along a field-proven oscilloscope designed to travel. Between trips, use the 453 and 454 in the lab. These ruggedized, portable oscilloscopes are designed to solve a vast range of measurement problems with *laboratory precision*. Wherever you are!

For a demonstration in your application, call your local Tektronix Field Engineer or write Tektronix, Inc., P.O. Box 500, Beaverton, Oregon 97005.

453 Oscilloscope \$2050
454 Oscilloscope \$2925

U.S. Sales Prices FOB Beaverton, Oregon

Available in U.S. through the Tektronix lease plan

Dean Burch: FCC's pragmatic boss

Some welcome his "laissez faire" philosophy;
others flay his quick decisions on complex issues

By Lois Vermillion, *Washington bureau*

Now facing the Federal Communications Commission are several very complex decisions that are critical to the future of the \$10 billion communications industry. Because of this, many in industry are anxiously watching and worrying about the hand on the FCC tiller—Dean Burch, the first Republican in nearly a decade to chair the commission.

It's hard to figure out the lean, 42-year-old Arizona lawyer who first made a national name for himself running the 1964 presidential campaign for Sen. Barry Goldwater (R. Ariz). To his supporters, Burch is a champion of free enterprise, who will let the marketplace regulate communications. To his critics, the chairman is a "reckless intellectual hipshooter," inclined to render simplistic, rapid-fire judgments on complex issues.

With his background and political stripe, it's not surprising to hear Burch describe himself as a "laissez faire" capitalist. But he acknowledges that he has "no fixed opinion" on many of the crucial issues now facing the commission. "I don't have preconceived notions about what systems will look like in five years," he says. "I don't have that kind of expertise."

Loading the FCC agenda are the following blockbuster issues: ownership and number of domestic communications satellites and the services they would offer; distribution of overseas communications and how it should be regulated; and the future of digital communications and of the special service common carriers who plan to offer it in competition with American Telephone & Telegraph.

One thing worrying industry is that Burch is too pragmatic; he wants to clear the FCC agenda as quickly as possible. The chain-smoking, often impulsive chairman has become known for his desire to bring an issue to a vote, no matter how involved or far-reaching it may be, for the sake of getting it off the agenda—a practice which a former FCC chairman calls "a bit rash; he could be pushing too hard." Burch's defense here is that "when a technology is ready, it shouldn't be kept in the wings," and he cites the domestic satellite decision, deferred through two Administrations, as an example of unnecessary delay.

As a professional politician, he has been successful so far in keeping his agency out of hot water with Capitol Hill and, unlike some top Nixon Administration officials, he's known to have an oft-used pipeline into the White House. There's no firm evidence, though, that he's merely a chore boy for the Executive branch.

But so far, Burch has presented no clear-cut image of himself in his FCC role since his appointment a year ago, except for a stated unwillingness to expand the FCC's tiny bureaucratic empire. Sitting before his vintage rolltop desk, Burch is inclined to speak of his FCC role in negative terms, such as "not imposing artificial barriers to technological development." He says that he favors a competitive communications environment. Ironically, this puts him on the side of the Democrats on the commission, which, shortly before he became chairman, cracked AT&T's virtual monopoly on common car-

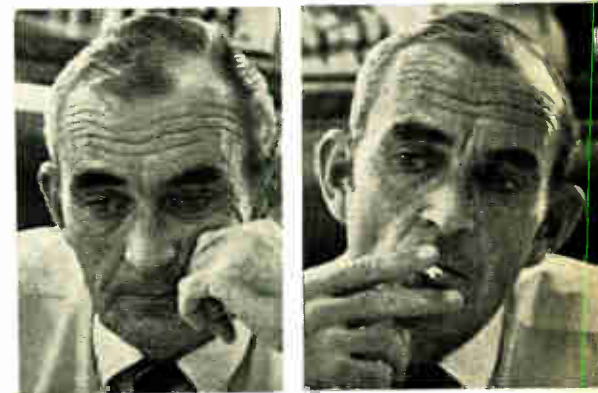

At the helm. The chain smoking chairman "favors competition" but has "no fixed opinion" on many FCC issues.

Probing the news

rier hardware interconnection and service in its landmark Carterfone and Microwave Communications Inc. (MCI) decisions.

Though Burch has only one vote on any item before the commission, he will have substantial influence over FCC decisions when the spot left vacant by commissioner Kenneth Cox, a Democrat, is filled. This will give the Republicans a 4-3 voting edge. The only continuous opposition he is likely to have to face in most major issues is from Nicholas Johnson, a Democrat whose term expires in 1973, and who began a slugfest with Burch over AT&T rate separations almost as soon as Burch took over [*Electronics*, Jan. 19, p. 34].

Burch's influence over the votes of the independent agency is important to another power—the Office of Telecommunications Policy in the White House. Now headed by 31-year-old Clay T. Whitehead, the recently reorganized and strengthened office has broad powers to shape government policy on computers and communications. Part of OTP's mission is to ensure the effective presentation of the Administration's views to Congress and the FCC (see page 38). In Dean Burch, OTP has a strong voice and a sympathetic ear. There's no evidence he functions merely as OTP's chore boy, but he was quick to accept the White House's policy on open competition in domestic satellites. And the FCC's recommendations for the U.S. position at the World Administrative Radio Conference [*Electronics*, Sept. 14, p. 45] strongly reflect those of OTP.

Many in industry and even within the commission are pushing for an in-house engineering research capability [*Electronics*, July 7, 1969, p. 67] so that the FCC could make more intelligent decisions. Burch rejects this proposal. Reliable engineering expertise is available outside, he says, and "we don't need it here—we'd have an organization like NASA before it was all over." Still, this may not spell the end of the possibility; an independent committee of industry and university experts told the Office of Tele-

communications Policy that outside think tanks may produce conflicting points of view. And without an in-house capability, the commission will have to solicit help from industry and probably the National Bureau of Standards, if it's to define the standards for foreign attachments on telephone lines.

Burch does agree, though, with industry that the FCC should have at least one member with an engineering background. The last such commissioner was T. A. M. Craven, who left in 1963; he is credited by former chairman Rosel Hyde with having initiated the development of a satellite communications policy. Burch says that while an engineering commissioner "wouldn't solve all the engineering problems," he could help provide alternate viewpoints. "I'm not going to contradict the chief engineer," says Burch, "but an engineering commissioner could."

Though Burch says he has "no fixed opinions" on the individual items on the FCC agenda, it's possible to predict some likely interactions between his general philosophy and specific issues. Domestic satellite communications is one area where he may not see his ideal of free competition realized. For though he opposes a "carrier's carrier," sources predict that with estimates of costs at \$150 million or more each, simple economics will rule out the dozen or so systems being planned. The idea most acceptable to industry and government remains a system put up by the Communications Satellite Corp., in which users would work through Comsat to set up a multipurpose network.

The rules for owning an earth station in a domestic system will probably be flexible. Burch foresees "great advantages in ownership by users in certain cases", perhaps in receive-only systems, such as commercial tv networks would use, but adds he hasn't yet made up his mind about the ownership of international earth stations.

The FCC also has to decide on a mix between cables and satellites in international communications, and its chairman lays claim to "no nifty formula." In view of Burch's

observation that cable is a known technology while satellite technology is comparatively untried, he probably will emphasize cables, yet allow satellites room to grow.

As for the computer-communications inquiry now drawing to a close after four years of vigorous lobbying by all parties, Burch comments, "We must create a climate for computer operations, with as much competition as possible." Ruling on this subject will probably resemble the FCC's tentative decision to let common carriers into the data transmission business under close FCC supervision, but not to regulate as strictly such new, special-service carriers as Data Transmission Co. and MCI.

Despite the laissez-faire Republicanism now apparent at the FCC, there is an aspect of competition on which it hasn't touched—the relationship between AT&T and its captive supplier, Western Electric. Phase II of the general AT&T investigation begun in 1965, which would delve into the so-called "incestuous" relationship between AT&T and Western Electric, may be shelved. FCC sources say there is a growing feeling that the Carterfone and MCI decisions have mitigated the problem.

Estimates of how Dean Burch will serve the public interest vary widely. Some in the communications industry feel he will support AT&T's dominant position. Similarly, some land mobile operators believe they'll make little headway acquiring more spectrum space because, they say, Burch supports broadcasters in their entrenched position. Yet broadcasters worry because of Burch's record so far in accelerating the growth of CATV.

Burch's views on competitive development of domestic satellites blend neatly with those of the White House, but Comsat sees his support of a balance between satellites and undersea cables as limiting competitive expansion of overseas satellite links.

Commenting on these differing views, one industry observer summarizes, "It's like viewing a piece of abstract sculpture. From one side it looks like one thing; from another, the image is altogether different."

Why just hope for laminate consistency?

Call on the Lint-Pickers!

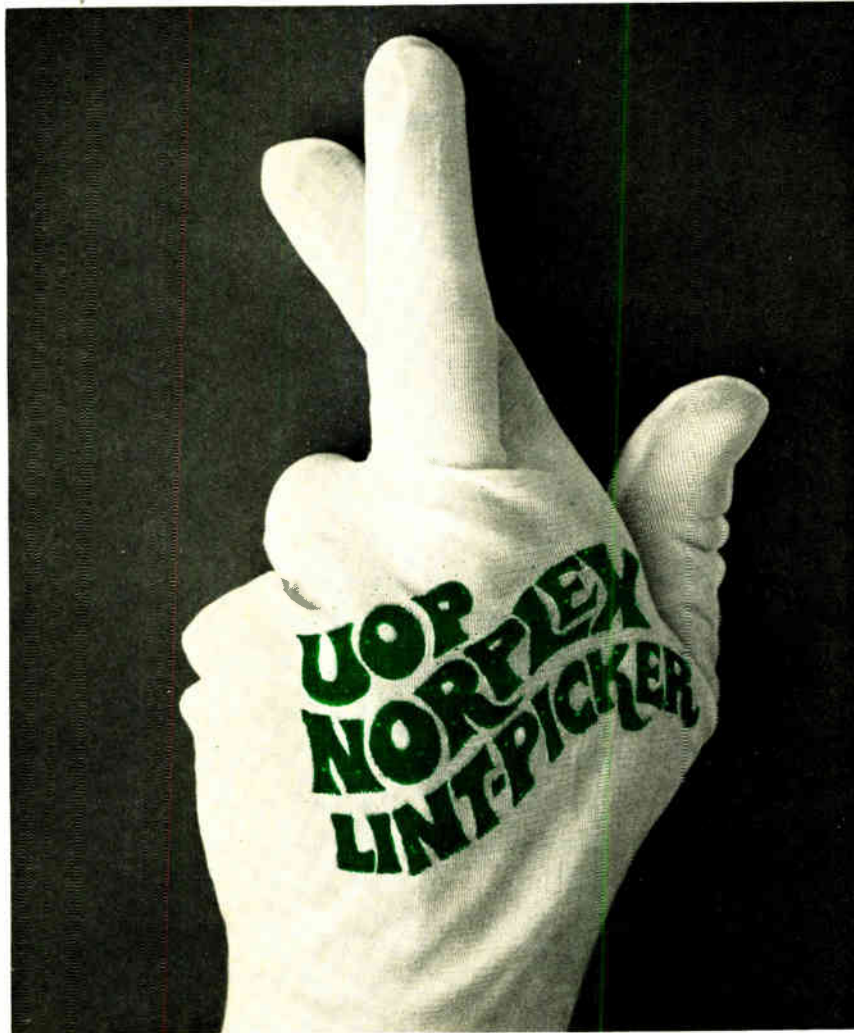

You hope your copper-clad laminates will be consistently perfect and perfectly consistent. And what you hope for, you get, from the "Lint-Pickers".

UOP Norplex is called that, you know, because we're the finicky-est folks in the laminating business. Our clean rooms, with precisely controlled temperatures and humidity, add to Norplex product dependability.

Special quality-control equipment, much of it designed by Norplex, helps assure reliable high-volume production. And assures the uniform quality that is guaranteed to meet

or exceed NEMA and MIL-P specifications. Also, our new, modern plant at Franklin, Indiana, is now adding extra capacity to turn out and speed your orders.

Most important, though, are Norplex's skilled technicians and workers, proud of their products, proud to be called "Lint-Pickers".

UOP Norplex is a division of Universal Oil Products Company, a half-billion dollar company busy making life better through research and product innovation world-wide.

Write for our latest catalog. It's designed to help engineers select the right laminates for every need.



Volume and surface resistivity testing of copper-clad laminates. Exterior control unit, designed by Norplex, gives fast, reliable readout.

Main Office and Plant
Norplex Drive
LaCrosse, Wisconsin 54601
608/784-6070

 **NORPLEX**
LAMINATED PLASTICS

Franklin Office and Plant
P.O. Box 186—Route 31 North
Franklin Industrial Park
Franklin, Indiana 46131
317/736-6106

DON'T LET THIS LOW PRICE FOOL YOU

Triplett's new 3½-digit Model 5020 digital panel meter is a complete, self-contained instrument ready for panel-mounted or bench-top use.

Available in 6 ranges from 10.00 mV to 1000 V DC and 7 ranges from 1.000 μ A to 1.000 A DC, the bipolar Model 5020 features accuracies of 0.1% of reading ± 1 digit as a voltmeter and 0.15% of reading ± 1 digit as an ammeter through 100% over-range. Its seven-bar, fluorescent readout gives a single-plane display for accurate, wide-angle readability.

Priced at only **\$240** (\$265 with BCD output) suggested USA user net, this new Model 5020 allows even the budget-minded to enjoy the accuracy and easy reading of a digital display. For a free demonstration, see your Triplett distributor or call your Triplett sales representative right now. Triplett Corporation, Bluffton, Ohio 45817.

TTT **TRIPLETT**
Manufacturers of the World's
most complete line of V-O-Ms

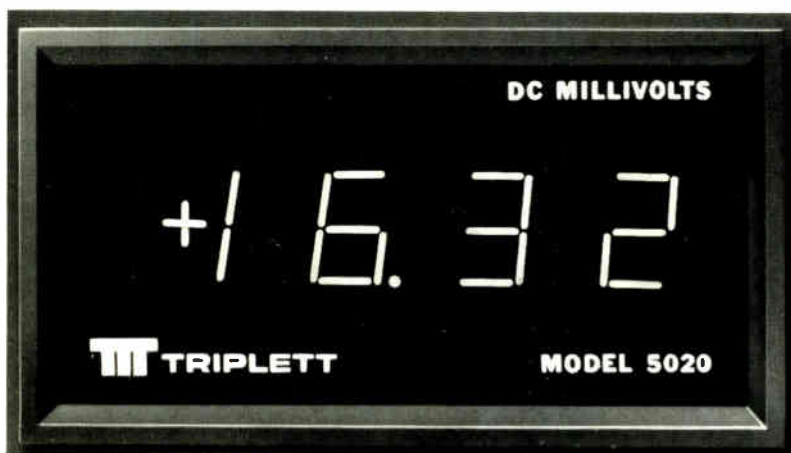

Shown actual size

1. Low-cost, bipolar 3½-digit instrument reads to 100% over-range.
2. Dual-slope analog/digital conversion gives high noise rejection, stability and accuracy.
3. Single-plane, seven-bar readout for accurate wide-angle readability.

Consumer electronics

Stakes are high in home video game

Companies promise much in rush to market video playback and recording units, but they're gambling that state of the art will deliver for them in time

Behind the stampede of companies rushing to announce video playback and recording systems lies a big technological gamble, perhaps as big as the one taken with color television. Companies are betting that the technology will move ahead fast enough to help them make good on today's promises of inexpensive home units in two years or less.

Intensifying the rush to market is the basic incompatibility of the systems under development. In this go-for-broke situation, only one or two approaches are likely to make it big. The 16-or-so companies already in the race feel the risks are worth it because the stakes are so high—some predict a billion-dollar video playback and recording market within a few years.

The technological gambles being taken by companies range from a laser-hologram system—perhaps the riskiest—to units using motion picture film or disks. Falling in between are those who are sticking with magnetic tape, hoping for improvements that will achieve higher resolution at slower speeds. Others are working on data reduction circuits to minimize the information needed for an acceptable picture.

RCA's SelectaVision color playback unit, which works by shooting a laser beam through embossed holograms into a vidicon, is perhaps the most ambitious effort. The company plans to sell the unit for \$400, starting sometime in 1972. Since its announcement of the playback unit last fall [*Electronics*, Oct. 13, 1969, p. 43], the firm has ruled out one of the four sound encoding techniques being considered, come up

with a new one, and narrowed down a dozen color encoding methods to only two.

At the same time, it claims to have eliminated the moire patterns and interference fringes that play havoc with images and that competitors claimed were inherent in holograms. Now RCA says it can produce acceptable black-and-white images, thanks to expensive recording optics, semi-clean rooms to reduce fringes caused by dust, a higher signal level achieved by changing the laser frequency, and a new photoresist for master tapes. The latter now are exceptionally smooth and linear, and don't crack when wound onto a reel, RCA says.

CBS, on the other hand, is taking a better travelled, though unconventional, route in its EVR playback unit [*Electronics*, April 27, p. 94]. EVR tape essentially is a silver halide photographic emulsion flanked on either edge by an ordinary sound stripe. However, color encoding requires some fairly complex circuitry, though not beyond the current state of the integrated circuit art. EVR systems are being sold now for September delivery—months to years ahead of every other nonprofessional system. But at \$795, they're expensive.

At the other end of the price scale is a video disk playback unit developed by AEG-Telefunken and Teldec, a German consortium [*Electronics*, Aug. 3, p. 127]. Here the medium is familiar, but the video reproduction method is new.

"Our decision to develop the video disk was prompted by one overriding consideration," says Teldec's Horst Redlich, "namely, that if it were possible to do so, we'd

probably have the cheapest system around. We also wanted a system with easy production that was simple to use," he adds. "We saw marketing possibilities for a video disk—for example, slipping it inside the morning newspaper—that could not be matched by other systems," says Redlich.

The unit, including an automatic changing mechanism, will cost between \$140 and \$280; disks can be retailed for between \$2.70 and \$5.40, Teldec believes.

Both Telefunken and Teldec were attracted to this medium because they realized that ordinary vinyl disks offer a considerably higher frequency response than

Home movies. Recording video units like Ampex's Instavision will permit the taping of television programs or of indoor and outdoor scenes.



Probing the news

that required for audio. RCA scientists had taken the same tack but lost interest when they concluded that only a few minutes of video could be stored on a platter.

However, the Germans chucked the traditional stylus-cartridge combination in favor of a fixed pressure-sensing stylus shaped like a skid with an abrupt edge on one side and a rounded edge on the other. The team reduced groove widths from mils to microns. And amplitude modulation of lateral deflections gave way to frequency modulation of vertical deflections, allowing adjacent grooves to touch.

Right now the 12-inch disk only plays 12 minutes of black-and-white video, but Teldec expects to have color capability soon and eventually extend the time up to 15 minutes. "We could reproduce color right now," says Redlich, "but the method is too costly and would make the price too high. But we have no doubt that we'll be ready with a color system that's as cheap as black and white when we go on the market in 1972." One important development here may be a foil that would improve both video and audio reproduction.

Back in the states, Avco is trying its own method of video data reduction in its Cartravision record-playback system. Using only every third field of the video image and playing it back three times should eventually permit an acceptable image to be reproduced on half-inch tape running at 3.8 inches per second, Avco believes.

Sony tried a similar technique in its magnetic video cassette system, which records every other field and plays it back twice [*Electronics*, May 12, 1969, p. 239], but encountered problems. It produced a respectable image with $\frac{3}{4}$ inch tape running at 2.6 inches per second, but adjusting heads for proper angular and axial offset was extremely difficult, servo specifications were critical, and high-precision recording heads of extremely narrow width were needed. Sony says the problems are compounded when two fields are skipped.

Taking a more routine approach,

Sony is planning to sell a color playback unit sometime next spring in Japan and by the end of 1971 in the U.S. [*Electronics*, Nov. 10, 1969, p. 236]. The unit would probably cost about \$400 initially and would play for an hour; thinner tape yielding 90 minute playing time would follow. Sony thinks it will probably reach an agreement with Matsushita and Victor of Japan on a system by this year's end.

Meanwhile, it's trying to develop higher performance tape with a thickness under one mil. The tape would probably be coated with chrome or cobalt. And it's trying to develop a simple and inexpensive mechanism and a cassette suitable for mass production that will prove trouble free in home usage.

Matsushita has developed a magnetic transfer copier [*Electronics*, March 31, 1969, p. 181] with a 15:1 playback to copy ratio; it hopes eventually to raise the ratio to 30:1. Adding an additional step to make multiple submasters (via routine electronic copying) would allow a number of these units to be run in parallel.

While many of the video units planned initially will be for playback only, the Netherlands' Philips expects to be selling a color recording-playback system near the end of 1971. "That's one of the reasons we chose magnetic tape," says Kees Jongelie, product manager for home video recording in the electroacoustics division. The company is trying to trim copying time down while maintaining quality, and is studying various transfer systems, including those of Memorex and Ampex. Chromium dioxide would be the tape used.

One cornerstone of the company's sales strategy is that "a recording-playback unit gives us some independence from preprogrammed video material. He says that a complete unit will sell for around \$500. Jongelie doubts whether some of the other systems will really be ready for market by 1972, but when they are, he adds, there'll be tough competition among them until one or two leaders emerge.

Another company well along the record-playback route is Ampex, which recently announced its Insta-

vision system, scheduled to hit the U.S. market in mid-1971, [*Electronics*, Sept. 14, p. 55]. "We feel it's essential to have recording capability for home use," says one company official. "There's a big question: will people put up with the inconvenience of renting prerecorded entertainment cassettes or spending a lot of money to buy them when there are alternatives, such as pay tv or CATV? After all, these are about as convenient as you can get—you just flip a switch." He adds, "we're not as sure as others that the playback market will take off—we think the jury's still out on that question."

In line with its more conservative view of the home market, Ampex is playing it close to the chest by first building for a market that already exists: closed circuit television. Its first color Instavision units will go for about \$1,500, including a black-and-white camera; black-and-white-only units will cost about \$900. But Ampex has programed its prices so that by dropping some extras not needed for home units and producing its recorders in volume, it expects to halve prices in five years.

Blank Instavision cartridges will cost \$13 for 30 minutes or for a 60 minute slower-speed, extended play version. "While this might seem expensive at first, it's cheap compared to home movies," he says. Sixty minutes of home movies cost \$80, including processing, or about six times that of an Instavision cartridge, he adds.

The units will be manufactured in Japan by Toamco, a joint venture of Ampex and Toshiba. Toshiba will market the units in Japan; Ampex will have the rights elsewhere in the world.

Fruition of this market depends on whether engineers can develop home units and cartridges that are inexpensive but at the same time easy to use, reliable, and provide an acceptable picture. And the question that no one can answer now is how big a technological gamble will it take to get such a system?

Contributors to this report included *Electronics*' staffers Charles Cohen in Tokyo; John Gosch in Frankfurt, and Leon Magill in New York; as well as James Smith of McGraw-Hill World News, Brussels.

Military electronics

Aerospace Corp.'s road widens

Beginning its second decade, nonprofit firm's major work is still for the Air Force, but transportation and nondefense work is increasing

By Lawrence Curran, Los Angeles bureau manager

The times have caught up with the Aerospace Corp., but the nonprofit firm hasn't been caught napping. During its first 10 years the company stayed close to its original charter as the system engineer, technical program director, and over-all technology monitor for what is now the Air Force Space and Missile Systems Organization (Samsco). But with defense cutbacks steadily eroding contract funds, the El Segundo firm is applying its technical knowhow, developed with Department of Defense funds, to pollution control, transportation, medical research and other general problem areas.

Of course, Air Force contract work continues to represent most of the firm's business as it starts its second decade. But new emphasis is being placed on computers and software.

The green light to seek non DOD business flashed last year when Defense Secretary Melvin Laird ruled that the firm could spend up to 20% of its time on outside contracts without DOD permission. While probably less than 1% of the firm's fiscal 1970 funds came from outside sources, the figure is expected to jump to 8% this fiscal year.

Additional work is expected to come from other Federal agencies, such as NASA, the Department of Transportation, the Department of the Interior, and from state and local governments. The corporation is working in several nondefense areas using fee funds. These are earned on every contract and amount to 3% of the total.

One concept the corporation has been trying to sell to the Depart-

ment of Transportation involves a personalized public transportation system that would use small vehicles propelled by pulsed linear dc electric motors. The vehicles would travel along a computer-controlled system of guideways.

Aerospace Corp. planners believe such a system could be the answer to mass-transit problems in traffic-clogged cities. They have already briefed interested officials in DOT, and in Los Angeles and Tucson, Ariz. The next step is to develop a scale model, using fee funds, though they're trying to get outside contracts either from DOT or local governments.

In another fee-funded project, the firm is working on a laser technique to locate and measure nitrogen dioxide pollutants in the air. A Q-switched ruby laser transmitter has been built that will use a frequency-doubled beam. Pumping the beam through a tunable dye permits tuning to the absorption band of nitrogen dioxide, which in turn will fluoresce after absorbing certain wavelengths of the laser's radiation. The task now is to determine at what wavelength fluorescence takes place. Arnold H. Silver, Director of the Electronic Research Laboratory, expects to be able to locate the pollutants with a resolution of 10 to 20 ft.

Other fee-funded work in air-pollution control includes development of a computer model of the chemical reactions that produce smog, and efforts to reduce pollutants emitted by automotive engines. Aerospace Corp. researchers are fitting an internal combustion engine with a device that produces a flame front rather than a spark to

obtain more complete combustion on a leaner fuel mixture. They're working on a way to increase efficiency by introducing the fuel mixture into the chamber as a gas rather than as an aerosol or liquid.

The nonprofit firm often literally gives its technology away—for example, to Loma Linda Calif. University Medical Center. Heart specialists at the center have used X-ray motion picture techniques to show the heart's function for research and diagnosis. In the past, several weeks were required to thoroughly study a patient's X-ray film one frame at a time. But a technique developed by Aerospace Corp. for missile test flight data reduction has speeded up the process considerably.

The X-ray film is projected onto a cathode ray tube linked to a computer, and an eight-point ellipse is superimposed over the picture of the heart. Using the ellipse, the computer calculates heart dimension and blood volume in a few milliseconds. Only three to five minutes are required for a printout of the heart's contractions, with the computer driving a California Computer Products plotter. Although this joint effort was initially undertaken by Aerospace Corp. with its own funds, it has been bolstered by a grant from the National Heart Institute.

The changing nature of defense contracting is reflected in the firm's Air Force work on guidance and navigation systems and communications hardware. "Ten years ago, there were three or four boosters in the inventory, and they used radio guidance mainly," relates Max T. Weiss, general manager of

NOW AVAILABLE!!!



MONO-LITHIC InSb INFRARED DETECTORS

- "Blip" Sensitivity in the 3 to 5 Micron Window
- Complete Surface Passivation
- Unsurpassed Uniformity from Unit to Unit
- Anti-reflection Coated Surface
- Well Defined Spatial Contours
- High Dynamic Impedance

No more flake-by-flake assembly routines with low yields and high costs! By applying thin film techniques to detector fabrication, Barnes now offers a unique line of highly uniform and reliable InSb infrared detectors in both single elements as well as multi-element arrays and mosaics. And our high volume production results in substantially lower costs—another significant breakthrough in detector technology by Barnes.

Whether your need is for thermal or photon detectors, for personal service and fast delivery — just call **THE DETECTOR PEOPLE.**



30 Commerce Road
Stamford, Connecticut 06902

Probing the news

the corporation's electronics division. "But now, with the Titan 3C, which has the most modern guidance we're working with, we're attempting to upgrade it with a new inertial measurement unit and computer." Weiss is convinced that some of the responses to a Samsco request for proposals for the upgraded system will be for strap-down units which "have a very good future because they can be small and simple."

The company has come a long way since the early days of communication satellites and the Echo reflector balloons. "If we got a few signals through a voice channel," Weiss recalls, "we thought it was great. Now we've got 26 satellites still in orbit in the Initial Defense Communications Satellite Program (IDCSP) and all but two of them are 100% functional." Aerospace Corp. did the concept formulation work that led to randomly spaced intermediate-altitude satellites. The firm handled the systems engineering and contractor direction tasks.

Weiss points out that the program's second phase will use four synchronous-orbiting equatorial satellites in a system that will provide higher power and narrower beams than the initial phase.

The firm's new emphasis on computers and software is being directed by the year-old Information Processing division. Its general manager, Stewart I. Schlesinger, believes one of the division's prime strengths is in real-time system software. This expertise could be employed in a complex system, such as the Army's Safeguard program, although Aerospace Corp. isn't directly involved in that effort. "Safeguard represents a complicated discrimination job," Schlesinger notes. "And the Air Force has the same kind of problem in software development."

Schlesinger doesn't say so, but his division's talents could already be at work in real-time discrimination tasks, such as those encompassed in the Minuteman ICBM's multiple independent re-entry vehicle (MIRV) system.

One important area for future

Aerospace Corp. work is millimeter wave communications for the military, Weiss feels. "The advent of Gunn and Impatt oscillators and good low-noise mixers makes it obvious that applications will come," he asserts. "Our laboratory people have been doing mixer diode work from 40 to 110 gigahertz. These components," Weiss continues, "could be used for military satellite communications where you need broad bandwidth and some degree of security."

Though he sees no immediate application of lasers to military communications, Weiss believes lasers may win out in the long run for space communications. They offer greater bandwidth than millimeter waves as well as smaller antennas, although atmospheric attenuation still hampers lasers more than it does millimeter wave sources.

Arnold H. Silver opts for lasers over the long haul, too, "But the question is when, and it's mainly a money question," he says. The earlier millimeter wave work didn't get too far because there wasn't enough understanding of atmospheric effects, he maintains. "This is an area in which we're greatly interested."

Proliferate or perish

Shrinking contract funds were an important spur to Secretary of Defense Melvin Laird's approval of more non-DOB business for the Aerospace Corp. The firm's annual contract with Samsco, which had reached a maximum of \$79.1 million in 1964 dropped to \$73.0 million in fiscal 1970, and 1971 projections fall to \$70.3 million.

Cancellation of the Air Force's Manned Orbiting Laboratory program last year hit the corporation hard—funding for that program alone was running at about \$10 million a year and occupied between 200 and 250 technical staffers. Some 200 technical employees were laid off at the beginning of fiscal 1970.

At the same time, most of the major systems engineering work on the Titan 3 family of launch vehicles was winding down, and there were no major new programs to take up the slack.

Instrumentation

Skyjackings spur detection work

Ferrous detector use on rise, and work to develop other sensors increases; fallout could provide new anti-pilfering devices

By Herman Lowenhar, *Military/aerospace editor*

The boarding gate at the San Juan airport earlier this month was jammed as 350 people inched aboard a giant Boeing 747 for the three-hour flight from Puerto Rico to New York. The jam resulted from precautions taken by worried Pan Am officials who, having had one of the \$24 million aircraft destroyed by Arab skyjackers the week before, were passing the passengers through one at a time and checking carefully for weapons. Travelers faced not only two searches, but were scanned one at a time by ferrous metal detectors. One detector did its job and spotted a five-inch knife in a passenger's pocket.

The scene at San Juan is being duplicated at airports around the world as airlines frantically try everything to prevent the skyjackings that have accelerated recently. The airlines are buying detectors in large quantities, but they won't be the entire solution to the problem.

What happens if a passenger is carrying a nonferrous weapon—an aluminum handgun or a stick of dynamite, for example? Then there is the problem of where to set the sensitivity of the metal detector. Women wearing metal-reinforced bras, for example, had been delaying flights out of London. "The metal detecting device went practically mad," said one official, adding that the number of women wearing the special metal bras was "extraordinary." Worried English authorities had set the sensitivity on their detectors too high.

The push now is to come up with more effective "hands off" equipment to detect concealed objects of all kinds. These range from chem-

ical sniffers using gas chromatography to those using so-called "nonlinear radar" techniques.

Particularly significant to the electronics industry is that the fallout from this new push could supply the design for entire families of detectors for business and industry. One potential market is the prevention of retail store and factory thefts. The stakes are enormous: store pilfering losses alone run to \$3 billion a year.

Meanwhile, the airlines are continuing to buy the metal detectors. At present, the Friskem division of Infinetics Inc., Wilmington, Del., and Schonstedt Instruments Co., Silver Springs, Md., share the ferrous detector market. Friskem, by far the largest producer, offers about 40 models, all using flux gate magnetometer sensors.

Twenty foreign and domestic airlines have bought 800 walk-through station metal detectors, most of them in the past year, after a joint test program by Eastern Airlines and the Federal Aviation Administration.

Walk-through stations cost \$800 apiece, but none of the airlines has more than a few at each airport—there are just too many gates to check and police.

Oddly enough, a bill now before Congress to finance installation of detectors actually may be putting a temporary crimp on the market. Many airlines and airports may be delaying purchases pending passage of the bill, which would make them eligible for a 50% reimbursement and would provide U.S. marshals to assist in anti-hijacking operations.

Meanwhile, the airlines are in-

creasingly worried about concealed explosives. One area attracting renewed interest is chemical sniffers that use gas chromatography to sample the air.

Three years ago, the IIT Research Institute developed a gas chromatography dynamite detector for the FAA that could sense one part per billion of the ethylene-glycol-dinitrate, which invariably contaminates dynamite. This detector uses a hydrogen flame as an accurate spectral source and the sampled air as a differential spectral absorber.

The same principle could be applied to detection of almost any material. And if the devices only performed spectral sampling, leaving the determination of the compounds sensed to a remotely located computer linked to it via a data-entry unit, hundreds of inexpensive sensors could be serviced.

One still unresolved problem is that to achieve maximum sensitivity, it takes 1.5 minutes to slowly scan the spectrum. A possible solution is to sample baggage in batches. Another is to use an interferometer spectrometer, a device developed by Block Engineering Inc., Cambridge, Mass. While an ordinary spectrometer excludes all energy outside the scanning filter's passband, the interferometer spectrometer accepts all the received energy, but produces a brief, cyclic null at each frequency as a small mirror is rapidly swept through all the positions needed to produce 180° interference paths for each spectral term in sequence. The output is an interferogram, equivalent to the Fourier transform of the spectrum. A Block-developed com-

Varo High Voltage Rectifiers: Silicon Performance at Selenium prices.

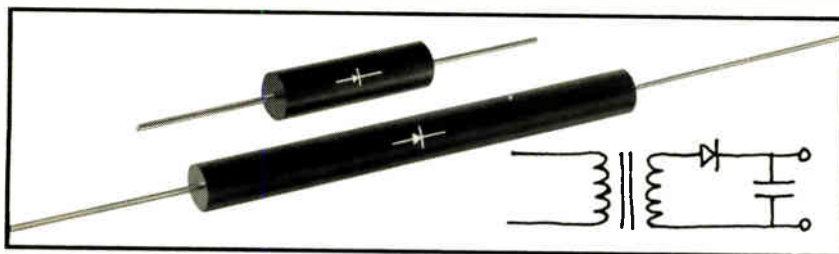

At last, economical high voltage silicon rectifiers at selenium prices! Ideal for use in all high voltage, low current applications.

- 5,000-40,000 Volts
- 5, 10, 25 milliamp ratings
- Standard and Fast Recovery

These are the high voltage rectifiers that make completely solid state television circuits possible.

Equally well suited for use in other cathode ray tube applications, electrostatic power supplies and voltage multipliers.

ONLY **\$1.32**

10,000v, 5mA rating. Quantity of 1,000. Complete details, applications, and price list available.



SEMICONDUCTOR DIVISION, 1000 N. SHILOH ROAD, GARLAND, TEXAS 75040 (214) 272-4551

Circle 137 on reader service card

TIGHT-WAD BREADBOARD DESIGNER

*The ELite 2 is stingy with your money - with your time
When it comes to advanced circuit design*

This dynamic lab in a box will enable you to design, layout, test and construct (and re-use) all IC and discrete components circuitry (LIS, MSI, MOS) **WITHOUT SOLDERING, SPECIAL TOOLS, PLUGS OR PATCH CORDS.**

PLUS THESE BUILT-IN FEATURES:

- Wide range function generator — sine, square, triangle
- Wide range pulse generator — bi-polar outputs
- 3 monitored power supplies — floating, stable, short circuit proof
- 12 data display lamps — high input impedance ± turn-on thresholds
- All breadboard interconnections with solid #22 gauge hook up wire
- Desk top convenience: 6 inches high, 17½ inches wide, 12 inches deep.
- **ORDER ONE TODAY**

Write or call for complete specifications catalog

PRICE
\$1,300
COMPLETE

ELI
EL Instruments Incorporated
61 First Street
Derby, Conn. 06418
Phone:
203/735-8774

Probing the news

puter then digitally samples the interferogram and processes it to rapidly derive its inverse Fourier transform, which is the spectrum itself. Sensitivity is extremely high and the computer can be used to service several interferometer spectrometers on a time-shared basis. Once the absorption spectra are extracted, they, in turn, could be analyzed by a second computer.

An even faster and simpler approach is to have the computer cross-correlate directly the sample interferogram and those of the compounds being searched for.

To detect nonferrous metallic weapons, such as brass-pipe bombs, "nonlinear radar" techniques are being applied. These have evolved from Microlab/FXR's early work on its Dynaid system, which uses diodes as nonlinear detectors and reradiators of microwave energy.

Weapons-detection is based on the fact that any metallic junction, even one with similar metals, has diode-like attributes. These "corrosion" diodes absorb incident microwave energy and reradiate at harmonics of the illuminating frequency. A gun, a knife, even a brass pipe with its ends brazed shut, contain many such "diode junctions." At microwave frequencies, since even the first harmonic which they radiate is well separated from the source frequency, a simple front-end filter can screen a suitable receiver from ordinary backscatter.

IIT Research Institute has produced an effective system for the Army's Mobility Equipment Research and Development Center at Ft. Belvoir, Va. The goal is to use it in Vietnam to rapidly search large groups for concealed weapons. Microlab/FXR has developed a similar device through an in-house funded program. This gear operates at 915 megahertz (allocated by the FCC for experimental work) and uses an fm-cw technique to effect the equivalent of range gating, thereby limiting the accepted signals to a range of a few feet and, therefore, eliminating spurious returns.

Matter: pick it apart, spread it out, identify it, analyze it

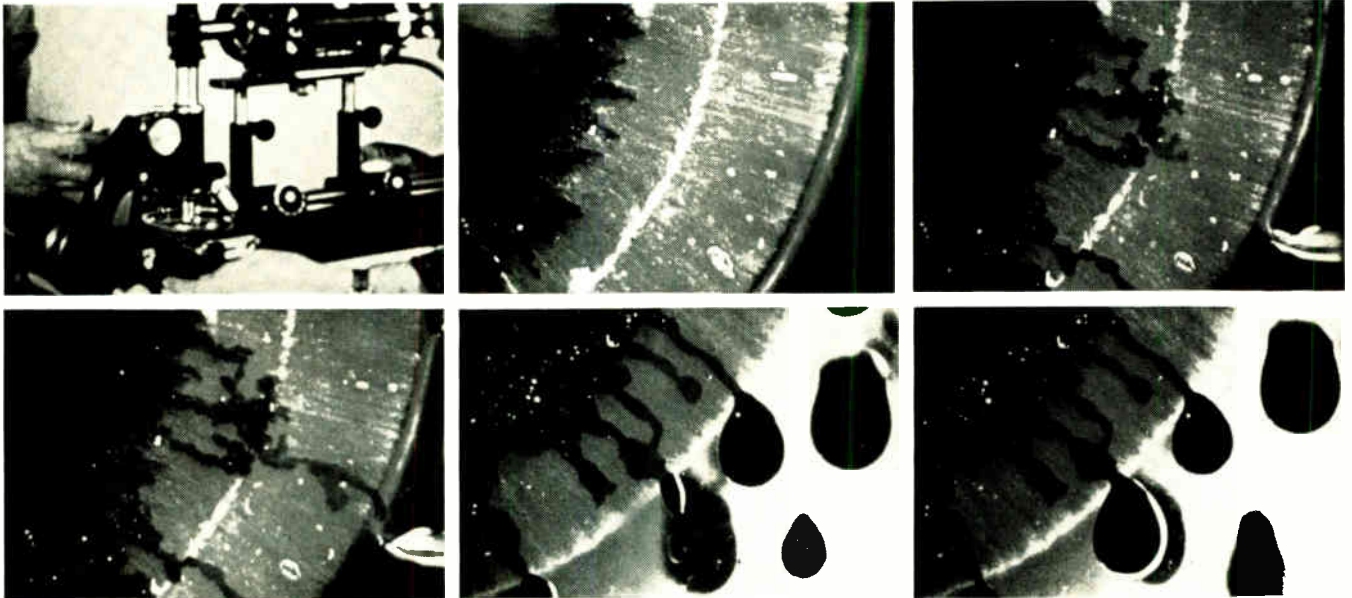

with photography.

Let Kodak show you how photography can divide and distinguish, speed up or slow down particles for study.

Photography can graphically sift granules of data one at a time, mushroom them to seeable size, capture their behavior—record events that elude other techniques.

At Kodak, building the recording media for data-recording and photographic monitoring systems keeps thousands of scientists and engineers busy. In many cases, they work with specialists in nonphotographic disciplines. Specialists who realize the data-recording potential of photography. This cooperative effort has stocked

the Kodak shelf with many novel ideas and solutions. The one you need may be among them. Talk to a Kodak photographic specialist. He's at a number specially reserved for your call—(716) 325-2000, ext. 5114. Or write:
Instrumentation Sales
EASTMAN KODAK COMPANY
Rochester, N. Y. 14650

In the series above, photography monitors impurity-extraction process in fuel.

Kodak

What's a 500 kHz plug-in doing in a 100 MHz mainframe?

Increasing its versatility, that's what!

When you need 100 μV sensitivity, rather than 100 MHz bandwidth, HP's new dual-channel 1806A plug-in lets your 180 Scope System do the job. With the 1806A, the versatile 180 Mini-Giant becomes a powerful tool for measuring and analyzing low-level signals up to 500 kHz.

A 100 $\mu\text{V}/\text{div}$ deflection factor lets you see beyond the surface of a signal — to detect ripples, discontinuities and harmonics invisible at less sensitive levels. To get the most out of the 100 μV sensitivity, drift is typically $<50 \mu\text{V}/\text{hr}$, CMRR is 100 dB, noise is $<20 \mu\text{V}$ tangential at full BW — and a pushbutton lets you limit bandwidth to 50 kHz, when you need to. Yet the price of the 1806A is only \$675.

For applications where you need high-bandwidth capabilities, there are a host of other plug-ins for the versatile 180 System. There's a 50 MHz, 5 mV/div plug-in for only \$695. 100 MHz with 10 mV/div and 50 Ω input, \$1200 (10 M Ω active probe, \$95 extra).

Other available plug-ins include: a differential/dc-offset amplifier, a 4-channel amplifier, and a 35 ps time-domain reflectometer that doubles as a 12.4 GHz sampler.

Today, oscilloscope technology is at a crossroads. The HP direction points to getting the best, now, at a low price — with assurance of increased measurement capabilities down the road, using existing mainframes. The new 1806A plug-in is the latest example of this approach at work.

To see the 180 System, call your local HP field engineer. Or, write to Hewlett-Packard, Palo Alto, California 94304. In Europe: 1217 Meyrin-Geneva, Switzerland.

080/15

HEWLETT  PACKARD

OSCILLOSCOPE SYSTEMS

Circle 96 on reader service card



NCR shifts to cores for memory of Century giant

Company finds thin film rods used in earlier machines too bulky for 300 design; supply of MOS insufficient

Memory systems manufacturers held their breath until the IBM 370 computer series announcement, thinking that there would be more extensive use of semiconductors in the mainframe. Those who were betting on continued use of cores breathed a sigh of relief to find that the concept of a semiconductor cache linked to a large mainframe core memory had been carried over from the 360 series. Then when the National Cash Register Co. unveiled its Century 300 computer last week, the sigh of relief was heard again—the top of the line will use an all-core mainframe memory that can vary in size from 128 to 2,048 kilobytes.

It had been known that NCR wanted a metal oxide semiconductor mainframe memory in the Century 300, but had difficulty finding enough suppliers to deliver 300,000 devices a month [*Electronics*, June 22, p. 34]. Cores have supplanted the thin film rod memory that had been used in the previous entries in the Century series—the 100 and 200 [*Electronics*, March 18, 1968, p. 49]—because the rods would take up too much room for the memory range offered in the 300.

NCR wanted at least three qualified suppliers of MOS memories before committing system design to semiconductors. General Instru-

ment Corp. and Signetics Corp. both had contracts to supply 256-bit random access memories, but scale-up problems from pilot line to production line prevented volume deliveries in time for the 300. NCR has not abandoned semiconductor memories, however. North American Rockwell Microelectronics Co. is pursuing NCR business, as are other companies, and an MOS facility is being built by NCR in Dayton to assure close control over at least one supplier.

Spokesmen at NCR's Electronics division in Hawthorne, Calif. say the Century 300 is intended to compete in a class that includes the RCA Spectra 70/60, the Control Data Corp. CDC 3500 and IBM's 370/155; the rental price will vary from \$15,000 to \$50,000 a month, depending on the memory size and peripheral equipment chosen. The computer would carry out such large-scale, multiprogramming tasks as real-time industrial accounting operations.

The memory cycle time is 650 nanoseconds per word, with a word size of four bytes. That speed is 2 to 4 times faster than that of the Century 200, depending on whether an instruction or an operand is being fetched; the 200 had a two-byte-wide instruction fetch vs. the 300's standard four bytes. The new machine also offers up to 4 times the memory size of the older version. Although compatible with the Century 100 and 200, the latest model has some new features.

One of these is the ability to access—simultaneously and independently—any of four memory modules driving a single memory

cycle. The arithmetic/logic processor consists of two units—a command setup unit and a command execution unit. Each unit has its own trunk, and can be fetching an instruction or an operand simultaneously with, but independently of, the other unit.

At the same time, the input/output control has independent memory access, offering users true simultaneity in that three operations can proceed at once.

None of these—the separate command setup and command execution units, nor the independent I/O control access to memory—was offered with earlier Century series computers. Nor did earlier models have four-way memory interleaving, a technique that “greatly reduces effective access time by placing successive words in adjoining

Control station. A crt unit at the operator's console of the Century 300 can display setup routines, job queues, priorities and other system data.





Silectron selection.

What you want, when you want it—Arnold's rugged family of cut, toroid, and DG Silectron cores.

The choice is yours. For power or control transformers, saturable reactors, inductors, magnetic amplifiers, and pulse transformers—our Silectron C- and E-cut cores. For power current transformers, and circuit breakers—our Silectron toroidal cores. For reducing watt loss and exciting current in distribution transformers—our distributed gap (DG) Silectron cut cores.

All bear the stamp of consistently high quality. Backed by 100% inspection. Plus our fast, responsive delivery.

Rugged, compact Silectron cores from Arnold. In a wide variety of thicknesses (1, 2, 4, and 12 mil) and shapes. Easy to assemble into your finished product. Now's the time to call or write.

ARNOLD
SPECIALISTS IN MAGNETIC MATERIALS

The Arnold Engineering Co., Dept. D-2, Marengo, Illinois 60152 • Member Company of Allegheny Ludlum Industries • Branch Offices and Representatives in Principal Cities

New products

memory modules," says an NCR spokesman. The independent memory access designed into the I/O control gives the system a transfer rate of 4.3 million bytes with minimum interference to internal processing.

As another new feature, the 300 includes as standard equipment an interactive cathode ray tube console to help the operator communicate with the system. The display unit is said to aid in multi-programming by providing such information as setup instructions for the operator, notification of programs terminated, peripheral status, and a review of job queues and program priorities.

The I/O structure is greater than that of the Century 200, allowing all the 200's commands plus eight additional ones, including decimal divide and word binary commands that enhance scientific performance.

All peripheral equipment used with the Century 100 and 200 systems are compatible with the 300, and a new peripheral has been added. It's a drum memory that can store 4.2 million bytes, and has an average access time of 8.3 milliseconds, with a 1-million-bit transfer rate. There's also a new controller that will increase the capacity of a recently introduced disk unit the company offers. The controller allows operation of the disk to store either 30 million or 48 million bytes. It has an average access time of 60 ms in either mode and will have a transfer rate of 315 or 500 kilobytes per second, depending on the recording mode being used.

Software for the 300 will include a complete set of high-level Cobol elements and Fortran, plus NCR's own NEAT/3 programming language. A multiprogramming system under development will include job accounting, automatic job scheduling, command systems disk and program library, file and unit sharing, and system-aided recovery.

First deliveries are scheduled for February, 1972.

Marketing Department, NCR, Dayton, Ohio 45409 [338]

Ferrite Shielded Air Core Yoke C3380. Designed for high speed precision character displays (nanosecond writing speeds). Undesirable magnetic coupling and stray fields eliminated by unique shield design.



DESIGN DEVELOPMENT FROM syntronic THE YOKE SPECIALISTS

Syntronic engineers and manufactures the most extensive line of deflection yokes available and continually develops new designs to satisfy the ever increasing requirements of the display industry. For large production or custom applications get the engineering control and production experience that only SYNTRONIC, the yoke specialists, can provide.



syntronic

INSTRUMENTS, INC.

700 Industrial Rd., Addison, Ill. 60101
phone 312-543-6444

Circle 138 on reader service card

CLASSIFIED ADVERTISING
SEARCHLIGHT SECTION
BUSINESS OPPORTUNITIES
USED OR SURPLUS EQUIPMENT

RADAR SYSTEMS GROUND AND AIRBORNE. AUTOMATIC TRACKING ANTENNA SYSTEMS. NIKE AJAX. NIKE HERCULES. M-33. M-33A. MPS-19. MPS-9. SCR 584. TPS-1D. TPS-2B. FAA-ASR-2. AIRBORNE SYSTEMS. APN-84. APN-102. APS-20. APS-27. APS-45. DPN-19. DIGITAL COMPUTERS. IBM 650. IBM 704.

LARGEST INVENTORY OF RADAR AND MICROWAVE EQUIPMENT IN THE WORLD.
RADIO RESEARCH INSTRUMENT CO.
45 WEST 45TH ST. N. Y. 10036 212-JU 6-4691

CIRCLE 966 ON READER SERVICE CARD

free catalog
POTTING APPLICATORS
MANUAL AND DISPOSABLE
6cc 12cc 30cc
FOR POTTING ENCAPSULATING, AND SEALING OF MINIATURE COMPONENTS
PHILIP FISHMAN COMPANY
7 CAMERON ST. WELLESLEY 01, MASSACHUSETTS

CIRCLE 967 ON READER SERVICE CARD

EMPLOYMENT SERVICES

Fee Paid Employment Service for all technical fields since 1959. Over 1,000 U.S. client cos. Send resume. Atomic Personnel, Inc., 1518 Walnut St., Box L, Phila., Pa., 19102.

USE ZIP CODES
IN THE MAILS

New Micro-Miniature Form C Reed Relays

Only .290 OD!

- The First FORM C Micro-Min. Relay Available!
- Measures .435 x .290 OD, only 0.03 cu. in.!
- Min. Overall Length with Bent Leads .600
- High Speed 100 microsec. Operate Time (ex. Bounce)
- Stock Voltages 3, 6, 12 and 24
- Leads or Pins. Also Available with Form A.

Special voltages, resistances, electrostatic and/or magnetic shields available. Write for new Bulletin MR-9.2.



COTO-COIL COMPANY, INC.
Pavilion Avenue, Providence, R. I. 02905
Tel: (401) 941-3355

Circle 99 on reader service card

99

Instruments

Minicomputer calls signals for testing circuits, cards, LSI

By Owen Doyle, *Instrumentation editor*

Versatile system can run 6,000 tests per second; no software skills needed to prepare sequences

All minicomputer makers face the temptation of getting into the automated systems business. Computer Automation Inc., for one, has given in and turned a home-grown setup for checking digital-circuit boards into a commercial tester called Capable. Built around the company's 208 minicomputer, the unit runs functional tests at rates of up to 6,000 per second.

Primary target for the company is high-volume builders and buyers of logic cards, such as big-computer houses and communications companies. However, Capable may attract other types of customers since it can check out any digital network from an off-the-shelf integrated circuit to a 128-pin circuit board or LSI network. In addition, it can run continuity and short-circuit checks on cables.

All of the tester's hardware, except for its teletypewriter, is packed inside a 20-by-27½-by-30-inch cabinet. Besides the computer with its 8,192-word memory, the cabinet holds interface circuitry, a patchboard, connectors for the device under test, a paper-tape reader, a control panel, and the power supplies.

In layout and operation, Capable resembles most automated test systems. The operator puts the test program into memory via the

reader, plugs in the device, and pushes a button.

The computer sends test signals through the interface and patchboard to the device, and compares the actual responses against the desired ones. After running the device through a complete program, the computer turns on a GO or a NO-GO light.

Capable's 64 input and 64 output channels give it the capability to check devices with up to 128 pins. An option that permits the programmed selection of pins during a test sequence extends this range to 256 pins.

Testing a device with eight inputs and eight outputs, Capable runs at the rate of 6,000 tests per second, and handles programs with up to 1,536 tests. At the other extreme, a 128-lead network can undergo 192 tests at a rate of 600 tests a second.

Computer Automation has a good idea whom it will be selling against. "Capable is head-on competition for General Radio," says director of applications Richard Drew, referring to GR's 1790 logic-circuit analyzer [*Electronics*, Aug. 18, 1969, p. 149]. Capable sells for \$27,500, versus \$35,900 for the 1790. Drew claims that, being a computer maker, his company will have an edge in the test market. "We have a great deal more flexibility when it comes to adding peripherals to the equipment in order to meet specific customer requirements," he says. "People might want data logging, or they might want a disk source for program storage or a (magnetic) tape

source. Instrument makers can add some features, but not all the ones we're able to put in."

Another selling point is that Capable is easy to program. "The whole system is unique in that you don't have to learn a language," says Drew. "Many people who have a requirement for testing aren't familiar with computers, so they're faced with the task of first learning how to operate the computer and then how to work the programming language. We've completely eliminated these steps."

Programming starts with an engineer writing the test sequence on a form supplied by Computer Automation. Each step in the sequence contains the desired inputs, the expected outputs, and the identity of the device terminals to be masked.

The form goes to the operator

Fast look. Making 1,536 tests a second, the Capable system checks a 128-pin circuit board.



Now true precision in Allen-Bradley thin film networks.

Resistance networks for A/D and D/A conversion, digital volt meters and numerical control systems demand extreme precision. Allen-Bradley can deliver. Precision that starts with a patented chromium-cobalt resistive material vacuum deposited on a substrate made to Allen-Bradley specifications. Precision based on exclusive computer drawn grids. Precision backed by extensive design and testing facilities. Precision on a continuing basis assured by Allen-Bradley's 14 solid years of experience.

Add the reliability of a single substrate, uniform temperature characteristics, much lower attachment costs and you see why Allen-

Bradley thin film networks are the logical replacement for discrete precision resistors.

SELECTED SPECIFICATIONS

RESISTANCE RANGE	1K ohms to 2 megs, standard 25 ohms to 50 megs, special (Single substrate range - 10,000 to 1)
TCR LEVELS -55°C to +125°C	± 25 ppm/°C ± 10 ppm/°C ± 5 ppm/°C
TCR TRACKING	± 5 ppm/°C standard to ± 1 ppm/°C special
TOLERANCES	Absolute to ± .01% @ +25°C Matching to ± .005% @ +25°C
RESOLUTION	Line width and spacing to .0001 inch
ENDURANCE	Exceeds MIL-R-10509F Characteristic E Procedure: MIL-STD-202D

Investigate the superiority of Allen-Bradley thin film networks. Write: Marketing Department, Electronics Division, Allen-Bradley Co., 1201 South Second Street, Milwaukee, Wisconsin 53204. Export office: 1293 Broad St., Bloomfield, N. J. 07003, U.S.A. In Canada: Allen-Bradley Canada Ltd., 135 Dundas Street, Galt, Ontario. Several standard networks are available through your appointed A-B industrial electronic distributors.



THE QUIET LAMP

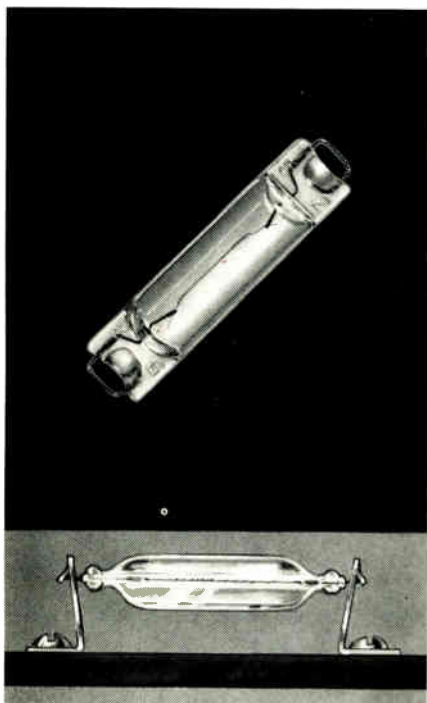

The design of this lamp makes it ideal for all audio-related applications where freedom from noise is desirable. There are no anchors, a principal source of noise. The lamp has no soldered connections and no soldered-on base. The clip-type mounting bracket is inexpensive and provides a low silhouette that conserves space. Can be supplied in 6 v. and 12 v. types. Write for catalog A-21. Tung-Sol Division, Wagner Electric Corporation, 630 W. Mt. Pleasant Avenue, Livingston, N.J. 07039; TWX: 710-994-4865, Phone: (201) 992-1100; (212) 732-5426.

TUNG-SOL® BASELESS CARTRIDGE LAMP

TUNG-SOL—WHERE BIG THINGS
ARE DONE WITH SMALL LAMPS

© Trademark TUNG-SOL Reg. U.S. Pat. Off.
and Marcas Registradas

New products

who puts it onto paper tape with the teletypewriter. To help him, an executive program already in memory tells the operator what information is to be entered next.

Once the operator loads the finished tape, the tester is ready to go.

Each type of device has its own patchboard, so one program can often test several similar types of devices. Changing from testing one device type to another involves changing patchboards and possibly the program.

Programming can be further simplified with SMART, another program supplied with the tester. The engineer preparing the test forms puts down only the desired inputs. A device known to be good is plugged into Capable, and the inputs-only program is run. SMART tells the computer to add the good responses to the program.

Besides SMART, the tester includes all the software for writing and running programs, and for diagnosing.

Switches on the front panel permit the operator to pick various modes for Capable. The purpose here is to allow the operator to find the cause of device failure.

As Drew explains: "The major thing you get with a computer in a tester is the ability to go through

your tests in a wide variety of fashions. Let's say you have a hundred tests. You go through 1 to 100, and your printout tells you there's a problem at test 33. You say: 'Let's start at test 30 and end at test 35.' Now you have the capability of going in a tight little loop."

This is just one example of how Capable handles a program. With the front-panel switches the operator can stop and start the program anywhere, order continuous testing, repeat a single test or block of tests or ask for syncs at various steps. He can also stop a test after the input signals are generated but before they're applied, and switch to the DEBUG program.

The customer specifies Capable's connectors, which can be edge connectors, cable terminals, or even IC sockets. The normal way to handle ICs, though, is to plug the circuit into an adapter, and the adapter into a Capable connector.

Inputs and outputs don't necessarily have to go to and come from a device's leads. Probes can run to points on a circuit board. For example, a "connector" may include a probe that clamps onto an individual IC.

Delivery time is 90 days.

Computer Automation Inc., 895 W. 16th St., Newport Beach, Calif. [339]

Wire versus write. The computer sends signals to the device under test through a patchboard. Software can do the patchboard's job, but in many cases it's cheaper to wire the interconnections rather than program them.

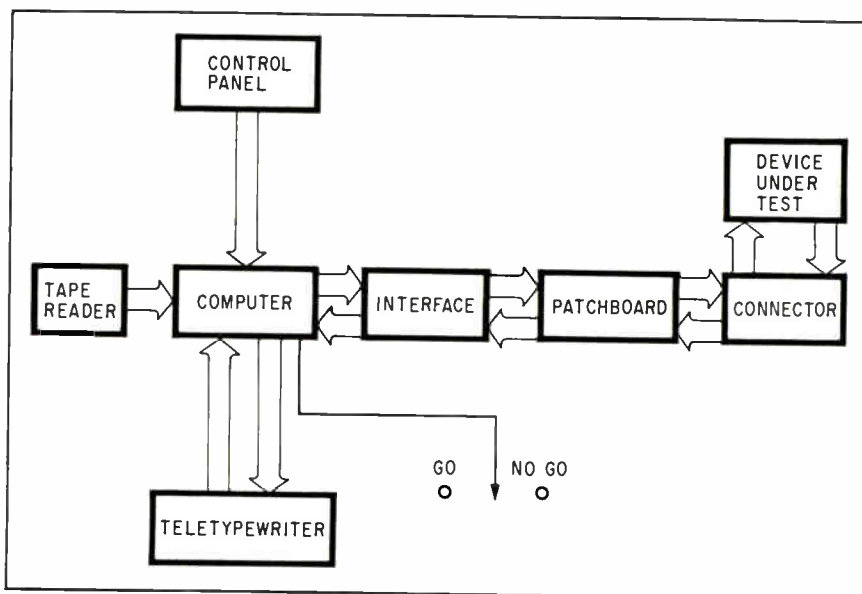

At 125° C, our 12-bit D/A converter is still a 12-bit D/A converter.

As long as you promise to keep the ambient down around a balmy 65°C, any number of people will volunteer to design and build a hybrid 12-bit D/A converter and stuff it into a reasonably small flatpack for you.

But why bother?

Ours is already sitting on the shelf. A 7-layer multi-layer in a 1.25" square flatpack.

Ready for service at any temperature within the MIL Spec (-55°C to +125°C) range. Without deviation from its $\pm 1/2$ LSB linearity.

You can put in up to 12 binary bits or 3 BCD digits (it's DTL and TTL compatible) and take out 0 to +5, 0 to +10, -5 to +5, or -10 to +10 volts. You get everything you might need for 8, 10, or 12-bit resolution—from input storage to output op amp. And if everything you might need is more than you actually need, we can leave some things out.

Like our temperature-compensated reference source. You only need one of these to handle up to 120 bits. So if you're using several D/A converters, we can put the reference source in one, leave it out of the rest. And save you a few bucks.

And if you'd rather use an external op amp in the output, we'll leave ours out. Or if all you want is our TaN ladder and IC switches, you can get them separately.

And, please, don't feel you're putting us out if you need a lot of any of these in a hurry. We can give you—quickly—any size or shape of hybrid you want, from a simple little thing tucked in a TO-5 package to a 30-IC, ten-layer MSI module. By the thousands.

The next step's up to you.

Want to try one of our D/A converters?

Call, and our local man will give you a demo right away. Learn a little more about them first?

Write, and we'll have data in the next mail.

Explore some hybrid problems or possibilities of your own? Ask for John Zucker, our resident hybridizer.

Any way you want to get us—or it—together, we're willing.

Unisem Corporation, P.O. Box 11569, Philadelphia, Pennsylvania 19116. Telephone: (215) 355-5000.

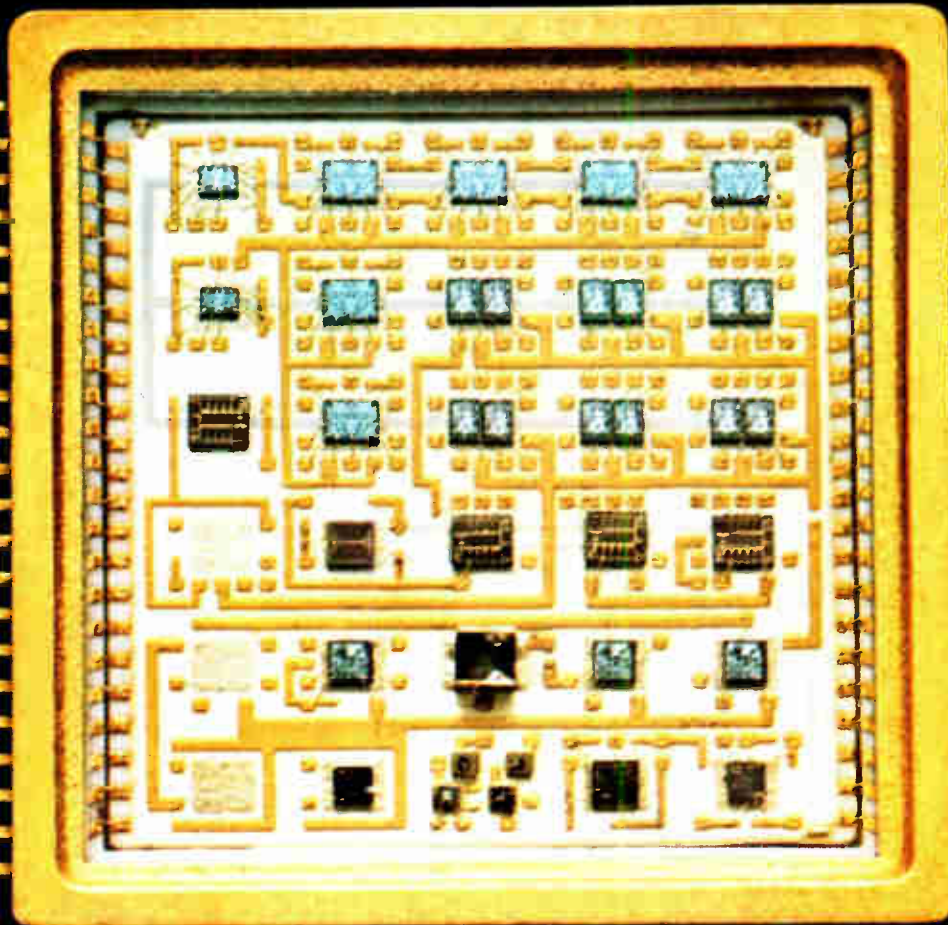
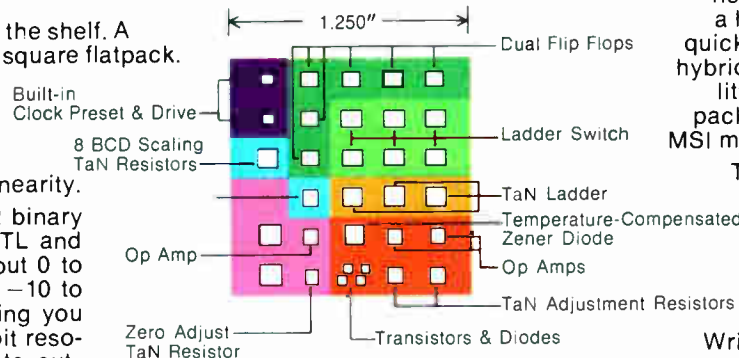

Need a helpful ally, taking on Mil-Spec contracts?

When it comes to military contracts, Brand-Rex can make getting the proper wire and cable the easy part of the job.

We offer an unusually broad range of products from tiny hook-up wires to mighty umbilical cables. Polyethylene, PVC, Kapton, Kynar, Teflon TFE and FEP are a few of the insulations we use regularly.

Brand-Rex's quality control procedures, well-known and accepted by military and aerospace

people, simplifies meeting MIL, NAS and other requirements.

Need an ally in a tough market? Contact the people who've been there for years, supplying cable for practically every major missile system and space shot. Whether your cable requirements are large or small write for the new Brand-Rex Military Specification Wire and Cable catalog.

Brand-Rex Division, American Enka Corp., Willimantic, Conn. 06226, (203) 423-7771

Connect for tomorrow.

BRAND-REX

Circle 104 on reader service card

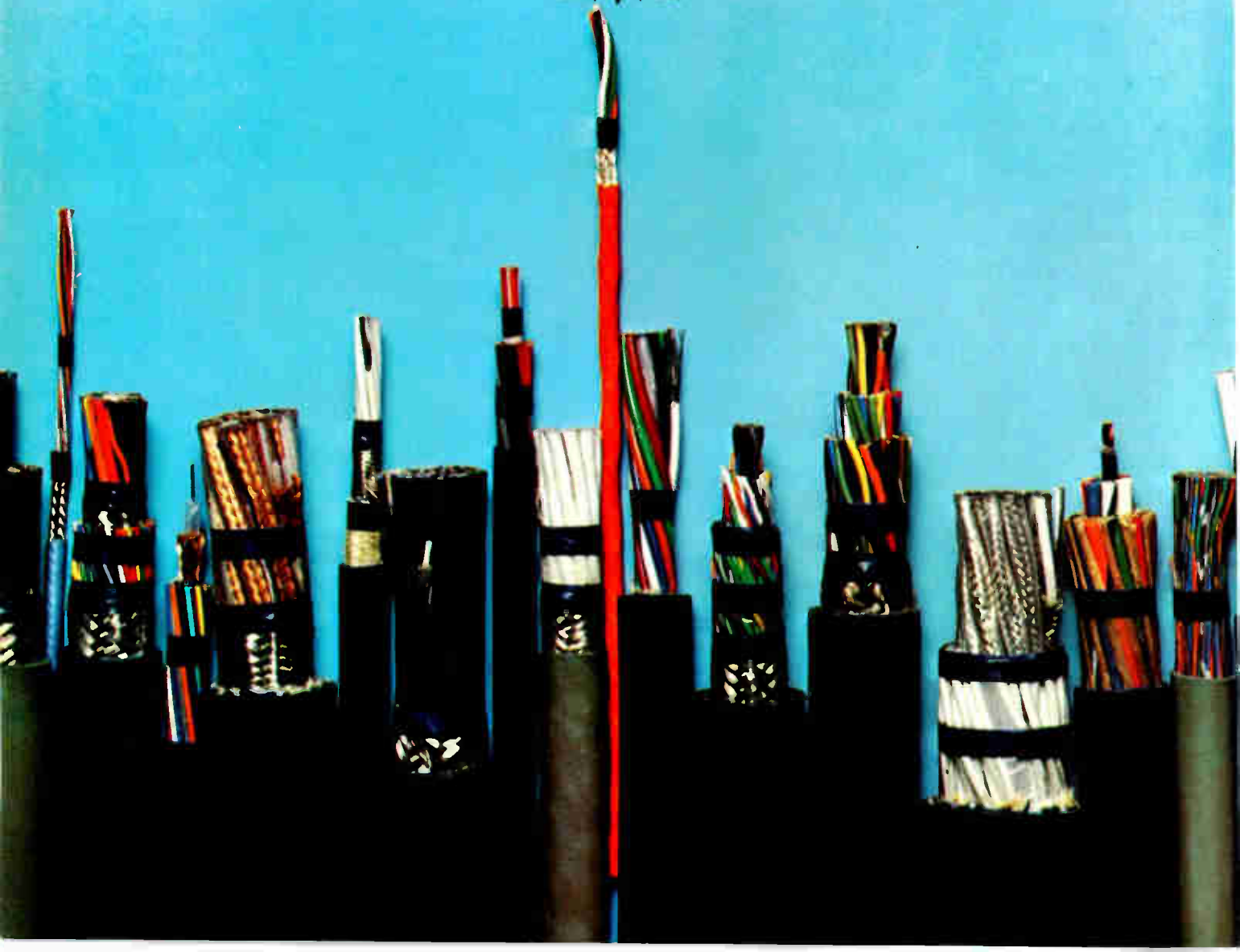
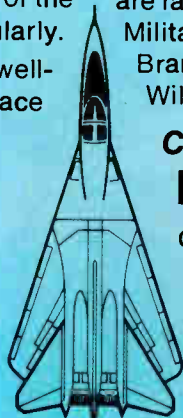

New products

Instruments

Infrared probe reaches the untouchable

Data from optical fiber converted into dc voltage, displayed on remote meter

It's difficult to measure temperature in out-of-the-way places, in high-voltage or high-radiation work areas, or where noise is an impediment, moving objects are involved, or direct-contact sensors are con-

sidered to be undesirable.

Job areas such as these suit the model 1017 thermal probe developed by Vanzetti Infrared and Computer Systems. The infrared thermometer is a modification of the company's thermal bond monitor introduced last year [*Electronics*, Dec. 22, 1969, p. 133].

A single optical fiber picks up IR radiation, which is a function of temperature, and transmits it through a detection head to a con-

sole. There the IR is converted into dc voltage and displayed on a 3½-digit voltmeter. The fiber's 14-in. length, thinness (0.14-in. outside diameter), and flexibility allow it to measure IR in places where ordinary instruments can't go.

Detection of IR in high-voltage or high-radiation areas is possible with the 1017, since the optical fiber is inert and available in different lengths. The console and detector head can be placed a safe

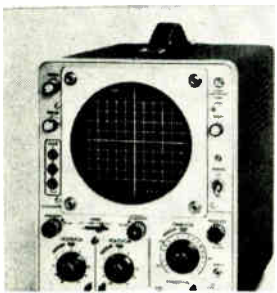

Five-inch, fully triggered, dual-trace scope model 553 contains a single time base and two independent vertical amplifiers that display two channels simultaneously and can alternate between channels or choppers between channels. It features 7MHz bandwidth and a sensitivity of 10 mV/cm, plus FET protected input. Marubeni-Iida (America) Inc., 200 Park Ave., New York [361]



Eight-inch industrial panel meter model 820 features a nonstatic glass front, long scale, dust-proof gasket, and a shallow barrel for applications where back-of-the-panel space is limited. It measures 6.5 x 7.75 x 1.81 in. It is expected to find use in industrial processing equipment, switchboard instrumentation, and computer networks. Triplett Corp., Bluffton, Ohio 45817 [362]

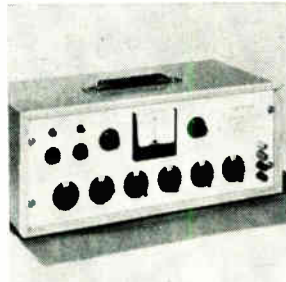

Resistance tolerance bridge that measures dc resistance to an accuracy of 0.1% comes in two models. The 57-2200-1 has a measurement range of 1 ohm to 10 megohms. The 57-2200-2 covers 1 ohm to 1 megohm. The instrument will display the deviation of the unknown resistance from the standard in 0.5 s. Solatron Enterprises, 421 E. Beach Ave., Inglewood, Calif. 90302 [363]



Digital voltmeter model 163 offers voltage sensitivity of 1µV per digit. It features 3½ digit display, 100% overranging, 2 µV per day stability, and is capable of floating up to 500V off ground. Full-scale ranges of ±1 mV to ±1,000 V allow the unit to be used when signal magnitudes vary widely. Price (1-4) is \$495. Keithley Instruments Inc., 28775 Aurora Rd., Cleveland [364]

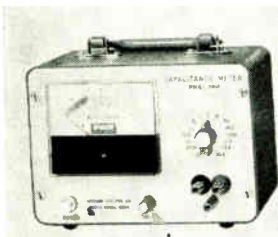

Capacitance meter model 2W1A gives direct indication of capacitances in 15 ranges from 100 pF to 10,000 µF. A test voltage of only 1V ac is impressed across capacitors being tested so the instrument may check all types of units including low-voltage aluminum and tantalum electrolytics. Four plug-in accessory modules are available. Sprague Electric Co., North Adams, Mass. [365]



Pulse generator model PG-1 is a digital signal source suited for development, research, industrial and educational applications. It features a wide frequency and pulse width range of 1 Hz to 1 MHz and 100 ns to 100 ms, low output impedance of 50 ohms, and a fast rise and fall time of less than 20 ns. Price is \$150 each. EL Instruments Inc., 61 First St., Derby, Conn. 06418 [366]



Oscillator model 1316 provides up to 1.6 W of output power (125 V open circuit or 5A short circuit) from 10 Hz to 100 kHz with 1% accuracy. Output is constant within 2%, drift is only 0.005% over a 12-hour period, and a synchronizing feature allows the 1316 to be locked to an external standard for greater accuracy and stability. General Radio Co., West Concord, Mass. 01742 [367]

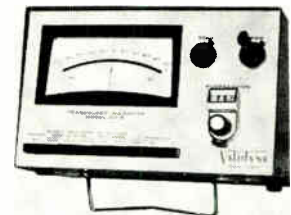

Transducer indicator CD12 is for use with variable reluctance transducers and other bridge excited units. It provides a 0 to 10 Vdc output for recording and dynamic monitoring, besides meter indication. Four-digit readout is presented on the manual balance control when used in the suppression mode, for null-balance readings. Validyne Engineering Corp., Northridge, Calif. [368]

New products

distance from the radiation area while the fiber monitors semiconductors and other electronic devices dissipating electrical power, or elements in nuclear reactors, in real time.

Since the fiber assembly is hermetic, it also can measure the IR of devices in a vacuum bell jar without vacuum loss. This hermeticity also allows the fiber to monitor IR during the deposition process of semiconductors when the devices are in an environment containing special gases.

The optics assembly is made of a single optical fiber, enclosed in a stainless steel tubing. The optical fiber is made of infrared-transmitting glass clad with a thin layer of a different glass. The refractive indexes of these two glasses are chosen in such a way as to contain the field of view of the fiber within a 56° cone around the fiber's axis.

The optical fiber fits into a detector head where it illuminates an IR sensor, whose output is chopped and sent to the electronics cabinet. There the signal is processed and displayed by the cabinet's digital panel meter.

The figures shown on the meter's face are directly correlated with the temperature of the targets.

The thermal probe, the company says, can be an important tool for measuring the temperature inside combustion engines. Its fast response records temperature variation during engine cycles and at different fuel compositions.

Both Alfa Romeo and Fiat, of Italy, are planning to use the probe to measure temperatures of engine



Place and show. A single optical fiber detects infrared radiation which is then displayed as a dc voltage.

parts, such as valves and bearings.

Another application is in monitoring the temperature of semiconductors and other components during soldering processes.

In the thermal probe the optical fiber and the detector head remain the same as in the thermal bond monitor, since the means of gathering information remains unchanged. However, in the thermal bond monitor, the values of the three threshold lights have to be set by the user for each type of chip, whereas the probe simply displays the dc voltage values on a digital panel meter. This voltage is directly correlated to the temperature, and the company supplies correlation charts.

The probe has a temperature range from 200°C to 1200°C; a five-step attenuation switch allows the instrument to cover the whole range. Custom fibers can monitor higher temperatures. The detector has an accuracy of $\pm 1\%$ of the reading, and response time is 1 ms.

Introductory price of the probe is \$1,375. Delivery time is 30 days.

Vanzetti Infrared and Computer Systems, 515 Providence Highway, Dedham, Mass. 02026 [369]

Norwegian firm invades industrial recorder field

An old-line Norwegian producer of consumer-type tape recorders has moved into the instrumentation market with a four-channel recorder for engineering and research.

The Series 100 machine, built by Tandbergs Radiofabrikk of Oslo and sold for \$3,685 in the U.S. by Intermed Inc., is designed to compete with a Japanese recorder, Teac Corp.'s R351F, which sells for \$5,225, and with Hewlett-Packard's \$4,285 model 3960. Intermed says the Norwegian machine is the lowest-priced quarter-inch-tape machine designed to meet IRIG specifications for the intermediate band.

Chief designer of the Tandbergs unit is Hans H. Westerby, who returned to Norway after working at H-P, where he was principal

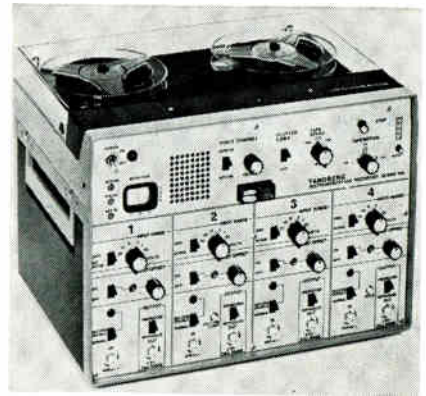

Watch and store. Output voltages of recorder's four channels are displayed on switched beam crt at upper left.

designer of the 3960.

The Norwegian company estimates that the U.S. market for instrumentation-type recorders amounts to about \$5 million, adding that H-P now has "a big share of it."

The principal competitive features of the Series 100 are price and size, says Jerry Ramsey, director of manufacturing for Intermed. The Tandbergs machine weighs 25 pounds, against 50 for H-P's and 117 for Teac's. Another feature of the 100 is a built-in cathode ray tube that displays the percentage deviation of the four channels simultaneously. This facilitates selection of input range.

The recorder provides three tape speeds: 1 $\frac{7}{8}$, 3 $\frac{3}{4}$ and 7 $\frac{1}{2}$ in./s. Maximum frequency response is 2.5 kilohertz, and signal-to-noise ratios are 42, 46 and 48 decibels, respectively. The ratios are not affected when copying data or transmitting the modulated carrier from one recorder to another. Drift is $\pm 0.01\%$.

Normally, all four channels are in the frequency-modulation mode. However, channel 2 can be operated to provide electronic flutter compensation, and channel 3 has three modes: data only, voice only, and data interrupted by voice.

An integrated tape-erase head eliminates the need for a separate degausser.

Delivery is from stock.

Intermed Inc., 2710 Forest Lane, Dallas, Texas 75234 [370]

STATIC TEMPERATURE CONTROLLER **STATOP**

This instrument, designed for thermocouples or resistor probes, is the solution for any problem of accurate controlling: plastic industries, heat treatments, heaters, dryers, chemical and spatial industries, oil, etc... and this for particularly economic conditions.

The success of the STATOP, in Europe as well as in many other countries, leads us to look for the diffusion of this kind of instrument towards U.S.A

We answer any documentation or price demand from users and installators who would be interested by this instrument.

However, the purpose of this advertisement is also to look for Companies specialized in controlling and likely to give out or manufacture this instrument under license.



CHAUVIN ARNOUX

190, rue Championnet - PARIS 18^e Tél.: 627 73-89 FRANCE

Chauvin Arnoux is one of the most ancient and important European Companies that manufactures measuring instruments, and has already negotiated under-license manufactures with the U.S.A. for types of instruments different of the one this advertisement is about.

Circle 107 on reader service card

2400°C

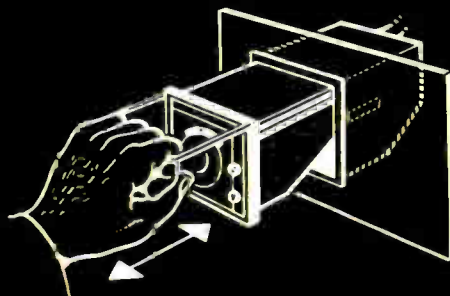

PLUG-N INTERNAL CHASSIS

Easy maintenance
Easy change of controlling operating-way



DIRECT INDICATOR OF TEMPERATURE TRUE VALUE

Permanent reading on the same scale as the set point
Galvanometer completely independent of controlling circuits

TOTALLY INSENSIBLE TO VIBRATIONS

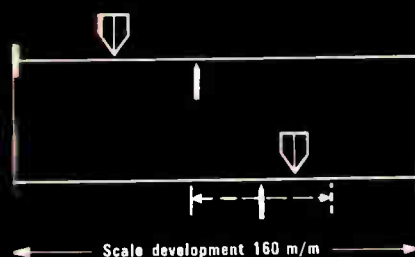

CONTROLLING WITH 2 OR 3 ZONES

ON-OFF CONTROLLING OR WITH PROPORTIONING AND DERIVATIVE ACTION
With adjustment (4 positions) of the pulses cycle-time that secures an optimum adaptation of heating with the enclosure to be regulated

OUTPUT CIRCUIT

- relay
- thyristor

ACCURACY 1% of the scale length

Fork : 0,4 %

Utilization : 0-60 °C

200°C

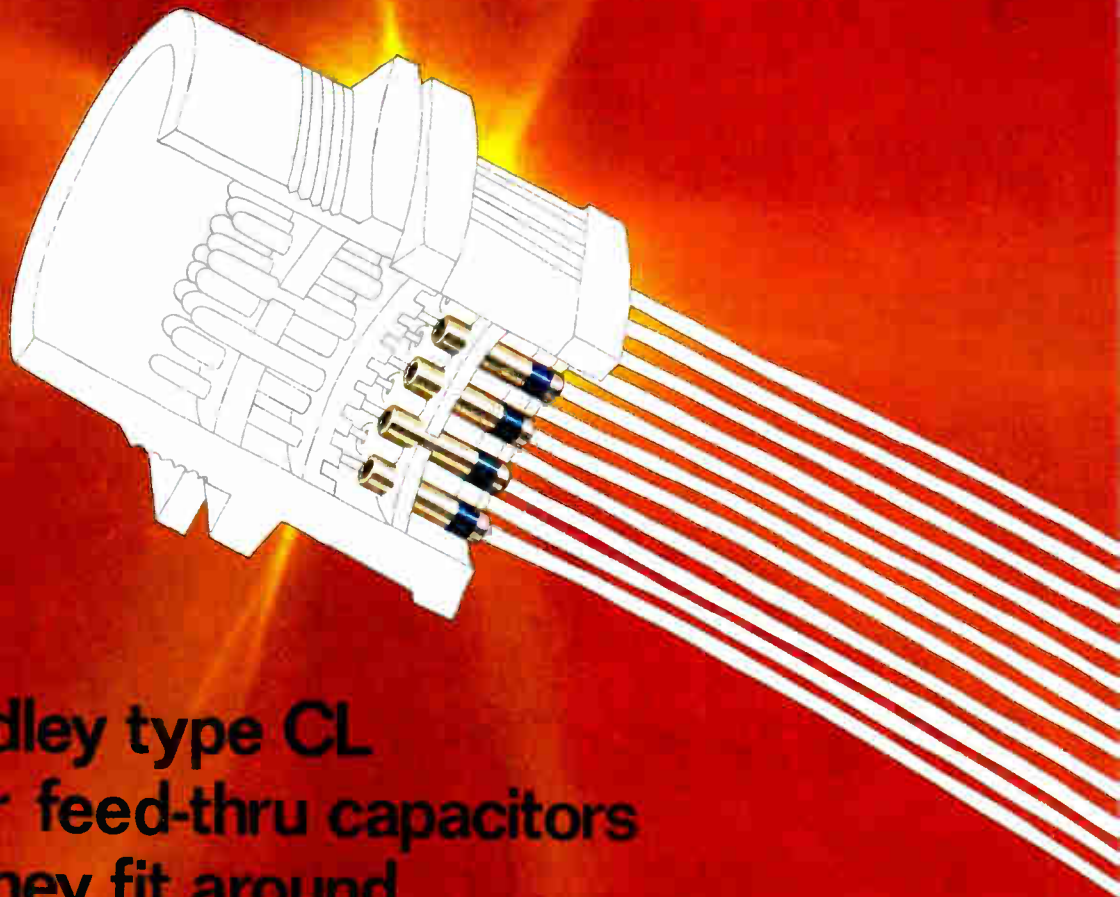

Allen-Bradley type CL multi-layer feed-thru capacitors so small they fit around the head of a pin.

VOLUMETRIC EFFICIENCY. Big words that explain why Allen-Bradley type CL feed-thru capacitors are so small. Our unique multi-layer concept shaves size to a minimum, without affecting performance. It took Allen-Bradley to get filter capacitors down to their fighting weight. Now rolled capacitors are no longer a design alternative.

Concentric layers of proprietary Allen-Bradley ceramic and noble metal electrodes are fired together for unmatched protection against moisture and contamination. Rugged. Non-polar. With lower inductance and far less noise.

Voltages to 200 WVDC. Temperatures to 125°C. Capacities to 1.0 μ F. High dielectric strength and reliability.

Several styles and sizes are available through your appointed A-B industrial electronic distributors. For further information write: Marketing Department, Electronics Division, Allen-Bradley Co., 1201 South Second Street, Milwaukee,

Wisconsin 53204. Export office: 1293 Broad Street, Bloomfield, N.J. 07003 U.S.A. In Canada: Allen-Bradley Canada Ltd., 135 Dundas St., Galt, Ontario.

ALLEN-BRADLEY



New products

Data handling

Plated wire bids for mainframe memory

Basic module has 4,000 72-bit words; speed-cost combination challenges cores

Memory systems suppliers have generally shied away from plated wire technology, betting that semiconductors will give the speed advantage often cited for plated wire and that cores will remain the

largest storage medium for computer mainframes until semiconductor memories truly come of age. But a few have chosen the plated wire route, primarily because of the combined speed and cost advantage it offers over ferrite core systems now available.

One such advocate of plated wire is Bruce Kaufman, president of Memory Systems Inc. Formed about 18 months ago to develop and produce these memories, the

company plans to deliver in December what it claims is the first large mainframe plated wire memory available to original equipment manufacturers.

The nondestructive-readout memory will have a basic module of 4,000 72-bit words and will cost as low as 3½ cents per bit. A diode matrix version will have a 300-nanosecond read or write cycle and 150-ns access time. A transistor matrix version will have a 200-ns

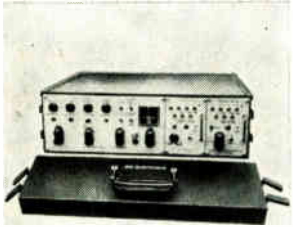

Phase jitterer FA1654 adds phase jitter to a data signal in the telephone voice frequency band. The jitter range is adjustable from 0 to 45° and jitter rate from 20 to 360 Hz. Accessories and accessory features include adjustable fixed phase shift, adjustable harmonic distortion, broad band and impulse noise. SEG Electronics Corp., Jamaica Ave., Richmond Hill, N.Y. [401]



All-digital ramp generator model IDA-6612V can provide variable sub-audio, sawtooth voltages over a 10-ms to 1-week time range while operating under digital computer instruction. It can be programmed or interfaced to provide waveforms needed to direct stress/strain parameters over variable time limits. Inter-Computer Electronics, 1213 Walnut St., Lansdale, Pa. 19446 [402]



Analog-to-digital converter designated Spectrologic S-1401 accepts a voltage or optional frequency input and delivers a digital signal suitable for direct input to the 620/i minicomputer. An internal sample-and-hold module permits precise determination of the time at which each sample is taken. Varian, Graphics & Data Systems Div., 611 Hansen St., Palo Alto, Calif. [403]

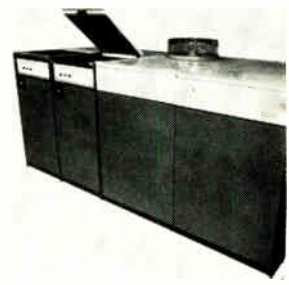

Disk drive M2700 has a 29-million 8-bit byte capacity and 30 ms average random access time, yet is only 17.5 in. wide. Despite its rapid transfer rate of 312,000 bytes per second in serial bit format, the compact unit occupies only 665 in.² of floor area. The cabinet's through-cable reduces cable length. Marshall Data Systems, Huntington Dr., San Marino, Calif. [404]



Magnetic card reader series MCR-100 is capable of reading up to 90 stored characters of information. It includes electronics that provide data and strobe outputs at logic voltage level. The standard model meets International Air Transport Association specifications with input standard 120 V ac. Price in lots of 100 is less than \$200. ID Systems Corp., Lexington, Mass. [405]

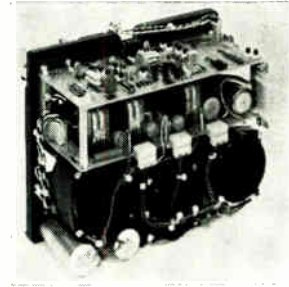

Magnetic tape transport model T/T 100 is a high speed, cassette loaded, tape storage device for applications such as data collection, store and forward operations, and data terminal systems of other manufacturers' design. Recording density is 1,000 bits/inch, 2,000 flux reversals/inch. Price is less than \$1,000. Sykes Datatronics Inc., 375 Orchard St., Rochester, N.Y. [406]



Data modem for wire-line communications designated Binet 6000A is for use on the direct distance dial telephone network. Operating at 2,400 b/s, the unit takes maximum advantage of the telephone system transmission capabilities. Automatic circuits compensate for variable line conditions. Standard RS-232 interface is provided. Bowmar/Ali Inc., Acton, Mass. [407]

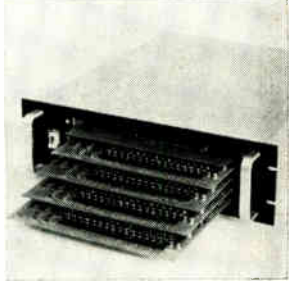

A complete 16,384-word, 18-bit memory system comes in a rack-mountable 5¼-in. enclosure. It includes a "closed cooling" technique that prevents foreign matter from entering the memory and eliminates fan filters. The memory features full cycle time of 1 μs. Access time is 350 ns over a 0 to 50° C range. Cambridge Memories Inc., 285 Newtonville Ave., Newtonville, Mass. [408]

Electronics in Medicine Conference

April 13-15, 1971
Boston

CALL FOR PAPERS

Prospective speakers are invited to submit 100 word abstracts of papers to be considered for the Third Annual Conference and Exposition on Electronics in Medicine.

Five copies of the abstract, along with biographical information and a list of illustrations, should be submitted by October 31, 1970. Submission date for full manuscripts from invited speakers is January 31, 1971.

Presentations should be specific and follow a case history format if possible. Suggested topics are: information processing and small computers in the hospital, laboratory automation, patient monitoring, automated history taking, design of prosthetics, and buying and evaluating medical electronics equipment.

Send all material to: Dr. John Truxal
Polytechnic Institute of Brooklyn
333 Jay Street
Brooklyn, New York 11201

Conference sponsors are four McGraw-Hill, Inc., publications: Electronics, Medical World News, Modern Hospital and Postgraduate Medicine.

New products

read and 90-ns access time.

The basic 4,000-word, 72-bit module may be stacked to form larger word and bit sizes, and duplication of external logic is avoided by using an OR on the sense amplifier outputs before they go to the interface. A two-dimensional multiplexing scheme allows each module to be factored into 8,000 words by 36 bits, 16,000 words by 18 bits, or 32,000 words by nine bits.

Kaufman sees a \$10 million to \$20 million annual market for main-frame plated wire memories by 1972, and cites their inherent advantages: nonvolatility (as opposed to volatile semiconductors), low power requirement, and nondestructive readout.

"But the main advantages," says Kaufman, "are high speed and low cost per bit. Semiconductor bipolar memories are very fast, but very expensive. Metal oxide semiconductor and core memories are low in cost, but slow. If the requirement is for a memory between 500 ns and 100, we are very competitive, because 500 ns is about as fast as a core memory can go without the cost going up tremendously."

Memory Systems is aiming at the commercial/industrial market—computers and minicomputers, controllers, data communications, and numerical control.

Improved techniques employed by plated wire memory manufacturers is a key factor. "The plated wire produced today is significantly

better, more uniform, and less sensitive to strain," says Kaufman.

Memory Systems makes its plated wire in a manner similar to other producers. The wire is cut into 15-inch lengths and inserted into assembled planes. The planes are made of epoxy with polysaccharide fibers. Memory Systems says other laminates were mechanically unstable and expensive.

Steel forming wires are used in place of the more delicate plated wire when the planes are assembled. The steel wires are sandwiched between two plastic layers, then a Mylar sheet with etched copper strips (the word straps) is placed around the sandwich. The whole assembly is laminated to an epoxy board, which supports it. Finally, the 8-mil-diameter steel wires are taken out and replaced by the 5-mil plated wires.

The firm's memories have two-dimensional multiplexing to save on electronics. For example, a 4,000-word, 72-bit module needs only 72 sense amplifiers instead of 288. Another feature is the use of two crossovers per bit for noise cancellation; instead of one plated wire, two wires are set up in a bridge arrangement to store each bit.

Besides supplying complete memories, the company plans to offer plated wire planes for those who want to attach their own electronics.

Memory Systems Inc., 3341 West El Segundo Blvd., Hawthorne, Calif. 90250 [409]

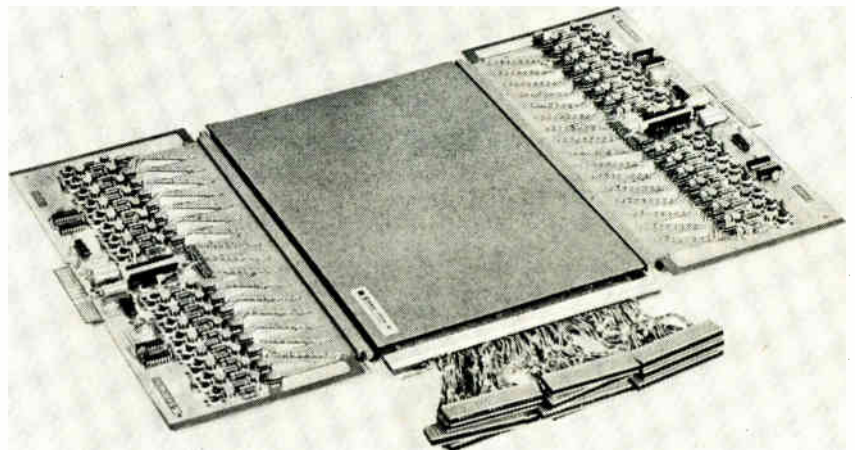



Should you make

...or buy?

Save money, time, delivery and headaches on your electronic assemblies. Clairex handles the purchasing, stocking, assembling and testing for you. Then delivers on schedule.

We quote quickly, too.

Call (914) 664-5602 or write Clairex®, 560 South Third Avenue, Mount Vernon, New York 10550.

CLAIREX ELECTRONICS

A DIVISION OF CLAIREX CORPORATION

You can buy "lacing tape" at lower cost... why pay more for Gudebrod's?

(Maybe your waste
container will explain!)

Not using Gudebrod Lacing Tape? Then your waste basket contents may be revealing! When harness workers run into tape having coating build up, or too little coating—or other irregularities causing tying problems—they'll often bury it in the waste basket. Yards and yards of tape will be wasted!

This won't happen with Gudebrod Tape. Every inch has exactly the same uniform finish—it consistently makes tight knots—workers really appreciate it. Naturally Gudebrod Tapes meet applicable MIL Specs. Save money with Gudebrod Lacing Tape—*not on the tape*—but at the harness board where faster production, high quality harnesses with fewer rejects count up in real dollar savings.

Talk this over with a Gudebrod Technical Representative—you'll be glad you did! He has a wealth of unique harness lacing experience.

GUDEBROD BROS. SILK CO., INC.
FOUNDED IN 1870



Electronics Division

12 SOUTH 12TH STREET, PHILADELPHIA, PENNSYLVANIA 19107

New products

Packaging and production

Pc board connections move in from edge

Rigid wires soldered at any desired location permit greater flexibility

Many engineers accept without question the traditional placement of plated pads or connector pins at the edge of a printed circuit board. But placing the pads or pins at the edge also entails some traditional

problems. They may need long connection runs on the board to get to them. They must be plated to make them stand up to many insertion cycles. The plating must be protected during soldering operations, and the mounting scheme is all but fixed because of the edge connector.

Molex Inc. now offers a way to make connections at any spot on the board with a system of connectors that allows flexibility in pc

board and cable design. In the Conectcon system, rigid wires are inserted in plated-through holes in the board and soldered to the circuitry to serve as male terminals for the connectors.

The wire that's used is 0.045 inch square, readily available since it's the type used with wire-wrapped terminals. The square cross section is used because it presses equally well in any range of hole sizes, while round wire would require im-

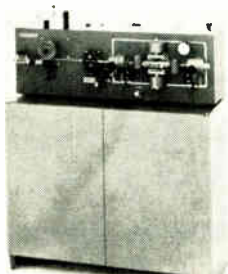

General purpose wire stripper model 2670 automatically measures, cuts and strips hard and soft insulations from wire in lengths from 1 inch to 100 inches without damaging the conductor. It handles single conductor, solid and stranded wires from 26 to 16 AWG. Top output for 2-inch lengths is 11,000 per h. Eubanks Engineering Co., W. Duarte Rd., Monrovia, Calif. [421]

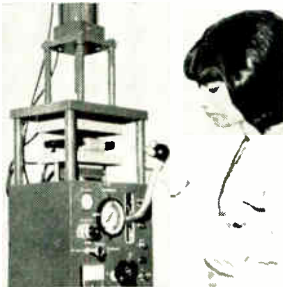

Molding machine JD-11 is designed to encapsulate transformers, DIPs, coils, ICs, and produce a broad variety of cups, cases and lead forms. It uses economical (hand) molds of aluminum to process soft-flow, epoxy molding compounds. Bench-mounted, the press has a base measurement of 1 sq ft. Morris Enterprises Inc., Schoenborn St., Sepulveda, Calif. [422]



Computer-controlled Wrapmaster 101 is a semiautomatic wire wrapping system designed to provide increased productivity at a minimum capital investment. Up to 16 independent wrap stations can be controlled by the 704 computer on a time sharing basis, using less than 10% of the 704's capacity. Unit can wrap panels up to 24 x 44 in. Raytheon Co., Lexington, Mass. [423]

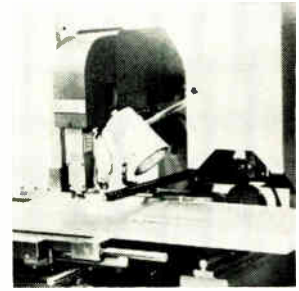

Numerical control insertion/wire termination system offers flexibility and economy for the user whose operation doesn't justify the cost of two individual machines. It is a double-headed unit, with one head for automatic insertion of components on pc boards; the other for semiautomatic back plane wire termination. Universal Instruments Corp., Binghamton, N.Y. [424]



Ultrasonic generator model 4320 uses integrated circuits, a simple design power generator and a compact package to achieve low cost. Primary application is in ultrasonic wire bonders used in assembly of transistors, diodes and ICs. The generator is available in 5- and 10-watt ratings. Data Systems Corp., 135 Commerce Dr., Fort Washington, Pa. [425]

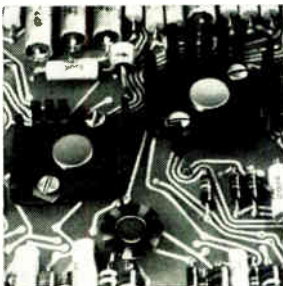

Heat dissipator series is designed to accommodate ICs packaged in the large TO-8 style cases having diameters up to 0.550 in. The base accepts square or circular IC lead patterns to 0.400 in. Standard dissipators and the retainer clamps are made of commercial black anodized aluminum. International Electronic Research Corp., W. Magnolia Blvd., Burbank, Calif. [426]



Die bonder series 2000 is designed for high speed processing of integrated circuits and devices on both lead frames and individual headers. It operates with rates in excess of 3,500 per hour on discrete packages and over 5,000 per hour with specially prepared and presented dice. On ICs, rates of more than 2,000 per hour can be achieved. Kras Corp., Fairless Hills, Pa. [427]

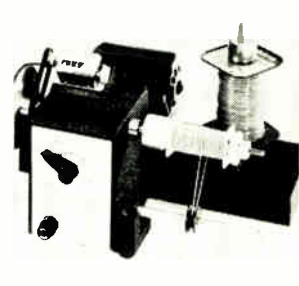

Coil winding machine model 4A, designed for short production runs, prototypes, and laboratory work, comes complete with standard dual-cone drive center assembly. The coil bobbin is supported between 45° conical centers connected by a 10-24 threaded rod and thumb nut. Machine winds No. 20 to No. 48 AWG. Price is \$245. Henry Mann Inc., Box 65, Feasterville, Pa. 19047 [428]

New products

practical tolerances on the pc board holes.

The female terminal of the Conectcon uses a double cantilever with an opening that prevents pins larger than 0.080 inch diameter from entering, to avoid overstress on the cantilever.

The connectors are injection molded and are available in several materials. Presently, they are made of nylon and center spaced on 0.156-in. centers. The wire is crimped into the housing, which will accept wires 20 gage or smaller.

The wires can be inserted in the board holes with a vibrating device, a set of templates, and a press. With such a setup, a vibrator can insert up to 300 pins a minute, says Kerry M. Krafthefer, Molex project engineer.

In an application, the square wire pins are first cut in a high-speed machine. The pc board is placed in the template, and the template closed and placed on the vibrator. The pins are then sprinkled onto the template surface. A preset vibrator cycle time, amplitude, and frequency guarantee that all holes in the template are filled; unused pins fall into a hopper. The template then is removed, placed in a press, and the completed board is

Well connected. Male terminal is a square pin soldered to circuit.

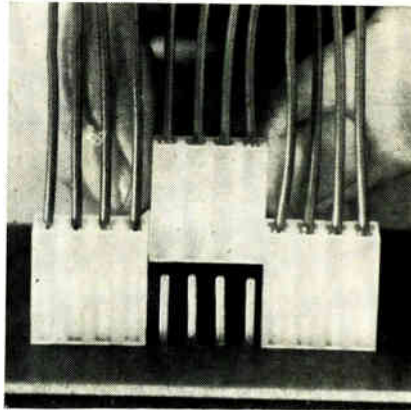
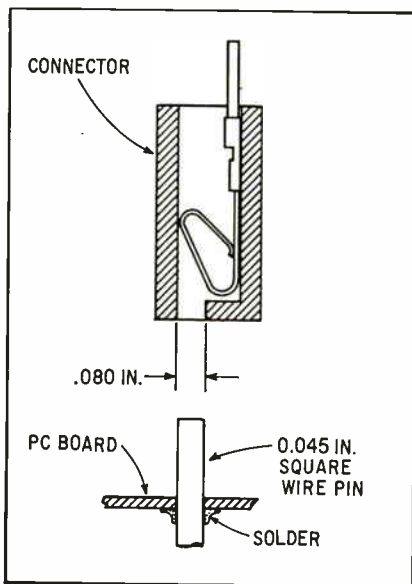

Flexible. Connections may be made at any spot on a circuit board.

removed from the template.

The board holes are 0.050 in. diameter, with tolerances of 0.002 in.—larger holes don't hold the pin as well, while smaller holes result in extrusion of the substrate material beneath the board. Round wires would require tolerances of 0.001 in., which would be too difficult to maintain in production.

Average contact resistance is 2.7 milliohms and the millivolt drop at 1 A is less than 3 mV.

The board scheme can be used for connecting cables to the board, for interconnecting boards directly with a perpendicular entry, or even for interconnecting boards in parallel, at any points on the surfaces.

Price of the interconnections system is about 1 cent per circuit in volume usage.

Molex Inc., 5224 Katrine Ave., Downers Grove, Ill. 60515 [429]

Ellipsometer gives reading in less than two minutes

Speed and ease of handling—features that are difficult to combine in an ellipsometer—have been built into one developed by Applied Materials Technology. The company, which does dielectric film deposition on silicon wafers, was running into quality control problems, where essentially “we didn't know what we had for film composition,” says Ted S. Rafalovich, marketing manager. Available ellipsometers were difficult to use in a production

environment, he says, so Applied Materials decided to build its own.

Ellipsometers derive their name from the elliptical vector pattern generated as polarized light passes through a quarter-wave plate. They measure a silicon wafer's refractive index and the thickness of dielectric films, parameters of particular importance in manufacturing silicon devices that require an insulating layer such as silicon dioxide.

Nitride and oxi-nitride passivation layers contain oxygen, and the more they contain, the lower their refractive index. This oxygen content is directly related to the dielectric constant, but is hard to control. However by using the new ellipsometer to take sample measurements of its refractive index, an operator can determine the percentage of oxygen in the nitride film in less than two minutes. Rafalovich says that the only other method of determining the oxygen content is by X-ray backscatter, a lengthy and complicated procedure.

The unit comprises a polarizer, analyzer, horizontal wafer-mounting table, quarter-wave plate, mercury lamp, and photomultiplier tube, all mounted on a single cast chassis, a feature that contributes to ease of measurement. The operator places the wafer on the table, where it reflects light transmitted from the polarizer to the analyzer via the quarter-wave plate. Then he adjusts the polarizer and analyzer for a minimum signal on a current meter, and plots the readings from the two arms and the scale on a nomogram to come up with the index number.

Film thickness readings are accurate to within ± 20 angstroms and refractive indices to within $\pm 0.03A$ over the range of 20 to 2,700A. The unit measures 20½ in. wide by 11 in. high by 10 in. deep, and weighs 22 pounds. The price of \$4,975 includes the direct-reading refractive index and thickness nomogram, as well as computer generated tables.

Delivery time is 8 to 10 weeks.

Applied Materials Technology, Inc., 2999 San Ysidro Way, Santa Clara, Calif. 95051 [430]

**"Bigger and better...this
engineer's bible..."**

-Electronics Magazine

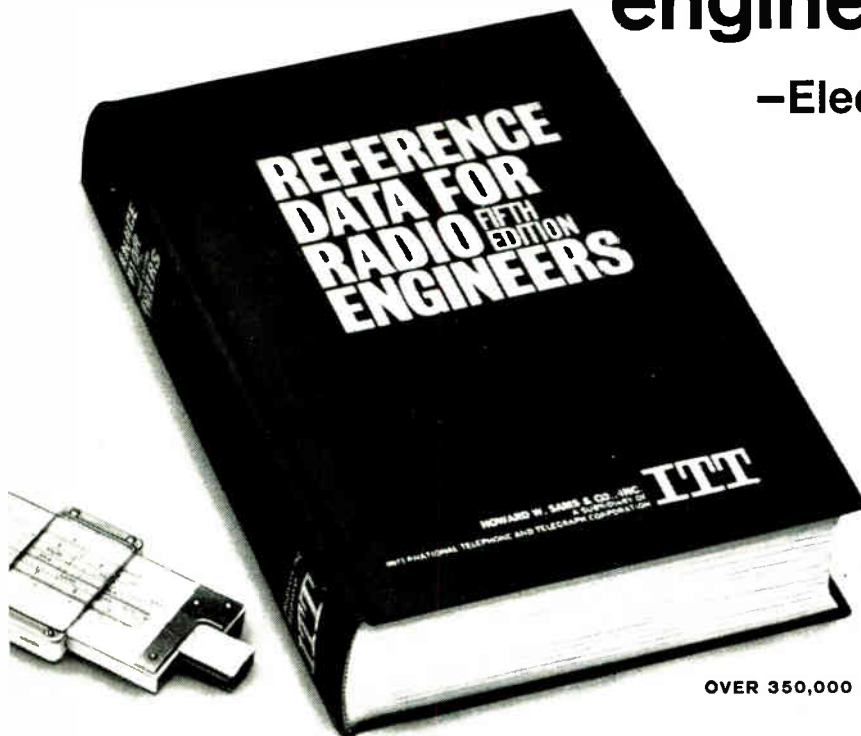

**5th EDITION of a
world-famous reference**

Now contains 50% MORE DATA to include major information developed over the past 12 years. Prepared by an outstanding group of practicing engineers, professors, and industry and government experts, under the direction of the International Telephone and Telegraph Corporation staff.

OVER 350,000 COPIES SOLD IN PRIOR EDITIONS

Reference Data for Radio Engineers

CHAPTER CONTENTS

Frequency Data	Transmission Lines
*International Telecommunication Recommendations	Waveguides and Resonators
Units, Constants, and Conversion Factors	Scattering Matrices
Properties of Materials	Antennas
Components or Parts	Electromagnetic-Wave Propagation
Fundamentals of Networks	Radio Noise and Interference
Filters, Image-Parameter Design	Broadcasting and Recording
Filters, Modern-Network-Theory Design	Radar Fundamentals
Filters, Simple Bandpass Design	Wire Transmission
Attenuators	*Switching Networks and Traffic Concepts
Bridges and Impedance Measurements	Digital Computers
Magnetic-Core Transformers and Reactors	*Navigation Aids
Rectifiers and Filters	*Space Communications
Magnetic Amplifiers	Electroacoustics
Feedback Control Systems	Nuclear Physics
Electron Tubes	*Quantum Electronics
Electron-Tube Circuits	Information Theory
Semiconductors and Transistors	Probability and Statistics
Transistor Circuits	*Reliability and Life Testing
*Microminiature Electronics	Miscellaneous Data
Modulation	Fourier Waveform Analysis
	Maxwell's Equations
	Mathematical Equations
	Mathematical Tables

*New chapters on subjects not covered in 4th Edition

1196 PAGES • 1350 ILLUSTRATIONS
plus 41 page index

The FIFTH EDITION of this widely used reference work has been completely revised and updated. It provides in a single volume comprehensive data on all basic phases of electronics, including tables, formulas, standards, and circuit information—PLUS—all-new data on microminiature electronics, space communications, navigation aids, reliability and life testing, international telecommunication recommendations, switching networks and traffic concepts, and quantum electronics. Includes over 1300 charts, nomographs, diagrams, tables, and illustrations. 45 data-packed chapters. 1196 pages of invaluable information for practicing radio and electronics engineers.

10-Day Free Examination

HOWARD W. SAMS & CO., INC., Dept. EL-590
A Subsidiary of International Telephone & Telegraph Corporation
4300 West 62nd Street, Indianapolis, Ind. 46268

- Send me REFERENCE DATA FOR RADIO ENGINEERS for 10-day examination, without cost or obligation. If I decide to keep the volume, I will send \$20.00 (plus postage) in 10 days; otherwise, I will return the book within 10 days.
- \$20 payment enclosed. Send my copy postpaid with full 10-day refund privilege. (Include sales tax where applicable.)

Name _____

Company _____

Address _____

City _____

State _____

Zip _____

Equipments and Systems

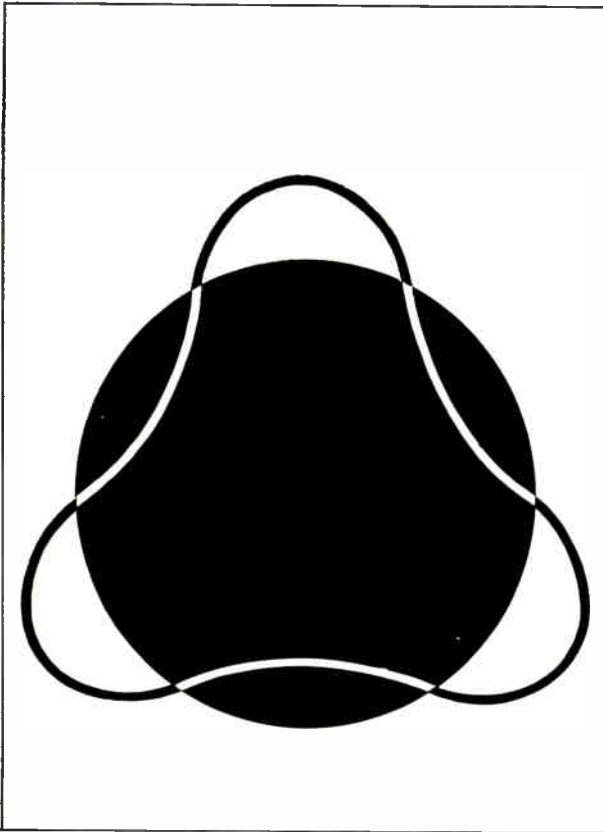

922.833

bearing the
TELEFUNKEN trademark
are symbols of
progress in the World

We manufacture and supply: Broadcasting and television transmitters · Communications transmitters · Maritime transmitters and transceivers · Professional receivers and direction finders · Radars · Radiotelephone sets and systems · Telecommunications equipment and cables · Data processing systems

Write for comprehensive documentation

ALLGEMEINE ELEKTRICITÄTS-GESELLSCHAFT
AEG-TELEFUNKEN
Export Department
79 Ulm · Elisabethenstraße 3
Germany



AEG-TELEFUNKEN

TOGGLE SWITCH **MINIATURES**

This modified version of the original Alcoswitch has the latest improvements: double hi-voltage barriers, low-loss hi-impact hi-temp materials, silver contacts, 1-2-3-4 poles. 6A @ 125 VAC. Ask for "A" Series.

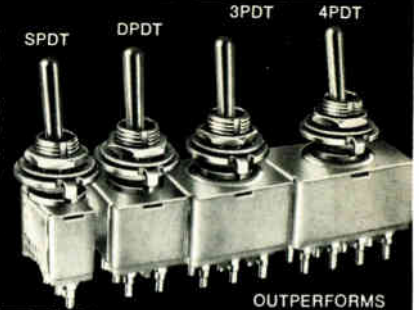

ALCOSWITCH®

OUTPERFORMS
COMPETITIVE MODELS

DIV. OF ALCO ELECTRONIC PRODUCTS, INC., LAWRENCE, MASS.

Circle 139 on reader service card

TOGGLE SWITCH **MINIATURES**

Miniature series with a standard $1\frac{1}{2}$ " bushing & toggle, features rear panel compactness. Hi-volt barriers inside & out. Available in 1-2-3-4 pole types. 6A @ 125 VAC.



ALCOSWITCH®

MUSTANG SERIES

DIV. OF ALCO ELECTRONIC PRODUCTS, INC., LAWRENCE, MASS.

Circle 140 on reader service card

E=2(C+EDP)X

Last year, Electronics magazine contained twice as much information on computers and electronic data processing as the next leading electronic publication.

If the cover of this magazine has your name and address on it, there is no better formula for keeping yourself abreast of the industry's technology.

Semiconductors

Planar Darlingtons stress reliability

Stability, price advantages also claimed over mesa types; two devices have low V_{SAT}

Taking strong exception to the view that an integrated power Darlington amplifier is best made as a mesa device [*Electronics*, July 20, p. 137], Unitrode Corp. is introducing a series of power Darlington

made by the planar process. Howard Wasserman, Unitrode product marketing specialist, says the planar Darlington offers greater reliability and stability than its mesa counterpart because it is completely passivated. He adds that it can be priced competitively with a mesa device. The company's U2-T101, for example, an 80-volt unit in a four-lead TO-5 metal can, sells for \$2.75 each in quantities of 100; a TO-66 version, the U2T2201, costs

\$2.95. "High-quantity pricing is comparable to alternative approaches such as using two discrete plastic transistors," Wasserman claims.

Perhaps the most significant characteristic of the Unitrode device is its low saturation voltage of 1.5 V maximum at 5 amperes. This low value "disproves the adage that Darlington transistors inherently have poor saturation specs," Wasserman says, and makes the

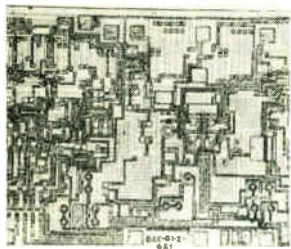

Digital-to-analog converter mono-DAC-01 is a high-speed, 6-bit current steering device on a single monolithic chip. It consists of an internal voltage reference, 6 precision current sources, 6 current steering logic switches, a diffused resistor network, and an internally compensated operational amplifier. Precision Monolithics Inc., 1500 Space Park Dr., Santa Clara, Calif. [436]

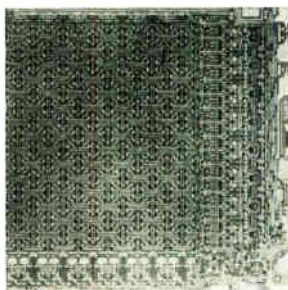

Random-access LSI memory type 3102 is a 256-bit bipolar unit that operates with a companion decoder to make main-frame memories with 120 ns maximum access time. Both memory unit and decoder exhibit only 10 μ A input leakage current. Load current is only 0.25 mA for the decoder and 0.50 mA for the memory unit. Intel Corp., Middlefield Rd., Mtn. View, California [437]

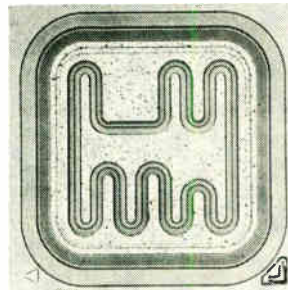

High-voltage npn transistors feature excellent beta linearity from 1 mA to 50 mA. Offered in plastic packages, they are registered as the 2N5964 and -5, which have dissipation capabilities of 700 mW, and as the 2N5830, -1, -2 and -3, which can dissipate 310 mW. Prices are 41 to 84 cents depending upon quantity. Fairchild Semiconductor, 464 Ellis St., Mountain View, Calif. [438]

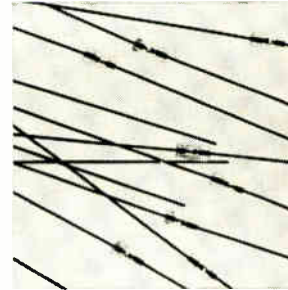

Rf attenuator diode MA-47083 functions as a silicon p-i-n device designed for use as a current-controlled resistor. It operates within the 1MHz to 10 GHz frequency range, providing low capacitance of 0.25 pF and low series resistance for fast switching applications. Minimum breakdown voltage is 300 V. Microwave Associates Inc., Burlington, Mass. [439]

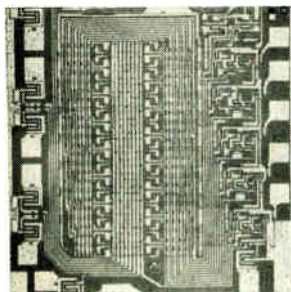

Read-only memory IC 8224, of medium-scale complexity, is organized to read 32 eight-bit words. It is compatible with TTL and DTL input/output structures. Maximum propagation delay time is 50 ns. Typical power dissipation is 310 mW; maximum is 400 mW. The unit comes in 16-pin dual in-line or flatpack configurations. Signetics Corp., 811 E. Arques Ave., Sunnyvale, Calif. [440]

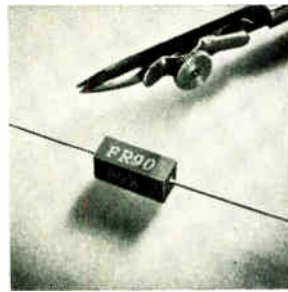

Diode MW20FR90 has 1.5 μ s recovery time and can operate at 12,500 V dc reverse voltage. Other specifications include: leakage at rated voltages of less than 5 μ A, and maximum average current of 20 mA. The epoxy-encapsulated devices are 0.187 in. square by 0.500 in. long and have 1-in.-long axial silver wire leads. Sarkes Tarzian Inc., Bloomington, Ind. [441]

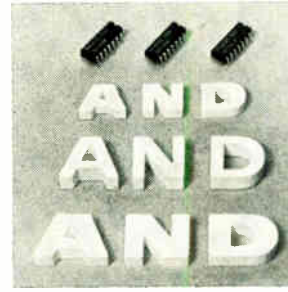

Three AND gates added to the 7400 TTL IC line include US7408A quad 2-input, US7409A quad 2-input with open collector output, and US7411A triple 3-input. They are useful in high-speed arithmetic sections to avoid excess propagation delays experienced when using NAND gates connected to perform the AND function. Sprague Electric Co., North Adams, Mas. [442]

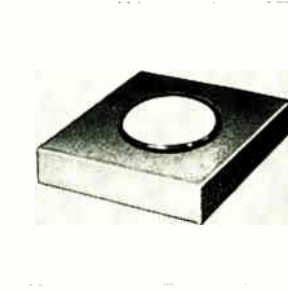

Varactor tuning diode chips in the C1N5139-C1N5148 series are for use in hybrid ICs in the uhf/vhf and lower microwave frequency ranges. The diodes' 4V capacitance values vary from 47 pF through 6.8 pF with corresponding Q values as high as 350 measured at 50 MHz. Price (100-999) is \$3.55 each. MSI Electronics Inc., 34-32 57th St., Woodside, N.Y. [443]

New products

Unijunction device suited for such high-gain switching applications as print-hammer, solenoid, and lamp drivers, and switching regulators. In addition, the Unijunction Darlington can be used in linear circuit applications such as motor controls and amplifiers.

The Darlington offers a valuable alternative to the silicon controlled rectifier. Like the SCR, it is able to control large amounts of power with a minimal input signal; however, unlike the SCR, the Darlington can be turned off easily, simply by reducing the control signal.

Other key specifications for the U2T101 and U2T201 are maximum collector-emitter breakdown voltage of 150 V, and a minimum direct-current gain range from 2,000 to 10,000 at 5 A collector current. Minimum current rating is 10 A, and the manufacturer is planning to introduce a 20-A version.

Both the driver and the output transistor on the monolithic chip are npn overlays, multiple emitter devices. The output device itself has more than 100 distinct emitter sites.

Wasserman expects the major market areas to be industrial and consumer, with special emphasis on computer peripheral equipment.

Unijunction Corp., 580 Pleasant St., Watertown, Mass. 02172 [444]

Darlington power. Passivated planar structure adds reliability.

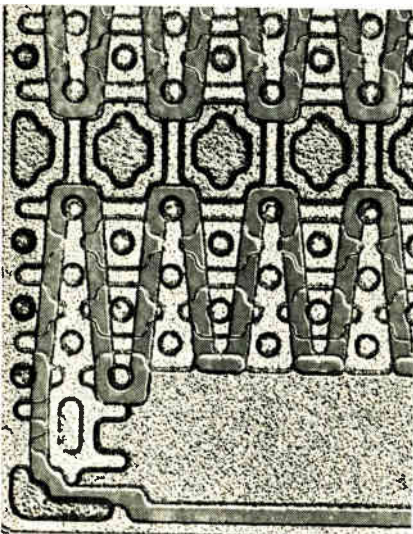

2-watt IC amplifier fits any sound system

More flexibility and self-sufficiency were the goals of design engineers at Motorola Semiconductor when they set out to develop a competitive 2-watt IC audio amplifier.

The monolithic amplifier, designated the MC1316P, can be used with all sound systems—that's its principal advantage, says Clay Tatom, manager of linear IC product planning.

Craig Marshall, a member of the product planning staff, adds that the amplifier requires fewer outboard components than comparable devices to work in a circuit. Just two resistors and two ceramic capacitors will do the job, Marshall points out.

"We think we've designed in enough flexibility to make it useful as a general audio amplifier and a television audio amplifier," he says. For example, the device's built-in preamplifier and power amplifier use separate pinouts, allowing the user to put a tone and volume control between the preamplifier and the power amplifier. This flexibility is an advantage, say Motorola engineers, because some TV sound systems put out 3 volts and some as little as 100 millivolts. With the MC1316P the lower-level voltages can be preamplified without introducing noise.

The device's sensitivity can be altered by changing the ratio of the two outboard resistors. Marshall says an input signal as low as 27 mV won't diminish the MC1316P's output power. The built-in power transistors are designed to limit the current themselves, contributing to short-term short-circuit proofing. The chip has been short-circuited under both ac and dc with a screwdriver and has survived for 10 seconds or more. "And if you heat sink it, you can get more than a 10-s short without destroying the device," Marshall says.

An additional lead frame provides heat sinking. Although tabs are bent up from the socket pins,

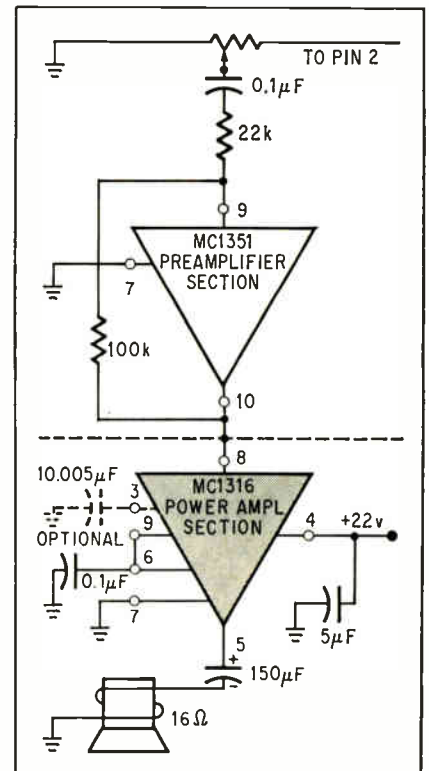
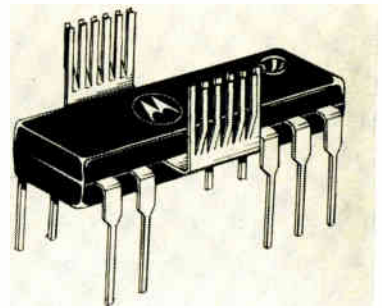

For TV audio. Direct coupling to pre-amp saves two capacitors.

the plastic dual in-line package is a standard configuration that's pin compatible with present sockets.

Ripple rejection is 23 decibels. Marshall says this allows the unit to operate with completely unregulated supplies—an extreme example. Input sensitivity of the power amplifier at 2 W is typically 0.4 V. Total harmonic distortion at 1 kilohertz with 2-W output is typically 1.5%; typical signal-to-noise ratio at 2 W is 70 dB.

Available from stock, the MC1316P sells for \$1.40 in quantities over 1,000.

Motorola Semiconductor Products Inc., Box 20912, Phoenix, Ariz. [445]

Save up to \$649,000 a year when you locate your next plant in Georgia.

Let us prove it. Georgia has retained the Fantus Company, internationally known site location consultants, to design 31 individual SIC industry location cost analyses. These studies tell in no uncertain terms how much money you could save by locating in Georgia. For instance, a construction machinery manufacturer can save \$649,000

a year. An electronic switching and relay equipment company can save \$427,000 a year. And a medicinal chemicals and pharmaceutical products firm can save \$366,000 a year.

To find out how much *your* company can save, just send us this coupon. You'll never know how profitable your company can be until you do.

Georgia Department of Industry & Trade, Industry Division, Dept. ELM, P.O. Box 38097, Atlanta, Ga. 30334

Please send me free information about my company's profit potential in Georgia. The following location cost analyses reports are requested:

- Mobile Home Subassemblies
- Truck Trailers
- Tufted Carpets & Carpet Yarns
- Glass Reinforced Plastic Products
- Latices and Resins
- Medicinal Chemicals and Pharmaceutical Products
- Metal Salts and Catalysts
- Rubber Belting and Hose
- Synthetic Textile Fibers
- Electrical Terminations and Connectors
- Electrical Switchgear and Controls
- Electronic Switching and Relay Equipment
- Fluorescent Lamp Ballasts
- Caps and Closures
- Institutional Feeding Systems
- Prefinished Building Panels
- Air Cleaning and Handling Equipment
- Air Conditioning and Refrigeration Machinery
- Character Recognition Equipment
- Construction Machinery
- Copper and Brass Mill Products
- Iron and Steel Castings
- Mine and Mill Equipment
- Paper Industries Machinery
- Plastics Working Machinery
- Business and Computer Forms
- Metal Furniture and Partitions
- Office Copying Equipment
- Small Scale Computers
- Powered Industrial Hand Tools
- Small Home Appliances

Name _____ Title _____ Company _____
 Address _____ City _____ State _____ Zip _____

SMALL SCALE COMPUTERS
 A REPORT ON THE LOCATIONAL ADVANTAGES OF GEORGIA

PREFINISHED BUILDING PANELS
 A REPORT ON THE LOCATIONAL ADVANTAGES OF GEORGIA

MEDICINAL CHEMICALS AND PHARMACEUTICAL PRODUCTS
 A REPORT ON THE LOCATIONAL ADVANTAGES OF GEORGIA

CONSTRUCTION MACHINERY
 A REPORT ON THE LOCATIONAL ADVANTAGES OF GEORGIA

ELECTRONIC SWITCHING AND RELAY EQUIPMENT
 A REPORT ON THE LOCATIONAL ADVANTAGES OF GEORGIA

CLOSURES
 A REPORT ON THE LOCATIONAL ADVANTAGES OF GEORGIA



(PLUG-INS
GO HERE)

**“Lock-in amplifier
customers tell us
we’re the
best buy on the market.”**

ITHACO INC.
735 WEST CLINTON STREET, ITHACA, N. Y. 14850

Since the majority of lock-in amplifier applications call for a basic instrument, we designed ours to be general purpose. And easy to use.

Some researchers, though, have applications that demand more specialized operation. For these people we provide specialized accessories. Just plug them into our basic instrument, and voila, it's no longer basic. But it's still easy to use.

Everyone gets what they pay for. And want. No wasted capability, no inflated prices.

So it really doesn't surprise us to hear that we're the best buy on the market. We know. We planned it that way.

If you'd like to hear more about our instrument and how it can help solve your application problem, give us a call, 607-272-7640. Ask for Mr. Ed Mitchell.

Circle 120 on reader service card

New Books

Special propagation problems

Antennas and Waves: A Modern Approach; Ronald W.P. King and Charles W. Harrison Jr.; The MIT Press, 778 pp., \$15.00.

Those microwave engineers who must deal with plasmas, dissipative media, and other special space and re-entry phenomena have obtained little illumination in the many otherwise comprehensive books on antenna design and application. This book, while far from comprehensive, does cover these special problems and related topics in great detail. It also attempts to bridge the gap between macroscopic phenomena, represented by Maxwell's equations, and microscopic phenomena, represented by quantum theory.

The engineer who designs antennas for submarines, for missiles and re-entry vehicles, and for operation in such difficult environments as those attending nuclear bursts will find it especially useful.

The book has been prepared un-

der the auspices of the Atomic Energy Commission and incorporates the results of much basic and applied research performed for that agency by the Sandia Corp., where Harrison is a staff member. King, a consultant to Sandia, is a professor of applied physics at Harvard University, and is well known as the author of several books on antenna theory, with special emphasis on dipoles. This type of antenna, singly and in clusters, bent and folded, is almost the exclusive focus of the book.

The book starts with a resume of basic electromagnetic theory, and then immediately goes into the properties of ionized media, stressing interaction at atomic levels. Treatment here, as throughout the book, is rather theoretical. In fact, the text often seems a collection of reports on selected topics, with theory as the common thread. However, most topics also are augmented by relevant experimental data so that the design engineer retains some grasp of the physical phenomena involved. Thus, the sections on L, T, dipole, transmission-

line, and cylindrical antennas all include detailed results of significant experimental work.

A separate chapter on coupled antennas provides good coverage of both circular and linear arrays. It including considerable material about current distributions, resistances, and reactances of the various elements, and composite radiation patterns, especially for comparison of theoretical and measured results. A brief chapter on receiving scattering arrays also is included, and another chapter covers the problem of antennas near the interface between a semi-infinite dissipative medium and the air. The chapter on cylindrical antennas is particularly good. It comprises 112 pages, and discusses the various equations which have been developed to approximate the current distribution on a cylindrical radiator. The authors then proceed to analyze the performance of a dipole, and an electrically short, moderate, and long antenna in a dissipative medium. Theory and experiment are regularly compared through extensive use of graphs.

Technical Abstracts

Registering the impact

Radiation hardened transistor magnetic register
D. Hampel and K. Prost
RCA Advanced Communications Laboratory
Somerville, N.J.

There is little point in having reliable, radiation-hardened active circuitry in an electronic system if that system's memory turns amnesiac when subjected to the photon and neutron irradiation of a nuclear burst. The Army's Harry Diamond Laboratories has funded a great deal of research in techniques for hardening memories, and this paper details some very successful results.

RCA's work has combined circumvention—the use of inherently immune components—with rather sophisticated compensation techniques. The results have been magnetic shift-register memories hardened to the same level as the best off-the-shelf hardened ICs, and capacitive memories with a potential hardness that is almost an order of magnitude better, or beyond the theoretical limit to which these ICs can be hardened.

Magnetic cores have a high natural immunity to neutron damage but can suffer a change of state when their driver circuitry saturates as photons from a nuclear burst sweep an intense, if transient, photo-current through them.

One solution developed by RCA uses magnetic cores as an immune temporary storage medium for the shift register's flip-flops, and has a drive configuration that pushes equal and opposite photon-induced photocurrents through the cores during nuclear irradiation. This type of circuit has been shown to work reliably in environments up to 8×10^{10} rads/seconds, which is about as intense a test environment as can be generated by any but the giant flash X-ray machines, such as Physics International's.

Another technique developed by RCA relies on capacitive interim storage, which permits the register's flip-flops to saturate as they please and depends on a residual charge imbalance to reset the flip-flops after the photocurrent surge has passed. This type of circuit has

proven itself in test environments up to 5×10^{10} rads/s and is estimated to be reliable in environments 10 times as severe.

Presented at IEEE Conference on Nuclear and Space Radiation Effects, La Jolla, Calif., July 21-23.

Minimizing errors

A low-level, high-speed, solid state multiplexer with programable gain amplifier
David Hartke
Xerox Data Systems
El Segundo, Calif.

Up to 1,024 analog input channels can be multiplexed onto a single line with the Xerox Data Systems DM40 differential multiplexer, which provides good linearity while rejecting practically all common mode noise and generating little noise of its own. Achieving this level of success required recognition of many sources of error—sources that can be found in the design or that pop up when the multiplexer is improperly used.

There are seven major sources of errors. First is input capacitance, which may cause a current to flow from the line toward the source at the instant a particular channel is connected. This current can cause an erroneous signal to appear on the line. Second is dynamic pump-out current, which occurs when the current flowing in or out of input capacitance is different when it's turned on than when it's turned off.

There's also a steady state pump-out current that doesn't amount to much unless the multiplexer dwells on a particular channel at some length. And there are the usual problems of overloading, crosstalk, zero offset, and noise.

The Xerox design takes all these error sources into account in an eighth-chassis design. In the Xerox scheme, 128 channels are connected to each chassis.

In addition, there is provision for several different kinds of contractors on the input lines, a variety of signal conditioning functions, power-off protection, and a multiplexer switch.

Presented at Wescon, Los Angeles, Aug. 25-28.



NANOSECOND TIME INTERVAL METER MODEL CC20

LABORATOIRES de MARCOUSSIS

centre de recherches de la compagnie générale d'électricité

91 - MARCOUSSIS (FRANCE) — Tél. 920.82.50 — Telex : 26 877 LABMARCO

RANGE : 1 nsec. to 999 msec.
1 nanosecond RESOLUTION
Crystal aging rate : 1 part in 10^9 /day
Internal MIRAP logic

994 298 237

2B - Paris 131

TAKE THE SKILL OUT OF PHASE MEASUREMENTS

SAVE TIME WITH AN EASY
TO READ DIGITAL READOUT

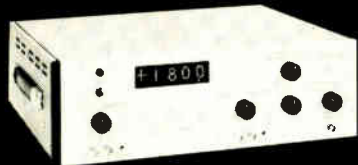

- Ideal for phase linearity and critical measurements where best commercial accuracy is required. Phase reading accuracy: $\pm 0.1^\circ \pm \phi/180 \times 0.25^\circ$ where ϕ is phase angle being measured.
- Switchable phase detector response time from 30 ms to 4 secs. optimizes phase information display time.
- With one instrument and without the need for accessories you have the flexibility of measuring phase at signal levels from 1 mV to 400 V on either channel over the range 10 Hz to 2 MHz. (Another WILTRON phase meter goes down to 0.5 Hz).
- For plotting or for external circuit control, phase information is available from three separate outputs: (1) 4 digit NIXIE tubes, (2) Analog of phase, (3) BCD 1248 for computer tie-in.
- For direct phase measurements on balanced transmission lines, lattice networks, etc., the input circuits can be switched to differential or single ended.
- Phase reference switchable from 0° to 180° for maximum accuracy at small and large phase angles.

NEW LOW PRICE: \$1,865.

WILTRON also offers a Model 350 phase meter with a meter readout for \$885.



930 EAST MEADOW DRIVE
PALO ALTO, CALIFORNIA 94303
(415) 321-7428

W102

New Literature

Electromagnetic shielding. Metex Corp., 970 New Durham Rd., Edison, N.J. 08817. Basic electromagnetic shielding theory is presented in simple, easy-to-read language in brochure ME-31. Circle 446 on reader service card.

Electronic keyboard. Controls Research Corp., 2100 S. Fairview, Santa Ana, Calif. 92704. A standard electronic keyboard providing all ASCII characters is described in a four-page product bulletin. [447]

Laser system. Raytheon Co., 190 Willow St., Waltham, Mass. 02154, has published a product folder on the model SS-218 laser system for trimming resistors and other deposited materials. [448]

Op amp settling time. Analog Devices Inc., 221 Fifth St., Cambridge, Mass. 02142. A 16-page engineering periodical discusses operational amplifier settling time. [449]

Coaxial connectors. ITT Gremar, 10 Micro Dr., Woburn, Mass. 01801, offers an up-to-date 148-page handbook covering rf coaxial connectors. [450]

Electron multipliers. Electro-Optics Division, The Bendix Corp., 1975 Green Rd., Ann Arbor, Mich. A series of data sheets describes several configurations of Channeltron and Spiraltron electron multipliers. [451]

Plastic transistors. Fairchild Semiconductor, Box 880A, Mountain View, Calif. 94040, offers a cross reference guide listing its complete stock of plastic transistors that are the nearest equivalents to more than 400 standard industry 2N types. [452]

Preset counter. Vorne Industries Inc., 5641 N. Northcott Ave., Chicago 60631. A solid state, preset counter capable of 60,000 counts per minute and having decimal display of the actual count is described in a new bulletin. [453]

IR spectrophotometers. Beckman Instruments Inc., 2500 Harbor Blvd., Fullerton, Calif. 92634. Bulletin 7175 covers two advanced, moderate-priced IR spectrophotometers that provide fast, accurate data. [454]

Metal film resistors. Dale Electronics Inc., Box 609, Columbus, Neb. 68601, has available a report on established reliability metal film resistors. [455]

Echo suppressor. Lenkurt Electric Co., 1105 County Rd., San Carlos, Calif. 94070, has issued a four-page product brochure describing the 931C echo suppressor. [456]

Capacitors. Gulton Industries Inc., Metuchen, N.J. 08840. Seventy-six page

brochure H4D contains sections entitled "Guide to the Use of Ceramic Capacitors", and "Capacitor Manufacturing and Quality Assurance." [457]

Plasma stripping. International Plasma Corp., 25222 Cypress Ave., Hayward, Calif. 94544, has released an applications bulletin describing how to employ the plasma stripping process when using KMER photoresist. [458]

Color tv camera. Ampex Corp., M/S 7-13, 401 Broadway, Redwood City, Calif. 94063. Four-page color brochure V285 describes the model BC-230 color tv camera for studio and remote origination. [459]

Function generator. Esterline Angus Division of Esterline Corp., P.O. Box 24000, Indianapolis 46224. A function generator that has a 0.01-Hz to 100-kHz frequency range is described in a two-color catalog sheet. [460]

Numerical control. The Singer Co., Friden division, 339 East Ave., Rochester, N.Y. 14604, offers a 76-page manual on numerical control systems. [461]

Coordinate measuring and inspecting. Ehrenreich Photo-Optical Industries Inc., 623 Stewart Ave., Garden City, N.Y. 11530. Precise optical scanning and coordinate measuring of workpieces ranging from integrated circuits and printed circuits to precision metal stampings are described in brochure ID-16. [462]

Semiconductor devices. International Rectifier, 233 Kansas St., El Segundo, Calif. 90245, has released a catalog presenting all its major semiconductor devices in an easy-reference format. [463]

Piezoceramic materials. Gulton Industries Inc., Metuchen, N.J. 08840. A 28-page catalog provides complete information and specifications on a comprehensive line of Glennite piezoceramic materials. [464]

Adhesives and coatings. Epoxy Products Co., 166 Chapel St., New Haven, Conn. 06513. Conductivity of epoxy-silver adhesives and the effects of cure conditions and heat-aging are included in the technical data offered with information bulletin No. 7. [465]

Computer system. Infotronics Corp., 8500 Cameron Rd., Austin, Texas 78753, has released a 20-page brochure on its recently announced Mini/Max computer system. [466]

Digital data acquisition. Esterline Angus, P.O. Box 24000, Indianapolis 46224. A two-color catalog sheet describes the model D-2020 digital data acquisition system. [467]



A VERITABLE GOLD MINE OF INFORMATION

These are the most valuable set of reference manuals available on magnetic shielding materials and fabrication methods. They cover MSD's complete line of Netic and Co-Netic Alloys. MSD has provided over 80% of the magnetic shield designs currently in use; its products are the recognized world standard in its field.

NEW WEST COAST OPERATION
 Magnetic Shield Division
 Perfection Mica Company
 1325 E. Esther Street
 Long Beach, Calif. 90813
 213/591-5638
 213/591-5639

Los Angeles Telephone
 213/775-8079



They're yours for the asking. Contact your MSD rep or write

MAGNETIC SHIELD DIVISION

PERFECTION MICA COMPANY
 740 Thomas Drive, Bensenville, Illinois 60106
 Phone 312.766-7800. TWX 910 256-4815

Circle 141 on reader service card

Narrow-Band TV



- If you don't need motion in your TV pictures, but need:
- Low-cost, long-distance, transmission over standard voice-grade phone lines
 - Tape recording on standard 1/4" audio tape
 - Hard-copy printout
 - Magnetic disc image storage (multiple pictures or color too)
 - An interconnection to a computer

Investigate our 201-series Video Converters, which compress the bandwidth of standard TV signals to as low as 500 Hertz, and our 220-series Video Converters which utilize a unique disc memory technique to re-convert to conventional 525-line TV format.

cv

COLORADO VIDEO, INCORPORATED • P.O. Box 928 • Boulder, Colo. 80302 • (303) 444-3972 Video Data Acquisition • Processing • Display • Transmission

The New Singer SA-70 Series has the Highest Sensitivity, Best Resolution, and Lowest Price of any spectrum analyzer in the 500 kHz to 1300 MHz range.



Highest Sensitivity

Sensitivities to -120 dBm . . . and that's 12 dBm better than previously available units. Sensitivity is defined as signal + noise = 2x noise, rather than by the average noise method, which is ambiguous and makes the specification "appear" to be 6 dB better.

Best Resolution

Close-in, equal amplitude signals, can be measured 300 Hz apart from each other at half power points . . . now unwanted signals are easily detected even if they are adjacent to the carrier. Extremely low incidental FM . . . only 100 Hz.

Markers for Accurate Dispersion Calibration

Crystal controlled RF markers are standard . . . the accepted method for calibrating dispersion and for pinpointing unknown signals.

Variable Persistence Display

In addition to the standard display, there is a variable persistence unit the Model SA-71A, with a storage capability of up to 2 hours. Use it for analyzing low duty cycle pulses, etc.

Large Measurement Range

Signals are viewed on a brightly illuminated CRT on either a log or lin amplitude scale. Total measurement range is 130 dB and that's 11 dB better than other currently available units.

Lowest Price

The Model SA-71A Storage Display System is only \$6890. If you can afford to give up storage, you can save \$1160.

Two national service centers to provide rapid repair, calibration and spare part support . . . Located on the East and West Coast.

The Singer Company,
Electronic Products Division,
915 Pembroke Street,
Bridgeport, Conn. 06608
In Europe contact:
Singer Sewing Machine Company,
Instrumentation Division, P.O. Box 301,
8034 Zurich, Switzerland,
Telephone: (051) 47 25 10

SINGER

INSTRUMENTATION

SEPTEMBER 1970

Money & Taxes

Keeping close tabs on your Stock Portfolio
Investors' Deductions

Insurance

Homeowners get a break on insurance
Has inflation trimmed your coverage?

Health

The fight against cancer
Take up cycling to spin off pounds

Travel & Sports

Fun on wheels

Real Estate Beat

A roof over relaxation
Lease instead of buy

Healthy, Wealthy and Wise

The Campus Scene: Facing the Marijuana Malaise

This month the teenage clan heads back to the high school and college scene. And parents head back to the same concerns that had everybody uptight all during the 1969-70 school year. Heading the list: marijuana.

Today there's still nothing that creates more anxiety in families. And there is nothing more loaded with misconception than "pot" and its use and abuse by young people. On this, you can get outdated fast — even opinions that were current last spring need some shaking out and a fresh look.

Top experts (psychologists, psychiatrists, sociologists) are now stressing two points:

- Pot smoking by a teenager should *not* be met with indignant alarm.

- Pot smoking *should* be met by firmness and careful investigation.

The pros make these additional points in addressing parents: Most teenagers who experiment with pot are not "hung up," alienated, or disturbed. (Harvard experts note that at least 66% of the students in some colleges have tried it.) Many, even most, teenagers can control it.

Still, if a parent looks further ahead, the risks begin to appear.

Teenage pot users fall into at least three groups.

The experimenter sees pot as an "experience" of his generation.

The protestor uses it as a way of speaking out. These types, say the

experts, may be in no great danger.

The problem smoker is different. He's the heavy user. His school and social adjustments are often poor. He may be a loner and potentially a drop out. If he uses pot to cope with growing up, a step-up to hard drugs is a danger.

If you learn that your teen-ager has been experimenting with pot, dialogue is what is needed. He will probably want to talk it out, if not with a parent then with a trusted — and informed — third person. What you need to learn about, say the experts, are his motivations. The idea is to discover any underlying emotional attitude or pressure that may point to the problem smoker.

One way or another, your answers may come fast. But drawing this line can be most difficult. If a parent must seek help, a well qualified school or college guidance counselor — or a psychiatrist — should be consulted. A parent should first talk with this person privately.

A specialist comments: "A smart teen-ager is apt to know a good deal about pot. Get someone who's well informed — who really knows the answers."

Added danger: Along with all of this, it's now pointed out by a specialist with the National Institute

To the Reader

Personal Business is a new feature that you will be seeing periodically in these pages. It appears exclusively in McGraw-Hill magazines. It is the result of years of research and development.

Personal Business takes a few minutes to discuss the personal concerns you share with other successful men.

Like the rest of this magazine, Personal Business's purpose is to be helpful to you, but in a somewhat different way. It will help you to make personal decisions about finance, taxes, and investments. It will help you to enjoy the good things of life and to make wise decisions for your family. It will help you, we believe, in the personal enlargement that every man knows is so important in the advancement of his career.

We hope you enjoy and come to rely upon Personal Business.

of Mental Health that in some people, even small doses of pot can cause dangerous reactions.

Pot may be adulterated with hard drugs or toxics

Memory, for instance, can be distorted. A parent can explain this uncertainty to a teenager. And there's the added chance that pot may be adulterated with hard drugs or toxics. Adulteration is a growing menace. Some say that pushers "hook" kids this way.

As for stepping up to hard drugs, remember that there is a sharp difference between smoking pot in limited amounts and using drugs such as LSD and heroin. Hard drug addiction is generally limited to the depressed and disturbed. In any case, there is no known drug progression per se from pot on up the line.



But what there is is a growing social pressure on teenagers to have a fling with a potent drug. Says one Harvard specialist: "Even here there is mounting social acceptability—so even a well adjusted teenager may try LSD or heroin."

The blase parent makes a dire mistake

Another reason not to take pot experimentation lightly is that a

teen-ager sometimes has admitted pot smoking to get off the hook with "easy" parents and cover up the fact that he's using a hard drug.

The parent who is blasé about marijuana may be making a dire mistake, say the pros. At the same time, the parent who coddles his own martinis and takes a self-righteous attitude about pot—will find his preachments falling on deaf ears.

A book that clarifies problems underlying teenage drug use is Graham Blaine, Jr.'s, *The Parent's Guide to Adolescence* (Little, Brown, \$1.95).

MONEY & TAXES

Keeping Close Tabs On Your Stock Portfolio

A man who has taken losses in the market can throw up his hands, fire his broker, go into real estate—or he can bone up on the stock market, and this may be a smarter proposition.

After the 1970 market flop, self-help will be a widespread trend. "For the average businessman," says one professional, "more knowledge can mean realistic investment objectives for a change, and smarter dealings with brokers and others who hand out advice."

It can also help a man avoid brokers who churn accounts.

How should you investigate an industry or company group? Many investors, says a top pro, not only brush aside industry surveys, but fail to evaluate the ones they do read. The surveys—obtained from a broker—should tie the industry into the whole economy (many don't), state the pros and cons (many make a sales pitch), compare leading companies (not lump them together), and draw some straightforward conclusions without too many hedges.

Many, if not most, surveys, especially those that go to the individual investor, are pretty bad, say some pros. "The big institutions get the good inside stuff," says one. "So pick your surveys with care,

and compare them."

Caution: Some brokers have cut down lately on their research staffs, and this is a point to check if you want any type of survey material.

Since many investment areas no longer fit into neat industry groupings, a second approach is needed. "Too many people ignore the 'sector' philosophy, and it hurts them," says Richard Cantor, a Manhattan consultant.

Here companies are grouped according to how well they meet rising needs of society, or how much they might benefit by new trends. Examples: manufacturers who would ride an ecology boom (makers of testing devices, filtration systems, etc.), or companies that would benefit greatly if interest rates should fall (homebuilders, leasing outfits, finance companies).

But keeping abreast of economic sectors takes time—and study. A carriage-trade suburban broker



notes that many nonfinancial executives read annual reports naively. "They judge too much by the president's optimistic statement," he says. Smart reading of an annual report can include the fancy language, but it must bear down on the footnotes—and the dollar figures.

Look at the company's sales growth. If it doesn't roughly parallel earnings growth, find out why.

Probe the earning-per-share for 10 years back. If it has doubled in that time, it about matches the growth of the gross national



Paris to Paris and back by air.

One 747 will fill about 75 Cessnas, and vice versa.

However, no 747 can land at the airport in Paris, Illinois.

All 37 models made by Cessna can. Which is a big advantage for you.

You see, there are a lot of towns like Paris, Illinois. And being able to fly from these towns to where the 747's are, saves you time.

Cessna is the best way to your seat in a 747. A 747 is the best way to Paris, France. We help each other get you where you're going.

Cessna Whenever you're ready

For more information, write Cessna Aircraft Company, Dept. C-PB, Wichita, Kans. 67201.

I would like to know more about:

- Learning to fly. Corporate transportation.
 Airplane ownership. Other _____

Name _____

Address _____

City _____ State _____ Zip _____

Cessna 

More people fly Cessnas than any other make

product. A doubling in, say, five years, means top performance. But this won't guarantee a good future, so you have to investigate the company—closely.

Stock charts are another field for study. A good chart shows the 10-year price activity of the company's stock, the industry's composite, and a general index such as the Dow-Jones Industrials or Standard & Poor's 500. A chart may not tell you when a stock will hit a bottom or a high, but understanding it will help you to keep tabs on a broker and judge a tip or recommendation more clearly.

A warning: Market letters can be good, indifferent—and very bad. They should be read for background and mood, but not for choosing stocks.

The Battle for Investment Survival, by Gerald M. Loeb, covers Wall Street's ins and outs and is good for anyone who takes a serious view of handling his own portfolio (Simon & Schuster, \$5.95). For solid, basic information, see Eiteman, Dice, and Eiteman's *The Stock Market* (McGraw-Hill, 564 pp., 4th ed., \$10.50). *The Money Game* by "Adam Smith" reveals a lot about the purely psychological side of the market (Random House, \$6.95).

1040 Woes: Investors' Deductions

There's much confusion over investment-related tax deductions. "Few areas in the law get so muddled on the Form 1040," says a Midwest tax pro who works with high-income businessmen.

A new federal court case, for instance, points up the frequently forgotten rule that if you spend money to inspect a possible investment—as opposed to one you already own—you cannot deduct the expense.

In this case, the taxpayer tried to deduct his travel expenses. All he could do, it turns out, was to add these items to his cost basis—if and when he actually paid his money to make the investment.

It's understood that you can deduct the cost of a safe deposit box, and books and periodicals, on in-

vestments—but you can go further. Fees for investment advice are deductible, and this is true whether you pay for counseling alone or full portfolio management.

State taxes on a stock sale are deductible—which some people miss.

Not only can you deduct the cost of travel to inspect investment property you own—assuming you have a valid business purpose—there are also some occasions when you can deduct the cost of travel to an annual meeting of a company in which you own a sizeable share. This, though, is a gray area; be able to prove that the trip was necessary—not just an outing.

A pitfall: IRS will clamp down fast if it discovers that you are deducting broker's commissions or any expenses related to tax-exempt bonds.

For a good straightforward review of most types of deductions, see J.K. Lasser's *Your Income Tax*, by Bernard Greisman (Simon & Schuster, \$1.95).

INSURANCE

Homeowners get a Break on Insurance

Some new fine print has been tacked to the homeowner's standard insurance policy. The changes are in effect in about 45 states, and the list is still growing. Now is the time to take stock of your coverage, fill in some gaps where necessary, and maybe even alter the type of basic protection you're carrying.

One of the major new built-in benefits—for which you pay no extra premium—raises the payoff limit on personal property from 40% of the coverage on the house to 50%. This means that "unscheduled" personal property which is not listed for special floater protection, such as furniture, china, silver, art works, clothing, and sports equipment, gets better protection.

Example: If your house is in-

sured for \$50,000, your unscheduled property is covered up to \$25,000, instead of \$20,000.

Another improvement helps the man who moves from one house to another. Formerly, personal property was covered only in transit, pending a new homeowner's policy. Now the coverage extends for the first 30 days up to the 50% limit. The in-transit coverage, however, is for just 10% of the usual protection.

The rule on theft from an unlocked car is a bit better too. Formerly, a car had to be locked. Now you're protected if you place the car keys in the hands of an authorized parking attendant. But you are still without protection if you leave the car unlocked and unattended.

Finally, "mysterious disappearance" is defined more liberally. Say that your wife leaves a ring on a wash stand in a restaurant, returns later and finds it gone. The policy now presumes a theft, so you're covered. But note: Protection in case of simple loss—where you have no idea what happened—now requires a special floater policy, under a somewhat tighter rule.

The new limitations add up, too.

On standard policies, there's a maximum recovery of \$500 for all jewels and furs lost in any one theft—formerly \$1,000.

You might consider broadening your list of such items already insured by a floater policy which covers virtually all risks. Rates



vary. Furs run about 50¢ a year up to nearly \$1.50 (Los Angeles) for each \$100 of value, and jewels about \$1.50 to as high as \$2.80 in New York city.

There's a change that affects

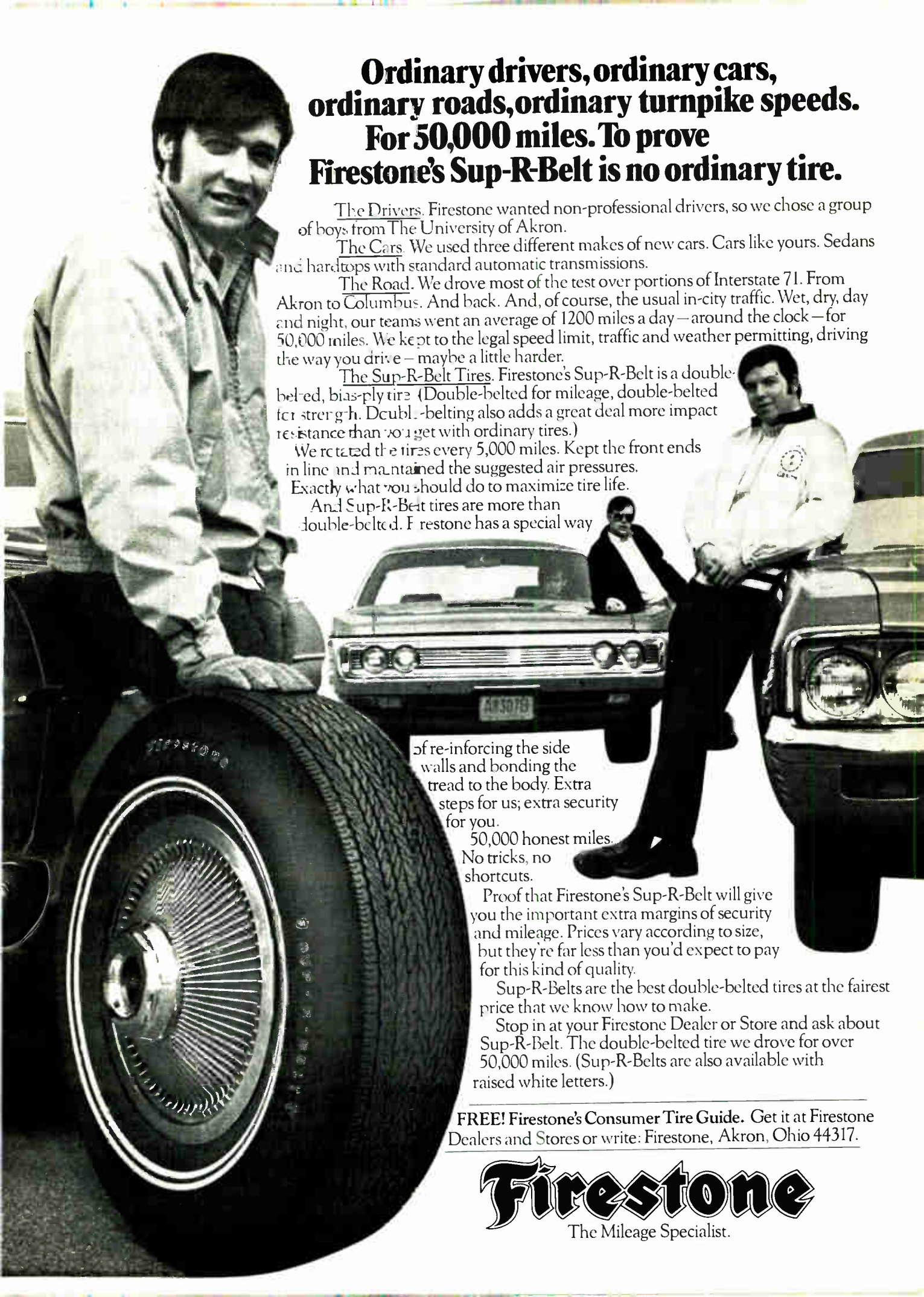

**Ordinary drivers, ordinary cars,
ordinary roads, ordinary turnpike speeds.
For 50,000 miles. To prove
Firestone's Sup-R-Belt is no ordinary tire.**

The Drivers. Firestone wanted non-professional drivers, so we chose a group of boys from The University of Akron.

The Cars. We used three different makes of new cars. Cars like yours. Sedans and hardtops with standard automatic transmissions.

The Road. We drove most of the test over portions of Interstate 71. From Akron to Columbus. And back. And, of course, the usual in-city traffic. Wet, dry, day and night, our teams went an average of 1200 miles a day — around the clock — for 50,000 miles. We kept to the legal speed limit, traffic and weather permitting, driving the way you drive — maybe a little harder.

The Sup-R-Belt Tires. Firestone's Sup-R-Belt is a double-belted, bias-ply tire. (Double-belted for mileage, double-belted for strength. Double-belting also adds a great deal more impact resistance than you get with ordinary tires.)

We rotated the tires every 5,000 miles. Kept the front ends in line and maintained the suggested air pressures. Exactly what you should do to maximize tire life.

And Sup-R-Belt tires are more than double-belted. Firestone has a special way

of re-inforcing the side walls and bonding the tread to the body. Extra steps for us; extra security for you.

50,000 honest miles.
No tricks, no shortcuts.

Proof that Firestone's Sup-R-Belt will give you the important extra margins of security and mileage. Prices vary according to size, but they're far less than you'd expect to pay for this kind of quality.

Sup-R-Belts are the best double-belted tires at the fairest price that we know how to make.

Stop in at your Firestone Dealer or Store and ask about Sup-R-Belt. The double-belted tire we drove for over 50,000 miles. (Sup-R-Belts are also available with raised white letters.)

FREE! Firestone's Consumer Tire Guide. Get it at Firestone Dealers and Stores or write: Firestone, Akron, Ohio 44317.

Firestone
The Mileage Specialist.

Security takes many forms. Sometimes it's mink... sometimes it's an ultrasonic burglary detection system.



Burglary and vandalism are constant threats to your home, office or shop. With DeltAlert on the job, dependable security costs just pennies a month.

A silent ultrasonic blanket detects motion in 15 to 30 feet of critical space in the home or business... lights go on automatically driving away prowlers.

When teamed with the separate DeltaHorn, DeltAlert provides an added shock of loud, ear-splitting noise...frightening off even the boldest intruder.

These sturdy units, finished in handsome walnut, are maintenance free and plug right into the wall socket. Keep well covered with reliable DeltAlert detection and alarm protection, and order your security now.

DELTAHORN, \$24.95
3 1/4" w x 3 1/4" h x 3 1/4" d



DELTAALERT, \$69.95
10 3/8" w x 3 1/4" h x 3 1/4" d

Superior Products At Sensible Prices
Write for free information. No obligation.



DELTA PRODUCTS, INC.

P.O. Box 1147 PB / Grand Junction, Colo. 81501

Please send me literature immediately.

Enclosed is \$ Ship ppd. Ship C.O.D.

Please send DeltAlert(s) @ 69.95 ppd.

Please send DeltaHorn(s) @ 24.95

Name

Address

City/State Zip

many of the unlicensed vehicles that people are buying these days, such as golf carts, snowmobiles, and beach buggies. These are no longer covered for theft and damage.

An easy guide to your basic homeowner protection: A Form 3 policy will give you broad coverage that's usually ample; Form 4 is for a tenant and Form 5 — the broadest protection — may overshoot your needs. The Form 5 covers all risks, but may cost double or more the premium for Form 3.

The point is that with a Form 3 you can add floater coverage tailored to your needs, paying only for what you buy.

Special features: Instead of the usual \$50 deductible, you can get deductibles of \$100, \$250, and \$500. This lets you save up to 20% of your basic premium cost. You can also buy inflation protection. For an added outlay of about 5% of your regular premium, you can get a proviso for a periodic increase in your basic property damage coverage of 1% every three months.

Has Inflation Trimmed Your Coverage?

With real estate values sky high, you'd be smart to check on the amount of your homeowner's coverage.

Say that five years ago, you bought a house for \$40,000. Today — assuming it's like most property in its class — it might be worth, say \$52,000. This means a 30% jump in value, or 6% a year. "For some areas this is quite conservative," says a Homeric, Inc., executive.

Suppose you have a total loss by fire. If you haven't increased your insurance, you're out of pocket at least \$12,000 on the structure alone.

If you have a partial loss, with fire or storm damage of \$10,000, say, you'll meet up with the 80% rule. Generally this means that to collect fully on your loss you must be carrying insurance up to 80% of the current market value of the house. If you are just a shade under 80%, the payoff may be somewhat under \$10,000; it varies depending on the case.

But if your coverage is substantially under 80% you get a "depreciation recovery" in case of a partial loss. If you have a \$10,000 fire, you might recover only about \$5,000 or so.

A man in the 50% top tax bracket would still be out of pocket \$2,500 despite a casualty loss tax deduction.

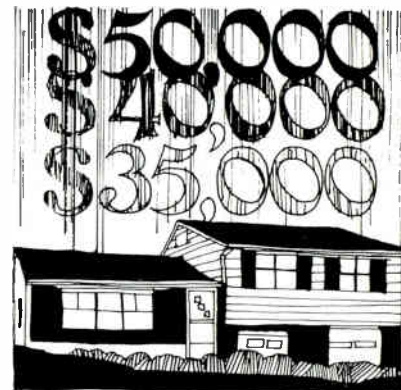

Don't underestimate the danger of finding yourself underinsured — despite a current softening of home prices in some areas. In executive neighborhoods, 5% to 6% annual increases in value have been par all over the country for the past five years. In the past three years, values in some posh suburban areas have inflated 8% to 10%.

In Connecticut towns such as New Canaan, Greenwich, and Westport, and in New Jersey towns such as Short Hills, Saddle River, and Ridgewood, the yearly price boost in some neighborhoods has run 12%. Lake Forest and Lake Bluff near Chicago have been up about 8%.

The cost of more insurance runs \$2.50 to \$5 per \$1,000 a year.

HEALTH

The fight against cancer

There's steady progress in the battle to find cancer's causes and cures.

This, say researchers, means scientific—not just statistical—evidence.

The government's National Cancer Institute notes that there's growing promise in the hunt for vaccines that would head off cancer.

As for the present best hope—treatment—results are looking better. Says ACS Vice-President Roald Grant: "A number of types of cancer—leukemia, Hodgkin's disease, skin, prostate—are yielding more and more to modern therapy."

Fifteen years ago 25% of cancer cases were "cured"—that is, patients lived five years with no recurrence. Now that rate is 33⅓%. But results in some areas are far better than that over-all average. Skin cancer is curable 92% of the time, and uterine cancer is thought to be 100% curable—if it's detected early enough.

That's a vitally important point—early detection. If a malignant growth is detected while it is still localized, the chances of survival increase greatly. With prostate cancer the survival rate is about 50% in the average case, but up to 71% with early detection. When lung cancer is found early, the survival rate is about 27%, but it's only 7% if the disease has spread.

At least half of all cancers can be detected during a full yearly physical examination. Doctors know the danger signs, and new testing methods make detection easier. Rectal exam with a sigmoidoscope is one example. With the latest equipment, it can reveal 75% of all rectal-colon cancers if the exam is thorough.

Says Dr. Richard Winter, director of New York's Executive Health Examiners: "If the sigmoidoscope is avoided because it's uncomfortable, the patient could be avoiding a relatively simple test that might save his life."

Among other cancer checks that should be made in an annual physical: a chest X-ray for lung cancer, and a digital examination of the prostate.

If you're over 50 and haven't had a gastrointestinal series of X-rays in several years, you should have it. The series will pick up an incipient carcinoma.

Cancerphobia—fear of the disease—keeps people away from early diagnosis. It's a killer in its own right. Says Winter: "The man who misses a few exam appointments because he's 'too busy' often has some fear lurking in his mind."

If you're looking for factual plant site data on the Carolinas, congratulations. You've come to the right ad.

We know what you want.

And it's not a mountain of tourist folders and statistical generalities.

You want facts. Facts without fiction. Facts that apply to your own special problems.

Congratulations.

That's exactly what you're going to get.

Write C. J. Turner, Mgr., CP&L Area Development Dept., Raleigh, N.C. 27602, 919/828-8211. F.G. Voss, CP&L Area Development Dept., Florence, S. C. 29501, 803/662-3264.

Carolina Power & Light Company



The great \$20 gift (even to yourself)

*An eyestopper!
Caslon's new
DIGITAL ALARM
CLOCK: easy to
read, easy to set.
A classically styled
time machine at a
sensible price!*

- SPLIT-SECOND ACCURACY
- SILENT SYNCHRONOUS MOTOR
- GENTLE DEPENDABLE REPEATING BUZZER ALARM
- ILLUMINATED FACE
- PRECISION CRAFTSMANSHIP
- 18 MONTH GUARANTEE

A unique premium and a welcome gift! Just \$20 each, delivered postpaid. 15 day return privilege.

CHOICE OF COLORS

- AVOCADO GREEN FROSTY WHITE CHARCOAL GREY

Please send me _____ CASLON DIGITAL ALARM CLOCKS at \$20 each, postpaid and insured. Color choices are marked above. My check is enclosed.

NAME _____

ADDRESS _____

CITY _____ ZIP _____

(Calif. Residents Add Appropriate Sales Tax)

FUTURE FINDERS

6000 SUNSET BLVD. • HOLLYWOOD, CALIF. 90028

Shall we send gifts in your name? Enclose details; we'll do the rest.

Take Up Cycling To Spin off pounds

Want a change of pace this fall? Try riding a bicycle. With steady pedaling, you can keep as physically fit as a jogger and do it a lot less monotonously. You can keep in shape with three or four sessions a week, each half an hour to an hour. And note: Cycle makers are now showing lightweight models made to order for the middle-age physique.

How long does it take to get in shape? If you start sensibly (on flat runs) and keep at it regularly, says one specialist, "in less than six weeks, you can be going on 25-mile bike rides." Added inducement: At 5 mph on a flat surface, you burn up an extra 4.5 calories a minute.

If you haven't been in a bicycle

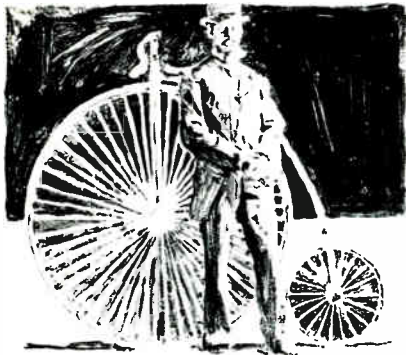

store lately, you may be surprised by the variety: sleekly designed unicycles, tandems, triplets, tri-cycles, mini-bikes, high-risers (for kids), and derailleurs (multi-speed bikes).

Your best bet, however, is to start off with a three-speed, lightweight (36 lb. to 46 lb.) touring bicycle. It will take you comfortably around town.

With thin (1% in.) tires, these bikes are easier to handle than the heavier, coaster-brake bikes with balloon tires that you rode as a youngster. By changing the gear ratio, you can also take hills more easily or increase speed without over-exerting yourself.

Be sure to get a bike with hand-brakes—they act on both wheels

and work immediately. The coaster brake (operated by pushing back on the pedals) is slower, stops only the back wheel, and may cause skidding.

Top names are Raleigh and Schwinn. Raleigh, an English bike, is slightly lighter and easier to maneuver. The Schwinn is sturdier and can take more abuse. Other makers: Columbia, Huffman, Murray Ohio, Stelber (\$75 up).

For the man with long-distance riding in mind, the 5- to 10-speed derailleur bike is a must. Features include dropped handlebars and thinner seats, enabling you to ride in a less tiring, hunched-forward position (\$80 to \$120).

If you're determined to get really serious, you may eventually want a custom-built bike. You can get them weighing as little as 22 lb. This lets you cover long distances—50 miles a day—with less effort (\$175 up).

If you want a bike you can stash in a car, boat, or small plane, see the folding bikes. Some of the imported models are hinged to fold in half merely by pulling a lever. But their 16-in. or 20-in. wheels make them uncomfortable for riding any distance. Names to check: Graziella (which has larger folding bikes also), Amica, Atala, Falter, Schwinn, Stelber (\$70 to \$90).

Safety note: Though not all states require it, the Bicycle Institute of America recommends that if you plan to ride at night, get a headlight visible for 500 ft. and a rear reflector that can be seen for 300 ft.

TRAVEL & SPORTS

Fun on Wheels—On and Off the Highway

Recreation vehicles—from four-wheel-drive Jeeps used by surf fishermen to rugged giant-size campers for hunters—will be more popular this fall than ever before.

Some will be bought at high prices: from \$1,500 or so for a small all-terrain vehicle (ATV) to as much as \$15,000 for a big camper outfit

that has everything but an indoor duck blind.

More will be rented, at costs ranging from \$100 to \$350 a week, with

Top brand campers are slicker than ever

bookings already under way.

The top brands in self-contained campers are slicker than ever. For



instance, Volkswagen's Campmobile—which sleeps two adults comfortably—comes with improved suspension to prevent side-sway in wind and give a steadier ride. Complete with pop-up top and tenting accessories, the tab is about \$3,700. Anybody who owns a VW bus can get a camping-conversion kit for \$600.

Chevrolet, Ford and Dodge feature small panel trucks that convert easily into campers. The Dodge Tradesman Van, for example, is a little heavier and more rugged than the VW and has a new selling point: factory-installed power steering and power brakes. It costs from \$4,000 to \$7,000, depending on the options and camping equipment.

Ford's Econoline camper and Chevy's Beauville Sport Van—which is convertible into a camper—fall into the same price range.

With a Detroit camper, you can get power in the 200-hp range, as against about 60-hp with a VW Campmobile. The added power will carry you over rough roads and through mountains under full load. And you can use all sorts of heavier camping equipment. A buying tip:

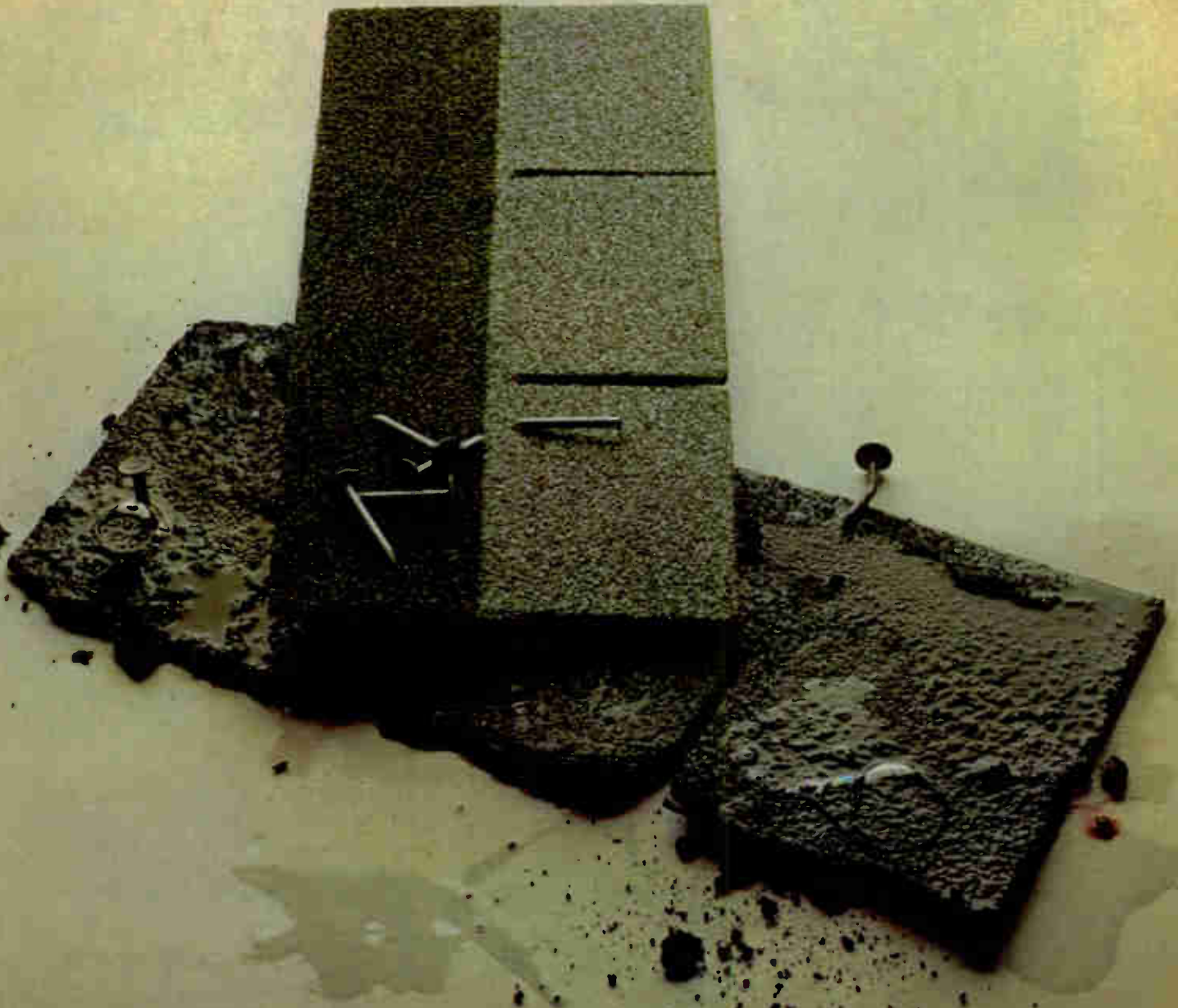

As inflation boosts the cost of replacing your home, we boost the amount your Homeowners insurance pays, automatically.

In just a few years, inflation can increase the cost of replacing your home and its possessions by thousands of dollars. If it does, we automatically increase the amount your Homeowners insurance will pay. It's one less thing for you to worry about. We protect you from loss by fire, tornado, burglary, vandalism and more, at low rates. We're the world's largest home insurer, for some very good reasons. (Current policyholders: if your coverage hasn't been updated with this new feature, call your State Farm agent.) **State Farm is all you need to know about insurance.**



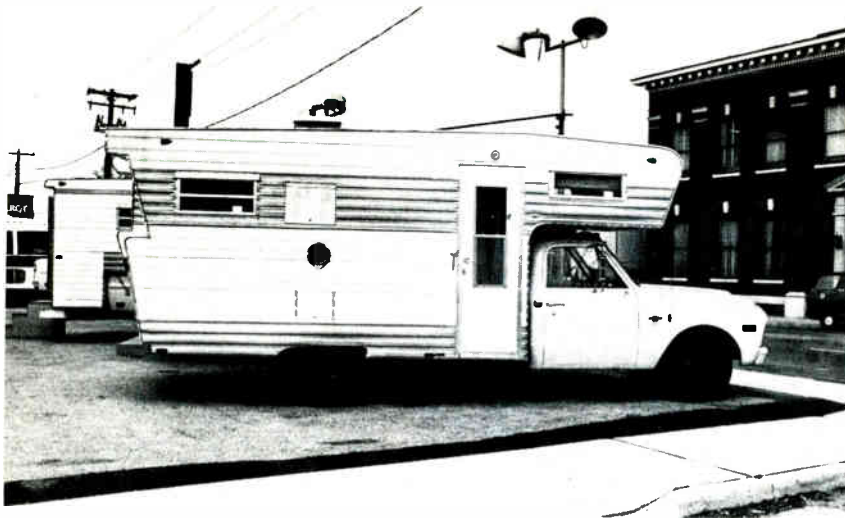

Shop all makes — and test drive before you buy.

Top of the line among self-contained campers is the Dodge Motor Home, with engine and chassis by Dodge and body by various U.S. makers. Units run 18 ft. to 28 ft. in length, sleep four to eight, and can be fitted with showers, TV, big stoves. You name it. Cost: \$7,500 to \$15,000 — or if you want to rent before you buy, \$250 to \$350 a week (plus mileage).

The pickup truck camper, with the unit fitted over truck and cab, is another rent-first item (\$150 to \$200 a week, plus 10¢ a mile). Pickup trucks by Chevrolet, Dodge, Ford, GMC, American Motors (Jeep), and International Harvester cost around \$4,000. The camping unit, put together by regional makers, runs about \$2,000 to \$5,000.

A truck such as Jeep's 350 V-8 can handle a camper up to 2,500 lb. A small pickup, such as Datsun's 1600, will support far less weight.

REAL ESTATE BEAT

Putting a Roof Over Relaxation

If you want to move your relaxation indoors for the winter, this is the time to start making plans for renovation of your game room.

Converting basement space is the usual way, of course. And if you decide not to tackle the job yourself, you'll have to allow at least two weeks for a remodeler to

Jeep-type cars are another idea for rough driving. American Motors' four-wheel drive Jeepster Commando is small but carries four passengers and is sleeker than a standard Jeep. The Jeep Renegade I is a modern version of the famous World War II model (both \$3,000). The super-rugged Land Rover by British Leyland is well worth a look, too — especially by fishermen who want to do stream-bed driving (\$3,500).

Among ATVs, that crawl like bugs, the Attex St-300-D is typical. It's smaller than a Jeep, has six wheels, simple controls (no steering wheel), seats three. Its 20-hp engine takes it 35 mph on land and 4 mph on water — \$1,600 range (ATV Mfg. Co., Pittsburgh).

The breed is multiplying. Now in pre-production in the \$4,000 range is the XJ-002 Jeep ATV (Jeep engine). It has 160-hp, with possible speed over 75 mph. (Bollide Motor Co., Huntington, N.Y.).

get started. Then, allowing for delays, he'll take about three to four weeks for the average job.

Here are some starting points:

- Cost of a game room in a \$40,000 to \$50,000 house can easily run from \$2,500 to \$5,000 or more. (Do-it-yourself will run at least 50% less.)

- The value of your property will be increased about 50% of cost.
- Cost of equipment can go sky-high. A pool table, for example, sells for about \$300 to as high as \$2,500. Figure roughly 40% to 50% more than basic renovation cost if you get everything from the latest indoor sports gear to stereo and color TV.

Finding a good man to do the work may take doing. Some tips: Get recommendations from a local contractor or architect; get three bids (to weed out the man who's too high or cut-rate), and be sure to obtain a contract that itemizes the work and gives a completion date. If it's an elaborate job that runs to \$5,000 or more, have a lawyer check the paperwork.

Before you re-do a basement, garage loft, or any other space, be sure you have a full 8 ft. ceiling; one of 7 ft. isn't good enough. Latest trend is the luminous, suspended ceiling with lighting built in, so figure this in your calculation.

Hydrofoam: a new trend in carpets

Paneling can be high-quality — and high priced. Teak, rosewood, or walnut veneer sells for up to \$100 per 4-ft. by 8-ft. panel. But serviceable vinyl plywood is just \$7 to \$10. In carpeting for basements, ask about hydrofoam, a moisture-absorbent covering.

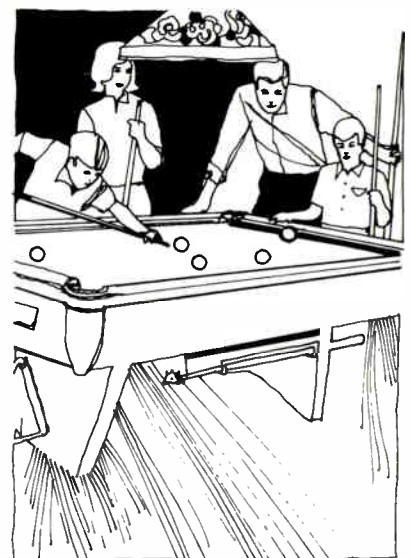

In laying out your plans, remember that indoor sports gear can take up plenty of space. A professional-



North Carolina's new Barge Site Survey will benefit 20 companies, at least.

Are you looking for an Eastern Seaboard industrial site which is served by water transportation? We have 20. All wrapped up and ready for development. They range in size from 160 to 4,000 acres.

We've got the details on each one: Zoning... Utilities (natural gas available)... Tax rate... Aerial photographs... Topography... Transportation and service facilities... And options... We've got two-year purchase options in hand.

The sites are in these areas: Wilmington, Hertford, Edenton, Elizabeth City, Greenville, Plymouth, Fayetteville, Morehead City, Murfreesboro, Washington, New Bern, Belhaven.

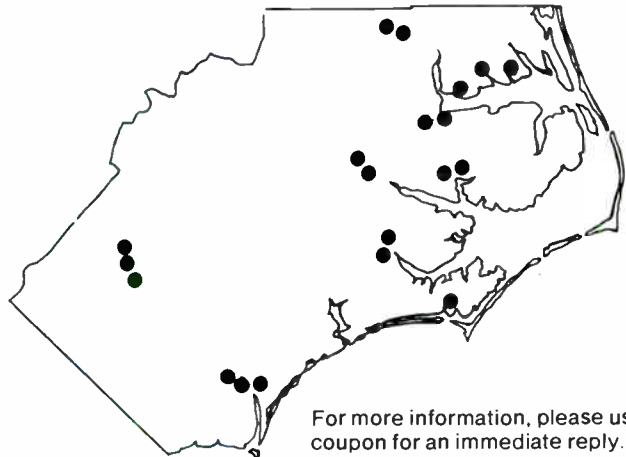

For more information, please use the coupon for an immediate reply.

north carolina

North Carolina Department of Conservation & Development
Division of Commerce & Industry
Box 27687

Raleigh, North Carolina 27611

Please send me more information on your new Barge Site Survey. I am particularly interested in the _____ area. I would like the complete package on the 20 sites.

Name _____

Firm _____

Address _____

City _____

State _____

Zip _____

28 WAYS POOR'S REGISTER WILL PAY OFF IN MORE PROFITABLE OPERATIONS FOR YOUR FIRM

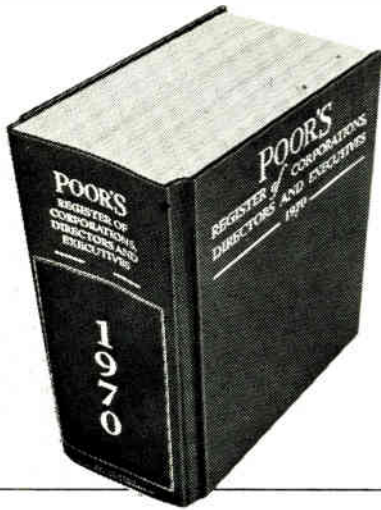

For **FREE INSPECTION**, without obligation, mail this ad with your name and address. Or, phone **COLLECT**: Mr. Philpott, 212 WA 4-6400, and you'll learn all the 28 ways to profit from Poor's Register.

Find out How This Incomparable Source of Vital Business Information will Measurably Advance Your Goals—from Planning Sales Strategy and Seeking New Business to Reaching the Nation's Top Executives By Phone!

Pinpoints America's prime business prospects . . . 260,500 key executives in 32,000 leading companies, plus 75,000 directors . . . representing 75% of national purchasing power. Leads you directly to the men who can say "Yes" — executives by name, title and duties . . . biographies-in-brief, home addresses and business affiliations of directors.

Superbly cross-referenced — by companies, products, geographically . . . and 900 industry classifications with SIC numbers.

You get three supplements a year at no extra cost to keep your REGISTER up to date with new names, addresses, positions, etc. Pays for itself — many times over!

STANDARD & POOR'S

Subsidiary of McGraw-Hill, Inc. P

345 Hudson Street, New York, N.Y. 10014

Most cards are for spending. This one is for saving.

This card is for business travel only. It guarantees that you will pay our pre-set commercial rate at every Travelodge. It can save your company important dollars.

We also give you free reservations from any place in the country. Just dial 800-255-3050.

Fill in your name. Attach to your business letterhead. Mail to: Travelodge, Dept. PB, Box 308, El Cajon, Calif. 92022. We'll send your card back.

TRAVELODGE

TLC
TRAVELODGE T L C CARD

Mr. _____

of _____

is to be given Tender Loving Care at every

size pool table is 4½ ft. by 9 ft., and with a heavy slate bed, weighs 1,000 lb. You'll need about 14 ft. by 18 ft. for a comfortable game. If you're a bit cramped for space, a family-size pool table is 4 ft. by 8 ft. (\$300 to \$800), takes less space, because shorter cues can be used.

Table tennis outfits run about \$75-up for top quality, with sturdy kids' models in the \$50 range. Besides wood, see a metal-framed composition table with easy-to-fold top (Abercrombie & Fitch, \$175).

A regulation size table tennis outfit is 5 ft. by 9 ft. But you should have 8 ft. at each end and 4 ft. on each side for a good fast game. Space saver: Add a table tennis top to your pool table; you can have a carpenter rig it; or check your sporting goods store (\$40).

The latest in high quality poker tables is octagonal, seats eight, has a padded surface, hidden trays for drinks and chips (Brunswick \$150-up).

A movable bar with built-in refrigerator and the usual gadgetry runs \$200 to \$400. A well-designed, custom-built, 8 ft. bar with sink and refrigeration costs \$1,500.

The home gym has become a big game room item, especially for the middle-ager. Here space is no problem. All you need is a cubicle (maybe 8 ft. by 8 ft.) to mount a horizontal bar, and a vertical one for isometrics.



After that come higher-ticket items. Among the possibilities: an indoor jogging machine with adjustable treadmill, meter, and timer (\$135 up); rowing machine, manual (\$90) or hydraulic (\$260); bicycle machine with timer, speed switch (\$150 to \$300). Check Sears, Montgomery Ward, Abercrombie.

For less strenuous relaxation, you can fill a corner with a base-

ment piano and drum combination. A 63 key cocktail piano costs \$400 to \$600, and a complete drum outfit \$400 to \$600. A dealer trade-in basement piano (a full 88), guaranteed tunable, costs \$200 to \$300.

Leasing instead of buying

Leasing an apartment—or a house, if you can find one—may be a way to sit out the high-priced housing market for a year or two.

It depends on your personal circumstances and where you live, but you could be better off leasing—even if you had to break the lease later on. The penalty is usually one to three months' rent, maybe a bargain in view of current mortgage rates.

If you have been a homeowner for years, you may be surprised by all the details a lease can cover. For instance, an apartment lease should spell out the question of redecoration—even down to the number of coats of paint. If you'll be putting in a partition or installing, say a special lighting fixture, it should give you permission and tell who will own any new fixtures when the term is up.

Look for special house-rules: things like use of the garage, late-hour entertaining, and so on. Trouble is that such rules—if reasonable—can become grounds for eviction if breached. If it's a new building or an old one being renovated, get a safeguard that won't let you be without utilities (heat, light, water) for longer than is absolutely necessary. It can be an important protection.

Generally, you can sublet *unless* a clause prohibits it. Try to get a firm statement giving you the right. You would continue to be liable for the rent, but you would have an out if you found a house to buy.

In a suburban town, go directly to the building manager: a real estate agent isn't apt to list many apartments. And sometimes if a broker does handle a rental, you (as tenant) may have to pay his commission. If leasing a house, try hard to swing an option to buy.

KENWOOD adds a new measure of fun to STEREO ENJOYMENT



MODEL KR-6160 —
260 WATTS, FET, IC,
FM/AM STEREO RECEIVER

"Mike-Mixing" in any Mode with its own Dynamic Microphone.



KENWOOD 15711 South Broadway, Gardena, California 90247

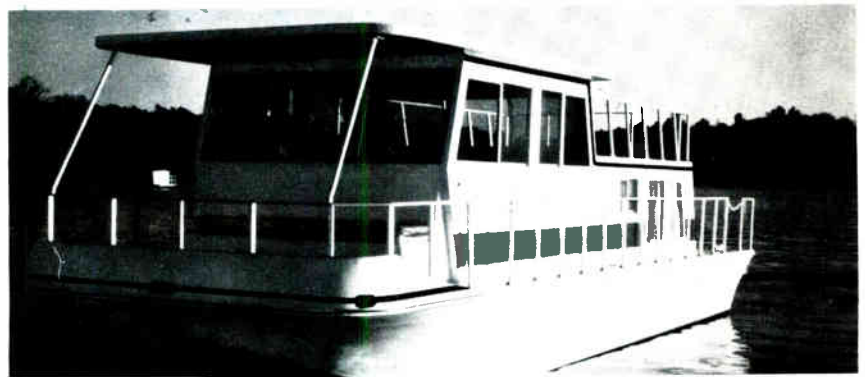

one hulluva boat

From backwaters to blue waters... America is accepting the 1971 Challenger. This unique 35' fiberglass family cruiser features sleeping accommodations for six, galley, dinette and bathroom with spray-type stall shower. An optional feature exclusive with Challenger is a walk-in lower stateroom with full standing headroom. For more information and color brochure write Challenger, Dept. PB, 1058 King Industrial Drive, Marietta, Georgia 30060.



Challenger 35

CRUISER

1058 KING INDUSTRIAL DRIVE MARIETTA, GEORGIA 30060

A Division of **GMD** GEORGIA MORTGAGE AND DEVELOPMENT CORPORATION



There ought to be room in your life for all kinds of money.

Life insurance is one kind of money. There are others. But you know that.

The important thing is, so do we. We know how important a good life insurance plan is to you – and how important other financial resources are, too.

We think this makes us better equipped to do a sound, rational job of helping you plan the life insurance part of your life.

State Mutual of America

A member of The America Group: many companies in many fields, looking from many directions at you and your financial future.

STATE MUTUAL OF AMERICA Individual and Group insurance including Life, Health and Annuities • HANOVER INSURANCE Multiple lines property, casualty, bonding insurance • HANOVER LIFE Stock life insurance company featuring Individual and Group life and health products • CITIZENS MUTUAL A Michigan multiple lines insurer, offering Workmen's Compensation, liability and property insurance • WORCESTER/GUARANTEE MUTUAL Property insurance companies offering personal and commercial coverages • BEACON/AMERICAN SELECT RISK Ohio-based property and casualty insurance companies • CALIFORNIA COMPENSATION California company specializing in Workmen's Compensation • MASSACHUSETTS BAY Multiple lines property and casualty company • AMGRO, INC. A premium finance company • COLONIAL MANAGEMENT Boston-based investment counseling company.

**THE
AMERICA
GROUP**

STATE MUTUAL LIFE ASSURANCE COMPANY of AMERICA, Worcester, Mass. 01605, Investing over \$3 million a week in American enterprise.



**Taxes:
hitting
young,
and old**

If you set up a custodian account for a child—under a uniform state law covering such accounts for minors—you would be smart to appoint someone else in the family to serve as custodian. Internal Revenue claims that if you serve as custodian, the securities in the account become part of your taxable estate if you die before the child reaches age 21 when the account automatically terminates. Now, the U.S. Tax Court has cleared away some doubt on the point—it backs the IRS.

For most people, nursing homes mean hard decisions and high costs. One confusion: whether the cost is tax deductible. A new Tax Court case sounds a warning: there must be medical care before you can take a deduction. But how much care? The nub of this is that if a member of your family goes into a home because of poor health, and a principal reason for going is the availability of medical care—then the whole cost, including meals and lodging is deductible. But it's a case of your mustering evidence of medical need—and care.

**New slant
on college
admissions**

There's more than money to consider in helping a youngster with future college plans. Take a sharp look at new changes in the philosophy behind admissions policies. Instead of just good grades and top-ranking high schools, admissions officers are paying a lot more attention to underprivileged kids from cities and small towns. A check of campus officials this month shows that the trend will continue....There will also be less emphasis on college boards; whereas 500-plus SAT scores have been a must at top colleges (even at second-line colleges), the policy will be to look more closely at students in the 400-plus range. Drive, creative ability in almost any field, and demonstrated interest in public affairs, especially, will be weighed most carefully. Net effect: greater competition for a freshman place. Even earlier planning for admission to a good college is suggested.

Early planning aid: Try Cass and Birnbaum's *Comparative Guide to American Colleges (1970)*; it's outstanding (Harper & Row).

**Manners
& modes**

Unofficial but highly reliable medical research shows that Gatorade is good for a hangover. The quick-energy drink for football players (cyclamates removed) enters the bloodstream 12 times faster than water and thus quickly replaces fluids lost. Dose: two 10 oz. cans before bed, and one upon awakening. Users say it works wonders.

Potpourri

Dining in Manhattan: With the first wisp of fall chill in the air, try lobster stew as made at the Plaza hotel's new Oyster Bar. Into 8 oz. half milk-half cream place 4 oz. pre-cooked lobster meat and 1 thick pat of butter; simmer 5 min. Remove half of the lobster, and put 1 slice toast in the stew—then put the meat back atop the toast and sprinkle with paprika....*The Complete Outdoor Cookbook*, by Dan and Inez Morris, is fine for hunters and anglers; camp cooking stuff is first rate (Hawthorne, \$7.95).

If you'll be flying to a remote tropical haven this winter, it might be smart to contact the International Assn. for Medical Assistance to Travellers. Get a free medical directory—a usable listing of local physicians in distant places, including tropical cities from Kingston to Honolulu to Nairobi. You're assured attention by qualified English-speaking MDS (IAMAT, 745 5th Ave., New York).

Westinghouse Combination Motor Starters... faster than a growing spark

A breakdown in insulation is the most common electrical problem on a motor. It creates a spark—a low-level fault. In just 1/4 second that low-level fault can cascade into a major electrical problem.

Our combination starters feature the Motor Circuit Protector which interrupts that little spark faster than any other device—in 1/60 second, faster than any low-level fault can grow.

And the Motor Circuit Protector gives you some other big advantages, too. There's a single adjustment to tailor protection to your motor. Protection against costly single phasing. Instant reset. And the unit is completely deadfront for personnel safety, and tamperproof so you can't alter its rating.

Westinghouse Electric Corporation, Control Products Division, Beaver, Pennsylvania 15009. F-8-70

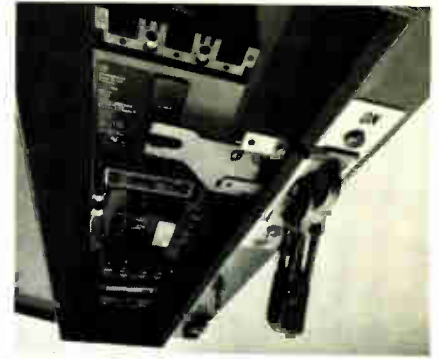

Westinghouse Combination Motor Starters feature the MCP for the fastest interruption of low-level faults.

You can be sure...if it's Westinghouse

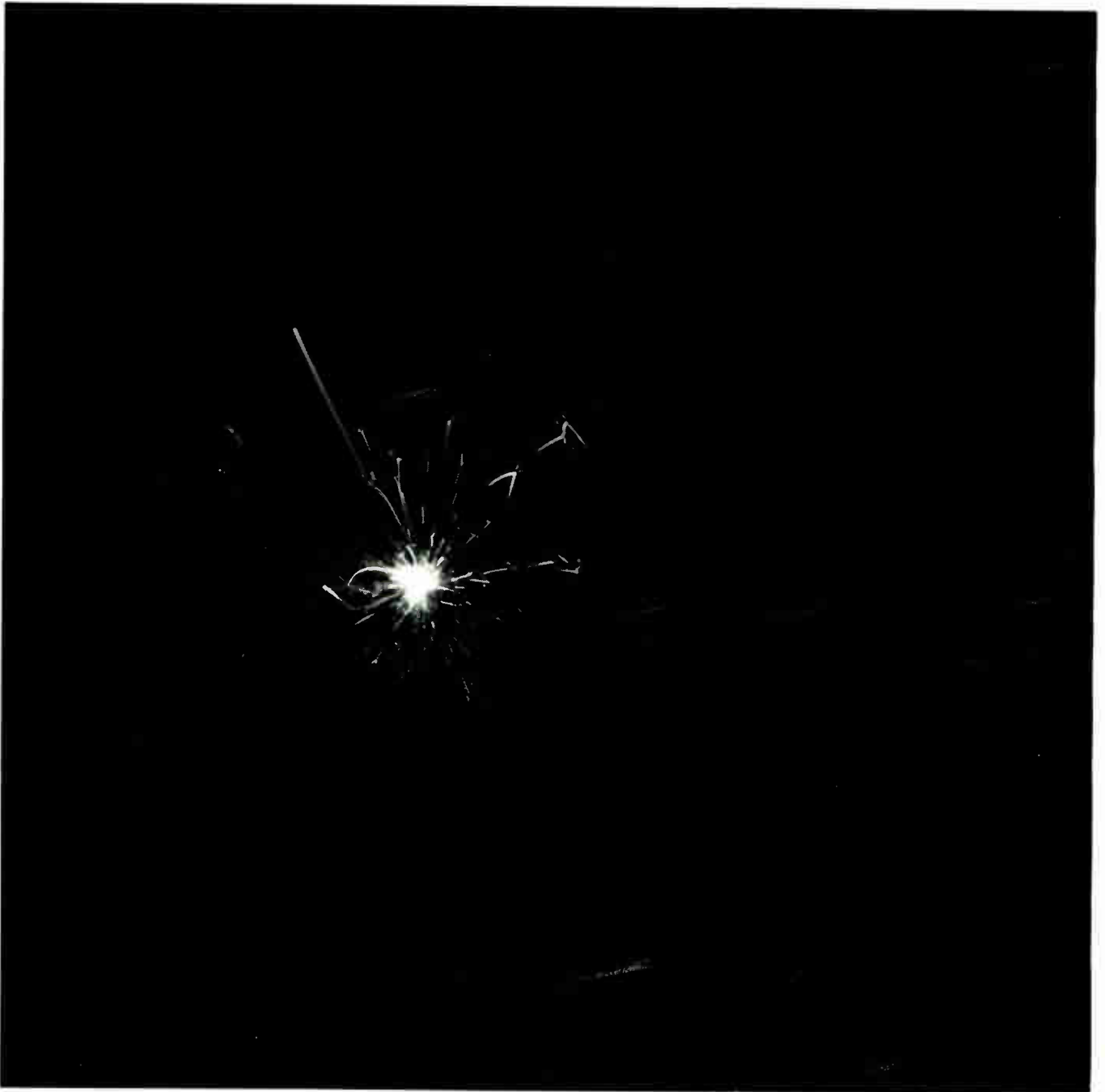

International Newsletter

September 28, 1970

Common Market contract plans come under fire

West Germany's Central Association for the Electrotechnical Industries is up in arms about recent Common Market proposals for concerted action among member countries on dishing out public contracts for large international projects. Under these proposals, the governments would get together to decide how such contracts should be let and to which countries—and companies—they should go. Affected are the communications, aerospace, data processing, and electrotechnical and nuclear power engineering sectors. Such government action, the association says, is a breach of open-market principles because it stifles free competition. It also means that politics would influence contract letting and could hurt Common Market technological performance and capabilities.

Deeply concerned because the German electrical and electronics industries are heavily dependent on public contracts at home, the association is calling for elimination of all obstacles to competitive bidding. The association also is dead set against Common Market plans to foster mergers in various industries by contract letting practices, fearing ultimate political control of corporate decisions.

Electronics gain in Japanese cars . . .

Japan's Toyota soon may be the world's most electronics-filled automobile. By the end of this year, the cars can be bought with electronic skid control and electronic fuel injection systems as options. The skid control was developed jointly by Toyota, its affiliate Nippon Denso Co., which will make the computer controlled system, and Aisin Seiki Co., a transmission maker. The fuel injection system, while developed entirely by Toyota and Denso, will be built under licenses to use Bendix and Bosch patents.

. . . as Toyota talks with TI on patents

Meanwhile, Toyota is negotiating an agreement with Texas Instruments that will probably include system patents, and also joint development of new systems. Neither Toyota nor TI will reveal details yet. But Toyota is interested in new systems—which might include air-bag crash control, radar or other detectors of nearby cars, and exhaust emission controls. Agreement might also include production of equipment for Toyota, although Toyota would probably prefer to have Denso handle the production. Denso already has concluded license arrangements with TI and Fairchild in semiconductors [*Electronics*, May 26, 1969, p. 182]. Although Denso is fabricating some small ICs on a trial basis, it is purchasing ICs for its automatic transmission control system [*Electronics*, Feb. 16, p. 69] and upcoming antiskid and fuel injection systems from regular semiconductor manufacturers, including Toshiba.

Automatic train control nears trial in Britain

British Rail, the state railroad monopoly, looks certain to start operational trials of its automatic train control system within a year [*Electronics*, April 15, 1968, p. 275]. The rail authority is giving the system a tryout to achieve higher traffic densities by improving on-time performance and cutting distance between trains while maintaining proper safety margins. In the system as presently visualized, the driver is told the maximum permissible instantaneous speed that cannot safely be exceeded. The brakes are applied automatically above that speed. The limit is

International Newsletter

calculated continuously by a train-borne computer, which integrates permanent data, such as train weight and train length, with local data, including upcoming signals, gradient of inclines, hazards, and other changing conditions.

Local data is sent to the trains by twin shielded cables laid 12 inches apart between the rails. Each has a low-frequency carrier on to which the data is frequency modulated. The cables cross over about every 100 yards. The shielding is broken at each crossover and also shorted by an interconnect between crossovers to minimize the effects of weather on impedance and attenuation. British Rail hopes that this system, plus further developments such as speed links and fixed computers at busy junctions, will increase traffic capacity by up to 20%, regardless of weather conditions.

Siemens unveils its biggest computer

Siemens AG, which saw its computer sales surge ahead at better than 35% in the last year to \$187 million, is readying a new weapon for its battle with IBM, which still holds 63% of the German market. The company's newest computer, the model 60 of its 4004 series, will have a cycle time of 765 nanoseconds for four bytes and a memory expandable to more than 1 million bytes. More significant, claim company spokesmen, is a price/performance ratio that tops IBM's 360/50 and even the recently introduced 370/155. When it's delivered next year the new machine, aimed at real-time and time-sharing jobs, will start renting at less than \$13,500 a month.

Government, coop launch tv cassette company in Sweden

The Swedish government, through a joint agreement with the Consumer Cooperative Federation, is going into the television cassette playback business. "We view this field as being of vital importance to society as a whole, and we want to be in it to prevent it being monopolized by advertising or commercial interests," says Karl-Axel Linderoth, an official of the cooperative.

It's uncertain just what the new company will do—simply handle programming and tape distribution or get into the hardware side, perhaps as a sales agent for foreign or domestic makers. However, it is not expected to start manufacturing. The only other firm in this field, Bonnier Audio-Visuals, owned by a large publishing house, has been criticized for having something of a monopoly. A firm spokesman says it welcomes the state-coop entry. But Bonnier has a big jump on the new competitor. It will have a line of recording and replay gear on the market by spring.

Viatron lines up overseas makers

Troubled Viatron Computer Systems, which only recently changed its top management [*Electronics*, Aug. 3, p. 93] now appears about to turn the corner. And some of the help is coming from abroad. The Japanese trading company Nichimen Co. has agreed to form Viatron Japan Ltd. Nichimen, which will own 51% of the venture, will exhibit the System 21 at the Osaka Trade Fair this week. What's more, Viatron appears near a similar agreement with a large British firm. In both Japan and England, the local firm would hire Viatron's present dealers and salesmen, making and selling System 21 data processing gear on a royalty basis. Perhaps more significantly Viatron has won the support of two large stateside banks: loans exceeding \$1 million and financial counseling.

Ceramic filters operate at 30-200 MHz

Vhf capabilities put filters in good position as video i-f amplifiers and CATV channel filters

A ceramic filter element with a strong physical resemblance to the germanium point-contact diodes that started the solid state revolution for aperiodic circuits may do the same for periodic circuits. The resemblance is especially close toward the end of the production process, where the elements are batch processed in a wafer of about the same thickness as those used in semiconductor diodes. Scribing separates the elements, which are mounted in all-glass, hermetically sealed package used for diodes.

The ceramic elements—called Piezonators—were developed at the Wireless Research Laboratory of the Matsushita Electric Industrial Co. They operate in the 30- to 200-megahertz range of the vhf band, which makes them ideal for use in the video i-f amplifiers of TV receivers and also as CATV channel filters. Matsushita expects to tool up for filter production, design a color TV set using them, and put the set on the market within a year.

The new material is a lead titanate with a small amount of dopants, the composition of which the firm considers proprietary. With a dielectric constant of about 200, an order of magnitude lower than that of previous materials, the material operates at higher frequencies by reducing stray capacitance and

maintaining a sufficiently high impedance for matching to the circuit. The new material has a very high electromechanical coupling coefficient, which gives the broadband response, because of directional characteristics that can be controlled to give a high coefficient for desired modes and a low one for undesired modes. Its physical structure minimizes spurious response due to mechanical coupling.

Piezonator material starts with a thickness of 500 microns to counteract warping during firing. After firing, wafers are ground and lapped to about 120 microns for use in the 50-MHz region. A final reduction in thickness to within 0.5 micron of the target puts filters within ± 100 kilohertz of design value. Final frequency is adjusted by controlling the thickness of electrode material evaporated on the wafer's faces.

Polarized wafers are scribed and diced to produce filter element chips. Because of the resulting rough edges the chips are asymmetrical on a microscopic scale, which further reduces spurious response by scattering and dissipating unwanted modes. Chips are mounted in glass packages between a nailhead and a pointed spring contact that applies a predetermined pressure on the middle of the chip. This point-contact mounting contributes to low vibration loss. Insertion loss is only about 5 or 6 decibels.

These filter elements have arrived on the scene at the right time, because it is just becoming possible to build monolithic ICs

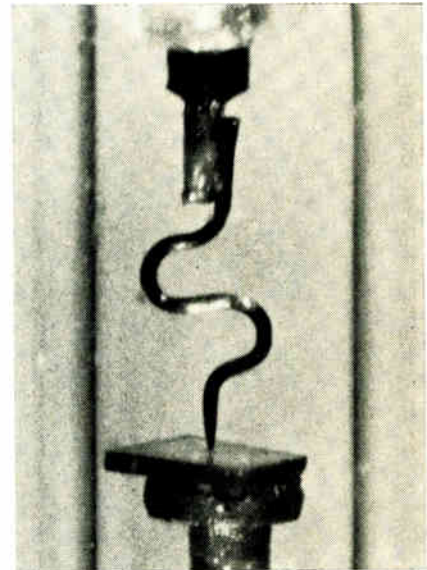

Contact. Resembling early transistors, filters are made like semiconductors.

with the required gain at video i-f amplifier frequencies. But the value of an IC amplifier disappears if the TV set still uses conventional filter circuits.

For example, current Matsushita color sets require a total of seven interstage transformers and wave-traps, a trimmer capacitor, three fixed capacitors, and two trimmer resistors in the frequency selective circuits of the video i-f amplifier. Two large shielded enclosures must be used to prevent inductive component coupling from degrading circuit performance. What's more, the components need 10 adjustments after assembly to assure desired frequency characteristics.

All these components can be replaced by two Jaumann-type ceramic filters [*Electronics*, Nov. 14,

1966, p. 160], one at the input to the i-f amplifier and the other between the i-f amplifier and video detector. The input filter—the more complex of the two—contains a ferrite-core transformer, a fixed capacitor for tuning, two ceramic filter elements, and a fixed capacitor for balance. The design uses the antiresonant frequency of one ceramic filter element to give about 26 dB attenuation of the sound i-f frequency of the channel being received. The antiresonant frequency of the other ceramic element is used to reject the adjacent channel. This filter replaces both the traps and bandpass filter used in a conventional color TV. Initial versions of the filter require one tuning adjustment, but company engineers say coils requiring no adjustment can be produced.

The output filter—which needs reject only what remains of received channels' sound i-f frequency—can be simplified and has only one ceramic filter element and a balancing capacitor.

The company's 110-MHz CATV channel filter is similar to the TV input filter but uses a trimmer capacitor rather than a fixed capacitor for balance. The trimmer is needed to obtain balance at the higher frequency, but it may be possible to use a fixed capacitor in the future. And for CATV two Jaumann filters in cascade can provide a channel filter with a wide bandpass and good selectivity.

A ceramic filter has also been developed at Matsushita for automatic fine-tuning circuits. Two transformers and three capacitors, which require two adjustments, can be replaced by one ceramic filter that requires no adjustments.

Great Britain

Ion implant machine aims at assembly-line job

A promising technology, ion implantation is still waiting for improvements in production techniques to get the throughput to up commercially practicable levels.

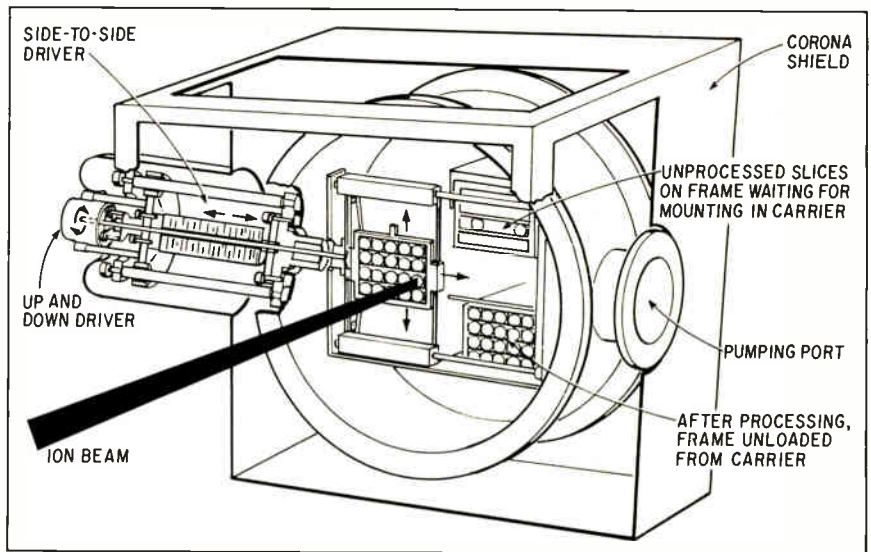

On the Beam. Drive mechanism of ion implantation machine moves the wafer carrier back and forth, then up a little, to average exposure to beam.

In Britain, scientists at the Atomic Energy Research Establishment at Harwell have designed and built an implanter they believe is suitable for industrial batch processing. It's made up of a high-current isotope separator, which generates and shapes the ion beam, and a specially designed target chamber.

The chamber is the key to the implanter's efficiency. It can pack in what the designers say will be enough semiconductor slices to make the installation economically viable. They claim that in an hour it will turn out 30 2-inch or 150 1-inch slices doped to 5×10^{15} ions per square centimeter and uniform to $\pm 1\%$.

The ion separator portion is already being made by Lintott Engineering Ltd. of Horsham, Sussex, and sold on its own in the U.S. for around \$135,000. Now Lintott plans to make the target chamber and early next year will offer a complete implant installation at somewhere around \$180,000 in the U.S. Because the cost is high, potential customers will be able to try out their slices in the Harwell unit.

In France, atomic energy research work also has spawned an ion implantation machine aimed at production lines [*Electronics*, Feb. 2, p. 63]. It made its debut with a \$100,000 price, delivered in Paris.

The ion separator of the British unit consists of an ion source with a maximum energy potential of 40,000 electron volts and a magnet for shaping and focusing the beam. The beam enters the target chamber through an accelerating lens that can add a further 150,000 eV to beam energy. Maximum beam current obtainable is about 1 milli-ampere with most elements, including all the usual donors and acceptors. Harry Freeman, who designed the machine, says that in sustained operation 150,000 eV total potential is most likely the practical maximum, with a beam current at the slice of 0.5 mA. "This should be more than enough to make production implantation commercially viable" Freeman claims.

Once formed by the separator magnet, the ion beam remains stationary, and all scanning motions are obtained by moving the slices. Freeman says he did this to avoid the problems of deflecting intense ion beams, and to reduce ion-beam heating of the silicon. The beam is normally 1 inch high and about 0.5 inch wide.

Inside the target chamber there are up to 20 rectangular frames measuring 5.5 by 4.5 inches and holding slices in horizontal rows. One-inch slices fit into a frame in four rows of five, 2-inch slices

in two rows of two wafers each.

To start a cycle, the operator loads the frames onto a rack in the top section of the chamber, closes it, and pumps it down to about 10^{-6} torr. From then on all motion of the frames is automatic and governed by preprogramed timing. The frames are lifted off the rack one at a time and fixed in a carrier that moves the frame from side to side and downward in steps, exposing each row of slices. When the carrier reaches its bottom position, the frame is lifted off and stacked in the bottom of the chamber while the carrier rises to pick up another frame.

Implantation depth is determined by voltage, and the total dosage by a combination of beam current and exposure time. To keep operation times down, current should be as high as possible. But high currents degrade ion beam uniformity, causing a nonuniform dosage across the silicon. Freeman compensates for this by having each horizontal row move from side to side a number of times, each time dropping a fraction of an inch.

The uniformity desired determines the vertical step intervals and the number of horizontal passes necessary, and hence the minimum cycle time. Then beam current is adjusted to provide the required doping level. Uniformity of 2% needs a total batch cycle time, including loading and normal dead time, of 1.75 hours; 1% uniformity needs 2.75 hours; and 0.5% uniformity, if it were ever required, would need 4.5 hours.

Japan

Glass laser fibers help transmit and amplify beams

Laser communication systems designers have another material to work with: glass fibers. Nippon Electric Co. and Nippon Sheet Glass Co. have jointly produced improved low-loss optical fibers for use as transmission lines. Called Selfoc, these fibers have much lower losses than similar materials

announced almost two years ago [*Electronics*, Dec. 23, 1968, p. 5E].

The companies also have taken the wraps off a continuous-wave glass laser oscillator that uses a similar fiber with about 4% neodymium doping. Output pulses of the glass fiber laser are shorter than those of other lasers, which should greatly increase system information transmission capacity. What's more, an amplifier for repeating the signal at the transmitted frequency also is being developed. It consists basically of the laser structure with mirrors replaced by lenses to inject energy into the amplifier and extract the signal at the output.

The fibers' low-loss characteristics stem from a continuous grading of the refraction index across the fiber radius. That gradation helps guide the light beam by reducing the amount of light lost through the fibers' sides. The new fibers exhibit losses of about 100 to 300 decibels per kilometer at the 0.63-micron output of a helium-neon laser, compared with 600 dB/km for earlier fibers.

Losses are quoted for helium-neon laser light, which often is used as a standard by laser workers. However, the glass fiber transmission line operates with much lower losses at long infrared wavelengths such as those generated by glass fiber and semiconductor lasers. The glass fiber laser operates at 1.06 microns, and semiconductor

units operate in the region somewhat shorter than 0.9 micron, with exact wavelength depending on temperature.

At these wavelengths, loss is only in the order of 50 to 150 dB/km. Nominal gain for a repeater would be in vicinity of 30 dB, so the best fibers now can be used with repeaters more than 0.5 km apart.

There is a difficulty in using the new amplifier with semiconductor lasers, in which frequency is a sensitive function of temperature. Without temperature control, these lasers cannot be used as repeaters in a system with straight-through amplification at carrier frequency. Otherwise, semiconductor lasers require repeaters that detect the incoming signal, regenerate it at baseband, and then use it to modulate another laser for further transmission.

The companies have lengthened individual fibers from 1 meter to 20 meters. Development is under way on fabricating longer fibers, with the 250-meter length that is standard for communications cables as the goal. Experimental methods for joining fibers include simple butt joints, immersion of two ends in liquid having a similar index of refraction, coating the two ends with nonreflective coating, and insertion of a lens between the two ends.

The laser's configuration is similar to that used for other glass

Guidance. Low-loss glass fibers, which can be used in laser oscillator and amplifier, have a graded index of refraction to guide light beam.

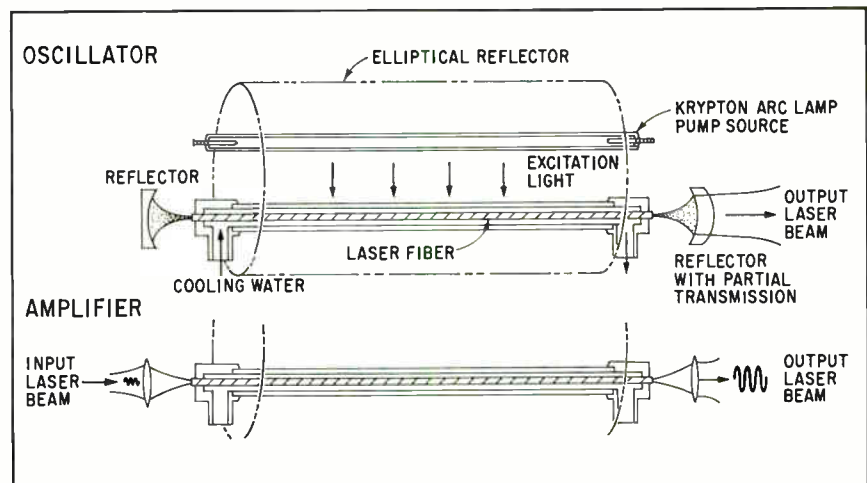

units. The neodymium-doped fiber and a krypton arc lamp pump source are located at the two foci of a surrounding elliptical mirror. The fiber has a diameter of 1.5 microns or less and a length of less than 40 centimeters—typically about 10 cm. Typical continuous power output is 3.5 watts at 1.06 microns.

Now an avalanche and trap recovery diode

Operating in a new avalanche mode, a gallium arsenide diode developed in Japan promises to find uses in laser ranging systems and as a more versatile replacement for mercury pulse generators. An offshoot of Gunn device work at Matsushita Research Institute, Tokyo, the new diode is similar to the Impatt diode, but can handle higher power. Researchers report output voltages of several tens of volts and currents of several hundred amperes. Typical rise times are on the order of 300 picoseconds.

Even though maximum repetition rate is below 1 megahertz, the usefulness of the device depends more on its capability, when biased just below the negative resistance point, of being accurately synchronized by applied pulses. The diode's inability to sync with pulses having higher repetition rate can be turned into an advantage, though, because the device can be used as a frequency divider. Although frequency characteristics are inferior to those of tunnel diodes, the new device's much larger current and voltage outputs may find it applications where the small output of the tunnel diode is unsatisfactory.

Under development for three years, the new device contains a region with higher doping than used in Gunn devices. Iron diffused about 10 microns into the 100-micron-thick n-type GaAs chip compensates somewhat for the impurities inside the chip. Even where compensation is maximal, though, material retains its n-type characteristics and becomes a type often called nu-type. Carrier density,

which is about 10^{16} carriers per cubic centimeter within the chip, becomes about 10^{14} carrier per cm^3 at the surface of the chip. A gold-germanium n⁺ contact is made to the nu layer, and a suitable contact is made to the other side of the wafer, to form a nu-n diode.

Almost all the voltage applied across the terminals of the device appears across the nu layer. If the voltage exceeds a threshold value, the device is biased into a negative resistance region. If the current then exceeds a threshold value, a pulse is generated.

Each pulse is followed by a period of steady moderate current flow through the device, then another period during which the current through the device decreases. Decreasing current increases the voltage until biasing is reestablished and another pulse can be generated. Pulse repetition rate can be adjusted by modulating the current through the diode.

The mechanism of the device operation has not been thoroughly explained, but it is thought to be dependent on iron doping—which acts as a deep-level impurity. Initial switching of the device appears to be by avalanching. This fills the recombination centers with holes, and the device terminal voltage falls to a low level because the semiconductor material behaves as if there are no deep impurity levels. As terminal current continues to flow into the device, the captured holes are released. When the charge flowing into the device about equals the charge captured in the deep impurity levels, the terminal voltage rises and the cycle repeats. Experimentation shows that charge storage is almost identical with the number of iron atoms.

Switzerland

Rare earths attract magnet researchers

At the Baden-based laboratories of Brown, Boveri and Cie, permanent magnet researchers are taking a hard look at compounds made of

rare-earth metals and cobalt. Judging from the results they have obtained so far, it looks as if conventional materials—alnico and barium ferrites, for example—soon may be replaced in some specialized permanent magnet applications. Among the materials the Baden scientists have investigated so far, compounds of cobalt with such rare earths as samarium, yttrium and praseodymium look like the most promising.

For users of permanent magnets the two most important properties of such devices are their maximum energy product and their coercive force. The two largely determine how small and strong a magnet can be made for a given power source and how large a load can be handled by a magnetic circuit—for example, in motors.

The coercive force of a magnet has an upper theoretical limit at the material's so-called anisotropic field. For rare-earth cobalt compounds this limit is very high—between 130,000 oersteds for yttrium-cobalt and 290,000 Oe for samarium-cobalt. Since about 15% of the theoretical value can be achieved in practice, coercive forces of up to 30,000 are obtainable. So far, however, BBC researchers have reached such values only with SmCo, fine-particle magnets. For comparison, alnico has a coercive force of around 2,000, say company experts.

The high coercivity should appeal to designers of small motors, the permanent magnets in which are often destroyed by demagnetization when overloading occurs. For the magnetic material, on the other hand, a higher coercive force will make for a sturdier device.

As for the maximum energy product, values of up to 20 million gauss-oersteds have been obtained for SmCo₅ permanent magnets—double the value that's possible with high-quality alnico alloys or with very expensive platinum-cobalt magnets. Such high energy product will make the new material suitable for magnets in electronic watches, for example.



5th International Exhibition of Industrial Electronics

- Electronic Components
- Measuring Equipment
- Equipment for Control and Automation
- Power Electronics
- Communications
- Electronics for the Tertiary Sector
and Administration
- Technical Literature, Education

BASLE

from March 9th to 13th 1971 in the halls
of the Swiss Industries Fair

Information: Secretariat INEL and MEDEX 71
P.O. Box
CH-4000 Basle 21/ Switzerland
Telephone: 061/32 38 50
Telex: 62685 fairs ch

MEDEX 71 = special event during INEL

- Instruments and Equipment for Medical
Diagnosis
- Equipment for Clinical Laboratory
- Therapy
- Hospital organization and teaching

Technical Meetings will be held during
MEDEX 71

1st International Exhibition and Technical Meetings for Medical Electronics and Bio-engineering

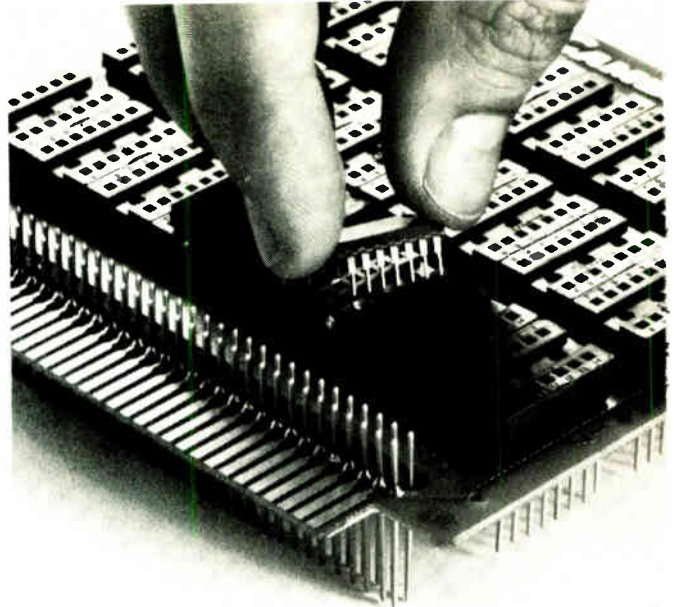

use our wire-wrap* cambi-cards to keep your ic's in line

Matter of fact, we'll help you package whole IC sub-systems. Start with our 4.5 x 4.5 inch or 4.5 x 9.25 inch Cambi-Card® printed circuit boards with 70-pin input/output edge connectors, containing Wire-Wrap sockets for 14, 16 or 24-pin dual in-line IC's. Then our precision fabricated card files with 13 or 26 positions. Next our 13 or 26 position power planes.

And if you need 'em, our card extenders, Wire-Wrap card connectors, blank Cambi-Cards for discretes, pluggable/patchable breadboards for 16, 32 or 64 DIPS, patch cord kits . . . even our super fast, economical wire-wrapping service.

For details, call us or write for Catalog 92, the latest word on IC accessories and wire-wrapping. Cambridge Thermionic Corporation, 445 Concord Avenue, Cambridge, Mass. 02138. Phone: (617) 491-5400. In Los Angeles, 8703 La Tijera Boulevard 90045. Phone: (213) 776-0472.

*Registered Mark of Gardner-Denver Co.

Standardize on

CAMBION®
The Guaranteed Electronic Components

Electronics advertisers

September 28, 1970

AEG Telefunken Werveagentur	116
AEG Telefunken Corporation	6
AEI Semiconductors Limited	23E
MCR Advertising Limited	
Alco Electronics Products Inc.	116, 133
Marketronics Advertising	
Allen Bradley Company	26, 27, 101, 108
Hoffman York Inc.	
AMP Incorporated	28, 29
Aitkin-Kynett Co. Inc.	
Andrew Corporation	50
Fensholt Advertising Inc.	
Arnold Engineering Company	98
Buchen Advertising Inc.	
Ates Componenti Elettronici S. P. A.	21E
Publicitas	
Barnes Engineering Company	92
Albert A. Kohler Company Inc.	
Bell & Howell Electronics & Instruments Group	23
Coordinated Communications Inc.	
Brand-Rex	104
Creamer, Trowbridge, Case & Basford Inc.	
Cambridge Thermionic Corporation	131
Chirurg & Cairns Inc.	
Carolina Power & Light	PB 7
McKinney & Silver	
Cessna Aircraft Company	PB 3
Gardner Advertising	
C.G.E.	121
Edition 2B Publicite	
Challenger Cruiser, A Division of Georgia Mortgage & Development	PB 13
Visual Persuasion	
Chauvin Arnoux	107
Edition & Publicite du Val D'Oise	
Chicago Miniature Lamp Works	17
Buti-Roberts Advertising	
Clairex Corporation	111
Michel-Cather Inc.	
Colorado Video Inc.	123
Wolff, Weir, Schultz Inc.	
Coto Coil Company Incorporated	99
Williams Company, The	
Delta Products Incorporated	PB 6
Wm. Loughran Company	
Dalight Corporation	20
Michel Cather Inc.	
Digital Equipment Corporation	53
Kalb & Schneider Inc.	
Dow Corning International Ltd.	12E, 13E
Marsteller International S. A.	
Eastman Kodak Company	
PCIM Market Development	95
Rumrill Hoyt Incorporated	
E-H Research Labs Inc.	32
Steedman, Cooper and Busse Advertising	
Elco Corporation	134
Schaefer Advertising Inc.	
Electronics	30, 31, 110
Ries, Cappiello Colwell, Inc.	
Electro Scientific Industries	27E
Hugh Dwight Advertising Inc.	
EL Instruments Inc.	94
Froehlich Advertising Services	
Erie Technological Products Company Inc.	25
Walker Schmidt & Mackall Inc.	
Exact Electronics	17E
Hugh Dwight Advertising Inc.	
Fairchild Semiconductor Inc.	12, 13
Carson/Roberts Inc. Advertising	
Firestone Tire & Rubber Co.	PB 5
J. Walter Thompson	
Florida Dept. of Commerce, Division of Commercial Development	24
William Cook Advertising Inc.	
Fluke Manufacturing Co., John Bonfield Associates	15
Future Finders	PB 7
Hassett Levin Inc.	
General Instrument Microelectronics	15E
Michael Lawler & Borradaile Ltd.	
General Radio Company	2nd Cover
GRAD Associates	
Georgia Department of Industry & Trade	
Cargill, Wilson & Acree Inc. Adv.	119
Gudebrod Bros Silk Co., Electronics Div.	112
Ramsdell, Bright & Nathans Inc.	
Hewlett Packard	
Colorado Springs Division	96
Tallant/Yates Advertising Inc.	
Hewlett Packard Company	2
Lennen & Newell Inc.	
Hewlett Packard San Diego Division	1
Lennen & Newell Inc.	
Howard W. Sams & Co. Inc.	115
George Brodsky Advertising Inc.	
Hughes Aircraft Company	46, 47
Foot Cone & Belding	
I. E. R.	14E
Pema	
Indium Corporation of America	8
Evans Garber Ligas & Paige	
INEL	131
Publicitas Service International	
Intel	9E
Ithaco, Incorporated	120
Hart Conway Co. Inc.	
Kenwood	PB 13
Albert Frank-Guenther Law Inc.	
Lambda Electronics Corp.	3rd Cover
Michel Cather Inc.	
LTT	24E, 25E
Publibel	
Mohawk Data Sciences Corporation	18-19
The Lampert Agency Inc.	

Motorola Semiconductor Products Inc.	
Lane & Wampler Advertising Inc.	45
National Electronics Inc., Subsidiary Varian Associates	22
Connor-Sager Associates Inc.	
Perfection Mica Co.	
Magnetic Shield Div.	123, 133
Garden Advertising	
Philips Electronics Instruments	81
Marsteller Inc.	
Philips Eindhoven Nederland	81
Philips Electrologica/Office Machine Division	29E
Media International	
Philips GAD-Elcoma	18E
Media International	
Philips N. V. Pit/Tmi Division	2E
Marsteller International S. A.	
Radiation Inc.	9, 10, 11
W. M. Zemp & Associates Inc.	
RCA Electronic Components	4th Cover
Al Paul Lefton Company	
RCL Electronics Inc.	14
Morvay Advertising Agency	
Relcom	77
RMC	
Rhode & Schwarz	31E
Schlumberger Ltd. EMD	3E
T. B. Brown Ltd.	
Schlumberger SIS	4E
T. B. Brown Ltd.	
Schlumberger SOMV	6E
T. B. Brown Ltd.	
Schneider R. T.	26E
Noirclerc Publicite	
Sfernice	32E
Publisher	
Signetics Corp. Sub.	
Corning Glass Works	73
Cunningham & Walsh Inc.	
Silec Electronique	10E, 11E
Promotion Vente Publicite	
Siliconix Inc.	35
Robertson West Inc.	
Singer Company, The, Electronic Products Division	124
Technical Industrial And Scientific Marketing Inc.	
Solartron Electronics Group Ltd.	5E
T. B. Brown Ltd.	
S. P. Electronica	7E
Studio Sergio Rosata	
Sprague Electric Company, The	5
Harry P. Bridge Company	
Standard & Poor's	PB 12
Goody Advertising Agency	
State Farm Fire & Casualty Company	PB 9
Needham, Harper & Steers Inc.	
State Mutual Life Assurance Company of America	PB 14
Bresnick Company Inc.	
State of North Carolina, Department of Conservation & Development	PB 11
Charles Crone	
Sylvania Electric Products Inc., Chemical & Metallurgical Div.	21
Doyle Dane Bernbach Inc.	
Syntronic Instruments Inc.	99
Burton Browne Advertising	
Systron Donner Corporation	7
Bonfield Associates Inc.	
Tektronix Inc.	43, 84
Dawson Inc.	
Teledyne Relays Company	36
S. Michelson Advertising	
Texscan Corporation	16
Maquil/Ross Inc.	
Travelodge	PB 12
Daily & Associates	
Triolett Electrical Instrument Company	88
Byer and Bowman Advertising	
TRW Semiconductors Inc.	48, 49
Fuller & Smith & Ross Inc.	
Tung Sol Division, Wagner Electric Corp.	102
Winius-Brandon Company	
Unisem Subsidiary of United Aircraft Corporation	103
Schaefer Advertising Inc.	
Universal Oil Products, Norplex Div.	87
Campbell-Mithun Inc.	
Varo Inc.	94
Tracy-Locke Inc.	
V/O Technasheport	16E
V/O Vneshtorgreklama	
Westinghouse Electric Corp. Control Products Division	PB 16
Ketchum, MacLeod & Grove Inc.	
Weston Instruments Inc., Newark Division	54
Arndt, Preston, Chapin, Lamb & Keen Inc.	
Wiltron Company	122
Vanderwyk Associates Inc.	

Classified & Employment Advertising

F.J.Eberle, Manager	212-971-2557
EQUIPMENT (Used or Surplus New) For Sale	
Ewald Instruments Corp.	194
Radio Research Instrument Co.	194

For more information on complete product line see advertisement in the latest Electronics Buyer's Guide
 Advertisers in Electronics International

Advertising Sales Staff

Pierre Braudé [212] 971-3485 Advertising Sales Manager	
Atlanta, Ga. 30309: Charlton H. Calhoun, III 1375 Peachtree St., N.E. [404] 892-2868	
Boston, Mass. 02116: William S. Hodgkinson McGraw-Hill Building, Copley Square [617] CO 2-1160	
Chicago, Ill. 60611: Ralph Hanning, Kenneth E. Nicklas, 645 North Michigan Avenue, [312] MO 4-5800	
Cleveland, Ohio 44113: William J. Boyle, [716] 586-5040	
Dallas, Texas 75201: Richard P. Poole, 1800 Republic National Bank Tower, [214] RI 7-9721	
Detroit, Michigan 48226: Ralph Hanning, 2600 Penobscot Building [313] 962-1793	
Houston, Texas 77002: Richard P. Poole, 2270 Humble Bldg. [713] CA 4-8381	
Minneapolis, Minn. 55402: Kenneth E. Nicklas, 1104 Northstar Center [612] 332-7425	
New York, N.Y. 10036 500 Fifth Avenue James R. Pierce [212] 971-3615 Warren H. Gardner [212] 971-3617 Michael J. Stoller [212] 971-3616	
Philadelphia, Pa. 19103: Jeffrey M. Preston 6 Penn Center Plaza, [215] LO 8-6161	
Pittsburgh, Pa. 15222: Jeffrey M. Preston, 4 Gateway Center, [412] 391-1314	
Rochester, N.Y. 14534: William J. Boyle, 9 Greylock Ridge, Pittsford, N.Y. [716] 586-5040	
St. Louis, Mo. 63105: Kenneth E. Nicklas, The Clayton Tower, 7751 Carondelet Ave. [314] PA 5-7285	
James T. Hauptli [415] DO 2-4600 Western Advertising Sales Manager	
Denver, Colo. 80202: Richard W. Carpenter Tower Bldg., 1700 Broadway [303] 266-3863	
Los Angeles, Calif. 90017: Ian C. Hill, Bradley K. Jones, 1125 W. 6th St., [213] HU 2-5450	
San Francisco, Calif. 94111: Don Farris, James T. Hauptli, 255 California Street, [415] DO 2-4600	
Paris: Denis Jacob 17 Rue Georges Bizet, 75 Paris 16, France Tel 727 33 42, 727 33 60	
Geneva: Denis Jacob 1 rue du Temple	
United Kingdom and Scandinavia London: Keith Mantle, Tel: Hyde Park 1451 34 Dover Street, London W1	
Milan: Robert Saidel, Roberto Laureri Jr. 1 via Baracchini Phone 86-90-656	
Brussels: Denis Jacob 27 Rue Ducale Tel: 136503	
Frankfurt/Main: Hans Haller Elsa-Brandstroem Str. 2 Phone 72 01 81	
Tokyo: Masaru Wakeshima, McGraw-Hill Publications Overseas Corporation, Kasumigaseki Building 2-5, 3-chome, Kasumigaseki, Chiyoda-Ku, Tokyo, Japan [581] 9811	
Osaka: Akihiko Kamesaka, McGraw-Hill Publications Overseas Corporation, Kondo Bldg., 163, Umegae-cho Kita-ku [362] 8771	
Australasia: Warren E. Ball, IPO Box 5106, Tokyo, Japan	
Business Department	
Stephen R. Weiss, Manager [212] 971-2044	
Thomas M. Egan, Production Manager [212] 971-3140	
Dorothy Carmesin, Contracts and Billings [212] 971-2908	
Frances Vallone, Reader Service Manager [212] 971-2865	
Electronics Buyers' Guide	
George F. Werner, Associate Publisher [212] 971-3139	
Regina Hera, Directory Manager [212] 971-2544	

A VERITABLE GOLD MINE OF INFORMATION



These are the most valuable set of reference manuals available on magnetic shielding materials and fabrication methods. They cover MSD's complete line of Netic and Co-Netic Alloys. MSD has provided over 80% of the magnetic shield designs currently in use; its products are the recognized world standard in its field.

They're yours for the asking. Contact your MSD rep or write
MAGNETIC SHIELD DIVISION

PERFECTION MICA COMPANY
 740 Thomas Drive, Bensenville, Illinois 60106
 Phone 312, 766-7800. TWX 910 256-4815



NEW WEST COAST OPERATION
 Magnetic Shield Division
 Perfection Mica Company
 1325 E. Esther Street
 Long Beach, Calif. 90813
 213/591-5638
 213/591-5639

Los Angeles Telephone
 213/775-8079

Circle 133 on reader service card



YOU'RE WHISTLING IN THE DARK...

if you think that heart disease and stroke hit only the other fellow's family.

**GIVE ... so more will live
 HEART FUND**



Contributed by the Publisher

PUSH BUTTON MINIATURES

Exceptionally high current. 6A @ 125 VAC. Snap-action with fast make and break contacts. SPDT, DPDT & 4PDT, usable as either Norm. Open or Norm. Closed switch. Silver contacts & terminals.

Push-ON, Push-OFF

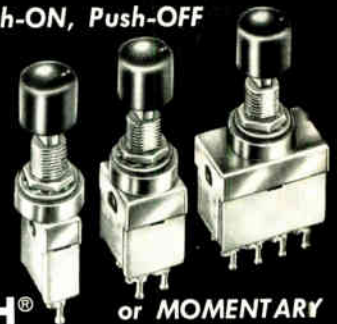

ALCOSWITCH® or **MOMENTARY**
 DIV. OF ALCO ELECTRONIC PRODUCTS, INC., LAWRENCE, MASS.

Circle 142 on reader service card

ROTARY SWITCH MINIATURES

Two series: MRA Series with adjustable stop & is 1-2-3-4 poles on a single deck with max. of 10 or 12 positions. MSRE waterproof series meet high reliability standards; non-adj. 1 to 4 poles. 500 mA @ 125 VAC.



ALCOSWITCH®
 DIV. OF ALCO ELECTRONIC PRODUCTS, INC., LAWRENCE, MASS.

Circle 143 on reader service card

INTERCONNECTION PACKAGING

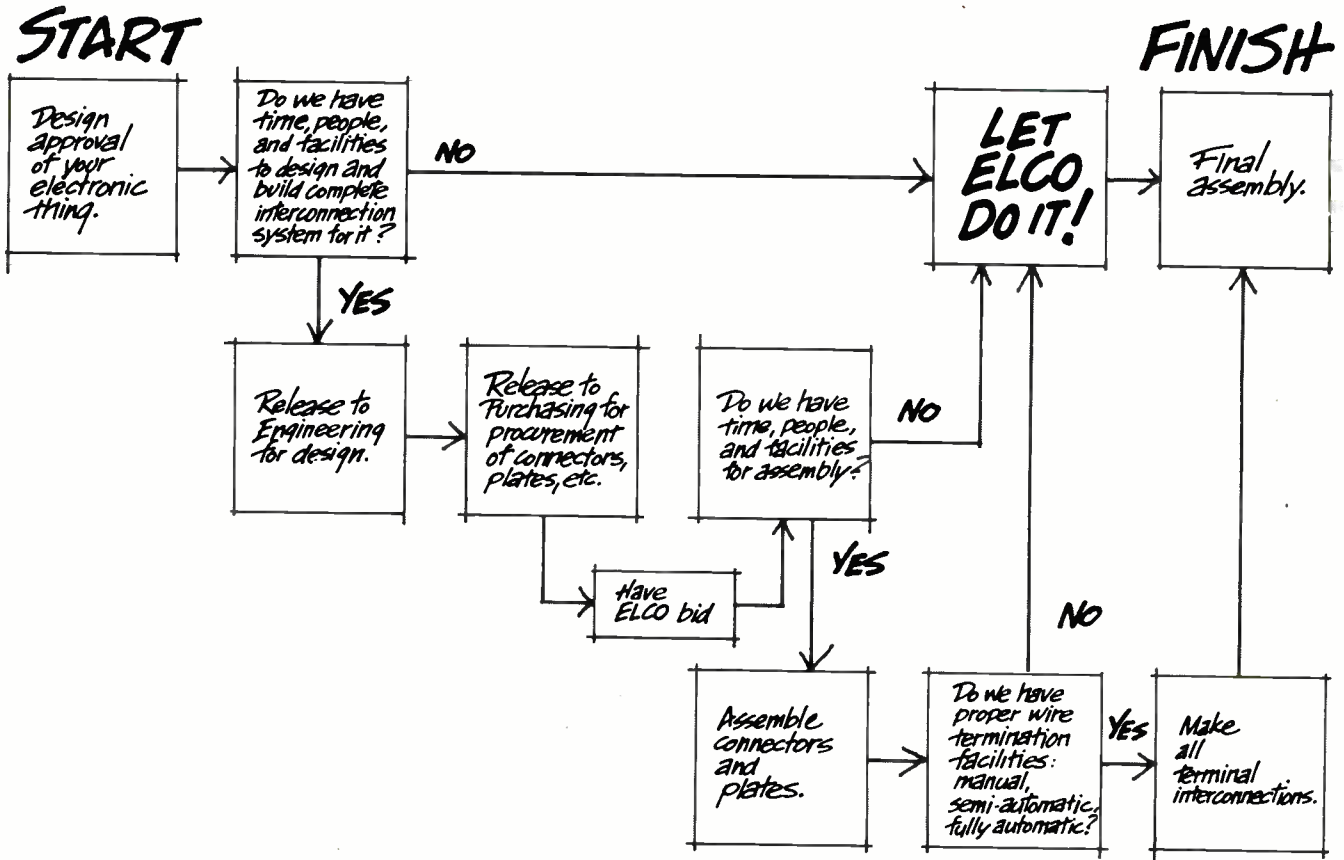

**The sooner you say no,
the more time and money
you save.**

Take the high road all the way, and you'll be done in six weeks.

The high road is our "Total Packaging Service": complete interconnection system packaging from design to wire termination.

It's saved a lot of our customers a lot of time and money. (And helped make us the largest manufacturer of metal-plate back-panel interconnection systems.)

But maybe that's more than you need.

All right.

Start at the last decision point, for instance: Should you have your production people making terminal interconnections, when they could be making something more profitable?

We think not.

Send us your back panels and wire list. We'll tie everything together for you. By hand, semi-automatically, or automatically with our Gardner-Denver think-and-do machines. You'll get an accurate job, with minimum wire lengths and densities.

Or start back a little further in the process—at the point where you have to get and assemble your connectors and back plates. We'll save you some time and money there, too.

Because.

We've got several hundred thousand standard connectors to work with. For square or offset grids. On .100", .125", .150", or .200" centers. And the plates to assemble them on. And the people to assemble them with. You can buy from us either

way. With savings, either way.

But what if your requirements are definitely not standard?

Ah.

That brings us back to the beginning. Where our designers can (a) help you avoid non-standard connectors or (b) design, quickly, those that can't be avoided. Big savings there.

Whichever decision (crisis?) you're facing, between design and production, give Elco a call. Call Jim Scaminaci direct: he's our interconnections man. You can reach him at (213) 675-3311, Ext. 235. Collect. Or call, write, or TWX Joe Roos, Product Manager at Elco Corporation, Willow Grove, Pa. 19090. (215) 659-7000. TWX 510-665-5573.

ELCO Interconnection Systems

High efficiency

Lambda LV series-

a breakthrough in power supply design

Designed to power TTL, ECL, RTL, DTL and HTL logic. Regulation 0.15% line or load. Less than 10mV RMS ripple. Convection cooled —no blowers. Built — in overvoltage protection.

LV Series modular and full-rack models

PACKAGE E	MODEL	ADJ. VOLT. RANGE VDC	MAX. AMPS. AT AMBIENT OF: ¹				PRICE ⁽²⁾
			40°C	50°C	60°C	71°C	
4 ¹⁵ / ₁₆ " x 7 ¹ / ₂ " x 11 ³ / ₄ "	LV-E-3-P-3-OV	2.8-3.8	47	39	28	13	\$325
	LV-E-4-OV	4 ± 5%	44	39	28	13	325
	LV-E-4-P-5-OV	4.5 ± 5%	41	38	28	13	325
	LV-E-5-OV	5 ± 5%	37	34	28	13	325
	LV-E-6-OV	6 ± 5%	33	30	27	13	325



PACKAGE EE	MODEL	ADJ. VOLT. RANGE VDC	MAX. AMPS. AT AMBIENT OF: ¹				PRICE ⁽²⁾
			40°C	50°C	60°C	71°C	
4 ¹⁵ / ₁₆ " x 7 ¹ / ₂ " x 16 ¹ / ₂ "	LV-EE-3-OV	3 ± 5%	98	90	74	61	\$490
	LV-EE-3-P-6-OV	3.6 ± 5%	92	85	70	57	490
	LV-EE-4-OV	4 ± 5%	87	82	70	54	490
	LV-EE-4-P-5-OV	4.5 ± 5%	81	77	70	52	490
	LV-EE-5-OV	5 ± 5%	74	70	65	45	490
	LV-EE-6-OV	6 ± 5%	64	61	56	40	490
	LV-EE-10-OV	10 ± 5%	41	39	36	25	415
	LV-EE-12-OV	12 ± 5%	34	32	30	21	415
	LV-EE-15-OV	15 ± 5%	28	26	24	18	415



PACKAGE G	MODEL	ADJ. VOLT. RANGE VDC	MAX. AMPS. AT AMBIENT OF: ¹				PRICE ⁽²⁾
			40°C	50°C	60°C	71°C	
5 ¹ / ₄ " x 19" x 16 ¹ / ₂ "	LV-G-3-OV	3 ± 5%	170	165	150	135	\$750
	LV-G-3-P-6-OV	3.6 ± 5%	160	155	140	125	750
	LV-G-4-OV	4 ± 5%	150	145	132	120	750
	LV-G-4-P-5-OV	4.5 ± 5%	135	131	119	108	750
	LV-G-5-OV	5 ± 5%	130	126	115	100	750
	LV-G-6-OV	6 ± 5%	110	107	98	90	750
	LV-G-10-OV	10 ± 5%	74	71	65	61	750
	LV-G-12-OV	12 ± 5%	65	63	57	54	750
LV-G-15-OV	15 ± 5%	50	48	44	40	750	



Package G models are only available without meters. For chassis slides, add suffix "-CS" to the model number and \$60 to the price.

NOTES: (1) Current rating is from zero to I max. Current rating applies over entire output voltage range. Current rating applies for input voltage 105-132 vac 57-63 Hz.

(2) Prices are USA list prices only, FOB Melville, N.Y.; North Hollywood, Calif.; Montreal, Canada. All prices and specifications are subject to change without notice.

Efficiency
greater than 50%, with advanced SCR circuitry

Convection cooled
no external heat sinking or forced air required

Overvoltage protection
built-in on all models

Regulation
line 0.15% + 10 mv for line variations from 105-132 vac.

load 0.15% + 10 mv, no load to full load or full load to no load

Low ripple
10 mv rms, max., with electronic ripple reducer

AC input voltage
105-132 vac, 57-63 Hz

Temperature coefficient
.03% + 0.5 mv/°C

Ambient temperature range
0°C to +71°C operating
-55°C to +85°C, storage

Thermally protected and short-circuit proof
current limiting circuit and self-resetting thermostats protect supplies.

Remote programming
200 ohms/v nominal, or volt/volt

Remote sensing
Complete serviceability
all components replaceable

5 year guarantee includes material and labor

 **LAMBDA ELECTRONICS CORP.**
A  Company

Lambda's Distributor Division maintains a total inventory of over 10,000 power supply units located in Los Angeles, Montreal and New York for 1-day delivery—5 year guarantee.

Write for complete Lambda Catalog!

Lambda Electronics Corp., 515 Broad Hollow Road, Melville, Long Island, New York 11746 • Tel. 516-694-4200

Circle 901 on reader service card

Design breakthrough in FM-IF systems: two new RCA IC's for more performance, with fewer components

Two new RCA Linear IC's now offer you a brand new approach to FM-IF system economy and performance. The CA3076 (high-gain IF amplifier/limiter) and the CA3075 (IF amplifier, limiter, FM detector, and audio preamplifier) have been designed to bring you an IF system with dramatic reductions in external components. And—to make the total economics of your system attractive—RCA has priced the CA3076 at \$1.60 (1,000-unit level) and the CA3075 at \$1.40 (1,000-unit level).

For your applications in communications receivers and high-fidelity equip-

ment, with FM IF's requiring bandwidths to 20 MHz, here are some highlights on these two new RCA types:

The CA3076 has an input limiting voltage (knee) of $50 \mu\text{V}$ (typ.) and 80 dB (typ.) gain with 2-kilohm load at 10.7 MHz. It contains an integral voltage regulator, for operation at power supply voltages from 6 V to 15 V.

The CA3075 limits with an input voltage of $250 \mu\text{V}$ (typ.) at 10.7 MHz. It has low harmonic distortion and excellent AM rejection—55 dB (typ.) at 10.7 MHz. Differential peak detection permits single-

coil tuning. The CA3075 incorporates an audio preamplifier with 21 dB (typ.) voltage gain, and an integral voltage regulator, for operation at power supply voltages from 8.5 V to 12.5 V.

For further information, see your local RCA Representative or your RCA Distributor, or write: RCA, Commercial Engineering, Section 701-28/C CA42, Harrison, N.J. 07029. International: RCA, 2-4 rue du Lièvre, 1227 Geneva, Switzerland, or P.O. Box 112, Hong Kong.

All components required for a typical IF strip are shown in this illustration.

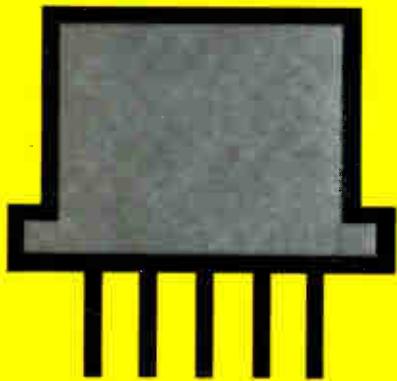
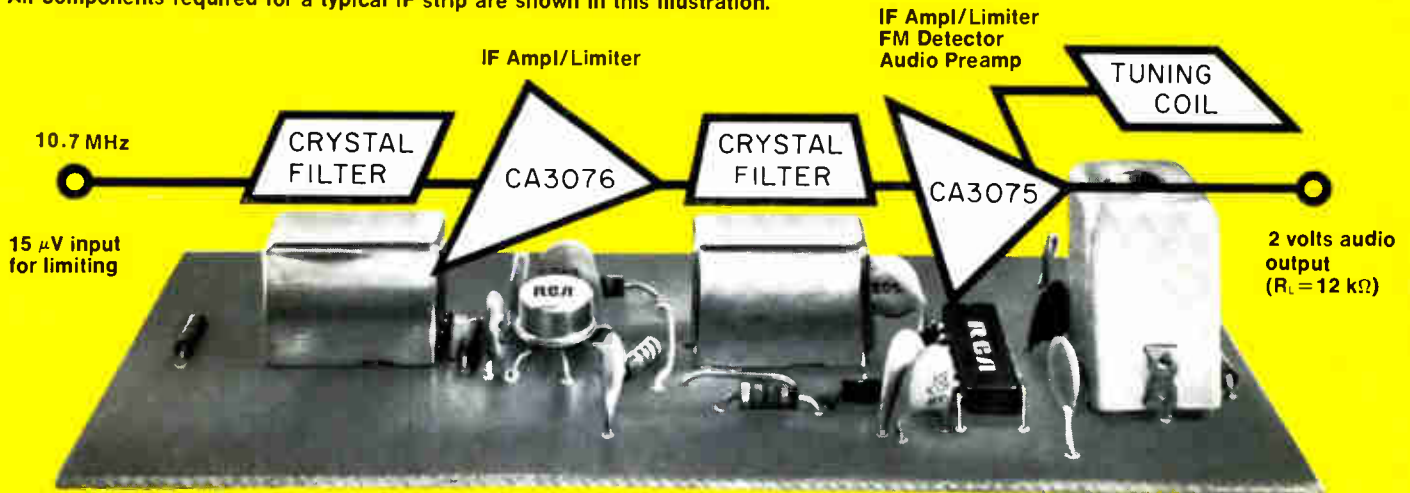

CA3076 IF ampl/limiter

Voltage gain: 80 dB (typ.) with $2\text{k}\Omega$ load
 Input limiting voltage: .. $50 \mu\text{V}$ (typ.)
 Freq. capability: Up to 20 MHz
 Package: 8-lead TO-5
 Price: \$1.60 (1000-unit level)

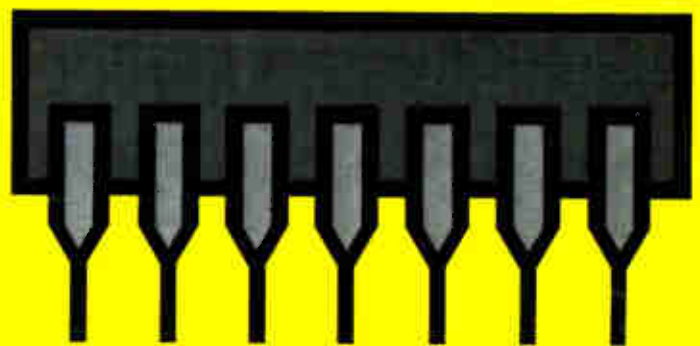

CA3075 IF ampl/limiter, peak detector, and audio preamp

Voltage gain (audio preamp): 21 dB (typ.)
 Input limiting voltage: $250 \mu\text{V}$ (typ.)
 Freq. capability: Up to 20 MHz
 Package: 14-lead DIP (formed leads)
 Price: \$1.40 (1000-unit level)