

Binary sequences aid system testing 82

Custom IC wins when it's multipurpose 88

Phase locking for integrated tuners 94

Electronics

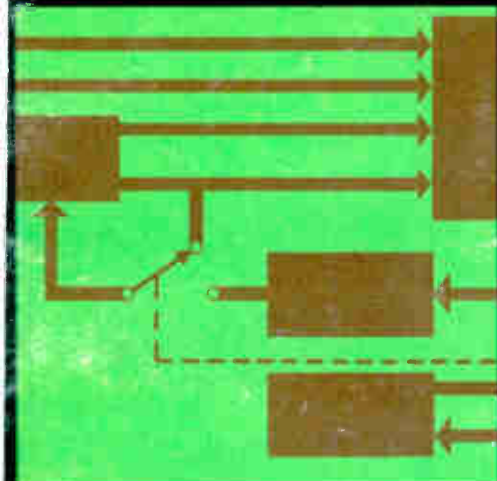
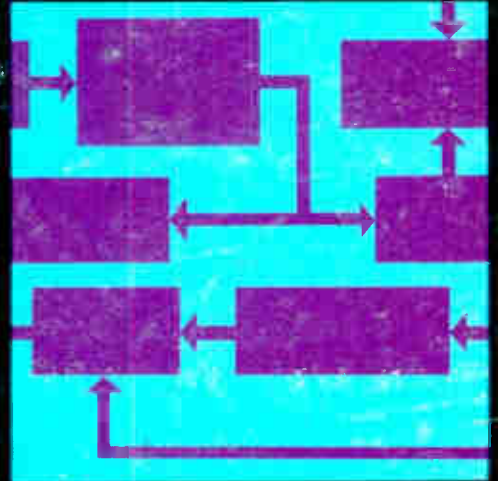

**Systems
engineering-
men, methods,
myths**

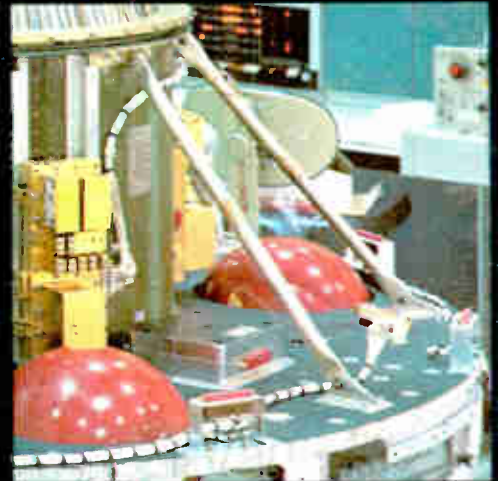

142 KSS956 44886 02-71
R KISSLER
BASIC COM ELEC
BOX 956
MOSES LAKE WA 98837

Inductors for all temperatures



UTC high Q coils give you better inductance stability over any temperature range

That's a tough claim to back up!

We do it by meticulously controlling every process variable that can affect temperature stability of an inductor. We pay special attention to every detail of design and manufacture—winding methods, materials compatibility, stabilization processes, assembly and impregnation—details other manufacturers ignore. Over any temperature range you specify, UTC inductors will outperform all others.

Available from our catalog are high Q inductors with guaranteed stability from -55°C to $+130^{\circ}\text{C}$. Adjusted inductance

tolerances are as tight as $\pm 1\%$ on standard inductors. Select from hundreds of inductors made to MIL-T-27B. If your specific need cannot be supplied, we'll tailor an item to your specifications.

When your designs call for better inductance stability, UTC is the answer. Check your local distributor for immediate off-the-shelf delivery or contact United Transformer Company, Division of TRW INC., 150 Varick Street, New York, New York 10013.

TRW
UNITED TRANSFORMER COMPANY

CROWBAR...?

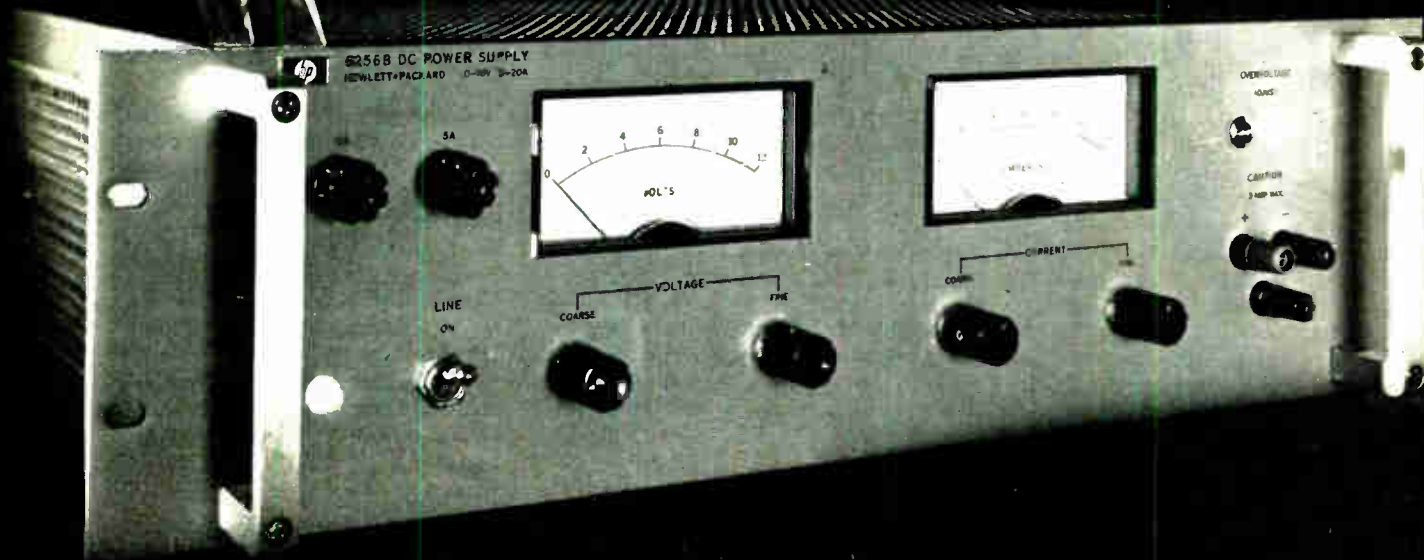

The One Inside is FREE

Not so many years ago, the prudent transmitter engineer discharged a high voltage capacitor bank by dropping a shorting "crowbar" across its terminals. Today's "crowbar" is a protective over-voltage circuit found on DC power supplies — usually at extra cost. Now HF includes a crowbar as standard on its recently updated series of low-voltage rack supplies . . . at no change in price.

Long established as preferred system supplies for component aging, production testing, and special applications, these supplies have now been redesigned and expanded to meet the stringent demands of today's power supply user. Advantages include low ripple (peak-to-peak as well as rms), well-regulated constant voltage/constant current DC with outputs to 60 volts and 100 amps.

Where loads are critical and expensive the extra pro-

tection — say, against inadvertent knob-twiddling — from a crowbar is invaluable. On all internal crowbars in this series, the trip voltage margin is set by screw-driver at the front-panel.

Pertinent specifications are: triggering margins are settable at 1V plus 7% of operating level; voltage ripple and noise is 200 μ V rms/10mV peak-to-peak (DC to 20 MHz); current ripple is 5 mA rms or less depending on output rating; voltage regulation is 0.01%; resolution, 0.25% or better; remote programming, RFI performance to MIL-I-6181D.

Prices start from \$350. For complete specifications and prices, contact your local HP Sales Office or write: Hewlett-Packard, New Jersey Division, 100 Locust Avenue, Berkeley Heights, New Jersey 07922 or call (201) 464-1234 . . . In Europe, 1217 Meyrin, Geneva.

HEWLETT  **PACKARD**
POWER SUPPLIES

Additional data sheets available upon request



LAB SERIES
smaller package,
lower power,
optional crowbar



CROWBARS
A Technical
Discussion



**1969 Power
Supply Catalog**
— includes total
HP power supply line.

Circle # for details 330

331

332

333

21902B

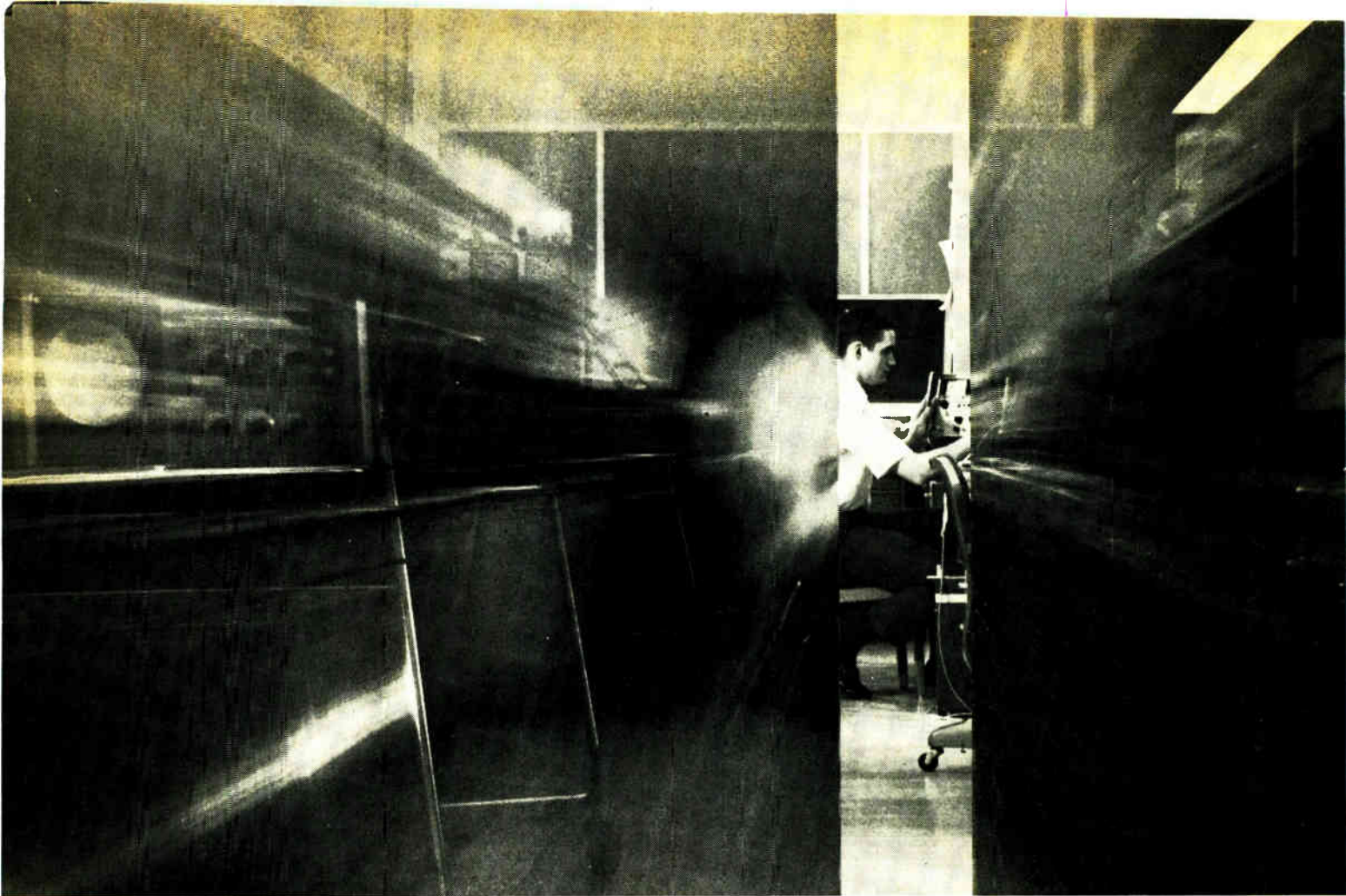

The Narrow Point-Of-View for Broad-Minded Engineers

When someone keeps telling you to be broad-minded and to get the "big-picture," aren't you often tempted to reply that sometimes a narrow point-of-view can be even more valuable? For example, one of the greatest race horses that ever lived, parlayed a narrow point-of-view into a fortune. By placing blinders on this horse, all extraneous objects were eliminated and he could concentrate on the immediate problem — the finish line and getting there first.

Hewlett-Packard has their own set of "blinders" for engineers who want to take a "narrow look" at individual signals over a wide range of frequencies. We call them wave analyzers.

Let's start with the HP 302A. When a very narrow point-of-view is required, a special 1 Hz bandpass is available. This bandpass, combined with a sensitivity of 3 μ V to 300 V,

is ideal for differentiating closely spaced signals with wide variations in amplitude. This wave analyzer can be battery operated and covers the frequency range of 20 Hz to 50 kHz. The price, \$1900.

Next in line is the HP 310A, a highly selective wave analyzer for the 1 kHz to 1.5 MHz range, 1 μ V to 100V. With selectable bandwidths of 200, 1000 and 3000 Hz, it is well suited for tape transport harmonic measurements, or frequency response and level measurements on carrier and radio systems up to 300 channels. Get direct readouts in volts or dB. All this capability for \$2500.

And finally, the HP 3590A — the most automated wave analyzer you can get today. Covering a frequency range of 20 Hz to 620 kHz with built-in autoranging and electronic sweeping, the HP 3590A almost operates

itself. With 85 dB dynamic range and 4 selectable bandwidths of 10, 100, 1000 and 3100 Hz you can separate closely spaced signals, characterize distortion, or analyze a frequency spectrum. With its plug-ins the HP 3590A runs from \$3280 to \$4800.

When a balanced input and selectable impedances are required, just add \$150 to the price of a 3590A and get the HP 3591A.

So, if the "big-picture" has become a big pain then it's time to quit "horsing-around" and call your local HP field engineer for more information. Or, write to Hewlett-Packard, Palo Alto, California 94304. Europe: 1217 Meyrin-Geneva, Switzerland.

HEWLETT  PACKARD

SIGNAL ANALYZERS

Electronics | April 28, 1969

News Features

Probing the News

- 103 **Integrated electronics:** Autonetics arrays its MOS forces
111 **Space electronics:** Intelsat catches its breath

U.S. Reports

- 39 **Memories:** Two stacked gates open way to nitride-oxide memory
40 **Lasers:** Gallium arsenide phosphide diodes pump c-w yag laser
Manufacturing: Cracks in aluminum interconnect strips on IC's
41 **Military:** IC's used in device to set artillery fuzes
42 **Microwave:** MERA fallout helps prove IC's can be used in microwave; Testing transmit-receive tubes in radar
46 **Government:** DOT plays budget games; NASA fund cuts
50 **Integrated electronics:** F-m telemetry transmitter uses all monolithic IC technologies
52 **For the record**

Electronics International

- 157 **Soviet Union:** Russians launch drive to sell components—including integrated circuits—at Paris Show
158 **France:** IBM's electronic exchange turns pushbutton telephones into computer terminals
158 **Great Britain:** Pixie makes graphics cheaper for computer-aided-design
159 **Japan:** Photodiode matrix is densest yet; simplified convergence board has only two magnets; 48-hour video tape unit records stills

New Products

- 119 **In the spotlight**
119 Display-terminal prices trimmed to fit into more schools, offices
125 **Components review**
125 Terminals form transistor sockets
129 **Instruments review**
129 Low-cost converter displays angles
133 **Production equipment review**
133 Yag laser puts out 200 watts c-w
135 Coating 4,000 capacitors an hour
139 **Semiconductor review**
139 Op amp gain is 50,000 at 3-20 volts
143 **Data handling review**
143 Diode circuit cuts memory's price

Title R registered U.S. Patent Office; © copyright 1969 by McGraw-Hill Inc. All rights reserved, including the right to reproduce the contents of this publication in whole or in part.

Technical Articles

- Systems engineering** 68 **What is a 'systems' approach? It's just the name of the game (cover)**
Though there's no consensus definition of systems engineering, this approach is characterized by total and continuous planning from start to finish
Raphael Kestenbaum, associate editor
- Circuit design** 77 **Designer's casebook**
▪ Pulse width varied by a "switched ground"
▪ Modified regulator yields variable d-c reference
▪ A negative-resistance circuit doubles V or I control
- Instrumentation** 82 **PRBS can fool the system**
Pseudo-random binary sequences offer a practical way to check a system's response to purely random inputs. Since they're, among other things, periodic and easily generated, such sequences are well-equipped to hoodwink systems
A.J. Martin, Solartron Electronic Group Ltd.
- Solid state** 88 **Single building block proves logical choice for custom IC's**
Multipurpose circuit for special-purpose systems provides features superior to those of off-the-shelf devices. As a result, testing requirements are greatly reduced, making custom circuits price reasonable in comparison with standard units
Donald K. Lauffer, National Cash Register Co.
- Integrated electronics** 94 **Phase locking: integrated tuned circuits made easy**
A 30-year-old idea—the phase-locked loop—has enabled Signetics engineers to build precisely tuned IC's, without precision components, for such applications as f-m radios and telemetry gear
Hans R. Camenzind and A.B. Grebene, Signetics Corp.
- ### Departments
- | | | | |
|----|--------------------------|--------------------------|------------------------|
| 4 | Readers Comment | 33 | Electronics Newsletter |
| 8 | Who's Who in this issue | 61 | Washington Newsletter |
| 14 | Who's Who in electronics | 146 | New Books |
| 22 | Meetings | 148 | Technical Abstracts |
| 31 | Editorial Comment | 152 | New Literature |
| | 155 | International Newsletter | |

Electronics

Editor-in-Chief: Donald Christiansen

Senior staff editors

Technical: Stephen E. Scrupski
News: Robert Henkel
International: Arthur Erikson

Managing editor: Harry R. Karp
Art director: Gerald Ferguson

Senior associate editor: Joseph Mittleman
Assistant managing editors: Eric Aiken, H. Thomas Maguire, Howard Wolff
Senior copy editor: James Chang

Department editors

Advanced technology: William Bucci, Richard Gundlach
Communications: John Drummond, Raphael Kestenbaum
Computers: Wallace B. Riley, George Weiss
Design theory: Joseph Mittleman
Instrumentation: Owen Doyle, Walter Barney
Military/Aerospace: Alfred Rosenblatt; William F. Arnold (Military); Paul Dickson (Aerospace)
New products: William P. O'Brien
Solid state: George Watson, Stephen Wm. Fields

Domestic bureaus

Boston: James Brinton, manager; Gail Farrell
Chicago: Frederick Corey, manager
Los Angeles: Lawrence Curran, manager
San Francisco: Walter Barney, manager; Peter Vogel
Washington: Robert Skole, manager; Paul Dickson, William F. Arnold

Foreign bureaus

Bonn: John Gosch
London: Michael Payne
Tokyo: Charles Cohen

Copy editor: Edward Flinn
Staff writer: Peter Schuyten

Assistant art director: Kenneth L. Dix
Production editors: Susan Hurlburt, Arthur C. Miller

Editorial research: Anne Mustain

Editorial secretaries: Lorraine Longo, Claire Goodlin, Barbara Razulis, Vickie Green, Bernice Pawlak

McGraw-Hill News Service

Director: Arthur L. Moore; Atlanta: Fran Ridgway; Chicago: Robert E. Lee
Cleveland: Arthur Zimmerman; Dallas: Marvin Reid
Detroit: James Wargo; Houston: Barbara LaRoux
Los Angeles: Michael Murphy; Pittsburgh: Louis Gomolak
San Francisco: Margaret Drossel
Seattle: Ray Bloomberg; Washington: Charles Gardner, Daniel B. Moskowitz, Herbert W. Cheshire, Seth Payne, Warren Burkett, William Small, William D. Hickman

McGraw-Hill World News Service

Bonn: Robert Dorang; Brussels: James Smith; Hong Kong: Wes Perry;
London: John Shinn; Mexico City: Gerald Parkinson; Milan: Ronald Taggiasco, Jack Star;
Moscow: Jack Winkler; Paris: Robert E. Farrell, Stewart Toy
Rio de Janeiro: Leslie Warren; Tokyo: Marvin Petal

Reprints: Gail Niles
Circulation: Isaaca Siegel

Publisher: Gordon Jones

Assistant to the publisher: Wallace C. Carmichael

Electronics: April 28, 1969, Vol. 42, No. 9

Published every other Monday by McGraw-Hill, Inc. Founder: James H. McGraw 1860-1948.
Publication office 99 North Broadway, Albany, N. Y. 12202; second class postage paid at Albany, N. Y.

Executive, editorial, circulation and advertising addresses: McGraw-Hill Building, 330 W. 42nd Street
New York, N. Y. 10036. Telephone (212) 971-3333. Teletype TWX N.Y. 710-581-4235. Cable address:
MCGRAWHILL N.Y.

Subscriptions solicited only from those professionally engaged in electronics technology. Subscription rates:
qualified subscribers in the United States and possessions and Canada, \$8.00 one year, \$12.00 two years,
\$16.00 three years; all other countries \$25.00 one year. Non-qualified subscribers in the U.S. and
possessions and Canada, \$25.00 one year; all other countries \$50.00. Air freight service to Japan \$50.00
one year. Single copies: United States and possessions and Canada, \$1.00; all other countries, \$1.75.

Officers of McGraw-Hill Publications Company: Joseph H. Allen, President; John R. Emery, J. Elton Tuohig,
Senior Vice Presidents; Gordon L. Jones, Jr., Group Vice President; Vice Presidents: John R. Callahan, Editorial;
Paul F. Cowie, Circulation; John M. Holden, Marketing; David G. Jensen, Manufacturing;
Jerome D. Luntz, Planning & Development; Robert F. Marshall, Administration; Robert M. Wilhelmy, Finance.

Officers of the Corporation: Shelton Fisher, President and Chief Executive Officer; John L. McGraw, Chairman;
Robert E. Slaughter, Executive Vice President; Daniel F. Crowley, Donald C. McGraw, Jr., Bayard E. Sawyer, Senior
Vice Presidents; John J. Cooke, Vice President & Secretary; Gordon W. McKinley, Vice President & Treasurer.

Title ® registered in U.S. Patent Office; © Copyright 1969 by McGraw-Hill, Inc. All rights reserved. The contents
of this publication may not be reproduced either in whole or in part without the consent of copyright owner.

Subscribers: The publisher, upon written request to our New York office from any subscriber,
agrees to refund that part of the subscription price applying to copies not yet mailed.
Please send change of address notices or complaints to Fulfillment Manager; subscription
orders to Circulation Manager, Electronics at address below. Change of address notices
should provide old as well as new address, including postal zip code number. If possible,
attach address label from recent issue. Allow one month for change to become effective.

Postmaster: Please send form 3579 to Fulfillment Manager, Electronics,
P.O. Box 430, Hightstown, New Jersey 08520

Readers Comment

A bit premature

To the Editor:

In your newsletter item predicting that Japanese picture-tube firms will wind up with the British market for 19-inch color tv tubes [March 3, p. 248], you make the statement that "the three U.K. tube producers apparently will phase out 19-inch production."

I am naturally unable to speak for the other U.K. producers, but my company has no plans—immediate or in the foreseeable future—to cease its production of 19-inch color tubes.

C.C. McCallum

Director and general manager
Thorn-AEI Radio Valves
& Tubes Ltd.
London

Bad jump

To the Editor:

There's a minor error in the circuit diagram accompanying the Designer's Casebook article entitled "High accuracy obtained from peak detector using op amp" [March 17, p. 94]. The jumper wire should be removed from the 20-kilohm potentiometer used for zeroing the output.

C.A. Farel

International Business
Machines Corp.
Boulder, Colo.

Not so fast!

To the Editor:

I have just finished reading your article on Pastoriza Electronics' release of the FAD-10 analog-to-digital converter [Jan. 6, p. 199]. Pastoriza is to be commended for demonstrating an ability to push the successive-approximation state of the art to speeds representing the lower limits of the cyclic technique.

In entering the realm of high-speed conversion, the author of that article has correctly chosen the proper standards by comparing successive approximation with the cyclic technique. Unfortunately, his

**The industry's tiniest 5 watt zener...
has double
the
surge capacity
of an
ordinary
10 watt...**

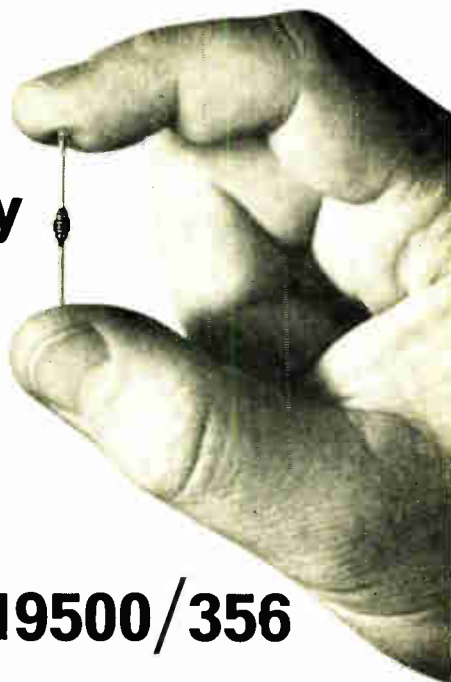

and now meets MIL-S-19500/356

**Unitrode's tough JAN Type 1N4954 Series
has fused-in-glass reliability,
voltage ratings from 6.8 to 400V,
and is available from stock**

- Surge capacities to 10,000 watts — 1 microsecond
- Surge current capability up to 40 Amps
- Sharp knees, voidless glass construction
- Price competitive to conventional 10 watt zeners
- Solves MIL-STD 704 surge problems
- No plastics, epoxies, silicones, oxides, gases or solders are used.
- ... and TX soon to come

580 Pleasant Street, Watertown, Mass. 02172 (617) 926-0404

UNITRODE



**TOUGH AS ALL GET-OUT
FROM THE INSIDE OUT**

With the silicon die metallurgically bonded between terminal pins of the same thermal coefficient, the hard glass sleeve is fused to the entire outer silicon surface. Result — a voidless, monolithic structure.

HARD GLASS FUSED TO SILICON SURFACE



TERMINAL PINS METALLURGICALLY BONDED DIRECTLY TO SILICON



For fast action call Fred Swymer COLLECT at (617) 926-0404
Or if you're not in that big a hurry, check off the reply card
and get our new complete diode catalog C-107.



What can you expect from a **\$395** pulse generator?

- 0.2-Hz to 20-MHz PRF
- 25-ns to 2.5-s duration
- 5-ns rise/fall time
- ± 10 -volt outputs across 50Ω
- ± 1 -volt DC offset
- Independent control of amplitudes and offsets for + and - pulses
- Square-wave output
- Amplitude fully analog-programmable
- Period and duration modulatable

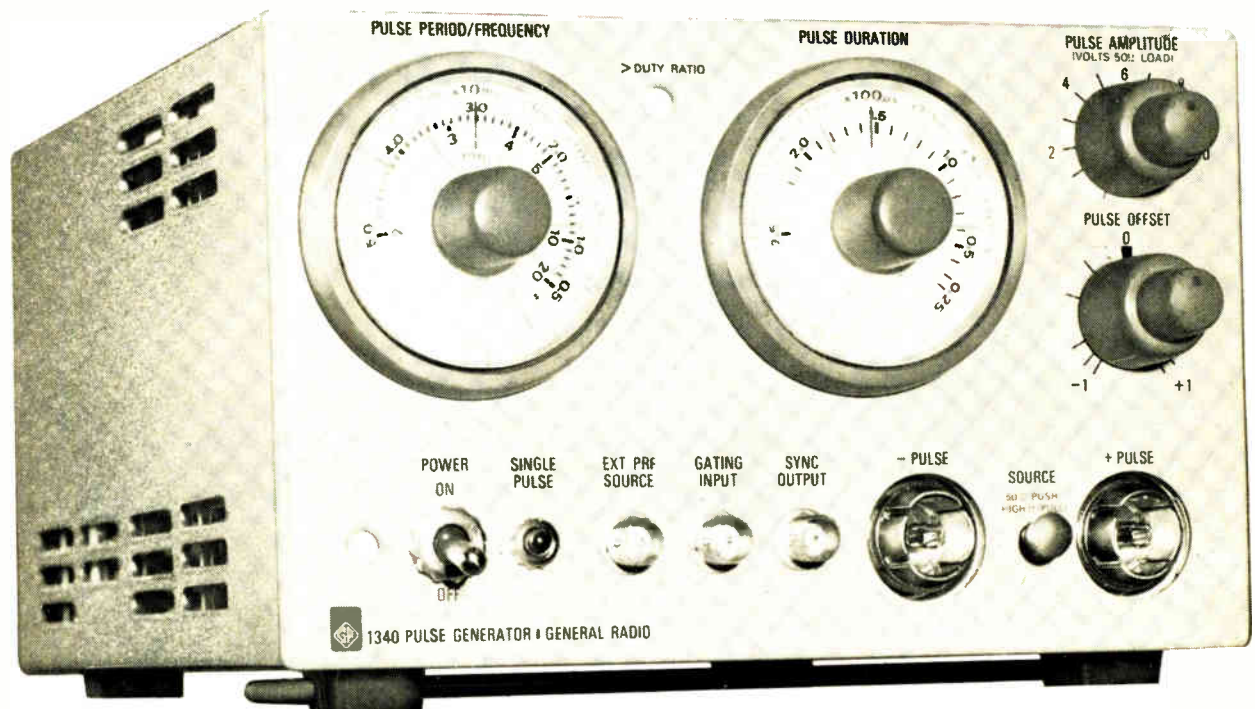

You get all these features and more in the NEW 1340 Pulse Generator. For more information call your nearest GR District Office, or write General Radio, West Concord, Mass. 01781. Telephone (617) 646-0550. In Europe Postfach 124, CH 8034 Zurich 34, Switzerland.

GENERAL RADIO

Readers Comment

comparisons are highly inaccurate and indicate a lack of understanding of the cyclic technique. For example, the cyclic technique is ideal for following multiplexers because most of the conversion is done during the multiplexer's settling time.

C.B. McKee Jr.

Bunker-Ramo Corp.
Canoga Park, Calif.

Sub holdup

To the Editor:

A recent story in your Washington Newsletter section states that informal sources have attributed a delay in the commissioning of the nuclear attack submarine Narwhal to troubles with Western Electric's AN/BQQ sonar classification set [Feb. 17, p. 72].

However, responsible Navy representatives have assured us that they are unaware of any problems with this equipment and that certainly the equipment has not been the cause of any delays in the Narwhal schedule.

H.E. Marrows

Western Electric Co.
New York, N.Y.

Editorial slant

To the Editor:

Concerning your very interesting article on electronics as applied to the automobile industry, "Detroit puts electronics in the driver's seat" [March 17, p. 84], you mention the

transistor-ignition and capacitive-discharge systems on page 94, but you do not give your own opinion for or against either one, other than to cite the counterclaims made by the Ford Motor Co. and the General Motors Corp. for their respective systems.

We would be very interested in hearing your own opinion on this subject of electronic ignition and the relative merits of the transistor-ignition and capacitive-discharge techniques.

T.H. Rolf von den Baume
Honeywell Controls Ltd.
Bowmanville, Ontario
Canada

Route guidance

To the Editor:

The March 17th cover story, "Detroit puts electronics in the driver's seat," sums up the situation in the automobile industry quite accurately. The voltage regulator is a good example of the engineering required to meet automotive demands.

However, the work on GM's Experimental Route Guidance System (ERCS) could have been tied in with urban traffic control, which we believe may be a much more important aspect of the whole program.

Edward F. Weller

Electronics and Instrumentation
Department
Research Laboratories
General Motors Corp.
Warren, Mich.

Applications Power*



PUTTING CURRENT-LIMITER DIODES TO WORK

PROBLEM: How to provide a *low noise* voltage reference with only two components?

SOLUTION: A Siliconix CL diode in series with a resistor.

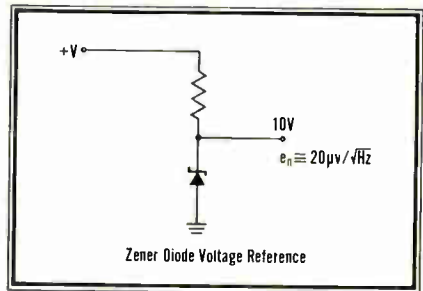

The zener diode voltage reference circuit has a typical noise voltage of $20 \mu\text{V}/\sqrt{\text{Hz}}$.

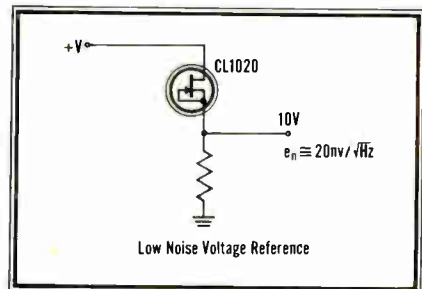

This CL diode circuit results in a 60 dB reduction in noise voltage—from $20 \mu\text{V}/\sqrt{\text{Hz}}$ to $20 \text{ nV}/\sqrt{\text{Hz}}$ at 100 Hz.

For further information and immediate applications assistance, call the number below. Ask for extension 19.

Siliconix
incorporated

1140 W. Evelyn Ave. • Sunnyvale, CA 94086
Phone (408) 245-1000 • TWX: 910-339-9216

* Applications power . . . a broad product line, an in-depth applications team at your service!

SUBSCRIPTION SERVICE

Please include an Electronics Magazine address label to insure prompt service whenever you write us about your subscription.

Mail to: Fulfillment Manager
Electronics
P.O. Box 430
Hightstown, N.J. 08520

To subscribe mail this form with your payment and check new subscription renew my present subscription

Subscription rates: qualified subscribers in the U.S.: 1 year \$8; two years, \$12; three years, \$16. Non-qualified: 1 year \$25. Subscription rates for foreign countries available on request.

CHANGE OF ADDRESS

ATTACH LABEL HERE

If you are moving, please let us know five weeks before changing your address. Place magazine address label here, print your new address below.

name _____

address _____

city _____

state _____

zip code _____



Model 79 Linear IC Tester

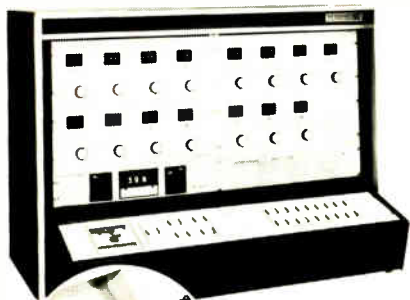

*New
automatic
Linear IC Tester
offers versatility
at low cost*

The wide range of automatic testing capabilities and low cost of the new Model 79 Linear IC (LIC) Tester from Test Equipment Corporation make it ideally suited for production, engineering and quality control applications.

TEC's Model 79 "LIC" Tester is completely automatic with the exception of test limits and range selections and is pre-programmed on performance boards (inset photo above) for up to 15 different test measurements. It provides five dc and eight dynamic tests. In addition, two auxiliary positions are available for customer-specified tests.

The Model 79 also features voltage/current crossover power supplies capable of 100 v/100 ma operation. The tester is capable of low current measurements to 999 pa full scale, low voltage measurements to 99.9 μ v full scale, and test time typically 100 ms or less per test. It accepts all IC package configurations.

Write today for full technical and pricing information on the new TEC Model 79 "LIC" Tester.

Test Equipment
CORPORATION
P.O. BOX 20215, DALLAS, TEXAS 75220 • 214/357-6271

Who's Who in this issue

Circuitry has been the professional preoccupation of Donald K. Lauffer since joining National Cash Register in 1961. Author of the article on a multipurpose building block for custom integrated circuits [p. 88], he has done advanced design work on a number of NCR computer and data processing projects, including the 315-100, Cram, and the Century series. Lauffer heads the micro-circuits design section at the company's Hawthorne, Calif., facility.

Lauffer earned both bachelor's and master's degrees from the University of California at Los Angeles. He teaches courses on IC design, fabrication, and application principles at his alma mater and at companies in the area.



Lauffer



Grebene

Born in Turkey 30 years ago, Alan B. Grebene, co-author of the article on phase-locked integrated circuitry beginning on page 94, took his advanced degrees in the U.S. after earning a bachelor's at Robert College in Istanbul in 1961. He holds a Ph.D. from Rensselaer Polytechnic Institute and an M.S. from the University of California at Berkeley. Currently, Grebene heads the linear circuits research section at Signetics where he concentrates on the design and development of assemblies for communications applications. He holds several U.S. patents on solid state devices and IC's.

A onetime designer of weapons control systems, A.J. (Tony) Martin, author of the article on pseudo-random binary sequences starting on page 82, is now a sales manager with England's Solartron Electronic Group Ltd. In this capacity, he brokers inputs and outputs among his company's engineers and customers, specializing in applications of test equipment.

Tony was a senior research fellow at the College of Aeronautics in Cranfield, England; he also spent a year at the University of Michigan studying applications for analog computers.



Martin

...having problems with your shielded room?

Investigate **SPRAGUE** **ALL-WELDED** **SHIELDED ENCLOSURES**



(Official United States Navy photograph)

INFORMATION RETRIEVAL NO. 516

These extended-range enclosures comply with requirements of MIL-E-4957A and MIL-STD-285, and provide exceptional magnetic field attenuation. Special welding techniques developed by Sprague Filter Division engineers eliminate performance degradation with time. Hydraulic door assemblies, a state of the art development, provide the highest shielding characteristics in the industry. Enclosures may be furnished complete with wiring, lights, breakers, line filters, etc. They are also available as basic rooms, permitting users to furnish them in accordance with their own particular needs. Sprague Filter Division engineers stand ready to help you with your shielding problems.

4SF-9123

...need reliable heavy-duty filters?

Specify **SPRAGUE** **POWER LINE** **FILTERS**

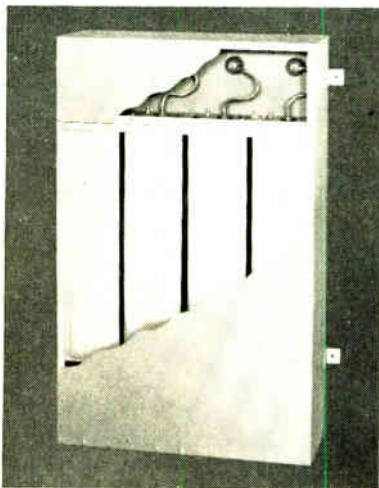

INFORMATION RETRIEVAL NO. 517

Developed to meet industrial and military needs for high-current, high-performance filters, Series JX614 Heavy-Duty Power Line Filters provide greater than 100 db attenuation at 14 KHz through 10 GHz (to 20 MHz when tested at full-rated a-c or equivalent peak d-c current). In addition, the performance of these filters will not vary at any load current within their design limits.

The result of an intensive design program by Sprague Filter Division engineers, Series JX614 Filters have successfully passed the applicable requirements of MIL-F-15733. These units are rated at 250 VAC - 60 Hz, and are available in single- or multi-circuit configurations at current ratings from 50 through 200 amperes. Heavy steel cases, all-welded construction, and flame-retardant standoff insulators assure dependability and long life.

4SF-9111

For complete technical data, write for Engineering Bulletin 8951 on shielded enclosures, or Engineering Bulletin 8410 on power line filters, to: Filter Division, Sprague Electric Co., P.O. Box 39, Annapolis Junction, Md. 20701.



'Sprague' and '®' are registered trademarks of the Sprague Electric Co.

THE BROAD-LINE PRODUCER OF ELECTRONIC PARTS

New
Cherry
Solid Gold
"Crosspoint"
contact switch



...engineered for enhanced reliability

Positive Switching of Low Energy Solid State Circuits

Whether you're designing for data processing or instruments, office machines or numerically-controlled machine tools, low energy solid state switching presents a difficult problem.

Now you can solve the solid state interfacing problem with a new Gold "Crosspoint" Contact snap-action switch from Cherry.

1. Provide high force per unit of contact area and . . .
2. Virtually eliminate contact closure interference from foreign particles. (Crossed knife edge configuration reduces potential contamination area to 1% of conventional $\frac{1}{8}$ " diameter contacts.)

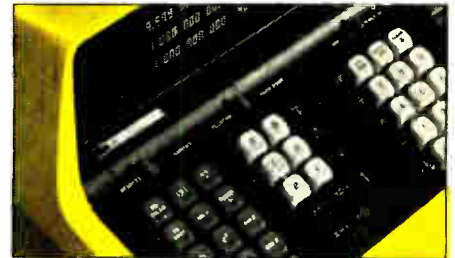

The Hewlett Packard programmable electronic calculator shown above represents the latest, most advanced design in desk top units. Each of the €3 keys in the model 9100A keyboard uses a Cherry Gold "Crosspoint" contact switch to operate arithmetic, logarithmic, trigonometric, hyperbolic, coordinate transfer and many other functions.

Solid State Compatibility has been applied to four basic Cherry switches: E21 enclosed miniature; E63 sub-miniature; E53 low torque, and S31 open type miniature.

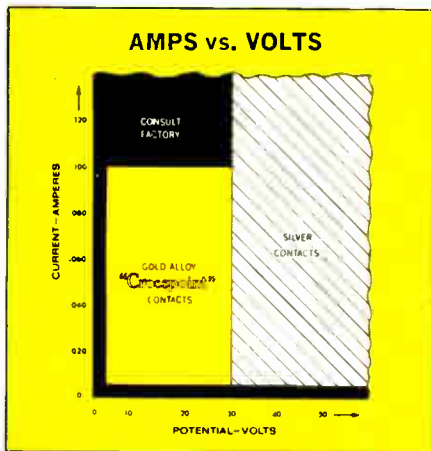

Cherry Gold "Crosspoint" Contact Innovation helps prevent two main causes of contact failure:

- Formation of insulating chemical films on contact surfaces and . . .
- Mechanical interference of foreign particles on contact surfaces.



A Proven Design Concept—The new Gold "Crosspoint" Contact innovation (two prisms at right angles to each other) will:

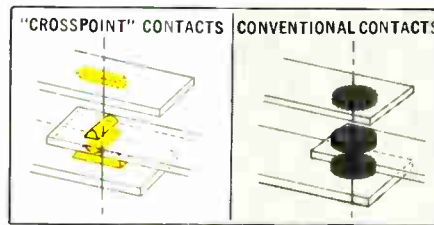

Precious Gold Contact Material

The solid layer of gold alloy used in the new Cherry switches provides interfaces inert to chemical action. This is a required control to obtain and maintain low contact resistance. Initial insertion resistance is typically below 50 milliohms.

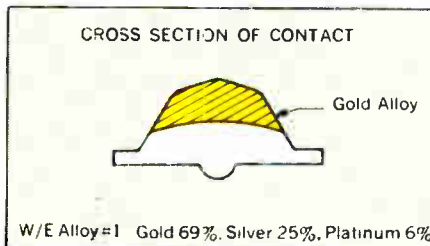

Long Life

Lifetime of the Gold "Crosspoint" contact switches is measured in millions of operations. This performance has been achieved by combining these unique contacts with dependable Cherry coil spring snap-action design. The low stress coil spring mechanism has been proven in more than 100 million applications.

Increase Your Design Latitude with this new approach to switching low level circuits.

FREE SAMPLE SWITCH
Write for a free sample of one of the four Gold "Crosspoint" Contact switch types. We'll send the switch of your choice for evaluation and testing.

FOR IMMEDIATE ACTION
Telephone (312) 831-5023



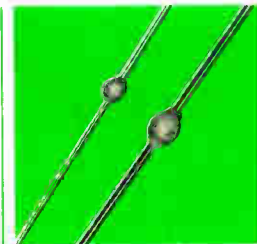
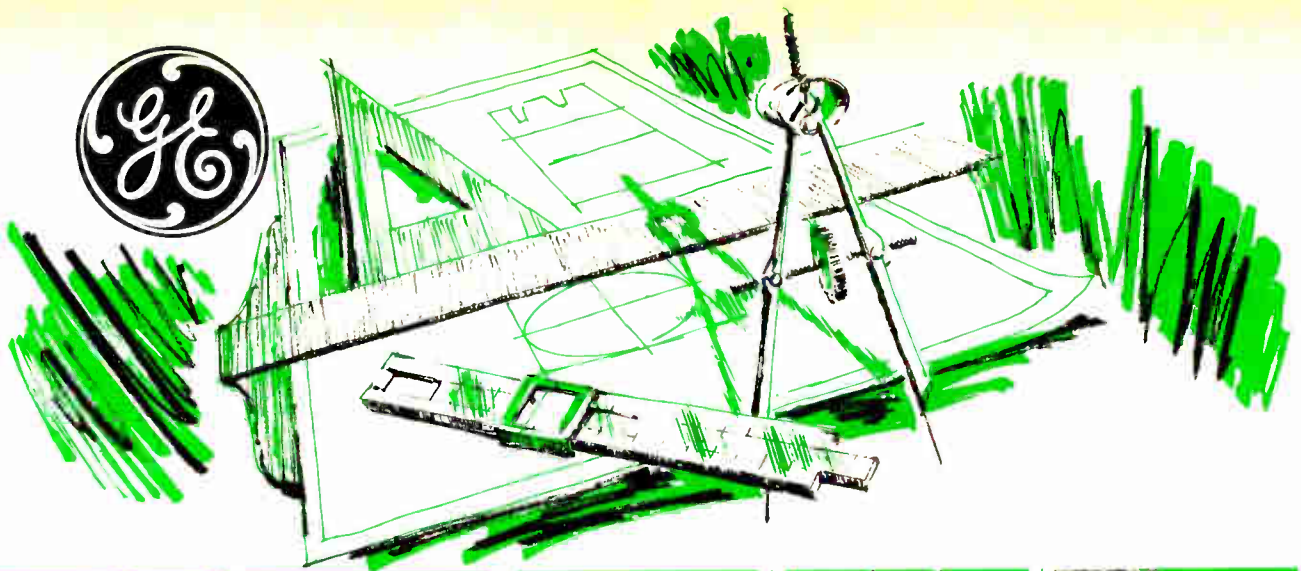

GE's 3 amp hermetic A15 replaces costlier A14 rectifier diodes

GE offers a higher rated companion to its field-proved, 1 amp A14 rectifier at a significantly lower cost than stud or other lead mounted units (depending upon configuration). The A15 is rated 3 amps at 70 C and the 200 to 800 volt models are transient voltage protected up to 1000 watts for 20 μ S in reverse direction.

A15's dual heat sink design means low thermal impedance and easy adaptation to PC board mounting . . . reduced installation cost.

Both the A15 and A14 are hermetically sealed in an all-diffused, glass passivated junction structure. No internal cavity means more resistance to environmental stresses . . . thus increased reliability.

High-power A15 is now available through GE distributors in quantities up to 9999 for applications including time delay circuits, battery chargers, TV damper diodes, communication equipment and small portable appliances. Circle number 505.



Select your instruments from industry's most complete line

● **Panel meters.** Measure a-c, d-c volts and amps. 1½ to 4½-inch sizes in THE BIG LOOK® style. 2½ to 4½-inch sizes in HORIZON LINE® style.

● **Meter relays and pyrometers.** Indicate, monitor and control temperature or other variables directly or with transducers. BIG LOOK and HORIZON LINE style. 2½ to 4½-inch sizes. "Piggy-back" control module.

● **Edgewise meters.** Measure a-c and d-c volts and amps. Miniature type 185, 2¼ inch or large type 180, 6-inch. Both can be multi-stacked vertically or horizontally. Standard accuracy of 2%, 1% optional.

● **Switchboard instruments.** Measure volts, amps, speed, vars, power factor, frequency, phase angle, other variables. 4½ and 8½-inch sizes. Standard one percent accuracy. For full line information, circle 506.



Reduce redesign cycles with reliable GE microwave circuit modules

GE microwave circuit modules (MCM) help reduce design cycles, provide retrofit and lead to improved system performance by optimum integration of active devices. And lower system cost results from circuit simplicity, easy application and longer life.

These rugged GE devices are built to deliver reliable performance in adverse environments of shock, vibration, high altitude and extreme temperatures. MCM's may be designed for use as oscillators, amplifiers, integrated isolators and circulators.

General Electric microwave modules encompass all planar triode and diode uses—from DC to X-band, from milliwatts to kilowatts. For details, circle number 507.



GE wet slug capacitors . . . highest efficiency in half the size

GE 69F900 wet slugs meet high-density application needs with highest volumetric efficiency of any capacitor. We halved the military (CL64) wet slug size, and essentially kept its electrical and performance traits.

The 69F900 has excellent capacitance retention at low temps . . . can be stored to -65 C. Operating range is -55 C to +85 C. It's tough too—withstands vibration to 2000Hz; 15G acceleration!

GE's capacitor is fully insulated; has low, stable leakage current. Ratings are available from 6 to 60 volts; capacitance ranges from 0.5 to 450 μ F. For more information, circle magazine reader card number 508.



New 36 point one-piece Terminal Boards

General Electric has stretched its reliable line of one-piece terminal boards to 36 contact points. And they are available in eight configurations of solder, screw and quick-connect points.

The new expanded line of CR151, Type D1 or D7, is rated 15 amperes with breakdown voltage of 3600. Of course, other designs are still available in ratings up to 30 amperes and breakdown voltage to 7500.

No insulation is required between board and panel because the molded plastic base already provides the protection. Marking strips or stamped markings can be provided on top and/or bottom.

The expanded D1 and D7 boards add just another dimension to what is already the broadest terminal board line on the market. For more information, circle reader card number 509.

10 more

electronic components tailored for designers

General Electric components are engineered for reliability and cost effectiveness. No other single manufacturer offers such a wide selection of quality electronic components as General Electric. Specify GE in your designs.

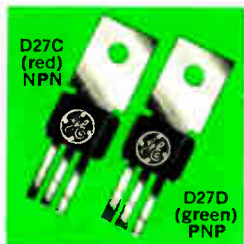

Complementary power transistors—up to 20W in audio applications

Complementary D27C/D27D silicon-encapsulated, planar, epitaxial power transistors have low collector saturation voltages and offer a dissipation of 8W total power with tab at 70 C. Their 0.5" leads can be formed to fit TO-66 and TO-5 configurations.

Key Characteristics

Collector current
3 amps (continuous)
5 amps (peak)
Collector saturation voltage
D27C: 0.5V typ., 3.0A
D27D: 1.0V typ., 3.0A
Collector-to-emitter voltage
30 and 40 volts
Total power dissipation (with tab)
1.7W (free air at 50 C)
2.1W (free air at 25 C)
8.0W (tab at 70 C)
Forward current transfer ratio
120 max., 200 mA
Gain band width product
D27C: 50MHz typ.
D27D: 40MHz

Their small size and power handling capability offer a great variety of applications including drivers, voltage regulators, power switching, audio output for automobile or phono stereo, TV, radio. And they are color coded for identification. Circle number 510.



Designing a radar? New GE 4-cell tetrode improves bandwidth 300%

Up go electronic bandwidths with GE's unique ZP-1081 "multi-cell" tetrode, a compact, air-cooled transmitting tube that incorporates four high-performance tetrode units in a single vacuum envelope. This innovative leads to very high transconductance and significantly low output capacitance, to provide high gain-bandwidth in amplifier circuits.

Electronic bandwidth of about 120 MHz has been demonstrated under RF power amplifier operation at 475 MHz. Related typical performances includes 70 KW of useful peak power output with a peak drive power of 15KW.

Output efficiency is close to 40%, and low operating voltages are used under RF grid-pulsed amplifier service. Bandwidth achieved is on the order of 200-300% of that available from previous tetrodes and associated circuitry operating at comparable power and frequency. For more information, circle number 511.

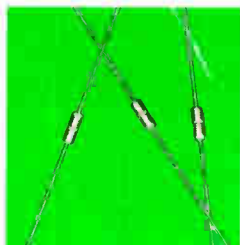

GE's Economy Pack... proved thermistors at budget prices

Growing uses of printed circuit boards in new applications have demanded hermetically sealed temperature compensation units at lower cost. And in response to this need, GE has put its proven 1H-Series (negative temperature Coefficient) Thermistors in a new Economy Package.

As low as 16¢ each in OEM quantities, these high-quality units are available in 5%, 10%, 20% and 30% tolerances with Zero-Power Resistance Values from 18K to 56K ohms at 25 C.

1.125 inch gold-plated Dumet leads may be welded or soldered... ideal for PCB designs.

Proved quality at lower cost makes GE thermistors the answer to your PCB needs. For more facts on the GE Economy Package, circle number 512.

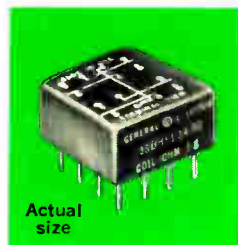

Smallest 4-pole relay available anywhere... GE's 150 grid

The General Electric 150 grid sealed relay is now a better buy than ever. It's the smallest available. And three years of application experience rank it with the most reliable GE sealed relays ever designed.

Low in price, it is even less than GE's standard 4-pole relay which is 4 times larger.

It meets Mil Spec 5757E, rated 2 amps, 250 MW sensitivity, and has all welded construction. Ask for the best 4-pole sealed relay buy on the market—GE's Type 3-SBH 150 grid.

Circle number 513 for more information.



Instant response for driving computer peripherals

When your equipment calls for instant response—inertial time constants low as 1 millisecond—look to GE's new Hyper-Servo* motor. It can accelerate faster than any previous GE design.

The Hyper-Servo motor makes possible new performance capacity in motor-driven peripheral data processing equipment. It is available in 3.4-, 4.6-, 4.8- and 4.9-inch diameters. And look at these performances: torque-to-inertia ratios in excess of 350,000 rad/sec² and; cont torque ratings from 32 oz-in at 2700 rpm to 326 oz-in at 2800 rpm.

These and other high performance characteristics make the Hyper-Servo motor adaptable to nearly every computer peripheral drive application. Circle magazine inquiry card number 514.

* Trademark of the General Electric Company.

Look to General Electric—your best source for more in electronic components.

ELECTRONIC COMPONENTS SALES OPERATION

GENERAL  ELECTRIC

285-47

STABISTOR DIODES & MODULES

for low voltage
regulating circuits.

Burns & Towne specializes in providing stabistors to exacting customer requirements. Single and multi-chip components and modules are ideally suited for:

- Meter Protectors
- Logarithmic Attenuators
- Signal Limiters
- Temperature Sensors
- Transistor Biasing
- Voltage Stabilizers

SILICON STABISTORS

Type No.	Forward Voltage Drop @ 1 ma (V)
SS-10	0.55 ± 10%
SS-20	0.65 ± 10%
SS-30	0.75 ± 10%
SS-40	0.80 ± 10%
	@ 25 ma

GERMANIUM STABISTORS

Type No.	Forward Voltage Drop (V)
GS-10	@ .250 ± 10% @ 1 ma
GS-20	@ .350 ± 10% @ 1 ma
GS-30	@ .350 ± 10% @ 1 ma

Standard modules from the shelf for excellent delivery. Other modules designed to non-standard specs to provide more flexibility at lower cost.

Modules feature:

- Linear IC input over-voltage protection.
- Linear IC latch-up protection.

STABISTOR MODULES

Type No.	Forward Voltage Drop @ 1 ma (min.)	(max.)
SM-10*	1.21	1.41
SM-20	1.0	± 10%
SM-30*	1.85	2.05
SM-40	2.0	± 10%



BURNS & TOWNE INC.

Haverhill, Mass 01830. Tel (617) 373-1333

Who's Who in electronics



Town

After a decade as vice president and engineering director of National Educational Television (NET), Howard W. Town has been named manager of product planning at the Ampex Corp.'s Video Products division. Town's appointment appears to reflect a belief at Ampex that educational television is assuming an increasingly important role in communications.

"Books," says Town, "can no longer do the job; we have a new tool to be used in the dissemination of information." That tool, of course, is instructional television. "Don't you really prefer seeing a good documentary on television than wading through piles of books?" he asks. Town concedes that the scholar may spurn such shortcuts, but he holds that the average person with little time to spare will benefit from the capsule histories and news summaries possible with video tapes.

Still, Town is aware that tv tapes could wreak the same havoc upon public information that book condensations have upon literature: provide the outline, but miss the particulars, the style, and the subtle interpretations. In such a capsulized and encapsulated culture, says Town, a great deal of responsibility lies with the individuals who decide which tapes or films will be broadcast and which point of view will be stressed.

Ready. Town's experience with NET has well prepared him, he says, to adapt an industry to the

growing needs of the instructional television market. "Naturally," he says, "the electronics for commercial and instructional television are the same." Among the differences is the availability of trained operating personnel in the commercial market and the shortage among colleges and universities. Moreover, educational institutions can't pay the costs of expensive, trained operators. The result, he says, is that as the instructional market grows, Ampex must seek ease of equipment operation with automation as the long-range objective. Cost is another factor which will determine how readily schools adopt video tape instruction. But Town hopes that as the volume of equipment increases, the cost of the equipment will decrease.

Town, who started his electronics career counting resistors in the basement of one of RCA's subsidiaries, says that Ampex has started a complete revamping of its product line; facility of operation will be one of the most important criteria. Ampex, he says, will continue to grow by acquisition until the company covers the entire spectrum of television broadcasting equipment; recent acquisitions have given the company an antenna and a transmission-line capability.

"The move to Houston? It wasn't so much the move that made me want to leave Texas Instruments," says L.J. Sevin; "It was the idea that if I'm ever going to amount to anything, I'll have to do it on my own. Fred Bucy is about my age [Bucy, TI's group vice president in charge of semiconductor operations and the heir apparent to the company presidency, is 39, while Sevin is 38], and Mark Shepherd and Pat Haggerty are young men, so if I'm going to be president or vice president of anything, it won't be TI. The shift to Houston more or less just triggered my decision."

Sevin was engineering manager of TI's metal oxide semiconductor operations until shortly after the company decided to move those

If all systems aren't "GO"
after the computer's moved,
you know who's going to hear about it.



If you'd just as soon skip a spicy conversation with the Data & Systems people, have a quiet one with Allied instead.

Allied Van Lines has highly-trained professionals who know just how to move your electronics equipment—safely and on schedule.

And our Electronic Vans are just as good as our personnel. They have a special bracing that keeps your computer from shifting . . . an air suspension system that soaks up jolts and bumps along the way.

Call the highly-trained Allied Agent in your area.



ALLIED VAN LINES

We make the kind of moves
you never hear about

Circle 15 on reader service card

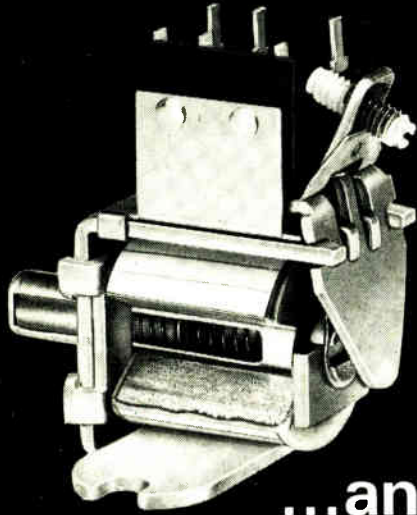

...and it sells for
about the price of a
thermal
time-delay relay.

This t-d relay is hydraulic-magnetic. So it's inherently more stable than a thermal device. There are no heat-loading problems. Not even under frequent recycling or continuous energization. That last point can buy you a lot. The continuous duty coil enables you to use the relay without a supplemental load-carrying device—provided you can get by with a contact capacity of 5 amps or less (125V resistive).

The delay element is structurally simple, exceptionally durable. Durable enough to permit us to warrant the relay for five years. We offer you a wide choice of models. Open frame, enclosed contacts, plug-in, hermetic. For any common AC or DC voltage. SPDT or DPDT. Delays from 0.25 to 120 seconds.

Our Bulletin 5006 will fill in the details. If you'll drop us a note, we'll send you a copy. Heinemann Electric Company, 2600 Brunswick Pike, Trenton, N.J. 08602.

HEINEMANN 

4276

operations from Dallas to a new plant outside Houston. This month, he and his manufacturing colleague, Louay Sharif, resigned to form their own company, Mostek [*Electronics*, April 14, 1969, p. 34]. They haven't yet been replaced, but TI indicates that both vacated jobs will be handled by a single MOS manager.

So far, Mostek consists solely of Sevin and Sharif, although TI is probably counting heads at its MOS facilities every morning. Sevin cheerfully admits that one day soon he'll be in the market for helpers, but he says he's looking for money right now. "We walked out of TI without any deal at all," he says. "We felt we had to make the break first. I returned all of the TI material I had at my home; I didn't want any difficulties with the company."

Matchmaking. The mating dance that brings together financial backers and fledgling semiconductor companies is a familiar one in many areas of the country—particularly on the West Coast—but it's a relatively strange phenomenon in Dallas, where TI is a colossus that doesn't look indulgently on entrepreneurial spinoffs. Mostek is working with a number of brokers; "We are not looking for the most money, but for the deal with the best chances of success," Sevin says.

The betting is that he'll get a satisfactory agreement soon, for L. J. Sevin (the initials stand for Leonce John) has a reputation as one of the top MOS engineers in the country. His book, "Field Effect Transistors," (McGraw-Hill, 1965) is considered a basic text. In his 10 years at TI, he has worked as an applications engineer and in thin-film memory systems before participating in the startup and growth of the firm's MOS operation.

"Applications work is a good background," Sevin says. "You get a good look at everything in electronics. The thin-film work was done when I thought that was the way to go for memories. However, I finally decided that MOS is best."

Sevin's loyalty to the Dallas area stems only from his experience at TI, since he is a native of Baton Rouge, La.

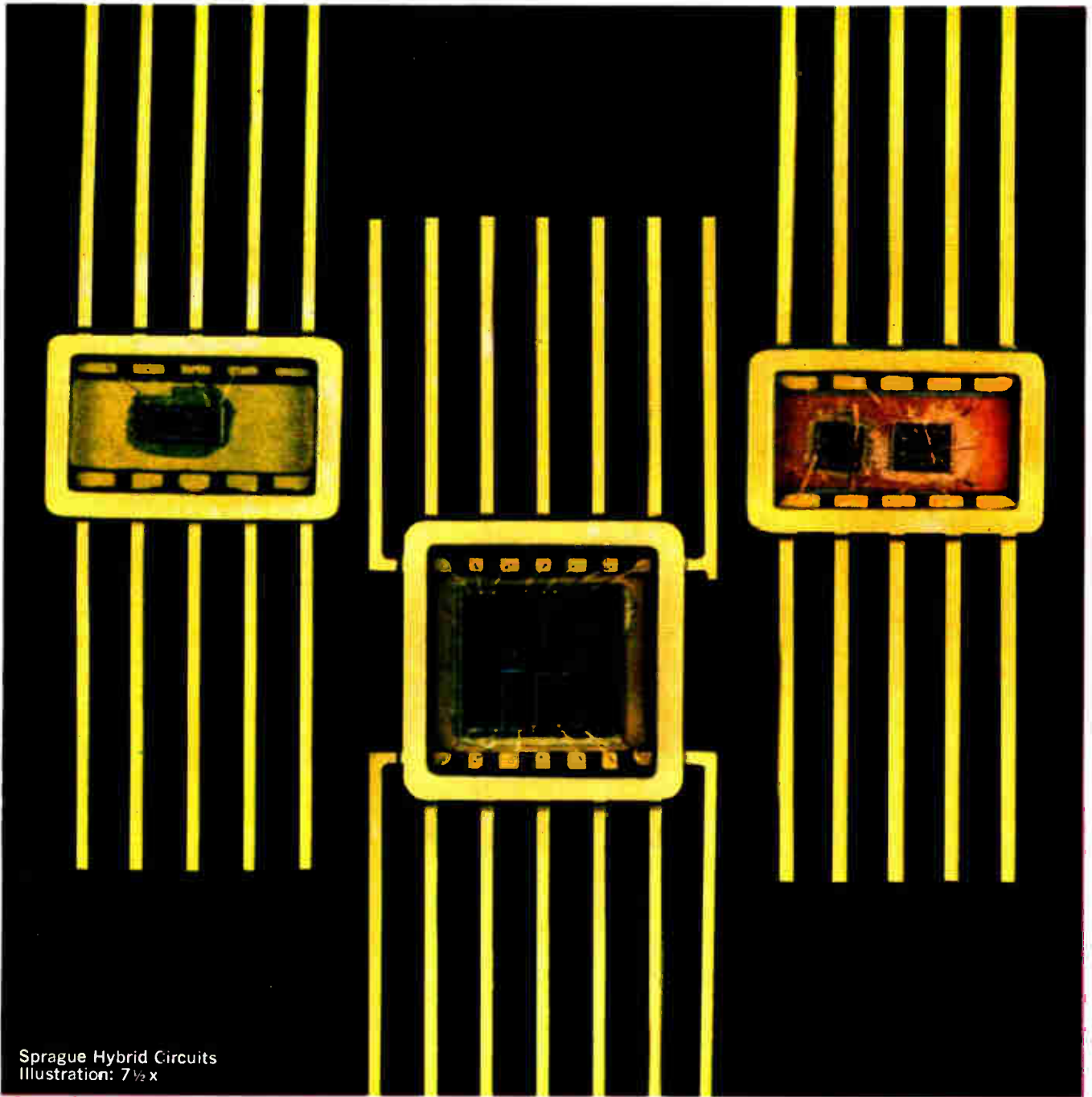

Sprague Hybrid Circuits
Illustration: 7 1/2 x

Look. Look into a 10-bit D-to-A with 2.8 MHz count rate.

Get 10-bit accuracy with only eight packages. You get ladder networks, ladder switches, and buffers. Just add a PC board and the fastest Op Amp you can find.

Only 240 mW total power dissipation. There's no

speed/power trade-offs with these new Sprague Hybrids. And you save space, too. The circuits are in 1/4" x 1/4" and 1/8" x 1/4" ceramic flatpacks, for operation -55 to +100° C.

Other D-to-A hybrids from 4 bits...

can be made from our standard line of packaged ladders, switches and buffers. Get the high accuracy tanta-

lum resistor ladder alone, or a complete kit for up to 12 bits. Start your conversion to Sprague hybrids now.

Call Sprague Info-Central (617) 853-5000 extension 1969.

Or call your Sprague industrial distributor. He has the 10-bit 2.8 MHz circuits on the shelf. For complete specification data, circle the reader service number below.



**Reliability is a spring, a wheel
and two thingamajigs.**

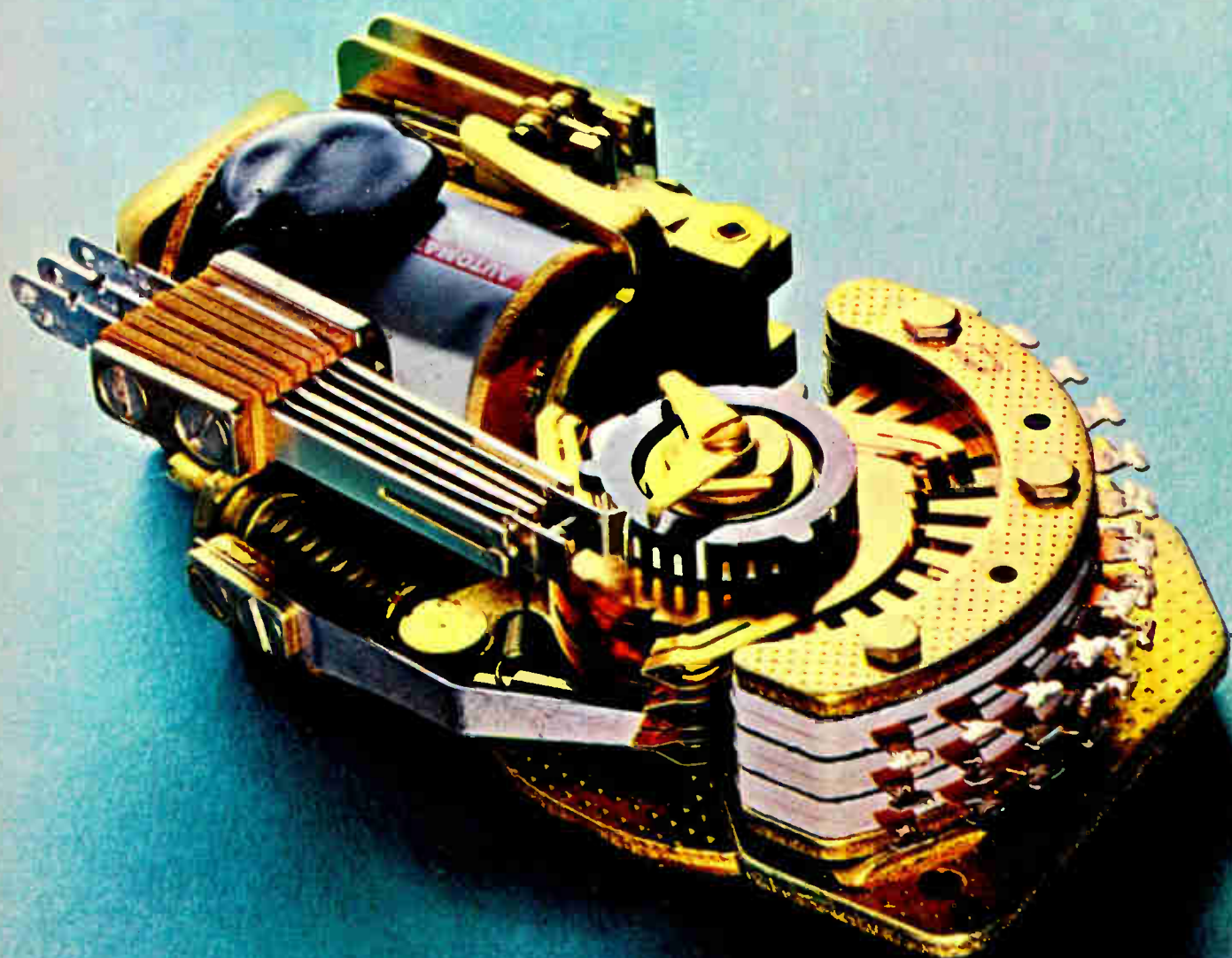



Every AE Type 44 stepping switch comes with them.

One-spring power.

The drive spring is a coil. What it does is store up power. When it comes time to switch, the spring lets loose and moves the wiper assembly forward. Each time using precisely the same pressure.

Notice our spring is tapered at one end. It's designed to perfectly match the power input. That's why you always get the best possible transfer of energy.

At one end of the drive spring is an adjusting screw. We turn it a little this way or a little that way and the tension is always perfect.

Try that with a flat spring.

We re-invented the wheel.

The ratchet wheel is a little different. The way it's made, for one thing. First, we blank it. Next, shave it. And finally, case-harden it. Then it's super strong.

Notice the big, square teeth that always provide a sure bite.

A thingamajig with teeth.

That thingamajig next to the wheel is the armature assembly. When the teeth on the end of it mesh with the teeth on the ratchet wheel, they stop the wiper assembly and position it precisely on the contact bank. Smooth as silk, every time. No jarring, no jamming, no banging.

No adjustments, either. As the teeth wear, they just drop further into the wheel. So nothing ever gets out of whack.

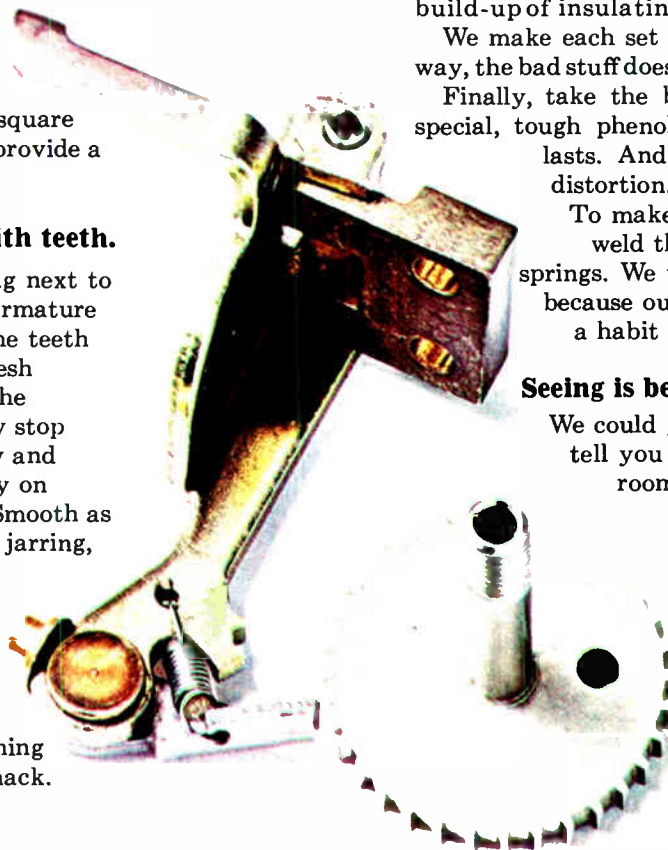

A pawl that floats.

On the end of the armature is the pawl. We made it "free floating" to eliminate the jamming and binding that go with the old style pawl stop block. And while we were at it, we stopped pawl breakage and put an end to double-stepping or overthrow.

Don't bother looking for this special set-up anywhere else. It's patented.

The other thingamajig.

It's called a contact spring. We've got some strong feelings as to what makes a contact spring strong.

In the first place, we believe there's strength in numbers. So we put two sets of contacts on each spring. This means you get a completed circuit every time. Without fail.

But some of the credit for this has to go to our solving the most common cause of contact failure—the build-up of insulating films on the contact points.

We make each set of points self-cleaning. That way, the bad stuff doesn't have a chance to build up.

Finally, take the buffers. We make ours of a special, tough phenolic material that lasts. And lasts. And lasts. All without wear or distortion.

To make sure they stay in place, we weld the buffer cups to the contact springs. We weld, rather than use rivets, because our lab found that rivets have a habit of falling off or wearing out.

Seeing is believing.

We could go on talking reliability and tell you about our testing and run-in room. There's a lot more to tell.

But we'd rather have our Sales Representative show you. And let you see first

hand the reliability that's built into every AE stepping switch.

Just call or write. Automatic Electric Company, Northlake, Illinois 60164.

AUTOMATIC ELECTRIC

SUBSIDIARY OF GENERAL TELEPHONE & ELECTRONICS

33 reasons why we're No. 1 in DVMs.

Dollar for dollar we shipped more DVMs last year than anyone else, including the industry giant.

One of the reasons is our Model 5700. It's the DVM used by laboratories to calibrate other DVMs. Without question it's the

best DVM on the market.

But since not everyone needs the kind of performance and features offered by the 5700, we offer 32 other models. Models for labs and for production lines, bench units and systems' units, militarized models,

four digit DVMs and five, from \$1150 to over \$8,000. (In fact, with plug-in modules you can come up with 300 different configurations.) In short, we make a model for every application and every budget. All as part of our standard line.



And every DVM we make is put together on the same production line, by the same people, using many of the same components and boards. In fact, quite often the assemblers don't know in advance which models they're assembling.

Which means that we've got to build every DVM as though it were our most expensive, over \$8000, unit.

And that may be reason number 34 why we're No. 1 in DVMs.

For a detailed description of our 33 models, write Dana Laboratories, Inc., 2401 Campus Drive, Irvine, Calif. 92664

DANA

SIGNAL TO NOISE IMPROVEMENT OF 300:1

With EG&G's New
AV-102
Silicon Avalanche
Photodiode

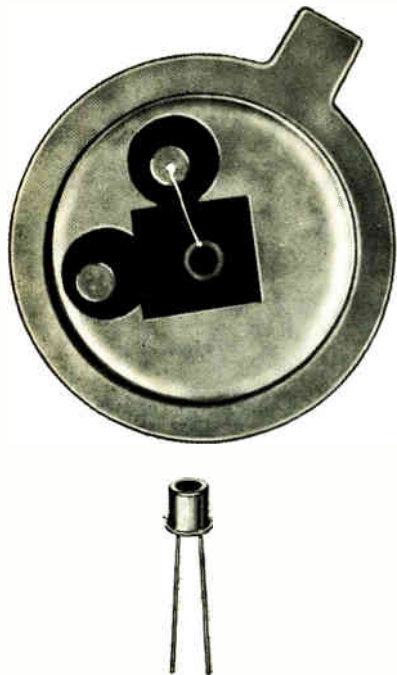

The new AV-102 Silicon Avalanche Photodiode is a state of the art device which features high internal gain resulting in typical signal to noise improvement of 300:1. It is designed primarily for high frequency applications up to 1 GHz.

Packaged in a TO-18 configuration, the AV-102 is specifically designed for the detection, characterization and measurement of low level light signals over the spectral range from 0.35 to 1.13 microns. Combining a high quantum efficiency (70%) and a high internal gain, the AV-102 permits measurement of signals which would normally be obscured by detector system noise.

With a typical operating voltage of 12 volts, the AV-102 is intended for many high frequency applications which now utilize S-1 photomultiplier tubes. It has obvious advantages of smaller size, lower operating power and higher reliability. Price is \$275 in small quantities.

For further information, contact EG&G, Inc., 166 Brookline Avenue, Boston, Mass. 02215. Phone: 617-267-9700. TWX: 617-262-9317. On west coast telephone 213-464-2800.



Meetings

Naecon spotlights airborne computers

Although sponsored by the IEEE, the Aerospace Electronics Conference (Naecon) is traditionally a forum for Air Force avionics contractors and potential contractors organized for the most part by Wright-Patterson Air Force Base project managers. As such, Naecon is usually an accurate reflection of the Air Force Systems Command's current areas of avionics interest.

This year's conference, at the Sheraton Dayton Hotel May 19-21, will focus on airborne computers, and according to one source at Wright-Patterson, the key word this year in airborne computers is multiprocessing.

In a session on digital processing techniques, for example, Anthony Costanzo of the Goodyear Aerospace Corp. will describe an associative, or content-addressable, processor that acts like a multiprocessor; it's to be used with an intercept radar. The Goodyear multiprocessor, financed by the Air Force Materials Lab, is considered a prime candidate for the Awacs program. A.A. Binder and D.P. Blowney of IBM Federal Systems division will cover the reconfiguration and control of avionic multiprocessor systems.

At the same session, a state-of-the-art paper will be presented on a prototype digital differential analyzer with a 1-megahertz iteration rate that was built for NASA's Marshall Space Flight Center. This paper will be given by L.C. Raiff and D.F. Zimmerle of the National Cash Register Co., which built the system.

Also coming under the heading of airborne computers will be a comprehensive tutorial on the trends in avionics systems. The paper, to be presented by Glen M. Harold of the Control Data Corp., will trace the history and predict the future of onboard computer systems.

The Naecon agenda includes a session on avionic communications at which multiple-access systems for tactical fighters will be discussed by Robert J. Price and Alfred L. Girard of the Raytheon Co. And a paper on an experimental SST terminal for an L-band, satellite-communications-surveillance air-traffic-control system will be given by an engineering team from the Boeing Co.

For further information contact J. E. Singer, 5705 Coach & Four Dr., E. Kettering, Ohio 45440.

Rites of spring: joint computer session

Usually, the joint computer conferences try to be all things to all men and as a result fall short of the mark. Not so with the Spring Joint Computer meeting. This year's conference, scheduled for Boston from May 14 through 16, is a cut above many of its semiannual predecessors.

The first session, for example, entitled Microprogramming—an Opportunity for LSI, will treat those in attendance to a panel discussion conducted by four of the computer industry's most knowledgeable practitioners of the discipline: Edward Bennett, president of the

Viatron Computer Systems Corp., whose company is renting computers for about \$40 a month with every expectation of making money thanks to microprogramming; Thomas Osborne, designer of Hewlett-Packard's powerful microprogrammed desktop calculator; and Stanley Pitkowsky and Stuart Tucker, experts in computer architecture and emulation, respectively, for the International Business Machines Corp.

Early birds. Also listed on the first day's agenda is a session on computer-aided design. And if a

(Continued on p. 24)

NEW



*New Allen-Bradley
hot-molded Type GD
dual variable resistor
shown actual size*

TWO
IN
ONE

Allen-Bradley hot-molded dual variable resistor

Here's the most compact two section variable resistor currently available—the new Allen-Bradley dual Type GD. It's one-half inch in diameter and only a fraction of an inch longer than the popular single section Type G control. The case is dust-tight as well as water-tight. ■ Both resistance tracks in the dual Type GD are solid, hot-molded elements, which provide long operating life. As with the single Type G, the noise level is low initially and actually decreases with normal use. Adjustment is smooth at all times with virtually infinite resolution. And low inductance permits operation at frequencies far beyond the usable range of wirewound controls. ■ In addition to standard application, these new dual Type GD controls are ideally suited for use in compact attenuators. ■ Dual Type GD controls are available with nominal resistance values from 100 ohms to 5.0 megohms. For complete specifications on tolerances, tapers, and options, please write Henry G. Rosenkranz, Allen-Bradley Co., 1201 South Second Street, Milwaukee, Wis. 53204. Export Office: 1293 Broad Street, Bloomfield, N. J., U.S.A. 07003. In Canada: Allen-Bradley Canada Limited.



ALLEN-BRADLEY
QUALITY ELECTRONIC COMPONENTS

Improved brightness solid-state lights are attention-getting panel indicators.



MV10B
Actual Size



MV10A
Actual Size

Solid-state lights from Monsanto are brighter than ever. 1,000 foot-lamberts is typical. They're RELIABLE—1,000,000 hours life*; FAST—1 ns switching time; and SMALL—.10 inch diameter for the MV10A3. SPECTRAL EMISSION is an attention-demanding 6,700 Å red.

Low current requirements, down to 5 ma for 50 ft/L output, make them compatible with low cost integrated

* $T_A = 25^\circ\text{C}$, $I_F = 50$ ma. Result of step-stress testing with end of life projections.

circuits. The long life and solid state ruggedness of these emitters eliminates the need for redundant indicators and in-field servicing, even in the most critical applications.

For more information on our MV10A and MV10B red indicators and other Gallium Arsenide Semiconductors, write or call Monsanto Electronic Special Products, 10131 Bubb Rd., Cupertino, Ca. 95014, (408) 257-2140.

Monsanto

Meetings

(Continued from p. 22)

similarly entitled session at the recent Solid State Circuits Conference in Philadelphia is any indication, those planning to attend had better arrive well before the 2 o'clock starting time.

Other promising sessions include two that reflect the growing interest in dynamic graphics. This interest extends all the way from Mickey Mouse movies, through graphic equivalents of complex mathematical expressions, to designs of integrated-circuit masks, skyscrapers, and transcontinental highways—all of which use the same graphic techniques. Papers will be presented at the conference on theory, implementation, and application of these techniques.

For further information contact American Federation of Information Processing Societies (Afips), 210 Summit Ave., Montvale, N.J. 07645

Calendar

Aluminum Strip Conductor Symposium, Electrochemical Society; New York City, May 4-9.

Rocky Mountain Bioengineering Symposium, University of Wyoming; Laramie, May 5-6.

Electrical and Electronic Measurement and Test Instrument Conference, IEEE; Skyline Hotel, Ottawa, Ontario, May 5-7.

Instrumentation Symposium, Aerospace Industry Division of the Instrumentation Society of America; Frontier Hotel, Las Vegas, May 5-7.

Design Engineering Conference, American Society of Mechanical Engineers; Waldorf-Astoria Hotel, New York, May 5-8.

International Congress on Instrumentation in Aerospace Simulation Facilities, IEEE; Polytechnic Institute of Brooklyn, Farmingdale, N.Y., May 5-8.

International Microwave Symposium, IEEE; Marriott Motor Hotel, Dallas, May 5-8.

Digital Communications Symposium, IEEE; Los Angeles, May 6.

Conference on Power Thyristors and their applications, IEE; London, May 6-8.

(Continued on p. 26)

Allen-Bradley's experience in resistor production reaches...

to the moon and back!

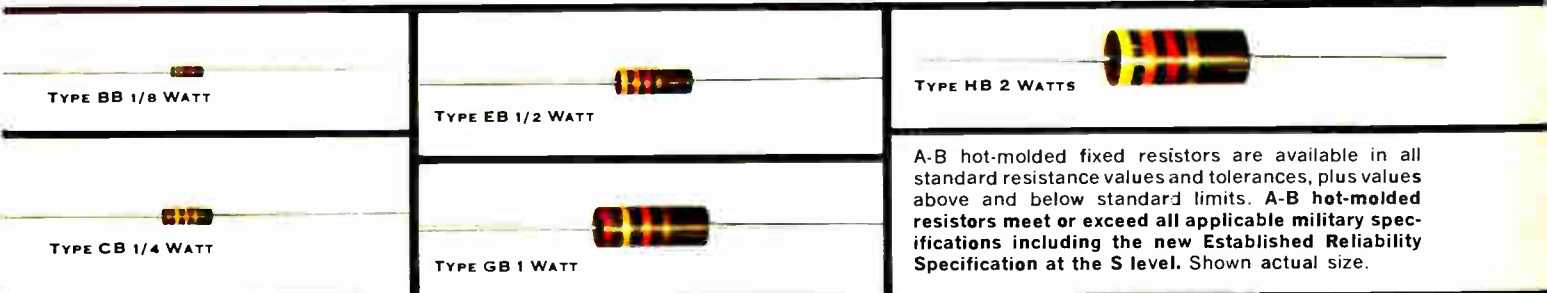

A-B hot-molded fixed resistors are available in all standard resistance values and tolerances, plus values above and below standard limits. A-B hot-molded resistors meet or exceed all applicable military specifications including the new Established Reliability Specification at the S level. Shown actual size.

After more than three decades and untold billions of hot-molded resistors, Allen-Bradley has accumulated manufacturing "know-how" which cannot be approached by anyone else. The fact that the resistors made by A-B over the years—if placed side by side—would more than reach to the moon and back, may be impressive. But "how" they are made is the key.

Allen-Bradley resistors are produced by an exclusive hot-molding technique—developed by A-B. They're made by completely automatic machines—also developed, built, and used only by Allen-Bradley. The human element of error is removed. Uniformity is so precise from one resistor to the next—year in and year out—that long-term resistor performance can be closely predicted.

And there has been no known incident of catastrophic failure of an A-B hot-molded resistor.

The reputation for quality and performance established by Allen-Bradley hot-molded resistors is reflected in the fact that they have been an integral part of virtually every U.S. space probe. And they are "on" the moon. No other resistor applications demand a higher measure of reliability.

For detailed specifications on this superior line of hot-molded resistors, please write Henry G. Rosenkranz and request a copy of Technical Bulletin 5000: Allen-Bradley Co., 1201 South Second Street, Milwaukee, Wisconsin 53204. Export Office: 1293 Broad St., Bloomfield, N.J., U.S.A. 07003. In Canada: Allen-Bradley Canada Limited.

EC 6815

QUALITY ELECTRONIC COMPONENTS



ALLEN - BRADLEY

©Allen-Bradley Company 1968

1/8" Shank
Solid Carbide
Circuit Board Drill

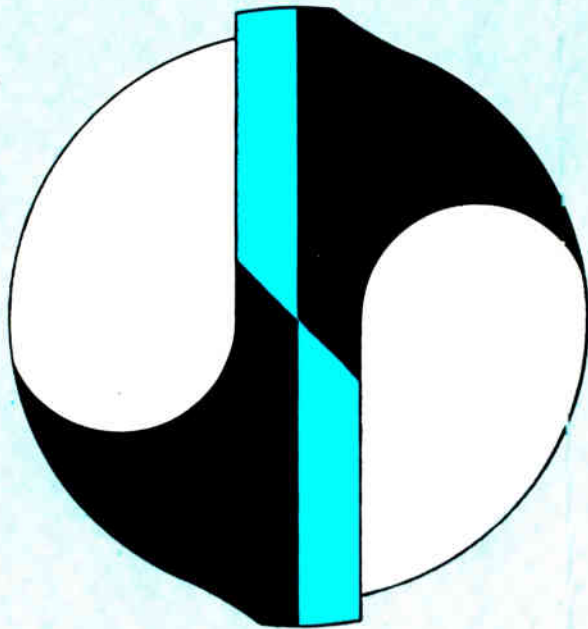

4 FACET POINT

for bur-free
no smear holes

any questions?



THE METAL REMOVAL COMPANY

Subsidiary of FEDERAL-MOGUL CORPORATION

1859 West Columbia Avenue • Chicago, Illinois 60626

Plants located in CHICAGO / LOS ANGELES / SAN JUAN

MASTER TOOL AND WHEEL MAKERS FOR THE WORLD
END MILLS / DRILLS / REAMERS / BURS / SPECIAL TOOLING

Meetings

(Continued from p. 24)

Congress on Nuclear Electronics, IEEE; EURATOM Lab., Ispra, Italy, May 6-8.

Frequency Control Symposium, Electronic Components Laboratory, Army Electronics Command, Shelburne Hotel, Atlantic City, N.J. May 6-8.

Pattern Recognition, Postal Department's Bureau of Research and Engineering and Systems Science and Cybernetics Group of the IEEE; Statler-Hilton Hotel, Washington, D.C., May 6.

Second National Conference, Association for Precision Graphics; University of Southern California, Los Angeles, May 7-8.

Annual Symposium & Equipment Exhibit, American Vacuum Society; International Hotel, Los Angeles, May 7-9.

Short courses

The ideals concept—A systems design concept, University of Wisconsin, Madison and Milwaukee; June 10-20; \$375 fee.

Theory and application of symmetrical components, Texas A&M University, College Station; August 11-15 and August 18-22; \$75 fee for each course.

Computer applications for vibration problems in engineering, University of Wisconsin, Madison and Milwaukee; August 11-15; \$200 fee.

Call for papers

The Application of Computers to the Problems of Urban Society, Association for Computing Machinery; New York Hilton Hotel, Oct. 24. June 1 is deadline for submission of abstracts to Jessica Hellwig, symposium chairman, Columbia University Computer Center, New York, N.Y. 10027.

Electronics and Aerospace Systems Convention and Exposition, IEEE; Sheraton Park Hotel, Oct. 27-29. June 2 is deadline for submission of abstracts to Howard P. Gates Jr., EASCON '69 Technical Program Chairman, P.O. Box 2347, Falls Church, Va. 22042.

Conference on Dielectric Materials, Measurements, and Applications, IEE; University of Lancaster, England, July 20-24, 1970. May 30 is deadline for submission of synopses to Conference Department, IEE, Savoy Place, London, W.C.2.

No other manufacturer offers as large a selection: hundreds of standard types of control knobs, more than 2,000 "specials". Almost every type, style and color combination is promptly available to you from local distributors and large factory stocks.

Turn to color with the new PANELRAMA knobs shown below...mix or match caps and body colors in almost any combination...to harmonize or contrast with every panel decor.

Or, you can choose elegantly-

styled Designer Series knobs with spun-aluminum caps on body colors of black; light, medium, or dark grays; and off-white. When you need a solid color, select from the nine decorative colors in our 400 series.

For military applications, specify Standard Series control knobs—thousands of quality knobs that meet MS91528. Or, specify the new self-locking push-to-turn knobs and Microverniers...for accurate, precision control settings. And when you need custom-

made knobs...to get Raytheon delivery. For a catalog or near regional sales or reader service distributor, call Raytheon first advantages of fast and easy distribution. Raytheon Company, Inc., Massachusetts 02169.



Here's why Raytheon knobs control more settings than any other brand.



400 SERIES

MICROVERNIER AND SELF-LOCKING KNOBS
PUSH TO TURN
PUSH TO TURN

STANDARD SERIES

PANELRAMA

DESIGNER SERIES

CUSTOM KNOBS

AMP interconnections

The inside of this black box is all AMP.

Side to side. Top to bottom. And every connector in it is right at home under MIL-E-5400 whether it be airborne or ground-based in support of aircraft.

Our connector technology has created dozens of products specifically designed for the interconnection of communications and navigational systems devoted to safe, efficient flight the world over. All of them meet the demanding criteria set by modern aircraft performance—design flexibility, lightness, compactness and reliability. No matter where in the world you build equipment to fly, and control flight, AMP offers world wide facilities to supply all connectors required in your avionics system design.

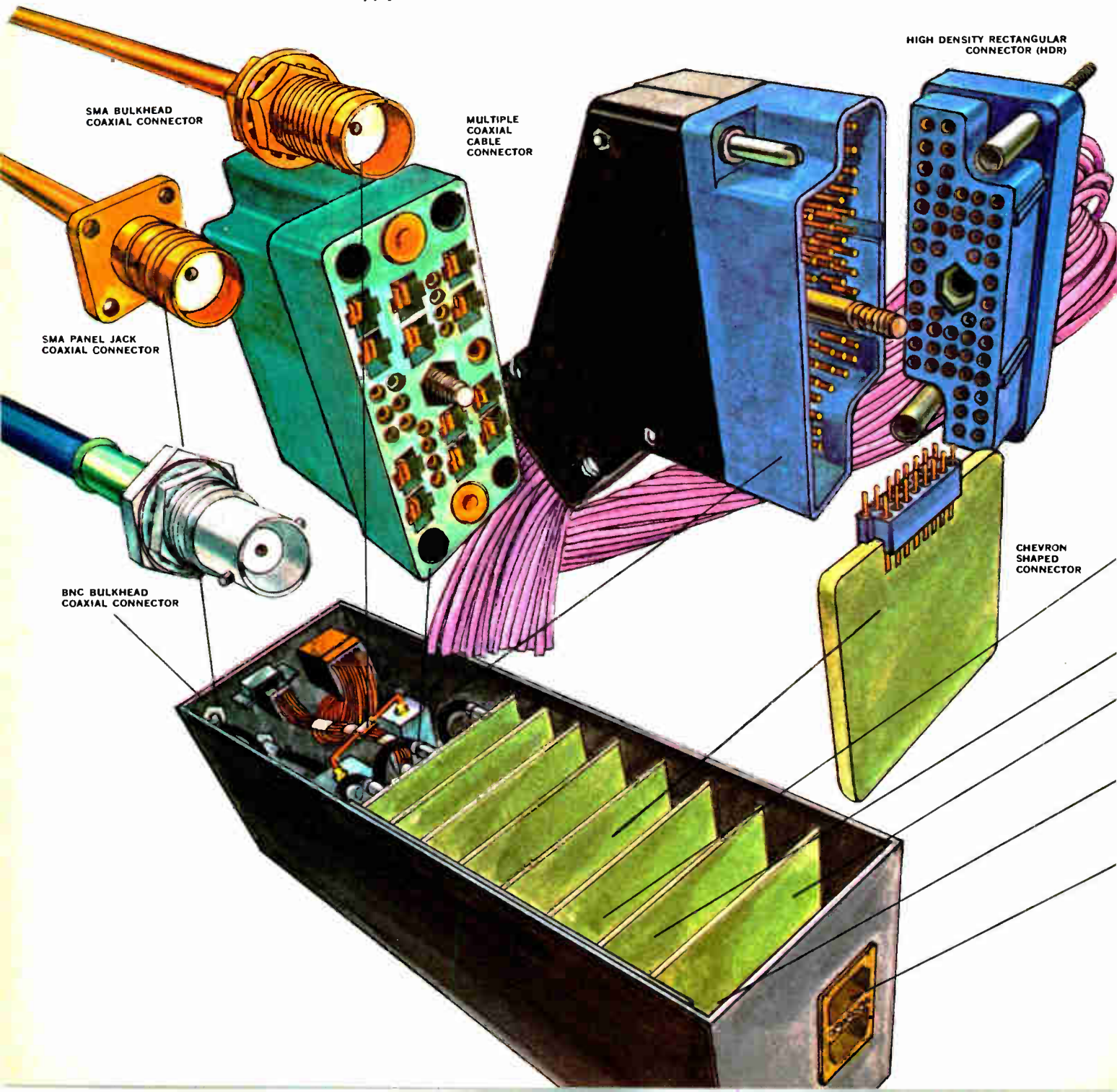

for MIL-E-5400

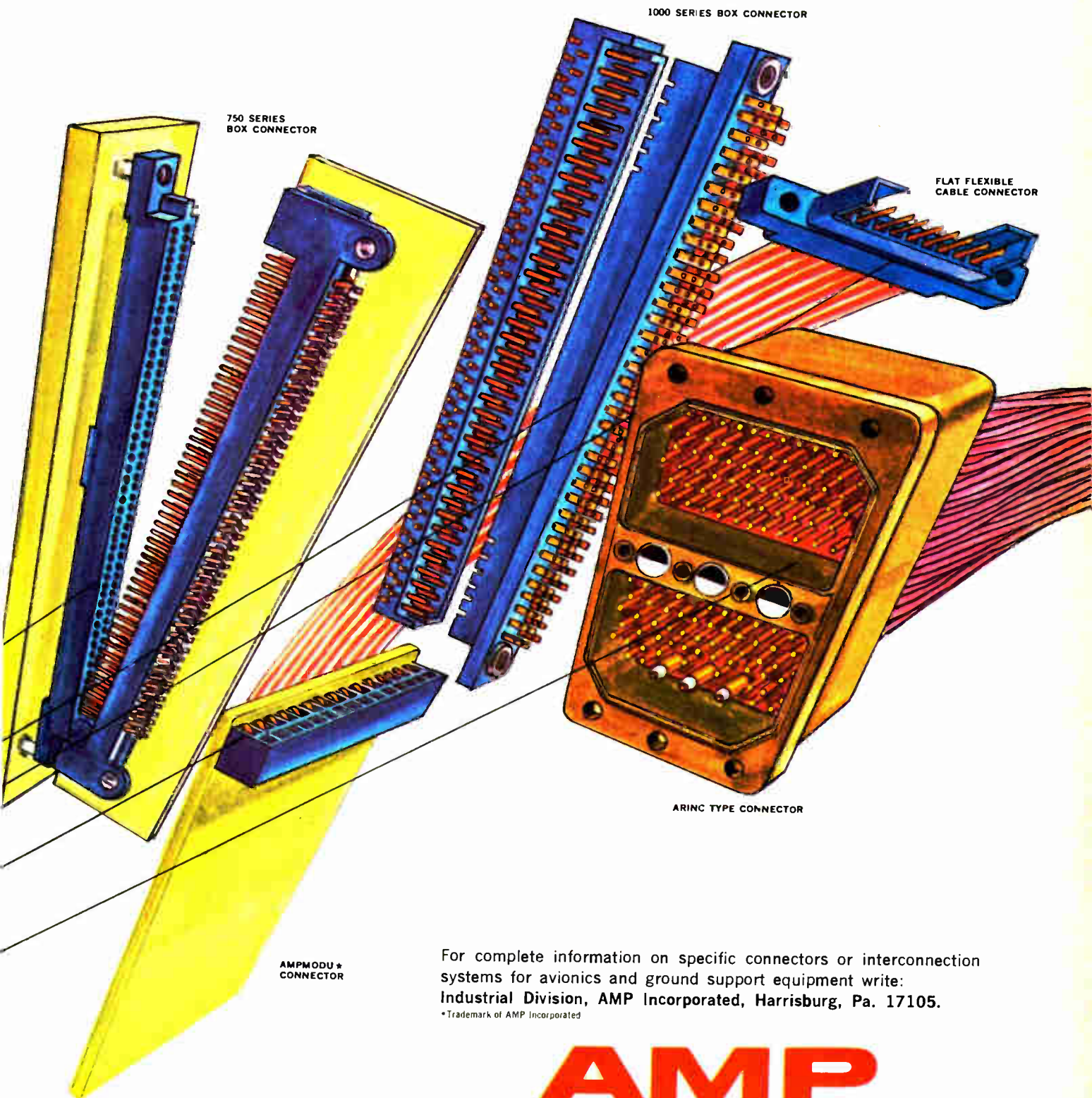

750 SERIES
BOX CONNECTOR

1000 SERIES BOX CONNECTOR

FLAT FLEXIBLE
CABLE CONNECTOR

AMPMODU *
CONNECTOR

ARINC TYPE CONNECTOR

For complete information on specific connectors or interconnection systems for avionics and ground support equipment write:
Industrial Division, AMP Incorporated, Harrisburg, Pa. 17105.

*Trademark of AMP Incorporated

AMP

INCORPORATED



When you're stuck with more wire than space...

Get around the problem, neatly, with Brand-Rex ribbon cables.

These slim space-savers bend into tight corners . . . hug contours around obstacles . . . keep wiring out of the way. They make high density interconnections easier to handle.

Brand-Rex gives you a wide choice of vinyl-insulated ribbon constructions (singles, pairs, shielded wires, coaxials) . . . with 2 to 100 conductors . . . to meet a variety of commercial and military requirements. Conductors can vary in type, size and color (striped wires also) within a given cable. They separate and strip easily, terminate in standard devices.

Write for the facts on Brand-Rex ribbon cable. And ask about any custom design you have in mind. Brand-Rex Division, American Enka Corporation, Willimantic, Conn. 06226.

Connect for tomorrow.

BRAND-REX

Editorial comment

It's no laughing matter

The Metroliners, high-speed trains running daily between New York and Washington, are supposed to herald a new era in fast, comfortable rail transportation. Yet the Metroliners reach top speeds of only 110 miles per hour, and while a passenger can purchase a cup of hot coffee on the trains, he cannot safely hold it during most of the trip.

About the time the Metroliner was scheduled for its maiden trip, columnist Art Buchwald made the following comments*:

"Although it doesn't seem to be much of a problem to get a man from the earth to the moon, it's still almost impossible to develop a fast train from New York to Washington. While some probes have been made by unmanned Pullmans, rail space officials said it was still too dangerous to send men to Washington in one of the new craft.

"The head of the rail space program, Wernher von Penncentral, said that despite setbacks he felt the United States could get man from New York to Washington in three hours, by 1972.

"What's been holding up the program?" I asked him.

"Train travel is a journey into the unknown. There are so many things that we have to know before we can put men on rails."

"What are some of the hazards to rail space travel?"

"The first of course is the liftoff. In order to get a man from New York to Washington he must have a ticket. So far we have not perfected the ticket system that would make it possible for a manned trip."

"You mean the ticket problem is holding up the race to the capital?"

"Wernher von Penncentral said indignantly, 'If Borman, Lovell and Anders had to buy tickets for their moon shot at Penn Station they wouldn't have made it either.'

"What other hazards are you faced with?"

"We still don't know what effects a fast train ride will have on the human body. Of course we've put dogs and chimpanzees on trains, and they've given us some medical data.

"But as far as man is concerned, we'd only be guessing. We don't know for example what happens to the human body when it goes through Trenton or Philadelphia, not to mention Wilmington, Del. And then there is the Baltimore belt. Can man live in the tunnels that run under Baltimore at 200 miles an hour? There are photographs of the New York to Washington roadbed, taken by Borman from the moon. Notice the craters and pits. We have to know

more about them before we risk a human life on a trip."

"I admit that you must be cautious," I said. "But isn't the rail space program being criticized for the slow progress that is being made in rail travel?"

"When you're dealing with something as new as passenger trains, you have to expect disappointments. We've had engine trouble, capsule setbacks, lavatory failures. But we're learning all the time. The research gained from the rail space program will not only benefit transportation but mankind as well."

"What would speed up the program?"

"The only thing that would speed up the program is if the Soviet Union announced that they were going to build a railroad from New York to Washington. Then Congress would allot us the money for a crash program. There is no pressure to do anything in this country unless we think the Soviets are going to do it first."

"Some people say we're spending too much money on our rail space program. What is your answer to that?"

"It's true that there has been this criticism, particularly since many people say there is no life in Washington.

"But we must consider the New York-to-Washington run the first step in a giant exploration. Who knows but someday man will go to Richmond, or Atlanta on a fast train? So we can't say that just because we're not going to get much out of going to Washington from New York that we're wasting our money."

"You think if man ever finds a way of sending a fast train from New York to the nation's capital he will open a whole new world?"

"I'll go farther than that. I predict that we may not see it, but your children and my children will someday be able to travel as far away as Miami on a train with the same ease and comfort that it now takes man to go to the moon."

Mr. Buchwald's wry message is more than an exercise in sarcasm. It represents a clear challenge. Why indeed can't we apply technology already in hand to the solution of a simple, down-to-earth problem? Perhaps the U.S. can take a cue from Japan where electronics control and communications techniques—most of them by no means brand new—are being applied to rail systems in which trains now run at 130 mph and are expected to reach speeds of 220 mph. [A full discussion of the Japanese efforts will appear in the next issue of Electronics.] ■

* Copyright the Washington Post Company; reprinted with permission of the Los Angeles Times Syndicate.



**METALS THAT TALK, SING
AND LISTEN...A SPECIAL
CAPABILITY OF CARPENTER!**

The reassuring sound of a family voice . . . the perfect fidelity of a favorite recording . . . theatres of color that bring lavish entertainment into millions of homes. These are the exciting developments in the field of audio/visual communications that all of us can enjoy. And essential to the flawless performance required of these products . . . specialty metals that make them talk, sing and listen. Carpenter produces a full range of electronic alloys used throughout industry, including Magnetic Core Irons, Glass Sealing Alloys, High Permeability Alloys, Electrical Resistance Alloys, Magnetostrictive and High Saturation Alloys, Controlled Expansion Alloys, and others. Why don't you entertain the thought of applying Carpenter electronic alloys to your product? See your Carpenter representative. Steel Division, Carpenter Technology Corporation, Reading, Pa. 19603.

*European Office: Emmastraat 39,
Amsterdam-Z, The Netherlands*

CARTECH CARPENTER
TECHNOLOGY

Electronics Newsletter

April 28, 1969

9 firms in running on Viatron contracts

First deliveries of metal oxide semiconductor LSI arrays to the Viatron Corp. are to begin this week. Nine semiconductor houses—most of them major—are working with Viatron on array development, and by late July or early August each company should have delivered 100-unit sample lots for testing and contractor selection. **Several potential contractors already have agreed to increase their plant capacity to meet Viatron's predicted MOS requirements—once estimated to exceed those of the National Security Agency, now the country's largest complex-array purchaser** [*Electronics*, Oct. 14, 1968, p. 193].

Viatron expects to deliver its first System-21 microprocessors late this year—about six months later than an earlier prediction—but the same data as stated in its four-month-old prospectus. **Though delivery has slipped, price has not, and the System 21 still is to rent at the advertised \$40 monthly.**

Despite some industry skepticism that Viatron can produce its systems to rent at that price, the company counts about 14,000 System 21's in its backlog. As Viatron does not write purchase orders as such, most are in the form of letters of intent. **Even so, several individual customers had stated possible requirements for as many as 5,000 to 10,000 System 21's each, if initially delivered units prove out, thus perhaps balancing a lack of firm purchase orders.**

Viatron now is preparing internal production facilities capable of turning out 1,000 microprocessors monthly, and is going to contract for facilities for about 4,000 per month more. It now is placing orders for housings, power supplies, and other parts. It already has ordered crt displays for the System 21.

Fairchild to supply memories for Illiac 4

Although Fairchild insists that no contract has yet been signed, the Burroughs Corp. has reportedly chosen Fairchild Semiconductor as the supplier of the semiconductor active memories for the Illiac-4 computer [*Electronics*, April 14, p. 47]. **More significantly, Fairchild and Burroughs may be getting together on a memory contract, which has been several years in negotiation, and whose size dwarfs any other in semiconductor history.**

Late this summer, Fairchild is expected to announce development of a 256-bit bipolar random-access memory. The 120-mil-square chip would have a packing density approaching that of MOS circuits, and a 50-nanosecond access time. **This chip, in 14- or 16-lead dual in-line packages on printed-circuit boards, would be the basic Illiac memory unit.**

Arrays of chips, face-down bonded in a ceramic package, would be the basic unit for the other contract: the main memories to go into Burroughs' B-6500 computer. **This multiyear deal would be for upwards of 11 billion bits, obviously at a price per bit that puts integrated circuits in the same ballpark as magnetic cores.**

IBM to open systems to rivals' programs

IBM isn't twiddling its corporate thumbs while awaiting the right moment to announce its next batch of computers [*Electronics*, March 17, p. 51]. Instead, the computer colossus is busily preparing another radical departure from design and marketing methods. **With the new machines,**

Electronics Newsletter

and, presumably, its older ones too, IBM will offer hardware that makes them compatible with programs written for competitive computers—such as those made by Honeywell, Control Data, or Univac. The move follows a flurry of antitrust suits, including one by the Justice Department.

IBM won't disclose the nature of the new hardware, or even confirm that it exists. But the design isn't hard to figure out. The compatibility is attained through emulation—a technique that IBM has used extensively in the past to make its System 360 computers run with programs written for its older 1400 and 7000 series machines. It involves replacing the standard read-only memory in the computer with one specially programmed to process the instructions set of a competitive machine. Basically, it's another application of the "firmware" concept.

TRW readies 3-Ghz, 2-watt transistor

TRW Semiconductors is ready to take another step up the frequency ladder in microwave power transistors by introducing a device that puts out 2 watts at 3 gigahertz. The highest frequency previously available has been that of TRW's own 2N5483—a 5 watt, 2-megahertz unit. Price of the new transistor, to be introduced in August at the Wescon show, hasn't been determined.

At the same time, Motorola Semiconductor is poised for its first move into the field of microwave power transistors. It will shortly introduce a line headed by the MM4430, a 2.5-watt, 1-Ghz device with a power gain of 6 decibels and a price of \$19 in quantities from 100 to 999.

H-P gives early peek at digital processor

Stealing a march on two companies that will show digital signal processors at the Spring Joint Computer Conference next month, the Hewlett-Packard Co. displayed its own machine at the Institute of Environmental Sciences Convention in Anaheim, Calif., April 21-23. Designated the 5450A, the instrument calculates with an H-P 2115A (or 2116A, if the user wishes) computer. But it can be programmed to perform Fourier, correlation, convolution, and other functions through front-panel push-buttons. A flick of a switch turns the instrument from a general-purpose computer to a machine that, as far as the user is concerned, is hard wired.

The 5450A employs the Cooley-Tukey algorithm for fast Fourier calculation. It will cost about \$49,000 and be ready for delivery in October. The computer division of Raytheon and Computer Signal Processors Inc., will show fast-Fourier machines at the SJCC [*Electronics*, March 31, p. 35, and April 14, p. 159]. Another maker of a fast-Fourier calculator, the Time/Data Corp. of Palo Alto, Calif., showed a special vibration-analysis system at the Anaheim meeting that generates gaussian noise with a controllable spectral content.

Westinghouse uses side-looking radar in mapping service

Westinghouse Electric's Aerospace division is offering a commercial airborne radar-mapping service using a side-looking radar it developed for the Army about four years ago. It is believed the service is the first to be offered commercially, although government agencies have mapped with radar for several years.

The Ka-band radar, which has some of its design and operational elements still classified, is leased from the U.S. Army Electronics Command and flown in a DC-6B.



When you need a new way to see in the dark...

Photographed in Vietnam by Howard Sochurek

bring ERIE in early.

The jungle night falls fast for a pilot downed behind "Charlie's" lines. But rescue choppers no longer wait for morning light to find him. The answer? New portable night vision devices that actually intensify available light, even starlight... thousands of times. From the start, those working on this project have relied on the Research Engineers and component capability of ERIE TECHNOLOGICAL. Our new sub-miniature high voltage supply is at the heart of the system. Proof: once again, that whatever your area of electronics, it pays to bring ERIE in early.

ERIE TECHNOLOGICAL PRODUCTS, INC.

644 West 12th Street, Erie, Pennsylvania 16512
Area Code 814 456-8592

Better solutions come from Weatherford

Try these for starters: Discretes. Transistors. Ceramic TTL.

TI's Preferred Semiconductors — for extra confidence in buying discretes. The flood of discrete semiconductors makes selection time-consuming and booby-trapped with potential errors. But you can now buy with greater confidence than ever. TI's new Preferred Semiconductor catalog wraps up the 285 computer-selected discrete devices that will best fill most requirements. All are in current use, economical, readily available from us and recommended for present and future designs. You really can't go wrong with TI's Preferred Semiconductor line. Get your free catalog from us or circle 311 on the Service Card.

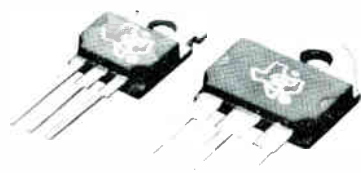

TI plastic power transistors — to cut component cost. The new TI plastic NPN/PNP complementary single-diffused power transistors are direct plug-in replacements for TO-3 and TO-66 devices. Being plastic, they are low cost; single-screw mounting is another cost-cutter. The new series — TIP 29 through TIP 36 — is rated 30-90 watts, 1-25 amps, 40-60 volts. Whenever you're looking to cut component costs, look to us for TI's plastic power transistors. Or for more details, call us or circle 312 on the Service Card.

TI Series 54/74 TTL — ceramic broadens the broad choice. All TI TTL functions are now available through us in a new ceramic hermetic dual-in-line package (14-pin or 16-pin). So your broadest TTL choice is now even broader. Featuring extremely high reliability, the new ceramic package meets all applicable military specifications. With this new hermetic C-DIP, plus greatly improved delivery on previously hard-to-get flat-pack TTL devices, we are ready to meet all your aerospace and military system requirements.



For better solutions, call



R. V. WEATHERFORD CO.

DISTRIBUTORS OF ELECTRONIC COMPONENTS AND EQUIPMENT

ANAHEIM, CALIFORNIA
1550 Babbitt Street
714-532-6741
714-547-7521

GLENDALE, CALIFORNIA
6921 San Fernando Road
213-849-3451

PALO ALTO, CALIFORNIA
3240 Hillview Drive
Stanford Industrial Park
415-321-5373

PHOENIX, ARIZONA
1917 North 25th Drive
Carson Industrial Center
602-272-7144

WEATHERFORD
SERVICE
PLUS

POMONA, CALIFORNIA
1095 East 3rd Street
714-623-1261
213-966-8461

SALES OFFICES: San Diego, California, 714-278-7400 • Seattle, Washington, 206-762-4200

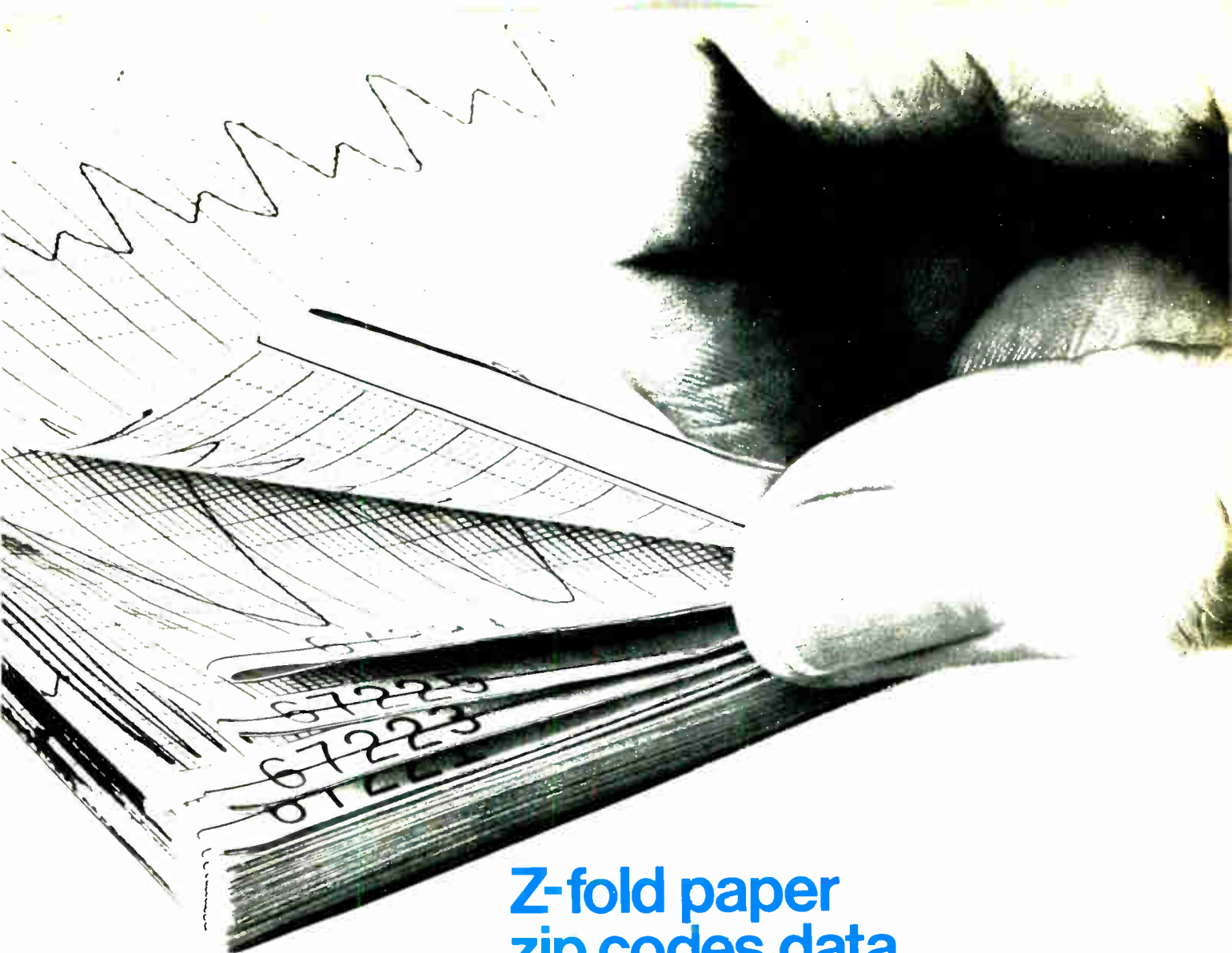

Z-fold paper zip codes data for quick retrieval

Data recorded on Z-fold paper by the Hewlett-Packard 7800 Series Rectilinear Recorder is instantly retrievable. Each page is numbered to simplify reference to recorded data. Z-fold chart packs store easily in their original cartons.

Contactless pen tip sensing and a *modulated pressure ink system* produce traces of equal density from all signals and throughout the recorder's variable speed ranges of .025 to 200 mm. per second. *You get blue ink reproducibility compatible to diazo or any similar process.*

Designed with modular, solid-state electronics, the 7800 Systems provide high-resolution, permanent, rectilinear recording of up to eight variables from dc to 150 Hz.

Eight 8800 Series Preamplifiers provide signal conditioning to the driver-amplifiers which drive the recording pens. The recording system is available with eight different or eight identical preamplifiers of your choice. Frequency

17802 B



response of the recorder is 150 Hz for 10 div p-p deflection and 58 Hertz maximum for full scale deflection. Maximum ac or dc non-linearity is 0.5% full scale. Additional features include: choice of chart paper in Z-fold packs or rolls; 14 electrically-controlled chart speeds; built-in paper take-up; ink supply warning light; disposable plug-in ink supply cartridge that may be replaced while the recorder is in operation and modular construction for easy maintenance.

For complete information on the 7800 Series, optional and related equipment, contact your local HP Field Office or write Hewlett-Packard, Waltham Div., 175 Wyman St., Waltham, Mass. 02154. In Europe: 1217 Meyrin-Geneva, Switzerland

HEWLETT  PACKARD
RECORDING SYSTEMS

THIS MATHEMATICAL MODULE COMPUTES...

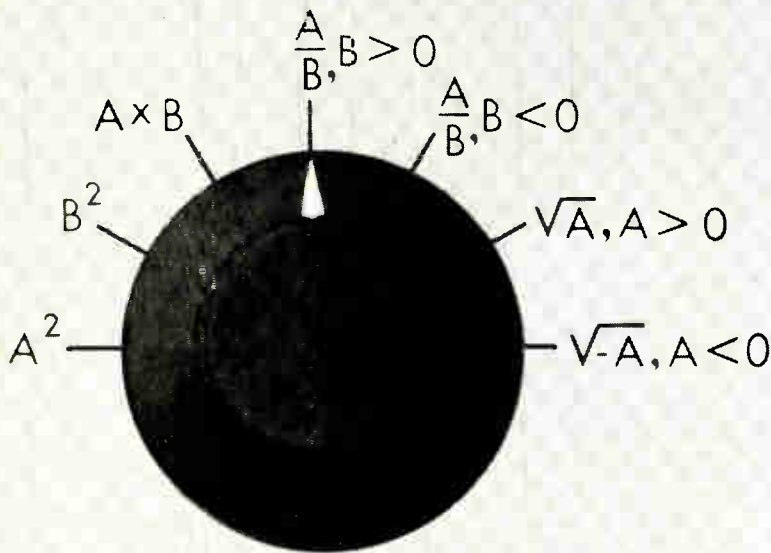

Fast analog computation of products, ratios, squares and square roots is readily performed by the PAR™ Model 230 Multiplier Unit. Applications include auto- and crosscorrelation, precision square-law detection and mean-square computations, determinations of the instantaneous ratio of two voltages, modulation and generation of sum/difference frequencies and broadband frequency doubling.

Features of this instrument include:

- True four-quadrant multiplication
- Dynamic Range $10^3:1$ (60 dB)
- 0.5% Accuracy (below 100 kHz)
- Self-contained averaging with variable time constants to 30 seconds
- Automatic overload indication

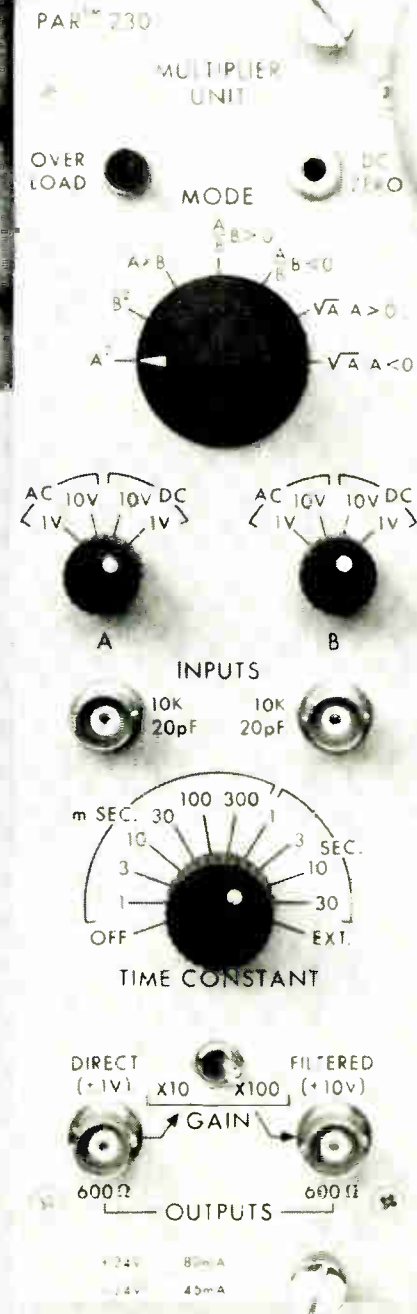

The Model 230 Multiplier Unit will be a valuable addition to the instrument inventory of any laboratory. It is designed to operate as a free-standing instrument, powered by a standard ± 24 volt supply, or as one module in a NIM or RIM (Research Instrument Module) instrument system.

Price of the Model 230 is \$595. For more information, including complete details on the RIM instrument system, write Princeton Applied Research Corporation, Post Office Box 565, Princeton, New Jersey 08540 or call (609) 924-6835.



PRINCETON APPLIED RESEARCH CORPORATION

Hughes sets new kind of trap to wed MOS to silicon nitride

In read-only memory, firm's researchers use two stacked gates to reduce electric field needed to drive bits of data into nitride trapping layer

In the race for practical memories allying MOS technology with the special storage properties of silicon nitride, a number of companies—such as Litton Industries, Sperry Rand, and Westinghouse—are known to be using tunneling or charge-storage phenomena to write data that will remain trapped up to a year. But one of the drawbacks to the tunneling type of MOS/nitride memory is that the electric fields required to drive electrons (bits of data) through the silicon dioxide insulator between the bulk silicon and the nitride trapping layer are so high (3×10^6 volts per centimeter) that the device approaches breakdown.

Researchers at the Hughes Aircraft Co. believe they have surmounted that obstacle. They use two gates and the nitride-oxide sandwich to produce a read-only memory that is nonvolatile and bulk-erasable. The uppermost of the two stacked gates reduces the field to prevent surface breakdown.

The work is being done at the firm's Newport Beach, Calif., semiconductor facility by a group attached to Hughes' research laboratories. Hans Dill, head of the field effect device research and development section, says the stacked gates permit electron injection over the Schottky barrier and into the nitride trapping layer—requiring fields of only 3×10^5 to 5×10^5 volts per centimeter for writing.

In a pinch. When a normal MOS FET is in saturation (+15 volts on the drain and +10 volts on the gate), electrons come from the source toward the drain through an induced channel. A pinch-off region develops next to the drain because the drain voltage is greater than

the gate voltage, and the electrons are accelerated toward the drain and away from the oxide interface.

With Hughes' stacked-gate "tetrode," on the other hand, and with +30 volts on the offset gate, +10 volts on the control gate, and +15 volts on the drain, channels are induced from both the source and drain, and a pinch-off region develops about halfway between the two. Thomas Toombs, a member of the technical staff, says this pinch-off region and the higher voltage on the offset gate are crucial to the Hughes technique.

There's a low electron concentration in the pinch-off region that allows the field from the offset gate to penetrate to the bulk silicon. This means electrons that get into the pinch-off region pick up enough energy to be injected over the

Schottky barrier between the silicon and silicon dioxide and propelled toward the offset gate, with its +30 volts. When they run into the silicon nitride layer, they're trapped and become bits of data in the memory.

Toombs says that to read, only 5 volts is normally applied to the offset gate. If no electrons have been trapped during writing, a channel will be induced under the offset gate. With the control gate on (5 volts is enough to turn it on), a channel is created from the drain to the source, allowing current to flow; this can be considered a binary 0 condition. If electrons have been trapped during writing, 5 volts applied to the offset gate with the control gate on is not enough to produce conduction from drain to source, and this lack of current flow

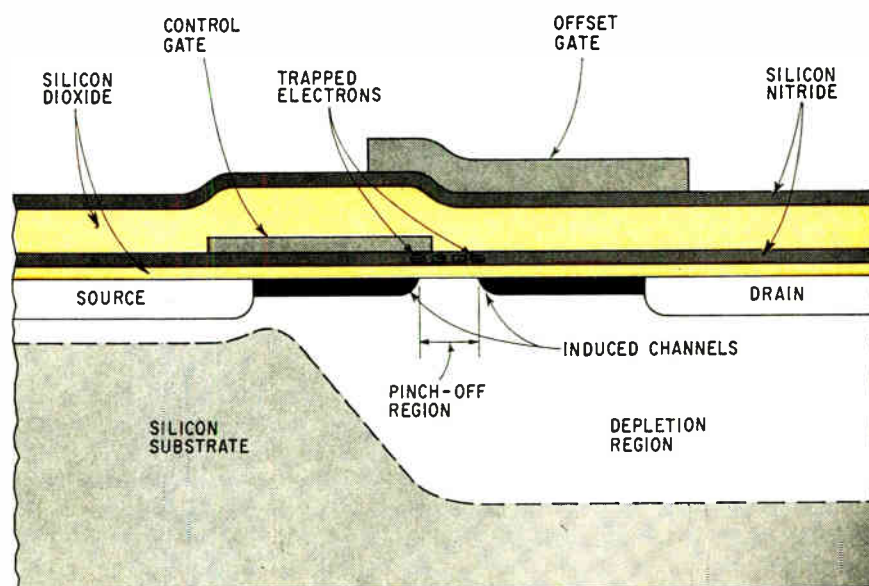

Getting the gates. Hughes Aircraft Co. believes it has managed the marriage of MOS and silicon nitride in a tunneling memory—without the high electric fields—by using two gates and the nitride-oxide sandwich.

U.S. Reports

can be considered a binary 1 condition in the memory. The 5 volts is always on the offset gate, so it's the voltage applied to the drain and control gate that determines the stored data's value.

Choosy. Hughes researchers can write selectively in their memory. With +30 volts on the offset gate but no voltage on the drain, no pinch-off region is created and no electrons can be injected into the nitride trapping layer. Similarly, with +30 volts on the offset gate and +15 volts on the drain, but no voltage on the control gate, no channel is induced from the source and no electrons will be available for injection. In these ways, a cell can be bypassed.

The memory is bulk-erased by tunneling. Applying from -60 to -80 volts to the offset gate with no voltage on the drain or control gate drives the electrons out of their traps and causes them to tunnel into the bulk silicon, clearing the memory.

The researchers have proved all the principles of the memory using discrete MOS FET's, but they're an estimated six months away from getting a 250-bit array and all the decoding and output circuitry on the same wafer.

Besides requiring lower fields for writing, they say, the dual-gate arrangement provides an order-of-magnitude improvement in writing speed over tunneling memories. Data has been written in less than 100 nanoseconds, but 1 microsecond is probably safer to avoid breakdown levels. Some firms working on tunneling memories claim 1- μ sec writing speeds, but Hughes officials believe speeds should be closer to a millisecond to prevent breakdown.

Lasers

First GaAsP

It happened last fall, but Texas Instruments saved the news for president Mark Shepherd Jr. to break at the annual meeting this month: using gallium arsenide phosphide diodes built by the Components Group, scientists in TI's

Equipment Group research and development laboratory succeeded in continuous-wave pumping of a neodymium-doped yag laser. It was, TI believes, the first use of a non-coherent solid state source to pump a laser, and it opens the door to a compact, easy-to-handle laser.

The TI experiment, under Ray Allen, was carried out at 77°K, and resulted in a 50-milliwatt output for a 5-watt input, according to Charles E. Baker, manager of the lab's optoelectronic systems branch. The lab is now preparing a room-temperature (300°K) experiment from which it hopes to get a 100-mw output switched-pulse mode in which it expects to produce a megawatt of power in a 50-nanosecond pulse.

Nine to a team. The diodes used as pumping energy emitters came from a set made by the Components Group's advanced optical sources unit, which had been fabricating diodes with varying percentages of phosphorous and arsenic to determine efficiency levels. The nine diodes that actually pumped the laser—they had to emit light at the same frequency at a given temperature—actually operated in the visible red at 8,100 angstrom units. The more phosphorous in the diode, the shorter the wavelength. The yag laser produced its normal infrared energy at 1.06 microns, but TI expects no difficulty in upconverting into the visible by passing the infrared through a barium sodium niobate crystal to get green light.

To perform the room-temperature experiment, new diodes, with different proportions of phosphorous and arsenic, will be required. Gary Pittman of the optical sources unit notes that as temperature increases, the wavelength of the diodes increases and the energy output decreases. The 8,100 Å emission was necessary to match the absorption spectrum of the laser. Pittman says, however, that there is another absorption band between 8,600 Å and 8,900 Å; he is currently trying to make diodes that will emit energy efficiently at that wavelength so as to obtain more efficient operation of the laser. (The closer the pump-

ing frequency to the rod's emission, the less energy is lost.)

"We're hoping that this will become the standard laser" (replacing argon ion types), says Baker. "You won't need any water cooling, and it's more compact than gas lasers." However, he notes that TI is far from having a product. Ion lasers typically are 0.1% efficient, while TI's GaAsP device has 1% efficiency. Allen, however, is talking about eventually achieving 10%.

It is, though, already marketing solution-grown dome diodes of the type used in the laser experiment, and it expects optoelectronics to be the fastest-growing segment of the electronics market in the 1970's. One array of emitters is already being used in a military system, in conjunction with TI's Tivicon tube, to produce a solid state image.

Solid State

Seaming flaw

The engineers at Fairchild Semiconductor were mystified. Customers had reported "opens" in some of Fairchild's circuits, but couldn't find them—and neither could the engineers when using a conventional microscope at 1,000 X magnification. But viewing the defective circuits through a nondestructive scanning electron microscope at 10,000 X, they could see—good grief!—cracks in the aluminum interconnect strips where the aluminum had dropped from the oxide onto the silicon substrate.

Fairchild's research center at Palo Alto, Calif., found the pattern of cracks even though the oxide "step" is only about 1 micron high. In the Alice-in-Wonderland world of 10,000 X magnification, in fact, the window in the aluminum looked like a deep gorge running along the edge of the oxide strip.

To some of Fairchild's detractors, it looked like a blow to Fairchild's unyielding advocacy of aluminum as the preeminent metal in microcircuitry. But in retrospect, with the problem solved, Fairchild's Harry Sello says it wasn't alumi-

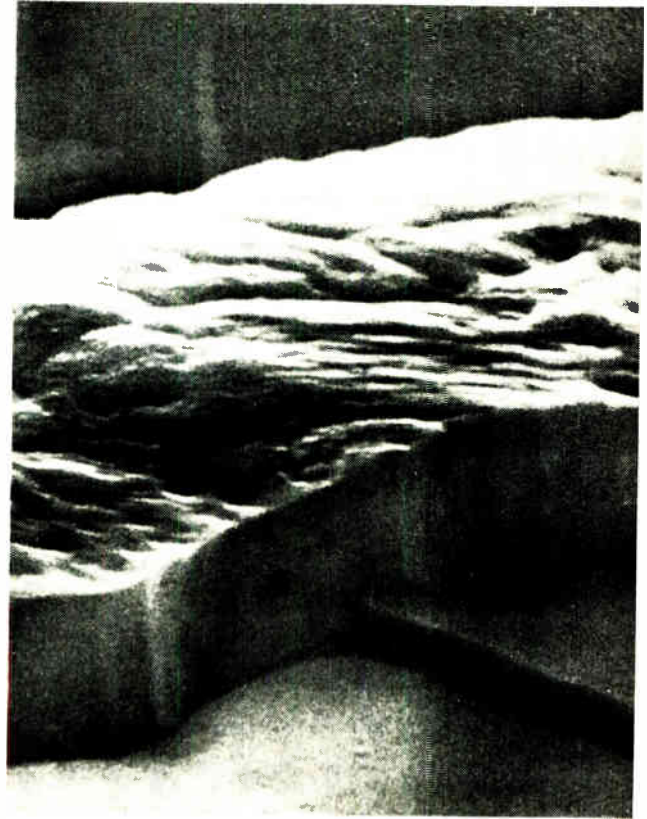

Fissured floes? No it's an aluminum interconnect strip cracked where it passes over an oxide step on a Fairchild IC. At right is one that isn't cracked. The photo at left is a 10,000 X magnification, the other is 20,000 X.

num's fault. Sello, R&D manager of materials and processes, puts it this way: "The problem is one that every semiconductor manufacturer will have to solve regardless of the type of metal he uses for interconnects and leads."

Crackdown. As Sello sees it, the problem is that an interconnect strip will tend to crack when it's dropped over an oxide step made at right angles to the substrate. It won't always happen, he adds; the frequency of cracking appears to be proportional to the complexity of the chip. On a complex IC chip, he says, there may be as many as 1,000 oxide steps over which a metalization pattern will be dropped. And "because Fairchild is moving into complexity faster than other companies, Fairchild had to solve the problem first," Sello declares.

At first he thought the problem was related to the fact that the oxide, silicon, and aluminum strip have different temperature coefficients; as the chip cooled unequally, he reasoned, the aluminum separated. Sello concedes that it took

several months to realize that this wasn't the problem. He has now pinpointed a common physical phenomenon as the cause of the breaks: a variation of nucleation, such as one can see in winter when ice on a pond forms first around twigs and sticks protruding from the water. In like fashion, the aluminum strip has a tendency to gather at the top and the bottom of the step, leaving the space between without an aluminum connection.

Playing the angle. If the angle of the step were more obtuse, Sello theorized, the phenomenon would not occur. Experiments have since proved his contention. The solution to the problem lay, then, in finding a method of widening the angle of the step to the substrate.

In another approach, the deposition process was varied to reduce the aluminum's tendency to nucleate, and to cause the metal to flow smoothly from the top to bottom of the step. Though he declines to give details, Sello says careful control of the temperature, pressure, and rate of the deposition

process has been combined with a proprietary "chemical filing" of the upper edge of the step to eliminate the flaw.

Military

Changing times

Artillery fuzes may have come a long way from the slow match, but it's still difficult to time them quickly and accurately. To set shell fuzes, gun crews now use a mechanical device that resembles a cross between a gradient and a medieval torture implement. The cumbersome timer can take a few minutes to set and doesn't always prove accurate under battlefield conditions; some projectiles explode too soon after they have left the gun.

However, the Army's Harry Diamond Laboratories (HDL) has used integrated circuits to develop a fuze and setter combination with which, it says, an artilleryman can

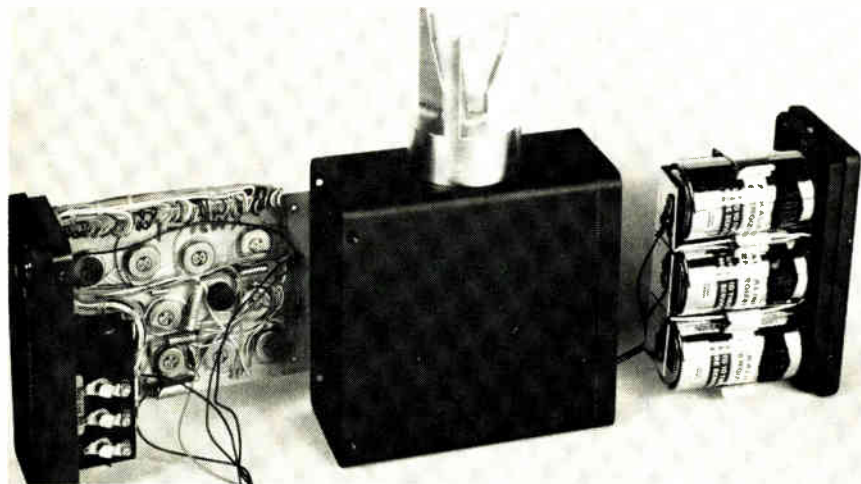

Ready, aim . . . Fuze setter using IC's promises accurate timing and ease of operation. "Crown" atrop black box fits over artillery shell's nose.

accurately schedule the explosion of a warhead with hardly more than a touch. HDL claims that the device will time 99.5% of all fuzes within a tenth of a second accuracy and set each one in no more than half a second.

Split seconds. Not only that. The device allows almost 2,000 settings at 0.1-second gaps between 2 seconds and 200 seconds, performs a partial electrical test of the fuze, and tests itself as well, according to Thomas E. Tuccinardi, an HDL fuze specialist. The setter, using an electronic timing circuit, does all this without turning on any power within the fuze and without any mechanical connections.

The fuze-setter consists of a multivibrator; set and clear generators; decade counters with appropriate switches; logic AND gates made from transistors, capacitors, and resistors in chip form; and three d-c batteries for power. The hybrid IC's—made by Bendix—contain a 1,280-hertz oscillator, buffer frequency divider, driver, and counter. Three knobs on the setter base touch three rings on the front of the fuze for connection.

The oscillator, acting like the balance wheel of a watch, keys the setting and firing of the fuze. A scaler divides the oscillator's frequency down to 10 hz—equivalent to a tenth of a second—and provides a wave-shaping current like the escapement in a watch.

The setter, which can reset the same fuze indefinitely, clears the fuze, counts down at a fast rate, and stops at the time remaining, which is the time desired by the gun crew.

Chain of command. When the setter is connected to the shell, its power switch turns on, activating the clear generator. The multivibrator triggers the set generator, which pulses the fuze, and the fuze sends back monitored pulses to the logic block, which references the accuracy of the feedback. If there's an error, the block orders the fuze setter to stop and turns on a red light to alert the gun crew to the error. If the fuze is all right, the setter keeps sending timing pulses until it reaches the desired time. When that time is reached, the logic stops the setter and activates a green light to inform the crew that the fuze is properly set.

In the fuze, the driver receives the timing pulses and pulses the feedback shift-register counter, which contains 2-inch magnetic cores to send back signals to the setter. When the projectile is fired, a spin-actuated dry-cell battery energizes the fuze circuit. And when the driver receives the final 10-hz signal from the divider, it sends a pulse to the output detonator. The fuze also contains an impact device so that if a fuze is fired in a "no-set" position it will explode the warhead upon impact.

Microwave

The more the MERA

An ambitious development program can sometimes provide technological fallout that in the end proves as valuable as the program's prime objective. Whether this will be true of Texas Instrument's MERA (molecular electronics for radar applications) remains to be seen, but the company is ready to preview an important example of such fallout at the International Microwave Symposium in Dallas, May 5-7.

What TI will display is a thin-film hybrid integrated circuit telemetry transmitter and receiver set that it believes proves the feasibility of microwave applications for IC's. Many of the components came from MERA. The f-m transmitter, which weighs 1.3 ounces and occupies less than 0.75 cubic inch, operates at 1.7 to 2.3 gigahertz. Its over-all efficiency, says TI, is greater than 12% at 2.25 Ghz.

A command receiver that also makes maximum use of IC's has been designed to cover either of the desired frequency ranges of 1.70 to 1.71 Ghz and 2.2 to 2.2 Ghz by a simple change of quartz crystals.

Ground up. While TI engineers J.C. Pinac and B.S. Skinner Jr. found that IC's could be used in microwave regions, they also found that circuit configurations and system block diagrams should be designed for IC use and not just converted to it. "Often," they say, "the optimum IC subsystem will be very different from a conventionally wired system."

Pinac and Skinner headed the work, conducted under the auspices of NASA, that started about three years ago, as a study of microwave integrated circuits, techniques, and components. It later evolved into a request for the design, fabrication, and testing of prototype devices.

In their transmitter, a sample of the output and a stable reference frequency are alternately applied to a limiter-discriminator for equal periods of time. The output of the discriminator is a square wave whose amplitude is proportional to the difference between the output

The Readable Little Meters

You can even read the littler little one at arm's length.

(Actual sizes)

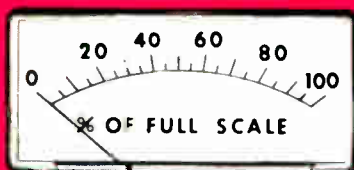

The littler little one.

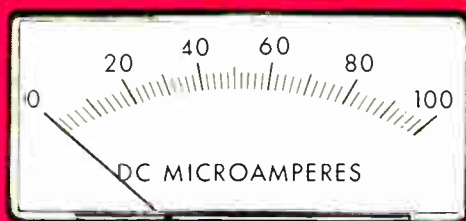

The bigger little one.

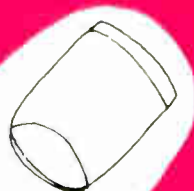

Put your left thumb here.

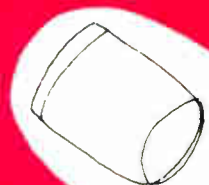

Put your right thumb here.

Honeywell's new Series 80T Panel Meters take up about half the panel space of full-size meters.

But hold this ad out at arm's length and see how easy the meters are to read. (How we ever got such large scales on such small faces without cluttering them, only our designers know.) And we've set the dial up front, so you can see it clearly, even from an oblique angle.

Behind the small face is Honeywell's unique taut-band mechanism - with about

50% fewer parts than a pivot-and-jewel. (One of the parts that's missing is the old space-consuming plastic barrel on the back of the meter.)

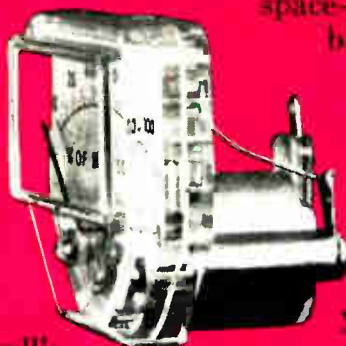

The new Series 80T Panel Meters come in 33 standard ranges. And they cost no more than pivot-and-jewel meters. So you don't have to pay a lot to get a little.

(We'd like to send you a catalog. Write Honeywell Precision Meter Division, Manchester, New Hampshire 03105.)

It takes all kinds of meters to make the Honeywell line.

Honeywell

Circle 43 on reader service card

U.S. Reports

frequency and reference frequency, and whose frequency is a function of the switching rate.

A synchronous detector following the discriminator converts the square wave to a d-c signal whose amplitude is proportional to the magnitude of the frequency error; its polarity is determined by the polarity of the frequency error. A low-pass filter eliminates any a-c components before the error signal is applied to the voltage-controlled oscillator to correct the center frequency.

Benefits. The resulting system is a compromise, the TI engineers say, but it offers certain advantages: freedom from a discriminator center-frequency stability effect; crystal stability without severe modulation restrictions; single crystal control; a need for only one multiplier; freedom from circuit or component matching and tracking; and adaptability to IC form. Only the modulator, vco, and power-amplifier stages were actually built for this project, though the complete transmitter was designed.

The vco—a Colpitts circuit in microstrip form—is tuned by a varactor diode. The varactor establishes the center frequency and accepts the telemetry modulation. Two microwave transistors in the oscillator yield an output power of about 70 milliwatts across the frequency band. The vco is followed by a Class-A buffer amplifier with a single transistor that supplies 140 mw. Both the vco and buffer amplifier were fabricated on a 20-mil glazed alumina substrate.

The power-amplifier section uses a power-divider, power-combiner approach to put out 1 watt. Two amplifiers are required in each branch of the power divider. Still another transistor supplies sufficient r-f power to drive a pair of devices to an output of 600 mw. In the feasibility models fabricated, only half the power amplifier was used. The transmitter circuits were mounted in a gold and copper plated kovar housing.

Receiving end. For the receiver, Pinac and Skinner say, the local oscillator signal is derived from a crystal oscillator through a step-recovery diode multiplier. The

mixer is of the hybrid balanced, image-terminated type and uses a pair of gallium-arsenide Schottky-barrier diodes. Microstrip filters are used in both the preselector band-pass filter and the step-recovery multiplier filter, as well as in the mixer to ensure small size. The i-f amplifier operates at a center frequency of 100 Mhz and has a 20-decibel gain. Detection is done by a phase-locked demodulator. The configuration yields an output signal-to-noise ratio of 15 db, which establishes an error rate of 1×10^{-4} .

Pinac and Skinner see a number of applications for the set, including employment in deep space probes. Each module dissipates its own heat, a vital factor since as many as 200 may be tied together in some applications; also, the set degrades "gracefully."

The TI engineers are hopeful of getting an application request soon. "We have the techniques, ability,

and prototype devices," they say. "We're just waiting now for a proposal request."

Safeguard watcher

All that stands between most radar receivers and burnout is what's called a transmit-receive, or tr, tube. These tubes make sure that a radar system's powerful transmitter signal is sent only to the antenna, not back down the waveguide leading to the sensitive and delicate receiver.

Strangely, for such a critical piece of equipment, until now there hasn't been any practical way of characterizing these tubes, performing quality control checks on them, or monitoring their performance in the field.

No smoke. Finally, Varian Associates has developed a performance monitor for tr tubes that does all three. Called the microwave pulse height detector, its use should make unnecessary the arbitrary replacement of tr tubes at set intervals to prevent unexpected failures. It should also eliminate the so-called look-for-smoke test now used to see if a tr tube works—if the receiver survives, the tube is good. Developed at Varian's Solid State Microwave group, Beverly, Mass., the monitoring device has the outstanding characteristic of being able to spot pulses as short as 500 picoseconds.

Such short pulse lengths defeated earlier attempts at economical tr tube testing. Sampling oscilloscopes were the only measurement tools available for the task, and even these would miss spikes falling between their sampling intervals. Trying to spot spikes from what could be a bad tube was 10, 15, or 20 minutes' work, and even then it was hard to spot a fleeting trace on the scope's crt. The usual "answer" was to skip tests on all but high-reliability contracts.

But now the Varian device can be set up in place of a receiver in a simulated radar system. Since any tr tube will let harmless spikes of low amplitude pass, the attenuator is set to cancel those; only

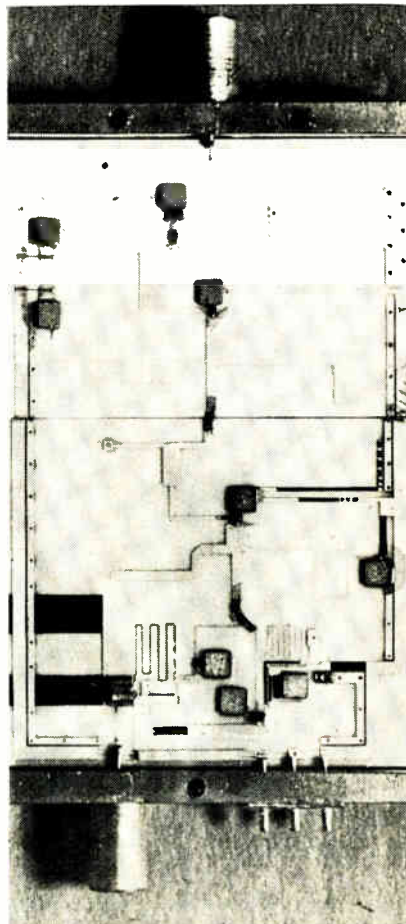

Sending. Microwave transmitter using TI's thin-film hybrid IC's.

Meet our power twins

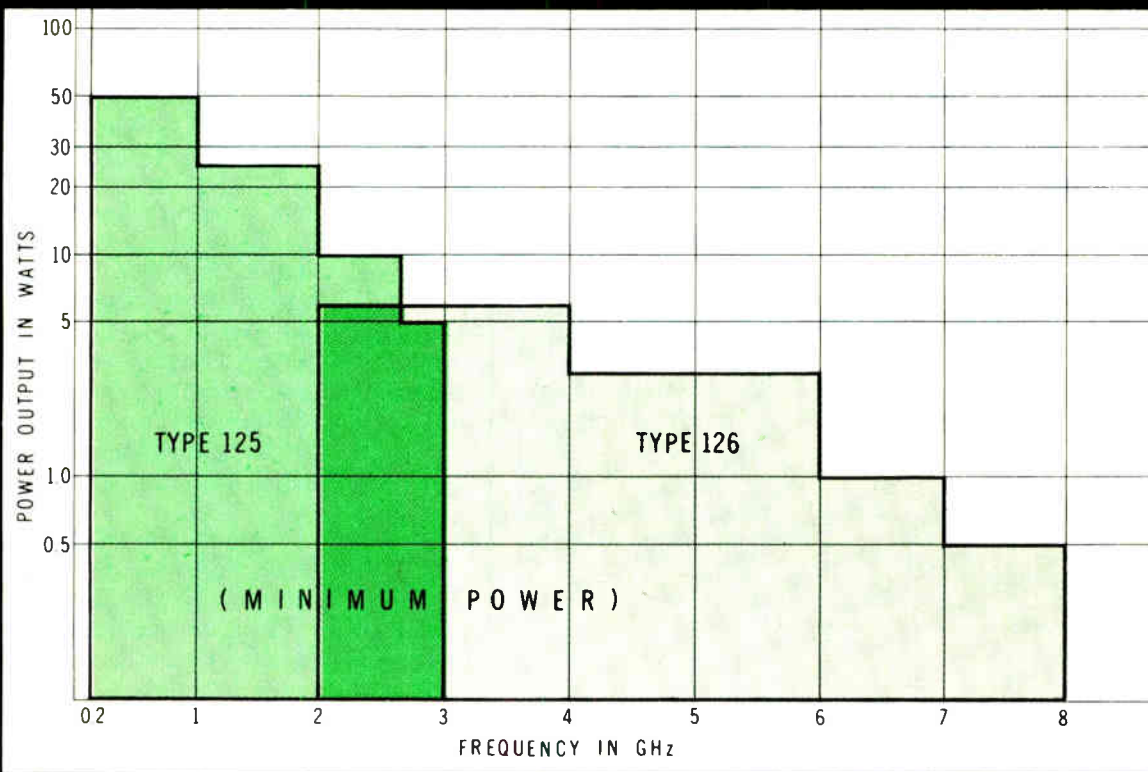

All's two **Power Signal Sources** cover the entire range from 200 to 8000 MHz. Powerfully.



Meet ALL's Power Signal Source twins: Type 125 covers the range from 200 to 3000 MHz, is priced at \$3950. New Type 126 operates from 2000 to 8000 MHz, at a price of \$4950.

Only ALL can do the job with just two units. Our Type 125 and Type 126 span the range of up to eight competitive instruments.

The chart shows the really abundant power you get at each frequency. The values shown are guaranteed minimum specs—higher CW values and peak-pulse powers of several hundred watts are attainable. But that's just the beginning.

Each source has internal 100% square wave modulation, external pulse and amplitude modulation capability, 0.004% frequency stability, and 1% power stability.

Want to use them for your low level signal source needs, too? Both units provide over 60 dB power adjustment range to cover all of your requirements.

So why consider six or more signal sources when ALL's power twins do the job—and at much lower cost! For convincing proof, call our "hot line" to arrange a demonstration. Just dial 516-595-3216 during East Coast business hours.



Or write for our new catalog describing ALL's full line of Microwave Instruments, including complete specifications for the Types 125 and 126 Power Signal Sources.

AIRBORNE INSTRUMENTS LABORATORY
DIVISION OF CUTLER-HAMMER INC | DEER PARK, LONG ISLAND, NEW YORK 11729



AIL/
DIVISION

Total Capability

IN CARBON VARIABLE CONTROLS

Singles, concentric duals, tandem duals . . . with or without switches . . . All available at Mallory. Practically everything you require in standard or special construction.

Long wear, noise free elements used in all carbon controls for satisfactory trouble free operation.

Switches attached to controls available in 1, 3, 5 and 6 ampere ratings . . . Special switches for high in-rush current applications such as color TV and tungsten lamp loads made to your specifications.

Mallory Controls Company, a division of P. R. Mallory & Co. Inc., Box 327, Frankfort, Indiana 46041.

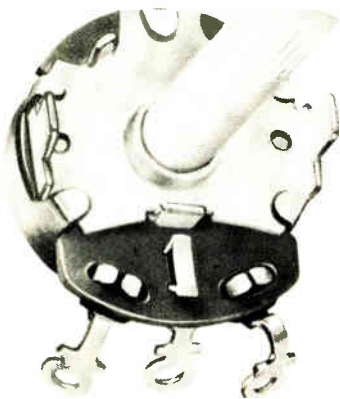

MALLORY

U.S. Reports

high-amplitude, injurious spikes are left to be spotted by the detector.

Pulse taker. The heart of the device is a very sensitive, high-speed detector diode and an amplifier of proprietary design. Capable of responding to very short pulses of microwave energy, the amplifier boosts the pulses enough for rectification and charge of a capacitor. This in turn feeds a pulse stretcher, which makes the pulse long enough for a digital counter to respond to it. If too many pulses get counted in a given interval, the tube is a reject.

Varian will sell counter-equipped monitors for \$825, and monitors with output jacks for a counter at \$275.

As a system monitor the pulse height detector could spot degradation in a tr tube's performance long before it has time to harm the receiver. A detector would be coupled into both the waveguide leading to the system's receiver and the attenuator set to coincide with the tr tube's specified spike leakage level. In a fighter aircraft, for example, any spike more powerful would light a warning in the cockpit. The pilot thus could test a tr tube before a mission by lighting off his radar system and looking at a warning indicator. Such detectors will cost only \$175.

Government

Escape mechanism

Traditionally, a Washington press conference is brought to a close when the senior reporter present says "Thank you." However, a new twist was introduced at a press conference this month with Transportation Secretary John Volpe on the Department of Transportation's budget. Just as the reporters were beginning to cut through the gobbledegook of the budget requests—particularly the one for the Federal Aviation Administration—Barry Locke, a member of Volpe's staff, called out, "Thank you, Mr. Secretary."

Volpe looked relieved, gathered

his papers, and walked quickly out of the room, leaving behind a group of thoroughly dismayed reporters.

Red-handed. The reason for Volpe's relief was the fact the questioners had caught the FAA playing games with the figures for airways and airport development. In President Johnson's fiscal 1970 budget, the figure for airways and airports was \$275 million contingent upon legislation creating a "user tax" to pay part of this. President Nixon's budget, however, calls for \$190 million, permitting the FAA to list an \$85 million "reduction" over the old budget. However, the \$190 million is also contingent upon a "user tax."

Volpe thus was claiming a cut in funds that were never really budgeted in the first place.

The new Administration's budget didn't cut back on the Johnson figure of \$134 million for facilities and equipment or the \$47 million for research and development [*Electronics*, Feb. 3, p. 135].

Volpe didn't spell out how he would spend the \$190 million—if he gets it. He did say that as much as \$130 million of it would be allocated for airways facilities, including airport towers, radar, and instrument landing systems. The other \$60 million would go for airport construction.

Phantom jet. As in the Johnson budget, there was no mention made of the supersonic transport—except a note that a decision is still pending. Volpe did estimate, though, that it would take "a couple of hundred million" to keep the SST going.











Although the Transportation Department didn't appear too anxious to make its spending plans clear, the Post Office took the opposite track. The new Administration is offering its wholehearted support to new electrical and mechanical equipment for the Post Office, and to R&D. Postmaster General Winton Blount unveiled a trimmed-down budget for the Post Office, but full funding—\$54 million—remained for research and engineering, up about 44% from the level for the current fiscal year.

The Johnson Administration's request for \$405 million for postal



The Minelco family of small components that solve big problems. Small? **Miniature!** Trimmer Potentiometers... Rotary Selector Switches... BITE (built in test equipment) Indicators. A size, a configuration, a type for every requirement. Name your specifications, we'll supply the component. We keep it in the family.

...THINK MINELCO!

 <p>NEW! MP32 5/16" dia. Pancake Trimmer Potentiometer</p>	 <p>Microminiature! MS1 1/4" dia. Trimmer Potentiometer</p>	 <p>For printed circuits! SW32 .350" dia. Rotary Selector Switch</p>	 <p>For panel mounting! SW37 .350" dia. Rotary Selector Switch</p>	 <p>Manual reset! BHGM 1/2" wide BITE Indicator</p>
 <p>Internal switching! M170 .2" x .4" x .7" BITE Indicator</p>	 <p>Electrical or mechanical reset! M151SMS 1/2" dia. BITE Indicator</p>	 <p>Tiny... bistable... highly visible! BHG21 1/4" dia. BITE Indicator</p>	 <p>Low-cost! MP2 .290" dia. Trimmer Potentiometer</p>	 <p>Infinite resolution! MF2 1/4" dia. Trimmer Potentiometer</p>

For additional information, contact:

MINELCO

a subsidiary of **GENERAL TIME**
Progress in the World of Time

600 SOUTH STREET, HOLBROOK, MASS. 02343 / (617) 963-7717

BITE INDICATORS • ROTARY SWITCHES • TRIMMER POTENTIOMETERS • ELAPSED TIME INDICATORS • EVENTS COUNTERS



Total Capability

IN SWITCHES

Rotary, lever and push button. Mallory has them all . . . and more. Dozens of different switches for hundreds of applications.

For prototype or production, Mallory can readily supply standard switches or custom-made units tailored to your specifications.

Terminal contacts are high quality, special alloy brass . . . silver plated. Low contact resistance is maintained by built-in self cleaning action between rotor and stator contacts.

Many switch sections are available in both phenolic and ceramic insulation.

Mallory Controls Company, a division of P. R. Mallory & Co. Inc., Box 327, Frankfort, Indiana 46041.

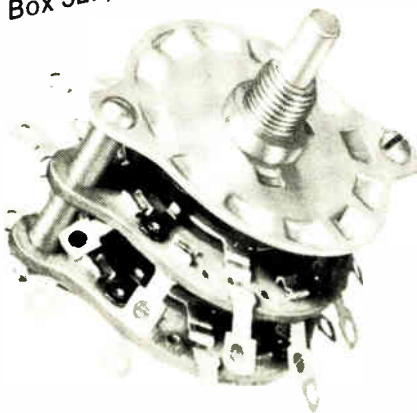

MALLORY

U.S. Reports

plant and equipment modernization is also supported in full by the new Administration.

Because research and equipment expenditures are vulnerable items in Federal agencies' budgets, advocates of a vigorous Post Office research program are applauding Blount for keeping his budget pruners at bay in this area.

Education cut. The office of Education might not fare so well, however. The new budget submitted by President Nixon calls for a fiscal 1970 outlay of \$3.2 billion, down from the \$3.6 billion sought by the Johnson administration. Although it's impossible now to tell which programs will be pared, there is a good chance that those involving computers and electronic teaching hardware will feel the knife.

First slice

The first cuts in the NASA and defense budgets are usually made by Congressional committees. This year, however, the new Nixon Administration got there first. In releasing his proposed budget for the year ending June 30, 1970, the President didn't reveal much about the defense budget that had not been previously announced by Secretary of Defense Melvin Laird [*Electronics*, April 14, p. 60]. The NASA budget, however, was another thing.

As slices go, the National Aeronautics and Space Administration didn't fare badly. And for those at the Office of Manned Space Flight, who were prepared for the worst, the "slice" was cause for rejoicing. The NASA appropriation will be reduced by \$45 million, with the rest of the revised budget a juggling act in which the following occurred:

- An added \$40 million was earmarked for further lunar exploration and Apollo flights.
- Money for Saturn V production has been boosted from \$11 million to \$57 million:
- The budget for tracking and data acquisition will be slashed by \$20 million.
- A request of \$8 million for small

planetary probes was cut out. A total of \$41 million was cut from space science and applications.

▪ Cuts totaling \$13 million were made in the advance research and technology budget.

In short, the juggling added up to \$131 million trimmed from a number of programs, but with \$86 million pumped right back into manned flight to continue lunar exploration and start the Saturn V assembly line going again. Specific casualties were heavy in the unmanned areas: Biosatellite F has been canceled, one Explorer knocked out and the whole Small Planetary Explorer program deleted, launch vehicle procurement for unmanned space programs has been sliced back by \$11.6 million, experiments will be deleted from Nimbus and Applications Technology Satellites, and a third of the funds for geodetic satellites have been cut. Of the \$20 million cut from the budget of the Office of Data and Tracking Acquisition, some \$12 million was to have gone for hardware.

The revised NASA fiscal 1970 budget goes along with the long-established practice of keeping the maximum dollars in manned flight even if it means taking money from other less prosperous programs. NASA Administrator Thomas O. Paine pointed out when presenting the revised budget that the Nixon Administration was behind a "strong space program." The revisions show that Nixon and Paine see "strong" as meaning manned space flight.

Defense cuts. Meanwhile, over at the Pentagon, in one last snip, the Defense Department pruned another \$79 million from the revised budget that Laird announced earlier this month. The cuts were in munitions and base facilities and \$4 million in a classified project. The Pentagon is now asking for \$77.5 billion in new obligatory authority and is planning to spend \$77.9 billion in fiscal year 1970 funds.

In juggling accounts, Laird changed some program timetables. The Advanced Warning and Control System (Awards) would lose \$15 million, but the \$60 million left, plus the \$40 million from 1969,

variable viewing time

5 cm/ μ s stored writing speed

split-screen displays

all in the Tektronix Type 549 Storage Oscilloscope

Waveform display showing train of pulses. Upper screen in the stored mode shows three pulses with falltime of the pulse trailing edge showing system deficiency. Lower screen in conventional display mode shows the same pulse train with corrections applied to provide a well formed pulse shape. Pulse width shown is 8 μ s with risetime of 0.1 μ s. Vertical deflection factor is 0.5 volts/cm. Horizontal deflection factor is 10 μ s/cm. Repetitive sweep used for both displays.

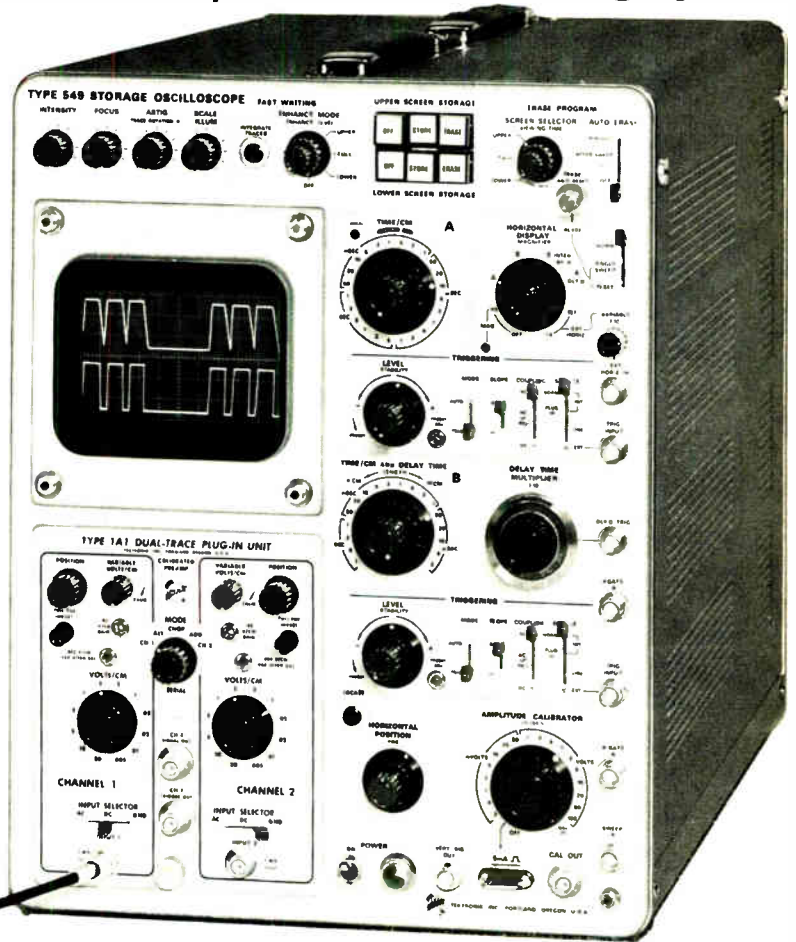

The Type 549 allows up to one hour of continuous visual storage, giving you ample time in most applications to measure and analyze stored waveforms. Stored displays can be erased in less than one-quarter of a second.

Split-screen displays

Unique with Tektronix storage oscilloscopes, split-screen displays bring you many advantages in waveform-comparison applications. You can use either half of the 6 cm by 10 cm display area for stored displays, the other half for nonstored displays, with independent control of each half. You can also use the entire screen for either type of display.

Variable viewing time

Variable viewing time — an outstanding feature of the Type 549 — allows you to automatically store displays, view them for a selected time, then automatically erase them on either or both halves of the screen. Two modes of operation are possible. In the After-Sweep Automatic Erase Mode, the selectable viewing time of 0.5 s to 5 s begins at the end of each complete sweep. After the viewing time, the display is automatically erased and the cycle begins again when the next sweep is triggered by a signal.

In the Periodic Automatic Erase Mode, the sequence of storing, viewing time and erasure is continuous and independent of the sweep or signal. In this mode, the viewing time can also be varied from 0.5 s to 5 s.

There is no degradation of stored traces during the selected viewing time, in either mode, and you can retain or erase displays manually whenever desired.

For a demonstration, contact your nearby Tektronix field engineer or write: Tektronix, Inc., P.O. Box 500, Beaverton, Oregon 97005.

Bistable storage advantages

With bistable storage oscilloscopes, such as the Type 564 and Type 549, the contrast ratio and brightness of stored displays are constant and independent of the viewing time, writing and sweep speeds, or signal repetition rates. This also simplifies waveform photography. Once initial camera settings are made for photographs of one stored display, no further adjustments are needed for photographs of subsequent stored displays.

Tektronix bistable storage cathode ray tubes are not inherently susceptible to burn-damage and require only the ordinary precautions taken in operating conventional oscilloscopes.

Plug-in unit adaptability

Vertical deflection characteristics of the Type 549 are extremely flexible through use of any of the Tektronix letter- or 1-series plug-in units. These include multi-trace, differential, sampling, and spectrum analyzer units. Depending upon the plug-in being used, bandwidth of nonstored displays extends from DC to 30 MHz.

Among other features of the Type 549 are 5 cm/ μ s stored writing speed, calibrated sweep delay from 1 μ s to 10 s, sweep speeds to 20 ns/cm, amplitude calibrator from 0.2 mV to 100 V and a locate zone for easy positioning of stored traces.

Type 549, without plug-in units \$2575

Type 1A1 Dual-Trace Plug-In Unit \$ 625

DC to 30 MHz at 50 mV/cm; DC to 23 MHz at 5 mV/cm.
2 Hz to 14 MHz at 500 μ V/cm, single-channel.

U.S. Sales Prices, FOB Beaverton, Oregon



Tektronix, Inc.

committed to progress in waveform measurement

Total Capability

IN WIRE-WOUND RESISTORS

Vitreous enamel, fixed and adjustable. Whatever you need in wire-wound resistors, Mallory can deliver. 1 ohm to 100K ohms. 3 watts to 200 watts. Cylindrical and flat, with standard or special terminals.

Excellent resistance to thermal and mechanical shock, humidity and electrolysis. High wattage dissipation. Long life and outstanding durability. Top reliability in extreme environments. Permanently welded connections.

Whatever your needs in wire-wound resistors, Mallory can fill them.

Mallory Controls Company, a division of P. R. Mallory & Co. Inc., Box 327, Frankfort, Indiana 46041.

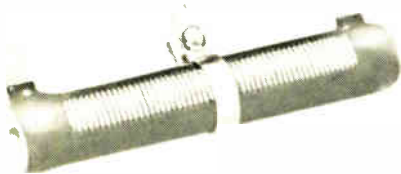

MALLORY

U.S. Reports

means that the Air Force will choose between Boeing and McDonnell Douglas for the prime contract a month later but still by the end of this year. Contractor proposals are due in August.

With a new total of \$100.2 million, the Nixon Administration has committed itself to build the Advanced Manned Strategic Aircraft (AMSA), which critics say could wind up costing \$12 billion. The Air Force would like to award initial development contracts in November, with first flights in mid-1973 and operational squadrons in 1976.

Since the FB-111 program, for which the Short-Range Attack Missile (SRAM) was intended, and a parallel B-52 conversion program would be cut, SRAM would lose \$326 million, \$153 million of it in 1969 and 1970 procurement funds. To keep the program limping along until development problems are licked, there is \$20.4 million left in the procurement kitty and R&D has been raised \$17 million to \$84.7 million. Laird has decided wisely not to buy the missile until it can be shown to work properly.

Some Navy ship programs, including the high-speed sub, salvage tugs, submarine and destroyer tenders, and a guided missile frigate conversion are cut back or deferred.

Integrated electronics

Omnibus chip

The problem: transmit to an f-m receiver the pressure and temperature encountered during a short flight by a projectile as it hurtles down a test range at 40,000 feet per second, undergoing accelerations as high as 500,000 G's. The solution: design an integrated circuit f-m telemetry transmitter combining all the monolithic technologies existing today.

The problem is often faced by the Arnold Engineering Development Center at Tullahoma, Tenn., part of the Air Force Systems Command. AEDC must instrument models of aircraft, missiles, and re-entry vehicles to obtain critical data in wind tunnels and other test facilities. The solution to teleme-

tering pressure and temperature levels picked up by AEDC-furnished transducers after a projectile is fired from a gas gun was provided by engineers at the Microelectronics Center of the TRW Systems group.

But you don't have to have a test range in your back yard to make use of the TRW transmitter. A major jet-engine manufacturer has expressed interest in it to telemeter pressure and temperature from inside the engines. So has the U.S. Wildlife Service, which would like short-distance telemetry of data from animals.

Short trip. Daniel Dooley, head of the Microelectronic Circuit Technology group in the TRW Center, says the device would be useful anywhere hard wires can't be used to transmit data over short distances, such as spacecraft environmental test chambers, rocket motor test installations, and in rotating machinery or other places in which the transmitter will be pulse-code modulated and analog-to-digital converters will provide its input.

Dooley says the transmitter combines thin-film capacitors deposited on a monolith, diffused resistors, and diffused pinch resistors—all of which are put on a substrate with high-frequency transistors. Dooley says that the device, designed to operate at 130 to 150 megahertz, displays the highest frequency with gain he knows of for a monolithic IC. "The gain isn't large," Dooley says, "it's just enough to sustain oscillation, and a minimum of about four is needed to do all this."

Designated the NRO-01, the circuit is on an 81-by-82-mil chip housed in a TO-5 can that is potted in epoxy before firing. After the IC is potted, the transducers and a one-inch-diameter wire loop antenna are also potted in another type of epoxy to help withstand the tremendous acceleration generated in the launch.

Pinched. "We needed high-value resistors," Dooley explains, "but most of the real estate was taken up by thin-film capacitors, so we went to diffused pinch resistors to get the 300,000-ohm value." The constricted channel (0.9 micron wide) that's used to get the pinched

**Five reasons why
more engineers have selected
Clairex photocells
over all others...**

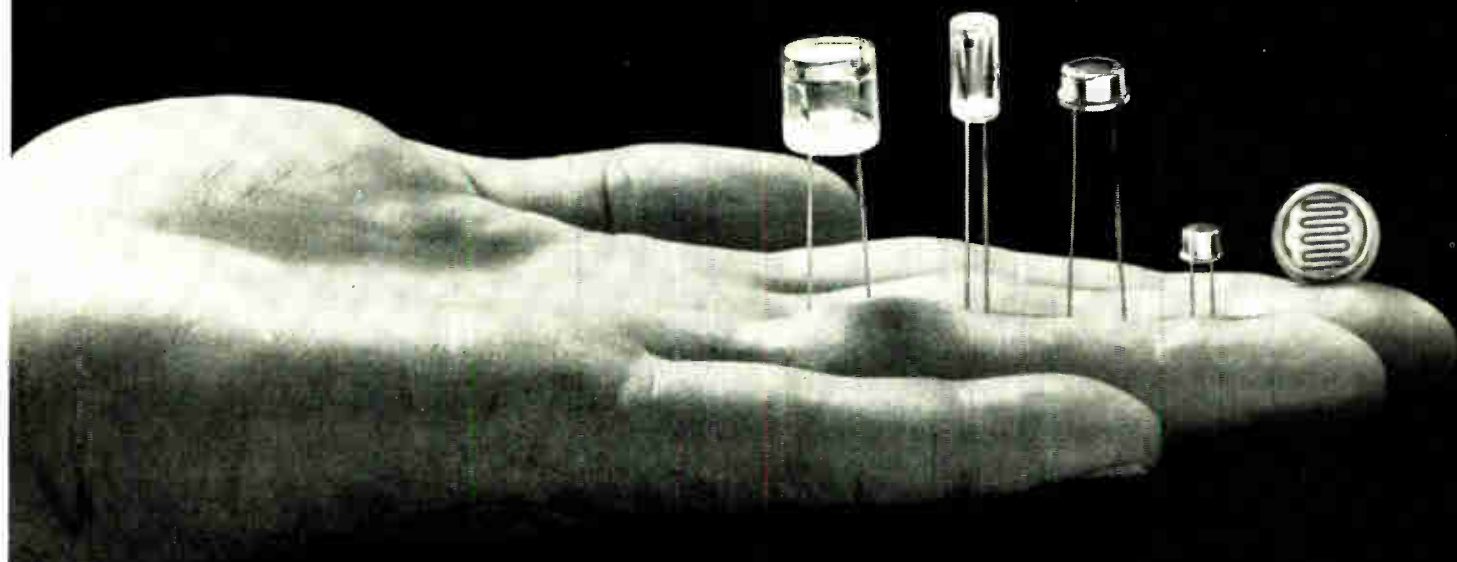

**These basic
Clairex packages cover
98% of all applications...
try one.**

Clairex has more experience supplying more high-quality photocells for more applications than anyone. Let us show you how we can perform in handling your problems. Call (212) 684-5512 or write Clairex, 1239 Broadway, New York, N. Y. 10001.

CLAIREX ELECTRONICS, INC.

Total Capability

IN FILM RESISTORS

Precision, semiprecision and power types. Whatever you need in film resistors, Mallory can give you. 1/8 watt thru 7 watt. Tolerances: Precision $\pm 0.1\%$ to 1% ; Semi-precision $\pm 2\%$ to 5% ; Power $\pm 5\%$ to 10% .

Precision helixing assures tight resistance tolerances and uniform heat dissipation. Molded or conformal coating with epoxy or silicon protects resistors from moisture and environmental contaminants. Special "No Flame" coating available for power types.

Whatever your needs, Mallory can fill them.

Mallory Controls Company, a division of P. R. Mallory & Co. Inc., Box 327, Frankfort, Indiana 46041.

MALLORY

U.S. Reports

resistors boosts the capability from the normal 200 ohms per square for diffused resistors to 10,000 ohms per square.

The TRW engineer believes the most important features of the transmitter, besides its operating frequency, are stability, modulation bandwidth, and signal strength. Regarding stability, he says acceptable drift is 7 kilohertz. Dooley says no batteries will survive 500,000 G's. A charged capacitor outside the IC provides power during the projectile's short flight. However, the capacitor discharges rapidly once it's separated from the battery used to charge it before firing. To counteract this, TRW engineers incorporated a two-stage voltage regulator on the chip to maintain stability.

Full-scale modulation bandwidth is 400 hertz (vs. 175 hz for a commercial f-m radio station). "The combination of modulation bandwidth and stability requirements represents quite a tradeoff," Dooley maintains. Discussing signal strength, he continues, "We wanted as low a power figure as possible because we didn't want to suck all the charge out of that capacitor, but we had to have enough power to be able to receive the signal. We met the spec of 75 microvolts across a dipole antenna located 10 feet from the transmitter. This is the only spec we didn't exceed, but even at that, the usual f-m receiver works at about 1.8 microvolts."

For the record

Phaseout. Defense cutbacks have forced the Sperry Rand Corp. to shut its Ford Instrument division, which manufactures fire control systems. The shutdown, which will be complete in about 12 months, will put 900 employees out of work, although a Sperry spokesman says that the company's other divisions will try to absorb as many of the 900 as possible. Contracts that run past the shutdown date will be completed at other Sperry divisions—Gyroscope, Systems Management, or Federal Systems.

Turnover. In what is regarded as yet another move to get its computer business out of the red, the General Electric Co. has appointed Hillard W. Paige to head its Information Systems group. Paige, currently in charge of GE's Aerospace group, will succeed J. Stanford Smith, who is taking charge of the firm's newly formed International group.

Credibility anyone? The Logistics Management Institute, a Pentagon-supported think tank, has just released results of a study indicating that defense contractors' profits are lower than earnings in non-defense operations. But the study, which shows defense earnings averaging 7.3% of total capital investment against 10.1% for the non-defenders, hasn't convinced Sen. William Proxmire (D. Wis.). Proxmire, chairman of a subcommittee that's been investigating war profiteering, is expected to call for an "independent" inquiry into defense profits by the General Accounting Office.

Ear to the ground. The Army is now in possession of a low-level radar device that can detect and chart underground tunnel complexes. Developed by Sylvania Electronic Systems, the device has already been successful in locating enemy tunnels in Vietnam to a "moderate" depth.

RADA data. Martin Marietta has received a \$2.4 million contract for advanced development models of the random-access discrete address (RADA) communications system. Thirty subscriber units and one relay unit will be delivered for field testing during the next year.

Running late. While Computer Displays Inc. is selling its video terminal [p. 119], Tektronix, the only other company to announce an under-\$10,000 terminal with both alphanumeric and vector capabilities, has slipped its delivery date. Last fall, the company said it would start delivering its type 4002 in August 1969 [*Electronics*, Dec. 9, 1968, p. 141]. Says Chuck Spencer, marketing manager, "We're now

U.S. Reports

quoting—but not guaranteeing—delivery in January of next year. Until a couple of months ago, we were quoting March 1970." The terminal isn't yet in production, he concedes, and the company is still tooling up and buying parts. Both the Tektronix 4002 and Computer Displays' ARDS-100A will be priced at about \$8,000, plus \$500 for the system's interface.

Another from DEC. The Digital Equipment Corp. has announced its latest entry into the computer market. Coming in four models, the 18-bit PDP-15 will cost between \$16,500 and \$92,000, depending on software and peripherals.

Cutting the apronstrings. Another chapter of the Fairchild Alumni Association has set up shop, this one called Advanced Micro Devices Inc. Under the direction of Jerry Sanders, who was eased out of his post as Fairchild Semiconductor's group director of marketing when the Motorola crew took charge of that operation last year, the new company will be a second source of both linear and digital integrated circuits for computers. Other ex-Fairchildren at Advanced Micro Devices include Jack Gifford, Sven Simonsen, Larry Stenger, Frank Botte, and Jim Giles.

Onward and upward. Capital expenditures by electronics firms will rise 16% this year from last, according to McGraw-Hill's annual survey of businessmen's plans for plant and equipment investments. The industry's outlays will increase another 4% in 1970, from this year's projected level, and 5% in both 1971 and 1972, the survey indicates. Among other findings: U.S. business in general will boast spending for air- and water-pollution controls 40% this year to nearly \$1.5 billion from last year's \$1 billion; manufacturers plan to sink 53% of their 1969 investment into expansion, and 47% into replacement and modernization; and overall capital investment will climb to \$72.4 billions this year, up 13% from last year, with manufacturers accounting for \$30.2 billion of the total, or 14% more than last year.

Reed Relays that deliver more of what you need most...

VERSATILITY ■ RELIABILITY ■ ECONOMY

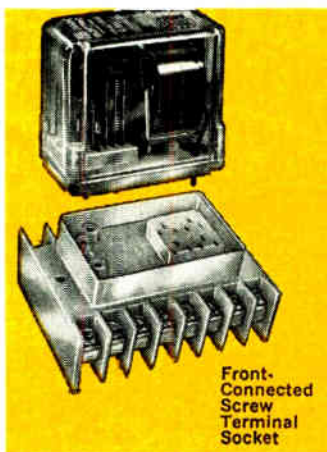

Automatic Controls' Reed Relays — standard, miniature, or your special designs — offer individually supported reed switches, magnetic foil wrapped coils, non-magnetic terminals, and rhodium plated contacts, providing peak performance and reliability. Standardized contact configurations assure off-the-shelf delivery and maximum economy. For more of what you need most — specify Automatic Controls' Reed Relays everytime!

NEW from Automatic Controls... Front-Connected Screw Terminal Socket.

Accommodates the Automatic Controls' "family" of general purpose plug-in relays and time delay relays.

Automatic Controls

Division



COOK ELECTRIC

200 East Daniels Rd., Palatine, Ill. 60067



FREE!
Automatic Controls
Industrial
Relay Booklet.
Send for your copy
today!



**Helipot
Ladder Networks
...60 ppm
accuracy for \$27.00
from stock***

* Model 811-A12, 100 piece price.

Helipot offers the widest variety of off-the-shelf miniature ladder networks. From low cost networks with 9-bit accuracies to precision 14-bit units. Either binary or BCD designs. And with a variety of stock resistance values and a selection of standard temperature ranges.

- They typically feature:
- 60 ppm accuracy (initial worst case accuracy at 25°C)
 - 0.6 ppm / °C tempco
 - 50 nanosecond settling
 - 20 ppm per year stability
 - low profile

They are constructed of Helipot's exclusive cermet thick film passive elements and fused to alumina substrates at extremely high temperatures. By screen printing all resistors on each network simultaneously, uniform electrical characteristics and excellent stability are achieved. In addition, every unit is 100% tested at 5 temperature points and serialized accuracy tapes are available for only \$1.00 more.

For more information, contact your local Helipot Sales Representative or Distributor or circle the Reader Service No.

Beckman®

INSTRUMENTS, INC.
HELIPOD DIVISION
 FULLERTON, CALIFORNIA • 92634

INTERNATIONAL SUBSIDIARIES: AMSTERDAM, CAPT. TOWN, GENEVA, GLENSHIRE, SCOTLAND, LONDON, MEXICO CITY, MUNICH, PARIS, STOCKHOLM, TOKYO, VIENNA

Model 811:
 A 12-bit Binary Ladder Network for use in DAC/ADC applications requiring fast switching and high accuracy over a wide temperature range.

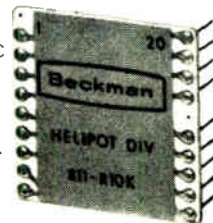

Model 812:
 A 12-bit R-2R Binary Ladder Network designed specifically for MOSFET switch applications.

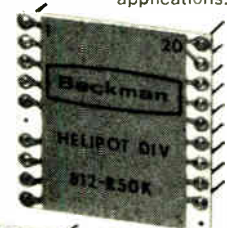

Model 813:
 A Conductance Ladder designed to be used with Fairchild's μ A722 10-bit current source.



Model 814:
 An Ultraprecision 14-bit R-2R Binary Ladder Network with accuracies to +30 ppm from -20° to +80°C.

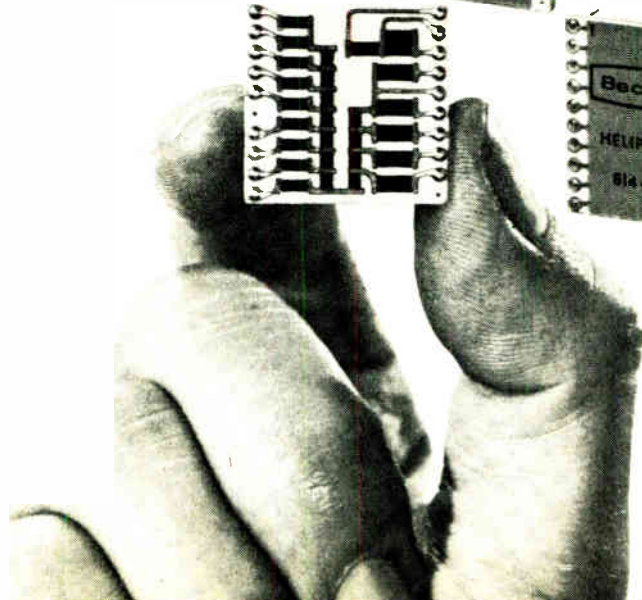

BCD Ladder Networks are also available in many standard configurations.

Circle 55 on reader service card

**We'll sell you plated
wire to improvise with,
no strings attached.**

INDIANA GENERAL *We make it easy for the design engineer.*

Not plated wire systems. Just plated wire. So you can experiment with your own prototypes. Nobody but Indiana General has production quantities for sale.

It's just a logical extension of the leadership that pioneered the development of ferrite memory cores. This high-quality, high-speed plated wire offers memory designers higher-speed non-destructive read-out and lower power. Its low creep permits the use of equal read and write pulses. And it allows for high packing density.

We call our wire Indalloy. It consists of an iron-nickel layer, 1 to 1.5 microns thick, deposited on a 5-mil diameter beryllium-copper substrate wire. Circumferential anisotropy, induced in the layer during manufacture, makes

this non-destructive read-out performance possible. Two grades are available:

Indalloy 1, with an extremely low creep, best suited for unipolar pulse operation; and Indalloy 2, which has a lower bit write threshold and high output. Either can be bought in lengths to 20 inches. Both have a resistance of $1.6 \pm 10\%$ ohms/foot.

We'll also be glad to establish comprehensive test programs with your engineers. Just submit your plane samples so our laboratory can pinpoint write/disturb thresholds. For further information, or samples, pluck our coupon.

Mr. H. Warner, Manager, Sales & Operations
Indiana General Corporation
Electronics Division/Memory Products
Keasbey, New Jersey 08832

Let's see if your plated wire can make it easier for me. Please send literature.
 I'm interested in placing a sample order; please contact me. Also, please send me the following memory products literature:
 Standard memory cores
 Memory planes and stacks

NAME _____
TITLE _____
COMPANY _____
ADD. _____ PH. _____
CITY _____ STATE _____ ZIP _____





New flame resistant **GLASKYD[®]** **7100 FR**

Alkyd Molding Compound

for economical high performance connectors

This card-edge printed circuit connector won't singe your reputation.

Made with GLASKYD 7100 FR, it's replacing DAP for some mighty good reasons. Point 1—it provides comparable wet electrical properties at a much lower material cost. Point 2—it's economical in other ways, too. In slug form, its fast molding cycle increases production significantly. Point 3—it has low weight loss at elevated temperatures and permanent flame resistance exceeding normally accepted requirements. So specify New

GLASKYD 7100 FR alkyd molding compound over DAP for savings and quality right down the line.

Among the many types of GLASKYD available, chances are there's a GLASKYD molding compound that will meet your needs . . . for flexural strength, impact strength, arc resistance, low water absorption, flame resistance, heat resistance, dimensional stability, and many more advantages. Write today for technical brochure to American Cyanamid Company, Plastics Division, Wallingford, Connecticut 06492.

CYANAMID

SALES OFFICES IN: CHARLOTTE • CHICAGO • CLEVELAND • DALLAS • DETROIT • LOS ANGELES • MINNEAPOLIS
OAKLAND • PHILADELPHIA • TUKWILA, WASHINGTON • WOODBRIDGE, CONNECTICUT • ALSO AVAILABLE IN CANADA.

IRRAVINTM

INSULATED WIRE



**Fights
solder-iron damage,
cost, carelessness.**

Send for a sample. We'll prove that IRRAVIN insulated hook-up wire fights accidental damage from hot solder-iron contact, ambient heat up to 115°C. There's no melting, shrinkback or flowing.

IRRAVIN hook-up wire costs less, too. It saves up to two-thirds that of other high temperature wires. Fact is, there is no other wire available that is so universal in use—so low in cost. And what's important, IRRAVIN insulated wire has superior abrasion and cut-through resistance. It's available in long continuous lengths, is U.L. Listed and conforms to MIL-W-16878. With advantages like that there's not much to complain about.

Convinced you ought to have a sample? Write ITT Wire and Cable Division, Surprenant Products, International Telephone and Telegraph Corporation, Pawtucket, Rhode Island 02862.

In Europe contact: ITT Europe-Components Group, Wire and Cable Division, Lister Road, Basingstoke Hants, England.

IRRAVIN—the wire
that stops the grumbles.

WIRE AND CABLE **ITT**



MICROWAVE IC PROGRESS REPORT #7: COMMUNICATION MODULES

Sperry's PACT (Progress in Advanced Component Technology) Program is developing a fully-integrated transmitter/receiver/duplexer module for an airborne communications array at X-band. The program has contractual support from the Air Force Avionics Laboratory, USAF, Dayton, Ohio.

The function of the phased array system is to establish communications between aircraft and synchronous satellite repeater stations, which in turn are linked to a ground station network and to other aircraft. This makes it possible for the crew of an airplane to be in constant contact with anybody, worldwide. Handy for all sorts of missions and indispensable in the event of conflict.

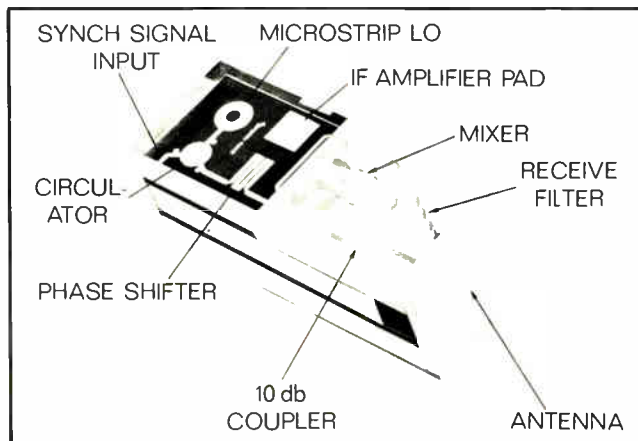

RECEIVER CIRCUIT FOR COMMUNICATIONS MODULE

Within the confines of each phased array element, which is less than an inch square and three inches long, is a complete transmitter/receiver/duplexer. Essentially composed of a signal source, a receiver, a mixer and an antenna, the module utilizes Sperry's advanced thinking throughout.

SPERRY
MICROWAVE ELECTRONICS DIVISION
CLEARWATER, FLORIDA



The rf circuitry is photo etched on metallized ceramic substrates 0.055 inches thick. Conductors are vacuum deposited gold on top of chromium. Follow-up plating produces half-mil thick strips. Transmission efficiency can be gauged by measuring rf energy loss, which, in this case, is no more than 0.15 db per inch.

Transmitter signals are generated by a Sperry Avalanche Transit Time Oscillator (ATTO), discussed in Progress Report #1. Energized by a DC voltage, the ATTO yields a 1-watt CW, X-band signal at an efficiency of 5%.

Sperry's gallium-arsenide Schottky-barrier diodes do the active conversion work in the receiver and the "rat-race" hybrid handles the signal with a single sideband noise figure of better than 6.5 db over a 12% bandwidth. (Sperry hybrid work was discussed in Progress Report #5.) Signal processing and control circuitry design has been materially aided by a Sperry-developed computer program.

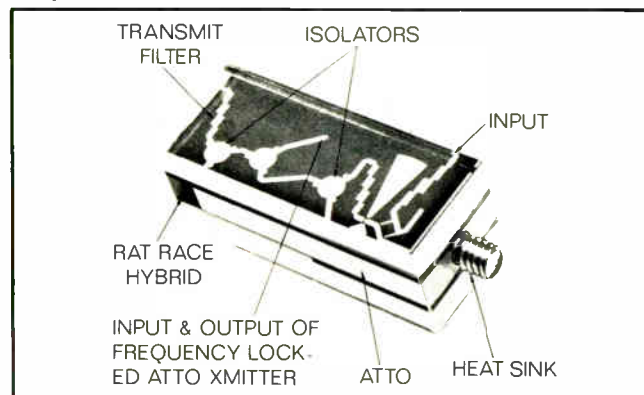

TRANSMITTER CIRCUIT FOR COMMUNICATIONS MODULE

What we have accomplished for the Air Force, we can accomplish for your microwave system, regardless of frequency or operational mode. At Sperry, PACT is more than a clever acronym. Our business is **microwaves**, and our goal is to provide customers with ways of accomplishing microwave functions.

May we hear from you about your system requirement?

*For faster microwave progress,
make a PACT with people
who know microwaves.*

Washington Newsletter

April 28, 1969

Industry takes a look at NASA's proposed standards for IC's

Industry is getting its first look at a set of NASA standards for high-reliability integrated circuits. Comments on the first of the seven documents in the set—now being examined by NASA centers, suppliers, and professional associations—are expected back soon. The proposed standards, like those for the military, will obviate the need to write a new set of IC reliability requirements into each individual contract negotiated by NASA.

The draft documents, the beginning of a total series of space agency electronics reliability standards, are expected to be completed within two years. Prepared by a NASA microelectronics subcommittee, the seven cover guidelines for preparation of detailed specifications, general requirements, methods, visual inspection, radiographic inspection, clean-room specification, supplier quality surveying, and line certification.

NASA officials feel that comments on these documents can be synthesized into a final set of standards within six months.

Officials again mull independent agency for communications

Government officials are again thinking of establishing an independent agency to oversee communications. This is the general feeling after much bureaucratic bickering and the rendering of an indecisive report by the Bureau of the Budget on where in the Governmental structure an agency could be carved out for communications.

The Budget Bureau study, commissioned by President Johnson at the same time he set up his task force on communications policy, recommended that communications be put under the Departments of Transportation or Commerce. But it then went on to say that neither department would be an ideal final resting place for an agency covering such a fast growing field.

For its part, the President's task force left the issue of bureaucratic structure alone, recommending only that communications be put under strong central control.

As now envisioned by some officials, the independent agency would pull together the Government's policy-making, operating, and planning functions in the communications field. The Federal Communications Commission would continue as a regulatory agency.

Army wants no more plastic transistors

While the Army is ready to buy plastic-packaged integrated circuits for fuzes [*Electronics*, April 14, p. 69], its thinking on plastic-encapsulated transistors is quite the opposite. "We don't want plastic transistors," says a source at the Army's Electronics Command's procurement and production division in Philadelphia. In fact, the division expects to award a \$1 million contract this summer to develop improved production process requirements that will just about eliminate plastic-packaged transistors from consideration.

A division source says, "There's an awful lot of military equipment, especially in the area of communications, using plastic transistors, and they give us problems." Among the complaints: too much moisture seepage, acid formations that attack the metal contacts, and failures above 140°C. The command wants the manufacturers now making plastic-pack transistors to come up with better processes, probably using hermetic sealing techniques.

Washington Newsletter

Land-mobile backers still seek uhf space

Land-mobile radio interests aren't giving up their battle for uhf spectrum space, even though a \$500,000 study by the Stanford Research Institute has reported plenty of the land-mobile spectrum not fully used. Max Guiberson, newly elected president of the Land-Mobile Communications Council, says the group's main goal this year will be to get additional frequencies. He further observes that only 25% of the available uhf channels are being used.

The SRI study, commissioned by the FCC, found, however, that better management of present land-mobile channels could give users much more space. And despite the complaints of Guiberson's group, it appears likely that the FCC will adopt some frequency-sharing plan rather than allocating uhf spectrum to land-mobile users.

NASA to ask funds for far-out mission

Though nobody has yet revealed the dollar amount involved, there is little doubt that NASA is going to seek funds for its unmanned "Grand Tour" mission to the farther planets in its fiscal 1971 budget. The agency is currently looking for the booster it would need to propel the ambitious probe out as far as Neptune. Under consideration: everything from the relatively humble Titan Centaur to the planned nuclear Saturn V Nerva.

As currently envisioned, the Grand Tour would send a probe out to Jupiter, Saturn, Uranus, and Neptune; these four will be suitably lined up between 1976 and 1978, but not again for more than 100 years.

Radiation fears stir PHS to study school use of electronics

The Public Health Service's National Center for Radiological Health will soon begin a survey of radiation-producing equipment in about 200 high and junior high schools around the country. The PHS and the center have been receiving reports—mostly through state agencies—of potentially hazardous situations involving the classroom use of such items as unshielded X-ray equipment, lasers, hand-held fluoroscopes, accelerators, and microwave devices.

The work will be conducted under provisions of the Radiation Control for Safety and Health Act, passed last year. Results of the survey will be reported to Congress and could conceivably result in legislation or Federally-promulgated standards.

Addenda

It appears that the Nixon Administration won't be pushing for passage of the Medical Device Safety Act. Sources on Capitol Hill figure that the bill will meet the same fate it has in the past several sessions of Congress: death in committee. The act would authorize the Food and Drug Administration to set safety standards for medical devices [*Electronics*, Feb. 17, p. 95]. . . . In trying to choose a prime contractor to develop the new S-3A (VSX), antisubmarine warfare plane, the Navy may have found itself in a dilemma. One of the two potential contractors is Lockheed, which has drawn fire for costly overruns on the Air Force's C-5A transport and the Army's Cheyenne helicopter programs. . . . One informed source says the Army, wearied by the Cheyenne scalping, complained to the Pentagon that Lockheed should not get any more big contracts for a while. The Navy may have delayed issuing the overdue contract award so it could look very closely at Lockheed's bid, possibly at the Pentagon's urging. The other competitor is the Convair division, whose parent company, General Dynamics, built the Navy's aborted and very expensive version of the F-111.

Performance / Efficiency / Size

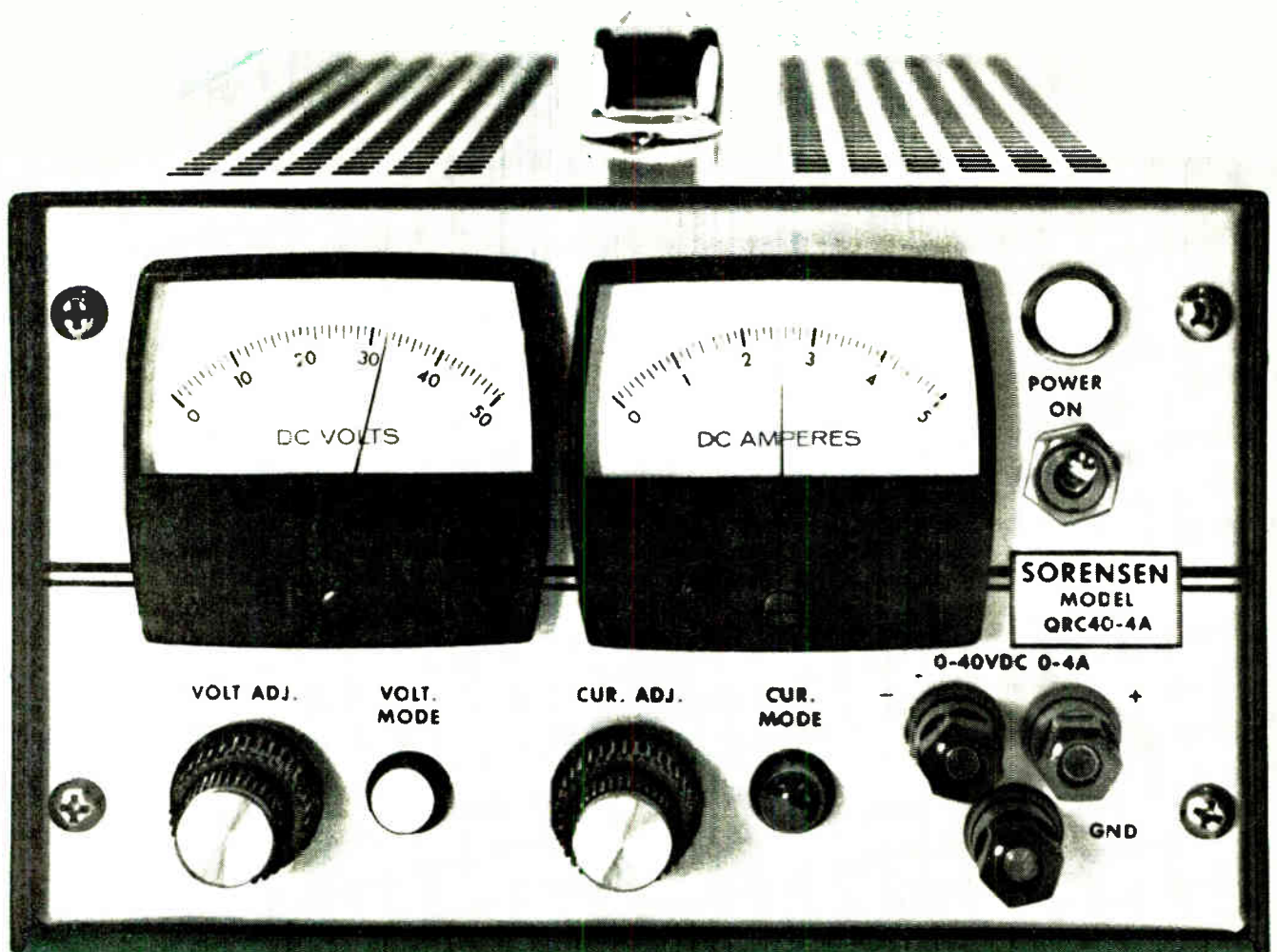

The QRC Series solves the specification/power/volume problem by utilizing all silicon, series regulator techniques with modern high speed transistor switching circuitry.

7 models, all available from stock, cover the voltage ranges of 0-20 and 0-40 Vdc at currents up to 30 amperes with prices starting at \$350 for model QRC 40-4A.

Features include: $\pm 0.005\%$ voltage regulation for line and load changes combined $< 1\text{mV}$ r.m.s. ripple (10Hz-7MHz)

0.01% resolution 25μ sec. response time optional overvoltage protection voltage and current regulation with automatic crossover remote programming and remote sensing -20 to $+71^\circ\text{C}$ operating temperature.

For more information contact your local Sorensen representative or; Raytheon Company, Sorensen Operation, Richards Avenue, Norwalk, Connecticut 06856.

Tel.: 203-838-6571;
TWX: 710-468-2940;
TELEX: 96-5953.



**With a
memory
like this
you can
forget the
logic**

FROM YOUR TRUTH TABLE

Inputs								Outputs			
A	B	C	D	E	F	G	H	W	X	Y	Z
0	0	0	0	0	0	0	0	0	1	0	1
0	0	0	0	0	0	0	0	1	0	0	1
0	0	0	0	0	0	1	0	0	1	1	0
0	0	0	0	0	0	1	1	1	1	0	0
0	0	0	0	0	1	0	0	0	1	0	0
0	0	0	0	0	1	0	1	0	1	1	1
0	0	0	0	0	1	1	0	0	0	0	0
0	0	0	0	0	1	1	1	1	1	0	1
0	0	0	0	1	0	0	0	1	0	1	1
0	0	0	0	1	0	0	1	1	1	1	1
0	0	0	1	0	1	1	1	1	1	1	1
0	0	1	0	1	1	1	1	1	0	1	1

TO YOUR MM 521

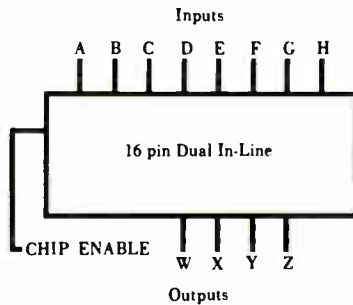

Use the logic easily programmed into our ROM (Read Only Memory) elements. With a minimum of time (typically four weeks), we can set up the simple interconnection metalization pattern your needs dictate and start shipments. Costs about a thousand dollars.

ROM elements are far simpler to make than a new, untried logic design. No logic race conditions; no logic circuit debugging. Our MOS ROM elements are fast, 500 nanoseconds. They operate from ± 12 volt supplies, easily compatible with DTL and TTL.

MM521, 1024 bit element (256 x 4), 16 pin Dual In-Line device, is \$45.00 in 100 quantity. MM522, 1024 bit element (128 x 8), 24 pin Dual In-Line is \$60.00.

Write for a memorable packet of information. National Semiconductor, 2975 San Ysidro Way, Santa Clara, California 95051. (408) 245-4320. TWX: 910-339-9240. Cables: NATSEMICON.

National/MOS

*the only
IC Decimal Counters
available!*

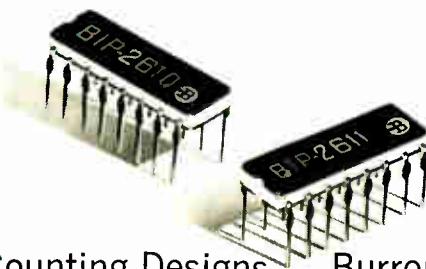

An Economical Approach to all your Decimal Counting Designs. Burroughs' new dual-in-line packaged decimal counters were designed to satisfy an industry need for a low-priced, highly-reliable, IC decimal counter that would replace the two packages now required to provide a decimal count. This Burroughs innovation fulfills these requirements through the use of 10-stage SCS ring-counter logic and provides the extra advantages of high noise immunity, (up to 6V peak); preset inputs; re-settable to any number; plus the inherent advantages of Bi-polar MSI. Designed for applications with 12 volt logic, this new hermetically-sealed counter is available in two configurations: **the BIP-2610, designed with output voltage sufficient to directly drive a NIXIE® tube, and the BIP-2611, a lower-cost unit designed with output voltage sufficient for all applications not requiring a NIXIE tube readout.** Call or write Burroughs Corporation, Electronic Components Division, Box 1226, Dept. C1, Plainfield, N.J. 07061. Tel: (201) 757-5000.

Burroughs



Technical Articles

What is a 'systems' approach? It's just the name of the game
page 68

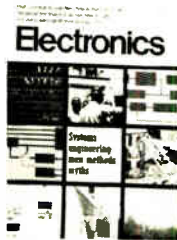

Systems engineering, variously considered a discipline, a process, a panacea, and even a bogeyman, is now being applied to major civilian projects, as well as to the vast military programs that gave it its start. Total and continuous planning is the hallmark of the systems approach from inception to phase-out. Systems engineering techniques are shouldering aside the wasteful patch-and-proceed methods used in the past. With the staggering commitments of men, money, and materials made for advanced-technology undertakings, there's scant margin for error. For the cover, art director Jerry Ferguson assembled a number of pictures to suggest the complexities involved in taking the systems approach.

PRBS can fool the system
page 82

Checks of a system's response to purely random inputs can prove difficult because of the problems involved in reproducing such signals. Pseudo-random binary sequences, however, offer a way out. They're periodic, can be generated with a clock and shift register, and have an autocorrelation function similar to that of random binary sequences. In short, they're well-equipped to hoodwink systems long enough to run an adequate test.

Single building block proves logical choice for custom IC's
page 88

A multipurpose circuit developed for a special-purpose system provides greater stability against transients, supply-voltage variations, and temperature extremes than off-the-shelf devices. In theory, such performance comes at a high price. But volume buying and greatly reduced testing requirements bring custom circuits into the off-the-shelf cost ballpark.

Phase locking: integrated tuned circuits made easy
page 94

The tuned circuit, heart of communications receivers, has long resisted integration on a monolithic chip. Approaches using external inductors or integrated active filters have not proved particularly successful. Now, however, a 30-year-old idea—the phase-locked loop—has enabled Signetics engineers to build precisely tuned IC's, without precision components, for such applications as f-m radios and telemetry receivers.

New etchant puts dielectric isolation in the groove

Coming

An anisotropic etchant that forms V-shaped isolation grooves, conserving silicon and alleviating control problems, makes dielectric isolation economical for all linear, high-voltage, and some digital IC's. Formerly, this technique was limited to expensive, radiation-hardened circuits.

What is a 'systems' approach? It's just the name of the game

Few can agree on exactly what the term means, but systems engineering, with its emphasis on total and continuous planning throughout the life of a program, has become a must when there are complex jobs to be done

By Raphael Kestenbaum

Associate Editor

To some it's a discipline, to others simply a process. Still others see it as an art, a philosophy, a panacea, or a bogeyman. But whatever systems engineering is, there's no denying that the "systems approach" has become the hallmark of vast military programs, is now being applied to the management of civilian engineering projects, and will be employed in meeting some of the nation's major social needs.

If the descriptions of systems engineering are vague, there's no mystery about its method: the total and continuous planning of a project from inception to phaseout. The need for this kind of planning and constant evaluation lies in the complexity of the tasks engineers are being asked to tackle. Systems engineering has been applied to Polaris, Minuteman, Saturn, the Ballistic Missile Early Warning System (BMEWS), the giant C-5A cargo plane, and the controversial Sentinel anti-ballistic missile system.

These and other military programs have produced a cadre of nearly 15,000 systems engineers, some of whom are now looking into the challenging social problems of our time. The contractors who've applied systems management to defense projects will have to go the same route when working on ambitious and sophisticated civilian programs. The stakes will be high and the penalties for guessing wrong drastic. The old way—proceed and patch—is wasteful; when there's a lot of men, money, and materiel involved, the job must be done right the first time.

"Systems engineers are waiting to apply their skills to law enforcement, health, education, and transportation," says A. Wayne Wymore, chairman of the systems engineering department at the University of Arizona. "No matter what the field," he

continues, "the systems engineer is the one who looks at the total problem, not just the electrical or mechanical components."

To the design engineer, the word "system" could mean an extensive radar setup or the navigation gear in an aircraft. To the systems engineer, it denotes the total resources brought to bear on a task or problem—prime and support equipment, personnel, buildings, land area—plus all the factors involved in planning, operating, and maintaining the system. He regards each individual part of this scheme—human or hardware—as a component of the system. He's thus concerned not only with equipment performance and cost, but with, say, the availability of spare parts, the training of personnel, job safety, and the quality of transportation to and from the project site.

As a procedure, systems engineering can be broken down into five broad stages: concept formulation, system definition, acquisition, deployment, and phaseout. These stages cover the life of any system, from brainstorm to junk heap. The systems engineer is most active during the first two phases, particularly system definition.

In concept formulation, he works with the customer to define the problem, set objectives, and map alternative solutions—all in the broadest terms. He also establishes the technical and economic constraints, often under a low-cost study contract but sometimes through informal discussions. The results of such discussions usually form the basis for the customer's specifications.

In the system-definition stage, analysis, simulation, synthesis, evaluation, and selection are performed. The analyst outlines the system components—hardware, personnel, facilities, and support

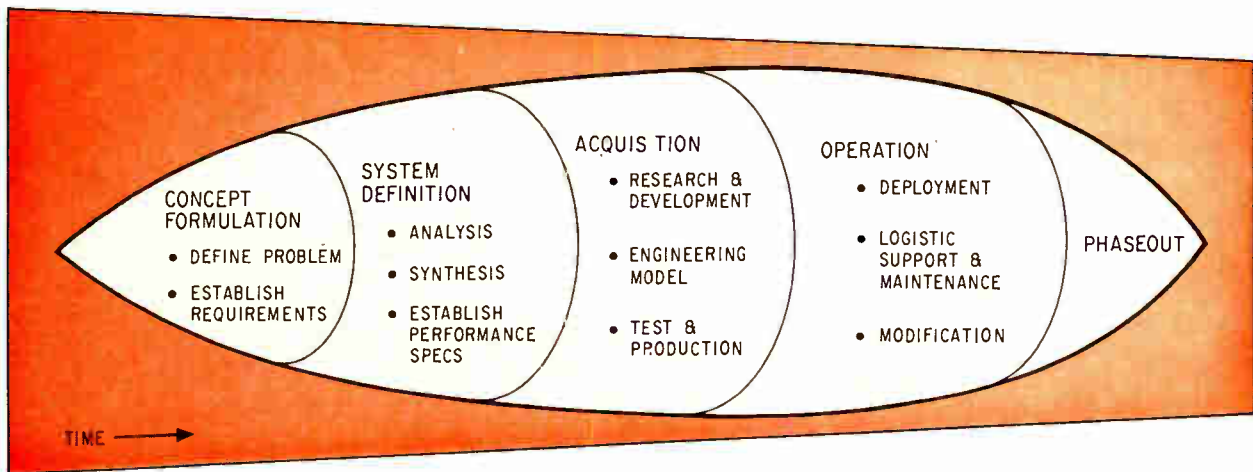

In stages. The tapering volume of this "life-cycle barrel" reflects the relative amounts of money and manpower invested at each phase of a systems engineering project.

—for each alternative plan. With the help of a computer, he then optimizes the factors of performance, cost, risk, and time, producing a number of reports, many in block-diagram form.

In synthesis, this information is converted into a "catalog" of hardware specifications. The alternatives are then evaluated and a candidate is selected for development. A detailed specification is drawn up.

In the acquisition phase, often handled by a subcontractor rather than the systems house, research, development, design, assembly, and testing are performed. The equipment is then installed and operated.

Maintenance and logistic support come into play during the fourth, or operation, stage, and design modifications are made at this point. Finally, the life cycle comes to an end when the system is phased out or replaced.

Special features

Some engineers maintain that this step-by-step organization of a project reflects nothing more than good but ordinary engineering sense. They're right —up to a point—but systems engineering has some unique characteristics, too. For one thing, fundamental to the process is the use of quantification—the assignment of numerical values to certain system elements—in deciding tradeoffs.

Also, and most important, systems engineering is an iterative process. As a project progresses and more data becomes available, certain assumptions are altered and design changes made. In addition, systems engineering is an interdisciplinary activity, drawing on the talents of physicists, mathematicians, psychologists, economists, and any other specialists a project might require. Finally, systems analysis focuses on the interface situation; each subsystem is evaluated in relation to its impact on the other parts of the system.

"The essence of the systems approach," says Bruce Miller of Northrop Nortronics' systems anal-

ysis group, "is the balance and tradeoffs you make with each component for the good of the system as a whole. Often, you deliberately sacrifice performance and accuracy in subelements to achieve the level of cost effectiveness and performance required by the total system."

To get a clearer idea of how systems engineering works, consider again the first two stages of the system's life cycle.

The concept-formulation stage begins with a problem. In the case of the Defense Department, the problem might be a Soviet strategic capability for which no countermeasure yet exists. In the civil sector, the problem might be the saturation of transportation facilities in the Northeast Corridor from Boston to Washington, D. C.

After the problem is defined, a general plan of attack is devised within the stated technical and economic bounds. The Pentagon might find that a new manned strategic bomber would suit its needs. For the Northeast Corridor situation, the solution could be a high-speed railway system connecting major cities.

Now the costs of ownership, development, operation, and maintenance must be estimated and a minimum acceptable performance standard agreed to, again in broad terms. A target date is set for operation.

When the process moves into the system-definition stage, the system's requirement and constraints are fed in and a firm specification comes out, as shown on page 70. Note the feedback loops, which indicate that the systems people are in frequent contact with one another.

Model work

In the systems-analysis stage, the analyst, often the systems engineer himself, delineates the functions and activities of the system's elements and subelements with the help of computer simulations. Here he presents the computer—digital, analog, or hybrid—with a set of differential equations linking

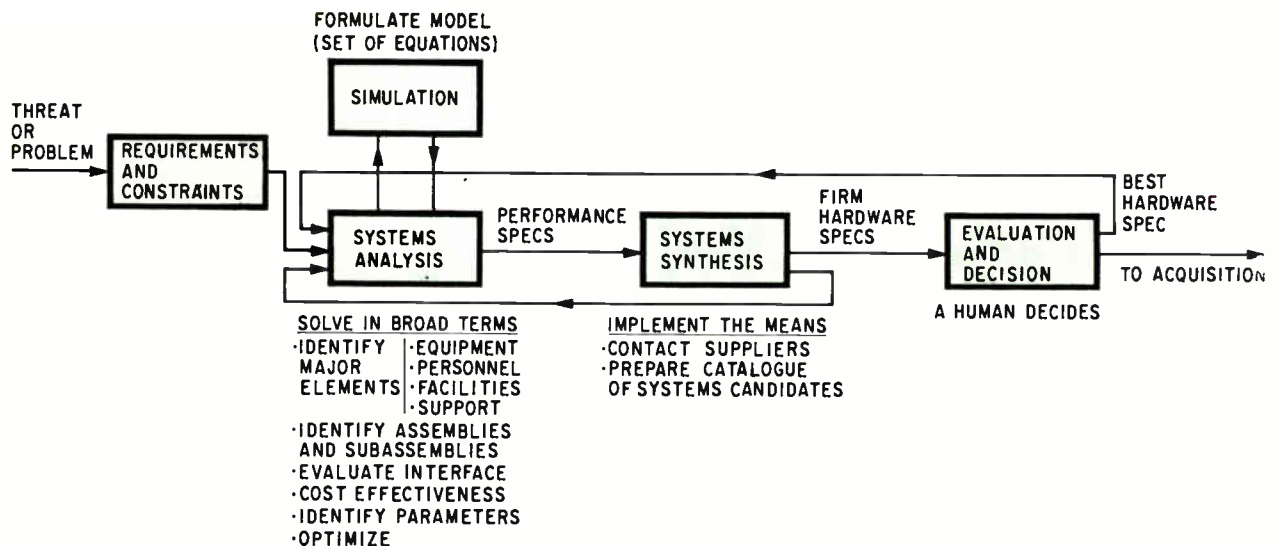

Systems definition. This stage takes the process from analysis to decision-making. Information accumulated at each step along the way—and through feedback—determines the final choice among candidate systems.

the system's parameters to operational conditions. The system is rarely simulated as a whole; instead, the subsystems are simulated and their models are tied together.

Simulation can also combine a mathematical model with hardware, if any has been built. In fact, the more hardware included in the simulation setup, the more accurate will be the analyst's predictions.

In practice, the analyst simulates iteratively. He must continually change his model as he learns more about the realities of the system, particularly about the interface phenomena.

After analysis, the necessary equipment, personnel, facilities, and support are pinpointed in the synthesis step. The analyst's functional specifications are transformed into such practical data as circuit diagrams. Whether to use existing equipment is one big question that's answered at this stage. Here the computer steps out of loop, temporarily; people decide the system's final form.

Down to business

As an example of how feedback loops operate in systems engineering—how equipment is modified by the changing needs of the over-all system—consider the backup guidance system developed by the TRW Systems Group for the Apollo program's Lunar Module (LM). What started conceptually as a relatively simple attitude-reference system grew, as the mission's purpose was refined, into a full-fledged guidance system.

TRW's abort guidance section of the Lunar Module is a strapdown inertial unit that provides attitude-reference, navigation, and monitoring information. It takes over control of the spacecraft if there's a failure in the primary guidance system at any point in the lunar landing portion of the Apollo mission, and helps guide the lunar vehicle safely into a rendezvous orbit with the Command and Service module.

The Apollo 9 flight in March marked the first application of a true strapdown guidance system.

The system uses no gimbals; instead, inertial sensors, such as gyros and accelerometers, are fixed to the body of the vehicle. The strapdown's "stable platform" is maintained mathematically by digital torquing from a guidance computer.

Early in the systems-analysis stage, the backup was defined as a minimal system providing an attitude reference on a flight director display to aid the astronauts in steering the Lunar Module. NASA was aiming for as little redundancy as possible in the Lunar Module. If there was to be any, the space agency wanted it in the life-support systems. Thus the system analysts rejected the most obvious solution to the guidance backup problem—a complete duplication of the primary guidance system. Work was done to see if the primary system could be pared down to an attitude-control system, but this was found to be difficult.

At the same time, TRW, United Aircraft, and others had been working on the possibility of developing a strapdown system to do the job. TRW proposed an arrangement with three gyros, two moderate-accuracy accelerometers, and an instrument-quality accelerometer placed along the thrust vector of the Lunar Module's engine.

However, system design was undergoing changes as various NASA groups refined their subsystem needs and altered the over-all model. For example, NASA and Grumman wanted to drive the flight director display faster and cut down on the waiting time needed for the display's gimbals to assume their correct position. Another requirement added was for a capability to monitor the system automatically in flight. These requirements and others fed into the system model changed the design requirements for the backup system.

Though some at NASA were reluctant to proceed with a new technology—a strapdown system that

- ANALYZE TOTAL MISSION REQUIREMENTS
- STUDY ALTERNATE APPROACHES TO SOLUTION
- DETERMINE COST EFFECTIVENESS
- PINPOINT TOTAL SYSTEM AND SUBSYSTEM NEEDS
- DEVELOP AND USE EFFECTIVENESS MODULES
- EVALUATE ALL SOURCES OF SUPPLY FOR SYSTEM OBJECTIVELY
- COMPLETELY MANAGE AND COORDINATE ALL SUBCONTRACTING
- DELIVER, INSTALL, AND TEST THE COMPLETE SYSTEM
- PROVIDE OPERATIONAL SUPPORT (SPARES, TRAINERS, MANUALS, FIELD PERSONNEL)
- MAINTAIN CLOSE CUSTOMER LIAISON THROUGHOUT PROGRAM LIFE

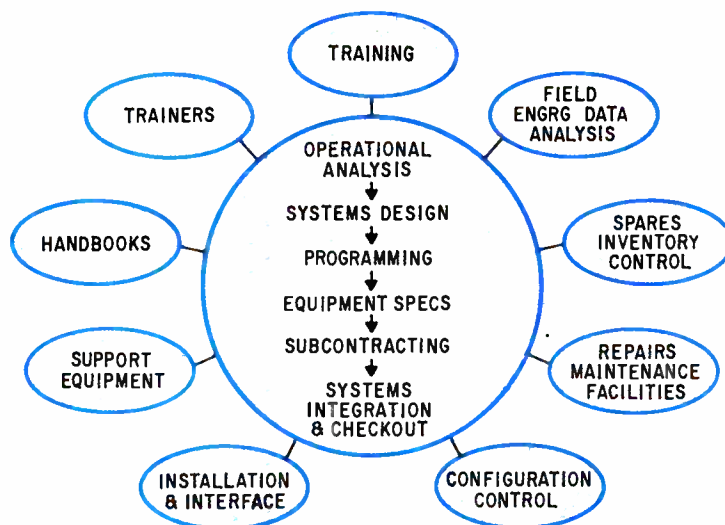

Programed. Sperry Rand works the support elements into its planning at the beginning of systems definition, along with the prime equipment. The steps at left describe the company's systems management approach.

had never flown—the agency decided to go ahead with it because analysis showed it could do the job at the smallest price in weight and complexity. TRW and others then fed a lot of data on strapdown technology into the system model.

Changing in midstream

The decision to go for fast display response and in-flight checkout caused TRW to replace its digital differential analyzer with a general-purpose computer. The analyzer could have handled some of the monitoring, but only with additional hardware.

In their initial bid, TRW proposed a computer with 700 words of 18 bits each in its memory and 14 instructions. The total attitude-reference system weighed about 35 pounds, about a quarter the weight of the primary guidance system.

But NASA continued to refine its mission requirements and its system model. The agency decided it wanted a crude form of Delta T guidance, that is, a preprogrammed velocity profile. So the strapdown system was modified again; the moderately accurate accelerometers became instrument-grade units, two displays were added, and the computer's memory was expanded to 2,000 words. With these modifications, the strapdown system could do such jobs as helping the astronauts get the LM into orbit by automatically turning off engines at the right time. This was the setup finally contracted for, with TRW responsible for the system and United Aircraft for the sensors.

But the systems analysis went on. The Houston Manned Spaceflight Center began mulling a more complex rendezvous and the weight and contingency tradeoffs involved. TRW was asked to undertake further studies to determine if the strapdown system could do more things automatically with little additional hardware. As a result of its studies, the company decided that it could provide the more complex rendezvous with the backup system.

Another factor influencing the over-all system model was a growing doubt among some NASA project officials that the spaceflight tracking network on earth would always be able to supply the LM with updated guidance data. Since the basic elements of a completed guidance system were already designed into the reference unit—the gyros, accelerometers and digital computer—TRW proposed a full guidance capability. This backup system could now track the Apollo command module, calculate the positions of the craft before rendezvous, and automatically guide them together.

The new system would require range and rate data from the LM's radar, so systems engineering got back in the act with a man-versus-machine decision. Should a hard-wired interface be used (like the one in the primary guidance system), or should the job be done indirectly by keyboard? This was a relatively easy choice as the hard-wire interface would be complex and expensive, and the keyboard was already aboard the module. It was therefore decided that an astronaut would give the backup guidance system the radar information via keyboard. Also, the computer's memory capacity was again expanded, this time to 4,000 words, and the instructions were increased to a total of 27.

This is the configuration that flew in Apollo 9. And according to David Meginnity, the TRW engineer in charge of the strapdown system, a "first look at the flight data" indicates that the backup system performed as well as the primary one. The astronauts in the LM were guided by the strapdown system during the first half-hour of the first burn of the descent engine as they moved away from the command module. And before separation, the astronauts used the backup system to check out the module's attitude-control system.

Another example of systems engineering in action would be ILAAS, the Integrated Light Attack Avionics System worked out for the Navy by Sperry

Loss effective?

No one seems to know when systems engineering was first practiced. Some say it was launched by such World War II contracts as the B-29 bomber or the \$2 billion Manhattan project. But not even at Bell Labs, where systems engineering has been developed into a way of life, are staffers able to identify the first systems job.

One thing is certain. What we now call systems engineering is a creature of the Defense Department. The surge of technology that followed World War II created a bewildering assortment of weapons from which the military had to choose. Hence systems analysis.

The Pentagon has long recognized the need for total planning. Poorly estimated contracts cost it large sums in the late 1950's. By 1962, contract overruns were eating up 40% of the department's development funds. Weapon systems' costs were typically running to three times the amounts estimated when the contracts were let.

Carryover. Development costs, the military learned, accounted for but a fraction of the total outlay for a system over its life span. For example, the Air Force still pays *n.c.a.* about \$40 million annually to operate and maintain *Brewers*, though the system was completed in 1964.

To put a halt to runaway costs, former Defense Secretary Robert McNamara initiated the policy of "total package procurement" and promulgated the concept of cost effectiveness—including the costs of support and maintenance—as a basis for decision making. A systems analysis office was opened in the Pentagon in 1961.

But though the Government hoped to reap savings from systems engineering, the technique itself is now indirectly under attack in reviews of Federal program expenditures. Transportation Secretary John A. Volpe has ordered a freeze on funds for the supersonic transport pending further study. The project, contracted to Boeing, has already cost the Federal Aviation Administration \$650 million.

Missile gap. In Congressional hearings on the Sentinel *ABM* system, Stuart Symington, (D., Mo.), senior member of the Senate Armed Services Committee, has challenged the Pentagon estimate of a \$5.5 billion total cost; Symington maintains that a figure of \$9.4 billion would be more realistic.

And critics recall that McNamara ordered the scrapping of the Skybolt missile and the high-altitude B-70 bomber when these projects were well under way and billions of dollars had already been spent on them. Rep. George H. Mahon, (D., Texas), chairman of the House Appropriations Committee, claims that \$8 billion has been spent by the military in the past 15 years on projects that never came to fulfillment.

The possible loss of such staggering sums has added fuel to the arguments over systems engineering. "Cost effectiveness?" snorts one observer. "You mean loss effectiveness." The systems approach, he adds, "is missing the boat if you have to lay out excessive sums before you discover you've got a flop."



Bench test. Sperry engineers decided early in the Navy ILAAS program to integrate four major electronic subsystems through a central computer complex. Here the inertial-radar-data computer control panel (left) and flight-test memory panel (upper shelf) are tested, while the staff member in the background checks out the system's inertial reference set.

Rand's Systems Management division. The Navy wanted a highly flexible and precise weapons delivery capability for its light attack aircraft. Following a study by Sperry, the ILAAS concept was formulated; four of the aircraft's major electronic systems—navigation, weapons delivery, communications, and flight control—were to be integrated through a central computer complex. The Navy's specification spelled out what the service wanted in the way of reliability, accuracy, weight, size, and power levels. It was then the company's task to implement these requirements and deliver a working system.

Sperry geared up its systems management organization (it employs 1,000 systems engineers). This group decided to go with building-block modular design to ease maintenance in case of local malfunctions caused by enemy hits. In the analysis step, Sperry engineers divided the major systems into functional subsystems. The navigation subsystems, for example, were to consist of computers, an inertial platform, radio aids, radars, converters, displays, controls, and recorders. These were further broken down into subassemblies. For instance, the inertial platform was to include gyros, accelerometers, amplifiers, and pickoffs.

Alternate approaches were analyzed in the light of simulation results and parameters. Interfaces were studied. An optimum configuration was finally selected for design, and a number of subcontracting specifications were drawn up for its development.

The components have since been built, assembled, ground-tested and installed in the Navy's A-6 Intruder attack aircraft, where the system is now undergoing further testing. In addition, the Navy is being supplied with ILAAS spares, trainers, manuals, field personnel, and other support elements. Sperry says it expects to keep in close touch with

a planned family

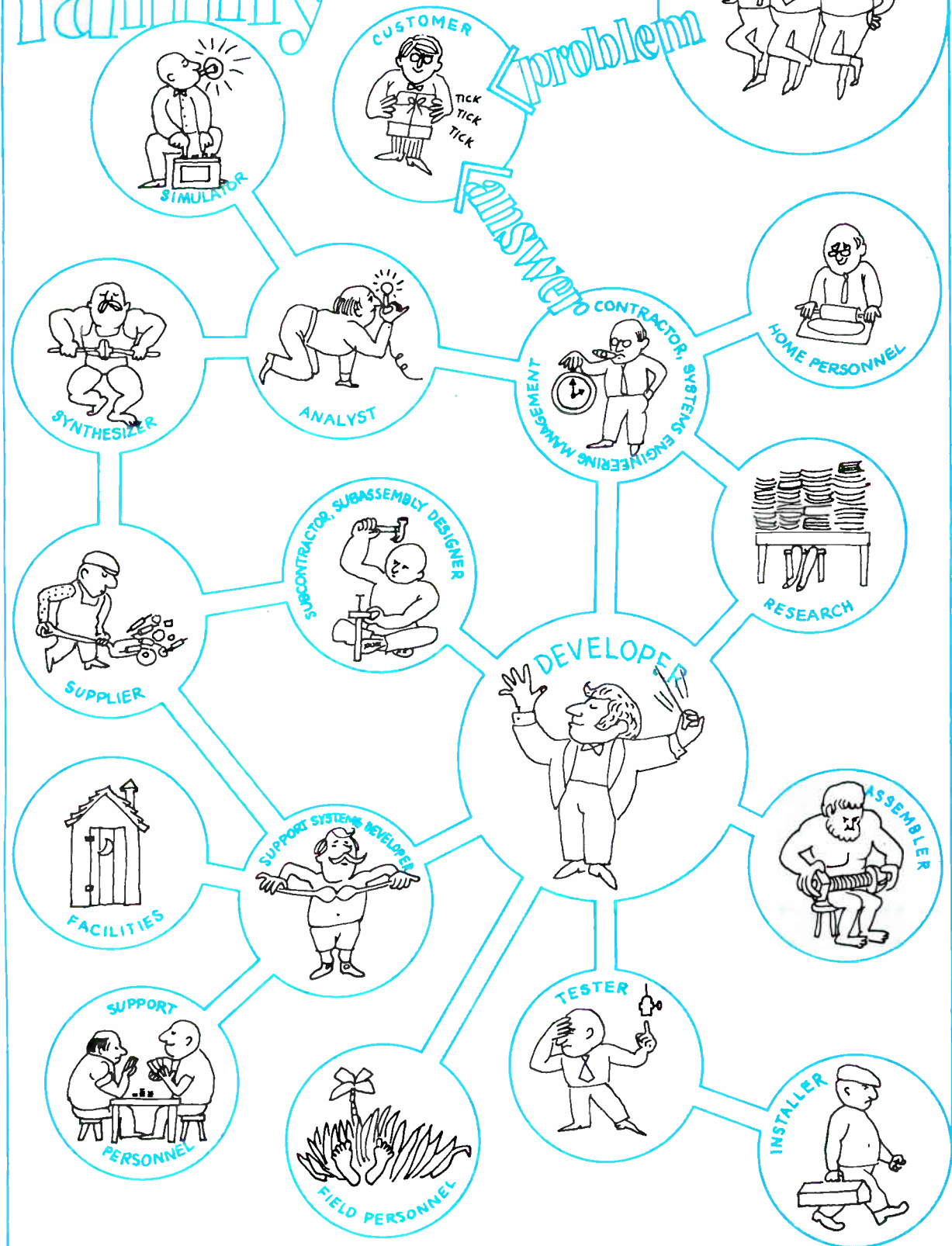

Family planning. As indicated here, there must be a constant flow of information among all the people involved in a systems scheme throughout the life cycle of the system.

One man's opinion

The University of Arizona's A. Wayne Wymore believes the time has come for systems engineering to stand on its own feet and stop being just "another subgroup of the IEEE." Wymore, chairman of the university's systems engineering department, sees the systems approach as more a point of view than anything else. It's an important point of view, though. With the problems engineers are being asked to take on today, it is imperative that they see things in terms of total systems and not just "knobs and dials."

"You can define systems engineering in terms of techniques, operations research, mathematical models, or computers, but that's missing the point, which is responsibility for the whole system," he says. "Tools are handy, of course, and if we could build systems by going into a Buddhist-like trance, then by God, we'd be teaching Zen Buddhism."

Generalists. Wymore believes systems engineering is eventually going to have the same relation to sociology, economics, and psychology that engineering has traditionally had to physics. "We send our students to take these courses in exactly the same spirit we send them to physics and chemistry classes—that is, to use the knowledge gained to make engineering decisions."

All this reflects Wymore's contention that "you can no longer solve systems problems on the basis of classical physics, mathematics, and mechanics alone." However, he says efforts to establish systems engineering as a distinct field of knowledge have engendered a good deal of opposition from "conservative academic forces" who feel that all engineers are systems engineers.

"They're missing the point," Wymore asserts. "Modern control theory has taught us there are restrictions to linear phenomena. It's pretty clear to anyone who takes a systems engineering viewpoint that control theory is not applicable to the big problems. It doesn't describe anything accurately enough to be applicable except in some very simple cases. Even in the aerospace industry, where systems engineering originated, it has only been successful because of self-imposed restrictions. But when you look at the interconnections of a system and all you have going for you is a



linear theory, you can't get very far."

Wymore speaks of control theory with some authority. He spent his internship in the fields of computer sciences and industrial control before joining the university's faculty.

Study program. The kind of background he thinks a systems practitioner needs is indicated by the six courses required in the systems engineering department: probability and statistics, operations research and optimization techniques, computer sciences, systems theory, engineering math including thermodynamics and circuit theory, and—most important—human factors.

"If you're going to take on the total responsibility for a technological system," says Wymore, "you've got to look at the human beings, who're elements of the system, and at the system-society interface."

Wymore, who's now developing a health service program for Arizona's Papago Indians, says his research into systems mathematics, together with that of Professors R.E. Kalman of Stanford University and M.D. Mesarovic of Case-Western Reserve University, is going to have a heavy impact on engineering practice in the next few years. The models that have been developed, he says, "are powerful enough to handle the very wild, hairy kind of things that describe the behavior of human beings."

the Navy if the system goes into operation.

Systems executives agree that what makes the process work is its emphasis on feedback and iteration among the people involved in all stages of a program's life cycle. All too often, systems engineering is thought of as a one-way street, with the systems engineer giving orders to the designer, who, in turn, predetermines the builder's work. The builder then tells the tester, installer, and repairman how their jobs should be done, and so on.

Actually, information and advice must flow up the line as well as down. The subsassembly builder must let the assembly designer know if he will fall short of his expectations or exceed them. The re-

searcher must keep the systems analyst informed of any new techniques that might prove better and cheaper. And feedback loops should link subcontractor and contractor, field engineer and designer, and support personnel and equipment operators. Finally, the systems engineer himself must be in constant touch with the customer.

How does the design engineer fare in all this? There are some in the technical community who fear that as systems engineering spreads, personal initiative will be swallowed up in the engineering superstructures. "Already," says Joseph R. Fisher of Sylvania, "the designer is losing his status" because though he can use his ingenuity to the fullest,

he does so within constraints placed on him by the systems management. "He has a more rigid set of requirements to meet," Fisher says. "In a big system, the designer can't start until the guy before him hands him his spec."

However, Martin Astrow of Sperry's Systems Management division believes systems engineering gives the designer greater responsibility, not less. "The designer now has to perform tests under environmental conditions to meet the spec," he says. "And he just has to know more. When ILAAS designers were told the equipment needed cooling, they had to go out and learn the fine points of thermal design before choosing among fins, a cold plate, or some other types of coolers."

Astrow doesn't feel that systems management has in any way encroached on the designer's creativity or diminished his status. "No one element is more important than any other in a system," he asserts. "If the circuits fail, so does the project."

Paper production

But if some engineers feel they're being imposed upon, so do certain contractors. These men resent the military's practice of telling them how to go about their systems engineering.

The issue was joined recently over the Air Force's rather rigid 375-5 systems engineering management procedure. After some success with earlier versions of the format in the Minuteman program, the Air Force decided to apply 375-5 to the biggest piece of hardware around—the C-5A transport contracted to Lockheed-Georgia. But the requirements laid down for documentation and justification of engineering decisions have generated mountains of paper down the line through the 2,000 subcontractors and sub-subcontractors. The project has nearly drowned in its own paperwork.

Grumblings have been heard in industrial quarters about "getting hung up on procedural matters" or "the flood of regulations being forced down our throats." [*Electronics*, Sept. 16, 1968, p. 153]. The grievances were spelled out to the military through the Council of Defense and Space Industry Associations (Codsia). As a result of the pressures from the electronics and aerospace industries and reform-minded parties within, the Air Force decided to issue a "softer" version of 375-5, a guide outlining what is needed from the contractor, not how the systems engineering should be done.

This modified version, still being smoothed out, will be published in four to 10 months, according to informed sources. These sources also believe that the "soft" 375-5 will immediately thereafter be put to the test in the contract-definition stage of the FX tactical fighter program [*Electronics*, Nov. 25, 1968, p. 34].

Meanwhile, the new format is serving as a guide to the Pentagon in the drafting of a tri-service document on systems engineering specifications. This document won't be published for two years, but a policy statement on systems engineering is expected from the Defense Department this year.

That some systems engineering jobs have wound up failures is due, in the main, to poor definition of the original problem, according to Eberhart Rechten, director of the Advanced Research Projects Agency. An outstanding example here is the F-111. As a plane designed to serve the widely varying needs of the Air Force and Navy, it's a washout. After six years of work, the Air Force has a plane plagued with mechanical difficulties, and the Navy has dropped the aircraft altogether and opted for the F-14A.

Another factor in poor systems engineering is overreliance on the system model. S.W. Golomb of the University of Southern California cautions against the tendency of the systems analyst to confuse the model with reality. "The model is like a map," he says. "It may obscure the complexities of the terrain. Though it provides a simple enough picture to be grasped at a glance and is helpful in plotting a route from one point to another, you will never strike oil by drilling through the map."

And even the best systems engineering in the world can be frustrated by outside events. A case in point is Lockheed-Georgia's C-5A; aside from the deluge of paperwork, the project has been beset by continuing labor strikes and materials shortages caused by the war in Vietnam.

In fact, the company was recently forced to announce a six-month production delay. Lee Poore, vice president for operations at Lockheed-Georgia, blames the holdup on inflation, labor problems, and unpredictable shortages of raw materials. "In the latter part of 1964," he says, "we were looking pretty good. It was a buyer's market then. But later, the Vietnam war took up everything available in the commercial plane market. Commercial aviation backlogs doubled and tripled. We soon found ourselves in a seller's market with lead times from 26 to 32 weeks instead of six to eight weeks. You can do the finest job in systems engineering and still can't foresee the problems you'll run into, any more than you can predict the changing state of the basic economy."

The C-5A contract was let in October 1965 at a cost of \$2.98 billion. Overruns have now brought the cost to \$4.34 billion, according to the Defense Department.

Some systems engineers find that too little attention is paid to people in all this planning, and several want more emphasis placed on a system's capacity to absorb adjustments. This built-in flexibility will be especially important, naturally, in systems designed to meet human—and thus shifting—needs. As one engineer puts it, "The systems engineer may become a villain to the citizen who in years to come must live in an unyielding atmosphere created long ago and far away by someone he never knew."

In this regard, the planner of tomorrow's cities, schools, and social services must emulate his counterpart in the military engineering field and be willing to accept and plan for the obsolescence of his system. ■



These specialists can't wait to get their hands on our new plastic transistors. How about you?

If you fit one of these descriptions, our new family of B-133000 plastic power transistors is for you:

You're a power-circuit designer. Interested in V_{CE0} up to 80 volts? Good gains up to 4 amps? And isolated collector? You know you are.

You're a manufacturing man. Get rid of those extra insulating washers and bushings. Our plastic transistors are electrically isolated. Mount them in a one-step operation with just a self-tapping screw.

You're a mechanical engineer. Here's a plastic package surrounded by a corrosion-resistant, protective metal form.

You're a components specialist. Now you can get interchangeability with other plastic configurations and TO-66 mounting arrangements.

You're a circuit reviewer. We're offering safe operating areas for all the 20-watt ($T_C = 25^\circ\text{C}$) B-133000's. They're rugged, second-breakdown-resistant, silicon mesa NPN devices.

You're a purchasing man. You get low cost two ways—a low price tag and you don't need any expensive mounting kits. Delivery is fast—from distributor stock or directly from us.

No matter who you are, you've got a good reason for checking on our B-133000's. Write: The Bendix Corporation, Semiconductor Division, Holmdel, New Jersey 07733.

B-133000-008 SERIES

Symbol	Characteristics
I_C Max.	4.0A
$V_{(BR)CEO}$	40, 60 or 80V
V_{CES}	60, 80 or 100V
P_T	20W at Case Temp. $T_C=25^\circ\text{C}$
P_T	2.8W in free air at $T_A=25^\circ\text{C}$
hFE	100-300 at $I_C=0.5A^*$
hFE	12-48 at $I_C=4.0A^{**}$
f_T Min.	1 MHz

*B-133000,3,6

**B-133002,5,8

Bendix **Electronics**

Chicago—(312) 637-4633; Denver—Electronic Component Sales, (303) 771-6200; Detroit—(313) 548-2120; Greenwich, Conn.—(203) 869-7797; Holmdel, N.J.—(201) 946-9400; Horseheads, N.Y.—(607) 732-1882; Lexington, Mass.—(617) 861-8350; Los Angeles—(213) 776-4100; Merriam, Kansas—Mid-America Marketing, (913) 432-8678; Minneapolis—(612) 926-4633; Orlando, Fla.—(305) 423-6048; Richardson, Texas—P. J. Scanlon Co., (214) 213-4661; Rochester, N.Y.—(716) 266-5550; Runnemede, N.J.—(609) 933-2550; Seattle—Ray Johnston Co., Inc. (206) 342-5170; Timonium, Maryland—(301) 828-6877; Export—Cable: "Bendixint," 605 Third Avenue, New York, (212) 973-2121; Ottawa, Ont.—Computing Devices of Canada, P.O. Box 508 (613) 829-1800; San Juan, Puerto Rico—Southern International Sales Co. 723-3879.

Circle 76 on reader service card

Circuit design

Designer's casebook

Pulse width varied by a "switched ground"

By Theodore T. Kalal

Wisconsin School of Electronics, Madison

Many circuits that vary pulse widths and repetition rates use relays as switching elements to operate mechanical devices. These elements, though, can be sources of undesirable noise. The circuit shown here, uses a relay, but merely as a load; the component could be replaced by another so long as the load currents could still be handled. The actual switching is done by a silicon controlled rectifier and two unijunction transistors.

When the switch is closed, C_1 charges until it fires unijunction Q_1 . The positive spike at the unijunction's base turns on the SCR and energizes the

relay, completing a path to the external circuit.

With its anode at about ground, the SCR has a negligible voltage drop across it during conduction. When this anode is at virtual ground, the junction of R_2 and C_2 drops from its 12-volt potential to virtual ground. C_2 then charges through R_3 , R_1 , and the SCR until Q_3 fires. The positive spike turns Q_2 on and places a low impedance across the SCR.

A spike several microseconds long assures the SCR's recovery. When the spike ceases, Q_2 can't sustain the relay current. The relay de-energizes and opens the contacts to the load. The SCR's anode then rises to 12 volts, and opens the circuit of Q_3 . C_1 begins to charge again and the cycle is repeated until the switch is opened.

Potentiometers R_1 and R_4 adjust repetition rate and duty cycle, respectively. Repetition rates from 2 to 60 seconds are possible with pulse durations from 0.5 to 25 seconds.

This circuit can be used to operate strip-chart recorders, and shutters in time-lapse photography.

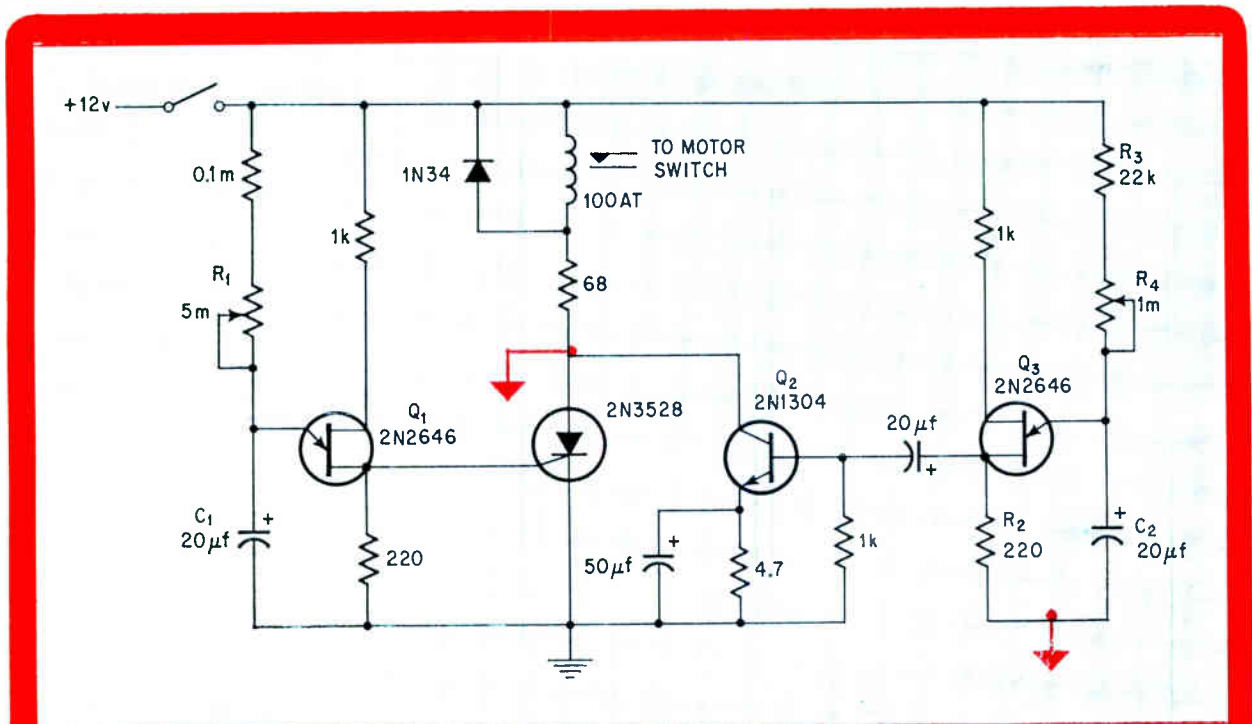

Turning on. When C_1 charges to the first unijunction's firing voltage, a pulse is sent to the SCR's gate, turning it on. The relay is energized and operates the device. When the SCR's anode is at virtual ground, this is applied to the second unijunction's circuitry, which then turns the SCR off.

Modified regulator yields variable d-c reference

By Arnold Steinman

Lawrence Radiation Laboratory, Berkeley, California

It is often useful when designing transistorized equipment to be able to vary the device's output d-c level. By merely adding a transistor to the standard transistor regulator circuits found in most power supplies, one can obtain a variable d-c reference for any choice of input and output voltages. The transistor is operated as a constant voltage source,

and varying its bias varies the d-c level between the power supply output and the ground reference.

Q_2 , Q_3 , and Q_4 form a standard voltage regulator whose output voltage can be varied by adjusting R_2 . Q_1 acts as the constant voltage source and determines the voltage between the negative terminal of the power supply and the reference ground. The reference voltage is set by varying R_1 , which varies the bias to Q_1 .

The output voltage can be varied from 15 to 24 volts while the reference voltage can be varied from -2 volts to -23 volts. The circuit can be built for different reference voltages by changing the values of R_1 , R_3 , and R_4 .

The input and output d-c voltages can be changed as long as care is taken not to exceed the transistor breakdown voltages and power dissipations.

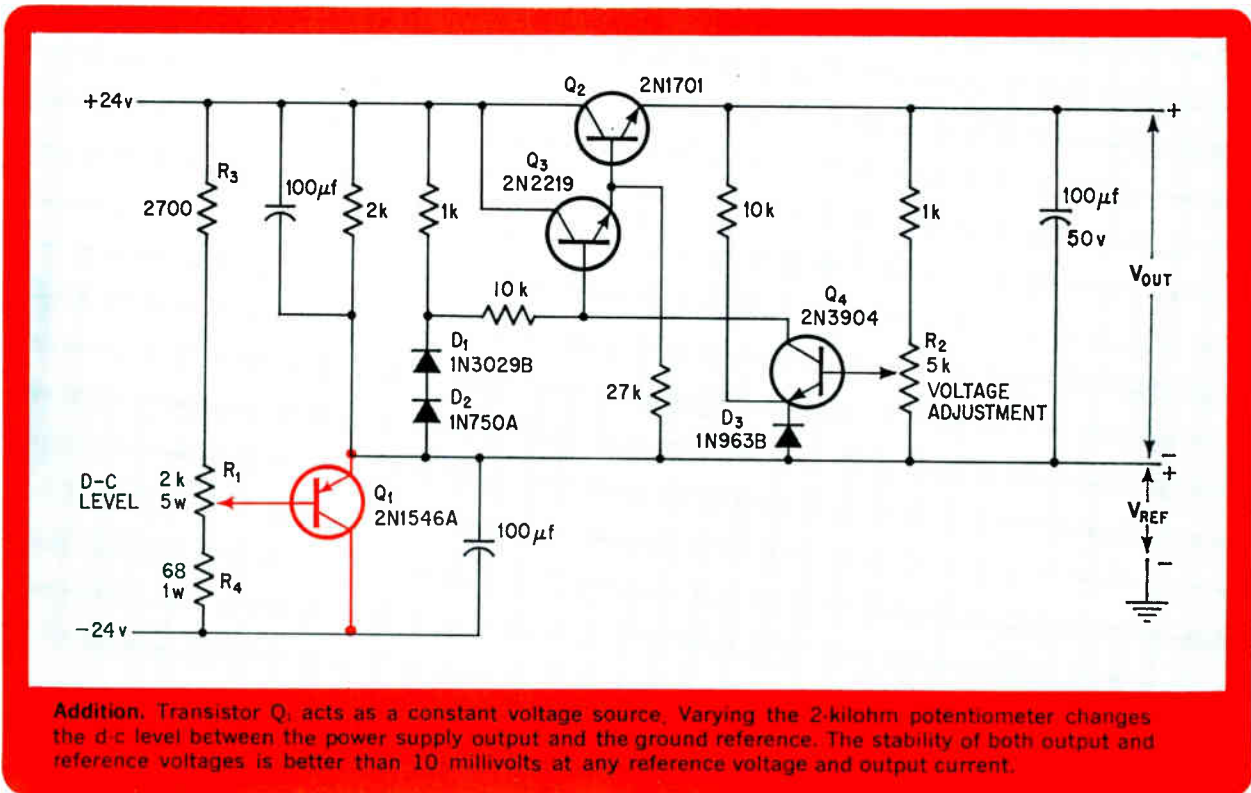

A negative-resistance circuit doubles for V or I control

By Francesco Broch-Toniolo

National Electric Energy Agency, Rome

A negative-resistance circuit having only two terminals can either be current- or voltage-controlled. The positions of a diode and a resistor determine the type of circuit.

In the current-controlled circuit, currents below I_A (see graph) cause only Q_1 to conduct. The collector voltage is kept low so Q_2 's base voltage is lower than its threshold value. When Q_1 's base

voltage reaches the conducting voltage of diode D_1 , Q_1 's collector current can no longer increase; Q_1 's collector voltage rises and Q_2 begins to conduct. The voltage at P rises, causing a smooth reduction in the base and collector currents of Q_1 , and consequently a further increase in the base and collector currents of Q_2 .

The value of R assures that current jumping will not occur as in a Schmitt trigger and that the circuit's voltage decreases gradually; the characteristics thus show a negative slope in that section. When the current reaches the value I_B , Q_1 stops conducting because the difference between the

voltages of D_1 and P has dropped below the threshold value of Q_1 's base voltage. For currents above I_B , only Q_2 conducts.

In the voltage-controlled circuit, neither transistor conducts at voltages below V_C . At voltages between V_C and V_A , Q_2 conducts. At V_A , Q_1 starts conducting by drawing current from Q_2 's base reducing its collector current. At V_B , Q_2 no longer conducts.

In the current-controlled circuit, I_A can be made greater than I_B , and in the voltage-controlled circuit, V_A can be made greater than V_B ; under these conditions two flip-flop circuits are obtained, one current-controlled and the other voltage-controlled.

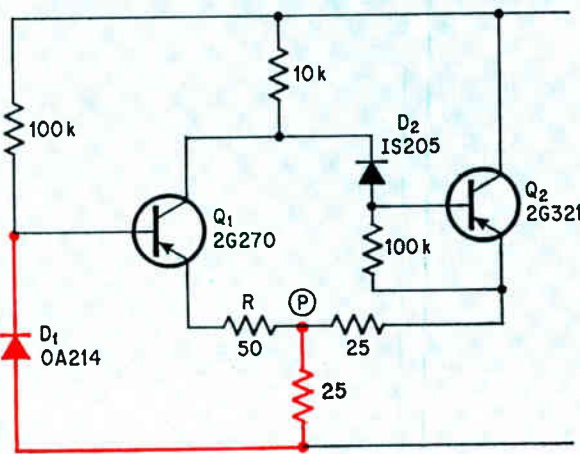

CURRENT-CONTROLLED

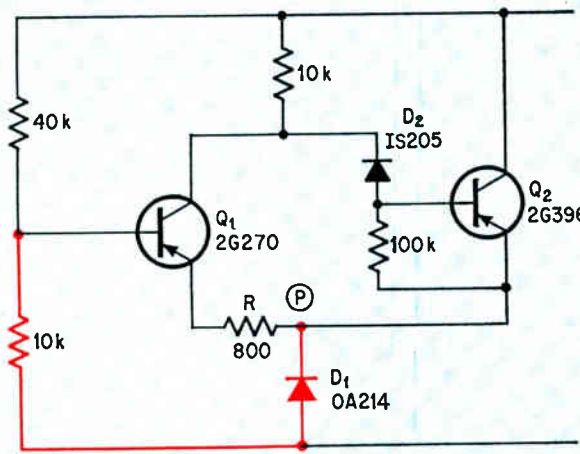
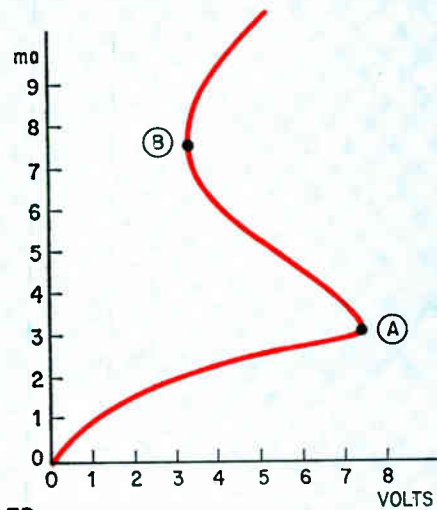

VOLTAGE-CONTROLLED

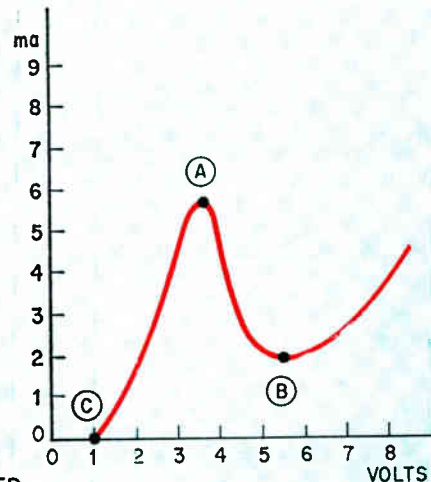

Curve fitting. Points A and B can be located on the voltage-current curve with a large degree of freedom by appropriate selection of the circuit components, thus obtaining any value of negative resistance between zero and infinity. Linearity depends on the transistors and diode.

**Our new
high energy
silicon power
transistors.
15 Amperes.
80 to 120 Volts.**

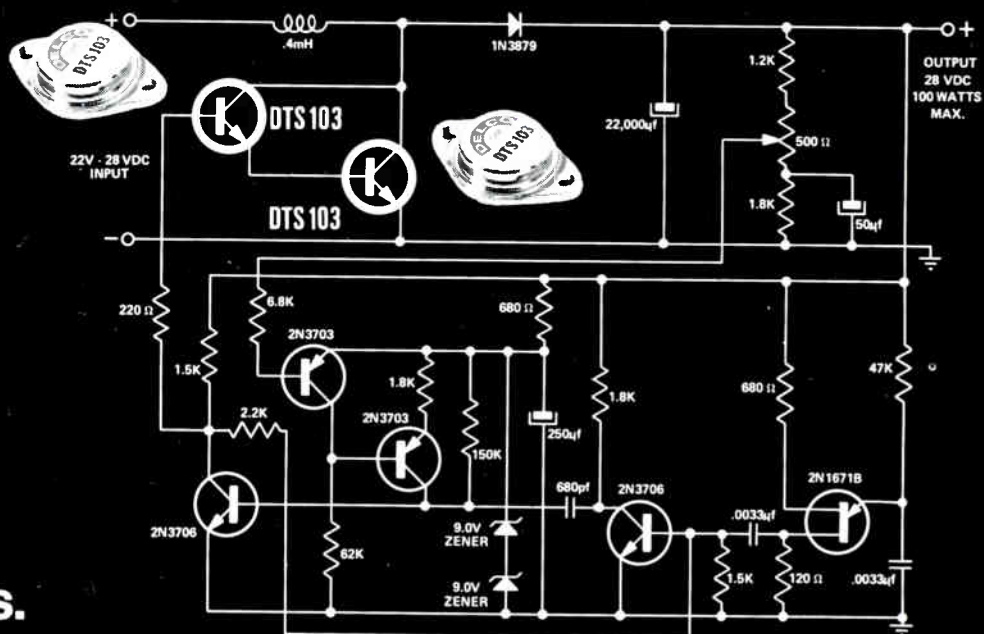

For Switching.

The Delco Radio DTS-100 series. NPN. Triple diffused. Rugged.

All the experience gained from our very high voltage silicon power line has gone into the development of these new transistors.

They were especially designed for the extreme under-the-hood environment of our I.C. voltage regulator. We found these devices ideal for applications requiring high efficiency switching or high power amplification.

The Delco triple sequential diffusion gives the DTS-100 series the high

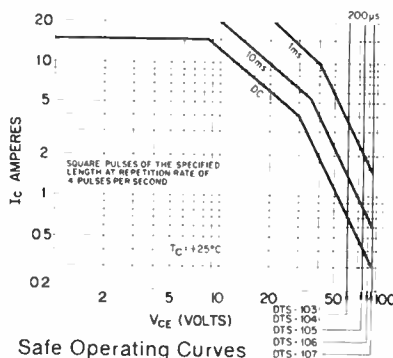

energy reliability that's needed for very tough switching jobs—resistive or inductive. The 28-volt shunt regulator above, for example, is amply handled by the DTS-103 (V_{CEX} of 80 volts). For complete data on this circuit, ask for our application note No. 42.

In the direct coupled audio amplifier above right, the DTS-107 displays the excellent frequency response, gain linearity and transconductance of this family. This circuit is covered in our application note No. 43.

Our solid copper TO-3 package provides maximum thermal capacitance to absorb peak power pulses. Its low thermal resistance ($0.75^{\circ}\text{C/W Max.}$) assures the extra reliability you expect from Delco.

Like more information? Just call us or your nearest Delco Radio distributor. All our distributors are stocked to handle your sample orders.

SEMICONDUCTOR DISTRIBUTORS: EAST—BALTIMORE, MD. 21201, Radio Electric Service Co., 5 North Howard St., (301)-539-3835 BINGHAMTON, N.Y. 13902, Federal Electronics, Inc., P. O. Box 1208, (607)-748-8211 CLIFTON, N.J. 07015, Eastern Radio Corporation, 312 Clifton Avenue, (201)-471-6600 NEWTON, MASS. 02195, The Greene Shaw Co., Inc., 341-347 Watertown St., (617)-969-8900 NEW YORK, NEW YORK 10036, Harvey Radio Co., Inc., 2 West 45th St., (212)-582-2590 PHILADELPHIA, PENN. 19114, Almo Electronics, Division of Sterling Electronics, Roosevelt Blvd. at Blue Grass Rd., Northeast Industrial Park, (215)-676-6000 PITTSBURGH, PENN. 15328, RPC Electronics, 620 Alpha Drive, RIDC Park, (412)-782-3770 WOODBURY, L.I., N.Y. 11797, Harvey Radio Company, Inc., 60 Crossways Park West, (516)-921-8700 **SOUTH**—BIRMINGHAM, ALA. 35233, Forbes Distributing Company, Inc., 1416 Fourth Ave., South, (205)-251-4104 MIAMI, FLORIDA 33142, Mountain Electronics, Division of Mountain National Co., 3730 Northwest 36th St., (305)-634-4556 RICHMOND, VA. 23220, Meridian Electronics, Inc., 1001 West Broad Street, (703)-353-6648 WEST PALM BEACH, FLA. 33402, Mountain Electronics, Division of Mountain National Co., 1000 N. Dixie Highway, (305)-833-5701 **MIDWEST**—CINCINNATI, OHIO 45237, United Radio, Inc., 7713 Reinhold Drive, (513)-761-4030 CLEVELAND, OHIO 44125, The W. M. Pattison Supply Co., Industrial Electronics Division, 4550 Willow Parkway, (216)-411-3000 DAYTON, OHIO 45414, F-J-R Ohio, Inc., 5212 North Dixie Dr. (513)-278-9411 INDIANAPOLIS, IND. 46204, Graham Electronics Supply, Inc., 133 S. Pennsylvania St., (317)-634-8486 KALAMAZOO, MICH. 49005, Electronic Supply Corp., P.O. Box 831, (616)-381-4626 KANSAS CITY, MO. 64111, Walters Radio Supply, Inc., 3635 Main Street, (816)-531-7015 MINNEAPOLIS, MINNESOTA 55401, Stark Electronics Supply Co., 112 3rd Ave., North, (612)-332-1325, ROSEMONT, ILL. 60018, F-J-R/Midwest, Inc., 9340 William St. (312)-678-8560 SKOKIE,

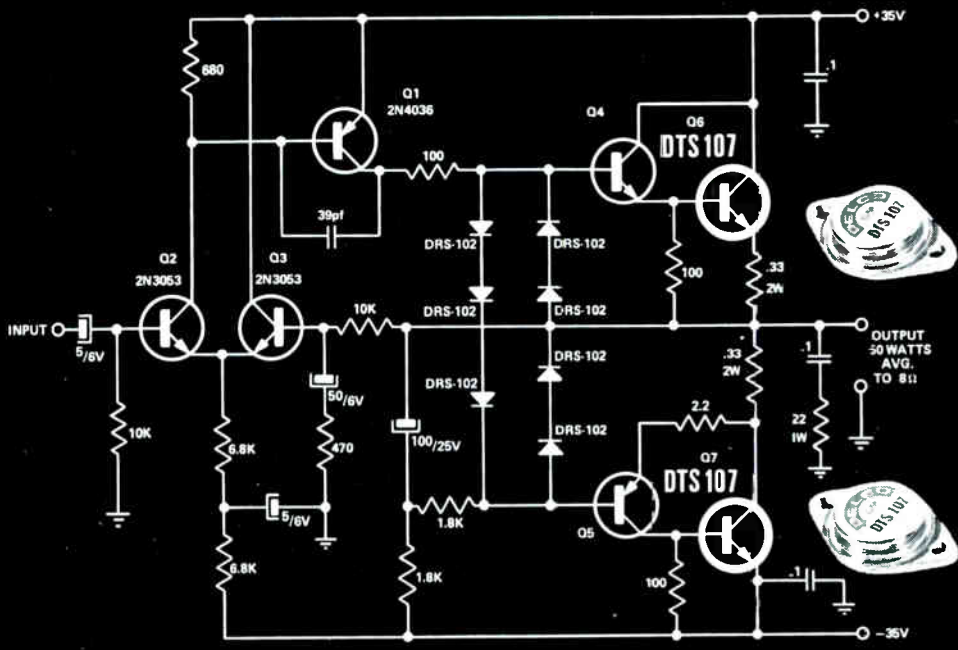

For Audio Amplification.

	Ic Cont. Amps.	Ic Pulsed Amps.	V _{CEX} @ .5mA Volts	V _{CEO} @ .25mA Volts	V _{CEO(SUS)} @ 250mA Volts	h _{FE} @ 5A	h _{FE} @ 20A (Min.)	V _{CE(sat)} @ 10A (Max.)	f _t MHz (Min.)	P _t Watts (Max.)
DTS-103	15	20	80	60	60	20-55	5	1.8	4	125
DTS-104	15	20	80	60	60	50-120	10	1.5	4	125
DTS-105	15	20	100	80	75	20-55	5	1.8	4	125
DTS-106	15	20	110	90	80	20-55	5	1.8	4	125
DTS-107	15	20	120	100	85	20-55	5	1.8	4	125

FIELD SALES OFFICES

Union, New Jersey* 07083 Chicago, Illinois* 60656
 Box 10-8 Chestnut Station 5151 N. Harlem Avenue
 (201) 687-3770 (312) 775-5411
Santa Monica, Calif.* 90401 Kokomo, Ind. 46901
 726 Santa Monica Blvd. 700 E. Firmin
 (213) 870-8807 (317) 459-2175 Home Office
Detroit, Michigan 48202 *Office includes field lab and resident
 57 Harper Avenue engineer for application assistance.
 (313) 873-6560
 *Office includes field lab and resident engineer for application assistance.



DELCO RADIO

DIVISION OF GENERAL MOTORS
 KOKOMO, INDIANA
 THE KOKOMOANS ARE IN POWER

ILLINOIS 60076, Merquip Electronics, Inc., 7701 N. Austin Ave., (312)-282-5400 ST. LOUIS, MISSOURI 63144, Electronic Components for Industry Co., 2605 South Hanley Road, (314)-647-5505 WEST—ALBUQUERQUE, N.M. 87108, Hyer Electronics Company, 130 Alvarado Drive, N.E., (505)-265-5767; 87106 Sterling Electronics Inc., 1712 Lomas Blvd., N.E., (505)-247-2486 COLORADO SPRINGS, COLO. 80902, L. B. Walker Radio Company, 9 E. Vermijo St., (303)-636-1661 DALLAS, TEXAS 75201, Adleta Electronics Company, 1907 McKinney Ave., (214)-742-8257 DENVER, COLO. 80219, L. B. Walker Radio Company, 300 Bryant Street, (303)-935-2406 ENGLEWOOD, COLORADO 80110, Hyer Electronics Company, 8101 E. Prentice Ave., (303)-771-5285 FORT WORTH, TEXAS 76102, Adleta Electronics Co., S. Expressway at E. Vickery, (817)-336-7446 HOUSTON, TEXAS 77001, Harrison Equipmen' Co., Inc., 1422 San Jacinto Street, (713)-224-9131 LOS ANGELES, CAL. 90015, Radio Products Sales, Inc., 1501 South Hill Street, (213)-748-1271 LOS ANGELES, CAL. 90022, Kierulff Electronics, Inc., 2585 Commerce Way, (213)-685-5511 OKLAHOMA CITY, OKLAHOMA 73102, Radio, Inc., 903 North Hudson, (405)-235-1551 PALO ALTO, CAL. 94303, Kierulff Electronics, Inc., 3969 East Bayshore Road, (415)-958-6292 PHOENIX, ARIZ. 85005, Sterling Electronics, Inc., 1930 North 22nd Ave., (602)-258-4531 SALT LAKE CITY, UTAH 84115, Hyer Electronics Company, 1425 South 2nd West, (801)-487-3681 SAN DIEGO, CAL. 92101, Milo of California, Inc., 2060 India Street, Box 2710, (714)-232-8951 SEATTLE, WASH. 98108, Kierulff Electronics, Inc., 5940 5th Ave., South, (206)-763-1550 TACOMA, WASH. 98402, C & G Electronics Company, 2502 Jefferson Ave., (206)-272-3181 TULSA, OKLAHOMA 74115, Radio, Inc., 1000 South Main Street, (918)-587-9124 CANADA—SCARBOROUGH, ONTARIO, Lake Engineering Co., Ltd., 123 Manville Rd., (416)-751-5980

Random telegraph sequence



Random binary sequence



Instrumentation

PRBS can fool the system

To electronic equipment, pseudo-random binary sequences look like band-limited noise, but since they're periodic and can be generated precisely, they make excellent test inputs

By A.J. Martin

Solartron Electronic Group Ltd., Farnborough, England

Wind gusts, electrical noise, or other types of random disturbances can by chance appear at a system's input. Therefore, any complete test of a system should include a check of how it responds to random signals.

The trouble with random signals, though, is that they're random; they can be defined only mathematically and are difficult to generate precisely. These faults make testing with random signals difficult because a good test signal should be measurable and repeatable.

Fortunately, systems are a bit gullible; they can be fooled into thinking, at least for awhile, that certain types of well-defined periodic signals are random. One example of this type of wave is the pseudo-random binary sequence (PRBS). Over segments of time shorter than its period, this sequence looks random.

Besides being a valuable tool, a pseudo-random binary signal is easy to generate. By using digital methods and analyzing certain shift-register configurations, an engineer can design a controllable and accurate PRBS generator. Its basic components are a shift register with a couple of feedback loops, some gates, and a clock. If a digital-to-analog converter and some logic circuitry are added, the generator also puts out a multilevel signal that has a pseudo-random amplitude distribution.

The need for random testing comes from an engineer's desire to know how his system will respond under the worst of conditions. Electronic systems are often exposed to noise generated by high-speed switches, such as fast relays, logic circuits, and silicon controlled rectifiers. Random input could also result from a sudden drop in input power when another system is turned on.

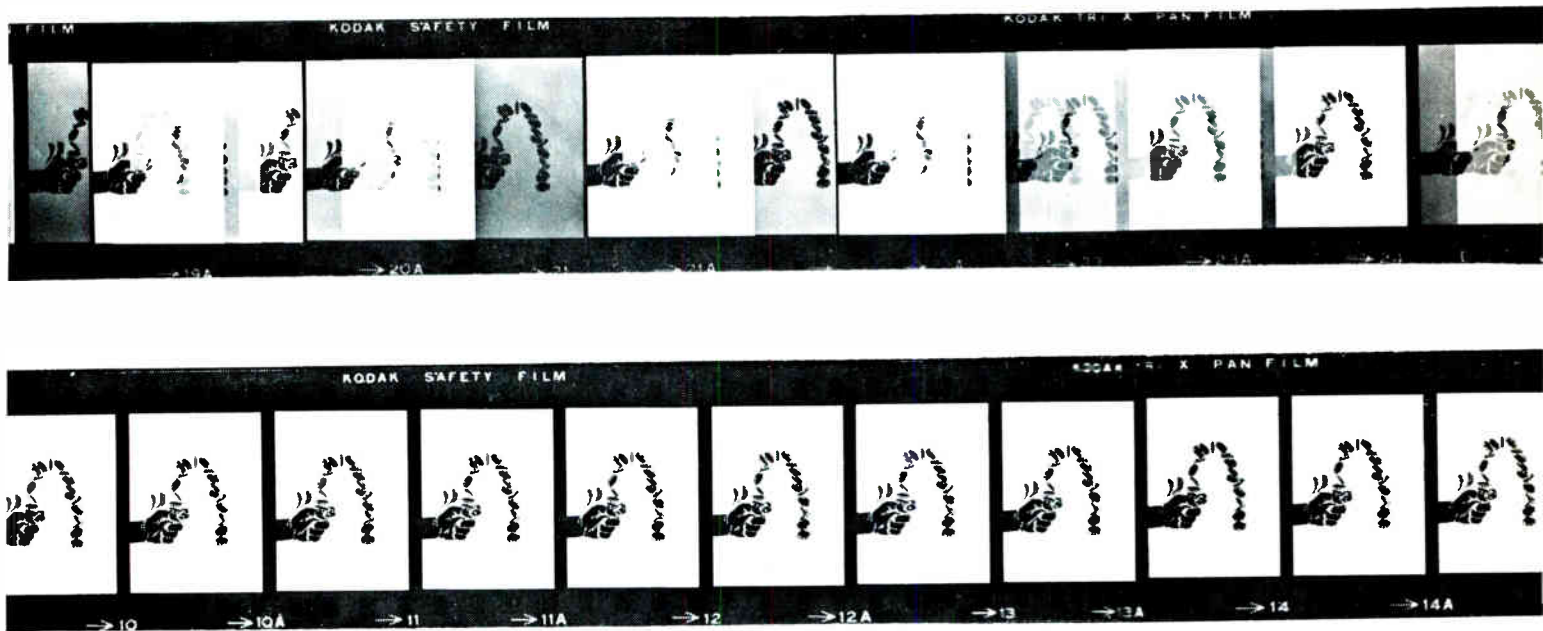

Pseudo-random binary sequence

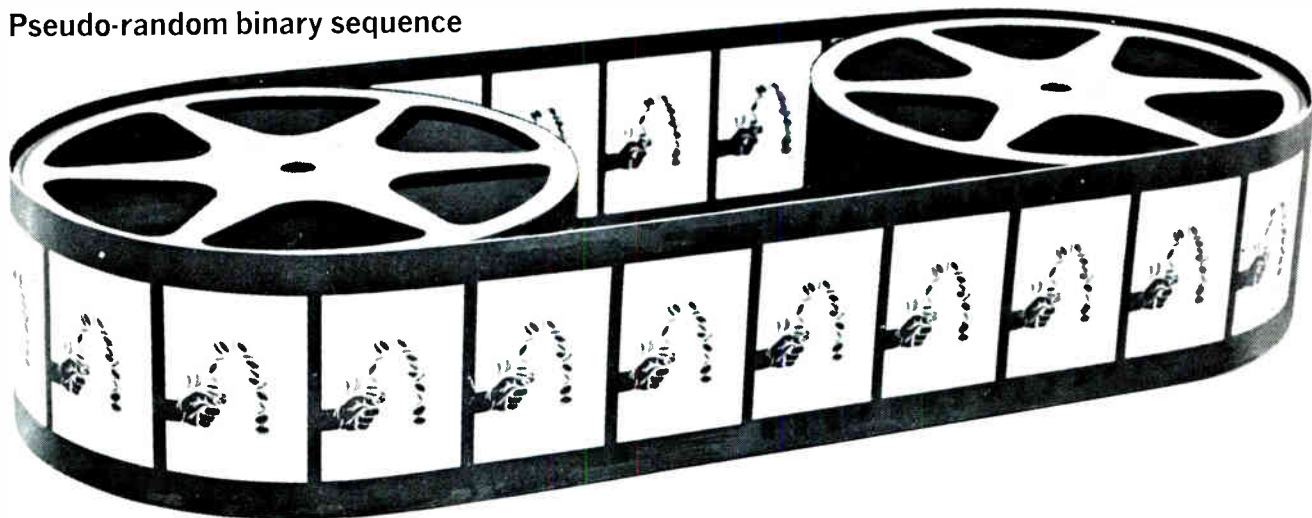

The question to answer here is will the system respond to an alien random input in a way that would produce an undesirable output.

But electronic systems aren't the only ones that can benefit from testing with random signals. The PRBS generator can simulate random loading of mechanical systems. After all, when a plane is flying or an antenna is sitting on top of a hill it's a little late to try to determine how these mechanical systems will react to gusts of wind.

Engineers usually design and test a system by measuring or observing its response to a deterministic input, such as a sine wave or a step function. There are two reasons for this approach. First, it's easy to build a generator that produces, over almost any frequency range, a precisely defined deterministic signal which can be measured without any formidable problems. Second, the response of a system to deterministic inputs is well understood since the concepts involved are straightforward.

However, random-signal testing, as opposed to pseudo-random testing, has been slow in developing because it's difficult to build random-signal generators with precisely controllable outputs. Just as a sine-wave generator that has deterministic properties which are ill-defined is of little help, so also a noise generator or a random-signal generator with a vague specification is useless. Besides all of this, the statistical nature of the random signal makes it difficult to build a close-tolerance noise generator from certain natural sources, such as gas-discharge tubes, nuclear sources or semiconductor devices.

On the other hand, the PRBS generator has an output with precisely defined statistical parameters. And since it's driftless, the output has good stationarity. In addition, the bandwidth can be exactly controlled, and the generator is programmable.

As an introduction to the nature of pseudo-random binary sequences, consider a coin being

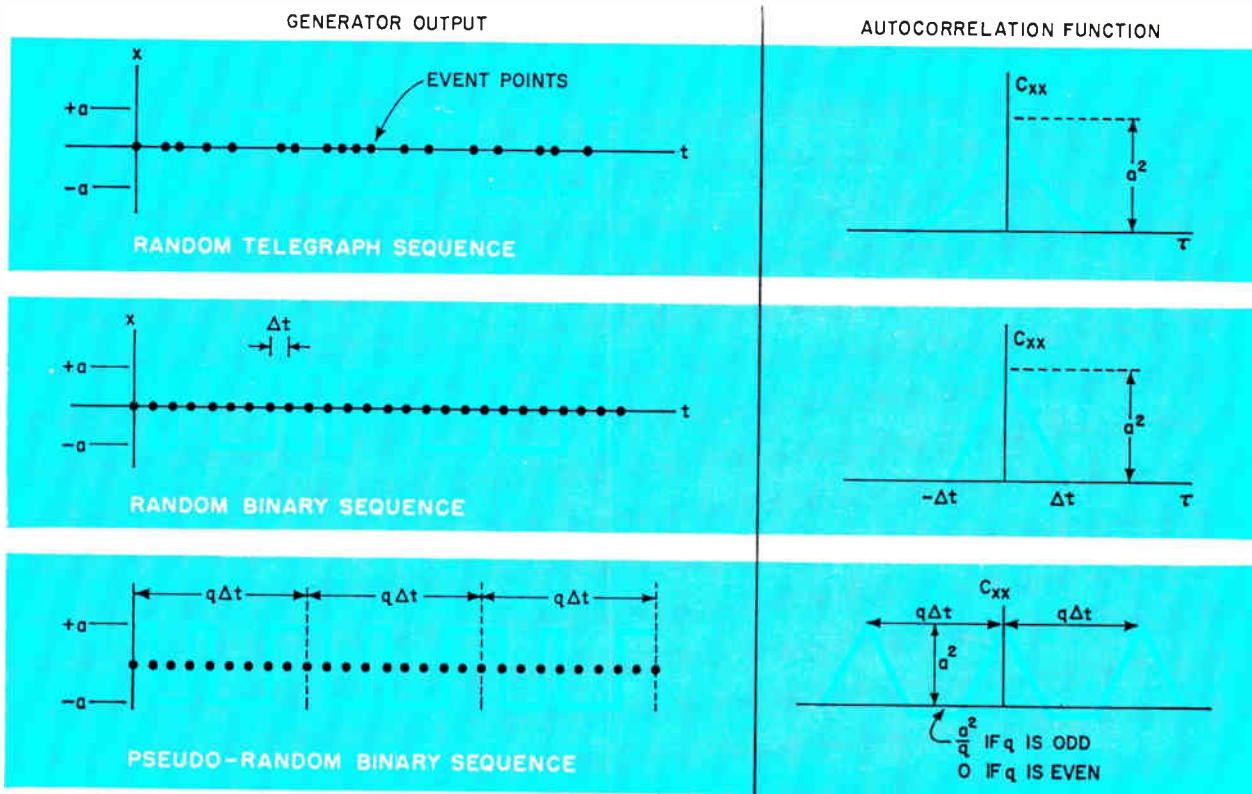

Flipper. Imagine a pulse generator controlled by a person flipping a coin—heads, the output is $+a$ and tails, it's $-a$. If he flips a coin at whim, the output is a random-telegraph sequence; if the flipping is periodic, a random binary sequence is generated. A pseudo-random binary sequence is a segment of a random binary sequence played over and over. For times less than the segment's length, the autocorrelation functions of the random binary and the pseudo-random binary sequences look very much alike.

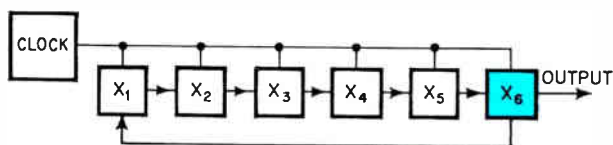

OUTPUT

X_6	1	0	0	0	0	1	0
X_5	0	0	0	0	1	0	0
X_4	0	0	0	1	0	0	0
X_3	0	0	1	0	0	0	0
X_2	0	1	0	0	0	0	0
X_1	1	0	0	0	0	0	0
t	0	Δt	$2\Delta t$	$3\Delta t$	$4\Delta t$	$5\Delta t$	$6\Delta t$

Moving over. The shift register's output is a sequence of 0's and 1's. If the output is fed back to the first stage, the sequence repeats every $6 \Delta t$ seconds.

flipped in the air a number of times. If the coin is flipped periodically, if the sequence of flips is filmed, and if the film is shown over and over, a person watching this continuously playing film sees a pseudo-random sequence of heads and tails.

To take it a step at a time, the occurrence on each flip of a head or a tail is equally likely, and the result of any particular toss is statistically independent of all the other tosses. So if the coin is tossed q times, the number of heads, $n(H)$, and the number of tails, $n(T)$, that occur on the average will be

$$n(T) = n(H) = q/2$$

if q is sufficiently large.

Imagine a device that produces an output of $+a$ volts when a head occurs and $-a$ volts when a tail occurs. And imagine also that this device's output after a particular toss, or event point, is constant until the next event point. The output is called a random telegraph signal. The randomness of this signal results, first, from not knowing when the coin will be flipped and, second, from not knowing if the coin will come up heads or tails.

Suppose now that the device is further constrained so that coin tosses, or event points, can occur only at intervals of Δt seconds. This constraint removes a degree of randomness from the signal. It's known with absolute certainty when

the coin will be flipped, i.e. when event points will occur. The only uncertainty is whether the signal will change or remain the same at a given point. A device working under this additional constraint—periodicity—puts out a signal known as a random binary sequence.

If another constraint is placed on the device—the total number of event points is q —and if these event points are recorded on a loop of tape and the tape is played continuously, the resulting signal will be periodic, with a period $T = q\Delta t$. Apart from the periodicity, this signal resembles the random binary sequence, and is called a pseudo-random binary sequence.

Look alikes

The only way to describe and compare random signals is with statistics. A complete specification requires that all the probability-density functions be defined. In practice, however, it's usually enough to specify the following parameters:

- Mean value

$$\bar{x} = \lim_{T \rightarrow \infty} \frac{1}{T} \int_0^T x(\lambda) d\lambda$$

- Mean square value

$$\overline{x^2} = \lim_{T \rightarrow \infty} \frac{1}{T} \int_0^T x^2(\lambda) d\lambda$$

- Rms value

$$= \sqrt{\overline{x^2}}$$

- Autocorrelation function

$$C_{xx}(\tau) = \lim_{T \rightarrow \infty} \frac{1}{2T} \int_{-T}^T x(t) x(t - \tau) dt$$

or power-spectral-density function

$$\Phi_{xx}(\omega) = \frac{1}{2\pi} \int_{-\infty}^{\infty} C_{xx}(\tau) \cos \omega\tau dt$$

- Probability density function

All can be easily specified for a pseudo-random binary sequence.

The autocorrelation function is a convenient statistical parameter for comparing random and pseudo-random sequences. From any observation of the pseudo-random binary sequence for less than one period, it would be inferred that the sequence is a true random binary sequence. Only when observation times exceed one period is there any indication of non-randomness. This subjective concept may be backed up mathematically by a consideration of the autocorrelation functions of the two types of sequences.

A pseudo-random binary sequence has a period of $T = q\Delta t$ where Δt is the period of the clock pulse, and q is the sequence length in bits. The signal's autocorrelation function is also periodic,

also with a period T . It may be shown that the autocorrelation function is

$$C_{xx}(\tau) = a^2 \left[1 - \left| \frac{kT - \tau}{q} + \frac{1}{q} \right| \right]$$

where $|kT - \tau| \leq \Delta t$

$$C_{xx}(\tau) = a^2/q$$

where $|kT - \tau| \geq \Delta t$

where $k = 0, \pm 1, \pm 2, \dots$

q = sequence length in bits

There's strong correlation at integral multiples of $q\Delta t$, a fact that relates to the fundamental physical nature of the pseudo-random binary sequence.

The random signal, on the other hand, has zero correlation for delays greater than Δt , so, on the average, there's no relationship between switching points—a result of the statistical independence as in the coin tossing process.

Both types of signals have essentially the same autocorrelation function for time delays less than one period. The difference occurs when q is an odd number since, in this case, the number of heads can't equal the number of tails. The offset of the autocorrelation function when q is odd has a nonzero mean value.

$$\begin{aligned} \text{Offset} &= a^2/q && \text{when } q \text{ is odd} \\ &= 0 && \text{when } q \text{ is even} \end{aligned}$$

When q is large, the zero-frequency offset is small.

At zero delay the autocorrelation function of both signals equals a^2 , which is the mean-square value of the signal.

The autocorrelation function of the random telegraph sequence is for a case when the event points satisfy a Poisson distribution that has a mean switching rate of Δt seconds. All that can be said is that the autocorrelation function approximates that for a pure random binary sequence.

The power-spectral-density curves of both the random binary and the pseudo-random binary sequences have envelopes of the form $(\sin x/x)^2$. So both are band-limited sequences. The difference is that the pseudo-random sequence's spectrum is a discrete, or line, spectrum, not a continuous one. As the period of pseudo-random signal lengthens, the lines of the spectrum come closer together and the spectrum looks more like the continuous spectrum of the random binary sequence.

The lines of the spectrum occur when ω is

$$\omega = 2\pi k/q\Delta t$$

The power at each line varies inversely with the sequence length. For example, if sequence length is doubled, the power at any particular line is halved. But line density is doubled since the total power in the signal is constant, independent of bandwidth. In other words, the area under the spectral-density curve is constant.

If the pseudo-random binary sequence were applied to a system, the system would have to remember the signal for longer than one period

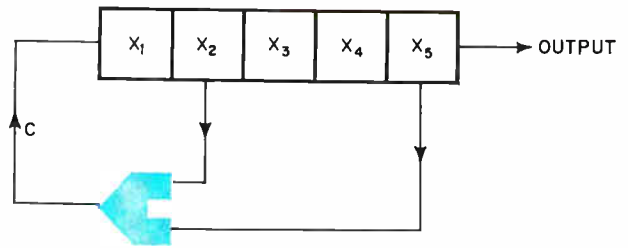
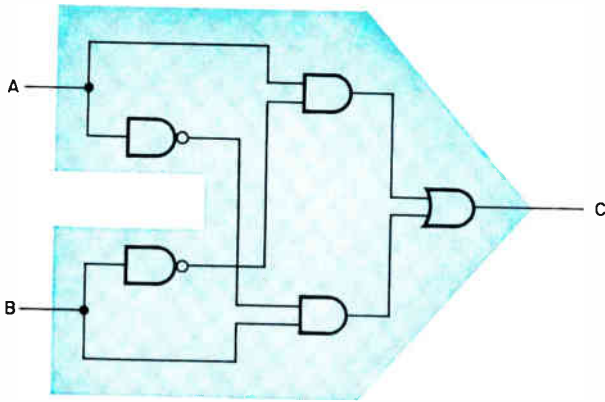

A → C

B → C

A	B	C
1	0	1
1	1	0
0	0	0
0	1	1

Booster. The length of a sequence depends on how many configurations of 0's and 1's are possible in the register. This circuit, in a feedback loop, increases that number.

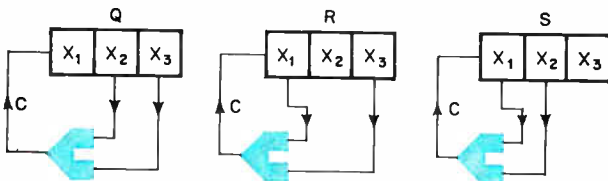

X ₁	X ₂	X ₃	C
1	0	0	0
0	1	0	1
1	0	1	1
1	1	0	1
1	1	1	0
0	1	1	0
0	0	1	1
1	0	0	0
0	1	0	1

X ₁	X ₂	X ₃	C
1	0	0	1
1	1	0	1
1	1	1	0
0	1	1	1
1	0	1	0
0	1	0	0
0	0	1	1
1	0	0	1
1	1	0	1

X ₁	X ₂	X ₃	C
1	0	0	1
1	1	0	0
0	1	1	1
1	0	1	1
1	1	0	0
0	1	1	1
1	0	1	1
1	1	0	0
0	1	1	1
0	1	1	1

The long one. When the feedback loops are arranged so that an n-stage register puts out a maximum length sequence—as is the case for the two registers on the left—the register runs for $(2^n - 1)\Delta t$ before repeating. So a maximum length sequence from a three-stage register is $7\Delta t$ long.

C	X ₁	X ₂	X ₃	X ₄	X ₅	LENGTH OF RUN
0	1	0	0	0	0	4Δt
1	0	1	0	0	0	
0	1	0	1	0	0	
1	0	1	0	1	0	
1	1	0	1	0	1	Δt
1	1	1	0	1	0	Δt
0	1	1	1	0	1	Δt
1	0	1	1	1	0	Δt
1	1	0	1	1	1	3Δt
0	1	1	0	1	1	
0	0	1	1	0	1	
0	0	0	1	1	0	Δt
1	0	0	0	1	1	2Δt
1	1	0	0	0	1	
1	1	1	0	0	0	3Δt
1	1	1	1	0	0	
1	1	1	1	1	0	
0	1	1	1	1	1	5Δt
0	0	1	1	1	1	
1	0	0	1	1	1	
1	1	0	0	1	1	
0	1	1	0	0	1	
1	0	1	1	0	0	2Δt
0	1	0	1	1	0	
0	0	1	0	1	1	2Δt
1	0	0	1	0	1	
0	1	0	0	1	0	Δt
0	0	1	0	0	1	Δt
0	0	0	1	0	0	2Δt
0	0	0	0	1	0	
1	0	0	0	0	1	Δt
0	1	0	0	0	0	

The marks. As this table illustrates, the output of the five-cell register (above table) is a maximum length sequence. Every possible register state occurs except the all-zero state; there are 32 possible states, i.e. 2^5 , and 31 states, i.e. 2^{5-1} , occur.

In any column there are 15 0's, i.e. $2^{5-1} - 1$, and 16 1's, i.e. 2^{5-1} .

There are 16 runs altogether; half of them are Δt long and a quarter are $2\Delta t$ long.

Of the eight runs that are Δt long, four are runs of 0's and four are runs of 1's.

to detect any difference between this sequence and a pure binary random sequence. This is the same as saying that a system would require an extremely narrow bandwidth (which is equivalent to a long memory) to be able to separate the lines in the power spectrum of a PRBS. So if a system has a wide bandwidth, it reacts in a similar way to either type of sequence.

The simplest of pseudo-random binary generators consists of a shift register, a clock, and a feedback loop. The clock drives the register at a fixed rate, and the loop joins the register's first cell to its last. The PRBS can be tapped from any of the register's cells.

The sequence certainly isn't random because the sequence of 0's and 1's is determined solely by how many cells are in the register and in what way the feedback loops are connected.

If the register in the drawing on page 84 is driven at a rate of $(1/\Delta t)$ hertz and if the register's initial state is as shown in the table's first column, then the output after each clock pulse is as shown along the x_6 row.

After six pulses the register is empty. With feedback, a continuously circulating pattern of 0's and 1's—a pseudo-random sequence—is generated.

Two AND gates, two inverters, and one OR gate, arranged as shown in the drawing on page 86 can greatly extend the sequence length. This arrangement of gates is similar to a half-adder; missing only is the AND gate used to produce a carry bit.

Consider the three-stage register in the drawing on page 86. The initial state of all the registers is 100. Both register Q and R generate a pattern in the output cell, x_3 , that repeats after every seven clock pulses. In register S, the pattern in the output repeats, but after only three clock pulses. Further, in the last case, the 100 state never repeats whereas in Q and R every possible condition of the shift register occurs except the all-zero state, which if it appeared would cause a collapse of the circulating pattern. The first two arrangements are generating what is known as a maximum length sequence.

For an n -cell register with feedback from the appropriate cells, the output is a sequence of 0's and 1's that repeats every $(2^n - 1) \Delta t$ seconds. This is the repetition period for a maximum length sequence; all possible states of the shift register occur (2^n states) except the all-zero state.

Maximum length sequences have the following properties:

- Every possible shift register state occurs once, except the all-zero state.
- In any cell, during a sequence the total number of 1's that occur is given by 2^{n-1} and the total number of 0's is given by $2^{n-1} - 1$.
- If the clock frequency is $1/\Delta t$, one half of the total number of runs in a sequence are Δt long, and one quarter of the runs are $2\Delta t$ long.
- The number of runs of 1's, Δt long, equals the number of runs of 0's, Δt long.

There are a couple of ways to convert the output

of a PRBS generator into a multilevel sequence. One approach is to feed the pseudo-random binary sequence to a lowpass, sharp-cutoff filter. The filter's output has a first-order probability distribution that is approximately Gaussian. Certain constraints have to be observed relating to the cutoff frequency, clock period, and sequence length. In general, the cutoff frequency must be much greater than the clock frequency, and less than the sequence's repetition frequency. The power-spectral density of the filter's output is still a discrete spectrum and the higher order distributions are not necessarily Gaussian.

Another approach is to use the first s cells in the register to generate an s -bit digital number which is fed to a d-a converter through scaling circuits. The converter's output is given by

$$z(t) = \sum_{i=0}^{i=s} \alpha_i x_i(t - i\Delta t)$$

where $x(t)$ is the pseudo-random binary sequence, and α_i is a scaling factor.

This expression is similar to

$$z(t) = \int_{-\infty}^{\infty} g(\lambda) x(t - \lambda) d\lambda$$

This equation gives the response of a linear time-invariant filter to an impulse $g(\lambda)$. The weighting coefficients, α_i , can be considered a digital representation of $g(\lambda)$. In fact, the coefficients could be chosen to give an approximation to a sharp-cutoff-filter weighting function. This idea is attractive when low frequencies are involved since it eliminates the need to design a low-frequency cutoff filter.

One thing the generator's register should always have is a 1. If the all-zero state occurs, the register's output drops to 0, and stays there. To preclude this, the designer of the generator can use the instrument's synchronization pulse.

Since the generator is usually used as part of a test or monitoring system, it should put out a synch pulse anyway. In Solartron's JM 1861 PRBS generator the complementary outputs of all the register's cells except the first are connected to an AND gate. Whenever these stages all have 0's, the gate puts out a pulse one-clock-period wide. This pulse, which is used as the generator's synch pulse, inserts a 1 into the first stage, thus preventing the all-zero stage from occurring.

This generator's clock frequency ranges between 0.001 hz and 1 megahertz, and the register length can be set at 5 cells (31 bits) up to 20 cells (over 10^6 bits). If the generator were set at its lowest clock frequency and longest register length, it would take 30 years to run through a sequence.

Any PRBS generator needs a wide frequency range so that it can test both slow (process control) and fast (communication) systems. ■

Single building block proves logical choice for custom IC's

Multipurpose circuit for special-purpose systems delivers more stability against transients, supply-voltage variations, and extreme temperature conditions than do off-the-shelf devices

By Donald K. Lauffer

National Cash Register Co., Hawthorne, Calif.

Getting the edge on competitors in the market for special-purpose digital computers is especially difficult if the designer uses standard off-the-shelf integrated circuits. Such IC's are designed for maximum yield and versatility; the supplier wants to manufacture them in volume and distribute them at a low cost to the users and a reasonable profit to himself. Built to meet a mass market, these circuits naturally satisfy a great many requirements irrelevant to the specific application of a special-purpose computer—and at the price of tradeoffs that can cost the computer whatever competitive edge it may have.

Custom circuitry can provide the kind of performance a specialized application demands, but the designer must keep expenses down to justify its use. He will have to order these circuits in large volume in order to amortize the special handling and overhead costs involved.

The logical approach to logic design, would be to employ a minimal number of configurations and if possible a single basic building block. Outside the obvious advantage of volume buying, there'd be benefits so far as inventory, testing, field maintenance, and card layout. The following presents a study made by the National Cash Register Co. to determine some of the characteristics desired in the design of the IC employed in the single building block for its Century Computer series:

- That it be able to provide AND, OR, and INVERT functions. NAND-gate outputs would be tied together for the AND function, and NOR outputs for the OR function.

- That the circuit be able to drive large fanout and capacitive loads from a low-impedance source, permit the use of a pullup resistor at the end of the transmission line for partial or complete ter-

mination, and drive such loads as incandescent lamps and relays. The output terminal should therefore have an open collector and a reasonably high current-sink capability at a low saturation voltage.

- That the circuit be able to withstand large voltage fluctuations. The supply voltage should be low enough so that the current generated through termination pullup resistors doesn't cause heavy power dissipation or exceed the current-sink capability of the circuit's output transistor.

- That the breakdown characteristics be such that latch-up wouldn't occur when the normal reactance of the logic or some miscellaneous loads are driven. The circuit should have a saturated output to guarantee a low-impedance logic state, and should be immune to transient loading effects.

- That the load resistor not be tied permanently to the output transistor but be tied to a separate terminal so that collectors can be ANDed together. The load resistor's impedance value should be about equal to that of the normal signal distribution lines.

- That the input current be compatible with output sink characteristics. Thresholds and input leakage must give enough output-to-input noise margin.

- That the circuit's transient characteristics, such as propagation delay, rise and fall times, and pulse shape, be highly stable under conditions of temperature and supply-voltage variation.

An important factor bearing on the design of a custom logic circuit is the backplane wiring. The backplane defines how power is distributed in the system and what line termination impedances should be used. The designer can use point-to-point wire bussing (soldering), manual or tape-controlled wire-wrapping, single or multi-layer etched backplanes, or combinations of all of these.

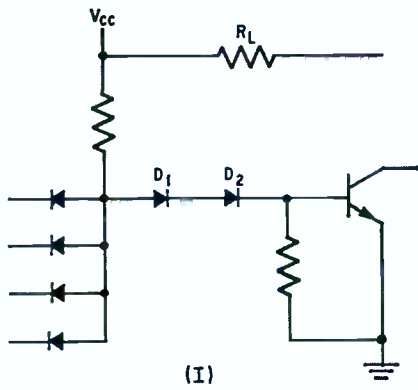

Too tight. Tight control of supply-voltage and resistor tolerances in a standard DTL eliminates it as a high yield integrated circuit.

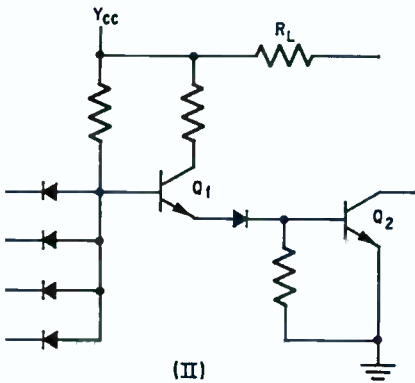

Slight relief. The additional stage, Q_1 , tends to relieve tight tolerances of standard DTL but adds a Miller effect and a stored charge delay.

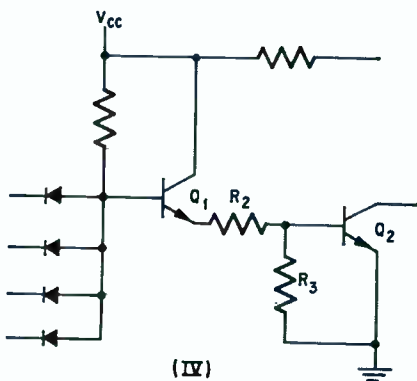

Poor bias. Threshold is fixed by ratio of resistors R_2 and R_3 . Input diodes, however, do not reverse bias and provide adequate noise margin for upper level input signals.

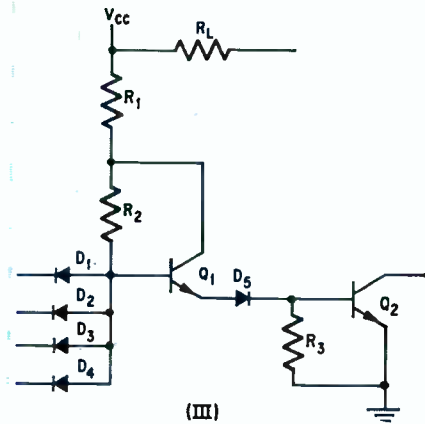

Delay tradeoff. R_1 and R_2 prevent saturation of Q_1 , thus eliminating storage delay. But the collector resistance causes phase-inversion feedback, delaying current transfer through the device.

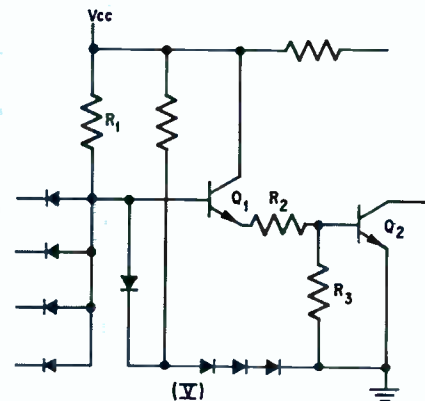

Well built. The node of the input diodes are clamped at a reference level to provide adequate reverse biasing of output transistor. This circuit has faster turn-on and less delay.

The choice largely depends on whether the system needs high-speed series logic with a highly sophisticated etched backplane and complete-line termination, or a slower logic in parallel with wire-wrapped backplane and partial-line termination. Both systems can be built to provide about the same performance. The wire-wrap approach is the more economical and flexible when applied to standard backplanes. It also permits rise times of 1 to $1\frac{1}{4}$ nanoseconds per volt—generally sufficient for most customer's needs. With these rise times and saturated logic circuits, the backplane must incorporate partial termination and reasonable noise margins (300 to 350 millivolts).

Rise times faster than 1 nanosecond per volt generally require complete termination and almost perfect impedance matching, which means fixed-etched backplanes and exact termination resistors. Batch-fabricated, multilayer etched backplanes can be costly, though, when logic changes are made.

Thus, the use of a wire-wrapped backplane puts the following constraints on the computer design:

- Saturated logic should be used to guarantee a low-impedance logic state and immunity against transient loading effects.
- Termination or pullup-resistor-type logic with an impedance in the range of 150 to 250 ohms should be used.

▪ Noise margin should be much larger in the pullup state than in the saturated state.

After deciding on the backplane, the output characteristics of the circuit can be defined. The output impedance of the circuit should approximate the characteristic impedance of the interconnecting wire-wrapped lines.

The best choice for the circuit's output is a grounded-emitter transistor with an open collector, and a separate pullup resistor connection on the outside of the package. The separate pullup resistor allows the option of using it at either end of the line and of using the output transistor to drive miscellaneous loads without having to sink pullup current. The resistor also gives the circuit the capability for wire-ANDing the outputs, without which the building block count and the average logic delays would have been increased by about 30%.

The maximum power supply voltage is determined by the pullup resistor (150 to 250 ohms) that partially terminates the line in its characteristic impedance, the circuit's power, its number per package, fanin, and fanout.

Satisfaction

A fanout of eight, fanin of four, and a capability of tying eight outputs into a wire-AND configuration should satisfy all logic functions with little compromise. Using a fourteen lead, dual-in-line package, the maximum power dissipation should be limited to about 350 milliwatts per package, over a temperature range of +15°C to +55°C. This limits the design to two circuits per package, if pullup resistors are to be included in the package.

Power dissipation as a function of supply voltage and pullup resistance, disregarding the other circuit components, is approximately

$$P \text{ (mw)} \approx 2V_{cc}^2/R = 13.3V_{cc}^2$$

For a $V_{cc} = 4$ volts, 5 volts, and 6 volts, all with a minimum pullup resistance of 150 ohms, the power is 213 mw, 333 mw, and 479 mw, respectively (assuming two pullup resistors). Thus the maximum supply voltage is 5 volts, if a 150-ohm resistor is used and the package includes two circuits. But 5-volt V_{cc} leaves only marginal power for the rest of the circuit (17 mw) so a high gain would be required for this choice.

It is apparent that complete- or partial-line termination forces the designer to provide currents of about 20 to 30 milliamps just for the termination, if high speeds are to be achieved. This feature alone eliminates many off-the-shelf circuits such as TTL for the circuit choice.

Another important consideration when choosing a supply voltage and pullup resistor is how much current will be needed to drive capacitive loads. This becomes especially significant when several outputs are tied together as in a wire-AND function, because each output contributes capacitance which must be charged to the load's threshold before the fanout will be switched. Maximum speed demands a high V_{cc} , a low pullup resistor, and a low threshold.

Taking the fifth

Circuits III and V shown on page 89 were fabricated monolithically using exactly the same components and geometries with identical specifications for the purposes of analyzing their transient characteristics. The designs used the following circuit specifications.

A supply voltage of four volts was chosen as best to obtain good circuit speed. The threshold was set at 0.8 volt to allow 350 millivolts of noise margin on top of a saturation voltage of 0.45 volt. This allows more than a volt of noise margin at the upper level, with an upper threshold of 2.5 volts. To achieve a fanout of eight at a reasonably low beta, input current was limited to a maximum of 3.88 milliamps. With the 150-ohm minimum pullup resistor, the output transistor must sink 60 ma at $V_{F(SAT)} \leq 0.45$ volt. The specification was increased to 70-ma sink current at 0.6 volt to assure both proper overdrive for speed and enough current to drive miscellaneous loads.

Supply drain current for the two circuits in the package was set to a maximum of 72ma to limit power supply requirements. By setting output voltage breakdown at 10 volts, different loads can be driven at power supplies ranging from 4 volts up to 10 volts and at the same time voltage protection is provided in the power supplies. Output leakage current was limited to 115 microamps to

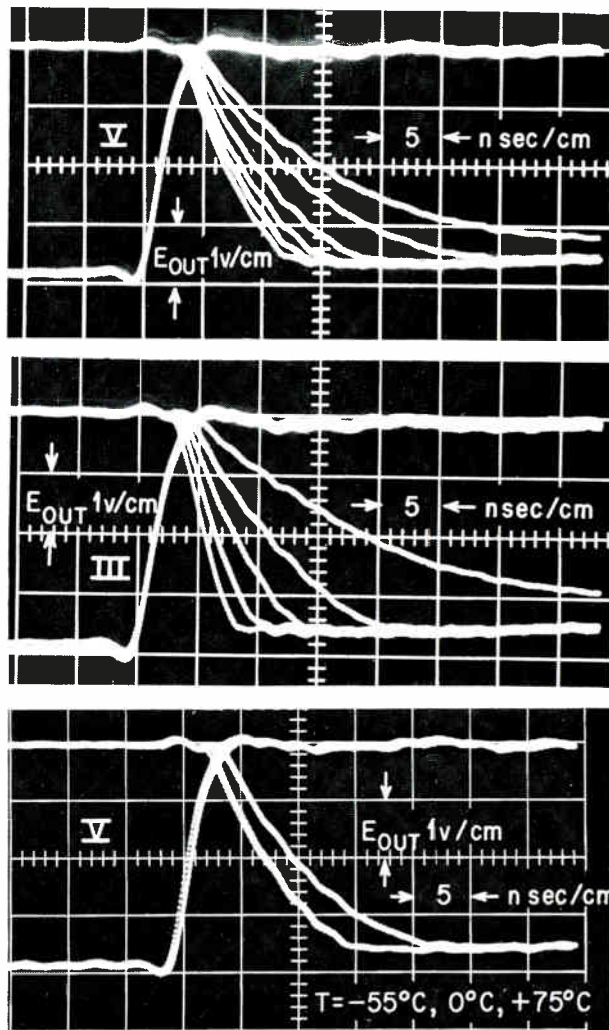

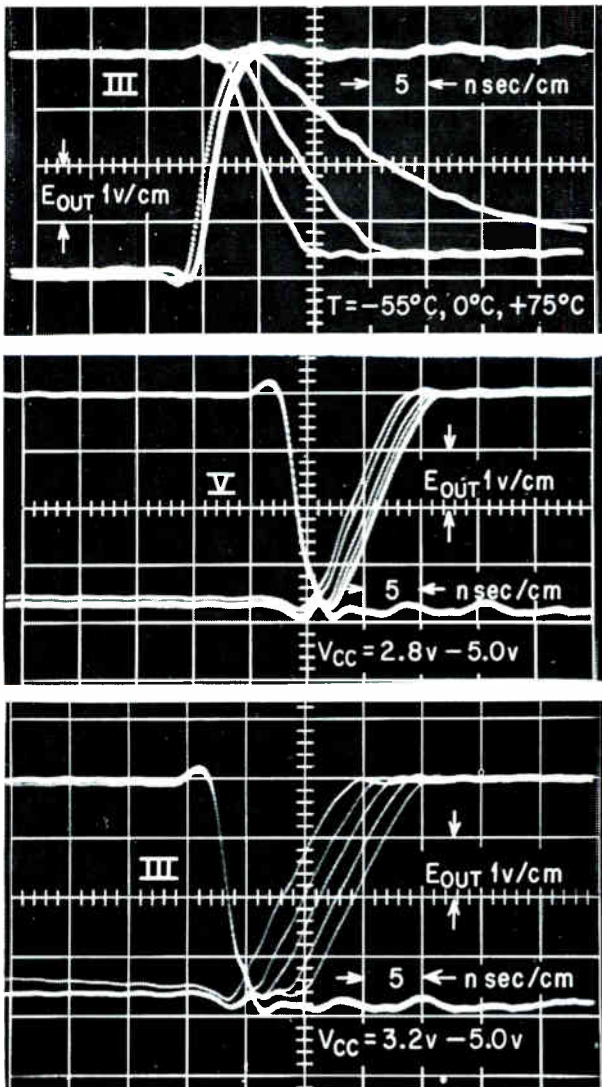

maintain upper level noise margin and to drive loads such as relays, which must have very low leakage to unlatch. Input breakdown voltage was set at 10 volts for overvoltage protection and interfacing with drivers.

The measured results of t_{in} , t_{off} , t_r , and t_f between these circuits show that even in the extended military lower temperature range, circuit V exhibits better transient stability than circuit III does in the commercial temperature range. Note that the third circuit's rise time is faster than the fifth's in certain cases of supply voltage and temperature. The system designer must, however, use the worst case in his environmental range of operation. Furthermore, the uncontrolled rise time could under certain conditions get fast enough to present noise problems.

Output voltage-current characteristics for the two designs, as they vary with temperature and power supply voltage, show that the active constant current (β_{IB}) region of the fifth circuit stays essentially constant with temperature. The β_{IB} product is the principal parameter that governs logic speed of the output transistor. This is the collector current that is available for driving capacitive loads through the active region transition of the output device. In the region at or below -20°C , silicon resistors tend to have a negative temperature

The circuit's threshold should be as close to the saturation voltage as possible for fast-rising waveforms, but far enough away from it to maintain an a-c and d-c lower noise margin. Good noise margin and fast circuit speed are difficult to achieve in the circuit without compromising one for the other.

Noise levels must be kept well below 300 millivolts for saturated logic and a 150-ohm termination, and below 800 millivolts for lines with 250-ohm terminations on one end and open circuits on the other. Ground and signal noise combined, a lower margin of 350 millivolts and an upper noise margin of 1 volt, is a safe constraint.

Now that the characteristics wanted from the single building block circuit are known, the next step is to examine available circuits and decide which come closest to satisfying needs. Further improvements can then be made in this circuit that will enable it to meet design constraints.

Resistor-transistor logic offers neither the gain nor the noise margin sought in the system. It also lacks the capability of ORing the outputs by tying collectors together.

Emitter-coupled logic (ECL) is faster and can drive higher fanouts than RTL, but is also a poor choice because ECL doesn't have a saturated output, the emitter follower is very sensitive to wire-wrapped reactance, and its short voltage swings don't provide adequate noise margin, and cannot switch loads, such as lamps and relays, to ground.

Transistor-transistor logic contains an active pull-up which prohibits collector ANDing the outputs, making it unsuitable for the special-purpose system. Even though the active pullup can quickly drive large capacitive loads, large transient currents are demanded from the power supply to yield fast-rising output waves which therefore generate two kinds of noise: power distribution noise, and signal noise developed from the fast rise time at the output. The design goal is to get high performance without generating excessive rise-time noise.

The input leakage currents of TTL, because of an inverse beta developed with multi-emitter input transistors, are three orders of magnitude higher than diode-transistor logic. Active pullup is needed to provide a low voltage current source for these high leakage inputs. If a resistor pullup were used, serious degradation of upper noise margin would result, especially at high temperatures.

The active pullup requires an intermediate phase-inverter transistor for control. The addition of this inverter stage adds both an extra Miller effect and a saturation storage delay to the total propagation delay of the circuit. When the output transistor saturates, the charge removal from the input transistor results in a current surge that generates noise on the input driving line. Furthermore, the propagation delay is very sensitive to the impedance of the driver, while other NAND types such as DTL are not as sensitive.

Several DTL schemes might be good choices. All are capable of providing collector ANDing, since the pullup resistors are not internally connected to the

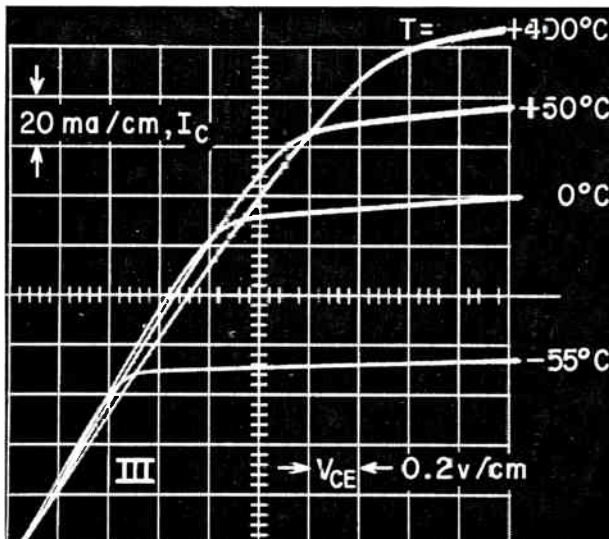
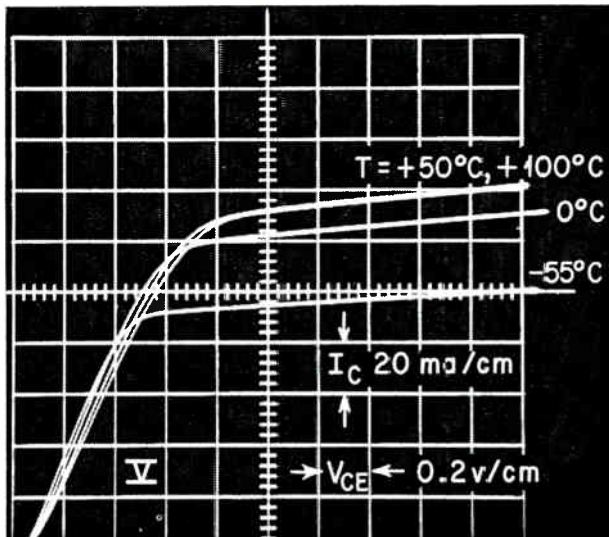

coefficient which causes tracking in the wrong direction in this region for circuit V. The third circuit's characteristics show multiplication of $\beta_{I_{B1}}$ with temperature. The variation of $\beta_{I_{B1}}$ as a function of power supply voltage shows that V tends to be significantly more stable than III.

The fifth circuit's output base current drive $\beta_{I_{B1}}$ exhibits a negative temperature coefficient due to the base resistor's positive coefficient and the reference diode's negative coefficient with temperature. But beta increases about 1% per degree Centigrade. These two effects therefore compensate to hold $\beta_{I_{B1}}$ constant with temperature. Circuit III's output base current and beta both exhibit positive temperature coefficients and therefore cause $\beta_{I_{B1}}$ to increase rapidly with temperature.

Comparing the d-c transfer characteristics of III and V as a function of temperature (the resistor ratio R_A/R_1 in V was set at 0.6) III's characteristics are steeper (which is desirable) than V's. However, analysis of the difference between the minimum and maximum breakover points show very little difference over the temperature excursion. This means that even though V's characteristics are not as steep as III's, the switching threshold band is identical in width over the temperature range.

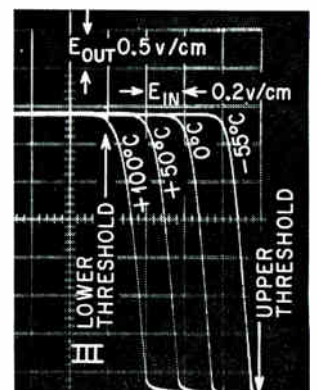
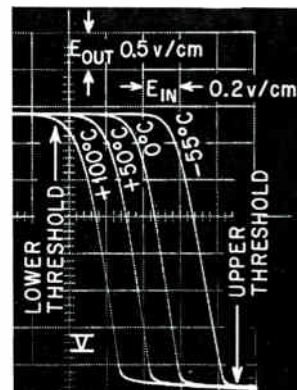

output transistor collectors.

Several factors determine which DTL circuit should be used. DTL's with multi-emitter transistor input gating contain parasitic capacitance at their common node, while those with collector-base diodes contain an isolation diode from input to ground for each diode.

If high voltage breakdown is important (over 7 volts), the collector-base diode must be used. And for high speeds, the collector-base configuration is best because parasitic capacitance at the inputs is driven by a low impedance source (a saturated transistor or low impedance pullup resistor). In the multi-emitter structure, the capacitance at the node must be charged through the node impedance, which is in general 5 to 10 times higher than the pullup impedance, which adds to the system delay.

The collector-base diode structure offers the advantage that the isolation diode will tend to clamp transients on long reactive lines. In fact, some manufacturers purposely place diodes on TTL-cir-

cuit inputs to rectify overshooting and ringing. The advantage of the multi-emitter diode structure is its small chip area. In either case, the delay at the node is generally small compared to other circuit delays.

The ideal transient properties of the logic circuit from the system designer's view are the following:

- High speed with virtually no delay within the device. If any delay is to occur, it should be from the rise and fall time of the circuit.
- Good dynamic noise range with immunity from transients generated by switching fanouts. Therefore, the prime objective is to provide a circuit with minimal internal delay and relatively slow rise time.

Five variations in DTL are shown on page 89. The first circuit, I, is the standard form. It has been used as a discrete circuit in vacuum tubes as well as transistors in all generations of data processing equipment to date. The problem with it as an integrated circuit is the tight control of resistor tolerances, supply voltage, fanout, and especially the pullup resistor (150 ohms). It is not within the realm

of high yield integrated circuits because with these constraints a high beta requirement is imposed.

The second circuit differs from the first by only a transistor and resistor replacing the diode D_1 . The added stage of gain tends to relieve the tight resistor and supply-voltage tolerances, and furthermore, reduces the gain constraint of the output transistor by a factor of $(\beta_1 + 1)$ where β_1 is the common emitter current gain of Q_1 . The disadvantage of this circuit is that its intermediate stage, Q_1 , suffers from the Miller effect and saturation-stored charge delay in the same way as the TTL phase-inverter stage, which directly adds to the total propagation delay of the circuit.

The third circuit has all the advantages of the second one with the additional advantage that Q_1 doesn't saturate, thus eliminating the additional storage delay.

Modified stage

The circuit uses a modified current-gain stage with resistive feedback to prevent saturation. The ratio of R_1 and R_2 is designed to prevent saturation of Q_1 at maximum temperature. The minimum sum of R_1 and R_2 is limited by input current specifications. Since Q_1 never saturates, no storage delay exists. However, the resistance in the collector circuit causes phase-inversion feedback to the base-driving network and, therefore, also causes collector-base capacitance multiplication (Miller effect) which appreciably delays the current transfer through the device.

The most direct means of eliminating both saturation and Miller effect is to remove the collector resistance as shown in IV. The emitter follower configuration doesn't saturate nor suffer from Miller effect delays. The resistance removed from the collector must be put in the emitter circuit to limit current through Q_1 otherwise short circuiting can occur. This resistance provides offset between the input diodes and the output transistor and therefore allows diode D_5 to be discarded.

The latter circuit does not have its threshold fixed at two diode drops as does the third one, but rather by the ratio of resistors R_2 and R_3 . The input diodes will not reverse bias and provide adequate noise margin for the upper level input signals. This is an intolerable condition and therefore eliminates the fourth circuit as a design consideration.

The best method of overcoming the weakness in the fourth circuit is to clamp the node at a reference level which provides adequate reverse biasing of the input diode. The fifth circuit has a diode-type voltage reference built into the circuit.

The Miller effect delay that exists in the third circuit does not exist in the fifth. There are other advantages of the fifth that the third doesn't have. Each circuit has a slightly different output base-charge time delay. This delay is the time required to charge the output transistor's base from approximately zero volts to the point at which the base-emitter junction is forward biased. The input to the third circuit must rise to a voltage level approxi-

mately equal to the sum of the turn-on threshold voltage of the transistor plus the forward voltage drop of diode D_5 before collector current will start to flow in the output transistor. The fifth's input must only rise to a voltage given by the expression $V_{TH}(1 + R_2/R_3)$, where V_{TH} is the threshold of the output transistor.

Variations with power

The biggest dynamic difference between the two circuits' delay characteristics is their variation with supply voltage and temperature. The equation for the base-charging current to the output transistor in the last circuit shows no variation due to changes in V_{cc} at all. It was assumed that $V_{BE} \approx V_D$ which is not strictly true. Calculations show that charging current varies by approximately 3.7% per volt change in supply voltage. Evaluating this charging current for the third circuit indicates a 48% change per volt. This big difference in current change with supply voltage effects the transient and d-c stability of this circuit.

The circuit that most closely matches the design constraints discussed is the fifth circuit. Almost every parameter of this circuit depends on the values of R_2 and R_3 or their ratio. The supplier, therefore, can easily improve the circuit's performance by changing only one mask.

R_2 and R_3 are fabricated as a single resistor with a tap. Adjustments are made by changing the size or position of the tap. Enlarging the tap's opening, lowers the value of both R_2 and R_3 keeping their ratio constant. Moving the tap in one direction or the other adjusts the resistors' ratio.

By lowering R_3 and R_4 , more turn-on and turn-off current is delivered to the output transistor, causing the circuit to switch faster. But this also increases power supply drain current. Adjusting the ratio of R_3 and R_4 changes both thresholds and the ratio of turn-on to turn-off current flowing to the output transistor. With this flexibility, the manufacturer can make improvements in the circuit rapidly and economically by altering only the oxide removal mask for the metalization contact. This can result in large savings to the designer when developing high performance custom circuits.

Systems that used the circuit operated successfully using a supply voltage tolerance of 3 to 5 volts, and met the transmission and noise immunity provisions. Use of the single dual-NAND gate building block enabled implementation of 80% of the system's electronics on 6 plug-in boards. The inherent temperature stability of the circuit allows it to be tested at room temperature, and thus reduce test costs. Handling and maintenance costs are low due to minimum use of plug-in board types and the use of a single building block. ■

The author wishes to express his appreciation to the staff at the Signetics Corp. for its technical assistance and contributions in the development of the subject circuit. Further he wishes to acknowledge the cooperation of Robert Gunderson, Wilbur Miller, Jack Fort, Raymond Chung, and Harry Veroba.

Phase locking: integrated tuned circuits made easy

Adaptation of this old technique provides a surprisingly simple way to get the resonant-frequency accuracy required in communications without having to employ any active filters or external inductors

By Hans R. Camenzind and A.B. Grebene

Signetics Corp., Sunnyvale, Calif.

The heart of a communications receiver—the tuned circuit—has proven to be the part most resistant to integration on a monolithic chip. The reason: of all the techniques used to produce an integrated equivalent of a inductance-capacitance circuit, none has yielded the resonant-frequency accuracy required in communications.

However, there's now an approach that gives every indication of solving the problem. By adapting a 30-year-old idea—the phase-locked loop—Signetics has been able to make precisely tuned integrated circuits without precision components. These circuits, soon to be introduced commercially, will make it possible to build f-m receivers, for instance, in which the i-f amplifier and demodulator are contained in a single IC.

Naturally, the phase-locked loop isn't a universal solution to the problem of integrating tuned circuits; it's not yet useful for single-sideband circuits, for example, and for tuning transmitters, IC's still have power limitations.

The phase locking used in Signetics' IC's is similar to the arrangement used for many years to track satellites, stabilize the frequency of klystrons, and filter information out of noise. The loop, as shown at the right, contains a voltage-controlled oscillator that produces a signal, f_2 , whose frequency is proportional to a d-c voltage. The signal is mixed with the input signal, f_1 , in a phase comparator (sometimes called an analog multiplier) that produces the sum and difference of the two frequencies at its output. This frequency mixture is then fed through a low-pass filter, amplified, and connected to the control terminal of the vco.

To understand these workings, imagine that f_1 is the only frequency at the input. If the difference

between f_1 and f_2 is large (much larger than the cutoff frequency of the low-pass filter), the entire output of the phase comparator is filtered out by the low-pass filter and there's no control voltage. The vco therefore runs at its preset frequency.

But if the difference between the signals is small, the vco signal, f_2 , locks to f_1 . Essentially, f_2 tries to duplicate the input voltage because of the error signal generated by the comparator-filter-amplifier portion of the loop.

Depending on the phase difference between the two signals, this error signal can be positive or negative, as shown on the next page. (To make the diagram simple, f_2 is a square wave.)

Thus, when the vco frequency is close to that of the input signal, the error voltage pulls the vco frequency toward the input signal—an effect similar

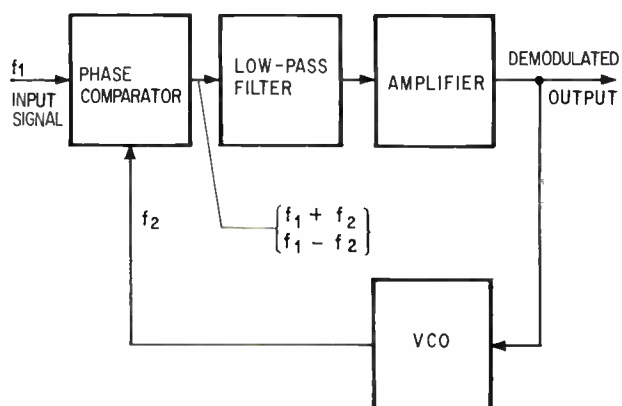

Looping and locking. In the phase-locked loop, an error signal locks the circuit on the input signal.

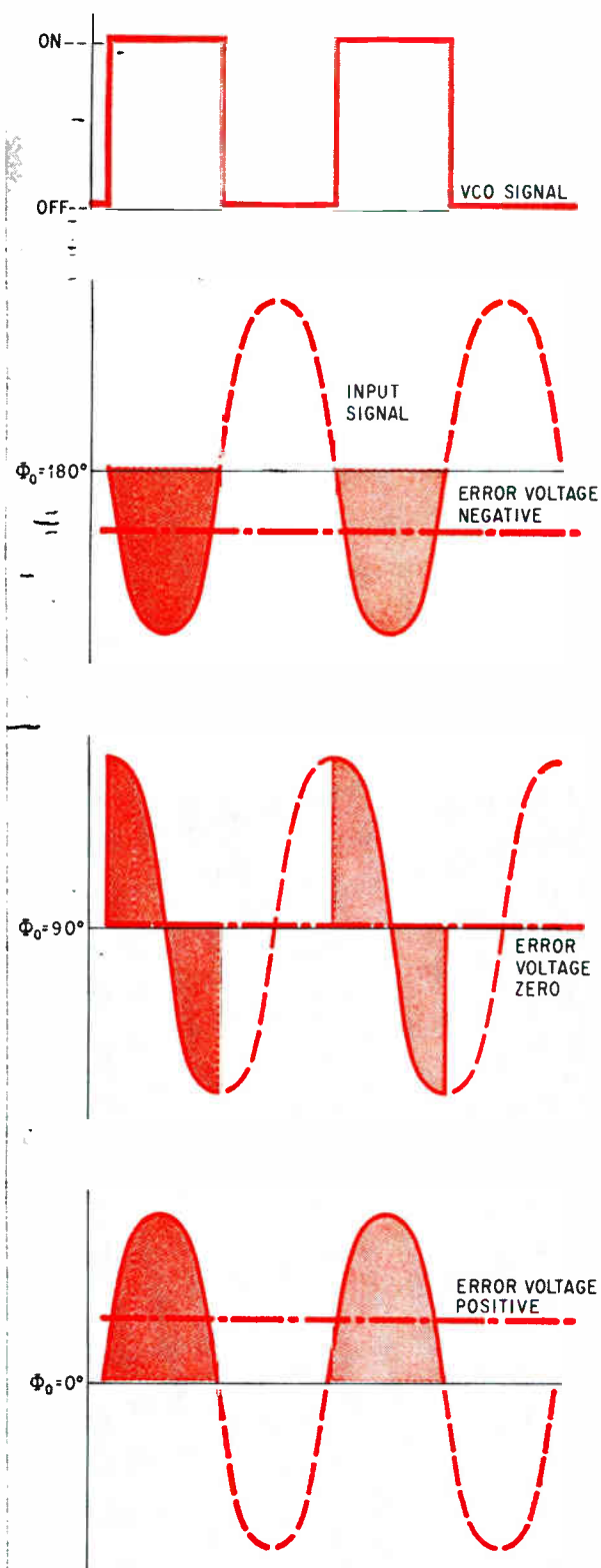

Phase in. Depending on the phase relation between vco and input signal, the error voltage is negative, zero, or positive, and drives the vco's signal toward the input signal.

to automatic frequency control in an f-m receiver. And once the vco is locked to the input signal, the error signal will make it follow variations in the input frequency. This means, in the case of f-m, that the modulation of the input signal is duplicated in the vco signal, and the error signal is the demodulated input signal.

If other frequencies besides f_1 are present at the input, their frequency differences and products are outside the passband of the low-pass filter and are therefore eliminated—or at least are strongly attenuated. The loop has roughly the selectivity of the low-pass filter translated into the input frequency range.

Phase locking has several interesting features:

- The vco frequency needn't be particularly precise or stable since once it moves close to an input frequency, it's drawn toward that level and held there. The "lock range" of a phase-locked loop can be many times the bandwidth. And the fact that inaccuracy and drift can be tolerated considerably eases IC design and fabrication.

- For f-m, the phase-locked loop performs the function of a demodulator. There's no need, therefore, for a demodulating circuit such as a ratio detector, a Foster-Secley discriminator, or a quadrature detector.

- The phase-locked loop is a highly selective circuit. Just a simple one-stage (and large-tolerance) RC low-pass filter produces a selectivity comparable to that of three i-f transformers.

- Since the vco frequency alone determines the received frequency, only one external element is needed for tuning.

- The level of the input signal doesn't matter much as long as it exceeds a certain threshold and is below a certain maximum that would saturate the input stage. In other words, the phase-locked loop is its own limiter because when the phase difference is 90° , any input signal amplitude results in a zero error voltage, as shown at left. And the range between the threshold and the tolerable upper level is quite wide.

Several phase-locked tuned IC's have been built at Signetics. One such circuit, the f-m i-f amplifier and demodulator shown on the next page, delivers a 100-millivolt audio signal with less than 1% distortion; the input signal can be between 800 microvolts and 100 millivolts. Component tolerances are the large values typical of IC's (about 20%), and no unusual processing steps are needed.

The vco is a modified Wien-bridge oscillator whose free-running frequency is set by an external trimmer capacitor, C_1 . The frequency can be shifted by using the junction field-effect transistor between bipolar transistors T_1 and T_2 to alter the loop gain. The gate of the FET, in other words, is the control input of the vco and carries the error voltage.

The phase comparator consists of a differential pair of transistors, T_5 and T_6 , whose gain is adjusted by means of another junction FET. The vco signal is connected to this FET and the input signal is connected to the differential pair. The difference

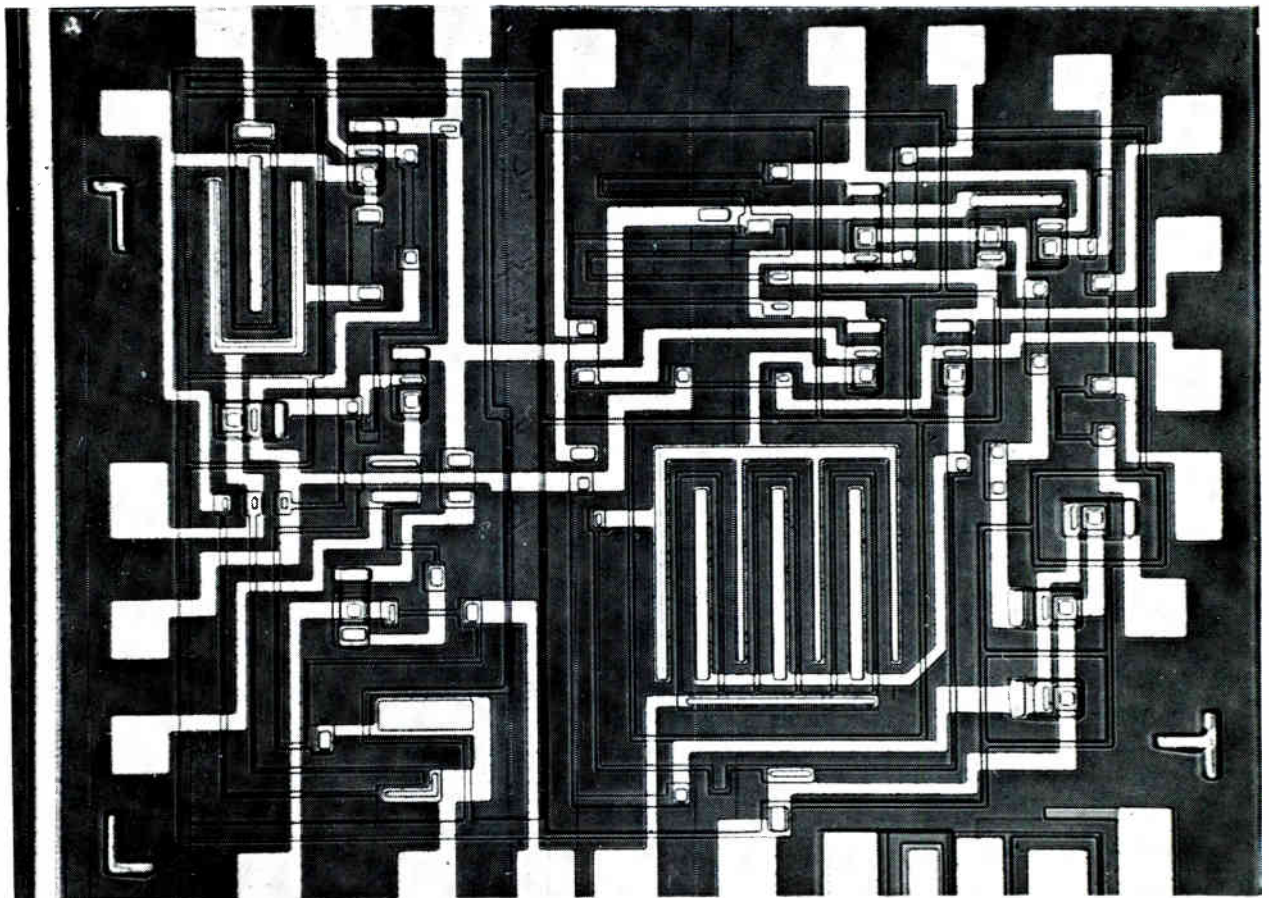
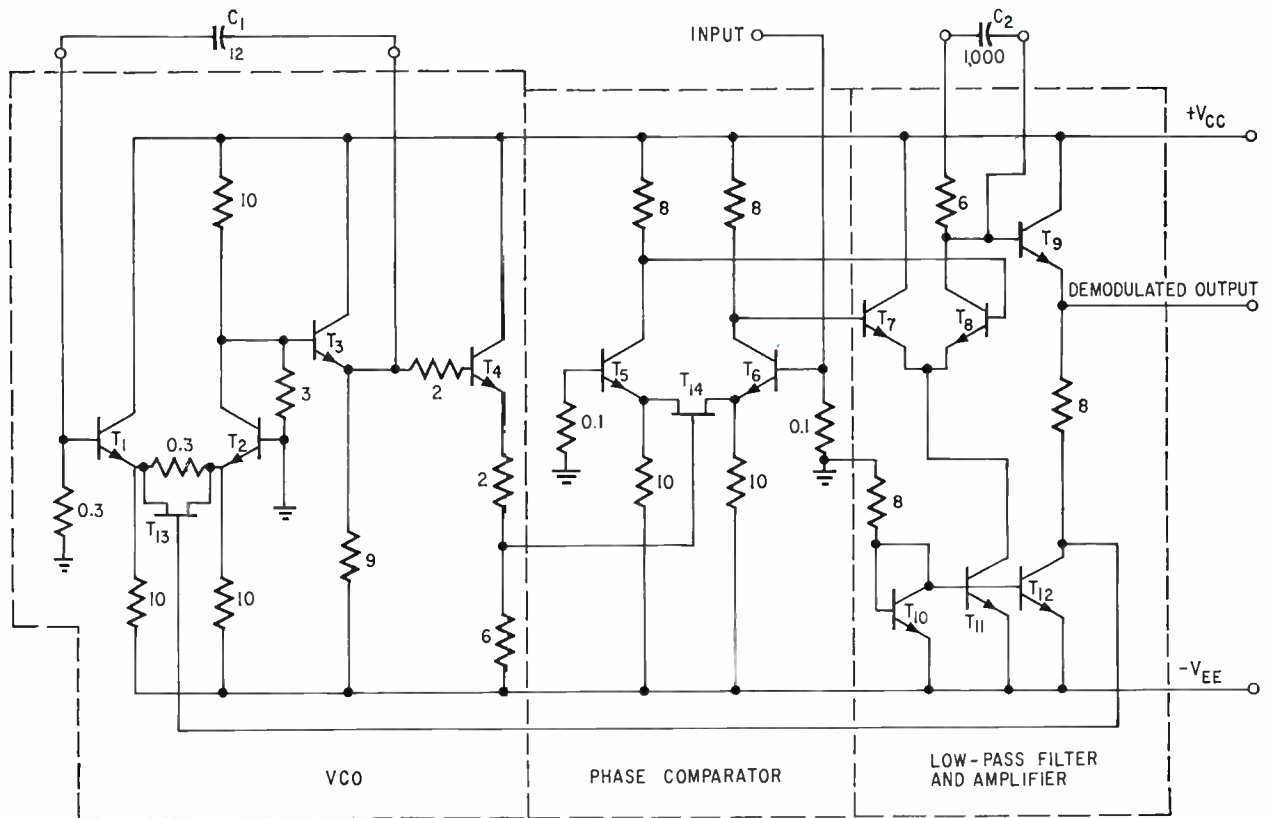

Similar. Experimental phase-locked f-m i-f amplifier uses bipolar and field effect transistors on the same chip. Its performance is almost identical to that of a discrete three-stage i-f strip. Resistances are in kilohms, capacitances in picofarads.

is amplified through T_7 and T_8 , filtered with an external capacitor, and fed through emitter follower T_9 , which provides low output impedance.

To get n-channel FET's on the same chip as the bipolar transistors, the base diffusion is used for the gate of the FET's. To keep the gate region narrow, a separate p diffusion is made underneath the gate region before the epitaxial layer is grown.

The interference rejection of the phase-locked circuit is almost identical to that of a discrete three-stage i-f strip. In fact, this circuit was placed in a high-quality f-m tuner (the Sherwood model S-3300) with no noticeable degradation in tuner performance. A single IC with two external capacitors (a 12-picofarad trimmer and a 1,000-pf $\pm 20\%$ paper capacitor) was thus used to replace two transistors, two IC's, three i-f transformers, one ratio-detector coil, 16 resistors, and eight capacitors.

The phase-lock principle isn't limited to consumer devices either. Signetics has built an f-m multiplex

receiver that operates over a frequency range from a fraction of a hertz to 300 kilohertz and is intended for multichannel f-m telemetry, data transmission, or telephony. Although it's more complex than the consumer-type amplifier-demodulator, it requires a smaller chip area.

It differs, too, in that the vco employs constant current charging and discharging of a capacitor to give an extremely linear (low distortion) voltage-to-frequency conversion. As shown on next page, external resistor R_1 determines the charging current and is used for fine tuning, while the value of C_1 —the timing capacitor—determines the coarse frequency range.

The bandwidth can be adjusted from 1% to 20% by R_2 , which controls the gain of the amplifier. The low-pass filter capacitor is external (C_2).

For a-m receivers, the phase-lock loop must be slightly more complex. To demodulate a-m, the signal is first fed through the phase-locked loop.

Rockier roads

Before the advent of phase locking, the most obvious way to integrate an i-f strip was to put all tuned elements outside the chip and integrate only the active elements and their biasing components. This method requires a separate IC for each stage, and therefore doesn't reduce the cost.

In principle, it's possible to combine all amplifiers in a single chip, but many pins are needed, and parasitic coupling between the input of the first stage and the output of the last stage is a serious problem.

To combine more circuitry on one chip, filtering and amplification can be separated. But this requires a filter that has the combined selectivity of all the LC filters that it replaces, and such a filter tends to be expensive. And then there's the problem of where to place the filter. If it's connected in front of the amplifier, the filter loss impairs the noise figure. On the other hand, if the signal is amplified first and then filtered, the filter must be able to handle extremely large voltages—if a weak signal is received at full gain, a strong neighboring signal could easily damage the filter input.

Drifting, drifting. Of course, frequency selection is not the exclusive domain of LC resonant circuits. Respectable performance can be obtained with only resistors and capacitors, which, unlike inductors, can be integrated. Many schemes have been proposed, among them the forward transmission active filter, a notch filter in the feedback path of the amplifier (illustrated), the gyrator, and the negative-impedance converter.

However, such circuits tend to drift too much with temperature. And to obtain the 0.5% tuning frequency precision needed in an i-f strip, adjustable thin-film components have to be used, and these are expensive.

Finally, there are a number of unique and occasionally ingenious approaches to eliminating inductors by mechanical or piezoelectric resonance effects. (The resonant-gate transistor is an example.)

To get precision, however, the resonating elements must be individually adjusted. With the microscopic dimensions of integrated circuits, this is expensive—or even impossible.

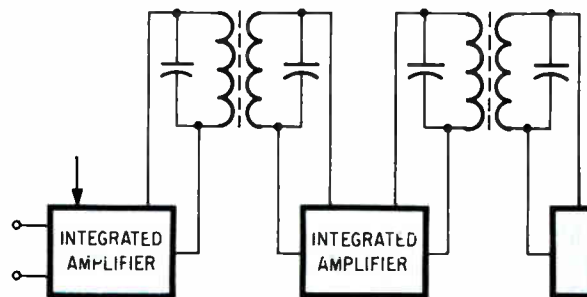

SEPARATE IC STAGES

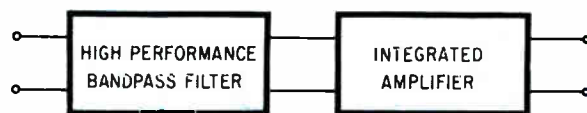

COMBINED IC STAGES

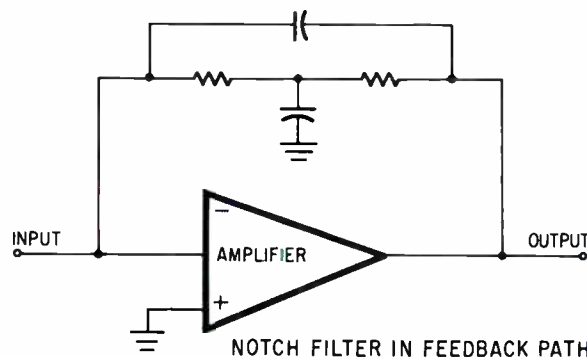

NOTCH FILTER IN FEEDBACK PATH

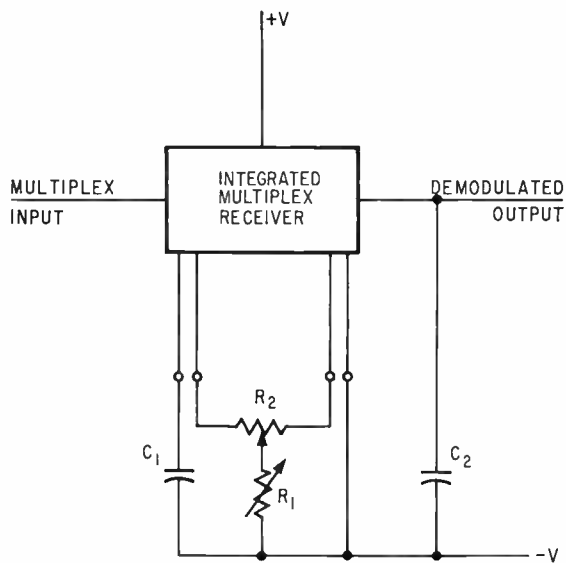

Externals. Multiplex f-m receiver uses a few outside resistors and capacitors to minimize distortion.

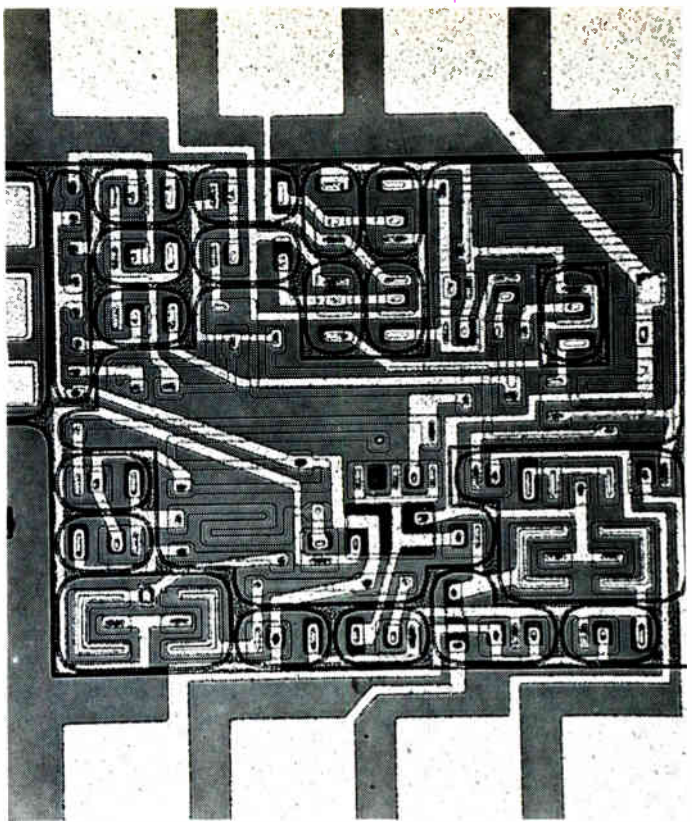

The vco frequency (which now represents the unmodulated carrier frequency) is then compared with the signal in a quadrature detector, whose output thus represents the difference in the amplitudes of the two signals—that is, the amplitude modulation.

So far, if the receiver operates at 1 Mhz or higher, it has been possible to integrate only the i-f section. Before the entire receiver—an f-m radio, for example—can be integrated in a single phase-locked loop, a few hurdles have to be surmounted.

First, the sensitivity of the loop has to be increased to the point where it's possible to lock onto a signal of only a few microvolts, and this requires a lot of d-c gain. Although it's not difficult (or expensive) to get high gain from an IC, minute mismatching at the input can saturate the amplifier completely. A chopper-stabilized amplifier is a possible solution here.

Second, because input signals vary in amplitude, a large dynamic range is necessary. The present range is limited to 60 decibels because a large signal upsets the balance of the phase detector, driving it into saturation. It will take careful design of the phase detector to extend to 80 or 100 db.

Finally, the frequency range has to be extended—for some applications, at least. With ordinary linear IC devices, the present upper limit is 50 megahertz. But with special designs (that is, with shallow base and emitter diffusions and very small areas), the cutoff frequency could be increased 20 times.

Surprisingly, the phase-locked loop has turned out to be a remarkably simple approach to the tuned circuit—and a foolproof one as well. For one thing, there's just about no stray coupling. This sort of coupling in an IC is largely capacitive and therefore especially noticeable at high frequencies, but the phased-locked circuit—aside from the phase detec-

tor and vco—operates at audio frequencies.

Also, the technique provides a large number of independently variable parameters, making it easy to suit the phase-locked loop to a particular application. For example, the vco frequency sets the center frequency of the filter but doesn't alter any other parameter. On the other hand, the bandwidth (the capture and lock range) can be adjusted by means of the d-c gain and the low-pass filter's cutoff frequency without altering the center frequency.

It's important to note that since the phase-lock approach is an unusual one, some of the usual evaluations can be misleading. It's impossible, for instance, to measure the selectivity of a phase-locked loop simply by applying a varying signal at the input and plotting the response at the output. The vco would jump toward the input signal as soon as the frequency difference became small enough, and would hang on to it until the range of the error voltage was exceeded.

The true test of performance comes with actual application. The user's operations provide the proving ground, so the communication channels between user and supplier must be kept wide open.

Bibliography

- W.E. Newell, "Tuned Integrated Circuits—a State-of-the-Art Survey," *Proc. IEEE*, December 1964, pp. 1603-1608.
- W.E. Newell, "The frustrating problem of inductors in integrated circuits," *Electronics*, March 13, 1964, pp. 50-52.
- F.M. Gardner, "Phase Lock Techniques," John Wiley & Sons, 1966, p. 52.
- H.C. Nathanson et al., "The Resonant Gate Transistor," *IEEE Trans. on Electron Devices*, March 1967, pp. 117-133.
- S.K. Mitra, "Synthesizing Active Filters," *Spectrum*, January 1969, pp. 47-63.
- A.B. Grebene and H.R. Camenzind, "Phase Locking as a New Approach for Tuned Integrated Circuits," *International Solid State Circuit Conference*, Philadelphia, February 1969.

Speed costs

particularly when you don't need it.

COST/PERFORMANCE — UTILOGIC II vs "THE OTHERS"

DECISION FACTOR	UTILOGIC II	930 DTL	MC800 RTL	7400 TTL	MC830 DTL	SUHL I TTL	SUHL II TTL
D.C. NOISE MARGIN (mv)							
"O" Level	800	450	300	400	450	650	550
"I" Level	1100	450	300	400	500	600	600
FAN OUT	16	8	5	10	8	6	6
SPEED (ns typical)	25	25	25	13	25	10	6
PRICE (100-up)							
Quad Gates	\$1.07	\$1.55	\$1.25	\$1.55	\$1.55	\$2.40	\$2.65
Dual Binaries	\$1.99	\$4.75	\$2.30	\$3.85	\$4.75	\$5.95	\$6.60

What the chart says is simply this: except where TTL speed is essential, Utilogic II is the best buy in both performance and cost. Utilogic II not only provides fan out up to 16 and noise immunity up to 1.1V (nearly twice what you get in other IC families) but is available in reliable silicone DIPs. In addition, it is the only logic family that allows you to implement functions any way you choose—with AND, OR, NAND or NOR elements. Last thing. Check the prices below.

Now, wasn't that fast?

UTILOGIC ELEMENTS (+10°C to +55°C) IN 14-LEAD DUAL IN-LINE PAK (100-UP)

SP300A	Dual 3-Input Gate Expander	\$0.99
SP301A	Diode Expander	0.99
SP305A	6-Input AND Gate	0.99
SP306A	Dual 3-Input AND Gate	0.99
SP314A	7-Input NOR Gate	0.99
SP317A	Dual 4-Input NOR Gate	1.07
SP321A	Dual J-K Binary	1.99
SP322B	Dual J-K Binary	2.35
SP333A	Dual 3-Input OR Gate	1.07
SP334A	Dual 4-Input OR Gate	1.11
SP337A	Dual 4-Input Expandable NAND Gate	1.11
SP356A	Dual 4-Input Line Driver	1.45
SP370A	Triple 3-Input NOR Gate	1.07
SP374A	Triple 3-Input OR Gate	1.11
SP375A	Triple 2-Input OR Gate	1.11
SP377A	Triple 3-Input NAND Gate	1.11
SP380A	Quad 2-Input NOR Gate	1.07
SP384A	Quad 2-Input OR Gate	1.11
SP387A	Quad 2-Input NAND Gate	1.11

For more information call your nearest Signetics sales office or distributor.

Signetics Integrated Circuits

A SUBSIDIARY OF CORNING GLASS WORKS

811 East Araucos Ave., Sunnyvale, California 94086



At IEEE, Hewlett-Packard unveiled the revolutionary 5360A

Here's why it stole the show—

BETTER MEASUREMENTS PLUS INTERNAL DATA PROCESSING

Using a revolutionary counting technique made practical by an internal computer, the 5360A measures more rapidly, accurately, and over a wider range than counters ever did before. And it can solve equations whose variables are the counter's measurements. Thus, it is a measuring and computing device both in one compact, ready-to-use package. Everything a general purpose electronic counter might be asked to do, the 5360A does better—a hundred, even a thousand times better.

GREATER SPEED AND ACCURACY THAN COUNTERS EVER HAD BEFORE

For equal accuracy, the 5360A is 3 to 1000 times faster than counters could be before, and for equal speed it's up to 100 times more accurate. For example, in 1 millisecond you can make a 1 MHz measurement to 7 digits! Previously, four digits was the limit. This is because the 5360A's accuracy is no longer limited to plus or minus one count of the counted signal.

AUTOMATICALLY MEASURES PULSED CARRIERS WITHOUT TRANSFER OSCILLATOR

Direct, automatic, digital measurement of pulsed signals (even a microsecond pulse length) is now possible with the 5360A—up to 320 MHz. And with the same HP frequency converter plug-ins used in model 5245, 5246 or 5248 counters, pulsed signal or CW range is extended to 18 GHz. No tedious transfer oscillator manipulation or calculation! And the 5360A will even measure a single burst of signal—something transfer oscillators cannot do.

COMPUTING COUNTER

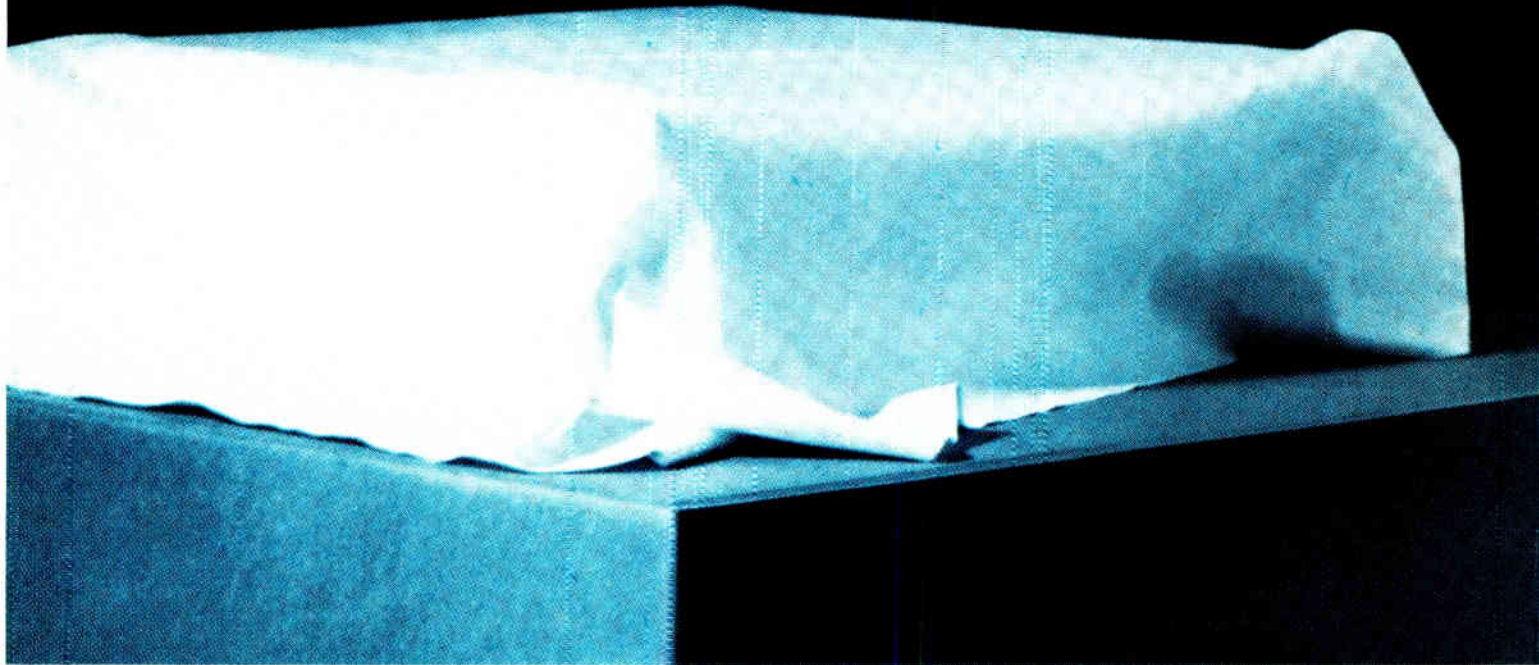

0.1 NANOSECOND TIME INTERVAL RESOLUTION

The 5360A gives the finest resolution in time-interval and waveform period measurements ever available in a direct reading digital instrument. Furthermore, with the model 5379A Time-Interval plug-in (not needed for period measurements) you get automatic error detection and measurement of positive or negative intervals down to zero seconds, at rates over 1000 measurements per second.

WIDEST FREQUENCY RANGE OF ANY COUNTER

Up till now, you had to use an accuracy-destroying prescaler or other accessory to measure up to 320 MHz. Not only is the 5360A's automatic measurement range 0.01 Hz to 320 MHz, but the 5360A also gives greater accuracy and speed than any previous counting technique. Frequency measurement range is extended to 18 GHz using the same spurious-free HP frequency-converter plug-ins originally designed for HP models 5245, 5246 and 5248.

A COMPLETE MEASURING AND PROCESSING SYSTEM IN ONE PACKAGE

Now you can get answers direct in final form without adding \$10,000 worth of processing equipment. The 5360A and its accessory plug-in program module (available now) or its keyboard (available later this year) provide real-time solutions to equations whose variables are the 5360A's measurements. For example, you can get direct digital phase measurements or the rms value of a series of measurements.

Prices: 5360A Computing Counter with 5365A Input Module, \$6500; 5379A Time-Interval plug-in, \$750; accessory keyboard, approximately \$1000; accessory plug-in program module, approximately \$190.

The leader in counter technology has taken another revolutionary step. If you missed the show, call your local HP field engineer. Or write for our fully illustrated brochure and data sheet: Hewlett-Packard, Palo Alto, California 94304; Europe: 1217 Meyrin-Geneva, Switzerland.

HEWLETT  **PACKARD**
ELECTRONIC COUNTERS

Circle 101 on reader service card

02905

AIRPAX

MULTIPOLE PROTECTOR with SINGLE TOGGLE ACTUATION

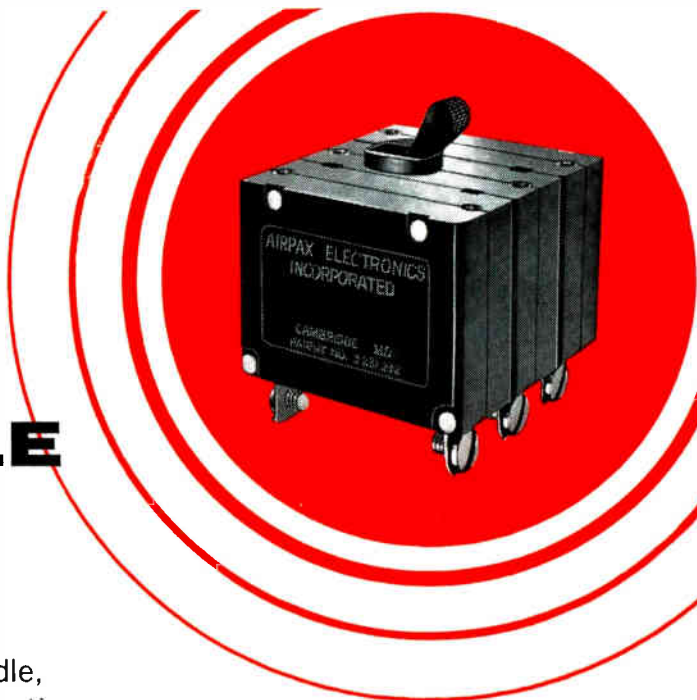

Airpax multipole APG magnetic circuit protectors operate with a single toggle handle, a feature which greatly simplifies panel mounting and provides a lower cost, compact unit with high operating dependability. Internal coupling assures instant action of all protectors should an overload occur in any protected circuit.

FEATURES

- Current ratings from 20 mA to 30A.
- Voltage ratings to 250 volts, 60 and 400 Hz and to 50 volts dc.
- Series, shunt and relay types, auxiliary switch available on series type.
- Choice of trip delays; trip free operation.
- Individual poles need not have identical characteristics.
- Quick connect or machine screw terminals.
- Available with 1, 2 or 3 poles.
- Electromagnetic operation with magnetic-hydraulic delay.

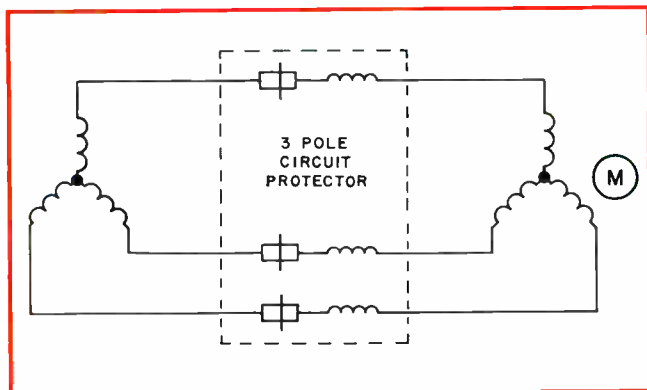

THREE PHASE MOTOR PROTECTION

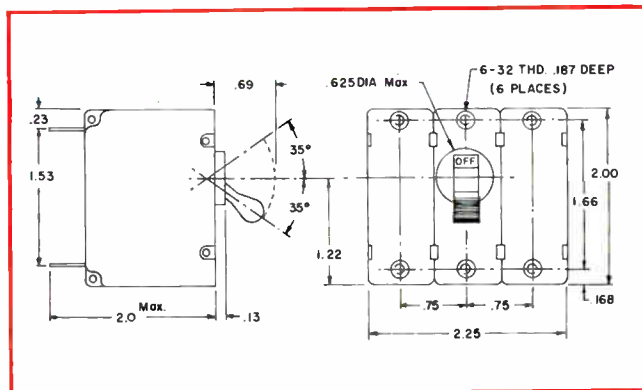

DIMENSIONAL DRAWING

AIRPAX ELECTRONICS

CAMBRIDGE DIVISION, CAMBRIDGE, MARYLAND 21613

PHONE (301) 228-4600

TELEX 8-7715

TWX 710 865-9655

Autonetics arrays its MOS forces

With a \$30 million order in its pocket and a new division to fill it, the company is serving notice on skeptics that it's in the commercial LSI business for keeps

By Lawrence Curran

Associate Editor

Ever since word leaked out that the Autonetics division of the North American Rockwell Corp. had been picked by Japan's Hayakawa Electric Co. to supply large-scale integrated MOS arrays for a 3-pound calculator [*Electronics*, Feb. 17, p. 215, March 17, p. 35], the U.S. electronics industry has been buzzing with wonder—and skepticism.

Typical is the reaction of a source at another company working hard on MOS products: "We feel Autonetics has a long row to hoe. Without faulting their technical ability, the Hayakawa contract calls for high-volume production with low unit prices. Not many in the industry have done this in MOS, and Autonetics doesn't have a history of being a high-volume, low-cost producer. Hayakawa will be pushing to get prices down, and we're not convinced Autonetics can do it."

There's no denying this move is a formidable challenge for Autonetics, which would probably like to forget an earlier foray into the commercial electronics sector in 1959 with the Recomp 2 computer. The machine was a conspicuous failure and the company eventually withdrew from the field. But Autonetics officials have been carefully weighing the risks of this move against the possible rewards for more than a year and have apparently decided that the game's well worth the risk.

The company won't be selling many standard items, but this situation is typical of the MOS world, which has vaulted quickly into LSI in a few short years.

Autonetics president S. Fred Eyestone isn't expecting any cake-

walk with Hayakawa. "They're fine people to deal with," he says. "But they'll be very tough on cost, as they should be. We'll do our best to be responsive." The two-year calculator contract is regarded as just a beginning by Autonetics management, even though its \$30 million value averages out to annual sales almost equal to the total worth of all 1968 domestic MOS shipments. Not only is the division counting on follow-on orders from Hayakawa for circuits for other calculators in its line, but it is tooling up to meet the requirements of at least four more potential contracts. Alvin Phillips, assistant to Eyestone, describes these contracts as "significant ventures in commercial microelectronics that should materialize in the next two months."

Phillips has been named director of operations for the Microelectronics Products division, a unit set up March 30 to centralize Autonetics' production, marketing, and engineering activities in the commercial sector of this field. He reports to Robert S. Carlson, vice president and general manager of the new division.

Way to go

Carlson believes a big part of his job is to make sure the division gets the support needed to change from an engineering-oriented operation accustomed to small production quantities to one geared for volume runs of commercial devices. "My feeling is that we're a good way toward having accomplished that," he says. "We're farther along than outsiders can appreciate, a fact that will be evident in a short time."

Besides establishing the new division, Autonetics has made a number of other moves that may help turn the industry's skeptics into believers as far as its commercial venture is concerned. The company recently has:

- Rounded out the management, marketing, and engineering teams that will head the Microelectronics Products division [*Electronics*, April 14, p. 34].
- Placed on stream the 40,000-

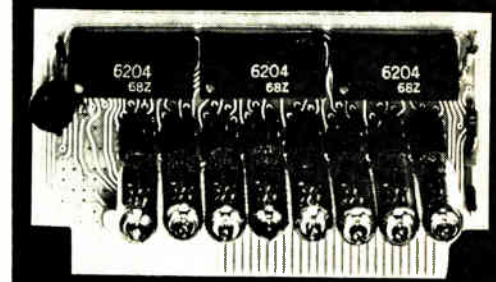
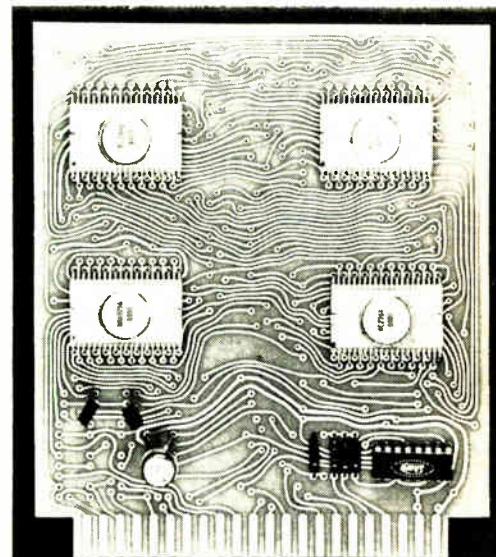

Board room. Autonetics is supplying five advanced MOS arrays to Hayakawa for new 8-digit, desk-top calculator.



Lead man. S. Fred Eyestone, president of Autonetics, regards huge Hayakawa MOS LSI contract as just a beginning.

square-foot production plant completed last fall at its Anaheim, Calif., facility and initiated plans to boost capacity from 250,000 arrays a month to about 387,000.

- Set aside 10,000 square feet for device assembly at a facility the company has had in Princeton, W. Va., since the early 1960's.

- Begun looking for an assembly site outside the U.S., with Mexico, Taiwan, and Hong Kong heading the list of possibilities.

- Studied opportunities in digital data handling equipment, including terminal and input devices, as well as modems, that could lead to business for the new division in what Eyestone calls "derived products with a lot of microelectronics content."

- Started talking with the Rockwell side of the corporation to determine exactly where microelectronics can be applied in the automotive industry.

Mutual attraction. Eyestone stresses that this sort of technology exchange was a key consideration in getting North American Aviation and Rockwell-Standard together in the first place. And, he notes, the marriage has lent strength to Autonetics' move into commercial microelectronics. "Management determination is a pretty important ingredient in the effort," says Eyestone. "We're putting our full resources behind it. This determination, plus what we've proved we can do in modest production quantities, makes us unconcerned about the skeptics.

"We didn't go to Hayakawa with a briefing team," he continues. "They sold themselves on us. The

contract represents a good opportunity—and also a chance to get burned. But we're not just in with one toe; we're here to stay."

Sweet smell of success

The rewards, if all goes well for Autonetics in this venture, should be substantial. A source close to the situation estimates that the initial order could lead to additional business worth about \$80 million over the next few years from Hayakawa alone. Autonetics officials decline to assign a dollar value to such prospects, but Eyestone observes: "It's reasonable to say that we've talked with Hayakawa about applying MOS to products beyond the QT-8D calculator. We intend to go after such business, and we ex-

pect follow-on work.

Autonetics is already delivering MOS LSI arrays to the Instrument Systems Corp., Huntington, N.Y., for the multiplexed passenger service and communications system the company is building for the Boeing 747 jumbo jetliner. These circuits, being produced under a contract worth about \$1 million, are coming from the new Anaheim facility and a pilot line in the new division's centralized microelectronics laboratory. A follow-on order is being negotiated.

Eyestone says Autonetics will be looking for additional multiplexing orders. The on-again, off-again supersonic transport being developed at Boeing could produce such business. The company is now compet-

Bill of particulars

Discussions leading to Autonetics' contract to deliver more than 2 million MOS LSI arrays, of five different types, for Hayakawa's QT-8D calculator began some 10 months ago. Worth \$30 million, the award specifies that shipments begin in May and reach a peak of 160,000 units a month; it covers Autonetics work until January 1971. Thereafter, Hayakawa will produce the circuits itself in Japan under the terms of a technical-assistance agreement.

One circuit interfaces between the calculator's functional MOS electronics and its input-output electronics. A second generates the logic functions for the calculator's automatic floating-point feature, while another performs the basic binary-coded-decimal functions, generating most of the control signals for the three other logic circuits. A fourth generates the macromode control signals associated with the calculator's functional keys. All are housed in Autonetics' new 42-lead package [*Electronics*, March 3, p. 48]. The fifth circuit, packaged in a metal can, generates the multi-phase clock signals required by the four logic circuits.

Price tags. Nobody at Autonetics will say just how much the arrays will cost. But one industry source says that just producing the circuits is a big enough challenge without having to make them for about \$15 apiece—his guess at the level needed for Hayakawa to turn a profit. This source says Autonetics got the contract because the bigger U.S. companies were unwilling to tie themselves up with the kind of contract Hayakawa demanded. He says the Japanese firm was willing to make its supplier the sole source, but the vendor had to agree not to make circuits for other calculator manufacturers. Says he: "Autonetics is trying hard to get into the commercial business. They've heard volume is the way, so they went and bought a contract. Their problem is to make the circuits and not lose a bundle of money."

An Autonetics official denies there is any restriction in either the basic contract or the technical-assistance agreement that would prevent the company from making circuits for other calculator companies. He adds, however, that it would be foolish to make arrays for a competitor, particularly in Japan, because of Hayakawa's sales leadership.

According to Alvin Phillips, director of operations at Autonetics' Microelectronics Products division, yields aren't a problem. He categorizes the buildup to meet the demands of the contract as a "massive logistics problem." But on the basis of yield forecasts, expansion plans, cost of the package, and the company's ability to automate production, Phillips says: "I have great confidence we will make a profit over the two years. It normally takes two years' worth of marketing expense to win this kind of contract. We don't have that overhead to offset in our prices because we did it through management marketing."

ing with the Hamilton-Standard division of the United Aircraft Corp. for a contract to supply a system for the SST [*Electronics*, June 10, 1968, pp. 25, 45].

Where it's at. But there's greater potential in the data processing field. Phillips says that the four contracts Autonetics is pursuing at the moment fall into this category. Efforts in these areas, he says, would encompass "high-density shift registers—variations of the 1,024-bit shift register we make, plus complex logic along the lines of the Hayakawa work." Phillips doesn't think Autonetics has significant competition at these levels of logic complexity "because other companies aren't anxious to take on arrays with 200 to 250 gates. Our willingness to go to a large chip—160 mils square—is persuasive; our rivals get nervous over 80 mils because they don't think they can get good probe yields."

Based on information supplied by customers and prospects, Phillips concludes that Autonetics is getting probe yields on a par with those achieved by semiconductor houses making devices with a quarter the area. The new director of operations, who came to Anaheim a year ago after serving as general manager of the integrated circuits department at Sylvania's Semiconductor Products division, estimates that his company has a one-year lead on the industry in MOS LSI. Autonetics, he adds, "has been engineering the process for five years and is finally doing something about it." He expects competition from such firms as the General Instrument Corp. and American Micro-systems Inc.—two of the technology's pioneers. And he expects Texas Instruments to be "among the most formidable in MOS production capability in about a year."

Eyestone concurs. He says that though he believes Autonetics is in "a unique position now, we aren't taking the attitude that we have a comfortable lead over anyone. We won't stop looking over our shoulders."

Phillips won't comment on the possibility that the Viatron Computer Systems Corp. of Burlington, Mass., is one of the four customers Autonetics hopes to sign in the next two months. But he did remark

HADRON

No longer do you need different lasers for different applications. Take our LPM Series — it's equally at home in the factory and in the laboratory. Using building block techniques, the entire LPM Series can easily be adapted to your requirements by the addition of standard fixtures.

Precision-engineered to meet production tool standards, the reliable and easy-to-operate LPM with its rugged ruby laser head is ideal for such industrial processes as microwelding, trimming, drilling, and dynamic balancing. The interlocking of work fixtures minimizes radiation hazards in industrial applications. Since little maintenance and no mechanical or electrical adjustments are required after initial installation, the "on-the-line" performance of this laser is excellent, making it a true production tool.

THE NEW CONCEPT

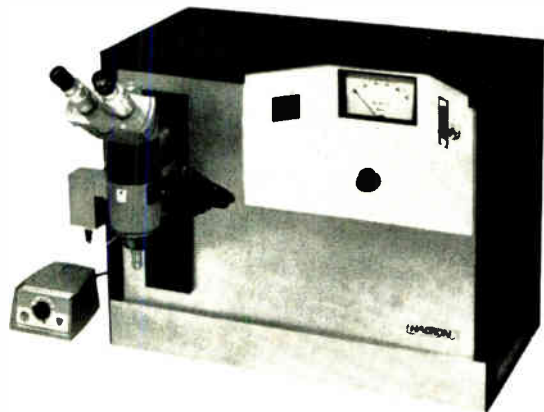

LPM Laser with
Universal Welding
and Drilling Fixture

IN LASERS

In the laboratory, the LPM series will satisfy the most exacting standards of the scientific researcher. It is a proven instrument for such varied tasks as fluorescence analyses, materials evaluations, radiation studies, and general laboratory applications. Economical to operate (uses 120-volt line voltage and requires only ½ gallon of water per minute for cooling), easy to connect, and light in weight (125 pounds), the entire laser system can readily be moved from one experiment to the other.

**Available with Integral Pockels Cell Q-Switch •
Output Energy (Normal Mode) up to 5 joules •
Repetition Rate up to 1 Pulse per Second • Pulse Width
800 Microseconds • Size 24" W x 18" H x 12" D •**

For complete specifications, price, and delivery information call or write:

HADRON

300 Shames Drive
Westbury, N. Y. 11590
516-334-4402



ELDORADO

THE LEADER IN NANOSECOND
AND FREQUENCY COUNTERS



200 Series
Crystal Time Base
Display Storage
Panel Mount
100 kHz: 4 digit \$325
15 MHz: 5 digit \$395
1 μ s Time Interval: \$395

1600 Series
Counter/Timers
with Display Storage
25 MHz: 5 digit \$ 550
25 MHz: 7 digit \$ 650
200 MHz: 6 digit \$1,050
200 MHz: 8 digit \$1,250
500 MHz: 8 digit \$1,650

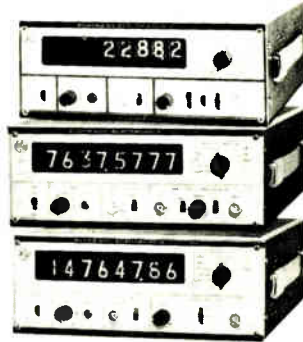

1400 Series
Universal Counter/Timers
15 MHz \$ 950
Preset \$1,050
150 MHz \$1,450
500 MHz \$1,825

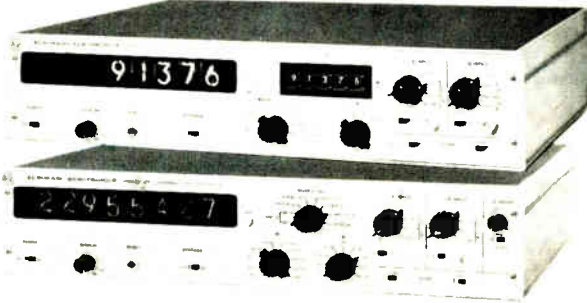

900 Series
Microwave Frequency Counters
Fast Sample, Optional Offsets
Remote Programming
6.5 GHz: 7 digit \$4,250

600 Series
Digital Delay Generator
Remote Programming
500 kHz Rep Rate
10ns Steps \$3,500
1ns Steps \$4,500

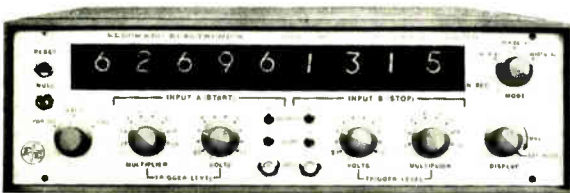

700 Series
Time Interval Counter
Full Input Conditioning
TIM, Period, Width,
Rise Time
1ns \$6,500
10ns \$1,750

Send for
Free Catalog



ELDORADO

601 Chalomar Road
Concord, California U.S.A.
(415) 686-4200



Top job. Robert S. Carlson is vice president and general manager of the new Microelectronic Products division.

wryly at a recent seminar in New York that he felt every MOS company was a potential supplier. Viatron is marketing a computer that, with peripherals, will rent for \$40 a month [*Electronics*, Oct. 16, 1968, p. 193] for which large, low-cost MOS arrays will be essential.

Fast start. Phillips is convinced that 1969 is MOS's year. But he notes that "it's difficult to measure the magnitude of the market because it's a moving target." He estimates, however, that the Microelectronics Products division will be billing between \$50 million and \$100 million annually in MOS LSI within five years.

Eyestone notes that one of the big reasons for moving into commercial microelectronics is that profit pickings are better in this sector right now than in the military and aerospace fields. Edward Ethell, Autonetics vice president in charge of advanced programs and marketing, says: "We anticipate a reasonably good profit performance from commercial-industrial business. The pretax rate in this kind of venture is 12% to 15%, while the return on investment is 10% to 20% after taxes. We don't expect to do worse than that."

Packing order. The most visible evidence of Autonetics' microelectronics activities is the facility completed last fall in Anaheim. Besides turning out circuits under the Instrument Systems contract, the plant should be humming with wafer-processing activity by midsummer as production of Hayakawa circuits builds toward a peak of 160,000 per month. Some \$2 million

was spent on bricks and mortar; another \$1 million went for equipment including 12 diffusion furnaces. And there's room to expand eventually to 24. Phillips says the Hayakawa contract will necessitate another \$2.3 million in outlays, mainly for equipment, \$800,000 worth of which is earmarked for the Princeton, W. Va., installation. The Anaheim plant was designed to accommodate the needs of the Microelectronics Products division for five years. About 80% of the work done there will be wafer processing. Most assembly operations will be handled in Princeton and whatever location outside the U.S. is eventually chosen.

Anaheim will send probed wafers and inspected packages to Princeton, getting back packaged circuits that are leak-tested and ready for final testing.

Navigation aides

The choice of Sam Carlson as general manager of the Microelectronics Products division perpetuates a notable inclination to head-hunt, successfully, at Autonetics' Navigation Systems division for top management talent. Eyestone himself came from this unit, as did Norman Parker, his predecessor as Autonetics' president. Carlson was vice president and general manager there before being tapped for his present post. But Eyestone asserts that Carlson's capabilities, not his prior affiliation, were paramount in his selection. He adds, though, that Carlson's work in navigation systems involved a wide range of technologies, including inertial measurement and computers.

For his own part, Carlson believes his strength lies in the ability to make an organization work—identifying the important objectives and steering toward them.

Earl Schaefer, chief engineer in Autonetics' engineering section, held the title of general manager of microelectronics [*Electronics*, July 10, 1967, p. 43] before the reorganization. In this capacity, he headed the firm's lab, which becomes the new division's engineering arm complete with sophisticated pilot production line. This operation implements the silicon-on-sapphire technology pioneered by Autonetics. The lab's line has 20 or so diffusion furnaces, not all of which

More Power than you ever pressed into a heat sink before!

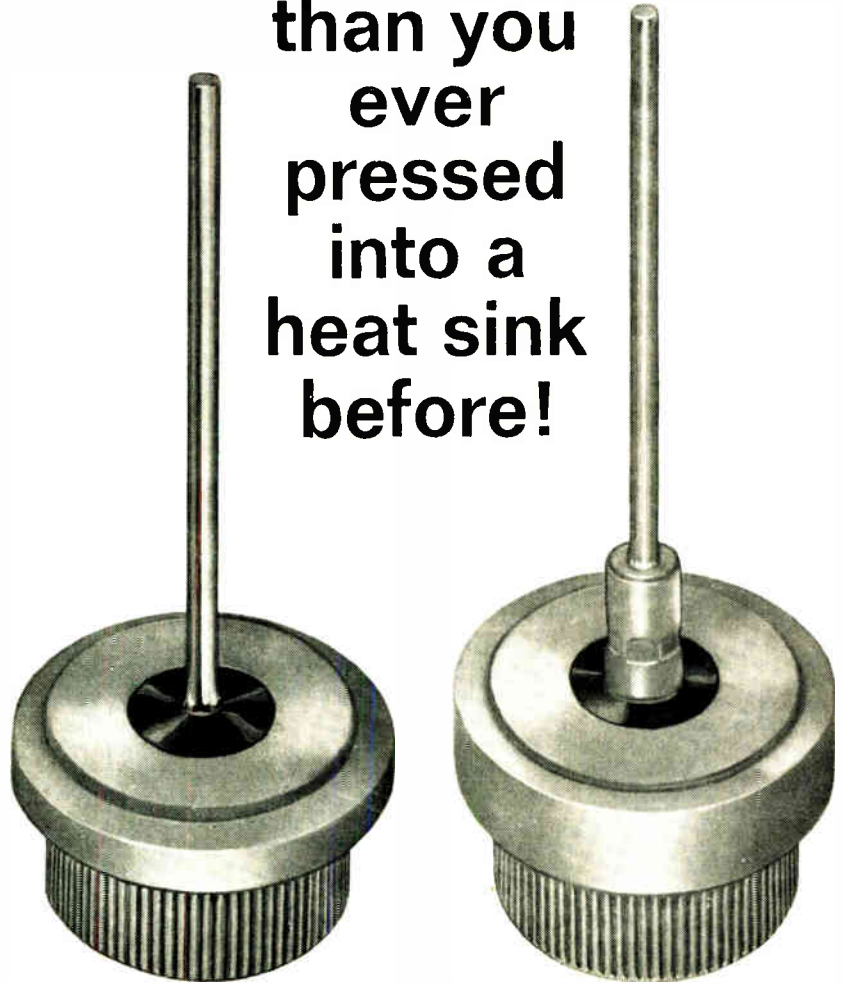

35 and 44 amps! Two new Tung-Sol diffused junction silicon power rectifiers in the JEDEC DO-21 package.

Both feature high surge capability and they cost less than equivalent-rated, stud-mounted units. Plus the economy of pressfit installation.

Use this coupon to get complete information in only a couple of days.

Quick-Action Coupon

Tung-Sol Division/Wagner Electric Corporation
630 W. Mt. Pleasant Avenue
Livingston, N.J. 07039

Please send data on new high power pressfit rectifiers:

() 35 amp () 44 amp () both

Name _____

Company _____

Address _____

City _____ State _____ Zip _____

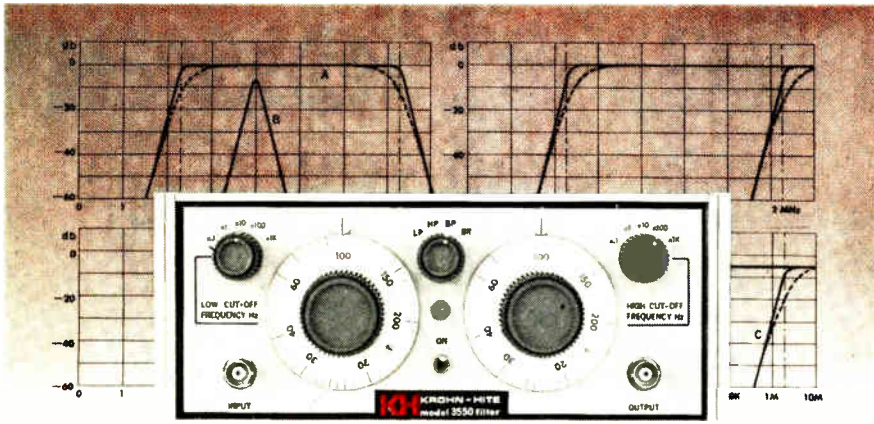

New, low priced all solid-state variable filters

cover 2 Hz to 200 KHz

MODEL 3550 — a new, all solid-state multifunction variable filter covering the 2 Hz to 200 KHz frequency range. Functions include band-pass, high-pass, band-reject and low-pass with 24-db-per octave attenuation slopes extending greater than 60 db. Frequency response can be switched from Butterworth to Low Q (transient free). Low hum and noise (200 μ v rms). Dynamic range of greater than 80 db. Insertion loss 0 db. Bench model: 8 $\frac{3}{8}$ " wide x 3 $\frac{1}{2}$ " high x 13 $\frac{1}{2}$ " deep. Rack model: 19" wide x 3 $\frac{1}{2}$ " high x 13 $\frac{1}{2}$ " deep. Price: \$525

MODEL 3500 — a new all solid-state variable band-pass filter covering the 20 Hz to 200 KHz range. Switches from Butterworth to Low Q. Attenuation slopes: 24-db-per octave extending to greater than 60 db. Hum and noise: 200 μ v rms. Dynamic range greater than 80 db. Insertion loss 0 db. Size: same as above. Price: \$395

See for yourself why these new Krohn-Hite solid-state variable filters make "do-it-yourself" filter design a relic of the past. Write for complete specifications.

OVERSEAS SALES OFFICES: BELGIUM, C. N. Rood s. a. DENMARK, SC Metric A/S; FRANCE, Antares; GERMANY, Nucletron Vertriebs-GMBH; HOLLAND, C. N. Rood n. v.; ITALY, Dott. Ing. Mario Vianello; SWEDEN, Teleinstrument; ISRAEL, R.D.T. Elect. Eng. Ltd.; JAPAN, Shoshin Shoji Kaisha, Ltd.; AUSTRALIA, Sample Electronics (Vic.) Pty., Ltd.; G. B., B & K Inst. Ltd.



580 Massachusetts Ave., Cambridge, Mass. 02139, U.S.A.
Phone: (617) 491-3211 TWX: 710-320-6583



Two hats. Alvin Phillips, assistant to Eyestone, is director of operations for the new division, set up March 30.

are dedicated to the same MOS process used in the new division's recently opened facility. Many devices for internal consumption will come from the pilot line, but some will be produced at Anaheim.

Three of a kind. Schaefer, Phillips, and Charles Kovac, director of market development and program management, are on a par in the new organization; they all report to Carlson. Kovac, who was marketing manager for the Navigation Systems division, expects the initial marketing efforts for MOS LSI devices to feature "exchanges with counterpart engineering organizations." But he emphasizes: "We're ready to set up a field organization that will work effectively in the commercial sector. Its number one job won't be to distribute standard items, but to identify opportunities in the Microelectronics Products division's strong suit—custom devices with a high technology content."

Kovac's program development manager for device sales, Robert Schultz, came to Autonetics from General Instrument, where he was vice president and general manager of the MOS Microelectronics division, as well as head of the Hicksville, N.Y., Semiconductor division.

Eyestone says that once the organization shakedown is complete, he expects Phillips, Schaefer, and Kovac to play leading roles in the second act—expanding to meet the needs of new business. Enough new possibilities have arisen from announcement of the Hayakawa contract, Phillips says, to justify such a program. Moreover, it will

have to be under way in less than three months to accommodate the stated 55% increase in capacity.

Eyestone would like to have a plant outside the U.S. within a year. "We're not trying to get where we're going immediately," he stresses. "But the pattern is set in the industry. We didn't come in to do just one contract. If we're going to stay and compete we have to have low-cost assembly."

As to what sort of derived micro-electronics products could be developed and marketed by the new division, Eyestone offers clues by pointing to some recently unveiled hardware. The D-200 computer, for example, introduced late last year [*Electronics*, Dec. 9, 1968, p. 33], has enough design flexibility, says Eyestone, to perform on-line storage or to predigest information for larger data processing systems. He says he expects elements of the D-200 series "to be applied by original-equipment manufacturers, unlike the commercial machines sold directly by Autonetics."

The central processor, control unit, and memory of the D-200, a general-purpose machine, are mechanized completely with MOS circuitry. The computer weighs just 9 pounds and uses only 10 watts.

Another possible line for the new division is test equipment requiring what Eyestone calls "quite a bit of innovation." The apparatus shown by Navan Inc., the special products subsidiary of North American Rockwell, at last month's IEEE show in New York sheds some light on what Eyestone is talking about.

Among Navan's offerings were a prototype hermeticity tester for semiconductor packages [*Electronics*, March 17, p. 56], which, though developed at the corporate science center, was built to Autonetics specs. Other prototype gear shown at IEEE and developed by Autonetics alone or jointly with the science center: a gas sampler that permits accurate chromatographic testing of the ambient contents of flatpacks; a reflecting projector to check circuits during the early stages of production for gross workmanship flaws; an oxide pin-hole detector that identifies defects less than 0.1 micron in diameter in dielectric layers; and two machines to test bond integrity and the tensile strength of fine wire.

Leasametric has it ...everywhere!



Rent or lease electronic instruments
from 36 offices coast-to-coast. Immediate delivery.

Call us first!

For more facts, send for the 1969 Leasametric catalog.

Leasametric
1011 Cadillac Way
Burlingame, California 94010
telephone (415) 347-3067

NAME _____

TITLE _____

COMPANY _____

ADDRESS _____



new mil-performance square cermet trimmers ... from CTS

Now... with CTS Cermet Multi-Turn Square Trimmers you get Characteristic C Mil-spec performance for all military applications. All new series 165 (style RJ24) and series 175 (style RJ22) meet tough Characteristic C of Mil-R-22097C. These same environmental characteristics are available... at lower cost... for commercial and industrial applications.

Both small $\frac{3}{8}$ "-square series 165 and compact $\frac{1}{2}$ "-square series 175 trimmers assure infinite resolution over a 20 ohm to 2.5 megohm range... and power rating of $\frac{1}{2}$ watt @ 85°C. TC ± 150 ppm/°C for 2k ohms and above. $-0 +175$ ppm/°C from 50 ohms through 250 ohms and $-0 +250$ ppm/°C from 500 ohms through 1k ohm. All available at no extra cost.

Low cost*, proven quality, and top performance—combined with **fast distributor delivery**—make CTS your best industrial trimmer choice. Can't use one of our standard series? Ask how we can solve specific application problems. Call or write for complete details to CTS of Berne, Inc., Berne, Indiana 46711. Phone (219) 589-3111.

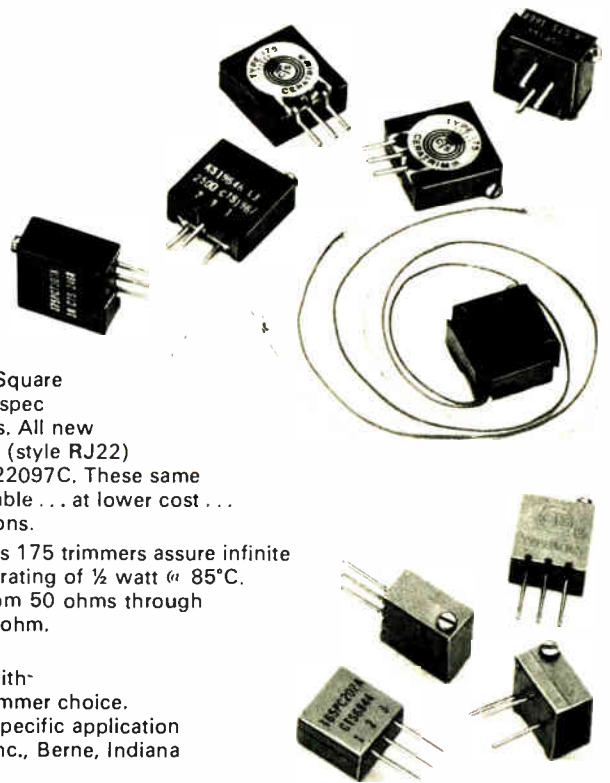







*Check these prices for 4-6 week production delivery. (Small quantities from stock)

Quantity	Series 165		Series 175	
	25-49 (each)	1000 (each)	25-49 (each)	1000 (each)
Commercial ($\pm 20\%$ Tol.)	\$4.55	-\$3.25	\$4.20	\$2.95
MIL-type ($+10\%$ Tol., Char. C)	5.30	3.80	5.10	3.65

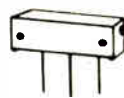
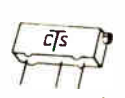

CTS CORPORATION
Elkhart, Indiana

Other CTS Cermet Trimmers include:

 Series 185 $1\text{-}\frac{1}{4}$ " x $.290$ " x $.364$ " multi-turn	 Series 190 $\frac{3}{4}$ " x $.160$ " x $.310$ " multi-turn	 Series 340 $\frac{1}{4}$ " x $\frac{1}{4}$ " square x $.270$ " high—single-turn	 Series 360 $\frac{7}{16}$ " x $\frac{1}{4}$ " x $\frac{29}{64}$ " single-turn	 Series 385 $1\frac{1}{32}$ " round x $.225$ " high—single-turn	 Series 660 $\frac{3}{8}$ " round x $\frac{1}{4}$ " high—single-turn	 Series 630 $\frac{1}{2}$ " round x $1\frac{1}{32}$ " high—single-turn
---	--	--	--	--	--	--

Intelsat catches its breath

Satellite consortium's month-long meeting in Washington resolved little, but paved way for substantive progress at next get-together in November

By Paul A. Dickson

Associate editor

Paradoxically, the most important—and cheering—aspect of the month-long Intelsat meeting, which wound up in Washington a few weeks ago, was negative in character: no unbridgeable schisms developed among the attending nations. Not that the get-together, officially billed as the Plenipotentiary Conference to establish Arrangements for the International Telecommunications Satellite Consortium, was a placid affair. Far from it. As expected, there were lively debates—largely behind closed doors—about procurement policies, the role of the Communications Satellite Corp. as the consortium's acting manager, the future of domestic and regional commercial satellite systems, the final organization of Intelsat, and related matters—all of vital concern to U.S. electronics and aerospace firms [*Electronics*, Feb. 17, p. 133].

Adding interest to the proceedings, attended by 68 member nations and 28 observers, was the presence of Soviet Russia and six Eastern-bloc countries. The cool hand played by the Communist representatives was in sharp contrast to the performance of the U.S. delegation, which can most charitably be described as inept.

Lull. For all the lack of definitive agreements, the genteel wheeling and dealing set the stage for more substantive progress in November, when the next full-scale meeting is scheduled. Between now and then, an interim committee will have a go at outlining proposals on which there is a consensus and delineating thornier issues in terms of major alternatives. In the mean-

time, the delegates have scattered to their seats of power for guidance on how they are to vote on agenda items come autumn.

Meanwhile, there's a good deal of speculation about how the USSR will play its cards. A State Department official who observed the meeting says: "Our best guess is that the Communist nations will join right after the definitive arrangements are made. But there's also a school of thought that they might even get in between now and the autumn meeting to get voting powers in making those arrangements." Other sources are less sure the Soviets will seek full-fledged membership; they believe they might opt for associate membership; they would be able to use Intelsat services but not to cast votes.

This variety of possibilities raises questions as to the position of the U.S. and the Soviet Union in the final scheme of things. The two superpowers and their allies were a study in contrasts during the meeting. The Russians, listening rather than talking, made few points. But when issues were raised, they presented a united front with their Eastern cohorts. On one matter in particular, the Communist nations came across loud and clear—the question of ending U.S. domination of the organization through Comsat. It appears certain that part of the price of Soviet membership will be an end to the company's role as sole manager. Jerzy Rutkowski, head of Poland's Radio Communications Department, says it's "ri-



On display. This open session at the Intelsat meeting was an exception: most of the action at the Washington conclave occurred behind closed doors.

Internecine warfare

William W. Scranton has his hands full. The former Pennsylvania governor is the head of the U.S. delegation for Intelsat negotiations, and the group is engaged in a bitter internal tug-of-war. The schism results from Comsat's insistence that it be retained as the sole manager of the Intelsat system and State Department's willingness to bargain away some of the company's authority to secure an international agreement.

Leonard Marks, once head of the U.S. Information Agency, was chairman of the delegation when the war of nerves broke out. Though a founding director of Comsat and a top-rated candidate for its chairmanship, he apparently sided with the State Department—a move that may change the early line on his future.

Comsat believes it's essential for it to continue as Intelsat's manager. Not for the money. The company's income from handling the unwieldy international consortium was only \$150,000 last year—only a modest portion of its \$30.5 million operating revenues. But the managership lends prestige to the company and allows it to keep a sharp lookout over its corporate interests.

Apparently, Comsat is not too anxious to get an agreement. Most legal authorities think the status quo would prevail in the absence of a settlement, and Intelsat would continue operating. But the State Department feels that an agreement is in the national interest. Moreover, it frets that the chances of reaching an agreement are reduced with each passing day. Both sides have polarized views, and it's going to take a lot of forcefulness on the part of Scranton to achieve any sort of rapprochement. He may even wind up having to call on his boss, President Nixon, to get the feuding factions to compromise.

William D. Hickman

diculous" to think that the Soviet-bloc nations would join Intelsat as long as Comsat continues in that role.

On the other hand, the U.S. found it hard to agree even within its own delegation. Though all sessions but the initial one were held behind closed doors, there was little doubt the U.S. was having troubles. Among the allegations that have come out of the meeting are that the U.S. delegation:

- Did not find as much support as it had expected among other members because it lacked a unified position and carefully considered reasons for the stands it took.

- Was racked by bitter infighting among elements aligned with either Comsat or the State Department.

- Was, by the last week of the month-long meeting, having such troubles that Abbott Washburn, who had started as an Administration observer, had virtually taken over as head of the delegation.

In addition, there were persistent rumors that the U.S. successfully spearheaded a drive to forestall final resolutions. The story ran that the U.S. wanted more time to work things out.

However, Ambassador Leonard Marks, who headed the U.S. delegation, noted, at the closing of the

meeting that it took 10 countries eight months to setup the interim arrangement for Intelsat. The fact that the 98 attendees were able to get as much done as they did represents an accomplishment of sorts in official circles.

Fine points

The position papers prepared and delivered by the Interim Communications Satellite Committee (ICSC) were acted upon for the most part, being boiled down to more manageable consensus reports. But nothing was resolved to the point where apparent agreements could not become minority positions when the delegates reconvened—though no major shifts are expected.

At the conference's closing most delegates favored a four-tier structure in which there would be: an international conference to make major intergovernmental decisions; a general assembly to conduct the business dealings of the organization; a board of governors to handle Intelsat's day-to-day activities; and a manager or managers.

However, a strong minority position was outlined by proponents of a three-tier setup that would eliminate the international conference, placing such respon-

sibilities under the aegis of the general assembly. The U.S. originally proposed a three-tier structure to the ICSC, an arrangement under which the assembly would meet annually or biannually. The board would operate like the ICSC and require a majority to pass procedural proposals and two-thirds margin to pass substantive proposals. The manager would function under the board.

Modification. In both structures proposed, management would be put in the hands of an international group. Says a State Department official assigned to Intelsat duties: "The U.S. held to the position that Comsat should keep its job based on its success with Intelsat thus far. But though nobody questions Comsat's ability, most nations feel that while Intelsat is going through transition to a permanent group it would be better to make management international."

At the closed-door meetings, however, Marks hammered away at the point that Comsat—in its present role—would clearly be under the board of governors "... not only pursuant to general policies but also in accordance with specific determinations of the board." He also emphasized that the U.S. position clearly leaves the door open for the replacement of Comsat at a later date.

The best bet, at least at this point, is that Comsat faces an uphill battle to retain its managership. The U.S. draft position was given "substantial support"—less than a majority—by the ICSC and received only limited support in the actual meeting.

Buyers and sellers

Procurement of hardware and services remains a major issue. The consensus finally reached was to the effect that contracts should be awarded through "open international tender to bidders who offer the best combination of quality, price, and most favorable delivery time." Nonetheless, this ticklish subject represents a potential logjam for the next meeting because of the strong feelings the issue has generated.

Sentiment among the European delegations and those from other technically advanced nations such as Japan favored greater interna-

Pick the
BEST IC
for the job

Problem: An accurate current-to-voltage conversion is required between a current source and a $2.0\text{K}\Omega$ load. Desired full-scale output is ± 12 volts (with a power supply of $\pm 15\text{V}$). The circuit must operate with a full-scale accuracy of 0.1% over the temperature range from -55°C to $+125^\circ\text{C}$. The output must be capable of slewing at $2\text{V}/\mu\text{s}$. Pick the best IC for the job.

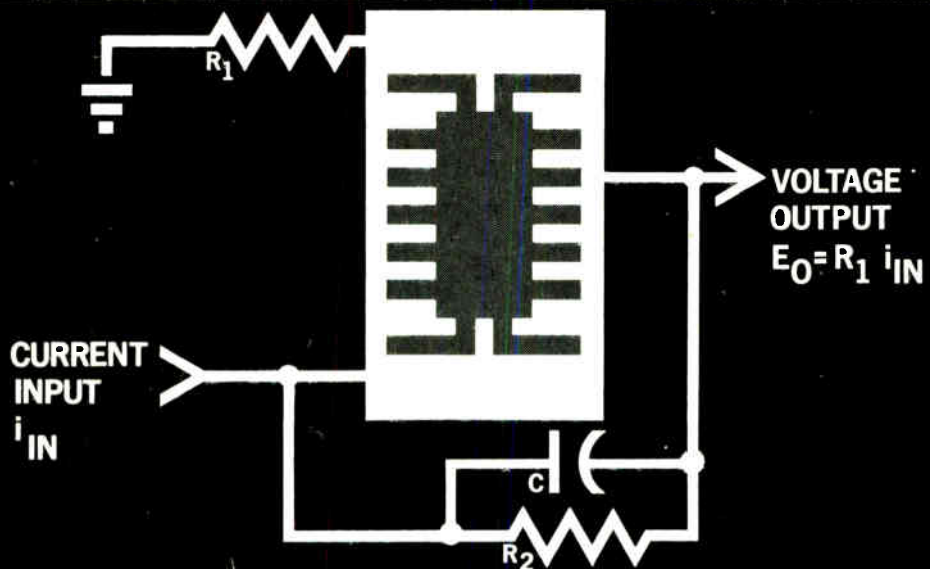

the **BEST** Solution:

THE RA-909 OPERATIONAL AMPLIFIER



Pick the RA-909 Compensationless Operational Amplifier. Low offset current and offset voltage over the full temperature range allow design of the current-to-voltage converter within 0.1% full-scale accuracy. The RA-909, with dielectric isolation, eliminates the need for external compensation and ensures a slew rate of better than $2\text{V}/\mu\text{s}$. An added advantage over any 709-type op amp—maximum power dissipation is only 80mW. Obviously, the best IC for the job.

The RA-909 is a direct replacement for all 709-type op amps, so use it in existing current-to-voltage converter circuits and increase their performance, too. Available in both a TO-99 package and a TO-86 flatpack configuration, the RA-909 offers other features such as transient response of 40ns (10 to 90% points) with a 200 millivolt output into a $2\text{K}\Omega$ 100pF load in the worst-case unity gain configuration; and a maximum equivalent input noise of $5\mu\text{V}$ RMS.

Contact your nearest Radiation sales office. Let us help you pick The Best IC for The Job.

WE MAKE THE **BEST IC** FOR THE JOB



RADIATION
INCORPORATED

SUBSIDIARY OF HARRIS INTERTYPE CORPORATION
MICROELECTRONICS DIVISION

RADIATION SALES OFFICES: P. O. Box 476, Lexington, Mass. 02173, (617) 862-1055 • 600 Old Country Road, Garden City, N.Y. 11530, (516) 747-3730 • 2600 Virginia Avenue N.W., Washington, D.C. 20037, (202) 337-4914 • P. O. Box 30867, Dallas, Texas 75230, (214) 231-9031 • 6151 W. Century Boulevard, Los Angeles, California 90045, (213) 670-5432 • P. O. Box 37, Melbourne, Florida 32901, (305) 727-5430 • International Sales: Marketing Department, P. O. Box 37, Melbourne, Florida 32901, (305) 727-5412

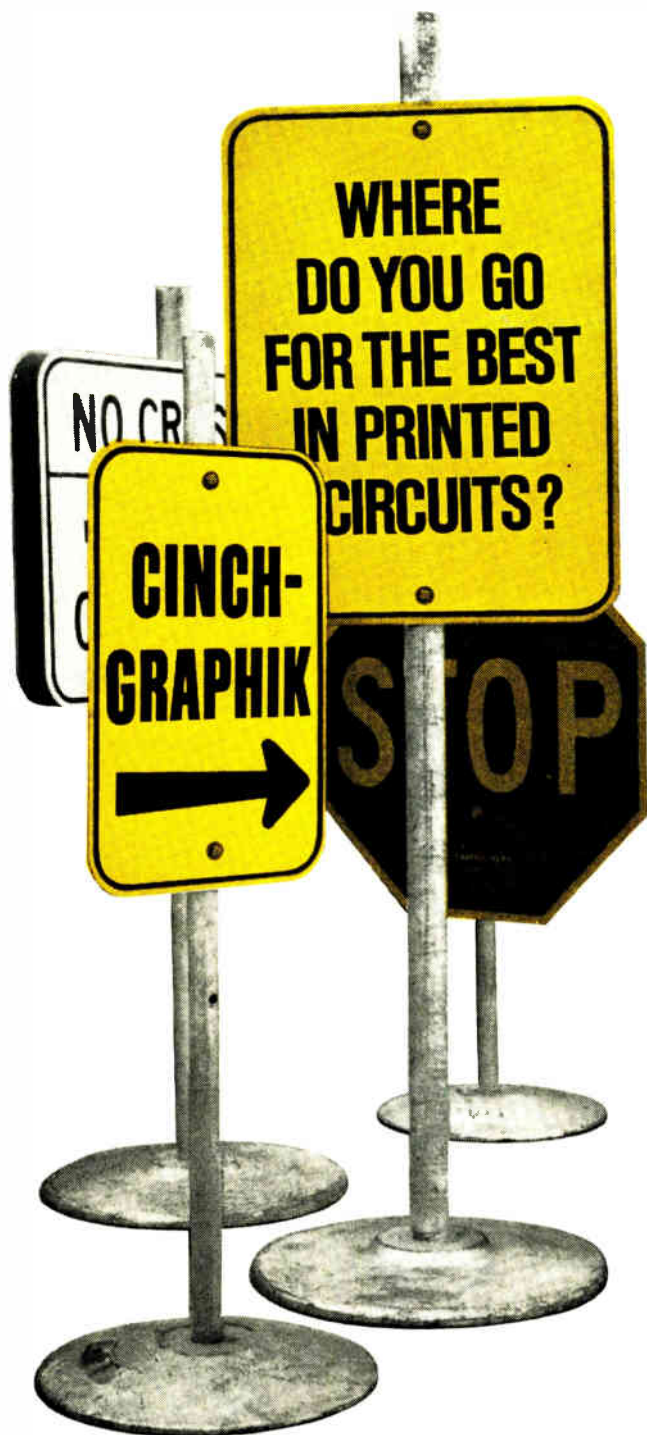

tional participation—even at a price. Says a Danish representative: "Intelsat should insure that no country has a monopoly, and competition should be insured even at a slightly higher cost." Delegations from Africa and South America believe that more widespread contracting will lead to European subsidies, and they don't want to underwrite them. The Venezuelan position is typical: "If international participation means additional cost, this should not be borne by the developing countries."

Several nations that haven't participated in contracts proposed that either a rebate or some form of technical assistance be made to noncontractors. The Polish observer suggests a contractor tax to be placed in a fund that would be used to support technical assistance for the nations not getting contracts.

Cost plus. Of the 68 nations now in Intelsat, 45 have yet to receive a contract, so the have-nots are a majority. Few, if any, members question that the U.S. is the all-around best supplier. But most still want at least a piece of the action. The U.S., through Comsat, has successfully worked others into Intelsat programs, but many believe there have been neither enough awards nor enough technicians and engineers involved.

At one session, a U.S. delegate observed that the reason Comsat didn't have more international representation on its staff was "because of a dearth of nominees rather than the unwillingness of the present manager to place them." In order to maintain its strong contracting edge through the "quality, price, and most favorable delivery time" provision of the consensus, though, the U.S. will somehow have to find ways to get other nations more heavily involved in things.

At the meeting, there was resistance to addressing the issue of "other satellite services"; many delegates considered it premature in relation to the setting up of a permanent agreement. To the disappointment of the U.S. and Comsat, the matter will undoubtedly be shelved until after the final organization is decided upon.

Network. Although there's a consensus favoring domestic satellite

New from United Aircraft

control logic

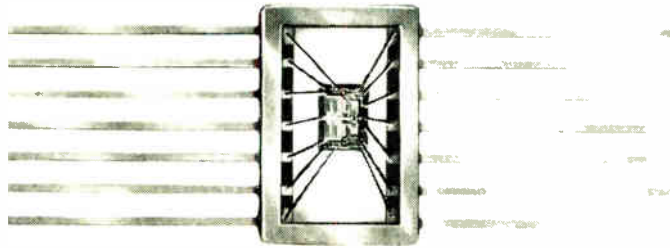

A family of 28 volt integrated circuits including dual and quad gates, expandable gates and gate expanders, set-reset flip flops, 5 volt to 28 volt converters and 28 volt to 5 volt converters, featuring:

- **Large supply variation tolerance** – 16 to 40 volts
- **High A.C. noise immunity** – rejects 2 u sec pulses of up to 90 V
- **High D.C. noise immunity** – 8.5 volt input threshold
- **High current sinking ability** – 100 mA steady state, 1 ampere transient
- **High output signal swing** – up to 90 V
- **Full military temperature operating range** – -55°C to $+125^{\circ}\text{C}$
Also available in industrial range from 0°C to $+85^{\circ}\text{C}$
- **Packaged** in $\frac{1}{4} \times \frac{3}{8}$ flatpack

United Aircraft control logic, operates from 16 to 40 volt sources and is ideally suited for directly driving indicators and actuators. Control logic replaces relays and discrete device circuitry and provides significant reduction in size and weight. For more information, contact:

Electronic Components DIVISION OF **United Aircraft**

TREVOSE, PENNSYLVANIA Tel. 215-355-5000 TWX: 510-667-1717
IN THE WEST: 128 E. KATELLA AVE., ORANGE, CALIF., (714) 639-4030

republic makes aluminum strip conductor

the electrogage® way

Republic Foil has been one of the leaders in developing aluminum strip for coil applications and led the industry in guaranteeing tight gauge control. Experience gained from producing Electrogage precision slit strip conductor for a number of years has led to the development of superior quality edge contoured strip. Electrogage edge contoured strip offers a uniformly curved edge from surface to surface free of any protrusions which could affect insulation values.

Both Electrogage contoured strip and precision slit strip conductor are carefully monitored for gauge and conductivity throughout fabrication.

Each master coil of end product is measured and certified for conductivity.

Write for a copy of our new 8-page Bulletin SC.

THE LEADING MANUFACTURER OF A COMPLETE LINE OF PLAIN & ETCHED CAPACITOR FOIL



REPUBLIC® FOIL INC.

General Offices, Danbury, Conn. 06813 Tel. 203-743-2731

BRANCH SALES OFFICES

Chicago, Ill. 312-545-2142 • Salisbury, N. C. 704-633-6020 • Cleveland, Ohio 216-871-6268

WEST COAST — Electrical Specialty Co., 213 E. Harris Ave., So. San Francisco, California;
2820 E. 12th Street, Los Angeles, California 90027

PLANTS • Danbury, Conn. • Salisbury, N. Carolina • Somerville, Mass.

programs, there's very little agreement on regional arrangements. The U.S. has taken the position that regional setups should be okayed only if they're consistent with the best use of the radio spectrum and orbital space, do not cause interference, and in no way produce an economic drain on the Intelsat system. The U.S. and others maintain that domestic and regional systems could be built into regular Intelsat birds by assigning certain circuits to a nation or area. Canada and others with domestic satellite interests have waged a good fight for the domestics and are expected to prevail; in the case of regional satellites, however, almost anything could happen.

The delegates in November will be trying to accomplish diplomatically what is now possible technically: a truly global system. The U.S. delegation (and presumably others) will have had time to regroup under a new chief, William W. Scranton, former governor of Pennsylvania.

If the consortium succeeds in involving the Soviet bloc, it will have gone a long way toward reaching its international goals. The Russians have a vested interest in finding a way to mesh their communications activities with Intelsat; their Orbita ground stations now number 28, with another 10 under construction. Bloc nations have made their position clear on a global system. As one Soviet delegate says, "We believe this task (global communications) could be solved by means of establishing a truly international satellite communications system." These sentiments are echoed by Poland's Rutkowski.

Russia believes that Intelsat should work through the International Telecommunications Union, a proposal that has won support in other quarters. The U.S. has proposed that if the Soviet Union opts for an associate membership, the consortium make "... allowances for the fact that such users have not borne any portion of the risk involved in establishment of the space segment." The U.S. suggested a 14% surcharge for services rendered an associate. Clearly, both sides are looking for paths to agreement. ■

TRIM OVERWAIT

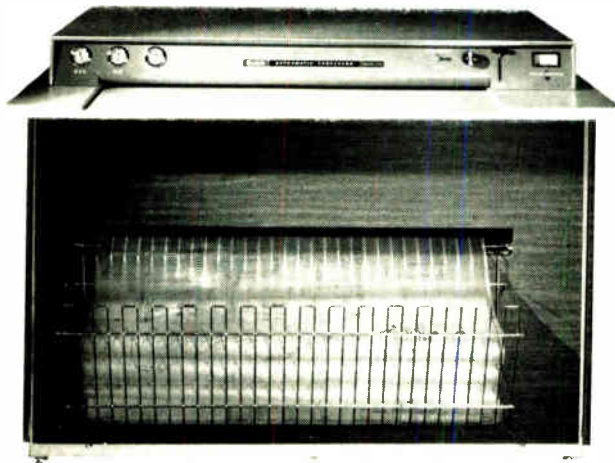

And overtime. And overhead. And overwork in drawing reproduction.

Overwait is the hour or so you used to have to spend waiting for film to be processed. No more. The KODAK SUPERMATIC Processor, Model 242, processes multi-sized KODAGRAPH ESTAR Base Films in just 60 to 90 seconds. That's developing, fixing, washing, and drying.

The KODAK SUPERMATIC Processor, Model 242,

offers more than speed. It delivers economy, uniform high quality, and versatility, too. Its one-minute handling of standard A-E sizes is something to count on. Its processing of KODAGRAPH ESTAR Base biggies—42" x 18-plus feet—is something to see.

If you're overburdened with overwait, why not reach for your phone and call your local Kodak Technical Sales Representative?

Or write us today: Eastman Kodak Company, Business Systems Markets Division, Rochester, New York 14650.

Kodak

DRAWING REPRODUCTION SYSTEMS BY KODAK

With these resistance meters...



you can go to extremes.

Use the HP 4329A High Resistance Meter for high-voltage components, leakage current, testing insulation qualities of PC boards and materials used in switches and relays—or use it as a picoammeter.

At the opposite extreme, use the 4328A Milliohmmeter for contact resistance, trouble-shooting grounds, semiconductor junction or contact lead bond quality.

The compact, solid-state 4329A has a resistance range from 5×10^5 ohms to 2×10^{16} ohms, with selectable test voltages from 10 to 1000 volts. Lighted range and scale indicators afford fast, accurate readings. Analog output. Price: \$750; model 16008A Resistivity Cell for volume and surface resistivities, \$200.

The 4328A gives you 20 microohm sensitivity from 100 ohms down to the milliohm range. It has a built-in phase discriminator for making precise measurements

on samples with series reactance up to twice their resistance values. And each probe combines both current drive and voltage sensing. At only seven pounds, it's a convenient package for either field or production line. Price: \$450; with option 01, internal rechargeable battery, \$475.

Call your local HP field engineer for the details, or write Hewlett-Packard, Palo Alto, California 94304; Europe: 1217 Meyrin-Geneva, Switzerland.

HEWLETT  PACKARD
RESISTANCE METERS

Display-terminal prices trimmed to fit into more schools, offices

Station bowing at spring computer show has vector capability, costs \$7,950; electrostatic printer produces 4,800 lines a minute at 5 cents a page

The education market will be a prime target of display-terminal manufacturers at the Spring Joint Computer Conference in Boston, May 14-16.

A display station with vector as well as alphanumeric capabilities, and priced at \$7,950, will be introduced by Computer Displays Inc. And the Univac division of Sperry Rand will show a desk-top visual terminal redesigned to provide a low-cost station for educational and other systems.

A third input-output station to be shown at the SJCC, an electrostatic printer developed by the Brush Instrument division of the Clevite Corp., runs at the extremely rapid rate of 4,800 lines a minute and yet is one of the less expensive printers on the market.

Computer Displays Inc., Waltham, Mass., is replacing its \$12,750 Advanced Remote Display Station (ARDS) 100 with an almost equivalent ARDS 100A costing \$7,950.

The terminal's capabilities include point plotting on a grid of 1,081 by 1,415 addressable points, vector plotting of lines up to 6 inches long at a single command, 16 different alphanumeric fonts (plus custom fonts), graphic display and input, and flicker-free display on a non-refreshed Tektronix direct-view storage tube.

With the ARDS-100, CDI became the first company to apply the Tektronix 611 display tube to computer input-output devices [*Electronics*, Feb. 19, 1968, p. 50].

"ARDS terminals are more than just data display and entry devices," says a CDI spokesman. "Other devices can be controlled from the keyboard, including hard-



Versatile. Terminal can display schematics as well as alphanumerics. Joystick at left is used as position controller in design work.

copy units and incremental tape recorders for program pre-editing."

Fallout. The company's president, Robert H. Stotz, and a vice president, Thomas B. Cheek, developed much of the ARDS-100 system when they were working on the Massachusetts Institute of Technology's Project MAC. MIT needed a display terminal priced low enough to provide flexible time-sharing at many stations.

The company had targeted a price range of \$8,000 to \$10,000 for its display, and though the goal wasn't reached with the ARDS-100, it has been with the 100A. "We have our production costs and methods stabilized now," says Kenneth D. McDaniel, CDI's marketing vice president. "We can predict our

volume more accurately."

McDaniel adds that like many new firms, CDI set its prices a little on the safe side to begin with. "Nobody wants to lose his shirt at the outset," he observes. But more important in the \$4,000 cut was redesign of the interfacing electronics and of the read-only memory used in character generation.

The basic console includes scope, keyboard, vector generator, symbol generator, and interface electronics. Though designed especially to interface with Bell System's Dataset 103 or 202, the ARDS-100 could also be directly linked to a computer, according to Stotz, and via the computer with magnetic tape or other peripheral stores.

To a computer, the original ter-

NOW, SEE HERE!



There's no need to work in the dark! If you do or, if you work under conditions in which you need a "near infrared" viewing device, Varo Optical has it now.

We developed the **DETECTIRSCOPE** for commercial use after 15 years of design, engineering and production experience in infrared viewing equipment for military use. The **DETECTIRSCOPE** provides science and industry with an invaluable tool for direct observation and photographing of anything in the "near IR."

The **DETECTIRSCOPE** is used by the electronics industry to study silicon crystal stress patterns. In medicine, the **DETECTIRSCOPE** is used to examine dilated pupils that close against ordinary light, and to penetrate surface skin to observe subcutaneous varicose conditions. And by the photographic industry to observe film during coating and slitting, and in handling highly sensitive color film.

The **DETECTIRSCOPE** can be handheld or mounted for stationary use. It's completely self-contained, operates on a 1.3 V mercury battery converted to 12,000 V, and at 1 foot has a field of view of 6".

If you're working in the dark, Varo's **DETECTIRSCOPE** can throw a lot of light on the subject.

For more detail and price contact:



VARO OPTICAL, INC. VARO INDUSTRIAL PARK
MT. PROSPECT, ILLINOIS 60056 (312) 259-8100

120 Circle 120 on reader service card



Data on view. Univac's Uniscope 100 can operate as either a data entry or display device. It displays all 96 ASCII characters, including upper and lower case alphabetic. The terminal can be rented for \$100 a month, or bought for \$3,000 in large quantities.

terminal seemed much like a teletypewriter unit; only a few program changes were needed to transmit alphanumeric and graphics directly to and from the display. And if the installation included a Bell System Dataset, no changes were necessary, though maximum data rate was limited to 1,200 bits per second.

Frippery. But once it got a number of units in the field, CDI found the ARDS-100 multipurpose interface to be a costly extra that most users could do without. The company has therefore redesigned the input-output section of the terminal to permit the user to purchase only the sort of interfacing appropriate to his application.

"With a Dataset interface module, the 100A is just about the equivalent of the 100," says McDaniel. "Most users never took advantage of the direct computer access features." The 103 or 202 Dataset interface modules are priced at \$535, bringing the total cost of a 100A in its most used configuration to \$8,485. Stotz notes, though, that quantity discounts will be offered.

Other interface modules can make the 100A an exact replace-

ment for the 100. Among them are modules allowing the 100A to operate directly from the bus of a computer at a write rate limited only by the phosphor in the Tektonix storage tube—800 to 1,000 characters per second. Called the high-speed option, this module will cost about \$995.

ARDS hardware already has been interfaced with IBM 1130, EAI 640, DDP-316, DDP-416, DDP-516, Interdata 3, and Varian 620I computers. CDI plans to offer standard modules for IBM 360 processors, and similar ones for the RCA Spectra 70's. No prices have been set for these modules; except for the IBM- and RCA-type units, and possibly a few others, the interface modules will be custom-made.

For users with more complex requirements, CDI will offer modules combining both the 103 and 202 Dataset interfaces (\$835), or the high-speed option plus the 202 interface (\$1,295).

Though modular interfacing is more than half the story, a redesigned read-only memory also saves money.

"The ARDS-100 used a 1024-word braided wire memory made by Memory Technology Inc.," says

Cheek, "but only about 75% of it was needed because of the way we use the ASCII character set. So in the 100A we're switching to a 768-word memory."

Also, CDI is taking advantage of an output buffer, or data register, already on the memory board. With the addition of clock signals from the 100A mainframe, the buffer is converted into a shift register. Thus, rather than performing parallel-to-serial conversion with a set of flip-flops, CDI can use the shift register on the memory board.

The company is quoting 60-day delivery time on the 100A.

Fast and quiet

Until recently, nobody has been able to figure out a really good way to print computer data on paper except by smacking the paper with a type face. Most of these impact printers are limited to less than 1,000 lines per minute; a few attain higher speeds, but only with a relatively small character set.

But the Brush Instrument division of the Clevite Corp. has introduced an electrostatic printer capable of 4,800 lines per minute. It's capable of printing any kind of graphic information, including vectors, curves and odd-shaped characters, silently, at less than 5¢ a page. The printer contains a row of 600 styluses that can be selectively charged to 300 volts. As a web of specially coated paper passes beneath the styluses, the coating acquires an opposite charge beneath each charged stylus. The charge then attracts a dark toner in a liquid suspension to form the characters as an array of black dots. The liquid is evaporated and the printed output comes out dry. It's the same principle used in an earlier Brush analog recorder.

Lots of character. The paper unwinds from a roll at a maximum average speed of 10 inches per second. Driven by a stepper motor, the paper stops momentarily every 1.25 msec and acquires a new charge pattern that produces a row of black dots across the paper. Subsequent rows are deposited at 80 to the inch. In one common character size, characters are formed from a dot matrix 5 wide and 7 high. A line of characters this size would be made from 7 rows of dots followed by about three blank rows forming

NUTA 96

- THE SMALLEST DIGITAL PANEL METER IN THE WORLD
- THE BEST ACCURACY IN THE 3 DIGIT CATEGORY: $\pm 0.1\%$ OF READING ± 1 DIGIT
- THE HIGHEST RELIABILITY: MEASUREMENT BY DUAL SLOPE INTEGRATION TECHNIQUE
- AUTOMATIC ZERO ADJUSTMENT
- AUTOMATIC CALIBRATION

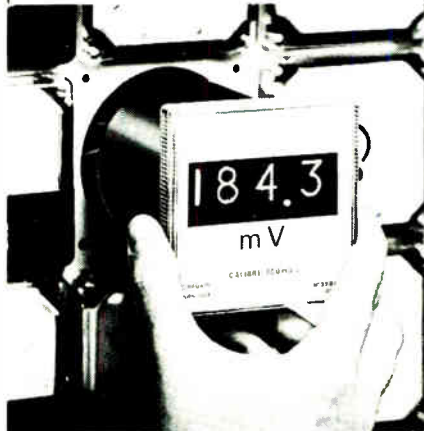

front flange 96 x 96 mm (3 3/4")
round case depth 96 mm (3 3/4")

A competitive price

Common features for all the instruments:

- 3 significant digits with over-range indicator as 4th digit for minimum reading of 1999
- 2 measurements per second
- Power 220 V $\pm 10\%$;
60 or 50 Hz (must be indicated)
- Temperature coefficient
< 0.04% per 10°C
- Calibration at 23°C;
operating range 0°C to + 50°C

Features for a typical DC Voltmeter:

Range 10 mV—Resolution 10 μ V
— Input resistance greater than 200 M Ω — Input current rejection 50 pA—Permissible overload 1000 times full scale — Various ranges up to 1000 V, with 1 M Ω to 10 M Ω resistance.

Other models:

D.C. Ammeter, A.C. Ammeter and Voltmeter, Ohmmeter, Tachometer, Frequency meter, Temperature measurements by resistor probes or thermocouples with cold-junction correction, Ratiometers.

CHAUVIN ARNOUX
190, rue Championnet
PARIS 18e — Tél. 627-73-89

POLYCONTROLE 97

Do you know many low-cost electronic multimeters having a 10 nanoamps full-scale range?

This one measures very weak leakage currents. It is quite useful also for testing diode reverse currents, and all unijunction and field effect transistor circuits, as well as IC operational amplifiers.

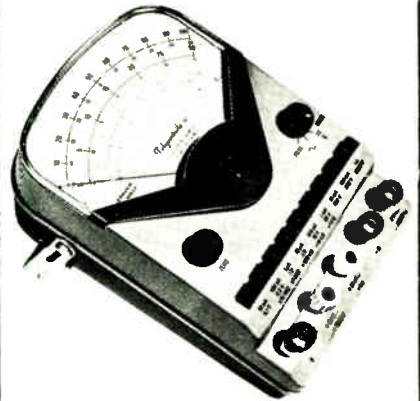

And, in addition:

- As a D.C. voltmeter, a 100 M Ω /V internal resistance
- A battery supply, the lifetime of which exceeds 3000 hours, i.e. more than 1 year, for a daily use of 8 hours
- No warm-up time, no zero drift and no recalibration necessity
- Complete overload protection
- Sensitivity: 10,000 times the usual multimeters sensitivity

Features:

D. C. (with central zero, each range is divided by 2) 1.5% accuracy	Voltage — 9 ranges: 0.1 V to 1000 V — Resistance 100 M Ω /V up to 1 V and constant beyond 100 M Ω Current — 9 ranges: 10 nA to 1A — Voltage drop from 100 to 180 mV
A. C. 2.5% accuracy	Voltage — 5 ranges: 3 V to 300 V — Impedance 1 M Ω shunted by 10 pF from 10 Hz to 5 kHz: negligible influence from 5 Hz to 200 kHz: influence < 2.5%
Ohms	50 Ω to 500 M Ω in 5 ranges Built-in battery supply without any adjustment

"These 2 instruments are manufactured by Chauvin Arnoux S.A., 190 rue Championnet Paris 18e — France — Phone: 627-73-89 — which is looking for any form of distribution agreement or manufacture under licence".

CHAUVIN ARNOUX
190, rue Championnet
PARIS 18e — Tél. 627-73-89

NEW VACTEC "PLASTIC" PHOTOCELLS

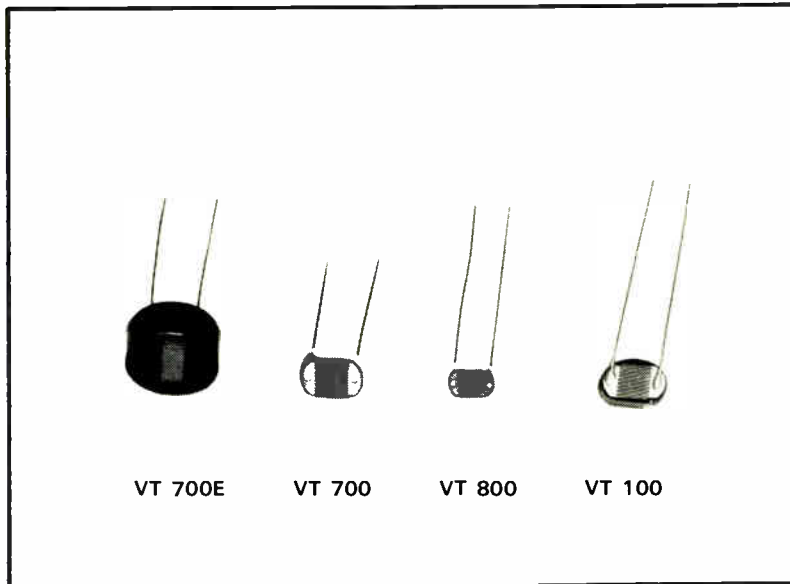

Actual size, priced as low as .25 each ($\pm 33\%$ tolerance) in 100,000 quantities.

Low Cost Way to Meet Most Photocell Requirements

Are you spending up to a dollar for photocells when Vactec can satisfy your needs for far less? Here's a complete line made the same, and with the same quality characteristics and precise tolerances as their metal cased counterparts. Yet they cost about *half* as much, because instead of sealing, they are protected by a thin transparent plastic coating.

Vactec "plastic" cells are conveniently controlled by ambient light, or from closely coupled low voltage lamps for remote control. Special processing provides resistance to humidity, making these devices suitable for indoor industrial and commercial applications like controlling relays in line voltage circuits; switching SCR's on or off; phase control in proportional circuits; or as feedback elements for motor speed controls in consumer appliances.

GENERAL SPECIFICATIONS

Material	Two Cdse and three Cds materials, including the new type 3 with exceptionally high linearity and speed.
Voltage Maximum	(dark 300V.)
Dissipation at 25°C	200 mw (VT 100) 250 mw (VT 700 and VT 700E) 125 mw (VT 800)
Ambient Resistance	-40°C up to +75°C Wide range as low as 600Ω at 2 F.C.

Write today for Bulletins PCD-41, 57, 57E, and 58.

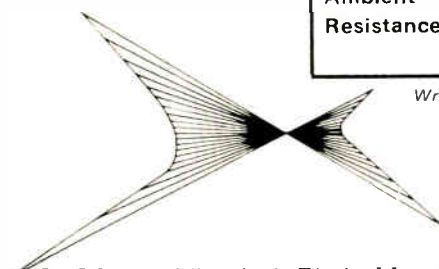

VACTEC, INC.

2423 Northline Ind. Blvd., Maryland Heights, Missouri 63042
(314) 872-8300

Specializing in standard Cds, Cdse, and Se cells. Custom engineering for every photocell need.
Listed in EBG under "Semi-Conductors" and EEM Sec. 3700.

the space between the lines. Within the line the characters would be five dots wide, ranging from one dot for an I to five for an E or W; two-dot spaces appear between characters. Besides this 5×7 matrix size, other common sizes can be used, such as 6×9 or 7×10 ; but fewer lines of these larger sizes would be printed per minute because the dot deposition speed is constant.

In the demonstration model shown to the press recently, the printer was off-line; its input was a series of bits corresponding to the data to be printed—a 1 for a dot, a 0 for no dot—stored on a magnetic tape unit that had been previously prepared on a computer. For an on-line printer operating in this mode, the image of the printed matter would have to be set up in the computer memory in advance, line for line. Also, for a computer to print alphanumeric characters lengthwise instead of crosswise or to print graphic information, it would have to set up an image of the whole page in an enormous block of memory space—more than most computers can spare. But Clevite plans to make available an interface unit that translates the American Standard Code for Information Interchange (ASCII) into the dot-for-dot format, so that the computer can transmit only the data to be printed, rather than the data's image in memory.

Special coating. The paper for the printer has a special coating that retains its white color yet easily accepts the electric charge and the toner.

Even though the printer in its present form prints at 4,800 lines per minute, much faster than any conventional unit, it's not limited to this speed by the printing process itself. Although in continuous operation a new row of dots is printed every 1.25 msec, Clevite engineers have gotten this down to as little as 60 microseconds with satisfactory results—corresponding to an output of 20 pages per second. This is too fast to be useful; people can't use printed information that fast, and that speed requires an enormous stepping motor to handle the paper.

Deliveries of the printer will begin in October. It's priced tentatively at \$15,000.

Anyone can think small.

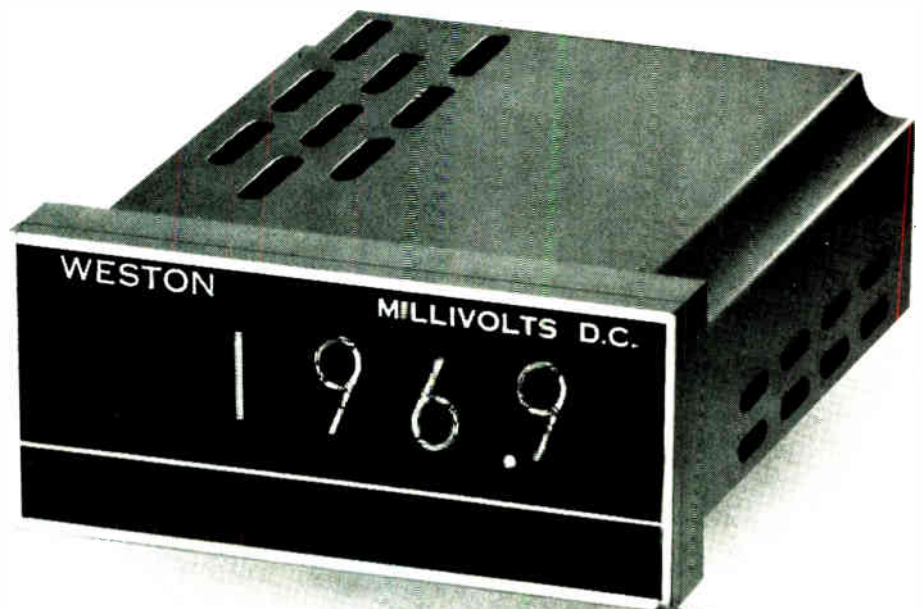

Frankly, we had something bigger in mind.



We built our second generation DPM* to fit into seven square inches of panel. *That's less than any other digital panel meter requires.* But we didn't stop there. The Model 1290 mounts completely from the front of the panel. *The entire chassis pulls out from the front for servicing or replacement.* Even the Nixie** tubes are pluggable! Think of the convenience in continuous systems opera-

tion. Despite the smaller package, Model 1290 has all the features our original DPM is so widely acclaimed for—3-digit plus 100% overrange display, 0.1% ± 1 digit accuracy, circularly polarized window filter, dual slope integration, full-buffered storage display and BCD output. Many of these standard Weston features are still "optional at extra cost" on competitive units. Our new compact

is styled for tomorrow, available today, and priced below \$200 in quantity. Anything else in the industry is just small talk. WESTON INSTRUMENTS DIVISION, Weston Instruments, Inc., Newark, New Jersey 07114.

a Schlumberger company

WESTON®

*U.S. Pat. #3,051,939 and patents pending.

**Registered trademark, Burroughs Corp.

Our package deal is a complete fabrication.

We make every part of our hermetic integrated circuit packages in our own plants.

We have to.

It's the best way we can be sure that every one will measure up to specs. Both ours and yours.

Take, for example, our off-the-shelf dual inline package. It uses our own special blend of hard glass and alumina to get the best properties. High electrical insulation, thermal shock resistance, hermeticity, and a thermal expansion that matches the metal alloy parts.

It meets Mil-specs and can be plated to your requirements.

If this package doesn't suit your needs, we'll design one to your specs.

Each hermetic package gets to you in first-class condition. No bent or shorted leads. No excess glass-ceramic flow.

In short, the perfect package deal.

*Sylvania Metals & Chemicals, Parts Division,
Warren, Pa. 16365.*

SYLVANIA
A SUEBIC COMPANY
GENERAL TELEPHONE & ELECTRONICS



Free-standing transistor socket has no insulator

Separate pins provide contact and support for semiconductors; automatic p-c board insertion lowers assembly costs

The consumer electronics industry has discovered that it is more economical to use transistor sockets than to solder components directly to printed-circuit boards. And Molex Products Co. has developed a new type of transistor socket that cuts assembly costs even further.

According to C.G. McDonough, manager of advanced design at Molex, "The cheapest three-termi-

nal transistor socket sells for about 4.5 cents in quantities of 100,000. But three of our terminals, in the same quantity, go for about 1.2 cents."

The socket, which is actually separate terminals, can be mounted three ways. The terminals can be provided in chain form and cut off as needed, in chain form and separated in groups, or loose.

With the continuous-chain feed, the terminals are cut off and inserted one at a time by an automatic head. In group form, the terminals required for a given p-c board are separated and blown through a plastic tube to the insertion head. With either method, a template guides the terminals into the proper location. In the third system, a vibrating feed is

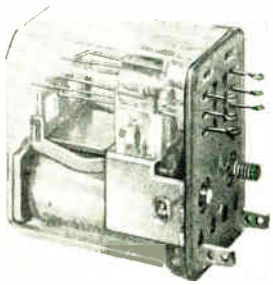

Comb-actuated relay AZ-426 is for remote switching of uhf and vhf signals. Crossbar-wire contacts are rated 0.5 amp at 26 v d-c, 0.3 amp at 115 v a-c, with minimum loss up to 1,000 Mhz at 300 ohms. Capacitance between contacts or between contacts and ground is less than 0.5 pf. Price is \$1.95 each in quantity. American Zettler Inc., 697 Randolph Ave., Costa Mesa, Calif. [341]

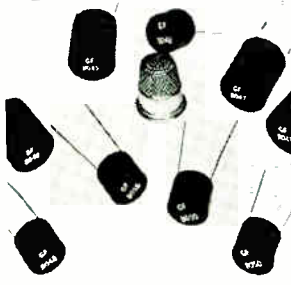

Arc suppressors, utilizing an RC network concept as an rfi filter, range in values from 0.01 to 0.001 μ f. Voltage ratings are 28 v a-c or 100 v d-c, and 125 v a-c or 400 v d-c. All units are available with axial or plug-in leads, in series or parallel. They come in two shell sizes: 0.50 x 0.40 in. and 0.62 x 0.70 in. Genisco Technology Corp., 18435 Susana Rd., Compton, Calif. [342]



Two magnetic latch relays, a 10 amp, 2 pdt and a 10 amp, 4 pdt designated series JL and KL respectively, are for use in extreme environments. Balanced-Force armature design insures reliable operation in shock of 100 g's, and vibration of 30 g's to 3,000 hz. Series JL measures 1.015 x 1 x 0.515 in., and KL is 1.015 x 1 x 1.015 in. Leach Corp., 5915 Avalon Blvd., Los Angeles. [343]

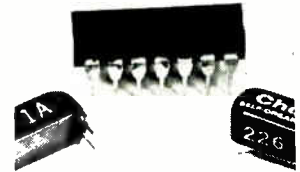

Reed relay 226-4-1A has a switching speed of less than 500 μ sec and can be IC driven from a 5-v logic supply. It is specified for low dynamic contact resistance and low noise at 500 μ sec. The device measures 0.8 x 0.2 x 0.2 in., suiting it for high-density p-c board applications. It is magnetically shielded. Self-Organizing Systems Inc., P.O. Box 9918, Dallas 75214. [344]



Infinite resolution, cermet element adjustment potentiometer model 3329 meets or exceeds applicable requirements of Mil-R-22097. It measures 0.25 x 0.18 in., and has a resistance range of 10 ohms to 1 megohm. Power rating is 0.5 w at 70° C. The 500-piece price is \$1.31 each; \$1.10 in quantity. Bourns Inc., Trimpot Products Division, 1200 Columbia Ave., Riverside, Calif. [345]

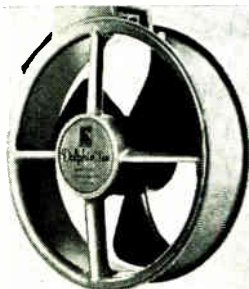

High reliability air mover, the Dolphin fan, provides up to 265 cfm from a 2 7/16 in. deep axial package for up to 5 years of continuous operation. It features oil impregnated sleeve bearings and mounts easily with clips on integral clamping rims. It is airflow reversible by mounting on either face and can be used continuously in ambients to 65°C. Rotron Inc., Woodstock, N.Y. [346]

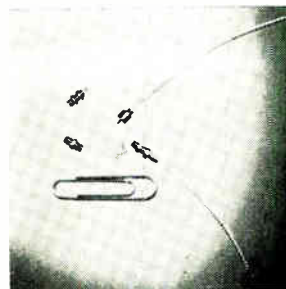

Ultraminiature coaxial and multi-contact 4- and 7-pin connectors meet the needs of high density packaging in space vehicles, aircraft, IC's, servo systems, transducers and medical applications. The bodies are gold plated brass; the sockets, gold plated beryllium copper; the pins, gold plated brass; and all dielectrics, TFE Teflon. Microtech Inc., Henderson Blvd., Folcroft, Pa. [347]

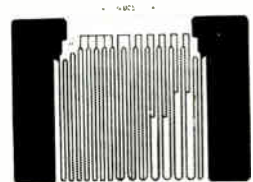

Miniature, high range chip resistor MHR is for hybrid IC's or precision resistive networks. Standard resistance range is 100 kilohms to 10 megohms with a standard tolerance of $\pm 1\%$. It is rated 1/20 w at 125° C, derated to 0 at 175° C, with a temperature coefficient of ± 100 ppm/°C in the -55° to $+175^{\circ}$ C range. IRC Div. of TRW Inc., N. Broad St. Philadelphia 19108. [348]

**What a coincidence!
You're flying
to Philadelphia
for the
NEP/CON '69 EAST
June 10-12.
So are we.**

And many of your fellow conventioners
will be going with us.
You'll enjoy it more if you fly with
your friends.

TWA

**Our people make you happy.
We make them happy.**



Adaptable. Individual terminals produce custom-made transistor sockets.

used with loose terminals. That technique, however, has a drawback—the holes in the p-c board must be countersunk to act as a guide for the terminals, meaning more space between holes. But the vibrating insertion method also has its advantages—a large number of terminals, and hence sockets, can be inserted at the same time. With all three methods, the terminals are held permanently in place when the complete board is soldered. Besides making the terminals, Molex also manufactures the insertion equipment. This includes the insertion heads and the pantograph arrangement that holds them, the templates, and the press that's used to firmly seat the terminals into the board before they are soldered.

Custom-made. According to McDonough, a complete vibration-insertion setup costs about \$6,000. This includes the vibrator, the press, and one set of templates; each set contains a top plate, a bottom plate, and a press plate. The tube insertion setup—which includes the automatic feeder, the cutoff machine, the air drive, and a set of templates—costs about \$9,000. The pantograph system, including the key table, sells for about \$4,000. Additional sets of templates, for different boards, cost about \$200. But McDonough points out that the systems are built on a custom basis, to meet the manufacturer's specific needs, therefore the listed prices are only approximate.

Molex Products Co., 5224 Katrine Ave.,
Downers Grove, Ill. 60515 [349]

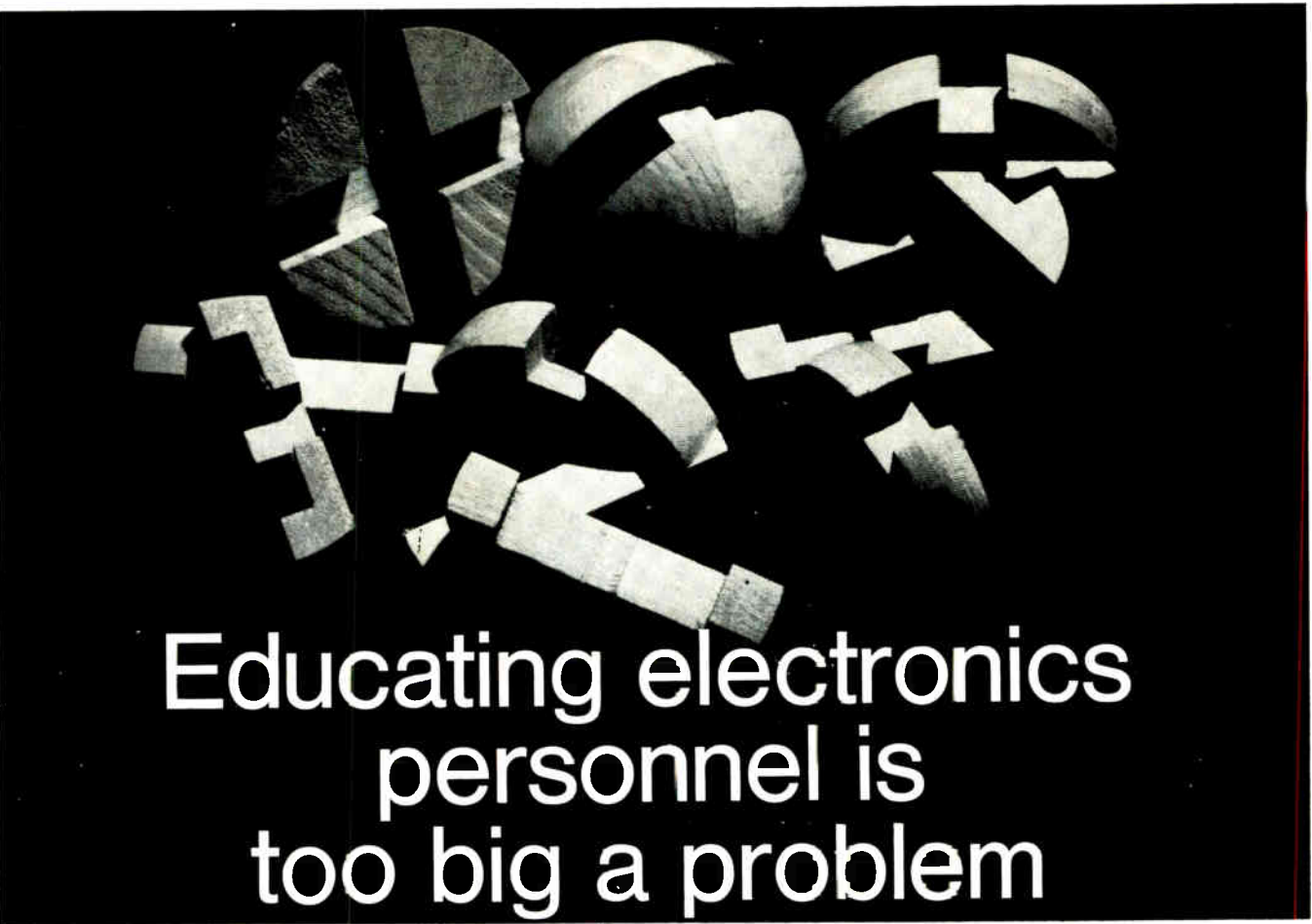

Educating electronics personnel is too big a problem to have only one solution.



Of course, you're sold on the importance of providing continuing education for your electronics personnel. So rapidly do new developments take place in electronics that knowledge begins to lose its value almost as soon as it is acquired. Valuable men can become outmoded and unproductive almost overnight. And the shortage of technical manpower at both the professional and supporting levels makes it imperative that you utilize fully every man you have.

Perhaps your company conducts in-plant programs of instruction. Or pays all or part of the cost

of evening classes in nearby technical institutes, colleges and universities. Whatever your educational program, we believe it will be more flexible and more effective if you supplement it with CREI Home Study Programs in Electronics.

We've prepared a brochure that tells how CREI Programs can help you update, upgrade and reorient electronics personnel. Use coupon below to send for a copy today.

Founded 1927



Accredited Member of the National Home Study Council



CREI, Home Study Division. McGraw-Hill Book Company

Dept. WTC-05, 3224 Sixteenth Street, N.W.
Washington, D.C. 20010

I want more information on CREI Programs in Electronics and now they can supplement our educational program for electronics personnel. Please send me, without obligation, your descriptive brochure.

Name _____

Title _____

Firm Name _____

Address _____

City _____ State _____ Zip _____

THINKING RELAYS?

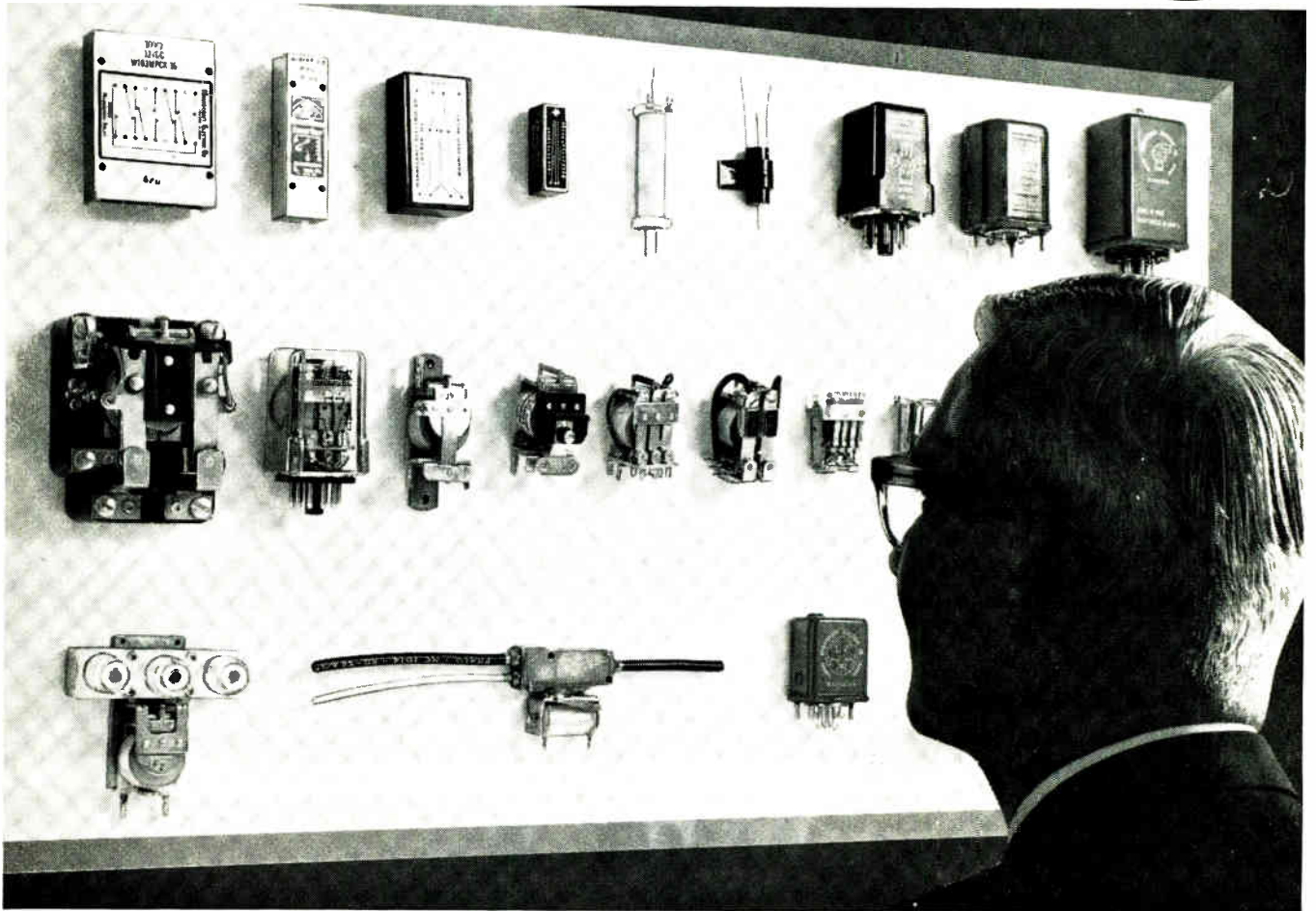

THINK MAGNECRAFT!

(that's all we think about, exclusively)

We specialize in relays. Not only dry reed and mercury-wetted relays, but a full line of quality, long lasting relays. There are Magnecraft general purpose, telephone type, time delay and power relays, as well as coaxial relays for UHF switching.

All Magnecraft relays are built to provide reliable performance in any application. And to insure this reliability, our demanding quality control system puts every part and assembly through repeated inspections before any shipment leaves our plant.

Everyone at Magnecraft concentrates on relays to provide you with quality products, quickly delivered and at competitive cost. That's because all we think about is relays! Just ask our wives!



FREE! Product File — Yours for the asking. Contains full details on all our stock relays.

Magnecraft[®] ELECTRIC COMPANY

5575 NORTH LYNCH AVENUE • CHICAGO, ILLINOIS 60630 • 312 • 282-5500

New instruments

\$1,000 converter tells all the angles

Synchro-to-digital unit is solid state and has five-digit display; accuracy and resolution are both 0.1° , and repeatability 0.02°

Solid state synchro-to-digital converters have already blasted electromechanical angle indicators out of the over-\$3,000 market, where converter accuracy is 0.01° or better. Now, they're zeroing in on the low-price market.

Two new challengers come from Theta Instrument Corp. One is a converter that tracks a rotating object at speeds up to 10,000 per sec-

ond; its price is \$1,500. The other unit, which has a \$1,000 price tag, measures the angular position of objects at rest; it doesn't respond fast enough to track.

Both units have five-digit displays with a range of 000.00° to 359.99° ; both accept 26-volt and 115-volt synchro data. Each has an accuracy of 0.1° , a resolution of 0.1° , and a repeatability of 0.02° .

Converters, whether solid state or electromechanical, are built into systems to display the angular position of a spinning object, say, an antenna; alternatively, they are used to test, calibrate, or align systems, such as navigational computers that process angular-position data.

Whatever its application, a converter generally receives its input from a synchro—an electromechani-

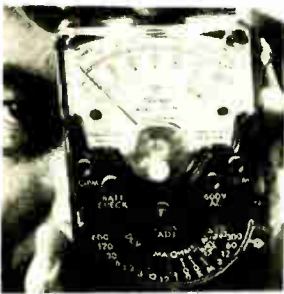

Volt - ohm - milliammeter model 310-FET features field-effect-transistorized circuitry, 10-megohm constant input resistance on all d-c voltage ranges, and sensitivity about 10 times greater than the conventional bench-type vtvm in the 0.3 v range and resistance readings to 5,000 megohms. Price is \$70 (with probes and leads). Triplett Electrical Instrument Co., Bluffton, Ohio [381]



Miniature meter model TM1 measures the time interval between opening and/or closing of contacts. Time range is 1 msec to 10 sec in 9 ranges. The readings are maintained for at least 1 minute on the 3-in. linear scale. Accuracy is $\pm 2\%$ full scale deflection. Unit weighs 1 lb 4 oz, measures $5\frac{3}{4} \times 3\frac{3}{4} \times 1\frac{3}{4}$ in. Amstro Corp., 120 Clinton Rd., Fairfield, N.J. [382]

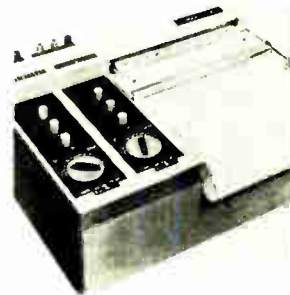
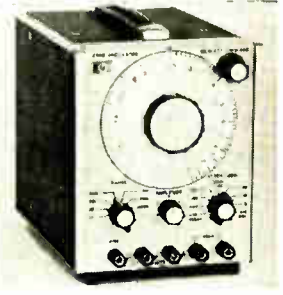
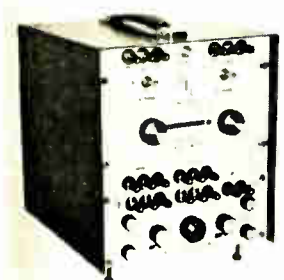

Chart recorder model 2741 has 11 switch-selected d-c voltage ranges, any of which can be set with front panel controls to become segmented scale or zero-center scale ranges. This allows the operator to custom make the recording range for his specific need. Result is better resolution and an easier-to-read recording. Simpson Electric Co., 5200 W. Kinzie St., Chicago [383]



Precision oscillator 204D has an 80-db attenuator for making measurements over a wide amplitude range, from 2.5 v rms into 600 ohms (5 v open circuited), down to less than 250 μ v rms. Frequency range is 5 hz to 1.2 Mhz. The a-c line operated version costs \$325. Equipped for mercury battery operation the price is \$340. Hewlett-Packard Co., Palo Alto, Calif. [384]



A-c to d-c thermal transfer standard model TRS-105 has a basic accuracy of 0.001% without the use of calibration curves or correction tables. The unit is designed to provide rapid and simple referencing of any a-c voltage up to 1 kv rms, to known d-c voltages. Price is \$1,500 and delivery is within 60 days. Julie Research Laboratories Inc., 211 W. 61st St., New York [385]



Multiple channel digital thermometer model 903 offers direct read-out and covers the range of -60° to $+160^\circ$ C. It has a guaranteed accuracy of 0.5° C, and a resolution of 0.1° C with memory display. Ten input channels are controlled by a master channel selector switch. Unit measures $2\frac{5}{8} \times 6\frac{3}{4} \times 9\frac{1}{2}$ in. Electronic Research Co., W. 75th St., Overland Park, Kan. [386]



Infrared radiation pyrometer/controller called Industrial Pacemaker permits sensing the temperature of a workpiece or material in process of fabrication, without touching it. It covers the temperature range 1000° to over 4000° F with several convenient models. Unit is housed in a vapor tight cabinet for severe environments. Irtronics Inc., 57 Commerce Road, Stamford, Conn. [387]



Integrating digital multimeter model 350 provides an accuracy of 0.01% and is designed with four basic d-c ranges of 100 μ v to 1,000 v. Guarded input, BCD and remote programming are standard features. Unit has pushbutton controls for range and function selection. Dimensions are 8.5 x 3.5 x 14.6 in. Price is \$695. Data Technology Corp., East Meadow Circle, Palo Alto, Calif. [388]



E F C fiberoptics for computer applications

**Punched Card and
Tape Readers
Reflective Readers
Light Piping**

For designers, specifiers and buyers of fiberoptic components in the computer or peripheral equipment industries, there is now a single source of design and manufacturing capability to meet your requirements...with competitive prices, firm deliveries and conscientious service. For more information, write or call

ELECTRO FIBEROPTICS CORPORATION

45E Water Street, Worcester, Mass. 01604
Phone 617 791-7391

Write for this booklet called *Sine Waves and Light Pipes*—an introduction to Electro Fiberoptics Corporation—plus technical data sheets.

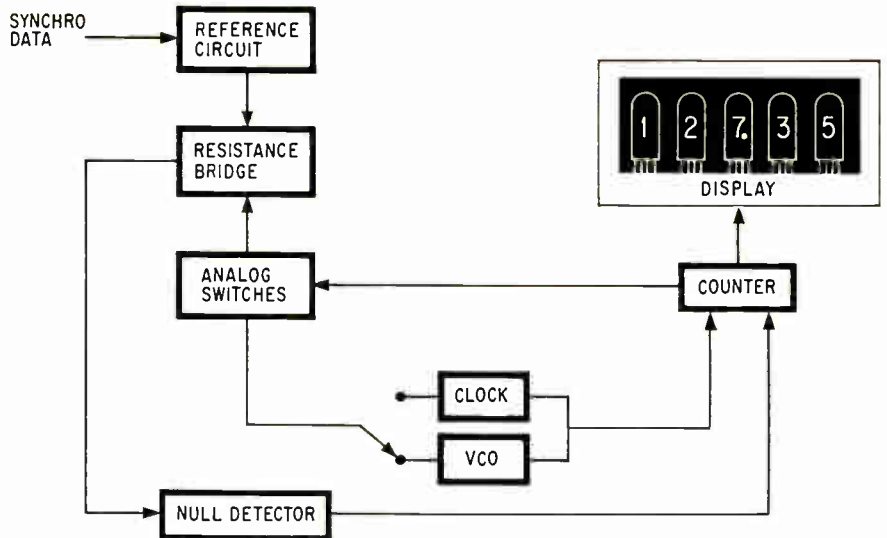
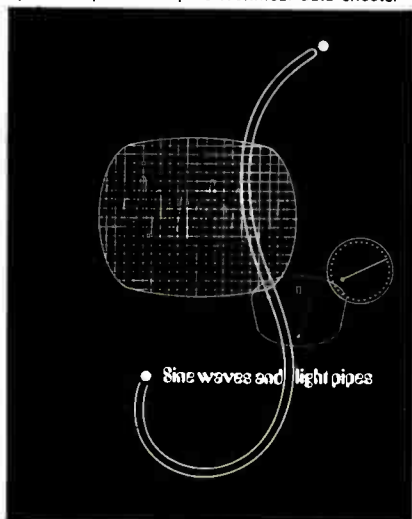

Null search. When the null point is found on the resistance bridge, the number in the counter tells the angular position of the synchro.

cal device that converts angular position into a signal.

Solid state converters have a number of advantages over their electromechanical counterparts. For example, they are more reliable, respond faster, are compatible with computers, and have numerical-tube displays, which are easier to read than the odometer wheels on electromechanical units. In addition, solid state units are usually smaller. Both of Theta's new converters, for example, are only 9½ inches wide, 3½ inches high, and 13 inches deep.

An individual converter can run at four frequencies. Customers specify the operating frequencies they want, and Theta engineers build four filters, one for each frequency, into the converter. The converter senses which of the four frequencies is at its input and switches the appropriate filter into the loop. Off-the-shelf units have 60-, 400-, 800-, and 4,800-hz filters.

The slew rates of the two types of converters are almost equal. Working in a 400-hz system, the static unit takes 300 milliseconds to respond to a 180°-step input; the dynamic converter responds to the same input in 200 milliseconds.

The big difference between the two units is that the slower goes only one way. Say both are checking the position of an antenna. If it rotates from 5° to 4°, the static converter has to search around almost the full circle before it finds the null point at 4°. The dynamic

unit, on the other hand, continuously tracks the antenna regardless of which way it's turning.

Down the taps. Both converters work about the same way. At the input there's a reference circuit, which reduces the voltage from the synchro to a level that can be handled by MOS field-effect transistors. The reference's output goes to a bridge, made of three 10-kilohm resistors. On one of these resistors is a row of taps, separated in such a way that the resistance between adjacent taps is proportional to a 5° rotation of the synchro.

Also in each converter is a counter that sends an interrogation signal to a bank of analog switches. The switches step down the row of taps until the null point is sensed. Built in with the switches is a FET-resistor network that cuts the 5° steps between taps into 0.1° and 0.01° increments.

When the counter finds the null, the clock that drives the counter shuts off. The number in the counter at this point is proportional to the angular position of the synchro.

The next time the synchro rotates, the clock goes on again, unless the rotation is large and sudden. In that case, a voltage-controlled oscillator takes over the clock's job and drives the counter quickly until the new null point is approached. Then the clock takes over again.

Theta Instrument Corp., Fairfield, N.J.
07006 [389]

FETs

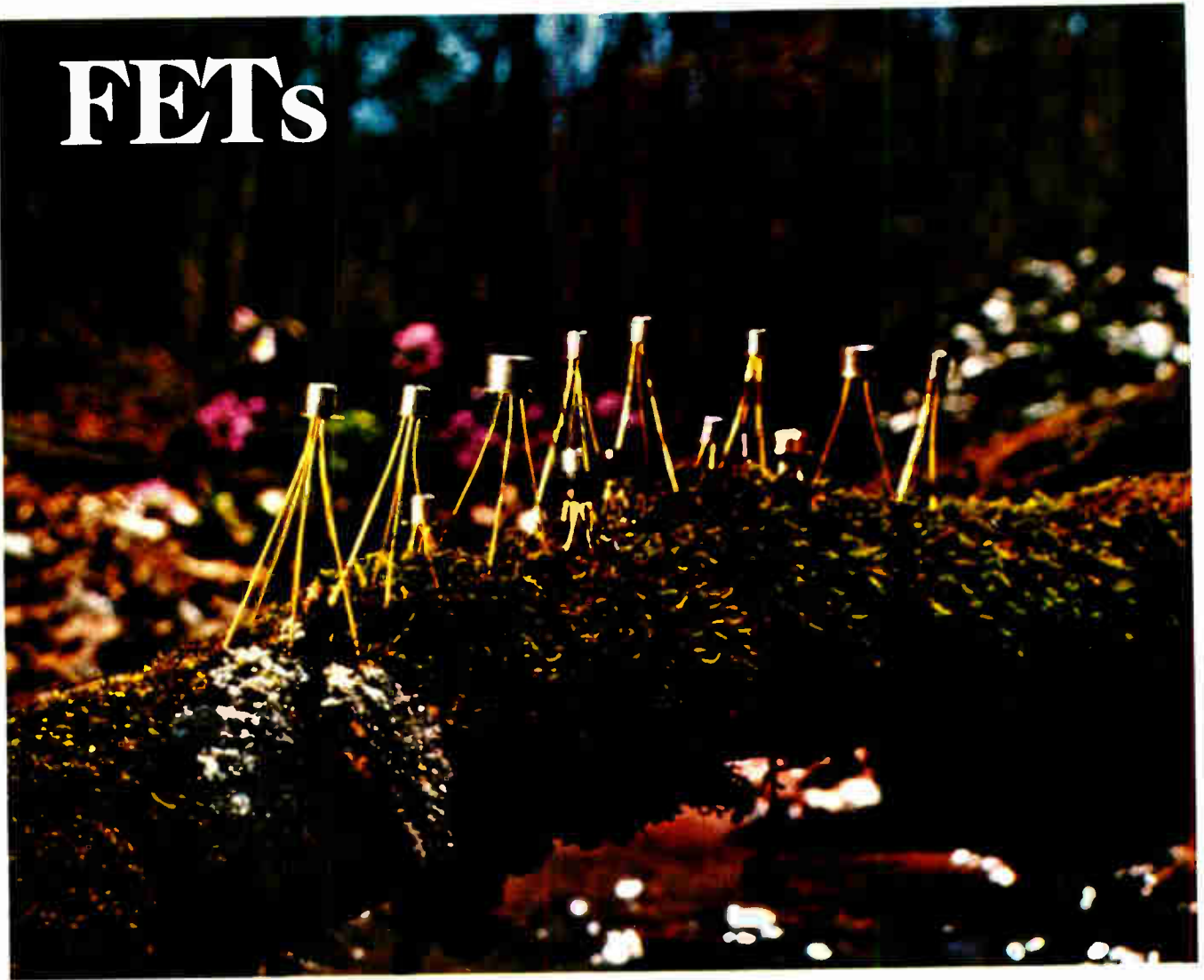

15 from the forest

From the forest of 977 FETs now available,* TI has selected 15 that satisfy 85% of all FET applications.

They're part of TI's line of 285 preferred semiconductors, selected after months of computer demand analysis to save you time and money in specifying discrete components.

TI's preferred 15 FETs are popular, proven and readily available from TI distributor and factory stocks.

Volume production of these devices allows TI to offer many of them at new low prices.



TI Preferred FETs			
Type	100-999 piece price**	Type	100-999 piece price**
T1S69	\$1.85	2N3822	\$1.80
T1S73	1.54	2N3823	1.65
T1S88	.62	2N3909	1.40
2N2386	1.80	2N3993	5.00
2N2498	2.45	2N4416	1.55
2N3330	2.50	2N4857	2.60
2N3619	.49	2N5045	8.40
2N3820	.63		

**Manufacturer's suggested price.

If one of the preferred 15 doesn't fit your specific circuit requirements, remember TI makes over 100 standard FETs in addition to many special ones.

Write for TI's new *Preferred*

Semiconductor and Components catalog: Texas Instruments Incorporated, PO Box 5012, MS308, Dallas, Texas 75222. Or just circle reader service card No. 518.



*1969 worldwide figure from D.A.T.A. Inc., publisher of *Electronic Data*.

TEXAS INSTRUMENTS
INCORPORATED

the portable standards lab



Well, not quite.

But the Biddle Model 72-3110 now makes it practical to bring secondary standards calibration to any instrument site and to achieve laboratory precision without requiring laboratory environment. It is more accurate and stable than any other portable potentiometer, and it will function accurately under conditions where others break down. To make this possible, Biddle updated two critical sections of the standard potentiometer—it replaced both the galvanometer and the Standard Cell.

Null Indicating Display. By using a solid state amplifier with a taut band meter, the 72-3110 has eliminated the inconvenience and difficulties of the galvanometer. The new system has ten times the resolution. The indication is legible, accurate and steady, no matter how the instrument is positioned. It is not affected by vibration and does not require constant resetting. In short, precise reading of the instrument is now a practical reality.

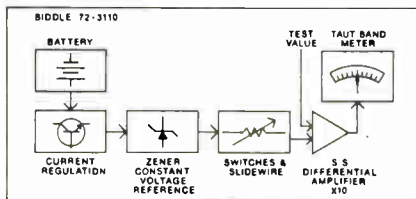

Solid State Voltage Reference. The use of the Zener Reference in place of the Standard Cell has resulted in increased accuracy, reliability and versatility. Among its advantages are:

Self Standardization. The Zener circuit maintains an extremely precise constant voltage level (within 0.001%) despite wide fluctuation in the battery output. This eliminates the repeated standardization of the reference voltage required by other instruments and assures accurate reading without continual checking. Moreover, there is virtually no warm up time. The use of an

18V battery source results in extremely long battery life—1½ years at 20 hours a week.

Stability. Besides circuit advantages, the 72-3110 has component advantages which give it greater stability in the face of electrical and environmental stress. It is quite possible, for instance, through excessive current drain, to change the value of the Standard Cell for extended periods of time. This can't happen with the Zener circuit. Moreover, the Standard Cell has a narrower thermal range, which is further limited by its glass casing. With the Zener circuit, the battery is the limiting factor. Finally, the Standard Cell is position sensitive. The 72-3110 will operate in any position.

Specifications.

Range: -11.1 to +111.1 mV. This covers the entire thermocouple emf range.

Error Limit: ± (0.03% of reading + 2 μV).

Regulation: Max. voltage change: 0.001%.

Temp. Coeff.: Less than 0.0003% per °C.

Long Term Stability: 0.01% per year.

Warm up Time: Less than 30 sec.

Measuring Dials: Two rotary switches provide 110 mV divisions, and a 14" slide wire with 220 calibrated divisions (0 to 1.1 mV).

Resolution: 1 microvolt.

Detector: Taut band meter with solid state amplifier.

Detector Sensitivity: 2 microvolts/div.

Of course, the Biddle 72-3110 is not a portable standards lab, but it is so far superior to anything else, what else would you call it?

JAMES G. BIDDLE CO.
Plymouth Meeting, Pa. 19462
(215) 646-9200



Yag laser shows power, versatility

Two krypton lamps pump unit to 200 watts c-w; applications include wafer dicing and resistor trimming

Until recently, commercially available yttrium aluminum garnet lasers were limited in continuous-wave power output to about 10 watts. In the last few months, however, Holobeam Inc. has introduced a yag unit which it claims can deliver 95 watts c-w. And hard on the heels of the Holobeam announcement comes a yag laser from the Korad department of Union Car-

hide Corp.'s Electronics division with a c-w output of 200 watts.

Walter Koechner, senior staff physicist, in discussing the K-Y5, stresses that Korad isn't in a power race. He's as interested in reliability and maintainability as power output. The two linear krypton lamps used as the pumping source have specified lifetimes of 100 hours, which, Koechner says, is

much higher than most comparable units. He says the lamp diameters match that of the laser rod; this means they don't have to be driven as hard as smaller-diameter pumping sources to get high power, and thus will last longer.

Koechner looks for the new device to be used in semiconductor processing to trim resistors and dice silicon wafers, noting that 80 to

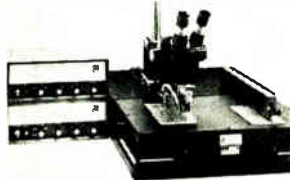

All lead flatpack soldering system features an X-Y table that allows fast precise positioning of the circuit board under the soldering head by use of a visible tooling templet. The table handles circuit boards up to 8 x 8 in. and positions within 0.001 in. accuracy. Price of the complete system is \$4,900. Development Associates Controls, 725 Reddick Ave., Santa Barbara, Calif. [421]

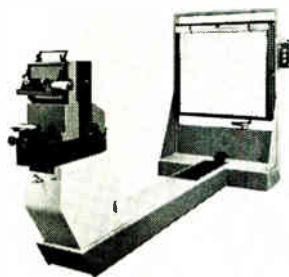

Dual ratio cameras series 1700 are for the production of high-resolution integrated circuit, printed circuit, reticle and chemical milling photomasks. Standard units are now available for the following reduction ratios: 5 to 1 and 10 to 1; 10 to 1 and 20 to 1; and 20 to 1 and 40 to 1. HLC Manufacturing Co., 700 Davisville Road, Willow Grove, Pa. 19090. [422]



Machines in the U1180 series use a new concept in rotary offset printing that makes it possible to mark many types of plastic and metal transistors and integrated circuits at rates of up to 16,000 per hour. Vibratory feeders are used that can introduce up to 500 components per minute into the printer's feed tracks. Markem Corp., 150 Congress St., Keene, N.H. 03431. [423]

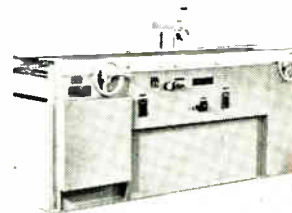

Wavesolder system 409 can process p-c boards as small as 2 x 1 in. and as large as 10 x 24 in. without pallets or board holders. It has a 10 in. Teflon coated foam fluxer, panel preheater with 3-position heat selector switch and an adjustable width conveyor. It is capable of production speeds from 1.5 to 10 ft per minute. Electrovert Inc., 86 Hartford Ave., Mt. Vernon, N.Y. [424]

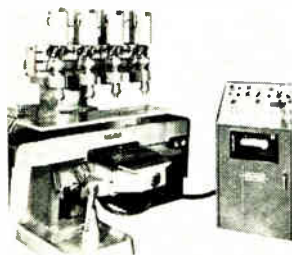

Numerically controlled multi-head machine model 83-600 is for circuit board work. It can be equipped with up to 6 heads which can operate either individually or in groups of 2 or 3. Its power quills have a speed range of 15,000 or 45,000 rpm. Drilling capacity ranges from 0.010 in. to 3/16 in. diameter holes. Moog Inc., Hydra-Point Division, P.O. Box 143, Buffalo, N.Y. [425]

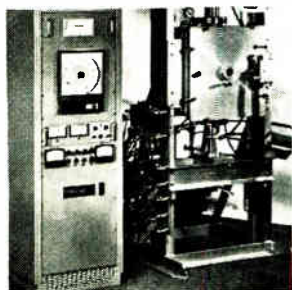

Hot press vacuum furnace model 1082-AP is for vacuum diffusion bonding and pressing powdered metal, ceramic and composite materials. The furnace, for operation to 3,000°F, is resistance heated. Forces of 25 tons can be applied to temperatures higher than 2,000°F. The unit will accept dies up to 7 1/2 in. diameter. Richard D. Brew & Co., 90 Airport Rd., Concord, N.H. 03301. [426]



Continuous vacuum system series SM can be used for small scale automated production of components and substrates requiring sputtering or deposition processing. The systems are capable of handling substrates up to 2 x 3 x 3 1/16 in. in size and up to two substrates per minute depending on required film thickness. High Vacuum Equipment Corp., Hingham, Mass. 02043. [427]

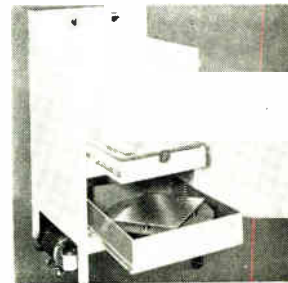

Printed circuit processing laboratory is assembled into a 24 x 36 in. mobile cart and will process one or two sided boards up to 11 x 14 in. It includes a whirler for obtaining uniform emulsion coating over the surface of the p-c board, an infrared drying oven, vacuum frame and ultraviolet exposure lights. Price is \$750. Cyclo-Tronics Inc., 3858 N. Cicero Ave., Chicago. [428]

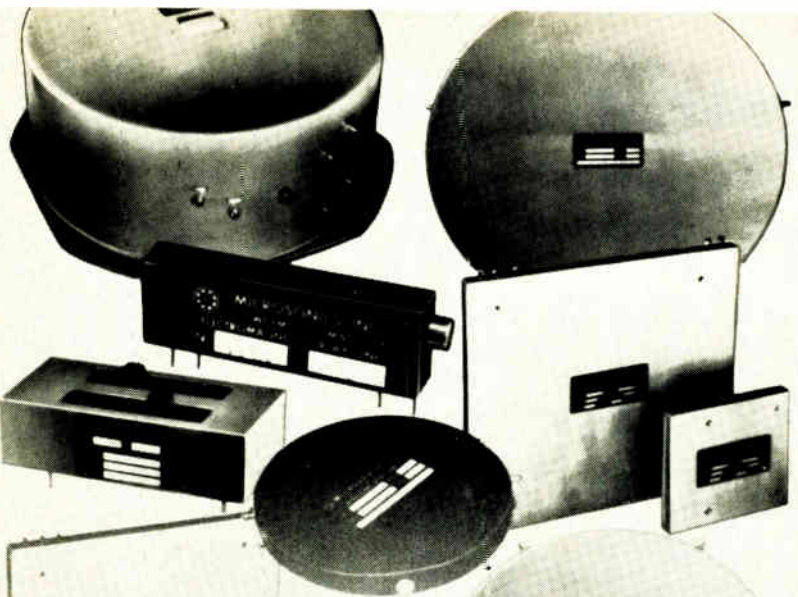

**LC & DC • DISPERSIVE • DIGITAL
MAGNETOSTRICTIVE • QUARTZ
GLASS • VARIABLE • TAPPED
LC & DC • DISPERSIVE • DIGITAL
MAGNETOSTRICTIVE • QUARTZ
GLASS • VARIABLE • TAPPED
LC & DC • DISPERSIVE • DIGITAL
MAGNETOSTRICTIVE • QUARTZ
GLASS • VARIABLE • TAPPED
LC & DC • DISPERSIVE • DIGITAL
MAGNETOSTRICTIVE • QUARTZ
GLASS • VARIABLE • TAPPED
LC & DC • DISPERSIVE • DIGITAL
MAGNETOSTRICTIVE • QUARTZ
GLASS • VARIABLE • TAPPED
LC & DC • DISPERSIVE • DIGITAL**

MICROSONICS

*for proven design, reliability &
performance in*

DELAY LINES

Serial Memories



Write for Bulletins today

MICROSONICS

60 Winter Street, Weymouth, Mass. 02188

Tel: 617 337-4200

A division of the Sangamo Electric Company

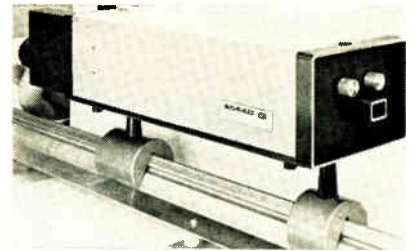

Power tool. Yag laser has the punch needed for cutting, trimming jobs.

100 watts of c-w power is required to cut the 2-mil-wide slot needed to separate silicon wafers into dice. But he doesn't expect semiconductor manufacturers to buy the K-Y5 for dicing alone. Its price is approximately \$35,000, which isn't competitive with diamond dicers that sell for between \$4,000 and \$8,000. Koechner believes a semiconductor manufacturer will use it for trimming as well.

In the latter application, the beam can be split using mirrors, allowing work to be done simultaneously at four to six trimming stations. Korad officials also anticipate military interest in the K-Y5, particularly for the target-illumination possibilities of its invisible 1.06-micron-wavelength beam. And with 200 watts c-w available, the laser could compete with carbon-dioxide devices in communications jobs.

Compact model. Cryogenic cooling is required to get sensitive detectors for CO₂ lasers, Koechner notes. But this isn't necessary for yag lasers like the K-Y5. The K-Y5's transmitter, or laser head, is 23 inches long; Korad officials say a 200-watt CO₂ laser for a communications application would have to be about 15 feet long.

But there are tradeoffs. The CO₂ unit would have an efficiency of 15% as against the yag laser's 2%. Moreover, the yag unit at \$35,000 costs about \$15,000 more than a comparable CO₂ system. But Korad officials say that if power density—focusing the beam on a small-size spot—is a consideration, yag is more attractive.

The K-Y5 achieves its 200-watt c-w output with external mirrors, rather than rod coating, for reflection. This reduces power somewhat, but allows Q-switching, frequency-doubling, and mode-locking—features unobtainable with coated-rod lasers. Q-switching affords the peak

powers needed in resistor trimming with minimum heating of adjacent surfaces.

Koechner explains that by frequency-doubling the Korad device's output to 5,300 angstroms, the unit functions in the green portion of the spectrum close to the region where many argon-ion lasers work. He foresees the K-Y5 replacing these systems in such jobs as underwater ranging since the Korad unit can be both frequency-doubled and Q-switched, boosting its pulsed-mode output to several kilowatts as against the several watts available from an argon-ion laser.

The device uses a refrigerated, closed-cycle cooling system. A 208- or 230-volt, three-phase, 60-hertz source is required. Korad is quoting 30 to 90 days for delivery.

Korad Department, Union Carbide Corp., 2520 Colorado Ave., Santa Monica, Calif. 90406 [429]

Production equipment

Coater speeds capacitor line

Machine can handle 4,000 ceramic blanks per hour and improve uniformity

Nearly all manufacturers of ceramic capacitors rely on hand-dipping, in which a production worker can coat 300 to 400 chips per hour with a silver compound.

A machine developed by the K. Dixon Corp. can dip 4,000 blanks per hour, provide a more uniform coating, and—because of vacuum-handling—eliminate the problem of chip breakage caused by mechanical tweezers.

The ceramic blanks are placed in bulk in a vibrator bowlfeeder which orients them for reception by a pair of opposed vacuum chucks for transfer onto the wheel chucks. A photocell steps the transfer mechanism as each wheel chuck arrives at the transfer station. The transfer chuck aligns the chip with the wheel and then both chucks are moved briefly in unison by a lever,

NOW...

Hamilton precision metals has added facilities...and is in the Photoformed® Parts business...



BIG!

Hamilton has added a new plant—just to produce precision, Photoformed® parts!

This new facility is equipped with the most modern photo-etching machinery on the market. The new equipment will produce precision parts in large quantities to the highest standard of dimensional accuracy.

Now, you can get from the Precision Metals Division, finished parts to the same degree of precision as world wide metal users have come to expect in Hamilton's strip and foil.

Hamilton offers the advantages of a completely integrated facility controlling every step from melt to finished strip or foil—and *now* to finished parts. This means that you get the same adherence to metallurgical standards and dimensional accuracy that has become the hallmark of Hamilton.

For the complete story on the capabilities of Precision Metals Division and what it can do for you, write for your copy of the Precision Metals catalog. It's yours for the asking—write today!

PRECISION METALS DIVISION
HAMILTON
WATCH COMPANY • LANCASTER, PA. 17604

COMPACT Hoyt METERS

**Designer's Choice
for size,
performance**

No. 685 Moving Coil pancake edge-wise meters, without barrel projection, may be mounted together for comparison reading applications. 30% larger dial area for better readability. Shielded high torque movement for all ranges 50 UA up to 750 volts. VU meters, and AC rectifier type voltmeters.

No. 2015 Custom 1½" Panel Meter. Hoyt proven high torque movements, quick response, fine damping. Linear design cases with optional color variations. No. 2015/B distinguishes panels with die cast metal bezel for mounting meter behind panel. Small, compact and unique in design. Available in all DC, VU and rectifier type movements.



No. 685 Meter
(without bezel)
2¼" x 7/8"

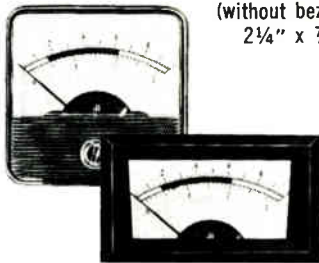

No. 2015, 1¾" square;
No. 2015/B (with bezel)



HOYT ELECTRICAL INSTRUMENT WORKS, INC.
BURTON-ROGERS COMPANY / Sales Division
46 Carleton St., Cambridge, Mass. 02142 (617) 491-7400

Circle 167 on reader service card

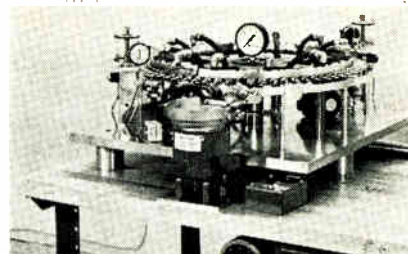

Coater. Machine controls vary both dip modes and rates.

and this actuates a solenoid vacuum switch, releasing the chip to the wheel chuck suction.

Each wheel chuck is mounted on a hollow shaft centered through a gear. At 180° intervals during rotation, the shaft is locked by a ball detent positioned to orient the chip vertically. Racks mounted near each of the machine's two dipping stations overturn the wheel chuck as the gear passes.

At each dipping station, the chip encounters a grooved wheel wetted with the metal compound in solution. The depth of the groove determines the depth of the dip for each piece. The proportionate rotation of the wheel and chip prevents an unwanted buildup of compound.

Each dipping station adjusts vertically by means of a vernier screw mechanism to accept various sizes of chips or grooves.

Strong pump. Pump housing and drain-and-return tubing for the dip station are Teflon, which assures resistance to any type of solvent which might be needed for the metal compound. The pumping system will drive fluids as viscous as toothpaste, Dixon says. Each station requires a minimum of 2 ounces of silver solution and will hold a maximum of 4 ounces. A removal screen acts as a filter in each reservoir to prevent clogging of the pump system.

In addition to the capacitor-dipping application, the company is looking toward addition of tinning stations around the wheel by adding a flow solder mechanism. Application of the machine to silvering of connector filters, crystals, and pellet resistors also appears possible, Dixon says.

Price of the standard model is about \$22,000. Delivery time is three months.

K. Dixon Corp., 18438 Topham Street, Tarzana, Calif. 91365 [430]

A new treatment of CIRCUIT DESIGN FOR INTEGRATED ELECTRONICS

By Hans R. Camenzind, *Signetics Corporation*

Written for the practicing electronic engineer with circuit design experience this book serves as a bridge to the field of integrated circuits. It provides an overview of integrated circuit processes, a detailed analysis of integrated components, and a thorough discussion of design techniques for both digital and linear integrated circuits. In addition, computer analysis and design of integrated circuits and measurement methods are presented.

"An excellent book filling a large gap in electronics teaching."

James Freeman, *University of Detroit*

"This book will be a useful reference and text. It incorporates both acceptable device design principles and circuit design techniques for integrated circuits."

J. S. Linder, *Texas A & M University*

"Written for senior or graduate-level, electronics engineering courses, this text, with excellent illustrations, has an outstanding organization of material."

Bob Koeper, *Design Dateline*

266 pp 277 illus. (1968) \$12.95

Write for TEN DAY exam

Addison-Wesley
PUBLISHING COMPANY, INC.

Reading, Massachusetts 01867



Make your own break.

You can take a lot of the chance out of your future by including yourself in the Electronics Manpower Register.

When you do, your experience and talents become part of a nationwide computerized placement service.

Our computer is programmed to give every registrant the same look for every opening. With your prior approval, you'll be considered for every opportunity that matches your resume.

All you have to do is send one to:

Electronics Manpower Register
Electronics
330 West 42nd Street
New York, N.Y. 10036

We'd like to send you a job in a plain brown envelope.

The name of our company is MITRE. And we design, develop and verify large, computer-based systems for the Government. Under both civil and defense contracts.

What you could work on covers a lot of territory. Military command and control, communications, medical information, education, urban planning, transportation, air traffic control.

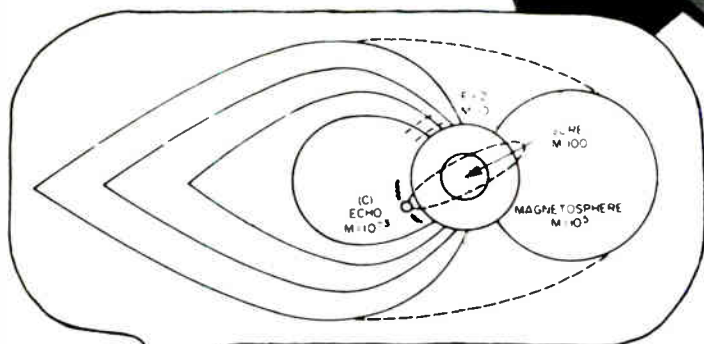

Obviously, we can't pack all the information about MITRE into a single ad. But we can pack what you need to know into a plain brown envelope.



THE
MITRE
CORPORATION
An Equal Opportunity Employer

in Bedford or Washington.

Address: Mr. Richard Seamans, The MITRE Corporation, 3904 Middlesex Turnpike, Bedford, Mass. 01730
In Washington: Mr. Robert Knotts, 1820BC Dolley Madison Boulevard, McLean, Virginia 22101

INTERVIEWS – S.J.C.C.

Call (617) 271-2484

to arrange a convenient appointment

MITRE HAS IMMEDIATE OPENINGS IN BEDFORD, MASS. AND WASHINGTON, D.C.

■ Systems Programming

A number of positions currently exist at our System 360 facilities in Bedford for both junior and senior systems programmers with an interest in multi-tasking operating systems (OS/360 MFT, MVT). Responsibilities will be in the areas of: system generation, data and task management, libraries, cataloging, language translators (especially PL/I) and accounting.

Experience with 360 Operating Systems, assembly language, system utilities, direct access devices and software and hardware configuration planning is desirable.

Our facilities include 360/40 and 360/50, and other computers, used in a variety of scientific and management applications.

■ National Military Command System

Scientists and engineers are needed in our Washington Operations for systems analysis and feasibility studies, communications system analysis, systems design, integration and design verification of the NMCS. This "capping system" contains all the facilities, equipment, doctrine, procedures, and communications needed by national command authorities to give them strategic direction of the armed forces. MITRE's main concern is with the technical design and integration aspects of the NMCS and the communications between NMCS and various other command systems, including the World-Wide Military Command and Control System — a group of systems operated by the unified and specified commands.

■ Communications Engineers

MITRE's responsibility in Bedford includes technical direction on such current communications systems as 490L Overseas Autovon, TACSATCOM, and Integrated Communication Navigation and Identification (CNI). There are also openings for communications engineers on 407L, Tactical Air Control System, and related tactical communications projects. Interest and background are desired in systems analysis; design, installation and checkout of communications networks; modulation and signal processing techniques; switching systems; voice and data transmission and satellite communications and associated airborne and ground terminal hardware.

MITRE's Washington Operations also has unusual new openings for systems engineers in: Weather Systems, Defense Communications Systems, and Information Systems. We are also conducting independent research in transportation systems, educational technology, medical data systems and urban planning.

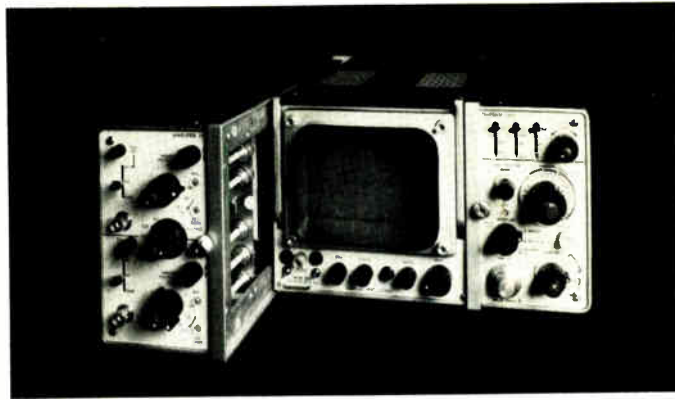

Here's the scope that makes the Jolly Giant green—Data Instruments Model 1700. For the engineer who looks at the trace instead of the nameplate, it has no equal. It's portable, and has a 5 inch rectangular PDA tube with a variety of plug-in amplifiers geared to the most current needs. The unit shown here is 50MHz, dual trace with chopper, alternating and summing modes, and a 10mv/cm sensitivity.

Now, it is true, that for a few hundred dollars more, you can get a midget version from the Jolly Giant. And if you focus on the nameplate, it's very readable. As far as the trace goes, the 1700 is 25% larger and consequently faster and more sensitive. Still, if you can calibrate your eyeballs you can read the midget almost as well.

Almost. But not quite. The 1700 has a much smaller spot and consequently a measurably cleaner trace. Besides all this, the 1700 is built to the requirements of critical military applications. It is ruggedized at no extra cost. And speaking of cost, the main frame is \$885. A series of time bases and vertical amplifiers ranging from \$142 to \$482 gives the unit wide applications including single shot function, TV monitoring, etc.

But why guess. Demonstrate it side by side with the midget trace, and decide which is better—a bigger trace or a bigger nameplate.

Data Instruments Div., 7300 Crescent Blvd., Pennsauken, N.J. 08110

50MHz, portable, plug-in
and you don't need calibrated eyeballs

\$1698

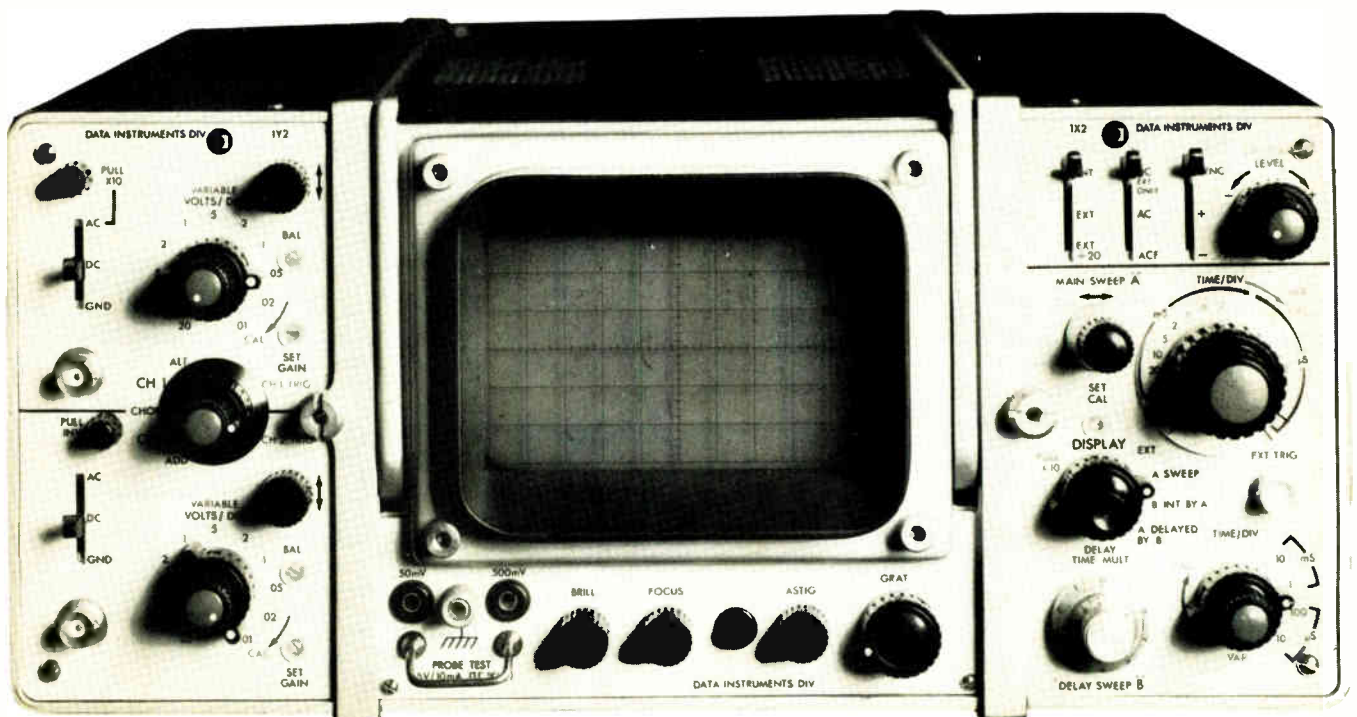

Another entrant in op-amp sweepstakes

Raytheon challenges Fairchild's 741 and National Semiconductor's 107 with a device offering typical gain of 50,000 at ± 3 to ± 20 volts

Raytheon Semiconductor got itself into the linear-integrated-circuit business a couple of years ago when its next-door neighbor, Fairchild Semiconductor, fell behind on deliveries of the 709 operational amplifier. Raytheon gleefully supplied Fairchild's customers, going on from there to offer what is probably the largest op-amp line in the business; it second-sources Fair-

child on the 709, the 709A, and the 741, and the National Semiconductor Corp. on the popular LM101, the LM 101A, and the LM107.

But with the exception of beam-lead IC's Raytheon has never been known as an innovator, at least until now. Drawing on a process derived from the beam-lead work, plus some fancy new circuit design, the company has developed

a new op amp that it expects to challenge the 107 and the 741 as the successor to the 709 [*Electronics*, Apr. 14, p. 33]. To be introduced next month as the RM4131, the circuit offers typical voltage gain of 50,000 at ± 3 volts to ± 20 —compared to gains of 10,000 at ± 5 volts to ± 20 volts for the 741 and the 107.

The designers at Raytheon expect

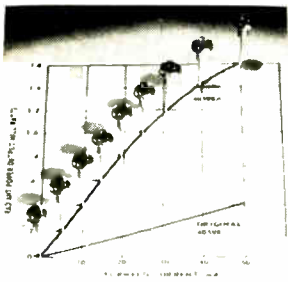

Gallium-arsenide IR emitting diode 40598A has triple the radiant power output of its prototype 40598. It emits 1 mw (minimum) radiant power output at an operating current of 50 ma and a wavelength of 9,300 angstroms. Applications include use in punched-card and tape readers, and high-speed counters. Price in 1,000 lots is \$7. RCA/Electronic Components, Harrison, N.J. [436]



High-voltage, 3-amp silicon rectifier stacks series HVS-3 are designed for industrial applications. They use avalanche rectifiers, which eliminate all RC components from the stack. Units are available in ratings from 9 kv to 30 kv. The individual rectifiers used will withstand reverse transients up to 3 kw. Transatron Electronic Corp., 168 Albion St., Wakefield, Mass. [440]



Pressfit silicon rectifier has a power capability of 35 amps. It employs a JEDEC DO-21 outline with a glass-to-metal hermetic seal and a terminal medial or pull rating of 10 lbs. Maximum d-c blocking voltage and maximum recurrent prvs are 50, 100, 200, and 300. Maximum rms voltage is 35, 70, 140, and 210 v. Wagner Electric Corp., 1 Summer Ave., Newark, N.J. [437]

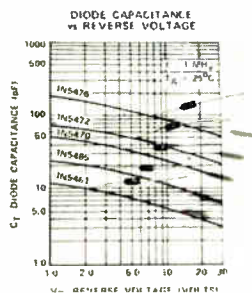

High Q, premium tuning diodes series 1N5461A, B, C through 1N5476A, B, C provide frequency control (either remote or programmed) of uhf circuits. They operate over a 30-v range and are available with a nominal capacitance tolerance of 2%. Nominal capacitance range runs from 6.8 to 100 pf in 16 devices. Motorola Semiconductor Products Inc., P.O. Box 20924, Phoenix [441]



Uni-Tunnel diodes series U1001 through U1010 are silicon backward diodes that exhibit high reverse conductance at milliwatt levels. When biased in the forward direction, these diodes operate with leakage tunneling current of microampere magnitude. Units are furnished in the DO-17 package. Price is \$4.75 in quantity. Centralab, 4501 N. Arden Drive, El Monte, Calif. 91734. [438]

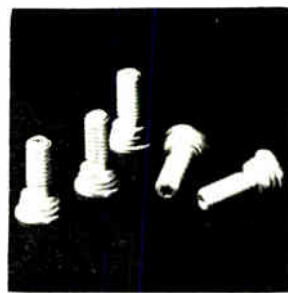

Snap varactor diode MA4-B300 provides a minimum output of 8 w at 2 Ghz in a X5 multiplier circuit. Input power of 30 w is required to drive the unit. In low and high order multiplier circuits minimum breakdown voltage is 100 v, with capacitance units of 6-8 pf. Maximum thermal resistance is 7° C/w. Microwave Associates (West) Inc., 999 E. Arques Ave., Sunnyvale, Calif. [442]

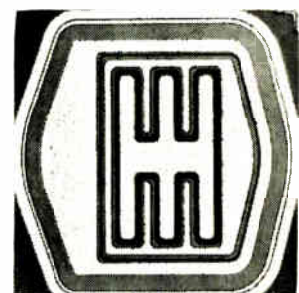

Three video output transistors give crisper picture display and facilitate circuit design. The SE7055 is a 220 v unit with a low collector base capacitance of 3 pf; the SE7056, a 300 v unit with a 3.5 pf capacitance; and the SE7057, a 450 v unit with a 2.5 pf capacitance. Prices (1-99) range from \$1.65 to \$15 each. Fairchild Semiconductor, 313 Fairchild Dr., Mtn. View, Calif. [439]



Silicon planar passivated, thyristor switches series GA200 feature rise time of 10 nsec to 1 amp or 20 nsec to 30 amps. Recovery time is as fast as 0.5 μsec. Voltage capability is up to 2,000 v with no significant decrease in speed when series stringing circuits are used. Surge current capability is up to 50 amps. Solid State Products, 1 Pingree St., Salem, Mass. [443]

Never use less than the safest High-Voltage leads

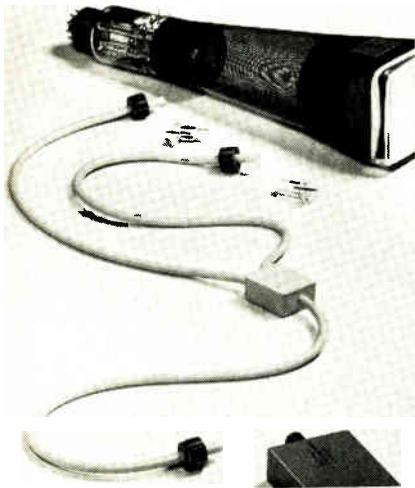

For example: a quick connect/disconnect 20 KVDC connector feeding two CRT tubes from a single terminal 20 feet away. It's a compact lead assembly with glass and epoxy receptacles and silicone insulated leads that can be mated safely by hand, yet it's rated 25 KVDC at 70,000 feet!

- Lightweight, flexible assembly
- Meets applicable MIL specifications
- RFI shielding available
- Rated at 10 amps
- No exposed high-voltage
- Corona and radiation resistant
- Foolproof assembly

Let us design an assembly that meets or exceeds your requirements. We're the leading maker of high-voltage, high-altitude custom lead assemblies. Whatever your connection problem, write or call today.

Capitron Division
 Elizabethtown, Pa. 17022
 717-367-1105 TWX: 510-657-4561

AMP

INCORPORATED

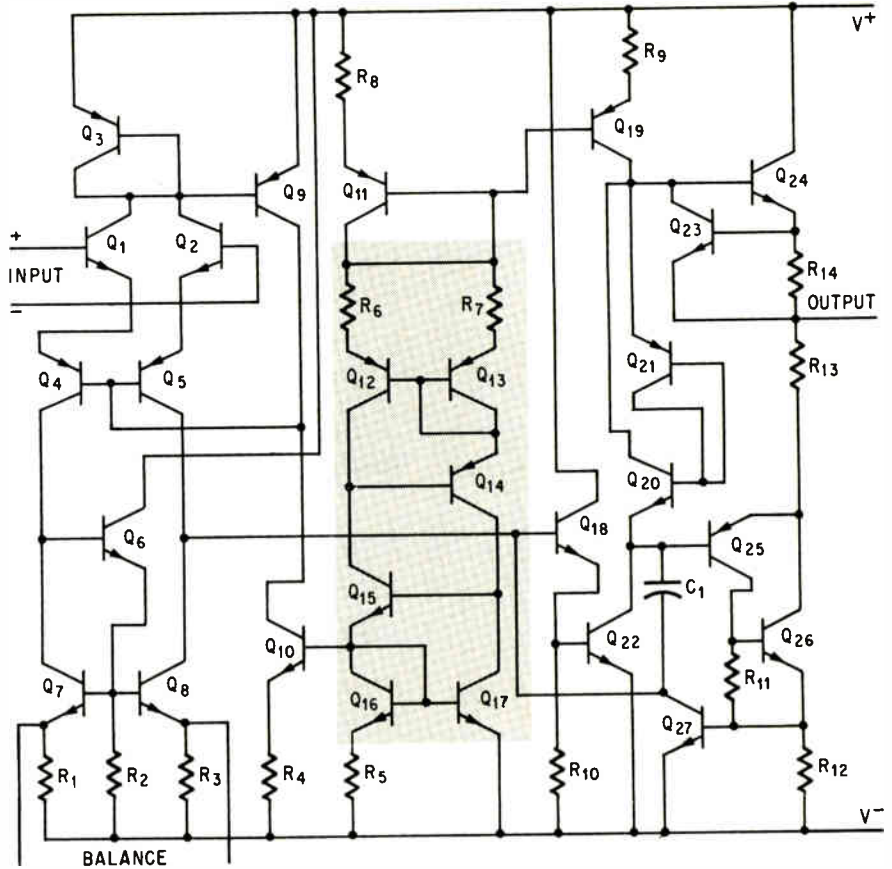

Steadfast. Shaded portion of op-amp schematic defines the current regulator that stabilizes gain, bandwidth, and slew rate.

the circuit to be welcomed for low-voltage applications where large power supplies are not available, medical electronics being an example. But it will also make the circuit price-competitive with the 101 and 741 and offer it in a variety of metal, ceramic, and plastic packages in order to fight it out all along the line. Further, Raytheon says that the 4131 is only the first in a series of proprietary op amps.

Just to keep its hand in as a second source, the company has also introduced a dual monolithic 741—something that Fairchild has promised but not yet produced.

Like its rivals, the 4131 is fully compensated, a factor that some designers feel limits the versatility of an op amp. But its open-loop bandwidth of 4 megahertz is five times that of its rivals, so that Raytheon can claim greater flexibility in frequency response.

The increased gain of the 4131 is partly a result of silicon nitride passivation—a technique that is rapidly becoming a panacea for semiconductor manufacturers. David A. Maxwell, manager of the advanced development department,

says that Raytheon found that the passivation techniques developed for beam-leaded IC dice drove transistor betas through the ceiling, even at low currents.

Semiconductor manufacturers have for some time exploited the fact that the phosphorus used in emitter diffusion tends to deposit a layer of phosphor glass that attracts sodium ions from the oxide layer. Charges in the oxide can otherwise cause leakage currents that increase transistor base currents and thus decrease beta (the ratio of collector current to base current).

Raytheon is essentially carrying the process of removing these ions one more step: it removes the phosphor glass and then passivates with a layer of silicon nitride, in which sodium is virtually immobile, 1,500 angstroms thick. The process improves the long-term stability of the device, Maxwell says. Raytheon has conducted tests in which sodium is smeared across the surface of a nitrated wafer and then baked for a week at 600°C. When the nitride is removed, a little at a time, no sodium can be found beyond 100 Å. By contrast, sodium pene-

trates oxides to 10,000 Å, or deeper, within days.

"We've found this technique essential to getting gain at low currents," Maxwell says. The 4131 has betas of 250 to 300 from one microampere through one milliamp; it is surpassed at the high end by the 107, which zooms to 1,500 or more at a milliamp, but Maxwell claims that the 4131 is superior at the low end.

Flat. To stabilize gain, bandwidth, and slew rate, designer Harry Gill, a senior engineer in linear circuit design, developed a new type of current regulator that produces a nearly flat 225 microamps from 2 volts to 45 volts, at which point the npn transistors begin breaking down.

The circuit is a modification of one that has been in use for a couple of years; it is shown by the shaded area in the diagram. Transistor Q_{13} is actually four pnp transistors in parallel; each transistor tends to contribute as much current as is being forced on the other leg of the regulator. This difference in current causes a difference in voltage between transistors Q_{16} and Q_{17} of 18 millivolts per octave of current. Since the current ratio is 4:1, the base-emitter voltage of Q_{16} is 36 millivolts, which is taken up by the output resistor R_0 .

Gill's addition was the transistors Q_{14} and Q_{15} , which multiply the output impedance of the current source by the transistor gain, thus flattening the current curve. Gill says that without the added transistors, current changes typically from 130 microamps at 2 volts to 290 microamps at 50 volts; with the transistors, the curve goes from 224 microamps at 2 volts to 260 microamps at 50 volts. The circuit is limited at the low end by the four junctions between input and output, which tend to turn off at low voltages.

Raytheon went to smaller geometries, with only 0.15-mil clearance from the edge of the contact to the edge of the diffusion, to fabricate faster pnp's. It also switched from square to round design to eliminate irregularities in emitter diffusion that resulted in injections that weren't uniform.

Raytheon Semiconductor Operation,
350 Ellis St., Mountain View, Calif.
[444]

When your 50 V filter fails better get a



**USCC
100 V RFI
filter**

and be safe!

Better System Protection

100 V at 85°C

50 V at 125°C

Increased Reliability

operating life eight times as great

Greater Transient Protection

up to 200 V

No Increase in Size

same case as the 50 V filter

In a packaging breakthrough, USCC has designed a 100 V RFI/EMI filter into a size previously available only for filters up to 50 V. This makes it the smallest 100 V RFI filter around.

The hermetically sealed, non-polar units are for operation in the 10 kHz to 10 GHz frequency range. Using feedthrough construction in bulkhead mounted configurations, the 2100 Series demonstrates superior RFI/EMI shielding. They also meet the applicable requirements of MIL-F-15733.

A unique internal construction, incorporating mechanical assembly techniques as well as soldered connections, provides improved reliability.

For complete technical information, write or call: U.S. Capacitor Corporation, 2151 N. Lincoln Street, Burbank, California 91504 Telephone: (213) 843-4222. TWX: 910-498-2222.

USCC

from the leader in assembly equipment



Advanced bonding equipment for every semiconductor assembly requirement.



MODEL 1350 ULTRASONIC WIRE BONDER

- Handles hybrids and LSI IC's up to 3" across
- Stitch bonds continuously at multiple levels
- Bonds wire with automatic feed and cut-off



MODEL 2000 FLIP CHIP BONDER

- Totally automatic bond cycle
- Adaptable to automatic die attach
- Two step leveling force

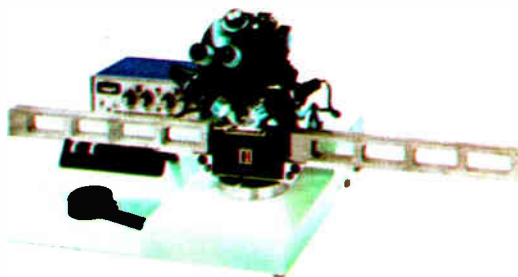

MODEL 1370 RACK FEED ULTRASONIC BONDER

- Hi-speed transistor bonding
- Production bonding of 14 lead IC's
- Bonds up to .020" wire for power device production



MODEL 2100 UNIVERSAL ASSEMBLY MACHINE

- Automatically bonds beam lead devices
- Thermocompression flip chip and die bonding
- Reflow solders flip chips or die with heated substage

Other Hugle Industries' products: Horizontal Epitaxial Reactors • Vertical Barrel Reactors
• Epitaxial and Diffusion Doping Systems • IR Microscopes • PCD Process Controllers

First in service to semiconductor manufacturers



HUGLE Industries

750 North Pastoria Avenue

Sunnyvale, California 94086

(408) 738-1700

400-nsec ROM sells for 3.5 cents per bit

Braided-wire unit has cycle time of 1 μ sec; drive circuit redesigned, glass-encapsulated diodes used instead of transistors to trim cost

While many firms strive for faster memories, Memory Technology Inc. is quite happy to have made a slower one. The company already sells braided wire read-only memories with cycle times of 300 and 500 nanoseconds. However, some applications don't need responses this fast. So it has broadened its product line to include slower-response and lower-cost units.

The result is the S (for slow) series. Access time of S-series memories is about 400 nanoseconds and cycle time is about 1 microsecond. Price is lower as well. An S-series memory sells for 30% to 50% less than a fast 300-nsec-cycle memory, and is about 20% less than the middle-speed 500-nsec-cycle model. In lots of 100, S-series data storage costs about three-and-one-half

cents for each bit.

MTI's marketing men point out that potential users now have a broader range of price-performance ratios to pick from. It thus should be easier to pick a unit that is right in terms of speed and cost for a given application. To users with machines that must fit a variety of applications, like industrial and process controllers, all three braids



Compact crt computer terminal model 2212 is for processing short messages between non-typist operators and computers. It has an integral 6-in. crt for data display, block alpha and block numeric key clusters, and a cluster of 24 editing and programable function keys. Screen can display up to 444 characters on 12 lines. Bunker-Ramo Corp., 445 Fairfield Ave., Stamford, Conn. [361]

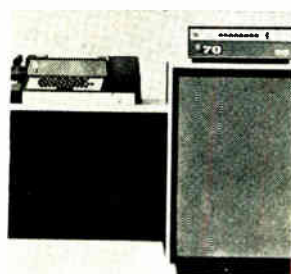

Compact Midi-Computer RC-70 is for OEM and systems requirements. It is an 860-nsec, 16-bit computer featuring an 8K memory (plug-in expandable to 32 K), memory parity, memory protect, bidirectional index register, high-speed multiply and divide, direct memory access, and priority interrupt. Delivery takes 2 weeks. Redcor Corp., 7800 Deering Ave., Canoga Park, Calif. 91304. [362]

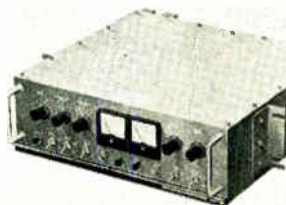

Solid state predetection combiner PDC-2T is designed to be used with telemetry receivers for data acquisition and monitoring and will provide optimum predetection combining for signals of any bandwidth up to 4 Mhz. It provides true maximal ratio combining of signals without regard to modulation type or index down to a 0 db output S/N ratio. Raytheon Co., Norwood, Mass. [363]

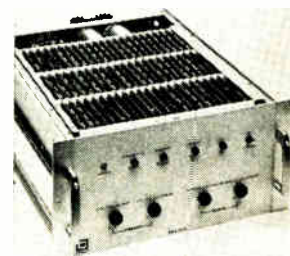

Data modem AE-96 can quadruple the capacity of a 2,400 bps voice grade line to 9,600 bps. This is achieved by a digital adaptive equalizer that allows the model to automatically measure and compensate for the intersymbol interferences caused by circuit amplitude and delay distortion. Initial circuit equalization takes 3.5 seconds. Codex Corp., Watertown, Mass. [364]



Compact digital logging instrument model DL-1210 Digilogger is designed to accept virtually any analog signal from 1 to 30 check points and provide numerical print-out. Basic unit consists of a 50-channel scanner, an automatic 12-column paper roll and ink printer, plus the necessary solid state electronics for conversion. Entex Inc., P.O. Box 770, Friendswood, Texas 77546. [365]



Low noise discriminator 6203 is for carrier systems transmitting up to 8 channels of data over Class A voice links. It provides long-term stability of $\pm 0.05\%$ and low temperature drift of $0.005\%/^{\circ}\text{C}$. It also features linearity of 0.25% and low power drain, requiring less than 0.5 w, or ± 20 v, 10 ma, per channel to operate. Develco Inc., 2433 Leghorn St., Mtn. View, Calif. [366]

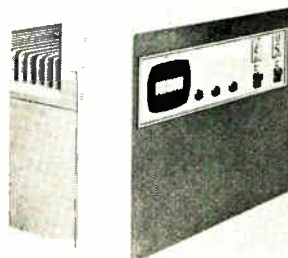

Compact positioning head drum system CPHD features a storage capacity of 900,000 eight-bit characters accessible in an average time of 60 msec. An important aspect in the design is that eight write/read heads are mounted on one head pad, resulting in compactness and economy to the end user. Bryant Computer Products, 850 Ladd Road, Walled Lake, Mich. 48088 [367]

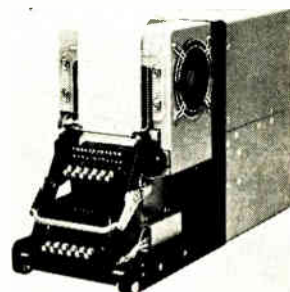

High-speed printer HSP3608 is especially designed for aerospace applications. The 19-lb unit is capable of operating in a zero G hard vacuum environment for prolonged durations. It provides 24 columns of printout with 48 characters (ASCII code) and speeds of 10 to 40 characters per second, serially. Potter Instrument Co., East Bethpage Road, Plainview, N.Y. 11803. [368]

New plastics for electronics

Fiberfil Carbasar, fiberglass reinforced polycarbonate, and Nylasar, reinforced nylon are part of a new generation of thermoplastics for electronics applications. They combine the best features of both long and short glass fiber reinforced materials.

These J-series thermoplastics incorporate both long and short fibers to deliver extra strength, stiffness,

heat resistance, uniformity and needed dielectrics.

They make ideal materials for coil forms, connectors, insulators, isolators, switch parts, housings, mountings and countless other electrical-electronic applications. Get the facts on these new materials. Ask your Fiberfil Representative or write Fiberfil Div., Rexall Chemical Co., Evansville, Ind. 47717.

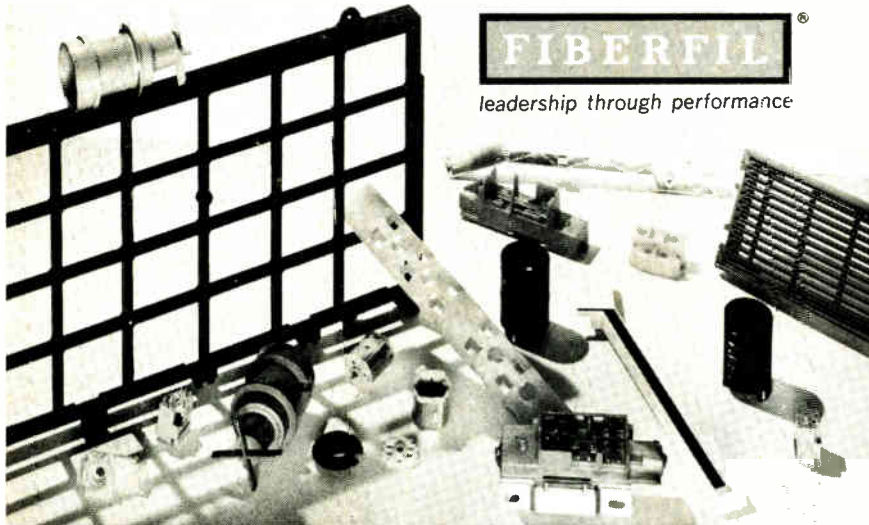

FIBERFIL
leadership through performance

Circle 170 on reader service card

double take!



MICRODYNE'S NEW IC TESTER TAKES SIMULTANEOUS D.C. and FUNCTIONAL MEASUREMENTS

Want to production test digital IC's faster and more accurately? Automatic Model 721 makes 1024 sequential D.C. and functional measurements in less than 100 μ s. Tests 5000 IC's a shift, with accuracy of 1.5%! Readout with go/no-go lamps and 3-digit volt/current meter for out of tolerance value. Program matrix card. Use coupon for more data.

MICRODYNE
SUBSIDIARY OF COMPUTEST CORP.
MICRODYNE INSTRUMENTS, INC.
203 Middlesex Tpk. • Burlington, Mass. 01803
Phone: 617/272-5691

MICRODYNE

Please send me Model 721 Bulletin.

NAME _____

TITLE _____

COMPANY _____

ADDRESS _____

CITY _____ STATE/ZIP _____

Dept. EL-28

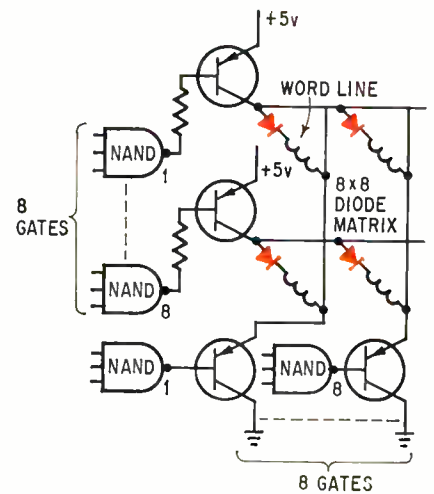

Less costly. The memory circuit uses diodes instead of transistors.

are available. Since they are completely interchangeable, a customer can speed up or slow down his system to suit his needs.

To bring cost down, MTT redesigned the drive circuit of its braid. Rather than using transistor drivers, it switched to less costly glass-encapsulated diodes.

Word wire. Instead of using a transistor to pulse each word line, a NAND-gate actuates a transistor which then turns on a group of diodes simultaneously. Each diode is series-connected to a word wire in the woven braid. When actuated, a word wire induces a current pulse in the transformer sense windings that correspond to stored data at the memory's output.

The proper multibit parallel code at the NAND gate's input selects the desired word lines, and thus governs the data read out of storage. Sensing in the new braid is unchanged from former models [*Electronics*, Sept. 18, 1967, p. 121].

A slight increase in parasitic capacitance between the word lines is responsible for the speed reduction. Rather than terminating all word lines at a common point as in the faster braids, word wires are terminated in groups of 8, 16, or 32 words depending on the application. Thus capacitive charges between word wires increases cycle time.

Depending on characteristics and quantity, S-series braids cost from \$300 to \$1,300. Delivery takes one month.

Memory Technology Inc., 223 Crescent St., Waltham, Mass. 02178 [369]

24 hours after we hear from you, you'll hear from us.

Name _____

Address _____

City _____ State _____ Zip _____

College _____

Degree _____ Year _____

I am interested in the following type of assignment:

I have had professional experience in the following area(s):

I have had a total of ____ years' experience.

AIRMAIL COUPON NOW TO:

Mr. Robert A. Martin
Head of Employment, Dept. 94
Hughes Aerospace Divisions,
11940 W. Jefferson Blvd.,
Culver City, California 90230

Join the team that designed the SURVEYOR

Opportunities for:

Electro-Optical Engineers
Aeronautical System Engineers
High-Frequency Design Engineers
Space Systems Engineers
Guidance and Control Engineers
Missile Systems Engineers
Component Engineers and
many other disciplines.

Current projects include:

PHOENIX, TOW, MAVERICK,
AIM-47A/AIM-4D Missile
Systems • Commercial and
Military COMMUNICATIONS
SATELLITES • APPLICATIONS
TECHNOLOGY SATELLITES •
and dozens of other important
programs and projects.

HUGHES

HUGHES AIRCRAFT COMPANY
AEROSPACE DIVISIONS

*An equal-opportunity employer
(U.S. citizenship required)*

TEST TWO
MILLION
DIODES... (IN 24 hrs.)

GET A 98%
PACKAGE
YIELD!

It happens every day with the 2130 multiplexed diode test system. By wafer screening with a Burns & Towne System, only operating diodes are packaged. Results are lower package cost . . . tighter price controls . . . greater testing economy.

This new Burns & Towne System makes 6 dc tests per die and screens over 80,000 per hour.

Testing programs can be changed in seconds merely by dialing in any test parameters at the system console. The system will stay on-line longer due to replaceable plug-in modules. With tolerances like 1 mv per volt and test increments of 1-nanoamp combined with an electrical stability of 1%, the way to go is Burns & Towne modular test and classifier systems for semiconductors.

Call or write for full specifications and price data.



BURNS & TOWNE INC.
SYSTEMS DIVISION 18-36 Granite St.
Haverhill, Mass. 01830. Tel (617) 373-1333

New Books

Lights conversation

Laser Communication Systems

William K. Pratt

John Wiley & Sons Inc., 271 pp.,

\$14.95

Taking a rigorous but easy-to-understand approach to the mathematical side of the subject, this book covers optical communications from the electrical engineer's viewpoint. Well-written and appropriately illustrated it isn't overloaded with long derivations—only those equations are given that demonstrate a point. The author, now a professor at the University of Southern California, worked at the Hughes Aircraft Co. during the early sixties, when much of its basic laser communications work was done.

After going through all the basic elements—modulation and demodu-

lation, optical components, detectors, propagation, noise, and receivers—he comes to his most valuable chapter, one on optimum system design. He sets up the problem as one of choosing, on the basis of minimum system cost, the operating frequency, the laser transmitter power, the aperture diameters, and the receiver field of view. The focus is on pulse and digital systems, but the results could be extended to analog systems.

The author derives a set of partial differential equations relating the parameters and cost of the system; then, with a simultaneous solution, he comes up with expressions for optimum values in terms of the optimum system cost. The resulting system parameters give the highest possible information rate and communication range for an arbitrary signal-to-noise value.

Recently published

Principles of Electricity, Leigh Page and Norman Ilsley Adams Jr., D. Van Nostrand Co., Fourth Edition, 532 pp., \$9.75

An undergraduate text on basic electrical theory, this book covers everything from Coulomb's law to transmission lines and filters. It also covers vector analysis and makes liberal use of partial differential equations.

Studies in Feedback-Shift-Register Synthesis of Sequential Machines, Robert L. Martin, The MIT Press, 195 pp., \$12.00

An expanded version of a doctoral thesis at MIT, this book provides insight into some of the properties of sequential machines using a feedback shift register as the basic block. Three main areas are the equivalent state problem, diagnosis of sequential machines, and related circuit forms. The memory-span test and the pair-graph are presented in detail. The book is aimed at graduate students and engineers.

Statistical Communication Theory and Applications, Harold R. Raemer, Prentice-Hall, Inc., 482 pp., \$12.95

This book is intended for practicing engineers using statistical communication theory in radar and radio communications. It has a systems engineering flavor, stressing the use of approximations and intuitive approaches. It also dwells on radar propagation and antennas.

Introduction to Modern Physics, Second Edition, C. H. Blanchard, C. R. Burnett, R. G. Stoner, R. L. Weber, Prentice-Hall, Inc., 498 pp., \$9.95

In this second edition sections have been added on satellite motion, lasers, and solid state electronics, but the book remains an introduction to the subject for engineering students. Topics covered include quantum mechanics, relativity, the neutron and nuclear forces, radioactivity, and high-energy physics.

Fluidic Components and Equipment 1968-69, edited by G. W. A. Dummer and J. MacKenzie Robertson, Pergamon Press, 831 pp., \$32.00

A collection of manufacturers' data and application notes on fluidic systems. It also includes a glossary of fluidic terms.

Antennas in Inhomogeneous Media, Janis Galejs, Pergamon Press, 294 pp., \$18

The first part of this book contains general material on antenna theory, and the remainder is intended for graduate students working on antenna problems. The book differs from most antenna texts, which emphasize the classical free-space environment, in that it presents methods of analyzing dielectric loading, buried antennas, and antennas in a re-entry environment or the ionosphere. The chapter on magnetoionic media is particularly applicable to space experiments and design of antenna probes.

Oceanic Patents 1959-1968, Evelyn Sinha, Ocean Engineering Information Service, 90 pp., \$15.00

A bibliography of patents, classified according to subject. Electronics patents are covered in sections on sonar, power sources, radar and radio, telemetry, and radioactivity.

Ham Radio Incentive Licensing Guide, Bert Simon, Tab Books, 160 pp., \$6.95

A guide to the qualifications for each amateur-radio license class. Four chapters give questions and answers for novice, technician/conditional/general class, advanced, and extra class. A listing of locations and times of examinations are included.

Introductory Topological Analysis of Electrical Networks, Shu-Park Chan, Holt, Rinehart and Winston, Inc., 482 pp., \$15.95

An advanced undergraduate-level text, this book covers the matrix approach, and the interrelationships of loop equations, node equations and state equations. Topological analysis is applied to active networks and switching networks in addition to passive two-ports.

No other 100W silicon power transistor in the industry can match this performance point

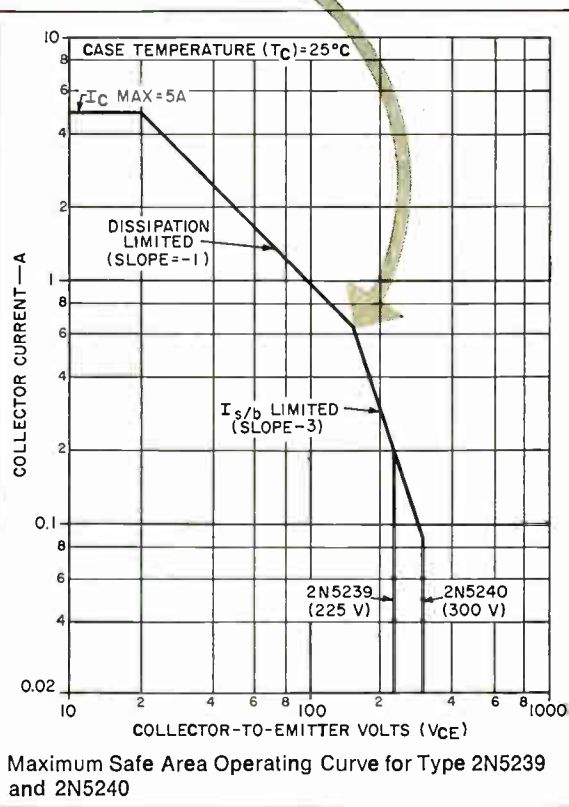
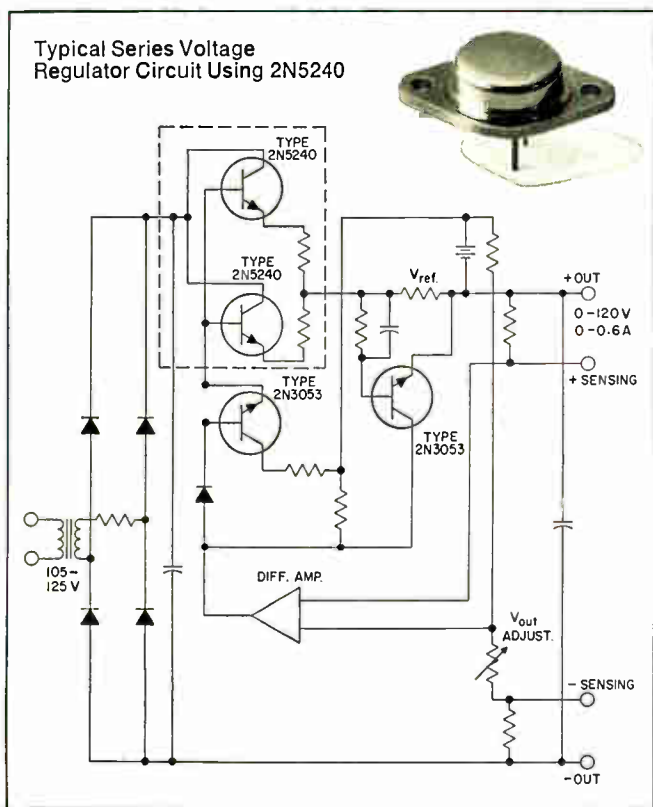

Now, full second breakdown protection up to 100 W dissipation and 150 volts, plus safe area rated up to 300 volts! That's a brand new level of power performance and reliability for high-voltage silicon transistors.

We made this capability possible by creating a unique pellet construction technique—multiple diffusion combined with the multiple emitter concept made famous by RCA "overlay." To you, this means better performing, more reliable circuits for high-voltage regulators, series regulators, high-speed inverters for off-the-line operation, switching bridge amplifiers for servo motor controls, and ultrasonic power amplifiers.

Depending on your circuit requirements, you can choose between the 2N5240 with a V_{ce} (sus) of 350 volts or the 2N5239 with a 250 volt rating. Both transistors have an I_c (max.) of 5A and P_t of 100 W.

For more information consult your RCA Representative or your RCA Distributor. For technical data, write: RCA Electronic Components, Commercial Engineering, Section IN4-4, Harrison, N. J. 07029.



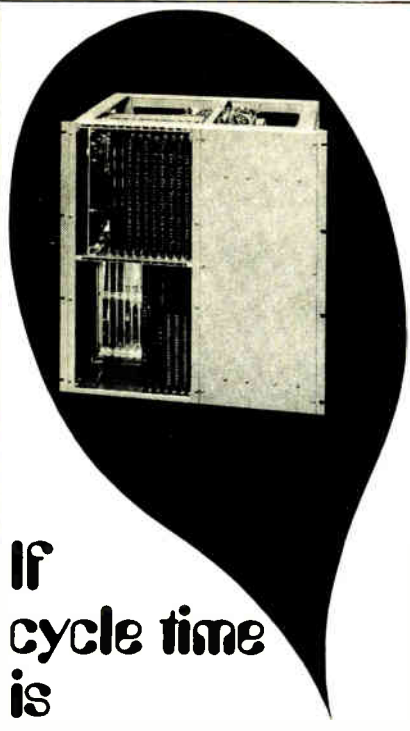

If cycle time is the name of your computer game, read the good news:

Toko Woven Plated-Wire Memory System HS-500 is now available.

Toko's woven plated-wire memory planes and stacks are already well known for their low-cost, high-performance characteristics. Now to be marketed for the first time is Toko's complete memory system, with a capacity of 4096 words by 16 bits expandable to 8192 words and 20 bits. Cycle time is a remarkable 500 ns. Other characteristics are 2D organization, destructive read-out operation, and TTL logic level interface. Cost of the system is remarkably low, and fast delivery can be guaranteed.

Besides this standard woven plated-wire memory system, Toko can undertake the manufacture of custom-made systems according to your specifications. Complete technical details from our New York office.



Head Office: 1-17, 2-chome, Higashi-Yukigaya, Ohta-ku, Tokyo, Japan

TOKO N.Y., INC.
350 Fifth Avenue, New York, New York 10001

Technical Abstracts

Trading off

Semiconductor memories—device aspects

Gordon E. Moore
Intel Corp., Mountain View, Calif.

Do semiconductor integrated circuits really pick up where magnetic memories leave off? Their advocates say they do; but the older forms manage to hang on to their share of the market.

Magnetic elements' big advantage is that they can retain their magnetic state in the absence of an external source of power. But to read information from magnetic elements requires a relatively large disturbance and produces a relatively small signal, often mired in noise. These characteristics require special interfacing circuits to be placed between the element and the rest of the system.

No such interfacing problem exists for semiconductor memories, because the storage elements are essentially identical to the peripheral circuits. But the storage is in terms of current flow, which must be maintained at the expenditure of power, or in terms of charge storage on a capacitor, which requires frequent refreshing.

Semiconductors clearly have the edge over magnetic memories in small sizes, where the interfacing cost of the latter is prohibitive. And semiconductors are capable of much higher speeds than magnetic memories, if for no other limitation than the propagation time through the interfacing circuits. Semiconductor memories are also proving to be of value as small, high-speed buffers that supplement large magnetic units and radically improve the latter's performance. There are many other possibilities.

Some of these are not economically realizable today because of a large cost differential favoring magnetic memories. Advocates of semiconductor memories maintain that this cost differential will eventually disappear.

Present trends in semiconductor technology support the prediction that magnetic memories will lose their cost advantage. Already a one-bit storage element less than 10

square mils has been fabricated, suggesting that state-of-the-art chips 100 mils square can hold as many as 1,000 bits. Such memories, in the form of dynamic MOS shift registers, resemble mechanically rotating devices, except for two major advantages: the shift registers' maximum access time for a particular bit is less than a hundredth that of the disk or drum, and a simple counter can keep track of a data block's starting point as it "rotates", so that access time for the entire block becomes essentially zero.

MOS circuits also offer the best promise for random-access memories, as opposed to the shift-register type. These devices are relatively slow, but their speed can be improved by combining MOS and bipolar circuits. This combination has the speed of a fast core memory at the cost of a slow one. For higher speeds, pure bipolar arrays using TTL or ECL circuits are necessary; these designs, having no competition in their speed range, have an assured future.

The exact design of semiconductor memories, and the time that they appear, depend on such factors as maintainability and developing a consistent design through a wide range of sizes and speeds. But their eventual appearance as an important form of information storage is almost inevitable.

Presented at the 1969 IEEE International Convention, New York, Mar. 24-27.

Computer-aided testing

Man-machine test-pattern generator
Robert G. Carpenter and
Lawrence K. Lange
IBM Components Division
Hopewell Junction, N.Y.

Computers are being used not only to facilitate design but to simplify circuit testing after the design is completed. Two programs have been developed to aid in the testing of integrated circuits. One defines logic equations for tests of specific areas on a chip, while the other allows the operator to draw logic diagrams on a cathode-ray

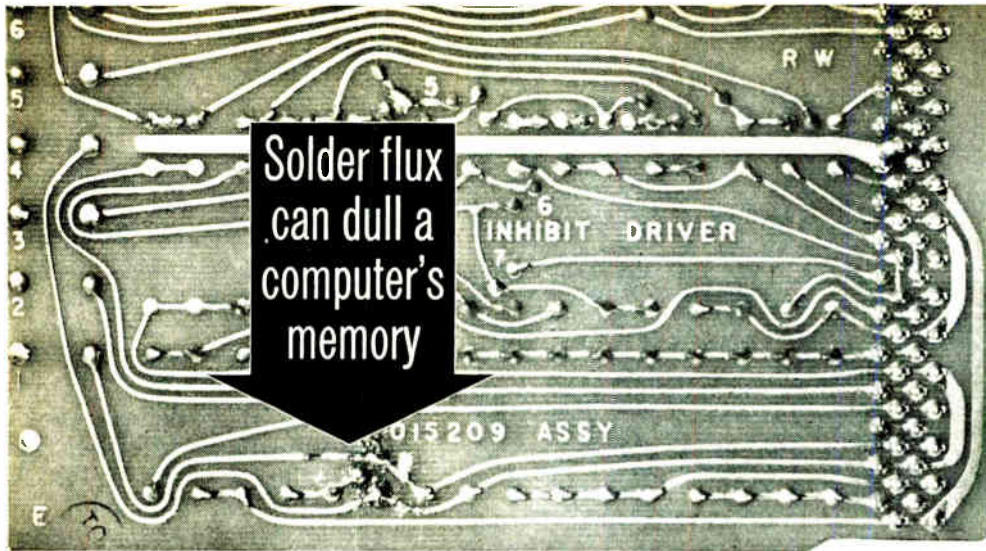

Clean up all circuitry with MS-190

Whether you build computers or transistor radios, you can improve their MTBF with MS-190 Flux Remover. MS-190 delivers a wet spray of non-flammable, non-toxic solvent which flushes away all solder residue and dirt in seconds. Also available in a heavy-duty formulation, MS-190HD, in case you have some novice solderers.

Try both MS-190 and MS-190HD—FREE. Write (on company letterhead, please) for a sample pack of two 16-oz. cans.

miller-stephenson chemical co.,inc.

Route 7/Danbury, Conn. 06813



Circle 171 on reader service card

80 MHZ WIDEBAND RF POWER AMPLIFIER

MODEL RF-805



- 10 Watts Output into 50 Ω
- 0.1 Volts In — 22.5 Volts Out
- .05 MHz to 80 MHz Broadband
- Low Distortion
- Solid State
- Flat 47 db Gain

The RF-805 is a solid state amplifier, broadband from .05 to 80 megahertz, which produces ten watts with -30 db harmonic and intermodulation distortion. Lower distortion is available at lower output levels. Gain is 47 db minimum, constant within 1 db, so that full output is developed with less than 0.1 volt at the 50 ohm input. Accurate output metering and overload protection is provided.

The RF-805 will raise the power of most manual and swept tuned signal generators and thus extend the usefulness and versatility of available signal generators. Receiver testing, wattmeter calibration, antenna testing, RFI testing, attenuator measurements, and filter and component testing will be aided with the use of this equipment.



R F COMMUNICATIONS, INC.
1680 University Avenue • Rochester, N. Y. 14610

Circle 172 on reader service card

When Only Excellent is Adequate TURN to Grayhill

for EXCELLENCE IN
MINIATURE ... SUB-MINIATURE ...
ULTRA-MINIATURE
ELECTRONIC COMPONENTS

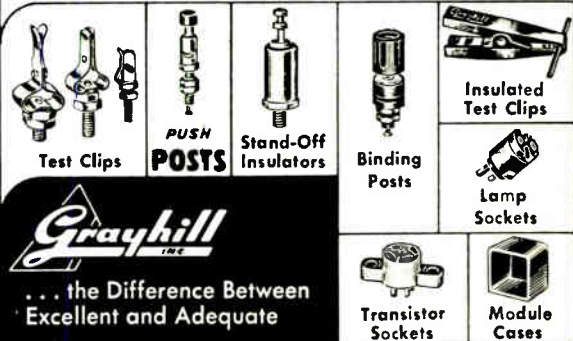

Grayhill Components are only fabricated from select materials ... in designs long proven to fully satisfy applications demanding long life and high reliability under extreme environmental and operating conditions. Here is Excellence, competitively priced.

Ask for Catalog G-304-A for full details



523 Hillgrove Avenue
LaGrange, Illinois 60525
Area Code 312, Phone 354-1040



Circle 149 on reader service card

149

When you've got a load to move,

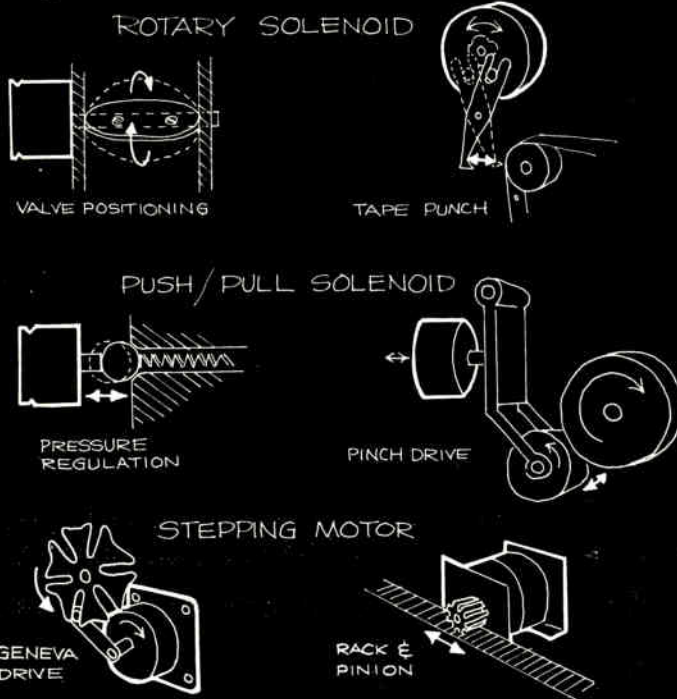

or circuits to switch . . .

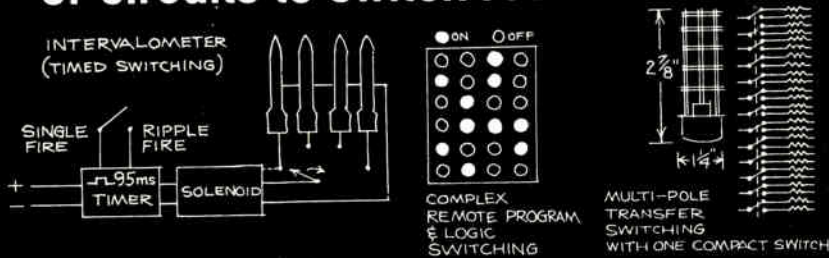

Ledex has the people and the products to make things happen.

Ledex Rotary Solenoids give you fast, direct rotary motion. There's a family of eight sizes with torque all the way up to 117 pound inches. For linear loads, our **Push/Pull Solenoids** respond in less than 10 ms. Both have a compact form factor and there are over 350 stock models to get your prototype off the board and into the shop fast.

Ledex Stepping Motors position loads remotely in predetermined increments over 360°, cw, ccw, or both. You can add a knob for manual positioning. Attach a load on either or both ends. And our newest model gives you 160 ounce-inches running torque.

You'll find versatile **Ledex Switches** everywhere . . . in missile nose cones, laboratory instruments, business machines, even automatic bingo games. They take up very little space to control, transfer, program and check out complex circuits.

For a neat **Packaged Control Solution** to your most complex switch problems, we'll deliver the answer in a small black box, ready to plug in. Chances are, the Ledex combination of people and products have solved an actuating or switching problem much like yours already. Just send us an outline of your problem.



LEDEX DIVISION, LEDEX INC.
123 Webster Street, Dayton, Ohio 45402 Phone: 513-224-9891



Rotary Solenoid

Circle 500



Push/Pull Solenoid

Circle 501



Stepping Motor

Circle 502



Stepping Switch

Circle 503



Packaged Control Solution

Circle 504

Technical Abstracts

screen, activate inputs, and compute outputs.

In the first method, logic equations are punched on cards and read into a memory array; the operator sets any input variable to a desired binary value. The computer then solves the equations, performing all operations until it comes up with a final binary value representing the output for the given set of circuit inputs.

In the second program, a table read into the memory lists the logic computing blocks and their interconnections. The computer then determines the logic level of each block in relation to the output—and thus where each block will be initially displayed on the crt. This display, a 10-by-10-dot array, can show 100 interconnected circuits.

There's great flexibility within this setup. Using a light pen, a tester can interchange circuits, transfer a circuit to an empty space, display combinational or sequential logic, and read data from a disk.

Presented at the IEEE International Convention and Exhibition, New York, March 24-27.

Under the hood

Thick film circuit automotive voltage regulator
R.W. Nolan and A.W. Winkley
Joseph Lucas Ltd.
Birmingham, England

Another change is in store for the voltage regulator in automobiles. Just as "electronic" regulators, made with discrete components, replaced electromechanical ones in the early sixties, so also may thick-film regulators supplant the "electronic" ones.

Because the thick-film regulator has less components and needs only one encapsulation its price is lower than the price of the "electronic" regulator. And the thick-film approach also reduces the size and weight, and boosts the reliability of the regulator.

Besides, the thick-film regulator doesn't need a large heat sink. And the regulating voltage can be set precisely since the resistors in the thick-film circuit can be adjusted.

Presented at the 1969 IEEE International Convention, New York, March 24-27



Perfect your CCTV system with **COSMICAR[®]** lenses

Shown are a few selected at random from COSMICAR lenses ranging from 8.5mm to 1,000mm and zooms.

COSMICAR is also prepared to custom-make lenses of any specifications.

Please write today to:



COSMICAR OPTICAL CO., LTD.

(Former name: ICHIZUKA OPTICAL CO., LTD.)

568, Shimoochiai, 2-chome, Shinjuku-ku, Tokyo Cable Address: "MOVIEKINO TOKYO"

Circle 173 on reader service card



Every year, **ELECTRONICS** attracts requests for over 125,000 editorial reprints.

They're like interest payments on our million-dollars-a-year editorial principles.

That's how much we spend annually to produce timely, authentic, and useful articles like those listed on the reader service card as reprints currently available.

Investment and interest make both **ELECTRONICS** and its readers more meaningful to its advertisers.

New, true dual-beam oscilloscope.



And only \$995*

True dual-beam, portable oscilloscope features line or battery operation. Choice of 15 or 30 MHz bandwidth plug-in Y-amplifiers (23 and 12 nsec rise times).** Solid state unit provides differential input, internal voltage calibrator, and both signal and time delay.

For complete data, write for Bulletin TIC 331BA to Motorola Communications & Electronics Inc., 4501 W. Augusta Blvd., Chicago, Ill. 60651.

*Exclusive of options. **15 MHz amplifier, \$395; 30 MHz amplifier, \$595.



MOTOROLA
Precision Instrument Products



Solid-state music

charms your ears?

Now,

Let's move to

Hybrid IC.



Sanken's
Hybrid Audio Power
Amplifiers are
25w and 50w

No external component required. You just put them and forget about protection and temperature.

- ★ Distortion is 0.5% at full power level.
- ★ Frequency range 20Hz to 100KHz at 1W output, 20Hz to 30KHz at full power.
- ★ Withstands output short circuit for more than 5sec.
- ★ Vcc:48V, Zin:70KΩ, Zout:0.2Ω

SANKEN ELECTRIC CO., LTD.
1-22-8 Nishi-Ikebukuro, Toshima-ku
TOKYO, JAPAN.
TLX: 0272-2323

New Literature

Inductances. James Millen Mfg. Co., 150 Exchange St., Malden 48, Mass. A bulletin on special and standard inductances covers a wide line of inductors, coils, r-f chokes, coil forms, etc. Circle 446 on reader service card

Ferrite devices. Microwave Associates Inc., Burlington, Mass. Twelve-page catalog SF-1005 outlines a complete selection of coaxial and waveguide ferrite devices for airborne, shipboard, and ground-based radar and communication systems. [447]

Operational amplifiers. Analog Devices Inc., 221 Fifth St., Cambridge, Mass. 02142. A 32-page handbook combines application information and comprehensive specifications for some 100 operational amplifiers and function modules, and introduces 14 new units. [448]

Spectrum analyzers. Signal Analysis Industries Corp., 12 DiTomas Court, Copiague, N.Y. 11726, has released a brochure on the series 20 real-time spectrum analyzers. [449]

EMI absorptive filters. Lundy Electronics & Systems Inc., Glen Head, N.Y. 11545, has published a catalog describing Lossy Line EMI absorptive filters for transmission lines, powerline and screen rooms. [450]

Acceleration transducers. Humphrey Inc., 2805 Canon St., San Diego, Calif. 92106, has released a brochure featuring five specific units of its complete line of acceleration transducers for aerospace and oceanographic applications. [451]

Radio navigation system. Northrop Corp., 9744 Wilshire Blvd., Beverly Hills, Calif. 90212, has issued a condensed report designed to explain significance of the worldwide Omega low-frequency radio navigation system. [452]

Materials processing lasers. Union Carbide Corp., Korad Dept., 2520 Colorado Ave., Santa Monica, Calif. 90406, offers a four-page brochure on its materials processing lasers—welder-drillers, resistor trimmers and dynamic balancers. [453]

Pressure transducers. Genisco Technology Corp., 1533 26th St., Santa Monica, Calif. 90404. The series 1300 absolute and gage pressure transducers are described in a data sheet. [454]

Electron beam equipment. Brad Thompson Industries Inc., P.O. Box CCCC, Indio, Calif. 92201. A catalog that includes several data sheets on positioners and manipulators for use in vacuum chambers and glove boxes

also shows electron guns and electron beam power packages. [455]

Time-count controls. E.W. Bliss Co., 217 Second St. N.W., Canton, Ohio 44702, has available a 16-page catalog describing industrial and commercial time-count controls. [456]

Miniature coaxial cable. Phelps Dodge Electronic Products Corp., 60 Dodge Ave., North Haven, Conn. 06473, has published an eight-page catalog covering miniature coaxial cables and connectors. [457]

Standard filters. Optics Technology Inc., 901 California Ave., Palo Alto, Calif. 94304. An eight-page catalog carries complete information on monopass narrowband filters, laser line very narrowband filters, neutral density filters, long shortwave pass filters, and laser beamsplitters and attenuators. [458]

Synchronous motors. Westinghouse Electric Corp., P.O. Box 868, Pittsburgh 15230. Component construction features of synchronous motors for constant speed applications at all commercial frequencies and voltages are described and illustrated in brochure DB3411-3. [459]

Electromagnetic compatibility. Chomerics Inc., 85 Mystic St., Arlington, Mass. 02174, offers a 14-page brochure entitled "An Application Guide For Electromagnetic Compatibility." [460]

Industrial switches. Consolidated Controls Corp., 15 Durant Ave., Bethel, Conn. 06801, offers a catalog on a complete line of adjustable pressure, temperature, and level-control switches for industrial applications. [461]

Television camera. Ampex Corp., 2201 Lunt Ave., Elk Grove Village, Ill. 60007, has published a brochure containing a description and specifications of the CC-330 television camera for use with a Plumbicon pickup tube in educational, governmental and industrial applications. [462]

Slide switches. Chicago Switch Inc., 2035 Wabansia Ave., Chicago 60647. Two subminiature slide switches are illustrated and technically described in a two-page data sheet. [463]

Hand winders. Geo. Stevens Mfg. Co., 6001 N. Keystone Ave., Chicago 60646, has released a two-page catalog on four heavy-duty machines that hand wind distribution transformers. [464]

Scan converter tube. Warnecke Electron Tubes Inc., 175 W. Oakton St., Des Plaines, Ill. 60018. A six-page catalog covers the RW-13EM dual-gun, sub-miniature scan converter tube. [465]

In electronics it's Electronics magazine to sell used equipment!

Your advertisement will produce Results in Electronics. Engineers turn to Electronics magazine for the latest technical developments — and for the latest buying information. You can reach them inexpensively in Electronics Searchlight Section.

For information:
Searchlight Section
Classified Advertising Dept.
Post Office Box 12
New York 10036



EMPLOYMENT OPPORTUNITIES

ADDRESS BOX NO. REPLIES TO: Box No. Classified Adv. Dept. of this publication. Send to office nearest you.
NEW YORK, N. Y. 10036: P. O. Box 12
CHICAGO, Ill. 60611: 645 N. Michigan Ave.
SAN FRANCISCO, Cal. 94111: 255 California St.

POSITION VACANT

Graduate electrical engineer with approximately five years' experience in industrial process and systems control. Excellent opportunity with medium-sized company in metals fabrication field—Detroit location. P-7747, Electronics.

EMPLOYMENT SERVICES

Florida/Nationwide EEs, MEs, IEs . . . Electronic, Aerospace, Industrial, Sales & Mfg. \$9-18,000. Tech Div Brodeur Personnel Service, Inc., 3947 Blvd., Center Drive, Jacksonville, Fla. 32207

CLASSIFIED ADVERTISING



SEARCHLIGHT SECTION

BUSINESS OPPORTUNITIES
USED OR SURPLUS EQUIPMENT

RADAR SYSTEMS GROUND AND AIRBORNE. AUTOMATIC TRACKING ANTENNA SYSTEMS. NIKE AJAX. NIKE HERCULES. M-33. MSQ-1A. MPS-19. MPS-9. SCR 584. TPS-1D. TPS-2B. FAA-ASR-2. AIRBORNE SYSTEMS. APN-84. APN-102. APS-20. APS-27. APS-45. DPN-19. DIGITAL COMPUTERS. IBM 650. IBM 704.

LARGEST INVENTORY OF RADAR AND MICROWAVE EQUIPMENT IN THE WORLD.
RADIO RESEARCH INSTRUMENT CO.
45 WEST 45TH ST. N. Y. 10036 212-JU 6-1691

CIRCLE 968 ON READER SERVICE CARD

SURPLUS IBM EQUIPMENT

FREE catalog of powers supplies, light & switch panels, semiconductors, test equipment, IC's, optics, etc.

GADGETEERS SURPLUS ELECTRONICS, Inc.
5300 Vine St. Cincinnati, Ohio 45217

CIRCLE 969 ON READER SERVICE CARD

free catalog

POTTING APPLICATORS
MANUAL AND DISPOSABLE

6cc 12cc 30cc
FOR POTTING, ENCAPSULATING, AND SEALING OF MINIATURE COMPONENTS

PHILIP FISHMAN COMPANY
7 CAMERON ST., WELLESLEY 81, MASSACHUSETTS

CIRCLE 970 ON READER SERVICE CARD

IF THERE IS

Anything you want

that other readers of this paper can supply

OR—

Something you don't want

that other readers can use, advertise it in the

SEARCHLIGHT SECTION

VIDEO DESIGN ENGINEERS

International Video Corporation has an immediate requirement for electrical circuit design engineers with experience in video signal and/or servo mechanisms design to work on advanced helical scan color video tape recorders.

These positions offer unique opportunities to apply new and creative engineering approaches to commercial video equipment design. IVC design engineers are able to see the results of their ideas quickly and receive recognition for their contributions and efforts.

To investigate these positions and learn about IVC's accomplishments, growth and future, please write or call in confidence to:

Lynn Dwigans
Technical Staffing



INTERNATIONAL VIDEO CORPORATION

675 Almanor Avenue
Sunnyvale, California 94086
(408) 738-3900 Ext. 264

CIRCLE 966 ON READER SERVICE CARD



ENGINEERS

Interstate Electronics, Anaheim, California has immediate requirements for these challenging opportunities:

ASW SYSTEMS

- Big Signal Processing
- Underwater Acoustics
- Fast Fourier Transform Techniques

WEAPON SYSTEMS INSTRUMENTATION

- Logic Designers
- Digital Analog Systems
- Scientific Computer Programmers

SPECIAL COMMUNICATIONS

Positions require BS or MS in electronic engineering or math with 2 or more years related experience. Call or send resume to:

KIETH BLUNT
(714) 772-2811 (Ext. 1521)
707 E. VERMONT AVE.
ANAHEIM, CALIF. 92803

INTERSTATE ELECTRONICS CORPORATION

Subsidiary of "AUTOMATIC"
Sprinkler Corporation of America

An equal opportunity employer M/F

CIRCLE 967 ON READER SERVICE CARD

For high speed harnessing
with continuous lacing...

HERE IS THE WORK SPEEDING - MONEY SAVING -

GUDEBROD SYSTEM "C"

GUDEBROD FLAT TAPE BOBBINS—This special packaging of Gudebrod Flat Braided Lacing Tape is highly popular in the harness shop. Whether used in all hand tying or with the Cable-Lacer (for which it was designed) the bobbin makes conveniently available, high quality Gudebrod Tape in most of its many types—all engineered to lie flat, tie tight.

GUDEBROD CABLE-LACER®—This unique harnessing hand tool has proved a production speeder and harness improver. Makes up to 30 knots per minute. While making firmer harnesses with tighter, more uniform knots, it eliminates wear and tear on operator's hands because special brake takes strain of knot setting. Holds bobbin of Gudebrod Tape in handle.

LONGER WIRE HOLDING PINS—They make wire threading much easier, quicker (no repeated wire redressing between pins). In harness tying they preserve the layout while using the Gudebrod Cable-Lacer. Special case hardened pins, nail better, stay straight, no nailheads.

GUDEBROD SWIVEL-TILT HARNESS BOARD MOUNT—Two dimensional balanced mobility puts every section of the cabling within easy, natural reach of the operator. Work done in this unstrained manner goes faster, is better, all day through.

There it is, the Gudebrod System "C" solving the cable making problems in a speedy, economical, profit improving way. Ask about System "C" (If you use intermittent tying, ask about Gudebrod System "S").



Gudebrod's
Special, Longer
Case Hardened Pins

© T.M.—UNION SPECIAL
MACHINE CO.

GUDEBROD
Electronics Division

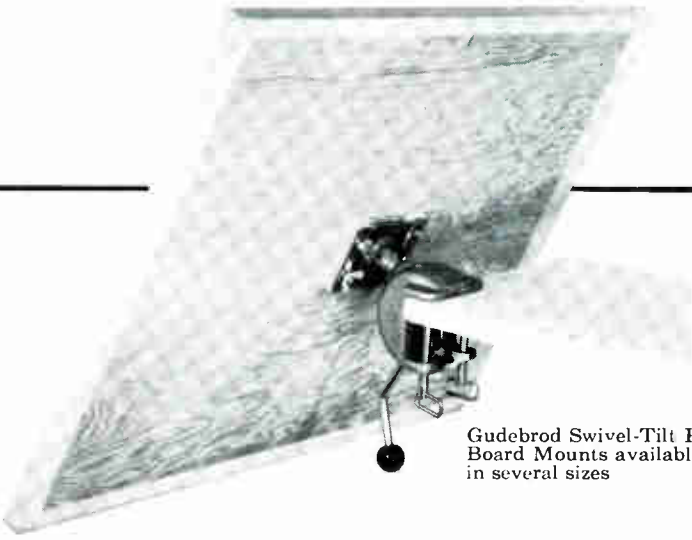

Gudebrod Swivel-Tilt Harness
Board Mounts available
in several sizes

GUDEBROD BROS. SILK CO., INC. Founded 1870, 12 South 12th Street, Philadelphia, Pa. 19107

International Newsletter

April 28, 1969

Ferrite rods work as vhf antennas

Ferrite rods may replace the telescoping antennas now used on f-m radio sets. Philips Research Laboratories at Aachen, West Germany, has worked out a process for sintering nickel-zinc-ferrite materials that have a permeability of 25 to 30 and a loss factor of about 1% at vhf frequencies. Other ferrites work satisfactorily as antennas only in the low- and medium-frequency bands.

Philips' has built experimental f-m antennas with rods 1 inch in diameter and 7 inches long. Paired with a transistorized tuner, they cover the 86-to-108-megahertz f-m broadcast band. The only possible obstacle to putting these rods into consumer radio sets is the cost of the new ferrite. Philips researchers say that, so far at least, it's rather high.

Plessey bipolar IC can switch 2 amps

An integrated circuit that does a job ordinarily considered work for a silicon controlled rectifier is in the offing from The Plessey Co.

The IC switches 2 amps into an inductive load on a 12-volt to 18-volt supply. The current pulse lasts 200 milliseconds and it triggers a solenoid that ejects the cassette in an automobile tape player soon to be marketed by Garrard Engineering Ltd., a Plessey subsidiary.

The main switching element on the 40-mil by 50-mil chip is a transistor with 15 emitters, each with its own series resistor. In addition to developing the solenoid-unlatching pulse, the IC stabilizes the player motor speed against battery-voltage changes by regulating the motor's back emf.

Plessey will make 300,000 of these IC's for Garrard.

France's hard line kills software deal

Rebuffed by the de Gaulle government, Leasco Data Processing Equipment Corp. has dropped its bid to buy a 20% interest in the Metra Group, France's biggest software and management consulting firm.

Although the government didn't get to hand down its verdict, official sources say a "non" was in the offing. Leasco apparently refused to guarantee that it wouldn't add to its holdings once it got a foot in the door.

Even with the guarantee, Leasco very likely would have been turned down. The government's computer agency, which is implementing the "Plan Calcul" that was set up to give France a native computer industry, is hypersensitive about possible U.S. domination of the fledging French software industry.

ELDO members make ends meet

The European Launcher Development Organization (ELDO) has weathered its latest budget crisis.

France, West Germany, Belgium, and the Netherlands have agreed to pick up the \$27 million additional assessment that Britain and Italy—ELDO's other members—have refused to contribute to the launcher agency's 1969 and 1970 monies. The exact split of the \$27 million among the four countries has yet to be set, but ELDO's best-heeled member, West Germany, is expected to take the largest share.

Britain, which thinks Europe should rely on U.S. launchers rather than spend money developing its own, intends to channel its ELDO savings to European satellite programs, particularly the television-relay satellite that the European Space Research Organization (ESRO) wants to build for Eurovision, the association of West European broadcast

International Newsletter

networks. France, though, may try to finance its heavier ELDO burden by getting its ESRO payments stretched out.

With funds now available to carry on development of its current Europa rockets, ELDO will start a design study for Europa 3. It would be able to heft into orbit a 1,100-pound payload.

Britain to test software control of pcm system

British telephone-system officials plan to start field trials next month of software-controlled pulse-code-modulation switching equipment. The test will give the Government Post Office a fix on the relative merits of the hard-wired logic pcm system it's developed in-house and of the computer-memory control developed by Standard Telephones & Cables, an ITT subsidiary.

The STC system uses two computers to share the load; one handles the exchange control, the other takes care of traffic processing. Every 10 milliseconds, the two computers switch functions. If one computer goes off the line, the other handles both functions.

Before opting for either hard-wired logic or software-controlled pcm switching, though, the Post Office apparently will take a look at a third system. Marconi Ltd. has well along in development a time-division-multiplex switching system it hopes will interest the Post Office.

German set makers never had it better

West German consumer electronics producers are finding it hard to keep their output up with their order books. Demand for tv sets, radios, and audio hardware is so high that some set makers have had to strip their showrooms of demonstration models to ease delivery delays.

Factory sales of tv sets, radios, and audio equipment last year ran \$790 million as the industry ground out some 2.5 million tv sets. This year the production total will reach 3.0 million sets, predicts Felix Herriger, who heads the electrical-electronics trade association ZVEI.

Even if Herriger's forecast is high, German manufacturers will be hard pressed to meet the demand for sets. A tight market in discrete components has developed and there's a shortage of labor. As a result, some set makers are holding off changing over to new models. And the parts shortage will spur sales of integrated circuits. Valvo GmbH, a subsidiary of Philips' Gloeilampenfabrieken, already has lined up the major German set makers as customers for three color-set IC's: a sync demodulator, a chrominance circuit, and a video circuit. Valvo will follow up later this year with a red-green-blue matrix circuit and a color-carrier circuit.

Philips boosts its EDP effort

Look for Philips' Gloeilampenfabrieken to make a strong run against IBM in the Scandinavian computer market.

The Dutch giant this month bought out the electronics-data-processing subsidiaries of Svenska Taendsticks AB, the big Swedish match maker. The chief new Philips acquisition is Arenco Electronics, which is currently at work on a \$10 million nationwide data-transmission network linking all 550 branches of the largest Swedish commercial bank. The other company involved is Arenco's subsidiary, Swedish Computer.

Philips executives make no bones about their motives for buying Arenco. The company intends to spend heavily to strengthen its hand in the fast-growing Scandinavian data-processing market and would have been "on a collision course" with Arenco.

Russians launch IC sales campaign with ambitious exhibit at Paris Salon

Soviet circuits match performance of many off-the-shelf American IC's; but unusual packaging may scare off potential buyers in Western Europe

Native semiconductor producers in Western Europe, already hard put to hold their own against hard-driving U.S. competitors, now face an added challenge—from the Soviet Union.

The Russians hastily started their West European sales campaign at the Paris Components Salon earlier this month, where their display was mobbed by showgoers itching to see Soviet integrated circuits. Spurred by the success of their last-minute Paris exhibit—their request for space was filed only two weeks before opening day and their stand had to be squeezed into a bar—the Soviets now plan to mount a bigger display at next month's International Electronic Components Show in London. Then they will follow up with a mobile exhibit that will swing through Scandinavia later this year.

Standouts among these Soviet exhibits are 12 families of IC's—both hybrids and monolithics—plus four families of MOS logic circuits. At Paris, Western experts rated them as state-of-the-art. "We thought they were much further behind," said Roger Combes, marketing director of SGS-France, a subsidiary of Italy's Società Generale Semiconduttori. "They're practically as advanced as the U.S."

Well placed. And the Russian wares, indeed, could find a place—although not at the top of the line—in the catalog of most U.S. semiconductor producers. The Soviet transistor-transistor logic, for example, has a delay time of 40 nanoseconds and a power dissipation of 18 milliwatts. That compares with 40-nsec delay and 60-mw dissipation for Texas Instruments' series

54/74 flip-flop. And the Russians' emitter-coupled logic, with 3-nsec delay and 80-mw dissipation, can stand up to Motorola's MECL I circuits.

With nothing revolutionary to sell, the Russians could be tempted to win their place in the market by undercutting prices as other newcomers have done. This they will not do, insists Nicolai Gssaev, deputy chief of the Soviet electronics export agency, Machpriborintorg. "Our prices will be competitive," he says, "and we're aiming at higher quality than Western producers offer." But Gssaev frankly admits the goal still has to be reached.

Prospects. Even so, the Russians figure they have solid prospects in Western Europe. Most likely first big customer: Italy's Ing. C. Olivetti & Co., which may buy Russian-made MOS for desk calculators.

And a gaggle of European firms have lined up at Machpriborintorg in quest of distribution rights for Soviet IC's. The Soviets, though, plan to market IC's directly to equipment manufacturers through their own men working out of embassies in Western Europe. For discrete components, on the other hand, there'll be capitalist middlemen. Already a West German distributor called Trans-Electronics Alfred Hempel KG has started peddling the Machpriborintorg line—IC's excepted—in its home market.

No matter who's selling for them, the Soviets figure to run into higher-than-usual sales resistance.

For one thing, there's the question of delivery. Many Western observers are skeptical about Russian claims that they can deliver im-



Hip, hip, array! Alexander Vasenkov, research chief of the Russian electronics industry ministry, hinted at Paris Components Show that LSI's for export were in the offing.

mediately anything in their limited IC product line. The Russians themselves say that there'll be only 150,000 IC's for export this year but maintain their target for 1970 is "several million."

For another, there's a problem in

packages. Russian encapsulation and pin-spacing differ from the norms in Western Europe. Thus there's a double drawback for users of the Soviet IC's: an added design difficulty and—much worse—a single-source supply. Because the Russian packaging is so different, there would be no backup source available in Western Europe.

No threat yet. Above all, the Russians will be competing against the tough and seasoned sales troops of U.S. producers like TI, Motorola, and Fairchild. Until the Soviets have an edge in technology or in prices, they don't pose a major threat in IC markets, most European semiconductor men feel.

But the Russians could nail down a substantial market in semiconductor raw materials, most of these same observers think. Supplies of high-quality silicon are tight in Europe, and the Russians say they have unlimited quantities to sell. Among the Soviet offerings are wafers with diameters of 75 millimeters, half again that of the wafers normally made in the U.S. and Europe. In addition to silicon, the Russians say they have available for immediate export silicon-on-sapphire wafers.

Already the Russians have one hot prospect for wafers. SGS-France intends to buy 50-mm wafers from them if the price is right.

More to come. Unless they get absolutely nowhere with their initial effort in IC's, the Russians apparently will plump out their line of advanced products. Alexander A. Vasenkov, chief of the research department at the electronics-industry ministry in Moscow, hints there's much more to come. "Back in Russia," he says, "we have both MOS and bipolar LSI arrays, plus lots of other interesting things. This is just our first step."

And as a tipoff to what might be in the works, the Russians at Paris had a prototype television set with all its functions—power supply, tuner, and audio output excepted—handled by a dozen hybrid IC's. The Russians have no plans to produce the set; but it shows, Vasenkov points out, "what we're doing to learn the possibilities of integrated circuits."

France

Pretty fair exchange

Ask data-processing consultants what the handiest computer terminal is and they'll quite likely launch off into a long debate over the relative merits of printers, punchers, and cathode-ray tubes. Ask the men at IBM's La Gaude research facility in France, and the unanimous reply will be a push-button telephone.

The reason for their concurrence is a new piece of IBM hardware, an electronic telephone exchange that can link 750 push-button telephones to a central computer. Each phone keyboard, then, becomes an input terminal for the computer; and the receiver can serve as an output terminal for voice readout. The exchange can also tie the computer to more conventional terminals like typewriters. And, of course, it switches ordinary phone calls.

With its new exchange, the 2750, IBM is offering its European customers a service U.S. customers can't get without having to turn to special lines and modems. Company officials won't talk about plans to get the 2750 exchange onto the American market, but it's a safe bet that IBM is itching to do just that.

Closed shop. Trouble is, the telephone-hardware market is still the fief of the American Telephone & Telegraph Co. And although the Federal Communications Commission has forced AT&T to ease its stance against non-Bell hardware, the Justice Department isn't likely to see IBM as the ideal candidate for a share of Bell's monopoly.

For the moment, IBM will concentrate on sales in Europe, where the government-run telephone systems in France, West Germany, and Italy have tentatively approved the exchange. Monthly rents for the 2750 range from \$1,800 to \$12,000, depending on the number of lines and optional extras.

Like Bell's 10LESS private exchange, IBM's 2750 features semiconductor switching rather than the electromechanical cross-points that characterize the first generation of "electronic" exchanges. But where

Bell opted for transistors, IBM has selected thyristors. They switch in about 1 microsecond, making them directly compatible with the logic circuits of the control unit, which is paired with a 512,000-bit ferrite-core memory.

The exchange can be programmed for a variety of special telephone services—paging, abbreviated dialing, and the like.

Great Britain

Graphic description

Computer graphics, at first glance, seem ideal for circuit designers. A little mistake? No problem. Simply erase with a light pen, redraw, and the computer does the rest.

It does it at a price, though, and the price has often been more than the traffic will bear, particularly when the data for the graphics is moving in and out of a big, time-shared computer. As a result, graphics design aids haven't caught on as strongly as most thought they would.

A way out may be offered by a small satellite computer that takes care of the graphics for a big com-

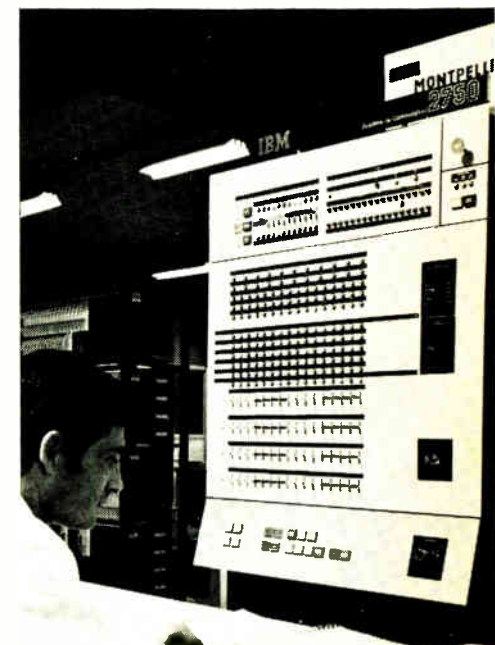

Quick switch. IBM's electronic exchange turns push-button telephones into computer input terminals.



Light writing. Heinz Lemke of the Cambridge University Mathematical Laboratory developed the command scheme for the Pixie CAD system. Only the light pen—there are no buttons to push—is used to change designs.

puter that handles the analysis of circuits after the designers have drawn them in near-final form. In the U.S., Bell Labs tried the idea and apparently found it wanting. In Britain, though, three researchers at Cambridge University have made it work in a system they call Pixie.

Unbuttoned. The three—Neil Wiseman, Heinz Lemke, and John Hiles—maintain that Pixie's economics are better than anything they've heard about so far. Another boost for graphics they see in Pixie is its ease of use—all inputs are by light pen; there are no pushbuttons to fiddle with. The first Pixie system, in fact, has turned out so well that the trio talked about plans for a more sophisticated version—Pixie 2—at the mid-April CADEX computer-aided-design conference at Southampton University.

Pixie uses as its main computer an ICT Atlas Mark 2 machine with a 120,000-word, 48-bit core memory and a multi-access system developed at Cambridge. The satellite computer is a Digital Equipment Corp. PDP 7 with an 8,000-word, 18-bit store; it's paired with a Digital Equipment 340 display.

Roughly speaking, the PDP 7 handles the interactive computing and the big computer is tapped only for analysis of designs. More important, the satellite machine

holds off making changes in its stored data structure until the designer is satisfied with his schematic. At this point, he instructs the computer to feed the contents of a temporary display file into an up-compiler whose routines change the data structure.

This changed data structure is transformed into a permanent display file and the designer can then manipulate his preliminary design by shifting from "drawing" to "pointing." In the pointing mode, circuit-element indicators stored in the permanent file blink when the pen is aimed at them. They can be erased, moved around the display, or assigned a value. In Pixie 1, there are three levels of manipulation—individual circuit elements, nodes of several elements, and entire subcircuits. In Pixie 2, there'll be eight levels.

Japan

Diodes galore

Prospects for massive optical memories, many experts say, depend largely on the matrixes needed to read out data stored as interference patterns on holograms.

If the experts are right, prospects have never looked better for holographic memories. A research team

at the Semiconductor Research Institute in Sendai, Japan, has found a way to pack upwards of 40,000 interconnected photodiodes onto an 8-by-8-millimeter section of a silicon chip.

That's the equivalent of more than 60,000 diodes per square centimeter. And Junichi Nishizawa, who heads the Sendai team, says this is by far the highest density yet achieved in a photodiode matrix. Quite likely so. A matrix man at Bell Labs, whose work in this field is world class, terms the Sendai development "very respectable." Bell, though, is trying for large arrays rather than high-density ones.

Nishizawa and his men have been fabricating their 201-by-201 arrays on very thin wafers—about 30 microns, or only a third the thickness of wafers normally used for integrated circuits. Their extreme thinness makes the wafers extremely tough to handle, and yields are very low. But because the diodes are on a 40-micron pitch and because the diode structures have to go all the way through the wafer, it's essential to keep the wafer thin.

One . . . The matrixes start as p-type silicon wafers with silicon dioxide passivation on both sides. The first step toward a matrix is to put in a grid of front-to-back connections through the wafer. This step starts on the back side of the wafer, where moats 10 microns wide and between 5 and 10 microns deep are etched in. This gives the back side a striped look, with the stripes on a 40-micron pitch.

Then a grid of 10-micron windows, again on a 40-micron pitch, is opened through the silicon dioxide on the front side. The grid is aligned so that the windows lie directly above the moats on the back side. With both sides prepared, n-type impurities are diffused into the wafer from both sides until they meet in the center to form a through connection for each diode.

Two . . . In the second step, the counterelectrodes and isolation regions that surround each diode are formed. The oxide coating on the front side is stripped off and an intrinsic epitaxial layer is grown on

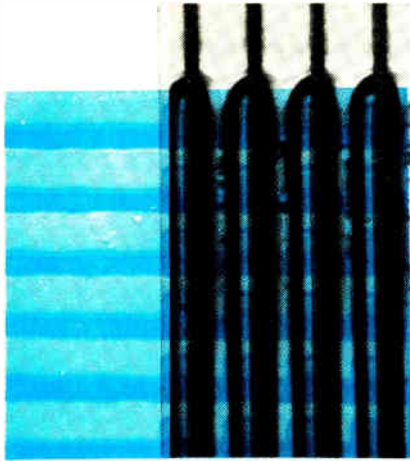

Tight fit. Beam leads connect "rows" of photodiodes in high-density matrix. Diodes extend through wafer to beam-lead "columns" on back.

the exposed silicon surface.

Because of autodiffusion, the epitaxial layer becomes slightly n— over the 10-micron squares where n material was diffused during the first step; elsewhere, the epitaxial layer is slightly p+. The n regions isolate the photodiodes and form the counterelectrodes. The n+ regions under them become the back connections.

Three. The diodes go in during the third step. Windows are opened over the centers of the 10-micron n— squares on the front surface, and boron is diffused in to convert the centers of the squares to the p+ material that becomes the light-sensitive surface of the diodes.

With the diodes in, the wafers are finished by putting down beam-lead "row" connections on the front surface and "column" connections on the back for the matrix. These beam leads are conventional ones, except that the material surrounding them is not etched away to leave the beams exposed. With beam leads and bonding pads, the chip size for the 201-by-201 array becomes about 10 mm square.

On the spot

Ordinarily when a set-maker's engineers bring a solid improvement into a color television set, the company's hucksters find a way to generate some sort of ado.

But how can you blare out a public fanfare for a smaller and simpler convergence circuit that makes a set a little more reliable for its buyer and a little more profitable for its producer? You can't. Anyway, that's the view of the Matsushita Electric Industrial Co., which has shifted without a whisper to a much-improved circuit for its smaller sets.

Halved. Crucial to Matsushita's new design are two permanent magnets that can be rotated as well as shifted in and out to move the red, green, and blue beams into convergence at the center of the screen under static conditions. One magnet, located between the red and green guns, shifts their beams along elliptical paths. The other, directly above the blue gun, moves the blue beam. In conventional convergence circuits, four magnets are needed; one moves the blue beam laterally, the others each move a beam radially.

With just two magnets taking care of static convergence, it follows that two yoke coils—one for red-green and one for blue—can handle the dynamic convergence, the correction needed when the beams are scanning well out from the center of the screen. Ordinary circuitry requires three coils.

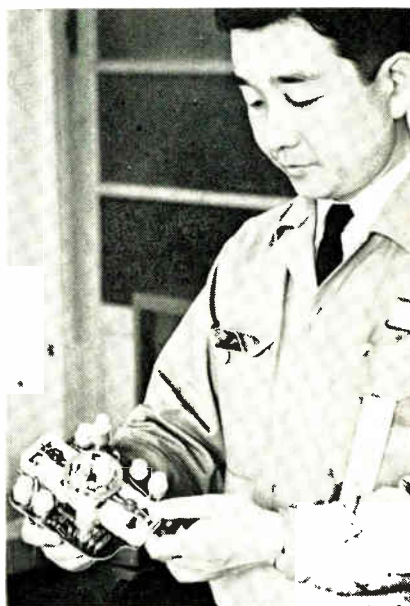

All there. Simplified convergence circuit mounts on a single board that fits on neck of picture tube.

With half as many magnets and two-thirds as many circuit components to package, Matsushita found it could pack its convergence assembly on a single board slipped over the tube neck. That's an added saving since there wasn't room around the neck for everything that was needed for a four-magnet assembly. As a result, it needed a second circuit board off the neck.

Still life

Many a bandit laments that video tape recorders are becoming commonplace security items in places like banks, department stores, airport terminals—all the best spots to pull a profitable caper.

And now, to make a bad situation worse, the Matsushita Electric Industrial Co. has made the vtr an even more effective surveillance instrument. Instead of recording motion pictures, Matsushita's new unit records stills. As a result, the vtr can pack 42 hours of peeping—instead of the usual 42 minutes—on a 7-inch reel of tape.

Count down. Actually, the vtr can be set to store stills on a tape over periods from 5 hours on up to 42 hours. At the 5-hour setting, it records eight pictures a second, at the 42-hour setting, one picture per second. In addition, the unit can be run as a conventional vtr with a tape speed of 33.3 cm per second.

Essentially, Matsushita's still-life unit is a two-head vtr modified to record and play back single fields (a normal tv frame has two interlaced fields). The camera—a conventional one—produces 60 fields per second, and a countdown circuit routes fields to the recording amplifier to match the vtr's setting. At the 42-hour setting, one field out of every 60 is recorded. In one corner of each field picked up by the camera, a clock records the time.

Repeat. During slow-speed playback, each field is reproduced for about 0.9 second. Because there is only a single field to play back, the spacing between the two heads is reduced so that the second head plays the field back on top of itself instead of interlacing as with a normal two-field frame.

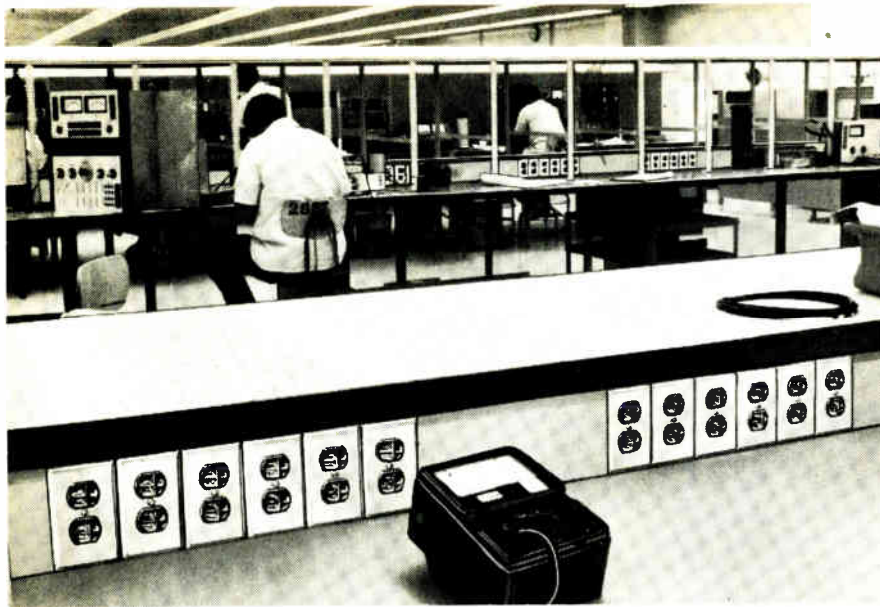

Electrical convenience for electronic equipment

Whether you make, use or test electronic equipment, the power you need can be delivered neatly in a Wiremold® surface wiring system. All necessary electrical

services and devices are housed in a *single raceway*, properly sized for present and future needs. Send for literature on the entire line of Wiremold systems.



THE WIREMOLD COMPANY / HARTFORD, CONNECTICUT 06110

Circle 174 on reader service card

ELGENCO 610A NOISE GENERATOR \$1275

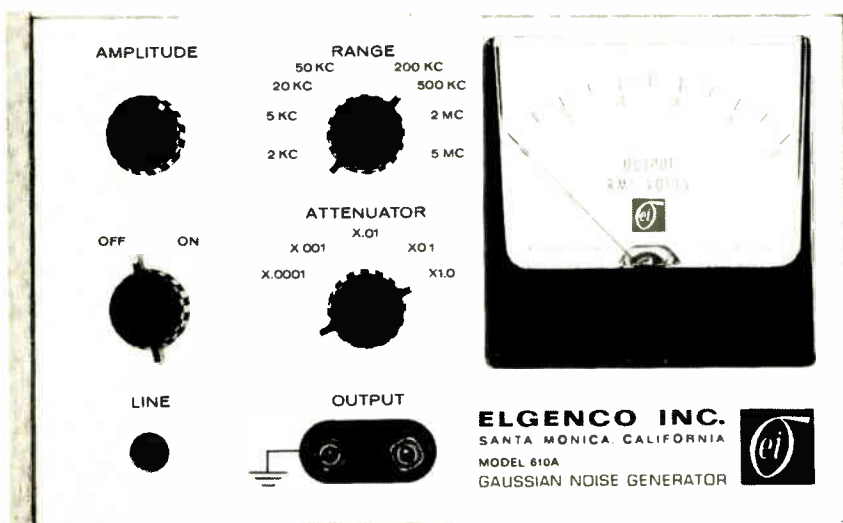

This 5 Hz to 2kHz/5 kHz/20 kHz/50 kHz/200 kHz/500 kHz/2 mHz/5 mHz Random Noise Generator is a precision instrument that has proven itself where lesser equipment is not adequate. All solid state and available from stock. Other Noise Generators covering the range of DC to 30 mHz and Demo Models are available. For name of nearest Sales Rep see EEM or contact Elgenco, Inc., 1550 Euclid, Santa Monica, Calif. 90404, Ph. 213-451-1635.

Advertising Sales Staff

Frank E. LeBeau [212] 971-6464
Advertising Sales Manager

Wallis Clarke [212] 971-2187

Assistant to sales manager

Donald J. Austermann [212] 971-3139
Promotion Manager

Warren H. Gardner [215] LO 8-6161
Eastern Advertising Sales Manager

Atlanta, Ga. 30309: Michael H. Miller, 1375
Peachtree St., N.E.
[404] 892-2868

Boston, Mass. 02116: William S. Hodgkinson
McGraw-Hill Building, Copley Square
[617] CO 2-1160

Cleveland, Ohio 44113: William J. Boyle, 55
Public Square [216] SU 1-7000

New York, N.Y. 10036

500 Fifth Avenue

James R. Pierce [212] 971-3615

John A. Garland [212] 971-3617

Michael J. Stoller [212] 971-3616

Philadelphia, Pa. 19103:

Jeffrey M. Preston

Warren H. Gardner,

6 Penn Center Plaza,

[215] LO 8-6161

Pittsburgh, Pa. 15222: Warren H. Gardner,

4 Gateway Center. [412] 391 1314

Rochester, N.Y. 14534: William J. Boyle,

9 Greylock Ridge, Pittsford, N.Y.

[716] 586-5040

Donald R. Furth (312) MO 4-5800

Midwest Advertising Sales Manager

Chicago, Ill. 60611: Kenneth E. Nicklas
Ralph Hanning 645 North Michigan Avenue,
[312] MO 4-5800

Dallas, Texas 75201: Richard P. Poole, 1800
Republic National Bank Tower,
[214] RI 7-9721

Houston, Texas 77002: Robert Wallin,
2270 Humble Bldg. [713] CA 4-8381

Detroit, Michigan 48226: Ralph Hanning,
856 Penobscot Building
[313] 962-1793

Minneapolis, Minn. 55402: 1104 Northstar
Center [612] 332-7425

St. Louis, Mo. 63105: Kenneth E. Nicklas,
The Clayton Tower, 7751 Carondelet Ave.
[314] PA 5-7285

James T. Hauptli [415] DO 2-4600

Western Advertising Sales Manager

Denver, Colo. 80202: Joseph C. Page David
M. Watson, Tower Bldg., 1700 Broadway
[303] 255-5484

Los Angeles, Calif. 90017: Ian C. Hill,
John G. Zisch, 1125 W. 6th St.,
[213] HU 2-5450

Portland, Ore. 97204: James T. Hauptli,
Thomas McElhinny, 218 Mohawk Building,
222 S.W. Morrison Street,
Phone [503] 223-5118

San Francisco, Calif. 94111: James T. Hauptli,
Thomas McElhinny, 255 California Street,
[415] DO 2-4600

Pierre Braude Tel: 225 85 88: Paris

European Director

Paris: Denis Jacob

88-90 Avenue Des Champs-Elysees, Paris 8

United Kingdom and Scandinavia

London: Oliver Ball, Tel: Hyde Park 1451

34 Dover Street, London W1

Milan: Robert Saldel

1 via Baracchini Phone 86-90-656

Brussels: F.I.H. Huntiens

27 Rue Ducale Tel: 136503

Frankfurt/Main: Hens Haller

Elsa Brandstroom Str. 2

Phone 72 01 81

Geneva: Denis Jacob

1 rue du Temple Phone: 31 95 60

Tokyo: Takeji Kinoshita, McGraw-Hill

Publications Overseas Corporation,

Kasumigaseki Building 2-5, 3-chome,

Kasumigaseki, Chiyoda-Ku, Tokyo, Japan

[581] 9811

Osaka: Akihiko Kamesaka, McGraw-Hill

Publications Overseas Corporation Kondo

Bldg., 163, Umege-cho Kita-ku [362] 8771

Business Department

Stephen R. Weiss, Production Manager

[212] 971 2044

Thomas M. Egan,

Assistant Production Manager [212] 971-3140

Dorothy Carmesin, Contracts and Billings

[212] 971-2908

Frances Valtone, Reader Service Manager

[212] 971-2865

TRW Polycarbonates

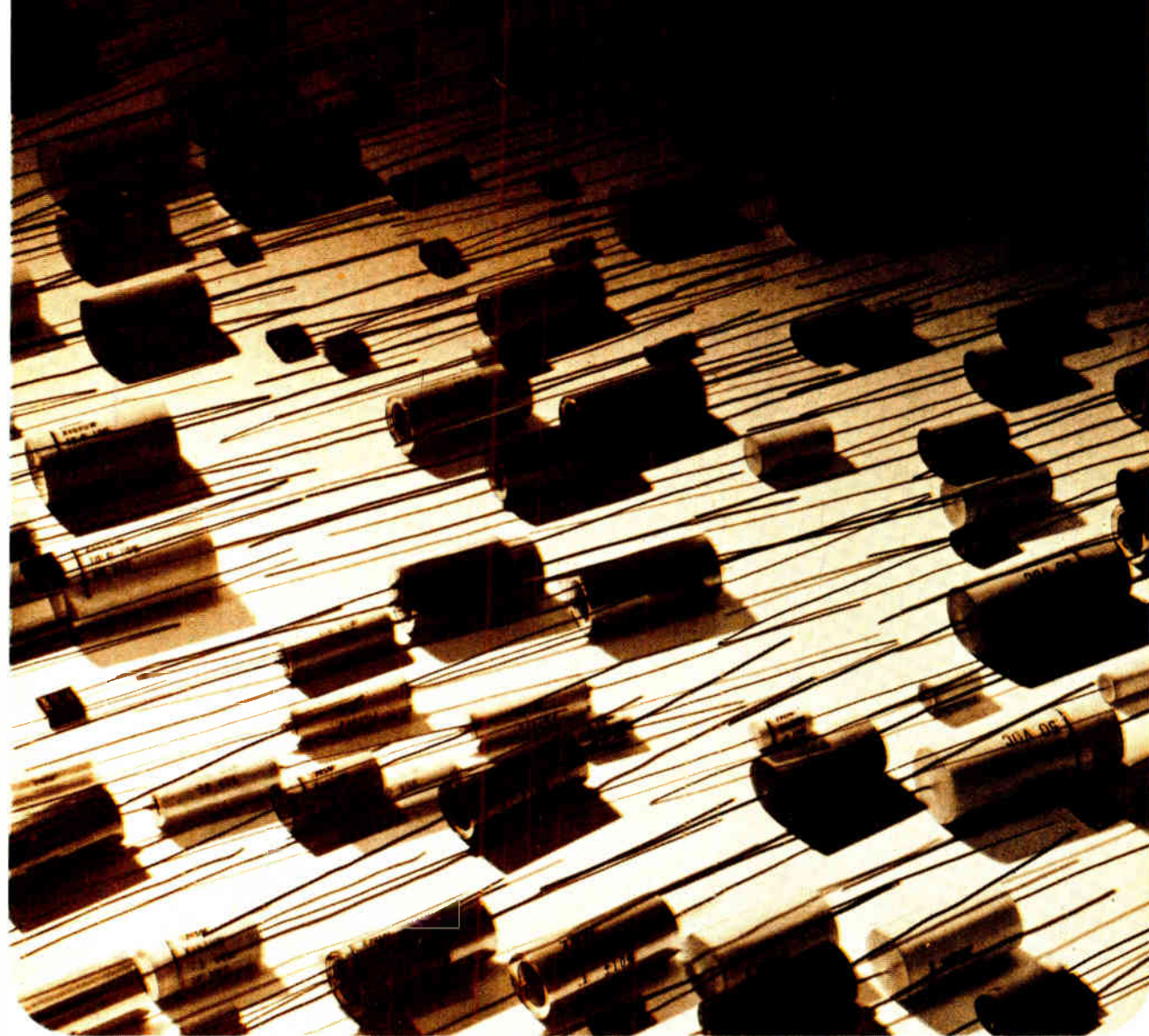

...small answers to big problems

Need capacitors with premium electrical and TC properties...and in the smallest possible package? Polycarbonate capacitors are your answer. And no one knows more about polycarbonates than TRW.

As the pioneer in polycarbonate capacitor development, TRW has the know-how to get that "extra

ounce of performance" out of this remarkable material. We can meet your design requirements with either metallized or foil wound polycarbonates in a wide range of capacitances, voltage ratings, shapes, and sizes. Standard types will solve most design problems...if not, let's talk about your special requirements.

For full information, contact TRW Capacitor Division, Box 1000, Ogallala, Nebraska. Phone: (308) 284-3611. TWX: 910-620-0321.

TRW®

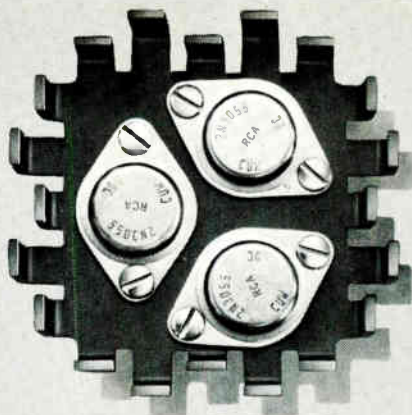

IERC's HP Heat Dissipator is only 1/3 the weight and 2/3 the volume of extrusions—yet it dissipates the same amount of heat.

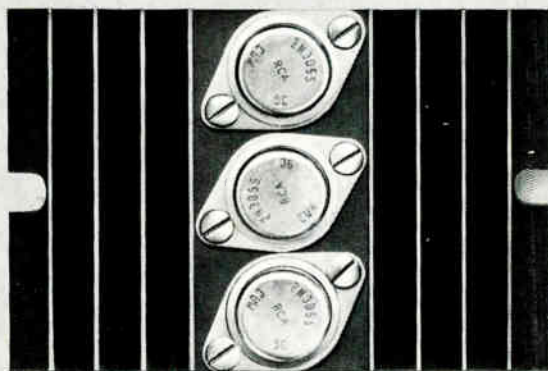

Here's proof.

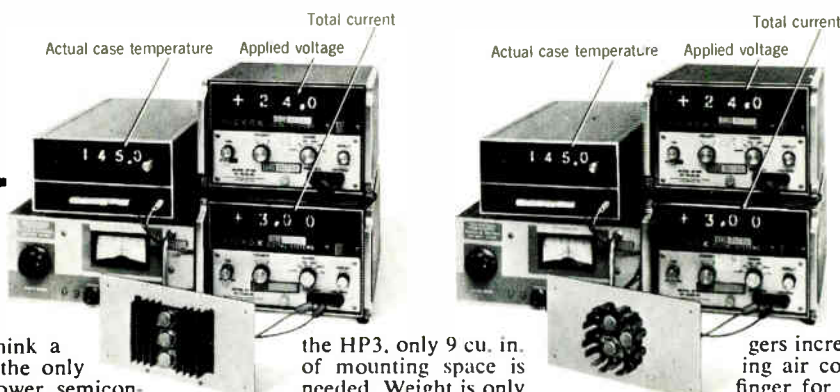

Many circuit designers think a hefty hunk of extrusion is the only thing to use to cool off power semiconductors. Of course, extrusions are big and heavy but that's the price one had to pay. No more.

The test setups shown above prove there is a better way.

On the left: A conventional extruded aluminum heat sink and three TO-3 case silicon transistors. 13.5 cu. in. (3 x 4.5 x 1) are required for mounting. Weight is 4.4 ozs. Total power dissipation is 72 watts with case temperature rise of 120°C (plus 25°C ambient).

On the right: IERC's efficient HP3 Dissipator with three TO-3s. (The HP3 will actually accommodate four TO-3s.) With

the HP3, only 9 cu. in. of mounting space is needed. Weight is only 1.5 ozs. But, as shown, *performance is exactly the same*. It's just that the HP3 does the job with only 2/3 the size and 1/3 the mass!

See the secret? It's the multiple staggered finger design. In still air the separate fingers dissipate, by radiation and convection, directly to the ambient—not to another finger surface. Conversely, extrusion fins radiate to each other. And, the free movement of convection currents is hampered by their being confined in the deep cavities between the fins.

In forced air the HP is even more efficient. The staggered fin-

gers increase turbulence, directing air completely around each finger for maximum dissipation. But with finned extrusions the forced air begins to leave the surfaces immediately. By the time it is part way down the extrusion it is hitting only the top edges of the fins, resulting in minimal dissipation.

Also, extrusions are directional. The HP is not. Mount it in any vertical or horizontal mode. It gives the same high efficiency with forced air from any direction.

Convinced? Then send for Technical Bulletin No. 139 and our new 4-page Short Form Catalog. They're loaded with ways to keep your transistorized circuitry cool and small.

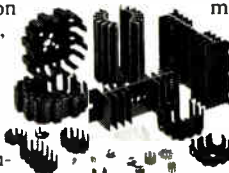

Heat Sinks/Dissipators
for all lead mounted and
case mounted semiconductors

METAL FILM SOURCERY

MIL-R-55182

MIL-R-10509

MIL-R-22684

Three performance levels—one basic source. No trick at all when you call Dale.

Don't buy tin oxide resistors just to get power at a low price. Dale's molded MF styles match these needs with the precision stability and tolerance of metal film. Designers and buyers alike know it's a better deal and dozens of companies are profiting from it. Many are consolidating their MIL-R-22684, 10509 and 55182 buys at this one broad, dependable source. Whether you want established reliability or prices as low as pennies per part—Dale can give you action.

*Here's Metal Film versatility
across the board*

Dale epoxy-molded MF resistors are available to meet the following specifications. For complete information, write for Catalog A.

MIL-R-55182	MIL-R-10509	MIL-R-22684
RNR 55 thru 65 RNC 55 thru 65	RN-55 thru RN-80	RL-07, RL-20

Call today 402-564-3131

DALE

DALE ELECTRONICS, INC.

1300 28th Ave., Columbus, Nebr. 68601
In Canada: Dale Electronics Canada, Ltd.
A subsidiary of the Lionel Corporation

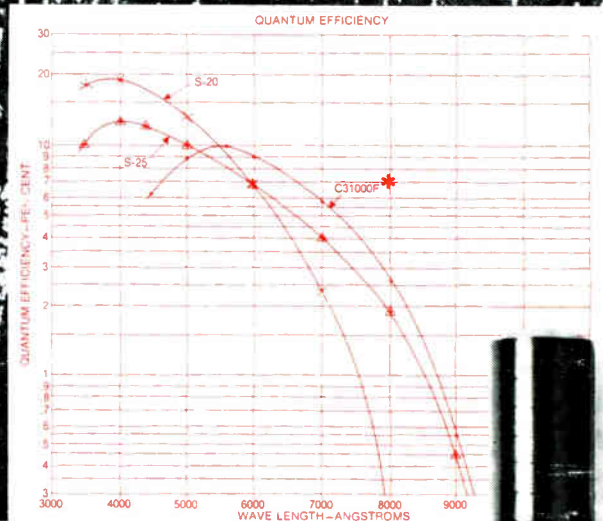
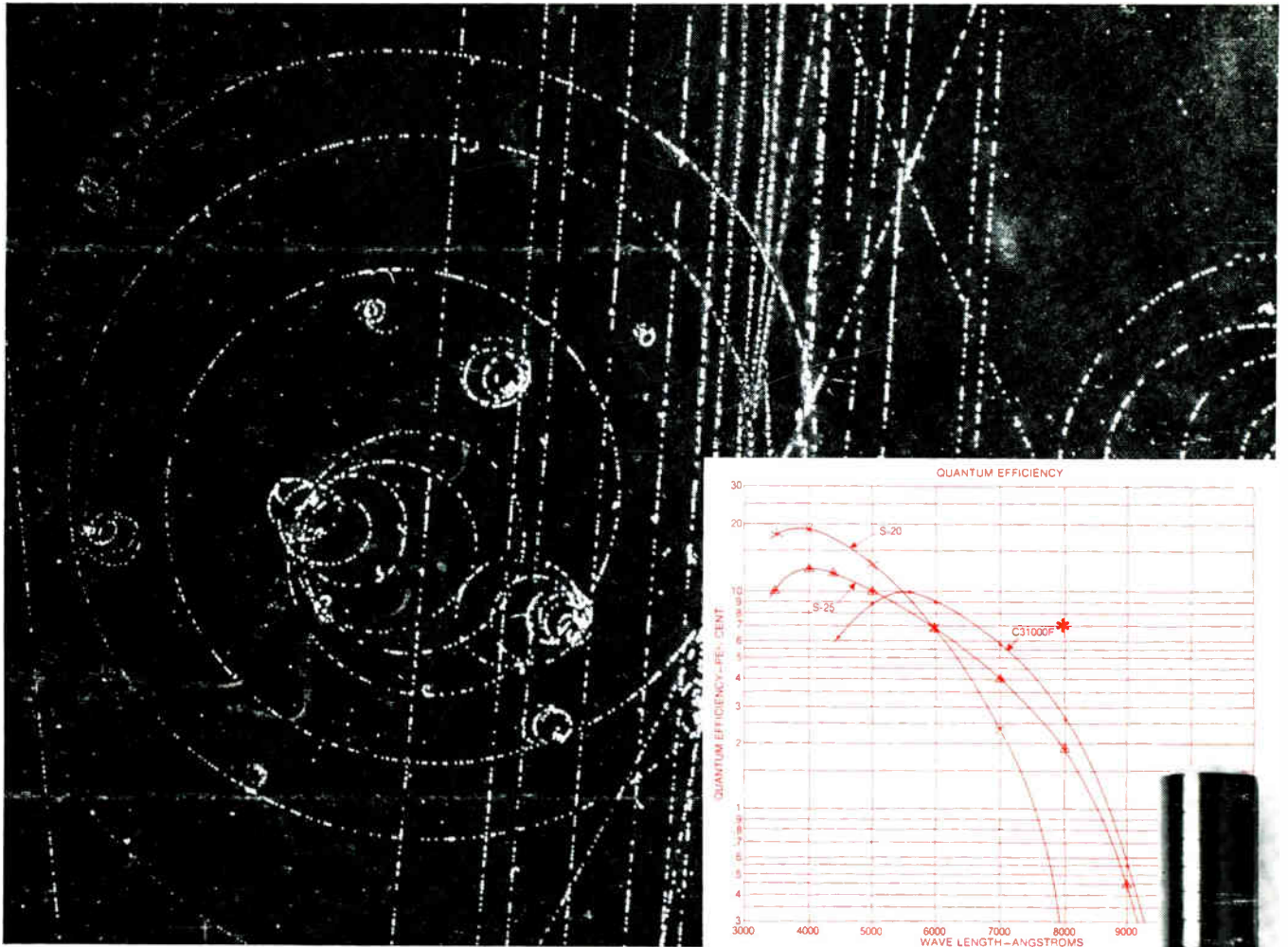

NEW! EXTENDED RED RESPONSE RCA-C31000F QUANTACON PHOTOMULTIPLIER

The C31000F is new! It's an extended-red, multi-alkali cathode version of the previously-announced C31000D. C31000F is recommended for applications in the red area of the spectrum, particularly laser detection and Raman spectroscopy. The latest addition to the RCA QUANTACON photomultiplier family, it is characterized by the use of Gallium Phosphide as the secondary emitting material on the first dynode.

Gallium Phosphide boosts the single electron resolution of this newest RCA QUANTACON photomultiplier as much as 10 times over that of tubes using conventional dynode materials. As a result, it is possible for this 2" dia. light detector, whose prototype is the industry-famous 8575, to discriminate between light-producing phenomena that generate one, two, three, or four photoelectrons.

Developed by RCA, the use of Gallium Phosphide places the C31000F and other RCA QUANTACON photomultipliers at the forefront of devices that can reveal nuclear, astronomical, and biochemical events never seen before.

For more information on this 12-stage device, and other RCA QUANTACON photomultipliers, including the C31000D and the 5-inch C70133B, see your local RCA Representative. For technical data on specific types, write: RCA Electronic Components, Commercial Engineering, Section D19P-2, Harrison, N. J. 07029.

* Minimum Q.E. at 8500 Å is 1%, corresponding to a radiant sensitivity of 7 mA/W. C31000E is the flat-faceplate version of the C31000F which has a curved faceplate.

RCA