

Hybrid computer needs no patchboards 100

Bigger, faster memories with cryoelectrics 108

EL matrix promises flat-screen tv 114

# Electronics®

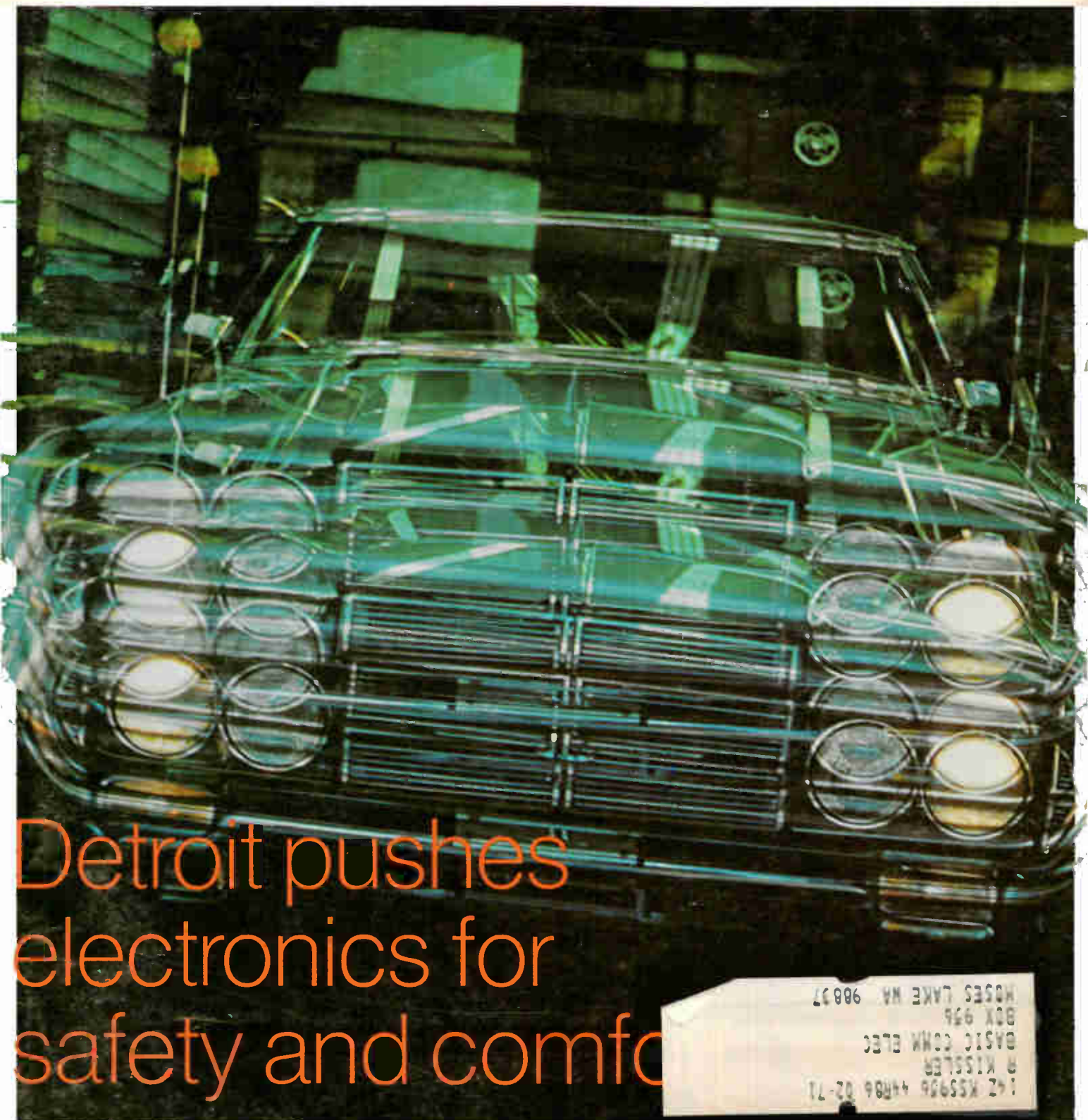

Detroit pushes electronics for safety and comfort

142 KSS906 44R86 02-71  
 R KISSLER  
 BASIC COMM ELEC  
 BOX 956  
 HOSES LAKE WA 98837

# New Instrument Showcase



**Real-Time Analyzer**

The Type 1921 Real-Time Analyzer is a new generation analyzer. It performs real-time one-third octave spectrum analysis in the frequency range from 3.15 Hz to 80 kHz employing a unique digital detection scheme to achieve performance unattainable with analog techniques. The major components of the analyzer are the Type 1925 Multifilter and the Type 1926 Multichannel RMS Detector.

**Sweep-Frequency Reflectometer**

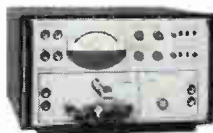

Reflectometry has been greatly simplified with GR's new 1641. It gives direct, precise readings of SWR and insertion loss (in dB) from 20 MHz to 7 GHz in two ranges in sweep- or single-frequency operation . . . residual SWR typically  $<1.02$  . . . direct reading in SWR and loss . . . all coaxial hardware internal . . . precalibrated, simplified operation . . . complete - add only source and scope.

**Digital Voltmeter Calibrator**



Calibrate your dc digital voltmeters quickly and easily with our highly stable 1822 calibrator . . . 100- $\mu$ V to 1111.1-V output . . . 10-ppm stability . . . mobile secondary standard . . . automatic stepping, programmable.

**Counter**



New 35-MHz IC counter-timer (the 1191-B) measures frequency, frequency ratio, time interval, period average, and period between successive pulses . . . 1- $\mu$ s minimum display time . . . frequency range extends to 500 MHz with GR scaler . . . 10-mV sensitivity (to 20 MHz) . . . optional high-precision time base and BCD data output.

**Pulse Generator**



The 1340 is the widest-range pulse generator in its price class, only \$395 in the USA. Extremely useful for testing IC's . . . 0.2 Hz to 20 MHz . . . 2.5 s to 25 ns duration . . . 5-ns rise time . . . 10-V output with  $\pm 1$ -V offset . . . amplitude, period, duration modulation.

**Impedance Comparator**



Versatile new 1654 Impedance Comparator with percent-deviation read-out of magnitude and phase angle . . . 0.003% comparison accuracy . . . 100 Hz, 1, 10, and 100 kHz . . . wide impedance ranges. Addition of new 1782 Analog Limit Comparator increases measuring speed of 1654 up to 4 components per second, provides limit-control settings and display lights for manual sorting. Optional models operate automatic sorting devices.

**Random-Noise Generator**



GR's new random noise generator, the 1383, generates wide-band noise of uniform spectrum level . . . 20 Hz to 20 MHz,  $\pm 1$  dB . . . 30- $\mu$ V to 1-V output, open-circuit . . . 50-ohm output impedance . . . meter and 10-dB-per-step attenuator.

**Megohmmeters**



Introducing two new megohmmeters - both are direct-reading, safe, stable, and easy to operate. The 1863 is the choice for production and inspection uses . . . 5 test voltages: 50 to 500 V . . . 50 k $\Omega$  to 20 T $\Omega$  ( $2 \times 10^{13}$  $\Omega$ ). The more flexible 1864 is best for the laboratory . . . 200 test voltages: 10 to 1000 V . . . 50 k $\Omega$  to 200 T $\Omega$  ( $2 \times 10^{14}$  $\Omega$ ).

Also new . . .

An attractive quantity-discount policy. All GR products are subject to a quantity discount ranging from 3% for 2-4 units to 20% for 100 units.

See these and many more exciting new instruments at the IEEE Show, Booth 2E26-2E36.

**GENERAL RADIO**

# In less time than it takes to read this page, you could learn to use this new Universal Impedance Bridge.

## Ready? One, two, three, go.

2. Adjust the range switch for an on-scale reading.



3. Obtain a null with the CRL dial. Now, read your measurement.

1. Select the function you want.

Nothing to it. No interacting controls to adjust and readjust. No multipliers. No non-linear dials. AUTO-BALANCE eliminates all that.

This new Hewlett-Packard Bridge is the first one that takes human beings into account as well as impedance. It's made for engineers who don't have time for a half-hour refresher course every time they want to use it.

You get direct digital readout of all C, R, and L values. Indicator lights show up-scale or down-scale unbalance. Decimal point and an equivalent circuit are automatically indicated. No problem with false or sliding nulls either: unique electronic AUTO-BALANCE takes care of that.

For a D or Q measurement, just switch from AUTO to low or high D or Q and turn the DQ control until you obtain another null. Simple. Particularly for low Q and high D cases.

So if you're the kind of engineer who's tired of complicated impedance bridges, Hewlett-Packard has your number: Model 4260A, \$550.

Ask your Hewlett-Packard field engineer for a demonstration. Or write us for complete specs: Palo Alto, California 94304. Europe: 54 Route des Acacias, Geneva.

*Data subject to change without notice.*

*Price f.o.b. factory.*

**HEWLETT**  **PACKARD**  
An extra measure of quality.

1844-R-1

THE COUNTER REVOLUTION GOES ON AT HP



## the automatic counter's automatic counter

- automatic range selection from 0.125 Hz to 20 MHz
- remotely programmable for systems applications
- exceptionally high speed and resolution for inputs down to 0.125 Hz
- measures pulsed frequencies automatically
- extra features at no extra cost

The new Hewlett-Packard 5323A Automatic Counter gives you a more useful automatic instrument than you've ever had before for either automatic systems or visual readout uses. It's considerably ahead of its class — the new class of "reciprocal taking" counters. It provides a greater speed-resolution combination of period measurement for making low frequency measurements (about 1000 times greater for clean signals below 1 kHz). Then, for rapid convenient readout, computing circuits invert period for direct display as frequency. It automatically provides the maximum resolution possible, regardless of measurement time, over the entire 0.125 Hz to 20 MHz range.

But the 5323A provides even more. A host of unique "extra duty" features gives you exceptionally higher performance for a lower price. For example, it can

automatically measure the carrier frequency of pulsed signals. It also has measurement times from 0.01 to 4 seconds, selectable in steps of 1, 2 and 4. Controllable hysteresis prevents jittering about range change points. Remote programming and digital output are standard. Better integrated circuit design keeps input power at a low 35W so there's no fan, and it'll use 50 to 400 Hz power.

This significant new speed, accuracy and convenience in frequency measurement is provided at less cost than similar counters, too. Price is \$2150 — for a uniquely useful instrument for: rapid confident use at the bench or for greater accuracy, speed and automaticity in data acquisition systems, mechanical or electrical testing, control systems or physical, earth or life science investigations.

For more information about an automatic counter worth your immediate attention, call your local HP field engineer. Or write Hewlett-Packard, Palo Alto, California 94304; Europe: 1217 Meyrin-Geneva, Switzerland.

02B26

Circle 2 on reader service card

HEWLETT  PACKARD

ELECTRONIC COUNTERS

## News Features

### Probing the News

- 125 **Avionics:** DC-10's air data system casts a long shadow  
133 **Communications:** Brazil works on that busy signal

### U.S. Reports

- 51 **Computers:** IBM may soon plunge—without a splash—into the "third-plus" generation with new computers  
52 **Companies:** Hogan's Fairchild, phase two  
53 **Avionics:** Complex monitoring  
56 **Manufacturing:** Checking for leaks in IC's  
58 **Space electronics:** Waiting for the Earth Resources Technology Satellite program to get under way  
60 **Communications:** GE vs. AT&T  
62 **For the record**

### Electronics International

- 201 **West Germany:** Lufthansa ready to fly its Boeing 707's with German-built throttle-control system; moving depletion layer of InSb slab makes new device with family of I-V curves  
202 **Great Britain:** Electronic ball-bearing checker bests microscope  
203 **Japan:** Low-cost ferrite circulator for common antenna systems works well both ways; Hayakawa's miniature calculator has all its logic circuits in a quartet of LSI packages

### New Products

- 151 **In the spotlight**  
151 LSI halves price of multimeter  
154 **Components review**  
154 Grooved fastener cuts relay costs  
157 Op amp trimming done internally  
161 **Instruments review**  
161 Ramps, pulses from test generator  
165 Digital meters' size, price featured  
169 **Subassemblies review**  
169 Redesigned d-a converter fits DIP sockets  
172 High-stability film-type trimmer  
177 **Microwave review**  
177 50-watt oscillator for rfi tests  
181 **Data handling review**  
181 Real-time acoustic signal analysis  
183 Processor enhances video signals  
185 **Semiconductor review**  
185 Monolithic IC puts out 18 watts  
187 Low-cost, hand-held logic probe

## Technical Articles

- Applied design** 84 **Detroit puts electronics in the driver's seat (cover)**  
Automakers, already using significant quantities of discrete semiconductor devices, are looking ahead to the time when integrated circuits will handle just about all command and control functions in a car  
John Drummond, associate editor
- Circuit design** 94 **Designer's casebook**
- High accuracy from peak detector with op amp
  - Dual transistor reduces track-and-hold error
  - NAND gate inputs expanded by adding resistor
  - Squelch acts faster with FET gate
  - Op amp/sine wave oscillator uses diode for stability
  - Negative signals converted to positive logic

- Meetings** 98 **A four-day stand under IEEE's big top**  
A survival guide for visiting EE's

- Computers** 100 **All-IC hybrid computer eliminates the patchwork from programing**  
A Japanese machine uses only IC's for computing elements, and a switching matrix replaces patchboard  
Kazuo Kurokawa, Electrotechnical Laboratory

- Memory technology** 108 **Cryoelectric memories: best hope for large and fast storage units**  
Robert Gange, RCA Laboratories

- Consumer electronics** 114 **Lighting the way to flat-screen tv**  
An experimental receiver with electroluminescent panels being developed in Japan may eventually replace conventional cathode-ray tubes  
Masami Yoshiyama, Matsushita Electric

## Departments

- |    |                          |     |                          |
|----|--------------------------|-----|--------------------------|
| 4  | Readers Comment          | 73  | Washington Newsletter    |
| 8  | Who's Who in this issue  | 188 | New Books                |
| 14 | Who's Who in electronics | 190 | Technical Abstracts      |
| 24 | Meetings                 | 192 | New Literature           |
| 33 | Editorial Comment        | 199 | International Newsletter |
| 35 | Electronics Newsletter   |     |                          |

# Electronics

Editor-in-Chief: Donald Christiansen

## Senior staff editors

Technical: Stephen E. Scrupski  
News: Robert Henkel  
International: Arthur Erikson

Managing editor: Harry R. Karp  
Art director: Gerald Ferguson

Senior associate editor: Joseph Mittleman  
Assistant managing editors: Stanley Zarowin, Eric Aiken, H. Thomas Maguire  
Senior copy editor: James Chang; Senior staff writer: Howard Wolff

## Department editors

Advanced technology: William Bucci, Richard Gundlach  
Communications: John Drummond, Raphael Kestenbaum  
Computers: Wallace B. Riley, George Weiss  
Design theory: Joseph Mittleman  
Instrumentation: Owen Doyle, Walter Barney  
Military/Aerospace: Alfred Rosenblatt; William F. Arnold (Military); Paul Dickson (Aerospace)  
New products: William P. O'Brien  
Solid state: George Watson, Stephen Wm. Fields

## Domestic bureaus

Boston: James Brinton, manager; Gail Farrell  
Chicago: Frederick Corey, manager  
Los Angeles: Lawrence Curran, manager  
San Francisco: Walter Barney, manager; Peter Vogel  
Washington: Robert Skole, manager; Paul Dickson, William F. Arnold

## Foreign bureaus

Bonn: John Gosch  
London: Michael Payne  
Tokyo: Charles Cohen

Copy editors: Larry Miller, Edward Flinn  
Staff writer: Peter Schuyten

Assistant art director: Kenneth L. Dix  
Production editors: Susan Hurlburt, Arthur C. Miller

Editorial research: Anne Mustain

Editorial secretaries: Lorraine Longo, Claire Goodlin, Barbara Razulis, Vickie Green

## McGraw-Hill News Service

Director: Arthur L. Moore; Atlanta: Fran Ridgway; Chicago: Robert E. Lee  
Cleveland: Arthur Zimmerman; Dallas: Marvin Reid  
Detroit: James Wargo; Houston: Barbara LaRoux  
Los Angeles: Michael Murphy; Pittsburgh: Louis Gomolak  
San Francisco: Margaret Drossel  
Seattle: Ray Bloomberg; Washington: Charles Gardner, Daniel B. Moskowitz,  
Herbert W. Cheshire, Seth Payne, Warren Burkett, William Small, William D. Hickman

## McGraw-Hill World News Service

Bonn: Robert Dorang; Brussels: James Smith; Hong Kong: Wes Perry;  
London: John Shinn; Mexico City: Gerald Parkinson; Milan: Ronald Taggiasco, Jack Star;  
Moscow: Jack Winkler; Paris: Robert E. Farrell, Stewart Toy  
Rio de Janeiro: Leslie Warren; Tokyo: Marvin Petal  
Reprints: Susan Nugent  
Circulation: Isaaca Siegel

## Publisher: Gordon Jones

Assistant to the publisher: Wallace C. Carmichael

Electronics: March 17, 1969, Vol. 42, No. 6

Published every other Monday by McGraw-Hill, Inc. Founder: James H. McGraw 1860-1948.  
Publication office 99 North Broadway, Albany, N. Y. 12202; second class postage paid at Albany, N. Y.

Executive, editorial, circulation and advertising addresses: McGraw-Hill Building, 330 W. 42nd Street  
New York, N. Y. 10036. Telephone (212) 971-3333. Teletype TWX N.Y. 710-581-4235. Cable address:  
MCGRAWHILL N.Y.

Subscriptions solicited only from those professionally engaged in electronics technology. Subscription rates:  
qualified subscribers in the United States and possessions and Canada, \$8.00 one year, \$12.00 two years,  
\$16.00 three years; all other countries, \$25.00 one year. Non-qualified subscribers in the U.S. and  
possessions and Canada, \$25.00 one year; all other countries, \$50.00. Air freight service to Japan \$50.00  
one year. Single copies: United States and possessions and Canada, \$1.00; all other countries, \$1.75.

Officers of McGraw-Hill Publications: Joseph H. Allen, President; J. Elton Tuohig, Executive Vice President;  
David J. McGrath, Senior Vice President-Operations; Vice Presidents: John R. Callahan, Editorial; Paul F. Cowie,  
Circulation; John R. Emery, Administration; John M. Holden, Marketing; David G. Jensen, Manufacturing;  
Jerome D. Luntz, Planning & Development; Robert M. Wilhelm, Controller.

Officers of the Corporation: Shelton Fisher, President and Chief Executive Officer; John L. McGraw, Chairman;  
Robert E. Slaughter, Executive Vice President; Daniel F. Crowley, Donald C. McGraw, Jr., Bayard E. Sawyer, Senior  
Vice Presidents; John J. Cooke, Vice President & Secretary; Gordon W. McKinley, Vice President & Treasurer.

Title ® registered in U.S. Patent Office; © Copyright 1969 by McGraw-Hill, Inc. All rights reserved. The contents  
of this publication may not be reproduced either in whole or in part without the consent of copyright owner.

Subscribers: The publisher, upon written request to our New York office from any subscriber,  
agrees to refund that part of the subscription price applying to copies not yet mailed.  
Please send change of address notices or complaints to Fulfillment Manager; subscription  
orders to Circulation Manager, Electronics at address below. Change of address notices  
should provide old as well as new address, including postal zip code number. If possible,  
attach address label from recent issue. Allow one month for change to become effective.

Postmaster: Please send form 3579 to Fulfillment Manager, Electronics,  
P.O. Box 430, Hightstown, New Jersey 08520

## Readers Comment

### For the defense

To the Editor:

I want to express my appreciation for your balanced and thoughtful coverage of an extremely complex issue in your editorial titled "Heading off IBM" [Feb. 17, p. 39].

As we have stated repeatedly, we believe we have violated neither the letter nor the spirit of any law, and we intend to defend the suits vigorously in the courts. Your magazine's fair coverage of the issue is most encouraging in this regard.

Thomas J. Watson Jr.

Chairman

International Business  
Machines Corp.  
Armonk, N.Y.

### School of hard knocks

To the Editor:

I sympathize with Robert Talbott's predicament as outlined in the article "Engineers accept the risk of layoffs as part of the game in defense field" [Jan. 20, p. 122], having faced the same sort of problems at one time. I've found that the engineering business demands great mobility and that one should learn to bend with the wind.

You note that Congressmen are constantly battling for more jobs and larger contracts for their constituents. With the recent change of Administrations in Washington, does anyone not suspect that the meteoric growth of engineering opportunities in Houston will slow down a bit and that more activity will begin to crop up in California?

The engineer is a problem-solver, and, like storms, problems can quickly change location and direction. When the astute engineer feels the winds of change blowing, he moves on before he's swept away. The practicing engineer should expect to move around a bit during his first 15 years of employment, and he should optimize his income and put his earnings to work.

My solution to the problem was to join the army of "job shop" engineers, as they're still called by

# Our package deal is a complete fabrication.

We make every part of our hermetic integrated circuit packages in our own plants.  
We have to.

It's the best way we can be sure that every one will measure up to specs. Both ours and yours.

Take, for example, our off-the-shelf dual inline package. It uses our own special blend of hard glass and alumina to get the best properties. High electrical insulation, thermal shock resistance, hermeticity, and a thermal expansion that matches the metal alloy parts.

It meets Mil-specs and can be plated to your requirements.  
If this package doesn't suit your needs, we'll design one to your specs.

Each hermetic package gets to you in first-class condition. No bent or shorted leads. No excess glass-ceramic flow.

In short, the perfect package deal.  
Sylvania Metals & Chemicals, Parts Division,  
Warren, Pa. 16365.

**SYLVANIA**  
A DIVISION OF  
GENERAL TELEPHONE & ELECTRONICS

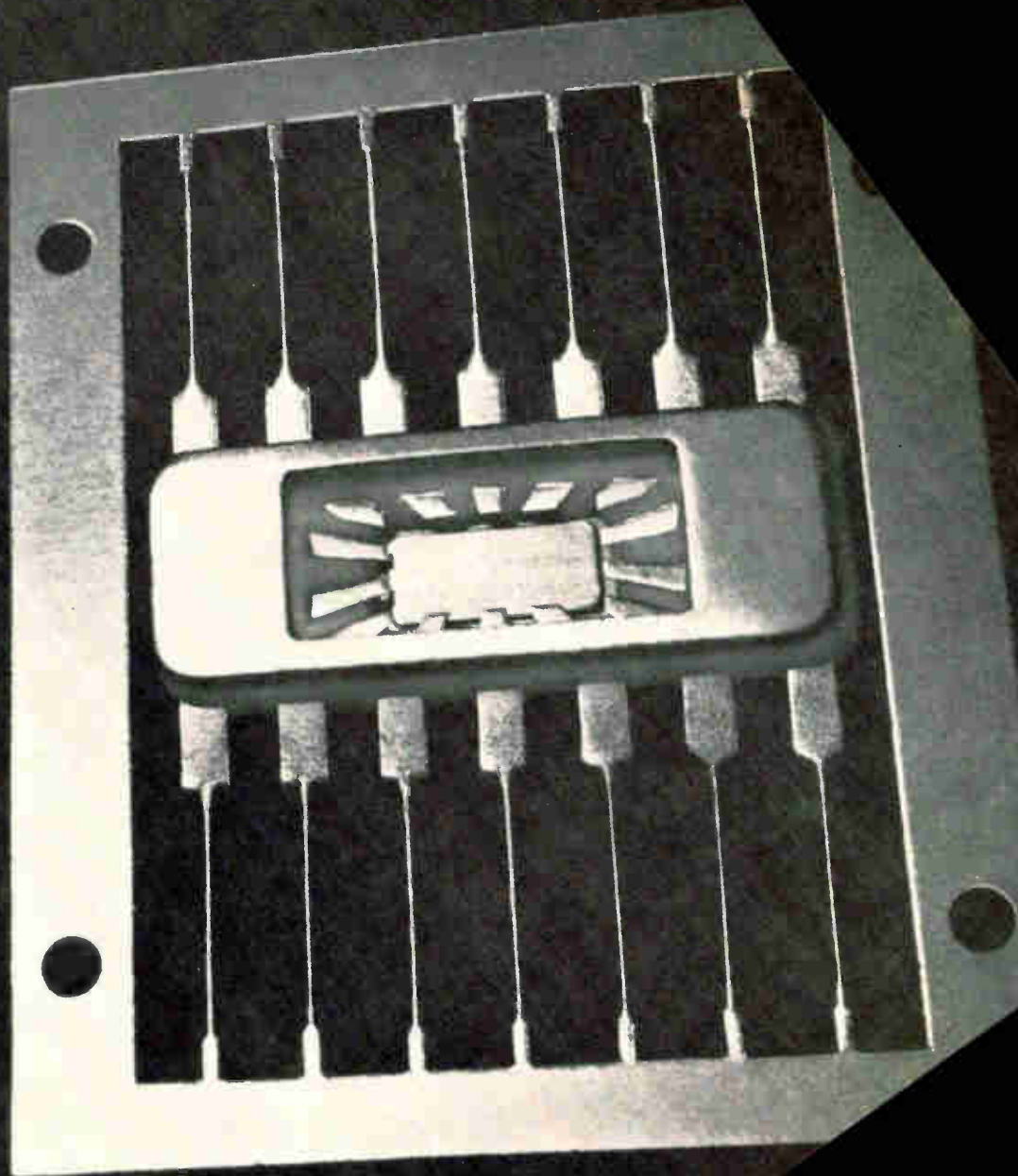

## A little something to look for when you're buying a power supply:

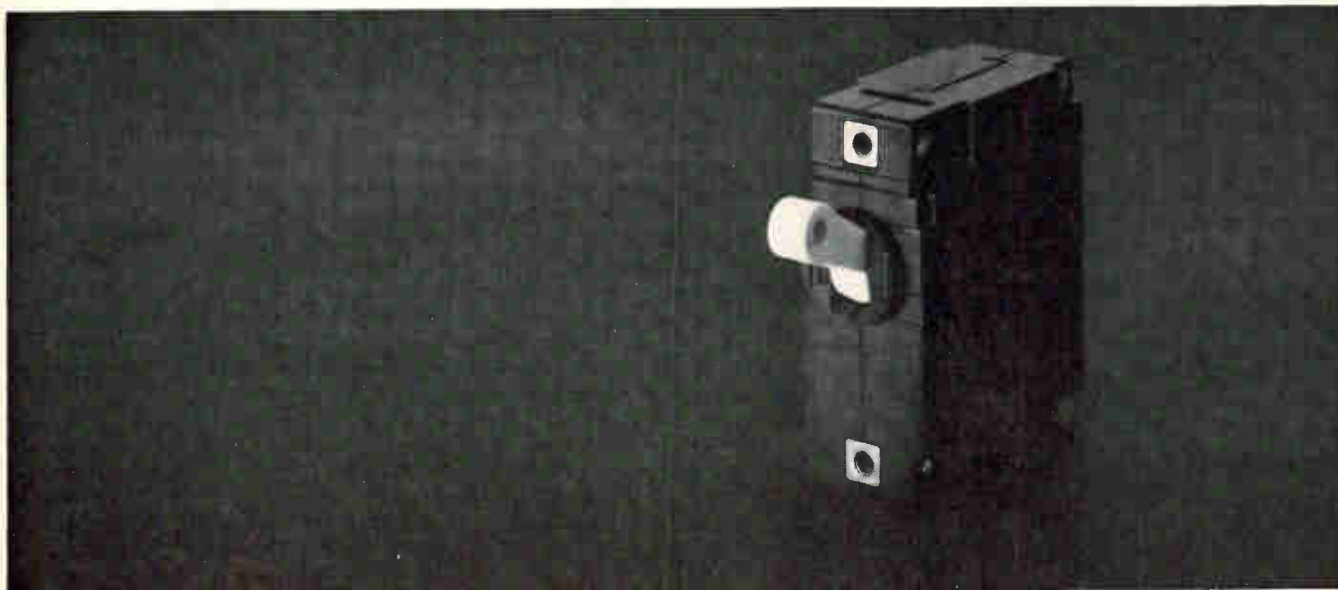

A Heinemann circuit breaker.

If you find one on the instrument panel, it's a safe bet you're looking at high-performance equipment.

(When a manufacturer uses a Heinemann breaker, he's traveling the premium-component route. There are many cheaper alternatives that will do almost the same job.)

It's also safe to assume you'll get long-term service without lots of servicing.

(The protection of a Heinemann breaker is probably the ultimate in precision. The breaker's nominal current rating is precisely calibrated and temperature-stable. Overload response characteristics are controlled to precise

tolerances. Even the toggle mechanism is made better than it has any right to be.)

In fact, the equipment may come with a longer warranty than you'd expect. (Heinemann breakers, themselves, are warranted for five years.)

All this is not to suggest that Heinemann protection should be a primary consideration in choosing a power supply. But if one unit has it and the other doesn't, all else being equal, the choice would seem to be clear enough.

Heinemann Electric Company, 2600 Brunswick Pike, Trenton, New Jersey 08602.

**HEINEMANN** 

4131



## Readers Comment

some in the industry. For Mr. Talbott's information, the best union is the job shop. In fact, the Government and management welcome the job shop engineer.

And contrary to the beliefs of Israel Katz (of Northeastern University), engineers are not ill-used by management. Management survives in its own sphere by using its total resources for optimum gain. The engineer is treated on the projection chart in much the same way as capital.

The important point is not that engineers move around so much, but that the good engineers—the thinkers and contributors—stay in the business and don't drop out. They are of value wherever they go. I might note that they also help lessen duplication of activity in the industry. The same job shop engineer may move from company to company—increasing his expertise and income—writing very nearly the same proposals at each.

Mort Stillman

Los Angeles

### Slipup

To the Editor:

Your table of British IC manufacturers in the article "The American Challenge' on a chip" [Jan. 20, p. 74] is certainly flattering to Motorola, which doesn't even have a plant in this country.

Could you possibly have meant Transatron, which, quite rightly, is featured in the body of the article

as one of the foreign-affiliated companies supplying 75% of the British IC market?

Transatron only opened its diffusion facility here last April, but this plant is already outbidding state-side Transatron factories for orders from the parent corporation.

Gerald Gulliver

Transatron Electronic Ltd.  
Maidenhead, England

▪ Reader Gulliver is right. The table should have listed Transatron in place of Motorola.

### Ineligible

To the Editor:

I earlier noted the absence of RCA in your roundup of infrared-sensitive phototubes. A more serious omission of RCA's name occurs in the New Products article entitled "Semiconductor microwave sources go off-the-shelf at more makers," [Feb. 17, p. 149].

Arnold M. Durham

RCA Electronic Components  
Harrison, N.J.

▪ The article cited covered readily available production items. In preparing the article, *Electronics* surveyed many manufacturers, and was told by RCA that its devices were "experimental."

Readers' letters should be addressed:

To the Editor,  
**Electronics**,  
330 West 42nd Street, New York,  
N.Y. 10036

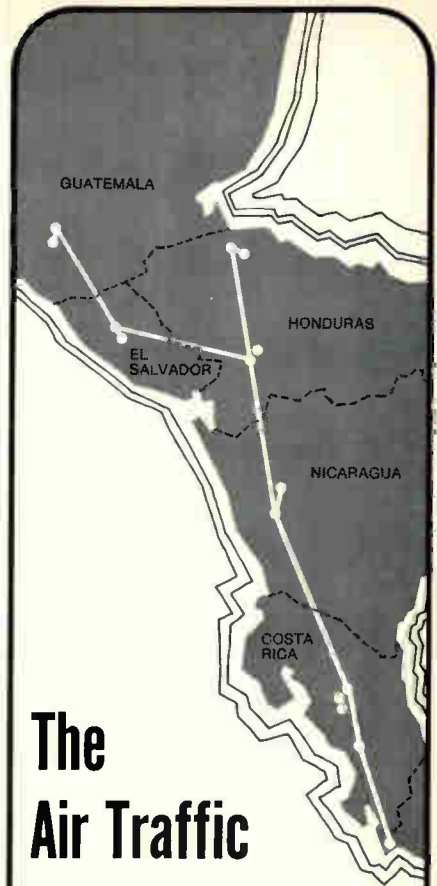

## The Air Traffic Control System Of Central America

uses Farinon radio and multiplex systems for reliable telephone circuits.

So do 16 US government agencies, 45 US telephone companies of all sizes, 36 communications agencies of other governments, and the Volta Aluminum Company of Ghana . . . among 223 others.

Farinon has won a world-wide reputation for performance, reliability, economy and all-around engineering judgment.

Write for our catalog of radio, microwave and multiplex equipment, accessories and services.

# Farinon

Farinon Electric, 935 Washington St., San Carlos, Cal. 94070

### SUBSCRIPTION SERVICE

Please include an *Electronics Magazine* address label to insure prompt service whenever you write us about your subscription.

Mail to: Fulfillment Manage.  
Electronics  
P.O. Box 430  
Hightstown, N.J. 08520

To subscribe mail this form with your payment and check  new subscription  renew my present subscription

Subscription rates: qualified subscribers in the U.S.: 1 year \$8; two years, \$12; three years, \$16. Non-qualified: 1 year \$25. Subscription rates for foreign countries available on request.

### CHANGE OF ADDRESS

ATTACH LABEL HERE

If you are moving, please let us know five weeks before changing your address. Place magazine address label here, print your new address below.

name \_\_\_\_\_

address \_\_\_\_\_

city \_\_\_\_\_

state \_\_\_\_\_

zip code \_\_\_\_\_

## Who's Who in this issue



**Drummond**

**Well-traveled** is the word for associate editor John Drummond who wrote the cover story on automotive electronics beginning on page 84. John's background includes nine years with CBS as technical supervisor in charge of tv set production, and resident engineer in Caracas, Venezuela. He has also managed a radio station in Panama. Holder of a physics degree from the City College of New York, John has been an instructor at the New York Institute of Technology and is a licensed school teacher.



**Kurokawa**

**Computers** of one sort or another have been the professional preoccupation of Kazuo Kurokawa since 1956 when he joined the instrumentation section of the Automatic Control division of the Electrotechnical Laboratory operated by the Japanese government. Author of the article on an all-IC hybrid computer beginning on page 100, Kurokawa has worked on the first low-speed, high-precision, analog computer produced in Japan. He has a doctorate from the University of Tokyo.



**Yoshiyama**

**Display systems** fascinated Masami Yoshiyama even before he won his physics degree from Kyoto University in 1953 and joined Matsushita Electric. Author of the article on flat-screen electroluminescent tv beginning on page 114, Yoshiyama has also worked on a semiconductor display system.

**Gange**

**Variety spices** the background of Bob Gange, who wrote the article on cryoelectric memories beginning on page 108. The holder of a physics degree from Rutgers, he has worked on guided missile systems at Hughes, weapons systems at Andrews Air Force Base, and logic designs at Electronic Associates. Since 1961, however, when he joined RCA Labs, Bob has concentrated on memory technology.

# *You say you want a*

low-profile snap-in mounting push button switch or matching indicator that is interchangeable with most 4-lamp displays . . . available in a full range of cap colors . . . with a choice of bezels with or without barriers in black, gray, dark gray or white.



## *and a*

legend presentation that's positive (like this one) or negative (like the one below) or just plain (like the one above) . . . one that's white when "off" and red, green, yellow (amber), blue or light yellow when "on" . . . or colored both "on" and "off."



## *and a*

highly reliable switch proven in thousands of installations . . . available in momentary or alternate action . . . N.O., N.C. or two circuit (one N.O., one N.C.) . . . that accommodates a T-1 $\frac{3}{4}$  bulb with midjet flanged base, incandescent, in a range of voltages from 6—28V.



*etc.  
etc.  
etc.*

# *Now, Dialight gives you custom panel designing with a standard line of push-button switches and matching indicators*

Dialight offers a broader range of switch and indicator possibilities than you'll find anywhere in a standard single-lamp line. Sizes:  $\frac{3}{4}$ ", 1",  $\frac{5}{8}$ " square and round. Send today for our new full-color catalog L-209.

## **DIALIGHT**

Dialight Corporation, 60 Stewart Ave., Brooklyn, N. Y. 11237

DT-124

NEW from LAMBDA

# A totally new concept in

The **FIRST AC-DC** power supplies using an integrated circuit regulation system:

## Lambda COM-PAK MARK II™ power supplies

- First all-silicon AC-DC Power Supply using integrated circuits to provide regulation system exclusive of input and output capacitors, rectifiers and series regulation transistors.
- 3-5/32" x 3-9/32" x 3-5/16" with single or dual outputs.
- 3-5/32" x 3-9/32" x 1-11/16" with single output.
- More current per cubic inch.
- Guaranteed for five years material and labor.
- Increased reliability through use of Integrated Circuit which replaces 32 discrete components from conventional designs.
- Convection cooled—no external heat sinks.
- Regulation Line or Load .01% + 1mV.
- Ripple and Noise 250 μV rms; 1mV p to p.
- Wide Input Voltage and Frequency Range 105-132 VAC, 57-63Hz.
- Wide Temperature Range - 20°C to + 71°C.
- Temp. Coeff. .01% +300μV/°C External Programming Resistor .015% + 300μV/°C Internal Resistor.
- Lightweight—Only 1 lb.

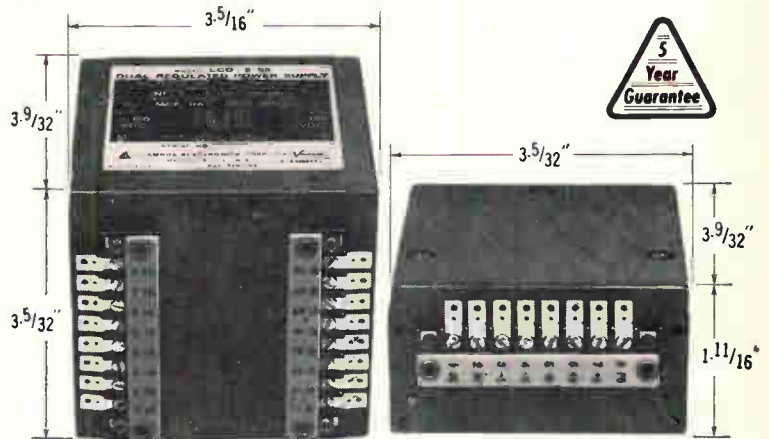

- for 1½" size; 2¼ lbs. for 3" size.
- Rugged die-cast aluminum construction.
- Mounting flexibility—four mounting surfaces.
- Overvoltage Protection—available as accessory up to 70 VDC.
- Multi-Current-Rated
- Complete Serviceability all components replaceable.
- Remote sensing.
- No overshoot on turn-on, turn-off or power failure.
- Remote Programming 1000 ohm/V nominal or Volt/Volt.
- Series/Parallel operation with similar single or dual units.
- Completely Protected—automatic current limiting.

### Features of Dual Output Models

- Independent Operation.
- Independent Remote Sensing.
- Independent Remote Programming
- Series Parallel Operation (Master/Slave)
- Each Supply Electrically Isolated and Floating with Respect to Ground.

### LCD-2 DUAL OUTPUT MODELS

3 5/32" x 3 9/32" x 3 5/16"

Model	VOLTAGE RANGE (EACH SIDE)	MAXIMUM CURRENT (MA) AT AMBIENT TEMPERATURE (1)				Price (2)
		40°C	50°C	60°C	71°C	
LCD-2-11	0-7 VDC	300ma	240ma	175ma	115ma	\$155
	0-7 VDC	300ma	240ma	175ma	115ma	
LCD-2-12	0-18 VDC	160ma	130ma	100ma	65ma	155
	0-7 VDC	300ma	240ma	175ma	115ma	
LCD-2-13	0-32 VDC	120ma	95ma	70ma	45ma	155
	0-7 VDC	300ma	240ma	175ma	115ma	
LCD-2-22	0-18 VDC	160ma	130ma	100ma	65ma	155
	0-18 VDC	160ma	130ma	100ma	65ma	
LCD-2-23	0-32 VDC	120ma	95ma	70ma	45ma	155
	0-18 VDC	160ma	130ma	100ma	65ma	
LCD-2-33	0-32 VDC	120ma	95ma	70ma	45ma	155
	0-32 VDC	120ma	95ma	70ma	45ma	
LCD-2-44	0-60 VDC	65ma	52ma	37ma	23ma	170
	0-60 VDC	65ma	52ma	37ma	23ma	
LCD-2-55	0-120 VDC	30ma	30ma	22ma	14ma	170
	0-120 VDC	30ma	30ma	22ma	14ma	

### LCS-2 SINGLE OUTPUT MODELS

3 5/32" x 3 9/32" x 3 5/16"

Model	VOLTAGE RANGE	MAXIMUM CURRENT (MA) AT AMBIENT TEMPERATURE (1)				Price (2)
		40°C	50°C	60°C	71°C	
LCS-2-01	0-7 VDC	550ma	455ma	350ma	240ma	\$90
LCS-2-02	0-18 VDC	330ma	275ma	210ma	140ma	90
LCS-2-03	0-32 VDC	240ma	205ma	155ma	95ma	90
LCS-2-04	0-60 VDC	145ma	115ma	87ma	57ma	100
LCS-2-05	0-120 VDC	50ma	50ma	45ma	30ma	100

### LCS-1 SINGLE OUTPUT MODELS

3 5/32" x 3 9/32" x 1 11/16"

Model	VOLTAGE RANGE	MAXIMUM CURRENT (MA) AT AMBIENT TEMPERATURE (1)				Price (2)
		40°C	50°C	60°C	71°C	
LCS-1-01	0-7 VDC	200ma	200ma	150ma	100ma	\$85
LCS-1-02	0-18 VDC	95ma	95ma	95ma	80ma	85
LCS-1-03	0-32 VDC	65ma	65ma	65ma	40ma	85
LCS-1-04	0-60 VDC	35ma	35ma	35ma	25ma	95
LCS-1-05	0-120 VDC	12ma	12ma	12ma	12ma	95

#### NOTES:

- (1) For operation at other than 57-63 Hz, consult factory for ratings and specifications.
- (2) All prices FOB Melville, N. Y. All prices and specifications subject to change without notice.

### OVERVOLTAGE PROTECTION

FOR USE WITH	Model	VOLT ADJ. RANGE	Price (2)
LCD-2-11, LCD-2-12, LCD-2-22, LCS-2-01, LCS-2-02, LCS-1-01, LCS-1-02	LC-OV-10	3-24 VDC	\$20
LCD-2-13, LCD-2-23, LCD-2-33, LCS-2-03, LCS-1-03,	LC-OV-11	3-47 VDC	20
LCD-2-44, LCS-2-04, LCS-1-04	LC-OV-12	3-70 VDC	25

Write, wire, or call to order direct, for information, or for new Lambda Power Supplies catalog. LAMBDA Electronics Corp., 515 Broad Hollow Road, Melville, L. I., New York 11746, TEL. 516-694-4200, TWX 510-224-6484.

# power systems design

The **FIRST** complete power supply assembly systems using standard Lambda component power supplies and accessories...make custom power supply systems obsolete!

**COM-PAK MARK II**  
integrated circuit LC power module with overvoltage protector

**1 3/4" H x 19" W x 14" D**  
LC Power Supply Assembly System

**Standard Systems Cables**

**Systems Power Control Panels**  
SP-1 for LRA-9 Price: \$20.00  
SP-3 for LRA-8 Price: \$20.00

**5 Year Guarantee**

**Rack Adapters**  
LRA-8 is 3 1/2" high Price: \$60.00  
LRA-9 is 1 3/4" high Price: \$60.00

**Systems Metering Panels**  
SMP-1 for LRA-9 Price: \$90.00  
SMP-3 for LRA-8 Price: \$100.00

**3 1/2" H x 19" W x 14" D**  
LC Power Supply Assembly System

**Chassis Slides**  
LRA-9-CS Price: \$50.00  
LRA-8-CS Price: \$50.00

• Lambda's dramatically new Power Supply Systems Concept eliminates the need for costly custom-designed multiple output power supply systems. You can order from the component power supplies and assemble your system with these standard accessories:

- Overvoltage protectors • Rack adapters
- Systems power control panels • Systems metering panels
- Standard systems cables • Chassis slides
- Assemble the system yourself or if you prefer, Lambda will assemble your power system from 18 standard power supplies and 36 accessories. You will receive the system ready to plug in.
- Up to 8 separate outputs in a 1 3/4" high rack adapter.
- Up to 16 separate outputs in a 3 1/2" rack adapter.
- Use of standard mass-produced power supplies and accessories gives lower unit costs.
- Fast delivery. No waiting for custom design.

• Substantial discounts are available to Original Equipment Manufacturers under the Lambda Commercial Purchase Plan.

- Maximum flexibility for later design changes.
- Guaranteed 5 years whether you assemble or Lambda assembles.

SEND FOR THIS  
**New 56 Page  
Lambda  
Catalog**

It gives complete information about all Lambda Power Systems, Power Instruments and Power Supplies



 **LAMBDA ELECTRONICS CORP.**

A **Veeco** SUBSIDIARY

515 BROAD HOLLOW ROAD, MELVILLE, L.I., NEW YORK 11746 TEL. 516-694-4200, TWX: 510-224-6484 CABLE: VEECOVAC PLAINVIEW NY

Circle 11 on reader service card



# When you come to power, you can count on our Joules.

DELCO SILICON TRANSISTOR TYPES	PEAK ENERGY RATING (Min.)	CONDITIONS	
		(Volts)	(Amperes)
DTS-103-107	1.6 Joules	40V	4 A
DTS-402	540 mJ	200V	9 A
DTS-423	105 mJ	300V	3.5A
DTS-424	228 mJ	325V	3.5A
DTS-425	131 mJ	375V	3.5A
DTS-431	300 mJ	200V	0.3A
2N3902	105 mJ	300V	3.5A
2N5241	300 mJ	200V	0.3A

Ratings derived from safe operating curves.

Joules of energy, that is. High energy reliability is an extra ingredient found in Delco silicon power transistors. It's because we design our transistors to have greater peak energy capability—to be able to withstand higher surges of voltage and current for a specified time. And we prove it. One hundred percent Pulse Energy Testing verifies all of our safe operating curves. That's why Delco triple diffused silicon power transistors have earned a reputation for survival in the toughest of switching jobs.

**SEMICONDUCTOR DISTRIBUTORS: EAST**—BALTIMORE, MD. 21201, Radio Electric Service Co., 5 North Howard St., (301)-539-3835 BINGHAMTON, N.Y. 13902, Federal Electronics, Inc., P. O. Box 1208, (607)-748-8211 CLIFTON, N.J. 07015, Eastern Radio Corporation, 312 Clifton Avenue, (201)-471-6600 NEWTON, MASS. 02195, The Greene Shaw Co., Inc., 341-347 Watertown St., (617)-969-8900 NEW YORK, NEW YORK 10036, Harvey Radio Co., Inc., 2 West 45th St., (212)-582-2590 PHILADELPHIA, PENN. 19114, Almo Electronics, Division of Sterling Electronics, Roosevelt Blvd. at Blue Grass Rd., Northeast Industrial Park, (215)-676-6000 PITTSBURGH, PENN. 15328, RPC Electronics, 620 Alpha Drive, RIDC Park, (412)-782-3770 WOODBURY, L.I., N.Y. 11797, Harvey Radio Company, Inc., 60 Crossways Park West, (516)-921-8700 **SOUTH**—BIRMINGHAM, ALA. 35233, Forbes Distributing Company, Inc., 1416 Fourth Ave., South, (205)-251-4104 MIAMI, FLORIDA 33142, Mountain Electronics, Division of Mountain National Co., 3730 Northwest 36th St., (305)-634-4556 RICHMOND, VA. 23220, Meridian Electronics, Inc., 1001 West Broad Street, (703)-353-6648 WEST PALM BEACH, FLA. 33402, Mountain Electronics, Division of Mountain National Co., 1000 N. Dixie Highway, (305)-833-5701 **MIDWEST**—CINCINNATI, OHIO 45237, United Radio, Inc., 7713 Reinhold Drive, (513)-761-4030 CLEVELAND, OHIO 44125, The W. M. Pattison Supply Co., Industrial Electronics Division, 4550 Willow Parkway, (216)-411-3000 INDIANAPOLIS, IND. 46225, Graham Electronics Supply, Inc., 122 South Senate Avenue, (317)-634-8486 KALAMAZOO, MICH. 49005, Electronic Supply Corp., P.O. Box 831, (616)-381-4626 KANSAS CITY, MO. 64111, Walters Radio Supply, Inc., 3635 Main Street, (816)-531-7015 MINNEAPOLIS, MINNESOTA 55401, Stark Electronics Supply Co., 112 3rd Ave., North, (612)-332-1325 SKOKIE, ILL. 60076, Merquip Electronics, Inc., 7701 N. Austin Ave., (312)-282-5400 ST. LOUIS, MO. 63144, Electronic Components for Industry Co., 2605 South



If your circuit involves inductive switching or is subject to transients, be sure to analyze the load line and specify your transistor energy requirements. Then, talk to the Kokomoans, the high energy people. They'll understand your need for Joules.

For information on power transistor load line analysis, ask for our Application Note No. 41.

For assured high energy capability in silicon power transistors, always specify Delco.

#### Kokomoan's Regional Headquarters

Union, New Jersey\* 07083  
Box 1018 Chestnut Station  
(201) 687-3770

Chicago, Illinois\* 60656  
5151 N. Harlem Avenue  
(312) 775-5411

Santa Monica, Calif.\* 90401  
726 Santa Monica Blvd.  
(213) 870-8807

Syracuse, New York 13203  
1054 James Street  
(315) 472-2668

Detroit, Michigan 48202  
57 Harper Avenue  
(313) 873-6560

Kokomo, Ind. 46901  
700 E. Firmin  
(317) 459-2175 Home Office

\*Office includes field lab and resident engineer for application assistance.



THE KOKOMOANS ARE IN POWER

**DELCO RADIO**  
DIVISION OF GENERAL MOTORS  
KOKOMO, INDIANA

Hanley Road, (314)-647-5505 WEST—ALBUQUERQUE, N.M. 87108, Hyer Electronics Company, 130 Alvarado Drive, N.E., (505)-265-5767; 87106 Sterling Electronics Inc., 1712 Lomas Blvd., N.E., (505)-247-2486 COLORADO SPRINGS, COLO. 80902, L. B. Walker Radio Co., 9 E. Vermijo St., (303)-636-1661 DALLAS, TEXAS 75201, Adleta Electronics Company, 1907 McKinney Ave., (214)-742-8257 DENVER, COLO. 80219, L. B. Walker Radio Company, 300 Bryant Street, (303)-935-2406 ENGLEWOOD, COLORADO 80110, Hyer Electronics Company, 8101 E. Prentice Ave., (303)-771-5285 FORT WORTH, TEXAS 76102, Adleta Electronics Co., S. Expressway at E. Vickery, (817)-336-7446 HOUSTON, TEXAS 77001, Harrison Equipment Co., Inc., 1422 San Jacinto Street, (713)-224-9131 LOS ANGELES, CAL. 90015, Radio Products Sales, Inc., 1501 South Hill Street, (213)-748-1271 LOS ANGELES, CAL. 90022, Kierulff Electronics, Inc., 2585 Commerce Way, (213)-685-5511 OKLAHOMA CITY, OKLAHOMA 73102, Radio, Inc., 903 North Hudson, (405)-235-1551 PALO ALTO, CAL. 94303, Kierulff Electronics, Inc., 3969 East Bayshore Road, (415)-968-6292 PHOENIX, ARIZ. 85005, Sterling Electronics, Inc., 1930 North 22nd Ave., (602)-258-4531 SALT LAKE CITY, UTAH 84115, Hyer Electronics Company, 1425 South 2nd West, (801)-487-3681 SAN DIEGO, CAL. 92101, Milo of California, Inc., 2060 India Street, Box 2710, (714)-232-8951 SEATTLE, WASH. 98108, Kierulff Electronics, Inc., 5940 6th Ave., South, (206)-763-1550 TACOMA, WASH. 98402, C & G Electronics Company, 2502 Jefferson Ave., (206)-272-3181 TULSA, OKLAHOMA 74119, Radio, Inc., 1000 South Main Street, (918)-587-9124 CANADA—SCARBOROUGH, ONTARIO, Lake Engineering Co., Ltd., 123 Manville Rd., (416)-751-5980

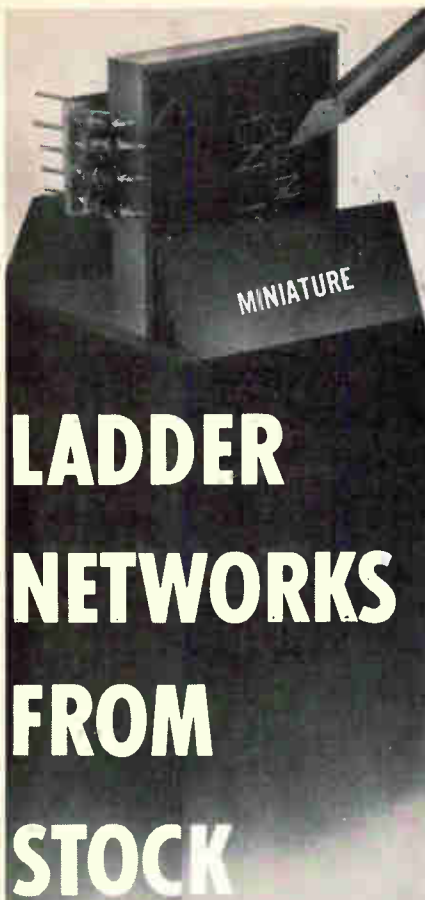

- 8 to 17 Bits
- 1/2 LSB Accuracy
- Switch Impedance Compensated
- Military / Commercial
- 1" x 1.40" x 0.2"
- 30 Volt Input
- R/2R, Binary, Mod. Binary
- \$15 to \$110\*

\*f.o.b. Mt. Vernon, N. Y., domestic

Write or 'phone for complete technical data.

General Resistance, Division of Chronetics,  
500 Nuber Avenue, Mt. Vernon, N.Y. (212)  
292-1500. In Europe: 39 Rue Rothschild,  
Geneva, Switzerland (022) 31 81 80.

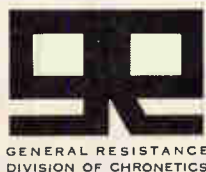

## Who's Who in electronics



Kemp

"We have a team of folks whose pencils may be rusty when it comes to writing the word 'fighter,' but they certainly know a lot about such aircraft programs as the XB-70, the RA-5C and the OV-10A." That's the way Robert Kemp, 50, described the organization charged with winning new military aircraft contracts for the North American Rockwell Corp.

The group is the North American Aviation divisions office, and Kemp has just been named a vice president of the unit. Also, as the firm's F-15 program manager, he is directing North American's efforts to win the development and production contract for the Air Force fighter. The competition here—McDonnell Douglas and Fairchild Hiller—is stiff, but North American has lined up some impressive allies in its bid for the award.

The only remaining XB-70 from North American is a museum piece now, and the fighters the firm counted on to keep its production lines humming have been shot down—figuratively. Only three F-107's were built in the mid-1950's and the mach 3 F-108 interceptor was canceled a few years later when the craft was still in the

design-development phase.

**Total integration.** Kemp exudes confidence about F-15 prospects, however, and this stems in no small part from the fact that he has on his team the Strike Avionics Systems division of Autonetics—developer and integrator of the F-111 avionics system. "Their forte is avionics integration, and there isn't much of that expertise in the industry," he declares.

Kemp and Autonetics Strike Avionics officials says the F-15's system will represent the first total integration of all aircraft avionics.

As if to counter complaints that it hasn't turned out large quantities of fighters for some years, North American has just enlisted Northrop as an F-15 team member. Northrop, builder of the F-5 fighter, will participate in design and manufacturing if North American Rockwell wins the contract. Initial F-15 proposals will be submitted to the Air Force in June.

**As corporations grow, they can reach a point analogous to early adolescence: they have trouble co-**



# You wouldn't want the Bank mad at you, would you?



(Model 340B keeps bank bits straight on digital data circuits)

Unlike voice, there's no margin for error in digital data communications. One out-of-phase pulse could ruin an entire machine calculation or a key control function. Things like that make banks, oil companies, or even Uncle Sam himself mad. To help keep you on the good side of important data subscribers, Sierra has developed the Model 340B Envelope Delay Test Set.

Plugged into the transmit side of a data circuit, Model 340B gives you an instant picture of its relative envelope delay at each frequency within the transmission pass band. Relative delay reads out directly in microsecond, or 0.1-microsecond increments on a bright digital display. Tuned frequency appears on a second digital display. You can tune across the pass band and construct a relative delay characteristic curve in seconds. You'll *know* the treatment needed to keep those bits in order.

Model 340B's broad frequency range (see Summary Specifications) covers both voice program channels and the 60-108-kHz group frequency bands. This enables you to transmit at voice level and measure at the group distribution frame, or vice versa. You can check circuits capable of transmitting wideband data at rates up to 40.8 kilobits.

You can operate Model 340B in end-to-end, end-to-end with return reference path, or loop-back modes. Precision of its internal master clock oscillator makes possible highly accurate end-to-end measurements without a separate reference circuit.

To offset slight long-term frequency drift, you need only adjust synchronization with a high-resolution, multiturn potentiometer.

For speed and operating convenience, Model 340B offers switch-selectable operating modes, three switch-selectable modulation frequencies, analog outputs of frequency and delay (receive level available optionally) for recording or oscilloscope display, and electronic sweeping. You can even use it as a 1 Hz to 1 MHz frequency counter.

Product File 269 presents every bit of the Model 340B story. For your set, write Philco-Ford, 3885 Bohannon Drive, Menlo Park, California 94025. Or call (415) 322-7222, ext. 329.

#### SUMMARY SPECIFICATIONS

Carrier Frequency	300 to 110,000 Hz
Frequency Accuracy (counter mode only)	±1 digit, ±10 Hz (1 Hz to 1 MHz)
Delay Measurements, Range:	
25-Hz Modulation	±20,000 μsec.
83 1/3-Hz Modulation	±6,000 μsec.
250-Hz Modulation	±2,000 μsec.
Delay Accuracy:	
Loop: 25-Hz Modulation	±1 digit, ±2 μsec.
83 1/3-Hz Modulation	±1 digit, ±1 μsec.
250-Hz Modulation	±1 digit, ±0.2 μsec.
One-Way (10 min.)	
25-, 83 1/3-, and 250-Hz Modulation	±1 digit, ±5 μsec.

**PHILCO** 

PHILCO-FORD CORPORATION  
Sierra Electronic Operation  
Menlo Park, Calif. 94025

# See where you can't be with COHU TV.



FURNACE FLAMES

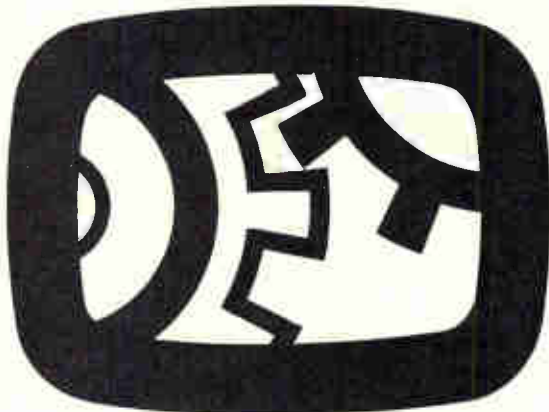

GEAR WEAR

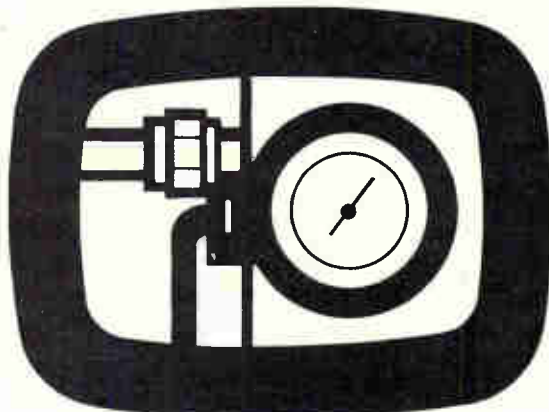

WATER PRESSURE

Contact your nearest Cohu engineering representative, or call Bob Boulio direct at 714-277-6700 in San Diego. TWX 910-335-1244 Box 623. San Diego, Calif. 92112



## Who's who in electronics

ordinating, their movements may be awkward, and they may use their resources ineffectively. To some degree, this is the problem that was faced by the overseas operations of General Telephone & Electronics. But the firm has done something about this problem: it has set up a special operation, the GT&E International Systems Corp. in Waltham, Mass.

According to its president, Richard W. Couch, the new corporation will coordinate overseas hardware and software projects. "Contracts will come to us both from customers and GT&E's many quasi-independent overseas subsidiaries," he says. "We will act as a systems engineering and management group, able to call upon any of GT&E's companies for technology and expertise."

"Technology and expertise" are the reasons why GT&E International Systems is situated in Waltham. "It made sense to be where our systems engineers are—that is, near Sylvania Electronic Systems and the Advanced Research Laboratories, both in Waltham," says Couch.

Most of the men coming into his group from Sylvania Electronic Systems and the labs got their know-how in military work, but "no one minds leaving it to work in the less restrictive civilian sector," he says. "In fact we have more recruits than positions. Though we will eventually number 150 men or so, now we are almost fully staffed at about 40."

**New scope.** "Last summer, the Thai Government asked if GT&E could set up an entire communications network for their country," says Couch. "Unfortunately, we weren't organized to do it then. But now, drawing upon all GT&E's member companies for hardware and advice, we can say, 'yes' and perform such jobs efficiently."

GT&E International Systems' first job will be a satellite ground terminal for Thailand—the country's second. Upcoming are a microwave communications system for an African nation, another Far Eastern satellite terminal, and an educational television system for an emerging nation.

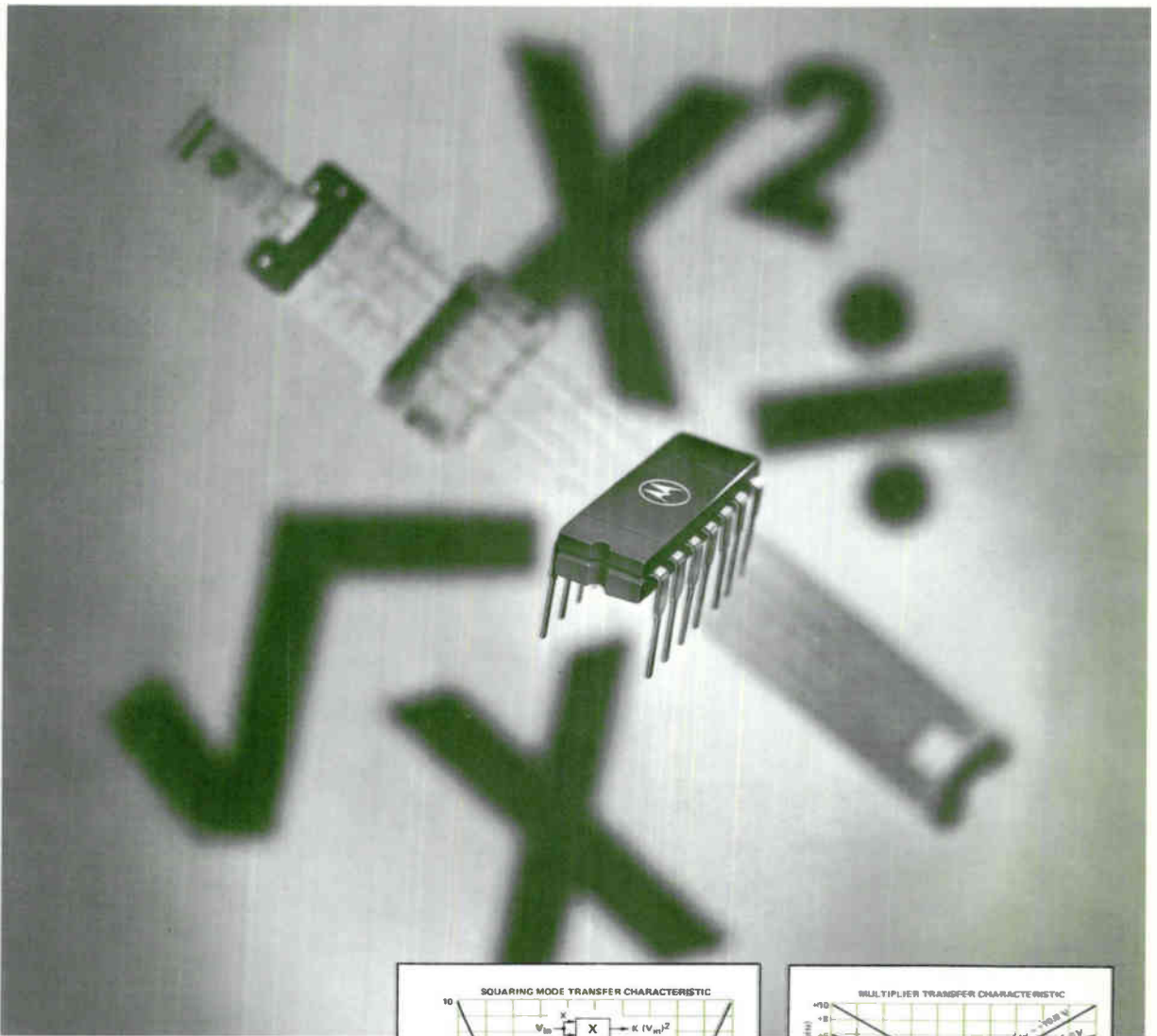

# MC1595 is the industry's first true Linear, 4-Quadrant Multiplier IC.

Here is the first element in what promises to be a large family of monolithic, linear multipliers. The MC1595 is designed for uses where the output voltage is a linear product of two input voltages; and, as such, its list of applications is almost limitless, particularly in the control and instrumentation fields.

For example, some of the applications are:

- To Multiply
- To Divide
- To Find Square Root

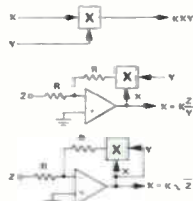

- To Determine Mean-Square

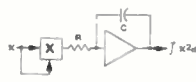

- Frequency Doubling



The MC1595 can also be used as a Balanced Modulator/Demodulator, and for Electronic Gain Control among many others. It even has the capability for determining true rms; plus direct power calculations.

- where the priceless ingredient is care!

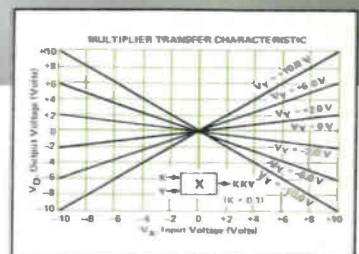
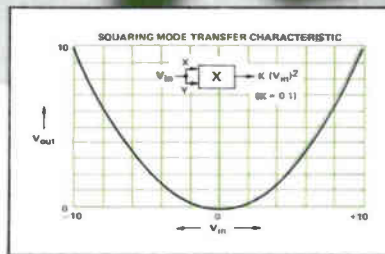

Here are some of the features that contribute to the wide versatility of the MC1595:

- Excellent Linearity — 1% max error "X" input; 2% error max "Y" input.
- Wide Bandwidth — Phase Error  $\leq 3^\circ$  from DC to 750 kHz.
- Adjustable Scale Factor.
- Large Input Voltage Range  $\pm 10$  V.

For more detailed information, check the specs on the back:



**MOTOROLA**  
Integrated Circuits

# Here's detailed data about the first true Linear Monolithic, Four-Quadrant Multiplier... MC1595

Check the specs... to see why it's destined to be the new major analog building block.



**MOTOROLA**  
Semiconductors  
BOX 812, PHOENIX, ARIZONA 85 38

## MC1595L

**LINEAR FOUR QUADRANT MULTIPLIER INTEGRATED CIRCUIT**

**MONOLITHIC SILICON EPITAXIAL PASSIVATED**

ESR A 1969 D 10



**L** SUFFIX  
CERAMIC PACKAGE  
CASE 690C  
TFO 1181

**Advance Information**

**MONOLITHIC FOUR QUADRANT MULTIPLIER**

Designed for uses where the output voltage is a linear product of two input voltages. Typical applications include multiply, divide, square root, mean square, phase detector, frequency doubler, balanced modulator/demodulator, electronic gain control.

\*When used with an operational amplifier.

- Excellent Linearity - 1% max error on X input, 2% max error on Y input
- Adjustable Scale Factor, "K"
- Excellent Temperature Stability
- Large Input Voltage Range - +10 Volts

**FOUR QUADRANT MULTIPLIER TRANSFER CHARACTERISTIC**

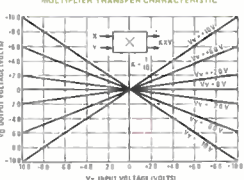

**SQUARING MODE TRANSFER CHARACTERISTIC**

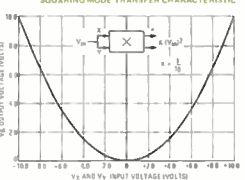

**CIRCUIT SCHEMATIC**

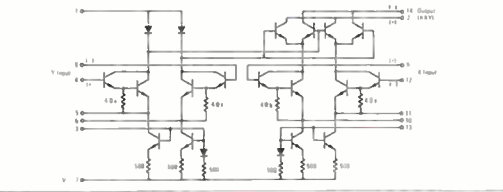

MAXIMUM RATINGS (T <sub>A</sub> = 25°C unless otherwise noted)				
Rating	Symbol	Value	Units	
Applied Voltage (V <sub>2</sub> -V <sub>1</sub> , V <sub>14</sub> -V <sub>1</sub> , V <sub>1</sub> -V <sub>2</sub> , V <sub>1</sub> -V <sub>14</sub> , V <sub>1</sub> -V <sub>4</sub> , V <sub>1</sub> -V <sub>8</sub> , V <sub>2</sub> -V <sub>12</sub> , V <sub>2</sub> -V <sub>8</sub> , V <sub>2</sub> -V <sub>4</sub> , V <sub>2</sub> -V <sub>12</sub> )	V <sub>12</sub> -V <sub>8</sub> , V <sub>4</sub> -V <sub>8</sub>	10	Vdc	
Differential Input Signal	V <sub>12</sub> -V <sub>8</sub> , V <sub>4</sub> -V <sub>8</sub>	10	Vdc	
Maximum Bias Current	I <sub>B</sub>	10	mA	
Power Dissipation (Package Limitation) Ceramic Package, Dissipate above 25°C	P <sub>D</sub>	150	mW	°C
Operating Temperature Range	T <sub>A</sub>	55 to +125	°C	
Storage Temperature Range	T <sub>stg</sub>	-65 to +150	°C	

**ELECTRICAL CHARACTERISTICS (V<sub>1</sub> = +32 V, V<sub>2</sub> = -15 V, T<sub>A</sub> = 25°C, I<sub>B</sub> = I<sub>13</sub> = 1 mA, R<sub>X</sub> = R<sub>Y</sub> = 15 kΩ, R<sub>L</sub> = 11 kΩ unless otherwise noted)**

Characteristic	Symbol	Min	Typ	Max	Units
Linearity					%
Output Error in Percent of Full Scale					
T <sub>A</sub> = 25°C					
10 ≤ V <sub>X</sub> ≤ -10 (V <sub>X</sub> ± 10 V)	E <sub>EX</sub>	-	0.5	1.0	
10 ≤ V <sub>Y</sub> ≤ -10 (V <sub>Y</sub> ± 10 V)	E <sub>EY</sub>	-	1.0	2.0	
T <sub>A</sub> = 55°C to +125°C					
10 ≤ V <sub>X</sub> ≤ -10 (V <sub>X</sub> ± 10 V)	E <sub>EX</sub>	-	0.75	-	
10 ≤ V <sub>Y</sub> ≤ -10 (V <sub>Y</sub> ± 10 V)	E <sub>EY</sub>	-	1.50	-	
Squaring Mode Error					%
Accuracy in Percent of Full Scale After Offset and Scale Factor Adjustment	E <sub>SQ</sub>	-	0.5	-	
T <sub>A</sub> = 25°C					
T <sub>A</sub> = 55°C to +125°C					
Scale Factor (Adjustable)	K	-	0.1	-	
(K = 1/R <sub>X</sub> R <sub>Y</sub> )					
Input Resistance	R <sub>INX</sub> , R <sub>INY</sub>	35	-	-	M Ohms
Differential Output Resistance (f = 20 Hz)	R <sub>OUT</sub>	35	-	-	k Ohms
Input Bias Current	I <sub>BX</sub> , I <sub>BY</sub>	2.0	8.0	8.0	μA
I <sub>BX</sub> = I <sub>B1</sub> - I <sub>B2</sub> , I <sub>BY</sub> = I <sub>B3</sub> - I <sub>B4</sub>					
Input Offset Current	I <sub>IOX</sub> , I <sub>IOY</sub>	0.2	1.0	1.0	μA
Average Temperature Coefficient of Input Offset Current	TC <sub>IO</sub>	2.0	-	-	μA/°C
Output Offset Current	I <sub>IOO</sub>	-	10	50	μA
Average Temperature Coefficient of Output Offset Current	TC <sub>IOO</sub>	-	20	-	μA/°C
Bandwidth (3 dB)	f <sub>3dB</sub>	3.0	-	-	MHz
Bandwidth to 3° Relative Phase Shift between V <sub>X</sub> and V <sub>Y</sub>	f <sub>90</sub>	750	-	-	KHz
Common Mode Input Swing (Either Input)	CMV	+11.9	-8.13	-	Vdc
Common Mode Gain	ACM	50	-60	-	dB
Common Mode Quiescent Output Voltage	V <sub>OS1</sub> , V <sub>OS2</sub>	-	21	-	Vdc
Differential Output Voltage Swing Capability	V <sub>OUT</sub>	-	21.4	-	Vdc
Power Supply Sensitivity	S	-	5.0	-	mV/V
Power Supply Current	I <sub>V</sub>	6.0	7.0	-	mA
DC Power Dissipation	P <sub>D</sub>	135	120	-	mW

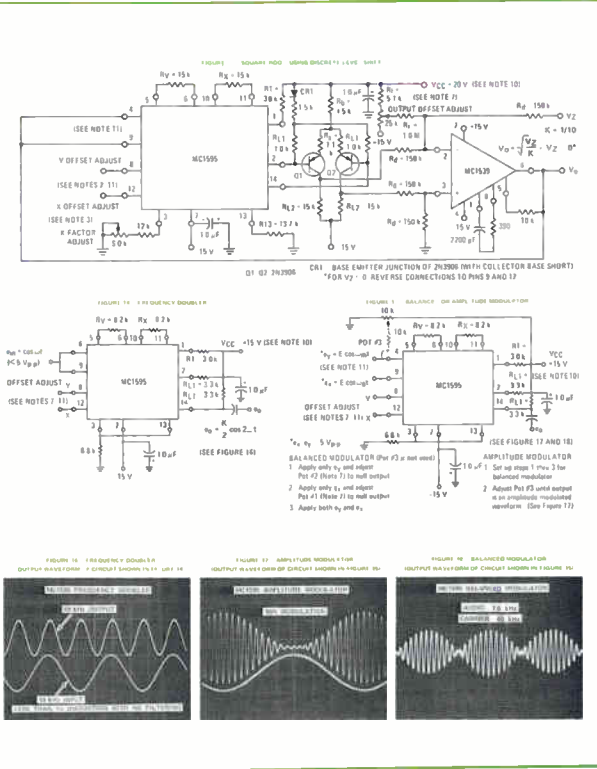
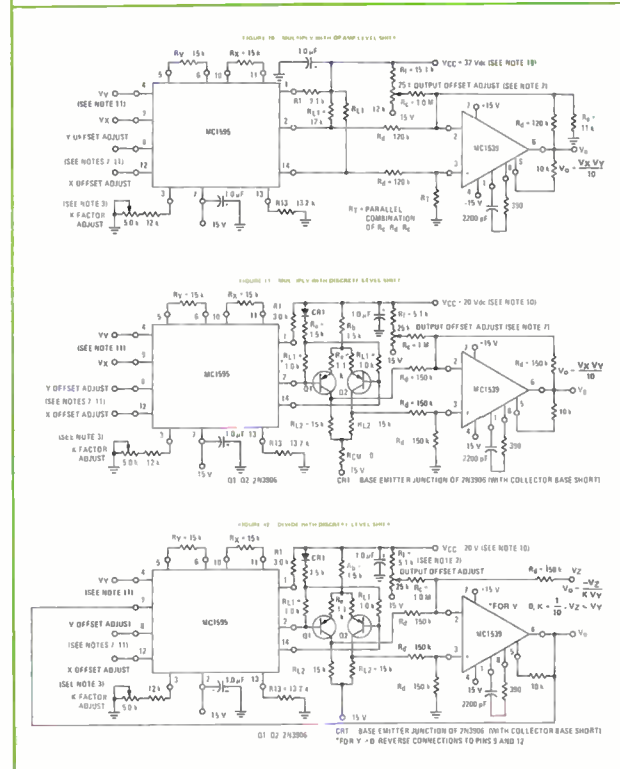

The MC1595 Multiplier is currently available from distributor stock in the 14-pin dual in-line ceramic package. For complete specifications and applications information, circle the reader service number from the preceding page, or write:

where the priceless ingredient is care!  **MOTOROLA**  
Integrated Circuits

Motorola Semiconductor Products Inc. / P.O. Box 20912 / Phoenix, Arizona 85036

The circuitry shown external to Motorola products is for illustration purposes only, and Motorola does not assume any responsibility for its use or warrant its performance or that it is free from patent infringement.

# Sure cure for a common headache



What to do about the headache of small "problem" parts? Make them yourself? That means a major investment in special machinery and skilled labor. If you already make them, how do you know somebody else can't make them for you more economically?

Like Anaconda, for instance. They have Anacondability—all the facilities and capabilities to

produce a large variety of parts that can be stamped or drawn—in any metal (copper, brass, bronze, nickel silver, iron, steel, stainless or aluminum)—and with any finish.

Most importantly, FMG engineers have often been able to redesign a part so that it can be made more economically (as much as 50% less!) with no sacrifice in quality!

It won't cost you a cent to find out

what FMG can do for you. Send a blueprint; they'll do the rest.

Get rid of that headache faster than you can say, "Anacondability"! Please write Anaconda American Brass Company, 414 Meadow St., Waterbury, Conn. 06720

Fabricated Metal Goods Division  
**ANACONDA**<sup>®</sup>  
AMERICAN BRASS COMPANY

Circle 19 on reader service card

←Circle 18 on reader service card

# 33 reasons why we're No. 1 in DVMs.

Dollar for dollar we shipped more DVMs last year than anyone else, including the industry giant.

One of the reasons is our Model 5700. It's the DVM used by laboratories to calibrate other DVMs. Without question it's the

best DVM on the market.

But since not everyone needs the kind of performance and features offered by the 5700, we offer 32 other models. Models for labs and for production lines, bench units and systems' units, militarized models,

four digit DVMs and five, from \$1150 to over \$8,000. (In fact, with plug-in modules you can come up with 300 different configurations.) In short, we make a model for every application and every budget. All as part of our standard line.



And every DVM we make is put together on the same production line, by the same people, using many of the same components and boards. In fact, quite often the assemblers don't know in advance which models they're assembling.

Which means that we've got to build every DVM as though it were our most expensive, over \$8000, unit.

And that may be reason number 34 why we're No. 1 in DVMs.

*For a detailed description of our 33 models, write Dana Laboratories, Inc., 2401 Campus Drive, Irvine, Calif. 92664*



# The AMP point-to-point most versatile

## One Technique Covers Widest Range Of Interconnection Requirements

Whatever your interconnection requirements, TERMI-POINT★ products can move in to fulfill them over the widest variety of applications. The components shown below are only a few of the applications now being used in industry. In addition, AMP Engineering is available to

be applied against any particular or unusual interconnection problems you may have in point-to-point wiring.

## AMP Pre-Wired Panels And Component Service

If you prefer AMP to pre-wire panels or connectors, a special division in our Harrisburg plant offers complete

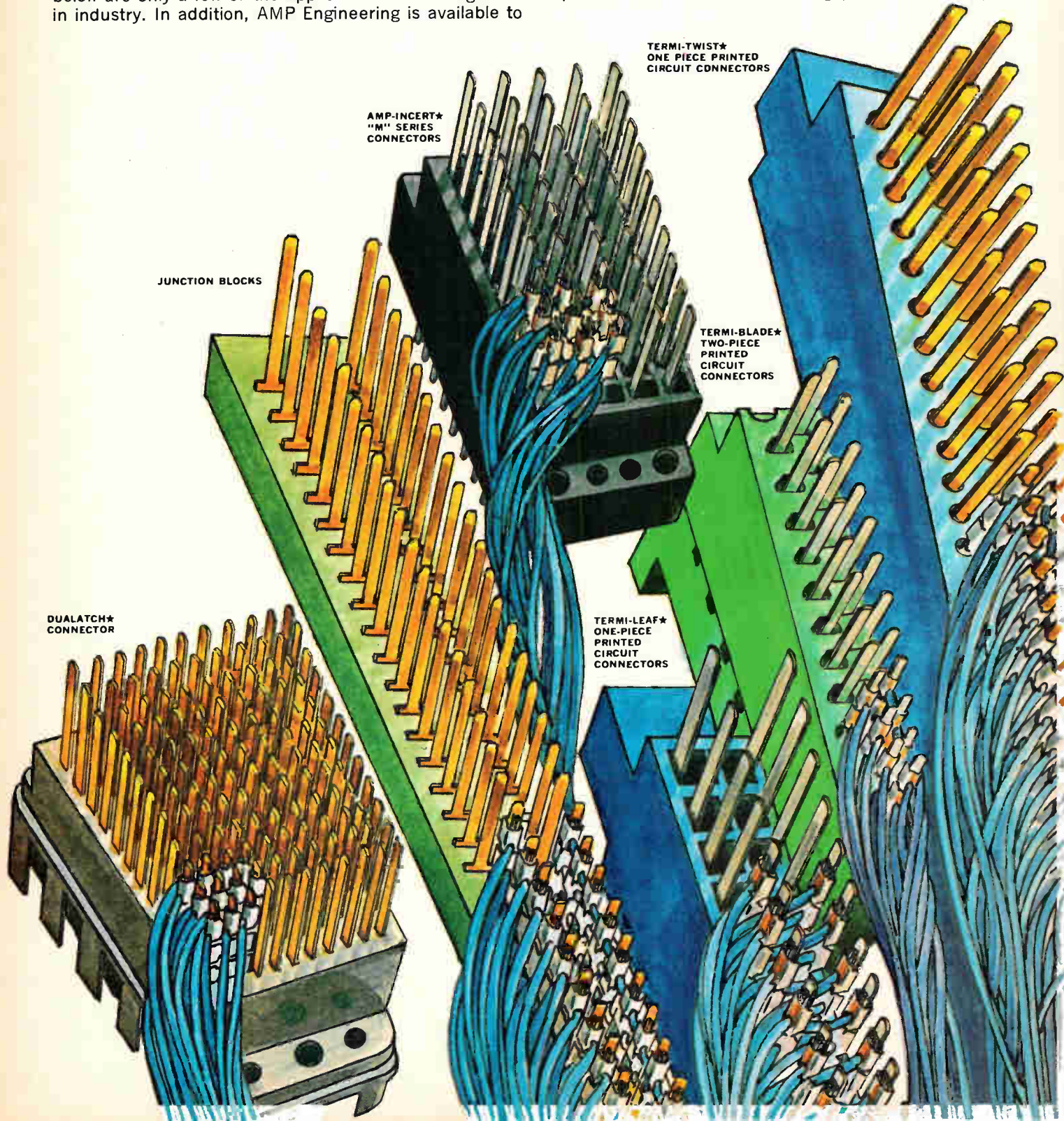



# wiring technique is the in the world

facilities from taping specifications to finished product. Fully tested panels will be shipped ready for installation to give you the benefits of automated wiring at lowest applied cost. Quotes on your point-to-point wiring requirements will be supplied on request.

## Write For Special Point-To-Point Wiring Report And Complete Product Information

Send for our 6-page special report, "A Stored Energy Connection for Point-to-Point Wiring" plus complete information including specifications and test data on TERMI-POINT Clips, Tools and companion products. Write .....  
**INDUSTRIAL DIVISION, AMP INCORPORATED, HARRISBURG, PA. 17105.**

★Trademark of AMP Incorporated

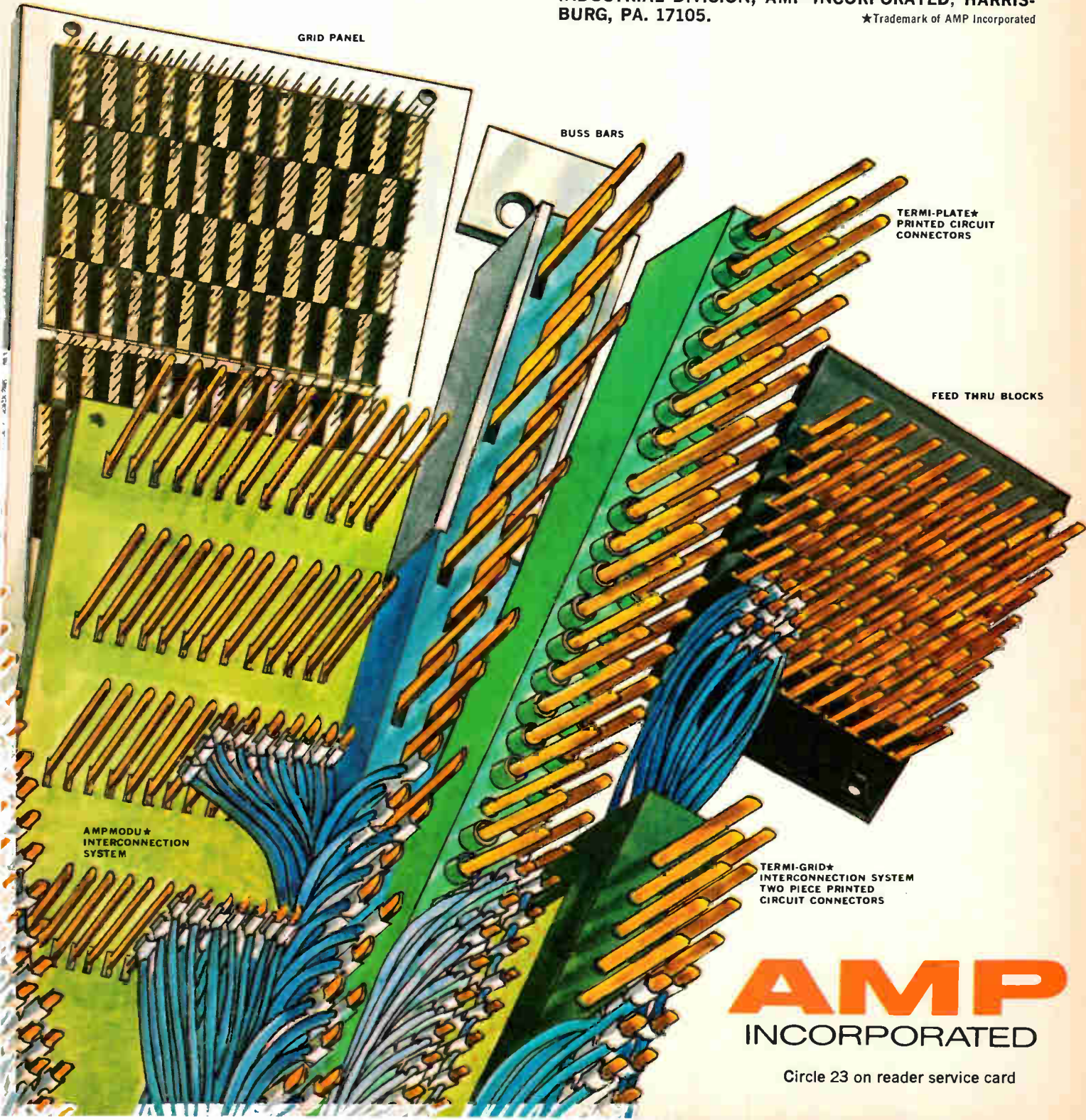

# AMP

INCORPORATED

Circle 23 on reader service card



Hewlett-Packard 4815A RF Vector Impedance Meter simplifies impedance measurements. It's fast and simple. No tedious nulling and balancing, you just touch and read positive and negative impedance directly. Measure components, networks or probe right into active circuits in their normal operating environment. Application Note 86 describes many applications of the 4815A RF Vector Impedance Meter. For your copy and complete specifications, contact your local Hewlett-Packard field engineer or write: Hewlett-Packard, Green Pond Road, Rockaway, New Jersey 07866. In Europe: 1217 Meyrin-Geneva, Switzerland.

**Pertinent Specifications:**

Frequency Range: 500 kHz to 108 MHz, continuous.  
 Impedance Range: 1 ohm to 100,000 ohms.  
 Phase Range: 0 to 360°.  
 Price: \$2,650.

**HEWLETT *hp* PACKARD**

IMPEDANCE INSTRUMENTS

1095

## Meetings

### Telemetry: all over the place

A scan of the more than 80 papers that will be presented at the IEEE National Telemetry Conference, April 22 to 24, indicates that the technology and applications of telemetry is growing rapidly.

On the applications side, papers at the Washington, D.C., conference will show how telemetry will be linked to advanced highway systems, crime control, medicine, animal tracking, fishing, and underwater oil drilling. Satellite telemetry will come in for much attention with papers on industrial applications of NASA telemetry, and the telemetry challenges of the upcoming Earth Resources Technology Satellite program. One session will be devoted to personal telemetry, which will feature such papers as the general design considerations for a wireless telemetry system for medical diagnosis. Another will be the transmission of electrocardiograms from an ambulance in transit.

**Stage props.** In the plenary session on the afternoon of April 22, four papers will be given that include some practical demonstrations. A paper entitled "Tomorrow's Telemetry Today" by Robert Darcy, project manager of the Applications Technology Satellite program, will be tied in with a live transmission from an ATS satellite. And a paper on future highway traffic systems will be amplified with a display from the Department of Transportation and a paper on the Tecktite 1 underwater-living experiment will be demonstrated by a live communications link with the program in the Virgin Islands. A discussion of portable elemental analysis instruments and transmission systems for space, geologic, biomedical, and forensic science investigation will be highlighted as data is submitted to instruments at the conference, telemetered to Goddard Space Flight Center, and identified by a computer at the center.

On the theoretical side, sessions will center on advanced data com-

pression schemes; f-m techniques; pulse-code modulation-bit synchronizers, and signal conditioners in the 1970's; computation and coding; and antennas and propagation.

Two papers have already generated some excitement, according to the technical program chairman. One is a discussion of recent results of convolutional coding on Pioneer 9 and will be given by two researchers from Ames Research Center. The other paper will discuss pcm synthesized at bit-rates up to 50 megahertz.

For further information write R.W. Rochelle, Code 710, NASA, Goddard Space Center, Greenbelt, Md. 20771.

### CAD in circuit theory

With computer-aided design becoming a major factor in the development of semiconductors, integrated circuits, and printed-circuit assemblies, it's no surprise that the organizers of the annual Midwest Symposium on Circuit Theory have included three papers on CAD in this year's schedule. It may be surprising that this marks the first time the computer has been featured in these presentations. The symposium will be held April 21 and 22 at the University of Texas in Austin.

In a paper on computer driver displays, Frederic Hills of NASA will tackle the question of whether on-line graphics are a practical tool for designing large circuits or are simply a convenience in small-scale experimentation.

Earl Joseph of Univac, in discussing CAD trends, will review the latest developments in graphics and on-line techniques, plus recent improvements in programs.

The third paper, by Lotfi Zadeh of the University of California at Berkeley, is entitled "Machine In-

(Continued on p. 26)

from dc to 3 GHz  
with only  
one plug-in

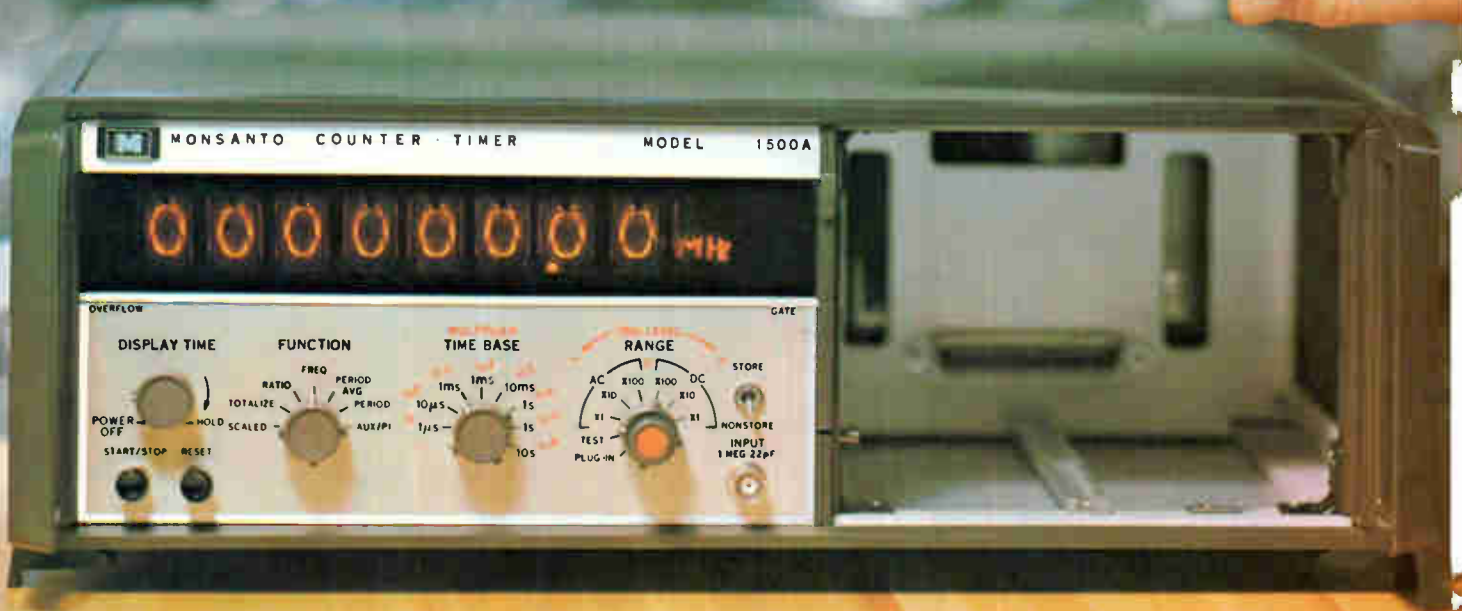

**This new "4th generation"  
I-C plug-in counter/timer  
Outperforms all others...**

**And will for years to come!**

Why compromise for less? The Model 1500A has a main frame counting range from dc to 125 MHz (to 3 GHz with a single plug-in). This instrument is fully programmable, has provision for external time base up to 10 MHz, and many other significant features, including the well recognized advantages of Monsanto's "4th generation" 90% integrated circuit design.

Shown above is the Model 1104B 3 GHz frequency converter plug-in. Also available: Model 1100A uncommitted

plug-in; Model 1101A 500 MHz prescale plug-in; Model 1102A 6-digit preset plug-in; Model 1103A 500 MHz frequency converter plug-in; Model 1107A time interval plug-in; Model 1201A DVM plug-in.

Unparalleled performance plus award-winning design make the Model 1500A the ultimate counter for the no-compromise engineer. The price for the main frame is \$2850.00, FOB West Caldwell, N. J. Other models of the 1500 Series offering a wide selection of fea-

tures and capabilities begin at \$1695.00.

Most engineers take Monsanto's reliability for granted because of our 2-year warranty. But, just in case, we maintain 37 Service Centers located strategically throughout the United States and overseas.

For a demonstration, or for full technical details, call your local Monsanto Field Engineer now or contact us directly at: Monsanto Company, Electronic Instruments, West Caldwell, New Jersey 07006, (201) 228-3800.

Circle 25 on reader service card

**Monsanto**

# THE GIANT KILLERS

## SMALLER TOUGHER



## FOR LESS!

Regulated DC Power Supplies Designed (and Priced) to Solve Big Problems...and you can get them in 3 days!

The Computer Products family of DC power supplies—3.6V 250 MA to 180V 10 MA, in P.C. and Octal Plug-in models—are consistently smaller, tougher and better-performing than our competitors' near-equivalents.

The prices: ABOUT HALF THOSE OF OUR COMPETITION, ITEM FOR ITEM.

These are the giant killers. They whip the problems of space, performance, cost and delivery.

Here's a sampling of performance specs and prices:

Output Voltage	6V	12V	Dual 15V
Input Voltage	115±10VAC	115±10VAC	115±10VAC
Output Current	200 MA	100 MA	100 MA
Line-load Reg. Ea.	±0.05%	±0.02%	±0.02%
Temp. Coeff. / °C	±0.05%	±0.02%	±0.02%
Ripple & Noise	0.5 mV RMS	0.5 mV RMS	0.5 mV RMS
Output Z @ 10 KHz	0.2 ohms	0.2 ohms	0.2 ohms
Case Sizes	2" x 3" x 1"	1.75" x 2.25" x 1"	2.30" x 3.50" x 1"
Model No.	PM522	PM563	PM552
PRICE (1-9)	\$36.15	\$24.95	\$42.95
(100-299)	\$28.05	\$17.95	\$33.95

**CALL OR WRITE FOR COMPLETE INFORMATION ON THE WHOLE FAMILY  
...OR CALL TODAY FOR 3-DAY SHIPMENT. PHONE: 305/565-9565**

Computer Products, Inc., 2801 E. Oakland Pk. Blvd., Ft. Lauderdale, Fla. 33306



**COMPUTER  
PRODUCTS™**

FORT LAUDERDALE

## Meetings

(Continued from p. 24)

telligence versus Human Intelligence." Zadeh will weigh the capabilities of man and computer, particularly in terms of interaction.

For further information write Dr. J. K. Aggarwal, Department of Electrical Engineering, University of Texas, Austin, Texas 78712.

## Calendar

**International Colloquium on Data Transmission, Federation Nationale des Industries Electroniques; Paris, March 24-28.**

**International Convention & Exhibition, IEEE; Coliseum and Hilton Hotel, New York, March 24-27.**

**Second International Laser Safety Conference, Medical Center of the University of Cincinnati; Stouffer's Motor Inn, March 24-25.**

**Semiconductor Device Research Conference, IEEE; Munich, Germany, March 24-27.**

**Conference on Lasers & Optoelectronics, IEEE; Southampton, England, March 25-27.**

**Symposium on Engineering Aspects of Magnetohydrodynamics; Massachusetts Institute of Technology, Cambridge, Mass., March 26-28.**

**The Changing Interface: An IC Systems Seminar, Electronics/Management Center; Park Sheraton Hotel, New York, March 28.**

**International Components Show, Federation Nationale des Industries Electroniques; Paris, March 29-April 2.**

**Vibrations Conference, Association of Mechanical Engineers; Philadelphia, March 31-April 2.**

**Quality Control Conference, University of Rochester; Rochester, N.Y., April 1.**

**Numerical Control Society; Stouffer's Motor Inn and Convention Center, Cincinnati, April 1-3.**

**Mathematical Aspects of Electrical Network Analysis, American Mathematical Society; Providence, R.I., April 2-3.**

**International Symposium on Computer Processing in Communications. Polytechnic Institute of Brooklyn;**

(Continued on p. 28)

# tricky tapers...

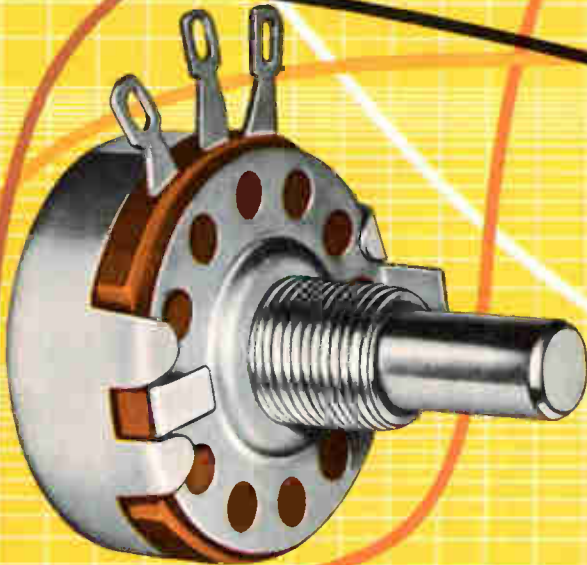

Allen-Bradley Type J  
hot molded variable resistor  
shown twice actual size

## Allen-Bradley Type J potentiometers offer tapers designed to your special needs!

■ When standard tapers fail to provide the control you desire, Allen-Bradley Type J potentiometers have the unique capability to provide a virtually limitless variety of curves to meet your specialized requirements. While not a precision device that is continuously taper-trimmed to very close tolerances, Allen-Bradley's control of the resistance-rotation characteristics during production assures a high degree of conformity.

Allen-Bradley Type J potentiometers have a solid hot molded resistance track made by an exclusive process which was pioneered and perfected by A-B. This solid resistance track assures smooth adjustment at all times—with none of the discrete changes in resistance that are encountered in wire-wound units. And being essentially noninductive, Type J controls can be applied in high frequency circuits where wire-wound units are useless. Furthermore, A-B's solid molded resistance track assures low noise and long life.

For more complete details, please write: Allen-Bradley Co., 1201 S. Second St., Milwaukee, Wis. 53204. Export Office: 1293 Broad Street, Bloomfield, New Jersey, U.S.A. 07003. In Canada: Allen-Bradley Canada Limited.

### COMPLETE LINE OF FRONT PANEL CONTROLS AND TRIMMING RESISTORS

The Allen-Bradley family of controls can meet virtually any requirement. There are hot-molded composition and cermet types. Single-turn and multi-turn units. Types to meet military requirements. There are ultra-compact units, and units that offer special tapers and special resistance. Standard resistances are from 50 ohms through 5.0 megohms. Operating temperatures from  $-65^{\circ}\text{C}$  through  $+150^{\circ}\text{C}$  can be met. All A-B controls feature smooth adjustment with almost infinite resolution and low inductance for high-frequency operation.



**ALLEN-BRADLEY**  
QUALITY ELECTRONIC COMPONENTS



©Allen-Bradley Company 1969

# synchro/resolver to digital converters

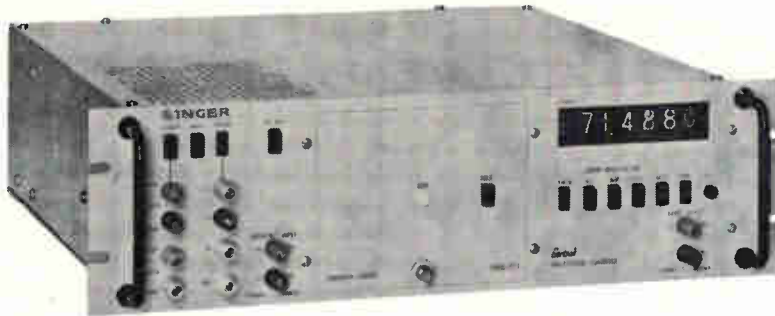

Now... Digitize shaft angle inputs  
with accuracy!

- .001° Accuracy
- .0005° Resolution
- Front panel Nixie display
- Rear panel BCD outputs in DTL positive logic (T<sup>2</sup>L compatible)
- Completely programmable
- Successive approximation or tracking modes
- All solid state, IC design
- Automatic Phase Correction

The new Gertsch Model ADC-1 Synchro/Resolver-to-Digital converter is a self-nulling bridge, using solid state switched ratio transformers to measure the shaft angle input of synchros or resolvers. The shaft angle is displayed on a 7-digit Nixie display and available as true BCD output on a rear connector.

For a demonstration, or for full technical details, call your local Singer Instrumentation representative or contact us directly at The Singer Company, Instrumentation Division, Gertsch Operation, 3211 S. La Cienega Blvd., Los Angeles, Calif. 90016, (213) 870-2761.

**SINGER**  
INSTRUMENTATION

## Meetings

(Continued from p. 26)

Waldorf-Astoria Hotel, New York, April 8-10.

High Frequency and Microwave Power, Radio Standards Engineering Division of the NBS Institute for Basic Standards; Boulder, Colo., April 14-16.

Computer Aided Design Conference, IEEE; University of Southampton, England, April 15-18.

Joint Railroad Conference, IEEE; Queen Elizabeth Hotel, Montreal, April 15-16.

International Magnetics Conference (Intermag), IEEE; RAI Building, Amsterdam, Holland, April 15-18.

International Geoscience Electronics Meeting, IEEE; Twin Bridges Marriott Hotel, Washington, April 16-18.

## Short courses

PCM communications systems, Purdue University, Lafayette, Ind.; June 2-7; \$250 fee.

Characterization of surfaces, Lehigh University, Bethlehem, Pa.; June 16-20; \$250 fee.

Display systems engineering, University of California at Los Angeles; Aug. 4-15; \$275 fee.

## Call for papers

National Cable Television Association Convention & Exposition, San Francisco Hilton Hotel, June 22-25. April 1 is deadline for submission of abstracts to NCTA, 1634 Eye Street, N.W., Washington, D.C. 20006.

Computerized Electronics, School of Electrical Engineering of Cornell University and the Office of Naval Research; Cornell Campus, Ithaca, N.Y., Aug. 26-28. May 1 is deadline for submission of abstracts to George Szentirmai, conference committee on computerized electronics, School of Electrical Engineering, Phillips Hall, Cornell University, Ithaca, N.Y. 14850.

Biennial Joint Materials Handling Conference, IEEE; Sheraton Motor Inn, Portland, Ore., Oct. 26-29. May 1 is deadline for submission of abstracts to Max Frey, conference program chairman, project engineer, Cascade Corp., P.O. Box 7587, Portland, Ore. 97220.

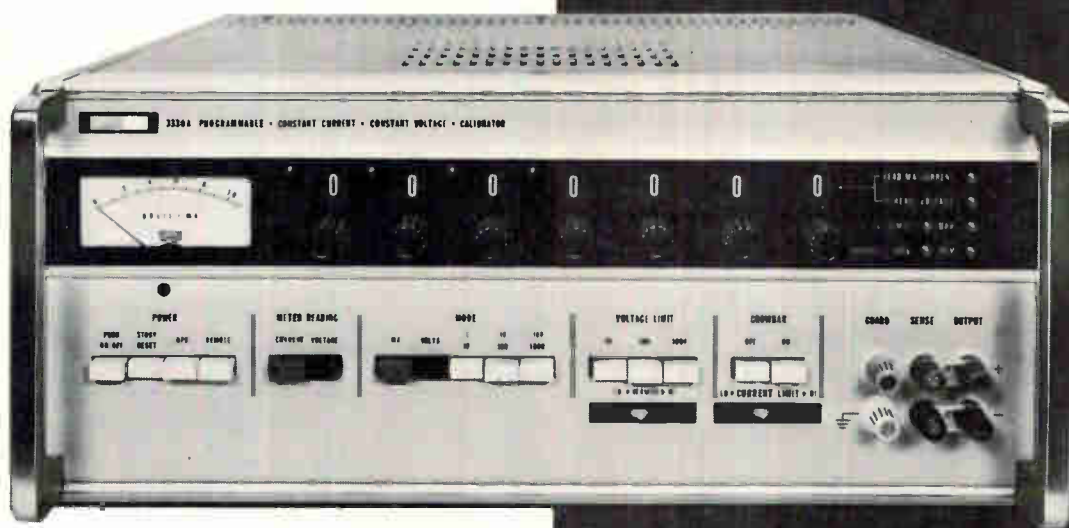
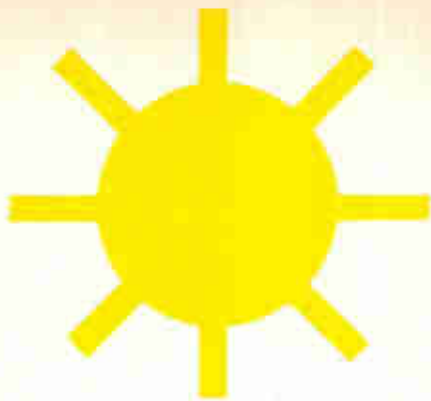

For the engineer whose responsibility is checking out incoming precision components, the new Fluke 3330 Programmable Constant Current/Voltage Calibrator will shorten your day and heighten your nights. For the first time, computer programmed checkout over a wide range of voltages and currents is available with an off-the-shelf low priced quality instrument.

The Fluke 3330 is unique. It can be operated in either a constant current or constant voltage mode. Modes can be changed without turning the unit off. Voltage range is 0 to 1000 volts in three ranges with 10% overranging. Voltage accuracy is  $\pm 0.005\%$ . Resolution is 0.1 ppm. Stability is 25 ppm per month. Line and load regulation are 2 ppm of range. Ripple and noise are less than 50  $\mu\text{V}$ . Voltage trip is adjustable from 1 v to 1000 v. Output current is 100 ma in the 10 and 100 v ranges and 50 ma in the 1000 v range.

In the constant current mode, ranges are 0 to 100 ma in three ranges with 10% overranging. Accuracy is  $\pm 0.01\%$ . Resolution is 1 ppm. Stability is 50 ppm/month. Line and load are 2 ppm of range. Compliance voltage is 1000 volts on the 1 and 10 ma ranges and 500 volts on the 100 ma range.

Crowbar effect through a programmable relay shorts output to limit voltage while changing loads.

Programmable functions are output range, mode, level and polarity, voltage and current limit, crowbar, and standby/operate. Programming time is tens of milliseconds. Price is \$2,995.

For full details write or call us today.

Fluke, Box 7428, Seattle, Washington 98133.  
Phone: (206) 774-2211. TWX: 910-449-2850.

In Europe, address Fluke Nederland (N.V.), P. O. Box 5053,  
Tilburg, Holland. Phone: (04250) 70130. Telex: 884-50237.  
In the U. K., address Fluke International Corp., Garnett Close,  
Watford, WD2 4TT. Phone: Watford 27769. Telex: 934583.

See us at IEEE

## PRECISION TESTING AND CALIBRATION MADE EASY...

or how the new Fluke  
programmable constant  
current, constant  
voltage calibrator goes  
to work calibrating  
and testing precision  
instruments, semi-  
conductors, resistors  
and  
sub-assemblies.

# Three new developments in filter-connectors.

They're the three different filter-pins you see in the picture. What makes them noteworthy is what they make possible—a variety of low-, mid- and high-frequency filter-connectors. There are three different types, and there are filter-pins of three different lengths to match the frequency. Naturally, the mating and mounting techniques for all three types are the same.

So are the advantages. All of which stem from the fact that each pin is surrounded by its own miniature ferrite filter to keep out EMI (electromagnetic interference).

Making the filter an integral part of the connector means that these new types—like all Bendix filter-connectors—save you space, weight and money. Because they cost considerably less than a filter-box setup. Weigh about 10 times less. And take up about 10% less space. And, these new types are available with socket contacts.

So now you've got even more ways to benefit from Bendix filter-connectors. Because Bendix already makes a wide variety. Including those intermatable with our Pygmy® Series (Mil-C-26482), JT Series, and LJT Series (Mil-C-27599 and Mil-C-38999). And if you don't see what you want, we'll design it. For details, contact: The Bendix Corporation, Electrical Components Division, Sidney, New York 13838.

**Bendix**  
  
**Electronics**





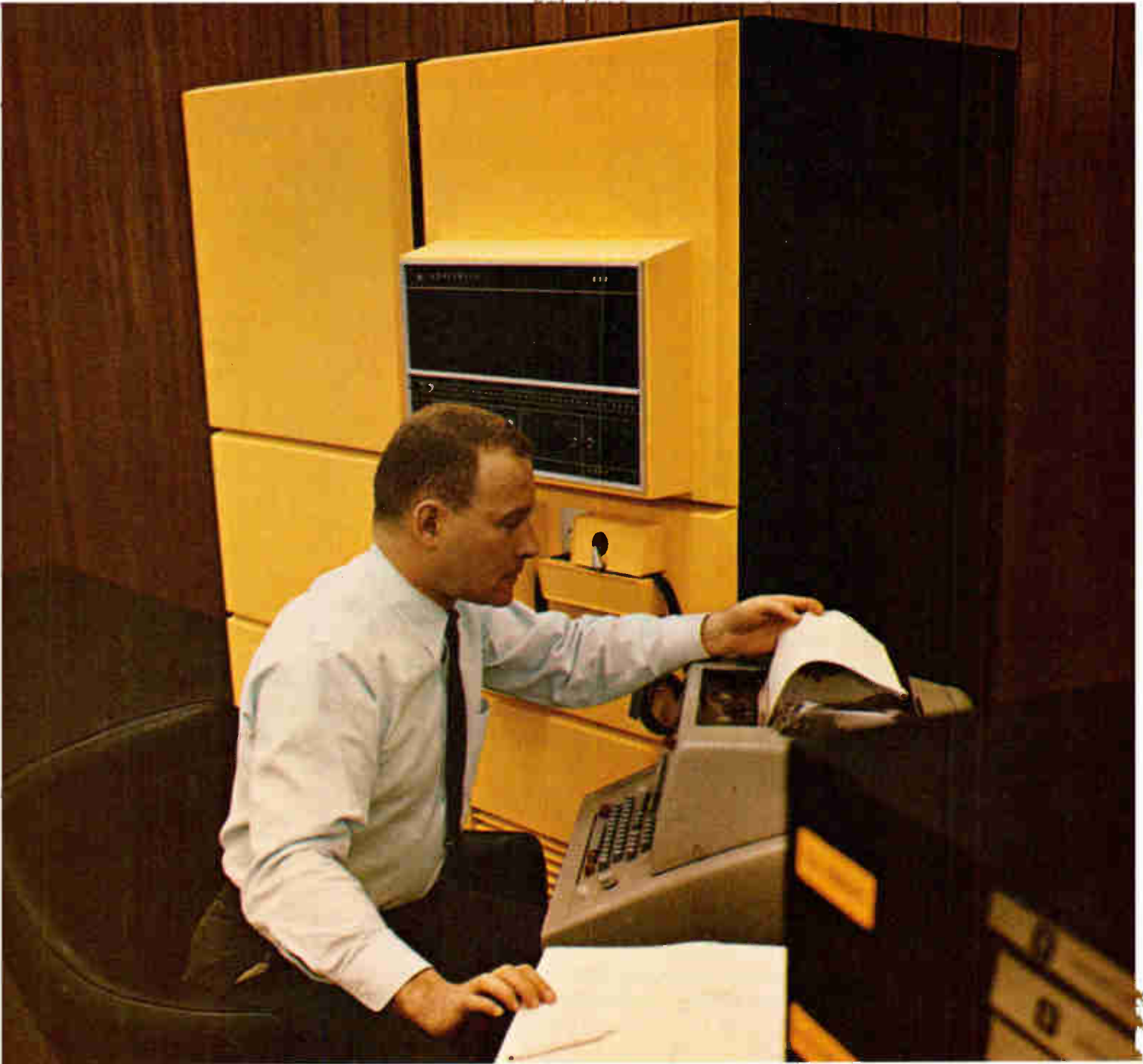

## Honeywell Series 32 Computers have the best price/performance ratio in their class

If you're a real-time systems man looking for a medium-scale, field-proven computer, you want what we've got — the H632, first member in the Honeywell Series 32 family of computer systems. The H632 has the competition beat cold, with the best price/performance offering of any computer in its class — 15% to 50% better.

That's for a real-time 1740-hour-MTBF computer system that can grow from 8K to 132K words using plug-in modules; from one central processor and one I/O processor to four each.

Series 32 systems offer special processor capabilities in multi-processor configurations. They make optimum use of available memory space. There's plenty of software for easy program development. A systems-oriented instruction set includes bit, boolean, and halfword operations. Peripherals and subsystems abound.

Delivery? How does six months A.R.O. sound?

The H632 is ideal in such applications as trainer/simulators, ground support/checkout, research, and tracking/navigation.

Send for our Series 32 summary brochure. It's printed in gold . . . just to remind you of the money you'll save.

Honeywell, Computer Control Division, Dept. 13, Old Connecticut Path, Framingham, Massachusetts 01701.

**Honeywell**  
A U T O M A T I O N

---

## Editorial comment

---

### A quantum jump for CAD

It was clear at the International Solid State Circuits Conference that computer-aided design is entering a new phase: it is becoming big business. NASA estimates that from \$50 million to \$100 million is being spent annually to develop CAD programs and techniques. Fairchild Semiconductor alone admits to an investment of \$3 million just to get where it is today; certain other major semiconductor manufacturers and some system houses have undoubtedly invested as heavily.

CAD's initial phase involved developing device models and debugging experimental programs. The stage it now moves into can be likened to the pilot production of a product—it is beginning to be applied to the solution of real problems, some of which could scarcely be considered before the advent of CAD. Cost savings are another benefit. In the case of LSI devices, for instance, CAD may save a quarter of the cost of bringing a device from the concept stage to production.

Nevertheless, the greater application of CAD has been accompanied by disillusionment. The technique simply falls short of certain preconceived notions. Specifically, users are reaching these conclusions:

- General-purpose CAD programs are not a panacea. In most cases, they must be modified to meet users' special requirements, and above all, versatility requires lots of memory. One school believes it is generally cheaper and faster to generate new programs from scratch than to modify existing ones to do special jobs.

- To fully exploit CAD, the user must immerse himself in the design, use, and modification of programs. One expert recommends latching onto a program and learning it inside out; his opinion is that modifying a familiar program to meet new problems is better than program hopping. A less desirable alternative, he suggests, is to have access to an engineer who knows the program intimately.

- The on-line or interactive program—whereby the user can interrupt and modify his approach in real time—is a must. As problems are solved in this manner, the solutions can be converted to fixed programs that can then be run on a batch schedule. But there will always be new, more complex problems arising that require interactive capability. One expert puts it bluntly: "If you don't need the

interactive approach, then it ain't design."

- Graphics are not coming into their own as rapidly as expected; "oversold" is the common complaint. Users may have expected a bit too much from input graphics (using a light pen, for example). In the end, the typewriter may turn out to be the best and simplest input device. On the other hand, output graphics are highly useful and often necessary. On the negative side, graphics consume memory. (Paraphrasing the proverb, Ron Rohrer of the University of California says "a picture may be worth 32 k words.")

- Shortcuts are required to avoid the wasteful use of memory and to speed computations. These include the use of quasi-sparse inversion (partitioning that exploits the zeros in a matrix) and "nesting" techniques to simplify modeling.

- Modeling lies at the heart of CAD and much work remains to be done in this field for high-frequency, transient, and nonlinear analysis.

The computer has made its greatest impact upon logic design, large-scale integration and array technology, microwaves, and reliability analysis. But much CAD has been carried out at relatively unsophisticated levels. For example, existing circuits and systems have been analyzed, parameter sensitivities studied, and component tolerances set using CAD. But the real test remains the synthesizing and optimizing of designs.

The best design should be one in which the system itself is first defined and modeled, then pieces of it, and finally the devices themselves. Such a technique, observed IBM's G.D. Hachtel at the ISSCC, requires the ultimate in a sophisticated model. Eventually, designers ought to be able to bypass such intermediate steps as the determination of individual resistor values. Ideally, one would inject system parameters and get hardware topology (for example, a set of masks for an LSI array).

In summarizing CAD's present drawbacks, George Baldwin of Bell Labs cited high initial cost, the large amount of memory required, a certain mysticism that still surrounds the use of computers, and the difficulty of making program improvements without having the system "crash."

While CAD has taken a quantum jump toward the real world, the challenges that lie ahead for the user far exceed those that have been met. ■

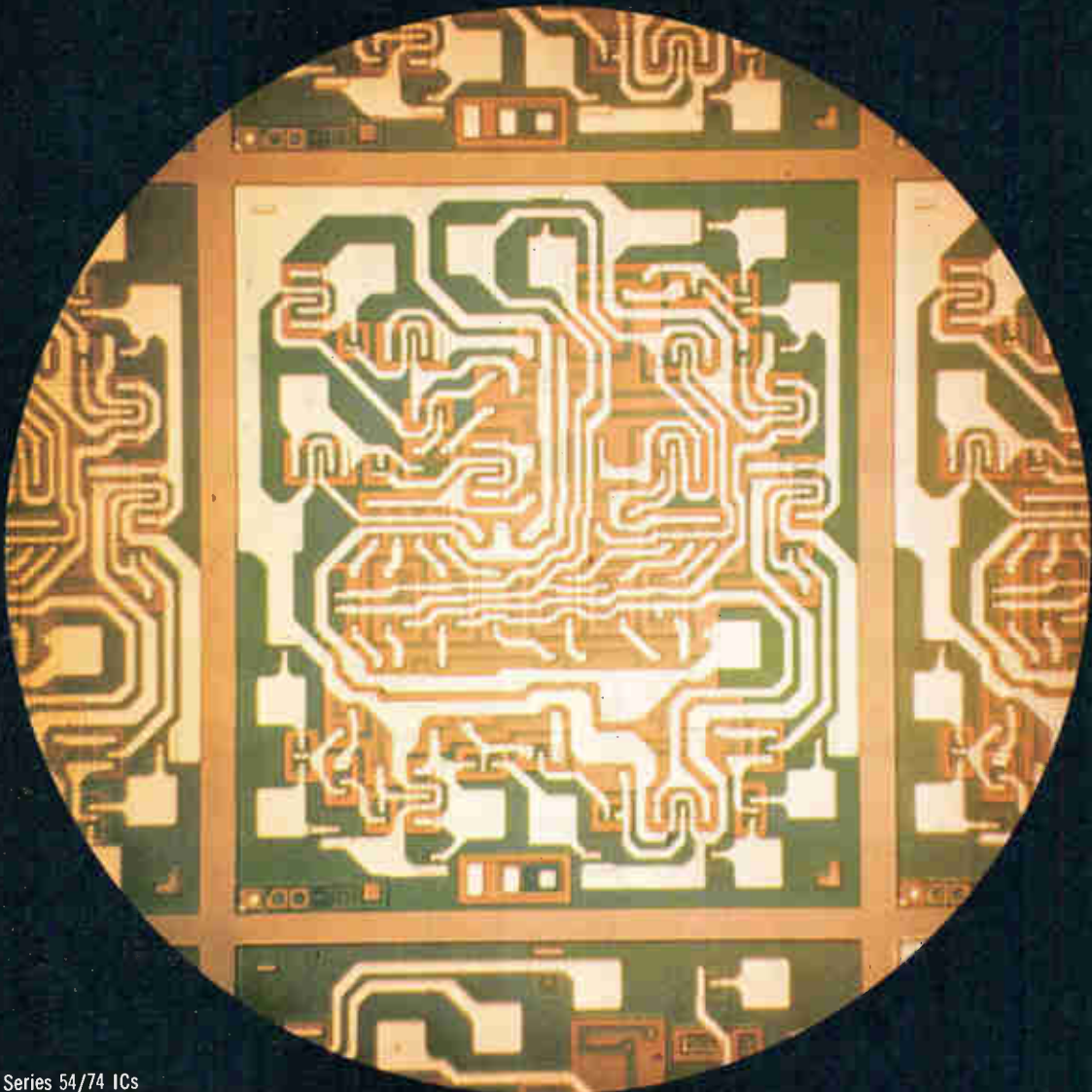

Sprague Series 54/74 ICs  
Illustration: The USN-7480 Gated Full Adder.

## Look. Look ahead with Series 54/74 arrays.

You reduce package count, simplify design, and lower costs when you design-in the complete Sprague line of Series 54/74 circuits. And make full use of the arrays.

From arithmetic to readout, it makes sense to go Sprague, where you get full line, complete specs, competent service, and on-time deliveries.

### OUR ARRAY OF ARRAYS

Decade Counter	USN-7490	4-Bit Binary Full Adder	USN-7483
Divide-By-Twelve	USN-7492	8-Bit Shift Register	USN-7491
4-Bit Binary Counter	USN-7493	BCD Decoder/Driver	USN-7441
Gated Full Adder	USN-7480	Quad Bistable Latch	USN-7475
2-Bit Binary Full Adder	USN-7482		

Call Sprague Info-Central (617) 853-5000 extension 5474.

Or for your copy of Sprague's complete Series 54/74 specification data, circle the reader service number below.



---

# Electronics Newsletter

---

March 17, 1969

## GI and TI ready nitride passivation for MOS lines

Both General Instrument and Texas Instruments are ready to announce lines of MOS integrated circuits made with a nitride passivation process that lowers threshold voltages and enables the circuits to drive bipolar IC's directly.

GI announced a low-voltage line last year but found that it couldn't make its oxide passivation process work at low levels. Since then, a number of manufacturers (American Microsystems, Siliconix, and National Semiconductor, for example) have produced metal oxide semiconductor devices that work directly with DTL or TTL circuits. Both TI and GI, however, say that although the oxide-passivated devices attain low field thresholds, they also have low gate thresholds, so that high clock voltages can produce parasitic effects in the device.

GI has been shipping nitride-passivated devices to a military customer for almost a year. At the end of April it will announce a line of 14 standard products. TI, which has been marketing MOS devices for only about a year, may not have a product until summer.

Both companies use silicon cut with a 111 crystal orientation. (The oxide process works best with 100 silicon.) Since silicon nitride tends to produce irregular surface states when it interfaces with silicon, the nitride is actually deposited after a thin oxide layer has been grown on top of the substrate.

## R.S. Carlson heads microelectronics for Autonetics

Autonetics has named R.S. Carlson general manager of its microelectronics activities as it moves into the business of selling MOS and silicon-on-sapphire large-scale integrated arrays. The division has just completed an agreement to supply arrays for a pocket calculator made by Hayakawa Electric of Japan [*Electronics*, Feb. 17, p. 215] that could be worth \$30 million over the next two years. This and other commitments made it necessary to pick a full-time manager to replace the ad hoc committee that had been steering microelectronics activities.

The appointment of Carlson, an Autonetics vice president and general manager of the Navigation Systems division for the past two years, may cloud the future of Alvin Phillips, who was brought in from Sylvania last year as assistant to Autonetics president S.F. Eyestone for microelectronics planning. Phillips appeared to be in line to head the operation, but the best guess now is that he will become director of microelectronics manufacturing.

## Space computer, heal thyself

NASA's Electronics Research Center in Cambridge, Mass., is seeking proposals to study automatic internal fault detection and correction for aerospace computers. Since space applications put computers far out of the technician's reach, NASA wants to find out how (and how fast) failures could be spotted; what recovery techniques could be used to offset these failures (without even telemetered intervention); how the computer could reschedule its work in case one of its parts failed permanently; how a system might be configured into a new arrangement of processors, input-output units, and memories (perhaps through a switching system like the one in a small telephone exchange), and how much damage such a system could sustain without failing entirely.

---

# Electronics Newsletter

---

## NASA considers moon survey work

In an apparent attempt to get more mileage out of Apollo hardware, NASA's Manned Spacecraft Center recently sent an informal feeler to North American Rockwell's Space division to study the feasibility of a lunar survey mission. This would "cram as many useful scientific instruments as possible" into the Apollo service module, as one source puts it.

No funds are committed for such a mission, which could be either manned or unmanned, but North American Rockwell responded to the feeler with its own money and will deliver the study to Houston officials this month.

The firm has talked with representatives of about a dozen companies that could provide sensors ranging from cameras to spectrometers. A representative who sat in on the meetings says next February has been set as a launch target date, despite the lack of funds.

## Air Force to test-fly first computer-based air command system

Flight tests will begin next week on the Air Force's first computer-based command and control system. Called ADA for airborne data automation and built around RCA's variable instruction computer (VIC), the system will not only provide information on the man-machine interface for use in specifying such systems as the Airborne Warning and Control System (AWACS) and the Advanced Airborne Command Post (AACP), but may also be the prototype of an airborne data system to back up both AACP and the Post Attack Command and Control System (PACCS).

RCA's Aerospace division, the prime contractor, demonstrated ADA's equipment to officers of the Air Force Electronic System Division in January and delivered the gear shortly thereafter.

## TI shifts TTL, high-technology work to Stafford

Texas Instruments' decision to move nearly 1,000 salaried personnel to a new plant 250 miles southeast of Dallas in the Houston suburb of Stafford underlines the confidence with which the company is planning its expansion. Having run out of space and exhausted the labor market in Dallas, TI faced severe production limitations at its base plant. But instead of expanding piecemeal, it decided to switch all its high-technology work, plus the rapidly growing TTL operation, to Stafford. All processing, assembly, testing, engineering, marketing, and management of the affected lines will be moved.

All MOS work, all LSI (meaning, at TI, discretionary wiring), and semiconductor memory sections will also be switched.

TI expects to hire about 1,000 hourly employees at Stafford, but so pressing are its labor needs at Dallas that no one will be laid off there.

## Getting traffic cops for computer data

Communications-oriented computers pose a special problem for their users—up to 50% of their processing capacity is given over to sorting the data traffic as it comes in and goes out over communications lines. However, in separate efforts, two firms—Sanders Associates and Comcet Inc.—have developed machines to ease the load on the central processors by acting as traffic cops.

Both the Comcet 60 and the Sandac 200 are hardwired, so there's no need for expensive software development. The Sanders unit handles as many as 256 terminals, the Comcet 64 lines [For more on the Comcet computer, see page 62]. Also, the Comcet 60 was designed to operate as a satellite of the "native" computer, but the Sandac 200 can stand alone.

Comcet has started taking orders; Sanders will start this spring.

## MICROWAVES

### Beamlead diodes improve balanced mixer.

State-of-the-art construction boosts ruggedness and reliability of X-band device.

A unique microstrip circuit design and a pair of matched beamlead Schottky diodes combine to make our new SYM-8401 series of X-band balanced mixers a significant improvement in broadband design.

The ceramic substrate microstrip circuit provides low signal path loss, high isolation and broad bandwidth. The matched pair of beamlead Schottky barrier diodes is permanently welded to the microstrip circuit. This construction assures a degree of ruggedness and reliability not obtainable with conventional assembly techniques.

The SYM-8401 operates in a frequency range from 8 to 12 GHz. Single sideband noise figure is 9 dB max. from 8.5 to 11.5 GHz and 10 dB max. from 8 to 12 GHz. A typical noise figure plot is shown in Fig. 1. These measurements include 1.5 dB noise figure of the IF amplifier.

Typical VSWR is shown in Fig. 2. Average VSWR is 2.0:1 at both signal and local oscillator ports. The IF impedance at each IF port is typically 100 ohms. This impedance is shown over the operating frequency range in Fig. 3. Permissible RF input power at signal or local oscillator ports is 400 mW max.

This series of mixers is packaged in a sealed miniature housing with OSM-type connectors at signal, local oscillator and balanced IF ports. CIRCLE NUMBER 300

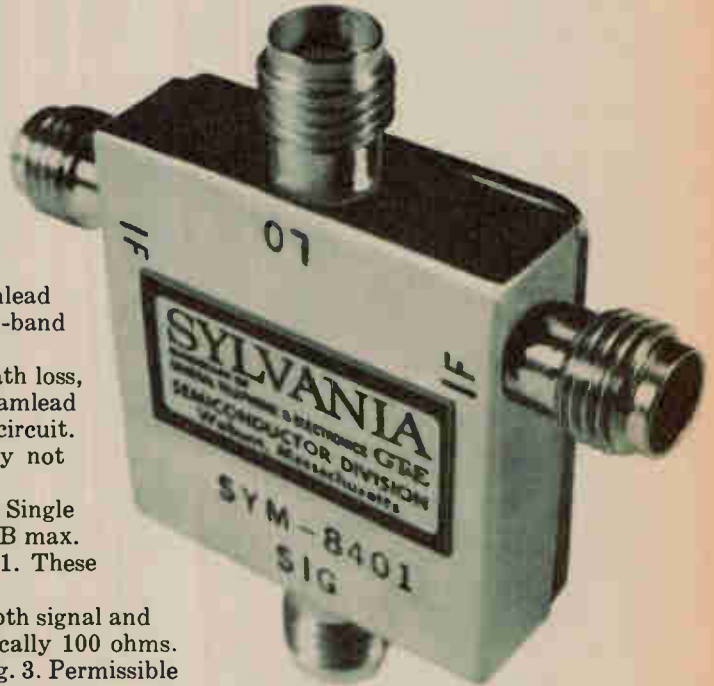

New type SYM-8401 X-band balanced mixer uses beamlead diode construction.

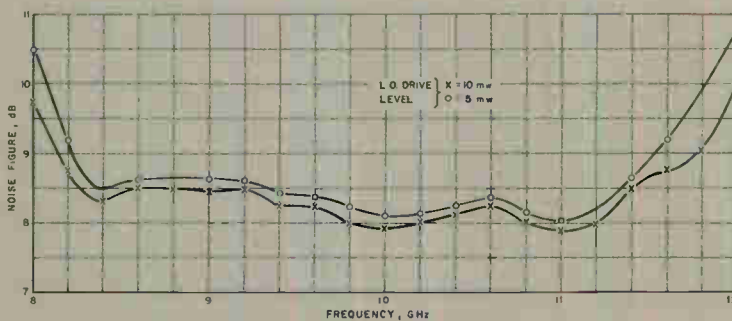

Fig. 1. Typical noise figure plot of X-band mixer over frequency range.

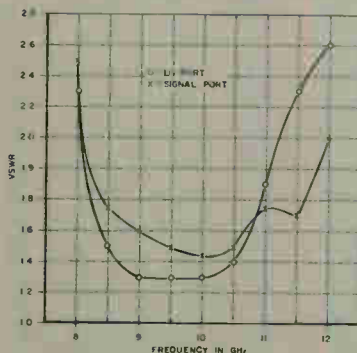

Fig. 2. Plot of VSWR of local oscillator and signal ports at a 5 to 10 mW power level.

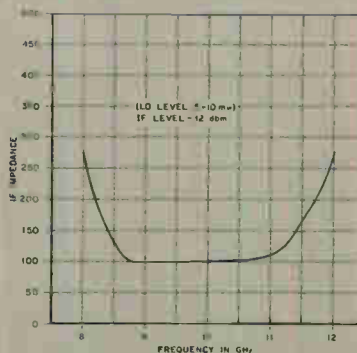

Fig. 3. Typical impedance levels measured at IF ports.

## This issue in capsule

### Electroluminescent Displays

You've got more choices when you use EL.

### CRT Modules

Let our engineers design your CRT display package.

### Integrated Circuits

New line/lamp driver cuts reflections on long lines.

### Circuit Boards

Need circuit boards? We'll make them for you.

### Television

Standard monochrome picture-tube line keeps on growing.

### Diodes

High-Q VVCs improve HF amplifier performance.

### Manager's Corner

That little extra something: Service.



Digital clock display panel shows six digits and two colons.

## EL DISPLAYS

### You've got more choices when you use EL.

Electroluminescent displays come in a wide variety of shapes and sizes. At least one should fit your application.

#### Typical electroluminescent readouts

Type No.	Number of Digits	Total Power (mW)	Total Current (mA)	Overall Length (inches)
<b>7 Segment Numeric</b>				
<b>3/8 Inch</b>				
NU31A	1	8.8	0.088	0.595
NU35A	5	44.0	0.440	1.990
NU38	8	70.4	0.704	3.700
<b>1/2 Inch</b>				
NU51S	1	10.0	0.10	0.685
NU54S	4	40.0	0.40	2.950
NU56S	6	60.0	0.60	4.000
<b>2 Inch</b>				
NU201S	1	90.0	0.90	2.295
NU203S	3	270.0	2.70	7.375
NU206S	6	540.0	5.40	13.685
<b>3 Inch</b>				
NU301S	1	350.0	3.50	3.280
NU303S	3	1050.0	10.50	10.710
NU305S	5	1750.0	17.50	17.010
<b>6 Inch</b>				
NU601S	1	720.0	7.2	6.092
<b>12 Inch</b>				
NU1201A	1	2000.0	20.0	15.000
<b>9 Segment Numeric</b>				
<b>1/2 Inch</b>				
NU51T	1	13.0	0.13	0.685
NU73T	3	39.0	0.39	2.435
NU76T	6	78.0	0.78	4.000
<b>3/4 Inch</b>				
NU71T	1	26.0	0.26	0.935
NU73T	3	78.0	0.78	3.248
NU76T	6	156.0	1.56	5.608
<b>1-1/2 Inch</b>				
NU151T	1	67.0	0.67	1.720
NU153T	3	226.0	2.26	5.748
NU156T	6	427.0	4.27	10.468
<b>14 Segment Alphanumeric</b>				
<b>3/4 Inch</b>				
AN71R	1	17.0	0.17	0.935
<b>1 Inch</b>				
AN101R	1	47.0	0.47	1.218
<b>2 Inch</b>				
AN201R	1	135.0	1.35	2.295
<b>5 Inch</b>				
AN501R	1	750.0	7.50	5.155

We have the broadest line of EL display devices available anywhere. Numeric displays are off-the-shelf items in sizes from 3/8" up to 12". Alphanumeric readouts start at 1/2" and go up to 12". Depending on the size you pick, we can put up to 12 characters on a single panel.

For example, we have a display especially designed for desktop calculators that shows twelve 1/2-inch characters on a 7 1/2" by 1 1/2" panel. Or, for another application, we have a panel of three 5-inch numerals. This panel is now in use to show flight numbers at the baggage pickup center at Chicago's O'Hare airport.

A third design that illustrates the versatility of EL displays is shown in the photograph. This is a readout for a digital clock incorporating six digits and two colons on a 2 3/8" by 1" panel.

In addition to the wide range of display arrangements that are available, you get many other advantages when you use EL readouts. For example, EL readouts are inherently free from catastrophic failure. Light output gradually decreases, over the life of the device. Use of operational duty cycles increases, rather than decreases, the life of EL devices. This is in rather marked contrast to vacuum or gas type displays where on-off cycling decreases brilliance and increases the chances of sudden failure.

EL devices are also cool running. There are no heat dissipation problems. In addition, the spectral output of EL devices closely matches the response curve of the human eye. And they can be turned on and off faster than the human eye can respond.

If the wide range of devices available in our line doesn't meet your exact needs, don't worry about it. EL offers almost unlimited design flexibility. Within practical limits of size and complexity, any symbol configuration can be formed that can be produced by graphic arts techniques. In short, if we don't have it, we can turn them out in quantity in a short time.

CIRCLE NUMBER 301

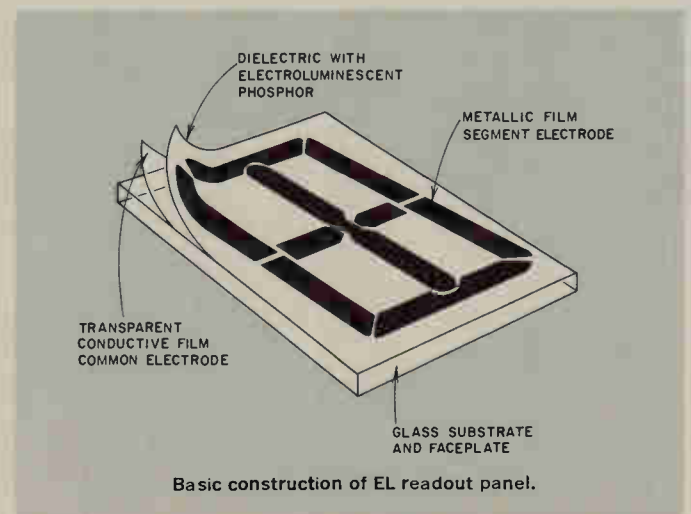



## CRT MODULES

### Let our engineers design your CRT display package.

We'll save you time and money, and you'll end up with a better system.

Our CRT engineering staff is offering a new service that can give you the best in display systems at minimum cost. We'll build a complete CRT display package, designed to fit your system.

Too often, the design engineer has to make do with the cathode ray tubes available on the market and force them to fit his system requirements. Sylvania has changed all that.

Because we are experts in CRT devices, we can pick the best tube for your system. Because we're experts in interfacing CRT systems, we can give you the best drive circuits to meet your system requirements.

In short, you get the optimum display system for your needs. You get it fast, and in most cases you get it at a lower cost than if you did your own design work.

Sylvania offers integrated display modules in three separate design approaches (see sketches). We can give you a tube system with a separate electronics black box for installation in your own equipment. Or, the module can be supplied as a rack-and-panel assembly. The third form of display module is the complete assembly mounted in a free-standing cabinet. Of course, all types of modifications can be made on these three basic structural designs.

By making Sylvania responsible for both the selection of the CRT and the drive circuitry, you can be sure that the best choice of tube and circuitry will result. Immediate circuitry, such as the anode power supply, bias supply, video amplifier and drive circuits will all be optimized to both the CRT and the associated system.



Typical CRT display package designed and built by Sylvania engineers.

Pricing on our integrated CRT modules is based on a one-time engineering charge and a per-piece price quotation. Why not talk to us about CRT display problems. We'll give you a fast solution.

CIRCLE NUMBER 302

Three basic CRT module configurations are; tube with black box, rack-and-panel assembly and complete CRT module package.

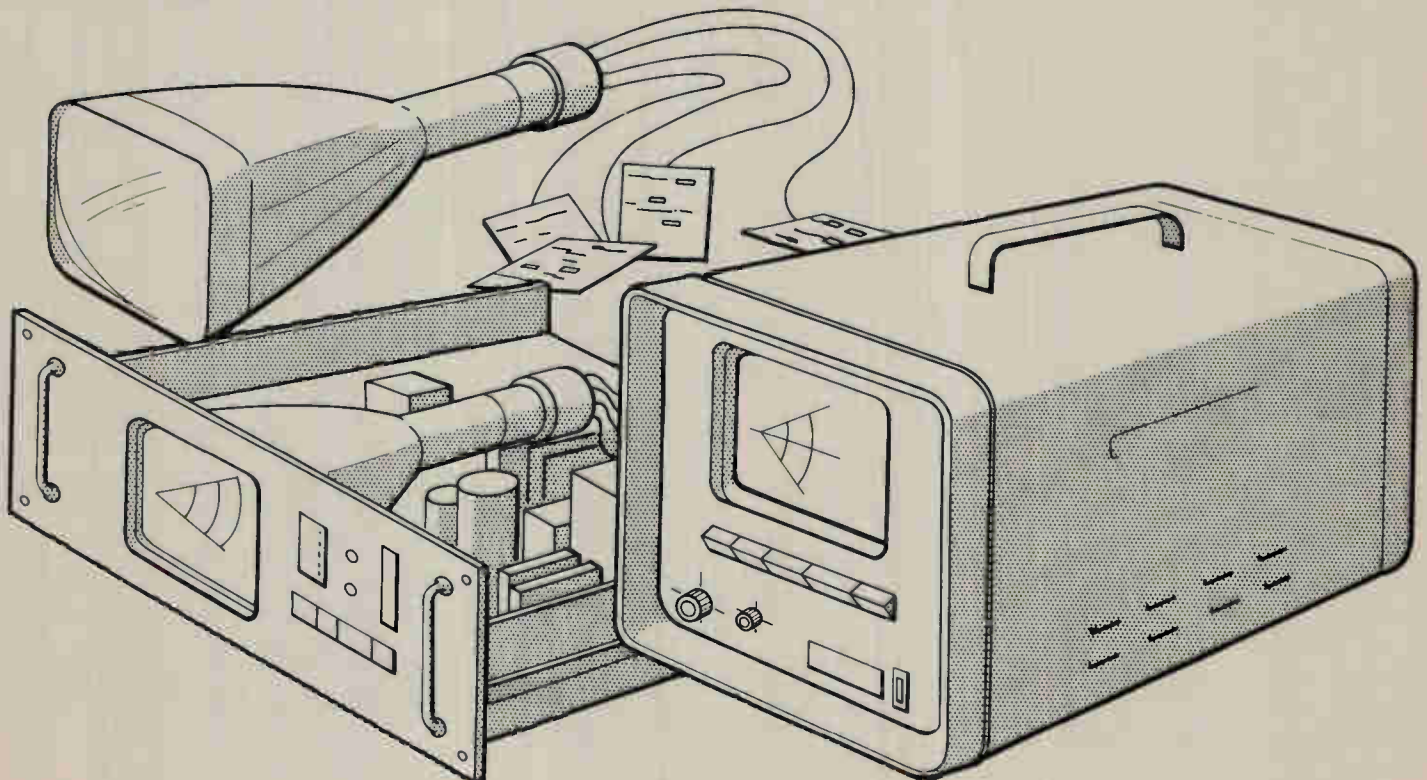

## INTEGRATED CIRCUITS

### New line/lamp driver cuts reflections on long lines.

High power output permits termination of long lines to eliminate problems caused by mismatching.

Sylvania's new SG-350 quad 2-input line/lamp driver gives you enough power output to drive a terminated line. This means you can eliminate reflections that cause spurious outputs and lower noise immunity. The major difference between the SG-350 (Fig. 1) and other drive circuits such as the SG-140 and SG-220 is that the standard SUHL active pullup network has been removed and the physical size of the output transistor has been increased.

Elimination of the pullup network means that the outputs of the SG-350 can be connected together to perform the wired-OR function. The larger geometry of the output transistor allows higher sink currents so that the circuit

can drive incandescent lamps, bus and terminated long lines, directly.

The "1" level at the output of the device is determined by an external resistor connected to a suitable power supply. For long-line driving applications, the value of this resistor is the same as the characteristic impedance of the line. Turn-off delay time is a function of the RC time constant of the pullup resistor and load capacitance plus the storage time of the device.

The big advantages of having the capability to drive long terminated lines are graphically illustrated in a series of waveform photographs taken using the test setup shown in Fig. 2.

Figure 3a shows system response when the test line is an unterminated twisted pair 20 feet long. (Letters refer to test points on Fig. 2.) Note that the transmitter input pulse is the same width as the delay of the line. When a pulse is transmitted down the line the returning reflections arrive at the transmitter when the output is off (high impedance). This causes the line to ring, particularly at the receiving end. Because of the high voltage excursions on the receiving end, we get spurious pulses at the receiver output. For each transmitted pulse there are five receiver output pulses. The spurious output pulses will continue until the line capacitance charges to the threshold level. If

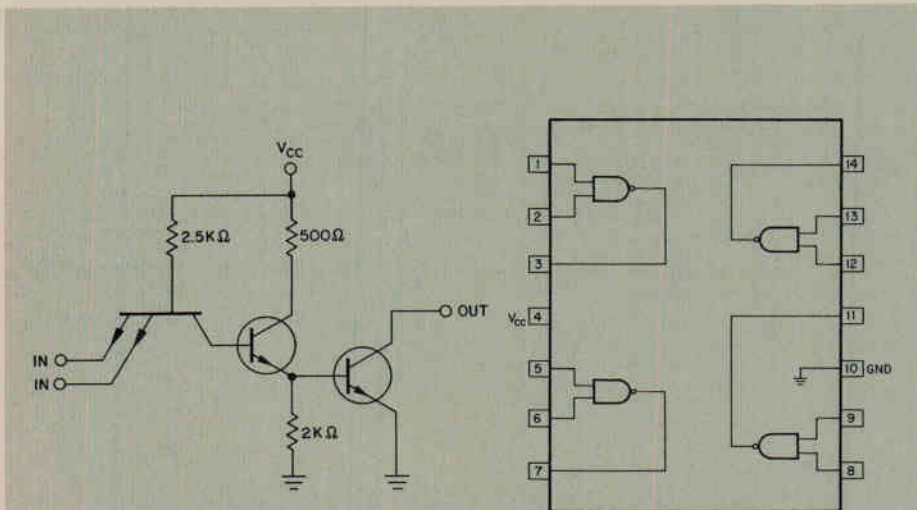
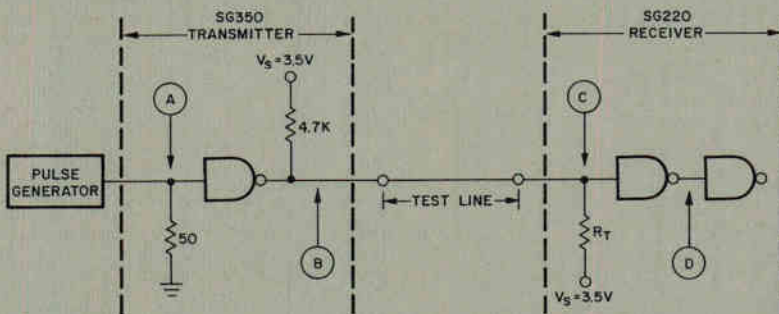

Fig. 1. Circuit and logic diagrams of SG-350 line/lamp driver.



- POINT (A) TRANSMITTER INPUT (TOP TRACE) 5V/cm, 0 AT 1 cm, DOWN.
- POINT (B) TRANSMITTER OUTPUT (2nd TRACE) 5V/cm, 0 AT 2 cm, DOWN.
- POINT (C) RECEIVER INPUT (3rd TRACE) 2V/cm, 0 AT 1 cm, BELOW  $\phi$ .
- POINT (D) RECEIVER OUTPUT (4th TRACE) 5V/cm, 0 AT BOTTOM.

Fig. 2. Test setup used to obtain waveform photographs.

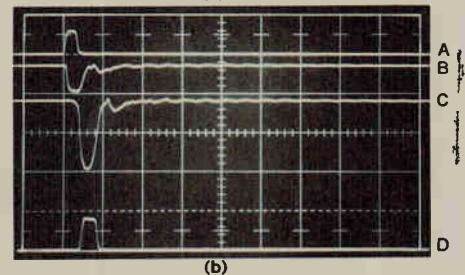
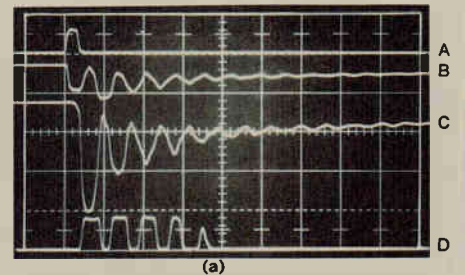

Fig. 3. Waveforms on unterminated (a) and terminated (b) 20-foot length of twisted pair.

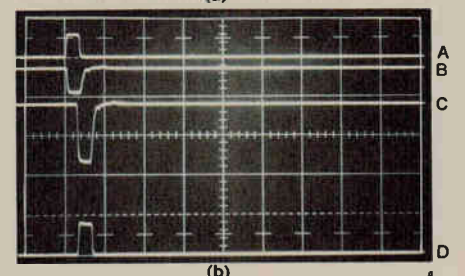
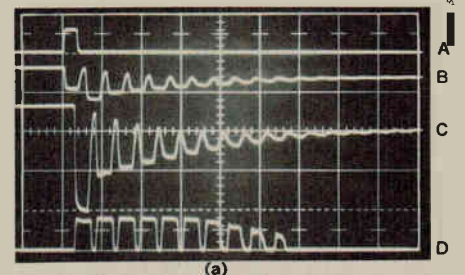

Fig. 4. Waveforms obtained on test of unterminated (a) and terminated (b) 33-foot length of RG-58 A/V coaxial cable.

## CIRCUIT BOARDS

### Need circuit boards? We'll make them for you.

We've expanded our in-house facility to take care of a growing number of outside customers.

For years, our printed circuit board operation has been supplying the needs of our Electronic Systems Division. Now we've decided to put all the expertise we've acquired to work for you.

Typical of our precision work is the board shown in the photograph. Dimensional tolerances were held within 0.0005" over a span of 20". These boards have been produced at a rate of 1200 boards per day only four weeks after starting production.

Our highly automated production facility is equipped to handle any kind and size of board you need—single sided, double sided or multilayer. And we're able to turn out high reliability, close tolerance boards. For instance, our modern automatic drilling equipment can hold tolerances of 0.001".

We'll work with you starting at any point from the drawing board, breadboard or from your artwork. We'll do prototyping and can give you high or low volume production.

And in production, you can be assured of getting consistent and reliable plated-through holes as well as high-quality circuit plating, thanks to our automatic plating system.

And our services don't stop there. In addition to handling all of your board requirements, we are completely equipped to do fully automated component insertion. We'll have more to tell you about this in a future issue of IDEAS.

If you need circuit boards, why not talk to one of our technically trained sales force. They'll bring our facilities right to your doorstep.

CIRCLE NUMBER 304

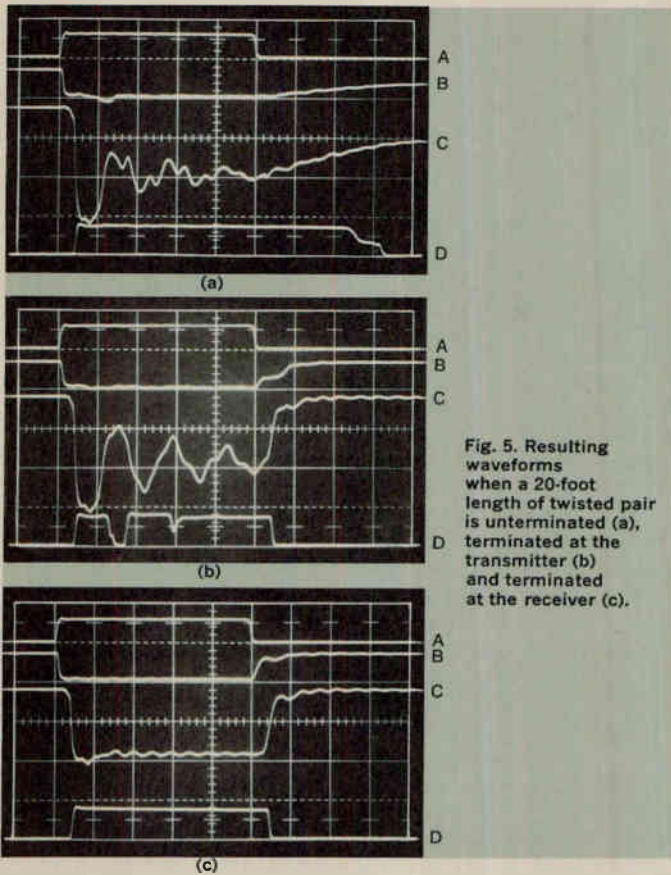

Fig. 5. Resulting waveforms when a 20-foot length of twisted pair is unterminated (a), terminated at the transmitter (b) and terminated at the receiver (c).

the driving pulses are shorter than the line delay, the number of spurious outputs will increase.

Figure 3b shows what happens when the same line is terminated with a 150-ohm resistor. Note that there is only one output pulse for each input pulse.

A similar comparison is shown in Fig. 4, for 33 feet of RG-58A/U coaxial cable. Fig. 4a shows the unterminated condition and Fig. 4b shows what happens when the line is terminated in 50 ohms.

System response for a 20-foot length of twisted pair is illustrated in Fig. 5. In this case the driving pulse is much longer than the delay time of the line. Figure 5a is the unterminated case where the presence of the driving pulse (which keeps the transmitter in the "O" or "on" condition) tends to clamp the magnitude of the reflections. Note that there are no spurious output pulses in this case, but that the length of the receiver output pulse is much longer than the input to the transmitter. This is caused by the recharge of the line capacitance to threshold level. Also, because of the magnitude of the reflections at the receiver input, the noise immunity is reduced. In higher electrical noise ambients this situation could produce spurious outputs.

Figure 5b shows the system response when the line is terminated at the transmitter end rather than at the receiver. This approach does not suppress the reflections because the termination is in parallel with the output impedance of an "on" transistor.

The results obtained when the line is terminated on the receiving end are shown in Fig. 5c. Note that the receiver output pulse width is the same as the input to the transmitter. Noise immunity is also improved thanks to the lack of reflections at the receiver input.

These results speak for themselves. It's easy to see the advantages you get when you use the SG-350 for terminated line driving applications. Of course, the SG-350 is completely compatible with the rest of the Sylvania SUHL line and has all of the inherent advantages of SUHL logic design.

CIRCLE NUMBER 303

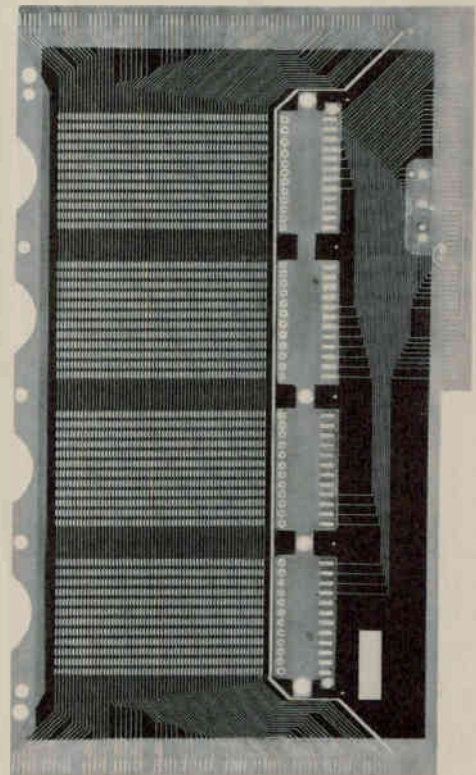

Circuit board holds dimensional tolerance of 0.0005" over 20" span.

## TELEVISION

### Standard monochrome picture-tube line keeps on growing.

We now have six sizes in the line that offer you the most tube for the least money.



22ZP4 standard tube.

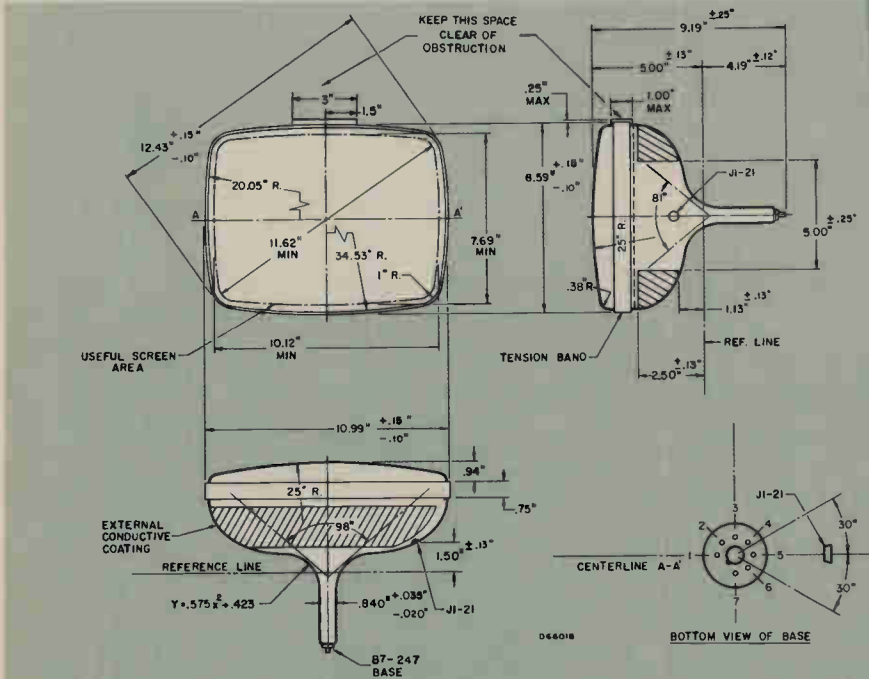

#### Standard tube types

Type Number	Screen Area (Sq. In.)	Overall Length (In.)	Implosion Protection System	Deflection Angle (Degrees)	EF/IF (Volts/Ma)	Type Focus	Max. Anode Voltage (Volts)	G <sub>2</sub> Voltage (Volts)
9YP4	40	9.24	T-Band	85	12.6/80	Lo Es*	15,000	100
12DEP4	74	9.19	T-Band	110	6.3/450	Lo Es*	15,000	100
17ESP4	141	11.20	Kimcode	114	6.3/450	Electrostatic	23,000	300
20YP4	184	12.27	Kimcode	114	6.3/450	Lo Es*	23,000	50
22ZP4	229	13.13	Kimcode	114	6.3/450	Electrostatic	23,000	400
23HFP4	282	14.88	Kimcode	110	6.3/450	Lo Es*	23,500	50

\*Low Voltage Electrostatic

When we introduced our "standard" 12" B & W picture tube a little over a year ago, we said we could offer lower price through volume production. Apparently, a lot of people believed us. The 12-inch tube has been a roaring success.

Now, we've expanded our standard-tube concept to other sizes including 9", 17", 20", 22", and 23" models (diagonal). A total of six different sizes that can save you money on the single most expensive component that goes into a TV set.

How do we know that these tube types are best for standardization? We made a survey to find out the most acceptable bulb configuration for each size. Then we determined which electronic factors were most important. These included focus and deflection voltages, gun-mount configuration, anode button location and other design considerations.

We put all this information together and came up with a series of tubes that meet the majority of design needs. We developed a series of

tubes that we can sell at the lowest possible price.

Now, you can have a "MADE IN U.S.A." TV set that can be price-competitive with foreign-made sets. And, in addition, you get the full range of field engineering services and technical assistance that only a domestic manufacturer can provide.

Shouldn't you look into our standard tube line for your next set design? We feel sure you will find that the price break and superior Sylvania quality will pay off for you.

CIRCLE NUMBER 305

**DIODES**

**High-Q VVCs improve H-F amplifier performance.**

Family of voltage variable capacitors for use in tuned circuits are now available with Qs of 600 and better.

When they couldn't get the special VVCs they needed anywhere, a major manufacturer of communications equipment brought their problem to Sylvania.

They required very high-Q VVCs tightly matched into quads by capacitance change ratio for use as the tuning device in high-frequency amplifiers. Fast action was essential to meet the customer's production schedules.

A special team consisting of the customer engineers and Sylvania's engineering and production groups was rapidly

formed to concentrate on a fast solution to the situation. By working closely with the user, and applying Sylvania's diode know-how, the required quantities were supplied on time. And the result is a new series of VVC diodes in the Sylvania line.

This high-Q series features typical Qs in excess of 600 and a choice of capacitance values from 4.0 pf to 33.0 pf, nominal. Tuning ratios are closely controlled to the typical values shown in the characteristics table.

When it comes to packaging, you can write your own ticket because Sylvania has the flexibility to meet your needs.

Whether you want your VVCs in chip form, DO-7 package or in any other form factor, Sylvania's VVCs offer a greater design margin.

The new series is also available in matched sets of two or more diodes with tightly controlled capacitance and change ratios between units.

When you need VVC diodes, take advantage of Sylvania's specialized design knowledge and our proven ability to deliver the goods. **CIRCLE NUMBER 306**

DIODE CAPACITANCE VS REVERSE VOLTAGE

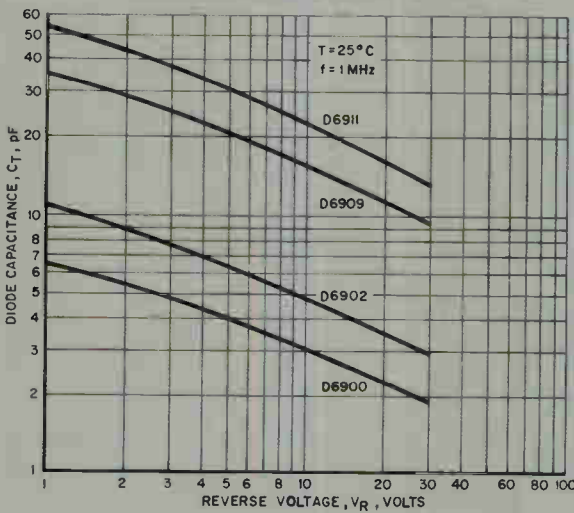

D6900 series high-Q voltage variable capacitors

TYPE	Capacitance (Cr) V <sub>R</sub> =4VDC f=1 MHz pF (nom.)	Quality Factor (Q) V <sub>R</sub> =4VDC f=50 MHz (min.)	Capacitance Ratio C <sub>2V</sub> /C <sub>30V</sub> f=1 MHz typical
D6900	4.0	600	2.8
D6901	5.4	600	2.8
D6902	6.8	600	2.9
D6903	8.2	600	2.9
D6904	10.0	600	2.9
D6905	12.0	600	2.9
D6906	15.0	500	2.9
D6907	18.0	500	3.0
D6908	20.0	500	3.0
D6909	22.0	500	3.0
D6910	27.0	500	3.0
D6911	33.0	500	3.1

Breakdown Voltage (I = 10μA) = 30VDC

SEE OUR SPECIFICATIONS IN  
**VSMF**  
MICROFILM CATALOG FILE

Use Sylvania's "Hot Line" inquiry service, especially if you require full particulars on any item in a hurry. It's easy and it's free. Circle the reader service number(s) you're most interested in; then fill in your name, title, company and address. We'll do the rest and see you get further information by return mail.

BUSINESS REPLY MAIL  
No Postage Stamp Necessary if Mailed in the United States

FIRST CLASS  
Permit No. 2833  
Buffalo, N. Y.

POSTAGE WILL BE PAID BY

Sylvania Electric Products Inc.  
Sylvania Electronic Components  
1100 Main Street  
Buffalo, New York 14209

Dept. D 3 3

\_\_\_\_\_

\_\_\_\_\_

\_\_\_\_\_

\_\_\_\_\_

\_\_\_\_\_

\_\_\_\_\_

\_\_\_\_\_

\_\_\_\_\_

## MANAGER'S CORNER

### That little extra something: Service.

There is one area where foreign TV picture tube manufacturers cannot compete with domestic producers. That area is service to the customer.

By service we mean assuring that you get fast aid and intelligent assistance when problems crop up on your production line.

Sylvania's Commercial Engineering Laboratories are set up precisely to give you that service. The Commercial Engineering Labs work hand-in-glove with field engineering, sales, marketing, quality control, design and development and the manufacturing group to provide a product that is competitive and fulfills the requirements of TV receiver manufacturers.

To do this, Sylvania's Commercial Engineering Labs at Seneca Falls, N.Y. evaluate hundreds of picture tubes made by both Sylvania and our competition on a regular, systematic basis. This evaluation procedure includes a detailed evaluation of all tube characteristics that are important to successful operation in TV receiver. A typical rundown of these characteristics includes emission, cutoff, brightness, ease of setup and registration, screen uniformity, convergence pattern, raster shift and many others.

The instrumentation available in the Lab for this work includes a number of color test stations used to evaluate color tubes under controlled, repeatable operating conditions. A wide range of operating voltages and currents are available at each station for normal and stress testing.

In addition, an Earth's magnetic field environmental chamber is available to analyze tube and receiver performance under various conditions of the earth's magnetic field.

In our labs, we can duplicate the magnetic environment that would be experienced by tubes operating in any part of the United States, Europe, Canada, or Mexico.

This accumulation of data on a regular basis allows Commercial Engineering to quickly analyze the possible causes of problems on a customer's production line or in field operation. It also helps in solving new design and unusual applications problems that are part of the color receiver production business.

In addition to aiding the customer, our Commercial Engineering Lab also aids our own manufacturing division. Because Sylvania sells to all major color set makers in the United States, Europe, Canada and Mexico, it is important that our products meet the varying requirements of a variety of manufacturers. To do this requires a complete knowledge of the operating requirements of many receiver design groups located all over the world.

This knowledge begins with the analysis of new receiver circuits that affect the operation of the picture tube. It includes such things as tube and chassis mounting arrangements as well as the location and characteristics of neck-mounted components. Our search for knowledge of actual operating requirements ends with a life test of the picture tubes in receivers purchased from the customer.

With this kind of data, we can react quickly to customer requirements and analyze production situations thoroughly to obtain quick solutions to problems.

This is the primary function of our Commercial Engineering Laboratories, and is just another example of our efforts to provide the best production and service to the customer.



D. G. Mackey  
Section Head, Commercial Engineering Lab.

This information in Sylvania Ideas is furnished without assuming any obligations.

# SYLVANIA

A SUBSIDIARY OF  
GENERAL TELEPHONE & ELECTRONICS

NEW CAPABILITIES IN: ELECTRONIC TUBES • SEMICONDUCTORS • MICROWAVE DEVICES • SPECIAL COMPONENTS • DISPLAY DEVICES

D3

NAME \_\_\_\_\_

TITLE \_\_\_\_\_

COMPANY \_\_\_\_\_

ADDRESS \_\_\_\_\_

CITY \_\_\_\_\_ STATE \_\_\_\_\_ ZIP \_\_\_\_\_

Circle Numbers Corresponding to Product Item

300      301      302      303      304

305      306

Please have a Sales Engineer call



### HOT LINE INQUIRY SERVICE

Need information in a hurry? Clip the card and mail it. Be sure to fill in all information requested. We'll rush you full particulars on any item indicated.

You can also get information using the publication's card elsewhere in this issue. Use of the card shown here will simplify handling and save time.

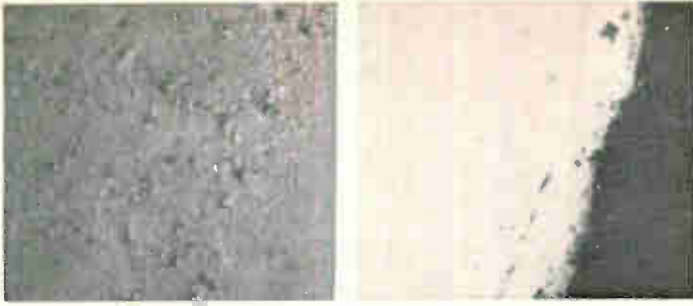

## Two revealing views of a Playboy bunny.

### We had to pull a switch to get them.

You're looking at two views of the interface between the white enamel of the bunny on a Playboy Club ashtray, and the black enamel background of the tray itself (magnified 70x).

The pictures were shot only seconds apart, through an Olympus Model N microscope—the only microscope that could have done it. Both show exactly the same field, but neither, alone, tells the whole story.

The photo on the left, taken by bright-field illumination, clearly shows the surface textures and irregularities of both the black and white enamel. But not which is which, because glare has washed out the color differences.

To make the photo on the right, we pulled a switch—the switch that converts the Model N instantly to dark-field incident illumination. Now the color differences are visible—as amorphous or crystalline inclusions or certain other irregularities would be, had there been any in our sample.

The Model N adapts easily to polarized and trans-illuminated observations, too; and its modular design accommodates a complete line of interchangeable accessory heads, eyepieces and camera equipment.

The Model N's Neopak bright-field/dark-field illuminator and objectives are also available in the Model NJ focusing head, for universal stand or custom mounting.

Like all Olympus microscopes, the N and NJ cost rather less than you'd expect. Send for our catalog of upright and inverted metallurgical microscopes. You won't find any other bunnies there, but we think you'll find it pretty revealing anyway.

This is what the bunny looks like when it isn't under the microscope.



PLAYBOY PUBLISHING CO.



OLYMPUS CORPORATION OF AMERICA  
PRECISION INSTRUMENT DIVISION / DEPT. E  
2 Nevada Drive, New Hyde Park, N.Y. 11040

Send information on  The Olympus Model N,  The Model NJ,  bright-field microscopes,  inverted microscopes. My applications include:

Name \_\_\_\_\_

Title \_\_\_\_\_

Organization \_\_\_\_\_

Address \_\_\_\_\_

City \_\_\_\_\_

State \_\_\_\_\_

Zip \_\_\_\_\_

"50 years of  
precision in microscopy"

## Olympus Model N

Bright-field/dark-field metallurgical microscope

# Better solutions come from Weatherford

## Try these for starters: Discretes. Transistors. Ceramic TTL.

**TI's Preferred Semiconductors** — for extra confidence in buying discretes. The flood of discrete semiconductors makes selection time-consuming and booby-trapped with potential errors. But you can now buy with greater confidence than ever. TI's new Preferred Semiconductor catalog wraps up the 285 computer-selected discrete devices that will best fill most requirements. All are in current use, economical, readily available from us and recommended for present and future designs. You really can't go wrong with TI's Preferred Semiconductor line. Get your free catalog from us or circle 311 on the Service Card.

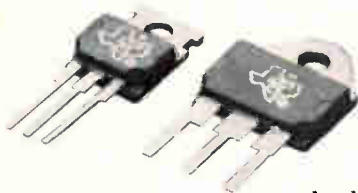

**TI plastic power transistors** — to cut component cost. The new TI plastic NPN/PNP complementary single-diffused power transistors are direct plug-in replacements for TO-3 and TO-66 devices. Being plastic, they are low cost; single-screw mounting is another cost-cutter. The new series — TIP 29 through TIP 36 — is rated 30-90 watts, 1-25 amps, 40-60 volts. Whenever you're looking to cut component costs, look to us for TI's plastic power transistors. Or for more details, call us or circle 312 on the Service Card.

**TI Series 54/74 TTL** — ceramic broadens the broad choice. All TI TTL functions are now available through us in a new ceramic hermetic dual-in-line package (14-pin or 16-pin). So your broadest TTL choice is now even broader. Featuring extremely high reliability, the new ceramic package meets all applicable military specifications. With this new hermetic C-DIP, plus greatly improved delivery on previously hard-to-get flat-pack TTL devices, we are ready to meet all your aerospace and military system requirements. Let us know if you'd like data sheets on TI's new C-DIP or circle 313 on the Service Card.

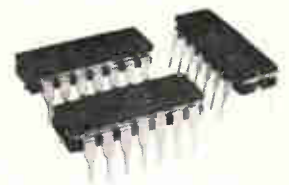

*For better solutions, call*



## R. V. WEATHERFORD CO.

DISTRIBUTORS OF ELECTRONIC COMPONENTS AND EQUIPMENT

ANAHEIM, CALIFORNIA  
1550 Babbitt Street  
714-532-6741  
714-547-7521

GLENDALE, CALIFORNIA  
6921 San Fernando Road  
213-849-3451

PALO ALTO, CALIFORNIA  
3240 Hillview Drive  
Stanford Industrial Park  
415-321-5373

PHOENIX, ARIZONA  
1917 North 25th Drive  
Carson Industrial Center  
602-272-7144

SALES OFFICES  
Pomona, California  
714-966-8461 714-623-1261  
San Diego, California  
714-278-7400  
Seattle, Washington  
206-762-4200





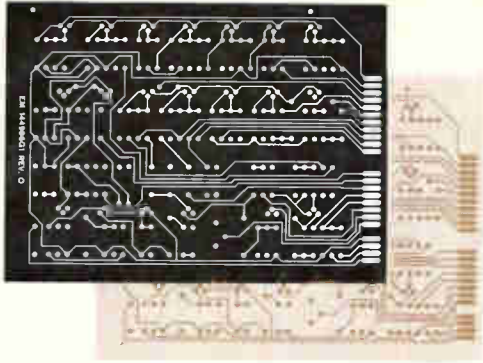

SLO-SYN<sup>®</sup> N/C POSITIONING SYSTEMS  
A VERSATILE GROUP OF  
NUMERICALLY CONTROLLED MACHIN-  
ERY THAT CAN BE USED INDIVIDU-  
ALLY OR AS COMPLETE PRODUCTION  
SYSTEMS FOR PC BOARD OR OTHER  
MANUFACTURING NEEDS. CAN BE  
OPERATED MANUALLY, BY PUNCHED  
TAPE OR WITH DATA PROCESSING  
SUPPORT FOR:

- ARTWORK GENERATION
- HIGH SPEED HOLE DRILLING
- INSERTION OPERATIONS
- WIRE TERMINATION

# 80% Faster

Printed circuit board sketch to etch in 8 hours or less! Pro-  
vides a new consistent standard of speed and quality control.

# New Technique

Easily programmed, error-free tape prepared directly from engineering  
sketch gives precise 1:1 generation of film masters.

# More Accurate

Table accuracy to  $\pm .001''$ ; repeatability to  $\pm .0005''$ . Position-  
ing resolution  $.001''$ ; optional resolution of  $.0005''$  available.

# Economical

Eliminates time-consuming drafting, drastically reduces lead-time, pro-  
duction time and possible error. Faster pay-off . . . increased profits.

# Versatile

Also used to prepare integrated circuit masters, schematics, inspection  
shadowgraphs, step and repeat printing. Additional capabilities tailored  
to specific needs. Call, write or wire for literature or demonstration.



THE  
SUPERIOR ELECTRIC  
COMPANY

521 MIDDLE STREET  
BRISTOL, CONNECTICUT, 06010

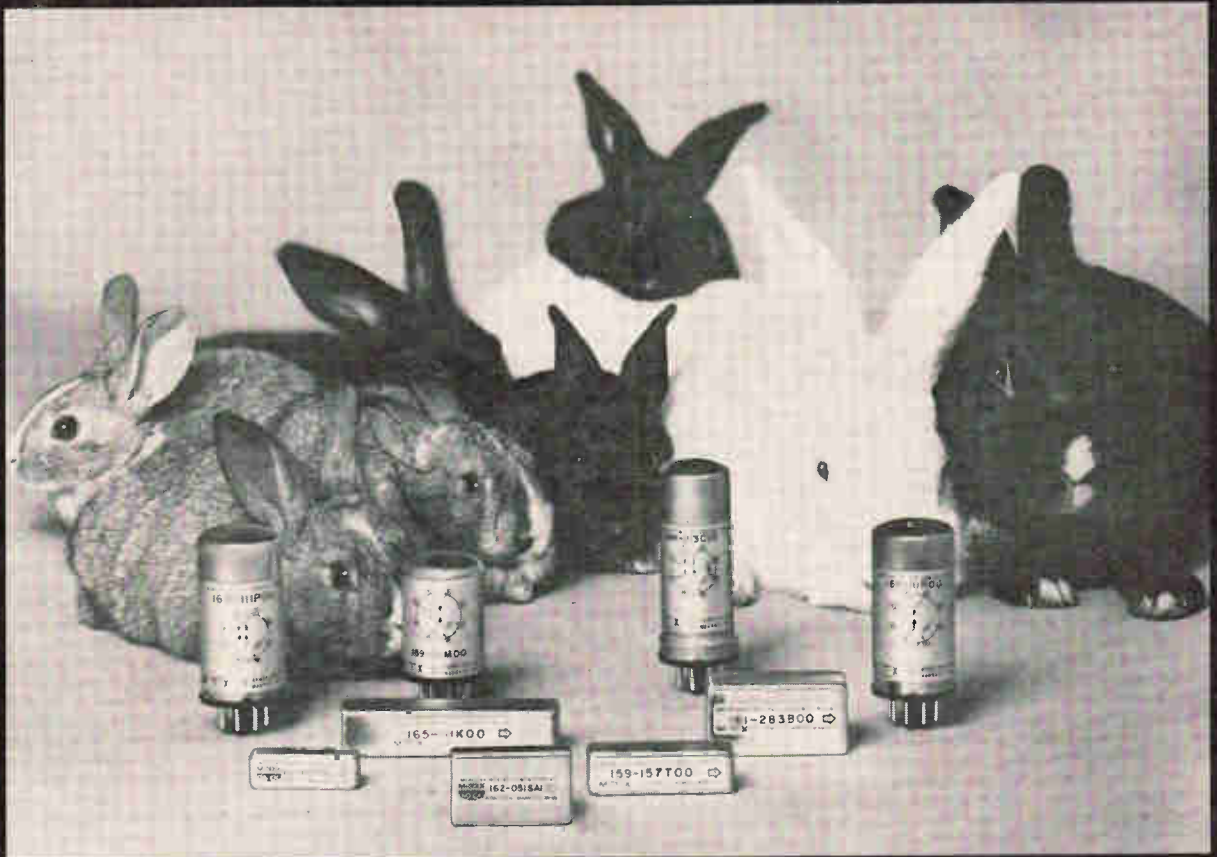

**Once you understand the basic technology,  
you can produce the whole Mercury Family.**

**We do...and did!**

No family planning problem here. We wanted a big Mercury family. We've got it!

Are you interested in a 2 amp SPDT, PCB module? We've got it! (Type 159.) Or miniature version of it? We've got it! (Type 160.) How about a 2 amp octal plug? We've got it! (Type 168.) A low level DPDT PCB module? Got that too! (Type 161.) You need husky 5 amp octal plug workhorses? Got them too! (Type 163 and 164.) Need something for direct PCB mountings? We've got it! (Type 165.) Miniature octal plug? Mini-DPDT

low level? Got 'em! (Type 169 and 162.)

Now you have another choice when specifying Mercury relays. A choice that is willing to show you some old-fashioned hustle! Talk to us about Mercury prices. Talk to us about delivery dates. Talk to us about your own tough Mercury problem. We'll show you what we mean!

At Midtex it's one big happy Mercury family . . . and there may be more to come . . . lately our design department has taken to ordering in dill pickles and strawberry ice cream for coffee breaks.

**MIDTEX**   
INCORPORATED  
AEMCO DIVISION

10 STATE STREET  
MANKATO, MINNESOTA 56001

PROGRAMMERS/TIME DELAY RELAYS/MINIATURE COAXIAL RELAYS/INDUSTRIAL RELAYS/MERCURY-WETTED CONTACT RELAYS



## Our new panel meter is a slim bargain. 2<sup>3</sup>/<sub>4</sub>" deep. \$149.\*

Presenting Minimeter. A low-cost little package that's the perfect replacement for old-fashioned panel needle meters. Minimeter measures with accuracy to 0.1% of reading  $\pm 1$  digit, 100  $\mu$ V resolution, 100 megohms impedance, auto-polarity, and numerals you can read from thirty feet away. You install it in seconds. It fits a 4" X 2<sup>3</sup>/<sub>4</sub>" opening. And as a result of a new and unique design concept, Minimeter is only 2<sup>3</sup>/<sub>4</sub>" deep. Calibrate it just once.

And save when you update every meter on every panel: Minimeter costs only \$149 in lots of 100\*

Minimeter is ready to slip in now wherever panel meters are used. For detailed information and a complete set of specifications, write Tyco Instrument Division, Tyco Laboratories, Inc., Bear Hill Industrial Park, Waltham, Massachusetts 02154. Or call (617) 891-4700 and ask for Jerry Schulze.

# TYCO

See us at I.E.E.E. Show - Booth 3E11-14.

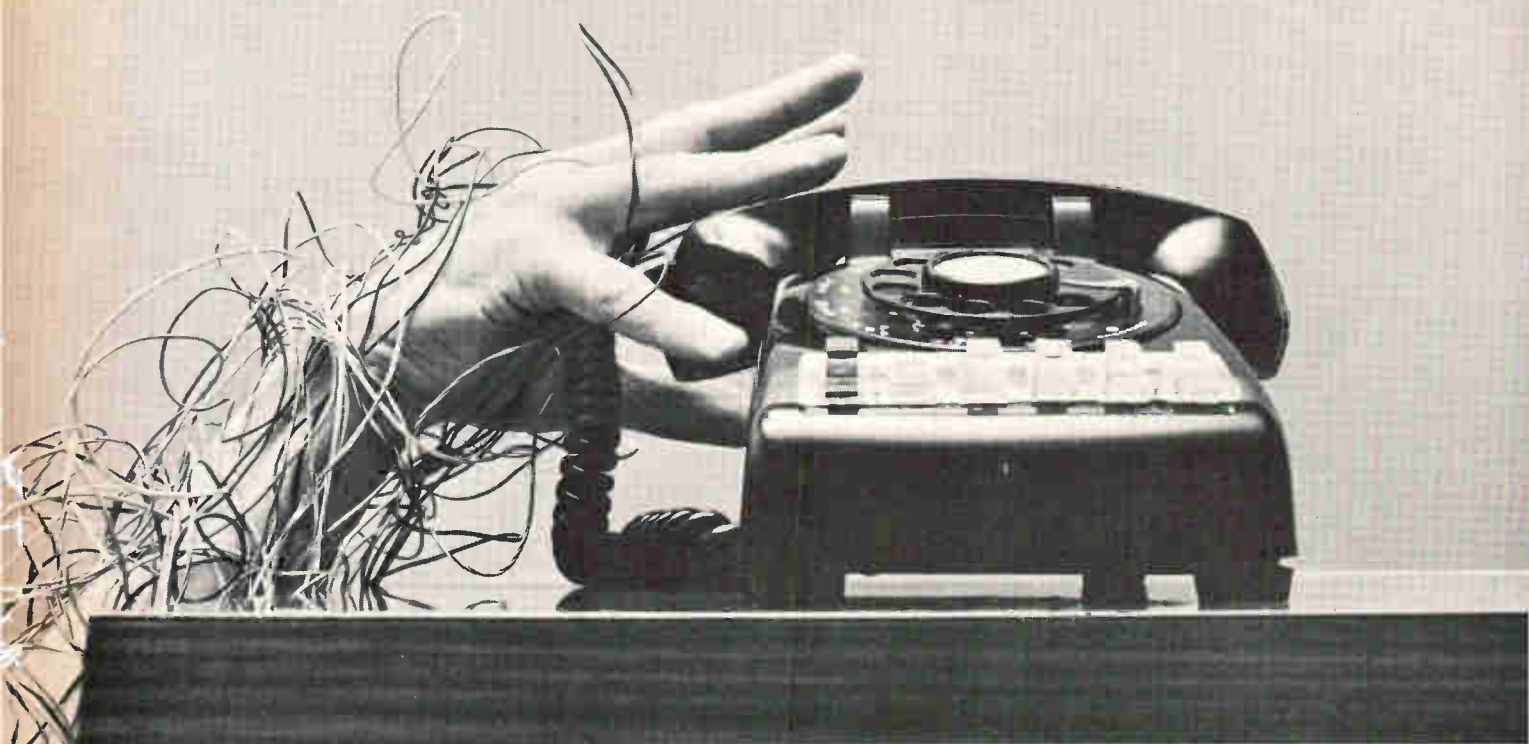

## Call your logic module supplier for automated wire listing and wrapping.

### Lots of luck if it isn't us.

No one else has a standard module line plus both automated services: wire listing and wire wrapping. So we're your sole source for a new way to save time, money, and trouble in building digital systems.

Fill in some simple forms defining your system. Our computerized design service will convert your design into an error-free, optimized wire list.

The computer will also program our automatic wire wrapping machines. These will lower your wiring costs at least 40% on any job worth doing. And once again you'll save a large chunk of time and money, because our computerized wiring verifier checks every connection. Finally, every board will be neatly wired, with multiple copies exactly alike — unlike the spaghetti bowl effect of hand wiring.

This is a proven system . . . not a flight of fancy. It was used for the entire family of Sigma computer products. And because we developed it for ourselves,

you'll only buy computer time, not development. Ask for our Application Bulletin No. 8 on "Automated Wire Listing."

*All this and more modules too.*

Our expanded J Series now has 123 low cost ways to solve digital system problems. You can choose among 76 logic modules, four power supplies, 33 cabinets and mounting cases, plus 10 solutions to cabling problems. There's even an edge lamp test assembly that lets you instantly check key points in your system. But our high performance T Series isn't a slouch. There are 73 modules to choose from plus all the hardware the J Series has to offer.

So call your logic module supplier, and if he isn't us tell him goodbye.

**SDS**  
Scientific Data Systems,  
El Segundo, California

# IBM may soon plunge (without splash) into the 'third-plus' generation

It's expected to unveil some computers that will carry 360 designations but feature ultrafast buffer memories and probably more monolithic IC's

The computer industry's third generation is less than five years old, having first seen the light of day on April 7, 1964, when the International Business Machines Corp. introduced its System 360. At that time, IBM hoped the new breed would last for 10 years at least—if for no other reason than to spare the company another set of labor pains for at least that long.

Many observers in the industry seem to think the third generation still has some time left, and indeed that the idea of "generations" of computers isn't a valid concept anymore [*Electronics*, Jan. 6, p. 131]. For all that, though, IBM itself appears set on taking another plunge; it's expected to bring out some new computers sometime this year. It's said to have at least two machines ready now, awaiting only the appropriate moment for announcement.

The new processors will reflect what IBM learned the hard way through its experience with the 360. They'll make extensive use of "firmware" in easily interchangeable read-only memories, or perhaps electrically alterable read-only memories. And by retaining compatibility with the present 360 line, IBM hopes to bypass the extraordinary difficulties it has had

with software for the 360's. [*Electronics*, July 11, 1966, p. 129; August 22, 1966, p. 149].

**Don't make waves.** Perhaps the most interesting aspect of the situation is IBM's determination to introduce its new machines one at a time instead of all at once, as it did with the 360. The tidal wave created by the 360 unveiling very nearly capsized IBM along with its competition. This fact alone is sufficient to squelch any talk at IBM about a fourth generation except in terms of evolution.

IBM will probably retain the 360 title for these machines, and simply intersperse new model numbers with those it already has. Numbers such as 35, 45, 55 might be applied to the smaller models; at the top of the line it already has a 65, a 75, and an 85—and a 67. These designations would probably upset RCA, whose 360-compatible Spectra 70 computers already come in models 35, 45, and 55.

One thing the new machines almost certainly will have, especially the larger versions, is a buffer memory in front of the main memory, making the latter look as if all of it—perhaps millions of words—is as fast as the former—100 nanoseconds or less. This approach takes advantage of the fact that

access to so-called random-access memories is hardly ever random, but uses the same few locations over and over again for a while, then switches to a few nearby locations one at a time.

IBM's interest in this approach is indicated by a number of more or less isolated factors. The company first tried it out on an old 7000 series computer, reporting the results at the Spring Joint Computer Conference in 1967. It's now been implemented in the System 360/85, and its utility in connection with magnetic disk files has been explored. The disk-file work was described at the IFIP Congress 68 in Edinburgh, Scotland, last summer. And the company has indirectly denied any interest in plated-wire memories [*Electronics*, Oct. 14, 1968, p. 33], thus separating itself from several dozen other organizations that are actively investigating, developing, or producing these units.

**Word to the wise.** To top it off, an IBM spokesman at last month's International Solid State Circuits Conference in Philadelphia was asked if the use of a buffer memory in the model 85 was an isolated case, so far as IBM was concerned. He replied, "No, it's not isolated," and shrugged his shoul-

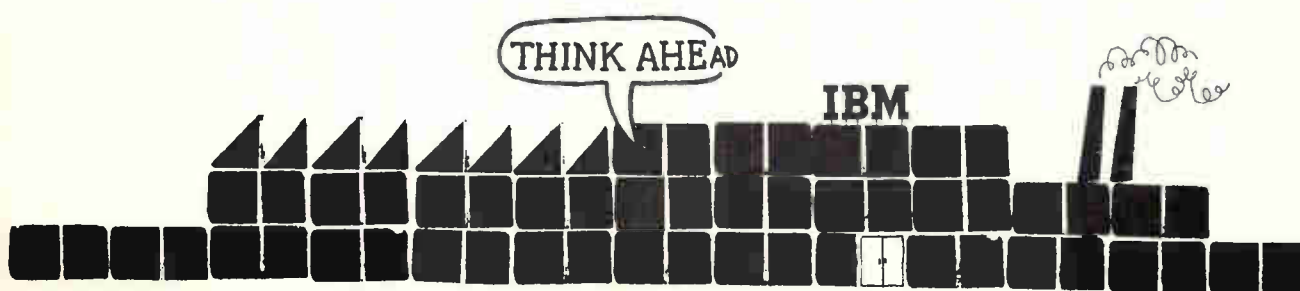

## U.S. Reports

ders—as if to say that if he told everything he knew about buffer memories at IBM, well . . .

The buffer memory in the model 85 represents one of IBM's larger leaps into monolithic integrated circuitry. It had previously introduced such IC's in small quantities and with little fanfare in its model 25, and had substituted them for a few hybrid microcircuits in its model 44. Much of the development work on the individual chips that make up the buffer memory was done by Texas Instruments, which also quite possibly is manufacturing some or all of the chips for IBM.

It's known that TI has a plant of quite respectable size at Sherman, Texas, of which a large portion—one estimate says 25,000 square feet—is devoted to emitter-coupled logic. According to this estimate, the space is occupied by 600 girls in three shifts assembling and packaging IC's. Obviously, not all this production capacity is for IBM; though the model 85 is a large computer, the buffer memory is physically only a small part of it, and the production rate for the computer itself, which contains mostly hybrid circuits, wouldn't call for such a large volume.

It's even open to question whether the buffer memory is an emitter-coupled circuit. Memories don't usually employ such sophisticated designs. Although IBM publicly described much of the storage's design and operation at last summer's IEEE Computer Conference in Los Angeles and at the ISSCC, it's still closemouthed about what the storage element looks like.

**Sifting the clues.** But the memory, which operates at an 80-nsec cycle time in the model 85, is capable of 60-nsec cycling, according to the ISSCC paper, and has a 40-nsec access time. From the moment of initial selection until the rise of an output, the signal has to pass through 10 transistors, not counting those in the storage cell itself. This puts the individual transistor delay definitely in the ECL ball park. The decoding and sensing circuits shown by IBM at Philadelphia weren't ECL; only the

storage element remains a mystery.

Buffer memories in any new IBM line wouldn't necessarily all be ECL, or even monolithic, but it's a good bet that the company will go more heavily into monolithic this time around than it did before. In fact, there are people in and out of IBM who think the company regrets its decision to go the hybrid route with the original 360. This decision was based on an estimation made some seven or eight years ago that monolithic circuits wouldn't be available in time to meet the 360 schedule.

Because of the Justice Department's pending suit against it, the firm is certain to be much closer to a deliverable product if and when it announces one than it has been in the past.

Historically, IBM has completed its engineering tests and what amounts to an ax-and-sledge-hammer test before announcing any new machine. The latter test, performed by an internal organization independent of all engineering departments, is intended to certify that the machine does indeed live up to its specifications, and that it meets all structural and safety requirements. It's also carried out on the first machine off the production line and on a sampling of subsequent machines, and it's largely responsible for IBM's reputation for reliability.

**Paper machine.** But at least twice during the career of the 360, IBM has stuck its neck out and announced a machine that was only on paper. The first time was right after General Electric won a contract from the Massachusetts Institute of Technology's Project MAC; IBM announced its models 64 and 66 for time-sharing (since superseded by the model 67) with almost comic haste.

Later, to counter Control Data's success with its 6600 computer, IBM brought out the model 90 series, with enough hedging—it never got into the salesman's book, for example—to suggest that the machine was really only a special engineering product rather than a production machine. Eventually, the company withdrew the series, explaining rather lamely that it had

“met its original marketing objectives,” whatever that means.

## Companies

### Hogan, phase two

After six months of tinkering and reorganization, C. Lester Hogan figures that Fairchild Semiconductor is ready to fly. To expand production facilities, he has already committed \$20 million for 1969, and this month he sent out a challenge to the industry: “By the end of the year we will stand toe-to-toe with anyone in the world and slug it out on the basis of price.”

Hogan, who is president of the parent, Fairchild Camera and Instrument, is still devoting most of his energies to the Semiconductor division, which he also heads. But he indicated this month that phase one of his reconstruction plan—“cleaning up our delinquencies and solving our logistical problems”—is over, and phase two has begun. “We are ready to take advantage of our technology and put it into large-scale production,” he said.

Last year, Fairchild sorely taxed its engineering and production departments by carrying out a pledge to introduce one new product a week for 52 weeks. The campaign was viewed with some glee by the

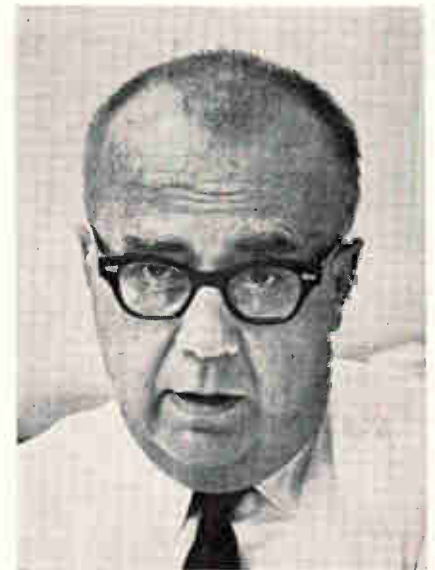

C. Lester Hogan  
Ready to slug it out on price

company's competitors (including the present management team when it was at Motorola's Semiconductor Products division), because Fairchild was tying itself in knots with advanced technology while other companies concentrated on grabbing mass markets.

**New tactic.** Yet Hogan is now ready to embark on a new product campaign that puts last year's in the shade. In order to avoid comparisons with last year, the company will not promote it this way. But in 1969 Fairchild will introduce a new product for every working day—nearly 300 in all.

"Of course," cautions group marketing director Douglas O'Connor, "there are new products, and products that are new to the company." Fairchild will second-source cheerfully. More than 250 of the new products will be discrete components, produced in an attempt to share in a market that Fairchild had almost abandoned. Some, though, will be in the advanced fields of semiconductor memories, complex metal oxide semiconductor circuits, medium-scale integrated circuits, and gallium arsenide displays.

O'Connor reiterates that Fairchild will not second-source the entire Texas Instruments series 54/74 line of transistor-transistor logic, but will be selective and make a few simple gates and flip flops. For

## Among the Navajo

"I thought the Shiprock plant was one of Bob Noyce's philanthropies until I went there," said C. Lester Hogan after a visit to Fairchild's facility on a New Mexico Navajo reservation. But Hogan was so impressed with what he saw there that his first move on returning to headquarters was to write an enthusiastic three-page memo praising plant manager Paul Driscoll and ordering even greater expansion of the Shiprock plant than had been planned.

Hogan was tickled personally by the humor of the Indians, which manifested itself by one worker pasting a Motorola batwing emblem over his Fairchild badge, and by the action of a group of supervisors who, knowing of Hogan's disdain for clock-watchers, arose and walked away from their desks en masse when an alarm sounded at five o'clock.

But he was even more taken with the work being turned out by the Navajos. Driscoll is the only non-Indian in the plant, which has grown from 300 employees to 1,000 since last September. Fairchild will therefore erect another building at Shiprock, and Hogan says he may even build new housing for the workers if he can think of a way to avoid the stigma attached to a company town.

complex functions, Fairchild is sticking with its own 9000 line of MSI.

**Important man.** Much of the restructuring that has enabled Hogan to view the future so cheerfully has been performed by George Scalise, group director of manufacturing services. The vagueness of that title belies Scalise's importance. It is Scalise who centralized production control, oversaw Fairchild's switch from a plant-oriented to a product-oriented company, and reorganized the production-control information system. (And it is Scalise who is the current favorite in the speculation over who will succeed Hogan as head of the division when Hogan abandons that post.)

It is the computer-operated information system that has given Scalise the most difficulty. "The hardware and software for management information systems exist, but they are outdistancing our ability to implement them," he notes. One way Fairchild is attacking the problem this year is with a major program on computer terminals, to provide inputs at various production stages. But Scalise says that the quality of information has already improved; he measures it in terms of how many times the company has had to reschedule orders and says, "If you assigned it a value of four last year, it's now less than two."

**Over the hump.** Says Hogan:

"We have control of the operation now. We can predict what will happen next month. Back in January, I wasn't sure that we could make it; it almost seemed that there were too many problems to get them all solved. But now we're over the hump; the customers don't know it yet, but by April, they'll be sending me bouquets."

To take care of the increased production and engineering, Fairchild has been expanding furiously. Hogan has added between 400 and 500 overhead employees at the Mountain View, Calif., headquarters since arriving on the scene. For a time, he was shopping for semiconductor facilities like a tourist in the Paris Flea Market (and finding as few bargains). Now Fairchild has decided to expand facilities at Shiprock, N.M.; Hong Kong; and Seoul, Korea, and to build new plants in Singapore and in Wiesbaden, Germany. To ease the present pinch it is assembling linear circuits in Tijuana, Mexico—in a different plant but in the same city that it pulled out of only last spring.

Avionics

## Complex monitoring

In most aircraft integrated data systems (AIDS), the signal conditioners are time-shared, each looking at a



George Scalise  
Likely to succeed at Fairchild

## U.S. Reports

number of test points in sequence. Analog switching routes a sensor signal into the conditioner, where it's digitized and stored either on tape for later analysis by a ground computer or in an onboard digital computer.

Individual signal conditioners for each test point haven't been used in AIDS because it has been too expensive to put upwards of 300 conditioners in a plane. But engineers at RCA's Electromagnetic and Aviation Systems division will propose just such a system to the Air Force for the upcoming competition for the instruments in the C-141 transport—a system able to monitor 300 to 400 test points. The request for proposals is expected this month.

James Burnett, staff engineering scientist at the RCA facility in Van Nuys, Calif., believes the firm's ability to develop a system that will be competitively priced with other AIDS units—even though it uses far more signal conditioners—revolves around RCA's microelectronics know-how.

A typical signal conditioner module has two custom medium-scale integrated chips mounted on a ceramic thick-film substrate bearing the passive components and some discrete devices. Each chip contains four high-performance operational amplifiers, with each op amp made up of 30 to 35 active elements.

**In house.** The MSI devices are designed in Van Nuys, including mask making, and Burnett says

they can easily be worked into the production stream at RCA's Somerville, N.J., site. The thick-film portions of the hybrid circuits are fabricated at Van Nuys. There's no need to go outside RCA for devices—a factor that contributes to substantially reduced signal conditioner costs, Burnett maintains.

He says solid state switching isn't used in more conventional systems, in which signal conditioners are time shared, because the switch resistance is too high and drastically disturbs signal calibration. Reed relays are used in these other systems because of their lower resistance, but they are less reliable than solid state switches. Reed relays have another drawback: it is possible to interconnect two prime aircraft circuits, distorting data on them if they are measurement circuits.

The RCA system that will be proposed for the C-141 accommodates up to 512 signal conditioners—128 in each of four acquisition units. It has a central electronics unit which includes a core memory that performs the addressing function, scanning 100 input signals per second. If there's an onboard computer, its memory would do the addressing. Data collected from the sensors is relayed either to an onboard computer or to a 5-minute loop recorder, which can double as a crash recorder. Detailed fault data can be dumped onto an incremental recorder for ground computer analysis rather than being erased when the 5-minute tape

reaches its end and starts the cycle again. Faults are isolated down to the line-replaceable unit level.

Besides getting rid of reed-relay switching, the one-test-point, one-signal-conditioner concept also allows any time constant to be put into a conditioner. An AIDS system using time-shared conditioners must process the signal and any noise present, digitize it, and store it all in about four milliseconds, then switch to the next signal it must process. In the RCA scheme, a longer time constant filters out aircraft noise.

**Error free.** Burnett says accuracy is further enhanced by converting the input signal into a stream of pulses in the signal conditioner. In this pulse train, a zero voltage is represented by 25 pulses returned to the central electronic unit. A full-scale signal, which may be as low as 30 millivolts d-c or as high as 40 volts a-c, is represented by 1,028 pulses. "This way," says Burnett, "If a noise spike wipes out a few pulses, there's no great loss in accuracy. While in a system that uses a binary-coded decimal form for the return signal, you can have as much as 90% error if a spike wipes out a few bits in an eight-bit word." The RCA technique converts the signal to computer-compatible binary-coded decimal form in the central electronics unit, where it's isolated from aircraft noise.

Each signal conditioner is continually putting out its pulse train. However, only when the core memory of the central electronics or the on-board computer memory sends the address of a given data point is a pulse train let out and into the computer or the central electronics unit. This is done by closing a solid state switch after the proper test point address has been determined by a decoder in the unit, and this is the only switching done in the RCA technique.

That input signal might be, for example, the rpm rate for an engine alternator. Acceptable levels for that rpm rate are programmed into the memory. If the input signal is out of tolerance, it will be stored in the incremental recorder for later computer analysis when the plane

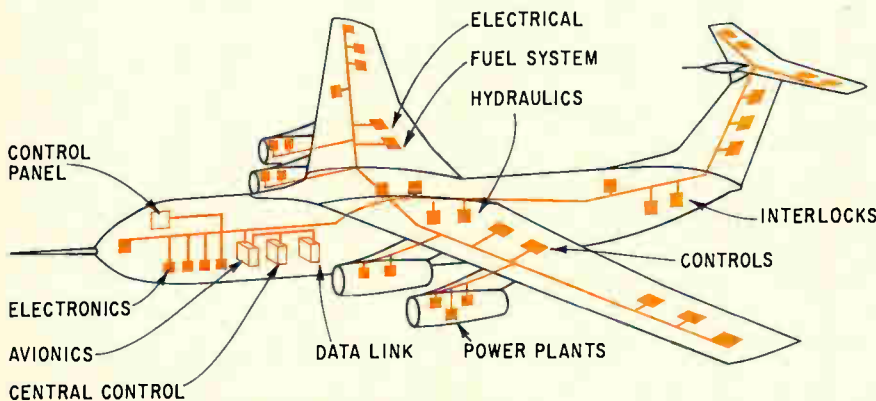

Flight plan. RCA's proposed aircraft integrated data system (AIDS) for the C-141. Unit would monitor 300 to 400 test points.



# Honeywell is out to clear the air in a lot of dirty businesses.



Stale smoke, dust, grease particles, pollen and other airborne filth are the enemies of all businessmen, from restaurant managers to machine shop operators. So, Honeywell has developed a new business machine that fits into your heating or cooling system and removes up to 95% of the impurities from the circulating air.

We call our self-washing electronic air cleaner a business machine because we sell it on a very business-like basis. **IT CAN SAVE YOU MONEY.**

In a retail business, the relationship between cleaner air, less maintenance, cleaner merchandise (or food) and more customers is pretty obvious. But it's hard to measure. So, here's a more measurable saving that applies to *any* type of business.

**Business machine cuts heating, cooling, ventilating costs.** Any ventilation system uses outside air—often polluted. A regular ventilating system must run almost continuously to replace stale inside air with only partially filtered outside air—a substantial operating expense. The Honeywell Electronic Air Cleaner cleans and reuses more inside air . . . the air you've already heated or cooled. That's a saving anyone can measure.

**No maintenance on the machine, either.** After it cleans the air, it cleans itself . . . automatically. Businessmen don't need more maintenance problems.

If you'd like to know more about Honeywell's new business machine, the self-washing electronic air cleaner, just mail the coupon. If we can't make a businessman's case for saving you money, we'll just leave quietly.

Mail to:  
Honeywell, Dept. 118  
Minneapolis, Minnesota 55408

I'm interested in more information about your Automatic Wash Electronic Air Cleaner.

- Please send new brochure.  
 Please have a representative call.

Name \_\_\_\_\_

Business \_\_\_\_\_

Address \_\_\_\_\_

City \_\_\_\_\_

State \_\_\_\_\_ Zip \_\_\_\_\_

**Honeywell**  
A U T O M A T I O N

# 24

## MILLISECS IS THE VERY FASTEST . . .

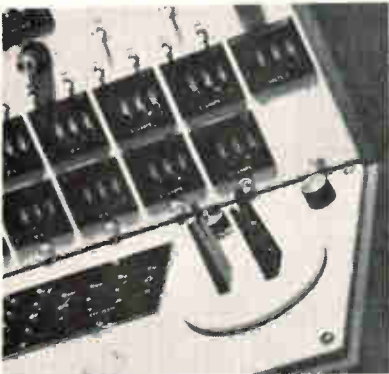

. . . If you are talking about automatic diode testing.

Burns & Towne makes an AUTOMATIC DIODE TEST SYSTEM of advanced design that will set conditions, run a test series, and classify 10 PRV categories in 24 millisecs.

It's the fastest, and most important it is faster than any mechanical probes or handlers.

Add to this flexibility in the form of plug-in modules, reliability in the form of solid state switching, and a range of 0 to 500 v. and 0 to 1 amp. and you have the finest production test system for diodes available.

 **BURNS & TOWNE INC.**  
SYSTEMS DIVISION 18-36 Granite St.  
Haverhill, Mass. 01830, Tel (617) 373-1333

## U.S. Reports

lands to determine whether the alternator should be replaced or repaired. The incremental recorder also stores a good deal of data about each flight leg—takeoff, climb, cruise, for example—so that even if no faults are dumped into it from the loop recorder, a good deal of trend information is gathered about aircraft performance that's useful for longer-term maintenance scheduling.

**Stiff competition.** Burnett says the RCA system lends itself easily to retrofitting existing aircraft circuitry, even though that circuitry was not designed with an AIDS system in mind "because the signal conditioners have enough input impedance upstream of the shorting point so that we don't compromise the aircraft circuitry." He feels this should enhance RCA's chances in the C-141 competition, which will be stiff and should include such firms as Garrett AiResearch, Hughes Aircraft, Lockheed Electronics (teamed with Lockheed Aircraft Service), Teledyne, General Electric, and possibly Conrac.

RCA has developed 13 kinds of signal conditioners to accommodate the variety of voltage levels on aircraft sensor inputs. Burnett says the calculated mean-time-between-failure for a conditioner is almost 2 million hours.

## Manufacturing

### Checking for leaks

Standard hermeticity tests of metal- or ceramic-packaged integrated circuits effectively weed out leaky assemblies. Unfortunately, however, such checks often flunk IC's that are perfectly good. In fact, an engineering team at North American Rockwell's Science Center has found that in a typical test-batch as many as 60% of the IC's are incorrectly rejected. But the North American researchers believe such spotty testing will soon be a thing of the past. They've developed a machine that is 100 times more accurate in weeding out leaky IC's.

A prototype will be shown at

the IEEE Show next week in New York by Navan Inc., the special products subsidiary of North American that will market it. It differs from conventional leak detectors on two counts. It can cull out gross or fine leakers with one test—a process that requires two separate checks in standard machines. Moreover, it tests devices without submitting them to the often degrading effects of hot glycol immersion—used to look for bubbles indicating gross leaks—or high-pressure helium tests to weed out fine leakers.

In the most widely used fine-leak detectors, the packaged parts are first subjected to pressures of 60 to 65 pounds per square inch for one to four hours to force helium into the package, which had been filled with dry nitrogen, through any leaks that may exist. Then they are placed in a mass-spectrometer helium detector. And a vacuum is created so that any escaping helium shows up.

**Finding fault.** Raymond Meyer, a member of the technical staff at the science center and inventor of the new hermeticity tester, says that if there is too much delay in getting devices out of the high-pressure helium capsule and into the vacuum, the helium can diffuse through the package. If this happens, none will be left to detect and a faulty part might pass.

"Now assume a device has passed the fine-leak test," Meyer continues. "It's then plunged into glycol at 125° to 150°C and checked for bubbles. But air entrainment between IC leads can occur," Meyer says, "and the bubble formed outside the package will expand with temperature just as a leak bubble will." This misleading bubble in gross-leak testing is what causes good packages to be rejected.

In the North American machine, the device to be tested is supported in a small chamber. A piston then comes down over the chamber cavity, enclosing it. Most of the remaining air in the chamber is cleared out in a three-second sweep cycle by pumping helium through the chamber; it's then vented.

**Discriminating.** After the sweep



ACTUAL SIZE

# RELAYS

## 1/6-Size Relay Model BR10

- Dry Circuit to 1 Amp.
- DPDT
- Welded or Soldered
- Universal Contacts
- To MIL-R-5757

Babcock's Model BR10 1/6-size crystal can relay packs a lot of performance in a small package. Its unique universal contacts give you "non-stop" operation from dry circuit to 1 amp...one subminiature relay to meet all your requirements for high-density circuit-board applications—at no cost premium.

You'll find that this small, versatile, DPDT unit has everything. Designed to specification MIL-R-5757, it features rugged unitized construction for increased shock and vibration resistance. Both soldered or welded versions are offered. Regular and gold-plated plug-in, solder-hook, and long-lead terminal styles are available, in standard circuit-board grid pattern, with a range of mounting types.

The Model BR10 has a record of dependability, attested by its proven conformance to MIL-R-5757 and specified use in programs requiring operation under the most severe environmental extremes. Built-in reliability, outstanding performance, application flexibility...all assurances that your relay is *better because it's Babcock.*

**The Babcock Model BR10 relay has proven its reliability in a variety of aerospace and commercial avionics applications.** Its subminiature size makes it ideal for single and multi-relay circuit-board installations. In fact, a brace of four BR10's has been found to take less board space than a similar group TO-5 units. You get efficient high-density packaging, *plus* full 1-amp. capability.



**Need 2-amp. performance?** The Model BR10 will operate dependably at 2 amps. (28 VDC), through 100,000 operations, in the temperature range  $-65^{\circ}\text{C}$  to  $+125^{\circ}\text{C}$ . Contact our Applications Engineering Group for further details.

### SPECIFICATIONS

Contact Rating.....	1 amp. @ 28 VDC
Operate/Release Time....	3.5 ms., max.
Pull-In Power.....	100 mw
Bounce Time.....	2 ms., max.
Shock.....	50 g's (11 ms.)
Vibration.....	30 g's, 38-2000 Hz
Operating Temp.....	$-65^{\circ}\text{C}$ to $+125^{\circ}\text{C}$
Life.....	100,000 operations, min.

Get complete information on the versatile, subminiature Model BR10 today...contact Babcock Electronics Corp., Relays Division, Subsidiary of Esterline Corp., 3501 Harbor Blvd., Costa Mesa, Calif. 92626. CALL COLLECT (714) 540-1234 or TWX 910-595-1517.

**Available off-The-Shelf from  
AVNET, POWELL or PDQ.**

Challenging opportunities now exist at Babcock for experienced relay-switch engineers.



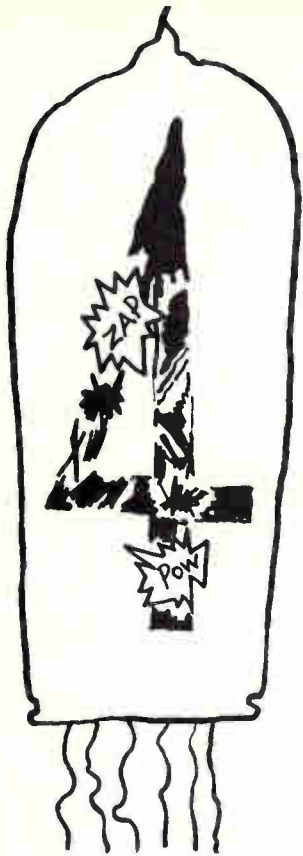

### 3 ways to prevent numerals from "spotting" at 55°C.

Fill with freon...  
keep in shade...  
or specify Datavue\*  
Indicator Tubes.

All Datavue tubes are rigorously tested to meet commercial and military specifications, produced for 200,000 hours of reliable operation. U.S.-made, they can cost less than \$3.95 each.

Datavue tubes feature: straight, stiff leads for fast insertion; fully formed, high-brightness characters; rated for strobing operation; wide range of alphanumeric, decimals, special characters. More than 40 different sockets, including right-angle types, are available.

Call your Raytheon distributor or sales office. *Raytheon Company, Industrial Components Operation, Quincy, Mass. 02169.*

\*Trademark of Raytheon Company



## U.S. Reports

cycle, gas is again pumped into the chamber. Any foreign gas leaking from the package—whether nitrogen or oxygen—is swept into the chamber, mixes with the helium, and is carried to a detector plate—a negatively charged collector coupled to a field effect transistor amplifier. The helium is energized in the detector, ionizing any nitrogen or oxygen molecules that leaked from the package, and the collector attracts the positively charged leak gases. The detector is set to see only the current associated with the ionized particles, not the current of energetic helium molecules.

The FET amplifier then boosts the current to a level that can be both recorded on a strip chart and used to trigger an alarm bell or a red light when a rapid release of a foreign gas indicates a gross leak.

A fine leak is detected by examining the strip chart to determine how much time is required for the signal to return to its zero state (0.3 millivolt is assumed to be the zero level of the gas—a state in which no ionized nitrogen or oxygen is present). If the reading doesn't return to the zero state quickly, the package is rejected as a fine leaker. A little foreign gas might be detected at the outset of a test run of a good device because of incomplete sweeping of the test fixture. But if the package doesn't leak, the detector quickly shows the gas returned to the zero state.

Meyer says conventional mass-spectrometer fine-leak detection and the gross-leak bubble test take about three minutes; the North American Machine does both in 45 seconds. Company officials expect the machine to cost less than mass-spectrometer leak detectors, but a price hasn't been set yet.

### Space electronics

#### Waiting for ERTS

Companies anxiously watching their mailboxes for the requests for proposals on NASA's Earth Resources

Technology Satellite (ERTS) will have to wait some more. Given the informal word earlier that the requests would be out by mid-February, bidders who would like to design the demonstration satellite have now learned that it will be mid-March. By now, however, companies should be getting used to waiting.

Despite the great show of interest by prospective users in flying such a spacecraft at the earliest possible time, NASA hasn't moved with much speed. In fact, Rep. Joseph E. Karth (D., Minn.) has bitterly attacked the agency for "foot dragging and the setting up of straw men and ridiculous yardsticks." Karth, chairman of the House Space Science and Applications Subcommittee, maintains that NASA has resisted unmanned spacecraft development, and that as long ago as 1964 it adopted the policy that earth resources experiments would be carried out as part of the manned spaceflight program.

Three months. Karth says this situation "stems from the parochial interests at NASA where bureaucratic empires are being built." He says he'll also "watch closely" for any interagency rivalry between NASA and the Departments of Agriculture and the Interior, which had tried to push their Earth Resources Satellite in 1966.

The request due next month is from Goddard Space Flight Center for combined project-definition and detailed design studies. Asked about the latest delay, one NASA official said, "It just took time to get user agencies to agree on the work statement and specifications." NASA had talked of getting fabrication of the spacecraft started by June of this year.

Once the studies are awarded, the companies picked will have only about three months to complete them. Said one veteran space vehicles engineer. "I've never heard of only a three-month detailed design phase." What this tight timetable means is that NASA wants to get up a demonstration spacecraft as quickly and cheaply as possible; a modified design of an existing spacecraft would probably be used. The agency hopes to launch ERTS-A

# FOR ALL YOU FAITHFUL USERS OF FAIRCHILD MICROWAVE TRANSISTORS... A MODEST REWARD:

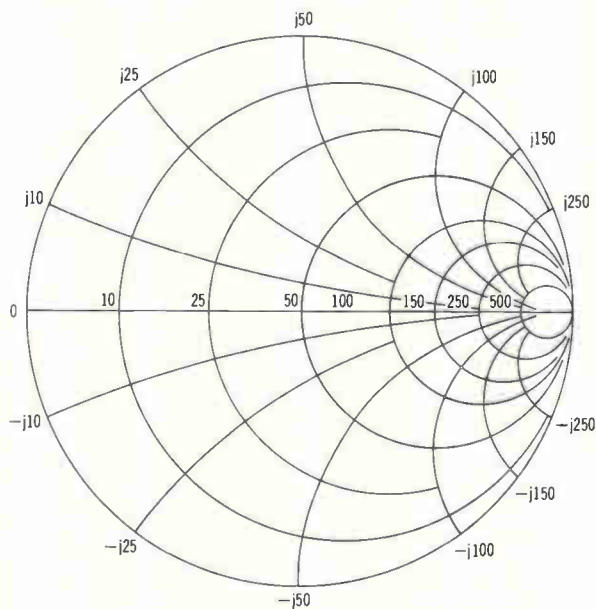

## S-PARAMETERS

Now all Fairchild microwave devices come thoroughly characterized by s-parameters. Circuit design is easier and faster with scattering parameters (reflection and transmission characteristics) because you can predict exactly what the devices will do in your linear circuits. No "glitches", no surprises. You'll spend a lot less time on your drawing board. And a lot less time tweaking breadboards. Your Fairchild salesman can give you the whole story. Or write for our brochure, "Fairchild Microwave Transistors/S-Parameters."



FAIRCHILD SEMICONDUCTOR A Division of Fairchild Camera and Instrument Corporation Mountain View, California 94040 (415) 962-5011 TWX: 910-379-6435

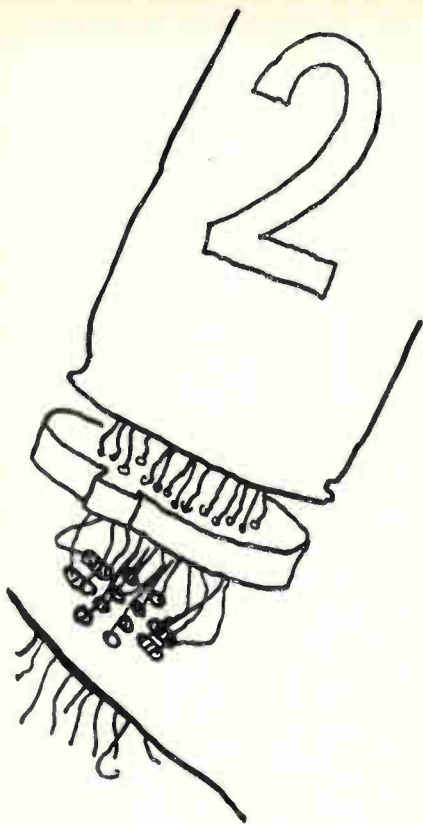

## 3 ways to insert indicator tube leads efficiently.

First, hammer them flat... or press with flatiron... or specify Datavue\* Indicator Tubes.

All Datavue tubes have straight, stiff leads for fast, accurate insertion... to save hours of assembly time.

U.S.-made Datavue tubes can cost less than \$3.95 each. Rigorously tested, they're produced for 200,000 hours of reliable operation.

Datavue tubes feature: fully formed, high-brightness characters; rated for strobing operation; wide range of alphanumeric, decimals, special characters. More than 40 different sockets, including right-angle types, are available.

Call your Raytheon distributor or sales office. *Raytheon Company, Industrial Components Operation, Quincy, Mass. 02169.*

\*Trademark of Raytheon Company



## U.S. Reports

in late 1971 or early 1972, and the second model a year later.

It now looks as if three companies will be selected by NASA to do definition and design under parallel awards of about \$200,000 each.

**Ground rules.** According to one spacecraft designer, the budget and time scale rule against a new design.

But at least one company feels differently. Robert H. Stivers, manager of unmanned space systems at North American Rockwell's Space division in Downey, Calif., says, "Our feeling is that it won't be a Nimbus, Tiros-M, or an ATS (Applications Technology Satellite)." The division, a newcomer to the satellite business, is redefining a spacecraft specifically for the earth resources mission. Engineers at some competing companies, particularly those with existing spacecraft designs, say North American hasn't got a chance this time around. However, Leonard Jaffe, director of NASA's space applications programs, won't rule out a new spacecraft design. But cost will be the most important factor in picking the ERTS builder.

A 500-nautical-mile circular polar orbit looks firm. In the orbit, the spacecraft will photograph a 100-mile swath with minimum image distortion and cover the globe every two to four weeks. Hughes may be planning to bid its ATS, but the required resolution for photography can't be obtained at ATS's synchronous orbit.

The three front runners for the studies at this point appear to be General Electric, RCA, and TRW Systems. This is because all three have been hard at work on the program for up to two years. All build sensors and have a data management analytical capability. And perhaps more important, all three have a spacecraft design applicable to the mission: TRW with its orbiting Geophysical Laboratory, GE with Nimbus, and RCA with Tiros-M. Other companies that may bid include Boeing with its Lunar Orbiter, Ball Bros. Research, with its Orbiting Solar Observatory, and Lockheed Missiles and Space.

No matter which spacecraft contractor is selected, ERTS will carry three 2-inch return-beam vidicons

to be built by RCA. Each will be sensitive to a different frequency: two in the visible and one in the near-infrared to 0.8 micron. The spacecraft will also carry two videotape recorders, also to be built by RCA, and a data-collection system. Still being considered are an optical and infrared scanner and a microwave scatterometer.

**Minimum lifetime.** Data management on an operational Earth Resources Satellite program is the pacing element in the technology. The communications problem goes up four orders of magnitude from that of current meteorology satellites, says Eric S. Burnett, an engineer at TRW's sensor systems laboratory. On-board storage will be handled by the videotape recorders, which will then dump the data via an S-band communications link to two 85-foot ground dishes. Lifetime of the recorder will be about 200 days; after that, transmission of data will be in real time only. The spacecraft will be required to have a minimum lifetime of one year.

The ERTS program will have some money for ground support, says Jaffe, but he indicates that it would be a minimum program. "We're going to get pictures in the hands of user experts so they can determine what they will need from an operational system." A major data center on the ground to handle earth resources data is really down the line a bit, he adds.

As a multipurpose satellite in the R&D phase, ERTS should enable users to determine their needs for an operational system. Karth sees an operational earth resources satellite by 1977 and he believes there could be several single-purpose earth resources satellites. Each Government agency could be flying its own satellite, designed specifically to send back the data required by the individual user.

## Communications

### GE vs. AT&T

Everyone in the communications and electronics business these days wants to cash in on the communi-

Pick the  
**BEST IC**  
for the job

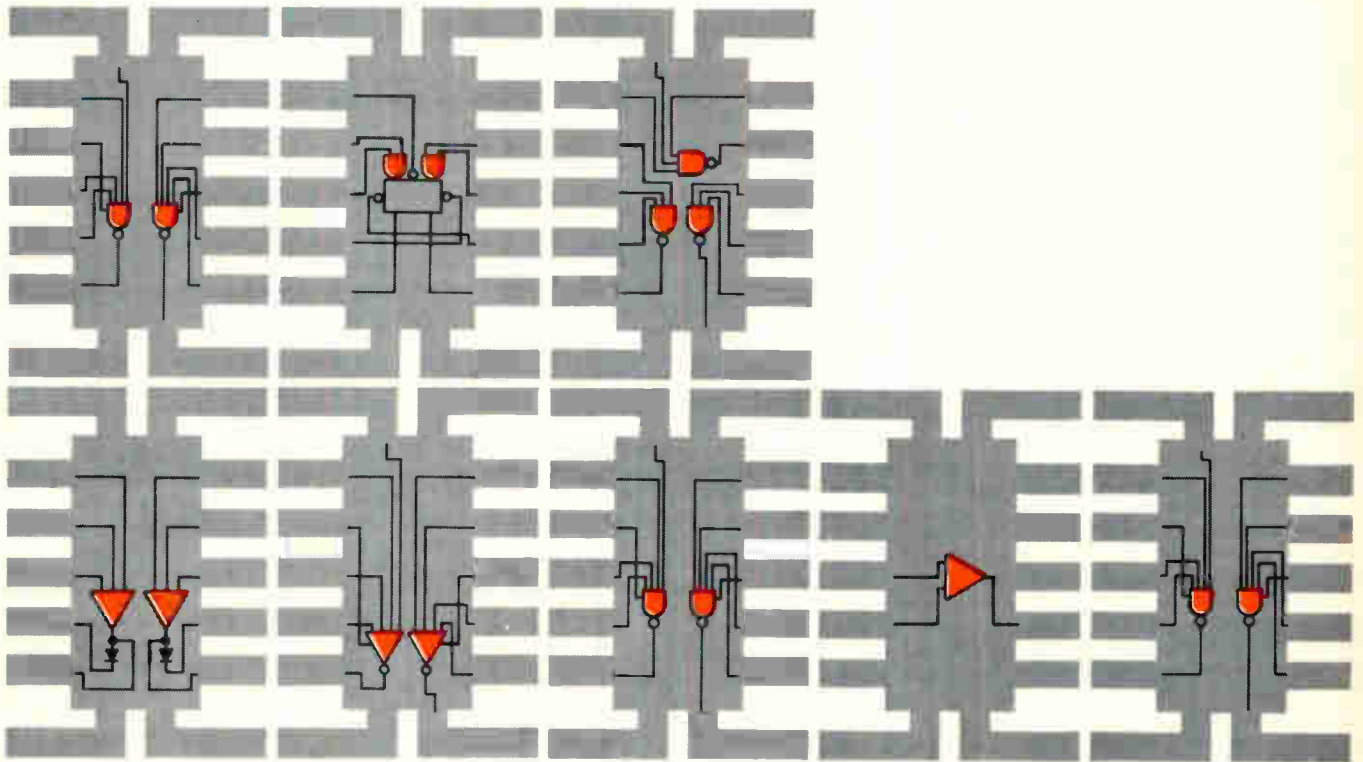

**Best line of defense against radiation environment**

Radiation offers the circuit designer two orders of magnitude improvement in hardening levels over conventional PN junction devices. This is accomplished by dielectric isolation, thin-film resistors over oxide, small-device geometries, shallow diffusions and other special design techniques. So when you pick the Best IC for a radiation environment application, doesn't it make sense to come to the leader in hardened circuit technology?

Our line of defense consists of 930 series DTL, a level shifter, a line driver and a linear 709. These are not prototype circuits. We can deliver Dual 4 Input; Dual 4 Input Power or Triple 3 Input Gates; Clocked Flip-Flop; Dual 4 Input Buffer; Dual Level Shifter; Dual Line Driver and 709 Operational Amplifiers. With the exception of the Dual Level Shifter and Dual Line Driver, all are plug-in replacements for their non-hardened 930 Series and 709 counterparts. The Hardened Dual Line Driver is a pin-for-pin replacement for Radiation's standard RD 209 Line Driver.

Want more information? Contact your nearest Radiation Sales Representative. He'll give you complete details and help you pick the Best IC for the Job.

WE MAKE THE **BEST IC** FOR THE JOB



See these circuits at IEEE Booth 4-H 19-21

**RADIATION**  
INCORPORATED  
SUBSIDIARY OF HARRIS INTERTYPE CORPORATION  
MICROELECTRONICS DIVISION

RADIATION SALES OFFICES: P. O. Box 476, Lexington, Mass. 02173, (617) 862-1055 • 600 Old Country Road, Garden City, N.Y. 11530, (516) 747-3730 • 2600 Virginia Ave., N.W., Washington, D.C. 20037, (202) 337-4914 • 6151 W. Century Blvd., Los Angeles, Calif. 90045, (213) 670-5432 • Saratoga, Calif., (408) 253-5058 • P. O. Box 37, Melbourne, Fla. 32901, (305) 727-5430 • International Sales: Marketing Department, P. O. Box 37, Melbourne, Fla. 32901, (305) 727-5412

## U.S. Reports

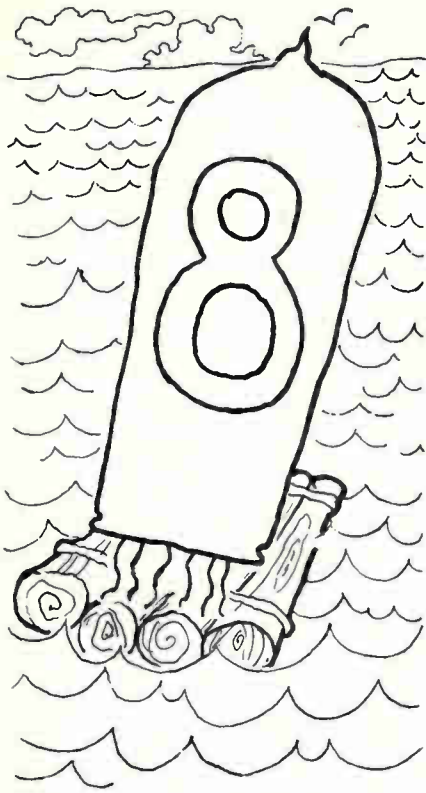

### 3 ways to keep indicator tube orders from drifting at sea.

Insist on delivery by rocket...submarine... or choose U.S.-made Datavue\* Tubes.

Raytheon offers you prompt deliveries of Datavue tubes and fast turn-around service on all custom alphanumeric, decimal, and special character orders. Tubes are U.S.-made, can cost less than \$3.95 each.

All Datavue tubes are produced for 200,000 hours of reliable operation. They feature: straight, stiff leads for fast insertions; fully formed, high-brightness characters for accurate reading; rated for strobing operation. More than 40 different sockets, including right-angle types, are available.

Call your Raytheon distributor or sales office. *Raytheon Company, Industrial Components Operation, Quincy, Mass. 02169.*

\*Trademark of Raytheon Company



communications satellite business. But with the Communications Satellite Corp. taking care of all U.S. interests abroad, the only opening still waiting for takers is the domestic satellite business.

That's why there was surprise at the Federal Communications Commission recently when General Electric walked in with a dramatic plan for a domestic satellite system, but disavowed any interest in setting it up.

In doing this, GE was directly challenging another corporate giant: American Telephone & Telegraph. Both companies are major manufacturers of electronic equipment and providers of communications services—AT&T with its phone service, and GE with its computer time-sharing operations.

**Upmanship.** Usually, the giants of the business fight quietly, without fanfare and in closely guarded language. This time, however, GE came in with brass knuckles.

GE told the FCC that it should authorize a "competitive alternative" to AT&T. The "alternative" should supply data, record (written), and video service in competition with AT&T. The proposal alluded to the benefits of competition, and the implication was clear: the buyer should have a choice between communications services. GE did not say who the supplier of the service should be, but Comsat would seem to fit the description.

The FCC is obviously interested in the GE plan. The commission allowed GE's proposals to be considered as a "late filing" in an already closed docket. And early this month Commission Chairman Rosel Hyde told the Senate communications subcommittee that the commissioners want to look into GE's plan before ruling on how domestic satellites should be handled.

The proposal outlined by GE may be a boon to business and industry. First of all, the plan calls for "telemail" service that would flash business-to-business correspondence at lower rates than the Post Office; provide data circuits for links between computers, and between computers and remote terminals, and serve as a video link for business conferences.

GE says that it would, of course, be willing to sell the operator of such a system its communications hardware. But the company says its main purpose in making the proposal is that its own corporate communications cost is soaring.

The domestic satellite system might turn out to be a way for all business and industry to cut down on its communications cost. The FCC will make its decision known by the end of the year.

### For the record

**New product.** Much to their disappointment, users of communications-oriented computers often find that they can only utilize 20% to 50% of their machine's capacity for processing; the rest is taken up with sorting input and output data coming from a tangle of communications lines. So with this in mind, Comcet Inc., of St. Paul, Minn., plans to build and sell a new computer designed specifically to handle this communications input and output problem.

Comcet 60, as the new machine is called, comprises a central processor, interface modules connected to the communications lines, adapters connected to the "native" computer—either an IBM 360 or a Univac 1108—a console, a control panel, and a system activity monitor.

The central processor contains a 900-nanosecond memory, expandable from 32,768 to 131,072 bytes of eight bits each; the processor works with 32-bit words. Also included are 16 general-purpose registers, four input-output channels, and 64 full-duplex (capable of operations in both directions) communications channels with speeds up to 230,400 bits per second.

Comcet, a subsidiary of Compress Inc., a Washington, D.C. software and consulting firm, will sell its machine for between \$150,000 and \$250,000 depending on the number of lines it can handle.

**Tuning colors.** Researchers at Stanford University have developed a 3-megawatt ruby laser that



# Never before

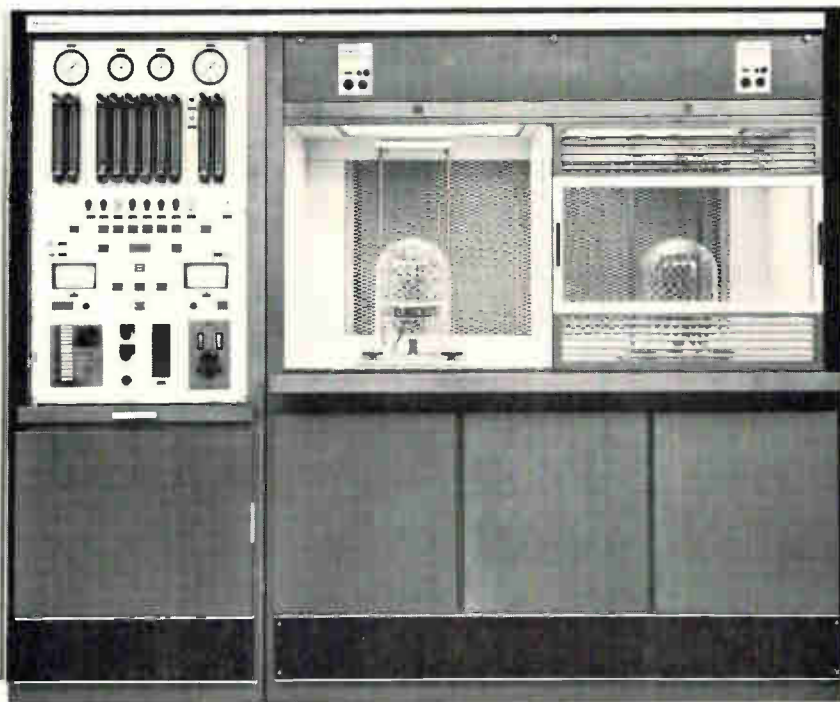

## A vertical reactor specifically designed for silane epitaxy and passivation depositions

Our new AMV Series also does everything any other epitaxial reactor does, only with more control and broader use capabilities. The electronic and mechanical designs incorporated into this series of reactors are surpassed only by the quality of the CVD capabilities now at the disposal of semiconductor manufac-

turers. No other equipment manufacturer even offers Silane epitaxial capability; we have perfected it.

Capacities up to twenty-one 2" diameter wafers; write for complete information. Call collect for immediate requirements.



## applied materials

Applied Materials Technology, Inc. 2999 San Ysidro Way  
Santa Clara, California 95051 (408) 738-0600 TWX: 910-339-9258  
BOOTH #4K25-27 FOURTH FLOOR I.E.E.E. AT THE COLISEUM

NEW  
UNIVERSAL  
TYPE

# IMPEDANCE BRIDGE

MODEL ZB-2

① Single null detector for both AC and DC measurements. Eliminates "electron ray" or "eye" tube.

② AC and DC null detector characteristics programmed from front panel.

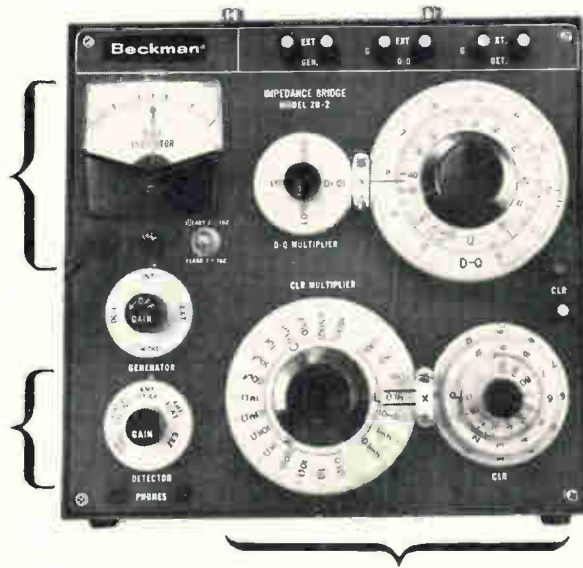

③ In-line readout for DQ and CLR for faster reading and higher accuracy.

■ The MODEL ZB-2 IMPEDANCE BRIDGE is a complete impedance measuring set providing a direct reading of capacitance, resistance, and inductance, as well as dissipation factor (D), used for capacitors, and storage factor (Q) used for inductors. Measurements may be made using either the self-contained 1 kc oscillator, an external oscillator, or internal or external DC voltages. AC nulls may be detected with the aid of the self-contained amplifier and null meter. DC nulls may be detected using the null meter alone.

Mechanical design innovations offer case dimension of 8½" x 9⅞" x 9" deep overall. Durability, compactness and portability are stressed to increase usefulness for lab or field requirements.

## SPECIFICATIONS

RANGE	ACCURACY
1. RESISTANCE—0 ohms to 11 megohms, AC or DC (8 ranges).	1. RESISTANCE—± (0.1% + 1 dial division).
2. CAPACITANCE—0 pf to 1100 uf (7 ranges).	2. CAPACITANCE—± (0.2% + 1 dial division).
3. INDUCTANCE—0 uh to 1100 h (7 ranges).	3. INDUCTANCE—± (0.3% - 1 dial division).
4. D-FACTOR—0 to 10.5 at 1 kc (2 ranges) with provision for extension through external networks.	4. D-FACTOR—± (2% + 0.0065).*
5. Q-FACTOR—0 to 1000 at 1 kc (2 ranges) with provision for external extension through external networks.	5. Q-FACTOR—Expressed as $D = 1/Q$ , where D is accurate to within ± (2% + 0.0065).*

\*On 100 uf, 100 pf, 0.1 mh, and 100 h settings, D and Q accuracy (expressed as D) is ±2% + 0.05.

**Beckman**

INSTRUMENTS, INC.

CEDAR GROVE OPERATIONS

89 COMMERCE ROAD  
CEDAR GROVE, NEW JERSEY • 07009  
(201) 239-6200 • TWX: 201-239-4704

INTERNATIONAL SUBSIDIARIES: Geneva; Munich; Glenrothes; Scotland; Tokyo; Paris; Capetown; London; Mexico City.

## U.S. Reports

produces as many as nine discrete colors simultaneously, six of them tunable.

**Oops.** The Air Force contract to build the second-generation Defense Satellite Communications System (DSCS-2) has been awarded to the TRW Systems Group, not Hughes Aircraft as predicted in these pages [*Electronics*, March 3, p. 40]. The third bidder was Philco-Ford. The Air Force expects to buy up to six of the craft, which will be powerful enough to beam signals to small terminals aboard ships and Army vehicles. The satellites will use a variety of antennas, including earth-coverage horns with gains of 28 decibels above one watt and steerable narrow-beam antennas with gains of 43 dbw. The narrow-beam antennas will focus a portion of the energy on areas 1,000 to 2,000 miles in diameter. The research and development phase of the program will be worth \$37.6 million to TRW, and production and launch options could bring the total figure to more than \$60 million.

**Vikings embark.** NASA's Langley Research Center has issued requests for proposals for the planetary lander and project integration portions of the Viking program. Firms have until April 2 to file their technical proposals. Bids on the orbiter portion of the program will be asked later this year. Two Viking spacecraft—each composed of a lander and an orbiter—are scheduled for Mars flights in 1973.

Meanwhile, the 900-pound Mariner F spacecraft launched last month is scheduled to arrive at Mars on July 31 and make an equatorial pass over the planet, while Mariner G, scheduled to fly next week, will arrive on Aug. 5 and make a polar pass.

**Strong attraction.** Raytheon has developed a permanent-magnet material, samarium cobalt, that's not only the most powerful available but is also four times lighter and 20 times less expensive than the previous record holder—platinum cobalt. ■

# Never before

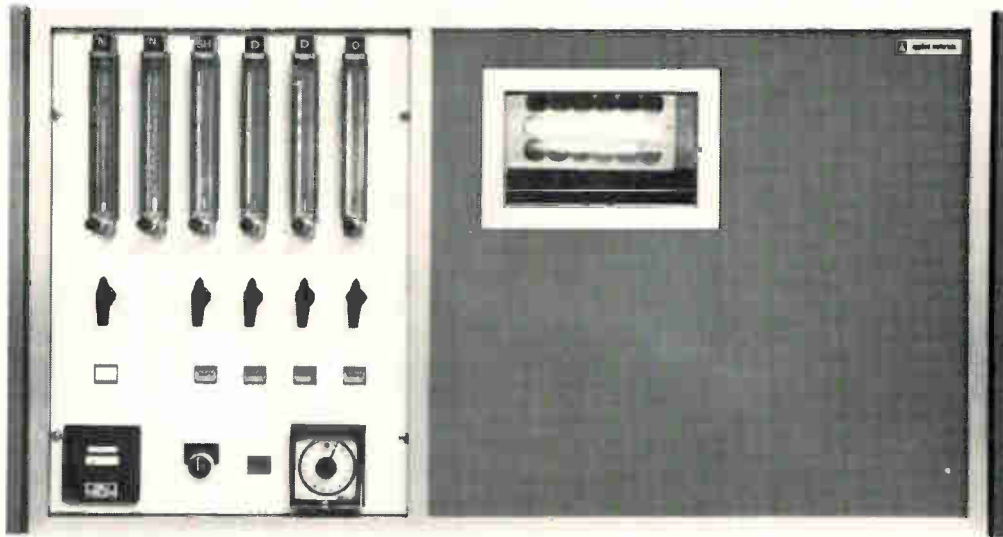

## The world's only silox reactor producing $\text{SiO}_2$ and doped $\text{SiO}_2$ films of unparalleled uniformity

Applied Materials SILOX vapor phase oxidation system is a proven oxide deposition reactor producing pure  $\text{SiO}_2$  and doped  $\text{SiO}_2$  films of excellent quality and thickness uniformity. Deposition thickness uniformity is typically  $\pm 7.5\%$  within a wafer,  $\pm 10\%$  wafer to wafer within a run. Wafers are processed in a cold wall reactor "batch" fashion. Cycle time for a

5,000 Å deposition is approximately 10 minutes.

The AMS-2600 has a wafer handling capability of eighteen 1.5" or ten 2" diameter wafers per run. Larger systems with similar specifications are also available. Write for complete information. Call collect for immediate requirements.



## applied materials

Applied Materials Technology, Inc. 2999 San Ysidro Way  
Santa Clara, California 95051 (408) 738-0600 TWX: 910-339-9258

BOOTH #4K25-27 FOURTH FLOOR I.E.E.E. AT THE COLISEUM

# TTL

**If you haven't  
checked on deliveries  
from the first source  
for TTL recently,  
you should.**

Because we've dramatically increased manufacturing capacity on all Series 54/74 integrated circuits. Call TI for delivery information on our 17 Series 54L/74L low power circuits, 26 Series 54/74 standard gates and flip-flops, 13 Series 54H/74H high speed circuits, and 23 TTL/MSI types. All are available in TI's dual-in-line plastic package. Most are in our military-rated flat pack and ceramic d.i.p.



**TEXAS INSTRUMENTS**  
INCORPORATED

# Before, but never as good



**Large volume  
horizontal reactors  
with guaranteed uniformity of  
resistivity and deposition thickness.  
New, modular concept**

Applied Materials has taken epitaxy and thin film deposition forever out of the realm of black magic. With the introduction of the AMH series, manufacturers of semiconductor devices can obtain new standards of reliability and performance in horizontal reactors. Less floor space; greater installation flexibility. No one knows more about epitaxy than Applied Materials Technology; no one offers so complete a range

of Chemical Vapor Deposition equipment for the semiconductor industry. Send your substrates for evaluation depositions.

All models available with Time Sequence Programmers and Automatic Temperature Control.

Write for our new Modular Concept brochure and complete information. Call collect for immediate requirements.



**applied materials**

Applied Materials Technology, Inc. 2999 San Ysidro Way  
Santa Clara, California 95051 (408) 738-0600 TWX: 910-339-9258

BOOTH #4K25-27 FOURTH FLOOR I.E.E.E. AT THE COLISEUM



## Texas-size data library on microfilm saves Texas Instruments \$850/week

When a company scores 95% "hits" with their data retrieval system, you know their archive of stored data is extensive.

When that company saves \$850 per week retrieving that data, you know the system gets them to the data quick and sure.

The company is Texas Instruments. And the data storage and retrieval system is Sweet's Microfilm File.

"Our problem," said Larry Williamson, drafting room foreman at TI, "was that we needed a fast way to find size specifications of purchased parts. We investigated other systems—and selected Sweet's system."

TI installed two product/vendor files at their plant. TI engineers go to Sweet's 300 times a week for data, and come away with it 95% of the time...and in less than 5 minutes. "The retrieval of data is so fast," Williamson says, "that we estimate we will save more than \$44,000 on an annual basis. And that's net savings, with the cost of the system figured in."

TI engineers find their data fast and often because Sweet's has more product data than anyone: 900,000 pages of *current* product data right now, with the next bimonthly update sure to put the total over one million. Every update adds new data as well as revised data from suppliers already in the File. In the last three updates (six months)—just under half (47%) of our system has been updated.

We don't have any trouble getting the data of all the important suppliers because it doesn't cost them anything to get in. In with as much as they want—not just their general catalogs, but application data, reliability test reports, specifications, even price and office listings. Enough data to satisfy the engineer no matter how deep he has to dig.

(Incidentally, if you stuffed the Sweet's product/vendor File into 4-drawer file cabinets, you'd need more than a hundred of them, and the floor space to line them up. Sweet's is complete on a desktop.)



TI's Larry Williamson pulls a full-size worksheet print of the data he wants—and the file stays wholly intact.

We put more in, and we make it easy to get it out, with a computer-printed (so we can do it every update) index with more than 5000 product breakdowns that tell you where the specific product you want is, not where the manufacturer's data for everything he makes is generally located.

Send the coupon below and learn more about the Texas-size savings with Sweet's Microfilm File.

Engineers need data. The quicker they find it, the quicker they can get back to work. **We make engineers out of engineers.**

**SWEET'S INDUSTRIAL DIVISION**  
MCGRAW-HILL INFORMATION SYSTEMS COMPANY

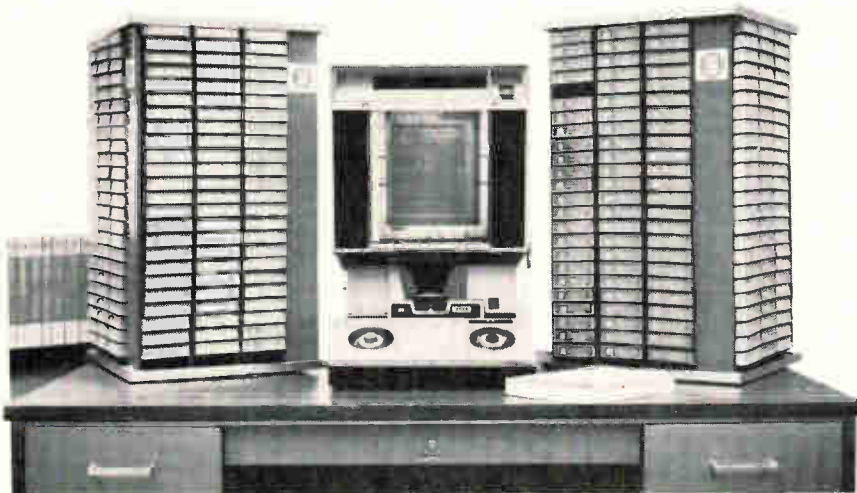

Please send a complete information package on Sweet's Microfilm File

Name \_\_\_\_\_  
 Title \_\_\_\_\_  
 Company \_\_\_\_\_  
 Address \_\_\_\_\_  
 City \_\_\_\_\_  
 State \_\_\_\_\_ Zip \_\_\_\_\_

Send to Sweet's Microfilm File, Dept. EL42  
330 West 42nd Street, New York, N.Y. 10036  
or call G. O. Stevens collect at 212-971-3586

Find out about Characteristic Search on Electronic Instruments Seminar during IEEE at N.Y. Athletic Club. Write Greg Guercio, Sweet's, 330 West 42nd St., New York City 10036 for no cost reservations.

## FREQUENCY COUNTERS

Output Frequency Min. Max.	Number of Digits	Input Volts mV	Stability	Gate Time Seconds	Measures	Freq. Extender Page No.	Mechanical Dimensions W X H X D	Notes	Manufacturer	Model	Price	Film Location
2 Hz 350 KHz	4	100 mV	0.1%	10, 1, 0.1	N/A	23	19 X 3 1/2 X 14	d f			815	BR 0300
0	2 MHz	5	100 mV	3 in 10' 1 day @ 25°C	10 μs- 10	Period Count Ratio	17	19 X 3 1/2 X 17	d f		995	CH 2237
20 Hz	6.5 MHz	7	50 mV	3 X 10' 1 week	no spec	N A	57	16 1/4 X 5 1/2 X 20 3/4	d f g h		4250	RB 6600
5 Hz	10 MHz	5	100 mV	1 in 10" 1 month	10, 1 0.1 & 0.01	Time Int. Period Ratio	103	5 1/2 X 6 1/2 X 11	d e		700	VN 2000
5 Hz	12.5 MHz	5	50 mV	5 in 10' 172 hours	1 μs- 10	Time Int. Period Ratio	93	7 1/2 X 4 1/2 X 9	e		575	CJ 2138
3 Hz	12.5 MHz	7	10 mV	2 X 10' 1 month	10, 1, 0.1 & 0.01	Time Int. Period Ratio	45	6 1/2 X 7 1/2 X 11	d e		925	TD 1100
1 Hz	12.5 MHz	4	100 mV	0.1%	1, 0.1	N A	141	7 X 3 1/4 X	d e		395	YC 0125

CONFIDENTIAL

(FOR SUBSCRIBERS ONLY)

# Shouldn't you have this new report on your desk now?

New Sweet's Characteristic Search gives you computer generated comparisons of 35,000 electronic instruments. Read how you can always have the best at the lowest price.

How do you keep on top of all the new electronic instruments on the market? Or the old ones? What do you do when what you've used before doesn't fit into the hole you have left? Build an expensive special? Stop worrying about it. There is an answer.

**The 6 Volume Electronic Instrument Report** Issued every four months, it gives you accurate comparisons in 125 different categories for up to 15 different instrument characteristics. Including manufacturer,

model number, current price and all important performance parameters. Even the exact frame number of the manufacturer's detailed data in the Sweet's Microfilm File.

**Find the exact item you need in less than a minute.**

Suppose you need a Frequency Counter with these parameters: 20Hz-5MHz output frequency, 5 digits, 100mv, stability  $3 \times 10^{-7}$  (1 week), gate times of 10, 1, and 0.1 seconds. Sweet's Characteristic Search lists dozens of Frequency Counters. Which would be right for you? Sweet's Characteristic Search shows almost all the instruments offered for sale in the U.S. Isn't that the kind of information you should have to do your thing?

**You can try it for 10 days FREE.**

You may examine the first volume of six on Instruments for 10 days... and use it in your work... free. If you wish to keep the first Volume, receive the remaining five Volumes, and new Editions for a year, we will bill you (or your company) the charter subscription price of \$495; the regular subscription price will not be less than \$595, effective after May 31. Who else could give you so much data (every four months), for so many instruments (over 35,000 listed) in easily compared form including current prices? Mail off the Reservation Coupon now.



**SWEET'S  
CHARACTERISTIC  
SEARCH**

**Electronic Instruments**

**Each 700 page Edition gives you the latest information about 35,000 Instruments in these 125 categories.**

**Vol. 1: Modulators:** A-M, Microwave, Phase, Pulse. **Generators:** Oscillators, Frequency Synthesizers, Marker, Phase, Time Code, Signal, Noise, Sweep, Squarewave, Function, Time Delay, Word, Pulse.

**Vol. 2: Power Supplies:** Laboratory Type, AC, Modular AC-DC & DC-DC, Constant Current, High Voltage.

**Vol. 3: Amplifiers:** Narrowband, Wideband, Operational, Magnetic, Microwave, Power, Servo, Strain Gage, Video, Differential. Also Attenuators (fixed), Attenuators (variable), Directional Couplers, Phase Shifters, Loads, Isolators, Shorts, Mismatches, Coaxial-Waveguide Adapters, Filters, Time Delay Units, Signal Conditioners, Microwave Detectors, Hybrid Junctions.

**Vol. 4: Bridges:** Power, Kelvin Capacitance, Deviation, Impedance, Inductance, Admittance, Wheatstone. **Calibrators:** Frequency, Crystal, Voltage. **Comparators:** Digital, Frequency, Phase, Voltage. **Converters:** Analog-

Digital, Binary-Decimal, AC-DC, DC-Frequency. **Decade Boxes:** Capacitance, Resistance. **Standards:** Capacitance, Frequency, Resistance, Voltage.

**Vol. 5: Analyzers:** Phase Angle, Pulse Height, Servo, Spectrum, Wave, Harmonic. **Counters:** Frequency, Bi-Directional, Digital, Electro-Magnetic, Preset. **Recorders:** Oscillographs (Portable), Oscillographs (Direct Writing), Oscillographs (Multichannel), Magnetic Tape, Pressure, Sound Level, Strip-chart, Telemetry, x-y, Digital Printers. **Testers:** Capacitance, Resistor, Diode, Transistor, Integrated Circuit, Cable, Module, Memory, Magnetic Tape.

**Vol. 6: Meters (Part 1):** Amp, Capacitance, Conductance, Digital Volt, Electrometers, Galvanometers, Laboratory, Impedance, Inductance, Multi, Electronic Volt, Watt, Calorimeters, Power Phase Angle, Ohm. **Meters (Part 2):** Distortion, Field Strength, Frequency, Frequency Deviation, SWR, Thermocouple, Oscilloscopes, Receivers, Slotted Lines, Frequency Selective.

Yes, I want to see and work with the first Volume on Instruments in the Sweet's Characteristic Search, Electronic Instruments, for ten full days free. At the end of that time I may return the book without obligation, cancelling my subscription.

If I decide to keep the Sweet's Characteristic Search, I will pay only \$495, the Charter Subscription price, and receive the remaining five volumes as they are published, and subsequent Editions for a year.

Please bill me

Bill my company on P.O. No. \_\_\_\_\_

Name \_\_\_\_\_  
(please print)

Company \_\_\_\_\_

Address \_\_\_\_\_

City \_\_\_\_\_

State \_\_\_\_\_ Zip \_\_\_\_\_

Authorized Signature \_\_\_\_\_

Mail to: Sweet's Characteristic Search, Dept. EL52  
330 West 42nd Street, New York, N.Y. 10036

**SEND NO MONEY...  
YOU ARE ENTITLED TO A 10 DAY FREE TRIAL**



## Still True

The Hewlett-Packard 2401C Integrating Digital Voltmeter is still the DVM to count on. You've been using it, trusting it to provide accurate measurements. You know it's *still* giving you exceptionally high noise rejection. You know it *still* comes with standard—not optional—interface features for systems use. It *still* gives you a choice of sample times to get the best combinations of resolution and speed for a given application.

*Still* gives you external start-stop for long-term integrals, even around zero. And *still* gives accurate frequency and period measurements.

When the time comes to consider more DVM's, experience is still the best teacher. Call your HP field engineer for details on precision measuring instruments. Or write Hewlett-Packard, Palo Alto, Calif. 94304; Europe: 54 Route des Acacias, Geneva.

HEWLETT  PACKARD  
DIGITAL VOLTMETERS



# NEW! Reeves Mini-RIG<sup>®</sup> Integrating Gyro

...a major breakthrough in reliability and cost reduction. Now, Reeves has developed the Mini-RIG—a subminiature, heaterless integrating gyro that lives up to its claims!

Through new production techniques Reeves has made a major advance, in both cost reduction and reliability, in the field of subminiature high-volume inertial sensors.

Mini-RIG is the first of a new generation of modular-design, fluid-filled, fully-floated gyros and accelerometers. Only one inch by two inches in size, it furnishes stability, guidance and control to missiles, aircraft and aerospace vehicles. It operates in either platform or strap-down systems.

**High Performance.** The heaterless Mini-RIG provides excellent control of gyro gain and damping over the whole military temperature range. Damping is compensated and transfer function controlled to a tolerance of  $\pm 20\%$  from  $-65^{\circ}\text{F}$  to  $+200^{\circ}\text{F}$ . For shorter temperature ranges, such as  $0^{\circ}\text{F}$ , to  $180^{\circ}\text{F}$ ,  $\pm 10\%$  tolerance is maintained.

**Reliability.** Reeves new balanced-line automated assembly makes it pos-

sible to perform the final assembly of a Mini-RIG unit in **less than one work day**. This reduces to the barest minimum the possibility of contamination during manufacture.

**Low Cost.** Reeves new manufacturing techniques have reduced the number of assembly operations and hand labor, relying on mechanical fixturing and electrical welding. Detail parts are interchangeable and the same stainless steel outer housing can be used for many versions. This means low-cost design modification for a wide range of applications.

Reeves, working by the Total Systems Concept, can package the Mini-RIG for any specialized need you may have. For important programs, we will provide Mini-RIGS on 60-day consignment. "Let them prove to you, what we claim for them"! All we ask is prompt, competent evaluation.

For complete data and application information, call or write Component Group, Reeves Instrument, Garden City, New York 11530.



**Reeves<sup>®</sup>**  
INSTRUMENT DIVISION  
DYNAMICS CORPORATION OF AMERICA / GARDEN CITY, NEW YORK 11530 

# IT'S SUPERFLEXIBLE

a  
new kind  
of  
HELIAX®

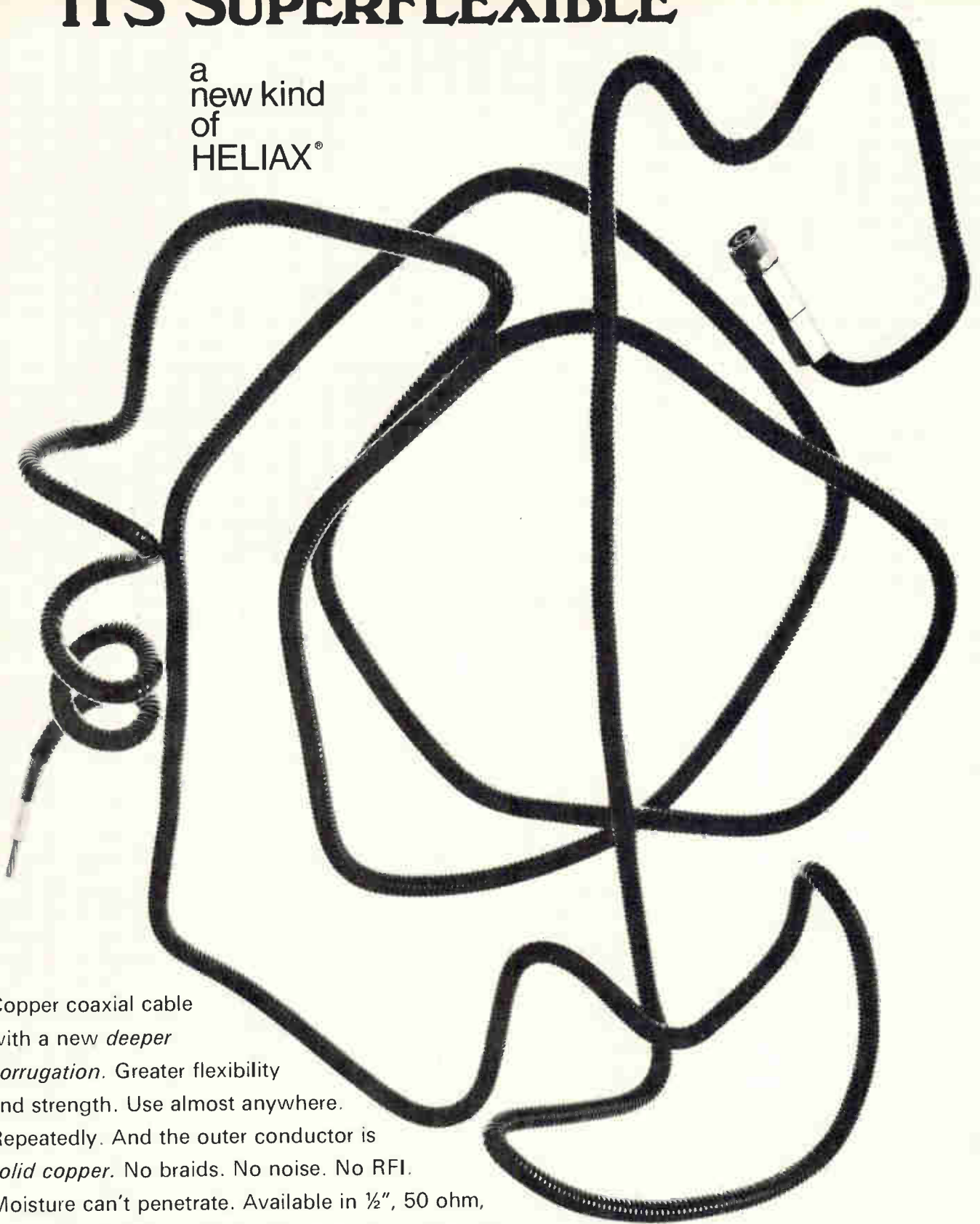

Copper coaxial cable with a new *deeper corrugation*. Greater flexibility and strength. Use almost anywhere. Repeatedly. And the outer conductor is *solid copper*. No braids. No noise. No RFI. Moisture can't penetrate. Available in 1/2", 50 ohm, foam dielectric, Type FSJ4-50. Connectors, Type N or GR-874. Like a sample? Communicate with Andrew.

12-68



**ANDREW**

CONTACT THE NEAREST ANDREW OFFICE OR ANDREW CORPORATION, 10500 W. 153rd STREET, ORLAND PARK, ILLINOIS 60462

---

# Washington Newsletter

---

March 17, 1969

## Space station rfp's due within month

The space agency is unwilling to let the concept of a space station die; it's using other funds to get the program into Phase B contract definition. The reason: major fallout of Phase B is a determination of goals that can be used to sell the program to the nation.

Requests for proposals on Phase B will go out within a month. There will be two parallel nine-month studies, one to be managed by the Manned Spacecraft Center in Houston and the other by the Marshall Space Flight Center in Huntsville. Three teams are ready to bid—Grumman-RCA, McDonnell Douglas-IBM-Martin Denver, and North American Rockwell-GE. Each contract will be worth \$3 million; total program cost is expected to reach \$6 billion to \$10 billion.

Contractors will look at alternative approaches to various aspects of the space station concept, including how many will be orbited in 1975-80, configuration, ground support, and experiments.

## Navy studying own I/CNI system

Like the Air Force [*Electronics*, Jan. 20, p. 33], the Navy is now looking into an integrated communications, navigation, and identification (I/CNI) system while not making the proposal an official program. But unlike the Air Force, which is interested in a far-ranging satellite system, the Navy currently "is not interested in putting all that money into satellites," says one source.

The Navy's investigation is a low-keyed effort by the Naval Research Laboratories to estimate requirements for a system compatible with present and planned equipment. Autonetics and IBM have small study contracts. A tentative set of I/CNI requirements is expected this summer with a firm set to follow in 1970. While there is no official coordination between the Air Force and the Navy right now, "we know what each other is doing," says the source.

## NASA set to tackle programmer shortage

One of the first projects that NASA has in store for its proposed \$8.1 million computer and instrumentation laboratory is a "total design approach" to hardware and software that will make the acute shortage of programmers easier to live with. The plan was disclosed by NASA official Bruce T. Lundin at House hearings.

The idea apparently is to come up with computer systems that won't require as many programs and programmers. Officials point out, for example, that 3,200 tapes are delivered each day to the Goddard Space Flight Center.

The NASA lab, awaiting Congressional approval, would be built in Cambridge, Mass., at the Electronic Research Center. Construction could start next July at the earliest and take about a year.

## Pentagon budget due for Senate scrutiny by 'specialist' panels

The Defense Department's 1970 money requests will get a thorough going over when the Senate Armed Services Committee begins its hearings on the budget this week. Sen. John C. Stennis (D., Miss.), the new chairman, is assigning committee members to ad hoc panels that will study specific parts of the mammoth budget. Each of these groups will be briefed on matters pertaining to its special field.

Selected so far are subcommittees on research and development,

---

# Washington Newsletter

---

tactical air power, and bomber defense. Contemplated are subcommittees on land power and production overruns. The latter will deal with orders that wind up costing the Pentagon more money than contracted for, as with the C-5A program. Temporary Congressional subcommittees aren't unusual, but Stennis's move marks a departure from the practice of former Chairman Richard B. Russell (D., Ga.) and reflects a growing concern over Pentagon procurement practices.

The Air Force and aerospace industry are happy with the makeup of the tactical airpower subcommittee. They should be. It's loaded with hawks on the subject: Howard W. Cannon (D., Nev.) as chairman, Stephen M. Young (D., Ohio), Stuart Symington (D., Mo.), Henry M. Jackson (D. Wash.), Strom Thurmond (R., S.C.), John G. Tower (R., Texas), and Barry Goldwater (R., Ariz.).

## **Paine expected to push NASA aims**

President Nixon's decision to retain Thomas O. Paine as head man at NASA could mean a balanced and ambitious space program. What remains to be seen is whether Paine's soft sell will be as effective in getting Congress to untie the purse strings as was the flamboyant approach of his predecessor, James Webb.

Since taking over from Webb, Paine has strongly advocated such programs as a national space station, a "grand tour" of far planets, and a strong earth resources program. There is little doubt that he will continue to push these programs with the new administration. In fact, when the NASA budget was presented in January he charged the incoming Administration with the responsibility for making early decisions on the major programs for the next decade in space.

## **Senators sharpen questions for Shaffer**

President Nixon's choice for new FAA Administrator, John H. Shaffer, who is a vice president of TRW and a former Air Force officer, will face some tough questioning in confirmation hearings. Senators will want to know just what he plans to do to relieve airport congestion; he'll also be asked for his views on how to prevent hijacking. Although the FAA is starting to field-test several devices to detect weapons, there's no equipment that meets all criteria.

## **Minipush starts for sea-based ABM**

The sea-based antiballistic missile intercept system (Sabmis) is down for only \$3 million in the 1970 budget, but the project is being edged into the spotlight by the unexpected furor over the land-based Sentinel ABM project. Rep. William R. Anderson (R., Tenn.), who was skipper of the nuclear sub Nautilus when it made the first transpolar voyage under the ice, wants more substantial research on Sabmis. However, Deputy Secretary of Defense David Packard says a full-scale move toward Sabmis is "not now under consideration."

## **Addendum**

Look for Congressional foes of the problem-plagued F-111 to lash out anew at the program. Their ire will be aroused by an expected Defense Department request for budget money to buy 70 more of the planes, and by the Pentagon's purchase of the first batch of F-111 advanced avionics systems (formerly the Mark 2). These systems cost up to \$1.5 million apiece, 50% more than original contract called for and more than the whole plane was to cost a few years ago.

# Sorensen modular power supplies

**± 0.005% regulation**

**\$8900**

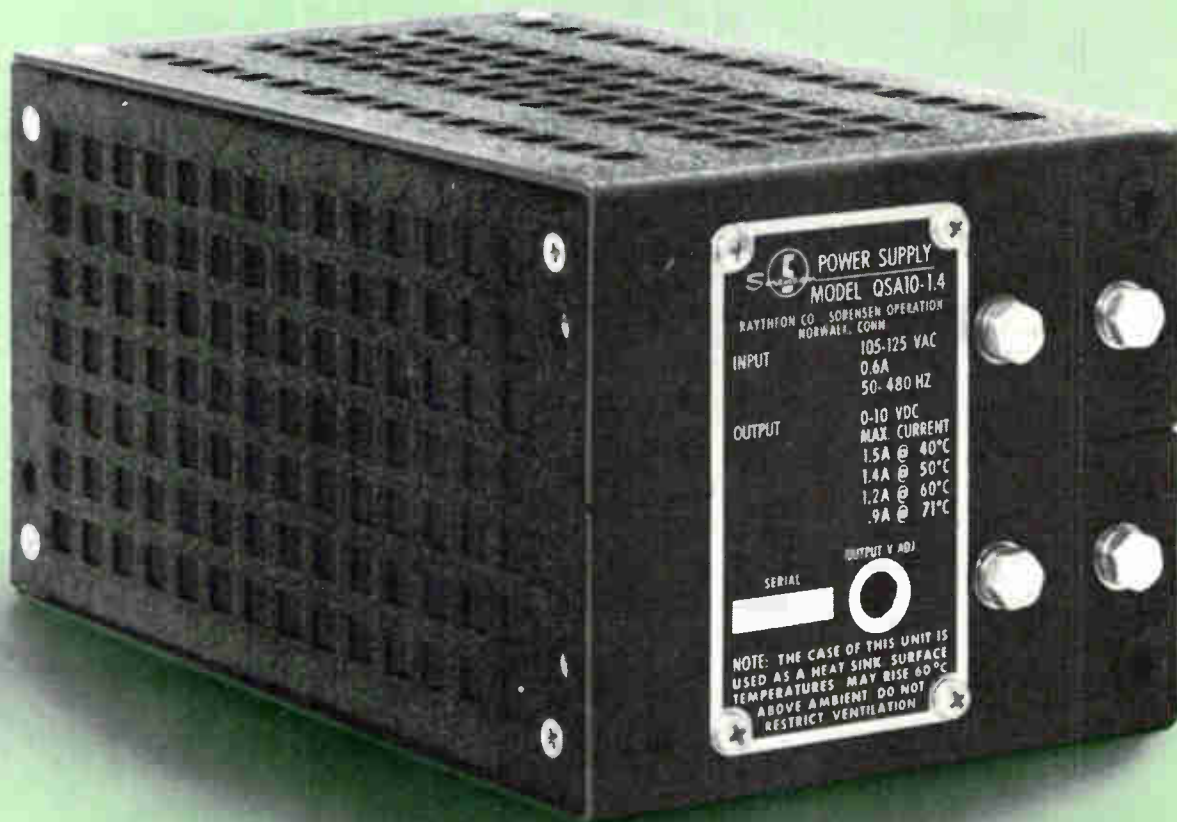

- Optional 10 $\mu$  sec. overvoltage protection.
- Requires no external heat sink in ambients to 71° C.
- 29 models—voltages to 330 Vdc at power levels to 300 watts.
- Remote programming—remote sensing—series/parallel operation.
- Overload and short circuit protection.
- Meets military specifications.

Model QSA 10-1.4, shown actual size, illustrates the compactness of the Sorensen QSA Series. These laboratory-grade, precision power sources are designed for OEM or system applications and utilize the latest solid-state regulating technology to provide a high degree of regulation and stability.

Sorensen produces 29 wide-range models, each with optional overvoltage protection. Other manufacturers require more than 100 models to cover the same area. By producing and stocking fewer models, Sorensen is able to provide better specifications, higher reliability, lower prices and "same-day shipments."

For more information contact your local Sorensen representative or; Raytheon Company, Sorensen Operation, Richards Ave., Norwalk, Conn. 06856. Tel.: 203-838-6571; TWX: 710-468-2940; TELEX: 96-5953.



**The new AO  
StereoStar/ZOOM  
Microscope  
gives you high  
resolution,  
new convenience,  
superior optics  
and wide  
magnification  
range.**

Here are a few of the outstanding advantages that make the new AO® StereoStar/ZOOM Microscope the finest instrument of this type available today:

- Widest total magnification range: 3.5–210X
- High resolution to meet the most exacting needs
- The most convenient zoom control available
- Choice of five interchangeable, rotatable zoom power bodies
- Crisp, sharp images at all magnifications
- Extra large field of view and high eyepoint eyepieces
- Wide choice of stands for every purpose
- Long working distance
- Even illumination over the entire field
- Coolest operating illuminator.

See for yourself. Contact your AO Sales Representative for a demonstration, or write for our 24-page, full-color brochure on the newest in stereo microscopes—the AO StereoStar/ZOOM.

®TM Reg., American Optical Corp.



**AMERICAN  
OPTICAL  
CORPORATION**

SCIENTIFIC INSTRUMENT DIVISION  
BUFFALO, N.Y. 14215

Circle 76 on reader service card

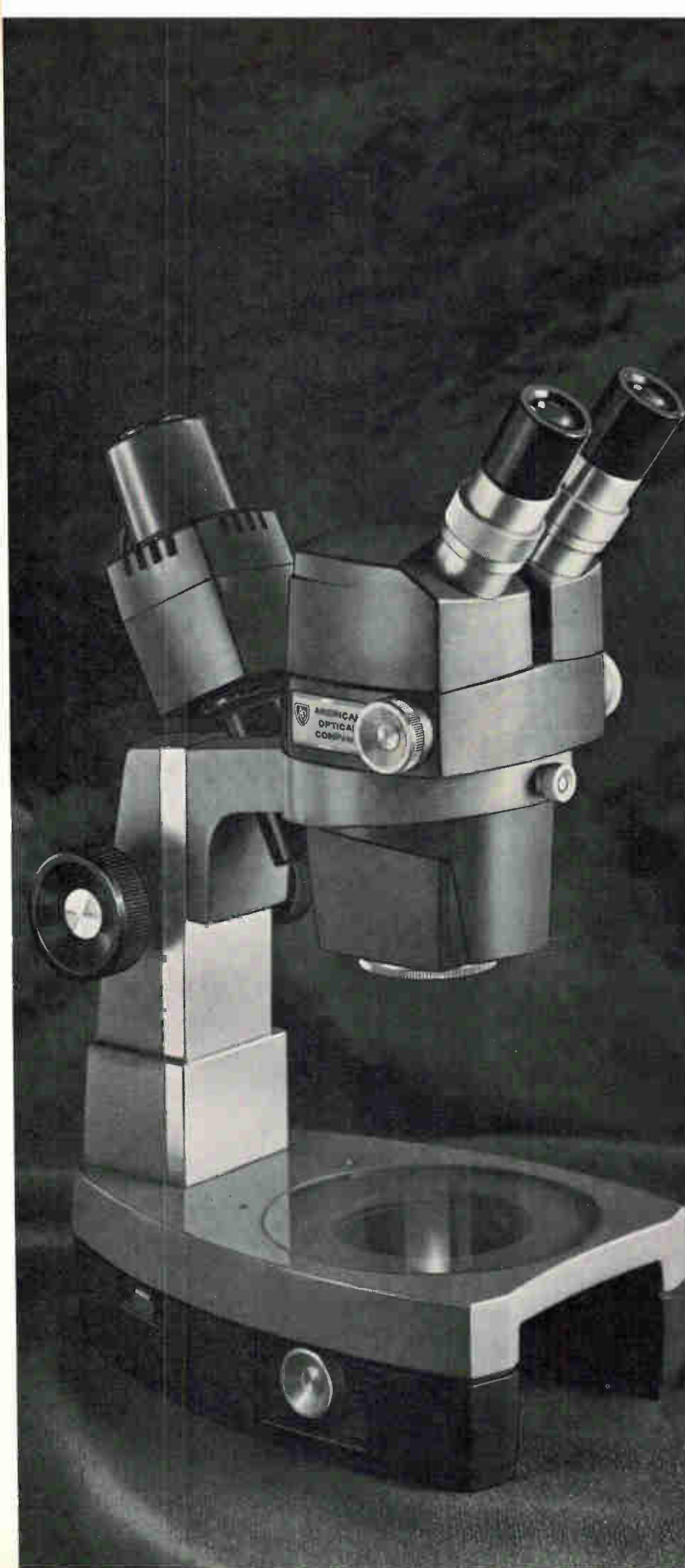

# Lock-in sharp response, wide-range electronic tuning

... with high-Q EPICAP diodes!

Now you can get the advantages of remote tuning and miniaturization made possible with solid-state tuning diodes — with a new level of premium and uniform performance — in Motorola's new 1N5461A — 1N5476A series tuning diodes!

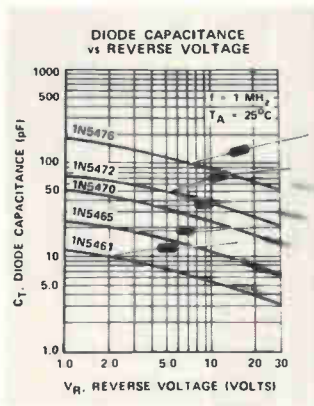

Combining such desirable features as very high Q's — for sharp response at high frequency; high tuning ratios — to facilitate tuning over broad frequency ranges;

and uniform linear changes in capacitance with voltage — making it a simple matter to “gang” them into multi-stage configurations for contin-

uous wide-band tuning requirements, this new diode series meets the most stringent performance and frequency control needs found in ECM, tactical and aerospace radio, and frequency synthesizer equipment.

Tuning ratios are closely controlled as indicated by guaranteed min/max values on each type (see table).

The series covers all standard nominal capacitance values from 6.8 pF to 100 pF with  $\pm 10\%$ ,  $\pm 5\%$  and  $\pm 2\%$  tolerances. Breakdown voltage is 30 volts (min.) and maximum leakage current is 20 nA @ 25 volts. This EPICAP<sup>®</sup> series is supplied in the Motorola RamRod<sup>®</sup> DO-7 “glass” case for maximum device stability.

A standard line (1N5441A-56A) is also available for less-critical general purpose applications. Check the specification table for characteristics to fit your needs.

Reminder “Off-The-Shelf” evaluation units are now at your local franchised Motorola Semiconductor Distributor. He will tune you in to top tuning diode performance. Call him.

TYPE NO. PREMIUM	Fig. of Merit (Q) @ 4 V/50 MHz	Tuning Ratio (TR) C2/C30 @ 1 MHz	Diode Cap. (CT) $\pm 10\%$ @ 4 V/1 MHz	STANDARD TYPE NO.	Fig. of Merit (Q) @ 4 V/50 MHz	Tuning Ratio (TR) C2/C30 @ 1 MHz
	Min.	Min/Max	pF†		Min.	Min/Max
1N5461A	600	2.7/3.1	6.8	1N5441A	450	2.5/3.1
1N5462A	600	2.8/3.1	8.2	1N5442A	450	2.5/3.1
1N5463A	550	2.8/3.1	10.0	1N5443A	400	2.6/3.1
1N5464A	550	2.8/3.1	12.0	1N5444A	400	2.6/3.1
1N5465A	550	2.8/3.1	15.0	1N5445A	400	2.6/3.1
1N5466A	500	2.9/3.1	18.0	1N5446A	350	2.6/3.1
1N5467A	500	2.9/3.1	20.0	1N5447A	350	2.6/3.1
1N5468A	500	2.9/3.2	22.0	1N5448A	350	2.6/3.2
1N5469A	500	2.9/3.2	27.0	1N5449A	350	2.6/3.2
1N5470A	500	2.9/3.2	33.0	1N5450A	350	2.6/3.2
1N5471A	450	2.9/3.2	39.0	1N5451A	300	2.6/3.2
1N5472A	400	2.9/3.2	47.0	1N5452A	250	2.6/3.2
1N5473A	300	2.9/3.3	56.0	1N5453A	200	2.6/3.3
1N5474A	250	2.9/3.3	68.0	1N5454A	175	2.7/3.3
1N5475A	225	2.9/3.3	82.0	1N5455A	175	2.7/3.3
1N5476A	200	2.9/3.3	100.0	1N5456A	175	2.7/3.3

Diode Capacitance (CT) same for premium or standard line.

†Nominal capacitance tolerance of  $\pm 10\%$ ,  $\pm 5\%$  or  $\pm 2\%$  indicated by suffix A, B, or C, respectively.

— where the priceless ingredient is care!



## MOTOROLA Tuning Diodes

\*Trade-Mark Motorola Inc.

Motorola Semiconductor Products Inc./P.O. Box 20912/Phoenix, Arizona/85036

# Room for improvement

General Electric's TO-5<sup>2</sup> transistor-size sealed relays give you more room for increased power, improved performance

We didn't cut any corners on this high-reliability, transistor-size sealed relay. We left them on so there'd be more room for a more powerful magnet—2½ times more powerful.

This added power means this type 3SBS, 2PDT, 1 amp relay gives you higher contact forces, larger contact gaps, and greater overtravel to minimize mechanical shifts. Shifts which usually increase early-in-life failures.

Though there's more room inside to give you all these advantages, the outside dimensions—top-to-bottom (.275") and side-to-side (.370")—are the same as any transistor-size relay.

So don't cut corners on your next transistor-size relay application. Specify GE's square Type 3SBS. For full details, write General Electric, Section 792-45, Schenectady, New York 12305.



ACTUAL SIZE

**GENERAL**  **ELECTRIC**



# Buckbee-Mears research developed the absolute filter.

*Tasting our success  
was a great experience.*

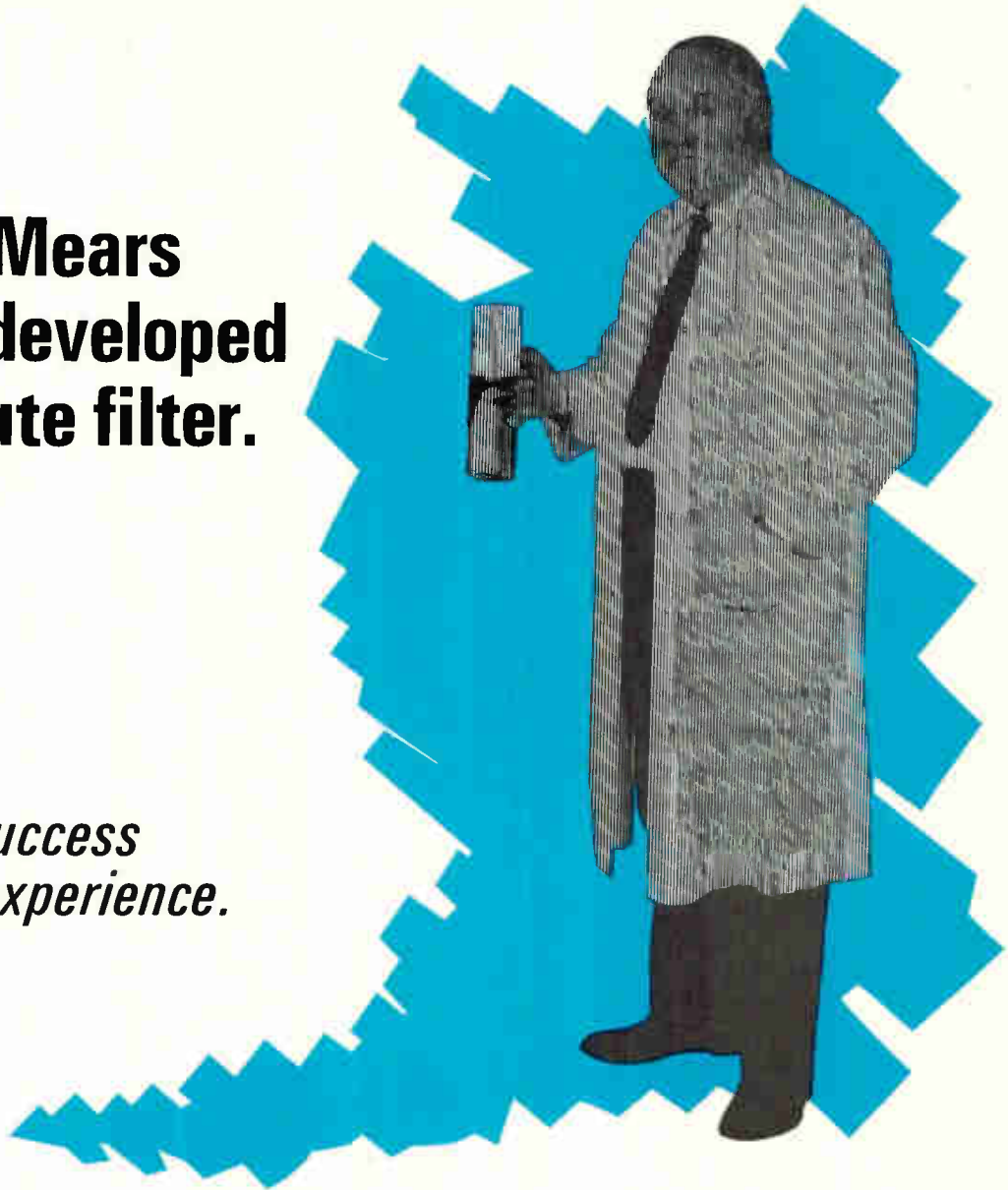

A key step in producing beer is pasteurization. Some of America's leading breweries have found they can produce a smoother beverage by using a precision-etched, Buckbee-Mears fine screen as a filter in the pasteurizing process.

It's no wonder. We make the only absolute filter available. With our process, we can hold the uniformity of holes in the filter screen constant. Our filter customers can choose just about any material they want, including stainless steel, molybdenum, nickel, monel and titanium — in any array.

Buckbee-Mears offers small or large holes in the array. Unlike die stamping, the on-centers can be adjusted close or far apart. Our absolute filters are self-cleaning because of planer construction. That's another exclusive advantage of our photomechanical reproduction process.

We etch absolute filter screens at a one-to-one ratio be-

tween metal thickness and hole size. Maximum hole size tolerance to  $\pm 10\%$  of metal thickness, minimum to  $\pm .0002''$ .

While we're delighted to help the nation's brewmasters upgrade their product, our absolute filters have many other uses. They include centrifuge, synthetic fiber filters, coffee brewer screens, particle size determination and back-up screens for sub-micron filters. Anyone with a filtering application where an absolute filter is required can use our capabilities.

Producing the only absolute filter screen on the market is another example of creative technology from Buckbee-Mears. We're in business to help you solve your problems. Call or write Bill Amundson, our industrial sales manager, about your absolute filter requirements. Phone 612-227-6371. Skoal!

PRECISION METAL AND GLASS ETCHING • ELECTRO FORMING • AUTOMATED DESIGN  
**bmc** BUCKBEE-MEARS COMPANY  
SAINT PAUL, MINNESOTA 55101

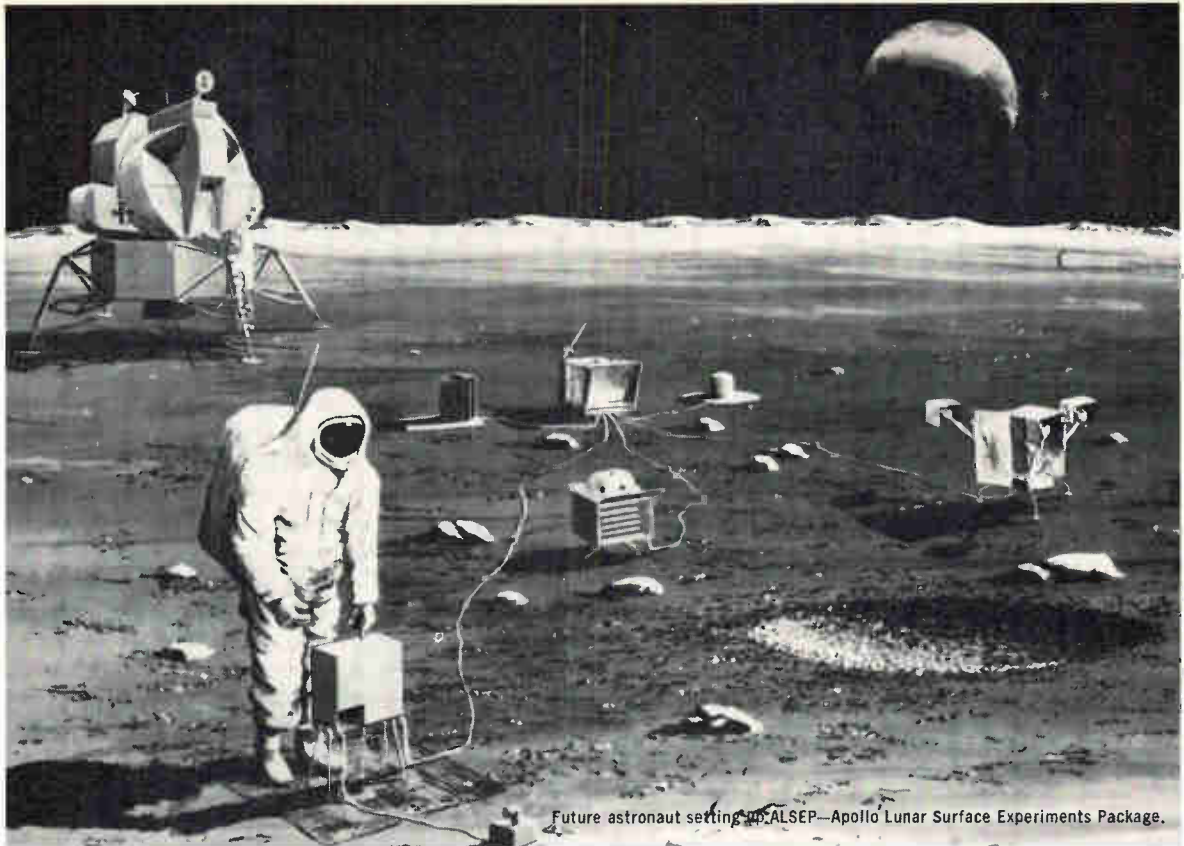

Future astronaut setting up ALSEP—Apollo Lunar Surface Experiments Package.

**Bendix needed a battery to command ALSEP, Apollo's full geophysical station for the moon.**

**Mallory made it.**

**What can we do for you?**



Bulova Accutron® lunar timer—self-powered to operate for years on the moon.

(NASA). A battery that could power the timer for as long as two years.

Mallory made it. The battery—a Mallory mercury battery. It resists the effects of temperature. And most important, it packs enough power in a small volume to provide steady flat voltage for years.

**ALMOST OUT OF THE LAB**

We've made some dramatic advances recently—and we're almost ready to publicize them. Here's a peek at a new development just out of the lab:

**Improved Anodes**—a glance at the graph will show you what our new improved anode structure does for battery efficiency at low temperatures. The same structure greatly improves performance under heavy current drains.

Bendix needed a battery. A battery to power the master timer of ALSEP—unattended instruments to be left by future astronauts on the surface of the moon. A battery that could meet the rigid environmental requirements of the National Aeronautics and Space Administration

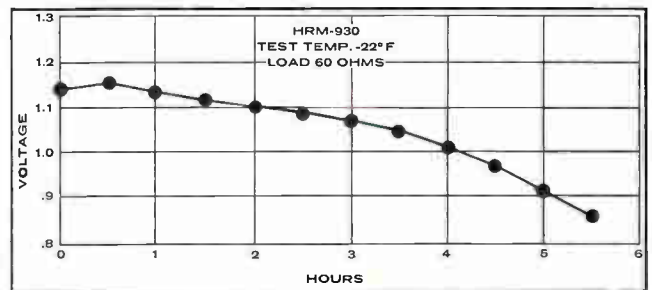

We're not talking specifics about this or other developments yet, but if you've got a challenging application, give us a ring.

**OVER 1000 DIFFERENT TYPES**

Mallory currently makes over 1000 batteries of all sizes and capacities. If we're not actually producing the battery you need, we'll be happy to work with you in designing a new one. Please write the Technical Sales Department, Mallory Battery Company, a division of P. R. Mallory & Co. Inc., South Broadway, Tarrytown, N.Y. 10591. Or call 914-591-7000. (In Canada: Mallory Battery Company of Canada Limited, Sheridan Park, Ontario.)

® Registered trademark of Bulova Watch Co. Inc.

It's good business to do business with Mallory



# CROWBAR...?



## The One Inside is FREE

Not so many years ago, the prudent transmitter engineer discharged a high voltage capacitor bank by dropping a shorting "crowbar" across its terminals. Today's "crowbar" is a protective overvoltage circuit found on DC power supplies — usually at extra cost. Now HP includes a crowbar as standard on its recently updated series of low-voltage rack supplies . . . at no change in price.

Long established as preferred system supplies for component aging production testing and special applications, these supplies have now been redesigned and expanded to meet the stringent demands of today's power supply user. Advantages include low ripple (peak-to-peak as well as rms), well-regulated constant voltage/constant current DC with outputs to 60 volts and 100 amps.

Where loads are critical and expensive, the extra pro-

tection — say, against inadvertent knob-tiddling — from a crowbar is invaluable. On all internal crowbars in this series, the trip voltage margin is set by screw-driver at the front-panel.

Pertinent specifications are: triggering margins are settable at 1V plus 7% of operating level; voltage ripple and noise is 200  $\mu$ V rms/10mV peak-to-peak (DC to 20 MHz); current ripple is 5 mA rms or less depending on output rating; voltage regulation is 0.01%; resolution, 0.25% or better; remote programming, RFI conformance to MIL-I-6181D.

Prices start from \$350. For complete specifications and prices, contact your local HP Sales Office or write: Hewlett-Packard, New Jersey Division, 100 Locust Avenue, Berkeley Heights, New Jersey 07922 or call (201) 464-1234 . . . In Europe, 1217 Meyrin, Geneva.

**HEWLETT**  **PACKARD**  
POWER SUPPLIES

Circle # for details

326

Additional data sheets  
available upon request

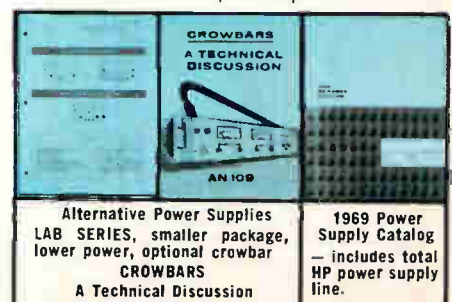

Alternative Power Supplies  
LAB SERIES, smaller package,  
lower power, optional crowbar  
**CROWBARS**  
A Technical Discussion

1969 Power  
Supply Catalog  
— includes total  
HP power supply  
line.

327

328

329



## Switch to The Switchables.

Helipot's new miniature rotary switches always give you precise, positive switch settings.

Only Helipot's new rotary precision switches have rugged, positive action detent. That's why they're the Switchables ... because they always switch to the precise position you switch them to.

They come in two, single pole-10 position models. Helipot Model 376 with six-inch leads is designed for instrument panel applications. And Helipot Model 375 with 10 gold plated terminals is for direct installation on printed circuit boards. Both have a black insulated plastic housing with easy-to-read contrasting index marks, have a contact current rating of 250 ma at 28 V DC, and are the economical choices for all applications



requiring rapid changes in settings such as test equipment and timing devices.

For all the details, specs and schematics, get in touch with your local Helipot Representative. He'll show you why Helipot's new miniature rotary precision switches are the Switchables.

**Beckman**

INSTRUMENTS, INC.  
HELIPOT DIVISION  
FULLERTON, CALIFORNIA • 92634

INTERNATIONAL SUBSIDIARIES: AMSTERDAM; CAPE TOWN; GENEVA; GLENROTHES, SCOTLAND; LONDON; MEXICO CITY; MUNICH; PARIS; STOCKHOLM; TOKYO; VIENNA

# Technical Articles

---

**Detroit puts electronics  
in the driver's seat**  
page 84

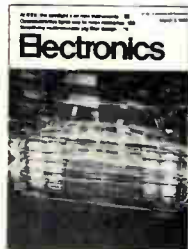

Automakers are now replacing electromechanical parts with discrete semiconductor devices in ignition systems, tachometers, sequential turn signals, and the like. What's more, Detroit is looking ahead to the time when integrated circuits, which have already been used in voltage regulators, will handle just about all the command and control functions in a car. If, as seems likely, the solid state electronics trend persists, the motor vehicle industry will emerge second only to the computer field as a consumer of microcircuits. For the cover, art director Jerry Ferguson shot this multiple exposure of a 1969 Ford Thunderbird—one of two production models with electronic braking.

**All-IC hybrid computer  
eliminates the patchwork  
from programing**  
page 100

A new hybrid computer from Japan is unique on two counts. For one thing, the analog section uses only integrated circuits for the computing elements. For another, a switching matrix that automatically interconnects the elements under program control from the digital computer replaces the patchboard. Moreover, by using a cathode-ray tube and light pen to draw the setup diagram, an operator can see exactly how his program is being run. If errors exist or changes have to be made, he can rectify matters with a flick of his wrist.

**Cryoelectric memories:  
best hope for large  
and fast storage units**  
page 108

Research on cryoelectric memories holds out the promise of faster and cheaper memories than any available now. In such units, a single driver can actuate up to 10,000 times as many storage elements as in conventional magnetic or semiconductor memories, and a single amplifier can sense as many more memory positions.

**Lighting the way  
to flat-screen tv**  
page 114

Japan's Matsushita is working on an experimental tv receiver whose flat, electroluminescent screen is energized by a matrix of electrodes. The solid state "sandwich" panel is designed to operate at the 525-line standard; it can display a picture on a 13-inch screen.

---

## Coming

**The new dynamics  
of the design interface**

With increasingly complex circuitry being built into semiconductor chips, the relationship between components suppliers and systems houses is changing. *Electronics* explores the implications of this shift in the design interface.

# Detroit puts electronics in the driver's seat

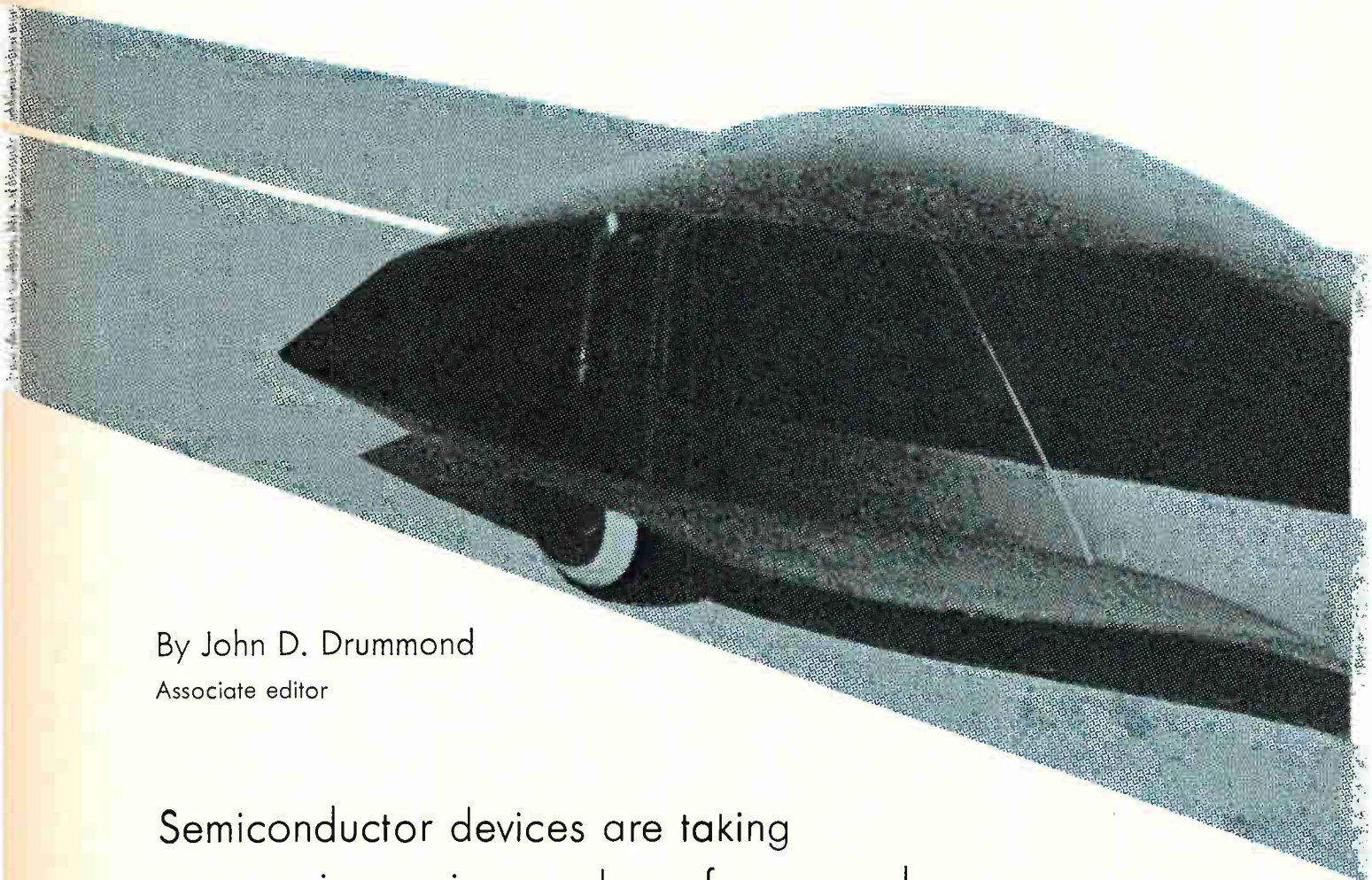

By John D. Drummond  
Associate editor

Semiconductor devices are taking over an increasing number of command and control functions in the automobile; discretes dominate the field now, but future cars — like the one pictured here — will rely on IC's

**A vast new market** for electronics engineering talent is surfacing in the vicinity of Detroit. The auto industry is going for electronic controls in a big way. But engineers and designers should be warned that while a new road has been opened to them, it's not an entirely smooth one.

The problems of replacing electro-mechanical parts with electronic circuits are compounded by the severe environment of the automobile. And the climate in the industry is rigorous, too. The car manufacturers are very cost-conscious and—in the wake of private and Governmental criticism—very safety-conscious. Thus the equipment the auto industry is seeking from the electronics engineer must be low-cost, producible in high volume, rugged, and extremely reliable.

The big push is in the direction of monolithic circuitry. Car makers are now using discrete semiconductor devices to control ignition systems, tachometers, and sequential turn signals, but integrated circuits will soon take over these jobs. Indeed, present research points to a time when IC's will handle just about all the command and control functions in a car. If the trend continues, the auto industry will someday be second only to the

computer industry as a user of microcircuits.

Engineers are now finding ways to get switching signals from electromechanical components, are matching transducers to solid state circuits, and are developing sensors to monitor such factors as engine torque, brake pressure, manifold pressure, and tire slippage. The data supplied by these sensors is evaluated by electronic systems that then produce the appropriate control signals.

Among the new designs resulting from this work is an electronic fuel-injection system that employs the variable inductance of a pressure transducer to control a monostable multivibrator's "on" time, which, in turn, sets the proper valve opening for the fuel.

Another innovation is an anti-skid braking system that uses sensors to measure wheel velocity and road-surface conditions, a small computer module to evaluate this information, and solenoid valves to apply the optimum brake pressure in response to electronic command signals.

And there's an automatic speed control system in which an MOS field effect transistor memory retains the desired speed setting after it's measured by a variable reluctance a-c generator working off

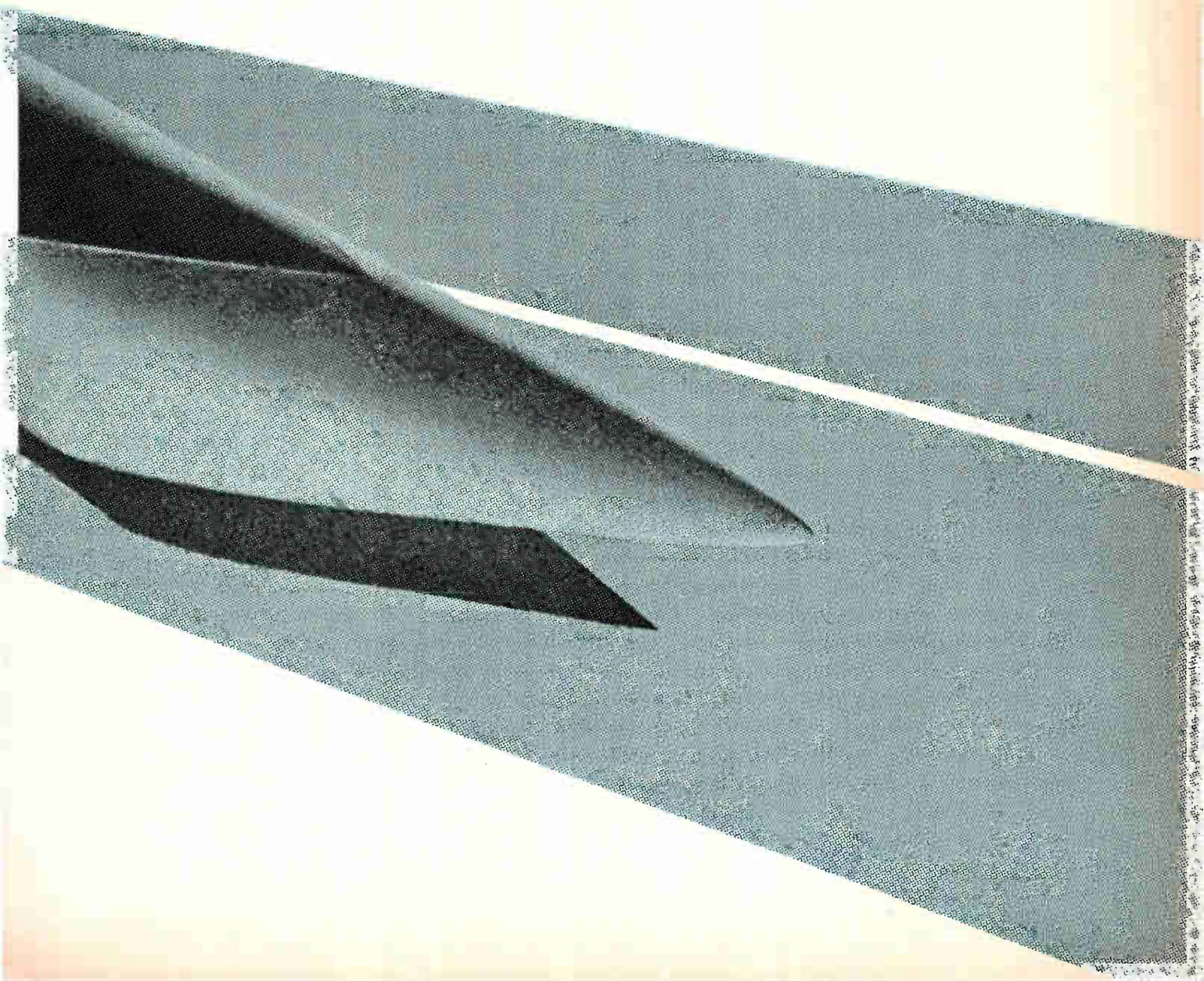

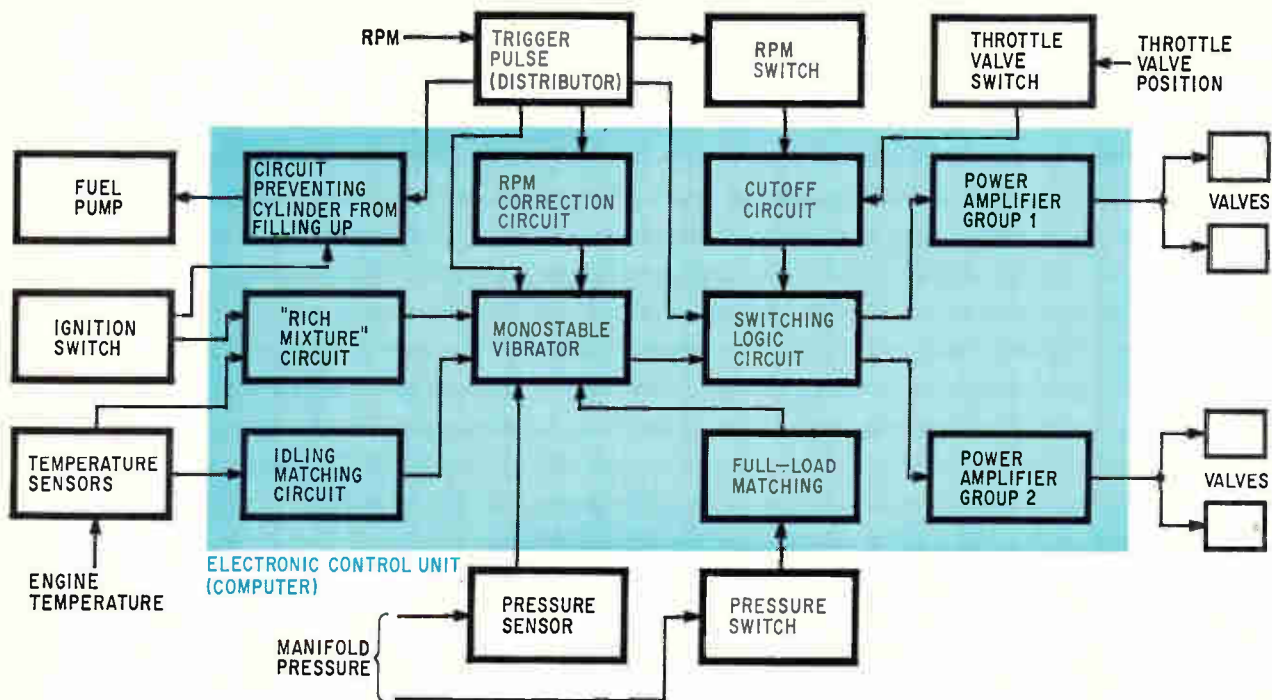

**Feeding the beetle.** Engine temperature, manifold pressure, and other related parameters are monitored by the control unit of Volkswagen's fuel-injection system. It issues command signals that regulate the fuel mix and the amount of fuel that's injected to meet the engine requirements.

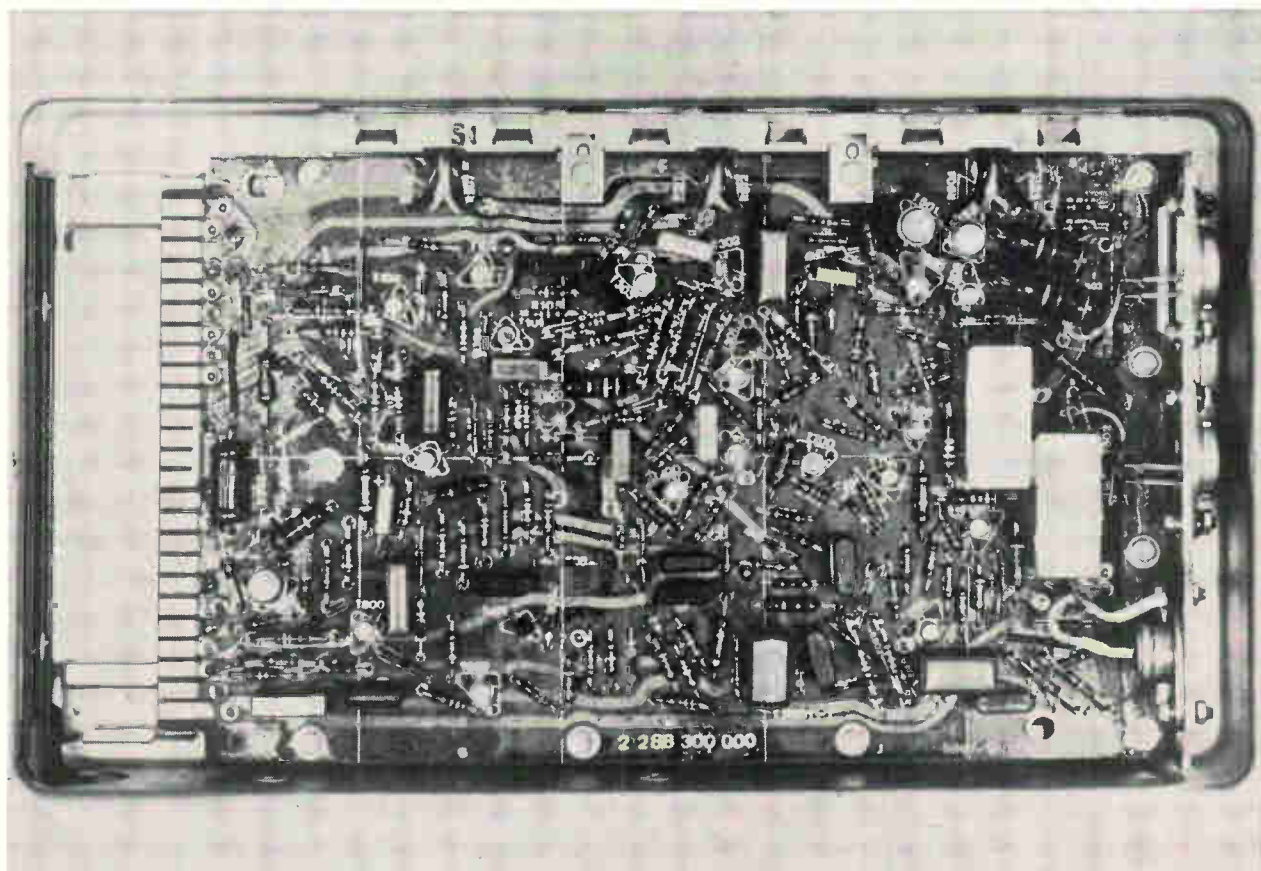

**Up tight.** Circuit board of computer that controls Volkswagen's fuel-injection engine holds more than 200 transistors, resistors, and diodes.



the speedometer cable. (The generator's frequency is proportional to the car's speed.) A feedback potentiometer controls the throttle setting.

Down the road is a computer-controlled automatic transmission system that will shift gears after considering such factors as acceleration, passenger load, and road conditions. A developmental version has already been tested on a Chaparral racer. Though this would seem to suggest that General Motors might be first out of the box with a commercial model—because of its sub-rosa cooperation with Chaparral developer Jim Hall—the company refuses to comment; its official position is that it doesn't participate in racing events.

Engineers also are working on a car equipped with infrared sensors and other guidance aids that will provide instantaneous information on the differential velocity and distance of leading and trailing vehicles. The system is being designed to respond automatically to situations by accelerating or braking the car.

And eventually—perhaps in a generation or so—there will be automated highways on which drivers will be able to switch to an autopilot mode either to keep going when driving conditions are poor or to relieve fatigue. Detroit is currently working on several autopilot designs.

Automotive electronics goes back only to the early 1960's; the first transistorized ignition system hit the road in 1963. The field didn't come of age, however, until 1967, when GM's Delco Radio division succeeded in developing a practical IC voltage regulator that could withstand temperatures as high as 260°F [*Electronics*, Oct. 2, 1967].

A regulator controls the current through the alternator field coil to furnish the optimum charging voltage for the car's battery. IC units have a number of advantages over relay-operated devices in this application. They're not affected by moisture, aging, metal fatigue, shock, or vibration, and they generally provide better regulation. Both GM and Ford, which came out with a similar unit in its 1969 cars, mount the IC's inside the alternator.

Although neither GM nor Ford has disclosed cost figures for the regulators, industry sources place GM's at \$1.90 and Ford's at \$2.60. This compares with an average of \$1.50 for the electro-mechanical units. Offered as an optional item—and after other costs are factored in—the GM regulator is tagged at \$10 and Ford's at \$12.

Although only about 3% of the Detroit-produced 1969 autos are equipped with IC regulators, some automotive experts predict that the devices will be standard items on all cars, trucks, and buses by 1972. Since about 11 million vehicles are sold each year, regulator manufacturers could gross \$25 million annually on this one item through sales to the industry.

An impressive example of the role electronics can play in the auto industry is the fuel-injection system introduced by Volkswagen last year as optional equipment on some models. The heart of the system is an electronic control unit that cuts

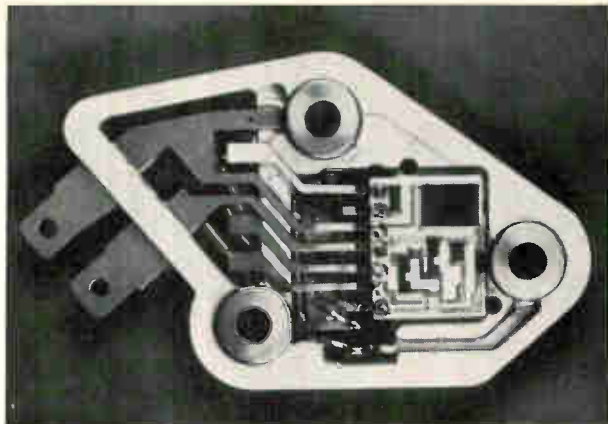

IC regulator. Using thick-film circuit on ceramic substrate, this voltage regulator produced by Motorola for Ford is typical of the units now replacing conventional relay-operated designs.

fuel consumption and increases engine efficiency by sensing the engine's requirements under constantly changing conditions and regulating the amount of fuel injected into the inlet manifold.

When the ignition switch is turned on, the control unit receives power through the main relay and begins to regulate the fuel supplied by the fuel pump. It also opens the injector valves in pairs and keeps them open just long enough to satisfy the engine's fuel needs.

A pressure sensor controls the basic fuel quantity by sampling the pressure on the intake manifold. A pressure switch, operated by the differential between the intake manifold and the ambient air pressure, monitors the fuel enrichment. Temperature sensors in the crankcase and cylinder head control the mixture enrichment during cold starting and the warm-up period. Trigger contacts in the distributor send a signal that tells the control unit when to inject the fuel and which cylinder group will get it. Upon deceleration, the throttle valve switch cuts off the fuel supply.

A functional diagram showing the relationship of the circuits that make up the electronic control unit is on the opposite page. System timing is handled by a monostable multivibrator that's triggered by pulses generated in the distributor at each revolution of the camshaft. The "on" time of the pulses, which provide information on engine rpm, is determined by the inductance of the manifold pressure sensor. This "on" time, as noted earlier, sets the proper valve opening to meet engine fuel requirements.

A logic switching circuit ensures that the valves open only at the proper time. This circuit uses inputs containing information on engine rpm, throttle opening, and trigger pulse timing, to determine the proper time to trigger the power amplifiers. Other circuits shown include one that prevents the engine cylinder from filling up when the starter isn't operating or when the engine is idling,

## Go-slow attitude

The development of a new device does not ensure its adoption by the automakers. For example, GM's Delco-Remy division in Anderson, Ind., has developed an electronic fuel pump and an electronic speedometer-odometer, but it hasn't been able to sell these products to any of GM's car divisions. According to a GM spokesman, these developments will be adopted when they can be economically mass-produced—or when Detroit feels the time is ripe.

Another case in point: the automotive industry is now in possession of an electronically controlled transmission, but it's tucked on the shelf and apparently will be kept there for a while.

**Once burned.** Some observers attribute Detroit's foot-dragging to its recent encounter with Ralph Nader and Congress over safety features. These observers reason that the auto firms aren't eager to adopt new circuits or systems that could fail and thus further tarnish their reputation. A highly placed official at GM asserted in this regard, that in producing the industry's first integrated-circuit voltage regulator, GM carried out the most rigorous testing ever conceived in order to preclude the possibility of a failure rate that could retard the use of IC's in future systems because of public mistrust.

However, because microcircuits as well as discretes have now demonstrated their high reliability in tortuous environments, the cautious approach by the automakers could very well be due more to dollars-and-cents considerations than to fears about reliability, as is being implied.

and one that adjusts the air-fuel mixture to the operating conditions.

The Volkswagen control unit measures about 6 by 12 inches and contains more than 200 components, including 25 transistors and 35 diodes.

### Short stop

Although airplanes have used computerized anti-skid braking systems since about 1960, the automotive industry is just getting around to adopting something similar.

The only automaker to come out with a computer-controlled anti-skid braking system so far is Ford, which offered it as optional equipment on its 1969 Continental Mark III and Thunderbird models. Ford's system controls the rear wheels only. Explains a Ford engineer: "Tests have shown that when brakes are applied with extreme pressure during panic stops on wet, slippery road surfaces, wheels lock, tires tend to skid and the rear end usually starts to slide to the side."

But Ford's system has run into unexpected criticism from GM, which claims that rear-wheel skid control doesn't quite solve the problem of wheel lock during panic braking. In fact, GM went all out to prove its point. In a demonstration attended by newsmen at its Milford, Mich., proving ground, it attempted to put a number of cars into skids

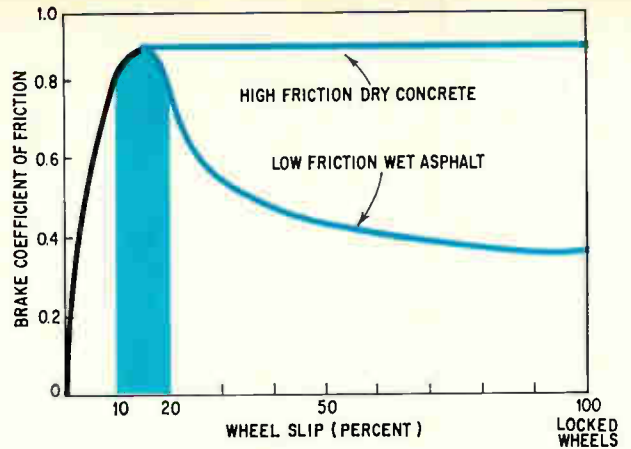

**Tire brake force.** Brake friction coefficient varies with road surface, vehicle speed, tire pressure, and other factors. The greatest braking force is applied to the car in the 10%-to-20% wheel slip range.

on straight and curved roadways. The first car, which had no anti-skid device, was put into a skid by suddenly slamming on the brakes at 50 miles an hour on a straight road. The wheels locked and the car spun completely around.

A second car equipped with a Ford-type rear-wheel skid-control device was tested in the same way. Although this car required a slightly longer stopping distance, it didn't spin when the brakes were applied. When a third car equipped with developmental four-wheel anti-lock brakes provided by GM was put to the test, it stopped in about three-fourths the distance required by the first car, and without skidding.

On a curved roadway, the car equipped with the four-wheel anti-skid device held the road and stopped in a relatively short distance while the car with the rear-wheel anti-skid system went off the road. The GM engineer conducting the test, Joseph Bidwell, said his company has a crash (or anti-crash) program under way to produce an effective anti-skid system.

Support for GM's argument comes from Thomas G. Schafer, the Bendix Corp.'s expert on adaptive braking. "Rear-wheel control provides vehicle stability and helps the car resist sideways movement during panic braking," says Schafer. "However, the four-wheel system, in which the front wheels are also controlled, gives the driver an additional advantage of steerability, since the front wheels can continue turning to align themselves with the rear wheels."

### Measuring slippage

Auto men measure the deceleration of a rotating wheel in terms of its amount of slip relative to the car's speed. For example, if the car is doing 60 mph and wheels are slowed to 50 mph when the brake is applied, there is a 17% slip, which is about ideal for braking. It is in the 10%-to-20% slip range that the greatest braking force is applied

to the car, and the anti-skid system must automatically maintain this slip average. When the wheel deceleration exceeds the maximum safe rate—the point at which the wheels begin to lock—the system's computer activates a solenoid in an actuator to begin the braking.

On wet, slippery surfaces, the frictional force between the tire and the road is reduced below the level required to sustain traction. Hence the function of the anti-skid system is to electronically maintain optimum slip average by pumping the brakes periodically. In the system, sensors detect wheel velocity and transmit the information to the computer control module. The computer then determines the required braking cycle and signals the vacuum-powered brake actuator, which regulates the pressure of the fluid in the front and rear wheels or the rear wheels alone, depending on the system. The coefficient of friction that determines braking is variable over a wide range of road conditions, ranging from about 1 on dry concrete to 1.05 on wet ice.

Ford's rear-wheel anti-skid system was developed by Kelsey-Hayes in cooperation with Texas Instruments, which designed the computer. A four-wheel system developed by Bendix' Brake and Steering division in South Bend, Ind., is now being tested on Ford's Mercury cars at a proving ground in Bemidji, Minn.—a fact suggesting that Ford may switch to a four-wheel control system in its 1970 cars. The betting in Detroit is that GM will also install a four-wheel anti-skid system in selected 1970 models.

In the Bendix braking system, shown below, a speed sensor measures instantaneous wheel velocity at the instant the brake is applied, together with the tire-to-road coefficient of friction. This information is assessed by the computer, which decides if the adaptive braking should go into action to keep the brakes from locking the wheels.

If the driver slams on his brakes with too much force, the computer activates solenoid valves to force the modulator to adjust the brake pressure around the valve. The adjustment provides the maximum braking force without locking the wheels. In addition to reducing the stopping distance, this

## The electric car

There were 18 electric cars produced in the U.S. over the past five years, according to a report by the Electric Vehicle Council. Clearly, these cars could open up a vast new market for semiconductor devices. All that keeps the lid on this market is the inability of manufacturers to come up with a suitable battery for the cars. What, then, is the status of the electric car today?

Now that a top speed of 80 miles per hour has been achieved, the makers appear to be emphasizing the car's maneuverability, low operating cost, easy maintenance, and quiet and pollution-free operation. But it seems unlikely that the electric car will challenge the supremacy of autos powered by internal-combustion engines in the over-all transportation picture. The present thinking is that the electric car will win a place as a second car for pleasure driving over short distances or for suburban shopping.

It's known that GM is experimenting with a number of battery types—from the standard lead-acid variety to fuel cells. The lead-acid battery has adequate power but limited energy storage; the fuel cell's characteristics are just the opposite. What may emerge, therefore, is a hybrid battery combining the best features of each type.

**Trade off.** Gulton Industries, the Yardney Electric Corp., and others have produced a number of high-energy storage batteries for experimental cars. But the automakers, in each case, have been forced to trade off speed for range, or vice versa. For example, GM's Electrovair II has a top speed of 80 mph but a range of only 40 miles. On the other hand, the Yardney car, built around a Renault Dauphine body, has a range of 80 miles but a top speed of only 25 miles per hour.

George A. Hoffman of UCLA's Institute of Transportation and Traffic Engineering suggests that oil companies provide a battery rental service to compensate for any loss of business resulting from the introduction of an electric car. "A motorist should be able to pull up into his service station on low battery and pull out again in 5 or 6 minutes with a fully charged rented or exchanged battery," says Hoffman.

The automakers are predicting that the electric car will be adopted, on a limited basis, within 5 years, or 10 at the most.

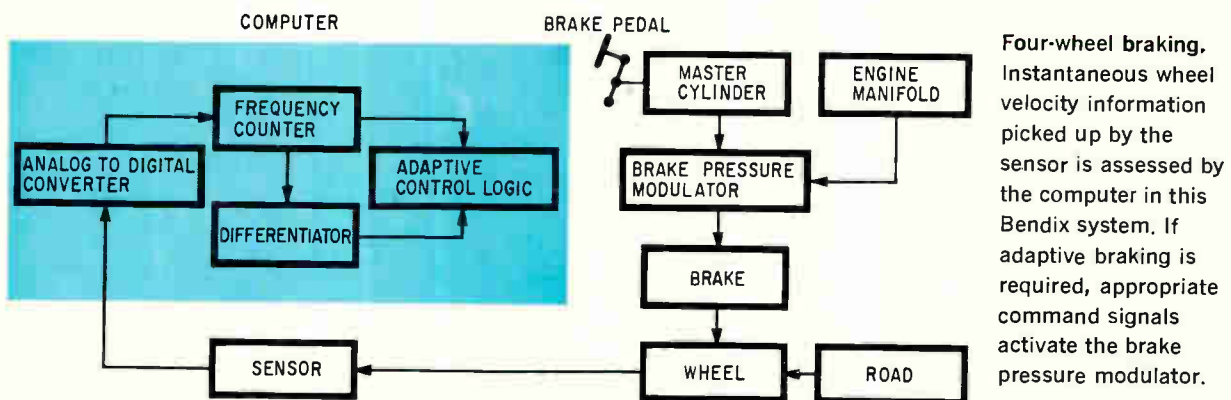

Four-wheel braking. Instantaneous wheel velocity information picked up by the sensor is assessed by the computer in this Bendix system. If adaptive braking is required, appropriate command signals activate the brake pressure modulator.

action appreciably increases the ability of the tire to withstand side forces without skidding. The modulator is powered by the engine manifold pressure. Brake pressure is under the complete control of the driver except when the output from the master cylinder equals or exceeds the pressure that can produce lock-up.

Also on the way are electronic speed controls. In fact, the aforementioned automatic system that uses a MOS FET memory to maintain a constant speed in response to the driver's command is now being offered as an optional item on some 1969 Ford cars. This system, developed by the Bendix

Automotive Electronics division in Baltimore, employs a variable reluctance pulse generator in series with a speedometer cable to provide speed information for the memory.

To set the memory, the driver taps a SET-ACCELERATE pushbutton on the steering wheel when the vehicle has reached the desired cruising speed. If he wants to go faster, he merely keeps his finger on the button and the car will accelerate at a constant rate of about 2 feet/second<sup>2</sup> regardless of terrain. Upon release of the button, the new speed is memorized and maintained—whether or not the driver's foot is on the accelerator.

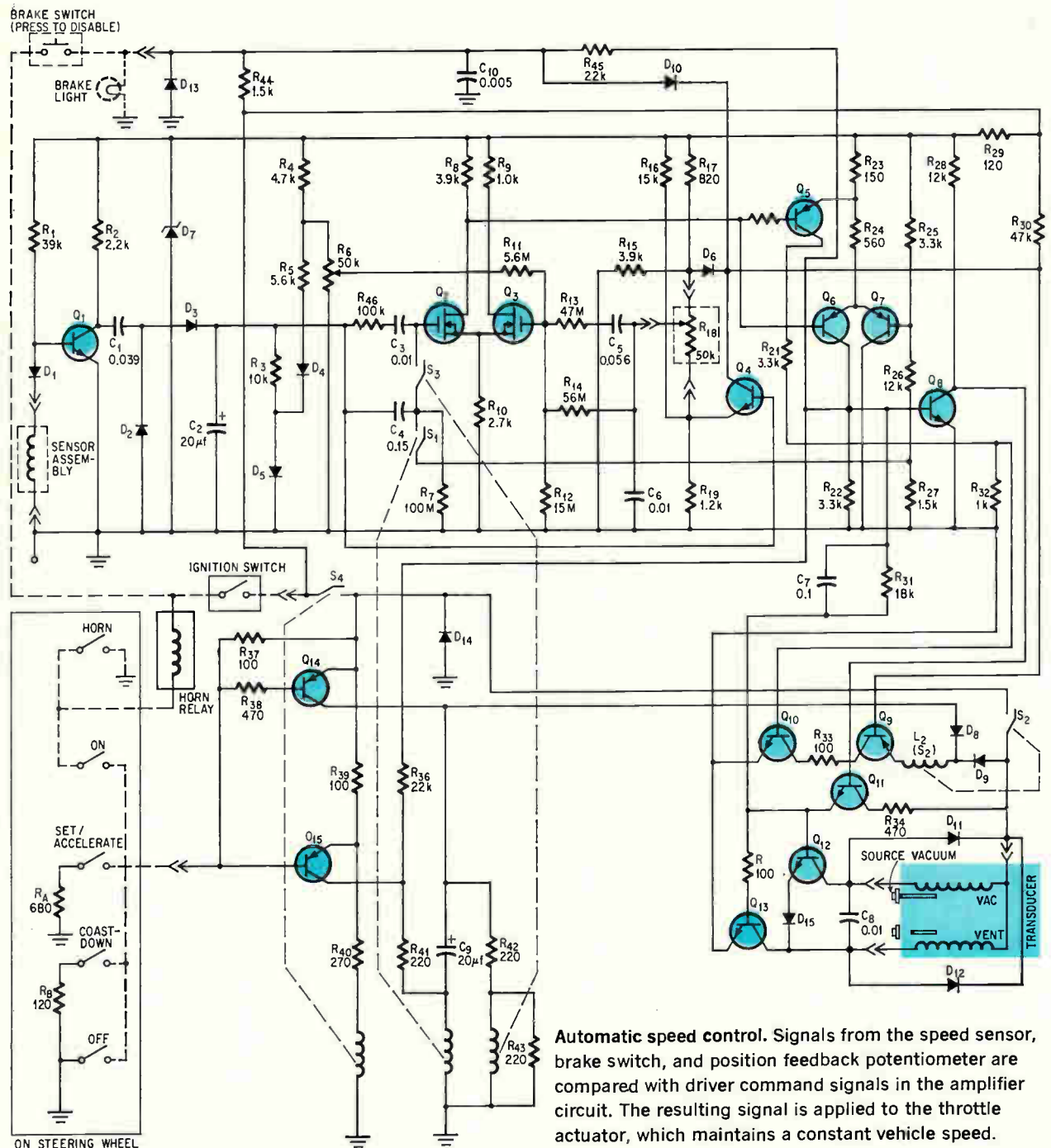

Automatic speed control. Signals from the speed sensor, brake switch, and position feedback potentiometer are compared with driver command signals in the amplifier circuit. The resulting signal is applied to the throttle actuator, which maintains a constant vehicle speed.

To decelerate without deactivating the speed control, the driver depresses a SET-COASTDOWN pushbutton that closes the throttle to slow the car. Again, when the button is released, the new speed is memorized. The system is automatically disabled when the brake pedal is depressed.

A number of safety features have been incorporated in the system to meet the industry's standards. For example, there's a redundant brake disable feature to protect against a defective or poorly adjusted brake switch. If no disabling signal is received when the brake pedal is depressed, the control system becomes automatically disabled when the car slows to approximately 8 mph below the set speed limit.

This automatic disabling occurs in the case of human errors, too, such as a mechanic's failure to hook up the wire lead to the brake disable switch. Also, the "on" command is always cancelled when the ignition switch is turned off.

### Command circuits

In the diagram on page 90, a sensor picks up data from the speedometer cable and produces a signal whose frequency is proportional to the car's speed. The signal goes to an averaging circuit, which generates a d-c voltage that's proportional to the input signal's frequency and thus corresponds to the auto's speed.

This voltage is then applied to a memory circuit, which also picks up an input representing the driver's command speed when the SET-ACCELERATE or SET-COASTDOWN pushbutton is depressed. The memory output is fed to a high-input-impedance comparator that checks the car's speed against a feedback voltage from a throttle potentiometer mechanically linked to the car's throttle linkage arm. An intervening feedback circuit prevents the throttle from closing too quickly when the vehicle's speed drops appreciably below the command speed; at the same time, it increases the sensitivity of the comparator to the feedback signal as the vehicle attains command speed.

Any error signal developed in the comparator is amplified and used to control a vacuum modulator made up of solenoid valves; this device, in turn, controls the pressure on one side of the diaphragm of a vacuum modulator and actuator. The solenoid valves are equipped with needle valves that open and close the engine manifold. Depending on the driver's command signal, one needle valve may remain open to allow a vacuum to be drawn into the modulator chamber, or it may open and close alternately with the other needle valve to let atmospheric pressure in the chamber.

The diaphragm, which controls the throttle linkage, is pushed forward by a heavy spring. Reduced pressure in the chamber will thus cause atmospheric pressure to move the diaphragm and compress the spring. By adjusting the chamber pressure, the diaphragm can be positioned at any point between the limits of its stroke.

When the brakes are applied, a brake switch



Slalom. These frames from a film made by Bendix show a car equipped with the company's four-wheel adaptive braking system being put through an obstacle course on a slippery proving ground in Bemidji, Minn.

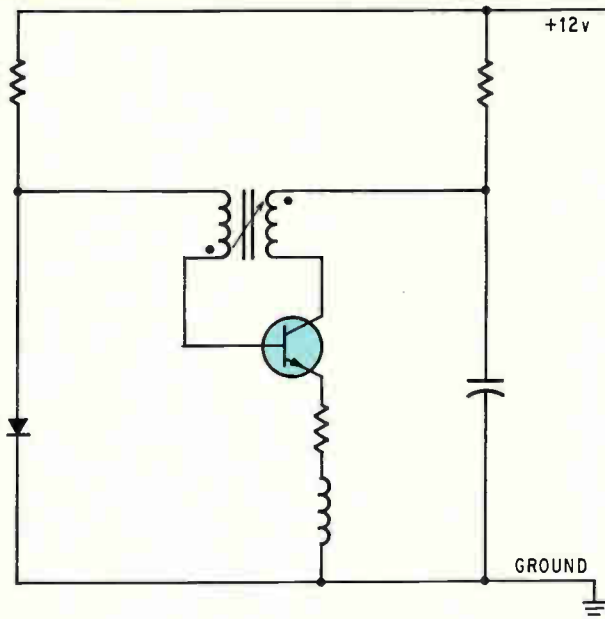

**Breakerless firing.** Designed for transistorized systems, Ford's ignition trigger has no breaker points and is basically a free-running blocking oscillator that acts like a switch being opened and closed by the vanes on the distributor shaft.

closes. A positive battery voltage is then applied through the closed switch to deactivate the speed control system by turning off the appropriate control transistors in the level-decoding logic circuit. The system can also be deactivated by a brake harness fail-safe circuit.

More than 3 million transistor-ignition and capacitor-discharge systems were sold last year, in addition to 1.6 million electronic tachometers and 2 million sequential flashers. It's estimated that these sales were worth a total of \$70 million at

automobile factory prices.

Surprisingly, new-car sales account for only 15% of the transistor-ignition and capacitor-discharge systems sold each year. Most of the units are purchased by sports car enthusiasts and motorists who have trouble starting their cars on cold days. On the other hand, the automakers aren't pushing these systems either, chiefly because they cost a great deal more than standard ignition systems.

The advantages claimed for the transistor-ignition system are relative freedom from breaker-point-related troubles, improved gas mileage at high cruising speeds, and longer spark-plug wear. GM, which developed the rival capacitor-discharge system, says the main disadvantage of transistor ignition is that it won't effectively restart a flooded engine in cold weather.

By comparison, asserts GM, its system makes for easy starting in cold weather, appreciably lengthens spark-plug life, and increases gas mileage at high speeds. It is not being offered as standard equipment because of its higher cost—about \$40 to the motorist—in comparison with conventional systems.

On another front, Ford has come up with a new triggering system that does away with the familiar breaker points used in all previous ignition systems. This could be a major step toward development of a maintenance-free ignition system, since there's no need to retune the engine or replace or adjust the points. Ford hasn't said when the breakerless ignition will be introduced, but rumor puts it in one of the company's 1970 model cars.

The circuit, shown above, is basically a high-frequency blocking oscillator switched on and off by metallic vanes on the distributor shaft. As the shaft rotates, the vane passes through the transformer's air gap, reducing the feedback signal. At a given vane position, the oscillation stops abruptly. Then, as the vane moves out of the air gap, the oscillator starts again. Thus the oscillator acts like a

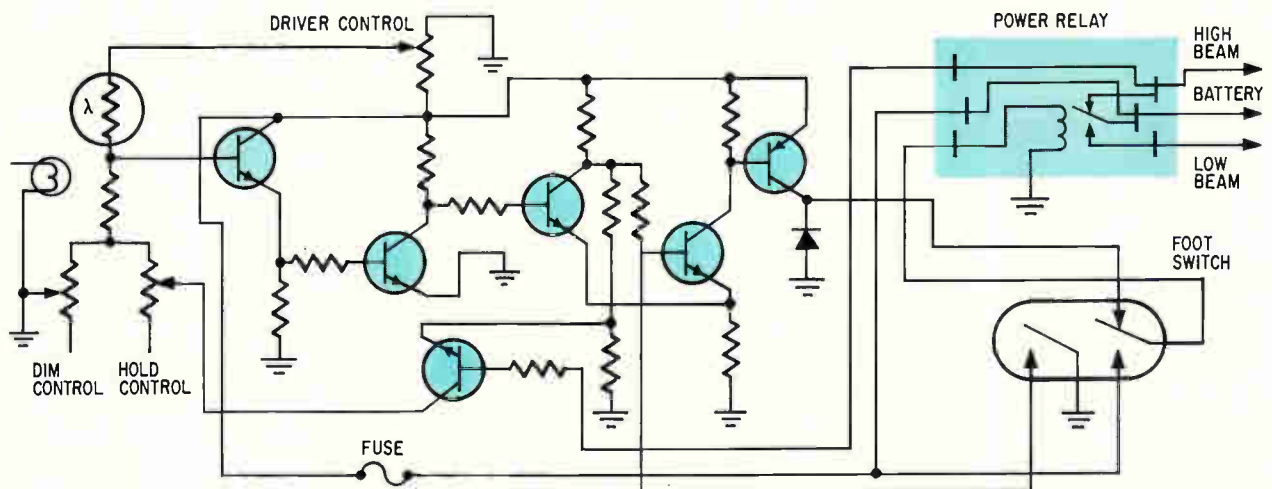

**Headlamp dimmer.** When the photocell is in the dark, the amplifier in this GM system is turned off and battery voltage is applied to the high beam. In bright light, the photocell's resistance is lowered and the amplifier is turned on to switch the relay contacts to low beam.

## Market prospects

Although the automakers are often depicted as hard and tightfisted bargainers, such electronics giants as Motorola, Bendix, Toshiba, General Electric, and RCA derive a substantial portion of their total income from dealings with the auto industry. In fact, John Welty, vice president and director of operations for Motorola's Semiconductor Products division on automotive electronics, estimates that the automakers are buying more than 72 million diodes a year for use in their alternators.

Welty says Motorola supplies more than half of this total, and that Delco Radio, RCA, and Toshiba—in that order—account for the rest. There are indications, too, that Fairchild Semiconductor, Texas Instruments, and Westinghouse are making inroads in the auto market.

**It adds up.** Aside from the semiconductor producers, who are estimated to gross more than \$60 million annually from the auto industry, such companies as Kelsey-Hayes, which developed Ford's anti-lock braking system with an assist from TI, Bendix Automotive Electronics division, the biggest independent producer of sophisticated electronic gear for the auto industry, Leece-Neville, and Stewart-Warner rake in more than \$100 million a year from the automakers.

With an attractive market building for semiconductor products in general and IC's in particular, the question is why the automakers haven't entered the field by acquiring any of a number of small producers. The fact is that the Delco Radio division of GM is the only major industry-owned subsidiary with a research and production capability in this field rivaling, say, Motorola's. Ford's plans for its own semiconductor outlet have been seriously set back by the recent closing of the Philco-Ford microcircuits facility in Santa Clara, Calif. Philco-Ford maintains an IC facility in its Pennsylvania plant, but it isn't big enough to meet all of Ford's requirements.

Chrysler has no semiconductor outlet of its own and relies on outside suppliers, chiefly Bendix, for its electronics. As a result, Chrysler does not appear to be a contender for leadership in the race toward electronic vehicle control. In fact, the company has just introduced a transistorized voltage regulator in its 1969 cars; GM, on the other hand, has moved from its early thick-film design to monolithic IC's in this application. American Motors has been left at the starting gate with not a single contribution to the move to automotive electronics.

switch opened and closed by the distributor vane.

As for tachometers, their principal outlet is, once again, the sports car market. A number of these meters now use IC's while others rely on discrete-transistor circuits. Most tachometers are designed around a multivibrator that's triggered by a pulse from the auto's distributor. A motorist with standard transmission depends on a tachometer to tell him the best time to shift gears; otherwise, its function is mainly decorative.

An electronic sequential flasher, which has no

moving parts, is inherently more reliable than the motor-driven or relay-operated units. Typical electronic flashers employ a number of silicon controlled rectifiers, silicon unilateral switches, and transistors to turn on a series of three or more lamps in sequence in the direction of turn. Some car manufacturers have already begun offering these items as standard equipment.

## High and low lights

A notable example of the switch to solid state circuitry to reduce packaging size and cost and improve performance and reliability is GM's recent decision to replace its vacuum tube-operated headlamp dimmer with the simple transistorized unit on opposite page. Called Guide-Matic, the circuit consists of a driver sensitivity control, a power relay unit that automatically switches the upper and lower headlight beams, a photoamplifier that boosts the control signal to the level required to operate the relay, and an override foot switch that deactivates the system.

The amplifier consists of a photocell, an impedance-matching circuit, a d-c amplifier, a regenerative trigger stage, a power output stage, and a circuit that grounds the dim control when the photocell is in darkness.

The system is initially adjusted to put the headlamp beam on high when the photocell is in darkness. In this condition, the voltage-divider action of the high-resistance photocell, in series with the DIM and HOLD controls, keeps the impedance-matching stage at cutoff.

With the first stage turned off, the power output stage is also off and the relay coil is de-energized. When light above the dimming level shines on the photocell, the first stage is turned on, causing the power output stage to conduct and the relay to switch the battery to low beam. When the motorist depresses the override foot switch, the relay coil switches battery voltage to the higher-beam lights.

## Pointing the way

For application further in the future is an experimental system designed to give motorists routing instructions at highway intersections. Recently developed by GM for the U.S. Bureau of Public Roads, it will be tried out this spring in the Washington, D.C., area. Called ERGS—Experimental Route Guidance System—the system consists of a low-power transmitter and receiver mounted in the car, plus associated roadside equipment.

When a driver leaves on a trip, he enters a five-letter coded word indicating his destination in a small console mounted on the car's dashboard. When he reaches an instrumented intersection, his car's transmitter sends the coded message to the roadside equipment, which processes it and sends back routing instructions that are displayed on a panel indicator. The instructions come from a computer that stores information on the best routes to various destinations. It sounds far-fetched, but it will certainly spare travelers some headaches. ■

# Designer's casebook

## High accuracy obtained from peak detector using op amp

By Alex E. Vinatzer

Machine Tool Works Oerlikon-Buhrle Ltd., Zurich

A peak detector's accuracy can be improved a thousand times with the addition of an operational amplifier and a field effect transistor. In the basic diode-capacitor peak detector, the capacitor's maximum voltage is subject to changes in the diode's forward voltage drop due to changes in the charging current and temperature.

With the nulling switch open and a positive voltage at the input, the circuit acts as an inverting amplifier, with the output and input related by  $V_o = -(R_f/R_i)V_i$ . The error caused by the diode can be neglected because it is divided by the loop gain, which is 1,000 if the op amp's gain is 2,000 and  $R_f = R_i$ .

As soon as the pulse's peak value has been reached and the downward transition of the pulse begins, the output is held constant at the peak value of the pulse, because the diode-capacitor detector and the source follower can not follow the change in polarity. The output remains constant after the input signal reaches its maximum, because if the input drops only slightly below the maximum, this change is amplified by 1,000 and the diode is therefore reverse biased.

Since the reverse current of the diode (10 picoamps) and the FET (100 picoamps) are so small, the output voltage remains stored for a relatively long time. The change in the output voltage after  $t$  seconds is given by  $\Delta V_o = t(I_r + I_g)/C$  where

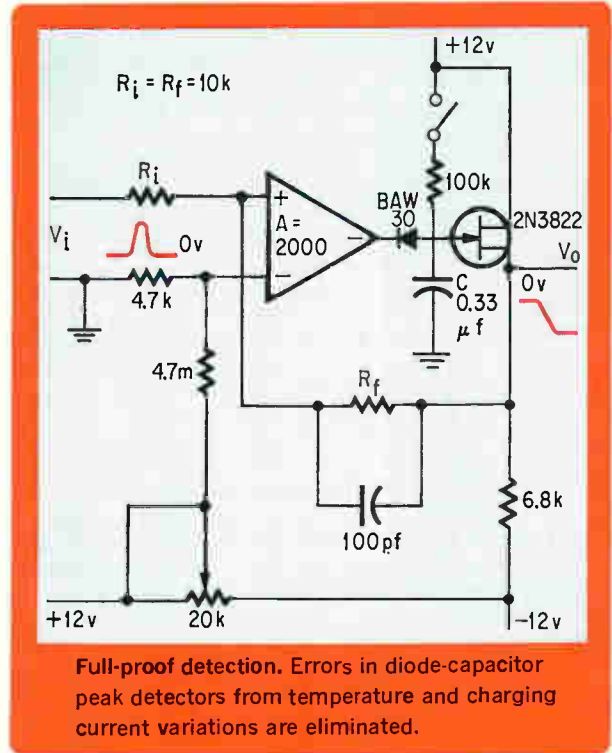

$I_r$  is the reverse current of the diode and  $I_g$  is the leakage current of the FET in amps,  $C$  is in farads, and  $\Delta V_o$  is in volts.

For fast rise times, the charging current of the capacitor can be several hundred milliamps, and therefore an additional emitter follower should be connected between the output of the operational amplifier and the diode.

The output can be adjusted for zero offset with zero input voltage, by closing the nulling switch and adjusting the potentiometer.

## Dual transistor reduces error of track and hold circuit

By G. Koch and U. Mocci

University of Rome, Italy

The accuracy of a sample and hold circuit increases when a dual transistor placed at the input to an operational amplifier limits the discharge current of the feedback capacitor. This decreases the holding error at the output.

The control voltages at  $x$  and  $y$  open and close the diode bridge. When the bridge closes, the diodes conduct and the circuit behaves as an in-



verter to incoming signals. The overall gain is unity because the feedback impedance equals the input impedance.

After the control voltages reverse, the bridge opens (hold time), and the input is prevented from being transmitted to the output.  $C_1$ , however, maintains the output voltage at the level of the last sampling.

During the hold time, the output isn't exactly constant because the capacitor discharges a current through the amplifier's input. However, the dual transistor reduces the capacitor's discharge current from 1 microamp to 10 nanoamps, thus reducing the holding error. The choice of  $C_1$  is a compromise in order to reduce the hold error and let the tracking transient be exhausted.  $C_1$ 's low value allows low steady current through the bridge diodes, and, therefore, the output is less sensitive to supply voltage variations.

For an input voltage range of  $\pm 10$  volts, a frequency range from d-c to 1 kilohertz, and a temperature range of  $0^\circ\text{C}$  to  $50^\circ\text{C}$ , the static and dynamic accuracy is better than 0.1% full scale with a holding error of 1 to 2 millivolts.

The values in the circuit have been selected for a track and hold time of 200  $\mu\text{sec}$ .

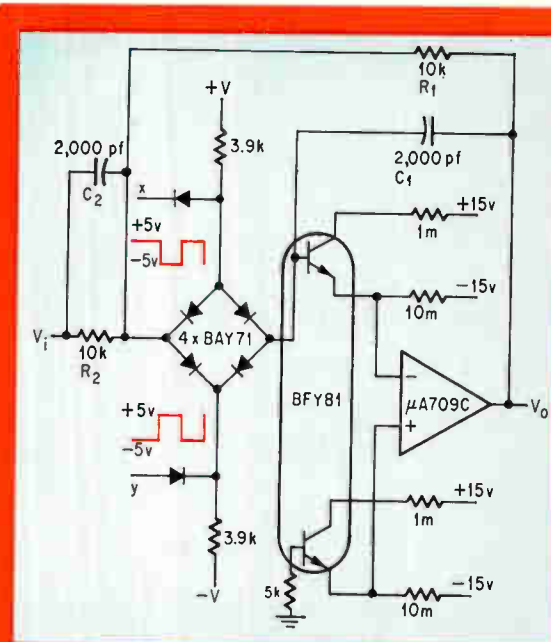

Better tracking. The dual transistor reduces the feedback capacitor's discharge current and, therefore, reduces the hold error.

## NAND gate inputs expanded by adding resistor

By Robert L. Frank

Sperry Gyroscope Co., Great Neck, N.Y.

Logic designers needing a NAND gate with more inputs than are available in standard resistor transistor logic packages have two options open to them: either cascade NAND and NOR or use special "gate expanders." But the first solution means using more gates, and the second means using a special package that usually has a limited use in the system. By changing the  $V_{cc}$  to the standard RTL package and adding a resistor, the designer avoids the additional propagation delay caused by cascading gates and eliminates the need to handle and stock "gate expander" packages.

In the circuit, three separate 3-input gates in a common package have been converted to a single 9-input gate. The output is high only when a negative voltage is applied to all inputs. The gates in the package have been combined by tying the outputs together and adding a series resistor to the  $V_{cc}$  voltage supply. This restores the paralleled

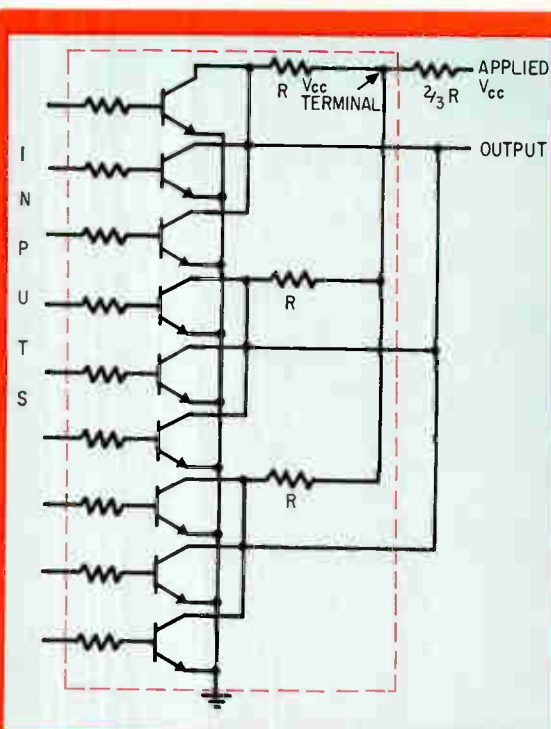

Packed. A new  $V_{cc}$  applied through an external resistor allows the collectors in a multiple-gate IC to be tied together.

internal resistors to the original internal resistor value. The circuit can be modified to include more or fewer inputs as desired, but all the gates in one package having a common  $V_{cc}$  terminal must be used in one expanded gate, or left unused.

Since the scheme results in a nonstandard voltage at  $V_{cc}$  and the published circuit of the manufacturer is often only an approximate equivalent, the modified circuit should be checked with the manufacturer for product use.

## Squelch acts faster with FET gate

By David A. Tong

University of Glasgow

Fast response is difficult to attain when squelching involves biasing an audio amplifier stage off, because the large input and output capacitors resist rapid d-c changes to the stage. Diode gates are a poor substitute, because the control current causes a voltage step at the output when the muting is re-

moved, resulting in an objectionable click. A field effect transistor as a voltage-controlled resistor solves the problem by minimizing the interaction of control and signal circuits.

The squelch circuit shown has very short turn-on and turn-off times and is free from clicks. The Schmitt trigger, consisting of transistors  $Q_1$ ,  $Q_2$ , and  $Q_3$ , has low hysteresis. The amplitude from the receiver's i-f stage needed to trigger the circuit is set by  $R_1$ . When  $Q_3$  is off the FET's resistance is about 250 kilohms and causes a large attenuation in the signal. The FET's resistance drops to about 500 ohms when  $Q_3$  is on with negligible attenuation. A 0.1-microfarad capacitor gives fast, reliable squelch operation with signals whose amplitudes are equal to the noise peaks.

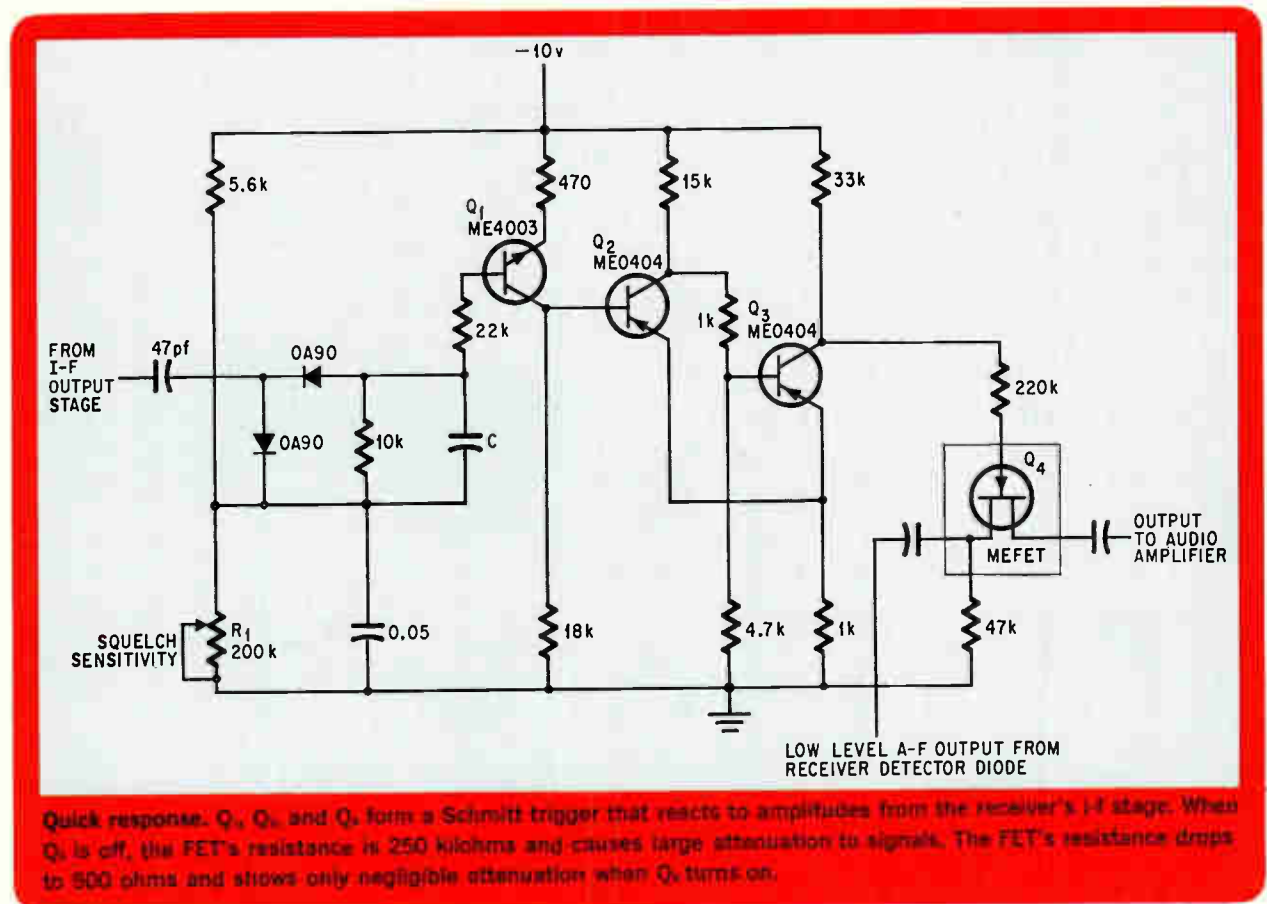

## Op amp sine wave oscillator uses diodes for stability

by Lindsay Molyneux

University of Newcastle Upon Tyne, England

An engineer who builds an audio oscillator that uses an operational amplifier finds that stabilizing the output by means of conventional components is his main difficulty. Stable oscillations require an overall system gain to equal unity. If the gain is greater, the oscillations build up until limited by distortion; if less, the circuit won't oscillate at all.

The circuit shown avoids the usual adjustment needed to get a loop gain of unity, by acting as a pulse-excited tuned circuit, the frequency of which is  $\frac{1}{2}\pi RC$ .

When the output voltages are too low to set off forward conduction of the diodes, the amplifier's gain is high (the negative feedback loop is open) and the output tends to increase rapidly because the positive feedback path is closed. As soon as one of the diodes conducts, the gain drops to a value

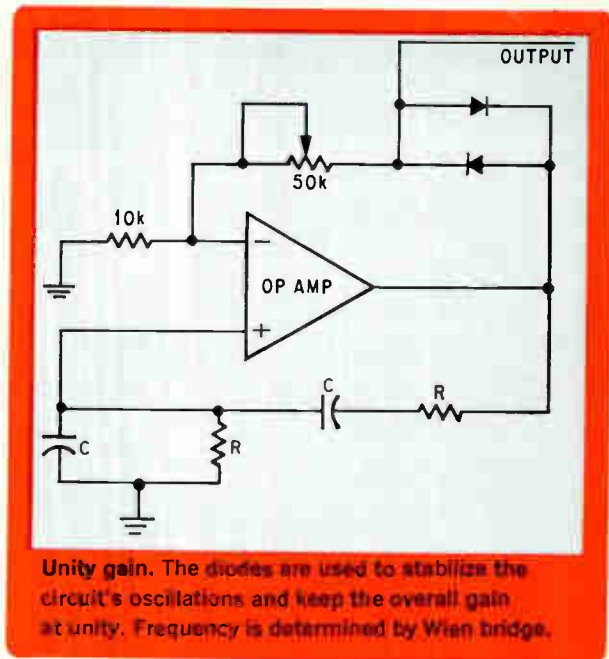

**Unity gain.** The diodes are used to stabilize the circuit's oscillations and keep the overall gain at unity. Frequency is determined by Wien bridge.

determined by the negative feedback loop.

A potentiometer regulates the output amplitude; an increase in amplitude results in less distortion.

## Negative signals converted to positive logic

By J. A. D'Cunha

McCurdy Radio Industries Ltd., Toronto

Most digital integrated circuits that use positive supply voltages in the range of 3.6 to 7.0 volts also require positive input control logic. However, the circuit shown transforms even a negative control signal, if that's all that's available, into the required positive logic at clock rates from d-c to greater than 2 megahertz. The problem involves more than just the simple inversion of the control signal. Negative d-c voltage levels below zero must be changed to the system's positive logic level.

In the absence of an input, the circuit draws only negligible leakage currents from the turned-off transistors. When a negative pulse or level is delivered to the input, all three transistors are switched on, and the inverted signal then appears at the output.

The noise immunity of the circuit is better than 400 millivolts tested over a temperature range of

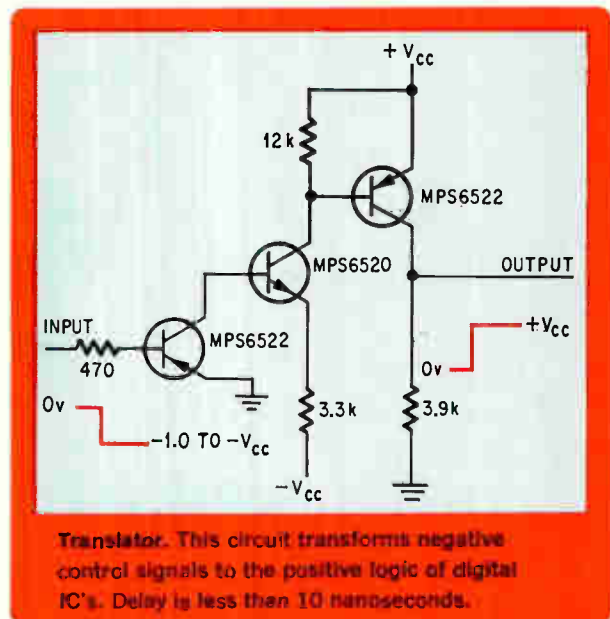

**Translator.** This circuit transforms negative control signals to the positive logic of digital IC's. Delay is less than 10 nanoseconds.

0° to 100° centigrade.

This circuit's simplicity allows it to be easily built on a single chip as an integrated circuit for use in logic design.

## Electronics' guide

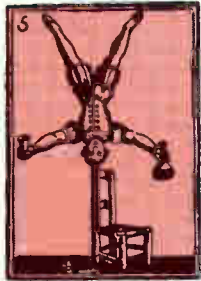

# A four-day stand under IEEE's big top

March 24 to 27

For children, the circus comes to New York in May. But for engineers, the greatest show on earth arrives in March. The 1969 edition opens next week at the New York Coliseum; when the IEEE closes after four days, about 70,000 engineers, salesmen, and students will have been through the aisles.

Coliseum exhibits will be stacked in the same order as last year. The first floor will feature machinery and hardware; the second floor, instruments, computers, and communications equipment; the third floor, components and more instruments; and the fourth floor, more components and produc-

tion materials and services. \*\*\*\*\*

But the show won't be all selling, job-switching and pamphlets-collecting. Technical sessions at the New York Hilton promise valuable state-of-the-art information in many areas.

And to round out the week, on Friday, March 28, **Electronics** will sponsor a symposium, "The Changing Interface — an IC/Systems Seminar," at the Park Sheraton Hotel. Here, the problems of putting large-scale integration into practice will be explored in terms of how deeply the IC maker and systems manufacturer are likely to invade one another's territory.

### MAKING WAVES

Back again is that ever-popular troupe of high-wire, performers — the microwaves.

The why and what of computer solutions to microwave problems will be covered Tuesday morning, while time- and frequency-domain reflectometry will take the spotlight that afternoon. There'll be a Wednesday morning discussion of low-noise amplifiers, and a Wednesday afternoon review of high-power, gridded, linear-beam, and crossed-field tubes. Also of interest will be a session on microwave IC's, with the emphasis on fabrication, testing, and avionics applications, and on the influence of innovation in this field.

### ★ More power to you ★

*The semiconductor jugglers—both circuit and device designers—will present two technical sessions on industrial applications for high-power devices. On Tuesday morning, there'll be "Static Converters—World Wide," and on Tuesday afternoon, a discussion of thyristors, transistors, zener diodes, and thick-film circuits. Radiation damage and hardened devices will be covered Thursday morning. Both bipolar and MOS devices will be discussed at this session in terms of radiation tolerances.*

### WONDERFUL TOWN?

No one has ever written a song about March in New York. It's difficult to rhapsodize about a month that can see rain turn to sleet and then snow, heaps of dirty slush wilt into filthy puddles, and gentle zephyrs shift to vicious, chilling winds. So New Yorkers, who've made the art of survival a way of life, comfort themselves with the knowledge that if they don't like the prevailing weather, it's bound to be better than what's coming. So much for what kind of clothing to pack.

For transportation around Manhattan it's best to hail a cab. While there are buses (crowded) and subways (noisy and dirty), routes are very difficult for the visitor to figure out (the official Manhattan subway map looks like a signal-flow graph gone mad), and the natives are sometimes less than helpful.

A trip to New York has its benefits, too, of course. Theaters abound within walking distance of the Hilton, which is within walking distance of the Coliseum. However, it's difficult to get tickets for hit shows like "Hair" or "The Great White Hope"; your best bet is to try the box office on a weekday night or a ticket agency any night if you're willing to pay the commission.

New York is one of the world's great girl-watching cities. Rockefeller Plaza at lunchtime is prime territory, as is the fountain in front of the Hotel Plaza (Fifth Avenue and 59th Street).

Finally, for long-range watchers there's the top of the Empire State Building. From there, on a clear day you can see New Jersey (the next best thing to forever).



**C**OHHERENT CLARITY AND LIGHT—that's the welcome touch in this year's laser sessions. The papers scheduled all point up the fact that this much-publicized device, which has promised so much for so long, is finally being used in industry.

The first of four laser meetings will center on the advantages of acoustical-optical interactions. Topics here will include deflection, modulation, and signal processing for radar, delay lines, and communications.

The Laser Comes of Age—a two-part session—will focus first on the cutting, drilling, and welding of IC's. In the second part, panelists will describe wideband laser recorders and laser metrology and alignment systems.

Finally, there'll be a session on holographic and imaging systems. Panelists will discuss the uses of holography in microscopy and ophthalmology, and will describe scanning-laser-beam imaging, real-time optical-image processing, and holographic memories.

## IC's will star at tech sessions as well as in booths

Those marvelous midgets, the integrated circuits, will be present in strength at both the product displays and technical sessions. A course in IC fundamentals will run all four days, from 8:30 to 10 a.m.

Aside from these meetings, a Tuesday morning session will take up the controversial question of thick- versus thin-film hybrid IC's. Applications and the materials and components capabilities of each type will be discussed.

And design engineers should find the meeting on LSI especially interesting; it will cover circuit designs and applications.



## IN THE CENTER RING, THE MAIN ATTRACTION

And now, what you've all been waiting for—this year's superstar, a dazzling delight, a veritable wonder of the ages, a pageant of pulsating picoseconds—the computer. The IEEE's new emphasis on these machines is reflected in the fact that it's slated no fewer than 11 sessions, including two all-day tutorial seminars, on computer-related topics. ■ ■

One of the major trends in the computer industry recently has been the growth of peripheral-equipment sales relative to sales of central processors. ■ ■ According to one oft-quoted statistic, of every computer dollar spent in 1955, 80 cents went for processing capability and 20 cents for peripherals; the feeling

now is that this ratio will be reversed by 1975. ■ ■ ■

In line with this trend, a session on computer peripherals has won a spot in the center ring. But of the session's five papers, three are on the subject of magnetic tapes and two are on displays. Whatever became of high-speed printers and optical character readers? ■ ■

However, a session on the threat of semiconductor arrays to entrenched forms of computer memories is aimed square at the future. And another particularly interesting session should be one on how to judge the suitability of various computers for particular applications. ■ ■



YOU CAN EAT inexpensively in New York, the saying goes, if you don't eat much. But like most old saws, this one is only half true; the enthusiastic restaurant explorer is bound to find a place to satisfy his palate and budget in a town with as many eating places as New York. To be very general about the midtown cornucopia, the visitor can sample the best in French food

almost anywhere in the area, but especially on 55th and 56th Streets east of Sixth Avenue, or he can try the best in steaks on East 45th Street (The Cattleman, Pen & Pencil, Press Box) or at Manny Wolf's on Third Avenue. And if he opts for delicatessen fare, there's that famous stretch along Seventh Avenue in the 50's. And

much, much more -- far more than can even be touched on here. The number and variety of restaurants -- Italian, Chinese, German, Greek, Armenian, Scandinavian -- is almost limitless. Perhaps the best tip we could give would be to note that the Manhattan Yellow Pages list restaurants by type or specialty and that excellent paperback guides to restaurants are available at most newsstands.

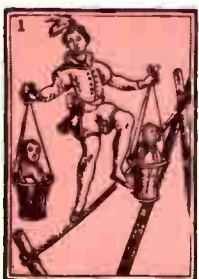

# All-IC hybrid computer eliminates the patchwork from programming

With a few simple sweeps of a light pen across the face of a crt, the operator can make programming changes quickly and conveniently and store them in the memory

By Kazuo Kurokawa

Electrotechnical Laboratory, Ministry of International Trade and Industry, Tokyo

**Remember the analog computers** that used programming patchboards and vacuum tubes? Well, they're still with us today, even though we're supposed to be in an era of solid state circuits and high-capacity memory systems. The fact is, only digital computers have benefited from such advances. But now this has changed. A new hybrid computing system has been developed that uses a switching matrix rather than a patchboard to interconnect computing blocks and uses new, stable integrated circuits for the active elements.

For the user, this means faster, more convenient setup and programming changes. But to achieve this, the computer designer had to take advantage of the capabilities of new input terminals—a light pen and cathode ray tube—and a magnetic storage system, combining them with a ferreed switching matrix that interconnects the various integrators, potentiometers, and other computer blocks.

New hybrid IC's, built around standard monolithic IC's, had to be developed, since available types have not measured up to the performance demanded by an analog computer; such precision circuits have not been produced in large quantities because the market for analog computers is limited. The analog machine's small signals require amplifiers with high gain, low noise, and low drift. These amplifiers must have a high input impedance to make the adders and integrators accurate enough.

All the operator need do is select the computing elements, draw the interconnection diagram on the crt with a light pen, press a few buttons on the console; the connections are made instantaneously in the computer.

If he wants to eliminate completed connections, he touches the light pen to the parts he wants

erased and presses another button, and the unwanted connections disappear. He can reduce any part of the pattern and place it in a corner of the screen, making more room for the section he is working on. He can store his program on paper tape, run it at any time, and compile it so it can be run using different system parameters. The operator's program controls ferreed switches that set up the computer electrically.

The computer stores the operator's program in the following manner. Each symbol's pattern is stored in the drum memory as a program that is put into operation by pressing the SYMBOL DISPLAY button. The symbol program is transferred to the core memory when the operator presses the GO button. To have any symbol displayed on the crt, the operator pushes the key marked by that symbol on the front panel, pushes the SYMBOL SIZE and SYMBOL DIRECTION keys, and sets the INDICATOR INPUT key to the element's number. This specifies the symbol and its size, direction, and number.

He moves a "tracking cross pattern" with the light pen to the exact location on the screen where he wants the element's output terminal to appear. The coordinates of this point are computed from the tracking cross pattern's position by counters and stored as part of the pattern display's program. When the GO button is pushed, the program for generating the pattern is activated and the element appears with its output terminal at the location specified by the light pen.

The program activates a particular element in the computer specified by the indicator key's number. The next pattern is positioned on the screen in the same way using the light pen to designate its new coordinates. When all the elements in the

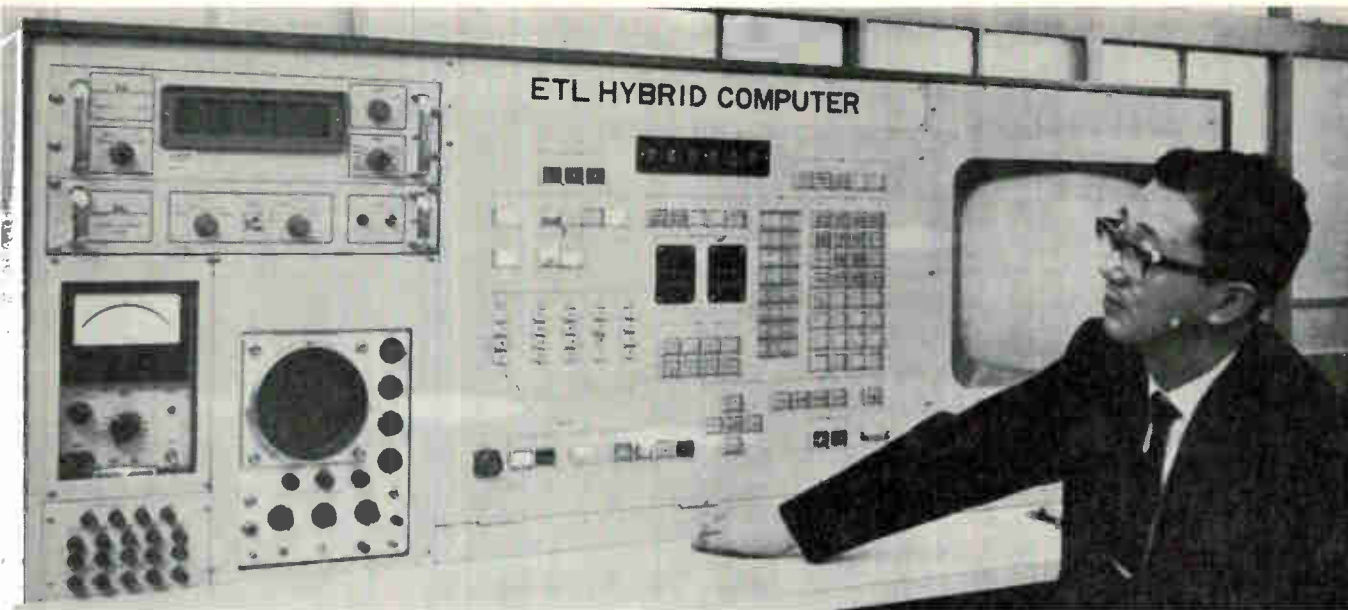

**Prototype.** The hybrid computer, composed of an integrated circuit analog computer, a digital computer, and a cathode ray tube display unit, gives a solution by merely drawing an analog set-up diagram on a crt display unit.



**Display.** An analog computer set-up diagram is shown on the screen of the crt display unit.

operator's program are positioned correctly on the screen, the function key SYMBOL CONNECT on the control panel is pushed. This specifies the program that connects the elements. The operator presses the GO button and the program is transferred to the core memory.

The tracking cross pattern is moved by the light pen to each input and output terminal that is to be connected. The input and output terminals of the computing elements are points. These points are made brighter than the symbol outline so they can emit enough light to be sensed by the light pen's

photo-diode.

The line segment connecting the elements appears on the screen after the GO button is pushed. The symbol-connection program uses the coordinates specified by the tracking cross pattern to direct which ferreed switches will be activated in connecting the computing elements.

The switching matrix consists of 105 microferreed switch units, each of which is an 8-by-8 matrix containing 64 double-pole, single-throw switches. The switch units are similar to those used in telephone exchanges and have a life expectancy from 25 to 40 years.

Computing elements and ferreed switches are divided into three groups, and an equation can be solved by the computing elements in one group. For those equations where one group is insufficient, a small number of elements from the other groups can be connected by a central switching exchange.

Each group contains the same line-up: 10 integrators, 10 summing amplifiers, 4 multipliers, 2 high-gain amplifiers, 24 potentiometers, 3 non-linear computing elements, and 34 ferreed switch units to interconnect the elements. There's also a central matrix composed of three ferreed switch matrixes.

The switching units for a typical group have 13 output-matrix units. Some of these contain eight inputs and 16 outputs for connections to integrators and summing amplifiers; the others contain eight inputs and eight outputs for potentiometers—and 21 input-matrix units with eight inputs and eight outputs each. Integrators and summing amplifiers have four inputs each, and therefore two of these elements can be connected to one input matrix.

## Pattern generation

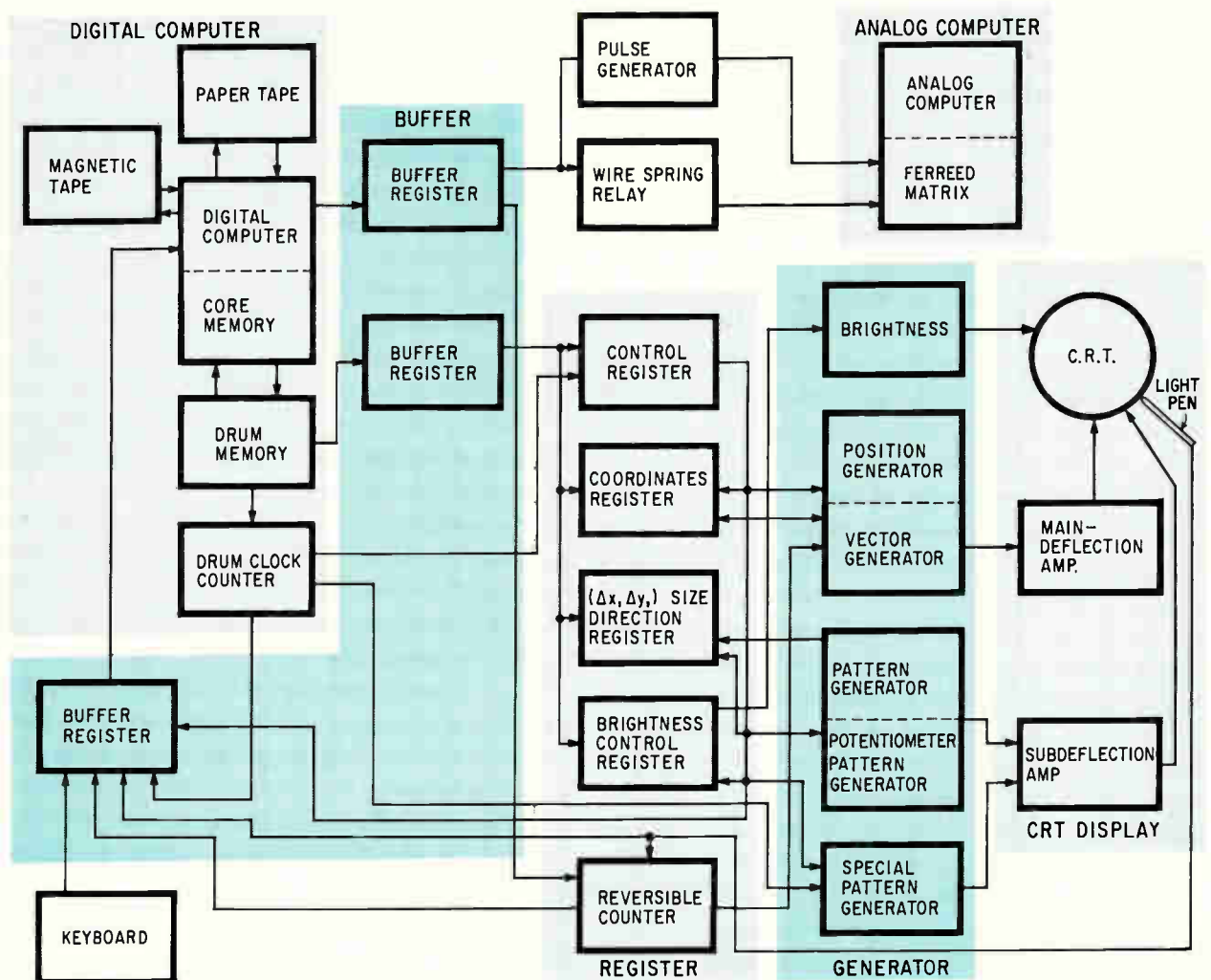

**Signal flow.** The pattern for each computing element is stored in the magnetic drum memory. When the keyboard's SYMBOL DISPLAY and GO buttons are pushed, this information is transferred to the computer core memory. The operator then selects a computing element on the keyboard, and its pattern information is transferred to a display track on the drum. This information is sent to the display unit as the display signal.

Initial conditions to integrators are connected via the input matrixes. Inputs to the peripheral equipment, such as the X-Y and penwriting recorders, can be connected either through the input matrix in the same manner as the computing elements or through the central matrix.

Wire-spring relays that select the ferreed matrix configuration are driven electrically. Pulses operate the ferreed switches, and the interconnections between the computing elements are completed. The ferreed switches act in accordance with decisions transmitted to them from the digital computer.

The tracking cross pattern consists of 25 dots arranged on eight radial lines with equal angular spacings of  $45^\circ$ . It is generated by counter circuits that keep track of the number of distance units

that the pattern is moved on the crt face and feed the information to the digital computer to be stored on the drum as pattern-origin information. Positive and negative x and y pulses and a stop signal are generated by a drum clock counter that feeds each signal to one of five AND gates. When the light pen senses a dot on the tracking cross pattern, a pulse is generated to the other input of all five AND gates. If the pen is placed on a dot in the positive x direction, an  $x+$  pulse arrives together with the pen's pulse to an AND gate that triggers an x reversible counter. Then, as the pen is moved in the  $x+$  direction, the counter positions the tracking cross pattern to each new location specified by the pen. In this way, the counters can direct the tracking cross pattern in any of the eight directions. Though it moves one unit at a time, the movement



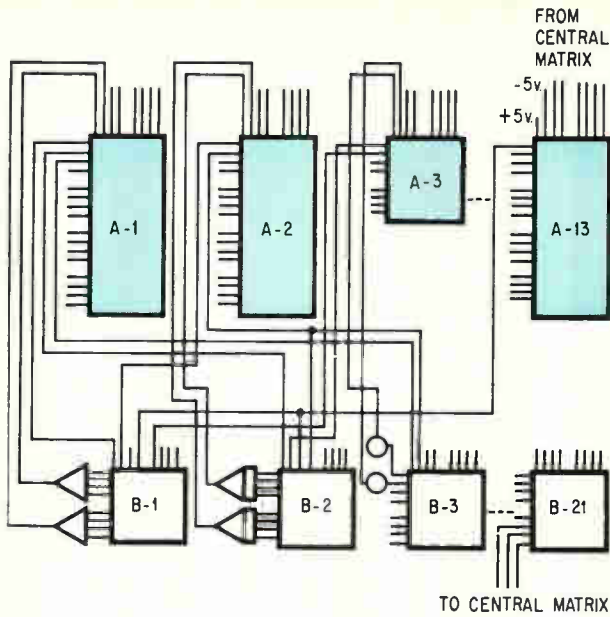

**Getting switched on.** The computing elements are interconnected by ferreed switch matrixes. The switches are driven by computer commands stored in the drum. The A matrixes connect the output terminals and the B matrixes connect the input terminals of the computing elements.

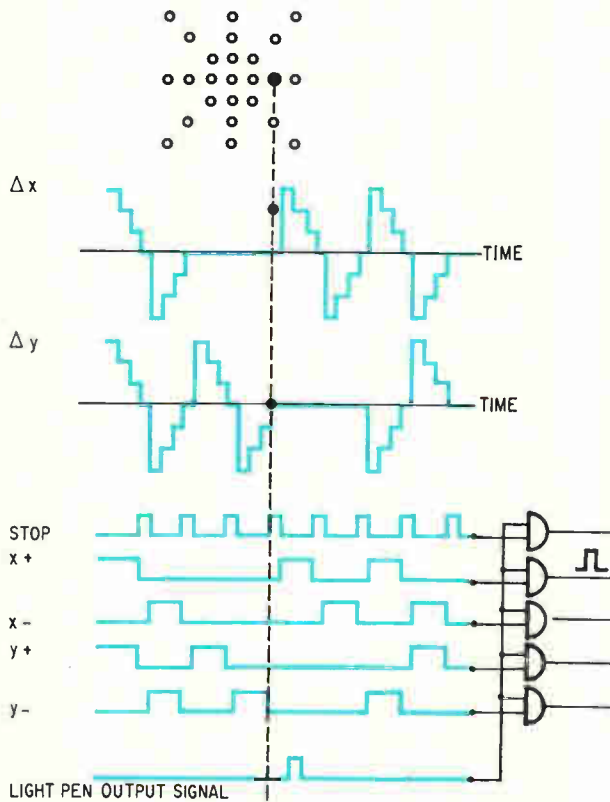

**Tracking cross pattern.** The pattern of dots is generated by the  $\Delta x$  and  $\Delta y$  signals, which originate from the drum clock counter. The stop signal and the x and y pulses feed AND gates, which become energized when the light pen touches a dot. The pattern serves as a reference frame for the computer so it knows where to position the crt display beam.

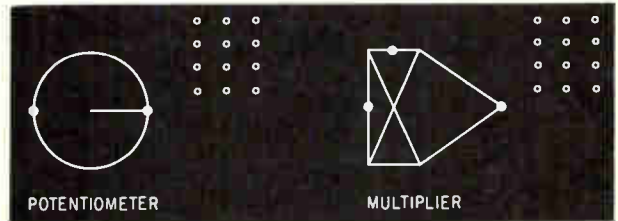
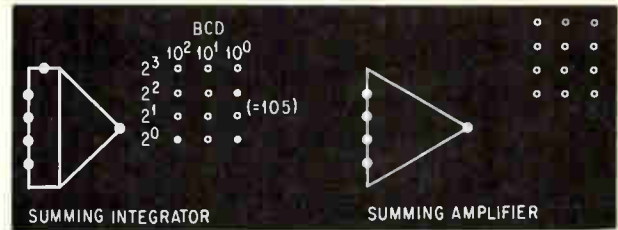

**Pattern display.** Typical patterns generated by the computer are shown as they appear to the operator on the crt. The 12 dots above the output terminals indicate the number of the element in binary-coded decimal notation. The left-hand column is the hundreds digit, the center is the tens digit, and the right-hand column is the units digit. The input at the top of the summing integrator is for initial conditions. The junction point connects groups reduced in size and displayed at the edge of the screen to a larger group being manipulated.

appears continuous because the basic unit is small permitting the control circuitry to operate quickly.

With the pen placed at a point to locate the integrator, the operator pushes the GO button. The coordinates of this point, which are monitored by the reversible counters, are sent to the computer. During the display cycle, the information is read out from memory in the form of signals transmitted to a deflection amplifier that positions the crt beam to the desired origin. When the integrator key is selected, a program activated from memory operates x and y registers in the sub-deflection circuit. The binary information from the computer is converted to analog signals that direct the beam in tracing out the integrator pattern.

### Making modifications

The display of interconnection line segments is similar to pattern displays. Each line segment is stored as a vector containing initial and final position coordinates. Only straight lines can be generated, but they can have any slope. After the tracking cross pattern has been placed at the output terminal of the element by the light pen, the

## Scaling the hybrid-computer's variables

To facilitate amplitude and time scaling, the integrators in the computer are arranged in groups of five. Each integrator group contains at its input a digital potentiometer with a range from 0.001 to 1 and an amplifier with gains of 1, 10, and 100. Potentiometer values are selected by ferreed switches and can be changed in increments of 0.001 to change time-scale factors. Time scale of all stages can be changed in one operation.

Similar potentiometers and amplifiers are at each integrator's output for amplitude scaling. These are also ganged to provide simultaneous control. A reciprocal amplitude scale gain-control unit closes the loop. As the digital computer varies the scale factor, the operator watches the answer and selects the most appropriate factor.

**More systematic.** The usual method of finding the time and amplitude scale factors,  $\alpha$  and  $\beta$ , is by trial and error. In the new hybrid computer, the scale factors are introduced in a more systematic manner. The following equation illustrates the method

$$y''(t) + a_1 y'(t) + a_0 y(t) = 0$$

$$y'(0) = y'_0 \quad y(0) = y_0$$

The independent variable can be related to the machine time,  $\tau$ , by the transformation equation

$$\tau = \alpha t$$

The dependent variable can be represented in the computer by a voltage of  $Y$ . Equation (1) is rewritten

$$\alpha^2 Y''(\tau) + \alpha_1 Y'(\tau) + \alpha_0 Y(\tau) = 0$$

$$\alpha Y'(\tau) = y'_0 \quad Y(0) = y_0$$

It is reasonable to relate the variable  $Y$  to the corresponding machine variable  $X$  through the amplitude scaling

$$X = \beta Y$$

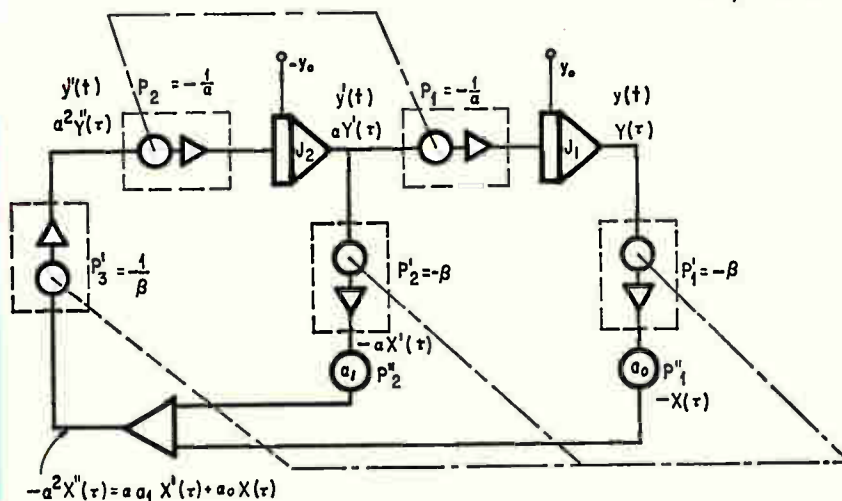

and the resulting machine equation can be written

$$\alpha^2 X''(\tau) + \alpha a_1 X'(\tau) + \alpha_0 X(\tau) = 0$$

$$\alpha X'(\tau) = \beta y'_0 \quad X(0) = \beta y_0$$

Solving for the double derivative

$$X''(\tau) = -\frac{\alpha_1}{\alpha} X'(\tau) - \frac{\alpha_0}{\alpha^2} X(\tau)$$

The time scale factor cannot be set up simply. In a nonlinear equation, amplitude and time scale factors are combined in one potentiometer setting, and this increases the complexity of the problem.

The new method makes systematic use of the  $1/\alpha$  rate of change of the variable on the time axis so that the variables of time in equation (1) become:  $Y''(\tau)$ ,  $Y'(\tau)$ , and  $Y(\tau)$ . The new (amplitude scaled) machine variables are made  $\beta Y''(\tau)$ ,  $\beta Y'(\tau)$  and  $\beta Y(\tau)$  which now become  $X''(\tau)$ ,  $X'(\tau)$ , and  $X(\tau)$ .

The new time variable is set up on the computer as the constant of the integrators, and the rate of change of this variable on the time axis is  $1/\alpha$  real time, so the speed of integration must be  $1/\alpha$  real time. The diagram shows how the equation is set up in terms of the scaled variables.

Each of the two integrators,  $J_1$  and  $J_2$ , has a potentiometer connected in series with its input. If the output of  $J_2$  is  $\alpha Y'(\tau)$ , then the output of  $J_1$  must be  $Y(\tau)$ . If  $\alpha Y'(\tau)$  and  $Y(\tau)$  are each multiplied by  $\beta$ , the products will be  $\alpha X'(\tau)$  and  $X(\tau)$ . The output of potentiometer  $P'_2$  is  $-\alpha X'(\tau)$ , and the output of potentiometer  $P'_1$  is  $-X(\tau)$ , so the output of the summing amplifier is  $-\alpha^2 X''(\tau)$ . If  $-\alpha^2 X''(\tau)$  is multiplied by  $-1/\beta$ , its output is  $\alpha^2 Y''(\tau)$ , which is the signal required to close the loop.

Potentiometers  $P_1$ ,  $P_2$ ,  $P'_1$ ,  $P'_2$ ,  $P'_3$ ,  $P''_1$ , and  $P''_2$  are all digital. The nonprimed potentiometers are built into the input of the integrators and are ganged to facilitate adjusting the time scale. The primed potentiometers are built into the output leads of the integrators and are ganged to facilitate adjusting the amplitude scale. The double-primed potentiometers are independent units used where needed for setting the coefficients.

$\alpha$  and  $\beta$  are set for the appropriate values by the following steps

- $P''_1$  and  $P''_2$  are set to coefficients  $a_0$  and  $a_1$ .

- Values thought to be appropriate for  $\alpha$  and  $\beta$  are selected and set by potentiometer groups ( $P_1$ ,  $P_2$ ) and ( $P'_1$ ,  $P'_2$ ,  $P'_3$ ).

- The step above is repeated as many times as necessary to obtain the appropriate values for  $\alpha$  and  $\beta$ .

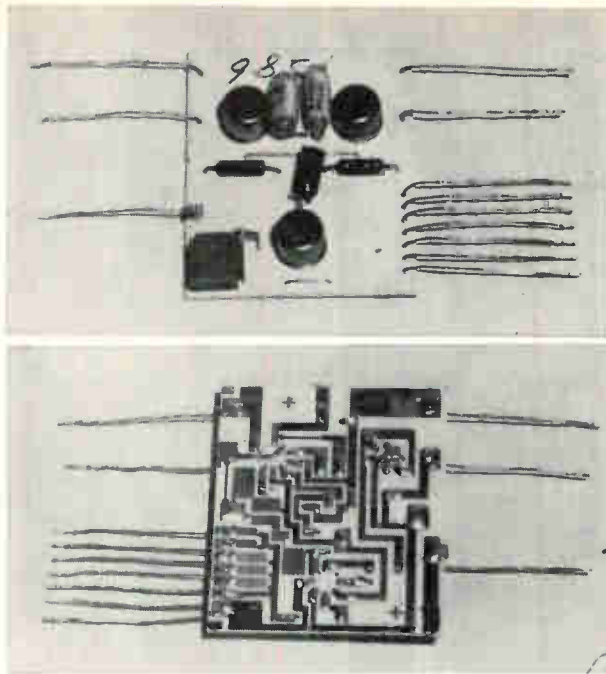

**Top and bottom views.** The complete summing amplifier consists of a monolithic integrated-circuit operational amplifier, four metal oxide semiconductor field effect transistors, thin-film resistors, discrete-component capacitors, and a potentiometer.

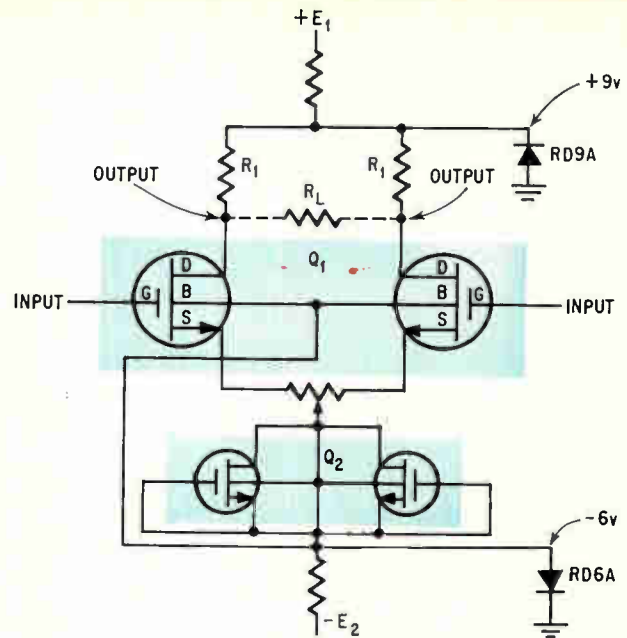

**Booster.** Because the open-loop gain and the input impedance are too low to build the summing amplifier with just an operational amplifier, a MOS differential amplifier is used as the input stage to the op amp.

vector writing button is pushed. The pen is then placed at the input of the next computing element displayed. When the GO button is pushed, a line connecting the two terminals appears on the screen. The coordinates of the straight-line segments are stored in the memory.

The diagram can be easily corrected or modified by the light pen and the pushbuttons on the control desk. To erase a pattern, the light pen is touched to the output terminal of the element and the SYMBOL ERASE button is pushed. A line segment can be erased by pushing the CONNECT ERASE button, which calls up the erase program from memory, and then touching the light pen to the end points.

Initial conditions are drawn on the crt in much the same way as the setup diagram, except that the voltage reference is the 5 volts used for the IC's. Multiplier factors can be varied over a range of  $10^5$  from 0.001 to 100. Potentiometers cover a range of 0.001 to 1, and amplifier gains can be varied in steps of 1, 10, and 100.

The hybrid IC operational amplifiers are built around the  $\mu$ PC 51 and  $\mu$ PC 53 monolithic circuits made by the Nippon Electric Co. The characteristics of the  $\mu$ PC 51 are similar to those of the  $\mu$ A 702 developed by Fairchild; the  $\mu$ PC 53 differs mainly in an added output buffer stage that lets the amplifier drive lower impedance loads. The  $\mu$ PC 53 can deliver full voltage output for loads of 2 kilohms or greater, while the  $\mu$ PC 51 cannot deliver full voltage output unless the load is greater than 100 kilohms.

The  $\mu$ PC 53 was adequate for a summing amplifier only with the addition of a high input-impedance MOS FET differential amplifier as a preamplifier. This was mainly because of the op amp's low input resistance and high input bias currents and the lack of sufficient gain at 0.1% accuracy.

So as not to deteriorate the IC's performance, it was important that the differential amplifier's output voltage be kept within the limits of the linear input range of the  $\mu$ PC 53—+1 volt to -3 volts. The MOS FET's were biased to operate in the saturation region. The sum of their drain-to-source voltages was kept below the negative supply voltage of -6 volts. To operate within the saturation region,  $Q_2$ 's drain-to-source voltage had to be at least 4 volts or more. Consequently,  $Q_1$ 's drain-to-source voltage is less than 2 volts and its pinch-off voltage had to be lowered by applying a negative bias to its substrate.

In addition to the IC op amp, the complete summing amplifier comprises the MOS FET's, tantalum nitride thin-film resistors, discrete capacitors, and a small potentiometer for zero adjustment. The amplifier is built on a ceramic substrate.

To build an integrator with an accuracy of 0.1%, chopper-stabilized amplifiers had to be used at the input to the  $\mu$ PC 53 to increase its gain and reduce its drift. And the integrators had to operate both quickly and slowly; the standard computing time for slow operation is 2 minutes, and repetitive periods for fast operation are 100, 50, 25, 12.5, 10, 5, and 2.5 milliseconds.

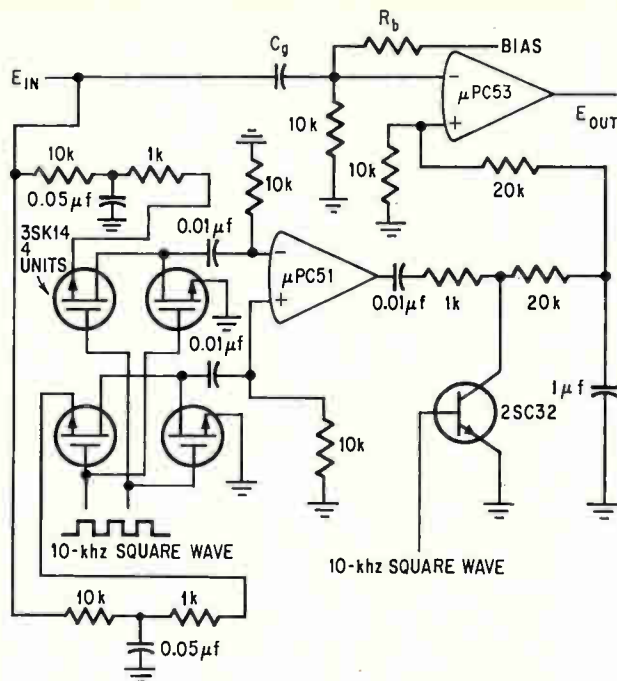

**Obtaining higher accuracy.** The d-c gain of the  $\mu$ PC 53 operational amplifier is insufficient to construct an integrator with an accuracy of 0.1%, so chopper-stabilized amplifiers are used for the reduction of drift and increase in gain.

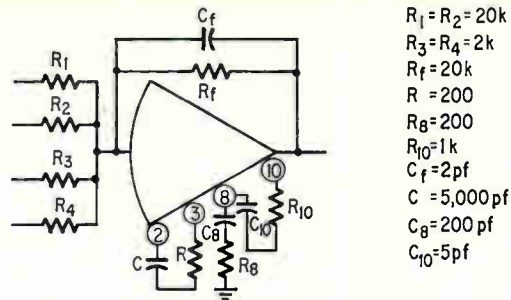

- $R_1=R_2=20k$
- $R_3=R_4=2k$
- $R_f=20k$
- $R=200$
- $R_8=200$
- $R_{10}=1k$
- $C_f=2pf$
- $C=5,000pf$
- $C_8=200pf$
- $C_{10}=5pf$

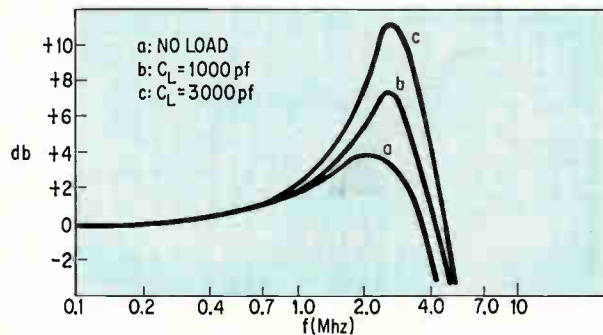

**Response.** The curves show the frequency response under different loading conditions with the selected values for the phase compensation circuit. The drift is 1 millivolt per day at room temperature for unity-gain amplifiers. The noise at the input is about 3 mv peak-to-peak.

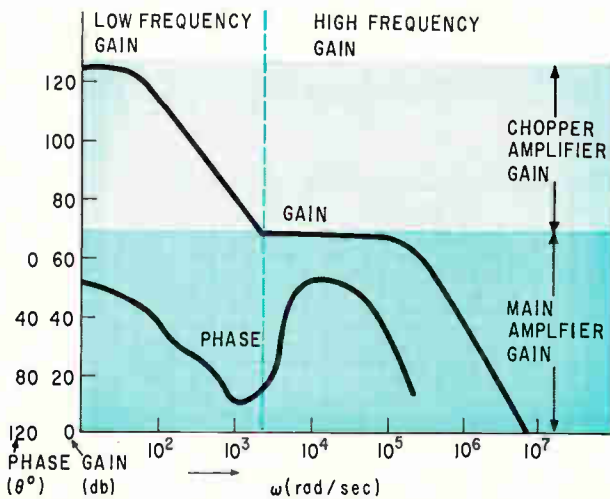

**Stability.** Curves show gain and phase shift versus frequency for the chopper-stabilized operational amplifiers. For low-frequency signals, the chopper amplifier provides enough gain and the amp's gain is the sum (in decibels) of the gains of the chopper amplifier and the main amplifier. Phase lag is determined mainly by the chopper amplifier. For high-frequency signals, the gain of the chopper amp falls below 0 decibels and the op amp's characteristics are determined solely by the main amplifier. For signals at the borderline, phase-shift dependence changes from the chopper amplifier to the main amplifier, with a rapid change occurring over a narrow frequency range. As long as the phase shift remains below  $90^\circ$ , the amplifier will be stable when connected in a feedback configuration.

The chopper circuit, whose main amplifier is a  $\mu$ PC 51 because low output impedance is not required for this function, is composed of four MOS FET's arranged in a double-twin circuit (top left). The circuit is active on both positive and negative half cycles of the excitation input, and thus gives twice the gain of a simpler circuit active on only the positive or the negative half cycles. The double-twin circuit also compensates for the spike voltages induced by the chopper excitation signals.

### Picking the parameters

The 10-kilohertz chopper excitation frequency was chosen to minimize the size of the capacitors in the filter circuits. The over-all d-c gain of the chopper-stabilized operational amplifier is 125 decibels, and the input impedance is about 20 kilohms. The integrator's capacitors are determined from the hold-mode characteristics for the integrator. The accuracy of integrators in the hold mode must be kept to within 0.1% during computation. In low-speed operation, this condition requires that the feedback capacitor be greater than 3 microfarads. Ten- $\mu$ f polycarbonate capacitors were chosen—even though the dissipation factors of polycarbonate capacitors are inferior to those of polystyrenes—because the polycarbonates are only about 1/25 as large.

In repetitive operation, the feedback capacitor must be greater than 5,000 picofarads for a 100-millisecond period, because the frequency characteristic of the chopper-stabilized amplifiers is es-

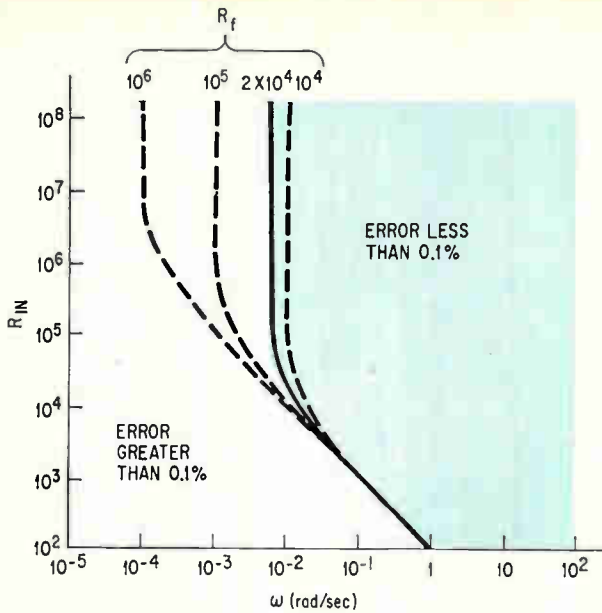

**Integrator resistance.** Integrating resistance was decided from the integration error, which depends upon the gain of the operational amplifiers, the time constant of the integrators, and the input impedance. The light-shaded region shows that the error is less than 0.1% for low-speed operation at a capacitance of 10 microfarads. For wide-band operation, at least a 100-kilohm resistor is needed.

essentially that of the main amplifiers, and the input impedance is 5 kilohms. For design simplicity, a 10,000-pf polystyrene integrating capacitor is used for all repetitive periods.

The integrating resistance, however, was based on the integration error, which depends upon the gain of the amps, the time constant of the integrators, and the input impedance. The hatched region of the graph (top left) shows that the error of the integrators, when the capacitance is 10  $\mu$ f, is less than 0.1% for low-speed operation. A resistance value of 20 kilohms was chosen based on the requirement that the integrators respond to at least 5 times the maximum repetitive frequency.

The changeover from low speed to repetitive operation is done with miniature relays. Therefore the effect of crosstalk can be reduced to a negligible value.

Circle tests, used to give an indication of integrator performance, showed that the over-all accuracy of the integrators was 0.2% at 16 kilohertz. The holding error for 2 minutes is within 5 millivolts for the 10- $\mu$ f capacitors, and the integrators are stable with a load capacitance that is at least 1,500 picofarads.

The multipliers developed for the computer are of the quarter-square type, using MOS FET's as the squaring elements. MOS FET's are known for their parabolic characteristics in both the saturation and nonsaturation regions. They are small

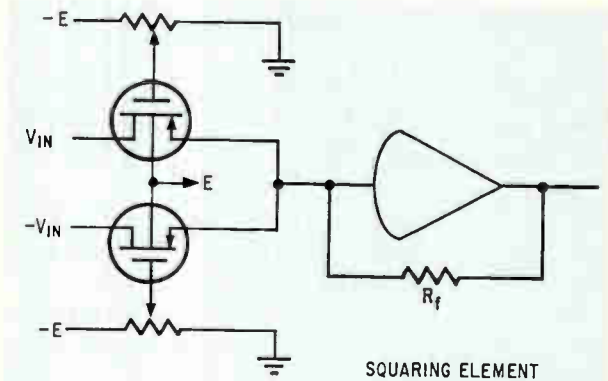
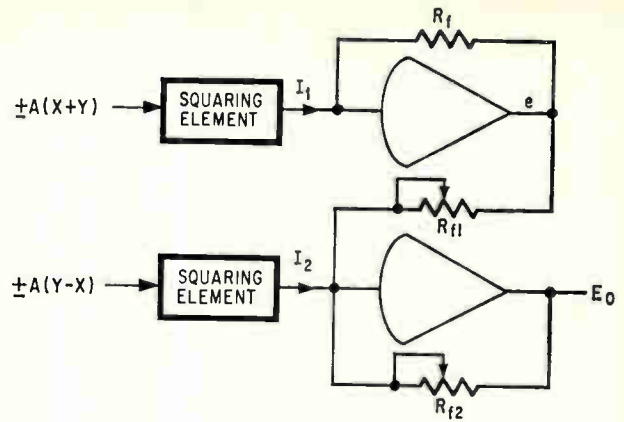

$$I_1 = K_1(X+Y)^2$$

$$I_2 = K_2(Y-X)^2$$

$$e = -K'(X+Y)^2$$

$$E_0 = KXY$$

$$-(X+Y)^2 = -X^2 - Y^2 - 2XY$$

$$+(X-Y)^2 = X^2 + Y^2 - 2XY$$

$$\frac{-X^2 - Y^2 - 2XY + X^2 + Y^2 - 2XY}{-4XY}$$

THE SECOND OPERATIONAL AMPLIFIER INVERTS SIGNAL (-4XY) AND ADJUSTS COEFFICIENT SO  $E_0 = KXY$

**Multiplier configuration.** The coefficient of one squaring element is usually not precisely the same as that of the other. They must be identical, though, to obtain the desired result. Potentiometer  $R_{f1}$  is used to adjust the gain of the upper squaring element's output so that its coefficient is identical with that of the lower squaring element. Then the output signal and level is adjusted by potentiometer  $R_{f2}$  so that when the input to each of the two input terminals is one machine unit, the output signal is also one machine unit.

and suitable for use with IC's. Their accuracy at small signal levels is good because of their continuous parabolic characteristics, and their frequency bandwidth—almost the same as for the IC operational amplifiers—was considered to be wide enough.

The input signal range of the MOS FET is 1 to 3 volts peak-to-peak, so the signal level of the analog computer ( $\pm 5$  volts) must be attenuated at the circuit input. ■

# Cryoelectric memories: best hope for large and fast storage units

The devices will be both speedier and cheaper than present types; a single driver can handle a great number of storage elements and a single amplifier can sense many memory positions

By Robert A. Gange

RCA Laboratories, Princeton, N.J.

**Faster and cheaper** memories than any available now—that's the promise held out by research on cryoelectric memories.

In a cryoelectric unit, one driver can actuate up to 10,000 times as many storage elements as in conventional magnetic or semiconductor memories, and a single amplifier can sense as many more memory positions. What's more, these elements can work very fast, with minimum noise, because they have very low power densities and an extremely non-linear transition between the superconducting and normal states.

The basis for these assertions is a "technology performance index" that compares various memory forms from the point of view of a physicist rather than that of an engineer. This index shows that further development of cryoelectric technology is very worthwhile, even with room-temperature magnetic and semiconductor technologies' rapid evolution. Even the sophisticated refrigerators to attain the extremely low operating temperatures that cryoelectric memories require are only a minor problem.

One large-scale cryoelectric memory design has been successfully worked out. It relies upon a new memory element and a new organization to maximize speed and minimize cost. And it indicates that the predictions based on the technology performance index are fully realizable.

Cryoelectric memories are based on an exotic physical phenomenon called superconductivity—the disappearance of electrical resistance from certain materials at temperatures near absolute zero, in the absence of a magnetic field [see "Removing resistance," p. 111]. These memories can be built of a large number of ring-shaped storage elements, each of which can retain a small electric current that cir-

This is the seventh installment in *Electronics'* continuing series on memory technology, which began in the October 28, 1968, issue.

culates indefinitely in the absence of resistance, just as a ferrite core retains a magnetic flux indefinitely.

To compare the inherent performance capabilities of different systems based on different technologies but serving a common purpose, a common denominator must be found that transcends design innovation and is more basic than such parameters as speed. Such a denominator can be derived from physical constants such as the speed of light and the characteristic impedance of transmission lines.

In all memory systems, an input signal selects a particular bit or word in preparation for storing data or interrogating previously stored data. It propagates along a line of B bits spaced X meters apart, during a time interval determined by the length of the input line, BX, and the velocity of propagation  $1/(LC)^{1/2}$ , or

$$Z_0 = (L/C)^{1/2}$$

where L and C are the distributed inductance and capacitance per meter of the input line. But the characteristic impedance of the input line is

$$T = BX(LC)^{1/2}$$

assuming that the line is lossless. In terms of characteristic impedance, therefore, the propagation time along the line is either

$$T = BXCZ_0 \quad \text{or} \quad T = BXL/Z_0$$

substituting for L or for C respectively.

Therefore, if the maximum number of bits per second transferred to or from the system is  $\beta$ ,

$$\beta = B/T = Z_0/LX = 1/CXZ_0$$

The second equality applies to cryoelectric and other magnetic memories, and the third to metal oxide semiconductor memories, in terms of the ruling reactance in the respective cases.

This represents an absolute upper limit on the rate at which information can be stored or retrieved.

An output constraint,  $\alpha$ , corresponding to the input constraint,  $\beta$ , depends on the technology being considered.

In a magnetic memory, each storage element couples a useful maximum flux linkage,  $\phi$ , to the output. This is less than the total input flux for that bit, because of losses in the memory. The input flux per bit equals the product of the input current,  $V_{in}/Z_{in}$ , and the inductance per bit,  $L_{in}X$ . The output parameter,  $\alpha$ , is, by definition, the ratio of the minimum input voltage to the maximum output flux or

$$\alpha = V/\phi_{out}$$

Substituting the greater value of the input flux in the denominator of this fraction

$$\alpha > \frac{V}{(L_{in} X) V/Z_0} = \frac{Z_0}{L_{in} X}$$

An analogous situation exists in semiconductor memories built with MOS storage elements, except that the coupling constraint relates to electric charge instead of flux linkage. The MOS element couples a maximum charge,  $Q$ , to the output. This is less than the input charge; the latter, in turn, equals the product of the input voltage,  $IZ$ , and the capacitance per bit,  $CX$ . In this case, the definition of the output parameter, again denoted by  $\alpha$ , is the ratio of the minimum input current to the maximum output charge, or

$$\alpha = I/Q$$

Substituting as before,

$$\alpha > 1/CXZ$$

The cryoelectric system is actually a form of magnetic memory, but the former's losses are quite small, and an additional factor must be included in the output parameter inequality:

$$\alpha > Z/LX \gamma$$

This factor,  $\gamma$ , is necessary because the memory's output, some seven orders of magnitude smaller than that of other magnetic memories, requires a high-gain amplifier, which is at the temperature of liquid nitrogen or at room temperature. (Even the former—about  $-200^\circ\text{C}$ —is warm compared with the elements' operating temperature.) This temperature difference is important because it permits the amplifier gain to be increased with no attendant increase in thermal noise.

Although the cryoelectric memory is free of

common-mode and other forms of coherent noise, the transition from cryogenic to room temperature generates thermal noise. This remains relatively small if the memory output signal is boosted by a transformer on the cryogenic side of the interface, so that the thermal noise is only a small fraction of the signal presented to the amplifier.

The factor  $\gamma$  depends on the transformer turns ratio, the inductances in the storage element that determine current paths when data is being stored, and the ratio of the currents used when data is being stored. The maximum value of  $\gamma$  is about 360; currently attained values are closer to 5 or 10.

Because the input parameter,  $\beta$ , is the maximum number of bits per second transferred into the system, it's also a measure of system bandwidth. The output parameter,  $\alpha$ , is the ratio of an input quantity to an output quantity, and as such is a measure of system cost.

20,000,000



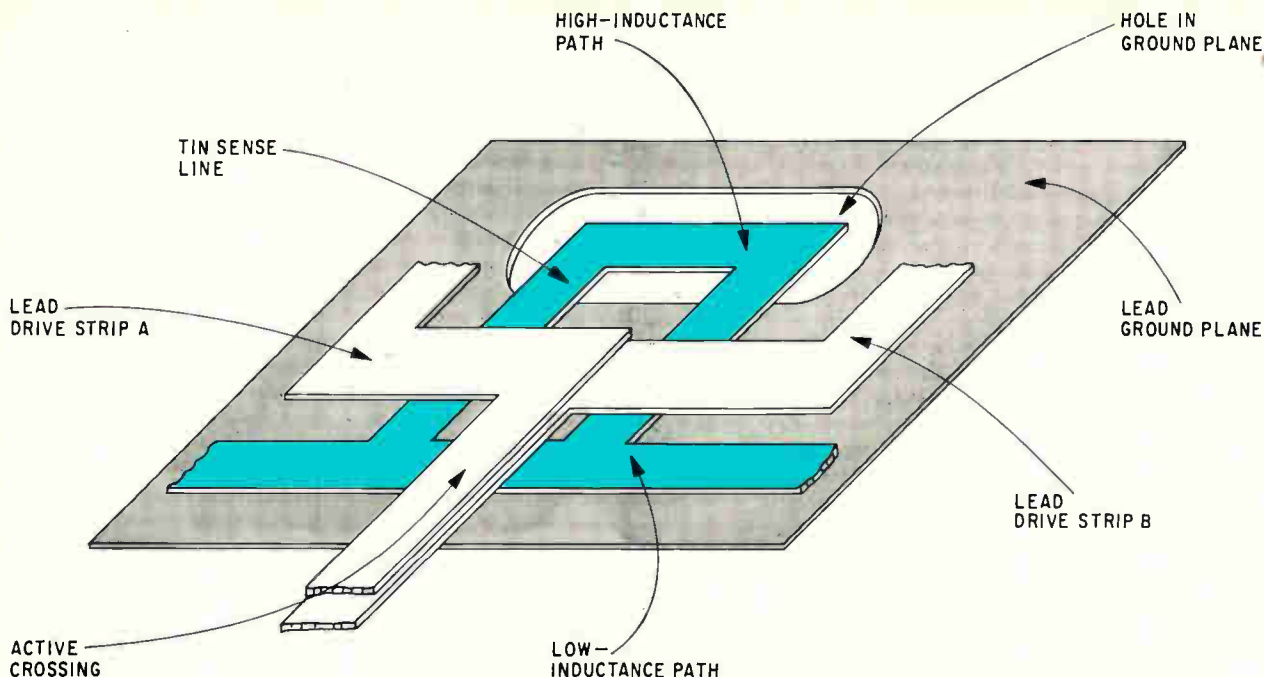

**Loop cell.** These four layers of lead and tin are the basis of a large cryoelectric memory. A circulating current in the tin loop corresponds to a stored binary 1. The increased inductance created by the hole in the ground plane tends to maintain this circulating current; current in the drive line sets up resistance in the loop, which tends to oppose the circulating current.

For example, of two systems, the one that requires the higher input voltage costs more because more energy passes through a given volume of it in a given time, and therefore it has higher dielectric losses. This translates into a larger number of drivers to activate a given number of bits, or fewer bits activated by a given number of drivers.

The higher input voltage also implies a higher input impedance and, for a comparable bit capacity, a higher inductance per unit length of line. This in turn means a longer propagation delay, or, again, fewer bits activated per driver.

The same higher input impedance also implies a longer time constant. This means it takes longer to decode an address, or that fewer lines can be addressed in a given time by a single decoder.

Higher input voltage also implies more noise coupled to the sense lines, with consequently fewer bits per amplifier, increasing costs still more.

Similar considerations are higher driver voltages, higher bit voltages, higher power supply requirements, and higher voltage stress. The last increases costs by reducing reliability.

And of two systems, the one with the lower output flux or charge requires better amplifiers and has a poorer signal-to-noise ratio.

Clearly, then, the ratio of  $\beta/\alpha$  should be as large as possible. But equally clearly, the ratio has natural upper bounds that cannot be circumvented through design innovation. These upper bounds are 1 for other magnetic and semiconductor memories and  $\gamma$  for cryoelectric memories.

Expressing the ratio  $\beta/\alpha$  in terms of the indi-

vidual expressions is rather awkward. But these can be re-evaluated as follows: For cryoelectric and other magnetic memories, in which  $\alpha$  is the ratio of input voltage to output flux:

$$\begin{aligned} \frac{\beta}{\alpha} &= \frac{Z_{in}}{XL_{in}} \cdot \frac{\phi_{out}}{V_{in}} \\ &= \frac{1}{I_{in}} \cdot \frac{I_{out} L_{out}'}{XL_{in}} \cdot \frac{B}{B} \\ &= \frac{I_{out}}{I_{in}} \cdot \frac{L_{out}'}{L_{in}'} \cdot B \end{aligned}$$

The input flux was expressed as flux per bit, but the output flux is the total. It equals the output current times the total output inductance; the prime in the formula distinguishes total inductance from the corresponding inductance per meter. Multiplying the entire expression by  $B/B$  introduces the number of bits into the denominator, converting that term to the total input flux. ( $L_{in}$  is in henrys per meter and  $XL_{in}$  in henrys per bit, so  $BXL_{in}$  is measured in henrys.)

For semiconductor memories, the ratio  $\alpha$  is that of input current to output charge:

$$\begin{aligned} \frac{\beta}{\alpha} &= \frac{1}{CXZ_{in}} \cdot \frac{Q_{out}}{I_{in}} \\ &= \frac{C_{out}' V_{out}}{C_{in} X V_{in}} \cdot \frac{B}{B} \\ &= \frac{C_{out}'}{C_{in}'} \cdot \frac{V_{out}}{V_{in}} \cdot B \end{aligned}$$



In these expressions the ratios of output to input inductance and capacitance are clearly visible and can be designated  $r_x$ . Likewise, the ratios of output to input current and voltage can be renamed  $r_y$ . Then the ratio  $\beta/\alpha$ , which is equivalent to bandwidth per dollar, can be expressed:

$$\frac{\beta}{\alpha} = r_x r_y B < 1$$

for other magnetic and semiconductor memories, and

$$\frac{\beta}{\alpha} = r_x r_y B < \gamma$$

for cryoelectric memories.

### Orders of magnitude

In the former, the input and output propagation velocities can be assumed to be equal, which means that  $r_x = 1$ . The inductance ratio  $r_y$  in a magnetic memory can range from about  $5 \times 10^{-5}$  to  $5 \times 10^{-4}$ ; the capacitance ratio in the semiconductor memory is just about in the middle of this range, or  $10^{-4}$ . These lead to the maximum module sizes for these two forms of memory: 2,000 to 20,000 bits per access line in a magnetic memory, and about 10,000 in MOS.

In a cryoelectric memory, however,  $r_y$  is about  $7 \times 10^{-6}$  and  $r_x$  only about 0.4; these quantities show that the maximum number of bits per access line can be as high as  $2 \times 10^7$ , or 20 million.

Thus a much larger number of bits in a cryoelectric memory is accessible with one driver or detectable with a single amplifier. Experimental results corroborate this prediction.

Only one large-scale cryoelectric memory has been successfully designed and built. The work was done at RCA Laboratories, and the second-generation results were announced about two years ago [Electronics, April 17, 1967, p. 111]. Further work has substantially increased the packing density without sacrificing either output signal amplitude or the operating tolerances on drive currents. These are typically 200 microvolts and  $\pm 10\%$ . The highest density arrays built to date have a quarter-million bits in 24 square inches. This is the largest cryogenic array ever built that works consistently over the entire area, as verified by numerous statistical measurements.

The lack of success of other attempts is attributed to the narrow dimensional tolerances required, the insufficient attention paid to system considerations in designing the elements, and the dependence on cryoelectric address decoders instead of room-temperature decoders.

### Generation gaps

The second-generation storage element consists of four metallic layers electrically insulated from one another, as shown opposite: a lead ground plane with holes etched in it, a tin digit strip containing a series of loops (one for each storage cell), and two lead drive lines. This is similar to the first-generation element, but the rearranged holes

## Removing resistance

Fifty-eight years ago the Dutch physicist H. Kamerlingh Onnes—who three years previously had been the first person to liquefy helium—discovered that mercury's electrical resistance suddenly disappeared if it were cooled to within about  $4^\circ$  above absolute zero. Other metals he was familiar with because less and less resistive as they were cooled, but their resistance eventually leveled off at a value and at a temperature that depended on how pure they were.

Onnes named the new phenomenon superconductivity, and called materials that exhibited it superconductors.

Shortly after Onnes' discovery, other investigators found that if a superconducting metal were placed in a sufficiently strong external magnetic field, it regained its resistance. The threshold implied by the word "sufficiently" is called the critical field.

**Second property.** Superconductors were thought to be simply ideal conductors until 1933, when they were found also to be perfectly diamagnetic—that is, in the presence of a subcritical magnetic field the field was wholly excluded from the interior of the material except for a thin layer a few thousandths of a mil under the surface.

By itself, this diamagnetic property might be explained by postulating that applying a field to a superconductor sets up eddy currents in its surface. These eddy currents would have associated magnetic fields equal and opposite to the applied field, and in the superconductor the eddy currents would persist indefinitely, in the absence of resistance.

But it isn't quite that simple. If a magnetic field is applied to a superconductor at room temperature, the eddy currents exist while the field is applied and then die away, so that the field passes through the material. Then if the superconductor is cooled below its critical temperature while the field is maintained, it actually expels the field when it becomes superconductive.

and digit strips permit a significantly higher density. Current in the drive lines produces a magnetic field that switches the tin in the digit strip immediately beneath into the normal state. The drive lines themselves remain superconducting. Ordinarily the digit current passes under the drive lines, but when that part of the loop becomes resistive, the current is diverted to the other side of the loop, where the inductance is higher because of the hole in the ground plane. When the drive currents turn off, the entire loop returns to the superconductive state; the inductance establishes a circulating current in the loop that corresponds to a stored binary 1; absence of current indicates a 0.

A third-generation anisotropic structured element attains even higher density by putting the drive lines over the high-inductance part of the loop without increasing the lines' inductance. Details of the technique are proprietary.

In the cryoelectric hybrid system built from these

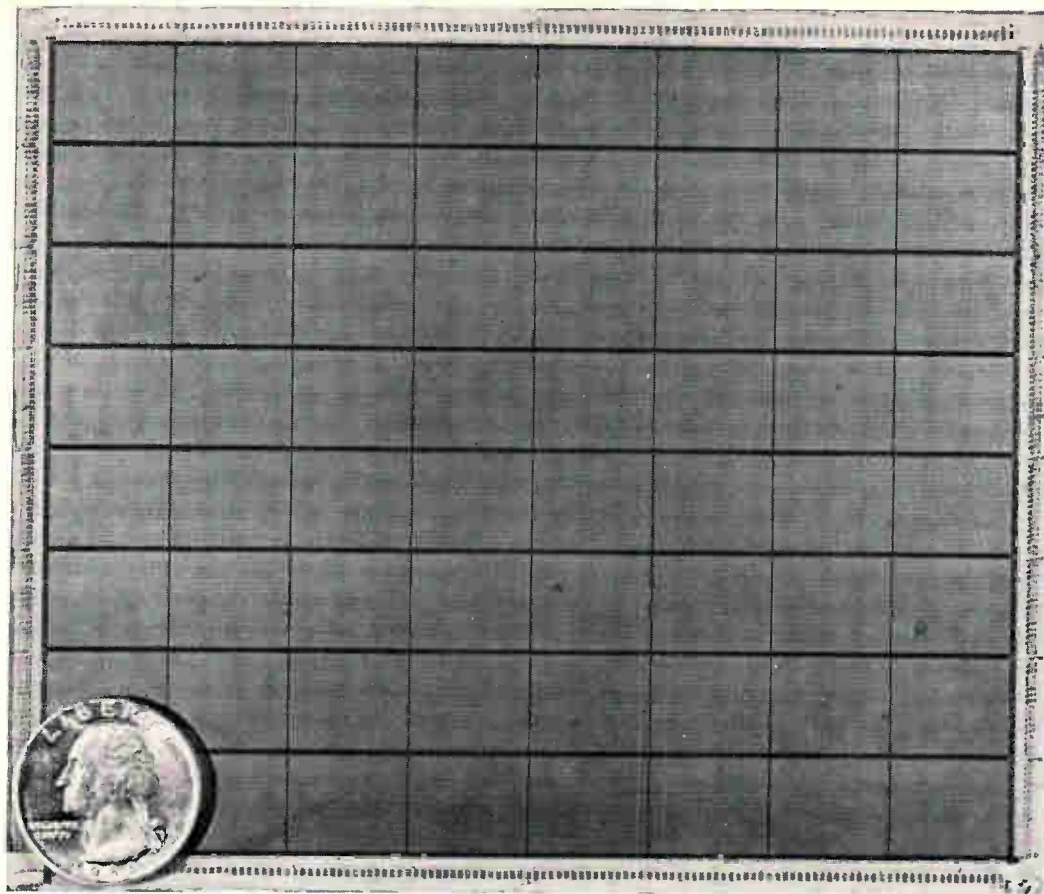

**Cold array.** This plane contains 262,144 cryoelectric storage elements in 24 square inches.

elements, the drive-line inductance is negligible even when the bit capacity is very large, because the superconducting metal is diamagnetic—it excludes all magnetism from its interior. (This property, incidentally, justifies the name “cryoelectric” for this form of memory. Cryogenic is too broad—it covers all low-temperature phenomena—and cryomagnetic implies ferromagnetism, not diamagnetism.)

The diamagnetic property also effectively eliminates all interaction and noise coupled through the substrate. Only one pair of decoders and drivers, therefore, is required for the entire system, and they can be made very small and simple. Furthermore, they may be kept at room temperature, so that they can be checked out independently of the memory array. Low interaction and noise also permit the sense signals to be unambiguously detected even when they are very small, so that the storage elements themselves can also be very small and closely packed.

Cooling the cryogenic portion of the memory isn't difficult, with currently available refrigeration equipment. Although the cost of this equipment is perhaps half that of the entire system, the ultimate size that the technology performance index predicts would require a refrigerator whose cost was small relative to that of the entire system.

If such a system suffered even a minor failure, it would be out of operation for quite awhile, because

cooling it to cryogenic temperatures after making the repair would take several hours. But the chances of its ever breaking down are very small, because at 3.5°K nothing deteriorates.

#### **Other work**

Much of the cryogenic memory work outside RCA Laboratories seems to be principally of academic interest. Some researchers are studying the Josephson junction—a sandwich of a thin normal layer between two superconductors that behaves somewhat like a tunnel diode—but this device is still far from any practical applications. Several projects were under way at one time to develop a cryogenic associative memory, but most of these have been discontinued or cut back; the projected costs remained very high relative to the rapidly decreasing costs of other technologies.

Unquestionably, if cryogenics ever becomes a commercially practicable memory technology, it will be used for large random-access stores—the area being pursued at RCA. The only published effort with prospects of practical application is at Siemens AG in West Germany. That project is based on using a continuous film, and at last report had encountered some problems with materials. Several similar projects in various organizations have encountered such problems; a continuous film project at RCA Laboratories was discontinued in favor of the present approach. ■

# Announcing the birth of Linear, our 3-year old baby.

**(and a free booklet on all the things he can do)**

In a way, linear has been the neglected child around our place for some time.

Of course, the line has been growing and getting healthier every day. We've just been a bit lax in getting it out into the world.

But now, Here It Is: mature, sophisticated and long-since out of diapers.

We have a wide line of linear devices ranging from core memory sense amplifiers to video amplifiers. They've been designed for both the circuit and the system designer.

Design flexibility is built into the line with operational amplifiers, differential amplifiers, high speed comparators, and RF/IF amplifiers, which can be used alone, or in conjunction to increase performance and design versatility.

Our new Linear booklet contains 49 linear circuit applications which illustrate some of the more subtle features that are built into the line.

The applications include: tuned circuit, AGC, sense, logarithmic, DC, summing and pulse amplifiers; local oscillators; modulators; hi-speed comparators; limiters; integrators; DC servos; Schmitt Triggers; line drivers; clock generators; voltage regulators; differentiators; line receivers; threshold and double-ended limit detectors. Buzz, buzz, buzz.

Signetics Linear Circuits are exhaustively tested to in-house and customer specs. In addition, all are subjected to the most stringent environmental testing through our "SURE" program.

All our linears are available through distributors in either 0°C to 70°C, or -55°C to +125°C operating temps.

And that's not the end. Like all precocious progeny, Linear is expected to produce some startling developments in the near future.

To keep up with this baby, you've got to have the book. Write to the proud parents: Signetics, 811 East Arques Ave., Sunnyvale, Calif. 94086.



SIGNETICS CORPORATION: A SUBSIDIARY OF CORNING GLASS WORKS

# Lighting the way to flat-screen tv

Developmental receiver uses a matrix of electrodes to energize an electroluminescent screen; the picture is bright figuratively—but not yet literally

By Masami Yoshiyama

Matsushita Wireless Research Laboratory, Tokyo

**Flat electroluminescent panels** may someday replace the familiar cathode-ray tubes in television sets if an experimental display being investigated by Matsushita researchers can be further developed for production. Designed to operate at the 525-line standard, the all-solid state panel can display a picture with a viewable diagonal measurement of 13 inches. Although the display system, including its companion receiver, employs a total of 8,600 discrete components, its power dissipation is only 100 watts.

An important feature of the flat display is that since there's no electron beam to contend with, there's no need for deflection coils or a high-voltage power supply.

The panel is made on a glass substrate and has a layer of zinc sulfide phosphor sandwiched between the vertical and horizontal electrodes that form the picture elements at their crosspoints. And there's a layer of barium titanate between the phosphor and rear electrodes to provide a non-linear impedance and thus improve performance.

There is still an obstacle to be overcome in this design, though. Because the zinc sulfide phosphor does not yield a particularly bright light, the display can't be viewed comfortably in a well-lighted room. It's hoped that both brightness and picture contrast can be improved by replacing the zinc sulfide phosphor with zincsulfoselenide,  $Zn(S, Se)$ .

Although the system is being developed to handle standard tv pictures, it could, with slight modifications, be applied to alphanumeric or graphic displays. Until now, the only EL displays capable of reproducing high-density tv picture elements have been converters or intensifiers using an optical input. One such system has already been developed by the Matsushita Research Institute of Tokyo [*Electronics*, Sept. 20, 1963, p. 30].

In a conventional 525-line system, about 10% of the lines occur when the beam is returning from the bottom to the top of the picture, and hence cannot display picture information. Also, a num-

ber of other lines are hidden under the top and bottom of the picture-tube mask. The maximum number of lines that make up the picture, therefore, is about 470. And in actual practice, the bandwidth limitations of the receiver, coupled with the difficulty of achieving full deflection of the picture tube's scanning beam, limit the vertical resolution of conventional receivers to about 340 lines. The horizontal resolution is about 80 lines for each megahertz of bandwidth at the broadcast scan rates.

The experimental display has 230 vertical and 230 horizontal electrodes, for a total of 52,900 picture elements, each measuring 1 by 0.75 millimeter. Unlike interlaced scanning systems, both fields—odd and even—are displayed successively on the same horizontal lines. And although the image reproduced isn't yet comparable to the average tv picture, it shows as much detail as some of the inexpensive helical-scan video tape recorders on the market today.

In addition, the experimental system isn't subject to the main shortcomings of previously developed flat-screen displays. The earlier designs have proven increasingly difficult to manufacture as picture elements are added. Furthermore, interaction between elements would start to set in as the number of elements increased, and this so-called cross-effect diminished picture contrast. The Matsushita display has its problems, but not these.

The number of reproducible picture elements largely depends on the number of vertical and horizontal electrodes on the panel. As shown on page 120, the vertical electrodes face the front of the display; they're made transparent so as not to obstruct illumination of the phosphor screen.

If an alternating voltage is applied between two electrodes, say  $x_i$  and  $y_j$ , the brightness of the picture element at the intersection will be proportional—within certain voltage limits—to an exponent of the applied voltage, and will be directly proportional to the voltage frequency. And if the

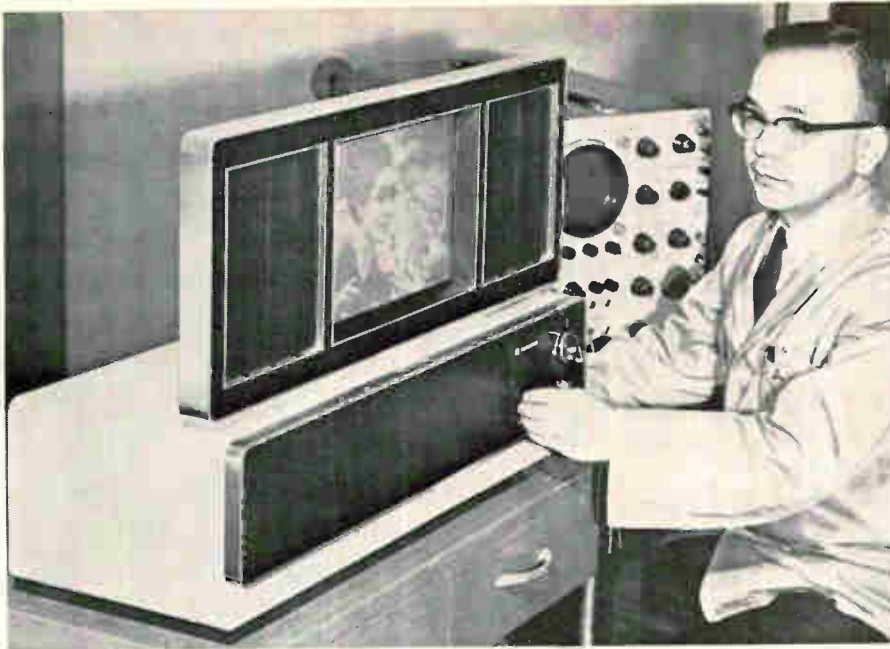

Tuning in. Still under development, the flat screen has a 13-in. diagonal. The receiver is being adjusted by Masami Yoshiyama, the author and head of the project. Though resolution is below par for close viewing, the tv picture at left, made from a live telecast, is comparable to those of some low-cost video tape recorders.



alternating voltage is replaced with a pulse, the brightness will then be proportional to an exponent of the pulse amplitude. If the light output from the element is monitored, the observed waveform will appear somewhat differentiated. The leading edge of the pulse will cause the light waveform to rise abruptly to maximum and then decay in an exponential manner. The trailing edge of the pulse has the same result.

#### Length and light

With a narrow pulse, total light output during rise and fall times will be just a little more than that during rise time alone. However, as the pulse width is increased—assuming that the separation between pulses is equal or greater than the pulse width—light output also increases. Regardless of the pulse width, though, the output can never exceed twice the amount of light provided by the short-duration pulses. Hence, techniques that

lengthen the pulse's "on" time cannot be used to appreciably increase picture brightness.

Brightness of the electroluminescent panel is thus an exponential function of voltage and can be represented approximately by

$$L = kv^t$$

where  $L$  is luminance,  $k$  a constant of proportionality, and  $v$  the applied voltage. Values for  $t$  are usually on the order of about 3.5 for the type of phosphor used in this panel. The use of a non-linear phosphor layer boosts the exponent to about 4.

An electroluminescent panel can be made to almost any size. And it lends itself to batch processing; individually addressable picture elements can be produced by sandwiching the phosphor between a matrix composed of  $n$  vertical conductive strips on one side and  $m$  horizontal strips on the other. Since the basic picture element has a

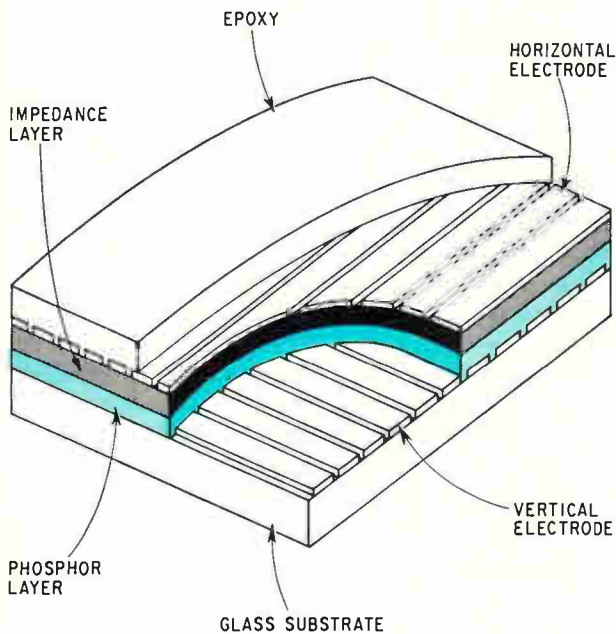
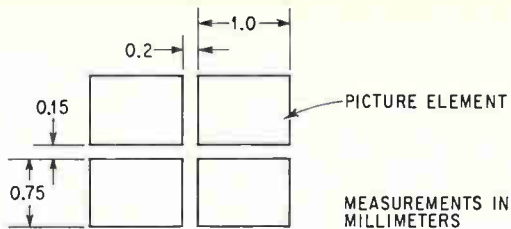

**Panel structure.** Built on a glass substrate, the flat display panel is basically a matrix of horizontal electrodes that form discrete picture elements at their junctions.

width-to-height ratio of 4 to 3—1 by 0.75 mm—the standard 4:3 picture aspect ratio is maintained even though the matrix consists of the same number of vertical and horizontal electrodes; in other words,  $n = m$ . Because of this matrixing technique, the  $n^2$  picture elements can be controlled by  $n$  drivers each for the vertical and horizontal strips, or a total of  $2n$  drivers.

To scan the matrix, a negative selecting pulse is applied to the horizontal electrode strip of the line being scanned at the same time the video signal for the entire line is being applied to the brightness control circuits of each vertical electrode strip. Since each line must be scanned in succession from top to bottom of the frame, all the vertical electrode strips have to receive the video signal simultaneously, rather than sequentially from left to right as it's transmitted. This is done by using a delay line to store the signal until the entire horizontal line has been scanned.

Brightness is controlled by the sampled video signal, which modulates the collector resistance of the transistors in the vertical strips. This method ensures the proper division of the negative selecting pulse voltage between the picture element at

the matrix crosspoint and the transistor's collector. At minimum collector resistance, the full pulse voltage is applied to the picture elements and full brightness is obtained. At maximum resistance, the voltage across the transistor rises, and the voltage at the crosspoint falls correspondingly.

Besides the selecting pulse to scan line by line across the picture, there are blanking pulses to keep the outputs of these elements not being scanned at a low level. The diagram at the right shows how contrast is impaired when, with this arrangement, an attempt is made to keep half the screen at full brightness and the other half at minimum brightness. The equivalent circuit shows that each picture element can be represented as a capacitor. Each vertical strip on the bright side of the screen is grounded by the brightness control circuits, while those on the dark side of the screen are open-circuited.

On the bright side of the screen, the voltage applied to the horizontal line appears across each of the grounded picture elements. Things are different on the dark side of the screen; although the vertical line segments connecting the individual picture elements are isolated from ground, a ground path exists through a series of three elements, represented by the capacitors. (Actually, the second and third capacitors in the string are made up of a number of capacitors in parallel.)

Because of this path, the applied pulse voltage appears across picture elements that are supposedly "off." Under the conditions given, the voltage  $V_D$  that appears across the "off" picture elements is

$$V_D = \left( \frac{n-1}{n} \right) V$$

Where  $n$  has a relatively large value, the voltage across the dark picture elements pretty nearly equals selecting pulse  $V$  in a practical display system.

If a voltage  $V/a$ —where  $a$  is less than 1—is applied to the unselected horizontal lines, the voltage  $V_D$  becomes

$$V_D = \frac{n-1}{n} \left( 1 - \frac{1}{a} \right) V$$

If the value for  $a$  is carefully chosen, the blanking pulse will simultaneously reduce the light output from the elements to which it is applied and suppress the luminance of the "off" elements of the selected horizontal line. Suppression is increased as the values of  $a$  and  $t$  increase.

When the scanning frequencies are high, however, the brightness resulting from the blanking pulses is not a linear function of the pulse repetition rate. It therefore became necessary to select the value of  $a$  by trial and error. It has been found that 3 offers the best compromise.

The complete display system includes the front end, horizontal and vertical oscillators, and audio

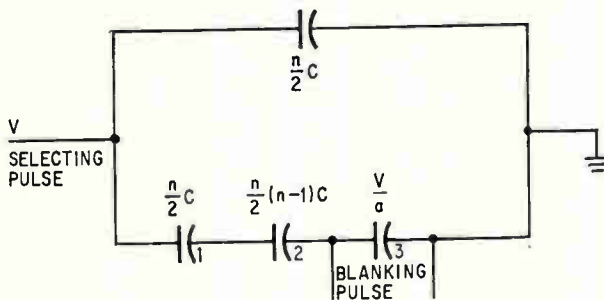
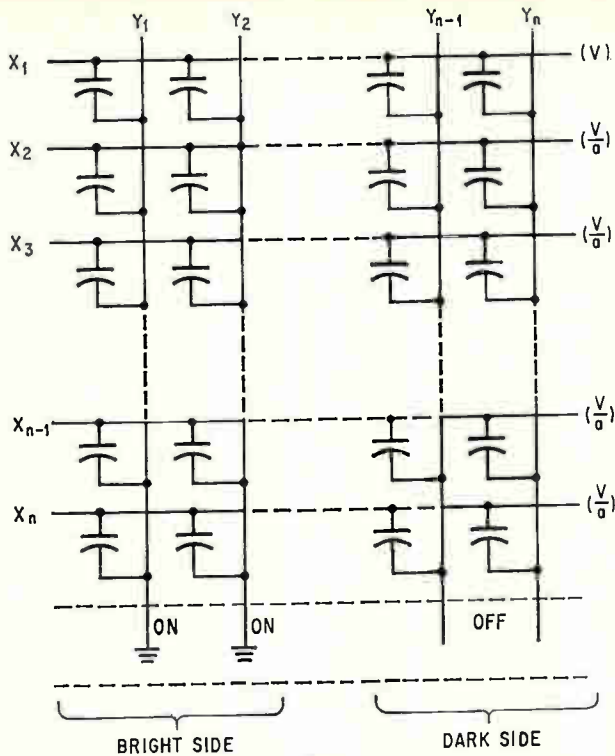

**Matrix.** Brightness is controlled by simultaneously applying the received video signal to all transistors in the vertical strips and a negative selecting pulse to each horizontal strip in turn.

and video amplifiers. The video amplifier includes gamma correction circuitry to compensate for the nonlinear characteristics of the panel.

The horizontal line for the video signal input is selected by a counter that advances one count for each pulse in the horizontal sync signal and that is reset by the vertical sync signal. For each advance of the counter, the pulse from the first trigger distributor steps down one line. For a given line, the output from this pulse distributor to the horizontal pulse generator causes the horizontal pulse generator circuit to apply a 300-volt selection pulse to that line.

At the same time, the second trigger pulse generator delivers an input to every horizontal pulse generator each time it receives a sync pulse from the horizontal sync signal. All the horizontal pulse generators except the one with input from the first trigger pulse generator deliver a blanking pulse. The one with input from the first trigger pulse

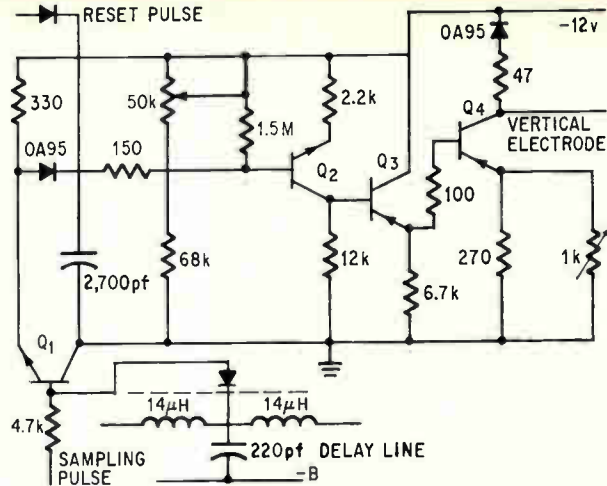

**Brightness circuit.** Acting as a variable resistor, the input transistor accepts a signal proportional to the delay line voltage when a negative sampling pulse is present.

distributor generates a selection pulse instead.

The video amplifier output is applied to a lumped delay line having a total delay of 50.6 microseconds, which is equal to the horizontal period of 63.5  $\mu\text{sec}$  minus the horizontal blanking period. The video signal for each horizontal line is delayed sufficiently so that the entire line is displayed as a whole.

The characteristic impedance of the line is 252 ohms, and the cutoff frequency of a section is 5.9 megahertz. Response is fairly flat to 1 Mhz. Signal attenuation near the far end of the line is about 3 decibels down at 1 Mhz and 6 db at 2 Mhz.

The brightness control input circuit is a sample-and-hold circuit, and all taps on the delay line are sampled simultaneously as the horizontal scan pulse is applied. It is the lack of loading on the line during propagation of the signal that allows this long signal delay to be obtained in this manner. And the use of several sections of line between taps prevents interaction between individual signals during sampling.

In the circuit, above, the input transistor, Q1 acts like a variable resistor whose resistance is determined by the sampled video signal voltage in the delay circuit. Applying a sampling pulse to the input diode makes it possible for a signal proportional to the delay line voltage to be applied to the transistor. After amplification, the signal is held in a 2,700-picofarad capacitor for delivery to the d-c amplifier stage, where it is used to vary the collector resistance of the output transistor.

The 2,700-pf holding capacitor is discharged and made ready for the next sampling pulse by a reset pulse applied about 40  $\mu\text{sec}$  after the sampling pulse.

Because approximately half the components of the display system are used in the brightness circuit, IC's could be used to reduce cost in volume

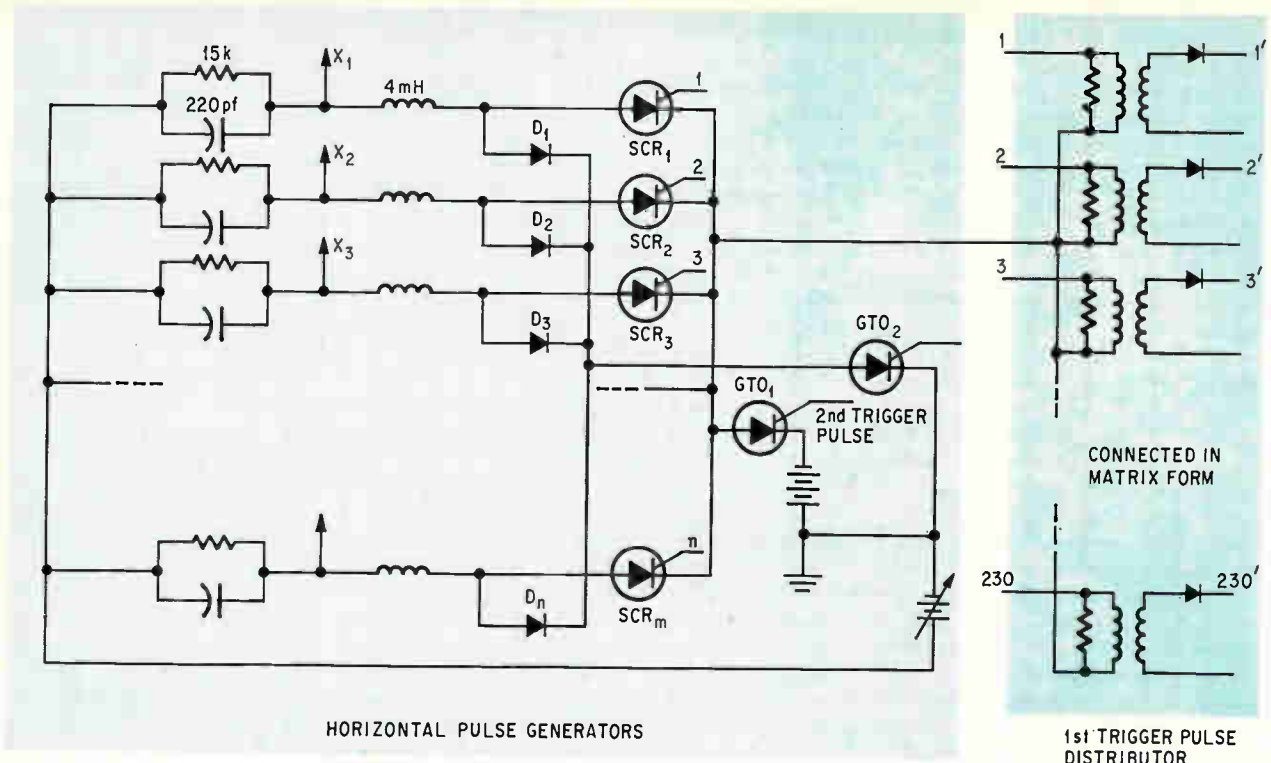

**Selection and blanking.** Basic circuit includes series chokes to limit current surge when a line is selected; capacitors act as load for power supply to improve regulation.

production. The only use of IC's so far has been in the counter circuits.

The first trigger pulse distributor, the second trigger generator, and the horizontal pulse generators are already fairly simple, but they can be further simplified by using the right components. For example, 30 gate turnoff rectifiers (GTO's) in TO-5 cans were used in the second trigger generator to control the blanking pulses simply because suitable larger units were not readily available.

The horizontal pulse generators, above, use two power supplies, each with a series GTO to switch it on and off. The GTO's are triggered by a second pulse generator. There is also a silicon controlled rectifier, diode, and resistor for each horizontal strip electrode.

For all these electrodes except the one to be scanned, turning on GTO<sub>2</sub> completes the circuit from power supply S<sub>2</sub> through the individual diode and resistor. Blanking voltage V<sub>2</sub> is thus applied to the strip.

A trigger pulse from the first trigger pulse distributor drives the SCR connected to the horizontal strip electrode. To scan a line, the circuit is completed through the SCR and the individual resistor. This places a reverse bias on the diode for that line, so it receives selecting voltage rather than blanking voltage.

After an interval of about 10 μsec, the second trigger pulse returns to zero. The reverse polarity pulse needed to turn the GTO's off is supplied by a coupling capacitor. This pulse need not be very

large, since the load is highly capacitive and current will have dropped sharply by the end of the 10-μsec period.

The SCR is also turned off, because the current flowing through it is interrupted. Sufficient time elapses for the SCR to completely recover before the GTO's are again turned on.

In the selection and blanking circuit, neither the capacitors nor chokes are vital; they were added to improve performance. The horizontal electrodes are essentially a capacitive load. The capacitive reactance component varies with the brightness along the horizontal line, exceeding 1,000 pf if the entire line is at full brightness. To cushion the load on the power supply, the series chokes tend to limit the rate of current increase when the time line is selected. At the same time, to allow use of a lower voltage power supply, they supply a small resonant voltage step-up when the line is near full brilliance. The capacitors load the power supply when the line is dark to improve voltage regulation.

This circuit includes the output pulse transformers from the trigger pulse distributor. For circuit economy, the output pulse transformers are connected in a matrix arrangement having 16 columns and 15 rows. It's thus possible to drive the distributor with a total of 31 medium-power, plastic-encapsulated transistors. Each row is driven consecutively with pulses that are 1,016 μsec wide and correspond to 16 horizontal line periods. At intervals of precisely 63.5 μsec, column pulses 2 μsec wide are applied to select individual lines. ■



# Three ways to improve on the performance, price and delivery of Op Amps like the 709C, 741C and MC 1439.

## LM301A/302/307

Our LM301A, 302 and 307 are more than interchangeable with the 709C, 741C and MC1439. They outperform them, are competitively priced and they are readily available. Ideal devices for long-interval integrators or timers, active filters, instrumentation amplifiers or in high impedance applications where noise is critical. All are completely specified for operation over 0° to 70°C temperature range.

LM301A—most versatile general purpose amplifier and comparator. Low input currents, low noise and guaranteed drift characteristics. 10V/ $\mu$ sec slew as a summing amplifier. (\$3.45 at 100 pieces)

LM302—fast voltage follower with super-low input currents. Fully compensated. (\$3.00 at 100 pieces)

LM307—internally compensated universal op amp. Same DC specs as LM301A. Direct plug-in replacement for 709-type op amps. (\$3.95 at 100 pieces)

Input for the asking. National Semiconductor Corporation/2975 San Ysidro Way, Santa Clara, California 95051/(408) 245-4320/TWX: 910-339-9240/Cables: NATSEMICON.

## National/Linear

# THE OUTCLASSERS!

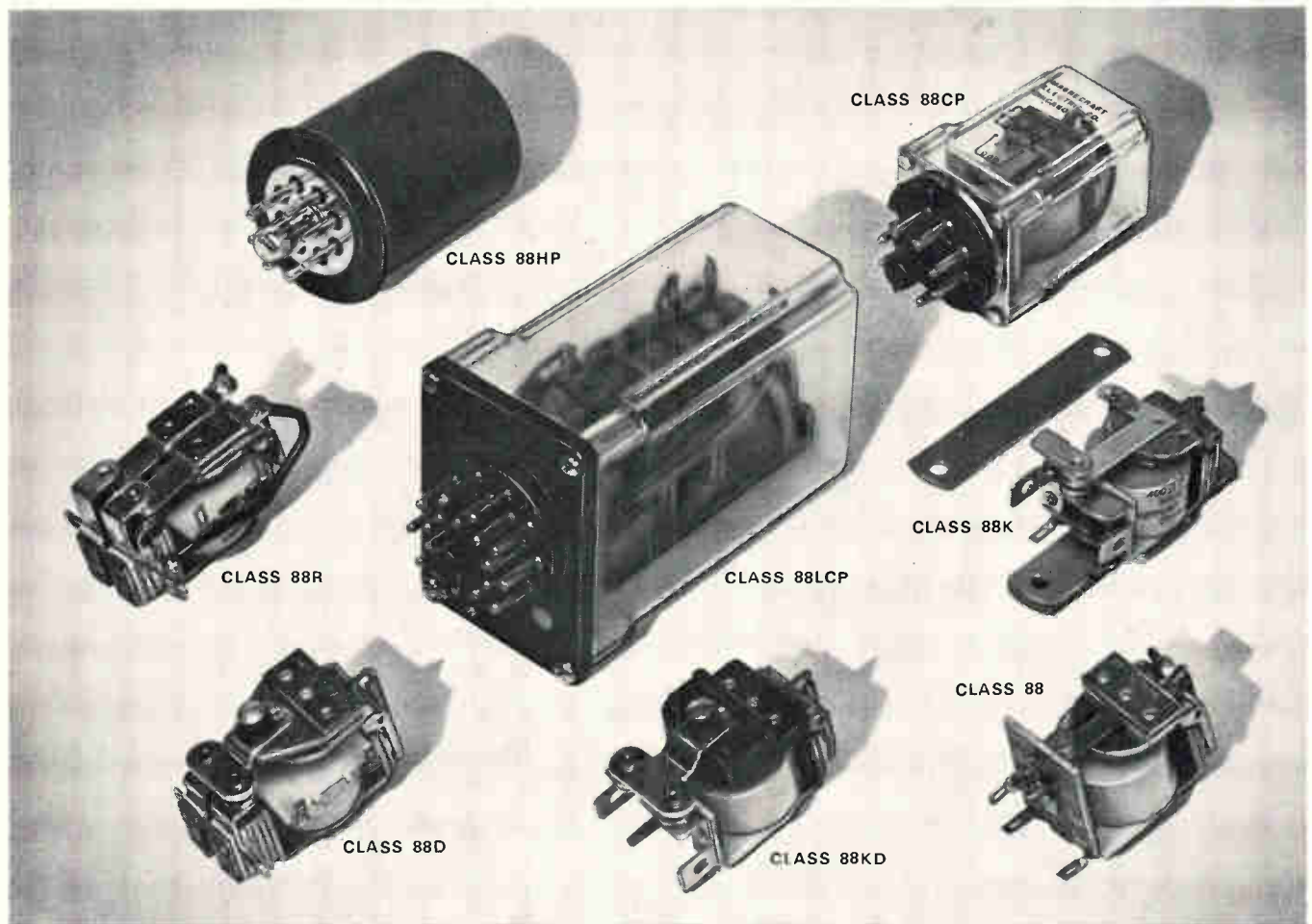

## MAGNECRAFT GENERAL PURPOSE RELAYS

Our general purpose relays aren't known as the least expensive. But they have earned the reputation for reliability with the most consistent performance record of any general purpose relay on the market.

In addition, Magnecraft has more general purpose relays in stock than anyone else. This means nearly all your requirements can be filled in days—if not hours. As for variety, we have it over the others with relays such as our improved Class 88KD 50 ampere relay that's ideal for industrial switching applications. And the new Class 88LCP Latching Relay that's composed of two Class 88 Relays with interlocking latching levers mounted on a common base and a crack-proof polycarbonate cover.

If all this doesn't overcome price alone, better forget us. But if you want large silver cadmium oxide contacts, precision hinge-pin armature bearings, molded nylon bobbins and overall custom made quality, then keep us in mind for all general purpose relays. Ours outclass the others at any price.

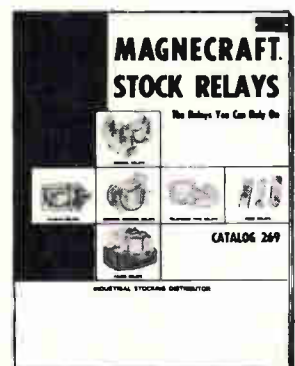

**FREE! Product File —**  
Yours for the asking.  
Contains full details on  
all our stock relays.

SEE US IN OUR BOOTH #3J16 AT IEEE SHOW

***Magnecraft*<sup>®</sup> ELECTRIC CO.**

5575 NORTH LYNCH AVENUE • CHICAGO, ILLINOIS 60630 • 312 282-5500

# Monolithic Voltage Regulators

## the complete works now in paperback

Five voltage regulator application notes including two just published; 60 pages of design information on positive and negative voltage regulators. Sixteen pages of specification information including significant graphs of performance characteristics. An eight page Reliability Report encompassing Production Processing, Quality Control, Screening, Life Testing, Environmental Testing and Design Philosophy. The most complete set of design aids in print for monolithic voltage regulators. You can see the performance; send for the book. National Semiconductor Corporation, 2975 San Ysidro Way, Santa Clara, California 95051 (408) 245-4320  
TWX: 910-339-9240 CABLES: NATSEMICON

### National/Linear

**TICOR III**  
**WINS**  
**ITS**  
**SPURS**

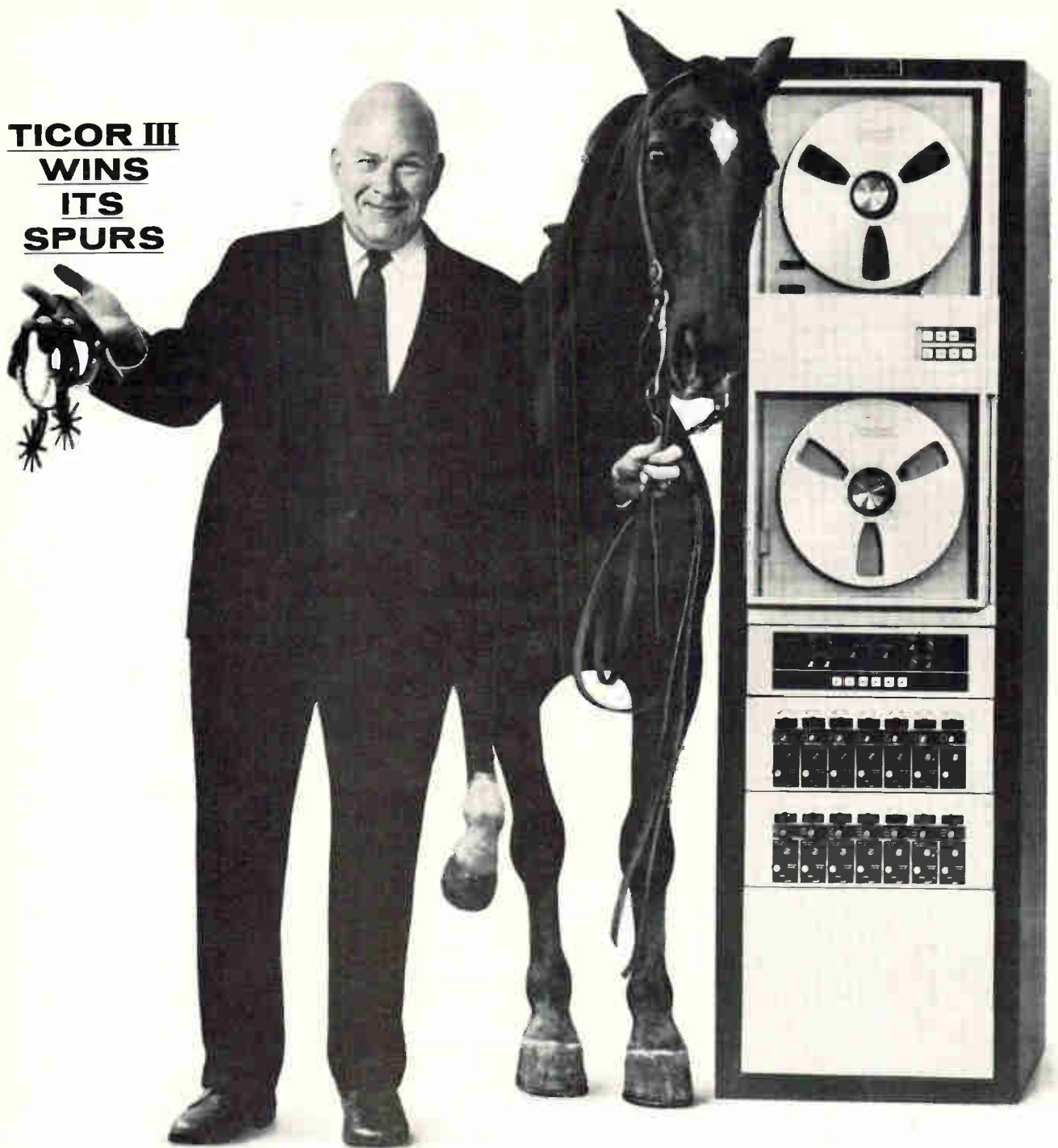

**MODEL 32 RENAMED TICOR III AFTER TWO BIG YEARS**

**Reduced cost, a lower Time Base Error** of  $\pm 0.4 \mu$  sec, and over-all upgrading in design and performance made Mincom's Model 32 Recorder/Reproducer the heir apparent to TICOR II. Now Model 32, after two successful years of field testing and hard work, has been renamed TICOR III. It will fully replace its famous parent, which in 1964 switched the entire industry to a new course with its low mass flutter suppression, 2 MHz performance and virtually negligible TBE. TICOR III, the latest in IC and packaging design, provides at a lower price its  $\pm 0.4 \mu$  sec TBE at 120 ips, 2 MHz on seven or fourteen channels, flutter suppression bandwidth of 270 Hz, optional bidirectional recording, plus interchangeable electronics for Direct 400 Hz–1.5 MHz or 800 Hz–2.0 MHz; DC–80 kHz IRIG FM, DC–500 kHz wideband FM, PDM, NRZ and other data techniques. Write for specifications, or call our Sales Department at (805) 482-1911.

**Mincom Division** **3M**  
COMPANY  
300 SOUTH LEWIS ROAD • CAMARILLO, CALIFORNIA 93010



# 150 MHz, 2.4 ns Portable Oscilloscope

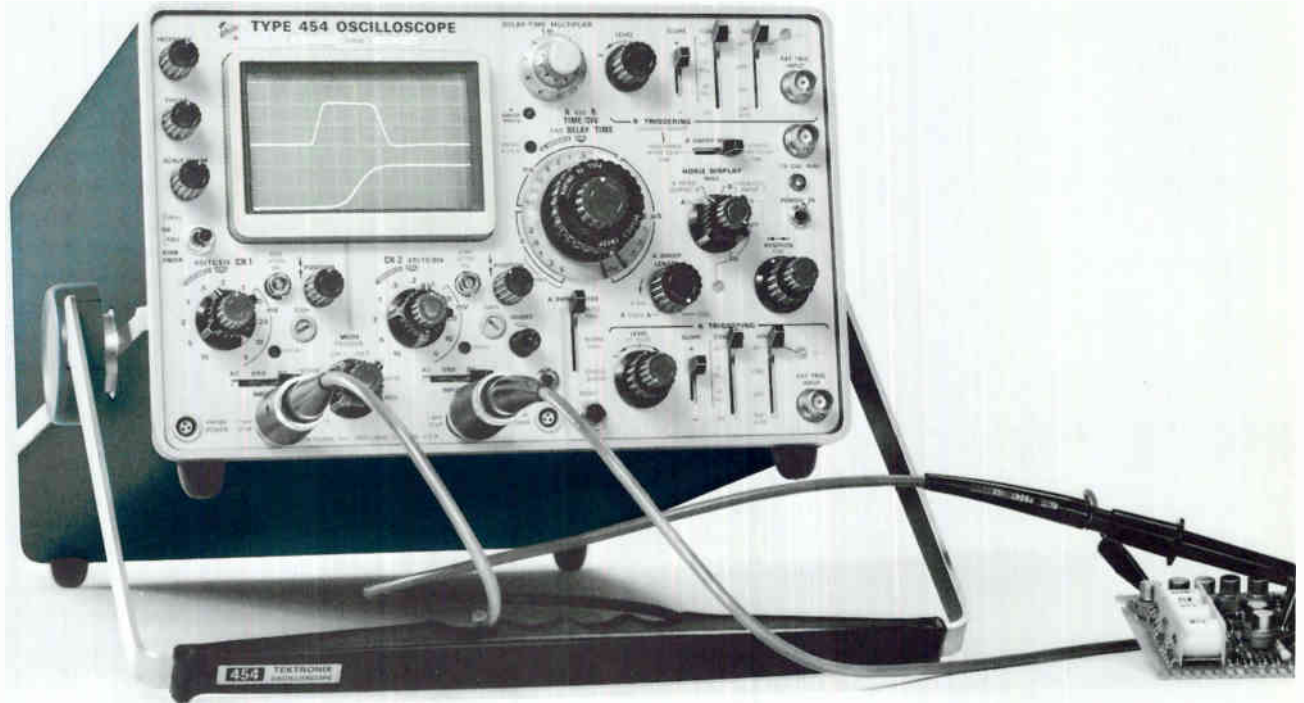

## PERFORMANCE

The Tektronix Type 454 is an advanced design portable oscilloscope providing measurement of fast-rise pulses and high-frequency signals beyond the capability of most conventional real-time oscilloscopes. New miniature 10X probes permit specifying the 150-MHz bandwidth, 2.4-ns risetime performance at the probe tip—where you need it!

The Type 454 is a complete instrument package with dual-trace displays at 5 mV/div deflection factor, triggering to above 150 MHz internally or externally and 5 ns/div normal or delayed sweep. Full bandwidth measurements (150 MHz) are provided at 20 mV/div deflection factor. For low-level applications the Type 454 provides single channel 1 mV/div at 33-MHz bandwidth. Full-sensitivity X-Y operation (CH 1 drives the horizontal, CH 2 drives the vertical) is also provided with phase difference between X and Y not exceeding 3° from DC to 2 MHz. An illuminated, parallax-free graticule defines the 6 x 10 div display area and a bright P31 phosphor contributes to sharp, clear waveform displays even under marginal conditions.

For single-shot applications a photographic writing speed of 3200 div/ $\mu$ s (>2500 cm/ $\mu$ s) is provided by the Type 454 Oscilloscope, C-31 Camera and 10,000 ASA film . . . without employing film fogging techniques!

## PORTABILITY

The Type 454 is mechanically designed to be easily carried. It meets temperature, humidity, vibration and shock tests which simulate environments "portable" instruments may encounter. A dust-tight front cover protects the panel and serves as a convenient storage compartment for accessories. The handle may be rotated to several positions to serve as a tilt stand or adjusted for convenient carrying. All these features and more are packaged in a rugged 31-pound instrument.

## RELIABILITY

Advanced design concepts and the use of solid-state components insures long-term stable performance and permits operation within specifications over an ambient temperature range of -15° to +55°.

Your Tektronix field engineer will demonstrate the Type 454 performance capabilities in your application, at your convenience. Please call him or write Tektronix, Inc., P.O. Box 500, Beaverton, Oregon 97005.

Type 454 (Complete with probes and accessories) .. \$2700  
Type R454 (Rackmount) ..... \$2785

U.S. Sales Price FOB Beaverton, Oregon

*please turn page for additional information*

# Making the Measurement . . . with the Tektronix Type 454 Portable Oscilloscope



454/P6046

## DIFFERENTIAL MEASUREMENTS

A 5-mV pulse with 1-volt, 50-MHz common mode signal displayed on the Type 454 using a P6046 Differential Probe and Amplifier. The photograph demonstrates the  $\geq 1000:1$  common-mode rejection ratio of the P6046 Probe and Amplifier. This same Probe/Amplifier/Oscilloscope combination provides 1-mV/div deflection factor at  $\approx 70$  MHz bandwidth!

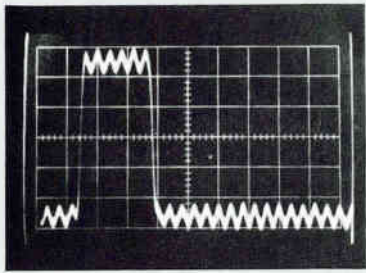

Vertical - 1 mV/div; Horizontal - 50 ns/div

## X-Y

The Type 454 converts to a calibrated X-Y Oscilloscope with a flick of two front panel switches. Phase difference between X and Y is less than  $3^\circ$  from DC to 2 MHz. The upper display is a 150-MHz signal that is 50% modulated by a 2-kHz signal. The lower display is an X-Y trapezoidal modulation pattern showing the 150-MHz AM signal vertically (Y) and the 2-kHz modulation signal horizontally (X). The straight vertical line to the right of the photo represents the unmodulated carrier amplitude. Multiple exposure.

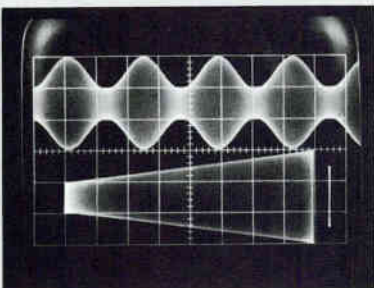

*The total value an instrument provides its user is related to its ease of application in making practical measurements. Compatible accessory items such as voltage and current probes, special purpose probes, cameras, Scope-Mobile® Carts, etc. contribute significantly to a total measurement capability and are essential if the user is to utilize instrument performance to full advantage.*

## MEASURING CURRENT

The new P6042 Current Probe provides measurements from DC to 50 MHz with sensitivity to 1 mA/div. Other Tektronix AC current probes are available and provide measurements from 8 Hz to 200 MHz.



P6042

## PULSE FIDELITY

The same pulse displayed by the Type 454, upper trace, and by a 7-ns, 50-MHz Oscilloscope, lower trace (double exposure). Note the difference in detail of the pulse characteristics displayed by the Type 454 with its 2.4-ns risetime performance. Full bandwidth/risetime performance is preserved by the miniature P6047 10X Probes supplied with the Type 454. The optional P6048 10X Probe offers additional high-frequency measurement performance with 1-pF input capacitance.

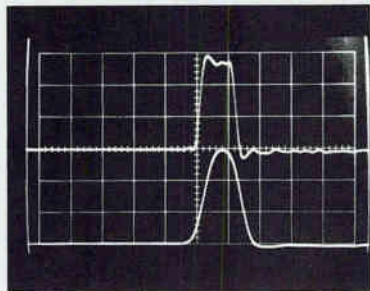

## PHOTOGRAPHIC WRITING SPEED

The Tektronix Type 454 Oscilloscope, C-31 Camera, 10,000 ASA film and P11 CRT phosphor provide a minimum photographic writing speed of 3200 div/ $\mu$ s ( $>2500$  cm/ $\mu$ s) without employing film fogging techniques. This writing speed is in excess of that required to record a single-shot pulse at the risetime and screen height limits of the Type 454 . . . the important extra margin of performance a high-frequency oscilloscope should have.

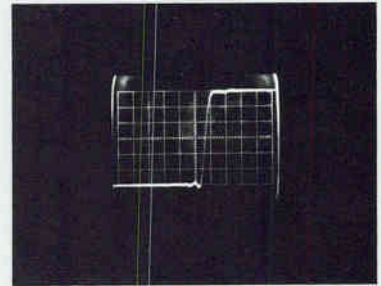

5 ns/div

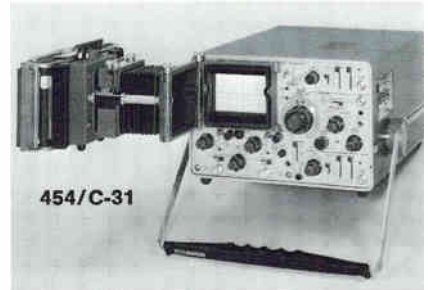

454/C-31

*Your Tektronix Field Engineer will demonstrate the Type 454 in your application at your convenience. Please call him, or write: Tektronix, Inc., P.O. Box 500, Beaverton, Oregon 97005.*

Type 454	\$2700
Type R454 (Rackmount)	\$2785
C-31 Camera	\$ 550
P6046 Differential Probe and Amplifier	\$ 725
P6042 Current Probe	\$ 625
P6048 DC-to-140 MHz 10X Voltage Probe	\$ 55
Type 200-1 Scope-Mobile® Cart	\$ 85

U.S. Sales Price FOB Beaverton, Oregon



## Tektronix, Inc.

committed to progress in waveform measurement

# DC-10's air data system casts a long shadow

Honeywell's digital unit, built around a simple silicon pressure sensor, threatens analog gear because of superior flexibility and reliability

By Frederick Corey

Associate editor

**Avionics advances** generally stem from military projects. But there are exceptions, and the latest—the solid state digital air data system developed by Honeywell for the McDonnell Douglas DC-10 airbus [*Electronics*, Feb. 3, p. 34]—may well be a trendsetter for both the services and the aircraft industry. Its development could mark the beginning of a shift away from analog systems with electromechanical components.

The military has done experimental work on digital air data computers, but the Honeywell system, two of which will be aboard each DC-10, is the first to be bought for a commercial application. It won't be the last. According to Cecil Cook, supervisor of the flight guidance control design group at the Douglas Aircraft division, "The advantages of the system are so overwhelming that others will have to go this way."

Even more sanguine is Raymond L. Bergeson, a section chief at Honeywell's Aerospace division, which developed the system. "The DC-10 is just the beginning," he says, looking ahead to the military's F-14, F-15, and VSX programs, all of which are expected to include digital air data systems. Such systems will also fly aboard the nation's supersonic transport, and some carriers are already considering retrofitting the digital design into existing aircraft, as well as including them as original equipment on new planes.

The quickened interest—both

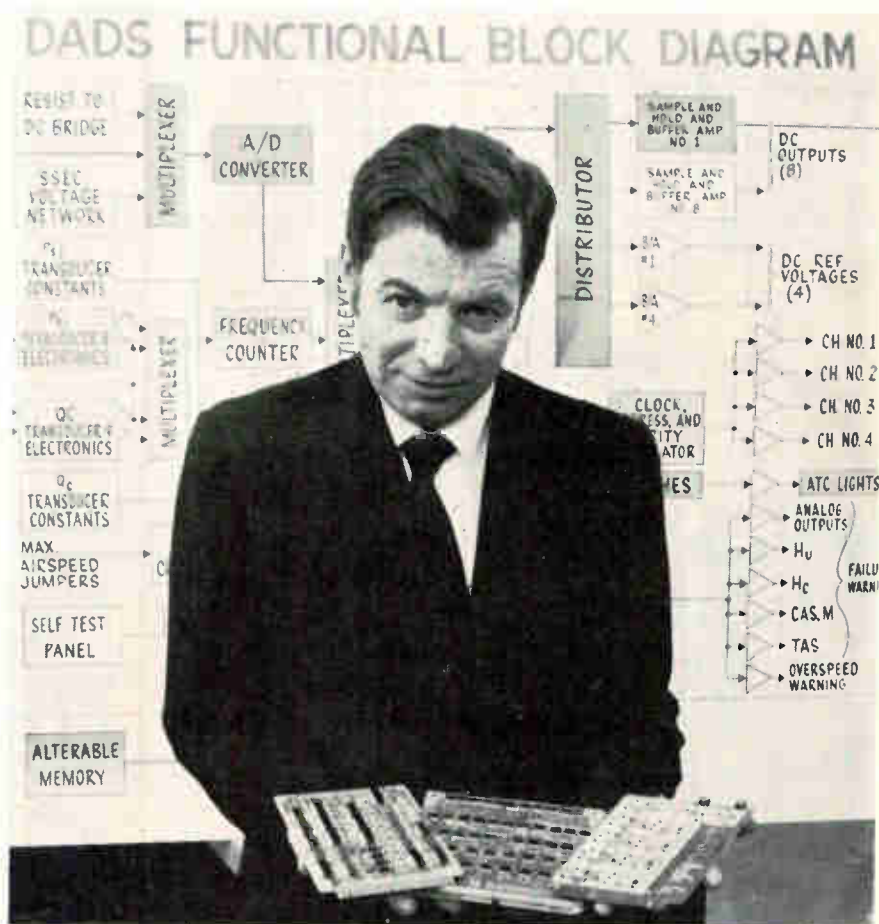

Showpieces. Honeywell project engineer George Lankow holds plug-in cards, 15 of which are used in digital air data system company builds for DC-10.

military and commercial—in digital systems is likely to touch off a new flurry of rivalry among the companies that bid on the DC-10. Honeywell beat out Bendix, Conrac, Kollsman Instruments, Garrett, and Sperry Rand, among others, for the award.

The solid state system promises to be more flexible, more reliable, and easier to maintain than the available electromechanical analog systems with their moving parts. Cook expects the new unit to prove twice as reliable as an analog system even though it will handle more

# GLASS ENCLOSED Thermostatic DELAY RELAYS

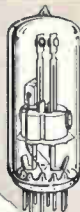

by **AMPERITE**



Offer true hermetic sealing — assure maximum stability and life!

## Delays: 2 to 180 seconds

Actuated by a heater, they operate on A.C., D.C., or Pulsating Current... Being hermetically sealed, they are not affected by altitude, moisture, or climate changes... SPST only — normally open or normally closed... Compensated for ambient temperature changes from  $-55^{\circ}$  to  $+80^{\circ}\text{C}$ ... Heaters consume approximately 2 W. and may be operated continuously. The units are rugged, explosion-proof, long-lived, and inexpensive!  
TYPES: Standard Radio Octal and 9-Pin Miniature... List Price, \$4.00  
PROBLEM? Send for Bulletin No. TR-81.

# AMPERITE

## BALLAST REGULATORS

Hermetically sealed, they are not affected by changes in altitude, ambient temperature ( $-50^{\circ}$  to  $+70^{\circ}\text{C}$ ), or humidity... Rugged, light, compact, most inexpensive.

List Price, \$3.00

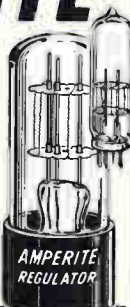

Write for 4-page Technical Bulletin No. AB-51

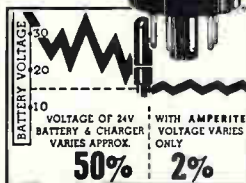

# AMPERITE

600 PALISADE AVE., UNION CITY, N.J. 07087

Telephone: 201 UNION 4-9503

In Canada: Atlas Radio Corp., Ltd.,  
50 Wingold Ave., Toronto 10

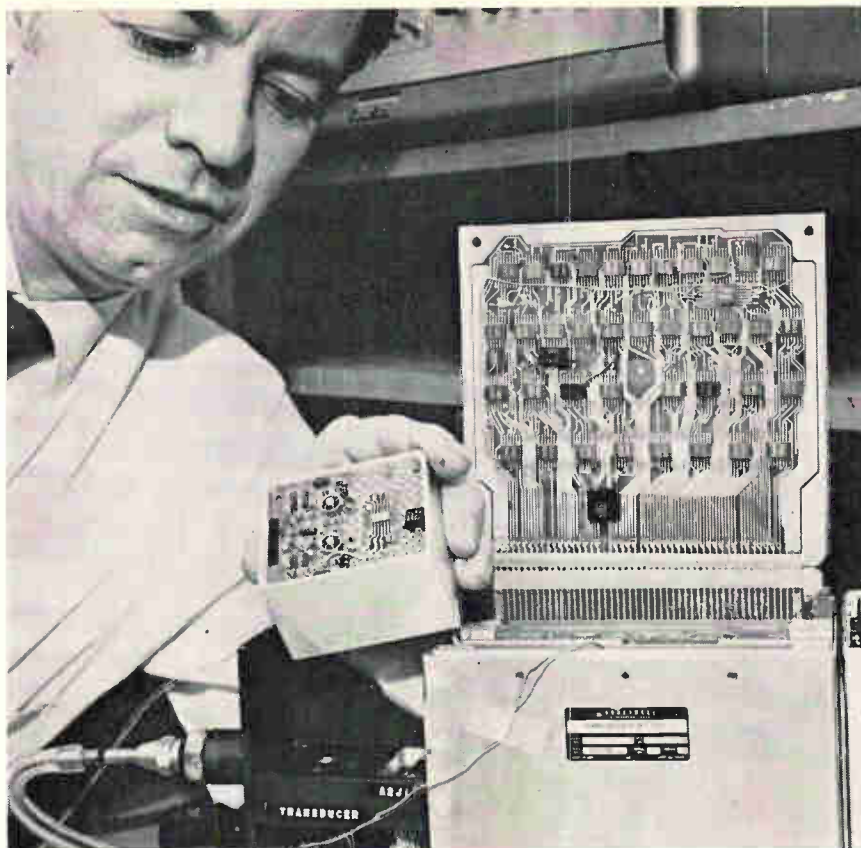

Key element. At the heart of the Honeywell air data system is a pressure sensor that converts data into formats acceptable to a digital computer.

functions than the analog units.

Its initial cost will about equal the prices on comparable analog units, says Cook. But he adds that the digital system will be far cheaper to operate because it has no gear trains to periodically check. Moreover, the digital system can isolate faults down to the level of a single plug-in card. Cost of ownership is estimated to be only a quarter that of analog apparatus, according to Cook, and maintenance costs of less than a penny per flight hour have been projected.

### Where it's at

The key to the new system is a silicon pressure sensor [*Electronics*, Jan. 20, p. 43] that departs completely from the design of electromechanically operated units. Made of a single-crystal diaphragm of silicon with diffused piezoresistive elements, the sensor is much simpler than its mechanical counterparts. The latter, Cook notes, have as many as 36 set screws for calibrating the transducer through its range. The solid state sensor needs no mechanical calibration and may even end up being a throwaway

item because its projected mean time between failures is more than 100,000 hours. In addition, it's expected to be anywhere from five to 10 times more reliable than the analog sensors it replaces; not only is the new sensor simpler, but it's also much less susceptible to drift.

The digital setup also affords the opportunity to continuously monitor the air data system's performance. Test problems can be put through a computation channel at a rate of one a second to verify that everything is working and hasn't been degraded, says Cook.

"With this system, the user will be able to do continuous line monitoring of 95% of all failures, including degradation," he says. "In an analog unit, you might be able to monitor 85% of the catastrophic failures."

**Workhorse.** Along with a sample signal, the Honeywell system can transmit a digital word indicating the signal is valid. Cook says this can't be done with analog units. And unlike its analog cousins, the new system can accommodate an output for barometrically corrected altitude readings, which are fed to



the computer from the altimeter. And the aircraft's maximum allowable airspeed can be manually entered into the digital computer by the pilot and tied into the same loop with the solid state sensor taking airspeed inputs. An analog system would need an additional sensor to handle this function.

American Airlines, the first carrier to buy the DC-10, is particularly enthusiastic about the digital system, Cook says. Both American and United Air Lines endorsed Douglas' decision to go digital last spring. And American's interest in this area isn't limited to the Honeywell design. This spring the line will test-fly digital air data systems from Conrac and Garrett in a Boeing 707. At stake is a possible contract to retrofit American's entire jetliner fleet.

### Getting the jump

As to why Honeywell won the award, Cook says the company's technical presentation and implementation were farther along than its rivals' when a decision had to be made around the first of this year. And Honeywell was ahead of the field in its sensor work, too. Its sensors can be easily interchanged because the electronics that goes with them is contained in a transducer package separate from the rest of the system. "Honeywell's use of a special-purpose computer and its understanding of the entire systems problem showed the firm had been working on the project for some time," the Douglas executive observes.

In Honeywell's pressure sensor, redundant pairs of p-type piezoelectric elements are diffused into a pressure-sensitive diaphragm made of n-type silicon. The elements' resistance, which varies with the strain on the diaphragm, controls the frequency of an RC oscillator. Pressure changes are thus sensed and converted to a variable frequency.

**Lower odds.** The redundancy assures a higher yield during manufacture. Each pair consists of one radially oriented element and one tangentially oriented. All the elements exhibit strong piezoresistivity along their lengths and have a distributed capacitance that isn't sensitive to pressure. In effect, the piezoresistive elements are resist-

# The Lasertron® Lineup

Select the one you need from these permanently aligned, adjustment-free He-Ne lasers.



**The Lasertron® Tube** A coherent light bulb, it is the heart of every U/L laser. Never needs adjustment or maintenance. Simply switch it on or off. Resonator mirrors are permanently aligned inside a rigid pyrex envelope. Unaffected by dust, humidity, vibration, temperature or aging. Available as an OEM component or as part of complete instruments, as shown.

**MODEL 200**  
**\$195** 0.6 mW. Built-in power supply. Ideal for student use.

**MODEL 201**  
**\$255** 1.0 mW. Built-in power supply. For educational and experimental use.

**MODEL 240**  
**\$295** 1.0 mW. Separate detachable power supply. Research grade laser. Tripod included.

**MODEL 241**  
**\$385** 2.0 mW. Separate detachable power supply. Ideal general purpose laser. Tripod included. Model 22 Precision Mounting Base optional at \$185.

**MODEL 261**  
**\$545** 4.0 mW. Separate detachable power supply. An all-purpose low-cost laser. Tripod included.

**MODEL 270**  
**\$1580** 10 mW. Separate detachable power supply. Precision 4-cone mount included. A higher power general purpose laser for imaging and display tasks.

*All models produce in TEM<sub>00</sub> mode, wavelength 6328 Angstroms. Solid-state power supplies. Full-year warranty with no restriction on operating hours. More than 3000 in use throughout the world!*

#### MAIL COUPON TODAY!

University Laboratories / 733 Allston Way, Berkeley, Calif. 94710  
 Gentlemen:

Please send complete information on He-Ne lasers and accessories.

Please send information on Lasertron tubes for OEM applications.

Name \_\_\_\_\_

Position \_\_\_\_\_ Dept. \_\_\_\_\_

Organization \_\_\_\_\_

Address \_\_\_\_\_

City, State \_\_\_\_\_ Zip \_\_\_\_\_

## University Laboratories

733 Allston Way, Berkeley, Calif. 94710 / Tel (415) 848-0491

# VACTEC Vactrols

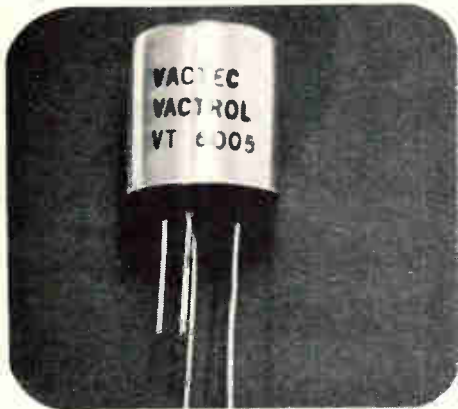

The standard of the VACTROL line is the inexpensive aluminum case, epoxy sealed VACTROL. Six types from 1.5v (incandescent) through 115v (neon). Less than \$1.00 in quantities of 1000.

*Keep up with  
all the big-name  
Photocell-Lamp  
Assemblies  
in everything  
except price!*

VACTROL is one of several photon isolators (photocell-lamp modules) on the market. Competitors include Raysistors, Photomods, and Datacels. But none is better than VACTROL.

VACTROL lamps are the same as competitors (we all buy from the same suppliers). But because Vactec makes photocells exclusively, you'll find ours provide the finest, most consistent quality, characteristics, and service.

VACTROLS combine the same photocells we supply for critical camera applications, with the best lamps we can obtain. VACTROLS come up short in only one department. Price. And you don't mind that, do you?

**A complete line for every requirement:  
LED, Incandescent, and Neon Types.**

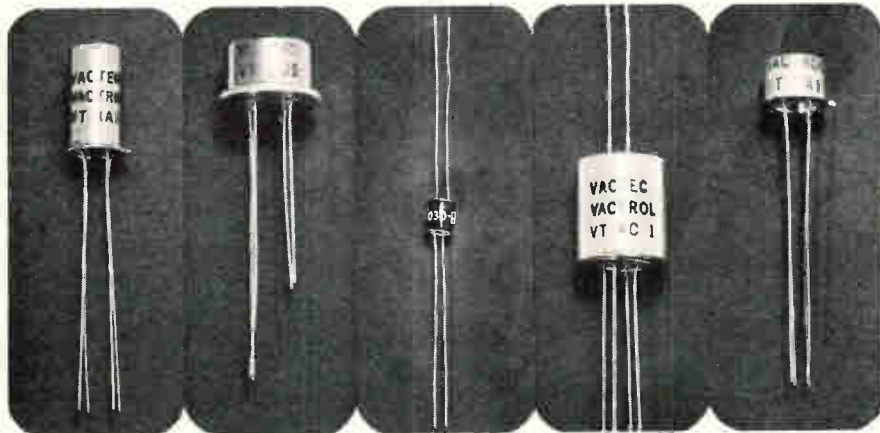

**Hermetic TO-5**  
New hermetically sealed, welded enclosure with glass to metal feedthroughs. Between 25°C and 30°C more than standard low cost Vactrols in modest quantities. Available in low voltage (incandescent) and high voltage (neon) types. Bulletin PCD 4C3.

**LED**  
Substitute a light emitting diode for the conventional lamp in photon isolators. VT 008-5 is hermetically sealed (modified TO-8). VT 030-18A is a TO-18 axial device, epoxy sealed. Extremely low signal requirements compared to conventional lamp devices. All solid state. No filaments to vibrate or burn out. Less than \$7.00 in volume.

**Dual Isolated Photoconductor LED**  
An isolated dual element photoconductive cell coupled with a light emitting diode. Cell elements track to within 2% over 3 decades of illumination. Expensive compared to the others. Useful in making linear isolators, multipliers, and dividers. Demonstrates our commitment to the complete Vactrol line.

**Low Profile TO-5 LED**  
Coming soon. New TO-5 LED Vactrol in a complete hermetic seal like the VT 008-5, in a smaller TO-5 package. Similar characteristics. Anticipated price less than \$6.00 in volume.

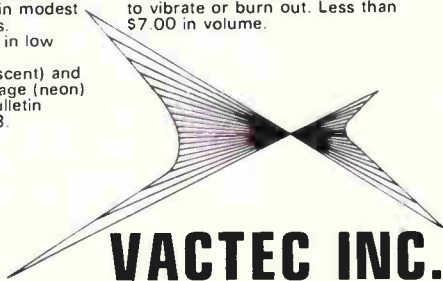

**VACTEC INC.**

2423 Northline Ind. Blvd. Maryland Hts., Mo. 63042 Phone (314) 432-4200

Specializing in standard Cds, Cdse, and Se cells; Custom engineering for every photocell need. Listed in EBG under "Semi-Conductors" and in EEM Sec. 3700.

ance-capacitance networks.

During manufacture, the differently positioned elements are probed to determine which have the best characteristics. These are then connected—through emitter followers in the wafer—to the feedback loops of separate external oscillators.

As the resistance of one element increases, the frequency of its associated oscillator decreases. At the same time, the resistance of the orthogonal element decreases increasing the frequency of its oscillator. The difference between these two frequencies is proportional to strain or pressure, while the sum is proportional to temperature. The oscillator circuits are made of silicon integrated circuits, as are the system's wideband amplifiers. Alongside these circuits is a discrete signal conditioner.

Honeywell uses two of the silicon transducers in the air data system—one to measure total pressure, the other to measure static pressure—in separate modules. The transducer that measures total pressure—actually a differential-pressure device—and the static transducers are essentially identical. However, one side of the diaphragm in the static device is evacuated, while one side of the differential device is open to the static unit, the other to total pressure.

Each transducer is calibrated before its final assembly to determine how the oscillator frequencies will vary under different but known combinations of temperature and pressure. A diode matrix board containing this information is then built into the transducer module and tied to the processor memory.

To measure the transducer output frequencies, the processor and the logic circuitry count the number of pulses received from each oscillator. The time base is provided by a precision crystal oscillator that, according to Honeywell, provides resolution equivalent to 0.0005 inch of mercury. Time-base pulses from the static and differential transducers are multiplexed and transmitted alternately. In this way, the outputs are converted into a binary word.

**Components count.** Besides the transducer modules and the central processor, Honeywell's system includes a digital input-output sec-

tion, an analog-to-digital and digital-to-analog conversion section, an analog output section, and a power-supply module. The analog output section provides d-c reference voltages. In all, there are 15 plug-in printed-circuit cards arranged functionally by sections. To ease maintenance, the components are mounted on only one side of a card. The system is packaged in the Arinc 404 full-length half ATR case.

### It's in the cards

Physically, there's no such thing as a computer "black box" in the Honeywell system. Rather, the central processor—which uses serial, fractional, two's-complement arithmetic, and transistor-transistor logic—is on plug-in cards and placed with the rest of the system.

The computer's 9-microsecond add time and 100- $\mu$ sec multiply, divide, and square-root times aren't exceptionally fast, says Bergeson, but are adequate for the application. The processor handles an 18-bit data word and a 12-bit instruction word.

A fixed 1,000-word memory, made up of bipolar silicon monolithic elements, stored instructions and constants, and a 64-word scratch-pad memory, made of MOS elements, fit onto a single printed-circuit card 6 inches square. The main memory chips—approximately  $\frac{1}{8}$ -inch square—contain about 100 words and fit into 40-lead DIP's. These packages measure  $\frac{3}{4}$  by 1 inch and were developed especially for the system.

The processor can be easily reprogrammed by changing the memory cards, Bergeson notes. And the memory capacity can be expanded simply by adding packages to the memory card.

System inputs include static and total-pressure connections to the pilot-static probe, barometric pressure probe connections, static source error correction (SSEC), maximum allowable airspeed, and a total resistance connection to the temperature probe. The transducers and converters are used to transform the analog inputs into binary words from which the computations are performed.

Values for nine parameters—altitude uncorrected, altitude corrected, rate of altitude change, computed air speed, true air speed,

# Time Sharing Economy



### Model 300

#### Business Calculator

+, -,  $\times$ ,  $\div$ , reciprocals, percentages, chain multiplication, weighted averages, automatic extension, etc. Two independent adders, a product register, large readout display and automatic floating decimal point.

**\$1070. per station\***

### Model 310

#### Statistical Calculator

All the features and functions of the Model 300 plus  $\sqrt{x}$  and  $x^2$  by single keystroke for  $\sum x$ ,  $\sum x^2$ ,  $\sum y$ ,  $\sum y^2$ ,  $\sum (x+y)$ ,  $\sum x \cdot y$ ,  $\sum \sqrt{x}$ , and  $\sum \frac{1}{x}$

**\$1177.50 per station\***

### Model 320

#### General Purpose Calculator

All the features and functions of the Model 310 plus  $\log x$  and  $e^x$  by single keystroke for more advanced statistical, scientific and engineering calculations.

**\$1282.50 per station\***

### Model 360

#### Extra Storage Calculator

All the features and functions of the Model 320 plus four extra data storage registers for complex calculations without re-entry of intermediate results.

**\$1497.50 per station\***

\*Four keyboards operating simultaneously from a single electronic package

## ...exclusively with Wang electronic calculators

Wang offers you more performance at less cost than any other electronic calculator available. A unique multiple-keyboard concept lets up to four operators utilize the electronic speed of its "brain" simultaneously like time-shared large computers. The "brain", in a convenient briefcase-size package, can be located anywhere up to 200 feet from the compact keyboards. You can choose any of the four models above for the most easily justified purchase you could make for efficient, dependable problem solving.



LABORATORIES, INC.

Dept. 3H, 836 North St., Tewksbury, Massachusetts 01876 • Tel. 617 851-7311

### Call today for immediate trial:

(201) 241-0250	(215) 642-4321	(309) 674-8931	(412) 366-1906	(601) 982-1721	(714) 234-5651
(203) 223-7588	(216) 333-6611	(312) 889-2254	(415) 692-0584	(602) 265-8747	(716) 381-5440
(203) 288-8481	(301) 588-3711	(313) 278-4744	(504) 729-6858	(608) 244-9261	(717) 397-3212
(205) 595-0694	(301) 821-8212	(314) 727-0256	(505) 255-9042	(615) 881-5324	(805) 962-6112
(206) 622-2466	(303) 364-7361	(317) 631-0909	(512) 454-4324	(616) 454-4212	(816) 421-0890
(212) 682-5921	(304) 344-9431	(402) 341-6042	(513) 531-2729	(617) 851-7311	(817) 834-1433
(213) 278-3232	(305) 564-3785	(404) 633-4438	(517) 835-7300	(702) 322-4692	(901) 272-7488
(214) 361-4351	(305) 841-3691	(405) 842-7882	(518) 463-8877	(703) 877-5535	(916) 489-7326
			(601) 234-7631	(713) 668-0275	(919) 288-1695

# When you've got a load to move,

## ROTARY SOLENOID

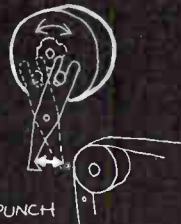

## PUSH/PULL SOLENOID

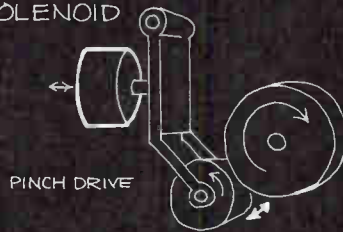

## STEPPING MOTOR

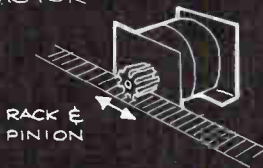

# or circuits to switch . . .

### INTERVALOMETER (TIMED SWITCHING)

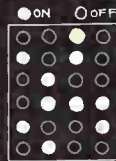
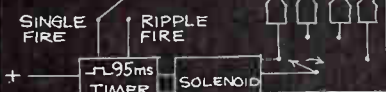

COMPLEX REMOTE PROGRAM & LOGIC SWITCHING

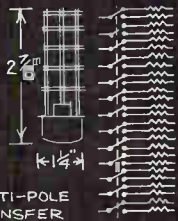

MULTI-POLE TRANSFER SWITCHING WITH ONE COMPACT SWITCH

# Ledex has the people and the products to make things happen.

Ledex Rotary Solenoids give you fast, direct rotary motion. There's a family of eight sizes with torque all the way up to 117 pound inches. For linear loads, our Push/Pull Solenoids respond in less than 10 ms. Both have a compact form factor and there are over 350 stock models to get your prototype off the board and into the shop fast.

Ledex Stepping Motors position loads remotely in predetermined increments over 360°, cw, ccw, or both. You can add a knob for manual positioning. Attach a load on either or both ends. And our newest model gives you 160 ounce-inches running torque.

You'll find versatile Ledex Switches everywhere . . . in missile nose cones, laboratory instruments, business machines, even automatic bingo games. They take up very little space to control, transfer, program and check out complex circuits.

For a neat Packaged Control Solution to your most complex switch problems, we'll deliver the answer in a small black box, ready to plug in. Chances are, the Ledex combination of people and products have solved an actuating or switching problem much like yours already. Just send us an outline of your problem.

See us at IEEE 4A25-27



**LEDEX DIVISION, LEDEX INC.**  
123 Webster Street, Dayton, Ohio 45402 Phone: 513-224-9891



Rotary Solenoid

Circle #510



Push/Pull Solenoid

Circle #511



Stepping Motor

Circle #512



Stepping Switch

Circle #513



Packaged Control Solution

Circle #514

maximum allowable airspeed, mach number, total temperature, and static air temperature—are transmitted by the air data system in a digital format.

**Mixing 'em up.** Arinc characteristic 576, however, requires certain systems outputs to be analog and others to be both analog and digital. As a result, the system going into the DC-10 converts the digital mach hold, airspeed hold, and altitude hold into analog formats, which are then buffered and routed via an analog output card. Similarly, altitude rate, computed airspeed, maximum allowable airspeed, and mach are presented in analog and digital forms.

When a computational cycle is completed, data is routed to either the d-a converter for the analog mode or a digital output buffer register. The latter transmits the serial binary and binary-coded-decimal data to four serial digital transmission channels—one each for computer airspeed, maximum allowable airspeed, altitude rate, and mach number. Two-line, balanced IC line drivers provide the required bipolar voltage levels.

The buffer register also converts the serial data for parallel transfer to latches for the air traffic control transponder's output and the static-source error-correction function.

The d-a converter produces a d-c voltage proportional to the digital word received from the central processor and the d-c reference source connected to a ladder network. This voltage goes to a hold-and-sample amplifier on the analog output card, where it is isolated by a buffer amplifier. In all, eight of these d-c outputs are connected to the hold-and-sample networks.

A-d conversion is needed for the total temperature, barometric pressure, and SSEC inputs. Reference voltages excite the total temperature resistance bridge, the barometric pressure potentiometer, the static-source correction voltage matrix, and the converter's ladder network. The computer-addressed analog d-c input is compared to the ladder output voltage during an 11-step conversion routine. At the end of the cycle, the resulting digital word is proportional to total temperature (resistance), barometric pressure (voltage), and SSEC correction (voltage programing).



## Introducing **THE STUBBORN STABILIZERS** for controlling temperatures without sensors, thermostats or heaters.

They work like magic. They're TI's new all-solid-state thermal controls. They stubbornly insist on maintaining stable thermal environments.

The secret is an exclusive polycrystalline material with a mind of its own. It keeps its own temperature in equilibrium regardless of line voltage variations and

changes in ambient temperature. It functions as a complete, self-sufficient thermal control system.

TI's thermal magicians have built a complete line of solid state devices around this self-regulating material. Component ovens for transistors and diodes. Temperature stabilizers for integrated circuits and thermocouple

reference junctions. Surge switches for current control and limiting. Flow and level indicators. There are more on the way.

Couldn't you use a stubborn stabilizer, too? Write for literature to TI Control Products Division, Attleboro, Mass. 07203, or phone (617) 222-2800 Ext. 318



**TEXAS INSTRUMENTS**  
INCORPORATED



# RZ GLASS

...the big news in sputtering targets...from Owens-Illinois

Owens-Illinois RZ Glass Sputtering Target is a NEW copper alumino-silicate glass readily sputtered on a silicon substrate. After sputter deposition, the RZ glass layer is etched to open up contacts to the silicon substrate. A simple oxidation-reduction process then produces *pure* copper conductive layers on the RZ glass, even in etched undercuts.

RZ glasses are ideal for making single or multilayer interconnections in medium or large-scale integrated circuits. The conductive layer is produced uniformly on RZ-coated substrates regardless of surface geometry.

You now have your choice of *three* sputtering targets from Owens-Illinois . . . 1. NEW RZ copper alumino-silicate, silicon-matching, 2. EE-9 alumino-silicate, silicon-matching, 3. EE-10 alumino-silicate, alumina and gallium arsenide matching.

All three are readily deposited at rates of 250 Å/minute with

standard R.F. sputtering equipment, followed by simple etch when needed. A new manufacturing process holds the sodium content of these glasses below 20 ppm.

Owens-Illinois can supply targets promptly in lengths, widths, and thicknesses to fit your R.F. set-up and substrate dimensions. We'll work with you on materials to meet your special needs.

Complete data, specifications, and sputtering procedures developed in the Owens-Illinois microelectronics research labs will be sent to you promptly on request. Ask for information on these other O-I electronic materials: package sealants, substrate glazes and insulating films, preform materials, glazed IC packaged parts and substrates. WRITE TO:

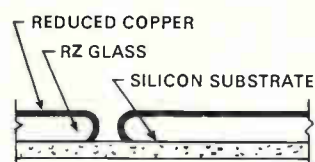

THE O-I FAMILY OF WORK-TOGETHER ELECTRONIC MATERIALS.

**OWENS-ILLINOIS**  
ELECTRONIC MATERIALS  
Toledo, Ohio 43601

# Brazil works on that busy signal

South American giant's shaky telephone system undergoing multimillion-dollar renovation and expansion

By Leslie Warren

Rio de Janeiro news bureau

"After two weeks here I feel like hanging Alexander Graham Bell in effigy."

That's the reaction of a U.S. businessman in Brazil after tangling with the country's rickety communications setup. It can take 15 or 20 minutes just to get a dial tone for local calls. Intercity calls can take hours to complete. For a nation of its size—larger in area than the continental U.S., with 90 million people—Brazil's telecommunications facilities may be the world's worst.

But things are beginning to look up. Today Brazil is one-third of the way through a massive, \$585-million program to build a modern telecommunications network and improve local telephone service. The program will concentrate on four points.

Lofty. Microwave antenna tower for new international communications center in Rio de Janeiro will tie in with a satellite ground station 30 miles away.

▪ A high-capacity microwave relay network of some 7,000 route miles, with channels for voice, television, Telex, facsimile, and data transmission. "By 1971, you'll be able to dial direct from Porto Alegre in the south to Belem at the mouth of the Amazon," says Jose Aristides Wiltgen, general secretary of the Ministry of Communications and president of Contel, the national telecommunications council. The cities he names are 2,500 miles apart.

▪ A link between this network and a troposcatter system to cover remote cities and towns in the vast but thinly settled Amazon basin, which takes in a third of Brazil.

▪ Tying all this in with international communications systems via Intelsat 3. A ground station 30 miles from Rio de Janeiro, with a 90-foot parabolic antenna, is now undergoing tests; it's been partially operational since last month.

▪ Adding another 1.1 million urban telephone lines to the country's present 1.6 million, with the lion's share slated for the badly overloaded systems in the major cities of Rio and Sao Paulo, each with around 5 million inhabitants. This will still leave Brazil some 500,000 lines shy of present demand as measured by the backlog of applications, some gathering dust for 20 years. And Wiltgen agrees that improved service will mean increased demand.

Nevertheless, as the head of a U.S. communications-equipment manufacturing operation in Brazil puts it: "In terms of investment and

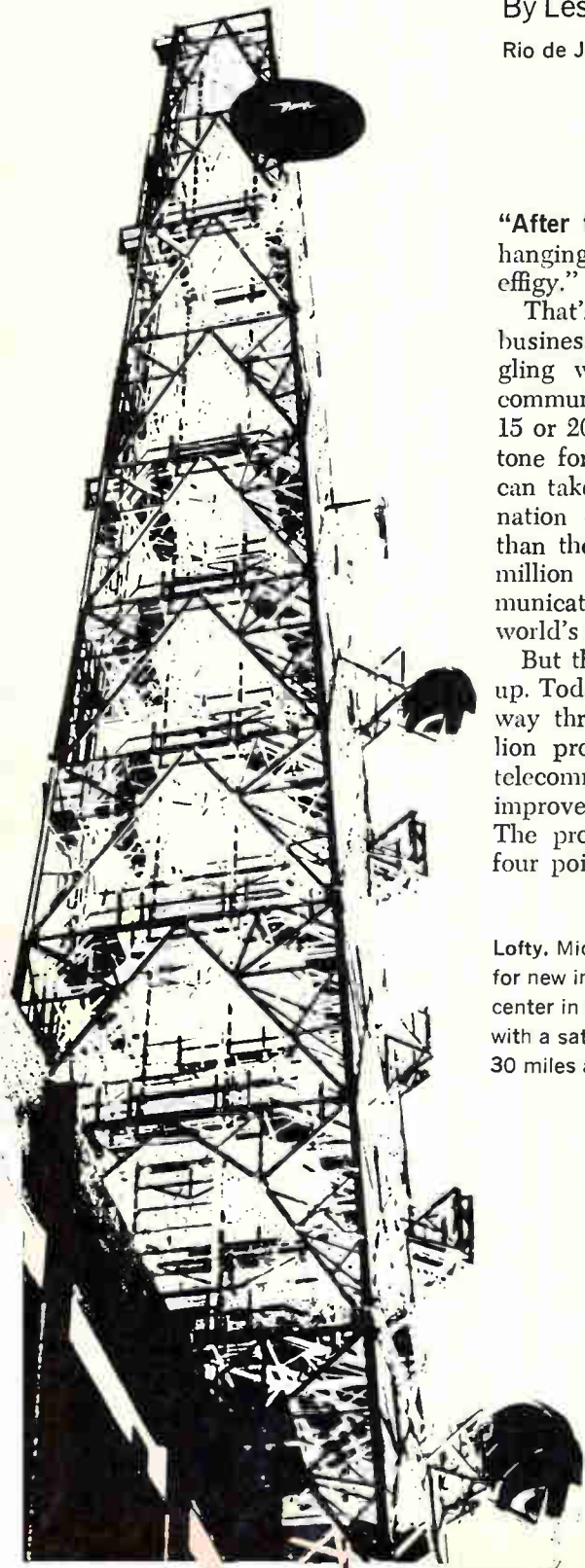

# Bulova forks solve low frequency problems

Let the experience behind 300,000 forks per year help you!



American Time Products forks are now available up to 25 kc, thanks to years of experience plus new design techniques developed by Bulova. (Including the tiny forks for Accutron® electronic timepieces, Bulova made 300,000 last year alone!)

Result: ATP units provide lower cost, smaller size, lighter weight and greater long term stability in such applications as Computers, Navigation Systems, Doppler Radar, Motor Drives, Encoders and Timers. Accuracies of up to 0.001% are available.

Bulova fork oscillators offer the added advantage of simplicity of design and circuitry. Fewer components mean greater reliability. Finally, Bulova fork products are uniquely capable of withstanding severe shock and vibration environments. No wonder Bulova sold 300,000 last year!

## FS-11 FORK FREQUENCY STANDARD

Standard Frequencies: Up to 10,000 cps

Accuracy: Up to  $\pm .001\%$

Input: 28V DC (others on request)

Output: 5 volts p-to-p min. into 10K ohms

Temperature Range: As low as  $-55^{\circ}\text{C}$  to as high as  $+85^{\circ}\text{C}$

Size:  $1\frac{1}{2}$  in. sq. x  $\frac{3}{8}$ "



## SUB-MINIATURE TF-500 TUNING FORK

Standard Frequencies: Up to 2400 cps

Accuracy: Up to  $\pm .001\%$

at  $25^{\circ}\text{C}$

Input: 28V DC (others on request)

Output: Up to 5V rms into 20K ohms

Temperature Range: As low as  $-55^{\circ}\text{C}$  to as high as  $+85^{\circ}\text{C}$

Size:  $\frac{3}{8}$ " x  $\frac{3}{4}$ " x  $1\frac{1}{2}$ " max.

Write or call for specifications on Bulova's complete line of tuning fork products. Address: Dept. E-16.

# BULOVA

AMERICAN TIME PRODUCTS

ELECTRONICS DIVISION OF BULOVA WATCH COMPANY, INC.

61-20 WOODSIDE AVENUE WOODSIDE, N.Y. 11377, (212) DE 5-6000



**Utility.** A key element in Brazil's drive to improve internal communications is the installation of 1.1 million new telephone lines in its major cities.

impact, the program is most astonishing."

## Lots of company

Today, Brazil's telecommunications system is a crazy quilt. There are more than 700 local telephone companies. But one company alone, Companhia Telefonica Brasileira, operating chiefly in Rio de Janeiro and Sao Paulo, has 85% of all subscribers. CTB operates a 460-channel microwave relay system between those two cities, and there is a 120-channel system between Rio and Belo Horizonte, plus a 132-channel link from Belo Horizonte to the capital, Brasilia. All are due to be replaced.

Other than that, all Brazil has in the way of intercity communications is a few low-capacity circuits in long lines or uhf, plus shortwave systems operated by various government bodies, airlines, and other private companies for their own use.

**Via mail.** The Post Office runs the telegraph system. Because of a shortage of messengers, it says, telegrams are usually mailed. Recently, the Post Office set up a Telex system serving 3,000 customers in 16 cities, and the service is to be extended to an additional 4,000 customers.

Actually, compared to the domestic problems Brazil's international communications are in better

shape. ITT and RCA, through local subsidiaries, provide radiotelephone, radiophoto, and Telex service via shortwave systems; Western Telegraph and Italcable do likewise by submarine cable. The Brazilian government is due to take over those services, and some of the installations, when the last foreign concession expires in 1971.

Modernization and improvement, therefore, are long overdue. Right now, public interest is focused on the \$3 million satellite ground station at Itaborai, for which Hughes Aircraft is supplying \$1.5-million worth of equipment. The reason is soccer, or futebol, as Brazilians call it. Brazilians are probably the world's most rabid soccer fans, and Brazilian teams twice running have walked off with the World Soccer Cup in international competition. The next World Cup matches are scheduled for mid-1970 in Mexico, and the Brazilians' insistence on watching them live has given an extra and concerted push to the government's communications program, just as last year's Olympics did for Mexico [*Electronics*, April 1, 1968, p. 95].

When fully functional—by the end of this year—the Itaborai ground station will operate with three r-f channels. One will be capable of handling 132 voice channels, one will be for television, and the third will take service messages





Once we all took lessons in ultrasonics from the porpoise. But today, thanks to Branson's 23 years of concentration in the field and laboratory, what once seemed an obscure principle has now been applied as a practical working tool.

How far have we come? Yesterday's scientific phenomenon has become a full line of Branson Ultrasonic

Cleaners, ranging from standard and custom units to rugged production-proven systems . . . plus a regular line of degreasers, and conveyORIZED and automated cleaning systems.

Result: Branson can handle cleaning from bulky castings to the most delicate electronic components.

If there's ultrasonic cleaning in your

future, don't you need someone with ultrasonic cleaning in his past? Find him at Branson.

Branson Instruments Co., a subsidiary of Smith Kline & French Laboratories, Progress Drive, Stamford, Connecticut 06904

**BRANSON**

For sound ideas in cleaning, testing and measuring

**The silent world of working sound.**

# PULSE

# POWER

Our PG-13 high output E/I pulser will put out  $\pm 100$  volts in the E-mode and  $\pm 2$  amps in the I-mode. PRF 1 Hz to 25 MHz. And with typical 3-I full parameter control to give you more flexibility. Examples: Rise and fall times are independently and continuously variable from 10 ns to 50 ms with greater than 100:1 dynamic range between them. Positive or negative, single or double pulses with the width of each pulse independently variable in the double pulse mode. Amplitude and baseline controls continuous and independent. Delay, first pulse to second pulse, variable from 15 ns to 500 ms.

You can gate the PG-13 or trigger it to 25 MHz or operate it "one-shot" from a front panel pushbutton. Sync pulse, +1V, 15 ns +. Input impedance can be switch-selected for 50 or 500 ohms, and you can vary threshold and sensitivity. Output protected against overloads and shorts; overload indicator.

The PG-13 is solid-state, DC-coupled. Meticulous, advanced design and construction.

For complete technical data or a demonstration, please write or phone: CHRONETICS, 500 Nuber Avenue, Mt. Vernon, N. Y. (914) 699-4400; in Europe: 39 Rue Rothschild, Geneva, Switzerland (022) 31 81 80.

SEE US AT IEEE BOOTH Nos. 2A10-2A14



PRODUCTS OF  
CHRONETICS



## Army attacks the problem

It was a Brazilian, stately Emperor Dom Pedro II, who is credited with giving Alexander Graham Bell a boost by calling attention to his stand at Philadelphia's Centennial Exhibition in 1876. And Rio was among the first cities where Bell's company installed a phone system.

But communications failed to keep pace with the progress made in other sectors in Brazil. The chief reasons for this were politics, nationalism, and inflation.

Recent civilian governments eager to promote development gave priority to hydroelectric projects, roads, steel mills, and other undertakings with more visible public relations impact. Left-wing and ultra-nationalist political pressures kept foreign-owned utilities from raising rates fast enough to stay ahead of inflation. Service deteriorated, thereby heightening sentiment for nationalization. In fact, an ITT telephone subsidiary was actually expropriated by a state government five years ago. (Later, ITT got its money.)

**By the numbers.** With the emergence of military regimes in 1964, however, the outlook for telecommunications began to change. Aware of its importance from the standpoint of national security, the military is giving telecommunications more attention. A Ministry of Communications was set up. The government bought Companhia Telefonica Brasileira from the Canadian-based Brazilian Light & Power for \$96 million, payable over 20 years. Phone rates were then raised steeply.

The Ministry of Communications, headed by Carlos Furtado de Simas, has over-all responsibility for telecommunications. Contel is the Ministry's advisory organ and has policing powers similar to but going beyond those of the U.S. Federal Communications Commission. Embratel, the government long-lines and international operating company, is headed by Gen. Francisco Augusto de Souza Gomes Galvao.

Nobody is applauding the military emphasis on telecommunications more than businessmen, for whom poor communications means losses running into the millions, in terms of contracts lost, delays in ordering parts, or getting in ahead of the competition with orders. To overcome difficulties, many companies either maintain their own single-sideband facilities or keep fleets of vehicles shuttling back and forth between plant and office with messages.

Manufacturers of telecommunications equipment, of course, are reaping a windfall from Brazil's ambitious telecommunications aims. ITT, Ericsson, Philips, Plessey's Automatic Telephone & Electric, Siemens, and Olivetti—all have plants in Brazil. And Nippon Electric agreed to set up a factory as part of its deal for contracts for the microwave relay system.

and television voice.

The station will be linked by two independent microwave systems, with a total of four r-f channels, to an international communications center in Rio for which ITT's local manufacturing subsidiary, Standard Electrica, is supplying equipment.

**Warp and woof.** The \$150-million national microwave network Brazil is weaving together will have three interconnected trunk routes, and probably a fourth to link Brasilia directly with Belem. This system, the backbone of the country's telecommunications structure, will eventually provide a total of 4,123,000 channels. Radio equipment is solid state, virtually all imported. The trunks will have a capacity of 960 channels for each radio frequency, with the exception

of the new Rio-Sao Paulo link, where capacity will be 1,800 channels. The systems will operate in two frequency bands, 4 and 6 gigahertz, with backup channels for automatic protection against failures, and automatic signaling equipment. Relay stations will be about 32 miles apart, and about a fourth of them will be attended. The system will be operated by Embratel, Empresa Brasileira de Telecomunicacoes, a Government company set up in 1962 to operate interstate, and eventually international, communications. Embratel may also take over telegraph and Telex from the postal department.

Work is furthest along on the 600-mile southern trunk. With 23 relay stations, it will run from Sao Paulo to Porto Alegre, thus linking

# TRYGON HAS THE POWER

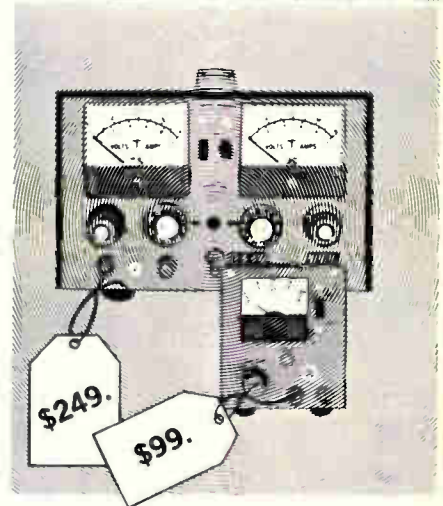

**to deliver these great laboratory power supplies immediately.**

Trygon's economy EAL and precision DL-series laboratory power supplies are available—right now—from 36 sales offices, nationwide. So when we say you'll have them, you can depend on it. You can also depend on them.

The versatile DL Series gives you two independent dual-range supplies (0-20V @ 1 amp or 0-40V @ 0.5 amps) in one half-rack package.

The compact EAL fits in a corner of your bench and your budget (only \$99) and comes in the four most commonly used laboratory voltage ranges.

## TRYGON POWER SUPPLIES

111 Pleasant Ave., Roosevelt, L.I., N.Y. 11575\*

I need the following unit(s).

Qty.	Model	Rating
....	EAL 10-1	0-10 VDC @ 1.0 Amp
....	EAL 20-500	0-20-VDC @ 500 ma
....	EAL 32-300	0-32 VDC @ 300 ma
....	EAL 50-250	0-50 VDC @ 250 ma
....	DL 40-1	2x0-40 VDC @ 1.0 Amp

Name/Title \_\_\_\_\_

Firm \_\_\_\_\_

Address \_\_\_\_\_

City \_\_\_\_\_

State \_\_\_\_\_

Zip \_\_\_\_\_

- Purchase Order Attached.  
 Contact us for Purchase Order.  
 Please send Trygon Power Supply Handbook.

\*PRICES SLIGHTLY HIGHER IN EUROPE.

TRYGON GMBH, 8 MUNCHEN 60, HADLWEG 20, GERMANY.

# ANTENNA and TOWER INSULATORS by LAPP

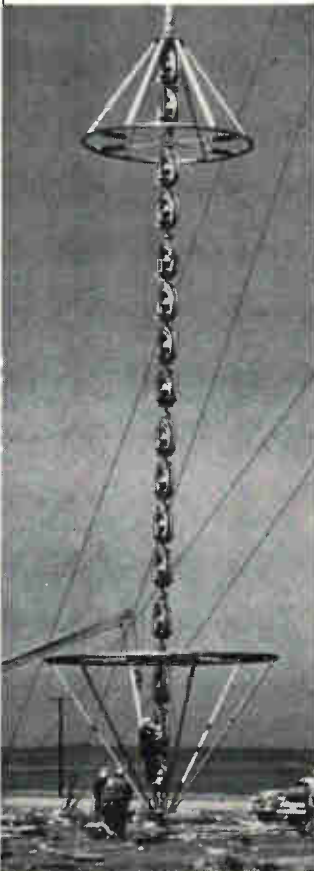
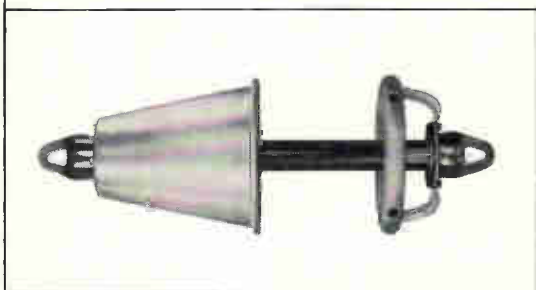
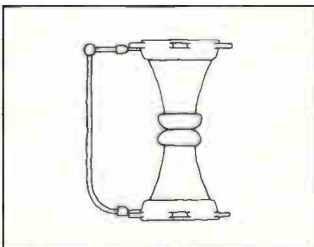
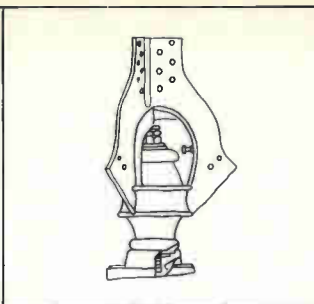

Lapp insulators support most of the world's large radio towers, both self-supporting and guyed masts. Lapp has designed and built base insulators from 80,000 lbs. to 9,000,000 lbs. ultimate strength. Lapp strain insulators have been made from 1200 lbs. to 620,000 lbs. ultimate strength. □ Lapp is also a dependable supplier of entrance, spreader and stand-off insulators for transmission lines. Other Lapp insulators and our gas filled capacitors are used in transmitters and coupling networks. □ Difficult insulating problems are welcome here at Lapp. We've been solving them for almost a half century. Write Lapp Radio Specialties Division, Lapp Insulator Co., Inc., 505 Sumner St., LeRoy, N. Y. 14482.



the nation's financial and industrial hub with the rich agricultural regions of the south. Nippon Electric is supplying the equipment. In fact, the Japanese company has walked off with the largest single slice of the microwave job, including the new Rio-Brasilia and Rio-Sao Paulo links, at a figure of around \$34 million.

The southern trunk initially will provide 660 telephone channels from Sao Paulo to Curitiba in the State of Parana, 360 channels from Curitiba south to Porto Alegre. A branch system will extend from Curitiba to Florianopolis, starting with 108 channels and then dropping down to 60 for the final stretch of the network.

In January, Embratel signed a contract with Standard Electrica for equipment for the western trunk, to run from Sao Paulo some 800 miles to Campo Grande in the State of Mato Grosso. The line will have 25 relay stations and a capacity for 960 channels.

Embratel's northeast trunk, for which Philips Gloeilampenfabrieken is supplying equipment, will run from the mining and metallurgical center of Belo Horizonte to the cities on Brazil's northeast bulge: Salvador, Recife, and Fortaleza. The route will be extended from Fortaleza to Belem with medium capacity equipment, for which General Telephone & Electronics has received the contract.

Embratel is adding a few more links to round out the microwave system. One will go from Rio to the ore-shipping port of Vitoria up the coast. Another will link Sao Paulo with the city of Uberaba in the state of Minas Gerais. This will provide an alternate route for north-south traffic bypassing Rio. According to Contel officials, a final decision has not yet been reached on the proposed 1,200 mile route from Brasilia almost due north to Belem. But the expectation is that it will be microwave relay also, rather than troposcatter.

**Through jungles.** Cost of the Amazon basin troposcatter system, for which final details are being worked out, is estimated at \$36 million. From Belem upriver 870 miles to Manaus it will provide 60 to 120 channels for voice, telegraph, Telex, facsimile, data, and

# HYBRIDS

## bridge the op amp generation gap

Philbrick/Nexus combines the best of monolithic and discrete technologies to create the now generation of op amps—the hybrids. They're micro-miniature and low cost, yet their overall performance is equal to or better than their discrete predecessors. And, built-in stabilization simplifies circuit design by eliminating external components.

### 1402—high performance FET for battery applications

The 1402 features a quiescent current drain of only 500  $\mu$ A with a power supply voltage range of  $\pm 4$ V to  $\pm 24$ V, full output frequency of 80 KHz and output capability of  $\pm 14$ V at  $\pm 5$ mA with  $\pm 15$ V power supply. TO-8 case; 0.5" diameter, 0.14" high. Price: \$75 each in 1-9 quantity.

### Other hybrids offering interesting performance characteristics:

**1404** offers the lowest power drain (50 $\mu$ A) of any general purpose hybrid on the market.  $\pm 2.5$  to  $\pm 15$  volt operation. Produces 1 mA output. Size: 0.75"  $\times$  0.45"  $\times$  0.20" high. Price: \$58 each in 1-9 quantity.

**1406** is a small (TO-8 case) fast general purpose op amp. Price: \$36 each in 1-9 quantity.

**1407** is a low cost high performance FET which features a gain bandwidth product of 30 MHz. Full output frequency is 100 KHz. TO-8 case. Price: \$63 each in 1-9 quantity.

**1408** is a low cost differential FET input. Size: 0.6"  $\times$  0.6"  $\times$  0.25" high. Price: \$30 each in 1-9 quantity.

**Q25AH** is a wideband, high reliability FET. 1,000,000 hours logged without a single failure. TO-8 case. \$180 each in 1-9 quantity.

No other manufacturer offers as wide a variety. Ability to innovate, design and manufacture will continue to provide a greater variety of hybrids from Philbrick/Nexus than you'll get from any other single source.

For complete specifications and technical assistance, contact your Philbrick/Nexus field-engineering representative or write, Philbrick/Nexus Research, 22 Allied Drive at Route 128, Dedham, Mass. 02026.

VISIT US AT THE IEEE  
BOOTHS 2A32, 2A34 and 2A36.



PHILBRICK/NEXUS RESEARCH

A TELEDYNE COMPANY

## In Upstate New York . . .



## the visibility is great— in more ways than one

Most manufacturers want plants with good visibility. It's good product advertising to have your new facilities seen by many.

Our growing network of express highways offers more than fast, easy transportation—there are fully developed, high visibility sites available now.

Add to this fact—our industrial climate is excellent—with 33% of the nation's industrial market within a 300-mile radius. A vast new highway system, with five express routes, makes most major eastern and midwestern markets an overnight haul. Ample labor is on hand to be upgraded to your needs.

Want visible evidence? We have up-to-date data on the industrial climate in 33% of the total area of New York State. For confidential, professional assistance . . .

Contact: W. K. Lampman, Manager of Area Development, New York State Electric & Gas Corp., 4500 Vestal Parkway E., Binghamton, N.Y. 13902.

Phone:  
607/729-2551.



WRITE FOR FREE 195-PAGE  
INDUSTRIAL DIRECTORY  
of our area — on your letterhead, please.

PLANT LOCATION ASSISTANCE  
**PLANK**  
NATIONWIDE NETWORK

high-fidelity transmissions. A spur north to Boa Vista, where Brazilian army engineering battalions are cutting a road through the dense jungle, will provide 12 to 24 channels, initially for telephone and telegraph facilities only. A third troposcatter route, starting at Campo Grande and reaching northwest a total of 1,430 miles to Rio Branco near the Bolivian border, will provide voice channels.

The troposcatter system will give Brazil additional ties to international communications, via Georgetown and Trinidad to the north, and Bolivia to the west, and thus fits in with plans for establishing an Interamerican telecommunications network.

"Our basic program won't be of much help unless we do something about the jam in local communications," says Wiltgen.

**Few phones.** Brazil presently has 1.6 installed telephones for each 100 inhabitants, a ratio "abysmally low, even by Latin American standards," says Contel engineer Romulo Furtado. To get on a par with France or Italy, where the ratio is 10 phones per 100 persons, would mean immediate installation of 7 million telephones. The government's plans fall far short of this goal. But Brazil is earmarking nearly \$400 million to add another 1.1 million lines, primarily in urban centers, by 1971.

Most of the money will be spent by CTB to double the number of phone line in Sao Paulo to 450,000 (76,000 have already been installed), and to add 385,000 lines to Rio's present 315,000. Ericsson do Brasil won the contract for the Sao Paulo expansion, and ITT's Standard Electrica for Rio. Local telephone companies elsewhere are placing orders for a total of 500,000 new lines. All equipment is being manufactured in Brazil.

**Package deal.** Where is the money to finance Brazil's big communications program coming from? Telephone expansion is largely self-financed, with subscribers required to buy \$500 worth of company debentures before they get their phones. The program has been going well in Sao Paulo and Recife, and it is picking up speed in Rio after a slow start, due to CTB's poor public image in that city.

Facts come in  
loud and clear  
on the Brush Mark 280.

Twice as loud and clear.

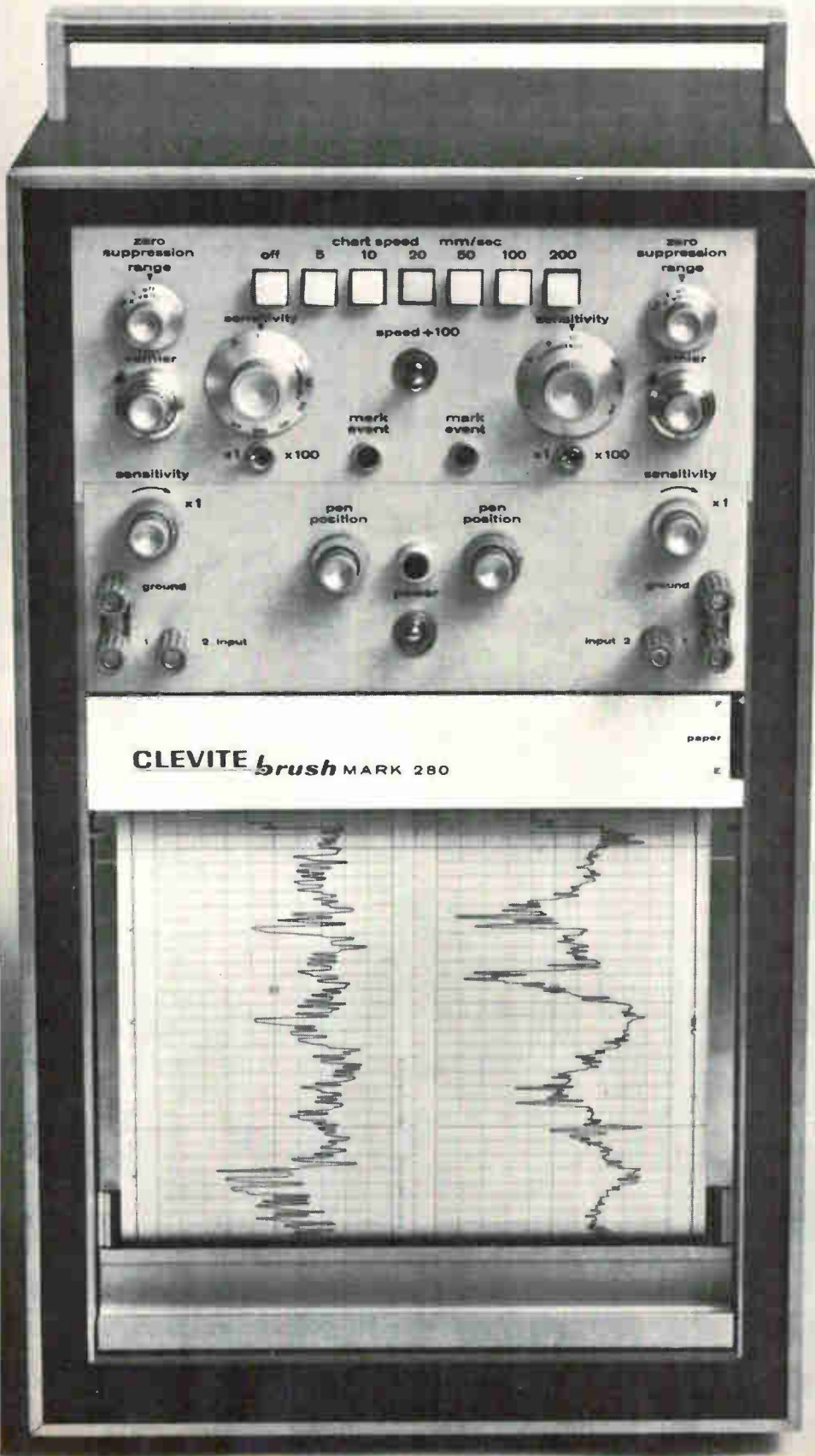

The Mark 280 is the best way yet to get high precision in a portable recorder.

The facts come in on 80mm channels, twice the width of conventional channels. Thus resolution is doubled — because measurements, no matter how complex, are displayed on twice the usual scale — are twice as easy to see and read.

The traces are just plain beautiful — clear, sharp and uniform at any writing speed — so there's no questioning the values you've recorded. They're produced by a pressurized fluid writing method that forces the trace into the paper—not just on it. Never a smudge or smear. The writing's dry on contact.

Accuracy? We guarantee 99½%, and most Mark 280's do even better—thanks to our foolproof pen-position feed-back system that enforces accuracy. Frequency response? To 35 Hz at full 80mm scale — out to 200 Hz at useable amplitudes. Calibrated zero suppression. It's one of many options.

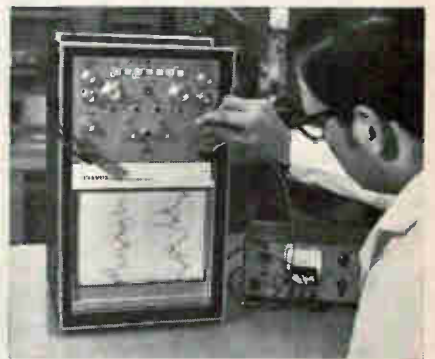

Doubled resolution, near-perfect accuracy, crisp clear traces, high frequency response. That's what you can expect from the Mark 280. Ask your Brush sales engineer for a demonstration. Or write for complete details. Clevite Corporation, Brush Instruments Division, 37th and Perkins, Cleveland, Ohio 44114. We'll include our handy "Chart Running Time" calculator and slide rule.

**CLEVITE BRUSH**

# Why does Sealectro make such a wide variety of programming devices?

## Just so we can give you the little things that count and switch and control and read and program and...

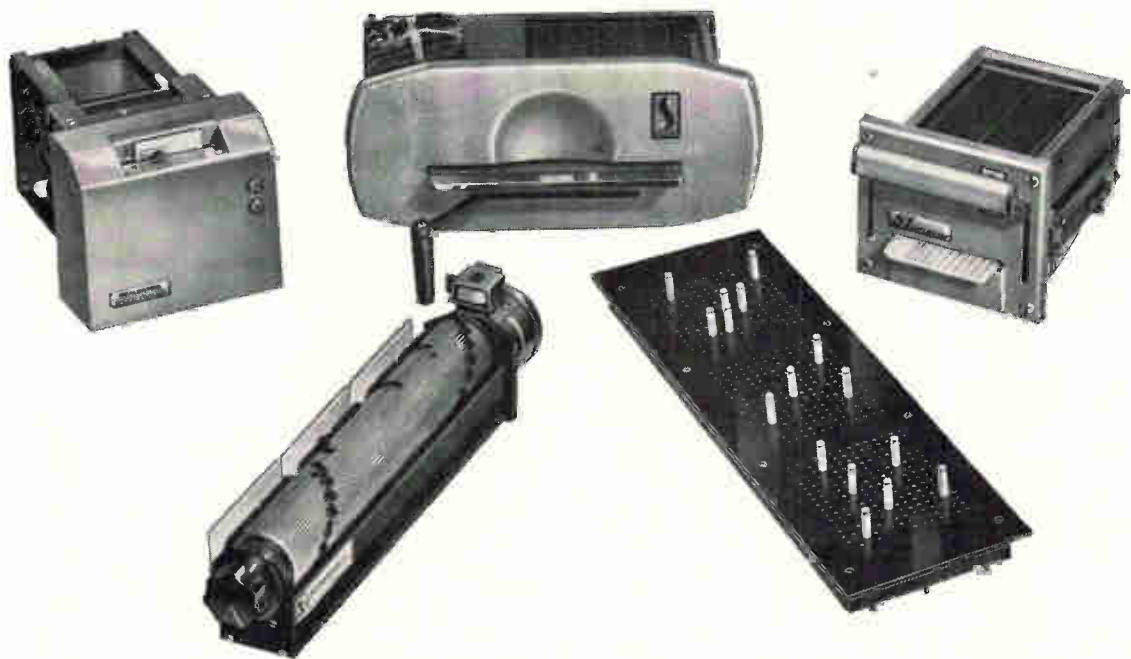

meet every programming requirement. Sealectrocard™ 10 x 10 Badge Readers, 51 x 12 Tab Readers and 80 x 12 Card Readers designed for maximum versatility . . . they just work and work and work. Sealectroboard™ programming boards for all types of programming, switching,

and program display — in any conceivable configuration. Sealectroswitch™ field-adjustable programming switches for timing and control or just plain switching.

It's the little things that count in programming and Sealectro provides every one of them.

Write or call to hear about our complete line.



PROGRAMMING DEVICES DIVISION

**SEALECTRO**  
CORPORATION

MAMARONECK • NEW YORK

PHONE: 914 698-5600 TWX: 710-566-1110

Sealectro Ltd. Portsmouth, Hants, England

Sealectro S.A. Villiers-le-Bel, Paris, France

Visit SEALECTRO at IEEE Show, Booths 4E03-4E07.



ZM1000  
 HEADOUT  
 TUBE  
 NOW



The Amperex ZM1000 is the first digital numerical indicator tube, designed from the ground up for high-volume applications. It provides big economies, not only in initial cost but also in application. Its low price of \$2.95 in thousand lots is only part of the story... in volume, the ZM1000 sells for less than \$2.00.

We scrapped every notion about how to make numerical indicator tubes and developed a completely new design that offers unsurpassed performance and reliability at mass-production prices.

Every ZM1000 has a built-in decimal-point indicator. Use it if you wish—or ignore it... in either case, there's no additional cost for the decimal-point. The ZM1000's large numerals are clearly legible at 35 feet, yet an 8-digit readout can be installed in only 6 inches of panel.

Superior design makes the ZM1000 more economical to use, too; its high-temperature base is designed to plug directly into a printed circuit board or an inexpensive, readily available socket.

- IMPORTANT FEATURES**
- Dynamic life expectancy..... 200,000 hrs.
  - Height of numeral..... 0.6"
  - Tube diameter..... 0.75"
  - Height of tube..... 1.67"

For complete data and comprehensive application bulletin on indicator-driver circuits for the ZM1000, write: Amperex Electronic Corporation, Semiconductor and Microcircuits Division, Slatersville, Rhode Island 02876.

**Amperex**  
 TOMORROW'S THINKING IN TODAY'S PRODUCTS  
 A NORTH AMERICAN PHILIPS COMPANY

IN THOUSAND LOTS

# RF power devices in hermetic stripline packages

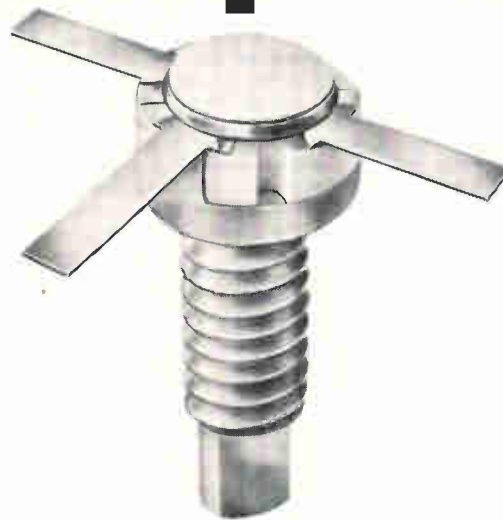

## TYPICAL DEVICES AVAILABLE

Power Rating	Device Number		Similar to
	ungrounded emitter	grounded emitter	
1w@1GHz	S3042	S3043	2N4429
2.5w@1GHz	S1007	S1008	2N4430
5w@1GHz	S1009	S1010	2N4431
15w@400MHz	S3512	S3511	2N5016
10w@1GHz	S1054	S1055	S1050

- Single chip reliability
- Choice of grounded or ungrounded emitter
- Available from the shelf in quantity
- Wide variety of devices available upon request

FOR MORE INFORMATION, CONTACT:

**Electronic Components** DIVISION OF **United Aircraft**<sup>®</sup>

TREVOSE, PENNSYLVANIA

Tel. 215-355-5000 TWX: 510-667-1717

IN THE WEST: 128 E. KATELLA AVE., ORANGE, CALIF., (714) 639-4030



For electrical contacts,  
as in mini-fashion,

# It pays to see a specialist

Like a successful model-on-the go, Deringer is an on-the-go company which concentrates all efforts on providing our customers with the best in electrical contacts, contact sub-assemblies and assemblies. When you consider the many factors involved in designing the optimum electrical contact for a specific application, the advantages of specialization are important to you. So contact Deringer. We'll send one of our "go-go" specialists right away.



**METALLURGICAL CORPORATION**

1250 Town Line Road (Rt. 60) Mundelein, Illinois 60060

Circle 145 on reader service card

# How AO fiber optic light guides solve illumination problems.

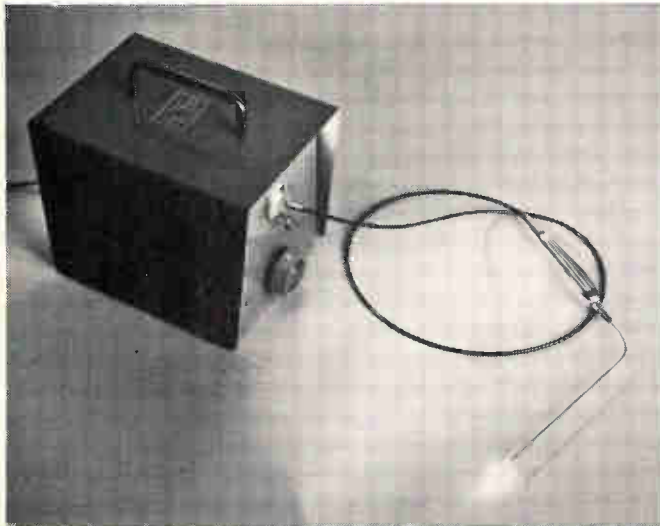

Transmit "cold" light like other forms of energy—by flexible routing to remote or inaccessible locations, hazardous areas, or any abnormal environment.

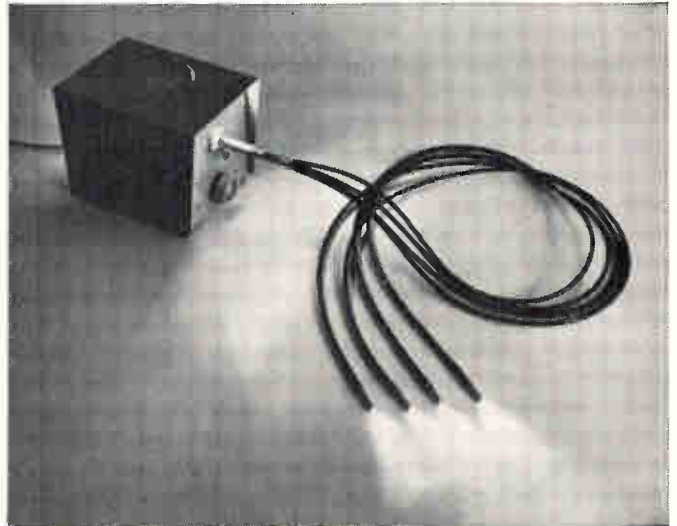

Supply multiple illumination from a single light source, with multi-branched light guides.

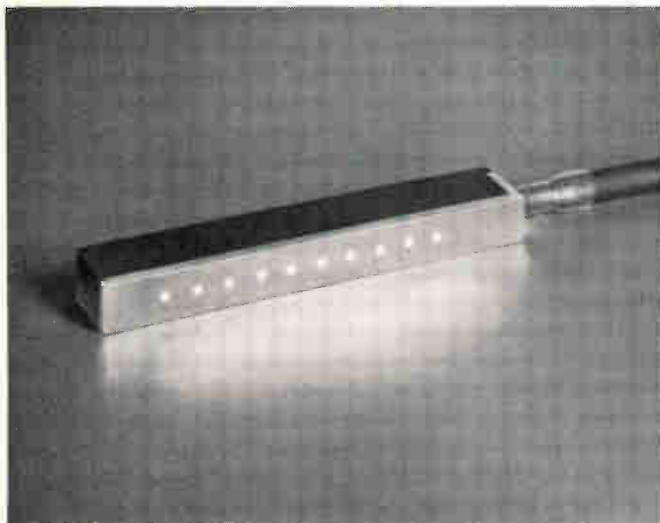

Simplify lighting problems by eliminating lens systems, multiple lamps, complex electrical circuitry.



Provide input-output geometry conversions such as round-to-square, round-to-slit, etc.

These are only a few of the ways in which American Optical fiber optic light guides are used to help solve illumination problems. Specific applications range from mark sense readout to electro-optical sensing in data processing, circuit verification, fire control, null detection, light pens, spot illumination, and many others.

**Simple, reliable, economical.** AO fiber optic light guides are simple, passive elements which remain extremely reliable under normal vibration, temperature or humidity changes, or other environmental fluctuations. This results in long service life with minimum maintenance.

Standard and custom light guides from American Optical have light transmission ranges from 400 to 1500 millimicrons. Standard light guides are

available in bundle sizes from .020" to 1/4", with 30 to 6000 fibers, lengths up to 72", plastic or stainless steel tips, and PVC sheaths. Custom light guides can be supplied in any length desired, with special end tips, sheaths, diameters, input-output face configurations, and branchings.

**A leader in optics since 1833,** American Optical Company brings a great breadth of related experience to the technology of fiber optics. Our versatility in fiber optics is unmatched by any other manufacturer. In fact, AO scientists already hold more than 200 important patents or patents pending in this relatively new field.

**For Fiber Optics Data Kit,** send reader service card, or write to Fiber Optics Department:



**AMERICAN OPTICAL COMPANY**

Space-Defense Division • Southbridge, Mass. 01550

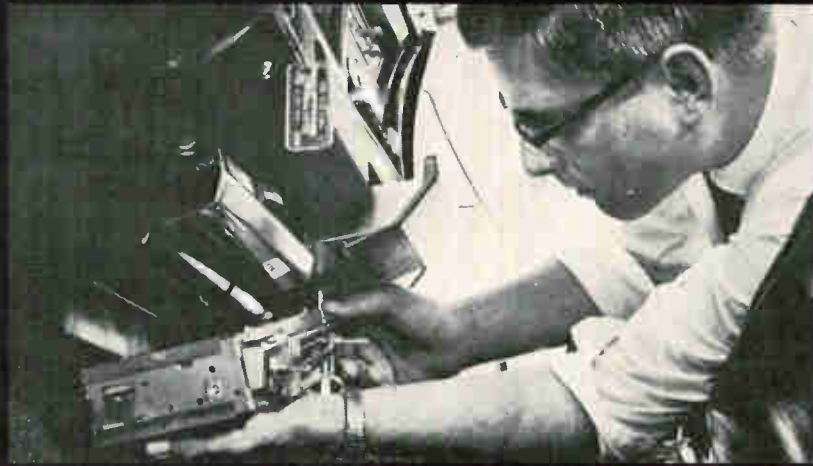

## Mondays never look the same to Bob Byse

When you're breaking ground on a new idea at Delco, you don't see a lot of your own desk. For Bob Byse, design engineering means work with two dozen solid professionals . . . people whose specialties range from microelectronics to model making to production. Wherever the project leads, Bob Byse is on his way. And every skill is at his disposal. Right through full production.

And beyond. If there's trouble shooting under dealer warranty three years from now, Bob Byse is still the man we'll call for. That's why no two Mondays ever look alike to Bob Byse and his colleagues at Delco.

The question is . . . can you say the same? Take a good hard look at how your responsibility shapes up, compared with Bob's. In fact, why not discuss it with us. By letter or telephone. Collect. Area Code 317/459-2808.

Contact: Mr. C. D. Longshore, Supervisor, Salaried Employment, Dept. 304, Delco Radio Division of General Motors, Kokomo, Indiana.

**DELCO  
RADIO**



AN EQUAL OPPORTUNITY EMPLOYER  
DIVISION OF GENERAL MOTORS  
KOKOMO, INDIANA

Circle 147 on reader service card

# "Freon"<sup>®</sup> solvents cut cleaning costs 40% and increased our production as well.

—Dr. James K. Clauss, Signetics Corporation



Dr. James K. Clauss, senior member of the technical staff at Signetics Corp.

Signetics Corporation of Sunnyvale, California, is one of the top four firms in the hottest product area in electronics—integrated circuits.

Signetics uses FREON solvents to eliminate electroplating residues which could adversely affect the seal integrity of the packages in which they encapsulate their integrated circuits.

Before Signetics started using FREON, this critical cleaning process for their integrated circuit packages was more elaborate and required several different cleaning agents. "Now," says Dr. Clauss, "FREON simplifies the process itself and reduces the usage of solvents."

Signetics also found FREON safer to use—no need for elaborate protective devices. This permits greater freedom for the employees using the product.

Increased efficiency is another bonus for Signetics. The use of FREON lets them eliminate several inconvenient and time-consuming steps in the drying process. FREON also permits continuous recovery operation.

In summing up, Dr. Clauss said, "FREON has all the qualities we're looking for—low toxicity, high purity, quick drying and stability."

For facts on FREON, write to DuPont Co., Room 7303, Wilmington, Del. 19898. (In Europe: DuPont de Nemours International S.A., Freon<sup>®</sup> Products Div., 81, Route de l'Aire, CH 1211, Geneva 24, Switzerland.)

\*Reg. U.S. Pat. Off. for DuPont's fluorocarbon solvents.

**DU PONT** **FREON<sup>®</sup>**  
SOLVENTS

# Only one man in a thousand needs this speed in a synchro-to-digital converter...

(the other 999 sleep nights knowing it's there)

Tracks both resolver and synchro data up to 20,000°/sec. with minimal velocity error, Kv of 200,000. Converts continuously to digital-data output with 0.01° resolution and accuracy. Optional: 0.001° resolution, 10-arc-second accuracy at 2,000°/sec.

Accepts both resolver and synchro-angle data from 11.8V to 90V line-to-line at 400Hz. All solid-state design with no moving parts provides essentially inertialess response. Options of 60Hz to 5KHz signal.



Operating modes may be locally selected or remotely programmed.

Three-mode operation: Continuous tracking; Update (repetitive track/hold with display time variable from 0.3 to 3 secs.); Hold (one-shot track/hold with continuous display sequence).

North Atlantic Model 545 Angle Position Indicator is available in a standard panel-mounting rack. A 16-bit binary version is available in a half-rack configuration, and synchro-to-digital modules are available for MUX systems—all elegant examples of North Atlantic's creativity in automatic test equipment, resolver/synchro instrumentation, and computer-interface equipment. For additional, rewarding details call our field-engineering representative (see EEM), use the reply card, or call or write North Atlantic Industries, Inc., Terminal Drive, Plainview, Long Island, N.Y. 11803, (516) 681-8600.

 **NORTH ATLANTIC**  
industries, inc.

# Printed circuit profits are in the holes

But Monarch/Edlund's NPB-S numerically controlled printed circuit drilling machine will put them in your bank account, where they belong. □ The NPB-S is a compact version of the famous Monarch/Edlund NPB, long the standard of the printed circuit board industry. □ The NPB-S can accurately produce 15 to 25,000 holes per hour when drilling 2 stacks of  $\frac{1}{16}$  thick circuit boards, 4 to a stack. This rate can be achieved on all the common types of board materials. This is a productive rate of 30 to 50,000,000 holes per year on a 8 hour shift. □ If your annual hole drilling requirements are approaching this volume you should be looking at the NPB-S to give you the efficiency and quality that spells more profits and more satisfied customers. □ The NPB-S will automatically produce 4 different hole sizes in a single set-up. Fixtures are simple, set-up time is short, and the operator will have free time to permit inspection or loading preparations. □ Short, Medium, or Long runs, NPB-S drills them all. Accurately. Economically. Profitably. Get the whole story from your Monarch/Edlund representative. Or write: Edlund Division, Monarch Machine Tool Company, P. O. Box 749, Cortland, New York 13045.

## Monarch





# LSI halves price of multimeter

French company uses 475-transistor chip in 16-ounce instrument to be unveiled at Paris Components Show; Honeywell to market instrument in the U.S.

By Stewart Toy

Paris news bureau

Most of the IC's are gone from the Digitest, and so is half of its price. Engineers at France's Schneider Radio Television pulled 12 integrated circuits out of their company's digital multimeter and replaced them with a single large-scale integrated circuit. Called the Digitest 500, the LSI multimeter will be introduced at the Paris Components Show, which begins March 24. The 500 is scheduled to arrive in the United States in June, carrying a \$195 price tag.

The meter works with either a-c or d-c and measures voltage, current, and resistance. It has 17 ranges with accuracies from 0.3% to 1.5%. Input impedance is 1,000 megohms per volt; low-range sensitivities are 100 microvolts and 100 nanoamps.

The Digitest 500 weighs 16 ounces and is 9 by 5 by 2 inches.

"We could have made it smaller," says Martin Birnbaum, general manager of Schneider's Professional Electronics division, "but you have to make the buttons big enough for the user to push, and the Nixie tubes have to be big enough to see."

The unit runs off 110 or 220 volts a-c, or 11 to 18 volts d-c.

Schneider turned to LSI because of stiff competition in the American multimeter market. The firm exports a large share of its Digitests to the U.S. where they're marketed by Honeywell Inc. As IC's began replacing discrete components in multimeters, Schneider had trouble matching the prices of its American competitors. IC's used in the company's digital multimeter, the \$400 Digitest 333, cost twice as much in France as they do in the U.S.

So Schneider went shopping in

the LSI market. After talking to many firms, including Texas Instruments, Motorola, and Fairchild, Schneider picked General Instrument Corp., last June, to help develop an LSI circuit for the proposed multimeter.

**Final choice.** Engineers at Schneider designed a dozen possible circuits for the new meter, and GI picked three as feasible for LSI. Schneider then made its final choice—a 475-transistor circuit.

Development work was done by engineers at GI's plant in Naples. GI plans to make the circuits at its Hicksville, N.Y. facility, and then send the chips to Naples for encapsulation.

GI's bill for development work came to about \$35,000. In addition, Schneider agreed to buy a minimum of 10,000 circuits at about \$8 per circuit. Based on a 10,000-cir-



**Frank display.** The price of this three-digit multimeter is \$195. Schneider, the meter's maker, kept costs down by using a custom-designed LSI circuit in place of a dozen off-the-shelf IC's. The meter has 17 ranges, and runs off line voltage or a battery.



## Look what \$325 buys in a 1 $\mu$ V Full Scale DC Null Detector/Microvoltmeter

It buys you a portable performer with 0.15 microvolt resolution. It's handy and convenient to use. It's rugged, too—works more than 1000 continuous hours on four carbon-zinc batteries. It's the Keithley Model 155—the lowest-priced electronic null detector on the market today.

The 0.03  $\mu$ v rms input noise is quieter than any other in its price class. Coupled with better than  $\frac{1}{2}$   $\mu$ v per day stability and 1 megohm input resistance at 1  $\mu$ v full scale, the 155 is ideal as a null detector for potentiometers, bridges, ratio devices and comparator circuits.

When the Model 155 isn't working as

a null detector, it doubles as a 1  $\mu$ v to 1000 volt microvoltmeter with 19 zero center ranges. Use it for measuring thermocouple and thermopile potentials, contact resistance, making Hall Effect studies, or whatever.

See this little giant perform. Call your Keithley Sales Engineer for your demonstration. Or contact Keithley Instruments, Inc. for complete details—28775 Aurora Road, Cleveland, Ohio 44139. In Europe: 14, Ave. Villardin, 1009 Pully, Suisse. Prices slightly higher outside the U.S.A. and Canada.



KEITHLEY

... the higher-priced 333  
won't be retired ...

cuit sale, the cost per circuit is \$11.50—a considerable saving over the \$35 Schneider pays for the 12 IC's in the 333.

Schneider also saves on discrete transistors. The 500 has 50 transistors, 130 less than the older meter has.

Besides reducing the component costs, LSI cuts the number of soldering points, which lowers labor charges. Schneider also figures that its quality control costs will fall because it's GI's responsibility to inspect the LSI circuit.

Going LSI meant that Schneider engineers had to redesign the multimeter. "We just couldn't replace 12 boxes with one without doing some rewiring," says Birnbaum. "So we redesigned the instrument."

First, the circuits were designed to interface the LSI circuit and the meter's 50 transistors. Then, Schneider engineers went inside the meter and redesigned the counters' logic and output circuits and some of the logic circuits in the analog-to-digital converter. The result is that the LSI circuit has only 16 soldering points.

The meter's logic and counter circuits are all on the LSI chip. One operational amplifier and some discrete components do the signal conditioning. The a-d converter is all discrete components, primarily field effect transistors.

Even when the 500 is on the market, Schneider won't retire the 333 because the older unit has a few features the new LSI version doesn't have. Polarity on the 333 is automatically displayed and the unit has 23 ranges. Also, the 333's accuracy is between 0.1% and 0.2%.

Schneider expects that the 333 will still have appeal as a bench-top instrument.

This summer, Schneider expects to reach its full production level of 700 to 800 meters per month.

At the Paris show the company is also introducing a digital panel meter that uses the same LSI circuit as the Digitest 500. This unit, the VT-500, will sell for \$120.

Schneider Radio Television, 12, Rue Louis Bertrand, 94 Ivry, France [338]

# Our eyes do everything but blink.

**Newest camera tubes promise unprecedented performance in low light level TV, pattern recognition, tracking.**

Called a Cinticon™ camera tube our newest electro-optical device combines an orthicon-like storage/amplifying film with a Vidicon gun and intensifier. The result is a small super sensitive tube that will operate in near darkness.

Applications that immediately come to mind are surveillance cameras, cameras for on-spot news coverage, research into behavioral sciences, remote observation in light sensitive areas, as well as a host of military uses, both airborne and ground.

## **Vidisector®, Uvissector™ and Vidicon Tubes**

What makes advanced devices such as the Cinticon tube possible is our decades long experience over a wide range of tube design, production and application know-how.

Our very high resolution image dissectors, Vidisector and Uvissector tubes are cases in point. These magnetically focused and deflected camera tubes have a wide spectral response that ranges from near infrared to ultraviolet.

Add the advantages of reliability and simple operation and you can see why we've been the leading producer of these tubes for industrial process control, star trackers, scanning spectrometers and slow scan TV systems.

Example of our expertise at work: Vidicons which are the eyes for unerring guidance of Walleye and Maverick missiles.

Another: a unique Generation I image intensifier. Available as either a single or multiple stage device, it utilizes fiber optics coupled to a Vidicon for industrial security,

surveillance or low light level TV.

## **Correlation**

Not just content with seeing accurately, we also build a tube that remembers what it sees. Our work in correlation tubes has initiated entirely new methods of image processing. Among them: pattern recognition motion compensation, map and document reading, tracking, as well as electronic manipulation of images such as in area correlation, multiplication and division.

Naturally, we'd like to put this experience to work for you. Write for our brochure on electro-optical devices. If you have a blue-sky problem you want brought down to earth call us direct. ITT Electron Tube Division, International Telephone and Telegraph Corporation, P.O. Box 100, Easton, Pennsylvania. Phone: (215) 252-7331

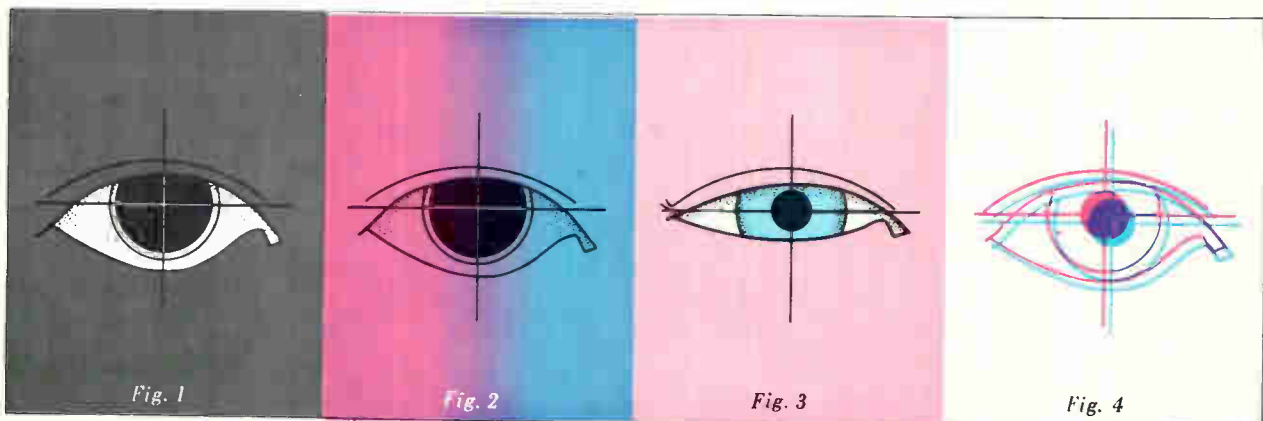

*Fig. 1 Cinticon camera tube combines orthicon-like storage with intensifier for super sensitivity under low light conditions. Fig. 2 Vidisector and Uvissector tubes ranging from near infrared to ultraviolet are reliable, simple to operate.*

*Fig. 3 Special design of Vidicons results in accurate guidance of Walleye and Maverick missiles. Fig. 4 Correlation tubes make possible new methods of electronic manipulation of images.*

ELECTRON TUBE DIVISION **ITT**

# Terminal helps stamp out stampings

Grooved pins cut costs of producing reed relay assemblies; notched ends facilitate soldering of leads and improve rigidity

Attaching wires to terminals is one of the most critical operations in packaging electronic devices. It's also one of the most expensive. The Automatic Electric Co., the manufacturing subsidiary of the General Telephone & Electronics Corp., manufactures reed switches by the thousands, some with as many as fourteen terminals, so when the Groov-Pin Corp. came up

with a potentially cheaper and more reliable terminal, AE was receptive. As it turned out, the potential was fully realized; although AE won't reveal the specific production cost savings afforded by the new terminal, they are known to be significant.

Until recently, Automatic Electric used stampings as the terminals of their Correeds—dry reed

switches with a sensitivity of 35 milliwatts at pull-in. These stampings were difficult to connect because of all the orientation involved in press-fitting them into the nylon frame holding the coil.

Seeking a replacement for them, Automatic Electric engineers looked at Groov-Pin's fastener, which is a combination terminal and pin. The nickel-silver pin is



High-speed, d-c static circuit breaker, model SD500 gives a clean, arc-free, bounceless break at 50  $\mu$ sec after current overload. It is available in 5 models, ranging from 25 ma to 1 amp. Each has its trip point adjustable from 50% to 150% of its rating. Price (1 to 3) is \$26.75 each; delivery, stock to 2 weeks ARO. Flight Systems Inc., P.O. Box 25, Mechanicsburg, Pa. 17055 [341]

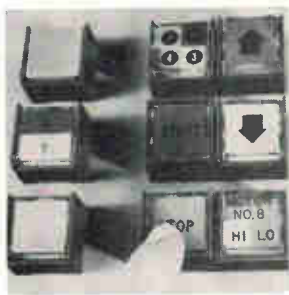

Oilight pushbuttons and indicators in the PM line offer a wide variety of interchangeable switching elements. Each square unit mounts in a 7/8-in.-diameter round hole, yet displays full 0.9 x 0.9 in. panel front area. Lighted devices use up to 4 miniature lamps to illuminate 1, 2, 3 and 4-section legible displays. Micro Switch Div. of Honeywell Inc., Freeport, Ill. [342]

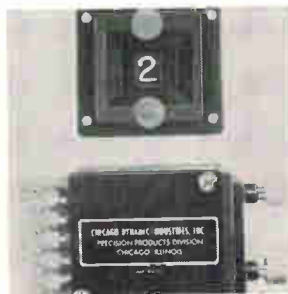

Bidirectional, miniature 10-position pushbutton switch series MBP/AS-27000 is available in decimal, binary, and binary with complement outputs, and with internal lighting if desired. Push one button to add, the other to subtract. Total panel height is 1 1/4 in. and behind panel dimension 1 7/8 in. deep. Chicago Dynamic Industries Inc., 1725 Diversey Blvd., Chicago. [343]



Proportional-oven controlled crystal oscillators series CO-211 range in stability from  $1 \times 10^{-9}$  per day through  $1 \times 10^{-7}$  per day. The seven 2 x 2 x 3 in. plug-in modules are electrically and mechanically interchangeable. Units operate over any ambient temperature range between 0° to 50°C and -55°C to +75°C. Vectron Laboratories Inc., 146 Selleck St., Stamford, Conn. [344]

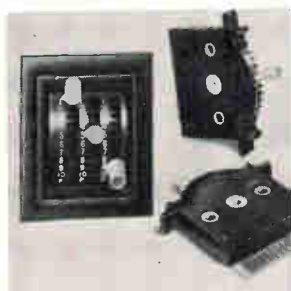

Programming circuit selector called Slide'n Switch is a modular switch featuring the ability to go from any one of a total of 11 positions to any other position without contacting intermediate switch steps enroute. Contacts are rated to carry 3 amps static, 250 ma during switching for a minimum of 250,000 operations. Sealectro Corp., 225 Hoyt St., Mamaroneck, N. Y. 10543. [345]

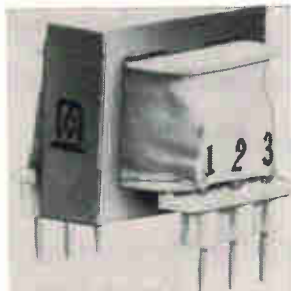

Plug-in p-c power transformers are for use in power supplies for op amps, control equipment, computer modules and instrumentation using miniaturized solid state circuitry. Units provide step down and isolation from power lines at relatively low power levels ranging from 0.325 to 7.5 va. They meet MIL-T-27G Grade 6, Class R. Microtran Co., 145 E Mineola Ave., Valley Stream, N. Y. [346]



Illuminated push-button switches handle 6 amps at 125 v a-c. The design encloses a dpdt action in a miniature case and still allows separate connections to the lamp thus increasing circuit flexibility. Plastic buttons are supplied in 3 basic sizes (1/2, 3/8, 3/4 in.), either round or square, in a choice of 9 colors. Alco Electronic Products Inc., Box 1348, Lawrence, Mass. [347]



Card-edge p-c connector series 600-121-27 is a 27-dual contact unit (54 terminals) with 0.100 in. center-to-center contact spacing. Current rating is 3 amps continuous, 5 amps max. A choice of dip solder or solder lug terminations is available in gold plated beryllium copper. Contacts accept a 1/16 in. p-c board. Continental Connector Corp., 34-63 56th St., Woodside, N. Y. [348]

1/32 inch in diameter and a half-inch long and has swaged grooves and ridges in the middle, making that center region slightly oversized. When one of these pins is inserted in the relay's nylon coil form, it is locked in by the cold flow of the nylon into the grooves. This lock is enhanced when the coil lead is soldered or welded to the pin; the heat causes additional

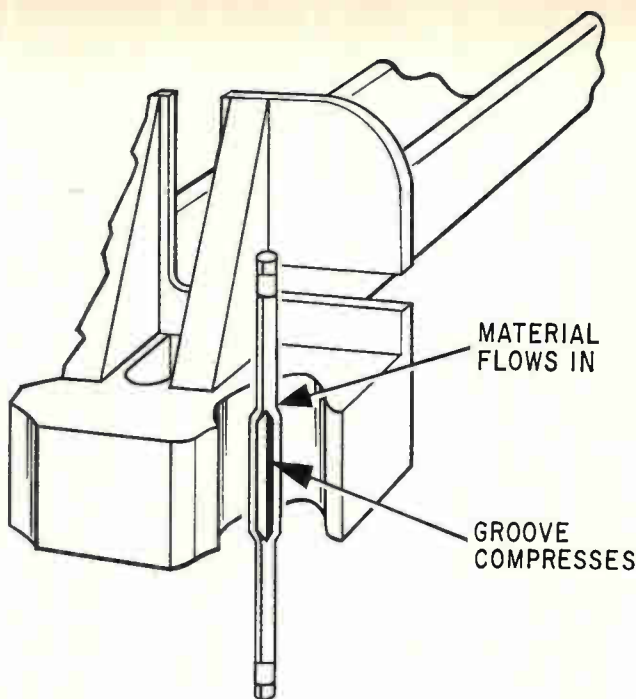

In the groove. Nylon from coil frame cold-flows into grooves of the pin, and at the same time compresses the groove as the pin is forced into the frame. Later, when wires are soldered to the pin, the heat causes additional flow.



Plastic-cased miniature tubular micas meet the electrical and environmental test requirements of MIL-C-5C and EIA RS-153A. They are available in a capacitance range of 1 pf to 1,000 pf and working voltages of 500, 300 and 100 v d-c. Standard capacitance is  $\pm 5\%$ . Dimensions are 0.312 in. diameter x 0.515 in. long. Aerovox Corp., New Bedford, Mass. 02741. [349]

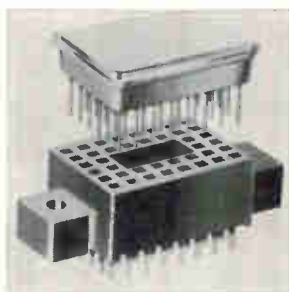

Forty-pin molded socket is designed to accept modules with round or flat leads. Wiping type beryllium copper gold plated contacts assure positive retention. Contacts are on a 0.100 in. grid pattern. Chamfered entry holes provide easy insertion. The socket comes with p-c termination. Dimensions are 1.375 x 0.700 x 0.360 in. Augat Inc., Perry Ave., Attleboro, Mass. [350]

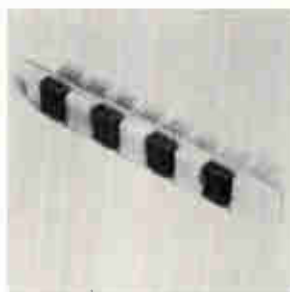

Wire-wrap plate connectors meet stringent military and commercial specifications. The 1000 series are for 0.100-inch grid spacings, and the 1200 series are for 0.125-inch grid spacings. Each series includes tuning fork components and male blade contacts. NAFI-type polarizing bushings are available for the 1000 series. Teradyne Components, 900 Lawrence St., Lowell, Mass. [351]

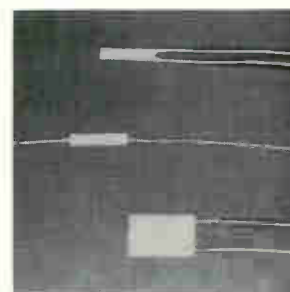

Surface temperature transducers series 4-510 employ reference grade platinum as the sensing element. Standard units feature a temperature range of  $-320^{\circ}$  to  $+650^{\circ}\text{F}$ , ice point resistance of 100 ohms, repeatability of  $\pm 0.5^{\circ}\text{F}$ , and a time response of 1 second. Unit price is \$87. Consolidated Electroynamics Corp., 360 Sierra Madre Villa, Pasadena, Calif. [352]



Monolithic gaussian crystal filter 6354 MA is for minimum delay distortion in f-m, non-overshooting pulse response in pulse modulated systems, and reduced ringing in swept frequency. Center frequency is 10.7 MHz; 3-db bandwidth, 2.5 kHz; 40-db bandwidth, 17.5 kHz max.; source impedance, 500 ohms resistance. Damon Engineering Inc., 115 Fourth Ave., Needham Heights, Mass. [353]

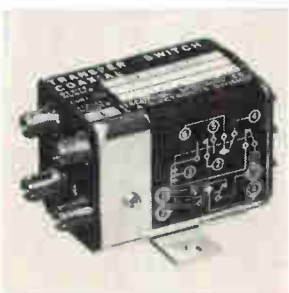

Subminiature transfer switch series 09-51 has a vswr of 1.25:1 at 12.4 GHz, and provides high interchannel isolation from 0 to 18 GHz. Actuating current is 53 ma at 26.5 v at  $25^{\circ}\text{C}$  for latching and 177 ma for fail-safe operation. Switching time is less than 10 msec. Life is over 1 million cycles. Electronic Specialty Co., 4561 Colorado Blvd., Los Angeles 90039. [354]



High-density, microminiature lamp has a maximum diameter of 0.054 in. and bulb length of 0.176 in. It is an unsupported filament, unbased T-3/8, for use in electronic circuit exciters, pointer indicators, readout lamps, and the like. Three ratings are available: 1.5 v, 0.051 amp; 3 v, 0.029 amp; 1.5 v, 0.015 amp. LAMPS Inc., South Western Ave., Gardena, Calif. 90247. [355]



Microminiature relays series MA and MS are TO-5 transistor sized. The hermetically sealed, dpdt devices are rated at 1 amp and designed to withstand high environmental stresses. They meet all applicable requirements of MIL-R-5757. Consistent contact performance is assured by strict environmental control throughout manufacture. Hi-G Inc., Windsor Locks, Conn. 08098. [356]



**CUSTOM  
OR STANDARD -  
YOUR BEST CHOICE  
IS THE WORLD'S LEADER**

Collins has designed over 1,000 different hybrid thin film circuit devices. Many are available off the shelf. For custom or standard designs, call Collins, the most experienced hybrid thin film manufacturer. See adjoining page for general circuit types and names of men ready to serve you.

# COLLINS HYBRIDS

Collins hybrid thin film circuits offer reductions in volume, size and cost while improving reliability and versatility. General types are AGC circuits, amplifiers, balanced modulators, counters, dividers, drivers, encoders, filters, mixers, oscillators, regulators, shift registers, signal conditioners, squelch controls, switches, terminators, and triggers.

## For Engineering Information

Collins' Engineering Representative in your area will advise you of available designs or assist you with custom requirements. Call:

BALTIMORE J. R. Daniel & Co., Inc., Jim Daniel, 301-825-3330  
BOSTON R. H. Sturdy Co., Charlie Sutherland, 617-235-2330  
CHICAGO Edward Schmeichel Co., Ed Schmeichel, 312-378-2070  
COLUMBUS Electronics Marketing Corp., Gerry Ihnat, 614-299-4161

DALLAS Dunbar Assoc., Inc., Craig LaTaste, 214-239-7151

DENVER Lindberg Co., John Lindberg, 303-757-6489

KANSAS CITY Midland Engineering Sales Assoc., M. J. McAllister, 913-262-6565

LOS ANGELES West Inc., Chuck Kelley, 714-540-9040

MINNEAPOLIS Merrill Franklin Co., Merrill Franklin, 612-920-8014

NEW YORK CITY Harold Gray Assoc., Inc., Harold Gray, 201-384-3643

ORLANDO William R. Lehmann Co., Bill Lehmann, 305-841-4901

PHILADELPHIA J. R. Daniel and Co., Inc., Joe McDonald, 215-887-0551

SAN DIEGO AXINN Assoc., Bill Anderson, 714-892-2030

SAN FRANCISCO Jack Pyle Co., Jack Pyle, 415-349-1266

SYRACUSE Naylor Electric Co., Inc., Jim Naylor, 315-472-9183

COPENHAGEN Tage Olsen A/S, Harry Diemer, 01-29-48-00

DEN HAGUE Schreiner and Co., H. Zuiderduin, 070-601930

HELSINKI K. L. Nyman, K. L. Nyman, 21425 or 31025

LISBON Casa Serras, Augusto Serras, 32-01-33

LONDON G. A. Stanley Palmer, Ltd., Ken Drury, Molesey 7254

MADRID H & O Wilmer, Curt Wilmer, 231-8301 or 231-7307

MEXICO CITY Collins Radio de Mexico, S. A., Roberto Pelaez, 25-11-92-56

MILAN Silverstar S.P.A., Italo Majer, 49.80.151

MONTREAL Collins Radio Co. of Canada, Ltd., Frank Williams, 514-631-9141

OSLO Luftmateriell A/S, Odd Ramsted, 33-32-03

PARIS Technique et Produits, Serge Sibon, 626-02-35

ROME Silverstar S.P.A., Franco Bartoccini, 855-366

STOCKHOLM John C. Lagercrantz, Stieg Svenson, 83-07-90

STUTTGART INDEG, Wolfgang Buhler, 06331/3008

TORONTO Collins Radio Co. of Canada, Ltd., Jim Murray, 416-757-1101

ZURICH Telion, Ltd. AG, Willie Bamert, 051-54-99-11

## For Immediate Delivery

Collins Distributors stock representative standard hybrid thin film devices for immediate delivery in your area. Call:

BALTIMORE Technico, Inc., 301-828-6416

BOSTON Cramer Electronics, Inc., 617-969-7700

CHICAGO Newark Electronics Corp., 312-638-4411

FT. LAUDERDALE Cramer Electronics, Inc., 305-566-7511

NEW YORK Technical Electronic Distributors, Inc., 201-384-3643

## For Free Designer's Manual

For a free copy of Collins Hybrid Thin Film Designer's Application Manual, call or write Tom Starr, Collins Radio Company, Newport Beach, Calif. 92663, Tele. 714-833-0600.



See Collins hybrid thin films at N. Y. IEEE.

flow of nylon into the pin's grooves.

The pins are notched at both ends to facilitate wrapping and soldering of the leads; however, leads can be attached over the entire length of the pin—unlike stamped terminals. The pins require little orientation; either end can be inserted in the coil frame and no rotation is needed. The notches also produce a more rigid assembly, according to Vincent Mano, sales manager for Groov-Pin, thus improving reliability.

Automatic Electric found another benefit in switching from standard stampings to grooved pins: the nylon coil frame could be simplified. The press-fit stampings required special keyholes of various diameters and shapes, but now there's no need for hard-to-remove core pins in the plastic mold.

The manufacturer of the grooved pins claims that the technique offers similar savings to connector and socket manufacturers.

Groov-Pin Corp., 1125 Hendricks Causeway, Ridgefield, N.J. 07657 [357]

## New components

### Op amp trimming done internally

#### Thick-film DIP units

designed as plug-in replacements for 709's

Putting operational amplifiers in standard-size dual in-line packages with standard lead spacing left something to be desired until recently. To eliminate voltage offsets and unwanted bias currents—the two prime sources of d-c error in an op amp—the user had to resort to an external transistor as his bias source. Since each op amp's trimming requirements in these areas is unique, this becomes an individual operation for each device.

Not so with two new hybrid thick-film op amps to be introduced next week at the IEEE Show by the Burr-Brown Research Corp. Bias currents are internally compen-

sated, and voltage offset is internally trimmed in models 3226/03 and 3227/03. These are the first hybrid thick-film products to come from Burr-Brown, which has a strong reputation as a supplier of discrete op amps. The firm plans to put a good number of its linear products into hybrid form, says Jerry Graeme, hybrid products manager.

The products marry Burr-Brown's monolithic integrated circuit op amp design with thick-film resistors and chip capacitors to provide a device that is fully compensated internally. It will also be a direct plug-in replacement for the popular  $\mu A709$ . Graeme says Burr-Brown's op amp will also provide strong competition for Fairchild's  $\mu A741$  on both price and specifications, even though the 741, like Burr-Brown's, also has internal phase compensation. The Fairchild op amp is a monolithic device that sells for \$22.50 compared to \$19.80 for Burr-Brown's model 3226/03; the Burr-Brown model 3227/03 is the same device with slightly relaxed specifications and a unit price of \$11.90.

**Guarantees.** Graeme says Burr-Brown guarantees minimum levels for all these specs: slewing rate, voltage drift, and bias current drift. Among monolithic op amp suppliers, he says only Fairchild's 709 and National's LM 101A have guaranteed minimum voltage drifts, and no one guarantees slewing rate and bias current drift minimums.

The minimum slewing rate of the model 3226/03, Graeme says, is 0.9 volt per microsecond over the entire output range of  $\pm 10$  volts. The device's typical slew rate is two volts per  $\mu\text{sec}$  compared with a 0.5 microvolt per  $\mu\text{sec}$  for the 741. Input bias current at 25°C is  $\pm 50$  nanoamperes maximum.

Maximum bias current drift for the model 3226/03 is  $\pm$  one nanoamp per °C. Its typical current drift is 0.5 nanoamp per °C as opposed to three nanoamps per °C for the 741. The model 3226/03 has a maximum voltage drift of  $\pm 15$  microvolts per °C. Graeme feels this feature will make it competitive with National Semiconductor's LM 201A monolithic op amp, which costs a little less at \$18 but has a maximum voltage drift of  $\pm 20 \mu\text{V}$  per °C and isn't



# Every Engineer or Draftsman should have the **NEW BY-BUK CROSS REFERENCE GUIDE P-45**

(supersedes By-Buk Catalog No. P-42)



## to better printed circuit drafting.

This **FREE** 24 page booklet contains color-coded standard MIL-SPEC SIZES and design standards . . . plus a newly added numerical index for easy reference to over 2000 pre-cut tapes, pads, shapes, transistor tri-pads, spaced IC

terminal pad sets and other drafting aids for faster, more accurate, distortion-free printed circuit master drawings.

### Send for your **FREE** guide today!

## BY-BUK COMPANY

4326 West Pico Blvd. • Los Angeles, Calif. 90019 • (213) 937-3511



Circle 212 on reader service card

## PAPER TAPE READERS FOR SMALL SPACES AND LOW BUDGETS

MDS Paper Tape Readers are low cost, reliable units engineered to meet your needs in programming and control applications. The line includes Models 2119, 2120, 2121, 2153, 2166 and 2911 . . . and the 2131 Edge-Punched Card Reader.

Simple design and rugged construction characterize these MDS Readers. They incorporate the well-known advantages of star-wheel sensing; reads 5, 6, 7 or 8 level; tape speeds to 60 characters per second; panel or flat-bed mounting. Panel sizes from 3½" x 11" to 8¾" x 19".

For simplicity in design . . . reliability in action . . . specify MDS Low-Cost Paper Tape and Card Readers.

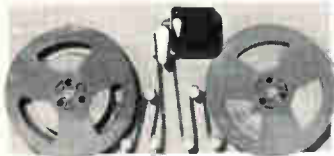

MDS 2121 Paper Tape Reader

MDS Low-Cost Paper Tape Readers make no compromise with quality.

ASK FOR THE MDS FOLDER FILE  
OR MEET YOUR MAN FROM MDS

## MOHAWK **MS** DATA SCIENCES CORPORATION OEM MARKETING

122 E. Ridgewood Ave. • Paramus, N.J. 07652

Telephone 201/265-7333

Every MDS Office is an OEM Marketing Office  
Digital Strip Printers • Buffered Tape Units  
High-Speed and Low-Speed Line Printers  
Card Punches and Readers

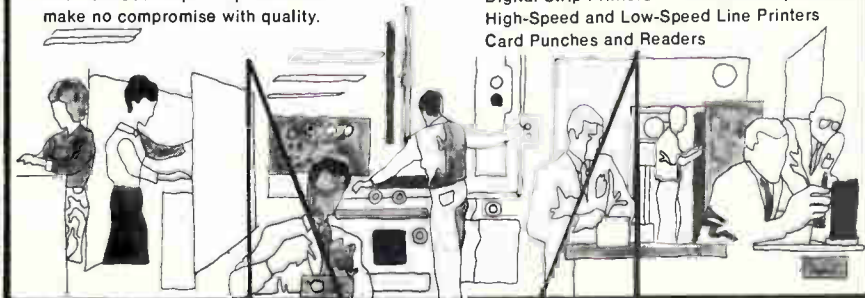

internally phase compensated as the Burr-Brown device is.

**Well balanced.** The design of his firm's monolithic chip (which is manufactured for Burr-Brown by Motorola's Semiconductor Products division) is well balanced in biasing, explains Graeme. "If you maintain a balance in the single-ended stage of your op amp, it tends to improve the slewing rate, and we've done this," he notes. He adds that the design, by getting around the cumbersome phase compensation required on the 709 chip, contributes to the better slewing rate.

"The point at which you apply phase compensation is important in its effect on slewing rate," he continues. "In many monolithic op

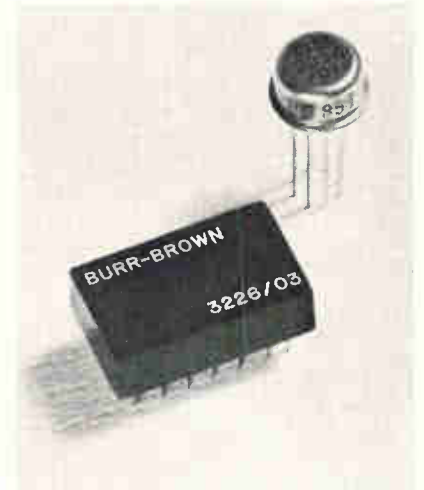

Contender. Hybrid op amp, front, competes with monolithic in TO-5 can.

amps it's applied at a high voltage swing—on the order of volts instead of millivolts. We get around this by avoiding the internal feedback loop used in many monolithic op amps which can be oscillatory."

The model 3226/03 has a guaranteed output of  $\pm 10$  volts and a minimum open-loop gain of 93 decibels. Unity gain bandwidth is 1.0 megahertz and full-power response is 15 kilohertz minimum. Model 3227/03 has a maximum voltage drift of  $\pm 30 \mu\text{V}$  per  $^{\circ}\text{C}$  (vs.  $\pm 15$  for the 3226/03), a minimum slewing rate of 0.6 volt per  $\mu\text{sec}$  (vs. 1.0 volt per  $\mu\text{sec}$ ), and a bias current drift of  $\pm 1.5 \text{ nA}$  per  $^{\circ}\text{C}$  (vs. 1.0 nA per  $^{\circ}\text{C}$ ). IEEE Booth No. 3A26.

Burr-Brown Research Corp., International Airport Industrial Park, Tucson, Ariz. 85706 [358]



Suppose you need a sequence of information... immediately. And the recording device must be remote. And the image resolution must be very sharp. And electronic methods haven't worked for you.



## You might do very well with new Kodak Bimat Transfer Film.

Difficult data-collection problems are everyday fare at Kodak. Photography is extremely adept at gathering and recording data that escape other methods.

KODAK BIMAT Transfer Film is an example. NASA chose it for Lunar Orbiter because—in effect—the “camera” was moving rapidly in its orbit over the moon’s surface, and electronic scanning could not produce the sharpness and resolution needed with any device that would fit into the capsule. However, as is so often the case, photography could.

Kodak engineered BIMAT Transfer Film and the space-vehicle photographic camera subassembly. In orbit, positive and negative images were produced simultaneously. The sharp, clear negative image (easily made permanent if the capsule had been programmed to return to earth) was scanned effectively by an electronic device and the image relayed to earth. A fast, simple, dependable system. Qualities you expect from Kodak, now applied to the advancing sciences.

You may not need ability to scan the moon’s surface. But if your needs include data collection where the location is remote, when conventional processing is impractical, and playback of sequential information is needed immediately,

you might do very well with KODAK BIMAT Transfer Film.

To learn more about how the new KODAK BIMAT Transfer Film can serve you, or to learn if some other problem you face might respond to a Kodak solution, use this coupon.

Department 412L  
EASTMAN KODAK COMPANY, Rochester, N.Y. 14650

Please send me information on KODAK BIMAT Transfer Film and liquid-free, rapid-access processing.

Name .....

Position .....

Company .....

Address .....

City .....

State ..... Zip .....

3-48

**Kodak**



## Bendix Autosyn Synchronos. Can you afford to buy less?

Not if you need the kind of performance and reliability you get from Bendix® Autosyn® Synchronos.

And you have a wealth of types to choose from. Ultrahigh-temperature synchronos that perform accurately at sustained temperatures up to 800°F. Ultracompact (size 08), lightweight (1.3-oz.) synchronos for critically tight designs. Ultraprecise synchronos with tolerances to 50 millionths of an inch. Dependable corrosion- and radiation-

resistant synchronos. And there's a complete line of Bendix Mil-Spec synchronos, too.

**AUTOSYN® SYNCHROS**

Size	Max. Diameter (In.)	Typical Weight (Oz.)	No. of Models
08	0.750	1.3	16
10	0.937	1.7	25
11	1.062	3.2	29
15	1.437	4.7	24
22	2.161	18	5

Altogether there are hundreds of types—your largest single source. What's more, our synchro design service can promptly solve your special problems. You can depend on it. As they do at GE, Sperry, RCA, Lear Siegler, Motorola and many other value-conscious firms. Ask for our catalog today. Write: The Bendix Corporation, Flight & Engine Instrument Division, Montrose, Pa. Or phone: (717) 278-1161.



**Aerospace  
Products**

## Source delivers a couple of extra waves

Function generator with frequency range from 0.0005 hz to 5 Mhz puts out pulses and ramps in addition to sine, square, triangular shapes

"More shapes and more speeds—these are what we need out of any new function generator," says Ray Hanson, an engineer at Hewlett-Packard Co.'s Loveland division. Hanson aimed at these twin targets when he was designing H-P's latest function generator, and it appears that he hit them both with the 3310A.

The new generator puts out

pulses and ramps, besides delivering the traditional sine, square, and triangular waves. And the unit's range is 0.0005 hertz to 5 megahertz compared with 0.01 hz to 100 kilohertz for H-P's older 3300A. And at \$575, the 3310A is \$75 cheaper than the 3300A.

The 3310A will be used in tests where function generators have long played a part. Sine and square

waves are needed to test the steady-state and transient responses of linear devices ranging from servo systems to high-frequency amplifiers. And triangular waves are needed when an engineer measures things like an amplifier slew rate and when he tests circuits that are triggered by a specific rate of change.

With ramp outputs, an engineer



Laboratory standard r-f peak wattmeter 4345 is for pulsed transmission systems. It samples forward or reflected power in an accurately machined 50-ohm reference line section. Full scale power is selected in five values from 250 w to 5 kw. Frequency range is 950-1,300 Mhz. Insertion vswr with connectors is less than 1.08. Bird Electronic Corp., Aurora Rd., Cleveland. [361]



Audio-video phase measurements with an active RC filter for increased response time are provided in the model 351 differential phase meter. The balanced or unbalanced inputs permit phase measurements on transmission lines, lattice filters, etc. without additional circuitry. Input sensitivity is 1 mv per channel. Wiltron Co., 930 East Meadow Drive, Palo Alto, Calif. [362]

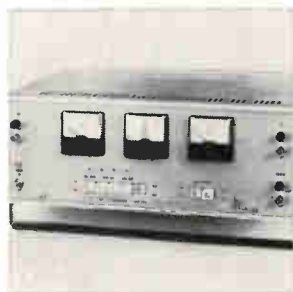

Time division multiplier 2885 converts d-c to 2 khz watts input to  $\pm 0.02\%$  linear d-c output. Frequency influence is less than 0.1% up to 10 khz. A circuit interchange enables use from unity down to zero power factor with less than 0.02% degradation. Standard input range is 150 v, 5 amps for a 1 v output. Hallmark Standards Inc., 145 Library Lane, Mamaroneck, N. Y. [363]



Power line sentinel voltmeter model 658-R offers an expanded scale meter movement reading 100/140 v, jeweled bearing moving coil D'Arsonval type with full wave bridge rectifier having wide operating frequency range. Accuracy from 110/125 v is  $\pm 2\%$ , below 110 and above 120 a-c volts,  $\pm 3\%$  accuracy. Hoyt Electrical Instrument Works Inc., Cambridge, Mass. [364]

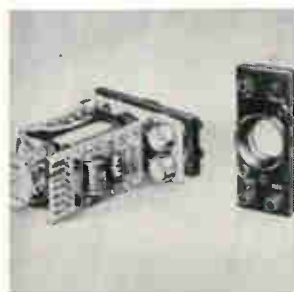

Module oscilloscope model 90975 uses a  $\frac{3}{4}$ -in. cathode-ray tube. Over-all dimensions of the scope are  $1\frac{1}{4}$  in. wide by  $2\frac{3}{4}$  in. high by  $3\frac{1}{2}$  in. deep behind the panel. It is designed to be built into equipment as a qualitative monitor. Price is \$40, less the National Union type 1DP1 cathode-ray tube. James Millen Mfg. Co., 150 Exchange St., Malden, Mass. 02148. [365]



Model PM6509 meter performs leakage current, breakdown voltage and resistance measurement in pico and nanoamp regions without auxiliary equipment. Current measurements down to 3 pa, breakdown voltage up to 1,000 v and resistance measurements up to 100 teraohms are accurately performed. Price is \$1,100. Philips Electronic Instruments, Mount Vernon, N. Y. [366]



Microwattmeter model 41A covers a range of 200 khz to 12.4 Ghz. It features a single power head measuring down to  $-60$  dbm with dynamic range of 70 db. The system requires no zeroing, except for fractional microwatt measurements, and has an over-all accuracy of  $\pm 0.5$  db. The power head offers overload protection to 300 mw c-w. Boonton Electronics Corp., Parsippany, N. J. [367]



Infrared thermometer called ThermoProbe T-1000 can spot check, monitor, and record temperature of circuit board components without contact. It measures temperature in 4 switch-selectable ranges from 20° to 500°C, with emissivity compensation from 0.2 to 1 on all ranges to provide accurate readings of a variety of surfaces. Raytek Inc., 1277 Terra Bella Ave., Mtn. View, Calif. [368]

# You're about the only guy who needs a bi-dimensional fram, right? We're about the only people who can tell you where to find one.

It's happened again. Somebody's managed to specify a part or sub-assembly that closely resembles your wildest nightmare. Oh, it works all right, but who makes 'em?

Enter, the Northern Plains Industrial Catalog. A computer crammed with facts and figures on nightmares just like yours. In fact the odds are darned good the Catalog has

a complete run-down on where to find your **bi-dimensional fram**.

Only one way to find out. And it won't cost you a penny. Just fill out and mail the coupon. Northern will put its high-speed computer on the problem and, in a few seconds, come up with the answer. If there is an answer.

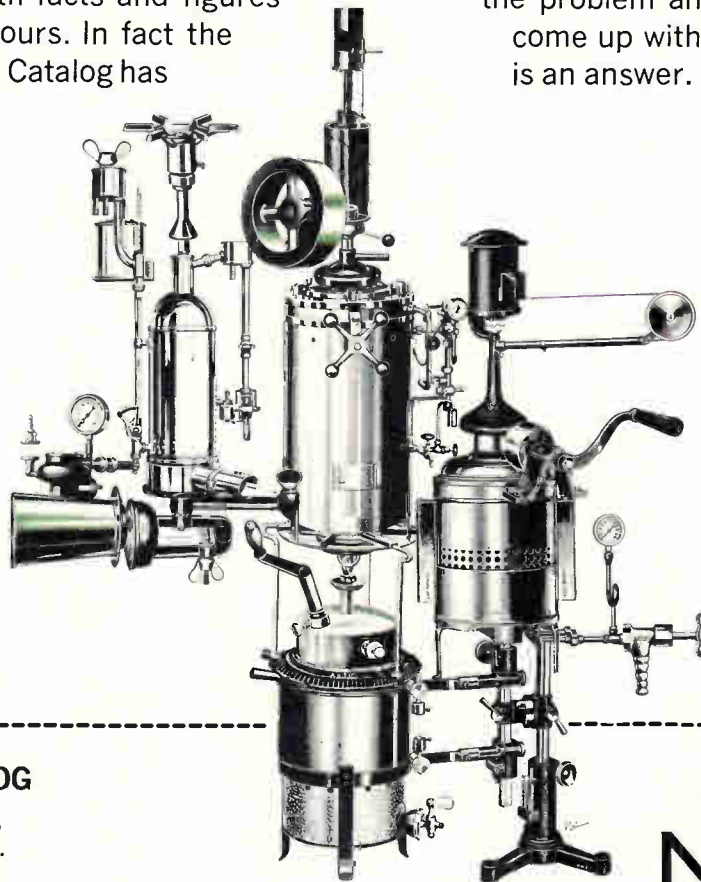

## INDUSTRIAL CATALOG

Area Development Dept.,  
Northern Natural Gas Co.  
2223 Dodge Street  
Omaha, Nebr. 68102

Dear Sirs: Please send Sources of Supply information on:

Drawing enclosed.

NAME \_\_\_\_\_ TITLE \_\_\_\_\_

COMPANY \_\_\_\_\_

ADDRESS \_\_\_\_\_

CITY \_\_\_\_\_ STATE \_\_\_\_\_ ZIP \_\_\_\_\_

E 369



Northern  
Natural Gas  
Company

Home Office: Omaha, Nebraska

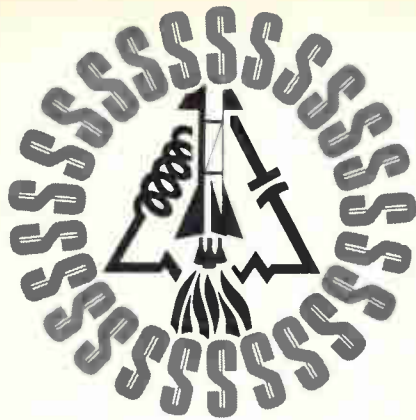

## SURROUND YOURSELF WITH PROFIT IN CARLSBAD

Put Yourself In A Position To Profit ... *In Carlsbad*

Put Yourself On The Scientific Frontier ... *In Carlsbad*

Put Yourself Where Your Work Force Is ... *In Carlsbad*

# CARLSBAD

**Profitable Position:** True manufacturing advantages because reduced operating levels in potash mining create opportunities to tap Carlsbad's reservoir of important skills. Several thousand persons, readily trainable, are available to the work force. Right! You're surrounded with profit potential when you're in Carlsbad.

**Profitable Position:** Carlsbad's work force is competent, capable — serious about making things go. Technical and vocational training, to meet your specific needs, is on hand, at a year-round branch of New Mexico State U.

**Profitable Position:** LTV's new plant, only miles away. Second-morning delivery, by common carrier, to West Coast, Denver, Oklahoma City-Tulsa, and Dallas-Fort Worth. Your own fleet reaches those markets on first-morning schedules.

**Profitable Position:** A full-service industrial park, with roads, streets, all utilities — all in place, ready for use, right now.

Get the Facts  Quickly and Confidentially From:

George Evans, Director  
Carlsbad Dept. of Development  
Box 1090, Carlsbad, N.M. 88220

can do more types of rate-change measurements. And with the 3310A's pulses, he can test logic circuits.

The generator's output frequency is controlled with either the front-panel dial or an external source. A 0-to-10-volt change will sweep the 3310A over its full frequency range.

The pulse width can be between 15% and 85% of the period; and the width of the baseline-to-peak portion of the ramp is adjustable between the same percentages.

The 3310A will put 30 volts peak-to-peak across an open circuit, and 15 volts peak-to-peak across 50 ohms. Up to 3 Mhz, a pulse's peak-to-peak value can be 24 volts.

For an open circuit, the 3310A's output can be offset by as much as  $\pm 10$  volts. When the load is 50 ohms, maximum offset is  $\pm 5$  volts.

Depending on the range setting,



Swept along. The output frequency goes from bottom to top when the control voltage moves from 0 to 10v.

sine-wave distortion is between 30 and 46 decibels. The rise and the fall time of square waves and pulses is 30 nanoseconds. And for ranges under 50 khz, triangular-wave and ramp linearity is 1%.

**Old ways . . .** The basic generating scheme is similar to that used in the 3300A. A current source feeds an integrator whose output is a linear, positive-going wave. When the wave reaches 5 volts, a detector flips a multivibrator, reversing the polarity of the integrator input current. The integrator's output is now a linear, negative-going wave. When it reaches  $-5$  volts, the detector flips the multivibrator, reversing polarity and ending one cycle. Output frequency is a function of the integrator current—**increase the current and the frequency increases.**

The square wave is taken from

# think digital

ELFIN®  
2.99\*

MS-4000-B  
3.85\*

MS SERIES  
4.97\*

RK SERIES  
4.97\*

Think ELFIN® — the new single plane segmented neon readout indicator that provides brighter displays and wide viewing. Only 0.41" dia. ELFIN® displays 0-9, + and -, some alpha symbols and decimal.

MS-4000-B miniature encased readout with the flat single-plane viewing, uses 100,000 hr. #683 T-1 subminiature incandescent lamps. Plug-in feature eases replacement.

ALCO's RK numeric and symbol readouts have a unique in-line design to provide clear displays without focusing problems. The precision machined piece aluminum case also serves as a heat sink.

The MS Mosaic numeric segmented indicators are available in 2 sizes and use either 6, 14 or 24V lamps for flexibility in design.

\*1000 Lot prices

# ALCO

ELECTRONIC PRODUCTS, INC.

Lawrence, Massachusetts 01843

Circle 163 on reader service card

Circle 213 on reader service card

# Allen-Bradley cuts space requirements with new sealed type Z cermet trimmers



**Type Z**  
½-watt trimmer  
shown 5 times actual size

this latest addition to the Allen-Bradley line of cermet trimmers...the type Z...affords high performance in an especially compact package

The cermet material—an exclusive formulation developed by Allen-Bradley—provides superior load life, operating life, and electrical performance. For example, the full load operation (½ watt) for 1000 hours at 70°C produces less than 3% total resistance change. And the temperature coefficient is less than  $\pm 250$  PPM/°C for all resistance values and throughout the *complete* temperature range (-55°C to +125°C).

The Type Z is ruggedly constructed to withstand shock and vibration. The unique rotor design ensures smooth adjustment and complete stability under severe environments. The leads are permanently anchored and bonded. The connection exceeds the lead strength—opens cannot occur. Leads are weldable.

The enclosure is *SEALED*. It is both dust-tight as well as watertight, and can be potted. Mounting pads prevent moisture migration and also post-solder washout. For full specifications on this new spacesaving cermet trimmer, please write Henry G. Rosenkranz, Allen-Bradley Co., 1344 S. Second St., Milwaukee, Wis. 53204. In Canada: Allen-Bradley Canada Ltd. Export Office: 630 Third Ave., New York, N. Y., U.S.A. 10017.

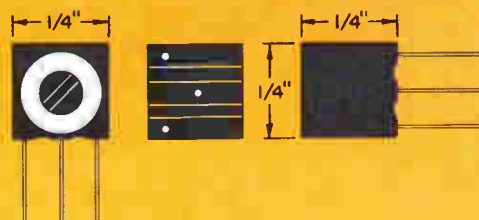

#### SPECIFICATIONS SUMMARY

- Adjustment:** Horizontal or vertical.
- Temperature Range:** -55°C to +125°C.
- Resistances:** 50 ohms through 1 megohm.  
Lower resistances available.
- Tolerances:**  $\pm 20\%$  standard,  $\pm 10\%$  available.
- Resolution:** Essentially infinite.
- Rotational Life:** Less than 2% total resistance change after 200 cycles.
- Rotation:** 300° single turn.
- End Resistance:** Less than 3 ohms.



**ALLEN-BRADLEY**  
QUALITY ELECTRONIC COMPONENTS

## ECCOSORB® ANECHOIC CHAMBERS NEW DESIGN 7



Illustrated folder gives details on anechoic and shielding performance of several new chambers used for antenna pattern, radar cross section, VSWR and RF compatibility measurements.

Circle 307 on reader service card

## DIELECTRIC MATERIALS CHARTS



Charts in full color contain data on all important materials used by electrical and electronic engineers.

Circle 308 on reader service card

## ECCO REFLECTOR® RADAR TARGET



### NEW FOLDER

Based on the Luneberg Lens, the Ecco Reflector is a wide-angle, constant cross section radar reflective device. Four-page folder in color describes monostatic, bistatic, omnizimuthal and omni-directional types.

Circle 309 on reader service card

## Emerson & Cuming, Inc.



CANTON, MASS.  
GARDENA, CALIF.  
NORTHBROOK, ILL.  
Sales Offices  
in Principal Cities

EMERSON & CUMING EUROPE N.V., Oevel, Belgium

the output of the multivibrator, and the sine wave is synthesized from the triangle by a sine shaper.

... and new. For the symmetrical functions, the currents into and out of the integrator are equal. The 3310A has a resistor network that introduces dissymmetry. During pulse and ramp operation, the current going into the integrator doesn't equal the current coming out, and the ratio of the currents is proportional to the ratio of the slopes of the two sides of the ramp or to the pulse's duty cycle.

One way H-P engineers extended the 3310A's ranges was to put a feedback loop around the integrator. At low frequencies, the loop keeps the currents at reasonable levels, improving symmetry and stability. On the low frequency ranges, when the voltage controlling the current source decreases, the source's output stays the same. But the integrator gets less current because the loop draws some of the source's output.

Another way H-P engineers widened the range was by improving high-frequency linearity with a peak detector that compensates for delays in the basic generating loop. Without this detector, the amplitude of the output increases as the frequency increases. The peak detector changes the delay time when the amplitude tries to increase.

Hewlett-Packard Co., 815 Fourteenth St., S.W., Loveland, Colo. [369]

## New instruments

## Two more dpm's sign up for IEEE

Weston's three-digit meter is only 7 square inches; newcomer keeps price down

A vet and a rookie will be among the companies bringing new digital panel meters to the IEEE Show. Weston Instruments Inc., an old hand in the panel meter business, will show its DPM 1290—a meter whose main feature is size; it takes

# brite glo®



MINI  
NEON  
PILOTS

Modern design series has a 1-piece body ideal for display configuration. BNE SERIES features a compact lens system protruding slightly above the panel. BNF SERIES' lens system extends more for greater illumination. BND SERIES' pilot assembly protrudes beyond panel to provide maximum light intensity. All units have one-nut mounting, and are available with or without built-in series resistors.

L. to R.  
Short leads, 10" lead  
metal base & 10" lead



### T-1 3/4 NEON LAMPS

An unusual ring-electrode construction glows on the entire surface for maximum brightness. The unobstructed glass allows the illuminated elements to be placed close to the top where it may be viewed to advantage.

For 75V to 95V operation.

## PANEL INDICATORS

A new advent to ultra-miniaturization is this ALCO Series that mounts in a 3/16" hole. Available only in the most popular 5 volt 60 ma. rating having an exceptionally high 100,000-hr. lamp life. The sealed high temperature plastic assembly contains a standard #680 or #683 T-1 lamp. Choose from a variety of colors. Supplied either with long wire leads (Type ME-680L), with pin contacts (Type ME-680).



# ALCO

ELECTRONIC PRODUCTS, INC.

Lawrence, Massachusetts 01843  
Circle 165 on reader service card

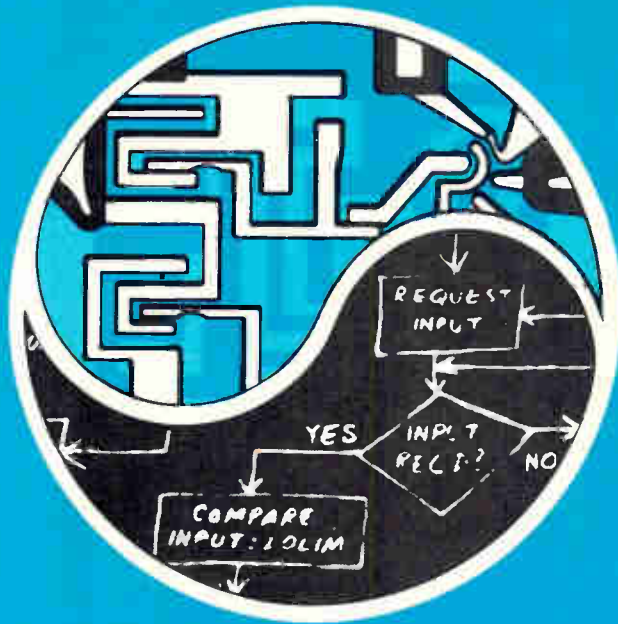

# THE CHANGING INTERFACE

## An IC/Systems Seminar

MARCH 28, 1969, PARK SHERATON HOTEL, NEW YORK, 9:00 AM—5:00 PM  
Presented by the Electronics / Management Center

### Program

**Implications Of LSI On The Electronics Market:** Glenn E. Penisten, Vice President, Components Group, Texas Instruments Inc., Dallas.

**The Rationale For An In-House IC Capability:** Alvin B. Phillips, Assistant to the President, Autonetics Division, North American Rockwell Corp., Anaheim, Calif.

**The Component Maker's Responsibility In The System/Component Interface:** Robert M. Walker, Supervising Engineer, Array Systems Engineering, Fairchild Semiconductor, Mountain View, Calif.

**The System Builder's Responsibility In The System/Component Interface:** Richard Stokes, Manager of Planning, Electronic Systems Organization, Burroughs Corp., Paoli, Pa.

**The Mask And Computer-Aided Design As Interface:** Wally Raisanen, Operations Manager for MOS and IC Memories, Motorola Semiconductor Products, Phoenix, Ariz.

**The Testing Interface:** William Dunn, Engineer-in-charge, Custom LSI, Sylvania Semiconductor Div., Woburn, Mass.

**The Integrated Circuit Design Interface In Bell Laboratories:** James M. Early, Director, Semiconductor Device Laboratory, Bell Telephone Laboratories, Allentown, Pa.

**How IBM Deals With The Interface Problem:** Paul Low, Manager of Logic Products, IBM, East Fishkill Facility, Hopewell Junction, N.Y.

**Controversies And Future Trends In LSI:** Donald Farina, President, ICST, Inc., Sunnyvale, Calif.

### Panel Discussion

**Moderator: Orville Baker, Vice President, Signetics Inc., Sunnyvale, Calif.** Speakers and invited guests will join in an open forum discussion of interface problems, and will answer questions submitted from the audience.

### ADVANCE REGISTRATION

"The Changing Interface" — March 28, 1969 — Park Sheraton Hotel, 7th Avenue & 56th Street, New York, N.Y.

NAME \_\_\_\_\_

TITLE \_\_\_\_\_

COMPANY \_\_\_\_\_

ADDRESS \_\_\_\_\_

CITY \_\_\_\_\_ STATE \_\_\_\_\_ ZONE \_\_\_\_\_

Registration Fee: \$65 (Fee includes all sessions, refreshments, luncheon, and a copy of the proceedings when published.)

**Note:** Attendance will be limited and applications will be handled on a first-come, first-served basis.

Mail registration and make checks payable to: Electronics/Management Center, An Information Service of McGraw-Hill, Inc., 330 West 42nd Street, New York, New York 10036



flying spot  
scanner,  
photometer,  
densitometer,  
or  
scintillation  
counter

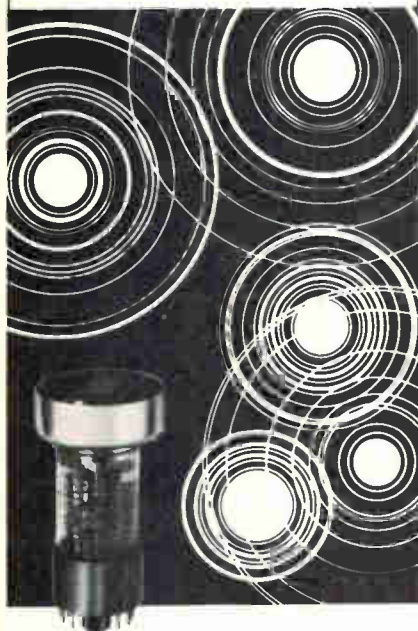

The new range of EMI photomultipliers with "SUPER" S-11 photocathodes will enhance your project performance. High quantum efficiency, (23/24%) high gain at relatively low overall voltage, and low dark current at the rated overall sensitivity are typical of these types. They maintain the EMI standard of excellent gain stability and linearity. The narrow spread in characteristics makes these types ideal for systems or for multiple installations. The table below gives the typical values for the significant parameters.

Dia.	Type No.	Amps/ Lumen	Volts/ Overall	Anode Dark Current Nanoamps
2"	9656R	50	1150	2
3"	9708R	50	1250	5
3.5"	9531R	200	1300	25
4"	9732R	50	1250	10
5"	9709R	50	1350	15

Note that the anode dark current is given for the overall voltage at the specified overall sensitivity. The maximum overall sensitivity is 10 times the values given above. Each Tube is individually calibrated and data is supplied with the tube.

Send for our new 64 page catalog giving data and technical information on the complete range of EMI photomultipliers.

**Whittaker**  
CORPORATION  
**GENCOM** DIVISION  
80 Express St., Plainview, L.I., N. Y.  
516-433-5900

7 square inches of panel area.

And Datascan Inc., till recently a custom-made-instrument house, will also be talking about small size when it shows its first off-the-shelf dpm, the 500; except what's small here is the price tag. Datascan says that in 100-unit lots the meter will cost less than \$175.

The Weston meter costs \$200 in 100-piece lots. Besides taking up little space, the 1290 is also easy to repair. The chassis can be pulled out of the mounting case, and its three read-out tubes are socket-mounted rather than soldered to the chassis.

The meter has 100% overrang-



For the panel. Datascan's first digital panel meter has 100% overranging and a BCD output.

ing, and its accuracy is  $0.1\% \pm$  one digit. It weighs  $1\frac{1}{2}$  pounds and has a binary-coded-decimal output.

The 500 also has a BCD output, a three-digit display plus 100% overranging, and an accuracy of  $0.1\% \pm$  one digit.

A Datascan spokesman says that the company got a lot of experience building digital voltmeters to customers' specifications, and this experience, particularly with integrated circuits, is the reason the company has been able to keep the meter's price down.

Ranges of the Datascan 500 are 100 millivolts to 100 volts, and 1 microamp to 100 milliamps. From  $0^{\circ}\text{C}$  to  $60^{\circ}\text{C}$ , the stability is  $0.01\%$  per degree centigrade.

The 500 is 2.7 inches high and 5 inches wide, and draws 5 watts.

Datascan Inc., 1111 Paulison Ave., Clifton, N.J. 07013 [370]

Weston Instruments, Inc., 614 Frelinghuysen Ave., Newark, N.J. 07114 [371]

# small power



"SNAP-ON" BUTTON



LONG BUTTON



MUSHROOM HEAD

ALCO Power Switches combine compact size, modern appearance, and functional flexibility to meet today's control needs, and mount in a 1" hole.

New, snap-on push buttons simplify selection of colors, shapes and legends.

These versatile switches allow "snap-on" contact sections for maximum flexibility in switching.

Manufactured from approved materials for stringent requirements. Rated 5 amps @ 230 VAC to handle most power applications.

The low cost of these space-saving power devices will surprise you!

**ALCO**  
ELECTRONIC PRODUCTS, INC.  
Lawrence, Massachusetts 01843

# *Cermet*

AND THE

## *Model 3329*

POTENTIOMETER

ONLY 0.25" Dia. X 0.18" high

±0.15% TC 150PPM/°C over entire resistance range 10Ω to 1 Meg.



Bourns presents the first commercial single turn potentiometer to meet or exceed the requirements of MIL-R-22097. Sealed for wave soldering and immersion cleaning... with reliability superior to anything on the market today. Manufactured in the tradition of excellence of design and workmanship you have come to expect from Bourns... the leader in the industry. Write or call the factory, local field office or representative today for technical data.



BOURNS, INC., TRIMPOT PRODUCTS DIVISION • 1200 COLUMBIA AVE., RIVERSIDE, CALIF. 92507

# Redesigned converter thinned, price trimmed

Switching circuitry in d-a module uses hot-carrier diodes for speed; thin-film devices for resistor network provide improved tracking

**What does a firm do** when it wants to sell digital-to-analog converters and finds that potential customers would rather build than buy them? If the firm is the Pastoriza division of Analog Devices Inc., it spots the part of the converter that gives builders the most trouble, then builds and sells that, thus taking advantage of the customer's do-it-yourself attitude.

The module that the firm designed to fit this market vacancy is called Minidac and it contains devices in the three problem areas: switches, resistor networks, and a voltage reference.

According to the company's technical director, James J. Pastoriza, Minidac carries with it some of the op amp's universality. In addition to a basic d-a conversion applica-

tion, the Minidac is expected to sell into subsystems designed for computer displays, high-speed graphics generators, character sensing devices, flying spot scanners, and test equipment.

Pastoriza points out that Minidac also forms the core of an ultra-high-speed digitally programable power supply. Therefore it could find its way into high-speed inte-



Laser system PRQ-1, using either ruby or neodymium glass rods, has a peak power output of 300 Mw. It is capable of 10 to 15 nanosecond and subnanosecond Q-switching; has an energy output of 1.8 to 3 joules with a pulse rate of 1 to 2 or up to 120 pulses/min. It has a 2 to 3 milliradian beam divergence with max. output beam uniformity. Raytheon Co., Waltham, Mass. [381]



Advanced Nd:YAG laser model 610 is for use where a high power, c-w, 1.06 micrometer source is required. External mirrors and a continuously adjustable output are featured. Unit emits more than 1 w of power in the TEM<sub>00</sub> mode and over 5 w in multitransverse mode operation. Optical length of the laser cavity is 38 cm. Sylvania Electronic Systems, Box 188, Mountain View, Calif. [382]



Diode laser transceiver TR-1 consists of a diode laser array, laser modulator, transmitting optics to yield a 12 milliradian beam divergence; the receiver contains collecting optics, a narrow-passband filter, aperture stop to determine acceptance angle, photo diode and power supply as well as pre-amplifier. Seed Electronics Corp., 9 Cypress Dr., Burlington, Mass. [383]



General-purpose agc amplifier model MN-120AG is an audio and instrumentation unit with a wide automatic gain control range capable of recovering very low signal levels. It produces a 0.5-v rms output into a 600-ohm load from inputs of 25  $\mu$ v to 25 mv within 0.5 db accuracy. Agc range is 60 db. Voltage gain is 26 to 86 db. Roveti Instruments, Annapolis, Md. 21401. [384]



Semiregulated single-to-three-phase static converter called Phasac P-2410 produces 1,000 va of three-phase power regulated to 5%. It provides labs and test facilities with this power at a fraction of the cost of installing new wiring. Any standard 115 v a-c, 60 hz outlet is adequate for operation. Price is \$345. Wanlass Instruments, 1540 E. Edinger Ave., Santa Ana, Calif. [385]



Solid state variable filter model 3550 is tunable over the range of 2 hz to 200 khz and provides low-pass, high-pass, band-pass, and band-reject operation. Mode of operation is easily selected by a front panel switch. An input FET amplifier provides high input impedance and zero db insertion loss. Price is \$525. Krohn-Hite Corp., 580 Massachusetts Ave., Cambridge, Mass. [386]



Inverter model 6-115, designed for excitation of electroluminescent panels, is used whenever 6 v battery sources are available and provides a 115 v rms output. Model 12-115 operates from a 12 v d-c source. Units measure 2 $\frac{3}{8}$  x 1 $\frac{1}{2}$  x 1 in. Printed-circuit board pins, leads or terminals can be furnished. Price (1-4 pieces) is \$24 each. Polyphase Instrument Co., Bridgeport, Pa. [387]



Power supply model PD-15 is a  $\pm 15$  v unit designed for operational amplifiers and IC's. It is an isolated supply and operates from 28 $\pm 4$  v d-c source. Line regulation for a  $\pm 4$  v change is better than  $\pm 0.5\%$ . Output ripple is less than 0.3% and the unit will operate from  $-20^\circ$  to  $+71^\circ$ C (case temperature) without derating. Mil Associates, Dracut Road, Hudson, N. H. 03051. [388]

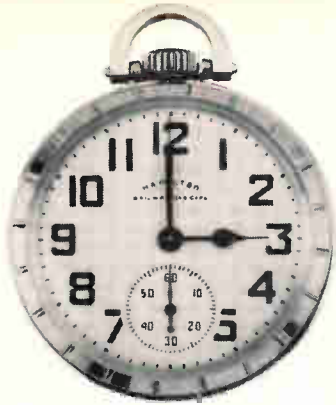

actual size



NEW Series 270

## ...time to go DIGI/EC

with the smallest, low cost, all solid state digital panel meter

- Size: 2 1/16" x 4 1/2" x 7 7/8"
- Accuracy 0.1%
- D.C. Ranges from 200MV and 20  $\mu$ A
- Non-blinking display
- High Input Z 100M $\Omega$
- 100  $\mu$ V/digit resolution
- Fast sample rate
- Completely self-contained
- Reading retention
- B.C.D. option

**\$195**  
QTY. 1-9

**\$129**  
QTY. 100

See us at booth 2K21-22 IEEE Show

Stocking Representatives  
Throughout the World



918 Woodley Road • Dayton, Ohio 45403 • (513) 254-6251

Circle 218 on reader service card

### In a word **DSE** means **CAPABILITY**

... Capability in products for airborne, ground support, oceanographic, and commercial-industrial applications. Only Dynamic System Electronics (DSE) offers complete systems capability in the Low/High-Level data acquisition and conversion field. DSE's capabilities in

- Data Acquisition
- Data Recording Systems
- Data Conversion
- Computer Interfaced Systems

are a matter of record. Call your local DSE representative or visit us at the Essex House during the IEEE Show to update yourself on DSE's products and capabilities in the Computer Peripheral and Data Conversion fields.

#### NEW MODEL 460 Airborne System

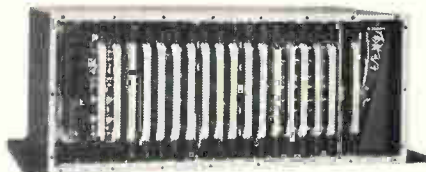

This compact, new-generation equipment Series offers flexibility and expandability using solid-state, high-reliability, ultra-low power logic. The units meet MIL-E-5400H and, like the 440 Series, are becoming widely accepted by the Aerospace industry.

**DYNAMIC  
SYSTEM  
ELECTRONICS**

1040 West Alameda Drive  
Tempe, Arizona 85281  
Phone (602) 967-8644  
TWX 910-950-1941

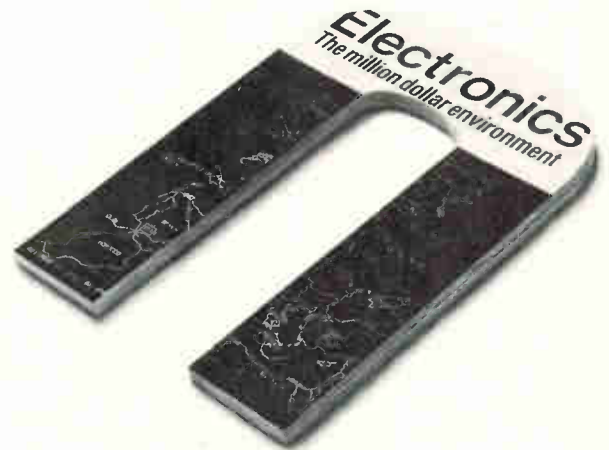

Every year, ELECTRONICS attracts requests for over 125,000 editorial reprints.

They're like interest payments on our million-dollars-a-year editorial principles.

That's how much we spend annually to produce timely, authentic, and useful articles like those listed on the reader service card as reprints currently available.

Investment and interest make both ELECTRONICS and its readers more meaningful to its advertisers.

... pin spacing suitable  
for DIP sockets ...

grated-circuit testers. In fact, IBM already uses about 50 specially designed Minidacs in what Pastoriza calls "an incredibly fast and thorough automatic testing system."

The original Minidac was introduced early last year, but its price was high—about \$250—and sales were low—only about 300 to 500 during 1968. Now Pastoriza is taking advantage of Analog Devices' sales force to increase volume, and its lower overhead to cut parts and assembly costs. As a result, the new Minidac will be priced as low as \$130 in quantity.

**More suitable.** Also, Pastoriza has taken some data from Analog's applications engineers and rebuilt the Minidac to suit it to more applications and thus further increase volume. The result is Minidac II, a 2- by 2- by 0.4-inch module with pin spacing compatible with dual-in-line package sockets. The old Minidac was 1.5 by 0.75 by 0.75 inches and required special circuit board connections. Thus, it was shut out of large numbers of applications because it was too thick or too difficult to connect.

But within the package, other differences exist between Minidac I and II. While the 12-bit conversion time of 200 nanoseconds has been retained, some of the switching circuitry has been altered to take advantage of hot-carrier diode switches, which improve speed.

In addition, the resistor network, formerly composed of discrete components, is being redesigned to use some form of thin-film devices, though the type hasn't been decided yet. Not only will this make the resistances track each other with temperature more closely than is possible with discrete components, but also costs will drop.

**Op amp loop.** Finally, the voltage reference has been made more stable by replacing a zener scheme with a combination of dual zener-diode regulation and an operational-amplifier feedback loop.

According to Pastoriza, "This is no more costly than the prior scheme; today a 709-type op amp costs less in quantity than a good zener. Also, the addition of the feedback loop has halved Minidac's

# IT'S HERE! The one supply to fill all your AC POWER REQUIREMENTS

- Need a precision 250 VA single phase supply?  
**HERE IT IS!**
- Requirements change to 500 VA single phase or two phase?  
**ADD A SECOND UNIT!**
- A three phase job coming up?  
**ADD A THIRD UNIT!**



## Powertron SERIES 250S SOLID STATE AC POWER SUPPLIES

The built-in facility for interconnecting Series 250S units to provide single phase, two phase or three phase output power, plus the numerous full power output voltage ranges and wide variety of fixed frequency, variable frequency, single phase and poly-phase plug-in oscillators make this the most versatile AC supply around. Compare its specifications. Write for catalog #1068.

PRICE  
**\$595.00**  
(less plug-in oscillator)



**INDUSTRIAL TEST EQUIPMENT CO., Inc.**  
20 BEECHWOOD AVE. • PORT WASHINGTON, N. Y. 11050  
Phone: (516) PO 7-5253

See it at IEEE Show Booth 2D33

Circle 215 on reader service card

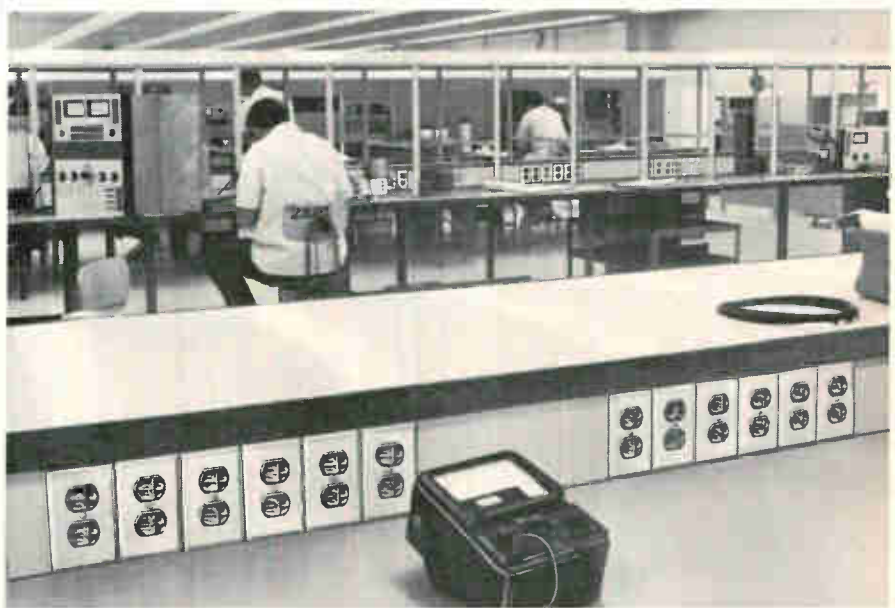

## Electrical convenience for electronic equipment

Whether you make, use or test electronic equipment, the power you need can be delivered neatly in a Wiremold® surface wiring system. All necessary electrical

services and devices are housed in a single raceway, properly sized for present and future needs. Send for literature on the entire line of Wiremold systems.



THE WIREMOLD COMPANY / HARTFORD, CONNECTICUT 06110



## 175 amp, 235 amp, 470 amp Regenerative Gate\* SCRs

Regenerative Gate SCRs operate with lower switching losses and higher continuous di/dt than any other SCR. Low power gate drive. No sacrifice required in any other characteristic.

Continuous Rating at 60 Pulses Per Second, 90°C\*\*

rms Current Rating	Pulse Width	Peak On-State Current
235 amp	100 $\mu$ sec.	3300 amps
470 amp	150 $\mu$ sec.	6000 amps

\*\*Verified by long-term life test.

Also available in 55 amp and 110 amp. Request Bulletin.

**NATIONAL**  
ELECTRONICS, INC.

a varian subsidiary  
GENEVA, ILLINOIS 60134  
PHONE (312) 232-4300

\*A National® exclusive.  
Patent Pending.

Circle 216 on reader service card

## WHERE THE PROFIT ACTION IS!

Phoenix continues to set the pace in the accelerating westward tilt that is changing the face of America. Our population explosion and vigorous economy are creating rich new markets locally, and in a fast-growing 8-state region served by Phoenix. You should have a plant or warehouse here to get your share of this dynamic action and profits.

For our FREE 28-page brochure, "DYNAMIC PHOENIX," write Stanton Allen, Manager, Economic Development Dept., Room E-35, Chamber of Commerce, Phoenix, Arizona 85004

**dynamic**  
**Phoenix**  
PROFIT CENTER OF THE SOUTHWEST

172 Circle 172 on reader service card

TYPE SHN 3

**ZIPPERTUBING® R.F.I.  
SHIELDING JACKETING**

**for quick application and protection  
of multi conductor cables!**

SHN 3 for R.F.I. shielding and protection. Tinned copper braid, attached to inside overlap provides gasket type seal and solderable termination point.

SHX 4 — of special knitted compounded wire for highly flexible R.F.I. shielding.

CPE conductive polyethylene for electrostatic protection.

MS provides low frequency magnetic shielding.

**For full information on specialized,  
high-performance jacketing, contact**

**THE ZIPPERTUBING® CO.**

**CORPORATE HEADQUARTERS**  
13000 S. BROADWAY  
LOS ANGELES, CALIF. 90061  
Los Angeles Phone: (213) 321-3901  
New Jersey Phone: (201) 256-4980

BALTIMORE • BOSTON • CHICAGO • DALLAS • NEW YORK  
ORLANDO • PHOENIX • SAN FRANCISCO • WEST GERMANY

Circle 217 on reader service card

temperature drift spec to  $\pm 10$  parts per million, and improved regulation in general, placing it well below 0.1%."

For hypercritical users, however, Pastoriza has added pins for the attachment of trimmers to compensate for component aging and of an external voltage reference. A final trimmer, built into the module, allows the user to precisely set the switching thresholds of Minidac's transistors to get the best performance whether the module is used with DTL, RTL, or TTL logic. This threshold optimization helps prevent short-duration transients from degrading Minidac's output accuracy.

Minidac II will be available in sample lots by mid-April, and a four- to six-week delivery schedule is expected thereafter. Prices range from a single unit price of \$200 for a 12-bit Minidac to \$130 for an 8-bit Minidac in 25 to 99 quantities.

Pastoriza Division, Analog Devices Inc.,  
385 Elliot St., Newton Upper Falls,  
Mass.. [389]

New subassemblies

## Pot stays steady in changing clime

Film-metal trimmer has low  
temperature coefficient  
up to 20 kilohms

When circuit designers need a trimming potentiometer, they usually think immediately of the wirewound or the cermet type. But a third type, made of thin film and metal, offers unique features, says the Amphenol Controls division of Bunker Ramo Corp. So Amphenol decided to add Film-Met to its line.

John Arnold, the division president, says Film-Met trimmers "have infinite resolution; low temperature coefficient of resistance compared to wirewound, and low distributed inductance and capacitance compared to cermet. And because of their homogeneous alloy characteristic, they have lower thermal and current noise figures.

Electronics | March 17, 1969

# can't get away for evening classes?



## here's a practical way to avoid technical obsolescence

Are irregular hours, travel and family obligations keeping you from attending classes—even though you worry about becoming technically obsolescent? Check into the Special Programs in Electronics for Engineers developed by CREI, the Home Study Division of the McGraw-Hill Book Company.

These are not simply courses, but comprehensive programs in advanced electronics offering major electives in such fields as:

Communications Engineering, Aeronautical and Navigational, Television Engineering, Automatic Control Engineering, Missile and Spacecraft Guidance, Radar and Sonar Engineering, Nuclear Instrumentation and Control, Computers.

Industry-recognized CREI Programs make it possible for you to catch up on new developments in electronics through study in your own home, at your own pace,

your own schedule. Free book gives complete information and details of technical material covered. For your copy, mail coupon below or write: CREI, Home Study Division, McGraw-Hill Book Company, Dept. J1856H, 3224 Sixteenth St., N.W., Washington, D.C. 20010.

Founded 1927



Accredited Member of the National Home Study Council



CREI, Home Study Division, McGraw-Hill Book Company  
Dept. 1856H, 3224 Sixteenth St., N.W.  
Washington, D.C. 20010

Send me free brochure describing CREI Programs in Electronics for Engineers.

NAME \_\_\_\_\_ AGE \_\_\_\_\_

ADDRESS \_\_\_\_\_

CITY \_\_\_\_\_ STATE \_\_\_\_\_ ZIP CODE \_\_\_\_\_

COMPANY \_\_\_\_\_

TITLE \_\_\_\_\_



## ELECTROMAGNETIC INTERFERENCE PROBLEMS?

**SPECTRUM CONTROL INC.**  
IS A NEW, PROFESSIONAL ENGINEERING ORIENTED  
COMPANY DIRECTED TO ALL DISCIPLINES  
ASSOCIATED WITH...

# ELECTROMAGNETIC COMPATIBILITY

- SPECTRUM CONTROL FINDS THE EMI PROBLEM...
- PROPOSES A PRACTICAL SOLUTION...
- CAN PROVIDE HARDWARE and EQUIPMENT to IMPLEMENT the SOLUTION

Visit Our Exhibit  
at the...



IEEE SHOW—  
Booth 3H12

**SPECTRUM CONTROL INC.**  
152 E • MAIN ST • FAIRVIEW, PA • 814/474-5593

Circle 174 on reader service card

## COMMERCIAL FLIGHT CONTROLS AND AVIONICS ENGINEERS

Conceptual design and development of  
flight controls, flight instrumentation, automatic landing, navigation,  
and advanced avionic systems.

Rapidly expanding commercial aircraft programs have created excellent openings, with growth potential, for engineers with recent commercial avionic experience in design, development, and test of all-weather landing systems, autopilots, flight directors, advanced displays, stability augmentation systems, inertial navigation systems, or air-data computers.

Engineers interested in developing new designs for aircraft of the 70's, not just repackaging today's shelf items, are invited to write Mr. C. R. Alexander, Professional Placement Manager, Dept. 1803, 3417 Empire Avenue, Burbank, California 91503. Or call (213) 847-1328 collect. An equal opportunity employer.

## LOCKHEED-CALIFORNIA COMPANY

A Division of Lockheed Aircraft Corporation

than cermets."

Translated to the Film-Met 3811, this means an infinite resolution over trimming ranges of 10 ohms through 20 kilohms, a temperature coefficient of 100 parts per million per degree centigrade over a range of  $-55^{\circ}\text{C}$  to  $+125^{\circ}\text{C}$ , and a contact resistance variation of 2% or 20 ohms, whichever is greater.

Key to the Film-Met 3811 is the resistance element developed by Amphenol.

Using a technique similar to that used for thin film integrated-circuit resistors, a nickel-chromium-iron alloy is vacuum deposited upon the resistance track area of a ceramic substrate. The composition of the alloy, however, is subject to wide variations because Amphenol is also making the 3811 available with a temperature coefficient of 50 parts per million per  $^{\circ}\text{C}$ . Thus, the percentage of nickel will range from 20% to 65%, chromium from 15% to 25%, and iron from 5% to 25%.

Because the alloy is subject to corrosion and oxidation, it is coated with precious metal alloy. "We're using platinum, rhodium, and iridium," says Samuel A. Johnston, advanced product planning manager at Amphenol. "It is deposited at resistance densities of between 8,000 and 13,000 ohms per square," he says.

The 3811's low contact resistance variation and low noise characteristics make it suitable for both balancing circuits and low-level circuitry that are followed by high-gain amplifiers. Because its performance characteristics stem from its inherent low distributed capacitance and inductance, the Film-Met can be used for applications where phase shift and pulse distortion must be minimized—such as in r-f communications equipment, radar gear, and high-speed data processing systems.

"Another application for Film-Met," says Arnold, "is at point of transmission-line termination. Due to its performance characteristics, it can be used in impedance-matching circuits."

In lots of from one to nine, the 3811 will be priced at \$2.94, and in lots of 100 or more at \$2.31.

Amphenol Controls Division, Bunker Ramo Corp., 120 South Main St., Jamesville, Wis. 53545 [390]



# TRW is Ray Liccini upgrading satellite communications

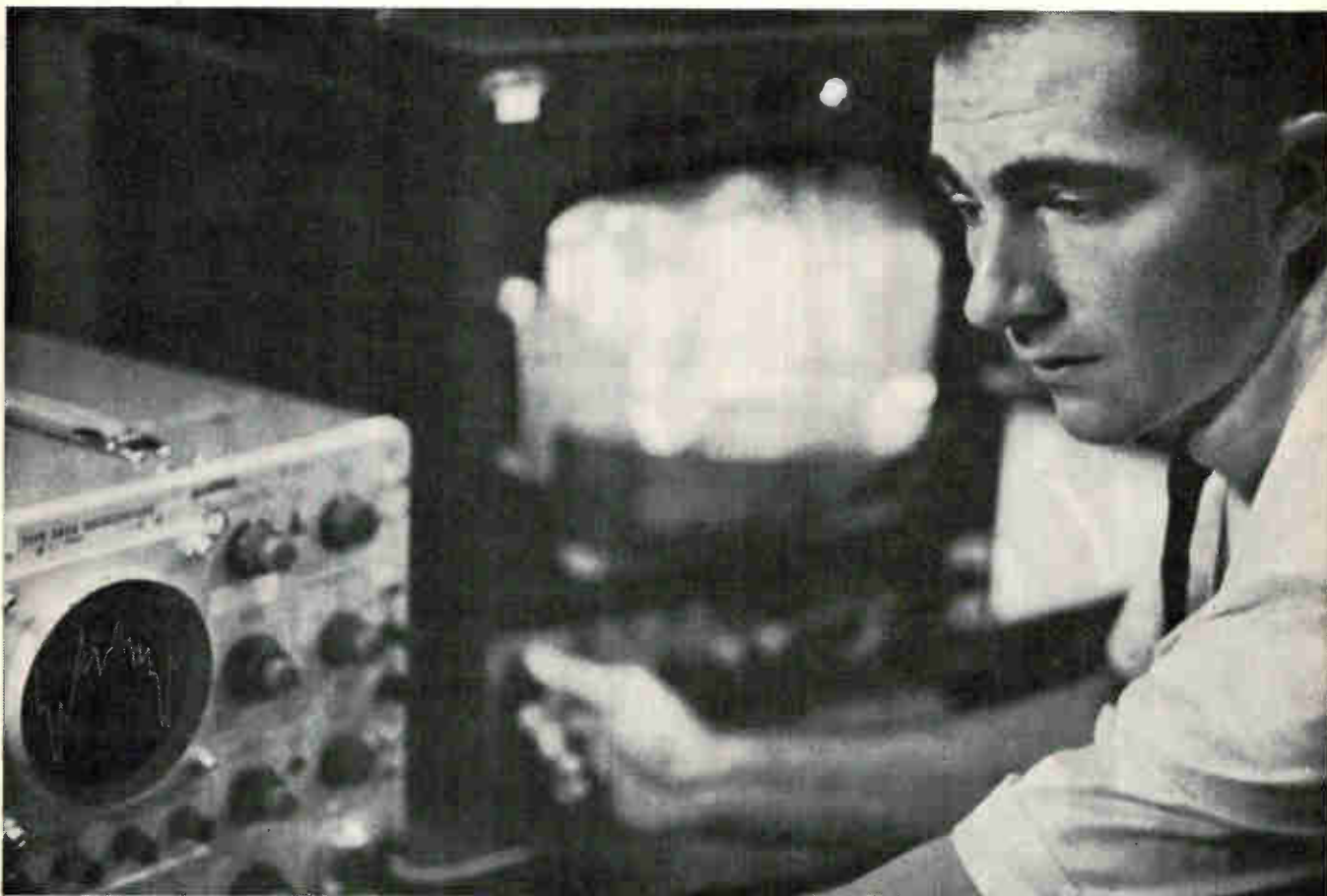

Ray is a Section Head in the Telecommunications Department of our Communications Laboratory. He recently completed a project aimed at improving voice and video communications with the Apollo spacecraft. Now he is working with phase-lock loop demodulation to enhance the quality of color TV reception from satellites under heavy noise conditions.

Recalling other places he has worked, Ray feels the opportunities are greater at TRW, and the working conditions are better but "independence is the significant difference."

If you are ready for this kind of professional opportunity and independence, you belong at TRW.

## **SENIOR COMMUNICATION SYSTEMS ENGINEERS**

Several senior staff positions in overall systems design involving satellites and ground stations, utilizing HF and microwave links. Systems engineers experienced in very wide band analog, high rate digital, and distributed receiving and transmitting systems. MS and 10 to 15 years experience.

## **COMMUNICATIONS SYSTEMS ENGINEERS**

To perform conceptual design in advanced communications systems, siz-

ing communication equipment for avionics, ground, and space applications, and estimating communication link requirements. BS and 5 years experience.

## **MICROWAVE SOLID-STATE ENGINEERS**

Design of solid-state microwave components and subsystems. Apply computer-aided design techniques to microwave integrated circuits. BS or MSEE and minimum of 3 years experience.

## **CIRCUIT DESIGN ENGINEERS**

To do R&D in microelectronics techniques, high power solid-state UHF transmitters, centimeter and millimeter wave communication satellite repeaters, wideband analog and digital receivers. BSEE and 3 years experience.

## **COMMUNICATION SYSTEMS ANALYSTS**

Conduct studies in advanced communications employing detection theory, coding theory, modulation systems optimization, spread-spectrum techniques, interference reduction methods, coherent phase-locked demodulators, data compression and optimal signal design. MS or PhD. EE required.

## **DIGITAL SYSTEMS ANALYSTS**

Analyze and design variety of digital

software systems, time sharing, real time programming, simulations, logic design, and engineering programming.

## **ANTENNA SYSTEMS ENGINEERS**

Conceptual design and analysis of advanced systems with emphasis on choice and optimization of approach and configuration. BSEE, 6 years experience.

## **SENIOR MECHANICAL ENGINEER**

Mechanical design on R&D, prototype, and production systems used on space, airborne, and ground based microwave antennas and components, BSME and 5 to 15 years related experience.

## **CONTROL SYSTEMS ANALYSTS**

Formulate control systems concepts, perform preliminary design and analysis of spacecraft and booster attitude control systems, dynamic analysis and analog hybrid simulations. Advanced degree.

# TRW<sup>®</sup>

*TRW Systems Group is a major operating unit of TRW INC. where more than 75,000 people at over 250 locations around the world are applying advanced technology to electronics, space, defense, automotive, aircraft, and selected commercial and industrial markets.*

**TO APPLY: SUBMIT YOUR RESUME IN CONFIDENCE TO H. D. WONG, PROFESSIONAL PLACEMENT, RM. P2701-C, TRW SYSTEMS GROUP, ONE SPACE PARK, REDONDO BEACH, CALIF. 90278. IF ATTENDING IEEE, CONTACT D. E. PAULSON, TRW SUITE, AMERICANA HOTEL, NEW YORK FOR A LOCAL INTERVIEW. TRW IS AN EQUAL OPPORTUNITY EMPLOYER.**

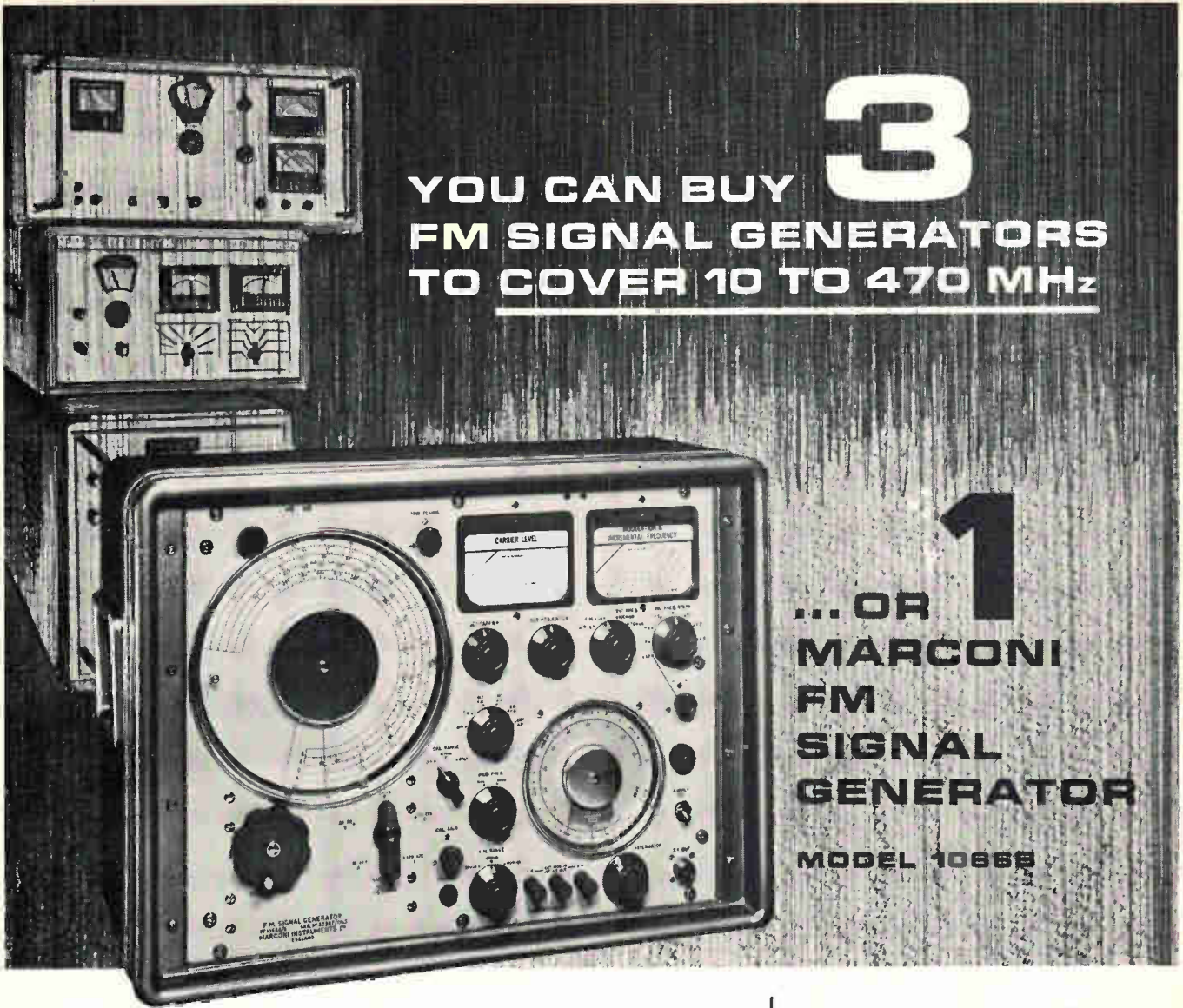

**YOU CAN BUY 3  
FM SIGNAL GENERATORS  
TO COVER 10 TO 470 MHz**

**... OR 1  
MARCONI  
FM  
SIGNAL  
GENERATOR  
MODEL 1066B**

The Marconi 1066B Series of FM Signal Generators are now considered standards of the industry for all RF and IF checks on FM equipment including telemetry, communications, sensitivity, bandwidth, and limiting of receivers, FM transceivers, etc. Outstanding features of these instruments are:

**1066B/1** (6625-929-4277)

- No sub-harmonics
- Stepped and Continuously variable incremental tuning
- Internal or external modulation
- Output 0.2  $\mu$ V to 100 mV into 50 $\Omega$
- FM on CW < 100 Hz

**1066B/6** (6625-937-2801)

- All the features of 1066B/1 plus . . .
- Built-in crystal calibrator: 10 mc & 1 mc
- FM deviation: up to  $\pm$ 400 KHz
- Modulation range: 30 Hz to 100 KHz
- Modulator distortion < 5% 215 to 265 MHz; < 10% elsewhere

*Available Upon Request*



**THE SIG GEN BOOK**

This 28-page book presents detailed discussions on signal generators and receiver measurements including: source impedance of feeder connected receivers, coupling to loop antennas, signal-to-noise ratio, automatic gain control, plotting response characteristics, measurement of adjacent channel suppression and spurious response, etc.



**TECHNICAL DATA SHEETS**

Technical Data Sheets on the Model 1066B/1 and Model 1066B/6 Marconi FM Signal Generators detail all specifications, operation, applications, features and accessories available.

**MARCONI INSTRUMENTS**  
Division of English Electric Corporation

111 CEDAR LANE, ENGLEWOOD, NEW JERSEY 07631 • (201) 567-0607

"SEE US AT IEEE—BOOTH #2D-02-08"

Circle 176 on reader service card

# Power oscillator tests equipment for rfi

Plug-in heads for checkout instrument cover 10 Mhz to 2.35 Ghz in both continuous-wave and amplitude-modulated modes

**Electromagnetic pollution**, another name for the old problem of radio-frequency interference, is particularly troublesome to the military because of the quantity of equipment that the services use, much of it in close proximity.

The susceptibility of this equipment to rfi must be tested under rules spelled out in Military Standards 461 and 826, and it is with

this in mind that Microdot Inc. developed a new power oscillator.

According to Microdot, the model 1927 is the only instrument on the market that allows susceptibility testing to military standards over the range from 10 megahertz to 2.35 gigahertz at 50 watts and in both continuous-wave and amplitude-modulated modes. Competing items that cover most or all of

that frequency range, and operate both c-w and a-m, deliver only about four watts, says J. Wayne Matthews, Microdot sales manager.

The model 1927 rack will accept six plug-in heads and the model 445 power supply can switch to any of them. The basic rack costs \$1,425, the power supply costs an additional \$2,000, and the heads range in price from \$1,375 to

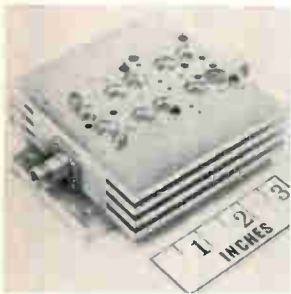

Solid state, high power r-f amplifier provides 100 w peak pulse power or 75 w c-w in the frequency range from 200 to 500 Mhz. A variety of models is available to provide gain values from 4 to 30 db. Power requirement is +28 v d-c, and input vswr is 2:1 maximum. Size of the 8 db model is 3.5 x 3.75 x 1.5 in. Acrodyne Industries Inc., 666 Davisville Road, Willow Grove, Pa. [401]



Impatt-diode oscillator X935 is for mechanically-tunable service in the 8.2 to 12.4 Ghz band. Power output is 100 mw c-w into termination with vswr less than 1.3:1. The unit has a single power supply requirement of 75 v at 50 ma. Size is 1.63 x 1.63 x 2 in. block with BNC bias receptacle. Price is \$395. Somerset Radiation Laboratory Inc., 2060 N. 14th St., Arlington, Va. [402]



The wide d-c error-voltage swing provided by models 243-T and 247 sweep-lock synchronizers offers a practical means for phase-locking two microwave or r-f sweep oscillators 30 Mhz apart. Each synchronizer can deliver an error-voltage excursion of up to 40 v, enough to drive most sweep oscillators over their entire spectrum. Sage Laboratories Inc., 3 Huron Dr., Natick, Mass. [403]



Stripline microwave power divider works in a frequency range from 8 to 12 Ghz. It accepts up to 50 w c-w input and provides 8 outputs mutually isolated by at least 10 db. Output signal phase is identical within  $\pm 10^\circ$  at all output ports. Insertion loss is 9.5 db  $\pm 1$  db to any output port. Input vswr is 1.5:1 max. Elpac Inc., 18651 Von Karman Ave., Irvine, Calif. [404]



Transistor power amplifier S230 functions as a transmitter in microwave communications systems. When factory tuned to any frequency between 1.85 and 2 Ghz, a power output of 2 w can be obtained at room temperature. For field tunable applications a power output of 1.6 w can be obtained over the 1.85 to 1.99 Ghz range. RCA Electronic Components, Harrison, N. J. [405]

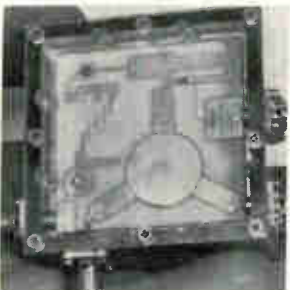

S-band parametric amplifier is built in hybrid microwave IC format on a single substrate. Principal components are a ferrite junction circulator, input matching networks, a high cutoff frequency varactor diode, pump and idle frequency filtering and an avalanche diode oscillator pump source. Range is 2.2-2.3 Ghz. American Electronic Laboratories Inc., Colmar, Pa. [406]



Three-stage Satcom receiver filter model 40C146000 operates over a frequency range of 7.25 to 7.75 Ghz with an insertion loss of 0.60 db at center frequency. It features a minimum instantaneous 0.7 db bandwidth of 50 Mhz over its tuning range, insertion loss of 0.60 db at center frequency. Frequency Engineering Laboratories, P.O. Box 527, Farmingdale, N. J. 07727. [407]



Permanent-magnet-focused, traveling-wave amplifiers offer 100 mw power output in S band (WJ-477), C band (WJ-476) and X band (WJ-472). The single-reversal units also have in common 13 db maximum noise figure and 30 db minimum small signal gain. Packaging is 3 x 3 x 10.5 in. and weight is 6.5 lbs. Watkins-Johnson Co., 5333 Hillview Ave., Palo Alto, Calif. [408]

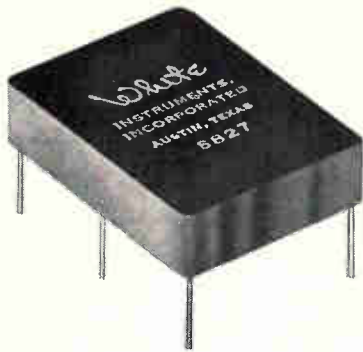

## ACTIVE FILTERS

### PACKAGED FOR PRINTED CIRCUIT BOARD MOUNTING

Integral transistorized amplifier—network packages—Low, high, band pass and reject responses at audio and sub-audio frequencies for use over a wide range of source and load impedances and power supply voltages.

Ask for literature.

Write for quotations on individual problems.

Moderate prices, early deliveries.



**White instruments, incorporated**

PHONE AREA 512 / 892-0752

P. O. BOX 698 AUSTIN, TEXAS 78767

Circle 219 on reader service card

### MINIATURE PCM ENCODER:

AIRBORNE  
SEVERE ENVIRONMENT  
HIGH ACCURACY  
HIGH SPEED



Model 1290

Phoenix Data's new airborne encoder is a high-speed, high-accuracy analog voltage-to-pulse code modulation device that operates at ambient temperatures from  $-50^{\circ}\text{C}$  to  $+100^{\circ}\text{C}$ . Model 1290 converts input voltages of full-scale amplitude of  $\pm 5\text{V}$  into 12 binary bits of digital data providing a data measurement resolution of one bit in 4,095.

It measures the input voltage against the internal precision reference voltage source with an accuracy of  $\pm 0.025\%$  of full range and holds an accuracy of better than 0.05% of full range over the temperature extremes.

It has a very high input impedance — 1,000 megohms — fast settling of the input amplifier plus high-speed encoding which allows a commutating through-put rate of 58,823 channels per second at the maximum bit rate of one bit per microsecond. Complete information upon request.



**PHOENIX DATA, INC.**  
3065 W. Fairmount Ave.  
Phoenix, Az. 85017 Ph. 602/277-4767

*Cut The Cost Of Printed Circuits*



Our new production techniques and rapid service saves you delay time and research cost.

We can produce single and small quantity orders extremely economically. Our quality is unsurpassed, and orders are usually processed within three days from receipt of the order. Large quantity orders receive the same fast service.

#### HOW TO ORDER

Layout your circuit board to scale in exact proportion to the size you desire. We can enlarge or reduce the copy to your specifications. Copy can be an ink drawing or laid out with the new circuit tapes. NOTE: The board we produce can only be as accurate as the copy we receive; so be sure to double check. Specify rigid or flexible board.

SEND FOR FREE SAMPLE OR QUOTATIONS TODAY - NO OBLIGATION

*American Engraving Inc.*  
MANGUM, OKLAHOMA 73554

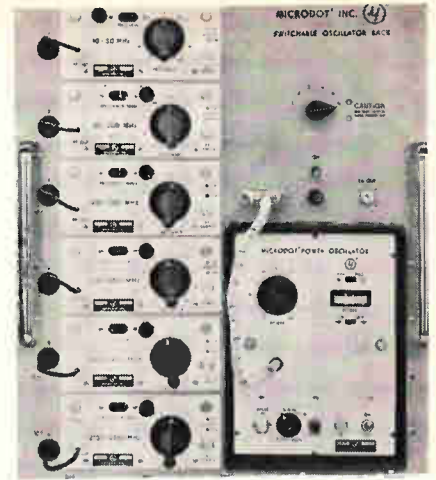

Multi-headed. Complete test setup includes six plug-in heads.

\$2,250. The complete six-head instrument sells for \$14,425. Thomas Eccles, chief engineer for microwave products, says this price is about one-half that for a comparable power oscillator built from off-the-shelf hardware.

The six heads available with the Microdot oscillator are 10 to 50 Mhz (\$2,000), 50 to 200 Mhz (\$2,000), 200 to 500 Mhz (\$1,375), 500 to 1,000 Mhz (\$1,575), 1,000 to 1,800 Mhz (\$1,800), and 2,150 to 2,350 Mhz (\$2,250). The latter S-band head is earmarked for testing telemetry equipment, and might be replaced with one covering the 2 to 10 Mhz band that is in the final stages of development. The a-m feature is an option that costs an additional \$190 per head.

The complete instrument may be either mounted in a 19-inch-wide rack or used atop a lab bench. A cavity designed for cooling at 50 watts includes a special tube.

An option allows sweeping at a given frequency over a bandwidth of about 10% at a variable rate up to 5 hertz or at a fixed rate of 30 hertz. The slower sweep rate enables the instrument to be used with an x-y plotter; the 30-hz sweep is for use with oscilloscopes.

The built-in wattmeter in the model 445 power supply allows continual r-f power monitoring of both incident and reflected power at 10 watts to 50 watts full scale.

A cousin to the model 1927, called the 1926, takes three heads and is for production testing and transistor testing and burn-in.

Microdot Inc., 220 Pasadena Ave., South Pasadena, Calif. 91030 [409]

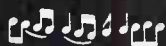

YOU'RE  
WHISTLING  
IN THE  
DARK . . .

... if you think that heart disease and stroke hit only the other fellow's family. No one is immune. Protect the hearts you love. For authoritative information, ask your Heart Association. For medical advice see your doctor. To safeguard your family . . .

**GIVE...**  
so more will live  
**HEART  
FUND**



*Contributed by the Publisher*

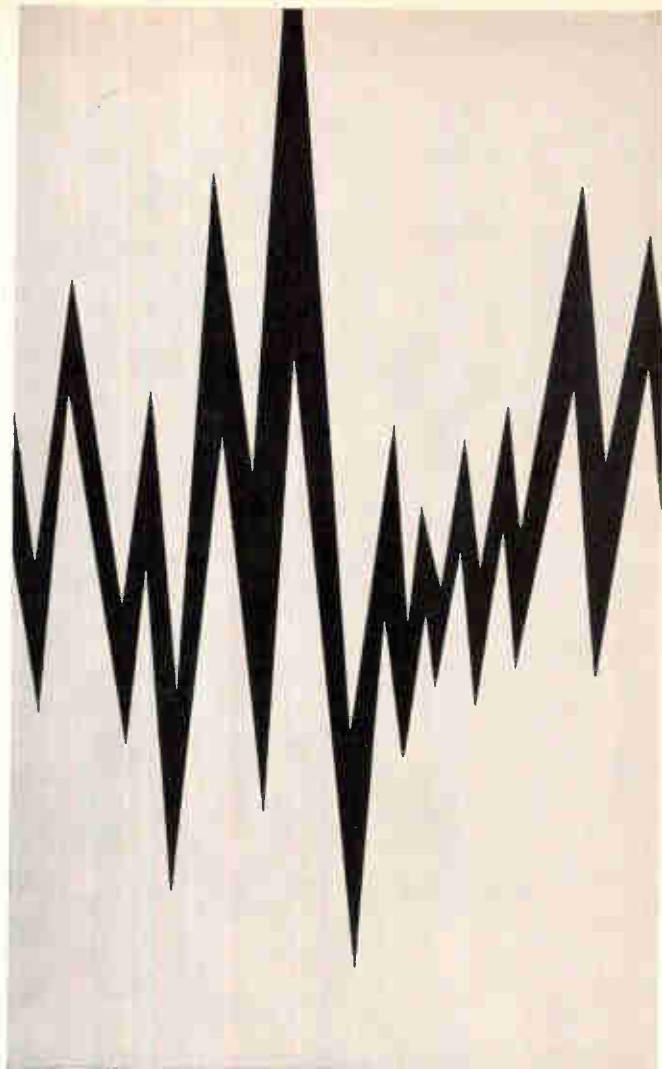

**Equipments and units bearing the TELEFUNKEN trademark are symbols of progress**



NI 892741

We manufacture and supply:  
Broadcasting and television transmitters · Communications transmitters  
Maritime transmitters and transceivers · Professional receivers and direction finders · Radars  
Radiotelephone sets and systems  
Telecommunications equipment and cables · Data processing systems

Write for comprehensive documentation

ALLGEMEINE ELEKTRICITÄTS-GESELLSCHAFT  
AEG-TELEFUNKEN  
Export Department  
79 Ulm · Elisabethenstraße 3  
Germany

**ALLGEMEINE ELEKTRICITÄTS-GESELLSCHAFT  
AEG-TELEFUNKEN**

# OK gang. It's "see the little boxes" time again.

See the little boxes.



See what they can do.  
Sine, square, triangle, ramp,  
tone burst, trigger, sweep,  
sine<sup>2</sup> phase lock, VCG, plus  
analog & digital control of  
frequency & amplitude.  
See the little boxes work  
at IEEE, booth 2A18.

**WAVETEK**  
A Division of Tektronix, Inc. 9700 NE

See the little boxes.

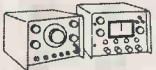

See what they can do.  
Measure voltage and frequency.  
Generate sine, square, triangle,  
ramp, tone burst, trigger, sweep,  
sine<sup>2</sup> phase lock, VCG, plus  
analog and digital control of  
frequency and amplitude.  
See the little boxes work at  
Wescon, booth 2417.

**WAVETEK**  
A Division of Tektronix, Inc. 9700 NE

See the new little boxes.



Now see what they can do.  
Sweep from two hours to 1GHz.  
Measure voltage and frequency.  
Generate sine, square, triangle,  
ramp, tone burst, trigger, sweep,  
sine<sup>2</sup> phase lock, VCG, plus  
complete digital remote control.  
See the little boxes work at  
Wescon, booth 1710-11.

**WAVETEK**  
A Division of Tektronix, Inc. 9700 NE

Except we now box phasemeters,  
sweep/signal generators to 1GHz  
and pulse samplers in addition to  
voltmeters and generators.

See the little boxes work at IEEE,  
booth 2F49.

**WAVETEK**<sup>®</sup>  
9045 Balboa Ave., San Diego, Calif. 92123; Tel. 279-2200  
P.O. Box 651, San Diego, Calif. 92112; TWX 910-335-2007

# Isolating acoustic signals in real time

Connected to spectrum analyzer, new hybrid computation unit identifies the sources of individual components of radar signals, speech, and noise

**Breaking down** complex acoustic signals into their components and identifying the sources is a neat—but not new—trick. However, the Federal Scientific Corp. says a computational unit it will display at the IEEE Show next week is the first analyzer to do the job in real time—and at a far lower cost than any equipment now used for this sort of signal analysis.

Federal Scientific describes its MCU-6 Multifunction Computational Unit as a special-purpose hybrid computer that analyzes signals with bandwidths up to 10 kilohertz and is designed to be attached to the company's previously available "Ubiquitous" spectrum analyzer. Two analyzers, the MCU-6, and a dual-channel digital averager, also built by Federal

Scientific, make up the basic processing system.

The primary job of the MCU-6 is to perform such special functions as cross correlation and power-spectral-density computations. These tasks could previously be handled only by much more expensive digital computers and at much slower speeds. And most of the competitive systems have much narrower

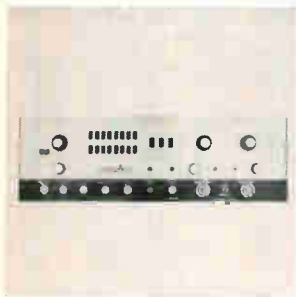

Data generator 212 features an internal clock rate to 75 Mhz and 1.3 nsec rise and fall times. Data length is fixed at 16 bits. Unit can run continuously or produce individual outputs in response to an external command or a manual signal; these 3 modes, plus data content of each bit, are set by push-buttons. Systron-Donner Corp., W. Jefferson Blvd., Culver City, Calif. [421]



Digital data translator accepts up to 20 bits, in any weighted code, for translation of purely numerical data into 8 significant decimal figures of preselected scale factors and units. Complete translation of a 20-bit input takes 1.5 msec max., permitting 500 translations/sec to be made. Price \$4,300. Adtrol Electronics Inc., 116 N. 7th St., Philadelphia 19106. [422]



Data acquisition system model 710 can multiplex and digitize 64 channels of low-level analog data onto magnetic tape. It contains a 16-channel FET multiplexer which is expandable to 64 channels with a switching speed of 1  $\mu$ sec/channel. Accuracy of the integrating digitizer is 0.015% of full scale at 15 msec/conversion. IRA Systems Inc., 332 2nd Ave., Waltham, Mass. [423]

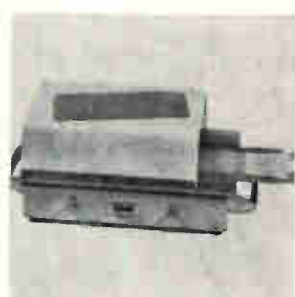

Card reader K10 allows for internal decoding of the input code and translation into any other code without the use of external logic. The single card reader, with a standard reading speed of 20 columns per second, features automatic indexing of the card by internal or external programming. Price starts at \$850. Electrologic Inc., 4732 Indianapolis Blvd., E. Chicago, Ind. [424]



Ruggedized card reader model 310 features an automatic re-read cycle. Computers can now be programmed to command cards to be immediately re-read as many times as required for the specific application desired. Unit is 24 in. long by 19½ in. high by 12¾ in. wide, weighs 70 lbs. Price is \$3,175 each in lots of 50. Omnitec Corp., 903 N. Second St., Phoenix 85004. [425]

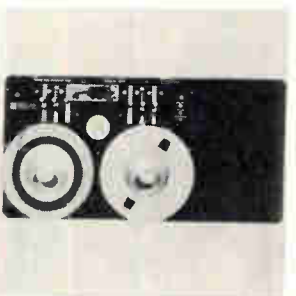

Capstan drive tape transport model 640 is for the recording of digital data on ½-in. tape in 7- or 9-track IBM compatible format. It provides on-site serviceability. Tape speeds are available up to 120 ips with packing densities of 800 bpi. Precise start-stop characteristics of 0.150 sec (high speed) are maintained. Digital Data Systems Inc., 7415 Hillcroft Ave., Houston. [426]



Data transmission sets series 2056 are two and three state (suited to return to zero operation), which operate at bit rates of 60, 85, 110, 150, 300, 600, 1200 and 1800. Digital interfaces may be either positive neutral, negative neutral, or polar. Varied mounting configurations are available. Prices start at \$350 with delivery 4-5 weeks. RFL Industries Inc., Boonton, N. J. 07005. [427]

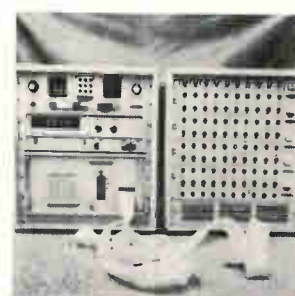

Static strain data acquisition system 910 features a random access keyboard for manual channel selection. It scans at a rate of 5 per second and handles 50 to 1,000 channels in 10 channel increments. Input to the system is by shielded cable to either barrier terminal strips or MS type 5-pin connectors. Electronics Ltd., P.O. Box 1972, Cedar Rapids, Iowa 52406. [428]

# FOR 8-TRACK RECORDING ON 1/4" TAPE



Since we pay a lot of attention to everybody's magnetic recording needs, we can readily understand both how and why yours are different. That's why we offer not only a tremendous range of tape heads, but also the expert counsel that guides you to the most effective specifications.

Study our technical literature on these 8-track heads (available free on request)

## MODEL B2L



The basic head of the 8-track stereo industry, for record and/or playback. Response through 15Khz at 3.75 ips.

## MODEL ZJ2L



First Combo head for 8-track stereo Record, playback, and erase in a single unit. Eliminates assembly tolerance, track alignment and pressure pad problems. Simplify circuitry internal automatic biasing.

## MODEL P-BQL



For duplicating or instrumentation applications. Maximum information storage at minimum cost. Four in-line tracks. A staggered pair provides 8 tracks on 1/4" tape.

Which one fits your needs? Nortronics, the world's largest tape head manufacturer, has what it takes to analyze your requirements and to recommend the right head... for any audio or instrumentation application.

When you have a tape head need, head for Nortronics. We'll head you right.

**Nortronics**  
COMPANY, INC.

8101 Tenth Avenue North  
Minneapolis, Minnesota 55427  
Phone—(612) 545-0401

Sales Offices throughout the world

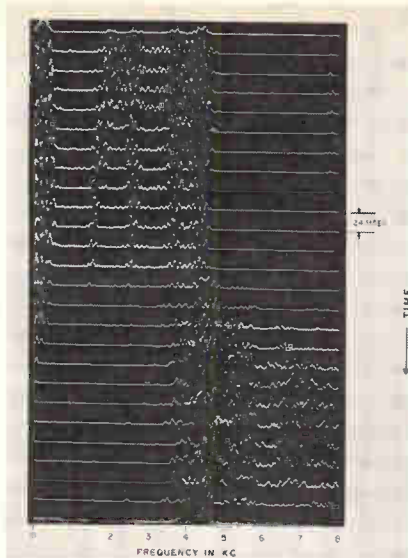

Voiceprint. Spectra of the spoken word "is", sampled every 24 msec. These are examples of input to the MCU-6.

bandwidth limits, according to Richard Rothschild, marketing vice president at Federal Scientific.

The company's system will be used for radar data reduction, speech analysis, and noise studies. In fact, one of its first jobs will be analyzing jet engines for the National Aeronautics and Space Administration. In this case, the noise originates in the fans and turbines of the engine, in the fuel combustion process, in the blast of the exhaust jet—and possibly in bearings' flat spots and other engine defects. The system will isolate these noise components one at a time, identify the sources, and note changes as a function of engine speed. NASA will be collecting this data for its noise abatement studies.

One of the advantages of the Federal Scientific system in such an application is that no connections need be made inside the engine; the only transducer required is an ordinary microphone. Modular design permits a user to put a system together a piece at a time.

The Ubiquitous spectrum analyzer, priced at \$19,500, is the foundation of any of several setups. Each additional unit fits a standard 19-inch rack. The MCU-6 will cost about \$10,000, and the complete processing system, designated the UPS-6, will sell for \$58,800 as a package. IEEE Booth No. 2B3.

Federal Scientific Corp., 615 West 131st St., New York, N.Y. 10027 [429]

DC Meters



Mod Meters



## Pick your panel meter

## from

VU Meters



## API's exclusive combination

Pyrometers



These API panel meters offer you a unique choice of styles, features and functions:

**DC meters**—standard 1% tracking and taut-band construction in 20 to 100  $\mu$ a ranges, at no extra charge. Optional 0.5% tracking at published prices. Stocked in 15 models with clear plastic, recessed-mounting and black phenolic case styles.

**Mod Meters**—with interchangeable scales for measuring different variables. Many meters for the price of one.

**VU meters**—for recording and broadcasting applications. Most stylish in the industry. Stocked in 12 models.

**Pyrometers**—widest selection available anywhere, including ruggedized type shown above.

For detailed specifications, ranges and prices, ask for Bulletin 47.

**api**

**INSTRUMENTS CO.**  
Chesterland, Ohio 44026  
(216) 729-1611



Data handling

## Video analyzer enhances pictures

Using digital techniques,  
system compares images  
frame by frame

**Gathering video data** from outer space presents a thorny problem: how to detect what has changed during a short interval of time. Because the signal level is very low and the background noise is very high, a change in the signal could go unnoticed.

Spatial Data Systems Inc.'s model 201 Digital Video Processor analyzes, compares, and enhances video signals, and senses small differences in real time. The system includes a magnetic tape recorder, a digital computer, a digital-to-analog converter, high-speed arithmetic and control logic, two video monitors, a magnetic disk memory, and a power supply.

The system digitizes television picture frames, each with a duration of  $\frac{1}{60}$  second, into 55,000 eight-bit binary numbers. These are then stored in the disk memory. The arithmetic unit accumulates successive frames, compares them, and isolates stationary components from background noise. This results in an improved signal-to-noise ratio and an enhanced picture appears on a monitor.

The digital computer controls the reading process, the arithmetic unit and disk recorder. The digitized pictures can be transferred from the disk recorder to the computer for further analysis so that specially selected brightness levels can be compared.

The 201 can be used in the detection of targets in infrared reconnaissance, radar, sonar, and planetary observations.

The price of the system ranges from \$50,000 to \$150,000 depending on specific customer requirements. Delivery time is 4 to 6 months.

Spatial Data Systems Inc., 108 Aero Camino, Goleta, Calif. 93017 [430]

## Small wonder!



### New air variable capacitors only 0.310" in diameter for vertical or horizontal tuning.

Johnson introduces these new Type "T" subminiature air dielectric capacitors for trimming applications that call for small size (0.310" diameter), high Q (greater than 1500 at 1 mHz), low TC, and low cost. Mounting dimensions of vertical mount "T" are identical to common  $\frac{3}{8}$ " diameter PC mount ceramic disc trimmers.

Nominal capacities available range from 1.3 pF minimum to 15.7 pF maximum. Minimum voltage breakdown is 250 VDC. End frame is 95% alumina, grade L624 or

better, DC200 treated. Metal parts are silver plated and Iridited to inhibit discoloration.

Plates are precision machined from brass extrusions and offer exceptional uniformity, stability, and absolute freedom from moisture entrapment. Temperature coefficient is  $\pm 30 \pm 15$  ppm/°C. Retrace characteristics are excellent. Outstanding stability during vibration from 10 to 2000 Hz. These new capacitors meet or exceed EIA-RS 204 and MIL Standard 202C Methods 204A and 201A.

- Please rush a sample of your new Type "T" capacitors, detailed specs and prices.  
 Include Catalog 701 covering the entire E. F. Johnson component line.

NAME \_\_\_\_\_ TITLE \_\_\_\_\_

FIRM \_\_\_\_\_ ADDRESS \_\_\_\_\_

CITY \_\_\_\_\_ STATE \_\_\_\_\_ ZIP \_\_\_\_\_



### E. F. JOHNSON COMPANY

3003 Tenth Avenue S. W., Waseca, Minnesota 56093

Providing nearly a half-century of communications leadership

## Unique anode design reduces dissipation factor and ESR.

By designing anodes with holes through them and risers welded separately to their tops, Mallory has reduced the physical electrical loss paths of its tantalum capacitors, particularly at higher frequencies (up to 1 MHz).

This greatly improves the electrical characteristics and performance of the Mallory capacitors, making them better than conventional electrolytic tantalum capacitors in the following ways:

- Lower dissipation factors
- Lower impedance at higher frequencies
- Larger permissible ripple voltages
- Less capacitance change with frequency
- Less capacitance change with temperature

These superior characteristics are in addition to the usual features of solid electrolyte tantalum capacitors.

Designated THF by Mallory, the new capacitors are available in the large and intermediate CV product range where improvements in the electrical characteristics are most significant.

THF capacitors are enclosed in standard Mallory F and G cases which correspond to Military C and D case sizes. They meet the requirements of Style CS12 and CS13 of MIL-C-26655B.

For data, write Mallory Capacitor Company, a division of P. R. Mallory & Co. Inc., Indianapolis, Indiana 46206.

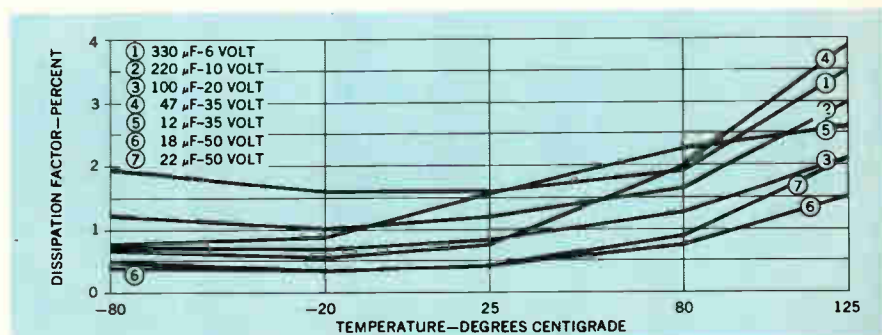
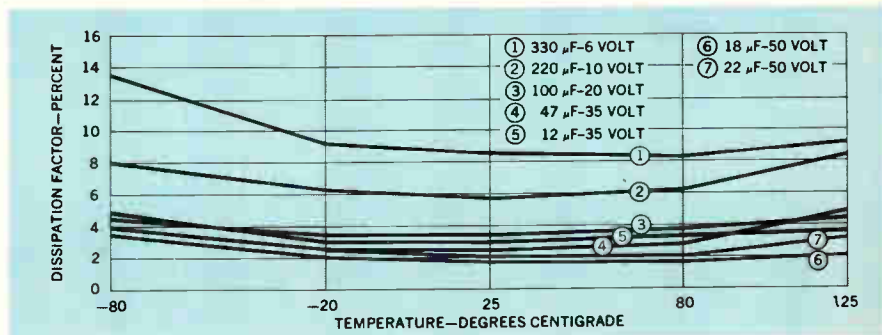
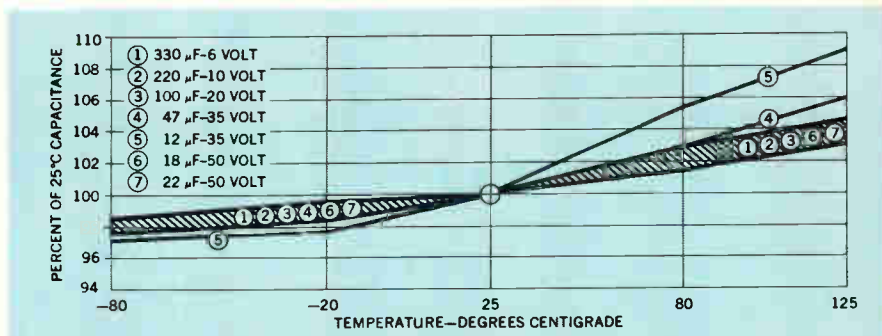
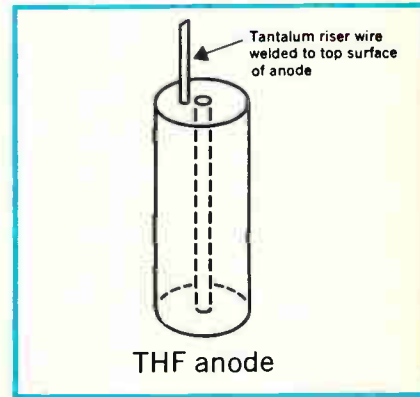
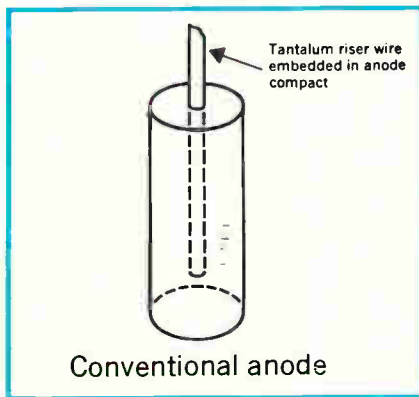

# Monolithic IC puts out 18 watts

Sony triples audio amplifier power level  
by precision growth of polycrystalline regions

The power race in the semiconductor industry last year matched transistor against transistor. This year, the contest is among integrated circuits. The latest entry is Sony's 18-watt rms monolithic IC.

The key to the high power output is the precise method of growing single crystal and polycrystalline silicon over specified portions of the chip during an epitaxial

growth process. These polycrystalline regions serve as both a connection to buried layers under the transistors and as vertical isolation regions. The impurity diffusion rate through the polycrystalline material is far higher and a definite advantage over that through ordinary single crystal material. Extremely low resistance connections can be made directly to collector

buried layer regions, and thus to the transistor collectors without the lengthy diffusions at the high temperatures needed to make a heavily doped connection through single crystal material.

If low resistance connections are not made from the metallization on the chip surface to buried layers, localized heating and high saturation voltage limit the power output

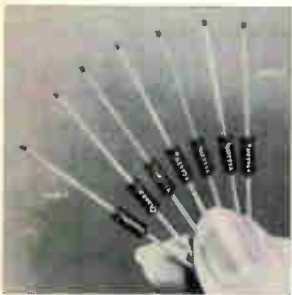

Subminiature h-v rectifiers are offered at prices under \$1. With their maximum peak repetitive reverse voltage ratings ranging from 1 to 5 kv, the devices can handle continuous forward currents of 0.25 amp at ambient temperatures of 75°C, and withstand current surges up to 15 amps at these temperatures. Motorola Semiconductor Products, Inc., P.O. Box 20924, Phoenix 85036. [436]

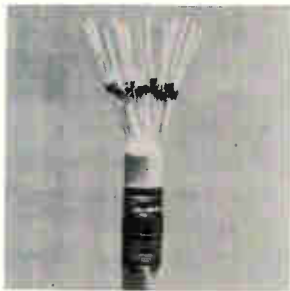

Microminiature reference diodes, electrically equivalent to the 1N821-1N829 series, are for applications with miniature circuits, hybrid circuits, and in conjunction with IC's. Operating and storage temperature is -55° to 150°C. Power derating above 25°C is 1 mw/°C. Maximum power dissipation at 25°C is 125 mw. Transatron Electronic Corp., Albion St., Wakefield, Mass. [437]



Gas-filled metal diodes serve as protective devices against transients or other sharp spikes, such as those which can puncture MOS FET's. Inherent firing voltage is 80 to 89 v. Leakage resistance is greater than  $3.5 \times 10^{14}$  ohms. Repeatability of firing voltage is approximately  $\pm 5\%$  and self capacitance 1.1 pf at 100 khz. Victoreen Instrument, 10101 Woodland Ave., Cleveland. [438]

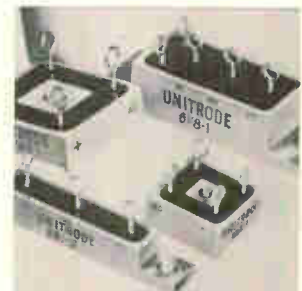

High-current, controlled-avalanche rectifier assemblies in the Magnum series have a piv range of 100 to 600 v. They include 25 amp single and three-phase bridges, 10 amp single-phase bridges, and 15 amp doublers and center-tap rectifiers. Units have prices varying from \$3.43 to \$12.60 in lots of 100. Unitrode Corp., 580 Pleasant St., Watertown, Mass. [439]



Triple-diffused silicon power transistors series SDT4921-SDT4925 are 300-v, 5-amp devices in TO-5 cases. They feature ultrasonically bonded leads and gold silicon eutectic die mounting. Beta at a collector current of 1 amp is a minimum of 20 and a maximum of 60. Collector to emitter voltage is less than 0.5 v. Solitron Devices Inc., 1177 Blue Heron Blvd., Riviera Beach, Fla. [440]



Monolithic timing circuit model 7100 is for any type of timing application, from monostable delay circuits to turn-on delays. Features include: 10  $\mu$ sec to 1 hour time delays; only 1 to 2 external components required for the majority of applications; and output compatible with 10 volt analog, MOS, RTL, DTL and TTL forms of logic. Optical Electronics Inc., Box 11140, Tucson. [441]



Inverter scr C398 is rated at 1,200 v with an average current of 300 amps and a di/dt of 800 amps per  $\mu$ sec. Other features include a frequency up to 5 khz square wave and 10 khz sine wave, a gate drive of 225 ma for high di/dt, and a turn-off time of 25  $\mu$ sec typical. Price is \$300 each in quantities of 1 to 9. General Electric Co., 1 River Road, Schenectady, N. Y. 12305. [442]



Selenium high-voltage rectifier TV18-TOK70 for black-and-white tv application features high life expectancy. The 24 kv piv rectifier has the length of a comparable h-v tube rectifier, 2 3/4 in. The baseplate material has a thickness of approximately 0.003 in. compared with 0.012 in. of standard material used until now. ITT Semiconductors, 6416 W. Belmont Ave., Chicago 60634. [443]

# alignment Problems? ?



## Solve them fast with MINEAC® ... world's smallest electronic autocollimator!

Twist . . . warp . . . strain . . . linear displacement? For precise measuring, monitoring and control of these problems to within 0.05 arc-seconds or 0.001 inch . . . MINEAC is the answer!

MINEAC — world's smallest electronic autocollimator — is ideal for dynamic applications where the target is subject to constant orientation changes. It requires no physical or electrical contact with the target. Using projected and reflected light beams, MINEAC generates electrical signals directly proportional to displacement error.

Other features? Size: 1.5 cubic inches. Weight: 3 ounces. Power in: 0.4 watts. Single and dual axis models are standard. Custom models with even higher accuracy and performance are available on special order.

For more information on MINEAC, call or write Electro-Optical Sales Manager.



### BARNES ENGINEERING COMPANY

30 Commerce Rd / Stamford, Conn. 06902  
Phone (203) 348-5831 / TWX 710-474-3367

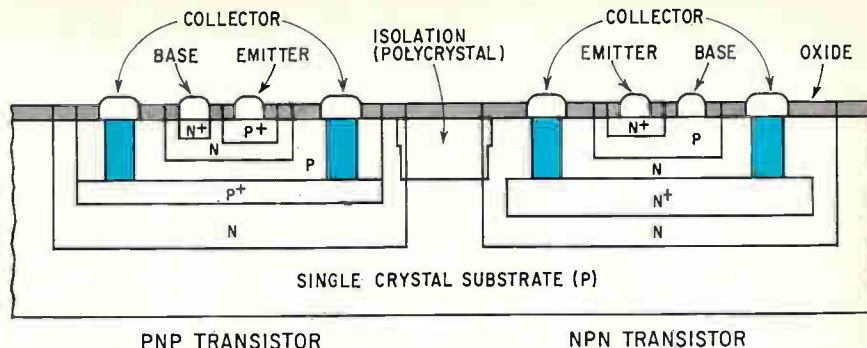

PNP TRANSISTOR

NPN TRANSISTOR

POLYCRYSTALLINE COLLECTOR LEAD

Down under. Polycrystalline connections to the buried layers have extremely low resistance, enabling the IC to have an output capability of 18 watts.

of any IC. And even if average chip-temperature doesn't reach a very high value, localized heating limits the maximum current. If vertical highly doped regions are used in an attempt to overcome this problem, the processes needed to produce the vertically highly doped regions usually result in lower breakdown voltage, and maximum power output is limited by low maximum collector voltage.

**No compromise.** Sony's process secures the desired connections without compromising maximum voltage rating. Any chip's maximum output is proportional to the product of its current and voltage; it follows then that Sony's achievement—high voltage and current ratings—produce a high maximum output rating. Maximum output of 18 watts rms—26 watts peak—is reached when the collector voltage is 40 volts. With the collector power supply in the 10- to 15-volt range, the maximum rms power output is only in the three- to four-watt range. Maximum current rating for the IC is four amperes peak to peak. The efficiency of the circuit with an output of 18 watts rms into an eight-ohm load is about 67%. Harmonic distortion is less than 10% at 18 watts; at 15 watts output, distortion is less than 0.4%.

Small power transistors can be used to take advantage of the low collector resistance connection used in the IC. This makes for a very small chip. Normally, most of the heating is in the resistance drop through the substrate to the active collector region. The great reduction in this heating allows very small transistors to be used even for a large output. Total size of the chip used is 59 by 69 mils, with

the power transistors taking up less than half of the chip.

The circuit has four npn power transistors—two npn transistors, one diode, and six resistors. Although conventional vertically oriented pnp transistors are used—as opposed to the lateral pnp transistors normally used in IC's—the characteristics and balance of the npn's are superior; two npn output transistors are used in the single ended push-pull stage. One is driven by a medium size pnp to give a pseudo complementary symmetry output stage. Where two transistors do the job in this circuit, three are normally used in conventional circuits when the pnp is a lateral type.

The resistivity of the polycrystal areas is lower than that of normal high-doped regions by at least an order of magnitude. And because subsequent processing has little effect on buried layers, they can be doped higher and thus have lower resistivity than was previously practical. This further lowers resistance losses, and decreases saturation voltage.

With this technology, the final isolation diffusion is done at the same time as the shallow base diffusion, saving a process step.

Also, the polycrystal is used merely as a tool for increasing the local diffusion rate. This is extremely important, according to Sony, because all of the characteristics of the integrated circuit are determined by pn junctions—individual element functions are pn junctions in single crystal material because of the slight lateral diffusion described.

Sony Corp., 7-35 Kitashinagawa-6, Shinagawa-ku, Tokyo [444]

New semiconductors

## Probe costs— and does—less

Hand-held logic verifier  
for \$29.95 suited for  
single-cycle systems

The best market research sometimes consists of keeping a watch on what other companies are doing.

"It was a Hewlett-Packard announcement that woke me up," says Robert Cartmell, designer of a hand-held probe for verifying the logic state of integrated circuits. The probe, designated the LP-500, will be put on the market next month by Kurz-Kasch Inc., a maker of plastics for electronic systems. The test instrument was designed by Cartmell for his own needs. "We were a little slow in recognizing its usefulness for other engineers," he says. After H-P announced its \$95 probe [*Electronics*, Nov. 11, 1968, p. 275], Kurz-Kasch decided to market the LP-500. It will sell for \$29.95.

Unlike the H-P model, the LP-500 can't detect high-speed pulses. "But it's good enough to check out probably 75% of the circuitry in a complex system," says Cartmell.

The pen-like instrument, six inches long, has a metallic probe on one end and two small readout windows at the other end.

Cartmell says its versatility for troubleshooting lies in the fact that it can detect an improper logic level in any system that can be single-cycled.

The probe's split screen—one window marked "0" and the other "1"—visually displays presence or absence of logic current levels for gates, flip-flops, one-shots and similar circuits.

For a true logic level, from one volt d-c and up, the "1" window is illuminated. The probe indicates a zero level, below one volt d-c, by lighting the "0" window. Infinity or doubtful as would be the case for either an improper logic level or an unwired pin is represented by the blanking out of both windows.

Kurz-Kasch Inc., 1421 South Broadway, Dayton, Ohio 45401 [444]

IMPORTANT AND

# up-to-the-minute

BOOKS FROM MCGRAW-HILL

**1. REAL-TIME DATA PROCESSING SYSTEMS. A Methodology for Design and Cost/Performance Analysis.** By PAUL STIMLER. This practical step-by-step guide will help you greatly reduce the time and effort you expend in the calculation of meaningful numerical values for—and the optimization of—real-time systems performance, costs and performance per dollar. The book carefully defines all technical terms and criteria for performance and cost, and explicitly states assumptions. In addition, the methodology is illustrated with such typical applications as message-switching and automatic airline reservation systems.

Topics covered include system models, throughput rate capability, the data-communication network, system costs and specification, the processor subsystem, multi-programming capability and much more. **259 pp., \$13.50**

**2. DIGITAL MAGNETIC LOGIC.** By DAVID R. BENNION, HEWITT D. CRANE and DAVID NITZAN. This book deals with a class of digital magnetic-core circuits consisting of magnetic components and interconnecting conductors, and offer extremely high reliability, long life, and adaptability to special environments—e.g., high-intensity radiation. It is the first book available on digital logic circuits using magnetic devices exclusively. **320 pp., \$15.00**

**3. TRANSMISSION LINES FOR DIGITAL AND COMMUNICATION NETWORKS.** By RICHARD E. MATICK. This book brings together in one volume all the relevant information and important concepts required for an up-to-date understanding and use of transmission lines. Those not acquainted with transmission lines can very easily acquire the basic concepts using nothing more than simple ac circuit analysis. Topics covered include velocity of propagation, skin effect, superconducting transmission lines, transformers & parameters and more! **384 pp., \$14.50**

**4. PRINCIPLES OF HIGH-RESOLUTION RADAR.** By AUGUST W. RIHACZEK. This is the first book published in the radar field which deals specifically with one of the field's most demanding problems—adequate resolution performance. It stresses principles rather than the ever-changing equipment, developing an understanding of the theory without resorting to high-level math, and limiting discussions to those aspects of resolution theory which either have immediate practical applications or a strong possibility of future applications. **498 pp., \$19.50**

At your bookstore or direct from publisher

10 DAYS FREE EXAMINATION

McGraw-Hill Book Co., Dept. 23-L-369, 330 West 42nd Street, New York, N. Y. 10036  
Send me the book(s) circled below for 10 days on approval. In 10 days I will remit for book(s) I keep, plus a few cents for delivery costs, and return others postpaid. Include local sales tax if applicable.

1-614800      2-046995      3-409029      4-528901

Name (print) \_\_\_\_\_

Address \_\_\_\_\_

City \_\_\_\_\_

State \_\_\_\_\_

Zip Code \_\_\_\_\_

This offer good in the U.S. and Canada only

23-L-369

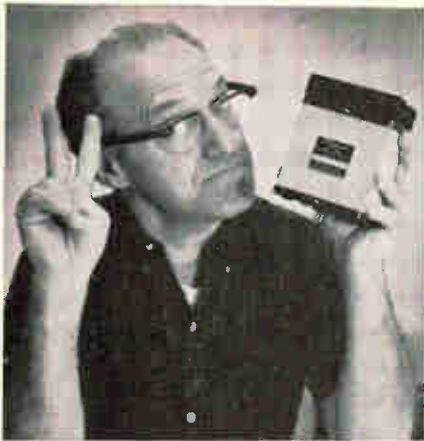

# ACOPIAN DUALS...

# 2

# POWER SUPPLIES IN THE SPACE OF

# 1

Where your equipment or system requires more than one regulated DC output, consider Acopian duals. They consist of two independent regulated power supplies housed in a single module. You can select two like outputs (such as for op amps) or any of 80,000 combinations of different outputs.

Acopian duals cut mounting space requirements roughly in half, cost less than two individual modules and, like all Acopian power supplies save you time because they're shipped three days after receipt of your order.

For information on the complete line of 82,000 different Acopian power supplies, including singles and duals, regulated and unregulated, and rack mounted assemblies, ask for our new catalog. Write Acopian Corp., Easton, Pa. 18042 or call (215) 258-5441.



## New Books

### Computer talk

Fortran Programming  
Fredric Stuart  
John Wiley & Sons Inc., 353 pp., \$7.95

Here's a good book for learning Fortran. The author, a member of the Business Statistics Department at Hofstra University, is one of the few authors who approach this subject while keeping in mind a reader who will actually be putting Fortran into practice. It's written very clearly and is easy to follow until the problems get more complicated. Then it would probably be best to have a computer at one's disposal in order to check out the trial programs. He gives many engineering problems and examples, and anyone who wants to learn Fortran must actually try his hand at it. The author's organization and level of verbal presentation make the learning process as painless as possible.

One of the nice features is that he has a listing of all commercial computers now in use, together with their Fortran compilers. He codes these by number and, then, whenever he must comment on the characteristics of compilers, rather than generalize, he presents a table with the appropriate comment for each one. Thus, the book is not only a text but also an operator's manual for using digital computers.

Some of the examples that would be of interest to electronics engineers are ones on a transistor biasing network, a thermistor bridge temperature sensor, and various statistical and curve-fitting problems.

### Recently published

Laser Communication Systems, William K. Pratt, John Wiley & Sons Inc., 271 pp., \$14.95

A primer on the subject of laser communications, the book has one chapter for each sub-assembly (optical components, detectors, etc.) in a typical system. The rest of the text deals with types of systems and includes a technique for optimum design.

Topics in Mathematical System Theory, Rudolf E. Kalman, Peter L. Falb, and Michael A. Arbib, McGraw-Hill Book Co., 358 pp., \$16.50

This text surveys recent advances in system theory and emphasizes rigorous mathemati-

cal methods. The book may be used as a text or supplement in courses on system theory. Each of the three authors covers the material from different points of view. Extensive background material has also been included to help engineers and students acquire the necessary mathematical precision.

Analysis and Synthesis of Linear Active Networks, Sanjit Mitra, John Wiley & Sons Inc., 565 pp., \$15.95

After reviewing active RC filters and passive RCL networks, the book explains the workings of active elements, such as negative resistances, impedance converters, and degenerate circuit elements. Also discussed are network theorems, the indefinite admittance-matrix approach, realizability conditions, and synthesis techniques.

Nonlinear Systems, Dragoslav Stijak, John Wiley & Sons Inc., 618 pp., \$22.95

Intended for a graduate course in system analysis, this book presents new graphical and analytical ways to study high-order nonlinear systems. Described are both a qualitative technique—the Liapunov-Popov approach to system stability—and a quantitative technique—the Krylov-Bogoliubov harmonic linearization combined with the describing-function method.

Introduction to Optimal Control, Ian McCausland, John Wiley & Sons Inc., 258 pp., \$12.00

A first-year graduate text, it presupposes a knowledge of classical control theory, linear system theory, including Laplace transforms, and some matrix theory and probability. Covered are the optimization of system parameters for minimum errors, the Wiener and Kalman filters, state representation of systems, and the calculus of variations as applied to control problems. Computer and other optimization methods are discussed.

Principles of High-Resolution Radar, August W. Rihaczek, McGraw-Hill Book Co., 498 pp., \$19.50.

Target resolution is the theme of this volume, which focuses on practices in modern radar. Single target discussion is followed by a description of the general resolution problem, the capabilities and limitations of radar, and waveform designs by computer plotting. Synthetic aperture radar is the main example used. The mathematics does not wander beyond the double integral.

Principles of Quantum Electronics, William S.C. Chang, Addison-Wesley Publishing Co., 540 pp., \$17.50

A rigorous, theoretical book for graduate students, it covers quantum electronics and its application to lasers. A review of quantum mechanics begins the discussion, which proceeds through the interaction of radiation and matter, and ends with inquiries into present laser problems.

Microwave Semiconductor Devices and Their Circuit Applications, H.A. Watson, McGraw-Hill Book Co., 617 pp., \$22.50.

The theory and circuit uses of a host of microwave semiconductor diodes and transistors are set out in this comprehensive volume. Also included are new ones such as the GaAs Schottky-barrier diode, the avalanche transit time diode, the bulk GaAs diode and certain microwave transistors. A review section on semiconductor physics, that goes from Schrodinger's equation to p-n junction theory, prepares the reader for what follows.



**World's Smallest  
Standard Magnetic Pickup**

**10 VOLT OUTPUT IS HIGHER  
THAN MANY LARGER MODELS**

Here is ELECTRO's answer to magnetic pickup miniaturization demanded by so many applications. Though so small that it takes 20 of them to weigh a single ounce, the 3080 can be depended upon to deliver a minimum output of 10 volts peak to peak under standard test conditions—20 pitch gear teeth, 1000 IPS surface speed, 100K ohm load, .005" pole piece clearance. Variations in conditions show equally impressive performance.

The ELECTRO 3080 may prove to be the answer whenever limited space is a factor in counting, triggering, positioning, or other applications.

The 3080 was designed to solve a specific problem in a sophisticated computer where high density packaging was a major factor. Here is another example of an ELECTRO custom-built magnetic pickup that has been added to the wide range of stock pickups which are available "off the shelf."

When you need a specialized magnetic pickup to solve a problem, check ELECTRO; chances are we have it in stock. If not, we invite you to talk over your problem with our engineers.



**ELECTRO  
MAGNETIC PICKUPS**

**ELECTRO PRODUCTS LABORATORIES, INC.**  
6125 West Howard St., Chicago, Ill. 60648 • 312/647-8744

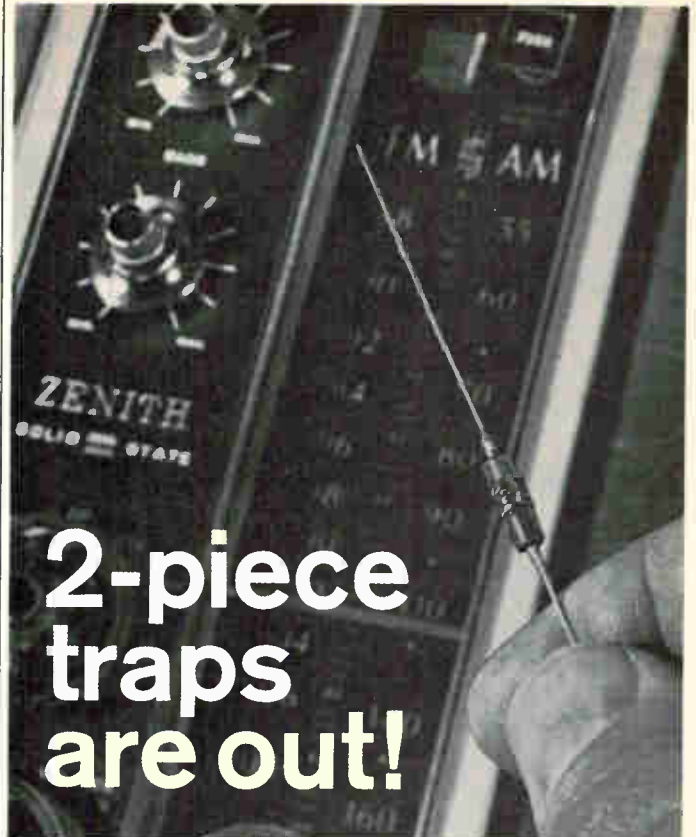

**2-piece  
traps  
are out!**

**Zenith uses Dale hybrid  
Series-Resonant Trap  
in FM circuitry**

Zenith wanted a better way to bypass 10.7 MHz in its FM receivers. To replace the standard 2-component inductor-capacitor trap, Dale provided this unique hybrid.

Dale's Series-Resonant Trap has the electrical characteristics of an inductor and a capacitor in series and provides a method of controlling both functions. The result: Controlled self-resonance in a miniaturized circuit.

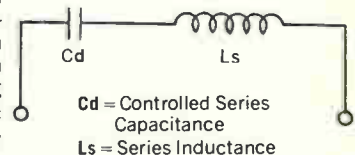

After four years of production use, Zenith says of the Series-Resonant Trap: "It saves space, saves time, works satisfactorily." Here are the basic specs:

- **Resonant Frequency:** 10.7 MHz  $\pm$  .5 MHz (Other frequencies available)
- **Impedance at Design Frequency:** 15 $\Omega$  or less
- **Impedance at  $\pm$ 50% of Design Frequency:** 1500 $\Omega$  min.

Space and money-saving components like this are a growing part of Dale's Sioux Division. Write for more information or call Dale at 605-665-9301.



**DALE ELECTRONICS, INC.**  
**SIoux DIVISION** Dept. ES  
Yankton, South Dakota 57078

Producers of: Toroids, Series Resonant Traps, Variable Pitch Inductors, Miniature High Frequency Inductors, Degaussing Coils, Industrial and Military Coils, Sub-Miniature Coils, Surge and Lightning Arresters, Custom Assemblies, Motor Driven Potentiometers.

# CREATE YOUR OWN MODEL NUMBER

... tailor an AMF Cybertran Video Preamplifier to fill your needs



## Broad Frequency Response

- High Input Impedance
- Low Input Impedance
- $f_1 .1 \text{ Hz}/f_2 25 \text{ MHz}$

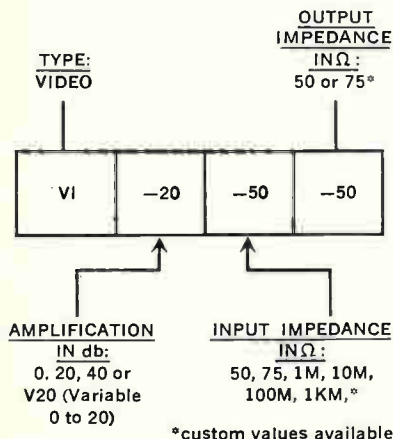

Never before has such flexibility been built into a line of video preamplifiers. AMF, Alexandria's VI Series of Cybertrans makes it possible for you to specify your video preamplifier requirements and have AMF ship it to you. Write or call Bob Peterson, Applied Cybernetics Products, 1025 North Royal Street, Alexandria, Virginia, 22314 Phone (703) 548-7221. TWX 703-931-4209. Representatives in major cities of U.S.A.

**AMF**  
ALEXANDRIA

## Technical Abstracts

### Taking the easy way

New, Simplified Bipolar Technology and its Application to Systems  
B.T. Murphy, Bell Telephone Laboratories, Murray Hill, N.J.,  
S.M. Neville, BTL, Indian Hill, Ill., and  
R.A. Pedersen, BTL, Allentown, Pa.

The wide popularity of insulated-gate field-effect integrated circuits in data processors and memories—particularly in large-scale arrays—stems from their low cost. This economy is mainly due to the simple fabrication process; by contrast, bipolar integrated circuit fabrication seems complicated indeed. A new process developed at Bell Telephone Laboratories may change all this; it makes it possible to produce bipolar IC's almost as easily as MOS IC's. In fact, the new process can be made as simple as the one used to produce conventional transistors.

The new process does away with the buried collector usually provided in bipolar IC's. It also isolates the circuit elements at the same time that the transistors are formed, further reducing the fabrication steps. There is some loss of performance, but the IC's are still useful in many applications such as memories and shift registers.

One version of the new process uses a collector-diffusion-isolation structure (CDI). Unlike the standard buried-collector (SBC) process, CDI uses a p-type epitaxial layer, and isolation is accomplished by means of the collector diffusion, which is also used to define the base and resistor areas. To get thin-base layers, the epitaxial layer must be thin. This limits the breakdown voltage to a few volts.

A low-power TTL gate, made by the CDI process, switches at about the same speed as those made by the SBC process—5 to 7 nanoseconds propagation delay. (Even though the smaller geometry afforded by CDI makes for a gain-bandwidth product that's twice as high as in SBC IC's, the larger collector-base capacitance cancels any speed benefits that would result.) The CDI gate operates at low voltage—2 volts. The problems of external noise, internal crosstalk, power conversion and distribution

created by this low voltage are compensated to some extent by a very low power dissipation of 4 milliwatts. The small geometry is a big advantage, too, since it permits more circuits to be formed in a chip of given size (CDI TTL circuits are two-fifths the size of their SBC equivalents).

For cases where backplane interconnections are less than 1 foot long, standard wiring should keep crosstalk down to a satisfactorily low level and permit an average propagation delay of 6 nsec. With the high packing density expected of these new circuits, 4,000 gates can be interconnected without exceeding the 1 foot limitation. When the backplane line lengths exceed 1 foot, high-impedance strip lines are a convenient way of controlling both impedance and cross-coupling. Careful layout should minimize this special wiring and permit 25,000 gates to be interconnected.

Another version of the new Bell Labs process uses base-diffusion isolation (BDI); there are only a few fabrication steps—the same as for a conventional planar transistor—but the switching speed is low. The isolation region is diffused at the same time as the base; during operation, isolation is provided for this region by applying a reverse bias that is large enough to cause the depletion layer to punch through the epitaxial layer to the substrate.

The absence of a buried collector layer in the BDI structure means that collector currents must be limited to 1 milliampere to prevent excessive power dissipation. Fortunately, the high sheet resistivities needed for current-limiting is available in the layer between the emitter and collector, and between the base and substrate.

Although CDI and BDI require an extra power supply for the isolation regions, this is not a serious burden since very little current is needed—merely the leakage current of the reverse-biased isolation junction.

Presented at the International Solid State Circuits Conference, Philadelphia, Feb. 19-21.



# IC And Semiconductor Screening?



**THE MOST EXPERIENCED  
SEMICONDUCTOR TESTING  
LABORATORY IN THE COUNTRY  
OFFERS A COMPLETE SCREENING AND  
BURN-IN SERVICE... GEARED TO YOUR  
PRODUCTION SCHEDULES  
...AT A DOWN-TO-EARTH COST!**

The most modern automated facilities to handle screening of integrated circuits, semiconductor components, circuit cards — including a Fairchild 5000 IC Tester and a Fairchild 600 Transistor Tester — backed by several million man-hours of semiconductor testing experience, are now available to you at Associated Testing Laboratories to meet your burn-in requirements without capital investment or increased overhead.

Associated's comprehensive facilities and experienced staff have the capability to handle any volume requirement — and to provide fast turn-around to match rigorous production schedules. And, of course, Associated's unparalleled experience in both commercial and military testing is your assurance of optimum screening, dependable documentation and efficient cost reducing programming.

For immediate information call 201-256-2800.  
New England: 617-272-9050, West Coast: 213-589-9196.

**ASSOCIATED  
TESTING  
LABORATORIES  
INC.**



200 Route 46, Wayne, New Jersey • (201) 256-2800

West Coast Office:  
6100 Wilmington Ave., Los Angeles, Calif. 90001 • (213) 589-9196

## Going to IC's? Or Higher IF's?

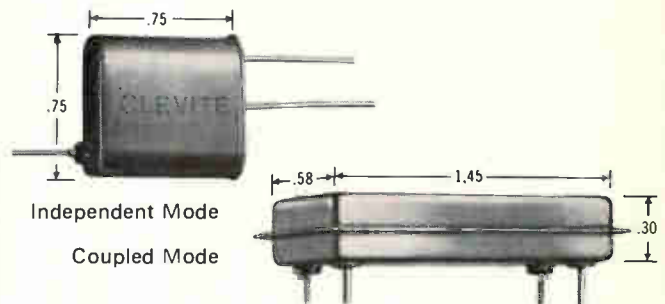

### Go two ways with Monolithic Quartz Uni-Wafer® Filters

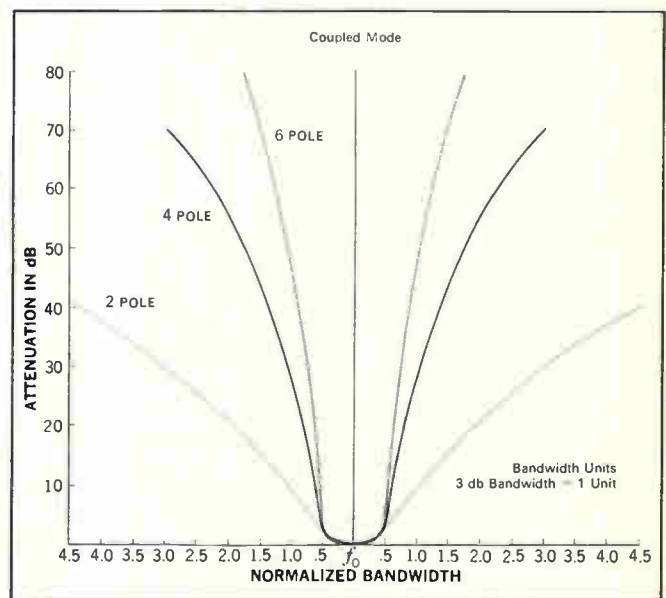

Go independent mode. Go coupled mode. You can go either mode with monolithic Clevite Uni-Wafer® filters. They're smaller and more reliable (fewer interconnections) than conventional filters.

Clevite Uni-Wafer filters are ideal for matching IC circuitry in communications receivers operating in the VHF and UHF frequency ranges as well as in telemetry, radar and aerospace systems.

They are 2, 4 and 6 pole crystal filters with a choice of center frequencies ranging from 8 MHz to 75 MHz. They've been developed using Clevite's advanced engineering techniques and Clevite's original thin film approach to quartz filters. In this concept, arrays of resonators are achieved on a single quartz wafer with resonator isolation and spurious suppression controlled by the trapped energy principle.

So if you're going to IC's or higher IF's, go Clevite Uni-Wafer filters. They're available in both independent and coupled mode.

For more information and complete specification data, write: Clevite Corporation, Piezoelectric Division, 232 Forbes Road, Bedford, Ohio 44146.

# CLEVITE

## New Literature

**Loss detector.** James Electronics Inc., 4050 N. Rockwell St., Chicago 60618, offers a four-page brochure describing the Apolimeter, a direct measuring instrument for detecting losses in electrical steels.  
Circle 446 on reader service card.

**Solid tantalum capacitors.** Union Carbide Corp., P.O. Box 5928, Greenville, S.C. 29606. An eight-page brochure covers the Kemet Micron series of micro-miniature solid tantalum capacitors. [447]

**Potting forms.** Stevens Tubing Corp., 128 N. Park St., East Orange, N.J. 07019, has available a data sheet on self-extinguishing, fiberglass laminated epoxy header plates and potting forms. [448]

**Microwave attenuators.** Narda Microwave Corp., Commercial St., Plainview, N.Y. 11803. Criteria for selecting the right microwave attenuators for the proper application are the subject of a 12-page article in a company technical publication. [449]

**Wire stripping.** Ideal Industries Inc., 5180 Becker Pl., Sycamore, Ill. 60178.

A full line of hand- and bench-mounted wire strippers is illustrated and described in an eight-page brochure. [450]

**Encoding switch.** Maxi-Switch Co., 3121 Washington Ave., Minneapolis 55411. A catalog sheet describes a simplified pushbutton encoding switch. [491]

**Slide switches.** Chicago Switch Inc., 2035 Wabansia Ave., Chicago 60647. A two-page data sheet contains photos, dimensional drawings, features, and specifications on two subminiature slide switches. [451]

**Computer systems.** Varian Data Systems, 611 Hansen Way, Palo Alto, Calif. 94303. A 20-page illustrated booklet describes the SpectroSystem 100/200 family of laboratory data processing systems. [452]

**Transducer data.** Trans-Sonics Inc., Burlington, Mass. 01803. A large summary chart lists the characteristics of the firm's standard surface-type temperature transducers. [453]

**Fluid analyzer.** Gam Rad Inc., 16825 Wyoming Ave., Detroit 48221. Bulletin

T-200 completely describes fluid analyzer model 370A. [454]

**Bobbin winding attachment.** Universal Manufacturing Co., 1168 Grove St., Irvington, N.J. 07111. A two-page bulletin illustrates and describes a quick twist-locking interchangeable bobbin winding attachment for models 2S and LS machines. [456]

**Dual plug-in supplies.** RO Associates Inc., 3705 Haven Ave., Menlo Park, Calif. 94025. Features and specifications for dual plug-in supplies for analog circuits and Nixie tubes are given in a catalog sheet. [457]

**Synchro digital converter.** Northern Precision Laboratories Inc., 202 Fairfield Road, Fairfield, N.J. 07006. A 72-page catalog details pertinent data on a line of standard electromechanical synchro-to-digital converters. [458]

**Diced chip capacitors.** American Lava Corp., Manufacturers Road, Chattanooga, Tenn. 37405. Bulletin 689 covers a line of AlSiMag diced chip capacitors. [459]

**Digital indicators.** Consolidated Controls

# CERMET TRIMMERS



Series 340 Top Adjust 1/4" x 1/4" x .220"  
Cermet Trimmer

## NEW FROM CTS

\$1.25 ea. in 1,000 lots down to  
93c ea. in 50,000 lots.

50  $\Omega$  through 500K  $\Omega$ .

$\pm 20\%$  tolerance.

3/4 watt @ 25°C; 1/2 watt @ 85°C, derated to no load @ 150°C.

Single turn.

Prototype Quantities From Stock.  
Production Quantities: 4-6 weeks.

Order from: CTS of Berne, Inc., Berne, Indiana 46711.  
(219) 589-3111.



**CTS CORPORATION**  
Founded 1896



Series 360 Side Adjust 7/16" x 17/64" x 25/64"  
Snap-in Type Cermet Trimmer

## NEW FROM CTS

\$1.04 ea. in 1,000 lots down to  
80c ea. in 50,000 lots.

50  $\Omega$  through 1 megohm.

$\pm 20\%$  tolerance.

1 watt @ 25°C; 1/2 watt @ 85°C, derated to no load @ 125°C.

Single turn.

Prototype Quantities From Stock.  
Production Quantities: 4-6 weeks.

Order from: CTS of Berne, Inc., Berne, Indiana 46711.  
(219) 589-3111.



**CTS CORPORATION**  
Founded 1896

Corp., 15 Durant Ave., Bethel, Conn. 06801. Digital indicators for direct readout of pressure and temperature are described in a four-page brochure. [460]

**Delay lines.** JFD Electronics Co., 15th Ave. at 62nd St., Brooklyn, N.Y. 11219, has available a 12-page catalog on its fixed, variable, lumped constant, and distributed constant electromagnetic delay lines. [462]

**Electronic comparators.** Techlab Engineering Division, The Potter Co., 3216 W. North Ave., Stone Park, Ill. 60165. Models 202 and 203 electronic comparators, which provide electronic gaging for rapid production and quality control inspection, are described in a four-page bulletin. [463]

**Precision instrumentation.** Robinson-Halpern Co., 5 Union Hill Rd., West Conshohocken, Pa. 19428, has published a short-form catalog on a line of precision instrumentation for measurement and control. [464]

**Visual image processing.** Information International, 11161 West Pico Blvd., Los Angeles 90064. A 12-page color

brochure describes and illustrates visual image processing via computer-based optical systems. [465]

**Jacks and panels.** Switchcraft Inc., 5555 N. Elston Ave., Chicago 60630. Product bulletin No. 180 describes the series TT compact telephone-type jacks and panels. [466]

**Radio interference filters.** Genisco Technology Corp., 18435 Susana Rd., Compton, Calif. 90221, has released a catalog covering a complete line of shielded enclosure and ground support equipment filters. [467]

**Flat ribbon cable.** Spectra-Strip Corp., P.O. Box 415, Garden Grove, Calif. 92642. Bulletin 060 describes cross-linked PVC flat ribbon cable. [468]

**Low-frequency network analysis.** Hewlett-Packard Co., 1501 Page Mill Rd., Palo Alto, Calif. 94304. How to determine network transfer and insertion characteristics over a 10 khz-32 Mhz swept frequency range is described in a 13-page application note. [469]

**Resin mixing system.** Fenwal Inc., 414 Main St., Ashland, Mass. 01721, has

available literature giving complete information on an economical, failsafe system for the mixing of two-part epoxy and polyurethane potting, coating or adhesive resins. [470]

**Silicon transistors.** Raytheon Co., Semiconductor Operation, 350 Ellis St., Mountain View, Calif. 94040, offers a 74-page catalog describing nearly 400 types of high reliability silicon transistors. [471]

**Servomotors.** Honeywell Inc., Grenier Field, Manchester, N.H. 03105. Two product sheets describe the HSM30 and HSM100 high-performance, direct-current servomotors. [472]

**Circuit protectors.** Airpax Electronics Inc., Cambridge, Md. 21613. Bulletin 16E-14 contains detailed information on single and multipole electromagnetic panel mount circuit protectors of the molded phenolic case type. [473]

**Substrate screening.** Aremco Products Inc., P.O. Box 145, Briarcliff Manor, N.Y. 10510. Product bulletin 3200 describes the Mech-Pak 3200, a mechanization system for screen printing microcircuit substrates. [474]

# CERMET TRIMMERS



Series 165-3/8" x 3/8" x 13/64" Cermet Trimmer

## NEW FROM CTS

\$3.25 ea. in 1,000 lots down to  
\$2.56 ea. in 50,000 lots.

50  $\Omega$  through 1 megohm.

$\pm 20\%$  tolerance.

1/2 watt @ 85°C derated to no load @ 150°C.

25 turns.

Prototype Quantities From Stock.  
Production Quantities: 4-6 weeks.

Order from: CTS of Berne, Inc., Berne, Indiana 46711.  
(219) 589-3111.



**CTS CORPORATION**  
Founded 1896



Series 190-3/4" x .160" x .310" Cermet Trimmer

## NEW FROM CTS

\$1.24 ea. in 1,000 lots down to  
98c ea. in 50,000 lots.

50  $\Omega$  through 500K  $\Omega$ .

$\pm 20\%$  tolerance.

1/2 watt @ 85°C derated to no load @ 125°C.

20 turns.

Prototype Quantities From Stock.  
Production Quantities: 4-6 weeks.

Order from: CTS of Berne, Inc., Berne, Indiana 46711.  
(219) 589-3111.



**CTS CORPORATION**  
Founded 1896

# power electronics

At the Westinghouse R & D Center in Pittsburgh, Power Electronics plays a more vital role in our activities than ever before. Directed to both future growth and to the addition of new products, the variety of challenging projects is a commentary on our research commitments.

Projects of first priority include high-power thyristor inverters, high frequency inverters, thyristor power switches, power regulators, thyristor motor drives, high power cycloconverters, frequency changers, firing circuits, logic and control circuits and advanced power conditioning.

Informal personal association with outstanding scientists and engineers is enhanced by our first class technical facilities. Innovative thinking and participation in seminars is highly encouraged. Rounding out the picture... a most attractive suburban locale with superb educational, cultural and shopping facilities and a full range of company benefits.

If your interests are in alignment with our objectives and you possess a degree in Electrical Engineering with experience in solid state circuitry, please send confidential resume to:  
**MR. C. CRISPEL, DEPT. E-317**



## Westinghouse

Research and Development Center  
Beulah Road, Churchill Borough, Pittsburgh, Penna. 15235  
*an equal opportunity employer*

CIRCLE 966 ON READER SERVICE CARD



## EMPLOYMENT OPPORTUNITIES

ADDRESS BOX NO. REPLIES TO: Box No. Classified Adv. Dept. of this publication. Send to office nearest you.  
NEW YORK, N. Y. 10036: P. O. Box 12  
CHICAGO, Ill. 60611: 645 N. Michigan Ave.  
SAN FRANCISCO, Cal. 94111: 255 California St.

### POSITION VACANT

Graduate electrical engineer with approximately five years' experience in industrial process and systems control. Excellent opportunity with medium-sized company in metals fabrication field—Detroit location. P-7747, Electronics.

### EMPLOYMENT SERVICES

Florida/Nationwide EEs, MEs, IEs . . . Electronic, Aerospace, Industrial, Sales & Mfg. \$9-18,000. Tech Div Brodeur Personnel Service, Inc., 3947 Blvd., Center Drive, Jacksonville, Fla. 32207

### CLASSIFIED ADVERTISING

## SEARCHLIGHT SECTION

BUSINESS OPPORTUNITIES  
USED OR SURPLUS EQUIPMENT

**Minifluid DISPENSER**  
AIR OPERATED  
for miniature potting and encapsulating  
Available in 3 sizes  
6cc - 12cc - 30cc  
\$34.00 UP  
**PHILIP FISHMAN COMPANY**  
7 CAMERON ST., WELLESLEY, MASSACHUSETTS 02181

CIRCLE 967 ON READER SERVICE CARD

RADAR SYSTEMS GROUND AND AIRBORNE. AUTOMATIC TRACKING ANTENNA SYSTEMS. NIKE AJAX. NIKE HERCULES. M-33. MSQ-1A. MPS-19. MPS-9. SCR 584. TPS-1D. TPS-2B. FAA-ASR-2. AIRBORNE SYSTEMS. APN-84. APN-102. APS-20. APS-27. APS-45. DPN-19. DIGITAL COMPUTERS. IBM 650. IBM 704.

LARGEST INVENTORY OF RADAR AND MICROWAVE EQUIPMENT IN THE WORLD.  
**RADIO RESEARCH INSTRUMENT CO.**  
45 WEST 45TH ST. N. Y. 10036 212-JU 6-4691

CIRCLE 968 ON READER SERVICE CARD

## SURPLUS IBM EQUIPMENT

FREE catalog of powers supplies, light & switch panels, semiconductors, test equipment, IC's, optics, etc.

**GADGETEERS SURPLUS ELECTRONICS, Inc.**  
5300 Vine St. Cincinnati, Ohio 45217

CIRCLE 969 ON READER SERVICE CARD

## W. GERMAN ELECTRONIC CO.

seeks business connections.  
We do quality specialty work.

Please contact:  
**Mr. OTTO JORG**  
2345 Patterson Street, Eugene, Oregon

CIRCLE 970 ON READER SERVICE CARD

### BUSINESS OPPORTUNITY

Capital Contacts Before you try Public or Private Placements to Underwriters, Investment Banking Houses, write for free helpful information to Confidential Consultant 817 51st St. Brooklyn, N.Y.

Remember . . .

MAIL MOVES THE COUNTRY

but . . .

ZIP CODE MOVES THE MAIL

# Looking for a better job?

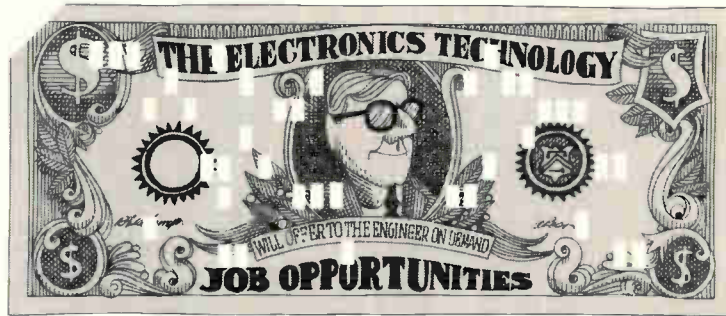

## Ask Electronics' computer all about it

Electronics magazine feels an obligation to help its readers find positions in the electronics technology which will make the greatest contribution to their profession and to society — jobs in which electronics men themselves will be happiest.

Electronics has joined with a nation-wide talent search company—National Manpower Register, Inc.—to form the computerized Electronics Manpower Register.

Your qualifications and job requirements will be pro-

grammed into a GE 265 computer, direct-linked to the Manpower Register's offices in New York. The computer, once your resume form (bottom of page and following page) is received, will continuously compare all your data with the specific manpower needs of electronics companies. When a match is made, you will be contacted directly or through an affiliated agency. The company and you will be brought together on a confidential basis.

*Continued on next page*

### Electronics Manpower Register

It is important that your information be complete and that you type or print legibly

IDENTITY		PRESENT OR MOST RECENT EMPLOYER	
Name	Date	Parent company	
Home address		Your division or subsidiary	
City	State	Zip	Location (City/State)
Home phone	Do you subscribe to Electronics <input type="checkbox"/>		or see a library or pass-along copy <input type="checkbox"/>
<b>GEOGRAPHICAL PREFERENCE (Check appropriate boxes and complete all blanks)</b>			
I will NOT relocate <input type="checkbox"/> I will consider opportunities in: <input type="checkbox"/> North East <input type="checkbox"/> Mid Atlantic <input type="checkbox"/> South <input type="checkbox"/> Midwest <input type="checkbox"/> Southwest <input type="checkbox"/> Calif. <input type="checkbox"/> Northwest			
Prefer: <input type="checkbox"/> Metro. area <input type="checkbox"/> Medium town <input type="checkbox"/> Rural area <input type="checkbox"/> Other: _____			
<b>EDUCATION</b>			
Degree	Major field	Year	College or University
<b>EMPLOYMENT INFORMATION</b>		FOR OFFICE USE ONLY	
Position desired		REGISTRATION NUMBER	INITIAL OF LAST NAME
Present <input type="checkbox"/> or most recent <input type="checkbox"/> position		From	To
Duties and accomplishments		Title	
HAVE YOU REGISTERED WITH THIS SYSTEM PREVIOUSLY? Yes <input type="checkbox"/> No <input type="checkbox"/>			

CONTINUED ON OTHER SIDE

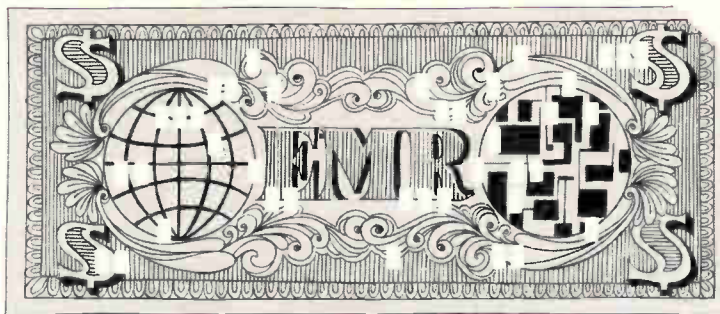

The cost of all this to you? Absolutely nothing. No fees or charges at any time.

Other advantages of EMR:

- Your resume is sent only to those companies that have a genuine requirement for your particular skills.
- There is no general "broadcasting" in the hope "someone will be interested."
- Your identity is protected because your name is released only according to your prior instructions. Your name can be deleted on request.
- EMR's service is nationwide. You may be considered for job opportunities anywhere in the U.S.

The Electronics Manpower Register is a powerful tool and should be considered when you are seriously seek-

ing a new position. And, although you may be reasonably happy in your present position, chances are that you might have that ideal job in mind.

This is why EMR makes good sense for you. If that job does turn up, you'll be there.

To get your name in the EMR file, just fill out the resume form and return to:

Electronics Manpower Register  
330 West 42nd Street  
New York, N. Y. 10036

Please enclose a copy of your resume if you have one. A detailed brochure further describing EMR will be sent to you.

## Electronics Manpower Register

A computerized employment opportunity service

CONTINUED FROM OTHER SIDE				
Previous Position	Employer	City/State	From	To
Duties and accomplishments				
Previous Position	Employer	City/State	From	To
Duties and accomplishments				
<b>GENERAL INFORMATION</b>				
(Summarize your over-all qualifications and experience in your field. List any pertinent information not included above.)				
Current annual base salary	Total years of experience	Date available (within four months)	U.S. Citizen <input type="checkbox"/>	Non U.S. Citizen <input type="checkbox"/>
My identity may be released to: Any employer <input type="checkbox"/>	All but my present employer <input type="checkbox"/>	Have you security clearance? Yes <input type="checkbox"/> No <input type="checkbox"/>	If yes, What level	
Mail (with a copy of your resume, if you have one) to:				
<b>Electronics Manpower Register</b>				
<b>ELECTRONICS</b>				
<b>330 West 42nd St.</b>				
<b>New York, N. Y. 10036</b>				
		<b>NO FEES OR CHARGES</b>		
		<b>EMR-12</b>		

# Solartron are world leaders in Dynamic Response Measurement.

On the British Concorde. And the French Concorde. Solartron dynamic response measuring instruments were chosen to test the component characteristics of the aircraft systems. Both manually, during design, and automatically, during production tests.

The principal instrument used was Solartron's Digital Transfer Function Analyzer. It tested the mechanical systems – hydraulic and pneumatic actuators, ailerons, and the lowering and raising of the nose.

And to test the flight system – autopilot, autostabilizer, engine control systems, and other units requiring a.c. suppressed carrier

facilities – the 'TFA' was coupled to Solartron's Modulator Demodulator. Where special excitation conditions were needed – so was Solartron's Mechanical Reference Synchronizer.

Because of its *total* capability in the Frequency Domain, it was equipment from Solartron that was used to make the required tests.

But now consider the possibilities of Dynamic Response Measurement in the other domain – Time.

See Solartron's Time and Frequency Domain equipment on Marconi Stand No. 2D02 – 2D08 at IEEE.

**Concorde proves it.**



See over

# Time Domain Measurement.

In systems which operate in real time, impulse response testing offers an important alternative to traditional methods of Frequency Response Measurement. Measurements carried out in

the Time Domain are important to engineers working in almost any industrial field.

Solartron now introduce two new instruments which enable Time Domain measurements to be taken - JM 1861

Programmable Pseudo Random Binary Sequence Generator (with optional Active Filter Unit JX 1862). And the JM 1860 Time Domain Analyzer (with statistical measurement capability, down to zero frequency).



Application	
Nuclear	
Chemical	
Automobile	
Communication	
Military	

# Frequency Response Measurement.



If, on the other hand, you just want frequency response, we give you complete system capability in both manual or fully automatic operational modes.

We have input/output interface modules for system communication with any peripheral - from digital

computer to analogue X/Y plotters.

Contact your nearest Schlumberger company or write for full details to us at Solartron. If you can meet us at the IEEE we will be pleased to answer your queries. We don't measure the time we spend on your problem.



**SOLARTRON**  
**A Schlumberger Company**  
**A force to reckon with**



**USA** Marconi Instruments Inc  
 111 Cedar Lane Englewood  
 New Jersey 07631 Tel: 201.576.0607  
**U.K.** The Solartron Electronic  
 Group Ltd Farnborough  
 Hampshire England Tel: 44433  
**West Germany** Schlumberger  
 8000 Munchen 15 Bayerstrasse 13  
 Tel: 55.82.01



**Switzerland** Schlumberger  
 15 rue du Jeu de l'Arc 1211 Genève 6  
 Boite Postale 189 Tel: 35.99.50  
**France** Schlumberger Diffusion  
 Internationale 241 avenue Gambetta  
 Paris 20 eme Tel: 797.57.69  
**Sweden** Schlumberger  
 Vesslevagen 2-4 Lidingsö 1  
 (Stockholm) Tel: 765.28.55



**Austria** Schlumberger  
 Tivoligasse 50 and 74 1120 Wien  
 Tel: 83.54.91  
**Italy** Schlumberger Divisione  
 Strumentazione Via Veniero 7  
 20148 Milano Tel: 36.71.87

Schlumberger products are marketed in 64 territories throughout the world by associate companies within Schlumberger Limited, or by agents.



---

# International Newsletter

---

March 17, 1969

## Fujitsu and Hitachi first in Japan with minicomputers

With the introduction of machines by Fujitsu and Hitachi, the mini-computer age has burst into full bloom in Japan. Other companies—members of Japan's "big six" computer makers as well as others—are expected to announce similar machines within the next few months.

First to hit the market—deliveries start in May—will be Fujitsu's Facom model R. Slated to sell for \$11,100, the model R is aimed at every on- or off-line function for which small, general-purpose computers might be suitable except business applications. It features a 16-bit word with one parity bit, a memory capacity of a minimum of 1,000 words and a maximum of 32,000, and a cycle time of 1.5 microseconds. Add and subtract time is 6  $\mu$ sec; input/output data rate is 800,000 bytes per  $\mu$ sec. The price includes the basic main frame (which can hold up to 4,000 words of memory) and 1,000 words of memory. Fujitsu also says that up to 255 peripheral units can be operated with the computer.

Computer-aided design was used extensively on the model R, says the company, adding that the machine is built around TTL IC's and multilayer printed-circuit boards. Construction is modular.

Hitachi's computer, called the Hitac-10, will sell for \$13,000. Deliveries will start in October. Hitachi is promoting its machine for off-line non-business applications; it also offers four types of a-d converters which will enable the computer to process analog data. For straight computation, the standard input/output unit is a typewriter. The price includes the typewriter and 4,000 words of memory. Up to 8,000 words will fit in the machine's frame.

The Hitac's basic cycle time is 1.4  $\mu$ sec for 16 bits; add time is 2.8  $\mu$ sec per word. The basic software includes programs for Fortran, desk calculator, assembler, macro assembler, and sub routines.

## Soviets postpone foreign IC show

The Soviet Union has postponed for six months the Mashintegralschema "invitation only" trade show for integrated circuits and IC production equipment. Originally the show was scheduled for June [*Electronics*, Jan. 6, p. 249]; now it's been put off to next January.

The Soviets say they postponed the show because it would have come too soon after a big automation show in May. Another reason: some 50 American firms were invited to Mashintegralschema, and few of them so far have accepted.

## Signetics to make IC's in Britain

Starting with a British IC assembly and test operation in May, Signetics plans to expand its operations in Western Europe. It aims to eventually construct a plant in a Common Market country.

The British operation will add diffusion processing and full manufacturing when a 20,000-square-foot plant in Scotland is completed, probably sometime next year. Signetics currently claims 5% of British IC sales, and it has decided that further market penetration requires a British manufacturing base to provide local service and to attract those customers determined to buy British.

Signetics joins Texas Instruments, STC Semiconductors, Transitron Electronics, and General Instrument among U.S.-owned microcircuit makers in Britain. General Instrument is about to start manufacturing MOS circuits on a small scale in Scotland.

---

# International Newsletter

---

## **Toshiba tv camera offers 3 innovations**

The under-\$1,000 color tv camera Toshiba will introduce at the IEEE show will incorporate what the company hails as three major innovations. The camera itself is a separate luminance type in which one of two vidicons delivers the luminance signal while the other takes care of the color signal.

The first innovation claimed by Toshiba is a new and inexpensive prism-type optical system for separating colors. Second, a  $\frac{2}{3}$ -inch vidicon has been developed especially for color. And finally, new solid state circuits have been developed and put together to simplify the camera's electronics.

The camera is self-contained; it requires no separate control unit and needs only one cable to connect it with a receiver. Conventional color tv cameras, says Toshiba, need nearly 100 wires and cables to link the camera head and control unit. Toshiba's camera measures 11 by 4 by 7 inches, weighs 10 pounds, and operates on conventional household line power.

## **East Germans adopt Secam**

The spirit of Bismarck is dead. East Germany has turned its back on the West German PAL color tv system and has decided instead to embrace the rival French Secam system, championed in the Eastern bloc by the Soviet Union.

East German and French officials signed a color tv agreement at the Leipzig Spring Fair. In addition to an exchange of patents and licenses, the deal calls for East Germany to promote Secam in "interested" countries, meaning the remaining unsigned Soviet bloc nations. So far, only Russia and East Germany have officially adopted the French system, but Hungary has started experimental Secam broadcasts and is likely to be the third to sign up.

None of these countries figure to be mass markets for color sets for some time. West German experts think the East Germans will try to start color broadcasts on Oct. 7 to mark the 20th anniversary of their country's founding. But they'll almost certainly have to do it with sets imported from France, according to these experts.

## **Romania builds computerized rubber plant**

Romania is building a computer-controlled rubber processing and manufacturing plant—the first such facility in Eastern Europe. A Siemens 305 process controller will handle production planning and meter raw materials after picking the appropriate recipe from among the 350 that can be used. Actual weighing will be done by 55 electromechanical scales driven by thyristor-controlled d-c motors.

After this weighing function, the computer will control the flow of materials to various machines in the plant and will record the production times and costs for each of the 20,000 different kinds of products to be turned out.

## **Hybrid audio IC puts out 50 watts**

Japan's Sanken Electric Co. appears to have taken the lead in the competition for the world's highest-capacity integrated circuit. Sanken's circuit—a hybrid—puts into an 80 by 45 by 20 millimeter package all the components for a 50-watt audio amplifier—the capacitors included. The only external connections are to the power supply, the speaker and its series electrolytic capacitor, and the input. Sanken designed the IC for stereo hi-fi sets.

# Lufthansa ready to fly its Boeing 707's with domestic throttle-control system

Analog computer keeps steady hand on the throttle, holds preset speed within two knots, shifts to special program when flaps go down

**When the airline** Deutsche Lufthansa announced last month that it would install automatic throttle-control systems on all its Boeing 707 jets it hardly seemed news. Simple throttle control systems were used on military aircraft even before World War II, and lately they've been turning up on large passenger aircraft as well. Britain's Trident jets have them, for example, and so do Douglas DC-9's.

But there was more to the announcement than there seemed to be. Instead of buying U.S.-made avionics as it usually does, the German airline settled on a domestic design. Because it couldn't get what it wanted elsewhere, Lufthansa teamed up with Bodenseewerk Geraetetechnik GmbH to develop a system that can control speed closely and yet not keep the throttle fluttering. The Bodenseewerk system keeps speed within 2 knots of the preset value in turbulent weather and within 0.5 knot when the flying's smooth. At the same time throttle activity—hard to express quantitatively—is about one-fourth that for planes fitted with other  $\pm 2$ -knot control systems, Bodenseewerk maintains.

But that's not all. The system features a landing flap program that handles speed control during aircraft descent and landing. In addition to that, it has what is termed a threshold-speed program that becomes effective when the airspeed drops below the preset value.

**Certified.** Lufthansa has flight-tested the prototype systems for more than 4,000 hours. Now that the Luftfahrt-Bundesamt, a German government agency roughly equivalent to the U.S. Federal Avi-

ation Administration, has approved the system, the airline has awarded Bodenseewerk a contract for \$650,000 worth of throttle control systems. This firm, a subsidiary of the Perkin-Elmer Corp. started serial production last month. The controller will be installed on each of Lufthansa's 21 Boeing 707's. The system, called FVR 02, costs about \$22,000.

The controller is built around an analog computer whose basic input is a signal from a comparison circuit in the airspeed indicator. The signal represents the difference between the actual airspeed and the airspeed that the pilot selects and sets on the system's control panel.

In addition to conventional circuitry, the computer has an accelerometer that senses any velocity changes picked up by the airspeed tube. By combining this with pitch angle data from the aircraft's vertical gyro, the accelerometer produces an output that keeps the throttle system from reacting to small decelerations—those caused by wind gusts, for example. It can also sense changes in gravity as small as 0.18 G.

**Flappable.** In a filter network that is also part of the computer, the outputs from the accelerometer and from the airspeed indicator are added. The sum is then amplified and becomes the control signal for the throttle-lever servo motor. It positions the plane's four throttle levers to maintain the selected airspeed.

The landing flap program becomes effective as soon as the airspeed drops because the landing gear has been lowered or the landing flaps extended. The system au-

tomatically takes care of speed adjustments that the pilot would normally execute which his throttles during landing.

Prior to a descent, the pilot sets a counter on the control panel to the aircraft's landing speed. Landing flap position information coming from sensors is fed to the control panel, which determines the speed that matches the flap position. This speed is then fed to the airspeed indicator where it is compared with the actual speed. The indicator's output is then processed as before.

**Keeping up.** The system's threshold-speed program comes into play when the aircraft velocity drops 2

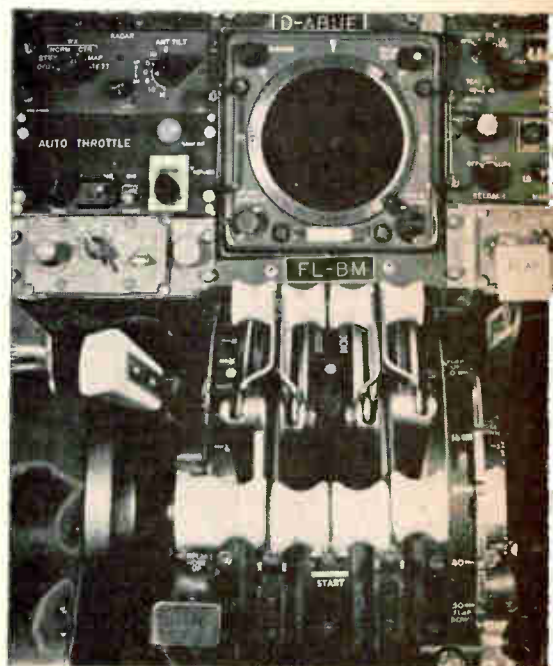

**No hands.** Control panel of automatic throttle for Boeing 707 mounts just forward of throttles themselves.

knots or more below the value that's set on the control panel. Such speed drops can occur as a result of head-on winds that last for longer periods than do short gusts. Normally, such conditions are counteracted by appropriate throttle movements by the pilot. The new controller, however, reacts by automatically going into the acceleration control mode.

In that mode, a boost voltage stored in the computer is fed—together with the input from the filter—to the computer's amplifier. Its output then drives the servo motor to advance the throttle levers until the aircraft's increasing acceleration gives the accelerometer an output that cancels the boost voltage. Then, the system switches from the acceleration control mode back into the speed control mode.

The computer is made up of plug-in circuit boards with solid state components. Some of the components are hybrid integrated circuits. The computer has a self-check feature that localizes component failures.

## Playing the field

Circuit designers may soon have a new kind of device to work with—a semiconductor whose depletion layer is magnetically induced and is controlled by the field-effect.

Changes in the field-effect field change the current-voltage characteristic curves of the device so that it's suitable for use as a rectifier, a control amplifier, or oscillator.

In particular, the new component could supplement, or even replace, field plates, "Sony diodes," [*Electronics*, May 15, 1967, p. 233 and Apr. 15, 1968, p. 246] and like components that are sensitive to magnetic-fields.

With the new device, better control of the magnetic barrier effect can be achieved. For one thing, control occurs without power dissipation. For another, any light or other radiation that might hit the semiconductor surfaces doesn't affect the control.

Ekkehard Preuss, a scientist at Siemens AG's research laboratories at Erlangen, will report on the new

component at the Semiconductor Device Research meeting, sponsored by the German section of the IEEE, to be held at Munich next week.

**Mylar.** The basic material used in the device is an indium-antimonide chip about 50 microns thick. Either one or both surfaces of the chip are covered with a 4-micron mylar film which acts as the dielectric.

The process involves three fields: a magnetic field, required for setting up the depletion layer; an electric field, required for getting current to flow in the first place; and, finally, the field-effect field which, when controlled, influences the I-V curves.

A magnetic field of about 10 kilogauss produces the depletion layer. That field, which is oriented so that its lines are transverse to the direction of current flow through the device, acts to reduce the charge carriers—an effect caused by the recombination of holes and electrons on surfaces that are parallel to the magnetic field.

With an electric field of about 10 volts/cm applied across the chip, the depletion layer alters the I-V curve. The amount of deformation, or nonlinearity, is a function of the magnetic field strength.

**Varying.** The depletion layer, and thus the current-voltage characteristic, is further influenced by varying the device's recombination velocity at its surfaces. This, in turn, is accomplished by controlling the field-effect which is set up by applying a voltage across the dielectric.

Changing the field-effect field in steps generates a family of current-voltage characteristic curves that deviate from a straight line according to the polarity and strength of the field. For example, a field of  $-9 \times 10^5$  volts/cm sets up a nearly straight I-V characteristic curve, similar to that across a resistor. As the negative field strength is reduced, the curve gradually deforms into a back-characteristic curve, one that is typical for a p-n junction. The deformation becomes more pronounced as the field's polarity is made positive and as its strength is increased.

## Great Britain

### On the ball

To the human eye the surface of a newly produced ball bearing may appear perfectly round and free of irregularities. But a microscope will show that production may have left surface marks and scratches that could damage both the bearing and the machine in which it is assembled.

As ball-bearing production techniques improve, it's becoming necessary to spot those irregularities with testing equipment more sensitive than the microscope. So the Hoffmann Manufacturing Co. of Chelmsford has built an electronic tester, about the size of an office desk, that measures irregularities on bearing balls ranging in diameter from  $\frac{1}{8}$  to 1 inch.

**Big picture.** The traditional microscope tester detects irregularities only by section, and its sensitivity is limited. Hoffman's "Assessor" scans the ball's complete surface and electronically records a report of total irregularity. Ultimately, this helps produce better balls and much quieter machines, says Hoffmann.

The ball is held in a 90° vee gage by three sapphire inserts. The stylus of a very sensitive displacement pickup contacts the ball. The ball is then rotated 2.7 times per second by a vacuum drive attached to a rod which is coupled to an electric motor and variable-speed gear drive. As the ball rotates, an electric signal, varying in amplitude and frequency, is produced by the pickup to measure the running qualities of the ball.

The signal from the pickup—a differential transformer—is 1 volt for 1 microinch of stylus movement. This signal is amplified, passed through four bandpass filters, and divided into four contiguous frequency bands spanning 1.5 octaves apiece. Each band can be related to the various stages of production.

**Banding together.** The actual coverage of each band is:

- Two to six irregularities per revolution (IPR) on 5.4 hertz to 16 hz, measuring initial shaping stage of production.

- Six to 18 IPR on 16 hz to 48.5 hz, measuring grinding stage.
- Eighteen to 54 IPR on 48.5 hz to 146 hz, measuring large scratches acquired during handling stage.
- Fifty-four to 162 IPR on 146 hz to 437 hz, measuring fine scratches.

Outputs from the frequency filters are displayed on four meters, which indicate the average diameter change in microinches of the ball in each of the frequency bands.

A typical set of readings from a good quality 3/8-inch ball would be: 1 μinch in the 2-to-6 IPR band; 0.3 μinch in the 6-to-18 IPR band; 0.25 μinch in the 54-to-162 IPR band.

Results of the tests are also displayed on cathode-ray tubes. The irregularities, shown as concentric circles, are magnified a maximum of 250,000 times.

## Japan

### Beating the beat

The scene on the screen should start to get better for ground-floor television viewers in Japan by early April. Then, at least 10 Japanese companies will be selling low-cost branching units to tie sets into common antenna systems.

The branching unit is built around a pair of ferrite circulators, which make it hard for a set's local oscillator to feed spurious radiation back into the antenna line. At the 26.75-megahertz intermediate frequency used in Japan, the local oscillator output gets within the frequency band of channels 8 to 12 when the set is tuned to channels 4 to 8.

Some European viewers have a similar interference problem. In the U.S., however, where the i-f is 40 Mhz, there's no problem in the vhf band, but there could be one in uhf and in community-antenna television systems.

So far, directional couplers have been used to prevent spurious radiation, but they've performed inadequately especially for color sets, where beat lines are particularly annoying. Much of the trouble with couplers comes from the high

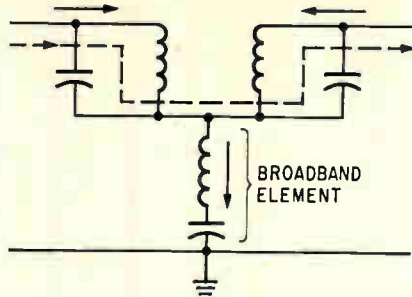

**Broadband.** A single series-resonant circuit (the inductance capacitance combination connected to ground) gives the circulator a broad band of high reverse attenuation and at the same time makes possible a circuit layout that lets low vhf signals (shown dotted) go through.

standing-wave ratio of ordinary common-antenna systems. The swr cuts the normal 25-decibel reverse attenuation of the coupler to 10 db or even 6 db. For really good protection against interference, a coupling system should have about 50 db reverse attenuation.

**Looking forward.** And in the forward direction—from the antenna into the set—the coupler has a drawback. There's attenuation each time the common antenna line is tapped; in a five-story dwelling, for example, the tv set of a family on the ground floor can get a signal that's 10 db down compared to the signal picked up by the top-floor tenants.

With the circulator, the coupling loss is just about constant all along the line. Better still, the reverse attenuation is higher than 50 db for the upper vhf channels, where there's an interference problem.

Nihon Hoso Kyokai (NHK), the Japan Broadcasting Corp., developed the circulator. It's made up of a mesh of conductors sandwiched between a pair of ferrite cores that are sheathed with a pair of copper plates. To broadband the circulator, a series LC circuit is connected between one of the copper plates and ground. Without the broadband element, there would be a high forward attenuation for the lower half of the uhf band and for the f-m radio band. And, of course, there's a magnet to set up the magnetic field that is necessary for a

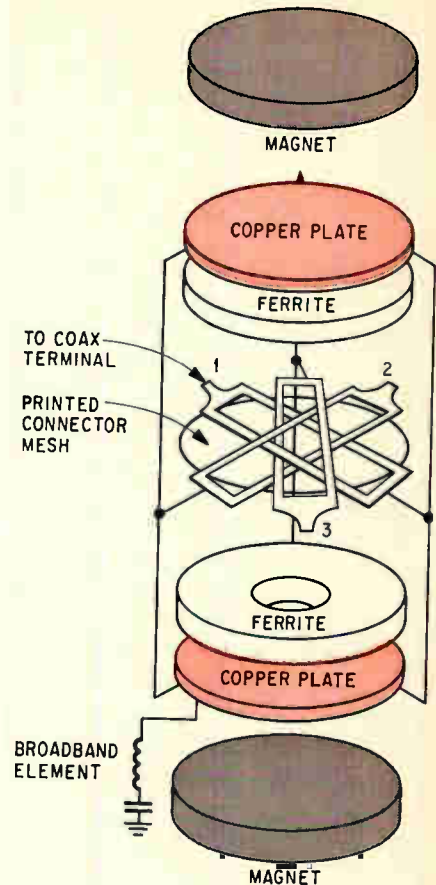

**Traffic circle.** Low cost branching unit for common tv antenna systems is built around a pair of small circulators like this one. Conductor mesh is printed on substrate with plated-through holes to handle crossovers.

ferrite circulator.

**In print.** In its early circulators, NHK actually interwove the connectors to obtain the mesh. The units that are going into the production have printed connections with plated-through holes in the substrate to get the equivalent of a mesh at low cost. The ferrite cores used in the circulators are 10 millimeters in diameter; an assembled circulator measures about 12 by 13 by 15 mm.

A complete branching unit is formed by mating a pair of circulators to a balun and a coupling transformer. The balun, which matches the unbalanced 75-ohm circulator to the balanced 300-ohm tv input, is made up of ferrite slabs and a copper plate rather than the conventional ferrite core with windings on it. The coupling transformer too, was specially designed.

## Electronics International

It is simply a ferrite core with three turns of a five-wire bundle on it.

The whole unit, NHK says, can be produced to sell for about \$3.50 initially and much less than that later on when the companies making it reach mass production.

### Countdown

After as many false starts and hesitations as a nervous rookie might make trying to get under a high pop fly on a windy day, the Hayakawa Electric Co. has settled on a design for its LSI miniature calculator.

Hayakawa will have a prototype to show at the annual convention and exhibition of the Institute of Electrical and Electronics Engineers in New York next week. Sales are tentatively scheduled to start in August.

The calculator is 9.8 by 5.3 by 2.7 inches; it weighs just a little more than 3 pounds. It can add, subtract, multiply, divide, and then display up to eight digits. But there's a decimal-point callback that stores the point position out to 16 digits during calculations. That way, the point ends up in the right place when the answer is rounded off to eight significant figures.

For its display tubes, Hayakawa made its already small Digitron even smaller—0.35-inch in diameter. For its LSI logic packages, the Japanese company will turn to Autonetics first for the circuit packages themselves and later for the know-how to build them [*Electronics*, Feb. 17, p. 215].

**Quartet.** Although its experimental version of the small LSI calculator had 11 metal-oxide-semiconductor packages, Autonetics and Hayakawa have managed to pack all the logic in four MOS packages, which average 780 elements each. Along with the LSI packages there are two MOS integrated circuits—a clock generator and a display driver.

Design of the LSI packages was eased by Hayakawa's decision to adopt four-phase logic. This technique speeds up MOS switching and cuts the drain on the power supply down to the point where the resistance of the MOS transistors in the LSI isn't a determining factor [*Electronics*, Feb. 17, p. 107]. So the transistors can be small.

Just as important, they can all be the same size, which makes computer-aided-circuit design much easier. The four-phase logic design developed by Hayakawa was the

springboard that enabled Autonetics to work out circuits with a packing density of 85 to 90 elements per square millimeter. Hayakawa's experimental calculators had IC's with something like 15 elements per square mm.

**Division.** The logic tasks are split up among the four packages. The first, called the NRD 2256, handles the display and numerical read-in functions. Decimal-point control is taken care of by the second circuit, the DC 2266. The third, AU 2276, handles digital addition and register input control. The fourth, the AC 2266, rides herd on the arithmetic and provides the registers.

The logic half of the computer—the four LSI packages and the two MOS IC's—has a circuit board to itself; so does the display half of the machine with its eight tiny indicator tubes and their drive circuits. The display tubes draw some power—15 milliamps at 55 volts for the anodes and 60 ma at 8 volts for the filaments—and they are controlled by three hybrid circuit modules, each with six two-transistor circuits. The tubes are operated in the time-division mode that Hayakawa pioneered for small electronic calculators. [*Electronics*, March 20, 1967, p. 241].

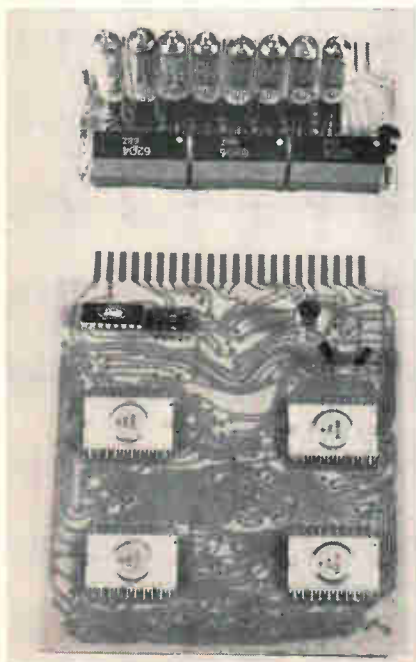

**Building blocks.** Hayakawa's LSI calculator carries all its logic circuits and display circuits on two small printed circuit boards. Larger board takes care of the four MOS LSI packages plus an IC clock and an IC display driver. Smaller board has the display tubes and their hybrid drive packages. Undersides of boards have only wiring on them.

# Electronics advertisers

March 17, 1969

■ Acoplan Corp.	188	Delco Radio,		Midtex/Aemco	48
Mort Barish Associates		Div. of General Motors Corp.	147	Chuck Ruhr Associates Advertising	
□ Adret Electronique	40E	MacBill/Ross, Inc.		Minnesota Mining & Mfg. Co.	122
Perez Publicite		Deringer Metallurgical Corp.	145	Mincom Division	
■ AEG-Telefunken	179	R.B. Advertising		Reachm McClinton & Company	
□ Alcatel	33E	Dialight Corp.	9	Mohawk Data Science Corp./	
Agence René Sicard		Michel Cather, Inc.		OEM Marketing	158
Alco Electronic Products, Inc.	163, 165, 167	□ Digital Development Corp.	30E	MacFarland Associates Inc.	
Marketronics Adv.		Management Communications		Monarch Machine Tool Co.,	
Allen-Bradley Co.	27, 164	Consultants, Inc.		Edlund Division	150
Fensholt Adv. Agcy.		DuPont de Nemours & Co.,		Sabatino Advertising Inc.	
American Engraving, Inc.	178	Freon Div.	148	Monsanto Company	25
Page-Lacy Agency		Batten, Barton, Durstine & Osborn, Inc.		Michel Cather Inc.	
■ AMF-Alexandria Div.		Dynamic System Electronics	170	Motorola Semiconductor	
Applied Cybernetics	190	Craig Miller Advertising		Products Incorporated	17 & 18, 77
E. G. White Adv., Inc.		Eastman Kodak Co.,		Lane & Bird Adv. Inc.	
American Optical Corp.	76	PCIM Market Development	159	■ National Electronics Incorporated	172
Fuller & Smith & Ross, Inc.		Rumrill Hoyt, Inc.		Connor-Sager Associates	
American Optical Corp.,		Electro Products Laboratories, Inc.,		National Semiconductor	
Space Defense Group	146	Transducer Div.	189	Corporation	119, 121
Fuller & Smith & Ross, Inc.		Grant, Schwenck & Baker, Inc.		Hall Butler/Blatherwick Inc.	
■ AMP, Incorporated	22, 23	Electronics Management Center, The	166	New York State Electric &	
Garceau, Hallahan & McCullough, Inc.		Slesar & Kanzer, Inc.		Gas Corporation	140
■ Amperex Electronics Corp.,		Emerson & Cuming, Inc.	165	Rumrill-Hoyt Incorporated	
Div. of North American Philips Co.	143	Edwin F. Hall		■ North Atlantic Industries Inc.	149
Sam Groden, Inc.		Fairchild Semiconductor, Inc.	59	Ross Roy of New York Inc.	
■ Amperite Co.	126	Chiat/Day, Inc.		Northern Natural Gas Company	162
H. J. Gold Co.		Farinon Electric	7	Bozell & Jacobs Inc.	
Anaconda American Brass Co.,		Jack Herrick Adv., Inc.		■ Nortronics Company Inc.,	
Fabricated Metal Goods Div.	19	□ Ferisol	19E	OEM Division	182
Wilson, Haight & Welch, Inc.		Agence Domenach		Stral Advertising Company Inc.	
Andrew Corp.	72	■ Fluke Manufacturing Co., John	29		
Fensholt Adv., Inc.		Bonfield Associates		Olympus Corporation	45
■ A. P. I. Instruments	182	Gencom Division—Whittaker Corp.	167	Kamery Associates, Inc.	
George Z. Griswold Adv.		A.D. Adams Adv., Inc.		Owens-Illinois Inc.	132
Applied Materials	63, 65, 67	General Electric Co.,		Meldrum and Fewsmith Inc.	
Hall Butler Blatherwick, Inc.		Specialty Control Div.	78	□ Pechiney St Gobain	17E-18E
Associated Testing Laboratories, Inc.	191	Robert S. Cragin, Inc.		PEMA	
Murray Heyert Associates		General Radio Co.	2nd Cover	■ Philbrick/Nexus Research Inc.	139
■ Babcock Relays Div. of		Horton Church & Goff, Inc.		Culver Advertising Inc.	
Babcock Electronics Corp.	57	General Resistance,		□ Philco Ford Corporation	15E
Jansen Assoc., Inc.		Div. of Chronetics	14	Hal Lawrence Incorporated	
■ Barnes Engineering Co.	186	J.S. Lanza & Associates		Philco Ford Corporation	
Albert A. Kohler Co., Inc.		Gertsch/Division of Singer Co.	28	Sierra Electronics Operation	15
Beckman Instruments, Inc.,		Marylyn Ritchie & Assoc.		Hal Lawrence Incorporated	
Cedar Grove Operations	64	Heinemann Electric Co.	6	Phoenix Chamber of Commerce	172
Lescarbours Adv., Inc.		Thomas R. Sundheim, Inc.		Jennings & Thompson Advertising	
■ Beckman Instruments, Inc., Helipot Div.	82	■ Hewlett Packard,		Phoenix Data Inc.	178
Hixson & Jorgensen, Inc.		Frequency & Time Div.	2	Craig Miller Advertising	
Bendix Corp.		Lennen & Newell, Inc.		■ Power Designs Incorporated	208
Electrical Components Div.	30, 31	■ Hewlett Packard International Div.	1	Lescarbours Advertising Inc.	
MacManus, John & Adams, Inc.		Lennen Newell, Inc.		Radiation Incorporated	61
Bendix Corp.		■ Hewlett Packard, New Jersey Div.	81	W.M. Zemp & Associates Inc.	
Flight & Engine Instruments Div.	160	McCarthy, Scelba, DiBiasi		Radio Corporation of America	4th Cover
MacManus, John & Adams, Inc.		■ Hewlett Packard, Palo Alto Div.	70	AI Paul Lefton Company	
□ Bernard Golay S.A.	22E	Lennen & Newell, Inc.		Raytheon Company,	
Langel Publicite		■ Hewlett Packard, Rockaway Div.	24	Components Division	58, 60, 62
Bourns, Inc. Trimpot Div.	168	Culver Adv., Inc.		Fuller & Smith & Ross Inc.	
Lester Co., The		Honeywell Commercial Div.	55	Reeves Instruments Division	71
Branson Instruments, Inc.,		Campbell Mithum, Inc.		Duncan-Brooks Inc.	
Industrial Div.	135	Honeywell, Computer Control Div.	32	□ Schlumberger Ltd. EMD	2E
Van Sant Dugdale and Co., Inc.		Creamer, Trowbridge Case & Basford, Inc.		□ Schlumberger SIS	4E
Brush Instruments		■ Industrial Test Equipment Co.	171	Sodipa	
Div. of Clevite Corp.	141	Mac Berman Associates		Scientific Data Systems	50
Carr Liggett Adv., Inc.		Intertechnique	24E	Doyle Dane Bernbach Inc.	
■ Buckbee-Mears Co.	79	Public Service		Sealectro Corporation	142
Midland Assoc., Inc.		ITT Electron Tube Div.	153	Lescarbours Advertising Inc.	
■ Bulova Watch Co.,		MacManus, John & Adams, Inc.		Semcor Division Components Inc.	207
Electronics Div.	134	□ Jenaer Glaswerk Schott & Gen.	29E	Marketing & Corporate Communications	
Levy Adv. Assoc.		D. Frenz Werbung		Inc.	
Burns & Towne, Inc.	56	Johnson Co., E.F.	183	SESCOSEM	14E
Hall-Karmatz Assoc., Inc.		Martin Williams Adv.		Signetics Corp. Sub.	
□ Burr-Brown Research Corp.	8E	Keithley Instruments, Inc.	152	Corning Glass Works	113
N.A. Winter Adv. Agcy.		Bayless-Kerr Co.		Cunningham & Walsh Inc.	
By-Buk Co.	158	□ Kikusui Electronics Corp.	34E	□ Silec Electronic	39E
Albert Frank Guenther Law Adv., Inc.		General Adv. Agcy.		Publicite Y Ch. Lambert	
Carlsbad, N.M. Dept. of Development	163	■ Lambda Electronics Corp.	10, 11	□ Sogie	36E
Geha-Paskind & Assoc., Inc.		Michel Cather, Inc.		Études et Creatinos Publicitarie	
Chronetics, Inc.	136	■ Lapp Insulator Co.	138	Solartron Electronics Group Ltd.	197-198
J.S. Lanza & Assoc.		Wolff Associates		Solartron Electronics Group Ltd.	3E
■ Clevite Corp., Piezoelectric Div.	191	Ledex, Inc.	130	T.P. Brown Ltd.	
Carr Liggett Adv., Inc.		Yeck & Yeck, Inc.		□ Solartron Electronics Group Ltd.	
Cohu Electronics, Inc.	16	Lockheed California	174	Digital Instrumentation	7E
Erwin Wasey, Inc.		McCann-Erickson, Inc.		T.B. Browne Inc.	
Collins Radio Co.	156, 157	□ LTT	26 E & 27E	□ Solartron Electronics Group Ltd.	
John G. Burnett Adv.		Promotion Vente Publicite		Hybrids	5E
■ Computer Products Inc.	26	■ Magnecraft Electric Company	120	T.B. Browne Inc.	
Grenman Assoc., Inc.		Mills, Fife & MacDonald Inc.		■ Sorensen Operation Raytheon Company	75
Control Products Div.,		■ Mallory & Company,	184	Urrutia & Hayes Inc.	
Texas Instruments Incorporated	131	P.R. Mfg. Division		Spectrum Control Inc.	174
Horton, Church & Goff, Inc.		Aitkin-Kynett Company		Altman-Hall Associates	
□ C R C	28E	Mallory Battery Company, Div. of		□ S.P. Electronica	12E, 13E
I R P		P.R. Mallory & Company Inc.	80	Studio Sergio Rosata	
CREI, Home Study Div. of the		Needham, Harper & Steers Inc.		Sprague Electric Company, The	34
McGraw-Hill Book Co.	173	Marconi Instruments	176	Harry P. Bridge Company	
Henry J. Kaufman Associates		McCarthy, Scelba & DiBiasi Adv. Agency		■ Superior Electric Co.	47
■ CTS Corporation	192, 193	Inc.		K.C. Shenton Company	
Reincke, Meyer & Finn, Inc.		□ Marconi & Co. Ltd.	32E	Sweet's Industrial Information	
■ Dale Electronics, Inc.,		Radio Communication Div.		Systems	68, 69
SIOUX Div.	189	Hampshire House Ltd.		J.J. Lane Inc.	
Swanson, Sinkey, Ellis, Inc. Adv.		□ M C B	25E	Sylvania Electric Products Inc.,	
Dana Laboratories, Inc.	20, 21	Dumesnil Publicite		Parts Division	5
Smith-Klitten, Inc.		McGraw Hill Professional		Doyle Dane Bernbach Inc.	
Delco Radio,		& Reference Book Division	187	Sylvania Electric Products Inc.,	
Div. of General Motors Corp.	12, 13			Electronic Components Group	37 to 44
Campbell-Ewald Co.				Doyle, Dane, Bernbach Inc.	

# SERVICE MASTER HANDIEST HANDFUL of service tools

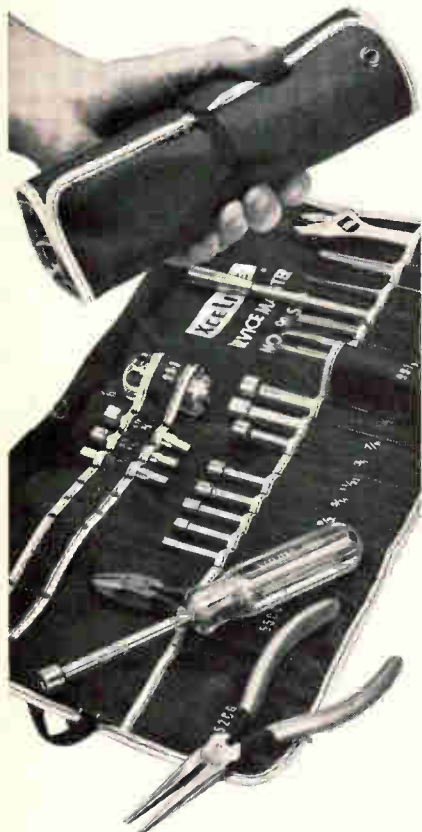

23 essential tools at your fingertips in this light-weight (only 2 3/4 lbs.), compact, easy-to-carry, roll-up kit. Contains long nose plier, diagonal plier, adjustable wrench, regular and stubby plastic handles with these interchangeable blades: 9 regular and 3 stubby nutdriver, 2 slotted and 1 Phillips screwdriver, 2 reamer, 1 extension. Eyelets in plastic-coated canvas case permit wall hanging. New elastic loop secures roll, eliminates need for tying.

## many optional accessories:

Junior and Tee handles... Additional nutdriver, Phillips & slotted screwdriver, and extension blade sizes... Allen hex type, Bristol multiple spline, Frearson, Scrufox, and clutch head blades... Awl/Scraper... Chuck adaptors to use blades in spiral ratchet drivers.

WRITE FOR CATALOG 166



XCELITE, INC., 130 Bank St., Orchard Park, N. Y. 14127  
In Canada contact Charles W. Pointon, Ltd.



Tateisi Electronics Co. Ltd.	20, 21
Dai-ichi International Inc.	
□ Technique et Produits	35E
Site de Publicite de Films et de Documentaries	
■ Tektronix Inc.	123, 124
Dawson, Turner & Jenkins Inc.	
Tempress Research Company Inc.	3rd Cover
Hal Lawrence Inc.	
■ Texas Instruments Incorporated, Components Group	46, 66
Don L. Baxter, Div. of Albert Frank-Guenther Law Inc.	
TRW Systems Group	175
Fuller & Smith & Ross Inc.	
□ Transformer Electronics Co.	6E
Dacey Wolf & Weir	
■ Trygon Electronics Inc.	137
Kameny Associates Inc.	
Tyco Laboratories Inc.	
Instruments Division	49
Kenyon & Eckhardt Inc. Adv.	
United Aircraft Electronic Components	144
Cunningham & Walsh Inc. Advertising	
United Systems Corporation Advertising & Merchandising Inc.	170
University Laboratories Inc.	127
West Associates	
■ Vactec Incorporated	128
Coleman & Associates Advertising	
Wang Laboratories	129
Impact Advertising Inc.	
□ Watkins Johnson Company	11E
Williams C. Estler Public Relations	
Wavetek	180
Chapman, McQuiston, Michetti Advertising	
■ White Instruments Inc.	178
Wilson & Associates, The Art Studio, Div. of Graphic Studios	
Wiremold Company The Charles Brunelle Company	171
Xcelite Inc.	206
Harold Warner Advertising Inc.	
Zippertubing Company	172
Edward S. Kellogg Company	

## Classified & Employment Advertising

F.J. Eberle, Manager  
212-971-2557

EMPLOYMENT OPPORTUNITIES ..... 194-196  
Westinghouse ..... 194

## EQUIPMENT (Used or Surplus New) For Sale

Fishman, P. Co.	194
Gadgets Surplus Electronics Inc.	194
Jorg, Otto	194
Radio Research Instrument Co.	194

■ For more information on complete product line see advertisement in the latest Electronics Buyer's Guide  
□ Advertisers in Electronics International

## Electronics Buyers' Guide

George F. Werner, General Manager  
[212] 971-2310

Robert M. Denmead,  
Midwest Regional Manager  
[312] MO 4-5800

William A. Capuzzi,  
New York, New England District Manager  
[212] 971-3793

Regina Hera, Directory Manager  
[212] 971-2544

Thomas M. Egan, Production Manager  
[212] 971-3140

## Circulation Department

Isaaca Siegel, Manager [212] 971-6057

## Research Department

David Strassler, Manager [212] 971-6058

## Advertising Sales Staff

Frank E. LeBeau [212] 971-6464  
Advertising Sales Manager

Wallis Clarke [212] 971-2187  
Assistant to sales manager

Donald J. Austermann [212] 971-3139  
Promotion Manager

Warren H. Gardner [215] LO 8-6161  
Eastern Advertising Sales Manager

Atlanta, Ga. 30309: Michael H. Miller, 1375  
Peachtree St., N.E.  
[404] 892-2868

Boston, Mass. 02116: William S. Hodgkinson  
McGraw-Hill Building, Copley Square  
[617] CO 2-1160

Cleveland, Ohio 44113: William J. Boyle, 55  
Public Square. [216] SU 1-7000  
New York, N.Y. 10036

500 Fifth Avenue  
James R. Pierce [212] 971-3615  
John A. Garland [212] 971-3617  
Michael J. Stoller [212] 971-3616

Philadelphia, Pa. 19103:

Jeffrey M. Preston  
Warren H. Gardner,  
6 Penn Center Plaza,  
[215] LO 8-6161

Pittsburgh, Pa. 15222: Warren H. Gardner,  
4 Gateway Center. [412] 391-1314

Rochester, N.Y. 14534: William J. Boyle,  
9 Greylock Ridge, Pittsford, N.Y.  
[716] 586-5040

Donald R. Furth (312) MO 4-5800  
Midwest Advertising Sales Manager

Chicago, Ill. 60611: Kenneth E. Nicklas  
Ralph Hanning, 645 North Michigan Avenue,  
[312] MO 4-5800

Dallas, Texas 75201: Richard P. Poole, 1800  
Republic National Bank Tower,  
[214] RI 7-9721

Houston, Texas 77002: Robert Wallin,  
2270 Humble Bldg. [713] CA 4-8381

Detroit, Michigan 48226: Ralph Hanning,  
856 Penobscot Building  
[313] 962-1793

Minneapolis, Minn. 55402: 1104 Northstar  
Center [612] 332-7425

St. Louis, Mo. 63105: Kenneth E. Nicklas,  
The Clayton Tower, 7751 Carondelet Ave.  
[314] PA 5-7285

James T. Hauptli [415] DO 2-4600  
Western Advertising Sales Manager

Denver, Colo. 80202: Joseph C. Page, David  
M. Watson, Tower Bldg., 1700 Broadway  
[303] 255-5484

Los Angeles, Calif. 90017: Ian C. Hill,  
John G. Zisch, 1125 W. 6th St.,  
[213] HU 2-5450

Portland, Ore. 97204: James T. Hauptli,  
Thomas McElhinny, 218 Mohawk Building,  
222 S.W. Morrison Street,  
Phone [503] 223-5118

San Francisco, Calif. 94111: James T. Hauptli,  
Thomas McElhinny, 255 California Street,  
[415] DO 2-4600

Pierre Braude Tel: 225 85 88: Paris  
European Director

Paris: Denis Jacob  
88-90 Avenue Des Champs-Elysees, Paris 8  
United Kingdom and Scandinavia

London: Oliver Ball, Tel: Hyde Park 1451  
34 Dover Street, London W1

Milan: Robert Salde  
1 via Baracchini Phone 86-90-656

Brussels: F.I.H. Huntjens  
27 Rue Ducale Tel: 136503

Frankfurt/Main: Hans Haller  
Elsa-Brandstrom Str. 2  
Phone 72 01 81

Geneva: Denis Jacob  
1, rue du Temple Phone: 31 95 60  
Tokyo: Takeji Kinoshita, McGraw-Hill  
Publications Overseas Corporation,  
Kasumigaseki Building 2-5, 3-chome,  
Kasumigaseki, Chiyoda-Ku, Tokyo, Japan  
[581] 9811

Osaka: Akihiko Kamesaka, McGraw-Hill  
Publications Overseas Corporation, Kondo  
Bldg., 163, Umegee-cho Kita-ku [362] 8771

## Business Department

Stephen R. Weiss, Production Manager  
[212] 971-2044

Thomas M. Egan,  
Assistant Production Manager [212] 971-3140

Dorothy Carmesin, Contracts and Billings  
[212] 971-2908

Frances Vallone, Reader Service Manager  
[212] 971-2865



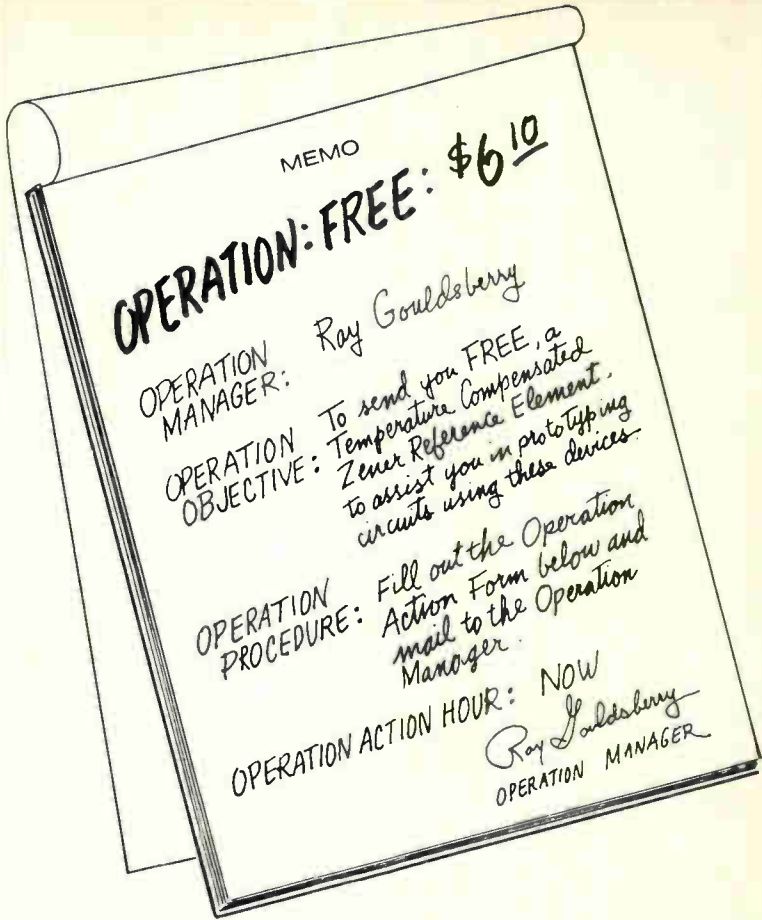

MEMO  
**OPERATION: FREE: \$6.10**

OPERATION MANAGER: *Ray Gouldsberry*  
 OPERATION OBJECTIVE: *To send you FREE, a Temperature Compensated Zener Reference Element to assist you in prototyping circuits using these devices.*

OPERATION PROCEDURE: *Fill out the Operation Action Form below and mail to the Operation Manager.*

OPERATION ACTION HOUR: *NOW*  
*Ray Gouldsberry*  
 OPERATION MANAGER

This high quality device selling for \$6.10 has these standard specifications:

- Zener Voltage ( $V_z$ ): 9.4 Volts  $\pm 2\%$
- Maximum Dynamic Impedance ( $Z_z$ ): 15 Ohms
- Maximum Voltage Change Over Temperature Range ( $\Delta V_z$  over  $-55^\circ\text{C}$  to  $+185^\circ\text{C}$ ): 115 mV
- Average Temperature Coefficient: .005%/°C

It will be sent to you free attached to card on which all critical parameters of your device have been recorded for you.

**Operation Action Form**

In what project will this device be used? \_\_\_\_\_

If this is a production project what quantity of Zener Reference Elements do you anticipate using? \_\_\_\_\_

Name: \_\_\_\_\_ Position: \_\_\_\_\_

Company: \_\_\_\_\_ M/S: \_\_\_\_\_

Street: \_\_\_\_\_

City: \_\_\_\_\_ State: \_\_\_\_\_ Zip: \_\_\_\_\_

Phone: \_\_\_\_\_ Ext: \_\_\_\_\_



3540 W. OSBORN RD. / PHOENIX, ARIZONA 85019  
 PHONE 602-272-7671 / TWX 910-951-1381  
 Visit us at IEEE: Booths 4J 16-18

# CALIBRATED DC POWER SOURCES

## DIGITAL READOUT

- Digital readout; 4 places to 10 volts, 5 places to 20 volts, with sixth place interpolation potentiometer.
- 0.1% + 1mV calibration accuracy
- 0.001% + 100  $\mu$ V stability per 8 hours
- 100  $\mu$ V peak-to-peak ripple and noise to 50MHz
- Flashing overcurrent indicator (Model 2020)
- Continuously adjustable current limiter
- 100  $\mu$ V regulation
- 0.001%/ $^{\circ}$ C temperature coefficient



**Model 2005**  
0-20 Volts, 0-0.5 Amperes  
\*\$325.00

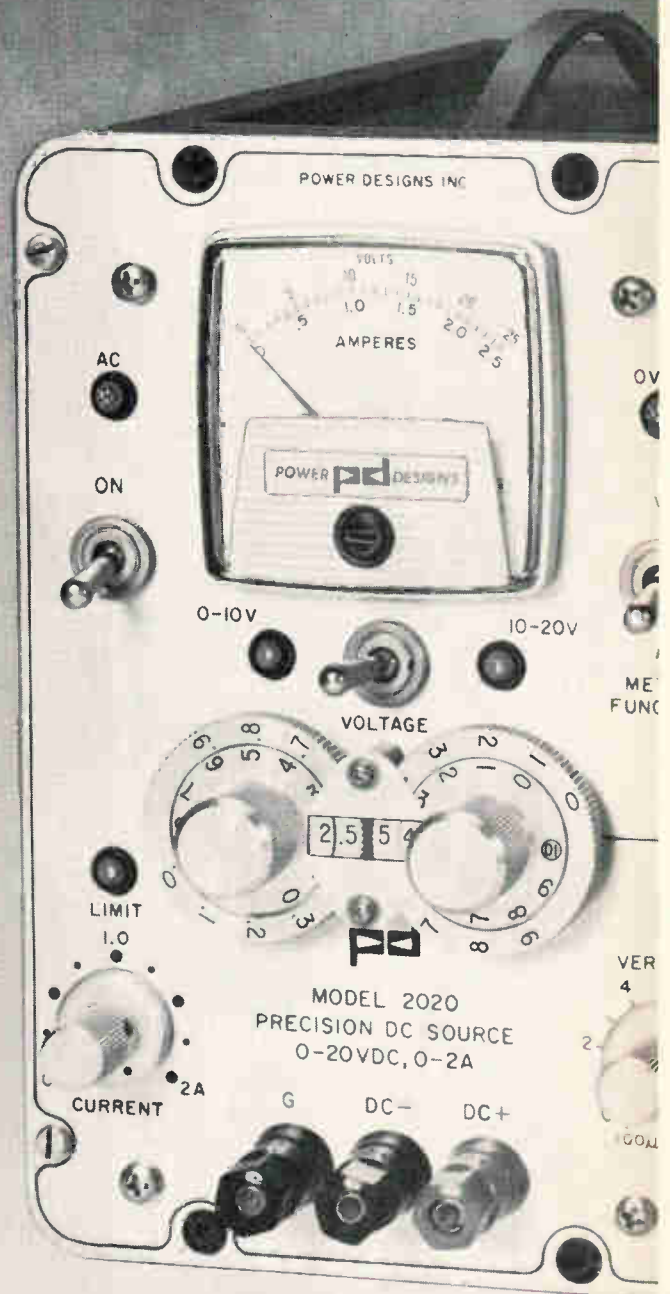

**Model 2020**  
0-20 Volts, 0-2 Amperes  
\*\$475.00

WRITE FOR DETAILED SPECIFICATIONS

 **POWER DESIGNS, INC.**

FOB WESTBURY, N.Y.

3381 JUNIPERO SERRA • PALO ALTO, CALIFORNIA  
415-321-6111 TWX: 910-373-1251

1700 SHAMES DRIVE • WESTBURY, N.Y.  
516 EDgewood 3-6200 TWX: 510-222-6561

# Electronics reader service

Use these handy post cards for more detailed information on: products advertised, new products, new literature.

Circle the number on the Reader Service post card that corresponds to the number at the bottom of the advertisement, new product item, or new literature in which you are interested.

Please print clearly. All written information must be legible to be efficiently processed.

If someone has beaten you to the post cards, you may obtain the needed information by writing directly to the manufacturer, or by sending your name and address, plus the Reader Service number, to Electronics Reader Service department.

All inquiries from outside the U.S. that cannot reach Electronics before the expiration dates noted on the Reader Service post card, must be mailed directly to the manufacturer. The manufacturer assumes all responsibilities for responding to inquiries. Electronics merely provides and clears requests for information from inquirer to manufacturer.

Correct amount of postage must be affixed for all mailings from outside the U.S.

## To subscribe to or to renew Electronics

Fill in the "For Subscriptions" area on the card if you desire to subscribe to or renew your present subscription to Electronics. Send no money. Electronics will bill you at the address indicated on the Reader Service post card.

## Multi-product advertisements

For information on specific items in multi-product advertisements which do not have a specific Reader Service number indicated write directly to manufacturer for information on precise product in which you are interested.

Warning: The Post Office now requires your ZIP CODE on all mail. Please include your ZIP CODE number when filling out your reply card.

6 \*For employment inquiries fill in home address. March 17, 1969 Card Expires May 17, 1969 14

Name \_\_\_\_\_ title \_\_\_\_\_

Company\* \_\_\_\_\_

Address \_\_\_\_\_

City \_\_\_\_\_ State \_\_\_\_\_ Zip Code \_\_\_\_\_

1	20	39	58	77	96	115	134	153	172	191	210	229	248	267	286	305	324	343	362	381	400	419	438	457	476	495	514	962
2	21	40	59	78	97	116	135	154	173	192	211	230	249	268	287	306	325	344	363	382	401	420	439	458	477	496	515	963
3	22	41	60	79	98	117	136	155	174	193	212	231	250	269	288	307	326	345	364	383	402	421	440	459	478	497	516	964
4	23	42	61	80	99	118	137	156	175	194	213	232	251	270	289	308	327	346	365	384	403	422	441	460	479	498	517	965
5	24	43	62	81	100	119	138	157	176	195	214	233	252	271	290	309	328	347	366	385	404	423	442	461	480	499	518	966
6	25	44	63	82	101	120	139	158	177	196	215	234	253	272	291	310	329	348	367	386	405	424	443	462	481	500	900	967
7	26	45	64	83	102	121	140	159	178	197	216	235	254	273	292	311	330	349	368	387	406	425	444	463	482	501	901	968
8	27	46	65	84	103	122	141	160	179	198	217	236	255	274	293	312	331	350	369	388	407	426	445	464	483	502	902	969
9	28	47	66	85	104	123	142	161	180	199	218	237	256	275	294	313	332	351	370	389	408	427	446	465	484	503	951	970
10	29	48	67	86	105	124	143	162	181	200	219	238	257	276	295	314	333	352	371	390	409	428	447	466	485	504	952	971
11	30	49	68	87	106	125	144	163	182	201	220	239	258	277	296	315	334	353	372	391	410	429	448	467	486	505	953	972
12	31	50	69	88	107	126	145	164	183	202	221	240	259	278	297	316	335	354	373	392	411	430	449	468	487	506	954	973
13	32	51	70	89	108	127	146	165	184	203	222	241	260	279	298	317	336	355	374	393	412	431	450	469	488	507	955	974
14	33	52	71	90	109	128	147	166	185	204	223	242	261	280	299	318	337	356	375	394	413	432	451	470	489	508	956	975
15	34	53	72	91	110	129	148	167	186	205	224	243	262	281	300	319	338	357	376	395	414	433	452	471	490	509	957	976
16	35	54	73	92	111	130	149	168	187	206	225	244	263	282	301	320	339	358	377	396	415	434	453	472	491	510	958	977
17	36	55	74	93	112	131	150	169	188	207	226	245	264	283	302	321	340	359	378	397	416	435	454	473	492	511	959	978
18	37	56	75	94	113	132	151	170	189	208	227	246	265	284	303	322	341	360	379	398	417	436	455	474	493	512	960	979
19	38	57	76	95	114	133	152	171	190	209	228	247	266	285	304	323	342	361	380	399	418	437	456	475	494	513	961	980

6 \*For employment inquiries fill in home address. March 17, 1969 Card Expires May 17, 1969 14

Name \_\_\_\_\_ title \_\_\_\_\_

Company\* \_\_\_\_\_

Address \_\_\_\_\_

City \_\_\_\_\_ State \_\_\_\_\_ Zip Code \_\_\_\_\_

1	20	39	58	77	96	115	134	153	172	191	210	229	248	267	286	305	324	343	362	381	400	419	438	457	476	495	514	962
2	21	40	59	78	97	116	135	154	173	192	211	230	249	268	287	306	325	344	363	382	401	420	439	458	477	496	515	963
3	22	41	60	79	98	117	136	155	174	193	212	231	250	269	288	307	326	345	364	383	402	421	440	459	478	497	516	964
4	23	42	61	80	99	118	137	156	175	194	213	232	251	270	289	308	327	346	365	384	403	422	441	460	479	498	517	965
5	24	43	62	81	100	119	138	157	176	195	214	233	252	271	290	309	328	347	366	385	404	423	442	461	480	499	518	966
6	25	44	63	82	101	120	139	158	177	196	215	234	253	272	291	310	329	348	367	386	405	424	443	462	481	500	900	967
7	26	45	64	83	102	121	140	159	178	197	216	235	254	273	292	311	330	349	368	387	406	425	444	463	482	501	901	968
8	27	46	65	84	103	122	141	160	179	198	217	236	255	274	293	312	331	350	369	388	407	426	445	464	483	502	902	969
9	28	47	66	85	104	123	142	161	180	199	218	237	256	275	294	313	332	351	370	389	408	427	446	465	484	503	951	970
10	29	48	67	86	105	124	143	162	181	200	219	238	257	276	295	314	333	352	371	390	409	428	447	466	485	504	952	971
11	30	49	68	87	106	125	144	163	182	201	220	239	258	277	296	315	334	353	372	391	410	429	448	467	486	505	953	972
12	31	50	69	88	107	126	145	164	183	202	221	240	259	278	297	316	335	354	373	392	411	430	449	468	487	506	954	973
13	32	51	70	89	108	127	146	165	184	203	222	241	260	279	298	317	336	355	374	393	412	431	450	469	488	507	955	974
14	33	52	71	90	109	128	147	166	185	204	223	242	261	280	299	318	337	356	375	394	413	432	451	470	489	508	956	975
15	34	53	72	91	110	129	148	167	186	205	224	243	262	281	300	319	338	357	376	395	414	433	452	471	490	509	957	976
16	35	54	73	92	111	130	149	168	187	206	225	244	263	282	301	320	339	358	377	396	415	434	453	472	491	510	958	977
17	36	55	74	93	112	131	150	169	188	207	226	245	264	283	302	321	340	359	378	397	416	435	454	473	492	511	959	978
18	37	56	75	94	113	132	151	170	189	208	227	246	265	284	303	322	341	360	379	398	417	436	455	474	493	512	960	979
19	38	57	76	95	114	133	152	171	190	209	228	247	266	285	304	323	342	361	380	399	418	437	456	475	494	513	961	980

6 \*For employment inquiries fill in home address. March 17, 1969 Card Expires May 17, 1969 14

Name \_\_\_\_\_ title \_\_\_\_\_

Company\* \_\_\_\_\_

Address \_\_\_\_\_

City \_\_\_\_\_ State \_\_\_\_\_ Zip Code \_\_\_\_\_

1	20	39	58	77	96	115	134	153	172	191	210	229	248	267	286	305	324	343	362	381	400	419	438	457	476	495	514	962
2	21	40	59	78	97	116	135	154	173	192	211	230	249	268	287	306	325	344	363	382	401	420	439	458	477	496	515	963
3	22	41	60	79	98	117	136	155	174	193	212	231	250	269	288	307	326	345	364	383	402	421	440	459	478	497	516	964
4	23	42	61	80	99	118	137	156	175	194	213	232	251	270	289	308	327	346	365	384	403	422	441	460	479	498	517	965
5	24	43	62	81	100	119	138	157	176	195	214	233	252	271	290	309	328	347	366	385	404	423	442	461	480	499	518	966
6	25	44	63	82	101	120	139	158	177	196	215	234	253	272	291	310	329	348	367	386	405	424	443	462	481	500	900	967
7	26	45	64	83	102	121	140	159	178	197	216	235	254	273	292	311	330	349	368	387	406	425	444	463	482	501	901	968
8	27	46	65	84	103	122	141	160	179	198	217	236	255	274	293	312	331	350	369	388	407	426	445	464	483	502	902	969
9	28	47	66	85	104	123	142	161	180	199	218	237	256	275	294	313	332	351	370	389	408	427	446	465	484	503	951	970
10	29	48	67	86	105	124	143	162	181	200	219	238	257	276	295	314	333	352	371	390	409	428	447	466	485	504	952	971
11	30	49	68	87	106	125	144	163	182	201	220	239	258	277	296	315	334											

# Reprint service

## All Electronics editorial matter available in reprint form:

For reprints of special reports and feature articles see list on right side of this page. Send your order to Electronics Reprint Department at the address indicated. To expedite mailing of your order for single reprints please send cash, check or money order with your order. Allow 3-4 weeks for delivery.

**Warning:** The Post Office now requires your ZIP CODE on all mail. Please include your ZIP CODE number when filling out your reply card.

Bulk reprints of editorial matter can be ordered from current or past issues. The minimum quantity is 100 copies. Prices quoted on request: call 212-971-2274, or write to address below.

To order reprints or for further information, please write to: **Electronics Reprint Department, 330 West 42nd Street, New York, N.Y. 10036.**

You may order any of the below listed reprints by key number. Discounts on quantities over 10.

- Key no. R-01 Computer-aided Design: Part I, The Man-machine Merger. 16 pages. \$1.25.
- Key no. R-04 Multilayer Circuit Boards: Sharpening An Imperfect Art. 7 pages. 50¢.
- Key no. R-05 Topology Cuts Design Drudgery. 12 pages. 50¢.
- Key no. R-06 Report on Japanese Technology: Sony. 20 pages. 50¢.
- Key no. R-010 Special Report on Large Scale Integration. 54 pages. \$1.50.
- Key no. R-011 Medical Electronics (1967). 8 part series, 44 pages. \$1.25.
- Key no. R-012 Special Report on Gallium Arsenide 17 parts. 32 pages. \$2.00
- Key no. R-016 Special Report on The Transistor: Two Decades of Progress. 48 pages. \$1.50.
- Key no. R-017 Special Report on Ferrites. 16 pages. \$1.00.
- Key no. R-018 European Electronics Markets 1969 20 page forecast report with a 6 page foldout. \$1.00
- Key no. R-019 U.S. Electronics Markets 1969 32 page forecast report with 4 page foldout. \$1.00
- Key no. R-020 1968 Electronics Index to Technical Articles and Authors Free.
- Key no. R-021 Infrared Detector Characteristics. 23 x 11 inch fold-out chart. 50¢
- Key no. R-87a The Packaging Revolution in Microelectronics, Parts I through VI. 64 pages. \$2.00.
- Key no. R-79 MOS Integrated Circuits. 12 pages. 50¢.
- Key no. R-78 The Overlay Transistor. 15 pages. 50¢.
- Key no. R-75 Biotelemetry. 2 part series, 16 pages. 50¢.
- Key no. R-64 Field Effect Transistors, Parts I, II, and III. 64 pages. \$1.00.

3

### Business reply mail

No postage stamp necessary if mailed in the United States

Postage will be paid by

First class  
Permit no. 42  
Hightstown, N. J.

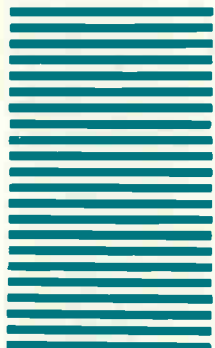

**Electronics**  
**Reader service department**  
**Box 444**  
**Hightstown, N. J. 08520**

2

### Business reply mail

No postage stamp necessary if mailed in the United States

Postage will be paid by

First class  
Permit no. 42  
Hightstown, N. J.



**Electronics**  
**Reader service department**  
**Box 444**  
**Hightstown, N.J. 08520**

1

### Business reply mail

No postage stamp necessary if mailed in the United States

Postage will be paid by

First class  
Permit no. 42  
Hightstown, N. J.



**Electronics**  
**Reader service department**  
**Box 444**  
**Hightstown, N.J. 08520**



## At .0008" dia., Craftsmanship is paramount

LEAD-BONDING CAPILLARY TUBES OF TUNGSTEN CARBIDE, with bore sizes as small as .0008", are made possible by Tempress' unique ability to machine and polish ultra-hard materials in microdimensions. This has brought a new efficiency to semiconductor manufacturing. Bonding tips are held in shank by a magnetic system, permitting instant replacement, even while heated. Heated shank maintains constant tube temperature from 0° to 350°C. This unique system for thermal compression

bonding of leads to semiconductors has brought important savings in time, tools, and materials to the nation's leading semiconductor manufacturers. Equally fine craftsmanship is applied to the Tempress line of diamond scribes, lead-bonding wedges, diamond lapping points, and other miniature semiconductor manufacturing tools.



# TEMPRESS

Tempress Research Co., 980 University Ave., Los Gatos, CA 95030

# All New Cermolox Designs for VHF-TV and FM Broadcasts

Working in VHF-TV? Try RCA-8792, RCA-8806 and RCA-8807... new broadcast tubes from RCA that meet the high linearity and high gain requirements of up-to-date, reliable VHF-TV. If FM service suits you, choose RCA-8792, 8793 and 8794. All are Cermolox® tubes, developed from proved, in-use designs. They feature new lows in feed-through capacitance and screen and cathode inductance plus superb IM values. Available at surprisingly

low cost, many of these RCA broadcast tubes lend themselves well not only to VHF-TV and FM, but to SSB, CW, and UHF Linear service as well. Investigate these RCA tubes for your needs. See your local RCA Representative or your RCA Distributor for details, including prices and delivery.

For technical data on specific types, write: RCA Electronic Components, Commercial Engineering, Section Q 19 Harrison, N.J. 07029.

RCA-8807 (top), 20 kW Peak Sync.  
RCA-8806 (center), 12.5 kW Peak Sync.  
RCA-8792 (lower), 1 kW FM 1.5 kW Peak Sync.

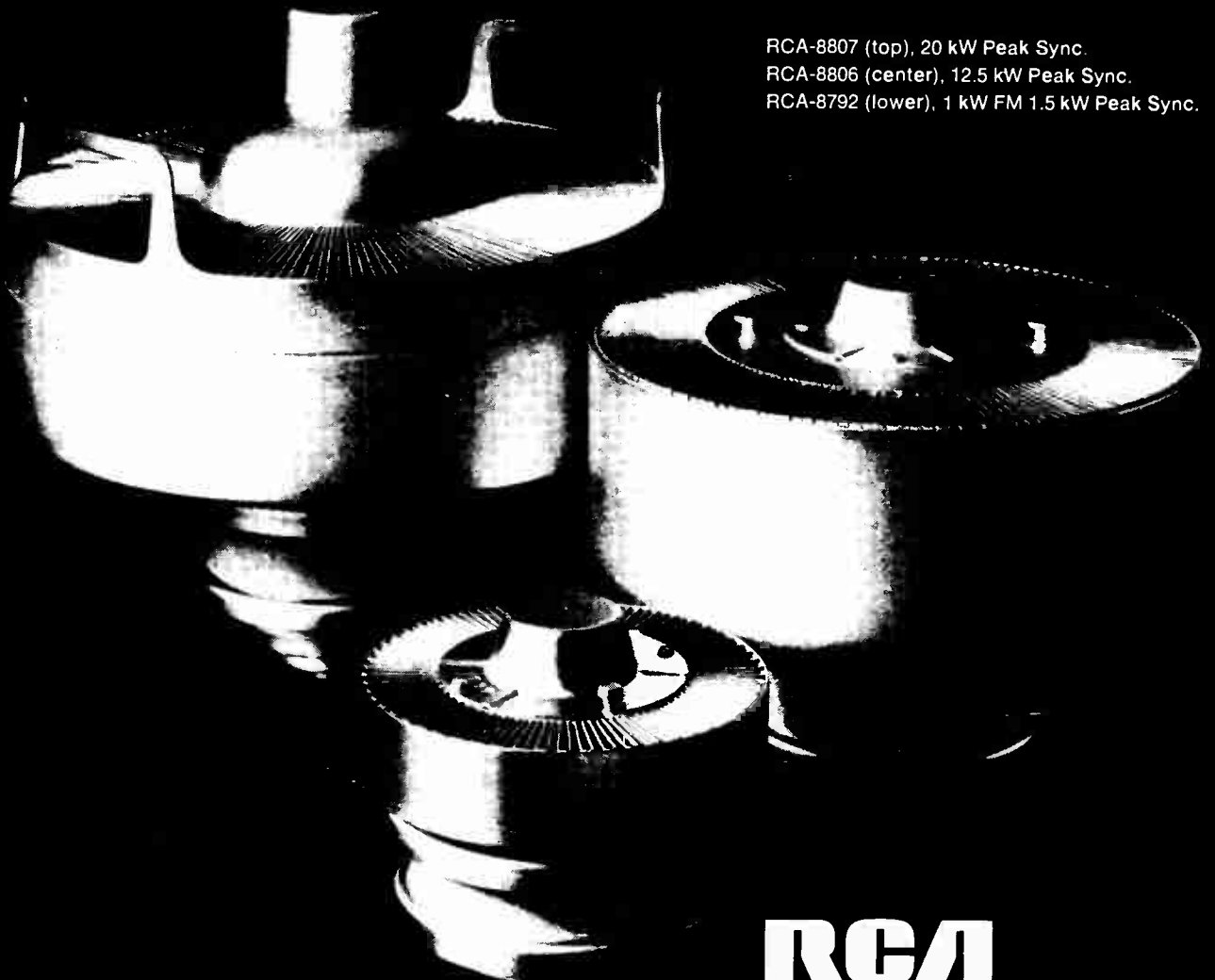

**RCA**