

Electronics[®]

Progress in IC processes: page 82

Finding transmission reflections: page 93

Electronics after the election: page 139

October 28, 1968

\$1.00

A McGraw-Hill Publication

Below: Manufacturing
computer memories, page 103

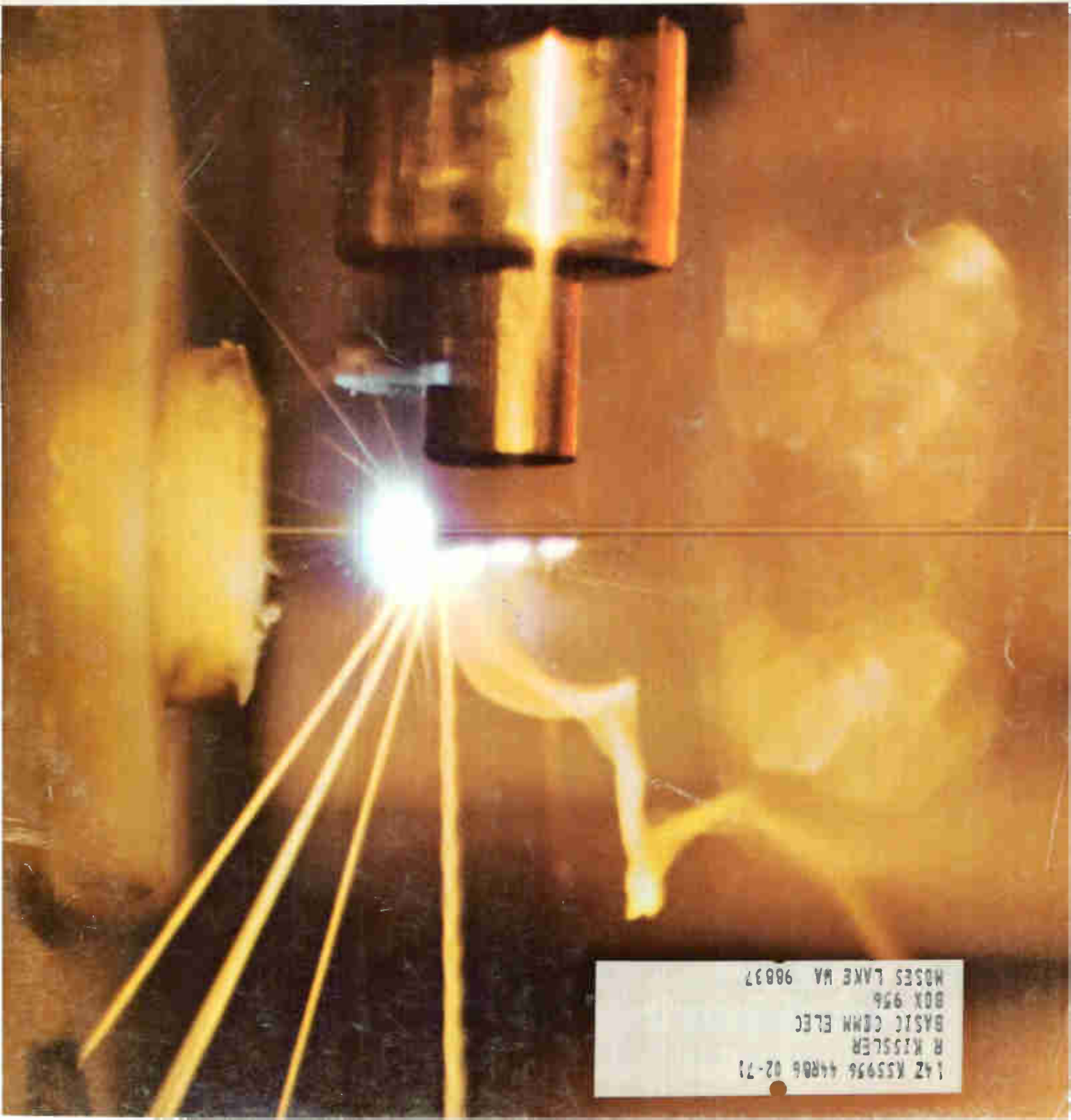

14Z K55956 44R66 02-71
R KISSLER
BASIC CONN ELEC
BOX 956
MOSES LAKE WA 98837

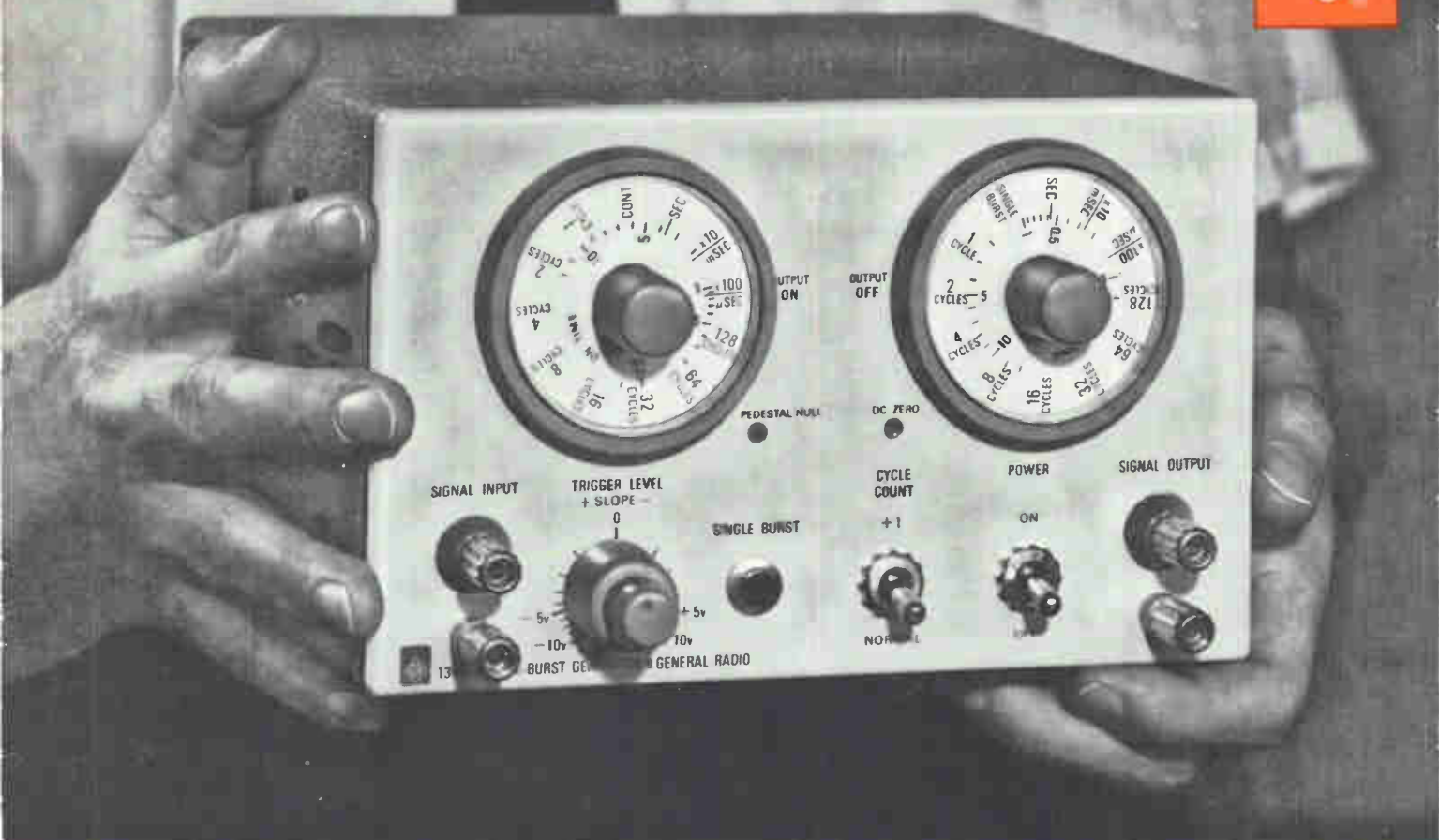

The tone-burst generator you designed

Tone-burst testing created a mild revolution when we introduced our first tone-burst generator in 1965. With properties of both continuous tones and pulses, tone-bursts quickly reveal important information about response curves.

You soon recognized the value of tone bursts in sonar and psychoacoustic testing, and the original 1396-A Tone-Burst Generator became an overnight success. Not only did you buy the instrument, but you told us how to improve it.

- You said, "Increase the upper frequency limit," and we did — to 2 MHz.
- In sonar and psychoacoustic testing, very long bursts are often required, so you said, "Provide for an analog ON as well as an analog OFF," and we did.
- You said, "Increase the signal suppression between bursts," and we did — to -60 dB.
- You said, "Add a single-burst button," and we did.

Furthermore, we increased the output voltage to 20 V and the output current to 50 mA; we reduced the output impedance to 25 Ω , and we increased the input impedance to 50 k Ω . Then we added convenience features like switch-selection of timing source, provision for direct drive of gate, and provision for nulling the DC output.

When we got through, we had the 1396-B — a completely new instrument — designed with you in mind because we minded you when we designed it.

For more information, write General Radio Company, West Concord, Massachusetts 01781; telephone (617) 369-4400. In Europe: Postfach 124, CH 8034 Zurich 34, Switzerland.

GENERAL RADIO

hp 3420B:

THE MOST ACCURATE DC VOLTMETER!

With the hp 3420B DC Differential Voltmeter/Ratiometer you get accuracy of 22 ppm, one-hour stability of <1 ppm, and resolution of 0.2 ppm — a combination of performance features that gives you the most accurate portable dc voltmeter available.

The 3420B is designed for convenient, logical and quick operation. In addition to pushbutton selectors, you get a rapid zero adjustment—without shorting the circuit under test, without disconnecting the input. Press the ZERO button and it

automatically opens the input and internally shorts the 3420B for precise zero adjustment. The 3420B operates from ac line power, or internal rechargeable batteries for those measurements where you want complete isolation from power line ground.

Circuit loading error is essentially eliminated with the $>10^{11}\Omega$ at null input resistance on the 1 V and 10 V ranges.



The 3420B gives you the convenience of four ratio ranges — the widest ratio range available on a dc differential voltmeter! Use the ratiometer for dc/dc voltage ratio measurements, resistive divider ratio measurements and dc voltage measurements normalized to engineering units.

Find out about the most accurate dc voltmeter. Check your Hewlett-Packard Instrumentation Catalog. Or, call your nearest hp field engineer or write to Hewlett-Packard, Palo Alto, California 94304. In Europe: 54 Route des Acacias, Geneva. Price: hp 3420B, \$1450; hp 3420A (ac line operation only), \$1300.

HEWLETT  PACKARD

ANALOG VOLTMETERS

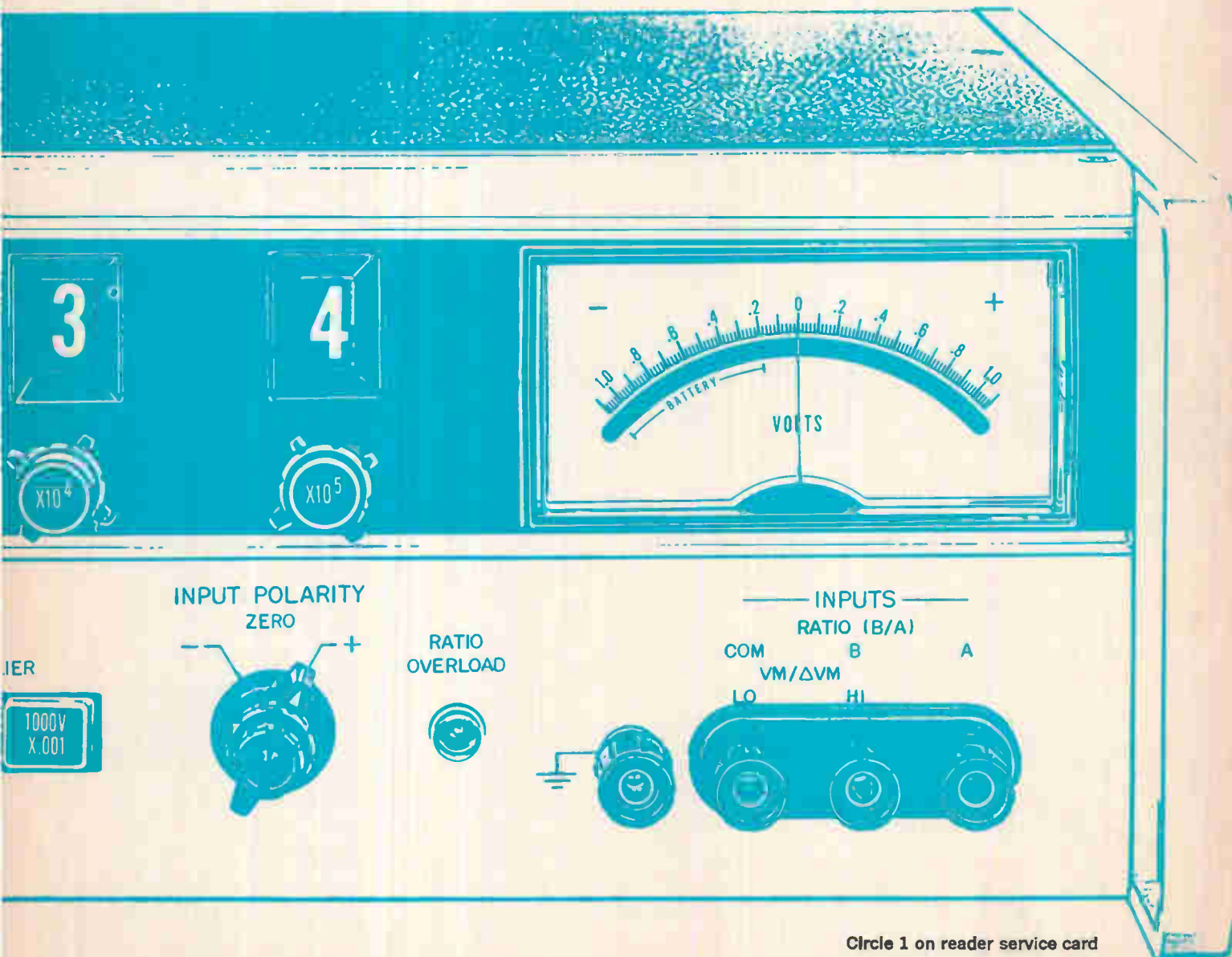

Circle 1 on reader service card

There's a new sweeping Sig Gen in the 100 kHz to 110 MHz league.

It's a powerful switch-hitter.

Digital frequency dialing accurate to 1% of frequency.

0.01% calibration check at 5 MHz intervals.

Sweep speeds and triggering versatility for all applications.

Monitor frequency to 110 MHz with low-cost 10 MHz counter—HP 5321.

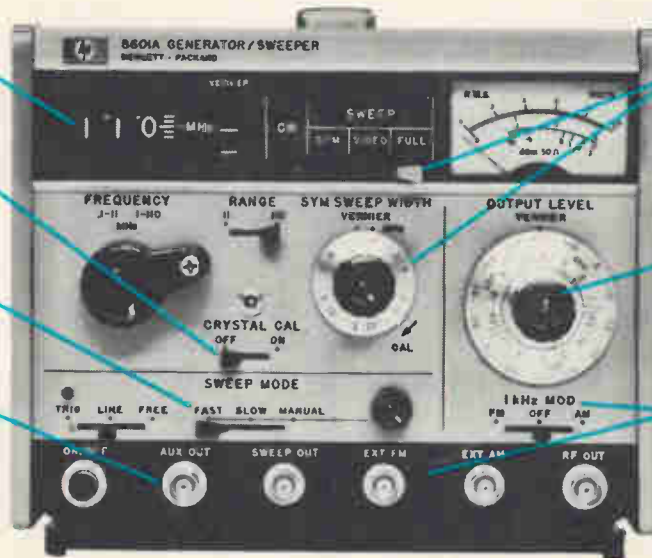

3 sweep functions—full, video, symmetrical—go from broad to narrow sweep with the flick of a switch.

± 1 dB output accuracy from 13 dBm to -110 dBm.

AM/FM modulation — internal, 30% AM and 75 kHz deviation FM.

Here's a combination signal generator/sweeper that'll go to bat for you in all types of lab and production work. Get 2-in-1 instrument performance in a small, lightweight package.

You can make fast, accurate swept measurements with the HP 8601A. With 0.5% sweep linearity and 1% frequency accuracy, it's so precise you don't even need markers. Flatness is ± 0.25 dB over the

full range from .1 to 110 MHz. It doubles as a signal generator with clean, calibrated output and modulation flexibility.

Put this All-Star to work for you—\$1975. Call your HP field engineer for complete information, or write Hewlett-Packard, Palo Alto, Calif. 94304; Europe: 54 Route des Acacias, Geneva.

HEWLETT  PACKARD

SWEEP SIGNAL GENERATORS

Circle 2 on reader service card

04810

News Features

Probing the News

- 133 Space electronics: Comsat labs to share new home
139 Politics: Election issues for electronics

Electronics Review

- 49 Integrated electronics: Toward MOS memories; Pi-substrate MOS; IBM going monolithic?
51 Displays: Now you see it
52 Consumer electronics: Radiation danger
52 Military electronics: Lining up
54 Instrumentation: Probing study
56 Advanced technology: Micron-size transistors
58 Patents: 'No' on software
58 Manufacturing: Down with gold
60 For the record

Electronics International

- 203 West Germany: Prontor puts IC into camera shutter; piezoelectric drive mechanism for a clock
204 Japan: U.S., Japanese come up with same self-isolation idea; IBM program-control and data system for tv, radio network
206 Around the world

New Products

- 149 Curve tracer displays scale, beta
153 Document reader ignores smudges
157 Components review
157 Shift register covers wide range
160 Readout tube's sections fluoresce
165 Instruments review
165 Flowmeter uses magnetic resonance
169 Microwave review
169 Impatt noise, price curves dip
175 Semiconductor review
175 TTL pair replaces four 14-lead IC's

Technical Articles

Integrated electronics 82

IC Processing: Healthy and still growing
An expert predicts further improvements in semiconductor technology even though most of the fabrication steps are well under control
Thomas A. Longo, Transitron Electronic Corp.

Circuit design 90

Designer's casebook
▪ Bootstrapping bias supply increases IC voltage capacity
▪ Wider frequency range for relaxation oscillator
▪ Reed switches form a nonmechanical lock

Design theory 93

No need to juggle equations to find line reflections—just draw three lines
A graphic technique that works with both linear and nonlinear loads determines transmission-line values
Robert S. Singleton, RCA

Computers 103

Special report: Memory technology

- 105 **Memories: practice and promise**
Wallace B. Riley, computers editor
106 **Staying ahead of the game**
Roy H. Norman, Ampex Corp.
109 **Scant room for improvement**
Dana W. Moore, Honeywell Inc.
112 **Smaller cores, bigger challenge**
John L. Turnbull and John J. Kureck
Ferroxcube Corp.
115 **Lower costs for longer words**
Albert M. Bates, Burroughs Corp.

Departments

- | | | | |
|----|--------------------------|-----|--------------------------|
| 4 | Readers Comment | 33 | Electronics Newsletter |
| 8 | Who's Who in this issue | 69 | Washington Newsletter |
| 14 | Who's Who in electronics | 180 | New Books |
| 22 | Meetings | 186 | Technical Abstracts |
| 31 | Editorial Comment | 192 | New Literature |
| | 201 | | International Newsletter |

Electronics

Editor-in-Chief: Donald Christiansen

Associate managing editors

Technical: Stephen E. Scrupski
News: Robert Henkel
Copy: Sally Powell

Senior associate editors

Joseph Mittleman, Harry R. Karp

Department editors

Avionics & Space: Alfred Rosenblatt
Computers: Wallace B. Riley
Communications: William Bucci
Components: George Watson
Consumer electronics: John D. Drummond
Design theory: Joseph Mittleman
Industrial electronics: Harry R. Karp
Military electronics: Richard Gundlach

Domestic bureaus

Boston: James Brinton, manager
Chicago: Frederick Corey, manager
Los Angeles: Lawrence Curran, manager; Burton Bell
New York: Howard Wolff, manager
San Francisco: Walter Barney, manager; Peter Vogel
Washington: Robert Skole, manager; Paul Dickson, William F. Arnold

Foreign bureaus

Bonn: John Gosch
London: Michael Payne
Tokyo: Charles Cohen

Copy editors

James Chang, Larry Miller

Graphic design

Art director: Gerald Ferguson
Assistant art directors: Valerie Betz, Susan Hurlburt
Production editor: Arthur C. Miller

Editorial research: Kay Fontana

Editorial secretaries: Lorraine Longo, Claire Goodlin,
Patricia Gardner, Barbara Razulis

McGraw-Hill News Service

Director: Arthur L. Moore; Atlanta: Fran Ridgway; Chicago: Robert E. Lee
Cleveland: Arthur Zimmerman; Dallas: Marvin Reid
Detroit: James Wargo; Houston: Barbara LaRoux
Los Angeles: Michael Murphy; Pittsburgh: Louis Gomolak
San Francisco: Margaret Drossel
Seattle: Ray Bloomberg; Washington: Charles Gardner, Daniel B. Moskowitz,
Herbert W. Cheshire, Seth Payne, Warren Burkett, William Small, William D. Hickman

McGraw-Hill World News Service

Bonn: Robert Dorang; Brussels: James Smith; Hong Kong: Wes Perry;
London: John Shinn; Mexico City: Gerald Parkinson; Milan: Ronald Taggiasco, Jack Star;
Moscow: Jack Winkler; Paris: Robert E. Farrell, Stewart Toy
Rio de Janeiro: Leslie Warren; Tokyo: Marvin Petal

Reprints: Susan Nugent

Circulation: Isaaca Slegel

Publisher: Gordon Jones

Electronics: October 28, 1968, Vol. 41, No. 22

Published every other Monday by McGraw-Hill, Inc. Founder: James H. McGraw 1860-1948.

Publication office 99 North Broadway, Albany, N.Y. 12202; second class postage paid at Albany, N.Y.

Executive, editorial, circulation and advertising addresses: McGraw-Hill Building, 330 W. 42nd Street
New York, N.Y. 10036. Telephone (212) 971-3333, Teletype TWX N.Y. 710-581-4235. Cable address:
MCGRAWHILL N.Y.

Subscriptions solicited only from those professionally engaged in electronics technology. Subscription rates:
qualified subscribers in the United States and possessions and Canada, \$8.00 one year, \$12.00 two years,
\$16.00 three years; all other countries \$25.00 one year. Non-qualified subscribers in the U.S. and
possessions and Canada, \$25.00 one year; all other countries \$50.00. Air freight service to Japan \$50.00
one year. Single copies: United States and possessions and Canada, \$1.00; all other countries, \$1.75.

Officers of McGraw-Hill Publications: Joseph H. Allen, President; J. Elton Tuohig, Executive Vice President;
David J. McGrath, Senior Vice President-Operations; Vice Presidents: John R. Callahan, Editorial; Paul F. Cowie,
Circulation; John R. Emery, Administration; John M. Holden, Marketing; David G. Jensen, Manufacturing;
Jerome D. Luntz, Planning & Development; Robert M. Wilhelmy, Controller.

Officers of the Corporation: Shelton Fisher, President and Chief Executive Officer; John L. McGraw, Chairman;
Robert E. Slaughter, Executive Vice President; Daniel F. Crowley, Donald C. McGraw, Jr., Bayard E. Sawyer, Senior
Vice Presidents; John J. Cooke, Vice President & Secretary; Gordon W. McKinley, Vice President & Treasurer.

Title © registered in U.S. Patent Office; © Copyright 1968 by McGraw-Hill, Inc. All rights reserved. The contents
of this publication may not be reproduced either in whole or in part without the consent of copyright owner.

Subscribers: The publisher, upon written request to our New York office from any subscriber,
agrees to refund that part of the subscription price applying to copies not yet mailed.
Please send change of address notices or complaints to Fulfillment Manager; subscription
orders to Circulation Manager, Electronics at address below. Change of address notices
should provide old as well as new address, including postal zip code number. If possible,
attach address label from recent issue. Allow one month for change to become effective.

Postmaster: Please send form 3579 to Fulfillment Manager, Electronics,
P.O. Box 430, Hightstown, New Jersey 08520

Readers Comment

Splatter and squelch

To the Editor:

I was interested to read the letter from Peter Laakmann [Sept. 2, p. 5] pleading again the case for single-sideband communications in the mobile services. His enthusiasm for ssb has, I am afraid, blinded him to its technical difficulties in this service. Let me grant him all the claimed advantages, and address myself immediately to two problems he has not mentioned.

The first, and probably most important, is adjacent channel splatter. It is unfortunately beyond today's state of the art to confine the energy of a single-sideband signal to its own channel to the degree required in mobile radio systems. In such systems, a vehicle receiving on one channel may be cruising in the immediate vicinity of a base station transmitting on an adjacent channel. Assuming the receiver is selective enough to reject all off-channel energy, it is still true that a large amount of power will fall into the receiver.

The second problem in single-sideband links is provision of a suitable squelch. Tone squelch is popular in mobile radio. In such systems, a low-level tone is transmitted either above or below the voice frequency band. A comparable technique can be used with ssb, but now some of the advantages of ssb, especially the reduction of intermodulation, no longer apply since a "carrier" is present.

I think the sharp threshold effect of f-m is highly desirable and would be necessary in any operational system. For essential communications, such as public-safety work, it is not sensible to ask every patrolman or fireman to be a trained listener, ferreting the signal from the noise.

Let me conclude by agreeing that much better use of the spectrum is needed. There are several ways of accomplishing this. Changes must be made in both the law (i.e., frequency-allocation philosophy) and technology.

The recent JTAC study points the way. But much bolder, more imaginative approaches are needed.

Add Sprague Series 7400A to your prints for Series 74N TTL circuits. They're pin-for-pin identical.



SERIES 74N	FUNCTION	SPRAGUE PART NO.
SN7400N	Quad 2-Input NAND	USN-7400A
SN7401N	Quad 2-Input NAND (No Collector Load)	USN-7401A
SN7402N	Quad 2-Input NOR	USN-7402A
SN7410N	Triple 3-Input NAND	USN-7410A
SN7420N	Dual 4-Input NAND	USN-7420A
SN7430N	Single 8-Input NAND	USN-7430A
SN7440N	Dual 4-Input NAND Buffer	USN-7440A
SN7450N	2-Wide 2-Input Expandable AND-OR-INVERT	USN-7450A
SN7451N	2-Wide 2-Input AND-OR-INVERT	USN-7451A
SN7453N	4-Wide 2-Input Expandable AND-OR-INVERT	USN-7453A
SN7454N	4-Wide 2-Input AND-OR-INVERT	USN-7454A
SN7460N	Dual 4-Input Expander	USN-7460A
SN7470N	D-C Clocked J-K Flip Flop	USN-7470A
SN7472N	J-K Master Slave Flip Flop	USN-7472A
	Dual J-K Master Slave Flip Flop:	
SN7473N	Single chip, pin 11 GND	USN-7473A
—	Single chip, pin 7 GND	USN-74107A
SN7474N	Dual D-Type Edge-Triggered Flip Flop	USN-7474A
—	Dual AC Clocked J-K Flip Flop	USN-7479A
COMPLEX ARRAYS		
SN7441N	BCD-To-Decimal Decoder/Driver	USN-7441B
SN7475N	Quadruple Bistable Latch	USN-7475B
SN7480N	Gated Full Adder	USN-7480A
SN7482N	2-Bit Binary Adder	USN-7482A
SN7483N	4-Bit Binary Adder	USN-7483B
SN7490N	Decade Counter	USN-7490A
SN7491AN	8-Bit Shift Register	USN-7491A
SN7492N	Divide-By-Twelve Counter	USN-7492A
SN7493N	4-Bit Binary Counter	USN-7493A

For complete technical data on Series 5400 and 7400A circuits, write to Technical Literature Service, Sprague Electric Co., 35 Marshall St., North Adams, Mass. 01247

SPRAGUE WORCESTER...the world's finest microcircuit facility



Sprague and *®* are registered trademarks of the Sprague Electric Co.

A little something to look for when you're buying a power supply:

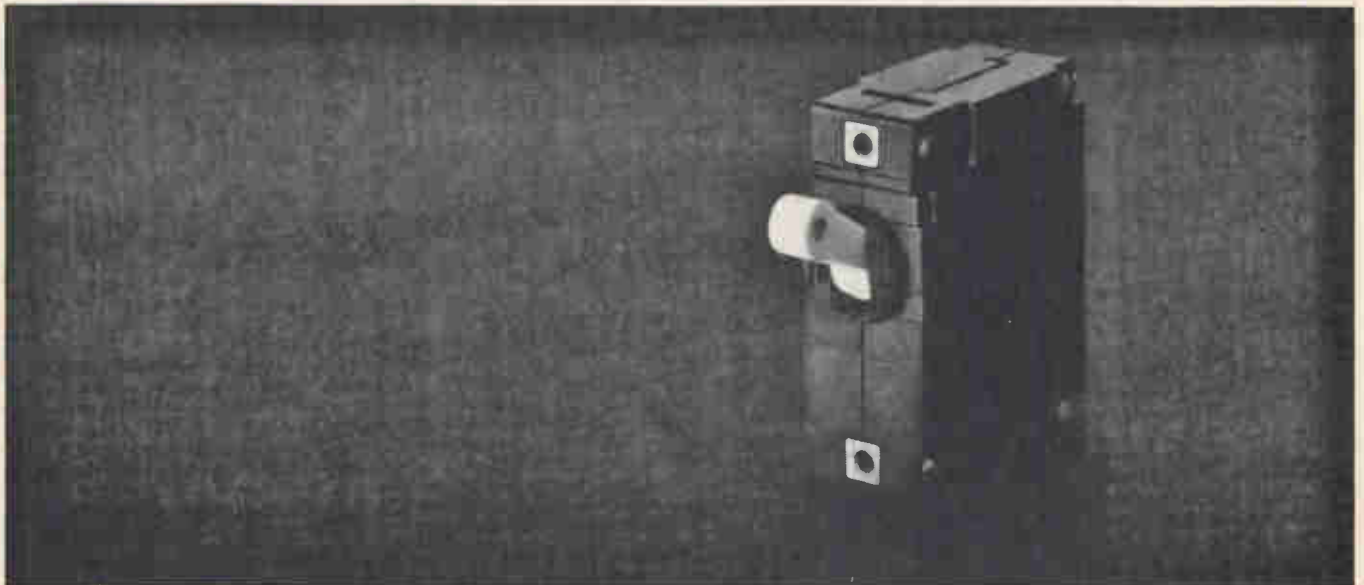

A Heinemann circuit breaker.

If you find one on the instrument panel, it's a safe bet you're looking at high-performance equipment.

(When a manufacturer uses a Heinemann breaker, he's traveling the premium-component route. There are many cheaper alternatives that will do almost the same job.)

It's also safe to assume you'll get long-term service without lots of servicing.

(The protection of a Heinemann breaker is probably the ultimate in precision. The breaker's nominal current rating is precisely calibrated and temperature-stable. Overload response characteristics are controlled to precise

tolerances. Even the toggle mechanism is made better than it has any right to be.)

In fact, the equipment may come with a longer warranty than you'd expect. (Heinemann breakers, themselves, are warranted for five years.)

All this is not to suggest that Heinemann protection should be a primary consideration in choosing a power supply. But if one unit has it and the other doesn't, all else being equal, the choice would seem to be clear enough.

Heinemann Electric Company, 2600 Brunswick Pike, Trenton, New Jersey 08602.

HEINEMANN 

4131

NEW O.E.M.

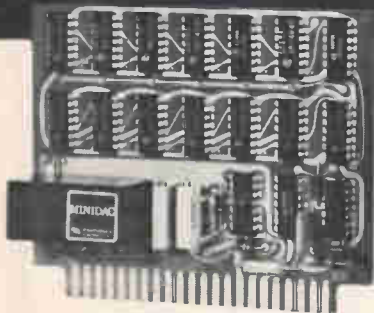

3 3/4" x 4 1/2" x 1/2"

A-to-D Converter

Pastoriza offers the first utility converter for systems applications . . . priced for quantity sales.

Having first introduced the modular A-to-D and D-to-A converter, Pastoriza Electronics now offers an unprecedented innovation: A printed circuit card A-to-D converter featuring . . .

High Performance

- 12 bits conversion in 8 microseconds.
- 10 bits conversion in 4 microseconds.
- 8 bits conversion in 2 microseconds.

Low Cost

Priced competitively with any ADC available today, and designed for volume production.

Open Book Concept

No black magic in the design — circuitry is accessible and repairable.

User Confidence

Design and component information is supplied to insure ease and confidence in customer application.

This complete single-card A-to-D converter includes reference supply and comparison amplifier, using dual in-line integrated circuit logic with a MINIDAC D-to-A module. It accepts 0 to +10 volts input range, and provides up to 12 bits resolution.

Write for eye-opening facts on this newest modular A-to-D utility converter.

 **PASTORIZA**
ELECTRONICS, INC.

385 Elliot St., Newton, Mass. 02164 • 617-332-2131

Who's Who in this issue



Singleton

Keeping abreast of his field can sometimes be a problem for a busy engineer, but Robert S. Singleton has found a neat solution. Singleton, author of the article on page 93 describing an easy way to solve for transmission-line reflections, spends part of the time away from his RCA job as an adjunct professor of electrical engineering at the University of Florida's Graduate Center.

At RCA, Singleton has been working on computer-aided design involving transmission lines. He worked previously for Bell Labs and the Martin Co. Singleton got his BSEE from the University of Florida and his MSEE from New York University.



Longo

Theoretical understanding isn't often associated with manufacturing know-how, but that's the combination of talents that Thomas A. Longo has brought to bear on the semiconductor industry. Longo, who sizes up the integrated-circuit processing technology in the article on page 82, has been vice president and general manager of semiconductor operations for Transitron Electronic Corp. since 1964. However, he started his career in a scholarly atmosphere. After he got his Ph.D. in solid state physics from Purdue, he

stayed at the university to do research on solid state phenomena—radiation damage, transport effects, and surface effects.

He began consulting for General Telephone Laboratories in 1957 and established a semiconductor laboratory for the company. Eventually he became a full-time employee, and when Sylvania was taken over by General Telephone, he managed research on advanced devices. An advocate of transistor-transistor logic, Longo influenced Sylvania, and later Transitron, to concentrate on TTL in their IC production.



Moore

After getting his BSEE from Union College and his MSEE from Carnegie Mellon University, Dana Moore, author of the article on core memories on page 109, went to work for the Burroughs Corp.'s research division. He then joined the Computer Control Corp. (which was acquired by Honeywell in 1966) as a development engineer.

Now memory systems inspection manager at Ampex, Roy Norman wrote the review of core memories on page 106. Norman received his BSEE in England in 1962 and has been with Ampex since 1963 (except for six months with Scientific Data Systems), where he has worked on the design of mass core memories and plated-wire systems.

Before joining Ferroxcube in 1965, John Turnbull worked for the Burroughs Corp. on core technology. He is now Ferroxcube's marketing manager for recording heads. John Kureck, co-author with Turnbull of the article on ferrite materials on page 112, received his BS degree in physics from Manhattan College in 1961. Joining Ferroxcube in 1963 as a development engineer working with memory cores, he is now operations manager for memory elements.

The article on planar thin films on page 115 was written by Albert Bates, manager of the magnetics and thin-film development department at the Burroughs Corp. He holds a BSEE from Drexel.

Now from Sprague!



All the advantages of tantalum in one **LOW COST** capacitor!

EPOXY-DIPPED TANTALEX® CAPACITORS . . .

For industrial, commercial, and entertainment electronic applications where tantalum capacitors were previously too expensive!

⊖ Type 196D Solid-electrolyte Tantalum Capacitors have special epoxy-dip coating which keeps costs down without sacrifice in dependability. Positively seals capacitor section while providing excellent electrical insulation. Protects against mechanical damage in handling.

⊖ Radial lead design for plug-in mounting on printed wiring boards. The .250" lead spacing will fit standard .125" grids.

⊖ High stability—very little capacitance change, even at outer limits of operating temperature range.

⊖ Low dissipation factor of these capacitors permits higher ripple currents.

⊖ Meet environmental test conditions of Military Specification MIL-C-26655B.

⊖ Prime capacitance and voltage ratings. Based on rating popularity of other types of solid tantalum capacitors.

⊖ Designed for continuous operation at temperatures from -55 C to +85 C.

For complete technical data, write for Engineering Bulletin 3545 to Technical Literature Service, Sprague Electric Company, 35 Marshall Street, North Adams, Massachusetts 01247.

Now available for fast delivery
from your Sprague Industrial Distributor

SPRAGUE COMPONENTS

CAPACITORS
TRANSISTORS
RESISTORS
INTEGRATED CIRCUITS
THIN-FILM MICROCIRCUITS
INTERFERENCE FILTERS

PACKAGED COMPONENT ASSEMBLIES
FUNCTIONAL DIGITAL CIRCUITS
MAGNETIC COMPONENTS
PULSE TRANSFORMERS
CERAMIC-BASE PRINTED NETWORKS
PULSE-FORMING NETWORKS

SPRAGUE®
THE MARK OF RELIABILITY

Sprague® and ® are registered trademarks of the Sprague Electric Co.



Interchangeability

Here's IRC's new $\frac{1}{8}$ -watt thick-film resistor. Its form factor—body size and 1" x .016" leads—conforms to all existing standard MIL sizes. This gives you total standardization and complete size interchangeability with all present MIL types with similar body geometry, including the proposed RLR05 style of MIL-R-39017.

It also gives you many other unmatched advantages:

STABILITY that results from IRC's newest generation Metal Glaze element. Tin oxide types can't match it under overload or high-temperature conditions.

COOLER OPERATION that was *designed* in. Runs cooler than tin oxide resistors with larger leads.

CRAZE RESISTANT BODY that withstands the pounding of automatic inserting machines. No field failures due to cracking or crazing. Resists solvents and corrosion, too.

PACKAGED FOR AUTOMATION. Lead tape reels are available to cut your assembly costs.

AVAILABILITY. No delays. Order your samples now.

New IRC RG05 resistors offer the best approach



Actual Size—
MIL-R-11 1/8-watt size
MIL-R-10509 1/8-watt size
MIL-R-39017 1/8-watt size

to standardization, design freedom, stability, and reliability. For complete data and sample, write IRC, 401 N. Broad Street, Philadelphia, Pa. 19108.

CAPSULE SPECIFICATIONS

Body Size	.150" x .063" dia.
Lead Size	1" x .016" dia.
Power	1/8-Watt @ 70 C.
Tolerances	±2% and ±5%
Temp. Coeff.	±200ppm/°C.
Resistance	10Ω to 30K
IRC Type	RG05



Division of TRW Inc.

A new concept in Logic/Memory Technology

COS/MOS

integrated circuits

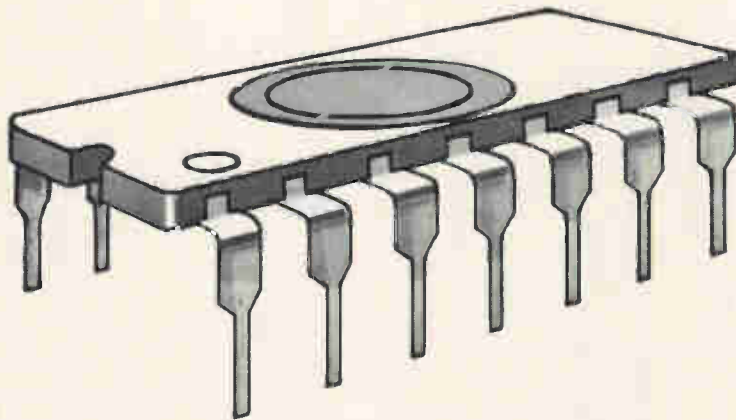

RCA COS/MOS integrated circuit in ceramic dual-in-line package

COS/MOS is a totally new integrated circuit technology based on RCA's proven capability of fabricating both N- and P-Channel MOS transistors on the same substrate. This RCA processing breakthrough has made possible the creation of a family of unique integrated circuits utilizing complementary symmetry circuit configurations which encompass both logic and memory.

COS/MOS offers a combination of features unapproached by any other monolithic circuits. COS/MOS now makes possible dramatic innovations in digital equipment design and performance that perceptive manufacturers will want to investigate immediately. COS/MOS circuitry offers opportunities for significant reductions in power consumption which can provide solutions to heat dissipation problems of compact designs or promote the conversion of line connected equipment to portable, battery-operated versions. For operation in electrically noisy environments, the extremely high noise margin of COS/MOS circuits, coupled with wide logic level swings, will provide new measures of design freedom. For users of

single-channel MOS circuitry, COS/MOS offers the advantages of operation from a single wide-range power supply, single clock operation from DC to the megahertz range, and compatible gates and flip-flops that interface directly with MSI logic and memory circuits. In addition, COS/MOS technology offers excellent cost and space saving potential by virtue of its adaptability to MSI and LSI (RCA LSI circuits now in development have many hundreds of transistors on a chip).

Any *one* of these COS/MOS features may now make practical some performance improvement or product enhancement that will give your equipment that competitive edge:

- Nanowatt quiescent power dissipation
- Single 10-volt wide tolerance power supply
- 10-volt logic swing
- 4 volts noise margin
- Fanouts up to 50
- Compatible gates/flip flops/MSI logic/MSI memory
- -55°C to $+125^{\circ}\text{C}$ operation

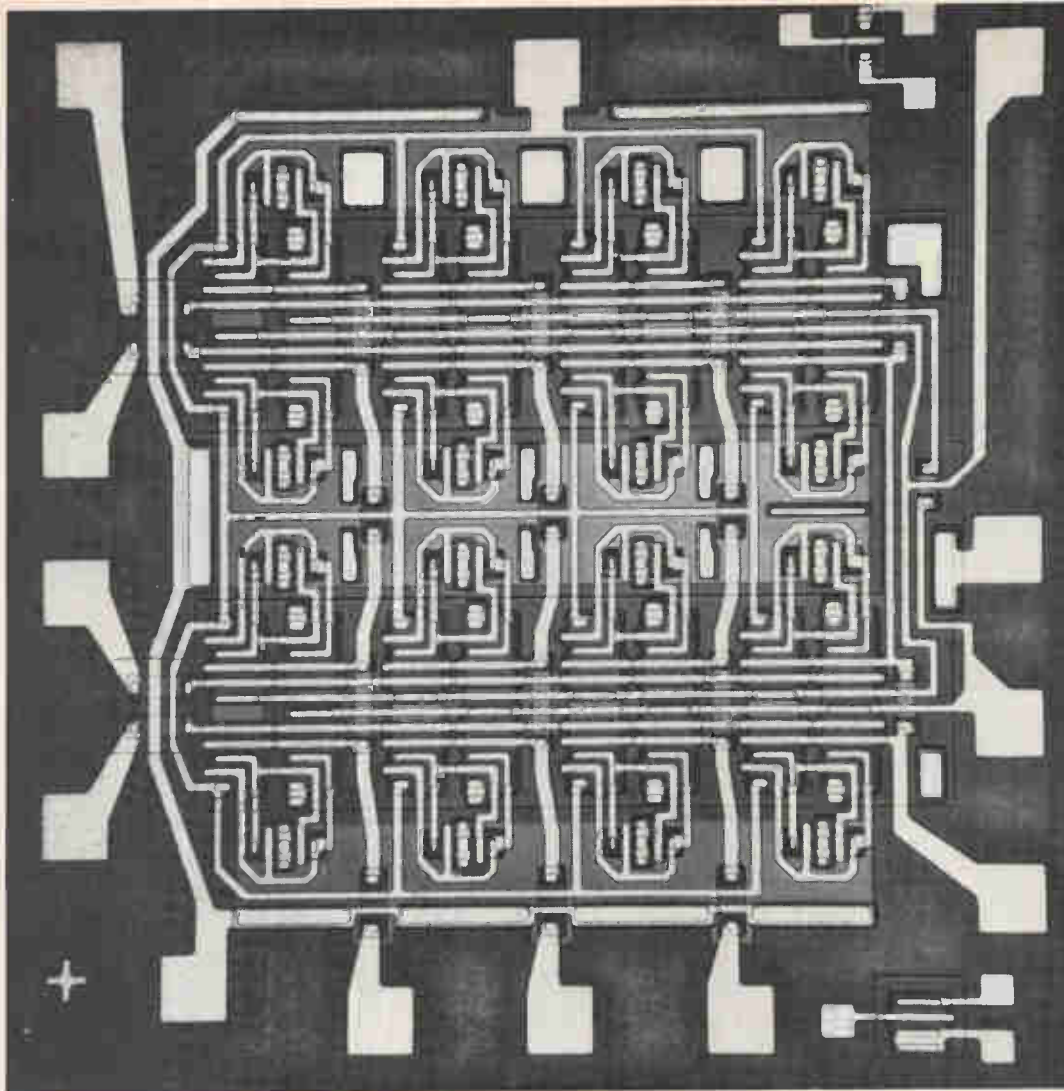

RCA-CD4005D, 16-bit NDRO COS/MOS Memory

Seven COS/MOS types now available

RCA COS/MOS Type No.	Pkg.	Circuit Function	Price 1-99 Units	Price 1000 Units
CD4000D	DIC	Dual 3-Input NOR Gate plus Inverter	\$13.05	\$ 9.00
CD4001D	DIC	Quad 2-Input NOR Gate	\$13.05	\$ 9.00
CD4002D	DIC	Dual 4-Input NOR Gate	\$14.50	\$10.00
CD4003D	DIC	Dual "D" Type Flip Flop	\$20.30	\$14.00
CD4004T	TO-5	7-Stage Binary Counter/ Frequency Divider	\$31.90	\$22.00
CD4005D	DIC	16-Bit NDRO Memory	\$23.20	\$16.00
CD4007D	DIC	Dual Complementary Transistor Pair plus Inverter	\$ 9.90	\$ 6.00

(These types are also available in ceramic flat pack at slightly higher prices.)

For further information, contact your RCA Representative, or check with your RCA Distributor for his price and delivery. For technical information and application note, write RCA Electronic Components, Commercial Engineering, Sec. IC-N-10-2, Harrison, N. J. 07029.

RCA Integrated Circuits

IN JUST

3
DAYS

ACOPIAN WILL SHIP ANY
OF 62,000 DIFFERENT
POWER SUPPLIES

This catalog lists 62,000 models of AC to DC plug-in power supplies available for shipment in just three days. Choose the exact outputs you need. Singles or duals, regulated or unregulated. Write or phone for your free copy.



Name _____
Title _____
Company _____
City _____
State _____ Zip _____

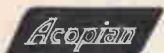

Acopian Corp., Easton, Penna. 18042
Phone: (215) 258-5441

Who's Who in electronics



Webster

"Beam-lead technology is going to be pushed hard here," says William Webster the new head of research at RCA Laboratories. "It looks like the most promising bonding technique, especially with MOS devices." Webster, 43 years old, explains that much of RCA's beam-lead work has been handled at the Electronic Components division in Somerville, N.J., but that "the work is so complex and sophisticated that we've been called in to help out."

He also notes that the labs are currently engaged in an extensive materials search, particularly in the area of electroluminescence. Both Webster and the man who replaced him as head of the labs' materials and devices section, Fred Rosi, feel that the II-VI and III-V classes of materials hold out the most promise in this field. Rosi, 46, says the labs are working to combine certain III-V compounds, which make for good p-n junctions, with the II-VI's, which have high electroluminescent efficiency, to get what he calls a solid solution alloy, such as gallium arsenide zinc selenide.

No boundaries. "Just as basic research and applied research tend to blend, materials and devices are no longer separate areas," says Rosi, who is now working interchanges between some of his materials personnel and device and processing people.

Like other research facilities, RCA labs continue to give a lot of attention to silicon, and especially to



Rosi

growing silicon epitaxially at low temperatures to avoid bulk diffusion of impurities. Rosi reports that his staff can grow the structures at 800°C, about 300° below the industry average.

As for another area of interest, liquid crystals, Webster says RCA sees them functioning as numeric indicators but must gain a better understanding of them before this expectation is realized. "We have yet to fully predict the effects of impurities in these substances, and we have to get a better confirmation of lifetimes." So far, he adds, the labs have gotten about 3,000 hours out of the crystals.

Large-scale integration, luminescent materials for displays, and new electronic switching techniques for telephone systems—these areas are due for greater

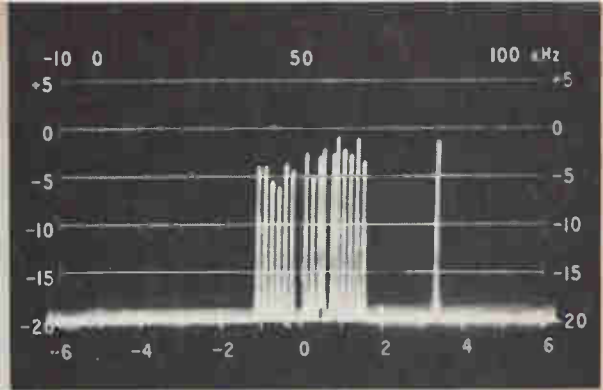

Three 4-kHz channels of L3 carrier multiplex system. Center channel has teletype subcarriers. Model 360A is in 12-kHz sweep width mode, sweeping from 6.780 to 6.792 MHz.



Switch-selected meter modes, normal or expanded scale, provide level measurement resolution of 0.05 dB. Signal generator level increments as fine as 0.01 dB can be readily resolved.

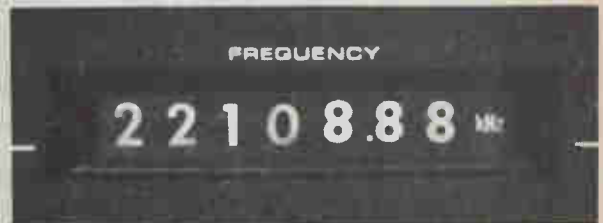

Frequency resolution to nearest 10 Hz in phase-locked tuning mode is displayed on flat-plane, high-brightness readouts. Alternative continuous tuning mode presents frequency resolved to nearest 100 kHz.

A Communications System Test Set (VLF to HF)...

From Sierra comes the most thoroughly human-engineered instrument for HF-radio and telephone-carrier applications in today's knob- and meter-ridden world: The Model 305/360 Communications System Test Set.

Model 305/360 gives you ultra-bright, unambiguous electronic digital readouts of frequency. Built-in counter automatically totals outputs of both the coarse and fine tuning oscillators, reads out tuned frequency with 10-Hz resolution. Attenuator levels appear in three-digit displays, with unique logic and switching circuits combining the levels of the 10-dB and 1-dB per step attenuators. Rear-projection meters with luminous pointers permit parallax-free viewing from any angle with easy resolution of fine-level increments.

Performance features include phase-locked tuning circuits, a single continuous tuning range covering voice frequencies through 32 MHz, and selective bandwidths of 250 and 3100 Hz. You can resolve signals separated by as little as 35-Hz.

Model 305/360 does everything humanly possible to keep foibles from fouling your readings. For the brochure, write Sierra, 3885 Bohannon Drive, Menlo Park, California 94025.

*Average to Very Bright

engineered for humans (A to VB*)



PHILCO-FORD CORPORATION
Sierra Electronic Operation
Menlo Park, California • 94025

Circle 15 on reader service card

Don't be dazzled by competitive claims; LOGICATOR is the *only* computer logic indicator with constant readability under all ambient light conditions. This modular display unit combines the advantages of a printed drum with an exclusive *back-lighting* feature . . . ideal for airborne instrumentation display . . . less than 1 watt of logic power required. LOGICATOR provides direct readout of any digital computer level voltages, eliminating the need for mechanical drives, servos, and

D-A converters. Modular design allows assembly of multi-digit displays of any number of 10 or 12-position drums. Units are designed to be compatible with the requirements of Mil-E-5400, Class 2. Additional features such as 1 million cycle minimum life expectancy, fast response time, time-sharing capability, and inherent magnetic memory, clearly indicate LOGICATOR's superiority. Isn't it logical that you should make a B-line* to Bowmar?

Gloom or glare, LOGICATOR® stands out when others fade out.

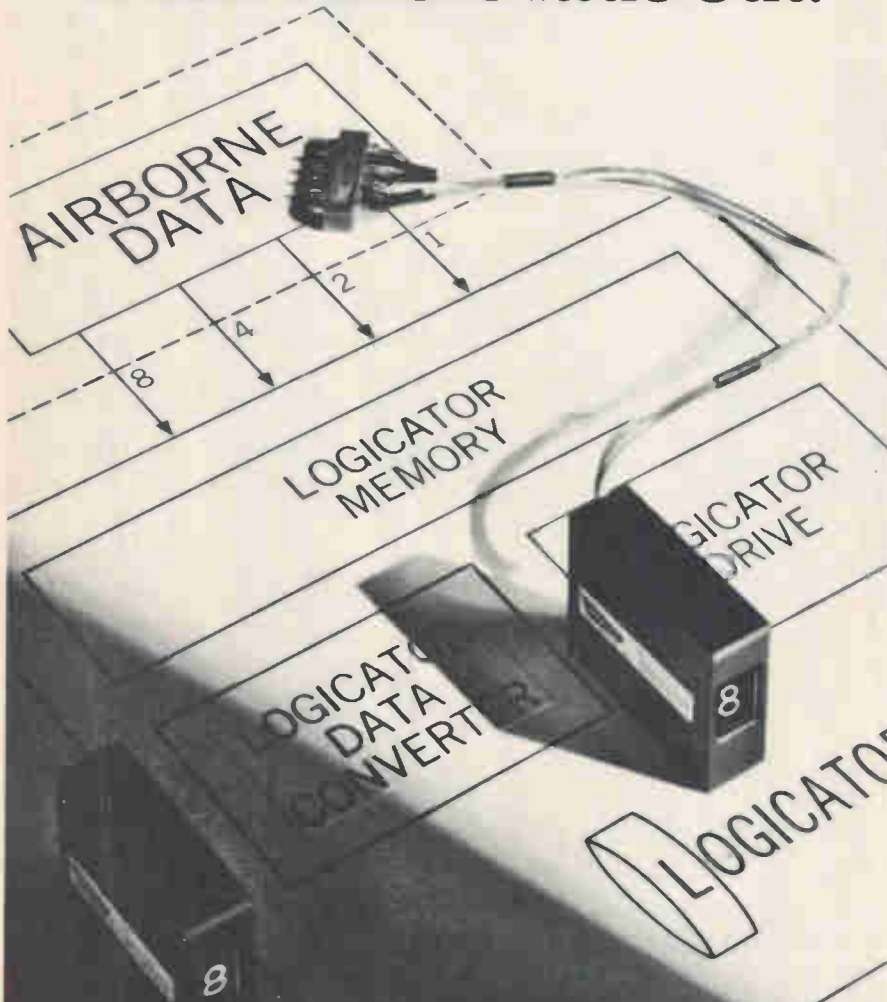

**The shortest
distance between
computer and display
is the Bowmar B-line***

*Call (219) 747-3121 for engineering assistance



INSTRUMENT CORPORATION
8000 BLUFFTON ROAD □ FORT WAYNE, INDIANA 46809

Who's Who in electronics



Ritt

emphasis at General Telephone & Electronics Laboratories now that Paul E. Ritt, 40, is director of research there.

In the past, the Bayside, N.Y., labs have concentrated on lasers, cathode-ray tubes, and advanced military research. But although work in these fields won't slacken, according to Ritt, "we will be doing more toward applying LSI technology to telephone switching systems, interfacing computers with communications, and developing organic materials to replace inorganic light-emitting substances."

Ritt, whose background is in materials, says: "I see no reason to doubt the possibility that organics can perform in much the same way as phosphors do now. Light-emitting characteristics are inherent in organic compounds, and the fact that you don't have to rely on the crystal symmetry of the compounds makes building your material easier."

Helping hand. The new director also stresses that the facility will take more of a systems approach to technological problems. "Although our main role is not to come up with marketable products, we do feel that we can help the divisions we serve, such as Sylvania, Lenkurt, and GT&E's telephone companies, by taking a systems view when we develop our black boxes."

The Straight Line

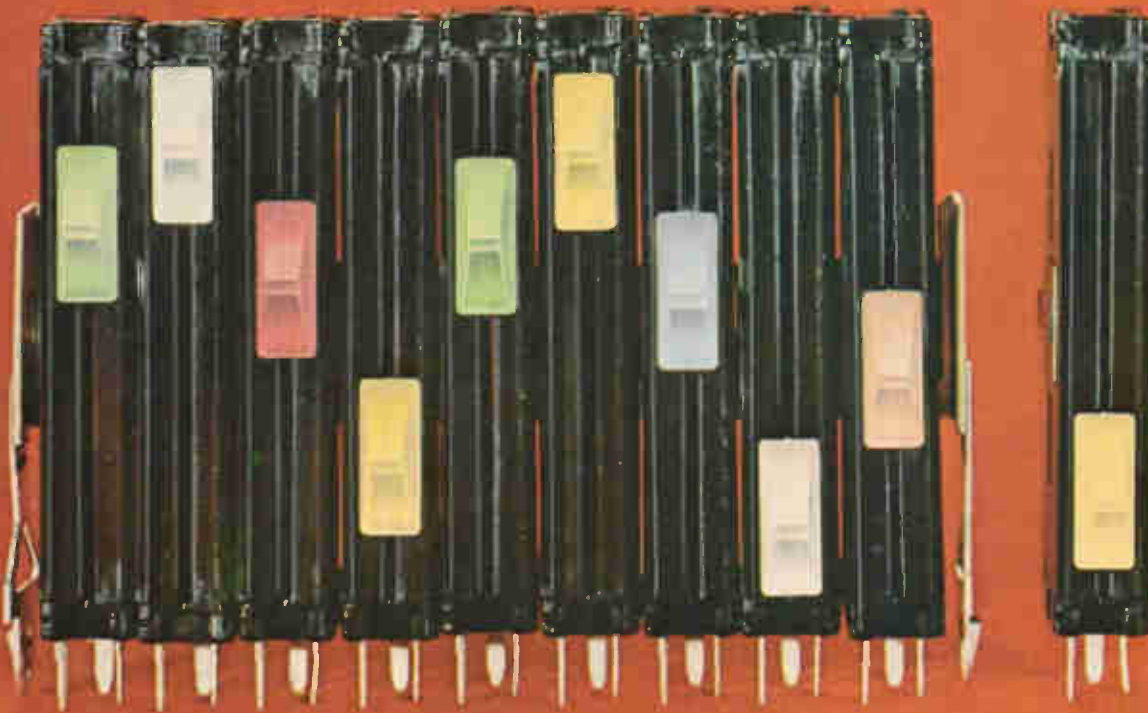

Covered under Patent No. 3,242,004 and others pending.

Functional new concept in Potentiometer design



Horizontal, vertical or side mounting available.



Multiple units lock and actuate with single knob.



Preliminary adjustment with template possible.



Needs only 1/3 mounting area of standard control.



Standard solder lug, wire-wrap or printed circuit terminals supplied.



Forward or rear facing twist-tab mountings. Snap-in mounts also available.

Variable resistors have been going in circles for years. Now Stackpole straightens them out. Using linear motion, Stackpole engineers created a potentiometer that conserves circuit board and panel space and offers a host of design advantages. Stackpole calls it SLIDE-TROL®. You'll call it ingenious! Utter simplicity, yet with all the quality and features of devices costing much more. SLIDE-TROL® is available in values of 40 ohms to 15 meg. ohms and since the element is rectangular and provides more area to dissipate heat, higher wattage ratings are possible. Phenolic housings eliminate shock hazards. Low noise and low contact resistance are assured by a patented 9-point movable spring contact. Only imagination limits the applications for SLIDE-TROL®. If you're looking for performance, economy and appeal in variable resistors, get the facts on SLIDE-TROL®. Write for samples and brochure: Stackpole Components Co., P. O. Box 14466 Raleigh, N. Carolina 27610. PH: 919-828-6201 TWX: 510-928-0520



STACKPOLE
COMPONENTS COMPANY

Also a leading producer of quality slide, rocker and rotary switches.

G/M COMPONENTS have proven to be superior in function and reliability of operation in thousands of military, space and commercial applications, including aircraft automatic flight control, guidance, weapon systems, fire control, missile and space vehicle flight and stabilization control, pressure-volume-temperature-control of bases and liquids.

They conform to MIL-T-27 and MIL-E-5400 specifications and provide a ready solution to problems involving solid state—integrated or micro circuit—analog computer design. Call or write for Bulletins.



GENERAL MAGNETICS - INC

135 BLOOMFIELD AVENUE
BLOOMFIELD, NEW JERSEY 07003
Telephone: (201) 743-2700

Analog Computing with Magnetic

NEW!

HIGH PRODUCT ACCURACY FROM -55°C TO $+100^{\circ}\text{C}$

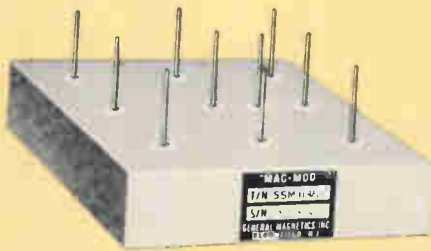

High Reliability DC x DC Analog Multiplier

- High accuracy over wide temperature range: -55°C to $+100^{\circ}\text{C}$
- Extremely low drift over temperature
- Product accuracy $(S1 \times S2) = (1\% \text{ of point } \pm 10 \text{ mv})$ or 0.5 of full scale, whichever is less over entire ambient temperature range
- Null: with both signals at zero = 2 mv max.
with one signal at $\pm 5 \text{ VDC} = 10 \text{ mv max.}$

This significant advance in solid state magnetics was especially engineered to meet increasingly critical aerospace, computer, weapon and guidance control, applications requiring maximum reliability. General Magnetics' type SSM 1138-2 Analog Multiplier provides limitless service life, high shock and vibration resistance and may be mounted directly on printed circuit cards. Write for Bulletin MM 112.

SPECIFICATIONS

- Input Resistance: 100 K ohms, both signal channels
- Four quadrant DC operation
- Frequency Response: 0 to 100 Hz
- Input: 0 to $\pm 5 \text{ VDC}$ to 100 Hz, both signals
- Output: 0 to $\pm 5 \text{ VDC} \pm 5\%$ into 10 K ohm load
- Power Requirements: $\pm 12 \text{ VDC}$

Circle 18 on reader service card

Magnetic Division Modules

ACCURACY OF 1% OR BETTER!

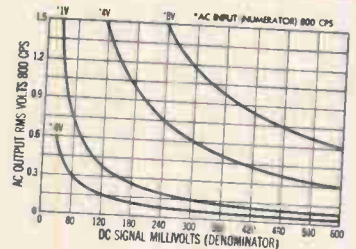

These Analog Division Modules employ a concept which eliminates high gain operational amplifiers and logarithmic circuitry used in electronic dividers. The result is fewer components, excellent stability, micro-miniature size, lower cost. The combination of magnetic and semiconductor circuitry results in analog division accuracy of 1% or better.

FEATURES:

Micro-miniature Size
Completely Solid State

Low Power Consumption
Wide Numerator and Denominator Ranges

REQUEST BULLETIN MM 110

NANO AMP LEVEL

Current Sensing Magnetic Modulator



This G/M extremely low level signal current magnetic modulator operates from 0 to $\pm 1 \mu\text{a}$ DC full scale with a frequency response of 0 to 100 cps minimum for a carrier excitation of 400 cycles. Excellent zero point, amplitude and phase angle stability with respect to line voltage, frequency and temperature range.

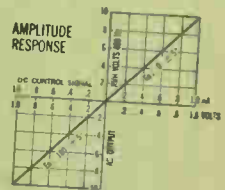

FEATURES:

Wide Frequency Response (over 100 cps)
0 to $\pm 1 \mu\text{a}$ DC Full Scale
Input
Input Resistance 1 Megohm

Drift: Less than 10 Nanoamps referred to Input Terminal
Complete Solid State Magnetic
Rugged, Unlimited Life

NEW!

Microblocks

Magnetic Demodulators

HIGH RELIABILITY - SMALL SIZE!

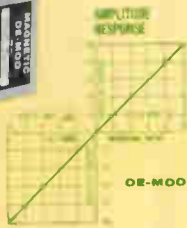

The new G/M Magnetic Demodulator is a solid state circuit for converting phase reversing AC signal voltages into phase detected polarity reversing DC voltages. The amplitude and polarity of the DC output are directly proportional to the phase and amplitude of the AC signal. High reference impedance results in very small reference power requirements.

FEATURES:

- Output as High as ± 10 V DC in Present Units
- Very Low DC Offset Null Voltages (As low as 0.1% of full scale)
- Operation Over Wide Environmental Conditions
- Completely Solid State - No Moving Parts

REQUEST BULLETIN MM 108

SOLID STATE MAGNETIC AC LINE REGULATOR

An entirely new technology is utilized, which completely eliminates tuned AC circuits; no bulky inductors or capacitors are employed to obtain a total AC line load and frequency regulation of 0.1%. The output is a clean sinusoidal wave form containing low harmonic distortion. These G/M line regulators are particularly applicable to flight instruments, and analog and digital computers where an accurate and stable AC reference source is required.

ELECTRICAL FEATURES:

- 0.1% total line load regulation
- Capable of handling $\pm 10\%$ line frequency variations without loss of regulation
- Output is a low distortion amplitude sinusoidal wave
- Efficient circuit design permits low power consumption
- Small size - lightweight - rugged
- Capability of operating at any center frequency to 50 KHz

TYPICAL APPLICATIONS:

MLR 1177-1



- Line Voltage: $115V \pm 20\%$
 $400 \text{ Hz} \pm 10\%$
- Output: $115V \pm 1\%$ 400 Hz (includes initial setting accuracy)
- Load: 5 watts
- Distortion: Less than 2%
- Regulation: $\pm 0.2\%$
- D.C. Power: $\pm 28 \text{ V DC}$

MLR 1176-1



- Line Voltage: $26V \pm 20\%$
 $400 \text{ Hz} \pm 10\%$
- Output: $26V \pm 1\%$ 400 Hz (includes initial setting accuracy)
- Load: 1 watt
- Distortion: Less than 2%
- Regulation: $\pm 0.1\%$
- D.C. Power: $\pm 15 \text{ V DC}$

REQUEST BULLETIN MM 111

$E_o = V \sin^2 \theta$ EQUATION SOLUTION ACCURACY - 2% fs



A micro magnetic multiplier and squaring block assembled with appropriate semiconductor-transfer gain to solve the indicated expression. Micro miniature, solid state microblock design features high accuracy, extremely stable operation through the application of micro magnetic stages in cascade circuitry.

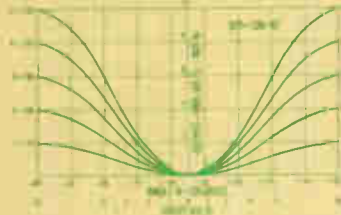

FEATURES:

- Operates over Wide Environmental Ranges
- Unlimited Life, Low Milliwatt Power Level
- Wide Frequency Range
- Wide Dynamic Computing Range

REQUEST DESCRIPTIVE LITERATURE

Micro "Mag Mods"® SINE WAVE OUTPUT, NO TUNED FILTERS!

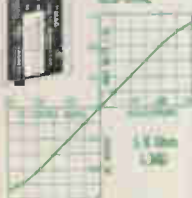

"MAG MODS"® provide four quadrant operation, extreme stability with negligible change of phase, gain and zero position over a wide temperature range. Design is simple, featherweight and rugged - with no semiconductors or moving parts to limit life. These Modulators are available in micro, miniaturized and standard sizes depending on requirements and feature an essentially drift-free, wide-band width circuit with superior phase and gain stability.

- Greatest Reliability, Unlimited Life
- Clean Sine Wave Output without Resonant Filtering

REQUEST BULLETIN MM 101X

Analog Voltage Multiplier



WORLD'S SMALLEST, MOST RELIABLE! REQUEST BULLETIN MM 109

VARIABLE AC CARRIER X VARIABLE DC SIGNAL

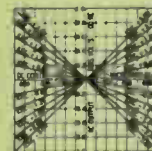

Available as small as 0.1 cubic inch and weighing as little as 0.1 ounce, Micro Magnetic Multipliers feature extreme stability with negligible change of product accuracy over wide temperature range, high shock and vibration proof. Band-width may be extended into the kilocycle range. Low milliwatt power consumption; four quadrant operation.

Product Accuracy of up to 0.5% of Full Scale, with very slight Derating over a Wide Temperature Range

Best connectors on

Blade-type connector. A rugged two-piece printed circuit connector that meets MIL-C-21097B. Tab housing of diallyl phthalate or phenolic is clinched and soldered to the daughter board. Receptacle contacts are crimp, snap-in type. Contact options include wrap posts or solder tabs.

Leaf-type connector. A one-piece connector for single or double-sided printed circuit boards. Snap-in leaf contacts lock in place on .156" centers, maintain constant pressure on circuit paths. Contact tail end options include crimp-to-wire, wrap post or solder tab. Housings of diallyl phthalate or phenolic are eggcrated. Contacts not pre-loaded; use only number of contacts required.

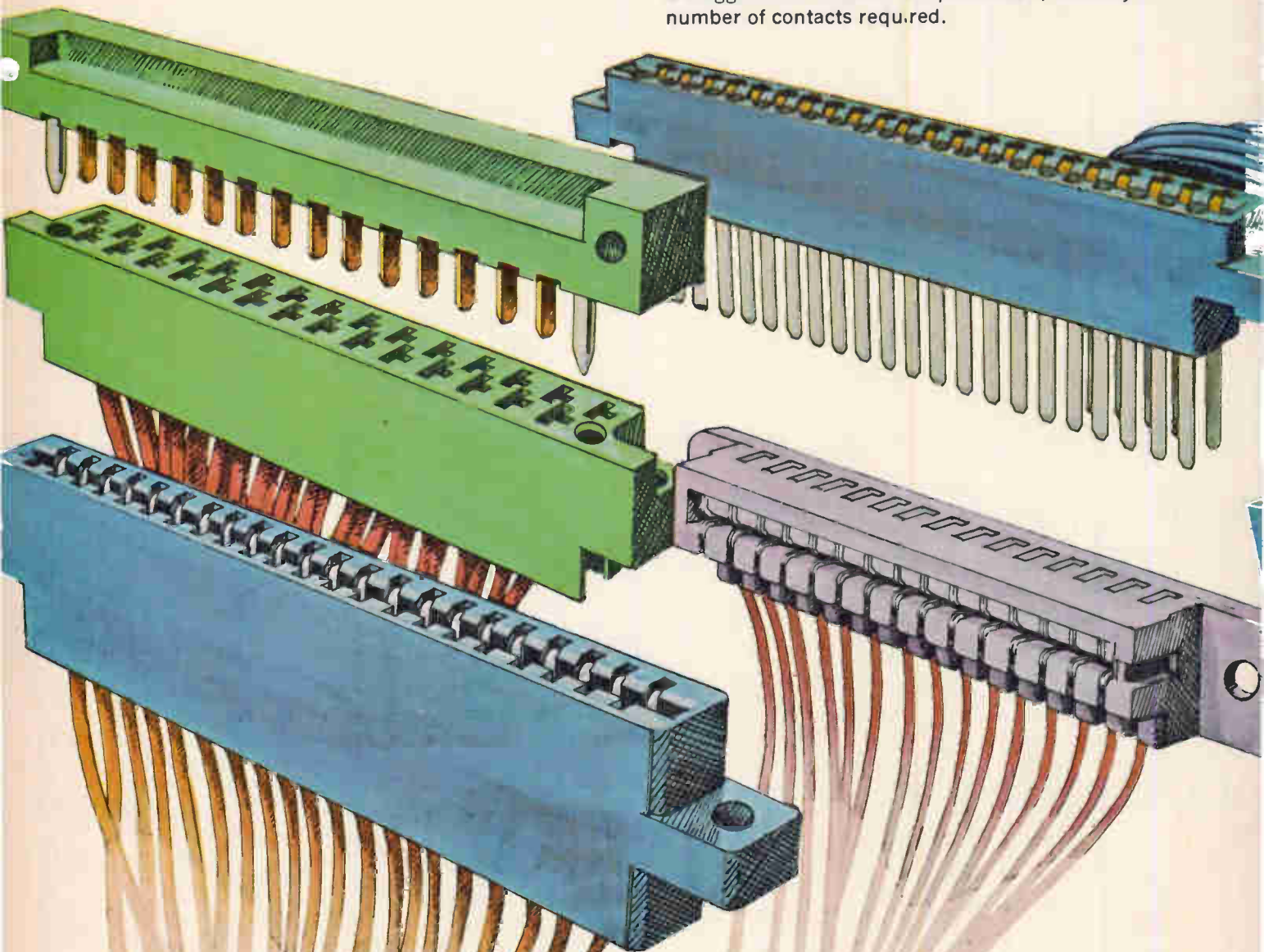

Fork-contact connector. A one-piece polysulfone connector with eggcrated contact cavities: up to 33 positions. Capability for .100" center spacing. Improved fork contact design with large curved contact surfaces for smooth insertion and excellent conductivity. Crimp, snap-in contacts.

Right-angle connector. Compact one-piece connector saves space in sub-assemblies on vending machines, appliances, etc. Right-angle board entry facilitates compact cabling. Housing may be keyed; slips on board edge. Recessed snap-in fork type contacts: available in 3 to 22 positions.

the printed circuit.

TERMI-TWIST* Connector. This connector combines economy and reliability with highly efficient application tooling techniques. Closed entry diallyl phthalate or phenolic housings accept boards from .054" to .071" thick. Snap-in, bifurcated contacts adaptable for a wide variety of wire attachment methods. Can be used with solder, weld, wrap or TERMI-POINT* clip techniques.

Part of a complete line of AMP-UNYT* printed circuit connectors available from AMP . . . Worldwide.

*Trademark of AMP Incorporated

AMP

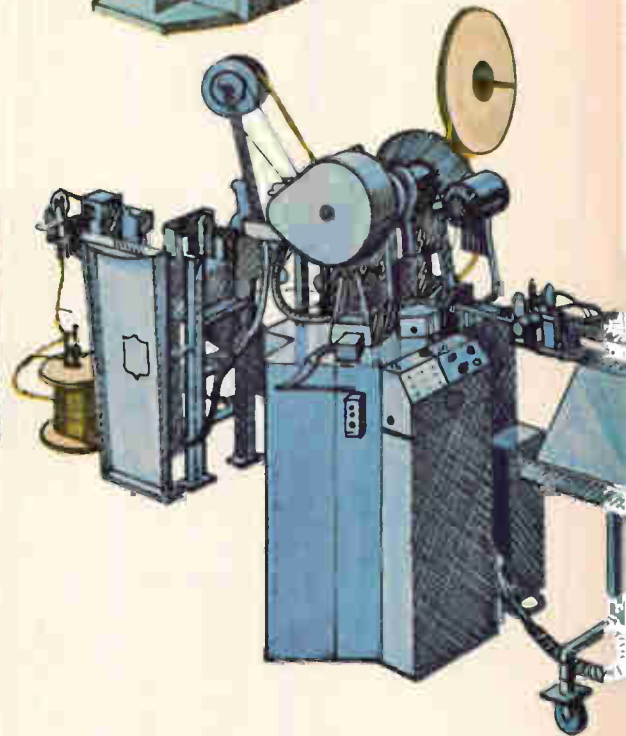
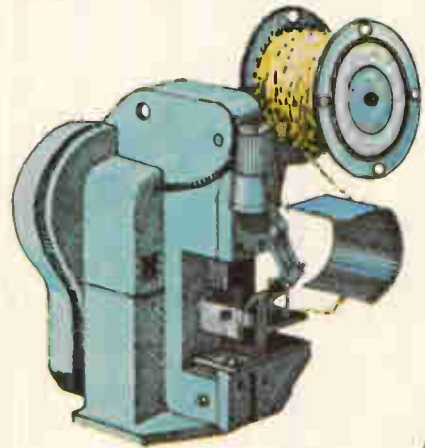
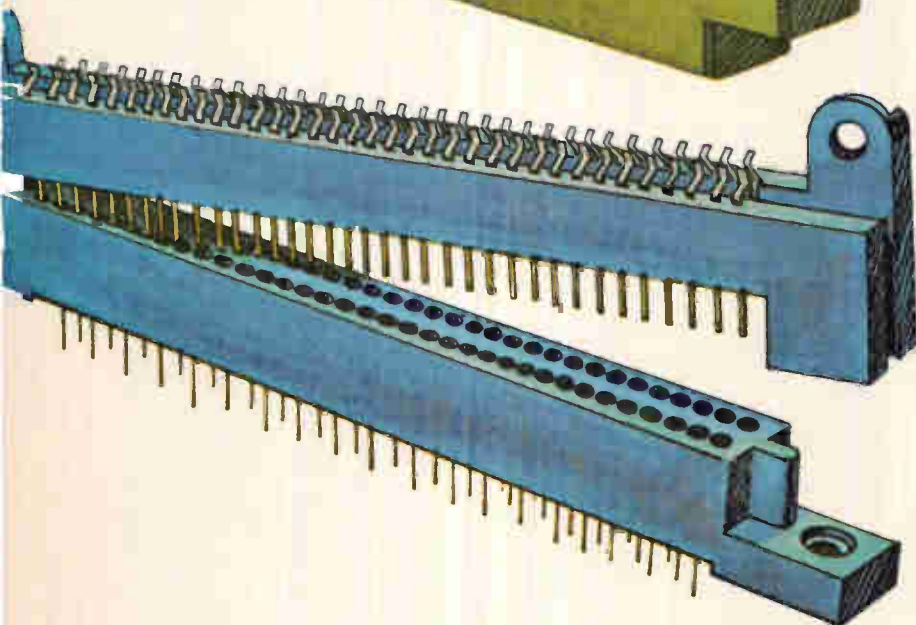
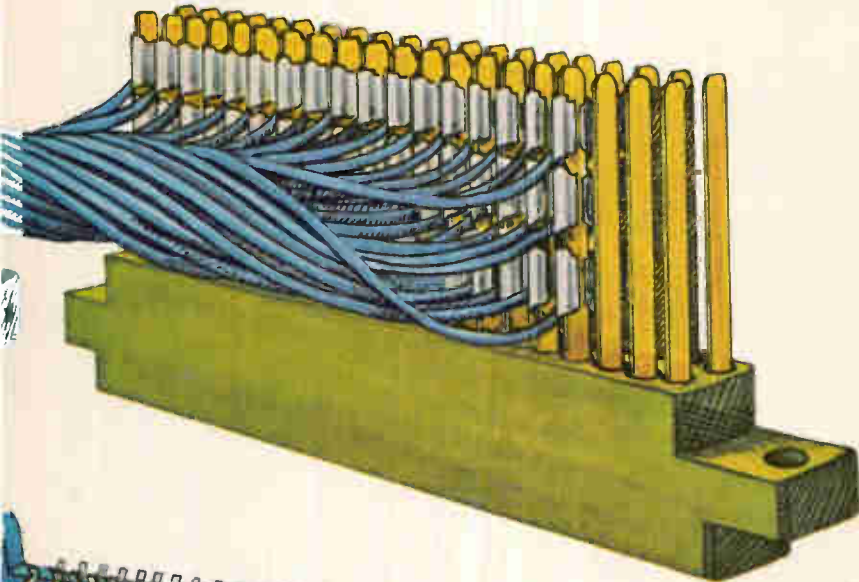

Box-contact connector. A superior two-piece board-to-board or board-to-wire connector provides high density with low insertion and extraction forces. Unique contact design allows wide mismatching tolerances. Ten to 180 contacts on .075" centers. For black-box, computer and other high reliability applications. Exceptional low cost for exclusive features incorporated.

A full range of semi-automatic and fully automatic machinery is available for high-volume production and lower installed cost. AMP's large assortment of printed circuit connectors permits proper selection of the best connector for any requirement. Matched tooling plus advanced engineering give you unsurpassed performance, economy and reliability.

For detailed catalog information on these products, contact AMP Incorporated, Harrisburg, Pa. 17105

Circle 21 on reader service card



A progress report from the N.E. Laboratories.

QAL 1A WIDEBAND PARAMETRIC AMPLIFIER

The QAL 1A parametric amplifier, designed for use in unattended ground terminals of Domestic Satellite Communications Systems, offers high performance at room temperatures. This broadband amplifier covers the complete band from 3.7 GHz to 4.2 GHz.

FEATURES

- 500-MHz Bandwidth
- Needs No Refrigeration
- Low Noise
- 100% Redundancy with Automatic Switching

For a copy of Satellite Communications Bulletin #S220, write Dept. 225, Northern Electric Co. Ltd., 1600 Dorchester Blvd. West, Montreal, P.Q.



Meetings

Microelectronics: sophisticated packaging

At first glance, the Society of Automotive Engineers seems an unlikely sponsor for a microelectronics conference. But a large and technically sophisticated part of the society's membership works in the aerospace industry, designing the structures that house electronic gear. And sophistication is an essential ingredient of packaging as circuits shrink, speeds soar, and power dissipation becomes more and more concentrated.

The society's Microelectronic Packaging Conference, in Palo Alto, Calif., Nov. 20 to 22, will concentrate on device mounting, subsystem interconnection, package sealing, process control and testing, and fabrication of thick- and thin-film hybrid circuits. There will be 12 papers presented in three sessions, five workshops, and tours of microelectronics fabrication facilities at Lockheed, Raytheon, and Stanford University.

Bonding techniques. Advanced device packaging will be explored by Ernest F. Koshniz of the Unitek Corp., in a paper comparing face bonding (beam-lead and flip-chip techniques) with conventional wire

bonding and with each other. Koshniz will also discuss characteristics of fabrication equipment for each method.

Schemes for speeding circuit connections will be presented by Leo Fiderer, John J. Shea, and Kenneth E. Solie. Fiderer will relate Hughes Aircraft's experience with a system of grid layers that can reduce the interval between wiring diagrams and interconnection hardware to minutes or hours from days or weeks. Shea and Solie will present Honeywell's "functional electronic block" approach, in which a metalized ceramic substrate is used to hold and interconnect integrated circuits, hybrids, and discrete components.

A sensitive and versatile tool for analyzing finished IC's will be described by J.L. Solomon and G.E. Hitt of IBM. They use the electron microprobe for nondestructive study of structure and chemical composition. They've even made stereo images of the chip surface to determine depth variations.

For more information, write Meetings Department, Society of Automotive Engineers, 2 Pennsylvania Plaza, New York 10001.

Calendar

Symposium of the American Vacuum Society; Pittsburgh Hilton Hotel, Oct. 30-Nov. 1.

Product Assurance Conference and Technical Exhibit on Reliability, Standard Maintainability and Parts-Materials Packaging, IEEE and Standards Engineers Society; Waldorf-Astoria Hotel, New York, Nov. 2-3.

American Institute of Ultrasonics In Medicine; Monteleone Hotel, New Orleans, Nov. 4-7.

West Coast Conference on Broadcasting, IEEE; Ambassador Hotel, Los Angeles, Nov. 6-8.

Northeast Electronics Research and Engineering Meeting (Nerem), IEEE; Sheraton Boston Hotel, Boston, Nov. 6-8.

Conference on Speech Communication and Processing, IEEE;

Massachusetts Institute of Technology, Cambridge, Mass., Nov. 6-8.

Seminar on Electric Contact Phenomena, Illinois Institute of Technology; Sherman House, Chicago, Nov. 11-15.

Automatic Support Systems Symposium for Advanced Maintainability, IEEE; Sheraton-Jefferson Hotel, St. Louis, Nov. 12-14.

Conference on Thermal Conductivity, Department of Commerce; National Bureau of Standards, Gaithersburg, Md., Nov. 13-15.

Analytical Symposium Advanced Technical Program, American Chemical Society, Society for Applied Spectroscopy, American Microchemical Society; Statler Hilton Hotel, New York, Nov. 13-15.

(Continued on p. 24)

**You require
standard integrated circuits?
We have them.**

**You require
special integrated circuits?
We make them.**

IC's from

VALVO

**VALVO GmbH
2 Hamburg 1
Burchardstraße 19
Western Germany**



digital to resolver/synchro converters...here's the next generation!

North Atlantic now brings you a new generation of solid-state digital-to-analog converters. They offer major advances in resolver/synchro conversion accuracy along with drift-free and stable performance unobtainable with currently available resistor/amplifier devices.

Typical of these new instruments are the Model 536 D/R and Model 537 D/S "shoebox" converters (11-13 bit) and the Model 538 D/R-S converter (14-17 bit). Both models use solid-state switched trigonometric transformers and feature input data storage registers thereby saving computer time. Conversion speed exceeds 10 microseconds. Built-in overload and short circuit protection assures trouble-free system integration and reliable on-line performance.

Your North Atlantic representative (see EEM) has complete specifications and application information. He'll be glad to show you how these new converters can be the answer to critical interface problems.



NORTH ATLANTIC industries, inc.
TERMINAL DRIVE, PLAINVIEW, NEW YORK 11803 • 516-681-8600

Meetings

(Continued from p. 22)

Meeting of the Anti-Missile Research Advisory Council, Advanced Research Projects Agency and the U.S. Naval Postgraduate School; Monterey, Calif., Nov. 14-16.

Symposium on the Applications of Lasers to Photography & Information Handling, Society of Photographic Scientists and Engineers; Airport Marina Hotel, Los Angeles, Nov. 14-15.

Conference on Engineering in Medicine & Biology, Biomedical Engineering Society; Shamrock-Hilton Hotel, Houston, Nov. 17-20.

Conference on Magnetism and Magnetic Materials, IEEE and the American Institute of Physics; Hilton Hotel, New York, Nov. 17-21.

Photovoltaic Specialists Conference, IEEE; Jet Propulsion Laboratory, Pasadena, Calif., Nov. 19-21.

Microelectronics Packaging and Interconnection Conference, Society of Automotive Engineers; Rickey Hyatt's House Hotel, Palo Alto, Calif., Nov. 20-22.

Conference on Applications of Simulation, Association for Computing Machinery, IEEE; Hotel Roosevelt, New York, Dec. 2-3.

Reliability Physics Symposium, IEEE; Hilton Hotel, Washington, Dec. 2-4.

Vehicular Technology Conference, IEEE; Hilton Hotel, San Francisco, Dec. 3-4.

Entry Vehicle Systems and Technology Meeting, American Institute of Aeronautics and Astronautics; Williamsburg, Va., Dec. 3-5.

Circuit Theory Symposium, IEEE; Hilton Plaza Hotel, Miami Beach, Fla., Dec. 4-6.

Symposium on Theory & Measurement of Atmospheric Turbulence & Diffusion in the Planetary Boundary Layer, Sandia Corp. and the Atmospheric Sciences Laboratory of the Army Electronics Command, Albuquerque, N.M., Dec. 5-7.

Vehicular Technical Group Conference, IEEE; Hilton Hotel, New York, Dec. 6-8.

Electrical Insulation Conference, IEEE; Biltmore Hotel, Los Angeles, Dec. 8-12.

National Electronics Conference, IEEE; Conrad Hilton Hotel, Chicago, Dec. 9-11.

(Continued on p. 26)



All components shown actual size



Only the new Allen-Bradley Type S cermet trimming resistors have all these features

Type S
shown twice actual size

for side adjustment



for top adjustment



The Allen-Bradley Type S is a one turn cermet trimmer in which you will find incorporated a wider range of features than in any other trimmer now on the market. Here are a few of the more important features.

- **COMPACT**—body is $\frac{3}{16}$ " dia.
- **BUILT FOR EITHER TOP OR SIDE ADJUSTMENT**
- **50 OHMS THRU 1 MEGOHM**
- **THE SEALED UNIT** is immersion-proof
- **TEMPERATURE COEFFICIENT** less than 250 ppm/°C over all resistance values and complete temperature range
- **UNIQUE ROTOR DESIGN** provides exceptional stability of setting under shock and vibration
- **SMOOTH CONTROL**, approaches infinite resolution
- **PIN TYPE TERMINALS** for use on printed circuit boards with a 1/10" pattern

- **VIRTUALLY NO BACKLASH**
- **WIDE TEMPERATURE RANGE** from -65°C to +150°C
- **RATED ½ watt @ 85°C**
- **EXCEPTIONAL STABILITY** under high temperature or high humidity
- **MEETS OR EXCEEDS ALL APPLICABLE MIL SPECS**
- **COMPETITIVELY PRICED!**

You'll find the new Type S trimmer equal to the traditional Allen-Bradley quality. You really ought to know more about the Type S. Won't you write for detailed specifications? Allen-Bradley Co., 222 W. Greenfield Ave., Milwaukee, Wis. 53204. In Canada: Allen-Bradley Canada Limited. Export Office: 630 Third Ave., New York, N. Y., U.S.A. 10017.



ALLEN-BRADLEY
QUALITY ELECTRONIC COMPONENTS

skill scarcities?
plant growth problems?
production problems?

expand in Milwaukee where the skills are.



Milwaukee's skilled labor force makes expansion easier. Over 205,000 production workers turn out an incredible range of products, from electrical control gear to women's fashions.

You won't be hampered by lack of labor skills in Milwaukee. We do the training for you. Tax-supported Milwaukee Technical College augments our labor force by 40,000 skilled workers annually. It trains young people . . . and up-dates the skills of older workers. And, because they've been raised in a tradition of industry, Milwaukeeans are honest, responsible workers.

No skill-drain worries, either . . . Milwaukee's labor force doesn't want to leave home. They like it here.

Over 2,000 companies like it here, too. Here they have the richest resource of all: dependable, skilled workers with know-how, whatever the job.

Whatever *your* product, we've got the skills.



*Milwaukee... Great for Business,
Great for Living... and Growing Greater*

Send for our "More" Booklet with many facts about Milwaukee. Division of Economic Development, Dept. E-108. Office of the Mayor, City Hall, Milwaukee, Wisconsin 53202



Meetings

(Continued from p. 24)

Fall Joint Computer Conference, IEEE; Hilton Hotel and Civic Center, San Francisco, Dec. 9-11.

Consumer Electronics Symposium, Conrad Hilton Hotel, Chicago, Dec. 9-10.

Adaptive Processes Symposium, IEEE; University of California at Los Angeles, Dec. 16-18.

Reliability Symposium, IEEE; Palmer House, Chicago, Jan. 21-23.

Winter Power Meeting, IEEE; Statler Hilton Hotel, New York, Jan. 26-31.

International Symposium on Information Theory, IEEE; Nevele Country Club, Ellenville, N.Y., Jan. 28-31.

International Solid State Circuits Conference, IEEE; University of Pennsylvania and the Sheraton Hotel, Philadelphia, Feb. 19-21.

Short courses

Oceanography, University of Wisconsin, Milwaukee, Wis., Nov. 12-13; \$70 fee.

Medical engineering, George Washington University, Washington, D.C., Dec. 2-6; no fee.

Reliability engineering and management institute, University of Arizona, Tucson, Ariz., Nov. 4-13; \$275 fee.

Call for papers

Transducer Conference, IEEE; Washington, D.C., Feb. 10-11. December 1 is deadline for submission of manuscripts to Henry P. Kalmus, chief scientist, Harry Diamond Laboratories, Department of the Army, Washington, D.C. 20438.

Particle Accelerator Conference, IEEE; Shoreham Hotel, Washington, D.C., March 5-7. November 8 is deadline for submission of abstracts to F.T. Howard, Oak Ridge National Laboratory, P.O. Box X, Oak Ridge, Tenn. 37830.

Aluminum Strip Conductor Symposium, Electrochemical Society, New York, May 4-9. December 15 is deadline for submission of abstracts to Dr. Bakish, Republic Foil, Inc., Danbury, Conn.

Foxboro engineers select A-B hot molded potentiometers

"Best repeatability—component-to-component
and setting-to-setting"



Foxboro Model 62H electronic controller for process regulation. The control mode adjustments use Allen-Bradley Type J hot molded variable resistors with values of 10, 100, and 200 megohms.

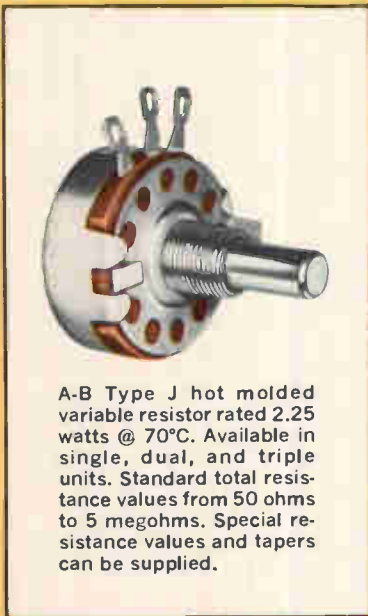

A-B Type J hot molded variable resistor rated 2.25 watts @ 70°C. Available in single, dual, and triple units. Standard total resistance values from 50 ohms to 5 megohms. Special resistance values and tapers can be supplied.

Widely used throughout the process industries, the Foxboro Model 62H Universal Controller is a highly dependable precision instrument. During the years of painstaking development, Allen-Bradley engineers worked closely with Foxboro to provide a potentiometer having unusually high resistance values, which would provide the precise performance required.

Allen-Bradley Type J potentiometers were the answer. They have a solid hot molded resistance track which is produced by an exclusive A-B molding technique that assures extremely long operating life. Accelerated tests—exceeding 100,000 revolutions—show very slight resistance change. Control is smooth at all times with adjustment approaching infinite resolution. There are none of the abrupt turn-to-turn resistance vari-

ations inherent in wirewound controls. Furthermore, Allen-Bradley Type J potentiometers are—for all practical purposes—noninductive, permitting their use throughout the frequency spectrum.

Whether your particular circuit design can be best satisfied with one of the millions of standard Type J variations or whether it calls for unusual resistance characteristics, it will pay you to look first to A-B Type J potentiometers. Their more than 25-year history of providing superior performance is your guarantee of complete satisfaction. For full details, please write for Technical Bulletin 5200: Allen-Bradley Co., 1201 South Second Street, Milwaukee, Wisconsin 53204. Export Office: 630 Third Avenue, New York, N. Y., U.S.A. 10017. In Canada: Allen-Bradley Canada Limited.



ALLEN - BRADLEY
QUALITY ELECTRONIC COMPONENTS

Pick a number...

Only Amphenol lets you pick from all four PC connector families

No matter which printed circuit connector family you choose, Amphenol produces it. In hundreds of thousands of combinations. No one else gives you this choice.

Expect to save. While gold, copper and labor costs go up, we keep modernizing production methods. Enough to maintain prices, even reduce them. We can show you how to save with all four families.

Check the PC connector families below. Then call your Amphenol Sales Office or Distributor. The connector you need is probably on the shelf. If it's a special we can help you design it. Write today for new PC Connector Catalog PC-5. Amphenol Industrial Division, The Bunker-Ramo Corp., 1830 S. 54th Avenue, Chicago, Ill. 60650.



1 BIFURCATED BELLOWS CONTACTS For smooth, positive mating action—that's easy on your PC board surface—pick Amphenol's 225 Series. Bifurcation provides 2 points of contact, even on irregular surfaces. Bellows action exerts positive pressure, even under extreme vibration. Gives you thousands of insertions and withdrawals without failure. Nine sizes, ten tail styles, four mounting configurations, two contact platings, and solder, taper pin or Crimp Poke-Home® terminations. Exceeds MIL-C-21097B.

2 TUNING FORK CONTACTS For the lowest contact resistance in the industry today—even with PC boards at the extremes of tolerance in thickness—pick Amphenol's 143 Series. Amphenol's tuning fork contacts provide excellent current-carrying capability with uniform tine pressure and positive wiping action. For non-direct card entry applications, the 143 Series receptacle can be mated with a 133 Series plug. Nine tail styles, eight sizes and choice of solder or solderless wrap terminations. Series 233/243 exceeds MIL-C-21097B.

3 PRELOADED CANTILEVER CONTACTS For a low cost, high performance connector—designed especially for automatic wire wrapping—pick Amphenol's 261 Series. Cantilever contacts are confined in the dielectric to a predetermined load force. This gives you uniform pressure and positive mating action. Contacting surfaces have a minimum of 50 microinches of gold over phosphor bronze. Wire wrap capability on .100", .125", .150", .156" and .200" centers. Also, high contact density multi-board connectors for your special applications.



4 MODULAR PLATE ASSEMBLIES For custom designed specials at production line prices—with up to 36,000 contacts—pick Amphenol's 230 Series Snap-Wrap® or 240 Series Mini-Wrap® connectors.

Design your own interconnection system using Amphenol's building block concept. The contacts you need are inserted into nylon insulators and mounted into aluminum plates. These plates can be drilled, formed or notched to your specifications. Snap-Wrap 230 Series: 7 contact styles, 12 color-coded insulators with plate sizes up to 22" x 45". Mini-Wrap 240 Series: 4 contact styles, 12 color-coded insulators, .100", .125" or .150" centers with plate sizes up to 21" x 24". The same modular concept is now available for direct card entry applications with our 250 Series.

®Registered trademarks of The Bunker-Ramo Corporation



AMPHENOL

THE BUNKER-RAMO CORPORATION

Circle 29 on reader service card

ac circuit design starts with an oscillator...

START WITH THE BEST

Hewlett-Packard invented the first stable Wien-bridge oscillator. Now



they have added several design improvements to two new solid state oscillators — 0.5% (0.05 dB) flatness—FET's in the bridge for im-

proved stability — $<0.1\%$ (-60 dB) distortion—balanced output—sync in/out without degradation in specs. Now, choose from 17 hp oscillators—the widest choice in the industry!

The new hp 204C Oscillator has a frequency range of 5 Hz to 1.2 MHz, 5 Vrms output. The 204C can be operated with line power, mercury battery or a rechargeable battery pack. Price hp 204C, \$250-285.

The new hp 209A Oscillator generates simultaneous sine and square wave outputs over a frequency range of 4 Hz to 2MHz. Amplitudes are independently adjustable. Output voltage is 10 Vrms for sine wave; 20 V peak-to-peak for square wave. Price: hp 209A, \$320.

Start with the best! Get complete

information on the two new—or all 17 hp Oscillators—from your near-



est hp field engineer. Or, write to Hewlett-Packard, Palo Alto, California 94304. Europe: 54 Route des Acacias, Geneva.

HEWLETT **hp** PACKARD

SIGNAL SOURCES

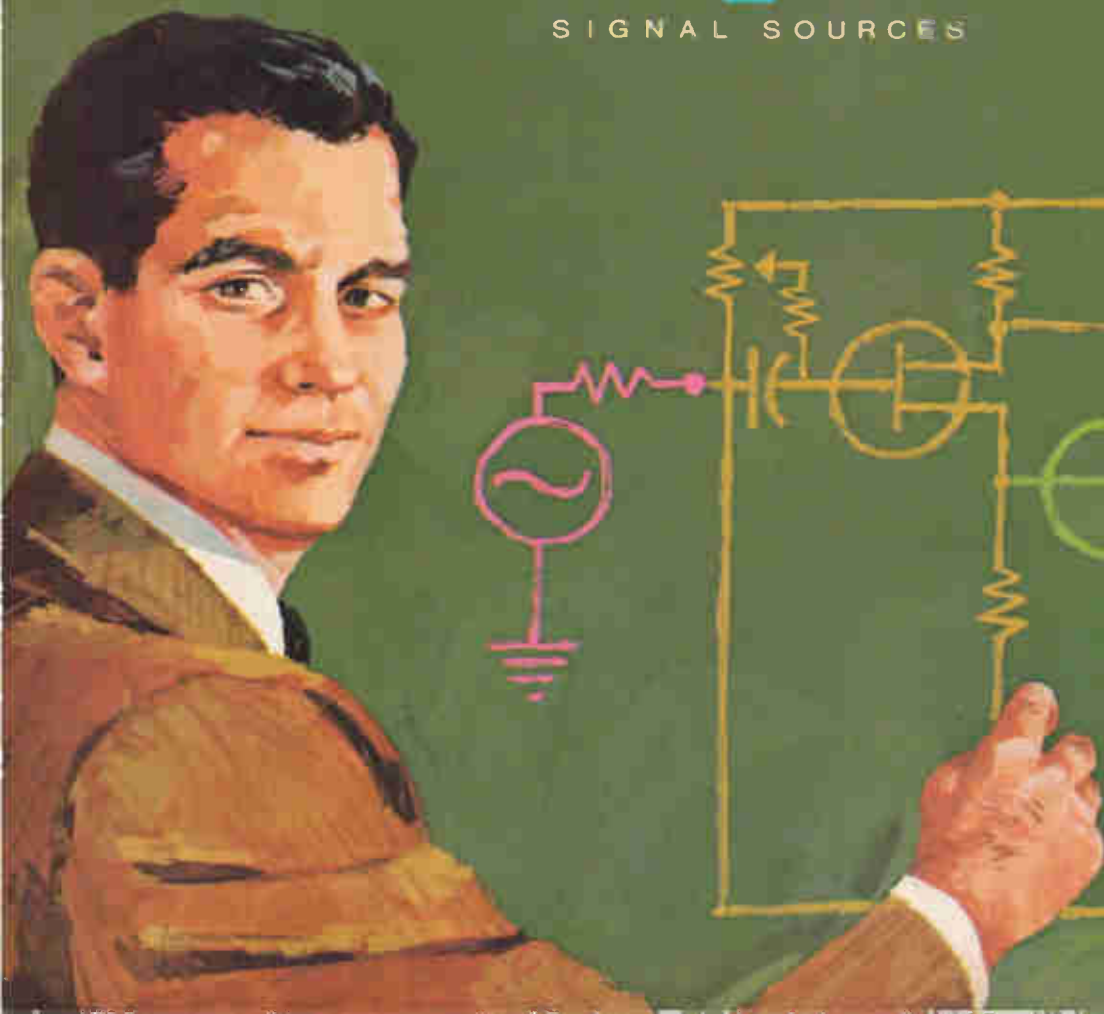

Editorial comment

Overhead needs a realistic ceiling

Irking most electronics companies is the perennial assumption by Congress that indirect expenditures on a Government-sponsored research contract should be held to an arbitrary percentage of the direct costs, regardless of the type of contract.

In the case of the recently defeated Mansfield amendment, it was 25%. That amendment to the Defense Department's appropriations bill was considered by a House-Senate conference just before the 90th Congress adjourned; the Senate had already passed it. The amendment read as follows: "No part of the funds provided in this Act shall be used to pay any recipient of a grant or contract for the conduct of a research project an amount for indirect expenses in connection with such project in excess of twenty-five percentum of the direct costs."

Although the amendment was dropped, the conference report appended to the Congress-approved budget calls for studies by the GAO and the Congressional Appropriations and Legislative Committees to devise a formula for calculating indirect costs on research contracts. The report asserts: "The Government should set the basis for indirect costs, based upon sound accounting principles, and the committee feels that if such allocation is properly made between direct and indirect costs, it appears that the proportion of indirect costs should not exceed 25%."

Electronics leaders contend, with justification, that the 25% figure is unrealistic. It was arrived at, they note, on the basis of Senate studies dealing almost exclusively with universities and other nonprofit institutions. Indirect expenses for industrial research normally run well above that percentage. Among the factors that go to make up these expenses are employee fringe benefits, laboratory equipment and space, and utilities. In industry, these costs are often equal to the direct costs, sometimes double, and occasionally three or four times as great. Depreciation charges on laboratories sometimes exceed 25% of direct costs.

Admittedly, in some cases the higher percentages are partially the result of the accounting system used. But William Moore, staff vice president of the Electronic Industries Association's Government Products division, noted in a memo to the House-Senate conferees that "no reasonable ac-

counting practices or changes in such practices could bring normal industrial overhead rates down to 25%."

The EIA is on record as contending that the enactment of any legislation such as the Mansfield amendment would be tantamount to "forbidding industry to accept Defense research contracts except at a loss." David Arnold, president of Hoffman Electronics Corp., said the 25% ceiling would "eliminate the availability of some of the best minds in the country." In addition, he said, it's an "out-and-out anti-industry provision obviously slated to assist universities and other so-called nonprofit organizations."

If an unrealistic ceiling were to be imposed, a more serious consequence could be the harm done to existing defense research projects not completely covered by existing appropriations.

The EIA memo to Congress rightfully points out that the electronics industry is not free to load all kinds of costs into its overhead rates. The armed services procurement regulations impose specific constraints on the types of costs allowed, and Defense Department and GAO auditors police the regulations. Government review of indirect charges is standard practice.

Undoubtedly there are some abuses. Sen. Mansfield contends that indirect funds have been spent for cleaning snow from college football fields and building roads to a stadium. The Senate debate on the amendment centered about the high salaries paid by some nonprofit research institutions, the indirect costs run up by university research groups, and defense contracts in the area of social science. Perhaps these topics warrant separate study. Congress' unhappiness about the way in which direct expenses are awarded, namely in addition to the basic grant, seems justified. For example, if a university receives a grant for \$100,000 and then incurs indirect expenses at the rate of 86% of direct charges (an actual case history), it is awarded a total of \$186,000.

But since the Congressional conferees had little data on the situation in industrial research, their decision to review the matter further is appropriate. If a workable formula for measuring and controlling indirect expenses can be developed, we're for it.

Goldilox built-in protection system gives you Mil. Spec. reliability in commercial TTLs.

And that's no fairy tale.

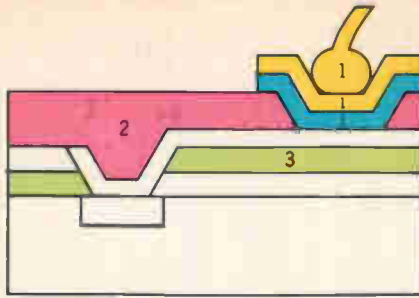

Only Westinghouse offers you TTLs with:

1. Titanium-Gold bonding at interconnects for heat stability—to eliminate purple plague.
2. Glass-over interconnects make chip surface impervious to corrosion, surface damage.
3. Silicon nitride passivation retards ion

migration, eliminates inversion and leakage.

Reliable? Without packaging, Goldilox devices have operated under water for over an hour!

The Westinghouse 600 TTL series give you all of the SUHL characteristics. A pin-for-pin replacement. And we offer a complete line of military and commercial devices to meet your requirements. Our TTLs come in the 14-pin plastic dual-in-line, ceramic dual-in-line, and flat packages.

For Goldilox TTL products, call your local Westinghouse sales office or Westinghouse Molecular Electronics Division, Elkridge, Maryland, (301) 796-3666

You can be sure... if it's

Westinghouse



Goldilox, The IC Protector.



Electronics Newsletter

October 28, 1968

Aeronautical service satellite plan on shaky footing

Unless the airlines, the Government, or Comsat does something soon, the proposed aeronautical services satellite may not get off the ground. The reason: money.

Both the Air Transport Association (ATA) and Aeronautical Radio Inc. (Arinc)—the airlines' communications arm—are enthusiastic about the idea of a vhf communications satellite for airlines. But they're concerned lest declining profits keep the airlines from putting together the \$50 million Comsat says the satellite would cost. This version would cover both the Atlantic and the Pacific [Electronics, Sept. 2, p. 44].

Arinc is now in the position of having to persuade Comsat to set up a schedule of delayed payments or to subsidize the airlines in the name of "public service"; cajole the airlines into going ahead with the system, or persuade the FAA to pick up part of the tab.

The FAA itself is reportedly divided on the merits of the plan; some officials think the inevitability of L-band aeronautical satellites is sufficient reason to pass up a vhf craft. It's understood that the FAA hasn't included the satellite in its proposed 1970 budget, now being drawn up.

Whatever happens will happen soon. A spokesman for the ATA says it must make up its mind by late November, presumably because Comsat wants to resolve the issue at the Intelsat committee meeting in December.

Bids from Philco-Ford and Hughes have been presented by Comsat to Intelsat's interim committee.

Apollo 7 clears way for trip around moon

The successful completion of NASA's Apollo 7 mission last week has given the U.S. manned-spaceflight program a tremendous lift. Meetings slated for mid-November will yield an official decision on whether Apollo 8 will try a circumlunar voyage in December, but space officials are confident of a go-ahead. The questions being asked now concern actual plans for the December flight, especially the length of the mission (a possibility: 24 orbits around the moon).

NASA officials have been so encouraged by last week's success that they now see landing two men on the moon during 1969 as an attainable goal; the only hangup involves the lunar module, which has been plagued by problems and hasn't yet been tested. The officials are also hopeful that the Apollo 7 triumph and the public attention given it will improve relations between Congress and the space agency.

Artificial hearts may use body power

As research on artificial hearts gathers speed, so does the search for power sources to run them.

In one case, researchers at General Electric's Re-entry Systems division have used the electrical potential in the bodies of rabbits to generate power. The team has been implanting electrodes of zinc and platinum-platinum black to produce 50 microamps at 0.8 volt, and thus far there have been no signs of biological damage from galvanic chemical reactions. One rabbit has been generating its own power for an implanted transmitter for nine months.

Also, McDonnell Douglas has developed an atomic battery that measures 1/20th of a cubic centimeter and generates 50 microwatts. The battery, supposed to last five years, consists of thin semiconducting layers

Electronics Newsletter

alternating with layers of a radioactive isotope that converts low-level nuclear radiation directly into electric current without heat.

Power struggle looms at Varian

Varian Associates, whose profit margins have been getting narrower over the past two years, has ended its on-again, off-again three-year search for a president. Picked to succeed Edward L. Ginzton, 52, was Norman F. Parker, 45, former president of Autonetics and most recently an executive vice president of Bendix. But the job may not be all it seems.

Ginzton, who's been running Varian for four years, wasn't exactly unwilling to step aside. He'll remain as chairman and chief executive officer, and insiders say Parker will have all the responsibility with less than full authority.

Sources close to Varian also predict a power struggle between the two men, and they say the extent of Parker's ability to make changes in the corporate staff will indicate who's winning.

In fiscal 1967, Varian's earnings declined to \$6.5 million from \$8.5 million a year earlier despite a sales rise to \$160.5 million from \$145 million; the 1967 profit includes a credit of \$676,000 from the sale of a business. And the trend is continuing: nine-month results for this year show an earnings decline of about \$2 million despite an \$8-million sales increase. Ginzton told employees on Aug. 5 that the company would have nothing to distribute this year under its profit-sharing plan.

But the real puzzler is why Parker, as a possible heir to the Bendix throne, would give up what was rumored to be a \$1 million lifelong financial package to move to Varian. One possibility suggested by an executive close to the situation is that the appointment of three more executive vice presidents at Bendix may have clouded Parker's prospects.

Systron-Donner eyes Dickson IC potential

Systron-Donner's president, George H. Burns Jr., says his firm is buying Dickson Electronics to apply that company's monolithic integrated-circuit capability to its own instrumentation business. There's one hitch, however: Dickson doesn't make IC's—or at least doesn't sell them. But Dickson's president, Donald Dickson, maintains that his company is completely set up to turn out IC's. It now primarily produces zener diodes and tantalum capacitors.

FCC may let pupils talk to tv teachers

The FCC is expected to permit instructional television channels to use "talk-back" circuits from classrooms to remote instructors. Present FCC rules allow only one-way circuits over instructional television, which is in the 2,500-to-2,690-megahertz band. The band is divided into 31 channels of 6 Mhz, which leaves 4 Mhz at the upper end unused. The talk-back service would be allowed in this upper portion and would use low-power transmitters and directional antennas to prevent interference with other antennas. Comments on the FCC proposal are due in November, and the commission will probably act early next year.

Addendum

Bendix's Navigation and Control division has won the competition to build the automatic flight-control system for the McDonnell Douglas DC-10 tri-jet. The contract for the integrated autopilot/flight director unit will total about \$25 million through 1974. The system will permit automatic all-weather landings.

SEMICONDUCTOR NEWSBRIEFS

PUBLISHED BY MOTOROLA SEMICONDUCTOR PRODUCTS INC.

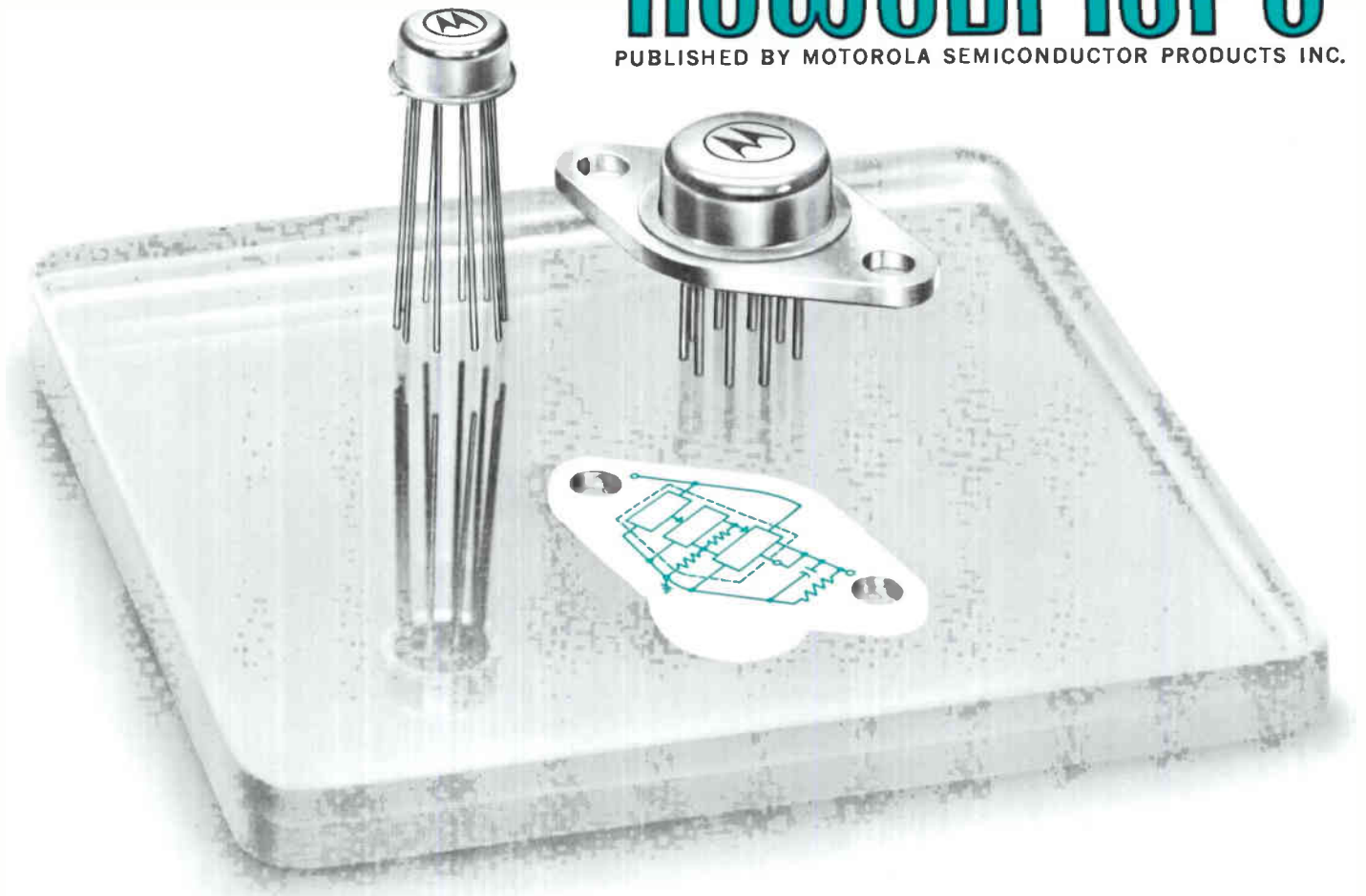

THE FIRST DOUBLE-REGULATED I/C VOLTAGE REGULATOR!

Here's a unique new monolithic I/C Voltage Regulator with an extra "built-in" reference-voltage regulator stage to provide regulating characteristics that are essentially independent of output voltage. No other I/C regulator available today offers this important advantage! So complete is this precision regulator that its 20 milliohm output impedance is independent of both output voltage and frequency up to 0.5 MHz. And, it can regulate loads up to 1/2 Amp (without using external power transistors)!

Available in two temperature ranges, the MC1560 (-55 to +125°C) and the MC1460 (0 to +75°C), also come in two different power handling packages — the new 9-pin TO-66 (suffix "R") which dissipates 10-Watts up to $T_C = +65^\circ\text{C}$ and the popular 10-pin, TO-5 ("G") for up to 1.80 W applications.

These remarkable I/C regulators also offer electronic "shutdown" control and short-circuit protection. The "shutdown" control can be actuated by an applied logic signal and can put loads in a "stand-by mode," or used as a dissipation control to protect the regulator under sustained output short-circuiting.

Other highlights include:

- Excellent transient response and temperature stability (0.003%/°C typ)
 - High ripple rejection, 0.002%/V (typ)
 - Single external transistor current boost to greater than 10 Amps
- They're 100-up priced as low as \$3.50 (MC1460G).

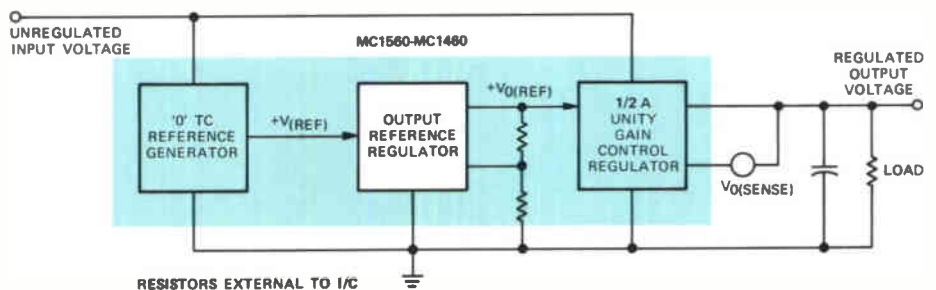

For details circle Reader Service No. 312

Now "No Ringing" Series 54/74 T²L Circuits From Motorola!

Motorola now supplies equivalents to the 54/74 T²L integrated circuit series — with an important added advantage — *diode clamped inputs!* So effective is this added circuitry that the "ringing" problem encountered with older T²L designs, is now virtually eliminated. In addition, the 3 J-K flip-flops in the line feature improved circuitry which offers greater protection against negative clock input transients.

The new MC7400P M TTL I/C line encompasses seventeen multi-function types including a full complement of gates (12 in all), covering NAND, NOR, AND-OR-INVERT functions and a gate expander. In addition to three J-K flip-flops, two of which are dual circuits, there is a Type "D" and a Quad Latch.

These integrated circuits are available in the 14-pin and 16-pin (MC7475P/MC7476P) dual in-line plastic packages.

FUNCTION	MOTOROLA	74N SERIES
Quad 2-Input NAND Gate	MC7400P	SN7400N
Quad 2-Input NAND Gate	MC7401P	SN7401N
Quad 2-Input NOR Gate	MC7402P	SN7402N
Triple 3-Input NAND Gate	MC7410P	SN7410N
Dual 4-Input NAND Gate	MC7420P	SN7420N
Single 8-Input NAND Gate	MC7430P	SN7430N
Dual 4-Input NAND Buffer	MC7440P	SN7440N
Expandable 2-Wide 2-Input AND-OR-INVERT Gate	MC7450P	SN7450N
Dual 2-Wide 2-Input AND-OR-INVERT Gate	MC7451P	SN7451N
Expandable 4-Wide 2-Input AND-OR-INVERT Gate	MC7453P	SN7453N
Single 4-Wide 2-Input AND-OR-INVERT Gate	MC7454P	SN7454N
Dual 4-Input Expander	MC7460P	SN7460N
J-K Flip-Flop	MC7472P	SN7472N
Dual J-K Flip-Flop	MC7473P	SN7473N
Quad Latch	MC7475P	SN7475N
Dual J-K Flip-Flop	MC7476P	SN7476N
Dual Type "D" Flip-Flop	MC7479P	SN7479N

For details circle Reader Service No. 313

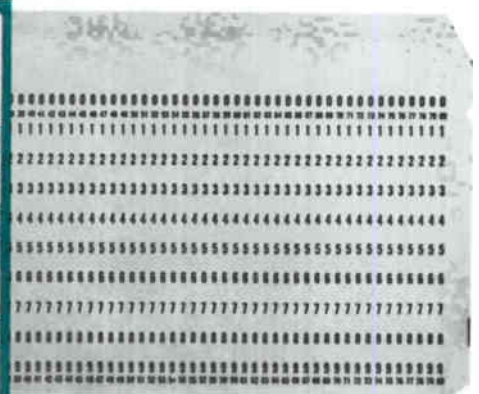
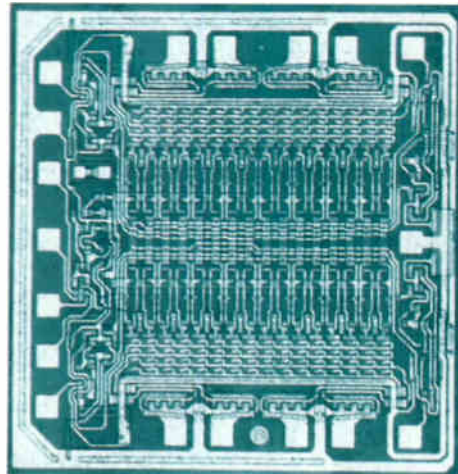

Your program-card and a logic table are all that's needed to computer-customize Motorola's XC170, 128-Bit "Read-Only Memory."

ECONOMICAL CUSTOMIZED MSI VIA COMPUTER INTERFACING!

Let's let our computers "talk" to each other!

Objective: to establish a close-matching interface between Motorola and users of MSI circuits in order to customize standard circuitry to specific requirements — and to do it at a considerable savings in both time and money!

The XC170, forerunner in this unique scheme, is a monolithic "Read-Only" memory circuit whose basic structure consists of 16 eight-bit "words" (128-bits in all), with each bit initially in the logical "1" storage state. By removing appropriate metal links on its metalization pattern, these bits can be changed to the logical "0" state to meet your particular function requirements. Open collector outputs on each buffered line allow multiple "Wired ORing" for large memory arrays. (Incidentally, the logic

levels of this circuit are compatible with both MDTL and M TTL families.) Address times are less than 45 ns.

All you need do to customize the XC170 is to supply a punched card that reflects the memory bit pattern that you have established, along with a table showing the R.O.M. contents. *Our computer does the rest!*

The customer's punched program-card provides the mask-making instructions for Motorola's computer-aided design facility. This card information also accompanies the processed parts through to final test where automatic equipment compares the results for compliance to the specified program.

Pricing and scheduling can be easily worked out in consultation with your local Motorola representative. You'll be saving both time and money!

For details circle Reader Service No. 314

"Step-Up" Saturated Logic To High-Speed MECL II With The New MC1035!

An exceptional new, multifunction circuit in the MECL II line, MC1035/1235, characterized as a dual Schmitt Trigger/Triple Differential Amplifier, now allows you to interface high-speed MECL systems with lower-speed saturated logic forms, while increasing low voltage swing signals to high MECL levels.

This versatile I/C consists of three differential amplifiers with emitter-follower outputs and a bias driver. It can also be used as a level translator (MOS to MECL), as well as in many linear applications. Examples include: an RF amplifier/FM amplifier-limiter; a wide-band video amplifier; an A/D comparator; a zero crossing detector; and, a V_{BIAS}

buffered supply. All of these applications are illustrated and described in the comprehensive data sheet for this remark-

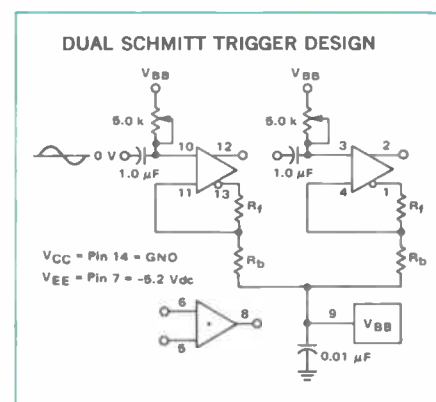

For details circle Reader Service No. 315

able monolithic I/C.

Each amplifier of the MC1035/1235 features:

- Voltage gain — 6.0 V/V (single-ended) or 12 V/V (differential)
- Bandwidth (at 3.0 dB point) — 45 to 50 MHz
- Useful gain — to 100 MHz
- Common mode rejection ratio — 80 dB
- Propagation delay — 3.5 ns (nom)

The MC1035 (0 to +75°C) is available in the ceramic 14-pin dual-in-line package while the full temperature range MC1235 comes in the 14-lead ceramic flat pack. And, it is low priced!

	Prices
MC1035L	\$1.50 (1,000-up)
MC1235F	\$3.00 (100-up)

The MJE3055 THERMOPAD plastic silicon power transistor performs like the TO-3 packaged 2N3055, still costs only about a dollar!



90-Watt THERMOPAD Silicon Transistor Heralds New Low-Cost Power Designs!

A whole new era in economical, high-wattage power circuit design has been ushered in with the introduction of the Motorola MJE3055 THERMOPAD silicon power transistor — a “metal-spec’d”

but plastic-packaged version of the popular TO-3 housed 2N3055. This 12 Amp, 60 volt, NPN unit dissipates a full 90 Watts, due to its unique direct chip-to-heat-sink thermal path design (only

For details circle Reader Service No. 316

0.030”) — the first plastic power transistor to break the ultra-wattage barrier!

For the designer who is looking for an economical, yet speedy power switch, the MJE3055 offers both high frequency response and fast switching times. And, this universal transistor will also serve you well in series and shunt regulators and high fidelity power amplifiers. Its exceptional linear beta is spec’d at two I_C points to provide the circuit designer with a complete picture of its high gain capabilities over a wide current range.

Motorola THERMOPAD devices have proven their mettle in stringent no-failure tests such as: high humidity, reverse bias and 100,000 hours at 150°C storage temperature, as well as 42,000 hours of operating life under ambient conditions.

Type	h_{FE} @ I_C	$V_{CE(sat)}$ @ I_C (max)	f_T (min)	Price (100-up)
MJE3055	20-70 @ 4 A 5 min @ 10 A	1.1 V @ 4.0 A	2 MHz	\$1.02

Uniwatt plastic transistors now “fill-the-gap” between Unibloc and Thermopad power dissipation ratings.

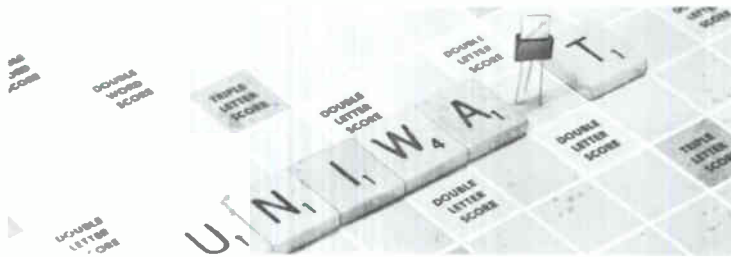

Here’s The “Uniwatt” — A Plastic Transistor That Fits Into The 1-To-6 W Power-Slot!

A new plastic transistor package — called the “Uniwatt” — now provides the designer with an economical device, capable of fulfilling medium power dissipation requirements to roughly six-watts. It fills the “thermal-gap” between the Unibloc plastic transistor case (310 mW) and the high power Thermopad plastic types (up to 90 Watts).

The Uniwatt package, about the size of a TO-5 metal-can device, has excellent thermal properties—being able to handle up to one-watt at $T_A = 25^\circ\text{C}$, with no heat sinking and approximately six-watts when its integral heat-sink “tab” is chassis mounted.

The initial Uniwatt packaged introductions include both high-voltage NPN

types and two NPN/PNP complementary series. The MPS-U01/U51 series features high, linear betas over a collector-current range of 1.0 mA to 1.0 Amp, while the MPS-U02/MPS-U52 series (designed for general purpose and driver applications) also offers low saturation voltages and a high f_T of 150 MHz at 20 mA. Two high voltage types, the NPN MPS-U03 and MPS-U04 provide V_{CE0} ratings of 120 and 180 volts, making possible the use of low-cost, medium-power plastic transistors in horizontal driver and video output applications.

They are all silicon Annular transistors, famous for their high performance and reliability.

Plastic Darlington Amplifier Saves Space, Saves Money!

Combining plastic encapsulation with closely matched transistor geometries on a single monolithic chip, Motorola has produced a peak-performance device for a “peanut” price. It’s the NPN MPS-A12 Darlington amplifier. And, even though

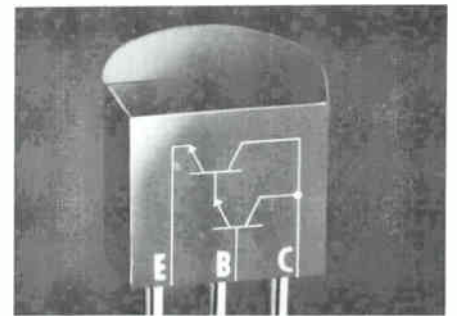

Monolithic Darlington amplifiers are now encapsulated in low-cost Unibloc plastic.

it offers betas in excess of 20,000, it comes for just 42¢ (1,000-up).

Its low cost, together with its high performance parameters and its 2-in-1 construction, make this Darlington applicable for a variety of compact economy designs. For example, it is ideal for pre-amp stages requiring high impedance inputs and as drivers in under 2-Watt amplifiers.

The unit displays excellent gain linearity from 1.0 mA to 100 mA. It also has a high f_T of 250 MHz @ 10 mA typ. Leakage current is only 100 nA at 15 volts.

For details circle Reader Service No. 318

Type No.	Polarity	V_{CE0} Rating	P_D @ 25°C		h_{FE} @ I_C (min.)	$V_{CE(sat)}$ @ I_C (max.)	f_T @ I_C (min.)	Price (5,000-up)
			T_A	T_C				
MPS-U01	NPN	30 V	1.0 W	8.0 W	70 @ 150 mA	1.0 V @ 1.0 A	50 MHz @ 50 mA	54¢
MPS-U51	PNP							62¢
MPS-U02	NPN	40 V	1.0 W	6.0 W	50 @ 150 mA	0.4 V @ 150 mA	150 MHz @ 20 mA	46¢
MPS-U52	PNP							54¢
MPS-U03	NPN	120 V	1.0 W	5.0 W	40 @ 10 mA	0.5 V @ 200 mA	100 MHz @ 50 mA	66¢
MPS-U04		180 V						76¢

For details circle Reader Service No. 317

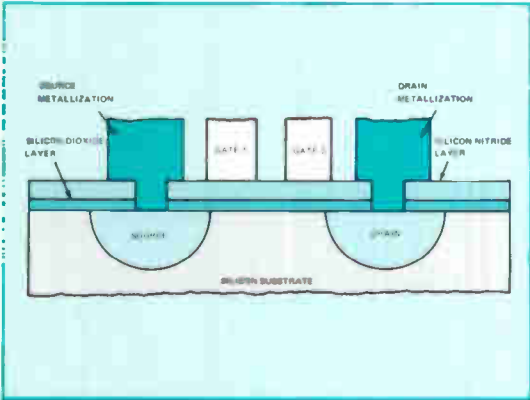

DUAL-GATE SILICON NITRIDE RF MOSFET

—Offers Cascade Performance Plus AGC Action . . . And It's Reliable!

RF circuit designers will appreciate the versatility and stable performance of the new MFE3006 dual-gate MOSFET. The series arrangement of two separate channels, each with an individual and independent control-gate, makes this MOSFET ideal for use in cascade configurations. In addition, this unit also provides excellent AGC action. Its application possibilities span a wide range of designs — from RF amplifiers and mixers up to 300 MHz, to gated amplifiers, choppers and DC amplifiers.

Typical highlight characteristics include a high power gain (G_{ps} of 24 dB; low noise figure (3.0 dB); and a reverse transfer capacitance (C_{rss}) of only 0.02 pF. The MFE3006 is fabricated using Motorola-developed Silicon Nitride passivation to assure long-term stability under both high temperature and reverse-bias conditions. All this, yet it's priced at just 90¢ (1,000-up).

For details circle Reader Service No. 323



JAN2N4948/49 UNIJUNCTION TRANSISTORS

— Are First State-Of-The-Art UJTs To Be MIL-Qualified!

Motorola's JAN2N4948/49 all-diffused, Annular UJTs have been awarded MIL-qualification to MIL-S-19500/388 (USAF) — the only up-to-date UJT devices to be so honored! Unlike outmoded "bar-alloy" types, these UJTs excel in three vital parameters required by today's military requirements: (1) Low $V_{EB(10A)}$ — 3.0 V max; (2) reverse-bias emitter current of 10 nA max; (3) and, a low maximum peak-point current of just 2 μ A. And, though the MIL spec doesn't call for it, they easily operate in the 1 MHz region — making them ideal for stable, sensitive triggering and time-delay functions in virtually every military electronics system. Even with all these advantages they cost only 1/3 as much as previous MIL UJTs.

Type Numbers	I_p (max)	$V_{EB(10A)}$ (max)	I_{EB20} (max)	Intrinsic Standoff Ratio (η)		Price (100-up)
				min	max	
JAN2N4948	2 μ A	3 V	10 nA	0.55	0.82	\$1.80
JAN2N4949	1 μ A			0.74	0.86	2.60

For details circle Reader Service No. 324

JFET Type Numbers		I_{DSS} (mA) Min / Max	R_e (Y_{11}) (μ mhos) Min	Prices (100-up)	
N-Channel	P-Channel			N-Channel	P-Channel
2N5358	2N5265	0.5 - 1.0	800	\$4.00	\$5.40
2N5359	2N5266	0.8 - 1.6	900	3.60	5.10
2N5360	2N5267	1.5 - 3.0	1400	3.30	4.80
2N5361	2N5268	2.5 - 5.0	1700	3.00	4.50
2N5362	2N5269	4.0 - 8.0	1900	3.30	4.80
2N5363	2N5270	7.0 - 14	2100	3.60	5.10
2N5364	9.0 - 18	2200	4.00

N-CHANNEL AND P-CHANNEL JFETS

—Offer Tight I_{DSS} Ratios As Well As Low Noise Figures

Motorola now provides an N-channel 2N5358-64 JFET series which is complementary to the P-channel 2N5265-70 line (introduced at the beginning of the year). In addition to their value in complementary circuit designs, these JFETs display performance characteristics that make them naturals for critical general purpose and military amplifier applications. Such highlight parameters as noise figures as low as 2.5 dB max @ 100 Hz make them prime choices for precision preamplifier applications.

Their I_{DSS} ratio is tightly specified at 2:1. Both series offer high minimum gate-source breakdown voltages ($V_{(BR-GSS)}$). Motorola originated Designers data sheets, containing comprehensive min/max curves and detailed parameter specs, are available for both the 2N5358-64 and the 2N5265-70 series, permitting the design of most circuits entirely from the information presented.

Motorola also offers a 40-volt version of the 2N5265-70 — the MFE4007-12 series — which provides the same tight I_{DSS} ratios but at a substantial cost savings.

All three series — the 2N5358-64, the 2N5265-70 and the MFE4007-12 — are available for your immediate needs from your local Motorola distributor's warehouse. The units are packaged in four-leaded TO-72 metal-cans.

For details circle Reader Service No. 325

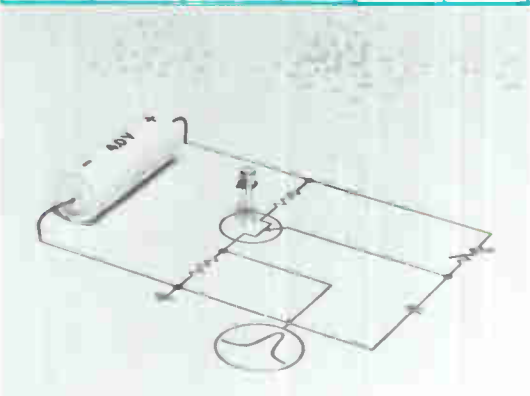

ULTRA-LOW-VOLTAGE UNIJUNCTION TRANSISTOR

—First Advanced UJT To Operate From 4 Volt Sources!

Motorola's newest state-of-the-art UJT — the 2N5431 — now makes it possible to build industrial and military timing, triggering and sensing circuits which can operate from batteries or other low voltage sources.

Packaged in the TO-18 case, this new 4-volt UJT is fabricated using a process similar to that used for silicon Annular transistors, famous for their reliability and performance. The results: a UJT which exhibits no more than 10 nA emitter leakage-current (I_{EB20}) and peak-point currents of only 0.4 μ A max, at 25 V, and 4.0 μ A at 4 V ($V_{BE(1)}$). It also has a tight η range of 0.72-0.80 and a narrow base resistance spread of 6.0 k Ω to 8.5 k Ω .

All this and low prices, too! The 2N5431 lists for just \$3.25 (1,000-up), with availability as near as your local distributor's warehouse.

For details circle Reader Service No. 326

HIGH-VOLTAGE PNP SILICON POWER TRANSISTORS

—Switch 250-300 Volts in Nanoseconds And, They're PNP Polarity!

The design of direct line-operated switching circuits, thus eliminating the need for step-down componentry, is now possible using Motorola's new silicon PNP 2N5344/45, 250-300 volt power transistors. Their switching capability is ultra-nimble, too — less than 900 ns (max.) at 500 mA and 100 volts. And efficient, low-power-loss, low-distortion performance is ensured due to saturation voltages which are typically less than 0.38 V (also at 500 mA).

Packaged in the thermally-efficient TO-66, they offer high dc safe operating areas (up to 1 Amp). Their —65 to +200°C range makes them ideal replacements for germanium units in higher temperature designs.

PNP Type	V _{CEO}	P _D @ T _C = 25°C	Total Switching Time @ 500 mA/100 V (max)	h _{FE} @ 500 mA	V _{CE(sat)} @ 500 mA (typ)	f _r @ 100 mA (min)	Prices (100-up)
2N5344	250 V	40 W	900 ns	25-100	0.38 V	60 MHz	\$12.00
2N5345	300 V						15.00

For details circle Reader Service No. 327

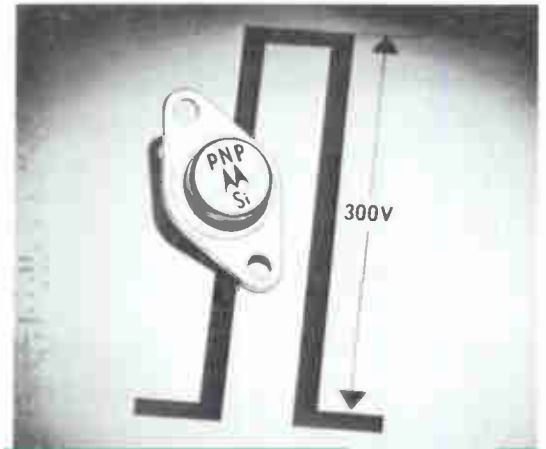

60-AMP 2N5435-40 "ADE" GERMANIUM TRANSISTORS

—Push Power Switching Performance To New Heights!

Motorola's continuing developments in ADE die technology (Alloy-Diffused-Epitaxial) now yields a line of germanium power transistors that can switch more power, faster . . . with higher betas and lower saturation voltages than ever before possible! The series is EIA-labeled 2N5435-40. And, like the rest of the ADE family, they provide double the power-handling capability of conventional units. Their high safe operating area limits and high, linear betas at high current levels qualify them for first consideration in critical, heavy-muscle designs. Cases: All-aluminum TO-3 (also available with flattened and pierced leads).

EIA Type No.	V _{CEs}	h _{FE} @ I _C /V _{CE}	V _{CE(sat)} @ I _C /I _B (max)	Switching Time @ I _C = 25A (max)			I _C (cont)
				t _r	t _s	t _f	
2N5435	60 V	20-60 @ 25A/2V	0.75 V @ 60 A/6 A	12 μs	10 μs	8 μs	60A
2N5436	90 V	10 min @ 60A/2V					
2N5437	120 V						
2N5438	60 V	40-120 @ 25A/2V	0.50 V @ 60 A/6 A				
2N5439	90 V	15 min @ 60A/2V					
2N5440	120 V						

For details circle Reader Service No. 329

LOW-VOLTAGE "BET" SILICON RF POWER TRANSISTORS

—Protect Against Secondary Breakdown In Battery-Powered UHF Designs!

Motorola's new NPN MM1601/02/03 "BET" RF power transistors are standout performers for 12-Volt (nom) UHF power amplifier or oscillator applications in military and industrial equipment. They can be used in Class AB, B or C designs to provide dependable and efficient performance up to 240 MHz.

Their Balanced Emitter construction guards against secondary breakdown and prevents burn-out, even under "worst-case" mismatched load conditions. They are packaged in Motorola's stripline "opposed-emitter" case structure which provides low lead inductance and ease of tuning.

An Application Note describing procedures for systematic RF input-output network design as well as comprehensive device data sheets are available.

Type No.	Case Type	Power-In (Max)	Power-Out (Typ) @	Frequency	Power-Gain (Min)
MM1601	144	0.6 W	3 W @	175 MHz	7.0 dB
MM1602	145	2.5 W	10 W @	175 MHz	6.0 dB
MM1603	145	8.5 W	25 W @	175 MHz	4.7 dB

For details circle Reader Service No. 328

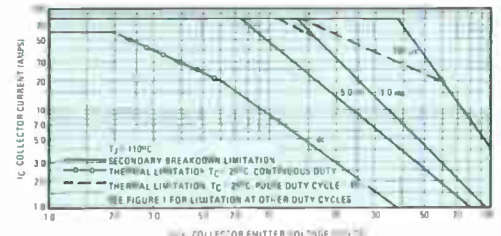

HIGH-VOLTAGE "SURMETIC" PLASTIC RECTIFIERS

—Protect Against Overloads To 5000 Volts, Cut Power Losses!

Surmetic rectifiers, long-time commercial/industrial standards in numerous low-cost, peak-performance applications — now wear higher-than-ever voltage designations . . . 4,000 and 5,000 V! The MR995/6 can be designed right into high voltage B+ supplies in communications and electro-static equipment, high-energy capacitive discharge systems, CRT applications, X-ray, and other designs where severe voltage overloads may be encountered. High-temperature current handling and 15 Amp surge capability "above and beyond" safety factors. And, they shrug off tough 240-hour Mil-S-750 moisture-cycling tests.

Type	V _{RM}	I _o	I _{FM} (surge)	V _{F(AV)}	I _r	Price (100-up)
MR995	4,000 V					80¢
MR996	5,000 V	250 mA	15 A	1.7 V	10 μA	90¢

For details circle Reader Service No. 330

NEW LITERATURE BRIEFS

Complete I/C Data Now In One Volume!



The industry's most complete integrated circuits specification guide — "The Integrated Circuit Data Book" — is now available.

Comprising nearly 1,000 pages of detailed device specifications, applications information and test data, it covers all standard Motorola integrated circuits — both linear and digital. "Quick" selector guides enable the designer to compare various circuit configurations and choose those best suited for his application. The book also contains complete alpha-numerical listings which identify each circuit type by function and provide page-number references.

Individual data sections cover all Motorola digital families: MECL, MHTL, MTTL, MDTL, MRTL, mWMRTL and MOS as well as linear types — Op Amps, Sense Amps, Diff Amps, Comparators, etc. and complex arrays. A section devoted to application notes is also included.

It is priced at only \$3.95/single copy. To order, fill out the coupon in this issue and mail with your remittance.

New 'Fundamentals of Integrated Circuits' Textbook



Here's an easy-to-read primer that answers the need for a basic guide to the understanding and use of integrated circuits. The book includes a fundamental review of general semiconductor technology as it applies to integrated circuits. Over 250 photos, graphs, charts and tables help to make this textbook completely understandable to anyone with a basic knowledge of electronics.

Mathematics are held to a minimum, making it an excellent training aid for engineers and technicians who are just beginning to use integrated circuits. An invaluable addition to your library, "Fundamentals of Integrated Circuits," by Lothar Stern, Manager of Motorola's Technical Information Center, contains 198 pages in a hard-bound cover. It is priced at \$8.95 in single-copy quantities.

To order, fill out the coupon in this issue and forward with your remittance.

If the "Coupon" is missing, send your remittance, with the title of the book(s) you are ordering, to:

Motorola Semiconductor Products Inc.
P. O. Box 20924
Phoenix, Arizona 85036

☆☆☆ VOTE ☆☆☆

It has been said, "All the ills of democracy can be cured by more democracy." Remember November 5, 1968 is Election Day. Your vote could mean a better America!

LITERATURE ORDER FORM

NOTICE: Requests for literature on items described in this publication cannot be honored after April 1, 1969.

Please circle the Reader Service number of item(s) you are interested in receiving.

E						
312	313	314	315	316	317	318
319	320	321	322	323	324	325
326	327	328	329	330		

Please Print Clearly

NAME _____ TITLE _____

COMPANY NAME _____

DIVISION _____ DEPARTMENT _____

COMPANY ADDRESS (Street or P. O. Box) _____

CITY _____ STATE _____ ZIP CODE _____

If you wish to receive mail at a different address, fill out below:

CITY _____ STATE _____ ZIP CODE _____

Do you wish a Motorola Representative to contact you?

VISIT PHONE . . . Phone No. _____ Area Code _____

BOOK ORDER FORM

To order books, fill out coupon and mail in envelope with check or money order made payable to:

Motorola Semiconductor Products Inc.

(P. O.'s accepted on orders totaling \$10.00, or more)

Quantity

"THE INTEGRATED CIRCUITS
DATA BOOK" (Single copy) — \$3.95
(Quantities of 2-24) — \$3.00/ea.

"FUNDAMENTALS OF INTEGRATED
CIRCUITS" TEXTBOOK . . . (Single copy) — \$8.95
(Quantities of 2-10) — \$7.60/ea.

"SEMICONDUCTOR POWER CIRCUITS"
HANDBOOK \$2.00/ea.

Total — \$ _____

Tear Along Perforated Line and Drop in Mail (No Postage Required)

FOLD HERE

FIRST CLASS
Permit No. 2565
PHOENIX
ARIZONA

BUSINESS REPLY MAIL
No postage stamp necessary if mailed in the United States

POSTAGE WILL BE PAID BY

Semiconductor NEWSBRIEFS
Motorola Semiconductor Products Inc.
P. O. Box 20924
Phoenix, Arizona 85036

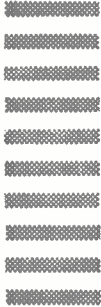

FOLD HERE



For Fast Action!

... on delivery of literature for items described in this publication — fill out this coupon, fold as indicated and drop in the mail.

(NO POSTAGE IS REQUIRED)

SEAL HERE

BOOK ORDER FORM

To order books fill out coupon, tear along perforated line and mail in envelope with check or money order. (P. O.'s accepted on orders of \$10.00 or more)

Address: Motorola Semiconductor Products Inc.
P. O. Box 20924 — Phoenix, Arizona 85036
Attn: Technical Information Center

NAME _____ TITLE _____

COMPANY _____

ADDRESS _____

CITY _____ STATE _____ ZIP _____

NEW LITERATURE BRIEFS

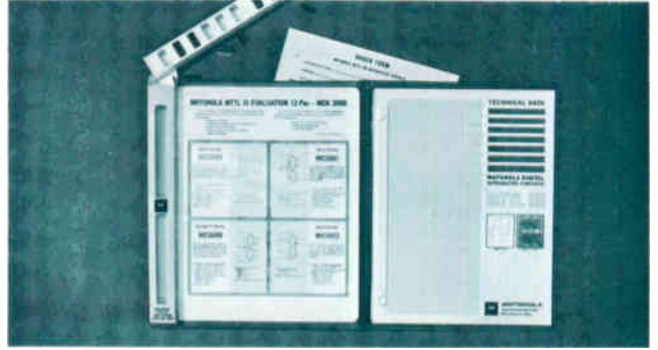

12 MTTL III Functions Now Available In Comprehensive Evaluation Kit!

Now's your chance to try out a complete cross-section of Motorola's new MTTL III line — the ultimate in TTL logic forms — at both a savings in money and time.

Order an MCK3000 Evaluation 12-Pac, today . . . and find out how the Motorola MTTL III line virtually eliminates the voltage transfer and "ringing" problems so common with earlier-generation TTL integrated circuits. You get a complete design kit, consisting of 12 plastic dual-inline packaged MTTL III circuit types (4 dual "D" and J-K flip-flops, 7 dual and quad gates and one dual line driver), along with a comprehensive product data and applications information brochure — all in a sturdy leatherette portfolio.

All this and it carries a special introductory price-tag of only \$34.30 (a savings of \$10.00 on the devices alone, based on 1-999 prices)! And, they're available "off-the-shelf" from your Motorola distributor.

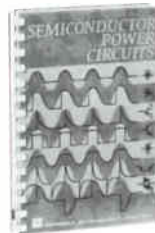

New "Power Circuits" Handbook Provides All-In-One Design Aid

Practical, helpful circuits using power transistors, thyristors, rectifiers and regulator diodes are comprehensively described in Motorola's new all-encompassing Power Circuits Handbook. Nearly 150 circuits are presented, most of which were specially designed, constructed and evaluated by Motorola, before text inclusion. The book is divided into application area sections which include in-depth design information covering: speed controls for ac/dc motors, inverters, ac/dc regulators, solid-state switching of both ac and dc source-voltages, servo and audio amplifiers and miscellaneous circuits such as 0-point switching, temperature controls, light dimmers, timers, and flashers. Price:\$2.00.

Published by Motorola Semiconductor Products Inc., P. O. Box 20924 Phoenix, Arizona 85036



©Motorola Inc. 1968

The circuitry shown external to Motorola products is for illustrative purposes only, and Motorola does not assume any responsibility for its use or warrant its performance or that it is free from patent infringement.

MTTL, MTTL III, MECL II, Unibloc, Uniwatt, THERMOPAD II, Surmetic, ADE, Designers and BET used in this publication are trademarks of Motorola Inc. Annular semiconductors are patented by Motorola Inc.

NOTE: If coupon is missing use magazine's Reader Service numbers to order literature on items described in NEWSBRIEFS.



0.1251
0.1253

CINCH UNIQUE BACK PLANE DESIGN PERMITS UNEQUALLED SYSTEMS FLEXIBILITY

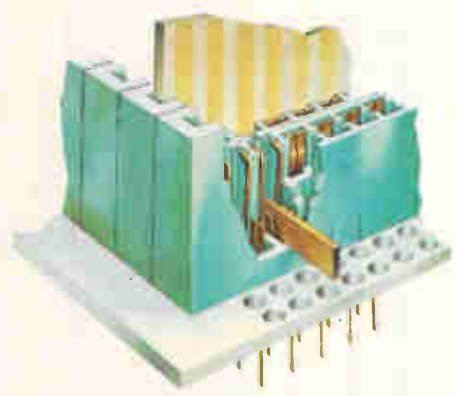

Using the basic connector-plane concept, Cinch engineers have developed an unusual device for data processing equipment and other high density automatic wiring applications. This new system substantially reduces the high labor content of conventional back plane interconnection systems and, at the same time, provides increased design flexibility and precise location of the terminal tips.

- The plane can be bussed from the PC board side or the terminal side.
- Individual contacts, including bussing contacts, can be easily replaced.
- Common voltage input can be provided to any position on the plane.
- Cinch designed automatic assembly equipment inserts an entire row of contacts in a single operation. ■ Contact tail positions on a .125" grid are held to a $\pm .010$ " radius tolerance when checked on an X-Y coordinate machine, as shown in the illustration.

HOW IS IT DONE? A new brochure describing this Cinch interconnection system and the Cinch capabilities available to you is available by writing to Cinch Manufacturing Company, 1501 Morse Avenue, Elk Grove Village, Illinois 60007. C-6812



DIVISION OF UNITED-CARR

MEMBER



CONSISTING OF CINCH MANUFACTURING COMPANY, CINCH-GRAPHIK, CINCH-MONADOCK, CINCH-NULINE, UCINITE (ELECTRONICS) AND PLAXIAL CABLE DEPT

Circle 43 on reader service card

How to select the best DVM in the medium price range:

	HP 3440 SERIES	FAIRCHILD 7000 SERIES
TO MEASURE DC VOLTS		
price	\$1295	\$1275
ranges	3	4
overranging	5%	20%
accuracy—		
24 hours	.05% r. ± .01% f.s.	.01% r. ± .01% f.s.
3-month stability	.05%	not specified
noise rejection		
common mode, 60 Hz	30 - 70 dB	not specified
normal mode, 60 Hz	30 db	30 dB
input resistance—10-volt range	10.2 megohms	1000 megohms
TO MEASURE MILLIVOLTS		
price	\$1610	—
accuracy—100 mV	.10% r. ± .05% f.s.	—
3-month stability	.05%	—
input resistance	10.2 megohms	—
common mode noise rejection	100dB	—
autoranging—100 mV to 1000 V	yes	—
TO MEASURE AC VOLTS (100 kHz)		
price	\$1775	\$1725
ranges	3	4
basic accuracy	.10% r. ± .02% f.s.	.10% r. ± .02% f.s.
auto ranging	no	yes
common mode noise rejection	not specified	not specified
TO MEASURE OHMS		
price	\$1525 (incl. mV and current)	\$1385
ranges	5	5
basic accuracy	.30% r. ± .01% f.s.	.05% r. ± .02% f.s.
max. voltage across unknown	1.0v	1.2v
MULTIMETER CAPABILITY		
price	—	\$1895
functions	—	dc, ac, mV, ohms, current
source of data	catalog—1968	#7000 - 8/67

NLS X2 SERIES

DANA 4400 SERIES

\$1180
3
20%

.02% r. ± .01% f.s.
not specified

\$1150
4
20%

.01% r. ± .01% f.s.
.01%

100 dB
30 dB
10 megohms

100 dB
60 dB
1000 megohms

\$1630 (incl. ohms)
.06% r. ± .05% f.s.
not specified
100 megohms
not specified
no

\$1395
.01% r. ± .01% f.s.
.01%
100 megohms
100 dB
yes

\$1480
4
.05% r. ± .02% f.s.
yes
not specified

\$1450
4
.10% r. ± .02% f.s.
yes
60 dB

\$1630 (incl. mV)

5
.02% r. ± .06% f.s.
16v

\$1795 (incl. mV and ac)

5
.01% r. ± .02% f.s.
1.2v

\$2230
dc, ac, mV, ohms,
current, ratio

\$1795
dc, ac, mV, ohms

#002 - 6/67

catalog - 1968



The rest of the series 4400 specs are in our new brochure along with those on all the Dana DVM's. A letterhead request will get you a copy.
Dana Laboratories, Inc., 2401 Campus Drive, Irvine, California 92664.

DANA



Introducing Honeywell Series 32

**Computer systems with the golden touch...
that work for pennies**

First member of the Honeywell Series 32 family of 32-bit real-time I/C computer systems, the H632, is 850 nanoseconds fast. A high-performance system for real-time scientific and control applications, like: ground support/checkout, trainers/simulators, hybrid computation, message switching/data retrieval, and general purpose scientific.

It not only costs less per instruction than any other medium-scale machine, but has an advanced concept of modular system integration and design that makes it shine in multiprocessor/multiprogrammable configurations. Of course, its software package is extensive, and a complete line of peripherals and

subsystems is ready to meet almost any requirement.

The H632 can grow with you . . . from a minimum 8K memory with one central processor and one input/output processor to a maximum system of 131,072 words of memory, four central processors, and four input/output processors. I/C construction throughout adds to system reliability (we're I/C people from way back).

Because the H632 does so many things so well for so little, we call it "the computer with the golden touch . . . that works for pennies." Want to learn more about the H632? Write for our new summary brochure. Honeywell, Computer Control Division, Old Connecticut Path, Framingham, Massachusetts 01701.

Honeywell

 **COMPUTER CONTROL**
DIVISION

1 mW-per-gate TTL now more economical than ever

Recent price reductions—plus the addition of MSI circuits—now bring TI's one-milliwatt-per-gate TTL line within the reach of even the most cost-critical industrial and commercial equipment designers.

New manufacturing techniques—plus high-volume production—have enabled TI to reduce prices by 25 to 40 percent. This means you can now obtain many of the same benefits that have helped to upgrade sophisticated military, avionic and space programs, at only about a 20 percent premium

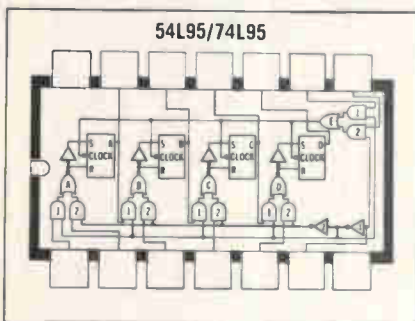

over standard Series 74 TTL.

Furthermore, the number of low-power circuits available has been expanded to 13. These include several new MSI functions, such as the 4-bit right-shift, left-shift register shown here. These new MSI circuits permit sizeable package count reductions, thereby increasing reliability while assuring you lowest cost per function. And you have your choice of package types—the hermetically sealed flat pack and the convenient, low cost plastic

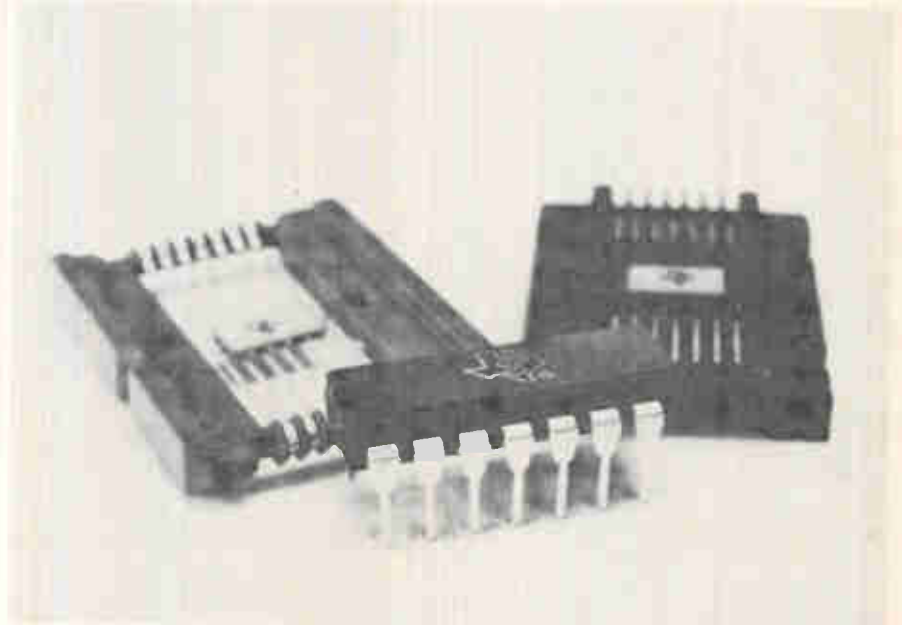

plug-in package.

All 13 Series 54L/74L circuits feature power requirements less than one-tenth that of comparable standard ICs. For example, power dissipation is typically 1 mW per gate and 3.8 mW per flip-flop. Furthermore, with 54L/74L circuits low power does *not* mean low speed. These circuits are about twice as fast as other ICs with similar power dissipation.

Because of their low power requirements, Series 54L/74L circuits make it possible to significantly shrink size of power supplies and energy sources such as batteries or solar cells. Also, requirements for heat sinks and other heat-dissipation provisions are re-

duced...further reducing the size and complexity of installations.

Series 54L/74L TTL is fully compatible with both standard and high-speed versions of the 54/74 TTL family. All these circuits may be combined, in any proportion, to give almost any desired speed/power-dissipation combination. On any count—price, performance, selection—equipment designers are now turning, as a matter of course, to low power TTL from TI. Why not find out how you can benefit, too.

For data sheets on Series 54L/74L, just write on your company letterhead to Texas Instruments Incorporated, P. O. Box 5012, M.S. 980-C, Dallas, Texas 75222.



TEXAS INSTRUMENTS
INCORPORATED

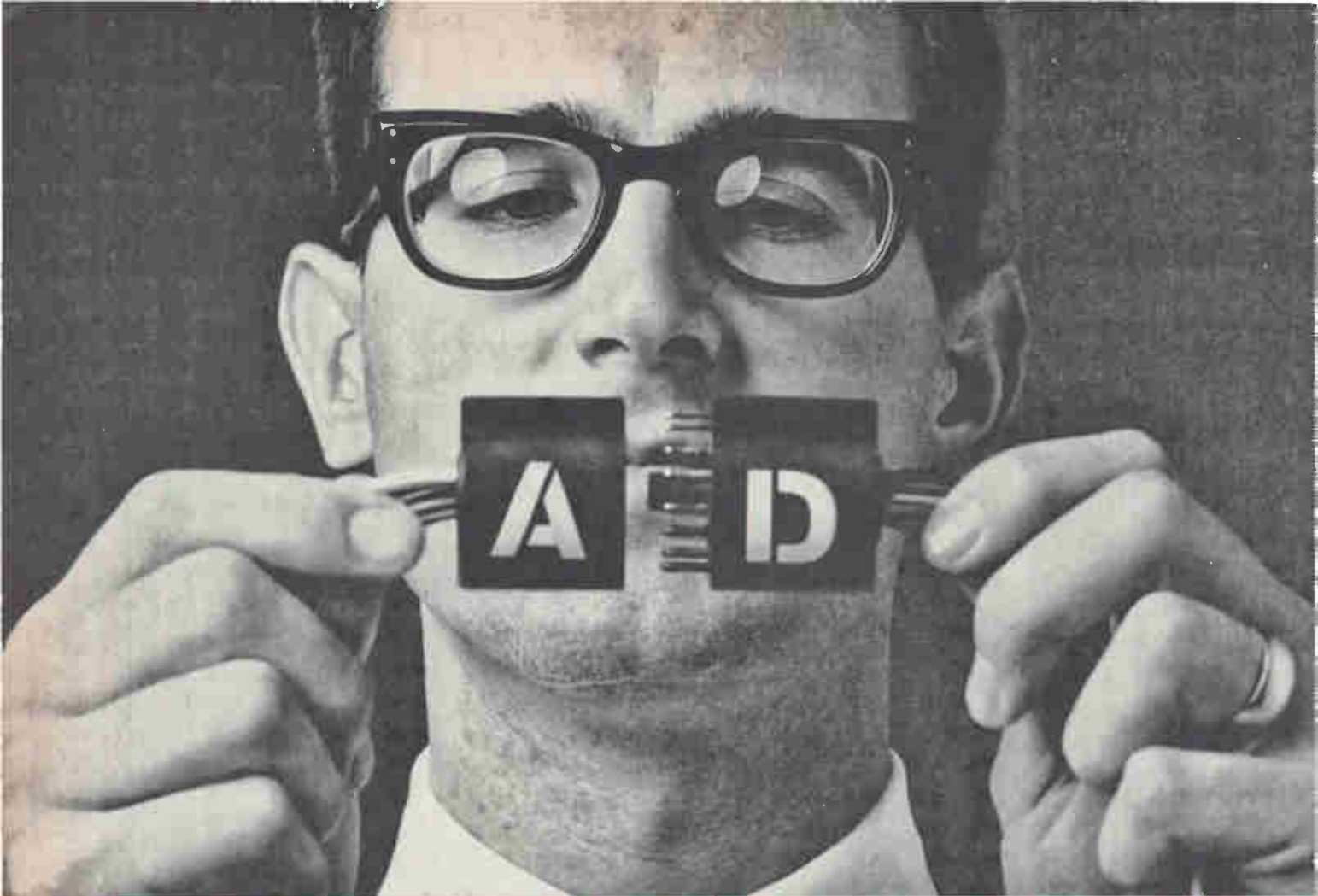

Even a digital engineer can interface our new analog instruments.

Analog engineers design analog instruments for analog engineers. Digital engineers aren't usually analog engineers. This leads to problems.

Because we're involved with both D and A, we developed a group of instruments everyone can understand and use.

Before they were put on the market, our systems engineers demanded that analog signals get in and out of digital equipment with blinding speed and stunning accuracy. As a result, here are bold statements about our new line: **Our new instruments are:** A. As fast and more accurate than . . . B. Faster and more accurate than . . . C. Almost as fast and just as accurate as anyone else's. Whether A, B, or C applies depends on the instrument you choose.

Here are some of the new ways to get from analog to digital and back again.

Multi-channel digitizers

64 channel high-level multiplexers with sample and hold amp, plus a 15-bit A-D converter in the same chassis. Accuracy: 0.01%. The MD51 has a sample and conversion time of 10 μ sec for \$8,250 plus \$200 for each eight channels. If you can spare another 20 μ sec, you'll save \$3,050 with the MD41.

Single channel digitizers

15-bit, high-level A-D converters with built-in sample and hold amps. Accuracy is $\pm 0.01\%$. The AD51 has a through-

put word rate of 100 KHz for \$5,400. The AD41, though it only costs \$4,000, isn't a slowpoke. Throughput is 33 KHz.

Digital to analog conversion

The DA40 is a 10-bit, 16 channel D-A converter. If you need more channels, up to 16 DA40's can be ganged together for 256 analog outputs. Each includes address decode and channel controls, plus a power supply. \$375 per channel.

One of the world's fanciest op-amps

Variations on a theme called the HT58 universal operational amplifier include a single-ended op-amp, differential amp, a unity gain buffer and a buffer with gain, all for use with our "T" and "J" series modules. Input impedance of 10^8 ohms and ± 40 ma. output current over a voltage range of ± 10 V. Accuracy: 0.01%. Settling time: 5 μ sec. You can adjust the gain, zero offset, and the input offset voltage temperature coefficient. \$170.

Our spec sheets meet the same requirement as our new instruments: they're understandable by digital engineers, analog engineers, and anyone else who can understand the specs above. For a complete set of spec sheets contact us digitally, or by using Mr. Bell's analog data transmission device.

SDS
Scientific Data Systems,
Santa Monica, California

Electronics Review

Integrated electronics

Toward MOS memories

Though many semiconductor manufacturers expect metal oxide semiconductors to someday replace magnetic cores in memory systems, their dreams of a large computer market are clouded by several immediate problems. Up to now, MOS-based memories have been characterized by low power and speed, complex logic circuitry, and the volatile memory properties common to all semiconductor designs.

At this week's International Electron Devices Meeting in Washington, the Westinghouse Molecular Electronics division announced two experimental MOS field effect transistor schemes that may show the way to more successful solid state memory systems. One, the MONOS (metal-oxide-nitride-oxide-semiconductor) element for read-only memory applications, is a non-volatile sandwich of silicon nitride and silicon dioxide. Turned on by a negative voltage, MONOS could lead to circuits having all their active, passive, and storage elements on the same chip, according to Hung C. Lin, manager of advanced techniques development.

For logic, too. The other development, a complementary MOS-bipolar structure, gets around the

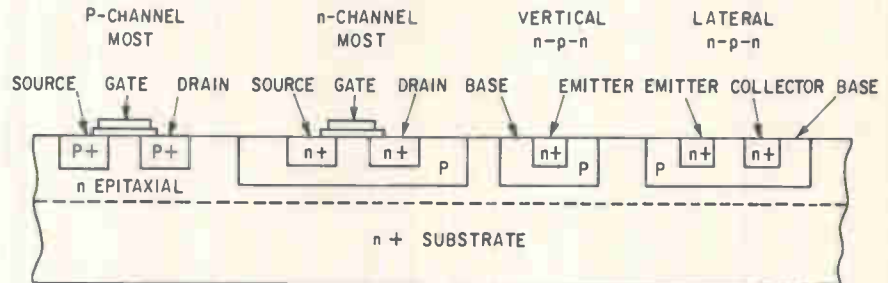

Faster recall. Complementary MOS-bipolar device, developed as a memory by Westinghouse, is 10 times faster than most MOS FET's.

fact that MOS FET's are usually limited to driving only low-capacitance loads by placing vertical and lateral npn bipolar transistors on the same chip to drive higher loads. The resulting devices are 10 times faster than most MOS FET's, Lin says, and are made with standard MOS manufacturing techniques. Potentially, he adds, the structures could be used not only as large random-access memories but as logic and shift-register elements. And the use of bipolar transistors at the output end could reduce the interface problems between MOS devices and others such as transistor-transistor logic or diode-transistor logic.

MONOS is basically a Dagwood version of previous sandwich structures demonstrated by Westinghouse and Sperry Rand. These earlier sandwiches had layers of silicon dioxide and silicon nitride between the silicon substrate and

the aluminum metalization. Since nitride permanently stores charges, giving the device its nonvolatile characteristics, such a structure becomes a memory element triggered by a positive charge.

To produce MONOS, Westinghouse added another layer of silicon dioxide less than 100 angstroms thick between the nitride and aluminum. The truly complementary one-chip memory device that might result from this development would have the action of a flip-flop, which usually requires four devices, Lin notes.

Limited pace. Right now, speeds are limited to the millisecond range because to go faster would burn up the dielectric. But Lin, positive that speeds will go below a microsecond, predicts production devices within a few years.

In its MOS-bipolar combination, Westinghouse connects the vertical and lateral npn transistors (the

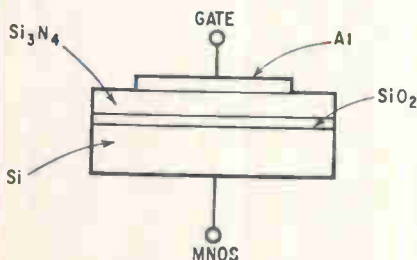

Sandwich fillings. Four-layer silicon nitride-silicon dioxide sandwich, left, is a nonvolatile memory element excited by a positive charge. The device at the right has an added layer of silicon dioxide, and is turned on by a negative current, a characteristic that could lead to a monolithic MOS flip-flop.

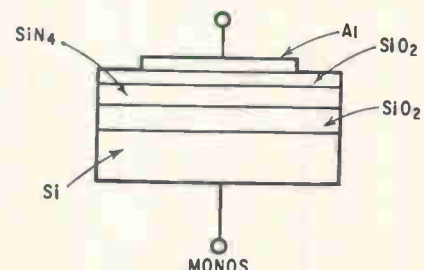

reference is to the relative positions of emitter and collector) to achieve a bipolar transistor with an isolated collector. This device has a composite gain of about 50 and is capable of driving hundreds of picofarads; it therefore needs no external buffer.

Although the company says it employs standard MOS processing, it does use an n+ silicon substrate for these structures instead of a p because it has to reduce the collector resistance of the vertical npn transistor. Other tricks, Lin says, include using an n epitaxial layer, shallow p-isolation regions with low surface concentration, and perfectly measured junction depths.

Pi-substrate MOS

The performance of complementary metal oxide semiconductor logic is so much better than p-channel logic that there must be a good reason why it's not used more often.

There is.

It's been very difficult to fabricate n and p channels in the same substrate.

General Telephone & Electronics Laboratories may have solved the problem, however, by using a π (that is, nearly intrinsic, high-resistivity p-type) substrate. A p-channel field effect transistor can be formed by diffusing low-resistivity p+ regions into the π substrate; the interface between the low- and high-resistivity regions is a rectifying junction that can eliminate drain-to-source current and thus establish the off state.

The p+ - π junctions have reverse leakage current measured in nanoamperes—comparable to that of conventional p-channel devices—when the substrate resistivity is greater than 10,000 ohm-centimeters.

Depletion mode. The p+ - π - p+ MOS FET switches on when a sufficiently negative gate-to-source voltage establishes a surface accumulation layer, providing a conducting link between drain and source.

The n-channel part of the com-

plementary circuit is formed by diffusing n+ regions into the substrate; it's very similar to conventional n-channel devices except that the substrate resistivity is much higher. Because of the substrate, the n-channel device will operate in the depletion mode and won't switch off unless certain precautions are taken. Use of Al₂O₃-SiO₂ gate insulators or selective gold doping solves the problem. As in other approaches to complementary MOS, the device must be separated by beam-lead or dielectric techniques.

Paul Richman, who with Walter Zloczower described the complementary MOS circuit at the International Electron Devices Meeting last week, says that their difficulties with the extremely resistive substrate have been economic rather than technological. The material is easy enough to make, but the only source is a chemical firm in Germany.

Simplified. Richman feels that the GT&E approach is the first simplified method of making complementary MOS IC's. The RCA and Westinghouse fabrication techniques have disadvantages, he says.

RCA's method of forming conventional n and p channels in the same substrate requires extremely careful control of the diffusion process and results in a rather high threshold voltage.

Westinghouse uses an elaborate procedure of etching pits, filling them with epitaxial p-type material, then etching back to form the p channels. This process involves critical mechanical operations and results in relatively slow circuits.

Neither GT&E nor Sylvania has immediate plans for marketing complementary MOS IC's. But Richman hopes that the new fabrication method will open up the memory applications for which complementary MOS integrated circuits are so well suited.

IBM going monolithic?

Since it introduced its solid logic technology (SLT) process in 1964, IBM has been turning out hybrid circuits by the millions. These con-

sist of flip-chips bonded by soldered copper balls to thick-film lands on ceramic substrates. The balls in turn contact the active regions of the chip.

While the rest of the industry has generally gone to monolithic circuits containing many elements on a chip, IBM has stuck with SLT and has been circumspect about its IC work. But now it's developed a "controlled collapse" bonding process that substitutes ductile solder balls for the copper ones. The solder's greater compliancy makes the process suitable for bonding many contacts to a substrate and thus applicable for IC's containing many elements.

IBM is presenting a paper on this new process at the 1968 Hybrid Microelectronics Symposium being held this week in Chicago.

More solder. The concern isn't saying whether it will begin manufacturing monolithic circuits in the same large quantities as SLT circuits. However, IBM points out that the new process is compatible with SLT.

In the controlled-collapse process, electrical contacts to the active areas of the chip are metalized with solderable materials. Then balls of solder about 4 or 5 mils in diameter are attached to the metalized contact pads, and a small part of the lands near the chip end is covered by a nonsolderable glass. Next, the chip is placed on the substrate and heated. The solder on the ends of the lands melts but the glass "dam" prevents most of it from flowing down the top of the lands and shorting the circuit.

The surface tension of the melted solder holds the chip off the substrate until the solder solidifies to form the electrical connection and a strong bond. The chip then sits about 7 mils above the substrate lands.

IBM says the use of compliant solder balls makes it possible to bond many contacts to lands even though the lands aren't exactly in a plane with one another. And the solder absorbs the strain caused by heating during bonding much better than copper.

Advantages. Reliability is expected to be 10 times better than

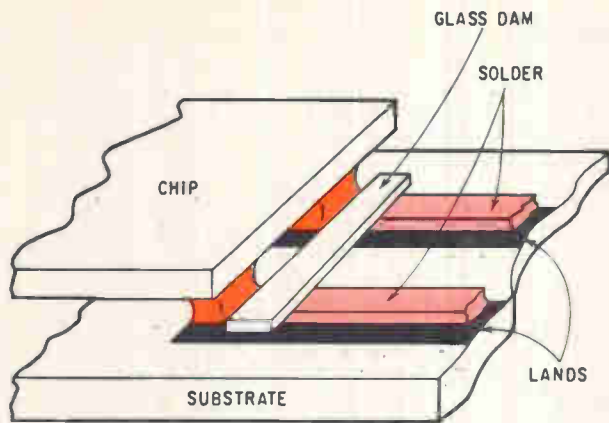

Compliant process. IBM's new bonding technique—applicable to multi-element IC's—uses solder balls to join chip to substrate. Glass on lands holds back molten solder, keeping chip from collapsing on the substrate.

that of the SLT process. The company quotes a bond failure rate of about 0.00004% per thousand hours and a chip failure rate of 0.0002% per thousand hours for the SLT circuits.

IBM has made experimental circuits with 5-mil-diameter pads spaced as close as 8 mils. Chips about 80 mils square with many elements have been proven reliable after many hundreds of temperature excursions ranging from -40° to $+150^{\circ}\text{C}$. The more elements a chip contains, and, therefore, the more contact points it must have, the lower the potential reliability. This is because the silicon chip and the alumina ceramic substrate have different coefficients of expansion. In the IBM process, the ductile solder compensates for the strains set up by these two materials under heat.

Another advantage of the controlled-collapse method is that defective chips can be removed easily. It's not necessary to heat the chip only in the contact area; the entire module can be reheated. Such modules have shown bond strengths equivalent to the first joining even after three or four replacements.

Displays

Now you see it

Using gallium arsenide for light-emitting diode switches seemed a bright idea to a General Electric research team working on displays

[Electronics, Oct. 14, p. 53]. The material allowed the researchers to construct a monolithic integrated circuit that contains light, memory, and logic elements but doesn't need interfaced buffer electronics.

However, there was one catch: gallium arsenide emits invisible near-infrared radiation. To convert this to visible light might have taken some tricky gadgetry but the team devised a simple electroluminescent photoconductor image converter (EL-PC) that changes the IR to usable light for displays. And not only does it make large GaAs displays possible, but it may find use in sighting mechanisms for laser communications systems and in night-vision sniperscopes.

Lighting up. Essentially a thick-film, light-controlled voltage switch,

the EL-PC makes the IR light 100 times brighter in converting it to the visible spectrum. The gain can be controlled electrically and, depending on the doping of the EL-PC's specially developed zinc-sulphide phosphor electroluminescent layer, the visible light can range from orange through blue.

The key to the EL-PC is the interaction between its cadmium-selenide photoconductor layer and zinc-sulphide phosphor layer. The amount of radiation falling on the cadmium regulates the electrical energy applied to the phosphor, and this in turn controls the phosphor's light output.

To get maximum sensitivity, the team developed a small-capacitance structure consisting of six pairs of concentric electrodes evaporated through a metal mask onto a common layer and arranged in two planes. Radiation enters the photoconductor layer through a window in the common layer, increasing optical efficiency because none of the radiation is lost either by absorption or reflection. The photoconducting cadmium selenide, doped with copper and chlorine, is spread over the common electrode surface.

Pellet contacts. The team got around the problem of electrically connecting the individual electrodes to the zinc sulphide and

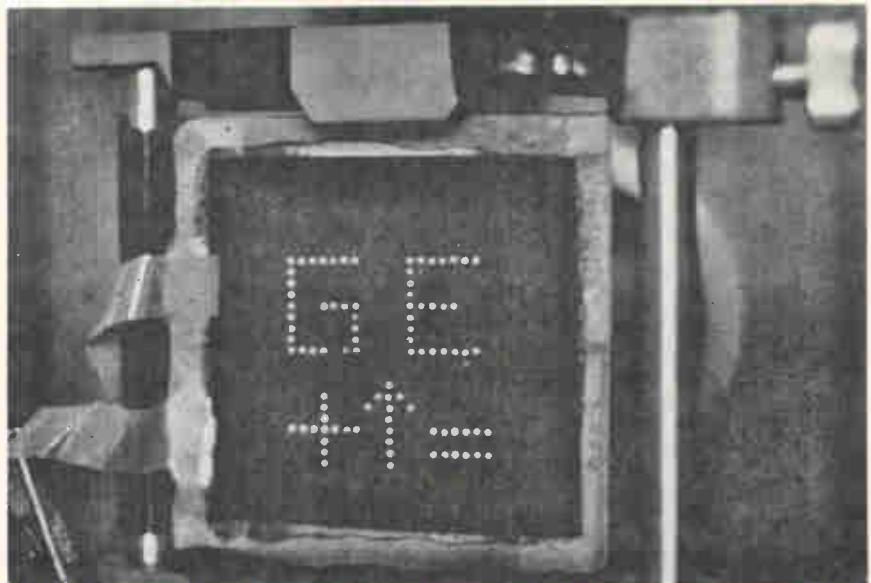

Converter. Thick-film layer converts infrared output of gallium arsenide into visible light. The display can also be amplified.

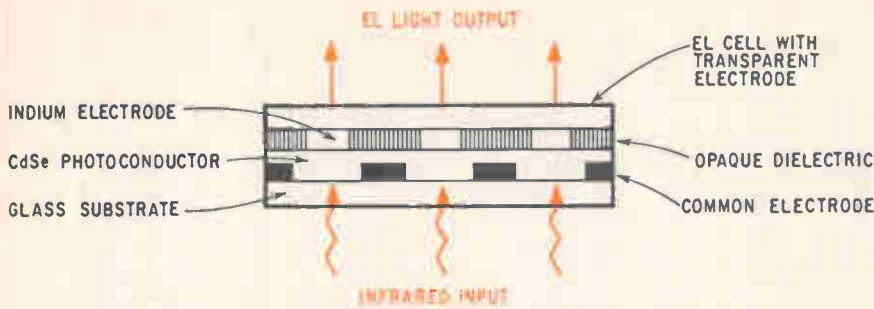

On View. Electroluminescent photoconductor image converter designed by GE can be applied over monolithic circuit that contains memory and logic and generates infrared light.

using an opaque layer to prevent optical feedback by impregnating the opaque layer with indium pellets. To complete the electrical contact between the two layers, the pellets are aligned with the individual electrodes. Typical operating voltage is 120 volts at 400 hertz. Encapsulated in glass, the EL-PC is about 1/20th of an inch thick.

According to design engineer Richard D. Stewart, GE's electronics laboratory has made 1½-inch-square panels and is developing larger ones. The two layers themselves have been made as large as 6 inches square.

Because of its great amplification, the EL-PC permits the operation of IR devices at lower power levels. And since low power means less heat, the packing density of infrared generators can be increased and resolution sharply boosted.

Consumer electronics

A free bite

"In other words, all producers of this equipment, like the proverbial dog, get one free bite."

With those words, Sen. Ralph W. Yarborough (D., Texas) gave notice to the electronics industry that he is going to work for a much tougher radiation-protection law than the one that barely squeaked through Congress two days before adjournment.

Yarborough, chairman of the Senate subcommittee on labor and a member of the Senate-House conference committee on the bill,

was so unhappy with the compromise bill that he refused to agree to it.

He objected because the act cut out three major provisions the Senate had included. These would have empowered the Government to seize faulty equipment, make in-plant inspections anytime, and require the same protection for workers as for users.

He also opposed the effective date of Jan. 1, 1970, calling it too far off.

The bill as finally passed requires the Secretary of Health, Education, and Welfare—in practice the National Center for Radiological Health—to set radiation standards for any electronic products that could be harmful. The first standards will probably be for color television sets and microwave ovens.

Is it enough? Interested parties may submit arguments when the standards come up for consideration. HEW will also set up a 15-member technical committee—made up of industrial, governmental, and "public" members—to advise on standards. One catch to the establishment of standards is that HEW must consider their "economic feasibilities." This is expected to stir much debate; what's economically feasible for a manufacturer may not be enough to satisfy a potential victim of radiation leakage.

Each product must bear a tag saying it has been tested by the manufacturer. The Government may not send inspectors into plants unless it has reason to believe that standards are being violated.

This is what Yarborough meant by producers being allowed "to get one free bite." He is afraid of a

repetition of the incident last year that brought the whole radiation issue to a head: General Electric put 90,000 color tv sets on the market, only to discover later that they were leaking radiation above accepted limits.

The law requires makers of faulty equipment to repair the product free, replace it, or refund the purchase cost. Dealers will thus have to keep records of buyers of products that could leak radiation.

Lost points. Sen. E. L. Bartlett (D., Alaska), who has been the leading champion of radiation safety in Congress and who pushed the Senate bill through, said the biggest disappointment "was the refusal of the House conferees to yield on the question of automatic inspection of manufacturing plants." He points out that with this provision gone, the right to seize "dangerous devices in commerce became even more important." "Unfortunately," he adds, "this provision was also lost in conference."

He also points out that the Senate proposal to have HEW issue "advisory standards" for licensing X-ray technicians and for accrediting their schools was also voted down.

Bartlett promises to continue to push for licensing of operators of X-ray machines. And he might also look into the possibilities of licensing operators of other equipment that might be dangerous, such as lasers.

In the next session of Congress, Yarborough can be expected to reintroduce his amendment to provide for protection of workers. And the first time leaking color tv sets or microwave ovens are found on the market, demands for the right of automatic in-plant inspection and seizure can be expected.

Military electronics

Lining up

A multimillion-dollar contract to set up protection lines for radiation-resistant integrated circuits

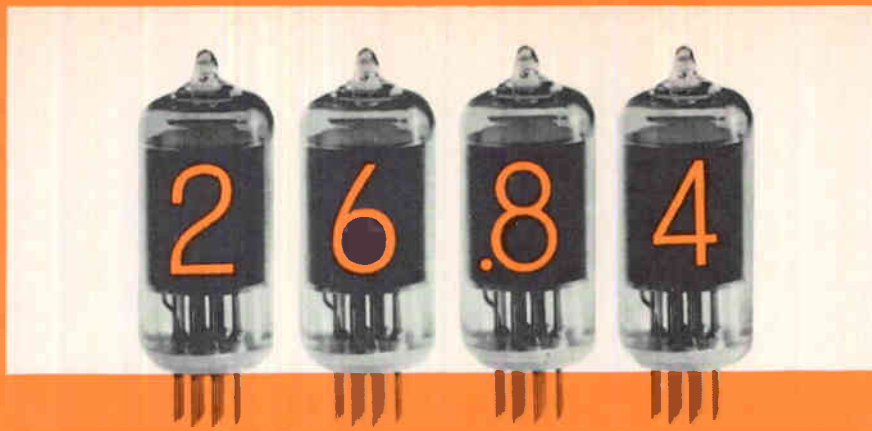

ZM1000 readout tube made for high-volume applications...

...and priced accordingly!

The Amperex ZM1000 is the first digital numerical indicator tube, designed from the ground up, to provide big economies both in initial cost and in application. It sells at more than a dollar below competitive types, and the price-break grows with the volume.

We scrapped every notion about how to make numerical indicator tubes and developed a completely new design that offers unsurpassed performance and reliability at mass-production prices.

Every ZM1000 has a built-in decimal-point indicator. Use it if you wish—or ignore it... in either case, there's no additional cost for the decimal. The ZM1000's large numerals are clearly legible at 35 feet, yet an 8-digit readout can be installed in only 6 inches of panel.

Superior design makes the ZM1000 more economical to use, too; its high-temperature base is designed to plug directly into a printed circuit board or an inexpensive, readily available socket.

IMPORTANT FEATURES

- Dynamic life expectancy: 200,000 hrs.
- Height of numeral.....0.6"
- Tube diameter.....0.75"
- Height of Tube.....1.67"

For complete data and comprehensive application bulletin on indicator-driver circuits for the ZM1000, write: Amperex Electronic Corporation, Semiconductor and Microcircuits Division, Slatersville, Rhode Island 02876.

Amperex
TOMORROW'S THINKING IN TODAY'S PRODUCTS

Circle 53 on reader service card

PRODUCING RADIATION RESISTANT IC's

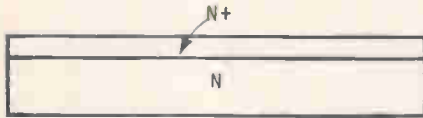

DIFFUSE IN N+



SELECTIVELY ETCHED DEEP CHANNELS IN THE MATERIAL

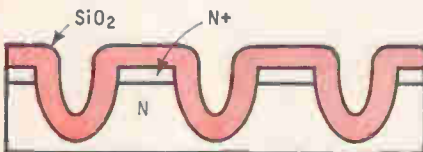

GROWTH OF SiO₂



GROWTH OF POLYCRYSTALLINE EPITAXIAL MATERIAL



WAFER FLIPPED OVER AND N MATERIAL REMOVED BY MECHANICAL POLISHING, ETCHING OR BOTH



DIFFUSION OF BASE, EMITTER AND TOPSIDE COLLECTOR CONTACT BY THE NORMAL METHOD

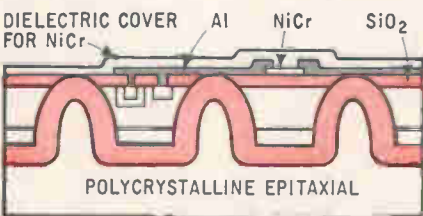

COMPLETED INTEGRATED CIRCUIT

will be awarded this month to the Fairchild Semiconductor division and Radiation Inc., giving those companies a firm foothold in this new market. The circuits will eventually be delivered to Raytheon's Space & Information Systems division for use in the Poseidon missile's guidance computer.

Companion contracts covering assembly lines for radiation-hardened transistors are going to Fairchild and Motorola.

The IC's will be built on lines operated by the suppliers but owned by the contractor [Electronics, July 8, p. 129], in this case Raytheon. This first award covers only the cost of developing the captive lines; actual production orders won't be let until next year, at which time Radiation and Fairchild will bid against each other. Contracts for the Poseidon circuits may total \$30 million over five years.

On the market. And by no coincidence, Fairchild will market as a standard line the same IC's it will offer to Raytheon. This commercial line will be the first of its kind in the industry.

Thomas Dyer, a senior project engineer for special IC's at Fairchild, says these radiation-hardened devices are aimed at the systems designer who has a radiation specification to meet. There are a dozen military programs with such specs, Dyer adds, and nonmilitary and quasimilitary hardware such as communications satellites also require radiation hardening.

For the Poseidon computer, Fairchild will be making three circuits in its 930 DTL line. With the insertion of a "7" in the part number to indicate radiation hardening, they are the 9732 active pullup buffer, the 9745 flip-flop, and the 9762 triple three-input gate. These circuits will also be in the standard line, along with the 9744 uncommitted output buffer, which is a mask option for the 9732, and the 9748 flip-flop, a mask option for the 9745.

Fairchild has already announced a line of commercial radiation-hardened discrete components [Electronics, May 27, p. 197]. Jerry Larkin, digital products marketing

manager at the Semiconductor division, predicts an IC market in the tens of millions of dollars by 1970; radiation-hardened discretes have already passed the \$10 million mark.

New topography. The new IC's are schematically the same as their conventional counterparts, and they are identical in logic and pin-outs. Topographically, however, they're entirely different. Parasitic diodes formed by p-n junctions in conventional IC's become photoconductors when irradiated. Even transient radiation dosages can forward-bias the emitter-base junction and cause diffused resistors to change in value, or can give rise to photocurrents that short-circuit the supply through the resistor to ground.

The dice that Fairchild and Radiation deliver to the captive lines will have dielectrically isolated components and thin-film nichrome resistors. Fairchild has been working on putting these two into production since 1965.

The technology is so tricky that the radiation-hardened circuits will sell for \$15 to \$35, as much as 10 times the price of the standard circuits. And that price is exclusive of lot qualification tests such as burn-in and shake.

Fairchild's standard line of radiation-resistant IC's—which it calls R² DTL—are available in ceramic flatpacks. The DTL line will be expanded, and the company will offer a line of R²T²L in the first quarter of next year.

Instrumentation

Probing study

First employed by semiconductor makers as an IC analyzer about two years ago, the electron microprobe has proved to be a supersleuth. It's used to determine the chemical composition, structure, and electrical activation of integrated circuits, and it can track failure-causing contaminants directly to their source.

A microprobe manufactured by

Pick the
BEST IC
for the job

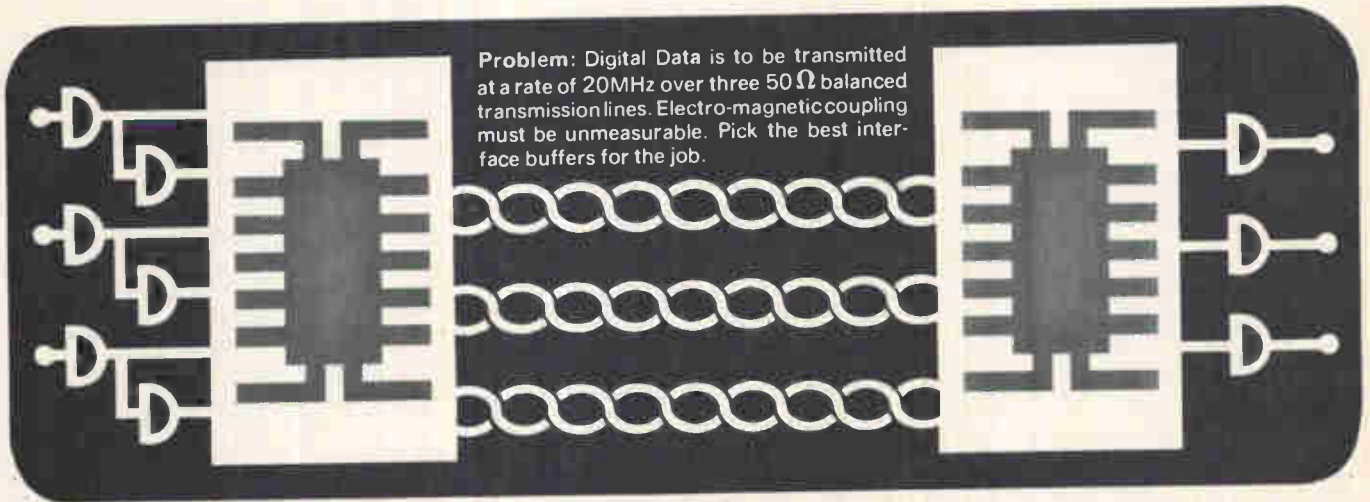

the **BEST** Solution:

THE NEW RA-245 LINE TRANSMITTER

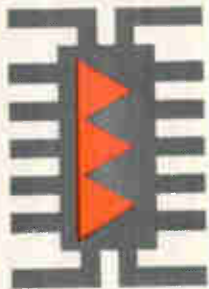

The best IC to use at the sending end is Radiation's dielectrically isolated RA-245. This line transmitter converts digital voltage pulses to current pulses. The high speed CML circuits assure data transfer rates in excess of 30MHz. Power dissipation is a constant, independent of data rate. The balanced system virtually eliminates the adverse effects of line capacity. Electro-magnetic coupling and susceptibility is greatly reduced. RA-245 is available in both the TO-84 flatpack and the ceramic dual inline package. Three voltage-to-current converters are in each package. Power dissipation is negligible when converters are not being used. So use only one or all three. RA-245 is the Best IC for the job.

THE NEW RA-246 LINE RECEIVER

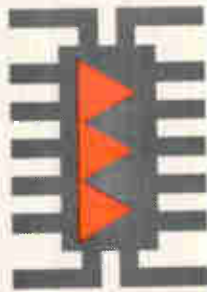

For best results, use Radiation's dielectrically isolated RA-246 at the receiving end. This 3-element buffer faithfully restores the current pulses to digital voltage pulses. The RA-246 current-to-voltage converter has built-in input terminations for balanced 50Ω lines. Outputs from each element are suitable to drive all standard saturated logic circuits (such as DTL, TTL, etc.).

Like the RA-245, the RA-246 is available in both the TO-84 flatpack and the ceramic dual inline package. And you can use any or all of the converters. The Best IC for the job.

Contact your nearest Radiation sales office for further information. Ask how the RA-245 can be used as a level shifter. And how to use the RA-246 as a threshold detector. We will help you pick the Best IC for the job.

WE MAKE THE **BEST** IC FOR THE JOB



RADIATION
INCORPORATED
SUBSIDIARY OF HARRIS-INTERTYPE CORPORATION
MICROELECTRONICS DIVISION

RADIATION SALES OFFICES: P.O. Box 476, Lexington, Mass. 02173, (617) 682-1055 • 600 Old Country Road, Garden City, N.Y. 11530, (516) 747-3730 • 2600 Virginia Avenue N.W., Washington, D.C. 20037, (202) 337-4914 • 6151 W. Century Boulevard, Los Angeles, California 90045, (213) 670-5432 • P.O. Box 37, Melbourne, Florida 32901, (305) 727-5430 • International Sales: Marketing Department, P.O. Box 37, Melbourne, Florida 32901, (305) 727-5412

LOW COST AUTOMATION takes many forms

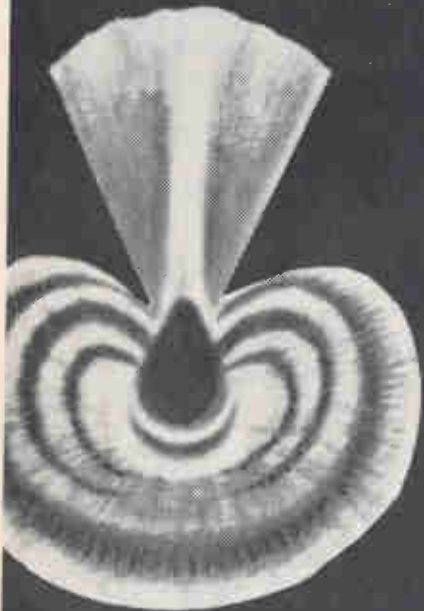

Our famous plug-in Cycl-Flex® electromechanical and solid state time and count controls cut down-time... are replaceable in 5 seconds or less.

Get the facts on these and 560 other forms of low-cost automation. Send for Catalog 15.

BLISS  **EAGLE SIGNAL**

A GULF + WESTERN COMPANY
DAVENPORT, IOWA 52808

Service-In-Depth...
Local Engineering, Stock, Repair

Electronics Review

Applied Research Laboratories is being used in all these roles by J.L. Solomon and G.E. Hitt of IBM's electronics systems group at Owego, N.Y. In a typical case, Hitt and Solomon applied the electron microprobe to the problem of wire-bonding aluminum pads that were so badly corroded they couldn't conduct. The microprobe detected chlorine in the corroded aluminum; a chlorinated solvent used to remove flux must have leaked in the package.

Down to the chip. Particle sizes in an IC are so small—some of them hardly weigh micromilligrams—that an analysis can only be performed by a nondestructive microprobe, Hill says. The cap of the IC package has to be removed, of course, to give the electron beam access to the chip inside. This makes the circuit unsuitable for further operation, but microprobing doesn't damage the chip.

The electron beam is directed, in a vacuum, at the IC target. It can be focused to a spot 0.2 micron in diameter anywhere on the chip, or it can scan the chip. Depending on the kind of information wanted, the effects of the beam can be detected by X-ray spectrometers or simply by measuring the current through the chip.

For chemical analysis, the microprobe can detect any element "from boron all the way up," according to Hitt. Elements with atomic masses lower than that of boron—hydrogen, helium, lithium, and beryllium—are too light to be detected. But this doesn't seem to be a basic limitation; work is being done to make the probe sensitive to lighter elements, and some success has been reported with beryllium.

In stereo. To analyze IC structures, the microprobe is combined with a microscope system. Stereo images made in this way can disclose variations in depth over the chip surface. IC cross-sections can be examined, too, although this involves destroying the chip.

In analyzing electrical activation, the electron beam replaces mechanical probes to measure junction breakdown voltage, leakage current, and junction capacitance.

The microprobe is becoming standard equipment in the semiconductor industry. Hitt and Solomon, who will report on their experience with the instrument at the SAE Microelectronics Packaging Conference in Palo Alto, Calif., Nov. 20-22, feel that it's almost a necessity. Other IBM facilities at Poughkeepsie and Endicott, N.Y., and Burlington, Vt., find it similarly useful.

Other industries aren't ignoring the technique, either. Aircraft manufacturers, for example, use it as a routine analytic tool to make sure that forgings have been properly heat treated. They process a sample slug of the alloy along with the structural part and then subject the slug to microprobe analysis.

Advanced technology

Micron-size transistors

A wristwatch-size computer that exceeds the capability of IBM's biggest model, the 360/85?

Possible, yes. Probable, no. But one major obstacle to such a development has been removed. Two Westinghouse Electric scientists have worked out a way to jam 12 million transistors onto a one-inch-square wafer.

To achieve such a dense package, electronics engineer Richard Matta and chemist L. C. Scala used an electron-beam microscope to etch the transistors instead of going with the conventional light-and-mask technique, which can etch about 25,000 transistors on a square inch. The gain in resolution, the scientists say, is about an order of magnitude—from about a 3-micron resolution with light to about 0.1 micron with an electron beam. The two techniques are basically the same, except that an electron beam replaces ultraviolet light.

The 12 million figure does not, however, take into consideration interconnections — admittedly a significant omission. But another team at Westinghouse has already begun to investigate that problem



Our Mercury family portrait

It's Midtex's Mercury family. First meet 159, he's the slender fellow on the left. He's a compact 2 amp SPDT Form C or D Mercury-Wetted Contact Module. The little guy next to him is 160. He does absolutely everything 159 does but in a miniaturized package.

The chubby little fellow is 161. He is a low level DPDT simultaneous transfer module for differential input switching.

And that stately looking gentlemen is 168, the

old industry standard for precise and sensitive rack or chassis equipment.

If you use any of the Mercury boys, give us a call and we'll give you the pleasant news on prices and delivery dates.

Or, circle our number on the reader service card and we'll send you the entire Mercury family album for your files . . . with complete personal (and technical) information.

MIDTEX 
INCORPORATED

AEMCO DIVISION

10 STATE STREET

MANKATO, MINNESOTA 56001

PROGRAMMERS/TIME DELAY RELAYS/MINIATURE COAXIAL RELAYS/INDUSTRIAL RELAYS/MERCURY-WETTED CONTACT RELAYS

LOW COST AUTOMATION takes many forms

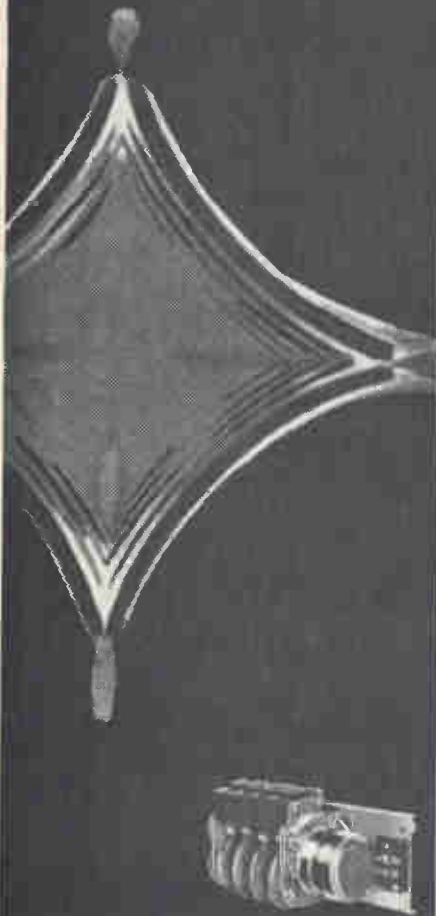

Our MP Repeat Cycle Timers inexpensively control up to 12 SPDT, 10 amp 120 VAC circuits from a common time base. Catalog 15 explains this and 560 other forms of low-cost automation. Send for it.

BLISS  **EAGLE SIGNAL**

A GULF + WESTERN COMPANY
DAVENPORT, IOWA 52808

Service-In-Depth...
Local Engineering, Stock, Repair

Electronics Review

and it's pinning its hope for a solution on the electron beam microscope, too.

To use the electron-beam microscope, Matta and Scala first had to find an effective resist; they investigated linear polymeric compounds and eventually came up with polymers of the methacrylic ester family.

Matta, who recently left Westinghouse, says the technique certainly isn't limited to transistors; integrated circuits can also be etched by electron beam.

With their present technology, the team has produced 1-micron transistors. With a 1-micron space between diffusion, and not counting the interconnection, it can fabricate 12 transistors on a 1-mil-square area—which works out to about 12 million transistors on a 1-inch wafer.

Patents

'No' on software

Arguments over whether computer programs should be granted patents have raged for almost two decades. The issue hasn't been finally resolved, but the Patent Office has made a preliminary finding: under existing law, programs may not be patented.

That's the way the issue will stand unless the courts overrule the Patent Office's decision or legislators order patents on programs. The reverse may happen, however; efforts to harden the Patent Office's ruling into law are growing.

The Patent Office's view was spelled out last week when patent commissioner Edward J. Brenner addressed a conference at George Washington University [Electronics, Oct. 14, p. 86]. At the same time, Brenner issued guidelines for patent examiners to prevent the granting of patents for programs, regardless of how they're described.

Protection. The action by the Patent Office doesn't take away anything that ever existed. The Patent Office has never knowingly

granted patents on programs. But the creators of software have long argued that the results of their expensive work should be protected to encourage innovation. Computer manufacturers, however, concerned lest the usefulness of computers be curbed, oppose the patents.

James W. Birkenstock, a corporate vice president of IBM, applauds the action of the Patent Office. He says it's folly to think that program patents would be useful, pointing out that the average useful life of a program is 18 months. But the Patent Office currently is processing complex patents only after three to six years. Birkenstock also reports that 10,000 computer programs are written daily; it seems unlikely that this volume could ever be effectively handled by Washington.

Since 1964, copyright registration has been available for programs. But programmers have used it only 50 times, because a copyright protects only the form of presentation of the program, not its substance.

Outdated. Patents would give programmers the kind of protection they want, but programs don't fit neatly into any category imagined when the patent laws were written more than 100 years ago. The law says processes can be patented, but mental processes can never be. Legal debates have centered around these definitions as they might apply to programs.

Brenner, however, is holding the door open for some future sort of protection for the creative work of the programmers. He recently published notices soliciting the views of those in the industry on the wisdom of changing the law to allow patenting of programs at all, and, if so, how.

Manufacturing

Down with gold

A technique often advanced as a theoretical alternative to gold diffusion to reduce propagation delay

THE MOST COMPLETE RANGE
IN THE WORLD
OF U.H.F. CERAMIC-METAL
TETRODES

In operation for more than
5 YEARS
on more than
500

low and high power U.H.F.
television transmitters
and translators

HIGH GAIN U.H.F. TETRODES
UP TO **1000 Mcs**

THOMSON THHB HOUSTON

... a trusted name

OUTSTANDING PERFORMANCES
IN SSB COMMUNICATIONS — TROPOSPHERIC SCATTER LINKS — RADARS



COMPACTNESS



RUGGEDNESS



THE MOST ADVANCED TECHNOLOGY * — THE LOWEST OPERATION COST

HIGH LINEARITY



LONG LIFE



HIGH RELIABILITY

VAPOR COOLED

* Special grids patented

ASK FOR SPECIFIC DATA SHEETS

THOMSON HOUSTON - HOTCHKISS BRANDT

ELECTRON TUBE DIVISION 8, RUE CHASSELOUP-LAUBAT - PARIS XV* - FRANCE - TÉL. : 566.70.04
THOMSON ELECTRIC Co INC. 50 ROCKEFELLER PLAZA · ROOM 916 NEW-YORK, 10020 N.Y. U.S.A. · Phone : (212)245.3900

LOW COST AUTOMATION takes many forms



EAGLE control relays last longer! There are over 3000 models in our catalog RGC-1, ready to prove their superiority in your application. See them all. Send for your copy.

BLISS  **EAGLE SIGNAL**

A GULF + WESTERN COMPANY
DAVENPORT, IOWA 52808

Service-In-Depth...
Local Engineering and Stock

Electronics Review

in saturation logic circuits has been made practical by both Hewlett-Packard and Fairchild Semiconductor.

Both companies put a Schottky diode in parallel with the transistor base-collector junction. H-P says this makes obsolete the present method of diffusing gold into the junction to reduce minority-carrier lifetime in the collector and, consequently, collector storage time, which is so critical to propagation delay. A transistor-transistor logic circuit built by the company has demonstrated typical turn-on and turn-off propagation delays of 2.5 and 3.5 nanoseconds, respectively. This is about twice the speed of equivalent gold-diffused TTL gates. (Motorola's MECL 3 has propagation delays of about 1 nsec.)

Production. The importance of H-P's work, says John Price of the H-P labs, lies not so much in the idea of using the Schottky diode, as in the achievement of a process that's compatible with present integrated-circuit technology and permits the device to be manufactured in production quantities with stable diode characteristics.

Fairchild may already have a customer for the circuits—an unidentified firm that was unsatisfied with the speeds of the circuits it was buying from Fairchild. But it will take a year, the company says, before the circuits are fully tested and the customer can begin to design them into equipment. H-P, on the other hand, says it has no definite plans yet to use the circuits.

Clean work. The biggest problem, says Price, was the requirement that the silicon surface upon which the diode metalization is evaporated be absolutely clean to permit stable and reproducible diode characteristics. A special cleaning process, which the company won't describe, solved the problem.

A considerable reduction of transistor storage time, he says, has been achieved using the Schottky diode as a limited-saturation clamp in parallel with the base-collector junction. If the diode clamp has a saturation current at least two orders of magnitude greater than the parallel base-collector junction,

then at least 99% of the excess base current will flow through the diode, and this reduces storage time by a factor of 100 or more. (In the diode, storage time resulting from an excess of minority carriers is virtually nonexistent, since saturation current density is high compared with that of a p-n junction, and the forward bias current consists almost entirely of majority carrier diffusion from semiconductor to metal.)

A fortunate coincidence resulted in simpler circuits. High field-concentration effects at the edge of the diode aluminum-semiconductor junction required a p-type guard ring to eliminate the high field-edge effect. But the guard ring can also function as the base of an npn transistor, thus reducing circuit complexity.

Aluminum was selected for the electrode in the Fairchild and H-P Schottky diodes because of its compatibility with IC metalization.

The Fairchild work, says the developer, Richard Aldrich, has been with diode-transistor logic, rather than TTL. The DTL inverter circuit with no gating is a redesigned version of a high-volume gold-doped circuit. The 35-nsec propagation delay (including turn-on and turn-off) that characterized this circuit has been cut to 15 nsec by the new technique, says Aldrich. Fairchild also uses the p-type guard ring in the same manner as H-P.

For the record

Stop-loss order. A system study to determine how electronics can help untangle the paperwork tie-up in the securities business will be undertaken by Sylvania Electric Products for Paine, Webber, Jackson & Curtis, one of the nation's largest brokerage firms. Stock trading in recent months has grown so rapidly that many firms have found themselves unable to keep up with the paperwork; as a result, stock markets have been operating on a four-day basis, leaving Wednesdays for catch-up bookkeeping.

TRW 5-WATT-2 GIGAHERTZ MICROWAVE TRANSISTOR

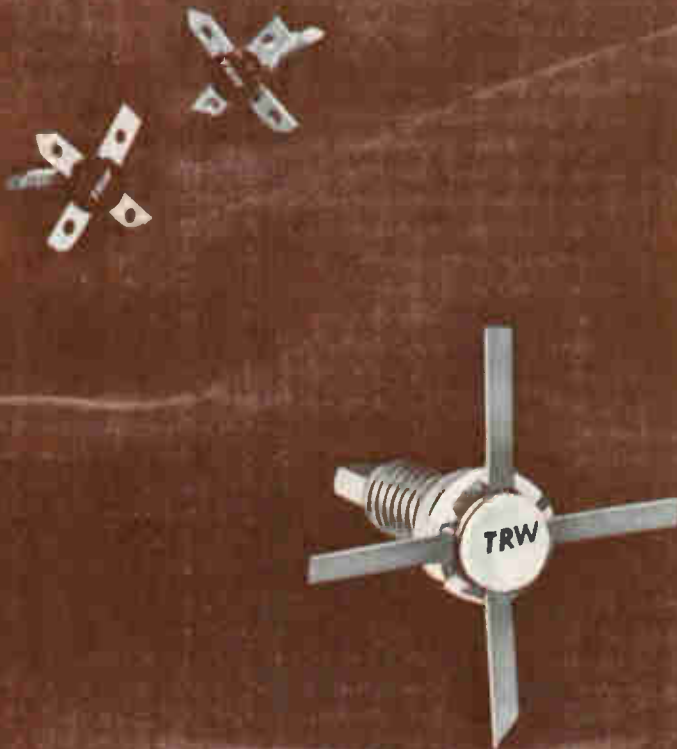

28 volts...33% efficiency...stripline design

A 5 watt 2 GHz microwave transistor in a hermetically sealed ultraceramic stripline package!

The new TRW 2N5483 provides 4 db gain at 2 GHz with 33% efficiency in simple, straightforward circuits. Two new companion transistors for input and driver stages deliver 1 watt at 6dB and 2.5 watts

at 5 dB. All operate from a 28V source.

Delivery is immediate... in production quantities. Order from the factory or any TRW distributor.

For complete information and applications assistance contact TRW Semiconductors, 14520 Aviation Blvd., Lawndale, California

90260. Phone: (213) 679-4561. TWX: 910-325-6206. TRW Semiconductors Inc. is a subsidiary of TRW INC.

TRW®

NPN-PNP pairs to 60 amps



TRUE NPN-PNP PLANAR POWER TRANSISTOR COMPLEMENTS IN RATINGS FROM 1 TO 60 AMPERES..... NOW, FROM TRANSITRON

More Complementary Pairs — More NPN-PNP complements than any other manufacturer. Pairs available in all ratings up to 60 Amps.

Wider Selection — Well over a thousand silicon planar types — both high power and high voltage . . . all available for fast delivery. NPN and PNP types with power dissipation 5 to 300 watts; collector current 1 to 100 amps; BV_{CEO} (NPN) to 200 V; BV_{CEO} (PNP) to 140 V; high-voltage NPN types with BV_{CEO} to 400 V.

Single-chip reliability — Exclusive single-chip

construction provides greater reliability than standard multiple-chip designs.

More Packaging Flexibility — Standard packages available include TO-114, TO-3, TO-63, TO-61, TO-59 and TO-5. (TO-5, TO-59 and TO-61 in isolated cases, also.) High power types available in smaller-than-usual packages, providing important space and weight savings.

Proved Performance — Transitron power transistors are in use in many military and aerospace programs where reliability and performance are critical.

TYPICAL POWER TRANSISTORS

Typical NPN type	Typical Complementary PNP type	Package	Maximum Power Dissipation (Watts)	BV_{CEO} (Volts)	I_C (max) (Amps)
ST14030	ST40003	TO-63	300	100	60
2N5250	—	TO-114	300	100	90
ST15044	ST54005	TO-63	187	100	40
ST17061	ST10008	TO-61	150	100	30
ST86021	—	TO-61	75	100	5
ST91058	ST76019	TO-59	60	100	10
ST92007	ST72037	TO-59	45	100	2
ST91055	ST72039	TO-5	15	100	5
ST74050	ST75004	TO-5	11	100	2
ST84028	—	TO-5	7.5	140	1

HIGH VOLTAGE TRANSISTORS

Typical NPN type	Package	(Watts) Maximum Power Dissipation	BV_{CEO} (Volts)	I_C (max) (Amps)
ST18007	TO-63	100	375	30
ST18010	TO-63	100	200	30
ST18011	TO-61	50	375	20
ST18014	TO-61	50	200	20
ST18015	TO-59	30	375	10
ST18018	TO-59	30	200	10

Want more information on Transitron power transistors? Call today for complete data and specifications. Specify types of particular interest.

Transitron
electronic corporation
188 Albion Street Wakefield, Massachusetts 01880



MOS SCRATCH PAD/CONTENT ADDRESSABLE MEMORY SYSTEM

As logic techniques and electronics have evolved, so have memories. The early delay-line memories that had been used only for storage were re-organized into Scratch Pad memories with serial-parallel operational modes, then Content Addressable Memories that permit a search of the memory content for a specific data code. Each organizational change increased the logic power of memory systems. Modern memories can form the basis for small, economical data-manipulation systems that, besides storing data, can gate, group or sequence data, or perform code or format conversion, random-access data search, table look-up and temporary data storage between systems operating at different data rates. A memory with a small amount of peripheral logic is now often a better choice for special purpose data systems than a small computer.

For storage as large as 10,000 bits, a silicon memory can be economically utilized, offering the additional advantages of small size and reliability. It can operate alone in a small electronic system (as in a desk calculator) or as an adjunct to a much larger main memory (for instance, in the computational or peripheral areas of a computer system).

Organization of a Scratch Pad/Content Addressable Memory using currently available MOS products is shown in Figure 1. Figure 2 shows the implementation of one bit of a 64-word memory organized this way. Memory capacity may be expanded by adding storage elements serially to increase the number of words, or by adding the elements shown in parallel to increase the number of bits per word.

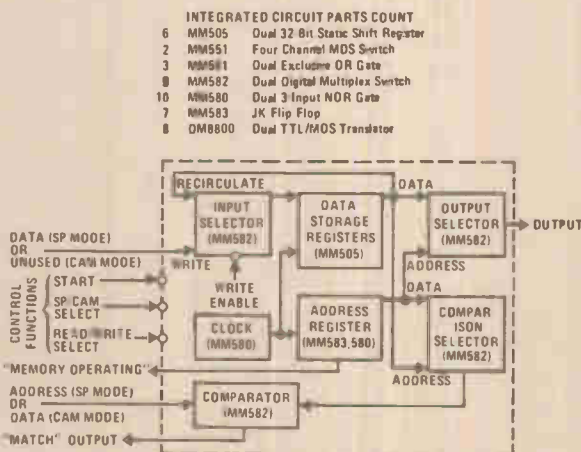

FIGURE 1. Functional Block Diagram of an MOS Scratch Pad/Content Addressable Memory

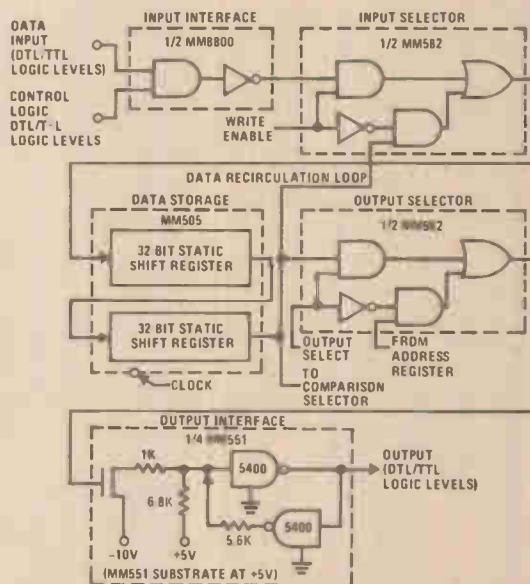

FIGURE 2. Data Flow In a 64-Word Scratch Pad/Content Addressable Memory

All memory operations begin at the first address in memory. The "start" command initiates operation, allowing the clock to sequence the address and memory registers through the possible memory states once. When the sequence is completed, the clock stops and a "memory operating" output is disabled to indicate that the memory is ready for another "start" instruction.

In the Scratch Pad mode, the system outputs the data in the storage registers in parallel. An address presented to the system is compared against the contents of the address register as it sequences through the memory states. The comparison is made by an Exclusive-OR for each bit, with all outputs fed to a NOR gate. When all bits match, a "match" signal stops the clock. If the memory was operating in the read mode, operation is complete and the required data is present at the output. If, instead, new data is to be written into the memory at this address, the comparator output combines with the "write" control signal (Figure 3) to generate a "write enable" signal to the input selector, allowing data present at the input to be transferred into the register.

In the Content Addressable mode, the memory register is searched for a stored word. The normal data input is not used, but instead the required data word is presented to the comparator input. The output selector switches the address lines to the system output, while the comparison selector

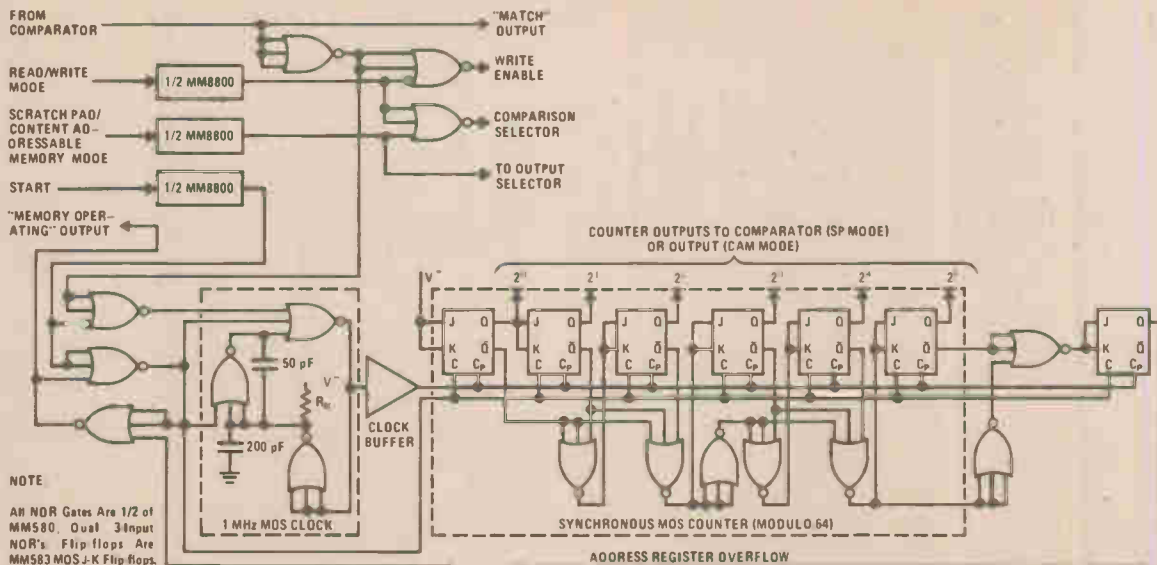

FIGURE 3. Control Logic, Clock and Address Register for 64-Word (6-Bit) MOS Scratch Pad/Content Addressable Memory.

is enabled so the contents of the storage registers are applied to the other side of the comparator.

Operation is similar to that of the memory in the Scratch Pad mode. When there is a match between the contents of the storage registers and the input data word, the clock is stopped and a "match" output is generated. The address of the stored word is now at the output of the memory system. If the word being sought is not stored in memory, the clock will sequence the memory through all its locations once, then stop. This will be indicated by the combinational function of the "Memory operating" line and the "match" line.

When a match is found, the output data remains constant as long as the "start" input remains at a logic "1". When this goes to zero, the clock continues until the address register is again at zero, and the information in the storage register is back at its original location.

An important consideration in the use of this memory system is the interface with bipolar logic circuits. This is readily taken care of on the input by the MM8800, a dual voltage translator designed to interface between conventional DTL/TTL voltage levels and MOS devices. On the output side, the circuit in Figure 2 achieves voltage and power translation with good DC margins. The resistor in the feedback produces logic switching with known hysteresis, a necessity when coupling slowly changing logic transitions into high-speed logic elements. Slowly changing inputs applied to a bipolar logic gate can cause the output to oscillate while the input is within the linear threshold region of the

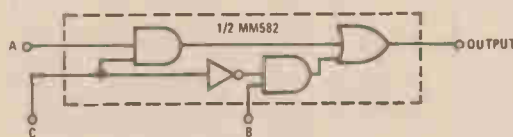

FIGURE 4. The MM582 is a Logic Steering Circuit That Performs the Function of a Single-pole, Double-throw Switch. When the Control Signal C is "True," A Appears at the Output; When it is "False," B Appears at the Output. Operation is Similar in the Input, Output and Comparison Selectors in Memory System.

gate. The hysteresis built into this interface circuit insures a single logic transition at the output of the high-speed detection gate.

A synchronous counter is used in the system (Figure 3) to prevent the possibility of spurious outputs that sometimes occur because of the addition of delayed transients in ripple counters, but the system itself is asynchronous. You can use your own system clock up to 1 MHz or you can tailor the clock shown in Figure 3 for any required rate. Any three inverting gates will oscillate when looped in series. The MM580 is particularly useful in this application because it has a passive pull-up resistor which can be combined with a capacitor for RC network delay timing. In the configuration shown in Figure 3, a logic "1" at the clock input stops the clock. Note also that all unused inputs of an MOS gate must be tied together.

Data sheets and pricing are available for all the MOS elements used in this system.

National Semiconductor Corporation

2975 San Ysidro Way, Santa Clara, California 95051
(408) 245-4320/TWX (910) 339-9240



this is our filter line: ∞

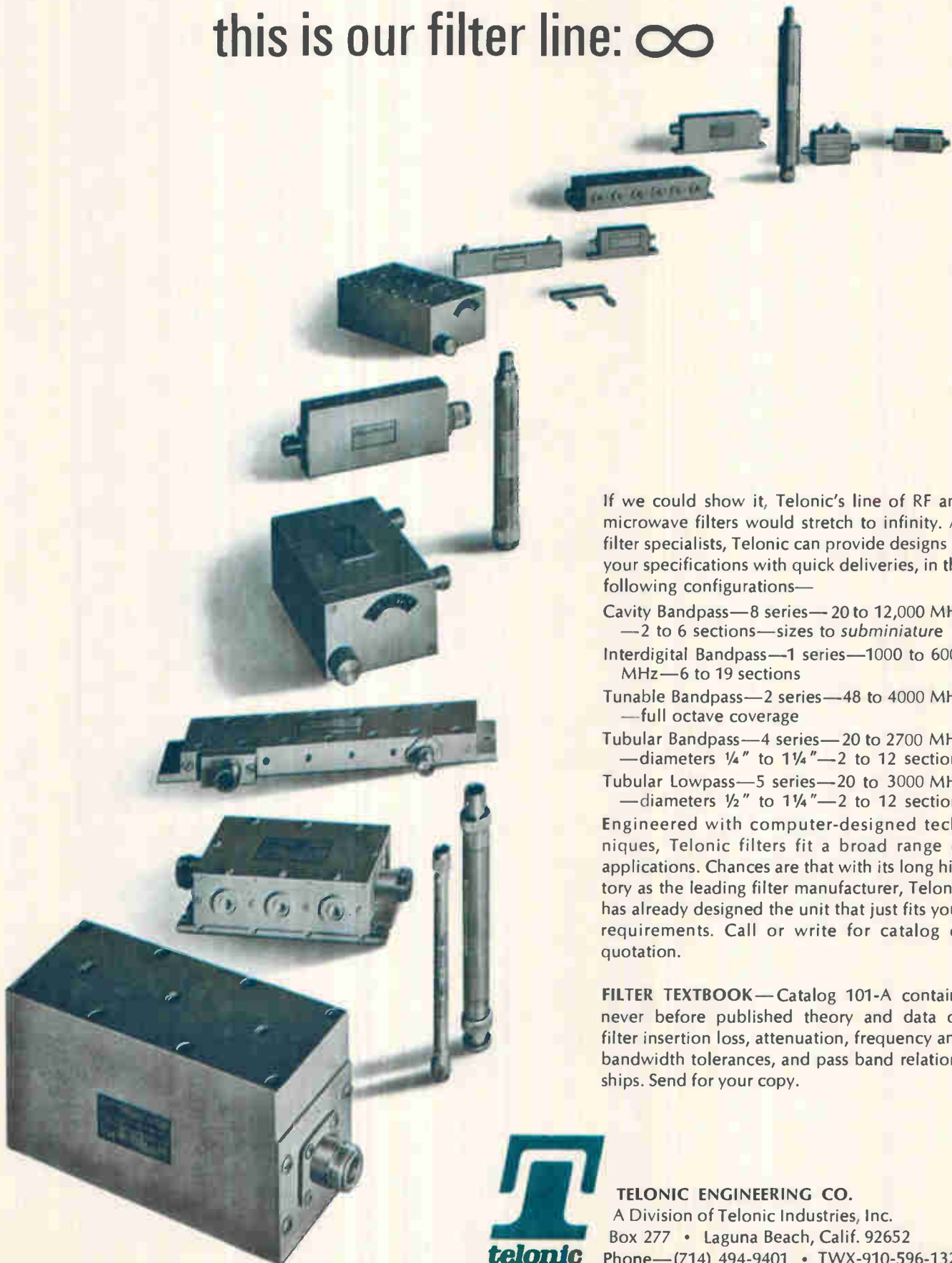

If we could show it, Telonic's line of RF and microwave filters would stretch to infinity. As filter specialists, Telonic can provide designs to your specifications with quick deliveries, in the following configurations—

Cavity Bandpass—8 series—20 to 12,000 MHz
—2 to 6 sections—sizes to *subminiature*

Interdigital Bandpass—1 series—1000 to 6000 MHz—6 to 19 sections

Tunable Bandpass—2 series—48 to 4000 MHz
—full octave coverage

Tubular Bandpass—4 series—20 to 2700 MHz
—diameters $\frac{1}{4}$ " to $1\frac{1}{4}$ "—2 to 12 sections

Tubular Lowpass—5 series—20 to 3000 MHz
—diameters $\frac{1}{2}$ " to $1\frac{1}{4}$ "—2 to 12 sections

Engineered with computer-designed techniques, Telonic filters fit a broad range of applications. Chances are that with its long history as the leading filter manufacturer, Telonic has already designed the unit that just fits your requirements. Call or write for catalog or quotation.

FILTER TEXTBOOK—Catalog 101-A contains never before published theory and data on filter insertion loss, attenuation, frequency and bandwidth tolerances, and pass band relationships. Send for your copy.



TELONIC ENGINEERING CO.
A Division of Telonic Industries, Inc.
Box 277 • Laguna Beach, Calif. 92652
Phone—(714) 494-9401 • TWX-910-596-1320

Reliability in depth:

It's a matter of record through all 32 channels of command.

True laboratory-calibre reliability is not a shallow generality when applied to the VR-3300. Off its eight-year service record aboard subs, surface ships, aircraft and mobile vans, these vital specifics of no-compromise, long-life, easy-maintenance construction and versatile operation come through loud and clear: all-metal surface magnetic heads, voice track standard. Straight line threading path. Front accessible amplifier mounting assemblies for adjustment and test. Torque motor drive for uniform tape tension. Proven high reliability with synchronous motor drive and dual differential capstans. Six speeds (60, 30, 15, 7½, 3¾, 1⅞ ips) with peak-to-peak flutter as low as .3%. Tape speed accuracy within ±0.25%. And a recording/reproducing I.R.I.G. Intermediate bandwidth. Up to 32 channels available. Loop Bin Adapter provides continuous loop operation using from 4 to 75 feet of tape. It is installable on any VR-3300 ever made. For in-depth specifications and application studies on this proven wideband performer, call your nearest CEC Field Office. Or write:

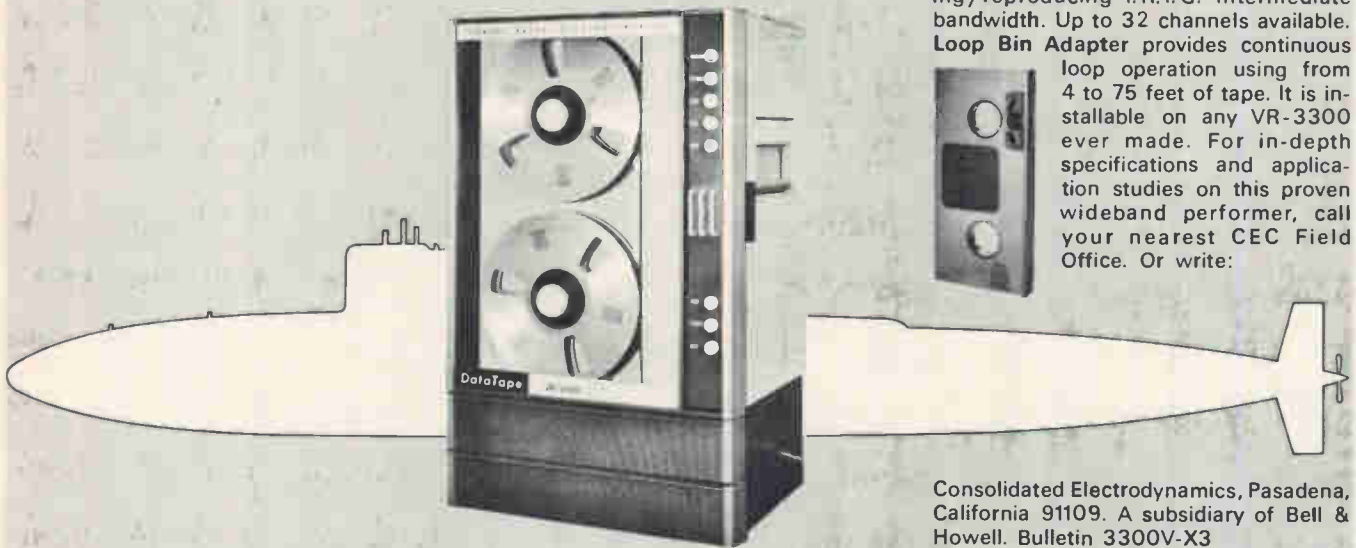

Consolidated Electrodynamics, Pasadena, California 91109. A subsidiary of Bell & Howell. Bulletin 3300V-X3

CEC / DATA INSTRUMENTS

 **BELL & HOWELL**

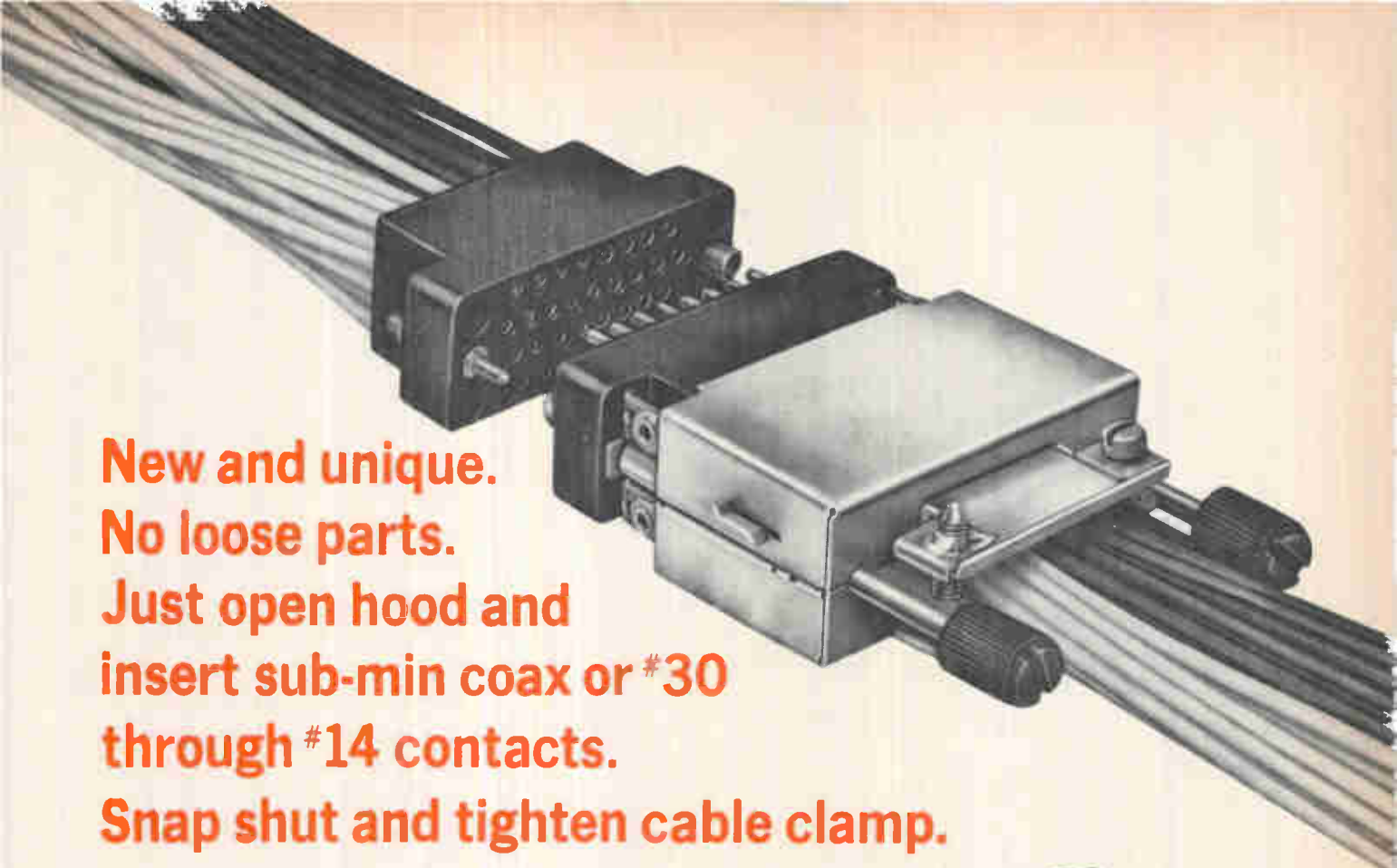

**New and unique.
No loose parts.
Just open hood and
insert sub-min coax or #30
through #14 contacts.
Snap shut and tighten cable clamp.**

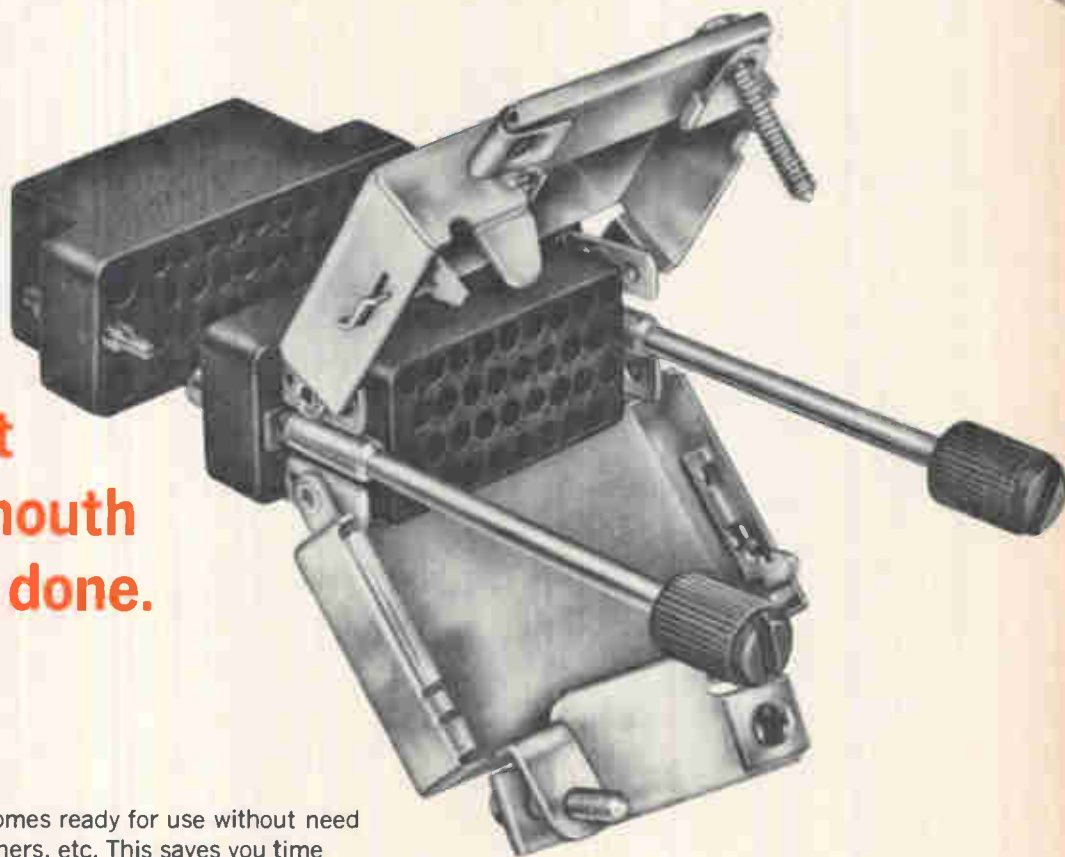

**Sometimes it
takes a big mouth
to get things done.**

This hood-block assembly comes ready for use without need to assemble nuts, screws, washers, etc. This saves you time and eliminates assembly headaches.

Hood opens wide for easy access to rear of block for insertion or removal of contacts. Slide latches on both sides provide for easy opening. Hood snaps shut with a positive lock. Reduces RFI. Finger-turnable jacks with no-fumble knobs assure faster plugging and unplugging. Available in 7 sizes. Write for bulletin giving all details on this and the Trim Trio family of contacts.

 **BURNDY**
NORWALK, CONNECTICUT

INTERNATIONAL SALES HEADQUARTERS AND MANUFACTURING FACILITIES:
CANADA: Ontario / ENGLAND: St. Helens, Lancs.
BELGIUM: Mechelen / MEXICO: Naucatlan de Juarez / BRAZIL: Sao Paulo
JAPAN: Tokyo / Sales Offices in Other Major Cities

Circle 67 on reader service card

ANDREW

Phase Stable
HELIAX[®]
COAXIAL
CABLES

- Repeatabe Phase Tracking
- Electrical Length Stability
- Precise Phase Adjustment

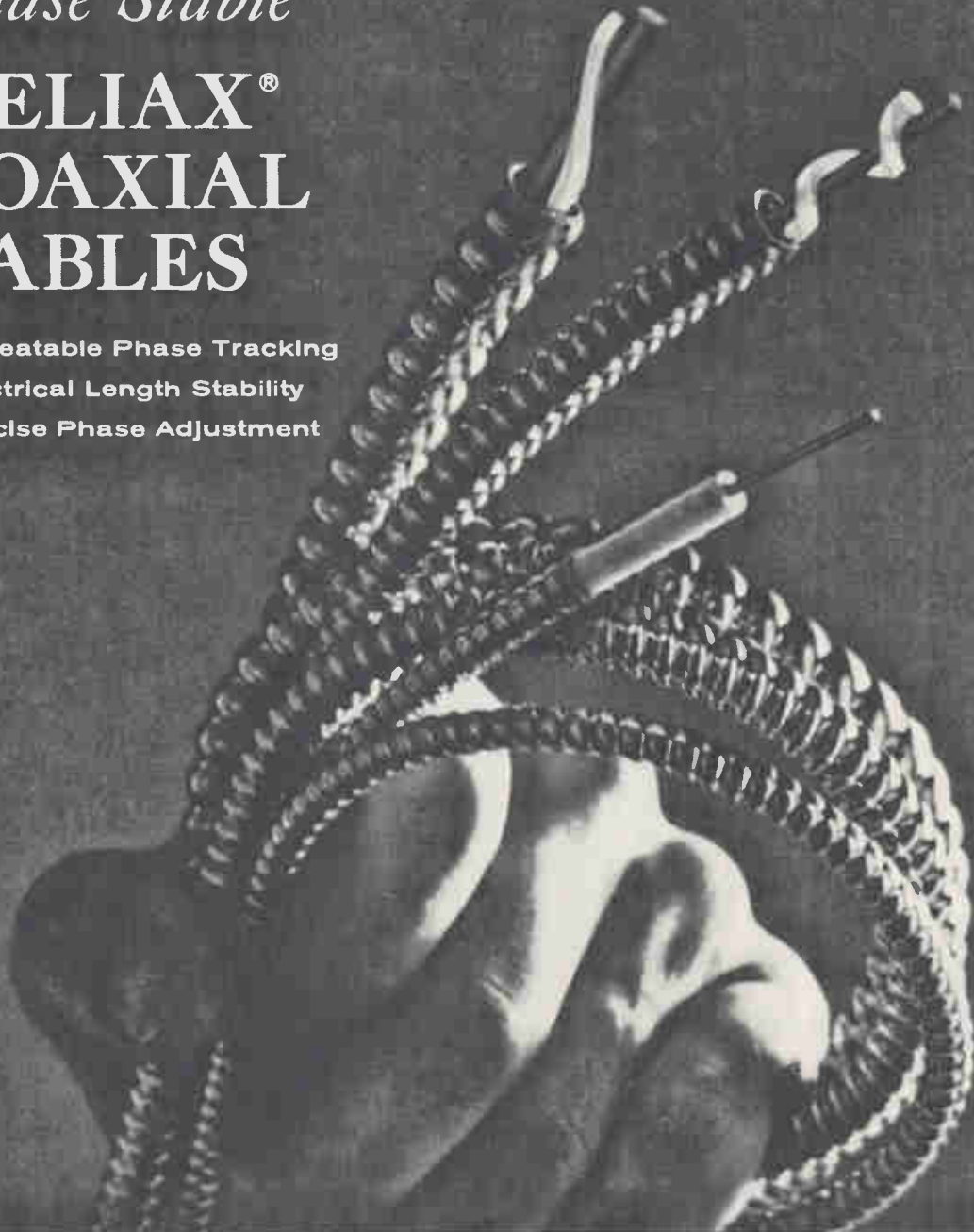

For phase-sensitive applications, special HELIAX coaxial cables are available in three general classes. ■ HELIAX coaxial cables can be supplied phase stabilized to provide a repeating, or "stable", phase-temperature characteristic. ■ Phase compensated cables maintain relatively flat electrical length versus temperature characteristics over selected temperature ranges. Phase-temperature coefficients of better than 1 PPM/°F over 30°F operating range have been achieved. ■ Sets of cables with connectors attached are cut to equal electrical length within very close tolerances. Phase adjustable connectors offer fine adjustment in the field. Andrew Corporation, 10500 W. 153rd St., Orland Park, Illinois 60462.

IN EUROPE: Andrew Antenna Systems, Lochgelly, Fife, Great Britain

Andrew
CORPORATION

31 YEARS OF ENGINEERING INTEGRITY

1788

Washington Newsletter

October 28, 1968

Post Office seeks automated sorting to put zip into mail

The Post Office will make a major effort to develop address-encoding and -reading equipment. The system it's aiming for would reduce the number of times mail is manually sorted from the current average of three to one. If the Post Office finds what it wants, it will purchase up to \$500 million in encoding and code-reading equipment over a 10-year period.

Plans are to encode city, state, and street addresses on all letters when they're first sorted. The equipment would be compatible with present optical character readers and electromechanical sorting machines. At the destination, the code would be read and letters sorted automatically all the way down to the sequence of delivery on the postal carriers' routes.

No decision has been made yet on the format or type of code—phosphorescent, bar, fluorescent, or alphanumeric. But the Post Office will be awarding study contracts this year aimed at getting prototype equipment into operation in 1971. The Post Office had a mail-encoding machine developed a few years ago, but it was too large and expensive.

FAA budget woes keep key projects in holding pattern

Delays in allocating R&D funds by the FAA—which is trying to figure out how to stretch its reduced funds—are upsetting the managers of several key programs. With four months of fiscal 1969 already gone, the managers still don't know how much money they'll be getting for their projects this year. The FAA is still trying to set some sort of priority.

One affected project is the Remote-Controlled Air-Ground System, which would reduce a pilot's communications workload by shifting channel switching from the cockpit to the ground and making it automatic. The first phase of the work was stretched out because of funding problems [Electronics, Jan. 22, p. 51]. Now Collins Radio has completed the feasibility phase, but the FAA's project manager doesn't know whether he can tell the company to start making test hardware.

Making the problem even more serious is the fact that the FAA is currently trying to work up its fiscal 1970 budget request.

Westinghouse gets Navy gyrator order

A contract to develop a monolithic gyrator will be awarded Westinghouse's Defense & Space Center by the Naval Electronics Systems Command. The work could lead to off-the-shelf integrated-circuit active filters.

The gyrator appears to be one of the more promising of the active filters, allowing circuit designers to perform inductance functions monolithically instead of with large discrete inductors [Electronics, June 10, p. 114].

Pilot project aimed at spectrum control may begin next year

There's a chance that work will begin next year on the first radio-spectrum engineering system. The Office of Telecommunications Management is pushing for a startup and has tentatively picked Los Angeles as the location. The Joint Technical Advisory Committee, in its report issued last summer [Electronics, Aug. 5, p. 56], recommended that to find out precisely who is using what space, a pilot project be launched in a communications-congested urban area. After computer analysis of the usage, a system would be set up to allocate frequencies by systems engineering procedures rather than by the present "block" method.

Washington Newsletter

After talking over the timing of its plans with the FCC, the Budget Bureau, and the White House, the Office of Telecommunications Management will decide within the next few weeks whether or not to request the money to get the program started in fiscal 1970. The project's cost is estimated at "many millions"—perhaps as much as \$10 million in its peak year.

Commonality gets more uncommon

Commonality is rapidly becoming just another dirty word around the Pentagon so far as joint development of a system by two or more services is concerned. Not only is McNamara's TFX or F-111 aircraft an expensive multiservice washout, but an anti-aircraft missile system, originally a joint Army-Navy effort, has made the final split.

The Navy has ordered its own design for the Advanced Surface Missile System (ASMS). Once tied in closely with the Army's SAM-D field anti-aircraft missile system, the ASMS will be designed under \$6 million parallel definition-phase contracts by Boeing, General Dynamics, and RCA. They will submit their designs in about six months.

The Navy may choose a contractor for the engineering development phase as early as May or June. ASMS, a high-speed area defense missile system using phased-array radar, will be designed to go on the new DXG class of guided-missile ships to be built in the next 10 years.

Bank law next year means a big market in antirobbery gear

Electronics companies are in line for a healthy chunk of a market that will grow dramatically next year when the new Bank Protection Act takes effect. A committee made up of officials from Federal bank regulatory agencies is now drawing up rules that will require each bank and bank branch to install an average of \$3,000 worth of protection and detection equipment to thwart burglaries and robberies.

Some banks already have sufficient alarms, cameras, and intrusion detectors to meet minimum requirements, but the total market is big: nearly 40,000 banks and more than 1,200 savings and loan associations will have to buy the equipment.

Experiments set for ATS-F and G

NASA has decided on the experiment list for the Applications Technology Satellite program's F and G craft and will announce its choices in mid-November. Insiders say the list includes: tv relay to small, low-cost ground stations, communications with other satellites, simultaneous communications with aircraft, and navigation and position location.

ATS project officials decided not to add ATS-D experiments to the ATS-E satellite scheduled for launch next spring because they didn't want to delay the launch by several months. Although it was a near certainty earlier to fly on ATS-E [Electronics, Oct. 14, p. 85], the L-band transponder proposed by the FAA still hasn't gotten a green light. And an ATS project official says ominously that "it's getting sort of late to add things to the satellite."

Addendum

The Pentagon will issue its first military standard on fluidics this week. However, it will call the new technology "fluierics" instead of fluidics. In the standard, fluierics will refer to fluid components that use no mechanical parts, while fluidics will refer to those fluid systems that include mechanical peripheral equipment.

WELDPOWER®



For High-Precision, High-Energy Welding

Yes, the Model 225C Mark I welder and the R-Series welding heads do form an impressive production system! The 225C Mark I is a power-packed AC-to-DC energy storer which is calibrated in both watt-seconds and charging voltage (0-1500 Vdc). Unaffected by input line variations, the welder has a peak output of 8,000 amperes and offers selectable pulse durations of approximately 4, 8, 17 and 33 milliseconds. New features include simplified operation (only a single operation control!) and, for those polarity-sensitive materials and oxides, a polarity reversal system.

The new R-Series welding heads, ideal companions for the 225C Mark I, offer adjustable electrode forces from 2 to 60 pounds, high acceleration for high-speed production and repeatability proven

through thousands of hours of endurance testing. Additional features include a firing indicator, adjustable external override and a precisely calibrated pressure indicator.

Raytheon's coherent design concept provides wide-range flexibility for both the Mark I and the R-Series. For example, the 225C Mark I is not only compatible with R-Series heads but with other Raytheon heads as well (Q-, O-, J and JA Series, to name a few).

For more information on these products and Raytheon's full spectrum of welding systems and services, call or write Raytheon Company, Richards Ave., Norwalk Conn. 06856 TWX 710-468-2940.



And for solutions to your welding problems... **Call Raytheon: 203-838-6571**

Powerful Computing Genie: \$4900

READY, WILLING AND ABLE.

Ready—to relieve you of waiting to get on the big computer. Constantly available. At your fingertips whenever you need it. Ready to abolish tedium from scientific and engineering computation.

Ready to slash through long routines and come up with answers in milliseconds.

The new Hewlett-Packard 9100A personal computer.

Willing—to perform log and trig functions, even hyperbolic and coordinate transformations, at the touch of a key. Willing to work with extremely large and small numbers simultaneously. Willing to take your programming commands in mathematical language.

No computer language or programming specialist required. Willing to communicate with you on *your* terms.

The new Hewlett-Packard 9100A computing marvel.

Able—to take on the most complex problems: roots of a fifth-degree polynomial... solutions to three simultaneous equations... Bessel functions... Fourier analysis... elliptic integrals... real and complex polynomial evaluation... coordinate geometry... regression analysis... numerical integration... vector analysis... and many, many more!

Able to be your fast, responsive mathematical servant.

The new Hewlett-Packard 9100A electronic genie.

This major computing capability is compressed into one 40 pound package. Its only moving parts are the keys, the switches and one decimal wheel. No noise.

The 9100A computing genie is being delivered *NOW*, with an extensive—and growing—program library that puts you in control.

Examine the keyboard, question every key and switch. Then decide to command the computing genie. A telephone call or purchase order directed to any HP Sales and Service Office (in principal cities throughout the world) will start the executive process.

If you are still skeptical, or of faint heart ask for a demonstration.

It will affirm, assure (and only slightly delay) your entry into the solid-state of personal computing power.

Be a Master.
Hewlett-Packard, Box 301,
Loveland, Colorado, 80537;
Europe: 54 Route des Acacias,
Geneva.

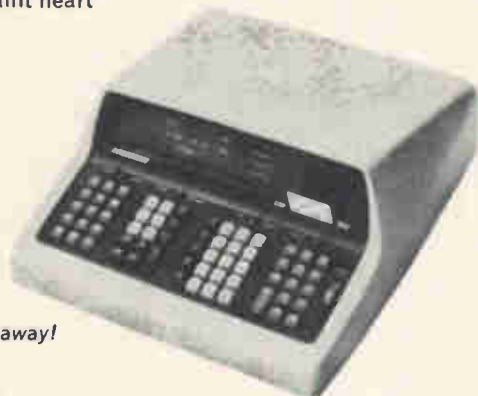

9100A puts answers just a touch away!

HEWLETT  PACKARD

Circle 72 on reader service card

764.8367	z temporary
6.328 848 815 05	y accumulate
32.80	x keyboard

Dynamic range 10^{-99} to 10^{99} , nearly 200 decades. Observation of math operations on 3 displayed registers. Up to 16 more registers for data storage.



Complex and vector arithmetic simplified with coordinate transformation keys, rectangular-to-polar and vice-versa, in milliseconds.



Trig functions covering all quadrants and any size angle in degrees or radians.



Up to 196 program steps, each a simple key stroke. "IF" keys permit looping and branching flexibility found only on large computers.



Edit programs easily. Single-step through programs to check and de-bug. Address an individual step and make corrections without re-entering the entire program.



Program from the keyboard. Record and store programs on credit-card-size magnetic cards for repeated use.

Designed for expansion. Printer, plotter, electrical data input, output will become available.

microtopics

product news from Philco-Ford Microelectronics

MIL Cerdip IC Packaging Makes Sense, Saves Dollars

On new MIL logic circuits you're designing, forget flat packs. You can cut costs without cutting corners by going to modern Cerdip packaging, in full temperature rating from -55° to $+125^{\circ}$ C.

Philco-Ford Cerdip packages cost no more than flat packs. They save substantially on production costs, because they're far more convenient to handle, insert and connect. Their hermeticity has been proved by qual-

ification testing, and their quality is assured by the most extensive inspection procedures in the industry.

We're the people with long Cerdip experience. Immediately available in this preferred style are our Series 930 DTL gates, buffers, expanders, flip-flops and multivibrators . . . and Series 9620 TTL gates, expanders and flip-flops.

Circle 213 on reader service card

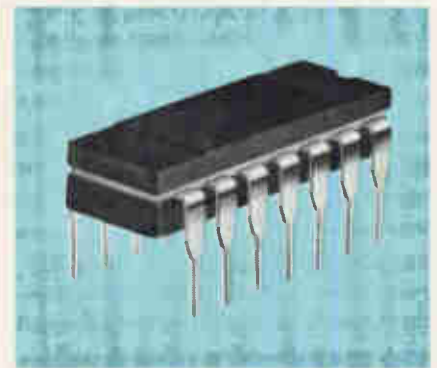
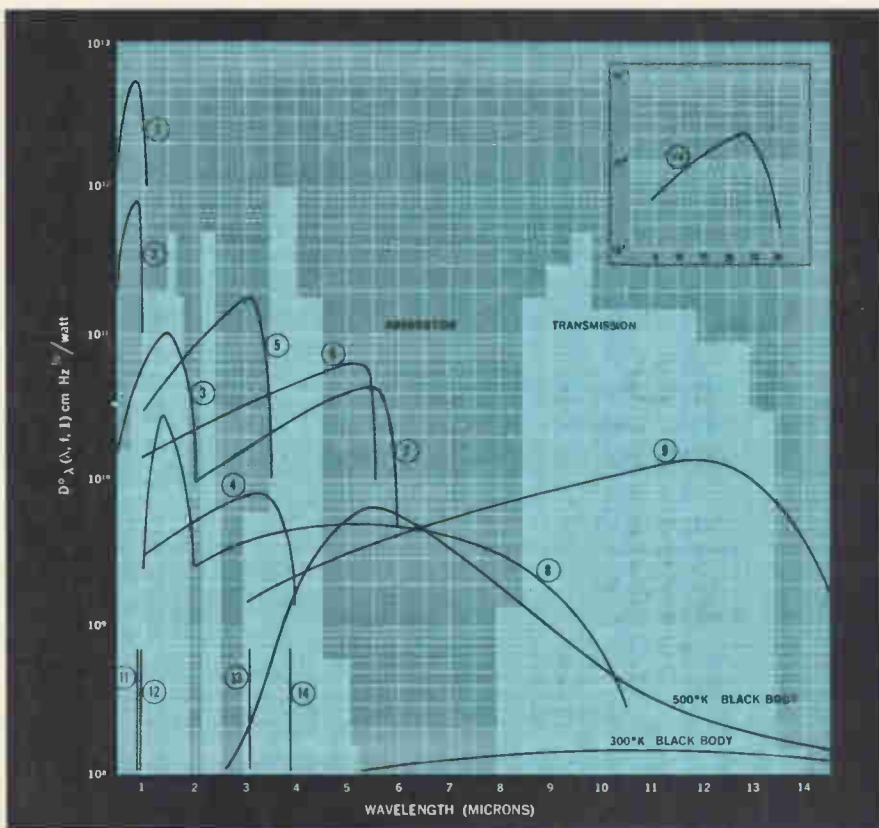

Photo-Detectors? – We cover the spectrum



1 Si (PV), 300°K	4 InAs (PV), 300°K	8 Ge (Au) (PC), 77°K	12° GaAs EMITTER 300°K
2 GaAs (PV), 300°K	5 InAs (PV), 196°K	9 Ge (Hg) (PC), 30°K	13° InAs EMITTER 77°K
3 Ge (PV), 300°K	6 InSb (PV), 77°K	10 Ge (Cu) (PC), 4°K	14° InAs EMITTER 300°K
	7 InSb (PC), 77°K	11° GaAs LASER 77°K	

(PV) indicates photovoltaic. (PC) indicates photoconductive.

*Line indicates region of spectral emission and is independent of the vertical axis.

Pick the portion of the spectrum where you want your guidance, surveillance, communications or instrumentation system to operate. Visible or IR. Anywhere from 0.4 to 30.0 microns. Then pick your detector from the field-proved Philco-Ford line, the most comprehensive in the industry.

Circle 214 on reader service card

MOS products now consolidated at Lansdale plant

Consolidation of engineering, manufacturing and testing of Philco-Ford MOS integrated circuits at our Lansdale plant is going ahead at full speed. A broad line of standard 128, 250 and 256 Bit shift registers, 1024 read-only and various read-write memories, multiplexers, A/D and D/A circuits will soon be in full production. Watch for MOS news from Philco-Ford!

Take the fast, economical Hybrid route to miniaturizing discrete circuits



TO-8

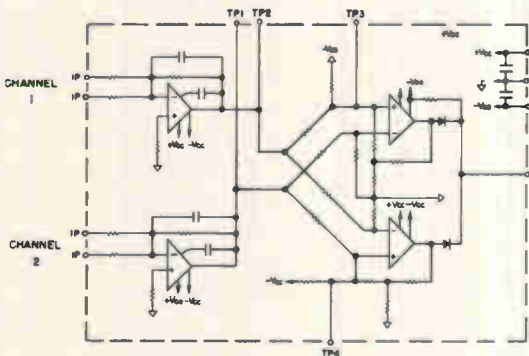

The circuit

Dual Channel Comparator

Design engineer supplied this circuit and detailed delivery information. Philco hybrid specialist and design engineer agreed on . . .

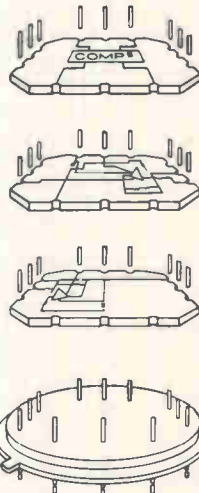

Partitioning

They came up with a three layer hybrid to optimize cost/performance. The go ahead was given, and . . .

One month later

Prototype delivered. Two weeks more and full-scale production. Performance: electrically equal to or better than discrete version. Superior under shock, vibration and constant acceleration.

If you are looking for a fast, low cost way to miniaturize circuits . . . can't afford the time, tooling costs and operational limitations of monolithics . . . will pay about the same cost as discretives . . . are ready to sit down in your office and talk about your circuit and delivery requirements, we'll send a specialist to you.

Circle 216 on reader service card

Axial-lead switching diodes offer lowest dynamic resistance

Through the use of advanced processing techniques, we are now making a line of glass-package, axial-lead high-speed switching diodes with the lowest dynamic resistance available anywhere. They use an improved substrate with lower resistivity, and at the same time maintain breakdown in excess of 80 volts. They make possible microwave switching assemblies with lower insertion loss and higher isolation than previously possible.

Available in production quantities, the new diodes have been widely used in switching applications through K_u band, at speeds of less than 1 nanosecond. They have been qualified for use in a number of military airborne systems.

Take a look at the performance of our new "A" series diodes. They're even better than our standard models, which equal or exceed any on the market. Dynamic resistance values are shown at 40 ma. drive current; lower resistances are obtained at higher currents.

Circle 215 on reader service card

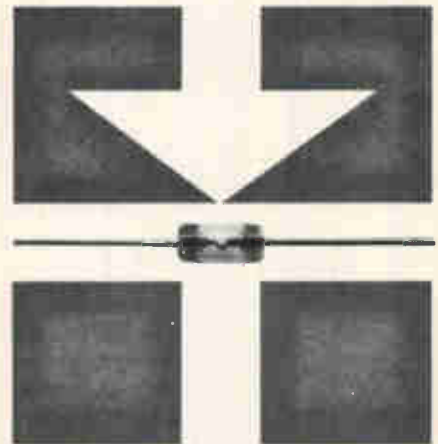

Type	Capacitance (max.)		Dynamic Zf @ 40 ma	
	pF @ 20V		New "A" Series	Standard Models
L8700	0.2		1.5	2.5
L8701	0.1		2.0	3.0
L8702	0.09		2.5	4.0
L8703	0.08		3.0	5.0
L8704	0.07		5.0	6.0

When NASA asked a PAM/PDM/PCM we selected the best

(1 from Ampex, 2 from Astrodata, 2 from CEC, 1 from Tektronix,

Two-thirds of them were ours—all of the key telemetry components. For example, Norden-designed stored-program decommutators in this system will handle every NASA format...with less than 15-minute turnaround...and using all 100 channels of display.

And these key telemetry components are just a fraction of Norden's Vector Telemetry Products.

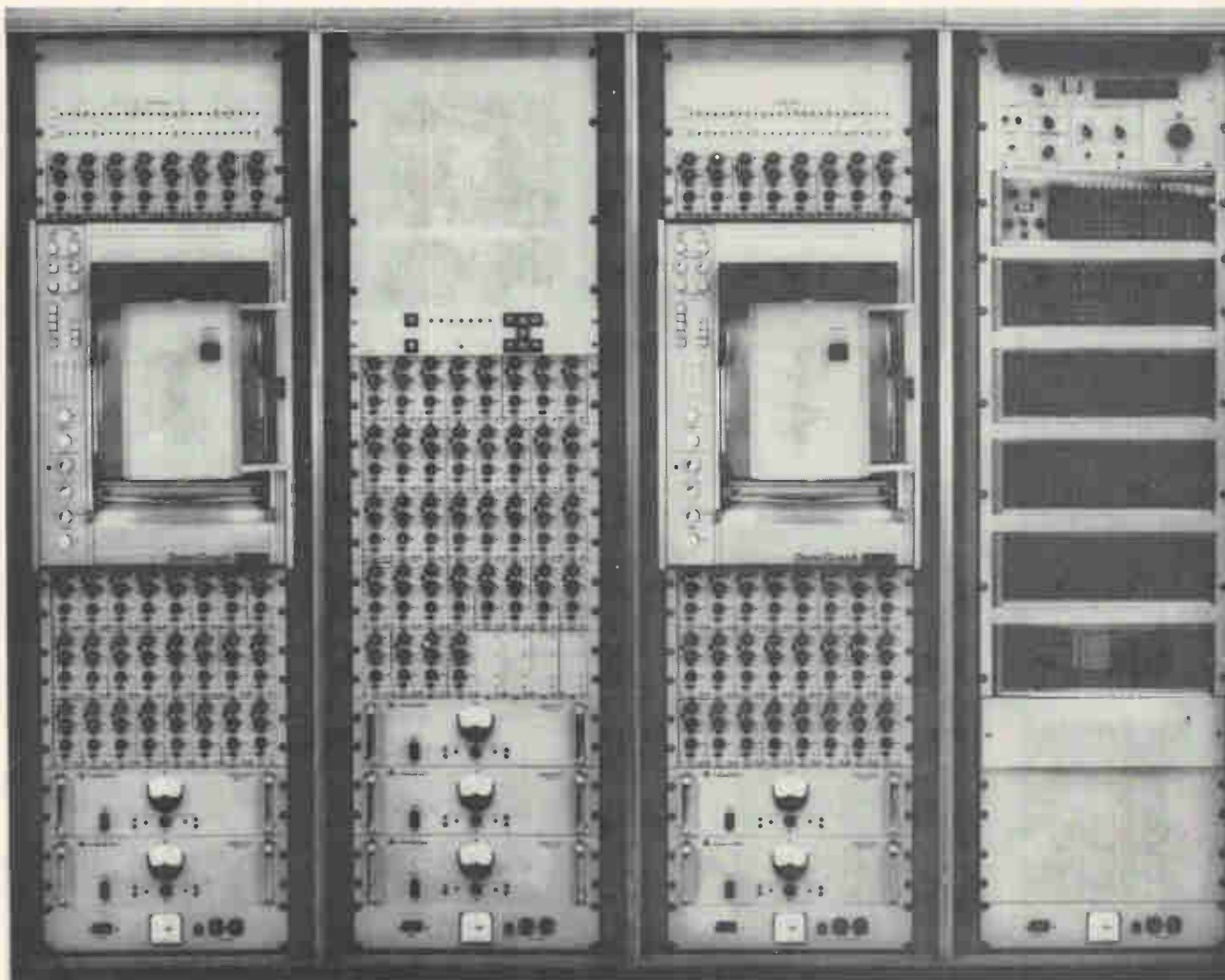

us to design display system components available

1 from Varian Data Machines and 14 from our Norden Vector line.)

They include a full range of Digital, FM and RF telemetry equipment for both ground and airborne applications.

This makes it entirely possible that we can help meet your design and/or equipment needs. For details, contact our Communications Products Department, Trevose, Penna. 19047. Or call (215) 355-5000, TWX 510-667-1717.

Norden DIVISION OF UNITED AIRCRAFT CORPORATION

U
A_®

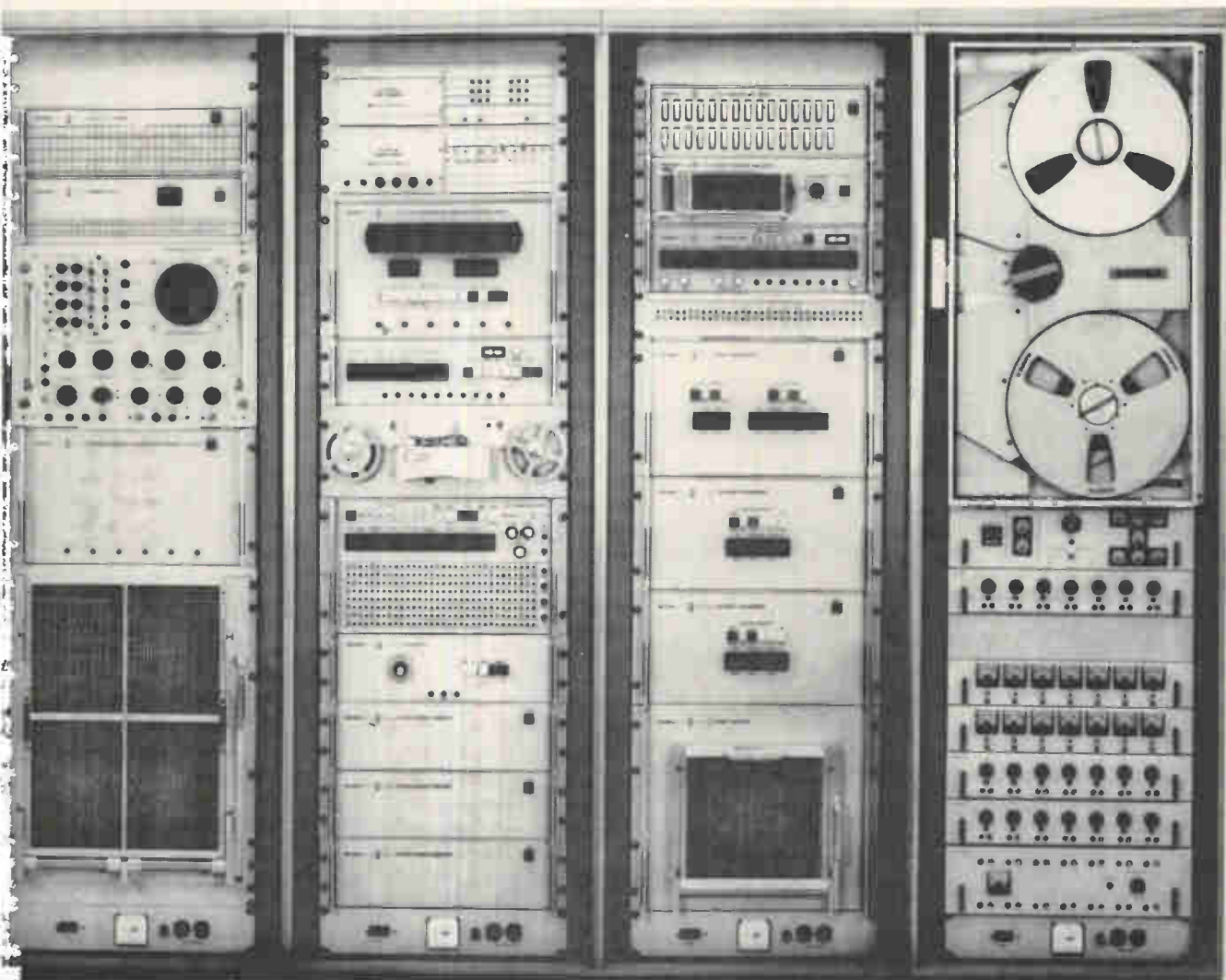

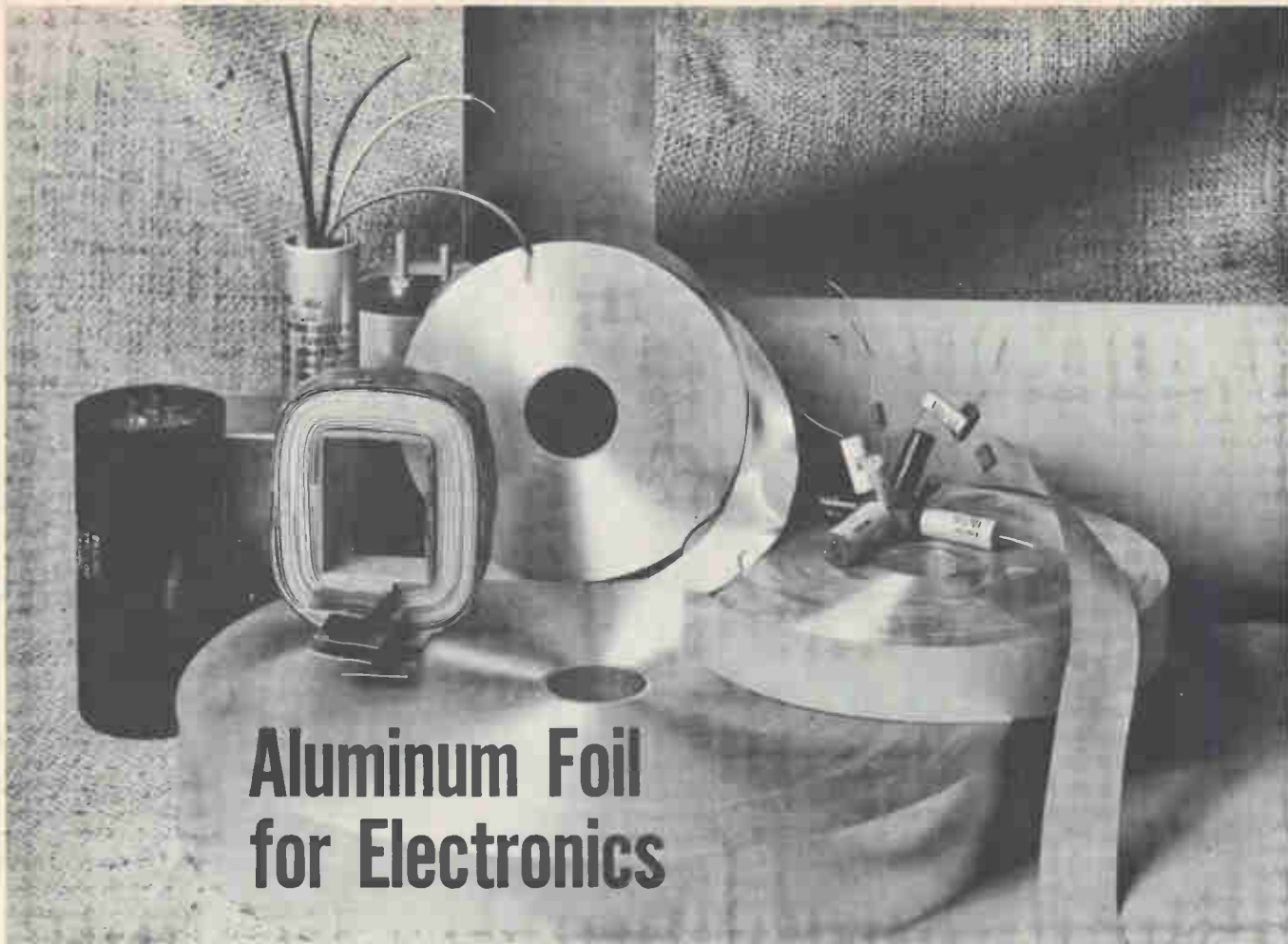

Aluminum Foil for Electronics

PLAIN FOIL

Republic has three types of standard purity (99.45% aluminum) capacitor foil available for the manufacture of paper and film wound capacitors.

ELECTRO-DRY®—A foil that has negligible organic and inorganic residues on the surface. This type can be used for high reliability and standard units. Electro-Dry is a superior dry foil.

SILWYND®—A foil that has a controlled lubricated surface made by a patented process. Silwynd is used for a free unwind and where a slight lubricant is essential to winding. The slip coating is a high grade silicone which makes Silwynd particularly suited to silicone impregnated capacitors.

ELECTRO-SLIK®—A foil that has a controlled residue produced from the rolling lubricant. The slight residue facilitates unwinding.

ELECTROGAGE®—Super-thin foil .00015" and .00017" features guaranteed gage for critical capacitor requirements. Available in Electro-Dry, Silwynd, and Electro-Slik.

Widths — Republic manufactures all commercial widths from 1/16" in .00015" thru .00035" gages, from 1/8" in .0004" thru .0007" gages, and from 1/4" in .00075" thru .005" gages.

Alloys — Plain capacitor foil is available in commercial alloys 1145, 1180, 1188, 1199 and 0191 (99.45%, 99.80%, 99.88%, 99.99% and 99.93% minimum aluminum content, respectively.)

HIGH PURITY FOIL FOR ETCHING

The following high purity alloys and gages are produced in commercial quantities at Republic:

Alloy	Gage in Inches
1180	.00040 — .0050
1188	.00065 — .0050
1199	.0010 — .0050
0191	.00065 — .0050

Widths — Widths are available in some alloys from 1/8".

FOIL FOR COIL WINDING

Republic supplies both precision slit* and edge contoured* aluminum strip conductor for coil winding.

Gages - up to .040" — Widths - from 1" Outside Diameters - up to 42" — Alloy - EC
* Depends on width and gage.

ETCHED ALUMINUM FOIL

Republic Foil produces a complete line of etched foils including high voltage, mid-range, low voltage and cathode. These foils are custom made to customer specifications and are available in several different alloys.

Gages — Etched foil is available in the following gages.

Cathode	— .0011" thru .002"
Anode	— .002" thru .0035"

Widths — Etched foil is available in all commercial widths from 1/8".

The consistent high quality of Republic's standard and high purity aluminum foils is maintained through the utilization of advanced test methods and meticulous inspection procedures.

Republic Foil Inc. is one of the world's leading producers of aluminum foils for the electronics industry and has the most complete line available from any one source. Experienced engineers are available to offer technical assistance and to tailor foil requirements to fill the most critical customer specifications.



REPUBLIC FOIL INC.

GENERAL OFFICES, DANBURY, CONN. 06810; TEL. 203-743-2731

BRANCH SALES OFFICES: Chicago, Ill. 312-545-2142 • Salisbury, N. C. 704-633-6020 • Cleveland, Ohio 216-871-6268

WEST COAST - Electrical Specialty Co., 213 E. Harris Ave., So. San Francisco, Cal.; 2820 E. 12th St., Los Angeles, Cal.

PLANTS Danbury, Conn. Salisbury, N. Carolina Somerville, Mass.



EUROPE'S STRONGEST GROUP IN SOLID STATE DEVICES CAN DELIVER THESE IC'S RIGHT NOW



DTL INTEGRATED CIRCUITS - FC FAMILY

(compatible with the 200 series)

Medium speed, high fan-out, and an exceptionally high noise margin, make the FC family ideal for small-scale computing, telecommunications, instrumentation, and control purposes. The stage delay of 31 ns suits many civil and military applications, and, where the higher speeds of TTL and E²CL are not required, DTL offers the advantage of system simplicity.

With over 40 circuits to choose

from, including higher-order functions, the FC family provides designers with the means of realizing optimum system efficiency. The fact that all gates can be had in a choice of versions - with or without collector resistor - means that the cost and the power demands of a system can be significantly reduced by using wired OR logic. A special level-shifting diode gives this family its exceptionally high noise margin.

MAJOR CHARACTERISTICS

Very high noise margin	typ. 1.2 V
Average propagation delay	
with fan-out of 8 and load of 30 pF	typ. 20 ns
with fan-out of 6 and load of 60 pF	typ. 31 ns
High fan-out over full temperature range	min. 8
Full industrial operating temperature range	0 °C - 75 °C
Popular package for easy mounting	dual-in-line

WE OFFER FULL DIGITAL CAPABILITY !

- We also make an extensive range of IC's for high and ultra-high-speed applications: the TTL FJ and FH families which are compatible with the 74N series and SUHL II respectively.
- We design **higher-order circuits** for large-volume requirements, compatible with any one of these digital families.

- We can make ultra-high-speed current-mode logic in the 2 to 3 ns range to suit your needs; emitter-emitter coupled logic, for example.
- We have a well-established process for making complex MOS circuits with excellent performance throughout life.
- We achieve high noise immunity with digital circuits. Our 12 V circuitry has a noise margin of 5 V, and a speed of several hundred ns.

RANGE OF STANDARD CIRCUITS

DESIGNATION	TYPE NUMBER
single NAND gate	FCH101* FCH111
dual NAND gate	FCH121* FCH131
triple NAND gate	FCH141* FCH161 FCH151* FCH171
quadruple NAND gate	FCH181* FCH191
sextuple NAND gate	FCH201* FCH211
dual line driver NAND gate	FCH221 FCH231
single 5-bit comparator	FCH281
single 10-bit parity checker	FCH291
gated 4-bit decoder	FCH301
input expander	FCY101
single JK flip-flop	FCJ101
single JK master-slave flip-flop	FCJ111 FCJ201
dual JK master-slave flip-flop	FCJ121 FCJ131 FCJ191 FCJ211
quadruple latch flip-flop	FCJ221
monostable multivibrator	FCK101
level detector	FCL101

* Without collector resistor.

PHILIPS

Get more detailed information from:

PHILIPS ELECTRONIC COMPONENTS AND MATERIALS DIVISION - EINDHOVEN, THE NETHERLANDS

distributed and sold in the U.S. by: AMPEREX ELECTRONIC CORPORATION

230 Duffy Avenue, HICKSVILLE, New York 11802 • 801 E. Charleston Avenue, PALO ALTO, California 94303 • 360 E. North Avenue, NORTHLAKE, Illinois 60164.

The endless line

It's a complete line – an endless line of Helitrim® cermet trimming potentiometers with a current field failure rate of only 0.08%.

And all have essentially infinite resolution. Plus a wide range of standard resistance values. And excellent setting and total resistance stability under a wide range of environmental extremes. Helipot stocks almost 2 million trimmers in a wide range of models and values at 13 stocking locations. All to fit your every need—whatever it is. To fit your budget—list prices from \$1.75. And to assure you immediate delivery—anywhere in the U.S. and in Canada.

For more details on “the endless line” of cermet trimmers, contact your local Helipot sales representative. He'll tell you all about cermet reliability, fill you in with all available test data and personally handle your Helitrim orders.

	MILITARY			HIGH TEMP.	GENERAL PURPOSE		
	Series 55, 56, 58 (RJ11 & RJ12)	Series 61 (RJ22)	Series 63 (RJ24)	Series 50	Series 82	Series 78	Series 76P, 77P, 79P
Resistance Range	10 to 2 meg Ω	10 to 1 meg Ω	10 to 2 meg Ω	10 to 2 meg Ω	10 to 1 meg Ω	10 to 2 meg Ω	10 to 2 meg Ω
Power Rating	1 watt @ +85°C	0.5 watts @ +85°C	0.5 watts @ +85°C	1.5 watts @ +125°C	0.5 watts @ +70°C	0.75 watts @ +70°C	0.75 watts @ +25°C
Operating Temperature Range	-85° to +175°C	-65° to +150°C	-65° to +150°C	-65° to +200°C	-25° to +125°C	-25° to +125°C	-55° to +105°C
Price (List 1 to 0)	\$5.50	\$5.50 (61P) \$6.50 (all others)	\$6.50	\$8.00 (50) \$7.50 (53, 54)	\$1.75 (62P) \$2.00 (62PF) \$2.50 (all others)	\$3.00	\$1.95
Typical Setting Ability	± 0.01%	± 0.05%	± 0.01%	± 0.01%	± 0.05%	± 0.05%	± 0.05%

Beckman
INSTRUMENTS, INC.
HELIPOT DIVISION
FULLERTON, CALIFORNIA • 92634

INTERNATIONAL SUBSIDIARIES: GENEVA; MUNICH; GLENROTHES, SCOTLAND; TOKYO; PARIS; CAPE TOWN; LONDON; MEXICO CITY; STOCKHOLM; VIENNA

October 28, 1968 | Highlights of this issue

Technical Articles

**What to expect from
new IC processes**
page 82

Years of work have paid off in a healthy, powerful fabrication technology, but there's still plenty of room for improvement. Integrated-circuit manufacturers are asking for larger-diameter silicon ingots, harder metals for chip intraconnections, and faster testing methods to increase the yield and reliability and reduce the cost of their product. When and how do they get them? An expert gives his prognosis.

**An easy way to find
line reflections**
page 93

Complex equations need not be used to solve for transmission-line reflections—they're time-consuming and tedious, and apply only to linear load impedances. With a simple graphic technique, the engineer need only draw three lines related to the load, line, and source impedances to find reflections caused by either linear or nonlinear loads.

**Computer memories,
a special report**
page 103

Electronics



An electrode moves downward, an electric arc flashes, the electrode snaps up, and another length of plated wire falls away to be incorporated in the memory of an aerospace computer. The cover photo, symbolic of recent changes in memory technology, keynotes Electronics' special report on memories. The report begins with three articles on ferrite-core systems and one on planar thin films. In future issues, cylindrical thin films, semiconductors, advanced techniques, and various special topics will be covered. Photographer Ron Dow took the cover photo at the Aerospace division of Honeywell Inc., Minneapolis.

Coming

**Detecting
air pollutants**

Complex techniques such as Fourier transform spectroscopy and pattern recognition, carried out by parallel filters and decision-making logic, enable pollution analyzers to detect and identify many atmospheric contaminants simultaneously.

IC processing: healthy, still growing

An expert predicts further improvements in semiconductor technology even though most of the fabrication steps are well under control

By Thomas A. Longo

Transitron Electronic Corp., Wakefield, Mass.

Where does integrated-circuit manufacturing stand today? For one who has been deeply involved in the industry since its infancy, the answer is easy: it has come a long way. Years of hard work by many companies have paid off in a healthy and dynamic processing technology. There are problems, of course—some of them serious—but the technology is capable of solving them. It's only a matter of time.

Briefly, the state of the art of IC manufacturing stacks up like this:

- Material preparation—control of purity and of impurity doping is excellent. Crystal imperfections are still a problem, however.
- Epitaxy—processes are adequate and are approaching a state of uniformity throughout the industry.
- Photolithography—with a vigilant approach to dust control, contamination is no longer a problem.
- Diffusion—one of the most advanced processes in IC manufacturing.
- Metalization—aluminum is still the best material, but it has its drawbacks, particularly in medium- and large-scale integration.
- Packaging—flip chips and beam leads have their good points, but wire bonding is still the standby. Plastic packaging of low-cost IC's is now a mature technique.
- Testing—static testing of digital IC's leaves little to be desired, but dynamic and linear-IC tests are still much too expensive and slow.

Raw materials: under control

Crystal growth has reached a highly sophisticated level. There has been tremendous improvement during the past seven or eight years both in purity and purity control, and in the techniques of introducing impurities.

As a matter of fact, there's probably nobody in

the semiconductor industry who can blame process problems on undesirable impurities. Far more significant are the mechanical problems that crop up in the form of crystal imperfections—dislocations, strain lines, slip planes, and the like. In large-area devices such as power transistors, silicon controlled rectifiers and integrated circuits, these mechanical imperfections tend to increase the incidence of low breakdown voltage, very high leakage current, emitter-collector shorts, and punch-through to the base region. The larger the chip, of course, the greater the chance of imperfections.

In IC processing, the quality of the epitaxial layer is strongly dependent on the mechanical perfection of the substrate semiconductor material. And the quality of the epitaxial layer determines, in turn, the quality of the components built into the layer.

The work done over the past 10 years to reduce imperfections has paid off to a great extent. Whereas it was difficult several years ago to get dislocation densities on the order of 5,000 to 10,000 per square centimeter, it's not uncommon now to talk about dislocation densities below a thousand as normal production quality.

It's important not only to be sure that mechanical perfection is there at the start of the process, but to ensure that it's maintained during the process—a greater challenge because of the stresses of device fabrication. The material is heated to 1,200° or 1,300°C, for instance, and then quickly cooled. Procedures like this cause internal stresses that can introduce many mechanical imperfections no matter how "perfect" the material is to start with.

A good example of process-induced imperfection is the concentration of defective IC's toward the edge of a silicon slice. Tests of IC's after they and the connecting metalization patterns have been built into the slice indicate that most of the defective circuits are around the periphery, where the stresses

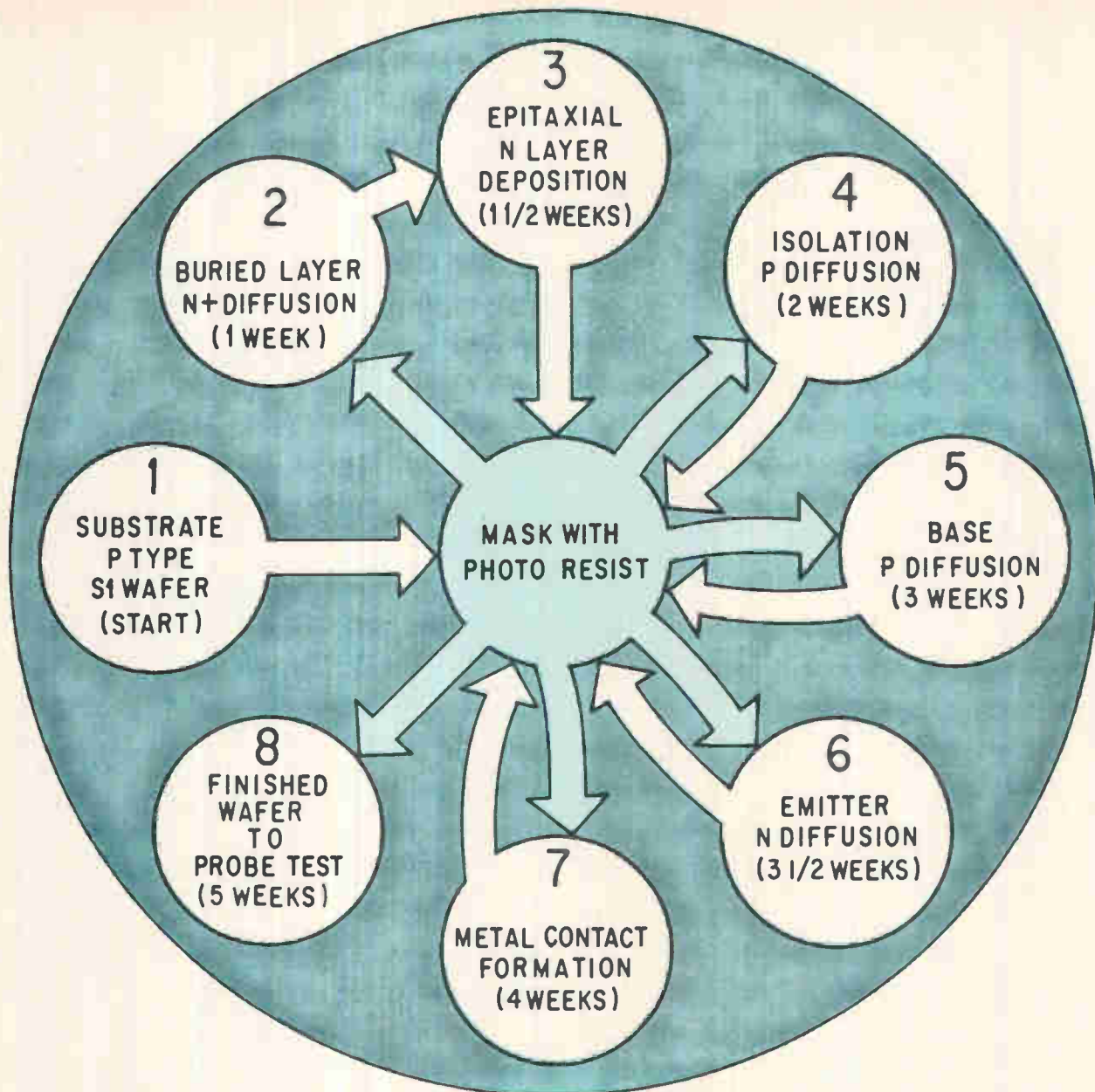

Back and forth. For smooth and economical production scheduling, a wafer makes its many trips between the photoresist room and diffusion room over a period of weeks, not days.

of handling and temperature are most acute. But a great deal has been done to improve yields by reducing the spread of imperfections from the edge.

Handle with care

Surface damage is a particular danger during the critical material-preparation procedures of sawing the crystal ingot into thin slices and lapping the surfaces of each slice to a smooth mirror-like finish. This finish is absolutely essential in IC manufacturing; without it, it's impossible to align the photolithographic masks during subsequent steps in the process.

There are ways to achieve the mirror finish without damaging the material—though there's always room for improvement here. But perhaps more rele-

vant to a review of progress and problems in semiconductor process technology is the question of slicing and lapping costs. Great strides have been made in reducing the cost of the subsequent processing steps; growing the material and preparing it for processing account for a major part of today's fabrication expenses.

The obvious way to reduce this outlay (and that for photoresist and diffusion operations) is to increase the diameter of the slices, prorating the costs over a larger number of IC's. But it's not that easy, and again the main problem concerns material perfection. A few years back, it was difficult to draw silicon ingots more than 1 or 1¼ inch in diameter with the proper degree of perfection in the slices. Then, four years ago, the Transitron Electronic

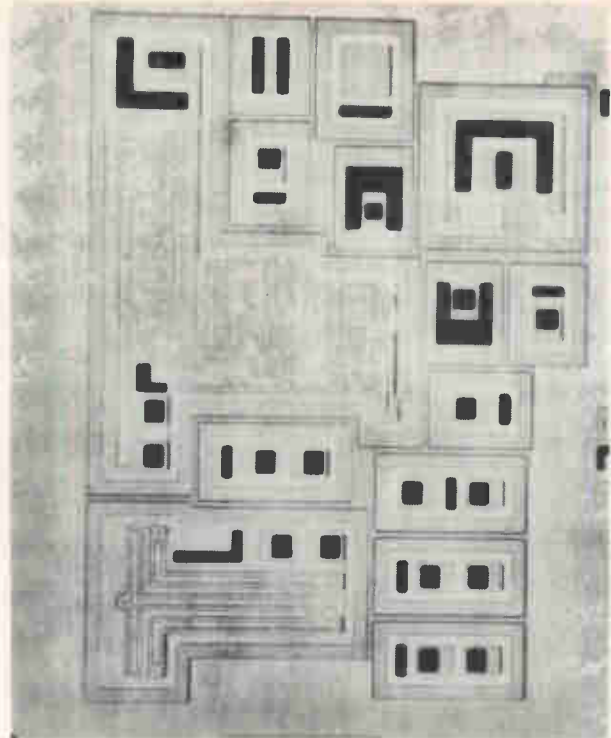
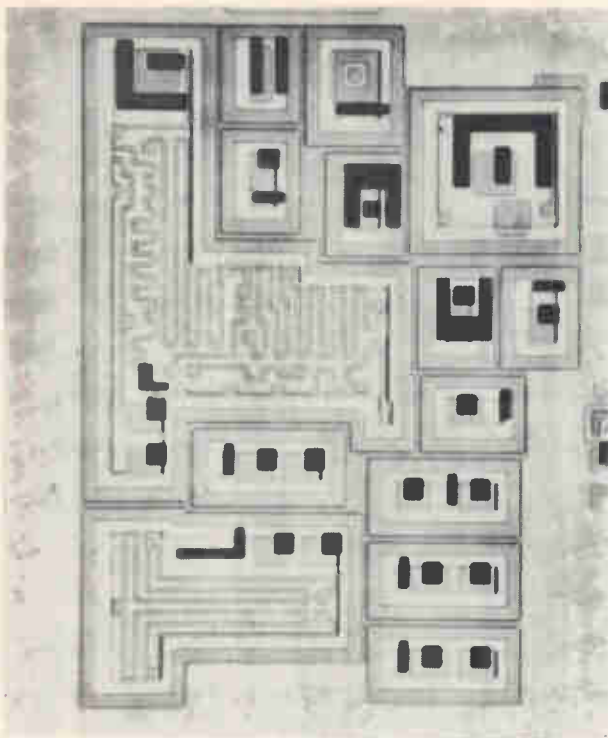

Off and on. The masks for the circuit at right were properly aligned; if the masks are off by as little a 1/10,000th of an inch, the short- and open-circuited elements at the left can result.

Corp. introduced 1 $\frac{5}{8}$ -inch-diameter slices in volume production—the product of considerable research and development in the crystal-growing field.

Many companies are now working on slices as large as 2 inches in diameter. The bigger the better, but the fact is that nobody can yet successfully grow crystals bigger than 2 inches in diameter and still get high-yield production of IC's.

The problem lies not just in growing and preparing the ingots; the larger the slice, the more difficult the subsequent processing. The diameter affects the mask making (it's not easy to maintain mask accuracy over a large area), the mask alignment procedure, and the handling of the slices on the production line (their fragility increases with size). Larger slices require larger diffusion furnaces, furnaces in which gas flow and impurity doping are difficult to control.

It wasn't hard to go from a 1-inch diameter to 1 $\frac{1}{4}$, or from 1 $\frac{1}{4}$ inches to 1 $\frac{1}{2}$. It has been difficult to go from 1 $\frac{1}{2}$ to 2, however, and it will be even more difficult to get significantly beyond 2 inches. But it has to be done. Certainly the technology is nowhere near its much-publicized theoretical limits, whatever they may be.

Large-scale deposition

Before epitaxial technology, slices had to be extremely thin, and therefore were extremely fragile. Epitaxy—the deposition of single-crystal silicon on a substrate by the pyrolytic decomposition of a silicon halide—has changed all that, boosting yields and cutting circuit costs.

But the epitaxial process can be rather expensive. The necessary equipment and materials are costly, the deposition process is time-consuming, and the engineering talent required to control everything doesn't come cheap. The only way to hold down these costs is to deposit the layers on many slices at one time.

Eight years ago, when the process was introduced, the epitaxial layer was deposited on a single slice at a time. It's now practical to simultaneously deposit layers on as many as 20 slices, even those 1 $\frac{1}{2}$ and 2 inches in diameter. And it will soon become possible to handle 80 or 100 slices at a time in production.

The key to epitaxial deposition on such a large scale lies in controlling the thickness and impurity content of the layer. A layer with a wedge-shaped cross section can have high saturation resistance and slow circuits, or unisolated components at the thick end and defective junctions at the thin end. And the mirror finish achieved with such care during lapping has to be maintained. It can easily be degraded; stains, pits, or surface projections make the slice unusable for photolithography because the device geometries are so small.

Beyond epitaxy

After getting its epitaxial layer, a slice goes back and forth between the photoresist room and the diffusion room as many as seven or eight times as the following photolithographic operations are performed on it:

- Oxidation to form a thin protective layer of

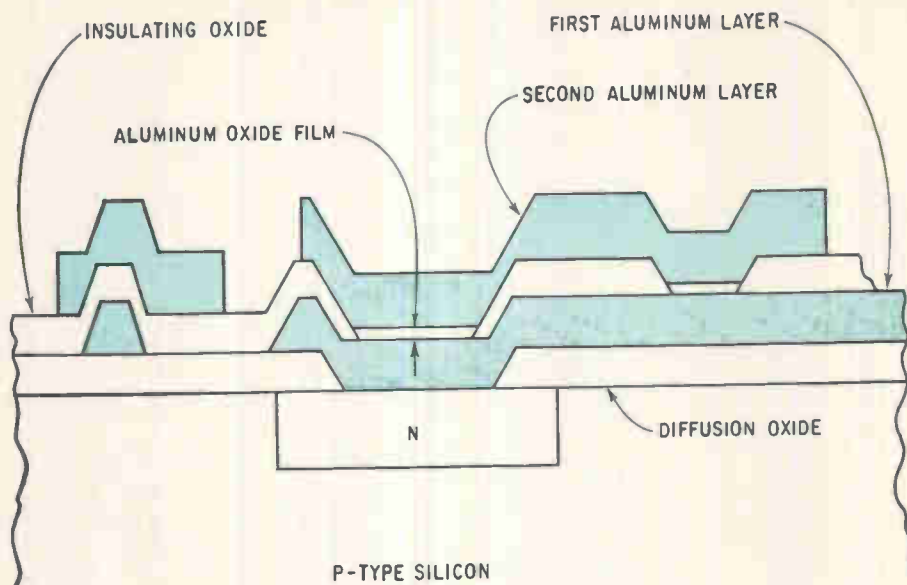

Via holes. The affinity of aluminum for oxygen makes connections between layers difficult because the oxide film adds resistance.

silicon dioxide on the surface.

- Application of photoresist.
- Exposure of the photoresist to delineate the mask pattern.
- Removal of photoresist in the delineated areas.
- Etching of the surface oxide in the delineated areas to form windows for diffusion.
- Removal of all photoresist.
- Diffusion of the impurities through the windows into the epitaxial layer.

And all these steps are repeated again and again. Few customers realize that in volume production, with thousands of slices moving through the line each day, the repetitive cycles of photoresist and diffusion take from four to six weeks. The conditions surrounding any given slice have to be kept constant over a period that long or the yield will drop disastrously. And with all the transferring of slices, they have to be handled and stored with great care. The only solution is to invest heavily in environment- and process-control equipment, and in the training of personnel. It's an expensive solution, but less costly than low-yield production.

After all, the IC business is based on a controlled photolithographic-diffusion process and trained personnel. With all due respect to packaging and testing—they're both important processes—you're not in the business if you can't make the chips. When you hear that a manufacturer is in trouble, that it can't deliver certain circuits, it's usually because the firm isn't able to make the chips.

Keep it clean

There are two major hazards in photolithography—dust and inaccurate mask alignment. Dust can be carried into a supposedly dust-free room by anyone entering it. In fact, as soon as people are gathered in a "clean room," it's no longer clean; people just generate dust. Even a taken-for-granted thing like a girl's face powder can ruin batches of slices.

Even in clean rooms, therefore, IC processing

requires extra local protection. This is provided by laminar-flow hoods, accessible boxes about 35 cubic feet in volume through which extremely clean air is passed.

Why all this concern with cleanliness? Well, when dust settles on the photoresist on a slice, each particle shades the area directly under it when the photoresist is exposed to ultraviolet light through the mask. In the subsequent developing step, all unexposed areas of photoresist are removed—including the specks under the dust particles. And when the oxide is removed at the bare areas, it's removed at the specks, too, creating pin holes through which unwanted impurities get diffused. So the net result of dust is a sprinkling of tiny diffused regions where they shouldn't be, that is, where they can form leakage paths that bridge junctions, degrading IC performance and reducing over-all yield.

The other big problem in photolithography, alignment, arises because of the large number of masks needed to make an IC. There are separate ones for isolation diffusion, collector and resistor diffusion, emitter diffusion, contact-window metalization, and interconnection-path metalization—as many as nine different masks. These masking steps are performed three or four days apart over a period of perhaps six weeks, and each mask has to be aligned with the preceding one to within 0.00001 to 0.00002 inch. If the mask patterns fall out of line, some of the circuit elements will be short- or open-circuited and most IC's on the slice will be defective.

Alignment not only has to be precise, but fast enough for economical production. Great strides have been taken here. A few years ago an experienced operator would need 3 to 5 minutes to align a mask. Now, because of improved equipment, it takes only about 45 seconds. And with more IC's on a slice, this represents a tremendous increase in productivity.

Cleanliness is nowhere near the factor in dif-

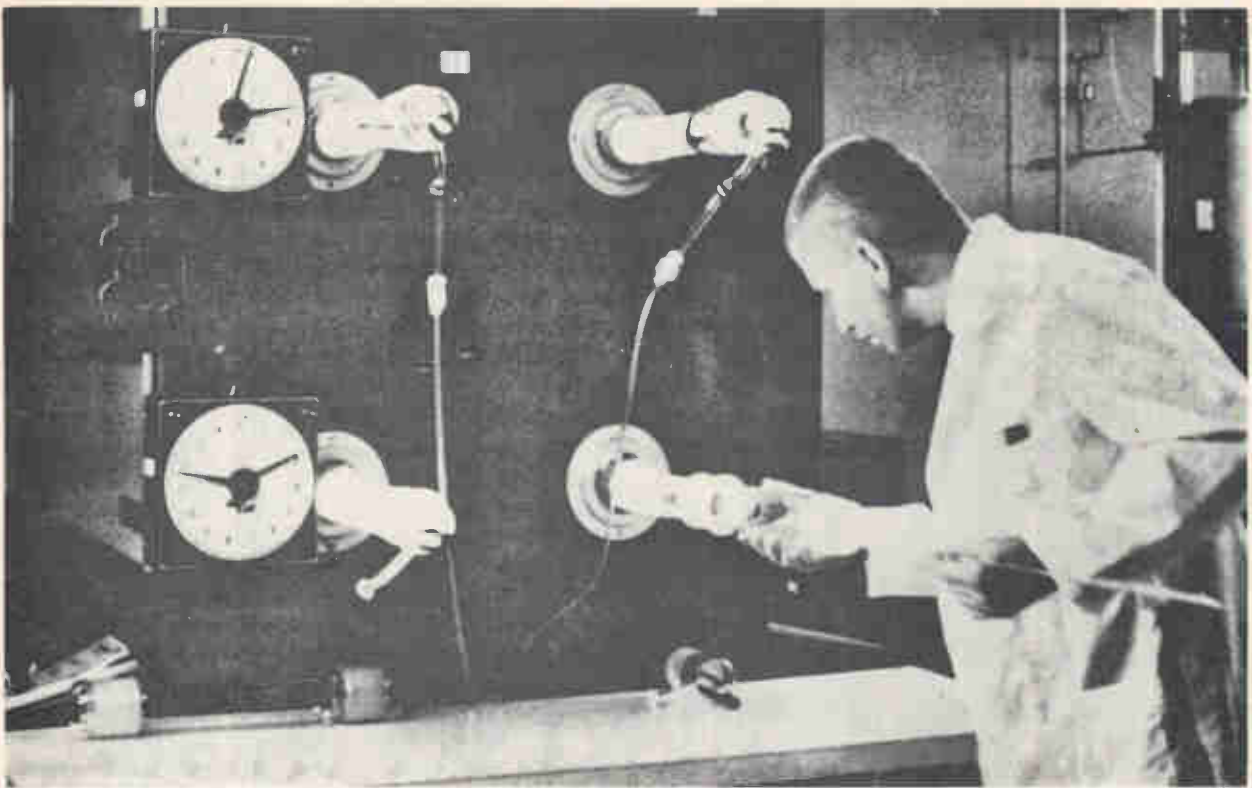

No sweat. Diffusion of impurities into the water is probably the most advanced process in semiconductor technology, even though it demands extremely precise temperature control. Today's equipment can maintain temperature within about 0.02% — a 1,000° C or more.

fusion that it is in photolithography. Years ago, however, the situation was different. In the manufacture of large-area devices such as power transistors and power rectifiers, cleanliness was of prime importance in diffusion but less critical in other steps. But with the IC's compactness, fine geometries, and narrow tolerances, the emphasis on cleanliness has shifted to photolithography.

Diffusion is today a stable and highly refined technology. The big improvements and cost reductions of the future are more likely to be made in photolithography than in diffusion.

Going to the source

Work is still being done to improve diffusion techniques, though, with primary aim being to find the best source of the impurity dopant. The range of choices is wide, covering such solid sources as boron trioxide for boron and phosphorus pentoxide for phosphorus, liquid sources like phosphorus oxychloride for phosphorus and boron tribromide for boron, and gaseous sources like diborane and phosphene. Right now, most manufacturers are steering away from solid sources; some are using gaseous sources but the majority have gone to liquid sources.

For a successful diffusion—a precise impurity gradient over a precise depth—careful control must be exercised over the composition and temperature of the source, over the flow of gas that carries the

impurity from the source to the slices, and over the temperature profile in the slice zone.

Most manufacturers have no serious problems in controlling these factors. It's not uncommon now to require control of a 20- or 24-inch diffusion zone at 1,200°C to within $\pm 1/4^\circ$ for hours. It's not easy, but it's being done.

Metalization is a different story; there are significant problems to be solved with the materials used to interconnect IC components. Aluminum is the most commonly used material for this purpose, and it's far and away the best. Its big advantage is its strong affinity for oxygen. When the protective surface oxide, which is 3,000 to 10,000 angstroms thick, is removed from the silicon to make a contact window, another oxide layer 50 to 100 angstroms thick appears as soon as the slice comes in contact with the atmosphere. This layer prevents most metals from contacting the silicon, but aluminum combines with it when heated and alloys right into the silicon. Moreover, the Al-Si alloy is a eutectic and gives a good ohmic contact.

But aluminum is soft and scratches very easily. So, from the reliability standpoint, aluminum can be a hazard; a scratch caused by routine handling of the slices after metalization can lead to an open circuit long after the chip has been packaged.

The industry probably throws away as many as 10% or 15% of all the chips it manufactures because of scratches observed in microscopic inspec-



Key operation. Looking at the wafer through a microscope, the operator positions the photolithographic mask with a joy stick. Procedures like this require skill and elaborate precautions against contamination.

tion, even though the chips passed their electrical tests. If an IC manufacturer wants to produce a high-quality product, visual inspection of every chip is mandatory. But scratches can still go undetected and become a reliability problem later on.

What alternatives to aluminum are there? That's simple. There are none. What's being sought is a

material less susceptible to scratches, a hard metal that would have little trouble absorbing the thin natal oxide and would form a good ohmic contact with the silicon. Like most ideals, this one has so far been pursued in vain.

There are palliative measures, however. For example, it's possible to deposit silicon dioxide over the aluminum by the low-temperature (500°C) pyrolytic decomposition of silane. The oxide layer gives some protection, though it's not completely effective.

Another protective measure is "glassivation," a process in which a thin layer of glass is put down on the aluminum under careful control. Again, it's not the ideal solution, but it helps by fortifying the surface to some extent.

Perils of progress

Aluminum's shortcomings have become more evident with the advent of medium-scale and large-scale integration. When IC's contain 50 or 100 or even more gates on a single chip, crossovers of the interconnections are hard to avoid. It's possible to diffuse a conducting path in the silicon under a metalization path, of course, but this circumvention is fairly expensive and introduces significant amounts of undesirable resistance. Certainly when 100 or 200 such underpasses are needed, as they are in circuits of only moderate complexity, it's time to look for something else.

Multilayer metalization is that something else. A metal interconnection pattern is deposited on the slice, an insulating silicon dioxide layer goes on top of that, and a second interconnection pattern is laid down on the oxide. The second metalization layer connects to the first and to the silicon through "via" holes at appropriate locations. And if the circuit is very complex, a third metalization layer can be added.

Other materials have been tried here, notably gold and a combination of gold and molybdenum, but aluminum remains the choice of most manufacturers.

The trouble with using aluminum, though, is that its chemical affinity for oxygen becomes a mixed blessing in multilayer metalization. The bottom layer develops a thin oxide coating as soon as it's exposed to the atmosphere, and this oxide skin creates a high resistance in the interlayer connection when the second layer is deposited and fills the via holes.

Some progress has been made in minimizing this resistance, and good results have been obtained in the laboratory and in small-scale production. But the process isn't yet sufficiently controllable or economical for volume production.

It's much easier to make an IC that has only 20 via holes than it is to make one with 120, because the chance of the interlayer connections being defective is correspondingly less. For production of a 120-via-hole circuit with acceptable yield, the multilayer process must have a 98% or 99% probability of success. Despite the achievements of the past

year, the industry is still struggling with this problem.

Why flip?

The standard method of connecting an IC chip to the world outside its hermetically sealed package is to link the package leads and the metalized pads on the chip with fine wire 0.015 to 0.080 inch long and about 0.001 inch in diameter. Typically, 14 of these wires are used, which means 28 bonds—half to the chip and half to the package.

Room for everyone

What stake will smaller companies have in the future evolution of semiconductor technology? Will they continue to be major contributors? Or will they be gradually overshadowed by the corporate giants? Author Longo has some cogent ideas on the subject:

"The big successes haven't been made by the traditional component suppliers—by the vacuum-tube or light-bulb manufacturers. The smaller companies, not the giants, have made the outstanding contributions and have reaped the rewards.

"The reason for this is the nature of the semiconductor industry; rapid and dynamic change is the rule. In this environment, it's easier for a small company to adjust and innovate. Such companies have grown up in the business, and their whole philosophy has developed around the semiconductor technology. It's less easy for very large corporations whose management, principles, and philosophy have evolved over many decades in connection with other businesses.

"The statement has been made that, when the technology stabilizes, the giants will take over the leadership. Well, my reply to that is that the technology is nowhere near stabilization. We have a fantastic technology that's been supported by billions of dollars of research, development, and production money, and whose power is almost beyond description. And yet there's considerable room for improvement, and this situation, will continue over the next five or 10 years at least. I'm certain."

Transitron favors ultrasonic bonding, but some manufacturers go with thermocompression bonding. Aluminum is the preferred material for the wires because it eliminates the possibility of purple plague. This condition, which can occur when a gold wire is bonded to the aluminum metalization, causes the wire to become brittle and eventually to fracture.

Beam-lead and flip-chip techniques are sometimes advanced as ways of reducing the cost and improving the reliability of IC's by eliminating wire bonding. This is debatable. When low-paid foreign

labor is employed to bond the wires in commercial IC's—a common practice among the major manufacturers—wire bonding is cheaper. Even if circuits are wire-bonded here, with no saving in labor costs, they can compete with flip-chip or beam-lead devices, which have to be mounted on metalized ceramic substrates.

The real value of beam leads and flip chips lies in hybrid circuits, in which several IC chips are mounted on a substrate and interconnected with conductors, resistors, and capacitors. A decision to go hybrid is a commitment to use a ceramic substrate, and this substrate might as well serve as a wireless mounting for the IC's too. IBM's SLT, used in the 360 computer, is an eminently successful example of this approach. But beam-lead and flip-chip techniques are of questionable practicality in single-chip circuits.

As for the question of reliability, the returns aren't in yet. Not enough experience has been gained with beam leads or flip chips to justify a quantitative comparison with data on wire-bonded IC's. There's no question that wire connections are susceptible to failure, but the problem has lessened considerably in the past several years with a reduction in the number of bonding wires. Every transistor in a discrete circuit has two internal bonded wires, but an MSI circuit containing 300 components requires only 14.

It's ironic that a multilayer circuit board can be less reliable than all the IC's and components it holds—and cost more.

What the reliability question boils down to is this: beam leads and flip chips are potentially very reliable, but the reliability of wire-bond circuits is becoming less and less a problem, chiefly because their number is decreasing.

Plastic encapsulation is a form of packaging that's revolutionizing the commercial IC industry because it's a simple technique and very, very cheap. The chip is bonded directly to a lead frame, wires are bonded from chip to frame (usually by low-cost foreign labor, and plastic is molded around the assembly. It's so cheap that the cost of the packaged IC is close to the cost of the chip—quite a different situation from conventional hermetic packaging.

In the early 1950's, some manufacturers introduced plastic-encapsulated germanium transistors. These products failed because they weren't moisture-resistant, and it became industry dogma that plastic could not be used. That view has been changed by improvements in plastic-encapsulation techniques, and, more significantly, by the silicon planar process, which produces chips already largely protected from moisture, before they're encapsulated.

Today, the problem is not so much moisture as thermal stress. If the temperature of the IC rapidly rises from 0°C to 100°C, for example—and this could happen as the result of a severe current surge—an internal connection from the lead frame to the chip could open, making the circuit inoperative.

Testing for this condition is tricky, because the thermal expansion or contraction can be reversible. Because the circuit may work perfectly when returned to room temperature, testing has to be done at the temperature extremes to detect the thermally induced intermittent.

Plastic devices are certainly reliable enough for commercial use, and they have been very successful in such applications. There are some who advocate their use in military applications, but this seems premature. Regardless of its improved moisture resistance, a plastic IC, or any plastic semiconductor device, cannot be guaranteed to stand up to 95% relative humidity at 100°C for extended periods of operation; some degradation of performance would be inevitable.

In the end, it's up to the user to assess whether his application can tolerate the slight degradation and reduced reliability of plastic devices under certain conditions. Or, looking at it another way, the user has to assess whether the lower cost of plastic IC's justifies the expense of maintaining a compatible environment.

Dramatic effect

Finally, testing. By the time the manufacturer gets to testing, the product has been built; what he really wants to know is how well he has done the job. Obviously, manufacturing costs are dramatically affected by how many devices are thrown away after testing. It used to be that a 30% yield was considered good in transistor production. Now, if IC yield is less than 75% at final test there's something wrong.

Everything possible is done to ensure a high yield at the final test, and this means severely testing the product while it's still just a chip, before an investment has been made in packaging. If a low yield is unavoidable, it's better to accept it in the chip stage to produce a high yield and corresponding economy at final test.

With testing becoming increasingly difficult, computers are taking over the job. Not only can they control as many as half a dozen test stations simultaneously but they can test highly complex IC's to whatever degree is necessary for the customer to get what he wants. Computers can also generate much useful information, including data on distribution of 10 or more parameters for thousands of IC's.

All this applies to the d-c parameters of digital IC's. A-c parameter testing lags behind, particularly in testing at temperature extremes. In the past at least, equipment for a-c testing was expensive, slow, and inconvenient, and the long connections to the environmental chambers introduced error.

Consequently, most manufacturers don't test a-c parameters at extremes like -55° and $+125^{\circ}\text{C}$ on a 100% basis. Instead, they make correlation studies in guard bands so that they can predict the parameter values at high and low temperatures from measurements obtained at a more convenient temperature. If the customer's specification requires

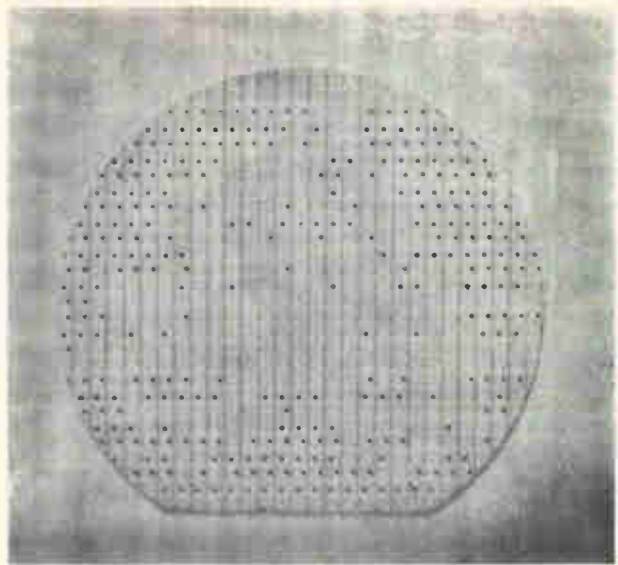

Fringe problem. Each dot indicates a defective IC. Crystal defects, and thus faulty IC's, tend to be concentrated around the periphery of the silicon slice because of the high thermal and mechanical stresses there.

100% testing at extreme temperatures, manufacturers will do it, of course, but it makes the circuits considerably more expensive.

Another kind of testing in a relatively early stage of evolution is linear IC testing. In operational amplifiers, for instance, there's a need for equipment to test, at high volume and low cost, such parameters as offset voltage, input bias current, input impedance, gain-bandwidth product, intermodulation distortion, and noise figure. And the need is becoming more acute because of the boom in operational-amplifier applications. With the less-than-a-dollar IC op amp just around the corner, the analog computer may come back strong. If it does, that market would consume millions of IC's a year.

Computer-controlled linear IC testers are now being developed, but they're still too slow. Test-equipment manufacturers are sanguine about the future, though, and predict significant progress before long.

Is silicon here to stay?

Silicon is a fantastic material. Its unique blend of electrical and processing properties have been exploited to a point where silicon technology out-classes all contenders.

It would be foolhardy to say a new material won't come along to replace silicon, but the industry will have to look long and hard for it. Certainly, there's nothing on the horizon.

This doesn't mean there isn't room for improvement. We're nowhere near the saturation point that a lot of people have talked about; the technology will continue to develop for many years to come.

this technique to about 5,000 hertz to prevent small amplitude oscillations.)

The push-pull stages, Q_1 , Q_2 and Q_3 , Q_4 , have no crossover bias and, therefore exhibit excellent d-c stability over a -55°C to 125°C temperature range. Crossover distortion is eliminated by the high open-loop gain (about 2,000 at 400 hertz) which quickly switches the push-pull inputs through the dead zone with an output-amplitude loss of less than a millivolt.

The 118-kilohm resistor provides a d-c feedback path around the output stage. This enables the d-c input level to Q_3 , Q_4 to be held well under the transistor turn-on voltage, preventing any d-c output offset current from flowing through the winding of an inductive load.

Two breadboard amplifiers exhibited unity-gain accuracies of better than 0.05%, and an output resistance of less than 0.05 ohm, and were stable with capacitive loads from 0 to $0.1\ \mu\text{f}$.

Wider frequency range for relaxation oscillator

By James Skilling

General Radio Co., West Concord, Mass.

The addition of a voltage divider and an isolating diode to a simple series-type multivibrator broadens by several decades the circuit's frequency range.

If R_{B1} , R_{B2} , and D_1 weren't in the circuit, limitations on the value of R would restrict the operating frequency range. R must be small enough so that at the point at which the transistors turn on—where the charging current shifts into R_B via Q_1 —the charging current is large enough to forward-bias Q_2 to allow regeneration to start. On the other hand, R must be greater than the value that would allow Q_1 's emitter current to exceed the holding current level I_H ; if I_H were exceeded the transistors would never turn off.

With the circuit as shown, R_B can be made very

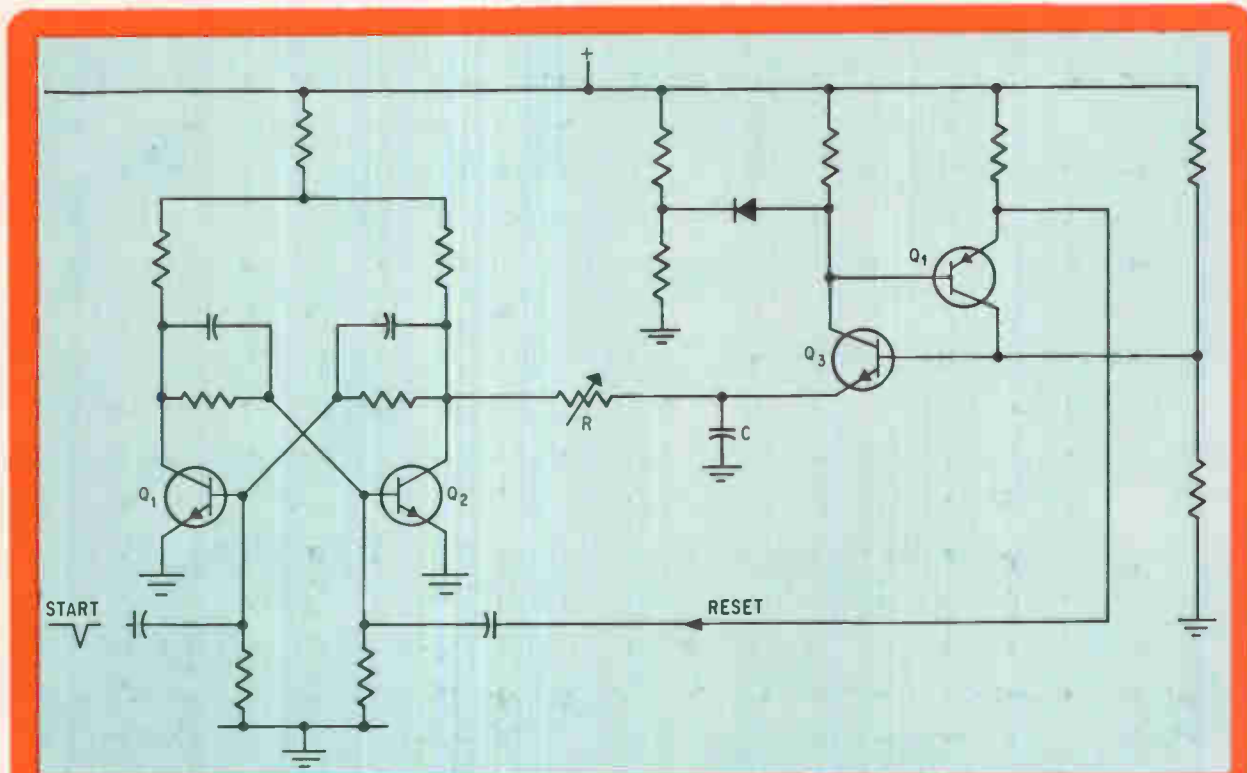

Combination. An astable multivibrator connected to a flip-flop forms a monostable multivibrator with the same input characteristics as a Schmitt circuit. The range of output pulse durations is as wide as the frequency range, so it's not hard to design a circuit with a range of three decades.

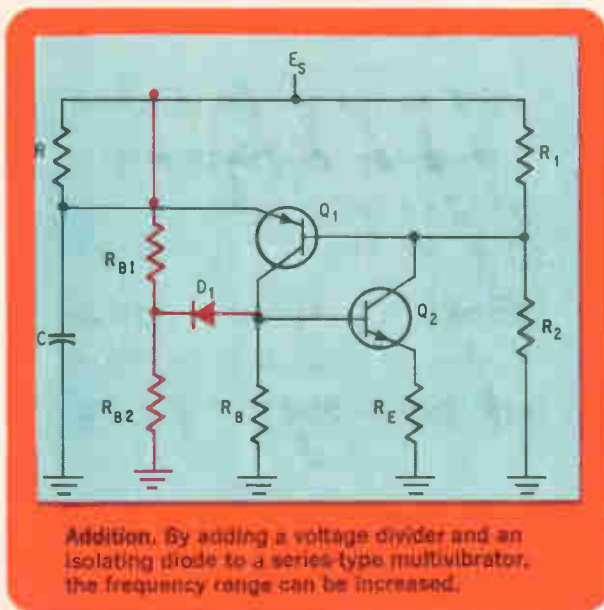

large to enable extremely small charging currents to turn on the transistors. The upper limit on R_B , and consequently on R , is determined by the requirement that leakage current through R_B should not produce a spurious circuit turn-on. The divider, R_{B1} and R_{B2} , holds the cathode of diode D_1 a volt

or so off ground so that it and the divider play no part in turn-on. However, after turn-on has raised the base voltage of Q_2 enough to forward-bias D_1 , the lower resistance of the divider is placed in parallel with R_B . Thus, the holding current is determined by the low impedance of the R_{B1} , R_{B2} , R_B network, and in turn-on characteristics are determined by R_B alone.

The input characteristics are the same as those of the conventional Schmitt circuit. The series circuit, or series Schmitt, can be operated as an astable, bistable, or monostable multivibrator, just as the conventional Schmitt can. However, an alternate way to obtain monostable operation is to couple an astable and a flip-flop, as shown on page 91.

In this circuit, Q_2 is normally turned off and has a collector voltage equal to the holding voltage of the oscillator (Q_3 , Q_4), which is in the nonconducting state. A start pulse causes the flip-flop to change states, saturating Q_2 and thus grounding R . The oscillator then goes through one cycle, producing a pulse that resets the flip-flop. The range of output-pulse durations is as wide as the range of frequencies. It isn't difficult to design a unit with a range of two or three decades.

The recovery characteristics of this type of monostable are also unusual; they can have the equivalent of duty ratios greater than 0.999999.

Reed switches form a nonmechanical lock

By R. Michel Zilberstein

Microsonics Inc., Weymouth, Mass.

A nonmechanical electrical lock can be made with dry reed switches. Several normally open and normally closed switches are connected in series and mounted on a board. Using a coded card to activate the normally open switches with permanent magnets will close the circuit, permitting operation of the electric door latch, automobile ignition, or whatever.

The lock won't operate with the wrong magnetic pattern, or with a single large magnetic field, because the normally closed switches will open, interrupting the circuit. The security factor of the lock depends on the number of reed switches and the pattern in which they're arranged. Each lock will respond only to the magnetic pattern that will close the normally open switches and leave the nor-

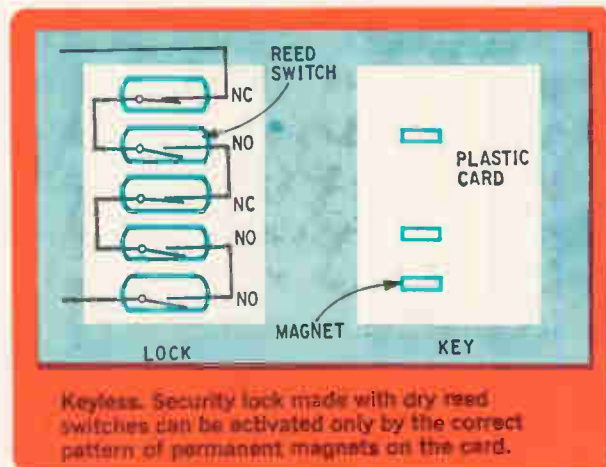

mally closed switches closed.

The card is an array of small permanent magnets arranged so that they're over the normally open switches when the card is inserted. The lock can be sealed in a nonmagnetic box, recessed into any flat surface, and then disguised with trim. The key can be a laminated plastic card.

No need to juggle equations to find reflection—just draw three lines

A graphic technique for determining these transmission-line values is faster and simpler than the usual mathematical approaches and can be used with either linear or nonlinear loads

By Robert S. Singleton

RCA, West Palm Beach, Fla.

High-speed switching circuits, such as those found in modern digital computers, have voltage and current pulses whose rise time are often so fast that the connecting wires must be treated as a transmission line. When rise times are less than the propagation times between circuits, reflections from sending and receiving ends of the line introduce distortion.

Reflections on transmission lines are usually well understood when the terminating impedances are linear, but not when they're nonlinear, as in a base-emitter junction.

A graphical technique of solving for reflections has several advantages over other approaches. It can be used with either linear or nonlinear loads. The technique is fast and simple because the engineer doesn't have to work with the complicated transmission-line equations usually applied. He need only know the source, line, and load impedances, draw three lines related to the slopes of these impedances, and follow certain graphical procedures.

More specifically, the engineer proceeds as follows:

He draws a line corresponding to the slope of the sending-end conductance, $1/R_s$. Then he draws

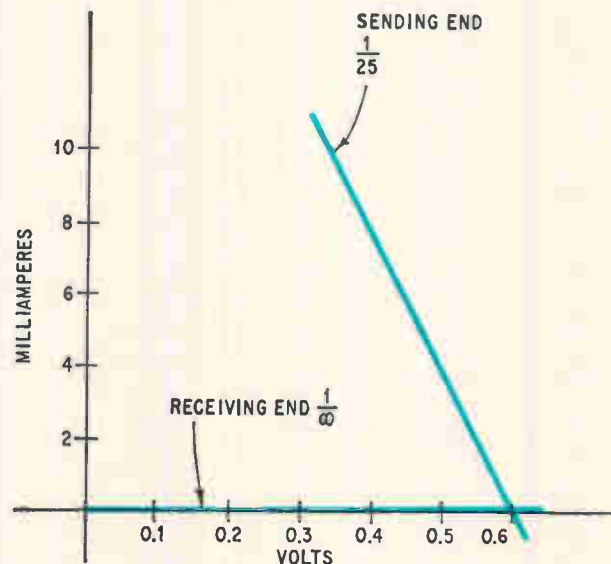

Starting the plot. To find the reflection voltages and currents with the graphical technique, the engineer starts by drawing two lines—one that corresponds to the conductance of the load impedance at the receiving end of a transmission line, and a second that corresponds to the conductance of the source at the sending end of the line. Both lines appear here in color.

Impedance plot		
	Sending end	Receiving end
Conductance (slope)	$1/25$ ohms	$1/\infty$
Slope polarity	Negative, (as v_s increases, i_s decreases)	Positive, (as v_r increases, i_r increases)
Intercept	$v_s = 0.6, i_s = 0$	$i_r = 0$

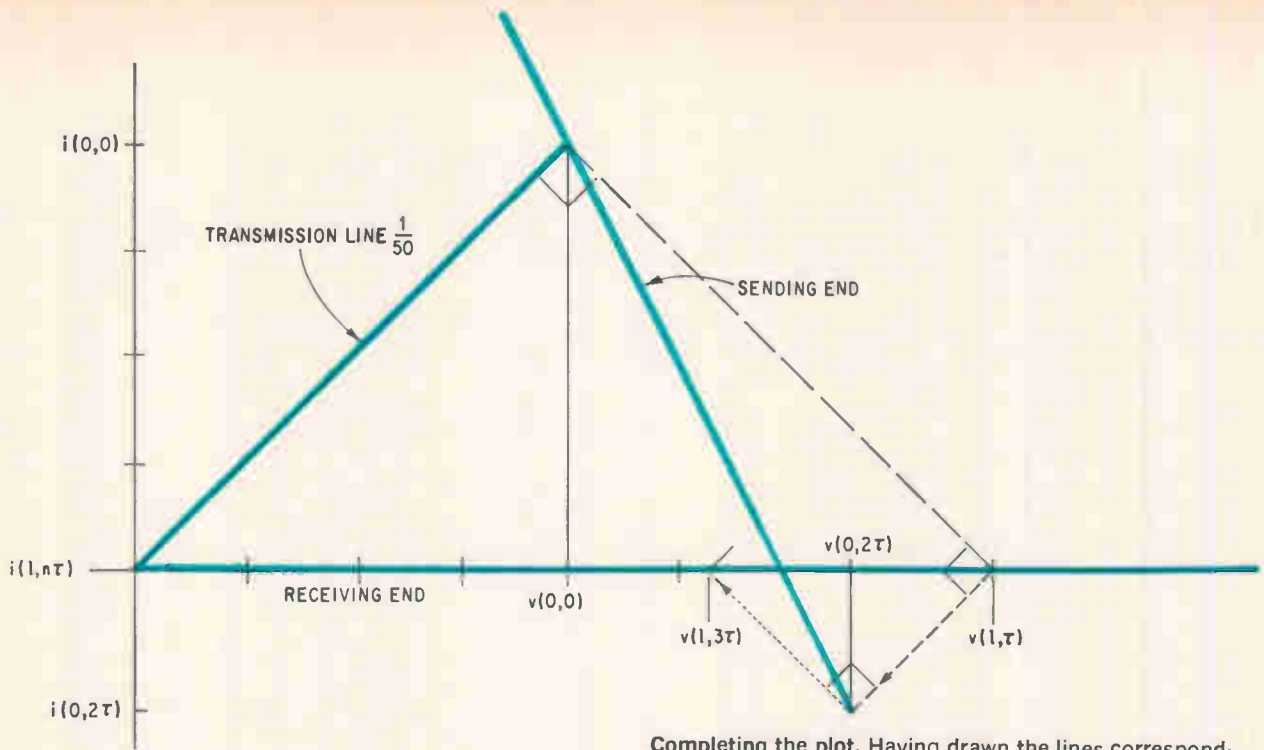

lines corresponding to the slope of the receiving-end conductance, $1/R_r$, and to the transmission-line conductance, $1/R_0$.

The point where the transmission line intersects the sending-end conductance line represents the values of voltage and current when the signal starts down the line. From this point he draws a line at right angles to the transmission line and follows it until it intersects the receiving-end conductance line. The point formed by this intersection represents the voltage and current values at the receiving end at time τ .

From this point the engineer draws a line at right angles to the sending-end line and follows it until it intersects the sending-end line again. This point represents the voltage and current at the sending end at time 2τ . Once again, from this new point he draws a right-angled line until it intersects the receiving-end line. This point represents the voltage and current at the receiving end at time 3τ . The process is continued in this manner until the sending-end line and receiving-end line converge to a point.

Determining reflection voltages

Assume that a lossless line with a characteristic impedance of 50 ohms is driven by a 0.6-volt step and a 25-ohm generator. The line also has an open-circuit load termination. Use the graphical method to determine the sending- and receiving-end voltage and current waveforms.

Solution: Construct the sending- and receiving-end conductance lines as shown on page 93, using the polarities defined for the line. Lines are constructed with slopes of the proper conductance and are located by using the tabulated network-boundary conditions.

Completing the plot. Having drawn the lines corresponding to the conductances of the load and source impedances, the engineer adds a third line (also shown in color) that corresponds to the conductance associated with the transmission line. The point where the transmission line intersects the sending-end line represents the value of voltage and current before it is sent down the line. At right angles to the transmission line and through this point, the engineer draws a line, shown dashed, until it intersects the receiving-end line. This intersection point represents the voltage and current at the load at time τ . A perpendicular is now drawn from this point until it again intersects the sending-end line. This new intersection represents the voltage and current at the sending end at time 2τ . The process is continued until the dashed line converges to a point.

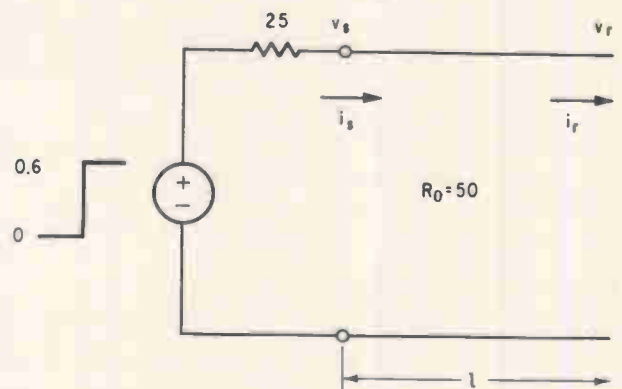

Transmission-line problem. A 0.6-volt pulse is applied to a 50-ohm transmission line terminated in an open circuit. The source impedance is 25 ohms and i_s and i_r represent the sending and receiving currents, respectively. In this case, the line length is given in terms of l .

Starting at the $t = 0^-$ conditions, construct the transmission conductance line. Note its intersection with the sending-end conductance line to get the sending-end solution at $t = 0^+$ and construct the (-) transmission conductance line. Note where this line intersects the receiving-end conductance line. This point represents the receiving-end solution at $t = \tau$; then construct the (+) transmission conductance line. This process is continued as outlined.

From the graphical solution, the terminal wave-

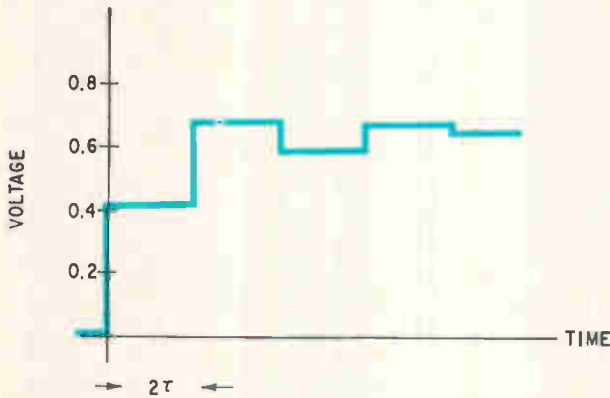
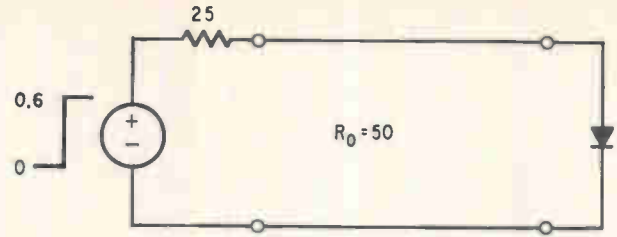

Sending-end voltage. Plot of the voltage at the sending end as a function of time indicates the additions and subtractions that result from the reflections. This plot is based on calculated values taken by the engineer from the graphic solution.

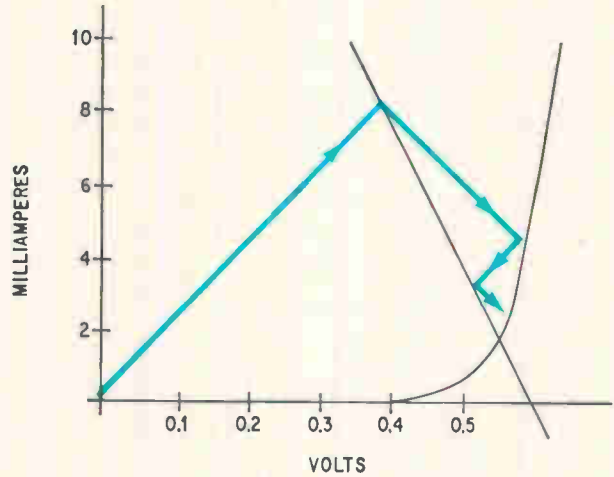

Nonlinear load. A diode is the load to a transmission line and the current and voltage values for the line are calculated from the graph.

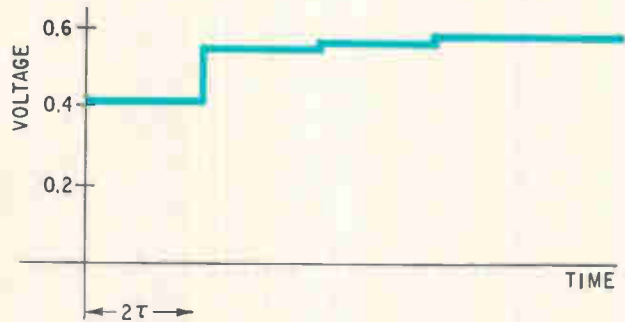

Sending-end voltage. Voltage values at the sending end of a transmission line terminated by a diode are calculated and plotted.

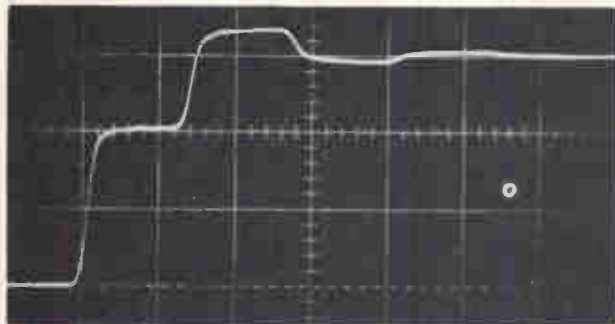

Proof-of-the pudding. Photo taken from the face of an oscilloscope attached to the transmission line verifies the calculated voltage values at the sending end of a transmission line, directly above.

forms can be constructed. As an example, the sending-end voltage is sketched above and is compared with an oscilloscope photograph of the sending-end voltage of the actual circuit operating in the laboratory.

Superposition

By applying the superposition theorem, an engineer can use the graphical method on problems where driving sources appear at both ends of the

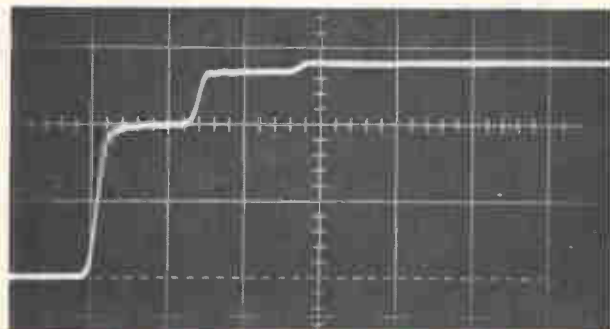

Verification. Photo of sending-end voltage of a line with a diode load has close agreement with calculated plot directly above.

line or the driving functions are more complex than the step function. When a step pulse is used as the driving source, the reflection value is obtained by solving separately for the sending- and receiving-end waveforms and then superimposing them for the total solution. Complex driving functions can be fragmented into appropriate step functions; each step is solved individually and the resultant waveforms are superimposed into a total solution.

Solving a problem

As an example, assume that in a transmission line terminated by a diode the driving function is a rectangle of width 3τ . This pulse can be treated as

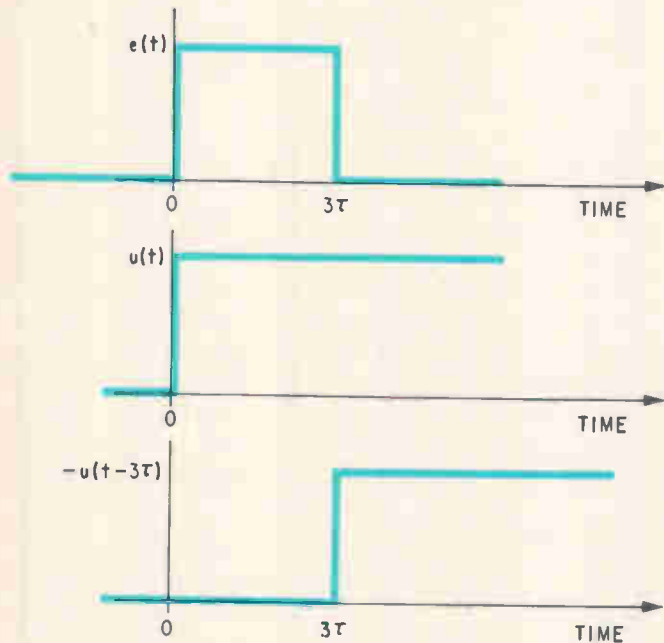

Decomposition. Pulse waveform at top can be formed by the algebraic addition of the two pulses beneath it. These pulses when combined in the proper time sequence add and subtract the parts that eventually shape the desired pulse.

one composed of two step functions, as shown directly above.

Solutions for the two step functions are found as before, and the results superimposed. Using the solution already obtained for the sending-end voltage, the engineer superimposes the waveforms as shown at the top right. The actual measured waveform is compared with the one obtained by superposition.

The graphical technique was used in the circuit and system design of the RCA Spectra 70 computer line. Reflections in the series 1600 system were reduced as a result of reflection-diagram analysis of transistor-transistor logic gates. The analysis clearly showed what characteristics the input diode needed to minimize amplitude reflections from receiving-

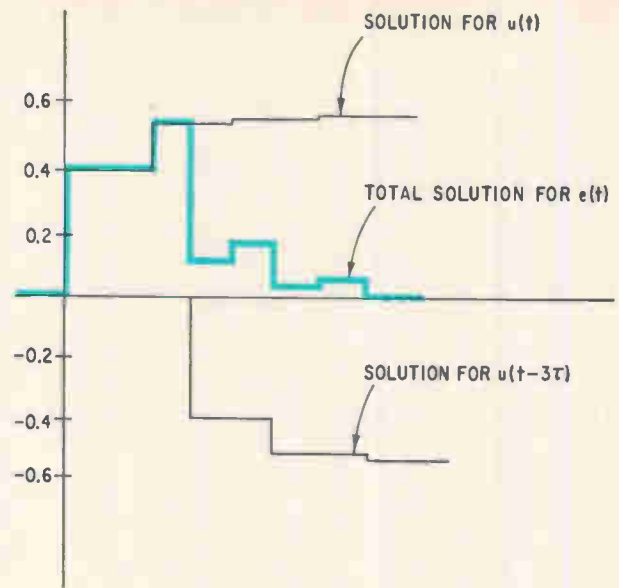

Superposition. When more than one voltage source is applied to a transmission line the engineer can calculate the voltage at the sending end by assuming separate signal voltages and then adding the results together.

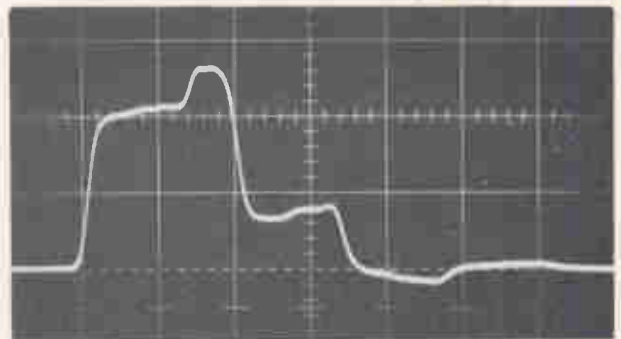

Proof. Photo of the sending-end voltage of a transmission line to which two inputs have been applied agrees closely with the calculated waveform directly above.

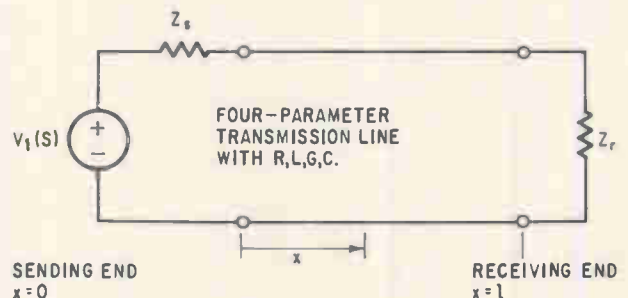

Transmission line. Conventional transmission-line network is divided into three sections—source at the sending end, line in the center, and the load at the receiving end. Parameter x represents length of line. At the load the line is l units long.

end gates. These characteristics have been incorporated as a purchase specification, and each vendor has altered his TTL line accordingly.

In the design of the series 1600 memory system, reflection-diagram analysis was used to predict the relationships between circuit parameters and current waveforms. The analysis of the series 1600 drive-line current is detailed on page 98.

Understanding the theory

The solution for the reflection voltages and currents is based upon the basic transmission line equations for finite current and voltage. These are expressed by

$$I(x, s) = \frac{V_1(s)}{Z_s + Z_0} e^{-\gamma x} \frac{1 - \rho_r e^{-2\gamma(1-x)}}{1 - \rho_s \rho_r e^{-2\gamma l}}$$

$$V(x, s) = \frac{Z_0 V_1(s)}{Z_s + Z_0} e^{-\gamma x} \frac{1 + \rho_r e^{-2\gamma(1-x)}}{1 - \rho_s \rho_r e^{-2\gamma l}}$$

where

$$\rho_r = \frac{Z_r - Z_0}{Z_r + Z_0} = \text{the receiving-end voltage reflection ratio,}$$

$$\rho_s = \frac{Z_s - Z_0}{Z_s + Z_0} = \text{the sending-end voltage reflection ratio,}$$

$$\gamma = \sqrt{(R + sL)(G + sC)} = \text{the propagation constant,}$$

and

$$Z_0 = \sqrt{\frac{R + sL}{G + sC}} = \text{the characteristic impedance}$$

Expanded into infinite series, these general solutions become

$$I(x, s) = \frac{V_1(s)}{Z_s + Z_0} \{ e^{-\gamma x} - \rho_r e^{\gamma(x-2l)} + \rho_s \rho_r e^{-\gamma(x+2l)} - \rho_s \rho_r^2 e^{\gamma(x-4l)} + \dots \}$$

and

$$V(x, s) = \frac{Z_0 V_1(s)}{Z_s + Z_0} \{ e^{-\gamma x} + \rho_r e^{\gamma(x-2l)} + \rho_s \rho_r e^{-\gamma(x+2l)} + \rho_s \rho_r^2 e^{\gamma(x-4l)} + \dots \}$$

The series solution describes an infinite series of waves propagating from points at $\pm 2nl$. The sig-

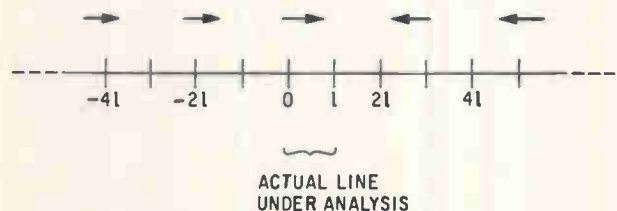

Breaking up the line. By partitioning a transmission line into $\pm 2nl$ equal sections the engineer can examine the voltages and currents for each part and then algebraically sum their affects. The decomposition thus makes it easier to handle the infinite series of waves coming down the line from each section.

nificant advantage in this interpretation is that the terms can be examined one at a time as they enter the problem's time sequence. The values at the end of each section are then added algebraically to give the total reflection for the line.

The lossless line is a useful approximation for most transmission-line applications. This is especially true at relatively high frequencies, where the s terms dominate the non- s terms in the equations for the propagation constant and the characteristic impedance. As an example, for a 50-ohm microstrip transmission line $R = 0.5$ ohm/foot, $L = 90$ nanohenries/foot, $C = 36$ picofarads/foot, and $G = 2$ picomhos/foot. Thus, at frequencies beyond 8 megahertz, $sL \gg R$ and $sC \gg G$.

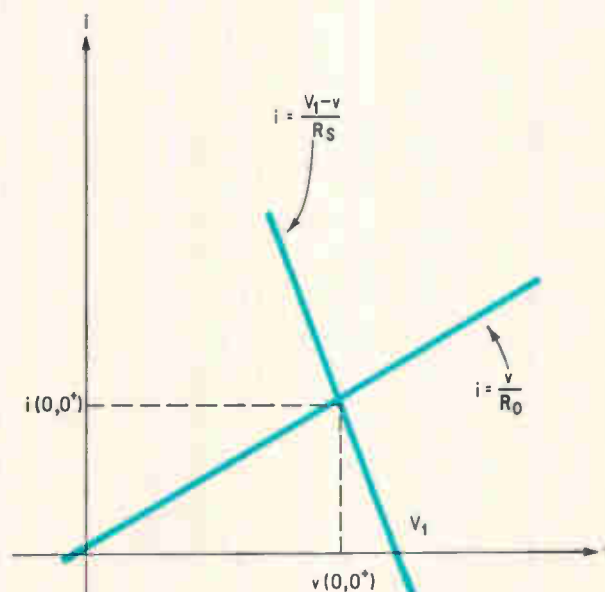

Crosspoints. The point at which the sending-end conductance line crosses the transmission-end conductance line represents the value of voltage and current as it starts down the line.

In a lossless line the propagation constant is $\gamma = s\sqrt{LC}$, and the characteristic impedance is $Z_0 = \sqrt{L/C} = R_0$, which is purely resistive. Assuming such a case with both the sending and receiving ends connected to resistors, the traveling-wave solution for the sending end of the line becomes

$$I(0, s) = \frac{V_1(s)}{R_s + R_0} \{ 1 - \rho_r e^{-\gamma 2l} + \rho_s \rho_r e^{-\gamma 2l} - \rho_s \rho_r e^{-\gamma 4l} + \dots \}$$

$$V(0, s) = \frac{R_0 V_1(s)}{R_s + R_0} \{ 1 + \rho_r e^{-\gamma 2l} + \rho_s \rho_r e^{-\gamma 2l} + \rho_s \rho_r e^{-\gamma 4l} + \dots \}$$

and for the receiving end

Calculating transmission reflections

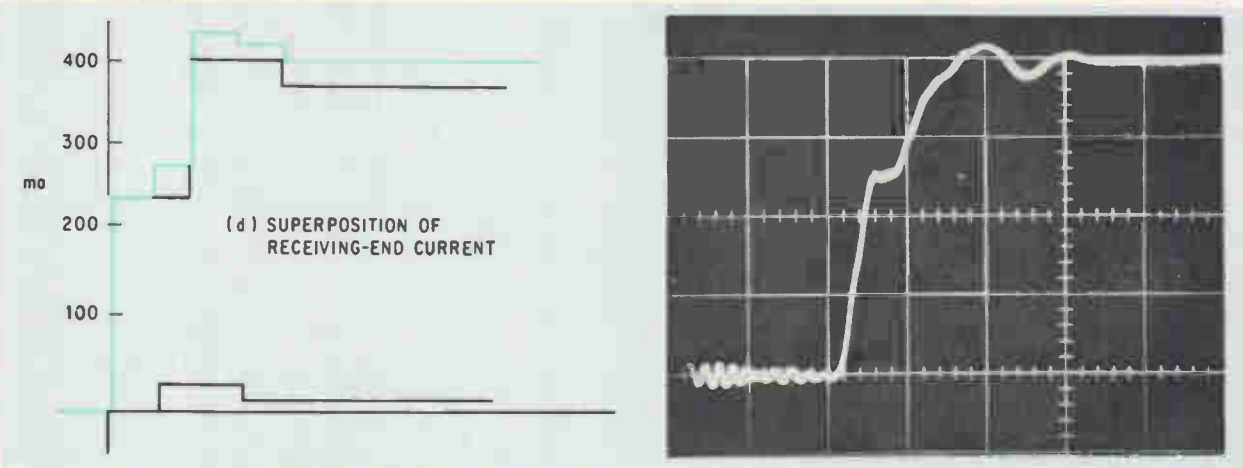
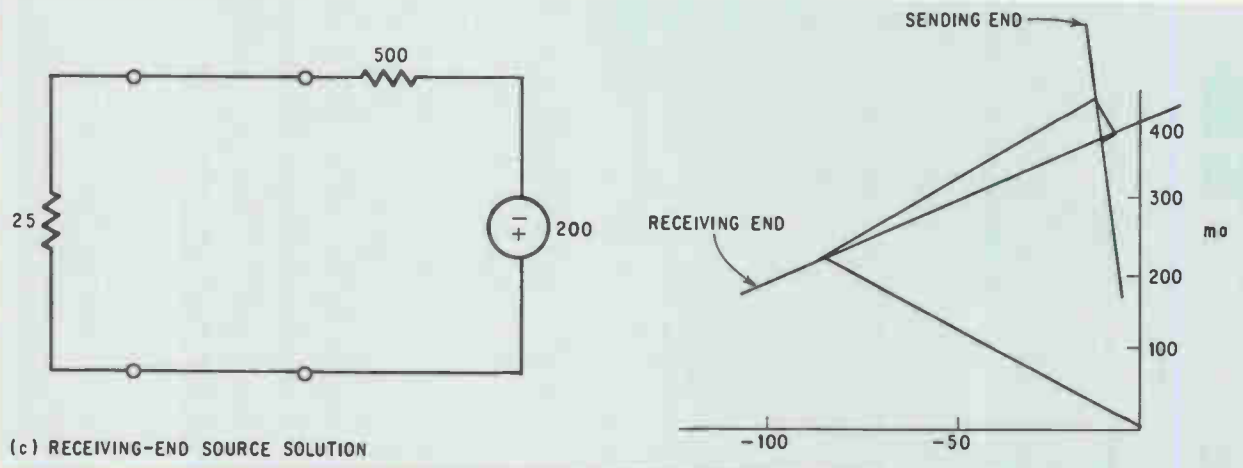
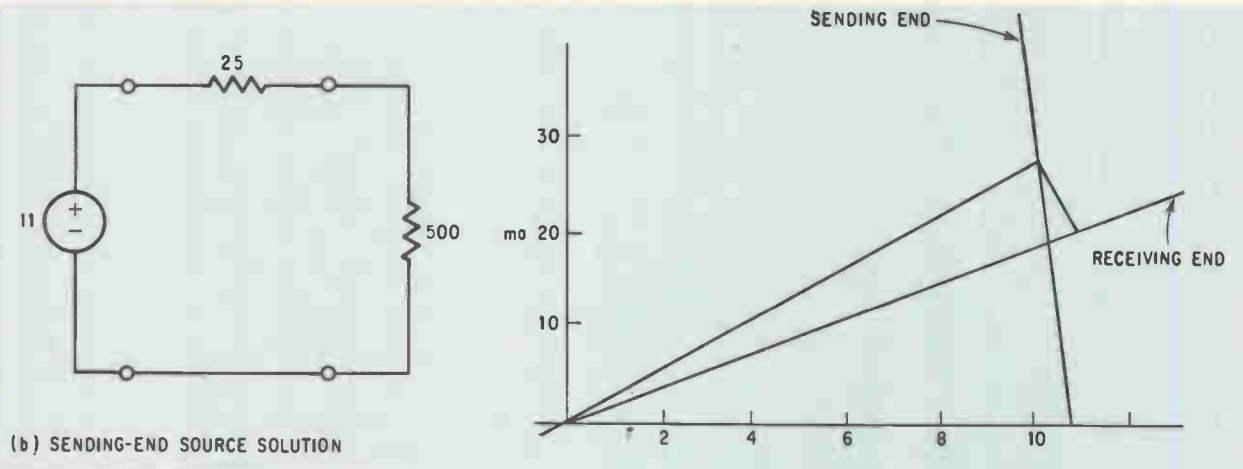
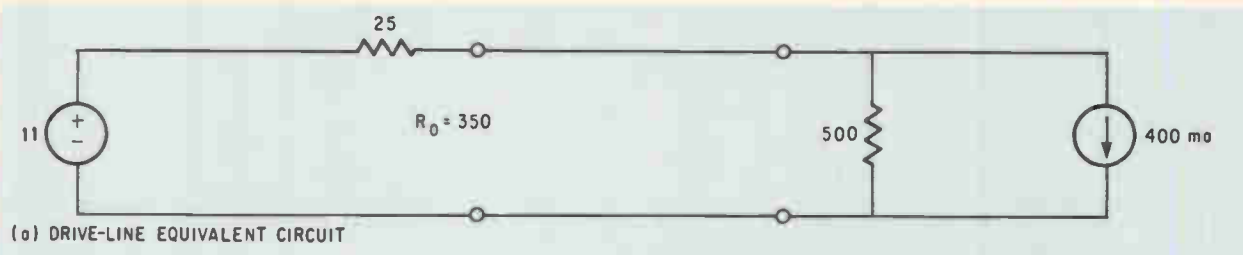

Memory drive. Graphical technique and superposition are used to calculate sending- and receiving-end voltages in memory-system whose line impedance is 350 ohms.

$$I(l, s) = \frac{V_1(s)}{R_s + R_o} \{ e^{-\gamma l} - \rho_r e^{-\gamma l} + \rho_s \rho_r e^{-\gamma 3l} - \dots \}$$

and

$$V(l, s) = \frac{R_o V_1(s)}{R_s + R_o} \{ e^{-\gamma l} + \rho_r e^{-\gamma l} + \rho_s \rho_r e^{-\gamma 3l} + \dots \}$$

Breaking up the line

If a step input is applied at the sending end, $V_1(s) = V_1/s$, the above equations can be solved at the time intervals $n\tau$ where $\tau = \sqrt{LC}l$, the one-way propagation time of the line. Thus, at $t = 0^+$ the sending end appears as

$$I(0, s) = \frac{V_1}{s(R_s + R_o)}$$

$$V(0, s) = \frac{R_o V_1}{s(R_s + R_o)}$$

which in the time domain transforms into

$$i(0, 0^+) = \frac{V_1}{R_s + R_o}$$

$$v(0, 0^+) = \frac{V_1 R_o}{R_s + R_o}$$

Note that this is the intersection of the two lines. Each line has a slope equivalent to the conductance: $1/R_s = i/(V_1 - v)$, the sending-end conductance, and $i/R_o = i/v$, the transmission-line conductance. This is displayed graphically on page 97.

At the other end

At $t = \tau$, when the traveling wave has reached the receiving end of the line

$$I(l, s) = \frac{V_1}{s(R_s + R_o)} (1 - \rho_r)$$

and

$$V(l, s) = \frac{V_1 R_o}{s(R_s + R_o)} (1 + \rho_r)$$

which transforms into the time domain as

$$i(l, \tau) = \frac{V_1}{R_s + R_o} (1 - \rho_r)$$

$$v(l, \tau) = \frac{V_1 R_o}{R_s + R_o} (1 + \rho_r)$$

These last two equations are solutions of the intersections of the two lines, $1/R_r = i/v$, the receiving-end conductance, $1/R_o = -i/v$, the negative transmission-line conductance, where the current in the latter expression is shifted by $V_1/(R_s + R_o)$ and the voltage is shifted by $V_1 R_o/(R_s + R_o)$, the same amounts of the previous solution at $(0, 0^+)$. This is graphically displayed at the above right.

This iterative process can be continued to show that the solution for terminal conditions at time $n\tau$ is the intersection of the lines

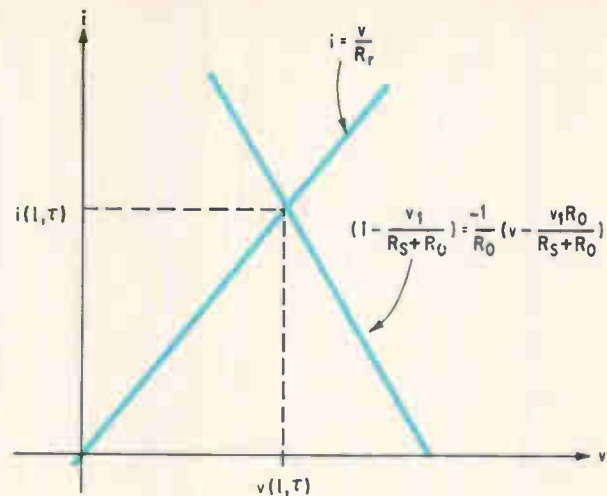

Voltage calculations. The intersection of the receiving-end conductance line and the transmission-line conductance line represents the point of voltage and current as they appear at the load impedance.

$$i - i([n - 1]\tau) = \frac{(-1)^n}{R_o} [v - v([n - 1]\tau)]$$

with $i = \frac{V_1 - v}{R_s}$, for n even (sending end)

and $i = -\frac{v}{R_r}$, for n odd (receiving end).

A solution, then, can be found by drawing the load line for the sending- and receiving-end resistances, then alternately projecting the load line of the transmission line and its reciprocal to where they intersect the sending- or receiving-end load lines. These intersections form the time-series solution for the equations as demonstrated in the previous example.

It is well known that when a transmission line is not terminated in its characteristic impedance and is excited with a wave front whose transition is faster than the delay of the line, ringing can occur on the line. With the advent of computer circuits which are capable of switching in a nanosecond, this is precisely the position in which the designer finds himself. Consequently, the engineer is forced to use transmission-line concepts in dealing with the propagation of data from one point to another within a machine using such circuits.

The reflection diagram described in this article is an extremely useful tool for analyzing such conditions and aiding the circuit designer to either avoid ringing or to take advantage of it. Examples of problems in which the technique has been utilized are:

- Reduction of distortion of otherwise controlled waveforms caused by ringing.
- Reduction of ringing which leads to logic circuits misoperation by its introduction as noise.
- Reduction of ringing which leads to device failure by overstress and breakdown.

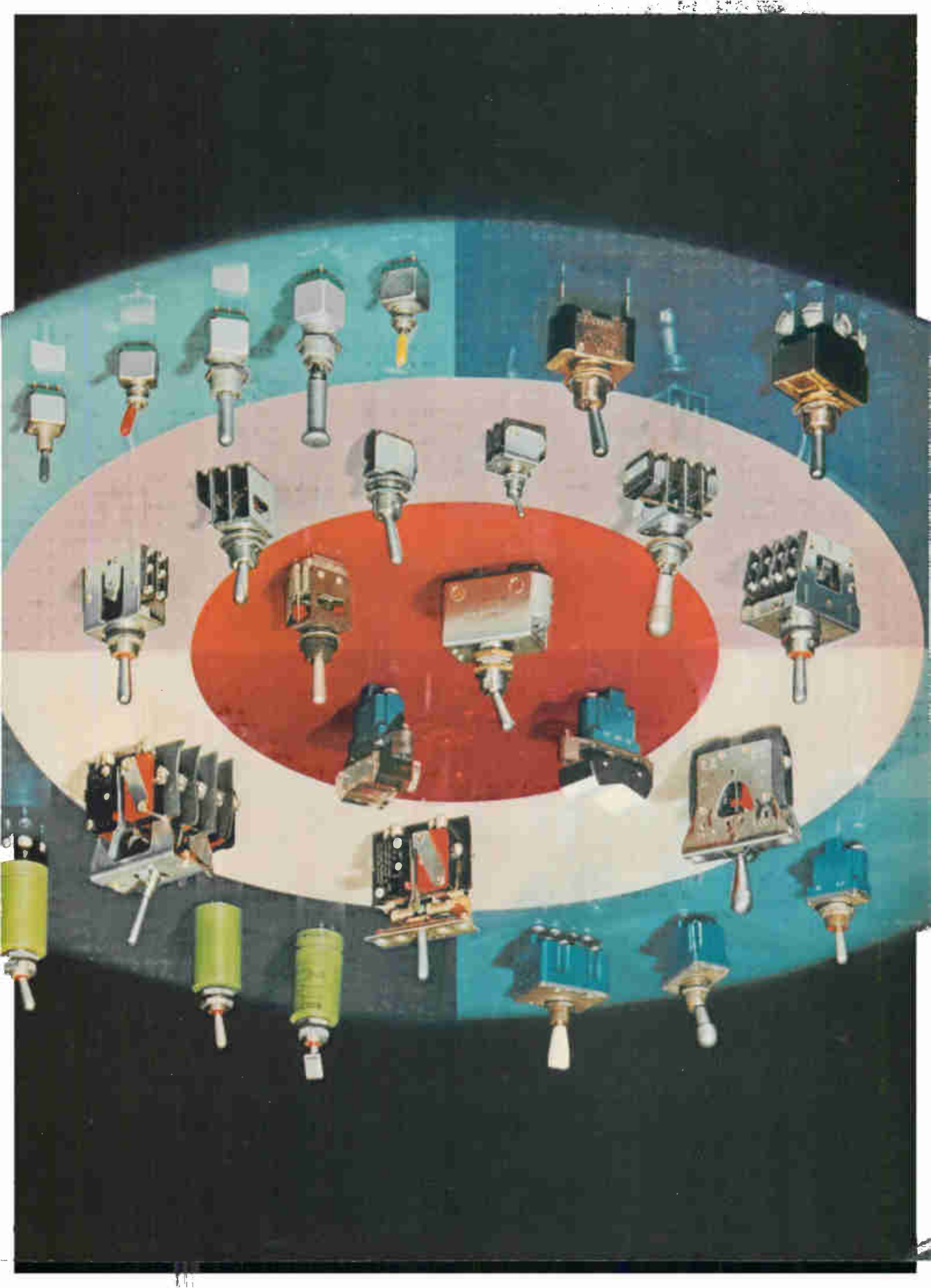

Sure way to target in on all your toggle needs. Call MICRO SWITCH!

You'll score every time, no matter what combination of features you require. MICRO SWITCH offers the world's broadest line of toggle switches with an almost limitless selection of specifications. Such as size, circuitry, capacity and toggle action.

You can select special features, too, and get them right off the shelf. For example, environment-proof construction, magnetic hold-in, electric memory, and dry circuit capabilities.

Many in the MICRO SWITCH line are designed to meet military specifications. What's more, quality is

assured by a program that is the model of the industry.

Maybe you can use some new design ideas—ways to simplify circuit design, combine functions in fewer controls, improve operator efficiency. The most extensive field engineering staff in the industry is available to offer you help and suggestions whenever you need them.

A sampling of our thousands of toggle switches are shown at left and described below. For more details, call a Branch Office or an Authorized Distributor (Yellow Pages, "Switches, Electric"). Or write for Catalogs 51 and 52.

1. Miniature toggle switches, Type TW—Weight and space savers (extend only $\frac{3}{8}$ " behind panel), yet they provide good operating feel and 35° toggle travel. Molded-in terminals. Lever seal and optional panel seal. Versatility, too: $\frac{1}{4}$ or $\frac{1}{2}$ " inch bushings. 1 or 2 pole. Small, standard or large pull-to-unlock levers with 2 or 3 positions. Colored lever caps.

2. Environment-proof toggle switches, Type TL—Only switch of its kind which meets the complete environmental sealing requirements of MIL-S-3950. Case is of high impact, arc-resistant material. Rugged, molded-in, stepped terminals. 1, 2 or 4 pole. 2 or 3 position with momentary or maintained action, and special "on-on-on" circuitry. Standard or pull-to-unlock levers. 15 amps 115 vac, 20 amps 28 vdc.

3. Assemblies with subminiature basic switches, Type AT—Versatility is the keyword for these compact assemblies. Miniature, standard, or pull-to-unlock levers. Momentary or maintained contact action 2 or 3 position levers. $\frac{1}{4}$ or $\frac{1}{2}$ " inch bushings. Up to a dozen or more precision snap-acting Type SM basic

switches, each SPDT. Silver contacts for 5 amp. rating or gold contacts for low energy reliability. Solder post, or single or double turret terminals.

4. Assemblies with high-capacity basic switches, Type AT—Precision snap-acting Type V3 basic switches are UL and CSA listed for 15 amps and $\frac{1}{2}$ hp at 125-250 vac. Up to 10 individual SPDT switches can be ganged in one assembly. Rugged construction, positive 3-hole mounting. Two lever lengths. Convenient screw terminals.

5. Magnetically-held toggle switches, Type ET—Two or three position levers, magnetically maintained, manual or remote electrical release. Environment-

proof construction. MIL-S-3950 (immersion-proof). MIL-S-5272 (explosion-proof). SPDT or DPDT. Turret, screw or leadwire terminals. Standard, flat tab, or pull-to-unlock levers.

6. Assemblies with hermetically sealed basic switches, Type AT—Maximum protection for switch contacts with hermetically sealed (MIL-S-8805, Class 5) subminiature or standard size precision basic switches. MIL-S-5272 (explosion-proof). MIL-S-6743 (corrosion-resistant). For temperature extremes from -300° to $+500^\circ$ F.

7. Rocker button toggle switches, Type TP—Pushbutton operation with toggle switch versatility. Translucent button for edge-lighting and engraved legends, or transparent button for removable legends. Above-panel or flush-panel mounting. Same circuitry and rating as Type TL.

8. Panel sealed toggle switches, Type TS—Rugged construction, vibration and shock resistant. Sealed lever, plus panel seal (MIL-S-3950B). 1 or 2 pole, 2 or 3 position. UL and CSA listing: 15 amp. 125-250 vac, $\frac{1}{2}$ hp 125 vac, 1 hp 250 vac. Solder, screw, or quick-connect terminals.

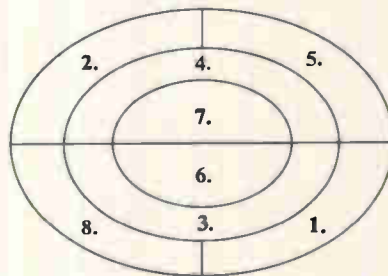

MICRO SWITCH

FREEPORT, ILLINOIS 61032

A DIVISION OF HONEYWELL

HONEYWELL INTERNATIONAL • Sales and service offices in all principal cities of the world. Manufacturing in United States, United Kingdom, Canada, Netherlands, Germany, France, Japan

2 new INDUSTRIAL CERMETS

MODEL
3069



MODEL
3009



... with *BOURNS* Reliability Sealed in!

Let's talk some straight cermet potentiometer facts about Bourns new cermet Models 3069 and 3009. They're just \$1.45*. Both feature Mil-Spec immersion seals for trouble-free operation after being subjected to printed circuit board processing. And there's the $\pm 0.05\%$ settability. Bourns cermet potentiometers have tinned pins for compatibility with both automated and hand soldering methods. They're round .021 diameter pins which alleviate complicated printed circuit board fabrication. Bourns cermet potentiometer's space-saving size is complemented by an RJ11 pin configuration if you want it. Bourns new cermet potentiometers have two more exceptional features: Date Code Traceability and Temperature Coefficient maximum of 150 ppm/°C over the entire temperature range.

These, then, are the facts. No embellishments, no frills. Bourns tells it straight because it best explains what the Models 3069 and 3009 do—and why. Electrically, they're identical. Physically, they differ slightly, but for a good reason. Those last four words say a lot about these two new Bourns cermet potentiometers and the versatile Bourns line. It's really why we design a product in the first place.

Complete data on the new Bourns cermet potentiometers—Models 3069 and 3009—is available upon request to the factory, your local Bourns Sales Office, or representative.

*500-piece unit price



SPECIFICATION TABLE

Standard Resistance Range	10 ohms to 1 megohm
Resistance Tolerance	$\pm 10\%$
Power Rating	0.75 watt
Operating Temperature Range	-55 to $+125^{\circ}\text{C}$
Temperature Coefficient	150ppm/°C**
Immersion	MIL-R-22097
Dimensions	3009 - .75 x .19 x .35; 3069 - .75 x .25 x .35
Terminals	Printed Circuit Pins—RJ11 configuration available on 3009

**100 ppm/°C available



BOURNS, INC., TRIMPOT PRODUCTS DIVISION
1200 COLUMBIA AVENUE, RIVERSIDE, CALIFORNIA 92507
714 684-1700 • TWX: 910 332 1252 • CABLE: BOURNSINC

TRIMPOT® AND PRECISION POTENTIOMETERS • MINIATURE RELAYS • RESISTORS • ELECTRONIC MODULES • TRANSFORMERS • INDUCTORS AND CERAMICS

Circle 102 on reader service card

Special report: Memory technology



Ferrite cores have held off all challengers so far, but gains being made by new approaches point to a day when cores will be . . . well, just memories

Introduction by Wallace B. Riley, Computers editor

- I. Core memory review by Roy Norman
- II. Outlook for fast cores by Dana Moore
- III. Nonlinear ferrite material by John Turnbull and John Kureck
- IV. Planar thin films by Albert M. Bates

Coming in future issues

Cylindrical thin films
Semiconductor memories
Advanced memory technology
Tradeoffs in particular applications
Specialized designs
Marketing trends

Memories: practice and

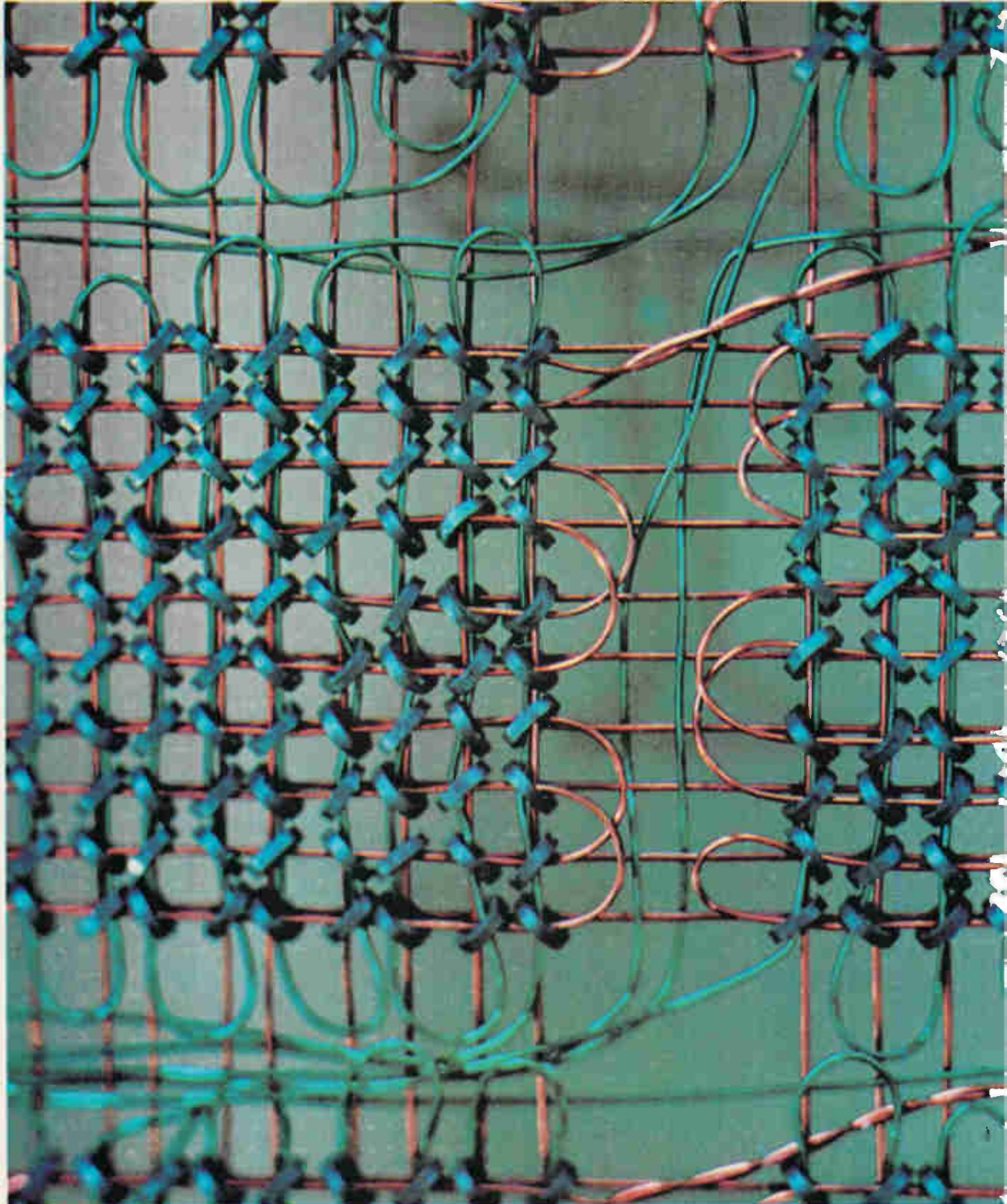
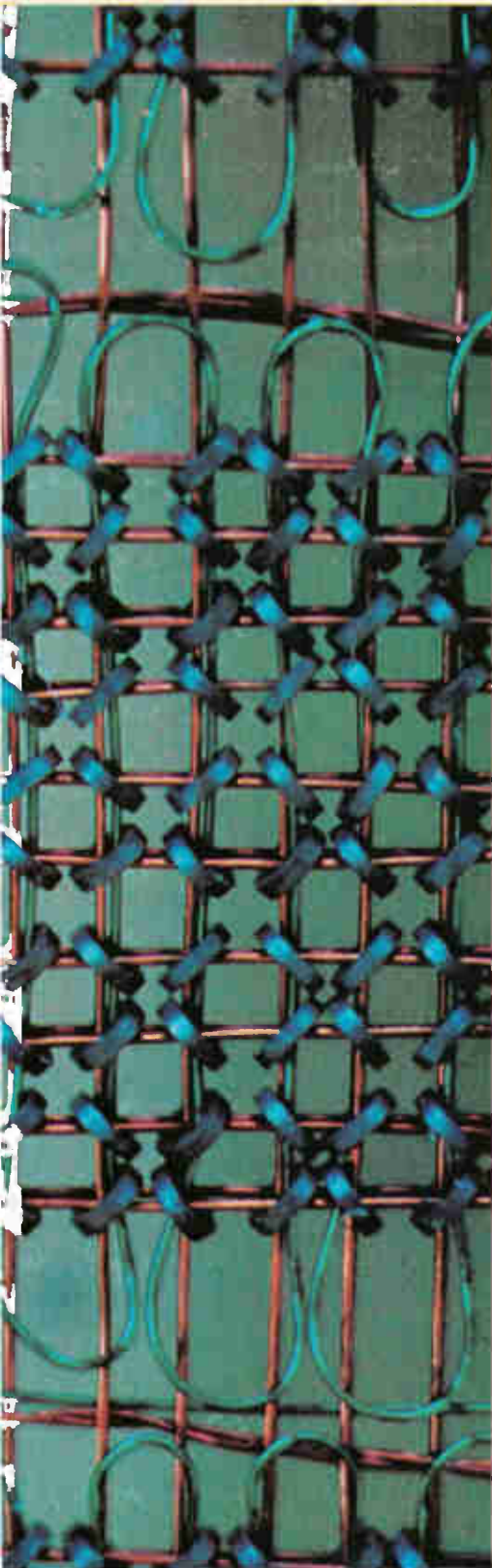

Photo courtesy IBM Corporation



promise



By Wallace B. Riley

Computers editor

Memory performance and cost are the twin keys to computer technology. Although new electronic devices, processor organizations, and software systems have contributed to the enormous advances in this field over the years, they would have been for nought had not faster and cheaper memories been developed along with them.

To acquaint electronics engineers with the state of the art in each of many kinds of memories, Electronics is presenting a series of articles on the technology. Each article is short, concentrates on a particular area, and is written by an expert in that area.

This issue contains articles on ferrite-core memories and on the planar thin-film memories. Subsequent issues will deal with semiconductor memories and with a variety of advanced forms, most of them still in the laboratory. These articles will be followed by a discussion of the tradeoffs encountered in designing for particular applications, descriptions of some more-or-less specialized designs, and a rundown on market trends.

Although electromechanical rotating memories are an important form of computer storage, they have been rather arbitrarily excluded from this series. All-electronic forms themselves present enough topics for a very lengthy report; besides, electromechanical memories in their various forms are at least potential material for a special report all their own.

The words "computer memory" are almost synonymous with "ferrite cores," so well entrenched has this technology become over the years. As several authors point out in the articles to follow, the demise of cores has been predicted over and over again—so far, always prematurely. As fast as new technologies have arisen to challenge cores, new developments have arisen to

boost the speed and performance of cores, and to lower their cost.

Cores will be with us for some time yet, if for no other reason than sheer momentum. Designers are accustomed to thinking in terms of cores; manufacturers have large investments in machinery for making and testing cores and stacks; and for all the producers' lamentations about the problem of getting wires through cores 18 mils in outside diameter, at least one manufacturer has succeeded in getting four wires through 16-mil cores on a production-line basis.

Meanwhile, continued advances in the thin-film field are pushing this technology into contention for the crown now worn by ferrite cores. Some of the thin-film approaches are described in the following pages, and, as the cover picture indicates, Honeywell Inc.'s Aerospace division has recently made a big splash with plated wires. As further evidence of the trend, Toko Inc. has begun putting woven wires in the Japanese version of the Univac 9000 series computer [Electronics, Sept. 16, p. 236].

Semiconductors are coming on just as fast. Thomas H. Bay, until recently the general manager of Fairchild Semiconductor, predicted at a meeting of the Western Electronic Manufacturers Association last summer that within five years no one would design any computer without a semiconductor memory in it somewhere—be it a scratchpad, a read-only memory, or some other form. And Motorola Inc. has established a memory products group that has embarked on a program of developing, manufacturing, and selling semiconductor memories. [Electronics, Aug. 19, p. 165].

Advanced memory technology includes investigations into optics, cryogenics, and ferroelectrics. A nonvolatile successor to the ancient acoustic delay line is being developed. And the delay lines used in many electronic desk calculators as well as in such specialized applications as radar signal processing are themselves being challenged by newer core memories that are economical even in small sizes. So there's still some mileage left in ferrite cores.

Memories I

Staying ahead of the game

By Roy H. Norman

Ampex Corp., Culver City, Calif.

The trend in ferrite-core memories over the years has been toward greater speeds at lower costs per bit. These memories have from time to time been threatened by other storage techniques that promised to be cheaper and faster, but they have always managed to hold their place.

Cores are again being challenged, and the threat this time is, in some ways, more serious than ever before. It's therefore wise to take a look at what's been done and what may be done in the future.

The increases in core memories' operating speed have been due primarily to decreases in the size of the individual cores. The earliest memories used cores more than 100 mils in outside diameter—"nearly the size of Cheerios," as one expert has put it. Then came a series of reductions in standard core sizes to 80 mils, to 50 and 30 mils, and finally to the 22 and 18 mils widely used today, as shown below. It's perhaps worth noting that each new standard core could almost pass through the hole in its predecessor.

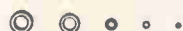

This process has been accompanied by a corresponding decrease in switching time—from the several microseconds of the old 100-mil cores to as little as 140 nanoseconds today. This, in turn, has been followed by a decrease in memory cycle time—always greater than switching time because of noise problems, current rise times, and delays in peripheral circuits.

Advances in speed have been paralleled by cuts in prices facilitated by the declining costs of semiconductors and other components. And advances in component design have permitted refinements in the design of circuits and whole systems, again reducing costs. Development of automatic wiring equipment for threading a maze of wires through thousands of cores and utilization of low-cost labor in such places as Hong Kong and Taiwan have also helped drop prices.

Economy vs. speed

For moderate storage capacities, the most economical system configuration is the coincident-current or three-dimensional organization. This ar-

angement, now used in the great majority of core memories, is inexpensive because it requires the minimum number of drivers and decoders. Other configurations can provide more speed than 3-D, but they're always more expensive.

Of the two basic types of 3-D memory in common use, one has four wires through each core, and the other has three. In both designs, the core's magnetic hysteresis loop must be so nearly square that the core is fully switched by currents carried in the same direction by two selection wires passing through it, but is undisturbed by either one of the currents alone. With this coincident-current scheme, the core array itself performs part of the address decoding, thus minimizing circuit costs. Instead of locating a specific core in a plane, external decoders locate two lines of cores that intersect at the address. A single set of driver circuits steers current through all cores in the data word, which are strung on a single selection wire.

A typical design stores 4,096 words of 32 bits each. It uses 32 planes each of 4,096 cores in a 64-by-64 array threaded with 128 selection wires—64 in each direction. Corresponding selection wires in all the planes are connected to each other and are driven by a single driver circuit.

In the four-wire design, two other wires are threaded through all cores in each plane, as below right, but are not interconnected between planes. The switching of any core in the plane from a 1 to a 0 generates a pulse that one of these wires carries out to the sense amplifier serving that plane. The other wire carries a current equal but opposite to one of the two half-select currents. This current can thus inhibit the action of the selection wires on a core and keep it in the 0 state.

These sense and inhibit functions are combined in a single wire in the three-wire design because the two operations need never be performed at the same time. However, this setup requires more complex circuits and is therefore somewhat more expensive than the four-wire system. This cost, though, is at least partially offset by the savings involved in threading only three wires.

With each reduction in core size have come predictions that threading four wires through every core in an array will be impractical. With 18-mil cores now coming into use, this prediction seems more realistic than ever. If the prophets are right for once, the faster, smaller cores will make the three-wire design the only practical 3-D form.

The simplest core-memory organization is the two-dimensional or linear select form, in which the cores are arranged in a single plane array with word wires and bit wires at right angles to one another, as on page 108, top. In data storage, currents on any one word wire and on the bit wires combine at the intersections to switch cores that are to store 1's or to prevent switching at cores that are to store 0's. For readout, a single, larger current on a word line—rather than the coincidence of two currents—switches all the cores on the wire. Thus currents greater than the normal full switch-

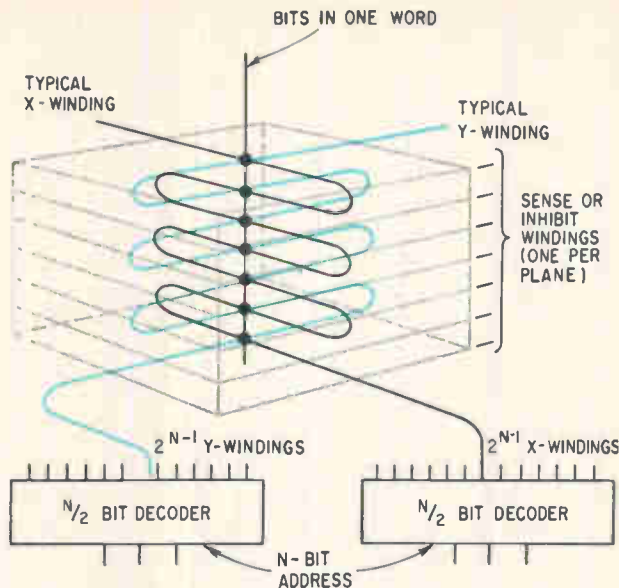

In depth. In the most common memory organization, 3-D, two sides of a stack are addressed to locate a vertical column of cores containing the stored data.

ing current can be used. The overdrive makes for very fast switching, but at a high cost because all the address decoding must be external. [For more on problems with 2-D memories, see p. 109.]

A compromise between the economy of 3-D and the speed of 2-D is found in an arrangement that has come to be known as 2½-D [p. 108, bottom]. Originated in 1951, it remained dormant until rather recently, when 3-D core memories began to reach what may be their ultimate limitations.

This approach has a level of address decoding

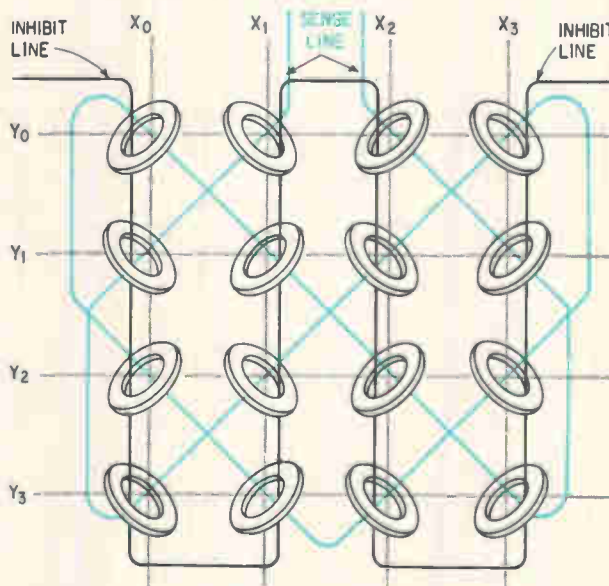

Sense and inhibit. Two additional wires in a 3-D stack sense a core's switching when reading a 1 and inhibit its switching when writing a 0.

in the bit dimension. Like the 2-D memory, one wire threads the cores in a particular word, and a bit wire passes through each of these cores at right angles to the word wire. But in a typical arrangement, the same word wire threads the cores for two words, and each bit wire loops around in a U shape to thread corresponding cores in both words. Coincident currents in the word and bit lines, as in a 3-D memory, switch one or the other of these cores, the bit current's direction determining the core that switches. In the other core, the two currents oppose one another. When storing a 0, the bit current is simply not turned on. A sense wire threads all the bits common to one doubled bit line.

Since the bit current drivers control whether or not a particular core switches, the 3-D memory's inhibit drivers and windings aren't needed. Their absence reduces noise and pulse overlap, and these are the prime factors contributing to the $2\frac{1}{2}$ -D organization's speed.

Bulk core memories contain perhaps 10 times as much data as computer main memories and run typically at one-third the speed. In these memories, the cost of the core array predominates over the cost of the electronics; therefore, they are usually built in the $2\frac{1}{2}$ -D configuration but with only two wires. The bit and sense wires are common.

The drive circuits in a $2\frac{1}{2}$ -D memory require lower voltages than do those in a 3-D memory, so that large-scale integration will be easier to apply to $2\frac{1}{2}$ -D. On the other hand, if the cost of electronic circuits continues to decrease as it has in the past, the cost differential between the two arrangements should diminish.

Although no competing technology has yet displaced ferrite-core memories as the primary storage element in high-speed memories, thin magnetic films pose a definite threat with their speed, and monolithic integrated circuits are being heralded as future challengers.

Thin films are very fast because they switch by magnetic domain rotation instead of by domain wall motion as in solid cores. A single planar thin-film element has an open flux path in most designs, which tends to make the film demagnetize itself, although this is not true in at least two proposed designs. Coupled film structures have flux paths that are closed except for two very small air gaps at the ends of the element. And plated wires usually have completely closed flux paths.

But most of these designs depend on the film's magnetic anisotropy—its higher reluctance in one direction in the plane of the film than at right angles to that direction. In the "hard" axis, the film has no magnetic threshold—its hysteresis loop isn't square—so that coincident-current organization isn't possible. The cost savings of a 3-D organization in ferrite cores are therefore not realizable in thin films. But films may be faster.

Advocates of semiconductor technology claim that prices on both bipolar and metal oxide semiconductor circuits will soon reach a point competi-

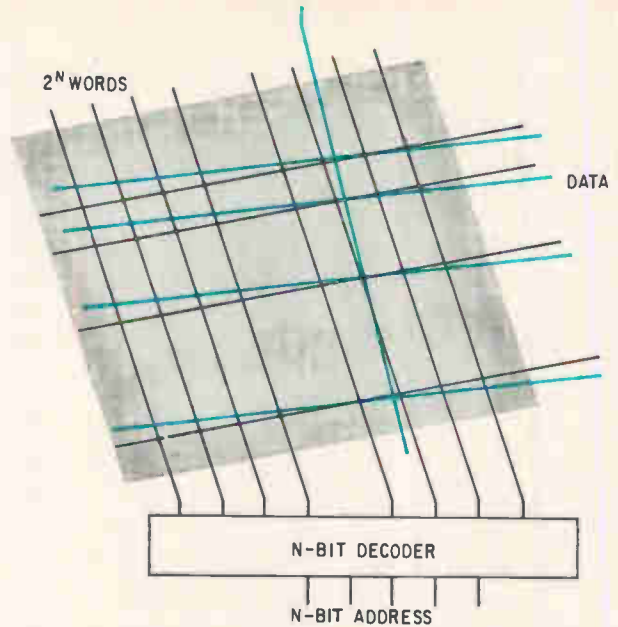

Fast plane. The simplest memory organization addresses one side of an array and brings data out at right angles to the addressing. The scheme is fast but expensive.

tive with core prices. Maybe so, but monolithic arrays are still selling for about a dollar a bit, compared with a nickel a bit for million-bit ferrite-core arrays. For another thing, cores are being made today with yields of 60% or 70%, and core-stacks can be reworked if necessary, whereas monolithic arrays are unreworkable and still have yields of only a few percent.

All this suggests that IC's must undergo an order-of-magnitude improvement in this area before they can compete seriously with cores.

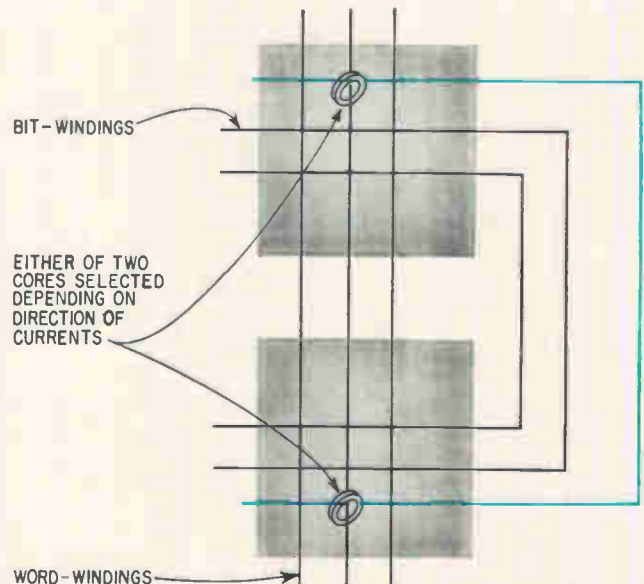

Compromise. The so-called $2\frac{1}{2}$ -D arrangement combines the speed of 2-D with the economy of 3-D.

Scant room for improvement

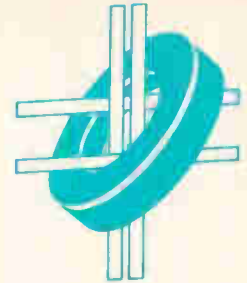

By Dana W. Moore

Computer Control Division, Honeywell, Inc., Framingham, Mass.

As in the Kansas City described in "Oklahomal", everything's up to date in core arrays. Unfortunately, there's evidence that they, too, have "gone about as far as they kin go."

There'll probably be a few design embellishments and some tradeoffs made in the future, but further significant improvement in the over-all cost and performance of cores is unlikely.

Cores have maintained their top position in the memory field only by fighting off the challenges of newer technologies. In the past, the threat posed by competitors offering comparable cost-performance figures and some degree of batch fabrication almost always produced core designs that were smaller, faster, more reliable, and easier to maintain than their predecessors—and less expensive, too. However, a couple of factors suggest that this will no longer hold true.

Around the edges

For one thing, most of the recent advances in core-memory technology have been made in the

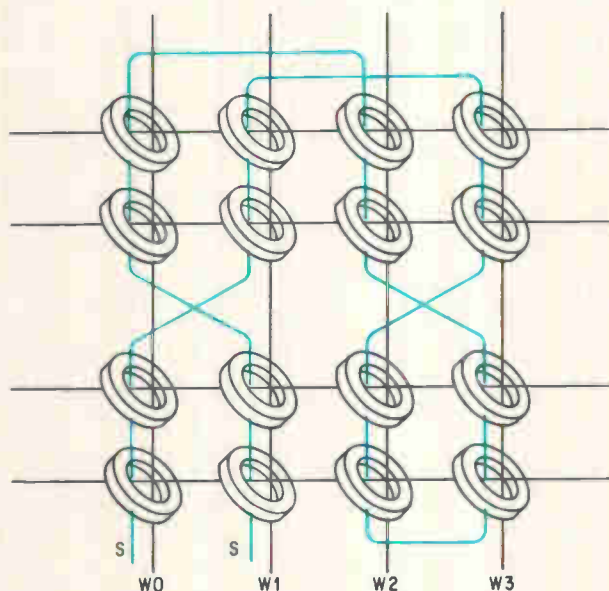

Bow-tie. This pattern of sense windings contributes to the low cost of 2½-D memories, because the wire runs parallel to the selection windings.

peripheral circuitry rather than in the arrays themselves. True, laminated frames have given way to the printed-circuit variety; the 2½-dimensional organization has been revived with its sense lines in the bow-tie configuration shown at left instead of the diagonal shown on page 107; manufacturers have capitalized on lower labor costs overseas; and high-speed core testers have been developed. But these appear to be the ultimate stages of refinement in a highly developed technology.

In fact, the peak of the core memory's cost-performance growth curve was probably reached two years ago when the 2½-D organization appeared and integrated circuits were introduced into repetitive circuitry.

The IC's were initially applied to logic circuits with standard 6-volt signal voltage swings, and to sense amplifiers. More recently, as shown on page 110, the rest of the selection circuits have been integrated and 15-volt switches have appeared that can carry as much as 400 milliamperes of current. The trend will continue as designs incorporate more complex and less expensive IC's, along with compatible packaging techniques.

The only organizational change that could bring about a core-memory renaissance with the present 18- and 20-mil standard cores would be the introduction of a linear-select arrangement with partial switching and two cores per bit—a design likely to be quite costly.

Automatic core-stringing represents one significant improvement that may yet be made on a large scale, but few manufacturers have invested in this equipment, particularly for the smaller core sizes. And with foreign labor costs on the rise, even the wide use of these machines would probably serve only to hold the line on core-memory prices rather than to reduce them.

Growing challenge

The other major factor indicating that the core-memory technology has run out of breakthroughs is the existence of well-established and strongly supported competing technologies. The top contenders—plated wire and semiconductors—have gained a firm foothold and are widening it every day. Chances are, therefore, that they, not cores, will be the subject of the largest future research and

development efforts.

The Univac division of the Sperry Rand Corp. is heavily committed to plated-wire production, and several other manufacturers of core stacks are putting money into plated-wire studies and facilities at the expense of further core R&D. And semiconductor arrays, although now competitive only in the area of small memories, are likely to compete favorably for all sizes by 1975 or so. Semiconductors—as storage elements, peripheral circuits, or both—have a greater potential for undermining core memories than any thin-film, laminated-ferrite, or multiaperture core technology to come along so far.

Still, semiconductor circuits can help reduce the cost and improve the performance of memory systems that are designed around $2\frac{1}{2}$ -D arrays of 20-mil cores.

Inevitably they must cut costs. With an already integrated design, you just watch the component prices fall as volume builds and IC processing yields improve. For example, a core memory using integrated circuits, and containing nearly 300,000 bits (16,384 18-bit words), can now be manufactured in volume at $3\frac{1}{2}$ cents per bit. That figure breaks down to $1\frac{1}{2}$ cents for the stack, $1\frac{1}{2}$ cents for the circuits, and a half-cent for hardware. Circuit costs are expected to drop by 50% within two years, and stack costs by 17%, so that the over-all system should be priced at only $2\frac{1}{2}$ cents a bit by 1971.

Improving the performance of core arrays is a ticklish problem, particularly when cycle times of less than 500 nanoseconds are required; that speed represents a sort of sonic barrier for ferrite cores. Attempts to break it generally take the form of a linear-select (2-D) organization and partial switching with one or two cores per bit. Both of these designs require high-amplitude pulses of short duration. With IC's, such pulses are feasible at a cost potentially low enough to overcome some other disadvantages of the designs.

Inside job

Partial switching takes advantage of the fact that a ferrite core switching from the 0 state to 1 during a write operation does so first around the inner surface of its aperture and then, rapidly but in sequence, outward in concentric rings. A high, narrow pulse of current may thus switch only the inner part of the core.

With linear selection, there are no half-selected cores to place an upper limit on the read current pulse; the lower limit is established by the need to fully reset all the cores on a selected wire from 1 to 0. Coincident-current ($2\frac{1}{2}$ -D, 3-D) designs demand a more delicate touch; their read pulse ideally mustn't disturb any cores except those at which it coincides with another pulse, so that the upper and lower limits define a rather narrow range. With a partially switching linear-select array, not only is there no upper limit established by disturb restrictions, but the lower limit is even

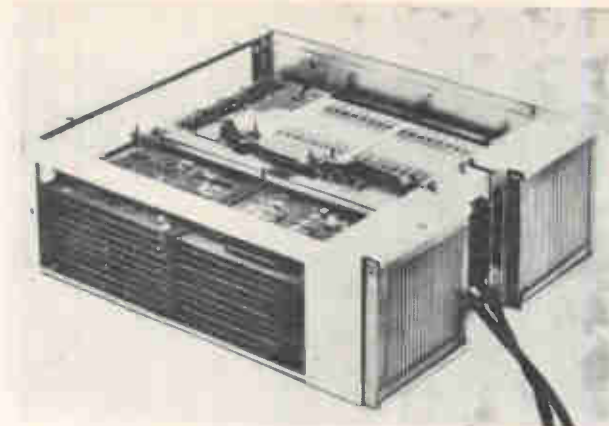

IC memory. Honeywell's ICM-500 unit is characteristic of the newer developments in high-performance ferrite-core assemblies.

lower because the read current pulse doesn't have to switch as much material. On the other hand, this smaller amount of changing flux generates a smaller output signal.

Partial switching isn't practical in coincident-current designs because it creates enough delta noise to swamp the lower output signal. Delta noise—the difference in output between a half-selected 0 and a half-selected 1—can be quite large even in a fully-switched coincident-current memory. Because the outputs of half-selected cores would be more unequal if they were partially switched, the delta noise would increase to an unacceptable level. This isn't a problem with linear selection because no cores are half-selected during reading. Therefore, narrowing the width of the current pulse through a core of a given diameter makes a shorter cycle time possible, even though the cores don't completely switch.

Writing styles

There are three ways the write operation can proceed in a linear-select array, as shown at right. All of them assume that all cores in an addressed word are in the binary 0 state before the operation begins.

- In the first method, a full-select word current tends to switch all the cores in the word to 1. It is offset by a half-select digit current through those cores that should remain 0, and is aided by a half-select digit current in the reverse direction through cores to be switched to 1. This one-and-a-half select current contributes to a very high-speed write operation.

- In the second, a full-select word current, as above, switches all cores to 1 except where it is opposed by a half-select digit current.

- Finally, a half-select word current switches only those cores where it is aided by a half-select digit current; the other cores remain in the 0 state.

The first two techniques share a very serious disadvantage—they require very close tolerances on

their currents. A core heavily saturated in one direction can tolerate a larger opposing current than a core that has partially switched in that direction. In either of the first two modes, the opposing digit currents, if large enough to cancel the word current, could partially reset cores already partially switched toward 0, especially if they were repeated several times. In that case, the read current would see cores that had already lost most of their flux and would produce lower than minimum acceptable 1 outputs.

But in the third writing mode, digit currents always reinforce the partially set state and oppose only the fully reset state. The digit current drivers can be of a single polarity. This mode is also inherently faster than the others because the word write current doesn't have to be overlapped as in canceling schemes.

The simplest way to implement the third mode would be to use half-select word and digit currents of nominally equal amplitudes and durations. However, the simple way is not the best way here, particularly when partial switching is involved. With impulse switching, a word current of very short duration can have an amplitude well above the core switching threshold without jeopardizing the core's remanent state, unless there's a coincident digit current.

In that case, the half-select digit current, added to the impulse word current, significantly increases the flux change from the level attainable by two equal half-select current pulses. This basic characteristic of ferrite material isn't useful in coincident-current designs because repeated impulses through unselected cores could alter the stored information.

These considerations lead to the conclusion set down earlier in this article—that only a partial-

switching, linear-select design shows any promise of significantly advancing core-memory performance.

On the other hand

Unfortunately, this potential performance improvement is offset by two other factors—the noise generated by partial switching in a one-core-per-bit design, and the cost of wiring a two-core-per-bit array.

As pointed out previously, in one-core-per-bit designs, a partially switched core's output signal for a 1 is smaller than the signal from a fully switched core—so much smaller that it's hard to distinguish it from a 0. Theoretically, a 0 output is characterized by absence of signal, but noise is always present because the hysteresis loop is never perfectly square. To obtain a reasonable difference between the 1 signal and the 0 noise, the core must be almost fully switched—80% or better. However, the resulting performance is only slightly better than that of a $2\frac{1}{2}$ -D design with the same size cores, and the cost is much higher.

Using two cores per bit can overcome this switching problem, but it's no answer to the cost problem. With two cores for every bit position, one is always in the 0 state and connected to the sense circuits in such a way that its noise cancels the noise from the switching core. But wiring up such an array is as complex as wiring a $2\frac{1}{2}$ -D array.

Two cores per bit and two wires per core make for simple wiring, but not for particularly fast operation. Small perturbations on the digit line always persist beyond the end of a normal cycle and couple linearly into the sense circuits, so that the next discrimination must be postponed until these perturbations die away.

The use of three wires per core—with the extra one for sensing—establishes nonlinear coupling and reduces the postponement. On the minus side, though, the array is identical to a $2\frac{1}{2}$ -D array in terms of wiring complexity, but twice as large for a given capacity.

A two-core-per-bit, three-wire-per-core linear-select design would cost almost twice as much as a $2\frac{1}{2}$ -D array. Its drive and sense circuits would also be more expensive because the selection process is less efficient, the currents are higher, and the output signals are small. Under these circumstances—and under the ever-larger threat of plated-wire and semiconductor memory technologies—a program to develop such a memory would be extensive and hard to justify.

There's still room for $2\frac{1}{2}$ -D design refinements to reduce costs, improve performance, or both. These refinements take advantage of better and cheaper IC's and better packaging.

In particular, the falling prices on semiconductors may permit the use of more circuits common to smaller memory modules; integrated sense-amplifier and preamplifier combinations, for instance, could pick up signals from shorter sense lines through smaller areas of memory. And re-

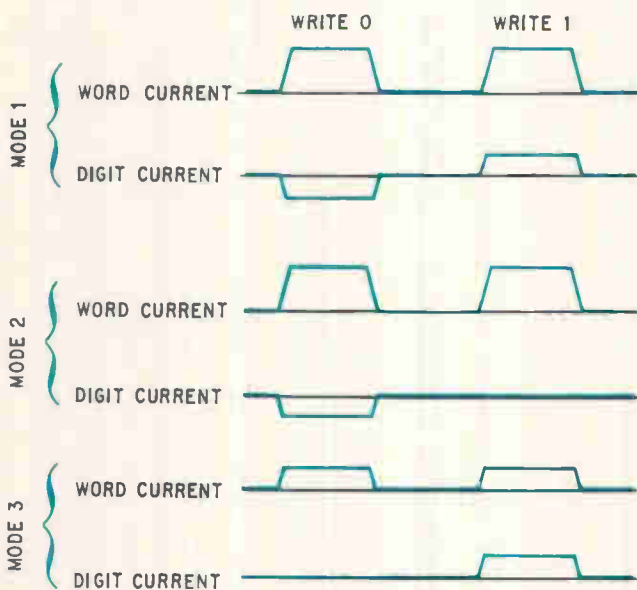

Three ways to write. Starting from the 0 state, a core switches or not depending on the digit current's direction, or on its presence or absence.

peated smaller X-drive matrixes would yield better drive-current wave shapes.

Another neat trick is suggested by the fact that read currents need be staggered only for read cycles. Thus, a read-regenerate cycle could partially switch the cores—in a shorter period than the clear-write—just enough to generate a reliably detectable signal. The clear-write, in turn, could turn on both word and bit currents simultaneously and complete the full switching that the clear part of a clear-write cycle requires, without staggering them. This timing, in the long run, could yield

moderate reductions in cycle time. And it's feasible with integrated peripheral circuits.

Circuit improvements along this line, together with core heat sinks, represent a more sensible approach than bulldozing through a two-core-per-bit design. They should push the cycle times of 2½-D designs beyond the 500-nsec barrier at only a small increase in the cost per bit.

Past emphasis in the ferrite memory field has been on batch fabricating the arrays. Ironically, it now appears that the stress should be on discrete arrays and batch-fabricated circuits.

Memories III

Smaller cores, bigger challenge

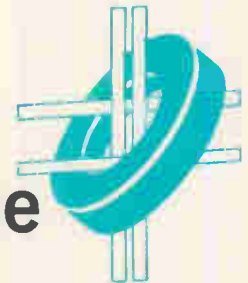

By John L. Turnbull and John J. Kureck

Ferroxcube Corp., Saugerties, N.Y.

One of the biggest problems faced by memory manufacturers is the need for smaller and smaller cores. One need creates another, and what's really needed now is a revised manufacturing and testing technology to handle the special problems presented by today's extremely small cores.

The techniques developed over the last 10 years to shape the dry powdered ferrite material into cores may be no longer usable. And quite possibly the problems encountered in testing small cores may place a more severe limit on their size than does the difficulty of wiring them by thousands into arrays.

Briefly, manufacturers are running into problems in the ferrite material itself, in the granules from which the cores are pressed, and in the density of the pressed cores, as well as in testing the finished product.

These problems, however, are not considered insurmountable. Core memories are here to stay for the foreseeable future, at least. Even though batch-fabricated elements such as thin films and semiconductor arrays are sure to give ferrite-core memories some tough competition, several companies are using cores now at speeds faster than even the fastest yet attained with the more exotic technologies. Sixteen-mil core arrays have been successfully wired, and one company is reported to be considering 12-mil cores in a two-dimensional, 100-nanosecond memory for its next generation computers.

Ferrites are ceramic materials, which are oxides of various materials. Within the crystal structure,

the oxygen ions form two distinct sites, which can be occupied by smaller metal ions. The magnetic moments of the metal ions in these two sites provide the material's magnetic behavior. In the simplest case, one site contains trivalent iron ions, and the other contains a divalent ion of a transition metal—generally one of the elements in the first long horizontal row of the chemist's periodic table. The outer electron shells of these elements begin to fill before the inner shells are complete, producing a net magnetic moment.

A special case of considerable interest is lithium ferrite. Lithium, a monovalent element, can replace either divalent or trivalent ions, or both. Unique bonding in the resulting complex crystalline structure gives magnetic properties that are stable over a wide range of temperature. All ferrites in computers are mixtures of these forms.

All of the memory materials can be fabricated into cores of any size. Raw materials are prepared into ferrite powder, which is then pressed into cores. The ferrite granules are generally spherical, with the smallest being 0.4 mil in diameter, a size established by the minimum opening in currently available screens.

Granule diameter establishes the thinnest possible core wall thickness, which in turn determines the minimum core diameter attainable by pressing. This diameter should be about 5 or 6 mils, a size that is considerably smaller than the present 18- to 22-mil standard sizes or the 12-, 14-, or 16-mil sizes that have been wired experimentally. The walls of 20-mil cores are two to three mils thick.

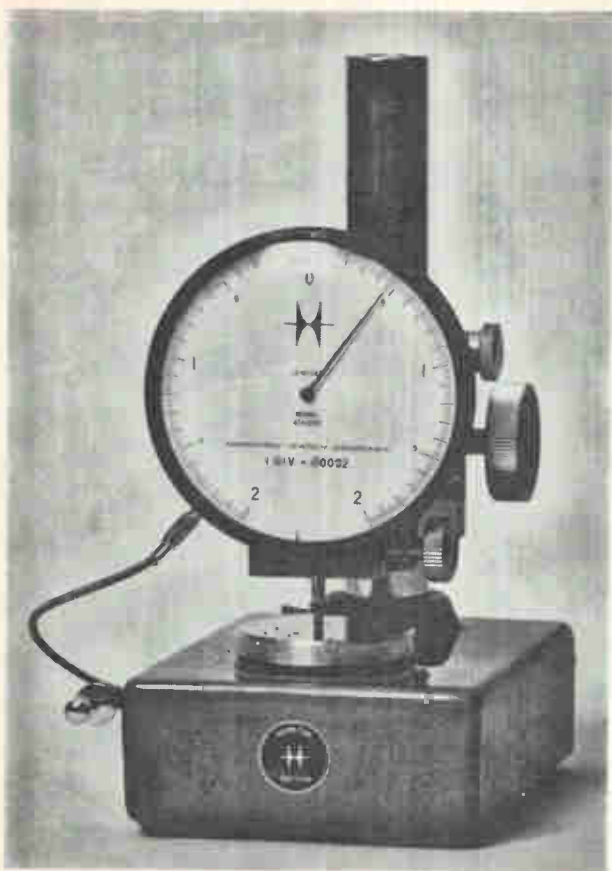

Micrometer. This type of gauge measures the height of cores, as part of a density measurement.

But small granules have a large surface area relative to their weight, and often don't flow freely to core-pressing machines, which are fed by gravity.

A pressing matter

The nature and extent of this problem can be visualized by considering that these minuscule granules have to flow into a toroidal cylinder 1 mil thick and 15 to 20 mils deep in no more than 200 milliseconds, and keep doing it again and again at intervals of 600 msec. No sticking in the chute can be tolerated.

Once the cylindrical die of a standard core-pressing machine has been filled with powdered ferrite, a punch compresses the powder into its familiar toroidal form. The punch is ordinarily driven by a small crank on a large flywheel rotating (as the 600-msec interval makes obvious) at 100 revolutions per minute. The pressing operation creates extremely high pressures—high enough to make the ferrite granules coalesce.

The pressed core is very nearly a single homogeneous mass, although traces of the granule boundaries can sometimes be discerned under the microscope. The sintering operation that follows pressing destroys any granular structure that may remain; the oxide particles, of which the original granules were agglomerations, diffuse to form the proper

crystal structure—a spinel.

Cores of all sizes are turned out by the same kinds of machines—indeed, often by the very same machines with changed punches and dies. The total force applied to the cores is thus about the same regardless of their size, so that the unit pressure is considerably larger when smaller cores are pressed. The increase in pressure is more than just a matter of applying a given force over a reduced area; the smaller cores must be pressed to a higher density than the larger ones to give them enough mechanical strength to withstand normally rough handling.

Fabricating the punch and die assemblies suitable for smaller and smaller core sizes is a difficult task. It's not impossible, thanks to modern machining techniques, but the very tiny parts now being made are likely to be somewhat fragile under the great stresses they encounter. Better die designs and materials are needed.

The smaller the cores, the shorter the tool life. The increased pressures cause more friction between the punch and the dies as they come together. And regardless of wear, the smaller tools must be maintained at closer tolerances and must therefore be replaced more often than the larger ones.

Measuring density

After the cores have been pressed, they are baked or sintered at 1,050° to 1,350°C to establish the square hysteresis loop and other magnetic and mechanical characteristics required in memories. After baking, a sample of each batch of cores is taken for density measurements. These measurements, a necessary control on the pressing operation, cannot be made before the sintering because the smaller unsintered cores are very fragile.

It takes very sophisticated equipment to measure the density of the smaller cores. The core's volume and weight must be determined and the quotient found. Since the pressing results in quite uniform roundness and diameter, the volume measurement is reduced to measuring the core's height—not a particularly difficult job for mechanical gauges with gradations down to 20 millionths of an inch.

Weighing the core is something else again. A single core weighs about 6 micrograms and has to be measured within a tolerance of 5%. Such measurements require an ultra-microbalance accurate to within 0.1 microgram. This balance, the same kind used in biochemistry and spectroscopy, works on the principle of force applied in a magnetic field. The force deflects a coil, and current through the coil returns it to normal; the amount of current is a measure of the applied force—the weight of the object being weighed.

Obviously, measuring the heights and weights of such small cores requires close environmental control—the technician can't afford to even breathe heavily. Such control imposes restrictions on the speed and precision of measurement, and this is one of the reasons why only samples are measured.

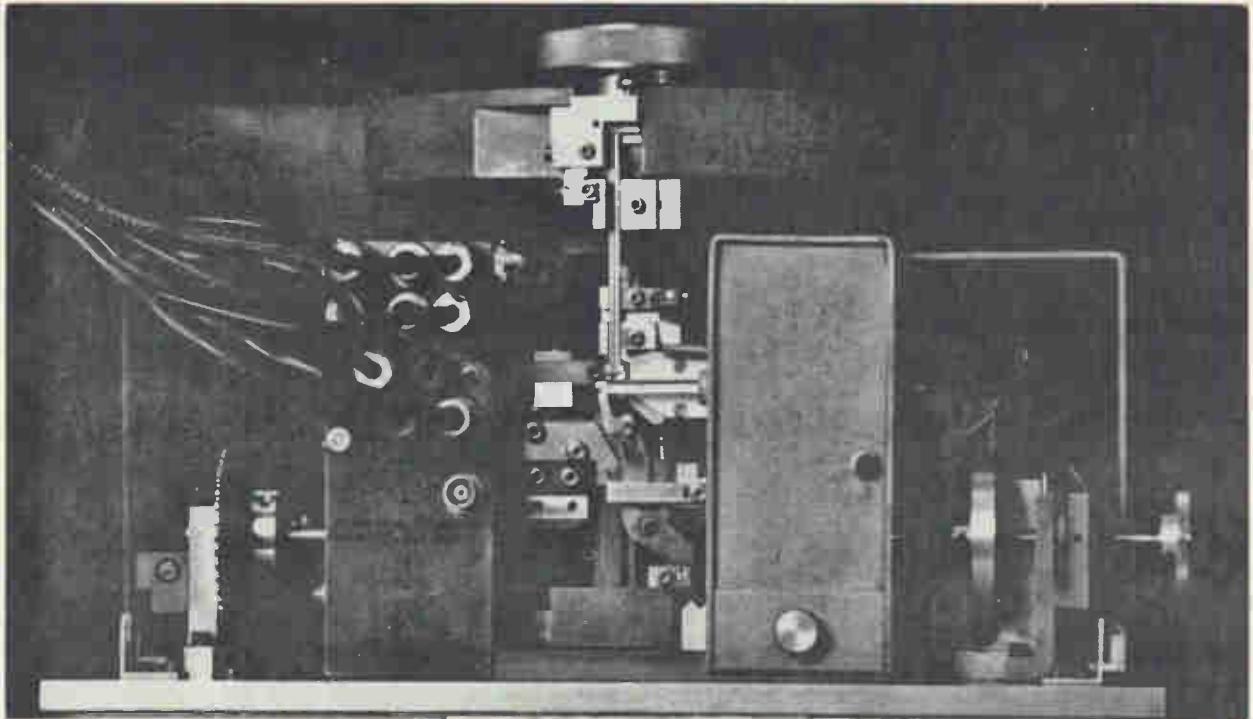

Core tester. Cores feed from the vibrator into the vertical chute, shown in color at the left. At the bottom of the chute, the split probe, also in color, moves through the hole in the core and makes an electrical contact on the other side. The two halves of the probe carry current pulses that switch the core and sense its output.

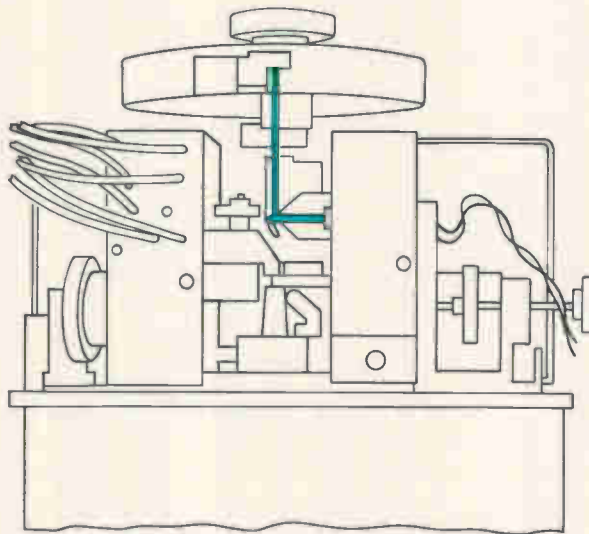

One conceivable solution to the problems involved in pressing cores and measuring their density might be to stamp the cores out of a sheet of ferrite that had been rolled out, like cookie dough, to the proper thickness. This thickness, and the weight of the stamped-out cores, would be relatively easy to control. The rolling and stamping tools might be simpler and therefore cheaper, and the tools might last longer because they would encounter less wear. This technique has been tried experimentally, and it looks promising. However, it raises some questions that in some ways might be just as troublesome as the ones involved in stamping out the cores individually. For example, the ferrite sheets, which would resemble paper tape, would be only a few mils thick and rather brittle,

so they would crack easily—perhaps under their own weight.

Passing muster

Just one faulty core in a million-bit memory will cause the whole assembly to fail—a reason sufficient to justify the testing of all cores before they're assembled into a memory.

In the standard testing operation, a vibratory feeder moves the cores into a funnel-shaped chute that orients them properly and drops them into a vertical track. The track's dimensions are such that the core falls freely but maintains its orientation. The core stops moving at the bottom of the track, and a split probe is inserted through its hole to electrical contacts behind it.

A current pulse pattern is generated on one of the two halves of the probe, while the other half senses the flux changes in the core as it switches. Sense amplifiers and logic circuits determine whether the core is up to specifications. If it is, the probe is withdrawn and the core is deflected into a collector; cores that fail drop straight into another collector. This arrangement ensures that while a few "good" cores might be thrown out if the deflector mechanism failed, a bad core could never land in the good pile.

The entire operation takes place in a single machine that typically tests 16 cores per second.

Although its output rate is far higher than could be achieved with any manual process, it is plagued by problems either intrinsic to the process or related

to the core sizes.

For example, a few cores are invariably broken or chipped before they get to the tester or while they're in the vibrator. These cores sometimes jam in the funnel or the vertical track so that the machine must be shut down, or they come to rest at an angle in the test fixture and break the probe as it comes through.

In addition, as thousands of cores pass through the tester, friction wears off particles of ferrite that may become embedded in the probe. These particles create noise that sometimes produces false test results, and they wear out the probe.

Reduced core size means reduced weight. Just as the fine granules of ferrite don't always drop into the press the way they should, small cores are restrained by air resistance and tend to dribble slowly down the track in the testing machine instead of dropping straight and true into position. Present testing machines run at a fixed rate and assume that a core has fallen into proper place before the probe moves in. If cores get much smaller, testers will have to be designed with positive feeding mechanisms to ensure that the core is positioned to take the probe.

With smaller cores designed to switch more quickly, the pulse generators connected to the probe will have to operate at higher frequencies than the present units, and the sense amplifiers will have to reject noise better.

Last but not most definitely not least, smaller cores will require smaller testing probes, or a new testing method. Scaled-down probes may be weaker than the present models and might break sooner or wear out faster. This could be serious, because the split probes are an inherently weak design.



Ultra-microbalance. This instrument weighs single cores to an accuracy of half a microgram.

Memories IV

Lower costs for longer words

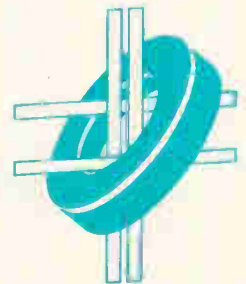

By Albert M. Bates

Burroughs Corp., Paoli, Pa.

As main computer stores, planar thin-film memories offer more speed and shorter access times—and thus greater throughput—than any other technology available today. Along with these advantages, the thin-film memories dissipate less power than two-dimensional and 2½-D ferrite-core arrays of comparable speed, and an order of magnitude less power than the most recently reported bipolar semiconductor types. And, taking speed and word length

into account, their cost per bit is low.

For these reasons, thin films stand a good chance of displacing ferrite cores as the mainstay of memories over the next few years, but the rising tide of semiconductor technology may make their reign a short one.

The Burroughs Corp. has been working on thin-film storage for more than 10 years. The first product of this work, a 300-nanosecond scratchpad

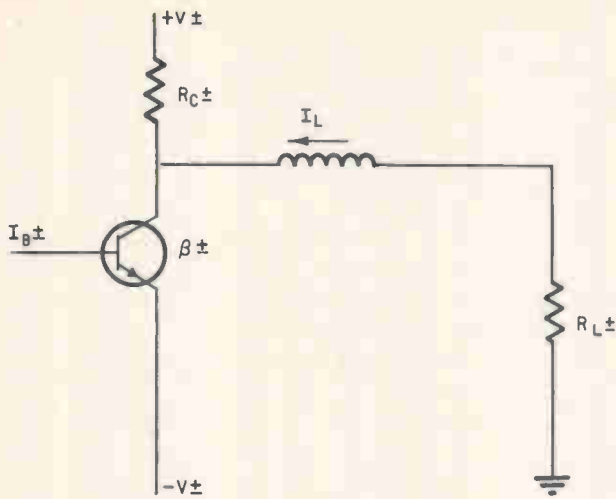

Points of variation. Tolerance in each of the components indicated contributes to a driver circuit's overall tolerance.

Cost vs. word length. The minimum cost for this film is shown here to be reached for longer word length and larger capacities than for either 2½-D or 3-D core memories. For 2½-D minimum cost is for very short words; for 3-D cost is almost independent of word length. Cost rises when sense-digit cost overtakes address decoder cost.

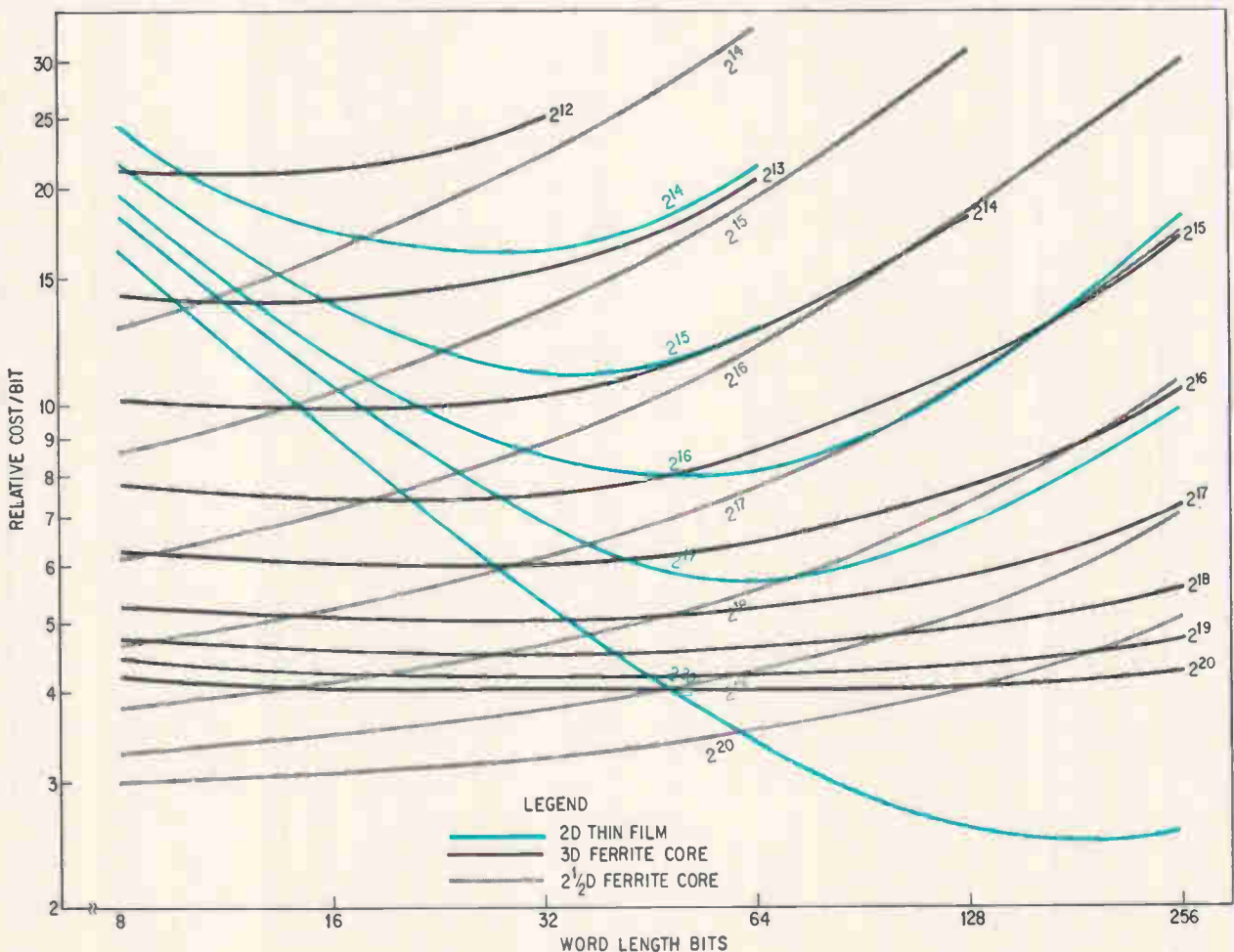

memory containing 128 words of 16 bits each, went into the company's D825 computer in 1961. More recent examples include a 500-nsec main memory of 16,384 words of 52 bits each for the B8500 computer, Burroughs' largest third-generation machine, and a 200-nsec memory module of 2,048 words of 64 bits each for the Iliac 4, a giant parallel processor being built by Burroughs for the University of Illinois.

The B8500 main memory, which contains more than 850,000 bit cells, dissipates less than 845 watts, or less than 1 milliwatt per bit; that figure includes dissipation from the associated electronic timing and control circuits. A fast 2½-D core memory of comparable speed, on the other hand, dissipates about 1,200 watts, or 1.4 milliwatts per bit.

Comparison with metal oxide semiconductor arrays is impractical in this context because MOS stores haven't yet been built in size and speed ranges even remotely similar to those of thin-film memories.

A film-memory system costs less than other types in relation to speed and word length. The chart on this page, which compares films with 2½-D and 3-D core memories, shows how the relative cost per bit—along the vertical axis—varies with word length—along the horizontal. The capacities of the

memories are indicated by the curves. In every case, larger memories cost less than smaller memories; and longer words, up to a point, are cheaper than shorter words.

The most expensive item in small memories is the electronic circuitry that decodes addresses. But for a given address complexity, extending the word lines to include more bits per word costs only a negligible amount and thus drops the cost per bit sharply. However, there's a catch. Every additional bit in a word requires additional sense-digit circuitry, and that expense eventually overtakes the cost of address decoding.

In the chart, the curves for 3-D memories are almost flat, indicating that the cost of these memories is almost independent of word length. The cost curves do begin to rise for exceptionally long words, however.

The point of minimum cost for 2½-D memories is off the chart to the left, indicating an exceptionally short word—perhaps only a couple of bits. The cost per bit for these memories rises quite sharply with increasing word length.

But with a thin-film memory, long words are the cheapest; and the larger the memory's total capacity, the longer the lowest-cost word becomes. The lowest-cost word length for a memory of 2²⁰ bits—about a million—would be about 200 bits. For this very reason, the main memory in the B8500 computer holds just about a million bits in 4,096 words of 240 bits each. Of these bits, 208 are used in actual system operation while the other 32 are spares.

Rock bottom

Though the chart is drawn in terms of relative cost per bit, the 2.5 level shown for thin films actually corresponds to about 2½ cents per bit, a cost considered a feasible ultimate low for memories of this type. Present costs are somewhat higher, because some design refinements haven't yet reached the production line.

Film memories are less expensive than core arrays because their memory planes are batch fabricated while cores must be manually strung or soldered, and because the driving circuitry is less complex, thanks to the negligible reactance on the drive lines and the aforementioned use of saturating transistors.

Greater tolerance

The thin films' power-dissipation characteristics are due in part to the small amount of material involved when the film switches, and in part to the wide tolerances on drive currents and the consequent simplicity of the drive circuits.

Although the drive currents in the thin-film memories operating in the destructive readout mode are about the same magnitude as those of core arrays, their tolerances are 10% to 15%, compared to 2% or 3% for cores. (Thin-film memories have also been designed to operate in the nondestructive readout mode, which doesn't need as large a drive

current. However, these memories also generate a small sense signal and thus require separate circuits for read and write drivers; in general, their electronics are more expensive in this mode. All Burroughs thin-film main memory designs are DRO, and NDRO won't be considered further in this article.

The wider tolerances on drive currents are permissible because the nickel-iron films used are less sensitive to temperature than are ferrite cores, and involve different switching mechanisms.

Most thin films in memories are of a nickel-iron alloy that is magnetically anisotropic, that is, it is more easily magnetized in a particular direction than at right angles to that direction. Furthermore, in the easy direction, these films have nearly square hysteresis loops similar to those of ferrite. In the hard direction they are almost linear.

Saturating circuits

The thin-film memory operating in the DRO mode requires only enough current to switch it; the upper current limit established by ferrite's temperature sensitivity isn't present. This makes for greater design freedom as well as for wider current tolerances. For example, saturating transistor drivers can be used where the current can be permitted to vary as much as 15%. Because its collector-to-emitter voltage is smaller than that of a nonsaturated transistor, the saturated transistor dissipates less power and contributes less to the system's over-all temperature rise. Also, circuits that saturate are easier to design and build than those that don't.

To store a bit in a thin-film memory, a word current rotates the bit cell's magnetic vector and a bit current establishes the direction in which the vector "flops back" when the word current turns off. Neither current can seriously affect another cell. The phenomenon called "creep"—the tendency of data to disappear when it's under an idle line located between two repeatedly addressed lines—is eliminated for all practical purposes by the spacing of the storage elements and by line impedances.

In most ferrite-core designs, the switching current is the sum of two closely controlled currents in different wires. Too large a current will affect cores on the wire that shouldn't be switched, and the exact amount of current that can cause switching depends on the core's temperature. The degree of precise control necessary under these conditions precludes the use of saturating transistors as drivers.

The fact that thin-film memories can use saturating transistors improves their power-dissipation properties even more. Because each of these transistors can provide more current than nonsaturating types can, fewer of them are needed. This not only further reduces dissipation, but lowers the temperature at the junction within each transistor and the voltage stress on the transistor. It thus increases the mean time between failures.

As an added bonus, the modest dissipations and

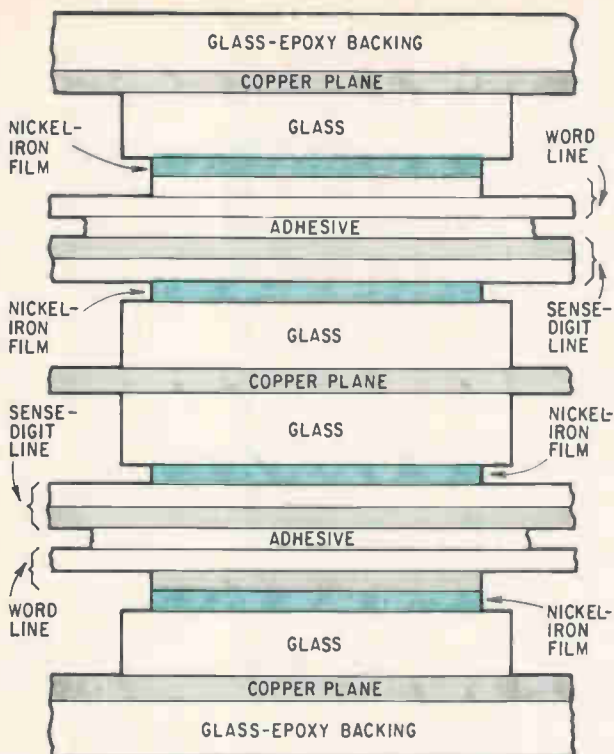

Glass stack. Thin-film array on glass substrate is assembled into a glorified club sandwich.

voltages indicate that integrated drive circuits will eventually be batch-fabricated on a single substrate, of silicon, with all the inherent advantages of that approach.

Power-supply voltages for thin-film arrays are also much lower than those of core arrays; a drive line for a film can be designed as a triplate strip line—one flat conductor between two ground planes—a configuration that reduces the parasitics between adjacent lines. The film cells also present a negligible inductive load to the drivers compared to the substantial back voltage and consequent spikes on the power-supply bus that exist in a ferrite-core array.

Talk is cheap

Two-dimensional organization of multiple word lengths give a system with a thin-film main memory access to several words in only a few hundred nanoseconds, and permit it to write as many words in one memory cycle. In the B8500, four words are accessible at once in 200 nsec.

Films are capable of switching in 5 nsec or less, whereas present-day standard cores 20 mils in diameter take anywhere from 100 nsec on up. Smaller cores, if and when they go into production, can switch faster, but they're still far slower than the films. One false impression should be corrected here. It's often assumed that to maintain their high speeds, film memories have to run hot—to practically cook. Actually, their operation is low-voltage and relatively cool.

In the B8500, an array of rectangular spots of

1,500-angstrom-thick nickel-iron alloy on glass substrates is backed by a solid copper sheet on a glass-epoxy board, as shown at left. The easy axis of magnetization is parallel to the long side of the rectangles, whose shape contributes more to the anisotropy than would squares or round spots. Two of these arrays are placed face-to-face, with the film spots registered over one another and with intervening lattice of word, sense, and digit lines of copper-laminated Kapton tape—a polyimide film manufactured by Du Pont.

The two face-to-face spots in each bit cell establish a flux path similar to the one in a toroidal ferrite core; the path lies entirely in magnetic material except at the ends of the cell, where the flux jumps a small air gap to pass from one spot to the other. This configuration is much more reliable

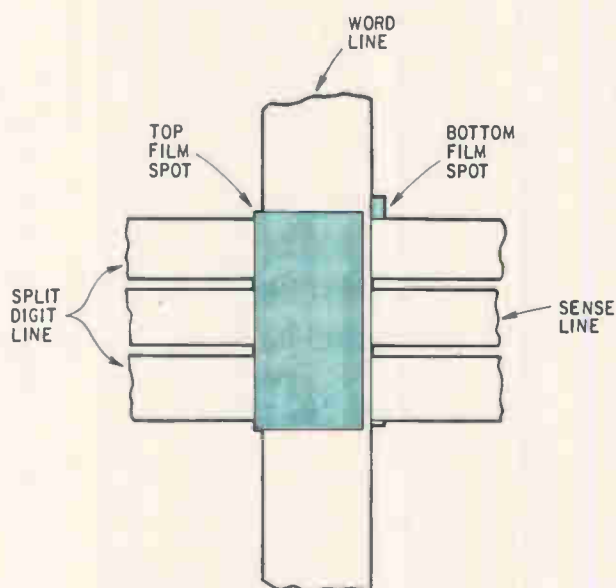

Facing spots. Split digit lines, straddling the sense line, and word line pass between two film spots facing one another on glass substrates.

than a single spot, which would require the flux to return from one end of the cell to the other through the air. The single spot would yield only half the output for a given cell area, and would be more easily disturbed by stray magnetic fields and neighboring drive fields.

Split digit

Word lines are about the same width as the film spots' narrow side, and generate a magnetic field parallel to the "hard" axis of magnetization when current passes through them. Each digit line is split in two, with the sense line between the halves; the three together are about as wide as the long side of the film spot, as shown above. When a current in the word line forces the spot's magnetization to turn from the easy to the hard axis,

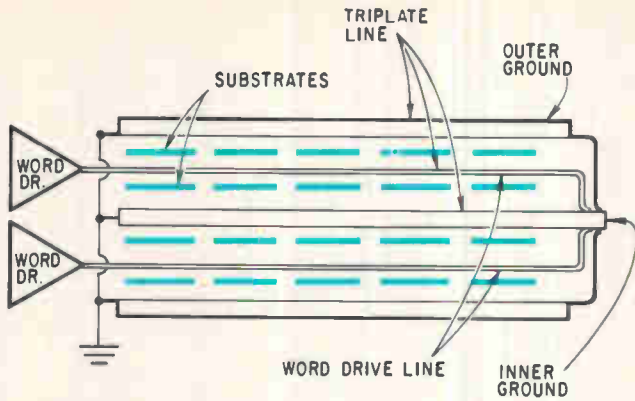

Common ground. Word lines and all ground planes, connected at one point, establish triplate strip line.

the rotation generates a pulse in the sense line. Then, while the word current is still present, identical currents in the two digit lines set up a resultant magnetic vector that determines the direction of magnetization in the spot—one way or the other along the easy axis—after the word current turns off.

The sense and digit lines must necessarily be parallel to one another. If the digit line was not split and was laid alongside the sense line, it would have a stronger effect on one end of the rectangular spot than on the other; the sense line would pick up a weak signal or none, reducing the memory's reliability.

If a single digit line was laid atop or underneath the sense line, the two would be coupled differently to the spot and tightly coupled to each other, generating much noise.

In the B8500, two of these face-to-face pairs are assembled back to back. Their common ground plane is the solid copper sheet backing each (the glass epoxy coating is eliminated at the center of this sandwich but protects the outside copper layers). All the word lines are connected to this common plane at the end opposite the driver circuits as shown above. The outside ground planes are also connected to the center plane at this point, producing the triplate strip line configuration for the word lines.

One memory plane basically comprises three copper sheets, four sets of film-on-glass arrays, two sets of lattice laminations, and associated electronic and mechanical hardware. (This is oversimplified; each copper sheet, for example, is in two pieces to ease the assembly procedure.) A memory plane of 1,024 words of 208 bits is assembled in a mass soldering operation lasting less than an hour. The necessary electronic circuits are added to this assembly, and four of the resulting frames are put together to make a single memory module. Each B8500 system contains from 12 to 16 modules, depending on the customer's application, and thus his memory requirements.

The cost of thin-film memories can be expected

to drop even further as present designs are further refined and especially as integrated-circuit techniques are applied. Ferrite-core memories, on the other hand, have probably already reached their minimum cost level.

Planar thin-film memories will continue to be developed and produced as long as large, fast systems such as the B8500 and Illiac 4 demand minimum access and cycle times. Memories for both systems are in production now: 256 for the Illiac 4 will be delivered in 1969, and a redesigned version of this memory, will be commercially available late next year.

If the speed and price predicted for large semiconductor arrays becomes a reality, both thin-film and ferrite-core main memories will eventually have to yield to MOS arrays, just as thin-film scratchpad memories, which were all the rage five or six years ago, have already yielded to bipolar silicon arrays. But until that time comes, present thin-film memory designs and their lower-cost and more efficient successors will command the largest share of the main-memory market.

Bibliographies

Memories II

- C.J. Quaitly, "A High-Speed Ferrite Storage System," *Electronic Engineering*, December 1959, p. 756.
- W.H. Rhodes, L.A. Russell, F.E. Sakalay, and R.M. Whalen, "A 0.7-Microsecond Ferrite Core Memory," *IBM Journal of Research and Development*, July 1961, p. 174.
- J.A. Rajchman, "Computer Memories: A Survey of the State of the Art," *IRE Proc.*, December 1961, p. 104.
- H. Amemiya, T.R. Mayhew, and R.L. Pryor, "A 10⁶-Bit High-Speed Ferrite Memory System—Design and Operation," *American Federation of Information Processing Societies, Conf. Proc.*, vol. 25, (Fall Joint Computer Conference), 1964.
- G.E. Werner and R.M. Whalen, "A 375-Nanosecond Main Memory System Utilizing 7-Mil Cores," *AFIPS Conf. Proc.*, vol. 27, part 1, (Fall Joint Computer Conference), 1965, p. 985.
- T.J. Gilligan, "2½-D High-Speed Memory Systems, Past, Present and Future," *IEEE Trans. on Electronic Computers*, August 1966, p. 475.
- D.W. Moore, "A Cost/Performance Analysis of Integrated-Circuit Core Memories," *AFIPS Conf. Proc.*, vol. 29 (Fall Joint Computer Conference), 1966, p. 267.
- W.F. Jordan Jr., "A Monolithic Decode-Drive Circuit for Magnetic Memories," *Digest, International Solid State Circuits Conference*, February 1968, p. 106.
- R.W. Reichard and W.F. Jordan Jr., "A Compact, Economical Core Memory With All-Monolithic Electronics," *AFIPS Conf. Proc.*, vol. 32 (Spring Joint Computer Conference), 1968, p. 253.

Memories IV

- E.E. Bittmann, "Thin-Film Memories: Some Problems, Limitations, and Profits," *Proc.*, International Conference on Magnetism, April 1963, p. T-149.
- H.P. Louis and W.L. Shevel Jr., "Storage Systems—Present Status and Anticipated Development," *IEEE Trans. on Magnetism*, September 1965, p. 206.
- R.H. Jones and E.E. Bittmann, "The B8500 Half-Microsecond Thin-Film Memory," *American Federation of Information Processing Societies, Conf. Proc.*, vol. 31 (Fall Joint Computer Conference), 1967, p. 347.
- IEEE Journal of Solid-State Circuits*, special issue on large-scale integration, December 1967.
- J. Reese Brown, "High-Speed Magnetic Memories," *Modern Data Systems*, February 1968, p. 62.
- A.V. Pohn and R.J. Zingg, "Magnetic Film Memory Systems," *IEEE Trans. on Magnetism*, June 1968, p. 146.

We reserve the right to make this ad obsolete without notice.

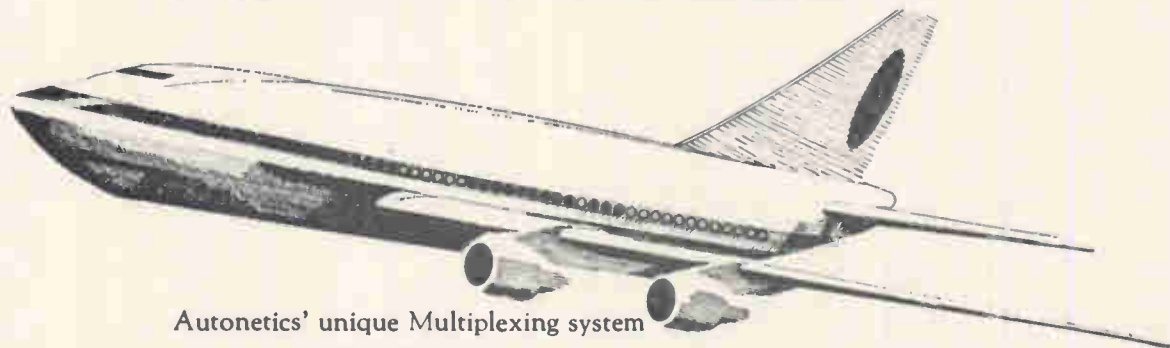

Autonetics' unique Multiplexing system can eliminate 80 miles of wire and save up to 1,500 pounds on large aircraft. Advanced microelectronic circuitry called MOS (metal oxide semiconductors) combined with other new techniques connect literally hundreds of aircraft subsystems through one coaxial cable.

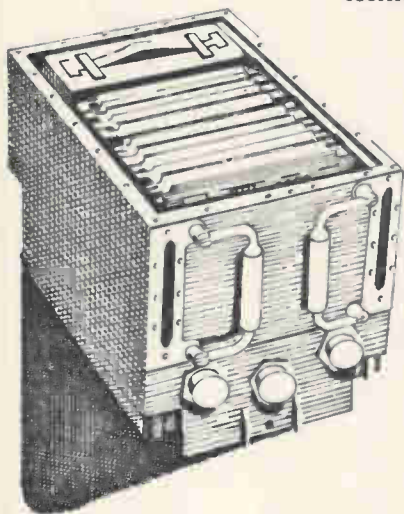

This advanced D26J computer uses commercially available integrated circuits and memories. It's flexible, fast, economical and reliable. Our delivery schedule is almost as fast.

This Autonetics MOS circuit contains more than 800 field effect transistors. It equals the performance of 100 integrated circuits. External or mechanical connections are reduced 30 to 1.

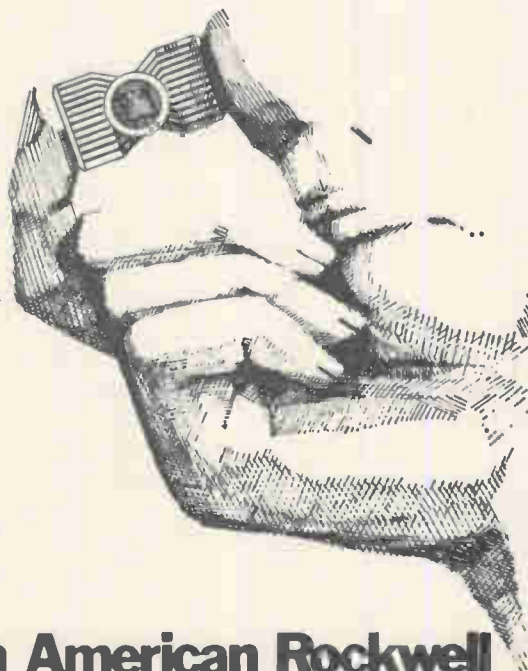

Someone is going to make these advanced Autonetics products obsolete some day. We intend to make sure it's us. For more information, write Department 080, 3370 Miraloma Avenue, Anaheim, California 92803.

Autonetics Division of North American Rockwell

Why waste time on bypass/filter capacitors?

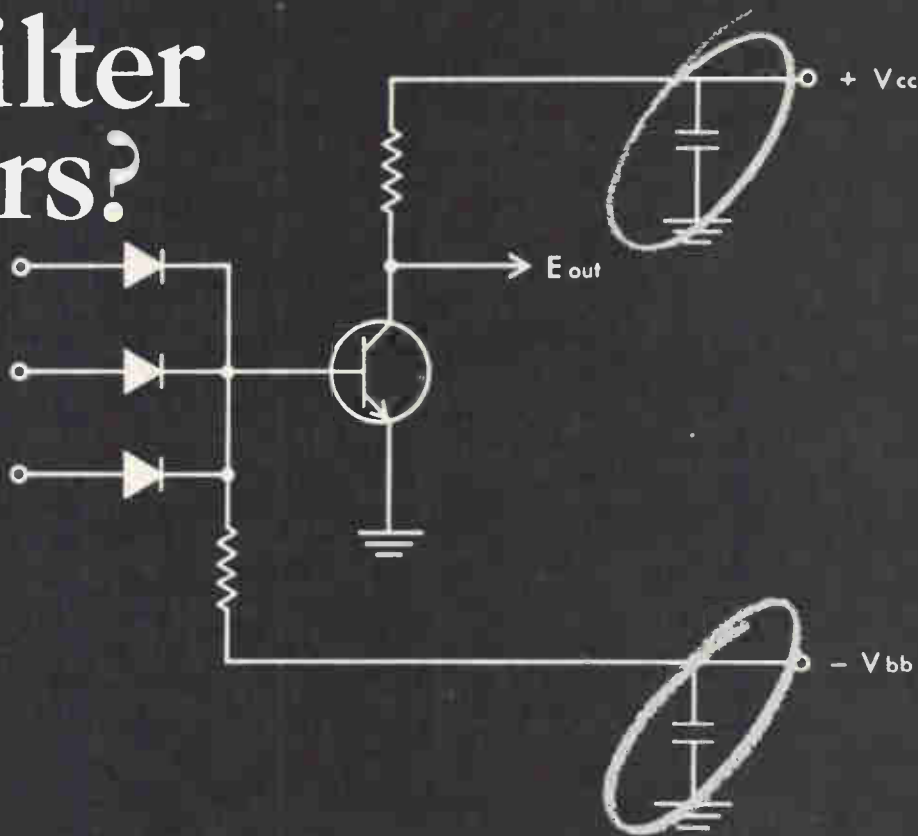

Specify CORNING® Glass-K Capacitors, and move on.



There's only one real concern with a bypass/filter capacitor. If it goes, your circuit will probably follow. Specify the guaranteed reliability of CORNING Glass-K Capacitors and forget it.

You can forget it for the same reason we can guarantee it:

1. Large capacitance in minimum case size, 1000 to 51,000 μf in $.250'' \times .100''$ or 12,000 to 100,000 μf in $.250'' \times .140''$.
2. Low power factor and low DC leakage.
3. Adaptability to cordwood, printed circuit, and point-to-point packaging and automatic insertion.
4. Tight end-of-life design with guaranteed stability.

Get this confidence at a competitive price, and inside two weeks for standard items. Get complete data by writing to: Corning Glass Works, Electronic Products Division, Corning, New York 14830.

CORNING
ELECTRONICS

Circle 121 on reader service card

the Cohu compacts

TV accessories in the
small, economy size

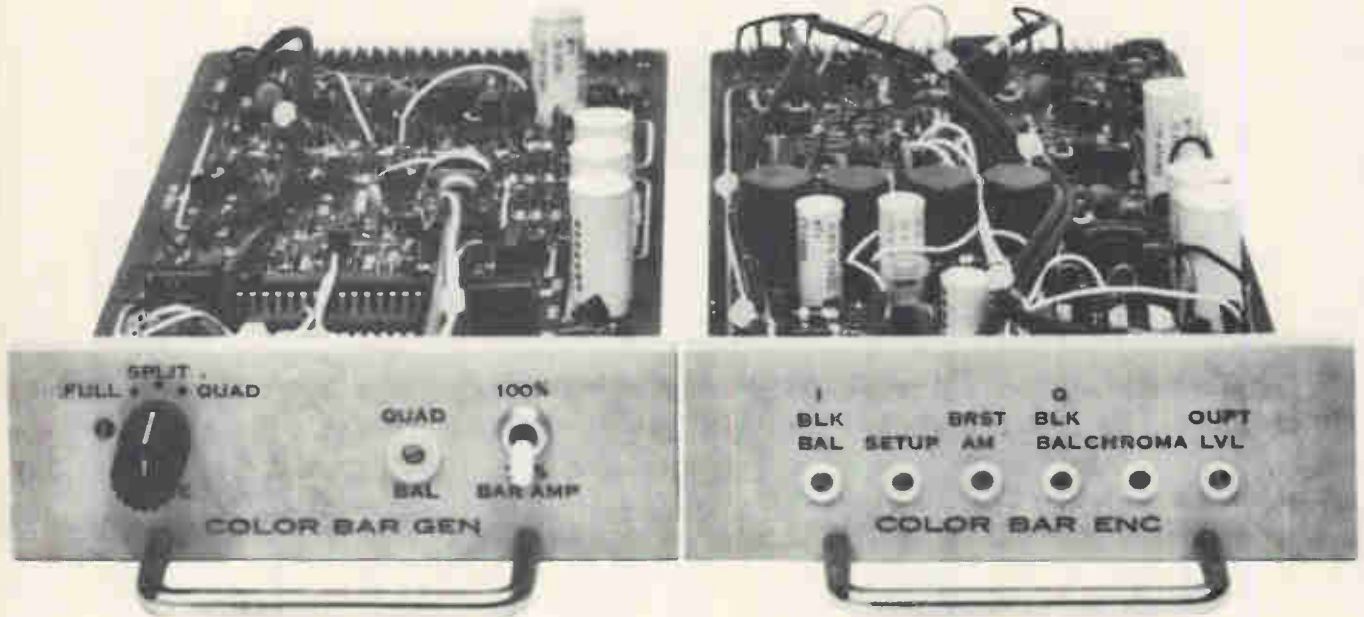

Cohu's Color Bar Generator facilitates adjustment of color monitors, encoders and other studio equipment requiring RGB I-Y-Q signals which meet EIA specifications. Video bar outputs are switchable from 100 to 75%. Special test pulses allow adjustment of quadrature without use of a vectorscope.

Cohu's Color Bar Encoder expands the basic usefulness of the color bar generator by adding an accurate and stable matrix and phasing circuit to provide encoded color bars which meet EIA RS-189 specifications. Television transmission characteristics can be checked with the encoded bar signals.

Compact, modular design of Cohu's 2610/2620 Accessory Series results from the use of integrated and solid-state circuits and provides reliable and versatile operation. Each compact is 1½" high by 4¾" wide and plugs into a frame which occupies only 1¾" of a standard 19" rack. In addition to the color bar generator and color bar encoder, other accessories include a drive generator, colorlock, black burst generator, dot • bar • crosshatch generator and background generator.

For specific data on each accessory, contact your local Cohu representative, or call Bob Boulio direct at 714-277-6700 in San Diego. Box 623. San Diego, Califor-

COHU
ELECTRONICS, INC

This cartridge-loaded recorder revolutionary packs up to 130 million digital bits.

Our new five pound MTR-8500 not only records seven times more than competitive models, but does so with virtually no errors. Thanks to a unique new design technique called High Density Digital Recording (HDDR, patent pending), you can pack 6,000 bits per track inch. And although we guarantee an error rate of 1×10^8 , we've yet to drop a single bit using HDDR.

The new 8500 cartridge-loaded unit is ideal for reconnaissance, surveillance and electronic countermeasure applications. It records almost a half hour at $1\frac{7}{8}$ ips and can record and reproduce at various tape speeds. Power consumption is only 20 watts, and it will operate on 28 volt aircraft systems.

Best of all, the new MTR-8500 complete with HDDR is available now for use in such rugged environments as 0-130°F, 100% humidity and altitudes up to 150,000 feet. For more complete information write Leach Corporation, Controls Division, Department E, **LEACH 717 North Coney Avenue, Azusa, California 91702. (213) 334-8211.**

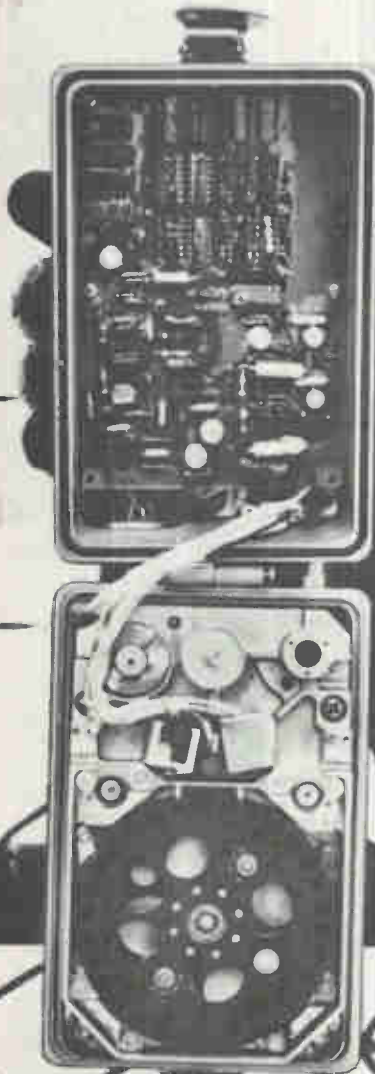

How to use the Singer Model NF-105 to make Noise and Field Intensity Measurements to meet the Tri-Service Specs

The Singer Model NF-105 has plug-in tuning units for specific bands of frequency. You can buy just the heads you need, add others as you need them. Rarely will contractual requirements for RFI testing make it necessary to purchase instrumentation that covers the entire spectrum — 14kHz to 1 GHz. This time-proven instrument, the most widely used in the world for RFI testing performs its measurements simply, accurately and quickly.

1.

In this standard noise and field intensity measurement, a Singer dipole antenna is placed in front of the instrument under test. The operator first tunes through the frequency band on the Model NF-105 to determine quickly what signals — if any — the instrument under test is emitting.

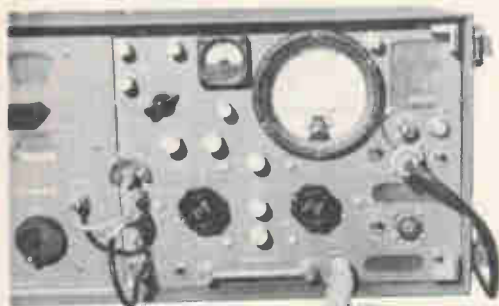
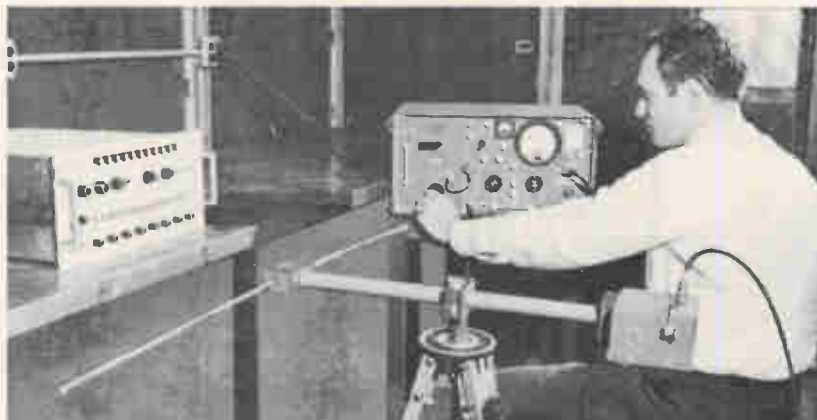

2.

When a signal is detected, the antenna is disconnected, and the output from an internal impulse generator is connected to the receiver's antenna input. Depressing this push-button activates the generator for self-calibration of the receiver. The generator produces a broadband highly stable signal at a predetermined amplitude for calibration.

A brochure on the Model NF-105 is now available. For your copy, please circle the Readers Service Card or write on your letterhead.

3.

After the receiver has been calibrated, the operator re-connects the antenna to the antenna input jack and reads the result directly on the front panel meter. The meter is calibrated in dB above one microvolt. Calibrated internal attenuators extend the effective dynamic range of the meter to 100 dB.



4.

It is as easy and as fast as this to pull out the plug-in tuning units and put in others to cover additional frequency bands. Singer, which has been setting the standard for noise and field intensity measurements for 15 years, makes instrumentation of this type to cover the range of 20 Hz to 26.5 GHz. Singer also makes a complete line of accessory equipment, including a comprehensive set of antennas, probes, remote indicators and other equipment.

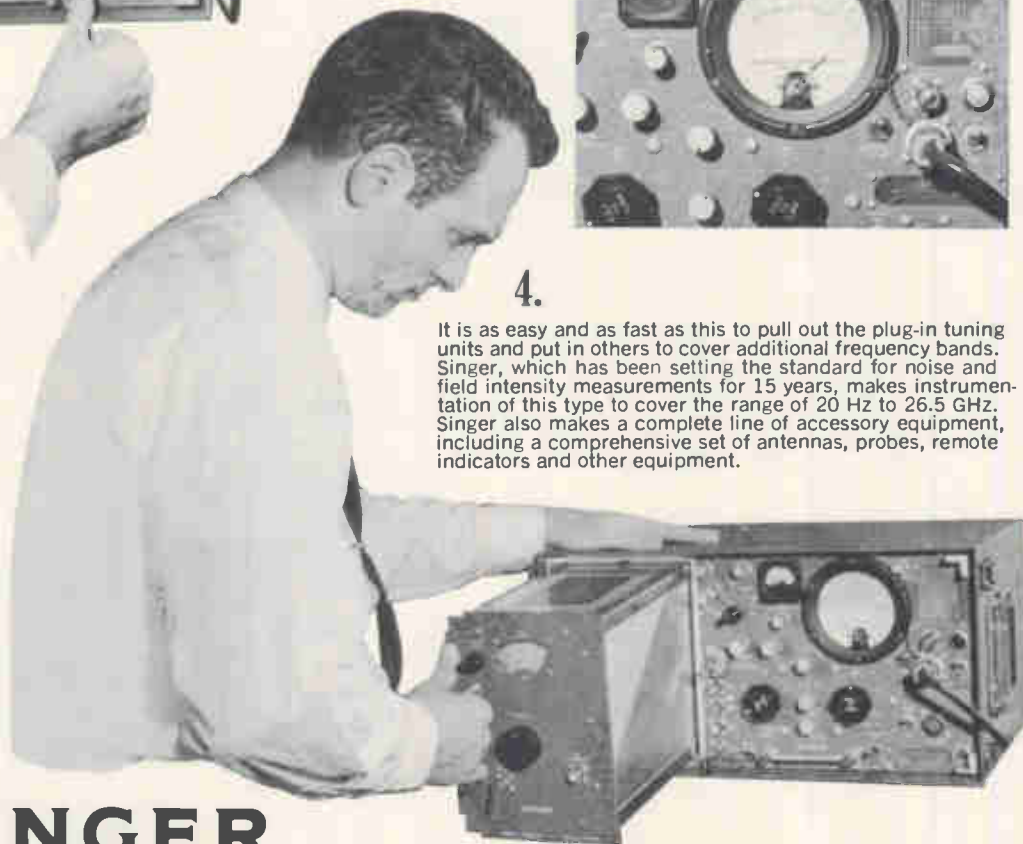

SINGER

INSTRUMENTATION

The Singer Company, Metrics Div., 915 Pembroke Street, Bridgeport, Conn. 06608 (203)366-3201

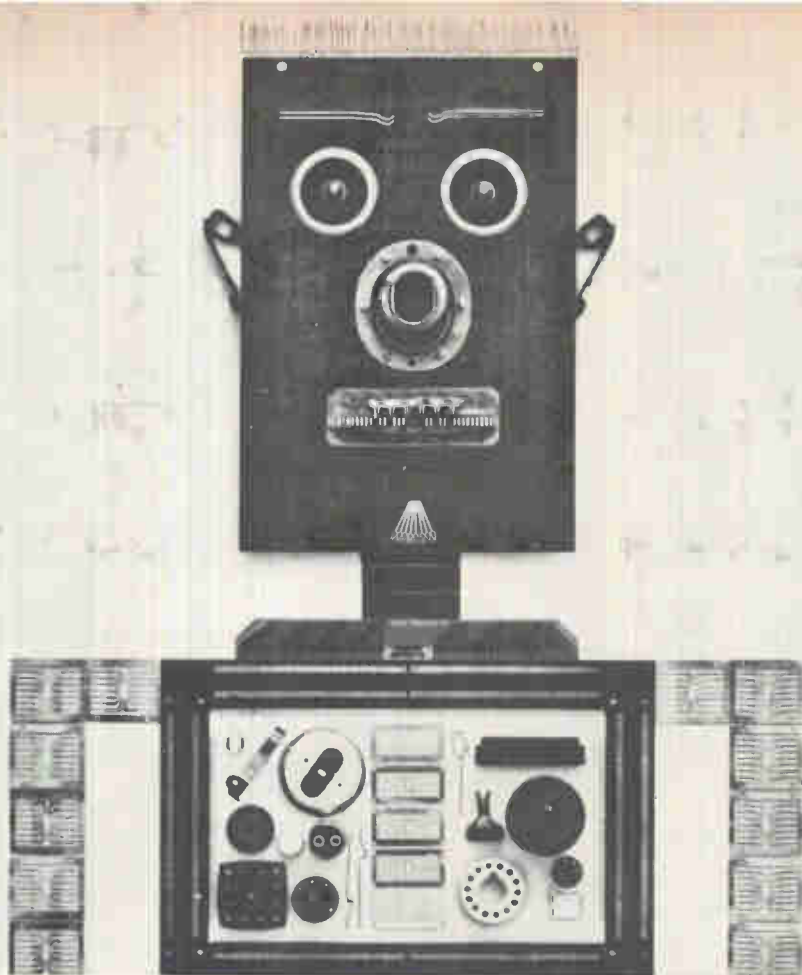

Sylvanians do as they're told.

Our living depends on it.

We turn out 50 million custom-fabricated parts a day. To exact specifications.

Including precision stamping of high-tolerance, miniature metal shapes.

Precision molding of intricate plastics parts.

Precision forming of wire for critical electronics.

Combining metals, plastics and wire into precision-built assemblies.

We live by our accuracy. After all, if we don't do what we're told, you

may not tell us anymore.

We've been doing it for over 17 years. On transistor leads, computer memory core frames, connectors, pen caps, aerosol spray tips, razor blade dispensers, integrated circuit frames. You name it.

We've got nine plants, the most advanced equipment, and the best engineers and die makers around to do it.

And we'll even help you design the part. Then we'll build the dies, produce the parts, and do the assembly. Exactly as we're told.

That means you get the parts you want, the way you want them, when you want them—probably at less cost than you could do it for yourself.

So the next time you need a custom fabricated part, call a Sylvanian and tell him what to do.

Sylvania Metals & Chemicals, Parts Division, Warren, Pa. 16365.

CUSTOM PARTS BY
SYLVANIA
A DIVISION OF
GENERAL TELEPHONE & ELECTRONICS

Dual 100-bit MOS... longest and lowest cost static shift registers

- 200 bits per package
...for economy and
reliability
- Lowest cost per bit
(one-tenth bipolar
registers)
- D-C to 1 MHz
operation
(no minimum
clock rate)
- Extremely low power
drain
(1.5 mW per bit)

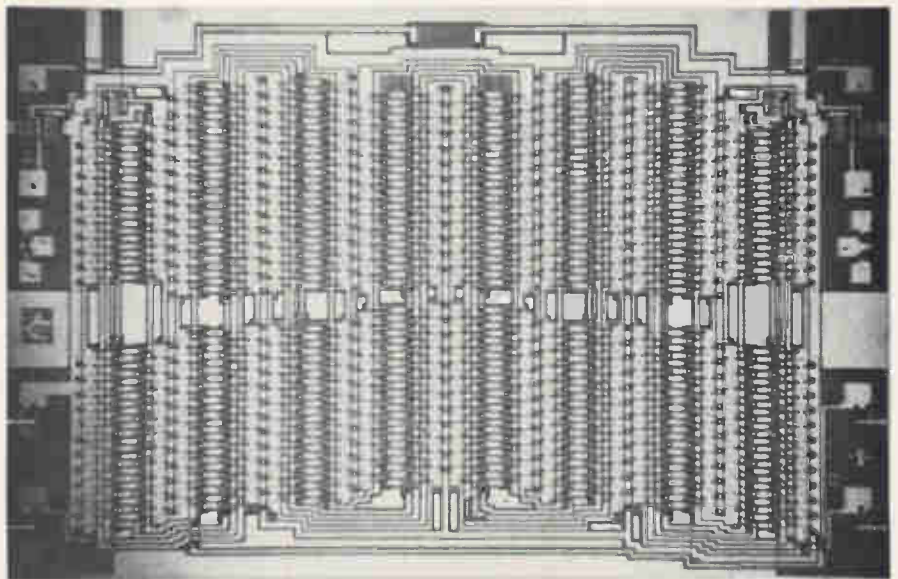

This is a photomicrograph of the longest static shift register available in a production device today. It's the new dual 100-bit MOS-LSI from Texas Instruments...the latest of a growing family of computer-designed MOS circuits. Other static shift registers include dual 50-, 32-, 25-, and 16-bit units.

In addition TI is currently producing other advanced MOS circuits including memories...random access and read only, analog switching circuits, linear circuits, and custom logic arrays.

Furthermore, TI's computer design capability reduces design lead time for custom products tailored

to your system needs.

A new MOS Static Shift Register Application Report is just off the press. For your copy—plus data sheets—write on your letterhead to Texas Instruments Incorporated, P. O. Box 5012, MS 980-B, Dallas, Texas 75222.



TEXAS INSTRUMENTS
INCORPORATED

WHEREVER LARGE VOLUMES OF AIR

MUST BE HANDLED

INEXPENSIVELY

AND RELIABLY...



THE
Dolphin (T.M.)
FAN

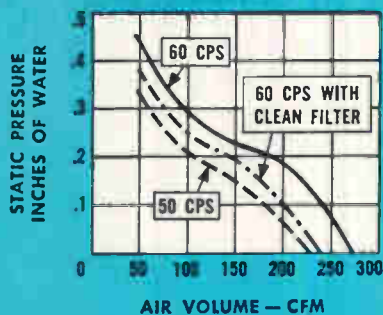

- Delivers up to 265 CFM air volume.
- Measures only 7" diameter by 2-7/16" axial depth.
- Molded of high impact polycarbonate plastic
- Multi-slot induction motor with sleeve bearings.
- 115VAC, 50-60 Hz, Single phase operation.
- Low Low Cost — Most economical 7" diameter fan available.
- Designed to meet U. L. requirements
- Easily mounted with clips on clamping rims
- Airflow reversible by mounting on either face

Add to the outstanding listing of features above a cost savings of approximately 25% over comparable fans and you have a truly outstanding performer for flushing computer consoles, power supplies, relay racks and just about any piece of electronic gear that can only spare a little room for a cooling device. Venturi molded of blue polycarbonate with a charcoal gray propeller, the Dolphin Fan is as attractive as it is efficient and reliable. Send today for complete descriptive literature to Rotron, Inc., Woodstock, New York 12498



VERSA-PROX NEW PLUG-IN VERSATILITY IN PROXIMITY SWITCHING

One temperature-stable amplifier with choice of plug-in modules to fit YOUR specific detection and control needs.

CHOICE OF PLUG-IN MODULES

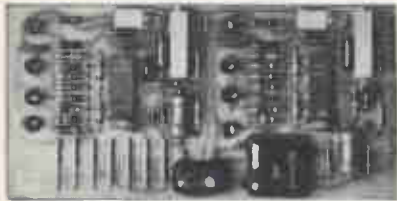

SENSOR DRIVING MODULES

Single oscillator and/or dual oscillator permit use of up to 3 sensing heads.

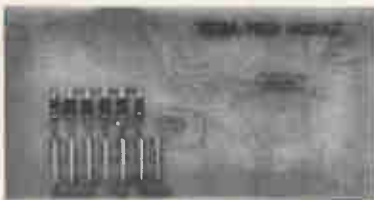

LOGIC MODULES

"And" gate—"Or" gate

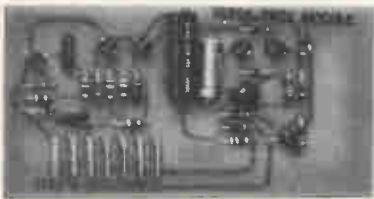

TIME DELAY MODULES

Delay Make { .05 to 1.0 sec.
.5 to 10.0 sec.
Delay Break { .05 to 1.0 sec.
.5 to 10.0 sec.

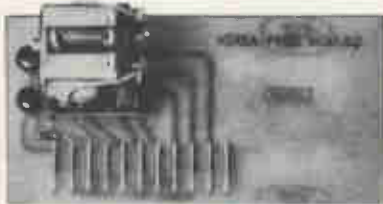

OUTPUT SELECTIONS

10 amp power relay
Electronic output
Dry reed relay (form A)
Mercury wetted relay (form C)

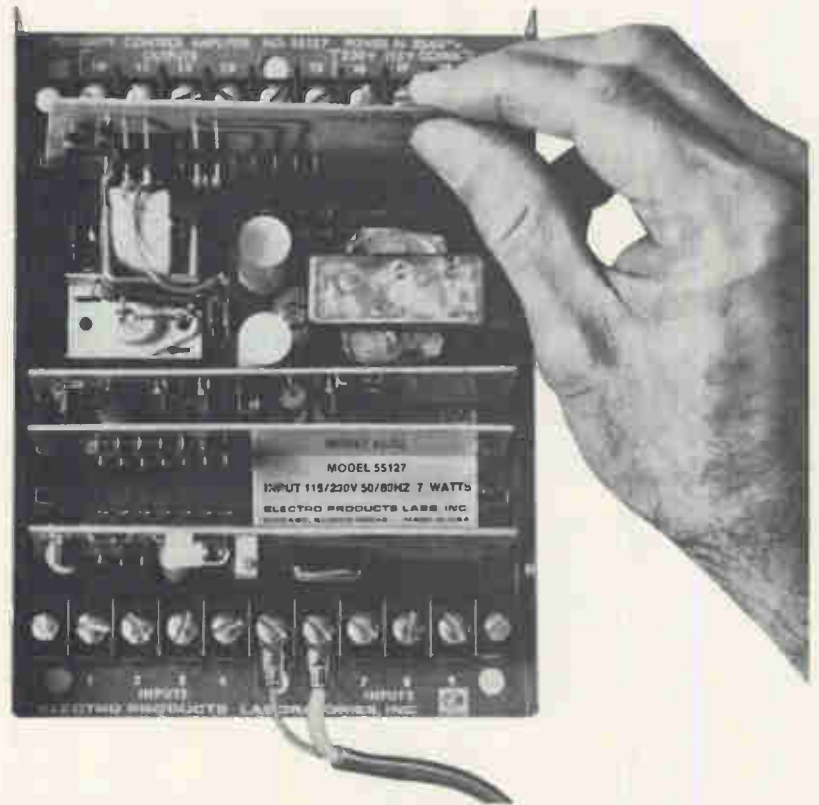

ELECTRO'S Versa-Prox is a new concept in proximity switch versatility. By means of simple plug-in modules in a five position "mother board" you can tailor detection or control to your exact needs—and change it in a matter of minutes, whenever you need changes.

A variety of modules are available to give you a wide range of choices in input, logic, time delay and output.

Temperature-stable from -40°F to $+160^{\circ}\text{F}$

The Versa-Prox amplifier not only sets new standards of flexibility, but accuracy and temperature stability as well. Tests showed remarkable temperature stability over varied sensing distances in a temperature range from -40°F to $+160^{\circ}\text{F}$. Sensing distance variation with line voltages ranging from 105V to 130V is negligible.

Temperature-stable sensing heads with a range of -40°F to $+176^{\circ}\text{F}$ are also available. These heads are also moisture and oil resistant.

For the complete story, check with your ELECTRO representative or write for complete data.



ELECTRO PROXIMITY SWITCHES

ELECTRO PRODUCTS LABORATORIES, INC.
6125-Y Howard St., Chicago, Illinois 60648 • 312/647-8744

By habit, precision jobs got wire wounds.

Until Corning.

Now, you have another choice.

A less expensive choice.

Glass tin oxide film.

Corning makes them.

In the precision range.

Makes them with a base of pure optical glass. And a fully oxidized metal film.

Environment can't degrade either. Film and substrate are molecularly bonded. Matching TC's do away with fatiguing stresses. Special silver-glass composition insures low termination noise.

Press-fitted end caps mean mechanical integrity. Tailored tough insulations wrap them up. It all adds up to long-term reliability.

General purpose, precision, or special, CORNING® Glass Tin Oxide Film resistors are a better buy—by design. From 1/10 watt in .150", up to 6000 watts in six feet, they're shown in our new Resistor Design Guide.

Get your copy from:

Corning Glass Works,

Electronic Products Division,

Corning, N.Y. 14830.

CORNING
ELECTRONICS

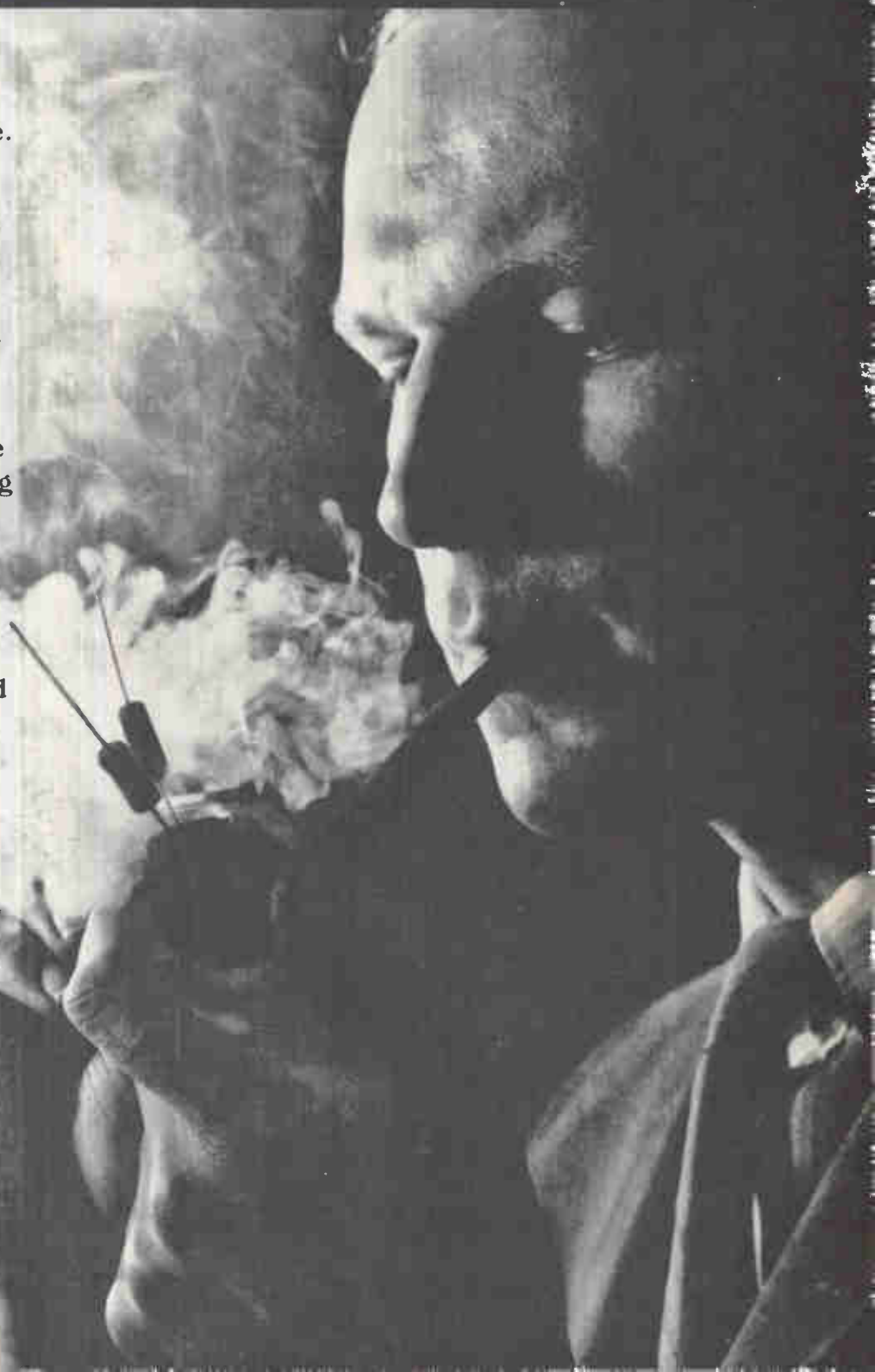

Everything but the chips

A total packaging capability for hybrid integrated circuits

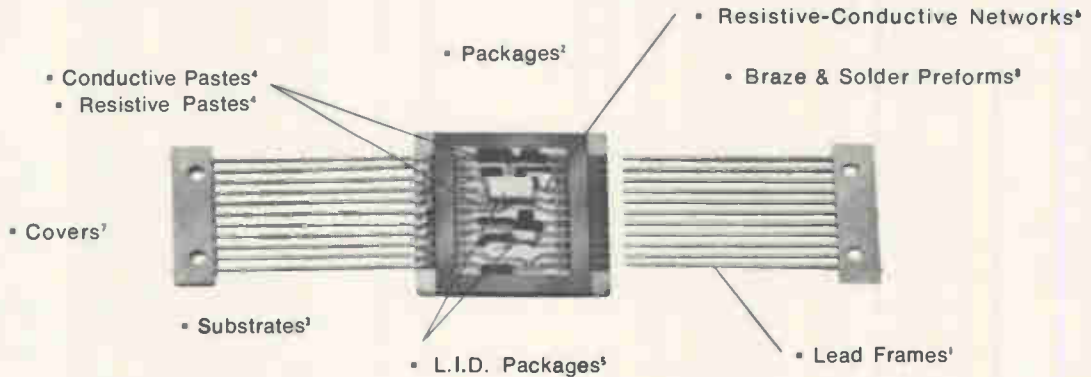

Alles bis auf die Halbleiterbestückung

Alles von einer einzigen Bezugsquelle: Ein Anruf eines Verkaufsbüros oder Vertreters von Alloys Unlimited verschafft Ihnen Zugang zu Forschung und Entwicklung wie auch Mengenbezug von Lagerartikel oder Sondergeräte — für sämtlichen Bedarf an gedruckten Verbundschaltungen. • Leitrahmen • Aggregate • Grundplatten • Leitpasten • Widerstandspasten • Leiterlose Kontaktgeräte • Widerstand/Leiternetze • Abdeckungen • Vorgeformte Hartund Weichlote

Die Einzelfirmen, die zum Konzern Alloys Unlimited gehören, sind Hersteller der oben verzeichneten Bestandteile. Alloys Unlimited mit ihren Tochtergesellschaften verfügen über komplette Liefermöglichkeiten für Verbundschaltungen; eine einzige Bezugsquelle für höchste Qualität bei konkurrenzfähigen Preisen.

Man verlange unsere neue Gratis-Broschüre mit Spezifikationen, Preisen, Bestellungsangaben und Verzeichnis der Absatzstellen in aller Welt.

Umfassendes Herstellungsprogramm für Verbundschaltungen

Aggregate, Grundplatten, Leitpasten, Widerstandspasten, Widerstand/Leiter Stromkreise, Leiterlose Kontaktgeräte, Leitrahmen—Erstausführungen, Abdeckungen—keramisch, Abdeckungen—Metal, Leitrahmen—Serienfabrikation

Everything but the chips

Everything from a single source: One call to any sales office or representative of Alloys Unlimited gives you access to R&D or Production quantities, off-the-shelf or custom parts, everything you need in the packaging of hybrid integrated circuits.

The individual companies which comprise Alloys Unlimited, Inc. are the leading manufacturers of the components listed above. Alloys Unlimited and its subsidiaries constitute a total packaging capability in Hybrids; a single source for top quality and competitive pricing.

Source Companies (Subsidiaries or Divisions of Alloys Unlimited, Inc.)

¹Photoetched—Micro Science Associates, Inc.; ²Stamped—Montvale Customtool, Inc. ³Veritron West, Inc. ⁴Frenchtown/CFI, Inc. ⁵Electronic Materials Div. ⁶Frenchtown/CFI, Inc. ⁷Cermex Division of Frenchtown/CFI, Inc. ⁸Ceramic—Frenchtown/CFI, Inc.; Metal Photoetched—Micro Science Associates, Inc.; ⁹Stamped—Montvale Customtool, Inc.; ¹⁰Eutectic Clad—Alloys Unlimited, Inc. ¹¹Alloys Unlimited, Inc.

Send for our new, free brochure with specifications, prices, ordering information and worldwide office locations.

Tout sauf les dés semi-conducteurs

Livraison globale depuis une seule source: Un appel à n'importe quel bureau de vente ou représentant de Alloys Unlimited vous donnera accès à des quantités d'étude ou de grande production soit de pièces prises en magasin ou fabriquées sur demande particulière, soit tout ce qu'il vous faut pour faire les assemblages en bloc de circuits hybrides intégrés. • Chassis conducteurs • Assemblages-blocs • Couches de fond • Pâtes conductrices • Pâtes résistives • Blocs conducteurs sans fils de connexion • Réseaux résistifs/conducteurs • Chapeaux • Soudures préformées

Les sociétés particulières entrant dans l'organisation Alloys Unlimited, Inc. sont les fabricants des articles ci-dessus indiqués. Alloys Unlimited et leurs associés présentent une capacité de livraison globale en circuits hybrides; une source unique pour première qualité à des prix méfiant la concurrence.

Demandez notre nouvelle brochure gratuite donnant toutes spécifications, prix, précisions pour commandes et bureaux d'écoulement en tous coins du monde.

Fourniture globale pour circuits intégrés hybrides

Assemblages-blocs, Couches de fond, Pâtes conductrices, Pâtes résistives, Réseaux résistifs/conducteurs, Blocs conducteurs sans fils de connexion, Chassis conducteurs—prototypes, Chassis conducteurs—en série, Chapeaux—céramiques, Chapeaux—métalliques



Alloys Unlimited, Inc.

A. U. Sales Corporation



15-MHz, Dual-Trace Portable Oscilloscope

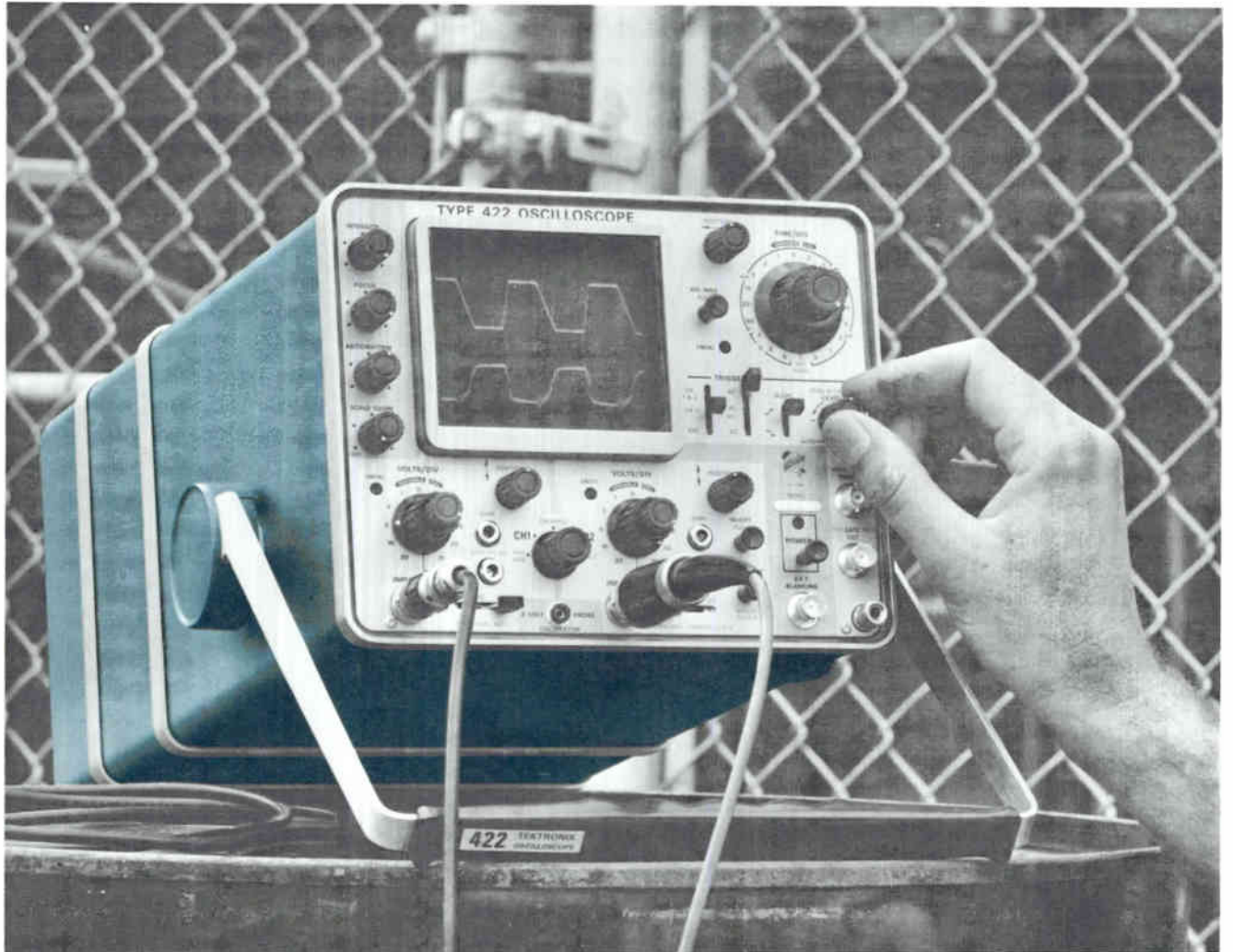

AC, DC or Battery Powered!

Your waveform measurements no longer need be compromised by adverse field conditions or the absence of a convenient power connection. The Tektronix Type 422 Portable Oscilloscope brings the precision of the laboratory "on site" to meet your measurement requirements.

This compact, rugged oscilloscope combines small size and lightweight with 15-MHz, dual-trace performance! Two models are available. One is pow-

ered from AC; the other from AC, DC, or internal rechargeable batteries. The AC version weighs less than 22 pounds including accessories and operates from 115 or 230 VAC $\pm 10\%$, 45 to 440 Hz, 40 watts. The AC/DC version (MOD 125B) with built-in battery recharger weighs 30 pounds including accessories and batteries and operates from an internal 24-volt rechargeable battery pack; from 115 or 230 VAC $\pm 20\%$, 45 to 440 Hz, 27 watts; or from 11.5 to 35 VDC, 23 watts.

please turn page for additional information 

Making the Measurement . . . with the Tektronix Type 422

Portable Oscilloscope

PERFORMANCE

Dual vertical input amplifiers cover major use areas with 23-ns rise-time and DC-to-15 MHz bandwidth over the 10 mV/div to 20 V/div deflection range. For observing low level signals, 1 mV/div deflection factor with 5-Hz to 5-MHz bandwidth is provided on Channel 2. Sweep rates are 0.5 s/div to 0.5 μ s/div, extending to 50 ns/div with the X10 magnifier. Easy-to-use trigger logic provides stable triggering to above 15 MHz. A Tektronix 4-inch rectangular CRT presents sharp, bright displays on an 8 x 10 div viewing area (0.8 cm/div). A parallax-free, illuminated graticule contributes to accurate measurements. Two miniature 10X attenuator probes are included and are stored in the front panel protective cover.

RUGGED CONSTRUCTION

The Type 422 is ruggedly constructed to withstand shock, vibration and other extremes of environment. Electrical specifications are valid over an ambient temperature range of -15° C to $+55^{\circ}$ C (AC version), -15° C to $+40^{\circ}$ C (AC/DC version).

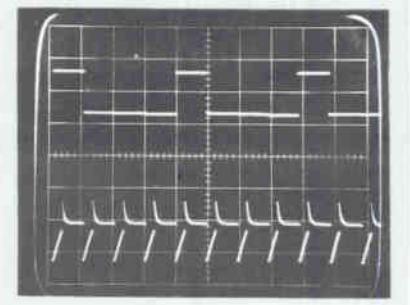

Dual-trace performance of the Type 422 Portable Oscilloscope permits convenient waveform comparison.

OPTIONAL ACCESSORIES

CAMERA . . . The C-30A, a compact, lightweight trace-recording camera, mounts directly to the Type 422 and provides photographic prints in 10 seconds.

SCOPE-MOBILE® CART . . . The Type 200-2 has an adjustable tray which friction-locks in any position from 0° to 60° .

PROBES . . . A full complement of voltage and current probes are available. Two P6012 10X miniature general-purpose probes are included as standard accessories. The P6019 current probe and 134 amplifier illustrated below permits 1 mA/div current measurements up to 15 MHz with the Type 422.

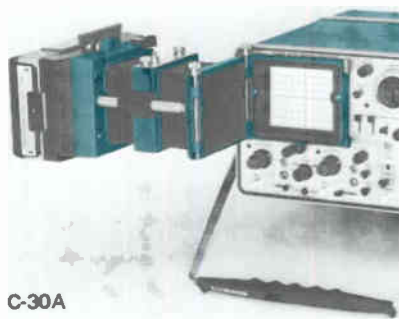

C-30A



200-2



P6019/134

Your Tektronix Field Engineer will demonstrate the performance of the Type 422 Portable Oscilloscope in your application. Please call him, or write: Tektronix, Inc., P.O. Box 500, Beaverton, Oregon 97005.

Type 422 Oscilloscope (AC version)	\$1425
Type 422 MOD 125B Oscilloscope (AC/DC without batteries)	\$1775
Battery Pack for Type 422 MOD 125B (order 016-0066-02)	\$ 125
C-30A Camera	\$ 450
P6019/134 Current Probe and Amplifier	\$ 275
Type 200-2 Scope-Mobile® Cart	\$ 75

U.S. Sales Prices FOB Beaverton, Oregon

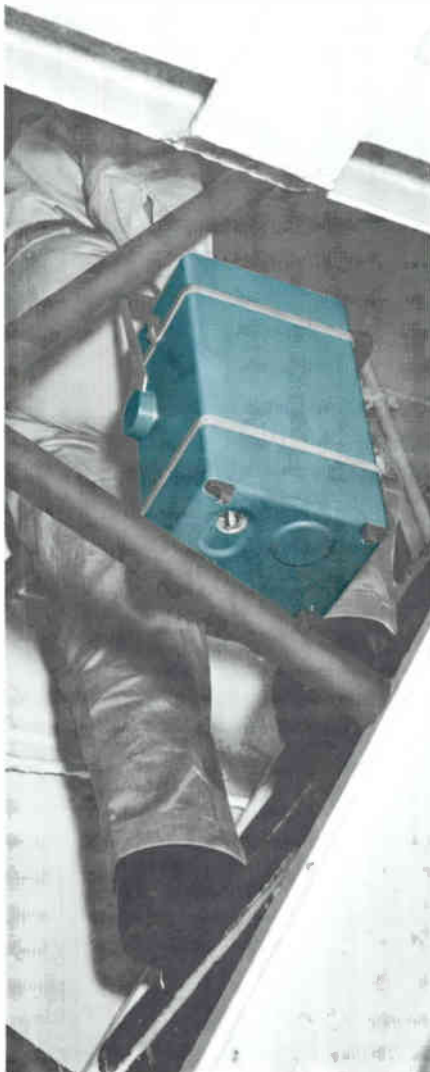

Tektronix, Inc.

committed to progress in waveform measurement

Probing the News

Space electronics

Comsat labs to share new home

Company is centralizing its R&D activities in suburban Washington complex; officials try to quiet fears that the facility will build satellites and hardware

By Paul A. Dickson

Washington regional editor

Next summer, Comsat's research laboratories go big time. They'll move from makeshift quarters to a modern new complex in Clarksburg, Md., a suburb of Washington, D.C. The move is exciting interest—and even some concern—among the company's present and prospective suppliers.

After opening day at the new labs, the level of the Communications Satellite Corp.'s research and development capabilities will be greatly enhanced. But what really worries electronics and aerospace contractors is the possibility that the facility might become a production center, building spacecraft and related hardware. If such proves to be the case, the amount of business done with outside companies would necessarily decline.

Nay sayer. W.L. Pritchard, who heads the labs, pooh-poohs such notions. "It won't be a production facility in the industrial sense," he says. "It's extremely unlikely the labs will build quantities of operational hardware. If we make an analogy between Comsat and AT&T our center's role will not be comparable to that of Western Electric; in both the nature and the quality of the work, it will be more like that of the Bell Telephone Laboratories."

But Pritchard points out that "production" is a hard word to pin down in the aerospace field. He hopes the labs will, for example, build or at least integrate research and development satellites. As for operational satellites, he says: "We wouldn't, for example, build Intel-

sat 5, but we might work on pieces of it and do much of the testing." The prospective situation is much the same for ground stations, says Pritchard. He believes that contracts for operational satellites and ground stations will always be awarded to outside suppliers. And he says: "It is my belief that as the labs grow, they will continue to generate more and more outside work as more projects are undertaken in-house."

Mission control

The labs' job, according to Pritchard, is threefold: advancing communications satellite technology and developing new uses

for it; supporting communications satellite programs; and providing the company with back-up knowledge for procurement of development, manufacturing, and related services.

Pritchard points out that these missions relate to Comsat's roles as a member of the International Telecommunications Satellite Consortium, manager for Intelsat, manager of the U.S. Earth Station Owners Consortium, and a U.S. corporation. Says Pritchard: "Comsat labs is, in short, expected to become an international center of excellence in satellite communications technology."

Piece work. The labs' basic mis-



Logical starting point. Comsat technician checks reallocation-logic section of an experimental time-division multiple-access system; work on this project will continue at the company's new lab.

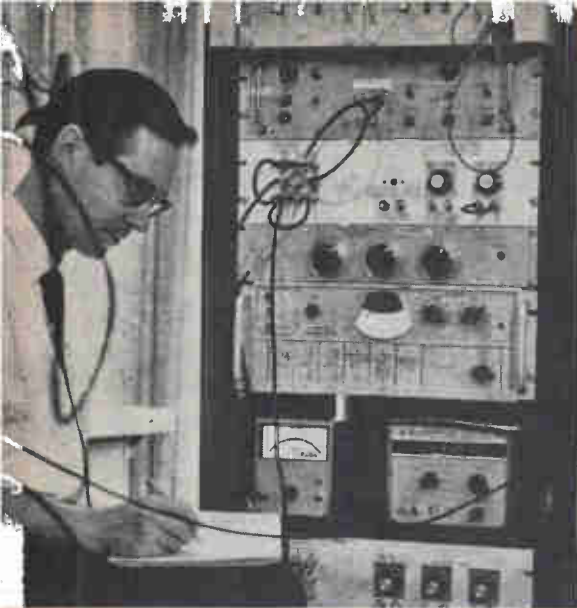

Jury rig. Using a makeshift test setup in the company's temporary quarters, Comsat engineer checks performance of an f-m ground-station demodulator.

sions will be carried out by the six original units, whose responsibilities break down as follows: communications processing, spacecraft, r-f transmission, systems integration, systems analysis, and physics. Pritchard points out that this setup will cover every field of technology pertinent to communications by satellite. Certain other areas, such as space physics and light-alloy techniques, will be kept under surveillance.

The labs will make a major effort in several fields, one of which is fully variable demand systems. There are two versions: one for larger nations with large-scale communications requirements that change daily, the other for smaller countries needing only one to 12 circuits. A time-division, multiple-access system is slated for the former and a single-channel-per-carrier setup for the latter.

In the time-division system, national variations in peak demand will be exploited so that burst-rate assignments can be changed constantly. The smaller system will use a pool of carrier frequencies, spaced just far enough apart to allow one phase-modulated voice channel. All stations in the international network will be linked by a common time-division routing channel. Every station will need a modem and frequency synthesizer to tune to any channel; a station with a dozen modems will be able to talk with a like number of countries in the network.

Both projects are being pushed for Intelsat application during the 1970's. The scheme for smaller nations will be tested early next year in Puerto Rico and the United Kingdom with existing spacecraft; the time division setup will be checked later in the year. Both projects are being funded through Intelsat; the system for the smaller nations is being geared for use with Intelsat 3, the other for Intelsat 4. In its capacity as Intelsat's manager, Comsat contracted this month with Centro Studi e Laboratori Telecomunicazioni of Turin, Italy, for a study of the technical, economic, and operational aspects of time-division multiple-access systems for Intelsat 4.

New bird. Another area in which all six labs will become increasingly involved is millimeter-wave technology. Pritchard believes that the use of higher frequencies is inevitable and says the time is now ripe for studying the field. The labs will participate in millimeter-wave experiments that will ride with NASA's Applications Technology Satellite E, developing such items as transponders and earth-station equipment. Pritchard adds: "We will probably develop—or have developed—an experiment millimeter-wave satellite for the 1970's."

A spacecraft could be ready as early as 1972. But Pritchard says many questions must be answered before work on the experimental satellite actually begins. One involves the booster for Intelsat 4; if it's big enough, the R&D bird could go up piggyback. If not, lining up another booster will be a problem.

Ground floor

Still another of the labs' preoccupations, Pritchard says, will be new hardware and techniques that could lead to the development of small, low-cost ground stations. This investigative work will, he says, widen the market for communications satellites services. Pritchard won't be specific on what a ground station might eventually cost but does say Comsat is aiming at facilities with price tags of "several hundred thousand dollars" that require a minimum of real estate and can operate almost unattended. Extensive domestic systems for countries like Brazil are but one

outlet for such technology. Since the labs systems analysis group is looking at advanced areas in broadcasting, navigation, and data gathering for communications satellites, low-cost stations would, of course, make new ideas more feasible.

Of the host of other areas the labs will be hitting hard during the next few years, none is as technologically broad as demand systems, millimeter waves, or low-cost ground terminals. The labs will work on specific hardware items—for example, wideband, low-noise receivers. Echo suppression and data compression will also get a lot of attention. Satellites themselves will also be studied, with deployable antennas, primary power supplies, and solar cells all on the list.

Going outside. Pritchard says the labs plan to increase outside contracting for rechargeable fuel cells in the near future. He also notes a growing interest in electrical propulsion systems, which would not only act as station keepers for a satellite but also serve to bring it from a parking to synchronous orbit. And, noting another new area of interest, Pritchard says, "We'll get going soon on lasers, checking theoretical aspects as well as hardware."

Pritchard won't say how much will be spent in each area but does suggest that the push will be strong, because of economic considerations. In data compression, for example, any sort of progress would represent a "financial bonanza" for Comsat and Intelsat. In



Downplayed. W.L. Pritchard, who heads the new Comsat complex, says it is a research, not a production, facility.

The way the money goes

Comsat's six laboratories are doing a lot of R&D for Intelsat; roughly half their efforts fall into this category. Should the company be confirmed as Intelsat's permanent manager after next year's negotiations, the outlook would be for stepped-up activity. At the moment, 14 programs, worth more than \$2.5 million, are being pursued at the labs:

- Development of a multiple-carrier performance monitor to measure earth-station radiation (\$267,000), a prototype pcm time-division multiple access system (\$725,000), and a prototype single-channel pcm frequency-division multiple-access system (\$346,000)
- Microwave studies covering, among other things, solid state diodes, r-f transistors, and ferrite devices (\$66,000) and space environment studies of radiation effects on the performance of various satellite elements (\$85,000)
- Research and development of techniques and devices for positioning spacecraft in orbit (\$175,000) and technology for such long-life mechanical devices as bearings and slip rings (\$240,000)
- Design studies for lightweight spacecraft (\$60,000), investigation of transmission delays, echo and echo-suppression techniques (\$200,000), and research and development of spacecraft electrical power generation, storage, and distribution (\$215,000)
- Studies in demand assignment (\$100,000), systems simulation (\$87,000), systems integration (\$72,000), and spacecraft thermal phenomena (\$145,000).

communications satellites, he says, compression ratios of 2:1 (as against the 6:1 levels sought in other fields) would be significant. A system wouldn't have to be low-cost nor would there be much corporate reluctance to spend a great deal of money on development. Thus, for a compression system that could halve the 1,200 voice circuits needed to transmit television to Europe, \$1 million or so could be spent, Pritchard says, since 600 circuits, which cost thousands of dollars a month to lease, would be freed.

Another tack

Pritchard is quick to point out that R&D is not the labs' sole mission. Assuring reliability of continuing programs is a major task. In fact, the business of reliability extends all the way from the physics laboratory, where new techniques and developments in semi-conductor technology are extractor supplying spacecraft. For example, work at the Hughes Aircraft Co. on the Intelsat 4 will be monitored at the plant by lab employees. At the same time, parallel development of certain crucial satellite elements will be conducted at the Clarksburg complex.

Each of the six labs is guided by its own manager. Two that will concentrate on advanced elec-

tronics are the r-f transmission lab, directed by Louis Pollack, and the communications processing lab, headed by John Puente.

Both are concerned with the larger technical issues outlined by Pritchard, but each has additional missions and problems to solve. Puente's operation, for example, is broadly concerned with the processing of signals received at an earth station from either a terrestrial link or a satellite. The lab has been involved in the development of demand-assignment systems. "One of our major concerns right now, aside from test and evaluation, is to develop the necessary interfaces within the existing terrestrial network," says Puente. Work is now in progress on signaling, switching, and multiplexing for the systems. Puente's lab is also looking at follow-on projects for the demand systems about to be tested. One long-range program centers on a completely integrated digital network. "We are now addressing ourselves to the problems of converting from analog to digital communications—a development that will come in five to 10 years," says Puente.

Following the leader. Puente's 50 staffers will also be digging into data compression and echo suppression. Puente believes effective echo suppression will pave the way

- ✓ new materials
- ✓ new products
- ✓ new processes
- ✓ new machinery



International Amphitheatre Chicago, Nov. 11-15

Technical Conference on Plastics Developments and Applications

The Plastics Show is the fitting climax to the centennial year of the plastics industry. At the Conference, run in conjunction with the exposition, interesting seminars will cover exciting new plastics applications in industry now, and for the future—automotive, communications, agriculture, construction, home furnishings, appliances, packaging and others, as well as machinery developments and management problems relating to plastics.

Fill out the coupon below for the Conference program and for a rapid registration form to get you in the show quickly and easily.

PLASTICS 100 1868-1968
KEYSTONE OF THE FUTURE

12th NATIONAL PLASTICS EXPOSITION



Sponsored by
The Society of
the Plastics Industry, Inc.

Mail this coupon for rapid registration.

12th National Plastics Exposition
250 Park Ave., New York, N.Y. 10017

NAME _____

COMPANY _____

ADDRESS _____

CITY _____

STATE _____

ZIP _____

ECCOSHIELD® RF SHIELDING MATERIALS



NEW FOLDER

Electrically conductive self-sticking tapes, metal foils, conductive fabrics, sealers, spray-on coatings, lubricants and adhesives to combat EMI/RFI. All are fully described. Send for FREE copy.

Circle 217 on reader service card

LOW DENSITY HIGH STRENGTH MATERIALS

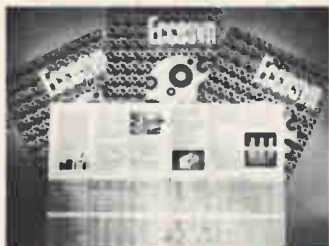

Eccosyn Syntactic Plastics are unique in the world of materials! Provide low density, high strength-to-weight, ideal for aerospace, hydrospace and structural uses. Casting resins, pack-in materials, adhesives and other are described in new literature.

Circle 218 on reader service card

NEW, COMPLETE DATA ON ECCOSORB® "FREE-SPACE" MICROWAVE ABSORBERS



Physically/electrically-tapered "building blocks" for anechoic chambers; conformable, flexible foams to reduce radar cross-section. 12 different high-performance types are described in new bulletin.

Circle 219 on reader service card

Emerson & Cuming, Inc.



CANTON, MASS.
GARDENA, CALIF.
NORTHBROOK, ILL.
Sales Offices
in Principal Cities

EMERSON & CUMING EUROPE N.V., Devel, Belgium

Post-1968 shopping list

The Interim Communications Satellite Committee represents all Intelsat nations in matters of policy and procurement until such time as the permanent arrangements are made. Recently, the ICSC identified studies, advanced hardware, and off-the shelf equipment which Intelsat will need in 1969 and beyond. Assuming that Comsat retains its job as Intelsat's manager, most of the work will be done at the company's new labs. The list, though still somewhat tentative, provides an indication of the direction of the consortium's R&D program. A sample of planned hardware development efforts includes: a medium-power traveling-wave-tube amplifier; microwave components for use on spacecraft, including diodes, oscillators, switching elements, and amplifiers; electric thrusters for spacecraft attitude control and stabilization; a prototype solid-state satellite command receiver; a power-drain sensor; a disk-memory simulation system; selective-attenuation echo suppressor; a regenerative fuel cell system; and advanced horizon-sensor gear.

for efficient communications for single, double, and even triple hop circuits in the future. Another pre-occupation of the lab will be signal processing on spacecraft; Puente believes that such functions as switching, modulation transfer, and telemetry transfer can be handled right in the satellite. His engineers and scientists will also be working on new modulation schemes and an integrated telemetry and command system for all communications satellites, as well as examining new means for more effective propagation. Meanwhile, a subgroup, known as the communication theory branch, will investigate long-range developments in communications.

Radioland

The r-f transmission lab is responsible for improving transmission efficiency. Space-borne transmitters, receivers, antennas, and modems are among the equipment slated for attention. Pollack says the 40 or so people working in the lab are now concentrating on three areas: earth station r-f techniques, antennas, and satellite r-f techniques. Antennas are a key area, he says; by 1970 Intelsat will need directable multiple-beam units for spacecraft to cover a number of ground stations. During the 1970's there will be a need for a sort of universal dish that can cover more than one spacecraft. Right now, an extra dish must be added for each satellite in an earth station works with.

And next year, Pollack expects his lab to begin working on laser communications projects. "We'll

start with preliminary, limited studies," he says. "But they'll be geared to determining just how laser communications systems will fit into future programs."

Big picture

Several question marks facing Comsat impinge on the future of the labs. A proposed domestic satellite system for the U.S. and an aeronautical services system—both now in limbo—could substantially increase the work load at the labs if they are ever approved. Corporate or Intelsat decisions on whether to get into such areas as direct-broadcast satellites and remote satellite sensing would also have an impact.

The biggest question over the short run will be answered next year as the permanent agreements for the Intelsat Consortium are negotiated. If, as most observers predict, Comsat stays put as manager, the labs will have a secure mandate as an international center for communications satellite technology. Should the company's managerial role be denied or curtailed, the labs' international aspect will be in eclipse. Currently, the labs are doing a lot to demonstrate good faith to Intelsat members. A number of foreign engineers and technicians are working in the labs, and several Intelsat contracts—for example, the one for the Intelsat 4 time-division study—have recently been awarded abroad, with more in prospect. With Comsat as permanent manager, Pritchard predicts increasing participation by other nations in the work of the labs.

increase ic yield



With Coors microceramics. Parts and complete packages. Of alumina and beryllia. Strong, chemically inert, dimensionally stable. Unaffected by age or environment. Part-to-part uniformity from 1st to nth. Precision-ground or as-fired surfaces. Easy to metallize, by you, by us. Most any size, any shape. Fast delivery. Prototype quantities, millions, or anything in between. Get higher yield, more profit. Start with the most reliable circuit packaging. Coors microceramics. Send for data pack.

Coors Porcelain Company
Golden, Colorado 80401

Coors CERAMICS

Circle 137 on reader service card

We've got them!

741

Operational Amplifiers

and we have them in quantity.

Features:

Short circuit and overvoltage
proof

Internally compensated

Direct electrical and pin
replacement for 709 and LM101



AMELCO SEMICONDUCTOR

A TELEDYNE COMPANY

1300 Terra Bella Ave • Mountain View • Calif. 94040



Election issues for electronics

Humphrey and Nixon may not represent great divisions in national opinion, but there are differences in their approach to military and space spending

The difference between Richard M. Nixon and Hubert H. Humphrey may amount to no more than a "dime's worth" as far as third-party candidate George C. Wallace and his supporters are concerned. Nonetheless, their approaches to the Presidency would be dissimilar, and the distinction is significant for electronics concerns supplying Government agencies, particularly those in the defense and aerospace fields.

Though there are many if's, it appears likely that strategic weapons systems and military research and development, to take a couple of examples, would fare better under a Nixon Administration. The space agency, however, might find itself on short rations no matter who wins next week's election.

But much depends upon the makeup of the Congress. Should Humphrey win while his party loses its majority in the House, an across-the-board impasse could develop. The outlook is similar if Nixon is elected and the Democrats keep control of the lower chamber. (The Democrats' hold on the Senate is secure.)

External pressures. And no matter which man is elected, appropriations sentiment could be roused by such events as an intensification of the Vietnam War, advances in Soviet or Chinese military strengths, Russian space or oceanographic spectacles, or new brushfire conflicts. "There are too many possibilities," says a Congressional aide. "Nobody on the Hill is making any predictions."

But when it comes to assessing the Presidential candidates' basic philosophies of military power and its relationship to foreign policy, would-be seers are on surer ground. Both Nixon and Humphrey favor

resuming negotiations at the summit in an attempt to iron out East-West differences and slow the arms race. But Nixon wants to deal with Moscow from a position of superiority rather than parity. He would encourage a buildup in U.S. strategic power; in particular, he would have the nation revitalize and expand its military research and development to forestall the weapons science and technology "gap" he fears is developing.

He would, for example, proceed with deployment of the Sentinel antimissile system, justifying the move as necessary to catch up with the Soviets' lead in missile defense. The danger of Chinese missiles—the original rationale for deployment—would be a secondary consideration with Nixon since the threat won't be a real one until the mid-1970's. Nixon would step up the "nuclearization" of the Navy and close what he calls "the widely acknowledged submarine gap vis-a-vis the Soviet Union."

Walking softer

Humphrey takes a different tack. He feels the fact that the Soviets have nearly matched U.S. nuclear strength—at least in quantitative terms—and now have a greater feeling of security, making them more amenable to arms-control measures. He would give high priority to arranging as early as possible talks on limiting offensive and defense weapons, ending all nuclear testing "under adequate safeguards," and controlling chemical, radiological, and biological weapons.

He contends that Nixon "does not share my commitment to control of the arms race." He feels that the U.S. arsenal of 1,000 Minuteman missiles, 656 Polaris mis-

siles, 600 long-range bombers equipped with 2,200 nuclear weapons, and several thousand additional tactical nuclear warheads in Europe "is many times over what we would ever need."

First step. Humphrey has not disassociated himself from the Johnson Administration's decision to install the Sentinel antimissile system. But he views the Sentinel as a limited defense against China's budding nuclear power. Before expanding it into an anti-Russian system, he wants to try for a U.S.-Soviet agreement not to deploy missile defenses against each other.

Nixon's insistence on nuclear superiority emphasizes expanded military research and development. Democratic Administrations, he charges, have been "hobbled by the static philosophy that technological potentialities are limited—that we have reached a plateau." Last year, he says, the Soviet Union for the first time spent more on research and development than the U.S.

"Thanks to rapid scientific and technological advances," Nixon says, "Moscow now commands a full panoply of offensive and defensive strategic weapons, including an orbital nuclear delivery capability, ever-improving tactical military equipment, modern communications facilities, surface naval and merchant vessels, and a large number of swift and quiet nuclear-powered submarines. Together, these advances could—if we stand still—ultimately make the Soviet Union militarily dominant."

Running scared. Nixon finds it "alarming" that "by the time the next President takes the oath of office, the Soviet Union will have drawn abreast of the United States in the number of land-based inter-



continental missiles—a truly stunning reversal of its inferior strategic position at the time of the Cuban missile crisis in October 1962.” He cites “reliable estimates” that the Soviets are spending more than the U.S. on strategic weaponry—“perhaps several billion dollars more annually, a massive outlay for a nation with an economy only half the size of ours.”

Nixon also notes that “while the Soviet Union continues to graduate twice as many scientists as the U.S., the American scientific community is demoralized by the present Administration’s wavering attitude toward research and development.”

During the Eisenhower Administration, R&D funding grew by an average of 15% a year, says Nixon. “But at the end of the present Administration, while world scientific knowledge continues to grow at a rate of over 10% annually, inflation, spurious economy moves, and basic policy miscalculations are effectively reducing U.S. research funds every year.” He charges that the decline in science

Question marks. Space agency officials are nervous about how well their pet projects would fare under both Nixon, shown inspecting the retired Gemini 5 spacecraft, and Humphrey, below in a lunar landing research simulator.



education “is the most damaging indictment of the present Administration policy,” noting NASA has cut the number of its graduate student grants from 1,300 to 50; the Defense Department has cut aid to colleges by \$30 million; the National Sciences Foundation budget has been decreased by one-fifth; and National Institutes of Health funds have been reduced by an estimated 25%.

Specific remedies

Nixon calls for more efforts to realize the laser’s potential for building tunnels, vaporizing coal, intercepting missiles, and providing space communications. He also wants more antipollution research and intensified work to increase computer applications for industrial productivity and relief from drudgery.”

Implicit in Nixon’s position on military R&D are possible go-aheads for a new manned bomber, a new generation of land-based intercontinental missiles, a missile-launching submarine beyond the Polaris class, as well as greater exploitation of the military uses of space and stepped-up research toward a more effective missile defense system than Sentinel.

On space. Along with motherhood and the American flag, both Nixon and Humphrey appear to favor space projects. To what extent, however, is another matter. As Vice President, Humphrey is chairman of the National Space Council. But as recently as three weeks before the election, he did not have a formal position paper on space. It can be surmised, though, that he would support ongoing projects but probably no spectacular new programs like a manned Mars mission. One reason Humphrey might not be willing to push an expensive space program would be his desire to channel as much money as possible into urban and related societal problems on the domestic scene.

Officials at NASA feel they could live with Humphrey. They aren’t at all certain about Nixon, however. He has a history of vacillation in this field. “At the Republican National Convention he said the space budget can be cut,” says a top official. “In a speech in Houston the other week he said the U.S. must be first in space. You

New...RCA-2N5497 Family Extends Your Current Choice in TO-66 Plastic Power Transistors to 3.5 A

Ruggedness, versatile configuration, high power density—these are key features of RCA's recently announced 2N5490 through 2N5497 n-p-n transistors in the highly reliable "plastic TO-66 package." Intended for a wide variety of medium-power switching and amplifier applications, this new family augments previously announced types 2N5293 through 2N5298, and extends RCA's total current handling capability with good gain over the range from 0.5 to 3.5 A...power dissipation from 36 to 50 watts.

These new power devices provide top performance. RCA mounts the silicon chip directly onto a solid copper base for better current handling, improved thermal resistance, and dissipation capabilities. Also, all units provide designs with freedom from second breakdown—the inherent advantage of RCA hometaxial-base technology.

Check the chart. For more information, see your RCA Representative or your RCA Distributor. For technical data on specific types, write: RCA Electronic Components, Commercial Engineering, Section IN-102, Harrison, N. J. 07029.

TYPE	$V_{CEr}^{(sus)**}$	h_{FE}
2N5293+	75 V	30-120 @ $I_C = 0.5$ A, $V_{CE} = 4$ V
2N5294+		
2N5295+	50 V	30-120 @ $I_C = 1$ A, $V_{CE} = 4$ V
2N5296+		
2N5297+	70 V	20-80 @ $I_C = 1.5$ A, $V_{CE} = 4$ V
2N5298+		
2N5490*	50 V	20-100 @ $I_C = 2.0$ A, $V_{CE} = 4$ V
2N5491*		
2N5492*	65 V	20-100 @ $I_C = 2.5$ A, $V_{CE} = 4$ V
2N5493*		
2N5494*	50 V	20-100 @ $I_C = 3$ A, $V_{CE} = 4$ V
2N5495*		
2N5496*	80 V	20-100 @ $I_C = 3.5$ A, $V_{CE} = 4$ V
2N5497*		

* $\theta_{J-C} 3.5^\circ\text{C/W max.}$

* $\theta_{J-C} 2.5^\circ\text{C/W max.}$

** $R_{BE} = 100$ ohms



... both Nixon and Humphrey would push efforts in oceanological research ...

can't tell where the guy stands." Some top planners in NASA are worried—privately, of course—that a Nixon victory could result in sharp cutbacks in space efforts; there's speculation that he would cut the agency's budget by \$1.5 billion from its current figure of just under \$4 billion.

Change of heart. But judging from statements late in his campaign and word from his staffers, it now appears that Nixon is a stronger supporter of space work than Humphrey. In addition, he is more solidly behind military space programs than Humphrey. However, it's unlikely he would try to sell Congress on any new multi-billion-dollar programs like Apollo.

Until his Houston speech, Nixon had come out strongly only for a boost in military space activities. And there is concern at NASA that he might want to follow up on previous Republican Congressional proposals that military and civilian space efforts be combined "to avoid duplication of efforts." Humphrey is strongly opposed to this suggestion; he wants the two areas clearly separated.

Humphrey would probably step up the nation's efforts in oceanology. As Vice President, he's chairman of the National Council on Marine Resources, and he has spoken far more often on oceanology than on space. There is little doubt that he would push such programs, but he would probably stop short of trying to establish a "wet NASA."

Nixon can also be expected to push oceanological efforts. But he has never made his plans definite. He has plenty of criticism for the Administration's efforts in this field.

Professional interest

Washington-headquartered industrial trade groups such as the Electronics Industries Association and the Aerospace Industries Association don't take a stand on candidates or parties. But insiders at these organizations will privately concede a preference for Nixon. Says a source at the EIA: "We might live a little better with Nixon—and live real well with

Nixon and a Republican Congress."

This view is unofficially echoed at the AIA. "Nixon is a friend of industry. Not that Humphrey is an enemy," says a source there. "What I'm worried about is having Nixon win with a Democratic Congress. The squabbling would be no good for anyone. It would be better with Humphrey and a Democratic Congress in that case."

Up in the air. Nixon won the hearts of the aviation and transportation industry early in his campaign when he took a strong stand favoring swift action to increase airport facilities. He proposed establishing a trust fund of user charge contributions to pay for new and extended runways and terminal facilities. At the same time he picked up support by pledging to strengthen the air traffic controller force and "improve their working conditions and provide them with the new equipment they need to keep our airways safe."

Nixon also says he has "serious questions about the absorption of the FAA into the new Department of Transportation; the assimilation would be studied closely by the independent blue-ribbon commission he promises to appoint to survey the whole executive branch set-up. And Nixon hints that the FAA might get back some of the autonomy it yielded when DOT was formed early last year.

Humphrey hasn't said much on transportation beyond echoing the party platform that Federal programs should be expanded to assist mass transit and cut down air congestion.

Lee or Lee. The communications industry can expect one thing as a result of the election: no matter who wins, there's a good chance that the next chairman of the Federal Communications Commission will be named Lee.

If Nixon is elected, he is likely to allow Rosel Hyde (a Republican) to serve out his term, which expires next June. It's expected that Hyde—who has been with the FCC since it was set up in 1934—will want to resign then. Nixon would probably elevate Robert E. Lee (also a Republican) to the

SINCLAIR'S YAGI ANTENNAS

RUGGED RELIABILITY... WHEN IT COUNTS!

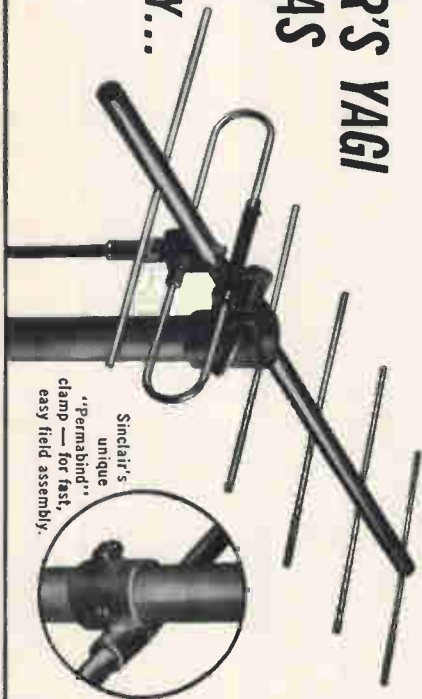

Sinclair's unique "PermaBind" clamp — for fast, easy field assembly.

Sure, most UHF-VHF yagi antennas function effectively — when the weather's good! It's when the wind starts to howl and the weather turns from bad to worse that the unmatched rugged reliability of a Sinclair Yagi really counts. Every standard Sinclair Yagi is designed to withstand 110 mph winds with a 1/2" radial ice coating. An integral part of this rugged construction is Sinclair's unique "PermaBind" clamp that makes for fast, permanent field assembly.

Standard Sinclair Yagis are available in a wide frequency range from 30Mc. to 470Mc. . . . gains from 6.5db to 17.0db . . . power ratings up to one KW. Send coupon today for complete FREE literature and prices.

676 ENSMINGER RD. P. O. BOX 23
SINCLAIR RADIO LABORATORIES, INC.
 TONAWANDA, NEW YORK

FREE LITERATURE

TO: SINCLAIR RADIO LABORATORIES, INC.
 676 Ensminger Rd. P. O. Box 23
 Tonawanda, New York 14150

Name: _____
 Title: _____
 Company: _____
 Address: _____
 City: _____
 State: _____ Zip: _____

we've added another to the series

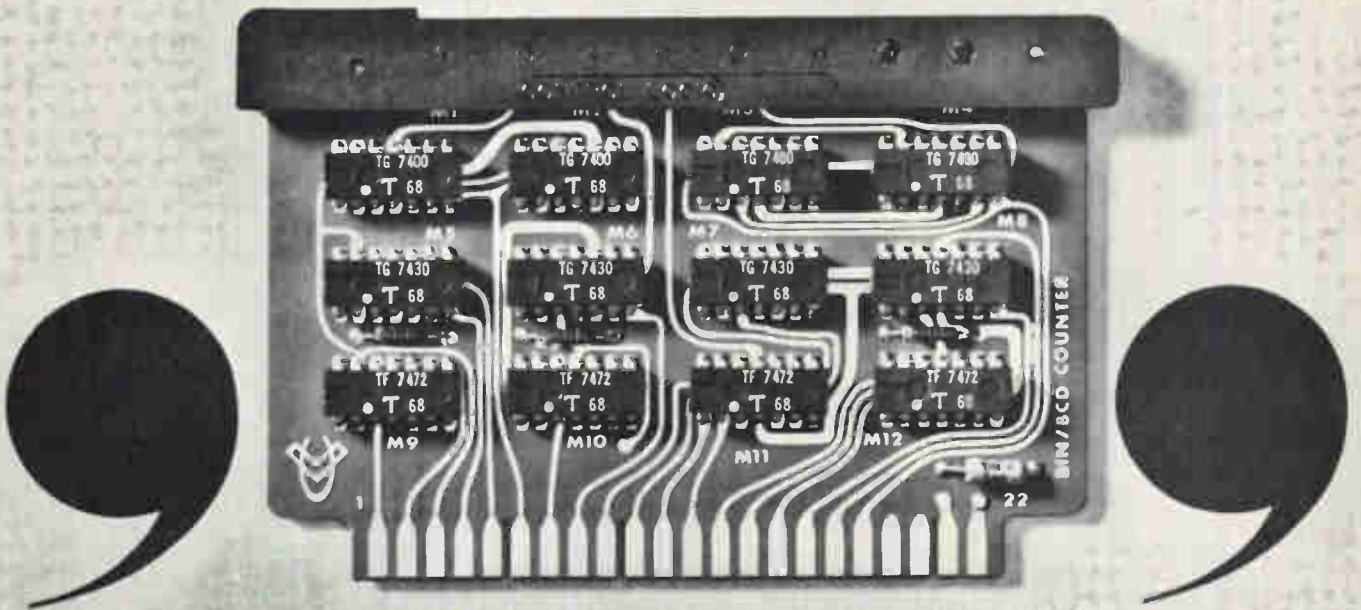

The 7400 T²L, our latest micro-logic circuit card. How did we do this? We just placed a comma after our last development, the automatic wire-wrap assembly. The series now looks something like this: T²L SUHL I, T²L SUHL II, DTL, AW, 7400 T²L, and . . . We've placed a comma after the 7400 because we're not done yet. Write or telephone for more information about our methods of punctuation.

 CONTROL LOGIC, INC., 3 Strathmore Rd., Natick, Mass. 01760 • 617/235-1865.

Our electron-beam systems can evaporate and deposit any material



Including elements, alloys, refractory metals, compounds and mutually insoluble materials.

When it comes to physical vapor deposition, electron-beam technology has proved itself superior to any other evaporation method in the most critical areas: controllability, reliability, capacity to provide high evaporation rates and ability to cope with any material to be evaporated.

- Only the surface area is heated to evaporation temperature.
- Crucibles are made of water-cooled copper.
- Evaporation rates are 100 to 10,000 times higher than are attainable by older evaporation methods.
- Rapid rates yield high-purity coatings at pressures as high as 10^{-5} Torr.
- Newly designed source-feeding systems permit continuous operation.
- Alloy deposition can be controlled precisely in either single- or multiple-gun operations.
- Self-accelerating electron-beam guns are available with 180° and 270° beam-deflection systems, in sizes from 3 KW upward.
- Solid-state power supplies are available from 3 KW upward.

Why settle for less? Write for your free copy of our new 12-page brochure, "The Electron Beam and Evaporation."

AIRCO Temescal

A DIVISION OF AIR REDUCTION COMPANY, INCORPORATED
2850 Seventh Street, Berkeley, California 94710 Telephone 415 841-5720

chairmanship. Lee is a strong backer of uhf tv. He would probably continue to push it as chairman—at the expense of cable television expansion.

If Humphrey were elected, he would also keep Hyde as chairman until his retirement. At that time he would probably name as chairman H. Rex Lee, who was just this autumn named to the Commission.

How the FCC fares under the next Administration will depend to a great degree on the recommendations made by the President's Task Force on Communications. Agency staffers expect them to be acceptable to both Republicans and Democrats. President Johnson has attempted to keep the task force nonpartisan and it's likely that the new President would probably trade on the results of the report. "Any Administration can recognize that communications policy is now a mess," says an FCC staff member.

Gangbusters. With so much campaign oratory devoted to the law-and-order issue, Capitol Hill observers say that no matter who gets elected, there ought to be quite a bit of business in lawman's hardware. "The boys will have to back up their talk with something the public can see," says a Justice Department source. "And the public can plainly see policemen, prowl cars, fancy radios, and other gadgetry." Both parties see eye-to-eye on the need for research into crime-fighting and substantial Federal funding to help state and local governments improve their police departments.

In two other areas where Government funding is important to the electronics industry—medical care and education—the Republican stance is not quite so positive. Nixon doesn't even have a staffer acting in a "shadow cabinet" role for such matters. The Nixon staff members who "cover" this area won't say much—except that the amount of funding probably wouldn't significantly differ from that spent by the Democratic Administration. The approach would probably be different, though. Nixon would emphasize matching arrangements to return more control to local agencies, and this could greatly slow efforts to establish computer-aided or controlled regional or national systems.

BOURNS NEW MODEL 3111 MIL-SPEC RELAY

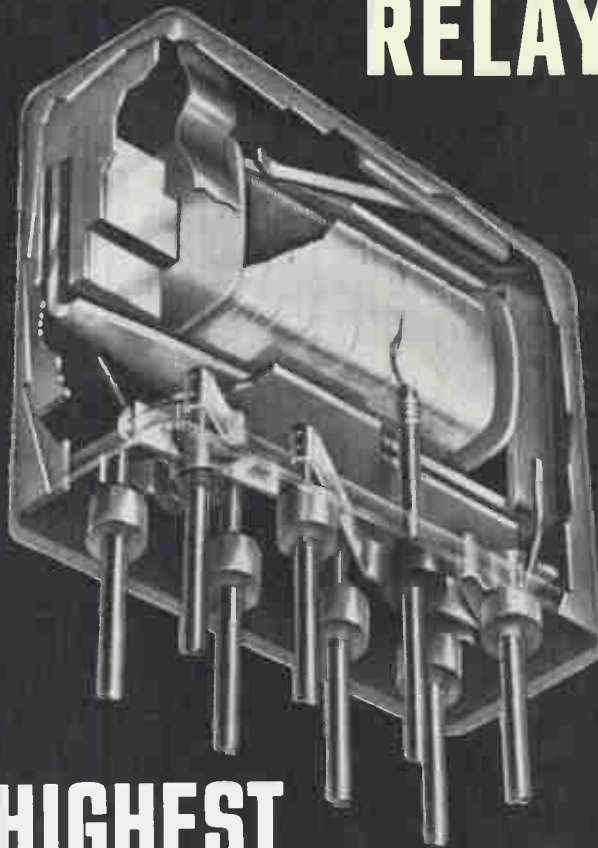

HIGHEST PERFORMANCE YET AVAILABLE

The Bourns Model 3111 TRIMPOT® Relay is a high performance, 1.0 ampere, DPDT unit that answers the demand for higher reliability and greater miniaturization. It is hermetically sealed in a 1/6 crystal can, with convenient 0.1" grid pin spacing.

The Model 3111 has an operating temperature range of -65 to +125°C. Contact rating is 1.0 ampere resistive at 28 volts D.C., with a pickup sensitivity of 130 milliwatts. Operate and release time is 4 milliseconds maximum. This model also features a self-damping return spring and balanced armature design assuring excellent shock (50G) and vibration (20G) performance. All requirements of MIL-R-5757 are met or exceeded by the Model 3111. And its price is just \$13.34*.

For further data and detailed specifications, contact your nearest Bourns sales office or representative, or write the factory direct.

* 500-piece unit price



SPECIFICATION TABLE

Size:	.23 x .50 x .40
Pickup Sensitivity:	130 milliwatts
Contacts: DPDT; Rating:	1.0 ampere at 28 volts D.C.
Operating Temperature Range:	-65 to +125°C
Standard Coil Resistance:	70 to 1500 ohms
Shock:	50G
Vibration:	20G
Life:	150,000 cycles
Pin Spacing:	0.1" grid



BOURNS, INC., TRIMPOT PRODUCTS DIVISION
1200 COLUMBIA AVENUE, RIVERSIDE, CALIFORNIA 92507
714 684-1700 • TWX: 910 332-1252 • CABLE: BOURNSINC

Circle 145 on reader service card

RCA Solid-State Data for Designers



Chart Your Way to Fast Switching — RCA "TD-II" Tunnel Diodes Can Switch at From 100 to 1800 ps

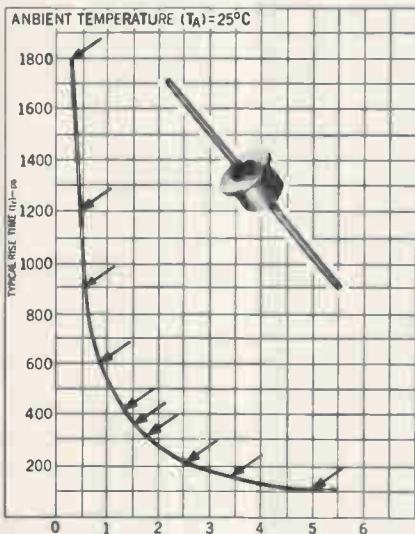

Type	I _p (mA)		I _p /I _v	C (pF)		tr (ps)	I _p /C (mA/pF) Typ.
	Min.	Max.		Min.	Max.		
40561	4.5	5.5	6/1	25	1800	0.25	
40562	9	11	6/1	25	900	0.55	
40563	18	22	6/1	30	600	0.85	
40564	45	55	6/1	40	350	1.45	
40565	90	110	6/1	40	150	3.35	
40566	4.75	5.25	8/1	15	1200	0.45	
40567	9.5	10.5	8/1	15	600	0.85	
40568	19	21	8/1	20	400	1.27	
40569	47.5	52.5	8/1	25	200	2.5	
40570	95	105	8/1	25	100	5	
40571	4.75	5.25	8/1	8	600	0.85	
40572	9.5	10.5	8/1	8	300	1.67	
40573	19	21	8/1	10	200	2.5	
40574	47.5	52.5	8/1	12	100	5	

The most reliable high-speed tunnel diodes you can design around—combining speed with reliability and hermeticity—are the RCA "TD-II" family of units. Type numbers from RCA 40561 to 40574 (axial-lead version of RCA types 1N3847 to 1N3860) make up a full line covering the spectrum of your needs. The chart above gives t_r in ps (typ.) and I_p/C in mA/pF typ. Go down the line and find your exact needs!

These units are designed for extremely critical switching and signal-processing applications requiring tight control ($\pm 5\%$) of peak-point currents and rise times as fast as 100 ps (types 40570 through 40574).

Types 40566 through 40569 offer $\pm 5\%$ control of peak-point current and rise times as fast as 160 ps. The rest of the family—types 40561 to 40565—offer $\pm 10\%$ control of peak-point current and rise times in the range from 1,800 to 125 ps.

All 14 TD-II types feature RCA's unique epitaxially-grown junctions that have brought a new standard of stability, performance and reliability to tunnel diodes. Leads are gold-plated for soldering efficiency, requiring no pre-tinning. And the package configuration lends itself well to high-volume PC-board mounting operations. Circle Reader Service No. 260 for general line information.

New Design Dimension in 8-A Plastic Triacs: TA7364 Controls Up to 1,000 W, TA7365 Up to 2,000 W



Need to control ac loads in motor speed controls, heat controls, relay protection, light dimmers? Two new plastic triacs—RCA's developmental types TA7364 and TA7365—offer a

number of important circuit advantages, in addition to being small, compact, flexible, and economical.

For example, exceptionally high "static" dv/dt capability gives immunity from false turn-on caused by high noise or high transient conditions found in heavy industrial environments. Increased commutating capability assures reliable operation under heavy inductive loads such as occur in motors, solenoids, and relays. And the high 100 A peak surge current capability offers important protection in applications such as incandescent lighting controls and motor start-up, where inrush currents can be many times higher than the RMS "on-state" circuit.

As a bonus, both the 200-volt TA7364 and the 400-volt TA7365 provide long-term reliability as a result of the advantages of hermeticity made possible by RCA's glass passivation of the chip. They also have low thermal resistance (2.2°C/W junction-to-case) so you can use smaller, more economical heat sinks. And they come in a package that's so easy to mount.

We'll help you with your design problems. Circle Reader Service No. 261 for complete details.

Complement Your Power Designs with Silicon! Design Up to 300 V Capability with RCA PNP and NPN Types

Now you can meet your product needs for complementary designs that feature high-voltage capability. Commercial, military and industrial applications needing high-speed switching or linear amplifier capabilities up to 300 V are ideal for RCA's new 2N5415 and 2N5416 units in TO-5 lead packages. Audio ampli-

fier and industrial power switching circuits call for RCA's 2N5322 and 2N5323... "beefed up" versions of the popular 2N4036.

Check the tabulation for specifications. Then circle Reader Service No. 262 for full details.

There's more coming. Look for low-cost silicon power PNP audio devices with gain up to 1.5 A, P_T of 5 watts. Look, too, for types with I_c 5 A and P_T 45 W...and voltage handling capability up to 75 V.

RCA PNP Type	RCA NPN Type	V _{CEO(sus)} (V)			I _c (A)	P _T * W	h _{FE}	
		PNP Types	NPN Types	PNP Types			@ I _c =50 mA	@ I _c =500 mA
2N5415	2N3440	-200	250	-1	1	10	30-150	—
2N5416	2N3439	-300	350	-1	1	10	30-120	—
2N5322	2N5320	-75	75	-2	2	10	—	30-130
2N5323	2N5321	-50	50	-2	2	10	—	40-250

*for T_c up to 25°C

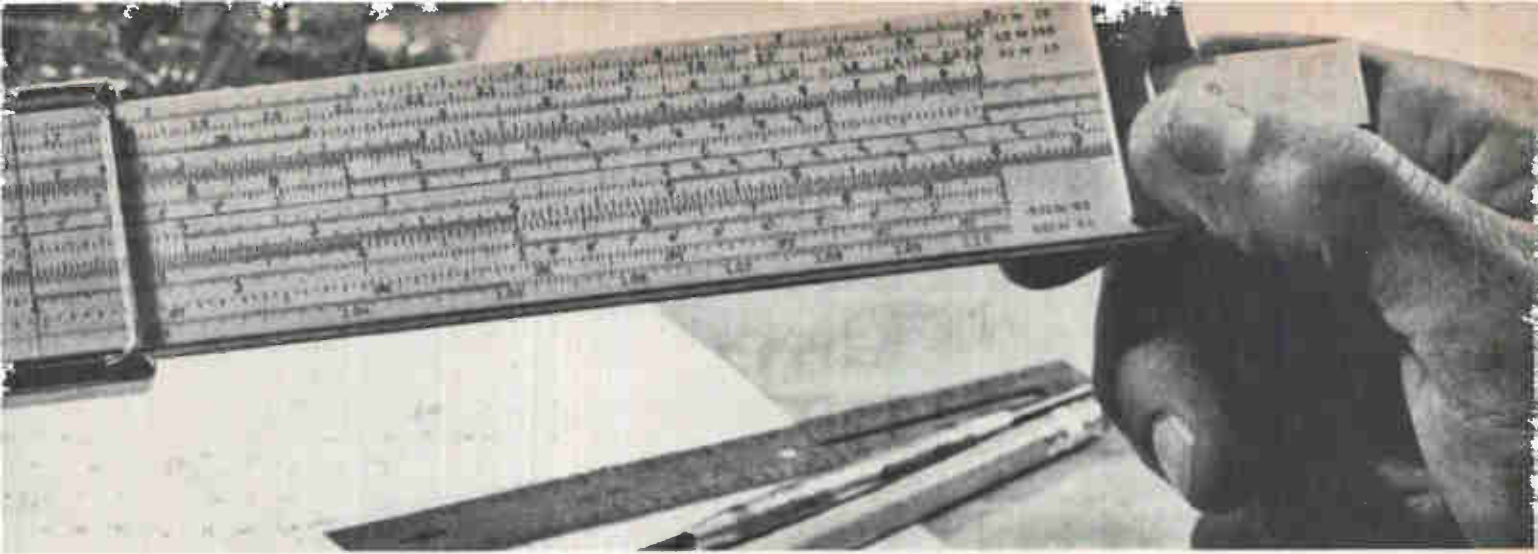

“Building Blocks” for High-Performance, Low-Cost Solid-State Circuitry

PHP

RCA's PHP MAX VALUE Silicon Signal Transistors provide an unmatched combination of Performance, Hermeticity and Price for a broad range of amplifier and switching applications. *Amplifier types*—with prices as low as 19¢ (1,000+ quantities OEM)—let you design up to 500 MHz and be-

yond. They provide low-noise, high-gain, low-capacitance performance over a wide range of voltage, current and power capabilities.

Switching types, with prices as low as 24¢ (1,000+ quantities OEM), combine high-speed performance with a voltage, power and current range covering a large percentage of high-speed switching and core driving applications.

Circle Reader Service No. 263 for cross-reference directory showing 444 industry types PHP MAX VALUE transistors can replace.

RCA CA3028A and CA3028B Integrated Circuits for Versatility and Economy in RF and IF Amplifier Designs

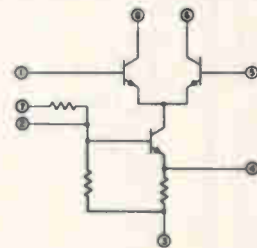

Here's true versatility for your IF designs—and more! RCA CA3028A and CA3028B integrated circuits are ideal for RF and IF amplifier designs; DC, audio and sense amplifiers; commercial FM band converter designs; oscillator, mixer and limiter applications... and much more.

RCA CA3028A is usable from DC to 120 MHz—provides a power gain of 32 dB (typ.) in differential and 39 dB (typ.) in cascode at 10.7 MHz. AGC range is 62 dB (typ.) at 10.7 MHz.

RCA CA3028B offers these big extras: tight control of input offset voltage, input offset current and input bias current for the more critical design uses. At power supply level of ± 12 V, input offset voltage is 5 mV (max.); input offset current, 6 μ A (max.) and input bias current is 80 μ A (max.). Peak-to-peak output voltage swing is 15 V (min.) with $f = 1$ KHz and R_L of 1.6 K Ω . Circle Reader Service No. 266 for full information.

See your RCA Representative for full information on all products shown. Ask your RCA Distributor for his price and delivery. For specific data sheets, write RCA Electronic Components, Commercial Engineering, Section QN-10-2, Harrison, N. J. 07029.

RCA

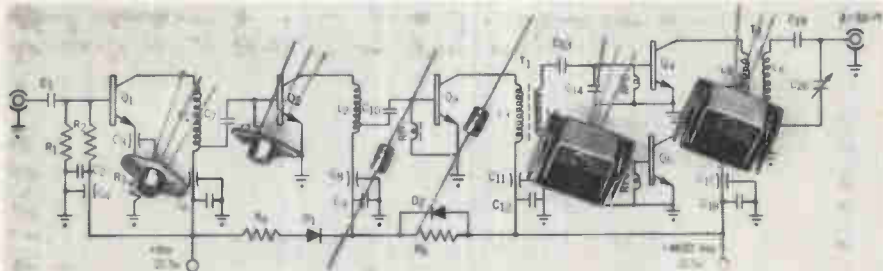

“Overlay” Transistors for Small Size, Big Power Amplifier in Aircraft AM Transmitters

Here is a simple amplifier circuit—designed around RCA “overlay” transistors. Emphasis is on ease of modification, adaptation to meet many needs, ready duplication and a minimum of adjustments in operation. The basic circuit is for a broadband amplifier for AM use in the 118-136 MHz aircraft communication band. The unit operates in low-voltage, high-power Class C service—delivers up to 40 W PEP at 95% modulation from 5 mW of unmodulated input drive, and 12.5 V power supply.

RCA devices used are RCA 1N3193 axial lead silicon diodes and RCA 2N3866, 40290, 40291 and 40292 silicon n-p-n “overlay” epitaxial planar type devices.

For a detailed Application Note, circle Reader Service No. 264

A Simple Way of Measuring the Voltage on a Capacitor Without Significantly Disturbing the Charge!

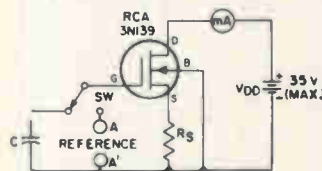

How many times have you wanted to read out the voltage on a capacitor in your circuit without disturbing the charge—or the operation of the circuit?

Here is a simple circuit-solution to the problem. It takes advantage of the high input-resistance and low input-capacitance of the RCA 3N139 MOS FET. This basic circuit may be modified in many ways to provide ultra-low (or zero) effective input-capacitance.

Circle Reader Response No. 265 for more information.

Have you talked to an analyst about your identification problem?

The problems of marking and identifying electrical and electronic components can drive a production engineer right up the old wall. "How can you print several color bands on a miniature diode?" "Is there an ink that'll dry on contact and meet Mil specs?" "How can you get fast, smudge-proof marks on things like ceramics, plastics and chrome?" "How can you simultaneously mark the tops and sides of transistors at high rates of speed?"

A Markem analyst thrives on problems like these. He can help you solve them by supplying the best machines, specialty inks, printing elements and other supplies. He can help by being there whenever you need service, whenever an operator needs training. And he can help by showing you how to get better identification for less money. For example, we recently introduced an Instant Type Former which lets you make metal type in-plant, as needed. No waiting for delivery . . . You can form new type inserts in less than a minute by simply "dialing" the legend.

Have a Markem analyst visit your plant to look into your marking operation. His ideas could save you a lot of grief. And a lot of money. Call your local Markem Sales office or Bernie Toomey at 603-352-1130. Write for our new "Problem Solver" booklet. Markem Corporation, 305 Congress St., Keene, N.H. 03431.

MARKEM®

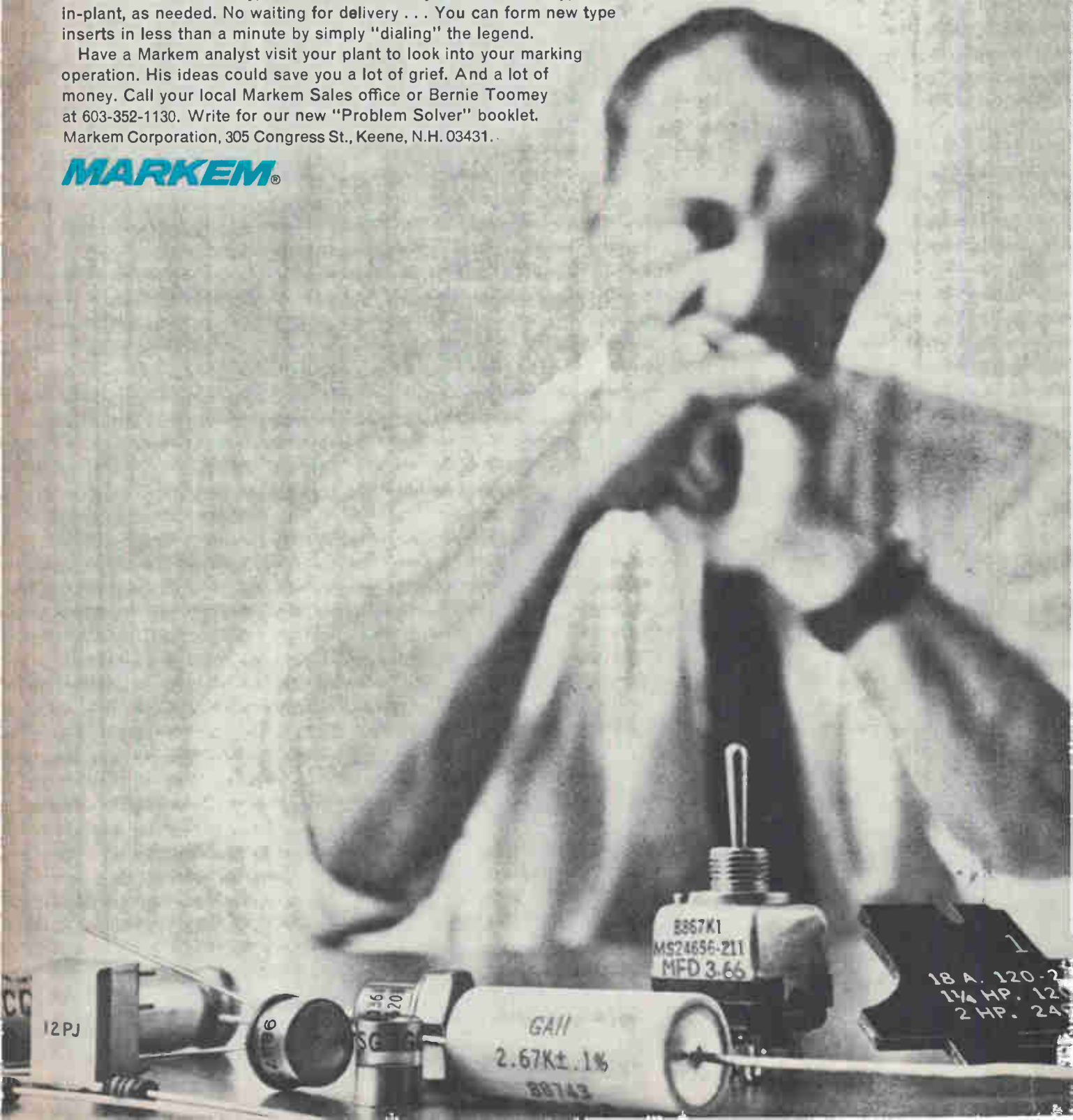

New Products

Instruments

Curve tracer shows scale and beta

Features of transistor tester with digital display may foreshadow significant design changes in many other Tektronix products

By Walter Barney

San Francisco bureau manager

A new generation of transistor curve tracers will be introduced in Boston next week with features that are likely to reappear in most other new offspring of the parent, Tektronix Inc. The instrument company will show the tracer, christened the Type 576, at the Northeast Electronics Research and Engineering Meeting, Nov. 6-8.

The features of the 576 include:

- A digital display of cathode-ray tube calibration, so the user knows the deflection parameters at a glance.

- Automatic calculation and display of beta per division on the crt.

- Performance of both parameter display and beta calculation by nine Tektronix integrated circuits that do the job of about 60 commer-

cial IC's—but aren't complex circuits in the usual sense.

- Use of a new type of cam switch that replaces the conventional rotary switch and reduces torque requirements by 75%.

The most striking difference between the 576 and other curve tracers is the panel of parameter readouts at the right of the crt. The top two displays give vertical and hori-

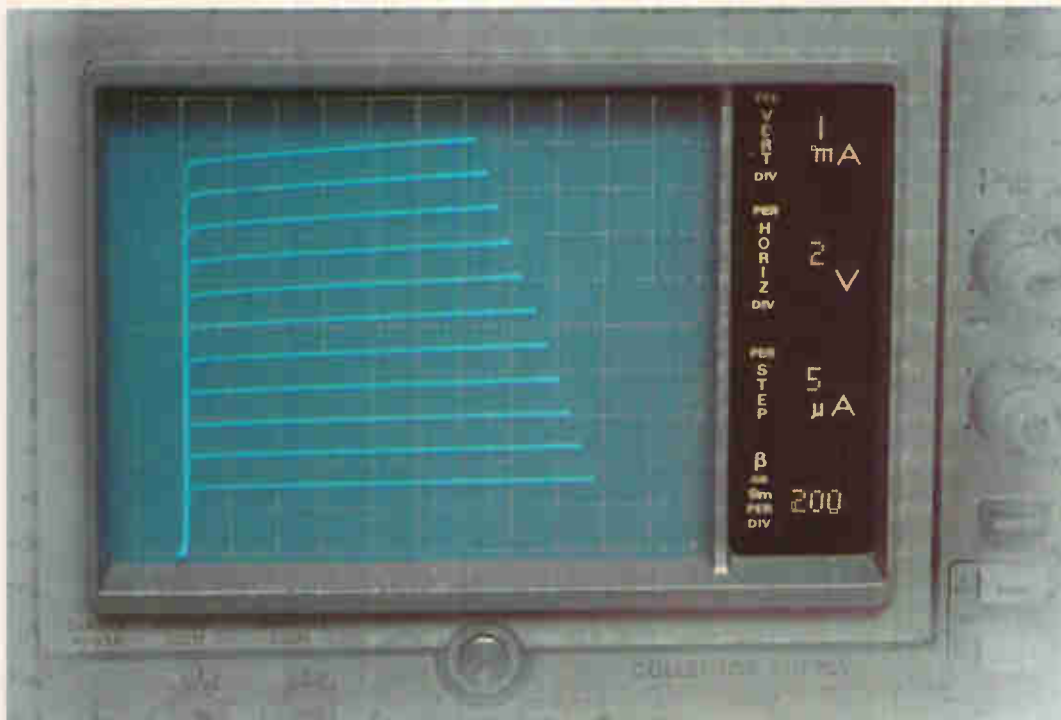

Full disclosure. Transistor performance is spelled out on front panel of curve tracer by digital display of horizontal and vertical scale, increments of input current, and transistor gain, which is calculated by the instrument.

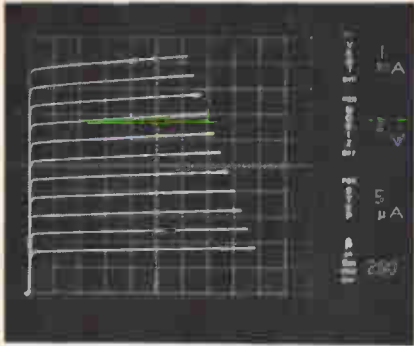

For the record. Engineer gets photo complete with calibrated readout.

zontal deflection per centimeter on the crt face. Because these readouts appear on the user's Polaroid pictures of his transistor curves, they needn't be written down. The readouts use fiber optics designed and built by Tektronix. They are so new that the company does not yet have a camera that will fit the 6.5-inch crt plus the readout. A suitable hood can be jury-rigged, and Tektronix promises a special camera within a year.

The third parameter display is for step-generator current or voltage amplitude. The fourth parameter, beta per division, requires a calculation by the user of conventional instruments.

Logic hodgepodge

All the electronics to display these parameters, including beta

calculator and the logic that selects the proper readout, plus lamp drivers and the fiber optics, are on a single circuit card. The nine IC's on this card represent Tektronix's response to what the company calls the indifference of the semiconductor industry. "The big IC manufacturers have kind of given up on us," says Larry Bowman, manager of IC engineering. Tektronix and other instrument makers may want to integrate a circuit whose anticipated volume is as low as 3,000 to 4,000 units a year, but IC makers customarily think in terms of hundreds of thousands of units.

The IC's in the 576 provide digital and analog functions on the same chip, and the digital logic itself is a hodgepodge of logic forms—resistor-transistor, emitter-coupled, transistor-transistor, and some that are peculiar to the chip.

Yet there are only about 500 transistors in the three IC's that make up the beta calculator. And the two types of circuits that generate character readout are also of modest complexity, with about 100 devices on a 60- by 60-mil chip. Designer Michael Metcalf, freed of restrictions of speed and a general-purpose system, was able to mix logic with only the ultimate function in mind. For example, to display a given level of current per vertical division on the crt, Metcalf

used a single multiple-emitter transistor to drive three lamps.

Tektronix, with an extensive in-house IC effort, has decided that its own designs can give it a cost and function advantage. The company has about 40 special devices in the design or prototype stages, so the 576 is the first of many instruments that will contain Tektronix IC's.

Simple, really

The 576's displays are not quite as complicated as they might look, since they do not have to show all numbers. The controls for the step generator and the vertical and horizontal divisions are calibrated in Tektronix's normal steps of 1, 2, and 5. Therefore, the only characters displayed are those numbers, plus a 0 (either on or blanked) and the letters designating volts or amps, or showing exponential factors in billionths, millionths, or thousandths. The more complex beta-calculator IC's use a matrix of the vertical deflection and step-generator levels. Metcalf says that making the calculator with off-the-shelf components would have taken 30 quad two-input gates, plus 20 lamp-driving transistors. Yet on the chip, that calculation was done by a transistor matrix.

The optics consist of two sets of bulbs (one with number information and units), plus optical fibers that

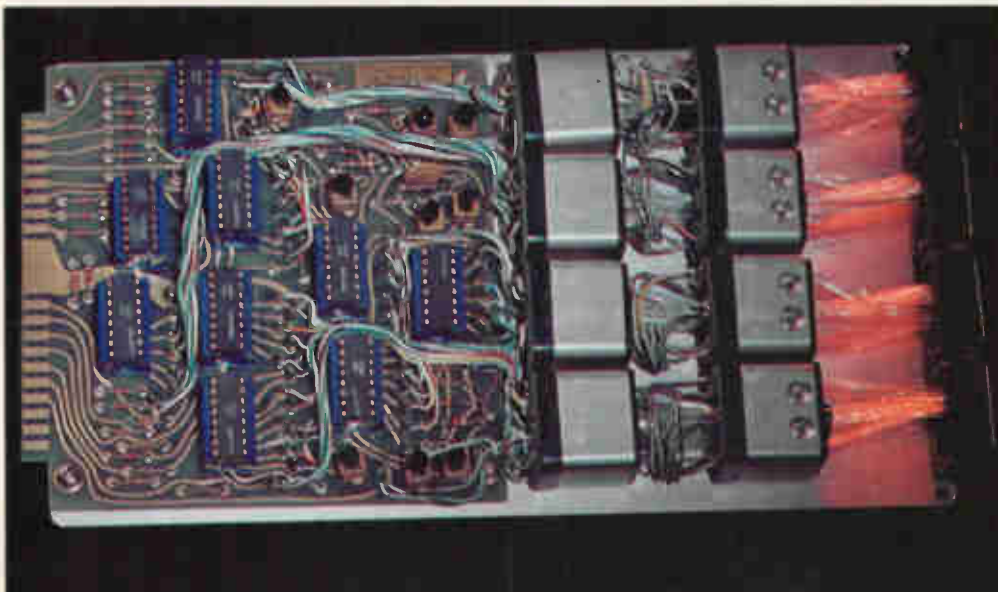

Display electronics. Circuit card contains nine IC's which perform readout logic and calculate beta. It also holds lamp drivers, and the fiber optics which carry light to the character readout sections, right.

end in a plastic faceplate. So simple is the display card that the entire subsystem, including IC's and optics, costs less than \$300. The Type 576 will sell for \$2,125; it's replacing an 11-year-old tube-type device that costs half as much. Customers not wanting the parameter display will get a reduction of \$275; if they decide later to add the display, it will cost them \$300.

Anti-squint. Since any oscilloscope measurement requires the user to juggle deflection-factor settings, the parameter displays are almost certain to appear in future Tektronix instruments. Engineers are conditioned to squinting at switch settings, and James H. Knapton, the project manager on the 576, still finds himself doing so even though the numbers are right there on the display.

The Tektronix cam switch works like a music box or player piano. Each contact on the switch is a small spring clip; these are laid out in a row on an etched circuit board. Just above the base rotates a plastic drum with multiple cams. The high points of the cam close the switch, and the low points permit it to spring open. A computer determined where each cam should be high and where low, and a numerically controlled device cut the bumps on the drum.

Almost upstaged

The display innovations in the 576 tend to overshadow the curve tracing, which has some important features of its own:

- The collector-voltage range selector and the series resistance selector are combined in concentric switches so maximum available power can be read out directly. This protects the device under test by preventing overheating. The operator can preselect the maximum available power in six positions from 0.1 watt to 220 watts; the switch is designed so that as the voltage range is changed, the appropriate resistors are switched.

- A new display amplifier, with a pair of low-impedance current-summing inputs as well as the customary high-impedance voltage inputs, permits the zero point to be set far off screen and consequently increases resolution. A 21-position display-offset switch provides equal increments of positioning

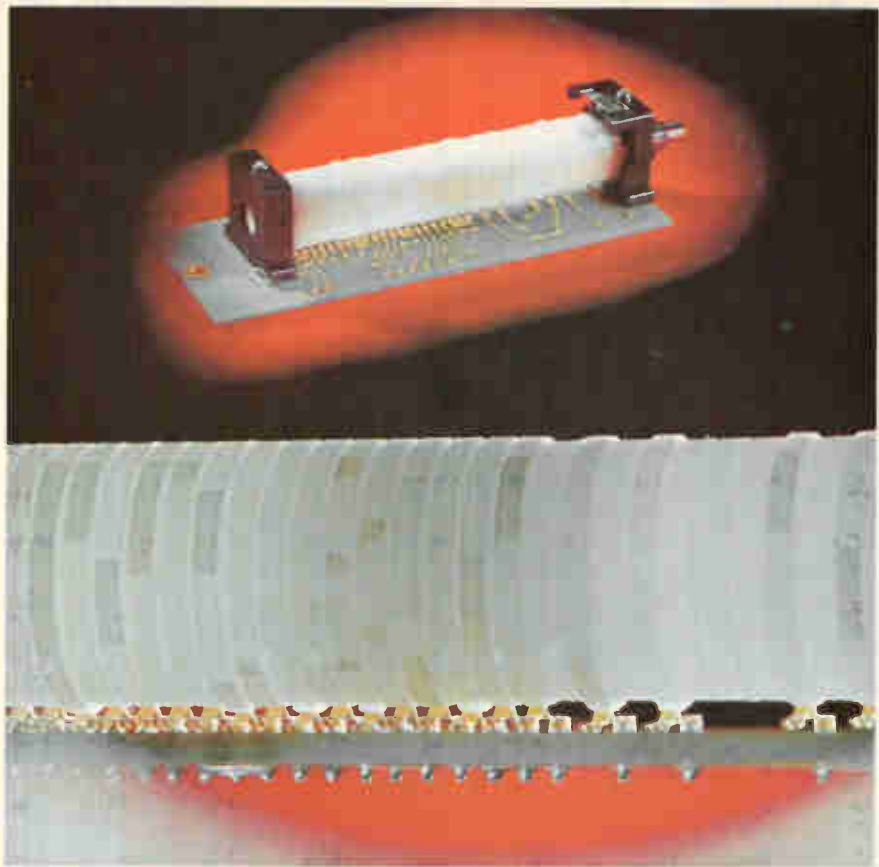

Bumps and troughs. The 576 uses cam switches, which have lower operating torque than wafer types. Detail, below, shows drum with multiple cams. High points on cams contact clips on etched board to close circuits.

from 0 to 10 divisions, unmagnified, or from 0 to 100 divisions when the 10-power magnifier is turned on.

- A continuously variable step-offset voltage of selectable polarity aids in checking FET's and voltage-driven transistor bases. FET's are difficult to test because they require large voltages and sometimes operate in a combination enhancement-depletion mode, making two setups necessary to complete one family of curves. The 576 has the higher voltage—40 volts maximum—needed for testing FET devices.

The step-offset voltage shifts the range of the step generator so it steps on both sides of zero in a single family of curves. In addition, it allows the starting point of the steps to be set far off screen. This helps in measuring curves for voltage-driven transistor bases, which require more voltage to turn the device on than to scan the operating range.

A single switch changes both collector and step-generator polar-

ity, and positions the trace at the proper starting point, so that the instrument can be changed from the pnp to the npn mode easily. On some previous instruments, it took four switches to do this. The 576 also has an invert switch so that the pnp and npn curves can both be displayed in the same quadrant.

Measurements on power transistors sometimes show loops instead of clean curves because the change in collector voltage changes collector-base capacitance. The 576 has a d-c mode in which filter capacitors are switched into the supply output, and the display consists only of a dot at the end of the curve. As the variable supply is turned down manually, the filter capacitors slowly discharge, and the dot moves along the scope. It traces successive end points that show the full curve, and a photograph taken during the whole sweep would show the curve.

Tektronix Inc., P.O. Box 500, Beaverton, Ore. 97005 [338]

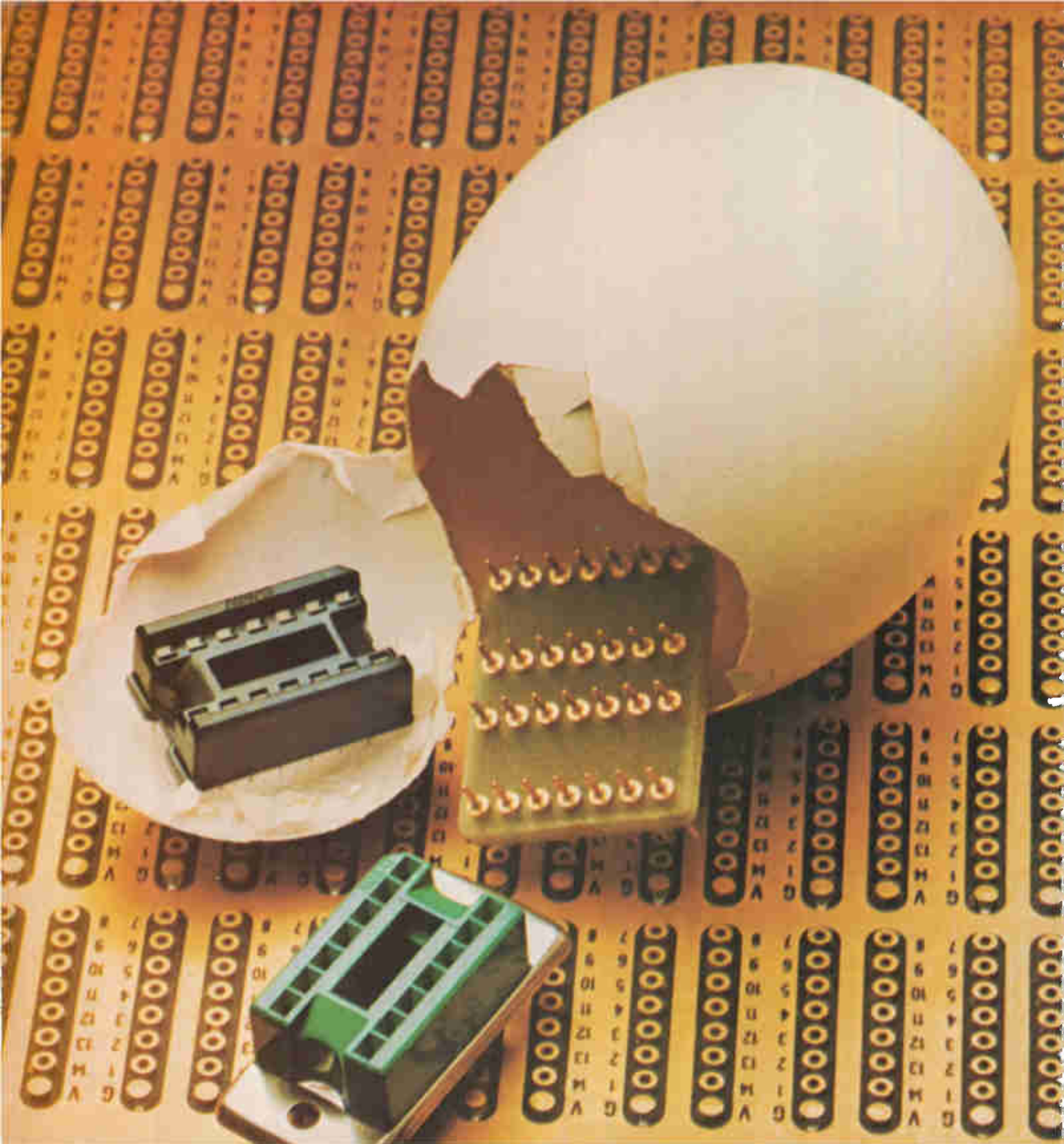

Get fresh thinking

Try Augat Creative Ideas On Your IC Packaging Problem

Actually we're old timers when it comes to handling IC's . . . been in the business since the beginning . . . all of three years. We work closely with the IC producers in developing our line. That's why we have sockets tooled and available when the producers announce new packages. We keep our sockets and panels simple . . . produce them efficiently. Maybe that's why our

prices are right. Augat has over 40 stocking distributors backed by technical representatives strategically located throughout the country. Why not find out which one is in your area. Our experience can save you a few headaches and a lot of money. Tel. 617/222-2202 or write for our complete IC folder. Augat Inc., 30 Perry Ave., Attleboro, Mass. 02703.

AUGAT^{INC.}

Reader welcomes characters who make a bad impression

Document scanner has 1,100-bit resolution; designed for quick handling of "turnaround" paperwork, it reads 750 numbers or letters per second

By Jacob Rabinow

Control Data Corp., Rockville, Md.

The flood of paperwork on Wall Street is so bad that stock markets shut down every Wednesday to let workers catch up on back orders. Things aren't quite so desperate in other areas, but most of the people attending the Business Equipment Manufacturers' Association show in Chicago this week will be looking for ways to speed their companies' record handling.

One thing they'll see is the Control Data Corp.'s new character-recognition machine, the 935 OCR Document Reader, a 1,100-bit-per-character system that handles up to 20 documents a second.

The 935 is designed to handle bond coupons, credit-card sales slips, checks, and time-clock records. These are "turnaround" documents—those that have a small

amount of information and pass through many hands before reaching the electronic reader. When they do get there, they come in a crowd, so the reader has to be fast.

The 935 can be adjusted to handle sheets of paper from 2½ by 3 inches to 8½ by 5½ inches, with thicknesses from 4 to 10 mils. The standard model reads USA Standards Institute font, and with plug-ins the 935 handles IBM 407-1, IBM 1428E, Farrington 7B, or Farrington 12F. Up to three parallel lines per document can be read at the rate of 750 characters per second. And the 1,100-bit resolution enables the 935 to read the poor-quality print sometimes produced by typewriters, high-speed printers and embossed-plate im-

The machine distinguishes between characters that touch or nearly touch each other, and can read through a considerable amount of interference such as smudges and ribbon splatter.

The maximum permissible line skew is plus or minus one character height, and the permissible character skew is 2°.

Although the 935 is well prepared to battle the inky "noise," the more care a user exercises when preparing a document the better the results in reading.

Stack and go. There's a vibrating table on the right side of the 935 where the user stacks the documents to be read. From the table they're passed in front of a photoelectric detector and on to an idler and a drive wheel. If the detector



Fibers for reading. Documents travel from the vibrating table, past the de-doubler to the scanner, and on to the sorter (above). In the scanner, images are projected onto a column of 80 optical fibers.

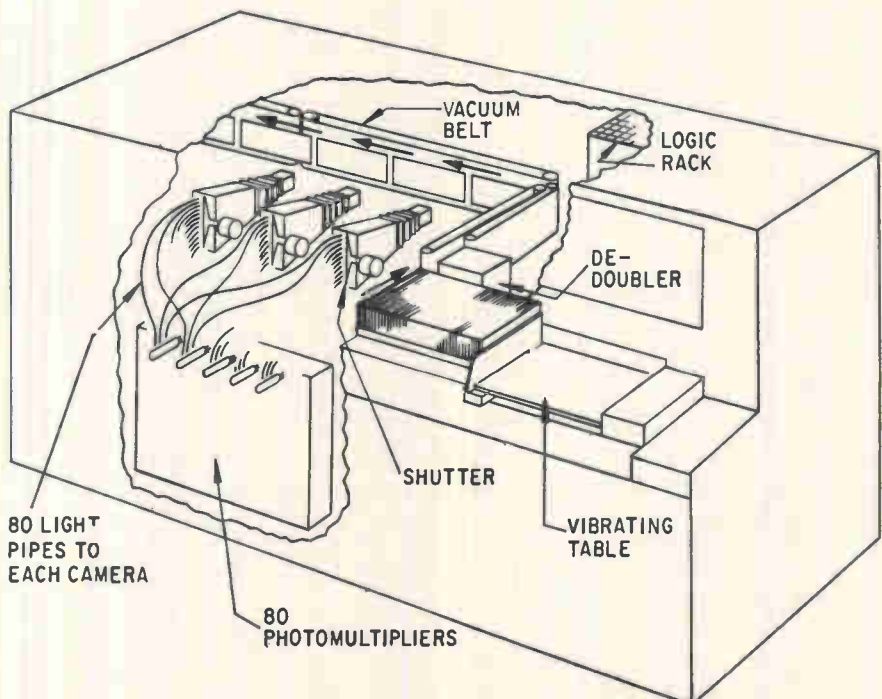

... there are three lenses and three columns of fibers: a lens and column for each line ...

sees more than one document trying to go through, the idler is braked. The opposing frictions of the idler and the drive wheel separate the cards and only one is allowed to pass.

The drive wheel carries the document to a vacuum belt, which moves the document in front of the scanning system. After passing the scanner, the document goes into gating modules that direct it into one of three hoppers.

Instead of flipper gates, the 935 uses high-speed toothed wheels to divert documents into a particular hopper. A document's leading edge is driven against one of these revolving wheels. The direction of the wheel's spin determines the direction of the document. Rotation, in turn, is controlled by clutches. The advantage of this system is that the wheel can change direction anytime in the cycle without harming the document.

If a document is so mutilated that it does jam the machine, the operator can expose the paper passages by throwing a single lever.

Each hopper has a high-speed printer that records specified information about each document or groups of documents in that hopper's stack.

Three looks. The scanning system has three lenses, whose positions are preset by the operator. Each lens reads one line per document. The right-hand lens reads the first line, and just as the first line passes out of its reading position, the second lens begins to pick up the second line; as the second lens finishes its reading cycle, the third lens begins to read the third line. Just when the third lens finishes looking, the first lens begins to pick up the first line of the next document.

This technique does put one constraint on the feed rate: the sum of the lengths of the three lines must be equal to the document length plus the space between two documents.

If just one line is to be read or if the sum of the lengths of the lines is less than the length of the document, the documents can be

fed one right after another. In practice, a small space is always provided to make sorting easier.

Every character is broken down into 14 vertical rows of 80 blocks each. Each row is 4 mils wide. When a lens looks at a character it projects an image of a row onto a column of 80 optical fibers. Each fiber, in turn, feeds a photomultiplier.

There's a column of fibers for each lens, but only one set of 80 photomultipliers. The top fiber of each column feeds one multiplier, the second fiber of each column feeds the next multiplier, and so on. Computer-controlled shutters blank out two fiber columns from their respective lenses when the other column is reading.

A familiar figure. The output of each photomultiplier feeds a quantizer that determines if particular blocks on the paper are black or white. The outputs of the 80 quantizers go to a 14-by 80-element shift register.

Each element puts out a signal whose polarity depends on whether the element at a particular instant contains black or white information. Resistor and resistor-diode recognition matrices are connected to this shift register and form the character-recognition circuits.

All the matrices work in parallel. As the unknown character steps through the matrices, it eventually pauses for a short time in a position where a corresponding recognition matrix detects the character's presence and signals the event to the output circuits.

Comparators determine which matrix has the best match to the unknown character, and the output of the comparators is fed to an encoder, which produces the binary code for the recognized character.

Usually, the encoder's output will go to the computer, which processes the information and drives a line printer or magnetic-tape deck.

The recognition matrices for various fonts are plug-in types installed by Control Data servicemen.

Besides processing the output,

an external computer continuously controls the 935. It tells the feed mechanism when to pass a document in front of the scanner, opens and closes the shutters, decides where to bin each document, and tells the printer what to write.

Making its mark. The 935 isn't limited to numbers and letters; it can also be set to detect marks made on a document. In the simplest mode, the 935 acts like those machines that grade test papers. The document user blacks in one or more preprinted zeros and the 935 responds to these marks.

In its second mode, the reader handles documents that have preprinted sets of numbers or letters. The document user crosses out one symbol in each set.

The third mark-sensing mode is unique to the 935 and requires that a shorter-focus lens be mounted in one of the optical systems. Marks can be spread vertically across an entire document. When the document passes by the modified optical system, the 80 fibers are made to scan the whole height of the document.

When operating in any mark-recognition mode, the 935 uses special "mark-sense" circuits instead of the shift register.

Coming. The high resolution of the 935's scanning system provides a base for future additions.

For example, Control Data soon will be able to give the 935 the ability to read hand-printed numerals by adding a component that contains the necessary logic.

Engineers at the Rabinow division have been experimenting and testing such a component for many years, and it's likely that future readers will handle hand-printed characters without any special constraint except, perhaps, for guide boxes on the document.

The reader is available in two models: the 935-1, which reads only a single line of numerals, and the 935-2, which reads one, two, or three lines of letters and numerals.

The 935-1 costs \$191,550 and can be leased for \$5,465 a month. The 935-2 can be bought for \$257,350 and leased for \$7,305 a month.

Rabinow Engineering division, Control Data Corp., 1455 Research Blvd., Rockville, Md. 20850 [339]

HERE'S HOW...

THE ELECTRONIC INDUSTRY IS USING
THESE FAMOUS ULANO FILMS IN
ULTRAMINIATURE MASK TECHNOLOGY
AND COMPLEX PRINTED CIRCUITRY

UlanoTM

RUBYLITHTM

AMBERLITHTM

HAND CUT MASKING FILMS FOR THE GRAPHIC ARTS

ULANO RUBYLITH... a revolutionary knife cut red film is laminated to a stable transparent plastic backing sheet. The red film is "light safe" so that when contacted to a sensitized emulsion and exposed to a suitable light source, light passes through the cut-out portions only... not through the red film. ■ The polyester backing is absolutely stable... insures perfect register. ■ Special effects such as crayon tones, paste ups, benday sheets, and opaqing are easily combined with versatile ULANO RUBYLITH.

ULANO AMBERLITH... a companion to Rubyolith serves as a color separation medium used as the master on camera copy board to secure negatives or positives.

A wide variety of Ulano films—
in rolls and sheets—is readily available

Designed FOR YOUR PARTICULAR NEEDS

Ulano offers the most versatile line of hand-cut masking films, including:

.0075—RUBYLITH 75 DR* .005—RUBYLITH 5 DR†

.005—AMBERLITH 5 DA†

Where exact register assures a critical importance, you will find these new, thick, polyester based films the positive answer.

* Available in sheets only, cut to your specifications

† Available in rolls and sheets

Cut a piece of the desired film large enough to cover area to be masked. Tape it down firmly at the top with dull-side up.

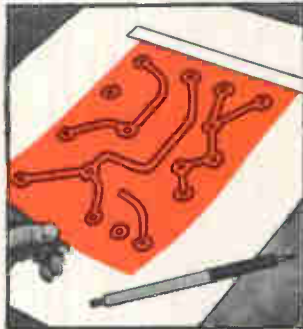

With sharp blade, outline the areas to be masked. Do not cut through the backing sheet. The Ulano Swivel Knife does the job quickly, easily.

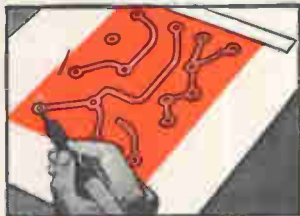

Using the tip of the blade, lift up a corner of the film thus separating it from the backing sheet.

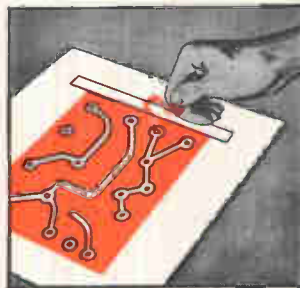

Now carefully peel off the film as outlined leaving a completed mask, positive or negative, that corresponds exactly to the desired pattern.



WRITE TODAY
on your letterhead for free
special sample kit 1748

"Ulano"—"Rubyolith"—"Amberlith" are registered trade marks of the Ulano Companies.

ulano

610 DEAN STREET, BROOKLYN, N.Y. 11238

In Europe: ULANO A.G., Untere, Heshlibachstrasse No. 22, Kusnacht, Zurich, Switzerland

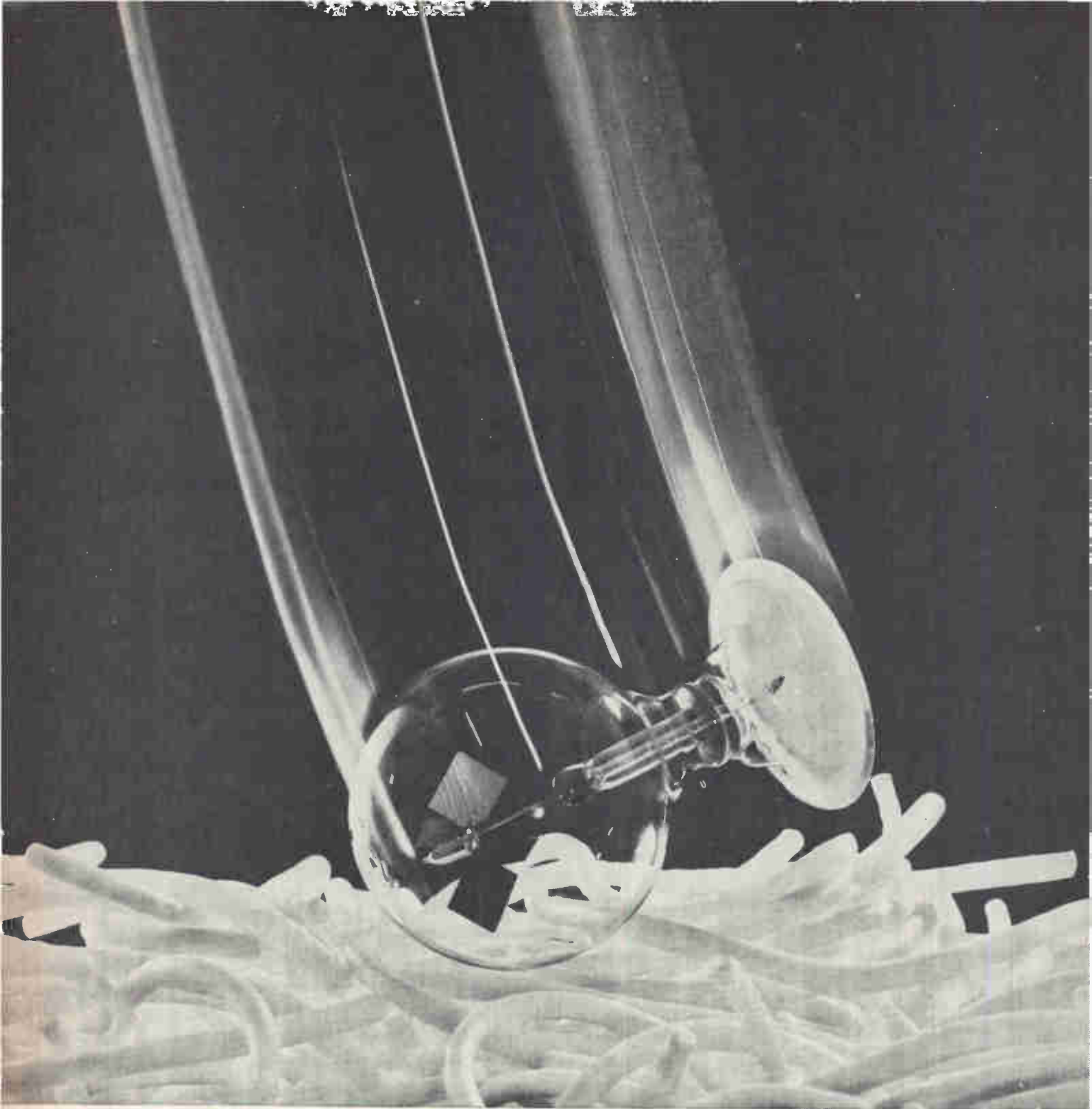

Packaging Sales, The Dow Chemical Company, Midland, Michigan 48640.

Try this on your fragile parts.

Pelaspan-Pac[®] loose fill packing. It weighs 3 to 6 times less than most other dunnage. It won't absorb water. It cuts shipping losses. Because it's highly shock-resistant, and it interlocks to prevent settling. It cuts cleanup, too. Because it's clean, nondusting and noncorrosive. Write for details.



Circle 156 on reader service card

New Components Review

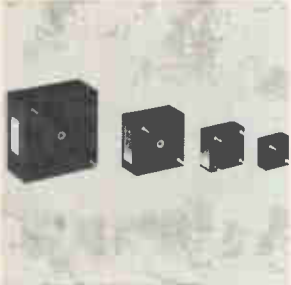

Standard toroidal inductors for transistor and p-c application feature pin terminals and flat molded construction. Six of the most often used inductance values are stocked from 5 mh to 5 henries in 4 sizes from $\frac{3}{4} \times \frac{3}{4} \times \frac{3}{8}$ to $2 \times 2 \times 1$ in. They can operate with d-c currents up to 2 amps and have Q's up to 250 at 10 khz. Magnetico Inc., 6 Richter Court, E. Northport, N.Y. [341]

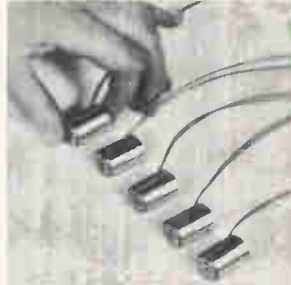

D-c solenoids series C-3860 meet MIL-S-4040 and MIL-Q-9858 specs. The design, measuring $1 \times \frac{3}{4}$ in. and weighing 50 grams, is available in ratings of 6, 12, 28, 48 and 115 v d-c. It provides pull forces up to 32 oz at $\frac{1}{8}$ in. stroke. Operating temperature range is -65° to $+125^\circ$ C. Price ranges from \$4.50 to \$10. James Electronics Inc., 4050 N. Rockwell St., Chicago 60618. [342]



Relay model 575 VoltSensor can be used to control or monitor temperature, flow, weight or pressure in continuous industrial processes. It has a set point continuously adjustable from -20 to $+20$ v by means of an external pot. Stability is better than $1 \text{ mv}/^\circ\text{C}$; hysteresis, less than 4 mv; repeatability, better than 1 mv. Calif. Electronic Mfg. Co., Box 555, Alamo, Calif. [343]



Cermet trimmer series 190 is a 20-turn, $0.750 \times 0.160 \times 0.310$ in. device. Resistance range is 20 ohms through 1 megohm and power rating is $\frac{1}{2}$ w at 85° C derated to no load at 125° C. Temperature coefficient is as low as $\pm 100 \text{ ppm}/^\circ\text{C}$ in the range of 1,000 ohms through 250 kilohms. Price is \$1.24 each in lots of 1,000. CTS of Berne Inc., Berne, Ind. [344]



Toroidal inductors offer a wide selection of inductance values from 1.82 mh to 1.78 henries in 2.5% increments with $\pm 1\%$ tolerance. They feature a crystal case $0.33 \times 0.73 \times 0.75$ in. with 0.1 in. grid leads for p-c boards. Maximum temperature rating is 130° C. Price (1,000 pieces) is \$2.90 to \$4.24. Magnetic Circuit Elements Inc., 3720 Park Palce, Montrose, Calif. [345]



Commercial counterpart of the RJ-11 film element trimmer series 8100 can dissipate $\frac{3}{4}$ w at 70° C, and derates to 0 at 125° C. It is available in a resistance range from 10 ohms to 2 megohms with temperature coefficients of ± 500 , 300 and $250 \text{ ppm}/^\circ\text{C}$ depending on value. Models are unsealed but can be production soldered. Dale Electronics Inc., P.O. Box 609, Columbus, Neb. [346]

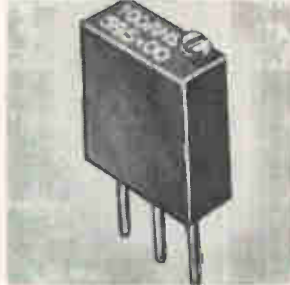

Potentiometers in the $\frac{3}{8}$ in. Squaretrim series 543 544 and 545 are available in base pin, flexible lead and side pin models. They cover a resistance range of 10 ohms to 50 kilohms. Resistance tolerance is 5%. Power rating is $\frac{3}{4}$ w at 85° C derated to 0 at 150° C. Operating temperature range is from -55° to $+150^\circ$ C. Weston Instruments Inc., Archibald, Pa. 18403. [347]

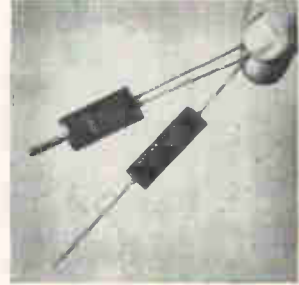

Wirewound resistor type S is oil impregnated and hermetically sealed to reduce thermal effects and to eliminate the effects of humidity and atmosphere. Specifications for 0.00065 in. minimum wire diameter include an accuracy of better than $\pm 0.001\%$; temperature coefficient of better than $1 \text{ ppm}/^\circ\text{C}$. Nytronics Inc., Industrial Ave., Kutztown, Pa. 19530. [348]

New components

MOS shift register covers wide range

Dual 25-bit IC operates at any level from 6 to 30 volts; it's intended for memories, delay lines, and crt displays

Several companies make metal oxide semiconductor devices that operate with clock voltages as low as 6 volts. They can also make them to operate at 24 to 30 volts. But dynamic shift registers that function over the entire range—from 6 to 30 volts—haven't been

available to system designers.

Now Hughes Aircraft Co. is introducing a dual 25-bit integrated-circuit shift register that will operate over the entire range. The HRM2026T is the first of four dynamic shift registers to be introduced in a family that will include

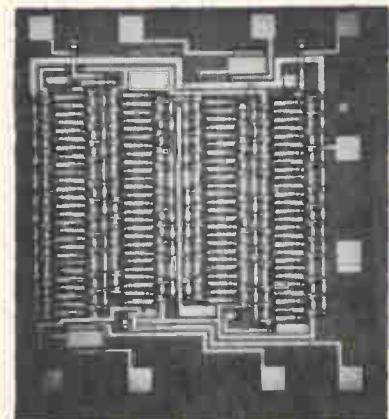

Founder. Dual 25-bit shift register is first of new line of MOS IC's.

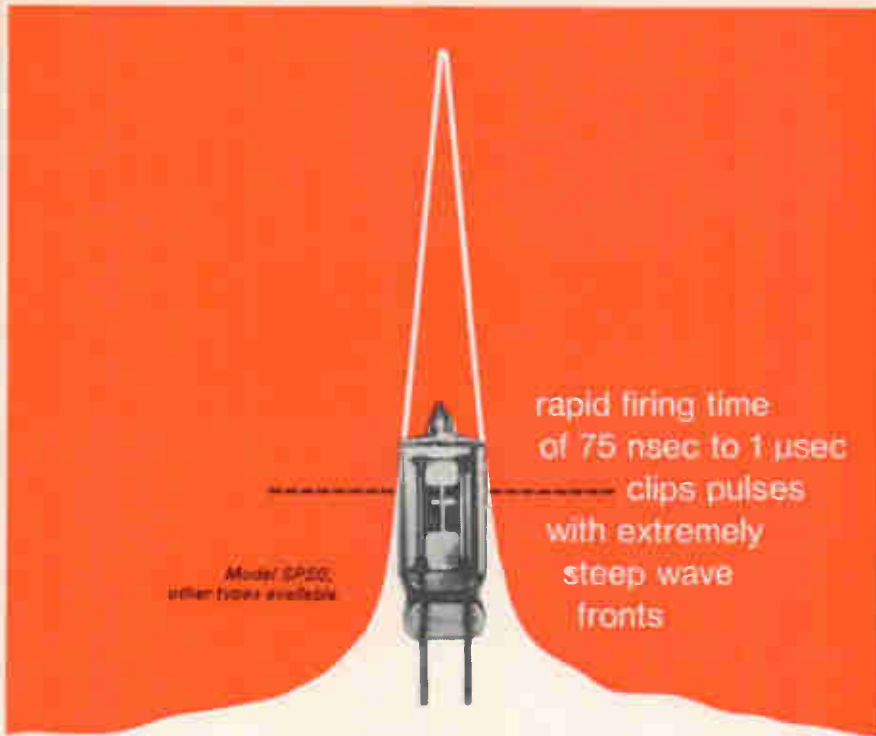

protect solid state
circuits from
catastrophic transient spikes
with **VICTOREEN**
SPARK GAPS

Extremely rapid firing time (as fast as 75 nsec, depending on circuit parameters) combined with excellent energy handling capabilities (100 joules for currents as high as 2000 amperes) anywhere in a broad range (85-5000 volts), including our new miniature version. And that's why they're providing sophisticated circuit designers with positive, economical protection for their solid state circuits.

Low interelectrode capacitance also makes them ideal for high frequency application where wave form must be preserved. In ignition applications, Victoreen Spark Gaps are used as hold-off devices to prevent current flow until circuit voltage reaches predetermined gap breakdown voltage. High repeatability and long service life enhance reliability of continuous duty systems in ambients from -65° to 125°F . Shock resistance to 100g for 11 milliseconds, vibration resistance a full 10g from 55 to 2000 cps. For positive protection of exotic solid state circuits, call Applications Engineering Dept., (216) 795-8200, Ext. 306.

A-2732

VICTOREEN INSTRUMENT DIVISION
10101 WOODLAND AVENUE · CLEVELAND, OHIO 44104
IN EUROPE: GROVE HOUSE, LONDON RD., ISLEWORTH, MIDDLESEX, ENGLAND



... extra diffusion step
widens voltage range ...

dual 50-, dual 64-, and dual 100-bit devices with clock repetition rates from 100 hertz to 2 megahertz. Carroll R. Perkins, manager of MOS marketing and applications at the firm's Newport Beach, Calif., facility, believes the devices will be used in dynamic memories and delay lines. "And with the logic configuration we've chosen," he says, "we can make them recirculating shift registers by feeding the output back to the input. This will be useful for such jobs as generating patterns for character display on a cathode-ray tube."

Perkins, who went to Hughes from Raytheon when Hughes bought that firm's MOS FET line, says many MOS companies, in striving to develop a 2-volt-threshold technology, have run into manufacturing problems—field inversions particularly. He says that problem was overcome, while the MOS FET line belonged to Raytheon, by using an extra diffusion step. "You can make low-voltage circuits if you don't understand or can't solve the field-inversion problem," he explains "but you can't get the wide operating range."

The HRM2026T (the T indicates an eight-pin TO-5 can; the device later will also be packaged in 14-lead ceramic flatpacks and dual in-line packs) dissipates about 700 microwatts per bit per megahertz with a drain supply of 12 volts and a clock voltage of 24 volts. Perkins says this is a little better than the industry average. But the device really shines, he says, at the lower voltage levels: a drain supply of 6 volts and a clock voltage of 6. The typical dissipation at these levels is 100 microwatts per bit per megahertz. This is an order of magnitude less than the industry average, Perkins says.

Direct drive. Each bit of the shift register is composed of six MOS FET's, for a total of 302, including output switches with less than 500 ohms of channel resistance at a 12-volt drain supply and a clock voltage of 24. Perkins says the lower output resistance means that the device can be driven directly by bipolar diode-transistor and transistor-transistor logic with

twice twist

Twist in. Twist out.

It's that simple to insert or remove terminal posts of our HW Series of Wire-Wrap printed circuit connectors.

Here's how it works. Our HW Series contacts are .025" square posts retained in the connector block by a simple 90° twist. Firmly. Because the hole in the block is also square, the contacts are rigidly retained by the resulting diagonal dimension of the post. It's a twist that gives far less breakage. And, because the posts twist out almost as easily as they went in, you don't have to discard a good connector if a contact should break.

Contacts are extracted with a simple hand tool by untwisting the terminal post to its original position, then sliding it out from the connector. And there are no adverse effects on the thermoset plastic material of the connector from the first or repeated twistings.

Let us tell you more about this new twist in wire-wrap printed circuit connectors. Descriptive literature is yours for the asking. Ask: Winchester Electronics, Main St. and Hillside Avenue, Oakville, Connecticut 06779.

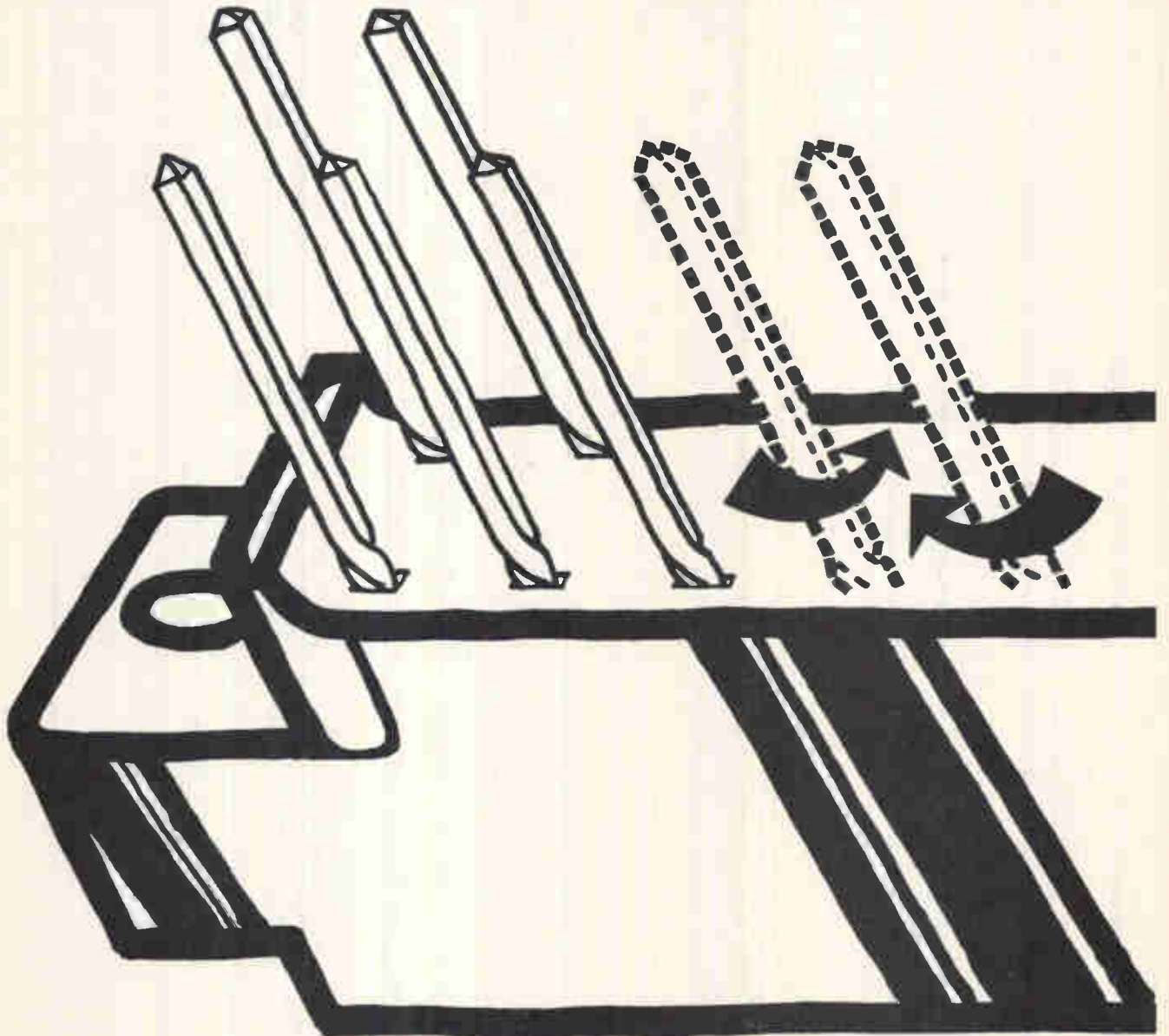

WINCHESTER ELECTRONICS 
LITTON INDUSTRIES

ALPHANUMERIC, DIGITAL AND SPECIAL READOUTS

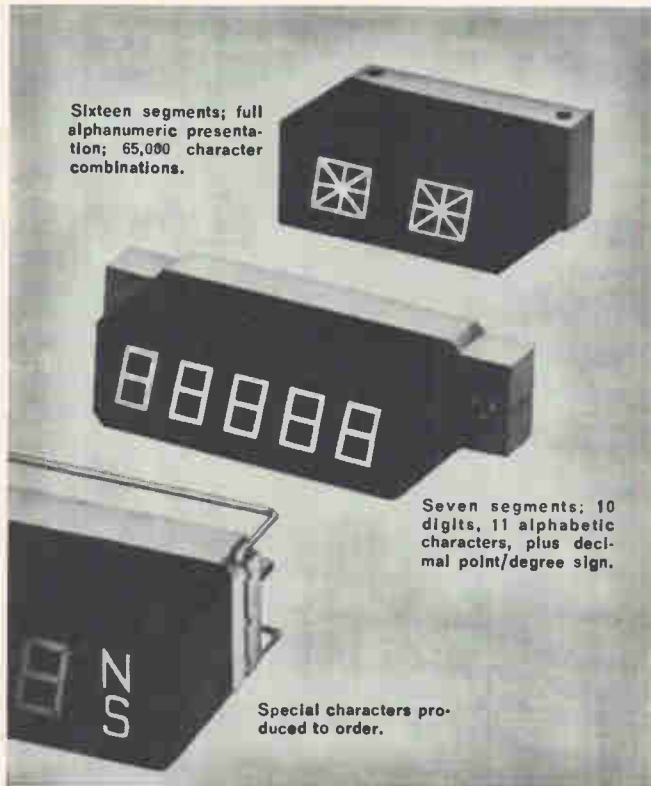

ALL WITH OPTIMUM CONTRAST AND ALL FROM TUNG-SOL

Optimum contrast in Tung-Sol readouts results from the molecularly bonded, flush-surface filter. The use of a new 20 mil lamp sharply reduces the load factor while maintaining good brilliance. Heat is minimized and reliability is substantially improved. Tung-Sol readouts are designed to be inter-mixed. All characters have the same vertical dimension for accurate in-line display. Viewing angle is 150°. Displays can be supplied in color.

MOUNTING FLEXIBILITY



Write for fully explanatory brochure T-431. Tung-Sol Division, Wagner Electric Corporation, One Summer Avenue, Newark, New Jersey 07104.

TUNG-SOL®
**OPTIMUM CONTRAST
READOUTS**

© REG. T.M. WAGNER ELECTRIC CORPORATION

appropriate bias conditions. With these conditions, he continues, the typical +0.5- to +5.0-volt swing out of the 6-volt bipolar logic will drive this array directly without further level translation.

American Microsystems Inc. is the only other firm that has announced MOS products that interface directly with bipolar logic, according to Perkins, but he maintains that AMI "hasn't found a way around the field-inversion problem." This leads him to believe that the AMI shift registers can't operate at both the low and high voltages.

A source at AMI confirms this, but says that the extra diffusion step "uses up silicon real estate." He adds that there is no speed advantage "because you are on the same power/voltage curve."

In quantities of 1,000 or more, the HRM2026T will cost six cents per bit, which Perkins says is about the same as the industry average of six to 10 cents a bit for dynamic shift registers. Hughes is quoting a two-week delivery time from distributors. The dual 50-bit device in the line will be designated HRM2027T, the dual 64-bit the HRM2042T, and the dual 100-bit the HRM2028T. The suffixes "K" and "B" will be used to designate flatpacks and dual in-line packages, respectively.

Hughes Aircraft Co., 500 Superior Ave., Newport Beach, Calif. 92663. [349]

New components

Readout tubes face a challenger

\$2 alphanumeric device,
driven by \$4 MOS IC,
fluoresces on low power

With a \$2 alphanumeric readout device and a \$4 integrated circuit to drive it, the Wagner Electric Corp.'s Tung-Sol division is trying to supplant the ubiquitous gas-ionization readout tube in test equipment, process controls, and computers. The cost is low enough,

Lower threshold voltage. The Tomorrow MOSFETs from Hughes run on 2 volts instead of 6 to permit lower gate drives. (Naturally, they also operate at higher voltage levels.) Hughes circuits interface directly with bipolar logic, virtually eliminating the need for level translators. This reduces the costs, space, and power consumption of extra hardware.

Medium thick field oxide. Thick enough to minimize metal-to-diffusion capacitances, not so thick as to cause yield reducing process difficulties.

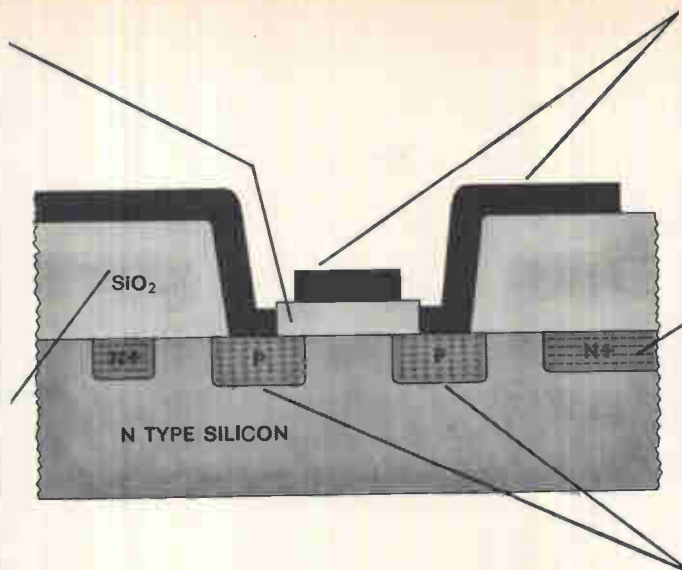

Metalization complete. Chrome-Gold metalization is used to produce a low resistance system. No "purple" metal. No requirement for temperature alloying. Completed devices provide good contacts.

Lower diode leakage. Phosphorus diffusion (Phosphorus) selectively added to the source and drain diode leakage, preventing "channelling," minimizing crosstalk in complex circuits, and isolate circuits.

More design freedom. Tomorrow MOSFETs have an extra rich Boron doped polysilicon gate, all "P" regions to reduce resistance, minimizing resistance for metalized polysilicon gates and allow more design freedom.

THE SECRET OF THE TOMORROW MOSFETS.

For the complete story on the Tomorrow MOSFETs, write Hughes Aircraft Co., MOSFETs, 500 Superior Ave., Newport Beach, Calif. 92663. Phone (714) 548-0671. TWX (714) 642-1353. And for useable MOSFET electronic circuits, see your local Hughes distributor for a copy of "The Application of MOSFET

HUGHES

HUGHES AIRCRAFT CO.
MOSFET DEVICES

RMC

TEMPERATURE COMPENSATING SOLDER-INS

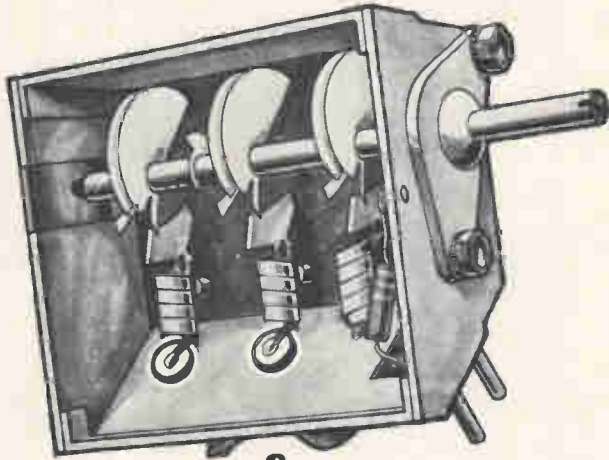

for UHF APPLICATIONS

SPECIFICATIONS

CAPACITANCE: Within tolerance @ 1 MC and 25°C

CAPACITANCE TOLERANCES: $\pm 5\%$, $\pm 10\%$ or $\pm 20\%$ (but not less than $\pm .25$ pf)

WORKING VOLTAGE: 500 VDC

INSULATION RESISTANCE: Greater than 7500 Megohms @ 500 VDC

FLASH TEST: 1000 VDC for 1 second

ELECTRODE: Pretinned for assured solderability

These new solder-in capacitors are designed for use in UHF applications requiring the absolute minimum in lead inductance effects. Solder-ins are available in a wide range of temperature coefficients in capacities from 1.5 to 105 pfd.

If your application requires special physical or electrical characteristics, contact RMC's Engineering Department.

Write today on your company letterhead for your copy of the RMC Catalog.

... logic driver is MOS integrated circuit ...

Tung-Sol engineers say, for readout device to find its way into automobiles and appliances. It could give a direct digital display of miles per hour on a speedometer, or indicate the channel number in the varactor-tuned television that's reportedly around the corner.

The readout unit, which Tung-Sol calls Digivac S/G, consists of seven diodes with a common cathode, all sealed in a glass envelope. The anode of each diode is a phosphor-coated segment 8 millimeters long and 1 mm wide. When a segment is connected to a voltage of 10 to 40 volts d-c, it fluoresces in the blue-green portion of the visible spectrum. The cathode operates at only 1.6 volts, a-c or d-c, and draws only a few milliamperes; as a result, its operating temperature is low and the power supply need not be large.

Because the segments are on the same plane, problems common to gas-ionization readouts—change in depth of focus and superposition of unlit characters over lit ones—are eliminated. The Digivac characters are more sharply defined than those of other readouts, too, according to Tung-Sol, because they aren't surrounded by a layer of ionized gas.

GI circuit. Tung-Sol has accumulated 4,000 hours of life tests on the Digivac, and chief engineer Rodney Ball predicts a 100,000-hour life expectancy.

The IC driver is a monolithic metal oxide semiconductor circuit made by the General Instrument Co. especially for the Digivac. It consists of an up-down decoder, a storage register, a counter, a coder-driver, and input, output and command terminals. The input signal can be in binary-coded decimal or pulse-count form. In addition to leading-zero blanking, the circuit provides false-count indication. It's packaged in a 1/4-by-1/2-inch flat pack with 24 leads; GI soon introduces a 14-lead version in a dual in-line package.

The seated height of the tube is 1.730 inches, and character size is 0.360 by 0.570 inch. A decimal point is optional at extra cost.

Tung-Sol division, Wagner Electric Corp., Newark, N.J. 07104 [350]

DISCAP
CERAMIC
CAPACITORS

RMC

RADIO MATERIALS COMPANY

A DIVISION OF P. R. MALLORY & CO., INC.
GENERAL OFFICE: 4242 W. Bryn Mawr Ave., Chicago 46, Ill.
Two RMC Plants Devoted Exclusively to Ceramic Capacitors
FACTORIES AT CHICAGO, ILL. AND ATRIA, IND.

Tear out this page.

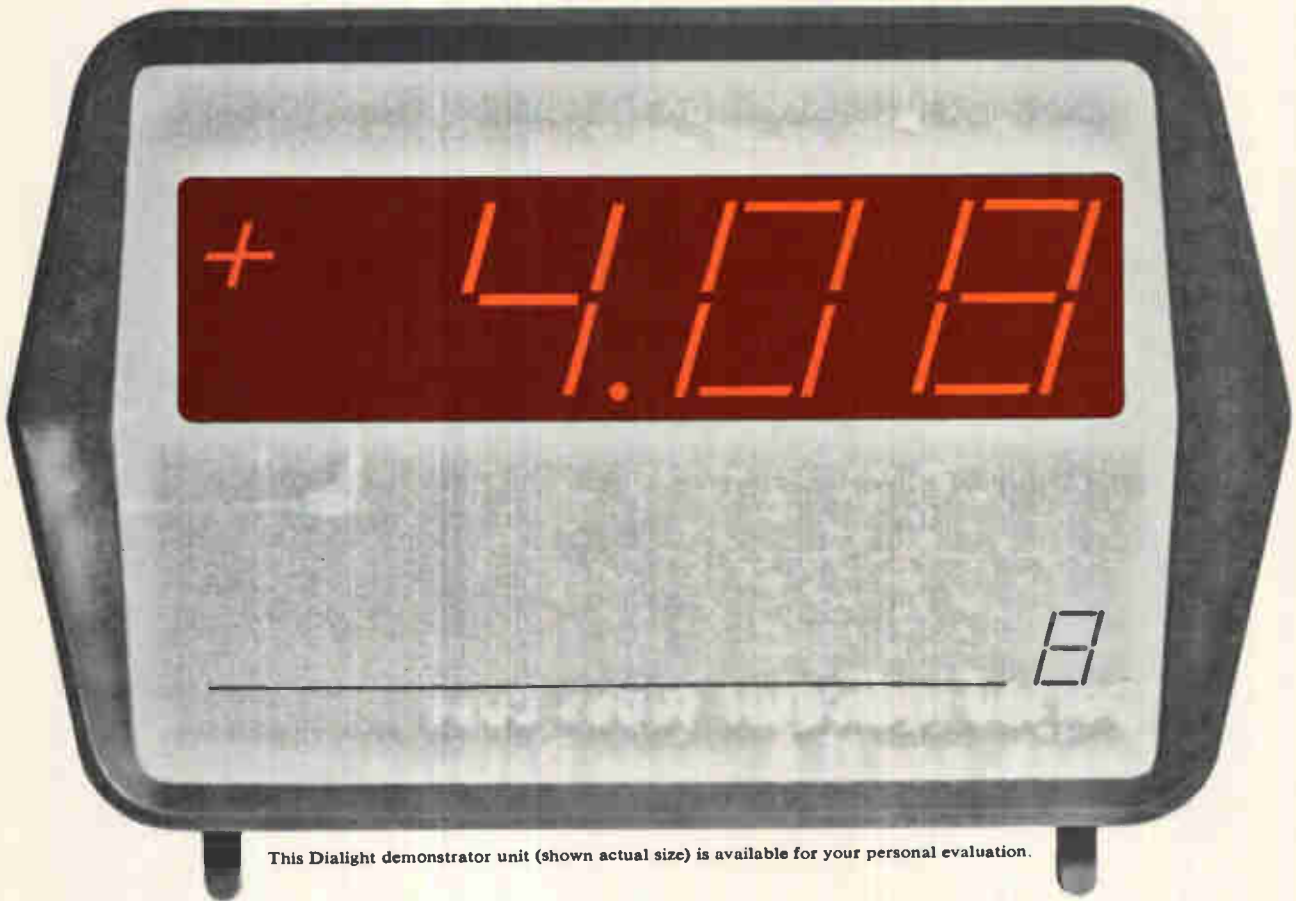

This Dialight demonstrator unit (shown actual size) is available for your personal evaluation.

*Place it next to any readout
you're now considering.*

*Then walk back 30 feet and
prove to yourself that low-cost
Dialight readouts are easier to read.*

The only way to be sure is to compare Dialight readouts with others. This little test will give you a rough idea of the difference. But it's not quite as convincing as the actual demonstration we'll be happy to provide you with on request.

Dialight readout modules cost as little as \$3.99 each (less lamps in 1000 lot quantities). They operate on 6, 10, 14-16, 24-28 volts AC-DC, 150-160 volts DC and 110-125 volts AC. Caption modules are available; each is capable of displaying up to six messages at one time.

Windows are of non-glare type in a choice of colors.

Options: universal BCD to 7-line translator driver, 10-line to 7-line converter for decimal input, RFI-EMI suppression screen. Custom translators available.

To arrange to borrow a Dialight demonstrator unit, write us on your company letterhead.

For copy of our current catalog, circle reader service number below. Dialight Corporation, 60 Stewart Ave., Brooklyn, N. Y. 11237. (212) 497-7600.



DIALIGHT

Circle 163 on reader service card

They can. Our CK8754, for example, costs much less...the lowest price available for any side-view type. You can save \$450 per thousand or more! Call us to find out.

This price reduction...with tubes made only in the U.S.A.... has been achieved without sacrificing quality. All tubes are EIA rated...produced for 200,000 hours of reliable operation. Datavue Tubes also feature:

- Straight, stiff leads for fast insertion in sockets. There's no

need to waste production time aligning and straightening leads.

- Full 5/8" characters for quick, accurate reading from distances up to 30'.

- High brightness, in-line characters...rated for strobing operation.

Datavue Indicator Tubes are promptly available in a wide range of alphanumerics, decimals, and special characters. Fast turn-around service on all custom designs is also assured.

For prices and data, call these Raytheon sales offices:

Dallas, Texas 214-631-3745
Dayton, Ohio 513-223-8128
Des Plaines, Illinois 312-296-6677
Englewood, N.J. 201-567-4911
(In Manhattan, call 947-6400)
Glen Burnie, Md. 301-761-0450
Inglewood, Calif. 213-757-0251
Quincy, Mass. 617-479-5300
San Carlos, Calif. 415-593-1021
Minneapolis, Minn. 612-927-9923

RAYTHEON

If imported indicator tubes cost \$3.95 each, can U.S.-made Datavue^{*} Tubes cost much less?

(To find out, call your Raytheon regional office.)

*Trademark of Raytheon Company

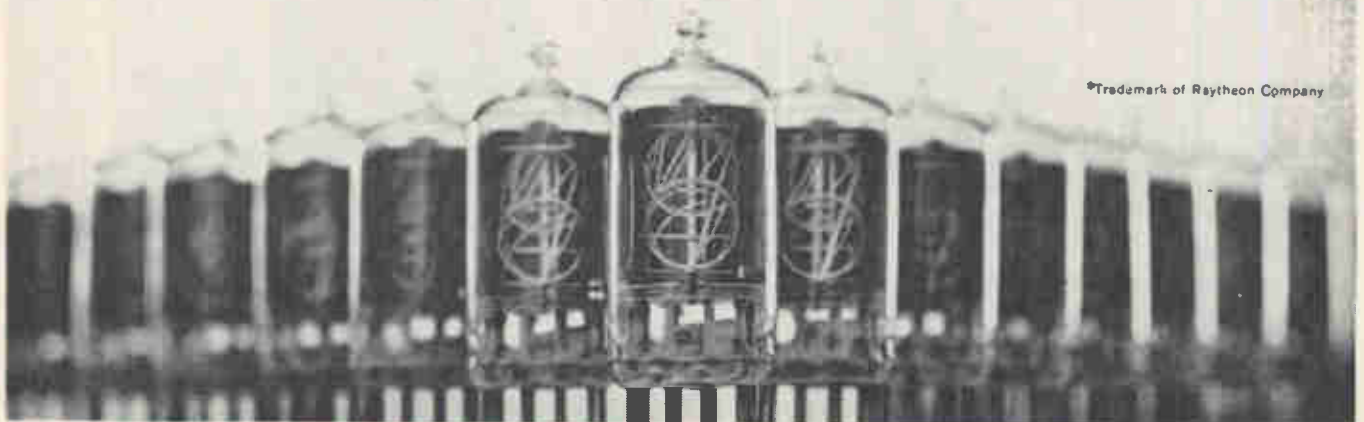

New Instruments Review

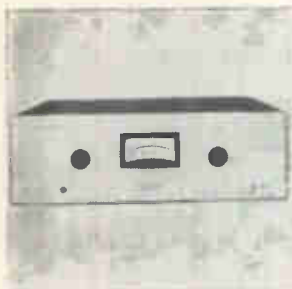

Noise standard model 150 is a stable source of noise signals over the frequency range of 0 Hz to 40 kHz. Over-all output is 1 V rms. Conformity to Gaussian amplitude probability density is better than $\pm 2\%$ of point to 2.5 sigma. D-c content is less than 5 mv. Over-all output level has a calibration accuracy of $\pm 0.3\%$. Signal Research Inc., Box 79, Titusville, N.J. [361]



Microwave power meter 432A has automatic zero set by depressing a momentary toggle switch. This eliminates manually adjusting a control to zero the meter before making a measurement. With its associated thermistor mounts, the unit measures power from 10 MHz to 40 GHz. Accuracy is 1% of full scale on all ranges. Hewlett Packard Co., 1501 Page Mill Rd., Palo Alto, Calif. [362]



Reactance converter and its accessory probes are designed for accurate sensing and measurement of minute physical events. Pressure, proximity-vibration, torsional vibration, piston stroke and force are sensed by the probes and converted to either digital or analog output. Frequency response is from d-c to 100 kHz. DISA-S&B Inc., 140 Greenwood Ave., Midland Park, N.J. [363]



Solid state meter model M7 is for quick vibration measurements in the field. It provides direct readings, with displacement indications accurate down to 0.0001 in., velocity to 0.001 ips, and acceleration to 0.1 g. Case dimensions are $6\frac{3}{4} \times 9\frac{3}{4} \times 6$ in. Weight is 7 lbs. Unit is priced at \$550 and is immediately available. MB Electronics, Box 1825, New Haven, Conn. [364]



High-speed 3-digit DVM called X-Mod 722A has 20% over-range, automatic polarity indication, and continuous tracking of 100 readings/sec. Resolution is 1 mv, accuracy $\pm 0.1\%$ of full scale. A switch-selectable filter provides 60 db of noise rejection at 1 Hz. Price is \$295; delivery within 60 days. Preston Scientific Inc., 805 E Cerritos Ave., Anaheim, Calif. 92805. [365]



Portable pattern recorder model 1410 is suited for precision measurements in the microwave laboratory, the anechoic chamber and the antenna test range. It features a single, long-life film potentiometer; solid state linear, log, square, and square root amplifiers; and 4 switch-selectable, full-scale dynamic ranges. Scientific Atlantic Inc., Box 13654, Atlanta, Ga. 30324. [366]



Portable radar range callibrator 210A provides a trigger and range marks in either nautical or statute miles, accurate to $\pm 0.01\%$ of range on ppi and other presentation type radar scopes. Use of IC's for digital countdown from a crystal standard eliminates tubes and blocking oscillators. Electronic Services Inc., 1258 Fitzgerald Ave., San Francisco. [367]



Sweep oscillator model 6151 provides electronically swept or stable single-frequency operation from 10 MHz to 1 GHz, using 6 oscillator plug-in units. Power output of more than 100 mw permits the 6151 to replace signal source/amplifier combinations. External measurements of the unit are $5\frac{3}{4} \times 19 \times 20\frac{3}{4}$ in. Alfred Electronics, 3176 Porter Drive, Palo Alto, Calif. [368]

New instruments

Flowmeter uses magnetic resonance

Device has no parts in flow stream, can handle conductive and nonconductive fluids, and doesn't need recalibration

After two decades, nuclear magnetic resonance is being taken out of the laboratory and put on the market.

Since the phenomenon was first detected, it's been used almost exclusively to measure the magnetic moment of atomic nuclei and de-

termine molecular structure and chemical composition.

But now it's gone commercial—in a magnetic resonance flowmeter, developed by the Badger Meter Mfg. Co., that doesn't require any contact with the fluid being measured. The flow chamber is a cer-

amic tube without moving parts or electrodes. About 40% of the meter's electronics is integrated, and the readout equipment is both digital and analog.

Badger hopes to sell the meter to the chemical industry. The unit will compete with conventional flowmeters that are, for the most part, electromechanical, and it costs roughly twice as much: about \$5,000, compared with \$2,500 to \$3,000.

"About 60% of the price is attributed to the electronics," says Allen C. Bradham, the product manager. "But the customer will be buying an instrument that is

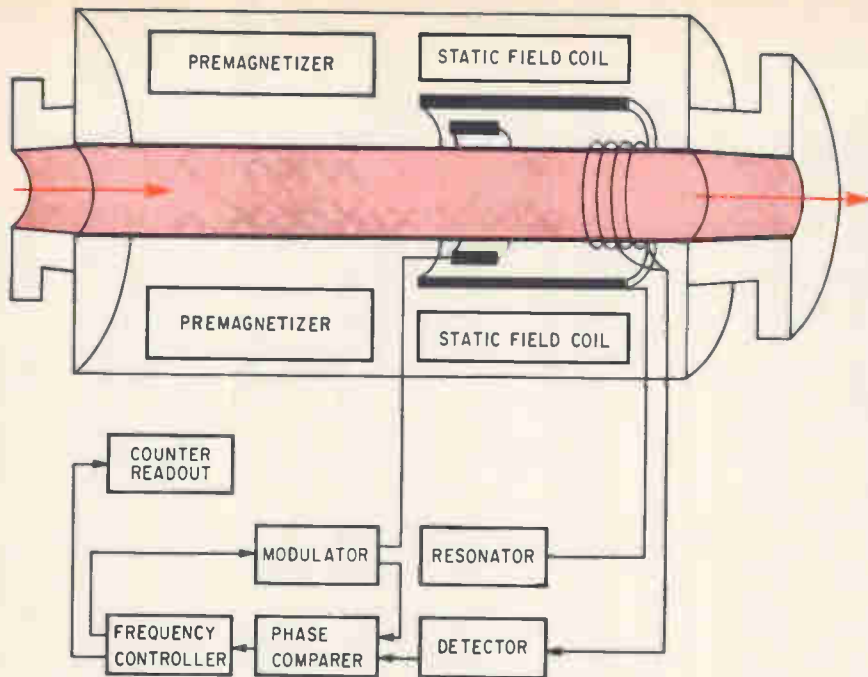

Moving on. The phase difference between the detector and the modulator outputs is related to the volume of the liquid flowing through the tube.

almost universal and free of obstruction.”

Bradham cites the following as the major advantages:

- Maintenance problems and costly downtime are virtually eliminated because there are no parts, rotors, or electrodes in the flow stream to wear out, clog, or corrode.

- Since the flow is unobstructed, there is no pressure drop to affect the meter's accuracy. Repeatability and linearity are both within 0.5%.

- Both conductive and nonconductive fluids—including hydrocarbons and other dielectric materials—can be metered, as can strong acids and abrasive or corrosive chemicals. “These things can't be said for conventional meters,” notes Bradham.

- Recalibration or separate meters aren't necessary for fluids of different composition or temperature because the meter factor, or output pulse, remains the same for different fluids under similar flow conditions.

Although nuclear magnetic resonance has been observed in 84 elements, Badger—aided by grants from the Air Force and the National Bureau of Standards—has concentrated on fluids containing hydrogen or fluorine atoms, where resonance is an especially pronounced phenomenon.

Three cards. As the fluid enters the meter, it passes through a magnetic field established by a permanent magnet housed between the inner flow tube and the outer shell. This magnetizes the nuclei of one of the fluid's elements. An f-m signal is then impressed into the magnetization, setting up a radio-frequency field that resonates the magnetization. An r-f transmitter, essentially a modulating system controlled by a voltage-controlled oscillator, reorients the magnetic vector and creates a demagnetized window in the fluid.

As the liquid continues to flow, receiver coils—also housed between the inner tube and the outer shell—detect the demagnetized window. Modulating and detected signals are then fed into a phase comparator. A frequency controller adjusts the modulation frequency to fix the phase difference. The frequency controller's output is fed into a totalizer, whose output can be used to control other flow instruments in a chemical process.

The circuitry for the flowmeter is housed in a wall-mounted cabinet that measures about 18 by 24 inches. Except for the power supply and scaler, the electronics are mounted on three plug-in boards—r-f, d-c, and regulator cards.

The r-f card has a transmitter, modulator, oscillator, amplifier,

and receiver. The d-c card carries the VCO, logic circuits, a phase demodulator, and a d-c amplifier. The regulator card includes the voltage and current regulators.

“We're using Texas Instruments' 7400 transistor-transistor logic,” says William H. Vander Heyden, manager of electrical research at Badger and one of the engineers involved in the project since it began seven years ago. “We could have gone to other logics, but we were looking ahead to the next evolutionary step in the electronics for the meter,” he said.

Phase locking. Badger uses a phase-locking technique to process the signals. The outputs of the receiver and the VCO are redirected to the input of the phase-comparison circuit, which can produce an output-voltage error signal proportional to the deviation phase angle between the two input signals. This error signal goes through a low-pass filter to remove extraneous information and is integrated to produce an input voltage to the VCO, thus establishing the operating frequency of the VCO. Adjusting the frequency of the VCO output and receiver output makes the VCO's output frequency proportional to the flow rate; each pulse from the VCO represents a discrete volume of fluid passing through the meter. The VCO pulses are then added for measurement of fluid quantity and flow rate.

The first magnetic resonance flowmeter Badger is offering has an inner-flow-tube diameter of 1 inch. The tube is 29 inches long and its ceramic liner is 99.5% alumina. The outer shell is carbon steel, and the void between the liner and shell—except the magnet and coils—is backfilled with ceramic cement. Operating pressures range up to 300 pounds per square inch.

The meter works in temperatures from -40° to $+150^{\circ}$ F, and handles fluids whose temperature ranges from -40° to $+300^{\circ}$ F.

The analog flow-rate indicator has an input range of 4 to 20 milliamps d-c, calibrated in percent of maximum flow rate. Digital readout is furnished in either six or eight digits, with a counting rate of 0 to 2 megahertz.

Badger Meter Mfg. Co., 4545 W. Brown Deer Rd., Milwaukee 53223 [369]

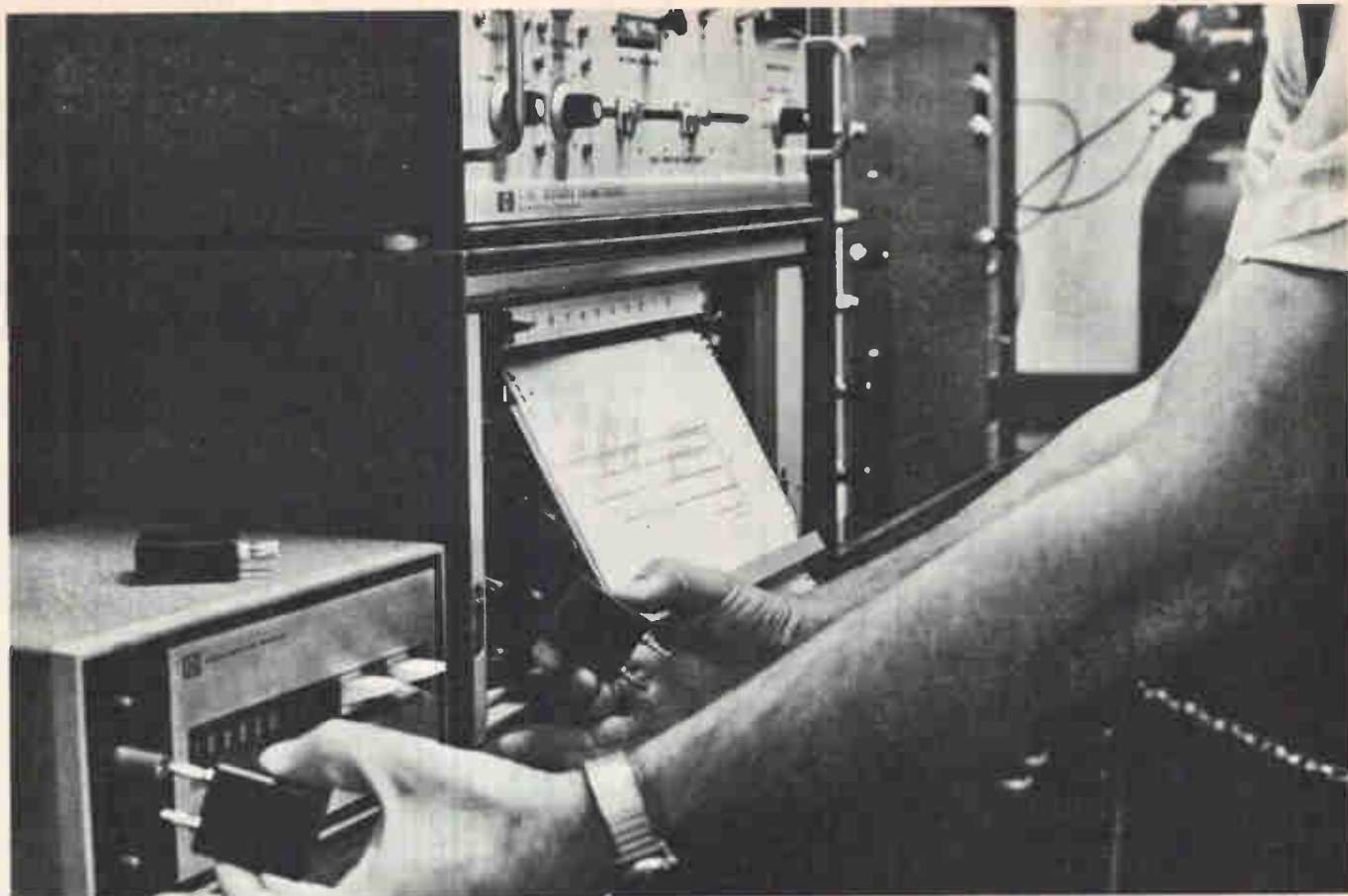

Plugging an E-CELL 'Data Stor' Integrator into a Digital Readout to measure the area under one peak of a Gas Chromatogram.

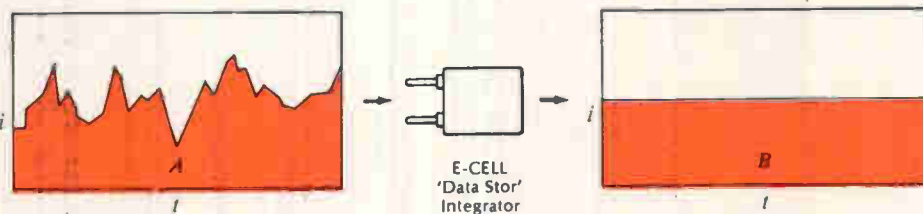

E-CELL 'Data Stor' Integrator transforms irregular signal into average integral. Area A equals area B.

Need to integrate the **area under the curve?**

Then we suggest Bissett-Berman's E-CELL^(TM) Measurement System — an exciting new approach to analog data acquisition and measurement.

A System consists of any number of Model 302 E-CELL 'Data Stor' Integrators and one Model 300 EDR E-CELL Digital Readout. A 'Data Stor' Integrator continuously accumulates and stores the x-y product of any individual data channel of the sensor or analog recorder to which it is connected. Each integral can then be read out at will, using a Model 300 EDR E-CELL Digital Readout.

Ideal for research, production, and teaching in chemistry, physics, medical research, process monitoring and control — wherever you need a quick and simple way to integrate "the area under the curve."

Consider these advantages:

- Mil spec reliability • Low cost • Accurate • Re-usable
- Non-volatile data storage • Compact size • Easy to use
- Versatile • On-line recording • Off-line readout

For literature and technical data, please send in the coupon below.

The Bissett-Berman Corporation, Components Division
 3860 Centinela Ave., Los Angeles, Calif. 90066

LITERATURE ONLY HAVE REPRESENTATIVE CALL

APPLICATION _____

NAME _____

COMPANY _____ DEPT. _____

STREET _____

CITY _____ STATE _____ ZIP _____

LEADER IN APPLIED COULOMETRY



**BISSETT
BERMAN**

COMPONENTS DIVISION
 3860 Centinela Ave.
 Los Angeles, Calif. 90066

If **FAST** warm up
 in a precision crystal
 standard is important to you:
 Sulzer Labs' **NEW 5C**
 does 5 parts in 10^{-10} **WELL**
WITHIN 12 HOURS!

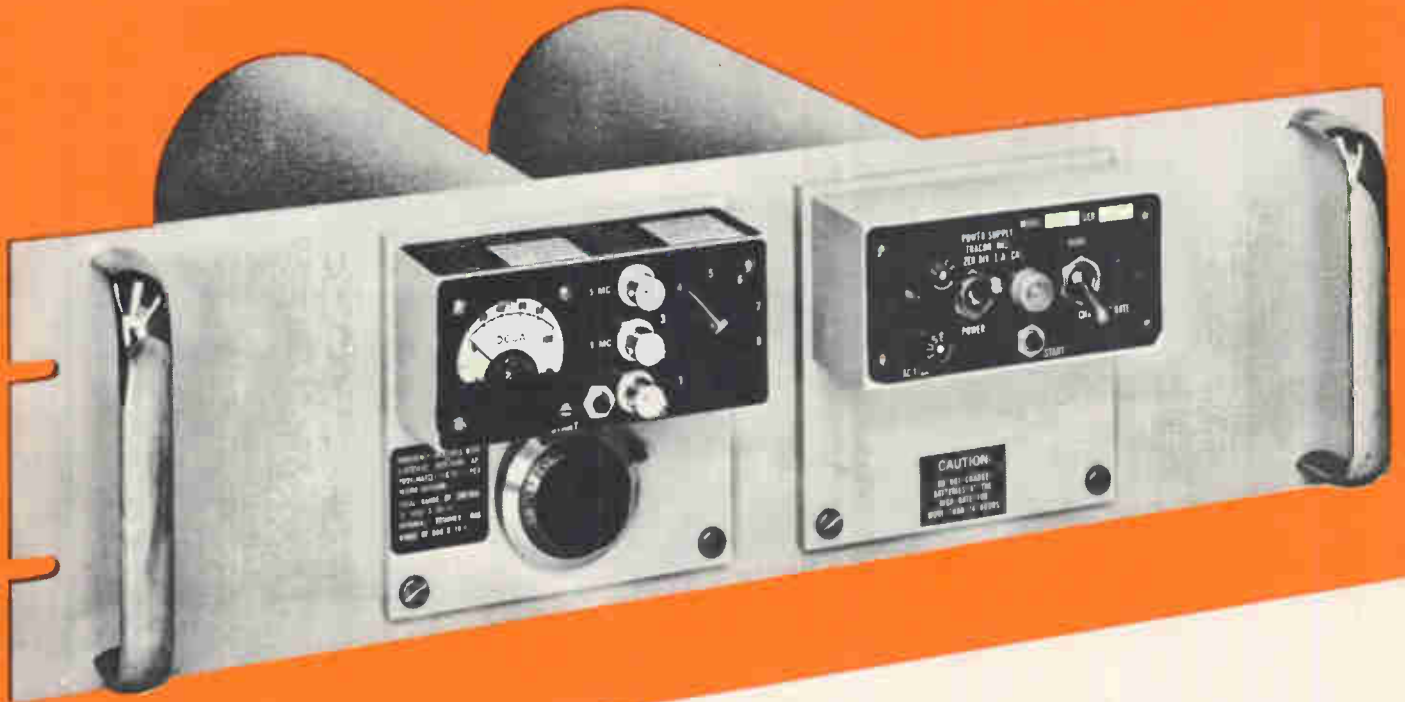
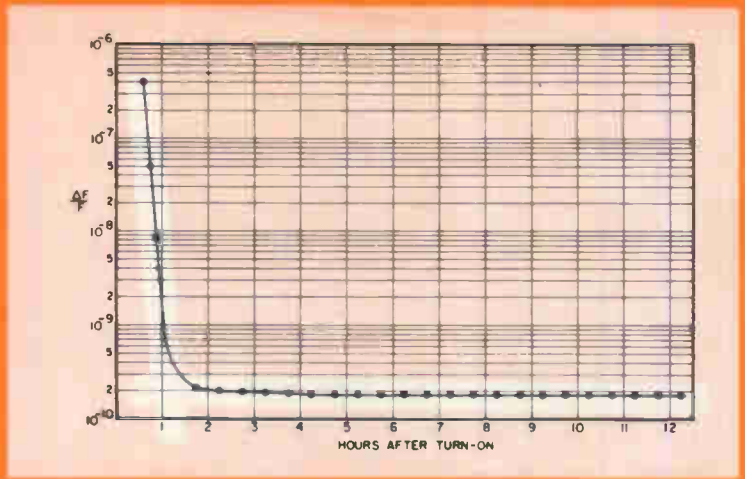

TEMPERATURE STABILITY:

better than 1 part in 10^{-11} per degree Centi-grade.

TYPICAL ULTIMATE AGING RATE:

1 part in 10^{-10} . . . plus all the features that you need in a quality crystal standard.

Proven in the field for over 12 months; field test graphs available with other information; write to: Tracor, 6500 Tracor Lane, Austin, Texas 78721

Phone: AC 512 / 926-2800

Circle 168 on reader service card

See at NEREM-'68, Booth 1C-25.



Specialized instruments to meet your specific needs

New Microwave Review

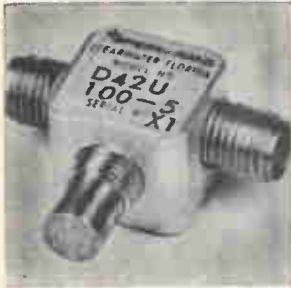

Miniaturized three-port circulators for frequencies between 1 and 18 GHz offer a minimum isolation of 20 db across a 10% bandwidth and carry a specified maximum insertion loss of 0.4 db. The D42C100, for the 6.5 to 8 GHz band measures 1/2 in. in each of the 3 dimensions. It weighs 1/2 oz. Sperry Microwave Electronics Division, P.O. Box 4648, Clearwater, Fla. 33518. [401]



S-band coaxial ferrite circulator MA-7K107 weighs 1 3/4 oz and features high isolation of 20 db minimum with low loss of 0.3 db max. over the 2.7- to 3.1-GHz range. Peak power is 1 kw and vswr is 1.2 max. Unit is designed for use in airborne data links, mapping and reconnaissance, search and target acquisition radars. Microwave Associates Inc., Burlington, Mass. [402]

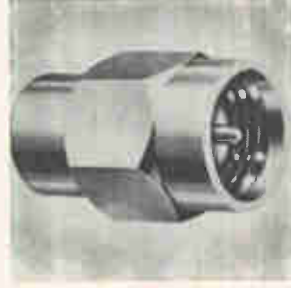

Miniature coaxial terminations series 4110 provide a compact and low vswr load for coaxial line and components. Its plugs and jacks mate with all of the common 3-mm connectors. The 0.5 watt devices feature vswr of 1.05 from d-c to 4 GHz, 1.10 from 4 to 8 GHz, and 1.15 from 8 to 12 GHz. Maximum length is 0.5 in. EMC Technology Inc., 1300 Arch St., Philadelphia. [403]



Miniature 9-section telemetry bandpass filter F196A was developed primarily for use as an output filter for a transmitter or multiplier. Its stop band extends through 10 GHz. Passband is 2.2 to 2.3 GHz. Vswr is 1.5 maximum. Size, excluding connectors, is 4.45 x 1.25 x 0.5 in. Connectors are OSM type. Peninsula Microwave Laboratories, 855 Maude Ave., Mountain View, Calif. [404]



Reflex klystron VA-259N is for telecommunication service. It delivers an output of 1.5 w over the frequency range of 6.575 to 6.875 GHz. Tuning over the full range is accomplished by a screw; a range of at least 30 MHz can be tuned electronically. Cooling is through conduction or by vapor. The tube weighs about 22 oz. Varian Associates, 611 Hansen Way, Palo Alto, Calif. [405]



Coaxial diode switch MT3010 covers the range 0.5 MHz to 12.4 GHz. It has a built-in integrated bias circuit and d-c blocks. Insertion loss is 0.5 db and isolation, 70 db. The unit measures 1.5 x 0.68 x 0.50 in. (less connectors) and weighs 1 oz. Applications include switching, modulating and attenuating. Alpha Industries Inc., 381 Elliot St., Newton Upper Falls, Mass. [406]



Solid state modulators cover 100 MHz to 14 GHz frequency range and feature low reflection with high isolation (50 db minimum) characteristics. Vswr's of 1.10 for low frequency models and 1.80 for high frequency models are coupled with low insertion losses. Units meet all requirements of MIL-E-5400. G-L Industries Inc., 825 Black Oak Ridge Rd., Wayne, N.J. [407]

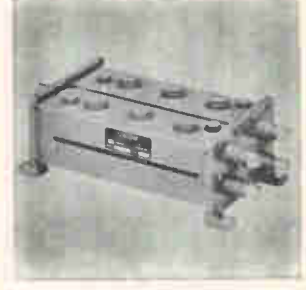

Four channel S-band (2.2-2.3 GHz) telemetry multicoupler S-401 allows simultaneous operation of four 50 watt transmitters into a single antenna. With channels separated by 25 MHz, it provides 24 db isolation with 0.6 db passband insertion loss. It measures 3.50 x 2.35 x 5.70 in. (plus connectors and mounting feet). Wavcom Inc., 9181 Gazette Ave., Chatsworth, Calif. [408]

New microwave

Two impatts: less noise or less money

10-mw oscillator without mil specs costs only \$200; extra circuit cuts noise in higher-power device

One's talking money and the other noise, but both are talking about microwave oscillators.

A young U.S. company and an established Japanese firm have developed oscillators made with impatt (impact avalanche transit time) diodes. But each company is

coming to market with a different sales pitch.

The device made by Somerset Radiation Laboratory Inc. costs \$200, about a third less than most other impatt oscillators. One reason the price is low may be that the output is also low: 10 milli-

watts continuous-wave minimum into a load with a voltage standing-wave ratio of 1.3.

But Sam Levine, Somerset's president, contends that 10 mw is plenty for many applications and blames high prices on overdesign.

"Microwave engineers have been brainwashed by the military," he says. "The services demand high performance, and price doesn't matter. Microwave equipment hasn't been put in the hands of engineers who want to design low-cost equipment. Till now, the only thing to come along for the civilian market has been microwave oven. Since our device is priced

We've submini-priced subminiature switches

and the deal's OFF. . .

Or on. Or off-again-on-again-off-again. Or on-again-on-again-on-again. Now, you can order both subminiature push button switches and subminiature toggle switches at the miniest prices on the market. How mini? Submini! Now how many?

Submini-Price List of Pushbutton and Toggle Switches

TOGGLE-SWITCH				
MODELS	1-24	25-99	100-499	500-999
7101	\$ 1.65	\$ 1.10	\$.96	\$.82
7103, 5, 7, 9	1.95	1.30	1.16	.97
7201	2.15	1.43	1.28	1.07
7203, 5, 7, 9	2.55	1.70	1.52	1.27
7211	2.85	1.90	1.70	1.41
7213	3.15	2.10	1.87	1.55
7215	3.45	2.30	2.06	1.71
7301	3.85	2.57	2.30	1.92
7303, 5, 7, 9	4.80	3.20	2.87	2.38
7401	4.85	3.28	2.90	2.43
7403, 5, 7, 9	6.05	4.10	3.61	3.00
7411, 13, 15	6.90	4.30	4.11	3.41

PUSHBUTTON SWITCH				
MODELS	1-24	25-99	100-499	500-999
P8121	\$ 2.55	\$ 1.70	\$ 1.52	\$ 1.27
P8221	3.45	2.30	2.06	1.71
P8321	4.80	3.20	2.87	2.38
P8421	6.05	4.10	3.61	3.00

American-made products at lower prices than imports.

1
2
3
4
Poles!

Call or write for quantity prices:
CKCOMPONENTS, INC.
103 Morse Street, Watertown,
Mass. 02172 tel.: (617) 926-0800

so low, designers can now start to think about using impatt oscillators in commercial systems."

Ins and outs. Ignoring military specifications, Somerset uses inexpensive parts wherever possible. Instead of spring-loaded contacts, the oscillator has less expensive contacts that Levine says are "almost as reliable."

Instead of a \$20 waveguide flange, the oscillator's body is made from a \$2.50 aluminum block. "There's no sacrifice at all in performance," says Levine. "Besides, the block's thick wall makes it easier for us to mount components."

Somerset's oscillator, called the X915, works at a fixed frequency between 8.2 and 9.6 gigahertz. From -40° to +70°C, the temperature coefficient is 200 kilohertz per degree centigrade.

The oscillator draws 2.5 watts maximum, and works from any d-c supply that delivers 60 to 90 volts



Singular. The Somerset oscillator works at a fixed frequency from 8.2 to 9.6 Ghz and has 2% efficiency.

and 10 to 40 milliamps. The efficiency is 2% and the pushing factor 0.02% per volt.

Levine says the oscillator can be used in low-power transmitters, beacon transponders, docking radars for ships, and parametric amplifiers. The first X915's were bought by a textile firm that will use them in a system that measures the moisture in a continuously moving roll of cloth.

The X915 is 1.5 by 0.5 inches. Delivery time is 10 days.

The Japanese firm, the Oki Elec-

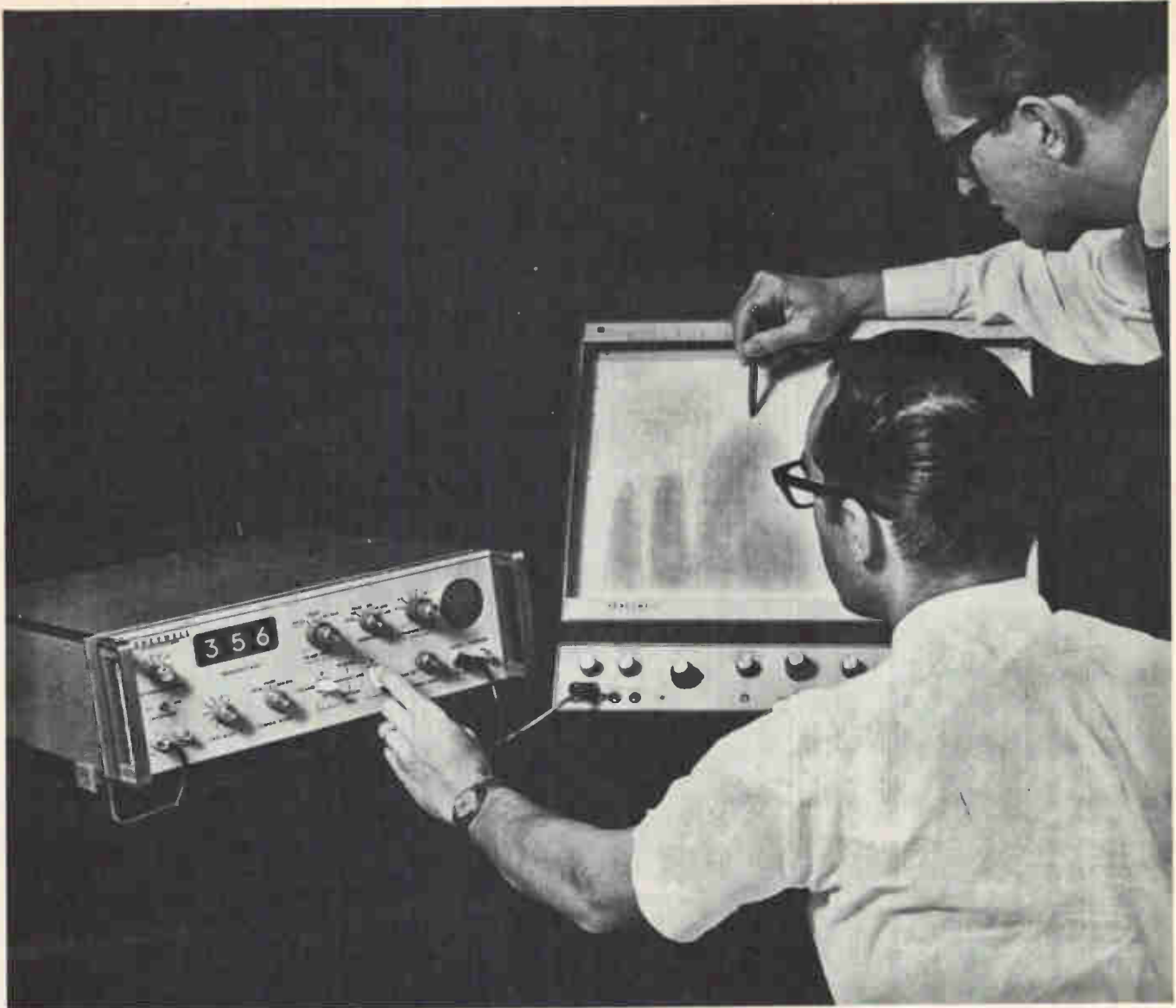

Automatically obtaining a graphic record of RF spectrum from 1-500 kHz.

Here's Honeywell's solution to RF spectrum analysis: a compact, automatic analyzer with 15" permanent record readout!

This versatile system brings a new ease to surveillance and spectrum analysis. It's our new VLF Receiver – the first in a series of automatic sweep receivers – coupled to an X-Y recorder with 15" display for maximum spectrum resolution.

Electronically tuned, the receiver covers the 1 to 500 kHz range in one band. Manual coarse or fine tuning is quick and precise, thanks to lever-actuated switches. In addition, the receiver may be tuned through single or recurring internal sweep, or externally programmed with a DC voltage.

Digital frequency readout is four-digit display, plus a fifth digit with front panel switch. For digital recording, BCD outputs are provided. Other features include: choice of AM, FM, NFM, Pulse, AM-USB, AM-

LSB, CW, and FSK, all front-panel selectable; choice of six bandwidths, selected by front panel or remotely; high sensitivity with low noise figure, and image rejection greater than 70 db.

Useful in a wide variety of analysis and measurement problems, this compact spectrum analyzer is another example of how Honeywell's broad line, backed by local sales and service, can provide the *precise* solution to your instrumentation problems. For full details on this new system, call your local Honeywell Sales Engineer, or write: Honeywell, Test Instruments Division, P. O. Box 391, Annapolis, Maryland 21404.

Honeywell

Honeywell engineers sell solutions

1/100TH SECOND STOP CLOCK!

RAPID • ACCURATE • DIGITAL READOUT

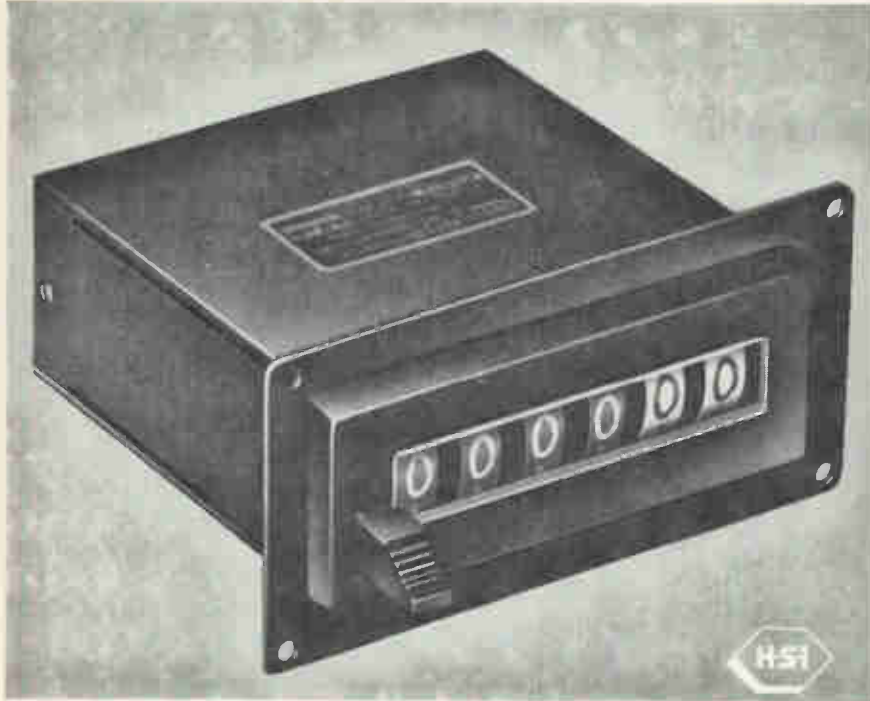

THE HSI SERIES 42 PLANETGEAR® STOP CLOCK makes it possible to measure, integrate or totalize with high accuracy and reliability. Average error over 10 or more readings is less than 5 ms. Well under this figure for integrating. Instant start-stop motor plus patented Planetgear low-torque transfer provide 5 exclusive features . . .

- No pre-start or stabilizing
- Memory lock for power loss
- No spurious counts due to line transients
- Quiet operation
- Extremely long life

Series 42 has large 5/16" high figures, 6 drum display, manual or electrical reset. Operates on 110v 60Hz. 6 watts.

**HSI PLANETGEAR TRANSFER . . .
YOUR BEST BET IN THE LONG RUN!**



HAYDON SWITCH & INSTRUMENT, INC.

Where Optimum Performance Is Standard

1500 Meriden Road, Waterbury, Conn. 06720/Area Code (203) 756-7441

VISIT US AT
NEREM-68
BOOTH 2J70

. . . output frequency is
changed mechanically . . .

tric Industry Co., calls its oscillator the AD and will sell it for about the same as other impatt oscillators: \$300 and up. The price will depend on the type of package the customer specifies and his coupling requirement. But, says Oki, the AD has a lower noise level.

Impatt devices suffer from random and f-m noise. Oki puts a proprietary injection-locking circuit into the AD that cuts the noise by more than 20 decibels compared with the noise of an AD without the circuit, while reducing output power by no more than 1 db.

Like Somerset, Oki uses a silicon diode in its device, but the Japanese company's oscillator can be mechanically tuned over a 1-Ghz band and electrically tuned through 100 megahertz.

Available with center frequencies from 6 to 12 Ghz, the AD delivers from 50 to 350 mw. The input is 75 to 90 volts d-c and 20 to 70 ma.

The AD in a waveguide package is 1.6 by 1.6 by 0.6 inches and weighs 8 ounces: a 3.5-ounce coaxial version is also available.

The company expects that AD oscillators will be able to replace reflex klystrons in many applications. They're already being built into an experimental communications system in Japan, and Oki expects that AD's will be used in doppler radars, transponders, and collision-avoidance systems.

Samples are ready now, and Oki says it will be delivering production quantities by March 1969.

Engineers at Oki have also built prototypes of impatt oscillators that deliver 300 to 500 mw at 10 Ghz. These devices have efficiencies that run from 5 to 7%.

These high-power oscillators have been run in parallel, so the company feels it will be able to offer 1-w and better microwave power sources in the near future. The 300- to 500-mw AD's should be ready sometime next year.

Somerset Radiation Laboratory, Inc.,
2060 N. 14th St., Arlington, Va. [409]

Oki Electronics of America Inc., 500
S.E. 24th St., Fort Lauderdale, Fla.
33316 [410]

how thermistors stabilize collector current

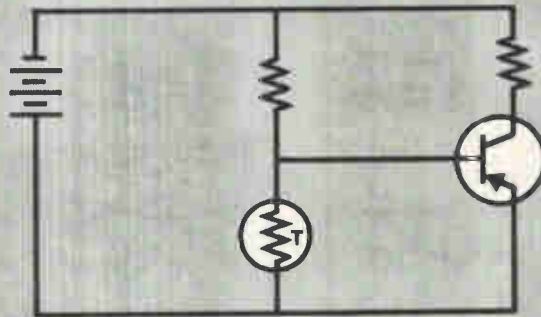

As temperature increases, I_{CO} increases and tends to increase the collector current of the transistor. However, simultaneously the resistance of the thermistor will decrease, thereby decreasing the base voltage and causing the collector current to decrease. By proper thermistor matching, these changes will offset each other and the collector current will remain constant over a wide temperature span.

Standard Keystone Rod Type Thermistors

TYPE	RESISTANCE AT °C							BETA ±10% (37.8-104, 4°C)	R@25°C R@125°C..	Neg. Temp. Coef.@25°C
	0	25	37.8	50	75	104.4	125			
Low/Medium Temperature Coefficient										
15-10-32-S1	15.0	10	8.31	7.05	5.18	3.76	3.08	1400	3.2	1.50
15-20-35-S1	30.6	20	16.4	13.8	9.90	7.01	5.65	1500	3.5	1.59
15-50-42-S1	80.6	50	40.1	32.9	22.6	15.3	11.9	1700	4.2	1.78
15-100-42-S1	161	100	80.2	65.8	45.3	30.6	23.8	1700	4.2	1.78
15-200-42-S1	322	200	160	132	90.6	61.2	47.7	1700	4.2	1.78
15-500-50-S1	847	500	391	314	206	133	100	1900	5.0	1.98
15-1K-50-S1	1690	1K	782	628	413	266	201	1900	5.0	1.98
15-2K-52-S1	3430	2K	1560	1240	808	515	387	1950	5.2	2.03
15-5K-54-S1	8680	5K	3860	3060	1980	1240	924	2000	5.4	2.07
15-10K-54-S1	17.4K	10K	7730	6130	3950	2480	1850	2000	5.4	2.07
15-20K-59-S1	35.6K	20K	15.3K	12K	7560	4640	3400	2100	5.9	2.17
15-50K-62-S1	90K	50K	37.9K	29.5K	18.5K	11.2K	8120	2150	6.2	2.22
High Temperature Coefficient										
15-1K-139-S1	2500	1K	656	451	227	111	71.9	3150	13.9	3.38
15-2K-139-S1	4990	2K	1310	902	454	222	144	3150	13.9	3.38
15-5K-181-S1	13.7K	5K	3150	2100	979	450	276	3425	18.1	3.74
15-10K-192-S1	28.2K	10K	6240	4100	1890	855	520	3500	19.2	3.83
15-20K-292-S1	67.2K	20K	11.6K	7140	2920	1190	685	4000	29.2	4.46
15-50K-292-S1	168K	50K	28.9K	17.8K	7320	2980	1710	4000	29.2	4.46
15-100K-404-S1	372K	100K	55K	32.4K	12.2K	4540	2080	4400	40.4	4.86
15-200K-424-S1	753K	200K	109K	63.9K	23.9K	8740	4720	4450	42.4	4.91
15-500K-482-S1	1.95meg	500K	268K	154K	55.6K	19.7K	10.4K	4600	48.2	5.03
15-1meg-583-S1	4.06meg	1meg	523K	294K	100K	33.7K	17.1K	4830	58.3	5.22

Leads: T.C. AWG #20
 Dissipation Constant:
 9mW/°C Approx.
 Time Constant:
 45 seconds approx.
 Tolerance: ±10% at 25°C
 Max. Operating
 Temperature: 125°C

The Keystone units listed in the table are standard stock thermistors. Beads, washer types, cryogenic units and units with special resistance values and tolerances can be supplied, as well as with special mounting assemblies on lead attachments. Write us on your specific requirements. Keystone Carbon Company, St. Marys, Pa. 15857. Phone: 814-834-1591.

Keystone
leads
 in creative thermistor technology

DCL. It'll give you a fit.

Honestly.

Because now it fits over 90% of the digital IC applications known to man. Any man. Even you.

(You mean you never even heard of DCL? It's Signetics's compatibly specified family of DTL and TTL logic circuits, interface elements and monolithic subsystems. And shame on you.)

Right now, the family gives you 60 members to work with. (And we mean right now, off-the-shelf.)

For instance, nine of the members are brand-new complex arrays, including counter, shift-register, adder and decoder functions.

Then there are nine new gates. Which means the DCL line now gives you 25 different gate configurations—the widest choice in the industry.

And in interface elements, we've solved a real

problem with our Nixie* Decoder/Driver. It interfaces directly with all DTL and TTL circuits and drives tubes directly.

When it comes to Dual Binaries, we've got seven new ones—offering both synchronous and asynchronous capabilities and clock rates up to 70MHz. (Result: now there's a DCL binary for every specific design need.)

And the whole DCL line is yours in two temperature ranges: -55°C to $+125^{\circ}\text{C}$ and 0°C to $+75^{\circ}\text{C}$ in both flat-packs and DIP's.

If you haven't met our highly compatible family, we'd like to introduce you via our DCL Handbook—yours for writing Signetics, 811 East Arques Avenue, Sunnyvale, California 94086. We think you'll enjoy the meeting.

In fact, you're very apt to have a fit.

Signetics Integrated Circuits 
A SUBSIDIARY OF CORNING GLASS WORKS



Mechanical sizes of the 5 watt and 750 milliwatt glass zener diodes are respectively 0.085 x 0.160 in. with 0.040 in. leads and 0.065 x 0.100 in. with 0.020 in. leads. Zener voltage ranges are 6 v through 400 v with "sharp knee" low leakage characteristics. Prices start at \$1.04 each at the 1,000 piece level. Micro Semiconductor Corp., 11250 Playa Court, Culver City, Calif. [436]

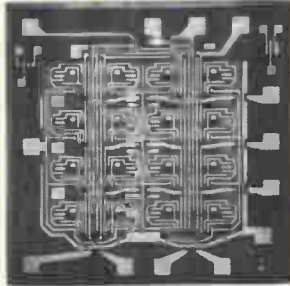

The CD4005D is a 16-bit non-destructive readout memory on a single monolithic silicon chip containing N-channel and P-channel enhancement type MOS transistors connected in complementary-symmetry configurations. It is mounted in the hermetically sealed, 14-lead dual-in-line ceramic package. RCA/Electronic Components, 4115 S. Fifth St., Harrison, N.J. 07029. [437]

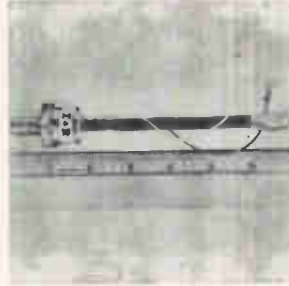

Fast-firing SCR's series 81RLB are 80 amp devices capable of handling 800 amps/ μ sec inrush current. They are obtainable to 1,200 v in a TO-94 package. In quantities from 25 to 99 prices range from \$62 for the 500 v devices to \$234 for the 1,200 v units. Delivery is immediate from factory and distributor stock. International Rectifier, 233 Kansas St., El Segundo, Calif. [438]

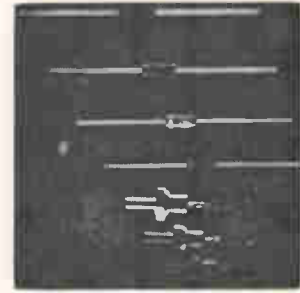

Plastic zener diodes called Surmetic 40 dissipate 5 w d-c, and can replace more than 300 glass, metal, and plastic devices. Featuring a silicon dioxide-passivated junction, they have leakage current of 50 na and surge capability of 180 w max. Zener voltages range from 3.3 to 200 v. Price (100-999) is \$1.85. Motorola Semiconductor Products Inc., Box 955, Phoenix. [439]

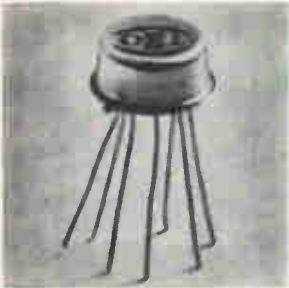

Single chip monolithic voltage regulator model 8100 does not require any external transistors for either positive or negative regulation. Intended for use on circuit boards and in potted modules as a point-of-use regulator, the unit is packaged in a 7-lead, TO-5 low profile can. Price is \$27 each in lots of 1 to 9. Optical Electronics Inc., P.O. Box 11140, Tucson, Ariz. [440]

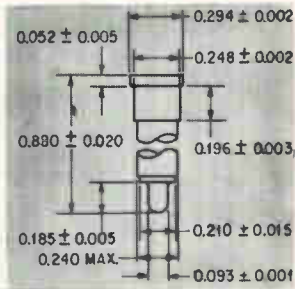

Bulk gallium arsenide diode CA5X3 provides 500 w pulses, with applied pulse length of 100 nsec, at operating frequencies of 7.5 Ghz to 8.5 Ghz. It is used in the LSA (limited spacecharge accumulation) operation mode. The diode, when supplied in the CAX800R resonator mount, permits mechanical tuning of 10%. Cayuga Associates Inc., Parker Road, Long Valley, N.J. [441]



Microwave transistor 800BLY is a silicon NPN device capable of providing 1 w output at 2 Ghz. It is mounted on a capstan header for use in stripline circuits. Units are intended for use in microwave link transmitters. They can also serve as an oscillator or power amplifier for driving a varactor diode harmonic generator chain. Mullard Ltd., Torrington Place, London WC1. [442]



Monolithic silicon integrated, wideband amplifier CMC602 can amplify signals from d-c to over 100 Mhz, with a minimum of 20 db gain. It features internally diffused agc diodes and external gain control. It will operate from -55° to $+125^{\circ}$ C, suiting it for use in industrial and military communication systems. Continental Device Corp., 12515 Chadron Ave., Hawthorne, Calif. [443]

New semiconductors

TTL circuit replaces four 14-lead IC's

MSI pair multiplex and demultiplex for communication and data jobs; a D-type flip-flop will complement them

As the first integrated circuits were announced, manufacturers used to proclaim how many discrete components each replaced. Now, with medium- and large-scale integration entering the field, the battle cry is the number of IC's replaced.

"These two TTL circuits will each replace four to five 14-lead packages," says Joseph T. Nola, manager of IC product planning at the Semiconductor division of Sylvania Electric Products Inc. "Both the SM 210 and SM 220 can replace as many as 20 to 25 logic gates

or perhaps whole printed-circuit cards."

The transistor-transistor-logic arrays, the latest additions to Sylvania's line of MSI devices, complement one another in most applications. The SM 210 is a dual four-bit multiplexer that also acts as a parallel-to-serial converter or an encoder; the SM 220 is a demultiplexer, serial-to-parallel converter, or decoder.

Bus terminals. In one typical application, SM 210's and SM 220's might sit at opposite ends of buses in a computer, with the SM 210 receiving inputs from memory or other devices and sending them

If you're concerned with
Transistor Pads and Clips—
Heat Sinks and Adapters . . .

JERMYN

ACCESSORIES

are worth
a closer
look . . .



Precision made in Kent, England by JERMYN Industries, these important items of circuit hardware are manufactured with traditional English craftsmanship. They are stocked and sold exclusively in the U.S. by GUDEBROD. Ask for our new Catalog GJ100 which describes the full line—or tell us about your custom needs.

GUDEBROD

Electronics Division

Gudebrod Bros. Silk Co., Inc.
Founded 1870
12 South Twelfth Street
Philadelphia, Pa. 19107

along the bus bar. The 220 would be placed at the opposite end to convert the bits back into their original format.

The two circuits, in a straightforward communications multiplexer-demultiplexer combination, have already been installed in the equipment of a large Midwest manufacturer. The information transfer rate in such a system varies with the sampling rate, but Nola estimates that this 210-220 combination could relay 30 megabits or more per second.

Nola notes that the SM 210 will accept as many as eight parallel channels of data, squeezing these into two output channels. The circuits can be cascaded easily, making possible, for example, transmission of 32-bit streams over two channels.

The 220 does not have both "true" and "false" state outputs,

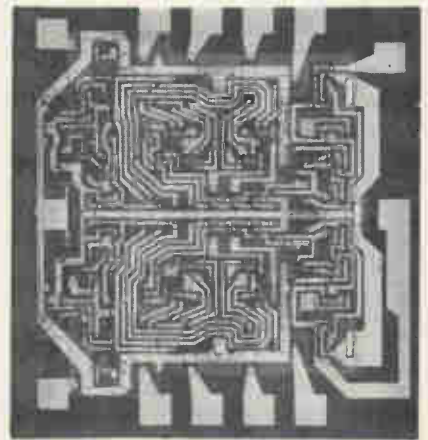

Versatile. Dual four-bit multiplexer can also be a converter or decoder.

which Nola says are needed by the user who wishes to drive J-K flip-flops. The J-K flip-flop is fast, but, Nola says, the added inversion circuitry needed to supply both states would slow the IC's, increase power dissipation (175 milliwatts, against about 135 mw for the 210), and require two more output stages.

Sylvania's answer to this is gating designed to be fast (outputs are produced in as little as 12 nanoseconds) and to feed the single-entry D-type flip-flops, which Nola says are becoming popular and which are nearly as fast as the J-K, achieving about 40-megahertz clocking with ease.

Sylvania has a D-type flip-flop

Now you can buy an INSTRUMENTATION AMPLIFIER for only \$125.00



- High CMRR: up to 120 db,
DC to 100 Hz
- Low Input Drift: $\pm 3 \mu\text{V}/^\circ\text{C}$ max.
- Low Input Noise: $6 \mu\text{V}$, rms, max.
- Voltage Gain: Adjustable from 1 to
1,000 by means of a
single resistor
- Static Linearity: better than $\pm 0.1\%$
- High Differential
Input Impedance: 50 M Ω
- Rated Output: $\pm 10 \text{ V}$ at $\pm 10 \text{ mA}$.

So, why use big, costly units?

Here's an amplifier for the engineer who's tired of paying for more performance than he really needs in his instrumentation applications. The Model 3061/25 is only one of many Burr-Brown encapsulated instrumentation amplifiers (including FET input versions) which provide most of the useful features of the big rack-mount units . . . at a fraction of the cost.

The use of matched Burr-Brown monolithic IC Op Amps and carefully selected discrete components provides a size-performance-price-reliability combination that's hard to beat. The unit is small enough (2.4" x 1.8" x 0.6") to be mounted adjacent to the transducer or source voltage to avoid noise pick-up. For driving long cables and high current loads, inexpensive power boosters are available.

Burr-Brown instrumentation amplifiers are ideal for amplifying signals from strain-gage bridges, thermo-

couples, pressure transducers and other low-level sources. You can even drive 80 mA galvanometers with the Model 3090/25. They are ideal for aerospace, medical and process control instrumentation as well as industrial research and test equipment.

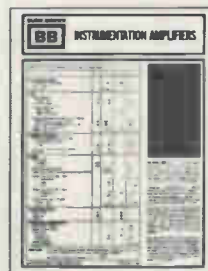

NEW 16-PAGE INSTRUMENTATION AMPLIFIER CATALOG AND APPLICATIONS GUIDE

For your copy, simply contact your local Burr-Brown Engineering Representative or use this publication's reader service card.

BURR-BROWN RESEARCH CORPORATION

International Airport Industrial Park • Tucson, Arizona 85706
TELEPHONE: 602-294-1431 • TWX: 910-952-1111 • CABLE: BBRCORP



Operational Amplifiers
Instrumentation Amplifiers
Function Modules
Active Filters
Power Supplies

ENGINEERING REPRESENTATIVES: ALABAMA, HUNTSVILLE (205) 534-1648 / ARIZONA, PHOENIX (602) 254-6085 / CALIF., LOS ANGELES (213) 665-5181, SAN DIEGO (714) 232-2017, SAN FRANCISCO (408) 244-1505 / COLO., DENVER (303) 399-4391 / CONN., EAST HARTFORD (203) 874-9222 / D.C., WASHINGTON (SEE MARYLAND) / FLORIDA, ORLANDO (305) 425-2764 / ILLINOIS, CHICAGO (312) 286-6824 / LA., NEW ORLEANS (504) 888-2266 / MO., SILVER SPRING (301) 588-8134 / MASS., BOSTON (617) 245-4870 / MICH., DETROIT (313) 358-3333 / MINN., MINNEAPOLIS (612) 781-1611 / MO., ST. LOUIS (314) 524-4800 / N.C., GREENSBORO (919) 273-1918 / N.J., CAMDEN (215) 925-8711 / N.M., ALBUQUERQUE (505) 255-1638 / N.Y., ALBANY

(518) 489-4777, BINGHAMTON (607) 723-9661, MT. VERNON (914) 968-2200, NEWBURGH (914) 562-6604, NEW HARTFORD (315) 732-3775, ROCHESTER (716) 473-2115 / OHIO, CINCINNATI (513) 761-5432, CLEVELAND (216) 237-9145, DAYTON (513) 277-8911 / PENN., PHILADELPHIA (SEE CAMDEN, N.J.), PITTSBURGH (412) 243-6655 / TEXAS, DALLAS (214) 357-6451, HOUSTON (713) 774-2568 / UTAH, SALT LAKE CITY (801) 466-8709 / VIRGINIA, (SEE MARYLAND) / WASH., SEATTLE (206) 767-4260 / CANADA, DOWNSVIEW, ONT. (416) 636-4910, MONTREAL, QUE. (514) 739-6776, OTTAWA, ONT. (613) 725-1288, VANCOUVER B.C. (604) 291-7161

.... How's Your Memory?

If you're not getting what you paid for, give us a call next time you have to order one. Chances are, you won't pay as much and you won't have to make any adjustments to get it to turn on.

DC-20

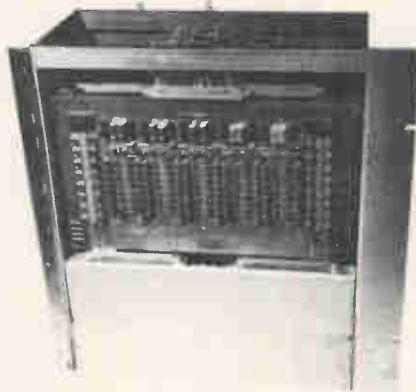

DC-51



DATA-CRAFT MEMORY PRODUCTS

MODEL	SPEED (FULL CYCLE)	MAX. CAPACITY
DC-20	600 NANOSECONDS	8K X 25
DC-30	1 MICROSECOND	1K X 32, 2K X 16
DC-31	900 NANOSECONDS	512 X 16, 1K X 8
DC-32	1.5 MICROSECONDS	8K X 26
DC-33	1 MICROSECOND	1K X 8
DC-34	1 MICROSECOND	8K X 18
DC-51	4 MICROSECONDS	256 X 18, 512 X 9

OUR MOST IMPORTANT PRODUCT IS YOUR SATISFACTION.
CALL OR WRITE US TODAY ABOUT YOUR REQUIREMENT.

Datacraft Corporation

776 N.E. 40th Court P.O. Box 23560 Ft. Lauderdale, Fla. 33307 Phone (305) 565-9441

coming along to complement its new multiplexer-demultiplexer pair. Called the SF-90 series, the new circuits will be ready before the end of the year.

Two fanouts. Nola expects to sell most of the SM-210's and SM-220's for commercial electronic data processing systems at first, probably for the busing application, which appears to be one of the most promising.

But the circuits can be used in any military or industrial system using AND-OR, AND-NOR or wired-OR logic configurations.

This designed-in versatility opens many applications to the IC pair, including process control, aircraft instrumentation, and attack avionics systems.

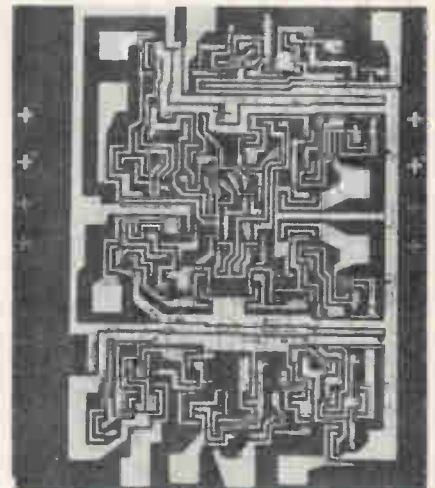

Complementary. In data communications, SM 220 converts bits to original format.

With this in mind, Sylvania will offer both industrial and military-specification SM 210's and SM 220's, with fanouts specified separately for each category.

Both IC's have fanouts of "seven equivalent SUHL I loads," says Nola. Their logic swing is wide: '0' is about 0.25 volt, and the '1' state is typically 3.25 volts. Drive capacitance is also high, about 600 picofarads.

Evaluation quantities can be delivered in a month or less; the prices for these and for production quantities have not been established yet.

Sylvania Electric Products Inc., Semiconductor division, 100 Sylvan Rd., Woburn, Mass. 01801 [444]

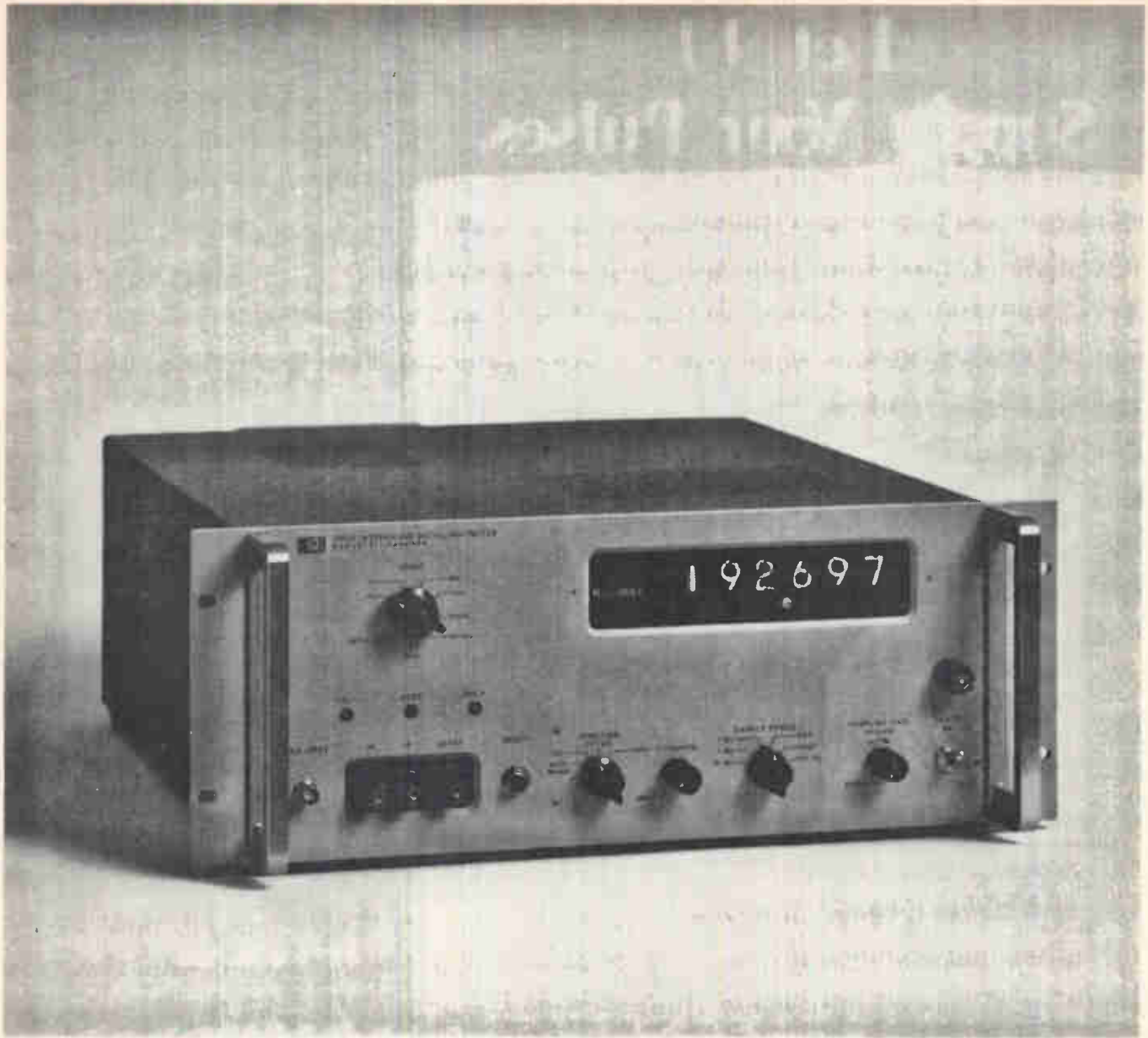

Still True

The Hewlett-Packard 2401C Integrating Digital Voltmeter is still the DVM to count on. You've been using it, trusting it to provide accurate measurements. You know it's *still* giving you exceptionally high noise rejection. You know it *still* comes with standard—not optional—interface features for systems use. It *still* gives you a choice of sample times to get the best combinations of resolution and speed for a given application.

Still gives you external start-stop for long-term integrals, even around zero. And *still* gives accurate frequency and period measurements.

When the time comes to consider more DVM's, experience is still the best teacher. Call your HP field engineer for details on precision measuring instruments. Or write Hewlett-Packard, Palo Alto, Calif. 94304; Europe: 54 Route des Acacias, Geneva.

HEWLETT  PACKARD
DIGITAL VOLTMETERS

Let TI Supply Your Pulses.

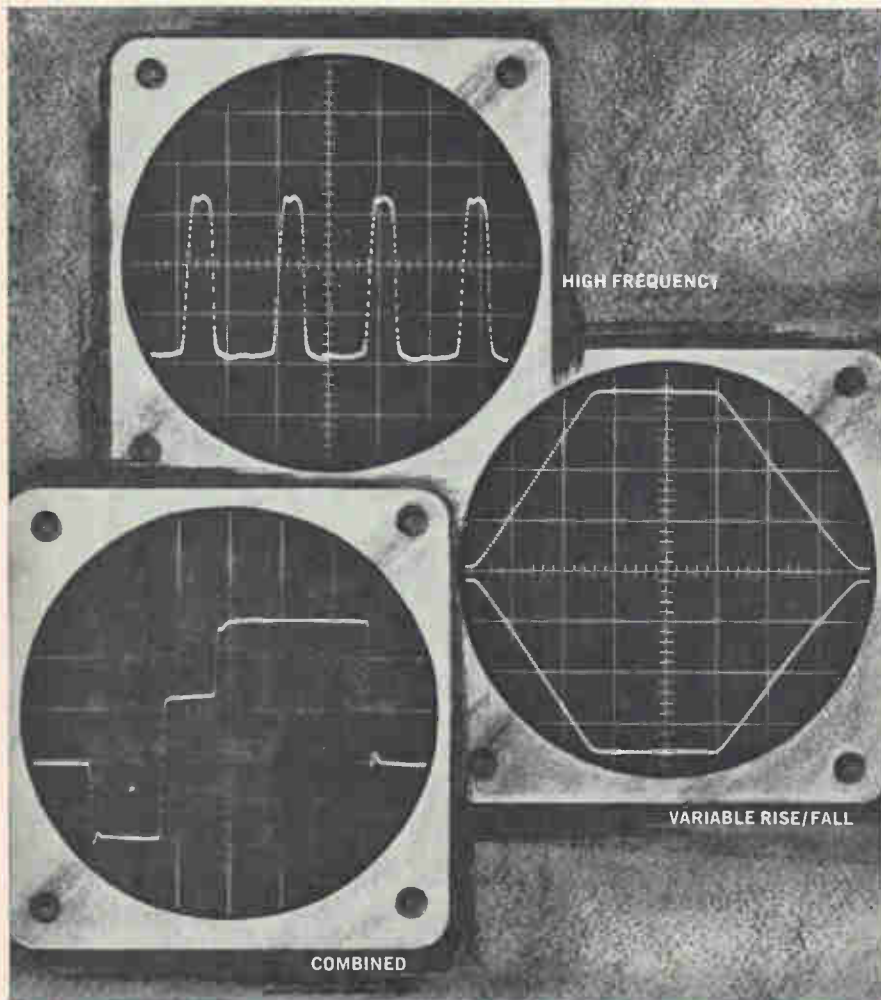

Texas Instruments pulse generator line offers you a wide choice in test pulses. There are rep rates to 100 MHz, positive or negative outputs to 50v, rise times less than 1 nanosecond and variable pulse widths, delays, amplitudes, and rise/fall times.

Select the pulse generator that best suits your needs, and be assured of TI quality and performance. Choose a high-voltage model for evaluation of core and thin magnetic film memory arrays, high-frequency types for state-of-the-art circuit design and TDR studies or units for

general-purpose testing.

And when you have special pulse generator requirements, build your own pulse generator from TI's complete modular line. These all-solid-state "building blocks" assure you custom performance and versatility.



But the best way to get the whole story is with TI's pulse generator data file. Write the Industrial Products Division, P.O. Box 66027, Houston, Texas 77006 (713-349-2171).



TEXAS INSTRUMENTS
INCORPORATED

143

New Books

On the hop

The Beginnings of Satellite Communications

J.R. Pierce

San Francisco Press, Inc., 61 pp. \$2.75

With electronics moving as fast as it is, it isn't often that someone has the time or perspective to set down his view of a particular development's history, and it's even less often that a writer of the skill of J.R. Pierce tackles the task. This slim volume will be of value to anyone in the communications field.

From his present vantage point, Pierce can evaluate and place in perspective such early efforts as Echo, Advent, and Telstar, both in terms of technical capability and concept. Closing with a note on what he considers to be the sleeper in the field of communications satellites—domestic communications—Pierce points out that not only could a satellite handle hundreds of thousands of telephone circuits, but could transfer blocks of circuits from one pair of cities to another to meet changes in demand. In light of this capability, he adds, previous switching concepts are not changed—they are obsolete.

FET's in the field

Junction Field Effect Transistors

Carl David Todd

John Wiley & Sons Inc.

285 pp., \$10.50

Readers certainly won't be bogged down by detailed theory and mathematical derivations in this text. The author assumes they're familiar with the theoretical differences between bipolar transistors and FET's, so he concentrates on the practical differences. He's writing primarily for design engineers and advanced students.

But the bibliography more than compensates for what the volume lacks in basic field-effect theory. It briefly summarizes 325 references and includes cross-reference charts, making it relatively easy to find material to meet special needs. Most of the references are from after 1958, but there are enough from earlier years to form a basic history of junction FET's.

Covered are a-c and d-c am-

Introducing the world's most advanced ICs for professional communications

The Plessey SL 600 series enables designers to produce a new class of transceiver equipment in terms of both size and performance.

This new Plessey series of communications circuits consists of six basic types, designed as a completely compatible family. Four of these ICs are the first of their type in the world. All meet the full Military temperature specification, offer low power consumption and require only a single +6V supply.

RF Amplifier SL610

The linearity of this circuit is unequalled by any normal transistor amplifier. Input signals of 100 mV (with no AGC) and 250 mV (with full AGC) at 10 MHz result in less than 1% cross modulation. The circuit has a gain of 10X.

SL611

Similar to the SL610 but with a gain of 20X.

IF Amplifier SL612

This low noise 15MHz amplifier has high gain low distortion and consumes typically only 20mW of power. Voltage gain of 50.

SSB AGC Generator SL621

The SL621 is the only circuit in the world able to provide this function and performance. It will follow fading signals but hold a fixed AGC level during pauses in speech as well as recovering rapidly from impulse noise interference. This circuit enables SSB performance to approach conventional AM behaviour.

Voice-Operated Gain Adjusting Device SL620

The only commercially available IC capable of this function. Provides an accurate audio AGC system, will hold microphone amplifier output between 70 mV and 87 mV for a 35dB range of audio input.

Audio Amplifier SL630

Provides an extremely versatile output capacity. Operates from any supply ranging from $\pm 6V$ to $\pm 15V$. Maximum power output at $-15V$ is 250 mW. Circuit includes wide range logarithmic AGC, automatic overload protection and will accept either single ended or differential inputs.

Double Balanced Modulator SL640

A unique circuit available only from Plessey. Replaces the diode ring for frequencies up to 76 MHz. Needs no transformers, saves power, cost, space and requires no external adjustment for balance. High stability inherent. Equally applicable for line communications - telephone channelling. A receiver mixer version, SL641, is also available.

For full information on any of these outstanding communication circuits, please write or telephone:

Plessey Incorporated

170 Finn Court, Farmingdale, Long Island, New York, 11735
Tel: 516MY4-7377 Telex: 126519 Cables: Plessey, New York



PLESSEY
microelectronics

CW SC62

Circle 225 on reader service card

*mechanical
refrigeration
to ~~-85°F~~ -100°F
for only
\$745*



Only Associated Gives You Full Range Military Testing At This Low Price!

Associated's Model SW-5101 Temperature Chamber offers a new concept in mechanical refrigeration that enables you to perform 90% of all military low-high temperature tests at equipment cost-savings of up to \$200.

SPECIAL FEATURES OF THE SW-5101:

- full 1 cubic foot test area
- temperature range from -100 to $+350^{\circ}F$.
- all solid state controller with $\pm 1/2^{\circ}F$ stability
- delivery from stock
- adjustable high-temperature fail-safe with signal lamp
- indicating thermometer in door
- combination hinged and removable door
- bench-top design, can be modified for stacking
- stainless steel feed-through port, $3/4$ " diameter

Check the SW-5101 specifications against your testing requirements. You'll find they add up to outstanding performance at a down-to-earth price — without sacrifice of quality or reliability.

The new Associated catalog of environmental chambers is yours for the asking. Write for your free copy today.

**ASSOCIATED
TESTING
LABORATORIES
INC.**



200 Route 46, Wayne, New Jersey • (201) 256-2800

West Coast Office:

6100 Wilmington Ave., Los Angeles, Calif. 90001 • (213) 589-9196

Circle 181 on reader service card

181

Is Your Budget Too Tight For Your Bandwidth?

\$284

○ Low Cost

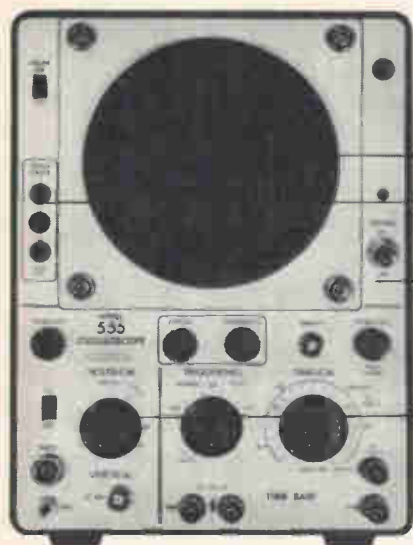

○ 8 cm x 10 cm Viewing Area

○ Voltage Calibrator

○ Solid State Reliability

○ 7 MHz Bandwidth

Try this one for size—Data Instruments Model 555. For any application, Production Line, Field or Laboratory, this scope is a perfect fit. Look at what it offers: (1) Performance. A 7 MHz bandwidth, and an extremely linear time base with variable controls over 19 calibrated ranges and a variety of triggering modes. (2) Display. A 5 inch Braun type tube with an edge lit, removable graticule provide highly precise and legible traces on an 8 x 10 centimeter viewing area. (3) Reliability. All attenuators are solid state and fully compensated. Backing up this solid state reliability is a full year's warranty and complete field and factory service.

Examine the specifications.

VERTICAL AMPLIFIER					
BANDWIDTH	SENSITIVITY/CM	ATTENUATOR	RISE TIME	ACCURACY	IMPEDANCE
DC-7 MHz	20mv	9 position	.05 μ s	\pm 5%	1M Ω + 33pf
TIME BASE			CRT	PHYSICAL	
SWEEP/CM	TRIGGER	HORIZONTAL AMP.	DIA.	DIM. & WT.	
1 μ s-1 sec. (19 ranges)	20Hz-7MHz (20mv)	Exp. X5 2Hz-200KHz	5" (1600V)	8" x 10.5" x 16" 22 lbs.	

Look at the scope in action. Drop us a note and we'll arrange a demonstration in your plant. You'll find the 555 fits your bandwidth requirements comfortably. At \$284 its very comfortable indeed.

Data Instruments Division • 7300 Crescent Blvd. • Pennsauken, N.J. 08110

New Books

plifiers, oscillators, negative-resistance circuits, digital circuits, r-f amplifiers, and photo FET's. A timely and excellent section on FET active filters includes design examples of the Wien-bridge notch, bandpass open-loop, and feedback low-pass types.

However, on one point, the author shares a common misconception. He says that because FET's are majority-carrier devices, they can be made less sensitive to nuclear radiation than bipolar transistors. Everyone thought so when FET's were first developed, but, unfortunately, experiments proved that junction FET's are much more sensitive than bipolars in some nuclear-radiation environments and about the same in most others. MOS FET's in fact, are the most sensitive of transistors and generally shouldn't be used near nuclear radiation.

Fred W. Karpowich

Avco Corp.
Wilmington, Mass.

Recently published

Theory of Waveguides and Cavity Resonators, Emile Argence and Theo Kahan, Hart Publishing Co., 448 pp., \$15

Translated from the French, this book deals with the general theory of electromagnetic waveguides and cavities and their applications, and particularly concerns itself with the applications of mathematical methods. Containing chapters on matrices, vector analysis, eigenfunctions, eigenvalues, and wave equations, it is directed at physicists, telecommunications engineers, and specialists in space research.

Computer-Aided Integrated Circuit Design, edited by Gerald J. Herskowitz, McGraw-Hill Book Co., 432 pp., \$15

Discussion of modeling procedures includes the experimental determination of model parameters and the relation of network and system computer techniques to integrated-circuits design. Covered are seven complete operating programs that have proved successful in IC design.

Radar Detection, J.V. DiFranco and W.L. Rubin, Prentice-Hall Inc., 654 pp., \$18.95

Cumulative detection of stationary and moving targets, sequential and binary detection, weighted Integrators, and multiple-target detection are discussed here. Highlights include a unified treatment of single-hit and multiple-hit detection (both coherent and incoherent), accompanied by full-page graphic results. Intended as a guide for radar-equipment and systems engineers and a text for a graduate course in radar detection theory.

Multiple-Input Describing Functions and Non-linear System Design, Arthur Gelb and Wallace E. VanderVelde, McGraw-Hill Book Co., 655 pp., \$15.50

Practicing control engineers and graduate

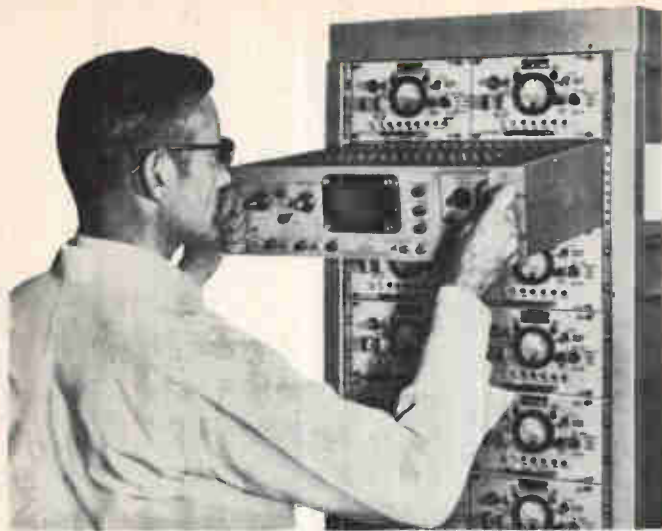

JUST SLIDE IT IN AND TURN IT ON

MIL Spec Scope K-106 (AN/USM-117)
a ready-made answer to military system display. Mil Spec requirements for scope ruggedization — performance — documentation — are all met in one 18 lb. fully transistorized oscilloscope. This is a stock instrument QPL'd and thoroughly job tested for more than 5 years by the Military.

Bandwidths range from 6 to 10 MHz. The cathode ray tubes are our own ETC brand, delivering the utmost clarity in data display. Accessories and plug-ins assure non-obsolescence.

For something a little special — wider bandwidths, unusual form factors, front panel variations, or somewhat different performance characteristics, let us know and we'll modify to your specs.

Facts, figures, specs, diagrams and photos—all the information you need to make the decision—are yours on call. Write Electronic Instrument Division, General Atronics, Phila., Pa. 19118, or phone (215) 248-3700.



GENERAL ATRONICS

MAC
goes
Mod(ular)

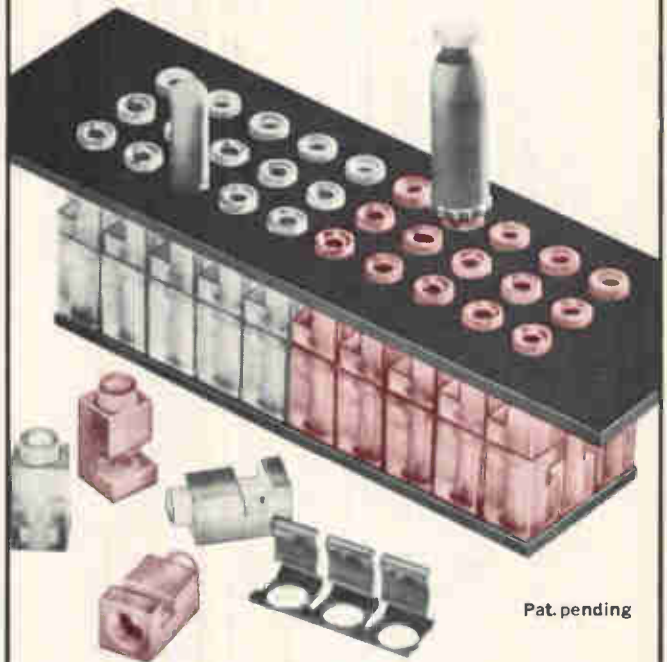

Pat. pending

color coded **CROSSPOINT PROGRAMMING**

Exclusive Features:

- Any size to 99 x 99 positions
- Modules color coded to your requirements
- 8 colors available
- Rigid, cordwood construction
- Two-layer crosspoint standard
- Three, four, five or more layers to your order

Additional Features:

- Fully guided, closed-entry contacts
- Shorting plug ● Component plug
- Skip plug
- Tin-plated contacts standard
Gold-plated contacts optional

For further information write

MAC Panel Co.
Box 5027 (X) High Point, N. C. 27262

MAVERICK, WALLEYE AND PHOENIX ARE MIGHTY SOPHISTICATED.

Like the engineers we need.

We developed the world's first air-to-air guided missile. The famous Falcon. Its success has kept us at work hatching far more sophisticated birds from the same nest.

Like Maverick. A TV-guided air-to-ground missile we're just starting to develop for the Air Force. On a long-term \$95 million contract.

But there's also Phoenix. And Walleye. And TOW.

A great breadth of activities, an expanding backlog of orders, that mean something to the missile engineer.

A chance to use his abilities. And to grow. And to go from one absorbing assignment to another, while his kids grow up tall and tan in the Southern California sun.

Typical openings for Missile Engineers and Analysts.

Missile Performance Analysts
Electro-Mechanical Product Design Engineers
Servo System Design Engineers
Aerodynamics Engineers
Circuit Design Engineers
Stress Analysts
Systems Engineers
Guidance Engineers
Microwave Engineers
Electro-Optical Engineers

All assignments require accredited engineering or scientific degrees and a minimum of two years of applicable, professional experience. U.S. citizenship is required.

For prompt consideration, please airmail your resume to:

Mr. Robert A. Martin, Head of Employment
Hughes Aerospace Divisions, Dept. 55
11940 W. Jefferson Blvd.
Culver City, Calif. 90230



An equal opportunity employer—M & F

New Books

students who desire a reference text will be interested in this volume, which takes a unified approach to function theory and its applications. Its coverage includes the limit cycle of nonlinear systems, and steady-state and transient characteristics; forced response of nonlinear systems to sinusoidal, random, and more general inputs; sampled-data nonlinear systems; the adaptive behavior of certain systems; and techniques for designing nonlinear systems.

Analog-to-Digital/Digital-To-Analog Conversion Techniques, David F. Hoeschele Jr., John Wiley & Sons Inc., 455 pp., \$15.95

For engineers, scientists, and technicians who design and use a-d and d-a equipment. Emphasizes electronic circuit techniques but also describes shaft position encoders and electro-mechanical switches. Includes discussion of the causes of error in each circuit or system described.

Antenna Engineering, Walter L. Weeks, McGraw-Hill Book Co., 370 pp., \$13.50

Directed at graduate-level electrical engineers, this book should serve both as an introduction and reference text. Where feasible, it presents the theory of the performance of antennas as governed by Maxwell's equations but also includes physical and factual discussions. In addition to dealing with traditional topics, it contains up-to-date material on frequency independent antennas, adaptive and signal-processing antennas, transmission-line loaded antennas, baluns, and noise considerations in receiving antennas.

Amplifying Devices and Low-Pass Amplifier Design, E. M. Cherry and D. E. Hooper, John Wiley & Sons Inc., 1036 pp., \$29.95

Of use to engineers and scientists as well as to students, this book presents methods for designing amplifiers that are useful, reproducible in quantity, and reliable. Discusses the values of vacuum tube and transistor parameters and their variations with operating conditions, temperature, and age. Special features are the unified, parallel treatment of tubes, transistors and FET's and the several amplifier designs, which illustrate principles.

Automatic Control Engineering second edition, Francis H. Raven, McGraw-Hill Book Co., 648 pp., \$14.50

The last four chapters of this book, centering on practical aspects of control systems, make this book valuable for bridging the gap between theory and practice. New chapters in this second edition cover phase-plane and Lyapunov methods, sampled-data systems, statistical methods and adaptive control systems, and describing functions. Aimed at engineers with little background in the field.

Engineering Systems and Automatic Control, Peter Dransfield, Prentice Hall, 429 pp., \$12.95

Using examples from various engineering fields, this volume covers linear analysis at a fundamental level. Nonlinearities and state-variable methods are introduced, with the basic ideas clearly separated from the detailed extension of the theory. Standard methods of stability analysis are used.

Discontinuous and Optimal Control, Irmgard Flugge-Lotz, McGraw-Hill Book Co., 286 pp., \$16.50

This book, written at a practicing engineer's level, covers nonlinear controls using simple examples. A heuristic geometrical approach is used to introduce the theory of optimal control. The goal is to provide a method for designing systems that avoid trial and error techniques.

NEW DELTA DESIGN!

MODEL 3000 FET VOM

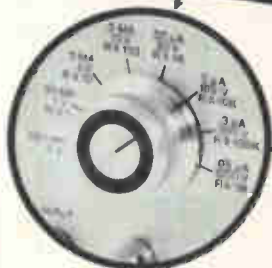

*A unique
and efficient
instrument
bridging the gap
between a
multimeter and a
digital voltmeter!*

Delta, pioneer of the famous Mark Ten® CD System, now offers a compact, versatile, and extremely sensitive VOM which combines FETs and ICs for extreme accuracy. Compact (6½" W x 8" H x 3½" D), portable, wt. 3¾ lbs. In full production at only

\$74.95
ppd.

Would you believe:

1. Mirror scale 200 μ A D'Arsonval meter
2. Integrated circuit (IC) operational amplifier for extreme accuracy
3. FET input stage with current regulator
4. Two stage transistor current regulator and Zener diode on OHMS for absolute stability and accuracy
5. Voltage clippers for protection of input stage
6. Fully temperature compensated for low low zero drift
7. Ten turns ZERO and OHMS adjust potentiometers
8. Epoxy glass circuit boards and metal case
9. Enclosed switches
10. Uses readily available type AA cells
11. Uses standard test leads for maximum flexibility and ease of measurement
12. 10 Megohms input impedance

Available in Kit form:
Feedback network with pre-selected components to eliminate all final calibration. Ready to use when assembled!

Kit:
Only **\$59.95** ppd.



DELTA PRODUCTS, INC.

P. O. Box 1147, Grand Junction, Colorado 81501

I enclose \$ _____ . Please send postpaid:

_____ Model 3000 FET VOMs @ \$74.95 assembled

_____ Model 3000 FET VOMs @ \$59.95 kit form

Name _____

Address _____

City/State _____ Zip _____

DP 8-7

Yes.

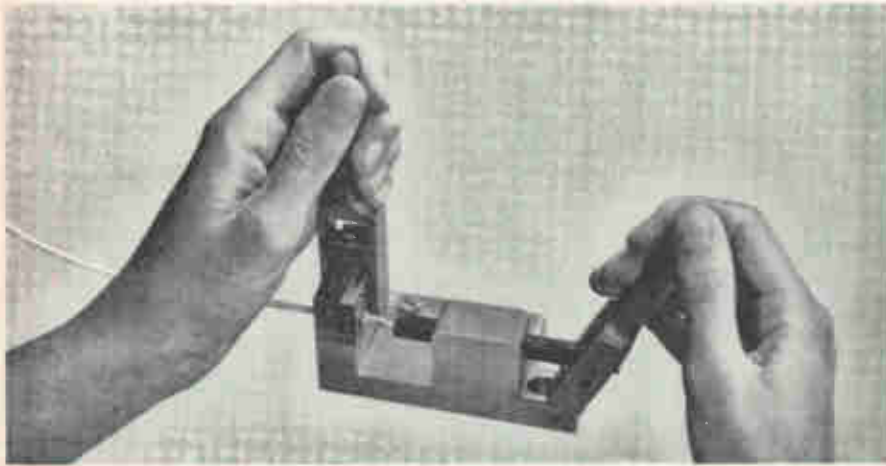

Our Emlock[®] connectors assemble just as fast as crimp types.

Speed of assembly used to be the supposed reason behind the specification of conventional crimp-type miniature connectors despite the fact that Emlock[®] compression fit connectors were generally recognized to be much more reliable. This situation is changed now. Emlock[®] compression fit connectors, thanks to our new T15 bench tool, are more than a match for crimp in assembly time. This is definitely not true of competitive compression types utilizing compliant braid gripping components rather than all metal elements, as we do.

With the new T15 tool, all you have to do to assemble an Emlock[®] connector, after preparing the cable, is install a

nut, wedge and washer, seat the ferrule against the braid and compress. It's that easy.

Prove it to yourself. One of our Technical Representatives will be happy to call on you for an actual demonstration of Emlock[®] assembly speed. While he is with you he will also show you that you simply can't pull the cable out of an Emlock[®] connector. Failure will be caused only by disintegration of the braid and never by pull-out of the compression.

Our new catalog has the whole story. Ask for Bulletin MMC, Issue 1. Phelps Dodge Electronic Products Corporation, 60 Dodge Avenue, North Haven, Connecticut 06473.

Technical Abstracts

Slow 'n easy

A new approach to color slow-motion video recording

C. Boice

Visual Electronics Laboratories
Sunnyvale, Calif.

The popularity of slow-motion, stop-action instant video replay at sports events has brought on a number of competing systems. In one, an existing quadruplex tape machine is modified to provide the slow-motion and stop-action replay. In another, the quadruplex machine is used with a helical scan recorder for the same purpose. But the system which enjoys the widest use among broadcasters is a magnetic disc recorder developed jointly by Visual Electronics and the MVR Corp.

In addition to stop action, the disc recorder provides several slow-motion speeds: one-third, one-fifth, and one-seventh. Compared with other systems, it is compact and lightweight. In addition, it has a self-contained monitor. Video information is recorded on the disc in a manner similar to standard tv recorders. The disc is coated with nickel-cobalt, which is covered with a rhodium-flash coating. Since both sides of the disc are recorded simultaneously, two record/play-back heads are used.

One head records and plays back the even tv fields on one side of the disc while the second records and plays back the odd fields on the other side. Starting at the inside edge of the disc, field number one is recorded on one side while field number two is recorded in the same position on the other. While field number two is being recorded, a carriage on the opposite side of the disc advances the head two track widths. It is then ready to record field number three. Once field number two has been recorded, the signal is turned off by an electronic switch and simultaneously applied to the other head to record field number three.

The process continues across the disc, recording every other track to provide space for interleaving information on the return travel. When the carriage reaches the

PHELPS DODGE ELECTRONIC PRODUCTS CORPORATION 



Tomorrow, Paul Barr may even get to his desk

Paul Barr is a hard man to catch. He may be at the bench sweating over a prototype circuit . . . or have his head under a car lift surveying the built-in problem. He's got lab people hopping and test drivers in and out of spins. A couple of friction experts shake their heads when they see him coming. But wherever development engineering leads on a sophisticated new braking system, Paul Barr's on his way. And no two Mondays ever start alike. The question is . . . can you say the same? Take a good look at how your career shapes up, compared with Paul's and his colleagues' at Delco. You might even call us collect. Area Code 317/459-2808. Or, write: Mr. C. D. Longshore, Supervisor, Salaried Employment, Dept. 404, Delco Radio Division of General Motors, Kokomo, Indiana.

**DELCO
RADIO**



AN EQUAL OPPORTUNITY EMPLOYER
DIVISION OF GENERAL MOTORS
KOKOMO, INDIANA

Circle 187 on reader service card

Extends the range of digital frequency display of CEI UHF Receivers from 235 to 1000 MHz when used as an accessory with the CEI DRO-302A Digital Readout. Also extends Digital Automatic Frequency Control capability of

Complete Readout Coverage

10 kHz to 1000 MHz

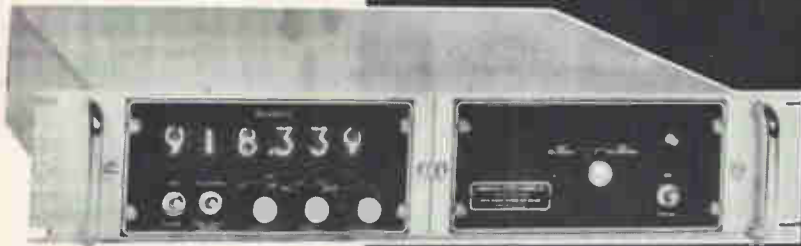

the DRO-302A (shown at left). The DRO-302A indicates frequency from 10 kHz to 300 MHz. Operates on 115 or 230 Vac, 50-400 Hz power. Minimum local oscillator input of 50 mV required over entire frequency range. Solid state, crystal-controlled, low cost, half-rack size. Call or write CEI for details.

With CEI's New DRX-1000

DIGITAL
READOUT
EXTENDER



COMMUNICATION
ELECTRONICS

SUBSIDIARY OF WATKINS-JOHNSON COMPANY

6006 Executive Blvd., Rockville, Md. 20852 • 301/881-3300

Circle 226 on reader service card

Technology...

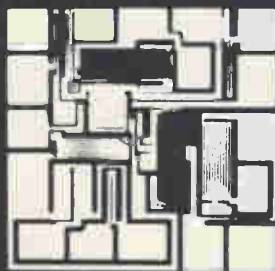

Applied research, design, development of electronic hardware, including digital devices, computers, display equipment, components and circuits for information processing and communications systems.

...and creative people!

- To design mil spec digital equipment utilizing advanced hardware techniques such as MSI and LSI.
- To design third generation mil spec digital display systems.
- To define and direct applications of digital display systems.

CONTACT THOMAS E. HOUSEHOLDER



THE BUNKER-RAMO CORPORATION
DEFENSE SYSTEMS DIVISION

8433 FALLBROOK AVENUE • CANOGA PARK, CALIFORNIA 91304
AN EQUAL OPPORTUNITY EMPLOYER

Technical Abstracts

outer edge of the disc the last two fields are recorded. Then, each head drops back one step. After 30 seconds, all tracks are filled and any new information is recorded over the old, effectively erasing it. If desired, a mode, called time lapse, can be applied to increase the recording time to one and one-half minutes. In this mode, only every third frame is recorded and played back at 3 to 1 reduced speed. However, the video will still appear at normal speed.

The operator can precisely find where certain points of information are located on the disc. The control panel has a row of 30 tally lamps across it. As the carriage assembly is moved back and forth across the disc, the lamps light in sequence to show where the head is positioned on the disc at any given time. If the operator feels that a certain event may be of interest for later replay, he presses a Cue button which latches on a tally lamp to show where the point of interest is located. At the end of the sequence, the operator presses a Search Forward or Search Reverse button to approach the start of the desired event from the closest direction. Any point on the disc can be located in less than seven seconds.

Presented at the International Broadcasting Convention, London, England, Sept. 9-13

Fixing up

Transoceanic air traffic control using satellites
R. E. Anderson
General Electric Co., Philadelphia

Some sort of air traffic control system is needed to keep track of planes flying transoceanic routes. With the increasingly crowded condition of these air lanes, there's little room for navigation errors.

A study of the problem by the General Electric Co. suggests that a pair of very-high-frequency communications satellites could do the job over the North Atlantic, giving a fix for each plane in the area every 5 minutes. Combined with conventional navigation aids, a system with a one-sigma error probability of 4 nautical miles could per-

The anything recorder.



does anything you want for less than anything else on the market.

The Anything Recorder can't be anything less than the Brush Mark 2300 lightbeam oscillograph... because no other recorder of comparable price has comparable capability. It takes the agony out of recording... in the lab, down in the shop or out in the field.

Here's how:

- It's ready to record when you are. Just plug it in, set the required sensitivity, select any one of sixteen recording speeds, push the button, and go. It produces sharp, clear analog traces of what's happening with an accuracy of 99.5 percent... can handle most any recording job that comes along.
- The 2300 is available with up to 16 analog channels, and offers frequency response from DC to 2 kHz at sensitivities as high as 200 microvolts per chart division. No other recorder has this frequency/sensitivity range in a single package.
- The 2300 has built-in floating and shielded ampli-

fiers which provide full functional control, high input impedance, high common-mode noise rejection. Controls for calibration, attenuation, gain, and trace positioning are right at your fingertips. No need for internal changes.

- The 2300 is portable... (has tilt-up handle)... and ready to go where you go—practically anywhere. It's built to take rough treatment, with all elements fixed on a solid one-piece casting that can't get out of alignment. Weighs only about 65 lbs.

The Brush Mark 2300 recorder. Dollar for dollar, it's better than anything anyone else has come up with yet.

Ask your Brush Sales Engineer for a "show me" demonstration. He'll show you the best all-purpose recorder value on the market. Or write for new 8-page Mark 2300 brochure. Clevite Corporation, Brush Instruments Division, 37th and Perkins, Cleveland, Ohio 44114.

CLEVITE BRUSH

VOLTAGE SENSITIVE RELAY DRIVER

Am I wild?
Adjustable
trip point
variable
continuously
thru zero
with no
discontinuity.
Trip point
range $\pm 20v$.



0.002%
f.s./°C
trip
point
stability!

Want to check my
hysteresis all you
smart engineers?
When you start
specifying, re-
member that I
told you that
the new Model
525 precision
voltage relay dri-
ver has less than 0.0
hysteresis; less than
4 millivolts.



About external connections:
Designed for PC card mount-
ing. All leads
on standard
0.1" grid spac-
ing and are a

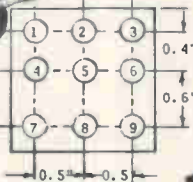

nominal 0.033" Dia.
x 0.45" long. (Model 520
and Model 525 have same
lead assignments so are
interchangeable). Bottom
view is shown.

Voltensor can be
used for motor
speed alarm,
transducer
monitor,
battery or power
supply monitor,
medical trans-
ducer, etc.



CALIFORNIA ELECTRONIC
MANUFACTURING COMPANY, INC.

P.O. BOX 555 • ALAMO, CAL. 94507 • TEL. 415 932 3911

Circle 227 on reader service card



More vital
statistics?
Wt. 1.75 oz.
and dimen-
sions 1.5x
1.5x0.7.



Talk about fast operators!
Operating time less than 10
microseconds. Infinite reso-
lution! Output
rise & fall time
2 microseconds.
The repeatability
better than 1mv.
Power: $\pm 25v$ to
 $\pm 15VDC$; VDC
 $\otimes 12ma$ (25v)
to 7ma (15v)
+load. Output $\pm 20v$ @
50ma nominal w/b 25v
supply down to $\pm 2v$ @
15ma with 15v.

Technical Abstracts

mit the lateral spacing between aircraft to be reduced from the present 120 nautical miles to about 90 miles.

The time it would take a radio signal to travel from a satellite to a plane and back would be converted into a range measurement by relating it to the free-space propagation velocity of radio signals corrected for ionospheric and atmospheric effects.

According to the GE study, the propagation time would be measured by keeping track of a time marker in the form of a tone-code interrogation on the transmitted signal. The interrogation signal would be a short audio-frequency followed by a digital address code in which audio cycles would be inhibited for 0's and transmitted for 1's.

Each aircraft would be assigned its own digital address code. When the plane's fix was to be determined, as scheduled by a ground-based terminal computer, the tone burst and address code would be transmitted by the ground station to one of the stationary satellites. This interrogating satellite would repeat the signal, sending this second transmission to all of the planes over the North Atlantic. But only the aircraft addressed would respond to the address code; after a precise delay, it would retransmit the tone code to the satellites, which would then retransmit the signal.

The ground terminal would observe the time it took for the signals to return, and with this measurement it would determine the distance from the known positions of the satellites to the plane and thus the plane's position.

A convenient frequency tone-code for transmission from the ground is 2.4414 kilohertz, derived by binary division from an accurate 5-megahertz oscillator. The frequency, which is within the audio passband of aircraft voice communications, could be sent by frequency modulation or by any other modulation capable of transmitting a phase coherent audio tone.

Presented at Eascon 1968
Washington, D.C., Sept. 9-11.

MICO

NEW MODEL 885 SEVEN RATIO WIDE-RANGE ENGRAVER

NO. 885

FOR LONG AND
MULTI-LINE WORK

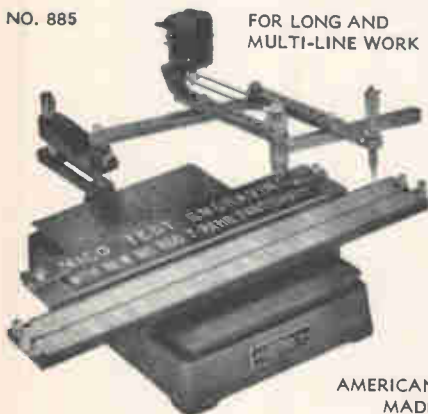

AMERICAN
MADE

- A time-saver for large plate work
- Engraves 3" x 19" area in one set-up.
- Seven pantograph ratios—from 1:5:1 to 6:1.
- Choice of 3-ball-bearing spindle assemblies for $\frac{1}{8}$ ", 3/16" or taper-shank cutters.
- HSS, COBALT and Solid Carbide Cutters.
- Single and multi-line copy carriers for holding blanks $\frac{3}{4}$ " to $3\frac{1}{2}$ " high.
- Accommodates Mico standard accessories.

Send for bulletins and prices

MICO INSTRUMENT CO.

77 Trowbridge St. Cambridge, Mass. 02138

190 Circle 190 on reader service card

PRECISION SPARK GAPS*

Oscilloscope of one of Joslyn's spark gap models—the 2001-28 made specifically for RCA—shows exact repeatability. All Joslyn spark gaps feature:

- Ultra-fast response (nanoseconds)
- Long life
- Wide dynamic range
- Stable operation
- Insensitive to light
- No isotope prompting
- Close tolerances
- Hermetically sealed
- Negligible voltage creep
- Lightning — EMP capability available

Ideal for protection of magnetron modulators, microwave stations, dc power systems, output of dc power supplies, all types of signal and data transmission lines, p.c. protectors, control circuits. Available from stock or custom designed.

Write today for new brochure JES-142. Joslyn Electronic Systems, Santa Barbara Research Park, P.O. Box 817, Goleta, California. Tel. (805) 968-3551.

JOSLYN
ELECTRONIC SYSTEMS

Patented and Patent Pending 350

Circle 228 on reader service card

business trips rule out evening classes?



here's a practical way to update your knowl- edge of electronics

Are irregular hours, travel and family obligations keeping you from attending classes—even though you worry about becoming technically obsolescent? Check into the Special Programs in Electronics for Engineers developed by CREI, the Home Study Division of the McGraw-Hill Book Company.

These are not simply courses, but comprehensive programs in advanced electronics offering major electives in such fields as:

Communications Engineering, Aeronautical and Navigational, Television Engineering, Automatic Control Engineering, Missile and Spacecraft Guidance, Radar and Sonar Engineering, Nuclear Instrumentation and Control, Computers.

Industry-recognized CREI Programs make it possible for you to catch up on new developments in electronics through study in your own home, at your own pace,

your own schedule. Free book gives complete information and details of technical material covered. For your copy, mail coupon below or write: CREI, Home Study Division, McGraw-Hill Book Company, Dept. 1842-G, 3224 Sixteenth St., N.W., Washington, D.C. 20010.

Founded 1927



Accredited Member of the National Home Study Council



CREI, Home Study Division, McGraw-Hill Book Company
Dept. 1842G, 3224 Sixteenth St., N.W.
Washington, D.C. 20010

Send me free brochure describing CREI Programs in Electronics for Engineers.

NAME _____ AGE _____

ADDRESS _____

CITY _____ STATE _____ ZIP CODE _____

COMPANY _____

TITLE _____

Here's a tiny gang capacitor . . .

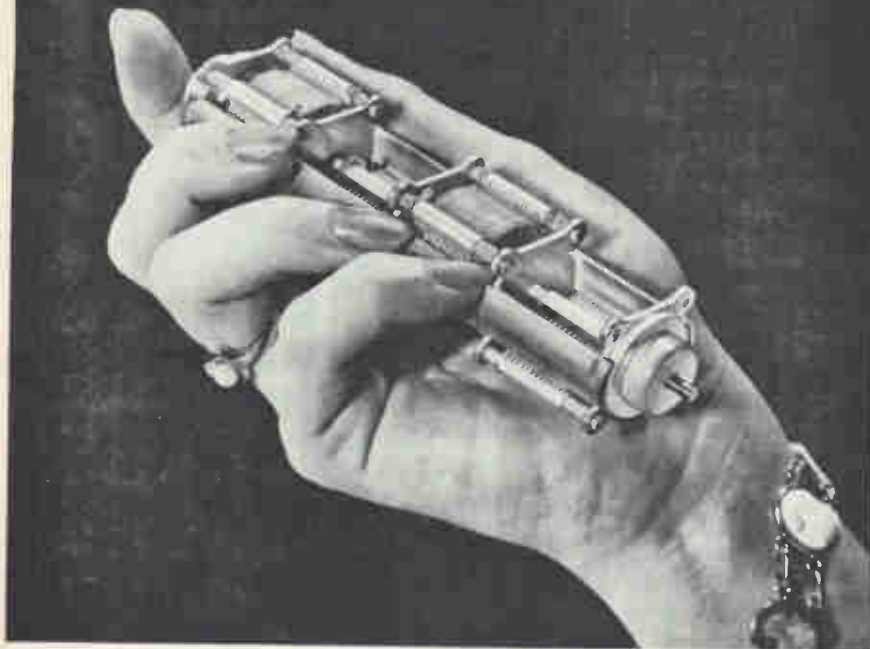

that's rugged, precise, modular

True modular versatility permits a wider-than-ever range of applications for the new, ultra-compact Johanson Type 6100 gang capacitor. Specify from one to five sections . . . each section can be supplied in different capacitance ranges and in the following capacity variations: straight line capacity, straight line frequency, butterfly or split stator. Mounting versatility is another big feature — a special bearing mount permits easy direct panel mounting.

Functional simplicity is the keynote of the 6100. Exceptionally high shock and vibration resistance are the result of a new design utilizing an exclusive spring-type bearing and special alumina support of the rotor and stator. In addition the new 6100 series features low temperature coefficient, low torque and smooth tuning.

Save space . . . save cost. Get all the facts on the Johanson 6100 *before* you design *your* next project.

Write for full details, specifications

Johanson MANUFACTURING CORPORATION

400 Rockaway Valley Road, Boonton, N.J., Phone (201) 334-2676

Circle 192 on reader service card

Upset stomach?

If you're looking for a remedy and you can't remember the name of a fast-acting brand, just consult the Trade Name Directory in your Electronics Buyers' Guide. You'll have your answer in seconds. EBG also has a Directory of Products and a Directory of Manufacturers and Sales Offices. Use it often.

Electronics Buyers' Guide
A McGraw-Hill Market Directed Publication,
330 West 42nd Street, New York, N.Y. 10036



New Literature

Motor drive. B&K Instruments Inc., 5111 W. 164th St., Cleveland 44142, has issued a four-page folder on the model UM 1018 motor drive that synchronizes the model 2305 graphic level recorder with automatic vibration exciter controls.

Circle 446 on reader service card.

Chromium-silicon monoxide. Cerac Inc., Box 597, Butler, Wis. 53007. A data sheet describes the availability of fused chromium-silicon monoxide for thin-film resistors. [447]

High-temperature furnaces. Aremco Products Inc., P.O. Box 145, Briarcliff Manor, N.Y. 10510. Product bulletin 2800 describes a new line of 152 standard furnaces for use at temperatures to 2,380°F. [448]

Photoconductive cells. Clairex Electronics Inc., 1239 Broadway, New York 10001, offers a data sheet describing narrow-tolerance photoconductive cells. [449]

Analog-to-digital converters. Theta Instrument Corp., 22 Spielman Rd., Fairfield, N.J. 07006. An eight-page booklet describes a line of a-d converters operating on the principle of dual-slope integration. [450]

Power supply modules. Dynage Inc., 1331 Blue Hills Ave., Bloomfield, Conn. 06002, has released catalog 68 announcing its total system capability of 3½-inch packaging for all power supply modules. [451]

Portable resistance bridges. James G. Biddle Co., Township Line & Jolly Rds., Plymouth Meeting, Pa. 19462. Bulletin 72-7 deals with Versitor portable resistance bridges designed to travel wherever a precision measurement is required and to preserve their full rated accuracy for years. [452]

Count-memory module. Integrated Circuit Electronics Inc., P.O. Box 647, Waltham, Mass. 02154. A data sheet describes the Datecon model CS-100, a 15-megahertz decimal counter and display module, which stores in a quad latch memory for display on a cold-cathode neon tube. Price is included. [453]

Electrical resistance alloys. Hoskins Mfg. Co., 4445 Lawton Ave., Detroit 48208. A 16-page catalog describes properties and performance characteristics of Alloys 750, 815, and 875 iron-chromium-aluminum electrical resistance materials. [454]

Epoxy resin system. Kenics Corp., 1 Southside Rd., Danvers, Mass. 01923, has published a bulletin on Kencast No. 781, a low-viscosity, flame-retardant epoxy resin system that combines

Figure it out the fast way



- Model CS-22A**
- 14 digits, 6 decimal places
 - Memory register
 - Rounding-off device
 - Overflow error check lamp
 - Double-set protection keys
 - 4 kg. (8.8 lbs.)

IC

Here's an assistant that can rapidly deal with your time-consuming figure work. Sharp's revolutionary electronic desk calculator model CS-22A.

It performs lightning-fast calculations up to 14 digits and 6 decimal places. In complete silence and mere milliseconds. A memory register holds intermediate answers for continued complex calculations. An overflow lamp warns when capacity is exceeded.

Sharp's model CS-22A is a mini-masterpiece of electronics engineering, fully utilizing ICs. Super compact and perfectly portable.

An infallible assistant.



- Model CS-17B**
- 12 digits, 6 decimal places
 - Double-set protection keys
 - 4 kg. (8.8 lbs.)

SHARP

HAYAKAWA ELECTRIC CO., LTD. Osaka, Japan

U.S. Subsidiary: SHARP ELECTRONICS CORP. 178 Commerce Road Carlstadt, New Jersey

Going to IC's? Or Higher IF's?

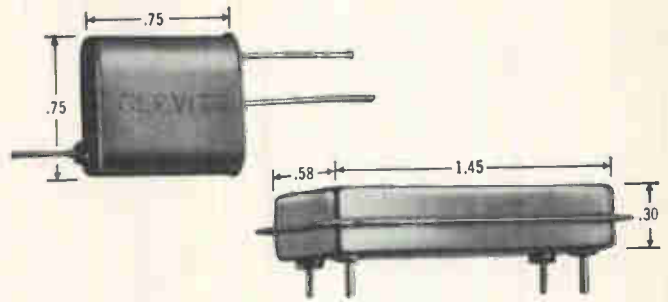

Go two ways with Monolithic Clevite Uni-Wafer Filters

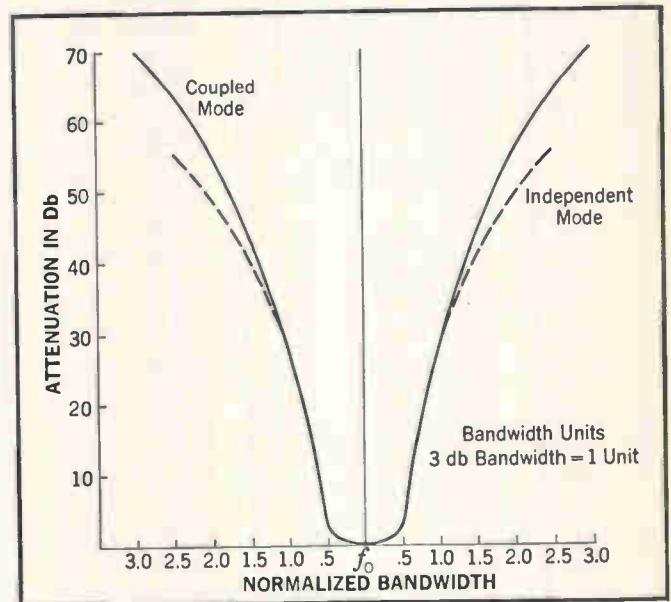

Go independent mode. Go coupled mode. You can go either mode with monolithic Clevite Uni-Wafer filters. They're smaller and more reliable (fewer interconnections) than conventional filters.

Clevite Uni-Wafer filters are ideal for matching IC circuitry in communications receivers operating in the VHF and UHF frequency ranges as well as in telemetry, radar and aerospace systems.

They are four-pole crystal filters with a choice of center frequencies ranging from 8 MHz to 75 MHz. They've been developed using Clevite's advanced engineering techniques and Clevite's original thin film approach to quartz filters. In this concept, arrays of resonators are achieved on a single quartz wafer with resonator isolation and spurious suppression controlled by the trapped energy principle.

So if you're going to IC's or higher IF's, go Clevite Uni-Wafer filters. They're available in both independent and coupled mode.

For more information and complete specification data, write: Clevite Corporation, Piezoelectric Division, 232 Forbes Road, Bedford, Ohio 44146.

CLEVITE

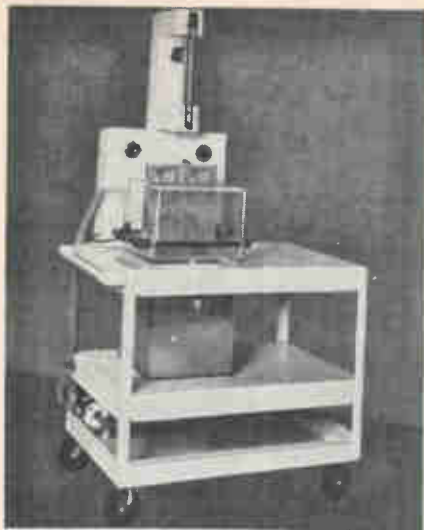

"fine line" etcher

for prototypes—limited runs

Model No. 201 (illus.), etches two 11" x 14" one-sided boards or one 11" x 14" two-sided board: **\$795** Pat. applied for

**ETCH YOUR OWN
P C BOARDS
AUTOMATICALLY**
(in less than 5 minutes)

from this →
to 11" x 14"

Shown Actual Size



- No cooling or venting required!
- Etches as fine as .001"!
- Cuts costs in half—saves time!
- Complete photo processing instructions!
- Work is illuminated while etching!
- No patterning . . . minimum undercutting!

NOW IN USE BY:

AMP, Inc.
Ampex Corp.
Atomic Energy Com.
Bendix
Charles Bruning
Esso Research
General Dynamics
General Electric
IBM
ITT
Lear Siegler
Magnavox
Micro Switch
NASA
Owens-Illinois

Sprague Electric
Union Carbide
U.S. Air Force
Western Electric
Whirlpool
M.I.T.
Oklahoma State U.
Purdue Univ.
Washington Univ.
Univ. of Calif.
Univ. of Chicago
Univ. of Colorado
Univ. of Georgia
Univ. of Hawaii
Univ. of Penn.

CYCLO-TRONICS, INC.

3858 N. CICERO — CHICAGO, ILL. 60641
TELEPHONE: (312)-282-6141

New Literature

high-strength physical and electrical characteristics. [455]

Mica paper capacitors. Custom Electronics Inc., Browne St., Oneonta, N.Y. 13820. Standard types and sizes of impregnated, reconstituted mica paper capacitors are listed in a 13-page catalog. [456]

Alphanumeric generator. Raytheon Co., 465 Centre St., Quincy, Mass. 02169, offers a 10-page brochure on its Symbolray alphanumeric generator for cathode-ray display or hard-copy printout. [457]

Alarm controller/indicator. Robinson-Halpern Co., 5 Union Hill Rd., West Conshohocken, Pa. 19428. A technical bulletin covers the model 725 controller and indicator that operates from any 0- to 100-microamp d-c signal. [458]

Timers. Timeco Inc., 1035 Twenty-sixth St., Huntington, W. Va. 25703. A 12-page catalog provides information on 12 time delay relays, 5 repeat cycle timers, and an interval timer. [459]

Digital instruments. Fairchild Instrumentation, 974 E. Arques Ave., Sunnyvale, Calif. 94086, has available a 20-page catalog covering its entire line of digital instruments. [460]

Capacitors. Corning Glass Works, Corning, N.Y. 14830. Performance curves that illustrate how TYO capacitors meet or exceed military specification performance requirements (MIL-C-11272) are featured in a four-page data sheet. [461]

Temperature monitor accessories. Scam Instrument Corp., 7401 N. Hamlin Ave., Skokie, Ill. 60076, has published a six-page brochure describing accessories for the Panagard continuous temperature monitor. [462]

Industrial controls. Farmer Electric Products Co., Tech Circle, Natick, Mass. 01760. The 66-page catalog D covers photoelectric, proximity, and timing industrial controls. It is available on letterhead request.

Solid state controller. Tia Electric Co., 178-X Alexander St., Princeton, N.J. 08540. Bulletin 200 describes an inexpensive solid state controller for temperature and other variables. [463]

Data reduction system. Beckman Instruments Inc., 2500 Harbor Blvd., Fullerton, Calif. 92634. Six-page bulletin 7114 provides complete specifications for the Omega data reduction system. [464]

Silicon rectifiers. Edal Industries Inc., 4 Short Beach Rd., East Haven, Conn.

WHERE THE PROFIT ACTION IS!

Phoenix continues to set the pace in the accelerating westward tilt that is changing the face of America. Our population explosion and vigorous economy are creating rich new markets locally, and in a fast-growing 8-state region served by Phoenix. You should have a plant or warehouse here to get your share of this dynamic action and profits.

For our FREE 28-page brochure, "DYNAMIC PHOENIX," write Stanton Allen, Manager, Economic Development Dept., Room E-35, Chamber of Commerce, Phoenix, Arizona 85004

**dynamic
Phoenix**

PROFIT CENTER OF THE SOUTHWEST

Circle 230 on reader service card

FAR U.V. TO INTERMED. I.R. 150 MM F/1.4



New, Ultra High Speed, lightweight, mirror lens. For low light level photography over a very broad spectral range from .2 microns in the far ultra-violet to 4.5 microns in the intermediate infrared.

Highly efficient light transmission yields an image about 16 times brighter than most telephoto lenses. Fits 35 mm single lens reflex cameras, or use with adapter on movie or T.V. cameras. Long working distance of 1.78" makes use with image intensifiers or photo detectors quite easy.

Excellent for photography under very adverse lighting conditions or ultra high speed shots. We have taken pictures by moonlight and candlelight on ordinary color film. Continuously variable light control from F/1.4 down to complete extinction. Weighs 40 ozs.; 6½ inches long.

NYE OPTICAL COMPANY

8781 Troy Street
Spring Valley, Calif. 92077
Phone: (714) 466-2200

10 of a series

TRANSICOIL SOLVES SERVO PROBLEMS

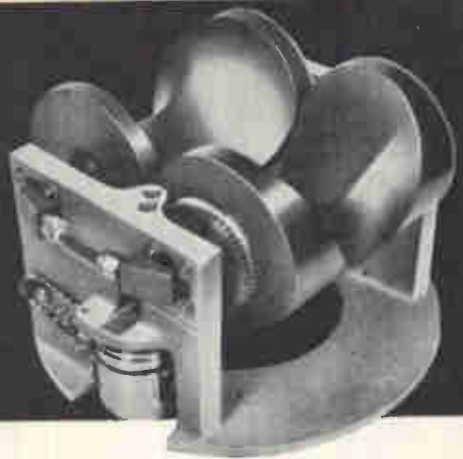
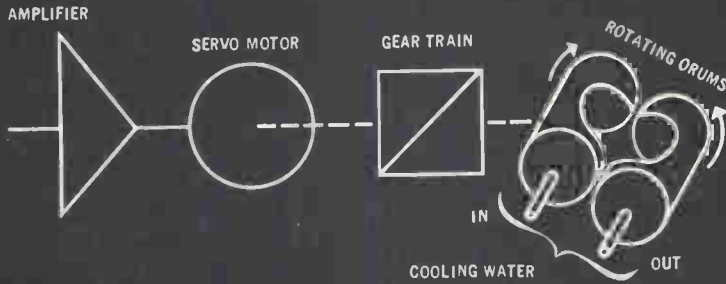

Transicoil Iris Assembly

This unique assembly was designed in conjunction with NASA for simulated deep space testing of the APOLLO module at the Manned Spaceflight Center in Houston. ■ The problem of controlling the amount of "sunlight" from the high-intensity arc lamps was solved by a servoed iris whose aperture is developed from the opening between two contra-rotating contoured drums. Cooling the apparatus in the high energy light beam required a constant water flow through the drums, and Transicoil's design included special rotating seals to hold the pressure without exceeding the low friction levels necessary for good servo performance. ■ From servos to seals, Transicoil's broad experience in the design and manufacture of precision electromechanical devices was instrumental in converting this unusual concept into practical hardware.

PERFORMANCE (CLOSED LOOP): Input: 0-130 mv dc • Output: Iris (drum) position • Angular Travel: 120° (approx.) • Time for Full Travel: 2 sec. max. • Power Required: 115V, 60 CPS; 28V dc • Size: 9" dia. x 5 1/2" high • Weight: 7 3/4 lbs.

WESTON-TRANSICOIL

COMPONENTS DIVISION OF WESTON INSTRUMENTS, INC.
WORCESTER, PA. 19490

a Schlumberger company

Circle 232 on reader service card



FREE

Get technical literature on new solid state, portable dual-beam oscilloscope. Choice of two plug-in Y-amplifiers. Features differential input, internal voltage calibration, and both signal and time delay.

Write to Motorola Communications & Electronics Inc., 4501 W. Augusta Blvd., Chicago, Ill. 60651.



MOTOROLA
 Precision Instrument Products

Circle 233 on reader service card

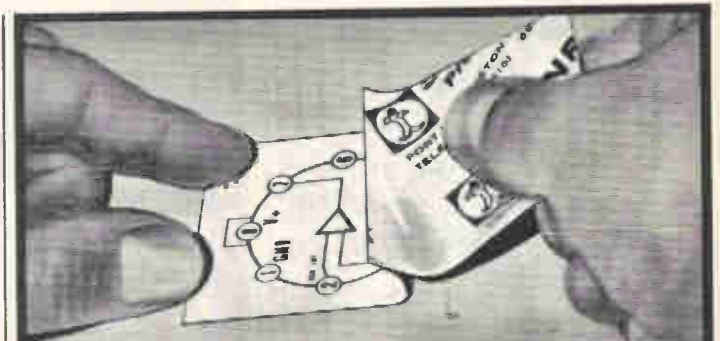

STANPAT GIVES SHARP, CRISP REPRODUCTION EVERY TIME!

STANPATS are made specifically for use on drawings. Inferior imitations create endless problems. STANPAT will preprint your own repetitive items for instant drafting. Every sheet is guaranteed to meet your exact requirements. Adhesion is instant . . . reproduction is always perfect. Unbelievable? Send today for free samples — judge for yourself. Be sure to enclose a sample of your own repetitive details and we'll send you a quote. Use quick-reply coupon.

Telephone: 516 883-8400

faithfully serving the architect and engineer for over 25 years



STANPAT PRODUCTS INC.

Dept. J10, 366 Main St., Port Washington, N.Y. 11050

Send free samples and literature. Quote on my attached art.

Name _____ Title _____
 Company _____
 Address _____
 City, State, Zip Code _____

Circle 195 on reader service card

195



APPROX. 1/2 SIZE

How CAMBION® standard coils, chokes and filters help you kick the specials habit

Tune in the "reliables" . . . CAMBION regular, PC, shielded, tunable and fixed coils. More than 1,000 varieties, all standard, all ready to go straight from the shelf.

CAMBION standard coils and chokes come in groups with overlapping inductance values. Your design work's no longer a guessing game. And you don't have to blow your cool trying to out-smart unknown characteristics.

And with CAMBION coil forms, your in-house winding facility is IN. More than 1,500 types for conventional and printed circuits. Like . . . from stock!

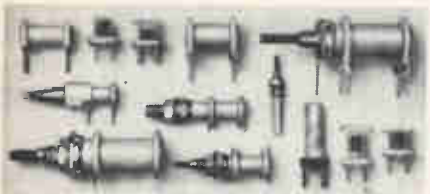

APPROX. 1/2 SIZE

For miniaturization midgets — CAMBION microminiature coils . . . only .250 square inches or smaller (that's a real small square).

Swing with CAMBION Doroids. These high frequency microelement inductors are available in 36 overlapping inductance ranges from .12 uh to 100 mh . . . with Toroid characteristics.

And for those of you who can't kick the specials habit, CAMBION has the design, engineering and manufacturing capability to solve your RF coil and transformer problems. Try us.

To turn our engineers on . . . call or write Cambridge Thermionic Corporation, 447 Concord Ave., Cambridge, Mass. 02138 Phone: (617) 491-5400. In Los Angeles, 8703 La Tijera Blvd. Phone: (213) 776-0472.

REG U S PAT OFF

CAMBION

Standardize on CAMBION . . .
21,541 guaranteed electronic components

APPROX. 1/2 SIZE

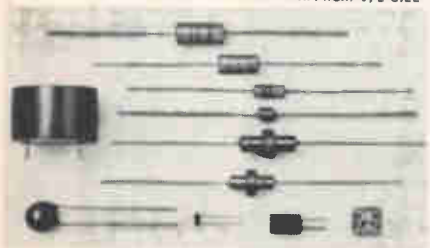

New Literature

06512, has published a four-page folder offering summary descriptions of its full capability in silicon rectifiers. [465]

Timing and control devices. A.W. Haydon Co., 232 N. Elm St., Waterbury, Conn. 06720. An illustrated six-page color bulletin provides information on timing and control devices marketed by the company. [466]

Varistors. The Carborundum Co., P.O. Box 339, Niagara Falls, N.Y. 14302. A technical bulletin contains specifications and characteristic curves as well as a thorough treatment of varistor applications. [467]

High-power terminations. Weinschel Engineering, Gaithersburg, Md., has published a catalog sheet on the model 569A coaxial high-power terminations that handle 20 watts c-w average, 10 kilowatts peak. [468]

Filters. Polyphase Instrument Co., Bridgeport, Pa. A 12-page filter booklet, bulletin 78F, highlights more than 2,000 predesigned LC filters for a variety of circuit problems. [469]

Two-in-one recorder. Techni-Rite Electronics Inc., 65 Centerville Rd., Warwick, R.I. 02887. A brochure describes the Ana-Vent recorder that charts both analog and event information in a single instrument. [470]

Solderless terminals. Zierick Mfg. Corp., 36 Radio Circle, Mount Kisco, N. Y. 10549. Over 50 different solderless terminals, both insulated and noninsulated, are described in a six-page folder. [471]

Microwave oscillators. Micro State Electronics, 152 Floral Ave., Murray Hill, N.J. 07974, has available a flyer describing its line of solid state microwave oscillators. [472]

Measurement error calculator. Hewlett-Packard Co., 1501 Page Mill Road, Palo Alto, Calif. 94304, offers a rise-time/bandwidth slide rule that will be useful to anyone making high frequency measurements with an oscilloscope. [473]

Control system. West Instrument Corp., 3860 North River Road, Schiller Park, Ill. 60176. Bulletin 90 describes a solid state temperature control system available with automatic reset. [474]

Lightbeam oscillograph. Brush Instruments Division, Clevite Corp., 37th and Perkins, Cleveland 44114. Bulletin 935-4 describes a modular, direct-printout lightbeam oscillograph system. [475]

MATSUO

Highly Reliable Capacitors

POLYESTER FILM CAPACITORS.

Type MXT
Type MFK
Type MFL
Type SW

In plastic tube.
Capacitance Range: .001 MFD to .47 MFD.
Voltages: 100v, 200v, 400v, 500v DC.

Dipped flat shape, non-inductive construction.
Capacitance Range: .01 MFD to .47 MFD.
Voltages: 100v, 200v, 400v, 600v DC.

Dipped flat shape.
Capacitance Range: .001 MFD to .22 MFD.
Voltages: 50v, 100v, 200v DC.

Super wrap with epoxy endfill.
Capacitance Range: .01 MFD to .47 MFD
Voltages: 100v, 200v, 400v, 600v DC.

METALLIZED POLYESTER FILM CAPACITORS.

Type FNX-H

Mylar wrapped semi oval with epoxy end seal
Capacitance Range: 1 MFD to 10 MFD
Voltages: 100v, 200v, 400v, 600v DC.

SOLID TANTALUM CAPACITORS.

Type TAX
Type TSX
Type TSL

MIL-C-26655A hermetically sealed.
Type TAX
Type TSX - TSL Sealed with epoxy resin.
Capacitance Range: 22MFD to 330 MFD.
Voltages: 6v, 10v, 15v, 20v, 25v, 35v, 50v DC.

for further details, contact:

MATSUO

ELECTRIC CO., LTD.

3-chome, Sennori-cho, Toyonoko-shi, Osaka, Japan
Cable Address "NCC MATSUO" OSAKA
TWX-523 4164 OSA

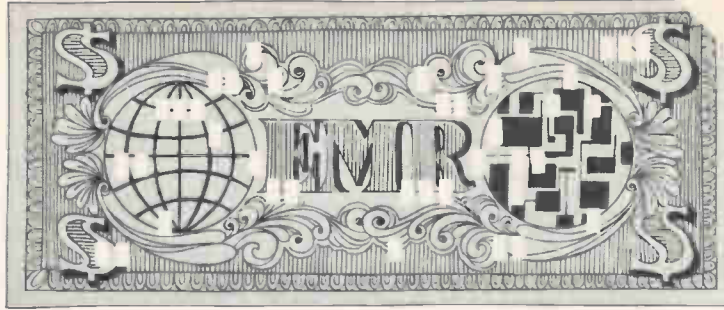

The cost of all this to you? Absolutely nothing. No fees or charges at any time.

Other advantages of EMR:

- Your resume is sent only to those companies that have a genuine requirement for your particular skills.
- There is no general "broadcasting" in the hope "someone will be interested."
- Your identity is protected because your name is released only according to your prior instructions. Your name can be deleted on request.
- EMR's service is nationwide. You may be considered for job opportunities anywhere in the U.S.

The Electronics Manpower Register is a powerful tool and should be considered when you are seriously seek-

ing a new position. And, although you may be reasonably happy in your present position, chances are that you might have that ideal job in mind.

This is why EMR makes good sense for you. If that job does turn up, you'll be there.

To get your name in the EMR file, just fill out the resume form and return to:

Electronics Manpower Register
330 West 42nd Street
New York, N. Y. 10036

Please enclose a copy of your resume if you have one. A detailed brochure further describing EMR will be sent to you.

Electronics Manpower Register A computerized employment opportunity service

CONTINUED FROM OTHER SIDE				
Previous Position	Employer	City/State	From	To
Duties and accomplishments				
Previous Position	Employer	City/State	From	To
Duties and accomplishments				
GENERAL INFORMATION				
(Summarize your over-all qualifications and experience in your field. List any pertinent information not included above.)				
Current annual base salary	Total years of experience	Date available (within four months)	U.S. Citizen <input type="checkbox"/>	Non U.S. Citizen <input type="checkbox"/>
My identity may be released to: employer <input type="checkbox"/>	All but my present employer <input type="checkbox"/>	Have you security clearance?	Yes <input type="checkbox"/> No <input type="checkbox"/>	If yes, What level
Mail (with a copy of your resume, if you have one) to:				
Electronics Manpower Register ELECTRONICS 330 West 42nd St. New York, N. Y. 10036		NO FEES OR CHARGES		
				EMR-6



You can give her hope.

How? Can you find loving parents for her, give her good health, adjust her to the realities of normal living, remedy any physical or other problems troubling her? Probably not.

But you can do this: give the United Way. Support the regular community agencies which provide help for all, all at once, all year long — for the young and old, the ill and troubled, the poor and neglected, for members of the Armed Forces and their families, and for victims of disaster.

Your voluntary United Way gift is your way of being a good neighbor and friend in your community. It is your way of saying you want to help make your community a better place for all families, including your own, through your United Fund or Community Chest.



Your fair share gift works many wonders
THE UNITED WAY



27 million families benefit by child care, family service, youth guidance, health programs, disaster relief and services for the Armed Forces from 31,000 United Way agencies.

—EMPLOYMENT—

ADDRESS BOX NO. REPLIES TO: Box No. Classified Ad. Dept. of this publication. Send to office nearest you.
NEW YORK, N. Y. 10036: P. O. Box 12
CHICAGO, Ill. 60611: 645 N. Michigan Ave.
SAN FRANCISCO, Cal. 94111: 255 California St.

POSITION VACANT

Aviation Electronics Engineers — Are you ready to accept the challenge of the General Aviation Industry? The cry for newer, better, more creative electronics equipment grows louder every day. If you have experience in aviation electronics, and are ready to assume the responsibilities of the design, development, and production of new equipment, then we should talk it over. General Aviation grows by leaps and bounds, and we are growing with it. We're the most rapidly expanding manufacturer of aviation electronics equipment in the mid-west. Growth has created openings at all levels in our engineering department. This is a unique opportunity for the creative engineer with leadership capability. Send your resume and salary requirements to: P-6863, Electronics.

—SEARCHLIGHT—

free catalog
POTTING APPLICATORS
MANUAL AND DISPOSABLE
6cc 12cc 30cc
FOR POTTING, ENCAPSULATING, AND SEALING OF MINIATURE COMPONENTS
PHILIP FISHMAN COMPANY
7 CAMERON ST WELLESLEY 81, MASSACHUSETTS

CIRCLE 961 ON READER SERVICE CARD

RADAR SYSTEMS GROUND AND AIRBORNE AUTOMATIC TRACKING ANTENNA SYSTEMS. NIKE AJAX NIKE HERCULES M-33 MSO-1A MPS-19 MPS-9 SCR 584 TPS-1D TPS-28 FAA-ASR-2 AIRBORNE SYSTEMS, APN-84 APN-102 APS-20 APS-27 APS-45 DPN-19. DIGITAL COMPUTERS IBM 650. IBM 704
LARGEST INVENTORY OF RADAR AND MICROWAVE EQUIPMENT IN THE WORLD.
RADIO RESEARCH INSTRUMENT CO.
45 WEST 45TH ST N. Y. 10036 212-JU 6-4691

CIRCLE 962 ON READER SERVICE CARD

LEGAL NOTICE

STATEMENT OF OWNERSHIP, MANAGEMENT AND CIRCULATION (Act of October 23, 1962, Section 4369, Title 39, United States Code)

- Date of filing: October 1, 1968.
- Title of publication: **ELECTRONICS**.
- Frequency of issue: Biweekly.
- Location of known office of publication: 330 West 42nd St., City, County and State of New York—10036.
- Location of the headquarters or general business offices of the publishers: 330 West 42nd St., City, County and State of New York—10036.
- Names and addresses of publisher, editor, and managing editor: Publisher, Gordon L. Jones, Jr.—330 West 42nd St., New York, N. Y.—10036; Editor, Donald Christensen—330 West 42nd St., New York, N. Y.—10036; Managing Editor, none.
- The owner is McGraw-Hill, Inc., 330 West 42nd St., New York, N. Y. 10036. Stockholders holding 1% or more of stock are: Paul T. Babson, 330 Beacon St., Boston, Mass. 02116; College Retirement Equities Fund, 750 Third Ave., New York, N. Y. 10017; Maxwell M. Geffen, 1271 Avenue of Americas, New York, N. Y. 10029; Donald C. McGraw, Elizabeth McGraw Webster, Donald C. McGraw, Jr. & Harold W. McGraw, Jr., Trustees under Indenture of Trust m/b James H. McGraw, dated 1/14/21 as modified; Donald C. McGraw & Harold W. McGraw, Trustees under an indenture of Trust m/b James H. McGraw, dated 7/1/37 as amended; Donald C. McGraw, individually; Donald C. McGraw and Catharine McGraw Rock, as Trustees of the Estate of Mildred W. McGraw, all of 330 West 42nd St., New York, N. Y. 10036; Stanford E. Taylor, Hawk Dr., Lloyd Harbor, Huntington, N. Y. 11742; Touchstone & Co., c/o Wellington Fund Inc., Claymont, Delaware 19703.
- Known bondholders, mortgages, and other security holders owning or holding 1 percent or more of total amount of bonds, mortgages or other securities: None.
- Not applicable.
- Extent and nature of circulation:

	Average No. Copies Each Issue During Preceding 12 Months	Actual No. Copies Single Issue Published Nearest To Filing Date
A. Total No. Copies Printed.....	80,851	83,189
B. Paid Circulation		
1. Sales through dealers and carriers, street vendors and counter sales		
2. Mail Subscriptions	74,957	74,230
C. Total Paid Circulation	74,957	74,230
D. Free distribution by mail, carrier or other means.....	4,804	8,276
E. Total Distribution	79,761	82,506
F. Office use, left-over, unaccounted, spoiled after printing	1,090	663
G. Total	80,851	83,189

I certify that the statements made by me above are correct and complete.

McGraw-Hill, Inc.
By JOHN J. COOKE,
Vice President & Secretary

TRAVELLING WAVE TUBES



F 4185

8 to 13,5 GHz - 5 W - 40 dB
weight: 700 g. - supply power 45 W

for mobile radio links • conduction cooling
• airborne environmental conditions

TWT manufactured by CSF reach 2 million operating hours per year on long distance radio links

TYPES UNDER PRODUCTION

low noise

F 4064 - NF 3,6 dB - Gain 25 dB - 1,2 to 1,4 GHz
F 4129 - NF 5 dB - Gain 27 dB - 1 to 2 GHz

medium noise wide band tubes

F 4123 - NF 8 dB - Gain 45 dB - 1 to 2,3 GHz
F 4024 - NF 8 dB - Gain 45 dB - 2 to 4,3 GHz
F 4025 - NF 10 dB - Gain 45 dB - 4 to 8 GHz
F 4026 - NF 11 dB - Gain 45 dB - 7 to 11 GHz
F 4156 - NF 12 dB - Gain 40 dB - 11 to 18 GHz

medium power tubes

F 4189 - Gain 35 dB - Power 10 W - 1 to 2,1 GHz
F 4017 - Gain 35 dB - Power 10 W - 1,7 to 2,7 GHz
F 4135 - Gain 35 dB - Power 10 W - 2 to 4 GHz
TOP 1090 - Gain 35 dB - Power 6 W - 4 to 5 GHz
F 4181 - Gain 40 dB - Power 30 W - 5,9 to 6,4 GHz
F 4056 - Gain 23 dB - Power 10 W - 6 to 7,5 GHz
F 4185 - Gain 40 dB - Power 5 W - 8 to 13,5 GHz



CSF-COMPAGNIE GÉNÉRALE DE TÉLÉGRAPHIE SANS FIL

GROUPEMENT TUBES ELECTRONIQUES
55, RUE GREFFULHE - 92 - LEVALLOIS-PERRET - FRANCE - TEL. 737.34.00

U.S. OFFICE: American Radio Company 445 Park Avenue - NEW YORK, N.Y. 10022 (212) 753.5046

SPI. 855

International Newsletter

October 28, 1968

BAC gets big order for Intelsat 4 craft

The British space industry, in the doldrums since the Wilson government's decision last spring to withdraw its support for a European communications satellite, received a much needed boost last week. The Hughes Aircraft Corp., as contractor for the Intelsat 4 project, awarded the British Aircraft Corp. an order believed to total \$8,766,000 and named it principal subcontractor.

BAC will assemble two of the four operational spacecraft in the program and will carry out full system integration and tests on them. The British firm, along with Compagnie Francaise Thomson Houston-Hotchkiss Brandt and AEG-Telefunken, will also make subsystems for three of the operational satellites. These include equipment for attitude position and control, power supplies, and some ground handling gear.

ELDO's future may rest on U.S. decision on Symphonie launch

The future of the crisis-plagued European Launcher Development Organization will be decided by European space ministers at a conference in Bonn starting Nov. 11, but their decision may hinge on whether NASA grants a Franco-German request for a U.S. Thor-Delta rocket to launch the Symphonie communications satellite. Symphonie, due to fly at the end of 1971, was to have been the first customer for ELDO's Europa 2 rocket. But Britain's refusal to pay her share of growing Europa 2 development costs, added to her decision to quit the organization by 1971, has left the launcher's future in doubt. Thus the request from France and Germany for U.S. assistance in getting their craft into space.

ELDO could get a new lease on life if the bid is turned down. The reason: a Franco-German effort to build a launcher from scratch would delay the launch at least three years, and France is in a hurry to move into satellite communications. The alternative would be for ELDO's Continental members to assume Britain's share of the extra \$49 million needed to keep Europa 2 on schedule—and ELDO alive.

Canadian Marconi and French firm compatible, but . . .

Despite denials or terse "no comments" from all sides, rumors are still racing through the Paris and Montreal financial communities that Compagnie Generale d'Electricite is negotiating to buy the Canadian Marconi Co.

In many ways the acquisition would be a natural one for CGE, which hopes to be a major contractor in the Menini satellite communications system proposed by the Quebec government as a link between the province and France. A study contract for the system has already been awarded to ITT's French subsidiary, Laboratoire Central de Telecommunications, and one French source describes Canada as "the world's most important telecommunications market."

In addition, Canada's other provinces are expected to build from 40 to 75 ground stations for a satellite system that will link the entire federation. Since CGE is deeply interested in such construction, and since the Canadian government will probably insist that any ground stations built in the country use equipment made in Canada, CGE would have to establish a Canadian presence before winning Canadian telecommunications contracts.

But two major obstacles are in CGE's path. First, Canadian Marconi is 51% owned by the English Electric Co., which would presumably fight

International Newsletter

to the last ditch any transfer of know-how to de Gaulle's France. Second, Canadian Marconi does a great deal of business with the U.S. and Canadian armed forces, meaning that Ottawa and Washington would have quite a bit to say about a shift in control of the company across the Atlantic to France.

English Electric, GEC to merge

As expected, the British General Electric Co. has emerged the winner in the contest for the English Electric Co. The last obstacle was removed when the Plessey Co., which had made the initial bid for EE, bowed out. The handwriting was on the wall for Plessey after EE stockholders became alarmed at the prospect of having their large, diverse company (\$1 billion in sales) taken over by the smaller Plessey (\$410 million). The shareholders promptly approved a union with the British General Electric Co.-Associated Electrical Industries combine [Electronics, Sept. 16, p. 233].

The new combination, to be called General Electric and English Electric Companies Ltd. to take advantage of the positive image of both companies, will most likely turn its attention first to reorganizing its heavy industrial activities.

As for Plessey, managing director John Clark says he hasn't lost interest in a merger and has "other opportunities." But now that GEC and EE are joined, there are no more potential partners immediately available. Instead, agreements with various companies covering specific projects seem to be on Plessey's horizon.

Bonn insists it be prime NKF builder

Anxiety is growing in West German government and aircraft-industry circles over indications that Britain wants to play the key role in developing the NKF plane. Intended as a replacement for the Luftwaffe's F-104G Starfighters and Fiat G-91's in the mid-1970's, the NKF was proposed about 10 months ago by two German aircraft companies [Electronics, Dec. 25, 1967, p. 158]. Since then, Bonn has managed to interest other NATO countries, including Britain, in buying it for their own air forces.

Reports persist that Britain will participate only if a British firm is named prime contractor. The Germans would find that condition hard to swallow; they insist that their aircraft industry can't take on the role of subcontractor for a plane it originally proposed. Also, Germany would need 500 craft at a cost of around \$2.5 billion—more than any other NATO country.

Process controllers from Telefunken, Siemens hit market

Competition in Europe's growing market for process-control computers is getting hotter. Two of West Germany's electronics giants—Siemens AG and AEG-Telefunken—have just introduced new machines tailored for small to medium control applications.

Telefunken's, the 60-10, is the smallest model in the company's series 60 family. It has a cycle time of 1.7 microseconds for a 12-bit word, and its core storage is expandable from 4,000 to 32,000 words. The Siemens entry, called the 301, has a 1.8- μ sec cycle time for 24-bit words and a top storage capacity of 16,000 words.

The computers are being offered in a market that's expected to expand in West Germany by 25% next year and by 35% annually in the early 1970's.

Electronics International

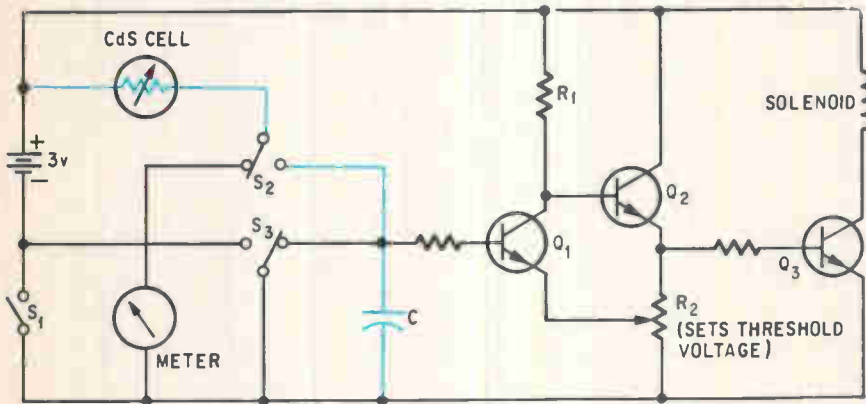

On the air. Operators man new broadcast control center at NHK, Japan's national broadcasting company. Said to be one of the most advanced setups in the industry, NHK's new Topics system—installed by IBM—was inaugurated last month.

West Germany

It's a snap

Life keeps getting simpler for the weekend photographer. There was a time when taking a sharp, well-lighted picture was a hit-or-miss proposition for an amateur. All too often the aperture setting would be wrong or exposure would be improperly regulated for light conditions.

The advent of the electronic shutter—at prices even amateurs can afford—has changed that picture. Introduced in Japan two years ago [Electronics, Aug. 22, 1966, p. 153], these shutters are now also being made in other countries. In West Germany, for example, where two years ago they were confined to professional cameras, demand for the shutters at reasonable prices has grown to the point where one large distributor says his suppliers are barely able to keep up with it. By the end of this year, well over 20% of all viewfinder cameras sold to nonprofessionals in West Germany will have electronic shutters.

Both of Germany's shutter makers—Prontor Werk Alfred Gauthier GmbH and Compur Werk

GmbH—are riding the crest of the wave. Prontor makes seven shutters that retail for as low as \$25.

Switch. Most shutters on the market today are built around discrete components, although Japan's Yashica Co. and Philips' Gloeilampenfabrieken of the Netherlands have developed integrated circuits that can do the job [Electronics, Sept. 2, p. 172]. And at this month's Photokina, the big bi-annual photo trade show at Cologne, Prontor unveiled a shutter using a Philips integrated circuit—and disclosed plans eventually to employ IC's in all seven of its electronic shutters.

Prontor considers IC's a natural for this application. Not only do they make shutters easier to manufacture, but they're more reliable and simpler to maintain than discrete circuitry. Though they still can't compete in price with discrete components, Prontor believes volume output will eventually get the price down to an attractive level.

The new shutter, dubbed the Prontor 500S electronic, uses an integrated circuit made especially for cameras by Valvo GmbH, a Philips subsidiary. The shutter is going into Voigtlaender AG's Vitesse 500 SE Electronic camera, which retails for \$106 in Germany.

The 500S not only controls exposure time, but features a self-timing circuit for delayed action. Exposure time ranges from 1/500th of a second to 10 seconds; the self-timer is set for approximately 10 seconds. In the exposure timing circuit, a cadmium sulfide photoresistor controls both the movement of the shutter-speed indicating mechanism and the circuitry that determines the shutter speed required for the lighting conditions. The photoresistor is switched from the indicating to the timing portion of the circuit at the instant the shutter mechanism begins its movement.

Click. In the circuit, switch S₁ closes about 10 seconds after the shutter button is pressed. As a result, transistor Q₁ is cut off while Q₂ and Q₃ conduct. This energizes the solenoid, which then sets off the shutter movement. Just before the shutter begins to move, the segment drive operates switch S₂, disconnecting the photoresistor from the indicating portion of the circuit and connecting it into the time-determining portion. The segment drive subsequently flips over switch S₃ before the shutter opens.

In the normal position, as shown in the diagram, S₃ keeps the capacitor short-circuited, maintaining its initial condition of charge for any exposure-time measurement. After it's switched, S₃ is in parallel with S₁. Thus, when the shutter button is released—causing S₁ to open again—S₃ keeps the 3-volt battery connected to the circuit.

The shutter-opening and exposure-time processes begin the instant S₃ operates. Depending on the photocell's resistance—a function of the incident light—the capacitor charges until the potential at the base of Q₂ is higher than that at its emitter. When that point is reached, Q₁ conducts, causing a voltage drop across resistor R₁. The potential at the base of Q₂ then falls to a level below that at

the emitter. Since Q_3 is now cut off, the potential at the base of Q_3 decreases, cutting off that transistor and deenergizing the solenoid. The shutter mechanism, with its spring arrangement, then closes the shutter segments.

The delayed-action circuit is almost identical, the only difference being that it uses a fixed transistor instead of a photoresistor. The value of the fixed resistor in the RC path is such that there's a 10-second delay after the button is pushed before the exposure-time determination begins.

New twist on time

Many kinds of drive mechanisms for clocks have been devised through the centuries, but the latest may also be the simplest and least expensive. Using piezoelectric principles, researchers at Philips Gloeilampenfabrieken's laboratories at Aachen have developed a clock whose drive mechanism consists of only a few ceramic and metallic pieces and several Plexiglas gears. Still, says Gottfried Arlt, head of the team, the clock is as accurate and long-lasting as any household electric clock now on the market.

The clock is a by-product of work being done by Arlt's group on physical-acoustical phenomena in solid state materials. However, the work holds such promise for low-power applications that the team is investigating other applications. For instance, a mechanical-piezoelectric current chopper that's lighter and smaller than conventional types has been developed. And clock makers are beginning to ask about the drive mechanism; with gears made of another hard plastic instead of Plexiglas it could be even more inexpensive.

Push-pull. The key element of the drive mechanism resembles the familiar bimetallic strip used in thermostats and thermal time-delay switches, except that both strips are of the same piezoelectric ceramic material—in this case, lead-titanate-zirconate—oppositely polarized. A voltage applied across

the element causes one strip to contract, the other to stretch. If the voltage alternates, the element oscillates at the same frequency.

The strips are attached to the flat surfaces of a thin piece of steel that's the same shape as the strips but slightly longer. Diffused onto the ceramic strips are metallic electrodes interconnected by a small jumper wire.

The element is mounted so that its bottom end is fixed and its top end can move freely. When standard a-c line voltages are applied across the electrodes to make the element oscillate, a small pawl attached to the steel piece imparts motion to a saw-toothed gear wheel, the main balance wheel. With each oscillation the pawl engages a different tooth, causing the wheel to move synchronously with the applied frequency. A worm gear on the shaft of the balance wheel directly drives the clock's minute hand. The hour hand is driven by a 1-to-12 reduction gear, which, in turn, is driven by the balance wheel. A small resistor is used to prevent damage to the drive element in case of a short circuit.

Except for the element and the gear axle, all the parts are made of relatively inexpensive materials. Suitable design of the pawl and the use of Plexiglas for the gear wheels keeps the wear and tear on the drive mechanism negligible. The noise of the clock is barely noticeable, and its accuracy is determined by the line frequency, something most countries regulate fairly well.

Japan

Isolationists

The history of technology is studied with cases of researchers working independently but hitting upon the same idea at about the same time. Another of these cases came to light last week at the International Electron Devices meeting in Washington, when, in successive

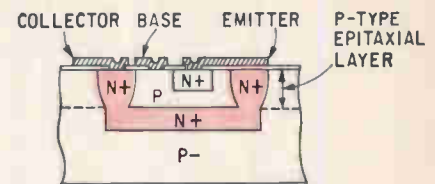

papers, Hitachi Ltd. and Bell Telephone Laboratories described identical schemes for fabricating self-isolating bipolar transistors on integrated circuits.

Earlier this year, Bell's B.T. Murphy disclosed the labs' then proposed structure, a configuration in which each transistor is set apart from its chipmates by the collector's n+ material when there's reverse bias. But at the meeting, where both the Japanese and U.S. companies had actual devices to talk about, it came out that Tsugio Makimoto of Hitachi had applied for a patent on the idea in August 1967.

Although patent lawyers for Hitachi and Bell Labs may find self-isolation something to wrangle over, Murphy and Makimoto are of the same mind about the high promise of the technique. It eliminates the lengthy isolation-diffusion step normally required in fabricating an integrated circuit.

Closer fit. Equally important, in Murphy's view, is the saving in chip space. Bell has made IC's with a packing density twice that of conventionally built devices in which each transistor is isolated by a "tub" of p material. Hitachi sees a packing density improvement of at least 1.5.

Both Japanese and U.S. research groups say the circuits have collector-saturation resistance low enough to prevent collector charge storage, a big plus for logic circuits where the transistors are driven into saturation.

Doing away with the p-material tube by using an enveloping n+ collector structure seems an obvious thing to do at first glance. But, says Murphy, nobody appar-

ently thought of it until Hitachi and Bell—unbeknownst to each other—started experimenting with very thin epitaxial layers for IC's.

A self-isolated transistor is fabricated on a p-type substrate that has an n+ buried layer diffused into it to match the collector region of the finished circuit. An epitaxial layer of p material is grown on the substrate, and n+ material is then diffused around the periphery of the transistor. This provides a low-resistance contact to the buried collector layer and at the same time forms—with the surrounding p material—a diode that can be reverse biased for isolation.

Base, emitter, and contacts are laid down in the same way as in an ordinary planar transistor.

Neck and neck. Bell has produced IC's with the technique, and Hitachi early this month achieved its first individual self-isolating transistors. Hitachi, though, has tried two different kinds of structures and is now considering a process involving simultaneous diffusions. One of Hitachi's self-isolating structures has a uniform base and the other a graded base obtained by a p+ diffusion into the epitaxial p layer. The uniform-base transistors have a frequency cut-off of 400 megahertz at unity current amplification, an amplification factor of 100, a collector-to-substrate breakdown resistance of 20 volts, and a collector saturation resistance of 10 ohms. The corresponding figures for graded-base transistors are 600 Mhz, a factor of 50, 50 volts, and 10 ohms.

That's show biz

With the push of a button in Tokyo last month, NHK, Japan's national broadcasting company, became the proud user of what it terms the most advanced information and control system in the industry—and one of the most advanced in the world. Called Topics (total on-line program and information control system), the computerized setup was developed by NHK with the International Business Machines Corp.



New way. Visual display units replace memo pads in NHK's information and control system. The IBM 2250 at left presents data in chart form, in this case dates and duration of rehearsals. The IBM 2260 at right displays information being displayed on another terminal elsewhere.

The logistics involved in putting the whole thing together is staggering. Consider that NHK combines the functions of a commercial television network like NBC, an educational one like NET, an f-m radio network, and two a-m networks, and it's obvious that Topics has its work cut out for it.

Keeping tabs. The system has two basic functions. Firstly, it serves as a central file for information about NHK's production and broadcasting activities. This data ranges from the state of uncompleted programs to who worked for how long building sets and how much he should be paid. All this is stored in an IBM 360/50 computer. Anyone with a question presses a few keys on an IBM 2260 Remote Display Terminal and gets his answer.

In its second function, Topics controls the actual broadcasting of NHK's tv and radio shows. Called ABCS (for automatic broadcast control system), this mode is run by an 1800 Data Acquisition and Control System. A computer gives orders every 10 minutes to ABCS to cover the next period of activity, and ABCS expands the order into longer, more complex routines. For example, told to ready a video tape recorder to receive output from a specific studio, ABCS finds a path through the preset matrix to connect studio and vtr. It then runs

the recorder through a warmup and checkout, monitors the recording process, rewinds the tape when the session is over, and shuts down the vtr. After the performance, the program is registered in Topics' files.

Countdown. When broadcast time nears, the system displays a schedule that alerts an operator to mount the tape on a specified vtr. Twenty minutes before air time, ABCS finds a path and makes sure that the right tape is on the vtr. With 10 seconds to go, it starts the recorder, and finally, 300 milliseconds before air time, it switches the recorder to the on-the-air matrix. It performs such tasks now for NHK's tv and radio nets and will be able to simultaneously handle a planned second educational network.

In the works for more than two years, Topics doesn't use any made-to-order machinery, though much of the equipment was specially adapted to NHK's needs. There are two 360/50's, each with a 2314 disk storage unit and 2303 drum storage unit; eight 2250 graphic display units; 184 of the 2260's; 23 model 2848 display controls; and seven 2701 data adapters, all of this being IBM equipment.

The system isn't intended to entirely replace conventional methods. In the broadcast control center, scattered among the computers

and peripheral equipment, there are a half-dozen facsimile machines. Their function: fast dispatch of memos to other NHK offices.

Great Britain

Out of the trunk

Mobile radiotelephones are generally so big they have to be fitted into an auto's trunk. John Brinkley of Standard Telephones and Cables, ITT's British subsidiary, has long held that this needn't be—that by starting from scratch and using integrated circuits and the latest miniaturization techniques one could design a mobile transmitter that would fit into a box no bigger than a car radio.

Brinkley, the firm's director of radiotelephone activity, wasn't challenged by the design problem alone. He figures that the world market for radiotelephones runs around \$250 million annually and should double in the next four years, and that the maker of a compact model could look forward to a healthy share of the market. Not only that, but the manufacturer would be in even better position if the transceivers operated at ultrahigh frequencies instead of the vhf of almost all existing models; resistance to interference would be better, and operation in tunnels and

narrow streets would be more reliable.

Shrinkage. Standard Telephones has done all this. Its new product, called the Star, is 9 by 7¼ by 2 inches and weighs 5 pounds. This compares favorably with other small radiotelephones, such as the CarryPhone Corp.'s attache-case number [Electronics, March 18, p. 218]. Output of the Star ranges from 5 to 7 watts. This, claims the company, gives a 20-mile range with a 6-inch mobile antenna and a 10-db high-mounted base antenna. The mobile transceiver comes with one, three, or five channels; in single-channel form it will sell for \$400 in Britain with the simplest base transceiver costing another \$470.

The high power-to-volume ratio is the net result of a half-dozen space-saving techniques. To combine two-level packing density with easy accessibility, receiver components are on the top of the unit, transmitter components on the bottom, each group on its own set of circuit boards. The receiver boards are fixed to one side panel, the transmitter boards to the other. For servicing, either side panel-circuit board assembly can be quickly removed so that both sides of all boards are accessible.

Keep it tight. In the receiver, there is only one transistor before the audio stage and all i-f amplification is performed by three RCA integrated circuits, one in the first

i-f and two in the second. All mixing is performed by two field effect transistors, and tuning is done by helical coils. In the transmitter design, all the circuitry for the final power amplifier, filters, and antenna switching is in the form of printed transmission lines on a single board, a feature described by engineers as the biggest individual space saver in the transceiver. Further space is saved by using a diode switch rather than a relay to select antenna transmit or receive.

The printed transmission lines make for power stability, and this allows transmission over the whole internationally designated radiotelephone uhf bandwidth—450 to 470 megahertz. Other designs, says designer Tony Pitkin, cover only 1 or 2 Mhz within that range. Further, the Star uses 25-kilohertz channel spacing instead of the conventional 50 Mhz because the transmit and receive frequencies are controlled by glass-encased quartz crystals.

Around the world

Soviet Union. The Soviet pronouncements to the contrary, Russia won't start regular color television broadcasting by its target date of 1970. Highly placed French officials are conceding privately that the plant France agreed to build in the Soviet Union to produce Secam-compatible color tv sets is hopelessly behind schedule.

Canada. Partly because it's no longer economical to mine small ore deposits, geologists have turned to an advanced version of the airborne magnetometer to map vast areas. The instrument, developed by Varian Associates, weighs about 200 pounds including peripheral equipment. It takes readings every 100 feet instead of the usual 600, and can be hooked into a ground-based computer by phone. A conventional airborne magnetometer setup usually weighs around 1,500 pounds, and its data tapes have to be taken to a computer center.

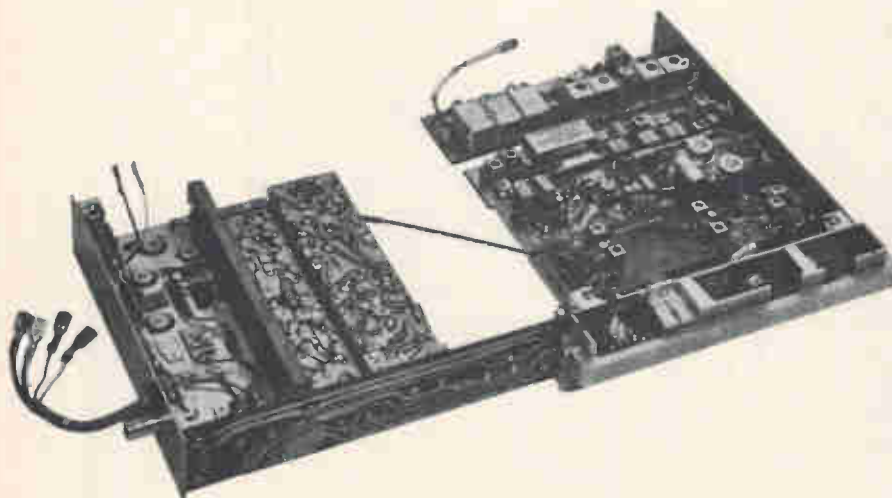

Under the dashboard. Standard Telephones & Cables has shrunk a mobile transceiver to the size of an ordinary car radio in its new radiotelephones.

Electronics advertisers

October 28, 1968

■ Acopian Corp. Mort Barish Associates	14	□ Cutler Hammer Inc. Campbell-Mithun, Inc.	11E	I R C, Incorporated Gray & Rogers, Inc.	10, 11
Allen-Bradley Co. Fensholt Adv. Agcy.	25, 27	Cyclo-Tronics, Inc. Bernard J. Hahn & Associates	194	■ Johanson Mfg. Co. Josephson, Cuffari & Co.	192
■ Amelco Semiconductor Serra Associates	138	Dana Laboratories, Inc. Jay Chiat & Assoc., Inc.	44, 45	Joslyn, Inc. Chace Company	190
■ AMP, Inc. Garceau, Hallahan & McCullough, Inc.	20, 21	Datacraft Corp. Advertising Art Services	178	Keystone Carbon Co. Downing Industrial Adv., Inc.	173
■ Amperex Electronics Corp. Div. of North American Philips Co. Sam Groden, Inc.	53	Data Instruments Division Technical Marketing	182	■ Leach Corp. Jay Chiat & Associates	123
■ Amphenol Corp. Marsteller, Inc.	28, 29	Delco Radio Div. of General Motors Corp. Macbill/Ross, Inc.	187	Litton Industries, Inc., Winchester Electronics Div. MacManus, John & Adams, Inc.	159
Andrew Corp. Fensholt Adv., Inc.	68	Delta Products, Inc. Noble De Roin & Associates	185	□ LTT Promotion-Vente-Publicite	204
□ AOIP Dumesnil Publicite	3E, 4E	Diallight Corp. Michel, Cather, Inc.	163	■ Mac Panel Co. Bennett-Advertising, Inc.	183
Associated Testing Laboratories, Inc. Murray Heyert Associates	181	Dow Chemical Co., The MacManus, John & Adams, Inc.	156	□ Marconi Instruments, Ltd. Taylor Adv., Ltd.	9E
■ Augat, Inc. Horton, Church & Goff, Inc.	152	□ Dow Chemical Europe S.A. MacManus, John & Adams, Inc.	13E	□ Marconi Co., Ltd., Line Communications Hampshire House, Ltd.	206
A. U. Sales Corp. John W. Hall	130	□ Dynamco, Ltd. Nicholas Daniels Associates	15E	□ Marconi Radio Communication Hampshire House, Ltd.	12E
■ Beckman Instruments, Inc., Helipot Div. Hixson & Jorgensen, Inc.	80	■ Eagle Signal Div. of E. W. Bliss Co. Feeley & Wheeler, Inc.	56, 58, 60	Markem Corp. Creamer Trowbridge Case & Basford, Inc.	148
Bissett-Berman Corp. S F Associates	167	Electronic Memories, Inc. Jay Chiat & Assoc., Inc.	205	■ Matsuo Electric Co., Ltd. Dalyusha, Inc. Adv.	196
Bourns, Inc., Trimpot Div. Lester Co.	102, 145	Electro Products Laboratories, Inc., Transducer Div. Grant, Schwenck & Baker, Inc.	128	Mico Instrument Co.	190
■ Bowmar Instrument Corp. Impact Adv., Inc.	16	Emerson & Cuming, Inc. Edwin F. Hall	136	■ Micro Switch Div. of Honeywell Batten, Barton, Durstine & Osborn, Inc.	100, 101
■ Brush Instruments, Div. of Clevite Corp. Carr Liggett Adv., Inc.	189	General Atronics Corp. Garceau Hallahan & McCullough, Inc.	183	Midtex/Aemco Chuck Ruhr Assoc., Adv.	57
■ Bulova Watch Co., Electronics Div. Levy Adv. Assoc.	7	General Magnetics, Inc. Carpenter, Matthews & Stewart, Inc.	18, 19	City of Milwaukee, Div. of Economic Development Grabin-Shaw Adv., Inc.	26
Bunker-Ramo Co. Diener & Dorskind, Inc.	188	General Radio Co. Horton, Church & Goff, Inc.	2nd Cover	Motorola Communications & Electronics, Inc. The Griswold-Eshleman Co.	195
■ Burndy Corp. Don Kemper Co., Inc.	67	Globe Union, Inc., International Div. The Brady Company	203	Motorola Semiconductor Products Inc. Lane & Bird Adv., Inc.	35 to 42
■ Burr Brown Research Corp. N. A. Winter Adv. Agcy.	177	■ Gudebrod Brothers Silk Co., Electronics Div. Ramsdell-Buckley & Co.	176	Mullard, Ltd. Parker-Rumrill International, Inc.	210
California Electronic Mfg. Co., Inc. Alpha Adv. Assoc.	190	Hayakawa Electronics Co., Ltd. Dai-ichi International, Inc.	193	National Semiconductor Corp. Jay Chiat & Associates	63, 64
Cambridge Thermionic Corp. Chirurg & Cairns, Inc.	196	Haydon Switch & Instrument, Inc. Reynolds & Foster, Inc.	172	■ Norden Division of United Aircraft Corp. Cunningham & Walsh, Inc.	76, 77
■ Cinch Manufacturing Co. Stral Adv. Co., Inc.	43	Heinemann Electric Co. Thomas R. Sundheim, Inc.	6	North American Rockwell, Automatics Div. Campbell-Ewald Co.	120
■ C & K Components, Inc. Van Christo Associates	170	■ Hewlett Packard, Colorado Springs Div. Tallant/Yates Adv., Inc.	3rd Cover	■ North Atlantic Industries, Inc. Ross Roy of New York, Inc.	24
■ Clevite Corp., Piezoelectric Div. Carr Liggett Adv., Inc.	193	■ Hewlett Packard, Loveland Div. Tallant/Yates Adv., Inc.	1, 30, 72, 73	Northern Electric, Ltd. Foster Adv., Ltd.	22
Cohu Electronics, Inc. Erwin Wasey, Inc.	122	■ Hewlett Packard, Microwave Div. Lennen & Newell, Inc.	2	Nye Optical Co.	194
Communication Electronics, Inc. William C. Estler—Public Relations	188	■ Hewlett Packard, Palo Alto Div. Lennen & Newell, Inc.	179	Pastoriza Electronics Co. L. K. Frank Co., Inc.	8
Consolidated Electrodynamics Corp., Sub. of Bell & Howell Hixson & Jorgensen, Inc.	66	Honeywell, Computer Control Div. Creamer, Trowbridge, Case & Basford, Inc.	46	Phelps Dodge Electronics Products Corp. Smith, Dorian & Burman, Inc.	186
Control—Logic, Inc. Van Christo Assoc., Inc.	143	■ Honeywell, Test Instruments Div. Campbell Mithun, Inc.	171	Hughes Aircraft Co. Foote, Cone & Belding	161, 184
Coors Porcelain Co. Tallant/Yates Adv., Inc.	137				
Corning Glass Works Electronic Div.— Capacitors Warner, Bicking & Fenwick, Inc.	121				
Corning Glass Works Electronic Div.— Resistors Warner, Bicking & Fenwick, Inc.	129				
CREI, Home Study Div. of the McGraw-Hill Book Co. Henry J. Kaufman & Associates	191				
■ C.S.F. GTE SPI	200				



Advertising Sales Staff

Frank E. LeBeau [212] 971-6464
Advertising Sales Manager

Wallis Clarke [212] 971-2187
Assistant to sales manager
Donald J. Austermann [212] 971-3139
Promotion Manager

Warren H. Gardner [215] LO 8-6161
Eastern Advertising Sales Manager

Atlanta, Ga. 30309: Michael H. Miller, 1375
Peachtree St., N.E.
[404] 892-2868

Boston, Mass. 02116: William S. Hodgkinson
McGraw-Hill Building, Copley Square
[617] CO 2-1160

Cleveland, Ohio 44113: William J. Boyle, 55
Public Square, [216] SU 1-7000
New York, N.Y. 10036

500 Fifth Avenue
James R. Pierce [212] 971-3616
John A. Garland [212] 971-3617

Philadelphia, Pa. 19103:
Jeffrey M. Preston
Warren H. Gardner,
6 Penn Center Plaza,
[215] LO 8-6161

Pittsburgh, Pa. 15222: Warren H. Gardner,
4 Gateway Center, [412] 391-1314

Rochester, N.Y. 14534: William J. Boyle,
9 Greylock Ridge, Pittsford, N.Y.
[716] 586-5040

Donald R. Furth (312) MO 4-5800
Midwest Advertising Sales Manager

Chicago, Ill. 60611: Kenneth E. Nicklas
Ralph Hanning, 645 North Michigan Avenue,
[312] MO 4-5800

Dallas, Texas 75201: Richard P. Poole, 1800
Republic National Bank Tower,
[214] RI 7-9721

Houston, Texas 77002: Robert Wallin,
2270 Humble Bldg. [713] CA 4-8381

Detroit, Michigan 48226: Ralph Hanning,
856 Penobscot Building
[313] 962-1793

Minneapolis, Minn. 55402: 1104 Northstar
Center [612] 332-7425

St. Louis, Mo. 63105: Kenneth E. Nicklas,
The Clayton Tower, 7751 Carondelet Ave.
[314] PA 5-7285

James T. Hauptli [415] DO 2-4600
Western Advertising Sales Manager

Denver, Colo. 80202: Joseph C. Page, David
M. Watson, Tower Bldg., 1700 Broadway
[303] 255-5484

Los Angeles, Calif. 90017: Ian C. Hill,
John G. Zisch, 1125 W. 6th St.,
[213] HU 2-5450

Portland, Ore. 97204: James T. Hauptli,
Thomas McElhinny, 218 Mohawk Building,
222 S.W. Morrison Street,
Phone [503] 223-5118

San Francisco, Calif. 94111: James T. Hauptli,
Thomas McElhinny, 255 California Street,
[415] DO 2-4600

Pierre Braude Tel: 225 85 88: Paris
European Director

Paris: Denis Jacob
88-90 Avenue Des Champs-Elysees, Paris 8

United Kingdom and Scandinavia
London: Oliver Ball, Tel: Hyde Park 1451
34 Dover Street, London W1

Milan: Robert Saidel
1 via Baracchini Phone 86-90-656

Brussels: F.I.H. Huntjens
27 Rue Ducale Tel: 136503

Frankfurt/Main: Hans Haller
Elsa-Brandstroem Str. 2
Phone 72 01 81

Geneva: Denis Jacob
1, rue du Temple Phone: 31 95 60

Tokyo: Takeji Kinoshita 1 Kotohiracho
Shiba, Minato-Ku Tokyo [502] 0656

Osaka: Ryoji Kobayashi 163, Umegae-cho
Kita-ku [362] 8771

Business Department

Wallace C. Carmichael, Manager
[212] 971-3191

Stephen R. Weiss, Production Manager
[212] 971-2044

Thomas M. Egan,
Assistant Production Manager [212] 971-3140

Dorothy Carmesin, Contracts and Billings
[212] 971-2908

Frances Vallone, Reader Service Manager
[212] 971-2865

Philco Ford Co., Microelectronics Div. The Aitkin-Kynett Co., Inc.	74, 75
Philco Ford Corp., Sierra Electronics Operation Hal Lawrence, Inc.	15
Philips Eindhoven, Nederland Media International	79
Phoenix Chamber of Commerce Jennings & Thompson Advertising	194
□ Plessey Microelectronics Creative Workshop, Ltd.	7E, 181
Radlatron, Inc. W. M. Zemp & Assoc., Inc.	55
Radio Corporation of America 4th Cover, 12, 13, 141, 146, 147 Al Paul Lefton Co.	
■ Radio Materials Co., Div. of P. R. Mallory & Co. M. M. Fisher Assoc., Inc.	162
■ Raytheon Co., Components Div. Fuller & Smith & Ross, Inc.	164
■ Republic Foil, Inc. The Graphic Group	78
□ Rochar Electronique, Schlumberger Div. Promotion Vente Publicite	2E
Rotron Manufacturing Company Lescarbours Adv. Inc.	127
Scientific Data Systems Doyle, Dane, Bernbach Inc.	48
Signetics Corp. Sub. Corning Glass Works Cunningham & Walsh Inc.	174
Sinclair Radio Labs. Inc. John E. Hayes Co., Inc.	142
Singer Company, The Metrics Division The Stanley Schwartz Company	124
Society of the Plastics Industry Inc., The E. M. Freystadt Associates Inc.	135
■ Sorsensen Operation, Raytheon Company Urrutia & Hayes Inc.	71
Sprague Electric Company, The Harry P. Bridge Company	5, 9
■ Stackpole Carbon Company, Electronic Components Div. Meek & Thomas Inc.	17
Stanpat Products Inc. Morton Advertising Inc.	195
Sylvania Electric Products Inc., Parts Div. Doyle, Dane, Bernbach Inc.	125
Technique et Produits Ste de Publicite de Films et de Documentaires	16E
■ Tektronix Inc. Hugh Dwight Adv. Inc.	131, 132
Telonic Engineering Company Jansen Associates Inc.	65
Temescal, Division of Alrco Allen & Dorward Inc.	144
■ Texas Instruments Incorporated Industrial Products Group Robinson-Gerrard	180
Texas Instruments Incorporated Components Group Don L. Baxter, Div. of Albert Frank-Guenther Law, Inc.	47, 126
Thomson Electric Co., Inc.	59
■ Tracor Inc., Industrial Instruments Div. Winn-McLane Associates, Inc.	168

Transitron Electronic Corporation Larcom Randall Advertising Inc.	62
Transistor Electronics Corporation Stevenson and Associates, Inc.	209
TRW Semiconductors, Inc. Fuller & Smith & Ross Inc.	61
■ Tung-Sol Division, Wagner Electric Corporation Feeley & Wheeler Inc.	160
Ulano Graphic Arts Supplies Inc. Lory Roston Associates	155
Valvo GmbH Intermarco	23
Victoreen Instrument Co. Palm & Peterson Inc.	158
Westinghouse/MED Pritchard Wood Associates, Inc.	32
Weston Instruments Inc., Trancoil Div. Arndt, Preston, Chapin, Lamb & Keen, Inc.	195
□ N. Zivy & Cie S. A. Hans Buner	14E

Classified Advertising

F.J. Eberle, Manager

EMPLOYMENT OPPORTUNITIES . . . 197-199

EQUIPMENT
(Used or Surplus New)
For Sale

Fishman, P. Co. 199
Radio Research Instrument Co. 199

■ For more information on complete product
line see advertisement in the latest Elec-
tronics Buyer's Guide

□ Advertisers in Electronics International

Electronics Buyers' Guide

George F. Werner, General Manager
[212] 971-2310

Robert M. Denmead,
Midwest Regional Manager
[312] MO 4-5800

Regina Hera, Directory Manager
[212] 971-2544

Thomas M. Egan, Production Manager
[212] 971-3140

Circulation Department

Isaaca Siegel, Manager [212] 971-6057

Research Department

David Strassler, Manager [212] 971-6058

TEC MAN/MACHINE INTERFACE INNOVATORS

Whether you want this...
or this...

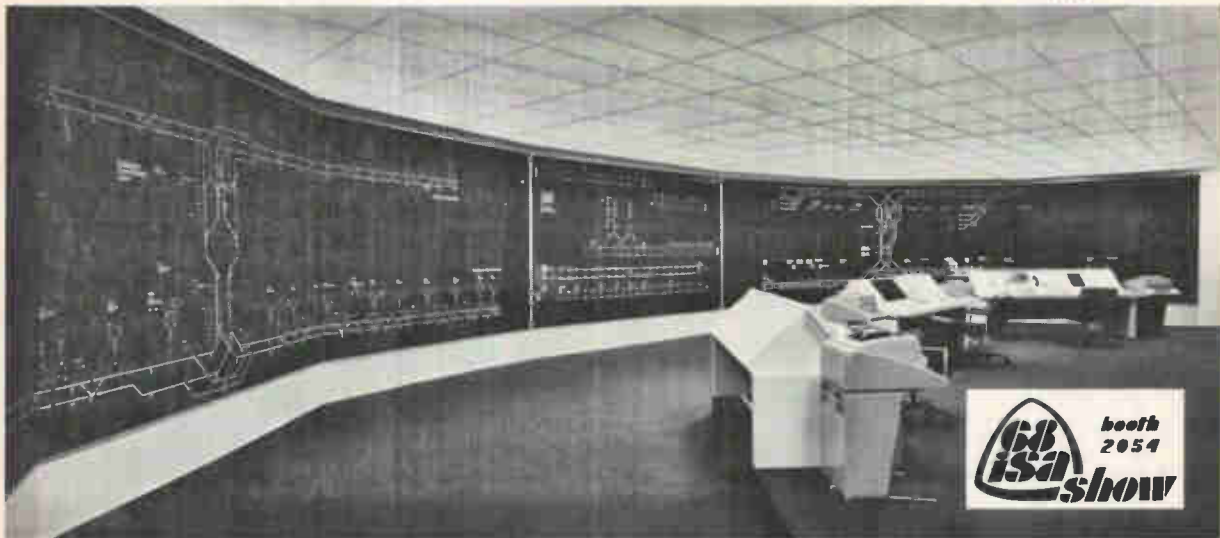

Large screen DATA•PANEL® Display Systems are provided to Westinghouse for the Central Train Control room of the San Francisco Bay Area Rapid Transit District (BART).

TEC is the one who can answer your display/control needs

**WHAT ARE YOU LOOKING FOR?
TEC HAS:**

- INDICATORS ■ SWITCHES
- READOUTS ■ PANELS
- KEYBOARDS ■ SYSTEMS
- TERMINALS

The works! Just about anything you'd possibly need for display and control functions in your system.



Stand-alone TEC DATA-SCREEN Display Terminal has full editing and interface capabilities.



■ TEC already has answers for thousands of man/machine interface applications. In fact, TEC originated, patented and developed a wide range of modern display and control devices and systems. Chances are TEC has exactly what you need now. Find out. Send for brochure or call (612) 941-1100.

Transistor Electronics Corporation

Box 6191 • Minneapolis, Minnesota 55424

Permanent magnets up to 13,500 Gauss and 4,400 Oersteds...



...from a production capability of a million magnets a week

Mullard can supply permanent magnets with remanent flux densities up to 13,500 Gauss or intrinsic field strengths up to 4,400 Oersteds, and they can be produced quickly to your specification. Mullard manufactures two main magnetic materials—

Ceramic 'Magnadur' offers exceptionally high coercive force and electrical resistivity (ideal for d.c. motors and generators).

Metal 'Ticonal' is a high efficiency metallic permanent magnet material offering a wide range of performance characteristics.

From these basic materials Mullard produces a range of variants to meet every magnet requirement in applications from meters to motors. Leading automobile manufacturers in the USA, for example, are using Mullard Magnadur segments in d.c. motors. Production capacity at the Mullard magnet factory is around a million magnets a week.

Every designer should obtain the Mullard technical information on permanent magnets. Also ask to be put on

the mailing list of the Mullard Bulletin—a regular publication which gives details of new components and applications . . . the result of extensive research and development programmes in the Mullard laboratories in England. Mullard employs 1,000 qualified scientists and engineers and has six major plants, with over 3 million square feet of floor space.

Write today for information on Mullard permanent magnets and for the name of your local Representative Mullard Limited, Mullard House, Torrington Place, London WC1, England.

USA enquiries to Mullard Inc., 100 Finn Court, Farmingdale, Long Island, New York 11735, USA. Telephone: (516) 694 8989 Telex: 961455.

Mullard

MOL 52

Get better performance in any direction

hp's 140 Scope System makes your most important measurement tool your most versatile tool



The hp 140 Scope System covers the entire oscilloscope spectrum from dc to 12.4 GHz with the extraordinary versatility you need to get step-ahead measurements—now and in the future!

Count these exclusive capabilities: hp's 140 Scope System is the only scope system to give you sampling bandwidth to 12.4 GHz . . . delayed sweep time base for sampling . . . 50 μ V/cm sensitivity dc coupled with no drift . . . plus plug-ins for direct readout of TDR and swept frequency. In addition, it offers full plug-in compatibility with standard CRT persistence in the 140A mainframe—or optional variable persistence and storage in the 141A mainframe. Select from these unique capabilities for your special measurement require-

ments. For your all-around, day-to-day use, pick the 20 MHz, 5 mV/cm dual trace plug-in.

With 17 high-performance vertical and horizontal plug-ins and three remote sampling heads to choose from, you match your oscilloscope system to your measurement requirements. The selection chart shows how.

For the complete story on the scope system that gives you better performance in any direction—hp's 140 system—contact your nearest field engineer. Or, write to Hewlett-Packard, Palo Alto, California 94304. Europe: 54 Route des Acacias, Geneva. Price: 140A Mainframe, \$595; 141A Variable Persistence and Storage Mainframe, \$1395; plug-ins, \$250 to \$1600; samplers, \$1000 to \$3000.

hp 140 Scope System PLUG-IN CAPABILITIES	VERTICAL PLUG-INS													COMPATIBLE TIME BASES					DUAL TRACE PLUG-INS	
	1400A	1401A	1402A	1403A	1405A	1406A	1407A	1410A	1411A	1430A	1431A	1432A	1420A	1421A	1422A	1423A	1424A	1425A	1415A	1416A
1. Wide Band			•		•								•	•						
2. Sampling								•	•	•	•	•						•	•	
3. High Gain Differential	•			•		•							•	•	•	•	•			
4. Dual Trace		•	•		•			•	•				•	•	•	•	•			
5. X-Y	•	•	•	•	•	•	•	•	•				•	•	•	•	•			
6. Delayed Sweep																				
7. No Drift						•	•						•	•	•	•	•			
8. High Common Mode Rejection				•		•	•						•	•	•	•	•			
9. Algebraic Addition		•	•		•				•	•			•	•	•	•	•			
10. Time Domain Reflectometry																				
11. Wide Band TDR									•	•								•	•	
12. Swept Frequency																				•

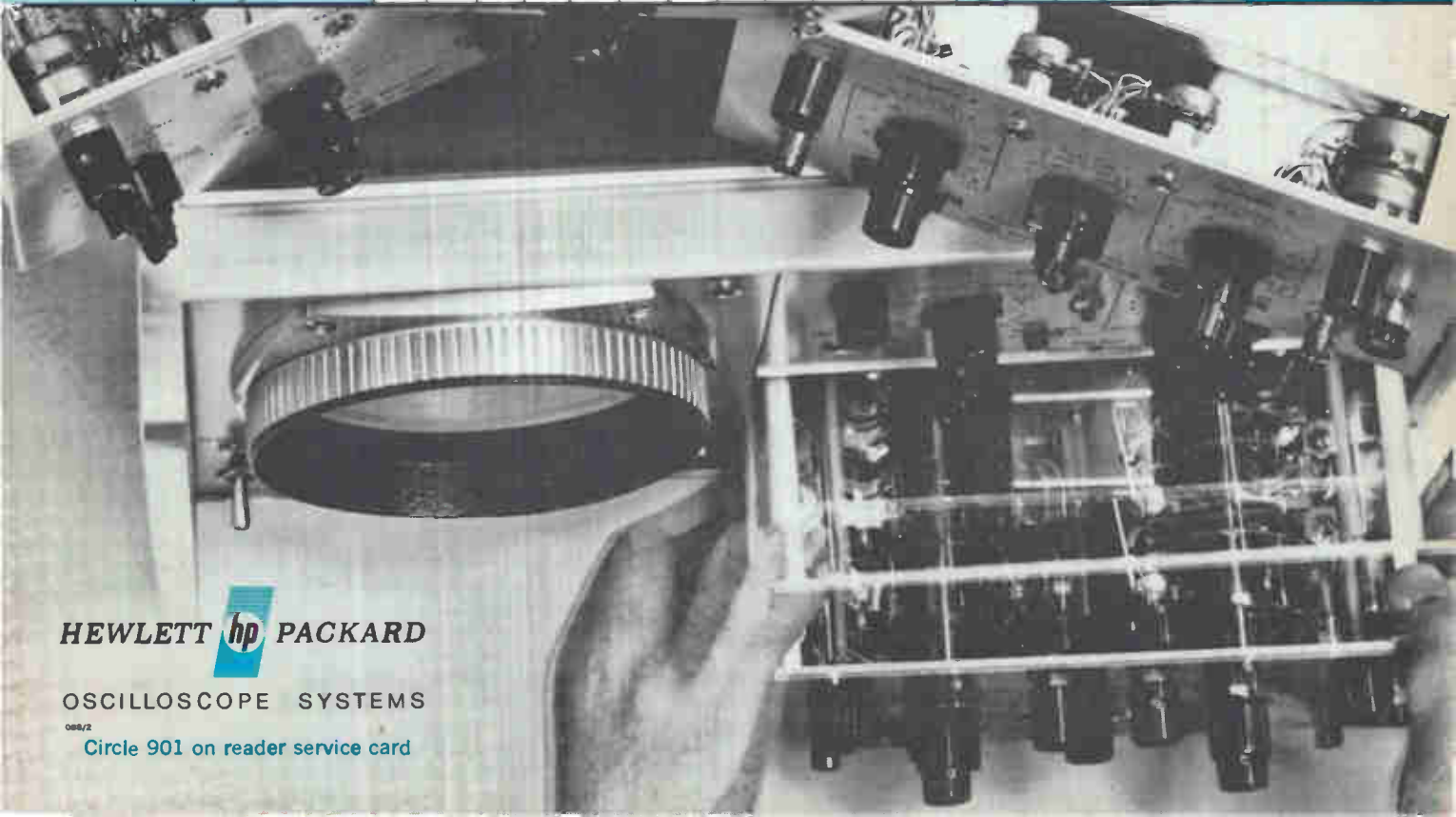

HEWLETT  PACKARD

OSCILLOSCOPE SYSTEMS

088/2

Circle 901 on reader service card



RCA is uniquely equipped to do this ...by bringing together in-depth capabilities from applied research to product design to applications assistance.

By drawing upon broadly-based experience and detailed knowledge of previously-developed products, we can put our heads together to provide our customers with a fast

response ability to attack and solve systems problems.

Right now we are developing an exciting new product, the transferred electron oscillator (TEO), which promises to open up to solid-state devices many microwave areas formerly restricted to klystrons.

These TEO's offer many advantages to the systems designer, including: no thermal runaway, better heat dissipation, excellent noise properties, mechanical and electrical tuning, AM or FM modulation, and no change in frequency and power output proven by life tests exceeding 6,000 hours.

RCA already is involved in a number of programs to develop both pulse and CW TEO's for use from L-through K-band. Our engineers can assist you in your system design using these TEO devices—ideal wherever small, rugged, low-noise, reliable sources of microwave power are required.

For more information on RCA TEO's and how RCA's in-depth capabilities can help you, just ask us to put our heads together. Write: Manager, Microwave Marketing, RCA Electronic Components, Harrison, N.J. 07029.

RCA

Participation...
We put our heads together to solve
your product/system interface

