

Electronics®

Voltage-tunable filters: page 98

Switching pulse-code modulation: page 119

Computer for an orbiting laboratory: page 129

October 3, 1966

75 cents

A McGraw-Hill Publication

Below: Extra layers of glass
create better microcircuits, page 108

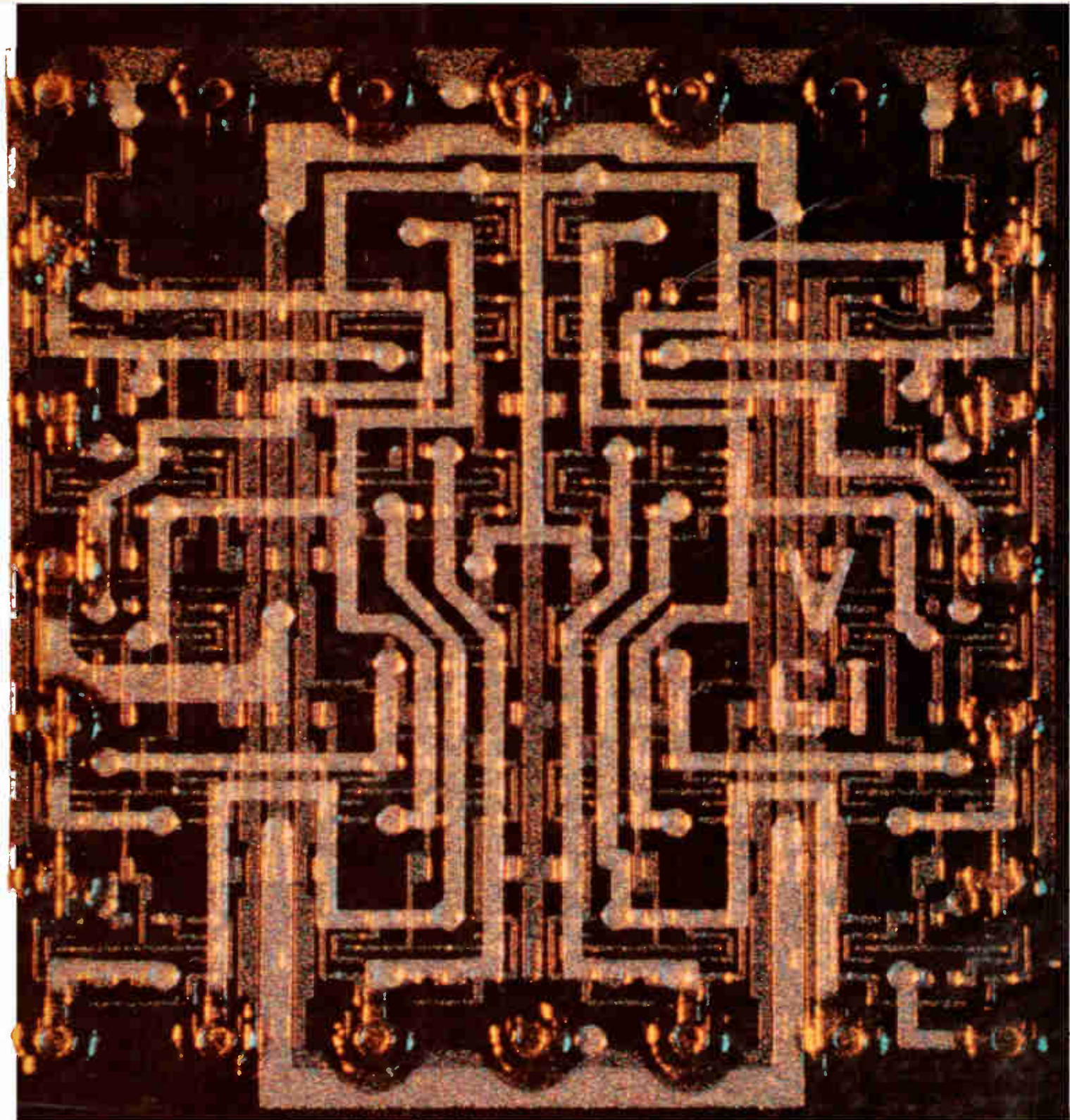



Just
add a
scope . . .

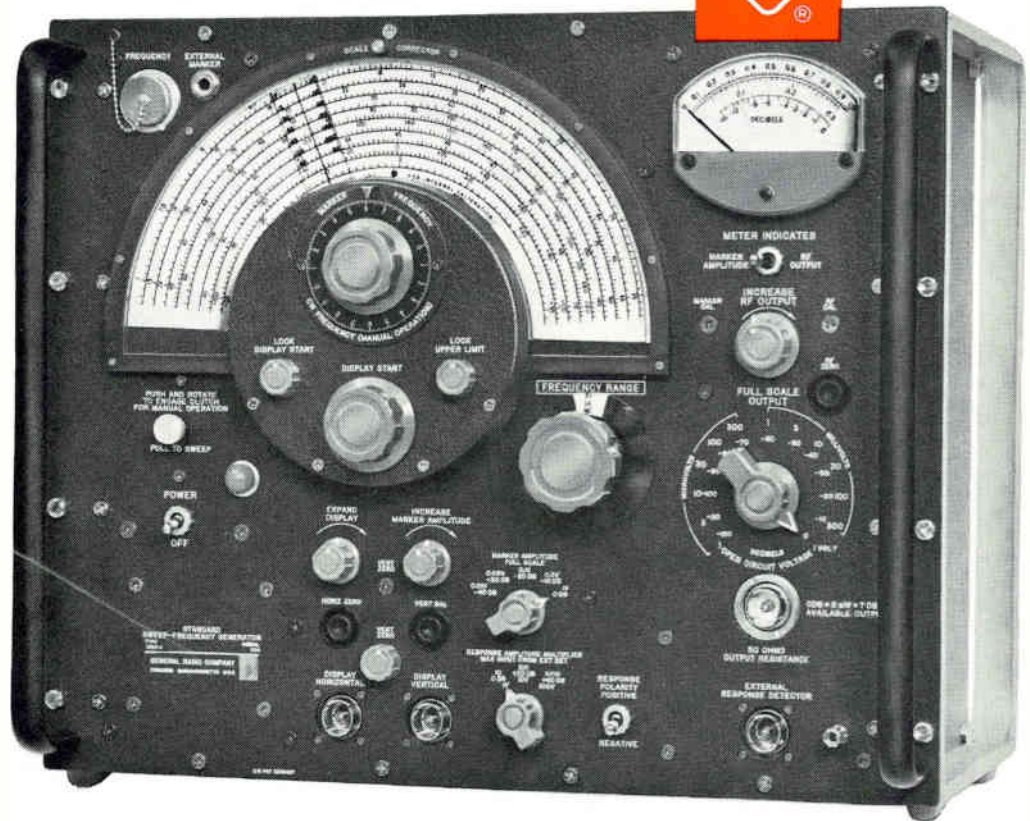

and you have everything you need for **Quantitative Frequency-Response Measurements**

The Type 1025-A Standard Sweep-Frequency Generator is both a sweep generator and a CW generator, with a marker generator, attenuator, and output meter . . . all wrapped up in a single package • it can be switched instantly from swept to CW mode without readjusting, recalibrating, or reconnecting • it covers 0.7 to 230 Mc/s in 10 overlapping octave ranges • has two bandsread ranges (400 to 500 kc/s and 10.4 to 11 Mc/s) • has a "perfect marker" . . . continuously adjustable and accurately calibrated both in frequency and amplitude, which allows you to take accurate quantitative data *directly* from a scope display • output is calibrated, 0.3 μ V to 1 V behind 50 ohms • frequency can be monitored by an external counter through a connector provided specifically for that purpose • price is \$3450, far less than the total cost of the separate instruments you would need for comparable performance.

Write for complete information or a demonstration.

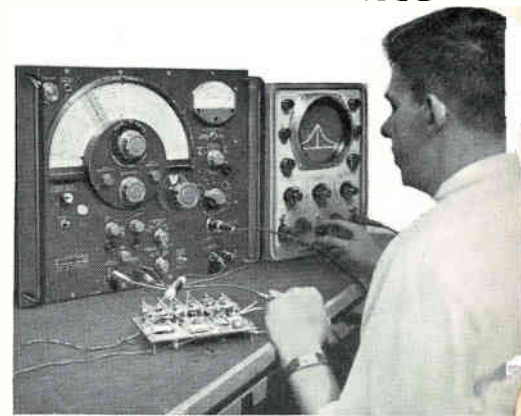

An experimental 5-stage, single-tuned, 30-Mc i-f strip with 1-Mc bandwidth being aligned with the Type 1025-A Standard Sweep-Frequency Generator. Data measured includes center frequency, 6- and 60-dB bandwidths, and gain. The generator can be accurately set to both the 10 μ V signal level at the front end as well as to 100 mV at the last stage.

BOSTON • NEW YORK • CHICAGO • PHILADELPHIA • WASHINGTON, D.C.
SYRACUSE • DALLAS • SAN FRANCISCO • LOS ANGELES • ORLANDO
CLEVELAND • TORONTO • MONTREAL
BOURNE END, ENGLAND ZURICH, SWITZERLAND

GENERAL RADIO
WEST CONCORD, MASSACHUSETTS

Circle 900 on reader service card

GOOD BYE **DOWN TIME**

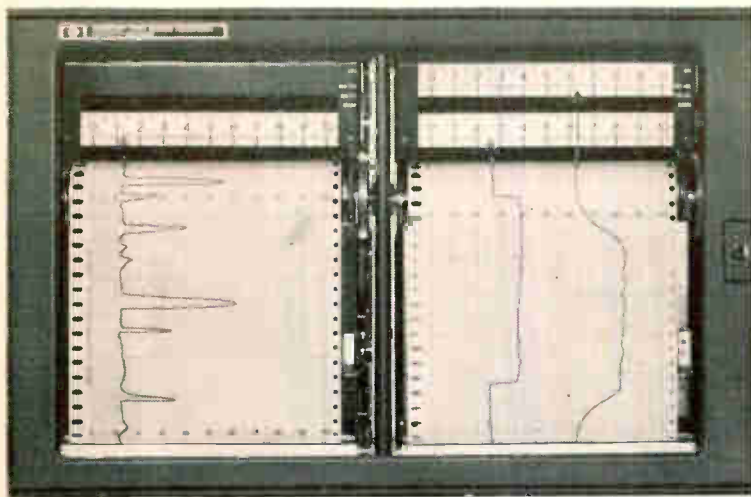

these new
strip-chart
recorders take
the downtime
out of
industrial
recording

Four new strip-chart recorders are now available from Hewlett-Packard; 6-inch one or two pen models and 11-inch one or two pen models. Design techniques including solid-state circuits and precision reference allow reliable, trouble-free operation. True modular design makes possible rapid interchange of modules on line with minimum downtime. Oversized inkwells and disposable pen tips provide inexpensive writing convenience. (Or you can have inkless writing on inexpensive electrosensitive paper for long-term unattended monitoring applications.)

The modular design also lets you order a low-cost recorder that is tailor-made to fit your application. You have a choice of sensitivity and speed.

As options you can use up to 6 limit switches, electric pen lift, event markers, and retransmitting pots. Other options include air purge, individual-remote pen lift, remote chart drive, electric writing, and jump speed chart drives. Two 6-inch instruments may be mounted side by side in a single 19-inch relay rack.

Standard features include guarded and floating inputs with high CMR and solid-state construction with zener reference. The

removable chart magazine tilts out 45° for easy notations and front loading.

It all adds up to recorders that stay on the job, not the repair bench.

Call your Hewlett-Packard field engineer for complete information. Or write Hewlett-Packard, Palo Alto, California 94304, Tel. (415) 326-7000; Europe: 54 Route des Acacias, Geneva. *Data subject to change without notice. Prices f.o.b. factory.*

SPECIFICATIONS

Sensitivity: Choice from 1 mv to 100 v full scale
Chart Speed: Choice from 0.5 in/hr to 10 in/min
Accuracy: 0.25% with 0.5 second balance time
Input Impedance: Potentiometric 1 mv to 100 mv; constant 1 MΩ above 100 mv

Prices:	6-Inch Recorders	11-Inch Recorders
Single pen:	5701A \$ 825.00	5703A \$ 995.00
Dual Pen:	5700A \$1325.00	5702A \$1895.00

**HEWLETT
PACKARD**  **MOSELEY
DIVISION**

1280

simple direct measurements

1 mv to 3 v

10 kHz to 1 GHz

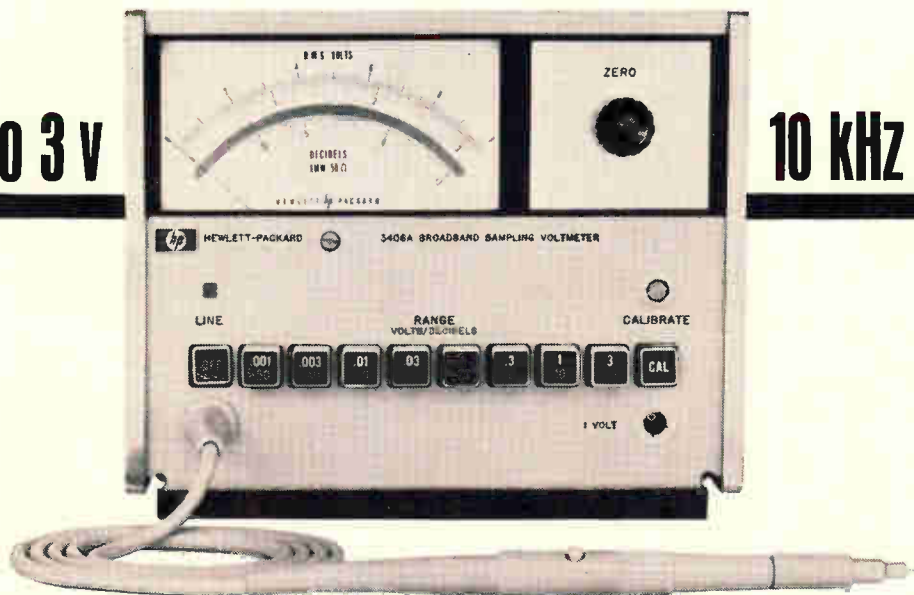

the first rf voltmeter to offer:

- 50 μ v readings with 20 μ v resolution
- $\pm 5\%$ measurements at 700 MHz (usable to 2 GHz)
- Linear scale, all ranges
- Recorder and "sample hold" outputs
- Probe with measurement retention
- Priced at only \$650!

The Hewlett-Packard 3406A RF Voltmeter provides greater accuracy and sensitivity over a broader frequency range than any comparable instrument available... and at only \$650!

The sampling technique employed in the voltmeter provides a "sample hold" output, which permits high-frequency peak measurements with a low-frequency scope, as well as true rms measurements, when you use the 3400A RMS Voltmeter. The 3406A/3400A combination costs just \$1175 for true rms measurements to 1 GHz. The 3406A, with a scope such as the HP 120B Oscilloscope, permits visual measurements over the same bandwidth for just \$1145!

Ideal for such applications as radar, high-frequency communications, telemetry and research and development labs, where measurements with this resolution and at these frequencies previously have been impossible.

Extra features include a front-panel calibrator, pushbutton range selection and the pushbutton probe which allows retention of a measurement. Accessories include the 11072A Isolator Tip, furnished with the instrument, plus these kits, which increase the flexibility of the 3406A:

11064A Basic Probe Kit (\$100)

11063A 50 Ohm "T"

11061A 10:1 Divider Tip

10218A BNC Adapter

(0950-0090) 50 Ohm Termination

11071A Probe Kit (\$185), same as 11064A

plus: 11073A Pen Type Probe

10219A Type 874A Adapter

10220A Microdot Adapter

11035A Probe Tip Kit

Ask your Hewlett-Packard field engineer for a demonstration, or write for complete specifications to Hewlett-Packard, Palo Alto, California 94304, Tel. (415) 326-7000; Europe: 54 Route des Acacias, Geneva.

Data subject to change without notice. Prices f.o.b. factory.

HEWLETT  PACKARD
An extra measure of quality

News Features

Probing the News

- 167 **Better Vietnam communications**
- 171 **Satellite in sight for airlines**
- 177 **West Germany steps into space**
- 183 **More power in space**
- 187 **IC's to hit the road in 1968 cars**

Electronics Review

- 45 **Communications:** H-f's sharper bounce; Faster talker; Laying the groundwork
- 47 **Industrial electronics:** Tooled for economy; Fingertip control; The long green
- 49 **Medical electronics:** Bedside companion
- 50 **Instrumentation:** Miss calculation
- 52 **Computer:** Faster Fourier
- 52 **Space electronics:** Resourceful satellite; On the right track; Little nudge
- 57 **Electronics notes**

Electronics Abroad

- 257 **Japan:** Onward and upward
- 258 **West Germany:** A little corner; Transistor time
- 259 **Soviet Union:** R_x for R&D
- 259 **East Germany:** A certain sameness
- 260 **The Netherlands:** End of the lines;
- 261 Keeping track
- 263 **Great Britain:** Light touch
- 264 **France:** Green light?
- 265 **Around the World**

Departments

- 4 Readers Comment
- 8 People
- 14 Meetings
- 16 Meeting Preview
- 23 Editorial
- 25 Electronics Newsletter
- 75 Washington Newsletter
- 193 New Products
- 236 New Books
- 238 Technical Abstracts
- 240 New Literature
- 251 Newsletter from Abroad

Technical Articles

I. Design

- Circuit design** 98 **FET's call the tune in active filter design**
Transistors replace inductors as the tuning element to reduce filter size and cost
James M. Loe, Philco Corp.

- Circuit design** 102 **Designer's casebook**
 - FET's produce stable oscillators
 - Switching amplifier converts unipolar to bipolar pulses
 - Detector stores peaks of video bursts
 - Circuit samples a signal, holds it up to 1 minute
 - FET stabilizes amplitude of Wien bridge oscillator

II. Manufacturing

- Materials** 108 **New dimensions in IC's through films of glass (cover)**
Better glassing methods and new materials permit the best features of monolithic and hybrid integrated circuits to be combined
John A. Perri and Jacob Riseman, IBM

- 111 **Portfolio of applications**
In color, photos show how glass has been used in integrated circuits

III. Applications

- Communications** 119 **Pcm telephone exchange switches data like a computer**
Digital voice messages can be switched directly without converting the signals back to analog
Andre Chatelon, Laboratoire Central de Telecommunications

- Computers** 129 **For a crew in lonely orbit, something to lean on in space**
Working in space is harder than scientists expected. A manned laboratory will need a special kind of computer to plan work, monitor astronauts and do the conventional jobs of navigation and control.
Andrew Adelman and Jack Cohen, IBM

IV. Engineering

- Opinion** 143 **Plain talk about obsolescence**
Readers disagree with what an Electronics author had to say about engineers becoming obsolescent.

Electronics

Editor-in-Chief: Lewis H. Young

Senior editors

Design: Samuel Weber

Application: George Sideris

News: Kemp Anderson Jr.

Assistant to the editor: Sally Powell

Senior associate editors: John F. Mason, Donald Christiansen, Robert Henkel, Joseph Mittleman

Department editors

Avionics: W.J. Evezia

Communications: Leonard Weller

Computers: Wallace B. Riley

Design theory: Joseph Mittleman

Electronics abroad: Arthur Erikson

Electronics review: Stanley Zarowin

Industrial electronics: Alfred Rosenblatt

Instrumentation: Carl Moskowitz

Military electronics: John F. Mason

New products: William P. O'Brien

Special projects: Donald Christiansen

Staff writers: Jan Rahm

Regional Bureaus

Domestic

Boston: Thomas Maguire, manager; Robin Carlson

Los Angeles: William B. Wallace, manager; June Ranill

San Francisco: Walter Barney, manager; Mary Jo Jadin

Washington: Robert W. Henkel, manager; William D. Hickman, John Rhea, correspondents; Patricia C. Hoehling

Foreign

Bonn: John Gosch

Tokyo: Charles Cohen

Copy editors

James J. Moran, David Goller, William Olcott

Graphic design

Art director: Saul Sussman

Assistant art directors: Donna M. Griffiths, Ann Mella

Production editor: Arthur C. Miller

Editorial secretaries: Claire Benell, Lynn Emery, Lorraine Fabry, Kay Fontana, Patricia Gardner, Lorraine Longo

McGraw-Hill News Service

Director: John Wilhelm; Atlanta: Fran Ridgway; Chicago: Reck Johnson;

Cleveland: Arthur Zimmerman; Dallas: Marvin Reid;

Detroit: N. Hunter; Houston: Ron Lovell; Los Angeles: Michael Murphy, Gerald Parkinson

San Francisco: Margaret Drossel

Seattle: Ray Bloomberg; Washington: Arthur L. Moore, Charles Gardner,

Herbert W. Cheshire, Seth Payne, Warren Burkett, Warren Kornberg

McGraw-Hill World News Service

Bonn: John Johnsrud; London: John Shinn;

Mexico City: Bruce Cross; Milan: Ronald Taggiasco;

Moscow: Howard Rausch; Paris: Peter Kilborn;

Rio de Janeiro: Wes Perry; Tokyo: Marvin Petal

Circulation and Research Manager: Milton Drake

Publisher: Gordon Jones

Electronics: October 3, 1966, Vol. 39, No. 20

Printed at 99 North Broadway, Albany, N.Y., 12207
Second class postage paid at Albany, N.Y.

Subscriptions are solicited only from those actively engaged in the field of the publication. Position and company connection must be indicated on orders. Subscription prices: United States and Possessions and Canada, \$6.00 one year, \$9.00 two years, \$12.00 three years. All other countries \$20.00 one year. Single copies, United States and Possessions and Canada 75¢. Single copies all other countries \$1.50.

Published every other Monday by McGraw-Hill Inc. 330 West 42nd Street, New York, N.Y. 10036. Founder: James H. McGraw, 1860-1948. Corporate officers: Shelton Fisher, President; John J. Cooke, Secretary; John L. McGraw, Treasurer.

Subscribers: The Publisher, upon written request to our New York office from any subscriber, agrees to refund that part of the subscription price applying to copies not yet mailed. Please send change of address notices or complaints to Fulfillment Manager; subscription orders to Circulation Sales Department, Electronics, at the address below. Change of address notices should provide old as well as new address, including postal zip code number. If possible, attach address label from recent issue. Allow one month for change to become effective.

Postmaster: Please send Form 3579 to Fulfillment Manager, Electronics, P.O. Box 430, Hightstown, New Jersey 08520

Readers Comment

Patent fences

To the Editor:

The article, "The laser decision" [Aug. 22, p. 36], points out the importance of developing patent fences simultaneously with technological development.

During October, 1962, I remember very well the excitement associated with learning of the semiconductor laser.

Significantly, Bell Laboratories received a basic patent on the semiconductor laser before the IBM-GE-Lincoln Labs announcement in October of 1962 that they had achieved coherent radiation from gallium-arsenide (Boyle et al, Patent No. 3,059,117, Oct. 16, 1962). It is interesting to note that this patent application was filed Jan. 11, 1960, almost three years before the announcement.

Norman Rautiola

Assistant to the president
Sparton Corp.
Jackson, Mich.

Look for the small ad

To the Editor:

I am delighted to see at least one personnel representative gullible enough to display his infinite wisdom concerning the industry practices of hiring engineers. Norman Skelton of Fairchild Semiconductors, Mountain View, Calif. has risen to the bait and accused Electronics of presenting an untrue and distorted picture of the industry in general. He has also generated, by his letter "Distorted view?" [Aug. 8, p. 8], the typical arrogance of the great givers of jobs to the deservng.

The odd part about Skelton's dissertation is that he presents himself as all-knowing about the hiring and advertising practices of a very large industry, but in actuality he works for only one company for whom it seems he is eager to do a public relations job. He feels that the complaint of false advertising is generally unfounded and goes to great pains to emphasize the cost to the company of such a venture.

Actually, nothing could be fur-

RESISTORS FOR PERSPICACIOUS DESIGN ENGINEERS

FILMISTOR® PRECISION METAL-FILM RESISTORS



Extended-range Filmistor Resistors now give you dramatic space savings in all wattage ratings — 1/20, 1/10, 1/8, 1/4, 1/2, and 1 watt — with absolutely *no sacrifice in stability!*

Filmistors offer extended resistance values in size reductions previously unobtainable. For example, you can get a 4.5M Ω resistor in the standard 1/4 watt size, which had conventionally been limited to .1 M Ω . Filmistor Metal-Film Resistors are now the ideal selection for "tight-spot" applications in high-impedance circuits, field-effect transistor circuits, etc.

Other key features are $\pm 1\%$ resistance tolerance, low and controlled temperature coefficients, low inherent noise level, negligible coefficient of resistance, and rugged molded case.

Filmistors *surpass* the performance requirements of MIL-R-10509E.

Write for Engineering Bulletin 7025C

ACRASIL® PRECISION/POWER WIREWOUND RESISTORS



These silicone-encapsulated resistors combine the best features of both precision and power wirewound types, giving them unusual stability and reliability.

Acrasil Resistors are available with tolerances as close as .05%, in power ratings from 1 to 10 watts. Resistance values range from 0.5 ohm to 66,000 ohms.

Their tough silicone coating, with closely matched expansion coefficient, protects against shock, vibration, moisture, and fungus.

Acrasil Resistors meet or exceed the requirements of MIL-R-26C.

Write for Engineering Bulletin 7450

BLUE JACKET® VITREOUS ENAMEL PRECISION/POWER WIREWOUND RESISTORS

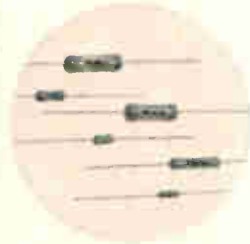

Axial-lead resistors available in ratings from 1 to 11 watts, with resistance tolerances to $\pm 1\%$. Non-inductive windings available to $\pm 2\%$ tolerance.

All welded end-cap construction securely anchors leads to resistor body. Vitreous coating and ceramic base have closely matched expansion coefficients.

Write for Engineering Bulletins 7410D, 7411A



Tab-terminal Blue Jacket Resistors can be had in a wide selection of ratings from 5 to 218 watts, with several terminal styles to meet specific needs.

Tab-terminal as well as axial-lead Blue Jackets can be furnished to meet the requirements of MIL-R-26C.

Write for Engineering Bulletins 7400B, 7401

KOOLOHM® CERAMIC-SHELL POWER WIREWOUND RESISTORS



Koolohm Resistors are furnished in axial-lead, axial-tab, and radial-tab styles, in a broad range of ratings from 2 to 120 watts. Both standard and non-inductive windings are available.

Exclusive ceramic-insulated resistance wire permits "short-proof" multilayer windings on a special ceramic center core for higher resistance values. The tough non-porous ceramic shell provides complete moisture protection and electrical insulation. Koolohms can be mounted in direct contact with chassis or "live" components.

Axial-lead Koolohm Resistors to MIL-R-26C are available in MIL styles RW55 and RW56.

Write for Bulletins 7300, 7305, 7310

STACKOHM® POWER WIREWOUND RESISTORS



Sprague Stackohm Resistors are especially designed for equipment which requires power wirewound resistors of minimum height. Their flat silhouette permits stacking of resistor banks in close quarters.

Aluminum thru-bars with integral spacers act as mounting means and also conduct heat from within the resistance element. Resistance windings are welded to end terminations for maximum reliability. An outstanding vitreous coating protects the assembly against mechanical damage and moisture. Ceramic core, end terminations, and vitreous enamel are closely matched for coefficient of expansion.

Stackohm Resistors are available in both 10-watt and 20-watt ratings, and can be furnished with resistance tolerances as close as $\pm 1\%$. Resistance values range from 1 ohm to 6000 ohms.

Both 10- and 20-watt types meet the stringent requirements of MIL-R-26C.

Write for Engineering Bulletin 7430

Send your request to Technical Literature Service, Sprague Electric Co., 35 Marshall St., North Adams, Mass. 01247, indicating the engineering bulletins in which you are interested.

ON READER-SERVICE
CIRCLE 495

ON READER-SERVICE
CIRCLE 496

ON READER-SERVICE
CIRCLE 497

ON READER-SERVICE
CIRCLE 498

ON READER-SERVICE
CIRCLE 499

SPRAGUE COMPONENTS

RESISTORS
CAPACITORS
TRANSISTORS
THIN-FILM MICROCIRCUITS
INTEGRATED MICROCIRCUITS

PULSE TRANSFORMERS
INTERFERENCE FILTERS
PULSE-FORMING NETWORKS
TOROIDAL INDUCTORS
ELECTRIC WAVE FILTERS

CERAMIC-BASE PRINTED NETWORKS
PACKAGED COMPONENT ASSEMBLIES
BOBBIN and TAPE WOUND MAGNETIC CORES
SILICON RECTIFIER GATE CONTROLS
FUNCTIONAL DIGITAL CIRCUITS

SPRAGUE®
THE MARK OF RELIABILITY

*Sprague and ® are registered trademarks of the Sprague Electric Co.

New Mercury Relay Applications From Adlake

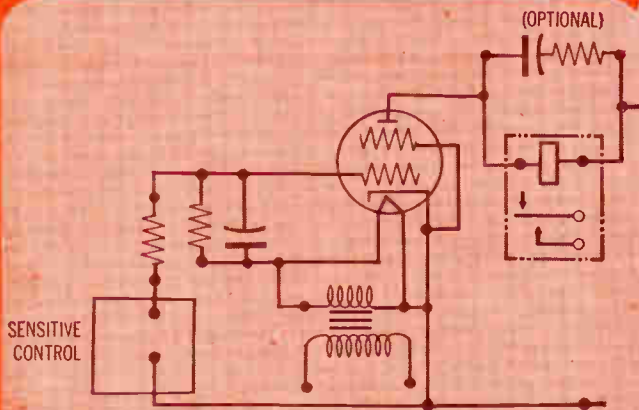

**MERCURY
DISPLACEMENT
RELAYS**

Small Currents Control "Heavy Duty" Load Relay

In applications having extremely sensitive controls, this circuit illustrates how very small currents are capable of controlling an Adlake "Heavy Duty" load relay. Resistive loads of 35, 50 or 75 amperes at 120 volts, 60 cycles, are easily met up to 44 operations per minute. 100 ampere loads at the rate of 6 operations per minute.

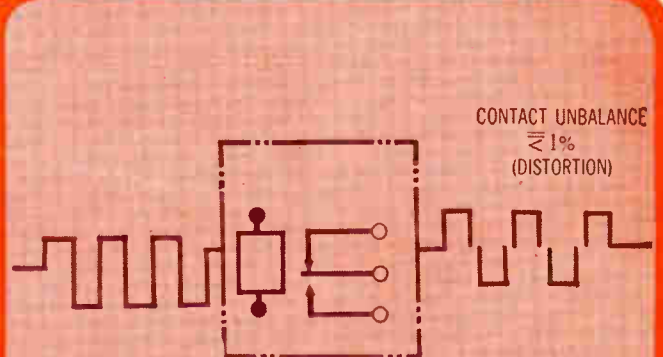

**MERCURY
WETTED
CONTACT
RELAYS**

Ideal for Data Transmission, or Tele-Typing

Adlake Polar Relays—Form C—are ideal for data transmission or tele-typewriting where a series of equal length impulses represent an alpha-numeric character or function. Baud rates up to 120 are available with Contact Unbalance—Distortion—of 1% or less including transition. Transition time is normally 200 microseconds or less.

Backed by sound research and disciplined engineering, Adlake applies the industry's broadest line of mercury displacement and mercury wetted relays to the creative solution of design circuit problems. However unique or special your application, Adlake can assist you in developing it. For prompt, personal and knowledgeable attention to your relay needs, contact the one source that is the complete source in the mercury relay field. Contact Adlake today for catalog and further information.



THE ADAMS & WESTLAKE COMPANY

Dept. 2106 • Elkhart, Indiana 46514 • Phone (A.C. 219) CO 4-1141

WINDOWS & CURTAIN WALLS • DOORS & ENTRANCES • TRANSPORTATION EQUIPMENT • MERCURY RELAYS • CONTRACT MANUFACTURING

ther from the truth. Most of the advertising and recruiting expenses of the larger companies are directly applied to some cost-plus-fixed-fee government contract. This means that the Defense Department picks up the entire tab at no risk to the company's profit structure. So why not go first class? Although regulations normally do not allow advertising as an expense, cost type contracts, which most of the large companies hold, permit advertising for technical help in trade and technical journals.

Here's the catch. Engineers are scarce, we have been led to believe. The contractor can convince DOD that large splashy advertising is the answer—witness Lockheed, Douglas, Hughes, NAA, etc. ads in the Sunday papers.

Actually, small ads are preferred by the job seeker. They are honest, to the point and usually are paid for by a company that expects nothing more than results from its investment.

Larry L. Gautney
Consulting engineer
Granada Hills, Calif.

■ In all fairness, none of Fairchild Semiconductor Division's recruiting advertising is paid for by cost-plus-fixed-fee government contracts. And in the semiconductor industry where sales have been exploding there is a real shortage of engineers.

Neuristor tv display

To the Editor:

The Newsletter item [Aug. 8, p. 31] about Japanese plans for development of a neuristor-driven flat panel television display was read

with more than casual interest. I proposed such a display in an internal memorandum at the Applied Physics Lab back in 1960.

But at the time, neuristors had only been simulated with somewhat complex lumped element circuits, so the idea was impractical. Your report of the Tohoku University plans prompted me to take another look at the problem in light of 1966 technology. And the temptation is to conclude that several microelectronics companies could probably construct a prototype panel within 12 to 18 months using a version of Rosengreen's pnpn neuristor [Electronics, March 1, 1963, p. 25] as the scanning mechanism.

An 18-inch by 25-inch display could be made from a sandwich of two panels: one containing a matrix of injection luminescent diodes or (more easily) uniformly distributed electroluminescent phosphors, and the other an array of neuristors. The neuristor array could be assembled from an interconnected collection of less than 500 large silicon wafers.

Uniformity of breakdown voltages along the neuristors would require selection of the wafers prior to assembly into the panel. The 10^5 cm/sec velocity reported for Rosengreen's neuristor would have to be increased by a factor of 10 to obtain two 25-inch wide screens. And the polarity of the video signal would probably have to be reversed on a frame-to-frame basis to provide the required a-c excitation of the electroluminescent phosphors. I'm sure a few other problems would crop up along the way.

A.J. Cote Jr.

Silver Spring, Md.

Ask your friends about us...



our Customer List is our best Advertisement!

With our communications equipment now operating in 32 countries, 37 of the United States, and 7 of the 10 Canadian provinces, you are sure to find a Farinon user near you.

Ask about . . . our SS2000 Solid-State Microwave

for the 2 GHz band, our PT Radio for point-to-point transmission in the VHF and UHF bands, and our LD Multiplex for up to 48 high-quality voice channels.

Farinon 935 Washington Street
ELECTRIC San Carlos, Calif. 94070
Area Code: 415 593-8491

SUBSCRIPTION SERVICE

Please include an Electronics Magazine address label to insure prompt service whenever you write us about your subscription.

Mail to: Fulfillment Manager
Electronics
P.O. Box 430
Hightstown, N.J. 08520

To subscribe mail this form with your payment and check new subscription renew my present subscription

Subscription rates: in the U.S.: 1 year, \$6; two years, \$9; three years, \$12. Subscription rates for foreign countries available on request

CHANGE OF ADDRESS

ATTACH
LABEL
HERE

If you are moving, please let us know five weeks before changing your address. Place magazine address label here, print your new address below.

name

address

city

state

zip code

Please send me:

- a Farinon Customer List
- a short-form catalog
- a Farinon sales engineer

Name

Title

Company

Street

City

State

Zip

What high-performance HF antenna can you airlift to the field and erect in 2 hours?

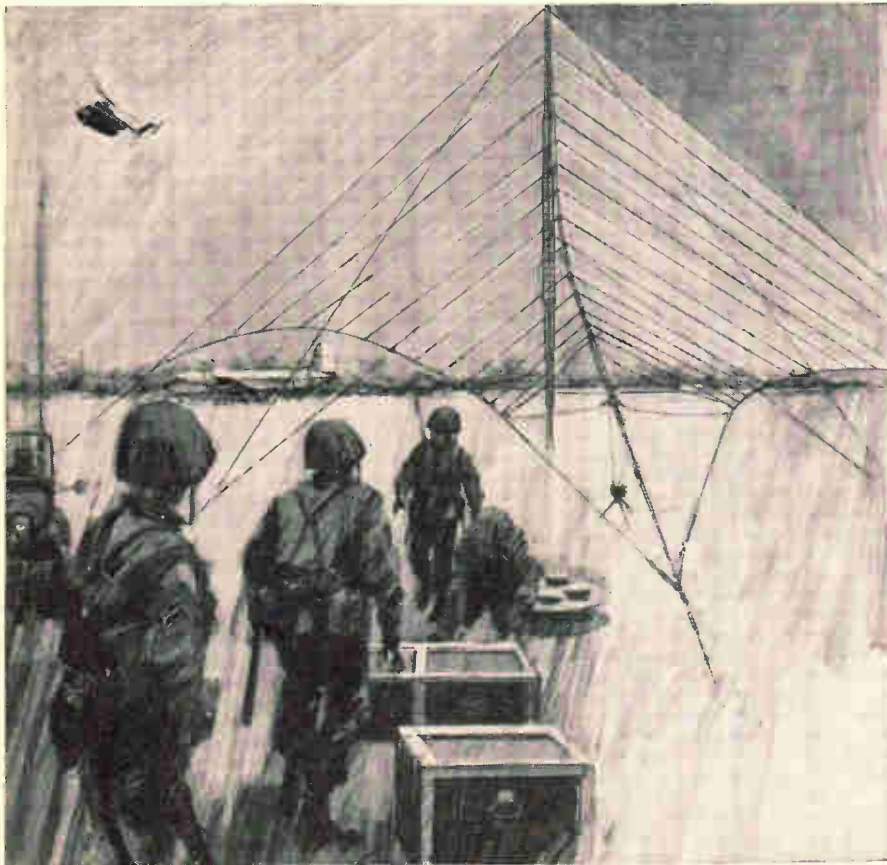

Granger Associates has the answer

now It's G/A's Model 747CA air-transportable HF antenna — which is only 10 feet long when packed, can be erected by five men in two hours, and stands up in 100-mph winds.

This antenna gets messages through when other transportable antennas don't. It does it by concentrating radiation at the elevation angle most likely to be best for the frequency used and the length of the circuit. Produces a useful gain of 10 to 13 db at any frequency from 4 to 30 Mc, with side lobes 14 db down.

Ordinary transportable antennas — like whips, dipoles and sloping V's — can't approach that kind of performance. The 747CA gives field stations an antenna fully comparable to a well-designed fixed-station antenna.

U.S. forces set up a Model 747CA in the Dominican Republic recently. Operated at only 1kw power, it delivered a better signal than an ordinary transportable antenna operated at 10 kw.

Send for complete technical data on Model 747CA.

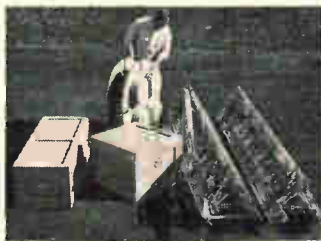

747CA antenna packed for airlift

Granger Associates

68

AN EQUAL OPPORTUNITY EMPLOYER

1601 California Ave., Palo Alto, California / Telephone: 321-417 5/ TWX: 910-373-1291
Granger Associates Ltd., Walton-on-Thames, Surrey, England / Weybridge 44842

People

Honeywell, Inc., plans to become a strong contender for infrared reconnaissance and mapping systems, which have been pretty much the domain of two or three companies. Honeywell's entree into the field is mercury cadmium telluride, described as "a unique long-wave detector" and now used in several devices. Developed at Honeywell's research center in Hopkins, Minn., the material was engineered into devices at Honeywell's radiation center in Boston. The radiation center recently won a Government contract to develop what Honeywell calls a next-generation infrared reconnaissance system.



To direct the push into systems of this kind, Honeywell has brought to Boston one of "the Michigan crowd." The University of Michigan has been a center of excellence in infrared research for several generations, and more recently in electro-optical processing and holography. After 13 years in teaching and research at the university **William L. Wolfe Jr.** becomes chief engineer of electro-optics at the Boston center.

"We're expecting to get more out of infrared systems than historically has been expected of them," says Wolfe, 35, who sees infrared entering a new phase where it will be competing more successfully with radar and other techniques. Only within the last year or two, he says, has there been widespread field experience with optical equipment. Radar, on the other hand, has been in military operations for years. One-of-a-kind design, he points out, has not only limited field experiments but raised the cost of infrared systems sky-high.

Wide interest. Wolfe says his group will be interested in "everything from a tenth of a micron out to a millimeter." This will include, among early programs, electro-optical trackers for space navigation, a technique that seeks to combine star-field pattern recogni-



Power tube calculator, applications data— all free from MACHLETT

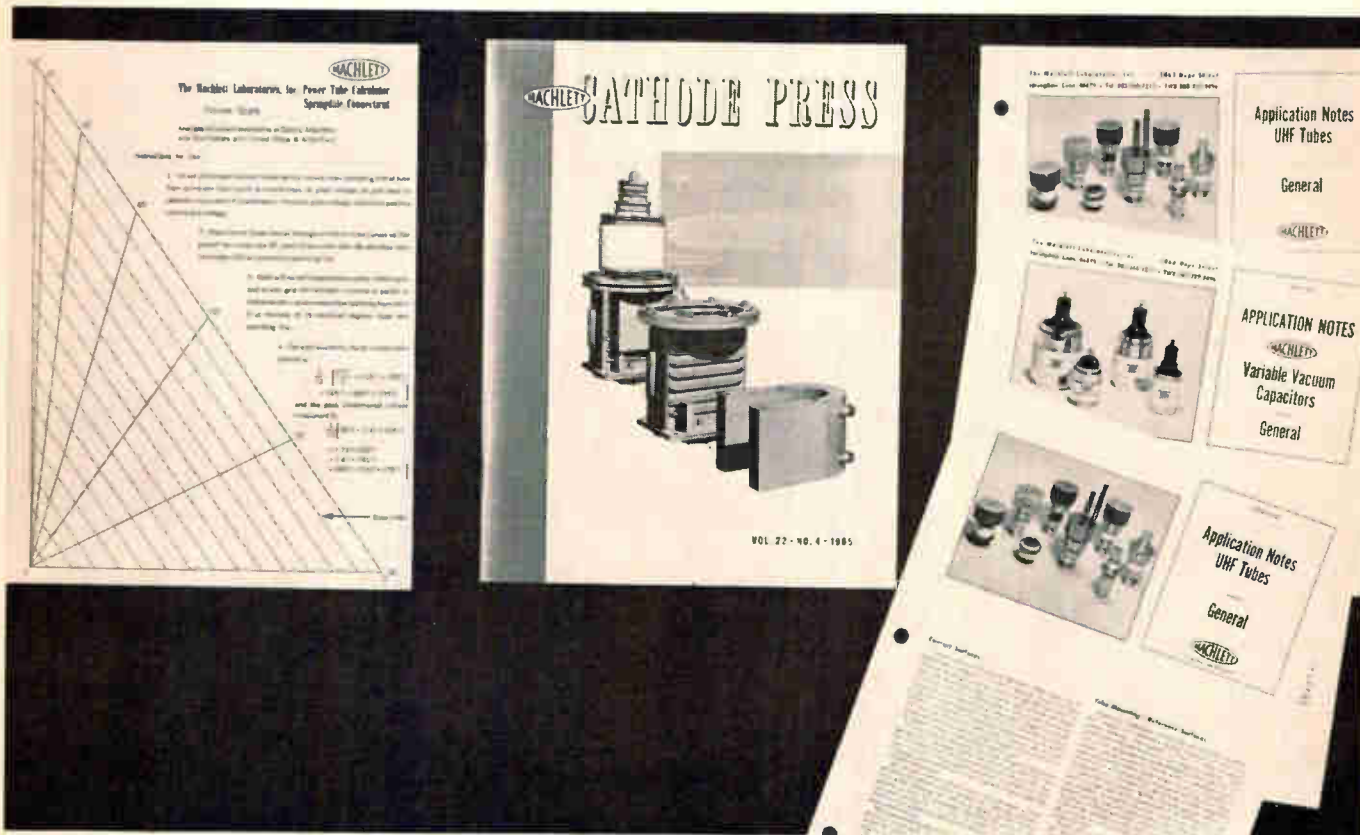

Use these aids—from Machlett—to make better tube selections, determine optimum cost-performance ratios and to cut operating costs.

- Power Tube Calculator provides a simplified method of calculating operating parameters of high power tubes.
- Applications bulletins provide valuable performance and operating data on high power triodes and tetrodes, UHF planar triodes, pulse modulator tubes, variable vacuum capacitors and others.
- Cathode Press, the Machlett technical journal, covers latest developments in power tubes and new installations.

For calculator, bulletins and free subscription to Cathode Press, send reader service card. Or write:
The Machlett Laboratories, Inc.,
Springdale (Stamford), Conn. 06879



THE MACHLETT LABORATORIES, INC.

A SUBSIDIARY OF RAYTHEON COMPANY

Pain Reliever



Cinch-Graphik printed circuits are a sure cure for packaging and production headaches. They are exactly manufactured by the world's most experienced printed circuit craftsmen to insure specification compliance, uniform assembly and dependable operation...*every* time. Caution: Cinch-Graphik's formula of CARE, SKILL and EQUIPMENT is often habit forming.



200 South Turnbull Canyon Road, City of Industry (Los Angeles), Calif. 91744 • Phone (213) ED 3-1201. Offices in 22 Principal Cities throughout United States, Canada, England and Australia listed under Cinch Mfg. Co. or United-Carr Incorporated • Cinch • Cinch-Monadnock • Howard B. Jones • Ucinite • Palnut

People

tion with tracking. Honeywell has a contract for star sensors for the Mariner/Mars probe in 1969.

He will also be directing work on horizon-sensing trackers. Honeywell has a contract with the National Aeronautics and Space Administration's Langley Research Center on a program to identify the radiation profile of the horizon and thus find ways of making better horizon sensors.

"And it's a mistake in electro-optics to overlook the eyeball," says Wolfe, who will direct further Honeywell work on an oculometer, a device that uses the search and track capabilities of the human eye.

The Sylvania Electric Products, Inc.'s electro-optics team that developed the frequency-modulated and supermode

lasers [Electronics, Sept. 20, 1965, p. 101] has now been expanded. It will form the nucleus of a group working in an advanced technology lab that will be responsible



for a broad range of electronic projects. The electro-optics group's director, **Burton J. McMurtry**, 31, was named manager of the new lab at Mountain View, Calif.

While the lab will continue to work with lasers "with at least as much dedication as before," McMurtry says, "my responsibilities now are greater, forcing me to deal in areas from microwaves to optics." McMurtry declines to elaborate on the new work, but the emphasis will probably be on multiple-sensor equipment and work in the optical portion of the electromagnetic spectrum.

To coordinate diverse techniques in building a particular system, McMurtry intends to draw upon experts from all the other Sylvania labs. His lab, he explains, represents an expansion of Sylvania's research activities, and other programs aren't going to be deemphasized. Sylvania is a subsidiary of the General Telephone & Electronics Corp.

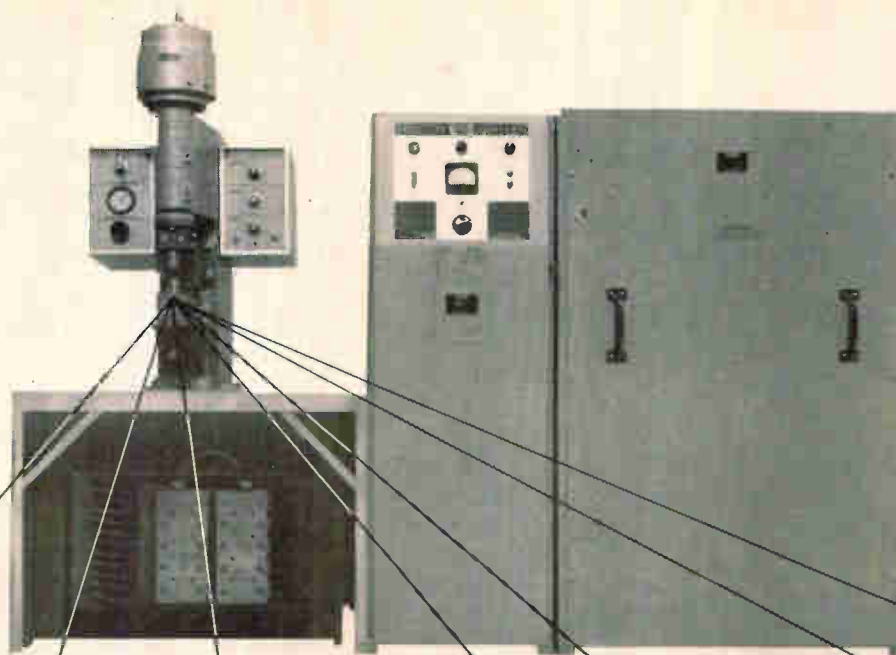

SHOWN APPROXIMATELY HALF ACTUAL SIZE



SEMI-CONDUCTOR PACKAGE

FLAT PACK

TO-3 CASE

HEATER ELEMENT

LIGHT SENSITIVE CELL

HIGH CURRENT SCR

AUTOMOTIVE BREAKER POINTS

weldPOWER[®] DC Welding Systems to 12,500 Watt-Seconds

Raytheon weldPOWER[®] 1103 supplies 12,500 watt-seconds of energy with only 6.6 kVA input.

The Model 1103 is particularly suited to precision welding of large mechanical and electronic components such as hermetic encapsulation of flat packs, semi-conductor devices, crystals, transformers and the like. The 1103 system consists of a Welding Head, Control Unit, Welding Transformer and Capacitor Cabinet as illustrated above. Power Supply features include: multiple pulse selection, polarized welding pulse, electronic voltage regulation of $\pm 2\%$ for changes in line voltage of 10, -20% ; power requirements are only 30 amps at 220 Vac or 15 amps at 440 Vac, single phase.

The Model KA Welding Head features: completely air-operated

and electronically controlled, precise control of "Approach", "Squeeze", and "Hold" time cycles, fast acting, low friction, low inertia, high acceleration, anti-electrode impact, adjustable linear ball bushings, utilizes straight shank electrodes and heat-exchange methods for electrode cooling, adjustable forging force to 3,600 pounds.

Raytheon maintains facilities for analysis and evaluation of your particular welding problems. For details on the 1103 system, other DC or AC welders, or evaluation studies, contact Raytheon Company, Sorensen Operation, Production Equipment Dept., Richards Ave., Norwalk, Connecticut 06856. Tel: 203-838-6571.



Circle 11 on reader service card

From 2A to 35A, from 100V to 600V...

Whatever your control application, RCA has the *right* TRIAC or SCR at the *right* price

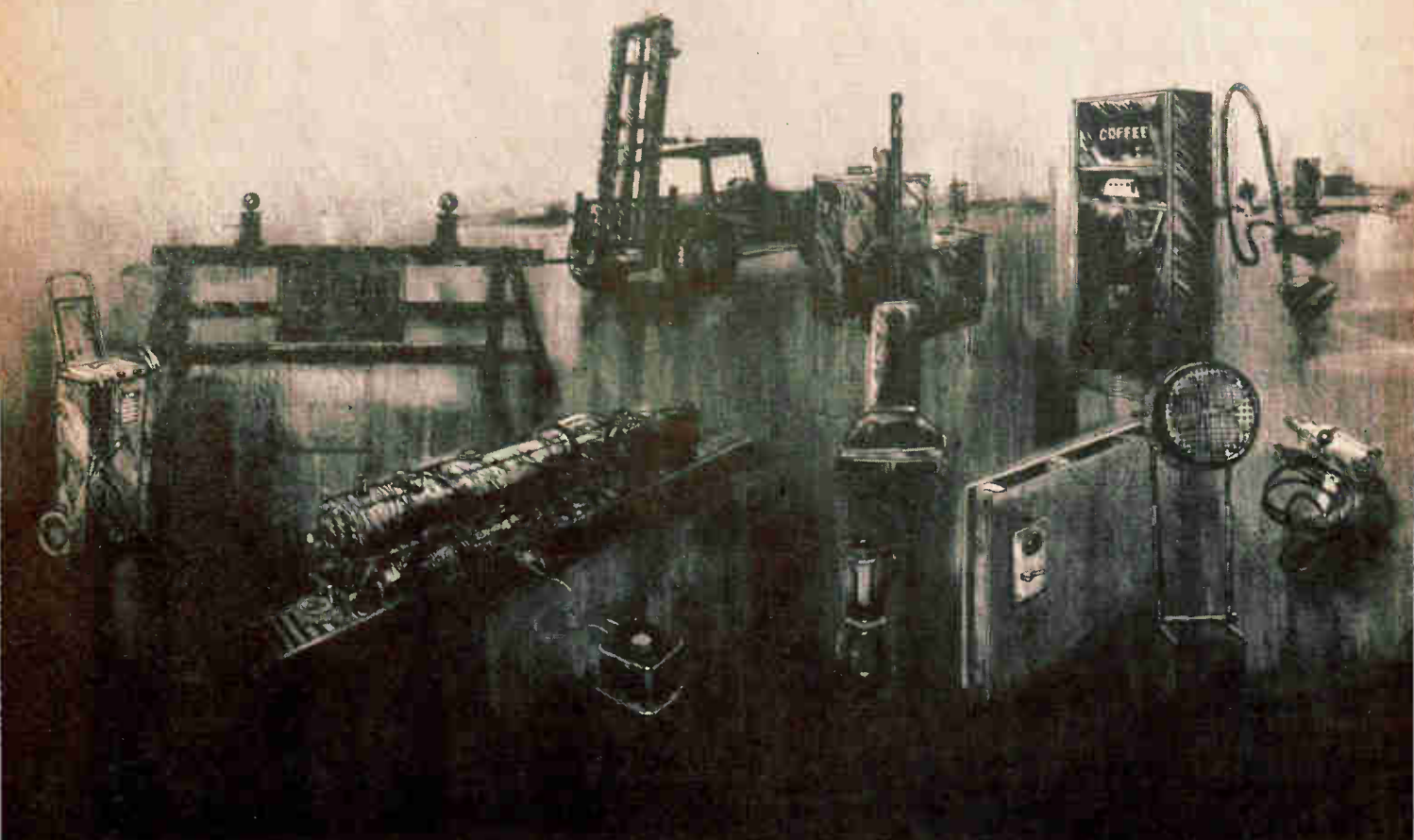

LOW VOLTAGE SUPPLY $V_{BOO} = 100\text{ V}$

- Flasher or Distress Lights
- Model Train Speed Controls
- Small DC Motors (Electric Windows)
- Fork-Lift Trucks
- Battery Chargers and Plating Supplies

RCA Type	I_{rms}
Triacs	
TA2892	2.5A
SCRs	
TA2888	2A
TA2652*	5A
2N3668	12.5A
2N3870	35A
2N3896	35A

120-VOLT SUPPLY $V_{BOO} = 200\text{ V}$

- Universal Motor Speed Control (Hand Tools, Floor Polishers, Food Blenders)
- Light Dimmers
- Vending Machines
- Gas Appliances
- Fan Controls

RCA Type	I_{rms}
Triacs	
TA2893	2.5A
TA2676	6A
TA2728	6A
TA2918	6A
SCRs	
2N3528	2A
TA2889	2A
2N3228	5A
TA2653*	5A
40378	7A
2N3669	12.5A
2N3871	35A
2N3897	35A

RCA ELECTRONIC COMPONENTS AND DEVICES, HARRISON, N. J.



The Most Trusted Name in Electronics

From continuous speed control of mass-volume appliances... to precise control of vital military radar, RCA offers a broad selection of reliable, low-cost Triacs and SCRs... plus the technical "know-how" to design them into your equipment. Call your local RCA Representative for prices and delivery.

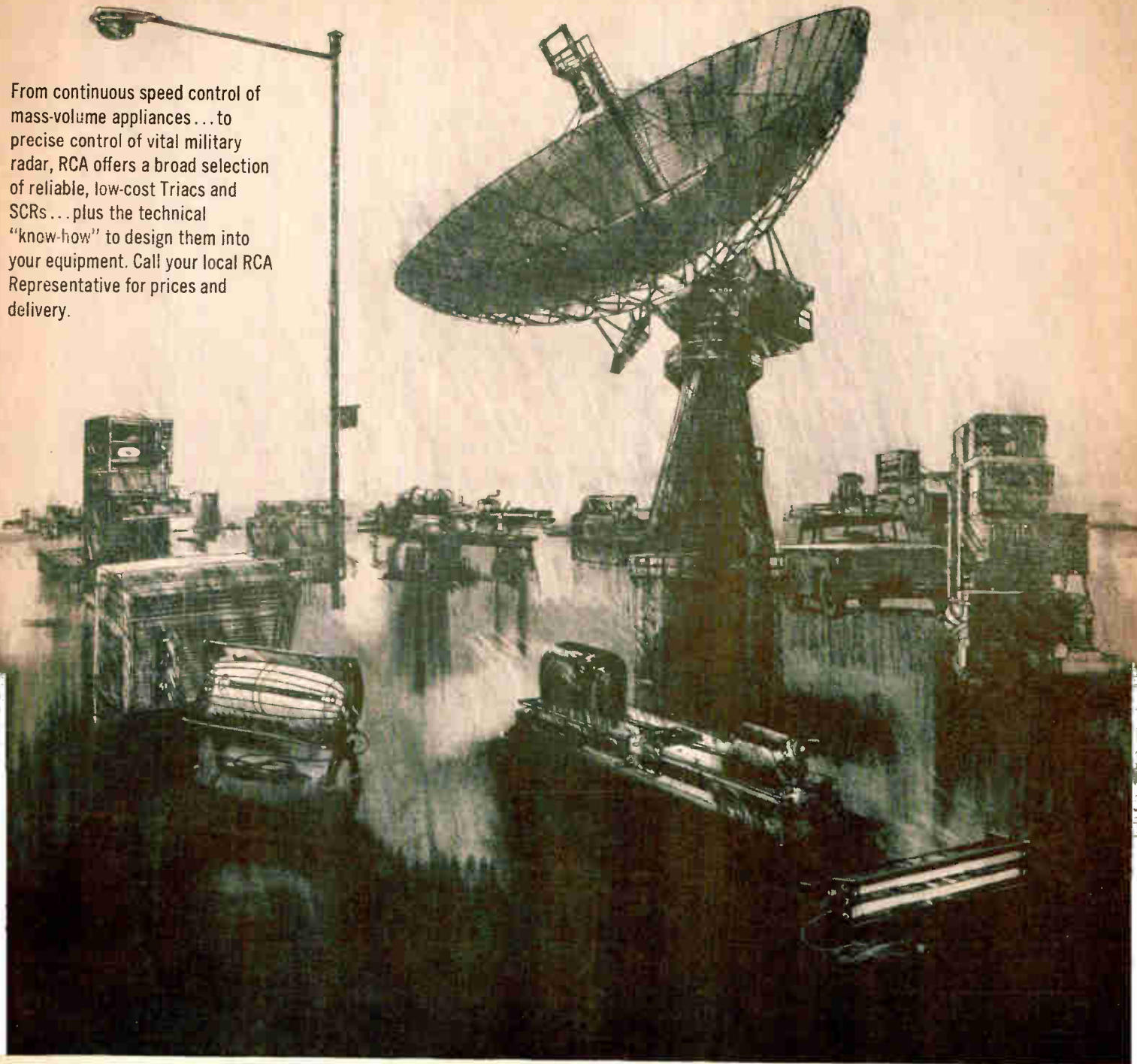

240-VOLT SUPPLY
 $V_{BOO} = 400\text{ V}$

- Space Heaters
- Air Conditioners and Ventilation Equipment
- Welder Control Equipment
- Street Lights
- Ovens and Ranges

RCA Type	I_{rms}
Triacs	
TA2685	6A
TA2729	6A
TA2919	6A
SCRs	
2N3529	2A
2N3525	5A
TA2654*	5A
40379	7A
2N3670	12.5A
2N3872	35A
2N3898	35A

HIGH VOLTAGE SUPPLY
 $V_{BOO} = 600\text{ V}$

- Ignition Systems
- Pulse Modulators (Radar)
- Fluorescent Lighting
- Machines and Controls (Motor-Driven Cranes)
- DC Power Supplies

RCA Type	I_{rms}
SCRs	
2N4102	2A
2N4101	5A
TA2655*	5A
2N4103	12.5A
2N3873	35A
2N3899	35A
40216	900A (pulsed)
*Fast-switching SCR, $t_{off} = 4\ \mu\text{s}$ typ.	

ALSO AVAILABLE THROUGH YOUR RCA DISTRIBUTOR

ERRORS make us angry!

that's why we
manufacture
variable
attenuators
with error of less
than 0.05 db*

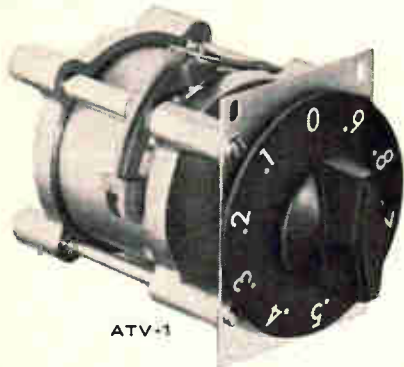

ATV-1

Think attenuators... say the words "Precision Performance"... and you must conclude Jerrold ATV-Series Turret Attenuators. Small, compact, they cost far less than you might expect.

Jerrold attenuators set the pace with intrinsic quality like coin-silver contacts for maximum conductivity, finest-quality deposited carbon disc and rod pad resistors for extreme accuracy, and positive spring-loaded detent mechanism for faultless resolution—in fact all the electrical features of "pull-and-turn" attenuators at one third the cost!

Model ATV-1, 0-0.9 db in 0.1 db steps (Fixed Attenuation 3 db), Accuracy ± 0.05 db at max. attenuation. \$275.00

Model ATV-9, 0-9 db in 1 db steps, Accuracy ± 0.1 db at max. attenuation. \$250.00

Model ATV-50, 0-50 db in 10 db steps, Accuracy ± 0.5 db at max. attenuation. \$195.00

Group this with 50 ohm impedance, VSWR of 1.06:1 at 1000 MHz (1.1:1 at 1200 MHz), low insertion loss .1 db maximum, and you come up with THE BEST BUY IN THE INDUSTRY! If you're operating DC to 1200 MHz... send for complete specs today.



MEASUREMENT AND
TEST INSTRUMENTATION

JERROLD ELECTRONICS CORPORATION
Government and Industrial Division
Philadelphia, Pa. 19105

Meetings

Environmental Test Equipment Show, Institute of Environmental Sciences, Bureau of International Commerce; U.S. Trade Center in Frankfurt, West Germany, Oct. 5-12.

National Electrochemical Society Meeting, Electrochemical Society; Philadelphia, Oct. 9-14.

International Astronautical Congress, American Institute of Aeronautics and Astronautics, International Astronautical Federation; Madrid, Spain, Oct. 9-15.

Underwater Photo-Optics, Society of Photo-Optical Instrumentation Engineers; Miramar Hotel, Santa Barbara, Calif., Oct. 10-11.

Mechanisms Conference, American Society of Mechanical Engineers; Purdue University, Lafayette, Ind., Oct. 10-12.

Ultrasonics Symposium, IEEE; Statler Hotel, Cleveland, Oct. 12-15.

Canadian Symposium on Communications, IEEE; Queen Elizabeth Hotel, Montreal, Quebec, Oct. 13-14.

Electrical Insulation Conference, IEEE; Chicago, Oct. 15-19.

Systems Science and Cybernetics Conference, Systems Science and Cybernetics Group, IEEE; International Inn, Washington, Oct. 17-18.

International Exhibition and Congress of Laboratory Measurement and Automation Techniques in Chemistry, Swiss Chemical Society; Swiss Industries Fair, Basel Switzerland, Oct. 17-22.

Military Aircraft Systems Meeting, American Institute of Aeronautics and Astronautics; Dallas, Oct. 18-19.

International Telemetry Conference, International Foundation for Telemetry; Ambassador Hotel, Los Angeles, Calif., Oct. 18-20.

Symposium on Microwave Measurement, the International Measurement Confederation; Budapest, Hungary, Oct. 18-20.

Symposium on Information Display, Society for Information Display; Hotel Bradford, Boston, Oct. 18-20.

Electronic Representatives Association Electronic Show, Electronic Representatives Association; Seattle Center Display Hall, Seattle, Oct. 19-20.

Nuclear Science Symposium, IEEE; Statler-Hilton Hotel, Boston, Oct. 19-21.

International Trade Exhibition of Electronic Components, Electronica 66; Munich, West Germany, Oct. 20-26.

Conference on Vacuum Microbalance Techniques, Newporter Inn, Newport Beach, Calif., Oct. 23-25.

Instrument Society of America Conference & Exhibit, Instrument Society of America; New York Coliseum, New York, Oct. 24-27.

International Symposium on Microelectronics, International Electronics Association, Munich, Germany, Oct. 24-26.

Machine Tools Conference, IEEE, Sheraton-Schroeder Hotel, Milwaukee, Wis., Oct. 24-26.

Machine Tools Industry Technical Conference, IEEE; general application group; Sheraton-Schroeder Hotel, Milwaukee, Wis., Oct. 24-26.

International Instrument Society of America Conference & Exhibit, Instrument Society of America; New York Coliseum, New York, Oct. 24-27.

American Vacuum Conference, American Vacuum Society; San Francisco-Hilton Hotel, San Francisco, Oct. 26-28.

International Electron Devices Meeting, IEEE; Sheraton-Park Hotel, Washington, Oct. 26-28.*

International Congress on Air Technology, Valley Education and Research Foundation; Hot Springs, Ark., Oct. 26-29.

Call for papers

National Aerospace Electronics Conference, IEEE; Dayton, Ohio, May 15-17, 1967. Nov. 15 is deadline for submission of 300-word abstract to Charles Goldman, chairman, technical program, '67 Naecon, 2505 England Avenue, Dayton, Ohio 45406.

Symposium on Nondestructive Evaluation of Aerospace and Weapons Systems Components and Materials, Society for Nondestructive Testing and Southwest Research Institute, San Antonio, Texas, April 17-19, 1967. Papers are requested on applications of nondestructive testing methods.

Semiconductor Device Research Conference, IEEE; Bad Nauheim, West Germany, April 19-22, 1967. Dec. 15 is deadline for submission of abstracts to W.J. Kleen, 8 Munchen 8, West Germany, Balanstr. 73.

* Meeting preview on page 16

Is there really a choice in differential voltmeters? You bet! You can buy Fluke solid state dc, ac/dc, or true rms differential voltmeters or you can buy our vacuum tube versions. After you take a look at the brief specs of each model, it's a sure thing you won't care about anyone else's differential voltmeter (if there are any).

DC DIFFERENTIAL VOLTMETERS						
MODEL	INPUT VOLTAGE	ACCURACY % OF INPUT	INPUT IMPEDANCE	MAX. METER RESOLUTION	PRICE	NOTES
801B	0-500 VDC	±0.05%	Infinite at null	50 µV	\$ 485.00	} +\$20 for rack models
825A	0-500 VDC	±0.02%		5 µV	\$ 590.00	
821A	0-500 VDC	±0.01%		5 µV	\$ 795.00	
871A*	0-1100 VDC	±0.02%		10 µV	\$ 565.00	
881A*	0-1100 VDC	±0.005%	Infinite at null to ±11V 10 Meg	1 µV	\$ 825.00	} +\$130.00 for rechargeable battery pack
885A*	0-1100 VDC	±0.0025%	above ± 14V	1 µV	\$ 965.00	
895A*	0-1100 VDC	±0.0025%	Infinite at null to ±1100V	1 µV	\$1,195.00	
AC/DC DIFFERENTIAL VOLTMETERS						
803B	0-500V AC or DC	±0.05% DC, ±0.2% AC	Infinite at null DC 1 Meg, 35-50 pf AC	50 µV	\$ 875.00	} +\$20 for rack models
803D	0-500V AC or DC	±0.02% DC, ±0.1% AC		5 µV	\$1,055.00	
823A	0-500V AC or DC	±0.01% DC, ±0.1% AC		5 µV	\$1,215.00	
873A*	0-1100V AC or DC	±0.02% DC, ±0.2% AC		Infinite at null to 10 Meg above 11 VDC	10 µV	
883A*	0-1100V AC or DC	±0.005% DC, ±0.1% AC	1 Meg, 40 pf AC	1 µV	\$1,215.00	} +\$160.00 for rechargeable battery pack
887A*	0-1100V AC or DC	±0.0025% DC, ±0.05% AC		1 µV	\$1,375.00	
TRUE RMS DIFFERENTIAL VOLTMETER						
931A*	0-1100V AC	±0.05% AC	1 Meg, 8 pf with BNC input	20 ppm of dial setting	\$ 895.00	+ \$ 50.00 for permanent probe + \$100.00 for rechargeable battery pack



FLUKE • Box 7428, Seattle, Washington 98133 • Phone: (206) 774-2211 • TWX: (910) 449-2850

All Fluke differential voltmeters from the least costly on up offer standard lab performance in portable instrumentation. They are "human engineered" for easy use. They give you direct digital readout, with automatic decimal point indicator. Fluke differential voltmeters feature highest possible off-null resistance. Solid state units are available as bench-top models adaptable for half-rack or full-rack mounting. All vacuum tube versions are available in cabinet or full-rack configurations. More accessories are available for greater flexibility. All but one of the solid state models are offered in both line and rechargeable battery operated versions. For full information, please call your Fluke sales engineer or write us.

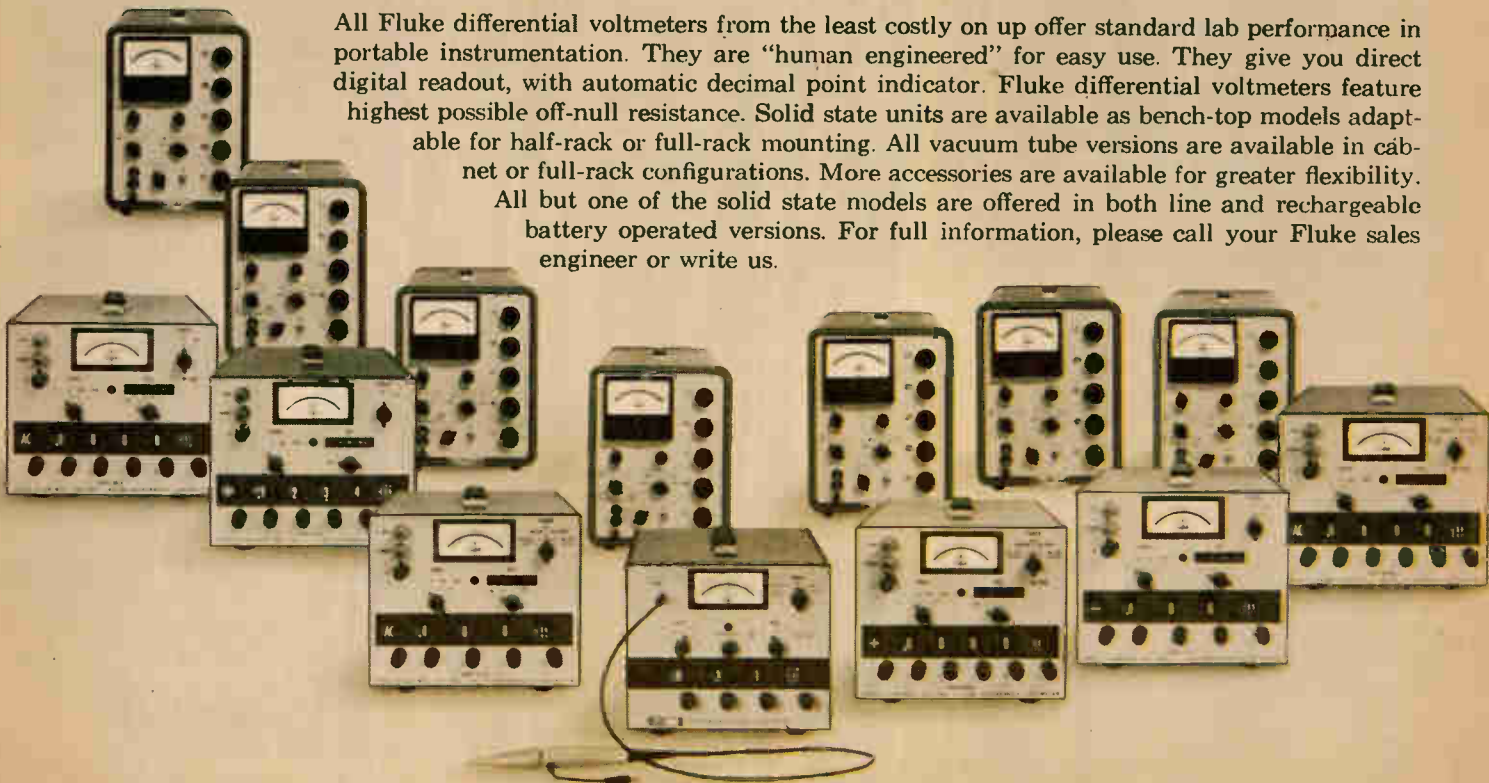

New from Sprague!

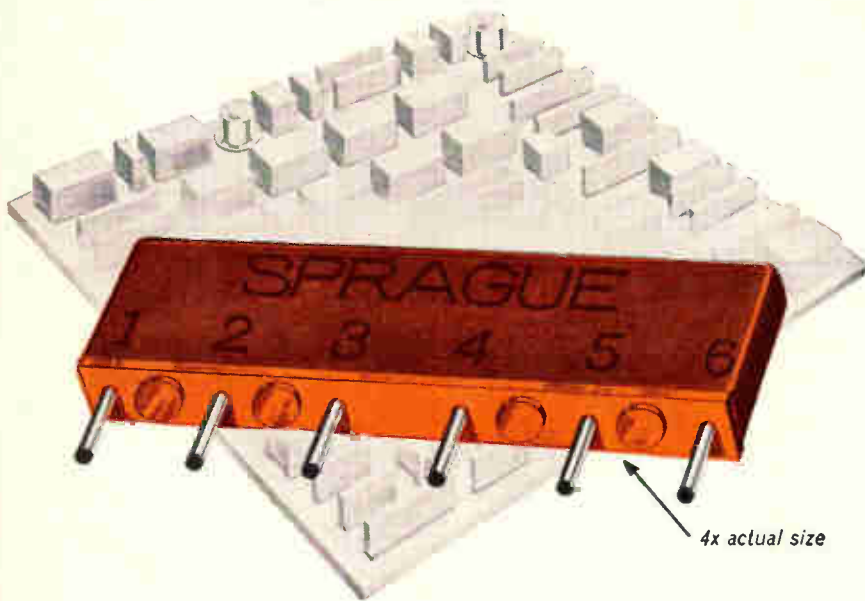

METANET[®]

TRUE METAL-FILM PRECISION RESISTOR

NETWORKS

Save Space, Time, and Money

- High packaging density—4 to 8 times that of individual components.
- Fewer components to stock, handle, inspect, install. Entire module can be hand-inserted faster than one axial-lead component.
- Permit substantial savings over equipment assembled with individual components.
- Epoxy terminal board keeps pin terminals free of resin coating, unlike conventional dipped components, and provides uniform lead spacing.
- Stand-off bosses permit efficient flux removal after soldering. Also prevent dirt and moisture traps around leads.
- Extremely stable and reliable. Meet performance requirements of MIL-R-10509E. Resistance tolerances to $\pm 1\%$.
- Ceramic capacitors can be incorporated for further savings and size advantages over individual components.

For complete information write to Integrated Circuit Application Engineering Department, Sprague Electric Company, 35 Marshall Street, North Adams, Mass. 01248

SPRAGUE COMPONENTS

RESISTORS
CAPACITORS
TRANSISTORS
INTEGRATED CIRCUITS
THIN-FILM MICROCIRCUITS
INTERFERENCE FILTERS

PACKAGED COMPONENT ASSEMBLIES
FUNCTIONAL DIGITAL CIRCUITS
MAGNETIC COMPONENTS
PULSE TRANSFORMERS
CERAMIC-BASE PRINTED NETWORKS
PULSE-FORMING NETWORKS

45M-4145 R3



Sprague[®] and [®] are registered trademarks of the Sprague Electric Co.

Meeting preview

Electron devices

When the three-day International Electron Devices Meeting convenes in Washington on Oct. 26, one of the best attended sessions may be the one on complementary transistors in integrated circuits.

Lateral pnp transistors contain elements that are diffused next to each other, in contrast to regular pnp's that have vertical structures with one element diffused within another. In making IC's the lateral pnp can be made together with npn devices, with no additional processing steps. But circuits made this way generally exhibit poor frequency response and low gain. Papers on fabricating techniques that overcome these drawbacks will be given by engineers from the Westinghouse Electric Corp., Hewlett-Packard Co. and Sprague Electric Co.

Expected in '67. Although harder to fabricate, IC's with regular pnp's to complement the npn's can be controlled with a narrow base width. Two papers, by authors from Radiation, Inc., and Texas Instruments Incorporated, will report on developments in this area. Although IC's using regular pnp transistors as complementary components aren't being used commercially now, the session's organizer, I.A. Lesk of Motorola, Inc., predicts "by next year we should see some on the market."

Several sessions will be devoted to microwave and power tubes. Bertram Green and Eduard G. Dorgelo of the Amperex Electronic Corp. will discuss the field-effect tube, which they call a new device for generating and amplifying radio-frequency energy. It's similar to a triode, but instead of a grid it has a control gate between the anode and the cathode that cannot intercept electrons. As a result, power gains of 8,000 to 10,000 have been achieved with a 2-kilowatt, continuous-wave tube.

An optical modulator of lithium tantalate that has been successfully used in a pulse-coded system will be discussed by R.T. Denton, T.S. Kinsel and F.S. Chen of the Bell Telephone Laboratories in a session on quantum electronics.

Just in case

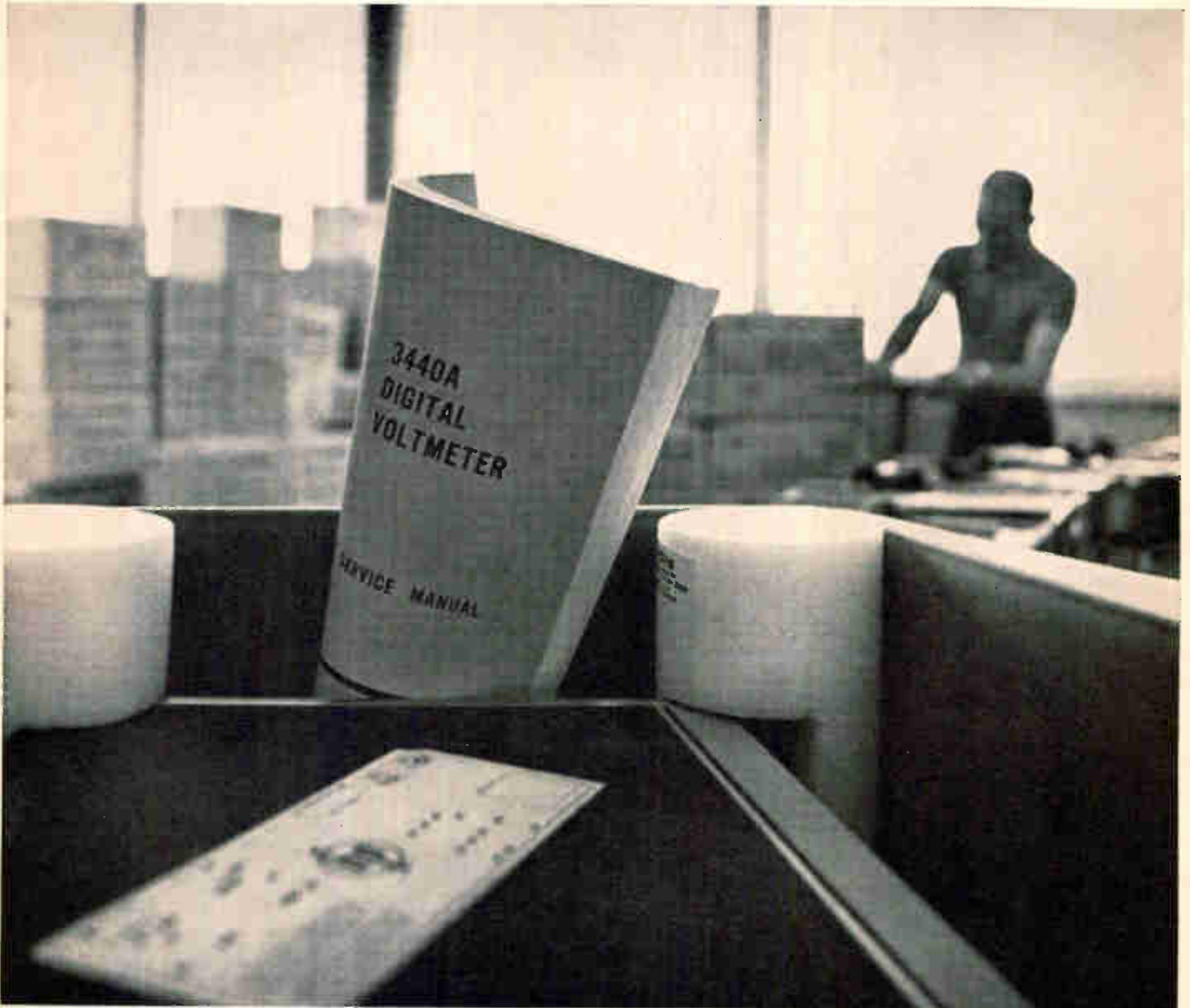

When your Hewlett-Packard 3439A or 3440A DVM arrives, it's accompanied by something rather useful, even though you'll probably never use it: a one-year warranty. The warranty covers parts, labor and return shipment. ■ By the time a DVM leaves our plant, we know it's going to be reliable. ■ It's been tested and retested. We've put it through an overnight environmental cycling test at 50°C to see if any failures show up. We also test it before it goes into stock. ■ We went to a lot of trouble with your 3439A or 3440A. That's why you have so little trouble with it. ■ A complete service manual is provided with each instrument describ-

ing how to operate the instrument, theory of operation, calibration and trouble-shooting procedures, and presenting complete schematics and parts lists. ■ Our service centers all over the country are ready to back our warranties . . . just in case. ■ The 3439A. Solid state. 4-digit readout. Manual, automatic, and remote rang-

ing. Extra-high sensitivity. Ac/dc voltage/current resistance measurements (dc accuracy better than 0.05% of reading ± 1 digit). Price, \$950. The 3440A has BCD output. Price, \$1160. Plug-ins, \$40 to \$575.



Data subject to change without notice.
Prices f.o.b. factory.

HEWLETT *hp* **PACKARD**
An extra measure of quality

Try to find a connection

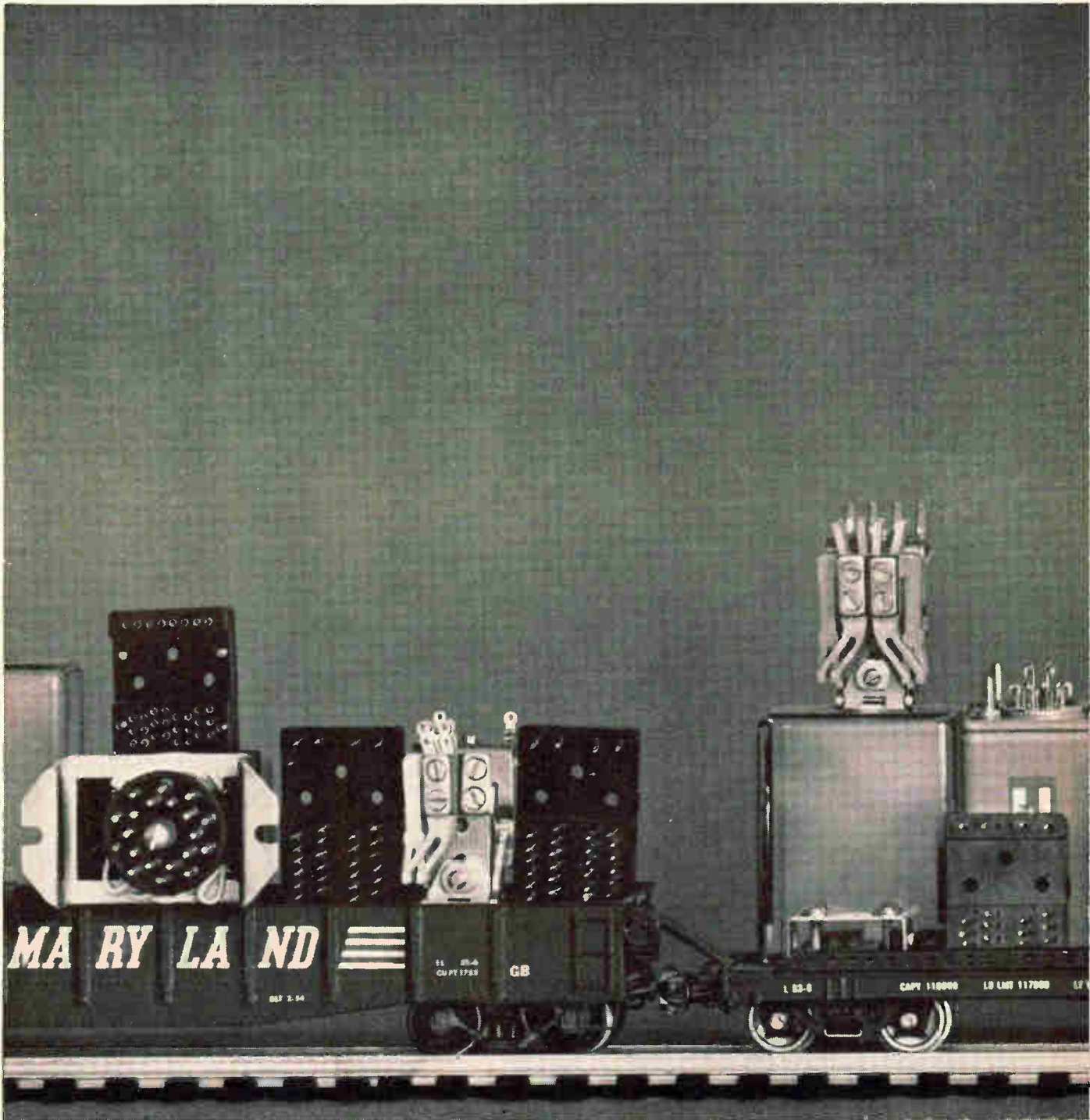

The growing popularity of AE's Class E Relay as the "workhorse of the industry" has set off a demand for a wide variety of mounting techniques.

Now AE can accommodate virtually every type of circuit connection or mounting used in electrical and electronic equipment designs.

Wherever designs call for "wiring in," AE Class

E Relays are available with solder-type, wrapped-wire, taper-tab and printed-circuit terminals.

AE has also developed special sockets for chassis or printed-wiring board mounting, that accommodate Class E Relays with PC or taper-tab terminals. And prewired types with octal plug-in bases.

Where extra protection is required, AE Class

you can't make with

AE Class E Relays

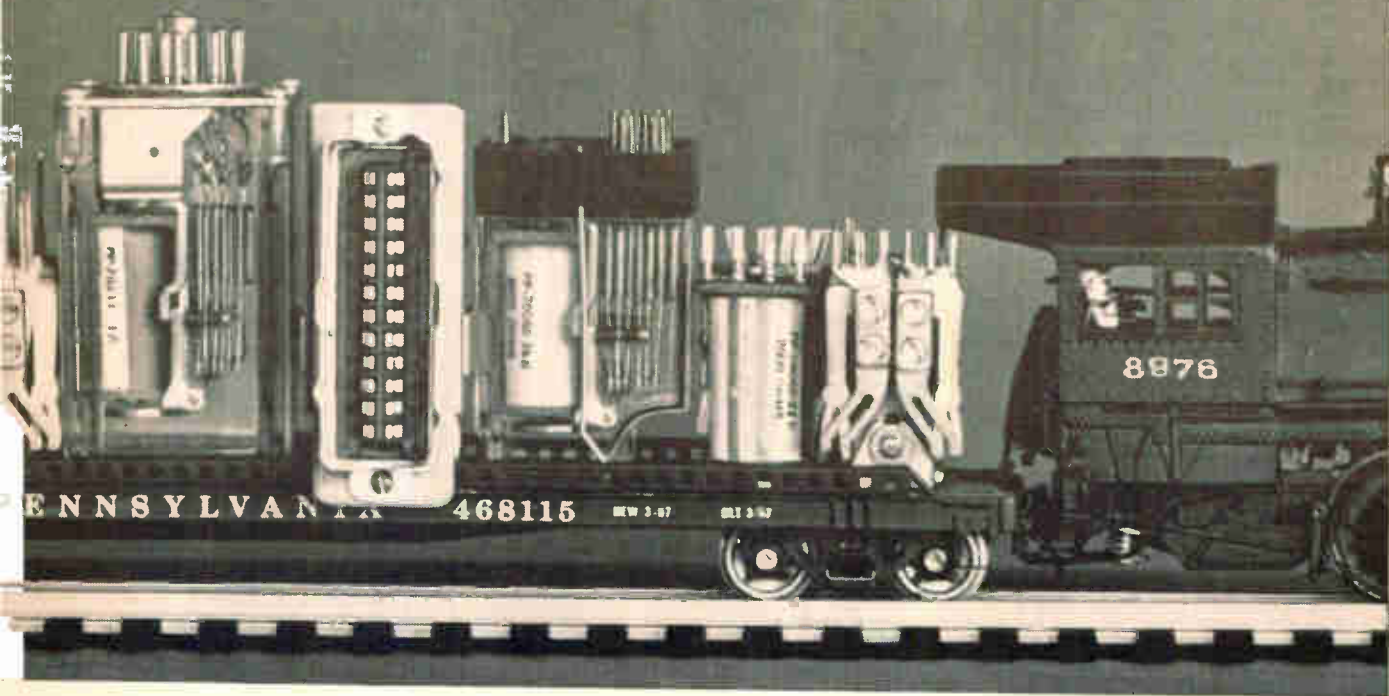

E Relays are available in hermetically sealed enclosures with either hook terminals or plug-in headers. Or plastic dust covers that snap on to the chassis- or printed-circuit type of socket.

For full information on the limitless variations in mounting and connections for AE Class E

Relays, ask for Circular 1942-C. Write to the Director, Relay Control Equipment Sales, Automatic Electric Company, Northlake, Ill. 60164.

AUTOMATIC ELECTRIC

SUBSIDIARY OF

GENERAL TELEPHONE & ELECTRONICS

GTE

How to perform dependable industrial counting and flaw tracking at low cost...

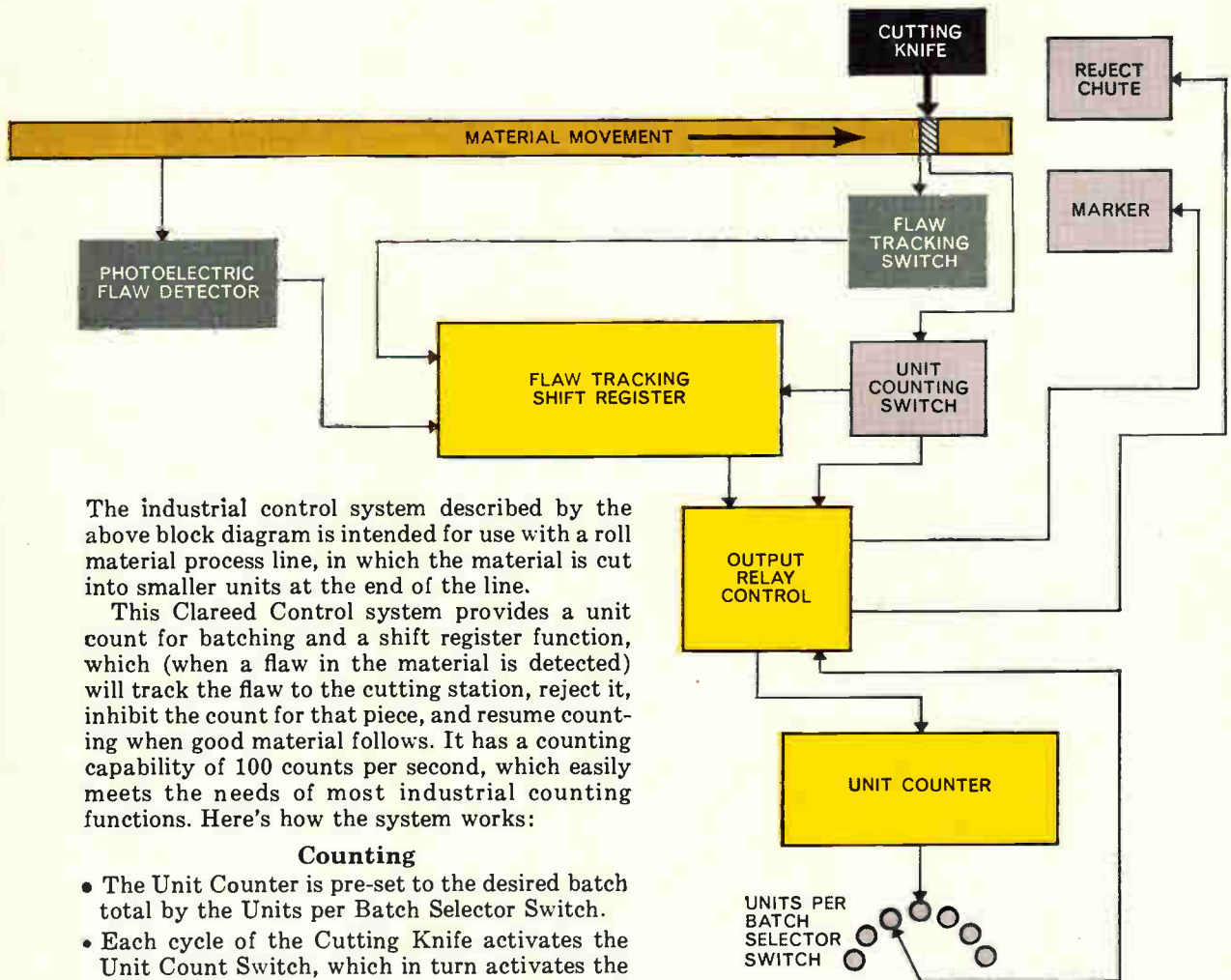

The industrial control system described by the above block diagram is intended for use with a roll material process line, in which the material is cut into smaller units at the end of the line.

This Clared Control system provides a unit count for batching and a shift register function, which (when a flaw in the material is detected) will track the flaw to the cutting station, reject it, inhibit the count for that piece, and resume counting when good material follows. It has a counting capability of 100 counts per second, which easily meets the needs of most industrial counting functions. Here's how the system works:

Counting

- The Unit Counter is pre-set to the desired batch total by the Units per Batch Selector Switch.
- Each cycle of the Cutting Knife activates the Unit Count Switch, which in turn activates the Unit Counter.
- When the Unit Counter reaches the desired batch total, a mark is placed on the last piece to indicate end of batch. The material is then moved to a packaging area.
- The Unit Counter resets itself to zero and begins counting the next batch.

Flaw Tracking and Rejection

- If a flaw is recognized by the Photoelectric Flaw Detector, it sets the Shift Register, which is then able to receive shift pulses from the Flaw Tracking Switch. (These pulses are generated by each cycle of the Cutting Knife, but are not utilized unless the Shift Register is set.) The Shift Register is so designed that the number of its stages corresponds to the distance between the Flaw Detector and the cutting position, measured in product unit lengths.
- The Unit Counter continues to count the good material ahead of the flawed material until the flaw tracking pulse reaches the next-to-last register stage.
- On the next knife cycle, the Shift Register (which has now tracked the defect to its last stage) inhibits the Unit Counter so that it will not count the flawed material as it is cut. It also activates the Output Relay controlling the Reject Chute and removes the uncounted defective unit. (When a continuous flaw in the material is detected, the Flaw Detector registers the flaw for each product unit length, and the Flaw Tracking Shift Register continues to function until all of the pieces are rejected.)
- If the material in the next-to-last stage is not flawed, the Unit Counter resumes its batch count and the Shift Register is reset to await the next Flaw Detector signal.

...with maintenance-free, long life **CLAREED® CONTROL MODULES**

You can optimize system performance with these, and many other Clareed Control counting, selection and logic circuits. Designing with Clareed Control Modules will assure that your system will operate dependably . . . to its design characteristics . . . over its planned life. Here's how:

- Your Clareed Control system is completely compatible with industrial environment and service conditions
- It is not subject to inadvertent switching by ambient or line transients . . . no elaborate buffering required
- You need only one control system power source . . . 24 vdc $\pm 20\%$
- You get inherent reliability. Sealed-in-glass switches are maintenance-free; you are not subject to environmental contamination or mis-adjustment

and, besides . . .

- You'll save on cost over solid state for most applications
- Your outputs are isolated contacts capable of handling low level to 50 va ac or dc power loads
- You'll realize ample switching speeds . . . completely compatible with production machine control systems.

Whether your system requires a simple counting circuit, or a complex logic function . . . and if you are now using electromechanical or solid state switching devices . . . it will pay you to look at Clareed Control.

Proven Clareed Control solutions span many different application areas, including counters, scanners, digital clocks, shift registers, logic arrays, and non-volatile memories. Write for Clareed Control Application Manuals. C. P. Clare & Co., Group 10N4, 3101 Pratt Boulevard, Chicago, Illinois 60645.

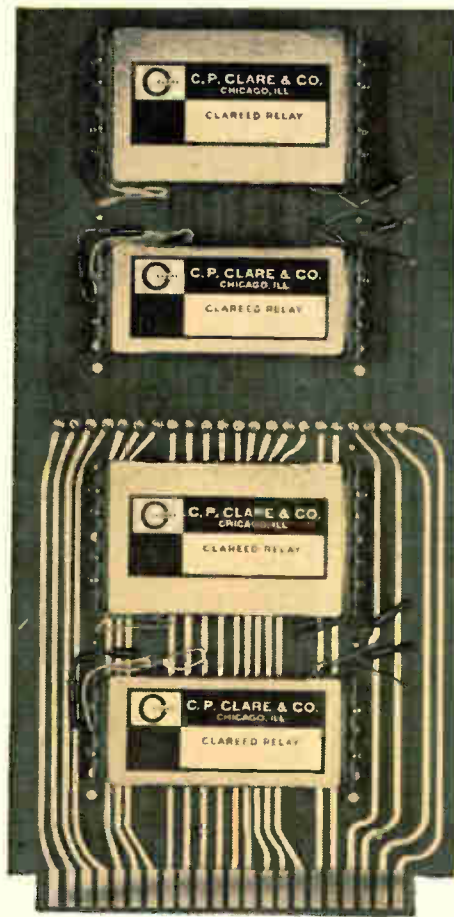

For complete information
contact your nearest
CLARE Sales Engineer



relays and related control components

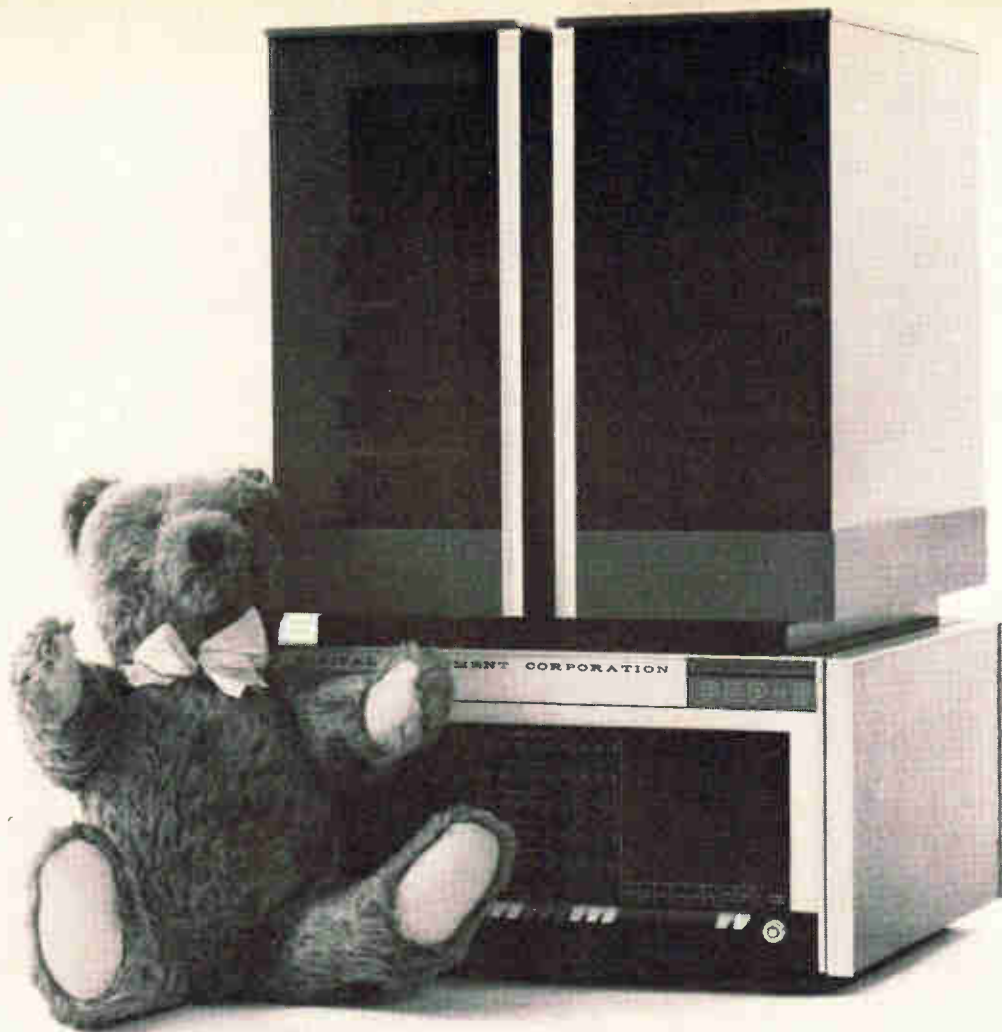

30 Days Hath Computer

Not just any computer, either. The approachable, friendly, personal PDP-8. Delivered.

The PDP-8 is a small, high speed, core memory, full general purpose computer for on-line, real-time investigations. It hath 4K memory, 1.5 usec cycle time, 12 bit words, complete and proven software.

It also has more than 500 owners that you might want to talk to. Physicists, life scientists, chemists, social scientists, instrument and systems makers. No accountants.

Basic PDP-8s are available in 30 days. Expanded memories, or special peripherals take a bit longer.

But matching a customer to a delivery slot is controlled by purchase orders. Not phone calls. Not intentions. Purchase orders. \$18,000.

Ask about new quantity discounts and new lower price for extra memory.

LINC-8 deliveries are only a little slower. PDP-9 deliveries, PDP-8/S deliveries, and PDP-10 deliveries are not 30 days either. But quicker than you think.

digital
COMPUTERS · MODULES

DIGITAL EQUIPMENT CORPORATION, Maynard, Massachusetts 01754. Telephone: (617) 897-8821 • Cambridge, Mass. • New Haven • Washington, D.C. • Parsippany, N.J. • Rochester, N.Y. • Philadelphia • Huntsville • Pittsburgh • Chicago • Denver • Ann Arbor • Houston • Los Angeles • Palo Alto • Seattle • Carleton Place and Toronto, Ont. • Reading, England • Paris, France • Munich and Cologne, Germany • Sydney and West Perth, Australia • Modules distributed also through Allied Radio

Editorials

Engineering makes the difference

Travelers returning from Europe this summer have reported an intriguing phenomenon: the technical gap between the United States and West Europe is widening again after 20 years of steadily narrowing.

Although several economic factors are exerting a drag effect in Europe, the big difference seems to be a spurt in the advance of U.S. technology particularly in that segment called engineering.

Government spending has been turned on again full force because of the war in Vietnam. U.S. military organizations are paying for a lot of the advances in communications, more reliable components, better antennas, low-light level devices and the packaging of integrated circuits.

At the National Aeronautics and Space Administration, more money is going into electronic subsystems and components, even though NASA's total expenditures have stayed about the same. That's because the big investments in propulsion systems have peaked and the major problems in space technology today need to be solved by new electronic gear or components.

In addition, on their own, many companies have diversified their activities or extended their product lines, after having been scared by the plateauing of business in 1962 and 1963. Firms have poured their own money into research and development with an emphasis on development.

Thus much of the accelerated activity in the U.S. falls into the category of development work or the application of known phenomena into new areas or new products. For example, there have been no radical theoretical advances in integrated circuits; mainly, engineers in a variety of companies and industries are learning how to apply them to their own problems and designs.

In Europe, companies have complained about the large sums the U.S. Government pours into research and development, which eventually turns up in products with which they must compete. Now, as R&D money in Europe grows even scarcer, many people blame American competition.

Turning to export business and establishing subsidiaries in Europe, U.S. electronic companies have bitten deeply into local markets, causing the sales of European firms to plateau or slide on their home grounds. The tough competition has forced some European companies to shrink the traditionally large profit margins they have enjoyed, leaving less money for R&D.

In addition, Europeans have tended to emphasize theoretical work and put development, application and production into secondary roles. In most countries the status of theoretical knowledge is very nearly on a par with that in America, particularly in

physics and mathematics associated with electronics. What's missing, of course, is know-how to apply the theory and to manufacture products that use it. Traveling in most countries of Europe a visitor can see integrated circuits, for example, being built by the dozen in a laboratory at a university or an industrial firm. But finding large scale production, by the thousands, is another story.

Too many Europeans still do not devote enough energy to what has to be called technology as opposed to science. What's happened in Europe ought to be an object lesson for those who want to turn electronics engineering into the study of physics and mathematics. Although an understanding of these subjects is essential to a good engineer, it is not enough. Real progress in a country—or in a company—results from the application of scientific phenomena to practical products. That is the U.S.' chief strength in electronics today.

Hybrid IC's: funeral services were premature

Two years ago at the Solid State Circuits Conference in Philadelphia, the experts were ready to bury hybrid integrated circuits. "Batch processing of monolithic IC's will be so economical hybrids won't be able to compete," they said. "In addition, the cost of mechanizing to build hybrids will make them for the rich only." E.A. Sack, an advocate of monolithic circuits at the Westinghouse Electric Corp.'s Molecular Electronics division, brought the house down after a discussion of the techniques that build IBM's hybrid circuitry when he quipped, "All of you who have \$100 million for automation equipment don't have to hear any more."

In October 1966, hybrid circuits are still alive and doing very well. The story on page 187 reports that hybrid IC's have the inside track in automotive electronics which promises to be the second largest market for IC's following close behind computers.

Clearly hybrid and monolithic IC's both have a place in industry. Monolithic circuits, despite their ardent enthusiasts, will never be suitable for some applications: where precision passive components are required; where high frequency and high power is normal; or where volume is not large enough to justify the high costs of making masks to build monolithic circuits.

Similarly, there are applications in which hybrids will never be satisfactory: circuits in which high speed in the nanosecond range is required.

Many semiconductor firms have seen the light in the past nine months. Some very strong advocates of monolithic circuits have started marketing hybrid IC's too: Fairchild Semiconductor, Motorola Corp., Philco Corp. and Westinghouse.

Rather than dying and disappearing, the hybrid integrated circuit opens up great new potentials.

CORNING[®] C-Style Resistors: 1 part to buy, 1 part to inventory, 1 part to handle



Why are you still buying 22684 parts . . . and T-O parts . . . and Characteristic D parts . . . and "comp" type parts? New CORNING C-Style Resistors meet and beat all four of those specs!

Think of the dollars this true multi-use resistor can save you—in the paperwork of purchasing and in the lower unit price you enjoy on quantity orders for a single part. Think how it can simplify your inventory and simplify handling in assembly. Our new CORNING C-Style Resistors can make your job a whole lot easier, your circuits a whole lot better. Look at the classic CORNING Glass Tin Oxide Film Resistor performance documented in the table. Then send the coupon for your test samples and data.

PERFORMANCE CHARACTERISTICS

Characteristics	New CORNING C-Style Resistors			Mil-R-22684B	Mil-R-10509F Characteristic D*
	70°C	70°C	125°C	70°C	70°C
Wattage C 4 (RL07S) Resistors, 10 ohms to 301K	1/4	1/8	1/10	1/4	1/8
Wattage C 5 (RL20S) Resistors, 10 ohms to 1 Meg.	1/2	1/4	1/8	1/2	1/4
Load Life ΔR	1.0%	0.5%	0.5%	2%	1%
Design Tolerance ΔR	-2 to +4%	$\pm 2.8\%$	-1.5 to +3%		
Temperature Coefficient from -55°C to +175°C		± 100 ppm		± 200 ppm	+200 -500 ppm
Dielectric Withstanding Voltage ΔR		$\pm 0.10\%$		$\pm 0.50\%$	$\pm 0.5\%$
Moisture Resistance ΔR		$\pm 0.50\%$		$\pm 1.50\%$	$\pm 1.5\%$
Short Time Overload ΔR		$\pm 0.25\%$		$\pm 0.50\%$	$\pm 0.5\%$
Temperature Cycling ΔR		$\pm 0.25\%$		$\pm 1.00\%$	$\pm 0.5\%$
Effect of Soldering ΔR		$\pm 0.10\%$		$\pm 0.50\%$	$\pm 0.5\%$
Low Temperature Operation ΔR		$\pm 0.50\%$		$\pm 0.50\%$	$\pm 0.5\%$
Shock ΔR		$\pm 0.10\%$		$\pm 0.50\%$	$\pm 0.5\%$
Vibration ΔR		$\pm 0.10\%$		$\pm 0.50\%$	$\pm 0.5\%$
Terminal Strength ΔR		$\pm 0.10\%$		0.50%	$\pm 0.2\%$
Voltage Coefficient		$\pm 0.001\%/Volt$			
Shelf Life ΔR		+0.10%/Year			$\pm 1.0\%$

*For type-marked, military lead Mil-R-10509F, Characteristic D, Resistors, specify CORNING NA-Style Resistors.

CORNING GLASS WORKS, 3913 Electronics Dr., Raleigh, N. C. 27602.
Send complete data, test samples of new CORNING[®] C-Style Resistors.

Name _____
Title _____
Company _____
Address _____
City _____ State _____ ZIP _____

CORNING
ELECTRONICS

Electronics Newsletter

October 3, 1966

Engineers push computer-aided circuit design

Interest in computer-aided design (CAD) is growing.

At a conference this month of Honeywell, Inc., engineers, a group of designers urged the company to establish a corporate-wide CAD information program.

The program the engineers especially want to use is NET-2, the second-generation CAD program being written at Los Alamos Scientific Laboratory by Allen F. Malmberg. Goal of the Honeywell engineers is to have NET-2 completely converted into Honeywell machine language "before the ink is dry on Malmberg's program," as one engineer puts it.

Honeywell's Electronic Data Processing division is one of the few companies using NET-1 for evaluation and design of monolithic integrated circuits and it has sold the idea to its circuit vendors, which now use a consulting firm for design and evaluation before building the circuits.

Other evidence of the attention being given to CAD is a move being led by Clinton Purdue of the Sandia Corp. At the National Electronics Conference in Chicago this week he will lead an effort to get separate professional status within the Institute of Electrical and Electronics Engineers for the fast-growing number of engineers in CAD work. Few engineers were satisfied with a compromise decision to have subgroup recognition granted by the professional group on reliability and quality control at last August's Western Electronics Show and Convention.

Low-noise masers now attuned to radar, RCA says

The Radio Corp. of America believes that a wider use of low-noise masers in radar systems is now possible. Simpson Adler, a physicist at RCA's Defense Electronics Products division, Moorestown, N.J., has developed a technique for the Navy that overcomes one barrier to its wide use in radar—saturation of the maser by the transmitter pulse, which blocks the receiver for several milliseconds. Adler has shifted the maser's frequency response during pulse transmission to prevent saturation. The technique allows the maser to recover in microseconds by operating as a quantum mechanical duplexer that doesn't deteriorate the low-noise capabilities.

Other measurements performed by RCA for the Navy indicate that the maser's gain and phase stability is suitable for monopulse radar. Receiver bandwidths can be varied as needed and bandwidth characteristics can be matched for multichannel receivers. The theory of the maser's duplexing action will be described at the IEEE Aerospace and Electronics Systems meeting in Washington, Oct. 3 to 5.

TI and Fairchild sign semiconductor licensing deal

A cross-licensing agreement has been signed by two of the biggest integrated circuit producers, Texas Instruments Incorporated and the Fairchild Camera and Instrument Corp. The agreement covers Fairchild patents for the planar process and TI patents for integrated circuits.

For Fairchild, the attraction of signing such an agreement with TI is clear: aside from getting free IC licenses, the agreement strengthens its hand in negotiating for planar-process royalties with other companies. Industry observers have claimed that Fairchild's patent position wasn't strong, even though as many as 10 other electronics companies have agreed to pay Fairchild royalties for the semiconductor-manufacturing process. The holdouts now are Motorola, Inc., and the Signetics Corp.

Electronics Newsletter

Inventor claims circuit alters device's curve

A Purdue University electronics professor says he has developed an inexpensive two-port circuit that tailors any component's output characteristic to simulate a new component without changing the physical makeup of the original. The professor, Leon Chua, says the six-transistor circuit can be fabricated for less than \$10. A full report on the circuit, called a Rotator, will be given Oct. 5 at the University of Illinois, Allerton Conference in Monticello, Ill.

The name Rotator was chosen, Chua says, because the circuit alters a device's curve by rotation; for example, a true vertical voltage-versus-current curve could result for a diode. Changing the position of this curve in effect simulates a new device.

Chua says the Rotator can be used with such devices as diodes, zener diodes, transistors, capacitors or resistors by connecting them to the input port of the circuit. He says three varieties of the device exist: resistive, inductive and capacitive.

Carriers offer rate cut in fight with Comsat

The international common communications carriers are fighting to keep the Communications Satellite Corp. from selling its services directly to customers, and they're willing to slash their Far Eastern rates 40% in exchange for support of their stand by the Federal Communications Commission.

The rate-cut proposal follows a contract that Comsat signed directly with the Pentagon for providing transpacific communications circuits. The carriers, however, objected, claiming that any contract would have to be made through them.

Before the Pentagon-Comsat agreement can become final, the FCC would have to approve it. And the FCC is on record opposing any bypassing of the common carriers.

Picture looks bad for airline tv

Television entertainment in airlines is dying. One carrier plans to drop inflight television, and others are said to be considering following suit. One reason for the decline in interest is the poor quality of the picture.

A technical problem with the television tape recorders used in airliners occurs when the craft suddenly changes speed or direction; this causes a gyro-type movement of the recorder head, producing picture distortion. In addition, the helical recorders being used produce a much lower quality picture than tv viewers are used to.

As a result of a general decline in inflight-tv interest, the Ampex Corp. has dropped its plan to use the one-tube color monitor developed by the Yaou Electric Co. of Tokyo; this system was to be introduced on Continental Airlines flights. And because of the problems, the Sony Corp., whose black-and-white system has been installed on Pan American Airways and American Airlines aircraft, has slowed development of a proposed color-tv system.

IC price cut?

Texas Instruments Incorporated reportedly has a price cut in the works that is making other integrated circuit manufacturers nervous. For example, it's said that TI plans a price of \$11 for a complex circuit that a competitor is selling for \$40. The competitor says it believes it can improve yields to get its price to \$22 a circuit but not any lower.



Ladies and Gentlemen!

**welcome to the
greatest show on industrial tapes
presented by *MYSTIK***

See the greatest collection of industrial tapes
ever assembled under one Big Top.

Electrical Tapes • Packaging Tapes • Strapping Tapes
Protective Tapes • Masking Tapes • Special Purpose Tapes

Over 100 top performers... 1,001 applications!

MYSTIK[®]
TAPE
THE MARK OF QUALITY

When it comes to Electrical Tapes,
Mystik is king!

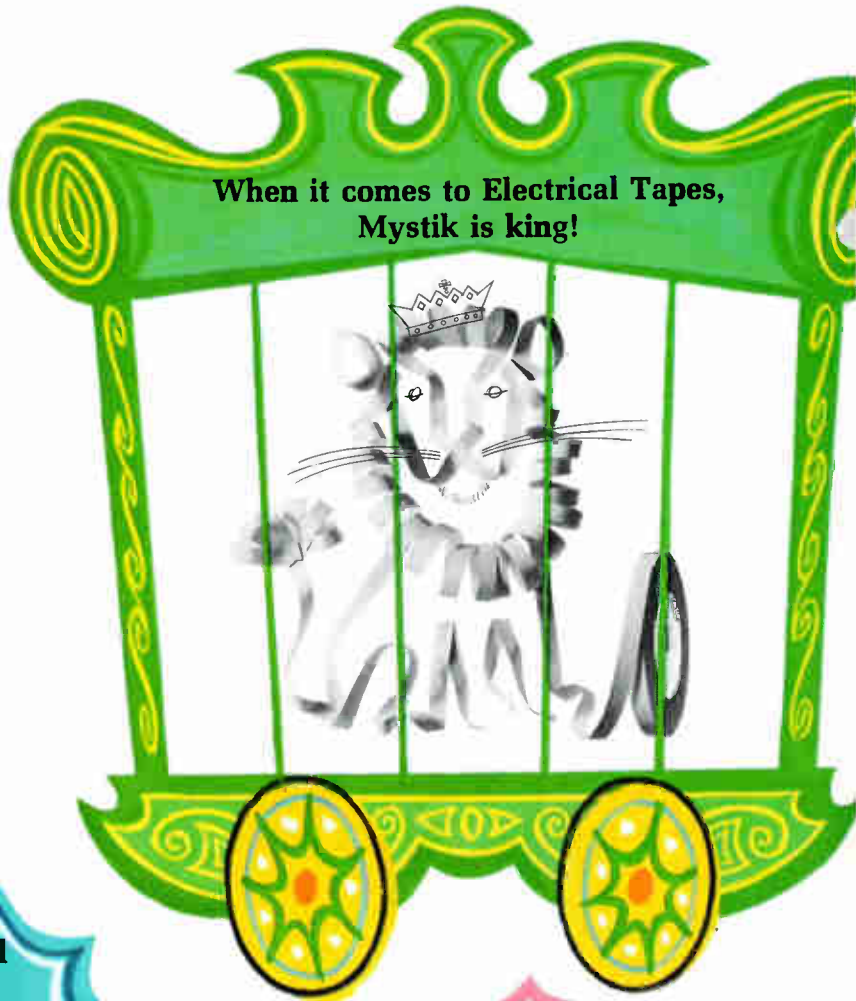

Reduce friction and keep cool
with Mystik Teflon Tapes!



Mystik filament-reinforced
Strapping Tapes are strong as a bull!



Mystik Protecto-Mask
is tough as a rhino!

UNDER THE **MYSTIK** BIG TOP there's a tape for your application.

ELECTRICAL TAPES

Mystik Tapes provide physical and performance characteristics of every description and are suitable for binding, shielding and insulating. Mystik is continually developing new tapes to keep pace with the needs of the rapidly expanding electrical industry.

PACKAGING TAPES

Versatile family for hundreds of applications. Sealing, color-coding, strengthening, you do it better for less with a Mystik Packaging Tape. Printable tapes allow an extra sales message for your package.

MYSTIK Tape

Tops for your application.

Binding, strapping, insulating, protecting or holding, there's a Mystik Tape that's perfect for your application. New tapes, such as Mystik's Nqmex, Kapton and Tedlar are constantly being added to our line to meet new demands of industry.

Your local Mystik distributor will be happy to help you in the selection of the correct tape for your application. He's well trained in tape applications and he is backed-up by Mystik's Field Representatives and Technical Service Department. You will find your Mystik distributor listed in the Yellow Pages under "Tapes". Call him. He will save you time and money.



MYSTIK TAPE DIVISION
THE BORDEN CHEMICAL COMPANY
1700 Winnetka Avenue
Northfield, Illinois 60093

Postage Will Be Paid by—

BUSINESS REPLY MAIL

No Postage Stamp Necessary if Mailed in United States.

FIRST CLASS
PERMIT NO. 60
Winnetka, Ill.

Remember
MYSTIK
 tops for
 every type of
 industrial tape

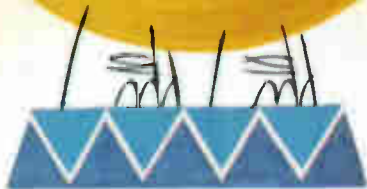

#6375 Printable Tape in various colors is used for displaying advertising messages, labeling, banding produce and parts.



#6497 Super Flextron® Glass Filament Reinforced Tape grips pipe securely, helps speed materials handling.



#5863 Waterproof Plastic Coated Cloth Tape for sealing and moisture-proofing overseas shipments; resists salt spray, oils, solvents and aging.



#6400 Mylar®, #6432 MYSTIKLEER®, and #6250 Cellophane are three transparent tapes ideally suited to packaging and office use.



#7452 Aluminum Foil Tape forms a ground shield on rear panel of a TV set.



#6462 Protecto-Mask® Transparent Film protects precisely finished panel during handling and prior to fabricating.



**BORDEN
 CHEMICAL**

MYSTIK TAPE DIVISION

1700 Winnetka Avenue
 Northfield, Illinois 60094

In less time than it takes to read this page, you could learn to use this new Universal Impedance Bridge.

Ready? One, two, three, go.

2. Adjust the range switch for an on-scale reading.

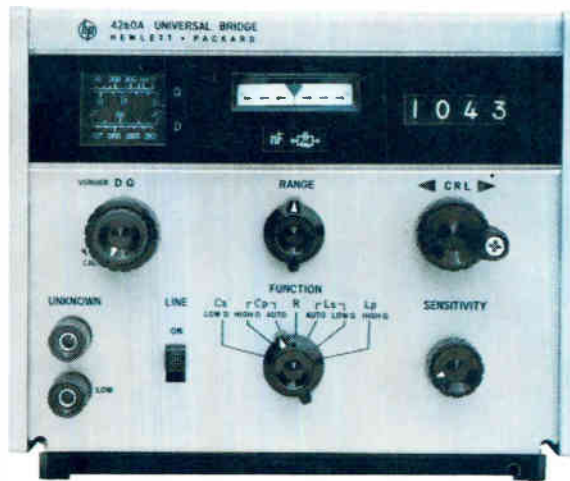

3. Obtain a null with the CRL dial. Now, read your measurement.

1. Select the function you want.

Nothing to it. No interacting controls to adjust and readjust. No multipliers. No non-linear dials. AUTO-BALANCE eliminates all that.

This new Hewlett-Packard Bridge is the first one that takes human beings into account as well as impedance. It's made for engineers who don't have time for a half-hour refresher course every time they want to use it.

You get direct digital readout of all C, R, and L values. Indicator lights show up-scale or down-scale unbalance. Decimal point and an equivalent circuit are automatically indicated. No problem with false or sliding nulls either: unique electronic AUTO-BALANCE takes care of that.

For a D or Q measurement, just switch from AUTO to low or high D or Q and turn the DQ control until you obtain another null. Simple. Particularly for low Q and high D cases.

So if you're the kind of engineer who's tired of complicated impedance bridges, Hewlett-Packard has your number: Model 4260A. \$550.

Ask your Hewlett-Packard field engineer for a demonstration. Or write us for complete specs: Palo Alto, California 94304. Tel. (415) 326-7000. Europe: 54 Route des Acacias, Geneva.

Data subject to change without notice.

Price f.o.b. factory.

HEWLETT  **PACKARD**
An extra measure of quality.

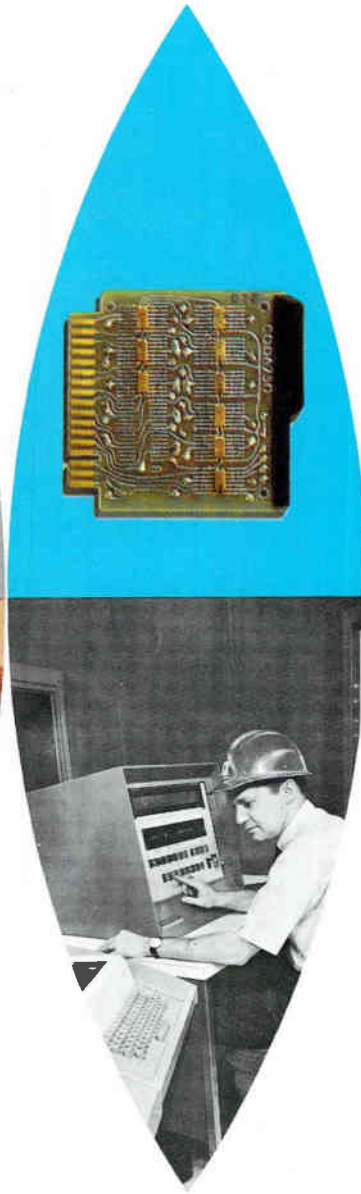
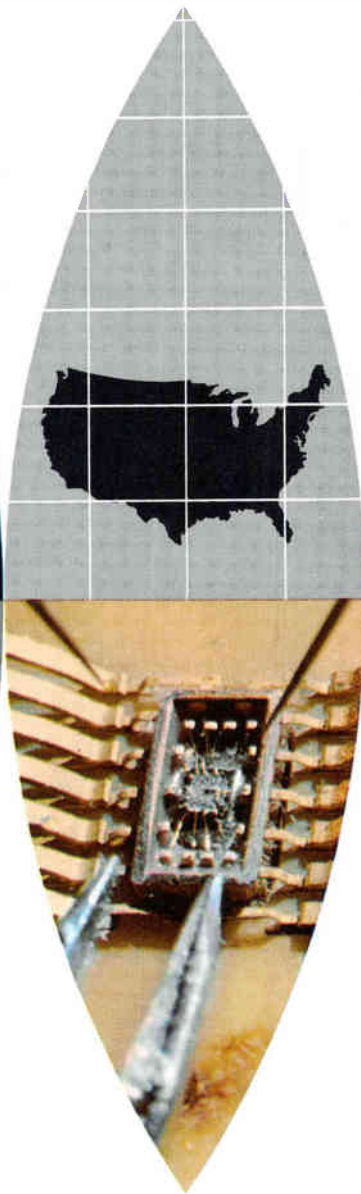
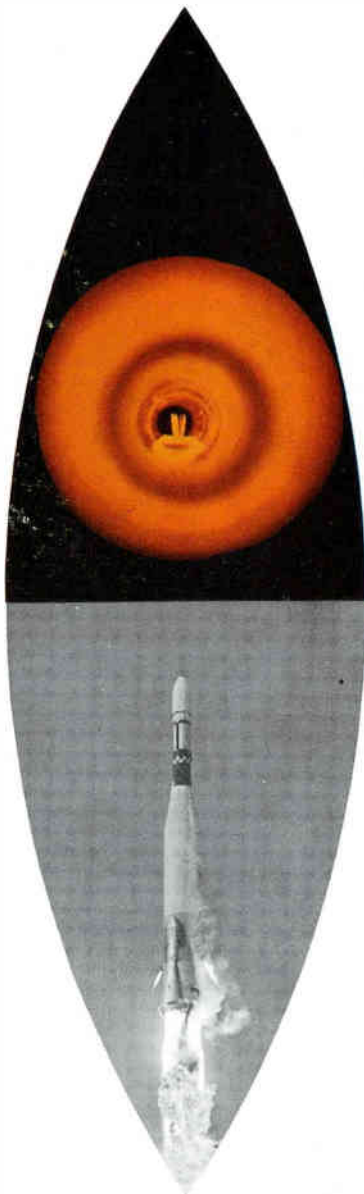

ONLY 3C OFFERS . . . **TOTAL DIGITAL CAPABILITY**

TOTAL BECAUSE . . . you get the most complete spectrum of digital hardware, associated software and customer support available today!

Products at the base of this capability include: digital logic modules . . . core memories . . . memory test equipment . . . special systems . . . and DDP computers that are the favorites in applications like flight simulation, message switching, freight yard control, laboratory work and computation analysis.

And in our own pioneering techniques laboratory we design and develop integrated circuits which are then mass-produced for use in most of our products. Extensive R&D like this helps to assure continued advanced hardware at low cost.

TOTAL BECAUSE . . . 3C (formerly Computer Control Company, Inc.) is now an operating division of Honeywell's new Computer Group.

To extend our digital capability even further, the computer facilities of the Industrial Division in Fort Washington, Pa. recently became part of our division in Framingham, Mass. This addition to 3C is well known for its H20 control system — ideal in the manufacture of chemicals, steel, food, textiles, and electric utility dispatching.

Result! A concentrated total digital capability under one roof that specializes in on-line real-time plus control applications.

TOTAL BECAUSE . . . also a member of the new Computer Group is the EDP Division — a leader when it comes to commercial/business data processing.

It's easy to see why Honeywell's new Computer Group can satisfy almost any digital application. Why not take a look at 3C total capability now — write for our new brochure, "3C TODAY".

Honeywell, Computer Control Division,
Old Connecticut Path, Framingham, Mass.

Honeywell



YOUR QUICK-SELECTION GUIDE to Spectra-Physics' STABILITE* Helium-Neon Gas Lasers

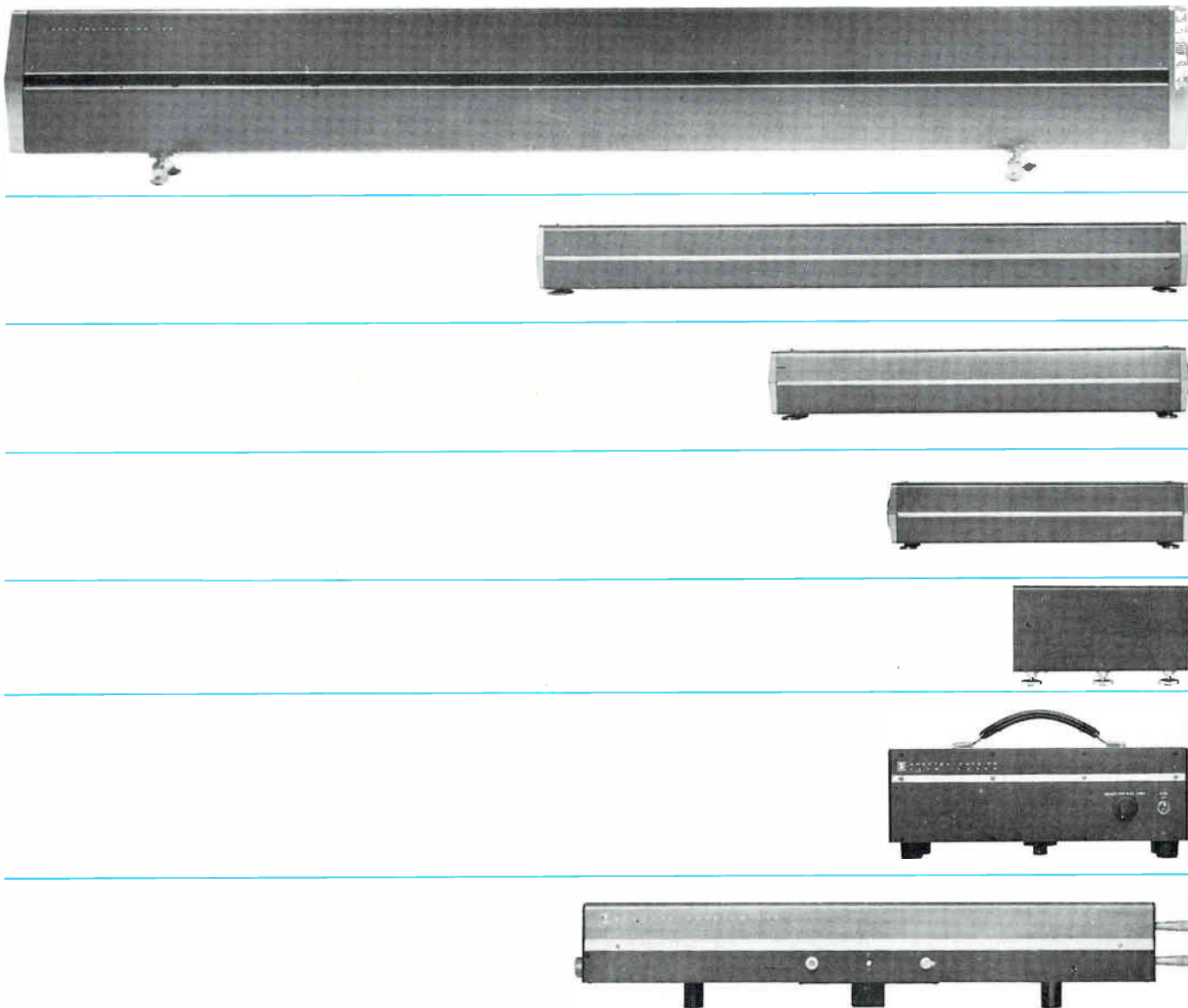

Send for the Literature:

* New STABILITE 6-page color brochure.











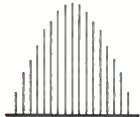

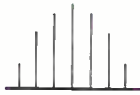
** "GAS LASERS," an article by Dr. A. Bloom, reprinted from the joint issue of *Proceedings of the IEEE and Applied Optics*, October 1966.

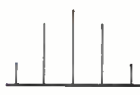

STABILITE: Spectro-Physics' trademark for HE-NE Gas Lasers

Here is the new generation of CW gas lasers, the *working* generation. These are the lasers being built into today's systems, the lasers that will be doing tomorrow's jobs.

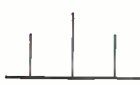
Look these over, match one to your needs; integrate its precision and dependability into your own operations. Your major benefit, aside from the utility of the laser itself, will be the satisfaction of using a product made and guaranteed by Spectra-Physics, leading producer — both quantitatively and qualitatively — of CW gas lasers, ever since their invention.

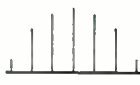
	MODEL	POWER TEM ₀₀ 632.8nm milliwatts	LENGTH overall inches	INSTANTANEOUS SPECTRUM axial modes center @ 4.7×10^{14} Hz 632.8nm	axial mode spacing MHz	PRICE with exciter (dollars)	APPLICATION
	* 125	50	75		83	\$8500.	General purpose for exacting applications such as holography, Raman Scattering, signal processing. Specially suited for factory installations, original equipment manufacturers and military systems configurations. Most appropriate STABILITE for a particular application is often determined by price/power/size considerations.
	* 124	15	32		214	3850.	
	* 123	7.0	22		341	2900.	
	* 122	3.0	16		517	1950.	
	119	0.1	9		1500	4850.	Single wavelength applications in heterodyne setups; long-path difference interferometry.
	130B	1.0	14		500	950.	General purpose where low cost and utility are primary considerations.
	115	3.0	29		250	3490.	Experimentation where micrometer adjustments, exciter modulation, r-f excitation are advantageous.

Laser Technical Bulletins:

- #1. Optical Properties of Lasers as Compared to Conventional Radiators
- #2. Properties of Laser Resonators Giving Uniphase Wave Fronts
- #3. Some Demonstration Experiments in Optics Using a Gas Laser
- #4. Noise in Lasers and Laser Detectors
- #5. Optical Systems for Laser Beams

Please write us at 1255 Terra Bella, Mountain View, California 94040. In Europe, Spectra-Physics, S.A., 18, rue Saint-Pierre, Box 142, 1701 Fribourg, Switzerland.

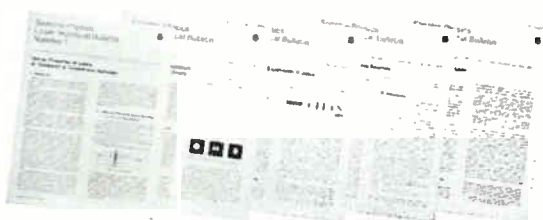



type 01-700

Type 01-370

Type 04-590



type 01-Round



01-600



Type 02-800



Type 44
Splashproof



Barrier Mount



Type 04-570



Type 01-Square

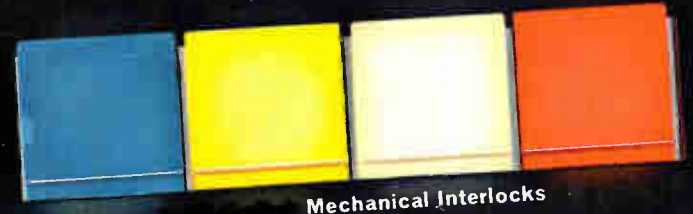

Mechanical Interlocks



Multi-Station Key Boards



Subminiature
Neon



Type 01-800

YOU CAN IMPROVE YOUR CONTROL AND PRODUCT APPLICATIONS WITH NEW DESIGNS, TECHNIQUES AND INNOVATIONS IN LIGHTED SWITCHES FROM

LICON[®]

SWITCHES

THE GOOD LOOKING SUPPLIER LINE THAT KEEPS AHEAD OF THE FIELD.



Type 04-590
NEW! Extruded bezel 4-lite Finest dress appearance in the industry. Colors, legends, snap-in mounting.



NEW! Sub-miniature Neon switch for rapid computer indication. Longest possible bulb life.



Type 01-370
NEW! Slide-base long-life bulb 1-lite push button switch. Plunger action.



Type 44
NEW! Splashproof water-sealed 4-lite switch. Snap-on switch module. Available in projected or screen colors, engraved legends.



Type 02-800
NEW! Economy 2-lite designed for easy snap-in. Front-of-panel mounting, servicing. Bezel-barriers for horizontal or vertical dress mounts.



Type 01-700
NEW! Economy 1-lite Screw-in mounting, front-of-panel bulb servicing.

WRITE FOR LATEST
 LICON LIGHTED
 SWITCH CATALOG



DIVISION ILLINOIS TOOL WORKS INC.
 6615 W. IRVING PARK ROAD • CHICAGO, ILLINOIS 60634

"Remember, you're never more than a few feet away from a product of ITW"[®]



PARTICULARITY IS A VIDAR DIGITAL DATA SYSTEM

It's a buyer's market today in digital data acquisition (systems that measure analog data and record it in digital form). You can order them from Vidar in innumerable combinations of input scanners, integrating digital voltmeters, clocks, output couplers, recorders, and what-not. They can be used for signals ranging from microvolts to thousands of volts. You can have your readouts served up on printed or per-

forated paper tape, punched cards, or magnetic tape.

Somewhere in this data-logging world — perhaps among our 5 standard systems — there exists an answer to your exact requirement for speed, sensitivity, accuracy, and economy. You can afford to be particular! And you needn't be a Ph.D. to understand or hook up a Vidar system.

Particular people are encouraged

to come to Vidar with their toughest data-acquisition problems (and the easier ones too!). You may be particularly impressed by our response. Get in touch with the Vidar engineering representative in your area, or contact us at 67 Ortega Avenue, Mountain View, California 94040; telephone (415) 961-1000.

VIDAR

**now...
new standards
of performance and reliability
in dielectric coolants**

FREON[®] E

SERIES

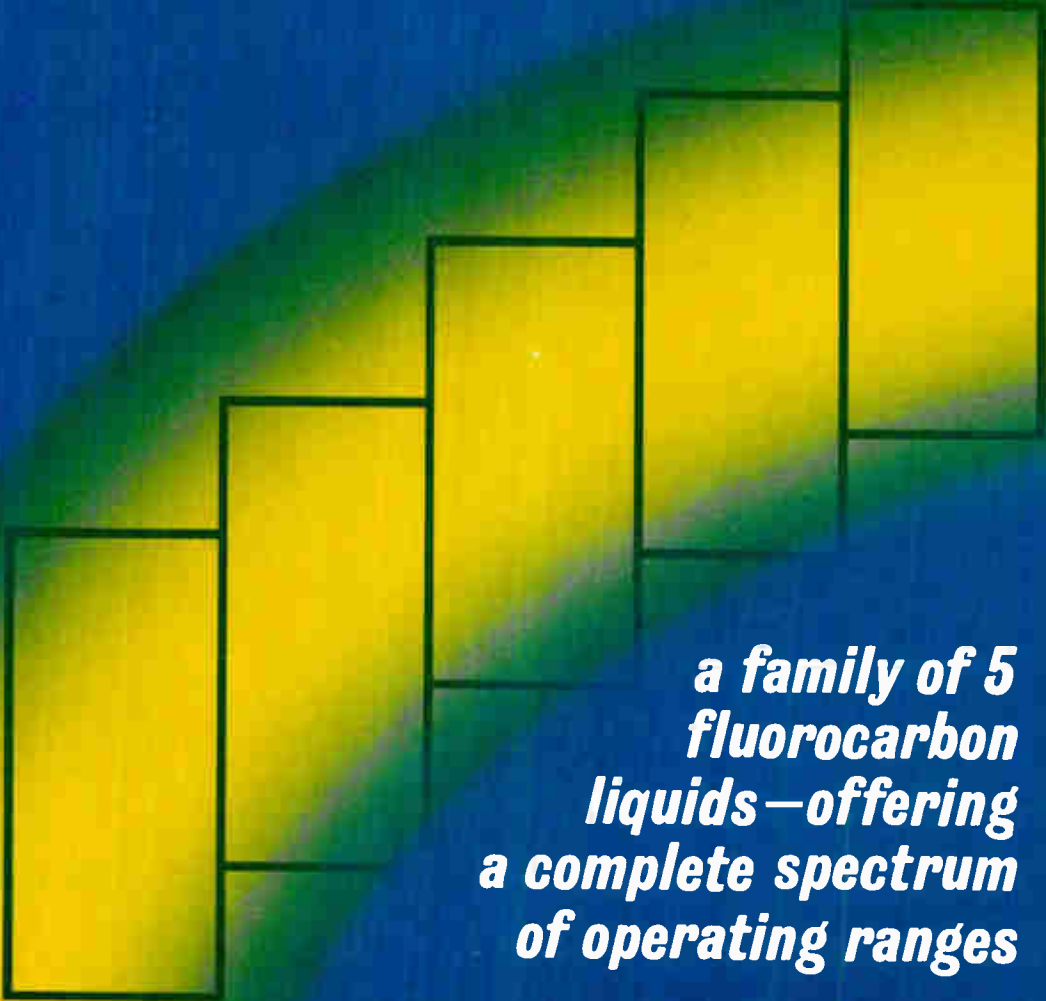

**a family of 5
fluorocarbon
liquids—offering
a complete spectrum
of operating ranges**

FREON[®] E SERIES

dielectric coolants let you specify— not speculate!

Du Pont's "FREON" E Series is a family of 5 homologous dielectric coolants setting totally new standards of performance and reliability. There's no guesswork necessary in choosing the right one for your equipment. With the

"FREON" E Series, you can choose the exact coolant that best meets your needs, and permits the customer to operate the equipment exactly as specified for the task.

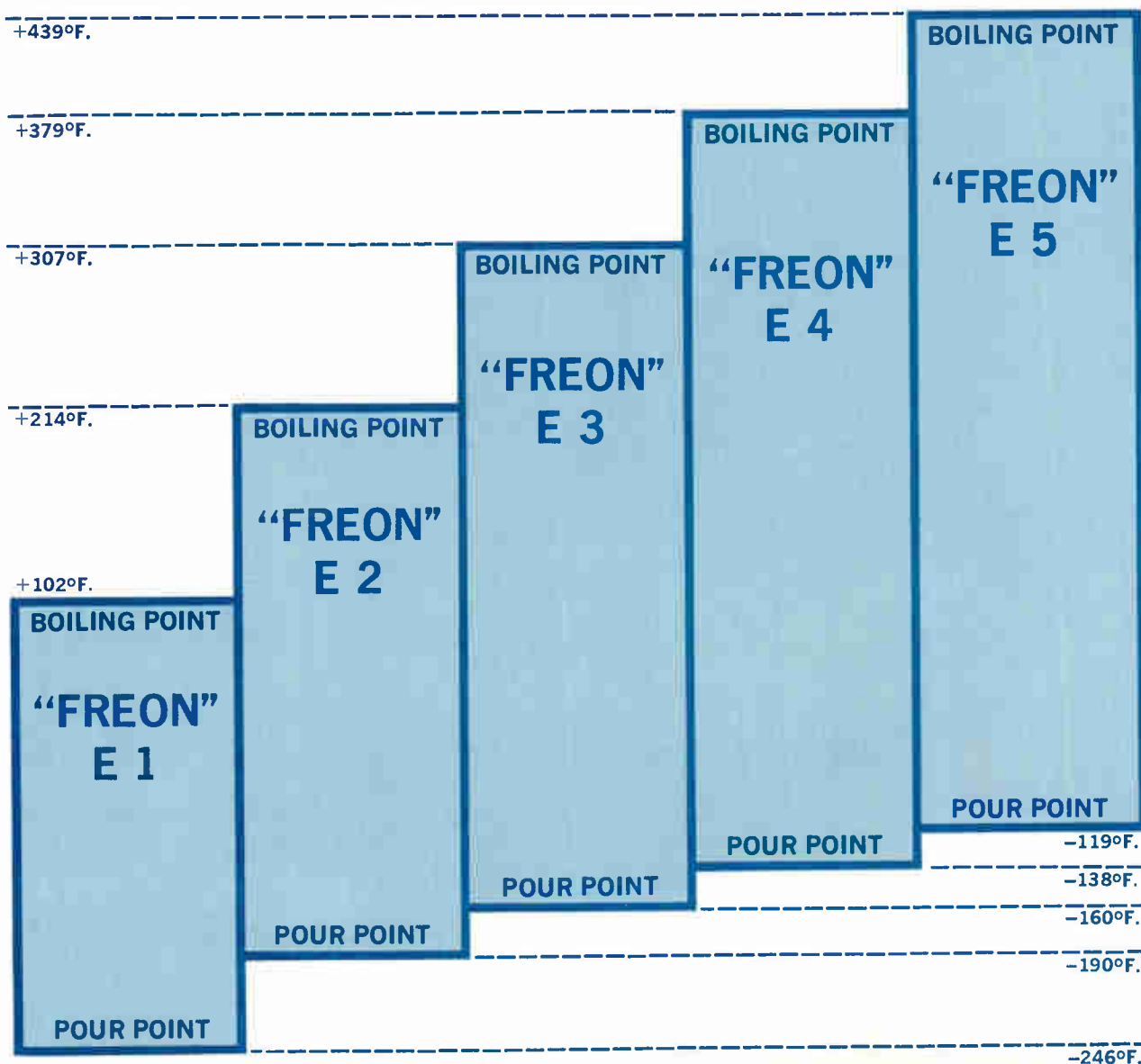

Here's why **FREON® E SERIES** coolants will increase your equipment performance and reliability:

1. Stable and compatible

"FREON" E Series fluorocarbon liquids are not affected at high temperatures (over 550°F!)—are inert with metals, plastics, elastomers.

2. Completely safe

No special safety precautions are necessary with "FREON" E Series coolants. They are nonflammable and relatively nontoxic. Use them anywhere!

3. Outstanding dielectric properties

These insulating fluids provide high dielectric strength in liquid and vapor—low losses—high resistivity.

4. Widest temperature ranges

The "FREON" E Series offers liquid limits

from -246°F. up to +439°F. at zero psig. Each coolant has a specific, constant, and extremely wide liquid temperature range. You choose the one to meet your exact needs.

5. Unmatched purity and uniformity

Each coolant in the "FREON" E Series is a single, pure compound—not a mixture of several different fluids. Thus composition is always the same—lot to lot—day to day.

6. Precise boiling points and vapor pressures

There's no plus-or-minus factor on boiling points . . . and no "averaging." You're always sure of coolant characteristics—and operating temperatures.

If you're looking for new standards of performance in a dielectric coolant, find out more about the "FREON" E Series. Simply fill out and mail this card.

I would like to know more about "FREON" E Series coolants for use in:

Name _____

Position _____

Company _____

Address _____

City _____ State _____ Zip _____

FREON[®] E SERIES

fluorocarbons offer new opportunities for creative design...

The unique thermal, electrical and chemical properties of "FREON" E Series fluorocarbons provide new opportunities for electronic and space-age engineering... in improving reliability by outstanding temperature control... in miniaturizing components or systems... in transmitting hydraulic pressure in systems operating under conditions of extreme temperature changes... in optical equipment... or you name it. Whatever new application you can think of, just jot it down on the reply card. We'll help you investigate the new use with necessary technical assistance.

In Europe, mail card to: Du Pont de Nemours International S.A., "Freon" & "Valclene" Products Department, 81, Route de l'Aire, CH 1211 Geneva, 24 Switzerland.

BUSINESS REPLY CARD

No postage stamp necessary if mailed in the United States

Postage will be paid by

E. I. du Pont de Nemours & Co. (Inc.)
"Freon" Products Division
Room 4313
Wilmington, Delaware 19898

FIRST CLASS
PERMIT No. 9
Wilmington, Del.



FREON[®]

fluorocarbons



BETTER THINGS FOR BETTER LIVING
...THROUGH CHEMISTRY



ACTUAL SIZE

Motorola's MV1805C Varactor Multiplier Sets a New Level of Power/Frequency Performance

Now, you can get up to 35 watts of solid-state power at 1 Gigahertz, to drive your higher frequency chains — or, as direct UHF power with Motorola's MV1805C. *No other single semiconductor will give you as much output power at this frequency.*

Motorola's new MV1805C step-recovery power varactor is an ideal driver for subsequent multiplication stages in communications links, radar and telemetry systems where designers also want the reliability of solid-state components. In addition, it is unmatched as a final power output stage for lower frequency systems — for example, in mobile communications — to step from 150 to 450 MHz.

In addition, this new device also features the high-efficiency performance you've come to expect from Motorola varactors . . . specified at 65% (min), tripling, to 750 MHz. More importantly, it's 100% functionally tested at 40 watts P_{in} — to give you the

assurance of guaranteed, full-range performance in all of your applications!

CHECK THESE "PERFORMANCE-RATED" SPECIFICATIONS:

Characteristic	Symbol	Rating	Unit
RF Power input	P_{in}	40	Watts
RF Power output	P_{out}	26 (min)	Watts
Tripler Efficiency	η	65 (min)*	%
Thermal Resistance	θ_{jC}	7 (max)	$^{\circ}C/W$

*Up to 750 MHz

MICROWAVE "TROUBLE-SHOOTERS" SOLVE CIRCUIT DESIGN PROBLEMS

Motorola's Microwave Applications Group offers engineering help, circuit design assistance and product samples, in addition to technical literature. So, for fast design aid, call your nearby Motorola sales office, or place a direct request with the Microwave Applications Group. For technical literature, write to Technical Information Center, Motorola Semiconductor Products Inc., P.O. Box 955, Phoenix, Arizona 85001.



MOTOROLA Semiconductors
— where the priceless ingredient is care!

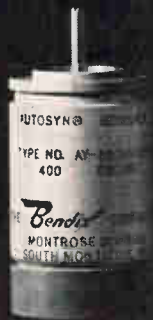

(Actual Size)

Weight-conscious engineers like what they don't see here.

Bendix® size 08 Autosyn® Synchros average only 1.3 ounces. And their maximum diameter is 0.750 inch.

It's this combination that explains the success of the 08 models in such a wide range of applications. In addition, all 16 standard 08 units feature 12-inch flexible leads, aluminum housings and corrosion-resistant construction. They're also available with stainless steel housings.

Some models are accurate and stable at operating

temperatures up to 800° F. Others are radiation-resistant. And if you can't find the 08 that's just right, we can build one to meet your needs exactly.

Need a larger size? Check our sizes 10, 11, 15 and 22.

Of course, the performance and reliability of every Bendix Autosyn Synchro are backed by one of the best names in the business. Call us at (717) 278-1161 in Montrose, Pa. Or write for our 42-page catalog.

Montrose Division



Communications

H-f's sharper bounce

"High frequency" is a dirty word in Government communications circles. Because of fading and multipath problems, h-f communication circuits are used reluctantly, though the United States has millions invested in equipment around the world.

But a change may be in sight. In a couple of months the Mitre Corp. will open an experimental h-f link between its headquarters in Bedford, Mass., and the Naval Electronics Laboratory in Point Loma, Calif. The link, called Discol—for digital sounder computer link—will use sounders to explore the sky-wave mode of communications in the h-f range, from 2 to 30 megahertz.

"The link will be developed along the lines of a consumers' cooperative," says Wilfred A. Fordon of Mitre. "If others want to use the test bed, they can get into the cooperative simply by paying for their own terminal and equipment."

Mitre, systems engineering adviser to the Air Force, works principally for the Electronic Systems Division at Hanscom Field, Mass., which manages development of military communications systems throughout the world for the Defense Communications Agency. The division put up about \$100,000 for the Mitre terminal; the Navy is financing its own station at Point Loma.

The basic goal is to investigate long-haul communications techniques for the military.

Big audience. Closely watching the progress of the test bed are the Strategic Air Command, which relies partly on h-f links, and the managers of programs like 484L, the project to develop secure, ground-air-ground voice and high-speed Teletype links.

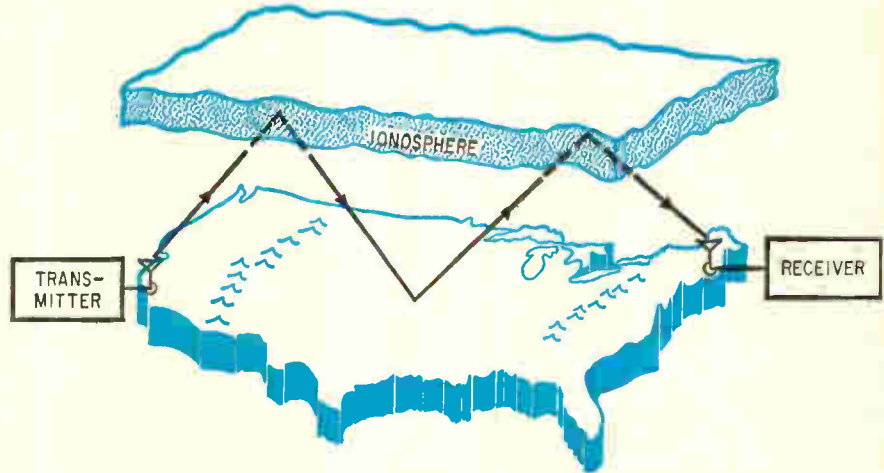

Experimental high-frequency link presages new interest in ionospheric bouncing.

Out of Discol may eventually develop new antennas and other devices for h-f.

In h-f systems, the channel depends strictly upon the ionosphere, which bounces signals from the transmitter to the receiver. The ionosphere consists of several layers of ionized gas 100 to 500 kilometers above the earth. Efficient reflection of a specific frequency is determined by the height, thickness and ionization levels within these layers—and these change from day to night, month to month and year to year throughout the sunspot cycle.

At present, optimum frequencies are chosen on the basis of three-month advance predictions which define only average conditions. The most effective use of h-f is made by veteran radio operators who have learned the h-f medium by long experience.

Fine tuning. The defense communications system is evolving into an adaptive network in which computers will automatically switch to optimum frequency, power and routing. Where h-f links are used, an adaptive network will require storage of data on the changing status of the ionosphere.

Discol will use synchronized,

stepped-frequency oblique sounders at each location to measure characteristics of the propagation path for point-to-point communications. The sounder transmitter and receiver both employ electronically controlled frequency channels in exact time synchronization. This is established by locking the timing circuits of individual equipment to a very stable quartz clock capable of maintaining synchronization to within a few millionths of a second.

At preset time intervals, the transmitter and receiver initiate a frequency-scan sequence in which they are tuned synchronously across the h-f band in steps of about 10 frequency channels per second.

Shape of the pulse. Within the band in which the sounder signals are detected, the ionosphere distorts the shape of the pulses, sometimes stretching them to many times their original length. This and other effects are seen in an ionogram recorded by the receiver.

A typical ionogram tells the communicator the full range of frequencies then usable, how much pulse-stretching is present and at what frequencies this distortion is most severe. The communicator knows at what frequencies he can expect

reliable communications on that circuit at that time.

The test link across the continent is planned in order to build up an extensive collection of data on seasonal variations along that path at least. Other links may be added soon.

At Mitre the work will be tied to other communications projects, such as block error-coding techniques. Says Fordon: "The current revolution in digital error control, the development of solid-state digital devices and the rapid movement in the military toward digital communications systems are all part of the renewed interest in h-f."

Fast talker

Another sign that h-f manufacturers haven't thrown in the towel despite the growing threat from satellite communications is the continuing research on h-f data modems.

The General Dynamics Corp.'s Electronics division in Rochester, N.Y., for example, is developing data modems for the Air Force which the company says will transmit digital data at 4,800 bits per second, about twice the rate of the best h-f systems now available.

The reason for such speed, says a General Dynamics engineer, is "frequency differential phase shift keying. The next best system uses time differential phase shift keying." General Dynamics says its system is less affected by h-f multipath problems and randomly varying signal phase or drifting phase over the transmission path.

Dual tone. Its data modem transmits two tones during one time interval rather than a single tone in successive time intervals (the time differential method). Since the tones are close together (a cycle or two apart) they are similarly affected; and the phase shift between the tones, which carry the data information, remains the same. The tone times are also made very long so that signal smearing due to the multipath effect is a small percentage of the total signal time.

According to General Dynamics,

From another angle

How well do the Russians make out with h-f?

Many United States communications specialists think they do very well [Electronics, Oct. 4, 1965, p. 136].

One theory is that the Russians are in a better geographical position to achieve a low angle in launch of their signals and are less affected by auroral activity.

There is also some speculation that they use some form of ducting. The use of ducts, or natural waveguides in the atmosphere, has been investigated for years in the U.S.

The Air Force plans this year to launch ionospheric communications satellites which will test h-f and vhf guided propagation in the lower ionosphere. Designed by the Raytheon Co., the satellite-to-satellite communications system will investigate the whispering-gallery effect—the existence of natural waveguides in the ionosphere which transmit radio waves from one place to another as the curved reflecting surfaces in some large cathedrals transmit sound waves from one end to the other.

the high data rate modem opens a new field of digital data transmission. If the data modem is set to operate at 4,800 bits per second and transmits data at 2,400 bits per second, the extra capacity can be used to encode additional information. At the receiver the operators can use a computer to determine errors and make corrections. In this way, General Dynamics says, error rates of one in a million are possible.

Laying the groundwork

As the time approaches to choose a contractor in the Pentagon's fast-moving effort to build and put up a tactical communications satellite, work is going on to develop the essential ground terminals.

To meet the tactical needs of all three services, terminals must be compact, inexpensive, lightweight and highly mobile. The terminals are being built around communications gear already developed in order to make the 1968 target date for the satellite system.

In contrast with present portable satellite ground stations that need several trucks to haul them from one site to another, the new terminals will have to be small enough to ride in the back of a Jeep, aboard a crowded Navy ship or tucked away in a small aircraft.

The Navy last month received proposals from companies interested in the contract-definition phase for shipboard terminals. The development effort will investigate the tactical satellite's two frequencies—ultrahigh frequency (300 to 3,000 megahertz) and X band (5,200 to 10,900 Mhz). At first the Navy will contract for only a handful of the shipboard terminals, but the size of the over-all market is expected to be significant because of the large number of terminals that ultimately will be needed.

Suitcase variety. One of several companies working on the ground terminals and said to have bid on the Navy work is Electronic Communications, Inc., of St. Petersburg, Fla., which has put together a terminal to work with the tactical satellite using equipment it developed earlier. Calling it a "small suitcase variety," the company says that the terminal, including antenna, weighs only 210 pounds and occupies just 6 cubic feet. It needs 4 kilowatts of power.

The company is planning a package that can be used by all the services.

The Electronic Communications terminal is made up of a receiver, transmitter, control box, modulator and demodulator. A special antenna developed by the company is an omnidirectional loop V design. Horizontally polarized, it is about 1¼ feet in diameter and is more compact than a directional dish, the company says. For aircraft use, it could be placed under a radome. The gain of the loop V antenna is on the order of 4.5 decibels.

The most important parts of the terminal — recently demonstrated for the military—are the URC-65 demodulator and the URC-66 modulator. Both are solid state and 90% of their circuits are made up of monolithic integrated circuits.

These units provide the time-frequency modulation scheme used by

Electronic Communications to combat transmission problems such as multipath fading and to optimize modulation. In the time-frequency method, each bit is transmitted serially, and utilizes bit, time and frequency redundancies.

Because equipment development is essentially complete, a company official says the terminal could be delivered soon. With it, up to 50 users could share a satellite link simultaneously. The terminal transmits teletype only, but vocoded voice can be added.

Antijam feature. Electronic Communications has a general development program "not necessarily tied to the satellite ground terminal" on a high-speed, frequency-hopping digital synthesizer. Such equipment could improve the multiple access and antijam features of the future satellite terminals, the official says.

Also in development at the Florida company is a building block line of modems for the operational satellite communications terminal. A good part of the microwave equipment is already developed—such as the URC-65 and URC-66. One or two other units will be added to the completely adaptive system for such things as 60 word-per-minute teletype and 4,800 bits-per-second vocoded voice.

The terminal is designed to work with near synchronous-altitude or synchronous-altitude satellites. Working with a satellite precessing at a rate of 30° to 50° a day, a soldier would have to adjust the electronic communication antenna only once every two to three days.

Moving fast. The Pentagon is in a hurry to get the first tactical satellite up. It is skipping the contract-definition stage [Electronics, Aug. 8, p. 61] and is selecting the contractor team to build the demonstration satellite from proposals that were submitted by industry in early September. Indications are that selection of the builders may come as early as late October or November.

Because of the tight timetable and the Pentagon requirement for existing equipment, it appears that the proposal accepted will be based on experience with an operational satellite.

Some of the companies that are understood to have bid on the tactical communications satellite include the Hughes Aircraft Co. with the Syncom and Early Bird satellites; the Boeing Co. with the Lunar Orbiter satellite; TRW, Inc., with the Orbiting Geophysical Laboratory; the Philco Corp. with the Initial Defense Communications Satellite, and General Electric Co. with the Nimbus spacecraft.

Industrial electronics

Tooled for economy

It's like driving a tack with a sledge hammer to go through a complex

program such as the Automatically Programmed Tool (APT), or any of its cousins, to generate tapes for numerical control machining of just a few parts. Now, for two-dimensional operations at least, a system has been built that generates the tapes directly from optically traced drawings. Developed by Tridea Electronics of South Pasadena, Calif., a subsidiary of the Conduction Corp., the system computes cutter offsets to determine the path of the tool and accepts inputs of program instruction to complete data for the tape.

Two of the systems are being built for the McDonnell Aircraft Corp. of St. Louis and according to A.G. Van Alstyne, director of advanced development for Tridea, his company now plans to market the

Operator, right, monitors optical tracer head used to generate numerical-control tape for two-dimensional parts directly from a drawing. Digital display indicates position of tracer head over drawing being traced. Head is mounted on a movable gantry and its position is encoded for the computer that calculates tape data.

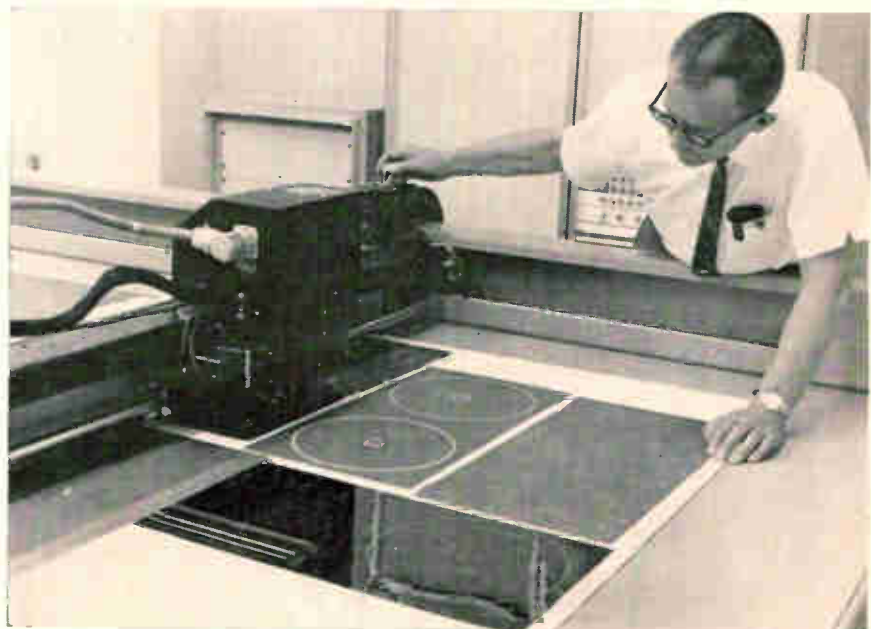

industrial systems generally.

Other companies also have indicated interest in the system, mostly aerospace companies. The Boeing Co., for example, submitted an irregularly shaped production part that had taken 80 man-hours to code for APT. On the Tridea system, the same numerical control tape was produced in 2 minutes.

In addition, savings are possible through numerical control machining of some single items. McDonnell Aircraft says a control tape for a template that required 2 man-hours of manual layout was done in 20 minutes on the Tridea system.

Follow the line. The Tridea system consists of a 5- by 12-foot table with a tracing head mounted on a movable gantry, a linear encoding system, a small computer and an operator's console with a television monitor, manual gantry position controls and a data input terminal. Two dual photodiodes in the tracing head scan opposite sides of the line they are following. They pick up reflected light on each side of the line and can be set either positive or negative so they will be compatible with either black-on-white or white-on-black drawings. The photodiodes can be rotated to maintain their alignment. Feedback signals from the photodiodes go to a resolver, which controls two d-c torque motors; one drives the gantry along the tracing table, the other drives the tracing head across the gantry.

A tracer scanning only a single side of a line is likely to follow crossing lines but the dual photodiode scanner sees both sides of the line and is less likely to be diverted to one side or the other. The resolver drive is continually converging on the line center from both sides to lock the scanner on the line. Some problem areas, such as a Y line junction, must be controlled manually by the operator. By watching the monitor, which shows which line the tracer is following, the operator sees when the tracer has made a mistake and he switches to a manual mode. Using a joy stick on the console, he can slew the head back to the point where the error started and man-

ually redirect the head onto the correct line.

A delay of about 30 seconds between reading the position of the head and punching the control tape occurs in a buffer memory. This allows time to erase and correct an error before it gets on the tape. When the operator makes a correction, all of the data in the memory, back to the error point, is automatically erased.

Head position is read by photo-sensors that scan precision stainless-steel tapes marked off 500 lines to the inch. One tape lies along the gantry's line of travel and the other locates the position of the tracer on the gantry. A linear encoder, made by Sheffield, Ltd., Scotland, converts the linear measurement directly into digital form.

Tight tolerance. Tridea's Van Alstyne claims that through optical interpolation of the position tapes, the system can duplicate the drawing onto the numerical control tape with a tolerance within 0.0005 inch. The buffer memory stores line segments as one point and a slope—the slope being determined from the preceding point. Adjacent slopes are compared to determine if the line is straight or curved. If it is curved, the computer calculates how many points are needed to keep within the specified tolerance of tangential error and then determines the cutting tool path.

A Tridea-designed interface converts the decimal output of the encoder to the binary coded decimal form required by the DDP 116 computer, made by the Computer Control Co., used for data processing.

Continuous check. The tv monitor at the control console is fed by a General Electric TE-21A camera, fitted with a beam-splitter mirror. Reflecting the drawing being traced, the mirror also superimposes a circle representing the cutter diameter.

Fingertip control

A late model car last month cruised slowly along a deserted country road 80 miles outside of Columbus, Ohio. The trip covered only a few miles, enough to convince a team of

Ohio State University engineers that a control stick they were working on could become one of the elements of an electronically controlled car.

The stick, which worked as well on the road as it had in the lab, replaces a car's steering wheel and gas and brake pedal. It also contains a device that signals the driver more accurately and more surely than his eyes that the distance between his car and the car ahead is changing.

Accordion effect. With a headway-warning system, explain the Ohio State engineers, cars can safely track closely behind other cars even at superhighway speeds. The system also prevents what highway engineers call the accordion effect, in which cars bunch up, then spread out, then bunch up again because drivers fail to maintain constant headways.

By maintaining headway, says the university engineers, superhighways can be packed more densely and the cars can move along faster with no loss of safety.

"We're still far from the development of a car that you can drive onto a superhighway and let drive itself," concedes Robert E. Fenton, a staff member of the school's Communications and Control Systems Laboratory and manager of the control stick project. But he does see the control stick as an interim step.

The headway indicator is built into the top of the stick, where the driver rests his hand to control the car. When the car moves closer than a predetermined distance to the car in front, a finger-like section in the stick juts forward, pressing against the driver's fingers. When the driver feels this he pulls back slightly on the control stick, signaling a special-purpose analog computer in the car's trunk to ease up on the throttle. The farther back the stick is pulled, the more the throttle is eased; if the stick passes a certain point, the computer commands braking. When the proper distance is found again, the finger-like section slides back.

On the other hand, when the car is falling back, the finger-like section slides in the opposite direction, pressing against the palm of the

hand, and a forward motion of the control stick then speeds up the test car.

Quick response. The tactile warning system was chosen, says Fenton, because when a driver is concentrating on the highway, his eyes scanning the scene ahead, it's best to have a signal that alerts another of the five senses to guarantee quick response.

Fenton explains that with the control stick a subject can maintain a 70-foot headway at 70 miles an hour with only a one-foot error; without the control stick the best drivers score a 10-foot error. Obviously, notes Fenton, "we are dealing with changes in motion which are considerably below the visual threshold."

So far the Ohio State engineers haven't bothered about the problem of actually determining the distance between cars. "We'll do that later; right now we want to prove that the control technique works reliably," Fenton points out.

"For the moment we program a ghost lead car into the computer; later we'll use a second car with a retractable wire strung between cars to measure the headway distance."

When the time comes to develop the headway sensors, Fenton says, three approaches are likely: an optical or a radio-frequency radar system or a system of magnetic sensors under the pavement which cars would trigger. Fenton says the magnetic system holds the greatest hope because it's relatively cheap and nearly foolproof.

Other experts, however, say that radar will never work in this application, that a laser device is a pipe dream, but that an infrared detector could work efficiently. Integrated circuits now make such a device economically feasible, they add.

The ultimate objective, according to Fenton, would be to use some roadside or under-the-pavement device to control the control stick, taking the steering, acceleration and braking function out of the driver's hands—and away from his feet.

That, he says, is still many years away.

The long green

Express buses in New York State may eventually have the traffic lights all their own way if a feasibility study now being concluded gets into the hardware stage.

Airborne Instruments Laboratory, a division of Cutler-Hammer, Inc., is studying, under a \$15,000 contract from the state's Department of Public Roads, whether traffic lights can be turned from red to green by infrared signals emitted by a gallium arsenide junction diode mounted in express buses. Under the plan bus drivers could aim the light beam at red traffic lights from as far away as 1,000 feet.

An infrared detector in the traffic-light pole would sense the signal from the oncoming bus and produce an output that would begin cycling the light from red to green. After the bus had passed, the traffic light would resume its normal operating cycle.

All green. By giving express buses a perpetual green light, New York is hoping to make travel by bus faster and more attractive to commuters. If it becomes attractive enough, travelers may leave their cars at home. A decrease in private cars would reduce congestion on

the highways.

Problems being considered by Airborne Instruments include the effect such an override on traffic lights will have on roads feeding into the bus routes, the best beam-width of the diode signal and its range.

The company has already built a breadboard model of a junction diode signaling system but this was for a contract from the National Academy of Science's highway research board. If a hardware contract is let by New York State for the bus system, first tests will probably take place in either Rochester or Buffalo.

Medical electronics

Bedside companion

A visual and audio communications system will give hospital patients reassurance in time of need and save valuable steps for overworked nurses.

Besides providing communication between nurses and patients, the system furnishes entertainment, closed-circuit television and can



Patient can easily move and tune the 5½-pound receiver, which is supported by a gravity-free arm attached to the bed.

monitor physiological probes that measure pulse and heart rate.

The system consists primarily of a tv camera and receiver. When the portable camera is at the nurses' station and the receiver by the patient's bed, the patient can see the nurse. When the equipment is reversed, the nurse can tune in on the patient.

For installation convenience the system operates with a single coaxial cable only $\frac{1}{8}$ inch in diameter. By contrast, most hospitals have a tangle of wires for tv and intercoms — always an inconvenience and sometimes a hazard in a patient's room. Some nurse-call systems need as many as 40 wires in the walls just for audio connections.

Low voltage. In addition, the system, made by Bell Hospital Services, Inc., of Bridgeport, Conn., operates on low voltages. Instead of consuming 300 watts as a conventional receiver does, each receiver operates on 12 volts d-c and uses only 8 watts.

Each receiver has a 5-inch screen and is suspended on a counterbalanced, articulated arm attached to the patient's bed. The patient can easily move and tune the set, freeing the nurse for other duties. He hears the sound through sterilized, disposable earplugs, eliminating the nuisance tv often causes in hospital rooms with several beds.

The system uses modified transistorized receivers manufactured by the Sony Corp. Bell removes power supplies and speakers and adjusts a few circuits. The resulting weight reduction simplifies balancing the receiver on the gravity-free arm. The $5\frac{1}{2}$ -pound sets are also light enough to be mailed back to Bridgeport for repairs.

Emergency. The control system for entertainment and closed-circuit tv contains a master antenna, radio tuners, amplifiers, mixers and a power supply. Individual amplifiers for each channel furnish impedance matching and automatic gain control for signals from the master antenna. Amplified signals are then mixed and relayed to coaxial distribution lines. When additional outlets are installed, amplifiers' settings are changed to com-

pensate for added line loss.

Power converter. The built-in power supply converts the hospital's a-c to regulated d-c to operate the receivers.

Both power and entertainment signals flow through the single coaxial line.

Instrumentation

Miss calculation

When missile men conduct target practice against expensive drone planes, their aim is to miss—although not by very much—so the drone can survive and fly again another day. To determine the effectiveness of the shot, the missile men must know how close they came. For this job, missiles are re-fitted with radio-frequency equipment to measure the miss-distance; but weight distribution and aerodynamic problems result. Now, the International Telephone and Telegraph Corp. is developing an electro-optical system to replace the miss-distance electronics on the missile with a dab of paint. All of the measuring and score-transmitting electronics will be packed into the recoverable drone.

The scoring system, being developed for the Air Force Systems Command at Eglin Air Force Base, Fla., will have an accuracy within 1 or 2 inches over its range of 100 feet. Radio-frequency systems such as pulsed radar or tracked beacons usually have accuracies within 5 and 10 feet over the same range. Continuous-wave radar boasts better accuracy—1 or 2 feet over a 100-foot range.

Time function. ITT's Federal Laboratories, Los Angeles, has already demonstrated and tested the optical concept with a bread-boarded system. In this model a gallium arsenide diode generates the light, which is directly modulated by radio-frequency tones of very stable frequencies. The modulated beam is collimated and aimed at a reflective target, such as a dab of paint. The difference of phase between the transmitted and re-

flected beam is a function of time, hence, a function of the distance between the light source and the target.

Obviously, if the phase shifted 360° it would be seen as a zero shift and would indicate a direct hit. To eliminate ambiguity within the desired range, two widely separated r-f tones are used. Somewhat on the principle of a vernier, a 5-megahertz tone provides the coarse measurement, which is equivalent to a 200-foot wavelength, and a 40-Mhz tone provides the fine measurements of less than 5 feet. If a range greater than 200 feet were required, an appropriate tone of a frequency lower than 5 Mhz would have to be modulated onto the light beam.

Stay in phase. The reflected 5- and 40-Mhz signals are received by a photomultiplier sensor and mixed with offset frequencies, which are phase coherent to produce two low-frequency carriers that retain the phase information proportional to the distance. The phase of the low-frequency signals are compared and combined to provide a single binary range word that is transmitted back to a scoring station on the ground.

One problem that had to be overcome was the error caused by doppler shift, which would also appear as phase shift. A counter frequency detects whether the modulated frequencies on the light beam have changed value and by how much. The amount of phase shift attributable to frequency change is calculated and canceled from the phase-shift information, leaving only that shift caused by distance. If desired, frequency information could be used to measure relative speed between the target drone and the missile.

All sides. Although the bread-boarded system does not provide a way of detecting targets approaching from all angles, several ways of doing this are being investigated.

In an operational system, many diodes and sensors could be attached on all sides of the drone so it can monitor all possible directions of a missile's approach by electronically sweeping the light beams through an arc. Another pos-

OTHERS TALK I. C. MEMORIES

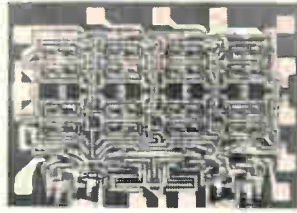

Transitron's been delivering

For over 6 months Transitron has been delivering HLTTTL 16-bit 10 M.C. monolithic memory cells for 0°C to 75°C temperature range. This circuit family has now been rated for -55°C to +125°C operation and is available for quantity shipment from Transitron.

- The Transitron 16-bit, 10 MC, bit-oriented IC memory elements, utilizing advanced HLTTTL technology, are being shipped in quantity.

- Available for -55°C to +125°C operation, these high-speed units are making possible the design of fast buffer and scratch pad memories for modern digital computers and systems which extend system capability significantly.

- Each memory element consists of 16 two transistor flip-flops, arranged in a 4 x 4 matrix, which provide the information storage. Two write and two sense amplifiers are also built into the element.

- Both data and data complement are available at the sensing outputs, which can be paralleled for use in larger arrays. Addressing, read and write levels are compatible with other HLTTTL circuitry.

- The design results in a non-destructive readout element exhibiting typical delays of 20 nSec. between addressing and read or write, making extremely high-speed operation possible.

TMC 3162 40 mA Output current sinking 0 to 75°C
TMC 3163 20 mA Output current sinking -55 to 125°C
TMC 3164 20 mA Output current sinking 0 to 75°C

- All memory elements are available in 14-lead flat packages or 14-lead dual in-line (plug-in) packages.

QUAD LINE DRIVERS FOR ADDRESSING MEMORY CELLS

HLTTTL Quad, 2-input, line and lamp drivers are now available from Transitron.

TNG 5611-5614 Quad, 2 input line driver.
TNG 5811-5814 Quad, 2 input lamp driver.

The quadruple line driver is especially useful in addressing the memory element or providing high fanout in other applications. These units are available in 14-lead FP or dual in-line package. Write for data.

TYPICAL WRITE & ACCESS TIMES

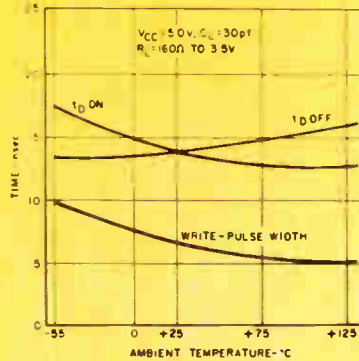

TYPICAL ADDRESS LINE THRESHOLD VOLTAGE LIMITS

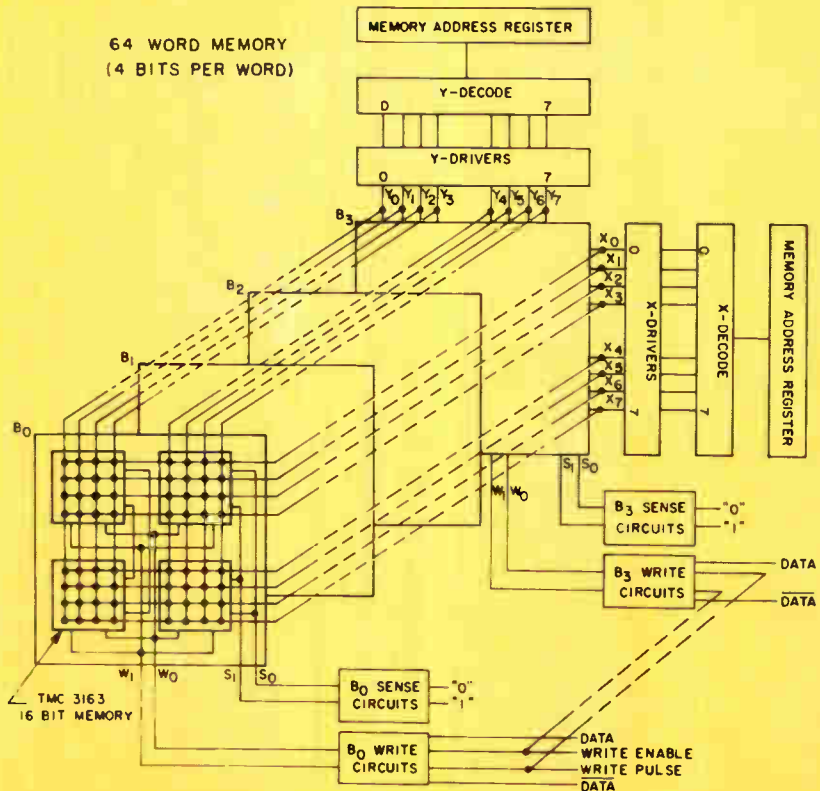
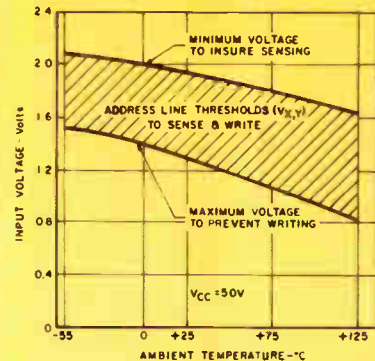

Write today for complete specifications and data on these new IC memory elements. Also, request literature on Transitron's full HLTTTL line.

Transitron
electronic corporation
Wakefield, Massachusetts

sibility, say ITT engineers, is a single diode and sensor mechanically rotating through 360°. Careful optical fanning of the beam might also be considered, but this would seem less desirable since part of the electro-optical system's advantage is narrow beamwidth.

The narrow beamwidth prevents interference between the transmitted and received signals and eliminates the need for frequency separation, such as required in secondary radar. Narrow beamwidth, coupled with high beam density, effectively rejects stray signals and maintains inherent system accuracy.

In addition to missiles, the ITT system could be effective in scoring miss-distance of bullets or any other painted projectile.

Various other uses are also possible. Because of its high accuracy, the electro-optical system might assist space docking and aircraft landings. The system might serve as a proximity fuse.

Computers

Faster Fourier

A new algorithm for Fourier analysis can reduce the computer time for performing the analysis by a factor of hundreds or thousands, which means that these problems can be solved in seconds instead of hours.

The new algorithm was worked out by James W. Cooley of the International Business Machines Corp. and John W. Tukey of the Bell Telephone Laboratories, and is included in a package of about 70 programs for the IBM 360.

With Fourier analysis, any function of time, such as a periodic but irregular voltage wave, can be expressed as a series of sines and cosines. The series can be infinite, but in any practical application only a finite number of terms in the series is used. The larger the number of terms, the closer the series approximates the desired function. To perform the analysis on a digital computer, the function must be

sampled at a number of points, the analysis performed at each point and the results added.

Many samples. If the function is sampled at n points, then at least n terms of the infinite series must be used in the analysis. Therefore the analysis must be carried out for n terms of the series at each of the n points, for a total of n^2 multiplications and additions. This is the classical approach that takes hours, even for a high-speed computer, for large values of n .

The Cooley-Tukey algorithm is a method of expanding an analysis at $n = 2$ points into an analysis at n points using only n operations. Then by carrying out the analysis for $n = 2$, and repeatedly doubling the value of n , an analysis at any arbitrarily large number of points can be obtained. The process can also be made to work if n is not a power of 2, but for practical applications the power of 2 is good enough. The number of points must be doubled $\log_2 n$ times to obtain the required value of n ; each doubling requires n operations; therefore the total number of operations is $n \log_2 n$. The ratio of improvement is $n^2 / (n \log_2 n) = n / \log_2 n$. If n is set arbitrarily at $2^{16} = 65,536$, then this ratio is $2^{16} / 16 = 4,096$; and if n^2 operations takes 10 hours, then the improved time is $10 / 4,096$ hours or about 10 seconds.

Space electronics

Resourceful satellite

The Interior Department, traditionally concerned with such matters as water resources and protection of the American Indian, has become the fourth civilian organization in the United States to have its own space program. The program is called Eros for earth resources observation satellite. Government officials explain that the word Eros is derived from the Greek, meaning to yearn for scientific knowledge and does not have anything to do with the Greek god of love.

Like two of its predecessors in space—the Communications Satellite Corp. and the Environmental Science Services Administration—the Interior Department will have the National Aeronautics and Space Administration launch the satellites.

Higher the better. The department has been working with the space agency for two years to determine just what satellites could do in the way of resources measurement and whether they could do it better than airplanes. NASA issued two study contracts to the department's Geological Survey—\$550,000 to study geology and hydrology from space and \$625,000 to study geography and cartography. The results indicated that only a satellite system could provide global observations at reasonable cost.

During this time NASA scientists weighed a resources satellite program of their own but could never get approval from their top management because of tight budgets.

The department's decision to take to satellites was announced last month by Interior Secretary Stewart L. Udall, who immediately named William T. Pecora, director of the Geological Survey, to head the project. Udall also hinted he would like other Federal agencies to share the project cost by pointing out how useful the satellite resources data would be. He specifically mentioned the Agriculture Department, which has a \$900,000 NASA contract to study how satellites could help it.

Potential. In discussing potential benefits of the satellite system, Pecora said it would cut the cost of updating topographic maps by \$100 million a year. He also listed such applications as assessing the health and distribution of crops, discovering mineral deposits associated with geological faults, warning of volcanic eruptions by discovering the slight swelling of the earth caused by lava and gases prior to an eruption, mapping the antarctic ice cap and spotting folds in the earth's crust that may contain petroleum deposits.

Pecora considers Eros an evolutionary program, beginning with a relatively simple satellite carrying a couple of television cameras and,

COMPONENT COMMENTS *From Speer*

If our JXP precision resistor is so superb, how come we're reluctant to discuss its reliability?



Because we don't want you to think of the JXP as a "high reliability" resistor.

It is one, of course. But the term in this case is a bit of an understatement (rather like describing the Grand Canyon as a hole in the ground.)

For the same reason, we'd just as soon that you didn't think of the JXP as a "military" resistor, despite its RN classification.

And even the term "metal film" fails to do justice to the JXP. Our Jeffers Electronics Division's metal film resistor has characteristics and performance capabilities that surpass the best of any resistor art, past or present.

How, then, should you think of the JXP? Simply as a "precision" resistor—because it's in this area of precision that our resistor can most clearly be seen to be in a class by itself.

The JXP gives you the highest precision at a reasonable cost, with tolerances down to 0.02% available upon request. But more than that, this extreme precision is arrived at deliberately, rather than by happy accident.

We manufacture the JXP under sophisticated "white room" conditions. We employ a fanatically tight system



of process and material controls. And we limit ourselves to a narrow population of resistor characteristics (25 PPM or less). So it's no wonder that our entire resistor output is identical in precision and stability. (In fact, any pair of JXPs can be matched, time and time again, to within 0.01% !)

We'd be delighted to send you complete information about our JXP precision resistor (including its military and reliability aspects—if you insist). Just mail us the coupon.

A patent attempt to win your admiration

Even though our various electronic components already offer excellent performance, this never seems to satisfy the restless individuals in our Research Laboratory. They're constantly developing new ways to improve both our products and our manufacturing processes.

During the last six months alone, Speer Carbon Company and Air Reduction Company (our parent) have been awarded a significant variety of patents—including: 3,227,983 (U.S.) for Stacked Resistors; 3,238,151 (U.S.) for Resistor Composition; 3,240,625 (U.S.) for Semiconductor Film Resistors; 727,273 (Canada) for a Method of Capping Film Resistors; 731,781 (Canada) for a Fluorescent Lamp Starter; 648,979 (Belgium) for Resistor Manufacture; 667,242 (Belgium) for Composition Resistors; and 49,129 (Luxembourg) for Composition Resistors.

We have no patent on mere excellence, of course. But when it comes to perfection . . . well, only time will tell.

We've even been distributing Distributors

In keeping with our basic policy of quicksilver service, we have been setting up a national network of Industrial Electronic Parts Distributors covering every major market area.

These men are hip-deep in both Speer carbon composition resistors and in Jeffers molded chokes. And both inventories, needless to say, offer the latest MIL and commercial specifications.

For the name of your helpful Speer Industrial Distributor, contact your Speer representative—or use the coupon.



JEFFERS ELECTRONICS DIVISION
SPEER CARBON COMPANY
DuBois, Pennsylvania 15801

Speer Carbon Co. is a Division of Air Reduction Company, Inc.

Send complete information on your JXP precision resistors.

Send the name of my helpful Speer Industrial Distributor.

Name _____

Title _____

Company _____

Street _____

City _____ State _____ Zip _____

Etch your own PC boards automatically!

(Less than five minutes
for one ounce copper.)



Shown
actual
size!

from this — to 11" x 14"

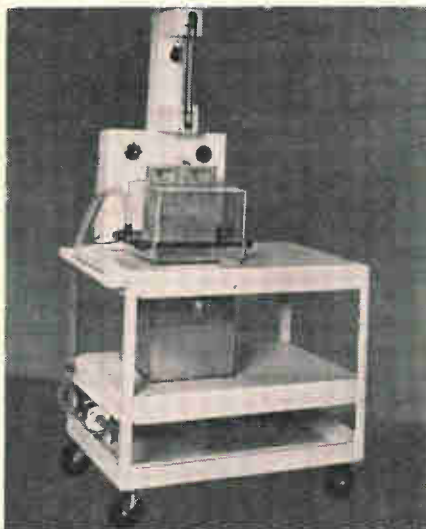

CYCLO-TRONICS "fine line" etcher

Pat. applied for

for prototypes—limited runs

No cooling or venting required!

Etches as fine as .001"!

Cuts costs in half—saves time!

Complete photo processing instructions!

Work is illuminated while etching!

No patterning . . . minimum undercutting!

Model No. 201 (illus.), etches two 11"x14"

one-sided boards **\$695**

NOW IN USE BY:

AMP, Inc./The Bendix Corp./Beta Corp., Sub. of Koppers Co., Inc./Charles Bruning Co., Div. of Addressograph Corp./The University of Chicago/University of Colorado/C. G. Conn, Ltd./Fab Tool, Inc./General Dynamics/Graduate Research Center of the Southwest/IBM Corp./Jordan Electronics, Div. of Victoreen Instrument Co./Lear Siegler, Inc./Micro Switch, Div. of Honeywell/Microwave Electronics Corp., Div. of Teledyne/Oklahoma State Univ./Sonotone Corp./Westronics/Woodward Governor Co.

Send for complete information

CYCLO-TRONICS, INC.

3858 N. CICERO—CHICAGO, ILL. 60641
TELEPHONE: (312)-282-6141

Electronics Review

if weight permits, a data-collection system to record environmental data. He envisions flying the first satellite in 1969. Total cost of launching the first craft will be \$20 million, he said.

William Fischer, research coordinator at the Geological Survey and the man directly responsible for the Eros project, explained that the satellite will carry two 2-inch vidicon camera systems. Each will have picture resolution of 4,000 lines, or good enough to distinguish objects on the ground smaller than 100 feet. The best performance to date has been the two Nimbus weather satellites' 1-inch vidicon systems, with their 800-line resolution that distinguishes objects a quarter-mile across. One of the Eros cameras will be sensitive to the red or near-infrared spectrum for the best viewing of vegetation; the other will operate in the green spectrum and primarily observe the ocean.

Call for bids. The next major step is to ask electronics and aerospace companies for bids on building the satellites. Present plans call for the satellite to resemble the successful Tiros weather craft—a definite advantage for the Radio Corp. of America's Astro-electronics division of Princeton, N.J. The division built that satellite for NASA and the Environmental Services agency and sent the space agency an unsolicited proposal for a similar earth-resources satellite built around the Tiros concept.

Since Eros will be an operational satellite—as opposed to a strictly research craft—all electronics will be within the present technology, Fischer emphasized. The satellites will be launched on improved versions of the workhorse Delta vehicle and will use the tracking stations of the space agency's Satellite Tracking and Data Acquisition Network, where Geological Survey personnel will gather and retransmit data.

When industry can expect a request for bids depends on how soon the department can find the money. The request could go out almost immediately if Udall decides to reprogram money for the project from the current fiscal year's bud-

get. But Fischer thinks the money will probably come from the budget to be submitted to Congress next January. In that case the request would not go out until after fiscal 1968 begins next July 1.

On the right track

Preliminary data from the Gemini 11 flight indicates that future spacecraft may be able to dock automatically by detecting the ion-electron wake of a spacecraft and centering on it.

In one experiment on the Sept. 13-16 flight three sensors mounted on the target docking adapter at the bow of the Agena measured the concentration of electrons and ions in the ionosphere. The Gemini was then maneuvered in five different modes ahead of the Agena to determine the effect of the craft's wake on the sensors.

Four of the sequences took place while Gemini was separated from the Agena and one was carried out at the apogee of the 800-mile orbit while the vehicles were docked.

"From the telemetered data we observed obvious wake effects," said David B. Medved of Electro-Optical Systems, Inc., Pasadena, Calif., which developed the sensors for the National Aeronautics and Space Administration. The company is a subsidiary of the Xerox Corp.

Tracking a man. Medved said the sensors even detected astronaut Richard Gordon Jr. during his walk in space, as charged particles stuck him and bounced into space. "When he was in a favorable position we could actually monitor his movements," Medved said.

He noted that the data could not be properly evaluated until it had been analyzed along with radar and photographic data from the flight. "However, the data seems good and we see no obstacle in using the wake as a way of achieving rendezvous."

The wake was measured by a comparison of the voltage and current relationships of the ion and electron particles as they moved through the sensor apertures onto

collecting plates or grids. Incoming signals were averaged by a processor aboard the Agena and fed to an analog-to-digital converter in the Agena telemetry system for real-time transmission.

Medved said the equilibrium electrostatic charge on Agena was also measured and found to be roughly -2 volts. He noted that some scientists had thought that the electrostatic charge might cause problems during docking.

During the powered space flight of the two docked vehicles the charge seemed to change to positive, he said, but declined to say what the voltage was.

Little nudge

Design techniques successfully tested in a new power conditioning and control unit are being used to develop what is expected to be the first ion engine for operational use. The power conditioner and control was part of a complete flight model electric propulsion system that recently made a record 1,183-hour vacuum test run at Electro-Optical Systems, Inc.

Johns Hopkins University's Applied Physics Laboratory in Scagsville, Md., is working on the design of a new satellite, believed to be a synchronous craft, for the Naval Air System Command. While no one will discuss details of the satellite, its mission or timetable, it is understood that the spacecraft will include two sets of ion engines to provide thrust at two levels—10 and 100 micropounds to keep the satellite on station.

Despite several successful flight tests and extensive ground tests with electric propulsion systems, the Pentagon and NASA have displayed slackening interest. This is particularly true for larger engines—with thrusts of thousandths of a pound—where neither agency feels it has any mission requirement at present. But activity has picked up somewhat in recent months on smaller engines, with thrusts of millionths of a pound, for attitude control and station-keeping of orbiting satellites.

Record run. Electro-Optical,

You're seeing sharper pictures today because of Duraperm pole tips



Taped show or live? Most people can't even guess which is which. Duraperm pole tips—produced to most exacting properties by Hamilton Precision Metals—faithfully record on tape many of your favorite programs, preserving sharp, clear pictures for pleasant viewing.

There are 7 proprietary metals, 112 commercial alloys and 12 pure metals now available. With expanded production facilities, Hamilton Precision Metals is now producing these metals *in quantity*. Strip and foil are available from 0.10" thick down to 0.000080" thin, and from 1/32" to 12" in width—wire in diameters from 0.1870" to as fine as 0.0010".

Check with Hamilton Precision Metals on your electronic metals requirements for precision strip, foil or wire. Write today for completely new brochure. It gives you complete information on our capabilities as well as detailed properties on over 100 metals.

HAMILTON PRECISION METALS

division of Hamilton Watch Company ■ Lancaster, Pa.

"Frankly, Jeff, we'd buy your system if it weren't for that X/Y recorder you specified. It's been around for years, and it's too unreliable for our job. Any other ideas?"

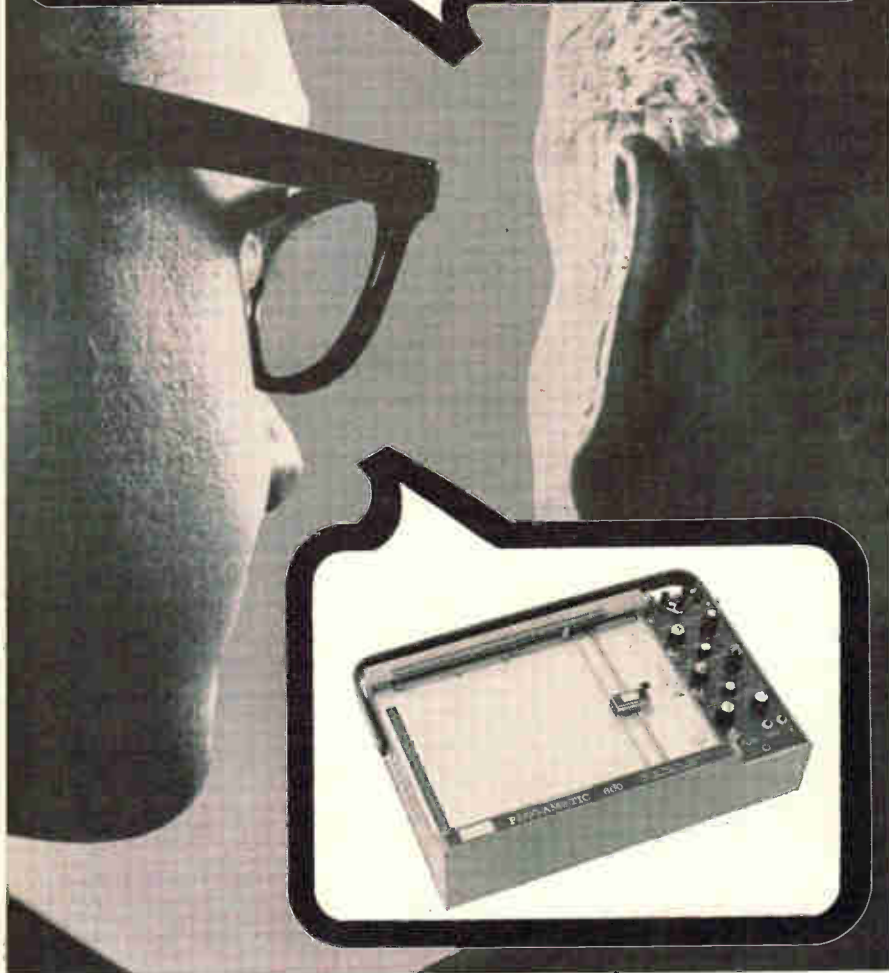

"If you like, Craig, I'll give you the system with the latest X/Y recorder on the market: The PLOTAMATIC® built by Bolt Beranek and Newman's Data Equipment Division. Other users swear by them. The PLOTAMATIC has a paper hold-down system that always works, never gets dirty, and yet allows you to adjust the paper for proper alignment after it's mounted. Input resistance is greater than one megohm, independent of gain setting. Accuracy and input versatility are as good as anything on the market, and you don't have to buy time base if you don't want it. No high voltages to produce RFI problems, either. Just between us, Craig, I think our people are in a rut with those X/Y recorders we've been using. They use them out of habit, and aren't up on the latest the market has to offer."

BBN's PLOTAMATIC line includes a variety of 8½" x 11" and 11" x 17" X/Y recorders for virtually every application. Keep up with the market—write us for a catalog.



BOLT BERANEK AND NEWMAN INC
 DATA EQUIPMENT DIVISION
 2126 SOUTH LYON ST., SANTA ANA, CALIF. 92705 (714) 546-5300

which was said to be designing and building the operational ion engines for the Applied Physics' satellite, ran the record test with a zero-G fuel feed, a beam neutralizer, a cesium contact engine and the power conditioner and controls. The power subsystem, however, ran for a total of 3,000 hours without failure before the company shut down the test. This included 1,814 hours with an ion engine simulator—or dummy load.

John Davis, manager of electric power systems at Electro-Optical, spelled out the test's significance: "Reliability, compatibility and weight of the power conditioner and electronic circuitry previously have been considered the main stumbling blocks to the use of electric propulsion on actual space missions."

Power unit weight was reduced to about 35 pounds, a power-to-weight ratio of 12 pounds per kilowatt. This furnishes three times the power at ½ the weight of the power equipment in earlier ballistic flight test versions, he says. The power-weight ratio is also 33% less than the 18-pound-per-kilowatt goal required for the test by the customer, the Air Force Aero Propulsion Laboratory, Wright-Patterson Air Force Base, Ohio.

The electronic subsystem and all circuitry is compatible with automatic operation of the thruster and fuel systems, and the test showed that such a system can run continually for two years, Davis says. The company has already operated ion engines "considerably in excess of 5,000 hours," he adds.

Redundancy. The power conditioner and control unit converted 56 volts of d-c input to the five different a-c and d-c power levels needed to operate the engine. Providing the power in space to run the engine at 5-millipounds thrust would require a 1,200-watt solar cell array. The power system was designed for a 3,000-watt system, but Davis doesn't feel that running it 50% derated subtracted from the significance of the test. "I don't think running it at 3 kw would cause less reliability," he maintains.

All system electronics were ex-

posed to the vacuum so that volatile materials from potting compounds would not contaminate the circuits. And no electronics were sealed in pressurized containers. Sealing is the best way to eliminate high-voltage breakdown, Davis says, but it is hard to maintain pressures for long periods.

Remove gases. All circuits also were baked at about 100° C for a couple of days, to remove any gases or impurities.

By designing in switching transistors operating at 10 kilohertz, the company eliminated iron-core magnetic amplifier units and reduced over-all power conditioner weight by 25%.

Electro-Optical also furnished some circuit redundancy. Parts more likely to fail—or about 25% of the total—were duplicated in the system. But this circuit redundancy was not needed in the 3,000-hour test, Davis notes.

The engine uses liquid cesium for fuel that is vaporized and forced through hot porous tungsten. This strips an electron from the cesium to supply ions. Electric fields accelerate and eject these electrically charged particles out of the engine to provide thrust.

Electronics notes

- **Super gyro.** All major parts of a super-accurate gyroscope now under development for the Navy will be made of ceramic. In Norwood, Mass., the precision products department of Nortronics, a division of the Northrop Corp., is working on an inertial navigation gyro for the next generation of missile-carrying nuclear submarines. It is intended for use in the ship's inertial navigation system. Precision fabrication techniques include metal to ceramic brazing, ion sputtering of metals on ceramic and machining of ceramic gas spin bearings. In a parallel program at North American Aviation, Inc.'s Autonetics division, engineers are exploring approaches to a super-accurate gyro.

- **More traffic control.** San Jose, Calif.'s three-year-old experiment

basic measuring tools from

**HEWLETT
PACKARD**



Field-proven hp 3400A RMS Voltmeter

Measure true rms value, 100 μ v to 300 v, 10 Hz to 10 MHz

Accuracy is $\pm 1\%$ full scale

High crest factor for accurate pulse, noise measurement

DC output 1 v at full scale

High maximum input, 1000 v peak

Use it to:

Measure level of noise with a crest factor of 100

Measure rms value of pulse trains

Measure true rms current, using hp 456A Current Probe

Make frequency response tests

Convert ac to dc for recorder or DVM operation

The Hewlett-Packard 3400A RMS Voltmeter measures the actual root mean square of ac voltages which are sinusoidal or nonsinusoidal and have crest factors (ratio of peak to rms) as high as 10 at full-scale deflection and as high as 100 at 10% of full scale. Overload protection to 30 db or 1000 v peak, whichever is less, on each range. Input resistance 10 megohms. Scale calibrated in both rms volts and db, the latter permitting

measurement -72 to $+52$ dbm. Price 3400A, \$525; Option 01 (db scale uppermost for better resolution), \$550.

Call your Hewlett-Packard field engineer for a demonstration of the 3400A or write for complete specifications: Hewlett-Packard, Palo Alto, Calif. 94304, Tel. (415) 326-7000; Europe: 54 Route des Acacias, Geneva.

Data subject to change without notice. Prices f.o.b. factory.

HEWLETT  **PACKARD**
An extra measure of quality

1044



Did You Know Sprague Makes 32 Types of Foil Tantalum Capacitors?

125 C TUBULAR TANTALEX® CAPACITORS



- Type 120D polarized plain-foil
- Type 121D non-polarized plain-foil
- Type 122D polarized etched-foil
- Type 123D non-polarized etched-foil

ASK FOR BULLETIN 3602C

Circle 332 on reader service card

85 C TUBULAR TANTALEX® CAPACITORS



- Type 110D polarized plain-foil
- Type 111D non-polarized plain-foil
- Type 112D polarized etched-foil
- Type 113D non-polarized etched-foil

ASK FOR BULLETIN 3601C

Circle 333 on reader service card

RECTANGULAR TANTALEX® CAPACITORS



- Type 300D polarized plain-foil
- Type 301D non-polarized plain-foil
- Type 302D polarized etched-foil
- Type 303D non-polarized etched-foil

ASK FOR BULLETIN 3650

Circle 334 on reader service card

TUBULAR TANTALUM CAPACITORS TO MIL-C-3965C



- CL20, CL21 125 C polarized etched-foil
- CL22, CL23 125 C non-polarized etched-foil
- CL24, CL25 85 C polarized etched-foil
- CL26, CL27 85 C non-polarized etched-foil
- CL30, CL31 125 C polarized plain-foil
- CL32, CL33 125 C non-polarized plain-foil
- CL34, CL35 85 C polarized plain-foil
- CL36, CL37 85 C non-polarized plain-foil

Circle 335 on reader service card

RECTANGULAR TANTALUM CAPACITORS TO MIL-C-3965C



- CL51 polarized plain-foil
- CL52 non-polarized plain-foil
- CL53 polarized etched-foil
- CL54 non-polarized etched-foil

Circle 336 on reader service card

For comprehensive engineering bulletins on the capacitor types in which you are interested, write to:

Technical Literature Service
Sprague Electric Company
35 Marshall Street
North Adams, Mass. 01248

45C-5161



Sprague and ® are registered trademarks of the Sprague Electric Co.

to control its traffic by a central digital computer has been so successful that it is ordering an International Business Machines Corp. data-acquisition and control system. The \$200,000 system, due in November, will replace an older and more expensive IBM 1710 which has been on loan from the company [Electronics, Nov. 29, 1965 p. 30]. Initially, 59 traffic signals in the city of 365,000 will be tied directly to the computer but this number will be gradually increased to include many of San Jose's 235 signals. IBM's approach to traffic control is also finding favor in Wichita Falls, Texas. That city of about 102,000 is installing an IBM 1800 for traffic control.

▪ **Homegrown.** The Autonetics division of North American Aviation, Inc., has decided to use its own inertial navigators, multimode radars and signal converters in the Mark II avionics systems it is developing for the F-111A tactical fighter and FB-111 strategic bomber under an initial \$40-million contract.

▪ **In the vanguard.** Industrial customers of Texas Instruments Incorporated's Semiconductor division will soon be able to get advice about applications at their doorsteps. It is outfitting a 25-foot-long trailer with a variety of equipment and a large stock of semiconductors for trips to plants between Detroit and Minneapolis.

▪ **Sold American.** The tactical air navigation equipment that the Hoffman Electronics Corp. developed with its own funds and then sold to the British government for the Phantom aircraft will also be going on the United States Air Force's C-5A transport. The award, amounting to more than \$3 million for 58 aircraft, was announced by the prime contractor, the Lockheed Aircraft Corp.'s Georgia division.

▪ **Water watch.** Thirty-eight water-quality monitoring systems are being supplied by Honeywell, Inc., to the U.S. Geologic Survey. The systems, to be installed along 12 rivers, will be able to monitor automatically as many as 10 water-quality parameters, including temperature, conductivity, dissolved oxygen, chlorides and acidity.

Circle 322 on reader service card →

Technical
Abstracts
on
Record / Reproduce
Systems

SATELLITE

ASW

SURVEILLANCE

APOLLO

CONTROL, CONTROLS DIVISION 717 NORTH CONEY AVENUE AZUSA, CALIFORNIA TELE: (213) 334-8211

we wrote the book

And a free copy is available for you. It's all about the development of magnetic tape recording systems. Write or phone: Leach Corporation, Controls Division, 1123 Wilshire Blvd., Dept. E-10, Los Angeles, California 90017, Phone (213) 482-0794. **LEACH**

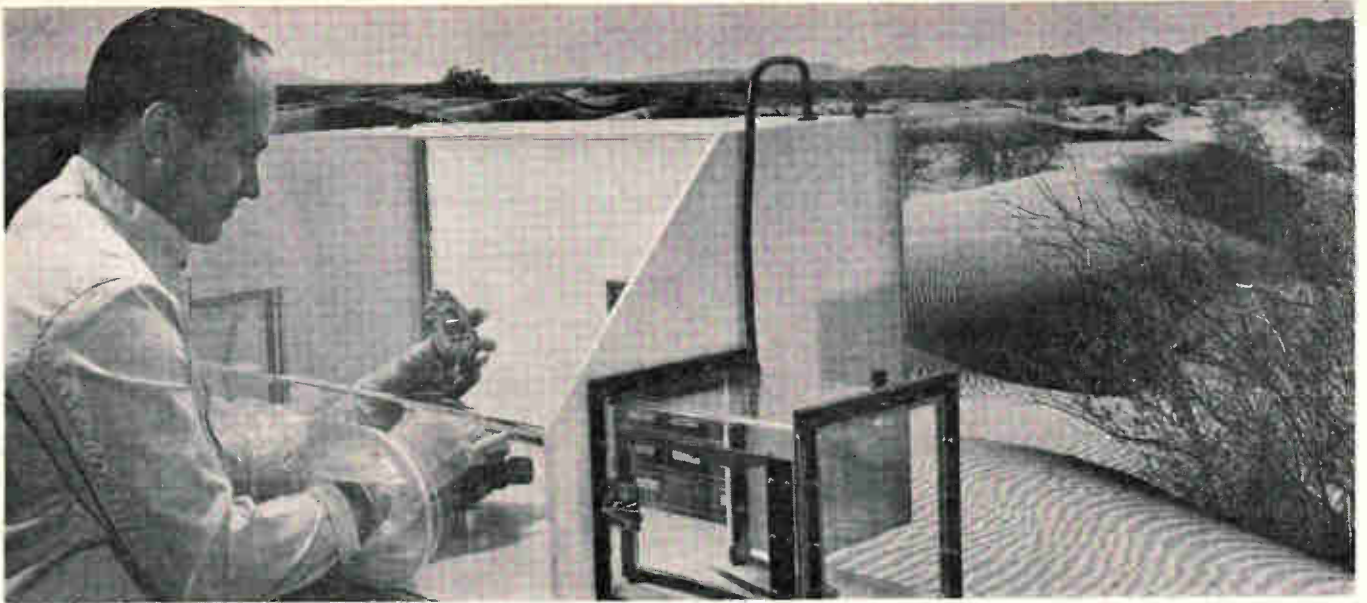

JUST HOW DRY IS A DRY BOX?

When it comes to atmospheric pressure sampling, experienced buyers are coming to CEC. Particularly manufacturers of semiconductors and hermetically sealed parts who must maintain strict moisture control during fabrication.

For they have discovered that CEC makes the moisture monitors which can consistently supply the *precise* answer. Namely—the 26-303ME and the 26-304ME.

The reason for these instruments' superiority is primarily due to the advantages of CEC's *Electrolytic Cell*. This unique cell has greater accuracy at low levels than any other, twice the life, and cannot become shorted by prolonged storage or disuse. Furthermore, the CEC Electrolytic Cell uses glass-supported electrodes, is potted for impact resistance, and is replaceable in seconds without tools.

These instruments are manufactured specifically for use with dry boxes. They feature a built-in vacuum pump, and therefore do not require positive pressure for sampling.

Now meet the stars:

26-303ME Portable Laboratory Moisture Monitor. This is the finest laboratory-quality moisture monitor designed for industry—yet it sells for *less* than any other comparable moisture measuring instrument.

Ask a CEC Moisture Monitor



Performance: Continuously measures 1-1000 ppm water in gas. Fast response—immediate recovery • Accuracy better than 5%.

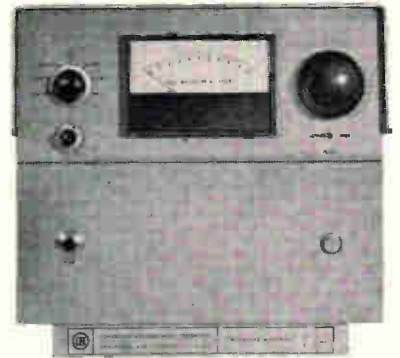

26-304ME Hydrogen Moisture Monitor. Especially designed for the continuous measurement of water in hydrogen- or oxygen-rich gas streams, it uses the error-proof CEC Delta Flow principle. **Performance:** Range 1-1000 ppm with a gas flow rate of 20 cc/min. • Accuracy 5% of full scale for any attenuator setting.

For all the facts about the complete CEC Moisture Monitor line, call or write for CEC Bulletin Kit 9042-X6.

Also available upon request—the booklet, "Moisture Monitor Hints," which covers moisture detection problems and how to solve them.

CEC

Analytical & Control Division

CONSOLIDATED ELECTRODYNAMICS

A SUBSIDIARY OF BELL & HOWELL/PASADENA, CALIF. 91109
INTERNATIONAL SUBSIDIARIES: WOKING, SURREY, ENGLAND
AND FRIEDBERG (HESSSEN), W. GERMANY

At Bendix... when FLEXPRI[®]NT Circuitry goes in

cost goes down 30%

You can hear the same story from many different companies.

In this case . . . it's Bendix. Their engineers specified a 4-layer set of Sanders FLEXPRI[®]NT Circuitry containing 70 conductors to interconnect 4 subminiature pin-and-socket connectors and various modules in their APN 141 radar altimeter. The result? A 30% lower installed wiring cost and greater reliability for this high performance equipment.

The reliability comes from the way Sanders produces FLEXPRI[®]NT Circuitry. No matter what the configuration or how many reproductions of it you might need, you can always bank on exact circuit repeatability pattern after pattern . . . circuit after circuit.

Strict manufacturing tolerances are also one of the basic reasons why you should specify Sanders FLEXPRI[®]NT Circuitry no matter what the quantity. The Bendix people required each one of their 4-layer FLEXPRI[®]NT Circuits to be produced within $\pm .005"$.

No problem! Made of DuPont Kapton[®] for superior dimensional stability, Sanders produced thousands of these special circuits with no deviation in tolerance limitations. That's reliability in volume.

Because Sanders FLEXPRI[®]NT Circuitry replaces old fashioned wiring techniques, you save the costly, time consuming jobs of wire cutting, stripping, tinning, soldering and lacing.

To learn just how much money you can save with Sanders FLEXPRI[®]NT Circuitry or if you have an unusual wire/space problem, call Sanders Associates, Inc. Our representatives cover the country and are fully qualified to give you complete engineering assistance on Sanders FLEXPRI[®]NT Circuitry, FLEXMAX flexible multilayer circuitry or INTRAMAX^{*} multilayer hardboard. For detailed information call or write Sanders Associates, Inc., FLEXPRI[®]NT Products Division, Nashua, New Hampshire 03060. Phone: 603-883-3321.

SANDERS ASSOCIATES, INC.
FLEXPRI[®]NT PRODUCTS DIVISION



Creating New Directions in Electronics



Round Trip Ticket

What more can we say about relay reliability. In the strange environs of space, warranty can be a pretty empty word. We like "integrity" better...a projectable promise backed by the relay industry's most comprehensive quality assurance program.

Babcock's tenure in space began with the earliest satellites under mission-critical conditions, progressed through the life-critical missions of Mercury and Gemini, and continues now with Apollo. This is not only experience and capability...this is responsibility.

To illustrate, let's look at Apollo—from the ground up.



Transistor Can.
SATURN IC stage



10 amp., Crystal
Can. Latching &
Non-Latching
SATURN II &
IVB stages

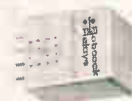

10 amp., 4 PDT
Latching &
Non-Latching
APOLLO
service module



1/2-Size, Latching
and Non-Latching,
APOLLO
command module

Each of these units has its own pedigree, and is produced on our own "TLC" line with Tender Loving Care. Each is the result of close customer liaison and application assistance. Each is the finest, most reliable relay of its type in the world.

Get acquainted with Babcock...our service and the complete Babcock line of high reliability and general purpose relays. Write Babcock Relays, Division of Babcock Electronics Corp., 3501 Harbor Blvd., Costa Mesa, Calif.; (714) 540-1234.



SITUATION WANTED



Young trimming potentiometer seeks small ($\frac{3}{8}$ " opening in electronics firm. Accurate, dependable worker. Good background. Will accept low pay for chance to prove ability and help company grow.

Hire Helipot's $\frac{3}{8}$ " cermet trimmer for the jobs too tough for wirewounds

Got a big job for a small, square trimmer? Sign up the new Helipot® Model 63P trimming potentiometer. Smallest of its class in size and price, the tough little 63P offers essentially infinite resolution, with ruggedness and reliability twice as high as you'd expect.

No wonder. Beneath its sealed $\frac{3}{8}$ " x $\frac{3}{8}$ " x $\frac{3}{8}$ " molded plastic housing, the 63P has a heart of cermet. No other resistance element can match its combination of high power rating, essentially infinite resolution, freedom from sudden failure, resistance stability, and wide 10 ohm to 2 megohm resistance range. Wirewounds or carbon won't even come close.

References? This new trimmer just graduated from Helipot. It's been thoroughly checked out and tested again and again.

It meets or exceeds requirements of MIL-R-22097B. We'll vouch for it... and so will you, once you've tried it. Send now for full details, or ask a Helipot sales rep to introduce you.

RESUME

GENERAL

Ambient temp. -65 to +150°C
Power rating, watts... 0.5 at 85°C, derating to 0 at 150°C
Adjustment turns, nominal..... 20

ELECTRICAL

Standard res. range, ohms..... 10 to 2 meg.
Resistance tolerance $\pm 20\%$
Resolution essentially infinite

MECHANICAL

Stop..... clutch action, both ends
Starting torque, max..... 5.0 oz-in.
Weight, approx. 1 gm.

Beckman®

INSTRUMENTS, INC.

HELIPOT DIVISION

FULLERTON, CALIFORNIA • 92634

INTERNATIONAL SUBSIDIARIES: GENEVA; MUNICH; GLENROTHES, SCOTLAND; TOKYO; PARIS; CAPETOWN; LONDON; MEXICO CITY

What drives design engineers wild?



Faulty electronic connectors. They are a nuisance to any circuit design engineer and there's no reason why you should tolerate such aggravation any longer.

Switch to CAMBION® *cage-type* jacks and forget about uncertain reliability. Your circuit interconnections are practically fail-safe . . . even in severe environments of high humidity, vibration, shock and contaminated air.

CAMBION's own "wear out" tests performed under applied current and simulated environmental conditions show no significant difference in contact resistance after as many as 40,000 insertion/extraction cycles.

Take a close look at a CAMBION *cage-type* jack and you'll see the reason. Three beryllium-copper spring leaves curve inwardly and are shaped to distribute a firm contact pressure over a large surface area. You get full pressure contact with up to 70% of the plug circumference as compared with 5% or 10% in competitive connectors.

To meet the growing demand for modern, miniaturized and airborne electronic equipment, CAMBION *cage-type* jacks

and matching plugs are available in .025-.040- and .080 inch sizes along with hundreds of other standard sizes and shapes each carefully engineered for quick, tight, space-saving connections. Because CAMBION connectors meet common millimeter and decimal measurements, they are compatible with engineering requirements throughout the world.

Restore your equanimity. Specify CAMBION connectors. They're guaranteed for dependable performance and they're available from stock. Our new Catalog #700 including supplement is packed with facts. Write for your free copy today. Cambridge Thermionic Corporation, 401 Concord Avenue, Cambridge, Massachusetts 02138. Phone: (617) 876-2800. In Los Angeles, at 8703 La Tijera Boulevard 90045. Phone: (213) 776-0472.

©REG. U.S. PAT. OFF.

CAMBRIDGE THERMIONIC CORPORATION
CAMBION®

Standardize on CAMBION . . . 21,541 guaranteed electronic components

A BILLION STANDARD POTS AND TRIMMERS?

(well, would you believe 211,209,077?)

Of course a number like two hundred million needs explaining. But if you study the Spectrol Catalog and count up such options as mountings, gangable combinations, resistance values, terminal variations, and other available features, you will find that Spectrol offers you 211,209,077 standard potentiometers and trimmers to choose from. But even as one of the industry's leading sources for "standards,"

Spectrol still maintains technical leadership in the design and production of "specials." And, the Spectrol double-edged capability doesn't stop there. For no one else can offer you a broader series of miniature rotary selector switches designed for direct printed-circuit-board application, or more accurate, more readable turns-counting dials.

Still don't believe? Sorry about that. But make your own count. Write for a Spectrol Catalog... or pick one up at our Wescon Booth 1201-1202.

Spectrol Electronics Corporation
17070 East Gale Avenue
City of Industry, Calif. 91745

spectrol

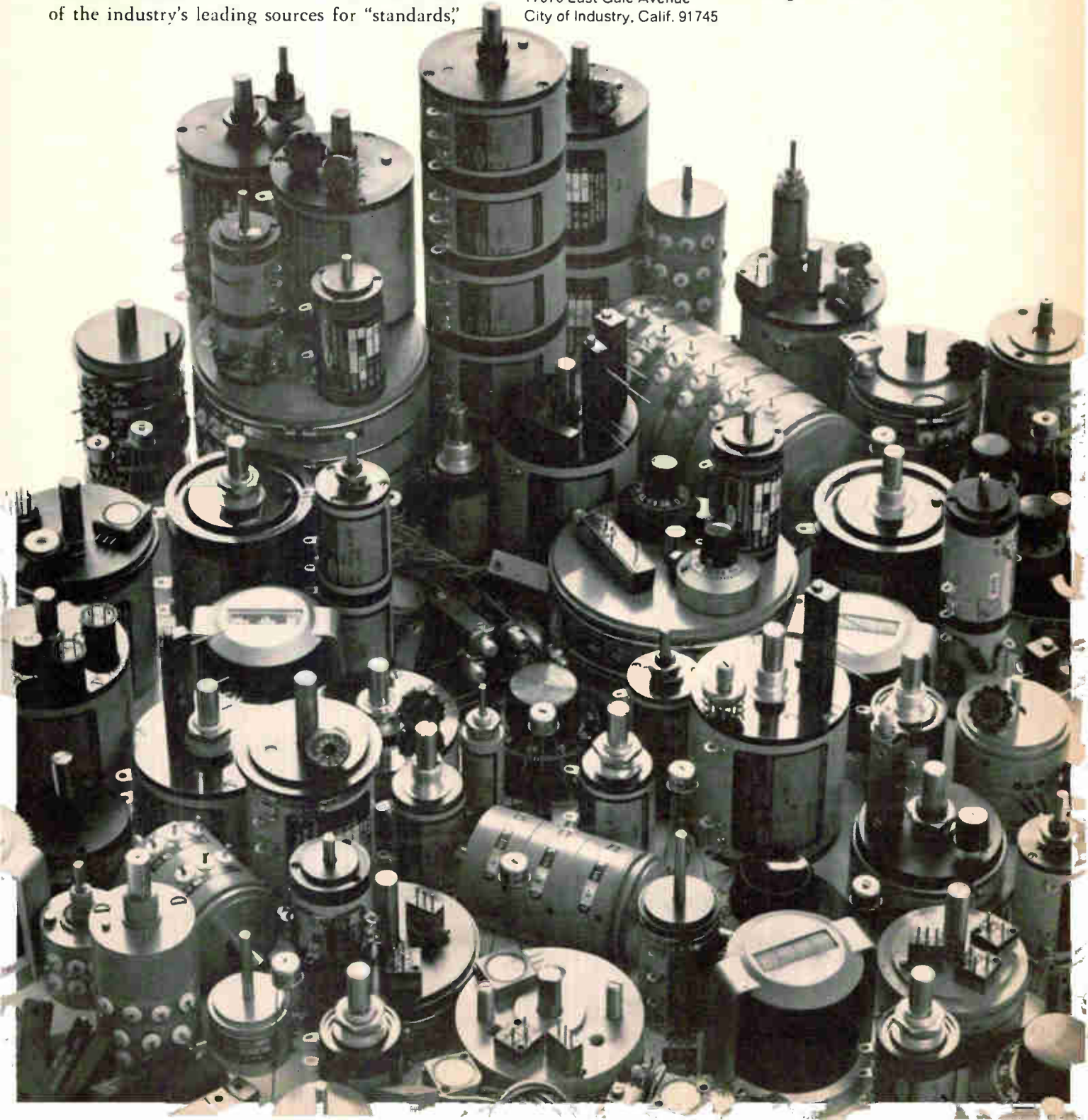



Data Display Devices from Raytheon

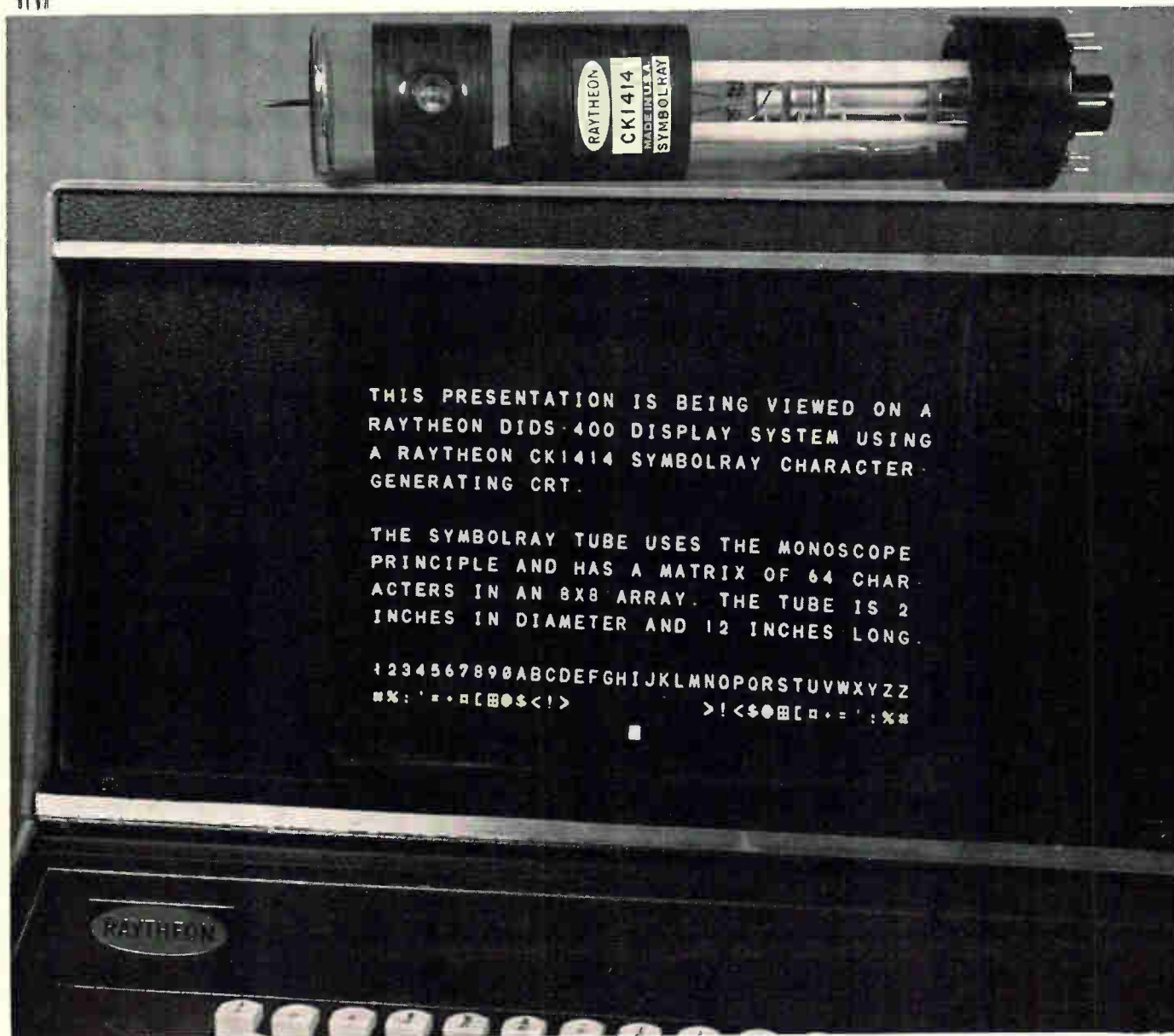

The presentation you see above was generated by a Symbolray* Cathode Ray Tube identical to the one lying on the console. A new type of monoscope, the Symbolray can generate alphanumeric characters from electrical signals for cathode-ray display or for hard copy print-out. The presentation here is shown on a Raytheon tube (CK1415) used in a Raytheon DIDS-400 display system.

An economical method of generating characters. Priced at less than \$100 in quantities of 1,000, the Symbolray provides a more economical method of generating

electronic displays than using large numbers of circuit cards.

The output of the Symbolray operating as a monoscope is obtained by electrically deflecting the electron beam to desired characters on the target and scanning them sequentially with small raster. The display cathode ray tube on which this output is viewed is scanned in synchronism. When the Symbolray method is used in conjunction with buffer-memory techniques, full messages can be displayed—as shown above. The Symbolray tube uses electrostatic deflection and

focus, and is available in designs with 64 and 96 character matrices.

Raytheon's wide range of Data-ray* CRTs cover the screen sizes from 7 to 24". Electrostatic, magnetic and combination deflection types are available for writing alphanumeric characters while raster scanning. Raytheon also offers combination deflection or "diddle plate" types and all standard phosphors. Or, Raytheon can meet your special CRT design requirements.

For more information—or a demonstration—call or write your Raytheon regional sales office.



New Raytheon Projectoray* Tube produces more than double the light output of standard projection-type cathode ray tubes. The tube's light output is 38,000-foot lamberts, which results in a light level of 15-foot lamberts on a 6' x 8' lenticular screen.

The tube's expected minimum operating life is 500 hours — 20 times the life of a standard projection tube.

The Projectoray's high light output and long life are due to its novel design. The design incorporates liquid cooling of the phosphor backplate. This allows the phosphor to be energized with a very intense electron beam. At high beam levels, very high peak light output is obtained. The light image is projected through a 5" optical window in the face of the tube. The electron gun is set at an angle to the phosphor and the deflection system compensates for keystone effects.

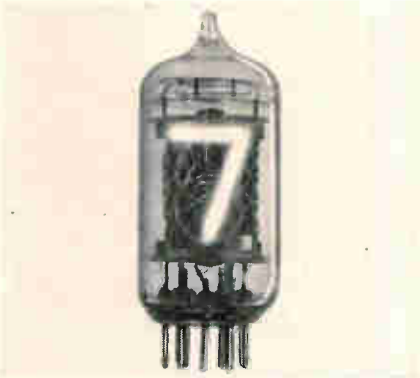

Datavue* Side-View Tubes. New Type CK8650, with numerals close to the front, permits wide-angle viewing. These side-view, in-line visual readout tubes display single numerals 0 through 9 or preselected symbols such as + and — signs. Their 5/8"-high characters are easily read from a distance of 30 feet. Less than \$5 each in 500 lots, they also cost less to use because the bezel and filter assembly can be eliminated and because their mating sockets are inexpensive.



Datastrobe* EM7 Readout Subsystem can display up to 60 messages (in characters, symbols, and schematics) at a cost of less than \$5 per message, when purchased in production quantities.

These messages can be one line of eight to ten characters, two lines of 40 characters, or three lines of 105 characters. A typical display area measures 1/2" high by 2 3/4" wide. Model EM8 Datastrobe has twice the display capacity — can display 120 messages, either singly or two messages simultaneously. Other formats are easily accommodated.

A complete digital readout subsystem compatible with integrated circuits, the Datastrobe includes decoding, driving and display functions.

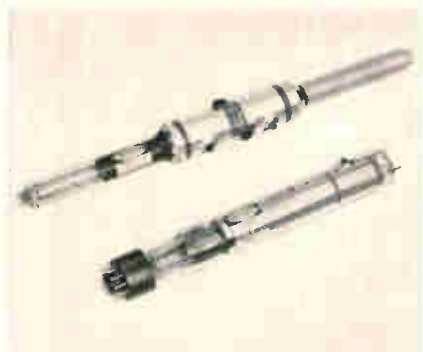

Recording Storage Tubes. The miniature tubes shown here are Raytheon's single-gun (CK1516) and dual-gun (CK1519). They provide high resolution, long storage, and fast erase capability.

Raytheon electronic input-output storage devices feature the above capabilities and immediate readout. Information can be written and stored by sequential techniques or by random-access writing. Complete, gradual or selective erasure is possible.

Raytheon storage tubes are readily available for applications in radar scan conversion, slow-down video, signal processing, signal enhancement, time delay, and stop motion.



Datavue* End-View Tubes. These tubes are easily read in high ambient light — do not wash out like other displays. Erroneous readings due to segment failure do **not** occur because the characters are fully formed. Raytheon Datavue End-View Tubes fit existing sockets and conform to EIA ratings. Models include round (CK8421) and rectangular (CK8422). Ultra-long-life types are designed for 200,000 hours or more of dynamic operation.



Send Reader Service Card for literature on the:

Symbolray CRT	486
Projectoray CRT	487
Recording Storage Tubes	488
Datastrobe Readout Subsystem	489
Datavue Indicator Tubes	490
Dataray CRTs	491

Or call your Raytheon regional sales office. Or write to Raytheon Company, Components Division, 141 Spring Street, Lexington, Mass. 02173.

*Trademark of Raytheon Company



Raytheon Components Division — A single source for Transistors/Diodes/Integrated Circuits/Industrial Tubes/Control Knobs/Panel Hardware/Raysistors/Circuit Modules/Display Devices

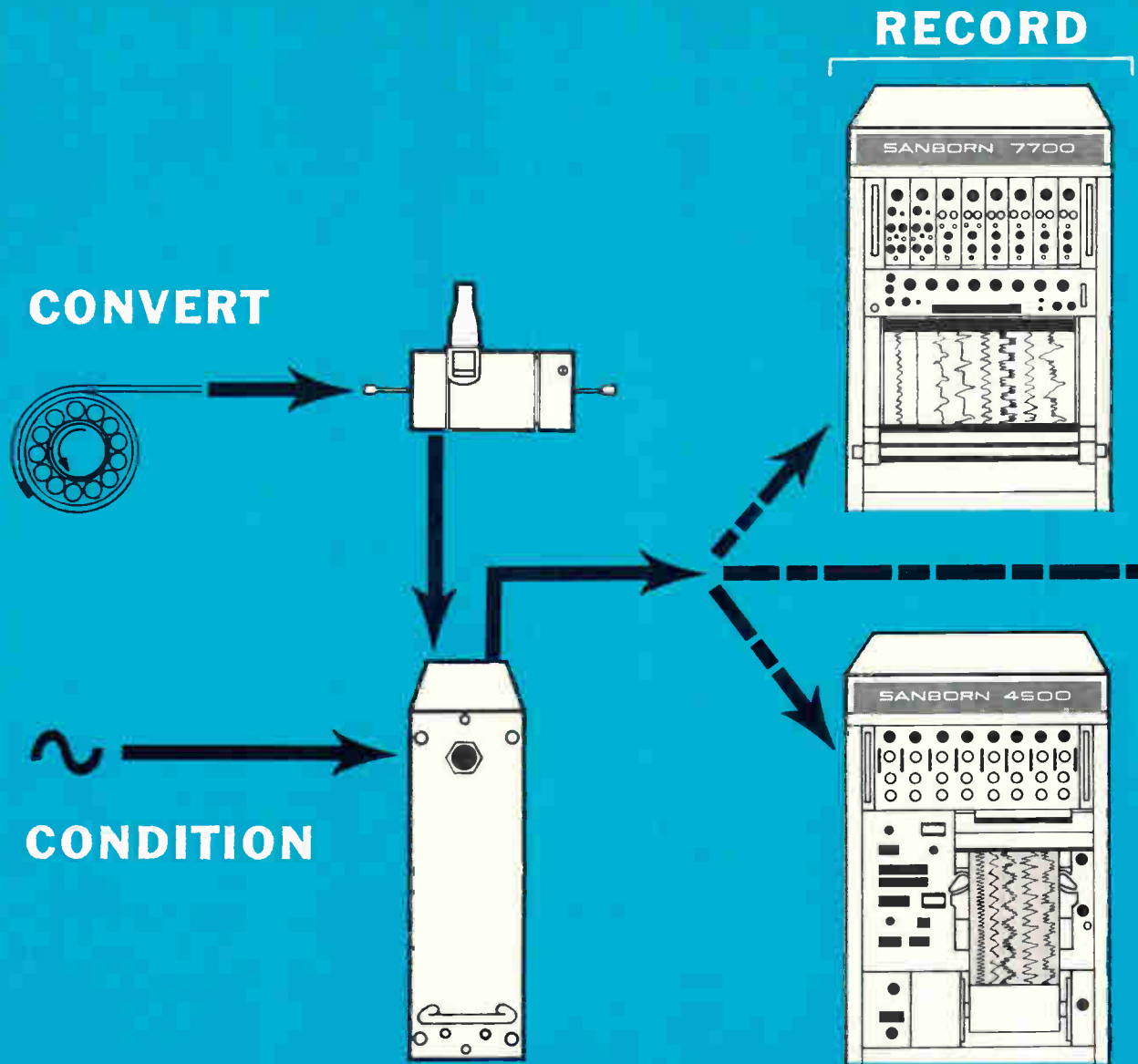

Put your data in the form most useful to you

Reliable Sanborn instrumentation puts your data in the form most useful to you, with minimum set-up time and simple, straightforward operating control. Only a few of the many possible functions and versatile variations of these compatible instruments are shown here—for measurement and data handling applications in scientific and industrial research, production and environmental testing, quality control, communications, telemetry and process control.

To translate and signal-condition variables, Sanborn makes a wide range of compact, low-cost linear motion, velocity, pressure and force transducers of the differential transformer type . . . wideband and narrow band dc data amplifiers with floating inputs isolated from floating outputs . . . and individual signal conditioners,

for use in Sanborn systems or as unit amplifiers to drive scopes, meters, etc., in general purpose dc, carrier, phase-sensitive demodulator, logarithmic, high gain, frequency meter, frequency deviation and accelerometer types.

To get clear, permanent proof of dc to 150 cps test or measurement results in graphic, analog form—with rectangular coordinate traces of 4 cycles/mm resolution even at small amplitudes—Sanborn thermal writing oscillographs give you complete freedom of choice in number of channels, signal conditioning flexibility, packaging and price. Wide choice of plug-in signal conditioners equip any channel to your specific inputs . . . or when individual-channel flexibility is not needed (e.g., up to 8 channels of strain gage or low level DC signals), systems can be equipped with low cost 8-

amplifier-channel modules on a single chassis. Systems range from portable 100 mm wide chart single-channel models to 6- and 8-channel systems with all-solid-state plug-in signal conditioners. Most have response range from dc to 150 cps within 3 db, at 10 div p-p. Max. sensitivity depends on signal conditioner used, can be as high as 1 uv/div. Two chart speeds in 1-channel systems, four in dual-channel systems, nine in 4- to 8-channel systems (all electrically controlled, except dual-channel systems).

For immediate readout of dc to 5 kc signals, high frequency optical oscillographs provide up to 25 channels of precise traces on 8" ultraviolet-sensitive charts, with one set of galvanometers. Choice of four types of 8-channel amplifier modules allows recording sensitivities from 500 uv/inch to 500 mv/inch; optional plug-in permits sys-

STORE

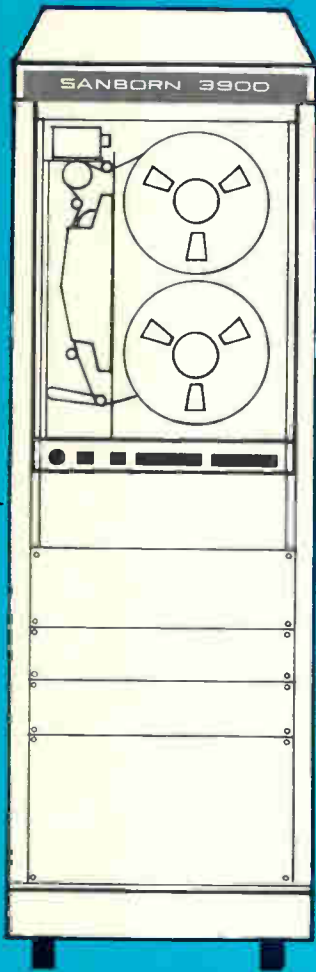

DISPLAY

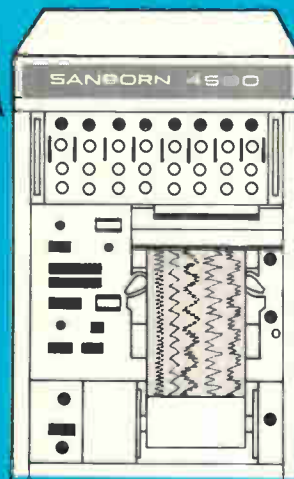
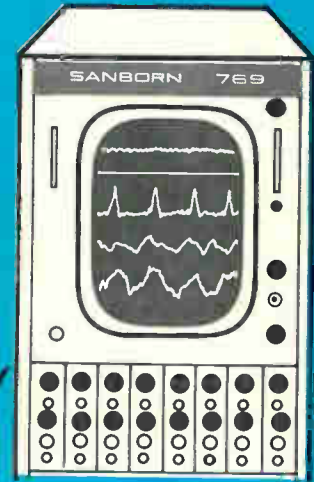
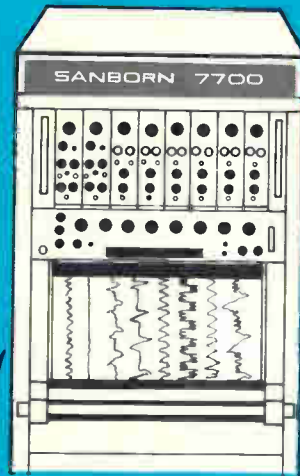

... see Sanborn

Circle 65 on reader service card

tem to drive 3900 Series tape recorders; front panel controls position traces anywhere on chart without mechanical positioning of galvanometer; traces may overlap and occupy full chart width. Paper loading in normal room light, full development a few seconds after exposure, permanency by chemical fixing if desired, and nine paper speeds from 0.25 to 100 inches/sec are additional features of these new 4500 Series optical oscillographs. Complete 8-channel systems from \$6950.

To store data from dc to 250 kc in its original electrical form and play it back with the time base expanded or compressed by ratios as high as 32:1 — on a scope, graphic recorder or numerical readout — new 3900 Series Tape Systems offer IRIG-compatible instrumentation performance at substantial savings. System prices from \$8900 (7-chan-

nel) to \$13,370 (14-channel). All have unique new H-P transport of simple design with high, maintenance-free reliability . . . 6 electrical speeds with no capstan change . . . 40 db or better S/N ratio, 0.2% p-p flutter (0-1 kc, 30 & 60 ips) . . . all-solid-state plug-in electronics, with record and reproduce amplifiers on the same cards . . . integral footage counter accurate to 99.95% . . . easy snap-on reel loading . . . console, rack or portable case housing. Bandwidths available are (at 60 ips) Direct: 100-100,000 cps. Std., 100-250,000 cps Wideband; FM: 0-10,000 cps Std., 0-20,000 cps Wideband. Low-cost 4-channel 1/4" tape systems also available with different transport, same electronics, portable case packaging.

To display variables under investigation — in analog or numerical form — Sanborn 760 Series scopes present up to eight bril-

liant traces simultaneously on a long-persistence 17" screen, allow positioning and amplitude adjustment of individual traces . . . and compact new 5601A Numerical Readout displays three 0.6"-high illuminated numerals and decimal point in each of four channels, with adjustable sampling rate, flashing decimal point for rate display, and capability of driving H-P 562A Digital Recorder for print-out.

Call your local Hewlett-Packard Sales Engineer for specifications and expert application help on any of these Sanborn instruments, or write: Hewlett-Packard, Sanborn Division, 175 Wyman Street, Waltham, Mass. 02154

**HEWLETT
PACKARD**  **SANBORN
DIVISION**

FIRST SOLID STATE SIGNAL GENERATOR

*Immediate
Delivery*

2002 SOLID STATE SIGNAL GENERATOR

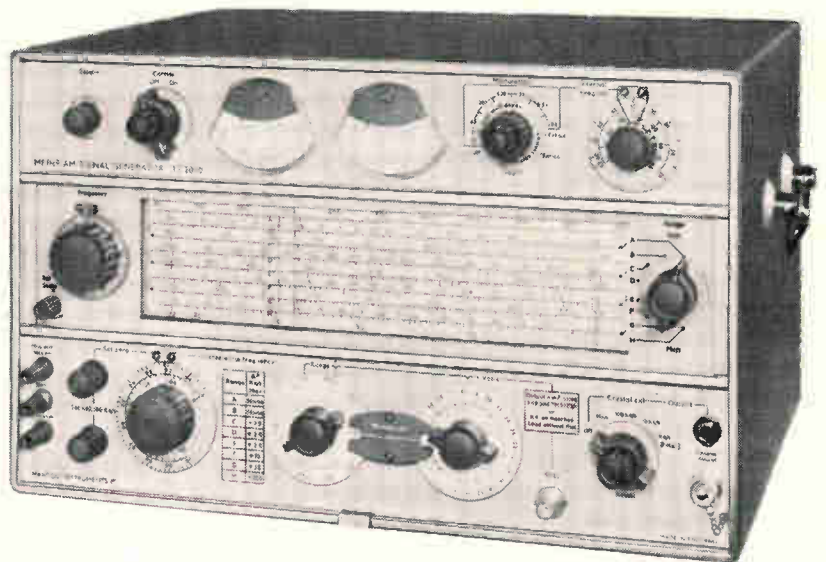

Marconi Instruments Signal Generator Model 2002 covers 10kc to 72mc and is fully transistorized. AM: 20cps to 20kc, 0 — 100%. May be used for manual or automatic frequency control, FM, phase modulation or sweeping above 100kc. Crystal calibrated: 1mc, 100kc, 10kc, 1kc.

READER SERVICE CARD NO. 338

Product Highlights

**FROM MARCONI INSTRUMENTS FAMILY OF
TELECOMMUNICATIONS MEASUREMENT EQUIPMENT**

MODEL NO.	DESCRIPTION	RANGE	READER SERVICE CARD NO.
791D	FM Deviation Meter	4mc to 1024mc	340
1245-6-7	Q-Meter and Oscillators	1 kc to 300 mc	341
995A/2M	FM/AM Signal Generator	1.5 mc to 220 mc	342
2090	Noise Loading Test Set (Transistorized)	Up to 2700 Channels	343
7816	Twelve Channel Noise Generator	300 cps to 3400 cps for mux/demux	344
1313	¼% Universal Bridge	7 Decade Ranges LCR	345
Autospec	Telegraph Error Correcting Equipment	Up to 75 Bauds	346

Available Upon Request
... Marconi Instrumentation. A technical Information Bulletin Issued Quarterly.

READER SERVICE CARD NO.
339



A Good Name for Good Measure

MARCONI INSTRUMENTS

DIVISION OF ENGLISH ELECTRIC CORPORATION • 111 CEDAR LANE • ENGLEWOOD, NEW JERSEY • (201) 567-0607

**Proven in 3rd generation computers —
CTS Series 770 HIGH-POWER PRECISION
CERMET RESISTOR MODULES
can open new design
concepts for you!**

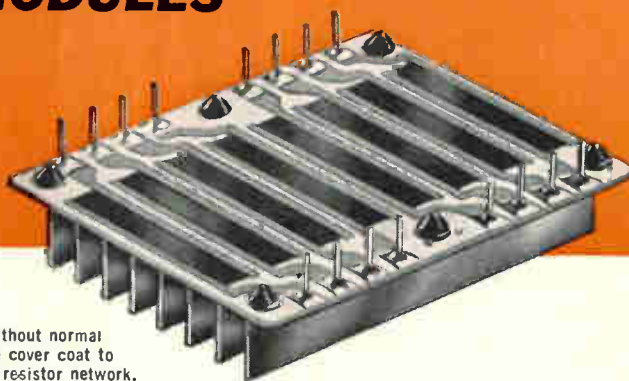

Shown without normal insulative cover coat to illustrate resistor network.

Consider these characteristics

- Cermet reliability now available for power applications.
- Compact modular packaging—overall dimensions are only 1.500" by 1.225" by 0.370" with heat sink.
- High power—8 to 20 watts per module depending upon allowable operating temperature, air flow, duty cycle and number of pins used.
- Low inductance—less than 10 nanohenries up to 200 megacycles.
- Layout flexibility—up to 24 external pins on .125" centers can accommodate a dozen or more cermet resistors.
- $\pm 1\%$ standard tolerance from 20 ohms to 1 megohm.
- Special low resistance values available down to 10 ohms.
- Available in quantity NOW—over 250,000 already produced.
- Available with copper heat sink bonded to alumina substrate.
- Dual-in-line staked pins for rapid insertion—can withstand 7.5 lbs. tensile or compressive force.

**770 Series Environmental
Specifications**

Load Life: 9 watts for 1,000 hours at 55°C ambient in 300 fpm air flow	0.4% ΔR max. 0.1% ΔR av.
Moisture Resistance: 95% R.H. at 70°C, 10 days load, 10 days no load	0.2% ΔR max. 0.05% ΔR av.
Standard temperature coefficient of resistance	-50 to +350 ppm/°C
Thermal Cycling: 5 cycles, -60°C to +125°C no load	0.10% ΔR max. 0.03% ΔR av.

Samples are available off the shelf.
Kit of three modules for \$13.00.

order yours today!

Think about it!



Founded 1896

CTS RESEARCH, INC./LAFAYETTE, INDIANA

Subsidiary of CTS Corporation, Elkhart, Indiana

Tektronix adds a new dimension to spectrum analyzers... now you can take high performance to the job

**new Type 491
10 MHz TO 40 GHz**

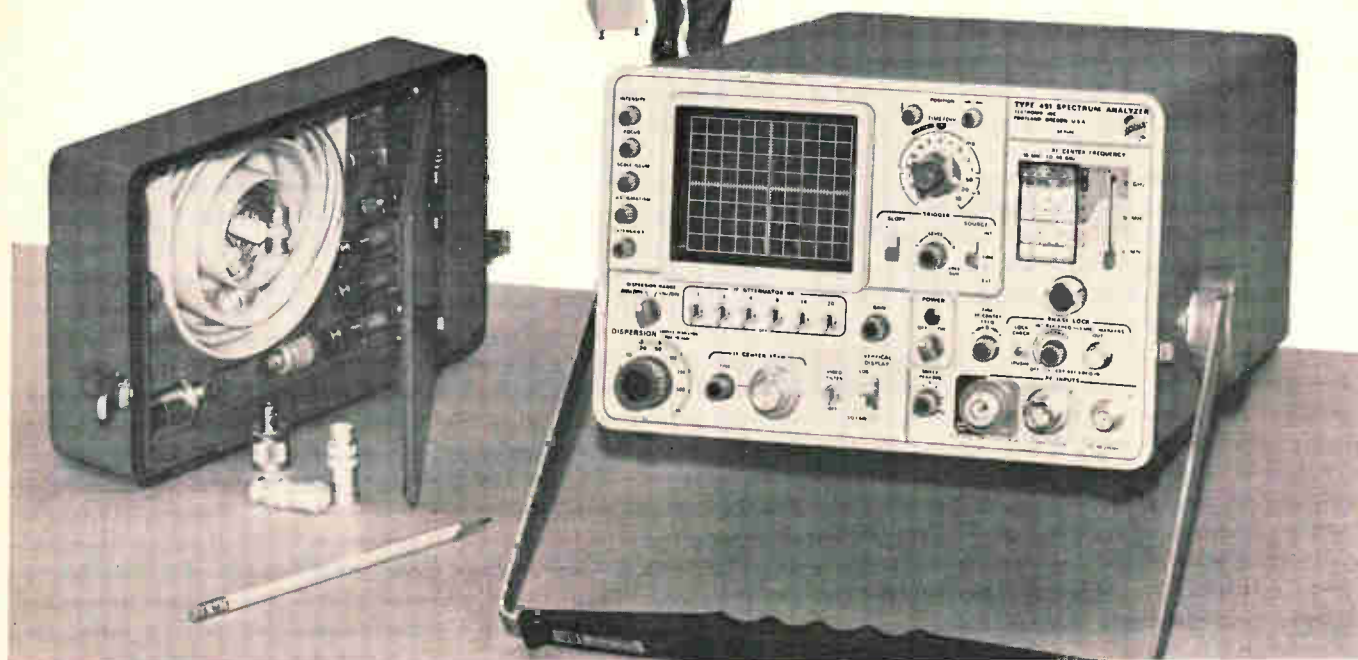

You can judge its performance by these features . . . internal phase lock for stable displays even at 1 kHz/div dispersion . . . resolution range of 1 kHz to 100 kHz coupled to calibrated dispersion for operational simplicity . . . dispersion range of 10 kHz (1 kHz/div) to 100 MHz (10 MHz/div) for direct readings of relative frequency from the display . . . CW sensitivity of -110 to -70 dBm depending on frequency . . . and display flatness of ± 1.5 dB over 100 MHz dispersion.

With oscilloscope-type triggering and sweep circuitry, you can trigger from internal, external or line sources, and have wide choice of sweep rates from 0.5 s/div to 10 μ s/div in a 1-2-5 sequence.

Other features include EMI (RFI) suppression . . . trace intensification of high speed segments of the waveform . . . camera compatibility with the Tektronix Type C-30 for easy, high quality photographs . . . bright display, small spot size, long persistence (P-7) phosphor on a new 4-inch rectangular CRT

with 8x10 div (1 div equals 0.8 cm) display . . . and DC-coupled recorder output.

The Type 491 is only 7" high by 12" wide and 22" deep, weighs less than 40 pounds and requires only 55 watts. Yet it has the broad frequency range and high performance you need for most applications. And setup is easy even at waveguide frequencies—just mount one of the external waveguide mixers to your source and couple it to the Type 491 with a flexible cable.

As shown, the carrying handle adjusts for various tilt positions and provides a sturdy support stand. The front panel cover serves as a storage case for the included accessories such as adapters, cables, waveguide mixers and coax attenuators. And the rugged construction of the Type 491 lets you carry it on the toughest industrial and military assignments.

Type 491 (with accessories) \$4200

U.S. Sales Price f.o.b. Beaverton, Oregon

Tektronix, Inc.



For complete information, contact your nearby Tektronix field engineer or write: Tektronix, Inc., P.O. Box 500, Beaverton, Oregon 97005

**Proven in 3rd generation computers —
 CTS Series 770 HIGH-POWER PRECISION
 CERMET RESISTOR MODULES
 can open new design
 concepts for you!**

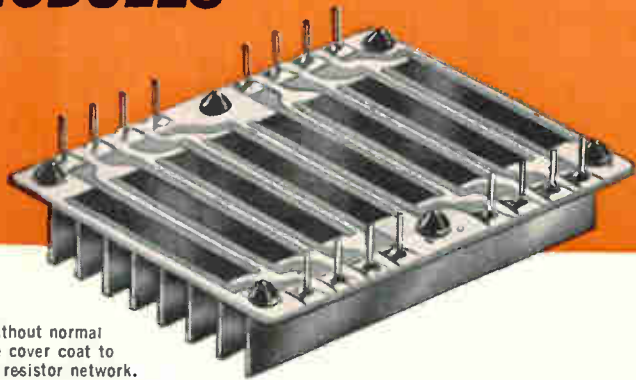

Shown without normal insulative cover coat to illustrate resistor network.

Consider these characteristics

- Cermet reliability now available for power applications.
- Compact modular packaging—overall dimensions are only 1.500" by 1.225" by 0.370" with heat sink.
- High power—8 to 20 watts per module depending upon allowable operating temperature, air flow, duty cycle and number of pins used.
- Low inductance—less than 10 nanohenries up to 200 megacycles.
- Layout flexibility—up to 24 external pins on .125" centers can accommodate a dozen or more cermet resistors.
- $\pm 1\%$ standard tolerance from 20 ohms to 1 megohm.
- Special low resistance values available down to 10 ohms.
- Available in quantity NOW—over 250,000 already produced.
- Available with copper heat sink bonded to alumina substrate.
- Dual-in-line staked pins for rapid insertion—can withstand 7.5 lbs. tensile or compressive force.

**770 Series Environmental
 Specifications**

Load Life: 9 watts for 1,000 hours at 55°C ambient in 300 fpm air flow	0.4% ΔR max. 0.1% ΔR av.
Moisture Resistance: 95% R.H. at 70°C, 10 days load, 10 days no load	0.2% ΔR max. 0.05% ΔR av.
Standard temperature coefficient of resistance	-50 to +350 ppm/°C
Thermal Cycling: 5 cycles, -60°C to +125°C no load	0.10% ΔR max. 0.03% ΔR av.

**Samples are available off the shelf.
 Kit of three modules for \$13.00.**

order yours today!

Think about it!



Founded 1896

CTS RESEARCH, INC./LAFAYETTE, INDIANA

Subsidiary of CTS Corporation, Elkhart, Indiana



McDonnell needed a battery for the Phantom II that pilots could count on!

Mallory made it.

What can we do for you?

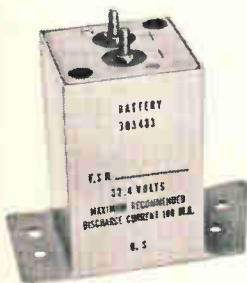

McDonnell needed a battery. A battery that could be relied on when the Phantom II's regular power system failed. A battery that would keep a warning system working in emergencies. A battery able to stand up to the extremes of temperature, vibration and pressure that a supersonic aircraft encounters. McDonnell brought its specifications to Mallory. Mallory made the battery—a mercury battery completely sealed in epoxy resin to withstand these conditions. A battery pilots can depend on!

TWO TYPES OF PATIENT BATTERIES

How long can a battery stand before it's used and still maintain useful capacity? Indefinitely! Some Mallory batteries have their electrolyte stored away from the anode and cathode. They can sit forever until they are needed—then the twist of a screw and they're ready to work.

And normal Mallory Mercury and Mallory Alkaline batteries are distinguished for long shelf life in many applications—emergency transmitters and alarms, cameras and remotely controlled instruments. Mallory Mercury batteries lose only a few percent of capacity per year at normal

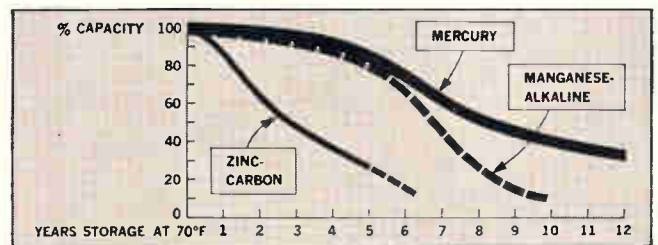

temperatures (21°C)—some have been stored for 12 years and still have retained useful capacity. Mallory Alkaline batteries are completely reliable even after two or more years of storage.

ALL SIZES, ALL CAPACITIES

Mallory is currently producing over 100 batteries of all sizes and capacities. And if we're not actually producing the battery you need, we'll be happy to work with you in designing a new one.

Please write us at the Application Engineering Department, Mallory Battery Company, a division of P. R. Mallory & Co. Inc., South Broadway, Tarrytown, N.Y. 10591. Or call 914-591-7000. In Canada: Mallory Battery Company of Canada Limited, Sheridan Park, Ontario.

It's good business to do business with Mallory



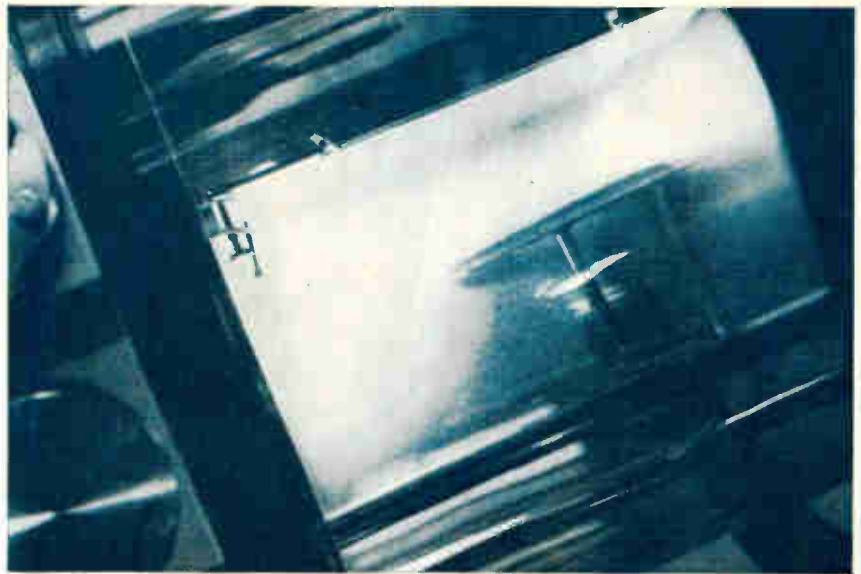

new

RF Sputtering of Insulators with PlasmaVac®... First Production System for the deposition of Insulators

Now, the microelectronics manufacturer can deposit the dielectric in thin-film capacitors, encapsulate thin film and integrated circuits, or carry on surface passivation of semi-conductors.

CVC's new RF Sputtering Unit is a versatile addition to the PlasmaVac low-energy sputtering system, so successful in the controlled deposition of metals,

alloys, and semi-conductors. This first commercially available system utilizing RF Sputtering expands PlasmaVac's capability to include materials like quartz, barium titanate, magnesium oxide, aluminum oxide, synthetic mica, pyrex and other commercial glasses. Sequential deposition of metals and insulators using both dc and RF sputtering to fabricate capacitors can be

done without breaking vacuum.

PlasmaVac with RF Sputtering can deposit more materials with better control than any other deposition equipment available today. And, PlasmaVac adapts easily to your production line or laboratory.

Write us today for full details. Consolidated Vacuum Corporation, 1775 Mt. Read Boulevard, Rochester, N. Y. 14603.



Consolidated Vacuum Corporation

ROCHESTER, N. Y. 14603 • A SUBSIDIARY OF BELL & HOWELL
International Subsidiaries: Woking, Surrey, England
& Friedberg, West Germany

See us at the A. V. S. Show, Masonic Temple, San Francisco, Oct. 26-28

Tektronix adds a new dimension to spectrum analyzers... now you can take high performance to the job

**new Type 491
10 MHz TO 40 GHz**

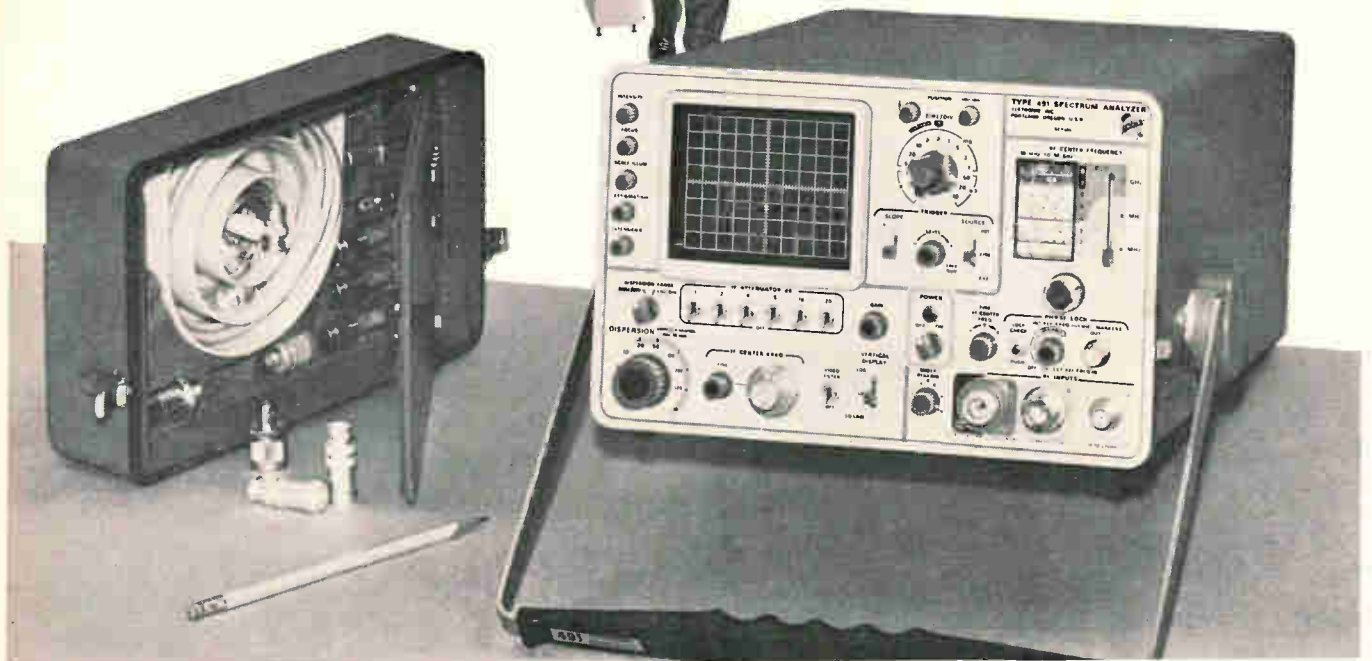

You can judge its performance by these features . . . internal phase lock for stable displays even at 1 kHz/div dispersion . . . resolution range of 1 kHz to 100 kHz coupled to calibrated dispersion for operational simplicity . . . dispersion range of 10 kHz (1 kHz/div) to 100 MHz (10 MHz/div) for direct readings of relative frequency from the display . . . CW sensitivity of -110 to -70 dBm depending on frequency . . . and display flatness of ± 1.5 dB over 100 MHz dispersion.

With oscilloscope-type triggering and sweep circuitry, you can trigger from internal, external or line sources, and have wide choice of sweep rates from 0.5 s/div to 10 μ s/div in a 1-2-5 sequence.

Other features include EMI (RFI) suppression . . . trace intensification of high speed segments of the waveform . . . camera compatibility with the Tektronix Type C-30 for easy, high quality photographs . . . bright display, small spot size, long persistence (P-7) phosphor on a new 4-inch rectangular CRT

with 8x10 div (1 div equals 0.8 cm) display . . . and DC-coupled recorder output.

The Type 491 is only 7" high by 12" wide and 22" deep, weighs less than 40 pounds and requires only 55 watts. Yet it has the broad frequency range and high performance you need for most applications. And setup is easy even at waveguide frequencies—just mount one of the external waveguide mixers to your source and couple it to the Type 491 with a flexible cable.

As shown, the carrying handle adjusts for various tilt positions and provides a sturdy support stand. The front panel cover serves as a storage case for the included accessories such as adapters, cables, waveguide mixers and coax attenuators. And the rugged construction of the Type 491 lets you carry it on the toughest industrial and military assignments.

Type 491 (with accessories) \$4200

U.S. Sales Price f.o.b. Beaverton, Oregon

Tektronix, Inc.



For complete information, contact your nearby Tektronix field engineer or write: Tektronix, Inc., P.O. Box 500, Beaverton, Oregon 97005

If we can't make the best thermostats,
we'd rather not make any.
That's why we sell Edison.

We know Edison thermostats are best
because we measure them by the same per-
formance and reliability standards our own
manufacturing people use for missile guid-
ance and communications components.

We know another thing, too. We couldn't
make better thermostats than Edison, how-
ever much we tried.

Luckily, we don't have to.

As a manufacturer who's also a distributor,
we're able to bring you the top lines in
the various product categories. Whoever
makes them.

So when it comes to thermostats, we bring
you Edison.

You get the fast off-the-shelf delivery you
expect from a national distributor like Arco.

And you get the engineering assistance
and help with application problems you'd
normally expect from a manufacturer.

Buy Edison thermostats and time-delay
relays from Arco and you get the best of
both of us, manufacturer and distributor.



DIVIDED WE STAND.

Arco Electronics
A Division of Loral Corporation
Community Drive, Great Neck, N. Y.
Dallas, Texas, Pasadena, California,
Menlo Park, California.

Circle 71 on reader service card



Three new 400-volt silicon power transistors for military duty:



They're designed for high efficiency inverters, voltage and current regulators, control and switching circuits and high-power communications where extreme reliability is required.

DTS-423M is a NPN 3.5-amp 400-volt device in a TO-3 package, offering high sustaining voltage capability.

DTS-431M is a NPN 5-amp 400-volt device in a TO-3 package, offering higher gain and lower saturation resistance.

2N2580M is a NPN 10-amp 400-volt device in a TO-36 package for extra high power applications. Specifications on all three devices are based on full

mil-type environmental tests performed in an approved military qualification test lab.

Check with our nearest sales office or Delco Radio Distributor for full details.

TYPE	V _{CEO}	V _{CBO}	V _{CEO} (sus)	I _C	I _B	hFE V _{CE} =5V @ I _C	R(sat) Max @ I _C	Power Diss Max
DTS-423M	400V	400V	325V (min)	3.5A	2.0A	10 @ 2.5A	0.8 ohm @ 1.0A	100W
DTS-431M	400V	400V	325V (min)	5.0A	2.0A	10 @ 3.5A	0.28 ohm @ 2.5A	125W
2N2580M	400V	400V	325V (min)	10.0A	2.0A	4 @ 10.0A	0.14 ohm @ 5.0A	150W

FIELD SALES OFFICES
UNION, NEW JERSEY*
Box 1018 Chestnut Station
(201) 687-3770
SYRACUSE, NEW YORK
1054 James Street
(315) 472-2668

DETROIT, MICHIGAN
57 Harper Avenue
(313) 873-6560
CHICAGO, ILLINOIS*
5151 N. Harlem Avenue
(312) 775-5411

SANTA MONICA, CALIFORNIA*
726 Santa Monica Blvd.
(213) 870-8807
General Sales Office:
700 E. Firmin, Kokomo, Ind.
(317) 459-2175

*Office includes field lab and resident engineer for applications assistance.

DELCO RADIO

Division of General Motors
Kokomo, Indiana

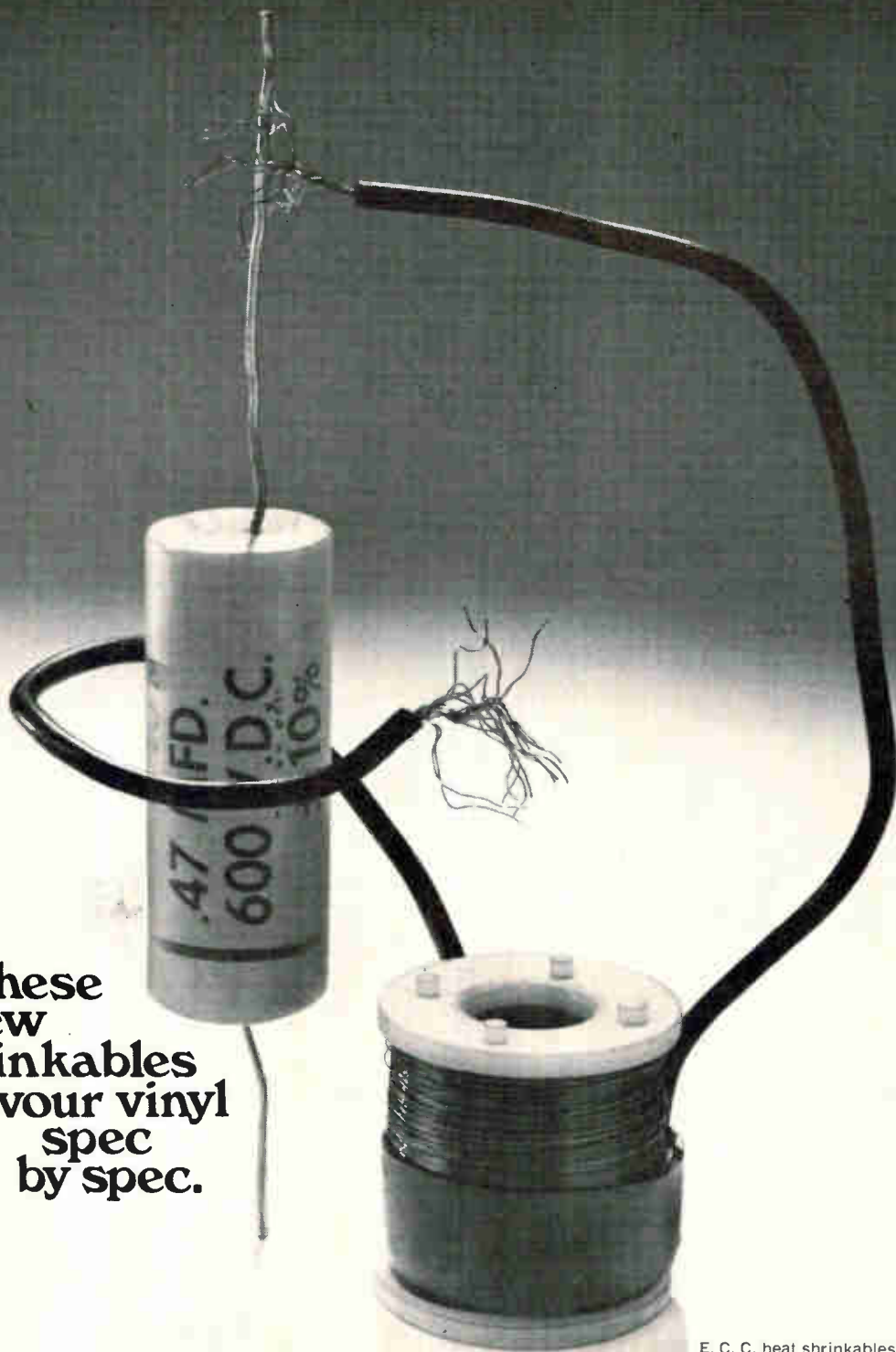

**These
new
heat shrinkables
devour vinyl
spec
by spec.**

E. C. C. heat shrinkables are recognized under UL component file F39100.

Yet cost no more. That's because new Insultite CP-150 and Insultite SRT are polyolefins. Heat shrinkable, irradiated polyolefins that provide polyolefin protection at a polyvinyl price.

Take new CP-150. It insulates and encapsulates any subject. Quickly. Tightly. Permanently. Won't split or rupture. Even over the most irregular surfaces. And it's particularly ideal for commercial, automotive, appliance, and computer applications.

As for new SRT? Wrap up your capacitor insulation problems once and for all. This clear, tough, thin-wall polyolefin is perfect for components that are subject to shock and strain, and where space and visual identification are considerations.

Both CP-150 and SRT devour vinyl specs. Like low temperature flexibility, abrasion resistance, structural strength, voltage standoff, and dielectric characteristics. And they shrink at a better than 2 to 1 shrink ratio. Come in a variety of printable colors and sizes. From $\frac{3}{4}$ " to 2" ID.

Think shrink with the Insultites. We offer commercial, military grade, flexible and semi-rigid tubing, heat-shrinkable end caps, and exclusive meltable inner-wall tape. Write for free samples today. (Specify diameters, please.)



ELECTRONIZED CHEMICALS CORPORATION

A subsidiary of High Voltage Engineering Corporation

Box 57, Burlington, Massachusetts, Area Code 617-272-2850



**3-in-1 T-pot design
gives you more
for your money!**







**One simple, rugged design adds reliability
to all three rectilinear Mil wirewound styles**

RT-10, RT-11, RT-12 – Dale meets all three with a single design. You benefit from this simplification through increased reliability, faster delivery, better price. Call us today!

- ① **ALL-MOLDED HOUSING** design eliminates seal problems. Meets MIL-STD-202 and MIL-R-27208A.
- ② **RUGGED COLLECTOR SYSTEM** assures you of noise levels well below mil requirements.
- ③ **FULL LENGTH WINDING** allows increased power handling capability. Permits use of large diameter thermoconductive mandrel which eliminates "hot spots" by acting as high mass heat sink.
- ④ **1-PIECE WIPER ASSEMBLY** of precious metal insures setting stability under all environmental conditions.
- ⑤ **STAINLESS STEEL ADJUSTMENT SCREW** has metal-to-metal clutching – prevents over-travel damage.
- ⑥ **CONSTANT LEAD SCREW SEAL** is assured by shaft-retaining spring which maintains unvarying pressure against high temperature silicone rubber "O" ring.

DALE MIL-R-27208A MODELS

RT-10		Model 691 P.C. Pin Model 697 Flex. Leads
RT-11		Model 1287 P.C. Pin Model 1288 Flex. Leads
RT-12		Model 1680 P.C. Pin Model 1697 Flex. Leads
RT-22		5000 Series – 1/2" square-trim models meet RT-22, made with same basic design considerations shown here.

WRITE FOR CATALOG B – containing specifications on 57 Dale T-Pots including many special models.



DALE ELECTRONICS, INC.



Washington Newsletter

October 3, 1966

**Ilaas endangered
by Vietnam cost . . .**

The future of the Navy's Integrated Light Attack Avionics System (Ilaas) is growing increasingly doubtful. It now appears unlikely that the Navy will equip any of its A-7A Corsair aircraft with Ilaas, which is a computer-controlled complex of radars, displays and guidance package. Because development of the integrated system is running late, early A-7A production models already are scheduled to fly without Ilaas. The latest reevaluation, however, appears to be strictly economic. "It's all a budget matter," a Navy source says, indicating that rising Vietnam expenditures are putting the squeeze on other parts of the defense budget.

Not only is it likely that Ilaas will miss the Ling-Temco-Vought, Inc., A-7A, but the entire program is in danger, according to Navy sources. The current research and development effort is expected to continue, but at a reduced level. However, a firm decision has yet to be made by the Pentagon. The Sperry Gyroscope Co., a division of Sperry Rand Corp., is developing and building four Ilaas prototypes under an initial \$23.9 million contract and has been counting heavily on a big production follow-on program.

If Ilaas development continues, the integrated system may be installed on other upcoming Navy attack aircraft including future versions of the A-7A.

**. . . may be replaced
by black boxes**

An avionics system similar to the one on Douglas Aircraft Co.'s A-4 Skyhawk will probably be aboard the Navy's A-7A aircraft instead of the planned Ilaas complex. The A-4 nonintegrated system is a collection of subsystems and black boxes purchased and installed by Douglas. The Navy estimates it could save about \$230,000 on each A-7A by going to an improved A-24 system rather than using Ilaas.

**Defense awards
keep coming . . .**

A good example of how Vietnam war spending is affecting various defense programs is the planned addition by the Pentagon of 280 more fighter planes for delivery in fiscal 1968. The new orders are good news for avionics producers who will share more than \$150 million in new business. The total \$700 million to be spent, however, will come out of funds earmarked for programs like Ilaas. The money is expected to go for the A-24 Skyhawk, the A-7A Corsair and McDonnell Aircraft Corp.'s F-4 Phantom.

**. . . but a plateau
may be here**

Defense contract awards, which rose \$10 billion during fiscal 1966 because of the Vietnam war, may well level off during the last half of this year and the first half of 1967. Washington experts are predicting that this year's awards will continue at about the fiscal 1966 level of \$37 billion. However, this is an increase in their projection of last spring that defense orders would drop to \$34 billion in fiscal 1967.

**Earlier launch
for next Surveyor?**

The launch date for the United States' third attempt at a soft landing on the moon reportedly has been set by the National Aeronautics and Space Administration for January 24. But the schedule may be speeded up

Washington Newsletter

following last month's \$85-million flop of Surveyor 2, which was caused by the failure of one of the small vernier motors to fire during a mid-course correction maneuver. The space agency considered adding a surface sample experiment on the next flight, but the loss of Surveyor 2 may knock it out. In the experiment, which the space agency says still has "candidate" status, the lunar soil would be scratched in front of the television camera to obtain data on the soil structure.

Because of the success of Surveyor 1, instrumentation for three other experiments is being considered for later spacecraft in the seven flight program: a micrometeorite detector, a single-axis seismometer to measure moonquakes and an instrument to analyze the lunar soil by bombarding it with alpha particles and measuring their reflection.

Approval seen for first manned Apollo flight

Despite the space agency's silence, indications are that three astronauts will be on board when the Apollo/Saturn 204 flight lifts off from Cape Kennedy late next month. The NASA Design Certification Review Board, which meets to review and approve flights, is expected to recommend that the next flight be a manned one. The board has examined the results of the August 25 Apollo 202 ballistic shot to determine why the command module fell 200 miles short of the planned splashdown point. Program officials report that the guidance computer was working correctly but that wrong data on the reentry angle was fed into it. If astronauts had been on board the Apollo they very probably could have landed the spacecraft on target.

Space technology tackles football

The space agency likes to show how aerospace technology is being applied to the solution of problems on earth as one way to justify its multibillion dollar budgets. Two such applications will be discussed at next month's annual American Institute of Aeronautics and Astronautics meeting in Boston: football—a systems challenge; and applications of the systems approach to planning problems of the archdiocese of Washington, D. C.

Air Force set to sign MOL contracts

Before October ends the Air Force will sign contracts with the Douglas Aircraft Co. and the General Electric Co. for the manned orbiting laboratory (MOL). The Air Force will have as much as \$240 million to spend on MOL in the current fiscal year; the total amount depends on how much money it can convince the Pentagon it needs. First launch in the \$1.5 billion program, aimed at a manned launch in 1969, is a Gemini capsule suborbital shot next month to test a heat shield modified for MOL.

Nike missile production may stall again

It appears the Army again will lose its annual battle to proceed with production of the Nike-X antimissile system. With the Pentagon still cool to deploying the system, it looks like another year of research and development. The Western Electric Co., the prime contractor, has received \$273 million for R&D so far this year and will receive another \$170 million before the end of fiscal 1967. This will raise the total amount spent so far on the controversial and long-delayed antimissile program to more than \$2.7 billion.

New Computer Grade Capacitors with proved high ripple ratings



The new line of Mallory CGS Aluminum Electrolytic filter capacitors, designed for 65°C ambient, looks the same as our present CG family . . . same case and top construction, but they're different inside.

A completely new set of specifications for ripple current has been established for this line. The new values are based on Mallory tests of many hundreds of capacitors under a variety of environmental conditions and ripple currents. Maximum ripple values stated for the CGS are the proved currents to which you can design with full confidence of long, reliable life. And they are *higher* than our previous values: for identical case size, about four times higher . . . for identical C-V ratings, over twice as high. ESR specifications are also lower.

Furthermore, you can now get about *twice as much* capacitance in a given case size as was formerly available in Mallory capacitors. Maximum capacitance is now 280,000 mfd at 3 WVDC or 1,800 mfd at 450 WVDC, in the 3" diameter by 5 7/8" case. And there are 880 other standard ratings from which to choose. For complete data, write for your copy of new Bulletin 4-80. Mallory Capacitor Company, a division of P. R. Mallory & Co. Inc., Indianapolis, Indiana 46206.

50th
ANNIVERSARY

MALLORY

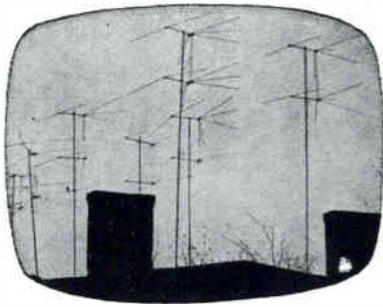

Stackpole Ceramag® ferrite components have been the accepted standard of the Television Industry for over twenty years.

In 1965, Stackpole began supplying Automatic Pincushion Correction Cores, a major advance, for color television receivers. 1964 saw the introduction of Stackpole 90° color components including Flyback, Yoke and Convergence Cores. As far back as 1954, these same components were introduced for the 70° color Deflection Systems.

The list of contributions Stackpole engineering and production know-how has made to the growth of color in television is long and varied. This same capability has been applied to the continual improvement of

black and white receiving equipment as well.

To be first with such items as Horizontal Output Transformer Cores and Automatic Pincushion Correction is not enough. Innovation must stand the test of performance. Stackpole Ceramag® components have, since 1947. Small wonder most manufacturers have come to depend so heavily on Stackpole's experience and quality. Stackpole Carbon Company, Electronic Components Division, St. Marys, Pennsylvania 15857. Phone: 814-781-8521. TWX: 510-693-4511.

Ceramag® Ferrite Components are Coloring the Entire Television Picture

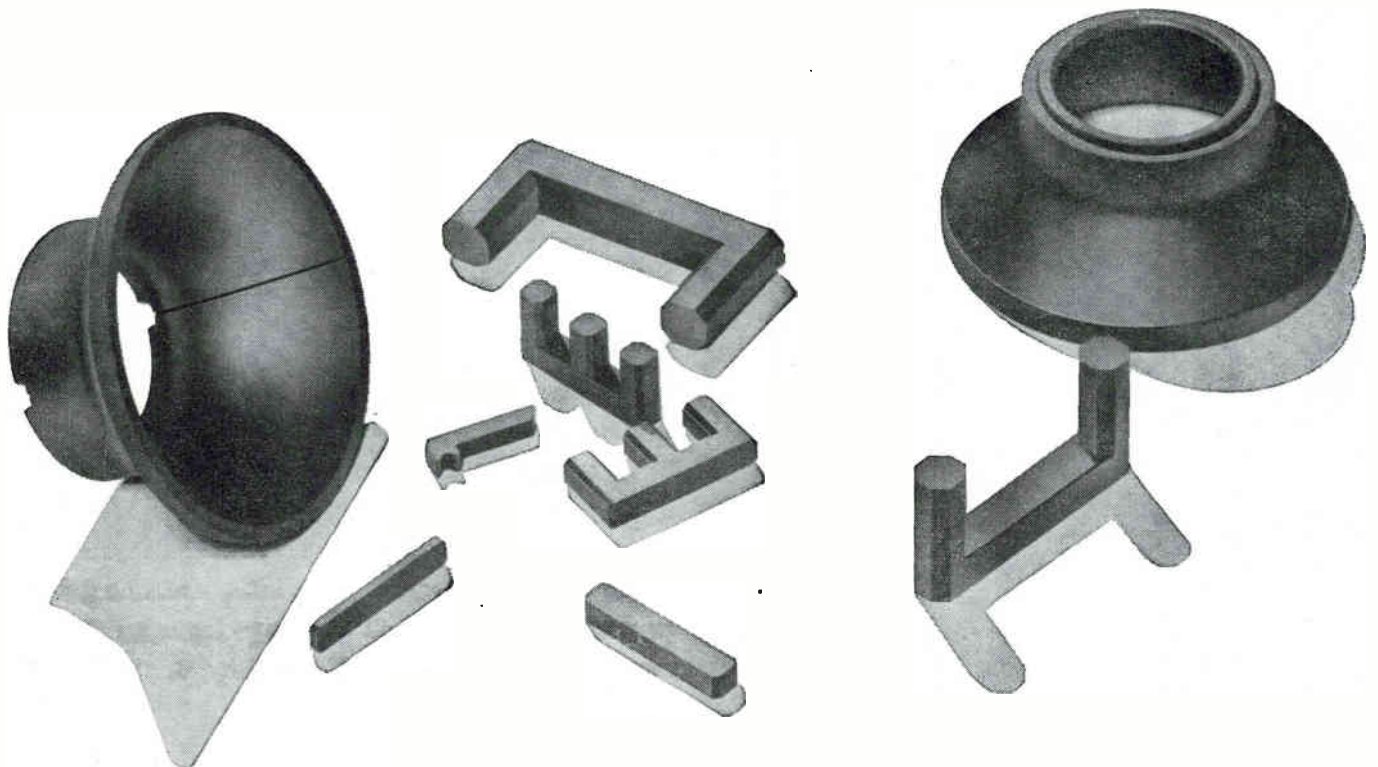

STACKPOLE
ELECTRONIC COMPONENTS DIVISION
"OUR 60th YEAR"

TRW
gives you...

**THE MOST
EFFICIENT
5 AMP
SWITCHING
TRANSISTORS
IN SPACE**

SPEED: 80MHz

GAIN: $50h_{FE}$ @ 1A

SATURATION: 1V @ 5A

Every characteristic the designer needs for top performance airborne inverters and switching regulators are combined in the new TRW 2N4305—2N4312 power transistors...high frequency...high gain...low collector saturation voltage.

Another plus factor in this outstanding new series is operating voltage characteristics as high as 120V.

Available in TO-5 packages. Available in Low Profile Isolated Stud packages. Available NOW from authorized distributors everywhere!

For detailed technical information write TRW Semiconductors Inc., 14520 Aviation Blvd., Lawndale, Calif. 90260. Phone: 679-4561, TWX: 910-325-6206, Cable TRWSEMICON / Telex: 67-7148.

TRW SEMICONDUCTORS



Texas Instruments chooses GAF x-ray film to prove there's not the tiniest mistake



Texas Instruments Incorporated, a prime manufacturer of miniaturized electronic equipment for both industry and government, uses GAF industrial x-ray film to prove zero defects in critical components, assemblies and sub-systems.

Diodes, rectifiers, capacitors, resistors and germanium and silicon transistors, used in everything from hearing aids to missile guidance control systems, are subjected to exhaustive radiographic examination to assure faultless performance and long life.

In the photograph above, Texas Instruments Quality Control Inspector, Mrs. Dorothy Gross, is studying a GAF Industrial 'H-D' radiograph. Industrial 'H-D' is an ultra-fine grain, very high contrast film designed to yield high image definition—even when radiographing minute subjects and very thin materials. Industrial 'H-D' is available in a wide

variety of package types and sizes.

Contact your nearest distributor of GAF x-ray products, and he'll introduce you to the GAF X-ray Representative assigned to your area. Or write directly.

gaf

GENERAL ANILINE & FILM CORPORATION

140 WEST 51 STREET, NEW YORK, NEW YORK 10020

Att: Customer Service Dept. E-103

Please send me more information on GAF Industrial 'H-D' x-ray film.

Name _____

Title _____

Company _____

Address _____

City _____ State _____ Zip _____

**I AM
THE WORLD'S
GREATEST
DIODE
STACKER!**



Big deal — *nobody* needs to stack diodes any more. Not if they're using COMCOR's new Ci-218 Hybrid Function Generator. Diodes aren't even used in its analog circuitry. Yet, it is at least *five* times more accurate than present "diode-type" card-set function generators. Why not! Eliminate the diodes and you eliminate the break-over voltage problem plus all the tedious calculations, inaccuracies, and empirical programming procedures that go along with it. With the Ci-218 there are no slope limitations. All func-

tions are generated using linear interpolation between 20 independent variable data points that can be placed in any one of the four quadrants. Set-up time is practically instantaneous with standard IBM cards. It even has surface generation capabilities. COMCOR took a new approach to an old problem — and won. Be a winner... the Ci-218 is adaptable to *all* analog/hybrid computers. For complete information call your COMCOR representative or write COMCOR direct. (714) 772-4510 or TWX 714-776-2060.



COMCOR
A SUBSIDIARY OF ASTRODATA, INC.

1335 SOUTH CLAUDINA STREET / ANAHEIM, CALIFORNIA 92803

Career opportunities available now in engineering and marketing.

Circle 81 on reader service card



LET'S TALK COMCOR!

Core, plane or stack problems?

Take 'em to the experts. (Us.)

Core? Construction? Format? Hostile environment? Whatever your problem, we've probably seen—and solved—it before. If not, Ferroxcube experts will always find the shortest path to the right answer. For instance—

Application: Core memory stack for real-time display system in ship-board fire control computer.

Problem: Hostile thermal environment, critically limited space restrictions.

Solution: Single-area, double matted printed-circuit board construction; bus-wire bridging to allow air-flow cooling of 30-mil wide temperature range cores.

Application: Core memory stack for navigational guidance computer in commercial avionics system.

Problem: Mil-reliability at commercial prices; NDRO operation; volume reproducibility.

Solution: Single-area, single-matted plane, plastic laminated terminal frame construction; bootstrap patterns with 30-mil cores on extremely tight centers.

Application: Low cost core memory stack for state-of-the-art commercial-computer main memory.

Problem: High speed, low noise, high output uniformity, repairability, expandability, 650 ns cycle time, ease of access and interface.

Solution: 2½D organization; planar construction to offer lowest cost and convenient access; 20-mil cores; stack mounted diode modules.

Application: Core memory stack for guidance computer in missile-borne avionics package.

Problem: Extremely hostile mechanical and thermal environments, critical space limitations.

Solution: Continuously-wired, folded-stack construction; wide

temperature range cores wired using novel shock and vibration damping techniques.

What's *your* problem? Cores? We pioneered them. We have 20-, 30- and 50-mil cores in both standard and wide temperature range types covering a broad spectrum of switching and drive current parameters. Planes and stacks? We use a wide variety of printed circuit board or laminated frame-strip construction techniques, 2½D, 3D or linear select. Cost? We meet and lick this problem every day. It's part of being the experts.

Want more information? Write for Bulletins 6005 & 6006.

Ferroxcube 

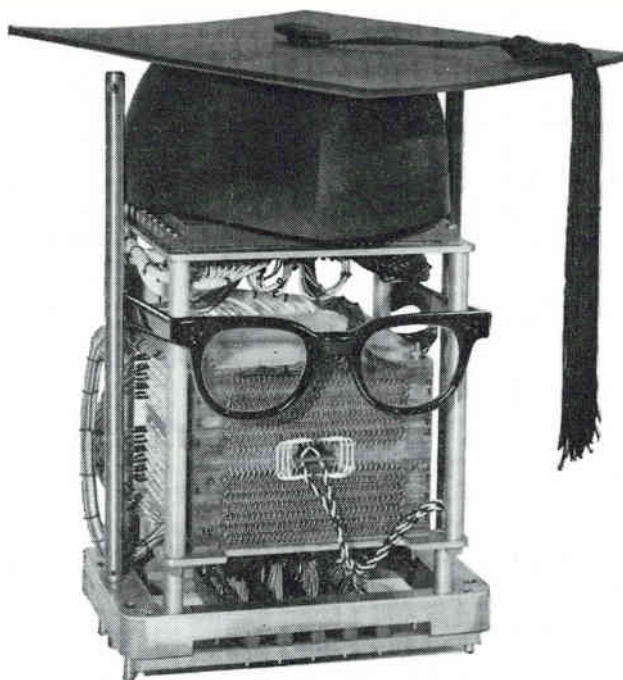

FERROXCUBE
CORPORATION
OF AMERICA
Saugerties, New York
914-246-2811

Boston
617-889-3110

Chicago
312-261-7880

Dallas
214-255-0441

Los Angeles
213-837-1484

Minneapolis
612-888-4681

New York Area
201-267-5888

Phoenix
602-265-1792

Philadelphia
215-927-6262

Washington, D.C.
703-893-4900



Years from now, people can still watch Surveyor's scan of the moon's surface

... thanks to Memorex precision magnetic tapes. When Surveyor relayed its famous closeup photographs of the moon's surface, Memorex tapes at JPL's Goldstone tracking station were busy recording these signals. All told, some 90% of the video and instrumentation tapes used in the Surveyor Program were Memorex. Now used to evaluate the mission, these tapes form a permanent record for future study.

Why was Memorex chosen? Simple. Space officials needed a tape that was rugged and reliable, and stood virtually no chance of missing any data. The logical choice was Memorex. Because of advanced design, careful manufacturing and uncompromising inspection and certification, Memorex tapes consistently outperform all others, reel after reel, year after year.

To find out what Memorex can do for you, call at one of our sales and service offices in this country and abroad, or contact us directly. We guarantee your satisfaction.

MEMOREX
PRECISION MAGNETIC TAPE

Memorex Branch Offices in Boston, New York, Philadelphia, Washington, Atlanta, Orlando, Dayton, Chicago, Detroit, St. Louis, Dallas, Denver, Los Angeles, San Francisco, Honolulu. Offices and Affiliates in London, Cologne, and Paris. Distributors in Japan, Canada, India, Australia, and New Zealand.

Circle 83 on reader service card

How nickel silver improves spring contacts for tuners.

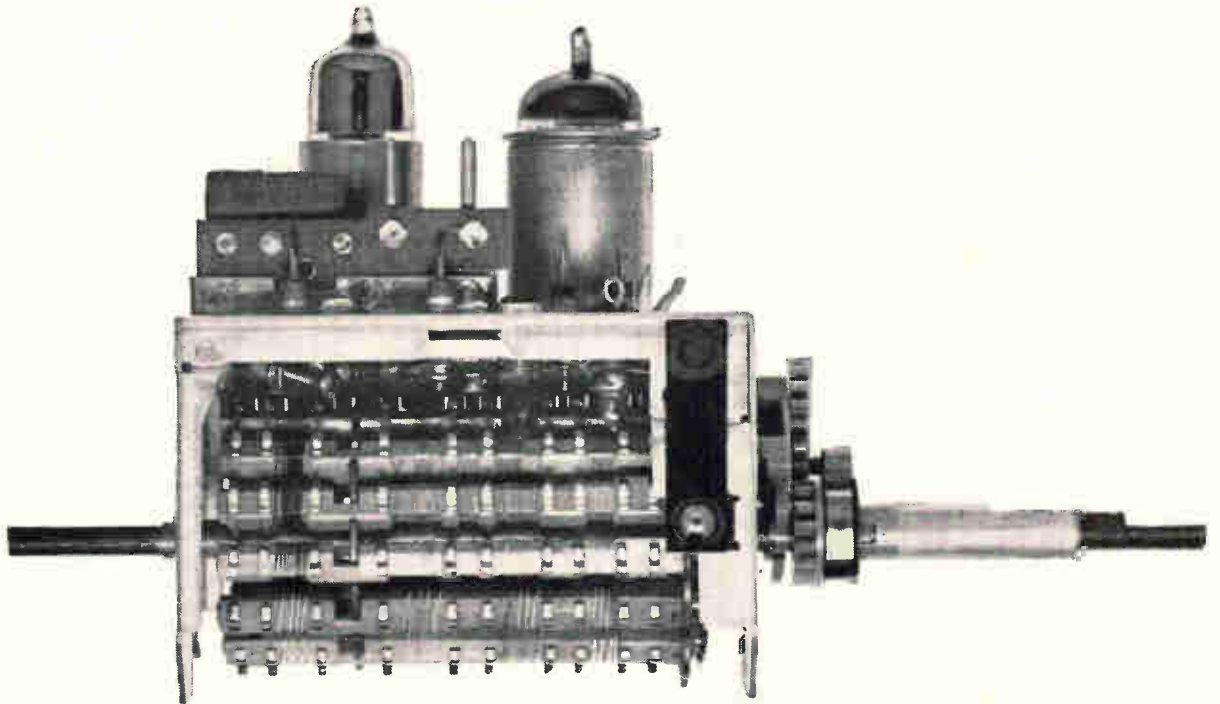

Because it has substantially reduced their complaints and service calls to customers, Standard Kollsman Industries, Inc. uses nickel silver for contacts and springs in their TV tuners.

They find that nickel silver provides three advantages for tuners: extended life, superior performance, and practical cost.

Nickel silver extends tuner life because of its wear resistance and good spring properties. It provides superior performance in wiping contacts because of its low rate of tarnishing. And nickel silver is practical in cost because of its low material cost, excellent workability and the fact that it eliminates the need for expensive coatings.

Standard Kollsman uses nickel silver alloy CA 764 on 130 contact points. Nickel silver alloy CA 770 is used on the ground spring of the stator board assembly.

Nickel silver—a long-lasting, low-cost alloy of copper, nickel and zinc—can be cold-worked to tensile strengths up to 120,000 psi and has an elastic modulus range of 18,500,000 psi to 21,500,000 psi. It's easy to work, readily lending itself to any conventional forming technique.

Next time you want: Improved shelf life. Better performance. Fewer service calls. Consider nickel silver for springs and wiring contacts. In the meantime why not write us for a copy of "A New Look At Nickel Silver."

The International Nickel Company, Inc., 67 Wall Street, New York, N. Y. 10005.

INTERNATIONAL NICKEL

Nickel—its contribution is quality





**Cinch
"Bow-Pin"
... versatile
contacts for
miniaturized
connector
applications**

ACTUAL
SIZE

**TARGET
PRICE FOR
VOLUME
REQUIREMENTS**

**UNDER 5c
A MATED PAIR**

Whenever a connector application requires both miniaturization and a high degree of reliability, the Cinch "Bow-Pin" is the answer. This versatile little contact can be utilized in strip connectors (as shown), circular connectors or rack and panel connectors.

This unique "Bow-Pin" principle provides distinct advantages over conventional miniature contact devices.

Positive contact is assured by the flexing action of the bowed spring wires (unattached at the front end) that results when the contact is inserted into a tube having an ID smaller than the widest dimension of the bow.

Rugged construction—The flexing members are of relatively large cross-section to withstand abuse. NO WELDING IS USED IN THE ASSEMBLY, eliminating the possibility of heat change in spring characteristics.

"Bow-Pin" strip connectors are currently available in 6" lengths with either .075" or .100" center spacing.

For more information on "Bow-Pin" contacts and strip connectors, write to Cinch Manufacturing Company, 1026 South Homan Avenue, Chicago, Illinois 60624.

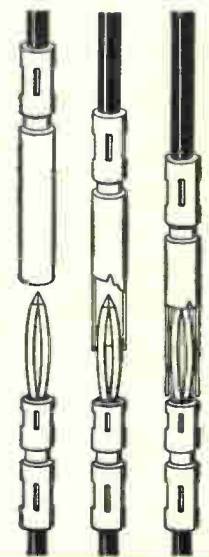

INSTANT X-RAYS

new research, design tool for workbench or lab... x-ray inspection where and when you want it with office machine simplicity...\$1970!

Here is a versatile new instrument that permits you to take your own x-rays—when and where you want them—at your workbench where your problems are.

Now you can obtain immediate insight into your design or research problem—locate, define, modify—speed development of your project with a quick “inside” look, step-by-step or any time you need one.

Operation is as routinely safe and simple as a blueprint machine or an office copier. Just insert the subject, select the exposure time and voltage, push a button. With film which processes in 10 seconds, the Faxitron 804 will give you clear, sharp radiograph prints on-the-spot in minutes or even seconds—or you can use standard wet films and cassettes up to size 14" x 17". Adjustable voltage from 10 to 100 KV assures excellent contrast over a wide range of object thicknesses and densities. Current of approximately 3 m.a. gives good penetration with a convenient exposure time.

You can buy the standard Faxitron 804 for \$1970 complete, f.o.b. McMinnville, Oregon. An optional extension collar assembly to provide full beam coverage for 14" x 17" cassettes is available at slight additional cost. For complete information, send for descriptive literature—or call collect Area Code 503, 472-5101.



FAXITRON 804



Field Emission Corporation

McMinnville, Oregon 97128

Pioneers in Pulsed Radiation Sources for Science and Industry

- Send descriptive literature
- Have a sales-engineer contact me
- My potential application is _____

Name _____

Company _____ Title _____

Address _____ Phone _____

City _____ Zip _____ State _____



Cinch "Bow-Pin" ...versatile contacts for miniaturized connector applications

ACTUAL
SIZE

TARGET
PRICE FOR
VOLUME
REQUIREMENTS

UNDER 5c
A MATED PAIR

Whenever a connector application requires both miniaturization and a high degree of reliability, the Cinch "Bow-Pin" is the answer. This versatile little contact can be utilized in strip connectors (as shown), circular connectors or rack and panel connectors.

This unique "Bow-Pin" principle provides distinct advantages over conventional miniature contact devices.

Positive contact is assured by the flexing action of the bowed spring wires (unattached at the front end) that results when the contact is inserted into a tube having an ID smaller than the widest dimension of the bow.

Rugged construction—The flexing members are of relatively large cross-section to withstand abuse. NO WELDING IS USED IN THE ASSEMBLY, eliminating the possibility of heat change in spring characteristics.

"Bow-Pin" strip connectors are currently available in 6" lengths with either .075" or .100" center spacing.

For more information on "Bow-Pin" contacts and strip connectors, write to Cinch Manufacturing Company, 1026 South Homan Avenue, Chicago, Illinois 60624.

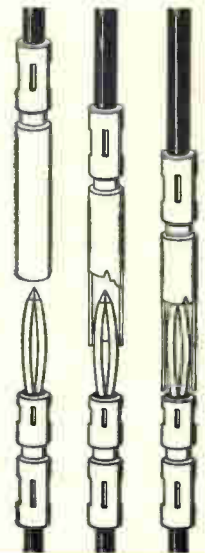

CINCH
DIVISION OF UNITED-CARR

INSTANT X-RAYS

new research, design tool for workbench or lab... x-ray inspection where and when you want it with office machine simplicity...\$1970!

Here is a versatile new instrument that permits you to take your own x-rays—when and where you want them—at your workbench where your problems are.

Now you can obtain immediate insight into your design or research problem—locate, define, modify—speed development of your project with a quick "inside" look, step-by-step or any time you need one.

Operation is as routinely safe and simple as a blueprint machine or an office copier. Just insert the subject, select the exposure time and voltage, push a button. With film which processes in 10 seconds, the Faxitron 804 will give you clear, sharp radiograph prints on-the-spot in minutes or even seconds—or you can use standard wet films and cassettes up to size 14" x 17". Adjustable voltage from 10 to 100 KV assures excellent contrast over a wide range of object thicknesses and densities. Current of approximately 3 m.a. gives good penetration with a convenient exposure time.

You can buy the standard Faxitron 804 for \$1970 complete, f.o.b. McMinnville, Oregon. An optional extension collar assembly to provide full beam coverage for 14" x 17" cassettes is available at slight additional cost. For complete information, send for descriptive literature—or call collect Area Code 503, 472-5101.



FAXITRON 804



Field Emission Corporation

McMinnville, Oregon 97128

Pioneers in Pulsed Radiation Sources for Science and Industry

- Send descriptive literature
- Have a sales-engineer contact me
- My potential application is _____

Name _____

Company _____ Title _____

Address _____ Phone _____

City _____ Zip _____ State _____

IMMEDIATE DELIVERY
FROM STOCK
TYPE SWOB I \$3100
TYPE SWOB II \$4200

2 CHANNEL DISPLAY
LARGE READOUT TUBE (14")

SWEEP SIGNAL
GENERATOR

PRECISION
ATTENUATOR

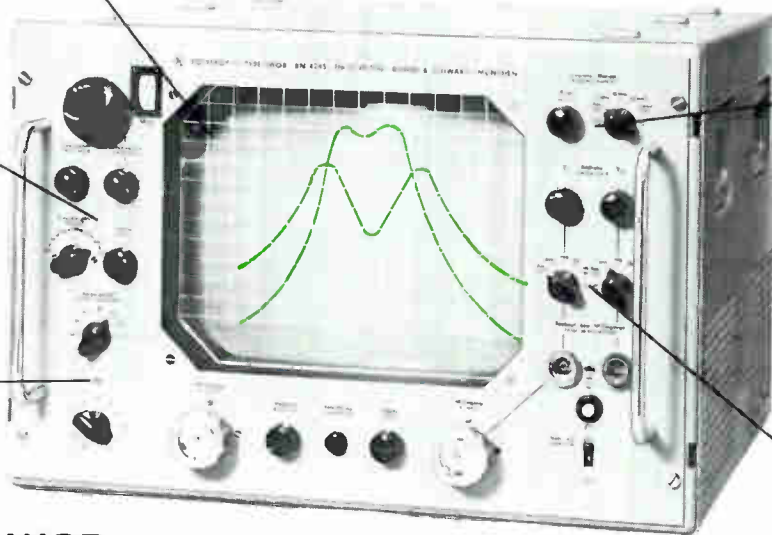

XTAL MARKER
GENERATOR

FUNCTION SELECTOR

TYPE SWOB

POLYSKOP® TYPE SWOB I 0.5 TO 400 MHz
TYPE SWOB II 0.5 TO 1200 MHz

SWEPT FREQUENCY SYSTEMS

FEATURES

- Replaces 5 Units: Sweeper, Precision Attenuator, Marker Generator, Electronic Switch, Display Unit
- Single Instrument Permits Optimized Design
- Insures High Accuracy By:
 - Dynamic Testing
 - 2 Channel Display for Substitution Measurements
 - Elimination of Parallax Error
 - Built-in Standards for Attenuation, Gain, and Frequency
 - Large (14") Display Unit
- Broadband System: Sweep width ± 0.2 to ± 50 MHz
- Saves Time: Makes measurements up to 50 times faster
- Saves Money: Ideally suited for production personnel

APPLICATIONS

Automatic plotting of dynamic characteristics and alignment work for single tuned and multi-stage circuits and filters, four terminal networks, cables, limiters, wide band amplifiers, TV receivers, discriminators, terminating resistors, antennas, etc.

PRODUCTION TESTING

Comparison:
Production and Reference Samples

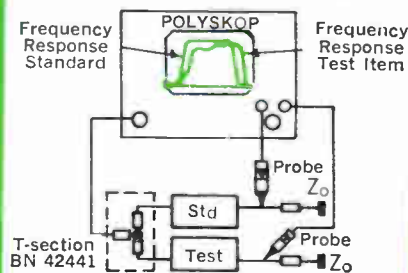

The Polyskop is a complete visual display sweep frequency measuring system available in two frequency ranges, TYPE SWOB I: 0.5 to 400 MHz (available in 50 Ω or 75 Ω), and TYPE SWOB II: 0.5 to 1200 MHz (50 Ω). They provide an automatic display of the amplitude-frequency response of a test item instantaneously, thereby eliminating point-by-point measurements. The Polyskops include a sweep frequency generator, with adjustable sweep width and center frequency, precision output attenuator, crystal marker generator (1, 10, 50 MHz, Ext.), electronic switch for 2 channel presentation, high impedance probes and large 14" CRT display. Accessories available: camera adapter, precision extension cables, and Type USWV to extend dynamic range from 30 to 80 dB.

Get The Extra Capability,
Greater Reliability, and
Longer Useful Life Of ...



ROHDE & SCHWARZ

111 LEXINGTON AVENUE, PASSAIC, N. J. 07055 • (201) 773-8010

Inquiries outside the U.S.A. should be directed to Rohde & Schwarz, Muehlhofstrasse 15, Munchen 8, West Germany

Something every Roman Centurion could have used:



PORTABILITY

The Roman soldier would have welcomed a portable razor, powered by rechargeable batteries, just as today's consumer does. The compact design and engineering excellence make portable products extremely useful items.

GULTON has developed the 'Second Generation' rechargeable battery. It recharges in a fraction of the time previously required.

This means that new portable product applications are unlimited. As unlimited as portable

electric razor sales to Roman soldiers would have been.

Talk to a GULTON battery applications engineer about your portable product. He'll design and manufacture a 'Second Generation' battery to fit your new product idea.

Come see us at booth 600 at the N.E.C. show in Chicago.

For information, call or write:

 **GULTON INDUSTRIES, INC**
Alkaline Battery Division, Metuchen, New Jersey 08840 (201) 548-2800

collage

A random collection of fact, opinion and miscellany... some of it a blatant attempt to peddle the products and capabilities of Motorola's Government Electronics Division.



IS YOUR S-BAND PLAYING SOUR NOTES?

Then blame your Stanley Steamer dealer, not us.

No one knows more about S-Band transponders than Motorola.* If you have doubts, ask the people who put together communications and command systems for Apollo, LEM, Ranger, Mariner and like that. They know. But the point is, since we are the number one builders of S-Band transponders, we should also be the number one providers of S-Band test systems. Alas, 'tis not exactly the case. Some people are laboring under the delusion that other people can make the proper test equipment for our units. This, of course, is like taking your Rolls-Royce to a Stanley Steamer dealer for maintenance. So please, Owners of Our S-Band Transponders, at least write to our Aerospace Center for spicy literature on our off-the-shelf, modular, pretty S-Band test equipment. In fact, send for the literature even if you have someone else's transponders. You'll find a mail box on your way to the Stanley Steamer dealership.

*if you even think you know more than we do, you may know too much to stay on anyone else's payroll. Send a resumé and let us tantalize you with ludicrously lucrative offers.

TWO tiny trusty transponders

If you're in the mood to test your small missiles and sounding rockets under severe environmental conditions, lay in a stock of our two new superhet transponders. One is

C-Band (SST-171C), the other X (SST-181X). Both are very rugged and accurate, yet weigh only 3.2 lbs., so you'll be able to pack in lots of other stuff.



AROD is not a Biblical name

AROD is "Govtalk" for Airborne Range and Orbit Determination, and our Aerospace Center is building about 2 million dollars worth for NASA's Marshall Space Flight Center. This system has a few tricky nuances that are allowing our boys to show some fancy footwork in applying integrated electronics to real live hardware. AROD reverses normal design techniques by putting doppler equipment in the space vehicle and the usually vehicle-mounted transponder on the ground. There are some very good reasons for this reversal, not just an innate perversity on the part of Marshall scientists. If we could afford a few more columns, we'd tell you all about it. For more information, write to our Aerospace Center.

ALOROTOM SPELLED BACKWARDS IS RADAR

Besides being a word that reads the same in both directions, radar is something that Motorola knows inside out... or at least sideways. Our new airborne side-looking reconnaissance radar system, SLR100, gives ample proof. The fruition of 10 years experience in the side-looking field, SLR100 is ideal for aircraft pod-mounting. It will deliver high-resolution terrain mapping and moving-target data recorded on film that can be developed in flight and viewed within seconds. Write Aerospace Center for details.

Also, we have developed an all solid-state radar relay multiplex that, if it weren't so blasted reliable, we'd be telling you how easily maintainable it is. Write to Chicago Center to learn more about this.

WHO NEEDS IT

Can there possibly be a use for a handsomely styled small box that does little else than silently disgorge great quantities of printed paper? Well, Sperry-Rand and NASA seem to think there is because they've ordered a slew of them as readout devices for the UNIVAC 1230 command and telemetry computers used in the Apollo program. The box in question is our TP-4000 high-speed, non-impact teleprinter. It spews out 3000 wpm, is all solid state. AND incorporates I/C design of such reliability you wouldn't believe it. And it's so quiet you can't tell it's working except for the paper flying out. Our Chicago Center has the spew for you. Write them.



Here it is almost the end and we haven't mentioned a single integrated electronics application so far. This would be like GE not mentioning "Progress". So, quickly, here's the word on RIC, an advanced Radar Intercept Calculator developed for Air Force RADC. RIC contains, among other things, some 2800 DTL flat packs... performing about 12,000 logic functions. If we'd built RIC in the conventional manner, it would fill at least three 6-foot relay racks. But this way it occupies only 3/4 of a cu. ft., weighs but 38 lbs., and uses only 200 watts of power. Our Chicago Center would love to send you a shiny new brochure on RIC.

The
buy
or
make
decision

We'd love to sell you anything discussed on these pages, but we know some of you would rather make them yourselves. So come do it at Motorola and get paid

(well) for it. Both Centers need scientists and engineers of many disciplines. If you don't want to write for our stimulating sales literature, send us a resumé. But don't just sit there.



MOTOROLA

Government Electronics Division

AN EQUAL OPPORTUNITY EMPLOYER

CHICAGO CENTER

1450 N. Cicero Ave., Dept. 7, Chicago, Illinois

AEROSPACE CENTER

8201 E. McDowell Rd., Dept. 7, Scottsdale, Arizona

CHEAP AND DIRTY.



NEVER!

Look at our new EBR for what it is.

A new, low-cost 2 amp, full-wave bridge (single phase) epoxy rectifier.

We mean low cost. Varo's new Epoxy Bridge Rectifier is available (in quantities) for less than a dollar apiece.

More than that, we haven't sacrificed reliability to bring you lower cost.

This neat little rectifier has controlled avalanche characteristics. It gives you the same reliability that you get with our 10 amp and 25 amp Integrated Bridge Rectifiers (IBR®).

It's prepackaged, too, so you save plenty of assembly time.

Our new EBR rectifiers are available with 200V, 400V, and 600V PRV ratings. The controlled avalanche series features 250V, 450V and 650V minimum avalanche voltages. We also make a non-controlled avalanche series.

Output current in the new EBR is 2 amps at 25° C (T_A) and all devices have 2000V minimum circuit-to-case insulation. And they're available with Faston® "110" terminals or silver leads.

After you've used our EBR's you'll probably start calling them something like those reliable little money savers from Varo.

But cheap and dirty.
Never!

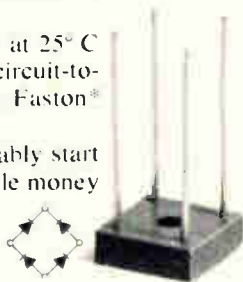

*-Trademark of AMP Incorporated

SPECIAL PRODUCTS DIVISION 2201 WALNUT ST., GARLAND, TEXAS 75041 (AREA CODE 214) 276 6141 TWX 214 276 8577

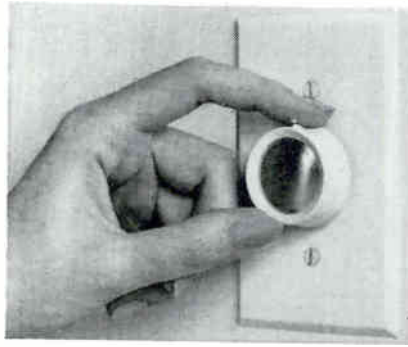

Lutron needed: the best combination of small size, reliability and low cost in capacitors for solid state dimmers.

So Lutron chose: capacitors of MYLAR®

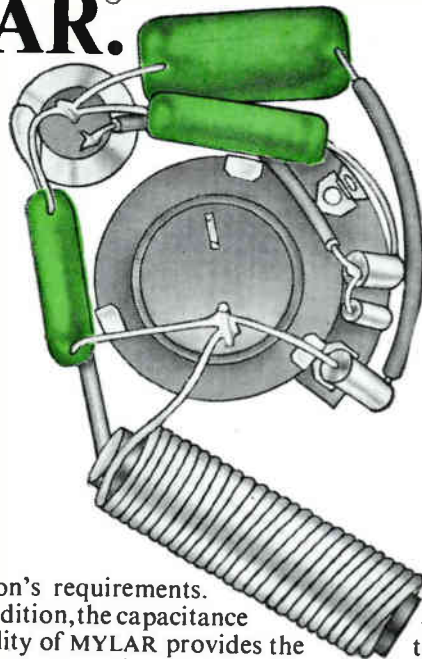

"Only capacitors of MYLAR* give us the size and reliability we must have, and at low cost," says Joseph M. Licata, Chief Engineer, Lutron Electronics Co., Inc.

Lutron's broad line of dimmers is miniaturized to fit single gang boxes for quick, easy installation. Because MYLAR has extremely high dielectric strength in thin gauges, capacitors made from this polyester film can be manufactured small enough to meet

*DU PONT'S REGISTERED TRADEMARK FOR ITS POLYESTER FILM.

Lutron's requirements. In addition, the capacitance stability of MYLAR provides the long-term reliability needed for trouble-free brightness control of all types of incandescent and fluorescent lighting.

Voltage requirements for Lutron's dimmers are 200 to 600 volts, and in many instances these units operate around the clock. Lutron's own tests and experience indicate capacitors of MYLAR

perform well in these conditions, even under extremes of humidity and temperature. Lutron has also found that in many cases, capacitors of MYLAR cost less than paper.

If capacitor size, reliability and price are important to you, check into MYLAR by writing: Du Pont Co., Room 4671A, Wilmington, Delaware 19898. (In Canada write: Du Pont of Canada, Ltd., P.O. Box 660, Montreal, Quebec.)

Better Things for Better Living...through Chemistry



VITRO

Micro Modules

MEASURE UP...

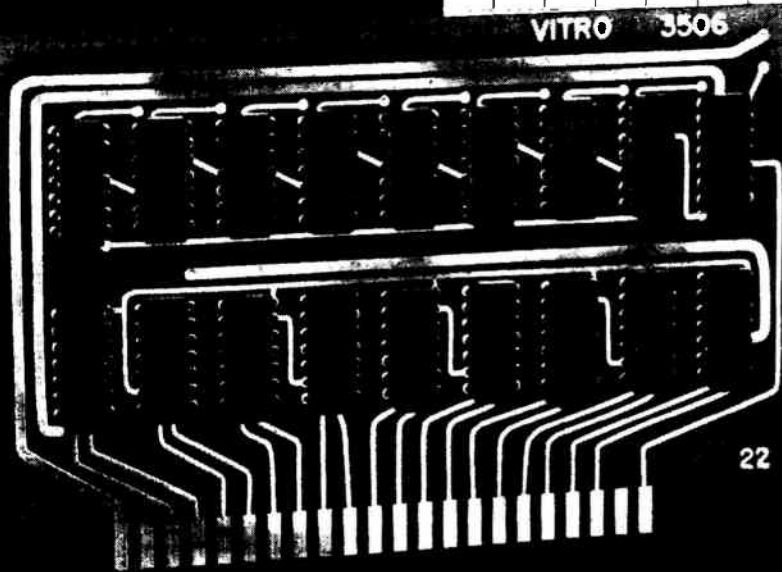
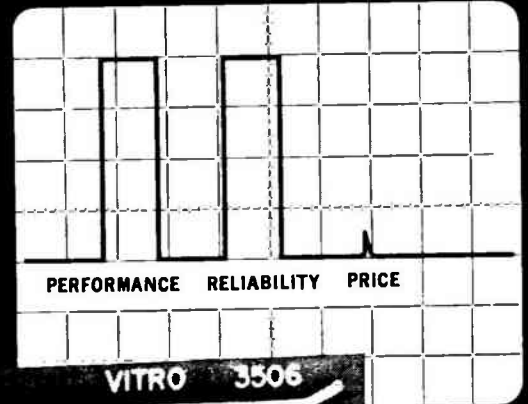

TO PROVIDE a microcircuit systems approach adaptable to breadboarding, small quantity and production runs

- all-new, highly competitive prices
- built-in drivers, inverters and buffers eliminate most interconnecting wiring
- up to 18 microcircuits per card enable high density and lower costs
- boards designed to meet MIL- and NASA standards
- boards keyed to assure proper mounting
- dual in-line packages easily replaced for ease of maintenance
- off-the-shelf delivery

The Vitro microcircuit systems approach is directly adaptable to a broad range of requirements. Whether the application be for breadboarding, one-of-a-kind units or total production runs, Vitro Micromodules are designed to provide the systems engineer with a low-cost, flexible, building-block approach to designing an integrated-circuit system.

The logic implementation on all Vitro boards has been standardized for positive NAND logical functions at a voltage swing from 0 to +3 volts. The diode-transistor logic devices employed have individual circuit speeds up to 10 MHz, and equipment speeds above 5 MHz. These circuit boards can be provided as directly off-the-shelf logic, with standardized performance to simplify a logic design application, or can be custom-built according to customer specifications. High density packaging is utilized providing up to 18 removable microcircuits on a single card. Ease of maintenance is assured since all dual in-line circuit packages can be easily removed and replaced in the field. To further simplify maintenance, Vitro-supplied chassis configurations are constructed of standard components assembled on a building block principle.

For further information on the complete line of Vitro microcircuits, mounting hardware, card files, wiring accessories, and power supplies, contact the Micromodule Sales Department, VITRO ELECTRONICS, 919 Jesup-Blair Drive, Silver Spring, Maryland 20910, Phone No. (301) 585-1000.

Vitro ELECTRONICS

A Division of Vitro Corporation of America
Producers of NEMS-CLARKE Equipment

v.23



Improve
Color TV life,
reduce costs

Multifunction G-E compactrons do the job of 2 or more ordinary tubes . . . require less wiring and simplify your circuitry. Now G.E. offers 5 new types. G.E.'s new 6AG9 is the industry's first ultra-high transconductance video output pentode to incorporate other functional elements (in this case, a triode). The 6EF4 is an improved 40-watt, high voltage regulator that protects against destructive arcing.

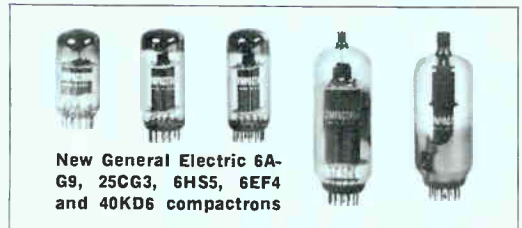

New General Electric 6AG9, 25CG3, 6HS5, 6EF4 and 40KD6 compactrons

The 6HS5 is a new type of high voltage regulator of the pulse-shunting variety. The 40KD6 and the 25CG3 are series-string versions of the 6KD6 and 6CG3 respectively, designed for 270-volt large-picture sets. Circle **Number 90** for more details.

How tiny can
a transistor get?



0.07 x 0.07 x 0.085 inches is all G.E.'s new microtab transistors measure. Yet each delivers precisely the same performance as its larger, conventional-sized counterpart. They're perfect for hearing aids, miniature operational amplifiers and very small instruments . . . or for your hybrid circuits, and linear and analog circuits. Equivalent to 2N930, 2N2484 and 2N918 transistors are already available for less than \$1.00 in quantities. Circle **Number 91** on the magazine inquiry card.

Designing small motors?
Better check this
new magnetic material.



Improved Cast Alnico 8

General Electric's new Improved Cast Alnico 8, the best material for small motor applications, is now available. Although this new material can be substituted directly for some existing designs at comparable costs, it is more economical and efficient to redesign the motor to utilize the improved properties available. Improved properties provide greater flux density, high coercive force, extreme temperature stability, and greater useful recoil energy. Circle **Number 92** for complete information.

What's new
for peripheral
computer equipment?

Instant response—inertial time constants low as 1 millisecond—is what you get with the new G-E Hyper-Servo* motor. And it accelerates faster than any other motor ever developed by General Electric. Hyper-Servo motors greatly increase the overall capacity of peripheral data processing equipment. They're available in 3.4-, 4.6-, and 4.8-inch diameters. Performances include torque-to-inertia ratios in excess of 350,000 rad/sec² and continuous torque ratings from 32 oz-in at 2700 rpm to 326 oz-in at 2800 rpm. A wide variety of models can provide the high performance drive motor for nearly every computer peripheral application. Circle magazine inquiry card **Number 93**.

*Trademark of the General Electric Company.



New high-response
d-c motor

Switch to the
lowest cost SCR



G-E C106 SCR's cost from 35 to 50¢ in volume. That's about half the price of other "low cost" SCR's. Yet you buy them at no sacrifice to performance or quality. New, planar C106's are reliable . . . give exceptional electrical uniformity and long term stability. They feature up to 200-v blocking capability, microamp triggering, and a configuration that's excellent for printed circuits, plug-in sockets, screw mounting, and point-to-point wiring. Circle **Number 94** on the magazine inquiry card.

Actual size G-E C106 SCR

MORE

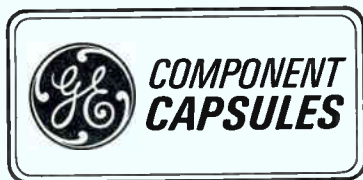

Tried this 45-minute timer circuit?

Check this circuit against others like it. See for yourself how it eliminates the need for many other components. The 2N2646 transistor applies a sampling pulse to base 2 of the 2N1671C and reduces required trigger current by 1,000:1 or more. Circle Number 95 if you'd like a comprehensive paper on this and many other circuits like it.

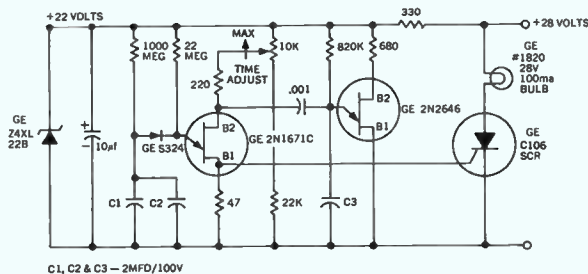

Featuring the low-cost 2N2646 transistor and C106 SCR

Look!
A 5-amp relay
in a
2-amp package



Weight: just 0.7 ounce maximum. Now, the proven magnetic motor design of G.E.'s 3SAF microminiature relay is combined with new, heavy-duty contacts and terminal leads. Result: 5-amp switching capability in a microminiature grid-space package. We call it the 3SBK. Electron-beam welding eliminates the need for solder flux, adding greater strength and delivering more trouble-free performance. Circle magazine inquiry card Number 96.

Up to 50 kv
in this small ignitron

Use the ZG-7248 ignitron for high-energy-rate switching or crowbar service. You'll find that when adequate anode-to-cathode temperature differential is maintained, it is a reliable 50 kv device that will conduct up to 25,000 amps and a total charge of over 20 coulombs. Or you can take advantage of the auxiliary electrode that's provided for circuit control at very low currents. Maintain a current of just 10 amps between the auxiliary electrode and the cathode, and the tube will maintain its conducting state even for main anode currents of a few amps. Circle magazine inquiry card Number 97.



The ZG-7248

Introducing...
new sub-miniature
wet-slug capacitor



Why struggle with larger-sized capacitors in your miniaturized circuits? Use G.E.'s new 69F900 sub-miniature tantalum wet-slug capacitor. Delivers performance and application characteristics virtually identical to those of standard military CL-64 units. Voltage ranges from 6 to 60 volts. Capacitance from 3.3 to 450 microfarads. And the 69F900 is especially suited for data processing, communication, and other industrial applications. Circle Number 98 on the magazine inquiry card.

Tiny tubes for new
telemetry frequencies



Use the tubes specifically designed for the new 2200-2300 MC telemetry frequencies—G.E.'s Y-1266 and Y-1223 ceramic planar tubes. The Y-1266 packs excellent gain and efficiency, and 2-watt power capability into a tiny, 2-ounce package. The Y-1223's new high dissipation anode gives 10-watt power output at 2300 MC to provide higher power... improved RF characteristics, too. Couple the two tubes together for a small, reliable, low cost, two-tube circuit for space probes. Circle Number 99 for more details.

WE MAY NOT OFFER EVERYTHING YOU WANT FROM ONE COMPONENTS SUPPLIER. BUT WE DO COME A LITTLE CLOSER THAN ANYONE ELSE.

285-15

GENERAL  ELECTRIC



A high-power signal generator

Wavering signals may cut the ice in certain Alpine applications. But there's no place for them in the r-f test and measurement laboratory. There you'll want rock-steady signals from a stable source of r-f power — the kind of performance you'd get with a Sierra Series 470A High-Power Signal Generator.

The four Sierra 470A's deliver signals at selectable frequencies through 2.5 GHz with ultra-reliable all-solid-state circuits. (Exception: The final output tube, a standard type, that can be changed in 30 seconds.) Power outputs range from around 70 watts at 400 MHz to 15 watts at 2.5 GHz. You can monitor power output plus grid and cathode currents on direct-reading front-panel meters. All units incorporate automatic no-load, underload protection. Prices are lower than you might expect at \$2,495 (for coverage of 200–500 MHz or 470–1000 MHz), \$2,775 (1000–1800 MHz), and \$3,300 (1800–2500 MHz).

One call to Sierra will produce an echoing avalanche of relevant data and information. Or write Sierra/Philco, 3885 Bohannon Drive, Menlo Park, California 94025.

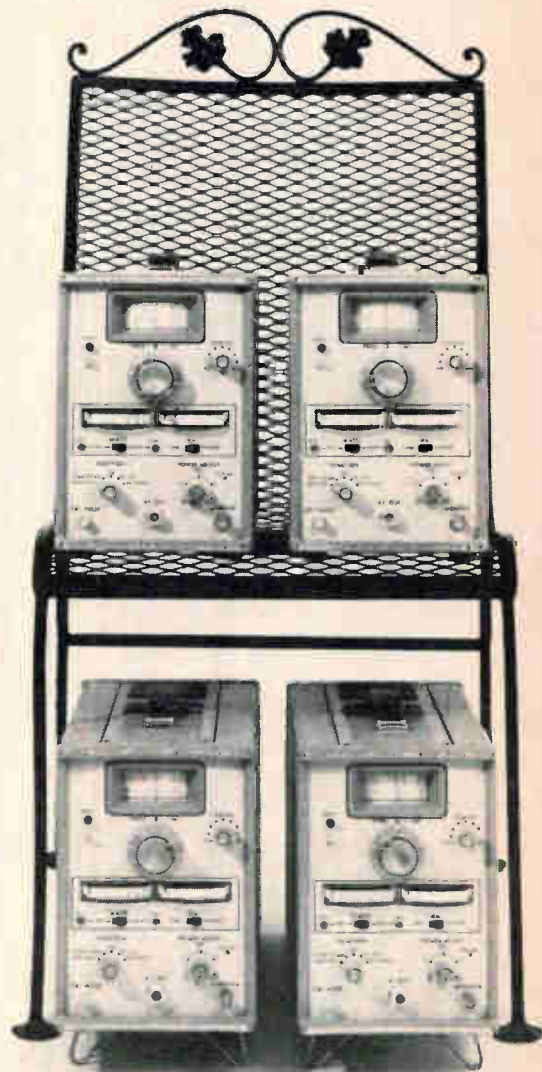

... Four others from Sierra

SIERRA ELECTRONIC DIV.

OF
PHILCO

A SUBSIDIARY OF *Ford Motor Company*

Circle 283 on reader service card

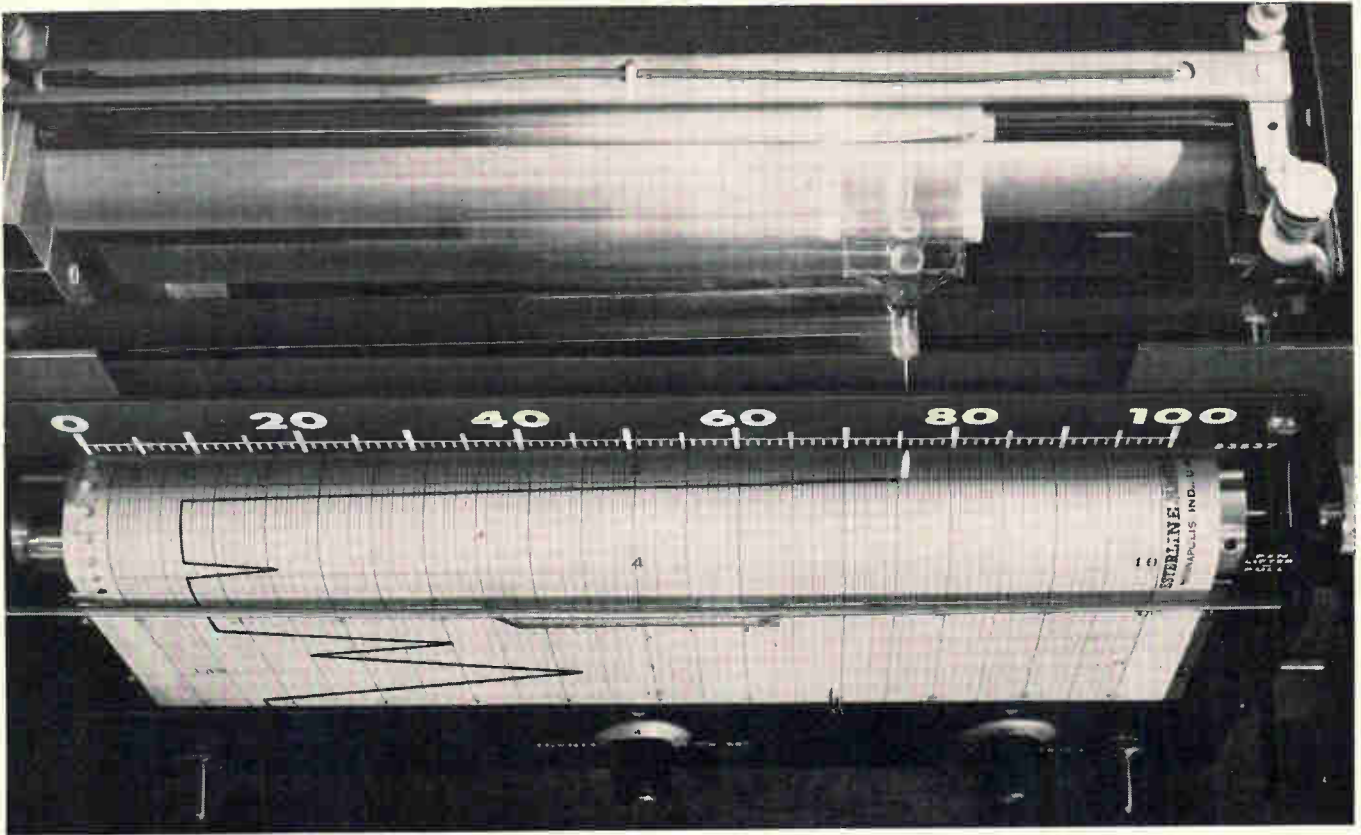

Only the pen moves. No pulleys. No drive cords. No gears.

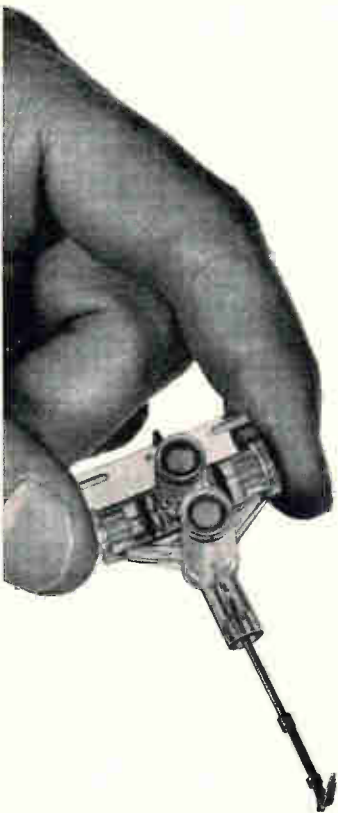

An inertial what?

An inertial ink pump for our 2/10 second response Speed Servo® Recorder

It uses the inertia of a small stainless steel ball to pump ink as needed.

It writes a legible record at speeds above 100" per second (2/10 second response over 10" span). Yet it doesn't bleed at the slowest speeds. We call it Speed Line Writing.

And for this new Speed Servo®, Speed Line Writing is required. Its servo motor has only one moving part. No gears, pulleys or drive cords.

Want more features? Take off balance input impedance of 500,000 ohms. Accuracy is $\pm 0.4\%$ of span for any range.

This recorder meets all specifications to 50,000 ohms source impedance and maintains rated accuracy to 100,000 ohms.

The Speed Servo's® feedback potentiometer is made of conductive plastic and has effectively

infinite resolution. It lasts thousands of hours longer than any wire-wound potentiometer.

Need Adjustable Zero Adjustable Span (AZAS)? This Speed Servo® option has zero elevation and suppression continuously adjustable from 0 to 100 MV for any span setting. Span is continuously adjustable from 1 to 100 MV.

You can choose from 15, 10 or 5 speed automatic chart drives. Dial speeds from $\frac{1}{2}$ " per hour to 8" per second.

■ Learn more about this exciting breakthrough in servo recording. Write for our Series "E" Catalog.

Esterline Angus Instrument Company, Inc.
Box 24000E • Indianapolis, Indiana 46224

*Excellence in
instrumentation for
over 60 years*



ESTERLINE ANGUS

Technical Articles

FET's call the tune in active filter design:
page 98

When NASA needed a way to reduce transmission power for voice communications to and from space probes on their way to distant planets, engineers searched for filters that were small and had narrow bandwidth and fast response time. The answer proved to be a voltage-tunable filter that uses field effect transistors as the tuning elements.

New dimensions in IC's through films of glass:
page 108

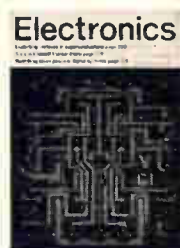

Better glassing methods and new materials allow the best of monolithic and hybrid microcircuits to be combined cheaply. It now seems clear that for many applications, monolithic integrated circuits alone will not be satisfactory. Covering a semiconductor chip with an impervious glass film allows a planar device to be transformed into a three-dimensional structure to do functions

a monolithic circuit can't perform. For the cover, an IBM circuit with 156 components demonstrates the complexity that is possible with new glassing techniques.

Pcm telephone exchange switches digital data like a computer:
page 119

One objection to a pulse-code modulation system in telephony has been the requirement to convert the digital signals back to analog ones before they pass through an exchange. Now an all-electronic system has been developed to switch pcm signals without such a conversion. The center is compatible with the pcm system described in Electronics, Sept. 19, 1966. The advantages include smaller and less expensive exchanges, while good signal quality is maintained.

For a crew in lonely orbit, something to lean on in space:
page 129

The more man learns about outer space as an environment, the clearer it becomes that working and living there will be more difficult than scientists expected. In the manned laboratories being considered, some kind of computer will be necessary as a watchdog, programmer and calculator. Here is how a machine could do this varied and complex job.

**Coming
October 17**

- **Users' guide to integrated circuits**
- **Automatic fault location**
- **Testing integrated circuits on the production line**

FET's call the tune in active filter design

A voltage-tunable audio filter uses field effect transistors as the tuning element instead of inductors; small size and low cost make them valuable in space communications where narrow bandwidth is required

By James M. Loe

Philco Corp., a subsidiary of the Ford Motor Co.

The National Aeronautics and Space Administration was searching for a way to reduce transmission power for voice communications from deep space, possibly as far out as the planet Mars. But that meant filters in the transmission equipment had to be small, response time fast and bandwidth narrow.

Conventional current-controlled variable inductors used in filters for tuning were too costly and bulky for space communications.

A solution came from engineers at the Philco Corp., a subsidiary of the Ford Motor Co. They developed a voltage-tunable audio filter that uses field effect transistors (FET's) as the tuning element in place of inductors. The result saved money and space. The conventional filter weighed two pounds and occupied 10 cubic inches. The new filter measures only 1.5 cubic inches and weighs 1½ ounces.

Four of the filters were included in a speech bandwidth compression system Philco delivered to NASA under the terms of a \$60,000 contract. The system permits transmission from space of a narrow band of encoded information that can be converted into synthetic intelligible speech on earth.

Designed for the audio frequency range, the family of high-Q (up to 100) low-pass, high-pass

and bandpass filters can be used up to several hundred kilohertz. The filter frequency is linearly related to control voltages over a 20:1 frequency range; a portion of this range is shown in the curves on page 101.

The new filters respond quickly to changes in control voltages. The rate at which the resonant or corner frequency (frequency at which response is three decibels down from the passband response) changes is a function of the rate at which the FET source-drain resistance varies. This value exceeds 400 Mhz/sec. This tuning rate, though not needed in NASA's application, may be useful in doppler radar systems, sonar systems and high-speed control systems.

Voltage tuning

A field effect transistor can serve as a voltage-variable resistor by keeping the voltage impressed between the source and the drain small.⁽¹⁾ For the FET's used in this design the voltage between the source and the drain is typically 0.1 volt peak to peak at a 10:1 tuning range.

Under this condition, the variable source-drain resistance of the field effect transistor is closely approximated by

$$R_{SD} = \frac{R_o}{1 - K_1 V_{gs}} \quad (1)$$

where R_o = the resistance at zero gate bias,
 K_1 = a constant, dependent upon FET type,
and
 V_{gs} = gate-to-source voltage.

The inverse relationship between the gate-to-source voltage and the source-drain resistance is compatible with active filter designs, which are

The author



James M. Loe is a project engineer at the Communications and Electronics division. He is presently assigned to the Advanced Communications Laboratory where he is engaged in the development of low bandwidth voice encoding equipment.

electrically equivalent to the conventional inductor capacitor (L-C) type of passive filters. Passive L-C filters can be designed to have a wide range of bandpass characteristics. Passive R-C filters are limited with respect to attainable bandpass shapes. The active R-C filters designed with FET's overcome this limitation.

Low-pass filter

The basic active low-pass filter can have a peaked or unpeaked response, as indicated in the diagram below. The response depends upon the damping factor chosen. In the figure above right field effect transistors were substituted for R_1 and R_2 . In the filter design, attenuation at the required corner frequency is initially specified. The required damping factor is selected from the universal two-pole filter characteristics of filter amplitude response versus frequency to obtain the specified corner attenuation rate.

For the low-pass filter circuit, the design conditions to be met are:

$$\begin{aligned} R_{IN} &> 10X_{C2} \\ R_{OUT} &< 0.1X_{C1} \\ R &= R_1 + R_2 \end{aligned}$$

where R_{IN} = input impedance of emitter follower Q_3 , a function of emitter resistor R_E and

R_{OUT} = output impedance of Q_3 .
 R_1, R_2 = source-drain resistance of Q_1 and Q_2 .

The design equations for the low-pass filter are

$$\omega_n = \frac{1}{RMC_2} = \text{resonant or corner frequency} \quad (2)$$

$$\text{when } M^2 = \frac{C_1}{C_2}$$

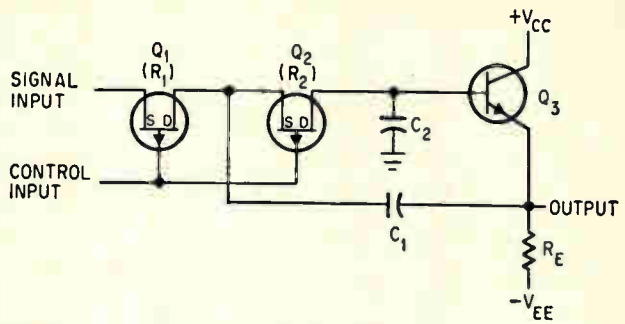

Matched field effect transistors, substituted for R_1 and R_2 in the basic low-pass filter, give an active voltage-tuned filter.

$$\rho = \frac{1}{M} + \frac{M}{2} \left(\frac{1}{1-K_2} \right) = \text{damping factor} \quad (3)$$

where K_2 = voltage gain of Q_3 .

By substituting equation 1 for equation 2, the corner frequency becomes a linear function of the FET gate control voltage,

$$\omega_n = \frac{1 - K_1 V_{gs}}{R_o MC_2} \quad (4)$$

High-pass filter

Similar principles may be applied to produce a voltage-tunable high-pass filter. The circuit is shown below. After selecting the damping factor at a required corner frequency to meet attenuation and overshoot requirements, filter component values are determined. In this case, the emitter-follower parameters are chosen so that

$$R_{IN} > 10R_2; \quad R_{OUT} < 0.1R_1.$$

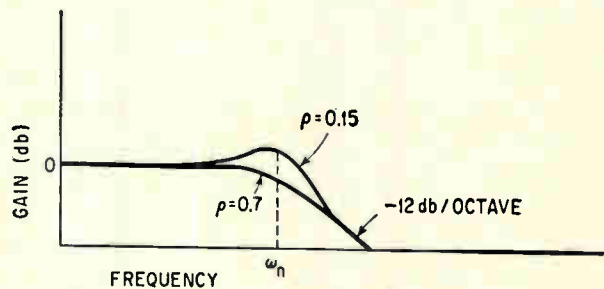
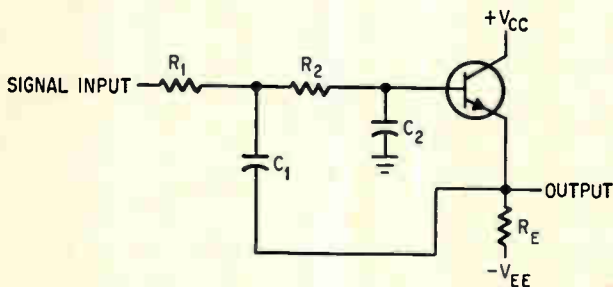

Basic low-pass filter can have a peaked or unpeaked response depending upon the damping factor.

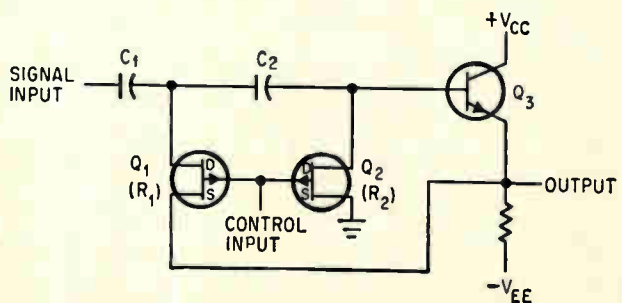
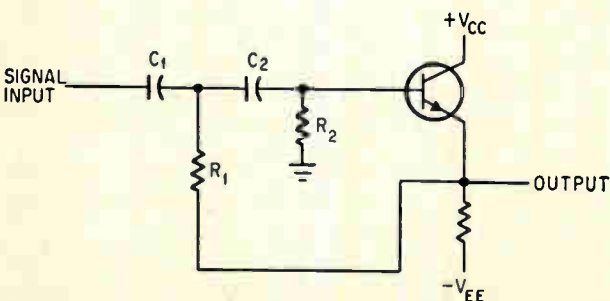

FET's acting as resistors in the high-pass active filter operate at the same controlling voltage and provide a damping factor of unity.

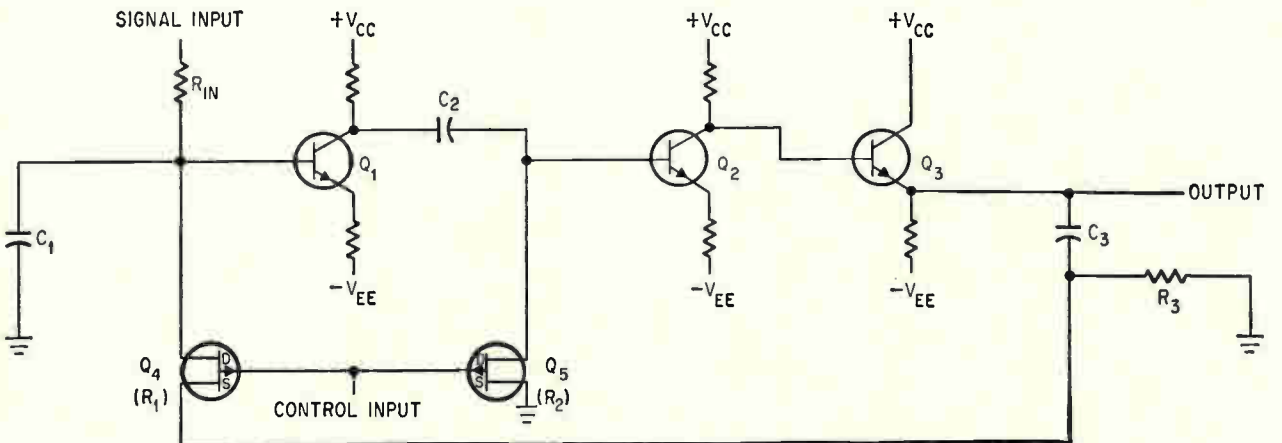
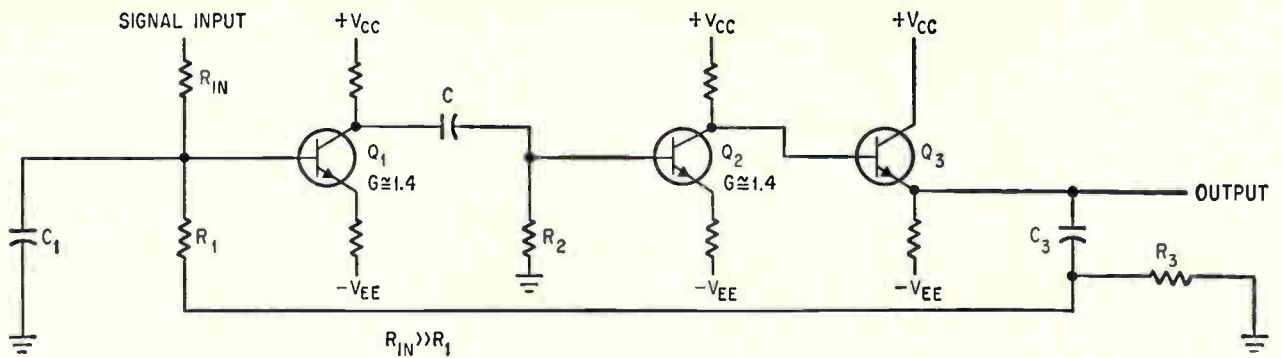

Active, voltage-tuned bandpass filter, derived from the basic bandpass filter, consists of two cascaded amplifier stages, Q_1 and Q_2 and emitter follower, Q_3 . Equalizing $R_1 C_1$ and $R_2 C_2$ minimizes the required gain for a given damping factor.

The design equations are

$$\omega_n^2 = \frac{1}{R_1 R_2 C_1 C_2} = \text{corner frequency} \quad (5)$$

where $C_1 = C_2$

$$\rho = \frac{1+M^2}{2\lambda M} + \frac{\lambda}{2M} (1-K_2) = \text{damping factor} \quad (6)$$

where $M^2 = \frac{C_1}{C_2}$,

and $\lambda^2 = \frac{R_2}{R_1}$,

and $K_2 = \text{gain of } Q_3$.

The corner frequency is linearly related to the control voltage. As a practical consideration, both FET's operate at the same control voltage, making the source-drain resistances $R_1 = R_2$. Under these conditions the damping factor is always unity. In certain designs this is not necessarily desirable. The restraint can be loosened, though, by making $C_1 \neq C_2$, but the filter design then becomes more complex.

Bandpass filter

An active, voltage-tuned bandpass filter is basically quite different from the low and high-pass

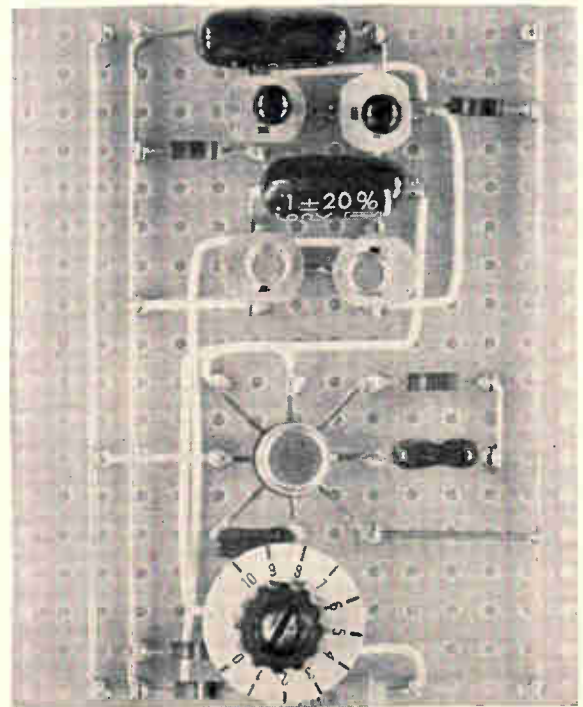

Experimental breadboard of voltage-tunable audio bandpass filter can be easily compressed into 1.5 cubic inches for space package. Philco delivered four such audio filters to NASA.

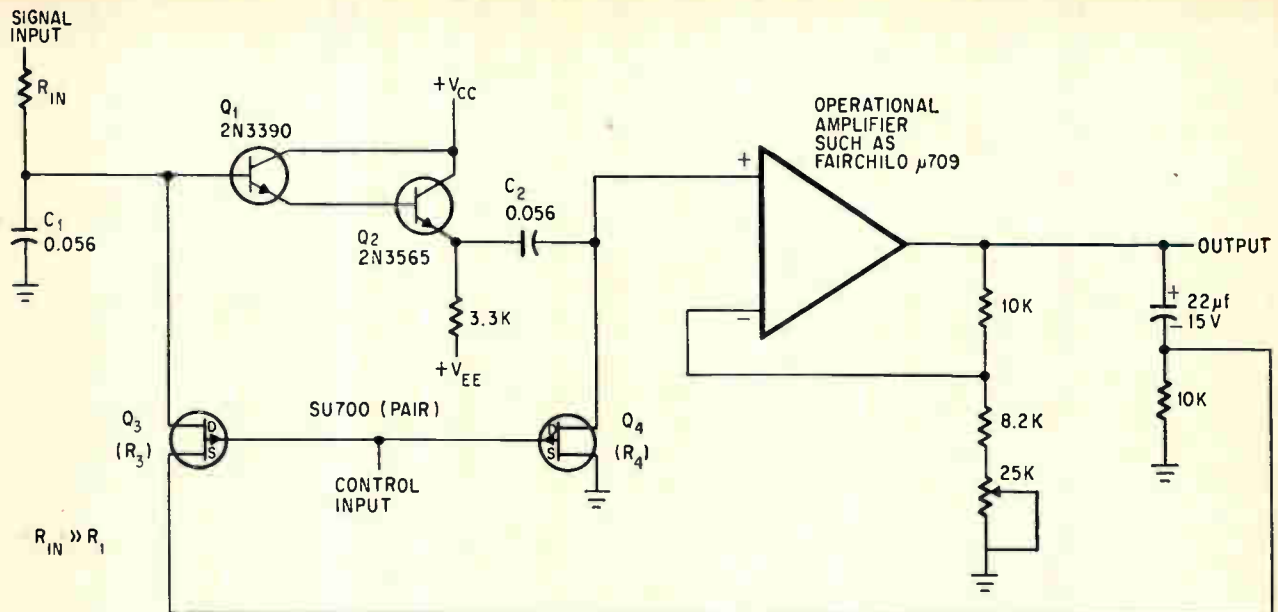

An integrated operational amplifier is used in the bandpass tunable filter to insure stability at high values of filter Q .

configuration. A simplified fixed-tuned version shown above, consists of two cascaded amplifier stages with an over-all gain of approximately two. The third stage, emitter follower Q_3 , provides a low output impedance. The frequency selective networks are a low-pass filter made up of R_1 and C_1 and a high-pass filter formed by R_2 and C_2 . The products R_1C_1 and R_2C_2 are equal since this results in the minimum gain required for a given figure of merit, Q . Capacitor C_2 and resistor R_3 provide a-c coupling and a d-c return path to the base of Q_1 .

When field effect transistors replace resistors that determine frequency, component values may be determined by these equations:

$$\omega_n = \frac{1}{RC} = \text{resonant frequency} \quad (7)$$

$$Q = \frac{1}{1 - 0.25G_1^2G_2^2} = \text{figure of merit} \quad (8)$$

G_1 and G_2 are the voltage gains of Q_1 and Q_2 respectively.

$$R_{IN}(Q_1) > 10 X_{C1}, \quad R_{IN}(Q_2) < 10 X_{C2} \quad (9)$$

R_1 is chosen to equal R_2 and $C_1 = C_2$. In the design of bandpass filters, figure of merit, Q , a function of the damping factor, is the basic parameter. It can be shown that here too, ω_n varies linearly in response to the control voltages.

Practical considerations

When a high Q bandpass filter is required it becomes difficult to satisfy the requirement of high amplifier input impedance and low output impedance. In addition, when the Q is high, slight amplifier gain variations strongly affect the figure of merit. To overcome these problems, an integrated operational amplifier, connected as shown in the

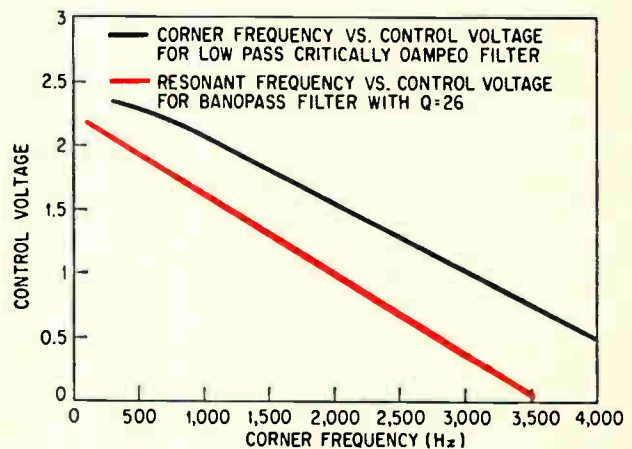

Linear relationship exists between corner frequency and control voltage in the low-pass critically damped filter and between the resonant frequency and control voltage in the bandpass filter.

diagram above is a useful substitute for the output transistor and provides a high range of Q from 10 to 100.

The field effect transistors in the active voltage-tuned filters are matched for operation over the 20:1 frequency range. The resistances at zero gate voltage, R_n , are matched within 5%, the resistances at $4R_n$ are matched within 10%, and at $20R_n$, matched within 20%.

The field effect transistors limit maximum peak-to-peak output signal swing to about 0.1 volt. At greater signal amplitudes the output signal becomes distorted.

Reference

1. James S. Sherwin, "FET's as Voltage Controlled Resistors," Solid State Design, August 1965.

Designer's casebook

Designer's casebook is a regular feature in Electronics. Readers are invited to submit novel circuit ideas, packaging schemes, or other unusual solutions to design problems. Descriptions should be short. We'll pay \$50 for each item published.

FET's produce stable oscillators

By Tom F. Prosser

Microelectronics Division, Philco Corp.,
Santa Clara, Calif.

Oscillators that are inexpensive but stable can be made with field effect transistors. The oscillators can be tuned to frequencies ranging from subaudio to near gigahertz and, with modifications, can sweep through a wide frequency range.

An example of the manually tuned type of r-f oscillator is shown in the circuit below. The circuit features load leveling for constant output voltage. Basically, it is a Colpitts oscillator.

The drain-source voltage of one FET, Q_1 , is limited by the variable resistance of a second, Q_2 . Consequently, the oscillator's output voltage is limited. Oscillations occur when the drain-source voltage of Q_1 is as low as 6 volts. Transistor Q_1 , made by Amelco Semiconductor, a division of Teledyne, Inc., has high mutual conductance ($g_m = 5,000$ mi-

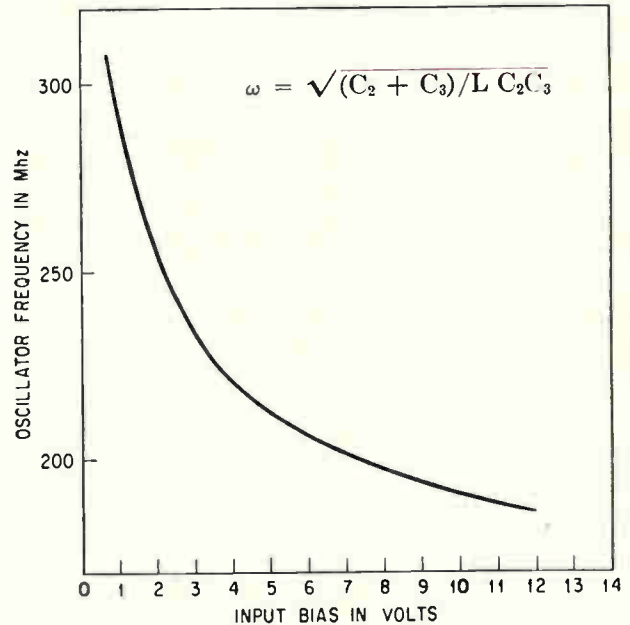

Frequency control characteristics of the sweep oscillator indicate that the oscillator can sweep over more than 100 Mhz in a nonlinear manner, or over a narrow range in a linear manner. The equation indicates the angular frequency of oscillation.

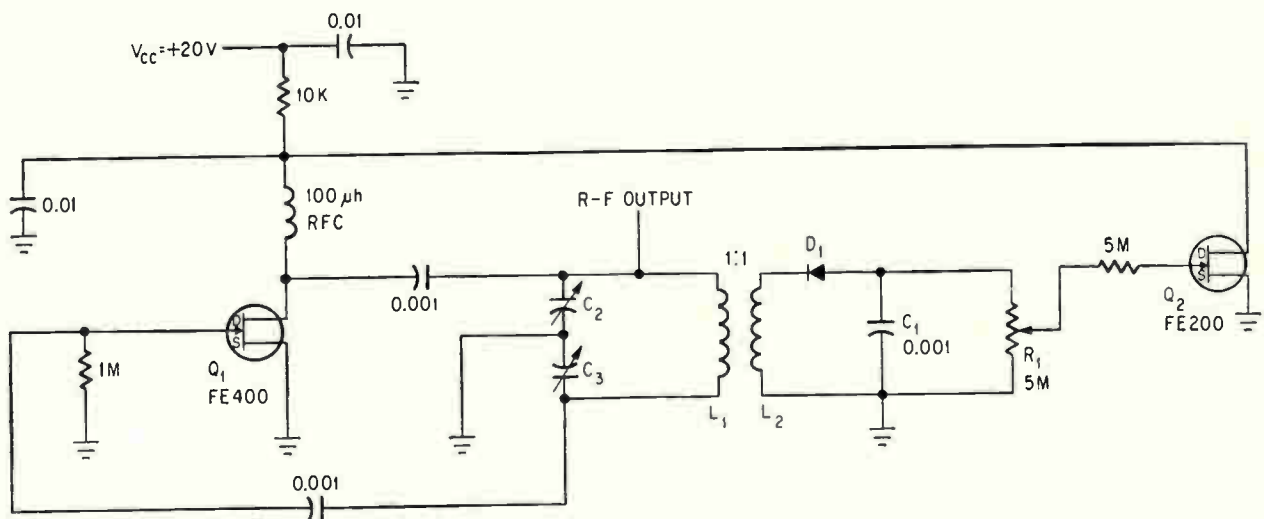

NOTE:
ALL CAPACITANCES ARE IN MICROFARADS
UNLESS INDICATED.

Load leveling is achieved in the oscillator when one FET, Q_2 , acts as a variable resistance. Despite load variations, Q_1 's drain-source voltage remains fixed.

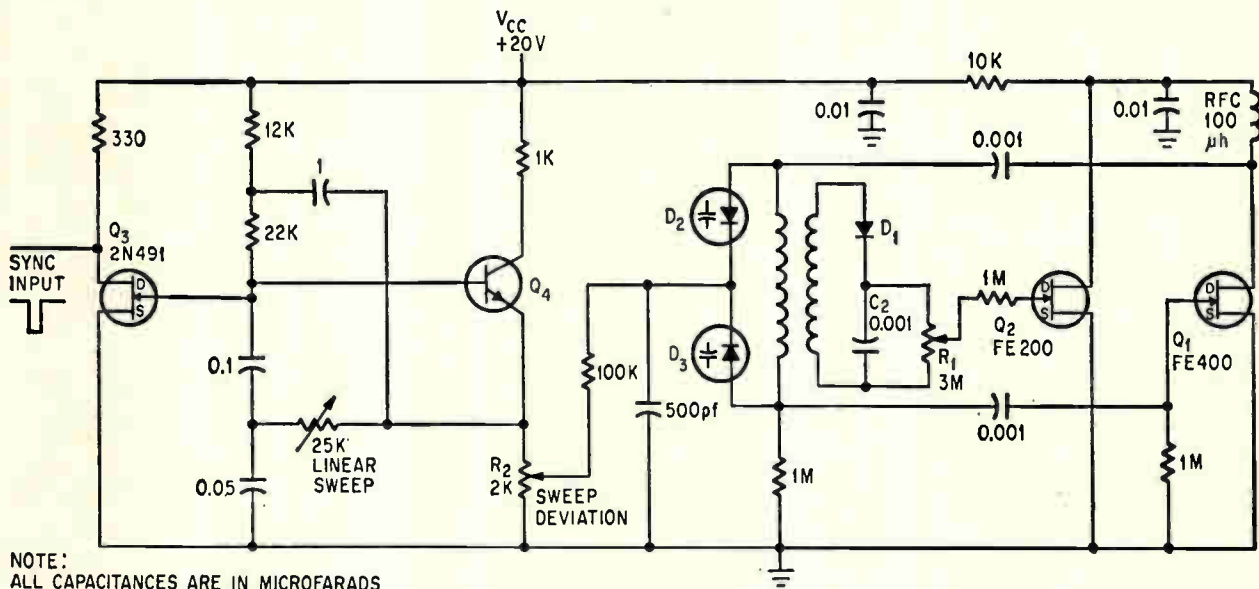

NOTE:
ALL CAPACITANCES ARE IN MICROFARADS
UNLESS INDICATED.

Transistor Q_3 's triangular shaped output sweeps Varicap tuning capacitors D_2 and D_3 and the oscillator frequency via the buffer amplifier, Q_4 . Load leveling is accomplished by Q_1 and Q_2 .

cromhos and generates low self-noise, under 4 microvolts.

The circuit produces an unloaded output voltage of up to 15 volts peak to peak in the 300- to 400-megahertz region. A portion of this voltage is coupled through the transformer, rectified by diode D_1 and filtered by R_1 and C_1 . The setting of resistor R_1 controls the operating point of FET Q_2 and hence the output amplitude. R_1 is set for a full-load oscillator output of 10 volts peak to peak.

A sweep-frequency version of the load-leveling oscillator is shown above. Components D_2 and D_3 are voltage-variable capacitances covering a frequency range from 200 to 300 Mhz. The voltage

output curve of unijunction transistor Q_3 is triangularly shaped. This output voltage buffered by amplifier Q_4 changes the capacitance of the Varicaps and hence the oscillator frequency. Resistor R_2 sets the sweep deviation by controlling the amplitude of the voltage applied to the Varicaps. Depending upon the setting of R_2 , the oscillator can sweep a wide range nonlinearly or a narrow range linearly. C_2 and C_3 refer to the capacitances of D_2 and D_3 in the formula on the graph.

As in the fixed-frequency oscillator, transistors Q_1 and Q_2 respond to output load change with fast leveling action while supplying high output voltages with low harmonic distortion.

Switching amplifier converts unipolar to bipolar pulses

By W.D. Waddle

Texas Gas Transmission Corp., Owensboro, Ky.

Conversion of positive pulses to positive and negative pulses is accomplished with the circuit on page 104 in both transistor logic circuits and interface amplifiers.

Such unipolar-bipolar converters are often used in business machines and data transmission sets. To achieve the conversion the input circuit is con-

nected directly to the output of a transistorized logic circuit.

When the input of the converter circuit is at zero potential, transistor Q_1 becomes forward biased and conducts heavily. Under this condition Q_1 furnishes a low resistance path for the current from supply voltage E_1 through part of resistor R to the load R_L . Thus, a positive voltage E_o is dropped across R_L .

Variable resistor R (a low value resistor, about 10% of R_o) is set to the limit of the positive pulse swing. During the rise of the input pulse, diode D_1 blocks current. Thus, resistor R becomes part of a voltage divider on the positive output voltage swing. The application of a positive voltage (approximately equal to E_1) to the input of Q_1 causes

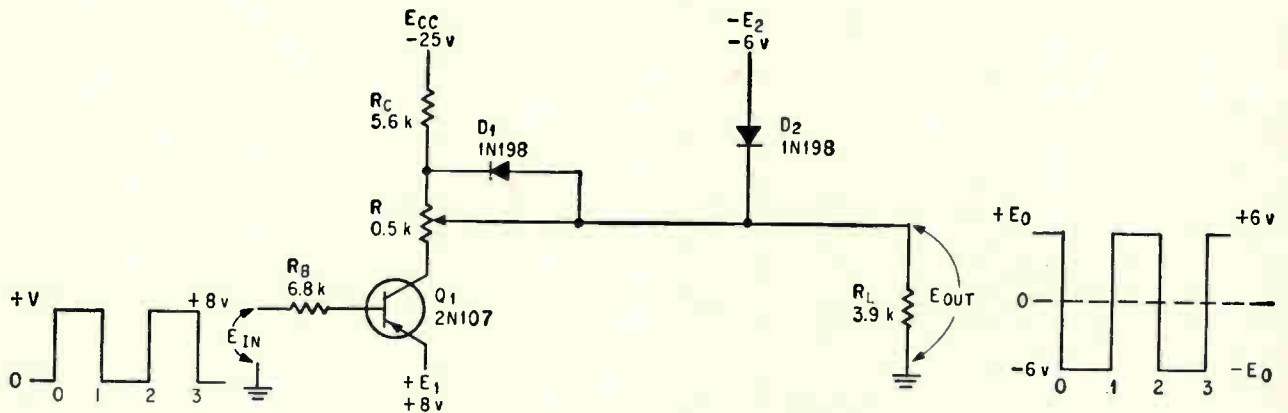

During the positive part of the input waveform, Q_1 conducts and produces a positive output voltage, E_o . When the input voltage reaches the value E_i , transistor Q_1 becomes reverse-biased, stops conducting and causes a negative output storage, $-E_o$.

the transistor to be reverse-biased and subsequently cut off.

Now that transistor Q_1 is not conducting, there is a high-resistance path for current from E_1 to R_L . Supply voltage E_{cc} is then free to provide current through resistor R_c , diode D_1 and load resistor R_L to develop a negative voltage across R_L , approximately equal to voltage supply E_2 . Diode D_1 passes current on the negative pulse and bypasses resistor R on the negative output volt-

age swing. Bias supply E_2 and diode D_2 limit the signal when the output swing is negative.

Typical operating values are as shown. The characteristics of diodes D_1 and D_2 are selected according to the switching rate required and the current through the diode on the negative output pulse. A transistorized buffer amplifier added at the input is a simple method of accomplishing the switching action. Resistor R_c is found on the basis of E_o , required on the negative output swing.

Detector stores peaks of video bursts

By David S. Greenstein

Honeywell, Inc., Boston

The peak detector shown senses the highest peak of an amplitude-modulated 2-megahertz burst to within 5 millivolts. Peak values from 5 millivolts to 1 volt are stored for approximately 100 microseconds and each time the peak exceeds the stored value a pulse is produced. This detection is useful where position information about a video signal is required. Burst detectors are found in radar, sonar and video and are used for sampling time delay signals.

Conventional diode detectors cannot achieve such accuracy or range because diode junctions are sensitive to temperature changes and require large turn-on voltages. Furthermore, conventional detectors don't usually furnish a signal when the storage is updated.

The comparator detects the amplitude of the

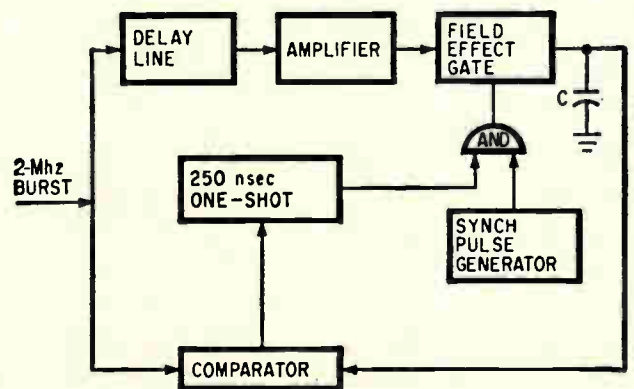

Comparator senses when the amplitude of the 2-MHz signal becomes 5 millivolts or more than the voltage stored on capacitor C.

2-MHz signal when it exceeds the voltage stored on capacitor C by 5 millivolts [see block diagram]. On sensing the amplitude, the comparator triggers the 250-nanosecond one-shot multivibrator, producing an output pulse. This pulse, coupled with one from the synchronized pulse generator, turns on the field effect gate circuit, raising the voltage stored on the capacitor to a new value.

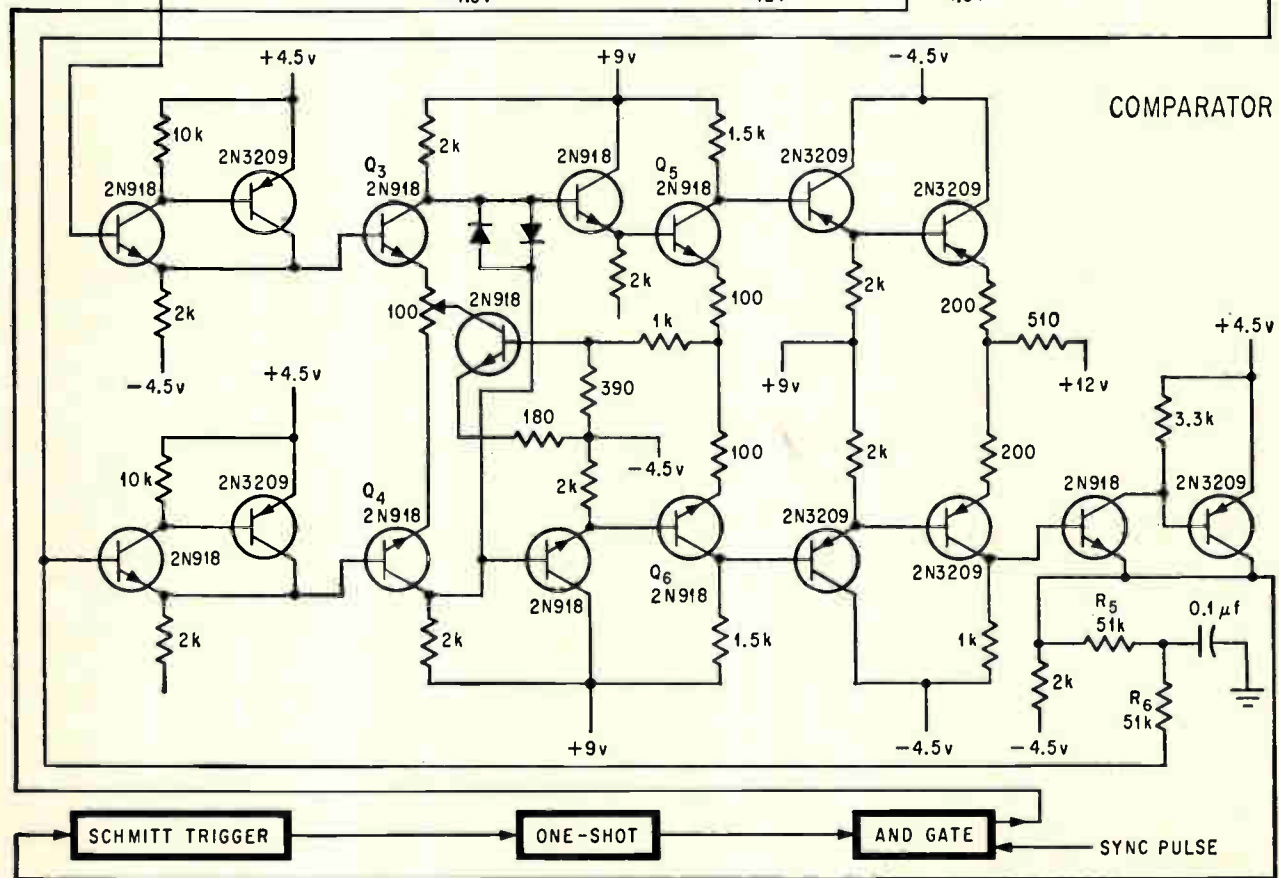
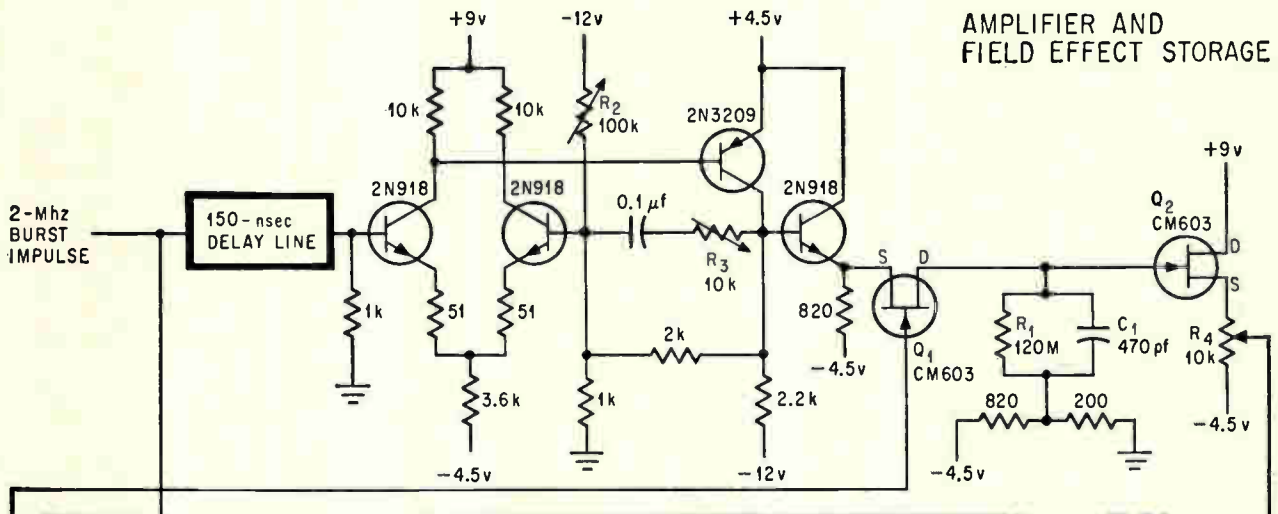

The peak is stored for 100 microseconds by capacitor C_1 . To assure storage for this period the capacitor must discharge with a time constant of at least 20 milliseconds.

A 125-nanosecond pulse from the synchronized pulse generator ensures that the gate is turned off after 90° of the 2-Mhz sinusoidal waveform. It is essential that the field effect gate be turned off or the capacitor will discharge.

The synchronized pulse generator is not necessary if the 2-Mhz maximums are flatter than those of a sine wave or if the input frequency is much below 2 Mhz. Compensation for the delay in the

field effect gate driving pulse is provided by the 150-nanosecond delay line, caused by propagation delays and the fact that the comparator triggers a one-shot at some time during the first 90° of the 2-Mhz signal.

Over-all gain for the amplifier and field effect storage section shown schematically must be 1 because the output of this circuit is the stored voltage that is compared with the 2-Mhz input;

capacitor C_1 is the storage capacitor. To store a voltage for 100 microseconds within 0.5%, the capacitor must discharge with a time constant of at least 20 milliseconds. Resistor R_1 in parallel with C_1 provides the required time constant.

Field effect transistors Q_1 and Q_2 have a negligible effect on the time constant because of their high impedance. Because of the finite gate-source capacitance, the turn-on pulse at the gate of Q_1 feeds through to the storage capacitor and appears as a negative step with an amplitude of approximately 1 volt. This step is constant for all signal levels. Compensation for the step is accomplished by adjusting the d-c level with potentiometer R_2 . Gain is adjusted with potentiometer R_3 . Potentiometer R_4 zero-adjusts the source follower.

N-channel field effect transistors, CM603, manufactured by Crystalonics, Inc., are used because of their low "on" resistance of 35 ohms maximum

and high gain-bandwidth product of 400 Mhz. The on resistance must be low because the low-pass network made up of the on resistance of Q_1 and capacitor C_1 must pass the 2-Mhz signal frequency.

The comparator is a three-stage, direct-coupled differential amplifier with a gain of approximately 800 in the frequency range of 25 khz to 9 Mhz. Low-frequency feedback is provided by R_5 and R_6 to produce low d-c gain. The comparator drives a Schmitt trigger that fires a 250-nanosecond one-shot. Improvements in the performance are possible since the sensitivity is largely a function of the gain and stability of the comparator.

To eliminate unwanted oscillations, the components are assembled on a sheet of brass. Transistor sockets are not used and the cases of Q_3 , Q_4 , Q_5 and Q_6 are mounted upside down in individual heat sinks bolted to the brass plate for positive grounding and isolation.

Circuit samples a signal, holds it up to 1 minute

By Robert S. Cuikay

Northeastern University, Boston

Where pulse information is required, as in data systems, the circuit shown is used to sample signals and store them for up to 1 minute. These signals vary less than 5%. The circuit has a high current transfer ratio and operates from -55° to $+85^\circ\text{C}$ with low power consumption.

The signal to be sampled is applied to the base of transistor Q_1 . Forward biasing the base-to-emitter junction of Q_3 with a positive voltage, V_2 , saturates Q_3 . Transistor Q_3 must be saturated during a specified sampling time, set by the input gate signal. Thus the collector of Q_3 saturates from a positive voltage of V_1 to approximately the emitter voltage of Q_3 and provides a current return path for the previously inhibited transistors Q_1 and Q_2 . The sampled signal is then transferred to the storage capacitor C_1 through a signal path indicated by:

$$V_s = e_s - V_{BE1} - V_{D1} + V_{D2} + V_{D3}$$

where

V_s = sampled input signal voltage
 e_s = input signal

V_{BE1} = base-to-emitter voltage junction drop of transistor Q_1

V_{D1} = forward junction voltage drop of the

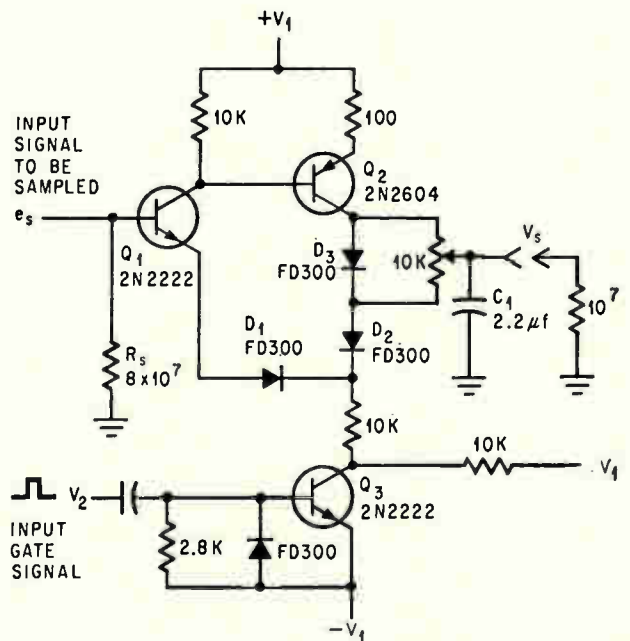

Sampling and holding an input signal up to 1 minute is possible with this high energy circuit. The circuit operates well over a temperature range of $+85^\circ$ to -55°C .

emitter-to-base protection diode

V_{D2} = forward junction voltage drop of isolation diode

V_{D3} = forward junction voltage drop of compensation diode.

To make the sampled signal equal to the input

signal ($V_s = e_s$), V_{BE1} , V_{D1} , V_{D2} and V_{D3} must total zero. Although the junction drops of V_{BE1} , V_{D1} and V_{D2} may not be properly matched, the adjustment of V_{D3} by a potentiometer across diode D_3 will allow for compensation of any voltage-junction drop differences.

When the sampling gate time ends, the voltage on the base of Q_3 equals the emitter's voltage. The equalization cuts off Q_3 and allows the collector node to rise to a positive voltage level of V_1 . The voltage V_1 reverse biases the protection diode D_1 and the isolation diode D_2 , stopping the sampling of the input signal.

Thus transistors Q_1 and Q_2 are cut off. Now, the only discharge or leakage paths for the sampled and stored input signal voltage on capacitor C_1 are: the load impedance in parallel with the storage capacitor; the reverse biased base-to-emitter junction

of transistor Q_2 ; the reverse leakage of the isolation diode and the capacitor leakage. It can then be read out as V_s .

The circuit has several features:

- The sampled signal transfer rate from circuit input to the holding capacitors is equal to the square of the current transfer ratio (h_{FE}^2) of transistors Q_1 and Q_2 . If a beta of 100 is given, the signal transfer ratio approaches 10,000. So high-beta transistors are not required.

- The input impedance of the circuit is given as $h_{FE}^2 R_{in}$ in parallel with R_s . Numerical values of R_s and R_{in} under typical circuit conditions are 10^7 and 8×10^7 ohms respectively. These resistor values yield an input impedance of approximately 8.8×10^6 ohms.

- The driving impedance to the storage capacitor and equivalent loads is less than 900 ohms.

FET stabilizes amplitude of Wien bridge oscillator

By Joseph J. Panico

Technology Division, GCA Corp.,
Bedford, Mass.

When the drain-source voltage, V_{DS} , of a field effect transistor approaches zero, the FET behaves very much like a linear variable resistance, and remains nearly linear at higher voltages below pinch-off. This characteristic makes FET's useful as a stabilizing element in oscillator circuits like the Wien bridge oscillator below.

In the circuit, output voltage V_o is rectified by D_1 and filtered by R_3C_1 . Potentiometer R_2 sets the gate-source voltage, V_{GS} , which in turn established the output amplitude.

Oscillations occur when

$$V_{DS} = \frac{V_o'}{3}, \text{ where } V_o' = \frac{R_5}{R_4 + R_5} (V_o).$$

the frequency of oscillation $\omega = 1/RC$.

The circuit provides distortionless output over a frequency range of d-c to 100 kilohertz if the transistor's V_{DS} does not exceed several hundred millivolts. The drain-source resistance, R_{DS} , becomes nonlinear at greater voltages than this. However, by adding a resistor in series with the FET drain, larger amplitudes can be obtained, with low distortion and very little sacrifice in control.

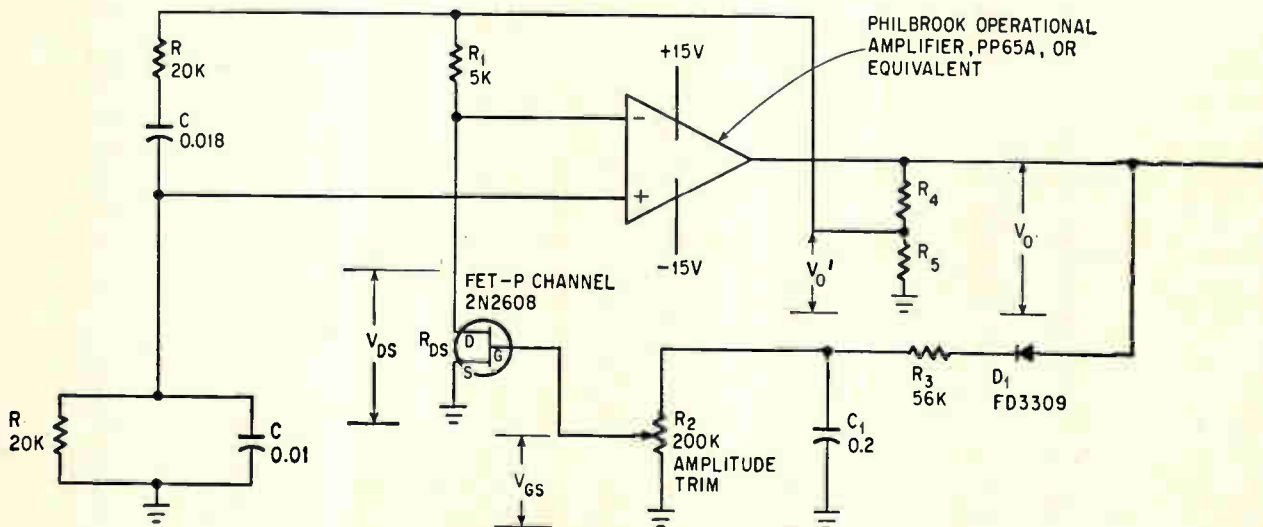

Oscillator output V_o , will be distortionless if it exceeds 10 volts, provided V_o/V_o' is greater than 10 to 1.

New dimensions in IC's through films of glass

Better glassing methods and new materials, such as silicon nitride, may permit the best features of monolithic and hybrid integrated circuits to be combined in bigger, better, cheaper IC's

By John A. Perri and Jacob Riseman

Components Division, International Business Machines Corp.
Hopewell Junction, N.Y.

From the marriage of monolithic and hybrid integrated circuit technology may come a new generation of circuits that will not require external components to function properly.

To pursue the analogy further, the marriage bond is likely to be glassing technology. This encompasses various methods of applying impervious glass films to the basic semiconductor devices and the development of better glasses. Glassy silicon nitride, for example, is now being investigated as a means of improved semiconductor processing and as an insulator that may allow fabrication of more complex, yet more stable, devices.

Covering a chip with an impervious, insulating film allows a planar device to be transformed into a three-dimensional structure. Extra wiring layers can be added—as in the multicircuit chip shown on the

cover—or thin-film passive components, or both, as illustrated on page 114.

The multilayer approach adds two key advantages of hybrid IC's to the attractions of monolithic IC's—more versatility in intraconnection and high-quality passive components. But the circuit remains integral. It is batch-fabricated, not an assembly of devices and wiring. Gains in performance can be expected. For instance, keeping all the passive devices and intraconnections within distances of a few thousandths of an inch is one way to get maximum speed in a logic or memory circuit. Device cost and reliability is improved by the absence of individually fabricated connections and bonds.¹ The use of a single package to house a score or more of circuits on one chip further improves cost and reliability.

The best of two worlds

It has been conventional to consider monolithic IC technology as exclusively a semiconductor field, emphasizing intrinsic technology [see "Extrinsic and intrinsic technologies," right]. The monolithic approach² has also emphasized fabrication of the entire circuit within the silicon crystal.

In the main, this approach exists in the fabrication of complex circuits and IC arrays. However, the arrays represent an important trend—the striving to get the most out of silicon technology by meeting the need for higher device speeds through smaller geometries and better intraconnection and packaging. This trend has focused attention on photolithographic problems and glassing techniques that solve them.

Remaining as a significant disadvantage of monolithic technology is the fact that passive components made of diffused silicon are poor performers

The authors



John A. Perri heads a development group responsible for device metallurgy and insulator technology at IBM's Components division. Since joining IBM in 1958, he has been concerned especially with glass passivation of semiconductors. He has a doctorate in solid-state chemistry.



Jacob Riseman, whose doctorate is in physical chemistry, also joined IBM in 1958 and has held many managerial posts in semiconductor and magnetic development. He is now in charge of silicon and thin-film technology.

compared with discrete and film components. This limits the performance of monolithic IC's, as does the impracticality of designing an IC for best performance of each diffused device. Selecting a diffusion process ideal for one device generally impairs the performance of the others.

A partial solution, effective in some IC's, is to deposit passive thin-film devices on the silicon dioxide coating that passivates the silicon surface and acts as a substrate for the thin-film intraconnections. This is frequently inadequate, if only because the thin-film components are large compared to the active devices and restrict the amount of intraconnection area available. As a result, hybrid IC's must often be used.

Now, the monolithic and hybrid technologies show signs of merging, to gain the best of the two worlds.

Ball-and-solder joints

A good illustration of a hybrid technique that can serve as the jumping-off point for a more advanced IC is the International Business Machines Corp.'s well-known Solid Logic Technology (SLT).³

Chip semiconductors are bonded face-down to a ceramic substrate that carries thick-film wiring and passive components. The chip is coated with glass to eliminate the need for expensive hermetically sealed packages and to allow interconnection by the low-cost, solder reflow method. The method is as reliable as the usual wire bonding.⁴

After diffusion, the devices are coated with 60 microinches of glass by the fired-frit process⁵ described on page 115. Small areas of the lands (thin-film electrodes on the device) are exposed by etch-

ing holes in the glass. The holes are filled with solder and tiny metal balls are placed in the holes, as in the diagram of a transistor on page 112. Then the silicon wafer is sliced into individual devices and soldered to the substrate.

The ball-and-solder joints between the chip and substrate, in the photo on page 112, are clearly the forerunners of the contacts of the complex IC's shown on the cover and page 113. The latter, a 16-bit memory circuit,⁶ is bonded to a module substrate by solder reflow. The glassing techniques have been extended to allow intraconnection of many devices. A similar contact could be used atop the more complex structure on page 114.

Numbers game

On the single SLT devices, the glass protects the semiconductor junctions and contacts, shielding them from mechanical damage during handling and automated assembly of the SLT modules. The glass is the package, but the devices are essentially the same as those packaged in metal cans.

The glass's function changes when the device grows into a monolithic IC. IC's sharply reduce device packaging, handling and intraconnection costs. Since a single package already contains many devices, the economies of glass are no longer as pronounced. Here, the numbers game comes into play—a chip containing a score or more of circuits requires a complex, hermetically sealed package, but since the cost is shared by 100 or more components it is less than one package per device.

Therefore, glass as a package is likely to be of lesser importance in monolithic IC's than glass as a stable insulating film between multilevel wiring. If the wiring isn't multilevel, the amount of integration possible will be severely curtailed.

Levels of wiring

Single-level wiring is the simplest use of glass. One thin film of glass protects the device and the thin-film wiring during solder reflow or thermo-compression bonding.

Two wiring levels require more sophisticated glassing techniques. The glass between the levels must insulate the many wiring crossovers yet allow for vias through the glass to connect the two levels. Vias are used in the circuit on the cover; the closeup photo on page 113 shows them clearly. A top layer of glass protects the upper wiring level and is the mechanical structure for the contacts to the next packaging level. In a sense, the result is a printed circuit board several orders of magnitude smaller than conventional boards.

Multilevel wiring allows more devices or circuits on a chip and reduces resistance and impedance in the lands by shortening the wiring. Typically, an aluminum-film land is 1 micron thick. As an electrode, carrying current from the surface into the device, it has a resistance of at least 0.03 ohm per square. When the land extends over the insulating surface, the added resistance of a 0.3-mil-wide (0.0003 inch) land is 0.1 ohm per mil of length. The

Extrinsic and intrinsic technologies

In the last 10 years, silicon transistor costs have decreased from dollars to pennies while performance, measured by speed, has risen into the nanosecond range.

This cost-performance improvement has resulted largely from developments in what is sometimes called intrinsic silicon technology—the steps required to make a basic semiconductor device. The developments include planar processing that allows a greater amount of batch fabrication; better diffusion methods; high-resolution photolithographic techniques; the use of thin epitaxial layers of silicon and better ways of controlling the distribution of impurities in the silicon crystal.

Of almost equal importance now and of considerably greater importance in the future is extrinsic semiconductor technology—the steps that take place after the semiconductor junctions are formed. These steps include intraconnecting devices and terminals on the same silicon chip, interconnecting the chip to the next packaging level and providing a safe environment for the sensitive semiconductor junctions and the closely spaced metal lands.

Glass has played a starring role in the extrinsic technology during the past five years, allowing more sophisticated device fabrication and packaging techniques.^{27, 28} It is certain to become more important in the future and may well determine the direction of semiconductor technology.

crossovers and vias of multilevel wiring permit the designer to use a shorter, more direct path between devices in most cases. Sometimes the additional substrate area of the extra glass layer offers the option of widening the wiring, thus lowering the resistance by reducing the number of squares in a given length.

Three or more wiring levels further extend electrical capability by adding substrate area that can be used for deposition of thin-film components, as in the diagramed example on page 114, to obtain the precision passive components needed by high-speed digital circuits and linear circuits. The resistor on an intermediate glass film is protected by the glass above it. This is a return to hybrid technology, except that thin-film intraconnections replace external interconnections.

Glass's other job

Although this report is concerned primarily with the extrinsic role of glass—its application after silicon processing—glass has some important intrinsic uses. The prime one is as silicon dioxide formed by the thermal oxidation of the silicon. This glassy phase, without grain boundaries, is a good diffusion barrier. It is etched to form a diffusion mask.

Glassy silicon nitride is being investigated as a diffusion mask for silicon and other semiconductors but its ultimate worth is still difficult to judge. It may prove superior to silicon dioxide as a diffusion mask, allowing smaller device geometries; improve device stability, because of lower ionic drift; and its higher resistance can lead to better dielectric isolation of high-speed devices.^{7,8,9}

Glass is actually the diffusion source in some processes, especially if diffusion is done under oxidizing conditions. Glass containing the diffusant is applied directly to the silicon. A particularly interesting result of this approach is the phosphosilicate glass formed during phosphorus diffusion. The process is not understood well, but the glass enhances device stability.¹⁰

Matching silicon and glass

Because the silicon in an IC is thicker than its glass covering, silicon dominates the extrinsic structure. The closer the glass's thermal coefficient of expansion matches the silicon's, the better the glass grips the silicon.

Mismatches of a factor of 2 can be tolerated if the glass film is thin, about 1.5 microns or less, and the glass is in tension. Greater mismatches can be tolerated if the glass's coefficient is lower than silicon's, placing the glass in compression.

Nevertheless, thermal expansion is a critical property in multilayer structures because the glass films must be thicker than for single-layer wiring. One reason IC designers are considering silicon nitride is its close match to silicon in its bulk coefficient of thermal expansion.

Thermal stability is also important. The glass must not soften or decompose, of course, at process temperatures used after the film is formed, nor during long use of the IC. Good thermal conductivity

helps dissipate heat from the circuit during use. Most dielectrics are poor heat conductors, but silicon nitride is better than silicon dioxide.

Chemical stability is necessary during processing and to allow the glass to withstand adverse environments, such as humid air. Moisture leaches some films, hydrates others, dissolves others and leaves some glass essentially unaffected.^{11,12} The rule—with some startling exceptions—is: the higher a glass's softening temperature, the better its chemical stability. Silicon nitride's ability to withstand long exposure to water at 1,000° C is another reason it is intriguing.

Permeability of the film to the ambient, especially water, is closely related to density. Naturally, the designer doesn't want a glass that is porous, nor one that contains water or contaminants such as partly decomposed organic molecules. Films with grain boundaries are also shunned, because diffusants may attack the semiconductor junctions through the boundaries.

Dielectric constant should be low to hold down parasitic capacitances in the devices. Generally, this isn't a problem because the dielectric area (area between metals acting as capacitor electrodes) is small in IC's. Resistivity of the film should be 10^{10} ohm-cm or greater, to insure leakage currents less than normal junction leakage currents—in other words, negligible.

Ionic migration in glass films is a more complex problem. It can lead to electrolytic reactions that degrade thin-film resistors, semiconductor surface properties and crossovers.¹³ Glasses that have a low concentration of diffusing species, such as sodium, and also low mobility are scarce. One of silicon nitride's outstanding features is a low rate of ionic migration; for example, sodium ion migration is, at 200° C, several orders of magnitude lower in silicon nitride than in silicon dioxide.

An essential mechanical property is the ability to remain a good substrate for thin-film deposition after the glass is handled. It must also be machinable by methods fully compatible with silicon technology, so that well-defined contact holes can be formed in the film. In this, silicon dioxide and silicate glasses are outstanding; acid fluorides etch only the glass, not the other device materials.

Other glasses need special masking films, requiring additional deposition and etching steps. This is a major drawback to the use of silicon nitride, even though it is a better diffusion barrier and insulator and can thus be used in thinner layers to obtain smaller devices and contact holes. Etchants for silicon nitride are powerful, so a chromium mask is used to protect areas that are not to be etched.

Glassing techniques

Glass is usually made by rapidly cooling certain liquids, chiefly molten oxides of silicon and boron. This, in essence, is the basis for the SLT glassing process, firing glass particles on the silicon wafer.

Two other basic ways of glassing semiconductors are: chemical deposition, consisting of reactions in

Out of the crucible and into the sputtering chamber

Glass is essential ingredient of multilevel wiring and protective coatings for integrated circuits.

Its composition is easier to control if it is made in bulk and fused or sputtered onto the semiconductor wafers, instead of being deposited by other methods.



Violet glow discharge bathes wafers in r-f sputtering chamber. Wafers are showered by molecules of glass dislodged from the cathode above by ion bombardment.

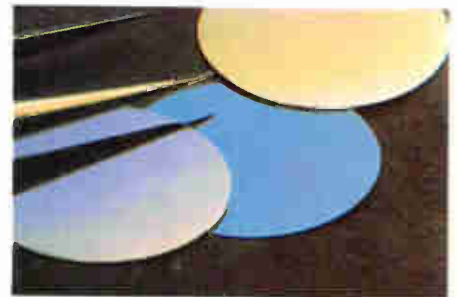
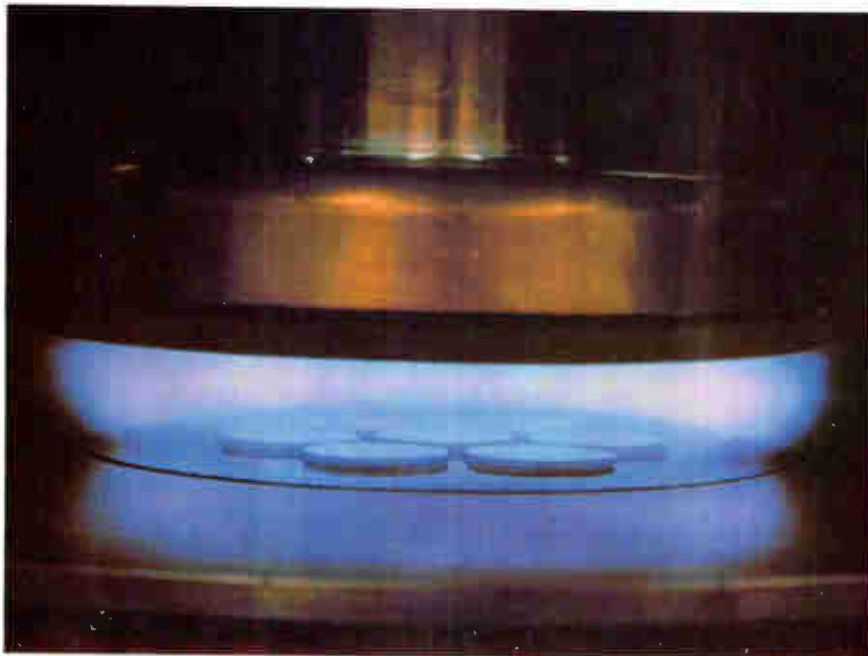

Silicon nitride coats these wafers; it is superior to silicon dioxide as an insulator, but is harder to process. The colors vary because optical interference between light reflected from the silicon and glass surfaces varies with coating thicknesses. Thicknesses are about 2,000 angstroms for the yellowish coating, 2,500 Å for the bluish one and 3,200 Å for the reddish glass. Silicon nitride is shinier than silicon dioxide because it has a higher refractive index.

Ball contacts: three for a transistor and 15 for a 16-bit memory circuit

Single-device chip soldered to interconnections on a ceramic substrate. Contacts are the tiny metal balls shown in the diagram below.

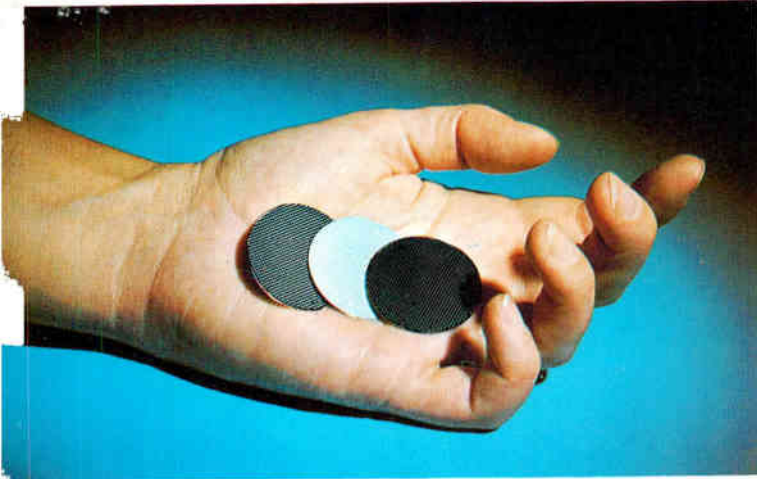

Three steps in forming a fired-frit coating are illustrated (left to right) by a silicon wafer bare except for its silicon dioxide coating, a wafer coated with frit and a wafer after firing of the glass.

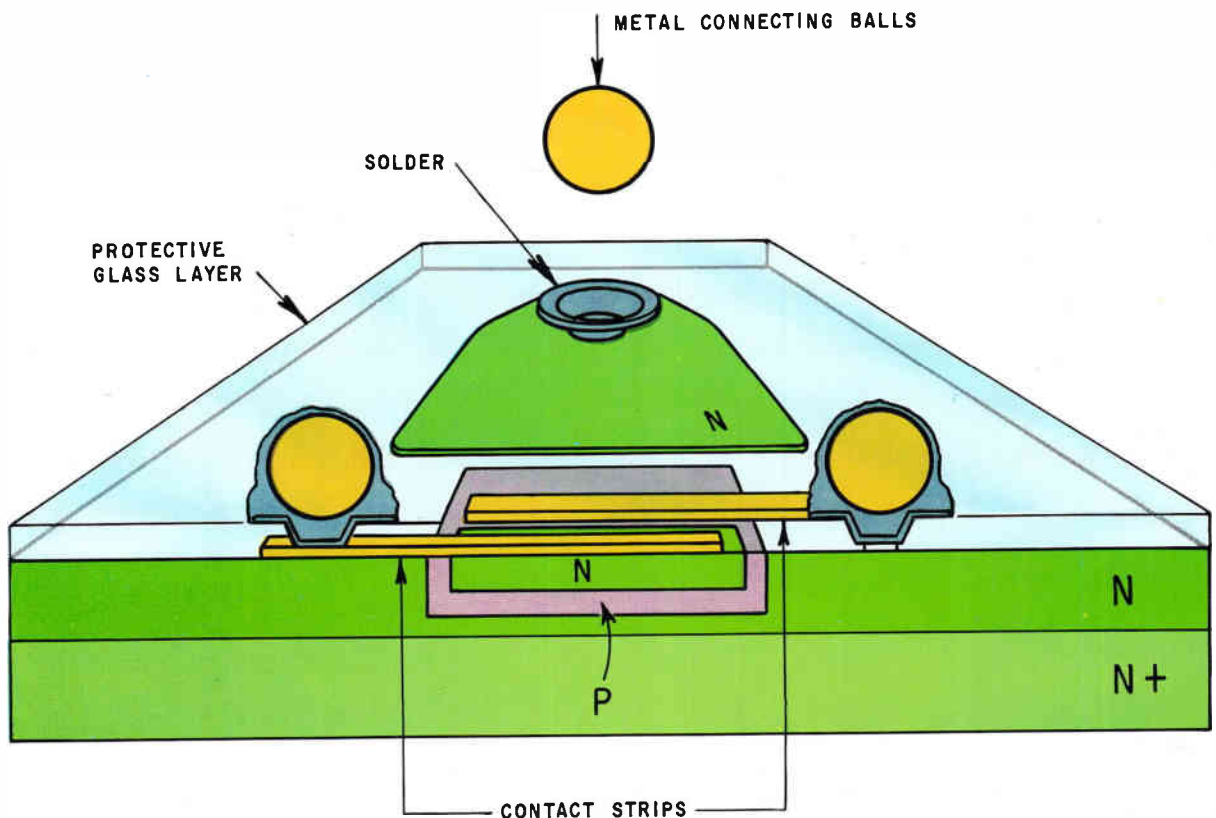
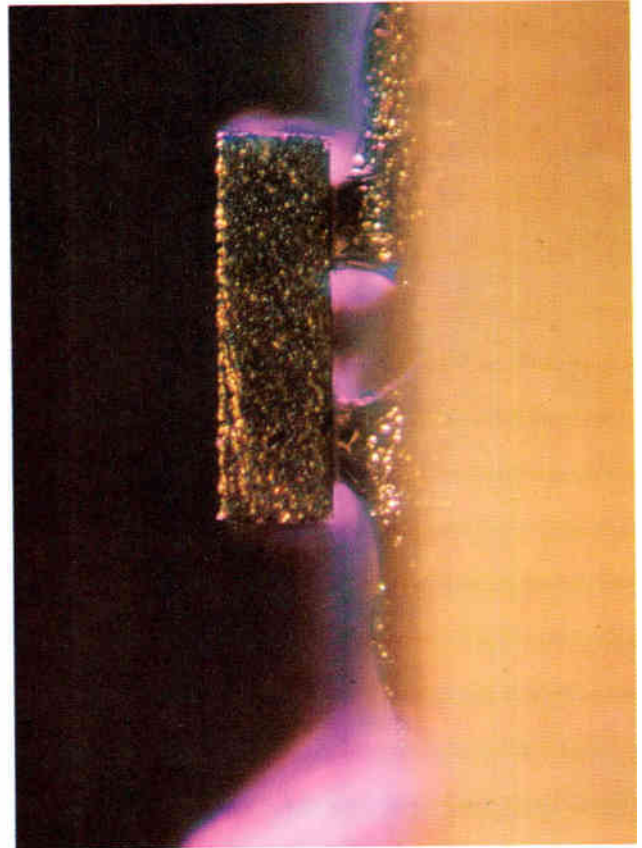

Transistor chip for hybrid integrated circuits has ball contacts fused into contact holes in 60-microinch-thick layer of glass. Glassing permits automation of assembly.

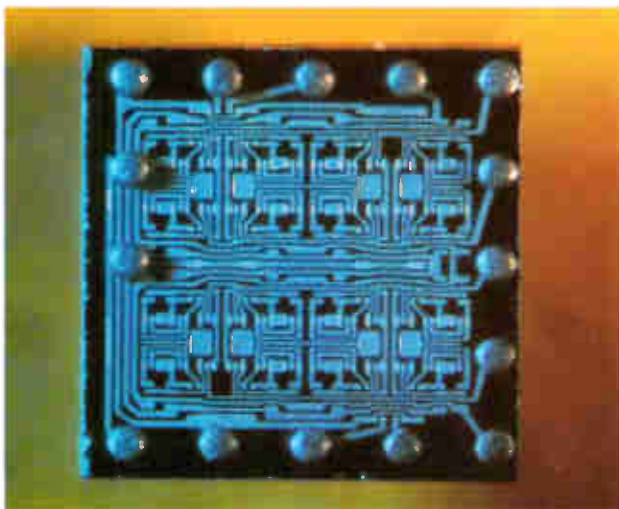
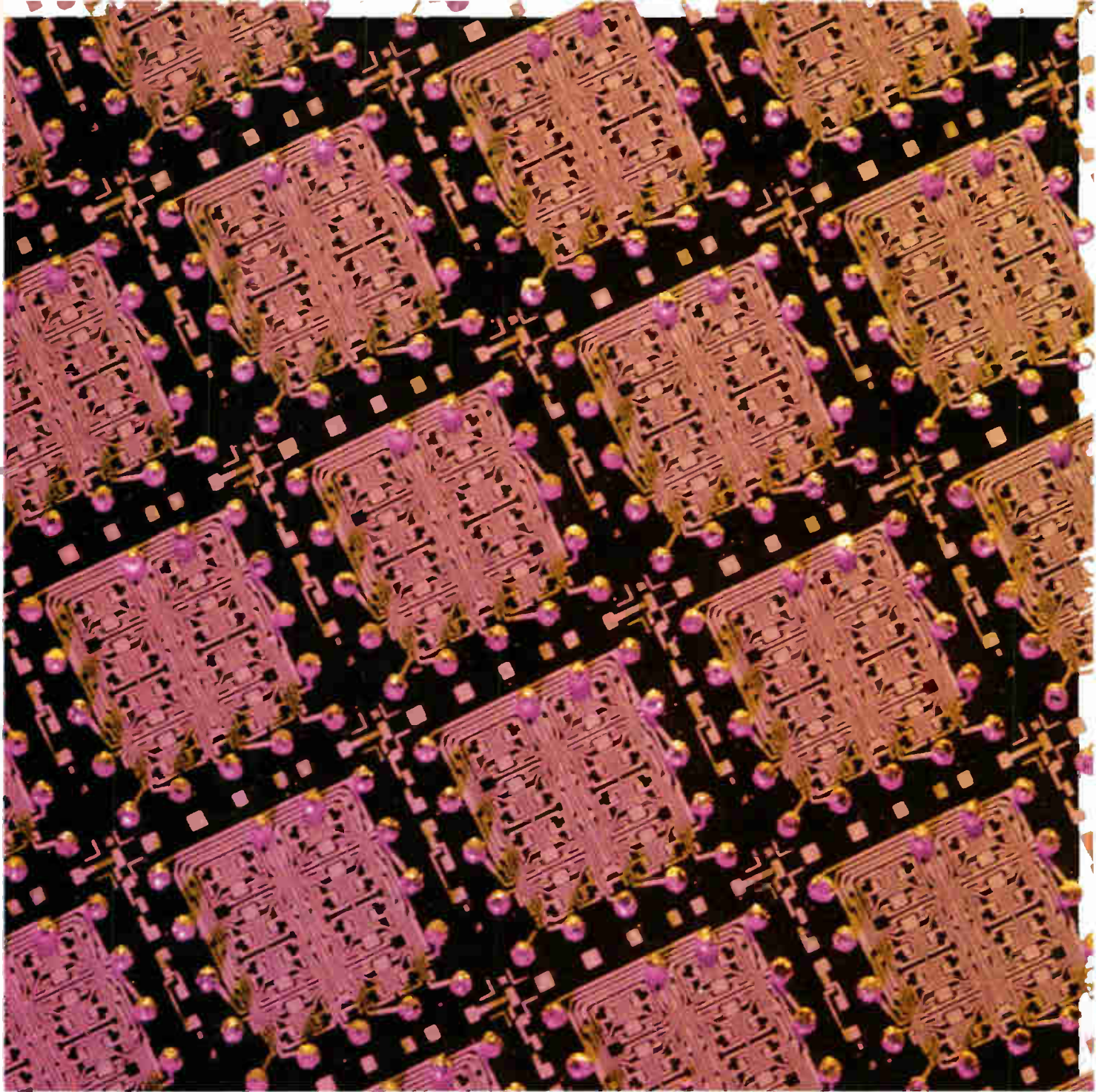

Glass layer protects active area of these 16-bit memory circuits. The glass also holds ball contacts that allow the circuits to be soldered to thick-film interconnections by processes similar to those used to solder the single-device chip. The circuits are produced in groups on a silicon wafer. A single circuit, cut from a wafer is at the left.

Extra glass means extra circuit performance

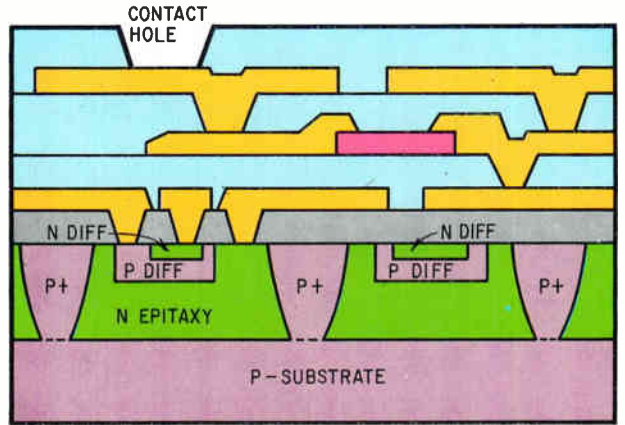
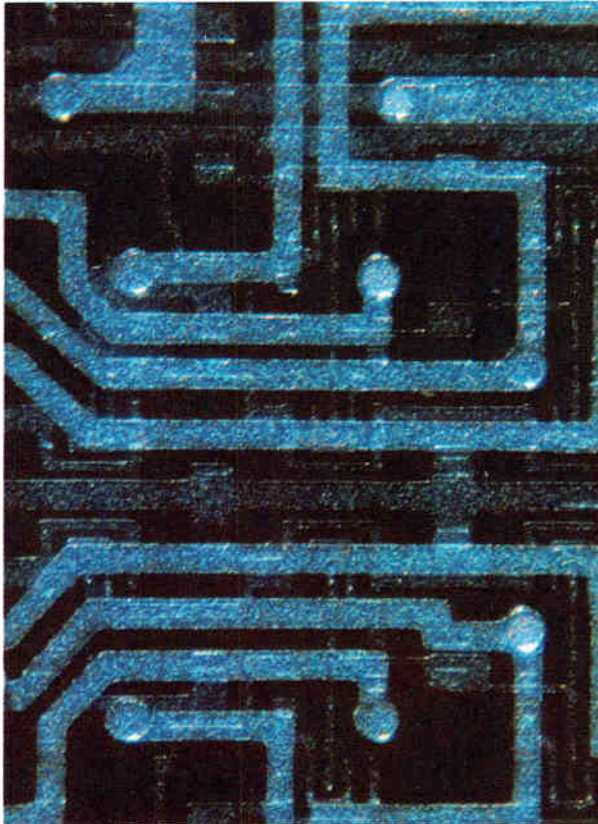

LEGEND □ GLASS ■ THIN-FILM RESISTOR ■ N
 □ METALLIZATION ■ GROWN SiO₂ ■ P

Monolithic-hybrid circuit with three wiring levels. Extra layer of glass provides the substrate area needed to deposit and intraconnect precision thin-film part.

Two levels of wiring on monolithic integrated circuit are insulated by glass layer. This is a closeup of part of the IC shown on the cover, a developmental device containing eight current-switch circuits and a total of 156 components. The small spots of metal are vias through the glass, connecting wiring on one level to wiring on the other level.

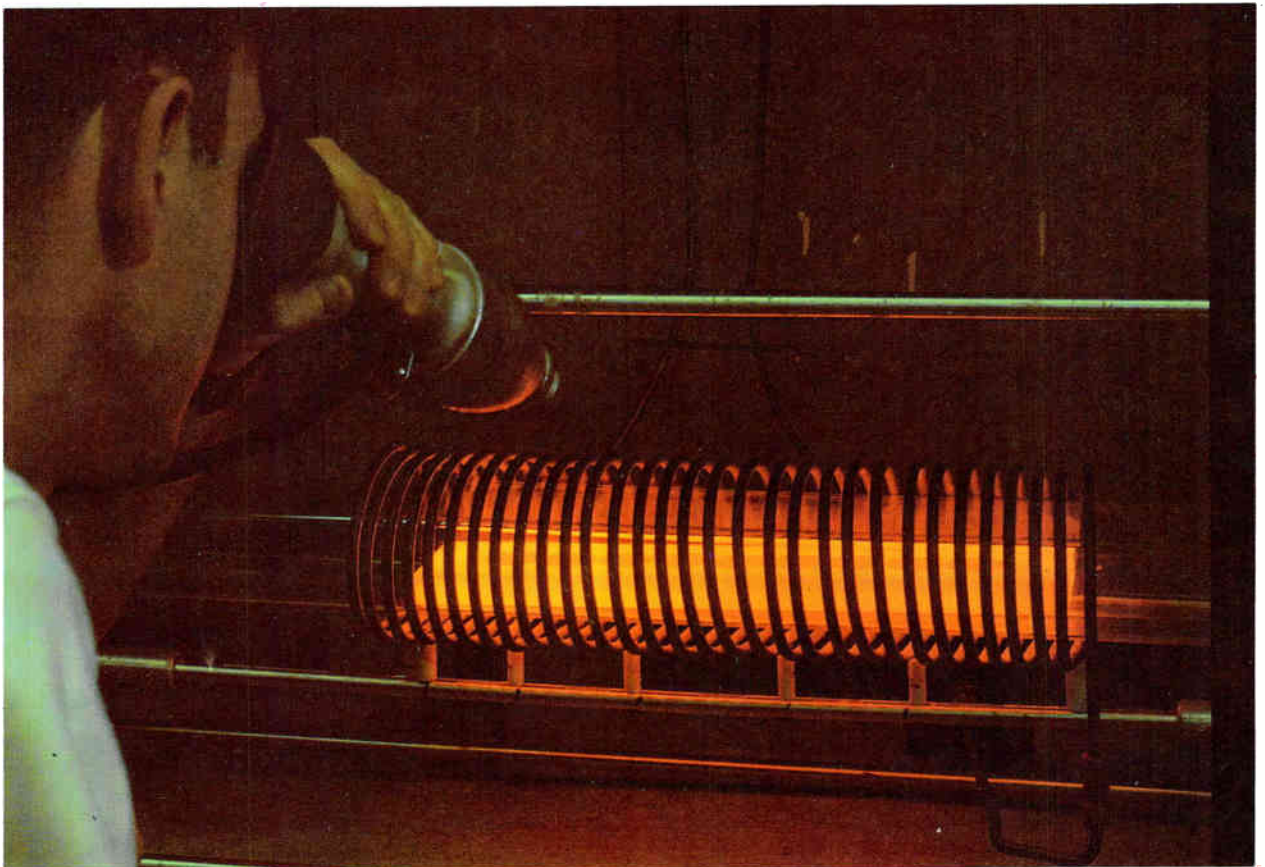

Optical pyrometer checks temperature of wafers in r-f heated furnace. Wafers, barely visible on a glowing carrier, are being glassed by chemical reaction.

chemical vapors, or reaction at the wafer surface of volatile compounds of the glass's constituents, or both; and vacuum deposition, including evaporation and sputtering. All other things being equal, the ideal glassing process would be the one done at lowest temperature. However, compromises are required to obtain the glass with the best combination of properties and compatibility with other device materials.

Some materials won't form stable glass in bulk form, but will do so in thin-film form. Silicon nitride is one of these, but it cannot be prepared by melting because decomposition occurs at its melting point of 1,900° C—a temperature so high that silicon nitride cannot be supercooled without crystallization. Besides, that temperature destroys diffused devices. Dense films of silicon nitride can be formed by pyrolytic (high temperature chemical decomposition) or sputtering techniques.

Fusing glass frit

The frit-firing method produces pinhole-free glass films of controlled composition and thickness. It is a simple process, well suited to mass production.

The frit is finely ground glass particles, about 0.1 micron in size, suspended in a mixture of ethyl acetate and isopropyl alcohol. The frit is compacted onto the silicon wafer, usually by centrifuging, and then fused to the silicon by firing it at or slightly below the glass's softening point.

Because of the small particle size, a 1-micron-thick film is formed in a few minutes of firing. Thickness of a 1.5-micron film can be held to ± 0.03 micron over a wafer and average thickness from wafer to wafer can be held to ± 0.06 micron. Films thinner than 0.5 micron can be made. The thickness control greatly facilitates the etching of contact holes in the glass; resolution is comparable to silicon dioxide and undercutting is at a minimum, making for low reject rates.

One advantage over other techniques is that the glass composition selected for the powder is the glass deposited—neither chemical complexity nor changes in composition during deposition are factors in selection. Also, the fusion flows the glass, forming an excellent bond to the wafer surface.

The major disadvantage is that the choice of glass is restricted by the allowable firing temperature, which thus becomes the dominant factor. Higher-temperature glasses would be desirable for chemical stability and better thermal expansion match with silicon.

One process boundary is the maximum temperature that metal lands and metal-semiconductor contacts can stand. Metal lands must be used under the glass on most high-speed transistors and monolithic IC's so that electrodes can fan out to conveniently spaced terminals from very small, closely spaced emitter and base contact holes. If the lands are aluminum, the temperature limit is the aluminum-silicon eutectic temperature of approximately 577° C. Lands are not required under the glass on diodes, since the single terminal can be placed di-

Another role for glass

Besides its extrinsic uses on devices made in single-crystal silicon, glass itself is a promising semiconductor material.

Two reports on this newest role of glass appeared in the Sept. 19 issue of *Electronics*. The first, "Looking through the glasses for new active components," [p. 129] also provides additional details on subjects such as ionic migration and the formation of unusual glasses. The second, "Transistors face an invisible foe," [p. 191] tells how one company makes switches, transducers and memory devices with glass films.

If the hopes of researchers pushing glass semiconductor development come true, glass will become a competitor of silicon, not merely its servant.

George Sideris

rectly on the contact area.

Secondly, if gold is used to control carrier lifetime in the silicon, the glass firing temperature must be compatible with the gold diffusion or activation temperature of about 1,050° C. This is not a serious restriction because several glasses can be fired near 1,050° C. These two considerations demonstrate that the frit-fusion method must be made part of the process at the start of device design, not as an after thought.

Chemical deposition

Pyrolytic decomposition and reactions such as oxidation and hydrolysis are closely related chemical glassing methods, similar to the processes that grow epitaxial layers on silicon crystal. The reaction is made to occur at the substrate surface, usually by making the substrate the hottest part of the deposition system. Reaction in the gas phase, an old technique, gives a loose, poorly adhering deposit.

Pyrolysis has been extensively investigated as a way to form silicon dioxide, the simplest silicate glass. Decomposition of ethylorthosilicate, $\text{Si}(\text{OEt})_4$, is an example of pyrolysis; oxidation of SiH_4 illustrates oxidation; and SiCl_4 plus water is an example of the hydrolysis method.^{14, 15} To form silicon nitride, SiH_4 or SiCl_4 may be reacted with NH_3 .⁸

Volatile compounds of the glass elements must be introduced simultaneously into the vapor phase to form more complex glasses, such as a borosilicate or an aluminum borosilicate. The compounds must also react at the substrate surface, in essence forming the glass in situ.¹⁶ Borosilicate-depositing compounds include B_2H_6 , BCl_3 and $\text{B}(\text{MeO})_3$, methylborate. Examples of volatile aluminum compounds are AlCl_3 and aluminum isopropoxide.

In principle, chemical methods deposit high-temperature glasses at relatively low temperatures and at relatively high rates, around 1,000 angstroms per minute. Offsetting these two advantages are several disadvantages:

- The process temperature limitations are the same as those for the fusion method. The composition and the thickness of the film is more difficult to control than in fusion or vacuum deposition. Control depends on vapor-phase composition and uniformity of substrate temperature.

▪ Only the simpler glasses can be deposited. This limits material selection. So does the requirement that the chemicals not attack the semiconductor structure, nor its metal parts.

▪ Reaction products and reactants include water and decomposed organic materials, which can become trapped in the glass layer in amounts that increase as formation temperature goes down.

Sputtering insulators

Straightforward vacuum evaporation of glass gives poor-quality films that vary in composition with thickness. Attempts to evaporate glass result in appreciable decomposition and fractionation. Even a film of simple glass, such as silicon dioxide, is poorly defined, varies in composition (SiO_{2-x}) and is highly stressed and porous.¹⁷

The two vacuum-deposition techniques worth discussing here are direct-current reactive sputtering and radio-frequency sputtering of insulators.

At first, only conductors and semiconductors were sputtered. In d-c sputtering, the target is a metal cathode in a d-c glow discharge. Atoms or molecules are ejected from the target by the impact of ions from the plasma. However, if the cathode is an insulator, the ion bombardment builds up a positive charge on the target surface; the charge can't be neutralized by conduction, so the process stops.

D-c sputtering can be used to deposit insulators by adding to the sputtering atmosphere a gas that will chemically react with the sputtered conductor to form an insulator. This reactive sputtering provides good quality metal-oxide films when the substrate temperature is kept high and the sputtering rate is kept low.¹⁸⁻²¹

Glasses don't deposit as easily as oxide films. To sputter a simple borosilicate glass requires the simultaneous reactive sputtering of boron and silicon. Or, one can be the cathode while the second is introduced by some other method. The second constituent either deposits on the cathode and is transported to the substrate with the first, or the two react at the substrate surface. The latter happens when a volatile boron compound is added to the glow bombarding a silicon cathode.

Composition control is poor and only simple glasses can be deposited. Film quality improves as substrate temperature is raised, but deposition can take place below 500° C.

R-f sputtering transports insulators straight from the cathode to the substrate. Film quality is high and, in principle, films are not limited to simple glasses. The d-c problem of charge buildup is eliminated by applying a high-frequency potential to a metal electrode behind the insulator.²²⁻²⁵ Then, ions and electrons alternately bombard the insulator. The ions provide the energy that dislodges the insulator molecules and the electrons neutralize the surface charge. Deposition rates are increased by an applied magnetic field that increases ion density and confines the glow.

R-f reactive sputtering is a useful process when high-purity insulator cathodes are not available.

Silicon nitride, for instance, can be formed by sputtering a silicon cathode in nitrogen or mixtures of nitrogen and argon.

Fused quartz and many glasses can be deposited by r-f sputtering at high rates, up to 2,000 angstroms a minute. Temperatures can be kept low, compositions are easily controlled and films with properties close to those of fused glass films can be deposited.²⁶ Good thickness uniformity can be maintained. However, large, defect-free cathodes must be fabricated, the equipment is complex and the temperature of the substrate is difficult to control.

References

1. W. C. Seelbach and C. D. Phillips, "More Complex Computer Logic Circuits from the Marriage of Diffusion and Film Technologies," Proceedings of the National Electronics Conference, Chicago, Oct., 1965.
2. A. B. Phillips, "Monolithic Integrated Circuits," IEEE Spectrum, June, 1964, p. 83.
3. E. M. Davis, W. E. Harding, R. S. Schwartz, and J. J. Corning, "Solid Logic Technology: Versatile, High Performance Microelectronics," IBM Journal, April, 1964, p. 102.
4. J. A. Perri, "Glass Encapsulation," Semiconductor Products and Solid State Technology, May, 1965, p. 21.
5. W. A. Pliskin and E. E. Conrad, "Techniques for Obtaining Uniform Thin Glass Films on Substrates," Electrochemical Technology, July-Aug., 1964, p. 196.
6. B. Agusta, P. Bardell, and P. Castrucci, "Sixteen-Bit Monolithic Memory Array Chip," Electron Devices Meeting, Washington, Oct., 1965.
7. V. Y. Doo, "Silicon Nitride, A New Diffusion Mask," IEEE Transactions on Electron Devices, July 1966, p. 561.
8. S. M. Hu, "Properties of Amorphous Silicon Nitride Films," Journal of the Electrochemical Society, July, 1966, p. 693.
9. Thomas Maguire, "Silicon's new wonder drug," Electronics, Jan. 10, 1966, p. 156.
10. D. R. Kerr, J. S. Logan, P. J. Burkhardt and W. A. Pliskin, "Stabilization of SiO_2 Passivation Layers with P_2O_5 ," IBM Journal, Sept., 1964, p. 376.
11. W. A. Pliskin, "The Stability of Glazed Silicon Surfaces to Water Attack," Proceedings of the IEEE, Dec., 1964, p. 1468.
12. W. A. Pliskin, "The Effect of Moisture on RF Sputtered and Fused Glass Films," American Ceramic Society Meeting, Washington, May, 1966.
13. D. R. Kerr, "Effect of Temperature and Bias on Glass-Silicon Interfaces," IBM Journal, Sept., 1964, p. 385.
14. E. L. Jordan and D. J. Donohue, Spring Meeting of the Electrochemical Society, Chicago, May, 1960.
15. J. Klerer, "Method for Deposition of SiO_2 at Low Temperatures," Journal of the Electrochemical Society, Nov., 1961, p. 1070.
16. D. R. Peterson, H. B. Bell, and A. L. Epstein, "Passivation of Semiconductor Surfaces by Vapor Deposited Vitreous Films;" D. L. Tolliver, H. C. Evtits and A. L. Epstein, "Glass Surface Sealing of Planar Transistors;" H. W. Cooper and J. J. LaBrie, "AC Evaluation of Passivating Coatings," Fall Meeting of the Electrochemical Society, Washington, Oct., 1964.
17. W. A. Pliskin, "Reactivity and Bond Strain of Electron Gun Evaporated SiO_2 ," Spring Meeting of the Electrochemical Society, San Francisco, May, 1965.
18. W. R. Sinclair and F. G. Peters, "Preparation of Oxide Glass Films by Reactive Sputtering," Journal of the American Ceramic Society, Jan., 1965, p. 20.
19. E. Bjorck, Le Vide, Vol. 19, 1963, p. 262.
20. C. R. Fuller and S. S. Baird, Spring Meeting of the Electrochemical Society, April, 1963.
21. R. M. Valletta, J. A. Perri and J. Riseman, "Reactively Sputtered SiO_2 Films," Electrochemical Technology, to be published.
22. G. K. Wehner, "Advances in Electronics and Electron Physics," Vol. 7, 1955, p. 239.
23. G. S. Anderson, W. N. Mayer and G. K. Wehner, "Sputtering of Dielectrics by High-Frequency Fields," Journal of Applied Physics, Oct., 1962, p. 2991.
24. P. D. Davidse and L. I. Maissel, "RF Sputtering of Insulators," 3rd International Vacuum Congress, Stuttgart Germany, July, 1965; P. D. Davidse and L. I. Maissel, "Dielectric Thin Films Through RF Sputtering," Journal of Applied Physics, Feb., 1966, p. 574.
25. P. D. Davidse and L. I. Maissel, "RF Sputtering of Insulator Films Offers Many Advantages," Insulation, April, 1966, p. 41.
26. W. A. Pliskin, P. D. Davidse, H. S. Lehman and L. I. Maissel, "Properties of Insulating Thin Films Deposited by RF Sputtering," IBM Journal, to be published.
27. J. A. Perri, H. S. Lehman, W. A. Pliskin, and J. Riseman, "Surface Protection of Silicon Devices with Glass Films," Electrochemical Society Fall Meeting, Detroit, Oct. 2, 1961.
28. J. L. Langdon, W. E. Mutter, R. P. Pecoraro and K. K. Schuegraf, "Hermetically Sealed Silicon Chip Diodes and Transistors," Electron Devices Meeting, Washington, Oct. 27, 1961.

Thin stuff



Kodak photographic film—the genuine silver-halide-sensitized article—can now be made pretty thin if you want it that way, and with a resolving power of 200 lines/mm for a test-object contrast as low as 1.6:1. ESTAR Ultra Thin Base, nominally 1½ mils thick, is getting down to resemble cellophane. Film that limp calls for careful attention to the design of your cameras, processors, and printers to handle it. If you are still game and want some for a few experiments, state your case to Special Applications, Eastman Kodak Company, Rochester, N.Y. 14650 (phone 716-325-2000, ext. 6156).

One experiment should be tried even before phoning. Send the boy out for a couple of rolls of KODAK VERICHROME Pan Film and make a few exposure tests to decide whether an emulsion only about 1/30 as fast is likely to serve your purpose. Such is the only film we can supply at present on ESTAR Ultra Thin Base and no vast quantities of that.

Optical memory, ready for shipment, cheap

Business in KODAK IR Phosphor Screens was fine as long as we advertised them, but then we got to wondering if the game was worth the candle. When the advertising slacked off, so did the sales.

They are cards coated with SrS:Eu,Sm and sealed in plastic. Left to lie around under daylight or fluorescents, they store up energy which is re-emitted as an orange glow when the card is hit by infrared. The infrared stimulation spectrum peaks around 1μ. Well worth the price* when interested in making an infrared laser beam visible.

Now comes a new reason for interest in the item. *Proceedings of the IEEE* (54:425, 1966) carries a letter to the editor that beefs up its importance somewhat. Dr. Richard A. Soref of the Sperry Rand Research Center has been inspired to look at it as an erasable optical memory offering random access, high capacity, destructive readout (when the infrared hits it), and several hours of storage time. He comes up with the following estimates, which we hope will be regarded as tantalizing:

With 1.15μ emission from a He-Ne laser focused to 3000

*2" x 3" — \$25 8" x 10" — \$95 20" x 24" — \$375
4" x 5" — \$49 14" x 17" — \$195

†In combination with electro-optic light deflectors (*IBM J. Res. Dev.*, 8:64, 1964; *Bell Sys. Tech. J.*, 43:821, 1964).

W/cm², 5 x 10⁵ bits of data per second could be serially read out and erased. With 1.06μ Nd⁺⁺⁺ emission, the erasure efficiency should double. Spatially, the phosphor has a minimum element size of 4 x 10⁻⁴ cm². Writing to exploit this packing density would take 0.8W at 0.488μ from an argon ion CW laser, and the reading would take 1.2W of CW Nd⁺⁺⁺ laser light.

Order KODAK IR Phosphor Screens from Eastman Kodak Company, Apparatus and Optical Division, Rochester, N.Y. 14650 (716-325-2000, ext. 5166).

Same address is being kept busier by the discovery that KODAK IRTRAN 4 Optical Material is the top choice in a window material for the CO₂ lasers that have focused attention at 10.6μ in the heart of the great clear 8-14μ atmospheric window. IRTRAN 4 Material contributes virtually no absorption of its own in this spectral region. It takes the necessary optical quality and retains the vital flatness and parallelism at elevated temperature. A drop of rain or sweat won't pit it.

IRTRAN 2 Material is even more rugged and costs less if you can afford a bit more absorbance.

We furnish either one with plano-plano surfaces or, for confocal reflection in the cavity, plano-concave of long radius. No size request of the many to date has strained our capacity.

But they can still have hairy ears

EASTMAN Q-Switch Solution 9740 for neodymium lasers has an absorption cross-section around 5 x 10⁻¹⁶ cm² and an excited lifetime around 4 x 10⁻¹¹ sec if one assumes a 3-level model for the dye. That these data should be considered by our engineers to be useful to the engineers who buy this saturable dye will clue the mere onlooker to what is happening in the profession of engineering, the discipline of quantum electronics, and the science of physics.

This is the saturable dye which first made possible the achievement of mode locking. Calculations based on this work (*App. Phys. Letters*, 8:174) have shown that it should be possible to concentrate millijoule pulses into gigawatt slugs of infrared only 0.006 cm thick. The following curves of the transmittance of EASTMAN 9740 Solution for 20-nanosecond pulses depict its saturation characteristics:

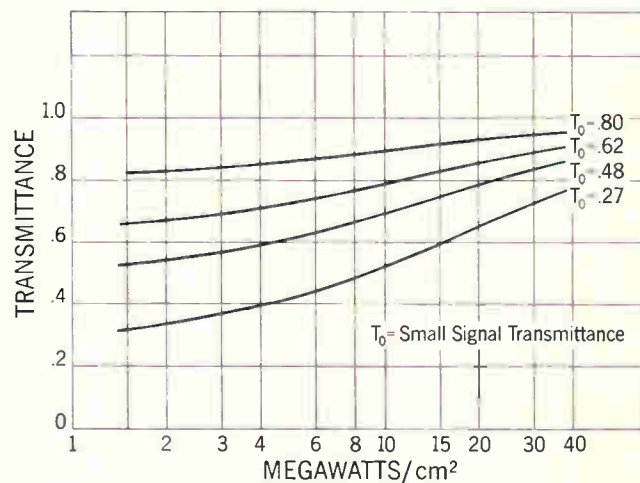

Further details from Distillation Products Industries, Rochester, N.Y. 14603 (Division of Eastman Kodak Company), which for \$100 supplies 100 ml of the dye solution and a quantity of solvent with which to reduce α from its stock solution value of 25 cm⁻¹.

Prices subject to change without notice.

The hope of doing each other some good prompts these advertisements

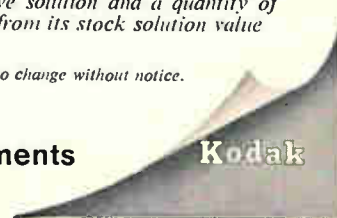



We couldn't make it fail.

We tried. We put the Datex Fail-Safe Size 11 Encoder through a military avionics qualification test that no other brush contact encoder has ever passed. Not one of the units we tested failed. (It's compatible with integrated circuit logic levels. It has a known MTBF of up to eight times greater than any other unit of its kind. These characteristics make it ideally suitable for such avionics systems as ILAAS, MARK II, and AAFSS.) If you think you can make it fail, or would like to see our test data, write or call any of our offices below.

DATEX

DIVISION OF GIANNINI CONTROLS CORPORATION
1307 South Myrtle Avenue, Monrovia, California 91016

Dallas, Texas (214) EM 3-6417. Dayton, Ohio (513) 299-5565. Des Plaines, Illinois (312) 827-8141. Elmsford, New York (914) 592-5500. Huntsville, Alabama (205) 539-9396. Monrovia, California (213) 359-5381. New York, New York (212) 687-3330. Pasadena, California (213) 681-7152. Skokie, Illinois (312) 676-3636. Washington, D.C. (202) 244-8700.

Pcm telephone exchange switches digital data like a computer

Voice messages that are pulse-code modulated can now be switched directly through an all-electronic telephone exchange built of logic circuits and a series of memories

By Andre Chatelon

Laboratoire Central de Telecommunications, Paris

Existing telephone networks employing pulse-code modulation within their transmission systems must have the digital signals converted back to analog signals before they pass through an exchange. Now an all-electronic telephone exchange has been successfully tested that switches pcm signals such as those in the transmission system described in *Electronics* Sept. 19, 1966 [pp. 139-148]. The compatibility of the two systems is excellent.

The resulting integrated network drastically reduces the size and cost of an exchange—less equipment is needed while signal quality is kept high. Since digital-to-analog conversion is no longer necessary in the exchange, the crosspoints in the exchange are simple gate circuits, driven by control logic instead of electromechanical switches and relays [see "Telephone exchanges: past, present and future," p. 122]. Savings will further increase as monolithic integrated circuits replace the present discrete circuits in the network designed by Laboratoire Central de Télécommunication (LCT) in Paris. The small size of the transistorized equipment is evident in the photo on the next page.

Computerized calling

The exchange handles digital data much like a computer, storing incoming signals and control information in memories and routing and switching the signals with logic circuits. The coded signals and control functions can be time-division multiplexed, simplifying the interconnections between exchanges and within exchanges.^{1,2} Signaling information, such as "line busy," can also be handled digitally.

Advanced developments in computer technology can be applied directly to the design of the ex-

change. For example, the gate circuits are low-cost computer types. Temperature variations and aging of the circuits do not affect signal quality, making the system reliable.

Also, as in a computer, functional flexibility is high. Often, only the information stored in a memory need be changed—not hardware and wiring—to change the exchange's logic operation and provide new telephone services.

Nevertheless, the difficulties of an all-digital network should not be underestimated. Large exchanges will have to handle many hundreds of millions of bits a second, since each two-way telephone call requires a traffic capacity of 128,000 bits a second. The maximum clock frequency at present is 6 megahertz.

Very fast devices were not used in the prototype exchange to keep costs down. Exchanges require a great deal of redundant equipment because telephone reliability requirements are more stringent than those of computers. The digital circuits are conventional diode-transistor logic or direct coupled transistor logic circuits made of components such as 2N914 and 2N2369 transistors and 1N914 diodes.

Next—integrated circuits

Pcm exchanges utilizing integrated circuits are being designed, however integrated circuits were too costly for commercial exchanges at the time the system described here was being designed. Now that IC's are readily available at low cost, there is no doubt that they will be used in the next generation of telephone switching equipment to further reduce system costs.

The advantages of using IC's in exchanges are expected to be as great as those realized in the

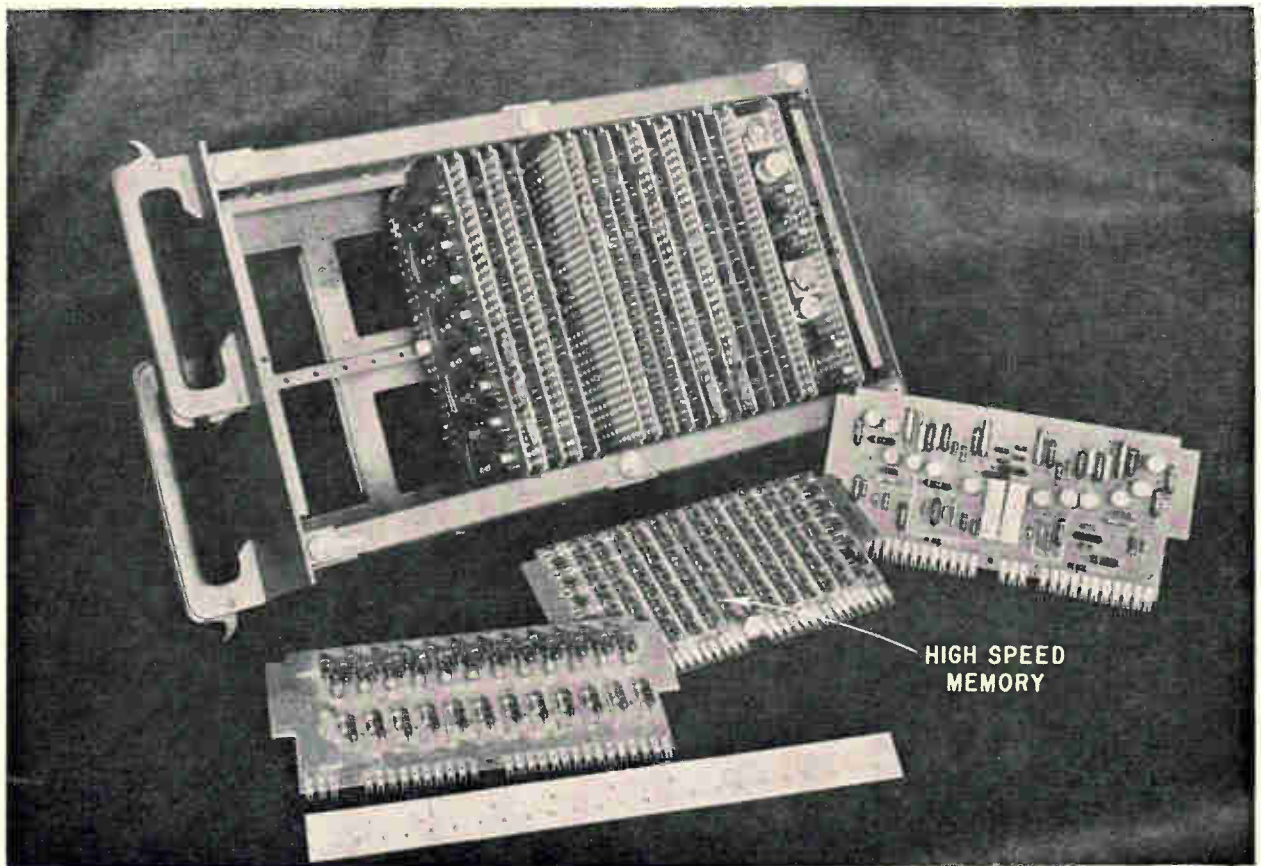

Transistorized logic circuitry and a high-speed diode-capacitor memory are basic elements of experimental pcm exchange. The memory's read-write cycle is 600 nanoseconds and maximum storage time is 125 microseconds.

pcm transmission system, although not necessarily for the same reasons. In the transmission system, for example, they reduce cross talk problems by lowering the switching levels. In the exchange, the greatest advantage is simplifying the interconnections of many parts of the equipment. This, plus smaller size, the expansion of exchange capacity with modular units and better reliability, will make future exchanges more economical.

System interfaces

In designing a pcm integrated network it is necessary to consider the interfaces with analog systems as well as with other pcm terminals and exchanges. Three particular problem areas exist. The first is at an audio interface where there is a pcm-audio conversion. For example, in the diagram upper right, an audio interface exists between a pcm terminal and a subscriber line or between a remote pcm concentrator synchronized to the exchange and a subscriber line. An audio interface also occurs when a pcm exchange is coupled to an existing electromechanical exchange.

A concentrator controls a small group of subscriber lines, multiplexing them onto a single line that goes into the exchange. Since it can be expected that all subscribers will not use their telephones simultaneously, the concentrator's line capacity to the exchange is smaller than the number of subscriber lines to which it is connected.

The second problem is synchronizing the multiplexed pcm signals that pass from one pcm terminal to another. For example, in the lower figure at the right there can be synchronizing problems between the pcm terminal and the pcm terminal exchange or between the pcm terminal exchange and the pcm transit exchange. The more terminals or exchanges the pcm signal must pass through the more difficult the synchronizing problems.

The third problem—switching pcm signals—occurs at all the pcm exchanges.

Audio interface problems are most difficult at the junction between a pcm exchange and subscriber equipment. Various solutions have been proposed for solving the subscriber interface problem;^{3,4} the technique developed by the LCT will use remote and local concentrators, like those outlined in the upper diagram at the right. The interface between the electromechanical and pcm exchange (lower figure), although similar to that at a local pcm concentrator, presents fewer problems because there is no need to send large ringing signals or supply large d-c voice currents.

The main problem at the subscriber interface is not the analog-digital conversion, but the requirement to send ringing signals and large currents for the telephone's transmitter. For example, ringing signals are thousands of times higher than the speech signals transmitted over the same line. In addition, if line amplifiers were used they would

have to be protected from being damaged by the ringing current.

Although multiplexing and analog-pcm conversion equipment is used on pcm trunk lines, it is not economical to use similar equipment for each subscriber line. In a trunk line the equipment cost is shared among many subscribers; equipment for each subscriber line would be too costly. Also subscriber equipment characteristics vary widely, preventing the design of a single pcm unit that could be used on every line.

It is fortunate that only one pcm-analog conversion occurs at the subscriber line because this reduces noise problems. Even in difficult cases, the extra cost of installing a hybrid coil and a low-pass filter on the subscriber line is justified. That cost is offset by large savings in other parts of the network. These savings include increased capacity by multiplexing, inexpensive time-division switching and shorter subscriber transmission lines resulting from the use of a concentrator.

In the future, when it will be feasible to use semiconductor amplifiers in the telephone itself, it will be possible to significantly reduce the amount of line equipment needed for analog transmission through the use of microphones that require less power and by incorporating electronic ringing circuits within the telephone.

Synchronizing the exchanges

The pcm exchange developed by LCT and illustrated in the block diagram on page 123 has the major advantage of being the most flexible one for telephone switching. In contrast to other systems,⁵ this new system works on a fully asynchronous basis. Clock frequencies may vary considerably without causing a traffic interruption. However, speech quality may be impaired if the clock frequency drifts more than one part in a million from its nominal value.

The purpose of synchronization is to get the incoming digital pulses in time positions that coin-

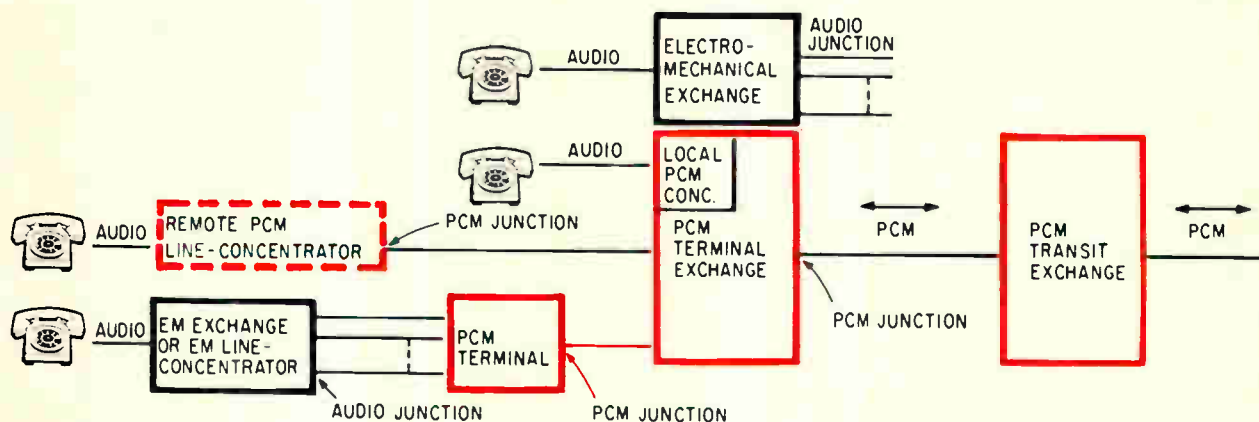

Mixture of pcm exchanges, pcm terminals and electromechanical exchanges would be typical in any telephone network. Units enclosed in solid color are autonomous pcm units that have their own clocks. The local pcm line concentrator in the exchange is controlled by the exchange's clock. Remote pcm concentrator (dashed colored line) would be slaved to the pcm exchange. Interfacing problems occur at the junction between audio lines and pcm terminals. Synchronization problems exist between autonomous pcm exchanges because their clocks must be synchronized.

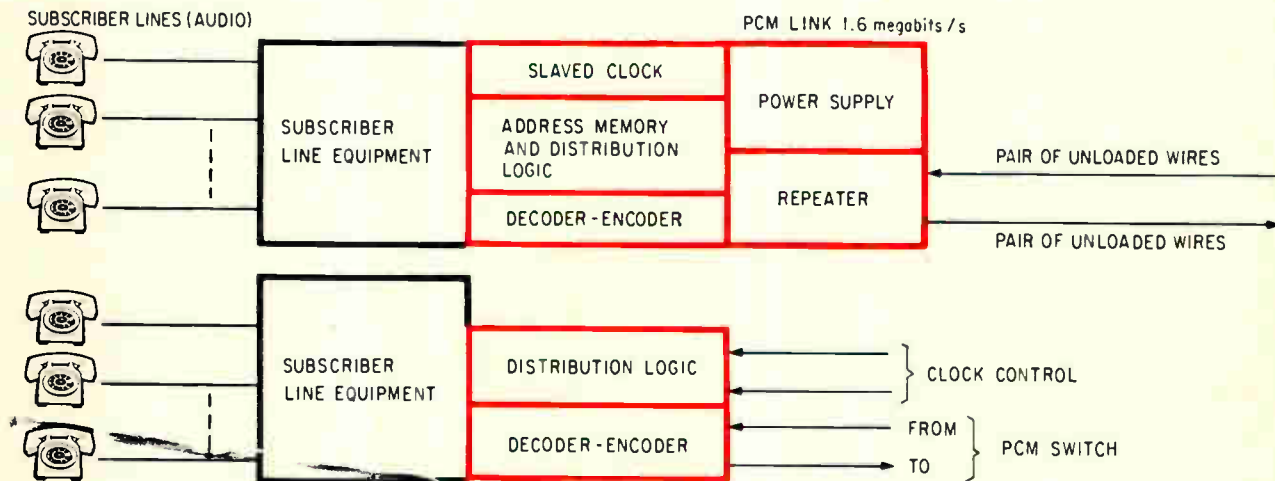

Concentrators form the interface at a junction of subscriber's audio (analog) lines and the pcm system. A concentrator can serve many subscribers over a trunk that has limited capacity because telephones are not all used at one time. A pcm concentrator remote from the exchange, (top diagram) provides a more flexible configuration than a local pcm concentrator located in exchange from which it obtains power and clock signals (lower diagram). Blocks in color outline main sections of pcm equipment.

cide with those given by the local clock. Synchronization must be achieved with clock frequencies that vary at remote terminals and with transmission lines that may have varying delays or phase shifts.

Synchronizing incoming signals is a function shared by three sections of the exchange: a synchronizing junction, called synchro-junction equipment, group equipment and common framing equipment. A synchro-junction unit is connected in each line and performs the major portion of the synchronization. Synchro-junction equipment also converts the serial pcm word one pulse after another—into a parallel word—a pulse appearing simultaneously on each of eight lines. Eight synchro-junction units deliver their parallel words and the channel numbers for each word to a group equipment unit. The group equipment stores 192 words that are subsequently switched across the exchange under the control of the central clock.

Framing equipment is shared by all junctions in the exchange; consequently the framing equipment

represents a small portion of the exchange's cost. The framing equipment detects the position of the synchronizing pulses in the incoming pcm signals. It is only used when the equipment is turned on or when the synchronization or the channel position has accidentally been lost. Since the framing equipment is similar to equipment in a pcm terminal, it will not be described further.

Synchro-junction equipment

The main purpose of the synchro-junction equipment is to simultaneously deliver to the group equipment the encoded pcm words for 24 telephone calls and an indication of the channel to which each word belongs. As indicated in the block diagram on page 124, an incoming serial word to a synchro-junction unit is first regenerated—that is the pulses are reshaped. The word is then written into a row of the junction memory. Each of the three rows of the memory is filled consecutively under the control of a three-position writing counter

Telephone exchanges: past, present and future

Electromechanical techniques dominate the design of telephone switching exchanges, even though electronic techniques are commonplace in transmission lines. Only in the past few years have exchanges become electronic and then only on a modest scale.

The lag in development of electronic exchanges has been because of the nature of the signals switched and previous inadequacies in electronic components. Most exchanges switch analog speech information, even though the switching equipment is basically digital in that the routing of the signals is controlled by the on-off operation of electromechanical relays and switches.

Two trends, the increase in complexity of modern telephone exchanges and the development of reliable, inexpensive transistors, have led to the substitution of electronic logic circuits for electromechanical relay logic. However, electronic circuits control the switching; they do not form the switching contacts at the intersection of transmission lines, except in relatively few exchanges such as the one being developed by Laboratoire Central de Télécommunications (LCT).

Even so, electronic control is an important development since control functions represent about half the cost of an exchange. Control circuitry costs less than electromechanical controls because an electronic unit can control many operations on a time-division basis, replacing many slower electromechanical units. This saving and others—such as the ability to change control functions by programing rather than component changes—have been realized with transistor logic. Integrated circuits offer further economies.

Crosspoints. The switching contact itself is another matter. Despite two decades of effort, exchange designers have not found a generally satisfactory electronic substitute for metallic-contact crosspoints to switch analog signals from one telephone transmission line to another.

The analog speech signals may have to go through as many as seven crosspoints in each exchange and pass through many exchanges before reaching their

destination. Therefore, contact losses must be kept low—a requirement met by relays, but difficult to satisfy with electronic components.

Series resistances of closed metallic contacts are only a few milliohms. When the contacts are opened, their capacitances are only a few picofarads and the very high leakage impedance that results helps to reduce cross talk. In contrast, electronic switches have closed resistances of a few ohms and open resistances of generally less than 100 megohms.

Although electronic switches can be very reliable, metallic crosspoints often operate for tens of years without failure. Finally, the cost of a metallic crosspoint is very low.

Incompatibility. Despite the advantages of relay-type crosspoints, they are becoming less suited for telephone switching. The newer, larger exchanges require as many as 20 crosspoints per line, lowering the cost advantage of metallic contacts. As the complexity of the switching system rises, electronic control becomes more necessary.

With electronic control the exchange designer is faced with the problem of matching electromechanical devices to electronic digital circuits. Although relays can switch in 1 or 2 milliseconds, they are slow compared with electronic logic. Also, the electronic circuits require lower power levels than relays, so special driving circuits are needed for the relay coils.

The lack of a straightforward electronic replacement for metallic crosspoints has led exchange designers to seek two other solutions. One, representing a transition between conventional electromechanical switching systems and fully electronic systems, is the development of miniature switches and relays such as reed relays that are designed to be controlled by electronic circuits.

LCT's use of pulse-code modulation in an all digital system exemplifies the other approach. While taking advantage of the added capacity and improved voice quality offered by pcm transmission, it is possible to eliminate the relay and its metallic crosspoint and substitute digital gate circuits.

and a bit counter that are both driven in synchronism with the incoming bit frequency.

By having three rows in the synchro-junction memory, it is possible to avoid overlap between the writing and reading times for a particular word. One word is written into the memory while another word is read out.

Under control of the central clock, the information in the synchro-junction memory is read out as an eight-bit parallel word. During the read cycle the clock also advances the channel counter at the output.

However, since the incoming bit frequency and the bit frequency set by the local clock usually differ, the time at which a given row is read tends to approach the writing time of the same row. An overlap detector measures the interval between the read and write times. If the time difference becomes too small it is stored in the overlap memory until the next synchronizing code arrives. During this synchronizing time slot, the writing counter is shifted in the direction that best separates the writing and reading time. Simultaneously, the channel counter is shifted to maintain agreement between the channel number and the information readout of the synchro-junction memory. Shifting is done only during the synchronizing time slot to prevent losing information in the memory.

Supermultiplexing

The series-to-parallel conversion that is performed in the synchro-junction memory is an important function in a pcm exchange. The logic elements can process parallel pcm signals faster than serial pcm signals. For example, a parallel word can be shifted in the time that it takes to shift a single bit of a serial word. The increase in speed allows a large number of parallel words to be multiplexed onto one channel of the input of a group unit. This is called supermultiplexing.

Supermultiplexing reduces the number of common access lines needed for the memories of the group and cord circuits. In a moderate size memory, a reduction in the number of access lines is important because the access equipment of each line, such as registers and address decoders, can represent a large fraction of the memory's cost.

Group equipment

A typical grouping unit, G, such as the one shown on page 126, assembles coded speech from eight synchro-junction units. Since each synchro-junction unit handles 24 calls as shown at the right, the group equipment's high-speed memory stores a supermultiplexed collection of 192 eight-bit words.

Under the control of the exchange's clock the group memory is read out cyclically as parallel words that appear on a supermultiplex highway at an input of the switching unit. The supermultiplex highway is a set of eight wires that carry many multiplexed parallel words from many input channels.

Incoming speech channels are synchronized so

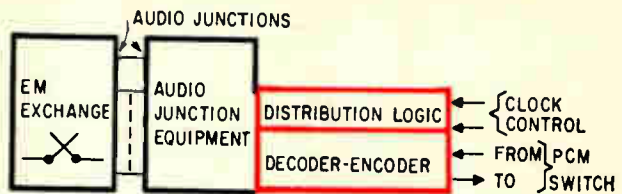

Electromechanical exchange interfacing with pcm equipment is similar to interface of subscriber's line and local pcm concentrator.

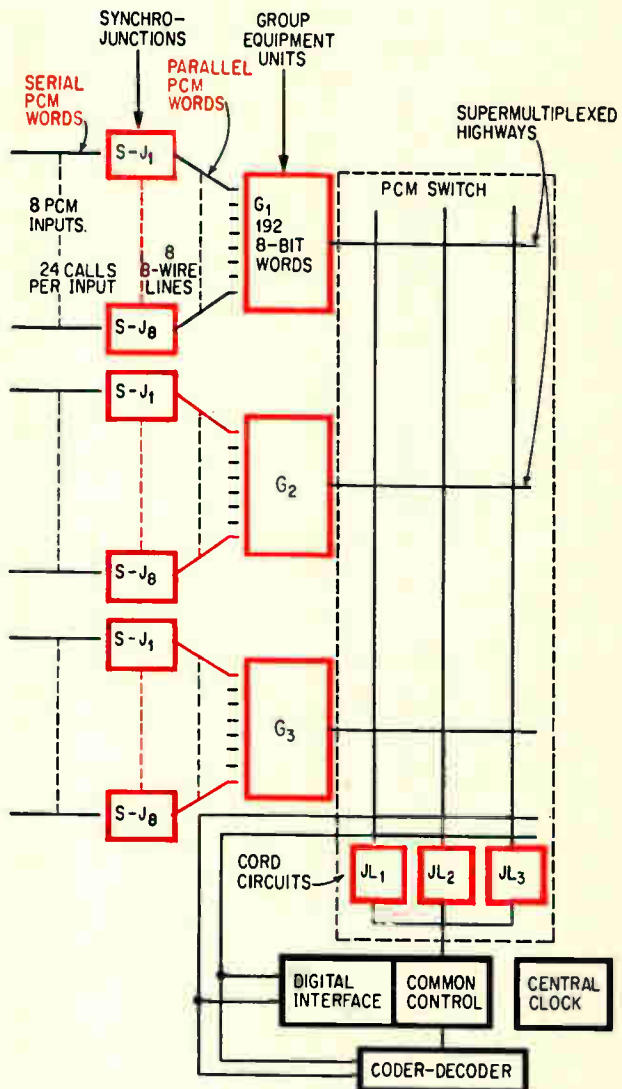

Switching configuration in a pcm exchange is a crossbar type that operates with time-division multiplexed signals. Synchro-junction equipment (S-J) converts words from serial to parallel and also helps synchronize incoming pcm signals with local clock. Group equipment (G) gathers coded speech information from synchro junctions to form 192 eight-bit code words. Cord circuits (JL) switch the information to the supermultiplex highways.

that a given channel always appears on the same row of the group memory; consequently when it is read out, a given channel appears on the same time slot at the input to the switching unit. This is an important factor in operating the pcm switching unit.

If only local pcm interfaces are used, the group equipment plays a minor role in synchronization

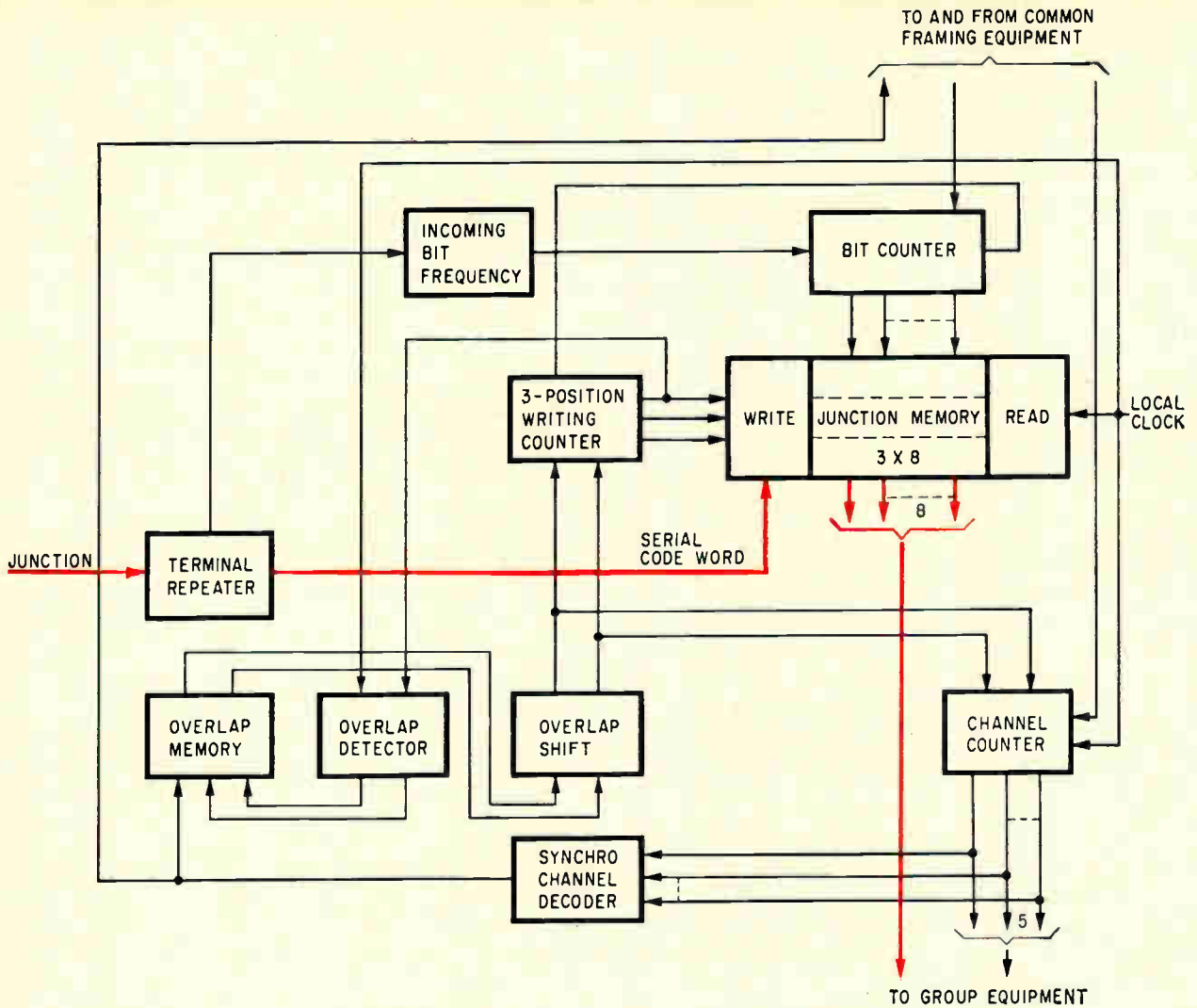

Synchro-junction equipment regenerates information in the repeater before converting serial input to parallel words. Colored lines show path of main information flow. Discrepancies between the incoming bit rate and local clock are detected and corrected by overlap circuitry. Channel counter indicates channel to which coded speech word belongs. Junction memory stores three 8-bit words.

since the local clock is already controlling the conversion of the audio signal to pcm.

When no pcm signals are being transmitted, it is possible to suppress the synchronizing equipment. Also worth noting is that slave units, such as remote concentrators, greatly simplify the synchronizing problem because they are locked to the exchange's clock.

Cord circuit

A pcm switching system differs from an analog type switching system in that the information to be exchanged through two highways may not be present simultaneously on these highways. Because the pcm exchange deals with multiplexed digital words, the appropriate highways must be connected as the information comes up for switching.

The cord circuit that controls switching of a set of crosspoints is illustrated in the block diagram at the right. Five random memories are needed in the cord circuit to store addresses and coded speech information and to control the operation of the circuit. Information is read into or written out

of these memories during either an even or an odd time slot of the circuit's timing cycle. There are 192 time slots for transferring information.

These memories operate at high speeds because information is exchanged through the highways at a rate of 8,000 times a second. A memory's read-write cycle is 600 nanoseconds and the maximum storage time is 125 microseconds. Diode-capacitor storage is employed to allow the use of inexpensive access circuitry.

When a coded speech word is exchanged it first comes from a group unit and is stored in the speech information memory (IM). Then the coded speech is read out of the information memory and directed to its destination—another group unit.

For the cord circuit to route the information that is extracted from the group equipment, it needs the addresses of the highways through which the information is to be exchanged. These addresses are stored in two memories called the odd space switching memory (SSMO) and the even space switching memory (SSME).

A fourth memory—the time switching memory

(TSM)—stores the time position (channel number) of coded speech signals that are to be exchanged. This memory also stores the address of the row in the information memory into which the coded speech signals are written. A fifth memory (CM) in the cord circuit stores supervisory information.

These memories have 96 rows, half the number of words in a group equipment, because it is convenient to have an equal number of cord circuits and group equipment. During each 125- μ sec sampling period, a cord circuit processes 96 two-way calls, or 192 words.

To switch the 96 calls in 125 μ sec the cord circuit's cycle is divided into 200 timing slots each about 600 nsec long. Only 192 of these time slots are used for speech signals; the remaining eight time slots are used for transmitting synchronizing characters.

Four consecutive elementary logic operations—each 150 nsec long—are performed during each of the 192 time slots:

- The contents of the space switching memory is read.
- This number is decoded.
- Coded speech word corresponding to one subscriber is read out of the information memory.
- The coded speech word corresponding to the other subscriber is written into the same row of the information memory.

Thus by performing control operations during the same time slots in which words are transferred,

one word in the information memory is replaced by a new one every 600 nsec.

Multiple crosspoints—switching points at the intersection of two sets of lines—connect a cord circuit to a highway. The multiple crosspoints are necessary because code words are transferred in parallel and because information transmitted in one direction is handled by one set of crosspoints and information in the other direction by another set of crosspoints.

Since the control operations in a pcm exchange are like those in any centralized control exchange, signaling and other auxiliary information may be transmitted over lines similar to the one used for the coded speech. Consequently, as indicated by the exchange block diagram on page 123, the common control receives its information from the junctions through a supermultiplex highway.

A pcm exchange can also send control signals toward the junction over the same path used for receiving. If these signals are not digital, a coder-decoder is used at the interface between the highways and the control equipment.

Establishing a connection

Assume that a cord JL_1 in the diagram on page 123 is to connect a channel x in a group G_n to a channel y in a group G_p . The basic requirement for performing this operation in the cord circuit below is as follows:

Information corresponding to the x 'th channel in

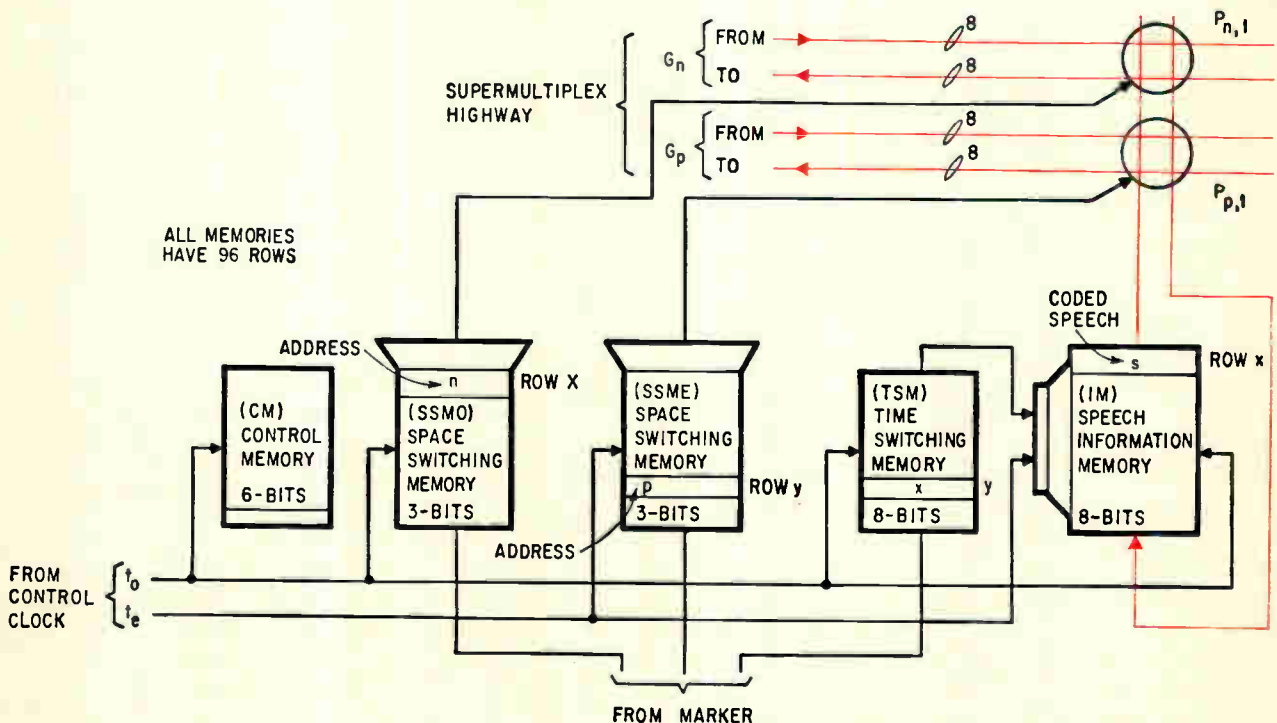

Cord circuit controls switching operation in exchange. Diagram represents cord circuit JL_1 in the figure on page 123 so crosspoints are given subscript 1. Only supermultiplex highways from group equipment G_p and G_n are shown with their crosspoints in the pcm switch (color). Space switching memories store addresses of the crosspoints over which speech information is to be transferred. Speech information memory stores coded speech words. Time switching memory stores the time position (channel number) of the speech information to be transferred; during a connection this memory also stores the addresses of the rows into which coded words are written.

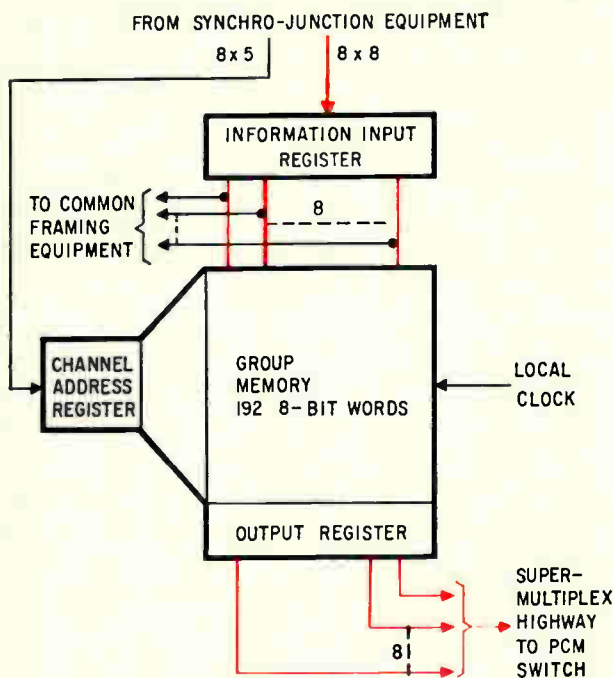

Group equipment's high-speed memory gathers 192 eight-bit words and reads these words out to the pcm switch under control of the local clock. Colored lines show flow of coded speech. Eight synchro-junction units each supply 24 eight-bit coded speech words to the group memory.

group G_n will appear on the highway to the cord circuit during an odd time slot, t_{ox} , and will be stored in the information memory. The term t_{ox} refers to an odd time slot during which a code word from the x channel is processed. This information must be transferred to the y channel of G_p during the even time slot, t_{ey} . When information is traveling in the reverse direction, information from G_p appearing in the time slot t_{ey} is transferred to G_n during the time slot t_{ox} .

To start the connection process, the common control sends the address, n , of the $P_{n,1}$ crosspoint to the x 'th row of the odd space switching memory (SSMO). At the same time the y 'th row of the time switching memory (TSM) receives the time position (channel number) of the x 'th channel. Similarly, the common control sends the address p of the $P_{p,1}$ crosspoint to the y 'th row in the even space switching memory (SSME). This transmission of addresses and time positions is done only once for each call, providing no rearrangement is necessary.

Once the addresses are transmitted, the central clock controls the cord circuit's operation. During each sampling period, the cord circuit cyclically processes all 96 calls for which it is responsible.

During the odd time slots, t_{ox} , the following operations are performed:

- The address, n , in the x 'th row of SSMO is read and the decoded output activates a multiple crosspoint, $P_{n,1}$.
- The speech information, S_{ox} , in the x 'th row of the information memory (IM) is read. This information, which is one of the speech signals to be transferred, was previously obtained from the

y channel of the G_p group (see last step under even time-slots below).

- The parallel eight-bit speech word S_{ox} is transferred toward the G_n group through the activated crosspoint $P_{n,1}$.
- The information on the supermultiplex highway coming from G_n is transferred to the x 'th row of the speech information memory where S_{ox} has just been extracted.

In the odd time slot, t_{oy} , the address x in the y row of the time switching memory is read. This information is stored in the access circuit of information memory where it is decoded. It is used during the next even time slot, t_{ey} .

In even time slots t_{ey} , the following operations are performed for the y channel in the G_p group.

- The address p in the y 'th row of SSME is read and the decoded output activates a multiple crosspoint $P_{p,1}$.
- The coded speech information S_{ex} of the x 'th row of the information memory is read. This information which came from the x 'th channel of the G_n group, was sent to the information memory during the previous t_{ox} time slot.

▪ The parallel eight-bit speech word S_{ex} is transferred toward the G_p group through the activated crosspoint $P_{p,1}$.

- The information on the supermultiplexed highway coming from the G_n group is transferred to the x 'th row of the information memory from which S_{ex} has just been extracted.

Performing these operations exchanges the speech information of channel x in group G_n and channel y in group G_p . When a single pcm switching stage is used, the digital information must be converted from parallel to serial words before transmission. When no pcm transmission is involved the parallel digital words may be converted directly to analog.

Coded signals on the transmission line are regenerated as needed and decoded for subscriber-line transmission as conventional analog signals.

The rearrangement process⁶ may be used to avoid blocking in the switching stage. Blocking occurs when a new call cannot be routed. In a pcm exchange this can occur when an incoming call has no access to outgoing lines that may be free. A rearrangement process can provide the access by changing the row in the cord circuit memory to which the call is assigned. In such a system, the memories must have 192 rows.

References

1. P. Mornet, A. Chatelon, J. Le Corre, "Application of PCM to an Integrated Telephone Network," *Electrical Communication* 1, 1963.
2. C. Dumousseau, "An Integrated PCM Exchange," (in French), Second International Congress on Telecommunications Techniques, Madrid, November, 1965.
3. H.E. Vaughan, "Research for Time Separation Integrated Communication," *Bell System Technical Journal*, July, 1959.
4. A. Pinet, "A Time Division Switching System," (in French), *Commutation et Electronique*, March, 1966.
5. D.H. Harding, "An Approach to a Tandem Exchange for an Integrated PCM Network," *International Congress of Electronic Switching*, Paris, 1966.
6. E. Touraton, J. Le Corre, French patent No. 1,212,984.

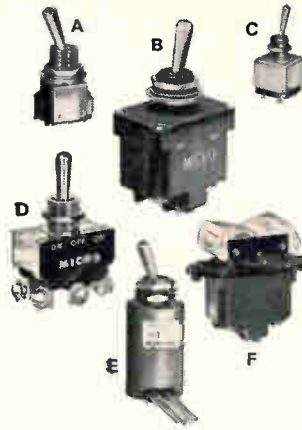

A AT Series Assemblies
—Combine up to 12
SPDT Switches.

B TL Series—Meets
MIL-S-3950A.
Momentary, maintained,
pull-to-unlock. 1, 2, or
4 pole.

C TW Series—Miniature,
5 amp. SPDT or DPDT,
2 and 3 position.

D TS Series—Up to 25
amp. 1 or 2 pole.

E ET Series—Magnetic-
hold, remote-release.
Environment-proof.

F TP Series—Rocker-
actuated, 20 amp. 1, 2,
or 4 pole.

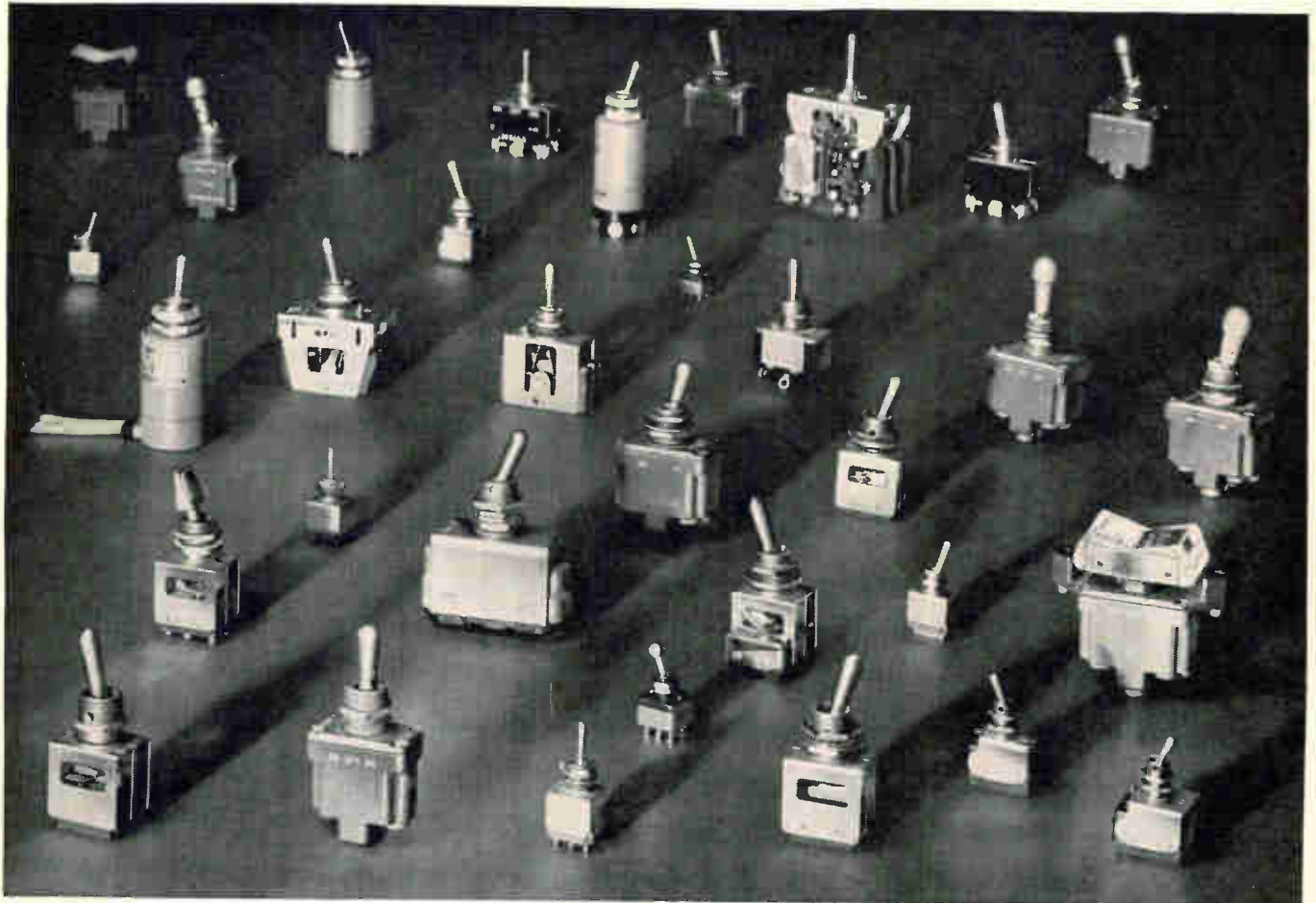

Here's a little extra design freedom in toggle switches

You are free to select the exact combination of features you need when you look in the broad MICRO SWITCH line. Size, circuitry, capacity and toggle action to answer most any requirement. Special features too, right off the shelf. For example, environment-proof construction, magnetic-hold-in, electric memory and dry circuit capabilities.

You may even pick up some extra design ideas as well—ways to simplify circuit design, combine functions in fewer controls, improve operator efficiency.

Catalog 73 gives details. Call a Branch Office or Authorized Distributor (see Yellow Pages, "Switches, Electric"). Or write . . .

MICRO SWITCH

FREEPORT, ILLINOIS 61032
A DIVISION OF HONEYWELL

HONEYWELL INTERNATIONAL—Sales and service offices in all principal cities of the world. Manufacturing in United States, United Kingdom, Canada, Netherlands, Germany, France, Japan.

3M Brand Inert Fluorochemical Liquids cut component failure rates drastically by removing heat faster.

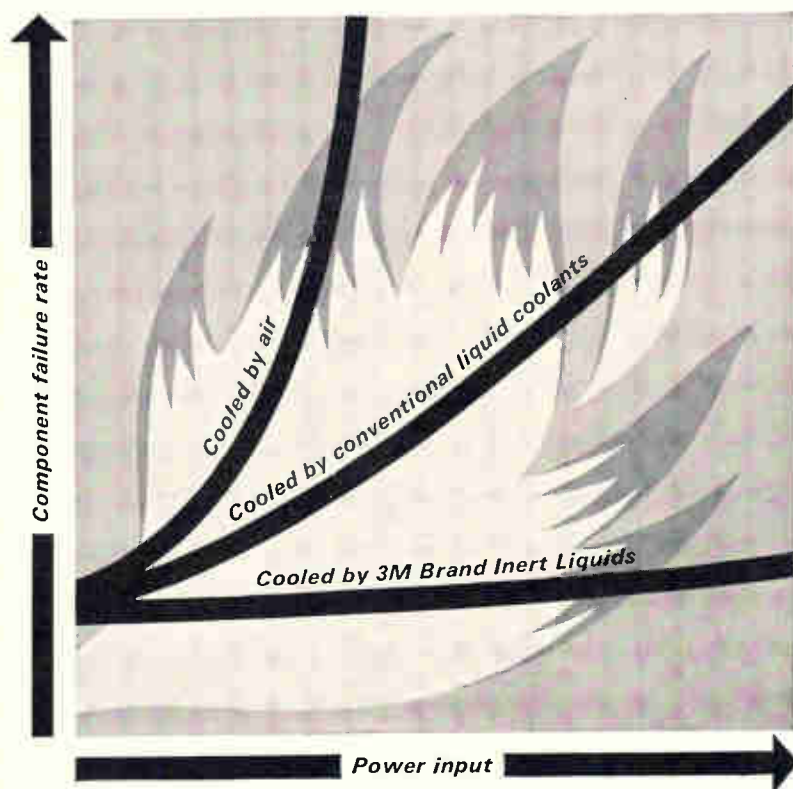

PRACTICALLY EVERYTHING we can say about 3M Fluorochemical Inert Liquids adds up to one thing for the designer and engineer: **INCREASED RELIABILITY**. Why? Because component failure rates increase sharply as component temperatures increase. Efficient heat removal lowers the temperature and increases reliability.

3M Inert Liquids are far more efficient at removing heat than air or other conventional dielectric coolants. Results: **LOWER COMPONENT TEMPERATURES, LOWER FAILURE RATES, HIGHER RELIABILITY**.

FOR THE FULL STORY: chemical inertness, non-flammability, high temperature stability, compatibility, high electric strength, low dissipation factors, write: 3M Company, Dept. KAX-96, St. Paul, Minn. 55119.

Chemical Division **3M**
COMPANY

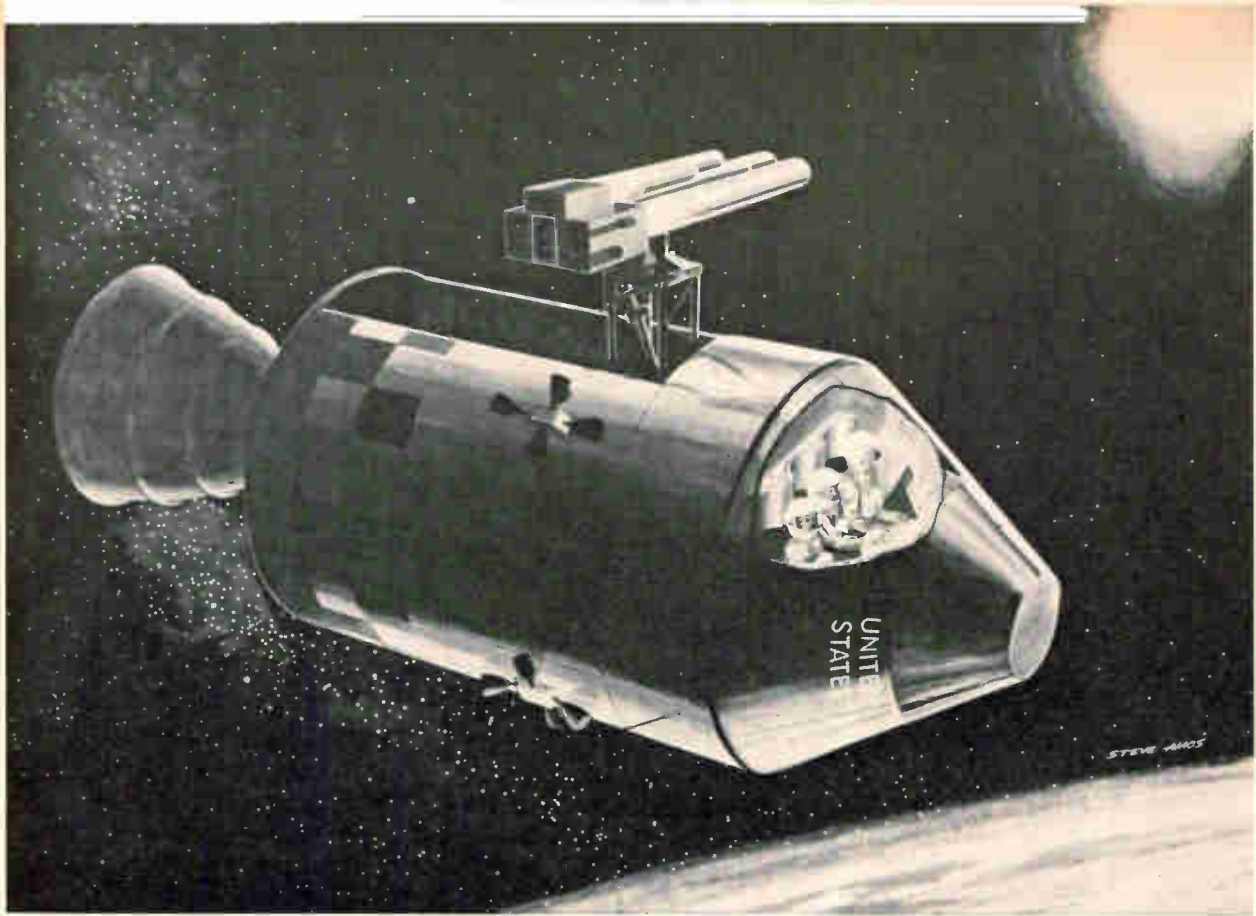

Computers

For a crew in lonely orbit, something to lean on in space

Computer for astronaut laboratory will navigate, arrange experiments and even devise new work schedules when someone falls ill during the long and demanding trips of the future

By Andrew Adelman and Jack Cohen

International Business Machines Corp., Bethesda, Md.

In an orbiting space laboratory a scientist-astronaut seated at a console enters the name of the star Alpha Centauri into a computer. A large telescope mounted outside the spacecraft swivels on its mount and comes to rest pointed at that star. Inside the spacecraft a cathode-ray tube driven by the computer displays the strength and wavelength of the star's spectroscopic lines.

Another astronaut puts on his pressure suit, steps

into space through an air lock, and begins to assemble parts of a large antenna. As he labors, the same computer gathers data on the amount of work that a man can do in space before becoming dangerously fatigued. The scientist at the console monitors the computer as it analyzes the astronaut's physiological responses, such as pulse rate, body temperature and breathing rate. Suddenly the computer detects a sharp increase in heart rate and

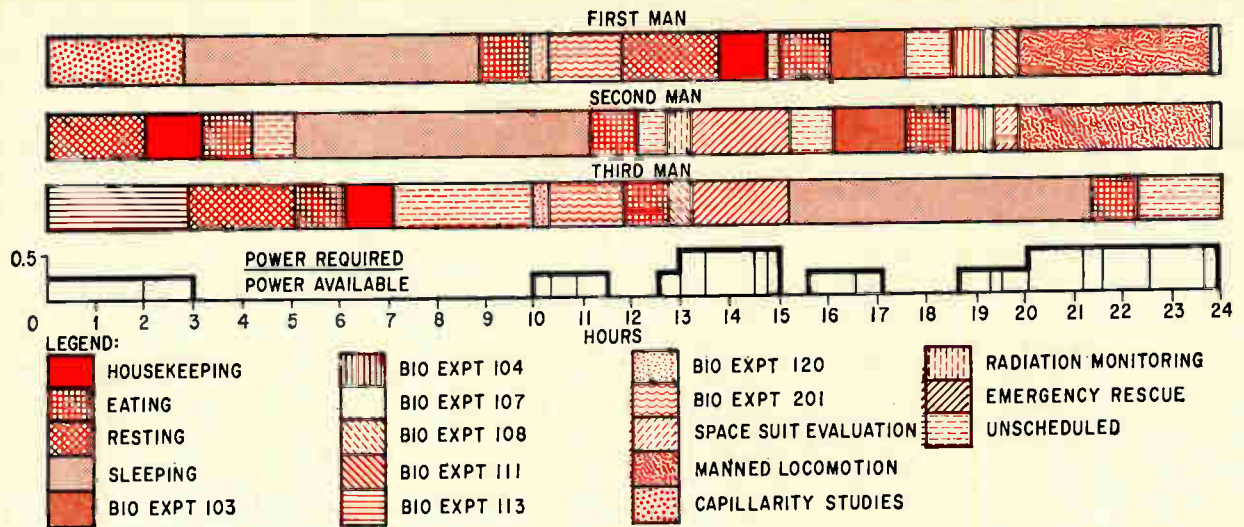

Flight schedule for one day of a typical three-man mission emphasizing biomedical experiments.

flashes an alarm. The scientist calls the man working outside, using a spacecraft-to-suit telephone, and learns that the alarm was false—the astronaut's wrench had slipped while he was tightening a bolt, causing him to spin in space and become momentarily disoriented.

Meanwhile the computer continues to perform other duties. It distills data on the effects of space radiation on plants and insects, runs routine tests on the operation of the telemetry link to earth, acts as navigator and types out a status report on the spacecraft's power supply and expendable materials. If one of the men in the spacecraft becomes ill, it prepares a new work schedule so that all essential procedures can continue until a replacement for him arrives on the next ferry rocket from the ground.

Exploitation, not exploration

This is a brief portrait of a computer that in years to come will help man exploit space, building upon the explorations of the Mercury, Gemini and Apollo projects. The computer has not yet been built, but computers that approach it in complexity and capability are being designed and developed for the first manned space laboratories. Their configuration will be very much like the system diagrammed on page 137, which was designed to be compatible with the electronic systems on the Apollo spacecraft.

The system is not merely a computer, it is the operational center of the orbiting laboratory and the link that joins men and equipment in space to men and equipment on the ground. As a processor, it helps guide and navigate just as do the systems in spacecraft today. In addition it checks out systems and experiment equipment, supports the performance of experiments and manages experimental data.

To do these things the spaceborne portion of the system must be more flexible and have greater capability than any other system ever flown. What's

needed is a general-purpose computer designed from scratch that can be applied to all the tasks expected in many expeditions and to some unexpected tasks as well. If a flight carries special equipment, then modular interfaces can easily be designed to adapt the general-purpose computer to the equipment.

A computer has been designed by the International Business Machines Corp. to deal with problems of a manned space laboratory [Electronics, June 13, p. 25].

Onboard checkout system

Manned space flights are now relatively short, so in-flight maintenance of electronic equipment is unnecessary. But long space laboratory missions will not succeed unless the crew can repair subsystems in space. The effect of in-flight maintenance on the reliability of a mission is estimated in the graph on page 131, which assumes that a single spare for each replaceable module is carried on board. The graph was developed during a simulation of a spaceborne data-processing run using the computer designed at IBM for the Saturn V rocket.

In space, continuous monitoring of subsystems and experiments would require sampling hundreds of signals periodically during static and dynamic testing. The subsystems include, for instance, miniature electrocardiographs, astronomical equipment, radiation-measuring equipment and micrometeorite detectors. The processor would communicate information on the status of the system to the astronaut and to the ground as it checks subsystems, experiment equipment and itself. These diagnostic tests guide maintenance by detecting and isolating faulty subsystems and interfaces. The test programs that exercise the subsystems by means of analog or digital data channels can be loaded by the astronaut or called in by the computer from an auxiliary magnetic-tape memory included in the data-processing system.

Supporting the experiments

The onboard data-processing system schedules the experiments, equipment use and the crew members' time; processes and displays data as the experiments proceed; and prepares the results for recording or telemetering.

Scheduling is important because the number of experiments will be large and the spacecraft's equipment and the crew's time must be used effectively. Scheduling must take into account subsystem monitoring, data and program setup (or housekeeping), experiment priorities and, for earth-oriented experiments, special requirements such as geographical location and amount of illumination. And of course the crew members must eat and sleep too.

Part of a schedule for a three-man spacecraft, shown at left, indicates the tasks to be performed during one typical day and shows the operating profile for a typical subsystem—the electrical power system. This flight carries many biomedical and behavioral experiments; the numbered experiments include automatic urinalysis, the response of the circulatory system to stimuli, and measurement of senses and perception. Schedules like this would be prepared for any mission, whatever experiments were planned.

And the onboard computer must alter them if unforeseen circumstances arise. If an experiment runs longer or uses more material than had been planned, or if a crew member is injured or ill, the computer must determine the best use of the remaining time and material.

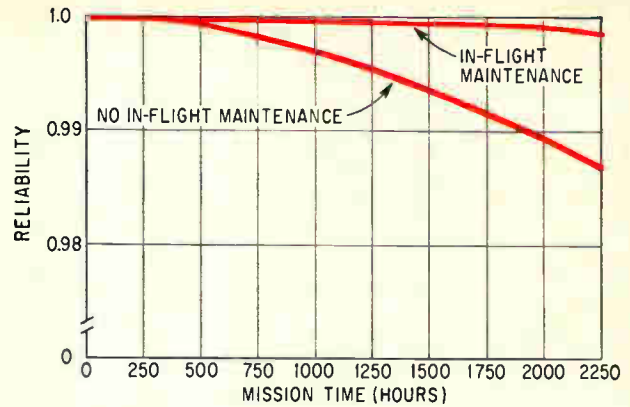

Reliability of a space laboratory can be greatly improved if spare parts are available so that astronauts can make repairs in space. Reliability is the probability of mission success.

Controlling the equipment

In the Mercury and Gemini programs, and in hypothetical mission profiles, the crew's time usually limits the number of adjustments that can be made in an experiment. The onboard data processor can ease the crew's work load and therefore speed up experiments.

The astronauts normally must physically install and connect the equipment for each experiment. Then the computer can go to work, beginning with calibration tests. In these, known inputs to the experiment equipment produce responses that are recorded for comparison with predicted values and the results of tests before launch. Later analysis

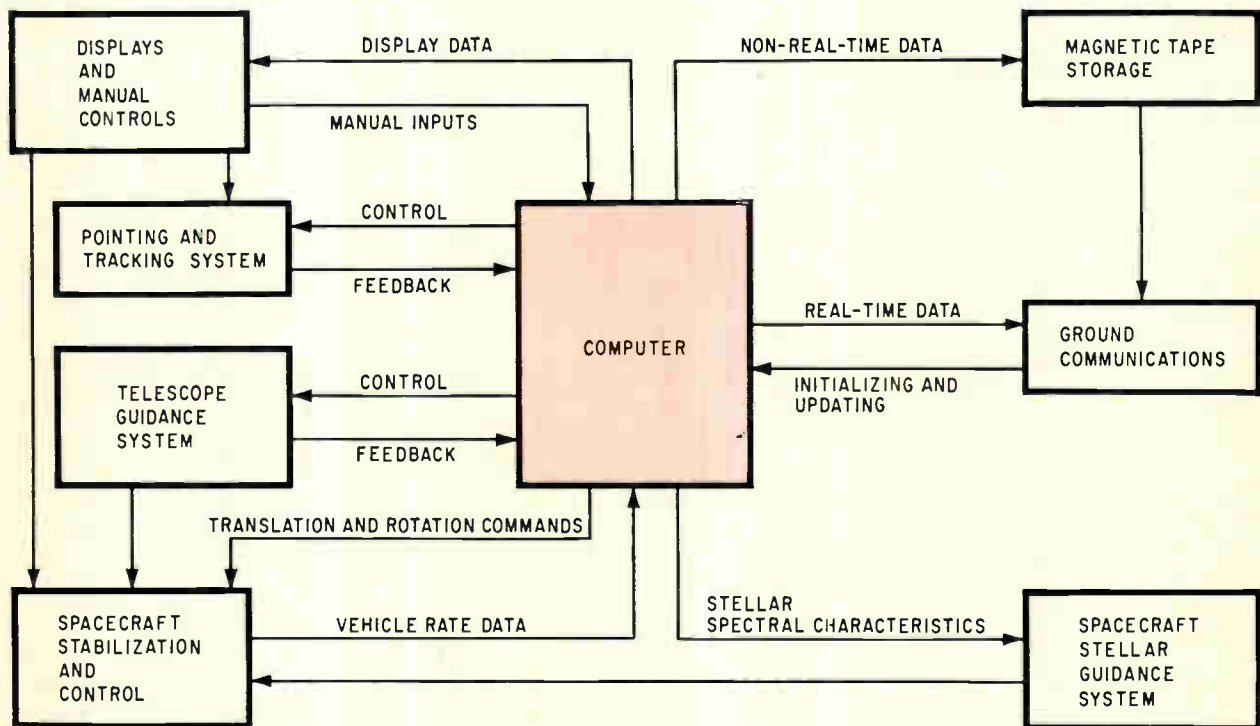

Data-processing system supports an astronomical telescope experiment by pointing the telescope, coordinating its guidance with the spacecraft stabilization, reducing data and storing it for ground communication.

Computer requirements for a telescope experiment

	Add times per second	Memory requirements (8-bit bytes)	
		Instructions	Data
Executive and diagnostics	180	1,510	760
Automatic telescope scan	1,100	900	200
Initialization	1,500	720	720
Sensor calibration	520	430	150
Integration	2,010	430	150
Fine-guidance drive control	3,500	210	130
Coordinate transformation	3,250	1,120	3,200
Sun angle computation	200	80	40
Spacecraft attitude commands	200	20	50
Precision pointing	4,270	100	320
Image motion compensation	400	90	40
Celestial body catalog storage and search	200	20	5,000
Total	17,330	5,360	10,760

of the experiment output data also demands comparison with the calibration data.

A typical experiment

Planned for the Extended Apollo Program is an astronomical telescope package like the one shown at the bottom of page 131 with its integration into the data-processing system.

The data-processing system supplies guidance in pointing the telescope and other sensors, compensates for errors in pointing, generates signals for the servo drive, compensates for the spacecraft's motion, provides displays for the astronauts and allows for manual control by the astronauts.

By means of the pointing and tracking system the astronaut initially aims the telescope and sets up its cameras and spectrometers. With inputs from the pointing and tracking system the computer generates signals to keep the telescope aimed correctly, converting from the spacecraft's inertial coordinates to the telescope's equatorial or other coordinates. Closed-loop operation of the fine-guidance controls together with the stabilization controls insures that the vehicle will not be disturbed during the operation. The computer automatically inserts a sunshade over the telescope when it's pointing almost directly at the sun.

Photographic recording of stellar and galactic objects requires three-axis stabilization so that the image won't move and cause blurring. To insure stability the entire telescope is mounted on its own gimbals and is independently stabilized against pitch and yaw as shown in the typical mounting arrangement on the opposite page.

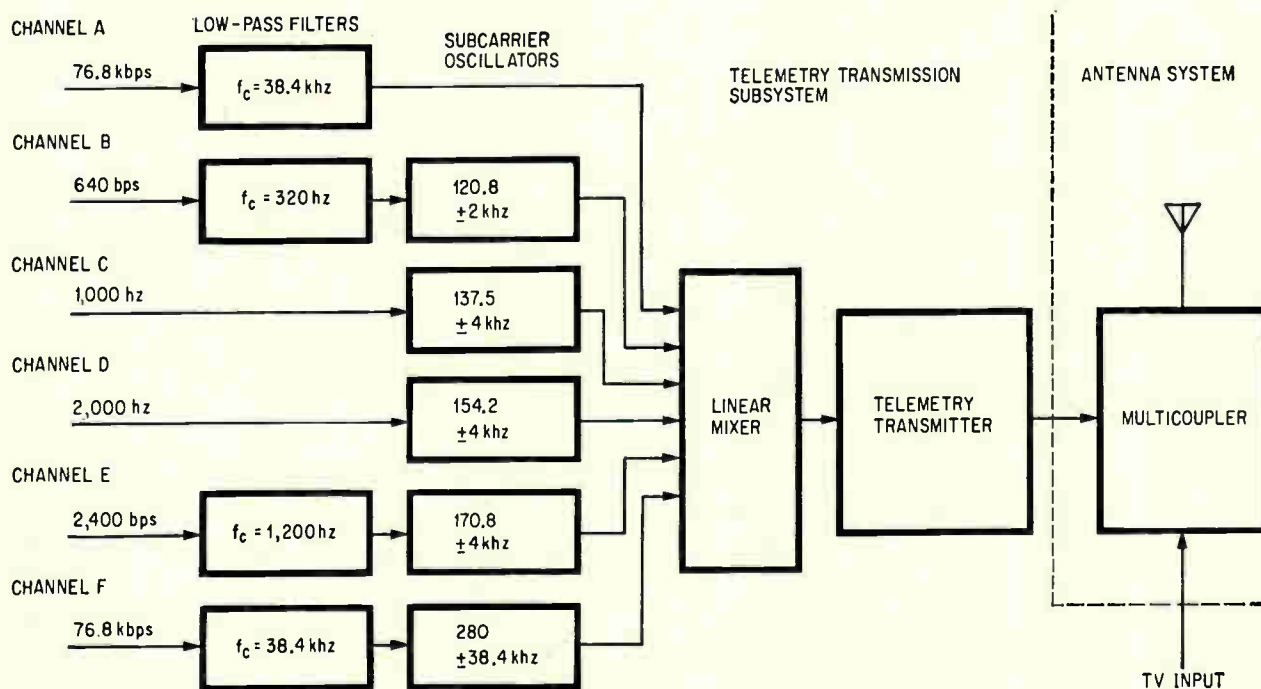

Telemetry subsystem would include filters to transform digital signals into analog for the mixer, subcarrier oscillators to make the signals separable at the receiver and provision for a television input at the antenna. The f_c numbers are center frequencies, which are within the bandwidths specified for the subcarrier oscillators.

Data display

The astronauts will frequently be guided by displays while performing many kinds of experiments over a range of scientific and technical fields. The crew members are not expected to rely on memory in performing experiments, even though they undergo extensive training before launch.

Small quantities of data to back up experiments can be prepared in printed manuals. Larger quantities for other experiments will be placed on microfilm, which permits the computer to select and sequence the data. For some applications, the data will be generated in real time—for example, the instructions for pointing the astronomical telescope.

In many cases the display data will be a by-product of the computations. For example the computer determines error signals for redirection of the astronomical telescope from the original pointing data.

To support an astronomical telescope experiment, a processor must be capable of doing many things, as shown in the table at the left. In preparing it, manual inputs, inputs telemetered from the ground and generation of control commands to the telescope were all taken into account. The estimates are based on programs written for experimental programs on the ground, simulation of spaceborne projects and the characteristics of data-processing systems.

The analysis assumes that:

- The computer is a hypothetical design with architecture and logic structure compatible with the IBM System 360.
- The computer performs all navigation and onboard checkout tasks needed for the experiments.
- The basic program, which in general is re-

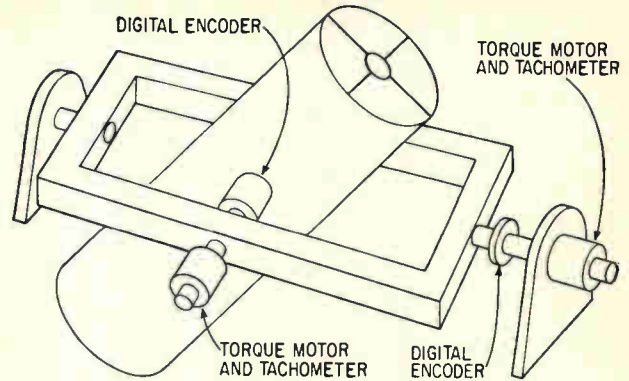

The mounting of an astronomical telescope on a spacecraft must have its own set of gimbals and controls to stabilize it independently of the spacecraft.

peated over and over, requires one second for each execution.

“Add times per second” refers to the length of time required to perform each detail function (the horizontal rows). The time required to add two numbers is sometimes taken as a typical elementary function in a computer. The time required to do something could be specified as so many microseconds, but this would depend heavily on the exact design of the computer. Specifying it by add times is less dependent on the design and serves as a better index of time.

For instance, in one second of program execution time the executive and diagnostic functions take as long as the adding of 180 pairs of numbers; initializing (setting up at the start of a run) takes as long as 1,500 additions, and so on.

Storage requirements are based on estimates of the number of instructions required for each function and on the amount of data required. As in

SIMPLEX CONFIGURATION

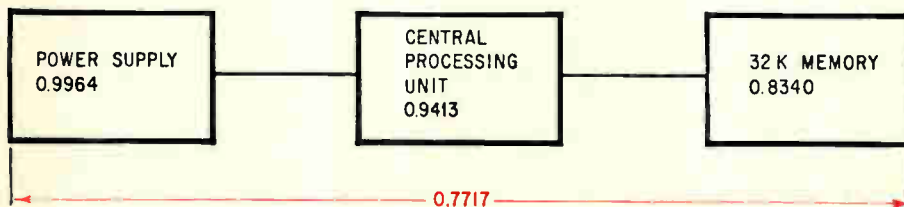

REDUNDANT CONFIGURATION

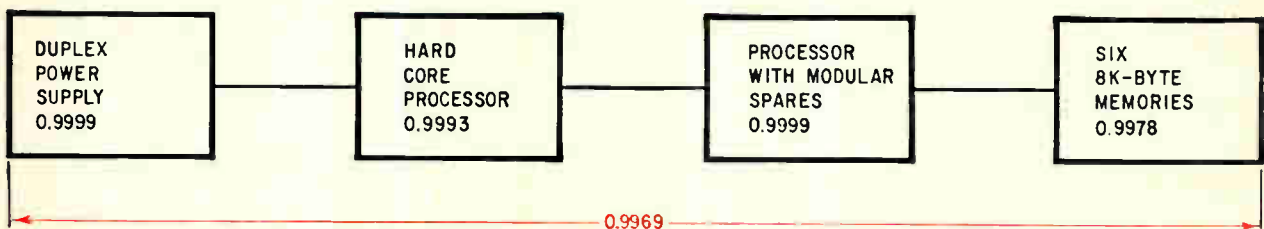

Reliability of a computer with redundant subsystems is improved by a factor of 75 over that of a simplex system (one without redundancy). The numbers in the blocks are the reliabilities or probabilities of nonfailure of each component; the numbers in color represent the reliability of the entire system, as obtained from the component reliabilities.

The IBM System 360, storage is expressed in terms of the number of eight-bit bytes; each byte corresponds approximately to one alphabetic character or two numeric digits. System 360 instructions are either two, four or six bytes long, depending on the operation.

Both the execution times and the storage requirements are estimates, so that ample margins for error or contingency must be allowed. A 10% margin for execution time puts the total at about 19,000 operations per second; a 25% margin for storage requires about 20,500 eight-bit bytes.

If the data-processing system supports more than one experiment at a time, it must have additional capability. The astronomical telescope experiment alone requires 20,500 eight-bit bytes; if other programs or data require "live" storage at the same time, it must be provided. Likewise, if other experiments are running, the system must be capable of executing instructions for them in addition to the 19,000 instructions per second required for the telescope.

What the program does

Tasks required of the laboratory experiment program include:

- Calibrating sensor performance and correlating it with experiment data.
- Identifying experiment data by time, spacecraft position, crew status and other operational data.
- Displaying quick-look performance data for evaluation by the astronaut.
- Compacting data and eliminating redundancy on board the spacecraft.
- Buffering or temporarily storing data in the process of recording it or transmitting it to the ground.

Because they are intermittent tasks, calibrating sensors and recording operational data do not overburden the data-processing system. Data display and data reduction are continuous, but requiring the computer to perform them lightens the load on the communication system, which would otherwise have to transmit a large amount of superfluous data to the ground.

Processing requirements from one experiment to the next will vary considerably and in some the data load may be quite heavy. Before each mission the data processor size and complexity must be evaluated against the complexity of the data-communications systems and the time required for the transmission of data to receiving stations on the ground.

Data-buffering requirements for a hypothetical Apollo Applications Program mission illustrate the magnitude of the data-handling task, as shown in the table on page 136. This mission includes biomedical and behavioral measurements with an on-board centrifuge, X-ray spectroscopy, a life-support system test, radiation environment monitoring, an astronomical telescope, a test of wideband r-f transmission and a solar-cell test. The biomedical and

Welcome backseat driver

Without computers on board manned spacecraft could still orbit the earth and take long rides through space on trajectories computed and controlled by earth stations. John Glenn proved it in the first Mercury flight.

But the worth of putting a computer at the disposal of the space crew is being underlined by Gemini, the present phase of the manned space program. Gemini computers are showing a spectacular ability to plan and control split-second maneuvers, which will help astronauts cope with unexpected flight conditions.

Gemini computers have had a checkered past, but the one on Gemini 11, the flight in September, did fine. It helped the crew rendezvous and link up with the Agena target on the first orbit. On the last orbit, it guided Gemini 11 into a hands-off reentry and landing virtually down the stacks of the recovery ships.

Without assurance of such precision in landing and rendezvous, it would be foolhardy to send men to the moon. The Lunar Excursion Module of the Apollo program has to descend safely as well as take off and rendezvous with the command module for the long trip home. At each step, guidance and navigation computers will be directing the hands on the controls.

Orbiting laboratories. Spacecraft designers are already planning stations that could remain aloft several years. As the accompanying article makes clear, the computers in these laboratories will have much to do besides flight control.

The first full-scale space lab is expected to be the Air Force's Manned Orbiting Laboratory (MOL). A modified Gemini spacecraft hitched to a 25-foot-long laboratory module will probably be launched into orbit by a Titan-3C rocket. Little can be said about the electronic equipment because MOL is classified.

However, the computer may resemble the design outlined in the main article. It is a general design based on concepts developed by the International Business Machines Corp. and others during feasibility studies that took place before the MOL project. These included the Air Force's Orbiting Space Station Study and the National Aeronautics and Space Administration's Apollo Applications Program and the Large Orbiting Research Laboratory.

NASA's ideas include orbiting a 22-foot sphere either at an altitude of 200 miles, or at a seemingly stationary position 22,500 miles high. Crews would be ferried to the station in Gemini or Apollo spacecraft.

A grander concept of the space agency is a giant cylinder, 33 feet in diameter, 120 feet long and weighing over 100 tons. Once in orbit, the craft would unfold into a huge, three-bladed, propeller-like structure that would remain in orbit five years.

A start in Gemini. Although the Gemini computers are highly flexible [Electronics, May 3, 1965, p. 71], they are not versatile enough for space labs.

The Gemini computers can be programmed for many maneuvers. Taped programs can be loaded into the newer models by the astronauts; older models were programmed on the ground. With his control panel, the astronaut can insert data manually and select the operating mode: prelaunch, ascent, orbital maneuver, rendezvous or reentry. Seven dials, resembling an automobile odometer, verify data inserted from a keyboard or display data taken from the memory.

The amount of thrust needed in each of three axes

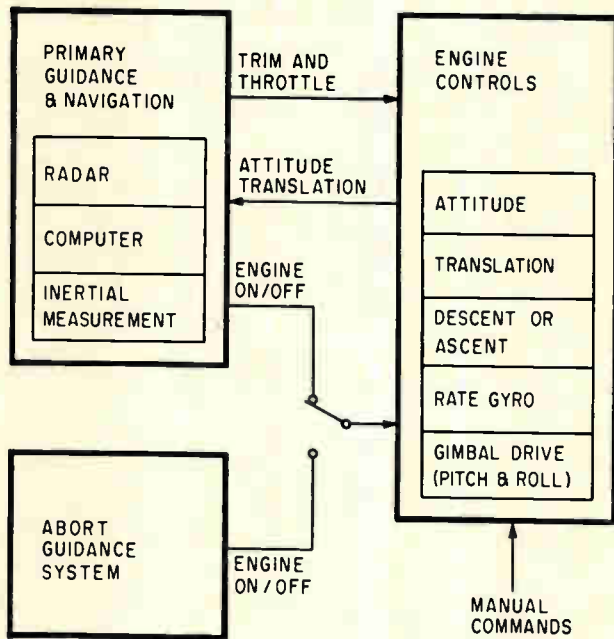

Lunar excursion module for Apollo will have its own guidance and navigation system.

for a particular spacecraft maneuver is displayed by the computer on an incremental-velocity indicator. As the astronaut operates the thrust controls, the computer continually recalculates and displays the additional thrust needed. When the readings reach zero, the astronaut shuts off the motors.

Acting on the stored programs, the computer processes the data serially, one bit at a time, with discrete-component diode-transistor logic circuits. Only one of the Gemini computers seriously malfunctioned. Data in the Gemini 4 computer became garbled because of a power-supply difficulty, not a computer flaw, and

the craft had to be brought down under ground control.

Apollo's computer. Because the Apollo flights are longer and more difficult, the Apollo computer will have more things to do than Gemini's. Also, the new computers are being built with integrated circuits.

In the Apollo command module, the computer will monitor the performance of the guidance and navigation subsystems and warn the crew of malfunctions. Periodically, it will calculate course corrections and update the inertial navigation system with the aid of celestial data obtained with an optical subsystem. Gemini's inertial reference is established before launch.

The celestial system is a little brother, in some ways, to the astronomical telescope experiment described on page 132. An Apollo crew member will find a star or lunar landmark with a telescope, steering the spacecraft if necessary to widen his field of view. At the instant a sextant is on target, a mark command will make the computer take in the angle and time data needed to calculate velocity and position of the spacecraft. The astronaut won't need the navigational tables that sailors use. A fixed memory in the computer will store essential data.

Landing control. Once they reach the moon, two of the Apollo crew will get into the lunar module, which also has a guidance and navigation computer. The computer will depend on radar for most of its data.

During descent to the moon, a landing radar will provide altitude and altitude change-rate information. Converted into engine commands, these will allow the module to settle gently. After takeoff, data that helps the lunar module rendezvous with the command module will be provided by another radar.

After rendezvous, the guidance and navigation computer in the command module will get fresh celestial and landmark fixes, plot the trajectory to home, aim the spacecraft and send it on its way.

Wallace B. Riley
George Sideris

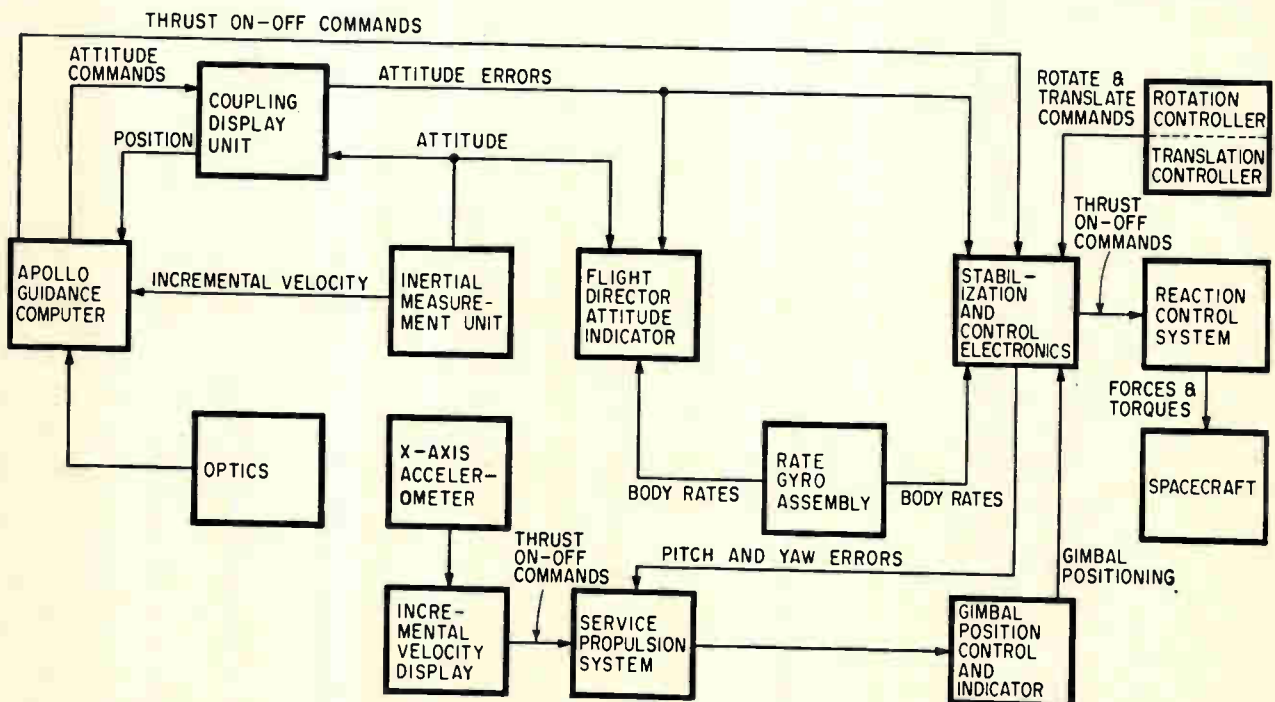

Apollo spacecraft will have a computer-controlled guidance and navigation system.

Samples per second	Number of channels			8-bit bytes per second	
	Engineering		Bio-med		
	Digital	Analog	Analog	Digital	Analog
1/60*	2	48		.03	1
1/30*		8			.25
1/10*	12			1.2	
1	21	9	15	21	24
2	5	5		10	10
5	3		12	15	60
10	5	4	1	50	50
20			5		100
100			2		200
200			4		800
300			2		600
400			2		800
1,000			1		1,000
1,500			2		3,000
Totals	48	74	46	100	6,645

* The first three sample rates are respectively 1, 2 and 6 per minute

behavioral experiments impose the major data-processing load, with sampling rates as great as 1,500 per second for an electrocardiogram. Engineering experiments require lower sampling rates, from 10 per second for a spectrometer to one a minute for telescope gimbal angle. Assuming that all analog outputs can be digitized into one eight-bit byte per sample, which allows a maximum res-

olution of one part in 256, the total processing requirement is less than 7,000 bytes per second. This estimate does not allow any margin for error as was allowed in the estimate of the size of the processor.

Ground support versus onboard processing

To conserve power and weight the onboard computer should be used only to monitor experiments and other operations, to obtain experimental results that are needed in real time—that is, during or immediately after the experiment—and to reduce other data before telemetering it to receiving stations on the ground.

Telemetered data is recorded on magnetic tape at tracking and data-acquisition stations for later analysis. Data-reduction stations process some of the data immediately, particularly that from data-acquisition stations in North America, for quick-look analysis and evaluation.

The telemetry system includes equipment for time- and frequency-division multiplexing, analog-to-digital conversion, programing and transmission of information from the spacecraft to the ground. The system also receives and demultiplexes data telemetered by astronauts or unmanned systems outside the spacecraft.

Both pulse-code-modulation and frequency-modulation systems are used. The pcm systems acquire data through addressable multiplexers, which are time-shared with data processing and computing systems. Functions to be telemetered are sampled under program control to permit switching between different modes of operation and variable formats. All the data generated for telemetry transmission while the spacecraft is out of range of ground sta-

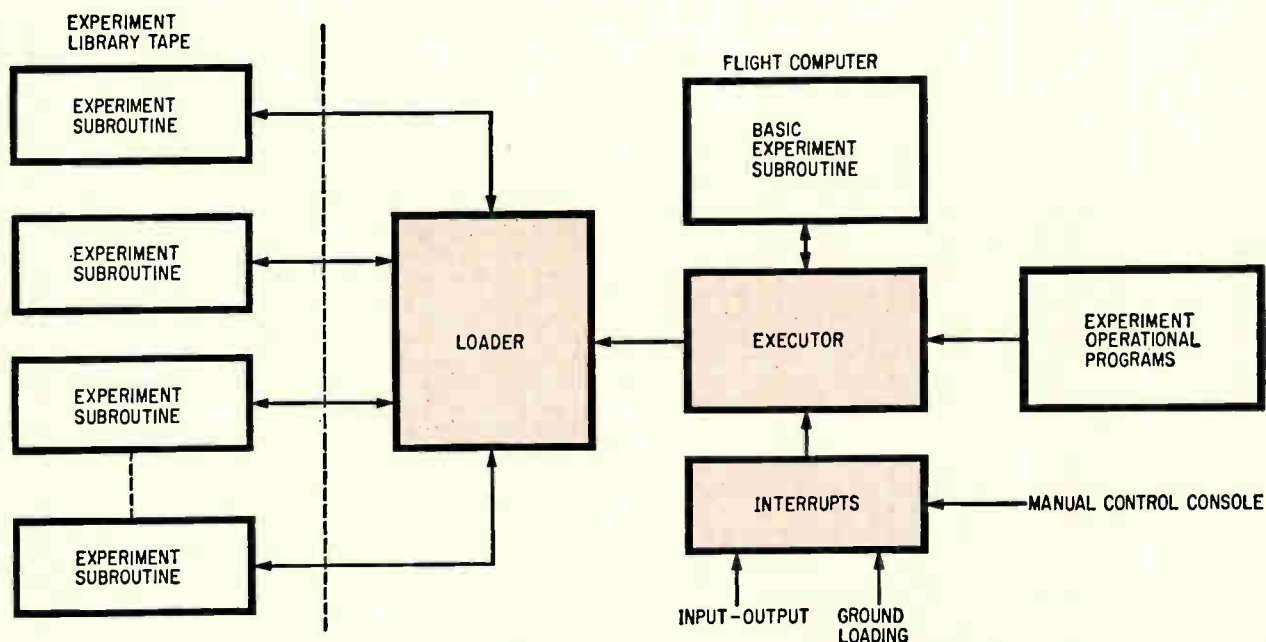

Programs for various experiments in the space laboratory are in the form of subroutines that can be called in by an executor and loader program, which supervises the operation of the entire data-processing system.

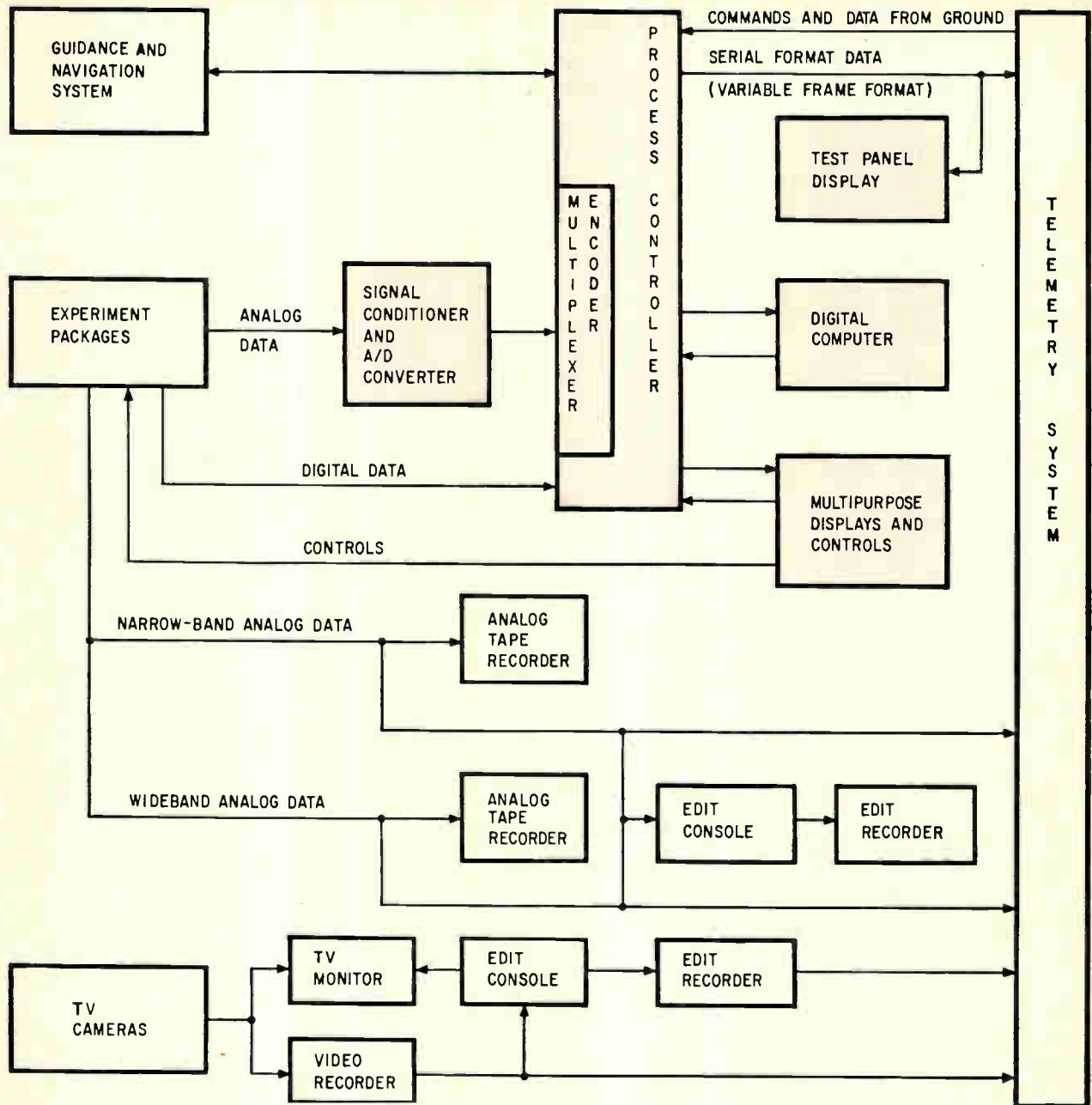

Data-processing system for a space laboratory. This organization is compatible with the Apollo project; the layout would be similar for a general-purpose system.

tions is recorded on magnetic tape.

A typical telemetry system provides f-m sub-carriers for continuous analog signal transmission and high-data-rate pcm/fm channels for digital transmission as shown in the diagram on page 132. Six telemetry channels with input rates from 640 to 76,800 bits per second modulate subcarrier oscillators at different frequencies. A television channel is added at the antenna multicoupler stage, and all seven signals are transmitted in the same primary frequency band.

Backup on the ground

The program of experiments in an orbiting laboratory must be planned on the ground and all experiments must be monitored from the ground.

These are special requirements of orbiting laboratories, and they call for an experiment management and a control facility that generates detailed test plans, sequences and procedures. The facility also must estimate the probable results of experiments as a guide and monitor and support all operations during the laboratory's flight. It would determine in advance how much equipment would be required for real-time processing and data reduction on the ground and how much for later exhaustive analysis and evaluation.

Some voluminous data that is not easily reducible on board and is not needed immediately on the ground can be photographically recorded on board, perhaps under computer control. These records would be available for analysis only after the mis-

sion was over. Because of its high storage density, film has a recording capacity greater than any other data recording or transmission system. High-resolution film can record as much as 300 bits per millimeter on a linear scale or 90,000 bits per square millimeter.

Data systems configurations

Variations of experiment equipment and operations from flight to flight and the time-phasing of operations during long missions require a general-purpose computer with a configuration similar to that of a large commercial and scientific ground installations.

The following design criteria are essential for manned space missions:

- A high-speed memory capable of modular expansion in increments of about 8,000 words.
- Compatibility upward between configurations of different sizes—so that a bigger model can run a program written for a smaller one.
- Compatibility with ground-based computers.
- Floating-point arithmetic, which automatically keeps track of the decimal (or binary) point.
- Built-in parity checking to detect errors.
- Rapid-access bulk storage for data not actively involved in computation.
- Modular input-output capability which permits real time data channels to be added or withdrawn as needed.
- Software packages—special programs to assist in the preparation of application programs, to check out the equipment, to perform utility functions and to control over-all operation.

For compatibility with ground-based computers the spaceborne computer must have an instruction repertoire that is a subset of the ground-computer repertoire and that operates identically. This compatibility would enable the experimenter to write, operate, simulate and debug his flight program package on the ground and know that it will operate in space. Compatibility also permits coding in Fortran-like, problem-oriented languages using existing scientific and data-processing subroutines and simulating flight hardware on existing commercial equipment.

The data processor that IBM has designed for real time space systems is built with advanced microelectronic technology to meet the requirements of light weight, low power consumption, small dimension and high reliability.

Most missions will require high data-processing speeds. The telescope experiment calls for 19,000 operations a second, or one operation every 52½ microseconds, and that experiment will not necessarily demand the fastest operation. The data-handling demands of experiments and laboratory housekeeping carried out simultaneously can increase the rate considerably. But a computer that can add two numbers in one microsecond will probably have ample speed.

The spaceborne computer, if it is to be reliable throughout a long mission, requires redundancy in

every major subassembly. Extra banks of memory, with distributed crossbar switching, will furnish the necessary memory redundancy; for instance, a 32,000-byte memory might be made of six 8,000-byte blocks, including two redundant blocks. Redundancy in the central processor is provided by means of switches between prime and spare modules. Backup supplies can be switched in if any of the main supplies fail.

The effect of redundancy on the reliability of a typical computer configuration for a 30-day mission is shown on page 133. The numbers in each block represent the probability of success; an increase here is equivalent to a decrease in the probability of failure by a factor of about 75.

Programming the flight

Experience with ground computing systems for data-processing functions and loads that vary as do those in a space laboratory shows that the spaceborne computer should have a flexible programming arrangement with an executor-loader arrangement as shown on page 136.

Experiment and operations subroutines are first written in a problem-oriented language compatible with the ground support system; they are stored aboard the spacecraft on magnetic tape.

An executor program controls the entire system, bringing appropriate subroutines into the main memory of the processor, combining the subroutines and controlling the input and output functions to produce a flight-program package as experiments proceed. Input and output devices can interrupt the executor, as can a ground-to-space command link that updates programs and information. The astronaut can override the executor manually.

This arrangement provides the flexibility that a space laboratory requires in flight, and accommodates the variations in experiments and supporting equipment from flight to flight.

The authors



Jack Cohen is the manager of Advanced Manned Space Programs for IBM's Federal Systems division. Previously he worked for NASA on Project Mercury and Project Apollo.



Andrew Adelman is a senior engineer in the Advanced Space Programs department at IBM. He has been with IBM since 1954 and has worked on many types of digital computer systems.

Philbrick's NEW BREED Micro-Hybrid Operational Amplifiers Obsolete Monolithics

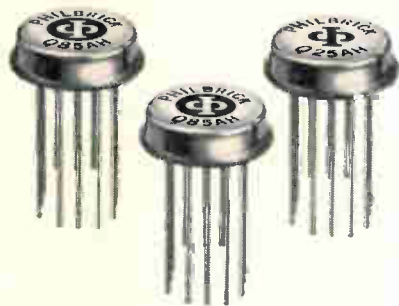

If you are still using monolithic-chip operational amplifiers, your system may be on its way to obsolescence — perhaps even before it gets off the board. A full year of industry-wide evaluation has proved it.

Philbrick's NEW BREED of "micro-hybrid" operational amplifiers combines the best of the linear-monolithic and discrete-component technologies. The result: a line of "micro-hybrid" operational amplifiers unequalled in reliability and performance. You'd expect premium amplifiers like these to cost more. They do — but your total system cost, including design, development, materials, and production, is usually substantially lower when you use NEW BREED Operational Amplifiers.

You can bid, win, and build highly superior "third-generation" systems with the NEW BREED — systems with an order of magnitude better performance, and absolute immunity to overloads, shorts, and supply-voltage stresses. Without the NEW BREED, your analog Aerospace/Weaponry designs are no longer competitive — technologically or economically.

More than 200 systems organizations have evaluated (and many have already approved) the NEW BREED. The facts are all assembled in our report entitled "THE NEW

BREED MICRO-HYBRID — A STATUS REPORT." Write, wire, or phone for your copy. Philbrick Researches, Inc., 22-OAllied Drive at Route 128, Dedham, Massachusetts 02026. TWX (617) 326-5754. Telephone (617) 329-1600.



GENETIC EVOLUTION OF THE NEW BREED HYBRID

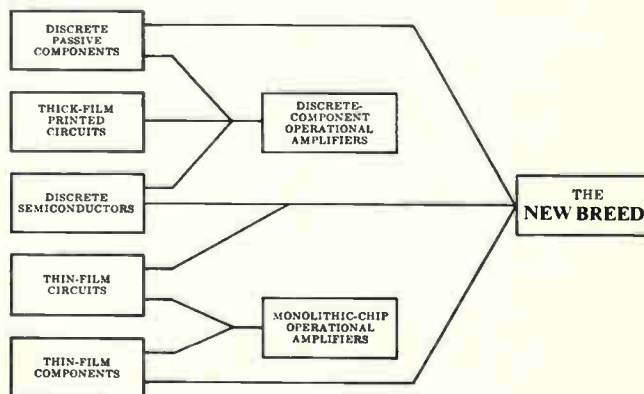

ELECTRONIC ANALOG COMPUTING EQUIPMENT for MODELLING, MEASURING, MANIPULATING and MUCH ELSE



PHILBRICK

"See us at the NEC Show October 3-5—Booths 3 & 4, and the ISA Show October 24-27 Booth 1541"



LOOK TO THE LEADER
IN INTEGRATED CIRCUITS

TEST THE BEST... WITH 50

before you buy... try TI's new

Our proposition is simply this:

We'll give you 50 molded TI integrated circuits with each order of 1000 units or more placed before November 1, 1966.

Do anything you like with these samples... hammer them... test to destruction... wire into your circuits... soak in boiling water... compare with any others. Prove to yourself that they're best — by test!

Money-back guarantee — If you're still not convinced that TI molded integrated circuits do your job better than any competitive types available, just return the unused circuits. We'll give you full credit for them. This offer is good for 60 days from date of any order placed before November 1, 1966.

Offer includes popular series — Devices included in this offer are the popular digital circuits from the 930-type DTL and Series 74 TTL families shown below right. Series 74 TTL is first choice of many designers for new equipment. Circuits in this line typically are 48% faster, have 25% higher fan-out and 15% better noise margin than DTL... at competitive prices.

Whether your system design calls for DTL or TTL circuits, you'll find a wide selection of single and multiple gates and flip-flops available. With either series, high-speed logic is now available to you at lower prices per function than ever before.

Rugged design proved by test — TI molded integrated circuits offer outstanding durability. The rugged, high-density package is molded from the same encapsulant used in millions of SILECT™ transistors and is backed by over 2,000,000 actual hours of test. Resistance to impact, heat and moisture are further borne out by successful testing to the following rigorous schedule: *Thermal Shock* — MIL Std. 750, Method 1056A; *Temperature Cycling* — MIL Std. 750, Method 1051; *Moisture Resistance* — MIL Std. 202C, Method 106B; *Hydropressure* — 3% JOY, 110 PSI for four hours.

Exclusive features save you money — You realize big reductions in total manufacturing costs with TI molded integrated circuits because they are specifically designed for use in automatic handling, assembly and test facilities. Exclusive features such as the positive index notch, pretinned leads and side-mounted lead design make it possible. Even the cartridge-type shipping container lends itself to automated production line use.

Fast delivery — Deliveries of TI molded integrated circuits are prompt... prototype shipments can typically be made within days. And TI's high production rates assure *continued* availability to meet your most critical production schedules.

To obtain your 50 free evaluation samples immediately, just place your order with any TI sales office or authorized TI distributor.

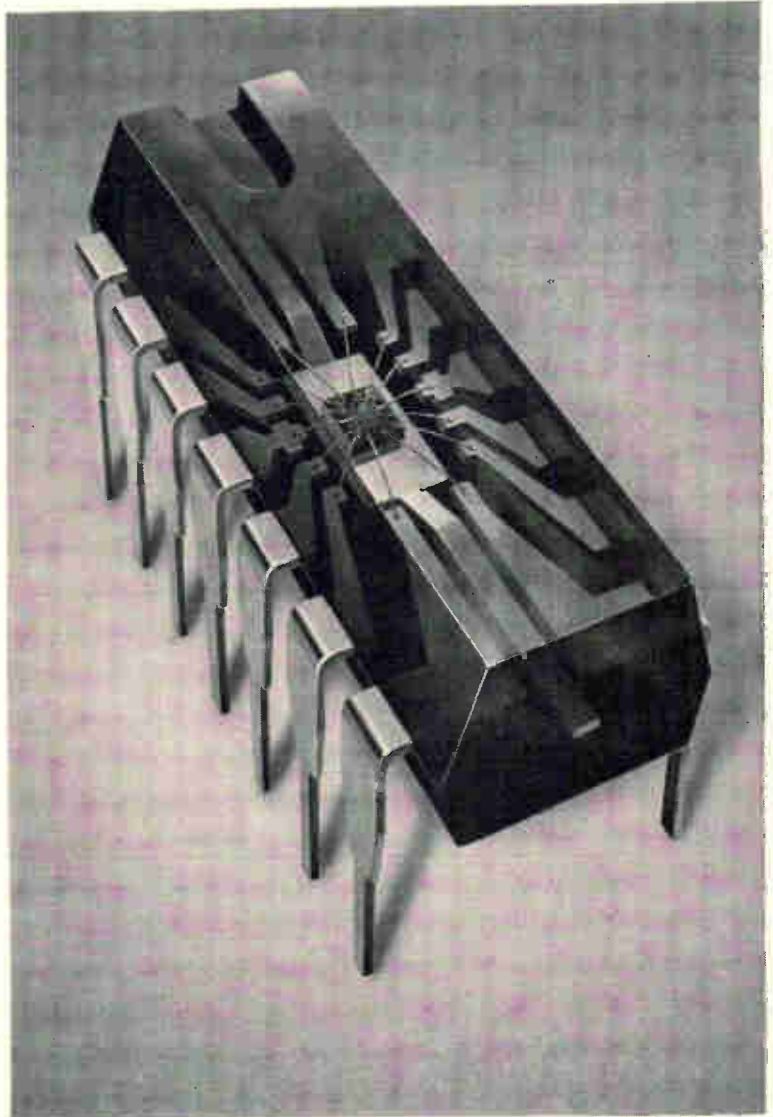

All these devices are included—

	Series 74 TTL		SN7460N	Dual 4-input expander
	0° to 70°C Operating Temp.		SN7470N	Single-phase Flip-flop
SN7400N	Quad 2-input NAND Gate		SN7472N	Master-slave J-K Flip-flop
SN7410N	Triple 3-input NAND Gate			930 Type DTL
SN7420N	Dual 4-input NAND Gate			0° to 70°C
SN7430N	3-input NAND Gate	SN15830N	Dual 4 Nand Gate	
SN7440N	Dual 4-input NAND	SN15831N	RS/JK Flip-flop	
	"power" Gate	SN15832N	Dual 4 Buffer	
SN7450N	Expandable Dual	SN15833N	Dual 4 Expander	
	AND-OR-INVERT Gate	SN15844N	Dual 4 Power Gate	
SN7451N	Dual AND-OR-INVERT Gate	SN15845N	RS/JK Flip-flop	
SN7453N	Expandable 2-input 4-wide	SN15846N	Quad 2 Nand Gate	
	AND-OR-INVERT Gate	SN15850N	Pulsed AC Flip-flop	
SN7454N	2-input 4-wide	SN15851N	One Shot	
	AND-OR-INVERT Gate	SN15862N	Triple 2 Nand Gate	

FREE SAMPLES FROM TI

molded integrated circuits

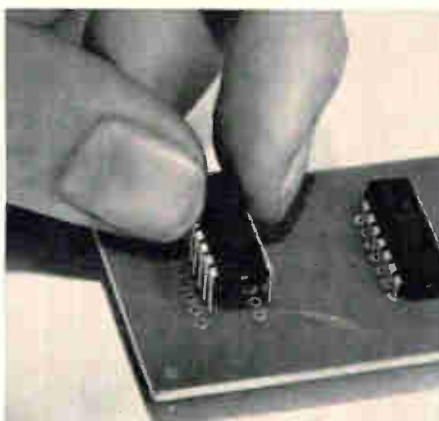
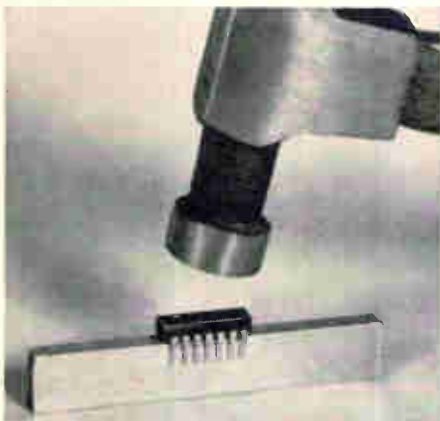
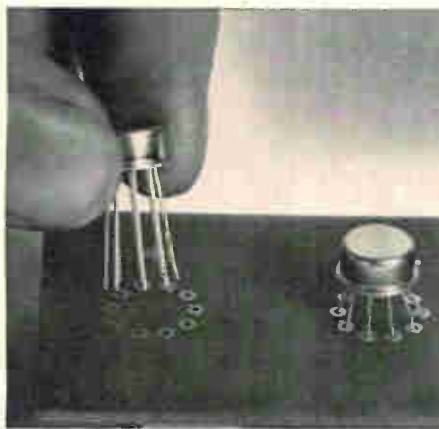
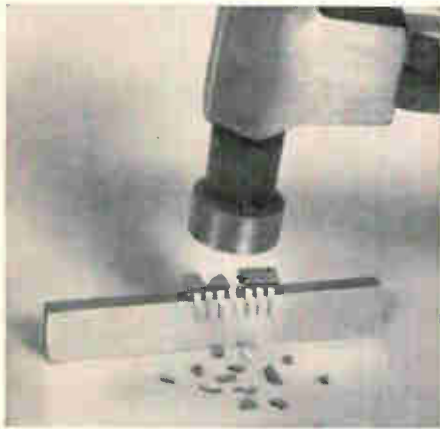

RESISTS SHOCK . . . TI molded integrated circuits resist impacts that would smash metal packages and shatter ceramic packages as shown in top photo. You benefit from fewer failures in handling accidents and greater reliability in service. The solid molded construction gives extreme resistance to acceleration, vibration and shock as proven in actual test (see opposite page).

EASY TO ASSEMBLE . . . TI molded integrated circuits are ideal for mechanized assembly, including automatic insertion and wave soldering. Faster, easier handling cuts total manufacturing costs. You realize big savings because of the in-line rigid lead pattern and convenient indexing notch. These features simplify assembly when compared with transistor-type circular lead packages.

RESISTS DAMAGE . . . You also realize savings from fewer rejects while achieving higher end-product quality because TI molded integrated circuits have outstanding durability. For instance, they'll hold up to heat that would induce failures in many competitive devices. Result: fewer assembly rejects due to high soldering temperatures.

SEE THESE TESTS FOR YOURSELF! CALL YOUR TI SALES ENGINEER



TEXAS INSTRUMENTS
INCORPORATED
 13500 N. CENTRAL EXPRESSWAY
 P. O. BOX 5012 • DALLAS 22, TEXAS

SEMICONDUCTOR PLANTS IN BEDFORD, ENGLAND • NICE, FRANCE • FREISING, GERMANY • DALLAS, TEXAS

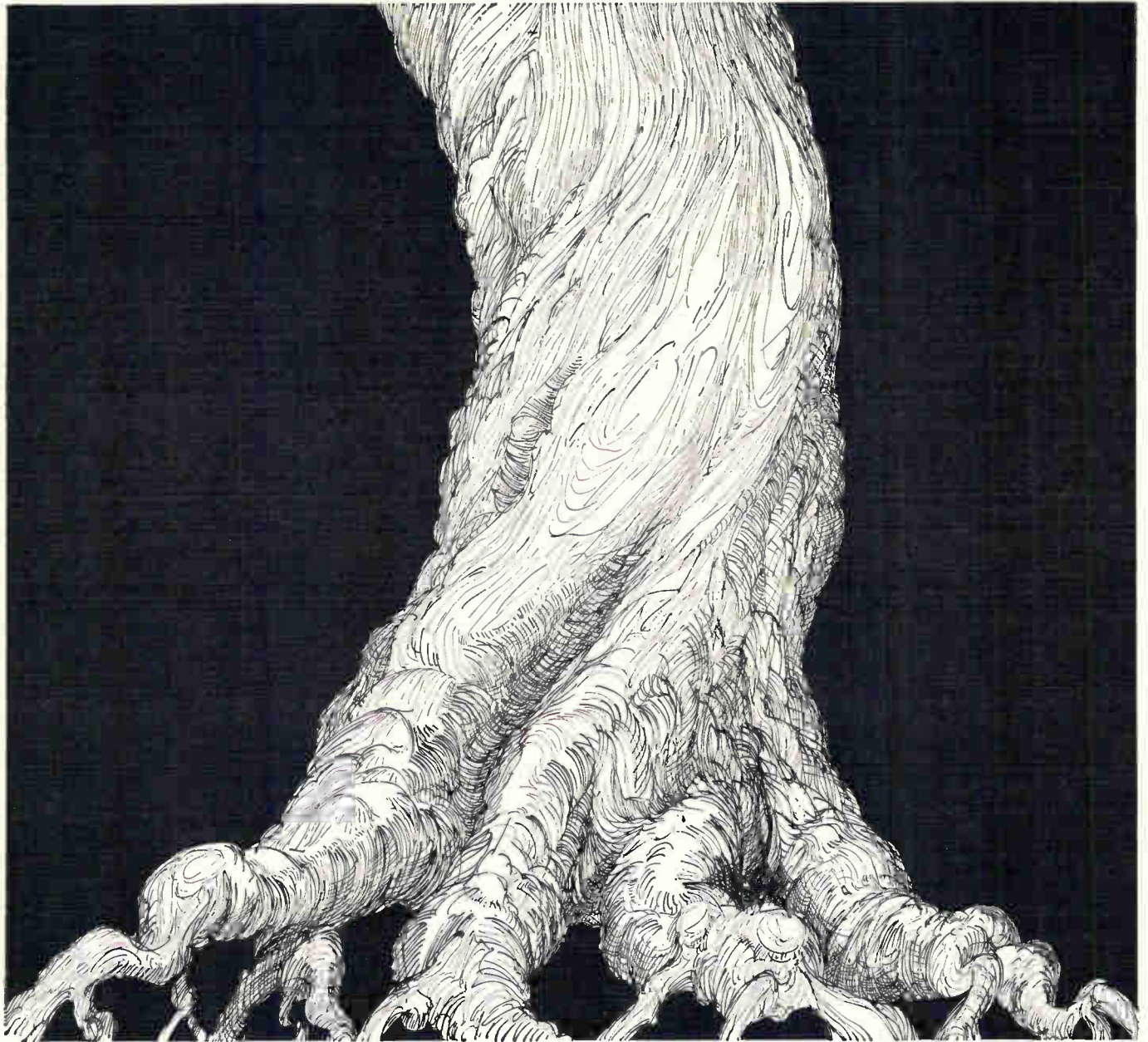

S T R E N G T H

A tree trunk — *codex* in early Latin — *naturally* grows just strong enough to support its height and type of crown according to its environment.

Codex error detecting-and-correcting equipment *is by design* just strong enough to overcome transmission errors in telegraphy, microwave, troposcatter, undersea and H. F. radio channels. By varying the *strength* of the new convolutional forward-acting code developed for these systems,

Codex tailors the error-correcting capability of each device to the frequency and kind of error common to any type of communications system.

The economy and flexibility makes Codex equipment the most effective and the least expensive on the market. To get your messages or data through, in spite of channel disturbances, turn to Codex . . . the people who know error detection and correction from the ground up.

CODEX

CORPORATION

• 222 ARSENAL STREET, WATERTOWN, MASSACHUSETTS •
ZIP CODE 02172 • (617) 926-3000 • TELEX 094-6332 •

Plain talk about obsolescence



In the June 13, 1966 issue, pages 142 to 146, *Electronics* published "The myth of obsolescent knowledge" an opinion article. Its author, Gerd D. Wallenstein, tried to lay to rest the engineer's fear of obsolescence of knowledge. He suggested that a certain kind of knowledge never loses its value and proposed a theory of perspective. Clearly the article stimulated a lot of thinking on the subject. Many readers wrote applauding his thesis; some disagreed with the concept and the way Wallenstein would face up to technological progress. Here are some of the dissident letters which the editors feel contribute substantially to the discussion of obsolescence of knowledge.

I. Blaming management

Management should investigate research areas in which technological change can affect the company, then train its engineers.

Gerd D. Wallenstein's article "The myth of obsolescent knowledge" is correct as far as the statement that all knowledge has value, that a person builds on his knowledge by adding new knowledge, and that an individual has a responsibility to do so. But an engineer has difficulty determining just what new skills or knowledge should be acquired to make him valuable to his company. It is especially difficult for him to develop skills in anticipation of a technological advancement because management will determine if it will adopt any particular technological innovation.

Thus, management has to be alert to possible technological advancements or changes. Managers should investigate research areas in which technological changes can affect company goals. They should attempt to predict or anticipate the effect any such change will have and to make policies redirecting the company's procedures and aims accordingly.

The problem of staff obsolescence in an organization lies on management's doorstep. The fact that employees are not qualified for their assigned tasks of the future is the fault of top manage-

ment. If the management of an organization is alert and dynamic in its perspective, it will be capable of handling what the future will demand by training its personnel to meet the needs caused by changes in technology. Advances in technology most certainly demand new skills and knowledge. Management should welcome such change rather than fear it.

Inertia is resistance to change, and often management settles in a state of inertia. This is why "management by crisis" occurs in an organization that does little or no planning for the future. Top management's role is to lead, but if the leaders are not alert to change, they are just as obsolete as the scientists and engineers they accuse of being obsolete.

Does it make sense to spend \$5,000 recruiting a specialist with a particular skill and to fire the individual he is replacing when, by planning for technological ad-

vances, the presently employed engineer can be trained for the same skill for \$2,000? In addition, this is no way to build morale and loyalty in an organization.

Training is the answer to the obsolescence of scientists and engineers, and training is the responsibility of management. When the management of a company complains constantly and bitterly about its personnel being unqualified for their tasks, investigation always

shows that this particular company has little or no training program. If a company is not growing, it is dying; for a company to grow, it must train its personnel for the future.

Technological advancements and changes are not easy to predict or ascertain. This fact alone makes it doubly difficult to evaluate training needs. Training is expensive and time-consuming, but it can solve the most vexing problems, one of which is meeting the demands and

needs of knowledge and skills for the future. Top management's responsibility to the company is leadership. If it does not cope with the problem of change in technology by preparing company personnel for such a change, it is not meeting the challenge of its obligations and does not earn the right to lead the company.

Robert A. Sinclair

Illinois State Water Survey
Urbana, Ill.

II. Rationalizing antiquity

Progress comes from a critical, not appreciative, evaluation of the past

An excellent case can be presented against "The myth of obsolescent knowledge," and it is unfortunate that its author did not do so. Like many who take the overview approach, Gerd Wallenstein restricts himself to favoritism, and this limited viewpoint defeats the perspective he claims.

The verities of truth, beauty, and human nature are ubiquitous as well as eternal, and are not found best expressed in those esoteric examples he cites. Bertrand Russell's social projectivity has been bypassed by mass communication falling on the base of a peasant's r-f stage. We learn more of human nature from Bill Cosby than from Franz Kafka. Beauty is more widely appreciated in a Wescon design winner than in old Chinese art.

The rules of electron flow do not vary, whether governed by space charge or minority carriers, integrated or segregated. However, their application in economies of design—the eternal verity of sound engineering—change with available tools.

The philosophic trap which can really lead to intellectual obsolescence, and the one which Wallenstein springs on himself, is that of attempting to validate antiquarianism: archaic examples, like old trees, obscuring the forests of knowledge. Truth, beauty, and hu-

man nature abide—they are time-proved. Their application in old art, old literature, and old circuitry are transient—they are time-worn. Creativity and progress can come only from a critical, not appreciative, evaluation of the record of the past. Total skepticism is necessary to sift the truth from its provincial and temporal chaff.

Henry Stude Jr.

Newark, Del.

The author replies:

If I understand him correctly, Stude believes that eternal verities of beauty, truth, etc., are directly accessible at all times. If this were so, then there is nothing to be learned from their manifestations of the past. Each new design, invention, work of art would automatically obsolete any previous one. But, this thinking is the epitome of the obsolescence syndrome.

Integrated circuits have not been found in a naive fundamentalist search for the most compacted circuitry possible with new tools, but by extension of knowledge and experience developed with the vacuum tube, transistor and printed circuit technology.

For examples of nonobsolescent knowledge, the reader is welcome to seek his own. One can substitute Rembrandt or Picasso for Chinese Sung painting, without departing from the concept of lasting values on which our culture is built. Examples by themselves do not matter, it is rather the contributions of our knowledge and culture made by those who produced them.

Skepticism and appreciation are inseparable companions—without some appreciation one would have no reference to use skepticism against. Total skepticism would deny value to the Wescon design winner as much as to anything else. If no achievements of the past have value to him, how will Stude go about finding truth, beauty, human nature? And where will he be 10 years from now when his present examples will have become past?

Gerd Wallenstein

Lenkurt Electric Co.



III. Shirking responsibility

An engineer claims that technical men do become obsolete and the fault usually lies with their companies

Gerd D. Wallenstein presents a strong case for being philosophical but ignores an important question: how did obsolescence happen to conscientious, hardworking, studious and experienced scientists and engineers? He discusses obsolescence as if it were a state of mind rather than a fact of life.

With such an outlook, the author misses a key point: many engineers do fall prey to industrial obsolescence. To me, the real burden of preventing obsolescence lies with industry. Few working engineers have the breadth of view of economics and the market place to recognize which obscure scientific phenomenon will grow into tomorrow's bread-and-butter technology. Management should if it is doing its job.

According to Wallenstein's argument, the fear of obsolescence is the major factor to avoid. An engineer or scientist can avoid obsolescence by merely revising his thinking to acquire an understanding of history so that the distant past and future acquire less importance than the immediate past and future. Thus the engineer realizes he can learn without fear of obsolescence.

Such a view, to me, is existentialist philosophy but has little bearing on the engineer's problem. According to a writer and philosopher, William Barrett, "One final and central point common to the existentialists is their emphasis upon time and history as fundamental dimensions of human experience. Our lives become meaningful to the degree that we bind together tomorrow, today and yesterday in an active whole."

Engineers, like most other professional people, endeavor to learn and to grow. Obsolescence comes not from a lack of engineering incentive but from a change of industrial objective.

The problem is inherent in the very definition of engineer: a

person concerned making properties of matter and sources of energy useful to man in structures, machines and products. This is quite different from the definition of a scientist, which might be considered as a person concerned with observation and classification of facts and especially with the establishment of verifiable laws. Thus the success of an engineer's job can be directly measured in terms of his company's profit as reflected by the marketability of its products.

Since the average engineer designs specific solutions to concrete problems, he is affected the most by changing technology.

One scientist, Theodore N. Ferdinand, has identified three kinds of obsolescence: professional obsolescence, aerial obsolescence and ex officio obsolescence. He defines obsolescence this way: "Obsolescence exists when an individual uses viewpoints, theories, concepts, or techniques that are less effective in solving problems than others currently available in his field of specialization." He explains that professional obsolescence occurs when one does not have a broad grasp of his discipline; aerial obsolescence when one does not have a thorough knowledge of his immediate specialty; and it is ex officio obsolescence when an administrator does not have the technical knowledge required for the position he holds.

Some engineers never fall into any of these classes of obsolescence, but more because of circumstances than philosophy.

Those who demonstrate superior technical ability are inevitably assigned to engineering in the new technologies and are afforded the latitude to become expert in them. Those who have the freedom to attend schools or pursue independent studies study those technical areas or disciplines which become important to their companies. And those whose administrative and ex-

ecutive ability are more valuable than their engineering talent can follow the broad development of new technologies rather than specializing narrowly.

On the other hand, circumstances can make another category of engineer obsolescent in several ways, but the three most common are:

- A company assigns an engineer to an area for which he is not trained or has not considered as consistent with his career objectives, background or training.

- Conflicting outside responsibilities or lack of availability of schools prevent the engineer from continuing his studies. When younger engineers, who are paid less, come along with knowledge of the new technology, the older man is made obsolete by economics.

- An engineer pursues his studies diligently, learning all he can about a specialty, even becoming an expert in that specialty, but his services are not needed when the specialty becomes obsolete. Or to put it another way, the industry becomes obsolete and the engineer is obsolete.

In real life, it is easy for an engineer to become wedded to a narrow specialty. As an engineer strives for success, he measures his progress in terms of money, status, or both. His company rewards him commensurate with his contributions, urging him to produce in such a way that the company stays competitive. Under corporate prodding, the engineer reads and studies material which is related to his work; he does not study unrelated subjects except as a hobby or avocation. If he's fortunate, he might pursue a field in a new technical area as an avocation that would allow him to switch his working specialty, but such an occurrence is a rarity. Broad technical reading can be accomplished only during the time reserved for vocational study. Unfortunately there is not enough time for such reading. Usually, the engineer has only enough time to study his specialty or he becomes noncompetitive and the company stops rewarding him.

Thus, the responsibility turns back to the management of a company. Although some companies do allow their engineers to take ad-

Rolled Metal Ribbon & Strips



(THINK OF **CROSS** FIRST)

MAJOR MICROWAVE MANUFACTURERS DO!

Top manufacturers like Microwave Associates, Watkins-Johnson, Varian Associates and Raytheon use CROSS-rolled ribbons for their most finicky chores. That's because CROSS rolls molybdenum and tungsten down to tolerances of $\pm .0001$. CROSS is the **only** company to do so on a production basis.

CROSS rolls tantalum, columbium, zirconium, rhenium moly, titanium, vanadium, copper, nickel, alloys and standard metals. CROSS will roll strips to precise order, meet any demand for precision metals.

There's a good reason why top companies think of CROSS first—because if CROSS does it—it's right the first time! Join the top manufacturers who've found out how perfectly CROSS meets your most exacting metal requirements.

Phone or write today.

H. CROSS CO.

363 Park Ave.
Weehawken, N. J.
201-UNION 3-1134

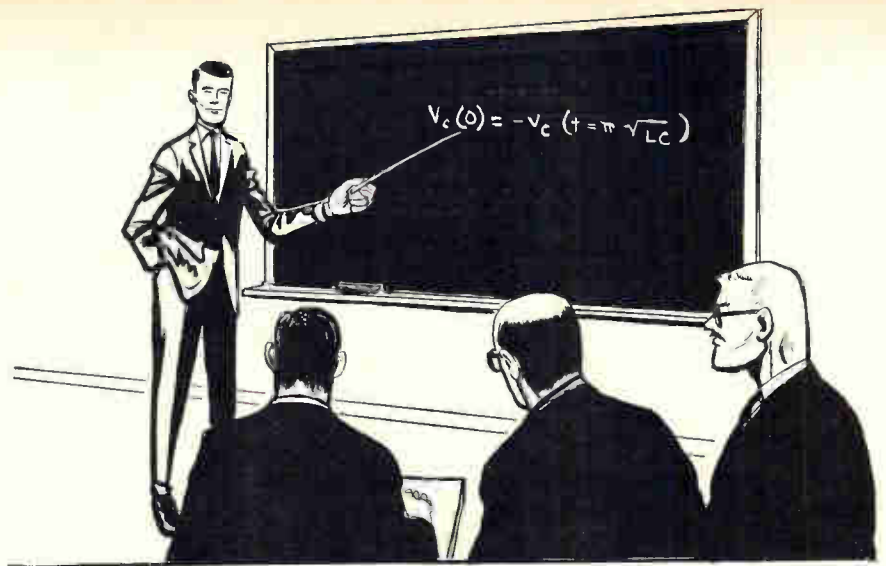

vanced courses and broaden themselves professionally, most restrict the courses to those that are strictly applicable to the engineer's present assignment. Management should provide the opportunity for engineers to do enough studying so they do not become obsolete. Unfortunately most firms do no such thing because they themselves have become obsolete or are in a state of advanced decay.

A company and an industry grow old in a subtle fashion, usually not discernible to those who are responsible for its growth. Generally, as long as profits remain at some predetermined level, members of management believe they are successful. When profits drop, the usual prescription is to tighten belts and "send the salesmen out." Rarely will the company do something as basic as review the product line or how the company is meeting five- or ten-year goals.

Only when profits or sales volume fall substantially below accepted levels for successive years does a product review start. By that time, the company concludes it is noncompetitive and the only way to become competitive is to hire a new team of technical specialists or merge with a company that has capability in up-to-date technologies. In either case, an unsuspecting engineer who has been performing in acceptable fashion suddenly finds his services are no longer needed. He's become obsolete.

Because a company cannot provide employment in anticipation of future work except for a few key employees, it normally shifts the burden of readjustment to its employees. When applied to engi-

neers, such a process is extremely wasteful. Engineering experience is a valuable business resource, though a perishable one. When a company replaces its engineering staff, it loses a team that has known how to meet objectives within the company's organizational structure.

The real tragedy is that this kind of an upset is not necessary. There are many unexploited opportunities that have not materialized because the electronics industry has lacked willingness to risk product development. Atomic energy, solid-state physics, computers, rocket propulsion, low-temperature physics and game theory were in obscurity for a generation before economics demanded that many companies obtain a working knowledge of these subjects. Only recently have schools started teaching through interdisciplinary departments.

Another approach to keeping a company competitive uses both the specialized knowledge of a young engineer and the experience of a professional engineer. The brainchild of a Harvard University professor, Theodore Levitt, this technique would have a specialized group in the company to receive ideas, work them out, and follow them through so that management receives planning information in a useful and timely manner.

I would agree with Wallenstein that engineers need not become obsolete. But I feel that the responsibility for avoiding obsolescence is not only the engineer's but also his company's. Most companies fall far short of their end of the bargain.

A.W. Reickford

Princeton, N.J.

**We're glad
so many of you like our
high-performance field
effect transistors.**

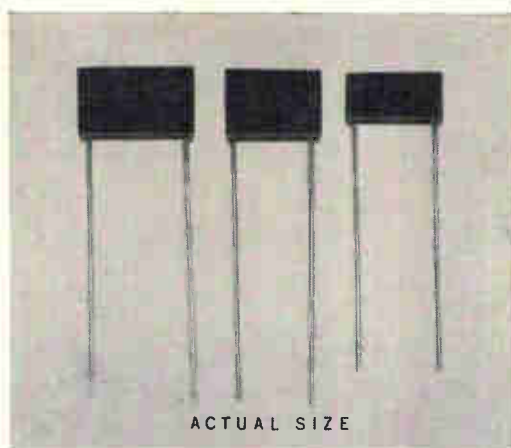

**We think you'll
like our stable new film
capacitors, too.**

KEMET Flat-Kap film-foil capacitors have such an effective dielectric they're 99.9+% stable, yet up to 95% smaller than other film types.

But FET's and Flat-Kaps are only two of the products designed for today's fast-shifting market. We're also committed to leadership in such areas as advanced laser systems... a family of single crystals and crys-

tal products... integrated and modular circuits... solid tantalum capacitors. They're all aimed at problems on the frontiers of electronics. All backed by the technology of Union Carbide.



For data on new film capacitors, write for Bulletin #22, Dept. E-101, Electronics Division, Union Carbide Corporation, 270 Park Avenue, New York 10017.

KEMET is a registered trade mark of Union Carbide Corporation

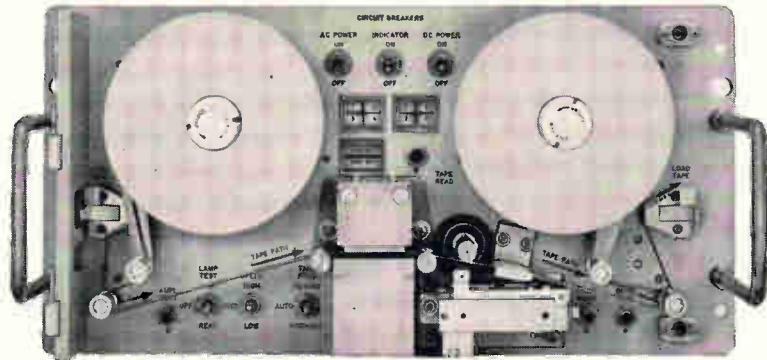

The 45-pound* Potter PT-5000 militarized perforated tape reader

*18"W x 9"H x 8"D

MTBF=30000 hrs

MTTR=15 min

Potter tape reader features subassemblies that are completely interchangeable and can be maintained with a screwdriver. Can be completely dismantled in 20 minutes.

The Potter PT-5000 militarized perforated tape reader—dual-speed operation, 250/500 characters-per-second from -25°F to $+135^{\circ}\text{F}$, built to stringent high reliability specs, featuring complete interchangeability of subassemblies without adjustments and built-in diagnostic test exercises and indicators. A high-reliability unit modularly constructed providing for malfunction isolation without the need for special tools or test equipment of any kind. Built to ABMA standards.

Send coupon today for all the details.

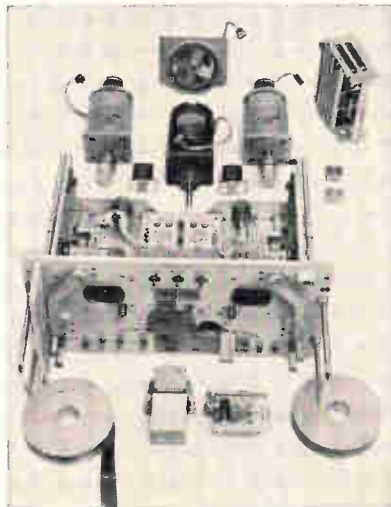

Completely dismantled in 20 minutes

POTTER POTTER INSTRUMENT



COMPANY, INC.

151 Sunnyside Blvd.

INSTRUMENT CO. INC.® Plainview, N. Y. 11803

(516) 681-3200 • TWX (510) 221-1852 • Cable PICO

In Europe: McGraw-Hill House, Shoppenhangers

Road, Maidenhead, Berkshire, England,

Maidenhead 20361

Please rush me complete facts on the Potter PT-5000 perforated tape reader.

Name _____

Title _____

Company _____

Address _____

City _____ State _____ Zip _____

Whose dual in-line 930 DTL?

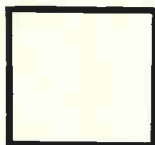
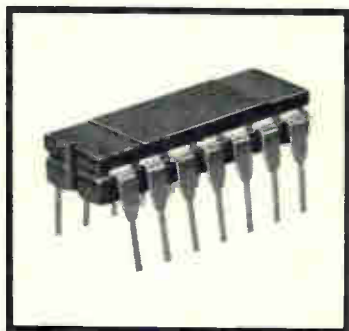

ITT

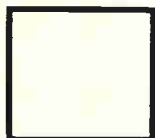

OTHERS

**Only your
purchasing agent knows
for sure!**

ITT offers all series 930 DTL circuits in a dual in-line package. Circuits manufactured by ITT are identical to and perfectly interchangeable with the other leading brand.

If you're convinced that dual in-line packaging is your answer — if you want

the lower component insertion cost, heavier leads and all-ceramic construction that only dual in-line can give you, evaluate ITT.

You can order any series 930 DTL in dual in-line today! Call your ITT distributor or factory representative.

ITT
SEMICONDUCTORS

ITT SEMICONDUCTORS IS A DIVISION OF THE INTERNATIONAL TELEPHONE AND TELEGRAPH CORPORATION
FACTORIES IN WEST PALM BEACH, FLORIDA; PALO ALTO, CALIFORNIA, LAWRENCE, MASSACHUSETTS, HARLOW AND FOOTSCRAY, ENGLAND, FREIBURG AND NURENBERG, GERMANY

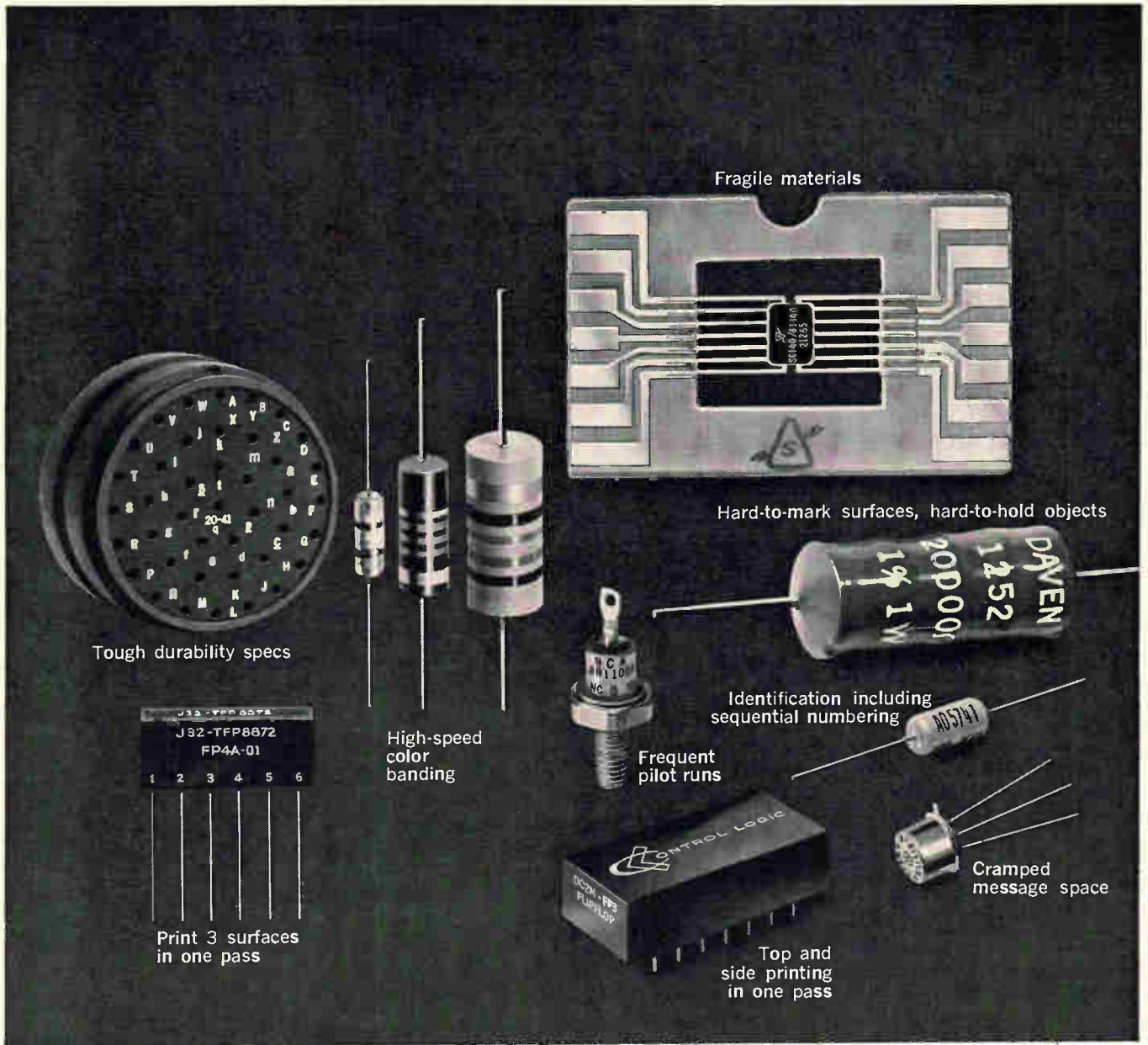

What marking job can we help you do better?

These are only a few of hundreds of marking jobs you can do more efficiently and more economically with Markem machines. So why waste time improvising and experimenting?

Call in a Markem man and get acquainted with today's broadest line of marking equipment. New high-speed color banding machines — some capable of putting three tiny bands on a miniature diode. Machines that combine sequential numbering with identification. Type so small you can print 14 characters plus trademark in an 0.125" diameter area. Quick-change type for short or pilot runs. New techniques combining special ink with flash-curing to help you meet severe durability specs. A production-speed imprinter so gentle you can safely mark flat pack ceramic components. And many other machines, specialty inks and printing elements.

Right now our research engineers and chemists are working on even better ways to mark components. We'd like to be working with you. Markem Machine Company, 305 Congress St., Keene, N.H.

MARKEM®

HELPING YOUR PRODUCT SPEAK FOR ITSELF

ITT 2N3375s are 100% factory tested to give you P_{OE} of more than 5 watts @ 400 MHz

28V CLASS B POWER OUTPUT VS FREQUENCY

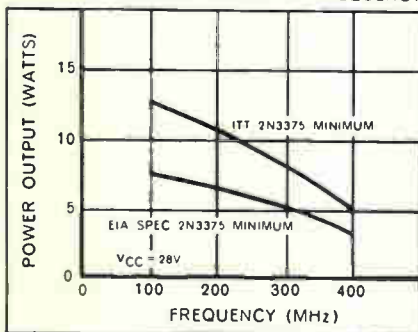

Every ITT 2N3375 gives you 66% more P_{OE} than EIA specs demand. The secret lies in ITT's unusually close control of resistivity, combined with interdigitated construction.

Order ITT 2N3375s today. They're on your distributor's shelf for immediate delivery.

ITT
SEMICONDUCTORS

ITT SEMICONDUCTORS IS A DIVISION OF THE INTERNATIONAL TELEPHONE AND TELEGRAPH CORPORATION
FACTORIES IN WEST PALM BEACH, FLORIDA, PALO ALTO, CALIFORNIA, LAWRENCE, MASSACHUSETTS, HARLOW AND FOOTSCRAY, ENGLAND, FREIBURG AND NURENBERG, GERMANY



Weston Model 1423 Integrating DVM 1 μ V Sensitivity at 50 M Ω for \$1950.

FEATURES: Strain gage and thermocouple type measurements are made with meaningful accuracy due to integrating and high sensitivity features of Model 1423. High common mode rejection allows low level measurement of potentials well above ground. Loading errors are reduced by 1000 times as compared to conventional DVM's.

SPECIFICATIONS: Accuracy: 0.02% \pm 1 digit. Common Mode Rejection: 150 db DC & 130 db at 60Hz—with up to 5K unbalance between input leads, and filter in use. Series (Normal) Mode Rejection: 60 db at 60Hz with filter. Overranging: 15% with fifth digit display. Display Time Control: From 4 reading/second to 1 reading/15 seconds. Overall Dimensions: 6 $\frac{1}{2}$ " x 14 $\frac{1}{4}$ " x 16 $\frac{1}{4}$ ". Price: Bench mount, \$1950; rack mount, \$1995. Price subject to change without notice.

Input Impedance & Sensitivity

Range	Input Impedance Minimum	Sensitivity
10.000 mV	50 megohms*	1 μ V
100.00 mV	500 megohms*	10 μ V
1000.0 mV	5000 megohms.*	100 μ V
10.000/100.00/1000.0 volts	10 megohms	1/10/100 mV

*Typical values twice as large

Contact **Weston Instruments, Inc., Rotek Division, 11 Galen Street, Watertown, Mass. 02172**

WESTON[®] prime source for precision... since 1888



Servo is a car saved



Overheated journals play the villain when it comes to derailments, damage and delay. Servo gets to the heart of the problem. Our Servosafe® Hot Box Detective System examines the journal box. Not the frame, the axle, the hub, or blue sky. We catch trouble in the making, before it becomes serious.

The infrared scanning unit, pictured above, is basic to all Servosafe Hot Box Detective Systems. Scanning units are easily mounted at trackside, and monitor journal temperature of trains passing at

any speed. Servosafe offers building-block flexibility, consisting of trackside warning and recording equipment, or expanded systems, including remote indicators, automatic alarms and data storage and command equipment, in conjunction with CTC.

Other Servo divisions produce systems and products which are designed to serve safety through science: the Servodynamics Division, the Infrared & Electro-Optics Division, and the Communications & Navigation Division.

servo corporation of america

Servo

111 new south road
hicksville, l.i., new york 11802
516 938-9700

Circle 153 on reader service card

**Last week,
you needed
a
switchlite.**



**Today,
you need a
pushbutton
switch.**



**Tomorrow, a
subminiature
toggle
switch.**



**Next Tuesday, a
hermetically-
sealed
switch.**



Good thing Control Switch is around to help.

We're unique among switch suppliers. No other manufacturer makes all the kinds of switches we make. And some don't make any of them.

When we're around to help, you can have your choice of:

- 3,150 toggle switches
- 4,200 pushbutton switches
- 1,240 hermetically-sealed switches
- 1,800 lighted pushbutton panel switches
- 460 basic precision switches
- 1,180 indicator lights.

Plus countless more standard variations. Get any or all of the catalogs listed at the right and see our line-up for yourself.

These are quality switches and switchlites. For computers, aircraft, missiles, equipment and controls that demand reliable components.

Keep your Control Switch distributor . . . or us . . . in mind. Today. Tomorrow. Next Tuesday.



CONTROL SWITCH DIVISION
1420 Delmar Drive, Folcroft, Pennsylvania 19032

Build a reference file! Check numbers on the Reader Service Card corresponding to those below for any or all catalogs you want.

- #450 Condensed Switch Catalog 100
- #451 Basic Snap-Action Switch Catalog 110
- #452 Toggle Catalog 181
- #453 Indicator Light Catalog 120
- #454 Hermetic Switch Catalog 130
- #455 Switchlite Catalog 220
- #456 Pushbutton Catalog 190



PPO[®]

POLYPHENYLENE OXIDE



is self extinguishing

(UL GROUP I)

Even in a section just 30 mils thick, PPO[®] polyphenylene oxide is self extinguishing and nondripping. That's one-half the thickness of the minimum of 62 mils demanded by UL for our Group I rating (the toughest there is). Furthermore, PPO can be dip soldered, copper clad, staked and easily cleaned with Freon TF.

These are key features of PPO, the new wide temperature range engineering thermoplastic from General Electric.

PPO also has superior electrical properties. Dissipation factor and dielectric constant are very low...and very constant...over a wide tempera-

ture and frequency range. Dielectric strength is high.

As an engineering material, PPO offers: 1) a heat deflection point of 375°F @ 264 psi. 2) a tensile modulus of 310,000 psi at 300°F. 3) only 1% creep after 10,000 hours at 73°F and *under 2% at 200°F*. 4) excellent dimensional stability, with a maximum water absorption of 0.12 percent. 5) moldability to close tolerances.

What design of yours would go better in PPO? For a starter, look at the pictures. You'll see a tv tuner strip... connector... tv deflection yoke... thin-walled electrical shell... and molded printed circuit board. Each of



takes dip soldering

(UP TO 800°F)

them end up better and less expensive in PPO. The same characteristics make PPO a candidate for double insulated housings.

Our technical people know of many more areas where you can benefit with PPO. They'll be glad to help solve your problem. Call your local Chemical Materials Sales Representative, or write Section 6J2, Polymer Products Operation, General Electric Company, One Plastics Ave., Pittsfield, Mass.

(By the way, PPO is also the greatest hot water resistant engineering thermoplastic yet developed.)

GENERAL  ELECTRIC

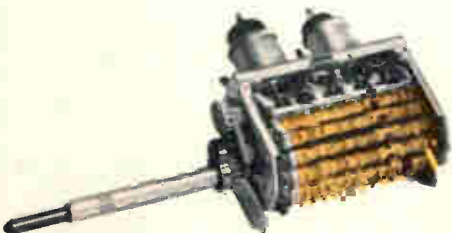

Circle 155 on reader service card

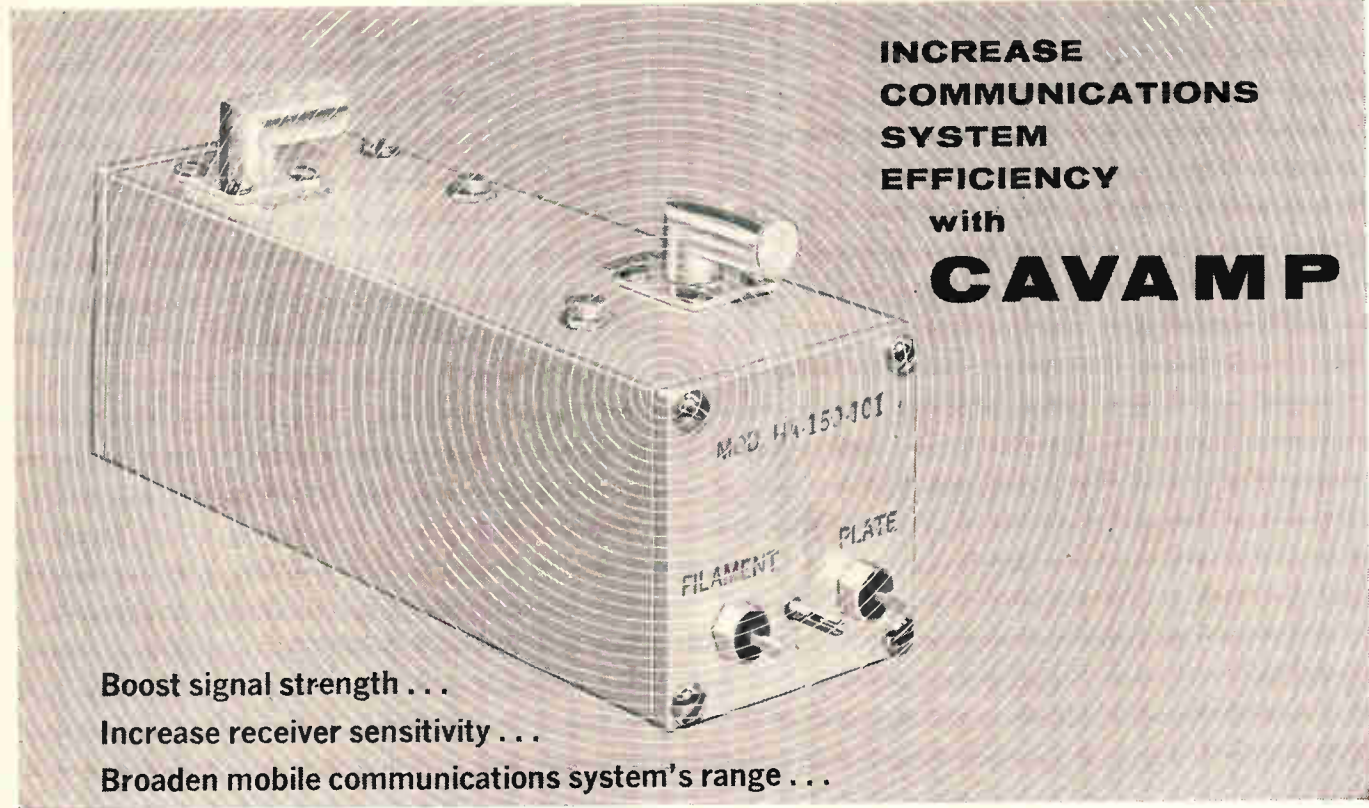

**INCREASE
COMMUNICATIONS
SYSTEM
EFFICIENCY
with
CAVAMP**

**Boost signal strength . . .
Increase receiver sensitivity . . .
Broaden mobile communications system's range . . .**

How? With Sinclair's Cavamp. For use in compact duplex or multicoupler systems, Cavamp combines amplifier with filter to reduce noise while boosting signal strength.

Cavamp is capable of quieting receivers of .6 microvolt sensitivity with less than .2 microvolt signals, supplying gains of up to 14 Db at a 5Db noise figure. It incorporates a double-ended 8058 nuvistor that insures greater overload protection (1 milliwatt maximum input) and lower intermodulation product levels.

Cavamp incorporates a narrow band pass filter to increase receiver selectivity.

Transmission line losses are offset, or receiver front end sensitivity is increased, improving system performance.

Designed for the 150 and 450 MHz range, Cavamp is factory tuned to your specific frequency, however, can be easily field retuned to any frequency in the band by making two screwdriver adjustments.

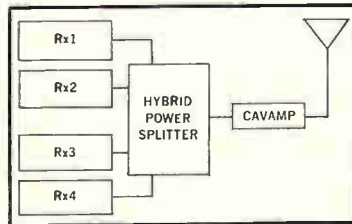

Receiver multicoupling for closely spaced receivers:

Four receivers, separated by 50 KHz, connected to a hybrid power splitter providing each with 25 Db isolation: power splitter loss of 6.5 Db offset by Cavamp with 12 Db gain. Band pass filter characteristic also protects receivers from nearby transmitters.

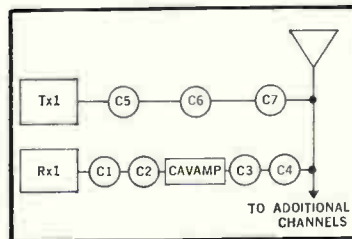

Receivers and transmitters connected to a common antenna with a passive multicoupler for an expandable system:

Transmitter, Tx1, separated from receiver, Rx1, by 500 KHz. Cavities C1,2,3,4 insert 6 Db loss at Rx1 frequency, 80 Db attenuation against Tx1. Cavities 5,6,7 insert 1.5 Db loss at Tx1 frequency, attenuate Tx1 noise at Rx1 frequency by 35 Db or more. 6 Db insertion loss not degrading to receiver operation: Cavamp offsets filter losses, provides 6.0 Db gain on Rx1.

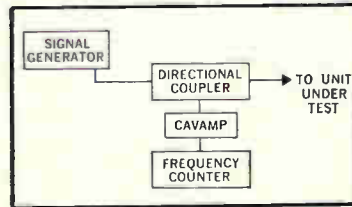

Increasing sensitivity of frequency measuring system:

Where frequency counter is used, high signal strength is often required to drive the counter. Cavamp increases counter sensitivity while the selectivity reduces false triggering from unwanted signals.

Clip the coupon and attach to your letterhead for full details and prices.

SINCLAIR RADIO LABORATORIES, INC.
523 FILLMORE AVE. DEPT. 101-P TONAWANDA, NEW YORK

FREE LITERATURE

TO: SINCLAIR RADIO LABORATORIES, INC.
Dept. 101-P 523 Fillmore Avenue
Tonawanda, New York 14152

Name: _____
Title: _____
Company: _____
Address: _____
City: _____
State: _____ Zip: _____

After a trip down a hot, corrosive oil well,

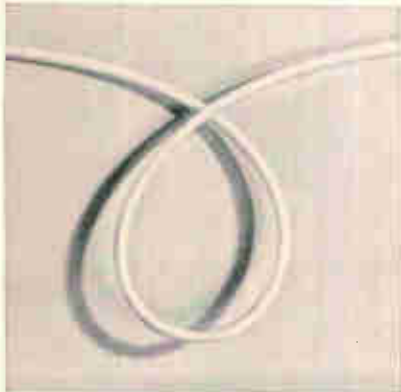

cable jacket of Kynar* stands up,

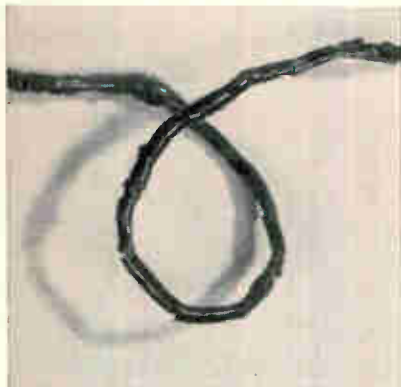

nylon breaks up.

That's what Ball Brothers Research Corporation found when it needed a jacket to protect instrumentation cable in deep oil well jobs.

The combination of temperatures above 200°F, chemical attack by sulfur bearing compounds and other corrosives, and constant rubbing against down-well piping was too much for other materials. Kynar made the grade in the toughest of tests . . . the

test of successful down-well performance.

Why not check your present insulation against the toughness, and cut-through resistance of Kynar? Write today for information relating to *your specific application*.

Plastics Department, Pennsalt Chemicals Corporation, 3 Penn Center, Philadelphia, Pa. 19102

Kynar...the fluoroplastic that's tough!

*Kynar is Pennsalt Chemicals Corporation's registered trademark for its vinylidene fluoride resin.



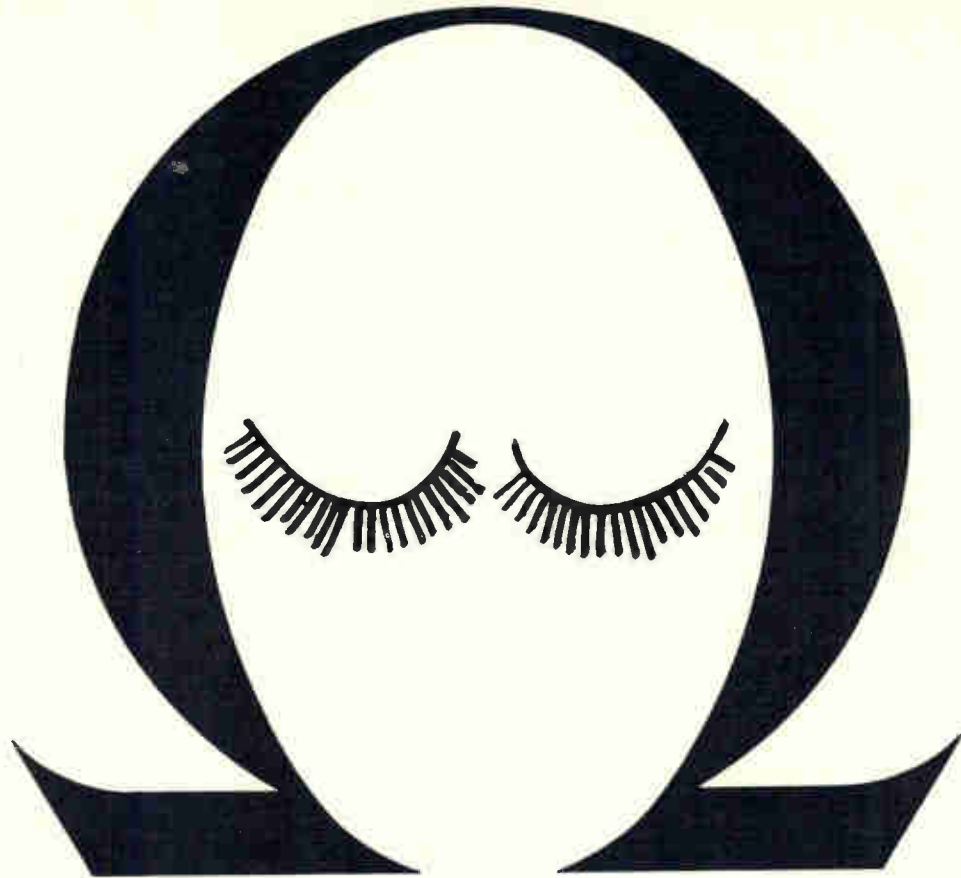

The Absolute Ohm

How a classic ESI system can bring you closer to the absolute in resistance measurement, and why it can be of more than academic interest in many electronic labs and plants.

The Absolute Ohm is a theoretical ideal, which can be ever more closely approached, but never attained.

Its legal value is the resistance standard maintained by The National Bureau of Standards. The accuracy of your resistance measurement depends on the degree of "direct traceability" to this NBS standard.

The ESI 242 Resistance Measuring System permits a chain of measurements to any resistance level from a single, directly traceable reference standard—with comparison accuracies of 1 ppm. Measurements can be made swiftly and simply; results are read directly, without calculation.

Even when you are not looking for greater accuracy in your resistance measurement and calibration, you may have good reason to consider our 242. It could help you speed up the pace of lab or quality control operations. Or in-

crease reliability. Or get better results from less experienced people on your production line.

The 242 includes Ratio Bridge, Decade Standard, Generator-Detector and 4-Terminal accessories.

We can't promise The Absolute Ohm in resistance measurements. But with the 242, we do offer The Definitive System. ESI, 13900 NW Science Park Drive, Portland, Oregon (97229).

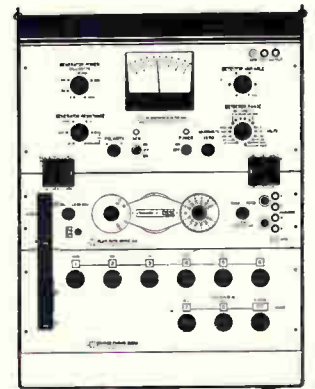

The Absolute Ohm's home away from home — our 242 Resistance Measuring System. Price: \$3400.



The legal residence of The Absolute Ohm is Washington, D.C. — at the National Bureau of Standards.

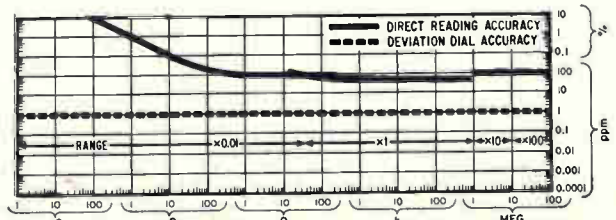

Accuracy of 242 System over specified ranges.

Electro Scientific Industries **esi**®

FOR LOWER COST PRECISION ROTARY SWITCHING... TRY THESE:



FOR TRULY OUTSTANDING DRY CIRCUIT SWITCHING... TRY THESE:

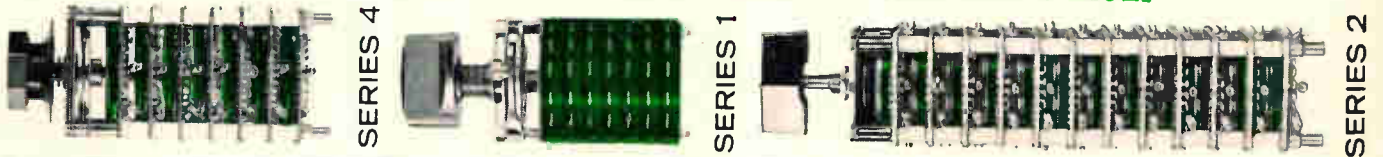

FOR EASIER ROTARY SWITCH SPECIFICATION... TRY THESE:

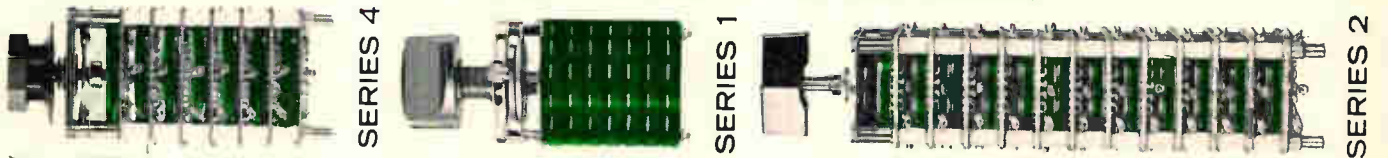

FOR FASTER ROTARY SWITCH DELIVERY... TRY THESE:

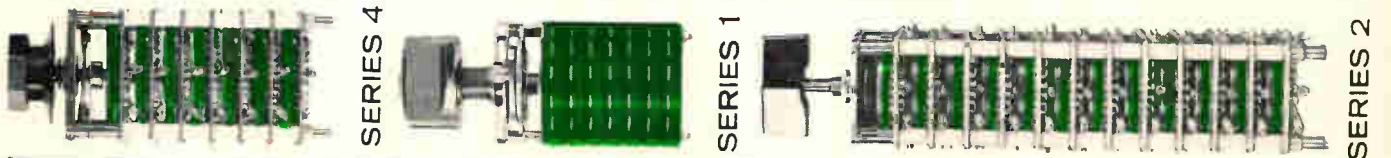

IF YOU DO, you'll find that Shallcross Series 1, 2 and 4 precision rotary switch lines offer:

LOWER TOTAL COST — INITIAL COSTS ARE NORMALLY LOWER (often 25 percent or more) than those for rotary switch counterparts claiming comparable quality. **INSTALLATION COSTS ARE REDUCED** by easily wired flared terminals (identified for location) and rugged construction features that virtually eliminate switch damage during harnessing. **MAINTENANCE AND REPLACEMENT COSTS ARE REDUCED** to the vanishing point by: (1) 50 in/lb stop strength ratings, (2) multiple contact wipers (for reliable circuit "making"), (3) positive action long life detents, (4) dust protection for internal switch parts, and (5) material-design combinations that reduce voltage breakdown and insulation

resistance failures. Add these cost "savers" to lower specification costs (below), and you'll see why Shallcross has the most economical top quality rotary switch line in the industry — as a matter of fact, an investigation will prove that Shallcross switches are often less in total cost than the lowest priced "clip types."

OUTSTANDING DRY CIRCUIT SWITCHING — Negligible "thermals," low contact resistances (1-2 milliohms typical from input to output), and low switching noise provide ideal dry circuit switching.

EASIER SPECIFICATION — Comprehensive cataloging, reproducible specification sheets (for easier drawing creation), and easily used part number systems expedite specification.

FASTER DELIVERY — Day-in-day-out deliveries for standard Shallcross switches equal any in the industry (eight distributors stock 1-3 deck "standards" — production quantities are normally shipped in two to three weeks).

The best values in quality rotary switching wear this brand—try them.



shallcross

SUBSIDIARY OF CUTLER-HAMMER

SHALLCROSS MANUFACTURING COMPANY, SELMA, N.C.
ZIP CODE 27576 • TEL. 919 965-2341 • TWX 919 770-7839

The most complete range of ceramic-metal tubes for U.H.F. Transmitters.

In operation for more than two years in a large number of U.H.F. Television Transmitters (BAND IV - BAND V)

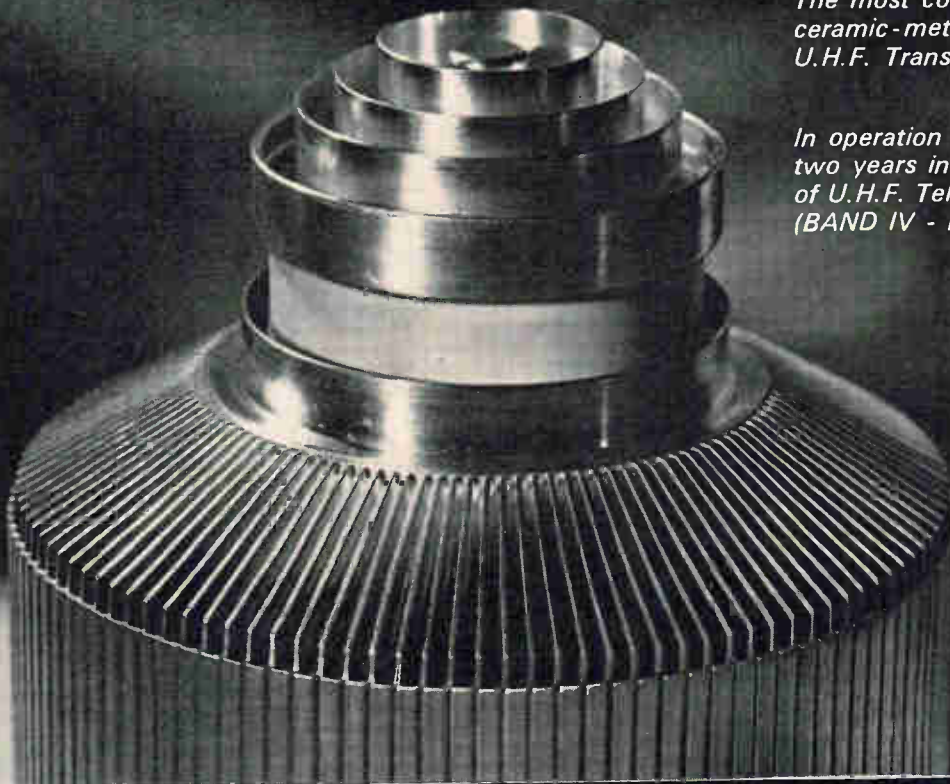

HIGH GAIN U.H.F. TETRODES UP TO 1000 Mcs

THOMSON  HOUSTON

20 kW Anode vapor cooled

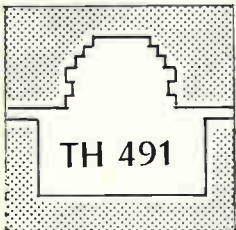

12 kW

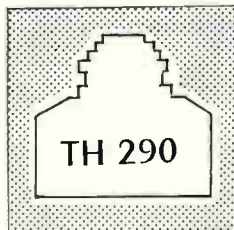

New

6 kW

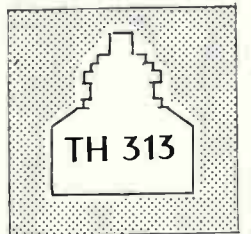

3 kW



1,5 kW

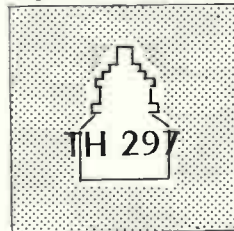





- EASY OPERATION
- LOW COST
- HIGH RELIABILITY
- LONG LIFE

COMPAGNIE FRANÇAISE THOMSON-HOUSTON

DIVISION TUBES ÉLECTRONIQUES - 8, RUE CHASSELOUP-LAUBAT - PARIS XV* - TÉL. : 566.70.04
 US OFFICE : THOMSON ELECTRIC Co INC. 50 ROCKEFELLER PLAZA • ROOM 916 • NEW YORK 20 (NY) USA • Phone : Circle 5.0444

The World's Best Receiver Systems use LEL Receiver Components Like These...

right out of LEL's Catalog!

RF PRESELECTOR	1st CONVERTER	2nd CONVERTER	LINEAR/LOG IF	LIM. DISCRIMINATOR
				
Strip Transmission Line RF Preselector FSB 2250-100-5-T-NF Freq. range2200-2300MC ResponseTchebychev Insertion loss1db max. Stop band loss40db Skirt shape5 poles Fixed tuned	Solid-State Mixer Preamplifier Model Series - 9 RF range 125MC-40GC (more than 60 coax or waveguide mixers are available within this range) N.F. (overall).....9db (typ.) IF cf160MC Bandwidth @ 3db50MC Gain (RF/IF)30db Lin. output+10dbm	Solid-State High Level Converter Internal Xtal L.O. Model RTC-1 RF cf160MC RF bandwidth35MC IF cf60MC IF bandwidth20MC Gain10db Noise Figure12.5db Lin. Input-10dbm	Solid-State Log Amplifier Model ITL-2 IF cf60MC Bandwidth @ 3db20MC Dyn. Range80db Sensitivity20MV/db Solid-State Linear Amplifier Model ITA-5 IF cf60MC Bandwidth @ 3db20MC Gain70db AGC60db Noise Figure7db max.	Solid-State Limiter Discriminator Model ITF-1 IF cf60MC Bandwidth @ 3db10MC Sensitivity1v/MC Input50 ohm OutputVld. Det.

LEL's catalog is a good place for you to choose from thousands of standard units engineered and manufactured with special receiver applications like yours in mind. Chances are you'll find just what you need. If not, we'll modify any catalogued item in short order . . . or build to your specifications. *Why not call LEL now?*



LEL DIVISION

varian / akron street / copiage / new york 11726 / 516 AM4-2200 / 516 PY9-8200 / TWX 516-691-5085

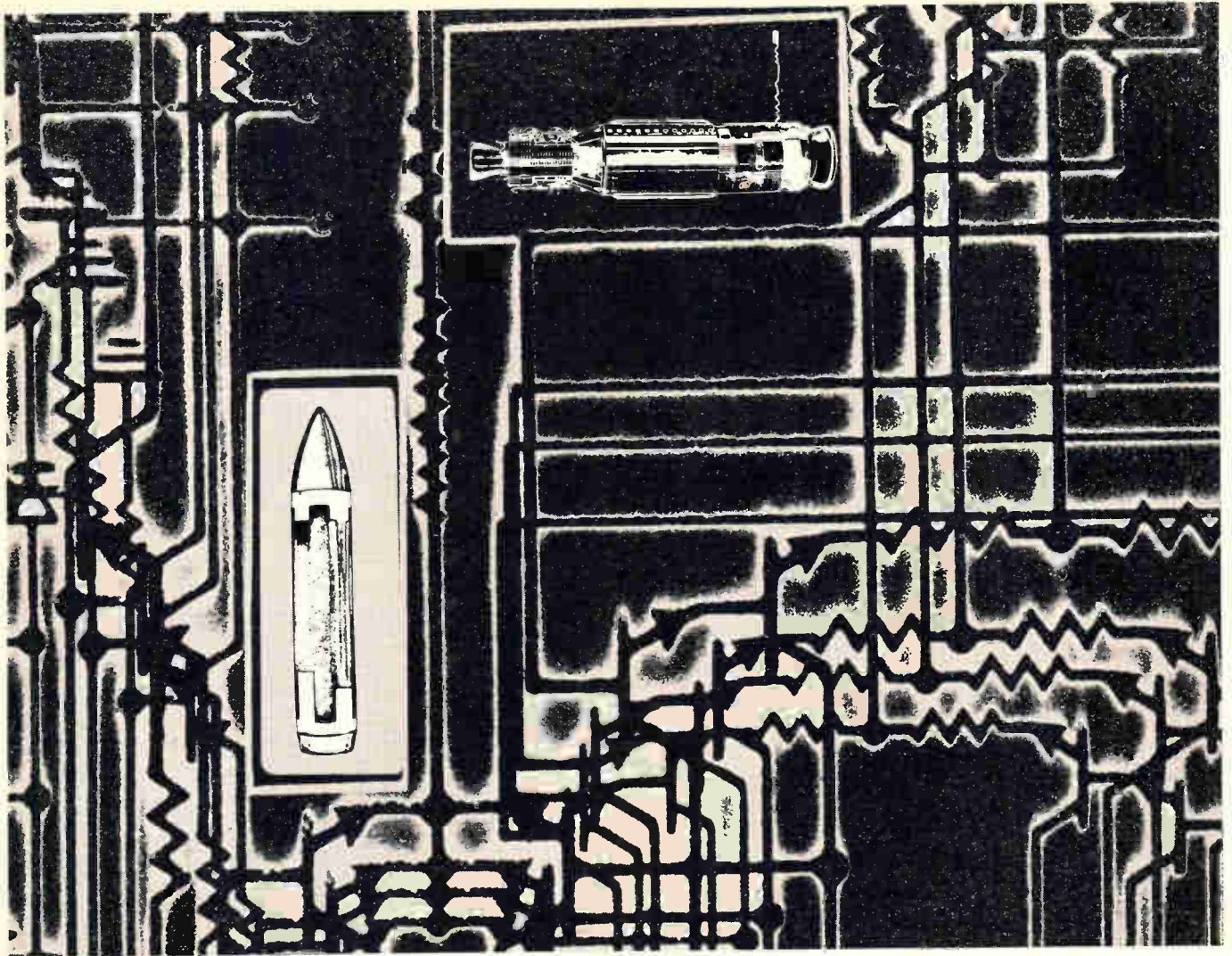

*up.
down.
on the ground.
the place for new electronics advances is Lockheed.*

Whatever environment you now work in—land, sea, or space—you'll find it to your advantage to look into opportunities at Lockheed. Take Agena and Poseidon for example. Major technical expansion is under way on both of these vital programs. And both Agena and Poseidon share the need for new concepts and major technical advances. □ Typical Agena assignments will include: digital communication systems for data transmission and command, digital and analog flight control systems, optical and infrared sensors, solar power panels, and power conditioning. □ Poseidon's general area of requirements ranges from weapon effects on electronics to the design and use of state-of-the-art test check-

out equipment in one of the largest checkout programs ever mounted. □ Undersea, Lockheed is active in the expanding field of deep submarines and ocean mining. Now under way—the Navy's unique Deep Submergence Rescue Vehicle and Lockheed's Deep Quest research vehicle designed to operate down to 8000 feet. □ On land, Lockheed is engaged in the development of unique land vehicle systems, information systems for states and hospitals, and many other important programs. □ For more complete information, you are invited to write Mr. R. C. Birdsall, Professional Employment Manager, P.O. Box 504, Sunnyvale, California. Lockheed is an equal opportunity employer.

LOCKHEED
MISSILES & SPACE COMPANY
A GROUP DIVISION OF LOCKHEED AIRCRAFT CORPORATION

announcing...

Allen-Bradley Active Filters, which offer a 60 db attenuation over the range of 10Hz (3Hz*) to 100KHz



Allen-Bradley active filters can provide as much as a 50 to 1 reduction in size and a corresponding reduction in weight over conventional passive elements.

The diagram below and performance curve at right illustrate how Allen-Bradley active filters prevent current fluctuations in the power distribution system above 10Hz (3Hz*), developed by pulse modulated communications equipment, such as teletypewriters and other randomly varying loads.

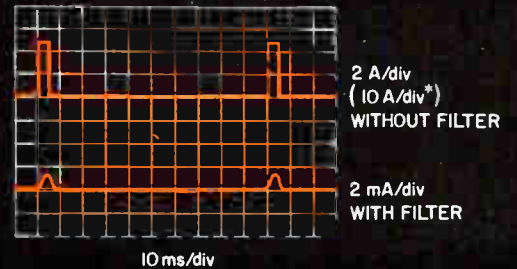
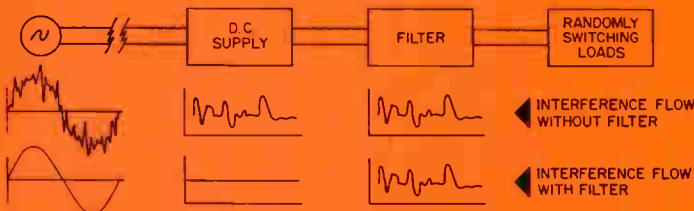

Typical example of A-B Active Filter performance

Directly as the result of some new ideas applied to the field of ElectroMagnetic Compatibility, Allen-Bradley has been able to produce a new *active* low pass filter that provides an attenuation of greater than 60 db over the range of 10Hz (3Hz*) to 100KHz. The maximum dc component of the load current is 5 amperes.

The primary purpose of this filter in the above application is to prevent impulses generated by rapid load fluctuations, which may be carrying information of a confidential nature, from being reflected back through the power supply and into the power distribution system.

These new filters are designed to satisfy specific requirements. For instance, power line filters are under development for 60Hz and 400Hz power frequencies. Here, a sharp pass band is afforded the power frequency while greatly attenuating all other frequencies.

Allen-Bradley active filters produce a far greater attenuation of unwanted signals than is possible with a filter composed of conventional passive elements, occupying the same volume. By using the A-B *active* filter, a size reduction of 50 to 1 is attained, together with corresponding savings in weight. These filters employ solid-state circuitry. No external power source is required other than that supplying the power to the load. In addition, complete inrush and short circuit protection is provided.

Allen-Bradley specialists in filter engineering are available to discuss with you such problems for which these new active filters might offer the best solution. Please write: Allen-Bradley Co., 222 West Greenfield Avenue, Milwaukee, Wis. 53204. In Canada: Allen-Bradley Canada Limited. Export Office: 630 Third Ave., New York, N. Y., U. S. A. 10017.

* WITH EXTERNAL CAPACITOR



ALLEN-BRADLEY
QUALITY ELECTRONIC COMPONENTS

This Wilcox Model 914 ATC transponder uses Allen-Bradley Type CB ¼-watt and Type EB ½-watt fixed resistors, Type G variable fixed resistors, and Type R adjustable fixed resistors. The Model 914 transponder is for aircraft operating under ground control radar.

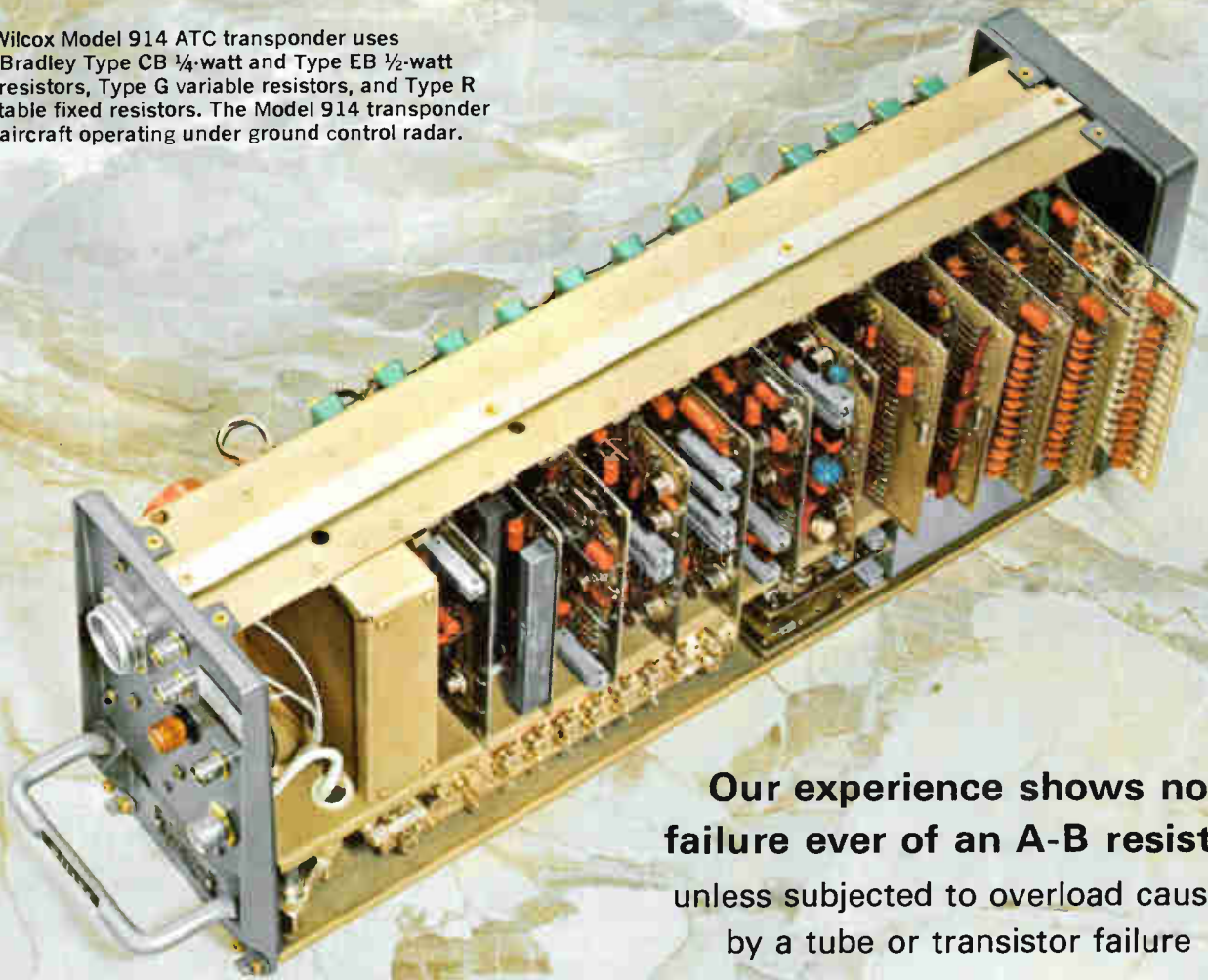

Our experience shows no failure ever of an A-B resistor unless subjected to overload caused by a tube or transistor failure

Wilcox Electric Co., Inc.

Prompt shipment of HOT MOLDED FIXED RESISTORS in all standard EIA and MIL-R-11 resistance values and tolerances. Values above and below standard limits can be furnished. Resistors are shown actual size.

TYPE BB 1/8 WATT	MIL TYPE RC 05
TYPE CB 1/4 WATT	MIL TYPE RC 07
TYPE EB 1/2 WATT	MIL TYPE RC 20
TYPE GB 1 WATT	MIL TYPE RC 32
TYPE HB 2 WATTS	MIL TYPE RC 42

Type R Hot Molded Adjustable Fixed Resistors are rated ¼ watt at 70°C. Supplied in resistance values from 100 ohms to 2.5 megohms.

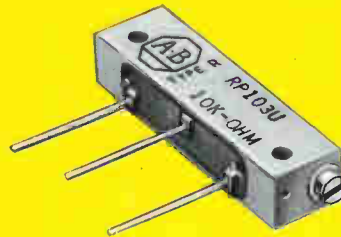

Type G Hot Molded Variable Resistors are rated ½ watt at 70°C. Resistance values from 100 ohms to 5.0 megohms.



“No failure ever” is an impressive record, especially since Allen-Bradley fixed and variable resistors have been used in Wilcox transponders for around ten years.

The reason for this consistently high performance is the unique hot molding process developed and used only by Allen-Bradley. In fixed resistors, it produces such complete uniformity that long term A-B resistor performance can be accurately predicted. Catastrophic failures don't occur with Allen-Bradley hot molded resistors.

Use of the hot molded resistance element in the Allen-Bradley Type G variable resistors assures very smooth operation—there are never any abrupt changes in resistance during adjustment. The Type G controls have

a very low initial noise factor, becoming lower with use.

Type R adjustable fixed resistors also have a solid molded resistance track. Adjustment of resistance is so smooth, it approaches infinite resolution. Settings will remain fixed under severe vibration or shock. The Type R molded enclosure is dustproof and watertight—it can be potted after adjustment.

For more complete details on the full line of A-B quality electronic components, please write for Publication 6024: Allen-Bradley Co., 222 W. Greenfield Ave., Milwaukee, Wisconsin 53204.

Export Office: 630 Third Ave., N.Y., N.Y., U.S.A. 10017.



ALLEN-BRADLEY
QUALITY ELECTRONIC COMPONENTS

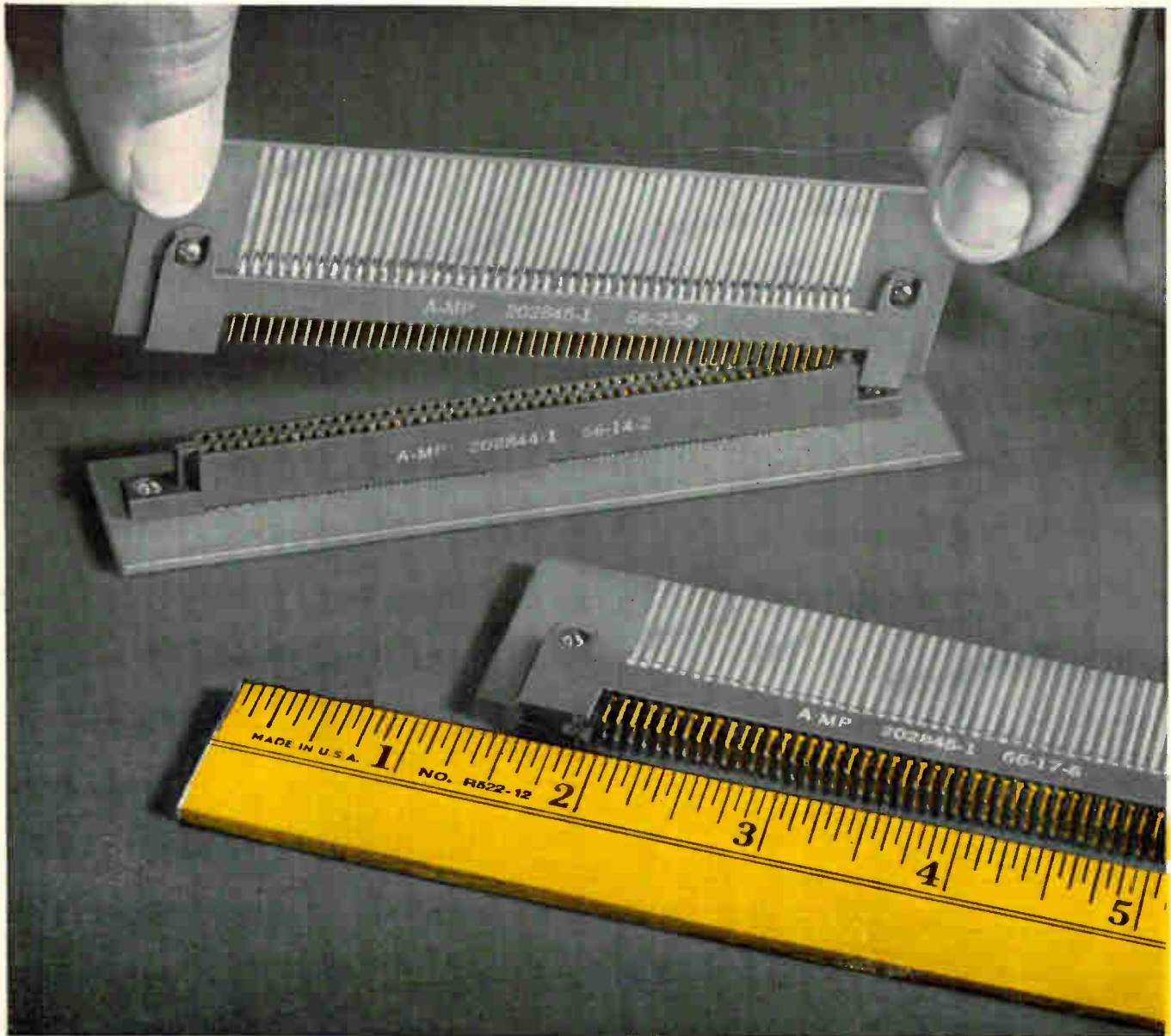

Dense between the ears—but what an I.Q.*!!

Between the ears of the A-MP* 750 Series Box Contact Connector are 100 contacts in a space of less than 4 inches—that's pretty dense! Yet this connector offers you the industry's lowest per line applied cost for a highly reliable two-piece printed circuit connector—that's economy plus Installed Quality*!

High density is achieved with two rows of 50 box contacts located on .075" centers. Receptacle contact tails are staggered to permit larger spacing between printed circuit wiring paths. Headers contain channel shaped pins which are latched in the header and have flat tails for easy connection to daughter boards.

The 750 Series Box Contact Connector provides economy in overall applied cost. Socket contacts are highly flexible allowing wide margins of misalignment of pins and eliminating the need for costly precision card guides. Low insertion and extraction forces permit mating of a large number of contacts without mechanical screws or cams. The 750 Series connector has contacts which can be easily replaced without removal of the connector.

High electrical integrity is assured by four elliptical spring beams arranged at right angles forming a box. These beams provide four areas of contact on the mating pin, whether it is square, round, rectangular, or channel shaped. The walls of the housing limit spring deflection and prevent overstressing of the contacts, even when subjected to severe shock and vibration.

This adds up to a rugged, tolerant miniature connector for your most demanding applications. Examine these unduplicated features:

- Contacts on .075" centers
- High misalignment tolerance
- Latched-in contacts can be easily replaced
- Gold over nickel plated beryllium copper contacts
- Polarized housings
- Sturdy diallyl phthalate housings
- Four redundant contacts for high reliability
- Resistant to vibration and shock
- Low installed cost

If your design calls for tight specifications requiring a tolerant, reliable, high density connector—all with an eye on economy, then the A-MP 750 Series Box Contact Connector is for you. Write immediately for complete details.

*Trademark of AMP INCORPORATED

AMP
INCORPORATED
 Harrisburg, Pennsylvania

A-MP* products and engineering assistance are available through subsidiary companies in: Australia • Canada • England • France • Holland • Italy • Japan • Mexico • Spain • West Germany

EPOXY JUNCTION FET 50¢

Pay less, get more: Fairchild's new 2N4360 is a low noise, low cost P-Channel junction FET you can get. You can get it immediately in any quantity, and pay much less than you would for devices with lesser performance specifications (only 50¢ in quantities of 1000). The 2N4360 features an extremely low noise figure, high gain, and high input impedance. The TO-18 epoxy package withstands an operating junction temperature of +125°C and can be stored at any temperature -55°C to +125°C. (TO-18 cans also available, 2N4381, 2N4382.) Get samples from your Fairchild Distributor, or get our data sheet.

FAIRCHILD
SEMICONDUCTOR



2N4360 Typical Specifications:

Equivalent Input Noise Voltage	0.02 μ V/Hz @ f=100Hz
Equivalent Input Noise Figure	0.1db @ f=100Hz
Gate to Source Breakdown Voltage (BV _{gss})	20V min.
Forward Transconductance (Y _{fs})	4000 μ mhos @ f=1kHz
Drain Current (I _{DSS})	10mA
Gate Reverse Current (I _{GSS})	0.15nA

Probing the News

Military electronics

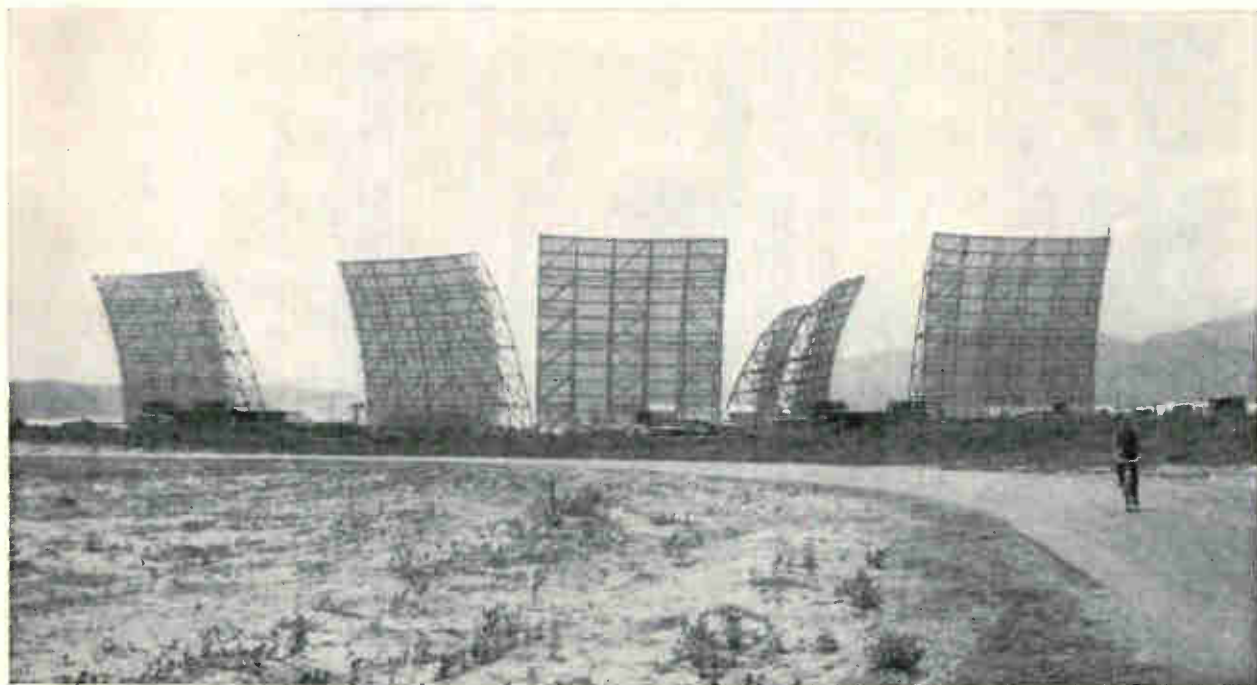

To improve tropo transmission over short-haul links, frequencies are being changed from 1 Ghz to 2 Ghz on some of the 60-foot billboard antennas like these at Nha Trang. Elsewhere, 120-foot billboards and a variety of parabolas, up to 60-feet in diameter, are being installed.

Vietnam communications network growing into Southeast Asia's best

Building communications terminals in a war zone is tough, but the U.S. is completing a permanent tropo network in Vietnam and Thailand and doing it on schedule

By William Hickman

Washington Electronics Bureau

The amazing engineering feat of building a gigantic, sophisticated communications network in the middle of a war continues unabated in South Vietnam and Thailand with \$50-million worth of new contracts ready to be signed. The cost of this backbone network, known officially as the Integrated Wideband Communications System (IWCS), is thus passing the \$175-million mark and there will probably be more contracts.

This month, the first portion of the upgraded tropospheric/scatter and microwave network will be turned on. By May, 1967, all of it will be ready, providing more sites and three times as many channels as at present.

The links now handle from 48 to 72 channels. The upgraded links will carry 300 channels and in some cases as many as 600.

New antennas. The upgraded IWCS will have 24 additional

billboard reflector antennas—12 are 60 feet high and 12 are 120 feet high. There will be 59 new parabolas: twelve 60-foot, fourteen 40-foot, twenty 30-foot, six 15-foot and seven 10-foot dishes. The tropo equipment used with the billboard antennas—the exciters, amplifiers and receivers—is being built with solid-state equipment wherever possible. It's the first time the United States military has used solid-state components in tropo-

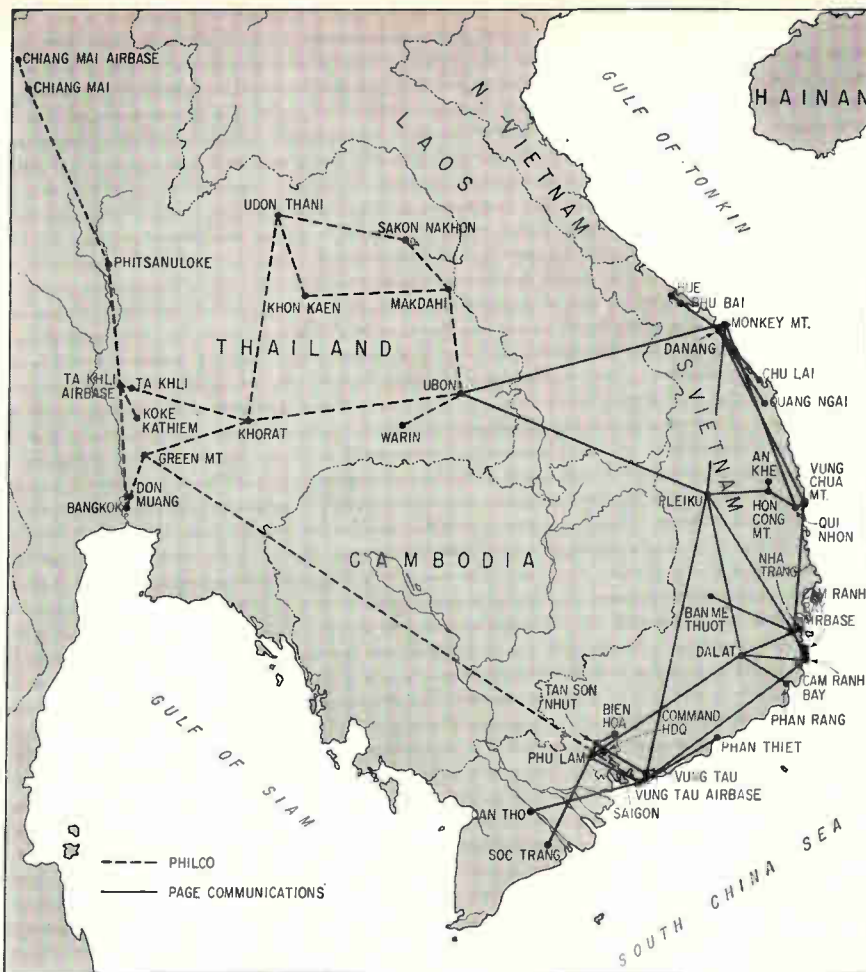

Integrated Wideband Communications System ties together bases in South Vietnam and Thailand with over a quarter of a million miles of troposcatter and microwave voice links. Page Communications is prime contractor for the system in South Vietnam, Philco in Thailand.

spheric scatter equipment.

In addition, some of the existing 60-foot reflectors are being modified. Short-haul transmission links will be changed from the standard 1 gigahertz to 2 Ghz to improve transmission. The 120-foot billboards, which provide only long-haul links, will all operate at 1 Ghz.

The parabolic antennas operate with the opposite technique. Rather than using 2 Ghz for short-haul, the higher frequency is being used for the longest tropo link in Southeast Asia, from Vung Tau at the southern tip of South Vietnam to Green Mountain near Bangkok. Some experts say this may be why the long parabolic link isn't too good.

I. Blending civilian and military

Installation of the IWCS is being supervised by the Army Strategic Communications Command, under the direction of Major General Richard J. Meyer. Prime contractors are the Page Communications Engineers, Inc., a subsidiary of Northrop Corp., for the work in

South Vietnam, and the Communications and Electronics division of Philco Corp., a subsidiary of the Ford Motor Co., for the work in Thailand.

Page's contracts have already hit \$70 million, with \$30 million more in new contracts soon to be signed. Philco has received \$50 million so far and will get \$20 million more.

New areas. The new contracts will take Page to the Mekong Delta, south of Saigon, to install tropo and microwave terminals and Philco to new sites in Thailand to support the growing number of U.S. troops there.

Lockheed Electronics Co., a division of the Lockheed Aircraft Corp., has recently been given a role in the IWCS. Under four cost-plus-fixed-fee contracts totaling more than \$5 million, Lockheed will monitor the installation of the equipment, evaluate its performance, and make recommendations regarding each portion's acceptability.

The system is managed by the

Defense Communications Agency and operated by the Army Strategic Communications Command.

II. System grows stronger

The communications system has been built with great speed and, according to Army officials, there have been no significant cost overruns or schedule slippages. And it should be noted that civilian engineers are working in a war zone. IWCS also is noteworthy in several technical areas:

- The circuits meet the quality standards of the Defense Communications Agency, which are roughly comparable to those of the American Telephone and Telegraph Co. in the U.S.

- No more than 10 to 12 minutes of outage per year is permitted per circuit.

- A tropo link spanning more than 450 miles without repeaters is installed—the longest tropo link in Southeast Asia. All the links form a 250,000-mile chain.

Hardware. While the equipment specifications to both Page and Philco were identical, the contractors chose different approaches. Page picked billboard antennas, and Philco selected parabolas.

Page adopted REL 2600 tropo transmitters and receivers built by Radio Engineering Laboratories, Long Island City, N.Y., a division of the Dynamic Corp. of America. The equipment is solid state, provides 300 voice channels and has high reliability; it exceeds the signal-to-noise ratio of 55 decibels that had



W.D. Carter, assistant director of engineering at Page, is responsible for the firm's work in Vietnam.

been the previous military standard.

The Government gave Philco its own LRC-3 transmitting-receiving equipment which Philco had manufactured and sold to the Government some years ago for the Military Assistance Program. The equipment was intended for Indonesia, but when U.S.-Indonesian relations cooled it was never sent. When the IWCS program came along the Army pulled the equipment from warehouses on the West Coast and furnished it to Philco.

For microwave equipment, Page bought an AN/FRC-109 radio system from the Lenkurt Electric Co., Inc., San Carlos, Calif., a subsidiary of General Telephone and Electronics Corp. Philco used some AN/FRC-109 equipment and some of its own CLR-2 series gear.

Lenkurt supplied Page with AN/FCC-17 multiplex equipment. And Philco bought its multiplexers, the AN/FCC-18, from General Electric Corp.

One new piece of equipment is the technical control center, located at each site. Each center is equipped with patch panels to switch calls and serves as an interface for tactical transmissions. It is also equipped with automatic fault finders that display malfunctions.

Each technical control facility keeps open a few channels for tactical use and provides the necessary signal converters. Since IWCS is composed of fixed stations, all signaling is done at 2.6 kilohertz. Most tactical military radio equipment is set at 1.6 khz.

Only two points in the IWCS network link Page's system in Vietnam to Philco's system in Thailand: at Ubon in Thailand and Vung Tau in South Vietnam. A much discussed, but highly classified, cable system to link the Bangkok area with the Saigon area is believed to be going in.

III. Enemy uses network too

Although the fixed communications sites are protected by U.S. forces, they are still very vulnerable to attack. Surprisingly, no damage has ever been inflicted by the enemy on the backbone communications system. U.S. communications veterans from Vietnam tell of seeing fierce fighting around the com-



WHO KNOWS?



How to design outstanding performance into antennas for business aircraft?



How to double the range for VOR reception?



How to achieve major reductions in VOR and ILS bearing errors?



How to produce antennas that protect against lightning strike damage?



How to produce antennas that reduce vulnerability to precipitation static?

Pilots of business aircraft using D&M antennas agree that Dorne & Margolin has the answers to these problems. More than 20 years of dedicated work... continuing research... successful development... and highly specialized manufacturing experience... these are the reasons why, when it comes to aircraft antennas and related equipment, pilots can say with assurance:

...D&M KNOWS!

Are you experienced in antenna engineering and skilled at problem solving? Do you want to assume responsibility on projects involving flight safety, communications, navigation or telemetry? Call or write: Chief Engineer at our new Bohemia plant or at Chatsworth.

dorne and margolin

INCORPORATED

WEST COAST
9730 Cozycroft Avenue
Chatsworth, California 91311

EAST COAST
2950 Veterans Memorial Highway
Bohemia, L. I., N. Y. 11716



20 Years of Leadership in Aircraft and Missile Antennas

IF YOUR COMPUTER SYSTEM REQUIRES A-D or D-A Conversion

where:

**A=resolver or
synchro**

D=10 to 16 bits

**JUST PICK UP
THE PHONE.**

North Atlantic
offers a complete line of
resolver/synchro interfaces
for computer systems,
aircraft/space vehicle simulation,
antenna position/programming,
and airborne use.
All silicon solid-state, 10 to 16 bits,
multi-speed, multiplexed inputs/outputs,
60 cps to 10KC.

As we said, just pick up the phone.



NORTH ATLANTIC
industries, inc.
TERMINAL DRIVE, PLAINVIEW, NEW YORK • (516) 681-8600

munications sites with the stations never receiving a hit.

According to some U.S. officials who have served in Vietnam, the main reason the enemy hasn't touched the network is because they are using it too.

The South Vietnamese Army has the use of two channels throughout the system and the army is infiltrated by the Vietcong.

Vietnam veterans say a Vietcong agent in the South Vietnamese Army could easily use the system as a command and control network. As one American officer who has served in Vietnam said: "When two Vietnamese are talking to one another, neither I nor any other officer I know of can tell whose side they are on."

American officials resign themselves to this fact of life, saying philosophically that it's better for the enemy to use the system than to destroy it.

After the war. Another reason the Vietcong or North Vietnamese communist forces haven't touched the network is its permanence. Since 120-foot antennas embedded in concrete can't be moved easily, South Vietnam is in for a fine civilian communications network when the war is over. "It will be the envy of the Far East," says W.D. Carter, assistant director of engineering for Page.

An Army official doubts, however, that the Vietnamese government will be financially able to operate it? If the U.S. forces stay on, as they have in Korea, the engineers working for Page and Philco might have life-long careers.

Jamming threat. Much of the IWCS equipment is also vulnerable to jamming, officials admit, but they are not particularly concerned with this possibility in the near future. They say the enemy does not now have the technical know-how or equipment to jam the signals. The possibility of jamming does exist, however.

The IWCS link from Green Mountain near Bangkok to Vung Tau on the coast of Vietnam crosses over Cambodia for much of its 450-mile hop. Officials say jammers along this route, where allied forces aren't allowed, could be damaging.

The communications network also crosses Laos, but this nation

is friendly to the U.S. and South Vietnam. American aircraft are based in the country and engineers are currently putting in a communications link there.

IV. Reaching outside Asia

Communications to outside the IWCS area is handled mainly by the 60-channel Wet Wash submarine cable, built by Page, that runs from Nha Trang to the Philippines. There, commercial cables are available to send messages on to California.

Two Syncom synchronous-altitude satellites are also available, but they have only two voice channels each and do not provide much relief for the Wet Wash cable.



Maj. Gen. Richard J. Meyer, left, heads up the Army Strategic Communications Command (Stratcom) which is directing the construction of the Integrated Wideband Communications System in Southeast Asia and will operate it. **Colonel Joyce B. James**, deputy chief of staff for operations for Stratcom, will be in charge of operating the system when it's completed.

The Initial Defense Communications Satellite project, with seven satellites in orbit and plans for several more, can assist some, but each satellite's channel capacity is also set at two.

There are other alternatives to reach outside Asia—mainly high-frequency radio. However, h-f radio is dependent upon atmospheric conditions and does not offer the necessary reliability. The h-f links feed terminals in Ethiopia, Guam and Formosa.

When the military has its tactical satellites in operation in about two years another alternate means will be available. The IWCS equipment is being built to interface with these Tacsats.

Satellite in sight for airlines

Comsat's newest customer will be commercial airlines; they'll have a satellite of their own in 1968 for communications over the Atlantic

By Robert Henkel

Electronics Washington Bureau

Comsat is moving again after bogging down last summer in its plans to put up a communications satellite for commercial airlines. It now looks as though a satellite to demonstrate this new role will be operational in 1968—more than a year behind the original schedule.

The technical hitches that delayed the project are "close to a satisfactory solution," says Edward J. Martin, head of advanced systems for the Communications Satellite Corp.

▪ The design approach for the spacecraft's very high frequency, antenna, the major stumbling block, has been selected.

▪ Another earlier problem was the difficulty in designing the satel-

lite within the payload limitations of the launch vehicle. This apparently has been solved by switching to a more powerful booster that will lift 10% to 30% more payload into the 22,300-mile synchronous orbit.

The satellite—called Aerocon—will be located over the equator between Africa and South America. It will relay aircraft transmissions to two ground stations—one in North America and the other in Europe—over existing 4-gigahertz and 6-Ghz satellite frequencies. Communications between the satellite and the aircraft will be on the present aeronautical uhf band.

The airlines are enthusiastic about the new communications

link. W.W. "Buck" Buchanan, director of systems planning for Aeronautical Radio, Inc. (Arinc), says that no development in airline operational communications since the radiotelephone "has offered so much promise or generated as much enthusiasm and support from the airlines."

Not only is the service needed now, but it will be essential when the supersonic transports start flying in the 1970's. While Comsat is now sure it can provide the service by 1968, there are still some engineers who say satellite aircraft communications are feasible as an experiment but not as an operational system. Besides communications for transatlantic aircraft, Aerocon is also expected to provide technical and operational experience needed to expand the service on a global basis. Three satellites would be required. One is estimated to cost \$5.2 million, two would be about \$8.6 million and three would run about \$13 million.

I. System limitations

Transatlantic airliners will communicate with the satellite on the 118 to 136 Megahertz band. Currently a pilot can reach a ground station on vhf only within line of sight—about 300 miles. Beyond this, he must switch to high-frequency radio, which was a much poorer quality because it is affected by deep fading, severe static and magnetic storms. "We are woefully far behind in providing adequate long-range, air-ground communications," admits Buchanan. "All long-range aircraft operations over the oceans and over land masses that lack radio communications are now vitally dependent on high frequency."

Tough road. Feasibility of satel-

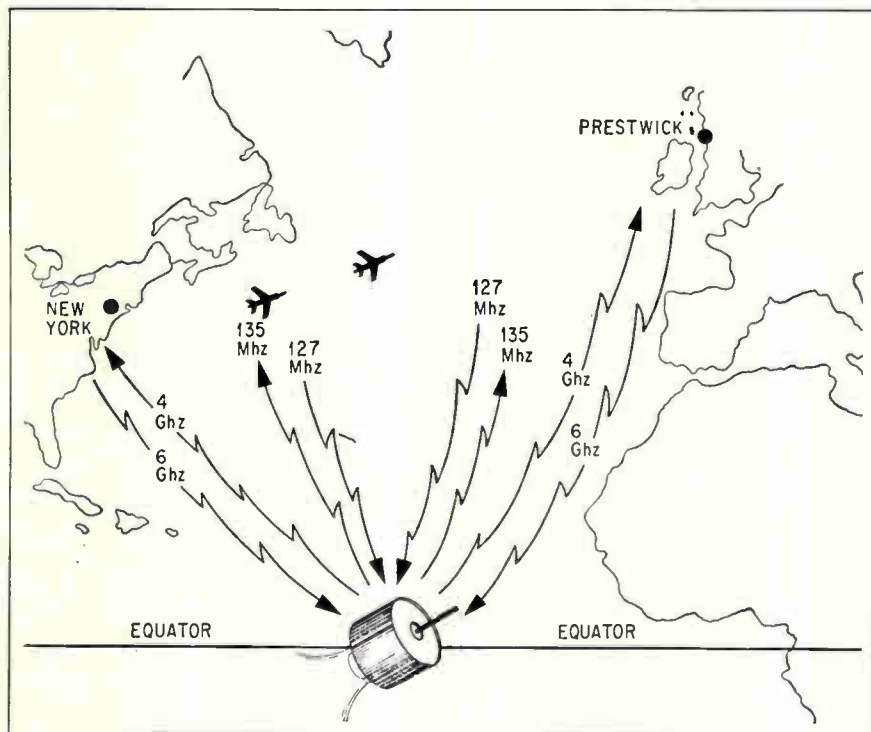

Aerocon, Comsat Corp.'s satellite will be stationed over the equator in the middle of the Atlantic Ocean to provide commercial airlines voice communications with both sides of the ocean. To avoid interference, different frequencies will be used for ground-satellite and satellite-aircraft links.

SCIENCE/SCOPE

New lightweight shipboard satellite communications systems developed by Hughes will enable shipboard commanders to communicate directly with each other, though separated by continents. One of seven such sets scheduled for delivery to the U.S. Navy by November was demonstrated at the August Western Electronics Show and Convention (WESCON) in Los Angeles. The system is designed to transmit and receive voice and teletype messages through DOD's random-orbiting military satellite network. Its mast-mounted antenna is unaffected by ship's pitch and roll or winds up to 75 knots.

First installation of the Phoenix missile control system in a U.S. Navy F-111B interceptor was completed August 16, 30 days ahead of schedule. In its first guided launch (from an A3A Skywarrior), the Phoenix located a tiny jet target drone at long range and destroyed it with a direct hit.

Newborn storms will be detected quickly by a new cloud camera aboard the first Applications Technology Satellite (ATS), scheduled to be put in a synchronous orbit over the equator later this year. The ATS will be stabilized by spinning on an axis parallel to earth's, enabling the new "spin-scan" camera to scan the earth from west to east on a latitudinal parallel. It will complete a 2000-line picture every 22 minutes, covering nearly all of North and South America and broad expanses of the Pacific and Atlantic. By comparing successive pictures, meteorologists will be able to position and track cloud elements, and thus spot rapidly developing disturbances. Camera was developed by Santa Barbara Research Center, a Hughes subsidiary.

New Hughes system for welding insulated wires, designated the HMT600, eliminates separate stripping, cleaning, and welding operations. It uses a heated electrode to melt insulation...removes it only in immediate area of weld. Welding current is triggered automatically after insulation is penetrated.

Canadian Westinghouse Co., Ltd. has recently been awarded a contract by Hughes Ground Systems Group estimated at 1.6 million dollars. The contract calls for the manufacture of electroluminescent display panels for Naval Tactical Data Systems (NTDS), which Hughes is developing for the U.S. Navy. Award of the contract to the Canadian firm is in support of the objectives of the Canada-U.S. defense production sharing program begun in 1958. Hughes is actively pursuing other contracts in Canada for similar programs.

Interest in the Army's new anti-tank weapon system, TOW, brought military men from nine Free World nations to Hughes this summer. Representatives of Belgium, Canada, Denmark, Italy, The Netherlands, Spain, Switzerland, Sweden, and West Germany came at the invitation of the U.S. Army.

One Hughes employee out of four is either a scientist or an engineer (just six years ago it was only one in eight). And still our need continues to grow. If you're interested in our advanced programs, please write Mr. J. C. Cox, Hughes Aircraft Company, Culver City, California. An equal opportunity employer.



.. although very high frequency won out, work on ultrahigh-frequency should not stop ..

lite communications for aircraft was proved in January, 1965, when an airliner communicated with Camp Roberts, Calif., via the space agency's Syncom III satellite at 136.47 Mhz. But it's "obviously a tortuous road between a demonstration and an international operating system," says Buchanan.

Because of problems the first time around, Comsat is sensitive about discussing when it expects to issue the request for proposals and when the system will be operational. There is no general agreement even within Comsat on when the request for proposals will be mailed to prospective contractors, but it will probably be close to mid-1969. Mid-1968 has been discussed as a completion date, but one Comsat engineer involved in the project says, "I'd be surprised if it is operational by then. Sometime near the end of 1968 would be more like it."

II. More tests

This schedule will give Comsat enough time to work in initial test data from aircraft communications tests with the vhf transponder on the Applications Technology Satellite-B to be launched later this year. At least 200 flight hours should be accumulated by mid-1967 in aircraft transmissions with the satellite, which will be placed in synchronous equatorial (stationary) orbit over the Pacific Ocean. The satellite transponder will receive signals on 149.2 Mhz with an 8-element phased array and transmit on 135.6 Mhz with an effective radiated power of 200 watts.

Airinc, which is coordinating the ATS-B tests, says that aircraft will be equipped for conducting voice and low-speed data tests with airborne and ground instruments measuring signal characteristics. At least three different types of aircraft antennas will be evaluated. Data from the tests will be used to design a data link and other future equipment not planned for the initial Aerocom.

The Aerocom satellite will only handle voice transmissions to provide integration with existing operating environment. Also, further

analysis of satellite-aircraft propagation path characteristics is needed before a data transmission system can be designed. Aerocom's double channel simplex mode means that aircraft pilots will talk on a party-line basis—the same way they do today. The number of ground stations having access to the system will be limited so that coordination is not expected to present any difficulties.

Disagreement. There were different viewpoints on vhf versus uhf but vhf was selected. The uhf frequencies discussed—the 1,540- to 1,660-Mhz band—pose no particular problems for the satellite designer, but do for aircraft electronics.

In the first place, Buchanan says, new aircraft equipment would be needed and airborne antenna problems that are difficult enough at vhf exceed the state of the art at uhf. He believes this would mean a technical development period of 5 to 10 years.

Because of these problems, a vhf plan will be presented to the November meeting of the International Civil Aviation Organization. The plan will call for two segments in the existing vhf band, each 200 khz wide and separated by 7 Mhz to be made available by mid-1968 for satellite communications systems. This would provide eight voice channels for the aircraft-satellite link, which Buchanan says would be adequate for the operational-evaluation period. The plan should have no trouble gaining approval of the international organization.

Uhf should not be forgotten, however, says Comsat's Martin. At the same time vhf is being initiated, he believes an aggressive research and development program should be started to determine the potential of the uhf band.

III. One year later

The Aerocom program started moving inauspiciously about a year ago. Comsat made several studies and discussed requirements and feasibility with Airinc, the airlines and the Federal Aviation Agency. Comsat issued a re-

quest for proposals in March. The specifications were based on the Applications Technology Satellite and Comsat's Intelsat-2 satellite, built by the Hughes Aircraft Co.

By using an improved Delta booster and the Surveyor spacecraft's third-stage motor, weight of the spin-stabilized satellite was set at 474 pounds on the launch pad and 210 pounds in orbit. Minimum effective radiated power was to be 25 decibels above one watt for vhf and 11 dbw for 4 ghz. Also specified was a circularly polarized vhf antenna that was essential to eliminate vhf signal fading. Conceptual designs for such an antenna on a spinning satellite were available but no test models had been built.

Comsat invited exceptions to these specifications to get more companies to enter the competition, Martin notes. But only one of the 69 companies invited to bid responded—Hughes [Electronics, June 27, 1966, p. 25]. And even the Hughes proposal didn't guarantee key specifications because of the difficulty of designing a vhf antenna, he says. The antenna was also the primary concern to many of the other prospective contractors. Because of this poor response, Comsat felt it could not proceed and it notified the FAA it planned to resolve these technical questions before going any further.

Design. Martin says only one design approach has offered any promise for early use. This antenna is a circular array of equivalent loop-dipole antenna elements properly phased to provide a directive beam oriented toward earth. Within the next few months, Comsat expects to have an efficient design in line with its weight requirements. This design will have been shown experimentally to meet gain and polarization requirements. This data will come from independent work being done by several companies and from a Comsat-sponsored design study being performed by Sylvania Electric Products, Inc., which currently is developing electronically despun microwave antennas for both NASA and the Air Force.

Comsat expects to have the results of the Sylvania study by December. The electronically despun system will probably consist of two 8-element vhf antennas



One
of these
connectors will
outlast the equipment
it was built for . . .

THE OTHER WON'T!

Some connectors are built so that they barely scrape by minimum acceptance specs . . . others are designed with long, satisfactory life, as well as specifications, in mind. And often there's little or no price differential between them.

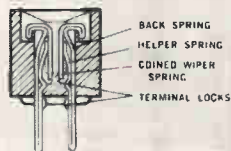

TRANSITRON PCD* printed circuit connectors, for example. Pick one up and you know it's built to last. You can see and feel precision in the molded body, in the spacing and setting of the contacts, in the finish of the metal.

And there's hidden quality . . . where it counts. In the patented Tri-Spring contacts, triple, independent leaf-spring action grips the board firmly over the entire contact area, significantly reducing wear, peel-back, and scoring. Inductive effect is entirely eliminated by shorting paths between board contact and wired tab.

And, interestingly enough, Transitron PCD Printed Circuit Connectors are no more expensive, in quantity, than many units which barely meet specifications.



Send today for this new condensed catalog which provides complete data on these and other fine PCD connectors.



Precision Connector Division

Transitron

electronic corporation
Wakefield, Massachusetts

mounted on each end of the satellite, Martin says. One wavelength at vhf measures about 8 feet so the elements will be arranged in a circular 8-foot array. ATS-B has dipoles in an 8-foot array but it is a single array of eight elements with linear polarization. No decision has been made on where to mount the microwave antenna on AeroCom. Comsat hopes to get some answers on this from bidders. The antenna could be mounted on the satellite's midsection, located on one end or built out from the satellite body.

IV. Weight problem

Progress to date on the vhf antenna has been encouraging. Comsat now feels the design approach under study can meet specifications on the critical element, although at a heavier weight than originally estimated.

"We were figuring a weight of about 12 pounds or so for the vhf array, but this was optimistic," Martin says. Another study indicated the weight would be more like 60 pounds, but he believes this is pessimistic. He says antenna weight will be somewhere between the two.

Total satellite weight has to be within the lifting capability of the long tank Thor first-stage booster, he points out. The one year postponement of the AeroCom launch makes it possible for Comsat to use a booster with more payload capacity.

Triple trouble. There are three vhf propagation problems that must be considered in designing the AeroCom satellite: fading caused by Faraday rotation, ionospheric fluctuation and sea-water multipath fades.

The polarization plane of a signal passing through the ionosphere rotates proportionally to the integrated electron density and the square of the wavelength; this phenomenon is called Faraday rotation. The method for eliminating this fading is to make the antenna insensitive to signal polarization or to use a circularly polarized antenna at both ends of the transmission path. With Comsat close to a design solution on the satellite antenna, a proven design approach is needed for the aircraft vhf antenna. If this aircraft an-

tenna can perform comparably with the anticipated spacecraft antenna, fading can be reduced to a "few tenths of a db," Martin says.

The ionosphere also causes amplitude fluctuations for short periods of time. Much more operating experience is needed over a variety of flight paths before the detailed impact on vhf satellite voice-link performance is known, according to Martin. But, he says, there is enough data to indicate that this fading will not be catastrophic and that the effect will be observed only a very small part of the time. The design philosophy to counteract this problem would be to include a system margin of a few decibels for the more likely fading periods. Decreases in the voice channel signal-to-noise ratio should be accepted for the rarer periods when such a margin proves inadequate, Martin believes.

The third propagation problem arises when a sea-reflected signal cancels the phase of the direct satellite-to-aircraft signal. Again, circularly polarized antennas at both ends of the link are needed. A look at preliminary results of airborne experiments made by the Massachusetts Institute of Technology's Lincoln Laboratories confirms the magnitude of this fading problem if linearly polarized, unshielded aircraft antennas are used, Martin notes. While the reflected signal undergoes a reversal in polarization isolation at the aircraft receiver with a circularly polarized antenna, complete circular polarization can never be achieved by the antenna. Thus additional protection is needed. This is accomplished by suppressing the aircraft antenna radiation pattern at angles below the horizon. Based on FAA's vhf antenna work, some 3 db of fading must be accounted for in the satellite design.

V. Definition search

Comsat faced a rather muddy definition of requirements for ground-to-air voice channel performance during mid-ocean operations. The best definition it has received so far is that circuit reliability must be much better than high-frequency radio and quality must be such that the voice is highly intelligible. This has been interpreted in several ways. Martin

says a simple link calculation shows about 10-db margin above single channel preparation on the critical satellite-to-aircraft path. This assumes vhf output power in the Aerocom specifications, aircraft receiver performance now understood to be available in prototype form, and a zero db aircraft antenna. This margin, he says, can be applied to increase channel capacity and handle possible persistent multipath fades. The remainder can be assigned as a safety margin for the occasional transmission degradation.

The demonstrated performance of aircraft antennas, however, will be the primary factor in determining this margin.

Hardware. Arinc's Buchanan agrees, stating that the aircraft antenna currently is the most pressing aircraft hardware design problem. He notes aircraft antennas used for vhf service lack adequate gain, power-handling capability and suitable radiation characteristics for satellite communications. He says the Boeing Co., the Douglas Aircraft Co., Dorne and Margolin, Inc., the Bendix Corp., the Collins Radio Co., the FAA and others are struggling with this problem. Some prototype designs have emerged and have been tested on a limited basis and prototype production is near on other designs. One of the continuing problems is that to keep up with the current system schedule, the antenna must fit on existing aircraft without structural modification.

The aircraft electronics for the satellite system is expected to cost approximately \$12,000 for each aircraft. Bendix equipment, now in prototype production, has worked in a number of flight tests. This includes a low-noise receiver, which is needed because signal levels from the satellite are far below the level required for most receivers now working in the 118- to 136-Mhz band. Bendix has also developed a 500-watt vhf transmitter amplifier and a frequency modulation-phase modulation modulator. The use of constant amplitude signals, such as f-m, is necessary because of the power limitations of the satellite repeater.

Present air-ground vhf aeronautical communications use amplitude modulation.

Versatility and simplicity in variable, regulated power supplies

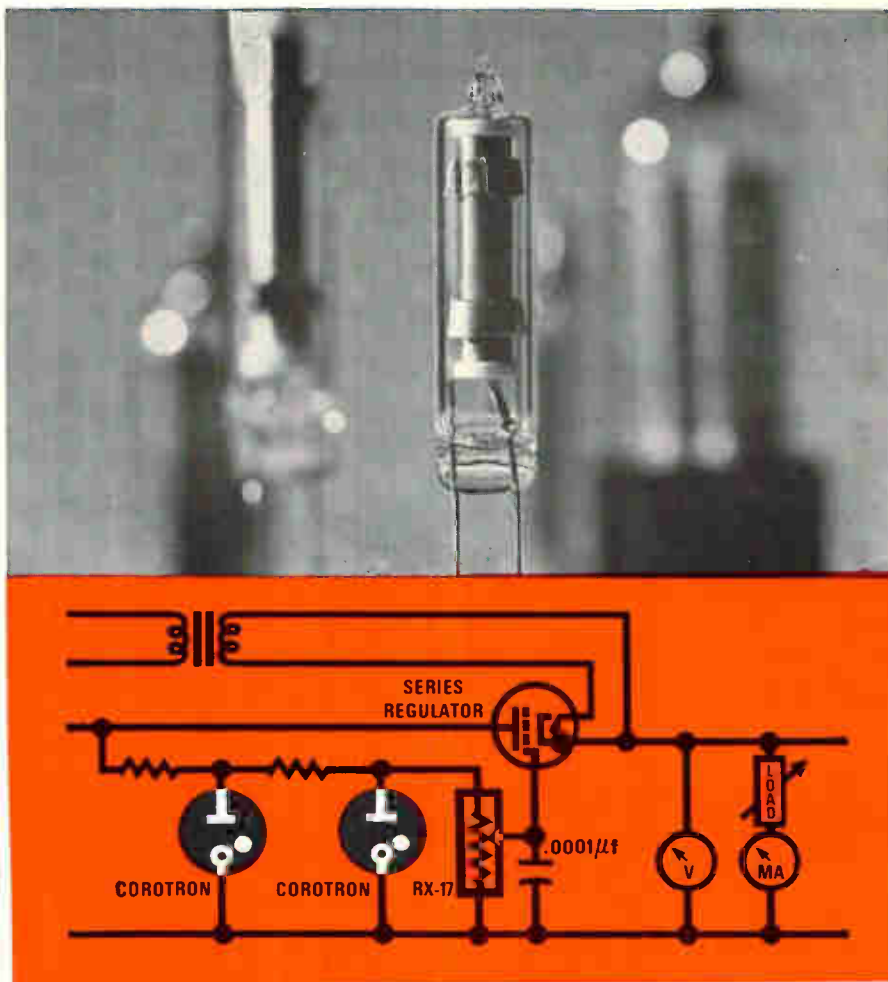

REFERENCE AND REGULATION TO 30KV

Voltage regulation can never be better, nor more stable, than the reference voltage. And you'll never find a better reference than Victoreen diodes, high-voltage equivalents of Zener diodes. But, unlike Zeners, Victoreen HV diodes are available in voltage ranges from 350 to 30,000 volts.

Unexcelled as a stable reference voltage source, a Victoreen HV diode can also be used alone as a simple shunt regulator, as a DC coupling element, etc. For Space-Age applications, you get a lot of bonuses, too — small cubage, light weight, resistance to high heat, high vibration and high accelerations to 2000g in some models. Victoreen HV diodes are unaffected by ambient light.

From the positively exotic to the commercial, if you have a voltage regulation problem in the range of 350 - 30,000 volts, quickly contact our Applications Engineering Department.

Components Division
THE VICTOREEN INSTRUMENT COMPANY
 10101 WOODLAND AVENUE • CLEVELAND, OHIO 44104
 EUROPEAN SALES OFFICE GROVE HOUSE LONDON RD ISLEWORTH MIDDLESEX ENGLAND



7324-A

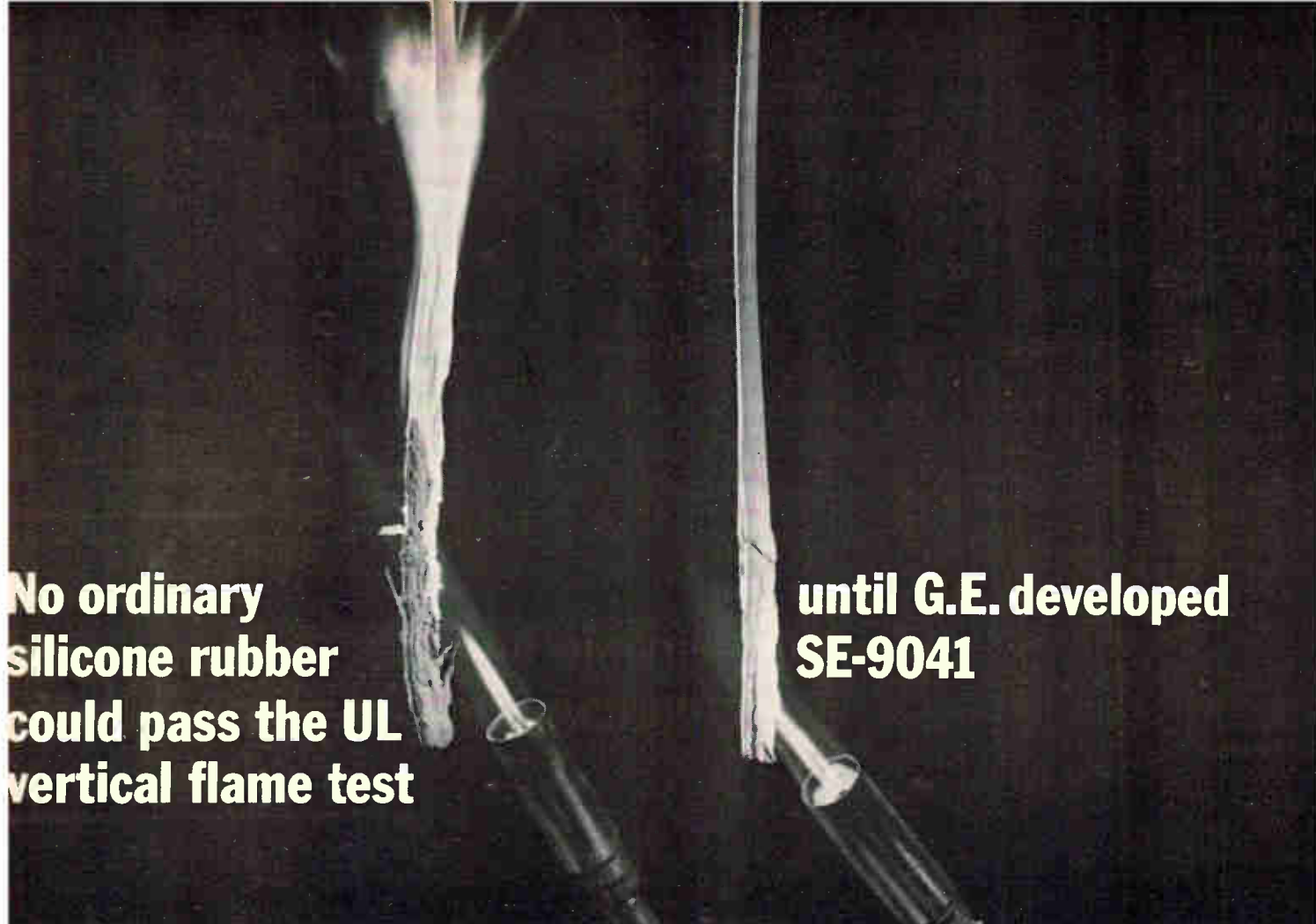

**No ordinary
silicone rubber
could pass the UL
vertical flame test**

**until G.E. developed
SE-9041**

Ordinary silicone rubber wire insulation was only half-safe. It met Underwriters' Laboratories requirements when held *horizontally* over a flame, but flunked UL's *vertical* flame test. That's why General Electric developed SE-9041—the first economical silicone rubber insulation to pass *both* UL flame tests. New SE-9041 meets UL specifications as insulation for any size conductors without flame-retardant exterior braids or saturants.

SE-9041 is versatile too. Although it was originally developed specifically for television wiring, this new

silicone compound can be used in any high voltage circuit from ignition wiring to klystron wiring. In electrostatic precipitators or magnetrons, for example.

But that's only part of the story. SE-9041 is also superior in dielectric strength. A No. 22 AWG conductor insulated with a 75 mil wall of SE-9041 would have a typical breakdown voltage of 500 volts/mil a-c. About 50% higher than values obtained with previous silicone rubber compounds! We especially formulated this new silicone rubber insulation to hold high-voltage stresses for prolonged periods of time.

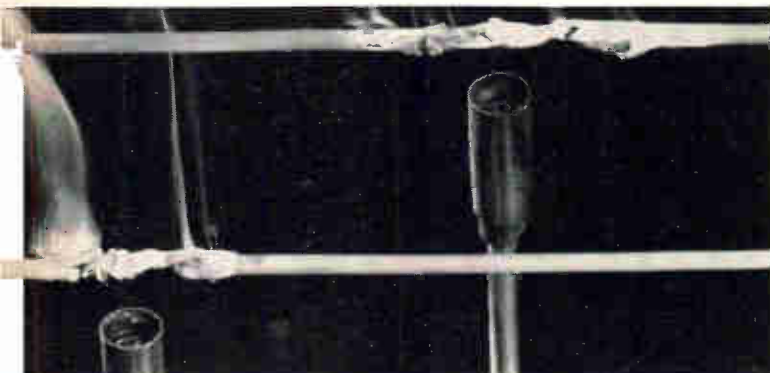

For horizontal wiring requirements, any silicone rubber insulation provides superior resistance to flame propagation. It's on the vertical jobs that SE-9041 built a reputation as a firefighter. First among lower-priced silicone insulations to pass the demanding UL vertical flame test.

GENERAL  ELECTRIC

Want a sample for evaluation? Be our guest.

Section N10236, Silicone Products Dept.
General Electric Co., Waterford, N. Y. 12188

Send me a free sample of SE-9041, plus all the literature you can put your hands on.

Name _____

Title _____

Company _____

Address _____

City _____ State _____ Zip _____

West Germany steps into space

Despite over-all budget cuts, Chancellor Erhard's government set aside \$60 million for space this year; about 30% of it will go for electronics

By John Gosch

Bonn News Bureau

Long after the West German economic miracle had changed from a postwar rebuilding effort into a scramble for prosperity, government planners in Bonn gave short shrift to space programs. The planners felt that space projects would tie up capital and siphon off skilled manpower needed to keep established industries flourishing.

Now, there's been a turnabout in official thinking. And as a result, space research and development has turned into one of the fastest growing industries in West Germany today.

Worried that the country might otherwise find itself hopelessly outdistanced in advanced technology within a few years, Chancellor Erhard's government this year jumped space spending to \$60 million, 66% more than last year's figure and nearly five times more than was spent only three years ago.

And the upward trend in space spending is expected to continue for a long time. Gerhard Stoltenberg, head of the Federal Ministry for Scientific Research, recently spoke of "increasing funds considerably." Stoltenberg didn't say how much, but there's talk in government circles of an outlay of some \$450 million over the next four years.

Electronics will get a good slice of the business. An official of the Ministry for Scientific Research in Bonn, which coordinates and finances German space efforts, estimates that about 30% of the money available for space will be spent on electronics.

And most of the major electronics companies in Germany share in the business. Siemens and Halske AG, the AEG-Telefunken group and Standard Elektrik Lorenz, a subsidiary of the Interna-

tional Telephone and Telegraph Corp., have an approximate equal share in design and development of communications, guidance and telemetry equipment. Bodenseewerk GmbH, an affiliate of Perkins-Elmer Corp., and Teldix GmbH supply instrumentation, navigational platforms and sensors. Teldix is a joint venture of Telefunken and the Bendix Corp. Boelkow GmbH and Telefunken are developing computer systems. Telefunken is now working on a small

hybrid computer for space applications.

Niche. The West German effort, of course, looks puny when compared to the massive programs mounted by the United States and the Soviet Union. This year's German space budget, for example, adds up to only a little more than 1% of what the National Aeronautics and Space Administration will spend. But West Germany nevertheless expects to find her place in space, largely through in-

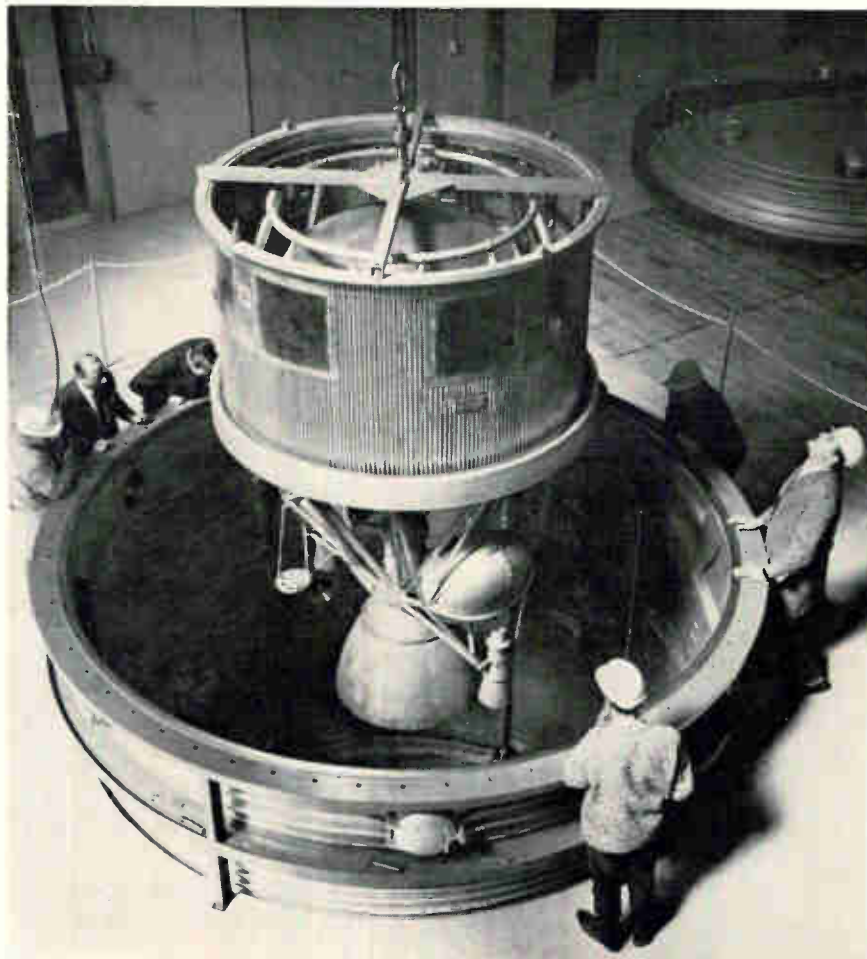

Third stage of Europa 1 rocket goes into vacuum chamber for final test. Boelkow and Erno will build 24 third stages for ELDO flight test program.

New From Andersen HIGH FREQUENCY SERIAL MEMORIES

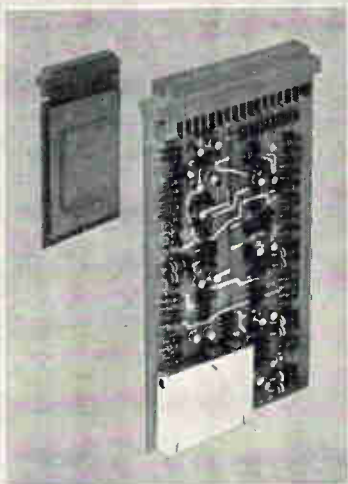

Model 5000 High Frequency
Serial Memory

Storage capacity up to 2500 bits
Data rate up to 40 Mc
Logic levels from 3 to 12 V (± 3 V to ± 12 V)
Availability of micro logic and transistorized circuitry

Andersen, a primary supplier of serial memories, now offers a new high frequency serial memory in a simple, compact and highly adaptable unit totally packaged on a $7\frac{1}{2}$ " x $4\frac{1}{2}$ " printed circuit card. Inputs may be either RZ or NRZ mode, either polarity logic may be used, and a choice is offered of either trailing or leading edge clocking. Output voltage may be RZ or NRZ and of any level from 2.8 to 6 volts of either polarity. Complementary outputs for the systems can supply and absorb up to 25 ma and drive up to 200 pf load capacitance.

Ask Andersen, first in High and Low Frequency Serial Memories and other advanced signal and data processing systems for radar, sonar, communication, telemetry, simulation, navigation and analysis.

ANDERSEN LABORATORIES, INC.
501 NEW PARK AVENUE,
WEST HARTFORD, CONN. 06110

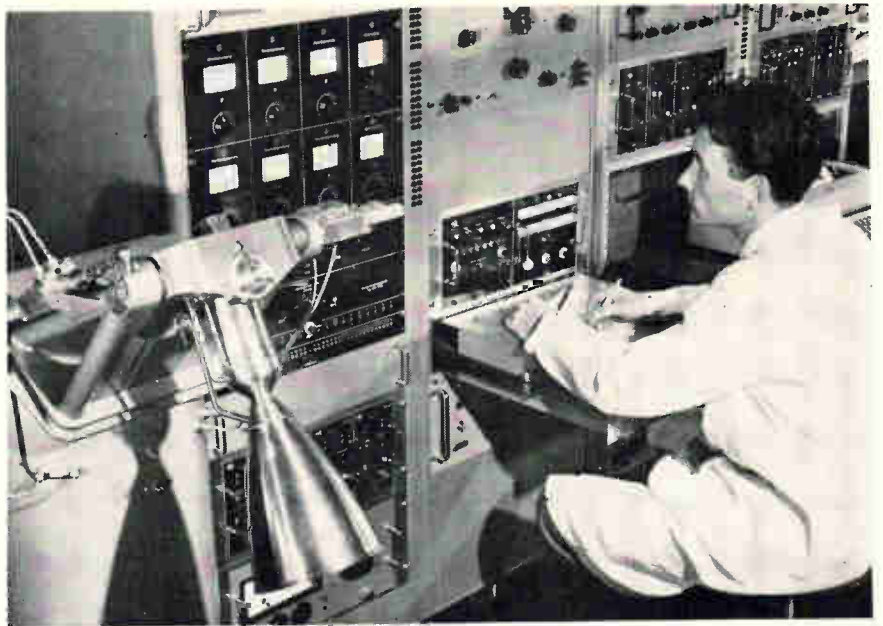

Boelkow developed complex test bench to monitor performance of Europa 1 third stage. Here, technician checks third-stage control unit.

ternational projects.

Currently, the industry's bread and butter comes from a pair of international efforts. For the European Launcher Development Organization (ELDO), West Germany is handling the third stage of the three-stage ELDO Europa I rocket. A German company is prime contractor for an experimental satellite ordered by ELDO's sister organization, the European Space Research Organization (ESRO). And joint U.S.-German space projects lie ahead.

The Germans have also mounted a modest national program that will fill some of the holes in space research left when the U.S. cut deep space probes from its program because of heavy spending for Apollo—the project to put a man on the moon by the end of the decade. And studies have started for commercial satellites that would put Germany in the space communications business.

I. Third stage first

By and large, the companies that stand to benefit most from the burgeoning West German space effort are young, team-oriented outfits that have sprung up since the war. Perhaps the most prominent is Boelkow GmbH, headquartered in Ottobrunn on the outskirts of Munich. Ludwig Boelkow, now 54, started a three-man consulting office in Stuttgart 18 years ago. Today, Boelkow heads a 3,000-man

company that last year had sales of \$50 million.

Almost half the 3,000 people are engineers and scientists, often called the Boelkow Eierkopfen (eggheads). As you'd expect, they have a hand in the third stage for Europa I—West Germany's first major space effort. Boelkow designed and developed the attitude control and operational monitoring systems for the stage. It is also responsible for design integration, check-out, reliability and testing.

For the third stage, Boelkow is working with another fast-moving aerospace company, Entwicklungsring Nord (Erno). Erno is a joint venture of Vereinigte Flugtechnische Werke GmbH and Hamburger Flugzeugbau GmbH.

Two American companies—indirectly—have a piece of the action. The Boeing Co. bought a 25% stake in Boelkow for \$2 million two years ago and has also advanced an additional \$1 million for plant investments. The United Aircraft Corp. has a 30% holding in Vereinigte Flugtechnische.

Together, Boelkow and Erno will build two dozen Europa I third stages; 10 have been completed.

II. Highly eccentric

Additional experience in building space hardware under international auspices is coming from the HEOS-A satellite (for Highly Eccentric Orbit Satellite) that ESRO has slated for a late-1968 launching.

HEOS-A, if all goes well, will measure the energy distribution of charged particles in interplanetary space. It will orbit out to an apogee of 138,000 miles for the interplanetary readings and then dip back to a perigee of 120 miles—inside the earth's magnetosphere—to take readings there since the charge distribution in space depends on the earth's magnetic field.

In the ESRO competition for the contract to build this satellite, a European group headed by Junkers Flugzeug und Motorenwerke AG came out the winner. Junkers is a subsidiary of the old-time plane maker Messerschmitt. In on the HEOS-A project with Junkers are Etudes Techniques et Constructions Aérospatiales of Belgium, Société Nationale d'Etude et de Construction de Moteurs d'Aviation of France and the British Aircraft Corp. The Lockheed Corp. is advising the group.

Junkers has over-all responsibility to ESRO for the \$6.4-million HEOS-A satellite and Junkers engineers say their main design pre-occupation is keeping the satellite free of magnetism. To meet the specifications, the magnetic field of the spacecraft must be smaller than 10^{-5} gauss, or less than one hundred thousandth of the earth's field. As a result, basic construction materials for HEOS-A will be aluminum and magnesium alloys. And Junkers has set up a special magnetism laboratory for the project at a spot 24 miles outside Munich where the earth's magnetic field is relatively low.

By Jupiter. Along with cooperative projects with European partners, joint efforts with the U.S. seem almost certain to give a lift to the fast growth of the West German aerospace industry. So far there's no firm program, but the foundations for U.S.-German cooperation in deep space probes were laid when Chancellor Erhard met with President Johnson last December.

With funds from the German science ministry, both Boelkow and Erno have made feasibility studies pointed toward probes at Jupiter [Electronics, March 21, p. 222]. Boelkow looked at three possibilities with spacecraft ranging from 770 pounds to several tons. Erno's Jupiter probe plan calls for a 1,430-

A vacuum relay:

- Carries high rf currents due to large surface area of contacts.
- Smallest size for its power rating.
- Operates faster than other high voltage relays due to small contact separation.
- Will interrupt high dc power.
- Has highest voltage ratings due to vacuum dielectric.
- Has long contact life.
- Low and stable contact resistance from dc through 30 mc.
- Requires no contact maintenance.

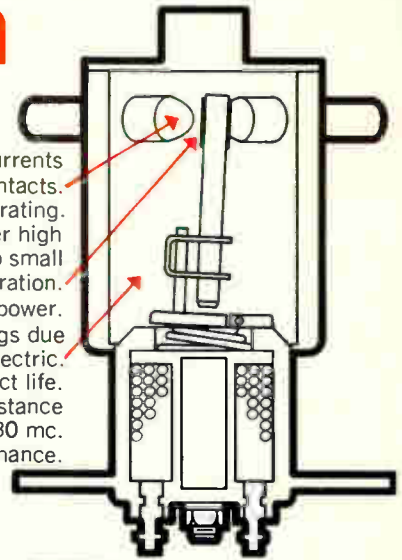

Jennings vacuum relays:







Have the additional benefit of 18 years of constant development effort and manufacturing experience. All Jennings vacuum relays have been field tested and proven successful in countless applications.

consequently:

Jennings vacuum relays are unexcelled for use in high voltage communication systems particularly in aerospace, land, or marine vehicles that cannot tolerate heavy weight and have limited space. Within their size and voltage range they also have no equal for switching dc or pulse forming networks.

Thorough knowledge of the characteristics of vacuum relays is a most useful tool in any electronic engineer's hands. It can easily be obtained by requesting Jennings new vacuum relay catalog No. 103.

Jennings Radio Manufacturing Corporation, a subsidiary of International Telephone and Telegraph Corporation, 970 McLaughlin Avenue, San Jose, California 95108.

						
	RJ1A	RJ2A	RF10	RB7A	RB1E	RB4
Contact Arrangement	SPDT	SPDT	SPDT	DPDT	SPDT	4PDT
Test Voltage (Peak KV)	5	18	20	9	18	17
Operate Voltage (Peak KV) (16 mc)	2	8	10	3	8	10
Continuous Current Amps RMS (16 mc)	7	15	30	4	6	6
Interrupt DC Power (KW)	N/A	1	50	1	1	1
Contact Resistance (Max. ohms)	.010	.012	.012	.020	.012	.010

ITT Jennings

how to get your Pulse Generator "made to order" from TI

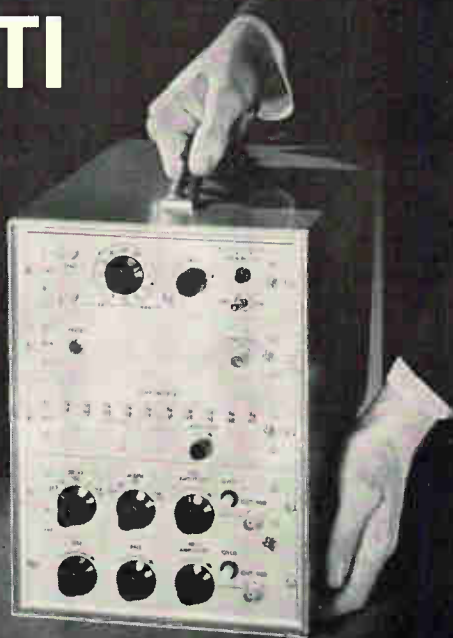

"Special" Pulse Generators are made to order at TI. Modular construction allows assembly of the right building blocks to meet your requirements. Now, "specials" cost you no more, frequently cost less than conventional pulse generators.

For example, the 6613 is an economical general-purpose unit with PRF from 15 cps to 15 mc, priced at only \$950. Another model, the 6325, is a ten-channel, word-bit programmable unit operating up to 25 mc. The single unit does the job of ten discrete generators, at half the cost, and fits in a cabinet 23 in. wide, 38 in. high, 18 in. deep.

TI Pulse Generators give you outstanding performance: PRF's to 100 mc, fast rise and fall times, variable pulse width and delay, variable rise and fall times, plus and minus outputs, pulse mixing, programmed and random word generation. You have your choice of portable or rack-mounting cases.

When you need special pulse generator performance, choose one of the thousands of standard pulse generator combinations from Texas Instruments. For more information, contact your nearest TI Authorized Representative or write to the Industrial Products Group in Houston.

INDUSTRIAL
PRODUCTS
GROUP



TEXAS INSTRUMENTS
INCORPORATED
P. O. BOX 66027 HOUSTON, TEXAS 77006
118 RUE du RHONE GENEVA, SWITZERLAND

750

pound spacecraft with a 220-pound scientific payload.

The probe would reach Jupiter after a flight of some 850 days and then carry out a batch of experiments as it flies by. Along with readings on the atmosphere around Jupiter and its magnetosphere, the probe would send back television pictures of the planet and its satellites. For transmission back to earth, Erno proposed a transmitter with 14-watts output operating on a frequency of 2,295 megahertz.

III. On their own

Although international space efforts will remain a mainstay of the West German aerospace industry for a long time, more emphasis is in the offing for the national program. This year, for example, 42% of the science ministry's space funds were earmarked for the national effort compared to 34% last year.

To be sure, West Germany hasn't set her sights yet on membership in the space club—countries like the U.S., the U.S.S.R., France and soon Japan, that have the rockets to put their own satellites into orbit. But German space officials feel that their national satellite program (NASA will handle the launches) will strengthen the industry in competition for ELDO and ESRO contracts. So far, West Germany has contributed more to the international programs than has come back to the country in contracts.

Shaping up. Despite the backseat it's had so far, the national program is shaping up quite well. Backbone of the program is the so-called "620 series" projects, which involve an experimental satellite, manned space transporters and high-altitude recoverable rockets.

Most ambitious and furthest along of the series is the 625A-1 satellite project managed by the German Society for Space Research GmbH. Boelkow is doing the project studies for the satellite, which is designed to take readings of electron and proton energy spectra in the Van Allen belt, to study the auroral zone and to check variations in the solar-particle spectrum during sun flares.

Three 625A-1 satellites are now in development, a prototype for testing and two flight units. NASA has agreed to launch the 625A-1

with a Scout rocket at the Western Test Range in the fall of 1968.

Recovery. Also in the national space lineup is project "621", aimed at developing recoverable high-altitude sounding rockets. Dornier System GmbH last year made a successful low-altitude recovery with a paraglider that unfolds its wings for descent. Next step in the program is recovery from an altitude of 24 miles. For the Dornier paraglider a telemetry and control system has been designed by Telefunken AG and Standard Elektrik Lorenz, an affiliate of the International Telephone and Telegraph Corp.

Boelkow has designed a fixed-wing rocket—intended for ionospheric studies—that can be recovered from 48 miles. The pivotal element in the electronic recovery system is a rocket-mounted search antenna with lobar characteristics. The antenna is defocused 30° from the axis of the rocket so that when the rocket rolls the axis of the antenna describes a cone. As long as the rocket points directly toward the homing transmitter on the ground, the unmodulated signal received at the antenna remains constant. But if the rocket points off the line of sight, the signal is amplitude-modulated at the rocket's roll frequency. The modulation is detected by a receiver on the rocket to develop an input for the control system that actuates the rocket's spoilers.

Blue sky. The science ministry has added a touch of blue sky to its program with feasibility studies for manned space transporters that would cost \$500 million or more to develop. Both Junkers and Erno have submitted schemes to the ministry but there's no question at the moment of earmarking space money for manned transporter hardware.

Much more likely to get a substantial chunk of the additional funds the government plans to spend for space over the next few years is a project still not officially on the ministry's program—a communications satellite called "Olympia." Boelkow made headlines this summer with a proposal that West Germany put Olympia up in time for live tv broadcasts of the 1972 Olympic Games at Munich [Electronics, July 25, p. 230].

phystable *

* A word we have coined to dramatize exactly how unique physically stable Phelps Electronics Styroflex coaxial cable actually is. Essentially an air dielectric cable, Styroflex inherently exhibits lower attenuation and higher propagation than solid dielectric types. The effect of temperature cycling on attenuation is minute and results from changes in metal resistivities amounting to less than 1% per 5°C temperature change. Continuous support assures perfect centering of the conductor during the load cycling.

If you are concerned with circuit design in AM, FM, VHF and UHF transmission, CATV, microwave communications, radar, forward scatter systems and telemetering, multichannel long line telephone networks or general pulse work, here is a coaxial cable worth knowing more about. Available, from stock, in 3/8", 1/2", 7/8", 1 1/8", 3 1/8" diameters in 50 ohm impedance, on 1000' reels, custom cut lengths or specially fabricated assemblies.

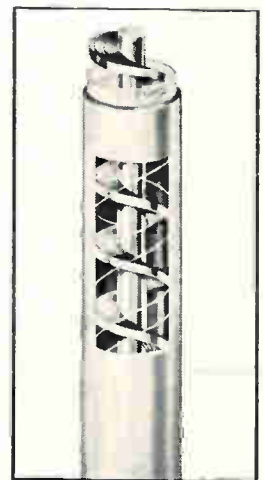

PHELPS DODGE ELECTRONIC PRODUCTS
NORTH HAVEN, CONNECTICUT



Worlds of Clifton Quality

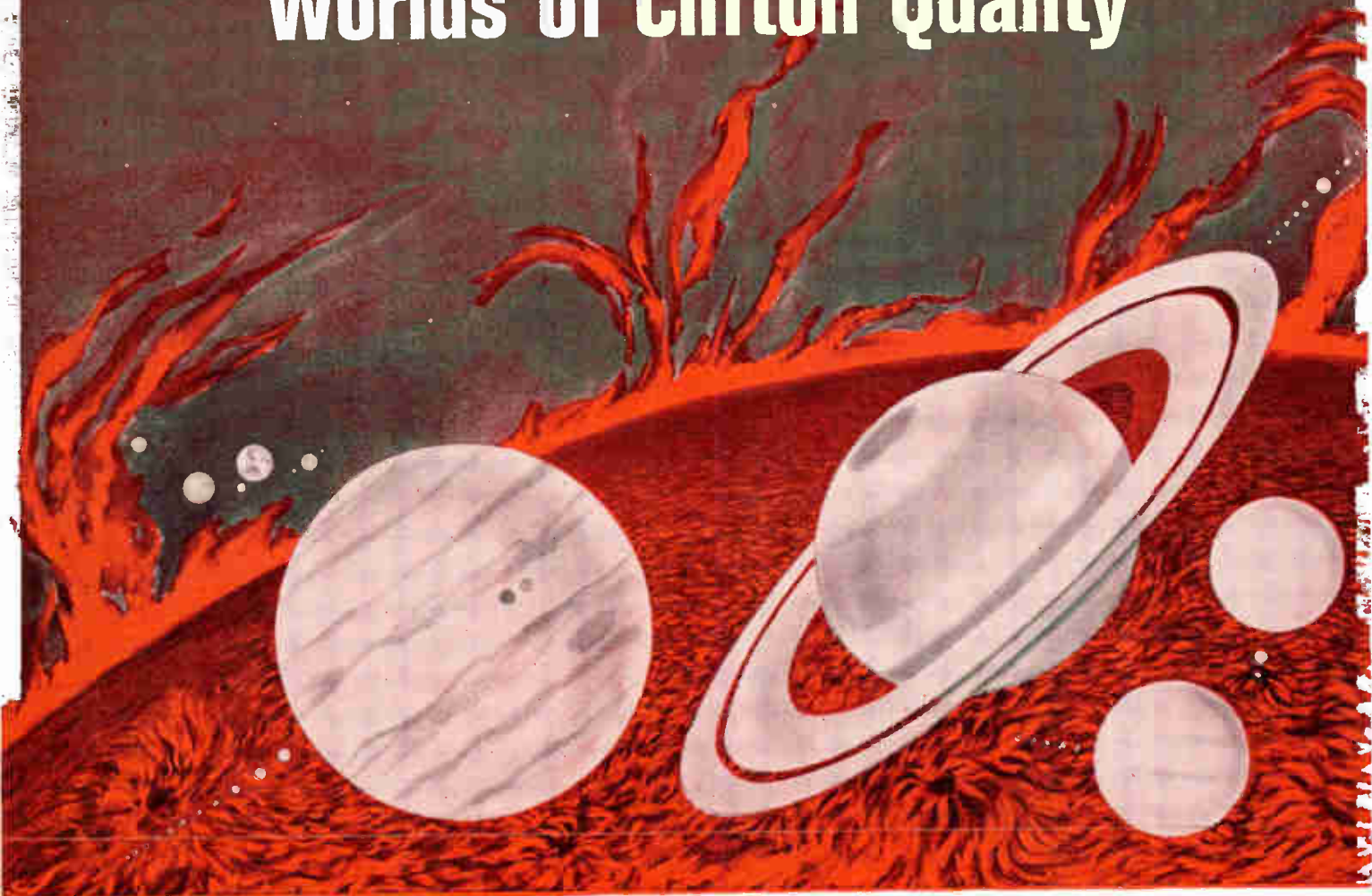

in our **NEW**, Competitively Priced DC Motors

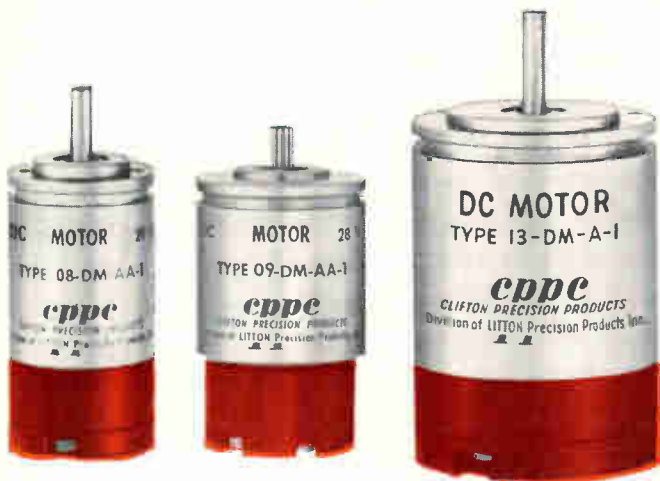

Built to exacting Clifton and MIL-E-5272 standards, these DC motors are a completely new design. They offer many advantages such as: stainless steel, corrosion resistant housings and ball bearings, and brush springs which maintain constant pressure over brush life. Brush life itself is up to 1000 hours depending upon environmental conditions and application.

These motors feature a five bar commutator. Due to the inherent design, the rotor produces a magnetic detent under zero excitation which minimizes gear train drift. Units available in both 14 and 28 volt excitation. Special voltages, shafts and housings available upon request.

Clifton Precision Products, Division of Litton Industries, Clifton Heights, Pa., Colorado Springs, Colo.

The illustration of our Solar System shows the nine planets and their 31 satellites in scale with each other and the enormous sun. The procession starts with Mercury at the left and ends with Pluto on the far right.

Circle 182 on reader service card

cppe

CLIFTON
PRECISION PRODUCTS
DIVISION OF LITTON INDUSTRIES



More power in space

Giant solar cell arrays are under development to provide power in kilowatt level for satellites of the future

By John Rhea

Electronics Washington Bureau

Like the residents of Kansas City in the musical "Oklahoma," solar cell efficiencies "have gone about as far as they can go." Nevertheless the National Aeronautics and Space Administration will push cells as the principal source of spacecraft power for another decade—even to kilowatt power levels in competition with the more glamorous nuclear systems.

The space agency feels that solar cells are more attractive than nuclear systems right now because the basic research and development on cells has been completed. Not all problems have been solved in nuclear power development—and with today's tight space budgets, the agency is less than keen about pouring more development money into it.

If solar cells can't be made more efficient than their present 10% to 11%, and this is generally conceded, then the space agency wants to cram more of them onto a satellite. So work is on to develop giant arrays that can be folded compactly at launch and then unfurled in space to catch the sun's energy and convert it into electricity. Arvin H. Smith, head of solar and chemical power systems projects at the agency's Office of Advanced Research and Technology, points out that space has two big natural resources: plenty of sunlight and unlimited room.

I. To new levels

To capitalize on these, the agency is in the midst of a technology effort on solar cell arrays to attain power levels believed impractical a few years ago. Several firms are working on arrays that could provide as much as 50 kilowatts, a big jump from the agency

high of 1 kw put out by the Orbiting Astronomical Observatory launched April 8. A secret Air Force "spy" satellite reportedly obtained a power level of 1.5 kw using solar cells, the Mariner 4 flyby of Mars got 700 watts, and the Nimbus weather satellites generated 500 watts.

Fuel cells, although used in the Gemini and Apollo spacecraft, are not being considered for future long-duration missions because of the great weight of the hydrogen and oxygen needed for them.

Going up. Within the next 10 years, Smith predicts some satellites will demand at least 4.5 to 5

kw. Two examples are communications satellites for direct television broadcasting to home receivers and large orbiting telescopes to be carried into space by Apollo astronauts and left there to operate alone. In these applications solar cells may be able to compete with the potential of nuclear power generators such as the SNAP-8 (Systems for Nuclear Auxiliary Power), which promises to provide 30 kw, although the technical problems are far from being solved. SNAP-8 has never had the full support of the agency's top management despite Congressional prodding.

However, the agency is continu-

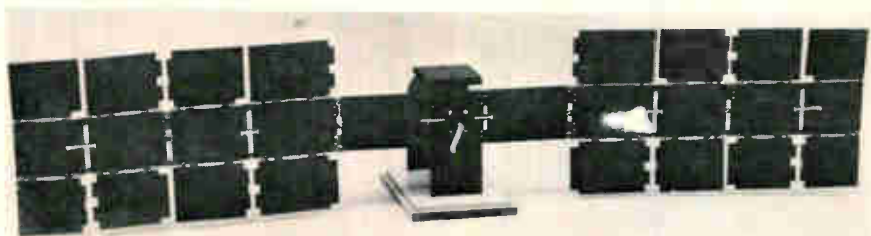

Solar cell paddles unfold like road maps to an area 30 by 60 feet. Boeing is studying ways to rig large cells arrays to increase power levels for satellites.

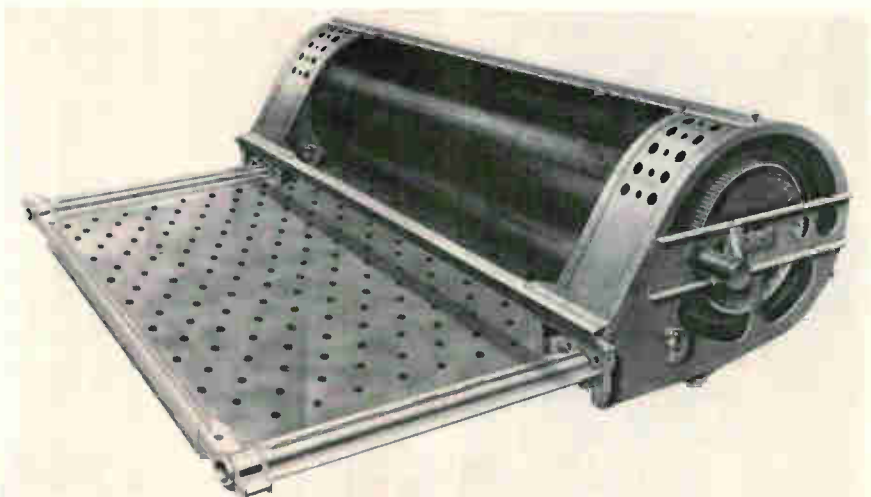

Window shade system unrolls a large flexible sheet covered with solar cells to a distance of 60 feet.

ULTRA-PERFORMANCE

TELONIC'S NEW MODEL 1001 SOLID-STATE SWEEP/SIGNAL GENERATOR DELIVERS UNMATCHED FLEXIBILITY AND PERFORMANCE FOR FREQUENCY AND CW TESTING FROM 100 kHz TO 20 MHz

ULTRA-WIDE SWEEP RATIO



A Frequency response of broad-band video amplifier, 100 kHz to 20 MHz.

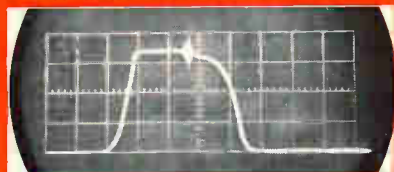

B Crystal filter response, 3 db bandwidth is 2.8 kHz wide at 10.7 MHz center frequency.

ULTRA-STABLE



C Same crystal filter as in (B) above, with 1/10 the sweep width (100 Hz/Div.).



D Five minutes later, no significant drift; bird's marker is 100 Hz wide.

ULTRA-NARROW MARKERS

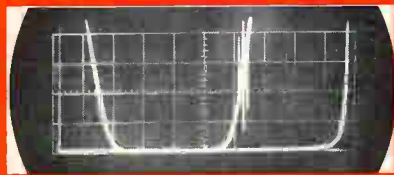

E Location of bird's marker is difficult to determine on vertical.

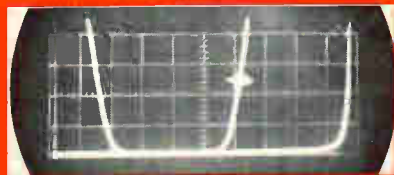

F Titled marker permits precise frequency determination.

PLUS

- VARIABLE SWEEP RATE FROM .01 TO 60 Hz
- MANUAL OR EXTERNAL SWEEPING FOR XY PLOT
- 1 VRMS OUTPUT WITH 103 db ATTENUATION

The 1001 sweeps frequency in three ranges from below 200 Hz up to the full range of 20 MHz—that's a ratio of 100,000 to 1 overall—plus CW and modulated CW! This one instrument serves for narrow and broadband applications in RF, IF, and video frequencies.

New solid-state power supplies for the 1001 provide exceptional frequency stability of 100 Hz for short term operation (1 min.), and 5 kHz over long term (1 hour). Calibrating and adjusting are minimized, test results more dependable.

Harmonic (1 MHz) and variable (100 kHz-20 MHz) frequency markers may be deviated from 10 kHz to as narrow as 100 Hz for precise frequency determination. Unique time-sharing circuit allows any combination of markers to be displayed simultaneously without interference. Marker tilt control provides precise readings even on steepest part of skirt.

THE

1001

SWEEP/SIGNAL GENERATOR

100 kHz - 20 MHz



SPECIFICATIONS

CENTER FREQUENCY	100 kHz - 20 MHz
SWEPT RANGE	100 kHz - 20 MHz
SWEEP WIDTH	
Narrow Range	200 Hz - 200 kHz
Intermediate Range	1 kHz - 2 MHz
Wide Range	10 kHz - 20 MHz
SWEEP RATE	
Variable	0.01 - 60 Hz
Line-Lock	50/60 Hz
OUTPUT	1 VRMS into 50 ohms
STABILITY	
Short Term (1 min.)	100 Hz
Long Term (1 hour)	5 kHz
HARMONIC MARKER	1 MHz
VARIABLE MARKER, RANGE	100 kHz - 20 MHz
VARIABLE MARKER, WIDTH:	
Narrow	100 Hz
Intermediate	1 kHz
Wide	10 kHz

APPLICATION DATA FILE DESCRIBING USE OF TELONIC SWEEP GENERATORS IN RESEARCH, PRODUCTION AND Q.C. APPLICATIONS AVAILABLE ON REQUEST.



60 NORTH FIRST AVENUE
BEECH GROVE, INDIANA 46107
TEL: (317) 787-3231 TWX: 810-341-3202

Representatives in all major cities in the U.S. and foreign countries. Factory offices located at Maidenhead, England and Frankfurt, Germany

More power in space

Giant solar cell arrays are under development to provide power in kilowatt level for satellites of the future

By John Rhea

Electronics Washington Bureau

Like the residents of Kansas City in the musical "Oklahoma," solar cell efficiencies "have gone about as far as they can go." Nevertheless the National Aeronautics and Space Administration will push cells as the principal source of spacecraft power for another decade—even to kilowatt power levels in competition with the more glamorous nuclear systems.

The space agency feels that solar cells are more attractive than nuclear systems right now because the basic research and development on cells has been completed. Not all problems have been solved in nuclear power development—and with today's tight space budgets, the agency is less than keen about pouring more development money into it.

If solar cells can't be made more efficient than their present 10% to 11%, and this is generally conceded, then the space agency wants to cram more of them onto a satellite. So work is on to develop giant arrays that can be folded compactly at launch and then unfurled in space to catch the sun's energy and convert it into electricity. Arvin H. Smith, head of solar and chemical power systems projects at the agency's Office of Advanced Research and Technology, points out that space has two big natural resources: plenty of sunlight and unlimited room.

I. To new levels

To capitalize on these, the agency is in the midst of a technology effort on solar cell arrays to attain power levels believed impractical a few years ago. Several firms are working on arrays that could provide as much as 50 kilowatts, a big jump from the agency

high of 1 kw put out by the Orbiting Astronomical Observatory launched April 8. A secret Air Force "spy" satellite reportedly obtained a power level of 1.5 kw using solar cells, the Mariner 4 flyby of Mars got 700 watts, and the Nimbus weather satellites generated 500 watts.

Fuel cells, although used in the Gemini and Apollo spacecraft, are not being considered for future long-duration missions because of the great weight of the hydrogen and oxygen needed for them.

Going up. Within the next 10 years, Smith predicts some satellites will demand at least 4.5 to 5

kw. Two examples are communications satellites for direct television broadcasting to home receivers and large orbiting telescopes to be carried into space by Apollo astronauts and left there to operate alone. In these applications solar cells may be able to compete with the potential of nuclear power generators such as the SNAP-8 (Systems for Nuclear Auxiliary Power), which promises to provide 30 kw, although the technical problems are far from being solved. SNAP-8 has never had the full support of the agency's top management despite Congressional prodding.

However, the agency is continu-

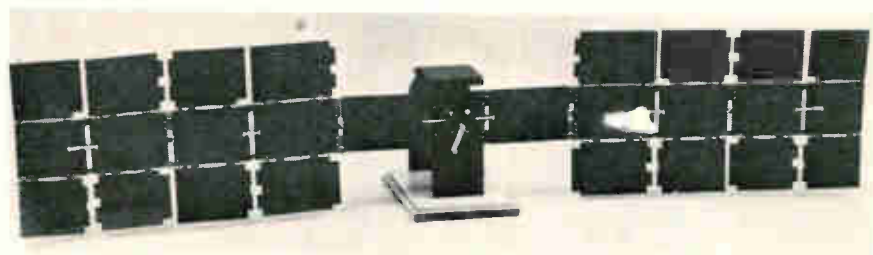

Solar cell paddles unfold like road maps to an area 30 by 60 feet. Boeing is studying ways to rig large cells arrays to increase power levels for satellites.

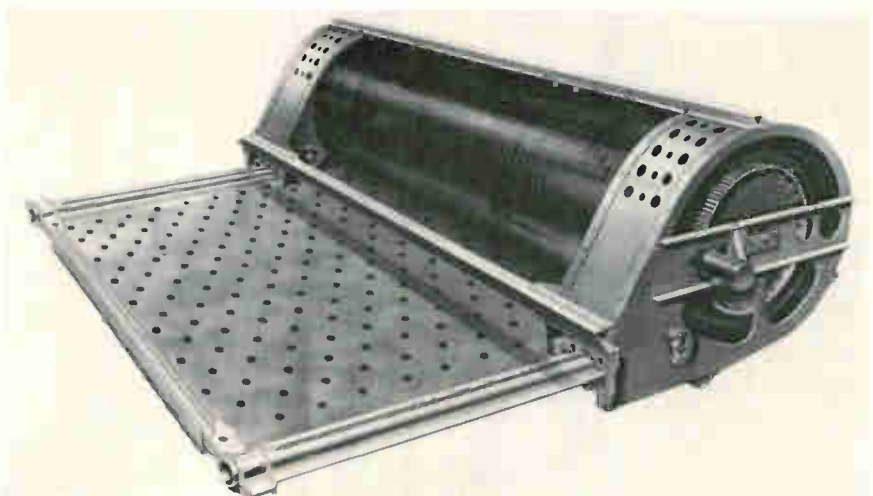

Window shade system unrolls a large flexible sheet covered with solar cells to a distance of 60 feet.

**WHEN
THE CHAIN
TO SPACE
DOESN'T
TOLERATE A
WEAK LINK...**



Of critical importance to present day telemetry systems is the reliable performance of high frequency patching components. **COAX** components assure the most dependable communication links available today • A unique cable strain relief feature in the single plug illustrated here is just one of several features which make **COAX** components superior • Write for complete data on all **COAX** components.

ADC

ADC PRODUCTS
A DIVISION OF MAGNETIC CONTROLS CO.
6405 CAMBRIDGE STREET • MINNEAPOLIS, MINN. 55426

ing its joint program with the Atomic Energy Commission to develop nuclear power devices for the advanced spacecraft being considered for the late 1970's. These craft are expected to need megawatts of power, and Smith concedes that only nuclear systems are compact enough to do that job. The joint nuclear program is costing nearly \$100 million a year.

The agency's solar cell research budget has been running around \$9 million a year for the past three years, most of it aimed at developing the large arrays and reducing the per unit costs through better manufacturing techniques such as automation.

II. Neatly packed

The biggest contract for developing the arrays went to the Boeing Co., Seattle, in May. A \$5-million, three-year effort calls for the firm to build a solar array nearly 60 feet long using beryllium for the structure and mounting 8-mil-thick solar cells with epoxy fiberglass. The array consists of individual panels, each 8 by 13 feet, and must be strong enough to survive a launch folded into a spacecraft's protective shroud. It then must unfold in space like a giant road map. A smaller program to develop folding arrays is being conducted by Electro-Optical Systems, Inc., Pasadena, Calif., a subsidiary of the Xerox Corp.

In another approach an array unrolls itself like a window shade. Tubular booms extend once a satellite is in orbit to pull out a flexible sheet covered with solar cells. The Ryan Aeronautical Co., San Diego, and Fairchild Hiller Corp., Rockville, Md., have study awards.

It's relative. A major goal of solar cell research is to reduce the weight of the panels in relation to the amount of electricity produced. While retaining the conventional 18-mil-thick solar cells, the agency has been able to reduce structural weight and thus decrease the ratio from 200 pounds per kilowatt of electricity for the 1962 Mariner 2 Venus flyby to 100 pounds per kw for the 1964 Mariner 4 mission to Mars. The immediate goal is to further reduce this ratio to 50 pounds per kw by using cells 8 mils thick and even lighter structures; the long-range goal is 25

If you are in the Electronics Industry . . . you probably belong in MARYLAND

AVAILABILITY OF LABOR

The availability of personnel, particularly engineers and scientists, is recognized as a chief criterion governing the location of an electronics firm.

There are almost 30,000 scientists and over 25,000 engineers living and working in Maryland and the District of Columbia. And the number is increasing every day.

PROXIMITY TO FEDERAL AGENCIES

Proximity to major decision makers in the industry, such as federal agencies in Washington, D. C., afford the unique advantage of constant personal contact, which is considered an increasingly important locational criterion.

No other state is as convenient to as many Federal agencies as Maryland. For example, Maryland's major government scientific installations include NASA, AEC, NIH, the National Bureau of Standards, plus some 20 others.

**THESE PRIME
REQUIREMENTS,
(plus others)
CAN BE MET IN
MARYLAND!**

Get All The Facts
Write, Wire or Phone Collect

MARYLAND
DEPARTMENT OF
ECONOMIC DEVELOPMENT

Division E • State Office Bldg. • Annapolis, Md

More power in space

Giant solar cell arrays are under development to provide power in kilowatt level for satellites of the future

By John Rhea

Electronics Washington Bureau

Like the residents of Kansas City in the musical "Oklahoma," solar cell efficiencies "have gone about as far as they can go." Nevertheless the National Aeronautics and Space Administration will push cells as the principal source of spacecraft power for another decade—even to kilowatt power levels in competition with the more glamorous nuclear systems.

The space agency feels that solar cells are more attractive than nuclear systems right now because the basic research and development on cells has been completed. Not all problems have been solved in nuclear power development—and with today's tight space budgets, the agency is less than keen about pouring more development money into it.

If solar cells can't be made more efficient than their present 10% to 11%, and this is generally conceded, then the space agency wants to cram more of them onto a satellite. So work is on to develop giant arrays that can be folded compactly at launch and then unfurled in space to catch the sun's energy and convert it into electricity. Arvin H. Smith, head of solar and chemical power systems projects at the agency's Office of Advanced Research and Technology, points out that space has two big natural resources: plenty of sunlight and unlimited room.

I. To new levels

To capitalize on these, the agency is in the midst of a technology effort on solar cell arrays to attain power levels believed impractical a few years ago. Several firms are working on arrays that could provide as much as 50 kilowatts, a big jump from the agency

high of 1 kw put out by the Orbiting Astronomical Observatory launched April 8. A secret Air Force "spy" satellite reportedly obtained a power level of 1.5 kw using solar cells, the Mariner 4 flyby of Mars got 700 watts, and the Nimbus weather satellites generated 500 watts.

Fuel cells, although used in the Gemini and Apollo spacecraft, are not being considered for future long-duration missions because of the great weight of the hydrogen and oxygen needed for them.

Going up. Within the next 10 years, Smith predicts some satellites will demand at least 4.5 to 5

kw. Two examples are communications satellites for direct television broadcasting to home receivers and large orbiting telescopes to be carried into space by Apollo astronauts and left there to operate alone. In these applications solar cells may be able to compete with the potential of nuclear power generators such as the SNAP-8 (Systems for Nuclear Auxiliary Power), which promises to provide 30 kw, although the technical problems are far from being solved. SNAP-8 has never had the full support of the agency's top management despite Congressional prodding.

However, the agency is continu-

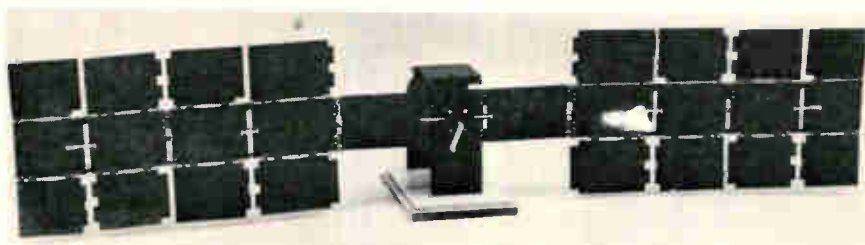

Solar cell paddles unfold like road maps to an area 30 by 60 feet. Boeing is studying ways to rig large cells arrays to increase power levels for satellites.

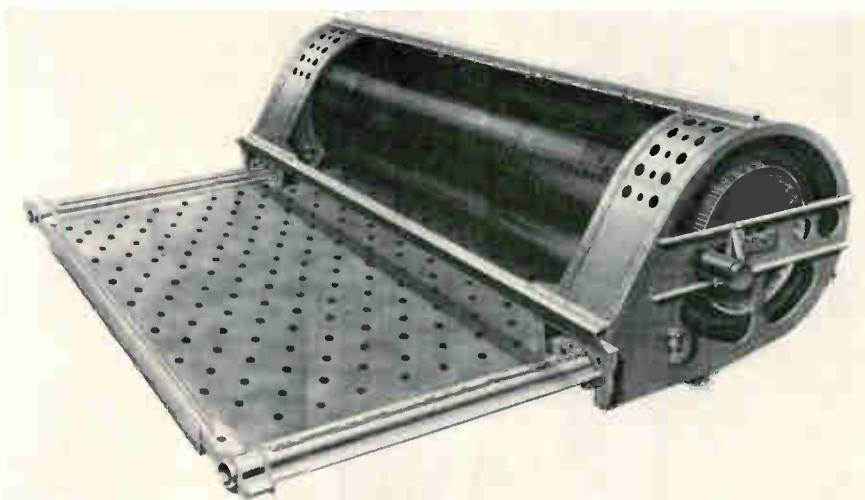

Window shade system unrolls a large flexible sheet covered with solar cells to a distance of 60 feet.

**WHEN
THE CHAIN
TO SPACE
DOESN'T
TOLERATE A
WEAK LINK...**



Of critical importance to present day telemetry systems is the reliable performance of high frequency patching components. **COAX** components assure the most dependable communication links available today • A unique cable strain relief feature in the single plug illustrated here is just one of several features which make **COAX** components superior • Write for complete data on all **COAX** components.

ADC

ADC PRODUCTS
A DIVISION OF MAGNETIC CONTROLS CO.

6405 CAMBRIDGE STREET • MINNEAPOLIS, MINN. 55428

ing its joint program with the Atomic Energy Commission to develop nuclear power devices for the advanced spacecraft being considered for the late 1970's. These craft are expected to need megawatts of power, and Smith concedes that only nuclear systems are compact enough to do that job. The joint nuclear program is costing nearly \$100 million a year.

The agency's solar cell research budget has been running around \$9 million a year for the past three years, most of it aimed at developing the large arrays and reducing the per unit costs through better manufacturing techniques such as automation.

II. Neatly packed

The biggest contract for developing the arrays went to the Boeing Co., Seattle, in May. A \$5-million, three-year effort calls for the firm to build a solar array nearly 60 feet long using beryllium for the structure and mounting 8-mil-thick solar cells with epoxy fiberglass. The array consists of individual panels, each 8 by 13 feet, and must be strong enough to survive a launch folded into a spacecraft's protective shroud. It then must unfold in space like a giant road map. A smaller program to develop folding arrays is being conducted by Electro-Optical Systems, Inc., Pasadena, Calif., a subsidiary of the Xerox Corp.

In another approach an array unrolls itself like a window shade. Tubular booms extend once a satellite is in orbit to pull out a flexible sheet covered with solar cells. The Ryan Aeronautical Co., San Diego, and Fairchild Hiller Corp., Rockville, Md., have study awards.

It's relative. A major goal of solar cell research is to reduce the weight of the panels in relation to the amount of electricity produced. While retaining the conventional 18-mil-thick solar cells, the agency has been able to reduce structural weight and thus decrease the ratio from 200 pounds per kilowatt of electricity for the 1962 Mariner 2 Venus flyby to 100 pounds per kw for the 1964 Mariner 4 mission to Mars. The immediate goal is to further reduce this ratio to 50 pounds per kw by using cells 8 mils thick and even lighter structures; the long-range goal is 25

**If you
are in the
Electronics
Industry . . .
you probably
belong in
MARYLAND**

AVAILABILITY OF LABOR

The availability of personnel, particularly engineers and scientists, is recognized as a chief criterion governing the location of an electronics firm.

There are almost 30,000 scientists and over 25,000 engineers living and working in Maryland and the District of Columbia. And the number is increasing every day.

PROXIMITY TO FEDERAL AGENCIES

Proximity to major decision makers in the industry, such as federal agencies in Washington, D. C., afford the unique advantage of constant personal contact, which is considered an increasingly important locational criterion.

No other state is as convenient to as many Federal agencies as Maryland. For example, Maryland's major government scientific installations include NASA, AEC, NIH, the National Bureau of Standards, plus some 20 others.

**THESE PRIME
REQUIREMENTS,
(plus others)
CAN BE MET IN
MARYLAND!**

Get All The Facts
Write, Wire or Phone Collect

MARYLAND
DEPARTMENT OF
ECONOMIC DEVELOPMENT

Division E • State Office Bldg. • Annapolis, Md

pounds per kw with 4-mil cells. **New materials?** Despite years of intensive searching for new materials, the single crystal silicon solar cell still dominates the field and will continue to do so for at least 10 more years, according to William Cherry, head of the space power technology branch at the agency's Goddard Space Flight Center.

Gallium arsenide was once considered the great hope, but this material has never consistently achieved efficiencies much above 6% in space and the cells were a 100 times as costly as silicon cells. Other materials that never caught on include indium phosphide, cadmium telluride, silicon carbide, gallium phosphide and selenium.

Cadmium sulfide shows great promise since the connection problems caused by moisture were solved by deposition and encapsulation techniques.

The agency's Lewis Research Center in Cleveland recently claimed a major advance in weight reduction with a thin-film solar cell made by depositing a cadmium sulfide on a light metallized substrate. The cells were built for Lewis by the Clevite Corp., also of Cleveland. Although these cells were less efficient than conventional types—the average was only 5.2%—the reduced weight resulted in a ratio of 10 pounds per kw, according to Adolph E. Spakowsik, head of the center's photovoltaic fundamentals section. A major test program is under way there.

With so many solar cells needed for higher power, a major goal is to reduce the cost of each. This is strictly a manufacturing problem, Smith says, and automation is essential. Manufacturers are moving to production-line techniques—particularly in the elimination of hand soldering.

On the line. One technique, fabrication of silicon solar cell junctions by heavy ion bombardment instead of chemical diffusion [Electronics, April 19, 1963, p. 26], has moved from the laboratory to the assembly line. Ion Physics Corp., of Burlington, Mass., a subsidiary of the High Voltage Engineering Corp., has begun production of the ion-implanted cells, and the first ones were flown on a secret Air Force satellite launched last month.

Why IEE rear-projection readouts make good reading

Not the kind of good reading you'd curl up with on a rainy night. But a more important kind if you're designing equipment that requires message display. Reason is that IEE readouts are the most readable readouts around. If you've seen them, you know this to be fact. If you haven't as yet, here is why our readouts make such good reading:



WIDE-ANGLE READABILITY

IEE's unique combination of single-plane projection, flat viewing screen, balanced ratio of brightness/contrast, and big, bold characters makes for wide-angle clarity and long viewing distances.

OTHER WAYS IEE READOUTS MAKE GOOD SENSE

As if the superior readability of our readouts weren't enough, here are a few reasons why IEE readouts make good sense in other areas:



SINGLE-PLANE PRESENTATION

No visual hash of tandem-stacked filaments. IEE readouts are miniature rear-projectors that display the required messages, one at a time, on a non-glare viewing screen. Only the message that's "on" is visible.



INFINITE DISPLAY VERSATILITY

Because our readouts use lamps, lenses, film, and a screen, they can display literally anything that can be put on film. That means you have up to 12 message positions with each readout to display any combination of letters, words, numbers, symbols, and even colors!



EASY-TO-READ CHARACTERS

Since IEE readouts can display anything that can be put on film, you're not limited to thin wire filament, dotted, or segmented digits. Order your IEE readouts with familiar, highly legible characters that meet human factors and Mil Spec requirements. This section from our sample type sheet gives you an idea of the styles available that offer optimal stroke/width/height ratio for good legibility.

BALANCED BRIGHTNESS/CONTRAST RATIO

The chart below is a reasonable facsimile of character brightness and how



it affects readability. The background is constant, but the brightness increases from left to right. You can draw your own conclusions, armed with the fact that IEE readouts give you up to 90 foot lamberts of brightness. Brightness, however, isn't the sole factor in judging readability. Background contrast is equally important—a fact we've simulated below, reading from left to right.



Obviously, brightness without contrast or vice versa, doesn't do much for readability. A balanced ratio of both gives you the crisp legibility of IEE readouts.



FIVE SIZES TO PICK FROM

IEE readouts now come in five sizes providing maximum character heights of $\frac{3}{8}$ ", $\frac{5}{8}$ ", 1", 2", and 3 $\frac{3}{8}$ ". The smallest is the new Series 340 readout that's only $\frac{3}{4}$ " H x $\frac{1}{2}$ " W, yet can be read from 30 feet away. The largest, the Series 80, is clearly legible from 100 feet away.

EASY TO OPERATE

IEE readouts are available with voltage requirements from 6 to 28 volts, depending on lamps specified. Commercial or MS lamps may be used, with up to 30,000 hours of operation per lamp. Lamps may be rapidly replaced without tools of any kind.

Our readouts operate from straight decimal input or will accept conventional binary codes when used with IEE low-current driver/decoders.

For more proof why IEE rear-projection readouts make good reading, send us your inquiry. You'll see for yourself why they've been making the best seller list, year after year!

IEE INDUSTRIAL ELECTRONIC ENGINEERS, INC.

7720 Lemona Avenue, Van Nuys, California
Phone: (213) 787-0311 • TWX (910) 495-1707
Representatives in Principal Cities

©1966 IEE

ULTRA-PERFORMANCE

TELONIC'S NEW MODEL 1001 SOLID-STATE SWEEP/SIGNAL GENERATOR DELIVERS UNMATCHED FLEXIBILITY AND PERFORMANCE FOR FREQUENCY AND CW TESTING FROM 100 kHz TO 20 MHz

ULTRA-WIDE SWEEP RATIO



A. Frequency response of broad-band video amplifier, 100 kHz to 20 MHz.

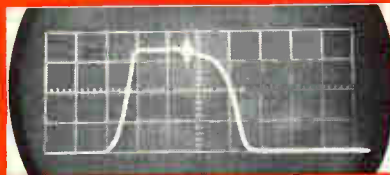

B. Crystal filter response, 3 db bandwidth is 2.8 kHz wide at 10.7 MHz center frequency.

ULTRA-STABLE



C. Same crystal filter as in (B) above, with 1/20 the sweep width (100 Hz drift).

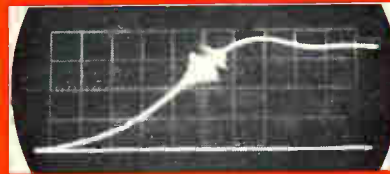

D. Five minutes later, no significant drift; birds' marker is 100 Hz wide.

ULTRA-NARROW MARKERS

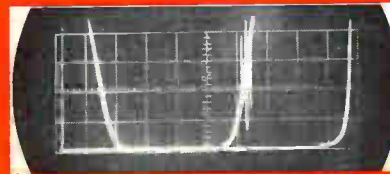

E. Location of birds' marker is difficult to determine on normal.

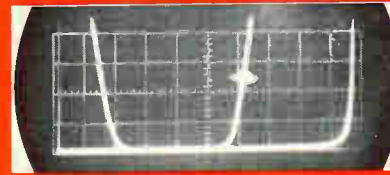

F. Tilted marker permits precise frequency determination.

PLUS

- VARIABLE SWEEP RATE FROM .01 TO 60 Hz
- MANUAL OR EXTERNAL SWEEPING FOR XY PLOT
- 1 VRMS OUTPUT WITH 100 db ATTENUATION

The 1001 sweeps frequency in three ranges from below 200 Hz up to the full range of 20 MHz—that's a ratio of 100,000 to 1 overall—plus CW and modulated CW! This one instrument serves for narrow and broadband applications in RF, IF, and video frequencies.

New solid-state power supplies for the 1001 provide exceptional frequency stability of 100 Hz for short term operation (1 min.), and 5 kHz over long term (1 hour). Calibrating and adjusting are minimized, test results more dependable.

Harmonic (1 MHz) and variable (100 kHz-20 MHz) frequency markers may be deviated from 10 kHz to as narrow as 100 Hz for precise frequency determination. Unique time-sharing circuit allows any combination of markers to be displayed simultaneously without interference. Marker tilt control provides precise readings even on steepest part of skirt.

THE

1001

SWEEP/SIGNAL GENERATOR

100 kHz - 20 MHz



SPECIFICATIONS

CENTER FREQUENCY	100 kHz - 20 MHz
SWEPT RANGE	100 kHz - 20 MHz
SWEEP WIDTH	
Narrow Range	200 Hz - 200 kHz
Intermediate Range	1 kHz - 2 MHz
Wide Range	10 kHz - 20 MHz
SWEEP RATE	
Variable	0.01 - 60 Hz
Line-Lock	50/60 Hz
OUTPUT	1 VRMS into 50 ohms
STABILITY	
Short Term (1 min.)	100 Hz
Long Term (1 hour)	5 kHz
HARMONIC MARKER	1 MHz
VARIABLE MARKER, RANGE	100 kHz - 20 MHz
VARIABLE MARKER, WIDTH:	
Narrow	100 Hz
Intermediate	1 kHz
Wide	10 kHz

APPLICATION DATA FILE DESCRIBING USE OF TELONIC SWEEP GENERATORS IN RESEARCH, PRODUCTION AND Q.C. APPLICATIONS AVAILABLE ON REQUEST.

Telonic INSTRUMENTS
60 NORTH FIRST AVENUE
BEECH GROVE, INDIANA 46107
TEL: (317) 787-3231 TWX: 810-341-3202

Representatives in all major cities in the U.S. and foreign countries. Factory offices located at Maidenhead, England and Frankfurt, Germany

IC's to hit the road in 1968 model automobiles

Experts predict a 10-million-a-year demand for integrated-circuit voltage regulators by 1969 and say the automotive market will eventually be the second biggest

By Lewis H. Young

Editor-in-chief

U.S. automakers will put the first integrated circuits into 1968 models, thus opening a market which many IC experts see as their second biggest—behind computers.

The pioneering application will be a voltage regulator made of a hybrid IC—that is, transistor and diode chips mounted on a ceramic substrate with thick or thin-film passive elements. They will be installed in luxury models produced by the Ford Motor Co. and the Chrysler Corp. and in trucks made by the General Motors Corp.

Official statements from auto executives have tended to minimize the impact of IC's on the auto industry. But informed engineers who have followed developments closely agree that pessimistic talk about IC's is a smoke screen, designed to conceal developments and throw the competition off guard. "It's definitely go on IC's for 1968 models," one auto executive confided.

Circuit cost. At the semiconductor companies, key executives have already seen the quantities required for 1968 and have agreed on prices. Each of the big three automakers wants 100,000 IC voltage regulators for 1968 models. Ford and Chrysler will pay about \$3 per circuit for the regulator to be installed in the Thunderbird, Lincoln, most expensive model Mercury and top-of-the-line Chrysler. General Motors will pay about \$3.30 for a sturdier model for a truck.

By 1969, the IC regulator will be installed across the board in all models according to current plans.

Target cost for 1969 is \$1.40 a circuit. Experts are predicting a demand for 10 million IC regulators a year for 1969 and 1970. Then the market will grow sharply.

Firm orders for IC regulators for 1968 model production will soon be in the hands of the Westinghouse Electric Corp. and the Fairchild Semiconductor division of the Fairchild Camera & Instrument Co. Also bidding for a share of the starting business are Motorola Inc. and the Philco Corp., a subsidiary of Ford.

I. Second biggest market

Semiconductor men are saying that the auto industry may be the second biggest market for integrated circuits, after the computer industry which is the largest. One engineer who studied possible applications believes that an auto eventually will contain more than 100 integrated circuits.

Automen believe that the IC now makes it economically feasible to consider replacing all the electro-mechanical controls of an auto with electronic devices to save space, money and power. "Many applications that now use a relay will eventually have IC's instead," said one executive.

IC's will turn up in devices that drivers and engineers never expected to see go electronic at all, for example, the automatic transmission. Currently the automatic transmission is switched by hydraulic fluids that are slow and relatively inefficient. Electronic switching could be faster and more

efficient, improving gasoline consumption. Chevrolet, a division of General Motors, has already installed an electronically controlled transmission in the Chaparral racing car with spectacular results. It, of course, has discrete components.

Safety checks. Another possible application is a tiny multiplexing system that would scan up to 50 key variables such as water temperature, oil and tire pressure and whether the doors are closed and seat belts fastened. It would also warn the driver if a critical or dangerous situation existed. Ford has developed a rotating drum on which are mounted many driver messages—such as "check oil and water"—which could work with the electronic multiplexer. Elsewhere in the industry, study is under way to produce a tiny cathode-ray tube to display similar warnings to the driver when the electronic system detected a critical situation.

But if such applications are several years away, some others will follow close behind the integrated-circuit voltage regulator.

Philco, for example, has already designed a car radio with five hybrid circuits in it, each a so-called Philco electronic module. Ford has not yet decided whether this radio will go into 1968 models or not; the decision will depend on economics. If Ford can envision the cost of the IC's dropping enough to make the new radio as cheap as a conventional transistorized one or cheaper, the company will go ahead.

Siliconix, Inc. and Motorola also have hybrid IC's for auto radios



NOW □□□

Adhesive Backed **SHIELDMU**

FASTER TO APPLY

high permeability
magnetic shielding
tape and foil with
adhesive backing!

- protects your sensitive electronic and electrical components against electro-magnetic interference
- strips to expose an adhesive that grips components firmly
- eliminates taping and spot welding
- cuts with scissors to provide an easier way to form shields firmly in place
- offers 2 to 3 times more shielding efficiency than material currently available
- offers ductility without significant degradation of magnetic shielding properties
- is available in 4 levels of permeability performance

Write, wire or call your local electronic distributor. He has Adhesive Backed SHIELDMU packaged to meet your needs on spools and in individual sampler albums. Or, contact:

Russell Industries, Inc.

96 Station Plaza, Lynbrook, N. Y. 11563
Phone: (516) 887-9000

Product of
MAGNETIC METALS COMPANY
also manufacturers of:

Transformer Laminations • Motor Laminations • Tape Wound Cores • Powdered Molybdenum Permalloy Cores • Electro-magnetic Shielding • Metallurgical Services • Custom Heat Treating • Photo Etched Precision Parts

ready for 1968 models.

Transistorized ignition. Most automen believe the transistorized ignition system will be the next successful application of integrated circuits in the auto. In it, an IC preamplifier and amplifier would magnify the signal generated by a magnetic pickup but a discrete power transistor would switch the high voltage.

Up to now, the transistorized ignition system has not been a commercial success, except on racing cars, because it costs too much. Consumers will not pay a \$65 to \$75 premium for such a system, particularly when the average driver cannot see the benefits.

At Chrysler, engineers predict they can build an ignition system with an IC preamplifier and amplifier costing a premium of only \$5 to manufacture. The consumer will then pay only about \$20 more than for a conventional system.

Incidentally, with IC's, the auto companies can build an ignition system with no distributor points and thus eliminate a maintenance problem. To do this previously required a preamplifier and amplifier with so many discrete components, its cost was out of line. But in an IC, components are so cheap, their cost no longer is restrictive.

Engineers at Ford are studying a variable reluctance magnetic pickup instead of breaker points; Chrysler engineers prefer a light source and a photo cell.

II. Moving the radio

IC's seem likely to solve one other problem that automen say is critical—electronic tuning for the radio so it can be moved out of the dashboard. With electronic tuning, the auto designer can put the radio almost anywhere—in the trunk, behind the seat or even in the roof or floor. "The dash is so crowded we have to move the radio out," explained one auto company executive. "In addition, if the safety people have their way, we will move the dashboard farther from the driver, so far he won't be able to tune the radio mechanically."

Because of the performance requirements of auto radios, particularly the demand for high tonal quality even when the volume is turned high, and the demand for a cost competitive with a mechanical

tuner, the electronic tuner has proved to be a major stumbling block. Philco, for example, is trying three different approaches, but none is on the verge of success.

Immediate future. Over the next five years, IC's are likely to appear in many places in the automobile. These are some examples close to acceptance.

- Temperature controller for the passenger compartment.
- Headlight dimmers.
- Electronic speedometers and odometers more accurate than current models. Ford has done a lot of work on this project and is running an electronic speedometer at its Advanced Development Laboratory in Dearborn, Mich.

■ Electronic tachometer. Ford and the Stewart-Warner Corp. are jointly developing such a device.

■ Windshield wiper controls. Electronic regulation would mean the driver could choose any speed of operation from barely moving to top speed instead of being limited to only two or three. In addition, electronic control would dissipate less power and not heat up as rheostats do now.

■ Optimum performance control. A closed loop system can vary the timing of the spark to produce optimum performance for the speed the engine is running.

■ Small motor controls. Cars are adding more and more d-c motors and each needs a speed control. The Chrysler Imperial, for example, has 36 motors to do chores from running windshield wipers to moving seats.

III. Emphasis on safety

In the past year, the auto companies have been taking their lumps from Congress on safety. With electronic devices made economically feasible by integrated circuits, automen believe they can make driving much safer. For example, a pressure gauge consisting of a tiny silicon transducer and a signal processing amplifier on a chip, can be placed in the gasoline tank to weigh the fuel accurately and read out on the dashboard in gallons or be placed in a tire to read out air pressure.

One reason auto companies are moving to integrated circuitry so fast is growing pressure from top executives to develop devices that

contribute to safer driving.

At Ford, the chairman of the board, Henry Ford II, is personally prodding the work. The company's subsidiary, Philco, has been given the responsibility to develop new automotive electronics. A laboratory for this purpose is being established at Philco's facility in Blue Bell, Pa.

At the Delco-Remy division of General Motors there was no interest in integrated circuits for autos as recently as last March. But during the spring, conditions changed and Delco now has several IC programs in progress at its Indianapolis plant.

Other auto suppliers who are working on IC devices are the Prestolite Corp. in Toledo and the Leeco-Neville Co. in Cleveland, primarily developing voltage regulators and transistorized ignition systems for police cars.

Impact of hybrids. To many semiconductor specialists the role hybrid circuits will play in auto equipment is surprising. Many of them were ready to bury hybrids only a year or so ago [see p. 23]. But in auto applications, hybrids appear to have the inside track for many years to come. The reason is simply economics.

One auto executive explained, "With hybrid circuits we don't have to pay all the costs of mask-making required for monolithic IC's. Our volumes are not nearly as large as the computer makers' and we can't afford such costs now."

Proof of how cheaply and quickly the hybrids can be put together comes from an experience at Fairchild, which did not even make a hybrid circuit when Ford asked it to submit samples about seven months ago. In fact, Fairchild ignored the first request. After Ford persisted, the company decided the potential in the automotive market warranted its entering this part of the business.

Late this summer, when Fairchild submitted its latest batch of samples, seven out of ten circuits met the auto company's specifications, a performance automen consider fantastic in such a short time.

Although the regulator is still considered a trial balloon by auto executives, they will accelerate development of other IC devices for autos throughout 1967.

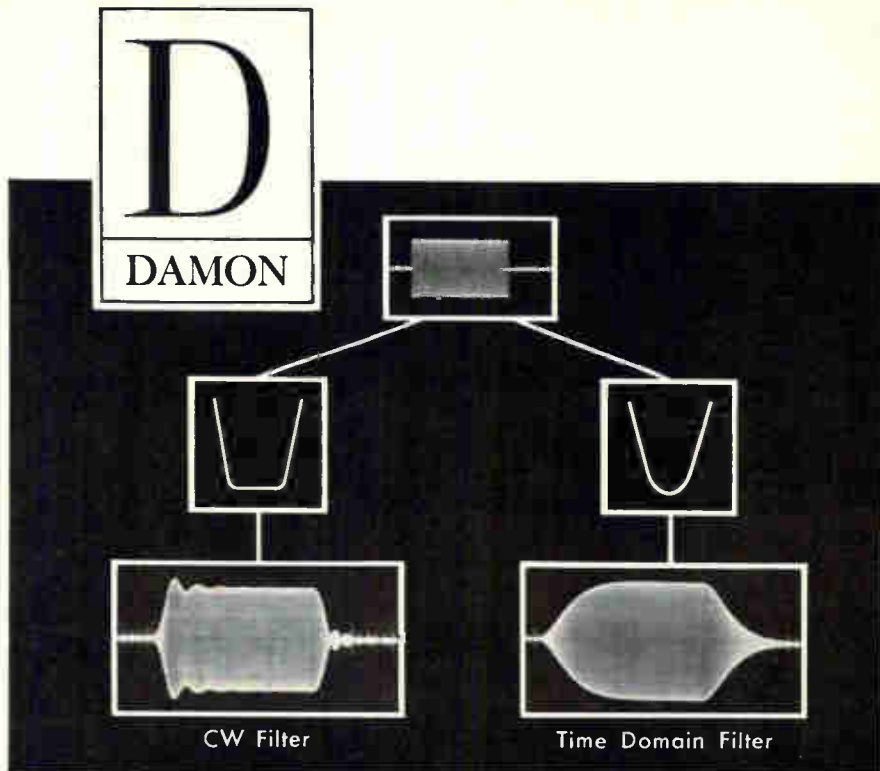

Superior Pulse Response

with Time Domain Crystal Filters

Damon applies advanced insertion loss design techniques to realize Time Domain Crystal Filters with prescribed transient behavior. Overshoot and ringing can now be eliminated in pulse systems. Damon has supplied filters with Gaussian, Bessel and Thomson polynomial characteristics. Completely eliminated are the pitfalls inherent in attempting to obtain desired pulse behavior from "equivalent" steady state design. Damon Time Domain Filters are aligned and tested under pulse conditions simulating actual equipment operation. Applications include Pulse Doppler Radar, FM-CW Radar, Spectrum Analysis, Pulse Interference Rejection, and Pulse Data Communications Systems such as PCM, FSK.

Write for Data on Time Domain Crystal Filters.

DAMON ENGINEERING, INC.

240 HIGHLAND AVENUE, NEEDHAM HEIGHTS 94, MASS.

(617) 449-0800

Announcing the Brush Mark 250, first strip chart recorder for the perfectionists of the world.

Meet the fastest, most accurate strip chart recorder on record: The new Brush Mark 250. When you read about all the features you'll know why we call it the first recorder for the perfectionists of the world!

1 Unmatched frequency response. Flat to 10 cycles on full 4½" span! Useful response to 100 cycles. Nobody has a strip chart recorder in the same league.

2 Wide selection of signal conditioners. Choose from 21 interchangeable preamps. Use one today; plug in a different one when your recording requirements change.

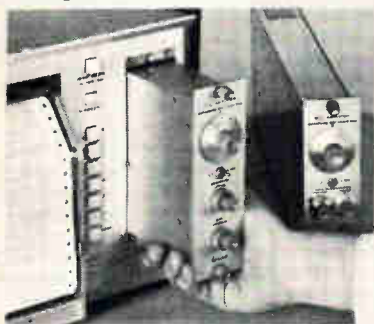

3 Crisp, clean rectilinear writing. Patented, pressurized inking system puts smudge-proof trace into the paper not just on it.

4 Contactless, non-wearing feedback system. Same one used in our multi-channel Mark 200 recorders. (No slide wires!) Accuracy? Better than ½%!

5 Multiple chart speeds. Push-button choice of twelve . . . from 5 inches/second to 1/10 of an inch/minute (up to 8 days of continuous recording).

6 Portable or Rack mounting. And either way you get the exclusive new dual position writing table.

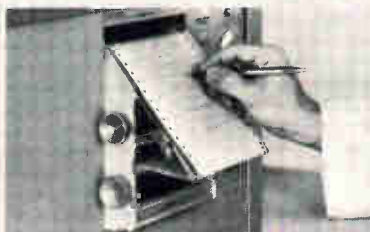

7 Removable chart paper magazine. Great for desk top record reviews. Man-sized manual winding knobs let you roll chart forward and back. Chart reloading is a cinch.



See what we mean? The Mark 250 is for the perfectionists of the world. Ask your Brush Sales Engineer for a demonstration. Or, write for chart sample and specifications. Clevite Corporation, Brush Instruments Division, 3633 Perkins Ave., Cleveland, Ohio 44114.

CLEVITE
—brush INSTRUMENTS DIVISION

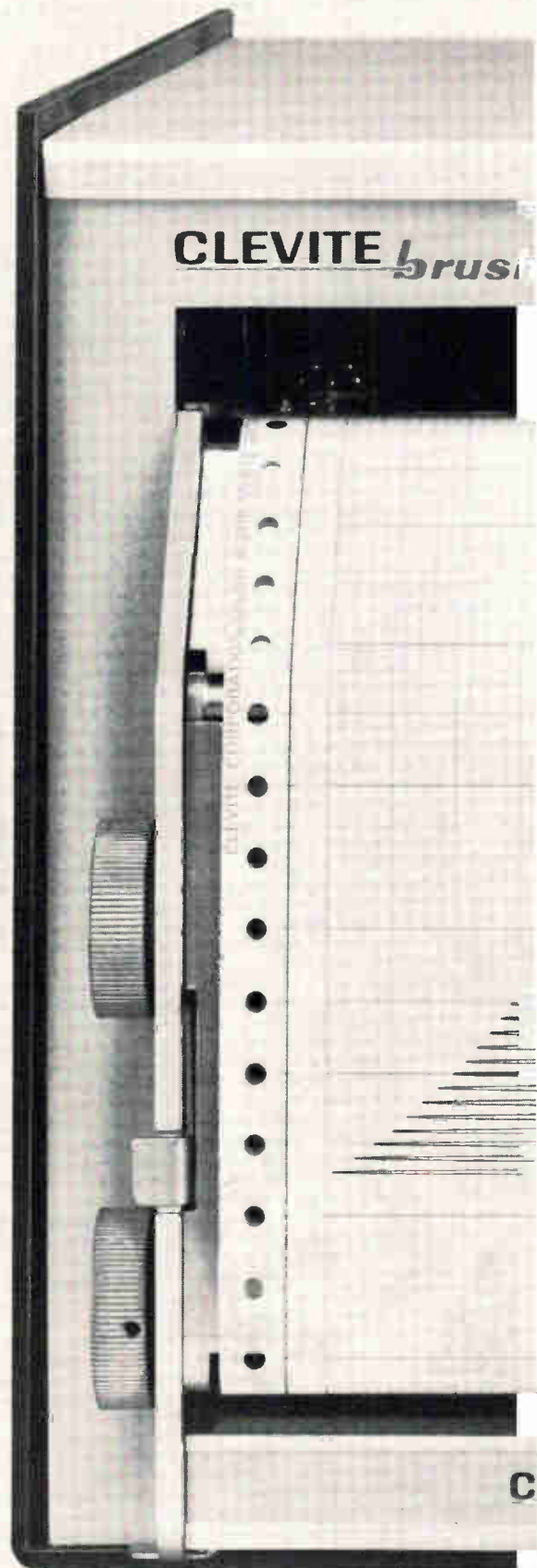

Shown approx. 76% of actual size with 1 μv preamplifier RD 4215-70; event markers optional.

contribute to safer driving.

At Ford, the chairman of the board, Henry Ford II, is personally prodding the work. The company's subsidiary, Philco, has been given the responsibility to develop new automotive electronics. A laboratory for this purpose is being established at Philco's facility in Blue Bell, Pa.

At the Delco-Remy division of General Motors there was no interest in integrated circuits for autos as recently as last March. But during the spring, conditions changed and Delco now has several IC programs in progress at its Indianapolis plant.

Other auto suppliers who are working on IC devices are the Prestolite Corp. in Toledo and the Leece-Neville Co. in Cleveland, primarily developing voltage regulators and transistorized ignition systems for police cars.

Impact of hybrids. To many semiconductor specialists the role hybrid circuits will play in auto equipment is surprising. Many of them were ready to bury hybrids only a year or so ago [see p. 23]. But in auto applications, hybrids appear to have the inside track for many years to come. The reason is simply economics.

One auto executive explained, "With hybrid circuits we don't have to pay all the costs of mask-making required for monolithic IC's. Our volumes are not nearly as large as the computer makers' and we can't afford such costs now."

Proof of how cheaply and quickly the hybrids can be put together comes from an experience at Fairchild, which did not even make a hybrid circuit when Ford asked it to submit samples about seven months ago. In fact, Fairchild ignored the first request. After Ford persisted, the company decided the potential in the automotive market warranted its entering this part of the business.

Late this summer, when Fairchild submitted its latest batch of samples, seven out of ten circuits met the auto company's specifications, a performance automen consider fantastic in such a short time.

Although the regulator is still considered a trial balloon by auto executives, they will accelerate development of other IC devices for autos throughout 1967.

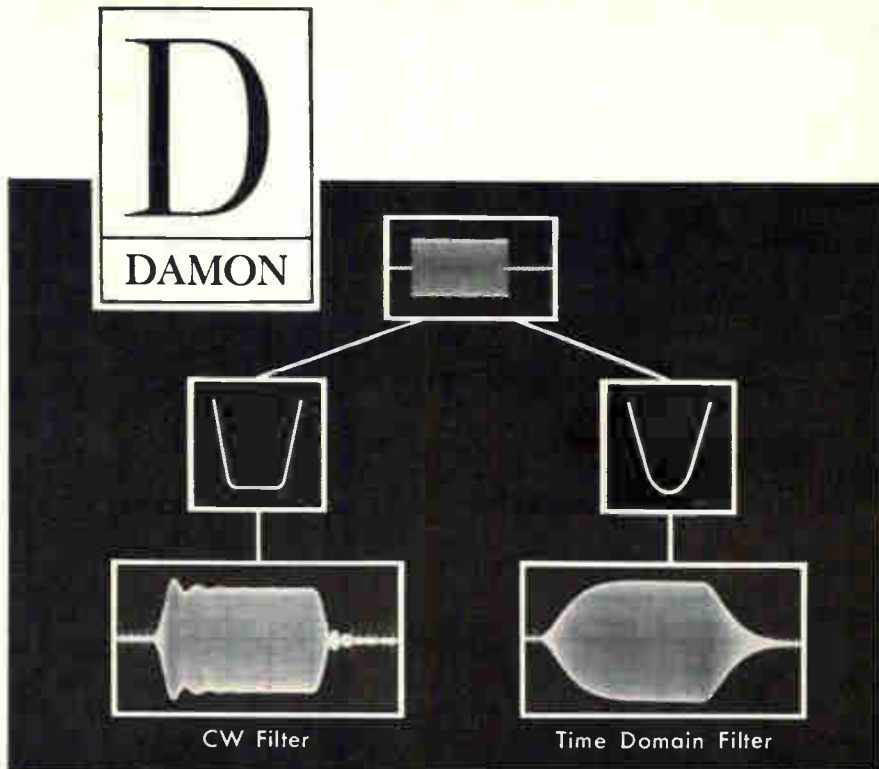

Superior Pulse Response

with Time Domain Crystal Filters

Damon applies advanced insertion loss design techniques to realize Time Domain Crystal Filters with prescribed transient behavior. Overshoot and ringing can now be eliminated in pulse systems. Damon has supplied filters with Gaussian, Bessel and Thomson polynomial characteristics. Completely eliminated are the pitfalls inherent in attempting to obtain desired pulse behavior from "equivalent" steady state design. Damon Time Domain Filters are aligned and tested under pulse conditions simulating actual equipment operation. Applications include Pulse Doppler Radar, FM-CW Radar, Spectrum Analysis, Pulse Interference Rejection, and Pulse Data Communications Systems such as PCM, FSK.

Write for Data on Time Domain Crystal Filters.

DAMON ENGINEERING, INC.

240 HIGHLAND AVENUE, NEEDHAM HEIGHTS 94, MASS.

(617) 449-0800

Announcing the Brush Mark 250, first strip chart recorder for the perfectionists of the world.

Meet the fastest, most accurate strip chart recorder on record: The new Brush Mark 250. When you read about all the features you'll know why we call it the first recorder for the perfectionists of the world!

1 Unmatched frequency response. Flat to 10 cycles on full 4½" span! Useful response to 100 cycles. Nobody has a strip chart recorder in the same league.

2 Wide selection of signal conditioners. Choose from 21 interchangeable preamps. Use one today; plug in a different one when your recording requirements change.

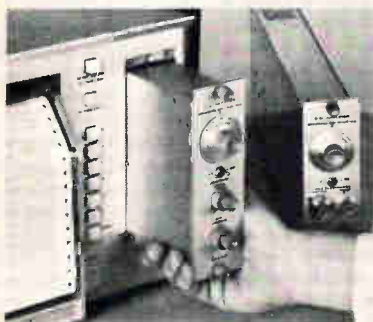

3 Crisp, clean rectilinear writing. Patented, pressurized inking system puts smudge-proof trace into the paper not just on it.

4 Contactless, non-wearing feedback system. Same one used in our multi-channel Mark 200 recorders. (No slide wires!) Accuracy? Better than ½%!

5 Multiple chart speeds. Push-button choice of twelve . . . from 5 inches/second to 1/10 of an inch/minute (up to 8 days of continuous recording).

6 Portable or Rack mounting. And either way you get the exclusive new dual position writing table.



7 Removable chart paper magazine. Great for desk top record reviews. Man-sized manual winding knobs let you roll chart forward and back. Chart reloading is a cinch.



See what we mean? The Mark 250 is for the perfectionists of the world. Ask your Brush Sales Engineer for a demonstration. Or, write for chart sample and specifications. Clevite Corporation, Brush Instruments Division, 3633 Perkins Ave., Cleveland, Ohio 44114.

CLEVITE
—brush INSTRUMENTS DIVISION

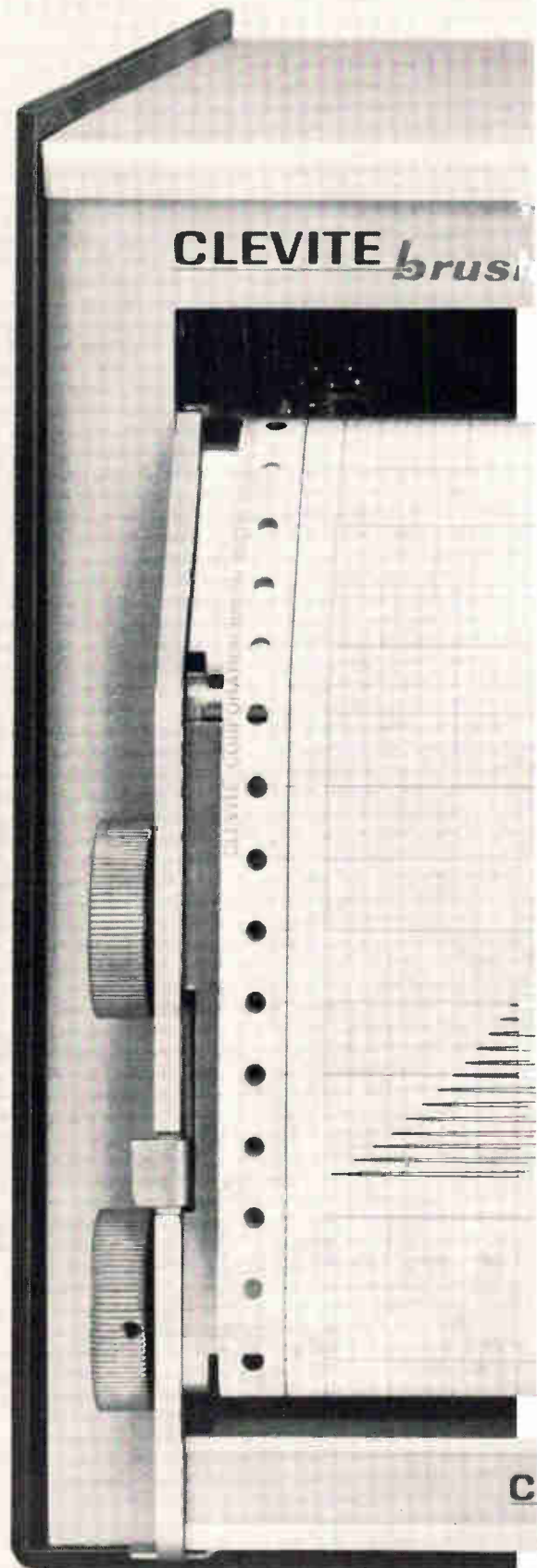

Shown approx. 76% of actual size with 1 μv preamplifier RD 4215-70; event markers optional.

RK 250

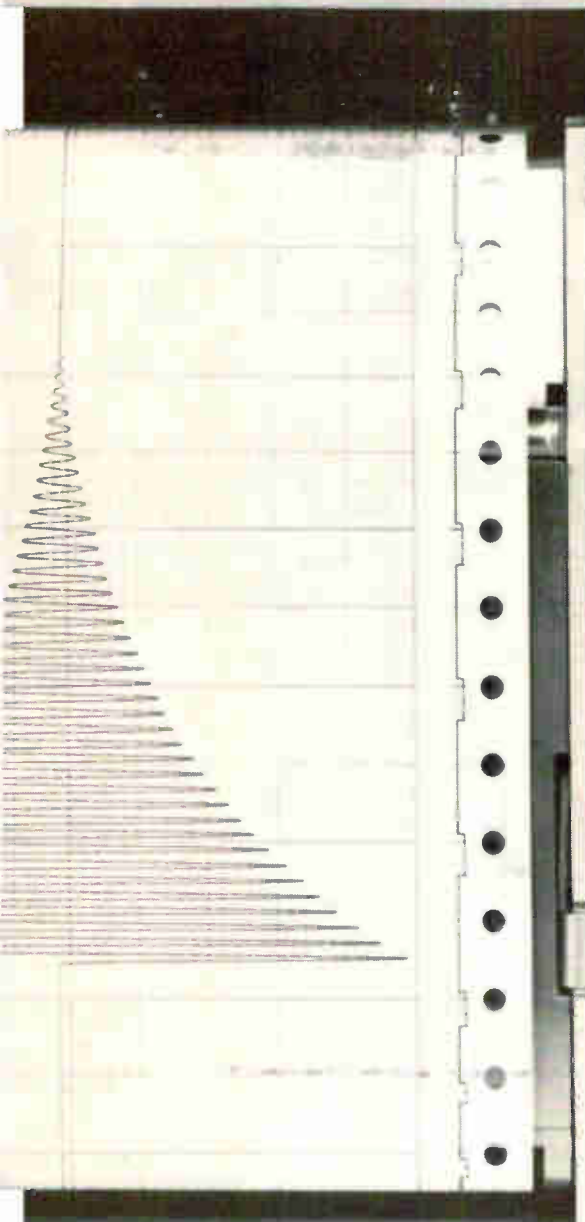

chart speed
inches/sec

inches/min

5

2

1

.5

.2

.1

stop

paper
F
E

power

D.C. AMPLIFIER

sensitivity

1 2 5

10 50 100 200 500 1000 0/1

100 mv/div

x 1 x 1000

zero suppression vernier range

10 mv

sensitivity pen position

x 1

brush

interlock warning

VITE brush

The Brush Mark 250

First recorder for perfectionists

Circle 494 on reader service card

CTC

trims size, cuts cost and eliminates temperature compensating circuits

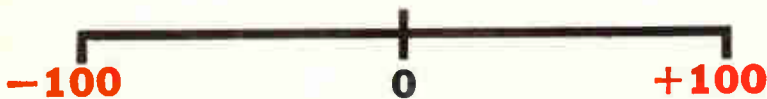

New IRC metal film resistors with any specified TC between -100 and +100ppm

Controlled Temperature Characteristic—a new IRC line of high-stability precision metal film resistors—is made by a technology so refined that TC can be controlled to any desired point between -100 and +100ppm, ± 5 ppm.

In analog computers, CTC resistors offer fast rise times, precision and stability over a wide temperature range. They can simplify or completely eliminate temperature compensating devices in a wide range of delicate sensing instruments.

Inductance and capacitance are negligible. CTC resistors replace wire-wound types with space and cost savings, and are far more reliable . . . even at higher resistance values. Write for complete data and prices. IRC, Inc., 401 North Broad Street, Philadelphia, Pa. 19108.

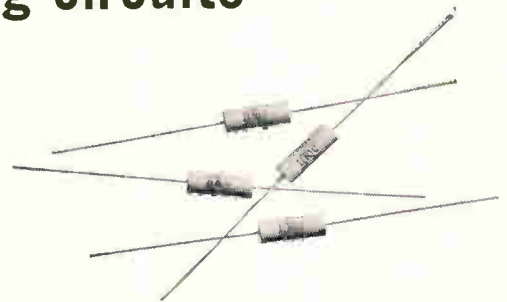

CAPSULE SPECIFICATIONS

SIZE	RN65
TC	Any TC between -100 and +100ppm, ± 5 ppm
TEMP. SPAN	Any 50°C increment between -55°C and 165°C
RESISTANCE	50 Ω to 360K Ω
POWER	¼-W @ 125°C, ½-W @ 70°C
STD. TOLERANCES	0.1, 0.05, 0.025%

INDUSTRY'S LARGEST SELECTION OF METAL FILM RESISTORS

 <p>ASSURED RELIABILITY METAL FILM</p> <p>An industry first. 0.1, 0.01 or 0.001% levels. 1/20 to 2 watts. 20 ohms to 1 meg. $\pm 25, 50$ and 100ppm. 0.25, 0.5 and 1% tolerances.</p>	 <p>HIGH STABILITY METAL FILM</p> <p>Molded and coated types, including microminiature, 1/10 to 2 watts. 30 ohms to 10 meg. 8 TC's from ± 25ppm. Tolerances from 0.05%.</p>	 <p>ECONOMICAL METAL FILM</p> <p>Molded and coated types for MIL-R-10509. TC guaranteed to within 100ppm. 1/10 to 2 watts, 10 ohms to 10 meg. 0.5 and 1% tolerances.</p>	 <p>DEPOSITED CARBON FILM</p> <p>Molded types from ¼ to 2 watts, coated types from ½ to 2 watts. 10 ohms to 1 meg. 0.5, 1 and 2% tolerances. MIL-R-10509.</p>
--	--	--	---



Feedback circuit conquers oscillator drawback

Solid-state oscillator maintains accuracy of 1% from 100 kilohertz to 110 megahertz by converting frequency to voltage

The heterodyning technique that is the basis of most low-frequency sweep oscillators has a serious drawback—inaccuracies that may be relatively small at microwave frequencies survive the mixing process undiminished in absolute value and are thus proportionately much greater at the final frequency. However, the Hewlett-Packard Co. will soon introduce a unit with special feedback circuitry to maintain frequency accuracy of 1% from 100 kilohertz to 110 megahertz. The unit plugs into the company's model 8690 main frame oscillator.

The new oscillator, model 8698A, obtains its frequency range by beating the second harmonic of a 100-Mhz crystal oscillator against a 200- to 310-Mhz voltage-tunable oscillator. The 4-Mhz variation that would result from a $\pm 1\%$ inaccuracy in the voltage-tuned oscillator's frequency would be disastrous in the lower range. In fact, this so-called residual frequency modulation normally determines the minimum sweep in low-frequency instruments, the company says. To reduce residual frequency modulation, the H-P unit has a feedback circuit whose main components are a second mixer similar to the first, a video amplifier, a binary divider, a pulse-count discriminator and a differential amplifier.

The video amplifier is necessary to make up the mixing loss. The signal then goes to the divider, where its frequency is reduced by a factor of 8, and then to the discriminator—basically a one-shot multivibrator that generates a fixed-width pulse whose voltage is a function of frequency.

This pulse is one input to the differential amplifier. The other is a tuning voltage of 1 to 5 volts. If these two voltage ramps differ, the amplifier produces an error signal that is fed back to the voltage-tuned oscillator (vto).

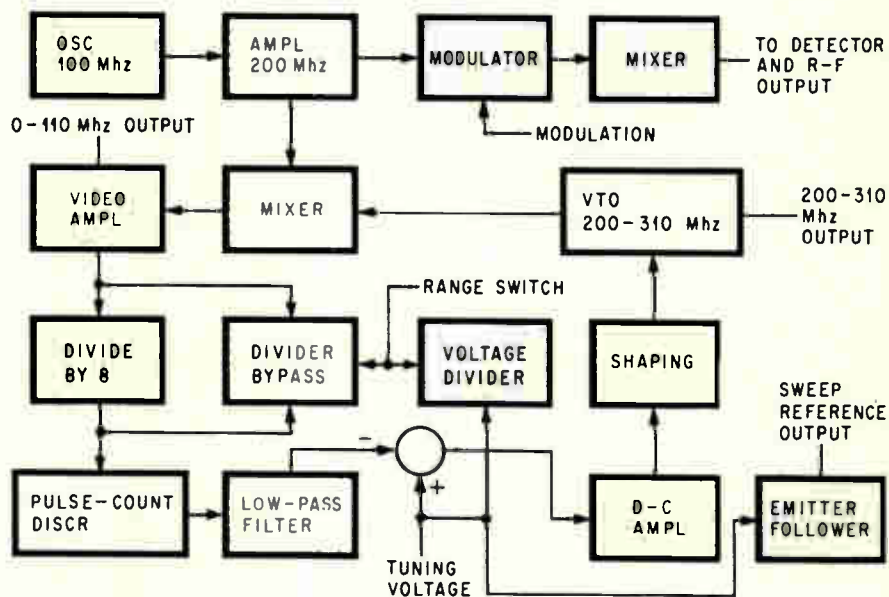

"What we've done," says designer Doug Gray, "is to lock the vto to the discriminator to achieve linearity and accuracy." The specified linearity is $\pm 0.5\%$. Gray demonstrated it by mixing the radio-frequency output with that of a 10-Mhz crystal, producing a zero beat and a marker on an oscilloscope waveform every 10 Mhz. The markers appeared directly over the graticule lines on the scope.

Residual frequency modulation is less than 100 hertz from 100 klz to 11 Mhz and less than 360 hertz at from 1 to 100 Mhz. The frequency ranges overlap because the binary divider is only in the loop to bring the radio-frequency signal down to a frequency where it can be handled by the multivibrator. At the lower frequency range, the binary divider is switched out.

"We originally tried a phase-lock approach, which is very 'in' these days," Gray says, "but we found that while we got good stability that way, the frequency accuracy was poor. With the pulse-count discriminator, we sacrificed a little stability for linearity and accuracy."

The 8698A joins a family of seven

other plug-in units that covers a range of 1 to 40 gigahertz. These units all contain backward-wave oscillators; H-P had to switch to heterodyning for the new unit because bwo's do not operate well under 1 GHz. H-P hopes to modify the new circuitry to build a plug-in to cover the remaining gap, from 110 Mhz to 1 GHz.

Because the new unit is used with the 8690 main frame, it has all of the latter's flexibility. Most low-frequency sweepers operate in the delta-F mode, sweeping a variable bandwidth on either side of a given frequency. With the 8690, start-stop frequencies, as well as interim marker frequencies for looking at a particular part of the spectrum, can be dialed. The unit also operates continuous wave.

Priced at \$950, the 8698A is not a piece of production-line test equipment. H-P does expect it to be of use in sweeping intermediate-frequency amplifiers, in determining filter characteristics and in similar low-frequency applications.

Hewlett-Packard Co., 1501 Page Mill Road, Palo Alto, Calif.

Circle 350 on reader service card.

LC Filters?

We'll try anything!

If you have a tough, tricky or unusual problem in LC filters, try Bulova first!

Bulova has built a reputation for being willing to "try anything". Even jobs that other companies "can't be bothered with"!



Are we crazy? Like foxes! Fact is, we can do things others can't—and that's the way we win friends and customers!

We'll custom-design units to solve your unique problems. We'll supply prototypes when you need them—in 2 weeks or less! We'll schedule production units to meet your schedule—and give you solid proof we can do it!

And what a range! High pass, low pass, band pass, lumped constant delay lines, IRIG filters—you name it! Frequencies from DC to 50MHz! Sharpest shape factors! Just tell us your requirements—when you need it—and let us tackle it. Our hot engineering group will show you why you should "Try Bulova first"!

For more information, write to us at Dept. E-25.

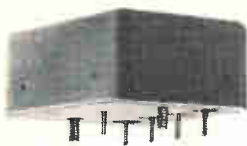

Try Bulova First!

FREQUENCY CONTROL PRODUCTS

ELECTRONICS DIVISION
OF BULOVA WATCH COMPANY, INC.

61-20 WOODSIDE AVENUE
WOODSIDE, N.Y. 11377, (212) DE 5-6000

New Components and Hardware

Miniature switch boasts high capacity

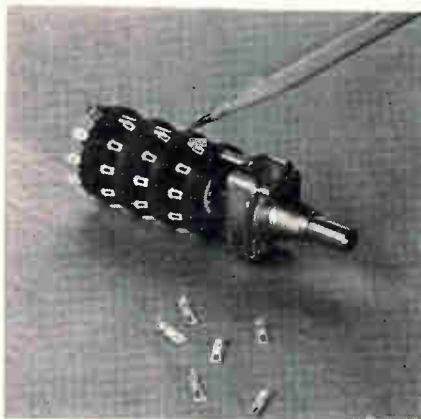

A rotary switch only 1 inch in diameter has an exclusive indexing mechanism and molded, high strength plastic stators. The manufacturer claims it has 20% greater switching capacity than existing switches of this size.

The rugged indexing mechanism, called Unidex, consists of a cast housing made of zinc alloy and fitted with simple parts for high reliability. Operational life is said to surpass other indexing systems by many thousands of operations and torque is constant for the full switch life.

Molded stators of diallyl phthalate per MIL-M-14 provide improved dielectric performance even though the maximum number of contacts for the new stators is greater than previous 1-in. switch stators. This is assured by molded insulation barriers between contacts, which increase the dielectric path. These barriers also securely position contacts.

The switch, known as type A, utilizes a newly designed contact, which has a smaller jaw and a larger solder eyelet than previous units. The smaller jaw permits use of 22 contacts on the 1-in. stator vs 18 on older models—a 20% increase in switching capacity with no increase in size. The new contacts have the ruggedness of contacts previously used in larger switches and the larger solder eyelet permits easier wiring. Type A switches meet the requirements of MIL-S-3786. They are available in

almost unlimited configurations. Detent angles of 30, 36, 45, 60 and 90 degrees are possible. Switches with just one section or with more than 12 sections can be supplied. Switching capacity per section is determined by the detent angle and the number of poles.

Contacts are rated up to 1 amp at 28 v d-c (resistive load) or 0.5 amp at 110 v a-c. Other contact types for higher ratings or inductive circuits are available. Torque range is from 8 in.-oz to 30 in.-oz.

Commercial versions of the type A switch have a temperature range of -25° to 85°C ; military versions from -65° to 85°C . Special units are available for up to 125°C temperatures.

Oak Manufacturing Co., a division of Oak Electro/Netics Corp., Crystal Lake, Ill. [351]

Circular pot offers low torque



A low torque circular potentiometer may be used as a sensing element in precision instrumentation systems. The CP39 has applications as a pickoff device for oceanographic current direction sensors and magnetic compass devices. It may serve as a low torque feedback element in a miniature servo system. Other applications include use as an electrical transducer connected to pressure gages, flow meters, scales and so forth.

An all-metal case construction and miniature ball-bearing-mounted shaft make the unit rugged and reliable. The standard CP39 has a 10,000-ohm resistance element with mechanical rotation continuous and 355° minimum elec-

trical travel. Starting and running torque is less than 1.0 gram cm. The unit may be operated immersed in silicone fluid.

The theoretical resolution is 0.20° and independent linearity is ±0.5%. The unit will operate in a temperature range of -65° to +185 F.

Humphrey, Inc., 2805 Canon St., San Diego, Calif., 92106. [352]

Trimming pots feature small size

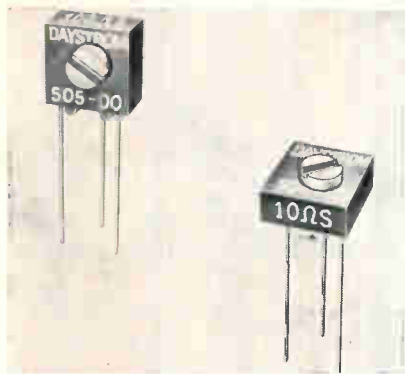

Two trimming potentiometers are only 0.02 cu in. in volume. The Squaretrim pots, designed for commercial or industrial use, feature the same wire-in-the-groove resistance element as the company's line of military pots.

Measuring $\frac{5}{16}$ in. square x $\frac{3}{16}$ in. thick, the series 504 (horizontal mounting) and 505 (vertical mounting) pots are 1/6 the size of units with equivalent ratings. Standard resistance ranges of the single-turn pots are 10 ohms to 20,000 ohms, with higher ratings available on request. The power rating is 0.6 w at 70°C, over the entire resistance range. Their tolerance is ±5% and resolution is as low as 0.124%.

Temperature range of the 504 and 505 series is -55° to +150°C and the temperature coefficient is 70 ppm/°C maximum. The pots weigh about 0.5 gram, require 3.0 in.-oz. maximum torque and have plated A nickel leads. The wiper idles at either end and rotational life is 200 cycles.

Load life of the series is 2,000 hours maximum at rated power, continuous at 55°C. Momentary overload rating is 2.5 times the rated power for 5 seconds. Insula-

Short course on how to choose a demineralizer...

1. It's not easy.

Every plant has different pure-water needs. Your company's raw water, processes and equipment usually differ sharply from the next company's.

2. Look for a demineralizer manufacturer who can advise you with total objectivity.

Barnstead is a good choice, because we make over 100 types of demineralizers, from midgets to monsters. And if a still is called for, you'll find we make a huge line of these, too — plus a broad range of accessory equipment.

Check the chart below, to see where your demineralizer requirements might fit. Then contact Barnstead for a no-obligation recommendation.

THE PROBLEM	THE SOLUTION
Take 10 common minerals out of "average" water.	Barnstead 2-Bed Demineralizers, 50 to 2500 gph and larger.
Get extra removal power for silica, CO ₂ ; ultra-high electrical resistance; constant pH.	Barnstead Mixed-Bed Demineralizers, 30 to 3,000 gph.
Purify water with unusually heavy mineral concentrations; lengthen operating cycles; minimize per-gallon operating costs.	Barnstead 4-Bed Demineralizers, 30 to 3,000 gph.
Eliminate full shutdowns for regeneration.	Two Barnstead 2-Bed Demineralizers, in parallel.
Eliminate manual labor involved in regeneration.	Barnstead demineralizers that automatically regenerate themselves.
Reduce maintenance and equipment investment to absolute minimum.	Barnstead throw-away or regenerable Cartridge Type Demineralizers, 5 to 3,000 gph.
Pretreat water loaded with sediment, organics, coloring, odors.	Barnstead sand, carbon, organic removal filters; coagulant feeders; water softeners; stills.



Barnstead

Still and Sterilizer Co.
317 Lanesville Terrace, Boston, Mass. 02131

*FILTERING A
VARIABLE
SOURCE?*

just

**MOVE
the
PASSBAND**

*with TELONIC TUNABLE
BAND PASS FILTERS*

▪ 50 MHz to 4 GHz ▪ Pre-calibrated

Telonic has now made your bandpass requirements a matter of simple selection. These new Tunable Filters are available in over 50 standard versions, including 3 and 5-section types, a special telemetry series, and even miniature versions, all stock-delivery.



All models cover a full octave and you may select a tuning range at any frequency between 50 MHz and 4 GHz.

But the primary advantage of a Telonic Tunable Filter is evident the first time you use it. All dials are pre-calibrated at the factory; you don't have to extrapolate or interpolate values or use calibration charts; repeat settings are accurate within $\pm 1\%$.

The Standard TTF Series, the Telemetry TTF Series and the Miniature TTA Series all exhibit low insertion loss, and low VSWR in the passband. Full specifications on all series are available on request.

New Telonic Filter Design and Microwave Data Slide Rule quickly determines exact filter type to meet your requirements. Just write, wire, or call.



Telonic
ENGINEERING CO.
A Division of Telonic Industries Inc.
480 Mermaid Street, Laguna Beach, California
Tel: (714) 494-7581 TWX: 714. 673-1120

New Componets

tion resistance is 1,000 megohms minimum at 500 v d-c and dielectric strength is 1,000 v rms for one minute. The equivalent noise resistance is 100 ohms per MIL-R-27208. Weston Instruments, Inc., Archbald, Pa. [353]

Compact program board for matrix switching

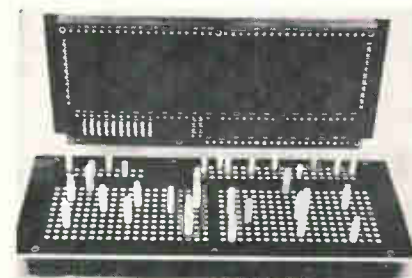

A mixed-level matrix program board has been developed to meet a need for a variety of matrix switching all in one board. The unit shown contains: two patch areas with three-deck bussed contacts; one area with a two-deck bussed contact matrix; the fourth area with a two-level matrix having bussed contacts in deck one and isolated contacts in deck two. This mixed-level program board is $\frac{3}{4}$ in. thick, and eliminates the necessity for three separate units.

The manufacturer can also provide mixed-level switching in any combination of two through six decks in a single package. The design includes a 0.250 grid for compactness with phenolic block construction for toughness. Contacts may be provided with gold or silver plating, and panels may be supplied blank, silk-screened or engraved per customer's specification.

Prices depend on the specification required. Typical delivery time for mixed matrix units is four weeks after receipt of order.

Co-Ord Switch, 102-48 43rd Ave., Corona, N. Y. [354]

Universal connector for plug-in IC's

A microelectronic connector allows the interconnection of all popular



PLASTICOTE[®] WIRE & CABLE by CHESTER

CHESTER CABLE CORP.

A Subsidiary of Tennessee Corporation

CHESTER, NEW YORK

(See reverse side)

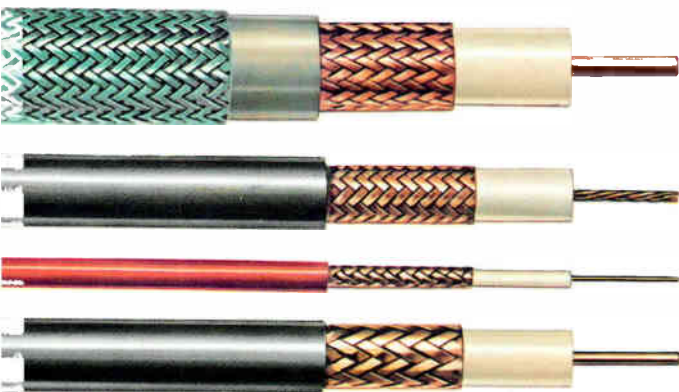

COAXIAL CABLE — Chester Cable Corp. offers a complete line of coaxial cable for military and commercial applications. Manufactured in accordance with MIL-C-17, JAN-C-17 and commercial specifications. Constructions include solid, air-spaced and foam dielectrics with conventional braid shields or flat copper tape shields, having PVC or polyethylene jackets. Custom designed constructions of triaxial cable and high frequency-high voltage cable are also available.

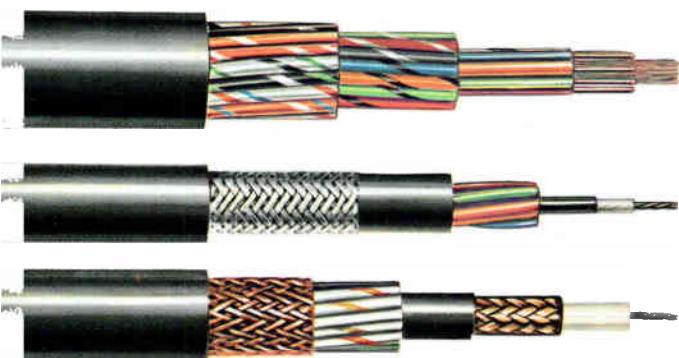

MULTI-CONDUCTOR CABLE — Wide range of custom designs available, manufactured in accordance with such industry standards as MIL specs., U/L, CSA, IPCEA, EIA, IMSA, ASTM, etc.

Chester Cable Corp. is a preferred source for quality electronic and electrical cable, insulated and jacketed with thermoplastic materials such as polyvinylchloride, polyethylene and nylon. Custom designs of shielded or unshielded cable include: Control Cable • TV Camera Cable • Missile Cable • Intercom Cable • Computer Cable • Special Hi-Voltage Cable and Parallel Bonded Ribbon Cable.



MIL-SPEC WIRE — Made in accordance with specifications MIL-W-16878 (Types B, C & D), MIL-W-76B (Types LW, MW & HW) and MIL-W-5086A for electronic systems. Available in single or multiple constructions, shielded or unshielded, with or without nylon or PVC jackets.



WIRE AND CORD FOR THE APPLIANCE INDUSTRY — U/L and CSA approved, 60°C — 80°C — 90°C — 105°C appliance wiring material — SVT, SJT, ST cord, SJTO & STO oil-resistant cord, SJT & ST oil-proof cord, SPT cord with or without individually insulated ground wire. Used for washers, dryers, refrigerating, air conditioning, vending, heating, X-ray and other electrical and electronic equipment.

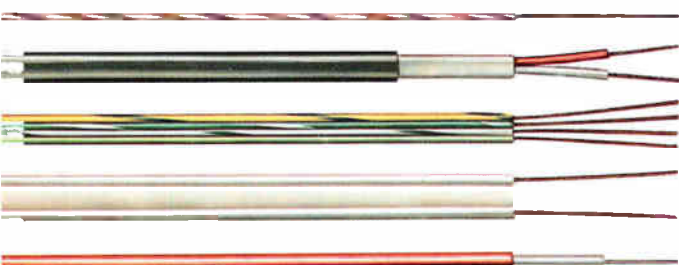

RADIO AND TV CIRCUIT WIRE AND CABLE — U/L and CSA approved, 60°C — 80°C — 90°C — 105°C appliance and radio circuit wire, microphone cable, shielded and unshielded audio circuit wire, twin lead antenna wire, phonograph cable, parallel-bonded color convergence ckt. cable, braided hook-up wire, hi-anode wire, hot chassis lead, balun-coil wire, shielded constructions with spiral, braided, aluminum-Mylar tape and conductive materials; all available in Thrif-T-Bond® tinned over-coated conductors.

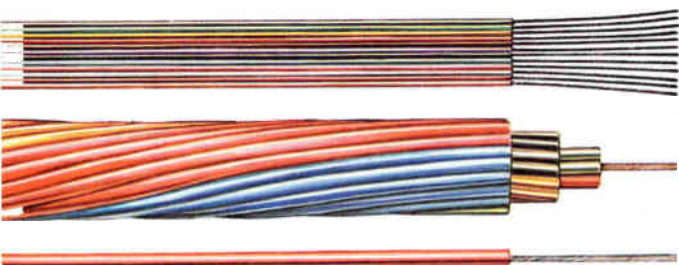

MISCELLANEOUS WIRE AND CABLE — Machine Tool Wire • Bus Drop Cable • Flexible Test Lead Wire • Municipal Signal Cable • Low Energy Circuit Control Cable • Station Control Cable • Inter-Office Communication and Signaling Cable • Deep-Well Submersible Water Pump Cable • Gas Tube Sign and Oil Burner Ignition Cable • Intercom Cable • Gasoline and Oil Resistant Wire • Computer Cable • Uninsulated Bus Wire • Parallel and Jacketed Cord • Braided Ground Strap, and special custom designed cable for your applications.



Write or phone for further information.

CHESTER CABLE CORP., A Subsidiary of Tennessee Corporation, CHESTER, NEW YORK 10918

Phone: 914 - 469-2141 • TWX: 914 - 469-7011

Printed in U.S.A.

New Components

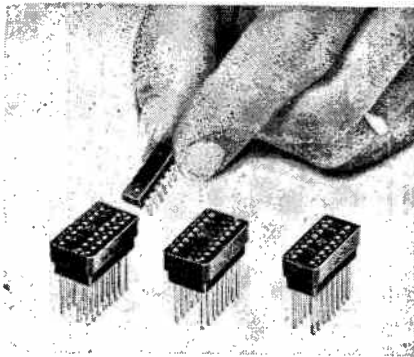

in-line or plug-in flatpack types of integrated circuits with flat or round leads. Called the universal Pin Pack connector, the device permits plug-in and operation of up to 16-position integrated circuit devices for purposes of testing, prototype design and production packaging.

The connector is available with 0.025-in. square wire-wrap terminals or solder tails. Various models are available for 14-lead devices, 16-lead devices, 0.100- by 0.200-in. spacing, 0.100 x 0.300-in. spacing or any combination.

Other features include a Polysulfone body for 150°C operation, choice of press-fit or screw-down mounting, removable contacts, and indexing guide and molded-in numbering of all positions. The connector is rated for multiple insertions. Metals & Controls Inc., a division of Texas Instruments Incorporated, 34 Forest St., Attleboro, Mass., 02703 [355]

Crystal oscillator mounts on p-c cards

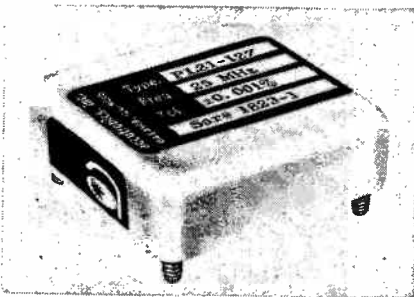

The PL series crystal oscillator provides accurate frequency stabilities within the temperature range of 0° to 60°C. Typical frequency toler-

TRG's new 104A laser system

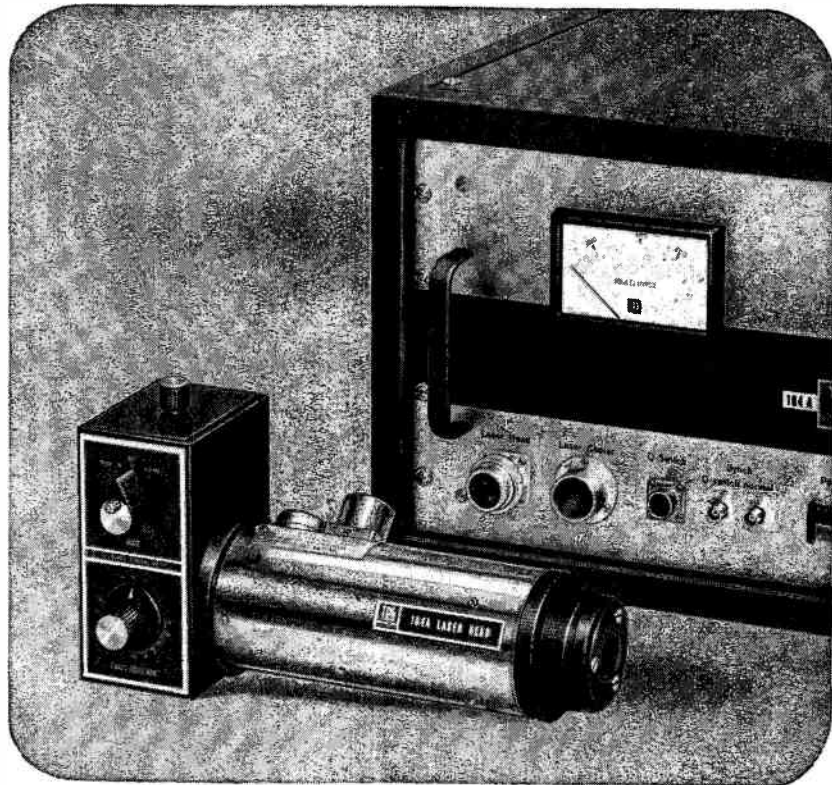

Rugged • Reliable • Versatile • Economical

TRG's new 104A laser system has been designed specifically to meet the needs of the scientific researcher and the industrial laser technologist. A medium-power, economical laser system that is capable of operation under a wide range of conditions — including those outside a laboratory environment — the TRG 104A can be used for many applications, such as: Atmospheric Studies; Ballistic Research; Chemical Research; High-speed Photography; Medical and Biological Research; Optical Ranging; Vacuum Evaporation of Thin Films; Microwelding.

Special Features

- Maintenance-free operation in excess of 25,000 cycles
- Flashlamp replacement does not require realignment of optics
- Simple function switch permits rapid selection of either normal pulse or Q-switched operation
- Optical alignment is maintained under normal operating conditions of shock and vibration

Accessories

- 104A-4 — Second Harmonic Generator
- 104A-5 — Liquid Q-switch
- 109A — Daly-Sims Single-Pulse Accessory
- 109-4A — Baseplate for mounting laser, Q-switch, and 109A accessory.

Specifications

	Output
Normal mode3 to 5 joules
Q-switched mode1 to 1.5 joules
Wavelength6943A
Minimum Recycle Time	...15 seconds

For more complete information write: TRG Inc., Section , Route 110, Melville (Long Island), New York 11746, Tel. (516) 531-6343.



TRG / A SUBSIDIARY OF CONTROL DATA CORPORATION

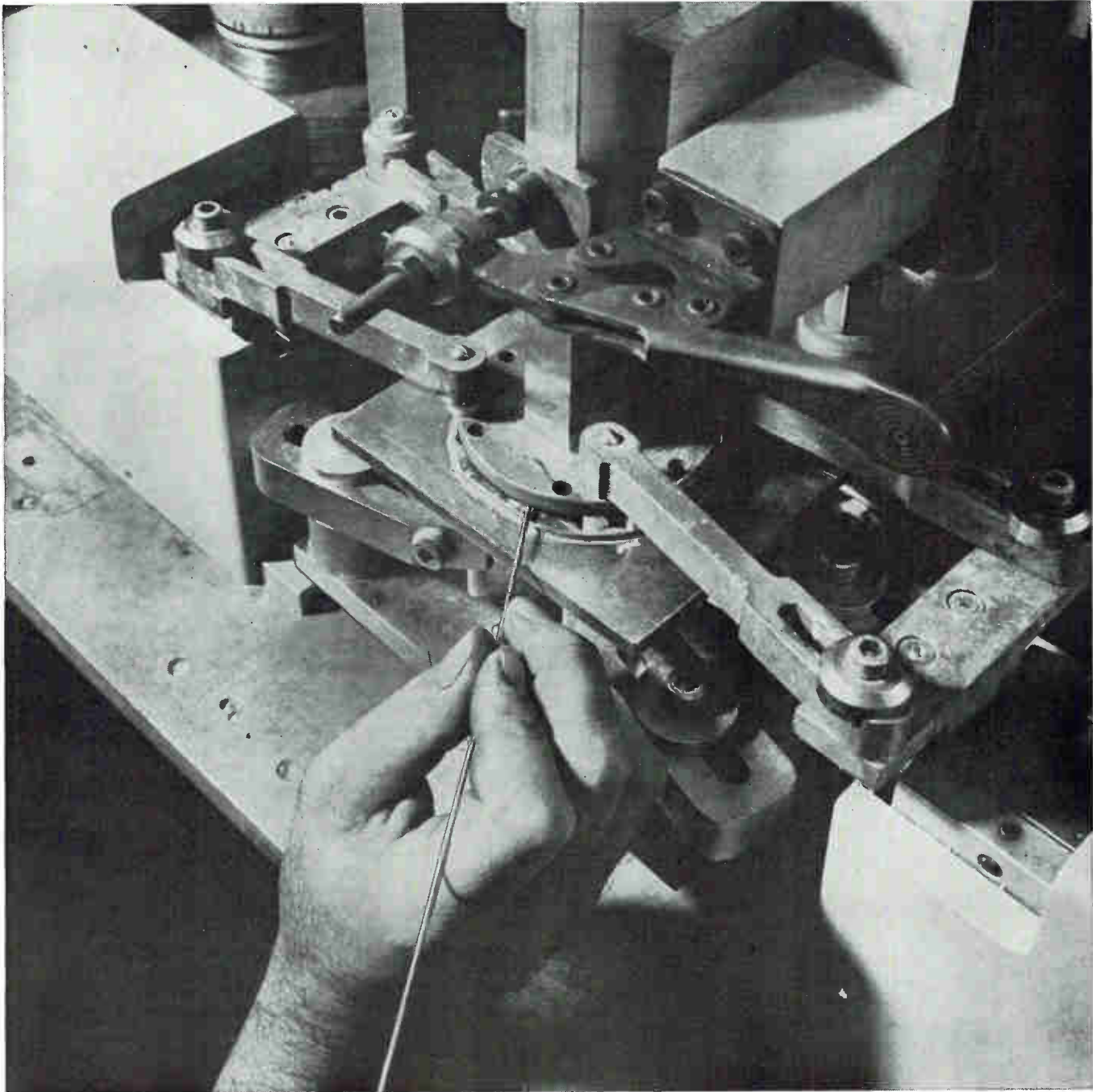

ENGELHARD Silvaloy 355 accomplishes void-free joint brazing in Hewlett-Packard waveguide tubing

Ordinarily, the standard 85% filling/15% void ratio is quite acceptable in joint brazing . . . even in critical aircraft applications.

But the Hewlett-Packard Company, Palo Alto, California, had something much more critical in mind when they approached Engelhard engineers. The task: to provide after machining a *completely void-free* joint on flange microwave tubing. The reason: any voids on the brazing of the completed joint would trap plating solutions . . . and these solutions would eventually corrode and ruin the waveguide.

For the answer, Hewlett-Packard brought the problem to Engelhard, one of the world's foremost specialists in the application of precious metals and brazing technology. Recommended was a system which employed Engelhard Silvaloy 355 silver brazing alloy and #1100 flux. As a result, the joints of Hewlett-Packard's waveguide tubing are now completely void-free . . . safe from the danger of corrosion.

For complete details on Silvaloy 355 and #1100 flux for a wide variety of brazing applications, write to the Technical Service Department today.

147A

Some other

ENGELHARD products

PLATINIZED TITANIUM ELECTRODES

Recent developments in platinized titanium electrodes allow optimization of configurations and coating types affecting many new applications in chemicals production and electroplating fields.

PRECIOUS METAL CONTACTS

in pure or alloyed forms of silver, platinum, palladium and gold provide unmatched resistance to atmospheric corrosion and electrical pitting. Engelhard will manufacture to specification or provide material in wire, rod or sheet form.

RHODIUM PLATING of electrical and electronic parts offers outstanding protection against surface corrosion, reduces noise level of moving parts, and improves efficiency wherever a low-resistance, long-wearing, oxide-free component is required.

TIN WIRE AND FOIL are produced by Engelhard's Baker Platinum Division to meet rigid electronic design requirements. Both extruded and Taylor Process tin wire are available in diameters as small as .001". Thin-gauge foil is supplied in sheets up to 8" x 18".

SEMICONDUCTOR MATERIALS are supplied in a wide range of precious and base metals and their alloys. These include solid sheet, wire, tape, base tab materials and clad products. New materials are constantly under development. Technical assistance is available.

LAMINATED CONTACT MATERIALS are produced in virtually any combination of precious metals and alloys with base metals and alloys. Types include edge, strip, inlay, spot, single or double-face laminations. Supplied in flat lengths, in strip, coil or fabricated forms.



New Components

ances of $\pm 0.001\%$ can be met within the frequency range of 5 Mhz to 100 Mhz.

Available supply voltages of 5 v d-c to 28 v make the unit ideal as a frequency source for integrated circuitry. Typical output voltages are greater than 3 v peak-to-peak square wave with less than 20 nsec rise time and greater than 2 v rms sine wave with less than 10% distortion into a 1,000-ohm load are typical. Various other output and supply voltages are available.

Physical dimensions of the PL series are $2 \times 2 \times \frac{3}{8}$ in. with four No. 6-32 mounting studs. Solder-type pins are used to provide adequate printed-circuit card mounting. Price range is \$71.50 to \$169.75. Accutronics, Inc., 12 S. Island Ave., Batavia, Ill. [356]

Silicon resistors with axial leads

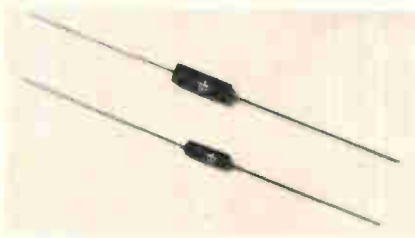

A line of silicon resistors is available in $\frac{1}{8}$ and $\frac{1}{4}$ watt packages. These Durapak encapsulated resistors range in value from 10 ohms to 2,200 ohms and offer a positive temperature coefficient of $+0.7\%/^{\circ}\text{C}$.

Units are available in two series, both having standard tolerances of 20%, 10% and 5%, and are supplied with axial leads of No. 22 Awg nickel-clad copper. Series $\frac{1}{8}\text{S10D}$ through $\frac{1}{8}\text{S2.2KD5}$ has body dimensions of 0.140 in. diameter by 0.406 in. length. Series $\frac{1}{4}\text{S10D}$ through $\frac{1}{4}\text{S2.2KD5}$ has body dimensions of 0.200 in. diameter by 0.585 in. length.

As temperature compensating elements, silicon resistors function to stabilize a given circuit parameter in a variety of electronic circuits. Typical stabilizing applications include: gain in amplifiers,

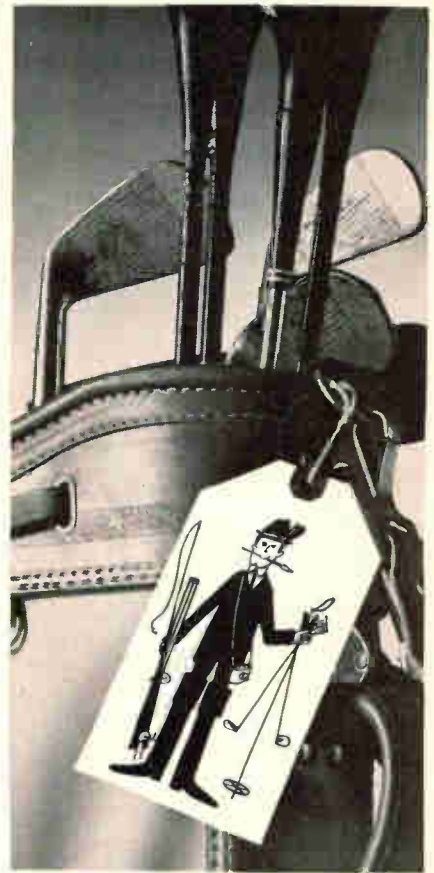

livability

(an industrial location advantage)

WESTERN PENNSYLVANIA There's pleasant living for you and your employees when you locate your plant in prosperous WESTERN PENNSYLVANIA. Ski on nearby slopes . . . fish for wary trout and bass . . . hunt big and small game . . . water-ski . . . golf . . . listen to music by a top symphony orchestra . . . go to art festivals, operas, big-league ball games and straw hat theaters . . . or visit reminders of an historic past. Large and small industrial sites are available, many on rivers and streams. There's room to spread out . . . to live and grow. This four-season livability . . . plus 100% financing at low, low interest rates . . . fair tax climate . . . pre-production training of a work force, usually at no cost to you . . . gives WESTERN PENNSYLVANIA a top combination of plant-location values.

West Penn Power

Part of the Allegheny Power System 

Area Development Department, Room 664
WEST PENN POWER—Greensburg, Pa. 15601
Phone: 412-837-3000

In strict confidence, I'd like to know more about WESTERN PENNSYLVANIA'S: Four-Season Livability Fair Tax Climate Financing Plans Pre-Production Training Please have your Plant Location Specialist call.

Name _____
Title _____
Company _____
Address _____
City _____ State _____
Zip Code _____ Phone _____

New Components

sensitivity in transducers, frequency in oscillators and pulse width in pulse generators.

These silicon resistors have been designed to operate under military test conditions of temperature cycling, barometric pressure, moisture resistance, vibration, shock, and dielectric strength. The Durapak encapsulant has previously been used in the manufacture of high-voltage rectifiers and has more than 100,000 hours of life-test data behind it.

Dickson Electronics Corp., 310 South Wells Fargo Ave., Scottsdale, Ariz., 85252. [357]

Plug/jack patch cord with molded insulation

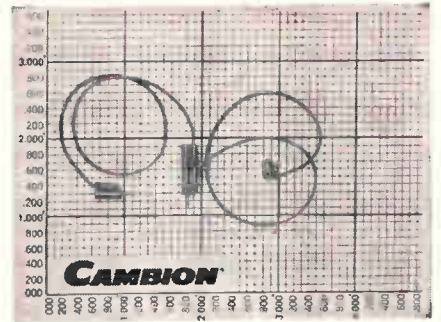

The Cambion 3705 plug/jack patch cord is available with molded plastic insulation. The finger-size unit's versatility and flexibility permit multiple patching and component economy. Digital logic can easily be optimized with the aid of these miniature patch cords.

Ruggedness of the molded insulation jacket insures long life even with rough handling. A high dielectric material, molded ABS (acrylonitrile - butadiene - styrene) plastic insulation provides high electrical stability, greater physical strength and resistance to moisture and most common acids.

The configuration of this rugged patch cord permits self-stacking for multiple connections at a single point. The 3705 is made in the popular international 1-mm (0.040 in.) size, providing unlimited applications for prototype and production.

The combination patch cord is

Quik/Sert SOCKETS

from BARNES...

THE MOST ADVANCED LINE OF SOCKETS FOR SEMICONDUCTOR AND OTHER MINIATURE DEVICES

- for production, test, aging, and breadboarding applications
- for flat pack and multi-lead TO-5 packaged I.C. s, transistors, relays and other miniature components
- for mounting on P.C. boards, chassis, breadboards, or use with mating base connectors
- for hard wiring, dip soldering, wire wrap, welding, tab or pin base mounting, compression fitting, or saddle mounting
- flat pack carriers and contactors, flip-top sockets for flat packs, module test connectors, and breadboard test connectors

Choose from over 3,000 standard sizes, configurations and materials. And Barnes can quickly produce custom sockets to meet any requirement. Call or write for complete technical data.

barnes
DEVELOPMENT COMPANY

LANSLOWNE PA 19050 ■ (215) MA 2-1525

**Leadership is
no accident!**



**in sports
or in
industry**



**KNOW-HOW
is one of the
reasons for ALPHA'S
LEADERSHIP**

Alpha Soldering Technology Seminars are held regularly at leading technical schools all over the country. They provide design and production engineers with an increased understanding of soldering in the space age. These 2-day sessions, with slides, films, and other visual aids, are conducted by recognized soldering authorities. To supplement this program, Alpha's Field Engineers and Customer Service Personnel continually conduct in-plant round table discussions directed at satisfying specific needs — solving soldering problems, recommending special soldering chemicals, suggesting preform applications and discussing unique semi-conductor materials. Additional reasons for Alpha's leadership include prompt, reliable service; an outstanding Research and Development Department geared to problem solving; unequalled know-how and experience in the development and production of solders, soldering chemicals, preforms and ultra-high purity metal fabrications for the semi-conductor industry; and the most complete quality product line available anywhere.

BULLETIN A103 TELLS THE ALPHA STORY.
WRITE FOR YOUR FREE COPY TODAY.

alpha **alpha metals, inc.**

56 WATER STREET, JERSEY CITY, N. J. 07304 201-434-6778

Los Angeles, Calif. • Alphaloy Corp. (Div.), Chicago, Ill.
Alpha Metals, Inc. (U.K.) Ltd., Hounslow, Middlesex, Eng.

**Designed
for
Advanced
Data Systems...**

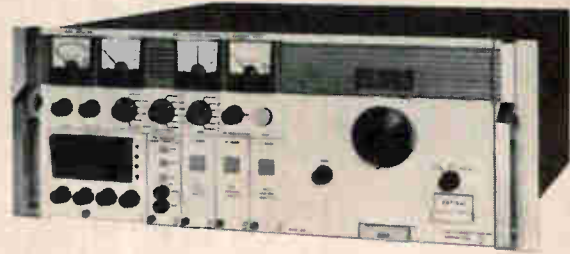

The **DCS** Series 400
TELCOM Receiver

Look at these features...

- All solid state design
- Superior performance
- Completely modular, plug-in construction
- RF heads for VHF and S-Band telemetry, sweep tuned and wide band heads for surveillance applications
- Plug-in pre-detection recording converter, spectrum display, electrically switchable IF Filters

Interested? Get the detailed specifications. Write for your free copy of the DCS Series 400 TELCOM Receiver brochure.

Would you like an appointment to see a TELCOM Receiver for yourself? Just call the DCS office below nearest you . . .

Dept. E10-66, East Liberty Street, Danbury, Conn. 06813
Telephone: 203-743-9241 • TWX 744-1990



DATA-CONTROL SYSTEMS INC.
Instrumentation for Research

Sales Offices
Silver Spring, Md., Huntsville, Winter Park, Long Beach, Santa Clara,
Albuquerque

Copenhagen London Rome Paris Munich Amsterdam

Leading cable makers
coast-to-coast demand

tough



If **Scotchpar**[®] polyester
film is tough enough
for cable...
how about your needs?

From Anaconda Wire & Cable Co. in New York, to Western Insulated Wire Company in Los Angeles, cable makers across the country pick tough "SCOTCHPAR" polyester film. It serves as a barrier, separator, insulator and manufacturing aid. Think how well "SCOTCHPAR" film could serve your needs. It combines outstanding dielectric properties with physical strength and resistance to moisture and solvents. It stays stable over a wide range of temperatures. It won't get brittle with age. Resistant to oils, impregnants, varnish, refrigerants. It's inert to fungus. Won't corrode copper. There is a thickness and type of "SCOTCHPAR" film to meet your exact requirements. Call or write:
Film & Allied Products Division, 3M Co., 2501 Hudson Rd., St. Paul, Minn. 55119, Dept. ICL-106.

3M
COMPANY

New Components

available from stock and is priced at 53 to 56 cents each in quantities of 500 to 999.

Cambridge Thermionic Corp., 445 Concord Ave., Cambridge, Mass., 02138. [358]

Miniature trimmers use foil dielectric



A series of miniature foil-dielectric trimmers, the C010, is available in four capacitance values—5, 10, 20 and 60 pf—and has a maximum permissible working voltage of 50 v d-c.

The trimmers combine compact size and light weight with high stability and adjustment accuracy. Considering their design and dimension and the fact that they can be operated at frequencies higher than 100 Mhz, the units find wide application in mobile communications, citizens' band, portable radios, car radios and miniaturized industrial equipment. Their low operating torque (less than 150 gcm) and full 360° rotation angle make possible the extremely accurate trimming required.

The trimmer dielectric consists of thin, specially treated, polyethylene foils, which have a high isolation resistance even under humid conditions. Both the foils and vanes are closely stacked on a sturdy plastic base whose structure is highly resistant to vibration. Thus, once the trimmer has been adjusted, no change in capacitance will occur.

Amperex Electronic Corp., Hicksville, L.I., N.Y., 11802. [359]



telephone quality handsets

There is no higher standard for handsets. Specify famous Stromberg-Carlson . . . known to telephony since 1894.

Both models shown incorporate push-to-talk switches and high-gain receivers and transmitters.

No. 33 lightweight handset is furnished with a rocker bar switch.

No. 35 comes with a button switch, or with both the button and rocker bar switches.

Write for complete technical data.

Stromberg-Carlson

114 Carlson Road • Rochester, N. Y. 14603

Circle 290 on reader service card

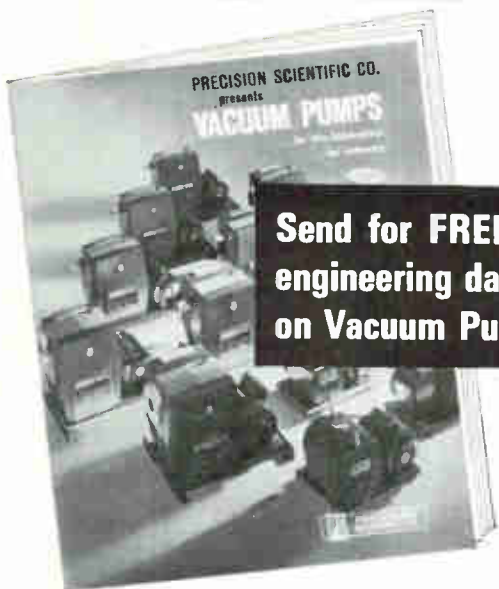

Send for **FREE**
engineering data
on Vacuum Pumps

Precision High Vacuum Pumps are job-rated

From this newest, most complete line of internal vane mechanical vacuum pumps you can select a model with guaranteed performance matched to your requirements. For lab use, for roughing or backing a system, or for integral use in your product—take your choice of both single and two stage models in capacities from 25 to 1500 liters/minute (free air) at prices from \$100 to \$1500. Guaranteed ultimate vacuum runs to 0.1 micron of mercury. And these pumps are quieter, smaller and more efficient than any on the market today. Consult your Precision Scientific distributor, or send for 24-page Bulletin 650.

PS PRECISION
SCIENTIFIC CO.

3737 W. Cortland St., Chicago, Ill. 60647
Local Offices: New York • Chicago • Los Angeles

Circle 289 on reader service card

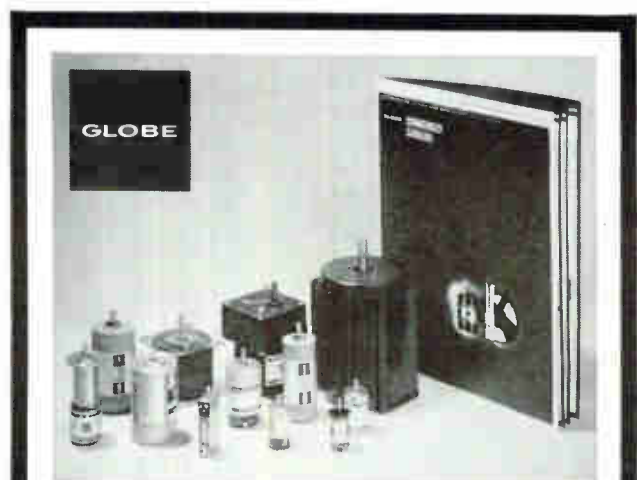

SIMPLIFY DESIGN WITH COMPACT MOTORS

Globe, the largest manufacturer of compact motors, is headquarters for a.c. and d.c. motors and gearmotors from 1/1000 to 1/5 hp. With Globe commercial and military motors you can cut size and weight, increase performance and reliability, and save money, too. Globe also produces an extensive line of blowers and fans and custom-built motorized devices.

For complete information on the entire Globe line, request Catalog C. Globe Industries, Inc., 2275 Stanley Ave., Dayton, Ohio 45404, Tel. 513 222-3741

Circle 205 on reader service card 205

Q

how can you compress
more magnetic action
into a given space?

A

start with Pfizer's new
soft magnetic iron oxides!

You'll find several significant advances in magnetic particle research, engineered into Pfizer's new IRN[®] magnetic iron oxides.

- Pfizer has succeeded in producing free-flowing magnetic iron oxides with a smooth texture—free of undesirable hard aggregates. These surface treated oxides are available in commercial quantities.
- Because these new IRN oxides are high in apparent density, it is possible to pack more magnetic action into a given volume. This permits production of thin coatings with the needed sensitivity for audio, high bit density computer, wide band instrumentation and video tape applications.
- IRN magnetic iron oxides provide exceptional magnetic and physical uniformity.

Pfizer—leader in magnetic particle technology—has a continuing program of research into all phases of this growing field. If you have any specific problems that demand new oxide answers, we'll be glad to put our staff to work on them.

For details write Pfizer.

Pioneering in Physical Chemicals

**MINERALS
PIGMENTS
& METALS**
DIVISION CHAS. PFIZER & CO. INC.

Pfizer

Dept. 75, 235 East 42nd Street
New York, N. Y. 10017

New Semiconductors

IC's wedge bottom means better fit

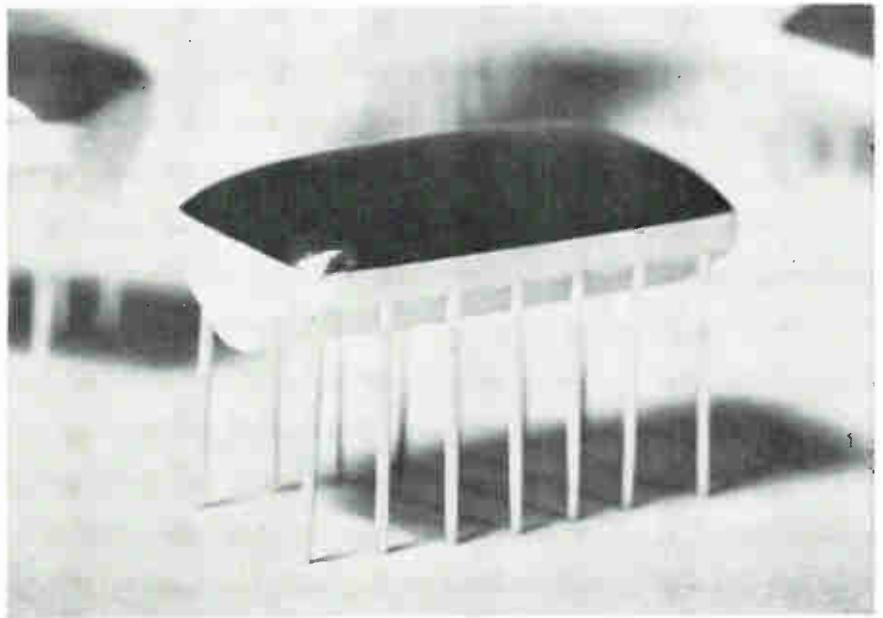

Wedge bottoms are the newest shape in dual in-line integrated circuit packages. The wedge acts as a built-in standoff for the package leads, keeping them clear of a printed circuit board during soldering.

Inside the epoxy package is the Philco Corp.'s new line of diode-transistor logic (DTL) circuits, which are packaged and tested at a new plant in Taiwan. Philco's Microelectronics division says that prices per gate function of the line are among the lowest offered. In quantities of 100 to 999 circuits, prices range from \$1.40 for a dual four-input expander to \$2.80 for a JK flip-flop.

Called the E-Line, the circuit family includes the standard 930 series of gates, buffers, line drivers and expanders. Typical toggle rate for the JK flip-flops is 25 megahertz. Fan-out and noise immunity levels are equivalent to those of circuits in hermetically sealed packages at temperatures of 0° to 75°C, according to Philco.

The packages have round Kovar leads, with the standard dual in-line spacings—100 mils between lead centers and 300 mils between lead ranks. The shape of the package makes it adaptable to automatic insertion into circuit boards

and the materials are immune to cleaning solvents, the company says.

Philco Corp., Microelectronics division, 2920 San Ysidro Way, Santa Clara, Calif. [361]

Operational amplifier features high gain

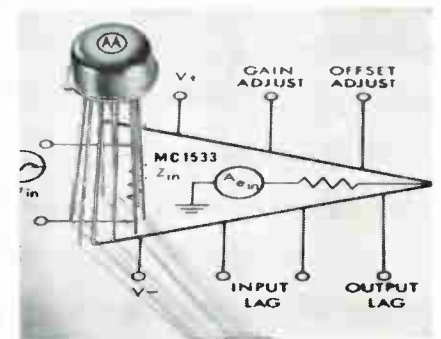

High gain and temperature stability are combined in an integrated circuit operational amplifier whose offset voltage and closed-loop gain are adjustable.

The amplifier, model MC15336, has a minimum open-loop voltage gain of 40,000; the typical figure is 60,000. The maximum input offset voltage at 25°C is 5 millivolts. The offset voltage shows relatively little change with temperature. With an

Solder 14 Flatpack Leads In 2 Seconds!

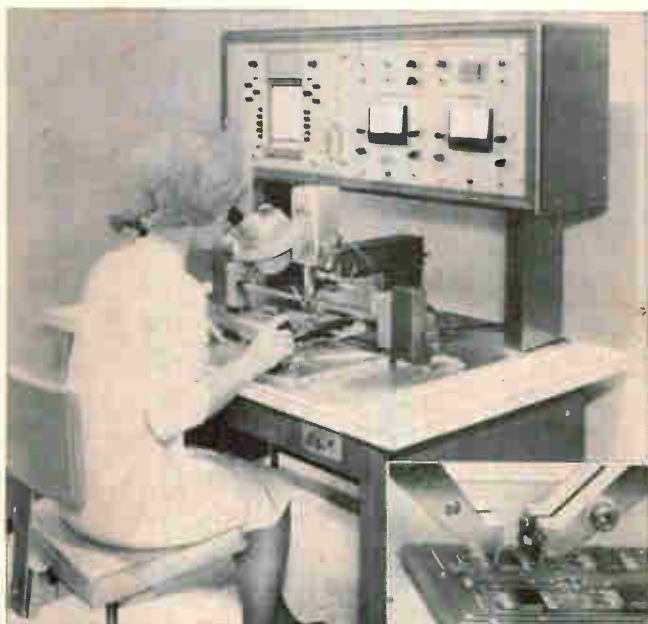

Weltek's new semi-automatic MODEL 900 solders all 14 leads of a flatpack to a p.c. board in just 2 seconds. A proven product, capable of full automation. Send for details.

Weltek

MICROJOINING MACHINES
by **WELLS ELECTRONICS, INC.**

1701 S. Main Street, South Bend, Indiana, U.S.A.

Circle 291 on reader service card

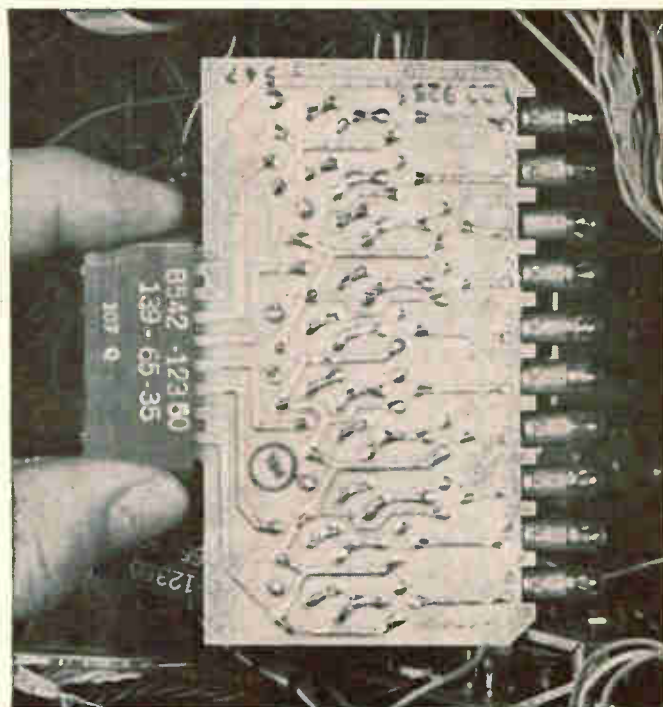

EAI[®]

Where Tung-Sol Tu-Pin Subminiature Lamps help hold down Computer Assembly costs

Electronic Associates, Inc., Long Branch, New Jersey, manufacturer of analog, hybrid and digital computers, is a major user of Tung-Sol Tu-Pin molded base lamps. EAI has found that ease of assembly and the negligible reject rate with Tung-Sol lamps contribute substantially to production economy.

Designed especially for computer applications, these self-mounted lamps provide transistor-like installation convenience. Tu-Pin lamps have a molded nylon encapsulation instead of a cemented-on base. No mounting socket is needed. Lamps are soldered directly into the circuit board. Assembly may be done with automated equipment.

Molding provides almost unlimited latitude for base configurations. Bases may be color-coded for accurate identification.

More information about Tu-Pin lamps and other molded base subminiature types will be supplied on request.

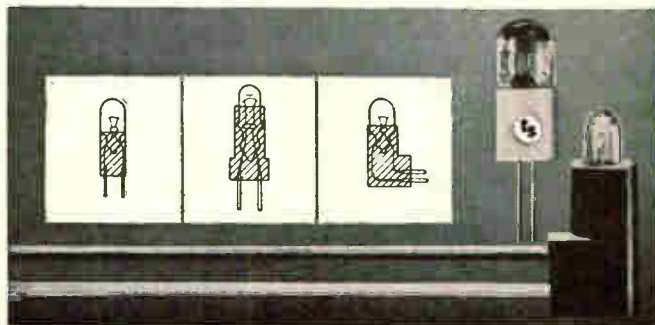

Molding permits extreme flexibility of base configuration.

TUNG-SOL[®] MOLDED BASE
SUBMINIATURE LAMPS

Tung-Sol Electric Inc., Newark, N. J. 07104

FREE
NEW 1967
ALLIED
INDUSTRIAL
ELECTRONICS
CATALOG

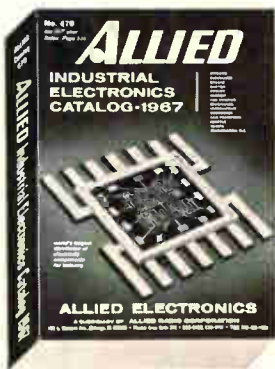

552 Value-Packed Pages

Here's the standard of the industry from Allied, the world's largest distributor of electronic components and equipment. 552 pages. 64,000 items, scores of new products. Factory OEM prices. Same-day shipment. Get your personal copy now.

ALLIED—WORLD'S LARGEST DISTRIBUTORS
OF FAMOUS QUALITY BRANDS, FEATURES

P&B
RELAYS

WIDEST SELECTION • SAME-DAY SHIPMENT

See your Allied Catalog for Potter & Brumfield Relays: General Purpose, Special Purpose, Power, High Performance, Mercury Wetted Contact, Telephone types—all in stock at Allied.

For FREE catalog, check reader service card or write direct to:

ALLIED ELECTRONICS

Our 46th Year

Subsidiary of ALLIED RADIO CORPORATION
100 N. Western Ave., Dept. 82-K, Chicago, Ill. 60680

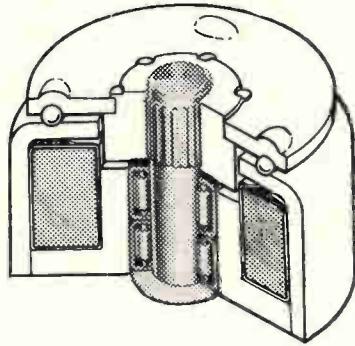

100 MILLION ACTUATIONS

This is a Ledex Endurance Engineered rotary solenoid.

Life expectancy without any field relubrication is 50 million cycles—100 million when you apply our Lube 2 every 10 million cycles.

A precision needle bearing, plus special materials, heat treatments and surface finishes make the difference.

Six sizes are available, with torque output from 12 to 445 ounce-inches.

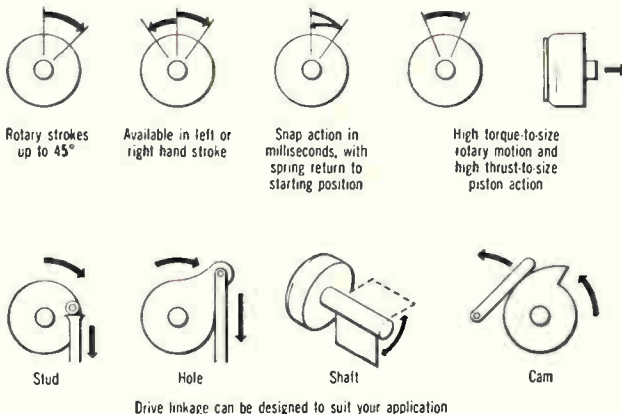

Drive linkage can be designed to suit your application

Ledex rotary solenoids are used to step, turn, pull, push, index, hammer, punch or trigger—wherever there's a need for fast, remote action.

Have an actuating problem? Longlife requirements? We'll design a solution for you. Write or phone 513-224-9891. Let's talk it over.



32-page catalog describes endurance engineered, standard and stock model rotary solenoids. Ask for C-264.



LEDEX INC., 123 WEBSTER STREET, DAYTON, OHIO 45402
Designers & Manufacturers Electronic & Electro-Mechanical Components
& Remote Control Switching Systems

New Semiconductors

external resistor, the offset voltage can be adjusted to zero.

Input offset voltage temperature coefficient from 25° to 125°C is typically 3 $\mu\text{V}/^\circ\text{C}$ and from -55 to +25°C is typically 5 $\mu\text{V}/^\circ\text{C}$. Input impedance is 500 kilohms minimum, 1 megohm, typical. Output voltage swing is ± 12 volts minimum, with ± 15 volt power supply and 10-kilohm load resistance. Typical common-mode rejection ratio is 100 decibels.

The 14-transistor device is constructed on a monolithic silicon substrate and is packaged in a TO-5 can. It can be used as a summing amplifier, an integrator or a high-gain amplifier with operating characteristics determined by external feedback components.

The amplifiers sell for \$34 each for lots of 100 or more and delivery is immediate.

Motorola, Inc., Semiconductor Products division, Box 955, Phoenix, Ariz. 85001 [362]

Thermistor packaged in hard glass

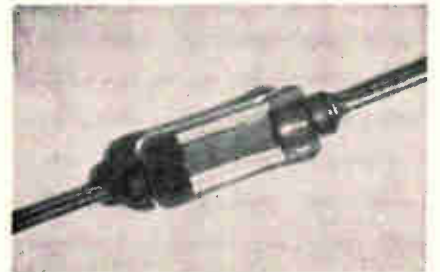

A solid-state, positive-temperature-coefficient thermistor is announced. The silicon 1/8-watt Sensistor is packaged in hermetically sealed, hard glass. Designated TG1/8, it is suited for temperature-sensing and temperature-compensating applications in electronics circuitry, such as transistor-bias control.

Previously, Sensistors were available in axial molded packages and in TO-5 cans. The TG1/8 package is a hard-glass (borosilicate) sleeve sealed on each end to molybdenum plugs. The resulting hermetically sealed package is only one-third the volume of the molded package, making it especially useful for mi-

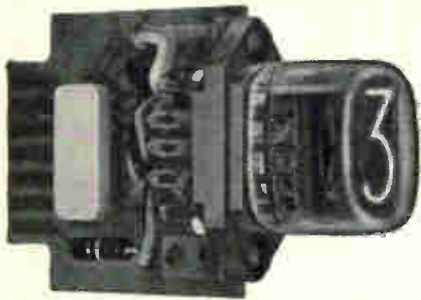

NATIONAL[®] Readout Tube Drivers

TTL Integrated Circuit Drivers
designed for National Readout Tubes.

Now available: Decoder/Driver
and Decimal Counter/Driver.

- 15 MHz Counting Rate
- Compatible with all side view
and end view readout tubes.

NATIONAL REQUEST
BULLETIN

ELECTRONICS, INC.
a varian subsidiary

PHONE: (312) 232-4300 • GENEVA, ILLINOIS, U.S.A.

Circle 293 on reader service card

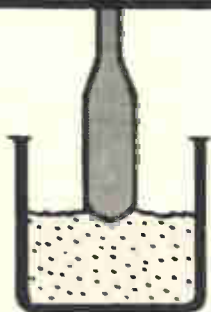

GROWING PAINS

Great care is taken . . . and a newly developed growing technique is used . . . to produce the high quality Czochralski crystals offered by Meller. These CZ sapphires are characterized by their high purity and low dislocation density.

The resultant combination of physical and chemical properties of the material is of particular value in substrate applications.

Meller offers as stock items CZ sapphire substrates, x-ray oriented [(1012) and (0001)], with diameters of 1/2", 3/4", or 1", and a thickness of .020". Substrates with other orientations, diameters, and thicknesses can be custom fabricated.

For a painless way of finding out how this new material can be of use in your work, contact



ADOLF MELLER CO.
P.O. Box 6001
Providence, R.I. 02904
Tel: 401-331-3717

Circle 294 on reader service card

this will explode all your old ideas about programming devices..

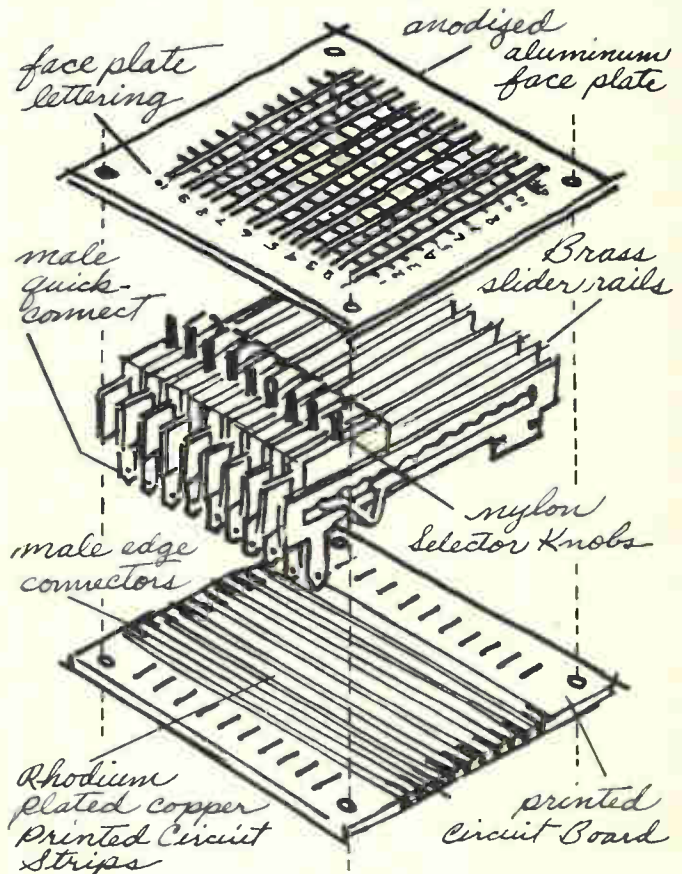

NEW CHERRY SELECTOR SWITCH CONNECTS ANY ONE OF 48 INPUT CIRCUITS TO ANY ONE OF 58 OUTPUT CIRCUITS—to program practically any device. And it does it *without* costly time-consuming soldering or slow, involved assembly work—and with complete visual clarity.

Like to learn more about this unusual programmer?

Write today for full details on the Cherry Selector Switch.

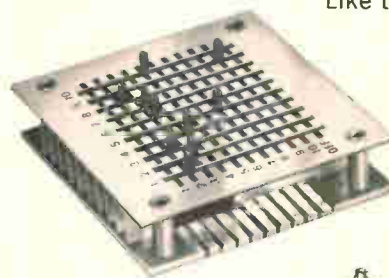

C10-20A

CHERRY 
**ELECTRICAL
PRODUCTS CORP.**

1656 Old Deerfield Road • Highland Park, Ill. 60035

Circle 209 on reader service card

209



WOOD ELECTRIC

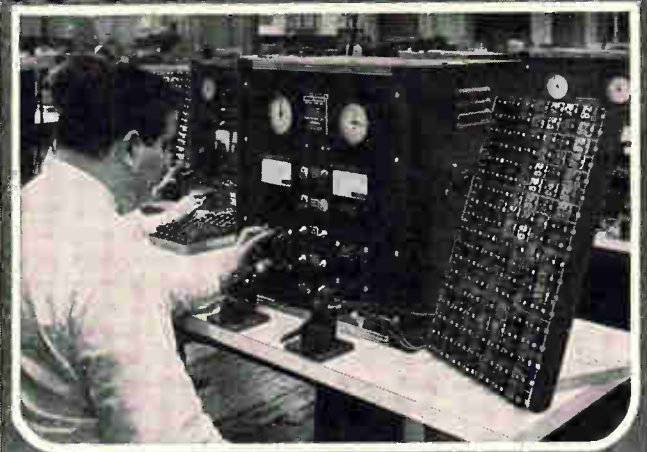
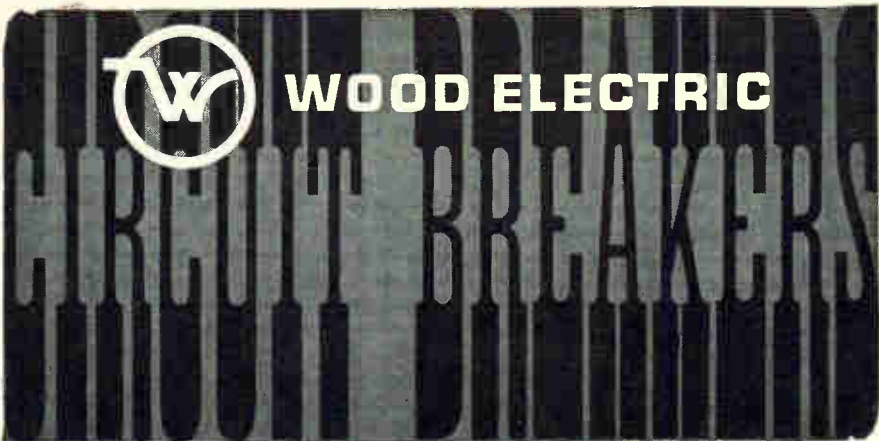

When the specs say . . .
"Must trip between
15 and 55 seconds"

You can depend on us!

The above photograph shows a Thermal Circuit Breaker Calibration Test. All units are adjusted to trip within specified trip bands and hold 100% of rated current with ultimate trip at 135% of rated current. Transfer of auxiliary contacts for remote indication is also checked during this test.

There are other specs and other tests, lots of them, but they all have one purpose in common—to assure the most reliable performance in the industry. If it's by Wood Electric—you can depend on it!

Wood Electric also manufactures a complete line of Magnetic Circuit Breakers that hold 100% of rated current indefinitely and operate at specified trip settings regardless of ambient temperatures. Choose from a wide variety of proven commercial and military type Circuit Breakers to meet the specific needs of your application. Models are available with ratings from 1/2 to 50 amps . . . AC or DC . . . single pole, two pole and three pole.

Write for Circuit Breaker Catalog CB-10-65



WOOD ELECTRIC CORPORATION

244 Broad St. Lynn, Massachusetts (617) 598-5313

New Semiconductors

chrominiature circuitry. The hard-glass packaging technique has been used for eight years on the manufacturer's line of carbon-film resistors, accumulating more than 70 million unit test hours with a failure rate of 0.002%/1,000 hours at a 60% confidence level.

The TC1/8 Sensistor features a linear resistance curve at temperatures between -55° and $+125^{\circ}\text{C}$ and has a large positive temperature coefficient of approximately $0.7\%/^{\circ}\text{C}$. It can accurately retrace its resistance-vs-temperature curve over this range within a $\pm 2\%$ tolerance. The thermistors also feature uniformity in characteristics from lot to lot, making continuing circuit recalibrations unnecessary.

This Sensistor is designed to meet or exceed electrical and mechanical requirements of MIL-T-23648A, including moisture resistance, shock, vibration and immersion. It is available in 32 ohmic values, ranging from 10 ohms to 2.7 kilohms, in both 5% and 10% tolerances.

An example price is \$2.80 for 1,000 to 4,999 units (10% tolerance, 10 ohms to 2.7 kilohms.)

Texas Instruments Incorporated, 13500 North Central Expressway, Dallas, Texas. [363]

Power transistors offer fast switching

The SDTS800 series of high-voltage, fast switching, silicon npn planar power transistors can dissipate 100 watts at 100°C case temperature. They are suitable for military, commercial, and industrial uses.

The devices, in a TO-63 package, are capable of collector-to-emitter sustaining voltages as high as 300 v, with 10-amp gains of 15 to 45 and typical beta of 50 at 5 amps. The gain curve is virtually flat from 10 ma to 2 amps. Saturation voltage collector-to-emitter is typically 0.6 v at 10 amps with gain-bandwidth-product of 40 Mhz. Switching times are in the micro-second range.

Soliton Devices, Inc., 1177 Blue Heron Blvd., Riviera Beach, Fla. [364]

Speed-up
Wire
Marking

with a

KINGSLEY
Wire & Tube

Marking Machine

right in your plant!



Write
for
Details

Now you can *permanently* mark wire or tubing directly on the insulation... quickly... economically... right in your own plant!

Cut costs and speed production with the same machine that has consistently proven so successful in the aircraft/missile field.

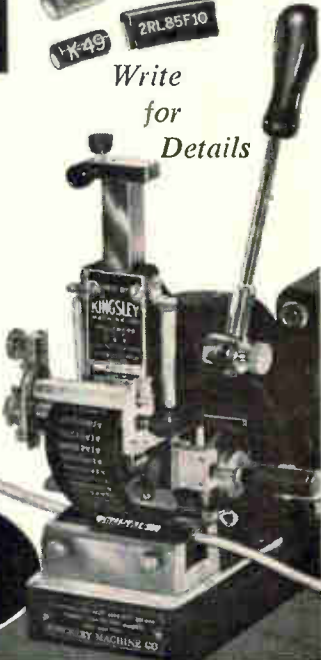

KINGSLEY
MACHINES

850 CAHUENGA • (213) 469-7243
HOLLYWOOD, CAL 90038

A-207

Circle 295 on reader service card

Pick up your
free copy of this
valuable index of
Japanese Electronics
Manufacturers & Products

at **BOOTH 739**

McCormick Place, Chicago
at the

**NATIONAL ELECTRONICS
CONFERENCE • OCT 3-4-5**

and discover a host of new, reliable sources
to meet your specific product requirements.



ELECTRONIC INDUSTRIES

ASSOCIATION OF JAPAN

Electronics Division

Japan Light Machinery Information Center

437 5th Ave., New York, N. Y. 10016 • (212) MU 6-0731

Circle 296 on reader service card

Lighted Pushbutton Switches



**USECO offers
greatest capacities, smallest sizes.**

USECO'S ORCON switches combine exclusive multi-circuit capacity, isolated contacts, sliding-wiping action, independent light circuit and connector convenience in $\frac{3}{4}$ " and $1\frac{1}{16}$ " diameter sizes. Standard and custom available. Plus indicator lights, ganged assemblies, multi-light units, adapters and accessories. For brochure, contact USECO, 13536 Saticoy Street, Van Nuys, Calif. 91409. (213) 873-3520.

USECO

Division of Litton Industries



Circle 211 on reader service card

211



Eliminate

your cable assembly problems. Let Times take over.

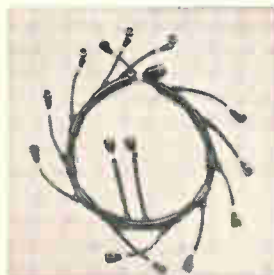

Here's what happens when Times takes on the job of getting your cable assembly problems off the ground:

- 1) Discussion of the problem. We'll find out quickly what can and cannot be done.
- 2) Quick delivery of a prototype and evaluation.
- 3) Specs written and
- 4) production started.

We have the staff and facilities to solve your problems—from design through manufacture. And the know-how to answer questions like:

How to achieve VSWR of 1.05 across C-Band. What is the phase temperature coefficient of RG-142B/U and RG-214/U. How to achieve 2% balance in a balanced transmission line. A computer cable with MTBF of 10⁶ hours. A cable with a delay of 80 nanoseconds per foot. An adjustable HF delay line. A flexible cable with 30 db/100 ft. loss at 10 gigacycles.

For immediate assistance you are invited to call and discuss your problems with our Product Engineers, and to send for our helpful Assembly Design Check List.

Send for free catalog.
Write or call our Product
Engineering Department

TIMES
WIRE & CABLE
Wallingford, Conn.

A division of The International Silver Company

New Instruments

Bidirectional counter reverses rapidly

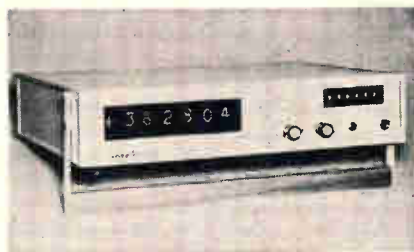

An absolute accuracy, high-speed bidirectional counter display, the model 650 series, will count in either direction and reverse at any rate between zero and 5 Mhz. It uses highly reliable silicon integrated circuits. The unit accepts quadrature or pulse input signals. Sine waves may range from 1 v to 30 v peak to peak, and square waves can have peak-to-peak amplitudes of 500 mv to 15 v.

This counter display is directly applicable for use with a wide variety of commercially available incremental position encoders. Optional axis-crossing detection modules may be ordered to multiply encoder resolutions by factors of 1, 2 and 4 (depending on system requirements). Up to 17 decimal decades can be accommodated by the cabinet illustrated. Single or dual in-line counters are also available.

Model 650 provides polarity sensing and indication; the model 630 is a complementary counting instrument. Other options include electrical outputs for digital recorders or computers; d-c to d-c converters for portable operation from standard batteries or system power supplies; and a power supply to energize associated encoders. "Pre-set", "start count", "stop count" are available. Units are available without displays for electronic data-processing applications. Many other options are available for complete system versatility.

Operating temperature range is 0° to 50°C (32° to 122°F). Size is 3½ in. high x 17 in. wide x 14 in. deep.

Price range is \$1,095 to \$1,695;

delivery, 6 weeks after receipt of order.

Janus Control Corp., 296 Newton St., Waltham, Mass. [372]

Plug-in unit improves scopes



A spectrum analyzer plug-in has been announced for the company's type 530, 540, 550 and (with adapter) 580 series oscilloscopes. Type 1L5 plug-in unit extends laboratory display capabilities of the scope to include calibrated vertical deflection to measurements of spectrum analysis in the frequency range of 50 hz to 1 Mhz.

Permitting simple and accurate measurements directly from the crt display, the type 1L5 offers such features as dispersion range of 100 hz (10 hz/cm) to 1 Mhz (100 khz/cm) in nine steps and variable; resolution range of 10 hz to 1 khz coupled to calibrated dispersion; analyzer sensitivity of 10 μv (rms)/cm to 2 v (rms)/cm; center frequency range of 50 hz to 1 Mhz; and display flatness of ±0.5 db at 10 mv/cm to 2 v/cm, and +0.5 db, -3 db, 10 μv/cm to 50 μv/cm.

A recorder output is available for providing a d-c coupled analog output of the spectral display for chart recorders or other uses—with 10 mv/cm deflection, linear with input voltage (d-c coupled from 600-ohm source impedance).

In addition to its use for spectrum analysis with the oscilloscope, the type 1L5 can also be used for conventional displays at a bandwidth of ≤10 hz to 1 Mhz with

Now, Clean Room Copper-Clad Laminated Plastics from Stock



Synthane Corporation makes and stocks a large supply of copper-clad laminated sheets in popular grades, thicknesses and foil thicknesses. All produced under clean room conditions. We probably have what you want ready to ship. If not, we can make it quickly from our equally large inventory of semi-finished materials waiting only to be pressed. Try Synthane first for copper-clad laminates. Synthane Corporation 36 River Road, Oaks, Pa.



Laminated Plastic Sheets, Rods, Tubes and Fabricated Parts

CORPORATION OAKS, PENNA.

Circle 297 on reader service card

What's NEW in laminated plastics?
Synthane FR-16!
It's a lower-cost flame-retardant, glass epoxy laminate
Designed specifically for printed circuits used in computers

Write for FR-16 Engineering Bulletin to Synthane Corporation 36 River Road, Oaks, Pa. 19456.



Laminated Plastic Sheets, Rods, Tubes and Fabricated Parts

Circle 298 on reader service card

Wafer capacitors offering the ultimate in Q...

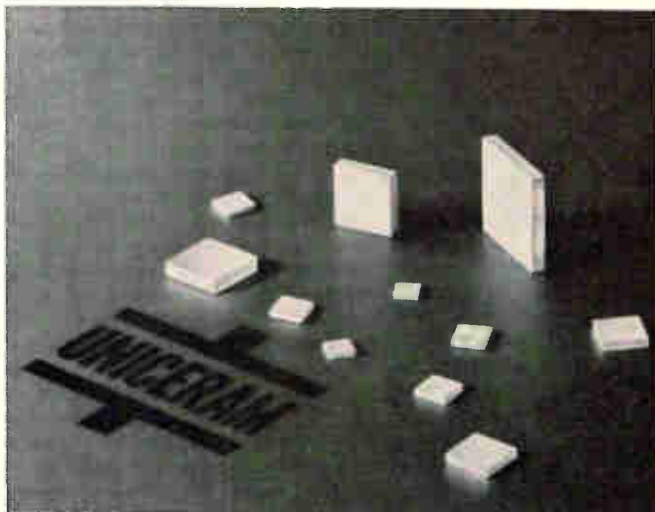

Capacitors shown enlarged 30%

JFD Uniceram

Uniceram monolithic High Q ceramic fixed capacitors are now available as multi-layer wafers with metalized edges. Leads are eliminated—so is the associated lead inductance.

Uniceram wafers combine the ultimate in Q with exceptional stability and reliability. Offered in over 1,000 models with capacitance values from 0.5 to 3000 pf.

Uniceram wafers are ideal for high speed switching and for operation at VHF and higher frequencies where low inductance is essential. These wafers, or chips, can be used in hybrid integrated circuits, can be soldered directly to printed circuit boards or used as discrete components.

Write for Catalog UNM 65-2



"TODAY'S COMPONENTS BUILT FOR TOMORROW'S CHALLENGES"

JFD ELECTRONICS CO. / COMPONENTS DIVISION 15th Avenue at 62nd Street Brooklyn, N. Y. 11219 / Phone 212-331-1000 • Sales Offices—Arcadia, Calif. Chi., Ill. / Balt., Md. / Saxonville, Mass. / Bklyn., N. Y. / New Hartford, N. Y. Cinn., Ohio / Phila., Pa. / Pitts., Pa. / Paris, France / Azor, Israel

Circle 213 on reader service card

213

New! -- Ballantine Solid State True RMS Voltmeter

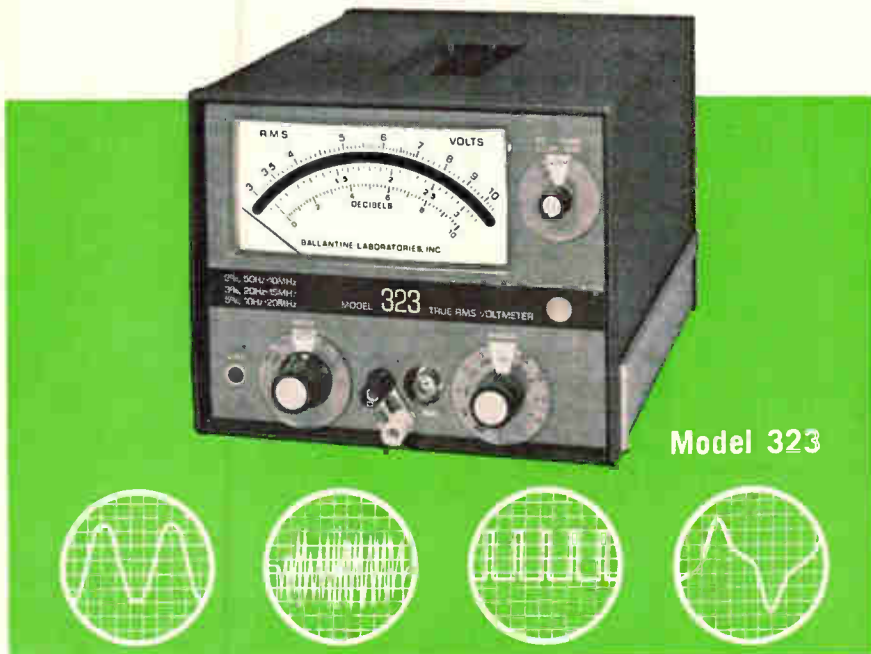

Model 323

Measures from 10 Hz to 20 MHz regardless of Waveform

Ballantine's new Model 323 is a rugged, all-solid-state voltmeter for True RMS measurements for 10 Hz to 20 MHz . . . and for a wide variety of waveforms. Use it as a completely portable instrument isolated from line effects (due to built-in rechargeable batteries), or plug it into the power line. (Model 323-01 is for use on power line, only.)

FEATURES:

- ★ Measures True RMS of sine waves, square waves, noise voltages and a range of pulses
- ★ Frequency range of 10 Hz to 20 MHz
- ★ Voltage range of 300 μ V to 330 V. (As null detector to 70 μ V)
- ★ Unmatched accuracy: 2% of indication, 50 Hz to 10 MHz; 3% of indication, 20 Hz to 15 MHz; 5% of indication, 10 Hz to 20 MHz. Ballantine's accuracy of 2% means 2% of the actual indication, whether at the top or bottom of a scale
- ★ Operates from built-in rechargeable batteries or line power
- ★ Ideal for recorder applications — DC output of 0.1 to 1.0 V for each range simultaneous with meter reading
- ★ Crest factor: 5 at full scale to 15 at down scale
- ★ Separate isolated signal and case grounds
- ★ Optional 80 dB Attenuator Probe, Model 1301, for operation up to 10,000 V

Prices: Model 323, \$520 (Battery & Line)
Model 323-01, \$485 (Line only)

Write for complete technical data today



BALLANTINE LABORATORIES INC.

Boonton, New Jersey

CHECK WITH BALLANTINE FIRST FOR DC AND AC ELECTRONIC VOLTMETERS/AMMETERS/OHMETERS, REGARDLESS OF YOUR REQUIREMENTS. WE HAVE A LARGE LINE, WITH ADDITIONS EACH YEAR. ALSO AC/DC LINEAR CONVERTERS, AC/DC CALIBRATORS, WIDE BAND AMPLIFIERS, DIRECT-READING CAPACITANCE METERS, AND A LINE OF LABORATORY VOLTAGE STANDARDS FOR 0 TO 1,000 MHz.

New Instruments

sensitivity of 1 mv/cm to 100 v/cm.

Price of the 1L5 is \$950. Availability is expected after October. Tektronix, Inc., P. O. Box 500, Beaverton, Ore., 97005. [373]

Constant-amplitude lab phase shifter

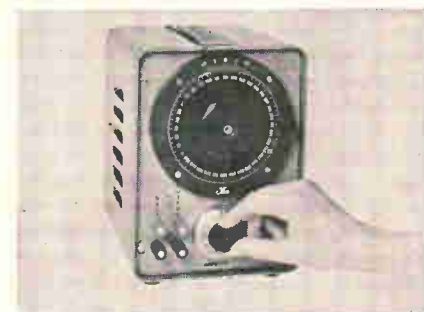

Model C phase generator, for laboratory measurements and experiments, will produce a constant-amplitude phase shift which may be continuously varied between 0° and 360°. The resulting phase-shift is directly indicated in degrees on a dial face. Absolute accuracy is within 30 minutes of arc. Phase accuracy and zero position will not be affected by loads that vary from open circuit down to 10,000 ohms.

Use and application of the phase shifter are similar to those of commonly employed RC networks, except that the inconvenience of various amplitude and phase-shift calculations have been eliminated.

Input for the Model C is 115 v, 400 hz (other models available to handle signal frequencies 60 hz to 5 khz). Output is variable from 0 v to 35 v by means of a 10-turn pot.

Price is \$550; delivery, 4 weeks. Theta Instrument Corp., Saddle Brook, N.J., 07662. [374]

True rms voltmeter covers 300 μ v to 330v

A solid state, true rms voltmeter, model 323, is available with built-in rechargeable batteries for battery or line use. A version for line operation is also available. Both have a range of 300 μ v to 330 v

For solderless wrapped connections, a new automatic wire stripper

The Model 841 Solderless-Wrap Wire Stripper offers high speed preparation of 20-30 AWG solid conductor wire for insertion in a wrapping tool. It cuts wire to lengths of 1" to 50' and fully strips 1/8" to 1 9/16" from each end without nicking or scraping, whether the insulation be PVC or something as tough as Mil-Ene, Teflon or Kynar. With optional assemblies, you can also use it for shorter stripping of 10-32 AWG stranded wire. Write for information on this and other Eubanks wire strippers.



Wire is fully stripped, ready for wrapping tool.

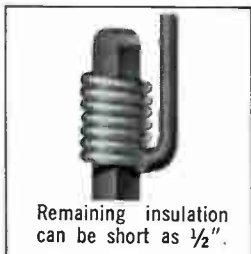

Remaining insulation can be short as 1/2".



Eubanks ENGINEERING COMPANY

225 West Duarte Road • Monrovia, California

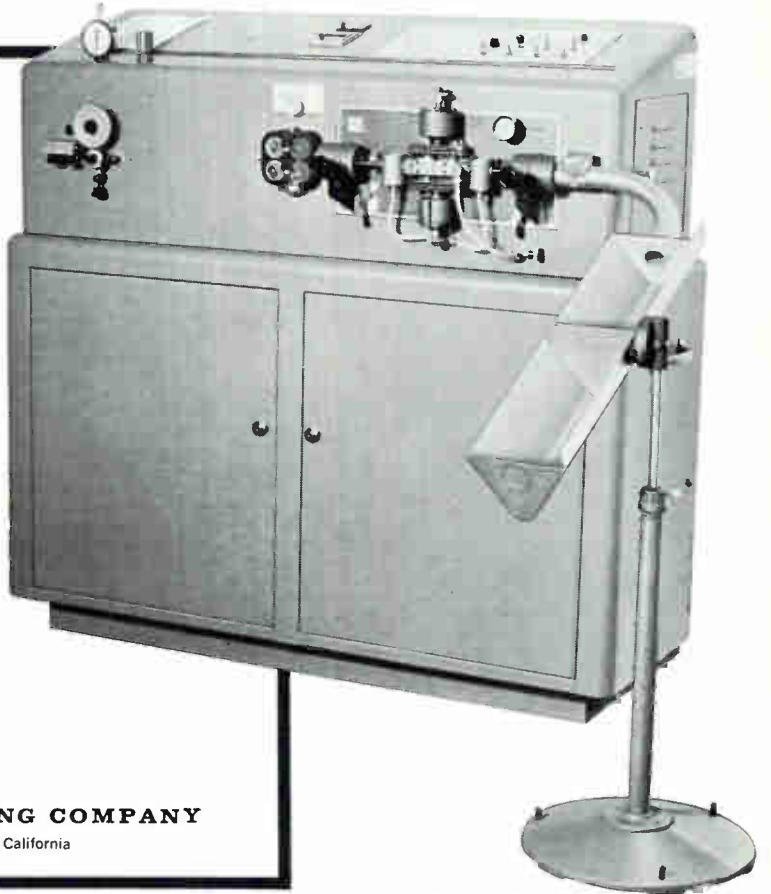

Circle 299 on reader service card

Career Opportunity in Norfolk & Virginia Beach Resort Area for Engineers and Engineer-Writers

Engineering writer positions open at Grades GS-9 thru GS-13 (salary range \$8,479 to \$16,905) to perform review, evaluation, quality assurance and management of electronic technical documentation programs. Positions commensurate with background and technical documentation experience in the fields of Sonar, Radar, Communications, ECM and NTDS.

Engineering positions open to develop installation standards, test requirement outlines, and test procedures for insuring optimum installation performance and operational readiness of Shipboard Radar, Communications, Countermeasures and Sonar equipments. A chance to express yourself and sell your ideas.

Excellent opportunities for advancement in rapidly expanding Navy activity. Local community provides excellent public, private and parochial schools. Several institutions for higher education are also available providing graduate programs.

Call Collect—Area Code 703—444-2743, or mail application for employment (Standard Form 57), available at any post office) to:

Naval Ship Engineering Center
Norfolk Division, Code 1902A
U.S. Naval Station, Norfolk, Va. 23511

An Equal Opportunity Employer

NCC to be Sure

POLYESTER FILM CAPACITORS

Type MXT



In Plastic Tube.
Capacitance
Range : .001 MFD to .22 MFD.
Voltages : 100v, 200v, 400v, 600v DC.

Type MFL

dipped Flat Shape.
Capacitance
Range : .001 MFD to .47 MFD.
Voltages : 35v, 50v, 100v, 200v DC.

Type MFK

-dipped Flat Shape.
Non-Inductive Construction.
Capacitance
Range : .01 MFD to .22 MFD.
Voltages : 100v, 200v, 400v, 600v DC.

METALLIZED POLYESTER FILM CAPACITORS

Type FNX-H

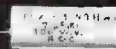

Mylar Wrapped Semioval
With Epoxy End Seal.
Capacitance
Range : 1 MFD to 10 MFD.
Voltages : 50v DC.

SOLID TANTALUM CAPACITORS

Type TSL.
Sealed with Epoxy Resin.



Capacitance
Range : 1 MFD to 220 MFD.
Voltages : 3v, 6v, 10v, 15v, 20v, 25v, 35v DC.

Type TAX.
MIL-C-26655A Hermetically Sealed.

MATSUO ELECTRIC CO., LTD.

HEAD OFFICE: 3-chome, Sennari-cho, Toyonaka-shi, Osaka, Japan.
Cable Address "NCC MATSUO" OSAKA

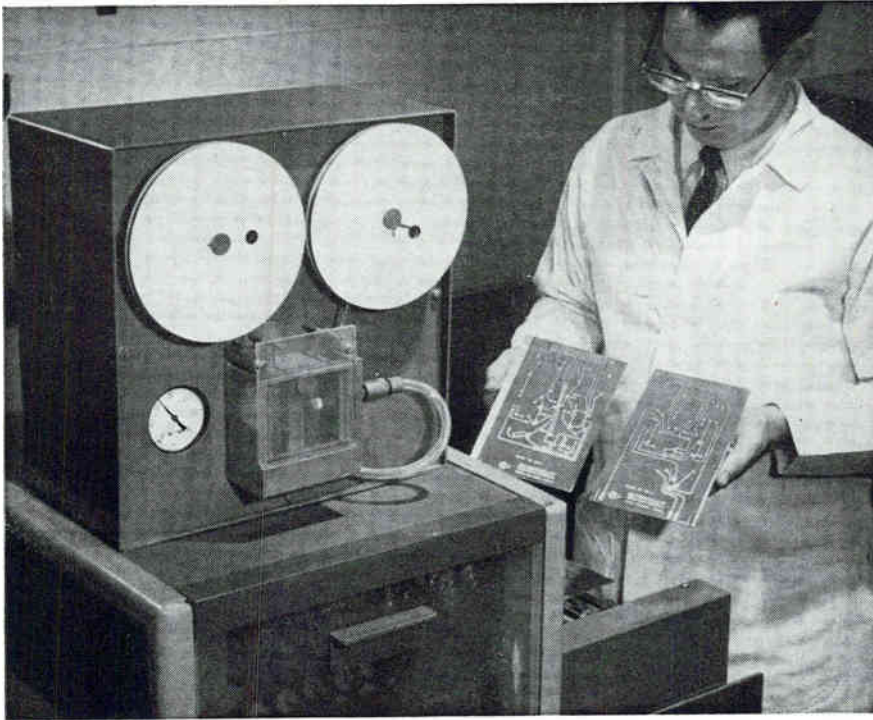

New Automatic Conveyor Control assures uniform etching of printed circuits regardless of length of production run

This new Automatic Conveyor Control monitors and adjusts etching time to make sure that the last piece to come off the etcher is exactly the same as the first. Variations in quality due to etchant depletion are eliminated, and no boards are lost due to over or under etching. You get complete use of the etchant to economical depletion. The machine operator, freed from in-process qc testing, can give full attention to overall production.

This new control system is available as optional equipment on Chemcut models 502 and 1000 horizontal conveyorized spray etchers. Since operating voltages for the system are obtained from the control panels supplied with 502 and 1000 etchers, the Automatic Conveyor Control can easily be retrofitted to etchers already in service.

CHEMCUT®

We invite your inquiry.
CHEMCUT CORPORATION
 500 Science Park, State College, Pa. 16801
 Circle 300 on reader service card

STANDARD SOLUTIONS...SPECIAL SITUATIONS...



Get to know and rely on Robinson/Nugent for fast, frequent and reliable sockets and connectors for all standard TO-packages, relays, crystals, diodes, IC's, lab, test, prototype and module packages. Production packaging and unique designs ... lead lengths from .1" to -; spacing from .05" to -; diameters from .01" to .1" ... machined and molded. Robinson/Nugent ... imagination to -!

**Robinson
 NUGENT
 INCORPORATED**

AREA CODE 812 945-0211

802 E. EIGHTH STREET • NEW ALBANY, INDIANA 47150

New Instruments



with a sensitivity of $70 \mu\text{v}$ for null measurements. Frequency range is 10 hz to 20 Mhz.

The instrument has an accuracy of 2% of indication at midband. Five-inch log voltage scales provide high uniform accuracy and resolution over their entire length. A 10-db scale is also provided. D-c output for a recorder is 1 volt for each db range.

The instrument occupies half of a standard 19-in. rack. Power requirement for the model 323 is built-in batteries, or 115/230 v, 50 to 420 hz; and for the model 323-01, it is 115/230 v, 50 to 420 hz, only. Ballantine Laboratories, Boonton, N.J. [375]

Test set measures transistor noise

Transistor noise figure test set, model 340, directly measures the noise figures of transistors and FET's at radio frequencies. It is designed to use plug-in filters and is available with test frequency heads of 455 khz, 1 Mhz or 10 Mhz.

The unit has a noise figure range of 0 to +30 db; base resistance range of 50, 100, 200, 500, 1,000, 2,000, and 5,000 ohms; collector voltage range of ± 1 to 30 v; collector current range of $30 \mu\text{a}$ to 30 ma.

Model 340 offers transistor manufacturers and users the opportunity to measure the noise figures of transistors at the actual frequencies at which they will operate, before they are assembled into finished products.

Quan-tech Laboratories, 43 South Jefferson Road, Whippany, N.J. [376]

New Subassemblies and Systems

Laser needs no adjusting



Mirror alignment is so critical for laser action that even lasers with built-in mirrors must be carefully adjusted before use. However, a technique has been developed by a West Coast glass-blowing company to align the mirrors and lock them into position during the manufacturing process, making possible a helium-neon laser that needs no adjustment. It's switched on like a light bulb.

The device has been dubbed the Lasertron by the new company that will market it, University Labora-

tories Inc. The alignment and locking technique was developed by Western Scientific Apparatus of Berkeley, Calif.

Since the finished tube can be put into a protective housing and does not have to be bent, it can be coaxial. The extra space is a reservoir for a supply of helium-neon gas that gives the tube a guaranteed life of 1,000 hours. The laser's wavelength is 6,328 angstroms.

The Lasertron runs off its own regulated, filtered d-c power supply, which can be plugged into 110-volt current. Operation is in the uniphase mode (TEM₀₀), with an unpolarized output power of more than 0.3 milliwatt. University Laboratories' president, Richard A. Jaenicke, says he expects the device will be used for industrial alignment tasks, as well as for classroom demonstrations.

The laser will be available next month and will be priced at \$195, with a power supply and mounting costing an additional \$100. University Laboratories Inc., 1740 University Ave., Berkeley, Calif. [381]

Hybrid junctions cover audio to microwave



The HJ and HJ-K series of broadband hybrids are four-port networks featuring high isolation, low vswr and low insertion losses. Typical applications include in-phase or out-of-phase signal dividers, signal combiners, phase comparators, impedance comparators, reflectometers, balanced mixers and steering and tracking systems.

The HJ series covers the frequency range of 10 khz to 400 Mhz. The HJ-K series provides overlapping coverage, ranging from 200 Mhz to 2 Ghz. In both series, power applied to any of the four ports is split equally between two other arms while the fourth arm is isolated.

Models in the HJ series include the HJ-17, covering 2 to 32 Mhz; HJ-55, covering 10 to 100 Mhz; and HJ-200, covering 100 to 300 Mhz. Specifications for all three models are identical, including 30 db isolation; 0.2 db amplitude balance; phase equality of $0/180^\circ \pm 1^\circ$; vswr, 1.3:1; impedance, 50 ohms; insertion loss, 0.5 db and power to 5 watts average. All three models are priced at \$135 in small quantities.

Typical HJ-K models include HJ-0.3K, covering 200 to 400 Mhz;

Stays supple
in continuous
operation at
very high
temperatures



HYGRADE[®]

THERMOFLEX Fiberglass Sleeving

is designed for application where temperatures run as high as 1200°F. Constructed of closely woven 100% fiberglass, it provides maximum abrasion resistance and great flexibility. It is specially treated to remove all organic matter and to make it fray-resistant. Because dielectric strength is determined by the space factor, Thermoflex is available in regular, double or special construction in various wall thicknesses. Especially recommended where high flexibility is required. Write for samples, data and prices.

MARKEL

SINCE 1922

L. FRANK MARKEL & SONS

Norristown, Pennsylvania 19404

INSULATING TUBINGS AND SLEEVINGS
HIGH TEMPERATURE WIRE AND CABLE

INSTANTANEOUS, AUTOMATIC READING AND VERIFICATION OF PUNCHED CARDS BY IBM®

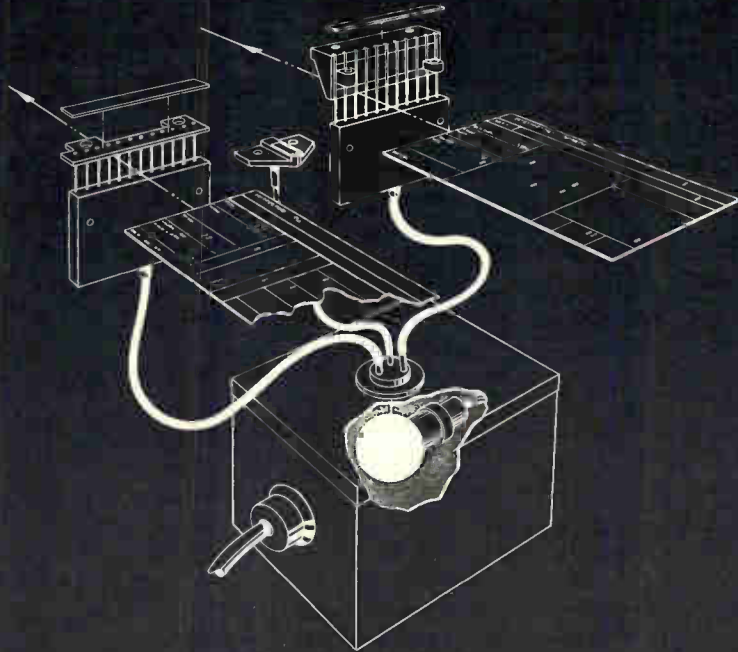

**with Bausch & Lomb
FIBER OPTICS LIGHT WIRES®**

The sensing units in the IBM 59 Card Verifier have been changed from a mechanical to an optical system, utilizing Bausch & Lomb Light Wires®. Result? Speed and reliability are increased. Plus . . . no mechanical failures, no parts to wear out.

The IBM development uses three Light Wire bundles connected to a common light source. The fibers in two of the bundles are each divided into twelve separate output points corresponding to the hole locations of the data cards. When cards are in reading (or sensing) position of the Verifier, light is transmitted through the punched hole, via the Light Wires, to an attached photo cell. Non-punched areas, being opaque, do not transmit. The other assembly, the emitter, serves as a timing mechanism.

Because of their unique properties, Bausch & Lomb Light Wires can do many things—simply and efficiently. Light Wires transmit light from a single source to multiple receptors. Pipe beams over and around obstacles. Bring light into tiny openings. Transform the shape of a beam. Monitor CRT tubes and radar screens. Illuminate explosive areas safely.

We will work with your engineers on fiber optics applications. Our capability extends from design and development to prototype and production of fiber optics and requisite hardware. Send for Catalog 32-2045, Bausch & Lomb, 61434 Bausch Street, Rochester, New York 14602.

**Bausch & Lomb Light Wires are incoherent fiber optics that transmit light. We also manufacture Flexiscope® which transmits images through coherent fiber optics.*

BAUSCH & LOMB 

Visit our Booth #619 at the National Electronics Conference, Chicago, Oct. 3-5.

New Subassemblies

HJ-O-375K covering 250 to 500 Mhz and HJ-0.75, covering 500 to 1,000 Mhz. These models also have identical performance characteristics, including isolation typically 40 to 50 db; 0.3 db maximum insertion loss; vswr, 1.35:1; impedance, 50 ohms; amplitude balance, ± 0.15 db; phase balance, $180^\circ \pm 1^\circ$ for E arm feed, and $0^\circ \pm 1^\circ$ for H arm feed and power to 100 watts average. All three models are priced at \$195 in small quantities.

Merrimac Research and Development, Inc., 517 Lyons Ave., Irvington, N.J. [382]

Shaft encoding system produces 115 v, 5 amps

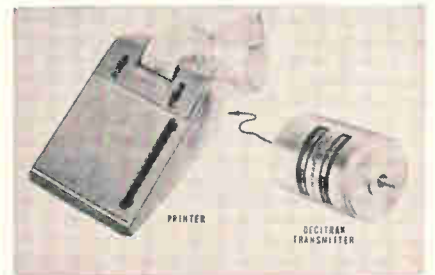

The high-power series of Decitrak shaft encoders produces a direct-decimal output of 115 v d-c, 5 amps by means of its scr logic system. Capable of actuating almost any parallel entry digital printer and digital display, performance of new Decitraks will not be affected by distances of 10,000 ft between encoding transmitter and readout.

In addition to its high-power level, the new encoding system features on-the-fly output. Data may be taken, without effect upon life, while the encoder shaft is turning at a rate of 1,000 rpm. Conventional brush encoders are severely limited in the amount of current which can be passed through the brushes during rotation.

Intended for such applications as a tracking antenna indicator, weighing scale digitizer, and table readout, the system features a direct decimal output so that expensive conversion from computer codes is unnecessary.

Transmitter size is 2½ in. diameter, 4 in. long. Available ranges

are 0 to 3,599, $\pm 1,799$, and 0 to 9,999. Accuracy is 1 part in 10,000. The Theta Instrument Corp., Saddle Brook, N.J., 07663. [383]

D-c power conditioner with regulated output

High power silicon microcircuit power conditioners have been developed to replace d-c power supplies. These units operate from 115v, 47 to 63 hz. They are intended to supply 1 v to 32 v d-c power to equipment employing microcircuits or any d-c load requiring precision regulation.

Model PD units employ almost entirely digitalized microcircuit components, resulting in extremely small size and high reliability (with a 100,000 hour mean-time-between-failure). A 50-watt module is only 1.5 in. x 2 in. x 3 in. in volume.

The manufacturer has available 184 standard units to 1 kw. Specials to 10 kw are also available.

Price ranges from \$200 to \$800 each.

General Power Corp., 6050 W. Jefferson Blvd., Los Angeles, Calif., 90016. [384]

Batch counters use solid state circuits

Electronic batch counters, series SC-A12, feature high-speed counting (up to 2,000 counts per minute), solid state circuitry, modular construction, direct dial presetting from 1 to 99, visual readout, and rapid automatic and manual reset.

A number of optional features are offered, including choice of inputs, energized, contact, or photoelectric, dual preset and choice of mounting methods. There are but two moving parts in the process, both long-lived and easily replaceable.

Because of its versatility, the SC-A12 is a direct replacement for counters of the electromechanical type. It measures 4 $\frac{3}{8}$ in. wide x 5 $\frac{1}{16}$ in. high x 4 $\frac{3}{4}$ in. deep without its cabinet. Prices start at \$112.

JMR Electronics Corp., 2133 Boston Road, Bronx, N.Y., 10460. [385]

if you want... PRECISE POSITIONING



- RAPID ACCELERATION
 - IMMEDIATE RESPONSE
- IN YOUR TAPE TRANSPORT
CAPSTAN DRIVE**

INLAND MOTOR has the answer in its DC DIRECT DRIVE TORQUE MOTORS

Precise Positioning... No gears — No backlash. The direct-drive torque motor shaft IS THE capstan itself...ensures high coupling "stiffness." It gives high mechanical resonant frequency offering design capabilities of an extremely wide servo bandwidth.

Rapid Acceleration and Deceleration... Produces more torque, size for size, than any other electro-mechanical device. As a capstan drive it has the highest, practical torque-to-inertia ratio.

Immediate Response... Since its torque is a direct function of applied current, independent of speed, response is positive and instantaneous at all operating speeds — limited only by the characteristics of the tape.

Direct Coupling = Precise Positioning

High Torque - Low Inertia = Rapid Acceleration

DC Control = Immediate Response



TORQY SAYS:

If you would like full information on Inland's Torque Motors used as a capstan drive in a tape transport application or engineering assistance on a particular servo design problem, let us know...we'll be glad to help.



INLAND MOTOR

CORPORATION
RADFORD, VIRGINIA
703-639-3973

SUBSIDIARY OF **KOLLMORGEN**

**The
easiest way
to cut
component
costs.**

Farm them out!

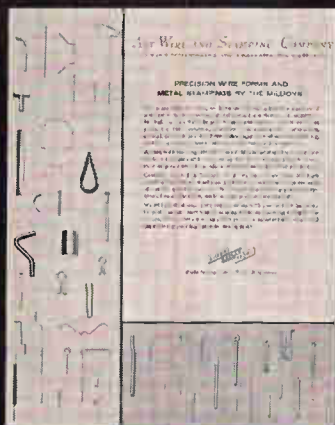

**Read why
in Art Wire's
New Bulletin
501**

Learn why Art Wire consistently produces wire forms, small parts stampings and cut tubing at considerable savings over your in-plant costs. And how we can go into high-speed automatic production even faster. For your copy use the inquiry card. If you're in a hurry, call 201-621-7272.

ART WIRE & STAMPING CO.
13 Boyden Place, Newark, N. J. 07102

New Microwave

C-band magnetrons are voltage-tunable



A line of voltage-tunable magnetrons may be obtained throughout the 4 to 7 GHz frequency range with 1 GHz of electronic tuning capability.

There are six standard packages available. For the 5.4 to 5.9 GHz range, minimum power output is 5 to 10 watts. For the 4 to 5 GHz, 4.5 to 5.5 GHz, 5 to 6 GHz, and 5.5 to 6.5 GHz ranges, minimum power output is 5 watts for each. For the 6 to 7 GHz range, minimum power output is 2 watts.

The units feature high efficiency (35% for the 5.4- to 5.9-GHz unit), flat power response, linearity, and shielded magnet construction. Size is 2½ in. x 2½ in. x 2¼ in. Price is \$1,350; delivery, three weeks. Micron Inc., 265 Osborne Road, Albany, N.Y., 12211. [391]

Amplifier provides logarithmic limiting



A logarithmic-limiting amplifier for use in microwave receivers simultaneously provides a logarithmic video output and a limited i-f out-

put, with a 50-db input dynamic range. When used in place of the usual automatic-gain-controlled i-f amplifier, improved performance is achieved in reception of high-speed pulses.

The limited i-f output is +3 dbm, ±½ db, for a range of input signals from -60 to -10 dbm. Video output is proportional, within ±1 db, to the logarithm of the input, over a 50-db input range of -60 to -10 dbm.

The standard model, known as the ITL3, is available at 30-MHz center frequency, 3-MHz bandwidth. The amplifier is designed to operate in a 50-ohm i-f system. The logarithmic video output is a negative pulse of 50 mv per db, delivered to a 1,000-ohm load. Noise figure is less than 9.5 db.

Dimensions are 6⅞ in. x 1¼ in. x 3 in. Weight is 20 oz. Power required is 0 to -10 v agc bias. Price of the ITL3 is \$750; availability, six weeks.

Varian Associates, LEL division, Akron St., Copiague, N.Y. 11726. [392]

Reflectometer coupler measures vswr's

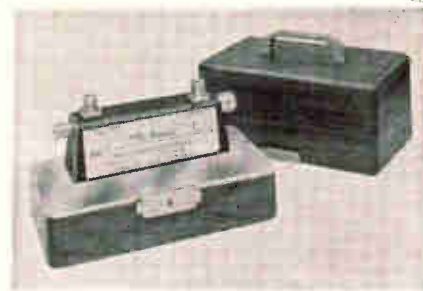

The 3070 series of reflectometer couplers are precision instruments designed to provide a continuous comparison of incident and reflected power.

High directivity of greater than 40 db in the models 3072 and 3073 allows measurement of vswr's less than 1.02 in the frequency ranges of 0.95 to 2.2 GHz and 1.7 to 4.2 GHz respectively. With the model 3074, which has a directivity of greater than 35 db, vswr's of less than 1.035 can be measured in the frequency range of 3.7 to 8.3 GHz. In the 7.0 to 12.4 GHz range, the

model 3075 has a directivity of greater than 33 db thus allowing vswr's of less than 1.05 to be measured.

Each reflectometer coupler is mounted in a wooden case and is equipped with a 7 mm to type N male, 7 mm to type N female and a precision 7 mm short. Price of each of the models, 3072 through 3075, is \$975 complete with case, precision short and two 7 mm to type NM and NF transitions.

The Narda Microwave Corp., Plainview, L.I., N.Y. [393]

Parametric amplifier available in 4 models



A range of parametric amplifiers is offered with improved low noise performance at room temperature. Four models are available covering the range 1 to 5 Ghz.

Typically, model VCA/S22 covers the frequency range 1 to 2 Ghz, with a noise temperature at 70°K. It has a tuning range of 150 Mhz and a 3-db bandwidth of 20 Mhz at 20-db gain. The amplifier uses approximately 10 mw of pump power at a frequency of 16 Ghz.

Amplifiers are supplied with a four-port circulator and pump klystron. Price is \$6,000; and availability, 100 to 120 days.

Ferranti Electric, Inc., East Bethpage Road, Plainview, N.Y., 11803. [394]

Small, lightweight mixer-preamplifiers

Miniature mixer-preamps are designed for militarized environments and for use in radar, communications and electronic countermeasure systems.

The mixers, which incorporate replacement diodes, are mounted to the cast aluminum housing of the

**Bong, Bong, Bong.
Ladeez an' Gen'lemen.
We now present a strong,
rugged, lightweight, who is
unbeaten in its bouts with heat.
From IMC, "The Boxer."**



There are 2 dozen different, but standard, interchangeable fans for Industrial, Military, & Consumer uses

Contact IMC Magnetics Corp., Eastern Division, 570 Main St., Westbury, N.Y. 11591. Phone 516 334 7070 or TWX 516 333 3319.

If you need data sheets for reference or consideration for future projects, write IMC's Marketing Division at the same address.

Circle 301 on reader service card

**Push-pull, push-pull, push-pull, push-pull,
push-pull, push-pull, push-pull, push-pull,
push-pull, push-pull, push-pull, push-pull,
push-pull, push-pull, push-pull, push-pull,
push-pull, push-pull, push-pull, push-pull,
push-pull, push-pull, push-pull, push-pull.
That's the monotony of reliability.**

Monotonous reliability characterizes IMC's solenoids, even at 4 millisecond speeds. There's a whole catalog of them in stock at IMC's Western Division, in sizes and configurations for avionics, instrumentation, computer peripherals and other systems.

If you need to push-pull, or to Indicate, Measure, and Control using steppers, synchros, resolvers, flag indicators or solenoids, contact the Applications Section at 6058 Walker Ave., Maywood, Calif., 90270. Phone (213) 583-4785 or TWX 910 321 3089.

For the catalog or data sheets contact the Marketing Div., 570 Main St., Westbury, N.Y. 11591 or circle the inquiry number.



Circle 221 on reader service card

221

Capacitors and Resistors

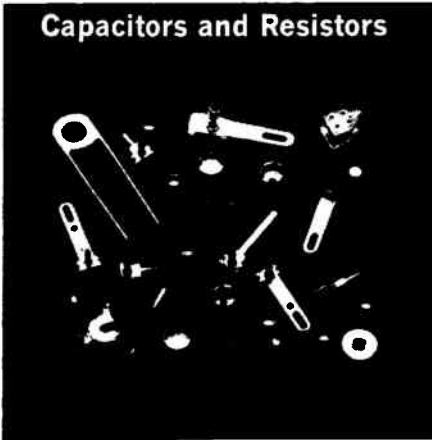

Relays



Our parts go into everything electronic



Connectors

Producers of *all types* of electronic components have their reasons for relying on Volkert Stampings. It comes out in the extra things Volkert does. Like converting a multi-piece design to a single stamping. Or consistently using high-speed equipment to reduce per-part costs.

Write or call Volkert Stampings, Inc., 222-35 96th Avenue, Queens Village, L.I., New York 11429. Telephone 212-464-8400.

Volkert STAMPINGS, INC.

Subsidiary of The Stanley Works

Circle 302 on reader service card

New Microwave

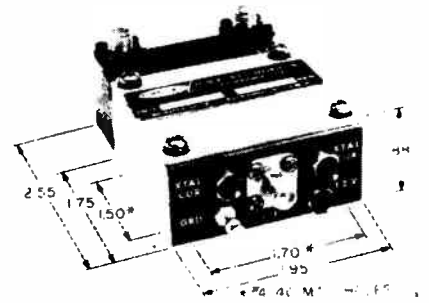

preamp. The housing thus combines rigid lightweight construction and excellent r-f shielding, according to the manufacturer.

Standard models are available in frequencies from 0.25 to 12 Ghz, gain at 20 to 25 db, and typical noise figure of 10 db or better. Dimensions of typical units are 2.55 in. x 1.95 in. x 0.88 in. Post amplifiers are also available on special order.

RS Electronics Corp., 795 Kifer Road, Sunnyvale, Calif., 94086. [395]

Airborne radar microwave assembly

A lightweight microwave assembly has been developed for airborne radar applications. The unit combines the company's Air-Strip technique for low-power miniature circuits and standard waveguide components for higher-power applications in a compact package.

The Air-Strip section contains two phase-coherent, low-noise balanced mixers; an automatic frequency control mixer; a single sideband generator; and a local oscillator network, including a newly developed 0° to 180° differential local oscillator phase shifter, two isolators preceding and one following the single sideband generator and variable attenuators in the local oscillator input and automatic frequency control signal arms.

The high-power waveguide components, as well as the local oscillator, mount directly on the Air-Strip package. The entire assembly operates over the temperature range of -54° to +125°C, and withstands full airborne shock and vibration environments.

Micro-Radionics, Inc., 14844 Oxnard St., Van Nuys, Calif., [396]

New CDS Type 6C PHOTOCHOPPER CELLS

- High Efficiency
- Low Temperature Coefficient
- Resistance Tolerance $\pm 50\%$
- Internal Electrostatic Shielding
- Dumet Leads

CLAIREX

"The LIGHT Touch in Automation and Control"
1239 Broadway, New York, N. Y. 10001
212 MU 4-0940

Write for new 4-page Bulletin
110/170 866



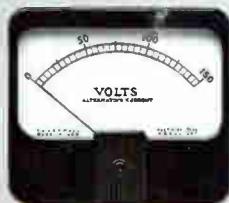

Make sure Honeywell's revolutionary new Auto-Torque mechanism is inside. It's the first substantial improvement in meter technology

in ages — a new kind of band-type meter — first to be machine manufactured. Auto-Torque is more reliable (since there are 50% fewer parts, you can practically wave



good-bye to service problems). Auto-Torque is more durable (since the moving system is suspended on metal bands under tension, there's no friction and wear). Auto-Torque is more accurate (since the mechanism is self-shielded, it can be mounted on any panel without special calibration — without worrying about "sticks", either).

Auto-Torque is more economical (quantity-order prices for volume buyers are below comparable pivot and



jewel meters). Auto-Torque is under the hood of the world's smartest-looking meters. And there are plenty of styles to choose from. In fact, Auto-Torque meters come to you in the widest selection of band-type meters available today . . .

For more information on Auto-Torque, write to Honeywell Precision Meter Division in Manchester, N. H. 03105.

Honeywell Auto-Torque Meters

**Before you
pick out a new meter,
better look under the hood.**

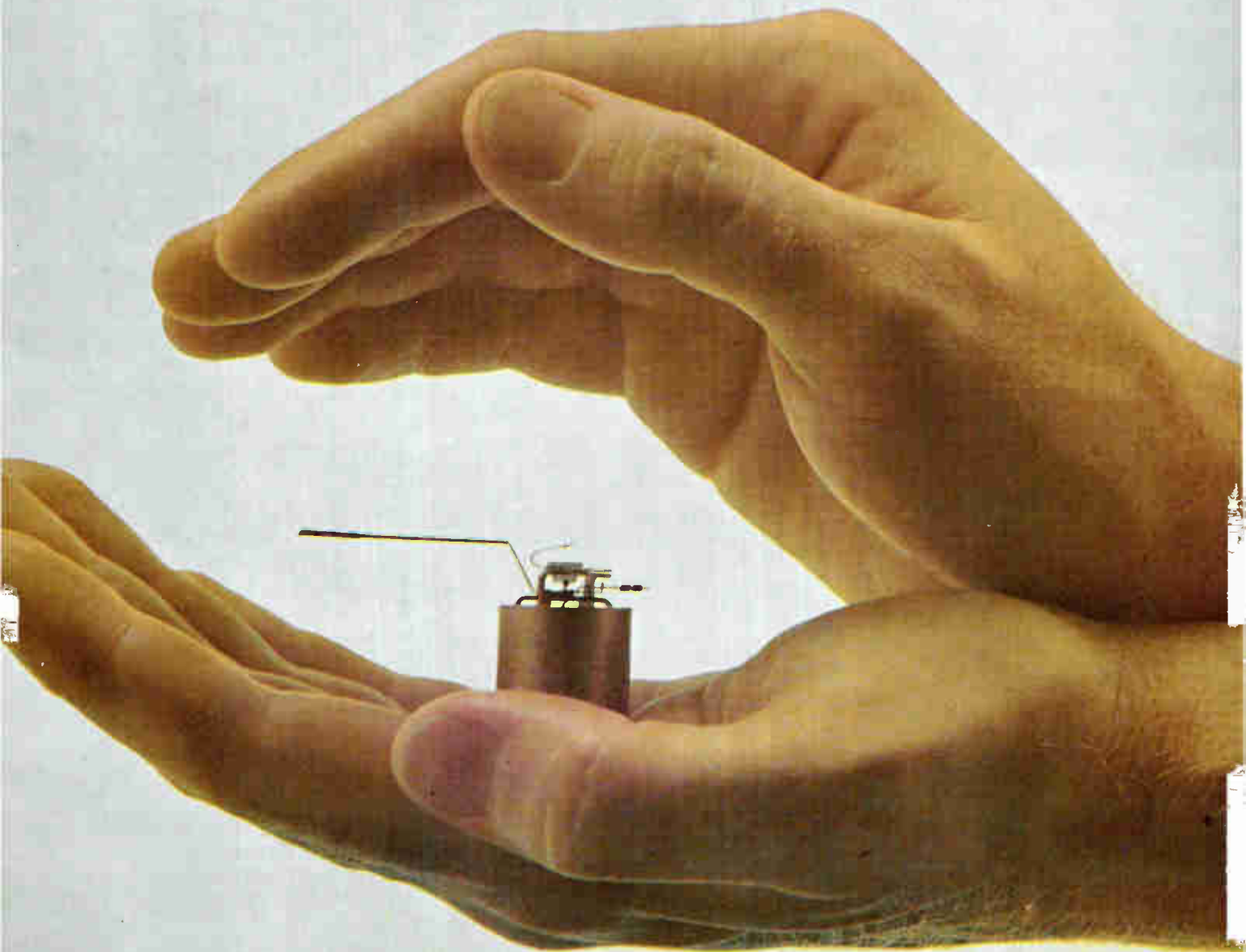

Analog Computing

G/M Magnetic Components have been proven superior in thousands of commercial, space and military applications. They conform to MIL-T-27A and MIL-E-5400 specifications and provide a ready solution to problems involving solid state, micro circuit, analog computer design. Call or write for Bulletins.

Micro "Mag Mods"®

SINE WAVE OUTPUT—NO TUNED FILTERS!



"MAG MODS"® provide four quadrant operation, extreme stability with negligible change of phase, gain and zero position over a wide temperature range. Design is simple, featherweight and rugged—with no vacuum tubes, semiconductors or moving parts to limit life. These Modulators are available in micro, miniaturized and standard sizes depending on requirements, and feature an essentially drift-free, wide-band width circuit with superior phase and gain stability.

FEATURES:

- Greatest Reliability—Unlimited Life
- Repeatable Data over Years of Continuous, Unattended Operation
- High Shock and Vibration Proof
- Low Milliwatt Power Consumption
- Wide Band Width
- Clean Sine Wave Output without Resonant Filtering

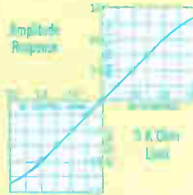

REQUEST BULLETIN MM 101X

Magnetic Division Modules

ACCURACY OF 1% OR BETTER!

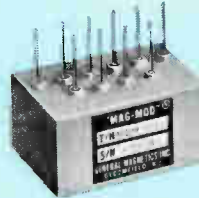

These Analog Division Modules employ a concept which eliminates high gain operational amplifiers and logarithmic circuitry used in electronic dividers. The result is fewer components, excellent stability, micro-miniature size, lower cost. The combination of magnetic and semiconductor circuitry results in analog division accuracy of 1% or better.

FEATURES:

- Micro-miniature Size
- Completely Solid State
- Low Power Consumption
- Wide Numerator and Denominator Ranges

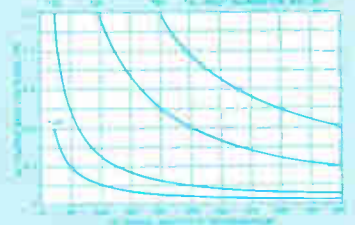

REQUEST BULLETIN MM 110

THERE IS NO
SUBSTITUTE FOR
RELIABILITY



Circuit and Fundamental Principles of Magnetic Modulators are covered by U.S. Pat. No. 2758162

New Production Equipment

Heated within, welder strips wire



Closer control over the welding of insulated leads to components is obtained when the welding electrode that melts the insulation is heated internally, according to the Hughes Aircraft Co. So, in its HMT-60 welder, the company put the heater into a removable capsule that fits inside the electrode and also squeezed in a thermocouple

for temperature control.

The machine can weld an insulated lead to a component in less than a second. Insulations such as Formvar, Thermaleze, Solderze, varnish and some types of vinyl don't have to be stripped from the wire because the heated tip of the electrode penetrates the insulation and bares the metal at the weld spot.

Hughes says that inside heating and temperature monitoring has several advantages over external heating. Eliminating the air gap between the heater and electrode improves heat transfer. This allows closer temperature control and reduces temperature fluctuations whenever contact with the workpiece draws heat from the electrode. Closer control helps prevent

Specifications

Heater temperature range	Ambient to 1,000°F
Dwell time	0.5 to 3 seconds
Power input	105-125 v, 1 amp, 60 hz, single phase
Pulse time	2-10 msec.
Head welding force	8 oz to 20 lbs
Dimensions	6½ × 9 × 7¾
Weight	10 lbs
Price without power supply	\$715.00
Delivery	Two weeks after receipt of order

deformation of the workpieces.

Mechanically, internal heating is advantageous, the company adds, since it allows great flexibility in the external shape of the electrode. Nor can the heater interfere with the application of the welding electrode. The electrode acts first as a hot stripper, penetrating and melting the electrode for a preset dwell time. Then the welding power supply is automatically triggered and a normal weld schedule is followed.

The HMT-60 system includes a VTA-60 precision weld head, an HMT-540 electrode heater control,

with Magnetic Microblocks

ALL UNITS SHOWN ACTUAL SIZE

Analog Voltage Multiplier

WORLD'S SMALLEST, MOST RELIABLE



Available as small as 0.1 cubic inch and weighing as little as 0.1 ounce, Micro Magnetic Multipliers feature extreme stability with negligible change of product over wide temperature range, high shock and vibration proof. Band-width may be extended into the kilocycle range. Low milliwatt power consumption; four quadrant operation.

FEATURES:

- Four Quadrant Multiplication or Squaring Monolithic Micro Circuit Block for Analog Voltage
- Multiplying of DC and AC Voltages
- Addition, Subtraction, Multiplication, Division and Extracting a Root of Many Voltage Variables may be Handled by one G/M Magnetic Microblock
- Product Accuracy of up to 0.2% of Full Scale, with very slight Derating over a Wide Temperature Range



REQUEST BULLETIN MM 109

Magnetic Demodulators

HIGH RELIABILITY — SMALL SIZE!



The new G/M Magnetic Demodulator is a solid state circuit for converting phase reversing AC signal voltages into phase detected polarity reversing DC voltages. The amplitude and polarity of the DC output are directly proportional to the phase and amplitude of the AC signal. High reference impedance results in very small reference power requirements.

FEATURES:

- Output as High as ± 10 v. DC in Present Units
- Very Low DC Offset Null Voltages (As low as 0.1% of full scale)
- Operation Over Wide Environmental Conditions
- Completely Solid State—No Moving Parts



REQUEST BULLETIN MM 108

General Magnetics • Inc

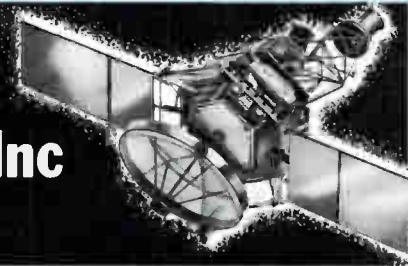

135 BLOOMFIELD AVENUE, BLOOMFIELD, N. J. 07003—Tel. (201) 743-2700

Circle 303 on reader service card

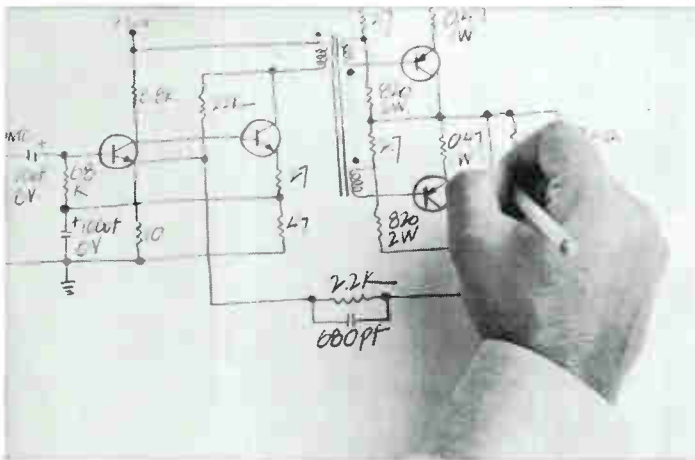

When your design is just an idea, don't specify a special transformer...

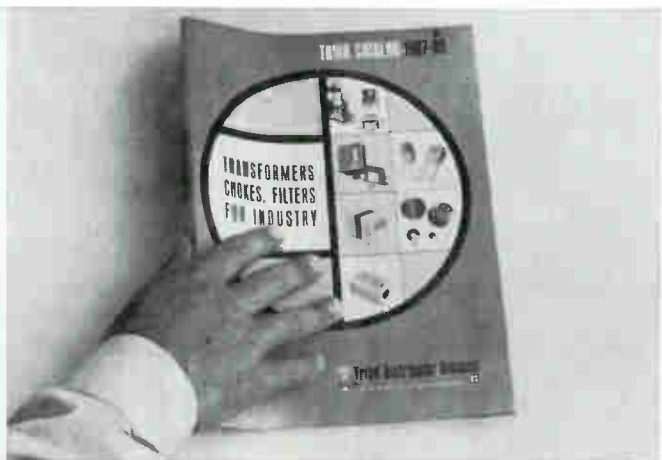

Until you've checked your TRIAD catalog.

You'll find more than 1700 transformers ready off-the-shelf for immediate delivery. One may fit your need, cut costly sampling, and get prototypes on their way faster. Try TRIAD first for standard transformers—and custom made items, too. TRIAD has the resources and the skill to solve your transformer, inductor and filter problems. And make your ideas pay off. TRIAD Distributor Division, 305 North Briant St., Huntington, Indiana.

Circle 225 on reader service card

Triad Distributor Division
of Litton Industries



CONTROL KNOBS FROM RAYTHEON

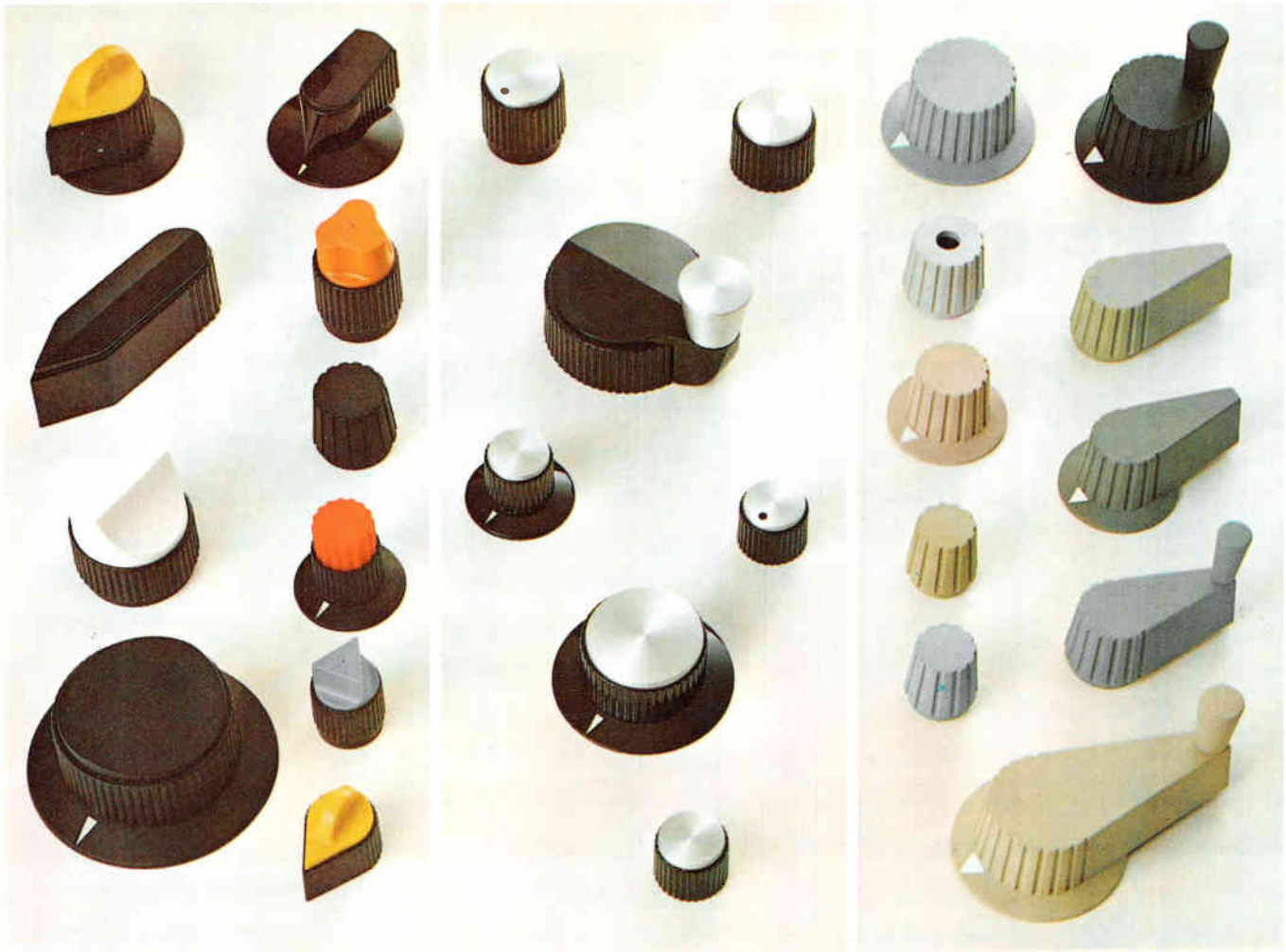

Military knobs, aluminum cap knobs, color knobs for every panel requirement

You can meet military specs, select styles and colors that harmonize or contrast with any panel design and decor — when you specify Raytheon control knobs.

Because, Raytheon offers the largest selection of military and commercial knobs. And *makes them promptly available to you through distributors from coast to coast.*

Meet MS91528C Military Specifications from more than 300 standard types. Raytheon has custom designed over 2,000 "specials."

Every knob in the Standard Series is functionally designed. All styles have an integrated design to give uniformity to your panel. And each knob meets MS91528C for resistance to flame, torque, temperature and humidity extremes, salt spray and

ultraviolet radiation. Colors include black, red, gray or to your special order.

Or, specify aluminum-cap knobs. These handsome knobs are made of strong plastic with satin finish aluminum caps. Raytheon aluminum caps are treated with an epoxy coating for corrosion resistance. Colors: black, gray, or to your order.

Color knobs highlight panels. Choose from eight colors plus black — in ten styles — to harmonize or contrast with commercial equipment design. Raytheon makes these 400 Series Knobs of durable high-impact ABS.

Call your distributor or nearest Raytheon regional sales office for catalogs and data sheets. Or, circle the reader service card. *Raytheon Company, Components Division, Lexington, Mass. 02173.*

Raytheon Components Division — A single source for Transistors/Diodes/Integrated Circuits/Industrial Tubes/Control Knobs/Panel Hardware/Circuit Modules/Display Devices



RAYTHEON MECHANICAL COMPONENTS

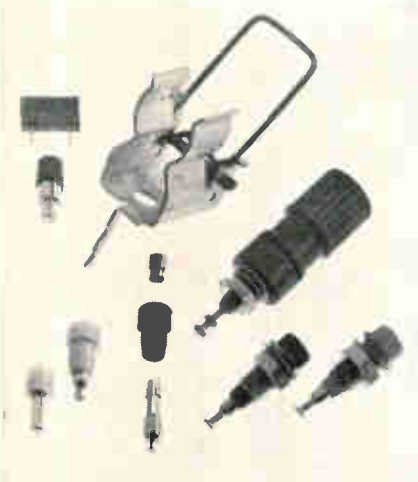

Select from Raytheon's broad line of panel components. Binding posts and all standard and subminiature test jacks and printed circuits meet military specifications. Fuse and resistor clips meet BuShips Spec 16E4 and MIL-E-16400.



Raytheon knob and shaft locks provide smooth locking action with simple adjustment—prevent slip in control settings or adjustments—meet military specs.

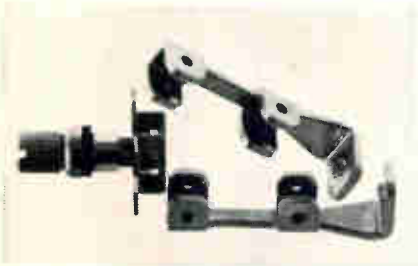

Select Raytheon panel hardware for reliability, economy. Terminal board brackets meet MIL-E-16400A, MIL-E-5400, MIL-P-11268. Unique captive hardware assembly meets MIL-E-16400.

For more information, call your distributor or Raytheon regional sales office. Or write: Raytheon Company, Components Division, 141 Spring Street, Lexington, Mass. 02173.



Production Equipment

actuator and mount, costing a total of \$715. For a complete setup, one of four Hughes welding power supplies can be added at a cost ranging from \$550 for a supply that delivers 50 watt seconds to \$1,265 for a 550-watt-second model. Copper wires as thin as 0.002 inch and as thick as 0.020 inch have been welded.

Hughes Aircraft Co., Vacuum Tube Products division, 2020 Oceanside Blvd., Oceanside, Calif. [397]

Probing system tests semiconductor chips



A probing system for testing semiconductors is fully automatic from first test through complete wafer. Model 2818 features wafer contact stepping, which is monitored by a detector head, eliminating excess stepping beyond the wafer area while accommodating $\frac{3}{8}$ -in. chips to 2-in. diameter wafers. The wafer moves to contact probe points, thus reducing over-all mass movement of the probe head. X and Y stage travel are both automatic and manual for rapid aligning.

A sensor indexing system incorporates a grid mask, which is used together with a photodetector to obtain a higher degree of stepping accuracy. This precision is determined in the mask accuracy, which is estimated at ± 0.5 micron. The device registration that results is within approximately 0.0002 in., thus eliminating the accumulated tolerances that occur with conventional use of lead screw indexing. The system has a speed of less than 250 msec, or more than 4 steps per sec, based on chip center-to-center spacing of 0.0250 in.

Model 2818 is provided with the

Coil winding engineers...

what do you want in Dielectric Tubing?

Precision

offers you...

The Best Materials

and combinations for your specific requirements.

The Exact Size

for your arbor and core laminations.

The Right Strength

to eliminate production headaches.

Properly Made

on the latest equipment to exacting requirements.

Consistently Made

without variation from order to order.

High Temp. Tubing

and tubing for abrasion and humidity resistance.

On Time Delivery

to flow smoothly into your production schedule.

plus...

Personal Contact

to make sure you get what you want!

NEW!

Send for Dielectric Tubing Material-Selector Guide and Tubing Data Sheets.



Precision PAPER TUBE COMPANY

1033 S. Noel Ave., Wheeling, Ill. 60090

Phones: Chicago, 631-1445

Long Distance, 312-537-4250



Couch
ROTARY
RELAYS

Cramped for space?

Use Couch 1/7-size Relays

Space/weight problem? The new Couch 2X 1/7-size crystal can relay gives you tremendous savings in space and weight. 0.1" grid — plus many outstanding specs — all in *microminiature*. Thoroughly field-proven in electronics and space applications.



ACTUAL SIZE

	2X (DPDT)	1X (SPDT)
Size	0.2" x 0.4" x 0.5"	same
Contacts	0.5 amp @ 30 VDC	same
Coil Operating Power	100 mw 150 mw	70 mw 100 mw
Coil Resistance	60 to 4000 ohms	125 to 4000 ohms
Temperature	-65°C to 125°C	same
Vibration	20 G	same
Shock	75 G	same

Broad choice of terminals, coil resistances, mounting styles. Write for detailed data sheets.

RUGGED ROTARY RELAYS  Dynamically and Statically Balanced

COUCH ORDNANCE INC.

3 Arlington St., North Quincy, Mass. 02171, Area Code 617.
Cypress 8-4147 • A subsidiary of S. H. COUCH COMPANY, INC.

Production Equipment

company's patented memory marking system, which eliminates the need for mechanical inkers. Cards are punched when the tester signals a reject. The card is then placed over a tested wafer and is marked by inking through a punched card. Marking is rapid, positive and will not damage the device. The punched cards then provide a permanent record.

Micro Tech Mfg. Inc., 703 Plantation St., Worcester, Mass., 01605. [398]

Gun applies solder and brazing paste



The FE-70, an automatic solder and brazing paste applicator gun, operates on a pneumatic principle. Like its smaller counterpart, the US-70 (see photo), the gun is air operated but mechanically controlled. Air pressure, acting on both a piston in the upper chamber of the applicator gun and on the paste, can be regulated to control accurately the size of deposit dispensed onto the assembly being joined. Working on a positive displacement, positive cut-off principle, the deposit rate ranges from one deposit per hour to 20,000 per hour.

The new applicator gun, for use in conjunction with the patented fusion automatic applicator, incorporates several new design concepts. First, the inside diameter of the fluid body has been increased to accommodate more paste alloy and flux. The result is that the paste to be deposited is in closer proximity to the nozzle orifice, and therefore can be more accurately controlled. Second, by reducing the angle of the paste inlet tube from 75° to 40°, the alloy can be moved

MINIATURE REGULATED POWER SUPPLIES

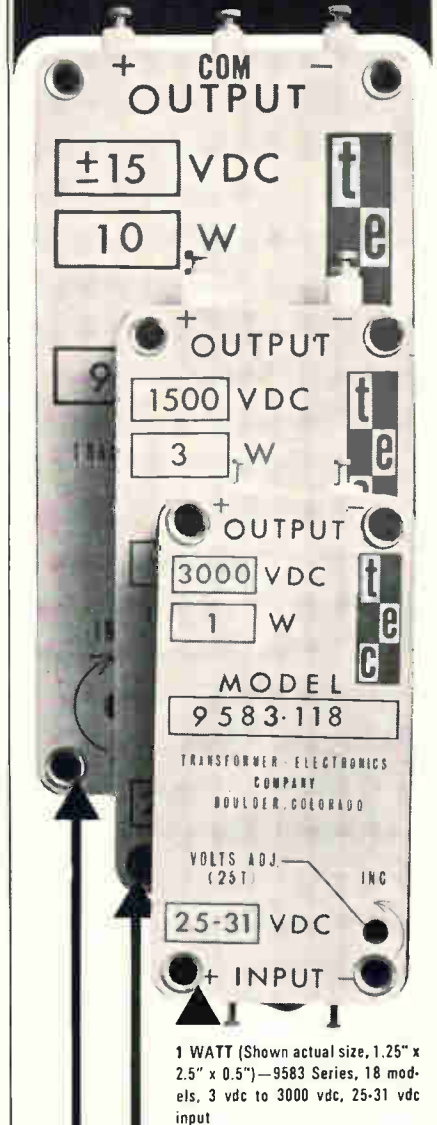

1 WATT (Shown actual size, 1.25" x 2.5" x 0.5")—9583 Series, 18 models, 3 vdc to 3000 vdc, 25-31 vdc input

3 WATT (Shown actual size, 1.5" x 3" x 0.6")—9567 Series, 24 models, 3 vdc to 5000 vdc, 25-31 vdc input

10 WATT (Shown actual size, 2" x 4" x 0.8")—9584 Series, 23 models, 5 vdc to 5000 vdc, 25-31 vdc input

Cost-Performance Optimized • Reduces System Design Effort • Meets Extreme Environments



**TRANSFORMER
ELECTRONICS
COMPANY**

BOULDER INDUSTRIAL PARK
BOULDER, COLORADO

TWX 303 443-2861 PHONE (303) 442-3837

POWER SUPPLIES • INVERTERS
CONVERTERS • TRANSFORMERS

See For Yourself By Testing Sankyo's Family of Time Switches, Timing Motors and Elec- tro-Mechanical Parts!



TS60-S



DFC

TS60-S.....Spring wound time switch, 60 minutes, 100 to 240 VAC, 50 or 60 cps. 5 amp. Other models for 5, 15 and 45 minute timers are also available.

DFC.....Automatic defrost timer for refrigerators. Defrost time 30 minutes for every 12 hours. Other specifications are available. 100 to 240 VAC, 50 or 60 cps. 1 to 5 amp.



GMD



ATM

GMD.....Synchronous type timing motor. 100 to 240 VAC, 50 or 60 cps. 2 to 3W, 3 550 to 3.6 rpm. 0.2 to 3 kg-cm torque. Other model GMC, GME (Synchronous types) and GMA (Inductor type) are available.

ATM.....DC motor driven automatic tuning mechanism for radios. Rated voltage is 6 VDC. Used for AM & FM radios of portable, home and car radios.

TS-2H.....AC motor driven time switch, 2 hours, 100 to 240 VAC, 50 or 60 cps. 5 amp. Other models are available upto 24 hours interval.

DFS.....Automatic defrost timer with thermostat for refrigerators. Defrost at fixed time and terminate at fixed temperature. 100 to 240 VAC, 50 or 60 cps, 5 amp.

ATA.....Spring wound automatic tuning mechanism for radios.

ITH.....Tape counter for tape recorders.

Sankyo

AMERICAN SANKYO CORP.: Rm. 808-10, 95 Madison Ave., N.Y.C., N.Y., U.S.A. Tel. LE-2-8020
SANKYO (EUROPE) EXPORT-IMPORT G.M.B.H.: 4 Düsseldorf, Bahnstraße 45-47, W. Germany Tel. 25652 3
SANKYO SEIKI MFG. CO., LTD.: Shimbashi, Tokyo, Japan Tel: 591-8371

into the fluid body under less pressure. Because the paste is a semi-solid, semiliquid substance, this reduction in pressure virtually eliminates the chance of separation typical of material of this consistency.

As a further improvement, the piston rod has been increased in size from $\frac{1}{8}$ in. to $\frac{3}{16}$ in. This new rod makes it possible to deposit a larger amount of paste at the joint area, and also to insure proper seating at the nozzle orifice.

Fusion Inc., 4658 East 355th St., Willoughby, Ohio. [399]

Automatic blast unit deflashes components

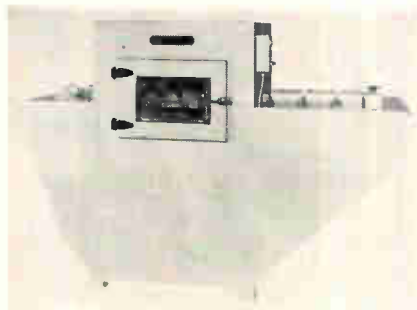

A dry blast unit has been developed for the automatic high production rate deflashing of capacitors and resistors. It has been designed to eliminate costly, conventional manual procedures for removing excess plastic flash.

The complete installation consists of a blast cabinet with an interior air blow-off vestibule and integral dust collector through which a conveyor is moved. The unit measures 84 in. long x 76 in. deep x 72 in. high. Within the blast cabinet, eight suction type blast guns are mounted on an adjustable device. Each gun is fed abrasives through a common manifold with individual controls. This allows appropriate blast coverage for the areas to be finished. The air blow-off vestibule is a baffled compartment within the blast cabinet which serves the purpose of removing residual abrasive from the work-holding fixtures and conveyor.

The conveyor is a roller chain driven by a variable speed drive supported throughout its entire horizontal length on impregnated hardwood rails. Different types of

ELGENCO Noise Generators



Model 610A

SOLID STATE NOISE GENERATORS

Model 602A 5 cps to 5 mc, 3 Ranges \$ 290

Model 603A 5cps to 5 mc, 3 Ranges \$ 495

Model 610A 5 cps to 5 mc, 8 Ranges \$1,175

Series 624 (Fixed frequency) 5 cps to 500 kc \$245 to \$490. Write for details on frequency ranges and spectral flatness.



Model 312A

VACUUM TUBE NOISE GENERATORS

Model 301A DC to 40 cps \$1,995

Model 311A Two outputs DC to 40 cps and 10 cps to 20 kc. \$2,395

Model 312A Two outputs DC to 120 cps and 10 cps to 20 kc. \$2,495

Model 321A DC to 120 cps \$2,095

Model 331A 10 cps to 20 kc. \$1,275

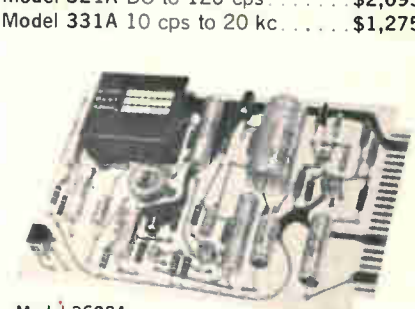

Model 3602A

NOISE GENERATOR CARDS

Series 3602, 3603, and 3606 \$144 to \$389

Various frequency ranges and output flatness available. Size: $4\frac{1}{2}'' \times 6\frac{1}{2}'' \times 1''$. Write for details.

ENCAPSULATED NOISE SOURCE MODULES

Series 1602, 1603, and 1606. . \$95 to \$340

Various frequency ranges and output flatness available. Size: $1\frac{3}{4}'' \times 1\frac{1}{2}'' \times \frac{3}{4}''$. Write for details.

ELGENCO INCORPORATED



1550 Euclid Street
Santa Monica, California
Phone: (213) 451-1635
TWX: (213) 879-0091

DEMONSTRATOR MODELS AVAILABLE
See EEM or Write for Name of Nearest Rep.

CRYSTAL FILTERS

MODEL P119BA



Microsonics manufactures crystal filters that provide high selectivity with excellent temperature stability and a wide range of frequency characteristics. Center frequency of the filters range from 10 KC to 150 mc. Bandpass, band reject, and linear discriminators are produced to the highest standards including qualification to MIL-F-18327.

Microsonics has unique ability to design and measure actual phase characteristics of crystal filters to a tolerance of a fraction of a degree. For example the characteristics of our Model P119BA are shown below:

SPECIFICATIONS

Center Frequency 10.7 mc ± 1 kc
 Bandwidth at 1 db47 kc min
 at 3 db50 kc ± 1 kc
 at 60 db100 kc max
 Differential phase between two filters over 3 db bandwidth $\pm 3.5^\circ$ max
 Phase slope over the 3 db bandwidth $\pm 400^\circ$ approx.
 Insertion Loss 3 db max
 Ripple 0.5 db max
 Z in / Z out 400
 Operating Temperature Range -45°C to $+85^\circ\text{C}$

Write for Bulletin 4350, P119BA



MICROSONICS, INC.

a subsidiary of the
SANGAMO ELECTRIC COMPANY

60 Winter Street

Weymouth, Massachusetts 02188

Area Code 617 337-4200

Production Equipment

work-holding fixtures may be mounted on the chain, depending upon the size and shape of the work to be finished. In the greatest number of applications involving capacitors and resistors, the parts to be deflashed are mounted on a chipboard card. The chipboard card is then manually loaded onto grip spring type fixtures, passed through the blast cabinet, and returned to the operator for unloading.

Pressure Blast Manufacturing Co., Inc.,
27 Pleasant St., Manchester, Conn.
[400]

Production bonder depends on ultrasonics



An ultrasonic production bonder, model 2905, is designed for wire bonding of hybrid circuits. It also offers improved features for bonding and die mounting transistors and integrated circuits.

The ultrasonic wire bonder features a work station that can move over an area of 1.10 in. x 1.10 in. using a micromanipulator with a reduction ratio of 5 to 1. Two push-buttons on the positioner allow the work station to be rotated 360° in either direction, and templates may be used below the positioner for rapid location of bonding points. The bonder handles aluminum and gold wire sizes from 1/2 mil to 2 mils.

In 30 minutes the bonder may be converted to a flip-chip die mounter capable of bonding flip-chip diodes, transistors and integrated circuits over a 2-in. x 3-in. area at the rate of 300 per hour. The unit may also be modified to mount conventional semiconductor dice ultrasonically

Distinctively Styled



1 1/2 in. AM-1 (actual size)

high torque, self-shielded panel meters

Clean, modern styling... easy scale readability... sizes 1 1/2 to 4 1/2". High torque mechanism gives 1% linearity, 2% accuracy and sensitivity to 20 ua. Magnetic system completely shields external field influences, permitting bezel-to-bezel mounting on any material without interaction or effect on calibration. Choice of colors or finishes, custom dials—ASA/MIL 4-stud mtg.

AMMON

AMMON INSTRUMENTS, INC.
345 Kelley Street, Manchester, N. H. 03105

Circle 331 on reader service card

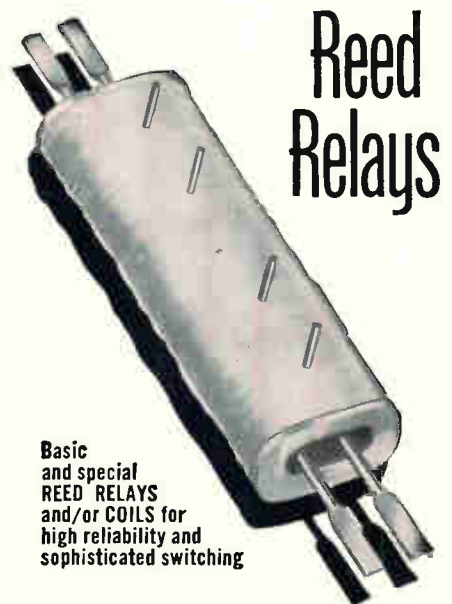

Reed Relays

Basic and special REED RELAYS and/or COILS for high reliability and sophisticated switching

Operating Inputs: low as 1mA. and 15mW.
Standard Coil Voltages: 6, 12, 24, 32, 48V in stock for immediate delivery.

Special Voltage or Resistance, multiple windings for flip flop, memory and crosspoint selection applications — to customer specifications.

Relay Contacts in Form A, B, C and latching. Also high vacuum type 5000V Form A.

Write for Bulletin and Prices

Coto-Coil

COMPANY INC.

61 Pavilion Ave.
Providence, R. I. 02905
Phone: (401) 941-3355

Circle 319 on reader service card

Need ...
FAST REVERSING ACTION?
Need ...
TIMED MEASUREMENT?
Need ... to meet
CHANGING PRESSURES?

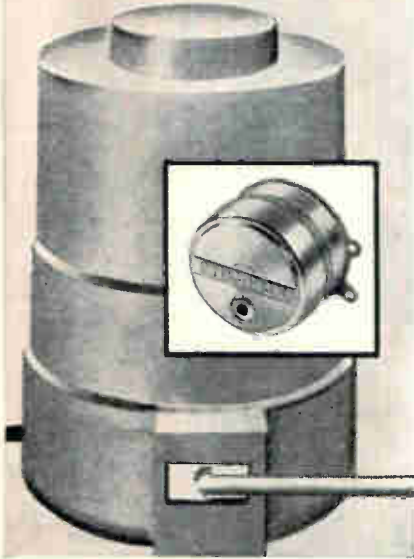

turn the job over to
SYNCHRON® MOTORS!

Any time you have *any* motor application that requires extreme flexibility, extreme versatility and extreme accuracy, think first of Synchron motors. Here at Hansen Manufacturing, we specialize in working with you to help you in design, engineering and production problems. Come to us for the motors, and the application experience you want. Call us—or if you're not in a hurry, write today for complete specifications on the type of motor and application you have in mind. No obligation, of course.



HANSEN REPRESENTATIVES: CAREY & ASSOCIATES, Houston, Tex., R. S. HOPKINS CO., Sherman Oaks, Calif., MELCHIOR & MACPHERSON, INC., San Carlos, Calif., THE FROMM CO., Elmwood Park, Ill., H. C. JOHNSON AGENCY, INC., Rochester, N. Y., WINSLOW ELECTRIC CO., Essex, Conn., Norberth, Pa., and New York, N. Y. EXPORT DEPARTMENT, 64-14 Woodside Ave., Woodside, N. Y.

at higher production rates.

Basic price of the model 2905 is \$4,100 without optics.
Hughes Aircraft Co., Microelectronic division, 500 Superior Ave., Newport Beach, Calif. [401]

Work-viewer system
aids p-c production



This SteroRama work-viewer system is a 3-in-1 combination instrument designed to aid electronic production and facilitate zero reject programs. The multiple optical tool offers a complete work and inspection station comprising a precision lens head and illumination source, both mounted on a free-swinging (panoramic) arm. It provides a large work-viewing area (over 40 sq. in.), with ample distance between lens and work material for the free use of hands with microwelding, microsoldering or other instruments. One of the chief applications of this work-view station is in the production of printed circuit boards.

The manufacturer says the depth of field of the precision lens head eliminates the need to make frequent adjustments. Work remains in sharp focus as it is moved freely through all focal point depths and distances—up and down, or sideways. This eliminates eye strain and fatigue which commonly accompany the use of an ordinary magnifying lens, according to the manufacturer.

Only fingertip pressure is needed to swing the lens away from the work in process. The 3-joint arm can be raised a distance of 19 in.

**CUSTOM
DESIGNED
POWER
SUPPLIES
TO**

Mil-E-16400

Mil-E-5400

Mil-E-4158

Mil-T-21200

Mil-P-11268

NASA-200-2

Mil-I-983

Mil-F-18870

*Detailed data on facilities,
capabilities and contract
accomplishments on request.*



90 ROME STREET
FARMINGDALE, NEW YORK 11735
Phone 516-694-5484
TWX 516-694-1505

THE HULL STORY...
ENCAPSULATION
BY TRANSFER MOLDING

**For components
like these...**

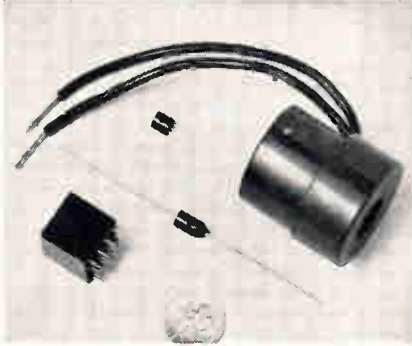

**why do the world's
leading manufacturers*
depend on Hull
packaged systems?**

Here's why:

**RECOMMENDATIONS BASED UPON
OVER 500 INSTALLATIONS**—Since 1956, Hull has accumulated a wealth of encapsulation know-how to guide selection of the *right* production equipment.

UNDIVIDED SYSTEM RESPONSIBILITY—The Hull "package" includes press, molds, loading frames, and auxiliary handling equipment . . . assuring smooth, economical flow of production parts.

INTO PRODUCTION, FASTER, SURER—Hull can help steer system design for optimum encapsulation while product is at "bread-board" stage . . . minimizing lost motion and delays.

LOW-COST, QUALITY PRODUCT ASSURED—Hull encapsulation systems offer a *proven* method for rapid, precise, and economical packaging of electronic components and circuits, large or small.

FOR MORE OF THE HULL STORY on encapsulation by transfer molding, write for a copy of Bulletin P963. **HULL CORPORATION**, 6036 Davisville Road, Hatboro, Pa. 19040. Telephone: (215) 675-5000. Export: 1505 Race St., Phila., Pa. 19102.

*Texas Instruments, General Electric, IBM, Motorola, Philips, Fairchild Semiconductor, Siemens & Halske—to name a few.



H-36

Production Equipment

from the working surface and it extends 19 in. from its main pivot. This enables it to travel in a complete circle over a large lighted area. The small, high-intensity, air-cooled floodlight attaches to any part of the arm.

Price is \$179; delivery, immediate.

The Ednalite Research Corp., 210 North Water St., Peekskill, N.Y. [402]

Slicing machine is fully automatic

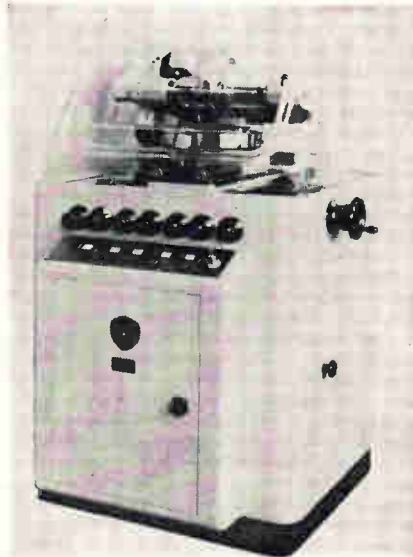

Type TS3 machine is designed for fully automatic slicing of germanium and silicon for transistor production, also for sawing quartz, ruby, glass, tungsten carbide and ceramic materials. It makes possible the most precise and clean cutting-off jobs, using relatively thin diamond-charged cutting blades, to obtain laminations of 0.15 to 15-mm thickness. This will enable savings in material and time, according to the manufacturer.

All combinations of motions performed by the machine are automatically actuated by an electrohydraulic control unit. Feed rates being infinitely adjustable. A limit switch will stop the machine after it has completed its operational cycle.

The work piece is fixed onto a rotary table 200 mm in diameter,

IMPROVE ACCURACY of THERMOCOUPLE CIRCUITRY

WITH KAYE —



Thermocouple Binding Posts Terminal Blocks

Especially designed to prevent spurious emf's.

Available in gold-plated copper, constantan, iron, chromel and alumel.

Send for Catalogue 115.



JOSEPH KAYE & COMPANY, INC.
737 CONCORD AVE. · CAMBRIDGE 38, MASSACHUSETTS
TEL. 617-868-7080

Circle 307 on reader service card

Mūl'ti-Vi'dērTM

Mūl'ti-Vi'dēr, *noun*.

1. A single new instrument that completely replaces digital voltmeters, digital ratiometers, differential voltmeters, Wheatstone bridges, Kelvin bridges, Wenner bridges, Mueller bridges, potentiometers, voltmeters, optical galvanometers, universal ratio sets, Kelvin-Varley dividers, direct-reading ratio sets, temperature regulated oil baths, mercury-stand resistance standards and all other traditional D-C tools.

2. An inexpensive D-C instrument that offers superior speed, accuracy, simplicity, reliability, convenience and flexibility.

3. A new tool that modernizes D-C research, design, test capability as the oscilloscope and electric counter did for all modern AC and time domain capability.

Ask for a simple demonstration of the many ways in which the Multi-Vider can increase output and reduce costs for your company. Write Dept. C 10

JULIE RESEARCH LABORATORIES, INC.
211 West 61st Street
New York, New York 10023



Circle 308 on reader service card

6 BIT A TO D CONVERTER 15,000,000 CONVERSIONS PER SECOND

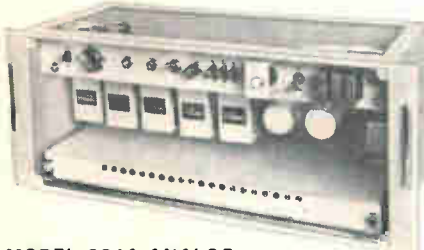

MODEL 834A ANALOG TO DIGITAL CONVERTER

Well-suited for telemetering or process control
Long life and high stability
All solid state, silicon semi-conductors

SPECIFICATIONS

Method: successive comparison.
Digital output: B.C.D. 12 bit parallel. Stability: $\pm 0.2\%$ /6 months. Conversion time: approximately 240 μ s. Operating temperature: -10°C to $+50^{\circ}\text{C}$. Width: 480 mm. Height: 199 mm. Depth: 225D mm. AC input: 100/110/220/240V $\pm 10\%$ 50 or 60 c/s.

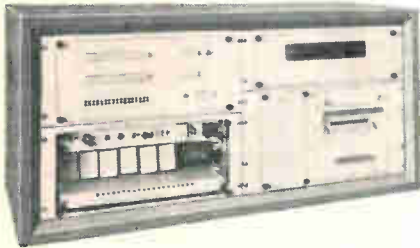

MODEL 198C DATA LOGGING SYSTEM

All solid state
Random access analog scanner
High reliability and accuracy
Operates over large temperature ranges
Low cost

SPECIFICATIONS

Scanning capability: 16 channels. Scanning speed: up to 5 channels per second. Accuracy: 0.1%. Output: printing paper tape. Logging cycles: 10 seconds to 1 hour (specify on ordering). AC input: 100,110,220/240V $\pm 10\%$ 50 or 60 cps (specify on ordering).



MODEL 507C DIGITAL VOLTMETER

All solid state and high speed.

SPECIFICATIONS

Measuring range: (1) 0.001 to 1,599 volts
(2) 0.01 to 15.99 volts
(3) 0.1 to 159.9 volts
(4) 1 to 1,599 volts

Accuracy: 0.1% of full scale. A/D conversion time: 600 μ s. Max. repetition rate: 1 kc. Reading mode auto: 100 c/s repetition rate.

Digital output:

4 digit decimal 10^{C} . parallel code connectable to the line printer Operating temperature: D to 40°C . Width: 480 mm. Height: 199 mm. Depth: 350 mm. Weight: approx. 13 kg. AC input: 100/110/220/240V 50 or 60 cps.

CHUO ELECTRONICS CO., LTD.
No. 21 Motohongo-machi Hachioji-shi,
Tokyo, Japan

which can be rotated to 360° and tilted to 15° . Setting is read off a vernier to 3 minutes-of-arc accuracy. A fine-adjustment table, with reading to 1 minute-of-arc, can be supplied if so required. The work table has 260-mm longitudinal travel and 160-mm step-wise cross motion.

Falcone Engineering Inc., 487 Orange St., Newark, N.J., 07107. [403]

Automatic tool installs terminals

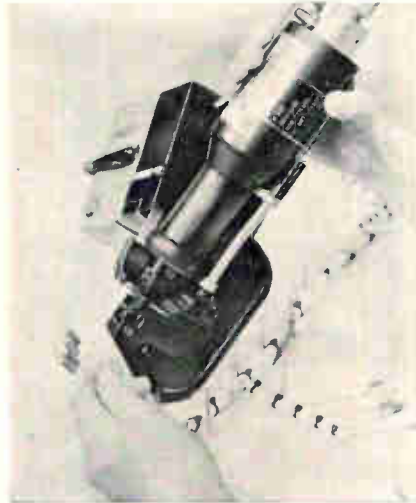

An automatic-feed tool can install solderless terminals on wire at a rate of over 1,000 per hour. A portable hand model and a bench-mounted model are available.

A Mylar plastic belt holds the terminals as they are fed into the compression dies, which are self-aligning and self-adjusting and can be snapped in and out. Based on straight-line action, the terminal installation tool will not release the terminal until the proper amount of pressure has been applied. Inspection integrity dots are embossed on the terminal automatically to indicate visually that the proper installation has been made.

The tool has only five moving parts, meaning long service without the need for maintenance. The tool operates on 90 to 100-lb air pressure. The bench model (No. 11907) is mounted on a hand rubbed $\frac{3}{4}$ -in. birch plywood base with four friction feet to prevent movement. The lightweight portable model (No. 11906) is for panel and harness board wiring. The Thomas & Betts Co., 36 Butler St., Elizabeth 1, N.J. [404]

What Kind of Panel Meter Do You Need ?

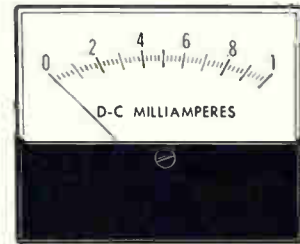

crisp, classic Horizon Line?



trim, built-in Horizon Line?

You can get it...from General Electric's full line

Built-in or front-mounted, G-E HORIZON LINE[®] panel meters add quiet sophistication that accents, never dominates, your electronic equipment. All ratings are available in 2 $\frac{1}{2}$ ", 3 $\frac{1}{2}$ ", and 4 $\frac{1}{2}$ " sizes. See the complete General Electric panel meter line at your dependable electronic distributor. 592-26

GENERAL  ELECTRIC

NEW CHEMELEC® TFE TEST SOCKETS



**RELIABILITY
FOR TEST** ACTUAL
SIZE
**AFTER TEST
AFTER TEST**
(UP TO 100,000)



Unique contact design gives Chemelec test sockets their extra, long-term reliability—makes them ideal for in-and-out service. In each pin hole are three beryllium copper leaves that bow in toward the center. Every time a lead is inserted, the leaves deflect to let it slide in easily, but press firmly against it to assure good contact.

Tapered entry holes and low insertion force (less than 1 oz. per lead) make them easy to plug into, and a built-in barb prevents accidental pull-out of the contact assembly.

The gold-over-nickel-on-beryllium-copper contacts in TFE fluorocarbon plastic bodies—to appropriate MIL specs—create sockets you can safely use in heat sinks or cryogenic environments, as well as in normal applications.

Three body sizes, with 3 to 14 contacts, in .100 to .325 pin circles.

For more information, write for Bulletin ST-1.



GARLOCK
ELECTRONIC PRODUCTS
GARLOCK INC.

Cherry Hill, N.J. 08034 • Phone (609) 424-1470

In Europe: Europélec S.A., Les Clayes-Sous-Bois, France
In the United Kingdom: Lectropon, Ltd., Slough, England

New Materials

Leak-detecting fluid foams white



A leak-detecting fluid, called Formula No. 577-V, is designed for vacuum testing. Its simplest application is to the connections and seals of a vacuum system that can easily be pressurized. Any leakage down to 1/10 of a standard cubic centimeter in three hours will be pinpointed by a white foam. If the vacuum is impossible to pressurize, then 577-V applied to the outside of the evacuated system will penetrate any leak and foam will be evident internally when viewed through ports in the system.

Formula 577-V may also be used for vacuum box weld testing and for locating leaks in small electronic components containing gas. In the latter case, the parts are dipped in 577-V and placed under a glass bell jar. Upon evacuation, foam forms wherever there is any leakage.

Additional properties of 577-V include low outgassing, high electrical resistance and excellent penetration of pinholes, hairline cracks and porous welds. Residue content upon evaporation is extremely small and the material is noncorrosive and nontoxic.

Leak-Tec division, American Gas & Chemicals, Inc., 511 E. 72nd St., New York, N.Y., 10021. [406]

Nonporous-coated evaporation sources

Aluminum-oxide-coated evaporation sources are used for the contamination-free deposition of thin films. They find application in the field of optics, microcircuitry, semi-

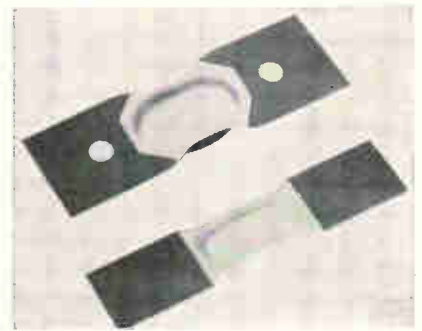

conductor and thin-film deposition industries.

Characterized by the application of high purity (99.9%) Al_2O_3 applied to a refractory metal base of molybdenum (99.9% pure), these devices will operate up to 1,900°C. The Al_2O_3 coating prevents the evaporant from alloying with or attacking the refractory metal and according to the manufacturer results in longer product life, impurity-free deposition, high operating temperatures and greater deposition control.

The aluminum-oxide is nonporous and is applied to the refractory base material in such a manner as to avoid chipping, cracking or peeling. This enhances the life of the evaporation source and allows the vacuum engineer to deposit a variety of materials such as gold, Inconel, Chromel, Kanthal, Nichrome and many others.

Designated the PB series, these sources come in a variety of sizes and configurations, and cost from \$5.85 to \$7.95 each, with off-the-shelf delivery.

Evaporation Apparatus Inc., 2208 South Wright St., Santa Ana, Calif., 92705. [407]

YAG crystals available for laser work

Yttrium-aluminum garnet (YAG) crystals are now available for use as essential components in lasers. They are offered with up to 1.5 atom % doping of Neodymium, and are guaranteed to lase.

The crystals are available in three standard rod sizes as raw blanks, with ground ends, polished ends, or as finished components

Metronix



SINE/SQUARE OSCILLATOR

MODEL **311** \$71.50 (FOB JAPAN)

5Hz ~ 560kHz, 600 Ω



HIGH SENSITIVE AC VTVM

MODEL **121** \$66.50 (FOB JAPAN)

full scale 1.5mV ~ 500V, 5Hz ~ 500kHz

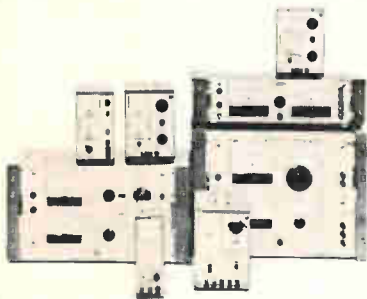

REGULATED DC POWER SUPPLIES

29 models are available. For particulars, please apply for catalog.

RIPPLE: 3mVpp

MODEL	VOLTS	AMPS	REGULATION (line or load)	FOB JAPAN \$
521A	1~18V	0.5A	±20mV	41.50
541A	1~35V	0.25A	±20mV	46.50
543	1~35V	0.5A	±20mV	73.50
531B	0~35V	1 A	±10mV	84.00
535C	0~35V	5 A	±3mV	250.00

Specialized dealers wanted:
Write today for details.

Metronix Metronix corp.

76, CHOFU-CHIDORI-CHO, OTA-KU, TOKYO

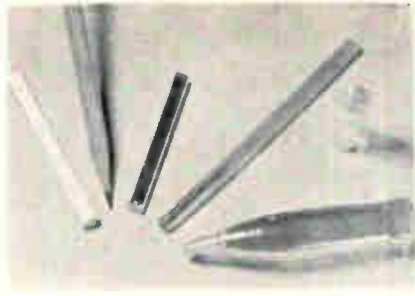

with dielectric coatings on both ends. Standard 3 mm diameter YAG crystals are 30, 50, or 75 mm long.

A typical 30 mm YAG crystal with dielectric coatings on both ends and guaranteed to last costs \$815.

Aremco Products, Inc., P.O. Box 145, Briarcliff Manor, New York, 10510. [408].

Fluorinated liquid cools flashtubes

Designed to withstand high energy pulses from xenon flashtubes, a fluorinated liquid can be used as a laser and flashtube coolant.

The transparent FC-104 flashtube coolant provides wide liquid range (less than -80°F to approximately +215°F); and improved heat transfer capabilities compared to other conventional coolants such as silicone oils. Its dielectric strength is greater than 35 kv per 0.1 in. The nonflammable liquid has high temperature stability (greater than +600°F) and is compatible with construction materials.

3M Co., 2501 Hudson Road, St. Paul, Minn., 55119. [409]

Fluid epoxy system bonds Mylar films

A two-part fluid epoxy system, known as X-11964, may be cured at room temperature or in 30 minutes with 100°C. The cured system is said to be very flexible and resilient with excellent adhesive property.

The X-11964 was formulated particularly for good adhesion to Mylar film material such as Mylar coated components and panels; however, it is an excellent adhesive for wood, glass, plastics, and ferrous and nonferrous metals.

Kenics Corp., One Southside Road, Danvers, Mass., 01923. [410]

What Kind of Panel Meter Do You Need?



distinctive Big Look?

You can get it... from General Electric's full line

Add bold, exciting, truly distinctive styling to your electronic equipment with General Electric's BIG LOOK® panel meters. All ratings are available in 1½", 2½", 3½", 4½" sizes. See the complete General Electric panel meter line at your dependable electronic distributor.

592-27

GENERAL  ELECTRIC

DUAL OUTPUT POWER SUPPLIES



Dual output power supplies are housed in one case 3-5/16" x 4-5/32" x 4-11/16" high. Identical or different output voltages from 1.5 to 75 are available in 1 volt increments for each of the DC outputs. The graph below furnishes maximum current corresponding to output voltage. Select the two outputs needed and telephone Acopian for all the details — plus guaranteed 3-day shipment after receipt of your order.

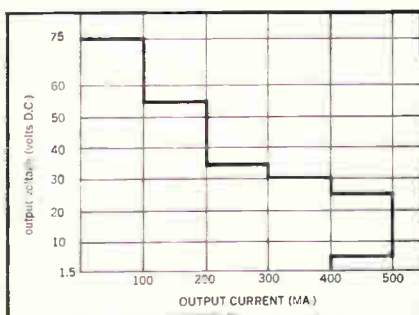

TYPICAL SPECIFICATIONS

Input Voltage: 105 to 125 VAC

Line Regulation: ± 0.5 to $\pm 0.05\%$
(depending on model)

Load Regulation: ± 1.0 to $\pm 0.05\%$
(depending on model)

Ripple: 5 to 1 mv (depending on model)

No additional external heat sinking required.

Write for Acopian's 16-page catalog and price list to: Acopian Corp., Easton, Penna., or call collect (215) 258-5441.



New Books

Switching theory

Introduction to Switching and Automata Theory

Michael A. Harrison

McGraw-Hill Book Co., 499 pp., \$16.50

In the title the word "introduction" should not be taken to imply simplicity. This is a textbook—and by no means for beginners. The theory is difficult enough to warrant clarification and explanation, and the selection of topics is wide enough for development along several avenues.

Problems at the end of each chapter make the book suitable for an undergraduate. However, the material is sophisticated enough for graduate study. Afterward the book could serve as an excellent reference.

The treatment lies between the fields of engineering and mathematics, never entering fully into either. This is not necessarily a detriment; the book can serve as a guide into either field according to the reader's desire. A good bibliography allows pursuit of specific areas.

The author attempts to develop a permanent basic theory and then expand it with almost entirely abstract mathematics. There is little discussion of practical equipment.

Harrison ranges from Boolean algebra to probability theory. To cope with the many subjects, he has introduced a large collection of short word forms, abbreviations and mathematical symbols. A glossary of these would have made reading easier. A related problem afflicts the appendixes, since they rely heavily on textual developments. The table of minimal switching circuits, for instance, is coded without being explained, leaving the reader to find the meanings of the designations in the text.

A preliminary section on mathematical background contains a good collection of basic thoughts on number theory, abstract algebra and mapping—material which provides a good, quick reference source. The description of Boolean algebra, slanted toward the classical theory rather than practical operations, helps the reader to understand the role this algebra

plays in the well-ordered mathematical structure that the author develops.

Development of the structure splits the rest of the book into sections called "combinational" and "sequential." In the combinational section, logic circuits are introduced, which is unfortunate since they date the text and do not impart enough information to be of any value to a circuit designer.

Harrison's treatment of minimization is noteworthy because the graphical Karnaugh map and the more mathematical Quine's algorithm are both presented. The dissertation on Quine's method is difficult to follow without previous background. An important part of minimization's role—reducing cost—is mentioned, but no further reference to cost functions is undertaken.

A highly advanced chapter on transformation and equivalence of groups of switching structures is concerned mainly with reduction of functions—it helps to give understanding to the tables of functions listed in the appendixes. The use of matrixes to transform Boolean functions is described clearly.

A good descriptive and manipulative discussion of tree networks is given (the practical consideration of "sneak paths" is one of the exercise problems). Also presented are an algorithm for constructing uniform contact folded trees and the Lyapunov tree, which is possibly more economical. The author includes an interesting discussion on the upper and lower bounds of the number of contacts needed to define a function of n variables.

Some studies into the reliability of two-terminal contact networks are made, but simplified by assuming independent element and non-time-varying probabilities. Borrowing terms from chess (opening, middle and end game), the author outlines a procedure for designing a known reliability factor into a switching network. In addition, arguments are presented on the probability bounds of the networks. The text assumes some prior knowledge of probability theory, but the background need not be extensive.

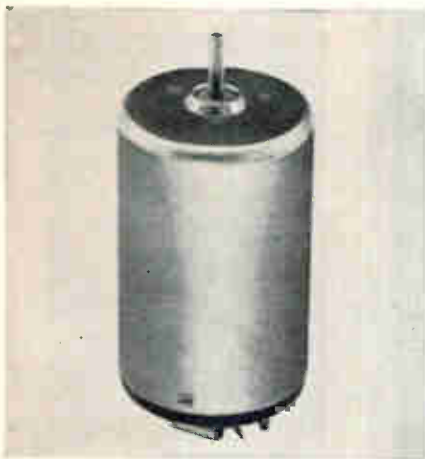

Who needs 55% efficiency in a micro motor 20mm or less in diameter?

No one.

But it is a testimony to Mitsumi's ability to meet unusual speciality micro-electronics requirements. Micro motor efficiency over 50% has been considered impossible for a motor as small as 20mm in diameter. Adoption of a new system in the magnetic circuit has upset this common concept.

Both electrical and mechanical noises have practically been eliminated by a built-in noise suppressor, and a specially constructed brush which has improved the rectifying capacity.

Ask for Mitsumi when you need a reliable, quality micro motor for portable tape-recorders, record-players, measuring instruments and 8mm 2-speed movie cameras. Over 30 types of AC or DC micro motors are immediately available.

Mitsumi is the world's leading maker of polyethylene variable capacitors, I-F transformers, synchronous motors, front-end FM tuners, UHF & VHF TV tuners, CdS photoconductive cells, trimming potentiometers, coils, sockets, trimmer capacitors, terminals, and fuse holders.



MITSUMI

MITSUMI ELECTRIC COMPANY, LIMITED
 1056 Koadachi, Komae-machi, Tokyo. 415-6211
 302, Cheong Hing Bldg., 72 Nathan Road, Kowloon, Hong Kong. 666-925
 Marienstrasse 12, Dusseldorf, W. Germany.
MITSUMI ELECTRONICS CORPORATION
 11 Broadway, New York 4, N.Y. 10004. HA5-3085
 333 N. Michigan Avenue, Chicago, Ill. 60601
 263-6007

In the section devoted to sequential machines, a completely new set of symbols is used to characterize the memory or state capabilities of this class of networks. Numerous diagrams and examples help develop the structure of sequential machines in a mathematical sense and the machines' responses to input stimuli. Machine states are investigated first without considering output and then with output.

As in the combinational section, the reader is led into areas of analysis, synthesis, equivalence and minimization of sequential machines—although not necessarily in that order. The definition and behavior of a probabilistic sequential machine is given in some detail. Reference is made to reliability, but it is not dwelled upon.

As a final attempt to touch upon all the basic branch studies pertaining to automata (in the sense that the author uses that word), context-free languages are given consideration. Whether it is because the subject matter deals with a new fundamental philosophy and therefore the reader has little experience to draw on or because the text requires more development, the presentation does not provide an adequate introduction.

Robert C. Joseph
 Airborne Instruments Laboratory
 Deer Park, N.Y.

Recently published

Introductory Computer Programming, Frederic Stuart, John Wiley & Sons, 155 pp., \$5.95

The Challenge of the Computer Utility, D.F. Parkhill, Addison-Wesley Publishing Co., 207 pp., \$7.95

High-Power Electronics, Vol. 2, edited by P.L. Kapitza and L.A. Wainstein, Pergamon Press, 117 pp., \$8

Circuits, Devices, and Systems, Ralph J. Smith, John Wiley & Sons, 776 pp., \$11.95

Antenna Analysis, Edward A. Wolff, John Wiley & Sons, 514 pp., \$25

Mathematics for Electrical Circuit Analysis, D.P. Howson, Pergamon Press, 170 pp., \$3.50

Electronics: A Bibliographical Guide—2, C.K. Moore and K.J. Spencer, Plenum Press, 369 pp., \$18

Signal Detection Theory, John C. Hancock and Paul A. Wintz, McGraw-Hill Book Co., 247 pp., \$11.95

Applications Manual for Computing Amplifiers: for Modelling Measuring Manipulating & Much Else, Philbrick Researches, Inc., Dedham, Mass., 116 pp., \$3

Zero Defects: A New Dimension in Quality Assurance, James F. Halpin, McGraw-Hill Book Co., 228 pp., \$10.50

What Kind of Panel Meter Do You Need ?

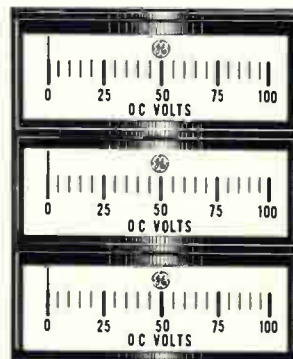

smart, slim edgewise?

You can get it...from General Electric's full line

Besides saving you valuable panel space, General Electric slim-line 2 1/4" Type 185 EDGEWISE panel meters add exceptional styling and readability to your electronic equipment. Mount individually or in clusters of two, three, or more. See the complete General Electric panel meter line at your dependable electronic distributor. 592-28

GENERAL ELECTRIC

HATHAWAY

NO. 1 DRIREED



smart "C" choice

The form "C" — another of Hathaway's refined electronic-switching elements. The FCD in your choice of 4 double throw relay packages—SPDT to 4 PDT.

Distributed Nationally by
COMPAR CORPORATION

For detail information call
or write...

HATHAWAY INSTRUMENTS, INC.
5250 EAST EVANS AVENUE
DENVER, COLORADO 80222
(303) 756-8301 • TWX 292-2935

Technical Abstracts

Interplanetary computers

Logical design techniques
for error control

Jack Goldberg, Stanford Research
Institute, Menlo Park, Calif.

Failure probability of only about 1% is all that will be allowed for the computers that will be carried on spacecraft setting out on journeys lasting six months to three years. Since each computer may have as many as 100,000 active devices, any of which might fail, the reliability goal is virtually impossible to achieve on the basis of inherent device reliability.

Therefore, the computers will need a high degree of automatic self-diagnosis and, since elements will inevitably fail, the ability to reassign functions among the elements that still work. Present redundancy techniques are inefficient and unsuited to reconfiguration—that is, they don't have the flexibility needed to make full use of fault-free elements as faults accumulate.

To illustrate the problems in system organization and network design, a reconfigurable computer is hypothesized. It is a general processor for counting, index-register storage and arithmetic and micro-program control.

A given processing step is done by combining the data in a selected register with data in the accumulator and distributing the result to a register or the accumulator. Selection and operation is under external control. Information is exchanged with the external system via a commutation switch. To bypass a faulty column, the switch must be able to direct n' bits to any subset of size n' among the n columns.

Each module of the processor can decode the selection and operation control signals, reducing the types of modules and the number of terminals. Information transfer between adjacent modules is restricted to a single bit from a selected register, transmittable in either direction, and a carry bit for arithmetical operations, transmittable in only one direction. Bypassing a stage for lateral information is accomplished simply by bussing cor-

responding transverse input and output lines in both directions.

To communicate around internal faults, a sequential network is proposed. It is essentially an asynchronous shift register of $2n$ stages, with parallel inputs to the first n stages and parallel outputs from the second n stages. Information on data channel quality is stored at cells corresponding to each channel. Data propagates toward higher index stages and comes to rest in a stable configuration. Symbols from valid source channels are collected in a contiguous string. Cells corresponding to faulty channels are skipped.

Although the system has inherent delay, it requires no internal clocking. For some switch sizes, it is more economical than the equivalent combinational network.

A directory table and a routing switch can also be used to program data commutation. The table identifies receivers by function and location. The stored identification is added to a data message, to route the message through a switch. For ordinary logical transfers, this method is time-consuming, although it has the advantage of flexibility. It is a convenient way to shift blocks of data out of a memory when failures in the access switch make portions of the memory unusable.

Faults in networks may be diagnosed by comparing redundant signals from the networks and duplicate networks, but this is costly and subject to error under multiple-fault conditions. Actually testing a given network is better. Despite recent advances in fault diagnosis, important problems in both analysis and synthesis remain. At present, methods of designing short test schedules are inadequate for combinational networks larger than 100 gates, multiple-output combinational networks and sequential networks.

Before reconfigurable computers can be built, advances are needed in analyzing the reliability of redundant networks, diagnosing faults in complex networks and synthesizing modular, programmable and easily diagnosable networks

MICO

NEW MODEL 885 SEVEN RATIO WIDE-RANGE ENGRAVER

NO. 885

FOR LONG AND
MULTI-LINE WORK

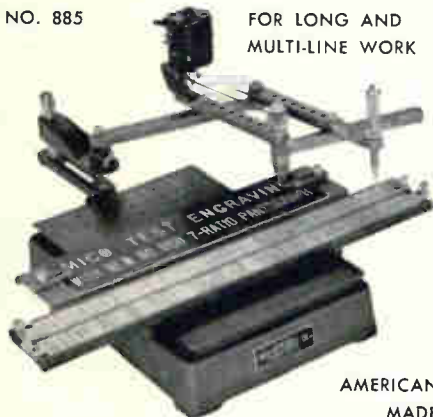

AMERICAN
MADE

- A time-saver for large plate work.
- Engraves 3" x 19" area in one set-up.
- Seven pantograph ratios—from 1.5:1 to 6:1.
- Choice of 3-ball-bearing spindle assemblies for 1/8", 3/16" or taper-shank cutters.
- HSS, COBALT and Solid Carbide Cutters.
- Single and multi-line copy carriers for holding blanks 3/4" to 3 1/2" high.
- Accommodates Mico standard accessories.

Send for bulletins and prices

MICO INSTRUMENT CO.

77 Trowbridge St. Cambridge, Mass. 02138

Circle 314 on reader service card

Primo

Super High Sensitivity SOUND LEVEL METER MICROPHONE (DYNAMIC TYPE)



Specifications

- Frequency Response: 20~16,000%
- Impedance: 50 Ω \pm 10%
- Sensitivity: -84dB 2dB
- Dimensions: 35 ϕ x 220mm
- Weight: 7.30gm.

DM-1332

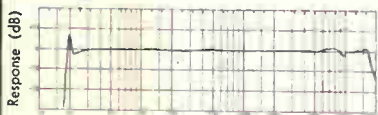

For catalog write to

PRIMO COMPANY LTD.

2043 MURE, MITAKASHI, TOKYO, JAPAN
TEL. 0422-43-3121 (Colling from Tokyo)

Technical Abstracts

that will include both logic and communication.

Presented at the Western Electronics Show and Convention, August 23-26, 1966.

Stacked lasers

High power stacked GaAs laser array
D.R. Muss, C.S. Duncan and S. Souro
Westinghouse Research Laboratories,
Pittsburgh

A unique, closely packed array of gallium arsenide laser diodes arranged as a series stack proves to be a highly efficient source of pulsed light in the near infrared. It is capable of peak powers greater than 300 watts at repetition rates below 200 pulses per second. The emission is nearly monochromatic at about 8,450 angstroms from a luminous area 0.05 by 0.05 centimeters; the beam emerges as a cone about 0.01 steradians when operated at 77°K.

Stacks of as many as 11 diodes have been fabricated; these are connected directly to one another by a very thin solder layer in a series of pn layers, as shown below, with heavy molybdenum electrodes at the ends and a common optical cavity for all the diodes.

The laser array is fabricated by diffusing a p-layer 25 microns deep on a thick n-substrate and dicing the large wafer. Lapping of the n-substrates of the dice to a 25-micron thickness results in a pn die 50 microns thick. The electrodes and the dice are assembled in a jig and soldered together. Two opposite faces of the stacks are rough lapped and the other two faces are lapped and polished flat, parallel to each other and perpendicular to the plane of the junctions. Stacks of 5, 10 and 11 diodes have been fabricated in this way.

Efficiency of the stacks is measured in terms of the peak light "current" out (assigning one electronic charge for each photon measured) divided by the peak drive current. The highest efficiency attained is 20%, with a drive current of 130 amperes. Peak output power is 380 watts.

Presented at the Conference on Preparation and Properties of Electronic Materials for the Control of Radiative Processes, Boston, Aug. 29-31.

What Kind of Panel Meter Do You Need ?



style-matched time meters?

You can get it...from General Electric's full line

The distinctive styling of the G-E BIG LOOK® panel meter line is yours with "look-alike" elapsed time meters. These accurate time meters measure hours or minutes and are offered with or without a reset knob. All ratings are available in 2 1/2" and 3 1/2" sizes. See the complete General Electric panel meter line at your dependable electronic distributor. 592-29

GENERAL  ELECTRIC

Your plant may be ready for new electronics equipment...

but how about your people?



Every day more sophisticated electronic equipment is used by more companies to perform more critical operations. Computers. Calculators. Control systems. Process instrumentation. Communications equipment. It's highly efficient... as long as you have qualified electronic technicians who understand it, know how to maintain it... and can fix it fast if it ever fails.

A good way to build a competent staff of skilled electronics technicians is to up-grade your present technical personnel. And a good way to do it is with a Cleveland Institute of Electronics Training Program. CIE "AUTO-PROGRAMMED" Courses are fast, effective and economical. What's more they can be "tailored" to your specific training needs. There are other advantages, too... and hundreds of satisfied users. Learn about them. Send coupon today for FREE details. Cleveland Institute of Electronics, Dept. E-22, 1776 E. 17th St., Cleveland, Ohio 44114.

SEND COUPON TODAY

Cleveland Institute of Electronics

Dept. E-22, 1776 E. 17th St., Cleveland, Ohio

Gentlemen: I am interested in learning more about your Electronics Home Study Programs. Please send complete information.

Name _____

Title _____

Company _____

Address _____

City _____ State _____ Zip _____

Accredited Member, National Home Study Council.

New Literature

Pressure transducers. Robinson-Halpern Corp., 5 Union Hill Road, West Conshohocken, Pa., 19428, has issued a four-page technical bulletin on its line of P40 series standard and high accuracy pressure transducers. Circle 420 on reader service card.

Electronic filters. Spectrum Instruments, Inc., Box 474, Tuckahoe, N.Y., 10707, offers a short-form catalog providing comprehensive technical data and specifications on its complete line of tunable electronic filters. [421]

Capacitance/inductance meter. Boonton Electronics Corp., Route 287 Parsippany, N.J., 07054. A technical bulletin describes the model 71A, an instrument that provides instant, direct-reading measurement of three-terminal capacitance and two-terminal inductance over ranges of 0 to 1,000 pf and 0 to 1,000 μ h, respectively, at 1 Mhz. [422]

Indicator lights. Dialight Corp., 60 Stewart Ave., Brooklyn, N.Y., 11237. Catalog L-201 presents complete data, drawings and new catalog number designations for the company's subminiature and miniature press-to-test indicator lights. [423]

Servo components. Inland Motor Corp., 501 First St., Radford, Va., 24141, has published a six-page, d-c direct-drive servo components condensed selection guide. [424]

Noise suppressors. Weinschel Engineering, Gaithersburg, Md. A two-page data sheet describes the model 936 noise suppressors for microwave test systems. [425]

Phase angle voltmeter. North Atlantic Industries, Inc., Terminal Drive, Plainview, N.Y., offers a two-page data sheet on its model 214, a four-frequency phase angle voltmeter. [426]

General-purpose relay. Sigma Instruments, Inc., 170 Pearl St., Braintree, Mass., 02185. A catalog bulletin covers the 4 pdt a-c and d-c series 67 miniature general-purpose relay and mounting sockets. [427]

Solid-state switches. TRW Equipment Operations, 23555 Euclid Ave., Cleveland, Ohio, 44117. A four-page brochure explains solid-state, automatic a-c bus transfer switches that feature speed, dependability, and maintenance-free operation. [428]

Relay selector chart. Cornell-Dubilier Electronics, 50 Paris St., Newark, N.J., 07101, has published a four-page selector chart describing its relay product line. [429]

Angular divider. Theta Instrument Corp., Saddle Brook, N.J., 07662, announces a four-page bulletin describing an angu-

lar divider for testing synchros and resolvers. [430]

Laminated tube sockets. Connector Corp., 6025 N. Keystone Ave., Chicago, Ill., 60646. Technical bulletin 40A contains eight dimensional drawings and 76 photos of laminated assemblies, as well as two dimensional drawings and one photo of electrolytic mounting plates. [431]

Magnetic shielding. Magnetic Shield division, Perfection Mica Co., 1322 N. Elston Ave., Chicago, Ill., 60622. Short form catalog No. 67 illustrates and describes various permanently stable, nonshock sensitive Netic and Co-Netic magnetic shieldings. [432]

Power transformers and inductors. Ferrocube Corp. of America, Saugerties, N.Y., has published a 32-page engineering reference manual on procedures and techniques for the design of power transformers and inductors. [433]

Relays. Solid-State Electronics Corp., 15321 Rayen St., Sepulveda, Calif., 91343, has issued a 28-page catalog providing data on miniature, solid-state optoelectronic and reed relays. [434]

Cylindrical substrates. American Lava Corp., Chattanooga, Tenn., 37405. Bulletin 667 describes AlSiMag 531 and AlSiMag 614 cylindrical substrates for discrete film resistors. [435]

Resolvers. Reeves Instrument Co., a division of Dynamics Corp. of America, Garden City, N.Y., offers two brochures on its compensated and uncompensated Size 15 and 23 resolvers. [436]

Panel meters. International Instruments Inc., 8826 Marsh Hill Road, Orange, Conn., 06477. Bulletin 391 covers a comprehensive line of edgewise panel meters. [437]

Transducer performance characteristics. Cohu Electronics, Inc., Box 623, San Diego, Calif., 92112. An illustrated brochure (5-27) discusses verification of transducer performance characteristics by a digital voltmeter/ratiometer. [438]

Chart recorder. Nesco Instruments, a division of Datapulse Inc., 509 Hindry Ave., Inglewood, Calif., 90306. The recorded chart may be pulled out for review and then automatically rerolled onto a take-up reel in the model 210 transistorized chart recorder described in technical bulletin 210. [439]

Test instruments. The Triplett Electrical Instrument Co., Bluffton, Ohio, 45817. Catalog No. 49-T describes a line of panel and portable electrical and electronic test instruments. [440]

Subminiature relays. Airpax Electronics Inc., Cambridge, Md., 21613. A bulletin

The Best Of Boston

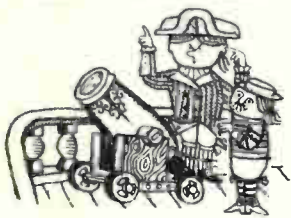

Decisions! Decisions!
The big ones are made
where the best things happen
Now as always at the grand-old,
brand-new Boston Statler Hilton.
Home of the New Trader Vic's!
Phone any Hilton Reservation
Service... for instant,
confirmed accommodations.

The Statler Hilton

Circle 316 on reader service card

**NOW!
APPLY KODAK
PHOTO RESISTS
this new AEROSOL way**



QUICK
CONVENIENT
ECONOMICAL

Three types to suit all
your etching needs
now available at local
industrial photo dealers

TYPE-P containing Kodak KPR*
—for copper, copper-clad
laminates, other metals. 16 oz.
\$5.95

TYPE-M containing Kodak
KMER*—for aluminum, stain-
less steel, titanium, other
metals. 16 oz. \$5.95

TYPE-T containing Kodak
KTFR*—for high resolution
etching of thin films. 16 oz.
\$6.95

*KPR, KMER, KTFR are pro-
ducts of Eastman Kodak Co.

INDUSTRIAL CHEMICAL
SPECIALTIES CORPORATION
1595 Black Rock Tpk., Fairfield, Conn.

Please rush me more information on Spray Resist
products and, also, name of nearest dealer:

NAME _____
COMPANY _____
CITY _____ STATE _____

Circle 321 on reader service card

describes the use of Ugon fast, sensi-
tive, subminiature relays in such appli-
cations as uhf signal switching, meter-
ing relays and instrumentation systems.
[441]

Function generators. Electronic Associ-
ates, Inc., West Long Branch, N.J. A
four-page engineering data sheet de-
scribes two card-programed diode func-
tion generators that minimize setup
time for analog or hybrid facilities.
[442]

Temperature control. Sprague Electric
Co., 35 Marshall St., North Adams,
Mass., 01247. Bulletin No. 89000.2
outlines an economical approach to
precise proportional temperature con-
trol of heaters, ovens and environ-
mental chambers. [443]

Analog power supply. Deltron, Inc., 4th
& Cambria Streets, Philadelphia, Pa.,
19133. Bulletin 202A describes a com-
pact ultraprecision 0.001% power sup-
ply for analog computers with output
range of ± 100 v at 10 amps. [444]

Silicon avalanche rectifiers. Sarkes
Tarzian Inc., 415 North College Ave.,
Bloomington, Ind. A 48-page book on
silicon avalanche rectifiers contains in-
formation on semiconductor theory,
rectifier manufacturing methods and
characteristics, and test circuits [445]

Tape recorders/reproducers. Raymond
Engineering Laboratory, Inc., Middle-
town, Conn., has available literature de-
scribing high reliability tape recorders/
reproducers for rugged environments.
[446]

Industrial coils and chokes. The J.W.
Miller Co., 5917 S. Main St., Los An-
geles, Calif., 90003, announces a 68-
page catalog covering r-f chokes, r-f
coils, i-f transformers and filters. [447]

Digital plug-in modules. Decision Con-
trol, Inc., 1590 Monrovia Ave., New-
port Beach, Calif., has issued a 40-page
catalog, No. 105, describing Versa-
Logic, a complete proprietary line of
digital plug-in modules. [448]

IC logic modules. Wyle Laboratories,
Products division, 133 Center St., El
Segundo, Calif. The series M line of
integrated-circuit logic modules is de-
scribed in a set of detailed specifica-
tion sheets. [449]

Capacitors for transistorized tv. Nu-
cleonic Products Co., Inc., 3133 E. 12th
St., Los Angeles, Calif., 90023, has
published a four-page application note
titled "Metalized Lacquer Film Capac-
itors in the Horizontal Deflection Circuit
of Transistorized T.V." [457]

Synthesized power zeners. Trio Labo-
ratories, Inc., Dupont St., Plainview,
N.Y., offers a technical bulletin de-
scribing a line of 80-watt, 3-ampere
synthesized power zeners, featuring
flatpack encapsulated construction, ad-
justable zener voltages and milliohm
impedances. [458]

**What
Kind of
Panel Meter
Do You
Need ?**



**bright, bold
meter relay?**

**You can get it...from
General Electric's full line**

Add years-ahead BIG LOOK® styling
to your equipment with G-E Type
195 contactless meter relays, fea-
turing solid-state, light-sensitive
switching for the ultimate in
simplicity and readability. All rat-
ings are available in 2½", 3½", 4½"
sizes with single or double set-
points. See the complete General
Electric panel meter line at your
dependable electronic distributor.

592-30

GENERAL  ELECTRIC

Circle 241 on reader service card

241

Employment **Electronics** Opportunities
QUALIFICATION FORM FOR POSITIONS AVAILABLE

ATTENTION: Engineers, Scientists, Physicists

This Qualification Form is designed to help you advance in the electronics industry. It is unique and compact. Designed with the assistance of professional personnel management, it isolates specific experience in electronics and deals only in essential background information. The advertisers listed here are seeking professional experience. Fill in the Qualification Form below.

Strictly Confidential

Your Qualification Form will be handled as "Strictly Confidential" by Electronics. Our processing system is such that your form will be forwarded within 24 hours to the proper executives in the companies you select. You will be contacted at your home by the interested companies.

What To Do

1. Review the positions in the advertisements.
2. Select those for which you qualify.
3. Notice the key numbers.
4. Circle the corresponding key number below the Qualification Form.
5. Fill out the form completely. Please print clearly.
6. Mail to: Classified Advertising Div., Electronics, Box 12, New York, N. Y. 10036.

COMPANY	PAGE	KEY	COMPANY	PAGE	KEY
AMELCO SEMI-CONDUCTOR Mountain View, Calif.	268*	1	LOCKHEED MISSILES & SPACE CO. Div. of Lockheed Aircraft Corp.	180*	12
ATOMIC PERSONNEL INC. Phila., Pa.	243	2	MARTIN COMPANY Orlando, Fla.	277*	13
BELL AEROSYSTEMS Tucson, Arizona	213	3	NATIONAL CASH REGISTER Electronics Div. Hawthorne, Calif.	244*	14
CORCORAN, JOSEPH P. Lafayette Hill, Pa.	176*	4	NEWPORT NEWS SHIPBUILDING Newport News, Virginia	204*	15
ELECTRONIC COMMUNICATIONS INC. St. Petersburg, Fla.	242	5	PAN AMERICAN Cocoa Beach, Fla.	267*	16
GENERAL DYNAMICS ELECTRONICS DIV. Rochester, New York	217	6	SANDERS ASSOCIATES, INC. Nashua, New Hampshire	246	17
GENERAL DYNAMICS FORT WORTH DIV. Fort Worth, Texas	176*	7	TEXAS INSTRUMENTS Dallas, Texas	194*	18
GRUMMAN AIRCRAFT Bethpage, Long Island, N.Y.	270-271*	8	UNION CARBIDE CORP. Oak Ridge, Tenn.	268*	19
HEWLETT PACKARD Palo Alto, Calif.	249	9	U. S. NAVY Naval Ordnance Lab. White Oak, Maryland	269*	20
IBM	244	10	UNIVAC DIV. SPERRY RAND CORP. St. Paul, Minn.	269*	21
LEAR SIEGLER INC. Grand Rapids, Michigan	248	11			

* These Advertisements appeared in the September 19th issue.

(cut here) (cut here)

Electronics QUALIFICATION FORM FOR POSITIONS AVAILABLE
 (Please type or print clearly. Necessary for reproduction.)
Personal Background

Name
 Home Address
 City State Zip Code
 Home Telephone

Education

Professional Degree(s)
 Major(s)
 University
 Date(s)

Fields of Experience (Please Check)

10/3/66

<input type="checkbox"/> Aerospace	<input type="checkbox"/> Fire Control	<input type="checkbox"/> Radar
<input type="checkbox"/> Antennas	<input type="checkbox"/> Human Factors	<input type="checkbox"/> Radio-TV
<input type="checkbox"/> ASW	<input type="checkbox"/> Infrared	<input type="checkbox"/> Simulators
<input type="checkbox"/> Circuits	<input type="checkbox"/> Instrumentation	<input type="checkbox"/> Solid State
<input type="checkbox"/> Communications	<input type="checkbox"/> Medicine	<input type="checkbox"/> Telemetry
<input type="checkbox"/> Components	<input type="checkbox"/> Microwave	<input type="checkbox"/> Transformers
<input type="checkbox"/> Computers	<input type="checkbox"/> Navigation	<input type="checkbox"/> Other
<input type="checkbox"/> ECM	<input type="checkbox"/> Operations Research	<input type="checkbox"/>
<input type="checkbox"/> Electron Tubes	<input type="checkbox"/> Optics	<input type="checkbox"/>
<input type="checkbox"/> Engineering Writing	<input type="checkbox"/> Packaging	<input type="checkbox"/>

Category of Specialization

Please indicate number of months experience on proper lines.

	Technical Experience (Months)	Supervisory Experience (Months)
Research (pure, fundamental, basic)
Research (Applied)
Systems (New Concepts)
Development (Model)
Design (Product)
Manufacturing (Product)
Field (Service)
Sales (Proposals & Products)

Circle Key Numbers of Above Companies' Positions That Interest You
 1 2 3 4 5 6 7 8 9 10 11 12 13 14 15 16 17 18 19 20 21

COMMUNICATIONS ENGINEERS

RF ENGINEERING

ECl, a recognized leader in high performance RF communications equipment, has immediate and challenging opportunities for outstanding RF engineers.

The AN/ART-47 and AN/ARR-71, an airborne transmitter/receiver combination, typify the challenges being met at ECl. This equipment has 1 kW transmitter output, and it covers 3500 UHF channels with AM or FM duplex capability. Yet the transmitter/receiver combination occupies only 2.65 cubic feet.

Many other equally ambitious programs are in progress. They include communication equipment for satellite, airborne, shipboard and



AN/ART-47 and AN/ARR-71 transmitter/receiver combination.

ground transportable applications in voice or data link systems.

You can work on these exciting programs — and live in one of America's most desirable locations — if you are an unusually competent RF engineer. You'll need at least a BS degree, three years of appropriate experience and sound knowledge of solid-state design theory.

Find out about ECl opportunities in RF equipment design. Send your resume, in confidence, to Budd Cobb, ECl, Box 12248E, St. Petersburg, Florida, or call him collect at (813) 347-1121. (An equal opportunity employer.)



ELECTRONIC COMMUNICATIONS, INC.
 St. Petersburg, Florida



E.E.'s

For FEE PAID positions throughout U.S.

Send Coupon Today

ATOMIC PERSONNEL, INC.

Suite L, 1518 Walnut St., Phila., Pa.

Experienced Engineers... Working "Full Time"... For You!

Send resume today. (If none, send coupon for confidential application.)

Name _____

Address _____

City _____ State _____

The Scientists and Engineers served by Corcoran in the last year have found the difference between "a job" and "the job."

- Nationwide. Fee paid.
- Please airmail background to:

JOSEPH P. CORCORAN

Personnel Consultants

505 B Germantown Pike

Lafayette Hill, Pa. 19444

(215) 825-0848

SPECIAL SERVICES

Technical Writing—electronics, data processing, servo systems; send circuit or logic diagram and designer's notes, and receive back, by airmail, full description and operating details from qualified UK engineer—graduate. SS-9948, Electronics.

YOU'RE H!RED

Do you need electronics engineers or technical management men? Electronics magazine is the way to recruit them. Electronics is designed specifically for the working engineer. 68,000 subscribers and an additional 133,000 pass-along readers turn to it to keep up with their industry. You can find the man that meets your qualifications with an advertisement in the Employment Opportunities Section.

For rates & information write: Electronics, a McGraw-Hill Publication. Classified Advertising Division, Post Office Box 12, New York 10036.

ENGINEERS & SCIENTISTS

Like to predict the unpredictable in the expanding field of communications-electronics?

Join **BELL AEROSYSTEMS COMPANY** in Tucson, Arizona

Communications equipment is only as good as its ability to operate without interruption due to unanticipated interference by other "friendly" electronic equipments, or by enemy ECMs. This entire subject is undergoing penetrating study and analysis by Bell Aerosystems as prime contractor to the Army's Electromagnetic Environmental Test Facility.

The current program is using analytical and experimental methods such as interference prediction modeling, computers, laboratory and field development and validation tests to analyze and define the incompatibility and vulnerability of existing equipments and systems, to recommend modifications and to test new equipment under development.

In addition, studies are being performed on the application of electro-optic devices and principles, advanced signal processing methods to communications-electronics systems and the increasing requirements for computer model analysis in the design and performance evaluation of complex systems.

Bell is expanding its research team in the areas above. The men who engage in this work will necessarily be in an unusually advantageous position to lead the field of communications-electronics.

POSITIONS AVAILABLE

ADVANCED PLANNING/CONCEPT DEVELOPMENT ENGINEERS & SCIENTISTS

Experienced in aspects of propagation theory, detection theory, signal processing, analog/digital simulation, electromagnetics and field theory. Should be research-oriented with a strong interest in new concept development and analysis. These positions relate to advanced studies in support of research laboratory marketing and program development functions. Openings from the BSEE through PhD level.

SENIOR DEVELOPMENT ENGINEERS

Experienced in radar systems analysis, radar detection theory, pulse transmission methods of voice communications, propagation studies or antenna development. Work includes theoretical analysis, mathematical modeling, coordination on computer programming and support of shop and field tests necessary for model development. BSEE plus 2-10 years experience.

OPERATIONS RESEARCH ENGINEERS

Experienced in communications systems engineering and operations research, including military TO&E, deployments and radio frequency measurements. BS/MSEE, math or physics plus 2-10 years experience.

OTHER POSITIONS

SENIOR, INTERMEDIATE & JUNIOR

Many additional openings in the areas of scientific programming, mathematical analysis of communications systems, test engineering, mechanical design of facilities and instrumentation, design of radar and radio transmitters and supervision of test engineering tasks. All positions require appropriate degrees plus 0-10 years experience.

Excellent salaries, a comprehensive benefit program and liberal relocation and resettlement allowances are provided.

Please address your resume to Mr. R. M. Davidson, Manager, Industrial Relations. All inquiries will be acknowledged promptly.

BELL AEROSYSTEMS

A **textron** COMPANY

1050 E. Valencia Road, Tucson, Arizona 85706

An Equal Opportunity Employer



Look closely.

That position
you've been looking for
may be listed here.

If you've been searching for a position offering personal and professional advancement with a growth company, take a closer look at IBM's facility in East Fishkill, New York. Here you can enjoy an exceptional scientific environment with a growing division of IBM—THE leader in THE major growth industry: information handling and control. Read on! Your new career may be here.

Component Engineers: Match components to circuit applications, considering component quality, reliability and cost. Design and implement evaluation testing to analyze component design. Aid circuit designer in selection of component parameters to achieve best compromise between component and circuit performance. Background in electrochemical or circuits design required. Position will encompass work in transistors, diodes, integrated circuits, pulse transformers,

delay lines, capacitors and resistors.

Industrial and Cost Engineers: Experienced in one or more of the following areas: estimating labor, materials and tooling cost of small components and assemblies, MTM, budgets, learning curves, manufacturing processes and methods, manpower planning, plant layout, space planning, packaging and materials handling.

Materials Engineers: Requires experience in epitaxial deposition of semiconductor materials related to device oriented laboratory. Positions are also available in developing diffusion processes and investigating related phenomena for device applications.

Quality Control Reliability Engineers: For final test quality control, failure analysis, reliability analysis, chemical laboratory, standards laboratory and test equipment maintenance and calibration.

Process Engineers: Opportunities exist in semiconductor device development, semiconductor manufacturing vendor liaison, pilot line or manufacturing engineering. Includes development of individual components, device design, diffusion, silk screening, printed circuits, plastic encapsulants, X-ray fluorescent analysis, instrumentation methods, photo resist, etching and materials processing.

These positions require a B.S. or advanced degree in Electrical Engineering, Mechanical Engineering, Chemical Engineering, Industrial Engineering, Physics or Metallurgy, plus one to five years' experience.

Please write, outlining your qualifications and interests, to: C. E. J. Cassidy, Department 554-X1M, IBM Corporation, East Fishkill Facility, Route 52, Hopewell Junction, N.Y., 12533. IBM is an Equal Opportunity Employer.

IBM®

POINT: GROWTH POTENTIAL IS IMPORTANT TO YOUR FUTURE



FACT:

G.E. CREATED 217 RADAR/SONAR JOBS IN 1965

■ G.E.'s Heavy Military Electronics Department gives an engineer room to stretch-out . . . breathe . . . obtain professional growth and personal satisfaction. Your immediate contributions at HMED are but starting points to new responsibilities and challenges.

Our radar/sonar engineers need not adopt present successes as the ultimate. They can grow with their ideas—realizing that at least one-third of the products and equipment General Electric will be making in the 1970's are not in existence today. Just last year HMED created 217 engineering positions to support its new contracts and to meet its increased responsibility for designing and developing major radar/sonar systems.

Technical challenge, advanced education and fine community living—all this is part of the climate conducive to your professional growth at HMED. There is ample opportunity for creative work and self-expression thanks to the big and exciting radar/sonar defense contracts held by the Department. Formal graduate study, through our Tuition Refund Plan, is also available at educational facilities in the area; and a wide variety of "in-plant" technical courses are open to you each year. Our engineers and their families are able to take advantage of the excellent recreational activities in the Syracuse community, too.

SEND FOR SPECIFIC JOB INFORMATION. Remember, opportunities for growth and advancement are available in the radar/sonar field right now. To make sure we send the most appropriate job information, send a resume in confidence to: L. M. Bessant, Manager, Professional Placement, Box 44, Bldg. 4, Court Street, Heavy Military Electronics Department, General Electric Co., Syracuse, N. Y. 13201.

177-84

ACT:

WRITE NOW FOR MORE FACTS

HEAVY MILITARY ELECTRONICS DEPARTMENT

GENERAL  ELECTRIC

An Equal Opportunity Employer

Ever come up with an elegant solution only to discover that nobody appreciated the thorniness of the problem let alone the subtleties of your approach to it?

It's not likely to happen at Sanders.

ELECTROMECHANICAL DESIGN & DEVELOPMENT ENGINEERS

To be responsible for D&D of state-of-the-art inertial instruments. Requires BSME with 2 to 5 years experience in D&D of precision electromechanical inertial instruments, gyros or accelerometers, with knowledge of materials, bearings and assembly techniques, and ability to carry concept through to hardware stage.

PRODUCT ENGINEER

To be responsible for production processing, production improvement, preparation of methods and process sheets, design tooling and test equipment, cost and schedule estimates, and preparation of technical reports on precision parts fabrication and assembly. Requires BSME with 3 to 5 years experience in electromechanical instrumentation, hydraulic components or precision inertial instrumentation.

SENIOR ECM STUDY ENGINEER

To join a group engaged in the theoretical and practical evaluation of ECM systems problems. Will develop simple analytical models, bench and flight tests to verify models and study advanced radar and ECM systems and techniques. The most desirable background for this work would be 3-5 years in the development of radar hardware coupled with analytical experience in such phases as external parameters, system error, operations and use, or any aspect of system performance and trade-offs. ECM, Elint, or communications work will also be considered. Military experience highly desirable. BSEE or MSEE preferred.

SENIOR CIRCUIT DESIGN ENGINEER

Candidates should have 3 or more years in circuit design and analysis using vacuum tubes, transistors, and other solid state devices. Background should include extensive experience in the design and engineering of circuits of these types: digital and logic, video and pulse, RF and audio, power supplies and regulator circuits, etc., for military systems. Advanced degree desired.

SENIOR RECEIVER DESIGN ENGINEER

Require 5 or more years in the design and development of complex receivers for communications, radar and missile systems. These receivers are generally airborne, covering frequency ranges through UHF, and requiring the application of solid state devices. Must have specific experience designing sophisticated AFC, phase-lock loops, low noise front ends, stable local oscillators, IF strips, etc. Will supervise other engineers and technicians. BSEE or Physics with 5 or more years experience.

MECHANICAL ENGINEER—

Heat Transfer & Packaging. Desired background would include 5 or more years experience in military electronics involving high-density packaging of electronic equipment, design of components for severe shock and vibration, heat transfer as related to packaging, refrigerating and liquid coolants and applications of structural design. Assignment fields may include radar, missiles, ECM, ASW, communications systems or others. BSME required.

Write in confidence to Mr. Lloyd Ware, Staff Engineer.

sanders associates, inc.



NEW DIRECTIONS IN
ELECTRONICS SYSTEMS

An Equal Opportunity Employer

NASHUA, NEW HAMPSHIRE



ENGINEERS



You can almost sense its intelligence. (Testing it is a little more complex.)

The F-111. A magnificent new fighting machine. However, our AGE engineers see it mostly as a fascinating complex of signals, information conversions and displays.

In more rigorous language, the Aerospace Ground Equipment we're developing to analyze the many pulses of the F-111 is a highly automated system in itself... including a video station, receiver/transmitter modulator station, indicator/controls station, central air data computer station, radar servo and indications station, computer station, penetration aids station, attitude and rate station, UHF communications station, HF communications station, TACAN station, HF communications flight-line tester, IR station, and UHF guidance station.

Other programs bring our engineers into equally sophisticated internal and external checkout systems for missiles like Atlas, Nike-Zeus, and Polaris. Some new work now underway in AGE encompasses the ANEW anti-submarine warfare system... flight-line and depot systems for terrain-following radar... SSB equip-

ment... sonobuoy system test generators, radar simulators, transponder test sets, and an ever-lengthening list of others.

Theoretically, this kind of AGE has to be more advanced in its "state-of-the-art" than the equipment it serves. If you doubt the hypothesis, the Electronics Division of General Dynamics may be the best of all places for you to test it. And yourself.

Opportunities are available now to graduate Electronic Engineers with related experience in systems integration, radar AGE design, IR AGE design, ECM AGE design, HF SSB systems design, analog computer circuitry design and digital logic design.

Or you might like to pit your intellect against a provocative study or development program in one of our other laboratories—radio communications, data equipment, ASW, reconnaissance & countermeasures, space communications & navigation aids, tracking systems.

Please send resumes to Mr. L. A. Corwin, Dept. 155

GENERAL DYNAMICS *Electronics Division*

1400 N. Goodman St., Rochester, New York 14601

An equal opportunity employer

(M&F)



**With all the companies offering the same positions,
how do you find the right one?**

Look to the company consistently active in major projects. Lear Siegler hardware is involved in all the significant aerospace programs. LSI Instrument Division products are currently in use on over 70 aircraft, spacecraft and missiles. And, we have been actively applying new concepts in the design and production of advanced flight navigation and reference systems and cockpit displays for more than 30 years.

Exercise and elbow room are what you get at LSI. In a half-million square feet of newly-completed aerospace facilities. For the right position: **CIRCUIT DESIGN ENGINEERS — TEST EQUIPMENT DESIGN ENGINEERS — NAVIGATION & COMMUNICATIONS SYSTEMS ENGINEERS—A.G.E. DESIGN ENGINEERS . . .** send your resume in confidence, or write for information to:

E. B. Mellinger
Professional Employment Manager

LEAR SIEGLER, INC.



INSTRUMENT DIVISION
4141 EASTERN AVE., S. E., GRAND RAPIDS, MICHIGAN 49508

SEARCHLIGHT SECTION

AUTOTRACK ANTENNA MOUNT



360 degree azimuth, 210 degree elevation sweep with better than 1 mil. accuracy. Missile velocity acceleration and slewing rates. Amplidyne and servo control. Will handle up to 20 ft. dish. Supplied complete with control chassis. In stock—immediate delivery. Used world over by NASA, USAF, MP-61-B. Type SCR-584, Nike Ajax mounts also in stock.

PULSE MODULATORS

MIT MODEL 9 PULSER 1 MW—HARD TUBE
Output 25kv 40 amp Duty cycle .002, pulse lengths .25 to 2 microsec. Also 5 to 5 microsec. and 1 to .5 microsec. Uses 6I21. Input 115v 60 cycle AC. Mfg. GE. Complete with driver and high voltage power supply. Ref: MIT Rad. Lab. Series, Vol. 5, p. 152.

2 MEGAWATT PULSER
Output 30 kv at 70 amp. Duty cycle .001. Rep rates. 1 microsec 600 pps. 1 or 2 msec 300 pps. Uses 5948 thyratron. Input 120/208 VAC 60 cycle. Mfg. GE. Complete with high voltage power supply.

15 KW PULSER—DRIVER
Biased multivibrator type pulse generator using 21E29 Output 3kv at 5 amp. Pulse lgths .5 to 5 microsec. easily adj. to 1 to 5 msec. Input 115v 60 cy AC. 8575. Ref: MIT Rad. Lab. Series, Vol. 5, pps. 157-180.

MIT MODEL 3 PULSER
Output: 144 kw (12 kv at 12 amp.) Duty ratio: .001 max. Pulse duration: .5, 1 and 2 microsec. Input: 115 v 400 to 2000 cps and 24 vdc. \$325 ea. Full desc. Vol. 5, MIT Rad. Lab. series, pg. 140.

250 KW HARD TUBE PULSER
Output 16 kv 16 amp. Duty cycle .002. Pulses can be coded. Uses 5D21, 715C or 4PR60A. Input 115 v 60 cy. AC \$1200 ea.

PLAN POSITION INDICATOR CONSOLE
Complete PPI console operating from 115 volt 60 cycle AC. 10" CRT range 4 to 250 miles. Digital height readout. Complete AN/UPA-25. Price \$1200.

SCR 584 AUTOTRACK RADARS
Our 584s in like new condition, ready to go, and in stock for immediate delivery. Ideal for telemetry research and development, missile tracking, satellite tracking. Fully Desc. MIT Rad. Lab. Series, Vol. 1, pps. 207-210, 228, 284-286. Comp. Inst. Bk available \$25.00 each.

MICROWAVE SYSTEMS

L BAND RF PKG.
20 KW peak 990 to 1010 MC. Pulse width .7 to 1.2 micro sec. Rep. rate 180 to 420 pps. Input 115 vac. Incl. Receiver \$1200.

200-225 mc RADAR SYSTEM
1 Megawatt output, 200 nautical mile range for long range detection of medium and high altitude jet aircraft as well as general search. Complete system in stock. Input 120/208 V, 60 cy. Type TPS-28. Mfg. Hazeltine

C-BAND RADAR
250 KW output. C-band. PPI indicator. 5C22 thyratron modulator. Antenna hi gain parabolic section. Input 115 volts 60 cycle AC. complete \$2750.00.

200 TO 2400 MC RF PKG.
200 to 2400 Mc CW. Tuneable. Transmitter 10 to 30 Watts. Output. As now \$475.

500 KW L BAND RADAR
500 kw 1220-1350 msc. 150 nautical mile search range P.P.I. and A scopes. MITL thyratron mod 5426 magnetron. Complete system.

100 KW X BAND RADAR
Complete 100 kw output airborne system with AMTI. 5C22 thyr. mod. 4J52 magnetron. PPI. 360 deg az sweep. 60 deg elev. sweep, gyro stabilizer, hi-gain revr. Complete with all plugs and cables.

AN/GPG-1 SKY-SWEEP TRACKER
3 cm. automatic tracking radar system. Complete package with indicator system. Full target acquisition and automatic tracking. Input 115 volts 60 cycle. New. In stock for immediate delivery. Entire System 4" long, 3" wide, 10" high. Ideal for infrared Tracker, Drone Tracker, Missile Tracker, R. & D.

500KW S BAND RADAR
250 miles search 115V 60 cy AC. Mfg. G.E.

RADAR AUTO-TRACK & TELEMETRY ANTENNA PEDESTALS 3 & 10 CM. SCR 584 AUTOTRACK RADARS. M-33 RADAR TPS-1D SEARCH. APS-45 TPS-10D HT. FINDERS. WX RADARS. PPN-32GCA. APS-10 APS-15B APS-27 (AMTI) SEARCH. APN-102 DOPPLER. DOZENS MORE. GARCINOTRONS. PFMS. 25-51-2-3-6 MEGAWATT PULSE MODULATORS. CAVITIES. PULSE TRANSFORMERS. IF STRIPS. WAVEGUIDE. BENDS 200 MC. 1 KMC. 3 KMC. 6 KMC. 9 KMC. 24 KMC. RF PKGS.

RADIO RESEARCH INSTRUMENT CO.
550 5TH AVE., NEW YORK 36, N.Y. JU 6-4691

PROFESSIONAL SERVICES

GIBBS & HILL, Inc.
Consulting Engineers

Systems Engineering
Operations Research • Development
Field Studies • Design • Procurement
Power • Transportation • Communications
Water Supply • Waste Treatment
393 Seventh Avenue New York 1, N. Y.

SEARCHLIGHT

CAPACITORS

MFD	VOLTS	PRICE	MFD	VOLTS	PRICE
1	5000	3.30	4	10KV	57.50
1	5000	4.90	6	600	1.49
1	7500	5.95	6	2500	5.95
1	13KV	24.95	7	800	1.79
1	25KV	49.50	8	600	1.39
2	1000	.69	8	1000	2.15
2	3000	4.50	8	1500	2.98
9	6000	14.95	9	10KV	89.50
2	7500	23.75	10	600	1.98
2	10KV	39.50	10	1000	2.35
2	16KV	89.95	10	2000	5.30
4	600	.89	10	4000	12.59
4	1000	1.95	10	5000	40.00
4	4000	8.95	75	6000	80.98
4	5000	25.50	100	2500	79.95

Requirements Solicited

MONMOUTH RADIO LABS
BOX 247 OAKHURST, N.J.
TEL. 201-222-0121 ART HANKINS, PROP.

FOR SALE:

ELECTRIC, GAS, and VACUUM FURNACES

Forming Gas Generators, Nitrogen Generators, Endothermic Generators, Ammonia Dissociators, Induction Heaters, Vacuum Metallizers, Strip Chart Recorders, Temperature Controllers, Programmers, Mass Spectrometers, Spectrophotometers, Refractometers, Gas Purifiers, Electron Tube Manufacturing, Aging, and Testing Equipment.

INSTRUMENTS & MACHINES INC.
1200 Grove Street Irvington, N.J.
201-371-7900

CIRCLE 966 ON READER SERVICE CARD

TEST EQUIPMENT

For over 20 years specializing in top brands only. Write for our latest listing. We buy complete inventories.



ELECTRONIC SALES

1413 Howard Street, Chicago, Illinois 60626
Telephone ROgers Park 4-0600

CIRCLE 968 ON READER SERVICE CARD

ELECTRON TUBES

KLYSTRONS • ATR & TR • MAGNETRONS
SUBMINIATURES • C.R.T. • T.W.T. • 5000-6000 SERIES
• SEND FOR NEW CATALOG A2 •
A & A ELECTRONICS CORP.
1063 PERRY ANNEX
WHITTIER, CALIF.
696-7544

CIRCLE 969 ON READER SERVICE CARD

SPOT WELDING TWEEZERS



TWI - 36" Lead \$11.65
AC and Stored Energy Power Supplies and Welding Heads

E W A L D INSTRUMENTS CORP.
KENT, CONN. 06757
CIRCLE 970 ON READER SERVICE CARD



One of our most important fringe benefits:

We won't let an engineer become obsolete.

Ever consider the possibility of coming to work some morning and finding your job has been invented away?

This can't happen to you at Hewlett-Packard.

Hewlett-Packard makes its contributions to the science of measurement by supplying the best possible instruments at the lowest price. To do this, and to put our trademark on 1600 instruments covering the whole spectrum of electronics, medical and chemical instrumentation, requires that our engineers keep up with technology. There is no other way.

The longer you are on the job, the sharper you get. Keeping our products up to date and creating new ones doesn't give you time to get obsolete.

Could you return to school after ten years and knock down A's and B's in tough technical courses, in competition with the new crop of students? Our engineers have done it. Perhaps you could, too. The reason? You never stop learning on the job.

If this kind of continual growth interests you, write Ray Wilbur, 1501 Page Mill Road, Palo Alto, California 94304. An equal opportunity employer.

HEWLETT  **PACKARD**

Designers only think
of Westinghouse Hipernom®
magnetic alloy for
highest permeability.
Think again.

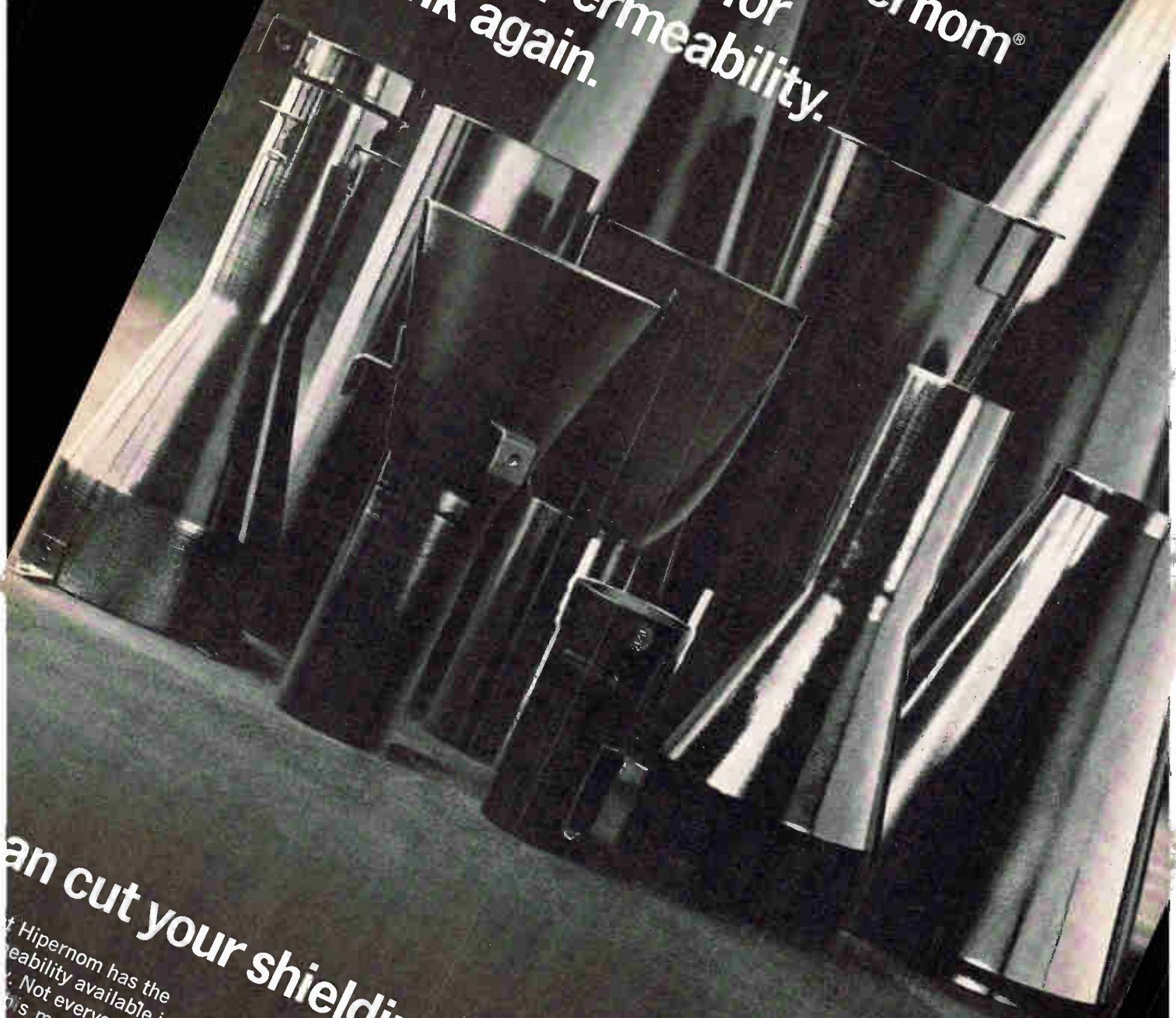

can cut your shielding costs.

Hipernom has the permeability available in a magnetic alloy. Not everyone, though, has this means when it comes to costs.

You can design possible shielding with Hipernom inner shields for your application. And they'll

be lighter, giving a saving on total material cost per shield. When you use Hipernom, you also get back-up from the largest group of metallurgists specializing in magnetics. Westinghouse has had research leadership in this field for over 50 years.

FREE 36-PAGE BOOK ON MAGNETIC SHIELDING. It's the only book of its

kind... a thorough seminar summing up Westinghouse's unmatched experience in magnetic shielding. For your free copy, write for "Shielding Book". Address Westinghouse Metals Division, Box 868, Dept. 123 Pittsburgh, Penna. 15230

You can be sure if it's Westinghouse

Newsletter from Abroad

October 3, 1966

Spain jockeying to make the most of color-tv split

Spain intends to turn the split in Western Europe over color television into an advantage for her fast-growing tv industry.

At this summer's plenary session of the International Radio Consultative Committee (CCIR) at Oslo, where a last-ditch attempt was made to adopt a single color-tv standard for Western Europe, Spanish telecommunications officials stayed on the fence. Now they've made it clear they plan to jump into the most profitable pasture.

The government-controlled broadcasting network, Television Espanola, recently sent letters to the developers of the two competing systems—PAL and Secam—asking them to spell out their offers on royalty fees and licensing arrangements. PAL (for phase-alteration-line) was developed by West Germany's Telefunken AG and has been selected by most West European countries. Secam (for sequential and memory) was developed in France and will be used there and in the Soviet-bloc as well.

The right to export color tv sets may be the deciding factor in the Spanish decision. The Spanish industry has its eyes on an "Iberian" market embracing Portugal and Spanish Morocco along with Spain itself. Both presumably will follow Spain's lead in color tv.

In the bargaining for a deal on color tv, Spanish officials will use a burgeoning market as a lure to dangle before Telefunken and the Compagnie Francaise de Television, which owns the rights to Secam. The black-and-white market has grown 20% annually in recent years as Spain's economy has boomed. The Spanish industry expects to turn out between 650,000 and 700,000 sets this year, compared to 550,000 sets in 1965. Television Espanola will make its color tv choice—strictly on a commercial basis—late in 1967. Limited color programming will begin in the fall of 1968. By 1969, when the network expects to have substantial color programming, the market for color sets should number about 70,000. It should reach 150,000 sets annually within a few years.

Italian set makers in color quandary

If it manages to color Spain PAL, Telefunken will partly recoup a setback in Italy, where the expectation of an early lift from color tv has been quashed by Premier Aldo Moro's coalition government. After backing the PAL system and giving the impression that all was set for starting color broadcasts late next year on the state-owned network, the government had to backtrack when the left-wing opposition kicked up a fuss over costs. Now the government says there'll be no color until 1970.

This puts the set makers in a quandary. Most Italian companies can't afford to make capital investments now to gear up for color tv production with no payoff in sight for several years. On the other hand, they're certain they'll be clobbered by imports from other Common Market countries later on if they don't do something now. To make matters worse, dealers already have felt a slowdown in black-and-white replacement sales as consumers, waiting for color, hang on to their old sets.

Japanese selling small computers on installment plan

Japan's six digital-computer manufacturers this month started offering small computers on a time-payment plan. This is a switch from the government-backed rental system and it's aimed at forestalling turn-in of old computers as new models come onto the market.

The scheme applies only to computers with list prices below \$139,000;

Newsletter from Abroad

for larger models, the manufacturers will continue to sell to the Japan Electronic Computer Co., the government-sponsored firm that leases the computers to users. JECC has the right to return computers.

To finance the outright sales to users, the manufacturers lined up two Japanese banks that have pledged to make \$16.7 million available for loans repayable in up to 54 months. The interest rate is a stiff 11.55%, but the computer makers still think time-payments will catch on. Prices will be right. Outright buyers will get late-model computers at 10% discount on the selling price to JECC. For computers introduced before the International Business Machines unveiled its 360 series in April, 1964, the discount is 35%. Anyone wanting an obsolescent computer no longer handled by JECC can get it at 65% off the former price to JECC.

The switch to installment buying for small computers comes when there's a boom in sight for electronic desk calculators. This year's output will reach about 38,000 units. The figure is expected to surge to 59,000 next year and to 80,000 in 1968.

Swedish industry anxious over space

Electronics, communications and aviation companies in Sweden have started a drive aimed at getting the government to set up some sort of space program. But the ruling Social-Democratic party most likely will sidestep the push.

The companies, banded together in a Space Technology Committee, have warned Education Minister Ragnar Edenman that the aerospace industry can't get off the ground without a lift from the government. As a starter, the committee wants a high-level agency established to run the space effort; and the committee is urging an adequately funded national space program.

For the Social Democrats, the warning to Edenman came at an embarrassing time—just after the party had suffered severe losses late last month in local elections largely because of inflation and housing shortages. And just two days after the committee sounded its alarm, the European Space Research Organization (ESRO) inaugurated its missile-launching site at the Arctic-circle mining town of Kiruna, putting space—and the industry's plight—into the headlines. The industry insists it's handicapped in getting electronics contracts from ESRO, to which Sweden belongs, because of the government's small contribution.

Beset by inflation, the government can't soothe the industry with more funds for space now. But the Social-Democrats very likely will move soon to ward off any attempt to make space an issue during the nationwide elections in 1968. The probable tactic: a long study that would pigeonhole the issue until after the elections.

Swiss watch U.S. inroads with alarm

The Swiss Federation of Clock and Watch Manufacturers now expects to have the prototype of an electronic wristwatch ready by next April. The date came to light during the furor caused by the takeover last month of a major Geneva watchmaker, Universal AG, by the Bulova Watch Co.

The Bulova-Universal merger, following by a few months a deal in which the Hamilton Watch Co. acquired a Swiss watch firm, provoked outraged howls about U.S. inroads in the industry and charges of a sellout of the Federation's electronic watch development. Universal's president is also a vice-president of the Federation.

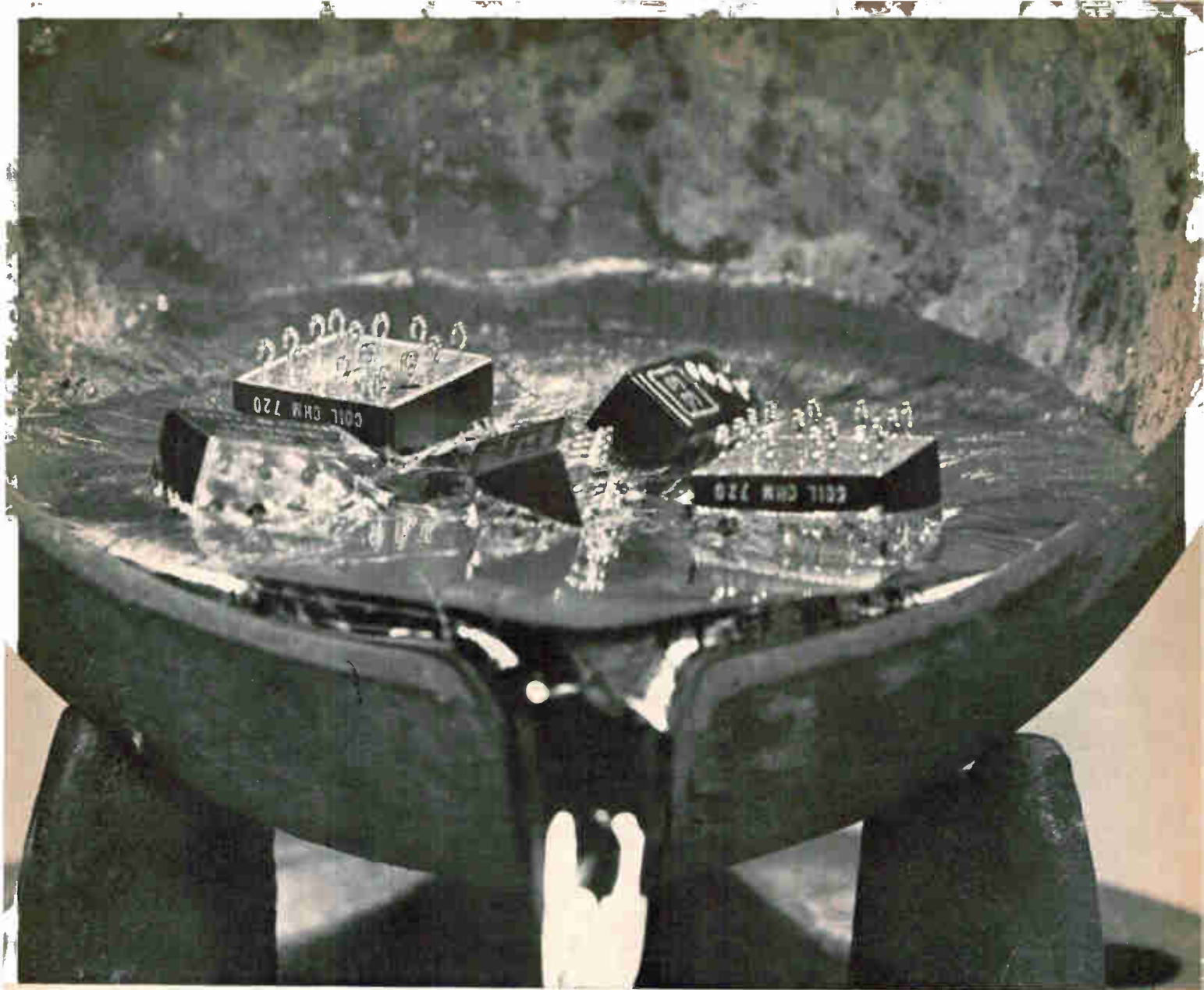

Molten-solder temperatures won't hurt G-E 150-grid relays

During degassing, G-E 150-grid relays get even hotter than the 356F it takes to melt solder. And it's good for them. High-temperature degassing removes much more of the organic volatiles that can contaminate a relay at normal operating temperatures.

Not many relays can stand the heat. G-E 150-grid relays can because they have a polyimide coil insulation and a welded can-to-header seal. Polyimide insulation withstands 50% more heat than conventional fluorocarbons. And a weld won't melt like a soldered joint.

New materials and fabrication methods are constantly being developed and used by General Electric to make its sealed relays more reliable. Get the full story from your G-E Electronic Components Sales Engineer. Or write for bulletin GEA-8024B, Section 792-39, General Electric Co., Schenectady, New York.

Specialty Control Department, Waynesboro, Va.

GENERAL  **ELECTRIC**

Circle 253 on reader service card

Engineers and Scientists:

*The Hughes Aircraft Company
is proud to announce the establishment of*

THE HUGHES PROFESSIONAL CAREER DEVELOPMENT PROGRAM

This new Program emphasizes individual career growth through a sequence of selected work assignments for graduate engineers who have acquired between two and eight years of professional experience. It is designed primarily for two types of development:

1. Specialized, in-depth assignments to develop unusual proficiency in a specific area of interest.

2. Broad, systems-types of assignments to prepare for system and project engineering responsibilities.

There will be a maximum of three assignments which will be determined jointly by the participant and the Professional Development Section. The assignments, which are flexible in length would normally extend for one year each. They may be selected from a broad spectrum of aerospace electronics hardware and systems-oriented programs and will be designed to provide optimum backgrounds in specialized areas of interest.

The Program will be limited to 50 participants in 1966. These will be selected from candidates who are graduates in E.E., M.E. or Physics from fully-accredit-

ed universities and who have acquired from two to eight years of professional-level technical experience. U.S. citizenship is required.

Those in the Program will receive salaries commensurate with levels established by their overall experience and qualifications.

We invite interested Engineers and Physicists to submit their qualifications for consideration.

Please forward your resume including details of your educational and experience background to:

Mr. Robert A. Martin
Head of Employment
HUGHES Aerospace Divisions
11940 W. Jefferson Blvd.
Culver City 56, California



An equal opportunity employer

We've got your crimp contact needs all wrapped up.

Insertable/removable precision machined crimp contacts for power or shielded signal applications. Miniature and subminiature sizes to fit a wide assortment of Winchester connector styles or others made to MIL C 22857. In addition, protective shells, hoods, jackscrews and other accessory hardware are available, including a broad selection of hand and automatic feed crimping tools.

That's what you'll find neatly packaged in the Winchester Electronics Handbook of Standard Connectors. Get your copy today. Then you can wrap up your contact problems.

Write Winchester Electronics,
Main Street and Hillside Ave.,
Oakville, Connecticut.



THE G4 IS A COMPLETELY NEW MECHANICAL CHOPPER
THE MECHANISM IS NOVEL (A PATENT IS PENDING)
OPERATION IS UNIFORM FROM 0 TO 1,500 CYCLES
THE NOISE IS MUCH LESS THAN ONE MICROVOLT
THE OFFSET IS MUCH LESS THAN ONE MICROVOLT
THE DESIGN IS INHERENTLY OF HIGH RELIABILITY
THE OPERATING LIFE WILL EXCEED 10,000 HOURS
THE G4 IS UNAFFECTED BY SHOCK AND VIBRATION

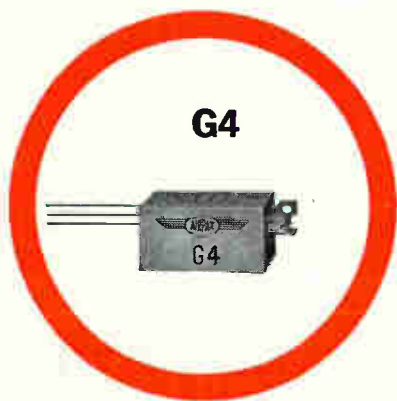

SPECIFICATIONS

CONTACT ACTION: SPDT, BBM
CONTACT RATING: 20V 1ma resistive
POWER CONSUMPTION: 200mw max.
CONTACTS TO GROUND: 5uuf max.

TRANSFER TIME: 5° minimum
DWELL TIME: 165° ± 10°
DISSYMMETRY: 10° maximum
PHASE ANGLE: 75° ± 10°

VIBRATION: MIL STD 202B Method 204A,
 Cond. B, maximum contact derangement 7°
SHOCK: 100 G per Mil Std 202B Method
 202A, maximum contact derangement 10°

INSUL. RESIS.: 10 K meg.at 100 VDC
TEMPERATURE: - 65°C to + 125°C
CASE VOLUME: 0.11 cu. inches
WEIGHT: 8 grams

electronics Abroad

Volume 39

Number 20

and upward

around the stands at the Electronics Show left no doubt that the industry once again was on an upward trend.

The show closed its doors last week after a nine-day run at the international fair grounds, where the industry had in sight a \$2.8 billion, putting it back onto a strong upward trend after last year's slump. Much of the lift is due to an unexpected revival in domestic consumer goods markets, and with semiconductor sales up, components makers have been lifted out of their doldrums. Especially well are silicon wafer producers; they've tripled their monthly output since the first year.

With a better, strong trade winds in prospect for Japanese integrated-circuit manufacturers. This year was the first at which Japanese finished IC's in earnest. And while United States producers are fighting for a crack at the market, they were effectively shut out from showing their wares at Tokyo. Products that can be freely imported were allowed; an import ban quietly put into effect in April by the Ministry of International Trade and Industry will block foreign-made digital IC's near circuits having 35 or more elements.

dozen. Judging from the excitement at the after-hours shop talk at the show, the Nippon Electric Co. is the leader among the dozen Japanese companies producing IC's or about to. NEC produces about 60,000 circuits a month, expects to hit a level of 100,000 monthly by next spring.

Working on wafers at Fujitsu Ltd. With IC's on upsurge, Japanese companies have invested heavily in new production facilities.

Much of NEC's production goes into its own computers. The company currently makes diode-transistor-logic circuits for its new Series 2200 Model 50 computer [Electronics, Sept. 5, p. 200]. It also had on display a high-gain, wideband monolithic operational amplifier whose gain can be varied through an external resistor. In development at NEC are 4-bit metal-oxide-semiconductor memories with write-in and readout times of 100 nanoseconds. Early next year, NEC plans to have on the market current-mode-logic circuits with propagation time of 3 nanoseconds and power consumption of 120 milliwatts per stage.

Behind NEC in the Japanese IC ranking comes Kyodo Electronics Laboratories Ltd. [Electronics, June 27, p. 195]. Kyodo expects to have its output of transistor-transistor-logic circuits up to a level of about 60,000 units a month by the end of the year. Following Kyodo is Fujitsu Ltd., which recently poured more than \$1 million into IC production facilities. Fujitsu reports that it's producing 10,000 circuits a month, most of them for its upcoming new generation of computers. But like NEC and Kyodo, Fujitsu is on the lookout for outside customers.

Along with the trio already in substantial production, two other



companies have readied for IC's. Hitachi Ltd. has set itself up with a \$3-million production facility and will start out with current-mode logic circuits for the version of the Spectra 70 computer it builds under license from the Radio Corp. of America.

Tokyo Shibaura Electric Co. (Toshiba), too, has a \$2.5 million facility just getting into production. Although digital circuits figure to be the bread-and-butter item for IC makers at the outset, Toshiba showed a two-band amplitude modulation receiver built essentially around three linear circuits. But Toshiba has no plans to put the set into production—the IC's cost too much.

A sixth company, Oki Electric Industry Co., turned up at the show with some digital circuits it has in development, but Oki wasn't ready to talk business.

Color up. As expected, color television captured the spotlight in consumer electronics. Even before the show opened, the Electronic Industries Association of Japan had to revise its forecast made in the spring for color tv sales. From 300,000 sets, the estimate was bounced up last month to 400,000 sets, half of them for export. Some say that the new estimate is still too low and that 450,000 sets seems more likely.

The major drawback for color set producers—a shortage of picture tubes—will soon be eased. Toshiba has just invested \$5.5 million to expand its monthly output to 60,000 tubes by next spring. The other two major manufacturers of color tubes, Hitachi and Matsushita Electronics Corp., will have their monthly outputs up to 25,000 to 30,000 by the end of the year. Matsushita Electronics is a joint venture of the Matsushita Electric Industrial Co. and Philips Gloeilampenfabrieken N.V. of Holland. Ashai Glass Co., which supplies all the bulbs for these tube manufacturers, is set to keep pace. It has added some \$2.75 million worth of production machinery to its plant and by the end of the year will have its monthly capacity boosted from the current 80,000 bulbs to 150,000.

West Germany

A little corner

There's a lot of talk in Germany these days about United States' domination of the country's computer industry—and small wonder. An estimated 85% of the German electronic data-processing market has been gobbled up by American firms or their European subsidiaries. Now, to make matters worse, there are rumors that Germany's oldest computer firm may be sold to an American company—reportedly Control Data Corp.—that wants to strengthen its position in the market.

In a recent speech, former Defense Minister Franz-Josef Strauss had mentioned that the big Swiss electrical equipment maker, Brown-Boveri and Cie., wanted to sell its German subsidiary, Zuse KG. Brown-Boveri acquired Zuse two years ago [Electronics, Oct. 19, 1964, p. 154]. Strauss fears that Zuse may be taken over by an American concern. Although without portfolio, he still wields considerable power as a party leader.

No comment. Strauss intimated that a consortium of German firms or a European group, presumably consisting of French and German partners, should be formed to prevent an American takeover of Zuse.

The board chairman of Brown-Boveri's German affiliate in Mannheim, Dr. Kurt Lotz, reportedly has approached CDC. Brown-Boveri in Mannheim merely says that it has been conducting talks with several firms for some time but it isn't saying with whom. CDC, which would like to get a bigger foothold in Europe, has a share of less than 1% in the German market. Officials at CDC in Minneapolis refused to comment on the report. Brown-Boveri is said to be asking \$30 million for Zuse—twice what it paid two years ago.

Disenchanted. Strauss brought to light something that had been rumored in German computer circles for a long time. Ever since Brown-Boveri took over Zuse things haven't worked out as expected. As one industry observer puts it,

“BBC failed to integrate the company effectively into its own operations.” Zuse engineers became dissatisfied with the Brown-Boveri management. Many people left and general stagnation set in. The result was that Zuse started to lose money. “Now BBC wants to pull out,” says one man in the know.

Transistor time

Clock makers always have a watch out for new ways to cut down friction in timepieces since less friction means more accurate, longer-lasting movements.

One method they've found is to mechanically isolate the time-governing element from the mechanism that drives the hands. But so far this approach has been limited to expensive precision timepieces, such as quartz clocks.

Now, engineers at West Germany's Diehl-Werke in Nuremberg—birthplace nearly 500 years ago of the world's first spring-operated portable clock—have developed a two-transistor circuit that in effect replaces the mechanical links between the balance-wheel and hands in conventional clocks. The company currently turns out 500 Dilectron household clocks a day; retail prices in Germany start at \$12. The clock runs for a year

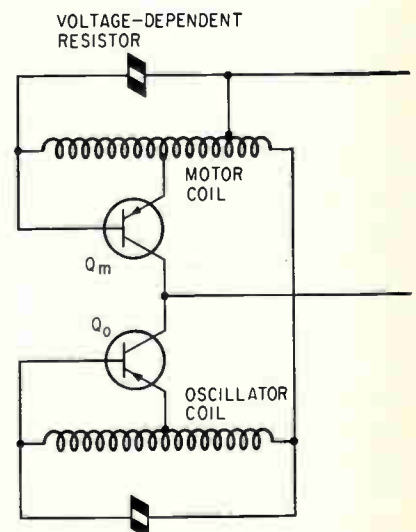

Two-transistor circuit in Dilectron clock replaces mechanical link used in conventional movements. Output of oscillator coil synchronizes the motor that drives the hands.

volt dry cell with time de-
 less than 10 seconds daily.
 of course, isn't the first to
 the market with an elec-
 trol household clock. But Ameri-
 can companies that beat Diehl in
 onto the market—some by
 as five years—generally
 transistor drive only for the
 wheel.

Transistors. In the Dilectron,
 the balance wheel is fitted with
 an oscillator coil, split
 rotor and driving windings,
 which is placed between the mag-
 netic balance wheel moves
 forward, alternating current
 is fed in the control winding.
 In the negative half of the cycle,
 a transistor Q_0 switches
 current flows through the
 winding. The resulting
 moves the balance wheel a
 keeps it running at 6- $\frac{2}{3}$
 times a second. A voltage-de-
 creaser holds the ampli-
 tude of the driving pulse constant
 as the battery voltage drops.
 The running impulse micro-
 moves the hands of the clock.
 The rotor turning by a circuit that,
 the oscillator circuit, consists
 of a transistor and a voltage-de-
 creaser.

The rotor coil is split into three
 sections—one for transistor con-
 trol, one for driving, and one for
 timing. As the rotor turns,
 the voltage develops across the con-
 ducing ring. In the negative half-
 cycle, the induced voltage switches
 the motor transistor and this
 power pulse into the driv-
 ing winding—one of the two driv-
 ings fed into the motor coil
 for revolution.

The other driving pulse comes
 from the oscillator driving winding,
 which is in series with the synchro-
 nizing winding of the motor coil.
 The oscillator current bucks the
 rotor current to keep the rotor
 synchronized with the bal-
 ance wheel.

It says it could shrink its
 size to wristwatch size. The
 company admits, however, it still
 has a lot of development work to
 do before it will have a competitor.
 The Accutron of the Bulova
 Co. and the X8 of Japan's
 Citizen Watch Co.

Soviet Union

Rx for R&D

In their bid for world leadership in
 science and technology, the Soviets
 have built up a sprawling research
 and development establishment
 that today has about 2.5 million
 people at work at some 2,000 in-
 stitutions. But despite Russia's im-
 pressive achievements in space, the
 country's economic planners all too
 often have found that the sprawl
 meant a stall in the advance of
 technology.

Now, sweeping changes are in
 sight. Last month, the government
 laid down a whole package of de-
 crees designed to tighten the ap-
 plied research and development ef-
 fort.

More money. For one thing, the
 government plans to boost its
 spending on research. The pack-
 age of measures, for example, ear-
 marks up to \$2.75 million for new
 buildings and new equipment at
 each of some 800 research facilities
 affected by the reorganization.

And, taking a cue from the suc-
 cess they've had with profit incen-
 tives in manufacturing plants, the
 Russian leaders will adopt the
 same tack for research institutes.
 The institutes will receive rebates
 of 75% of the profits they make in
 their dealings with state-owned
 business enterprises. Few Soviet
 production outfits run extensive
 R&D programs on their own. Most
 contract the work from specialized
 institutes or, that failing, buy tech-
 nology from Western countries.

In addition to profits for insti-
 tutes, the directives call for bon-
 uses for originators of new tech-
 niques and products.

School ties. Along with money
 incentives to get more mileage out
 of the R&D talent now available,
 the government plans to tighten
 the ties that link colleges and uni-
 versities throughout the 15 Soviet
 republics. Under the new directive,
 all of the country's 754 institutions
 of higher learning will come under
 control of the Ministry of Educa-
 tion in Moscow. Before, more than
 half of them were under the wing

of other government agencies.
 Nearly all the medical institutes,
 for example, previously were under
 the jurisdiction of health ministries
 in the 15 republics.

One of the toughest tasks edu-
 cation officials face with their ex-
 panded responsibility is breaking
 down the long-standing tradition
 among scientists in the country to
 concentrate on fundamental re-
 search. Says a Western observer
 in Moscow, "Research here is com-
 pletely compartmentalized. It is al-
 most never related to production."
 Pravda, the Communist Party or-
 gan, agrees. In an editorial lauding
 the educational reforms it com-
 plained that "scientists of these
 higher educational establishments
 took an insufficient part in investi-
 gations that have important eco-
 nomic value."

Getting status-conscious acad-
 emicians to work closely with fac-
 tory researchers may be more
 easily decreed than done; but as a
 Western economist puts it. "These
 changes definitely get at the basic
 problems of Soviet research."

East Germany

A certain sameness

Among the officials who ride herd
 on East Germany's economy, the
 vogue these days is for "rational-
 isierung" — streamlining produc-
 tion. Judging from this year's Leip-
 zig Fall Fair, the vogue is already
 strong in the electronics industry.

Industry officials at the fair made
 much ado about the results they've
 achieved through a push to stand-
 ardize product lines and automate
 production lines. They say that new
 manufacturing techniques have cut
 production costs by almost \$700,-
 000 so far this year in the 27 East
 German plants that turn out tele-
 communications hardware and test
 equipment. In consumer electronics
 they maintain they've stepped up
 productivity to the point where
 their 29-plant home-entertainment
 industry turns out a television set
 every 24 seconds, a superhetero-



The Donja 1201 is one of 29 different sets produced in East Germany using just three standard chassis.

dyne receiver every 20 seconds and a portable radio every 25 seconds.

Look-alikes. In their effort to streamline production the East Germans have heavily standardized their hardware. In test equipment the same chassis and cabinets turn up again and again. And wherever possible, circuits like input stages and amplifiers are common.

Western observers at the Leipzig Fair were struck by the uniformity in styling; but they rated the equipment high in quality and performance. Among Eastern-bloc countries, East Germany is considered in the forefront in telecommunications and test equipment. About 45% of the industry's output is exported to other countries in the bloc. And East German engineers are directing a bloc-wide effort to develop electronic telephone-exchange equipment.

The same sort of standardization has slashed the number of hours needed to produce consumer goods in East Germany. For television sets, the standardization level now has climbed to 82%; that is, 82 out of every 100 components are common to all the sets manufactured in the country.

As a result it takes only 5.4 man-hours to produce a tv set compared with 27 hours in 1957. The standardization level is even higher—

better than 90%—for table radios.

As with test equipment, the East Germans use only a few standard chassis for their radio and tv sets. There are 29 tv set models, variations on three basic chassis. For superheterodyne receivers there are just four basic chassis but 54 different "models." The goal is even more standardization. In a few years, East German tv plants will all work with a single basic chassis.

Industry officials assert, however, that despite standardization there's enough variation in the sets to satisfy consumers. But for fairgoers from Western countries the sameness in styling in radio and tv sets was just as marked as it was for test equipment.

The Netherlands

End of the lines

Many a traveler jetting around Europe has found that he spends as much time waiting in lines at air terminals as he does in actual flight. And even for long intercontinental flights, passengers' laments stem in large part from outdated, overlong procedures for checking in. [Electronics, Sept. 19, p. 23].

Now the end of the lines is in sight for travelers who enplane at Amsterdam's Schiphol Airport, one of the busiest in Europe. When new terminal facilities there open next April, an electronic data-processing system for ground handling will help whisk passengers onto their planes.

The system, called Airlord (for airlines load optimization recording and display), can handle up to 40 departing flights at a time, enough for projected traffic at Schiphol 10 years from now. Before then, Airlord very likely will be keeping travelers reasonably content at other airports. Although the Dutch airline KLM will be the first to install the system, its developers say that other carriers are sizing up its possibilities. Airlord is produced by Spoorweg Sein Industrie N.V., a subsidiary of Philips Gloeilampenfabrieken N.V.

Tabs. In a central processor and memory Airlord keeps tabs on all the data involved in the ground-handling operation. As each flight comes up for loading, the operations control room feeds in the type of aircraft plus the weight of fuel, crew baggage and company material the flight will carry. To this data is added the weight of freight, mail and the catering department's load.

At the check-in counters (there'll be 22 at the Schiphol installation), passengers won't be limited to one or two counters per flight as they are now. Through their input-unit keyboards, check-in clerks can feed passenger data for any flight into the central processor. The clerks also can query the central processor to see if passengers without reservations have any chance of getting on a flight.

When he processes a passenger, the clerk punches into his keyboard the flight number and destination, plus the weight and number of pieces of baggage. Then he slips the ticket and a boarding pass in a slot in the input unit. If there's been no slip-up in the reservation, the central processor signals back "accepted" and the input unit prints out a boarding pass with the flight number and departure gate number on it. The near-instanta-

neous flow of data between the check-in counter and the central processor slashes check-in time compared to the usual procedure of phoning, list-checking and then writing out a boarding pass.

In view. As each passenger checks in, the central processor calculates in less than a second the new total weight for the flight and the number of seats still available in first class and economy class. A complete up-to-the-second status for each called flight is displayed on panels in the operations room. At other spots around the terminal like the freight department, mail department, catering department and the boarding gates there are displays to show the flight data needed at the spot.

The boarding gate display, for example, shows the number of passengers that checked in for a flight and the number of passes collected as the passengers file through the gate. When the two numbers match, the gate official flashes a "boarding completed" signal to the flight controller.

Although Airlord should bring an end to long lines at Schiphol's check-in counters, travelers there still will have to queue up a second time for seat assignments at the departure gate. Looking forward to eliminating that nuisance, Spoorweg has designed the system so it could be extended to handle seat-allocation at the check-in counter. The system is also set up so that it could be linked to a computer-controlled reservations system. And Spoorweg says Airlord could be tied into self-service check-in counters when electronically readable tickets are introduced.

Keeping track

As Europe becomes more and more a common market, keeping track of freight cars is becoming more and more of a headache. In countries like Belgium, France, West Germany and the Netherlands, foreign freight cars often account for 30% to 40% of the total that carry goods.

To keep track of boxcars, Europe's railroads are turning to electronic data processing. And within

Electronics | October 3, 1966

ity fed with a video-modulated microwave signal. With a 2-milliwatt laser, maximum range of transmission was about 20 miles on a clear day. That works out to a threshold sensitivity of 0.3 microwatt with receiver bandwidth of 10 megahertz, receiver noise figure of

Electronics | October 3, 1966

shipped dismantled and listed on invoices as machinery parts. The look at interference among stations using the 150 to 285 khz band.

Electronics | October 3, 1966

Taylor's total reliability plan: Glass-Epoxy Copper-clad

in sheets, panels or punched blanks to your specifications and reliability requirements

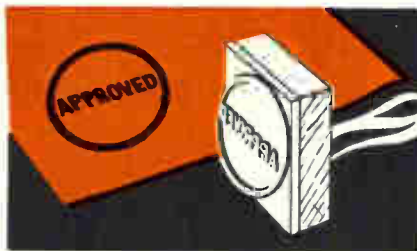

Accepted by an increasing number of major OEMs and commercial etchers who give their stamp of approval, because . . .



. . . they get highest quality level assurance from two fully-equipped copper-clad plants using white-glove techniques . . .



. . . in atmosphere-controlled white rooms, under extremely tight quality control procedures, to produce copper-clad . . .

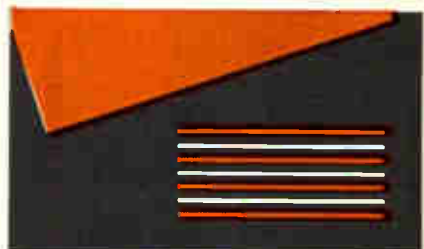

. . . to specifications and established reliability requirements in standard sheets, ultra-thin sheets and multi-layer prepregs . . .



. . . then deliver when promised, or in an emergency, from plant or warehouse stocks in special packages.

Let us prove the advantages of Taylor's TOTAL RELIABILITY PLAN to you! Ask for a demonstration today. Write for a sample (give grade designation and copper combination) and Bulletin GB-2.



Taylor copper-clad

TAYLOR CORPORATION • Valley Forge, Pa. 19481

Phone: 215-666-0300 TWX: 215-666-0659

West Coast Plant: La Verne, Calif.

Also manufacturer of Taylor laminated plastics, Taylorite® vulcanized fibre and Tayloron® prepregs

Circle 261 on reader service card 261

Tungsten Road, Cleveland, Ohio 44117. Tel: (216) 266-2971.

Progress Is Our Most Important Product

GENERAL ELECTRIC

Circle 263 on reader service card 263

BOSTON, MASSACHUSETTS • 02114

Circle 265 on reader service card 265

neous flow of data between the check-in counter and the central processor slashes check-in time compared to the usual procedure of phoning, list-checking and then writing out a boarding pass.

In view. As each passenger checks in, the central processor calculates in less than a second the new total weight for the flight and the number of seats still available in first class and economy class. A complete up-to-the-second status for each called flight is displayed on panels in the operations room. At other spots around the terminal like the freight department, mail department, catering department and the boarding gates there are displays to show the flight data needed at the spot.

The boarding gate display, for example, shows the number of passengers that checked in for a flight and the number of passes collected as the passengers file through the gate. When the two numbers match, the gate official flashes a "boarding completed" signal to the flight controller.

Although Airlord should bring an end to long lines at Schiphol's check-in counters, travelers there still will have to queue up a second time for seat assignments at the departure gate. Looking forward to eliminating that nuisance, Spoorweg has designed the system so it could be extended to handle seat-allocation at the check-in counter. The system is also set up so that it could be linked to a computer-controlled reservations system. And Spoorweg says Airlord could be tied into self-service check-in counters when electronically readable tickets are introduced.

Keeping track

As Europe becomes more and more a common market, keeping track of freight cars is becoming more and more of a headache. In countries like Belgium, France, West Germany and the Netherlands, foreign freight cars often account for 30% to 40% of the total that carry goods.

To keep track of boxcars, Europe's railroads are turning to electronic data processing. And within

Taylor's total reliability plan:

Glass-Epoxy

Copper-clad

in sheets, panels or punched blanks to your specifications and reliability requirements

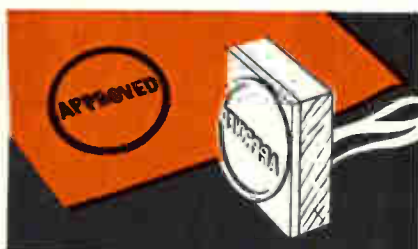

Accepted by an increasing number of major OEMs and commercial etchers who give their stamp of approval, because . . .



. . . they get highest quality level assurance from two fully-equipped copper-clad plants using white-glove techniques . . .



. . . in atmosphere-controlled white rooms, under extremely tight quality control procedures, to produce copper-clad . . .



. . . to specifications and established reliability requirements in standard sheets, ultra-thin sheets and multi-layer prepress . . .



. . . then deliver when promised, or in an emergency, from plant or warehouse stocks in special packages.

Let us prove the advantages of Taylor's TOTAL RELIABILITY PLAN to you! Ask for a demonstration today. Write for a sample (give grade designation and copper combination) and Bulletin GB-2.



Taylor copper-clad

TAYLOR CORPORATION • Valley Forge, Pa. 19481

Phone: 215-666-0300 TWX: 215-666-0659

West Coast Plant: La Verne, Calif.

Also manufacturer of Taylor laminated plastics, Taylorite® vulcanized fibre and Taylorlon® prepress

0 to 100 μ a—
no charge for
1% tracking
taut-band

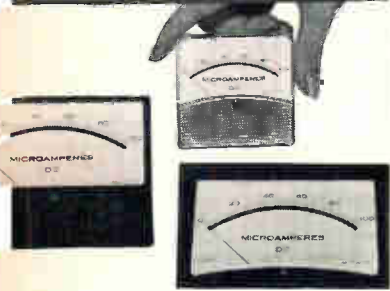

ffered only by **api**

API is the only manufacturer who offers $\pm 1\%$ tracking and frictionless taut-band construction as standard specifications for production-quantity meters, at no extra cost.

Precise tracking is the most useful attribute of a panel meter in modern electronic applications. Taut-band meters give truer readings, respond to smaller signals, resist damage from shock or vibration and do not deteriorate in operation.

Order from Stock

Best of all, API also offers quick delivery from stock of DC panel meters with the double-header bonus of taut-band plus 1% tracking.

You get all this in the most popular ranges of nine models in API's economically priced Stylist and Panelist lines (illustrated). Take your pick of these full-scale DC ranges:

Microamperes	Millivolts
0—20	0—5
0—50	0—10
0—100	

(You also get the double header in the 0-25 millivolt range, but it isn't stocked.)

If precise tracking is a real fetish with you, don't forget that API can give you 0.5% tracking at reasonable extra cost. No other manufacturer features this "super-calibration" and backs it up with catalog prices.

Bulletin 47-A describes all API panel meters and pyrometers
ISA Show—Booth No. 1405

api
INSTRUMENTS CO.
CHESTERLAND, OHIO • PHONE: 216-423-3131

the next year, the International Railway Union, which sets technical standards for railroad equipment when they affect international operations, will select a system for automatic identification of freight cars as they pass key checkpoints.

A leading contender for the selection is the so-called Wagtag system, developed jointly by Spoorweg Sein Industrie N.V. and the research laboratories of its parent company, Philips Gloeilampenfabrieken N.V. The system now is undergoing field trials in both Holland and France.

After a look at optical systems, Spoorweg couldn't see the light and instead turned to an induction system. Wagtag, Spoorweg claims, can read out faultlessly the standard 12-digit international railcar identification code at train speeds up to 100 miles per hour and transmit the information to a data-processing system.

No ambiguity. For the system, each railcar would carry a book-size unit containing five code oscillators, a synchronizing oscillator, a 12-cell ring counter, a pickup coil, and a rectifier. The oscillators, which operate in a frequency range of 50 to 130 kilohertz, drive small ferrite transmitting rods.

Power to drive the oscillators and ring counter is picked up by induction as the boxcar passes rail-side readout units. They put out a 15-khz field that is picked up inductively by the coil in the boxcar unit and rectified.

As the boxcar enters the induction field of the readout unit, all five code oscillators start emitting. And when it receives all five frequencies at once, the railside unit transmits a start pulse that turns on the ring counter. Each cell of the counter has a diode matrix that quenches two of the five oscillators so an unambiguous three-out-of-five digit code is transmitted as each cell goes on in turn. The cells are monolithic integrated circuits each having a transistor and three diodes.

The railside unit thus receives a series of 12 digit codes representing the identification number of the car. To keep the railside receiver synchronized with the boxcar code signals, the synchronizing oscillator is quenched by the diode matrix in every other cell of the counter.

A full readout cycle takes just 25 milliseconds, fast enough to take three readings on each boxcar at speeds up to 100 miles per hour. The three readings are stored in the railside receiver's memory and

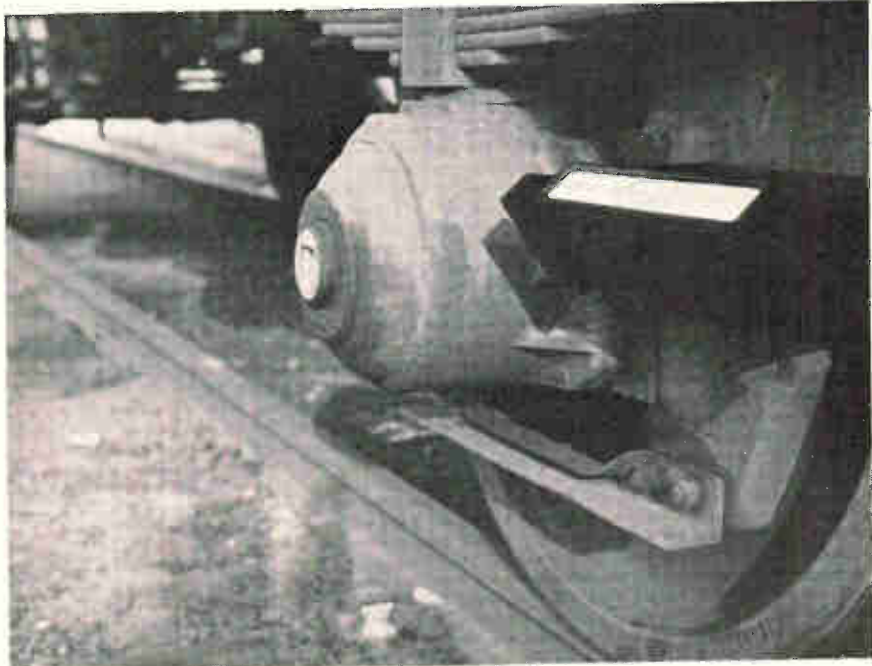

Wagtag unit on boxcar automatically transmits series of 12 code signals that identifies the car as it passes railside readout unit.

Electronics Abroad

checked against one another. The correct identification number is extracted by prefixed combining rules and then converted into a telegraph code for transmission into a data processing system.

Great Britain

Light touch

Researchers at Mullard Ltd. apparently have pulled abreast of United States technology in microwave phototubes, one of the most promising devices in sight for demodulating laser beams in optoelectronic transmission systems.

Last month at the Sixth International Conference on Microwave and Optical Generation, held at Cambridge, a trio of Mullard scientists reported on an S-band traveling-wave phototube developed under a defense contract. Performance of the Mullard tube comes very close to that of microwave phototubes built by Sylvania Electric Products Inc., the U.S. pioneer in the field. Sylvania, a subsidiary of the General Telephone & Electronics Corp., built its first experimental twp's more than three years ago.

Sensitive. Like its predecessors, the Mullard tube resembles a conventional traveling-wave tube except that a photocathode replaces the usual thermionic cathode. The cathode material is S20 type, which has a quantum efficiency of 6% at the helium-neon laser wavelength of 6,328 angstroms. Equivalent resistance of the twp is 1 megohm and the passband from 2 gigahertz to 4 gigahertz.

To try out its twp, Mullard transmitted standard television test patterns on a laser beam. The beam was modulated by an ammonium dihydrogen phosphate tunable cavity fed with a video-modulated microwave signal. With a 2-milliwatt laser, maximum range of transmission was about 20 miles on a clear day. That works out to a threshold sensitivity of 0.3 microwatt with receiver bandwidth of 10 megahertz, receiver noise figure of

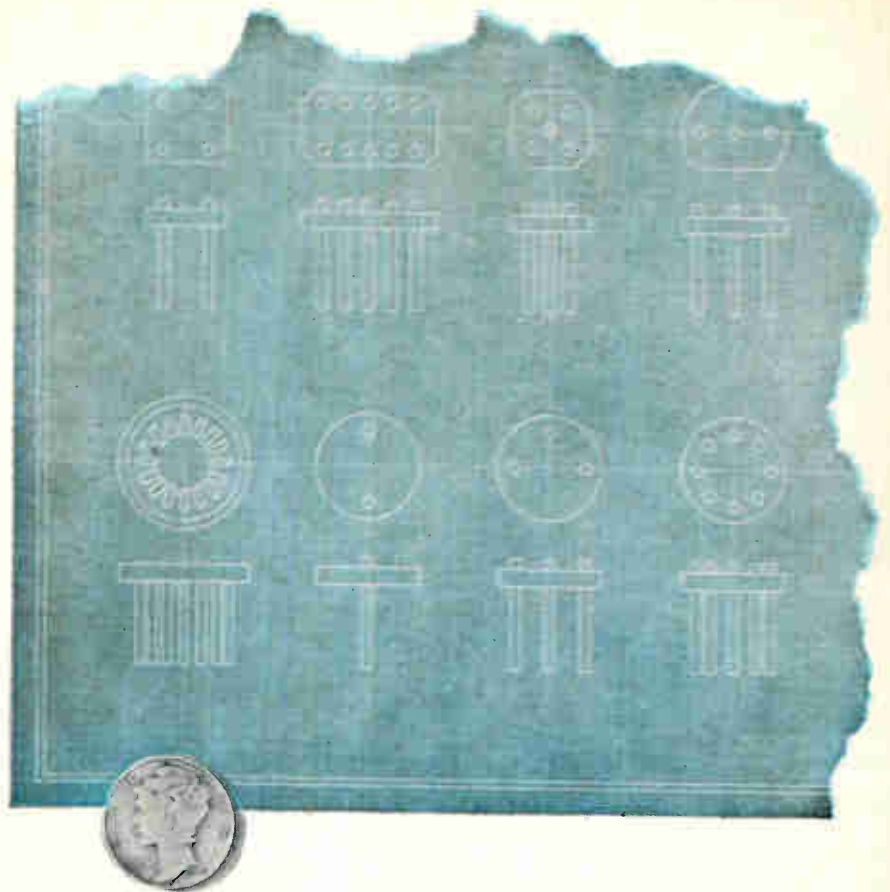

As low as
10¢
a dozen

... when you buy G.E.'s new plastic platform headers in quantities of a million or more. Today, General Electric is selling plastic platform headers like these for less than 1¢ to 5¢ each depending on design.

Want to figure your savings? Better plug in a calculator.

And there's more than economy. You have flexibility in the number of leads and in pin configuration. General Electric engineers will work directly with you to develop the plastic header best for your application.

The new plastic platform header is an exceptional product designed for new plastic encapsulated devices. It's available with virtually any type wire desired, including gold plated Dumet. Continuous temperatures to 400°F are taken in stride. The plastic header is ideal for silicon transistors and a wide range of other devices.

Plastic platform headers. A breakthrough. The kind of progress you've come to expect from General Electric.

For more information, or for a quote on your requirements, call or write: General Electric Company, Lamp Metals & Components Dept., 21800 Tungsten Road, Cleveland, Ohio 44117. Tel: (216) 266-2971.

Progress Is Our Most Important Product

GENERAL  ELECTRIC

TRYLON ROTATABLE LOG PERIODIC ANTENNA
 Single-layer, horizontally polarized,
 6.5 to 32 mc. 65° azimuth beamwidth.
 10 db gain/std. dipole. Power to 50 kw PEP

**"One cannot continually disappoint a Continent."
 We have designed, constructed, and installed
 antenna and tower systems in North America,
 South America, Europe, Asia, Africa, Antarctica.
 We wish someone from Australia would call us.**



Circle 264 on reader service card

Electronics Abroad

6 decibels and a modulation depth of 10%.

Different approach. In its test, Mullard used the twp both as a straight detector and in a super-heterodyne setup. Instead of heterodyning with a pair of laser beams, though, Mullard did it differently. To handle modulation on the laser beam outside the twp's frequency range, a pump signal at a frequency within the passband was applied at the output end of the tube's slow-wave structure. Mixed on the electron beam in the tube, the modulation and pump frequencies combine to produce a microwave output within the passband of the tube.

France

Green light?

Looking forward to the third all-French satellite launching early next year, French officials plan to track the satellite with a trio of lasers. They'll be spotted at St. Michel-de-Provence in southern France, at Hammaguir in the Algerian Sahara and at Athens, Greece.

Plans call for red-light lasers; but chances are by the time the D-1-C is lofted into orbit there'll be a switch to green light. The French laser supplier, Compagnie Générale d'Electricité, has developed an experimental laser unit that converts 1-gigawatt infrared pulses into 300-megawatt green-light pulses with a wavelength of 5,300 angstroms, half the wavelength of the converted infrared pulses. Except to say that the lasing material is neodymium-doped glass, CGE is keeping details to itself.

Because the green beam stands up better than a red beam in long transmission through the atmosphere, CGE has high hopes that government space officials will prefer the new laser. It has much higher power: 300-megawatt pulses compared with 50-megawatt pulses for CGE's red-light ranging laser.

Close. In selling government officials on the green laser, through, CGE may run into some steadfast

Engineers - Statisticians Move to Norfolk/Virginia Beach

Vacation center of the Middle Atlantic States has a moderate climate with four seasons; fine housing, recreational and educational facilities.

**RELIABILITY ENGINEERS
 MAINTAINABILITY ENGINEERS
 STATISTICIANS**

Excellent merit advancement opportunities in rapidly-expanding Navy activity.

FAILURE DATA ANALYSIS

To determine cause of part and/or circuit malfunctions, including over-stresses, improper application, failure rates, MTBF's, etc. Two years' experience in failure analysis of electronic components, units and systems desirable. Should be knowledgeable in failure data reporting systems and failure modes. Requires a BSEE degree. Experience in design or statistics helpful.

DESIGN ANALYSIS

Review operational and proposed equipment designs to detect reliability and maintainability deficiencies. Conduct maintenance task analysis to identify long repair time items and evaluate effect

upon system down time. Propose equipment changes to improve reliability and maintainability. Requires a BSEE Degree with experience in maintainability, reliability engineering, equipment or systems design. Familiarity with Navy equipments desirable.

STATISTICAL ANALYSIS

Develop mathematical models and concepts in the areas of:

System performance predictions • Statistical techniques in the field of reliability/maintainability • System effectiveness • Test acceptance criterion • Provisioning requirements • Sampling methods • Relationship between reliability, maintainability • System operation cost and system maintenance cost.

Requires a BS degree.

**SALARY RANGE: \$6,387—\$16,905
 GS-5 thru GS-13**

Call Collect—Area Code 703-444-2743, or mail application for employment (Standard Form 57, available at any post office) to:

**Naval Ship Engineering Center
 Norfolk Division, Code 1902A
 U. S. Naval Station, Norfolk, Va. 23511**

An Equal Opportunity Employer

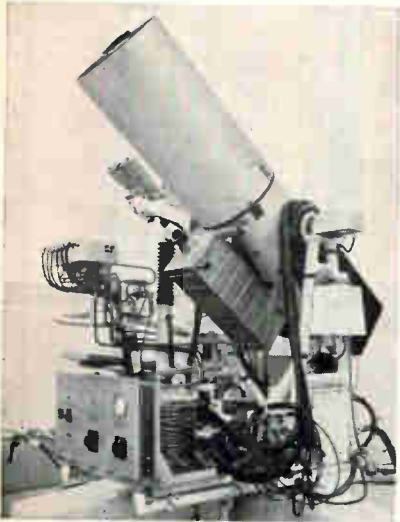

CGE ruby-laser rangefinder is mounted on sighting telescope at St. Michael. Laser package—without telescope but with data processor—sells for about \$100,000.

customer resistance of its own making. The red-light lasers CGE produces are highly accurate over long distances. They put out 20-nano-second pulses with peak power of 50 megawatts at a wavelength of 6,943 angstroms. Divergence of the beam is about 3 milliradians without focusing by optical lenses.

The St. Michel tracking unit is operating and early this year ranged on the Explorer 29 satellite, called GEOS-A before it was launched. During 44 passes of Explorer 29 the French station obtained 584 laser ranging echoes. At 1,400 miles, maximum range of the CGE red laser, the values obtained varied less than 5 feet from the computed orbit. This was very close to the laser-ranging measurements made at the Wallops Island, Va., station of the National Aeronautics and Space Administration. NASA's figure was 3 feet.

Around the world

Japan. Police are investigating the illegal export to Russia of transistor production equipment—more than 100 units worth \$4.1 million. Much of the equipment was shipped dismantled and listed on invoices as machinery parts. The

shipments were made between September, 1964, and June, 1965.

Tanganyika. The East African Posts & Telecommunications Administration expects to have operating before the end of the year a thin line tropospheric scatter system linking Mwanza and Bukoba, some 112 miles apart across Lake Victoria. The system will have six telephone channels and unlike conventional high-capacity troposcatter links operate at low power in a narrow frequency range. The solid-state transmitter has a maximum output of 10 watts in the 790 to 960 megahertz frequency range. Antennas are dishes with 30-foot diameter. The Marconi Co. of Great Britain is supplying the equipment.

West Germany. Next year's budget for the Ministry of Scientific Research includes \$2.5 million for computer research and development, the first direct R&D support for the computer industry from the Bonn government. Most of the money will be spent to develop electronic data processing systems for administrative work.

Iraq. The new international airport under construction at Baghdad will get a full kit of radio navigation, communications, meteorological and air traffic control equipment including a blind-landing system. Standard Telephones and Cables Ltd., a British subsidiary of the International Telephone and Telegraph Corp., has a \$2.5 million contract to supply the hardware.

Japan. Hitachi Ltd. has developed a new type of stereo phonograph cartridge—a stylus-tipped pair of silicon transistors. In the cartridge, small pressure variations applied to the emitter by movement of the stylus are converted into large variations in collector current. Hitachi plans to sell the cartridge for about \$55.

Africa. Telecommunications officials from some 60 countries are meeting in Geneva under the auspices of the International Telecommunications Union to work out frequency allocations for African stations broadcasting in the 525 to 1605 kilohertz medium-frequency band. The officials also will take a look at interference among stations using the 150 to 285 khz band.

3 good reasons why ANELEX PRINTERS fit your needs best

1. LOW COST . . . Available in a wide range of speeds—from less than 300 to more than 1000 lines per minute. Pay only for the speed you need.

2. FULLY ENGINEERED . . . Delivered complete with electronics (fully buffered) ready to plug into and operate from your equipment. Keeps internal engineering cost down.

3. EASILY SERVICED . . . All Analex Printers have a high order of parts interchangeability. What's more, they all use the same general operating principle. Maintenance procedures and personnel training are greatly simplified.



ANELEX RELIABILITY

Analex Printers are used in all environments . . . from the arctic to the tropics, on the ground and in the air, in industry and in the military . . . Just one more reason why the world's leading computer and systems manufacturers specify Analex. For some practical engineering information, write . . .



SYMBOL OF QUALITY

ANELEX CORPORATION

150 CAUSEWAY STREET
BOSTON, MASSACHUSETTS • 02114

Electronics advertisers

October 3, 1966



ADC Products	184	Controls Company of America	154	Hansen Mfg. Company Inc.	231
John Gompper & Associates		Harry P. Bridge Company		Keller-Crescent Company	
API Instruments	262	Corning Glass Works,	24	Hathaway Instruments Inc.	238
George Z. Griswold Advertising		Electronics Division		Eby & Everson Inc.	
AMP Incorporated	165	Rumrill-Hoyt Inc.	230	Hewlett Packard,	3rd Cover
Garceau, Hargrave & McCullough Inc.		Coto Coil Company Inc.	228	Colorado Springs Division	
Acopian Corporation	236	The Williams Company		Tallant/Yates Inc.	31
Mort Barish Associates Inc.		Couch Ordnance Inc.	146	Hewlett Packard International	
Adams & Westlake Company	6	Culver Advertising Inc.		Lennen & Newell Inc.	
E. H. Brown Advertising Agency Inc.		Cross & Company, H.	54	Hewlett Packard	2, 17, 57
Airpax Electronics Inc.	256	Leo Hecke Incorporated		Loveland Division	
Welch, Mirabile & Company Inc.		Cyco-Tronics Inc.	74	Lennen & Newell Inc.	
Allen Bradley Company	163, 164	T. W. Blakeslee Advertising Inc.		Hewlett Packard Moseley Division	1
Fensholt Advertising Agency Inc.		Dale Electronics Inc.	189	Lennen & Newell Inc.	
Allied Radio Corporation	207	Swanson, Sinkey, Ellis Inc.		Hewlett Packard, Sanborn Division	64, 65
Marvin H. Frank Company		Damon Engineering Incorporated	203	Culver Advertising Inc.	
Alpha Metals Inc.	203	L. K. Frank Company Inc.		Honeywell PMD Division	223
Black Russell-Morris Inc.		Data Control Systems	118	Batten, Barton, Durstine & Osborn Inc.	
Ammon Instruments Inc.	230	Bodge-Eade Incorporated		Hughes Aircraft Company	172, 254
Culver Advertising Inc.		Datex Company		Foote, Cone & Belding Inc.	
Andersen Laboratories Inc.	178	Faust/Day Incorporated		Hull Corporation	232
Smith, Dorian & Burman Inc.		Delco Radio Division of	72	Michener Company Advertising	
Anelex Corporation	265	General Motors Corporation		IMC Magnetics Corporation	221
James J. Cavella Advertising		Campbell-Ewald Company	22	Monad Advertising Design	
Arco Electronics Division of	71	Digital Equipment Corporation		IRC Incorporated	192
Loral Corporation		Kalb & Schneider Incorporated		Gray & Rogers Inc.	
Campbell Ewald Company		Dorne & Margolin Incorporated	169	Industrial Chemical Specialties	241
Art Wire & Stamping Company	220	Snow & Depew Advertising		Corporation	
Williams & London Advertising		DuPont de Nemours & Company	39 to 42	Robert A. Paul Advertising Agency	
Automatic Electric Company	18, 19	Freon Division		Industrial Electronic Engineers Inc.	185
Tatham-Laird & Kudner Inc.		Batten, Barton, Durstine & Osborn Inc.		Gumpertz, Bentley & Dolan Inc.	
Babcock Relays Inc.	58 D	DuPont de Nemours & Company,	91	Inland Motor Corporation Sub. of	219
Leland Oliver Company		Mylar Division		Kollmorgen Corporation	
Ballantine Laboratories	214	Batten, Barton, Durstine & Osborn Inc.		S. Gunnar Myrbeck & Company	
Lang-Lawrence Advertising Inc.		Eastman Kodak Company	117	International Nickel Company Inc.	84
Barnes Development Company	202	Rumrill-Hoyt Inc.		The Marschalk Company Inc.	
Industrial Public Relations Inc.		Electro Scientific Industries	158	ITT Jennings Radio Mfg.	179
Barnstead Still & Sterilizer Company	195	Nadler & Larimer Inc.		Company Division	
Creamer, Trowbridge & Case Inc.		Electronized Chemicals Corporation	73	L. H. Waldron Advertising Agency	
Bausch & Lomb Inc.	218	Kenyon & Eckhardt Inc. Advertising		ITT Semiconductor Division	149, 151
Wolff Associates Inc.		Elgenco Incorporated	229	Neals & Hickok Inc.	
Beckman Instruments Inc.	59	Wesco Advertising		J F D Electronics Corporation	213
Helipot Division		Engelhard Industries Inc.	200, 201	Michel-Cather Inc.	
Hixson & Jorgensen Inc.		Keyes, Martin & Company		Japan Lite Machinery Corp.	211
Beckman Instrument International	OAS 6	Esterline Angus Instrument Company	96	Electronic Association of Japan Div.	
Hixson & Jorgensen Inc.		Caldwell, Larkin & Sidener Van Riper Inc.		Pace Advertising Agency	
Bendix Corporation, Montrose Division	44	Eubanks Engineering Company	215	Jerrold Corporation	14
MacManus John & Adams Inc.		Moore Bergstrom Company		Lescarboura Advertising Inc.	
Bolt Beranek & Newman Inc.	56	Fairchild Semiconductor Inc.	166	Julie Research Laboratories Inc.	232
Leland Oliver Company		Faust/Day Inc.		Conti Advertising Agency	
Borden Chemical Company,	27 to 30	Farinon Electric Company	7	Kaye & Company Incorporated, Joseph	232
Mystik Tape Division		Thomas D. Boyd		Robert Hartwell Gabine Inc.	
Conahay & Lyon Inc. Advertising		Public Relations Consultant		Kingsley Machine Company	211
Brush Instruments Division of	190, 191	Ferroxcube Corporation of America	82	Nides Cini Advertising Inc.	
Clevite Corporation		Solow/Wexton Inc.		Leach Corporation	58 A
Carr Liggett Advertising		Field Emission Corporation	86	Jay Chiat & Associates	
Bulova Watch Company	194	Ken Webber Advertising		Ledex Incorporated	208
Electronics Division		Fluke & Company, John	15	Yeck & Yeck Incorporated	
Frank Best & Company Inc.		Bonfield Associates Inc.	234	L E L Division of Varian Associates	161
C. S. F.	OAS 2	Garlock Company Incorporated		Snow & Depew Advertising	
SPI Agency		Richardson, Thomas, Bushman Inc.		Classified Advertising	
CTS Corporation	67	General Aniline & Film Corporation	80	F. J. Eberle, Business Mgr.	
Burton Browne Advertising		Hazard Advertising Company Inc.		EMPLOYMENT OPPORTUNITIES	242-249
Cambridge Thermionic Corporation	60	General Electric	233, 235, 237, 239, 241	EQUIPMENT	
Chirurg & Cairns Incorporated		George R. Nelson Inc.		MERCHANDISE	
Chemcut Corporation	216	General Electric Company	93, 94, 267	(Used or Surplus New)	
Adams Associates Inc.		George R. Nelson Inc.		For Sale	248
Cherry Electrical Products Corporation	209	General Electric Company,	263	ADVERTISERS INDEX	
K & A Incorporated		Lamp Metals & Components		A & A Electronics Corp	248
Chester Cable Corporation	197, 198	Dix & Eaton Inc.		Atomic Personnel Inc.	243
Lewis Advertising Agency		General Electric Company,	155	Bell Aerosystems	243
Chuo Denshi K. K.	233	Polymer Products Operation Div.		Corcoran Personnel Consultants, J. P.	176
Standard Advertising Inc.		Ross Roy Inc.		Electronic Communications Inc.	242
Cinch Manufacturing Company	85	General Electric Company,	176	Ewald Instruments Corp.	248
Stral Advertising Company		Silicone Products Dept.		General Dynamics	247
Cinch Graphik Division of	10	Ross Roy Inc.		Electronics Division	245
United Carr Fastener Company		General Electric	253	General Electric	249
Reach, McClinton & Company Inc.		Specialty Control Dept.		Hewlett Packard	248
Clairex Corporation	222	George R. Nelson Inc.	224, 225	Instruments & Machines Inc.	248
Michel-Cather Inc.		General Magnetics Inc.		Lear Siegler Inc.	248
Clare & Company, C. P.	20, 21	George Homer Martin Associates		Monmouth Radio Laboratories	248
Reincke, Meyer & Finn Inc.		General Radio Company	2nd Cover	Norman Electronic Sales	248
Cleveland Institute of Electronics	240	K. E. Morang Company		Radio Research Instrument Co.	248
Foote, Cone & Belding Inc.		Globe Industries Inc.	205	Sanders Associates Inc.	246
Clifton Precision Products Company	182	Odiorne Industrial Advertising		For more information on complete product	
Ivey Advertising Inc.		Granger Associates	8	line see advertisement in the latest Electronics Buyers' Guide	
Codex Corporation	142	West Associates		Advertisers in Overseas Advertising Section	
Weston Associates Inc.		Guilton Industries Inc.	88	following newsletter from abroad	
Comcor Inc. Sub. of Astrodata Inc.	81	Di Russo & Falborn Inc.		Hamilton Watch Company	55
Marketing Directions		Hawmont, Heller & Sperling Inc.			
Computer Control Company Inc.	32, 33				
Franklin P. Folts Inc.					
Consolidated Electrodynamics	58 B				
Corporation					
Hixson & Jorgensen Inc.					
Consolidated Vacuum Corporation	69				
Wolff Associates Inc.					
Control Switch Division of					

Executive, editorial, circulation and advertising offices: McGraw-Hill Building, 330 West 42nd Street, New York, N.Y., 10036. Telephone (212) 971-3333. Teletype TWX N.Y. 212 640-4646. Cable: McGrawhill, N.Y. Officers of the McGraw-Hill Publications: Joseph H. Allen, President; Bayard E. Sawyer, Executive Vice President; Vice Presidents: J. Elton Tuohi, Jr., Operations; John R. Callahan, Editorial; Donald C. McGraw, Jr., Marketing; John M. Holden, Marketing Services; Huber M. Gemmill, Circulation; Angelo R. Venezian, Production; Robert M. Wilhelm, Controller. Officers of the Corporation: Donald C. McGraw, Chairman of the Board; Shelton Fisher, President; L. Keith Goodrich, Hugh J. Kelly and Robert E. Slaughter, Executive Vice Presidents; John J. Cooke, Vice President and Secretary; John L. McGraw, Treasurer. Title R registered U.S. Patent Office; © copyright 1966 by McGraw-Hill, Inc. All rights reserved, including the right to reproduce the contents of this publication, in whole or in part.

Electronics advertisers

October 3, 1966

Licon Division of Illinois Tool Works Incorporated	36, 37	■ Sanders Associates Inc.	58 C
Waldie & Briggs Inc.		Chirurg & Cairns Inc.	229
Litton Industries Inc.		Sankyo Seiki Company Ltd.	229
Triad Distributor	225	Chinwa Advertising Company Ltd.	
West, Weir & Bartel Inc.		■ Servo Corporation of America	153
Litton Industries Inc. USECO Division	211	Basford Incorporated	
West, Weir & Bartel Inc.		Shallcross Manufacturing Company	159
Litton Industries Inc.		J. T. Howard Advertising Agency Inc.	
Winchester Electronics Division	255	Sierra Philco Inc.	95
West, Weir & Bartel Inc.		Hal Lawrence Inc.	
Lockheed Missiles & Space Company	162	Sinclair Radio Laboratories Inc.	156
McCann Erickson Inc.		John E. Hayes Company Inc.	
		■ Sorensen Operation	
Machlett Laboratories Inc.	9	Raytheon Company	11
Fuller & Smith & Ross Inc.		James Advertising Inc.	
■ Magnetic Metals Company Inc.	188	South Dakota Industrial Development Inc.	268
J. B. Ferguson Jr. Advertising		Maurice Paulsen Advertising	
■ Mallory & Company Inc. P. R. Battery Division	68	Spectra Physics Incorporated	34, 35
Needham, Harper & Steers Inc.		Hal Lawrence Inc.	
■ Mallory Capacitor Division of P. R. Mallory Company	77	Spectrol Electronics Corporation	61
Aitkin Kynett Company Inc.		Jones, Maher Roberts Advertising	
Marconi Instruments	66	Speer Carbon Company	53
Armand Richards Advertising Agency		Hazard Advertising Company	
□ Marconi Instruments Ltd.	OAS 4	Sprague Electric Company	5, 16, 58
Lovell Rupert Curtis Ltd.		Harry P. Bridge Company	
■ Markel & Sons, L. Frank	217	Stackpole Carbon Company	78
George Moll Advertising Inc.		Meek & Thomas Inc.	
Markem Machine Company	150	Stattler Hilton Hotel of Boston	241
Culver Advertising Agency		Calkins & Holden Advertising	
Maryland Dept. of Economic Development, State of	184	Stromberg Carlson Corporation	205
Rosebush Advertising Agency Inc.		Rumrill-Hoyt Incorporated	
■ Matsuo Electric Company Ltd.	215	Synthane Corporation	213
Fuji Agency		Arndt, Preston, Chapin Lamb & Keen Inc.	
Meller & Company, Adolf	209		
Susan E. Schur		TRG Inc.	199
Memorex Corporation	83	Culver Advertising Incorporated	
Hal Lawrence Incorporated		TRW Semiconductor	79
Metronix Corporation	235	Fuller, Smith & Ross Inc.	
Standard Advertising Inc.		Taylor Corporation	261
Mico Instrument Company	239	Gray & Rogers Inc.	
■ Microsonics Incorporated	230	■ Tektronix Incorporated	70
S. Gunnar Myrbeck & Company		Hugh Dwight Advertising	
■ Micro Swith Division of Honeywell Company	127	■ Telonic Engineering Company	196
Batten, Barton, Durstine & Osborn Inc.		Jansen Associates Inc.	
Minnesota Mining & Manufacturing Company, Chemical Division	128	■ Telonic Instruments Incorporated	186
Young & Rubicam Inc.		Jansen Associates	
Minnesota Mining & Manufacturing Company, Scotchpar Division	204	Texas Instruments Incorporated, Industrial Products Group	180
Klau-Van Pietersom Dunlap Inc.		Robinson-Gerrard Inc.	
■ Mitsumi Electric Company Ltd.	237	Texas Instruments Incorporated, Semiconductor Components Division	140, 141
Dentsu Advertising Ltd.		Dan L. Baxter Inc.	
Motorola Incorporated		Thomson Houston Inc.	160
Government Electronics Division	89	Mitchell-Morrison Inc.	
The Bowers Company		■ Times Wire & Cable Division of International Silver Company	212
Motorola Semiconductor Products Incorporated	43	Mohr & Company Inc.	
Lane & Bird Advertising Inc.		Transformer Electronics Company	228
□ Mullard Ltd.	OAS 3	Dacey, Wolff & Associates	
Roles & Parker Ltd.		Transitron Electronic Corporation	51
		Larcom Randall Advertising Inc.	
National Electronics Inc.	209	Transitron Electronic Corporation, Precision Connector Division	174
Connor-Sager Associates Inc.		Larcom Randall Advertising Inc.	
North Atlantic Industries Inc.	170	■ Trylon Incorporated	264
Murray Heyert Associates		George Moll Advertising Inc.	
		■ Tung Sol Electric Inc.	207
■ Pennsalt Chemicals Corporation	157	E. M. Freystadt Associates	
Aitkin-Kynett Company Inc.			
■ Pfizer & Company, Charles M. P. M. Division	206	Ultra Carbon Corporation	268
Newmark Posner & Mitchell Inc.		Church & Guisewite Advertising	
Phelps Dodge Electronics Products Corporation	181	Union Carbide Corporation	147
Smith, Dorian & Burman Inc.		J. M. Mathes Inc.	
■ Philbrick Researches Inc.	139	U. S. Naval Ship	215, 264
Culver Advertising Inc.		Henry J. Kaufman Associates	
□ Philips Eindhoven	OAS 1		
Technical Advertising		Varo Incorporated	90
□ Plessey Electronics Company	OAS 5	Tracy-Locke Company Inc.	
Roles & Parker Ltd.		Victoreen Instrument Company	175
Potter Instrument Company Inc.	148	Palm & Peterson Inc.	
Michel-Cather Inc.		Vidar Corporation	38
Precision Paper Tube Company	227	Hal Lawrence Inc.	
T. W. Blakeslee Advertising		■ Vitro Corporation of America	92
Precision Scientific Company	205	Buchen Advertising Inc.	
Tri-State Advertising Company Inc.		Volkert Stampings Inc.	222
■ Primo Company Ltd.	239	Fred Wittner Company	
General Advertising Agency			
		Wells Electronics Inc.	207
Radio Corporation of America	12, 13, 4th Cover	Weco Advertising	
Al Paul Lefton Company		Westinghouse Metals Division	250
Raytheon Company, Components Division	62, 63, 226, 227	McCann/ITSM	
Fuller & Smith & Ross Inc.		West Penn Power Company	201
Rohde & Schwarz Inc.	87	Fuller & Smith & Ross Inc.	
Armand Richards Advertising Agency		Weston Instruments Inc.	
Robinson/Nugent Inc.	216	Rotek Division	152
Creative House Inc.		Arndt, Preston, Chapin, Lamb & Keen Inc.	210
		Wood Electric Company	
SBD Systems Inc.	231	L. K. Frank Company Inc.	
Murray Heyert Advertising Inc.			

Test to High Reliability Standards With General Electric's New Helium Mass Spectrometer Leak Detector



■ **SENSITIVITY:** Get higher product quality. Test with the highest sensitivity available— 2×10^{-11} std. cc/second. And get fast response and recovery as well.

■ **SPEED:** Test more pieces faster. Pump down to 20 microns in 15 seconds. Complete an entire test cycle in as little as 25 seconds with G.E.'s Helium Mass Spectrometer Leak Detector.

■ **SOLID STATE ELECTRONICS:** Minimize downtime. Five-sided access assures easy maintenance.

■ **ACT NOW:** Get complete data sheets on G.E.'s high sensitivity, high speed Leak Detector. Contact any one of G.E.'s nationwide Vacuum Products Sales Specialists and ask for publication GEZ-4154.

Or write to Mr. R. T. Clark, Manager—Marketing, Vacuum Products Operation, General Electric Company, Schenectady, New York 12305.

P.S. The price is attractive, too.

GENERAL ELECTRIC

268-18



The shape of tomorrow, today

For more than 20 years Ultra Carbon has assisted industry build and produce the tomorrows that become our today's. Our graphite parts are widely used by the electronic industries. Some are for:

Alloying Operations • Alloying Jigs and Fixtures • Bushings • Weights • Unitized Boats • Plugs • Inserts

Epitaxial Growth • Epitaxial Susceptors • Strip Heaters • Disc Heaters

Materials Preparation • Reduction Boats • Zone Refining Boats • Boat Covers

Polycrystalline Rod Production • Sockets • Chucks • Eccentrics • Support Rings

Crystal Pulling and Slicing • Heating Elements • Pedestals • Connectors • Crucible Holders • Slicing Blocks

The *Ultra Carbon* experience and in-plant capability for micromachining are your assurance of graphite parts to meet your needs today to shape tomorrow.

Write for information to Ultra Carbon Corporation, Box 747, Bay City, Mich. 48709.



Advertising sales staff

Frank E. LeBeau [212] 971-6464

Advertising sales manager

Atlanta, Ga. 30309: Michael H. Miller, 1375 Peachtree St., N.E., [404] TR 5-0523

Boston, Mass. 02116: William S. Hodgkinson McGraw-Hill Building, Copley Square [617] CO 2-1160

Chicago, Ill. 60611: Robert M. Denmead, J. Bradley MacKimm, 645 North Michigan Avenue, [312] MO 4-5800

Cleveland, Ohio 44113: William J. Boyle, 55 Public Square, [216] SU 1-7000

Dallas, Texas 75201: Richard P. Poole, 1800 Republic National Bank Tower, [214] RI 7-9721

Denver, Colo. 80202: Joseph C. Page, David M. Watson, Tower Bldg., 1700 Broadway, [303] 255-5484

Detroit, Michigan 48226: J. Bradley MacKimm, 856 Penobscot Building [313] 962-1793

Houston, Texas 77002: Kenneth George, 2270 Humble Bldg., [713] CA 4-8381

Los Angeles, Calif. 90017: Ian C. Hill, John G. Zisch, 1125 W. 6th St., [213] HU 2-5450

Minneapolis, Minn. 55402: J. Bradley MacKimm, 1104 Northstar Center [612] 332-7425

New York, N. Y. 10036: Donald R. Furth [212] 971-3615 James R. Pierce [212] 971-3615 George F. Werner [212] 971-3615 500 Fifth Avenue

Philadelphia, Pa. 19103: William J. Boyle, Warren H. Gardner, Jeffrey M. Preston, 6 Penn Center Plaza, [215] LO 8-6161

Pittsburgh, Pa. 15222: Warren H. Gardner, 4 Gateway Center, [412] 391-1314

Portland, Ore. 97204: James T. Hauptli, Pacific Building, Yamhill Street, [503] CA 3-5118

St. Louis, Mo. 63105: Robert M. Denmead The Clayton Tower, 7751 Carondelet Ave. [314] PA 5-7285

San Francisco, Calif. 94111: James T. Hauptli, 255 California Street, [415] DO 2-4600

London W1: John W. Patten, Edwin S. Murphy Jr., 34 Dover Street, Hyde Park 1451

Milan: 1, via Baracchini Phone: 86-90-617 86-90-656

Frankfurt/Main: Gerd Hinske, Dieter Rothenbach, Elsa-Brandstroem Str. 2 Phone: 72 01 81

Geneva: Michael R. Zeynel, 1, rue du Temple Phone: 31 95 60

Paris VIII: Denis Jacob, Kenneth Davey, 17 Avenue Matignon Phone: 359 6637

Tokyo: Nobuyuki Sato, 1, Kotohiracho Shiba, Minato-Ku [502] 0656

Osaka: Ryosi Kobayashi, 163, Umegee-cho, Kita-ku [362] 8771

Wallace C. Carmichael [212] 971-3191 Manager Electronics Buyers' Guide

David M. Tempest [212] 971-3139 Promotion manager

Milton Drake [212] 971-3485 Research and circulation manager

Wallis Clarke [212] 971-2187 Assistant to sales manager

Wallace C. Carmichael [212] 971-3191 Business manager

Stephen R. Weiss [212] 971-2044 Production manager

Thomas M. Egan [212] 971-3140 Production manager Electronics Buyers' Guide

YOU CAN'T OVERLOOK US! ...WE INTEND TO BE PERSISTENT!



Let Us Send You The Facts On **PROFIT-LIVABILITY!** FOR ELECTRONICS FIRMS!

70 South Dakota communities have industrial development corporations ready to assist you in locating your new plant. We believe that you'll be pleasantly surprised with the advantages South Dakota has to offer new and expanding industry.

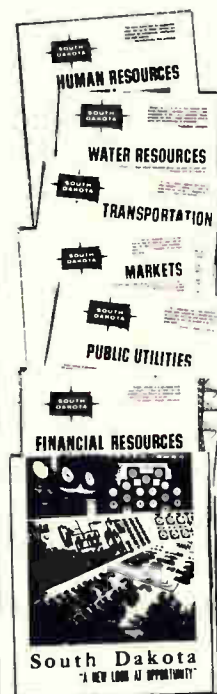

PROVED LABOR PRODUCTIVITY

Value added by manufacture per worker is one of the nation's highest. Eager, alert labor force with work stoppages at absolute minimum.

FINANCING & TAXES

Local development corporations ready to serve all industries. Revenue bond financing available. Debt-free state with no corporate or personal income tax... plus a free port law!

CENTRAL LOCATION

You're closer to everyone and everywhere in South Dakota, geographical center of the U.S. and the heartland of the entire North American continent.

ENERGY FOR YOU

Electrical power available at low cost rates from hydro, fossil and atomic plants to serve the most demanding production needs.

GREAT OUTDOOR ADVENTURE

The beautiful Black Hills, Missouri Great Lakes, fantastic fishing, fabulous big and small game hunting, water resources that challenge the imagination... all combine for a recreation bonanza at your doorstep.

GET THE SOUTH DAKOTA STORY

CALL OR WRITE

JAMES W. MONROE, DIRECTOR Industrial Development Expansion Agency

ROOM H
PIERRE, SOUTH DAKOTA 57501
PHONE 224-5911 EXT. 307 AREA CODE 605

Electronics reader service

Use these handy post cards for more detailed information on: products advertised, new products, new literature.

Circle the number on the Reader Service post card that corresponds to the number at the bottom of the advertisement, new product item, or new literature in which you are interested.

Please print clearly. All written information must be legible to be efficiently processed.

If someone has beaten you to the post cards, you may obtain the needed information by writing directly to the manufacturer, or by sending your name and address, plus the Reader Service number, to Electronics Reader Service department.

All inquiries from outside the U.S. that cannot reach Electronics before the expiration dates noted on the Reader Service post card, must be mailed directly to the manufacturer. The manufacturer assumes all responsibilities for responding to inquiries. Electronics merely provides and clears requests for information from inquirer to manufacturer.

Correct amount of postage must be affixed for all mailings from outside the U.S.

To subscribe to or to renew Electronics

Fill in the "For Subscriptions" area on the card if you desire to subscribe to or renew your present subscription to Electronics. Send no money. Electronics will bill you at the address indicated on the Reader Service post card.

Multi-product advertisements

For information on specific items in multi-product advertisements which do not have a specific Reader Service number indicated write directly to manufacturer for information on precise product in which you are interested.

October 3, 1966 Card Expires December 3, 1966 14

20

Name _____ title _____

Company _____

Address _____

For Subscriptions
 new renewal
 3 years \$12.00
 1 year \$6.00

1	20	39	58	77	96	115	134	153	172	191	210	229	248	267	286	305	324	343	362	381	400	419	438	457	476	495	514	962
2	21	40	59	78	97	116	135	154	173	192	211	230	249	268	287	306	325	344	363	382	401	420	439	458	477	496	515	963
3	22	41	60	79	98	117	136	155	174	193	212	231	250	269	288	307	326	345	364	383	402	421	440	459	478	497	516	964
4	23	42	61	80	99	118	137	156	175	194	213	232	251	270	289	308	327	346	365	384	403	422	441	460	479	498	517	965
5	24	43	62	81	100	119	138	157	176	195	214	233	252	271	290	309	328	347	366	385	404	423	442	461	480	499	518	966
6	25	44	63	82	101	120	139	158	177	196	215	234	253	272	291	310	329	348	367	386	405	424	443	462	481	500	900	967
7	26	45	64	83	102	121	140	159	178	197	216	235	254	273	292	311	330	349	368	387	406	425	444	463	482	501	901	968
8	27	46	65	84	103	122	141	160	179	198	217	236	255	274	293	312	331	350	369	388	407	426	445	464	483	502	902	969
9	28	47	66	85	104	123	142	161	180	199	218	237	256	275	294	313	332	351	370	389	408	427	446	465	484	503	951	970
10	29	48	67	86	105	124	143	162	181	200	219	238	257	276	295	314	333	352	371	390	409	428	447	466	485	504	952	971
11	30	49	68	87	106	125	144	163	182	201	220	239	258	277	296	315	334	353	372	391	410	429	448	467	486	505	953	972
12	31	50	69	88	107	126	145	164	183	202	221	240	259	278	297	316	335	354	373	392	411	430	449	468	487	506	954	973
13	32	51	70	89	108	127	146	165	184	203	222	241	260	279	298	317	336	355	374	393	412	431	450	469	488	507	955	974
14	33	52	71	90	109	128	147	166	185	204	223	242	261	280	299	318	337	356	375	394	413	432	451	470	489	508	956	975
15	34	53	72	91	110	129	148	167	186	205	224	243	262	281	300	319	338	357	376	395	414	433	452	471	490	509	957	976
16	35	54	73	92	111	130	149	168	187	206	225	244	263	282	301	320	339	358	377	396	415	434	453	472	491	510	958	977
17	36	55	74	93	112	131	150	169	188	207	226	245	264	283	302	321	340	359	378	397	416	435	454	473	492	511	959	978
18	37	56	75	94	113	132	151	170	189	208	227	246	265	284	303	322	341	360	379	398	417	436	455	474	493	512	960	979
19	38	57	76	95	114	133	152	171	190	209	228	247	266	285	304	323	342	361	380	399	418	437	456	475	494	513	961	980

2

First class
Permit no. 42
Hightstown, N. J.

Business reply mail

No postage stamp necessary if mailed in the United States

Postage will be paid by

Electronics

Reader service department

Box 444

Hightstown, N.J. 08520

October 3, 1966 Card Expires December 3, 1966 14

20

Name _____ title _____

Company _____

Address _____

For Subscriptions
 new renewal
 3 years \$12.00
 1 year \$6.00

1	20	39	58	77	96	115	134	153	172	191	210	229	248	267	286	305	324	343	362	381	400	419	438	457	476	495	514	962
2	21	40	59	78	97	116	135	154	173	192	211	230	249	268	287	306	325	344	363	382	401	420	439	458	477	496	515	963
3	22	41	60	79	98	117	136	155	174	193	212	231	250	269	288	307	326	345	364	383	402	421	440	459	478	497	516	964
4	23	42	61	80	99	118	137	156	175	194	213	232	251	270	289	308	327	346	365	384	403	422	441	460	479	498	517	965
5	24	43	62	81	100	119	138	157	176	195	214	233	252	271	290	309	328	347	366	385	404	423	442	461	480	499	518	966
6	25	44	63	82	101	120	139	158	177	196	215	234	253	272	291	310	329	348	367	386	405	424	443	462	481	500	900	967
7	26	45	64	83	102	121	140	159	178	197	216	235	254	273	292	311	330	349	368	387	406	425	444	463	482	501	901	968
8	27	46	65	84	103	122	141	160	179	198	217	236	255	274	293	312	331	350	369	388	407	426	445	464	483	502	902	969
9	28	47	66	85	104	123	142	161	180	199	218	237	256	275	294	313	332	351	370	389	408	427	446	465	484	503	951	970
10	29	48	67	86	105	124	143	162	181	200	219	238	257	276	295	314	333	352	371	390	409	428	447	466	485	504	952	971
11	30	49	68	87	106	125	144	163	182	201	220	239	258	277	296	315	334	353	372	391	410	429	448	467	486	505	953	972
12	31	50	69	88	107	126	145	164	183	202	221	240	259	278	297	316	335	354	373	392	411	430	449	468	487	506	954	973
13	32	51	70	89	108	127	146	165	184	203	222	241	260	279	298	317	336	355	374	393	412	431	450	469	488	507	955	974
14	33	52	71	90	109	128	147	166	185	204	223	242	261	280	299	318	337	356	375	394	413	432	451	470	489	508	956	975
15	34	53	72	91	110	129	148	167	186	205	224	243	262	281	300	319	338	357	376	395	414	433	452	471	490	509	957	976
16	35	54	73	92	111	130	149	168	187	206	225	244	263	282	301	320	339	358	377	396	415	434	453	472	491	510	958	977
17	36	55	74	93	112	131	150	169	188	207	226	245	264	283	302	321	340	359	378	397	416	435	454	473	492	511	959	978
18	37	56	75	94	113	132	151	170	189	208	227	246	265	284	303	322	341	360	379	398	417	436	455	474	493	512	960	979
19	38	57	76	95	114	133	152	171	190	209	228	247	266	285	304	323	342	361	380	399	418	437	456	475	494	513	961	980

Reprint service

All Electronics editorial matter available in reprint form:

For reprints of special reports and feature articles see list on right side of this page. Send your order to Electronics Reprint Department at the address indicated. To expedite mailing of your order for single reprints please send cash, check or money order with your order.

Bulk reprints of editorial matter can be ordered from current or past issues. The minimum quantity is 100 copies. The higher the quantity ordered, the more economical the cost per copy. Prices quoted on request.

3

Business reply mail

No postage stamp necessary if mailed in the United States

Postage will be paid by

Electronics
Reader service department
Box 444
Hightstown, N. J. 08520

First class
Permit no. 42
Hightstown, N. J.



20

October 3, 1966 Card Expires December 3, 1966 14

Name _____ title _____

Company _____

Address _____

For Subscriptions

- new renewal
 3 years \$12.00
 1 year \$6.00

1	20	39	58	77	96	115	134	153	172	191	210	229	248	267	286	305	324	343	362	381	400	419	438	457	476	495	514	962
2	21	40	59	78	97	116	135	154	173	192	211	230	249	268	287	306	325	344	363	382	401	420	439	458	477	496	515	963
3	22	41	60	79	98	117	136	155	174	193	212	231	250	269	288	307	326	345	364	383	402	421	440	459	478	497	516	964
4	23	42	61	80	99	118	137	156	175	194	213	232	251	270	289	308	327	346	365	384	403	422	441	460	479	498	517	965
5	24	43	62	81	100	119	138	157	176	195	214	233	252	271	290	309	328	347	366	385	404	423	442	461	480	499	518	966
6	25	44	63	82	101	120	139	158	177	196	215	234	253	272	291	310	329	348	367	386	405	424	443	462	481	500	900	967
7	26	45	64	83	102	121	140	159	178	197	216	235	254	273	292	311	330	349	368	387	406	425	444	463	482	501	901	968
8	27	46	65	84	103	122	141	160	179	198	217	236	255	274	293	312	331	350	369	388	407	426	445	464	483	502	902	969
9	28	47	66	85	104	123	142	161	180	199	218	237	256	275	294	313	332	351	370	389	408	427	446	465	484	503	951	970
10	29	48	67	86	105	124	143	162	181	200	219	238	257	276	295	314	333	352	371	390	409	428	447	466	485	504	952	971
11	30	49	68	87	106	125	144	163	182	201	220	239	258	277	296	315	334	353	372	391	410	429	448	467	486	505	953	972
12	31	50	69	88	107	126	145	164	183	202	221	240	259	278	297	316	335	354	373	392	411	430	449	468	487	506	954	973
13	32	51	70	89	108	127	146	165	184	203	222	241	260	279	298	317	336	355	374	393	412	431	450	469	488	507	955	974
14	33	52	71	90	109	128	147	166	185	204	223	242	261	280	299	318	337	356	375	394	413	432	451	470	489	508	956	975
15	34	53	72	91	110	129	148	167	186	205	224	243	262	281	300	319	338	357	376	395	414	433	452	471	490	509	957	976
16	35	54	73	92	111	130	149	168	187	206	225	244	263	282	301	320	339	358	377	396	415	434	453	472	491	510	958	977
17	36	55	74	93	112	131	150	169	188	207	226	245	264	283	302	321	340	359	378	397	416	435	454	473	492	511	959	978
18	37	56	75	94	113	132	151	170	189	208	227	246	265	284	303	322	341	360	379	398	417	436	455	474	493	512	960	979
19	38	57	76	95	114	133	152	171	190	209	228	247	266	285	304	323	342	361	380	399	418	437	456	475	494	513	961	980

1

Business reply mail

No postage stamp necessary if mailed in the United States

Postage will be paid by

Electronics
Reader service department
Box 444
Hightstown, N.J. 08520

First class
Permit no. 42
Hightstown, N. J.



To order reprints or for further information, please write to: **Electronics Reprint Department, 330 West 42nd Street, New York, N.Y. 10036.**

Prices for the below listed reprints unless otherwise specified are 1-10 copies 50¢ each; 11-24 copies 35¢ each; 25-99 copies 25¢ each; price for 100 or more is 20¢ each.

You may order any of the below listed reprints by key number.

- Key no. **R-90** Communications Satellites Part II. 18 pages. 75¢
- Key no. **R-89** Communications Satellites Part I. 24 pages. 75¢
- Key no. **R-88** Belting Out Plastic Transistors On Mechanized Assembly Lines 8 pages. 25¢
- Key no. **R-87** The Packaging Revolution In Microelectronics (Parts IV, V and VI. 32 pages). \$1.00
- Key no. **R-86** Computer Time Sharing Part II 12 pages.
- Key no. **R-85** U.S. Electronics Markets 1966 24 page forecast report with 6 page foldout chart.
- Key no. **R-84** European Electronics Markets 1966. 16 pages with 4 page foldout chart.
- Key no. **R-83** A Look At Japanese Electronics Technology 36 pages.
- Key no. **R-82** Computer Time Sharing Part I 20 pages
- Key no. **R-80** The Packaging Revolution In Microelectronics (Parts I, II, and III. 32 pages). \$1.00
- Key no. **R-79** MOS Integrated Circuits 12 pages.
- Key no. **R-78** The Overlay Transistor 15 pages.
- Key no. **R-77** Cold Cathode Tubes (3 part series, 28 pages).
- Key no. **R-76** Automated Trains: Who's On The Right Track? 16 pages.
- Key no. **R-75** Biotelemetry [2 Part series 16 pages].
- Key no. **R-74** Unijunction Transistors, 24 pages.
- Key no. **R-64** Field Effect Transistors (Parts I, II and III. 64 pages). \$1.00
- Key no. **R-63** Silicon Power Transistors 8 pages. 25¢
- Key no. **R-60** Transistor Heat Dissipators, 32 pages.
- Key no. **R-31** 1962 Electromagnetic Spectrum Chart, [22" x 30" foldout chart]. \$1.00

NEW hp 180A OSCILLOSCOPE

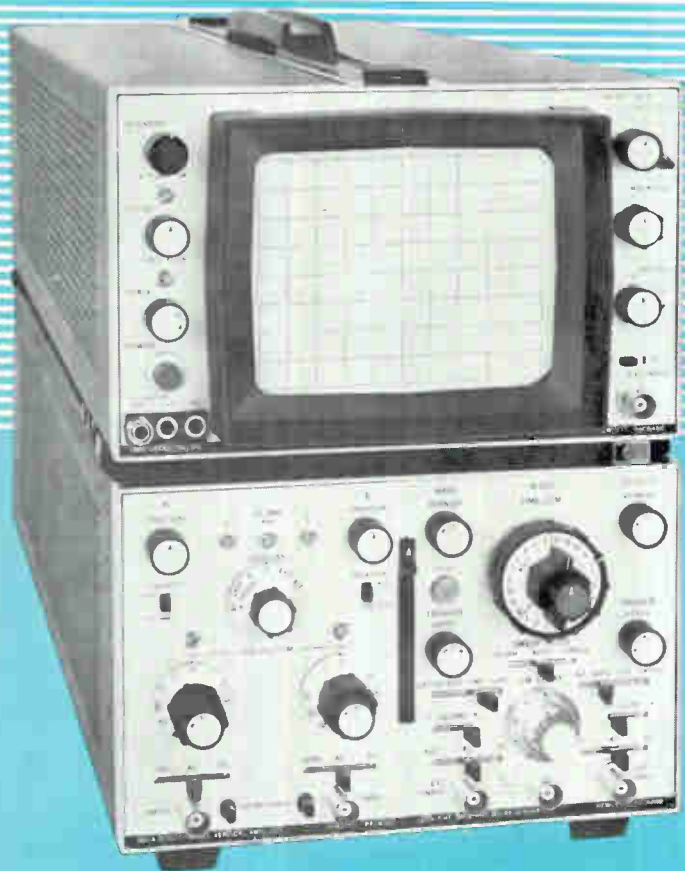

**SEE
MORE!**

**DO
MORE!**

More Performance Than Any Other High-Frequency Scope! Big Picture



8 x 10 cm CRT

Display. Plug-In Versatility



with 5 mv/cm, 50 MHz Dual Channel Amplifier; Time

Base and Delay Generator with Mixed Sweep; Time Base with 5 nsec/cm Sweeps. Rugged, Easy-

to-Carry



30-Pound Package. 100% Solid State Circuitry. Convenient Snap-Off Covers

for Easy-to-get-at Circuitry.

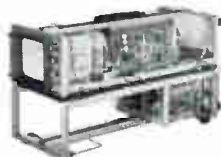

Optional 5¼" Rack Mount.

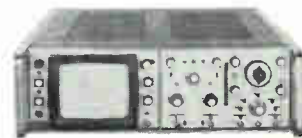

Get the BIG picture! Call an hp field engineer for your demonstration, today! Or write, Hewlett-Packard, Palo Alto, California 94304, Tel (415) 326-7000. Europe: 54 Route des Acacias, Geneva. Price: hp Model 180A Oscilloscope, \$825.00; hp Model 180AR (rack) Oscil-

loscope, \$900.00; hp Model 1801A Dual Channel Vertical Amplifier, \$650.00; hp Model 1820A Time Base, \$475.00; hp Model 1821A Time Base and Delay Generator, \$800.00, f.o.b. factory.

HEWLETT  **PACKARD**
An extra measure of quality

Circle 901 on reader service card



RCA

2N4440 "overlay" new high performance version of 2N3375 $P_{out} = 5$ Watts min at 400 MHz with $P_{in} = 1.7$ watts

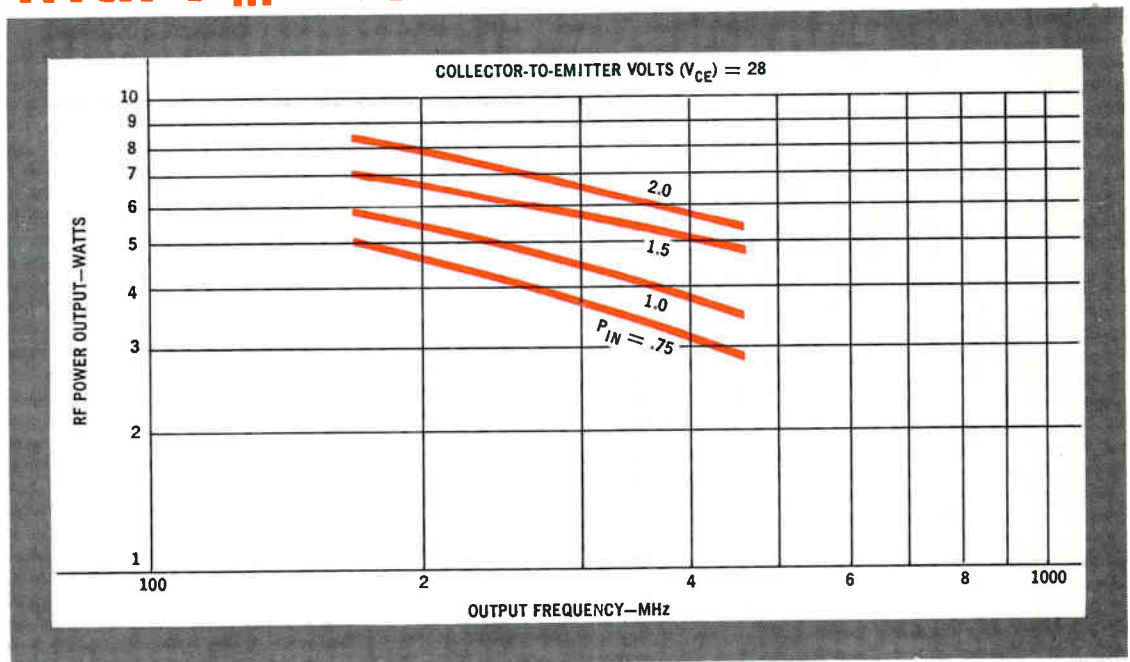

RCA now introduces 2N4440, a new high performance version of "overlay" type 2N3375—the industry's most famous rf-power device. Specified for Class A, B, and C service, this premium transistor extends solid-state performance for rf amplifier, multiplier, or oscillator service into the 175 to 400 MHz range.

The latest addition to RCA's extensive "overlay" family, 2N4440 offers:

$P_{out} = 5$ W (min.) @ 400 MHz; $P_{in} = 1.7$ W
 $P_{out} = 6.5$ W (typ.) @ 225 MHz; $P_{in} = 1.7$ W
 $BV_{ceV} = 65$ V (max.)
 $BV_{ceo} = 40$ V (max.)

Add to this performance the efficiency of an isolated-collector stud package (TO-60) and the increased reliability of 100% Power Rating Testing (each unit is tested at maximum power level for one second), and you have an important new design tool for VHF, UHF, and Microwave communications circuits.

For additional information, plus price and delivery, see your RCA Representative. For technical data, write: RCA Commercial Engineering, Section IN10-1, Harrison, N. J.

Also available through your RCA Distributor
RCA Electronic Components and Devices



The Most Trusted Name in Electronics