

# Electronics®

Choosing a diode for r-f switching: page 70

New ways to bond integrated circuits: page 86

Moment of decision for European color tv: page 97

March 22, 1965

75 cents

A McGraw-Hill Publication

Below: the cold-cathode tube finds new applications, page 78



RECEIVED  
MAY 1965  
ELECTRONICS

# M. Fourier would have liked this Recording Wave Analyzer

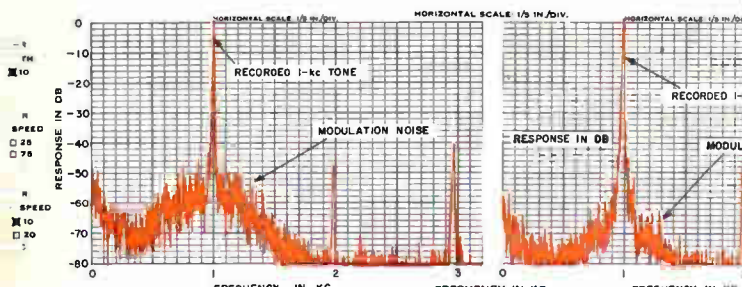
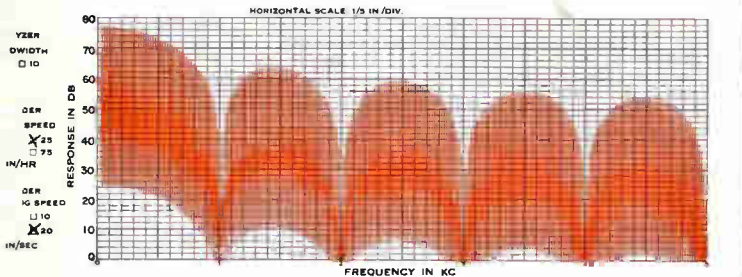
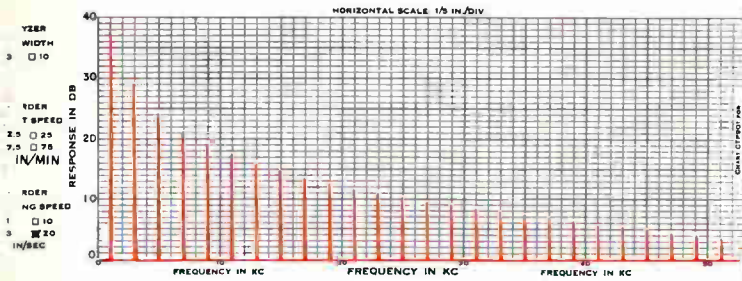

Graphic plot of modulation noise on a 1-kc tone for two different types of magnetic tape. Note that one tape has 10dB less noise. The Recording Analyzer is ideal for this type of measurement since its 80-dB dynamic range permits uninterrupted recording over wide ranges.

- Three bandwidths let you choose the best selectivity for each measurement . . . 3 c/s or 10 c/s for detailed measurements, 50 c/s for rapid analysis or for measurement of drifting signals. Bandwidth skirts are better than 80-dB down at  $\pm 25$  c/s,  $\pm 80$  c/s, and  $\pm 500$  c/s for 3-, 10-, and 50-cycle bandwidths, respectively.
- Linear frequency scale from 20 c/s to 54 kc/s.
- Two outputs for recording, 100 kc/s with 80-dB dynamic range for inputs above 0.1 V, and 1-mA dc.
- 80-dB dynamic range for recording. You can make uninterrupted recordings . . . no attenuator switching in the midst of measurements.
- High input impedance (1-M $\Omega$ ) on all ranges.
- Voltage range is 30 $\mu$ V to 300V, full scale, in 15 ranges. Accuracy,  $\pm$  (3% of reading +2% of full scale).
- As a "Tracking Generator," instrument is both a signal source (delivering 2V across 600 $\Omega$ ) and a detector tuned to each other exactly.

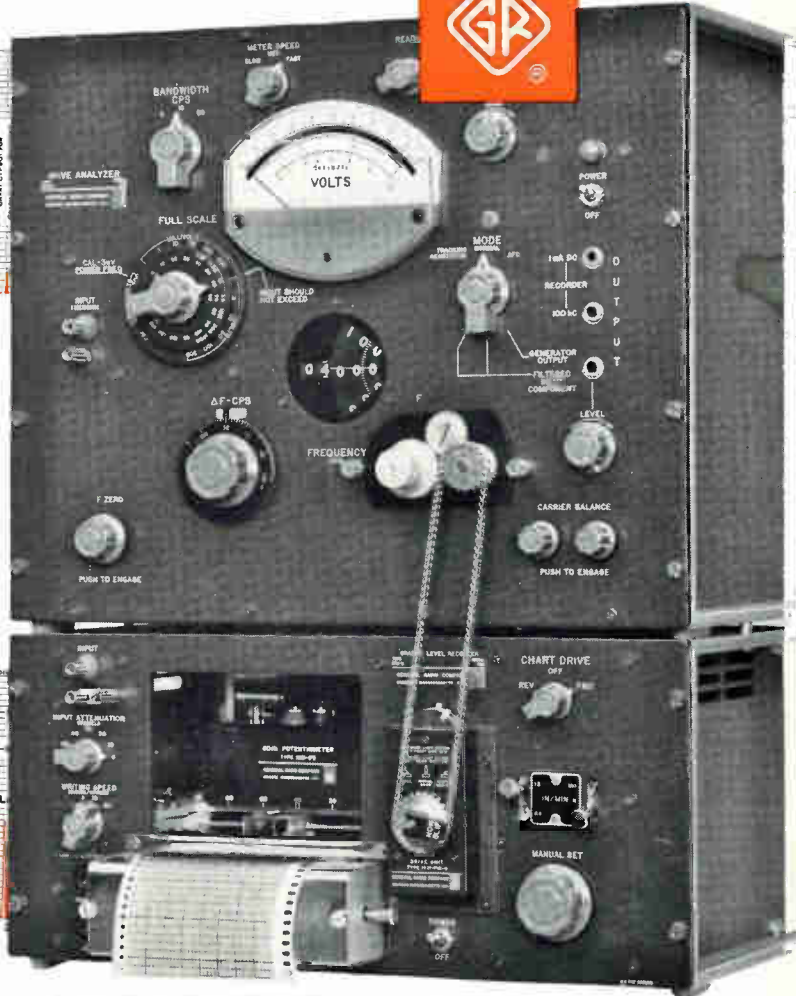

Type 1910-A Recording Wave Analyzer comes complete with Type 1900-A Wave Analyzer, Type 1521-B Graphic Level Recorder, and all accessories.

## For point-by-point measurements where the recorder is not used, these additional wave analyzer features add versatility and convenience

- Easy-to-read in-line frequency readout graduated in 10-cycle increments.  $\pm 0.5\%$  calibration accuracy. Output for counter where extreme accuracy is desired.
- Incremental-frequency dial lets you fine-tune any component, covers  $\pm 100$ -cycle range independently of analyzer setting.
- AFC follows slowly drifting signals.
- Choice of 3 meter speeds - meter does the averaging.
- Excellent tunable filter. For example, the instrument can be used to produce 3-, 10-, and 50-cycle bands of noise over a tunable range from 20 c/s to 54 kc/s when a random-noise generator is connected to the analyzer.
- Price: Type 1900-A Wave Analyzer alone, \$2150; Type 1910-A Recording Wave Analyzer, \$3500 in U.S.A.

Write for Complete Information.

We believe M. Fourier's disciples will like this Analyzer, too.

IN CANADA: Toronto 247-2171, Montreal (Mt. Royal) 737-3673  
IN EUROPE: Zurich, Switzerland - London, England



## GENERAL RADIO COMPANY

WEST CONCORD, MASSACHUSETTS

NEW YORK, N. Y. 964-2722  
(Ridgefield, N. J.) 943-3140

CHICAGO  
(Oak Park) 848-9400

PHILADELPHIA  
(FL. Washington) 646-8030

WASHINGTON, D. C.  
(Rockville, Md.) 946-1600

SYRACUSE  
454-9323

DALLAS  
FL 7-4031

SAN FRANCISCO  
(Los Allos) 948-8233

LOS ANGELES  
469-6201

ORLANDO, FLA.  
425-4671

CLEVELAND  
886-0150

Circle 900 on reader service card



# YOUR WIDEST RANGE IN X-Y RECORDING ACCESSORIES

MOSELEY'S COMPLETE LINE OF ANALOG, DIGITAL AND SPECIAL PURPOSE ACCESSORIES, GIVE YOU MAXIMUM USEFULNESS FROM YOUR X-Y RECORDER



Model 60D Logarithmic Converter, accepts ac or dc input, produces dc output proportional to the log of the positive peak amplitude of the input, \$575.



Type 101 Waveform Translator, converts high speed repetitive waveforms on an oscilloscope to accurately inked graphs with an x-y recorder, \$675.



Model 40D Keyboard, permits plotting of tabular data in point-graph form, plots points from zero to  $\pm 1999$  on each axis, \$975.



Roll Chart Accessories: Type Q-12 hand crank and pull-through-tear-off assembly, \$85; Type Q-3 (illustrated) variable speed motor drive, \$650; also automatic chart advance model.

Types D-1B, D-2 Character Printers, for plotting individually identified points; D-1B single character, \$120; D-2 a six-symbol character wheel, \$525.

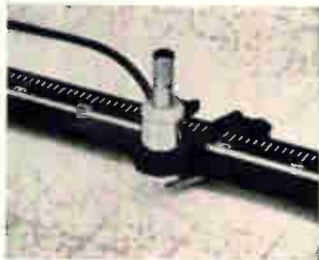

Type F-3B Line Follower, optically follows lines made with pencil or pigment type ink, permits regeneration of original data directly from previously recorded curves, \$795. 7500A Line Follower available for read and write capability, \$1650.

Type A-1 AC-to-DC Converter, dual-channel accessory for converting ac, 20 cps to 100 kc, to dc for input to x-y or strip-chart recorders, \$585.



Type G-2 Null Detector, controls operating modes of x-y recorders during the plotting of continuous, discontinuous or point function data, \$175.

Data subject to change without notice. Prices f.o.b. factory.

Write for complete catalog on Moseley x-y, strip-chart recorders and accessories. Moseley Division, 433 N. Fair Oaks Ave., Pasadena, Calif. 91102.

HEWLETT  
PACKARD  MOSELEY  
DIVISION

*designed by* **MICROWAVE ENGINEERS**  
*for* **MICROWAVE ENGINEERS**

*A new generation of sweepers from Hewlett-Packard, offering:*

- Broad frequency coverage, 1 to 40 gc**
- Unique versatility in sweep mode selection**
- External or internal power sampling**
- PIN diode leveling and modulation, to end frequency pulling and incidental FM**
- Simple x-y recording capability**

**BRIEF SPECS—hp 690 Series Sweep Oscillators**

MODEL	FREQUENCY (gc)	POWER (maximum-leveled across band)	ACCURACY (center frequency)	PRICE
691B	1-2	at least 60 mw	± 10 mc	\$3550*
692B	2-4	at least 40 mw	± 10 mc	\$3350*
HO1-692B	1.7-4.2	at least 15 mw	± 13 mc	\$3650*
693B	4-8	at least 15 mw	± 20 mc	\$3350*
HO1-693B	3.7-8.3	at least 5 mw	± 25 mc	\$3650*
694B	8-12.4	at least 10 mw	± 30 mc	\$3450*
HO1-694B	7-12.4	at least 5 mw	± 40 mc	\$3750*
695A	12.4-18	at least 40 mw	± 1%	\$3500
696A	18-26.5	at least 10 mw	± 1%	\$4500
697A	26.5-40	at least 5 mw	± 1%	\$6500

Option 01: Internal leveling, 691B/692B, \$325; 693B, \$375; 694B, \$400 extra.

\*GRID-LEVELLED "A" MODELS \$350 LESS.

*Data subject to change without notice. Prices f. o. b. factory.*

9528

Hewlett-Packard total experience in microwave measurement has led to this new group of sweepers which offer performance and operation features never before available.

The 690's give you Start-Stop Sweep, up or down, between any points in the range; Marker Sweep for expanding any portion of the major sweep; Delta F Sweep, symmetrical sweep around a center point; Manual Sweep, for detailed study of a localized area; automatic recurrent sweeps; sweep sync'd with line frequency; sweep-concurrent voltages for scope and x-y recorder. All this from one instrument, plus new ease of operation. Outstanding marker visibility, push-button sweep and modulation selection, leveling options, and new accuracy and value.

Check the brief specs; compare with similar instruments. Then call your hp field engineer for complete data. Or write Hewlett-Packard, Palo Alto, California 94304, Tel. (415) 326-7000; Europe: 54 Route des Acacias, Geneva; Canada: 8270 Mayrand St., Montreal.





# Electronics

March 22, 1965  
Volume 38, Number 6

Page 4	Readers Comment
8	People
10	Meetings
15	Editorial
17	Electronics Newsletter
63	Washington Newsletter
139	New Products
170	New Books
172	Technical Abstracts
181	New Literature

## Electronics Review

Page 33	Two for the laser	36	Uniform regulations
33	Color-coordinated	36	Write numbers
34	Looking for an angle	38	Powerful space savers
34	Night light	39	Klystron substitute
35	Computer at throttle	40	Magnetic logic
35	Seeing dark objects	41	Get the message

## Electronics Abroad

183	Correcting tv color	185	Components show
184	Computer firms' tonic	186	Crackdown
184	Millimeter-wave laser	186	Fast printer
184	One-piece networks	187	Around the world
185	Satellites for Bonn		

## Probing the News

121	Job slump seems to be bottoming out
122	Array radar in the air
126	Early Bird watching in downtown Washington
128	More light on lasers

## Technical Articles

### I. Design

<b>Solid state</b>	70	<b>Selecting the right diode for r-f switching circuits</b> The choice depends on power, frequency, isolation and minimum insertion loss Robert Fekete, Sylvania Electric Products
<b>Components</b>	78	<b>Using the cold-cathode tube: part I (cover)</b> Improved glow tubes are finding new display applications and doing duty in a variety of circuits M.A. MacDougall, Mullard, Ltd.
<b>Circuit design</b>	83	<b>Designer's casebook</b> Grounded-grid circuit sweeps better than Miller or bootstrap; simple circuit tunes audio amplifier; timing circuits control relays

### II. Manufacturing

<b>Production</b>	86	<b>Better bonding methods improve hybrid circuits</b> New techniques attach components to thin films of integrated circuits J.W. Slemmons and J.R. Howell, Autonetics Division, North American Aviation, Inc.
-------------------	----	---

### III. Application

<b>Industrial electronics</b>	93	<b>From war gear to coal mines</b> A military producer designed this electronic system to keep track of miners and their pay scales in Great Britain J.E. Dick, Hawker Siddeley Dynamics, Ltd.
<b>Consumer electronics</b>	97	<b>Goals for an all-European tv system</b> Amid politics and propaganda, Europe is trying to choose between NTSC, Secam and PAL Joseph Roizen, Ampex Corp., and Richard Lipkin, consumer electronics editor

Title R registered  
U.S. Patent Office;  
© copyright 1965  
by McGraw-Hill, Inc.  
All rights reserved,  
including the right to  
reproduce the contents  
of this publication,  
in whole or in part.

# Electronics

**Editor:** Lewis H. Young

**Senior editors**

Technical: Samuel Weber  
News: Kemp Anderson, Jr.

Senior associate editors: John F. Mason, George Sideris

**Department editors**

Avionics: W.J. Evezia  
Circuit design: Michael Elia  
Communications: Alexander A. McKenzie  
Components: Michael F. Tomaino  
Consumer electronics: Richard Lipkin  
Industrial electronics: Louis S. Gomolak  
Instrumentation: Carl Moskowitz  
Manufacturing: George Sideris  
Military electronics: John F. Mason  
New products: William P. O'Brien  
Solid state: Jerome Eimbinder  
Space electronics: Joel A. Strasser  
Staff writers: Leon H. Dulberger, Stanley Zarowin

**Regional editors**

Boston: Thomas Maguire, editor; Robin Carlson  
Los Angeles: William B. Wallace, editor; June Long  
San Francisco: Laurence D. Shergalis, editor; Mary Jo Jadin  
London: Derek Barlow, editor

**Copy editors**

Howard Rausch, Sally Powell, Walter Barney

**Graphic design**

Art director: Saul Sussman  
Assistant art director: John C. Wright, Jr.  
Editorial production: Ann Mella  
Production editor: Arthur C. Miller

Editorial secretaries: Claire Benell, Mary D'Angelo, Lynn Emery,  
Kay Fontana, Carolyn Michnowicz, Lorraine Rossi, Lorraine Werner

**McGraw-Hill news service**

Director: John Wilhelm; Atlanta: Fran Ridgeway; Chicago: Bruce Cross;  
Cleveland: Arthur Zimmerman; Dallas: Marvin Reid;  
Detroit: Donald MacDonald; Los Angeles: Michael Murphy,  
Ron Lovell; San Francisco: Margaret Ralston, Ed. Addeo;  
Seattle: Ray Bloomberg; Washington: Arthur L. Moore, Glen Bayless,  
Charles Gardner, Herbert W. Cheshire, Seth Payne

**McGraw-Hill world news service**

Bonn: Richard Mikton; Brussels: Arthur Erikson; London: John Shinn;  
Mexico City: Wesley Perry; Milan: Bruce Bendow;  
Moscow: Donald Winston; Paris: Dan Smith;  
Rio de Janeiro: Leslie Warren; Tokyo: Marvin Petal, Charles Cohen

Circulation manager: Hugh J. Quinn

Reprints: T.M. Egan

**Publisher: C.C. Randolph**

**Electronics: March 22, 1965, Vol. 38, No. 6**

Printed at 99 North Broadway, Albany, N.Y.  
Second class postage paid at Albany, N.Y.

Subscriptions are solicited only from those actively engaged in the field of the publication. Position and company connection must be indicated on orders. Subscription prices: United States and Possessions and Canada, \$6.00 one year, \$9.00 two years, \$12.00 three years. All other countries \$20.00 one year. Single copies, United States and Possessions and Canada 75¢. Single copies all other countries \$1.50.

Published every other Monday by McGraw-Hill Inc. 330 West 42nd Street, New York, N.Y. 10036. Founder: James H. McGraw, 1860-1948.

Subscribers: The Publisher, upon written request to our New York office from any subscriber, agrees to refund that part of the subscription price applying to copies not yet mailed. Please send change of address notices, subscription orders or complaints to Fulfillment Manager, Electronics, at the address below. Change of address notices should provide old as well as new address, including postal zone number if any. If possible, attach address label from recent issue. Allow one month for change to become effective.

Postmaster: Please send Form 3579 to Fulfillment Manager, Electronics, P.O. Box 430, Hightstown New Jersey 08520

## Readers Comment

### African tv

To the Editor:

The Electronics Abroad article regarding television networks and development in Africa [February 8, 1965, p. 151] omits the progress made by the Government of Uganda.

Uganda has more television transmitters than any other two African countries. Six 5-kilowatt, 625-line Marconi transmitters constitute the six-station network in this East African country. Each transmitter is connected to a 14-bay antenna, resulting in effective radiated powers varying from 120 kw to 190 kw.

While most of the equipment is British, the antennas, towers, and transmission lines were supplied from the United States. A unique feature of the Uganda television network is the multilingual sound system utilizing f-m transmitters for relaying the several languages.

Peter K. Onnigian

General manager,  
Jampro Antenna Co.  
Sacramento, Calif.

### Philips empire

To the Editor:

This morning, as I honed my face with a "Philishave" that has done its daily duty about 3700 times now, I read the article "The giant of Eindhoven" [Feb. 8, 1965, p. 93].

This article stressed the sound organization of Philips corporate structure, but glossed over lightly what I consider to be the key to Philips success: 95% of Philips production is devoted to consumer goods and industrial items, and a mere 5% to defense contracts.

It is clear to me that anybody who makes things that are generally useful,—razors, toasters and light bulbs—and makes good ones at that, will stay in operation for a long time; while firms that rely heavily on the transitory whims of the defense industry will always be on the verge of bankruptcy.

Perhaps it is high time that the American electronics industry take



# All from Sprague!

## Make the right move... specify Sprague SOLID TANTALUM CAPACITORS!

 <p><b>TYPE 150D</b> Metal-Encased Hermetically-Sealed <b>TANTALEX<sup>®</sup></b> CAPACITORS (polarized)</p>	 <p><b>TYPE 151D</b> Metal-Encased Hermetically-Sealed <b>TANTALEX<sup>®</sup></b> CAPACITORS (non-polarized)</p>	 <p><b>STYLE CS12</b> Metal-Encased <b>TANTALEX<sup>®</sup></b> CAPACITORS to MIL-C-26655A (uninsulated case)</p>	 <p><b>STYLE CS13</b> Metal-Encased <b>TANTALEX<sup>®</sup></b> CAPACITORS to MIL-C-26655A (insulated case)</p>	 <p><b>TYPE 155D</b> Metal-Encased Hermetically-Sealed <b>TANTALEX<sup>®</sup></b> CAPACITORS (for high vibration)</p>
 <p><b>TYPE 172D</b> Metal-Encased Hermetically-Sealed <b>TANTALEX<sup>®</sup></b> CAPACITORS (for 'cordwood' modules)</p>	 <p><b>TYPE 250D</b> Metal-Encased Hermetically-Sealed <b>HYREL<sup>®</sup> ST</b> CAPACITORS (for Minuteman Program)</p>	 <p><b>TYPE 350D</b> Metal-Encased Hermetically-Sealed <b>HYREL<sup>®</sup> ST</b> CAPACITORS (polarized)</p>	 <p><b>TYPE 351D</b> Metal-Encased Hermetically-Sealed <b>HYREL<sup>®</sup> ST</b> CAPACITORS (non-polarized)</p>	 <p><b>STYLE CSR12</b> Metal-Encased <b>TANTALEX<sup>®</sup></b> CAPACITORS to MIL-C-39003 (uninsulated case)</p>
 <p><b>STYLE CSR13</b> Metal-Encased <b>TANTALEX<sup>®</sup></b> CAPACITORS to MIL-C-39003 (insulated case)</p>	 <p><b>TYPE 180D</b> Metal-Encased Hermetically-Sealed <b>TANTALEX<sup>®</sup></b> Feed-Thru CAPACITORS</p>	 <p><b>TYPE 164D</b> Metal-Tube Axial-Lead <b>RED-TOP<sup>*</sup></b> <b>TANTALEX<sup>®</sup></b> CAPACITORS (polarized)</p>	 <p><b>TYPE 166D</b> Metal-Tube Axial-Lead <b>RED-TOP<sup>*</sup></b> <b>TANTALEX<sup>®</sup></b> CAPACITORS (non-polarized)</p>	 <p><b>TYPE 167D</b> Metal-Tube Single-ended <b>RED-TOP<sup>*</sup></b> <b>TANTALEX<sup>®</sup></b> CAPACITORS (polarized)</p>
 <p><b>TYPE 168D</b> Metal-Tube Single-ended <b>RED-TOP<sup>*</sup></b> <b>TANTALEX<sup>®</sup></b> CAPACITORS (non-polarized)</p>	 <p><b>TYPE 165D</b> Film-Jacketed <b>TANTALEX<sup>®</sup></b> CAPACITORS (for 'cordwood' modules)</p>	 <p><b>TYPE 154D</b> Molded-Case Bullet-nose<sup>®</sup> <b>TANTALEX<sup>®</sup></b> CAPACITORS</p>	 <p><b>TYPE 190D</b> Molded-Case Rectangular-Shaped <b>TANTALEX<sup>®</sup></b> CAPACITORS (for printed boards)</p>	 <p><b>TYPE 160D</b> Film-Jacketed Axial-Lead <b>TANTALEX<sup>®</sup></b> CAPACITORS (Hearing Aid Type)</p>
 <p><b>TYPE 161D</b> Film-Jacketed Single-ended <b>TANTALEX<sup>®</sup></b> CAPACITORS (Hearing Aid Type)</p>				

\*Trademark

### Number 1 in Solid Tantalum Capacitors Across the Board!

Pioneer in the development of tantalum capacitors, Sprague has the largest and most complete research and production facilities in the capacitor industry. That's why Sprague, with its unmatched experience, is

your *dependable* source of supply!

For additional information, write Technical Literature Service, Sprague Electric Company, 35 Marshall St., North Adams, Mass., indicating the types in which you are interested.

#### SPRAGUE COMPONENTS

CAPACITORS  
TRANSISTORS  
RESISTORS  
INTEGRATED CIRCUITS  
THIN-FILM MICROCIRCUITS

PULSE TRANSFORMERS  
INTERFERENCE FILTERS  
PULSE-FORMING NETWORKS  
TOROIDAL INDUCTORS  
ELECTRIC WAVE FILTERS

CERAMIC-BASE PRINTED NETWORKS  
PACKAGED COMPONENT ASSEMBLIES  
BOBBIN and TAPE WOUND MAGNETIC CORES  
SILICON RECTIFIER GATE CONTROLS  
FUNCTIONAL DIGITAL CIRCUITS



\*Sprague' and '®' are registered trademarks of the Sprague Electric Co.

db db db db  
**FOR MAXIMUM GAIN**  
 \$\$\$\$\$  
**AT MINIMUM COST...**

# You Can't Beat MADT\* Communications Transistors

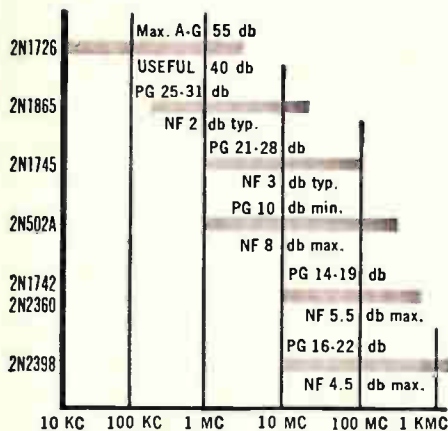

MADT Communications Transistors are now available in production quantities from Sprague Electric. For complete information on these and other MADT High-Performance Amplifier Transistors, write to Technical Literature Service, Sprague Electric Co., 35 Marshall St., North Adams, Massachusetts.

\*Trademark of Philco Corp.

45T-4131



'Sprague' and '®' are registered trademarks of the Sprague Electric Co.

a long look at itself and ask "What happens if world tensions can be eased to the point we don't need a massive defense program?" Frankly, I would enjoy every minute of designing "the best damned television set ever built" a lot more than designing a monitor to meet "MIL-umpteem X."

T. R. Flint

Ottawa, Canada.

### When the can is opened

To the Editor:

The article "FET detects alpha particles better and more precisely" [Feb. 8, 1965, p. 64] describes a novel and apparently practical way to use an FET. However, from the absence of any reference in the article to the contrary, the reader might get the impression that opening the package of ordinary diodes, transistors, and FET's is the usual method of obtaining a semiconductor charged-particle detector.

There exists a complete technology of semiconductor charged-particle detectors designed expressly for that purpose. A wide variety of such detectors are available from a number of commercial suppliers.

I do not recognize the "type APD-C pn-junction diode" referenced in the performance table in the article, but if an ordinary commercial semiconductor particle-detector is used in a separate detector-amplifier configuration, signal-to-noise ratios of several hundred are commonplace. This far exceeds the value of 67 quoted for the open-can FET.

Thus one of the major conclusions of the article—that the consolidated FET detector is superior to detector-amplifier combinations—is not at all correct unless one chooses to use as the detector something far inferior to ordinary

commercially available units.

Robert H. Dilworth  
 Chief electronics engineer  
 Oak Ridge Technical Enterprises  
 Corp.  
 Oak Ridge, Tenn.

### The authors reply

Obviously we did not have the high quality p-n junction radiation detector "readily" available for comparison with the FET detector. We did not intend to imply that the opened FET detector was superior to all p-n junction diode alpha detectors but rather to report that it did yield a superior signal-to-noise ratio when compared with the detector diodes in our possession.

The article was intended to describe what we felt to be interesting experimental observations of an FET application which could have future significance should a device manufacturer wish to develop an optimum alpha-particle detector configuration with a high-quality MOS FET.

C. R. Seashore  
 C. D. O'Brien

Honeywell Inc.

### Girlwatching in Italy

To the Editor:

I particularly appreciated the photograph on page 104 of the September 21, 1964 issue because it shows that in good old Europe there is more on earth than business and electronics.

Notice that half of the Olivetti employees (now working hard for Olivetti-General Electric, presumably) find time to pause and track the pretty figure passing the window.

E. Atsma

Leiderdorp,  
 The Netherlands





# slash semiconductor testing costs

with

- faster programming — simplified digital switching
- absolute device protection — programmable clamps and limiters
- individually programmable test times — 50 milliseconds to 5 secs
- more accurate testing — 0.5% accuracy

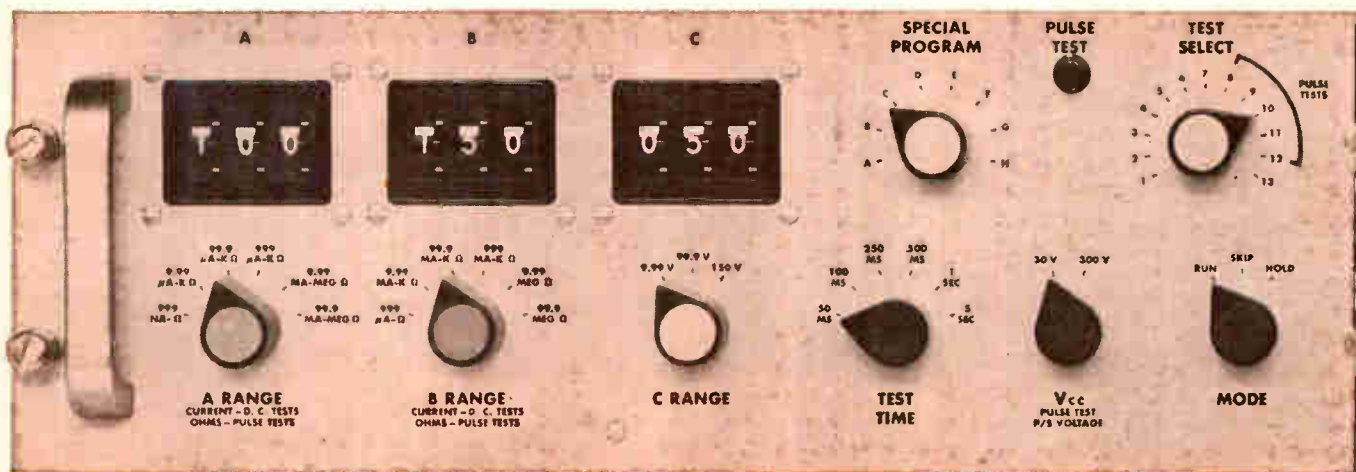

The Model 658 Transistor/Diode Test System provides: digit-switch programming from 1 nano-amp to 2 amps with readout from 0.3 nanoamp; d-c and pulse testing; tests in any random sequence. The 658 is expandable up to 48 tests. Testing modules fit in a separate drawer holding eight units; rack enclosures are available. Using digit-switches you can read test results directly. With the 658, you get *socket control*—shortest lead lengths from device to test circuit. Test sockets are interchangeable. You cannot find a more flexible, economical system.



write for information

INDUSTRIAL  
PRODUCTS  
GROUP



**TEXAS INSTRUMENTS**  
INCORPORATED  
P. O. BOX 66027 HOUSTON, TEXAS 77006  
7 RUE VERNONNEX GENEVA, SWITZERLAND

# DESIGNED FOR ALL CIRCUIT PACKAGES

Type 6  
Potted or Can

Type 2  
P.C.B.—Top

Type 4  
P.C.B.—Edge



## MIL-SPEC 1/4" MECHATRIM®

Metal Film Trimmer Potentiometer

The unique HT250 Mechatrim® is available in 3 mounting styles to satisfy your packaging requirements. Produced from the same basic assembly they each comply with MIL-R-22097B char. C environmental requirements. For infinite resolution, high frequency performance, non-wirewound reliability, and low-cost, specify Mechatrim® for your circuit.

Send for your Free  
MECHATRIM® "DO IT YOURSELF" Assembly Kit

**MECHATROL,** a Division of Teledyne, Inc.

1200 PROSPECT AVE., WESTBURY, L. I., N. Y. 11591 (516) ED 3-6000 TWX 516-333-6122

## People

**Robert M. Goodman** doesn't call himself an electronics engineer, although he has the credentials.

"You'd do better just calling me an investigator. When I start on a project, I'm an expert in only one field. But by the time I've finished it, I've developed an expertise in dozens of fields," he says.



Goodman is the new manager of the Bioinstrumentation Laboratory of the Franklin Institute Research Laboratories in Philadelphia. The lab makes use of electronics, physics, biology, chemistry and most of the other sciences in its work on life-science instruments.

Franklin is a nonprofit institute, but Goodman knows the business world. He was one of the founders of American Electronic Laboratories, Inc., which was started with \$500 and now has annual sales of \$10 million. "I quit that because I got tired of never seeing my family . . . but now that I don't have that pressure of business, things are still too hectic" he says.

"The most reliable circuits are redundant circuits—it's the same with managers," says **Alan J. Grant**, an engineer who was recently appointed president of Litton Industries, Inc.'s Guidance and Control division. Grant's philosophy on management: you've got to realize you're only as good as your assistants.

The president of a company, he explains, is really at the bottom of the organization chart; things start with subordinates and gradually work down to the top officers.

How do you put your ideas into practice? Communication is the key, says Grant, a former teacher at the Illinois Institute of Technology. "It makes good sense to use language people understand—if they understand what you want, they'll do the job."

Before joining Litton he was vice president-manager of North American Aviation, Inc.'s Autonetics division.



## 10 X More Power With Water-Cooled UHF Planar Triodes

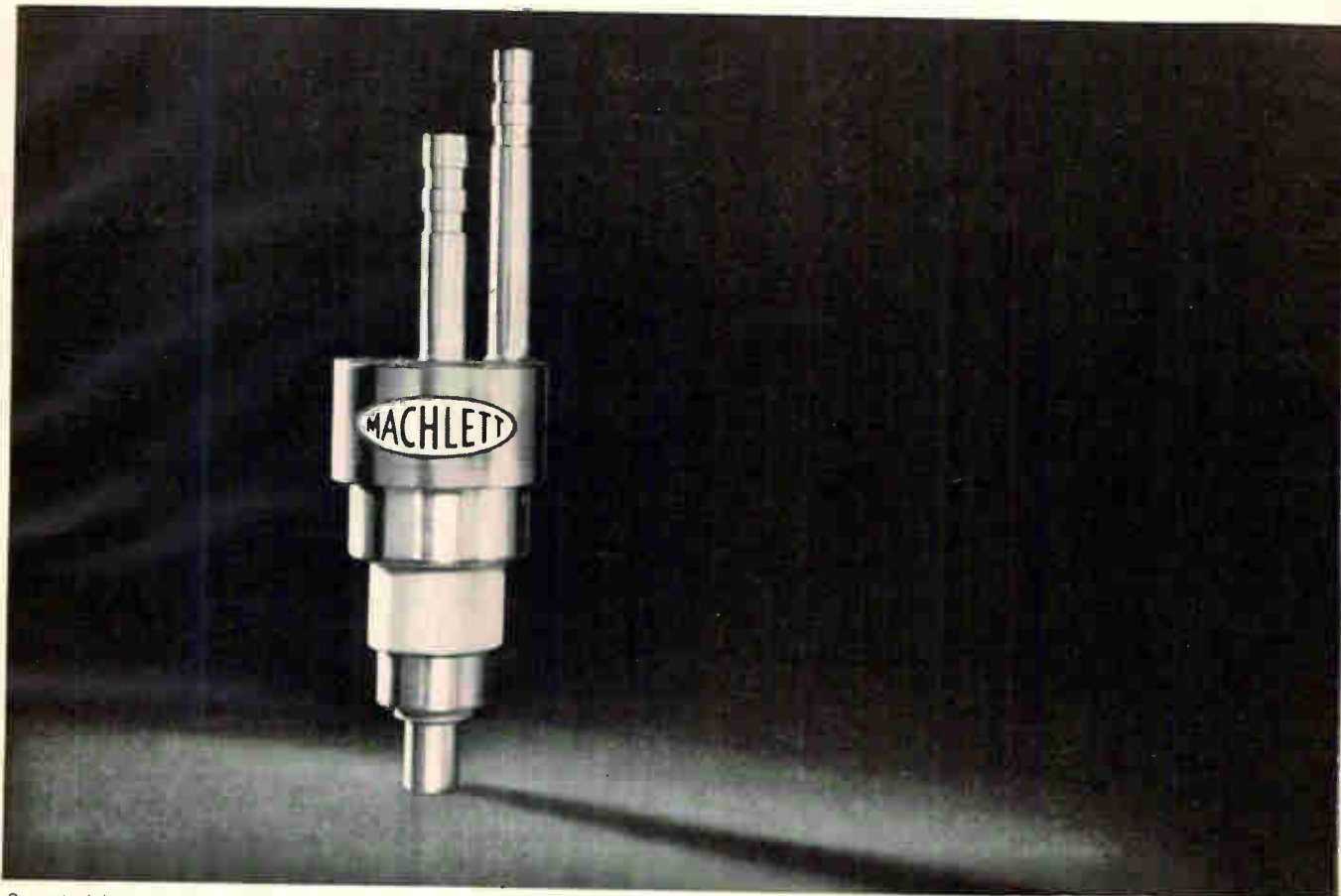

See actual demonstration at IEEE show, Booth 2611.

Machlett Laboratories has developed a simple, yet unique water cooling device for UHF planar triodes which permits CW output powers up to 10 X higher than previously attainable. Plate dissipation capability on one tube, the ML-7815, with water jacket, exceeds 400 watts. Comparable figure for forced-air-cooled ML-7815 is 100 watts; same tube with anode cover is 10 watts. Water cooling also makes possible operation at high cathode current densities—eg., a variation of the ML-7289 with water jacket is rated at 2 kV with 400 mA cathode current; a standard ML-7289 is capable of 1 kV and 125 mA cathode current. Water jackets are currently available on special ML-7289, ML-7698, ML-7815, ML-7855, ML-8403 and ML-8533. Write the Machlett Laboratories, Inc., Springdale, Conn. 06879. An Affiliate of Raytheon Company.

**MACHLETT**

ELECTRON TUBE SPECIALIST

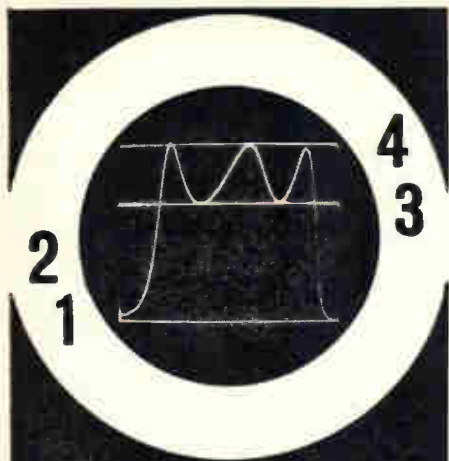

see **4** response  
traces on single-  
trace scope

measurement by comparison  
up to 1,200 mc



**NEW**  
**JERROLD**  
**SOLID-STATE**  
**3-POSITION**  
**COAXIAL SWITCHER**

Model TC-3 \$295<sup>00</sup>

Turn any single-trace oscilloscope into a 4-trace scope; insert two reference traces automatically in addition to test trace and baseline. These references have advantage of permanent relative accuracy over scribed or painted lines.

Results are repeatable, as accurate as your reference attenuators. Generator and scope drift do not affect accuracy of measurements. Frequency from dc to 1,200 mc extends usefulness of comparison technique well into the UHF band. The TC-3 Coaxial Switcher can save you thousands of dollars in speed and accuracy. Write for literature.

**JERROLD**  
**ELECTRONICS**

Industrial Products Division,  
Philadelphia, Pa. 19132  
In Canada: Jerrold Electronics,  
60 Wingold Ave., Toronto 19, Ont.  
Export: Rocke International,  
13 E. 40th St., New York, N.Y. 10016

**SWEEP GENERATORS • AMPLIFIERS**  
**PRECISION ATTENUATORS • COMPARATORS**

## Meetings

**IEEE International Convention, IEEE;** N.Y. Coliseum and New York Hilton Hotel, New York, Mar. 22-25.

**Society of Motion Picture and Television Engineers Semiannual Conference and Exhibit,** SMPTE; Ambassador Hotel, Los Angeles, Mar. 28-Apr. 2.

**Association of Electronic Manufacturers National Convention, AEM, Inc.;** New York Hilton Hotel, New York, Mar. 29-Apr. 1.

**Electron Beam Annual Symposium,** Pennsylvania State University, Alloyd Corp.; Pennsylvania State University, University Park, Pa., Mar. 31-Apr. 2.

**Electronic Parts Distributors Show, Electronic Industry Show Corp.;** New York Hilton and Americana Hotels, New York, Mar. 31-Apr. 4.

**IEEE Seminar on Space Vehicle Reliability, IEEE;** Airport Marina Hotel, Los Angeles, Apr. 2.

**National Packaging Exposition, AMA;** McCormick Place, Chicago, Apr. 5-8.

**IEEE Lectures on Microelectronics, IEEE;** Chicago Lane Technical Institute, Chicago, Apr. 5, 12, 19, 26.

**Cleveland Electronics Conference, IEEE, ISA, CPS, Western Reserve University, Case Institute of Technology;** Cleveland Public Auditorium, Cleveland, Apr. 6-8.

**Conference on Impact of Batch-Fabrication on Future Computers, PGEC/IEEE;** Thunderbird Hotel, Los Angeles, Apr. 6-8.

**Airlines Electronic Engineering Committee General Session, AEEC of ALCAC;** Eden Roc Hotel, Miami Beach, Apr. 7-9.

**IEEE Region 3 Meeting,** Robert E. Lee Hotel, Winston-Salem, N.C., Apr. 7-9.

**Electronic Components International Exhibition, FNIE, SDSA, Parc des Expositions (Fair Grounds),** Paris, Apr. 8-13.

**National Aeronautic Meeting and Production Forum, SAE;** Sheraton-Park Hotel, Wash., Apr. 12-15.

**IEEE Region Six Annual Conference,** Las Vegas Convention Center, Las Vegas, Apr. 13-15.

**Telemetry National Conference, AIAA, IEEE, ISA;** Shamrock-Hilton Hotel, Houston, Tex., Apr. 13-15.

**Specialists Conference on Thin Film Action Devices, G-ED/IEEE, NASA;**

**Johns Hopkins University, Baltimore,** Apr. 14-15.

**Numerical Control Society Annual Meeting, NCS;** La Salle Hotel, Chicago, Apr. 21-23.

**Society of American Value Engineers National Convention, SAVE;** Statler-Hilton Hotel, Boston, Apr. 21-23.

**Anti-Missile Research Advisory Council Meeting, IDA;** Institute for Defense Analyses, Arlington, Va., Apr. 26-30.

**Rocky Mountain Bioengineering Annual Symposium, IEEE, USAF Acad., Fitzsimmons Gen. Hospital, et al;** Brown Palace Hotel, Denver, May 3-4.

**American Astronautical Society Annual Meeting, AAS, IIT Research Institute;** Conrad Hilton Hotel, Chicago, May 4-6.

**Packaging Industry Annual Conference, IEEE;** Milwaukee Inn, Milwaukee, Wis., May 4-6.

**"Post Apollo Missions" Meeting, AAS;** The Conrad Hilton Hotel, Chicago, May 4-6.

**ICA Annual Conference, ICA;** Hilton Hotel, Pittsburgh, May 4-7.

**Design Engineering Conference, ASME;** New York Coliseum, New York, May 17-20.

**Society of Photographic Scientists and Engineers Annual Conference, SPSE;** Sheraton-Cleveland Hotel, Cleveland, May 17-21.

**Aerospace Fluid Power Systems and Equipment Conference, SAE;** Statler-Hilton Hotel, Los Angeles, May 18-20.

### Call for papers

**Boulder Millimeter Wave and Far Infrared Conference, IEEE;** Stanley Hotel, Estes Park, Colorado, Aug. 30-Sept 1. **June 1** is deadline for submitting 500-1000 word abstract to M. W. P. Strandberg, Technical Program Committee, Mass. Inst. of Technology, Cambridge, Mass.

**Canadian Electronics Conference, Canadian Region of IEEE;** Exhibition Park, Toronto, Oct. 4-6. **May 10** is deadline for submitting 500-1000 word summary of paper and 100 word abstract to W. M. Lower, Chairman Technical Programme Committee, Canadian Region of IEEE, 1819 Yonge Street, Toronto 7, Canada.



A Fluke '65 Pacesetter is a solid state differential voltmeter which has twice the range, ten times the sensitivity, weighs half as much, works from plug or rechargeable battery, costs about the same, and holds the same classic quality as every vacuum tube Fluke Meter ever built. Here are two new ones. Write for details. Call your Fluke rep for a demonstration.

Series 871 DC Differential Voltmeters and 873 AC/DC Differential Voltmeters are available in both line and combination line and rechargeable battery powered models. DC and AC accuracies are 0.03% and 0.2% of input, respectively. Range is 0 to 1100 V. Full scale null sensitivity is 1 millivolt. Reference is stable to better than 50 PPM per year.



FLUKE • Box 7428, Seattle, Washington 98133 • Phone: (206) 776-1171 • TWX: (910) 449-2850

Model 871AB DC Differential Voltmeter

Model 873AB AC/DC Differential Voltmeter

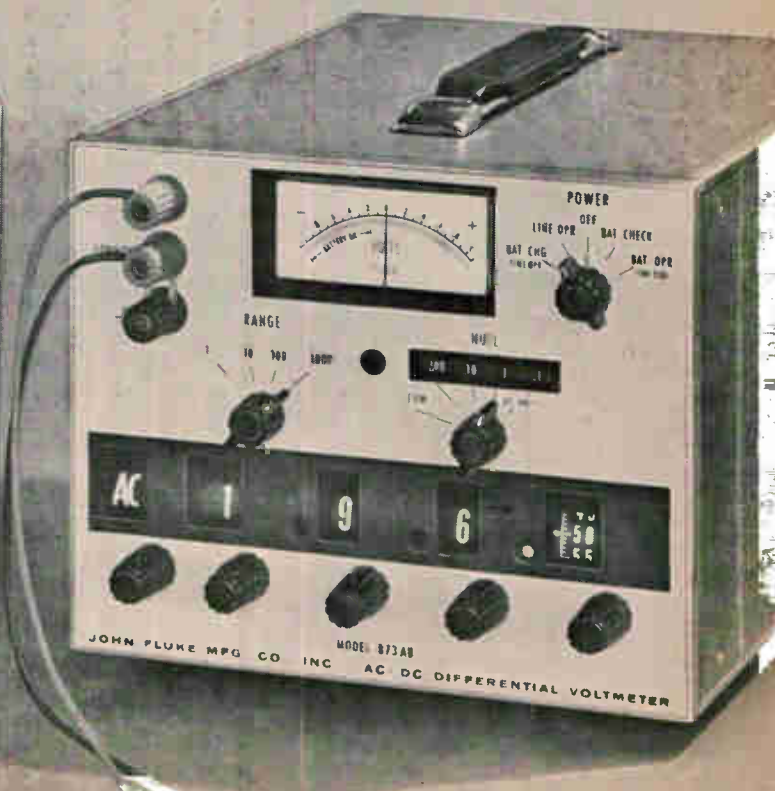
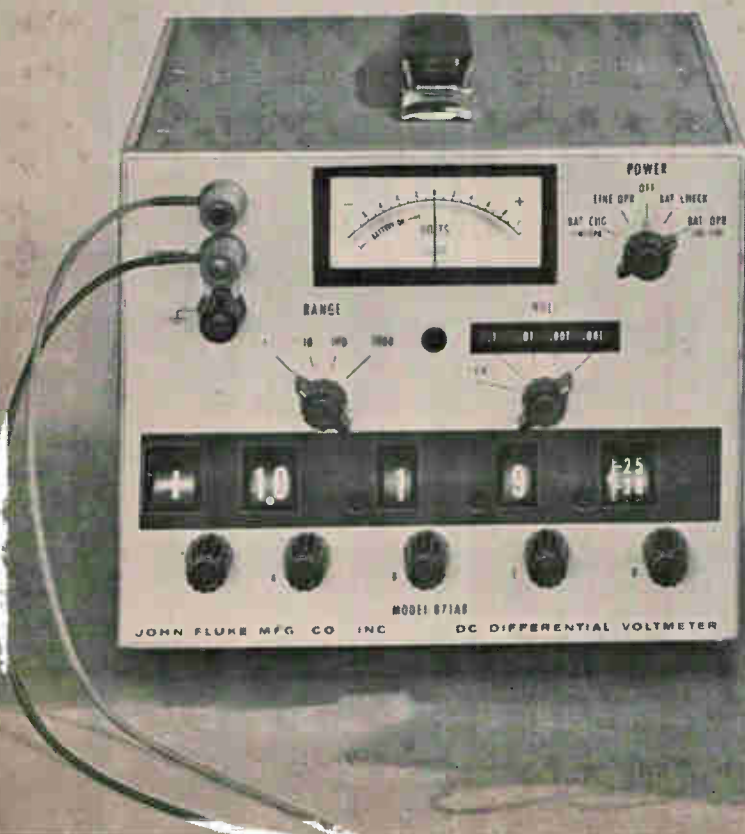

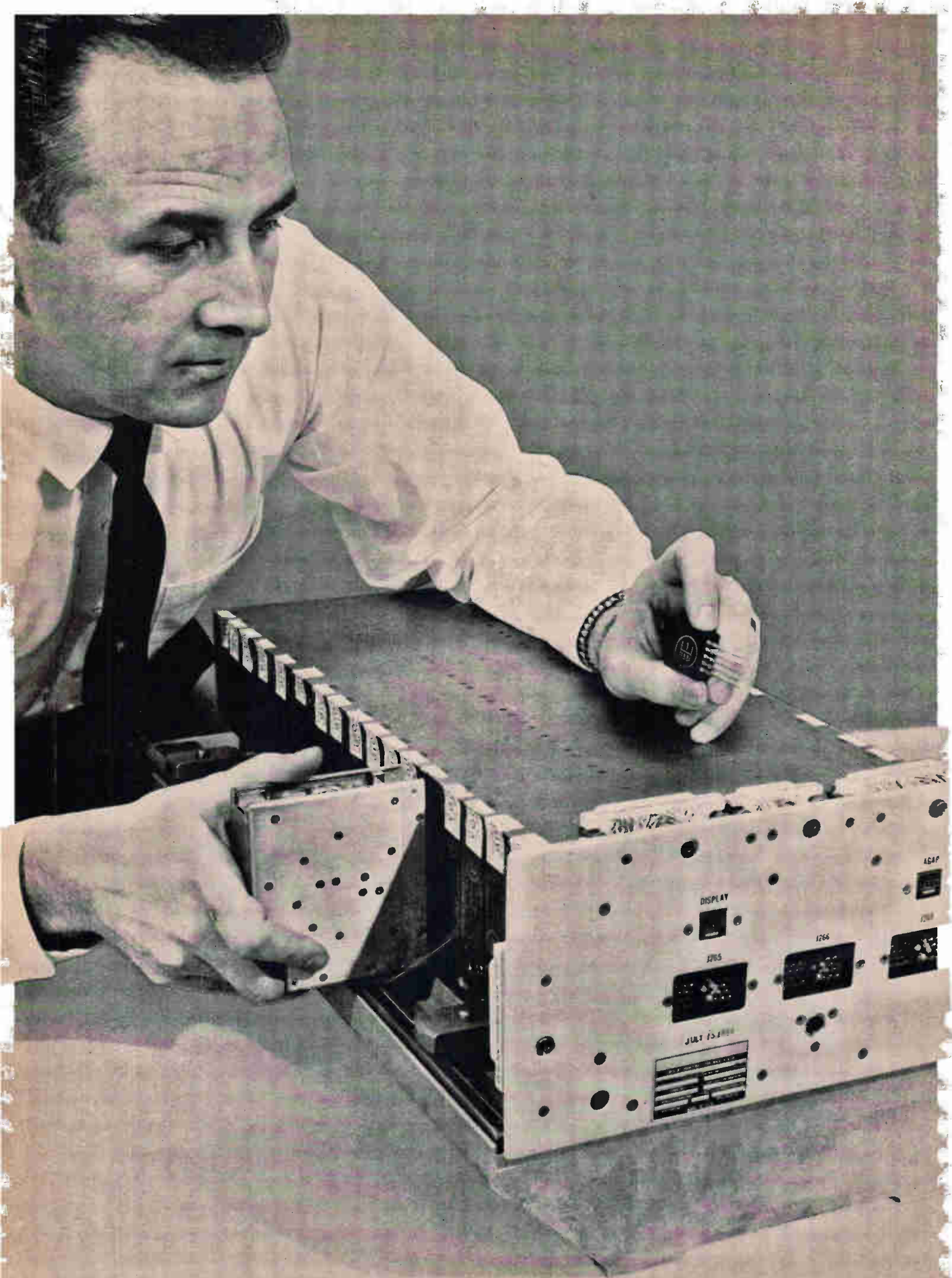

Photo of Electronic Control Assembly courtesy Honeywell, Inc.



# How TI semiconductors eliminated transformers in Apollo's stabilization and control system

...Honeywell designers used TI dual field-effect transistors in the compatible "flat pack" instead of transformers

Four Electronic Control Assemblies (ECA) in the Apollo Stabilization and Control System use hybrid thin film modules in their signal conditioning sections. Each module weighs 0.5 ounce. Similar units, using transformers, would weigh more than five ounces each!

TI compatible components used by Honeywell in Apollo are electrically and mechanically compatible with TI integrated circuits\*. Size and lead spacing allow the "flat pack" discrete components to be handled, tested and assembled using techniques developed for integrated circuits.

Electrically, compatible components can serve a wide variety of circuit functions in conjunction with integrated circuits. Interface circuitry, differential amplification and many other circuit objectives can be realized with these TI-developed devices.

In their Apollo program responsibilities, Honeywell was faced with design goals that required highest reliability coupled with the smallest practical size and weight. Their extensive experience in design approaches prompted a decision to use a combination of sophisticated techniques. In the signal conditioner, for instance, the use of TI dual semiconductors in the "flat pack" allowed them to call on the extensive experience and facilities of Texas Instruments to provide devices optimized for the application. Honeywell's Apollo signal conditioner uses TI advanced "conventional" components

and highly sophisticated field-effect devices, both in compatible packages.

The signal conditioner uses dual field-effect transistors, similar to the TI 2N3333 family, plus 2N3043 dual low-level, low-noise amplifiers. The 2N3043 compatible components give a volume reduction of thirty-two times, compared with an electrically similar pair of 2N930's in TO-5 cans.

If your design objectives require discrete compatible components, and your goal is to use high quality miniature discrete semiconductors, contact Texas Instruments. The TI lines include a wide variety of compatible components: matched and unmatched transistors and FET's in flat pack; amplifiers and switches in TO-50 package; and diodes and power transistors are available, especially designed for compatible applications where volume and weight savings are critical. Some applications where TI compatible components are being used today include digital and analog interface circuitry, drivers, differential amplifiers, diode matrices, power switching, and many others.

See your TI field sales office or authorized TI distributor for additional information. Many compatible components are available for off-the-shelf delivery right now.

For a copy of a new technical leaflet describing compatible components, write to P. O. Box 5012, Dallas, Texas 75222.

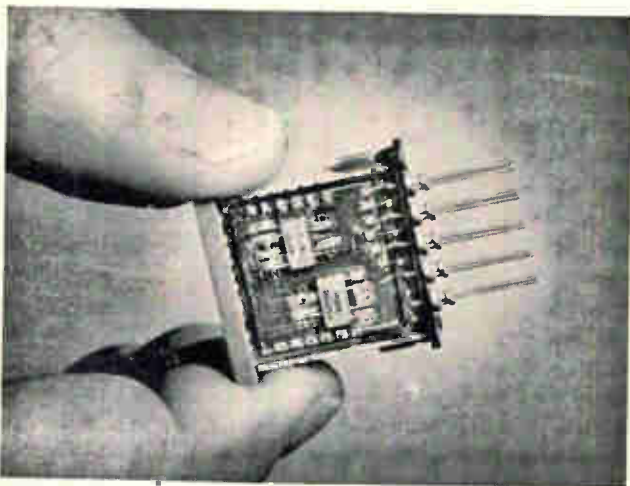

This is the Apollo signal conditioner module which uses matched dual field-effect transistors in flat pack, together with dual conventional transistors in flat pack. (It is shown here before final encapsulation in plastic.)

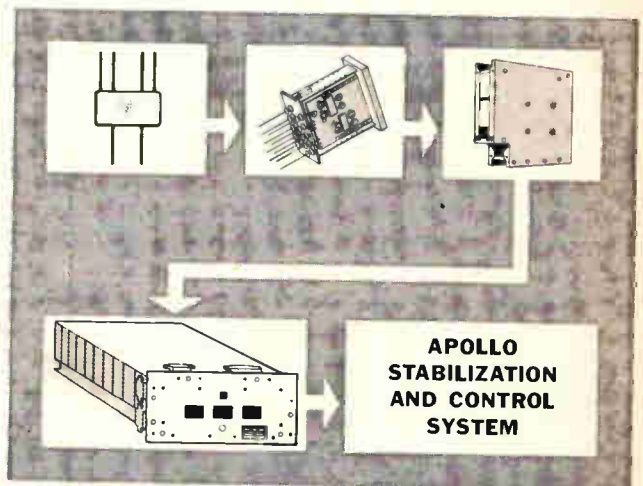

This diagram shows the system "tree", from TI micro-sized dual transistors in flat pack to the final Apollo system.



## TEXAS INSTRUMENTS INCORPORATED

13500 N. CENTRAL EXPRESSWAY  
P. O. BOX 5012 • DALLAS 22, TEXAS

SEMICONDUCTOR PLANTS IN BEDFORD, ENGLAND • NICE, FRANCE • DALLAS, TEXAS

\*Patented by TI

Circle 13 on reader service card

20838

# "IMPOSSIBLE"

## RECORDING JOB?

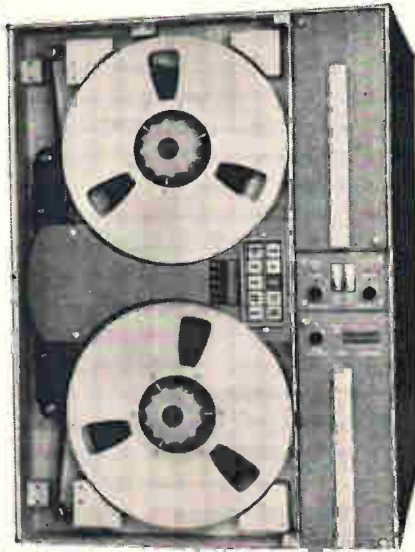

### PROBLEM

bandwidth  
data capacity  
flexibility  
space  
weight  
power  
rfi  
environment

Many state-of-the-art performance features make the Winston P-5000 a leader in the magnetic instrumentation recorder field. Write for complete information.

## FAIRCHILD

**WINSTON RESEARCH CORPORATION**  
A SUBSIDIARY OF FAIRCHILD CAMERA AND INSTRUMENT CORPORATION

6711 So. Sepulveda Blvd., Los Angeles, Calif. • 90045  
Telephone: 213 - 670-3305 • TWX: 910 328-6128  
1625 "I" Street, N.W., Washington, D.C. • 20006  
Telephone: 202 - 628-2588 • TWX: 202 965-0499

### SOLUTION

2.0 mc at 120 ips  
14 tracks  
5 speeds bi-directional  
19 x 24.5 x 11 inches  
140 pounds  
375 watts  
mil-I-6181D  
mil-T-5422E



Editorial

## Facing color-tv problems

Color television is riding a worldwide wave of enthusiasm, but technical shortcomings could dampen the ardor of buyers.

In the United States, the number of sets is expected to jump 67% this year, from three million to five million. In Vienna this month, representatives of the International Radio Consultative Committee are gathering again to try to choose a single system for Europe. But the Old World will have color tv soon whether the conference succeeds in agreeing or not. Great Britain says it will go it alone with a system—probably the NTSC system used in the U.S.—if no unanimity emerges in Vienna. And the Soviet Union wants to telecast the celebration of the 50th anniversary of the Communist revolution in color in 1967.

Still, serious technical problems remain. In Europe, these problems have been recognized and have caused the impasse of the consultative committee [p. 97]. Some progress in solving them is being made in Europe [p. 183]. U.S. manufacturers, on the other hand, want to pretend they don't exist.

NTSC's shortcomings—single-sideband distortion and the possibility of color distortion due to phase shift—are well known. Even more distracting to the viewer, however, is the difficulty of adjusting hue, a prime control for bright and true color. It is almost impossible for the average tv devotee to get the color right every time. In fact, critics of the NTSC system have nicknamed it "Never Twice the Same Color."

One set owner told us about a chaotic afternoon watching football on color television. To get the University of Alabama's crimson uniforms to show up crimson, he had to set the hue control so that the players' faces were a dull yellow. Then every time a different camera transmitted, the hue went out of adjustment. Finally, midway in the third quarter, the sun slipped behind the stadium wall, requiring a completely new adjustment of the color.

Some discriminating viewers say that owning a color television set is better than having a reducing machine in the living room. The viewer is up and down a dozen times an hour adjusting the color.

That prompts the question: why hasn't somebody designed an automatic hue control for NTSC color television? The quick answer from manufacturers is: "We are trying to cut the cost of a color set, and an automatic hue control would be too expensive."

We don't agree. We think an ingenious engineer can design an inexpensive automatic hue control. One reason we have devoted 12 pages to discussing the technical side of color television in this issue is our hope that the material will stimulate a reader to design such a control.

Happily, it is the kind of project that doesn't take enormous resources for research or plant. Mainly what is needed is imagination and perspiration.

For the man or company that develops automatic hue control that's inexpensive and reliable, a rich reward is waiting—and the gratitude of millions of tired viewers.

# TOGETHERNESS



**A great motor...**



**a great tach...**

## make a great motor tachometer

Look at these parameters in a "synchro size" size 8 full drag cup motor rate tachometer.

We chose a Clifton motor with good torque (.275 in-oz), low power consumption (3 watts/phase) and high acceleration (120,000 rad/sec<sup>2</sup>), and added a tachometer with exceptionally high output for length. Combining them produced a tachometer with the lowest inertia in the industry for the size, output and torque.

One further ingredient was added. This component (and our whole, new line of servo motors and tachometers) is produced by a quality-minded company deeply experienced in the design and manufacture of

**Small: .75" diam x 1.241" length**

**T/J: 90,000 rad/sec<sup>2</sup>**

**Output: .3V/1000 rpm**

**Nulls: .015V max**

**Power Consump. <3W/phase**

rotating components. Look to CLIFTON for leadership in the servo motor and tachometer field.

Clifton Precision Products, Division of Litton Industries, Clifton Heights, Pa., Colorado Springs, Colo.

**cppe**

**CLIFTON** PRECISION PRODUCTS  
DIVISION OF LITTON INDUSTRIES





---

# Electronics Newsletter

---

March 22, 1965

## Stiff competition for C-5A avionics

Because of the nature of the prime contract, avionics subcontractors face stiff competition for a share of multibillion-dollar C-5A military transport program. The Air Force has decided to award a single fixed-price plus incentive contract covering development, production and spare parts. Three companies—the Boeing Co., Douglas Aircraft Co., and Lockheed Aircraft Corp.—are bidding for it.

Usually the winner of a development contract has the inside track on getting a production order at a negotiated price. Contractors often take a loss on development and try to make it up on production.

The dollar value and length of the C-5A program alone make it a plum. But with the competing prime contractors having to figure a wider range of costs more closely, they are more likely to rely on competitive bidding for the avionics subcontracts.

## Varactor diodes on the way out?

The Radio Corp. of America has decided on a calculated risk: it will halt production of varactor diodes. The company believes it will be able to produce microwave-frequency transistors soon at a lower price than the diodes.

Although interest in varactor diodes has been increasing in recent years, RCA expects a sharp decline in the next two years as the prices of comparable transistors are reduced.

## U. S. firm to enter a capacitor field

By next year, United States electronics companies expect to break the tight grip held by Japanese and Dutch producers on sales of solid aluminum electrolytic capacitors. Harry Neiders, marketing manager of the Mallory Capacitor Co., a division of P.R. Mallory & Co., says American producers are finally solving the processing problems that make it difficult to produce such capacitors at low cost.

These components are not made now in the U.S. The imports are selling for 10 to 20 cents each. Mallory hopes to match this price in volume production next year.

This type of capacitor is used primarily in transistorized table and car radios. The designs of this year's radio models are already frozen, but the company will introduce its capacitors at the IEEE show. Other U.S. companies are expected to bring out comparable capacitors later this year. At a capacitance of 0.1 to 2 or 3 microfarads, and at operation below 50 volts, Mallory's devices are comparable to Mylar capacitors, but smaller.

## Laser material is its own Q-switch

A new material that generates laser-ray spikes without additional optical equipment has been developed by scientists at the Westinghouse Electric Corp. The material, neodymium glass with a small amount of uranyl ions added, achieves Q-switching by itself.

Usually external Q-switches are used to prevent emission of the laser ray until it has reached a high peak power. The Westinghouse material does the same thing inside the glass. The absorption of pump energy by the uranyl ions holds back the laser action of the neodymium. This delay

---

# Electronics Newsletter

---

allows time for the larger number of neodymium ions to be pumped to their higher energy level before the laser burst occurs.

## **Underground signals hit snag**

The Army's three-year effort to develop long-distance underground radio communications may soon be dropped. Results have been poor and the Army Materiel Command at Ft. Monmouth, N.J., believes future tests may not be any better.

The technique involves bouncing radio signals off a sheath of ions that lie above a layer of granite 15 to 30 miles under the earth's surface.

The approach would work well, Army engineers believe, if the layer of granite were even. Instead, the Army has discovered that deep faults and shifts in the stone make communications difficult.

## **Custom-made ICs mass-produced**

Radiation, Inc., has adopted a technique for forming many custom-made integrated circuit configurations from one master circuit. Each component in the master circuit is connected to a tiny fuse; to eliminate any of the components, the corresponding fuse is blown with a high current, opening the connection to the component. The company's first circuit to use the blowout technique will be a 40-diode array—eight rows each containing five diodes.

## **Baby Sage slated for the Pacific**

The Pentagon has decided to build a second Baby Sage 412L air-defense system. The multimillion-dollar installation will be on the Ryuku Islands, a chain south of Japan, which includes Okinawa. [Electronics, Oct. 5, 1964, p. 17]. The first fixed station is now operating in West Germany; it includes radar, communications, data-processing and weapons-control display equipment.

## **2 firms to sell wares on the road**

Road shows by electronics companies appear to be gaining in popularity.

Texas Instruments, Inc., is planning to pack up its exhibit after the IEEE show in New York and tour the West. And Tektronix, Inc., trying to drum up business for its \$36,000-integrated-circuit tester, decided on a road tour for the unit, which can conduct four tests per second and check monolithic hybrid or multiple-chip circuits.

## **Surveillance radar foils Vietcong raid**

Under cover of night earlier this month, a band of Vietcong moved quietly toward marines guarding the United States air base at Danang. They were within 300 yards when the marines opened fire and drove them off. The alert had been given by a battlefield surveillance radar, the AN/TPS-21, built by the Admiral Corp. The portable system signals the presence of intruders with an audible tone, not a visual display.

## **Addenda**

The General Electric Co. has developed a color image orthicon for use under poor lighting conditions. It was especially designed for television coverage of on-the-spot news. . . . The Communications Satellite Corp.'s Early Bird arrived at Cape Kennedy last week. Although Comsat officials are hesitant to name a firm date for launch, word around the Cape is that April 6 is the target date.



# IDEAS

from SYLVANIA Electronic Components Group

## INTEGRATED CIRCUITS

### Build a 20mc synchronous 4-stage binary counter ...from just 4 J-K flip-flops

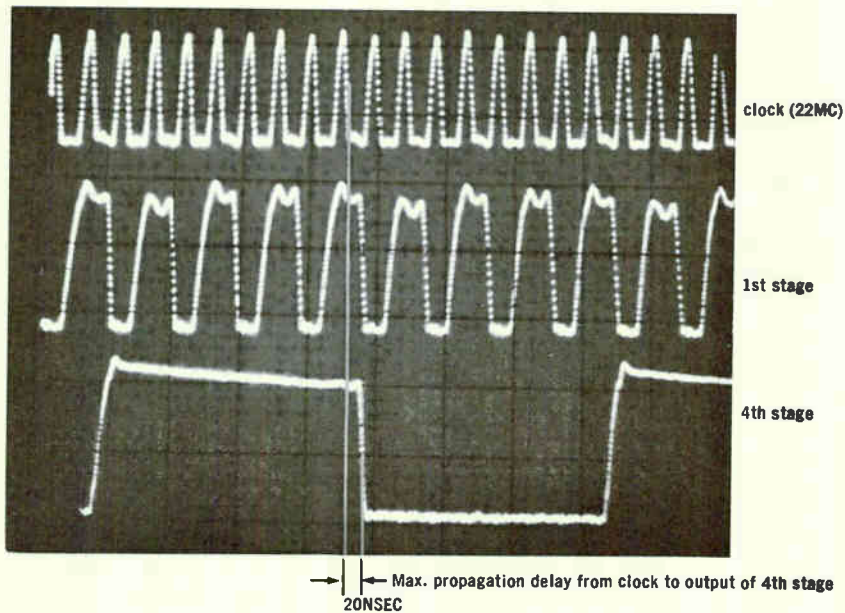
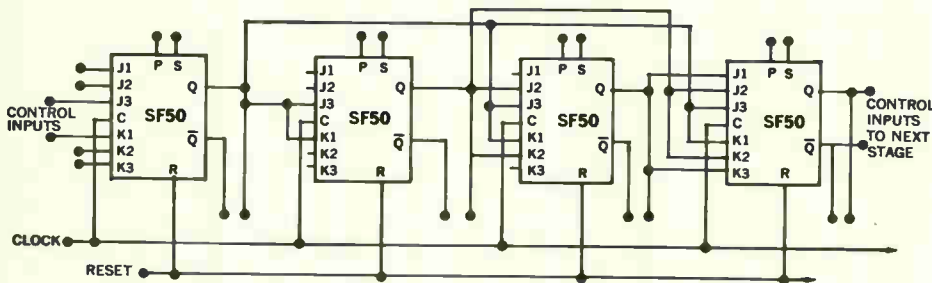

tional counters can be incorporated with the exact same high-speed performance.

The counter's combination of simplicity and outstanding performance is the direct result of the J-K flip-flop on which its design is based. Designed with systems in mind, the Sylvania SF-50 J-K flip-flop is one of the newest devices in Sylvania's Universal High-level Logic (SUHL) line of integrated circuits. It has tpd of 30 nanoseconds, three J and K terminals and internal complementing. These features are combined with other SUHL characteristics of high noise immunity, fanout, capacitance drive and low power.

With the SF-50 the design engineer also gets full logic capability to make a complete high-speed binary family of digital decade counters, count-up count-down counter, ring counters and other assemblies.

CIRCLE NUMBER 300

## in capsule

**Receiving tubes**—where to use rugged, 10,000-hour premium types.

**Diodes**—new whiskerless, shock-resistant diode for fast switching usage.

**Integrated circuits**—three new circuits that round out the industry's most complete logic line.

**Cathode ray tubes**—how to relate and record multiple data in a single CRT.

**Transistors**—why linear beta is necessary in NPN core drivers.

**Photoconductors**—PL assemblies offer a new approach to musical effects.

**Microwave diodes**—new step recovery diode series for high harmonic generation.

**Surge arrestors**—now a metal spark gap for better protection from large transient overloads.

Using only four Sylvania SF-50 J-K flip-flops, a complete 4-stage synchronous binary counter having a clock rate greater than 20 megacycles can be built.

In addition to its speed, this counter has a number of outstanding characteristics including coherent outputs, all of which appear simultaneously, synchronized to the clock. And the gating function is performed

internally (i.e., within the J-K flip-flop), thereby reducing delay to that of the integrated circuit itself.

With a counter of this design, the Set, Preset and Reset terminals provide for a synchronous entry. And the first stage of the counter can be simply controlled through the J-K terminals to either advance or inhibit the counter.

Still another feature is that addi-

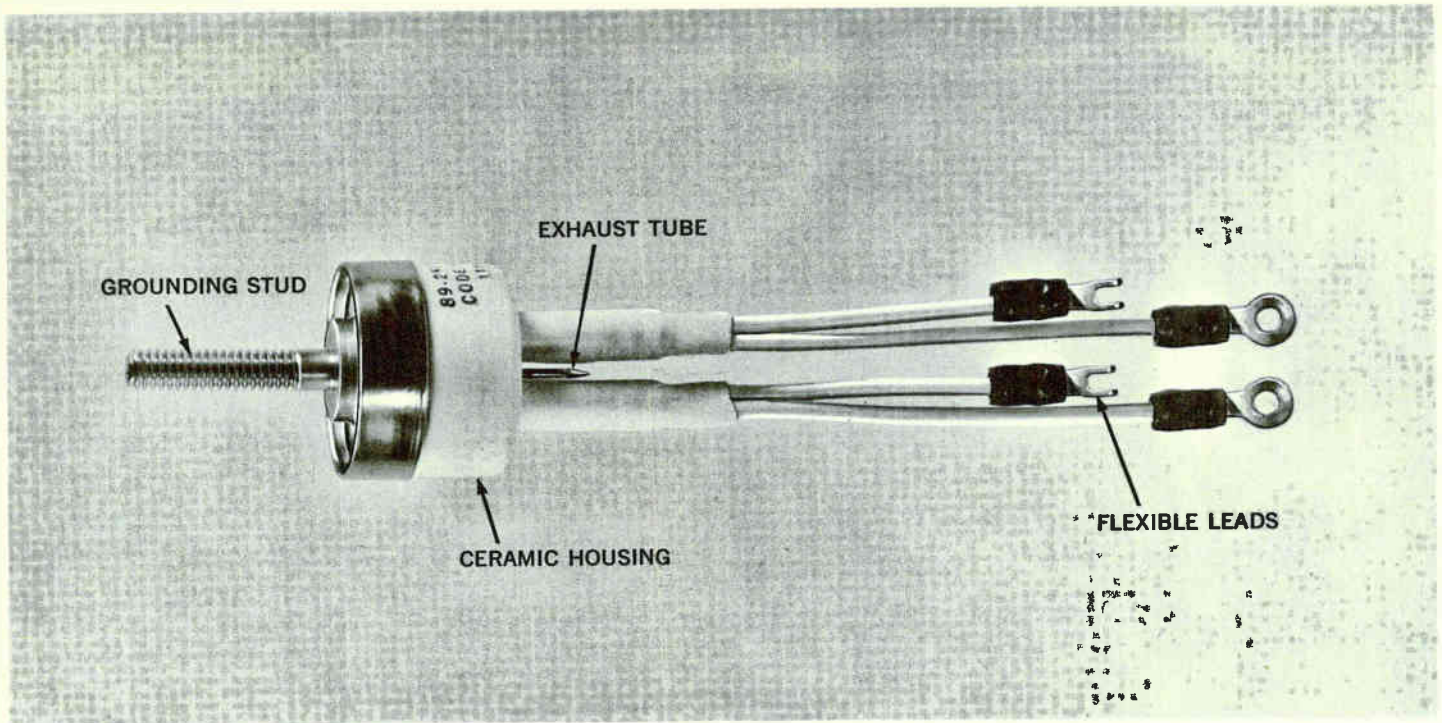

## The critical component is the spark gap

*In an electronic surge arrester (ESA) the most critical component is the spark gap. This device must switch-to-ground repeated high energy surges, thereby reducing transient energy to a level safe for secondary protectors (e.g., zener diodes, silicon rectifiers, etc.). The secondary protector, in turn, must render a safe value to the end equipment. Short circuits across the gap after a surge must not occur. Nor may the gap's impedance vary*

*widely from a range determined by the circuit being protected.*

Sylvania's newest spark gap device, the metal ceramic SG-1360, is a three-electrode balanced line designed for use as a primary protector in communications and control equipment. It protects against transient overload of the magnitude generated during a lightning strike. It also has the ability to transfer 110 coulombs and will withstand an average of twenty such

high energy discharges.

The unit's metal-alloy electrodes eliminate the disadvantages characteristic of carbon and plug protectors at high energy levels, i.e., carbon flaking or carbon deposits which may bridge the gap.

The SG-1360 is hermetically sealed and filled with inert gas to eliminate problems associated with dust and contamination and assuring both uniformity and dependable performance.

CIRCLE NUMBER 301



### LITERATURE CHECK LIST. For copies of Sylvania publications listed here, circle indicated number on the Reader Service card.

**Sylvania Integrated Circuits**—description of Sylvania's Universal High-level Logic line; contains circuit and logic diagrams, characteristics curves, typical specifications, etc. (SM-2945). **Circle number 310.**

**Sylvania Counter Tube Handbook**—describes operating principles, circuit design practices, and typical applications (ET-3911). **Circle number 311.**

**Guide to Sylvania Industrial & Military Cathode Ray Tubes**—typical specifications for Sylvania's complete line of oscilloscopes, radar indicators, video recorders, industrial monitors, receiver check tubes and flying spot scanners (ET-3914). **Circle number 312.**

**Electron Tube Application Notes**—designer's guide to the Do's and Don't's of electron receiving tube applications (ET-3907). **Circle number 313.**

**System Designer's Handbook of Sylvania Industrial & Military CRT's**—complete specifications on Sylvania's line of multi-gun, high-resolution and double-deflection cathode ray tubes (ET-2958). **Circle number 314.**

**Sylvania 300mw T-4 Photoconductors**—summary data including general features and technical characteristics of T-4 cadmium-sulfide photoconductors (ET-2953). **Circle number 315.**

**T-2 Miniature Photoconductive Cells**—performance characteristics and application information on ¼" high-reliability photoconductive cells (ET-2979). **Circle number 316.**

**19" Rectangular Color TV Picture Tube, Tentative Engineering Data**—characteristics and ratings of Sylvania's new 19" rectangular color bright 85 picture tube (ET-2950). **Circle number 317.**

**Tunnel Diodes Measurements Technical Report**—technical information about Sylvania's Tunnel Diode line (SM-2960). **Circle number 318.**

**2N2784 Micropower Transistor**—contains electrical characteristics, typical curves and life test data for the Sylvania 2N2784 transistor (SM-2943). **Circle number 319.**

**Silicon Power Rectifiers**—describes complete line available in over 500 field-proven types, 3 to 450 amps, up to 1200 volts, in 7 packages (SM-3902). **Circle number 320.**

**Silicon Varactors**—describes Sylvania's D4800 series of silicon varactors (ET-2984). **Circle number 321.**

**NPN Germanium Alloy Transistors**—oval-shaped units for high stacking density; describes 8 typical circuits (SM-3929). **Circle number 322.**



# Three new circuits round out the complete logic of the SUHL\* line

\*Sylvania Universal High-level Logic

A J-K flip-flop, a Quad 2-Input Nand/Nor Gate and a Line Driver are brand-new additions to Sylvania's line of monolithic SUHL circuits. All three series combine the outstanding advantages of SUHL with their own superior performances.

Added to the other existing circuit series in the line, Sylvania offers design engineers the widest range of logic on the market. The Sylvania line now consists of 15 basic functions, each of which is a series of 4 circuits, designed for 2 full Military and 2 Industrial application ranges.

### Clock speeds to 20mc

The Sylvania J-K flip-flop (SF-50 series) is an outstanding device that has input and output characteristics compatible with the rest of the logic elements in the SUHL family. It is designed to operate at clock speeds up to 20 mc.

In addition to having a determin-

ate state on the output for every condition on the J and K terminals, the SF-50 series provides the capability to AND up to 3 inputs at the J and K terminals. This results in a reduction of the number of elements needed to implement system functions such as counters and shift registers. All these inputs are usable as data inputs since complementing is done internally. (See story on page 1 for more on the J-K.)

### Quad 2 & line driver

The new Quad 2-Input Nand/Nor Gate (SG-140 series) offers four 2-input gates in a single chip. The new Line Driver (SG-130 series) is designed especially for computer systems requiring a gate for driving fanouts up to 40 and capacitance loads up to 1,000pf while still maintaining high speed.

### SUHL advantages

All SUHL circuits are produced using

buried layer, monolithic epitaxial construction with Sylvania's advanced fine line technology. With their versatility and their inherent high drive capability, combined with the range of circuit functions available, Sylvania integrated circuits can substantially lower the can count in many computer designs.

Operating on a single +5.0V power supply, the 15 circuit types have a fanout capability ranging from 6 to 20, typical switching speeds of just 10 nanoseconds, noise immunity of 1.0 volt (25°C) and average power dissipation per stage of 15 milliwatts. They also withstand radiation effects measuring as high as  $10^{14}$ n/cm<sup>2</sup>.

All of these circuits are available off-the-shelf in either a 14-lead hard-glass flat package or a 12-pin TO-5 package, both hermetically sealed to  $1 \times 10^{-8}$  cc/sec., 100% verified with radiflo testing.

CIRCLE NUMBER 302

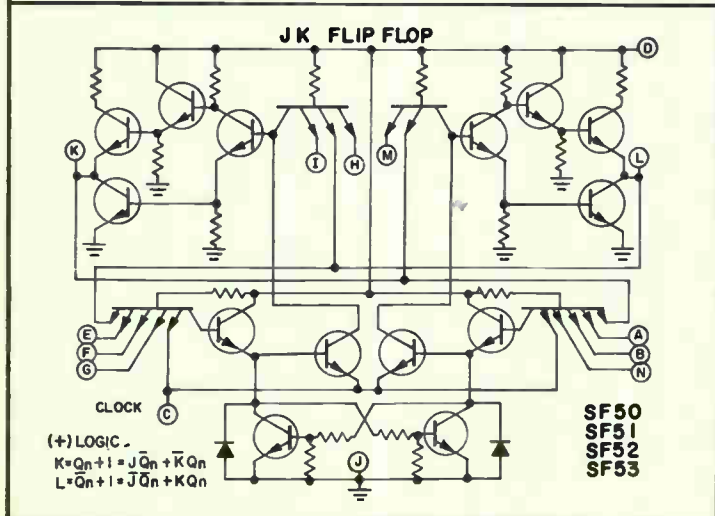
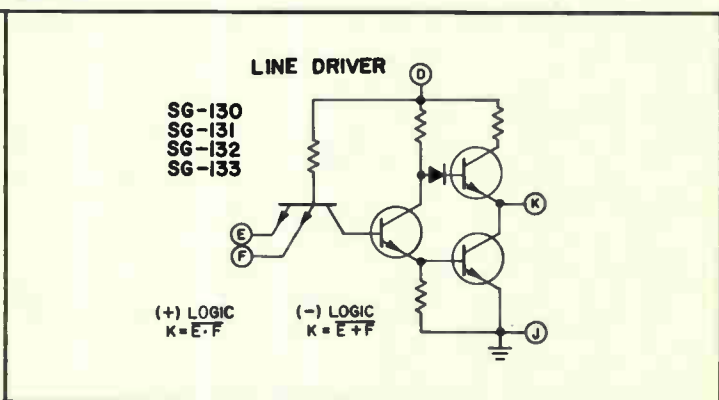
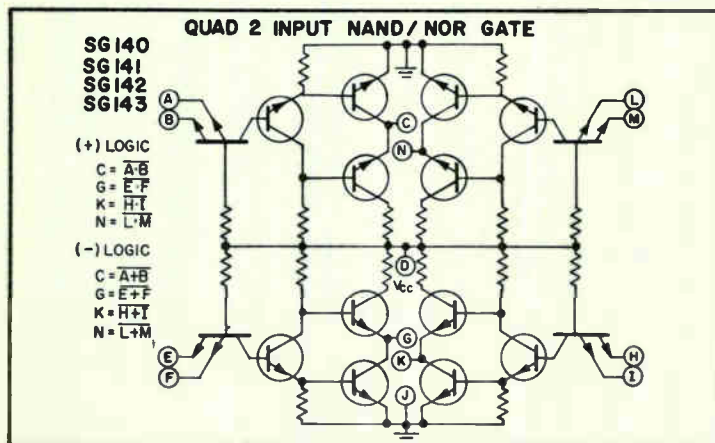

### SYLVANIA'S COMPLETE LINE OF DIGITAL INTEGRATED CIRCUITS

Function	Military and Industrial			
	Military -55°C to 125°C		Ground System 0°C to 75°C	
	MP* FO 15	MS FO 7	IP FO 12	IS FO 6
Dual 4-Input Nand/Nor Gate	SG-40	SG-41	SG-42	SG-43
Expandable Quad 2-Input OR Gate	SG-50	SG-51	SG-52	SG-53
Single 8-Input Nand/Nor Gate	SG-60	SG-61	SG-62	SG-63
Exclusive-OR with Complement	SG-90	SG-91	SG-92	SG-93
Expandable Triple 3-Input OR Gate	SG-100	SG-101	SG-102	SG-103
Expandable Dual 4-Input OR Gate	SG-110	SG-111	SG-112	SG-113
Expandable Single 8-Input Nand/Nor Gate	SG-120	SG-121	SG-122	SG-123
Line Driver	SG-130	SG-131	SG-132	SG-133
Quad 2-Input Nand/Nor Gate	SG-140	SG-141	SG-142	SG-143
Dual 4-Input OR Expander	SG-170	SG-171	SG-172	SG-173
Dual 4-Input AND Expander	SG-180	SG-181	SG-182	SG-183
Set-Reset Flip-Flop	SF-10	SF-11	SF-12	SF-13
Two-Phase SR Clocked Flip-Flop	SF-20	SF-21	SF-22	SF-23
Single-Phase SRT Flip-Flop	SF-30	SF-31	SF-32	SF-33
J-K Flip-Flop	SF-50	SF-51	SF-52	SF-53

\*MP—Military Prime, MS—Military Standard, IP—Industrial Prime, IS—Industrial Standard

# A new, simplified approach to high-order harmonics

The newest and simplest method in high-order harmonic generation is also an economical one. For low power requirements, Sylvania's D-5300 series of step recovery diodes saves money because fewer devices are needed to achieve the desired frequency output.

Transition time of Sylvania's 15-volt step diode is specified at a scant 0.2 nsec which insures high efficiency repeatability.

Several approaches to the generation of high-order harmonics have been used in the past. Many of these necessitated complicated circuitry and most were relatively inefficient.

The new unit is a silicon epitaxial diffused junction device with rapid switching characteristics that are carefully controlled. With a sinusoidal drive voltage applied, the diode conducts in the forward direction, creating a stored charge. With the voltage reversed, conduction diminishes until the stored charge is depleted; this rapid transition from a conducting to a non-conducting state creates the abrupt step waveform rich in high-order harmonics.

The D-5300 series is available in a choice of three package styles—miniature glass, miniature ceramic, and large ceramic.

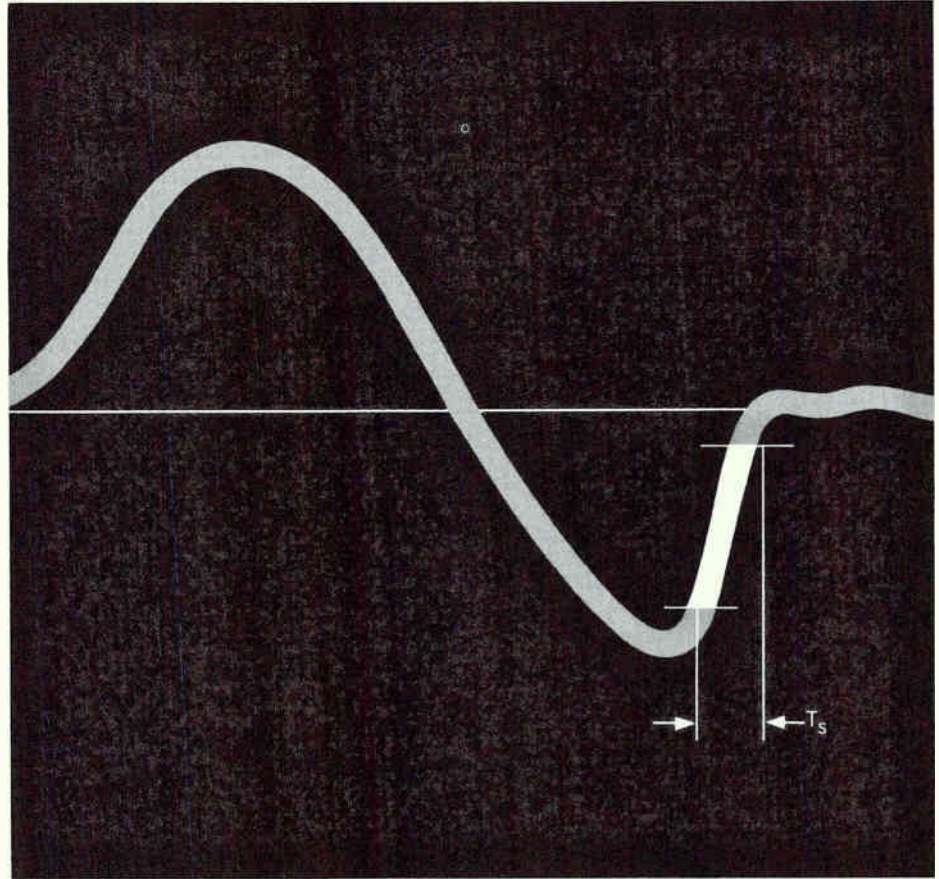

ELECTRICAL CHARACTERISTICS

Type Number	D5310A	D5311B	D5312C	
Breakdown Voltage, $V_B$	15 volts	24 volts	45 volts	Min.
Transition Time, $T_s$	0.2 nsec	0.4 nsec	0.7 nsec	Max.
Junction Capacitance at 0v, $C_{j0}$	1 pf.	2 pf.	4 pf.	Max.
Forward Current, $I_F$ ( $V_F = 1.0$ volt)	30 ma	40 ma	50 ma	Min.
Reverse Leakage, $I_R$ ( $V_R = 10$ volts)	10 na	10 na	10 na	Max.

CIRCLE NUMBER 303

## TRANSISTORS

# Linear beta essential to sudden current changes

Linear beta is an important characteristic to look for in an NPN core driver. It's virtually an essential feature in high current switching or other applications that entail sudden changes in current.

This high degree of beta linearity, in combination with other outstanding characteristics, is found only in Sylvania silicon NPN core drivers. Typical of these types are the 2N2537 and the 2N2219. These devices span their functional ranges with a stability unlike other transistors. In the typical samples tested, the curve is almost flat between 100 and 500 Mc.

A combination of still other important features is evident in these epitaxial units — high latching voltage, low storage time as well as the flat beta characteristics. These may be expressed as:

$LV_{CE0}$  (35 typ):  $t_s$  (25 nsec typ):  $h_{FE}$  (65 typ @ 150 ma,  $V_{CE}$  10V):  $F_t$  (300 mcs typ)

There is uniformity of characteristics from transistor to transistor. And saturation voltage is low:

$V_{CE}$  (sat) typ 0.25V @  $I_C = 150$  ma,  $I_B = 15$  ma  
 $V_{CE}$  (sat) typ 0.5V @  $I_C = 500$  ma,  $I_B = 50$  ma  
 $V_{BE}$  (sat) typ 0.85V @ 150 ma,  $I_B = 15$  ma

Complementary PNP and NPN pairs

are available. Because of their highly compatible characteristics, including the flat betas in both types, they work ideally in combination.

Sylvania's NPN core drivers are the only ones supplied in a wide variety of packages—from the popular TO-5 to the versatile TO-51 co-planar.

CIRCLE NUMBER 304

$h_{FE}$  VS  $I_C$  @  $V_{CE} = 10$  V, +25°C

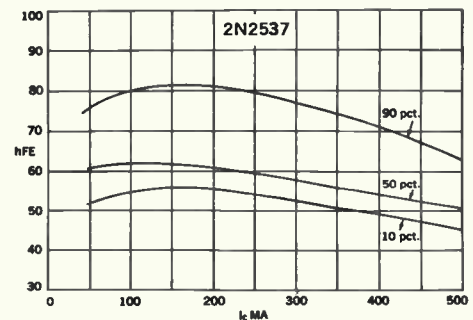



CRT's

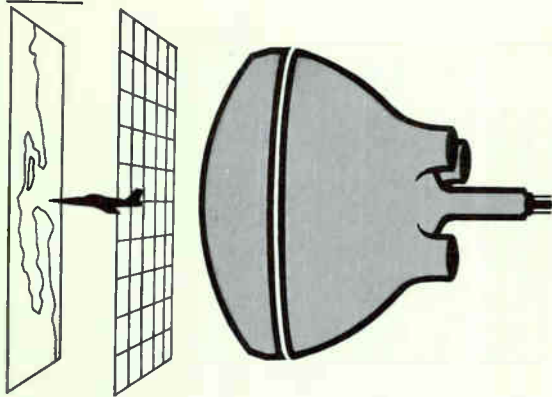

## Relate & record multi-source data in one tube

**Given:** A 19" CRT.

**Source #1:** The moving trace represents an airborne formation.

**Source #2:** Outline map of Florida.

**Source #3:** Grids added to the map.

**Source #4:** Camera records the action.

**Solution:** Next time ask Sylvania for a multiple-window CRT.

Sylvania has full capability to design and build such a tube. Overlay material can be optically projected, while at the same time a camera viewing through another window can photograph the composite electronic and

optical information.

An attention-getting device of March's IEEE Show, a 19" rear-window CRT graphically shows how a window can be put to practical use, without any interference with normal front viewing.

Rear-window tubes can go considerably beyond aircraft use. They can be effectively applied to virtually any area where display and photographic recording of electronics voltage data might be simultaneously needed. Telemetry, troop movements, altitude, distance, pressure measuring and non-

parallax graticule scales are cases in point.

Sylvania has furnished single-gun CRT's with screens sized from 7" to 19". Until now, round glass envelopes with slow decay phosphor screens have been used. But virtually any shape or size screen with any number of cathode ray guns and multiple rear windows is possible.

The 19" round SC-3875 also features highly sensitive character writing deflection plates which can also produce numeric symbols.

CIRCLE NUMBER 305

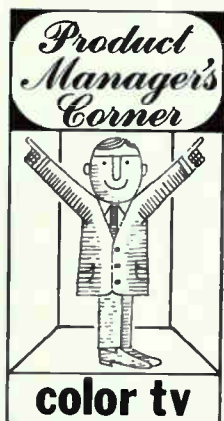

## The bright spot in color television

Introduction of Sylvania's new *color bright 85* picture tube also announced the major advancement in the state of the art in recent years. This new tube offers brand-new benefits to everyone—the set designer, the set manufacturer, the distributor, the retail sales outlet and the consumer.

What is the *color bright 85* tube? It's a product brought about by the corporate development of a startling new phosphor based on rare-earth

elements and by Sylvania's unique screening process. The big change was, of course, the new red phosphor, a europium-activated yttrium vanadate that had been only a laboratory item previously.

By the use of the rare-earth "phosphor," it was possible to produce a tube that displayed an authentic primary red for the first time. This in turn enabled our engineers to "undeaden" the blue and green phosphors. The result was all hues of the rainbow in truer, more lifelike colors.

What people see in color is a highly subjective thing. The new rare-earth tube makes it possible to tune a set through a wider range of color shades. This gives everyone the opportunity to adjust the picture to his own liking.

Probably the benefits to the dealer and the retail salesmen are the most pronounced. Here at last is a product that is clearly demonstratable to the potential color buyer. A major problem in color has been the necessity to demonstrate it in low ambient light levels. Now, at last, it is possible to bring out the full benefit of color under normally lighted showroom con-

ditions. Now the dealer can show the beauty of distinctive cabinet styling and, at the same time, display the sharp, bright, vivid color picture. The consumer has a better opportunity to make up his mind on both the benefits of color TV as well as the furniture that will fit the décor of his home.

The rare-earth *color bright 85* tube is the hottest thing in television today. It makes possible rectangular tubes that approach the brightness levels of round tubes. What's going to happen in the future? It's hard to say. Nobody can program invention, but certainly we can expect continual improvement. When it comes, Sylvania will continue to be in the lead!

CIRCLE NUMBER 306



*J. W. Ritter*  
J. W. RITTER

# New shock-resistant WL diode proves self in fast switching applications

A versatile new microminiature diode recently added to the Sylvania line has proved itself in fast switching applications, such as logic circuits, and also as a small signal switch. Sylvania's newest silicon planar diode has all the attributes of whiskerless construction, plus several improved

performance characteristics. It comes in an .060" diameter glass package.

Besides its excellent reliability and shock-resistant ruggedness, it shows power dissipation capabilities to 500 mw. Its other typical characteristics include 100ma forward current at 1 volt, reverse voltages from 50 to 120

volts and reverse currents 10-50 nanoamps. It is capable of switching speeds of 3-10 nsec, and its junction capacitance at -6 volts is 1 to 2 pf.

Sylvania's new whiskerless diode is supplied with or without leads. And it can be used with standard automatic insertion equipment.

CIRCLE NUMBER 307

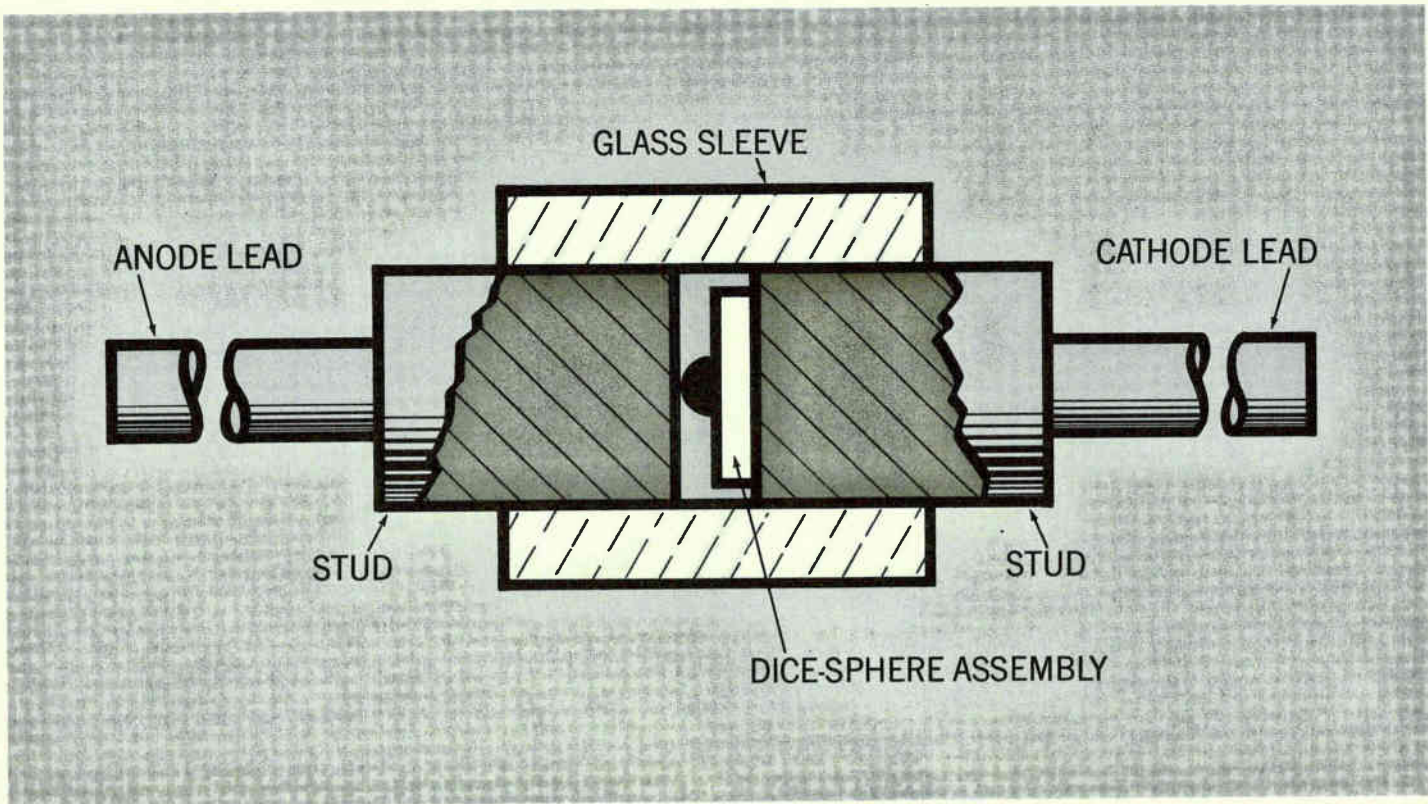
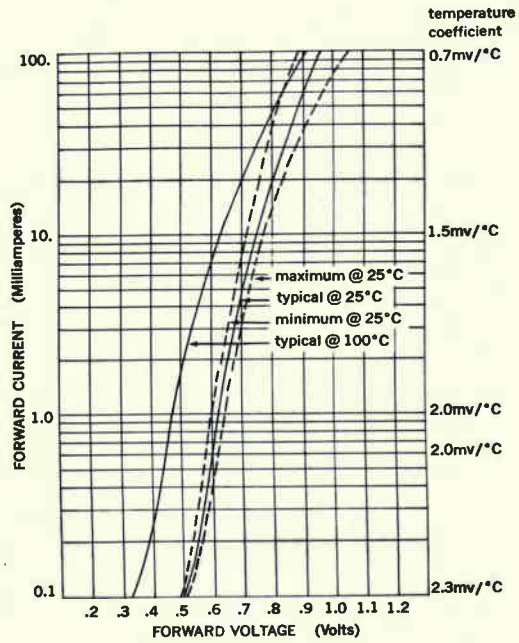
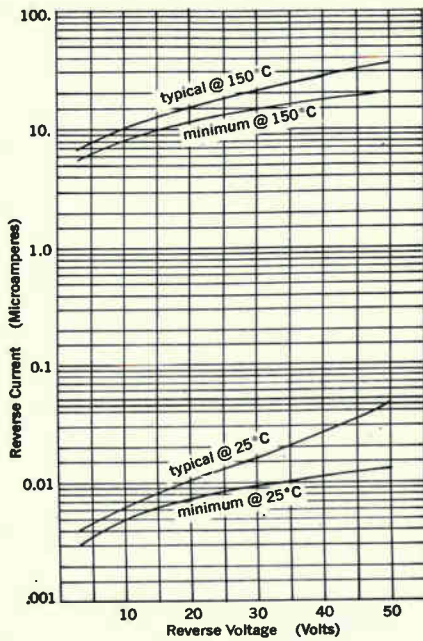



# Where to use rugged 10,000-hour premium tubes

It takes an exceptional tube to offer reliability at 10-g's vibration or 500-g's impact shock, or at extreme temperatures. Standard electron tubes cannot always be equal to extreme environments, though they be quality products. But now, there is an outstanding tube line for new designs and upgrading existing equipment.

Qualities like 10,000-hour life, exceptional stability, maximum uniformity and extreme physical ruggedness make Sylvania GB Gold Brand Tubes a logical answer for equipment designs needing extreme reliability. Every tube in the GB line is engineered to the specialized requirements of critical commercial and industrial service.

Evidence that these GB tubes do a given job better than any others lies both in their proven performance as well as in stringent testing. Some of the typical tests and controls are: Multiple Life Tests at high temperature and room temperature conditions; 500-g Impact Shock Tests; Extended 2.5-g Fatigue and 10-g Vibration Tests; Thermal Shock Tests (Glass Strain); Low Pressure Breakdown (High Altitude); Basic Tube Parameters—controlled to 0.65% AQL; Noise and Vibration to 2.5% AQL; and Continuity and Shorts to 0.4% AQL.

Here are a few of the technological reasons why these tubes are proving to be true problem solvers:

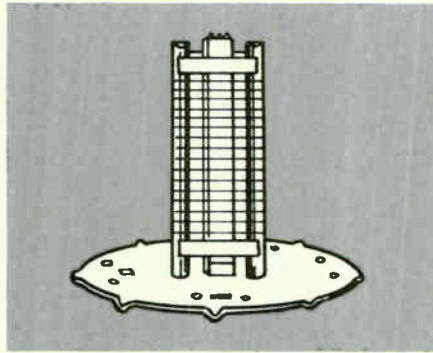

**BONDED GRID DESIGN** • new gold plating process—to assure strong bond between gold and grid... to eliminate flaking and peeling of the plating as tube ages... to preclude interelement shorts from this cause.

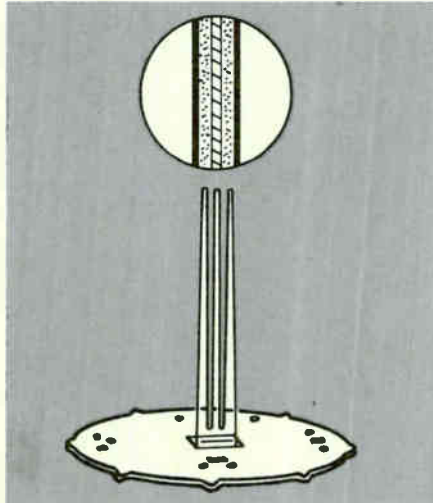

**IMPROVED HEATER DESIGN** • high durability rhenium-tungsten heater wire—to increase ductility and mechanical strength improving neuter life.

- heavy insulating coating—to guard against heater-to-cathode leakage.
- dark overcoat—to increase heat transfer to cathode and thereby assure lower heater operating temperatures, longer life.
- individual coating of bends after forming—to eliminate hot spots and shorts, major causes of heater failure.

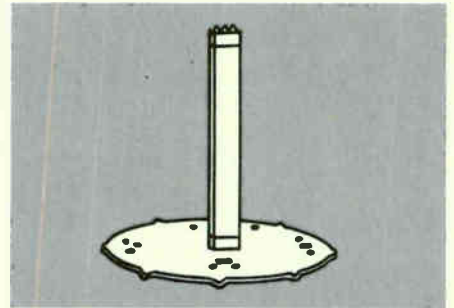

- INCREASED CATHODE STABILITY** • cathode sleeves (produced by cold-rolling a blend of powdered metals)—to minimize contaminants that can often cause interface build-up between sleeve and coating, also interelement leakage.
- powdered metals—to allow precise control of mix (not possible with molten metals)... to provide roughened surface for coating and to practically eliminate interface resistance and loose or flaking coatings.
  - duplex emissive coating (mixture of progressively activated materials)—to provide built-in boost to maintain constant emissive level to prevent Gm slump.

CIRCLE NUMBER 308



## HOT LINE INQUIRY SERVICE

Use Sylvania's "Hot Line" inquiry service, especially if you require full particulars on any item in a hurry. It's easy and it's free. Circle the reader service number(s) you're most interested in; then fill in your name, title, company and address. We'll do the rest and see you get further information almost by return mail.

## BUSINESS REPLY MAIL

No Postage Stamp Necessary if Mailed in the United States

POSTAGE WILL BE PAID BY

## SYLVANIA ELECTRONIC COMPONENTS GROUP

Sylvania Electric Products Inc.  
1100 Main Street  
Buffalo, New York 14209

Dept. 3

FIRST CLASS  
Permit No. 2833  
Buffalo, N. Y.

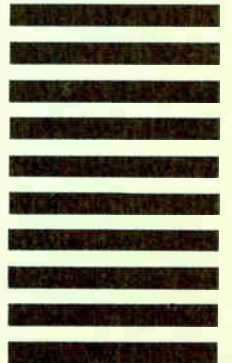

# PL assemblies, new approach to musical effects

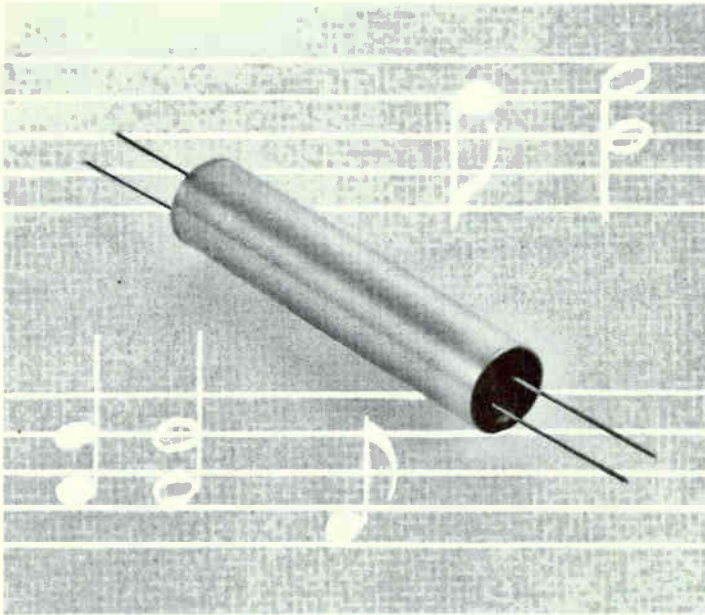

**Problem:** Design vibrato into a new electronic organ.

**Solution:** Try a Sylvania PL assembly.

Now, with a photoconductor optically coupled to an incandescent lamp, you can develop vibrato, tremolo and percussion effects in electronic musical instruments.

The lamp is a miniature high reliability indicator type. The photoconductor is a miniature, hermetically sealed, cadmium sulfide cell. Sylvania

couples them in a sealed, lightproof housing and pots the unit into a rugged assembly.

The Sylvania Type PL-8224C, for example, consists of a 50-milliwatt photocell (Type 8582) and a 24V, 15-20ma lamp. These are packaged in a metal cylinder approximately 1½" long and 5/16" in diameter. The Type

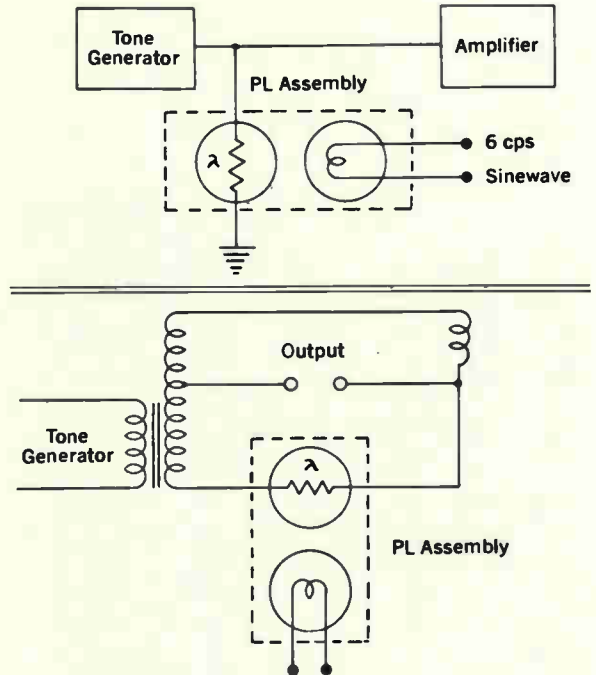

PL-8212E employs the same photocell with a 12V, 35-45ma lamp.

In commercial and industrial remote control application, the PL assembly eliminates extraneous signal pickup because the critical amplifier circuits are electrically isolated from both the remote station and interconnecting cables.

CIRCLE NUMBER 309

# SYLVANIA

SUBSIDIARY OF  
GENERAL TELEPHONE & ELECTRONICS GTE

NEW CAPABILITIES IN: ELECTRONIC TUBES • SEMICONDUCTORS • MICROWAVE DEVICES • SPECIAL COMPONENTS • DISPLAY DEVICES

NAME \_\_\_\_\_  
 TITLE \_\_\_\_\_  
 COMPANY \_\_\_\_\_  
 ADDRESS \_\_\_\_\_  
 CITY \_\_\_\_\_ STATE \_\_\_\_\_

**Circle Numbers Corresponding to Product Item**

300	301	302	303	304	305	306	307
308	309	310	311	312	313	314	315
316	317	318	319	320	321	322	

Please have a Sales Engineer call



## HOT LINE INQUIRY SERVICE

Need information in a hurry? Clip the card and mail it. Be sure to fill in all information requested. We'll rush you full particulars on any item indicated.

You can also get information using the publication's card elsewhere in this issue. Use of the card shown here will simplify handling and save time.



# DEEP SPACE AT "GROUND ZERO"

When NASA's astronauts board their Gemini spacecraft it will be with the feeling of old hands at familiar jobs. Even ground crews will operate with the facility of seasoned experts. This is the way it must be, even though it will be a first for both men and machines—each person, each system functioning in unison.

McDonnell engineers designed and built the trainers and simulators for Gemini's orbital rendezvous missions as well as launch, orbital flight and reentry.

The Gemini Mission Simulator is one example of how the skills and facilities of McDonnell Electronics Division are applied to mirror desired situations through true simulation.

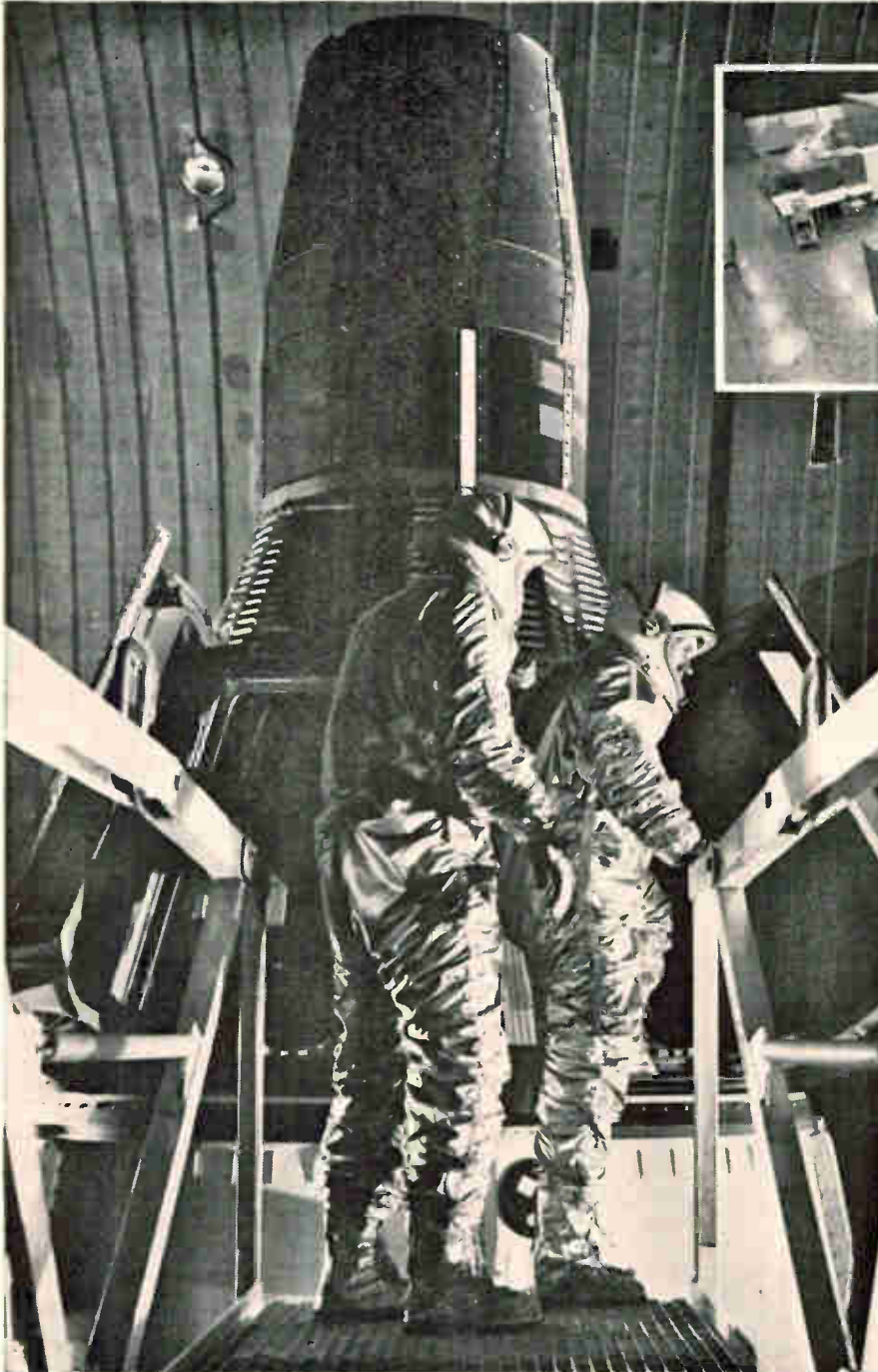

GEMINI MISSION SIMULATOR

Our brochure, "Skill in Electronics" will show you why McDonnell is a leader in end-mission related electronics such as Trainers and Simulators.

Write to:

## **MCDONNELL ELECTRONICS DIVISION**

DEPT. 946 • BOX 516 • ST. LOUIS, MISSOURI 63166

APPLYING ELECTRONICS AS AN INTERDISCIPLINARY SCIENCE



St. Louis Bicentennial Space Symposium and Fifth National Conference on the Peaceful Uses of Space, May 26-27-28, 1965  
For information, write: Box 7133, St. Louis, Missouri 63177

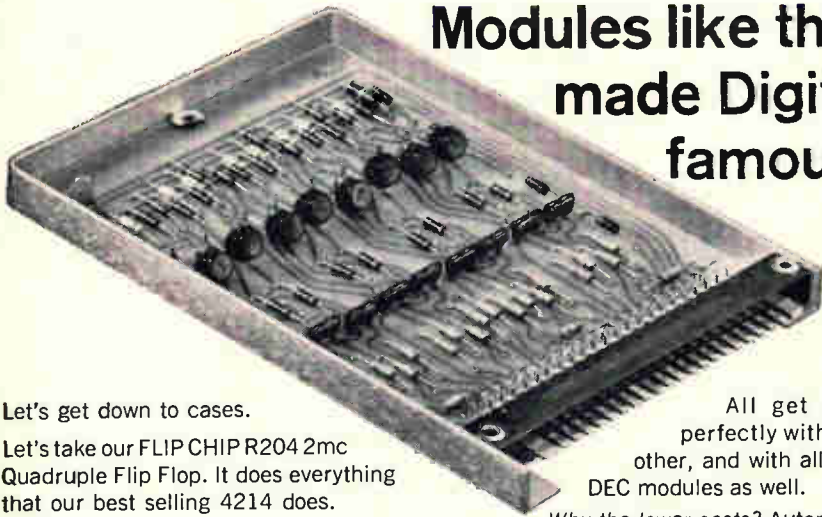

## Modules like this made Digital famous

Let's get down to cases.

Let's take our FLIP CHIP R204 2mc Quadruple Flip Flop. It does everything that our best selling 4214 does.

And it costs 60 per cent less.

Yet its quality is even better, according to our own tests, and according to customer feedback, too.

And it does things the 4214 *can't* do. For one, it is two times faster than its counterpart. For another, it has a much wider temperature range.

And this is typical of our complete new line of DEC FLIP CHIP modules.

*Meet many digital needs.* DEC FLIP CHIP modules come in 4 series, including basic 0-2 megacycle DTL silicon logic circuits, basic 0-10 megacycle silicon circuits and silicon analog-digital units.

All get along perfectly with each other, and with all other DEC modules as well.

*Why the lower costs?* Automation and mass production.

Our module making facilities have been automated from circuit screening to final test to reduce production costs and provide the tightest quality controls.

And we've reduced our set-up costs by increasing the size of our manufacturing lots to take further advantage of the mass production economies made possible by all this automatic equipment.

For instance:

MODEL NO.	FUNCTION	COST*
R001	Diode Network	\$ 4.75
R200	2mc Flip Flop	9.50
R204	4 2mc Flip Flops	32.70

\*Quantity discounts available

*Good news for your engineers.* FLIP CHIP modules have well-defined, easy-to-follow loading rules. This makes designing easier and even lets you call on computers for help. And because they have built in safety features to guard against short-circuit damage—FLIP CHIP modules encourage creative experimentation.

*Accessories to match.* FLIP CHIP mounting panels are new, too. They've been designed so that you can automate your wiring procedures with computer-controlled equipment.

And to round out the line, you have a choice of power supplies and housing cabinets.

We'll be happy to supply technical specs and application data. Just contact us at your nearest DEC sales office.



## Our new FLIP CHIP™ modules do more... and cost less



ATTEND  
 SILICON TRANSISTOR CORP.'S  
 SEMICONDUCTOR  
 APPLICATIONS  
 TRAIN MARCH 22-24  
 NEW YORK AMERICANA

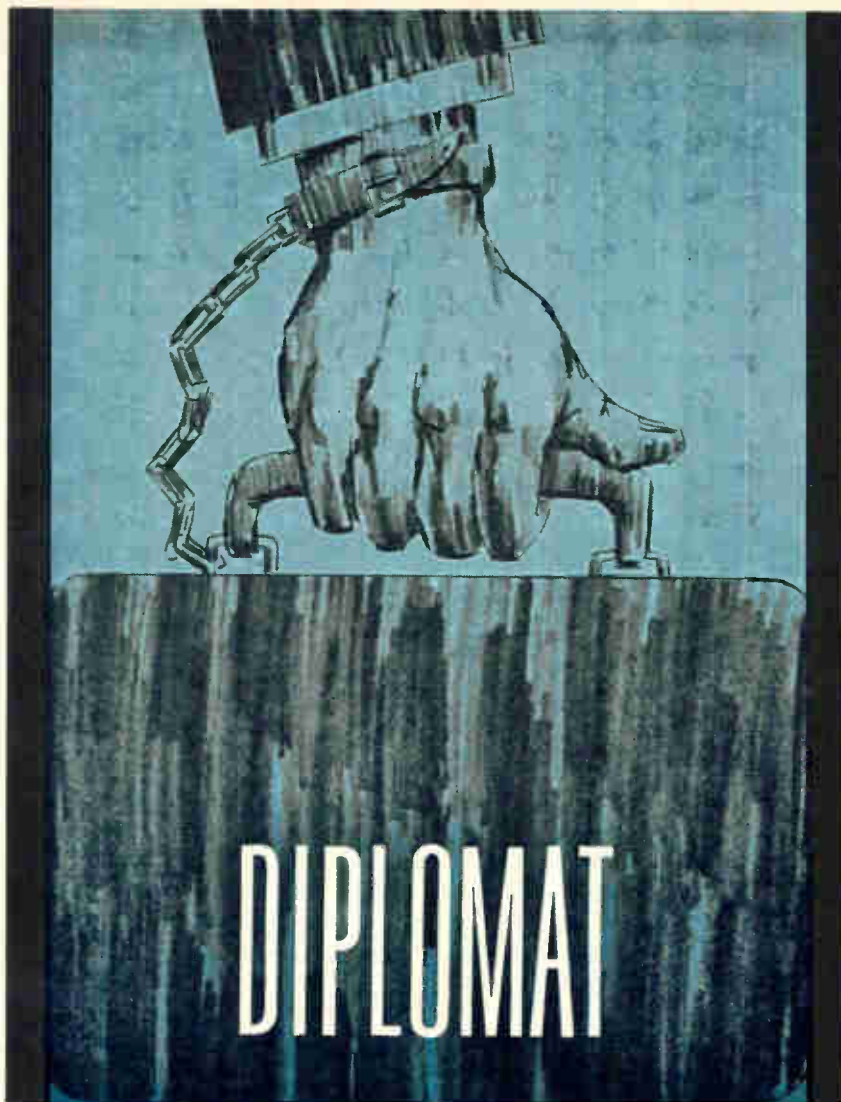

STC4401      2N3054      2N3441

## INDUSTRIAL SILICON TRANSISTORS IN A SMALL PACKAGE

Mission accomplished. Results are concrete. Three low cost, high quality, silicon power transistors, designed for industrial applications, available in the small TO-66 package.

**STC4401:**  $V_{CB0} = 50$  volts max.;  $I_C = 4$  amp max.;  $h_{FE} @ I_C = 1.5A$  25-100;  $f_T = Mc$  typ;  $P_T = 25$  W max.

**2N3054:**  $V_{CB0} = 90$  volts max.;  $I_C$  is 4 amp max.;  $h_{FE} @ I_C = 0.5A$  25-100;  $f_T = 1$  Mc typ;  $P_T = 25$  W max.

**2N3441:**  $V_{CEV} @ I_C = 50$  ma = 160 volts min.;  $V_{CEO} (SUS) @ I_C = 100$  ma = 140 volts min.;  $I_C = 3$  amp max.;  $h_{FE} @ I_C = 0.5A$  dc 20-80;  $f_T = 0.8$  Mc typ;  $\theta_{J-C} = 7^\circ C/w$ ;  $P_T = 25$  W max.

As a dedicated diplomatist, get complete specifications and information on these transistors cultivated specifically for industrial applications circuitry.

EAST GATE BOULEVARD, GARDEN CITY, NEW YORK 11532, 516 Pioneer 2-4100. TWX 510-222-8258

**REGIONAL OFFICES:**

CHICAGO, ILL. 60625, 5555 NORTH LINCOLN AVE., 312-271-0366-7, TWX 910-221-1304

LOS ALTOS, CALIF. 94022, 1 FIRST STREET, 415-941-2842. HUNTSVILLE, ALA. 35807, POST OFFICE BOX 1467

**SILICON**   
**TRANSISTOR**  
**CORPORATION**

**CONSIDER YOUR HARNESSING OPERATION . . .**

SURVEY of HARNESS  
TYING OPERATION  
for  
*YOUR COMPANY*



**GUDEBROD BROS. SILK CO., INC.**  
FOUNDED IN 1870  
*Electronics Division*

Area Code 215, WA 2-1122 • TWX 215-869-8861

12 SOUTH 12th STREET, PHILADELPHIA, PENNSYLVANIA 19107

• BRANCH OFFICES •

BOSTON, MASSACHUSETTS 02111  
115 Chauncey Street, Area Code 617, MA 6-9347  
CHICAGO, ILLINOIS 60654  
1362 Merchandise Mart, Area Code 312, DE 7-3026

NEW YORK, NEW YORK 10001  
226 West 36th Street, Area Code 212, LA 4-8886  
BURBANK, CALIFORNIA 91504  
2836 Ontario Street, Area Code 213, 848-3888  
TWX 213-848-7861

PLANT: Pottstown, Pennsylvania 19464



# Mr. Executive . . . Would you like to save money while improving the product?

(Take only a minute to read this unique, no cost offer of a survey and report)

There is available at Gudebrod a wealth of experience, gained in a specialized attention to the harnessing of wire cables since the earliest days of electronic equipment. Gudebrod has the latest information on tools and techniques, the latest information on materials and layout, the latest information on government requirements and industry trends. There is no comparable source for such information in the industry. Some companies, in the course of normal business have taken advantage of this Gudebrod experience and knowledge. You, too, can benefit from them. We can recommend ways in which to improve the operation of your harness room—and ways to save money at the same time. Here is what we propose—there are three parts.

**First**, we arrange, at your convenience, to have a Gudebrod representative make a

thorough survey of your harness operation—specifications, methods, materials.

**Then**, this survey is sent to the Gudebrod Home Office for review by an experienced consultant.

**Finally** (and most important), a Consultant's Report (as illustrated on the left hand page) is delivered to you. This will contain special, written, confidential recommendations on how *your* harnessing can be improved, how *you* can save money.

With self-interest, Gudebrod believes that by improving the state of the art throughout the industry, they will also improve their own business atmosphere. In your own concern for your company, why not talk to us about a survey of your harness operation—to improve it—to save money? To repeat—you will be involved in no cost or obligation.



**UDEBROD BROS. SILK CO., INC.**

FOUNDED IN 1870



*Electronics Division*

12 SOUTH 12th STREET, PHILADELPHIA, PENNSYLVANIA 19107

Area Code 215, WA 2-1122

See Us at Booth No. 4032 • IEEE Show

*When a connector's  
connector pins are smaller,  
it stands to reason you can have  
more contacts in the connector.*

*Bendix Double-Density "Pancake"  
connectors let you be unreasonable  
about how many contacts  
you can have in a connector.*

You can have as many as 135 contacts in one Bendix® Pancake connector. Center-to-center spacing can be as compact as .090 inch.

And you still have a smaller, lighter connector. In most aerospace applications, our Pancake connectors have up to 50% less length and 60% less weight than comparable-performance connectors. Weight reduction is cumulative,

too: the more Pancake connectors, the more total connector length and weight goes down.

And these are off-the-shelf connectors we're talking about, with proven dependability. Contact pin bending resistance is greater, contact retention is greater. Rigid glass-filled epoxy inserts eliminate contact splaying and dielectric puncture, and unitized sandwich construction

reduces components for reduced failure rate.

Pancakes come in crimp and solder, and in over 5 shell types and 9 sizes with 25 multiple-key position insert patterns in 8- through 24-size shells, many of them MIL standard layouts.

For details, write us in Sidney, N. Y. And be unreasonable in what you expect. That's what we're in business for.



*Up to 125% more contacts in one smaller, lighter Pancake connector means up to 50% less connector length and 60% less connector weight here.*

**Scintilla Division**



Circle 32 on reader service card



## Advanced technology

### Two for the laser

Out of one laboratory this month came word of two laser advances: First, a new laser produced a frequency-modulated ray, and then the laser was used to achieve a single-frequency output containing the energy of all the modes of the original laser.

The single-frequency laser, considered a fundamental advance in laser technology, was reported by Sylvania Electric Products, Inc.'s Electronic Systems division, Mountain View, Calif. Sylvania is a subsidiary of the General Telephone and Electronics Corp.

**Length changed.** A conventional helium-neon gas laser, operating at 6.328 angstroms, was modified to include a potassium dihydrogen phosphate (KDP) crystal inside the laser cavity in the optical path. The crystal was oriented so its electrical axis was parallel to the laser polarization. A radio-frequency field applied to the crystal changed its index of refraction, causing a change in the optical length of the cavity. Result: the original laser modes were phase modulated; the original modes were quenched and replaced by new modes that were an f-m carrier and sidebands. The frequency of the carrier was 104 megacycles.

The resulting f-m output was free of the noise inherent in conventional lasers, and there was no apparent loss of power due to the modulation.

**Converts energy.** In the second development, the entire output of the f-m laser was converted into what is essentially a single-frequency ray. This was done by placing another phase modulator into the f-m output beam, and driving the modulator 180° out of phase, but with the same peak phase deviation as the output of the f-m



Frequency-modulated laser developed by Sylvania achieves a single-frequency output that retains the energy of all the modes of the original laser.

laser. The second modulator "de-modulates" the f-m output, converting all of the energy of the original modes into a single frequency, or supermode; that is, the sideband energy was shifted back into a single-frequency carrier. Conventional methods of achieving single frequency involve suppressing certain modes.

The single-frequency development offers promise of simpler receiving-system designs.

The f-m laser was developed by Stephen Harris, a professor at Stanford University who is a consultant to Sylvania, and Russel Targ, a scientist in the Sylvania optics lab. The follow-up supermode laser was developed by researchers M. Kenneth Oshman and Gail Massey.

## Packaging

### Color-coordinated

Now even digital multimeters are color-coordinated. The Cubic Corp.'s newest model, the 25001, comes with a warranty that it will operate accurately between -40° and +55°C, provided that the customer doesn't tamper with the color scheme. It's yellow on the outside and multicolored inside.

The color has nothing to do

with artistic temperament. John R. Dastrup, chief engineer at Cubic's industrial division, explains that the interior colors have been selected to keep the inside temperature even, though not necessarily constant.

Besides operating over a wide temperature range, the multimeter can put up with wind, rain and sand. It even floats.

Keeping out moisture or dirt was easy: just seal up the device so it's airtight. But the problem of heat transfer was vexing.

**Color choice.** The usual design steps were applied: picking good thermal conductors for hot areas and less effective ones for cooler areas, bright surfaces to reflect heat, dull surfaces to absorb heat. But in some cases the engineers painted, plated or anodized with specific colors and in specific patterns to even out the heat. An inside fan circulates the air.

Where the packaging density of small components, such as resistors, made it impractical to circulate the air directly around them, they were mounted on honeycombs that dissipate heat quickly. Micrologic circuits were also used, because the smaller the object the less chance there is of a temperature differential across it.

Heat sinks inside the case dissipate the heat to the outside.

The instrument measures d-c voltages from 100 microvolts to

999.9 volts, accurate to  $\pm 0.01\%$ . It measures a-c voltages for 1 millivolt root mean square to 500 volts, and has a usable frequency range from 30 to 10,000 cycles per second. It's also capable of measuring resistances from 0.01 ohm to 9.9999 megohms, and ratios from 0.00001 to 99.999.

---

### Instrumentation

---

#### Looking for an angle

North Atlantic Industries, Inc., has a new angle for measuring angles—and says the method is 20 times more accurate than any other technique on the market.

The solid-state instrument translates an angular analog signal into a digital readout that's accurate to within 20 seconds of arc. Rapid and accurate angle-measuring techniques are vital for navigational components, antenna positioners and machine-tool controls. The standard unit, which costs \$4,500, is called an Automatic Resolver/Synchro-to-Digital Converter.

**All-electronic.** Other equipment on the market uses servo-driven shaft encoders to convert angular analog data, representing the resolver or synchro shaft angle, to a digital display. But it's claimed that these electromechanical techniques are less accurate and less

reliable than electronic methods.

The new instrument will respond to an input signal within 0.1 second with a resolution of  $0.01^\circ$ . It's no larger than conventional electromechanical machines—about 200 cubic inches—and can provide readout in either binary or decimal form on Nixie tubes or on a printer. This adaptability makes it easy to plug the instrument into a computer directly, without an encoder, to drive logic or other digital conversion equipment.

The input signal, from either three- or four-wire devices, is fed into a ratio bridge that contains a series of precision divider transformers. Ratios of the bridge are proportional to predetermined angular increments. A bridge switching circuit scans these standard output voltages and compares them with the input voltage. The resulting error signal is proportional to the angular difference between the internally scanned standard angle and the angle defined by the input signal. The amplified error signal is applied to a hold/release trigger. A scanner samples the digits representing an angle, and the information is applied to a storage register. The register serves as a buffer element for logic operation.

**Rejects angle.** Should the trigger output indicate that the internal standard ratios are higher than the input data, the angle digit is rejected in the programmed scan. If the ratios are lower, the bit is held

and the next bit sampled.

As an example, take an input angle of  $215^\circ$ . The first bit scanned indicates  $180^\circ$ . It is held, because it is smaller than the input angle. However, the next bit,  $90^\circ$ , is rejected since it and the bit being held total more than the input angle. The next bit,  $45^\circ$ , would also be rejected, for the same reason, but the next bit,  $22.5^\circ$ , would be held. This process continues until the angular value is reached and the loop becomes stable. The digital output display now represents the input angle.

---

### Industrial electronics

---

#### Night light

A new electronic tool has been added to the police arsenal. It's a portable infrared device that lets the user see in the dark. Similar systems have been used by the military, on guns, but they've been too large and expensive for the police.

Two companies have developed spyscopes that can be held to the eye with one hand. Varo, Inc., will offer a model in June for \$495; the International Telephone and Telegraph Corp. hasn't set a price yet on one it plans to market. Both weigh less than two pounds.

The Varo unit, called a Detectir-



**Caught in the act.** Policeman shows how the Detectirscope enables him to see in the dark. The picture at the left shows what the policeman sees in the scope.



scope, has interchangeable lenses for wide-angle or telescopic viewing. It can clearly pick out objects up to 100 yards away.

The viewer operates on a 1.5-volt mercury battery that has a life of 100 to 200 hours. The rest of the system is powered by rechargeable nickel-cadmium batteries that last one night.

Aside from police use, infrared scopes are used by film processors. The scope can be turned on in a darkroom where negatives are being processed, enabling a film processor to see his film without exposing it.

### Computer at the throttle

Three rapid-transit cars will start traveling back and forth along 4½ miles of track near San Francisco this month at speeds up to 80 miles per hour. There will be no one at the controls and no paying passengers, but every trip will be watched, clocked, recorded and assessed by a handful of men and an assortment of electronic equipment.

This curious scene will be repeated seven days a week for about three years. It represents a \$7.3-million test of automated commuter equipment conducted under a federal grant by the Bay Area Rapid Transit District [Electronics, July 13, 1964, p. 87]. The cars will be controlled by elaborate electronic equipment devised by four companies competing for a plum: \$10 million of electronic equipment for a \$1 billion, 150-mile rail network that will serve the San Francisco area.

**Free advertising.** Also at stake is millions of dollars of free publicity for the winner. There's little doubt that the rapid-transit system adopted by the district will serve as a model for other systems.

The system will be supervised by computers. Trains will be automatically scheduled for rush-hour traffic; they'll start, stop, open and close their doors at stations and adjust their speed without human intervention.

The competitors are the General Electric Co., the Westinghouse Electric Corp., the General Rail-



Rapid-transit cars, like the one above, will be used this month in a San Francisco test of computer-controlled railway transit.

way Signal Co. and the Westinghouse Air Brake Co. General Railway and Westinghouse Air Brake worked together recently on the automated train in the shuttle between Grand Central Station and Times Square in Manhattan. (Last year fire destroyed the system and it was never replaced.)

In the Westinghouse Electric system, a Prodac 50 computer continuously and directly controls every car by signaling through wires laid between the tracks. Besides juggling schedules, the computer regulates speeds and keeps the cars at safe distances from one another. It guides trains in and out of stations or into the terminal for repairs or storage during off hours.

**Pulse ahead.** The GE system uses a modified radar technique to keep two cars at safe distances from each other. The signals, continuously pulsed from an antenna at the front of one car, travel along a waveguide parallel to the tracks; in this way the signal is guided around curves. When a radar signal hits a reflector on a car up the line, the trailing car's analog computer quickly calculates the safe distance between the cars and tells the following car whether to stop, slow down, or continue at full speed. Preset communication equipment along the wayside signals to the car's computer, telling it safe speeds for a strip of track ahead. Wayside devices also signal the car to start slowing down for a station. In the event the car's computer or the trackside devices go amiss, a supervisory computer at a central control room takes over.

The General Railway and the Westinghouse Air Brake systems,

submitted separately, are identical except for some of the hardware. In each case, trackside receivers and transmitters, spaced from 1,600 to 150 feet apart, signal an analog computer aboard the trains. The distance between the receivers and the transmitters represents traffic-control blocks; if a train is in an area one block up the line, the train to the rear automatically is held in its own block. The signals are carried to the cars through the rails.

Those two systems and GE's use tuned coils spaced about 3,000, 500 and 100 feet before a station to signal a smooth station stop.

**Mixed bag.** The contract that the companies signed to provide test equipment gives the transit district the choice of selecting parts from the four proposals and putting together its own electronic control network. Any company can bid on any of the winning equipment, and the producers are required to make their equipment available to competitors.

About 80% of the system is scheduled to be in commercial operation by 1969; a year later the full 150-mile network should be in business.

---

### Military electronics

---

#### Seeing dark objects

With existing radar, the military can't learn much about an unidentified satellite except that it's there. What does it look like? Is there a suspicious shape that might indicate the presence of a nuclear

bomb? Our most advanced radar can't say; for so-called "dark" objects—targets that don't send out a cooperative beacon—it can provide only tracking data. But if experiments being conducted by the Air Force are successful, the military will be able to identify parts no bigger than one meter square on a satellite in a 1,000-mile-high orbit.

The system, being studied at the Rome Air Development Center, uses an interferometer technique similar to that used in continuous-wave, baseline radar—but it doesn't need a cooperative beacon transponder.

**Rate of change.** Both techniques compare the difference in phase of returned signals at two stations, but the new system measures the rate of change of the phase. The Rome engineers are working with a master station and a slave; eventually a second slave will be added. The equipment measures the range, the range rate, the angle and the angle rate of returned pulses.

Two types of 2.4-millisecond pulses are transmitted in steady 100-pulse cycles. One pulse is at a constant frequency, and the other is linearly frequency-modulated. The range rate and the angle rate are measured by the constant frequency pulse, and the angle and range are determined by the linear f-m pulse. The master station determines the range and the range rate, while both stations are needed to determine the angle and angle rate.

Four pulses—one for each parameter—are transmitted sequentially by a 150-kilowatt transmitter on a carrier frequency of three gigacycles. All four of the parameters are measured each half-second.

For range measurement, the returned f-m pulse is compared with an internally generated f-m reference signal. Range rate is determined by the conventional doppler method—measuring the doppler frequency shift caused by the target's motion.

**What's the angle?** Angle measurements are made by calculating

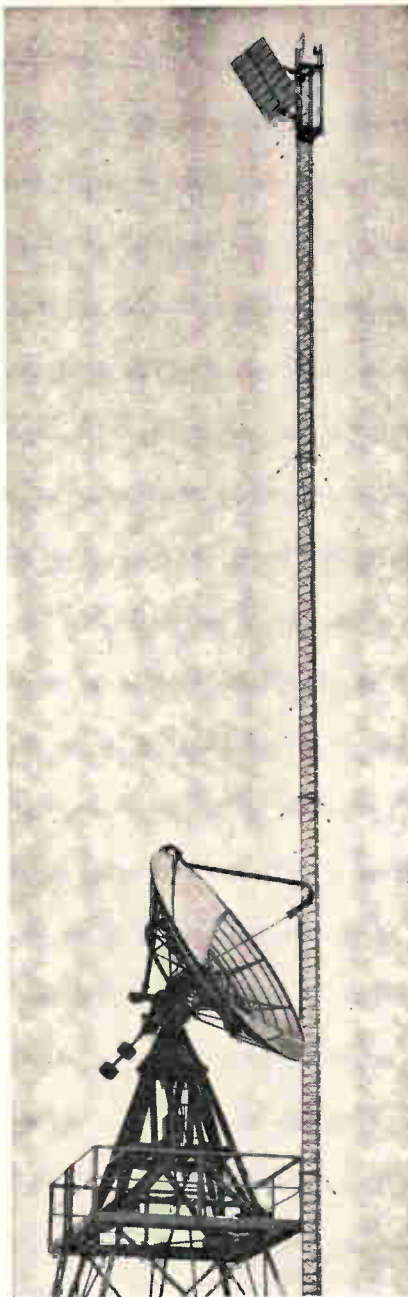

Master station radar antenna points at target. Reflector at the top of tower is part of microwave data link between master and slave stations.

the time and frequency differences of signals reflected back to both stations. The angle is proportional to the time difference and the angle rate is proportional to the doppler frequency difference.

A target must be at least 200 miles away from the system to track accurately, because the design assumes that the antennas are essentially parallel.

## Uniform regulations

Military contractors operate under a profusion of government regulations administered by representatives of the Army, Navy, Air Force and Defense Supply Agency. Now the Pentagon is beginning to ease that burden and make the regulations uniform.

It's consolidating and simplifying contract administration. By 1966 it expects to reduce the number of administrative offices from 165 to 84, and office employees from 20,000 to 18,200. By 1969 it expects savings from the program to total \$19 million a year.

**New agency.** The program, three years in the making, is administered by the Contract Administration Service, a new arm of the Defense Supply Agency. The system has been tried for 1½ years in Philadelphia, and the Pentagon is happy with the results.

The new organization opened its first regional office last September in Philadelphia. A Detroit office will go to work April 1. By the end of this year, other regional offices are scheduled to open in Dallas, Boston, New York, Cleveland, Chicago, Atlanta, St. Louis, Los Angeles and San Francisco. These will be backed up by 23 district offices and 50 area or plant offices.

Security clearances for employees of defense contractors are handled by an office in Columbus, Ohio.

**Some excluded.** Besides military work, the new agency administers large contracts given by the National Aeronautics and Space Administration. But awards involving major weapons systems are excluded from its control; these are supervised by project managers at the plants.

---

## Communications

---

### Write numbers

The Bell System is offering a push-button gadget, named Magicall, that can automatically dial any



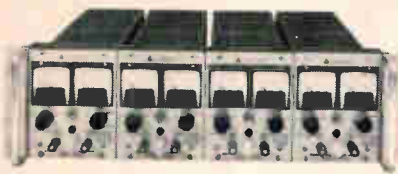

4 DC outputs in a single rack



1/4 rack and 1/2 rack models



Non-metered models available



Minimum bench width



Flush chassis mounting



LRA-1 \$60.00

LRA-2 \$25.00

Rack adapters

## Now... 2 NEW 0-120 VDC models in LAMBDA all-silicon LH series 1/4 and 1/2 rack Multi-Current-Rated™ power supplies

- Meet RFI Spec.—Mil-I-16910.
- Modular-Subrack design for bench, chassis and rack use.
- Regulation—.015% or 1 MV (line or load)



- Ripple—250 microvolts rms. 1MV P-P
- AC Input — 105-135 VAC, 45-480 CPS.
- 1/4 rack: LH 118, 121, 124, 127, 130—5<sup>3</sup>/<sub>16</sub>" x 4<sup>3</sup>/<sub>16</sub>" x 15<sup>5</sup>/<sub>16</sub>"
- 1/2 rack: LH 119, 122, 125, 128, 131—5<sup>3</sup>/<sub>16</sub>" x 8<sup>3</sup>/<sub>8</sub>" x 15<sup>5</sup>/<sub>16</sub>"

Model	Voltage Range	CURRENT RANGE AT AMBIENT OF: (1)				Price (2)
		30°C	50°C	60°C	71°C	
LH 118	0-10VDC	0-4.0A	0-3.5A	0-2.9A	0-2.3A	\$175.00
LH 119	0-10VDC	0-9.0A	0-8.0A	0-6.9A	0-5.8A	\$289.00
LH 121	0-20VDC	0-2.4A	0-2.2A	0-1.8A	0-1.5A	\$159.00
LH 122	0-20VDC	0-5.7A	0-4.7A	0-4.0A	0-3.3A	\$260.00
LH 124	0-40-VDC	0-1.3A	0-1.1A	0-0.9A	0-0.7A	\$154.00
LH 125	0-40-VDC	0-3.0A	0-2.7A	0-2.3A	0-1.9A	\$269.00
LH 127	0-60VDC	0-0.9A	0-0.7A	0-0.6A	0-0.5A	\$184.00
LH 128	0-60VDC	0-2.4A	0-2.1A	0-1.8A	0-1.5A	\$315.00
New LH 130	0-120VDC	0-0.50A	0-0.40A	0-0.35A	0-0.25A	\$225.00
New LH 131	0-120VDC	0-1.2A	0-0.9A	0-0.8A	0-0.6A	\$320.00

(1) Current rating applies over entire voltage range. DC OUTPUT Voltage regulated for line and load.

(2) Prices are for non-metered models. For metered models add suffix (FM) to model number and add \$25.00 to price. For non-metered chassis mounting models, add suffix (S) to model number and subtract \$5.00 from non-metered price.

Announcing at IEEE Show in Lambda Booth 2506-2508

**NEW LM SERIES ALL-SILICON, MODULAR POWER SUPPLIES**



# LAMBDA ELECTRONICS CORP.

515 BROAD HOLLOW ROAD • MELVILLE, L. I., NEW YORK • 516 MYRTLE 4-4200

## SHAPE OF THINGS TO COME?

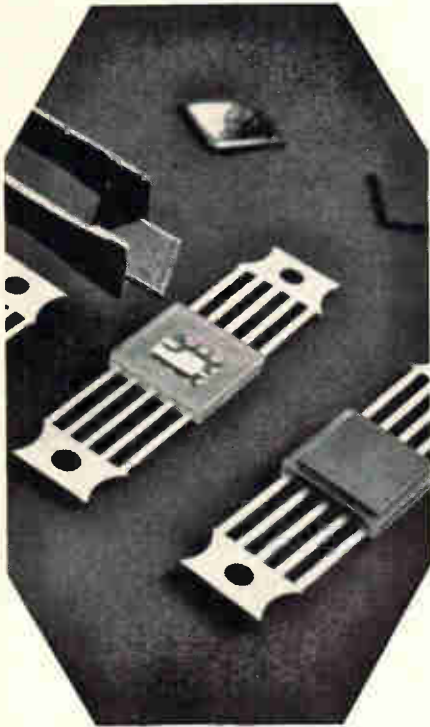

## YOU CAN ORDER TODAY!

Ultra Carbon's flat glass package can make your dreams a reality. ULTRA/FGP<sup>®</sup> is here ... ready to protect your integrated circuits with a hard, monolithic glass and Kovar body. The Kovar and glass lid can be fused in place with existing sealing equipment without heat damage to the delicate circuitry. Molecular adhesion gives the required seal hermeticity . . . is accomplished right in your own plant to assure proprietary rights. Several sizes are already in production . . . will be stocked as soon as our current order backlog is filled.

Yes, ULTRA/FGP is here today . . . why not investigate, now? Then, you'll also be ready for the ULTRA shapes of tomorrow! Post Office Box 747, Bay City, Mich. 48709.



## Electronics Review

number it has in its memory.

The installation price of the electronic unit is \$25 for a 400-number memory and \$35 for a 1,000-number memory. In New York State, the monthly charge for either is \$10.

**No dialing.** Magicall contains a roll of paper with magnetic backing. A subscriber writes a name and phone number on the ordinary surface of the paper. Then he dials the number on a special plug-in unit that's connected only when a new number is being written. A recording head inside the instrument picks up signals corresponding to the dialed number and records them on the magnetic side of the paper.

To make a call, a control button is pressed to move the paper roll forward or back until the desired name is framed between two horizontal lines on the face of the instrument. The subscriber then presses the call button and the call is placed.

Names and numbers can be removed with a rubber eraser. Recording a new number over the old one on the magnetic side of the paper automatically erases the old number.



Magicall gets your number.

**Turn the paper.** Inside Magicall are two electric motors: one to turn the paper roll and the other to drive the reproducing head across the magnetic surface. The instrument contains more than 40 transistors and diodes.

The paper rolls are interchangeable, so a subscriber can make up several lists of numbers and insert them as needed to make a series of routine calls.

Magicall was developed and is being produced for the Bell System by the Dasa Corp. of Andover, Mass.

The Bell System also offers, for a lower fee, a dialer that uses separate punched cards.

## Components

### Powerful space savers

As avionics engineers pack more and more electronic equipment aboard aircraft, the need for smaller yet highly efficient power supplies grows. Most commercially available power supplies are bulky because they use discrete components.

Now a new family of power supplies, reduced to one-fourth the size of conventional units, is being delivered to the Navy for testing. Efficiency is claimed to have been boosted to 75% from about 13% in some cases. The developer of the equipment, Litton Industries, Inc.'s Data Systems division, foresees applications for the smaller power supplies in commercial airlines and in computers.

**Custom made.** The units, specially tailored for the Navy's advanced avionics programs, incorporate thin-film circuits, multiple diffused silicon circuits and silicon chips to replace bulky diodes, resistors and transistors. Integrated circuits were used in the reference and control portion of the power supply and the power-conversion section—but only to the extent that they were needed to meet Navy specifications and could replace discrete components without boosting costs.

**Classified.** Although the actual installations of the units are classified, it's believed they will be incorporated in the Navy's integrated helicopter advanced avionics systems (IHAAS), the integrated light avionics systems (ILAAS) and the Navy's new F-111B fighter plane.

One unit takes 28 volts d-c from an aircraft's power line and converts it to 6 volts; this system is



used to drive microelectronic logic systems in an airborne data link. Another power supply converts 28 volts d-c to 12 volts, supplying power for an ultrahigh frequency receiver. A third group of units converts a higher-power source to 3 volts d-c.

All heat-producing components of the small units are mounted directly onto heat sinks, eliminating the need for bulky fans or convection-cooling techniques.

### Klystron substitute

Klystrons, developed in World War II to meet the demands of high-power radar, have long been the workhorse microwave power tube. But recently, solid-state devices have been edging them out of areas where low power is needed; and new techniques using traveling wave and negative grid tubes may soon push them out of the high power areas, also.

Two techniques are being tried at the Rome Air Development Center. In one, two traveling wave tubes were paralleled, thus doubling the power. In the other, five negative grid tubes were cascaded; eventually, the engineers hope to obtain a level of power comparable to a klystron that takes up nearly twice as much space as the negative grid tube package.

**Double, double.** The parallel experiment used two Varian Associates VA 126 traveling wave tubes, each of which produces four megawatts full peak power in the five-gigacycle range. The signal bandwidth is 10%. This month, the engineers will try to get four megawatts average power, and after that they will try to parallel four tubes, hoping to quadruple the power output.

If these experiments work, the engineers say they can start thinking of using the tubes in phased array radars of higher power. Klystrons have proved unsuitable for phased array radar because of their poor phase stability and limited bandwidth.

The key to the parallel technique was isolating the tubes, says Merton Kraft, the Rome engineer who



## how to measure resolver or synchro position with 30 second repeatability

In both production test and ground checkout systems, North Atlantic's high performance Angle Position Indicators provide exceptional operator ease and precision in the measurement of synchro and resolver position. Features include digital readout in degrees and minutes, 30 second resolution, continuous rotation, plug-in solid-state amplifier and power supply modules. Due to the design flexibility of these units, they can be readily provided with a variety of features for specific requirements. Typical units in this line incorporate combinations of the following features:

- Single Synchro or Resolver Input
- Dual Synchro or Resolver Inputs
- Retransmit Synchro, Resolver, Potentiometer, or Encoder
- 2-Speed Synchro Input
- Multi-frequency Inputs
- DC Input
- 0-999 Counter

#### BASIC SPECIFICATIONS

Range .....	0°-360° continuous rotation
Accuracy .....	6 minutes (standard)
Repeatability .....	30 seconds
Slew Speed .....	25°/second
Power .....	115 volts, 400 cps
Size .....	API-8025 ..... 1¾" h x 9½" w x 9" d
	API-8027 ..... 3½" h x 4¾" w x 9¾" d



Your local North Atlantic representative has complete data on the API line. Call him today or write direct for technical literature.

**NORTH ATLANTIC industries, inc.**  
TERMINAL DRIVE, PLAINVIEW, L. I., NEW YORK • Overbrook 1-8600

# HOW TO FABRICATE

in model shop  
or production  
with

**di-acro**  
PRECISION  
METALWORKING  
EQUIPMENT

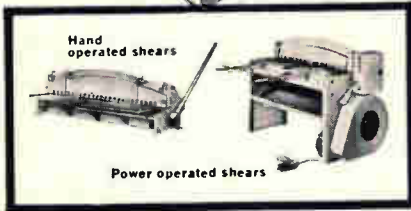
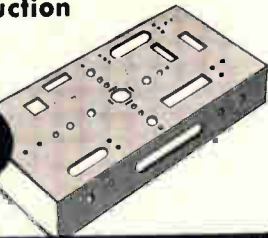

## SQUARING

Power shear blanks to die accuracy at high speed—up to 16 gauge mild steel. Heavy duty construction for efficient, accurate and trouble free performance.



## NOTCHING

Notcher cuts up to 6" x 6" in 16 gauge mild steel in one operation. No expensive dies, no punch press set-up—just set the gauges and toe the switch.

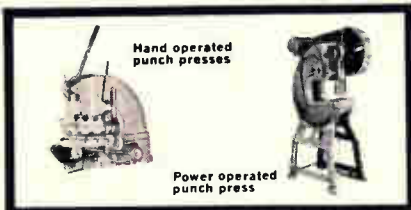

## PUNCHING

OBI 5-ton punch press—single or automatic cycling—up to 190 strokes a minute. It's accurate and easy to set up. Safe to operate no special skills needed.

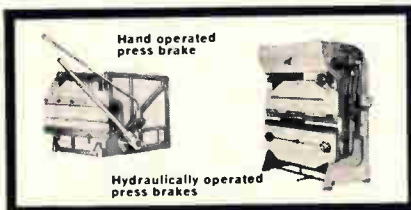

## BRAKING

Hydraulic powered press brakes give full control. Dual speed cycle . . . fast approach and return—safe work speed. Available in 12, 25 and 35 ton models.

For complete information on these and all Di-Acro machines see your Di-Acro distributor or write for Catalog 65.



**DI-ACRO CORPORATION**

434 Eighth Avenue • Lake City, Minn.

## Electronics Review

developed it. He used ferrite isolators and circulators to keep the signal traveling in only one direction. The tubes were combined with a hybrid junction whose phase and amplitude parameters were adjusted so that efficiency was about 95%.

**Big boost.** In the cascading experiment, which is also designed to develop hardware for phased array radar, five Eitel-McCullough, Inc., negative grid tubes were used to make a power amplifier operating at 432 megacycles. The amplifier is radio-frequency pulsed; it starts at one watt and builds up to 100 watts. The total gain is about 50 decibels and bandwidth is 10%.

Negative grid tubes have better phase and linearity characteristics than klystrons. Also, negative grid tubes last about 30,000 hours, compared with only about 5,000 hours for the best klystrons.

## Computers

### Magnetic logic

A digital computer with parallel magnetic logic has been developed at the Instrumentation Laboratory of the Massachusetts Institute of Technology. The computer does not use transistors for the logic operations.

Although designs for such machines have been proposed earlier [Electronics, June 1, 1964, p. 40], MIT believes the machine it has built for the Air Force is the first of its kind. The computer makes arithmetic computations in parallel, which is much faster than serial calculation. Thus it works on an entire number, rather than on one bit at a time.

**Major assets.** The designers, Harry Margulius, assistant director of the lab, and John Marino, staff engineer, say that aside from speed, the computer's biggest assets are its reliability, low cost, low power consumption, small size and resistance to radiation.

"The computer lends itself in an unusual way to design for a specific job," says Margulius. "If an indus-

trial process is slow, the machine can be tailor-made for slow operations."

The designers see potential applications in process control and in portable computers, and wherever small, general-purpose machines are needed.

**Radiation resistance.** MIT wanted to develop a computer for the military with narrow pulse width, and, therefore, low duty cycle, to conserve power and resist radiation. The components consume virtually no power when they are quiescent and they are active only for the time of pulse. Transistors are used as power amplifiers and to improve the fan-out ratio; transistor circuits used in this way may have wider tolerances without degrading the performance of the logic system.

The basic building block is the magnetic core. Logic power is built up by the core transistor logic circuits, which consist of a core, several input windings, a shift winding, output windings, a transistor amplifier, and a delay and impedance matching network. The core logic element is not just used for AND/OR gates; it can do anything up to and including majority logic.

Although the computer's clock rate is only 250 kilocycles, it can add 24-bit words in 12 microseconds, multiply in 150 to 200 microseconds and divide in 200 microseconds. Transistor logic, according to the designers, would require a clock rate of several megacycles to achieve this speed.

The computer repertoire has 25 instructions, but it can be expanded to 64 instructions.

Some sections of the machine work asynchronously, and can achieve signal-propagating speeds as high as 8 to 10 Mc.

**Neuron study.** The computer evolved from research into the possibility of using devices that resemble the neuron. Such devices fire only above a certain threshold of energy, and once fired, don't fire again until they are recharged.

The computer can retain its last previous state even if its power is accidentally shut off. A job in progress need not be started over if it's interrupted by a power failure; the



computer simply picks up where it left off.

## Avionics

### Get the message

The Air Force and the Radio Corp. of America are developing a speech-recognition machine that works like a human ear. In space, speech processing will be necessary for voice communication. It's way to overcome radio interference and tightly packed channels.

RCA's Defense Electronic Products division has constructed a network of 500 electronic neuron models, coupled with a bank of 19 filters that simulate the frequency response of the ear's cochlea. In addition to responding like a biological auditory system, the speech-processing device demonstrates logic functions.

A laboratory model of the machine will be delivered to the Air Force Avionics Laboratory at Wright-Patterson Air Force Base in Ohio in June. The device recognizes 40 phonemes, the smallest distinguishable units of speech.

**Pick a sound.** Speech recognition by phonemes offers the simplest approach for handling a large vocabulary. A syllable-recognition system would be far more complex since it would have to identify 2,000 distinct sounds.

Frequency-energy relationships that vary according to signal time are used to specify sounds. The input signal is analyzed for maximum and minimum acoustical energy levels, energy slopes, simulation events, sequences of events, time duration and transition of energy. Decision networks in the neural network abstract and weigh these features to recognize the phoneme. Output of the device can be a binary code.

When perfected—and this is some time away—speech-recognition instruments will have many applications, such as phonetic typewriters, voice-controlled machine operations, automatic language translation and secure communications.

**TAKE YOUR  
PICK . . .**

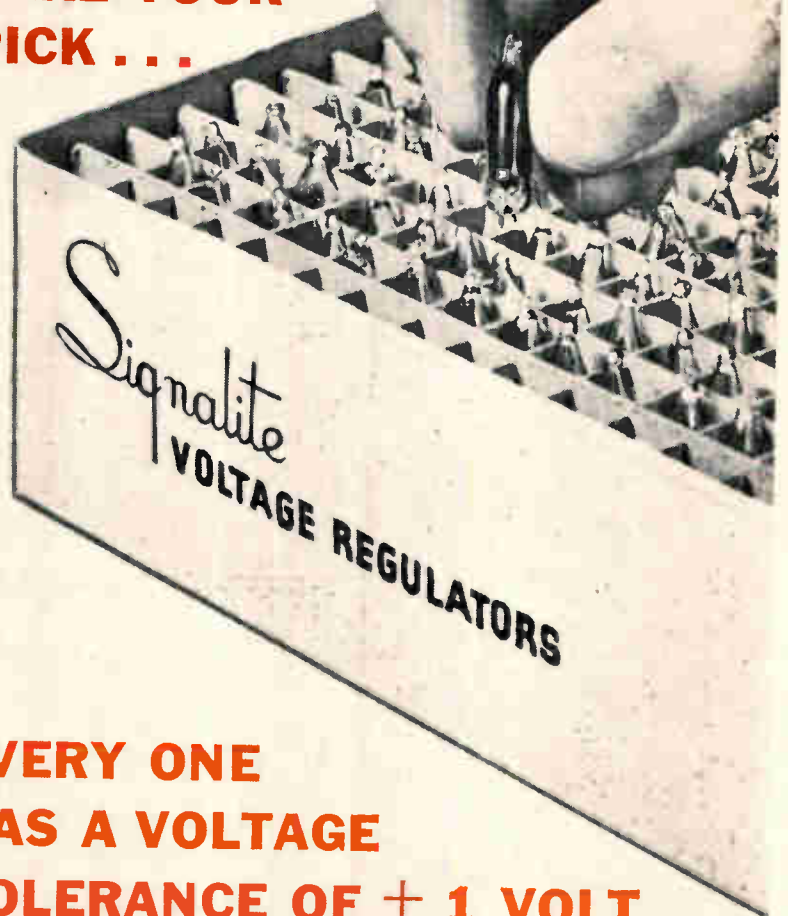

**EVERY ONE  
HAS A VOLTAGE  
TOLERANCE OF  $\pm 1$  VOLT**

Typical Characteristics			Some Proven Applications
	Z82R10	Z100R10	
BREAKDOWN VOLTAGE DC (in Dark or Light) MAX	115	150	Reference Voltage Sources Regulated Power Supplies Oscilloscope Calibrators Photo Multipliers Zener Diode Voltage Sources Digital Voltmeters Timing Circuits Overvoltage Protection Suppressed Zero Voltmeters Frequency Dividers Indicating Voltmeters
REFERENCE VOLTAGE (measured at)	82 $\pm 1$	100 $\pm 1$	
	(2.0 MA)	(3.0 MA)	
VOLTAGE REGULATION (variation in reference voltage exhibited by individual tube)			
LESS THAN 1 VOLT CHANGE FROM	0.3 to 10.0 MA	0.6 to 12.0 MA	
TEMPERATURE COEFFICIENT (TYPICAL)	-2mv / °C	-9mv / °C	
LIFE EXPECTANCY (hours)	30,000 hours	30,000 hours	

Tentative specifications subject to change without notice.

The above specifications represent only 2 of the 19 different voltage regulator tubes available. Other voltages available are 82, 91, 100, 103, 105, 110, 115, 139 and 143. For more detailed specifications, write for Signalite Application Newsletter Supplement #1 or contact us and describe your particular applications. If there is a glow lamp to meet your needs, we'll have it. If there isn't, we can design it.

**Signalite** INCORPORATED

NEPTUNE, NEW JERSEY • AREA CODE 201- 775-2490 • TWX 201-775-2255





TIGER TALE #1

## How do you ship an 84 ft. Whale?



### Put it in a Tiger's Tail!

We can put just about *any* size cargo into our straight-in-loading Swingtail CL 44s. Delicate shipments you can hold in one hand—or bulky shipments up to 84 feet long! Little jobs. Medium-size jobs. Really-big jobs. Even live whales!

Let our airfreight specialists tell you how we do it. Just give them a call. They'll come right over to tell you about the Tigers' new, low wholesale "Blocked Space" rates, frequent schedules and customized service. And they'll work with you to figure out the best way, the most efficient way to reduce your total distribution costs.

Phone, or write to the Tiger office nearest you. Or call your local freight forwarder.

**FLYING  
TIGER  
LINE**

*The Airfreight Specialist*





# This is ITT Electron Tube Division

**ACHIEVING THE BEST** is impossible without care and capability. Producing the best electron tubes—whether “standards” by the hundreds or “specials” by two’s—our care and capability becomes evident as in the envelope assembly of this miniaturized BWO (A) . . . in the final visual inspection of this massive hydrogen thyratron prior to packing (B) . . . in the eagle-eyed inspection of the delicate web-like grid of this industrial power triode (C) . . . exhaust and hydrogen fill process required for these thyratrons (D) . . . in the frequent inspection of tubes in stock (E) . . . in cradle-coddling this broadcast triode being readied for shipment (F) . . .

It's evident too in our production of the world's largest liquid cooled power tubes each weighing more than 80 pounds, or lightweight miniaturized, high resolution image dissectors for space exploration. Care and capability are part of the talents of the people of ITT Electron Tube Division who work for you at two new plants in Easton, Pennsylvania, and Roanoke, Virginia. Here they produce power tubes, hydrogen thyratrons, TWT's, BWO's, mm wave klystrons, storage tubes, image converters . . . and the tubes that are just beginning to take shape from ideas. This is a glimpse of what you'd see at these two unique facilities.

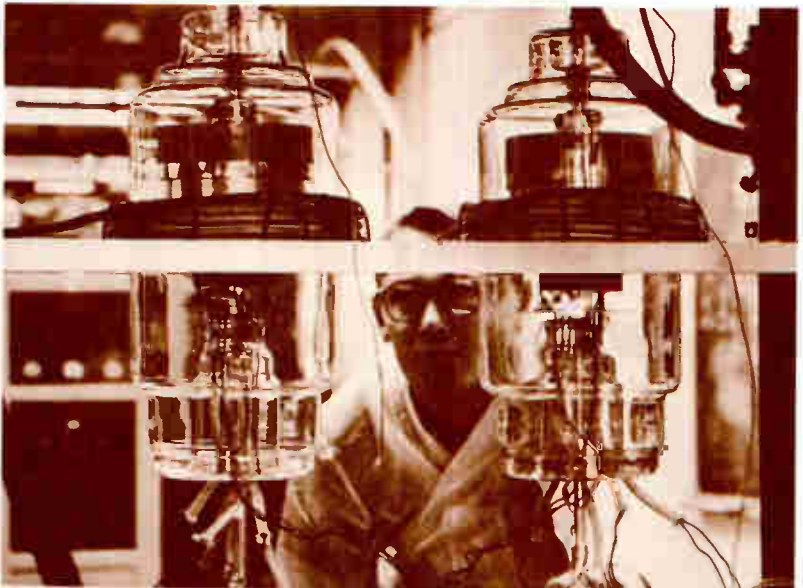
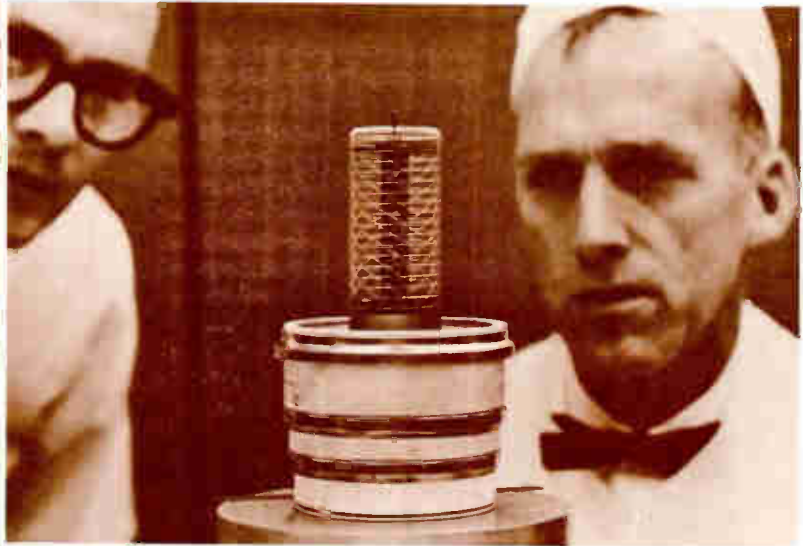
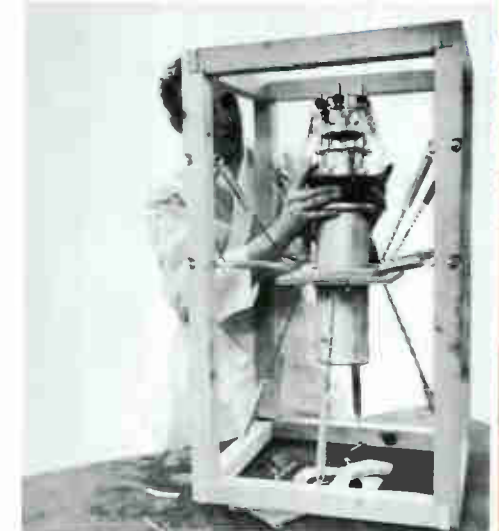
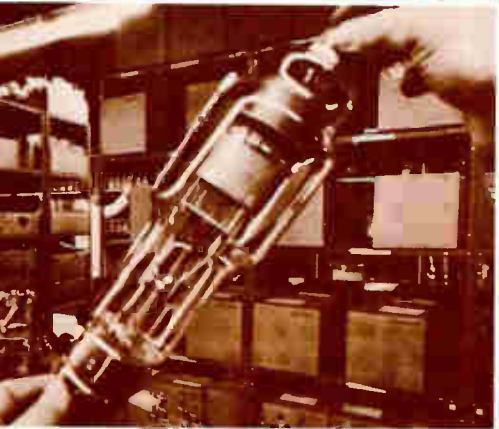

F





G

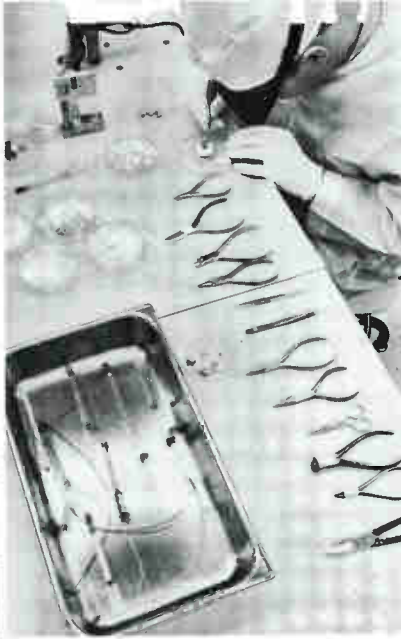

H

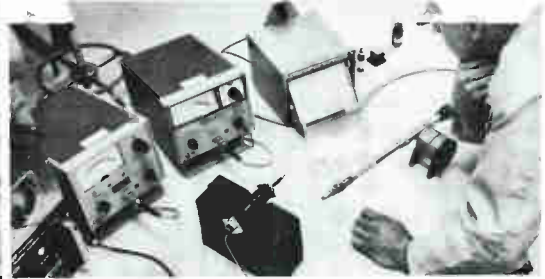

J

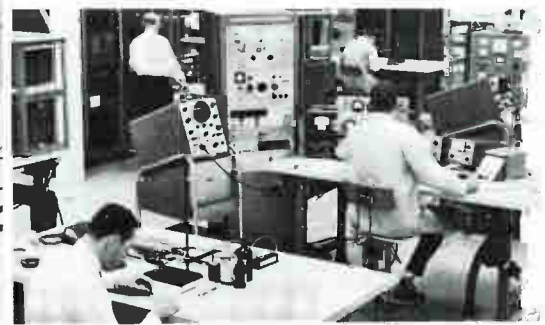

M



Q



R



N



P



O



U



# This is ITT Electron Tube Division

... engineers checking new needs against past performance, getting the facts that mean a new or improved tube (G) ... while microscopic elements of a new TWT are assembled with a surgeon's skill (H) ... design and craftsmanship are verified by precise recording and metering (I) ... followed by more test and development in this section (J) ... passing tests means production in this controlled atmosphere assembly room (K)



K



L

... where latex finger covers prevent minute quantities of skin oil from contaminating klystron elements during welding (L) ... storage tubes await transfer to the next stage of manufacture in the clean room air lock (M) ... where a facile technician weaves a web of wires, constructing the cathodes of a broadcast triode (N) ... wires are welded into a single structure in a hydrogen atmosphere (O) ... and inspected for possible flaws prior to complete assembly (P) ... joining and sealing the envelope that gives the tube its shape and substance is the work of

39 experienced glass blowers (Q) ... red hot heat degasses metals and the first shock of power begins a 20-hour seasoning of this triode (R) ... we test power triodes in this 600 kw test set, one of two such sets in existence (S) ... or carefully check the overall performance of these airborne weather radar thyatron (T) ... evaluate broad band TWT's (U) ... test peak power of hydrogen thyatron up to 288 megawatts in the largest test installation of its kind (V) ... conduct life tests on hydrogen thyatron in aisle after aisle of chambers such as these (W) ... and start to ship the ones that pass (X). ■ Ship well cradled, accompanied by a tattle-tale that tells of careless handling. Colored beads at the arrow's base stick to a tacky section in the middle if the crate is tilted off vertical (Y). ■ Care and capability ... from your requirement to design, development, production, to you ... care and capability, two factors that make ITT Electron Tubes just a bit

better than standard number and nomenclature indicates. (Is there a suffix for that spec number that means best?) ■ A partial listing of the hundreds of available tubes is on the next page. For a more complete tabulation or specifications write ITT Electron Tube Division, International Telephone and Telegraph Corporation, Easton, Pennsylvania.

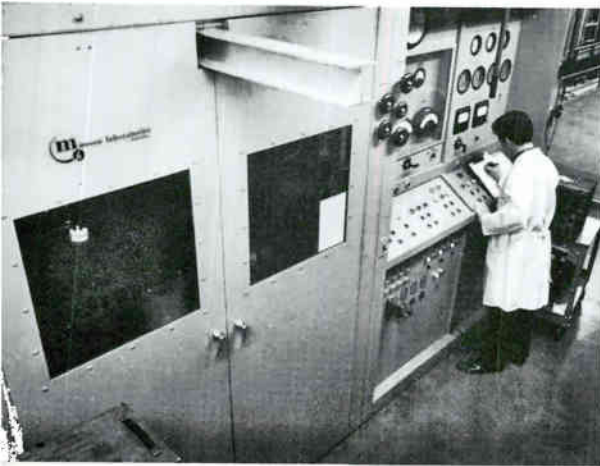

S



T

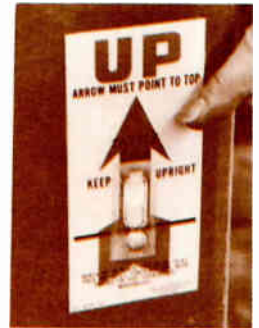

Y

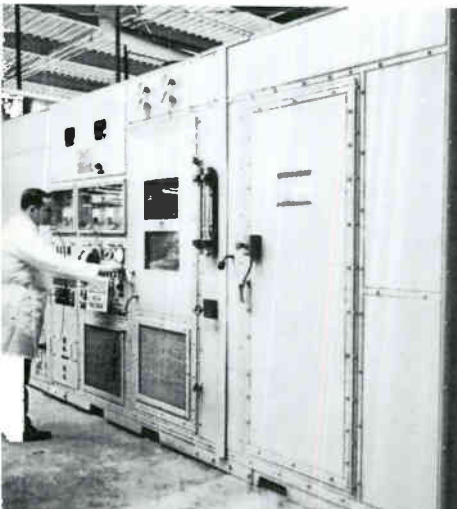

V



W



X



Here are a few of the hundreds of tubes available. Which ones do you need?

### PULSE POWER TRIODES

TYPE	Epx	Pulse Current Rated F11 Ipk
F-7C23	17.5	25
F-5680	17.5	35
F-5918	35.0	140
F-6398	65.0	400
F-6401	17.0	75
F-6920	35.0	140
F-7012	17.5	40
F-7560	46.0	375
F-7839	65.0	160
F-8033	65.0	500
F-8047	22.0	150
F-8145	75.0	300

Epx — max. peak inverse voltage

### TRAVELING WAVE TUBES

TYPE	Frequency KMF	Power Output (Watts)	Focus
F-2075	1.1 to 1.8	2	PPM
F-6658	1.7 to 4.0	2	S
F-6868	1.7 to 4.0	10	S
F-2086	2.0 to 16.0	2	PPM
F-2038	2.0 to 4.0	100(P)	S
F-6825	2.0 to 4.0	1000(P)	S
F-2057	2.0 to 4.0	1000(P)	PPM
F-2507	4.0 to 8.0	1000(P)	PPM
X-282	4.0 to 8.0	10	S
F-2019	4.0 to 8.0	10	PPM
F-2032	5.4 to 5.9	4000(P)	S
F-2071	5.0 to 11.0	1	PPM
F-2084	5.4 to 11.0	10	PPM
F-2552	7.0 to 11.0	20	PPM
F-2072	8.0 to 12.0	10	PPM
F-2087	8.2 to 12.4	15	PPM
F-2088	8.5 to 9.6	25	PPM
F-7340	7.0 to 11.0	1000(P)	S
F-2533	7.0 to 11.0	1000(P)	PPM

### CW POWER TRIODES

TYPE	Dissipation <sup>2</sup> (KW)	Input <sup>2</sup> (KW)
F-7C25	2.5	6.5
F-8C25	12	30
F-5604	10	32.5
F-5606A	10	30
F-5666	12.5	20
F-5667	7.5	20
F-5668	20	28
F-5669	10	28
F-5771	22.5	60
F-5874	25	30
F-6009	6	12
F-6366	3	7
F-6367	3	12
F-6374	70	150
F-6398	225	400
F-6399	6	9
F-6400	6	12
F-6696	60	144
F-6697	35	144
F-6800	10	40
F-6803	70	175
F-6804	35	150
F-6925	3	12
F-6926	6	12
F-7206	20	60
F-7207	17	30
F-7532	10	18
F-7560*	175	600
F-7820	4.3	
F-7831*	20	60
F-7832*	30	60
F-7837	90	200
F-7838	25	200
F-8033	90	200
F-8045	90	200
F-8046	35	200
F-8104	8	12
F-8131*	8	18
F-8132*	5	18
F-8133*	10	18
F-8146*	40	80
F-8147*	20	80
F-8148	40	64
F-8333	30	60
F-8387	45	250
F-8386*	100	250
F-8387*	45	250
F-8388	100	250
F-8550	45	120
F-8555*	3	16

\*Ceramic Construction

### HYDROGEN THYRATRONS

TYPE	Po MW	Epy KV
3645	.05	3.0
6777	.12	8.0
8370	.22	5.0
5957	.33	8.0
4635A	.35	8.0
7621*	.4	8.0
5622	2.0	16.0
6587	2.0	16.0
7782*	2.0	20.0
7665*	3.5	20.0
5949A	6.0	25.0
5948	12.0	25.0
7322*	12.0	25.0
8354*	12.0	25.0
7666*	18.0	25.0
1257	33.0	33.0
7390*	33.0	33.0
7667*	40.0	33.0
7890*	48.0	40.0
7866*	60.0	50.0
F-74B*	66.0	33.0
8479*	100.0	50.0
8301*	100.0	50.0

\*Ceramic Construction

### POWER DIODES

TYPE	Epx	Ipk
F-7030	25	30
F-7100	30	30
F-7131	40	40
F-7779	25	30
F-7869	56	65
F-7906	50	50
F-7907	50	50
F-8034	25	25
F-8109	60	60
F-8110	60	60
F-8207	30	20
F-8208	45	10

### BACKWARD WAVE OSCILLATORS

TYPE	Frequency KMC	Power Output (Watts) (mw)	Focus
F-2508	1.0 to 2.0	100	PM
F-2513	1.3 to 4.0	25	PM
F-2507	1.8 to 2.8	100	PM
F-2509	2.0 to 4.0	100	PM
F-2514	2.0 to 8.0	20	PM
F-2556	2.0 to 4.0(1)	10	PM
F-2512	3.6 to 7.2	20	PM
F-2517	3.7 to 5.5	50	PM
F-2544	4.0 to 8.0(2)	10	PM
F-2555	4.0 to 8.0(1)	10	PM
F-2510	4.0 to 8.0	25	PM
F-2521	5.4 to 5.9	250	PM
F-2516	5.3 to 11.0	25	PM
F-2518	6.6 to 8.7	50	PM
F-2547	7.0 to 11.0(1)	10	PM
F-2520	7.0 to 12.4	20	PM
F-2554	8.0 to 12.0(1)	10	PM
F-2511	8.0 to 12.4	25	PM
F-2557	12.0 to 18.0(1)	10	PM

(1) sub-miniature size—1.5 lb., 13 in.<sup>3</sup>  
(2) miniature size 3.5 lb., 36 in.<sup>3</sup>

### HYDROGEN DIODES

TYPE	Epx KV	ib a
F-51	15	
7178	16	500
F-52	18	325
F-91	15	150
8274	20	300
8275	30	500
8376	33	750
8276	40	2000

### IATRON STORAGE TUBES

TYPE	Diameter (Inches)	Focus Mode	Deflection
F-229	2.5	ES	ES
F-235	4.0	ES	ES
F-7173	4.0	EM	EM
F-212	5.0	ES	ES
F-241	5.0	ES	ES
F-243	5.0	ES	ES
F-267	5.0	EM	EM
F-3001	5.0	ES	ES
F-3006	5.0	ES	EM
F-3007	5.0	ES	EM
F-3010	5.0	ES	ES
F-3013	5.0	ES	EM
F-3014	5.0	ES	EM
F-7423	5.0	ES	ES
F-3018	5.0	ES	EM
F-201	6.0	EM	EM
F-245	7.0	EM	EM
F-247	7.0	ES	ES
F-3501	7.0	ES	ES
F-271	10.0	ES	ES
F-272	10.0	EM	EM

### TRIGGERED SPARK GAPS

TYPE	Maximum Holdoff Voltage KV	Energy Discharge Joules
F-810	14.0	200
F-811	7.5	200
F-820	30.0	2500
F-821	19.0	2500
F-822	42.0	2500
F-823	7.5	2500
F-830	86.0	4500
F-831	70.0	4000

### NOISE SOURCES

TYPE	Frequency Gc
F-2813A	1.0 to 2.0
F-2824A	2.9 to 3.1
F-2837A	5.4 to 5.9
F-2854A	8.5 to 9.6
F-2864A	15.0 to 17.0
F-2887A	26.0 to 40.0
F-2897A	50.0 to 75.0
F-2898A	60.0 to 90.0
F-2899A	90.0 to 140.0

### KLYSTRON TUBES

TYPE	Frequency GC	Power Output MW
F-2904	28.0 to 33.0	1100
F-2906	28.0 to 33.0	600
F-2900	33.0 to 40.0	1100
F-2905	33.0 to 40.0	600
F-2907	44.0 to 49.0	1100
F-2908	44.0 to 49.0	600
F-2902	69.0 to 76.0	250

electron tube division

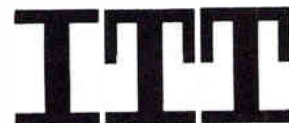

ITT Electron Tube Division, International Telephone and Telegraph Corporation, Easton, Pa



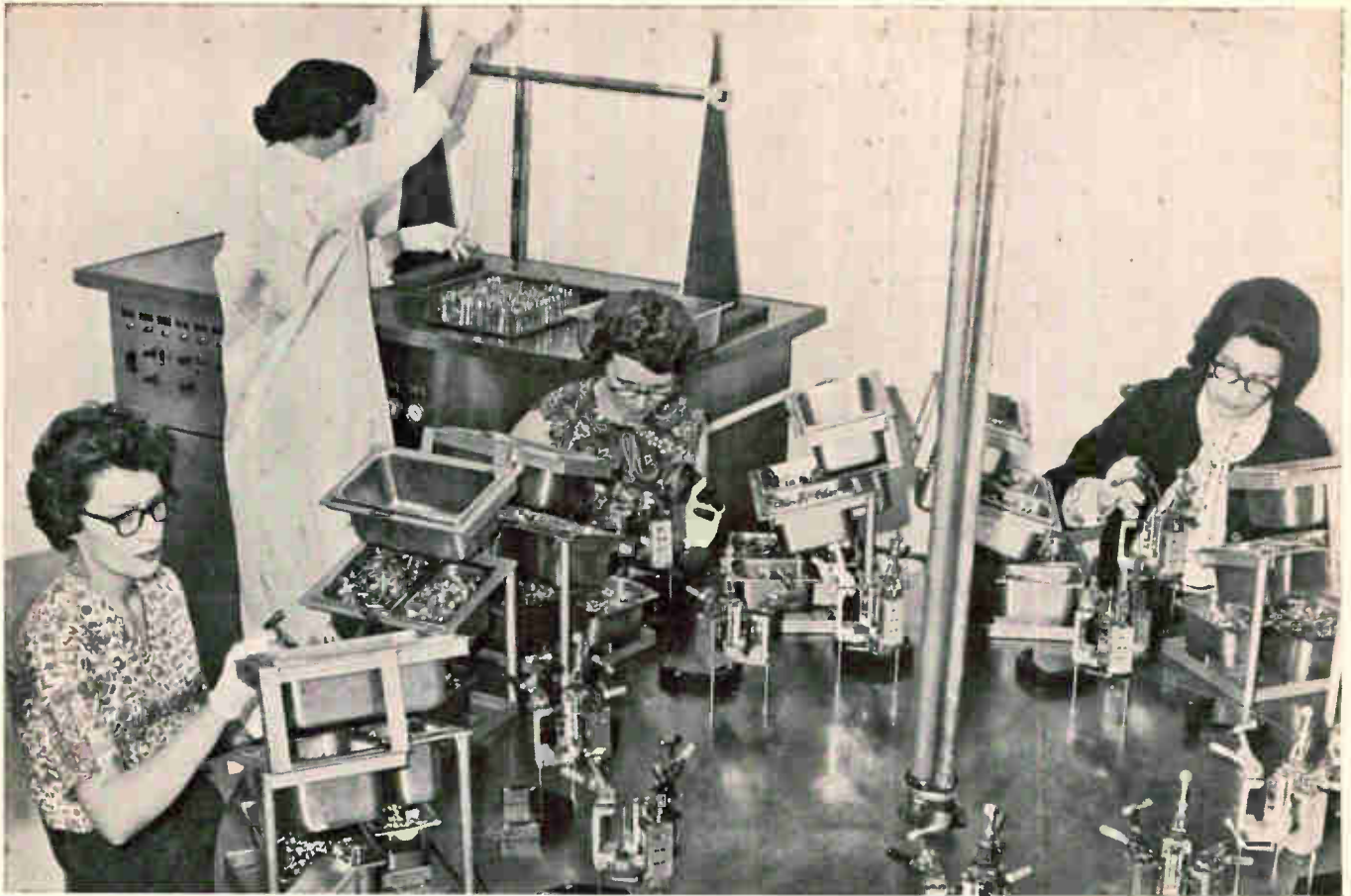

Because FREON solvents are nonflammable, relatively nontoxic and free from irritating odors, The Rauland Corp. can safely locate its cleaning equipment directly at the end of its assembly line for maximum efficiency.

## Rauland "super-cleans" color-TV picture-tube subassemblies with Baron Blakeslee ultrasonics and FREON® TF

Cleaning of color-TV-tube gun subassemblies is a critical operation because of the extremely high voltages to which they will be subjected. Any particulate matter not removed could cause arcing and a blown tube . . . any leftover lubricants would seri-

ously affect the rise time and service life of the tube. For this critical cleaning operation, The Rauland Corporation, Chicago—a subsidiary of Zenith Radio Corporation—uses FREON TF and Baron Blakeslee, ultrasonic equipment.

Now, cleaning of the subassemblies is a quick, simple, low-cost operation . . . thanks to a cleaning system engineered and installed by Baron Blakeslee, an authorized FREON solvent sales agent. This cleaning system uses FREON TF. The combined action of extremely low surface tension and high density enables FREON TF to penetrate minute crevices and effectively release and float away soils . . . even particulate matter. This results in complete, residue-free cleaning.

If you would like to investigate the many ways you can use FREON solvents in your cleaning operations, write Du Pont Company, "Freon" Products Div., Room 2318-A, Wilmington, Del. 19898.

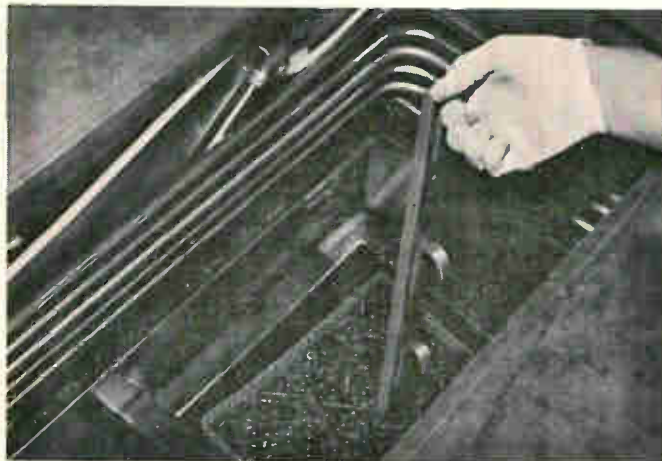

This combination cleaning system was engineered specifically for The Rauland Corporation by Baron Blakeslee, Inc., Chicago, Illinois. It is just another example of the complete cleaning-system engineering you can expect from your representative for Du Pont FREON.



Better Things for Better Living  
... through Chemistry



## Sigma relay idea of the month

# A self-monitoring long-distance alarm circuit that assures a state of constant readiness.

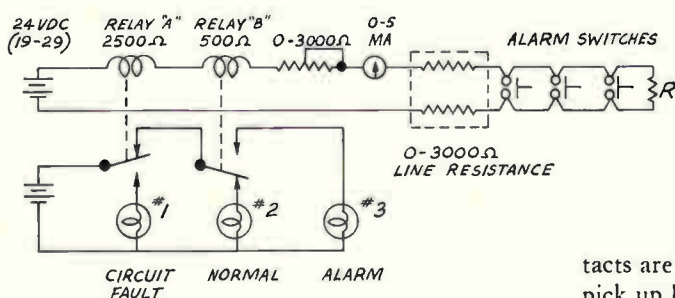

You may be able to use or adapt this relay idea. It's an alarm indicating circuit with fail-safe features that will operate over long wires from a central station. It uses two sensitive relays, such as the Sigma 4 or 26, to indicate by lights or signals, three conditions: 1. Normal condition—system functional. 2. Alarm condition—as a result of contact closure. 3. Fault condition—circuit resistance high or open.

Where the circuit is in the normal standby condition, current flow is sufficient to energize Relay A, but not Relay B. Lamp #2 is on, indicating NORMAL conditions. If any alarm con-

tacts are closed, circuit current is high enough to pick up both relays, causing lamp #3 to indicate an ALARM. An audible signal or any automatic device such as a fire extinguishing system can also be wired for simultaneous actuation. If the circuit is accidentally opened or has been tampered with, Relay A drops out, energizing lamp #1 which indicates circuit FAULT.

Typical applications include protection against fire, intrusion, high or low water level, excess pipe line pressure, or any industrial hazard where the chances of accidental circuit opening or penalty for failure are high.

If you have a relay idea—or can show us how to improve this one, we'd like to hear from you. Your relay idea could be the next one we publish.



## Sigma relay of the month

# New 10 amp DPDT relay with no internal switch wiring. Result: Longer life.

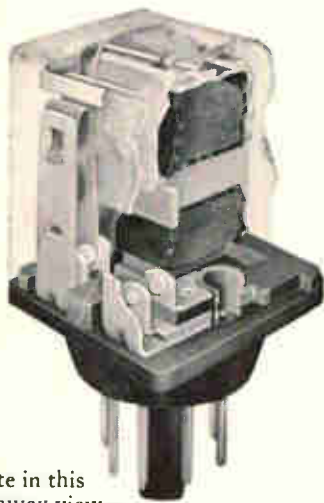

Note in this cutaway view—

1. Complete absence of internal switch wiring. 2. Long contact blades. 3. Switch, coil and frame assemblies mounted directly on the octal plug. These features result in an extra rugged, heavy-duty general purpose relay.

The new Sigma Series 46B general-purpose relay eliminates internal switch wiring and uses heavier switch members, to provide lower circuit resistance. At 10 amperes less than  $\frac{1}{2}$  watt is dissipated in the switch.

Long, flexible moving contact blades reduce stress and add to the durability of the 46B. Rated life of both the AC and DC versions ranges from 500,000 operations on a 10 amp, 115 VAC resistive load, to 10 million operations with a 1 amp, 28 VDC resistive load.

The UL approved 46B is rugged. Switch, coil and frame assemblies are solidly fixed to the octal plug-in base, instead of the plastic dust cover. This unitized design enables it to withstand severe industrial conditions of shock and vibration.

Test and compare the Sigma 46B—free of charge—against the make you are now using. Just send for the new Sigma Series 46B Bulletin and a free relay redemption certificate. Fill out the certificate upon receipt, return it to us, and we will send your free Sigma Series 46B to you.

SIGMA DIVISION



SIGMA INSTRUMENTS INC

*Assured Reliability With Advanced Design/Braintree 85, Mass.*

# PRESSURE MEASUREMENT REPORT

## CEC

REPORT NUMBER 1

### Meet CEC's multi-talented 4-361 Pressure Transducers

These advanced instruments are designed to function in nuclear radiation environments with simultaneous high temperatures or cryogenic temperatures. Each of the 4-361s provides a new spectrum of capability, accuracy and reliability combined within a single pressure transducer family.



TYPE 4-361

A major advance in the 4-361's design is all-welded construction. Even the unbonded strain-gage sensing element (itself a unique one-piece unit) is welded to the transducer assembly and uses boron-free ceramic insulators for maximum reliability in nuclear radiation environments. No plastics, solders or organic materials are used in the construction of these instruments.

Result...both the high temperature (4-361-0001 & -0005) and cryogenic temperature (-0002 & -0006) models are capable of maintaining superior performance characteristics under broad temperature extremes, acceleration, vibration and shock. And—all have the capability for precision adjustment of sensitivity, residual unbalance, thermal zero shift and thermal sensitivity shift.

☐ The 40-mv output permits these transducers to be used in conjunction with all conventional measuring devices

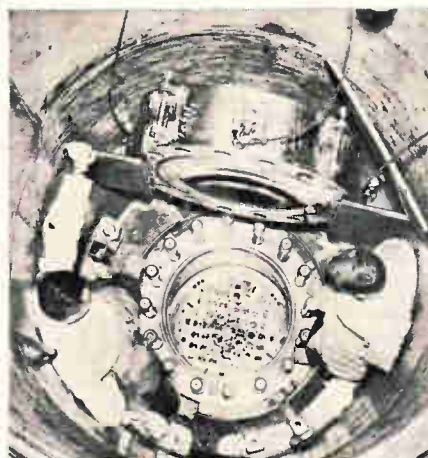

and signal conditioning equipment such as millivoltmeters, oscillographs, galvanometers, oscilloscopes and amplifiers.



TYPE 4-361 SENSING ELEMENT

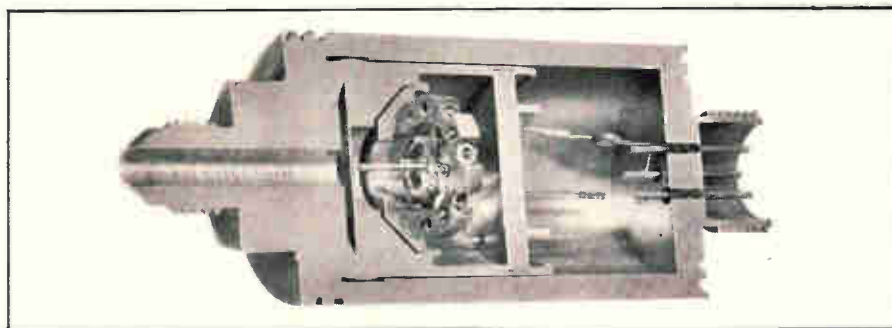

☐ The 4-361 is a case in point why CEC has become the acknowledged leader in the field of pressure measurement.

#### Some significant specifications:

☐ **Pressure Range...** 0-100 psi through 0-5000 psi absolute and gage. Standard ranges are 100, 250, 500, 1000, 2500 and 5000 psi. (0-100 psi through 0-1500 psi absolute and gage for cryogenic models).

☐ **Pressure Limits...** 1.5 times rated pressure without calibration shift, and 2 times rated pressure without permanent damage.

☐ **Rated Excitation...** 10-v DC or AC rms; carrier frequency 0-20 kc.

☐ **Input Impedance...** 350 ohms nominal, 330 ohms minimum at 77°F.

☐ **Sensitivity...** 40-mv  $\pm 25\%$ —10% open circuit at rated excitation and room temperature.

☐ **Combined Linearity & Hysteresis...** within  $\pm 0.75\%$  of full range output (at zero pressure, rated excitation, and 77°F).

☐ **Output Impedance...** 350 ohms  $\pm 10\%$  at room temperature.

☐ **Compensated Temperature Range...** 77°F to 600°F ( $-320^\circ\text{F}$  to  $+77^\circ\text{F}$  for cryogenic models).

☐ **Operable Temperature Range...**  $-423^\circ\text{F}$  to  $700^\circ\text{F}$ .

☐ **Weight...** 9 ounces maximum, excluding mating electrical connector.

The 4-361s are part of CEC's complete line that ranges from primary and secondary pressure standards to operational transducers for any environment or application. For all the facts about these advanced new transducers, call or write CEC for Bulletin 4361X3.

**CEC**  
Transducer Division

**CONSOLIDATED ELECTRODYNAMICS**

A SUBSIDIARY OF BELL & HOWELL/PASADENA, CALIF. 91109  
INTERNATIONAL SUBSIDIARIES: WOKING, SURREY, ENGLAND  
AND FRIEDBERG (HESSEN), W. GERMANY



***New; increased power, compact size,  
with the reliability of glass...***

## **4-amp glass rectifier**



*this small*

## **5-watt glass zener**



*this small*

# ***Two more firsts from Unitrode®***

These new units, with hard glass fused to the silicon surface — have the same voidless monolithic construction as the original Unitrode diodes and zeners of long-proven performance. Differing only in their slightly larger size, the new units offer higher power and higher surge capability with the same controlled avalanche and transient overload protection of the smaller devices. Unaffected by all military environmental testing, specified catalogue parameters are end-of-life limits.

New rectifier types are rated to 4 amps, PIV's from 50 to 800 volts, surges from 60 to 100 amps — all with controlled avalanche reverse characteristics.

New zeners, with 5 watt continuous ratings, fill the rating gap between 1 watt and 10 watt with low dynamic impedance and low leakage — voltage range is 6.0 to 400 volts. They withstand surges of 200 watts — two to three times that of conventional stud mounted 10-watt zeners. Axial leads make mounting a simple task. Write or call . . . Unitrode Corporation, 580 Pleasant St., Watertown, Mass. 02172. Tel: (617) 926-0404, TWX: (617) 924-5857.

Nationwide distribution by Compar.

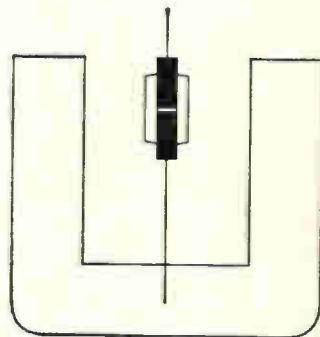

**UNITRODE®**  
*"better always/ by design"*



**every radar display should be**



**scan converted!**

---

You're looking at the reason. In the lower picture is the continuously televised radar presentation of upper New York Bay made possible by the U. S. Coast Guard's RATAN system and Raytheon's CK1383. The upper picture is a PPI radar display of the same data.

Heart of RATAN, an experimental Radar and Television Aid to Navigation system, is the dual-gun CK1383 Recording Storage tube that converts a harbor radar's circular scan to a horizontally scanned TV presentation. It also provides a bright display with target trails for course and speed indications of all moving vessels in the area (see insert). Thanks to Raytheon scan conversion, ships and even small pleasure boats may one day use low-cost UHF TV receivers to guide them safely through a harbor under all traffic and weather conditions. This is just one example of the many application possibilities of the CK1383. Characteristics such as high resolution, simultaneous write and read, variable automatic erase and high signal output make possible the design of advanced systems for stop motion, integration for signal-to-noise improvement, information storage for data, processing, slow-down video, time delay and phase shift.

Raytheon now offers miniature, ruggedized storage tubes in single and dual-gun versions as well as a broad line of standard and special storage tubes and display devices.



*For complete data on Raytheon storage tubes and display devices write Raytheon Company, Components Division, Industrial Components Operation, Quincy, Massachusetts.*





**Did you know that 19 of the 22 major connector manufacturers recommend Buchanan® Crimp Tools? — the other three make their own.**

**T**he reason is simple. Buchanan tools can be used with almost *any manufacturer's* contacts. No need to replace the tool every time you use a different contact. Simply change the positioner in the head. By selecting the proper positioner, you program the tool to provide crimp depth, crimp location and point of ratchet release. As we do not manufacture connectors, the full focus of our research and design has been spent to produce these most valuable tools. When you buy from Buchanan you avail yourself of an

experienced staff devoted exclusively to crimp applications and service assistance.

Buchanan tools are fully qualified to mil spec, proprietary and commercial requirements.

For more detailed information, write or call today, Buchanan Electrical Products Corporation, 1077 Floral Avenue, Union, New Jersey, (201) 289-8200, Telex 01-25471.

*See these tools in action at Booth 2433-2435 IEEE*



a subsidiary of Elastic Stop Nut Corporation of America

# Test signals

Accurate oscillators for every application, 0.00005 cps to 10 mc.

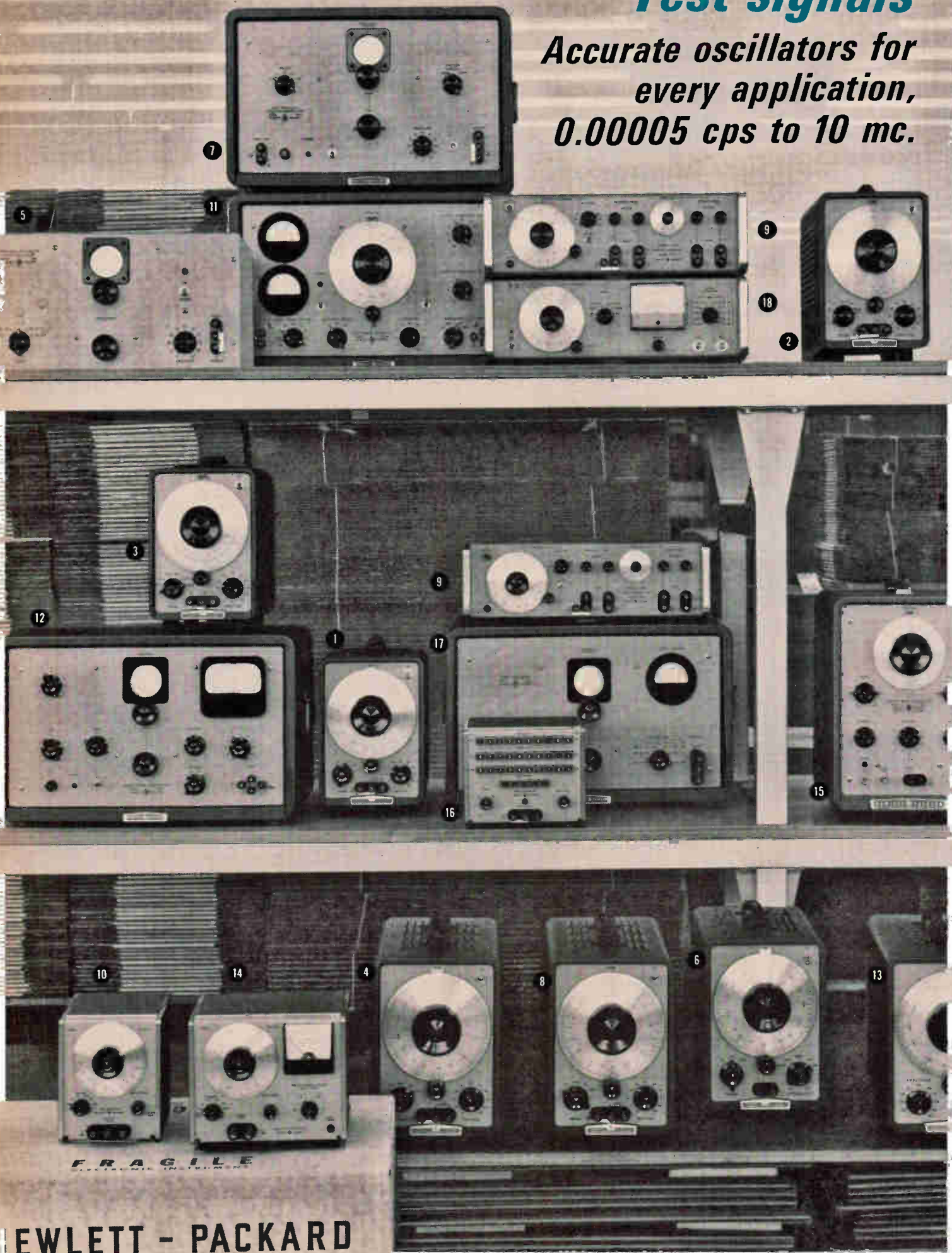

FRAGILE

HEWLETT - PACKARD



One of these accurate, easy-to-use Hewlett-Packard oscillators is just right for your test measurements. The resistance-capacitance oscillator, pioneered by Hewlett-Packard, offers simple operation, high frequency stability, wide frequency range, with low distortion, excellent frequency response and high amplitude stability. Controls are few and easy to use. Latest advancements are represented by new solid-state models. Each is designed to make your test work faster, easier and more economical.

Call your hp field engineer for a demonstration of the model most useful to you. Or write for complete data to Hewlett-Packard, Palo Alto, California 94304, Tel. (415) 326-7000; Europe: 54 Route des Acacias, Geneva; Canada: 8270 Mayrand Street, Montreal.



An extra measure of quality.

9784

	Model	Frequency Range	Description, Features	Output	Price
1	200AB Audio Oscillator	20 cps to 40 kc, 4 ranges	Ideal for amplifier testing, modulating signal generators, testing transmitter modulator response; balanced output	1 watt (24.5 v/600 ohms)	\$ 165*
2	200CD Wide Range Oscillator	5 cps to 600 kc, 5 ranges	Subsonic to radio frequencies, useful for testing servo and vibration systems, medical and geophysical equipment, audio amplifiers, video frequency circuits; low distortion independent of load	160 mw (10 v/600 ohms)	\$ 195*
3	200J Test Oscillator	6 cps to 6 kc, 6 ranges	Ideal for frequency measurements; < 0.5% distortion	160 mw (10 v/600 ohms)	\$ 350*
4	200S Test Oscillator	5 cps to 600 kc, 5 ranges	Frequency response testing	3 v/50 ohms	\$ 225*
5	200T Test Oscillator	250 cps to 100 kc, 5 ranges	Telemetry, carrier current tests; excellent frequency and amplitude stability	160 mw (10 v/600 ohms)	\$ 500*
6	201C Audio Oscillator	20 cps to 20 kc, 3 ranges	High power, designed for testing amplifiers, speakers, crossover nets; 40 db attenuator in 10 db steps	3 watts (42.5 v/600 ohms)	\$ 250*
7	202A Low Frequency Function Generator	0.008 to 1200 cps, 5 ranges	Source of continually variable, transient-free sine, square, triangular waves for electrically simulating mechanical, physical, medical phenomena; ±1% stability	28 mw (30 v p-p/4000 ohms)	\$ 550**
8	202C Low Frequency Oscillator	1 cps to 100 kc, 5 ranges	Ideal for subsonic, audio, ultrasonic applications such as vibration, electrocardiograph, electroencephalograph; < 0.5% distortion and < 0.1% hum; recovery time < 5 sec at 1 cps output	160 mw (10 v/600 ohms)	\$ 325*
9	203A Variable Phase Function Generator	0.005 cps to 60 kc; two lower ranges of 0.0005 and 0.00005 cps available on special order	Provides 4 simultaneous outputs, 2 sine and 2 square waves; one sine and one square wave phase-adjustable over 360°; sine wave distortion < 0.06%; rise and fall of square wave < 200 μsec; amplitude stability ±0.1 db; each output has an attenuator (cont. variable over 40 db); ideal for subsonic and audio vibration measurements and servo applications	Max. output voltage 30 v p-p open circuit for all outputs; output power is at least 40 mw (5 v rms into 600 ohms)	\$1200
10	204B Solid-State Portable Oscillator	5 cps to 560 kc, 5 ranges	Solid-state, portable, battery or optional ac operation output fully floating, will drive balanced and unbalanced loads referenced above or below ground; highly stable; distortion < 1%	10 mw (2.5 v/600 ohms)	\$ 315***
11	205AG Audio Signal Generator	20 cps to 20 kc, 3 ranges	A single instrument for making high-power audio tests, gain and frequency response measurements; two VM's measure input and output of device under test	5 watts adjustable/50, 200, 600, 5000 ohms	\$ 600**
12	206A Low-Distortion Audio Signal Generator	20 cps to 20 kc, 3 ranges	Distortion < 0.1%; ideal for testing FM broadcasting units, high fidelity audio systems; metered output, variable in 0.1, 1 and 10 db steps to 111 db	+15 dbm/50, 150, 200 ohms	\$ 900**
13	207A Special-Purpose Oscillator	20 cps to 20 kc, 1 range	Covers 20 cps to 20 kc in one sweep of dial; versions available with x-axis and/or motor drive at extra cost	160 mw (10 v/600 ohms)	\$ 425*
14	208A 208A-DB Portable Test Oscillators	5 cps to 560 kc, 5 ranges	Excellent frequency response and stability; output monitored by VM with 2% accuracy into 600 ohms; 208A is calibrated in volts; 208A-DB is calibrated in db; solid state; operates from rechargeable batteries and ac line	10 mw (+10 dbm) (2.5 v/600 ohms)	\$ 525 \$ 535
15	211A Square Wave Generator	1 cps to 1 mc	Provides square waves for audio, video testing, 20 nsec rise time; full amplitude variation on each of 2 outputs	3.5 v/75 ohms 27 v/600 ohms	\$ 350*
16	241A Pushbutton Oscillator	10 cps to 1 mc	Pushbutton selection of frequency for repetitive, production testing; excellent resettability, stability	10 mw (2.5 v/600 ohms)	\$ 490
17	650A Test Oscillator	10 cps to 10 mc, 6 ranges	Ideal for measurements in audio, supersonic, video, rf ranges; metered output flat within 1 db; distortion < 1%, 20 cps to 100 kc; less than 2%, 100 kc to 1 mc, approx. 5% at 10 mc; 50 db attenuator, 10 db steps	15 mw (3 v/600 ohms)	\$ 550**
18	651A Test Oscillator	10 cps to 10 mc, 6 ranges	Ideal for measurements in audio and communications frequencies, television frequencies; meter output flat within ±2%; typical amplitude stability 0.1%; 90 db attenuator, 10 db steps; two outputs 50 and 600 ohms; 4% frequency response	200 mw (3.6 v/50 ohms) 16 mw (3.16 v/600 ohms)	\$ 590

Cabinet models; rack mount models \$5 additional. \*\*Cabinet models; rack mount models \$15 less. \*\*\*AC operation optional, \$35 extra. Data subject to change without notice. Prices f.o.b. factory.

# COMPONENT COMMENTS *From Speer*

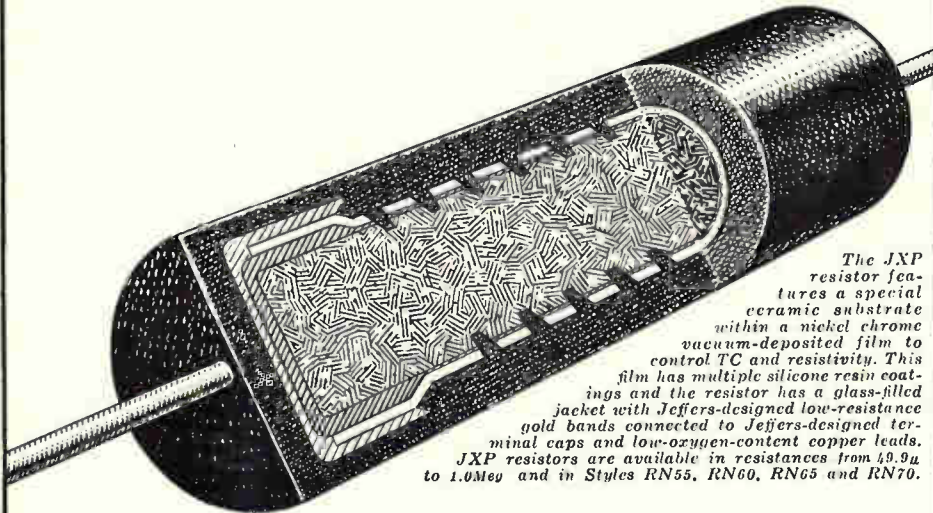

The JXP resistor features a special ceramic substrate within a nickel chrome vacuum-deposited film to control TC and resistivity. This film has multiple silicone resin coatings and the resistor has a glass-filled jacket with Jeffers-designed low-resistance gold bands connected to Jeffers-designed terminal caps and low-oxygen-content copper leads. JXP resistors are available in resistances from 10.9 $\mu$  to 1.0Meg and in Styles RN55, RN60, RN65 and RN70.

## Introducing JXP—the custom-tailored resistor with more precision than you may need

We're well aware that a tolerance of 0.1% (or even less) is one luxury most designers don't need in a resistor. But if you're one of those who have been waiting for just such manufacturing precision, you'll want to drop by Speer's Suite 1223 at the Essex House during the IEEE Show.

There you'll meet the JXP—the first custom-made, temperature-stable metal film resistor manufactured to precise target values.

Unlike most special film resistors, the JXP isn't an "off the shelf" assembly line item that accidentally checked out to the desired values. We established a *special task force* within our Jeffers Electronics Division, and we developed the JXP *deliberately*.

We might add that we engineer these new resistors with parental care, under conditions of hospital cleanliness. Thus



### Be our Guest

If you'd like to receive reprints of these "Component Comments," mail the coupon. We'll place you on our mailing list.

they always achieve predictable performance parameters. Notable ones, too. For example, temperature coefficients are close to zero ppm over the common temperature ranges. Matching to within 0.02% is no difficult feat. Matched sets can track within 5 ppm/°C of each other over the temperature range of -55° to +175°C. And JXP resistors meet all MIL-R-10509, Characteristic E, specs.

To learn more about our new ultra-precise resistors (or to discuss our familiar line of carbon composition resistors), see us in New York this week. Or mail this coupon, and we'll forward our JXP resistor brochure.

#### JEFFERS ELECTRONICS DIVISION,

Speer Carbon Company  
Du Bois, Penna.

Speer Carbon Co. is a Division of Air Reduction Company, Inc.

- Rush your JXP resistor brochure.
- Rush "Resistors for Precise Temperature Measurements of Cryogenic Environments."
- Arrange for me to receive reprints of "Component Comments."

Name \_\_\_\_\_

Title \_\_\_\_\_

Company \_\_\_\_\_

Address \_\_\_\_\_

City \_\_\_\_\_

State \_\_\_\_\_ Zip \_\_\_\_\_

## Some chilling experiments in resistor capability

It has come to our attention that a rather intriguing application has been found for our regular carbon resistors.

During the past decade, a number of researchers have been studying the effects of cryogenic environments upon various metallic and nonmetallic materials used in military defense applications. In order to insure precise temperature measurements under conditions approaching absolute zero, many of these researchers decided upon using Speer resistors as resistance thermometers.

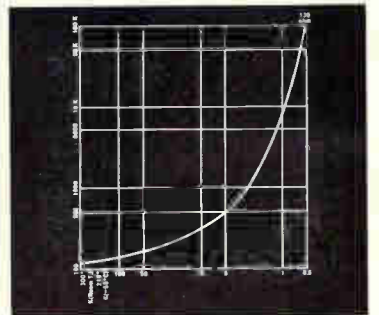

Log graph shows resistance-temperature characteristic of Speer 130-ohm carbon resistor between 300°K and .1°K.

Reports have been filtering in from Brown, RPI, Amherst—even from as far away as the National Physical Laboratory of New Delhi. And we're pleased to note that, invariably, our resistors have taken to this extreme cold like polar bears. Here, for example, is what one professor wrote about his studies: "The Speer resistors are generally most useful for accurate direct measurement in the temperature region 1° K to 0.01° K. The feature which makes them more desirable than other carbon resistors is their reproducibility (to within ¼%) from run to run even with cycling to room temperature and back."

We've prepared an article on these various studies, entitled "Resistors for Precise Temperature Measurements of Cryogenic Environments." You can get a copy by merely using the coupon.





# If you ship from 5 to 50 pounds anywhere in the U.S. you're missing a bet

## ...unless you check Air Express.

Among air cargo services, Air Express is quickest *and* often cheapest. Frequently even cheaper than surface!

For example, you can actually ship a 20 pound package from New York to Chicago by Air Express for less than motor carrier (\$6.20 vs. \$6.82).

Another point. Air Express rates are figured door-to-door. You only have one call, one waybill.

And there's more. Air Express can deliver by sunset tomorrow to any one of 21,000 U.S. cities.

Pickup is made within 2 hours of your call. Your packages get top priority on every scheduled airline after air mail.

On the ground, thousands of delivery trucks speed deliveries between you, the airports and your customers. Compare this with any other service available.

There is only one Air Express... it's a joint venture of all 39 scheduled airlines and REA Express. No wonder Air Express gives you the best service in the air and on the ground.

Next time you ship from 5 to 50 pounds, try Air Express. Simply call your local REA Express office for detailed information.

Air Express outdelivers them all... anywhere in the U.S.A.

*For booklet "When Air Express?" write Emil Seerup, Vice President, REA Express, Dept. C2, 219 E. 42nd St., New York, N. Y.*

**Air Express**  
Division of REA Express



## Kodak advertises:

chemical sweepstakes for laser fans . . . a richer potion for the coppermiths . . .  
photographic data-recording made easier

### Chelates for sale

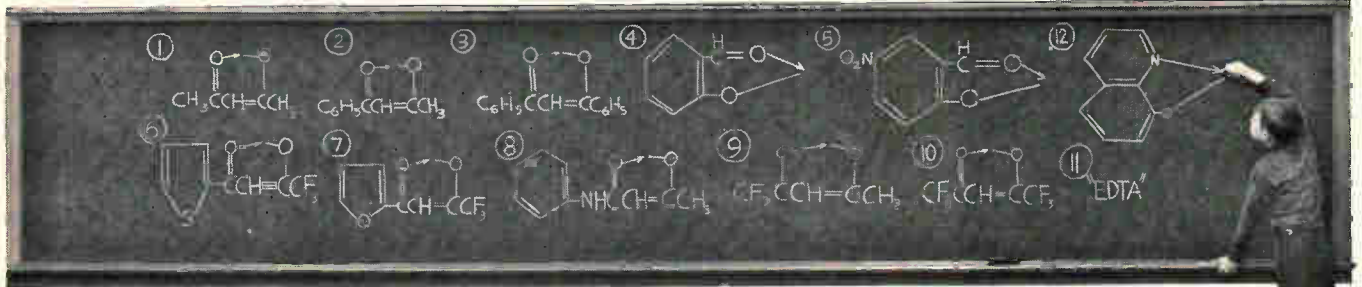

It is now necessary to keep up with many subjects that were not formerly considered part of the electronics art. Otherwise a man risks embarrassment and professional obsolescence. To pick out a good ligand to absorb pump energy and feed it to the right rare-earth ion is no child's play, and in the stylish new field of organic lasers such choice of a chelate combination is prerequisite to achievement of coherent brilliance.

We have a proposal. At about \$10 for a gram, we are currently furnishing any of the following combinations of the above-numbered ligands with the following rare earths:

①→Er<sup>+++</sup>, ②→Y<sup>+++</sup>, ②→La<sup>+++</sup>, ②→Ce<sup>+++</sup>, ②→Pr<sup>+++</sup>,  
②→Sm<sup>+++</sup>, ②→Eu<sup>+++</sup>, ②→Tb<sup>+++</sup>, ④→La<sup>+++</sup>, ④→Ce<sup>+++</sup>,  
④→Pr<sup>+++</sup>, ④→Eu<sup>+++</sup>, ⑥→Sm<sup>+++</sup>, ⑥→Eu<sup>+++</sup>, ⑥→Gd<sup>+++</sup>,  
⑥→Tb<sup>+++</sup>, ⑥→Yb<sup>+++</sup>, and EDTA→Ce<sup>+++</sup>.

The following chelates we have made experimentally and may have enough left over to sell to interested parties: ①→Eu<sup>+++</sup>, ①→Gd<sup>+++</sup>, ①→Tb<sup>+++</sup>,  
①→Tm<sup>+++</sup>, ①→Lu<sup>+++</sup>, ②→Nd<sup>+++</sup>, ②→Dy<sup>+++</sup>,  
②→Ho<sup>+++</sup>, ③→Sm<sup>+++</sup>, ③→Eu<sup>+++</sup>, ③→Tb<sup>+++</sup>,  
④→Nd<sup>+++</sup>, ④→Sm<sup>+++</sup>, ⑤→Eu<sup>+++</sup>, ⑦→Eu<sup>+++</sup>, ⑧→Tb<sup>+++</sup>,  
⑨→Sm<sup>+++</sup>, ⑨→Eu<sup>+++</sup>, ⑩→Eu<sup>+++</sup>, ⑫→Eu<sup>+++</sup>.

All other combinations (except chelates of the radioactive rare earth Pm) and any other proposals for ligands will be cheerfully considered for custom production.

Prices and proper chemical names will be quoted by Distillation Products Industries, Rochester, N. Y. 14603 (Division of Eastman Kodak Company).

### Resist change or change resists

We have raised the solids content and changed the solvent combination in KODAK Photo Resist. We are calling the new stuff KPR Type 2 and shall continue to supply the old formula for as long as enough customers resist change.

KODAK Photo Resist has had its little effect on electronic design—comparable in its little way with the little effect that KODACHROME and KODACOLOR Film had on picture-taking. (Take lots of black-and-white snaps last vacation?) In retrospect it seems inevitable that an effect had to be felt from a product that sort of coalesced design and fabrication, causing the actual manufacture to commence way back on the drawing board. At any rate, one needn't look very hard at a 1954 circuit to recognize it for the antique it is, and now even consumer electronics has to turn to photographic techniques to produce its tiny, tighter-toleranced printed circuits.

### A technology goes into hiding

We hoot and shout that the new KODAK RAR Films for data-recording can be processed as hot as 130°F. You counter that you can find your thrills elsewhere than on a developing-tank thermometer. Maybe you're not getting the full impact. *Consider the logic—*

The hotter the process, the shorter the time to the results. Basic principle.

The shorter the time, the less film is undergoing treatment inside the machine at a given instant.

The less film the machine has to contain, the smaller the machine.

Big machines that fill big rooms need crews with a sense of responsibility. Little machines over in a corner of the department draw no more attention than the pencil sharpener.

A hundred feet of film can capture and give back a staggering quantity of information. It works very directly. You can see the data. That's the good part. It was the bad part—the need to get involved in a fussy, unfamiliar technology—that

A single dip or spray of KPR2 should give these manufacturers (and any other customers to whom the difference between two dips and one dip is important) about 0.0003" of coating to expose to light under the negative of the circuit drawing. This thickness of resist remaining after development suffices for a stopoff in the electroplating. It defines the plating area better, untrammelled by humidity complications, because our new solvent system contains no water-miscible ingredients.

*Anybody who has tried working copper with the old KPR and wanted better results might now make a fresh approach. Order a quart of KPR2 from a Kodak Graphic Arts Dealer. Our suggested price is the same as for the old formula with the lower content of magic photopolymer. If added active ingredient in the bottle cuts the labor cost, it's a wonderful buy, particularly if it's free. We have to help our electronics friends. The new circuitry is no longer new, and competition is fierce.*

limited the number of high-volume data-recording applications. Now comes the day when the technology at last hides inside a little black box.

We can't kid you. We don't know where to send you for an all-purpose data-recording system, like a pencil sharpener that takes all calibers. Every engineer who has been thinking of photorecording without doing much of it has a special problem. (If it weren't a special problem, an engineer wouldn't be needed.) Where to take the special problem hasn't been clear. Now that neat solutions are more likely, we make an offer:

*Any engineer who is considering a photographic approach to a data-recording problem he faces and who will sit down and describe the conditions in a letter to Eastman Kodak Company, Special Sensitized Products Division, Rochester, N. Y. 14650, will receive a prompt and thoughtful answer. If we think he is over-optimistic, we'll say why. If we think some other company can help him better, we will direct him there. If we think that somewhere in the large corps of photo-technologists we employ on a diversity of tasks there are a couple of fellow engineers who can tell him what to do to advance his cause without dipping him any deeper into photo-technology than he wants to be dipped, we will arrange to get him and those fellows together in a room with a blackboard.*



# A COOL 400 V



Delco Radio's new DTS 413 and DTS 423 power transistors, are conservatively rated at 75 and 100 watts. Our standard TO-3 package assures low thermal resistance (junction to heat sink  $1.0^{\circ}\text{C}$  per watt) for cool power. The silicon element gives you high voltage protection, high frequency response and low saturation voltage.

The price is low (less than 3¢ a volt for sample quantities) for two reasons: special inter-digitated geometry of the devices and our unique 3D\* process for high yields.

Now you can reduce current, the size of other components, and increase efficiency in high energy circuits. Vertical and horizontal TV outputs, for example.

Your Delco Radio Semiconductor distributor has these two new power transistors on his shelf. Call him today for data sheets, prices and delivery.

\*Triple sequential diffusion

RATINGS	DTS 413	DTS 423
<b>VOLTAGE</b>		
V <sub>CEO</sub>	400 V (Max)	400 V (Max)
V <sub>CEO</sub> (Sus)	325 V (Min)	325 V (Min)
V <sub>CE</sub> (Sat)	0.8 (Max)	0.8 (Max)
	0.3 (Typ)	0.3 (Typ)
<b>CURRENT</b>		
I <sub>C</sub> (Cont)	2.0A (Max)	3.5A (Max)
I <sub>C</sub> (Peak)	5.0A (Max)	10.0A (Max)
I <sub>B</sub> (Cont)	1.0A (Max)	2.0A (Max)
<b>POWER</b>		
	75 W (Max)	100 W (Max)
<b>FREQUENCY RESPONSE</b>		
f <sub>t</sub>	6 MC (Typ)	5 MC (Typ)

**FIELD SALES OFFICES**  
 UNION, NEW JERSEY\*  
 Box 1018 Chestnut Station  
 (201) 687-3770  
 SANTA MONICA, CALIFORNIA\*  
 726 Santa Monica Blvd.  
 (213) 870-8807

DETROIT, MICHIGAN  
 57 Harper Avenue  
 (313) 873-6560  
 SYRACUSE, NEW YORK  
 1054 James Street  
 (315) 472-2668

PALO ALTO, CALIFORNIA  
 201 Town & Country Village  
 (415) 326-0365  
 CHICAGO, ILLINOIS\*  
 5151 N. Harlem Avenue  
 (312) 775-5411

General Sales Office:  
 700 E. Firmin, Kokomo, Ind.  
 (317) 452-8211—Ext. 500

**DELCO RADIO**

Division of General Motors

\*Office includes field lab and resident engineer for applications assistance.



# “Bat radar is fine— if you’re just after bugs.”

*An iconoclastic approach to natural phenomena... and recruiting... by John Byrne, R & D Director of Motorola's Military Electronics Division*

Recently, a zoologist colleague of mine, in a bit of interdisciplinary one-upmanship, snarled “You electronics people spend millions on radar research, yet you will never produce a system as elegant as the lowly chiroptera; excuse me, bat.” Had this surly character been applying for a job at our Radar Systems Laboratory, I would have torn up his resumé and thrown it in his face. In the first place





bats do not have true radar, but a type of orally-activated sonar that allows them to avoid obstacles and catch insects in the dark... sometimes.

**Target detection and object avoidance: bats vs. man** Despite some research on my part, I am unimpressed with the reliability of bat systems, and I have yet to discover any MTBF data. I did read that bats "seldom" run into things and that the most skilled bats can catch thrown mealworms and flying fruit flies 80 to 95% of the time. This may impress the "oh-the-wonder-of-it-all" types, but if that's your idea of reliability, don't come to me with a resumé. Perhaps our radar is a bit bulkier, but at least it's maintainable. Find me a bat with comprehensive spec sheets and interchangeable parts.

**Now take our new airborne terrain-avoidance radar system** It will guide low-flying vehicles over and around topographical obstacles at night and under all weather conditions. It also combines the capabilities of terrain-following, ground-mapping, and station-keeping. If you can find a bat like that, let me know. It uses a unique interferometer scanning method with a narrow synthetic beam, and has an information rate up to an order of magnitude greater than current operational equipment. Also, we may be the first to use integrated electronics extensively in a system of this kind, but that's another story. While I'm at it, I'd like to bring up the target detection capabilities of our radar guidance and fuzing systems. Unhappily, for security reasons I cannot be as specific as I'd like about how much more accurate and reliable our equipment is compared to bats. However, one reason the bat racks up an 80-95% "kill" record is his anatomical advantage. As

often as not, he misses his prey with his mouth, but snags it in passing with a wingtip. We can't afford such error tolerances in our radar target detecting devices, fuzing systems and missile guidance systems. If we could, we wouldn't have a need for top people.

**Not on my supersonic jet** I'll be the first to admit that bats detect smaller objects than our radar does. Myotis Lucifugus, for example, can detect a wire as small as a tenth of an inch in diameter... but he has to be within seven feet of it. A good man-made airborne radar system will pick up an object about a full yard in diameter, but at a distance of 50 miles or more. So if you still prefer bat radar, fine. Put it in your supersonic jet, not mine. Then don't blame me if you suddenly find yourself in a 10G pull-up trying to avoid Mt. Rushmore.



Advanced guidance and target detection devices for current missile programs.

**Getting down to earth** So, as I said, bat radar is fine if you want to catch bugs. However, we've solved much tougher problems. One was development of an airborne system which transfers data from a variety of sensors (including our operational AN/APS-94 side-looking MTI surveillance radar for the army). Rather than wax poetic, let me just say when it comes to data transfer systems we have a clear technical lead in several discrete areas, including solid-state circuitry, low-noise wideband receivers, and semi-secure tracking... and they work!

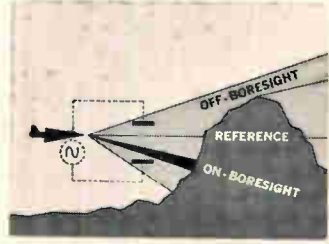

Advanced terrain-avoidance, terrain-following radar system with 1/10 second electronic vertical sweep.

**So, we're looking for applicants** But not men who are overwhelmed by bat radars. You should be able to design a more useful system blindfolded. If however, you can package your system into a bat-size module, I'll send you a blank check, plus a gold key to the executives' wash room.

**Join the fun** As you may have deduced, our engineers are involved in some rather far-out radar projects. If you'd like to join them, there may be a place for you if you can contribute in these areas: **SURVEILLANCE MAPPING RADAR** for drone aircraft—like our AN/DPD-3, successfully flight-tested by the Army, and the first of its kind. **RADAR INDICATORS** — along the lines of our new general purpose, all-transistorized AN/SPA-25. **RADAR TRANSPONDERS** — the rugged kind. One of ours augered in from over 500,000 ft., was dug out of the ground and tested 30 hours later. Frequency and sensitivity were still within specs! **SUBMINIATURIZED RADAR** — our attaché case-sized system for tactical handheld use is a marvel of integrated circuitry, molecular components and circuit commonality.



First Army surveillance radar to be flight-tested in a drone.



**MOTOROLA**  
An equal opportunity employer.

**Military Electronics Division**

SCOTTSDALE, Arizona, 8201 E. McDowell Road  
CHICAGO 51, Illinois, 1450 N. Cicero Avenue



**FREE LITERATURE!**

I'll send you details on Motorola's radar systems, equipment, and capabilities... even if you're not an applicant. I'll even throw in reference data on bats... if I haven't soured you on the subject. Attach this coupon to your letterhead and mail to me at our Scottsdale address, Dept. 202.

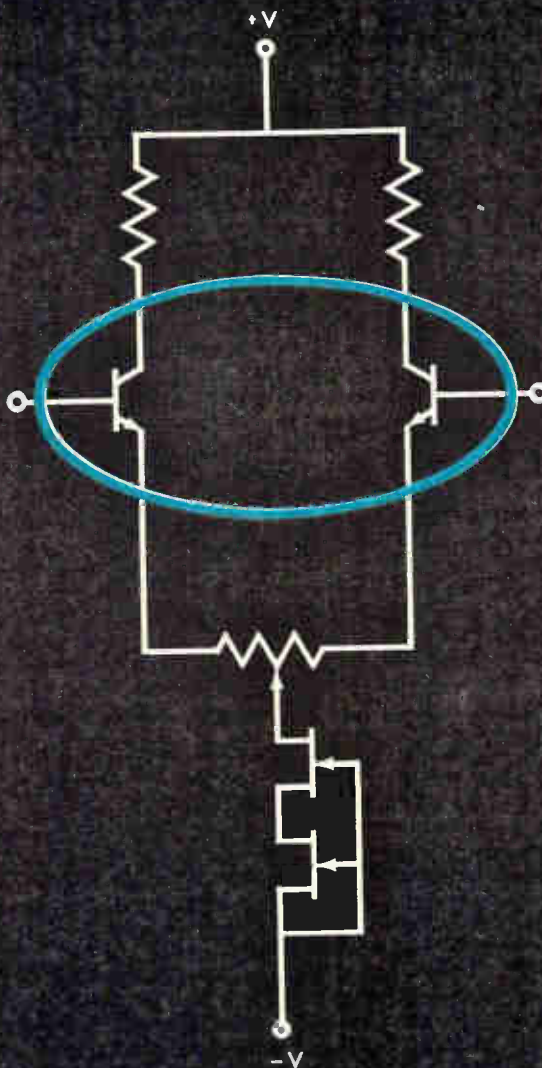

## THE LOW NOISE TWINS!

Solve your noise problems with Prime Dual Transistors from UNION CARBIDE ELECTRONICS. Lower noise is assured by advanced silicon planar processing and unexcelled quality control.

Use a simple constant current source, like the cascaded FET's shown. These Union Carbide FET's will improve your common mode rejection. If you prefer, simplify your entire job by using a Union Carbide Amplifier. The one shown is the H-1010.

You can obtain all of these products immediately from your distributor.

Call your distributor today and order from his extensive stock of UNION CARBIDE semiconductor products.

**UNION CARBIDE CORPORATION** 365 Middlefield Road, Mountain View, California 94041  
TWX: 415-969-9166; Telephone: 415-961-3300

**DISTRIBUTORS**  
R & D ELECTRONICS  
CAMBRIDGE, MASS.  
(617) 444-4500

EASTERN RADIO  
CLIFTON, N.J.  
(201) 471-6600

AVNET  
FRANKLIN PARK, ILL.  
(312) 455-8160

HALL-MARK  
TULSA, OKLA.  
(918) TE5-8458

AVNET  
SUNNYVALE, CAL.  
(408) 736-9989

K-TRONICS  
LOS ANGELES, CAL.  
(213) 685-5888

RADIO ELECTRIC SERVICE  
BALTIMORE, MD.  
(301) 539-3853

HALL-MARK  
GARLAND, TEXAS  
(214) 276-8531

ALMAC ELECTRONICS  
SEATTLE, WASH.  
(206) PA 3-7310

KIERULFF ELECTRONICS  
SAN DIEGO, CAL.  
(714) 278-2112

Here are specs on two of the many prime duals from UNION CARBIDE ELECTRONICS.

Characteristics	2N2453A		Units	2N2920		Conditions
	Min.	Max.		Min.	Max.	
$\beta_{FE1}/\beta_{FE2}$	0.9	1.0		0.9	1.0	$I_C = 100 \mu A, V_{CE} = 5V$
$ V_{BE1} - V_{BE2} $	3.0		mV	5.0		$I_C = 10 \mu A, V_{CE} = 5V$
$\Delta(V_{BE1} - V_{BE2})$	5.0		$\mu V/^\circ C$	10.0		$T_a = -55 \text{ to } +125^\circ C$ $I_C = 10 \mu A, V_{CE} = 5V$
$h_{FE}$	150	600		300		$I_C = 1 \text{ mA}, V_{CE} = 5V$
Registered NF (spot)	7		db	3		$I_C = 10 \mu A, V_{CE} = 5V$
Available NF (spot)	2		db	2		$f = 1 \text{ kc}, R_G = 10 \text{ k}\Omega$
$BV_{CBO}$	80		V	60		$I_C = 10 \mu A, I_E = 0$

**UNION  
CARBIDE**  
**ELECTRONICS**



---

# Washington Newsletter

---

March 22, 1965

## Industry fears DOD do-it-yourself

The defense industry fears that the Pentagon itself may try to perform some work that it now gives to private contractors. Electronics companies are particularly concerned with computer programming, maintaining and operating complicated electronic gear, writing technical manuals, and managing missile and other major weapons systems.

The General Accounting Office and some congressmen have complained about the amount of contracted work. The House Civil Service subcommittee claims that the Defense Department could save \$1.4 billion a year by doing much of the work itself.

In the past, the Pentagon defended its contracts on the ground that it couldn't do the work itself. But in the current drive to cut costs, it is having second thoughts and studying the possibility of finding that capability.

Industry officials are pressuring Secretary of Defense Robert S. McNamara with a fresh order from President Johnson—delivered at a recent Cabinet meeting—to shift wherever possible from government to private performance of work.

Deputy Defense Secretary Cyrus Vance, commenting on the White House directive, said it could “cost tens of millions of dollars.”

## AEC estimates electronics needs

The Atomic Energy Commission estimates that the proposed \$6.4-billion, 15-year high-energy physics research program, into the nature of the atom, represents an electronics market of \$130 million to \$190 million. Included are computers, instruments for control and detection and radio-frequency gear.

One of the major proposals endorsed by the Johnson Administration, the AEC and an array of leading scientists is construction by 1980 of a giant atom smasher, on the order of a trillion electron volts, at a cost estimated at \$300 million.

## Satellite costs up in the air

The European and American organizations that will share in the commercial satellite system disagree over how to divide the charges between satellite and ground station costs.

Europeans, led by the British, want the satellite fee kept to a minimum. For the U.S., the Communications Satellite Corp. wants it high enough to earn a reasonable profit.

Most of the foreign countries participating in the satellite system will use government-owned ground stations. These foreign governments will get all revenues earned by these facilities. But they will get only a minor percentage of revenues earned by the satellites, because the U.S. owns more than 50% of this part of the system.

Comsat doesn't yet know who will own the U.S. ground stations. The FCC has yet to rule for Comsat, individual carriers or a combination ownership.

## Fubini likely to quit Pentagon

There is a strong likelihood that Eugene Fubini, the Pentagon's top official in electronics and communications matters, [Electronics, Oct. 5, p. 103], will resign about the middle of the year as assistant secretary

# Washington Newsletter

of defense and deputy director of defense research and engineering.

Fubini, who has been at the Pentagon since 1961, has sold his home in the suburbs of Washington and friends say he is seriously considering three job offers—two from universities and one from a company. Fubini himself declined to comment.

## Pentagon pushes value engineering

Defense Secretary McNamara is ordering increased emphasis on value engineering in an effort to double savings by 1967 from the current annual rate of \$250 million.

McNamara has asked the military services and the Defense Supply Agency to restudy their programs and determine where VE personnel can be most productively assigned. He also has named a high-level group to evaluate these studies and to submit recommendations to him by April 30.

The Society of Value Engineers is arranging a series of briefings, at the Pentagon's request, to make sure industry understands the increased VE incentives now available. The briefings will be held in Dallas April 29, New York May 4, Chicago May 12, Atlanta May 18 and Los Angeles May 28.

## All-weather landing: the next step

The Federal Aviation Agency is expected to approve by this fall an extension of automatic all-weather landing systems for commercial airlines.

Trans World Airlines, Inc., and Pan American World Airways, Inc., have asked permission to use automatic controls down to 100 feet with quarter-mile visibility. United Air Lines Inc., and American Airlines, Inc., are expected to seek the same permission shortly. All trunk lines now can use automatic controls down to 200 feet with half-mile visibility.

At the moment, there are only six airports in the country equipped with gear that's compatible with the landing systems proposed by the airlines. However, some 30 more airports are expected to qualify by the end of summer.

## U.S. may increase computers research

Possible results of a Budget Bureau report on government use of computers are an immediate sevenfold increase, from \$100,000, for National Bureau of Standards research on computer compatibility, and an eventual quadrupling of the \$2.5 million the bureau now spends on all computer research.

The bureau also intends to develop a consumer's guide for agencies buying computers.

## Army outlines equipment needs

The Army is beginning to publish on a trial basis a detailed description of equipment it is contemplating buying. Seven items of the first listing of 23 are communications equipment.

Purpose of the list is to help contractors in their long-range planning. It will be published in Commerce Business Daily, a Commerce Department publication, on the first Tuesday of each month. The published listing constitutes neither a firm commitment to buy nor an invitation to bid.



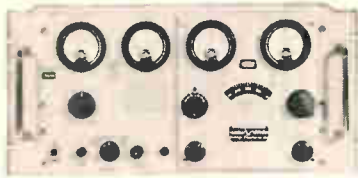

- TMR-2A: 215 to 265 mc Tuning Range; VFO or XTAL controlled. FM or PM.  
FM demodulators—Wideband, Narrowband, Phase lock.  
Phase Demodulators—Short loop.  
Pre-D: Plug-in record and playback modules.

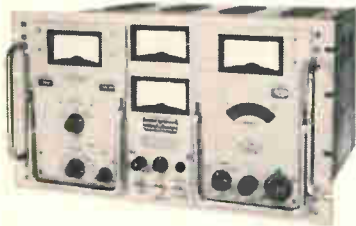

- TMR-5A: 55 to 2400 mc; Tuning Units VFO or XTAL controlled. AM/FM, PM.  
FM Demodulators—Wideband, Narrowband, Phase lock.  
Phase Demodulators—Short loop.

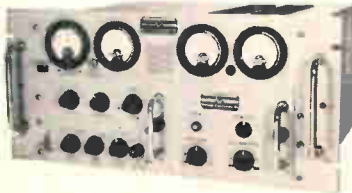

- TMR-6: 50 to 1000 mc; Fixed Frequency XTAL controlled RF Tuning Units. AM, FM or PM.  
FM Demodulators—Wideband, Narrowband, Phase lock.  
Phase Demodulators—Long loop.  
Pre-D: Plug-in record modules.

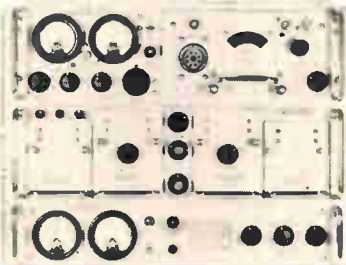

- TR-101: 100 to 2400 mc; Tuning Units VFO, XTAL controlled and Automatic Phase Control. AM, FM or PM.  
Dual Data Channels.  
FM Demodulators—Wideband, Intermediate, Narrowband.  
Phase Demodulators—Long loop, Short loop.



- TR-711: 100 to 2300 mc; Tuning Units VFO, XTAL controlled and Automatic Phase Control. AM, FM or PM.  
FM Demodulators—Wideband, Intermediate band, Narrowband.  
Phase Demodulators—Long loop, Short loop.  
Plug-in display unit or Pre-D record and playback modules, or oscilloscope.
- These receivers are compatible with TDC and DC series Diversity Combiners and the PRU-1 and PD-101 Predetection Record/Playback units. Plug-in IF bandwidth determining modules and plug-in demodulators are used in these receivers. Other options are described in individual receiver data sheets.

## DEI TELEMETRY RECEIVERS...

Technically Superior  
Reliable by design  
Modular for flexibility  
Available now

Telemetry receivers are very important at DEI. Development and planning never stop. We consider new requirements, new components and the constant need to advance telemetry system performance. It is a rare telemetry receiving function that cannot be met by a DEI catalog receiver/module combination.

DEI receivers that have been in use for many years are updated by module changes to achieve new system characteristics. System modifications are introduced with minimum interruption when the DEI modular approach is used.

For your telemetry applications, consult DEI, the company where receivers and receiving systems are constantly being improved.

*Write or call DEI for your copy of detailed specification sheets.*



**DEI**  
RESEARCH  
DEVELOPMENT  
MANUFACTURING

*Defense Electronics, Inc.*

*Rockville, Maryland*

ROCKVILLE, MD. (301) 762-5700, TWX: 302-427-4660; SHERMAN OAKS, CALIF. (213) 872-2870, TWX: 213-783-2742; COCOA, FLA. (305) 632-5400, TWX: 305-632-5442; WILLOW GROVE, PA. (215) 659-5051; INT'L.: ROCKVILLE, MD.: CABLE: DEIUSA

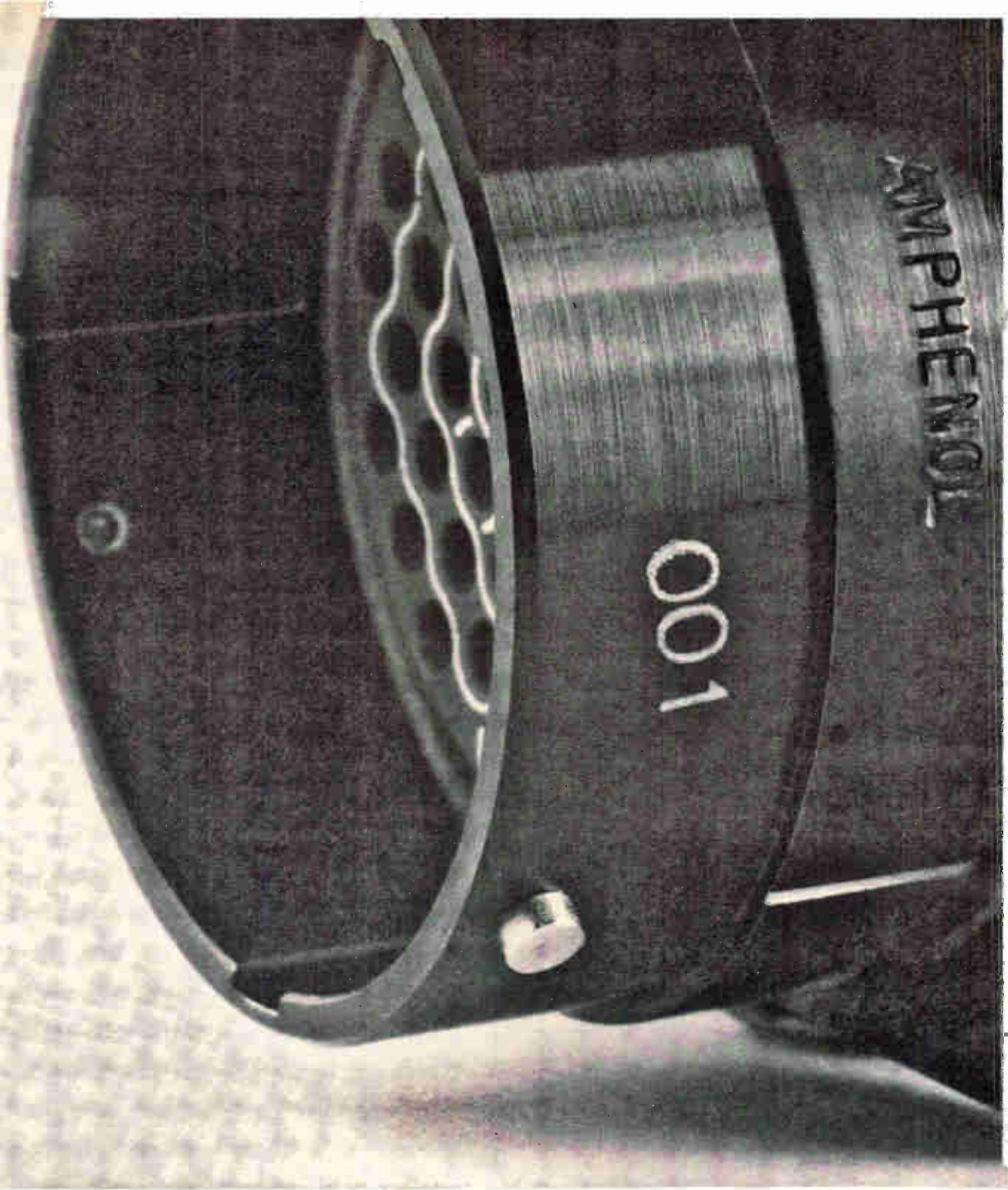

***Now Amphenol introduces  
connector traceability  
—by the number***

The "001" tells you this Amphenol 48 Series connector was assembled with a group of 1,472 other MIL-C-26500 connectors on Thursday, December 10, 1964.

All 48 Series connectors assembled on one day in the same production run are stamped with an identical number. We call it a Specific Control Number, or SCN. It's your reference



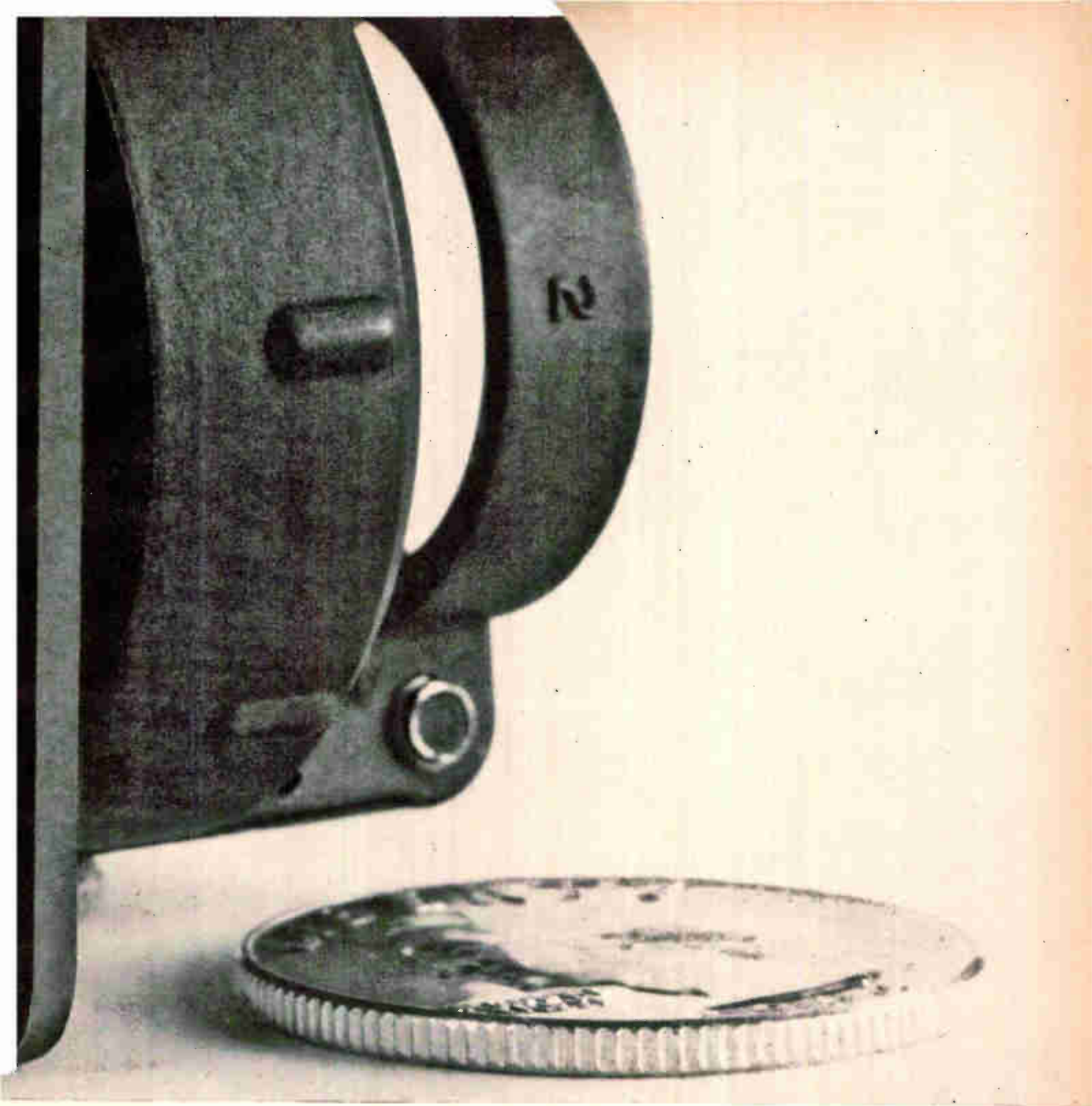

to a complete recorded history of the part and all others made during that particular production run.

This Amphenol SCN system assures complete traceability of every component part in every stage of production. We can start with a single component and trace up to the complete connector, or trace back from a connector to a part.

If any defective condition should be traced to "001", all that's needed is to check the connectors marked "001". It's a real time saver if you're dealing with thousands of connectors in a jet aircraft, missile, submarine, or computer.

We can give you a ready portfolio of traceability information when you need it—during design, during bread-

boarding, or during test model inspection.

Amphenol's is the only documented reliability you can get with a connector. So why settle for somebody else's confidence limits? Ask your Amphenol Sales Engineer. Or write the Amphenol Connector Division, 1830 South 54th Avenue, Chicago, Illinois 60650.

**Amphenol** CONNECTOR DIVISION

AMPHENOL-BORG ELECTRONICS CORPORATION

Specify Amphenol... the leading name in cable, connectors, assemblies, RF switches, potentiometers, microelectronics

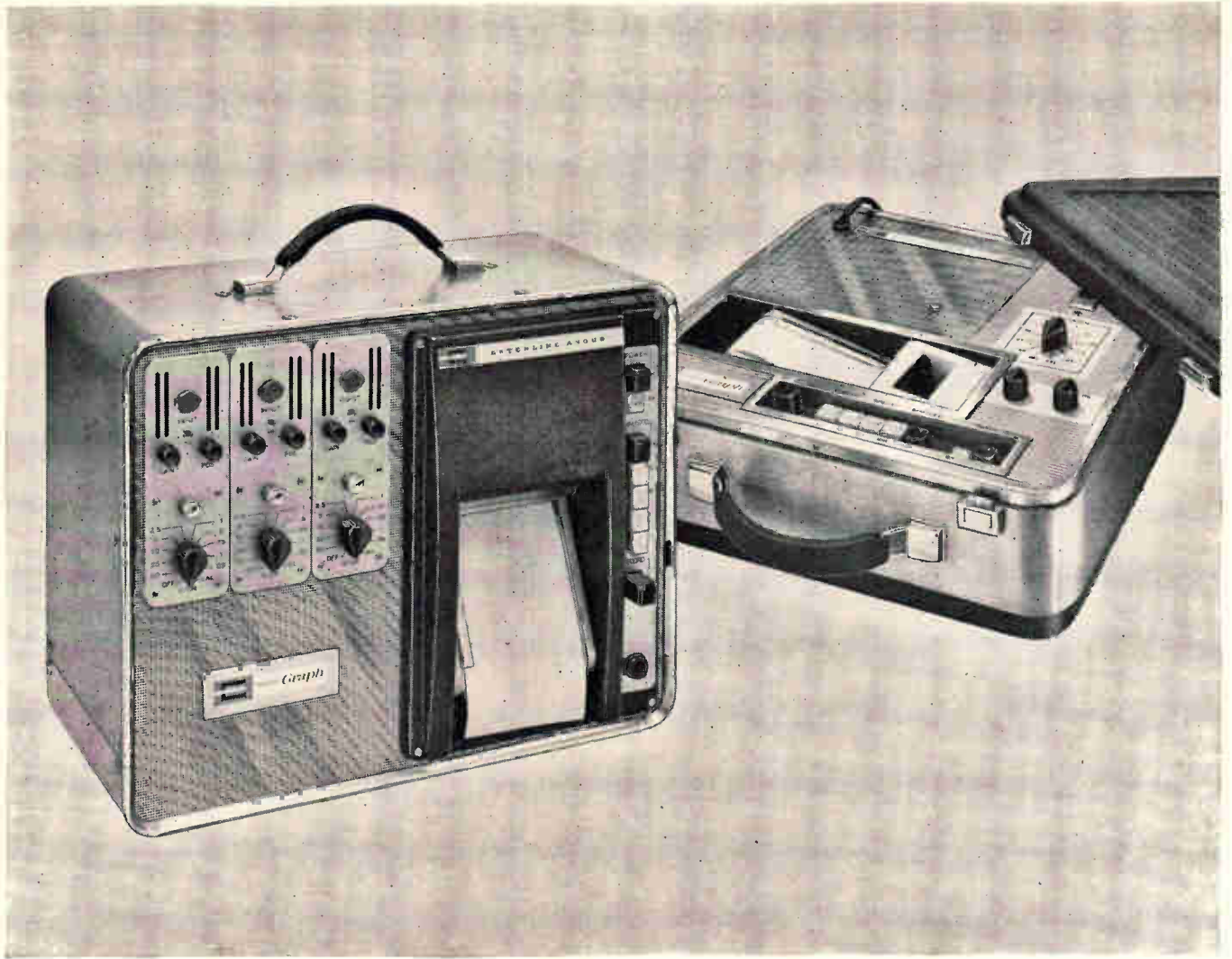

90 cps full scale response  
+  
3 channels

= your best Oscillo Graph buy

Take your choice—the only Three-channel Portable Oscillo Graph available, or Two or One-channel Oscillo Graphs.

All feature exceptional frequency response . . . flat to 90 cps at 30 mm peak-to-peak. It's down only 3 db at 125 cps. Other features:

- Balanced differential amplifier in modular form for Two and Three-channel Recorders. Same amplifier is built into the Single-channel Recorder.
- Four push-button controlled chart speeds—1, 5, 20 and 100 mm per second.
- Stylus motor uses no permanent magnets. Eliminates the clutter of brushes, slip rings, armature leads and linkages found in other stylus drive mechanisms.

Like cabinet model Esterline Angus Oscillo Graphs, portables employ the exclusive inkless, heatless Direct-Carbon-Transfer writing method. Advantages of D-C-T?

- Finest trace provides greatest resolution. 0.005 inch trace occupies only 1/2% of full scale. Competitive oscillographs produce a trace which is three times wider.
- No pens to clog or ink to splatter.
- Chart paper at half the cost of heat sensitive paper.
- No stylus temperature adjustments to bother with.
- Chart requires no special handling and is unaffected by light, humidity or temperature.

For trouble-free writing, economy and unequalled response, investigate Esterline Angus Oscillo Graph Recorders.

Write for colorful Series "O" catalog.

ESTERLINE ANGUS INSTRUMENT COMPANY, INC.  
Box 24000 E • Indianapolis, Indiana 46224

# ESTERLINE ANGUS



*Excellence in instrumentation for over 60 years*



# Technical Articles

---

**Selecting the right diode for r-f switching:**  
page 70

In many microwave systems, several transmitters share a single antenna. Currently, a p-i-n diode or varactor diode is often used to connect the antenna to the appropriate transmitter. These components have been designed and built to perform this function more reliably than high-speed computer diodes.

**New applications for cold-cathode tubes:**  
Part I: page 78



Although there is little new about the cold-cathode tube, engineers have been finding new ways to use it. For example, a long slender tube makes analog displays of temperature, speed, or fuel content possible. And tubes are doing more than just display work. In this article, new display applications are described; in the next two parts, trigger tubes and beam

switching will be the main subjects. The cover was taken for Electronics by British photographer Ron Applebee at the London plant of Mullard, Ltd.

**Bonding techniques for hybrid circuits:**  
page 86

The hybrid integrated circuit is preferred for linear work and when the volume of circuits to be built is small. But to operate satisfactorily the circuit has to be built right. A lot of work is being done in bonding techniques, joining component leads and thin films. Here are three new bonding methods.

**Europe's goal: Easy-to-operate color tv:**  
page 97

In Vienna, representatives of the International Radio Consultative Committee are meeting to choose one of three television systems for Europe: the United States' NTSC, France's Secam, or West Germany's PAL. The U. S. system has been in commercial use for 10 years; if it did not have technical shortcomings, there would be no contest. The French and German systems are said to eliminate technical weaknesses of the NTSC system. This article uses dramatic artwork in four colors to compare the vying systems.

---

**Coming  
April 5**

- **Special feature:**
  - Electronic instruments on board Gemini**
  - Malfunction detection system
  - Low-light-level television
  - Biomedical sensors
  - Rendezvous radar
- **Using cold-cathode tubes: part 2**
- **Production tips for engineers**

# Selecting the right diode for r-f switching circuits

Choice depends on power, frequency, good isolation, minimum insertion loss

By Robert Fekete,

Sylvania Electric Products, Woburn, Mass.

In many microwave systems, control of high-frequency power by switching is necessary. For example, several transmitters or receivers may share a single antenna. Varactor or p-i-n microwave diodes may then be used as radio-frequency switches to connect the antenna to the appropriate sender or receiver. The choice of the proper switching circuit and diode depends on operating frequency and power level, isolation, insertion loss, desired switching times, and bandwidth. Varactor and p-i-n diodes, which are controlled for microwave operation, give the best and most predictable performance.

Switching with varactor diodes is not unlike switching with conventional diodes. With the diode properly inserted in the transmission line or waveguide connecting the source and the load, transmission of r-f power can be controlled (switched on or off) by changing the polarity of the bias voltage. Power may range from microwatts to kilowatts, and the operating frequencies may be as high as 10 gigacycles per second. The forward-biased diode presents a low impedance and a reverse-biased device a high impedance, provided that the operating frequency is below the self-resonant frequency of the diode.

## Switch characteristics

Good isolation capability is important since the prime purpose of the switch is to connect or remove a specific portion of the system. Isolation (IS) is measured with the switch off and is given in decibels by:

$$IS = 10 \log \frac{P_{IN(max)}}{P_{L(off)}} \quad (1)$$

where  $P_{IN(max)}$  = maximum power available from

$$\text{the generator, } = \frac{V_o^2}{4Z_o}$$

$P_{L(off)}$  = power delivered to load with switch off

$V_o$  = generator voltage

$Z_o$  = characteristic impedance of transmission line

Insertion loss is the ratio of the power absorbed by the load before insertion of the four-terminal network containing the diode switch to the power absorbed with the network in place, between the generator and the load. The expression for insertion loss in decibels is:

$$IL = 10 \log \frac{P_{IN(max)}}{P_{L(on)}} \quad (2)$$

where  $P_{L(on)}$  = power transmitted from generator to load with switch on

Optimum performance depends on the over-all system design as well as the careful choice of the proper diode.

The dissipation ratio which results from the insertion of the diode switch network is given by:

$$D = \frac{P_{IN(max)}}{P_D} \quad (3)$$

where  $P_D$  = dissipation of the diode after insertion.

Dissipation ratio is measured with the switch in the off condition (no transmission of power is taking place).

## Equivalent circuit

In switching service, the varactor diode can be represented by a pair of small-signal equivalent circuits as shown on page 71 (one for the on condition, the other for off). The varactor package con-



tributes a series inductance  $L_s$  and capacitance  $C_p$ . The diode itself contributes a voltage-dependent junction capacitance  $C_j$  shunted by leakage resistance  $R_p$ , and series resistance  $R_s$ , which is the sum of the semiconductor bulk and contact resistances.

Usually,  $R_p$  is much greater than the capacitive reactance of the junction at the operating frequency, and therefore can be neglected. The junction capacitance of a varactor with graded-impurity junction construction is given by:

$$C_j = \frac{C_{j0}}{[1 - V_b/\phi]^{1/3}} \quad (4)$$

where  $C_{j0}$  = junction capacitance of the p-n junction at zero bias

$V_b$  = d-c bias voltage (positive polarity for forward bias, negative polarity for reverse bias)

$\phi$  = contact potential of p-n junction, approximately 0.5 for silicon diodes

The reduction in normalized junction capacitance that occurs as bias voltage is increased is shown at the right.

If the varactor diode is forward biased into conduction, the semiconductor part of the package can be represented by  $R_s$  only, for the junction capacitance is nearly infinite and its reactance therefore approaches zero. The active part of the reverse-biased varactor is then a lossy capacitor composed of  $C_j$  and  $R_p$  with a quality factor  $Q$  given by:

$$Q = \frac{1}{2\pi R_s C_j (V_b) f_{op}} = \frac{f_{co}}{f_{op}} \quad (5)$$

where:  $f_{op}$  = the operating frequency  
 $f_{co}$  = resistive cutoff frequency of the varactor.

The resistive cutoff frequency can be expressed by combining equations 4 and 5 and using practical units for frequency (gigacycles per second), resistance (ohms) and capacitance (picofarads):

$$f_{co} = \frac{159}{(R_s)(C_j)(V_b)} \quad (6)$$

Cutoff frequency can be specified at different bias voltages; a common one is a reverse bias of -6 volts. The value of  $f_{co}$  at -6 volts is typically in the 10-to-300 Gc range, depending on the capacitance and breakdown voltage.

Variable-resistance diodes with p-i-n (p layer, intrinsic layer, n layer) construction are also used in microwave switching circuitry. The equivalent circuit for a p-i-n diode biased for forward conduction is identical to that of a varactor; therefore, all calculations and curves using the equivalent circuits shown are valid for both varactor and p-i-n diodes.

### Diode switching circuits

There are many possible diode-switching configurations, but only the transmission-type single-pole single-throw (spst) switches will be presented here. Transmission-type switches are parallel tuned, parallel untuned or series untuned.

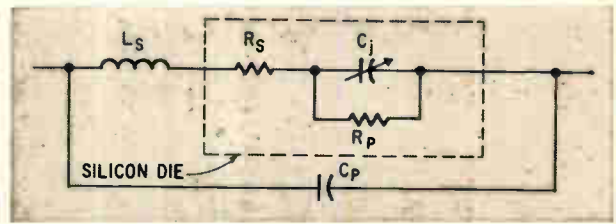

Small-signal equivalent circuit for a reverse-biased (non-conducting) varactor diode. The package contributes components  $L_s$  and  $C_p$ . The components  $R_s$ ,  $C_j$ , and  $R_p$  represent the device itself.

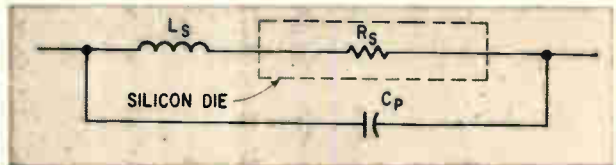

Small signal equivalent circuit for the varactor diode when forward biased. The semiconductor portion of the device is represented by  $R_s$ .

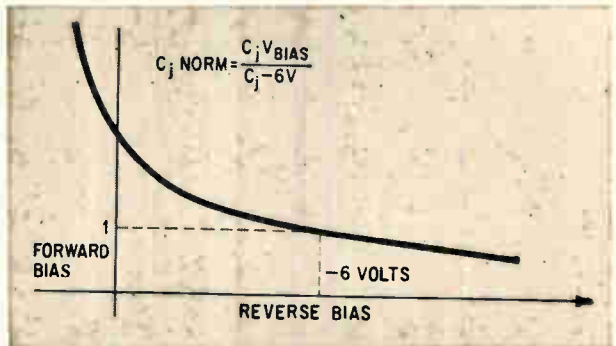

Normalized junction capacitance versus reverse voltage for a typical varactor diode. Capacitance  $C_j$  is normally specified at -6 volts, but some manufacturers specify  $C_j$  at voltages ranging from 0 to -12 volts.

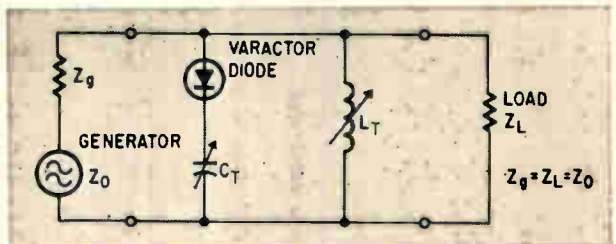

Simplified parallel tuned switching circuit. The switch is in the on condition (allows transmission of power) when the varactor diode is in the off condition (reverse biased).

### Parallel tuned switches

Good isolation and slight insertion loss can be obtained with a parallel tuned switch, but the bandwidth is narrow. A typical circuit for a parallel tuned switch is shown above and the equivalent circuits for the on and off conditions, are presented on page 73. When the varactor diode is reverse biased, the switch is on and power is transmitted from the generator to the load. With the varactor

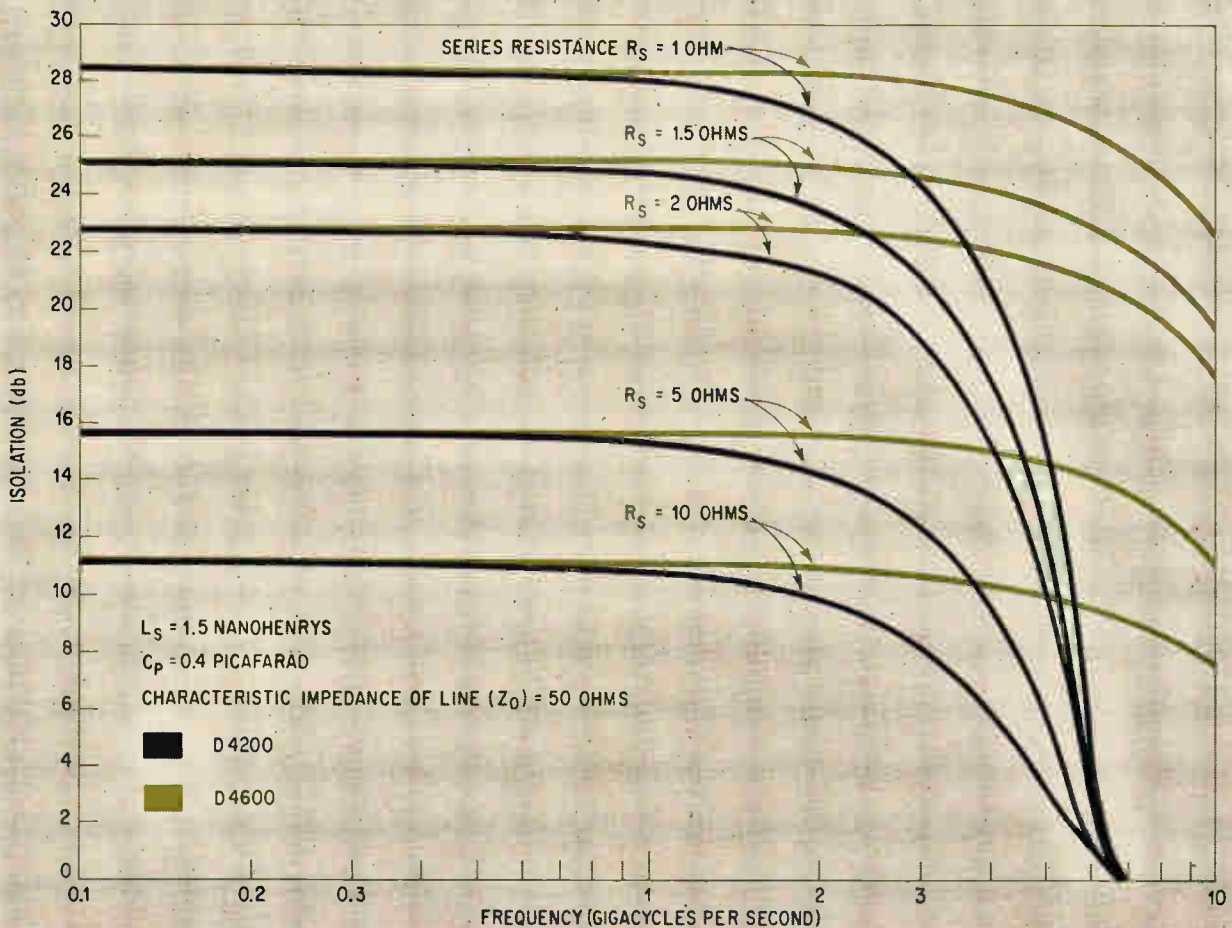

Isolation capabilities for two varactor diode families in tuned shunt-connected r-f switching circuits. Reduced varactor diode series resistance provides increased isolation capability. Curves shown in color for D4600 diodes indicate superiority of these devices at higher frequencies.

diode reverse biased and the operating frequency below the self-resonant frequency, the diode acts like a lossy capacitor. The series combination of the varactor diode and capacitor  $C_T$  is tuned to resonance by the parallel inductance  $L_T$ . At the antiresonant frequency, a parallel tuned circuit represents a very high impedance and therefore only a slight insertion loss will be caused by the presence of the diode switching network.

Thus, the parallel inductance is used to minimize the insertion loss by tuning out the capacitive reactance of the diode.

Turning the varactor diode on turns the switch off. If a forward bias is applied, the varactor diode will conduct and behave as a lossy inductance. The inductive reactance of the varactor is tuned out by the series capacitance  $C_T$ . The series-tuned circuit composed of the varactor diode and  $C_T$  represents a very low impedance at the resonant frequency. Since the transmission line is now shunted by a low impedance, reflection of the incident power occurs resulting in a high degree of isolation between generator and load. Thus, the series capacitance  $C_T$  is used to achieve maximum isolation.

The determination of the proper diode for this circuit is simplified if design curves for isolation

vs. frequency are available. For example, the curves for the D4200 and D4600 shown above indicate that the D4600 would be the probable choice for operation at higher frequencies. Representative insertion loss and dissipation loss curves are also shown on pages 73 and 74.

A circuit diagram of a practical parallel tuned switch using coaxial or stripline transmission is given on page 75. Because isolation and insertion loss is optimized by the use of tuned elements, the operating bandwidth of the circuit is limited to a few percent of deviation from the operating frequency.

#### Parallel untuned switches

A simplified circuit and wider bandwidth can be achieved with the parallel untuned switch. Since neither isolation nor insertion loss can be optimized, both of these characteristics will be somewhat inferior to a tuned network's. If more isolation is required, a number of diode switches may be cascaded by spacing them at quarter wavelengths along the transmission line. Performance characteristics of diodes in parallel untuned switches are shown on pages 76 and 77. The curves clearly indicate that both junction capacitance and series



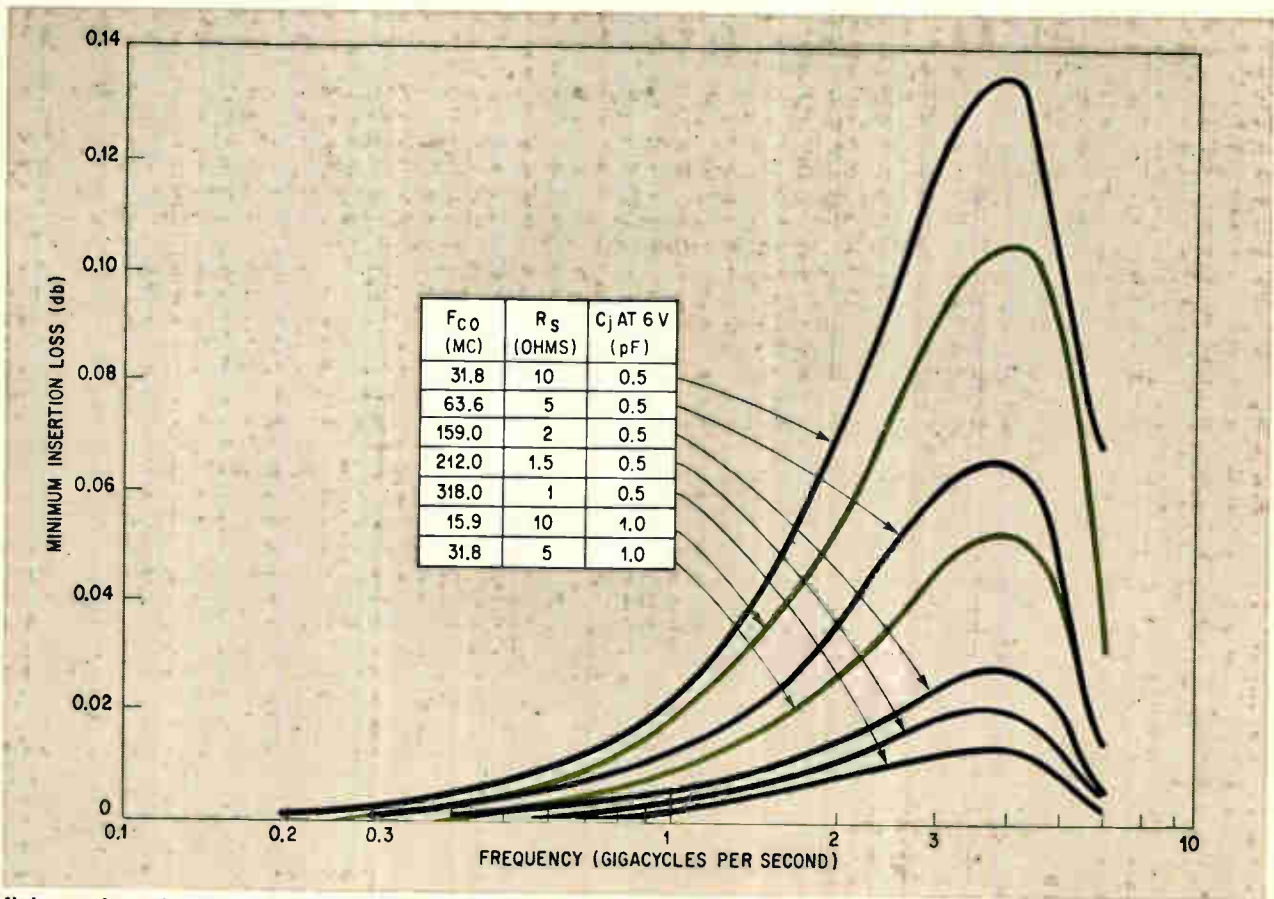

Minimum insertion loss plotted against frequency for a D4200 varactor diode family in tuned shunt-connected r-f switching circuits. Curves shown in black indicate how a reduction in diode series resistance decreases the insertion loss. Curves shown in color illustrate the adverse effect on insertion loss capability caused by increased junction capacitance.

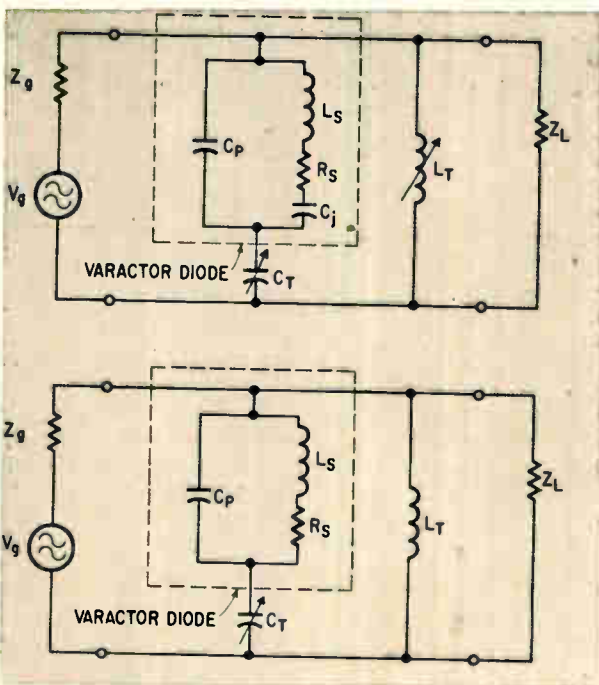

Equivalent circuits for the parallel tuned switching circuit. Top circuit represents the four-terminal network during transmission of power. In the bottom circuit, the switch is in the off condition.

resistance have to be kept to a minimum for practical isolation and insertion loss values. The self-resonant frequency is in X-band for the D4600 and D5151. In the vicinity of the self-resonant frequency, isolation occurs when the device is reverse biased and transmission when it is forward biased, because at this frequency, the switch is essentially a tuned structure. The parasitic elements of the diode provide the tuning.

#### Series untuned switch

In the vhf and low uhf range, high isolation and low insertion loss can be achieved using very low-capacitance diodes in the series untuned configuration. Performance characteristics are given on pages 76 and 77.

#### Design considerations

The biasing networks can slightly modify the operation of the switching circuits previously described. The performance curves were calculated using the small-signal equivalent circuit of the varactor diode. Deviations from the curves shown may occur in large-signal operation, mainly in the case of the reverse biased varactor. If a large r-f signal is applied to a device in a tuned structure, the average capacitance is a function of the signal

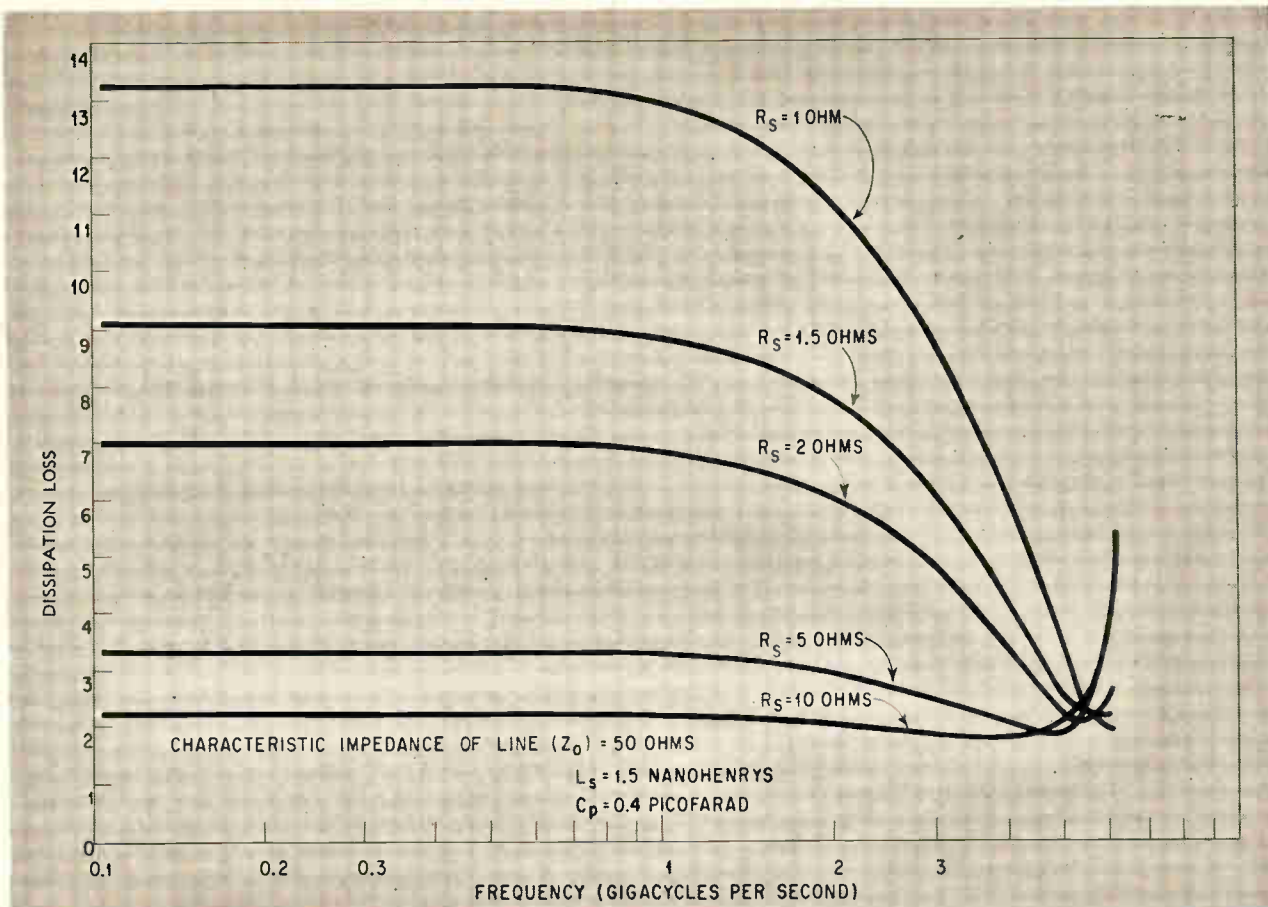

**Dissipation ratio** is measured with the switch off and is equal to the maximum available generator power divided by the diode dissipation. Curves shown are for D4200 family diodes in tuned shunt-connected r-f switching circuits.

level (voltage swing); and depending on signal amplitude, detuning may occur. With p-i-n diodes and forward-biased varactor diodes, no significant detuning takes place.

The breakdown voltage of the reverse-biased diode must be high enough so that the input r-f voltage swing will not result in conduction or breakdown. The approximate required breakdown voltage may be calculated from:

$$(V_B)_{min} = 2.82 \sqrt{P_{in} Z_0} \quad (7)$$

The table shown below gives the minimum breakdown voltage requirements versus input power for a 50-ohm line. Since the maximum breakdown voltage obtainable for present varactors is approximately 150 volts, and it is advisable to use more than the minimum calculated breakdown voltage, the use of p-i-n diodes is required when the input power exceeds 20 watts.

The voltage swing across the switching diode can be reduced if a transmission line with a charac-

teristic impedance less than 50 ohms is used. In this case, however, the design curves shown here cannot be used directly.

The reverse bias for diode switches may vary from a few volts to approximately half the breakdown voltage, depending on the input power and the diode used. Forward bias must be sufficient to cause heavy conduction in the order of 20 to 100 milliamperes. The turn-on and turn-off time of the diode switches is determined by the device and the switching pulse. Usual turn-off time (time required to remove the diode from the forward conduction condition) is from 1 to 5 nanoseconds for varactor diodes and over twenty nanoseconds for p-i-n diodes. Turn-on times range around 0.5 to 1 nanosecond for both types of devices.

The turn-on time of a parallel switch is determined by the turn-off time of the diode, while the turn-on time of a series switch is determined by the turn-on time of the diode.

### Selection of diode

The design of a switching network requires that the following be known: operating frequency,  $f_{op}$ ; power level to be switched,  $P_{in}$ ; bandwidth, BW; minimum isolation,  $(IS)_{min}$ ; maximum insertion loss,  $(IL)_{max}$ ; and switching time,  $T_s$ .

The operating frequency and the power level determine the type of diode package that can be

### Power Capabilities

$P_{in}$ (Watts)	0.1	0.5	1	2	5	10	20	50	100	200	500	1000
BV (Volts)	6.3	14.1	20	28.2	44.6	63	89.4	141	200	282	446	630

Minimum varactor diode breakdown voltage for various values of input power.



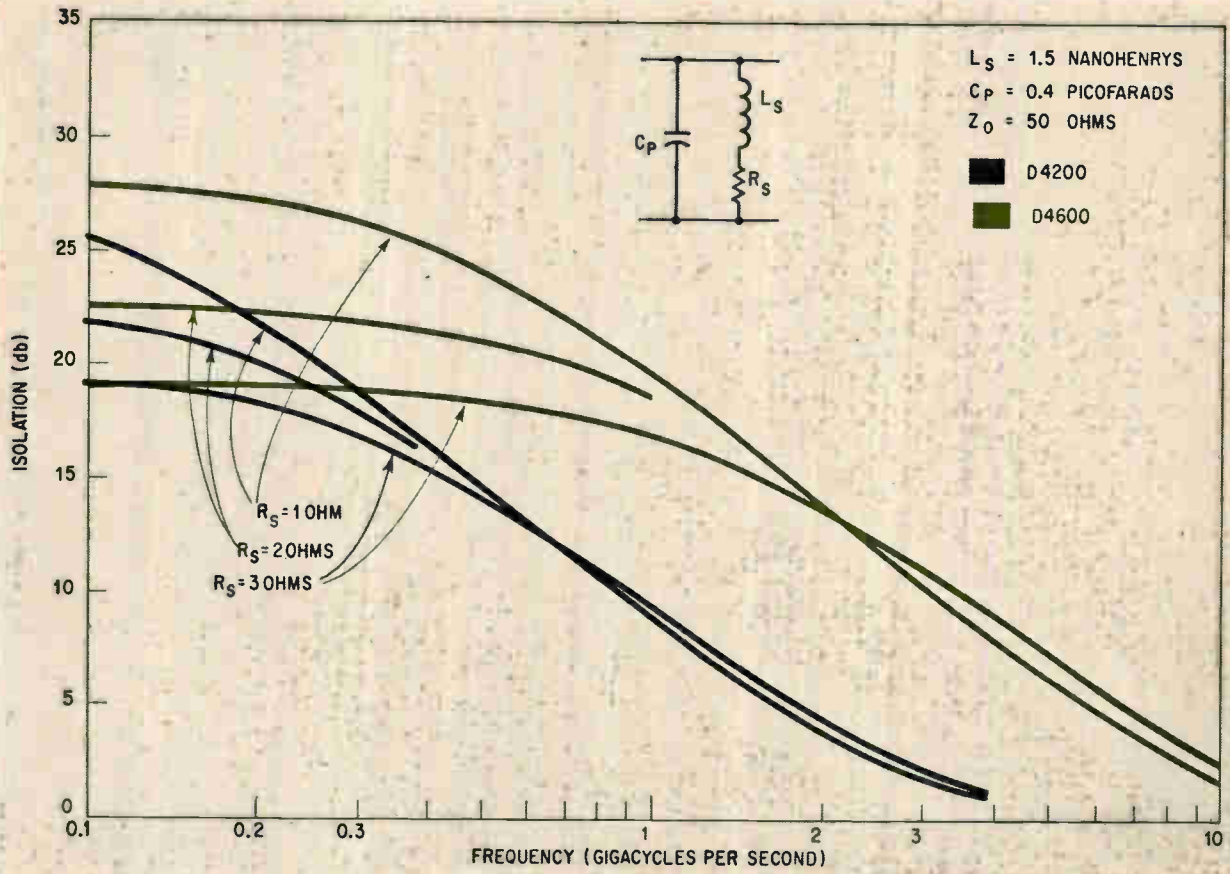

Isolation versus frequency for two varactor diode families in an untuned parallel-connected switching application.

used. Initial selection of several diodes for consideration should be based on these two characteristics. For example both the D4200 series and D4800 series varactor diodes may be used to 4 Gc, but the D4800 has higher dissipation capabilities. The D4600 (varactor diode), D5020 (p-i-n diode) and D5150 (varactor diode) can be used up to the X and Ku bands, but the D4600 and D5020 carry higher dissipation ratings. The D5151 is preferred for low-power small-signal switching service at higher frequencies.

The voltage rating for the diode may be determined by using equation 7 or by referring to the breakdown voltage table. For example, the D4200 and D4260 have similar frequency and dissipation capability, but the D4200 has a 6-volt rating while the D4260 has a 90-volt rating.

The specified bandwidth will influence the selection of the switching circuit. If only a narrow bandwidth (up to about 10% deviation from operating frequency) is required, a parallel tuned switch may be used. This offers the advantage of optimized isolation and insertion loss at the operating frequency. For wideband operation (octave bandwidth), the parallel untuned switch is the recommended choice.

After the switching circuit is chosen, the required maximum series resistance of the diode, giving the required minimum isolation, is deter-

mined from the design curves showing the correlation between isolation, frequency and series resistance. The maximum acceptable junction capacitance is determined from the insertion loss-frequency curves. If  $R_s$  and  $C_j$  are known, the cutoff frequency of the diode may be obtained from equation 6 (for varactor diodes only).

An actual example will help to illustrate the procedure. The specified requirements for a switch

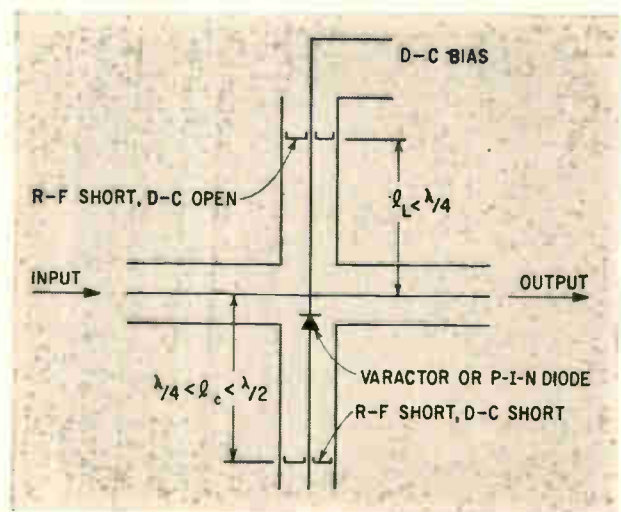

Coaxial shunt-tuned diode switch

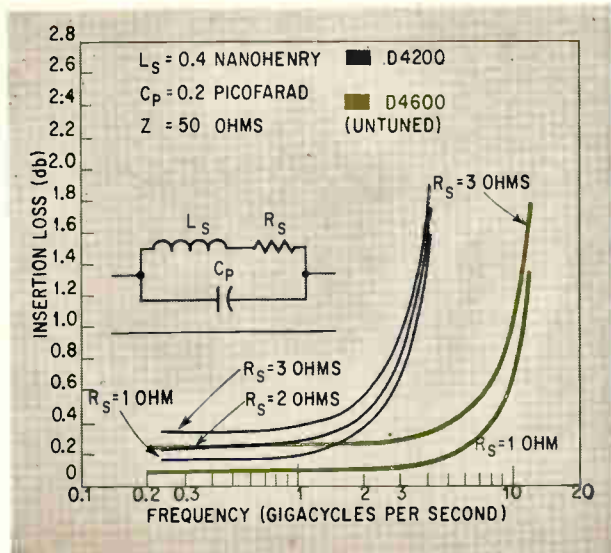

Insertion loss as a function of frequency for D4200 and D4600 varactor diodes in use as untuned series switches.

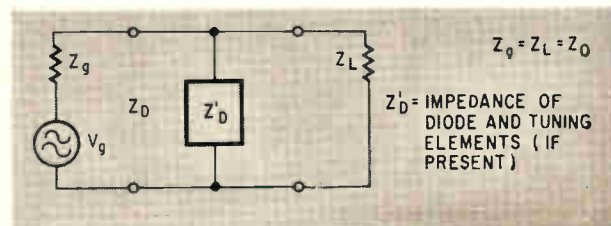

Simplified circuit for a parallel-connected diode switch.

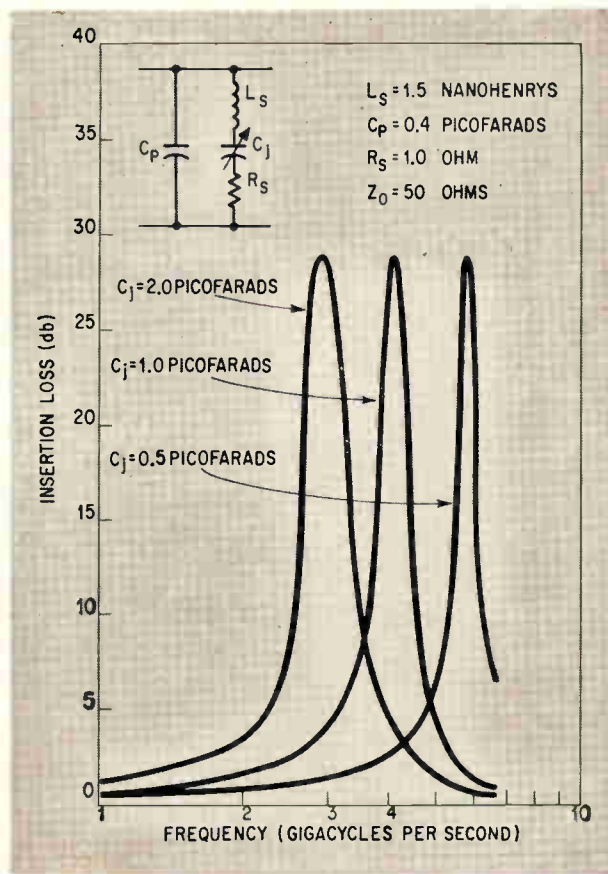

Insertion loss plotted against frequency for D4200 family used in an untuned parallel switching application.

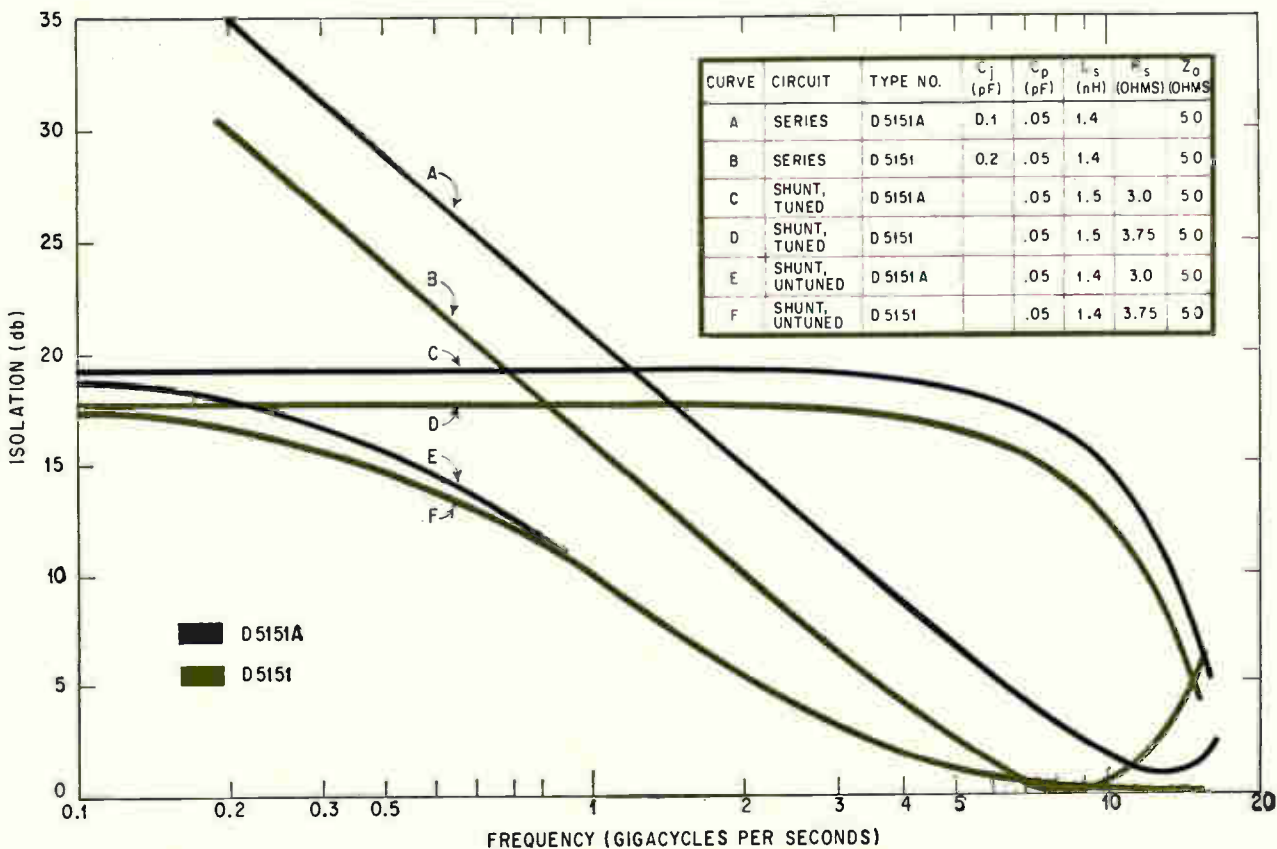

A comparison of isolation capabilities for series, tuned shunt, and untuned shunt circuits.



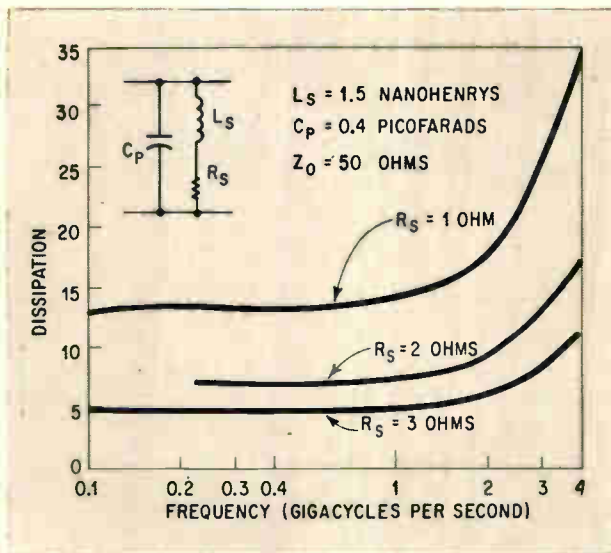

Dissipation ratio for the D4200 family plotted against frequency in an untuned parallel switching application.

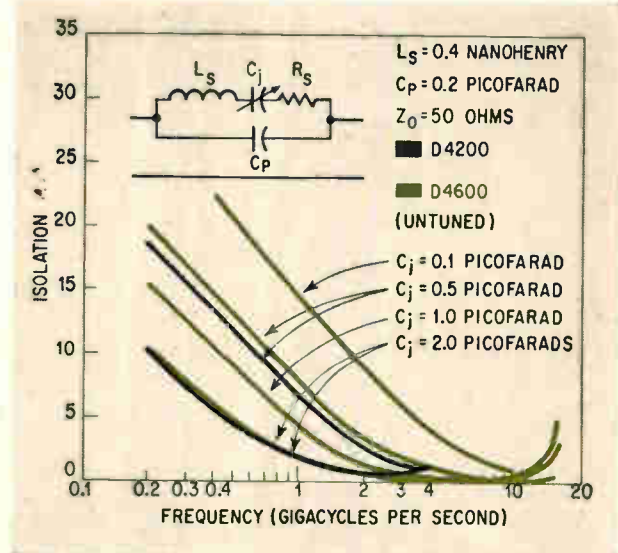

Isolation plotted against frequency for D4200 and D4600 varactor diodes used as untuned series switches.

are: operating frequency, 5 gigacycles per second; input power to be switched, 1 watt; bandwidth 1%; minimum isolation, 20 decibels; maximum permissible insertion loss, 0.5 decibel; turn-on time, 10 nanoseconds.

The minimum required breakdown voltage, calculated from equation 7, is  $V_B = 2.82 \sqrt{1 \times 50} = 20$  volts. For a safety factor of at least two, the breakdown voltage is set at about 45 volts. The operating frequency requirement can be met by many diodes, including the D4600 (varactor diode), D5020 (p-i-n diode) or the D5151 (switching diode). However, the required switching time is 10 nanoseconds, which is beyond the capability of a p-i-n diode, eliminating the D5020.

The narrow bandwidth requirement encourages the use of the tuned parallel circuit. From the figure on page 72, a maximum  $R_s$  of about 2.5 ohms will give 20 decibels of isolation at 5 Gc with one D4600 series varactor. The diagram at the bottom of p. 76 shows that a D5151A switching diode provides about 18 decibels isolation, which is not quite the required minimum. This restricts the choice to the D4600 varactor diode if the use of a single diode is required in a 50-ohm system.

The insertion loss vs. frequency curves shown on page 73 indicate that a maximum junction capacitance of 1 pf can definitely be tolerated without exceeding the 0.5 decibel insertion loss. The required varactor parameters then, are  $V_B = 45$  volts;  $R_s = 2.5$  ohms;  $C_{bias} = 1$  picofarad maximum.

During transmission, the varactor diode will be biased to approximately  $\frac{V_B}{2}$  or 22.5 volts. This is the bias point where  $C_j = 1$  picofarad maximum. The junction capacitance at -6 volts is approximately 1.5 times its value at -22.5 volts, or 1.5 pf. The required minimum cutoff frequency, is obtained from equation 6, and is

$$f_{co} = \frac{159}{(1.5)(2.5)} = 42.5 \text{ Gc}$$

The varactor diode in the D4600 series having this value of  $f_{co}$  is the D4642C.

#### Comparisons of curves

A set of curves comparing the isolation characteristics of series switching, parallel tuned switching and parallel untuned switching circuits is shown on page 76. The curves are plotted for varactor diode types D5151 and D5151A. In a series r-f switching application with the same operating conditions, the insertion loss rises from below 1 db at 3 gigacycles per second to about 4 db at 10 Gc. Above 10 Mc, it increases sharply. The insertion loss in an untuned shunt circuit rises sharply to 17.5 db at 9.5 Gc for the D5151 and then drops off sharply; the same type of characteristic is observed for the D5151A, but the loss reaches 19 db at approximately 15 Gc. The tuned parallel r-f switching circuit reaches a peak loss with the D5151, which is under 0.07 db and occurs at 11 Gc. The peak loss for the D5151A is only 0.015 db and occurs at about 12 db.

#### The author



Robert Fekete heads Sylvania's microwave varactor and tunnel diode applications and measurements group. He has been with Sylvania since 1960. He graduated from Budapest University in 1954 and engaged in developmental work with point-contact semiconductors at the Communication Technique Industrial Research Institute in Budapest from 1954 to 1956. He arrived in the United States in late 1956 and, prior to joining Sylvania, participated in the design and development of test and measuring equipment for the International Business Machines Co.

# Using the cold-cathode tube: part 1

Improved glow tubes are finding new applications in display and are performing many duties normally associated with more sophisticated devices

By M.A. MacDougall,  
Mullard, Ltd., London

**Cold-cathode tubes**—gas-filled tubes that operate by ionization—are not new, but engineers are taking a second look at them. Technical improvements and added sophistication of design have given them a variety of applications other than display, their normal function.

The well-known multicathode alphanumeric indicator tube has been used in electronic displays and readouts for years. But display circuits have become more sophisticated and now must do more than indicate information. The newest cold-cathode tubes can perform some of the functions you would normally expect to find in complex circuitry. Today, you can use a cold-cathode tube for triggering, counting, stabilizing voltages, storing pulses or switching slower counting circuits. Most of the newer tubes have been designed to operate with transistor circuits.

One such tube, the ZA1004, was developed to provide a more reliable device than the somewhat crude indicating lamps used previously. The tube has two possible uses. It may be a simple visual indicator, for an operation check on computer circuits; it may be used as a light source for a cadmium sulphide or cadmium selenide cell for switching purposes, as in a combined binary-to-decimal decoder and numerical drive tube.

## Author



Michael A. MacDougall is product manager in the Industrial Markets division of Mullard, Ltd., in London. He joined the company in 1958 as sales engineer, having previously worked as a circuit design engineer. He holds a Higher National Certificate for electrical engineering and radio.

The improvements in design have made the economics of cold-cathode tubes more interesting than ever. They are an accountant's dream; a typical modern tube has a life expectancy several thousand times better than the conventional thermionic tube, although they employ voltages of the same order. They are much cheaper than either semiconductor devices or vacuum tubes; they do not require costly materials with a high degree of purity in their manufacture, nor do they need transformers or cooling systems to operate. The tubes require no warm-up period and they can take severe overloads.

Since the display application is most familiar, this series will start by exploring that usage. In the second article (April 5), applications of trigger tubes will be examined and in the third (April 19) the use of the beam switching tube.

## Glowing analog displays

The bright glow of the cold cathode tube was first exploited to display numbers. In the multicathode tube, each of the cathodes is shaped like a particular number or letter. If a single tube contains the numbers 0 to 9, stacked one behind the other, a given number may be displayed by switching current through that cathode.

Until recently, the cold cathode tube was limited to such digital displays. New designs now make electronic analog displays possible. For example, a simple cold-cathode diode shaped as a long narrow glass tube has been designed so that the glow length associated with the cathode is proportional to the current supplied to the tube. Thus it acts like a thermometer which is sensitive to current variations instead of heat (see photo on p. 79).

The tube is at present only known by its development type number, DDB101. Samples have been made with an indication length of between one and eight inches. The tube has an electrical breakdown



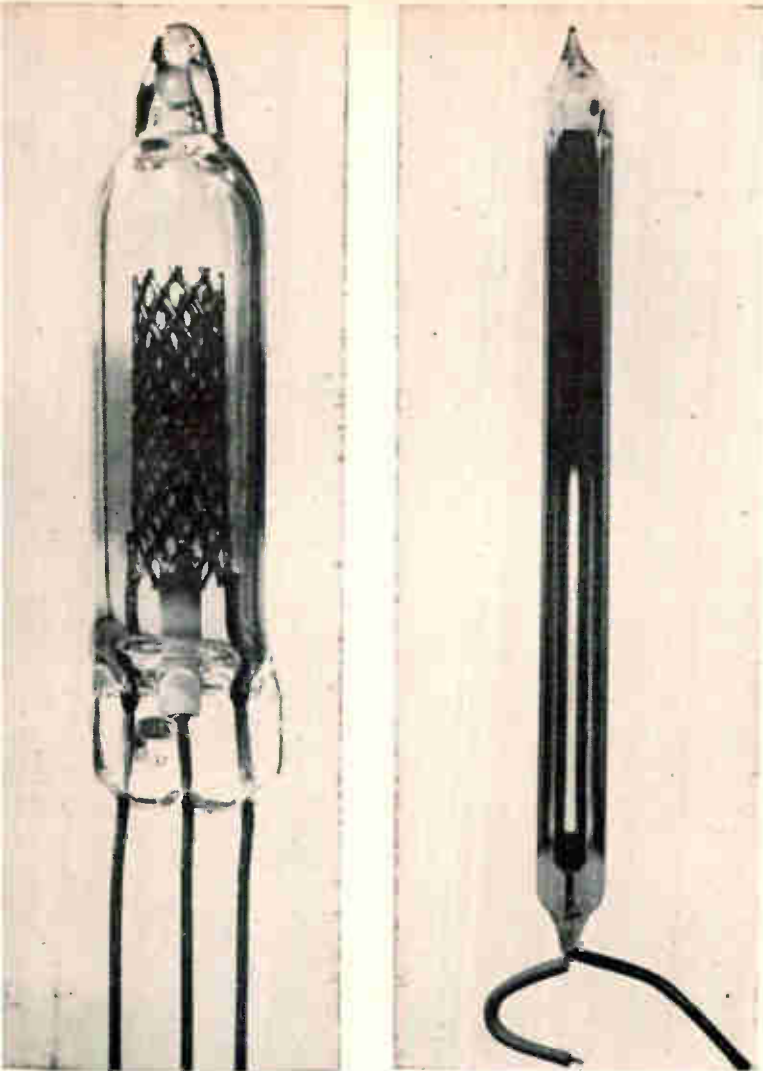

New cold-cathode indicator tubes are being designed specifically for transistor circuits. An example is Mullard's ZA1004. Tube is 26 millimeters long.

Glow column on cathode of this Mullard gas tube gives visual analog display. Length of glow is proportional to the current passing through the tube.

voltage of approximately 150V and a maintaining voltage of approximately 130V, so that it can be controlled quite simply from a 30 volt transistor circuit. There are two tubes currently in development. One, an inch long, is designed for use in a transistorized tape recorder; the second, with four inches of display, is to have more general use.

Even though the tubes will have an accuracy of no better than  $\pm 5\%$ , they should have a number of applications. One might be in the instrument panel of an airplane, spaceship, or automobile. In the auto, an analog indication of speed, engine temperature, or fuel supply would give stylists greater freedom in interior layout because of the space savings. The analog indicator could not be used where precise meter readings are required.

#### End or side view

Some indicator tubes now on the market are viewed from the side and some from the end [photos, p. 80]. The side-viewing tubes can be arranged close together; end-viewing tubes require

a greater center-to-center distance. There is, however, an appreciable saving in front panel space when using end-viewing tubes for display. The choice will ultimately depend on the particular requirement. The photo on page 80 shows use of side-viewing tubes in a desk calculator.

It is always desirable that the display have maximum contrast with the background. A red filter is often incorporated in the tube to reduce the effect of incidental illumination. A more elegant approach is to mount a circular polarizing filter on a shield in front of the complete display unit to remove extraneous reflections.

#### No sudden failure

Sudden and complete failure of the display is a minor worry with the tubes. The more natural end of a tube's life is reached when a part of one number is no longer visible. This occurs after an extremely long period, typically more than 30,000 hours; even then the deterioration is only gradual, making the display useful until the next convenient servicing opportunity—perhaps 1,000 hours of operation later.

For satisfactory operation of indicator tubes, a voltage is required large enough to cause initial breakdown ( $V_b$ ), and subsequently to control the current through the tube at its required level.

These requirements are achieved simply in the basic circuit and its electrical equivalent, shown on page 82. Since the tube is, in effect, a constant voltage device, a resistor at the anode brings about voltage drop so that  $(V_b - V_m) = IR$ . The desired number is obtained by connecting the appropriate cathode to the zero volt line. This is a simple system where the switch is provided in the cathode circuit. The switch can be a simple mechanical contact, a cold-cathode trigger tube or a transistor. If more than one cathode is connected, more than one will glow. Where the unwanted cathodes are not completely isolated, it is therefore necessary that they be held at a potential of between 60 and 110 volts positive with respect to the conducting cathode. This additional requirement may be designed into the drive circuits as shown in the simple transistor drive circuit on page 82, or with a cold-cathode trigger tube as shown in the numerical display circuit on page 82. This particular circuit also performs a counting function. Design of the circuit using the trigger tube is relatively simple, and it is only necessary to calculate the correct potential distribution within the circuit.

#### Transistor circuit

In the case of the transistor circuit, however, it is necessary to consider in slightly more detail the characteristics of both transistor and numerical indicator tube. In this configuration, the number tube and the transistor are connected in series; therefore if the voltage-current plot of the transistor is superimposed on the tube characteristic, the possible points of intersection will indicate the area of operation in the final circuit.

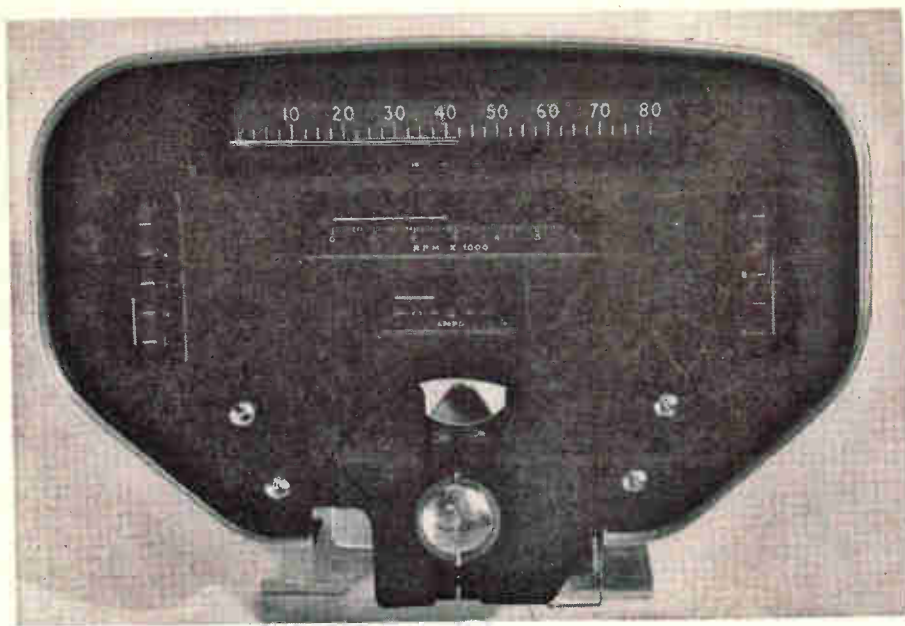

◀ Instrument panel for auto uses analog display tube to indicate speed, fuel consumption and other variables.

Small numerical indicator tube, Mullard's ZM1080, is representative of types that can be mounted ten abreast, in a numerical display panel 7½ inches wide.

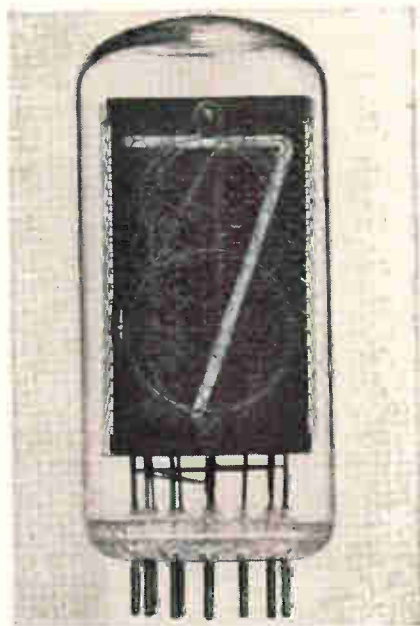
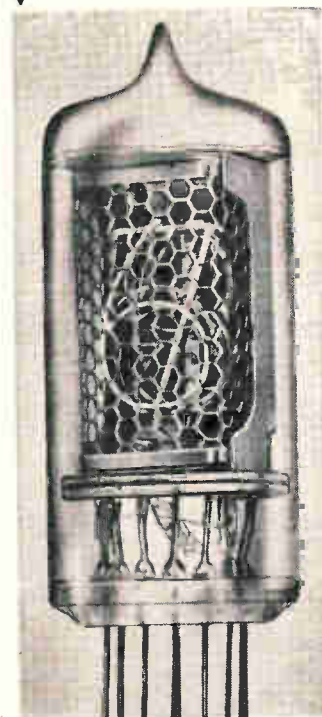

◀ A side-viewing numerical display tube, Mullard's Z522M, displays numerals zero to nine. Numbers are 31 millimeters high, 15 millimeters wide.

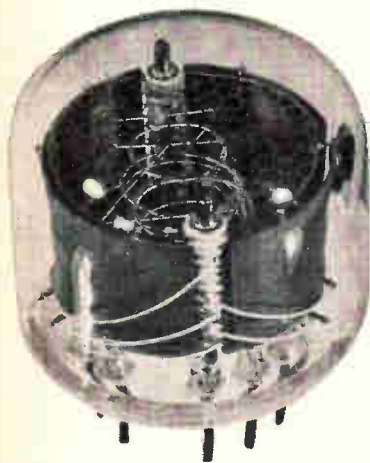

◀ End-viewing indicator tubes, such as this Mullard Z520M, can save considerable front panel space, though the distance between centers of each tube must be greater.

▶ New electronic desk calculator, the Anita, uses twelve side-viewing multicathode tubes, transistor gate circuits. Calculator achieves an input counting speed of 20 kc.





# How the tube works

In its simplest form, the cold-cathode tube is a gas diode—two electrodes in a gas-filled envelope. It would make a perfect insulator if it were completely shielded from light, cosmic rays, radioactivity and x-rays. However, if any form of external radiation is introduced into the enclosure, the gas molecules are ionized. When voltage is applied between the electrodes, the ionization produces electrons that are attracted to the anode and positive ions that are attracted to the cathode.

If the ionization level is increased, the current also increases. Raising the voltage also raises the current; and there are two other threshold effects. First, as the electrons gain sufficient energy from the increasing potential, they remove other electrons from adjacent gas atoms by collision. Second, the flow of positive ions toward the cathode reaches an energy level high enough to eject additional electrons from the cathode surface. These two effects are usually expressed in terms of the coefficients  $\eta$  and  $\gamma$ , where  $\eta$  represents the number of electrons formed by one electron falling through unit potential in the gas, and  $\gamma$  is the number of electrons released at the cathode by the bombardment of one positive ion.

It is necessary to apply a voltage in excess of the maintaining voltage to cause a sustained current to flow. Threshold levels are shown in the curve below. As the potential is increased, the current increases rapidly in region I, where the only ionizing source is that of external radiation. In region II, however, there is the additional source of ions from collision and bombardment and the current increases more rapidly. The peak of this curve is the ignition or striking voltage. A stage is reached where there are enough electrons in the gap for the current flow to be maintained at a voltage below this peak. This point is the maintaining voltage.

Both the ignition and the maintaining potential are dependent on  $\eta$  and  $\gamma$ ;  $\eta$  in turn depends on the characteristics of the gas and  $\gamma$  on the construction and physical arrangement of the cathode. The ignition and, to a lesser extent, the maintaining potentials also depend on gas pressure and electrode spacing.

## Initial ionization

The required initial ionization is commonly supplied by a small amount of radioactive material—uranium oxide, krypton or tritium. Usually less than one microcurie is used—about one-thousandth of the amount used in a wrist watch. With such small quantities, no precautionary measures are required.

New techniques for inserting this minute, but controlled, amount of initial ionization constitute major advances in achieving repeatable characteristics without inordinately long delay time.

## Glow on cathode

Current through the cold-cathode tube excites an appreciable glow in the gas. The graph below shows voltage distribution plotted against distance from the cathode. Next to the cathode, in the region of greatest change in potential, there is a dark region. Where the curve flattens out, there appears a bright glow, usually called the negative glow. This region extends about one millimeter from the cathode and appears as a bright sheath complete encasing the surface; this is the glow commonly associated with the tube. Next to the sheath comes another dark region, the Faraday dark space; then the curve rises and a glow called the positive column appears, extending to the anode. Neon signs use this column to produce a long glow in the tube, but in normal cold-cathode tubes, the electrodes are spaced to eliminate the effect.

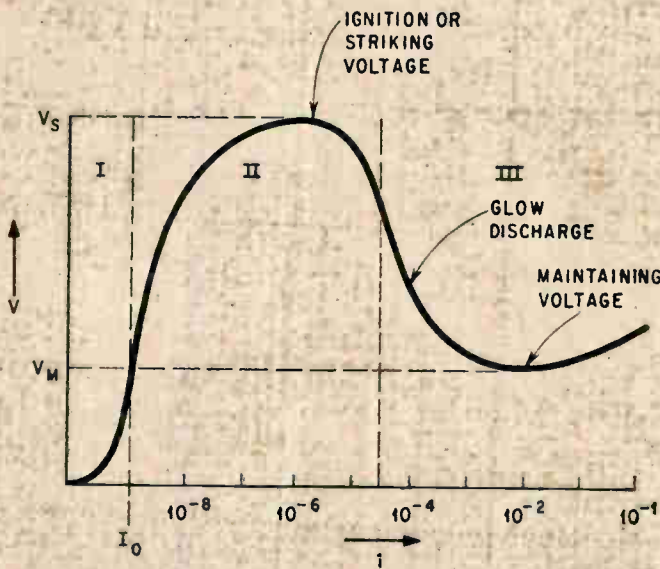

Voltage-current characteristic of a gas-filled diode.

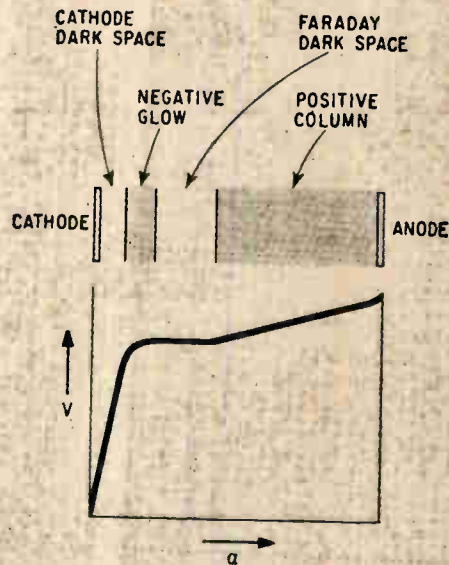

Voltage distribution between anode and cathode of a gas diode shows relation to the glow discharge

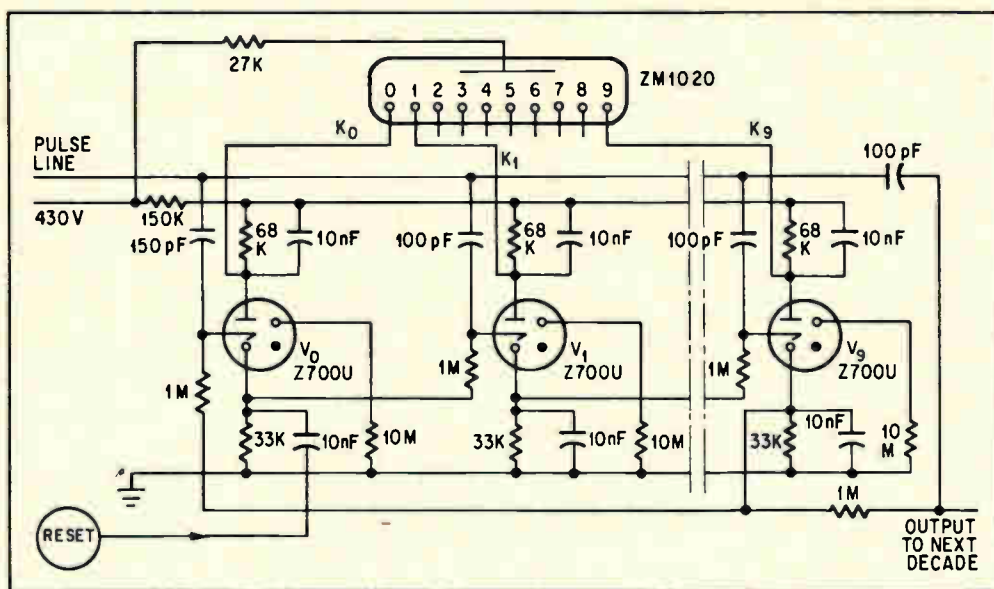

This circuit is an inexpensive solution to numerical display where few tubes are required. It can be designed with either trigger tubes or transistors. When trigger tubes are used, it is only necessary to calculate the correct electrical potential distribution within the circuit.

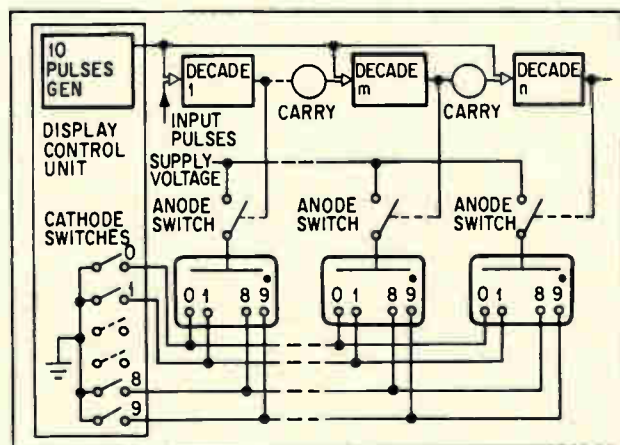

Dynamic drive circuit cuts down the number of transistors or trigger tubes required for numerical display.

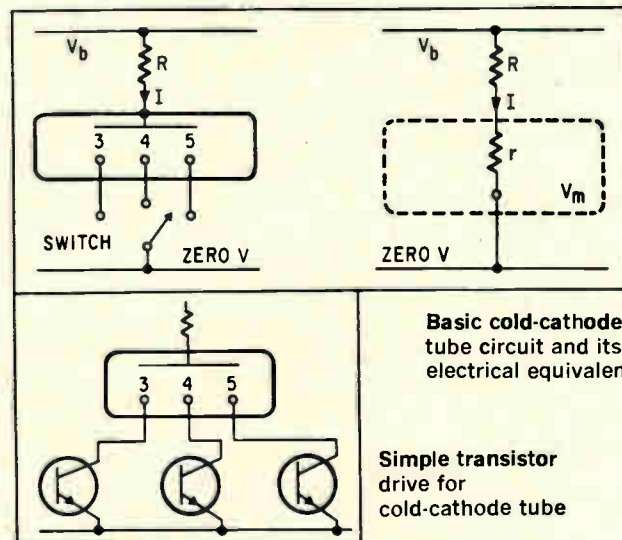

Basic cold-cathode tube circuit and its electrical equivalent

Simple transistor drive for cold-cathode tube

The circuit can be modified to attain closer control of the actual operating point.

### An inexpensive solution

Either approach, trigger tube or transistors, provides an inexpensive solution where few numerical indicators are required. In cases where many decades are to be supplied, large numbers of transistors may be required. A dynamic driving technique has been developed to reduce the over-all cost of components. The principles of this system are illustrated by the block diagram above.

The cathodes of all the indicator tubes are arranged so that all like numbers are connected to the same switch (either a transistor or a cold-cathode trigger tube). An additional switch, driven from the output of the counter to be displayed, is inserted in series with the anode of each tube. The carry pulse is generated as usual; but when display is required, the carry pulse is inhibited, and each decade of the counter is fed by a train of 10 inspection pulses. The inhibited carry pulse is used to

operate the switch in the anode of the number tube. At the same time, the inspection pulses close each cathode switch in turn. The switches close in complementary order—cathode for switch 9 closes on the first pulse, 8 on the second pulse, and so on. When both the anode and a particular cathode switches are closed for any tube, the tube displays a character—that of the number stored in the driving decimal counter.

### Fewer transistors

This dynamic drive requires only  $10+n$  switches compared with  $10 \times n$  for a more conventional system. Only short pulses of current are applied to the numerical indicator tube, and these pulses are available only 10% of the time. This will not impair the display, provided that the rating of the numerical indicator tube under these conditions is such that the repetition frequency exceeds the persistence of human vision. Brightness of display will be nearly equal to that obtained for the constant current mode of the tube.



# Designer's casebook

Designer's casebook is a regular feature in Electronics. Readers are invited to submit novel circuit ideas, packaging schemes, or other unusual solutions to design problems. Descriptions should be short. We'll pay \$50 for each item published.

## Grounded-grid circuit sweeps better than Miller or bootstrap

By Chang Sing

National Taiwan University  
Taipei, Taiwan

**Grounding the grid** of a sawtooth generator, rather than the cathode or cathode resistor, overcomes the inherent limitations of other sweep circuits. In the bootstrap sweep, the waveshape linearity deteriorates significantly with slight reductions in gain, and the zero voltage level and the slope of the sawtooth often are not stable. The Miller sweep has these problems plus the disadvantage of producing an undesirable step voltage before the sweep voltage waveshape.

The simplified circuit diagram of a basic sweep circuit shown above is from Millman and Taub's "Pulse and Digital Circuits."<sup>1</sup> If the voltage of the variable generator is instantaneously equal to the voltage across the capacitor, the charging current,  $i$ , will be a constant  $E/R$ , and a perfectly linear voltage ramp results across the capacitor. If point Z is grounded, the circuit represents the Miller integrator with the cathode at ground; if Y is grounded, the circuit represents a bootstrap sweep.

Connecting point X to ground makes the circuit equivalent to the grounded-grid amplifier. A negatively increasing linear sweep will appear between Y and ground.

A grounded-grid sawtooth circuit requiring an input trigger is shown at right. If the trigger signal is a square wave,  $V_2$  is cut off during negative half cycles, cutting off  $V_1$ . Capacitor C charges toward the supply voltage  $E_{bb}$ . During the positive half cycles,  $V_2$  conducts, causing  $V_1$  to conduct, and C discharges through both tubes. The load  $R_L$  should be very large compared to the series impedance of the tubes when C is discharging. Note that the circuit configuration of  $V_1$  and  $V_2$  resembles that of a pentode constant-current generator.

The solid waveshapes at bottom show a linear sweep output. The dashed line shows a nonlinear voltage discharge across an uncompensated capacitor (plate-to-cathode of  $V_1$  shorted).

A free-running, grounded-grid sawtooth gener-

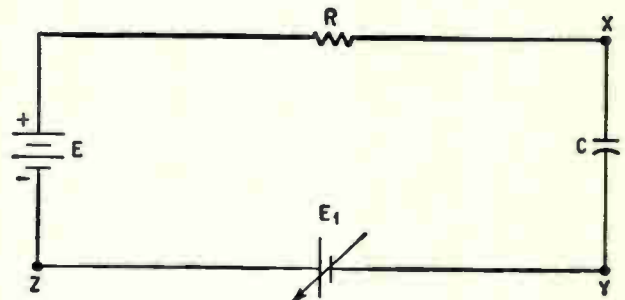

**Basic representation** of the sweep circuit.  $E_1$  instantaneously equals the voltage across the capacitor. If X is connected to ground, the circuit represents a grounded-grid sawtooth generator.

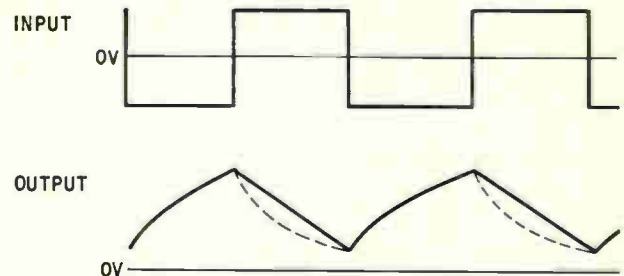
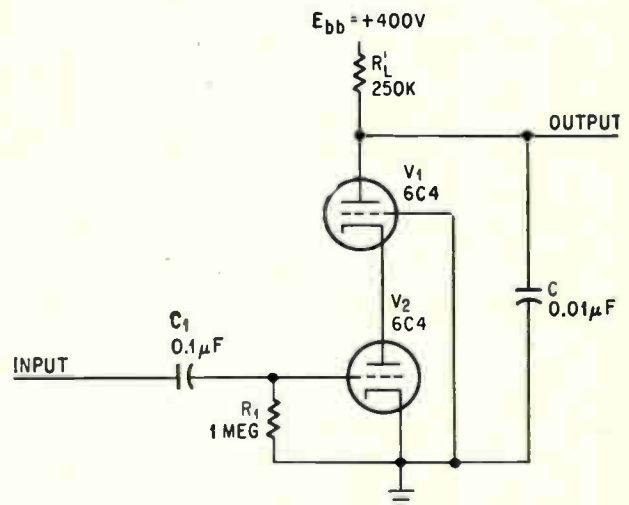

**Triggered linear sawtooth generator** using a grounded-grid amplifier. A grounded grid produces the effect of an electrostatic screen between input and output circuits, eliminating the initial step voltage that usually occurs in the Miller sweep. The nonlinear sweep shown by the dashed lines would occur if  $V_1$  were replaced by a short circuit (uncompensated capacitor charging current).

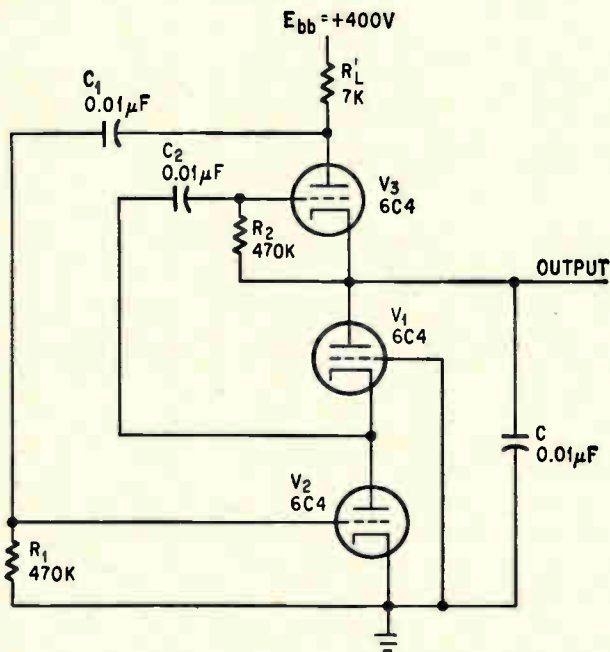

Free-running, linear sawtooth generator using a grounded grid.  $V_2$  and  $V_3$  are similar to a multivibrator. Reducing the value of  $R_L'$  increases the value of the sweep period.

ator is shown in the circuit diagram at left. It is similar to the basic grounded-grid circuit, except that  $V_3$  assumes the function of  $R_L$  during the capacitor discharge cycle. Tubes  $V_2$  and  $V_3$  operate as a multivibrator. When  $V_2$  is cut off,  $V_3$  conducts the capacitor charging current. During the next half-cycle,  $V_2$  conducts and  $V_3$  is cut off, causing  $C$  to discharge linearly through  $V_1$  and  $V_2$ . In this circuit,  $R_L'$  is selected to equal the plate resistance of  $V_1$ , and the multivibrator is symmetrical; that is, the capacitor charge and discharge periods are equal. As the resistance of  $R_L'$  is reduced, the linear sweep time increases.

The grounded-grid sawtooth generator has higher output impedance than other time-base sweep circuits. During the sweep interval, the output is isolated from the rest of the circuit because  $V_3$  is cut off and the grid of  $V_1$  is grounded. The grounded grid is effectively an electrostatic shield that helps to stabilize the slope of the waveshape and eliminate the initial step voltage.

#### Reference

<sup>1</sup> Millman and Taub, "Pulse and Digital Circuits," McGraw-Hill, New York, pp. 212-216 and 487.

## Simple circuit tunes audio amplifier

By Jean F. Delpech

Institut d'Electronique  
Orsay, France

The resonant frequency of the audio amplifier shown at the right can be tuned from 800 to 1,000 cycles per second by the variable resistor  $R_2$ . The circuit is derived from the classic R-C phase shift oscillator.

At the resonant frequency the amplifier will not go into oscillation because the gain is low. Reduced gain results from the small, unbypassed resistor in the emitter circuit (the upper section of  $R_1$  in the diagram). The gain of the amplifier is controlled by this unbypassed resistance. The Q of the circuit is greater than 20 and can be varied by  $R_1$ .

In the three-step ladder network of the feedback loop, the resonant frequency is varied by  $R_2$ .

Stability of the amplifier is not affected by changes in supply voltage that vary considerably from +22 volts, although oscillations can occur

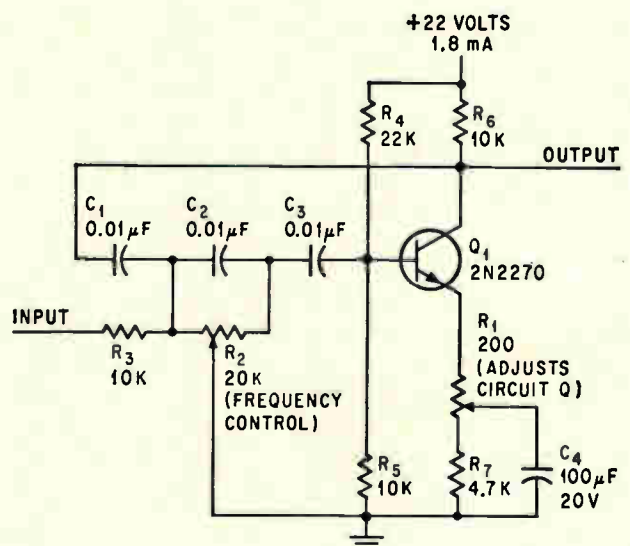

when the transistor is over-driven. A sensitive and inexpensive amplifier for an a-c bridge is possible because of the inherently low

Amplifier can be tuned from 800 to 1,000 cps by adjusting  $R_2$  in the feedback loop. The circuit is stable at the tuned frequency because the gain is kept low by the unbypassed portion of  $R_1$  connected to the emitter. The circuit Q is greater than 20, and varies as the value of  $R_1$ .

when the transistor is over-driven. A sensitive and inexpensive amplifier for an a-c bridge is possible because of the inherently low



noise figure of the 2N2270 transistor and the simplicity of the circuit.

This circuit has also been used as an amplifier

for the signal channel of a small phase-lock detector, in a-c bridge measurements, and in measuring narrow-band noise figures.

## Timing circuits control relays

By Peter Haas

SPC Associates, West New York, N. J.

**Low-level signals** generated by transistor circuits are often required to control relays. Sometimes, the instant at which the relay is energized or de-energized, must be delayed with respect to its driving pulse. This is usually accomplished by an R-C configuration located in the base circuit of the transistor driving the relay. The circuit can be arranged so that the delay occurs at either the start or termination of the driving pulse.

A fast-make, slow-break circuit energizes the relay at the same moment that the driving pulse occurs, and de-energizes the relay after the driving pulse has been removed.

In the fast-make, slow-break circuit, when  $Q_1$  is turned on,  $Q_2$  turns on by current supplied through resistor  $R_1$  and diode  $D_2$ . This immediately causes relay  $K_1$  to become energized. Capacitor  $C_1$  begins to charge through  $D_1$  and  $R_2$  the instant  $Q_1$  turns on. Resistor  $R_2$  limits the initial charging current to a value which will not destroy  $Q_1$ . When  $Q_1$  is turned off,  $C_1$  discharges through  $R_3$  and the base-emitter junction of  $Q_2$ , keeping  $Q_2$  in conduction for a period that depends on the  $R_3 - C_1$  time constant. When  $Q_2$  turns off,  $K_1$  becomes de-energized.

An output pulse that is longer in duration than an available input pulse can be obtained from a fast-make, slow-break circuit.

On the other hand, a slow-make, fast-break circuit energizes the relay with some delay after the driving pulse is applied, but de-energizes the relay the instant the driving pulse is removed.

Such a circuit operates as follows: The instant  $Q_1$  turns on,  $C_1$  charges through  $R_2$ , until the voltage across  $C_1$  causes  $Q_3$  to conduct. When  $Q_3$  conducts,  $K_1$  is energized. Note that before and while  $Q_3$  conducts, the base-emitter junction of  $Q_2$  is back-biased. Therefore,  $Q_2$  is effectively out of the circuit. This back-bias results from the voltage across  $R_2$  and  $R_3$ , making point A more negative than B in the circuit.

When  $Q_1$  turns off, the reverse bias is removed. Resistor  $R_1$  is selected so that  $Q_2$  is biased into full

conduction, and  $C_1$  discharges through the saturated transistor  $Q_2$  and  $R_4$ , turning off  $Q_3$ .  $R_4$  limits the peak discharge current through  $Q_2$ . The R-C network that delays relay operation until after the start of the input pulse serves the function of a one-shot delay.

In control applications where a pulse width must be detected, the slow-make, fast-break circuit can be used. The relay does not become energized unless the input is present for longer than a preset time. An advantage in such an application is that the input pulses can occur quite close together, because the circuit recovery time is extremely short.

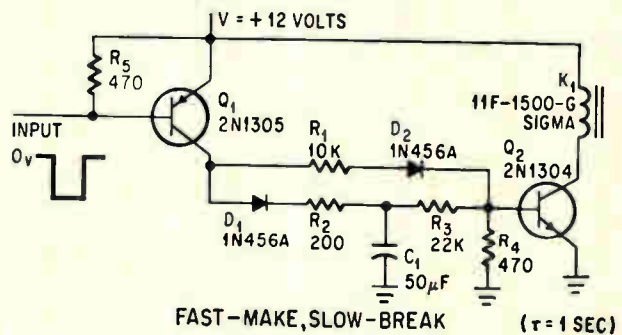

FAST-MAKE, SLOW-BREAK ( $\tau = 1 \text{ SEC}$ )

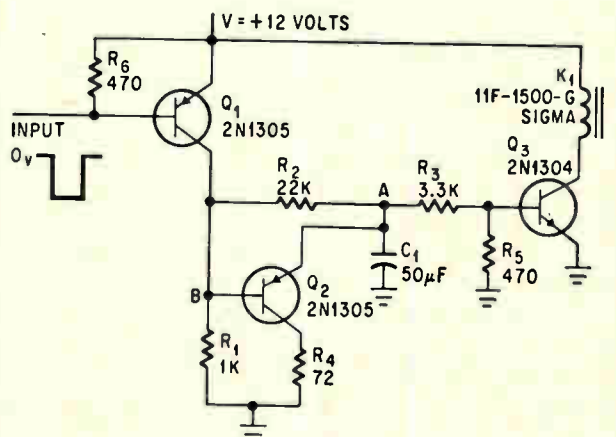

SLOW-MAKE, FAST-BREAK ( $\tau = 0.1 \text{ SEC}$ )

Relay in top circuit is energized at the same time the driving pulse is applied, but de-energizes at a time (determined by  $R_3$  and  $C_1$ ) after the driving pulse is gone. Relay in the circuit at bottom energizes when the voltage on  $C_1$  drives  $Q_3$  into conduction, but de-energizes at the same moment the driving pulse is removed. In either circuit,  $Q_1$  may be replaced by a mechanical switch.

# Better bonding methods improve hybrid circuits

Rigid process control is needed to bond component leads to thin-film conductors. Electrical control of bonding time and temperature fills the bill

By J.W. Slemmons and J.R. Howell

Autonetics, a division of North American Aviation, Inc. Anaheim, Calif.

**Hybrid thin-film circuits** provide microelectronic systems engineers greater freedom of circuit design than do monolithic integrated circuits. Hybrid techniques can be used to build highly precise circuits and circuits with greater complexity—they can, for example, be used to interconnect several monolithic circuits with other components.

Such circuits are made by attaching discrete components and semiconductor devices to networks of passive components and conductors that have been vacuum-deposited on glazed ceramic, sapphire or glass substrates. This construction requires microjoining techniques that make consistently reliable bonds between component leads and thin films, a requirement best met by microjoining equipment

that operates as automatically as possible.

Three new forms of diffusion bonding—resistance-heated, pulse-heated and microgap bonding—are results of the continuing effort to develop such production equipment. Improved microsoldering techniques are being developed as well.

These improved methods provide better control over the bonding variables that are critical in the assembly of hybrid thin-film circuits. They reduce dependence on operator skills with the result that bonds are more consistently strong than bonds made by conventional diffusion bonding and soldering.

Close control of bonding is required for several reasons, chiefly:

- Nondestructive tests of thin-film bonds are difficult to make. Visual inspection criteria (like those used to inspect conventional solder joints) have not been validated.

- Excessive bonding pressure or temperature could damage semiconductor devices or thin-film conductors.

- Inadequate or excessive bonding pressure or temperature could result in weak bonds.

None of the new bonding methods is perfect, none satisfies all requirements for bonding component leads to thin-film conductors, and certainly none is the ultimate in hybrid-circuit connection. But the techniques are sufficiently advanced to be used now on the production line, while studies to refine the methods continue.

Ultrasonic bonding is being evaluated and appears promising. In many cases, lead bonding will probably be eliminated by registrative bonding or vapor-deposited intraconnections.

Autonetics uses the new techniques to make

## The authors



J.W. Slemmons, a senior metallurgist and welding engineer, develops and evaluates microjoining processes for the Minuteman missile guidance and other systems. His master's degree thesis, on low-power electron-beam welding, won the James F. Lincoln Arc Welding Foundation's national award.



J. R. Howell, senior metallurgist, worked on high-reliability soldering processes for Minuteman and on advanced joining techniques including laser, electron-beam and parallel-gap welding, and beryllium brazing. At present, he is engaged in a physics of failure program aimed at determining failure causes in component intraconnections.



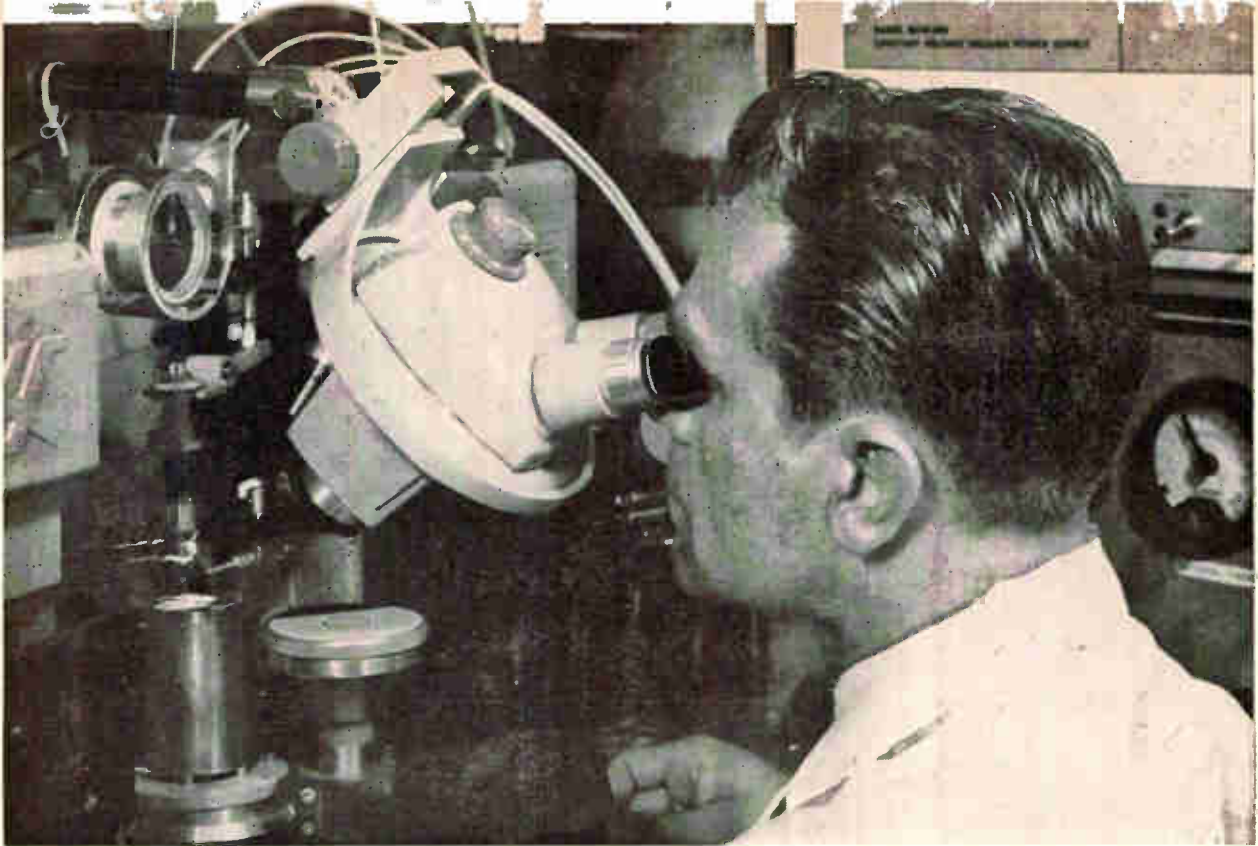

Pulse-heated thermocompression bonder has electrically heated tool for bonding leads to semiconductors and thin films.

hybrid thin-film circuits for prototype radar systems and to develop advanced hybrid circuits. One radar made with hybrid circuits is the R45 radar, which is 2½ feet long compared to 6 feet for the F15 North American Search and Ranging Radar system [Electronics, Feb. 21, 1964, p. 10].

Uncased transistors and integrated circuit dice are used whenever possible. Uncased chips offer numerous advantages over discrete components in size, reliability, fabrication and cost.<sup>1</sup>

It can be shown, for example, that to fully connect two integrated circuits cased in 10-lead packages requires 140 metal-to-metal interfaces or bonds. If the uncased chips are connected through leads bonded to a thin-film conductor, the number of bonds drops from 14 per lead to 8, by the elimination of package leads. Using only jumper wires from die to die reduces the number to 4 per lead.

Besides the obvious savings in labor, parts and space, reliability can be improved by the elimination of redundant bonds and packages, and by the avoidance of some problems caused by incompatibility of materials.

Reducing the lead requirement cuts down the total thermal energy required for bonding and minimizes heat degradation in the hybrid circuit's materials and components. Also, the smaller sizes of the devices and bonds makes it easier to replace faulty devices during production. Cased devices are difficult to replace after leads are attached.

### Three techniques

At present resistance-heated and pulse-heated thermocompression diffusion bonding (TC bonding) are the most attractive methods available for bonding the leads of uncased devices.

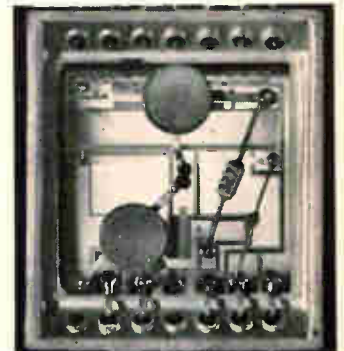
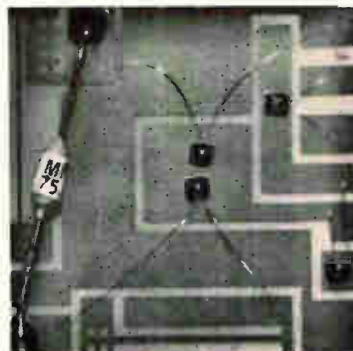
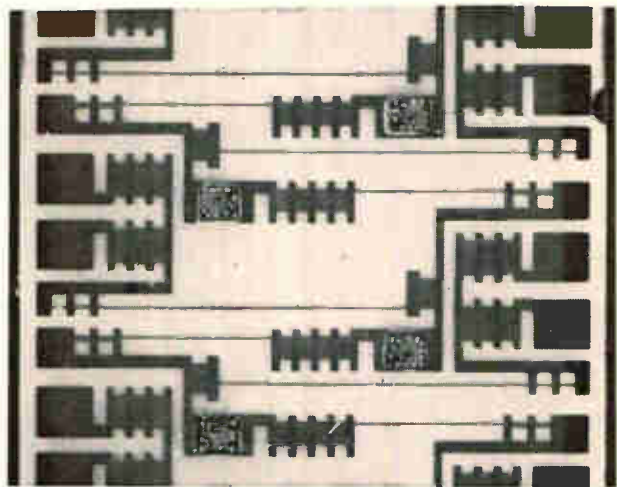

Hybrid circuits. At top, integrated circuits have been bonded to thin-film resistor network. At lower left, a soldered capacitor and bonded microtransistors have been added to a thin-film circuit. The packaged hybrid circuit at lower right has soldered components.

These two improved methods of TC bonding can bond lead wires to both semiconductor devices and thin-film conductors. The same tools can be used for both bonds because bonding temperature is controlled electrically in the tool tip, rather than by heating the substrate as in conventional TC bonding.

TC bonding refers to the coalescence by diffusion of two materials (at least one of which is ductile) over a controlled area. The materials are pressed together by a shaped bonding tool at a temperature too low for interface melting. TC bonding does an effective job of bonding fine, ductile lead wires, such as the 1-mil-diameter (0.001 inch) gold wire preferred for uncased-device leads.

Some Autonetics hybrid thin-film circuits require cased miniature components—capacitors, resistors and inductors—and microminiature active devices—transistor and diode dice mounted on Kovar or molybdenum tabs and coated with an encapsulant.

Soldering can bond the relatively large leads, 10 to 30 mils in diameter, of cased miniature components. Many of the limitations of manual soldering can be overcome by dynamically controlled resistance soldering and solder reflow methods.<sup>2, 3</sup>

But soldering cannot be used to bond the thin gold leads, 2 to 10 mils in diameter, that are preferred for encapsulated microdevices. The molten solder dissolves the gold, thereby weakening the joint. Microgap diffusion bonding—a cross between parallel-gap welding and TC bonding—can be used to bond these intermediate-sized leads.<sup>3</sup>

Both of these methods, too, require close control. The thinnest lead, 2 mils, is 250 times as thick as a typical 2,000-angstrom thin film, creating film adherence and solution problems.<sup>4</sup>

Heat input must be controlled to prevent cracking of the thin-film substrate or dissolving of the conductor and subsequent dewetting (the melted material shrinks away from the underlying layer). There may be excessive peel stresses at the joint, due to stresses applied to large, rigid leads. The large solder mass needed to connect large leads may also induce stresses due to differences in thermal coefficients of expansion. Furthermore relatively large amounts of heat needed to melt the solder may degrade thin-film components.

### Thermocompression bonding methods

Since its development in 1957, TC bonding has become widely used in the semiconductor industry. Autonetics became proficient in the technique to meet reliability requirements of the Minuteman missile. Work in this area resulted in an evaluation of the shortcomings of conventional methods.<sup>4, 5, 6</sup>

Bonding gold wire to thin-film terminal pads, usually aluminum, on the semiconductor chip requires careful control. Temperature control is needed to prevent alloying of the film and the silicon and to avoid other undesirable effects such as the formation of brittle intermetallic compounds at the gold-aluminum interface at temperatures above

200°C.<sup>7, 8</sup> Pressure control is needed so that the substrate will not be fractured nor the lead material excessively deformed.

In resistance-heated TC bonding, the major source of bonding heat is a tungsten-carbide tool. The tool is a capillary similar to those used in ball bonding.<sup>6</sup> Heat generated in its resistive element (see illustration, p. 89) by 60-cycle current is conducted through the tool tip and the wire to the bond interface. This heating method is more controllable than heating the substrate.

There are additional advantages over conventional TC bonding: the same equipment can bond a wire to the semiconductor die and to several locations on the thin-film circuit; both types of bonds can be made with the same force; combining the wire feed with the bonding tool eliminates the need to align them separately as in conventional wedge bonding; and no filler materials are needed.

However, there are some disadvantages: wedge bonds do not have equal pull strength in all directions; bonds to the device and the thin-film circuit may require different heats; the bond cannot be inspected nondestructively and may have to be analyzed with an instrument such as a scanning electron microscope.<sup>9</sup>

Pulse-heated TC bonding is similar, except that the tungsten carbide bonding tool is heated by a pulse of direct current. A similar unit using a-c power was previously reported.<sup>10</sup> Slotting the capillary makes it hottest at its end, where bonding occurs. Bonding pressure, which is predetermined, is applied through the capillary.

The pulse duration of the equipment used for this evaluation is controlled from 1 millisecond to 10 seconds. The unit illustrated on pages 87 and 89 has a pneumatically controlled-sequencing mechanism to minimize potential operator error.

A pulse-heated bonder is especially advantageous for temperature-sensitive components. Keeping the components at ambient temperature until the pulse is applied minimizes heat damage, provided the pulse is controlled to avoid thermal shock.

In contrast to substrate-heating and resistive-heating methods, pulse heating enables bonding times to be minimized and bonding time and energy to be discretely controlled. Annealing of the lead wire occurs only during bonding. Also, there is no possibility that stray current will surge through the electronic circuit being fabricated, as might happen during microgap bonding.

Bond strength evaluations were made for both forms of TC bonding. In each case, 25 bonds were made, using optimum conditions for bonding 1-mil gold wire to copper, gold and aluminum thin films. The bonding conditions and results are given by the data and curves on page 90. Tests were made with an improved version of a tensile tester previously reported.<sup>5</sup>

### Microgap bonding

Microgap bonding is similar to parallel-gap welding. However, the series electrodes are smaller and



## Three improved methods of diffusion bonding

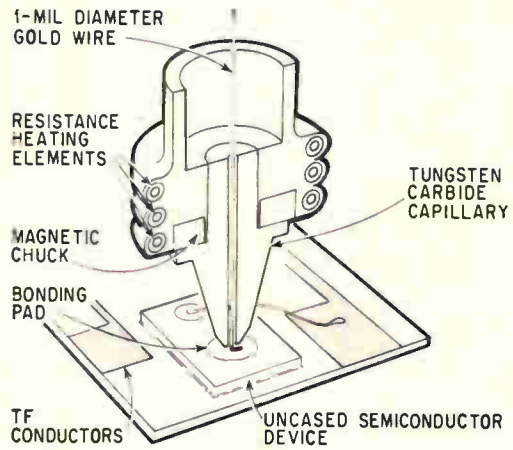
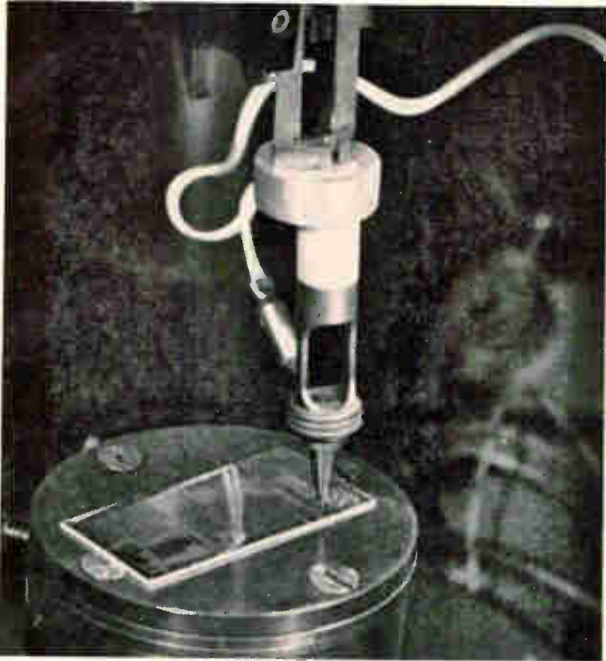

Resistance-heated thermocompression bonding tool and cross-section of a typical bond made by the tool.

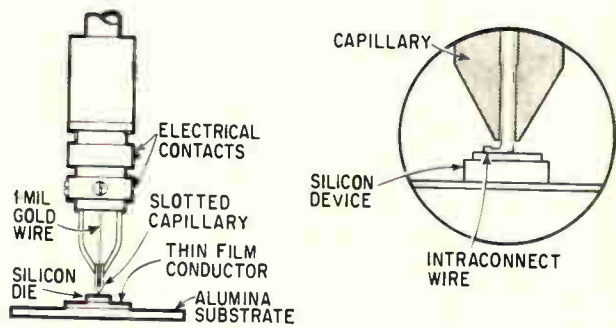
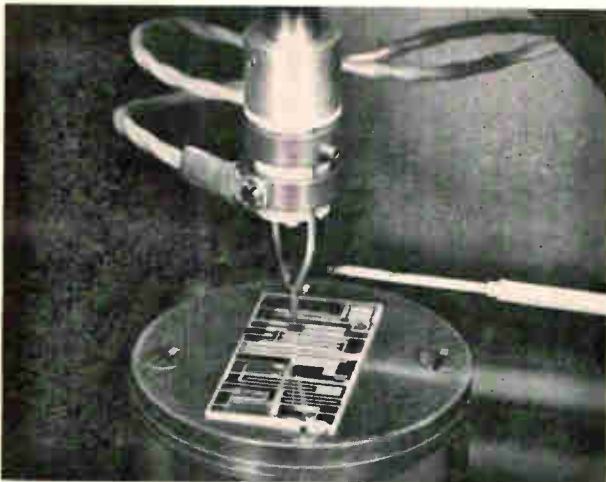

Pulse-heated thermocompression bonding tool provides tighter control of bonding time than other methods.

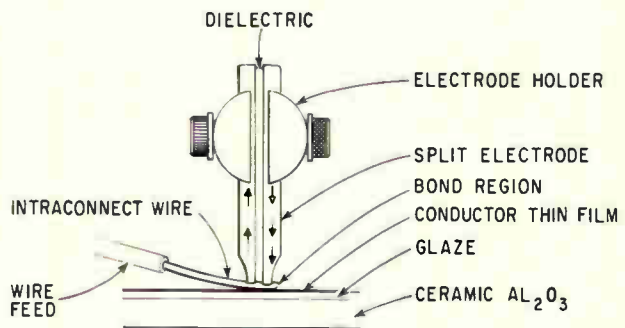
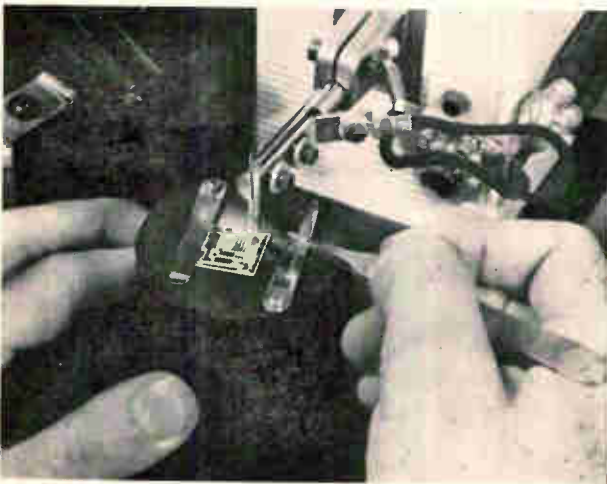

Microgap diffusion bonder's two-electrode tip bonds lead by passing heating current pulse through the lead.

# Tensile strength of diffusion bonds

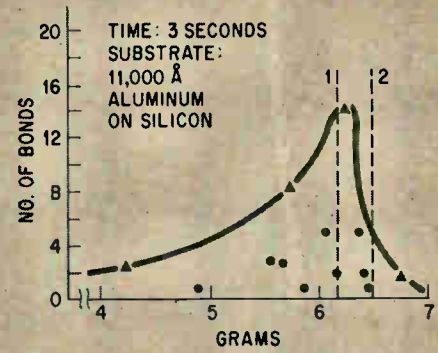
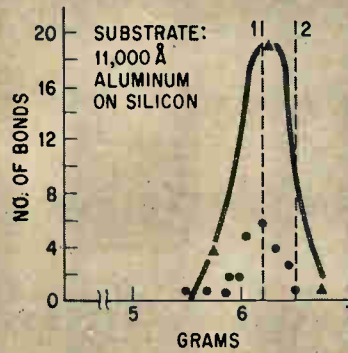
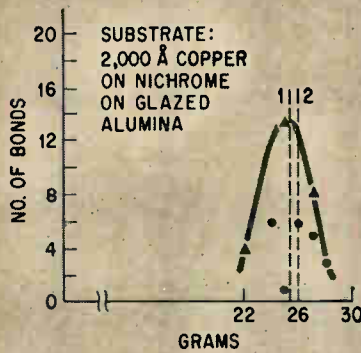
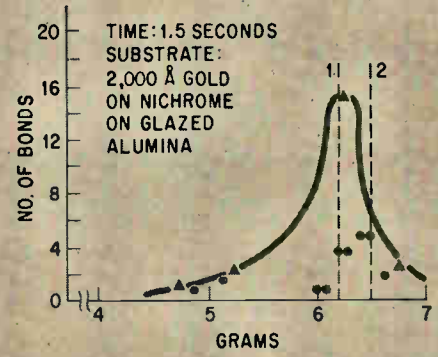
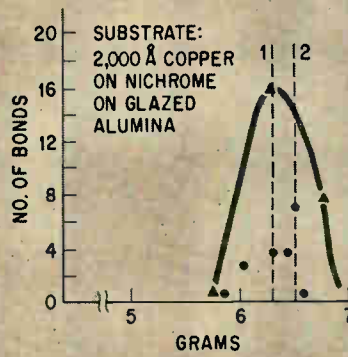
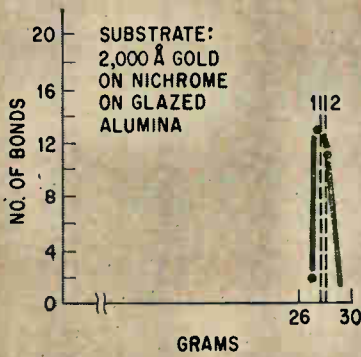
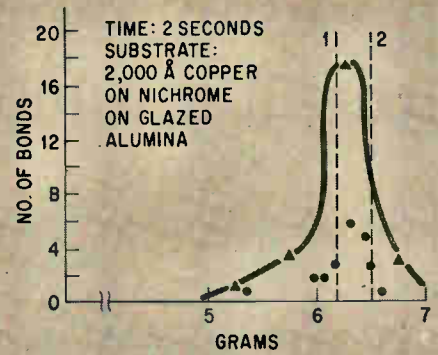
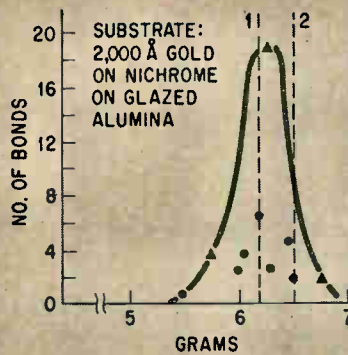

## Microgap bonding

### 45° tensile-strength tests

Wire: 2-mil gold, original tensile strength 28 or 26 grams

Bonding conditions, gold film

Pulse amplitude: 40-80-80

Pulse time, msec: 2-3-2

Pressure: 200 grams

Bonding conditions, copper film

Pulse amplitude: 20-62-20

Pulse time, msec: 0-3-0

Pressure: 250 grams

Electrodes: 15 (molybdenum)

1. Average breaking strength of bonds in grams

2. Average breaking strength of wire in grams

● Individual test data (gold to nearest 0.1 gram, copper to nearest gram)

▲ Grouped data in 2-gram increments

## Resistance-heated wedge bonding

### 45° tensile-strength tests

Wire: 1-mil gold, original tensile strength 6.5 grams

Bonding Conditions

Force: 50 grams

Time: 6 seconds

Temp: 482° C (capillary)

1. Average breaking strength of bond in grams

2. Average breaking strength of wire in grams

● Individual test data to nearest 0.1 gram

▲ Grouped data in 0.5-gram increments

## Pulse-heated wedge bonding

### 45° tensile-strength tests

Wire: 1-mil gold, original tensile strength 6.5 grams

Bonding conditions

Force: 50 grams

Time: see curve

Voltage: 1.99 v

1. Average breaking strength of bond in grams

2. Average breaking strength of wire in grams

● Individual test data to nearest 0.1 gram

▲ Grouped data in 0.5-gram increments. All failures occurred in the wires



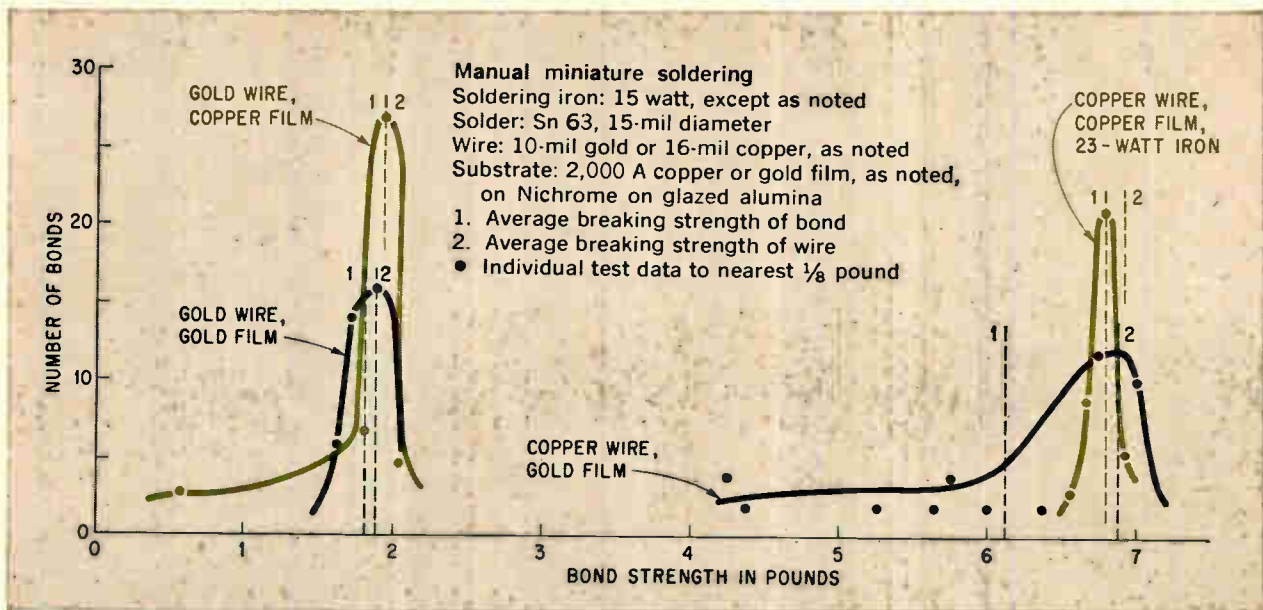

Results of lap shear tests made on joints soldered manually with miniature soldering irons. Curves compare bond-strength distributions for various combinations of gold and copper wire and films. Copper-film data is in color.

closer together and the bonds are made by diffusion rather than fusion. (The commercially available "welders" for bonding leads to thin films should be called diffusion bonders, too, because heat is generated in the lead and there is no fusion as in conventional welding.)

This bonder is the logical choice for discrete microcomponents. The leads, up to 10 mils diameter, are too large for capillary-type TC bonders. Soldering is impractical because the gold generally used as lead material is extremely soluble in solder.

The shape of the electrodes is shown on page 89. The gap should be about the size of the wire diameter. When pressed on the ductile lead (gold, platinum or copper), the electrodes deform it under each contact. Passing an alternating-current, or direct-current, pulse through the lead between the electrodes heats the lead and causes diffusion at the interface between the lead and thin film.

Tungsten and molybdenum alloy electrodes are superior to copper for bonding small gold wires. The operator uses a microscope and micropositioner to align the leads on the thin-film conductors.

Advantages of this technique are many. Bonding times are short and heat damage to components is minimized. Joints can usually withstand higher temperatures (above 300°C) than soldered joints. Consistently strong bonds can be made easily on small, ductile wires. Bonding conditions for most material combinations are readily determined. No filler materials are needed. The bonding pad area is smaller than that required for soldering. Electrode life can be long.

However, there are disadvantages: bonds cannot be inspected, so rigid process control is needed; bond areas are larger than for TC bonding; operators must be skilled at aligning electrodes; stray

currents may damage components, and variations in electrode-to-lead interface resistance may affect bonding heat.

Results of strength tests of 25 bonds made with optimum conditions are illustrated on page 90. The gold wires broke before the gold-to-gold bonds failed. However, several gold-to-copper bonds failed at the edges of the bonds; the higher force needed to bond to copper tends to notch the wire excessively. Curving the edges of the electrodes would avoid this, but create a tip-dressing problem.

#### Manual and machine soldering

Small, temperature-controlled soldering irons and flux-cored, eutectic lead-tin solder are used to attach large-diameter (5 to 30 mils) leads to thin films. The equipment is inexpensive and the joints can be visually inspected, but there are limitations.

Soldering time and temperature must be carefully controlled. Skilled operators are needed. Bonding areas on the thin films must be large. Flux residues must be cleaned from the circuits. The solder's melting point limits the circuit's operating temperature.

A semiautomated process is now being evaluated for hybrid-circuit fabrication. Preliminary results indicate it gives more consistent joint quality as a result of controlled heat input.

This process is the dynamically controlled resistance soldering that was originally developed at Autonetics to attach integrated-circuit flatpacks to multilayer printed circuit boards and to attach discrete components to ceramic printed circuits. Adjacent to the heating tip is a tiny thermocouple that senses and limits the soldering temperature as each joint is made.

Solder preforms are generally used, giving a more

uniform bond area. If parts are pretinned, a flux is not needed.

A microsoldering process is also used to bond the uncased silicon devices to the substrate. The solder is generally gold-silicon or gold-germanium alloy and the mating film is generally vapor-deposited gold. The solder, which can be applied as a preform, is generally heated until it flows. Heat is provided through the substrate or by heated tools. A shielding gas is usually employed. Bonding with conductive epoxies is being evaluated.

### Solder-joint evaluation

The evaluation of manually soldered joints is summarized by the curves on page 91. These curves compare the results of lap shear tests.

In the copper-to-copper joints, all lap shear failures occurred in the wire and all peel failures in the interface between the copper and Nichrome films. Peel strength averaged 1 pound.

In the copper-wire/gold-film joints, lap shear failure occurred in both the copper wire and the Nichrome. Average peel strength was less than  $\frac{1}{8}$  pound (only 4 out of 15 samples had measurable strengths), attributed to high peel stresses induced through the rigid 16-mil wire and low adhesion between the solder and the underlying Nichrome.

In the gold-wire/copper-film joints, lap shear failures occurred in the wire. Peel strength averaged  $1\frac{1}{16}$  pounds. Most peel failures occurred at the interface between the solder and gold wire, probably because gold-tin intermetallics formed as the gold dissolved in the solder. The ductility of the gold wire makes the peel strength significantly higher and more consistent than that of copper wire.

In the gold-gold joints, lap shear failures occurred in the gold wire at the wire-solder interface. Peel strength averaged  $\frac{2}{3}$  pound. Peel failures occurred in both the solder-Nichrome and wire-solder interfaces.

These results show why it is undesirable to solder small gold leads. Also, soldering to gold film may present difficult problems unless the solder readily wets the Nichrome under the gold.

Typically, if a 10-mil gold lead is subjected to a 4- or 5-second manual soldering operation, approximately 2 mils of gold are dissolved in the solder. Decreasing soldering time reduces the amount of gold dissolved, but when leads are only 1 to 3 mils in diameter, the gold dissolves too fast for good joints to be formed.

Preliminary tests of solder wettability on gold-Nichrome films indicated that the thinner films (250 and 500 angstroms) produced poor results. Solderability of the 1,000-angstrom gold film was satisfactory. Solder dissolved the thinner gold films, exposing the Nichrome, and dewetted.

### Production status

All of the basic processes from which these techniques were derived have been well established in the components industry. However, there are still

gaps in the data relating to their use in hybrid thin-film circuit construction.

This is their status, according to the four basic criteria for joining methods:

- **Reliability:** Mean time between failure of TC bonding to devices is known from experience in the semiconductor industry, but improvement is required. There are favorable indications from industry for the reliability of thin-film TC bonding, microgap bonding and microsoldering, but mtbf's are not yet established.

- **Producibility:** There is ample production experience only with device TC bonding. The processes are slow because joints are individually made, but equipment can be semiautomated. Autonetics' TC bonders feature automatic control of time, temperature and applied force, but require operator positioning.

- **Repairability:** All joints, except those that are microsoldered, can readily be repaired if bonding pads are made sufficiently large. Solder joints may be degraded if repair is attempted.

- **Inspectability:** Only microsoldered joints are visually inspectable. The quality of the other types of joints can be statistically monitored; solder joints can be continuously monitored by thermocouple temperature sensing on soldering machines.

The evaluations and experience to date indicate a need to further improve joining equipment and processes, obtain better thin-film adherence to substrates, develop nondestructive test methods for diffusion bonds, correlate the effects of bonding temperature with long-term degradation of thin-film passive components, and conduct statistical reliability evaluations of joining materials and processes.

In addition, lead sizes and materials must be standardized. Eventually, the use of leads to connect components to thin-film conductors must be eliminated and, concurrently, mounting and joining techniques automated to eliminate human variables.

### References

1. S.D. Robertson, "Low-Cost Systems with Integrated Hybrid Microelectronics," Autonetics Technical Memorandum 3443-4-10, July 16, 1964.
2. L.S. Phillips, "Thermocompression Bonding to Thin-Film Microcircuits," British Communications and Electronics, Vol. 10, No. 6, June, 1963.
3. J.R. Howell and J.W. Slemmons, "Joining Concepts for Microelectronics Systems," Autonetics Technical Report X4-690/3110, May 1, 1964.
4. H. Goldfarb, "The Effect of Vacuum Deposited Gold Film Thickness on Solderability," Autonetics Materials and Processes Laboratories Report TR-64-135, Feb. 24, 1964.
5. J.W. Slemmons and J.R. Howell, "Evaluation of Thermocompression Bonding Processes," Autonetics Technical Report TR-240/3110, Mar., 1964.
6. D.D. Robinson, "Linear Microcircuits Scarce? Now You Can Breadboard Your Own," Electronics, Oct. 19, 1964, p. 58.
7. T.A. Longo and B. Selikson, "Aluminum Wire Bonding of Transistors," Semiconductor Products, Nov. 1963, p. 27.
8. G.V. Brandewie and D.D. Shaffer, "Evaluation of Reaction Products Surrounding TC Bonds in Westinghouse Integrated Circuits," Autonetics TR-64-118, Feb. 28, 1964.
9. T.E. Everhart, O.C. Wells and R.K. Matta, "Evaluation of Passivated Integrated Circuits Using the Scanning Electron Microscope," Journal of the Electrochemical Society, Aug., 1964.
10. J.B. Northrup and C.L. Zachry, "New Interconnection Methods for Microcircuits," Autonetics Technical Report T4-324/3111.



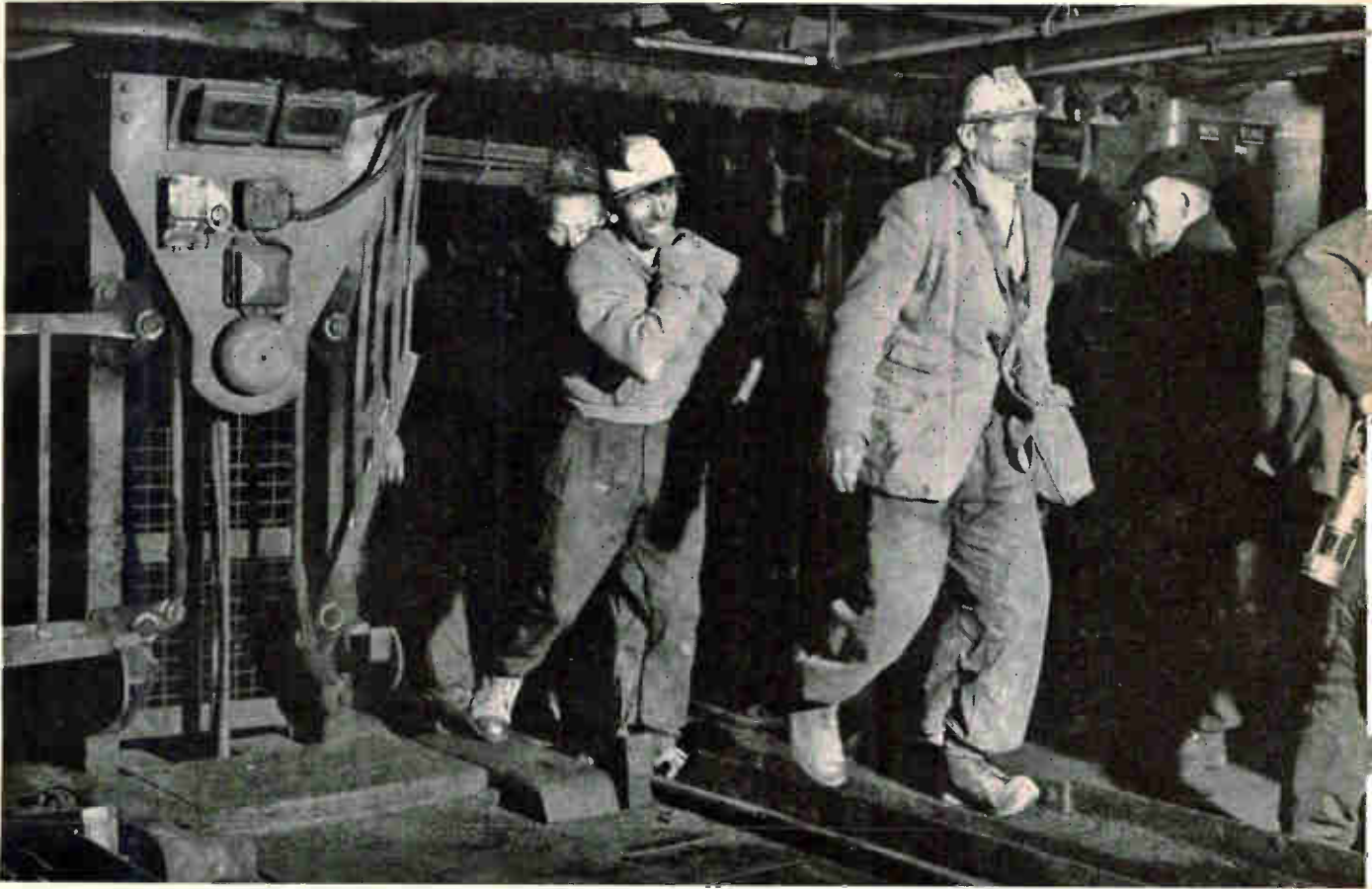

Industrial electronics

## From war gear to coal mines

Hawker Siddeley, a giant in military electronics, has devised a simple system to keep track of miners' locations and their complex pay scales

By J. E. Dick, Hawker Siddeley Dynamics, Ltd., Coventry, England

A simple electronic system has found a job in Britain's nationalized coal mines. It's logging the locations and pay scales of 1,400 miners at the Brookhouse colliery in Yorkshire, and doing it faster and easier than clerks ever could. A similar system is being installed at the Bevercotes colliery in Nottinghamshire, Britain's showcase for automated mining.

It may also be creating a bridgehead in industrial electronics for the Hawker Siddeley Group, Ltd., noted for its military aviation and electronics equipment. The coal-mine systems are products of the group's new industrial electronics operation.

The coal industry's complex wage structure includes hourly, piecework and contract systems. It

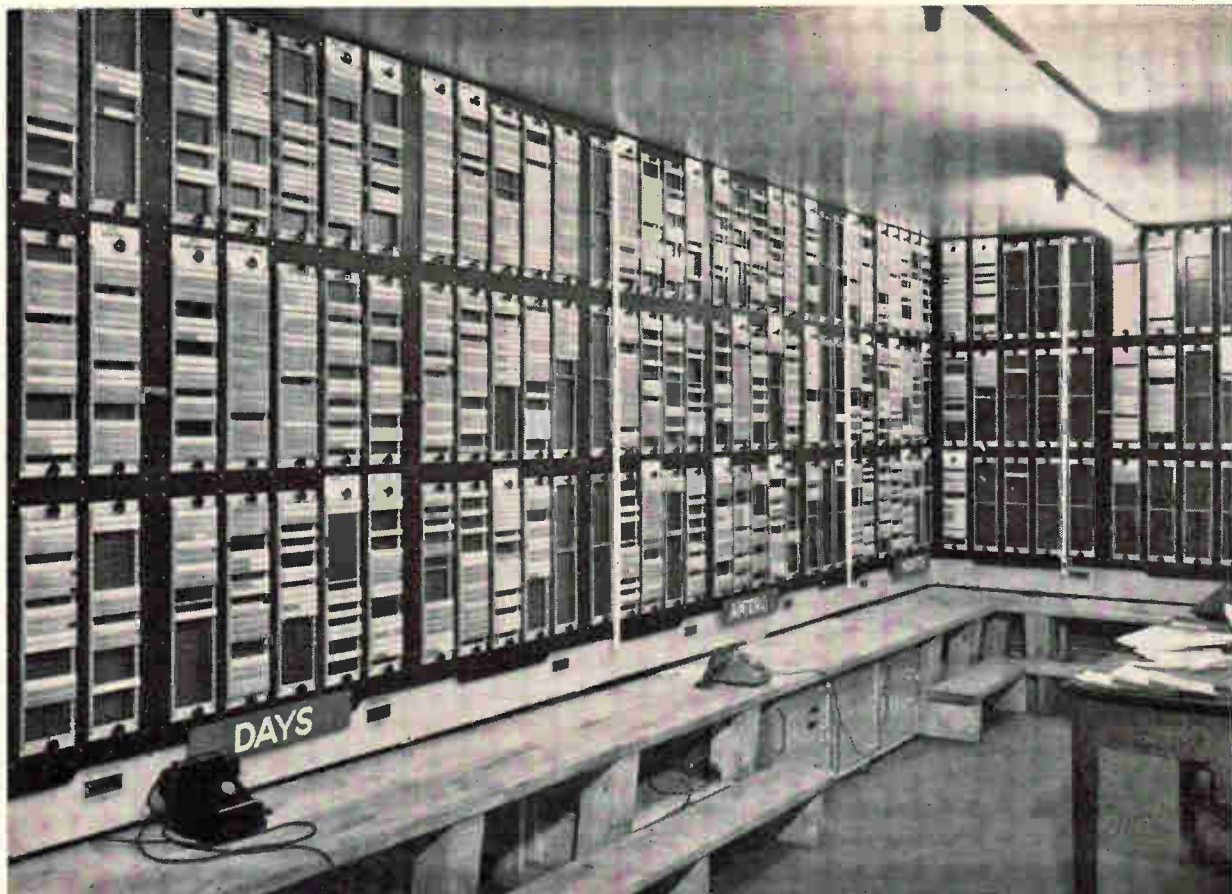

Time office at Brookhouse colliery. Boards are scanned for binary-coded wage data from each name plug. Control electronics fit under counter beneath grey telephone. Printout is done by teleprinter at extreme right.

also takes into account water money (for working in wet areas), flame money (ability to diagnose danger if a gas should be present in the air), and even differentials based on the mine's location. Then there's absenteeism to be reckoned, and accidents, and sickness.

For a colliery with 1,400 to 3,000 employees, this used to mean about a 10-man clerical staff. The new deployment system is operated by the gang foreman, who goes down into the pits after checking his crew in.

### Steel pins and name plugs

Any system used in a coal mine has to be simple, rugged, reliable and inexpensive. It must be capable of being repaired on a substitution basis by men inexperienced with electronic equipment. Complex redundancy, a standard in military systems, simply won't do.

Hawker Siddeley's deployment system uses name plugs with steel pins representing the 8-4-2-1 binary code. When a plug is inserted into a deployment board, each pin serves as a coupler between an input and an output signal loop. If no pin is present, very little signal is coupled out. A coded name plug's position in one of the five-column deployment boards tells where a miner is working. The pins give the miner's encoded check number

or the code of the special wage paid to his work gang.

A control unit scans each row, or plug, in a column. The digital data is read into the control unit and combined with a printing format; then it is used to operate a teleprinter and tape punch. The punched tapes are mailed to the home office where their information is stored in a computer and used to calculate weekly payrolls.

The Brookhouse system is shown at the top of this page. The control unit is in the panels below the grey telephone.

The face of each name plug has space on which to write the information that is encoded by the steel pins. Each plug contains up to 25 pins—there will always be an odd number when the plug has been correctly coded; the odd number is used as a parity check.

### Deployment boards

Holding the name-plug sockets is a printed circuit board with a matrix of horizontal driver, or signal-input, loops and vertical driven, or signal-output, loops, as shown at the bottom of page 95. With a pin in a hole, a three-volt rms input signal, at a repetition rate of six kilocycles per second, is coupled to the driven loop and the output is 0.5 millivolt peak-to-peak, representing



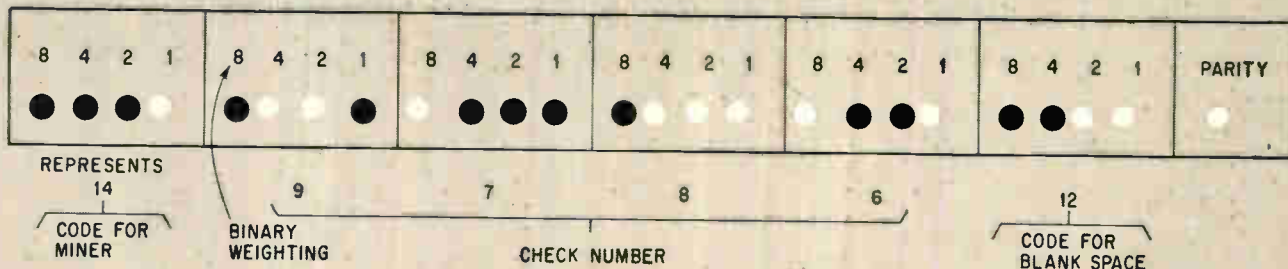
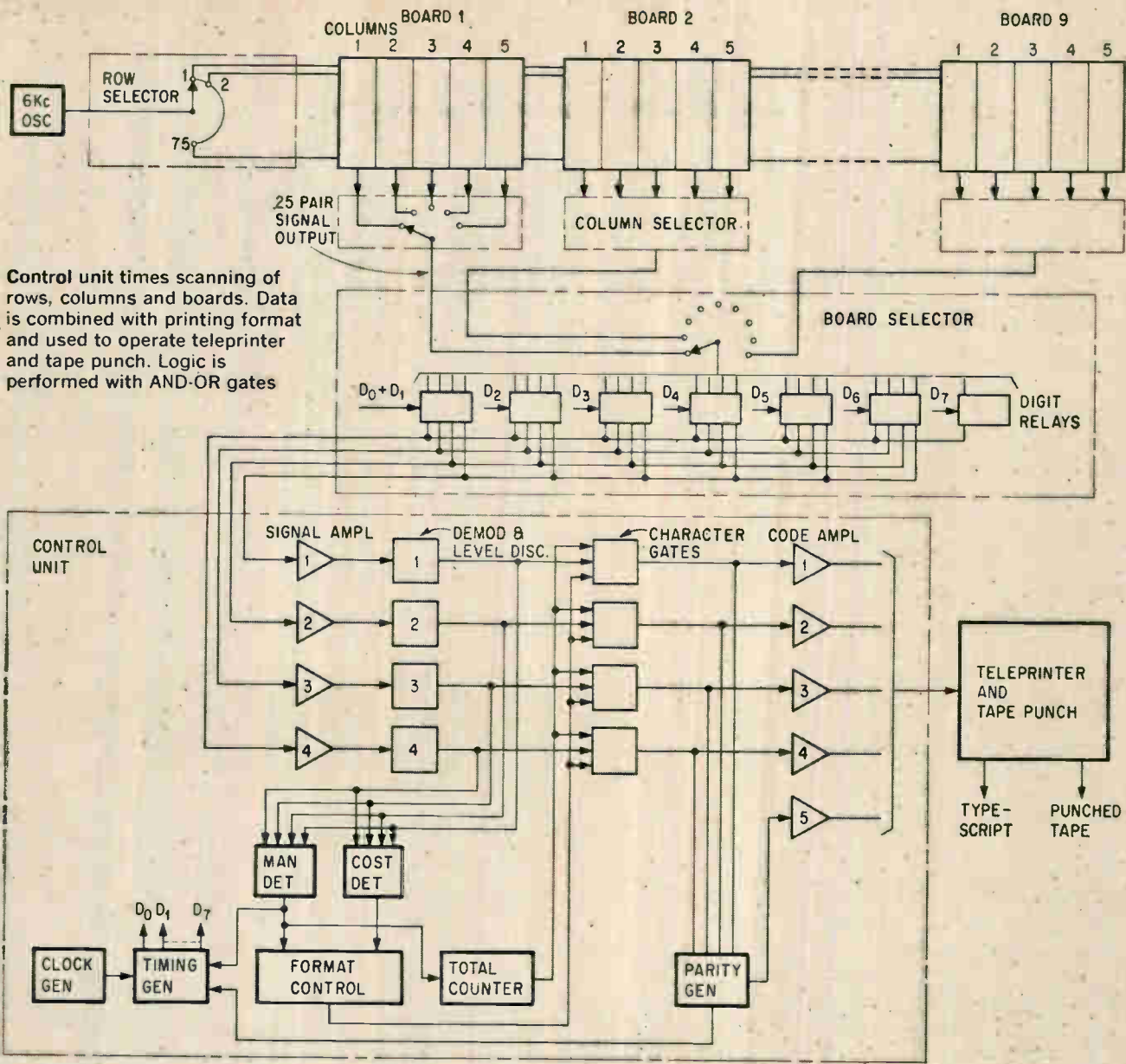

Binary coding of a name-plug is by steel pins. Pins are used as couplers, or cores, in matrix of magnetic drive and driven loops.

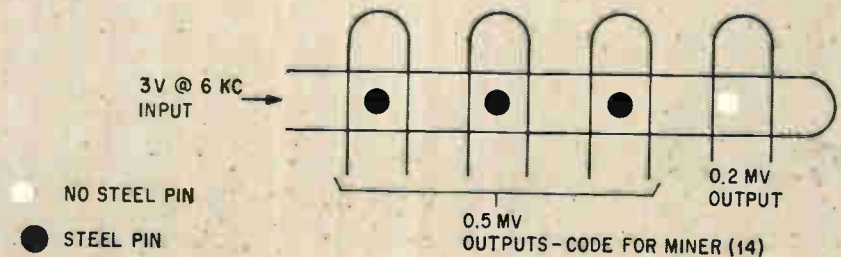

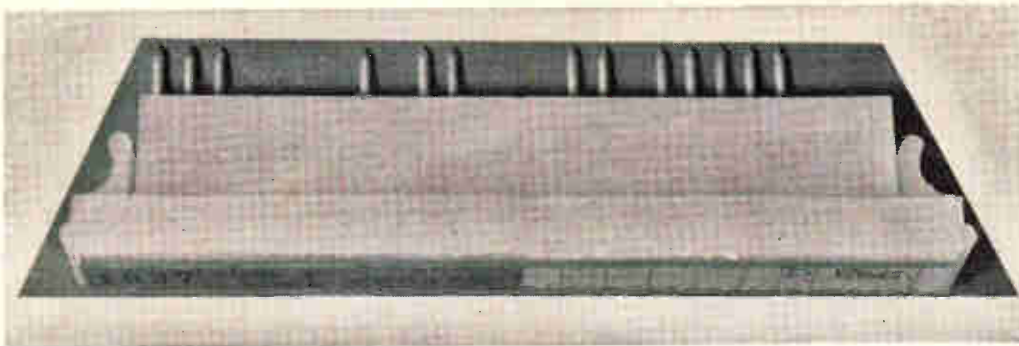

Name plug with steel pins in place. Pins may be removed and repositioned to change code. Encoded data is penciled in under clear face on front of name plug.

a binary 1. With no pin, the output signal is 0.2 millivolt, peak-to-peak, representing a 0. The blank-space code, when combined with the printout format, provides a space between one miner's number and another's.

Each column can hold 75 name plugs. There are five columns to a board and, in the Brookhouse time office, nine boards in the system.

#### Switching from row to row

The input signal to the loop-matrix (shown at top of page 95) is provided by a 6-kc oscillator that generates a sinusoidal output of about 3 volts rms. This signal is connected sequentially to each horizontal row, by a stepping switch, one per second; induction produces the ones or zeros.

Inductive coupling was chosen for ruggedness and economy. If pins and sockets do not come in contact, the pins do not have to be machined to close tolerances. With some space between a pin and its socket, a name-plug can be inserted into place on the board without concern about bending, eliminating frequent replacement. The polyethylene name-plugs are held in place by friction with vertical metal guides on the front of each column.

The row-selector is basically a 75-position stepping switch that applies the energizing signal to each row, in turn, of every column scanned. It consists of a 3-level, 25-position, one-way selector with level-switching by relays.

The column selector is one 25-pole, 5-position switch for each deployment board. The switches, attached to the deployment boards, are stepped by the control unit. Each selects one of the five

columns on its associated board. The output of a column-selector switch consists of 25 pairs of signal wires and control wires.

#### The control unit

The signal cables from all of the deployment boards are brought into the board-selector unit; each cable consists of 25 twisted-wire signal pairs that are selected sequentially and connected, in groups of four, to seven 4-pole digit relays. These relays are operated in sequence; each group of four signal wires is switched through, in turn, to four output wires. Only one of the four poles is used on the seventh relay.

The control unit is constructed of printed circuit cards and solid state components for reliability and ease of servicing. To obtain the input signals, the control unit provides the scanning signal, one row per second, or four rows per second for empty sockets. It also produces timing signals for the row, column and board selectors, also times the logic operations within itself.

Input from the digit relays is amplified and goes to the discriminator that converts a 0.2-mv signal to a logical zero rated at -12 volts, and 0.5 mv to a logical one of zero volts.

The control unit also:

- Carries out a parity check—makes certain that each name plug gives an odd number of 0's and 1's—and stops the scanning if a plug responds with an even number of bits.
- Counts the name-plugs scanned and prints this total after all of the boards have been scanned.
- Produces the five-wire (8-4-2-1) code to drive the teleprinter.

The system is rated at 200 to 250 volts, 50 cps at 100 watts required input power.

For a mine employing about 1,000 men, one of these systems would cost \$14,000 to \$16,800.

#### Printout

The teleprinter employed is a Creed Model 75 with a five-hole tape perforator to give printed typescript and punched paper-tape outputs simultaneously. It operates at 10 characters a second. The teleprinter keyboard may be used, if necessary, to provide additional data not shown on the man-power deployment board.

#### The author



When his company decided to diversify, J. E. Dick was asked to leave his work on weapons systems and manage the new industrial electronics division of Hawker Siddeley Dynamics, Ltd. After a careful study of military-industrial conversion, he selected a staff consisting of two industrial electronics engineers for every one military designer. They're concentrating their efforts on digital telecontrol equipment.





Consumer electronics

## Colorful, faithful, easy to operate: goals for an all-European tv system

Amid politics and propaganda, representatives of 15 countries are comparing technical merits of 3 methods. Here are some factors they're considering

By Joseph Roizen, Ampex Corp., Redwood City, Calif.  
and Richard Lipkin, Consumer Electronics Editor

**Representatives of 15 European countries** are gathering in Vienna to make an important decision: a common system of color tv. They're members of the International Radio Consultative Committee (CCIR) of the International Telecommunications Union, which represents nations on both sides of the Iron Curtain.

At least three previous meetings have failed to reach an accord. But this is the year of decision. Any recommendation made by the Vienna group will

probably be accepted by the European Broadcasting Union and adopted throughout the continent. If no agreement is reached at the sessions that begin March 24, some countries will go it alone with their own systems, and chances of an early all-European color system will be smashed.

At first glance there shouldn't be any problem at all. In the United States, a color system has been in commercial use for over 10 years — NTSC, for National Television Systems Committee. Three million

homes have color receivers, and the number is expected to climb to five million this year.

But the truth is that NTSC does have some technical difficulties, and some of these are eliminated in France's Secam and West Germany's PAL systems.

### What's wrong with NTSC

The main problem with the NTSC system is color distortion due to phase sensitivity. Phase shift, caused by the topography of the transmission path, often requires the viewer to adjust his color knob with every station change. Differential phase shift, where one color is distorted more than another, cannot be eliminated as easily. It is caused by cumulative nonlinearities in the transmitter-receiver chain.

Another possible problem is single-sideband distortion, which causes colors to slop over to the right of where they should be. Finally, the complaint is raised that NTSC receivers need four interdependent controls — brightness, contrast, hue and saturation. That requires too many adjustments of too many knobs to assure the right combination.

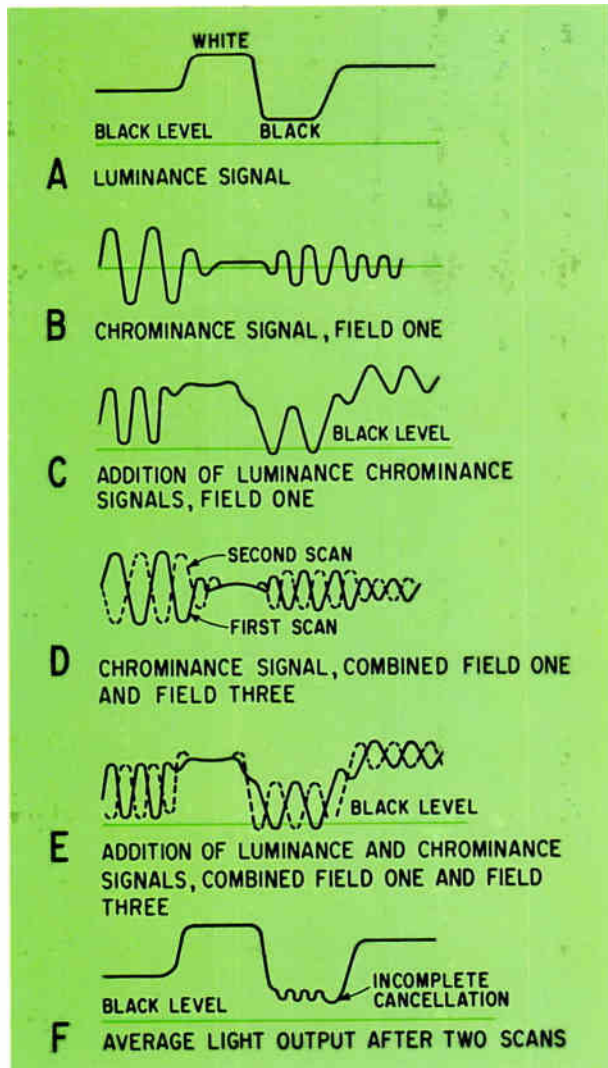

Frequency interlace, plus persistence of vision, leaves original luminance information undistorted despite addition of chrominance signal. Subcarrier frequency is chosen so that it reverses every frame, canceling after two frames.

Yet neither of the two competing systems, Secam and PAL, offers a panacea. They also have their deficiencies, so there is no clear-cut choice. The best system in one situation is not the best in another. As if these technical problems were not enough, the delegates will also have a bundle of political problems.

The French have made the choice of Secam a matter of national pride. The Germans are pushing almost as hard for PAL. Aside from the prestige, these countries would like to win the royalties that will go with the prize.

Still, the ultimate decision must be technical. To understand the inherent advantages and weaknesses of these different methods of transmission, one must understand the NTSC system and then compare its operation with Secam and PAL.

## NTSC: basis for all color TV

With NTSC, as with the other systems, the color signal starts with the camera. In the color-tv camera, the image is broken up by dichroic (color-sensitive) mirrors so that all light corresponding to the red primary goes to one video pickup tube, green to another and blue to a third. The three output voltages,  $E_R$ ,  $E_G$  and  $E_B$ , are proportional to the amount of each primary color in the original picture element. These signals are then gamma-corrected; that is, they are made nonlinear to correspond to the transfer characteristics of the kinescope phosphors.

### Color-tv terms

Gamma-corrected  $E_R$ ,  $E_G$  and  $E_B$  are not transmitted as such. They are transferred into color information representing brightness, hue and saturation.

Hue puts a color in a descriptive class such as red, green, blue, yellow or purple. Saturation refers to the purity of a color — the absence of dilution by white light. Highly saturated colors, such as those found in a color spectrum, are described as vivid. Low-saturation colors, called pastels, are pale. Brightness is an indication of the color's light intensity, from bright to dark. The measure of a color's brightness is its luminance. The measure of its hue and saturation is its chrominance. Monochrome television is actually a system capable of conveying only luminance information. Color tv, by adding transmission of hue and saturation, becomes an extension of monochrome television.

The luminance signal is transmitted at full bandwidth exactly the same as a monochrome signal complete with horizontal and vertical synchronization pulses. In this way the color signal is compatible with black-and-white receivers.

The luminance signal, designated  $E_Y$ , is created by matrixing together the  $E_R$ ,  $E_G$  and  $E_B$  signals in proportion to the eye's sensitivity to the brightness of the primary colors. This proportion — 59% green, 30% red and 11% blue — renders the best possible monochrome grey scale to the color image. Then

$$E_Y = 0.59 E_G + 0.30 E_R + 0.11 E_B$$

where  $E_G = E_R = E_B = 1$  for maximum white.



ngle-sideband distortion in NTSC



ormal picture with clean color transition.



ngle-sideband distortion causes color crosstalk.

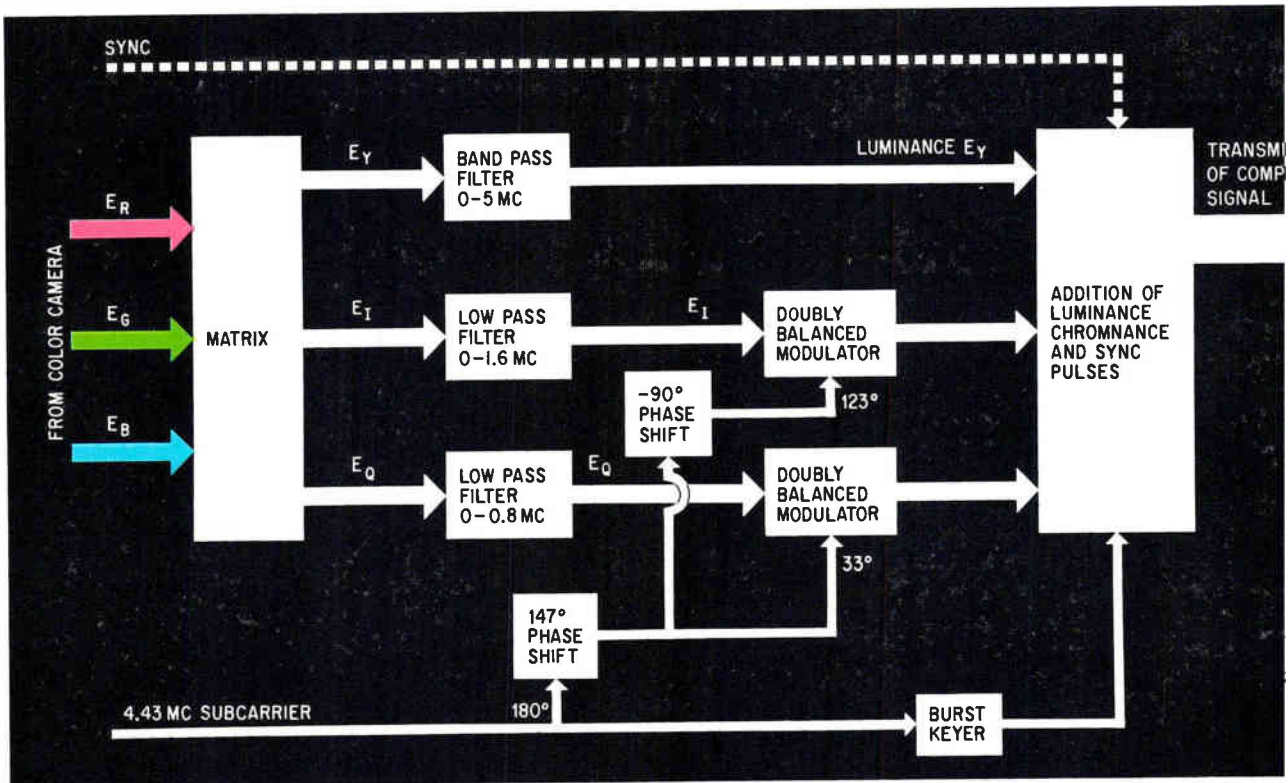

NTSC transmitter. The camera signals are matrixed to form  $E_Y$ , which corresponds to a standard monochrome signal. To this is added a subcarrier that is modulated in phase quadrature with two color signals,  $E_I$  and  $E_Q$ .

### Adding the color information

To conserve bandwidth, this luminance signal is added, before transmission, to a color subcarrier that contains the chrominance information.

The subcarrier frequency selected for Europe's 625-line, 50-field-per-second tv is nominally 4.43 Mc (actually 4.4296875 Mc). The U.S. uses a 525-line, 60-field-per-second system, with the color subcarrier set at 3.5 Mc. In both cases the frequency is an odd multiple of one-half the frame frequency and an odd multiple of one-half the line frequency, so that the subcarrier reverses in phase for every frame and every line. Because of this phase reversal, the effect of the subcarrier on  $E_Y$  is canceled. This technique, based on frequency interlace and the persistence of vision, is illustrated on page 98.

Note that the luminance and chrominance information does not change appreciably from frame to frame so that, because of persistence of vision, the light errors are averaged out in the eye every other frame. However, in areas of saturated colors, where the composite signal goes below cutoff, cancellation is not complete and light dots remain on the screen. But the subcarrier is a high frequency so that the remaining dot structure is either very fine or disappears completely on most monochrome sets.

### Deriving chrominance signals

Now for the chrominance signals to be modulated onto the subcarrier. For compatibility, the  $E_Y$  signal carries all luminance information. To eliminate the luminance information from  $E_R$ ,  $E_G$  and  $E_B$ , they are added to  $-E_Y$ . The signals formed ( $E_R - E_Y$ ,  $E_G - E_Y$  and  $E_B - E_Y$ ) are the color-difference signals. In the

receiver these difference signals are added to  $E_Y$  to recover  $E_R$ ,  $E_G$  and  $E_B$ .

In all three color systems, some form of  $E_R - E_Y$  and  $E_B - E_Y$  are transmitted as the color signals. Green information is recovered in the receiver from the remaining difference signals and  $E_Y$ .

The right side of the NTSC receiver on page 101 illustrates how the difference signals may be added to the luminance signal. Here the luminance signal is applied to the cathodes of the kinescope, and the difference signals are applied to the grids. During the transmission of white information, when the dif-

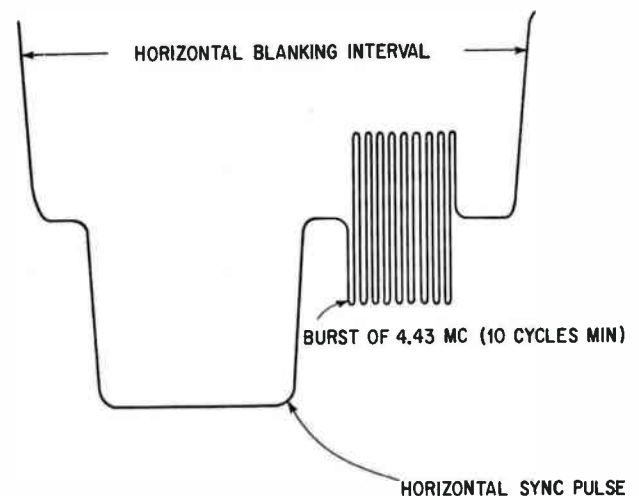

Color synchronizing burst, transmitted on back porch of horizontal sync pulse, is used by receiver to match its local oscillator with the one at the transmitter.



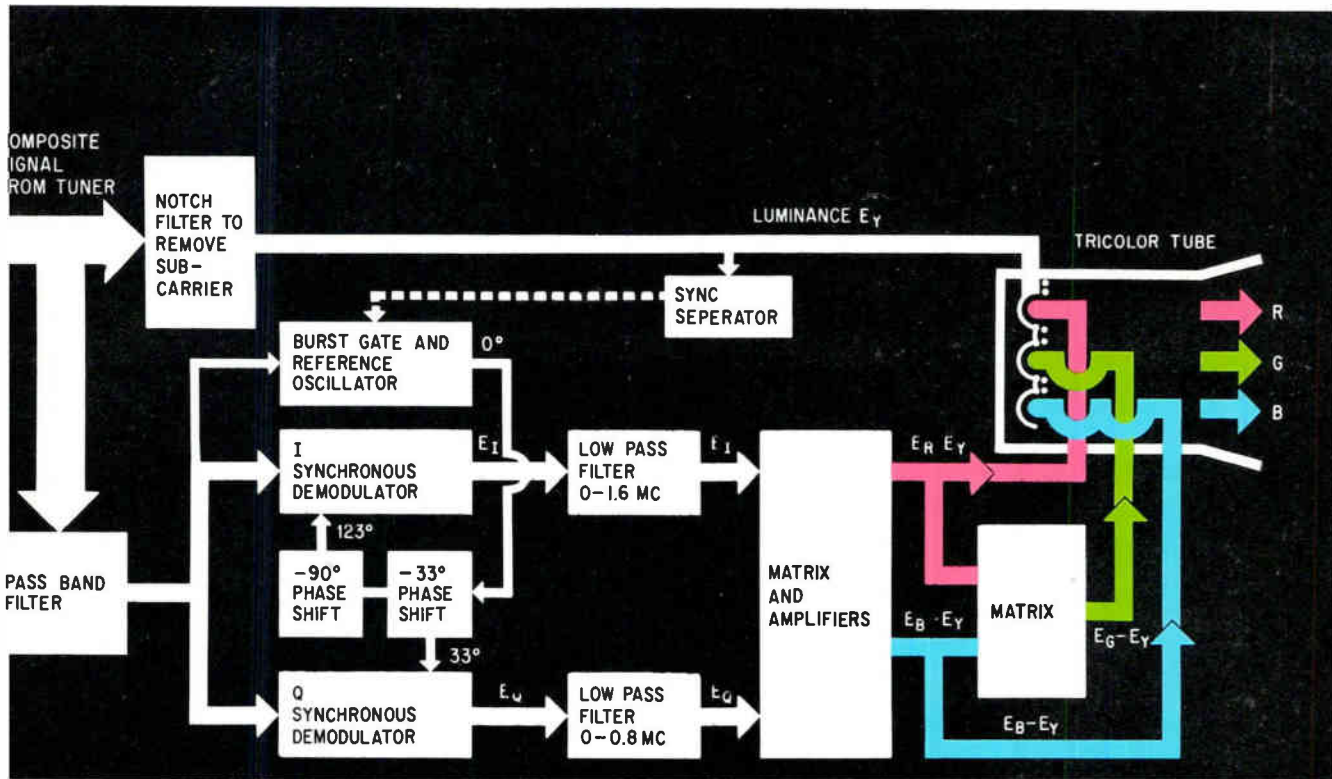

NTSC receiver. To recover  $E_I$  and  $E_Q$  without distortion, a local oscillator provides two subcarriers,  $90^\circ$  apart, kept in perfect phase and frequency synchronization with the transmitter's subcarriers.

ference signals equal zero,  $E_Y$  alone feeds all three color guns. This is to be expected since driving the three colors at the same level produces shades of white. Notice that this color receiver can accept a normal monochrome signal (corresponding to  $E_Y$ ) and produce a black-and-white picture.

**Quadrature modulation**

The two color signals transmitted in NTSC are variations of  $E_R - E_Y$  and  $E_B - E_Y$  called respectively  $E_I$  and  $E_Q$ . The reasons for the change will be explained later. Consider first the problem of trans-

mitting two independent signals on one subcarrier. In NTSC, this is accomplished by a technique called quadrature modulation.

Note in the NTSC transmitter shown on page 100, that one signal amplitude-modulates the subcarrier at an angle that is  $90^\circ$  out of phase with the other. Each modulator is doubly balanced so that the subcarrier frequency itself is suppressed. When the two modulator outputs are added together, the resultant signal varies both in amplitude and phase.

$E_I$  and  $E_Q$  are separated at the receiver by two modulators operating as synchronous detectors; these

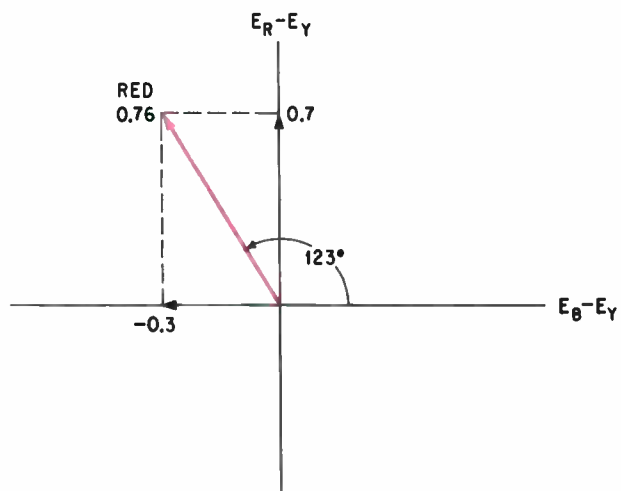

Resultant chrominance signal has an instantaneous phase and amplitude that can be shown vectorially using as axes the two difference signals that are modulated  $90^\circ$  apart. Saturated red is shown.

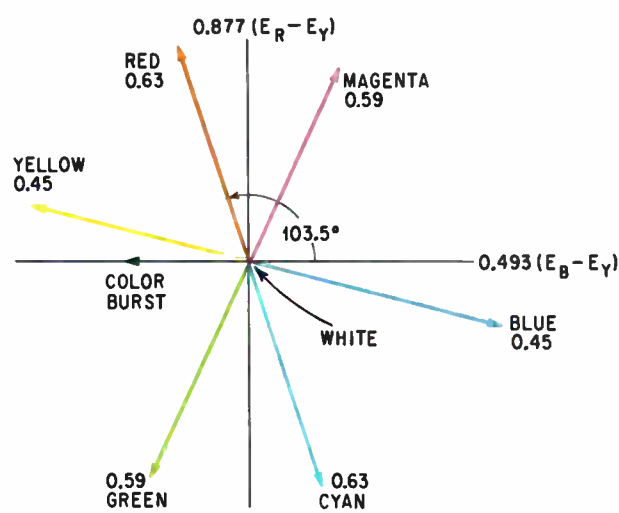

Chrominance phasors for saturated colors have instantaneous values shown after levels have been adjusted to prevent overshoot in monochrome receivers. Note that complementary colors add to form white.

multiply the incoming signal by two 4.43-Mc carriers, also 90° out of phase. The carriers in the receiver must be supplied by a local oscillator that is kept in strict phase and frequency synchronization with the oscillator at the transmitter.

Color-carrier synchronizing information is transmitted in NTSC during the back-porch interval following the horizontal synchronizing pulse as shown on page 100. The color sync is a burst of at least 10 cycles of subcarrier. Phase detectors in the receiver, which operate during the blanking period, match the burst with the output from the local oscillator.

### The color phasor

The phase of the subscriber is crucial in NTSC because it determines the hue of the reproduced color. This can be shown by representing an instantaneous color signal as a phasor using  $E_R - E_Y$  and  $E_B - E_Y$  as axes.

Shown on page 101 is a representation of a color signal for a scene that contains only saturated red. Values are determined from these equations. Since

$$E_Y = 0.59E_G + 0.30E_R + 0.11E_B, \text{ then}$$

$$E_R - E_Y = -0.59E_G + 0.70E_R - 0.11E_B$$

$$E_B - E_Y = -0.59E_G - 0.30E_R + 0.89E_B$$

Since there is no green or blue present in saturated red,  $E_R - E_Y = 0.70$  and  $E_B - E_Y = -0.30$ . The resulting color signal has an amplitude of 0.76 volts per unit and lags the blue difference signal by 123°.

Similarly, the amplitude and phase of saturated blue and green can be determined as shown on page 101. The positions of saturated cyan (greenish-blue), yellow and magenta are also found easily because they are the complementary colors for red, green and blue respectively. Complementary colors are equal in amplitude but opposite in phase, so that when combined they form white. White is represented by the origin since there is no chrominance signal for white. The amplitude of the color signal, therefore, determines saturation or dilution by white.

Notice in the color phasor diagram that the axes are not  $E_R - E_Y$  and  $E_B - E_Y$ , but  $0.877 (E_R - E_Y)$  and  $0.493 (E_B - E_Y)$ . These are the relative voltage adjustments necessary before quadrature modulation, so that the combined chrominance and luminance signal does not overdrive monochrome sets into the blacker-than-black and whiter-than-white regions more than 33% at maximum saturation. In the color receiver, amplifiers with relative gains of  $1/0.877$  and  $1/0.493$  compensate for the reduced transmission levels of the color signals. Note that the burst is 180° out of phase with  $E_B - E_Y$ . This simplifies the receiver's oscillator-synchronization circuitry.

### Phase shift causes hue error

The main problem with NTSC is its sensitivity to phase shift. To reproduce a hue accurately, the resultant color phasor must be held within a tolerance of  $\pm 5^\circ$  (at  $\pm 10^\circ$  hue error is noticeable). The time-base accuracy for reproduction of such a signal is on the order of a few nanoseconds. This makes video recording by a rotating mechanical device in a tape recorder extremely complicated. Hue is also affected by multipath induced errors between the

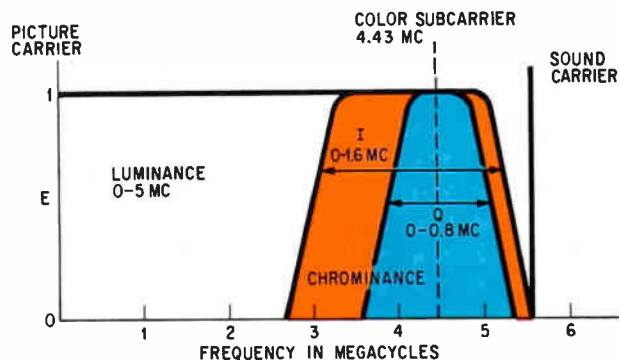

**NTSC/PAL frequency spectrum (625 lines).** Three independent signals occupy the spectrum between 3.6 and 5.2 Mc, two between 2.8 and 3.6 Mc. I and Q are separated from one another by quadrature modulation and from the luminance signal by frequency interlace.

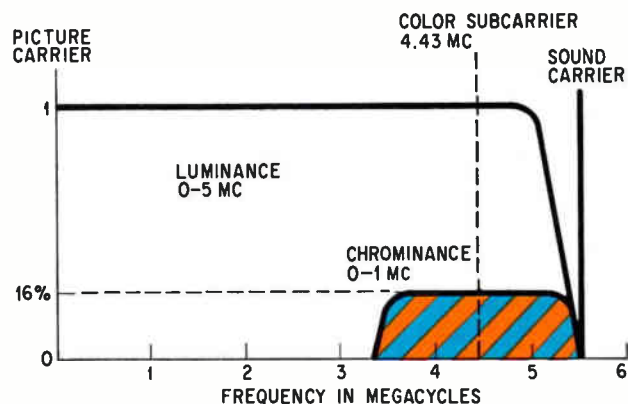

**Secam frequency spectrum (625 lines).** In Secam, the two color-difference signals are separated by time, each being transmitted alternately every line. The chrominance level is kept at 16% of the maximum luminance level to improve monochrome compatibility.

transmitter and the receiver, and by phase shifts in transmitting equipment.

The photographs on page 103 show the appearance of a color-tv screen when reception is as it should be and when all the colors have shifted first by  $+70^\circ$  and then by  $-70^\circ$ . This is corrected in the receiver with the hue control (the color knob) that changes the angle between the received burst and the local carrier. However, if one were to switch from one station broadcasting color to another, the phase shift probably would be different because of different transmission paths, and the hue would have to be reset. This can be annoying to the viewer.

Even worse is differential phase error, where some colors are shifted by one angle and other colors are shifted by another angle. In this case the hue control can only attempt to strike a happy medium.

### Limiting the bandwidth

Bandwidth requirements for the color signal determine the final character of the NTSC signal.

Psychologists have found that the eye can perceive only the color of relatively large areas; it perceives detail as variations in brightness. It makes sense, then, to limit the bandwidth of the chrominance so that color is applied only to large areas while the wideband luminance signal supplies detail.



In general, a bandwidth of 1.6 Mc supplies all the color detail the eye can resolve in a 625-line system.

Each of the color-difference signals in phase quadrature has associated with it a pair of sidebands centered on the subcarrier frequency and occupying the same spectrum space. Notice in the video spectrum on page 102 that there is only enough space between the color and sound carriers for double-sideband transmission of 0.8 Mc. To increase the bandwidth to 1.6 Mc, vestigial sideband transmission is necessary. However, both sidebands are needed in the receiver to separate signals modulated in phase quadrature. Loss of sideband information causes crosstalk.

Only one of the difference signals, however, needs to be limited to a 0.8-Mc bandwidth; the other may have the larger 1.6-Mc bandwidth. In this way, two signals are transmitted in phase quadrature for frequencies from 0 cycles per second to 0.8 Mc (where there are double sidebands), and one signal is transmitted in amplitude-modulation for frequencies from 0.8 to 1.6 Mc. A choice is necessary to decide which color signal should have which bandwidth.

### Color perception

Not only does the eye resolve changes in brightness better than changes in color, it also resolves some chrominance changes better than others. The eye's greatest acuity for color detail is for variations from orange to cyan.

An axis, drawn from the orange to cyan on the color phasor diagram on page 106, could then be called the maximum-acuity axis. The high-acuity axis is called I; the low-acuity axis — drawn perpendicular to I — is called Q.

For best use of the proportional bandwidth allocations, I and Q were chosen as the modulation axes rather than  $0.877 (E_R - E_Y)$  and  $0.493 (E_B - E_Y)$ . The maximum-acuity axis is transmitted at the wider bandwidth.

$E_I$  and  $E_Q$  are matrixed from  $E_R$ ,  $E_G$  and  $E_B$  in the same way as the color-difference signals, but in different proportions. The values for  $E_I$  and  $E_Q$  can be worked out by projecting them onto the original axes. They are

$$E_I = 0.60E_R - 0.28E_G - 0.32E_B$$

$$E_Q = 0.21E_R - 0.52E_G + 0.31E_B$$

In the receiver, with demodulation axes at  $33^\circ$  and  $123^\circ$ ,  $E_I$  and  $E_Q$  are recovered. With axes at  $0^\circ$  and  $90^\circ$ ,  $E_R - E_Y$  and  $E_B - E_Y$  are recovered directly without the need for further matrixing; however, this demodulation occurs only on the double-sideband portion of the signal, thereby limiting the color bandwidth to 0.8 Mc. A full-bandwidth NTSC receiver is shown on page 101. However, most color receivers made in the United States are narrow-band.

### Misplaced lips: color them blue

Another possible difficulty that can plague the NTSC signal is single-sideband distortion. When this occurs, crosstalk between  $E_I$  and  $E_Q$  prevents the receiver from properly switching colors. Many viewers have noted color programs in which a girl's lips are in the middle of her cheek. Screens with normal reception and with single-sideband distortion are

## An NTSC problem: phase shift



Desired reproduction, phase within  $\pm 10^\circ$



Phase shifted  $+70^\circ$



Phase shifted  $-70^\circ$



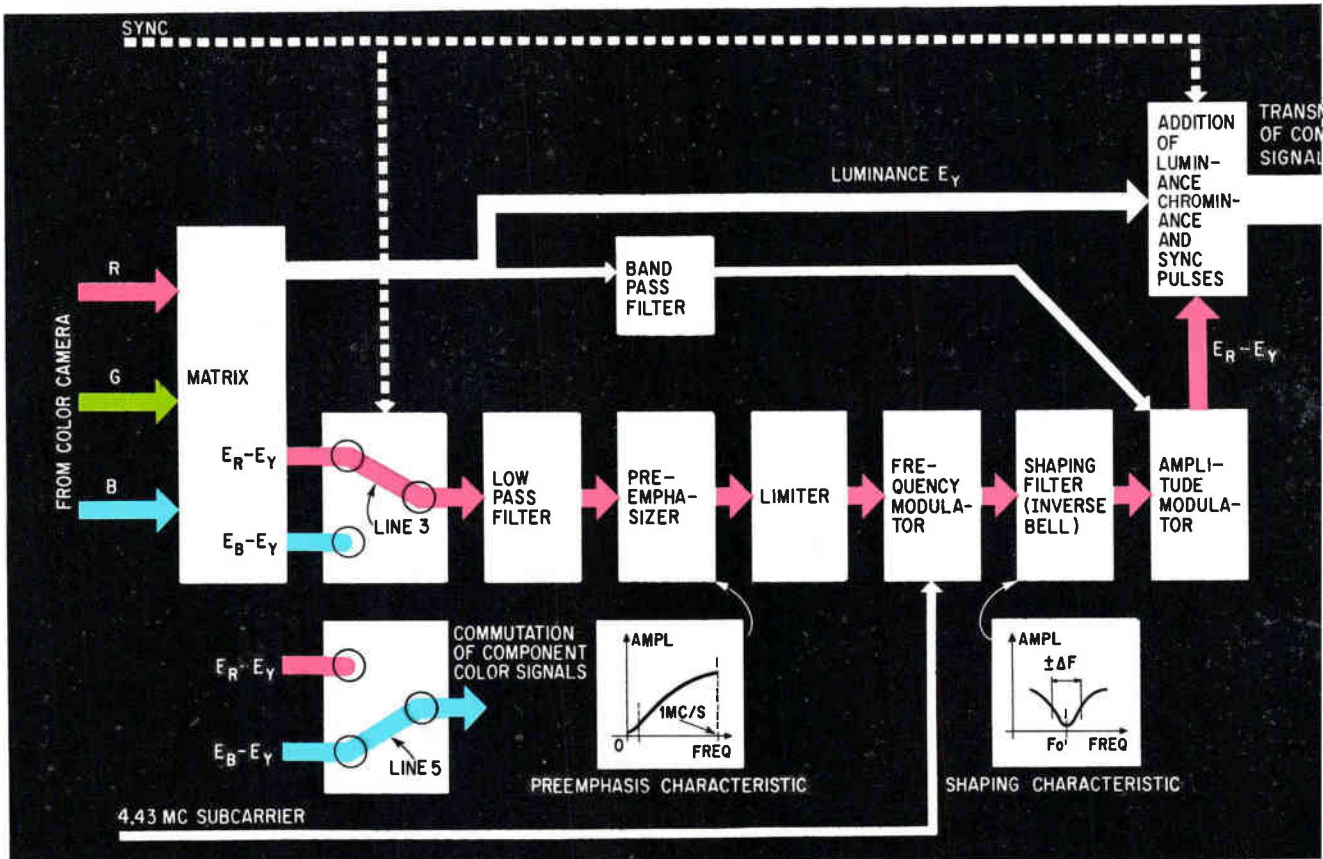

Secam transmitter. Line 3, a red difference signal, is being transmitted. The lower view of the color commutator shows the transmission of the following line, a blue difference signal (line 5).

compared on page 99.

A final complaint with NTSC: the necessity of having to set four interdependent controls – brightness, contrast, hue (color knob) and saturation (tint knob) – makes it difficult to come up with the right combination.

## Secam: an end to crosstalk

Secam was invented by Henri de France of the Compagnie Francaise de Television, a subsidiary of the Compagnie Générale de Télégraphie Sans Fil (CSF), for the express purpose of eliminating NTSC's prime drawbacks – sensitivity to phase distortion and crosstalk between the two simultaneously transmitted color signals. In his system, only one color signal is transmitted at a time. A memory device in the receiver provides the missing information. Hence

the name Secam – sequence and memory.

The transmitted color signal alternates between  $E_R - E_Y$  and  $E_B - E_Y$  from line to line. Since both signals must be available simultaneously at the receiver, a delay stores each transmitted line so that it is available as the missing signal for the next line.

Because of the fact that only one signal is being transmitted at a time, Secam is able to frequency-modulate the subcarrier. In this way the resulting color signal is insensitive to distortion in phase and amplitude. The Secam color signal is so stable that there is no need for hue and saturation controls on the receiver.

However, because the color signals are not transmitted simultaneously, interlace scanning cuts the vertical color resolution in half. This is because the delayed line and the direct line, which are added together, are not adjacent. Lines 1, 3, 5, 7, etc. are set

**Mechanism of error cancellation** shows that by altering phase of I component every line, any color error is canceled over 2-line period. Picture information does not change much from line to line.

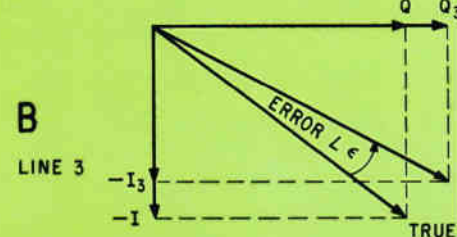
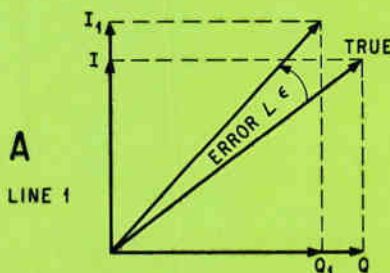



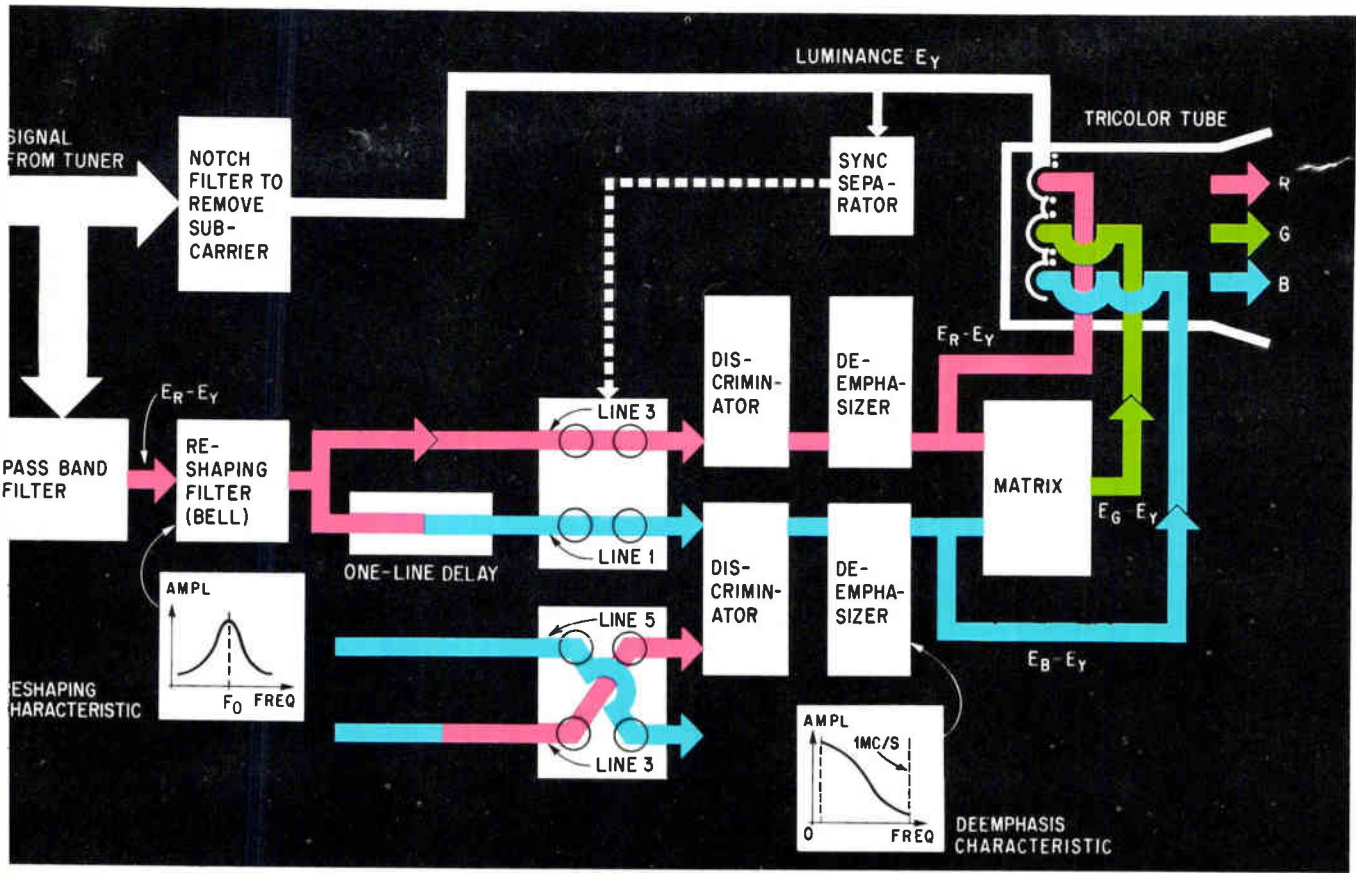

Secam receiver. Line 3 is being received. Simultaneously, line 1 is available from the delay line. The lower view of the color commutator shows the reception of the next line, line 5.

down in one field; lines 2, 4, 6, 8, etc. are set down in the next field. Secam's premise is that when the vertical color resolution is halved, it is still considerably more than the horizontal color resolution, and the reduction cannot be perceived.

**Modulation of color difference**

In Secam, it is the color-difference signals ( $E_R - E_Y$  and  $E_B - E_Y$ ) that modulate the subcarrier, not  $E_I$  and  $E_Q$ . One reason is that since only one signal is transmitted at a time, both signals may be transmitted at the same bandwidth. Hence, proportional bandwidths are not necessary with Secam. Another reason is that in the receiver the color-difference signals are then available after demodulation, without the need for matrixing as with NTSC.

In Secam, the color bandwidth is established at 1 Mc. The 4.43-Mc subcarrier has a maximum deviation of  $\pm 700$  kilocycles. This means that a maximum positive value for one of the difference signals will cause the subcarrier to increase to 5.13 Mc; a maximum negative signal will decrease it to 3.73 Mc. For color-difference signals equal to zero — for white information — the carrier is at rest frequency.

It has already been shown that the range of  $E_R - E_Y$  is  $\pm 0.7$  for highly saturated red and cyan. Similarly, the range of  $E_B - E_Y$  is  $\pm 0.89$  for saturated blue and yellow. These two signals are amplified by  $-1/0.7$  and  $1/0.89$  ( $-1.5$  and  $1.1$ ) respectively, so that the maximum color-difference signal of  $\pm 1$  corresponds to maximum subcarrier deviation.

Actually, saturated colors are rare; the practical range of 1.5 ( $E_R - E_Y$ ) is  $-0.35$  to  $+0.75$  while that of 1.1 ( $E_B - E_Y$ ) is  $-0.61$  to  $+0.28$ . By choosing a negative coefficient for 1.5, the practical signal range can be kept to within  $-0.75$  to  $+0.35$ .

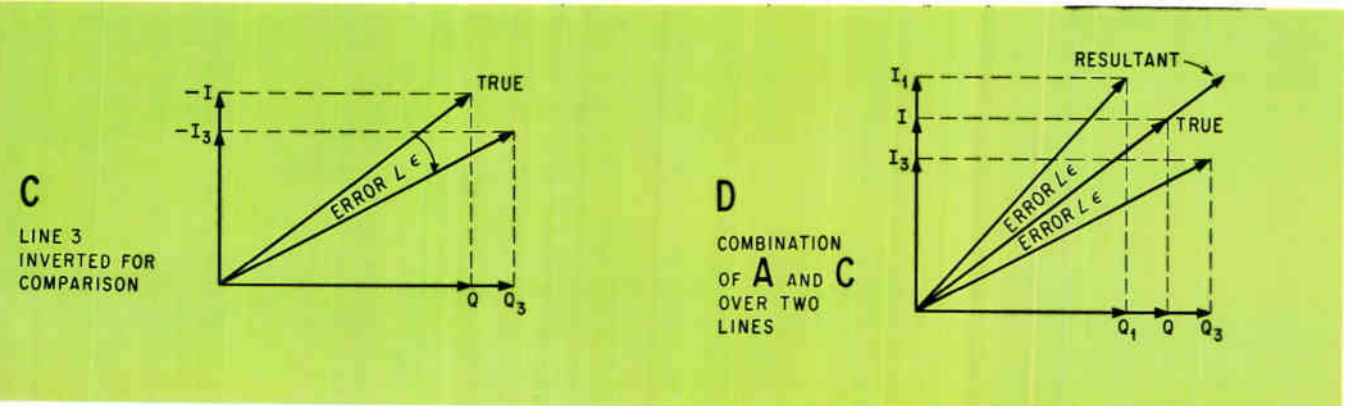

## Strengthening the signal

This leaves positive deviation space for pre-emphasis of the difference signal to improve its transmission characteristics. Preemphasis is a common technique with frequency modulation, whereby the strength of high frequencies is increased, relative to lower frequencies, so that higher frequencies correspond to higher deviations. A preemphasis curve is shown with the Secam transmitter. In the receiver, a deemphasis filter returns the difference signal to its original form. This is shown in the Secam receiver on page 105.

## Reducing subcarrier levels

As previously shown, the Secam subcarrier is always present, unlike the suppressed subcarrier in NTSC. To make the subcarrier's presence less objectionable on a black-and-white receiver, two techniques are used. First, the color-modulated color signal is kept at a level 16% of the luminance at maximum white. This is shown in the Secam spectrum on page 102. Next, the modulated color signal is passed through a filter with an inverse-bell-shaped characteristic, which reduces its amplitude at the rest or white frequency. At the Secam receiver, a filter with a bell-shaped characteristic restores the shape of the modulated signal. These filters are also shown in the Secam receiver and transmitter.

## Noise causes degeneration

Although reducing the level of the subcarrier reduces the problem of compatibility, it creates another major problem — sensitivity to noise. In fringe areas, where the NTSC signal is received well enough, Secam's color signal-to-noise ratio is so low that the color degenerates almost completely. The degeneration takes the form of light streaks across the screen, called silverfish.

The prime source of noise is the luminance signal ( $E_Y$ ) to which the color signal is added. To increase the color signal-to-noise ratio during those brief periods of rapid luminance transitions, the previously frequency-modulated color signal is amplitude-modulated by high-frequency components of  $E_Y$ .

This amplitude modulation is suppressed by limiters in the receiver and has no effect on the transmission or reception of color information — except, of course, to improve the signal-to-noise ratio. Also, since high-frequency components occur mostly during scene changes, the amplitude modulation does not noticeably affect compatibility.

## Switching color

Each color channel in the receiver alternately uses the color signal being transmitted and the color signal stored in the memory from the last line. The electronic switching is controlled by the horizontal sync pulse; however, without some initial synchronization, the receiver could operate in perfect antiphase, sending the wrong color information to each channel.

Secam does not have to transmit a color burst to synchronize the phase of the subcarrier as in NTSC; but it does transmit a signal to synchronize the color switch in the receiver during vertical retrace. This

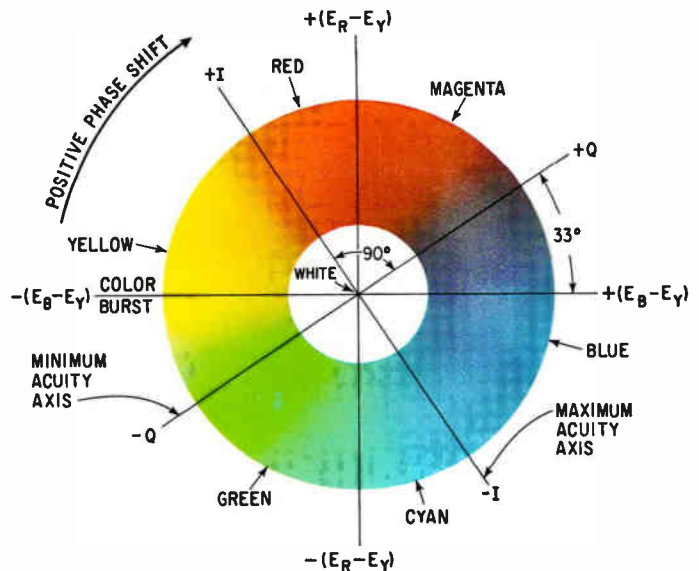

**Color phasor diagram** shows I modulation axis corresponding to changes from orange to cyan where the eye has its greatest acuity for color change. Therefore, color detail for orange and cyan is reproduced up to 1.6 Mc. Color detail for all other colors is reproduced only up to 0.8 Mc., the bandwidth limit of Q. Brightness detail is reproduced at the full video bandwidth of 5 Mc.

information then rephases the switch, if necessary.

Secam offers both an advantage and a disadvantage in signal-handling inside a tv studio. Because the signal is insensitive to phase distortion, it may be recorded on standard monochrome videotape recorders of broadcast quality. Although both the Ampex Corp. and the Radio Corp. of America have videotape recorders that satisfactorily capture the NTSC signal, the machines are much more complex and cost about \$10,000 more than comparable black-and-white recorders.

However, switching, fading and other studio techniques must be accomplished individually using the red, green and blue signals rather than the composite signal as in NTSC. This means that studios must have three times as much signal-handling equipment—all three channels of which must be perfectly matched.

## PAL: signal strength without distortion

In an attempt to produce a color system that has the signal strength of NTSC and the insensitivity to color distortion of Secam, Walter Bruch of Telefunken AG proposed PAL, or phase alternation line.

PAL, like NTSC, transmits the  $E_I$  and  $E_Q$  color signals in phase quadrature — but with one difference. The phase of the subcarrier in the I modulator at the transmitter and at the receiver is reversed 180° for every line. In this way, phase error or unwanted crosstalk components in one line are reversed in phase on the next line and hence cancel at the receiver after a two-line period.

The figures on pages 104 and 105 illustrate the error-cancellation mechanism of phase alternation. After two lines of transmission, the observer perceives the true color, the errors being averaged together.



To receive the PAL signal, Bruch has designed two color receivers: simple PAL and deluxe PAL.

### Relies on the eyes

The simple PAL receiver is exactly the same as the NTSC receiver except for the addition of a switch to reverse the I demodulator axis every line. If the PAL system is chosen, the simple PAL receiver probably will be chosen for manufacture because it's inexpensive and simple. But it has one drawback: it depends on the eye to integrate the results that appear on the face of the color kinescope from line to line. This works fine until the phase error increases above 25°. At this point it is possible to perceive the difference in color from line to line in what is known as the venetian-blind effect.

The venetian-blind effect can be tuned out, however, with a control that adjusts the reference phase of the local subcarrier to keep the average error within 25°. This control corresponds to the hue control on the NTSC receiver. But remember that in NTSC a phase error of only 10° is noticeable and

that the hue control cannot tune out differential phase error or single-sideband distortion, both of which are eliminated automatically with PAL.

### Another delay device

In deluxe PAL, errors are canceled electronically within the receiver by a delay device similar to that used in Secam. Hence there is no venetian-blind effect and no need for a phase control (hue control) of any sort.

The deluxe PAL receiver is shown on page 108 with vector representations of the component color signals. The diagram illustrates how simultaneously adding and subtracting the delayed and undelayed signals recovers separate I and Q components averaged over two lines.

The average I and Q components then go to synchronous demodulators as in NTSC to recover  $E_I$  and  $E_Q$ ; however, the subcarrier in the I demodulator must reverse polarity in every line. To maintain the correspondence between the I switch in the transmitter and the I switch in the receiver, PAL

## Europe's search for a single system

Europe is ready for color television. The problem is to find the color system that's most suitable for Europe.

The International Radio Consultative Committee, meeting now in Vienna, is trying to agree on a single color-tv system. If it succeeds, it will encourage another step toward a single communications network for Europe.

Black-and-white tv is rapidly overcoming the technical barriers between countries. From its start as a group of national systems, it has become a continental network. A microwave system, Eurovision, carries programs from Britain to the Iron Curtain and from Helsinki to North Africa. Through a link with Intersvision, a similar network in the Soviet bloc, programs can now go from Trafalgar Square to Red Square.

Even differences in scanning rate are on the way out. Britain's 405-line rate and France's 819 are being converted to West Germany's 625. This will do away with complicated converters between countries, and with the resulting picture degradation.

### U.S. turns to color

While Europe was blending its black-and-white systems into a unified tv network, the United States was plunging into color tv. Several manufacturers rushed into the field and exited just as sud-

denly. Only the Radio Corp. of America, whose investment was too large to write off, continued to build large-scale facilities for making color-tv equipment.

While Europe concentrated on broadening national monochrome service, a few countries were looking into color. The British Broadcasting Corp. was reasonably satisfied with the National Television Systems Committee (NTSC) system employed in the U.S. and asked the government to approve color service.

But the issue was complicated in 1960 when France introduced her Secam system and gained support from Britain's independent tv network, ABC Teddington. With the country's two networks favoring different color systems, the British government held off any decision.

A further complication came from Germany with the introduction of the PAL color system.

### Endless comparisons

Throughout Europe, meetings of the European Broadcasting Union were subjected to seemingly endless comparisons of the three systems. Each system had its merits and deficiencies, but no one stood clearly above the others. Each meeting ended in a standoff, with agreements to await further studies.

The weary committees started

referring to NTSC as "Never Twice the Same Color" while calling Secam "Something Essentially Contrary to the American Method." The German compromise system was wistfully referred to as "Peace at Last."

A big part of the competitive battle is being waged by companies that have the most to gain, in royalties and receiver sales, from adoption of any system. The Radio Corp. of America has been sending a mobile van, full of NTSC equipment, on demonstrations throughout Europe. France's Compagnie de Générale de Télégraphie Sans Fil (CSF) has a big stake in the adoption of Secam, and West Germany's Telefunken AG is pushing hard for the PAL system.

So far, the only agreement by the European broadcasters has been that they ought to agree. And even that accord is perilous; Britain, which wanted to go into color four years ago, has threatened to go it alone with NTSC if the present CCIR meeting does not result in the choice of a uniform system — any system. The French and Germans have hinted at similar actions.

Because of these pressures, the current Vienna meeting may well end with most—but not all—countries choosing one system. Then the organization's task would be to convince the outvoted members not to go it alone.



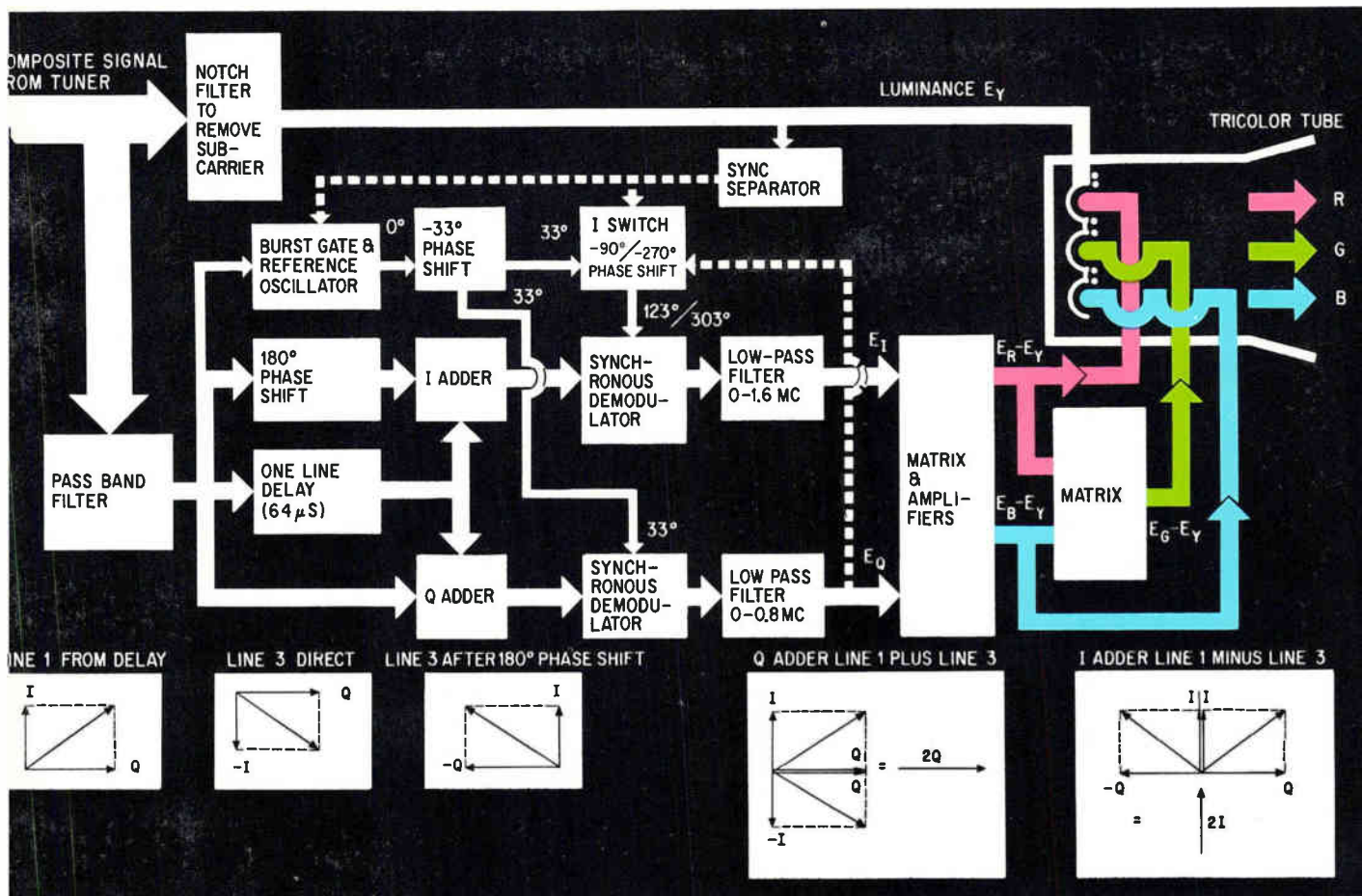

Deluxe PAL receiver. Simultaneously adding and subtracting the delayed signal (line 1) and the direct signal (line 3) recovers separate I and Q components averaged over two lines. The PAL transmitter is exactly the same as the NTSC transmitter except that the subcarrier in the I modulator reverses in phase every line.

— like Secam — transmits pulses during vertical retrace, in addition to the color burst. These pulses are picked up by the Q-demodulator.

### Loss of saturation

PAL may eliminate hue error, but it does this at the expense of saturation. In deluxe PAL, the outputs of the demodulators are  $E_I \cos \epsilon$  and  $E_Q \cos \epsilon$  where  $\epsilon$  is the phase error. For a phase error of  $30^\circ$ , for example, color is desaturated by 15%. In simple PAL, the averaging done in the eye creates a similar desaturation. Therefore PAL receivers, unlike Secam, require a saturation control.

### A different subcarrier

The subcarrier frequency must be changed slightly in PAL because of the shift of the I component every line. With the subcarrier used in NTSC and Secam, an annoying pattern called dot crawl appears on the monochrome receiver. The suggested PAL subcarrier (4.43361875 Mc) is an odd multiple of one-quarter of the line frequency plus 25 cycles. This does not significantly alter compatibility.

### How much will it cost?

In the tv studio, NTSC and PAL are handled similarly. Both allow use of the composite signal in switching and special-effects apparatus, and both require special color videotape recorders. However, PAL is much easier to record since the time-base

stability requirements of PAL are substantially less than with NTSC.

When it comes down to the final decision, the cost of studio equipment is not a determining factor; but receiver cost is. It is difficult to estimate the cost of a receiver that is not in production; however, a poll of European manufacturers published by the European Broadcasting Union last year gave these probable costs based on the price of an NTSC receiver: Secam, an additional 3.9%; simple PAL, an additional 2.3%; and deluxe PAL, an additional 6.3%. Since these are added manufacturing costs, retail prices would be expected to be about twice this amount.

The fact that an NTSC receiver is the cheapest of the three, plus the fact that NTSC has been operating for over 10 years, are the most important arguments in favor of choosing the American system.

### The author



Joseph Roizen has visited almost every major television studio in the free world and a few behind the Iron Curtain in his position as video consultant for Ampex International. In the United States he teaches electronics, color television and magnetic recording at the University of California at Berkeley and at Foothill Junior College in Santa Clara County, Calif. He has

written 50 articles and papers, and holds several patents.



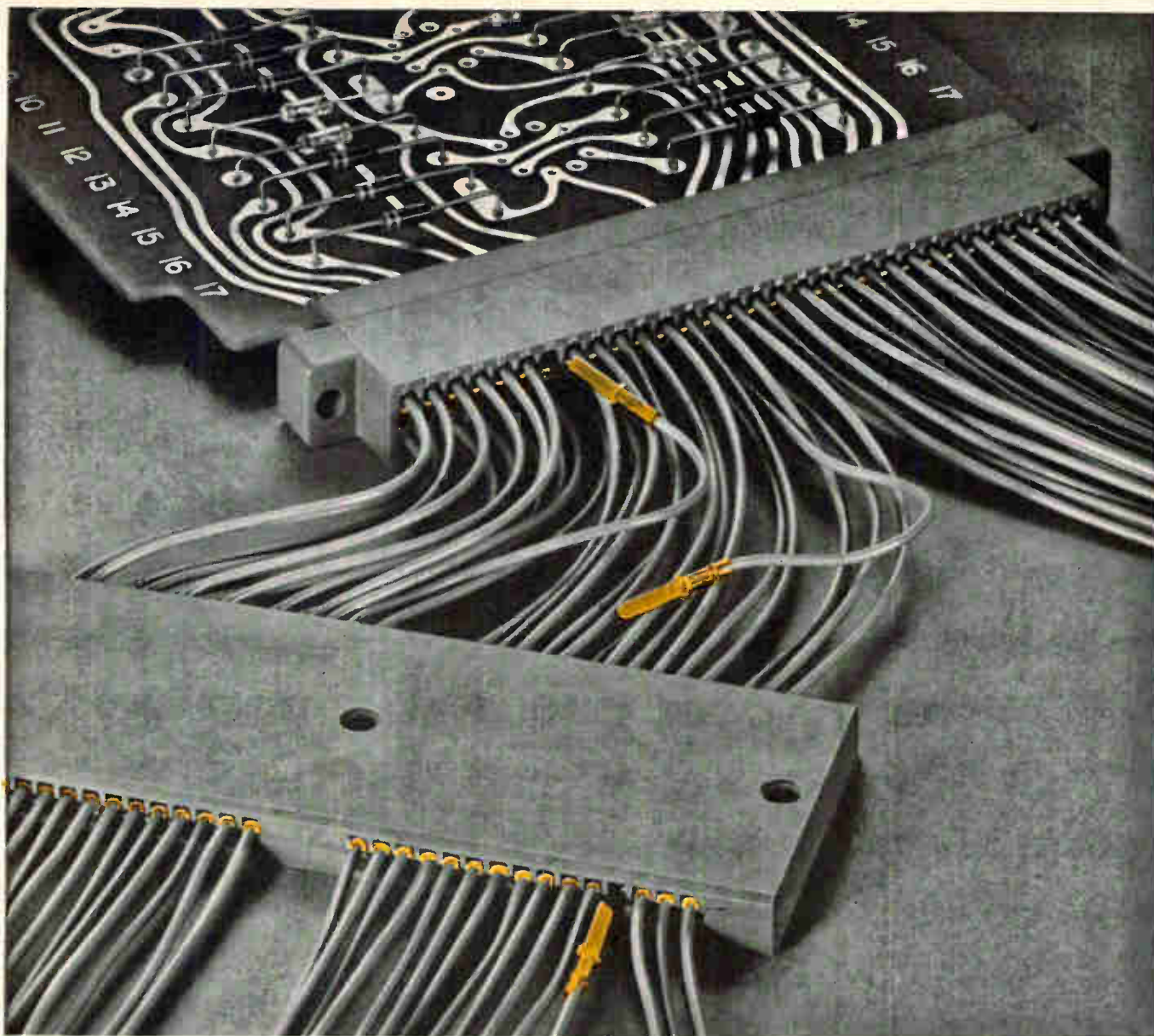

## Keep tabs on the ins and outs of wiring

Now you can modernize your wiring... use only tab terminals on your leads. Employ harnessing techniques using tab terminals on each end; snap one end to our AMP-TAB\* Printed Circuit Board Connector, the other to the AMP-TAB Feed-Thru Block.

Our new Feed-Thru Block was designed as a companion to the popular AMP-TAB Printed Circuit Connector. By using the same contact on both ends of the wire, you can assemble your racks at the lowest installed cost. And... you need no insertion tools to do it! Gold-over-nickel plated tab terminals are not only hand insertible, they require only one-third the space of other terminals.

It all adds up to one of the most practical ways we can think of to solve your wiring problems. And... look at these bonus features:

- Hand inserted contacts—no insertion tool required
- One tool crimps entire wire range
- High density—.100" mounting centers
- "Egg crate" housing design eliminates need for contact sleeves
- Built-in keying slots for stacking blocks
- Contacts available in strip form for high production

Whether you are commoning, distributing or simply feeding-through your leads, let our Feed-Thru Block pick up the tabs. Write today for complete information.

\*Trademark of AMP INCORPORATED



A-MP\* products and engineering assistance are available through subsidiary companies in: Australia • Canada • England • France • Holland • Italy • Japan • Mexico • West Germany

MEET US AT THE IEEE SHOW BOOTHS 2527-31 & 2438, MARCH 22-25, 1965.

## New Model 5013 data acquisition system...

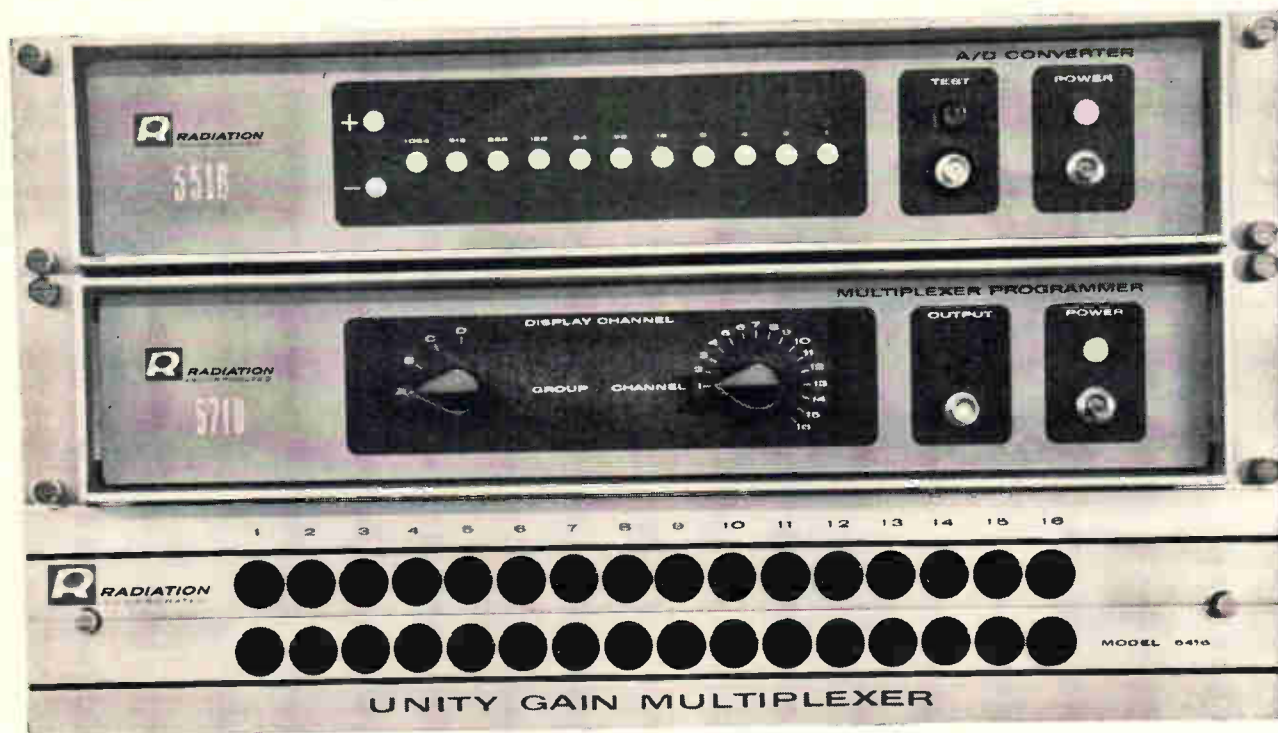

**From analog data  
to computer tape**

**for only \$9,500** plus cost  
of recorder

- 50,000 samples/sec
- 12-bit resolution
- 16 analog inputs



## New Radiation high speed system provides outstanding performance at unusually low cost

Do you acquire analog data which eventually must be processed in a digital computer? If so, now you can do it more economically and in one step with this new Radiation system, the Model 5013.

The basic system consists of A/D converter, multiplexer programmer, unity gain multiplexer, and formatting logic. Yet, this compact system requires only 10.5" of vertical panel space. While intended for rack mounting, the system is also available in a portable cabinet for desk-top use.

Model 5013 accepts analog data from up to 16 sources. The inputs are multiplexed, and each is converted into a 12-bit binary word. The system then formats these data for entry into the write amplifiers of the digital tape recorder of your choice.

Radiation's new Model 5013 is available for delivery. If you wish, we will be glad to provide interfacing equipment for the digital recorder of your choice or engineer a complete installation based on this unique, low-cost system. Additional options offered are: up to 64 input channels, pre-set digital information inputs, digital time coding, gapped-tape capability—using core buffer, plus any of the equipments shown at right.

Send the coupon for technical details or contact Radiation for applications assistance. Radiation Incorporated, Products Division, Department EL-03, Melbourne, Florida 32902. Phone: (305) 723-1511.

### MODEL 5013 SYSTEM—BRIEF SPECIFICATIONS

High reliability and long life are assured by solid state modular construction and wire-wrap connections. Circuit changes and maintenance are simplified through use of plug-in Radiation Digital Logic Modules. The three units comprising Model 5013 are human-engineered for ease of operation. Each is only 3.5" high, resulting in unusual compactness. The system consists of:



**A/D Converter (Model 5516) \$3,741**

Has input of  $\pm 5$  v, full scale, 50 kc word rate, is self-contained unit. Output format is 12-bit binary or 11-bit binary plus sign. Options are: 1. built-in sample and hold, add \$233; 2. display, add \$293; 3. buffered output, add \$83.



**Multiplexer Programmer (Model 5710) \$1,995**

Incorporates selector for displaying each individual channel on the A/D Converter without interrupting the normal coding process. Supplies necessary sequencing and programming signals to accommodate up to four Unity Gain Multiplexers for a 64-channel system. Derives clock from Model 5516 or may be externally synchronized.



**Unity Gain Multiplexer (Model 5416) \$1,995**

Has wide input flexibility and high reliability (MTBF 16,767 hours). This modular building block accepts single ended, differential or mixed inputs. Offset and zero drift are less than  $5 \mu\text{v}$ , 20 to 30°C. Maximum sampling rate is 50 kc, two or more channels.

### OPTIONAL UNITS—BRIEF SPECIFICATIONS

The highly stable, solid-state units below are designed to increase the flexibility of the basic Model 5013 System:



**D/A Converter (Model 5610) \$3,950**

Accepts 8-bit parallel binary multiplex, provides 12 inputs, 12 D/A converter outputs. Adjustment free. Output: 0 to  $-5$  v excursion for zero to full scale. Voltage resolution: 0.39% (9.76 mV). Settling time: less than 2  $\mu\text{sec}$ . Available without display at \$3,750.



**Read/Write Electronics (Model 5810) \$6,000**

Adaptable to 7 or 9-track requirements. Binary or BCD: 200, 556 or 800 bits/inch. Manual write lockout control. Contains parity generator on write and parity check on read. Adaptable to write heads with either center-tapped or single winding.



## RADIATION PRODUCTS DIVISION A DIVISION OF RADIATION INCORPORATED

MELBOURNE, FLORIDA 32902

Gentlemen: Please send technical data on products listed below:

Model 5013     Model 5516     Model 5710     Model 5416     Model 5610     Model 5810

Name \_\_\_\_\_ Title \_\_\_\_\_

Firm \_\_\_\_\_

Address \_\_\_\_\_ City \_\_\_\_\_ State \_\_\_\_\_ Code \_\_\_\_\_

# Marooned in the Dunes? Call DIAL-A-PART Any Time!



Wherever you are . . . whatever the time . . . you can order the parts you need and get the engineering answers you want—pronto—with exclusive 24 hour new CAMBION® DIAL-A-PART Service!

Call (617) 876-2800 any hour of the day or night, Monday through Friday, for (get ready) the widest possible choice of plugs, jacks, terminals or connectors.

Next time you're stranded pick up the phone and call

CAMBION, your best source of supply for battery holders, panel and chassis hardware, digital modules, solder terminals, swagers, terminal boards, insulated terminals, coil forms, shielded coil forms, coils, RF chokes, capacitors, connectors — plugs and jacks, component clips, handles, kollet knobs, thermoelectric modules, magnetic bearings, etc. . . (whew!). Call now . . . Call any time DIAL-A-PART . . . (617) 876-2800, Cambridge Thermionic Corporation, 401 Concord Ave., Cambridge, Mass. 02138.

## **CAMBION®**

DIAL-A-PART SERVICE

Standardize on CAMBION . . . The Guaranteed Electronic Components



# WRITE A SPEC FOR YOUR IDEAL POWER SUPPLY

## YOUR REQUIREMENTS

(Fill in and compare with our standard specifications)

VOLTAGE REGULATION \_\_\_\_\_

CURRENT REGULATION \_\_\_\_\_

VOLTAGE RIPPLE (RMS) \_\_\_\_\_

CURRENT RIPPLE \_\_\_\_\_

OTHER REQUIREMENTS \_\_\_\_\_



# THEN Compare\* IT WITH SORENSEN'S NEW QRC SERIES

First, start with voltage regulation of  $\pm 0.005\%$  line and load combined ■ Then, add voltage ripple of 1 mv RMS ■ Current regulation of  $\pm 0.05\%$  of maximum current output ■ Current ripple as low as 1 ma RMS ■ Transient response 50  $\mu$  sec. to return to  $\pm 20$  mv band ■ Excellent stability, typically 0.05% for 8 hours (after warm-up) ■ Resolution approximately 0.01% ■ Input versatility 105-125/200-240 VAC, 50 to 400 CPS ■

Then, build in every conceivable design feature like: High efficiency ■ Constant voltage/constant current crossover (so sharp the units never leave the specified regulation bands) ■

Constant voltage/constant current indicator lights ■ Vernier controls on both voltage and current adjustments ■ Output voltage and current meters ■ Voltage and current programming ■ Series parallel operation ■ Remote sensing ■ No turn-on, turn-off overshoots ■ Plug-in control boards ■

Price? How about \$450 for 0-40 volts, 0-8 amps, in a 3½" high package? Still want to compare? For more information on the QRC series, call your local Sorensen representative, or write: Sorensen, A Unit of Raytheon Company, Richards Avenue, South Norwalk, Conn. ■ Or use Reader Service Number 200 ■



### ELECTRICAL AND MECHANICAL SPECIFICATIONS

MODEL NUMBER	OUTPUT VOLTAGE RANGE (VDC)	OUTPUT CURRENT RANGE (AMPS)	VOLTAGE REG. (LINE & LOAD COMBINED)	VOLTAGE RIPPLE RMS	CONSTANT CURRENT RANGE	CURRENT REGULATION	CURRENT RIPPLE RMS	RACK HEIGHT (INCHES)	PRICE
QRC20-8	0-20	0-8	$\pm 0.005\%$ or $\pm 1$ mv	1 mv	0-8	$\pm .05\%$ or $\pm 4$ ma	2 ma	3½	\$410
QRC40-4	0-40	0-4	$\pm 0.005\%$ or $\pm 1$ mv	1 mv	0-4	$\pm .05\%$ or $\pm 2$ ma	1 ma	5¼†	315
QRC40-8	0-40	0-8	$\pm 0.005\%$ or $\pm 1$ mv	1 mv	0-8	$\pm .05\%$ or $\pm 4$ ma	2 ma	3½	450
QRC40-15	0-40	0-15	$\pm 0.005\%$ or $\pm 1$ mv	1 mv	0-15	$\pm .05\%$ or $\pm 8$ ma	4 ma	5¼	575

†Half rack.

# New Dav Pak

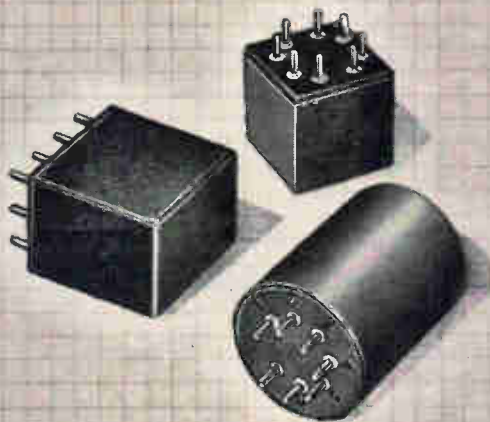

## resistance networks cut assembly time and inventory —end resistor matching problems!

Brand new from Daven—  
Dav Pak precision wire  
wound resistance network  
packages in standard  
sizes down to .590"  
square.

First advantage: seven standard sizes mean faster delivery and lower initial cost on most applications. Other advantages: these pre-packaged resistor modules cut assembly time, inventory time, inspection time. And completely eliminates resistor matching problems!

Daven has utilized its long experience in producing thousands of different types of precision wire wound networks to come up with this money-saving, reliability-adding idea.

All Dav Pak modules exceed the requirements of MIL-R-93. Resistance tolerances are as low as  $\pm .005\%$ . Resistance ratio match as low as  $\pm .002\%$ .

And the seven standards are available with a variety of pin placements to fit your specific requirements.

The Dav Pak is designed for analog computer circuits, voltage dividers, summing networks, RC networks, etc., and can also be supplied with other components to form network circuits. Daven's Engineering Department is at your service for specific applications. Write today for details.

**DAVEN**   
MANCHESTER, NEW HAMPSHIRE  
(603) 625-9746 • TWX 603 623-4938 • Cable: Daven Manchester N H



# ... AND AT SEA



USS Northampton, first naval vessel to utilize ship-to-shore tropospheric scatter equipment.

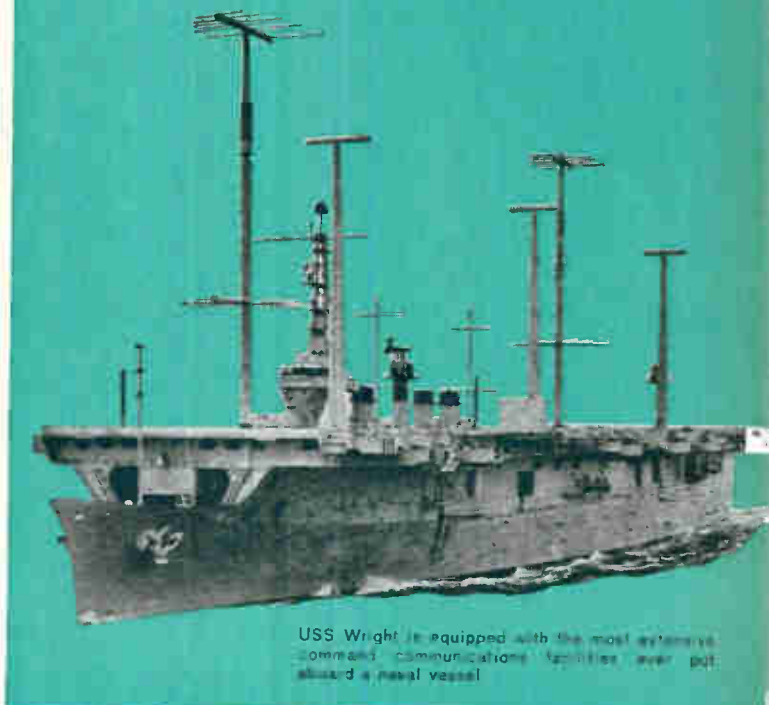

USS Wright is equipped with the most extensive command communications facilities ever put aboard a naval vessel.

Nuclear-age naval strategy poses special problems that cannot be met by conventional naval communications systems. In contributing to the solution, Radio Engineering Laboratories (REL) provides a new dimension of seaborne communications through the adaptation of its famed tropo scatter radio equipment.

Today, this REL equipment operates aboard the Command Ships USS Northampton and USS Wright . . . making possible the first reliable over the horizon ship-to-shore multichannel link in communications history. For tomorrow, developments now underway give promise of revolutionary ship-to-ship tropo communications.

As contrasted with conventional naval communications, tropo scatter equipment offers many key advantages: 1) Broader Bandwidth, 2) Greater Reliability, 3) Improved Circuit Quality, and 4) Virtually "Jam Proof" Performance.

Thus, at sea as on land, REL continues its more than 40 years of engineering and performance leadership for world-wide telecommunications requirements. Leadership that provides solutions unlimited for communications problems . . . just like yours.

For additional technical data and information, call or write REL today.



**RADIO ENGINEERING LABORATORIES**  
Division of Dynamics Corporation of America  
Long Island City 1, New York



Circle 115 on reader service card

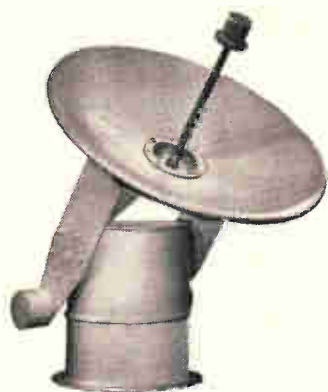
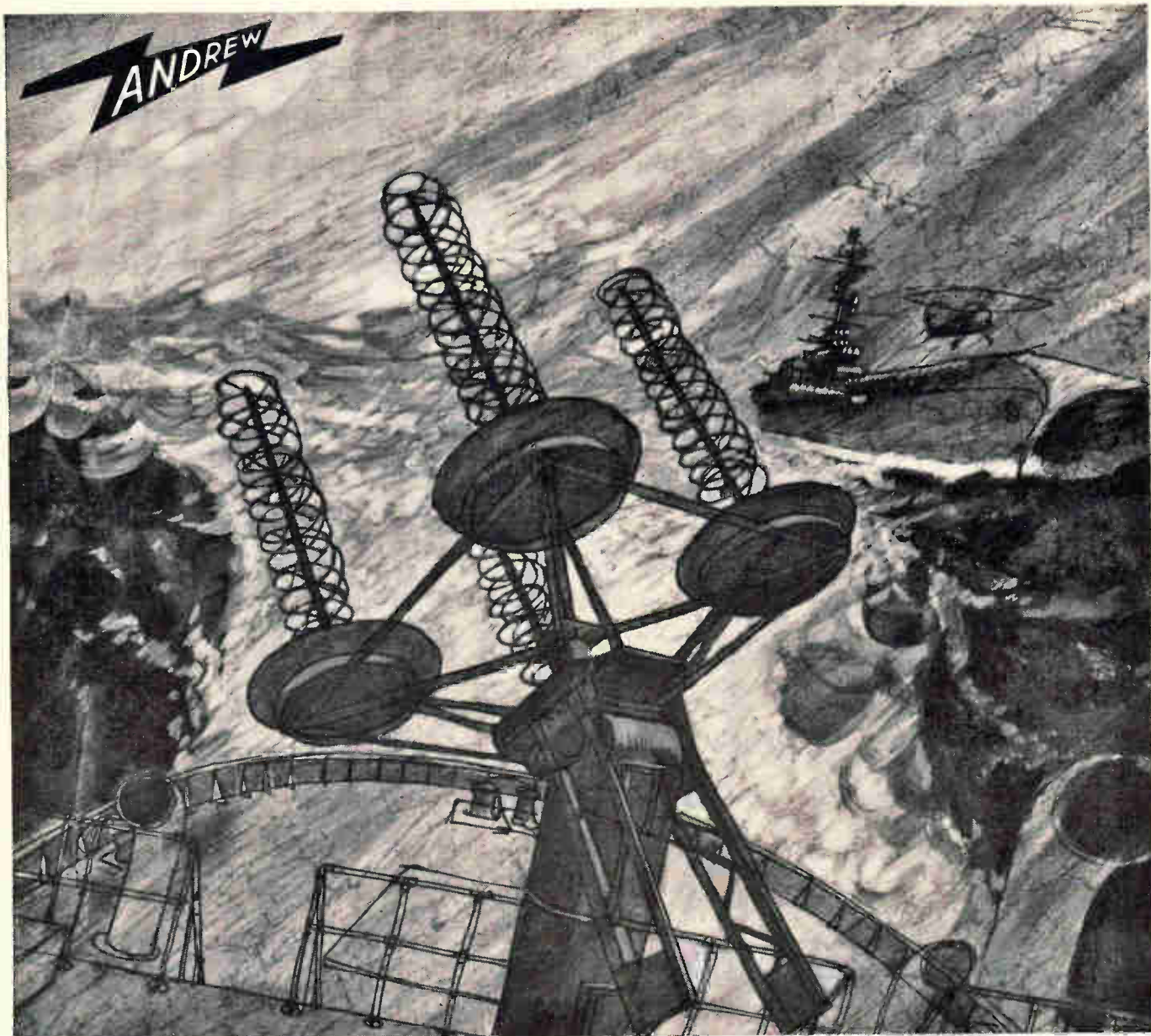

Standard single or dual axis positioners offer electro-manual control, solid state power supply, 125 mph design, and permanently sealed and lubricated motors. Optional features include optical equipment for aligning elevation and azimuth axis, servo controls, mechanical stops and adaptors, special mounts and counterweights.

**EUROPEAN OPERATIONS: ANDREW CORPORATION, HØJSGAARDS—ALLE 82, HELLERUP, DENMARK**

## command control and telemetry antenna systems

DESIGNED...ENGINEERED...  
AND MANUFACTURED AS A COMPLETE PACKAGE

Andrew antenna systems are designed as complete packages. Antenna and positioner engineering are integrated to guarantee system performance.

Andrew positioners are available with a wide choice of low, medium and high gain telemetry antennas to meet your requirements. HELIAX<sup>®</sup> coaxial cable provides the most reliable connection between transmitter or receiver and the antenna.

**ONE SOURCE—ONE RESPONSIBILITY...** Contact your Andrew sales engineer or write for complete system information and delivery.

6-65

**28 YEARS OF ENGINEERING INTEGRITY**

**Andrew**  
CORPORATION  
P. O. BOX 807 • CHICAGO, ILLINOIS U.S.A. • 60642



little  switch

# BIG SAVINGS

Half the cost of conventional multi-position switches and loaded with multiple performance design advantages. Spectrol's miniature switches give you performance characteristics for printed and micro-circuit applications never before available in so small a package at such low prices. Reliable, trouble free operation is assured by the unique construction features of the type 88 rotary indexing switches.

**DIRECT MOUNTING** — Reduces wiring costs — mounts directly on printed circuit boards.

**TROUBLE-FREE OPERATION** — Contacts are kept free of oxides and other harmful film deposits by the self scrubbing design that polishes during every duty cycle.

**FULL POTTING PERMITTED** — Dust-free, moisture-free operation insured by silicone rubber sealing and packing gland techniques.

**MILITARIZED** — Designed to stand up under high shock, vibration, temperature extremes, and other severe environments per MIL-STD-202B.

**LOW ARCING — LOW NOISE** — Higher contact force and elimination of tracking made possible by the cam actuated "lift-off," "drop-on" wiper action.

**THREE CONFIGURATIONS** — Choice of knob, screw driver adjust or bushing panel mount.

88-3-8  
SLOTTED  
HEAD



88-3-10  
KNOB



88-5-6  
BUSHING



ACTUAL SIZE

## BRIEF SPECIFICATIONS

## MODEL 88

Switch type..... Single pole, 10 position, non-shorting

Switch action..... Positive detent action, 36° indexing

Current rating..... 250 MA at 28 VDC

Case dimensions

(inches).....  $\frac{3}{16}$  H max x  $\frac{1}{2}$  D (88-3-8)

Price 1 to 9 pieces....\$3.75

Call your nearest Spectrol distributor for immediate off-the-shelf delivery at factory prices, or write for complete specifications. Spectrol also manufactures a complete line of trimming potentiometers and turns-counting dials.

**SPECTROL** ELECTRONICS CORPORATION

1704 South Del Mar Avenue  
San Gabriel, California

Adams Court  
Plainview, L.I. New York

# LOOK!

## This Model 630 Integrating Digital Multimeter From Electro Instruments Is The World's

# MOST VERSATILE

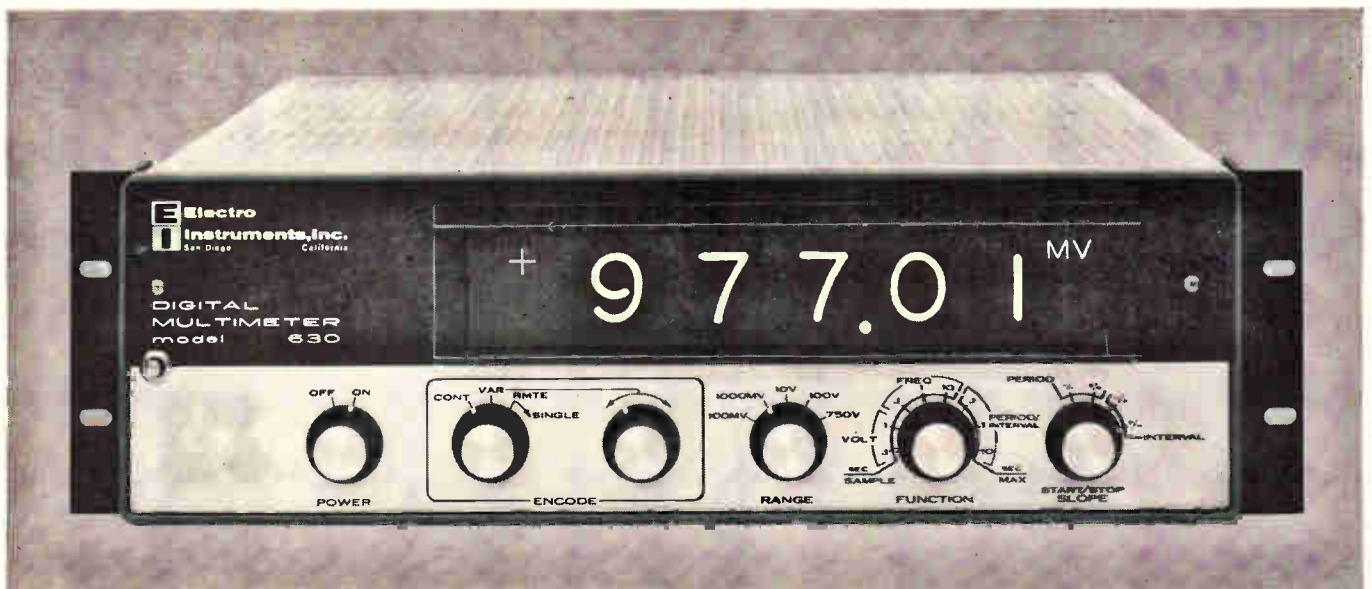

It has 1 megacycle frequency counter... eliminates errors in measurements near zero and/or involving polarity changes... lets you measure DC voltages, frequencies and time intervals with one instrument... has built-in storage to eliminate "rolling" of digits in readouts... and 1 microvolt resolution. And its price is only

# \$3,295

**Electro Instruments, Inc.** 

8611 Balboa Avenue San Diego, California 92112  
Electro International, Inc., Annapolis, Md.



# When you need High-reliability aluminum electrolytics ...Look at the Mallory line!

Whatever ratings you need, and whatever your reliability specifications may be, you can find the answer to your capacitor problems in the broad range of high-reliability Mallory aluminum electrolytic capacitors.

**Computer Grade Type CG**, leading choice for power supply applications, have the high capacitance values and superior filtering performance demanded for solid-state and conventional power supply circuits. Life-tested up to 60,000 hours without failure, equivalent to 20 years' service at 40°C ambient. Exceptionally low DC leakage, low impedance at frequencies to 4800 cps. Ratings from 160,000 mfd., 3 volts to 180 mfd., 450 volts.

**Miniature types:** Computers, test equipment and other applications. Type TPG, rated -40°C to +85°C are our "miniature computer grade." Life-tested to 10,000 hours; over a million piece-hours of certification with only one electrical failure. From 450 mfd., 3 VDC to 20 mfd., 150 VDC. Vertical mount, single-end model VPG also available. Type TTQ are economy priced miniatures, also rated -40°C to +85°C; they're produced under quality control procedures patterned after MIL specs. Life expectancy is 10 years or more under normal operating conditions. Values: 300 mfd., 3 VDC to 2 mfd., 150 VDC.

**Premium grade PG.** The standard for telephone service and instrumentation. Built to specifications which indicate life up to 30 years under normal service conditions. Ratings from 100 mfd., 450 VDC to 13,000 mfd. at 3 VDC.

**Heavy-duty Types HC and NP.** Bakelite case units for welding and other heavy power supply service. Polarized Type HC: ratings from 500 mfd., 200 VDC to 15,000 mfd., 10 VDC. Non-polarized Type NP in ratings from 100 mfd., 450 VDC to 500 mfd., 125 VDC.

For complete data and a consultation, write to Mallory Capacitor Company, a division of P. R. Mallory & Co. Inc., Indianapolis, Indiana 46206.

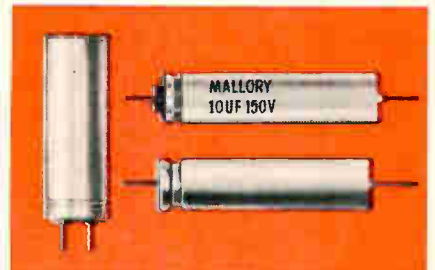

## MALLORY

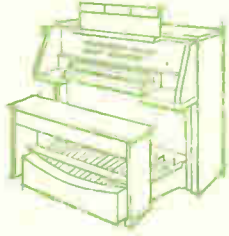

**1. In electronic organs using tuning capacitors, maintenance of correct pitch is directly dependent on capacitor reliability.**

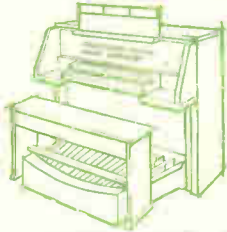

**2. That's why the Hammond Chord Organ relies on 95 capacitors of "Mylar".**

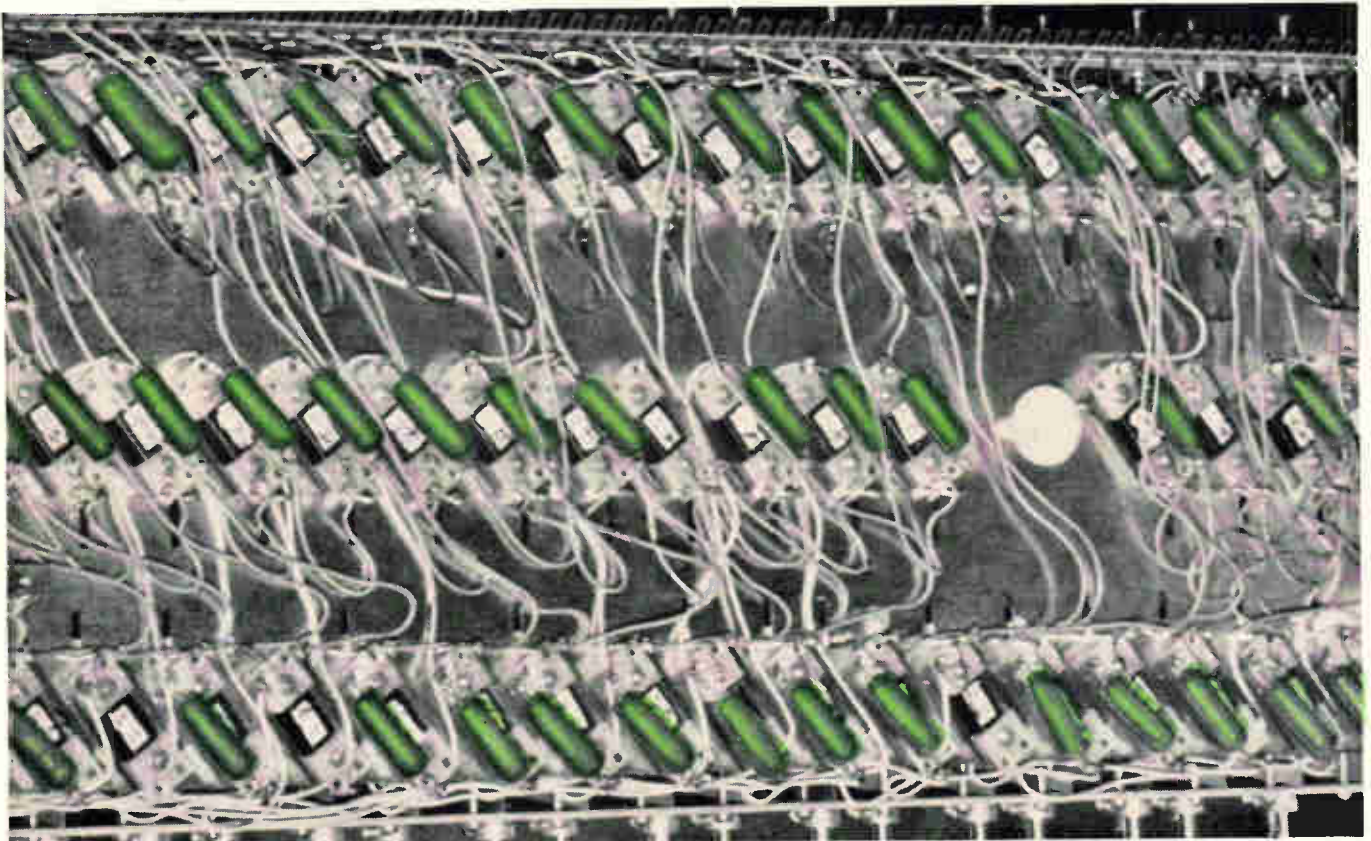

This is a section of Hammond's exclusive tone wheel generator from the Grand 100 organ. 94 capacitors of

"Mylar" in sizes of .1 and .25 microfarads are used here, with 56 others in the amplifier and other circuit locations.

Until capacitors of "Mylar" were developed, the usual electronic organ capacitor dielectric was paper. In unusually humid situations, paper dielectrics can absorb moisture, causing them to leak, change capacitance and interfere with the operation of the organ.

Hammond Organ Company avoided these problems by enclosing paper capacitors in metal cans. This was expensive and bulky. Then Hammond engineers switched to capacitors of "Mylar". End of problem.

Today Hammond uses capacitors of "Mylar" in all organs for many purposes. There are 150 capacitors of "Mylar" in the Grand 100, where tuning is controlled by Hammond's exclusive tone wheel generator. In this case the additional benefit of small size was instrumental in

the decision to choose capacitors of "Mylar".

Not only do capacitors of "Mylar" give Hammond consistent reliability plus substantial savings in space . . . *but they cost no more, and often less, than paper capacitors.*

Reliability—proved in use by Hammond for 10 years, proved in 23,000,000 unit hours of intensive Du Pont sponsored independent testing—is just one important advantage of capacitors of "Mylar". For complete data that may help in your design problems, write Du Pont Co., Rm. 2310-A, Wilmington, Delaware 19898. In Canada: Du Pont of Canada, Ltd., P. O. Box 660, Montreal, Quebec.

BETTER THINGS FOR BETTER LIVING...THROUGH CHEMISTRY



\*Du Pont's registered trademark for its polyester film.



# Probing the News

Manpower

## Job slump seems to be bottoming out

A nationwide survey indicates that 1964's drop in hiring is over, but the nonspecialist is still having trouble finding a suitable job.

**Employment opportunities** for electronics engineers are slightly better than they were a year ago, but they are still far below those of the lush 1950's and early 1960's. Many engineers are scrambling for jobs; but the layoffs that caused last year's slump in employment [Electronics, May 18, p. 105] have ended as the industry has absorbed the cuts in government spending.

Still, job hunting is a tough business today. A survey of openings across the country shows that companies are being more selective than ever.

### I. New breed of specialists

Generally, companies say they are looking for specialists, but the specialties have broadened. Now they seek microwave engineers, instrument engineers or solid state circuit specialists; narrow expertise, such as in infrared sensing, is in less demand.

Recent graduates and younger men, who can be trained and who do not command high salaries, are in demand—but the demand is not as great as it once was.

The pattern of government spending complicates the job picture. Companies engaged in work on countermeasures, antisubmarine warfare, ground communications or insurgent warfare, for instance, will tell you, "Send us more engineers." With aircraft and missile companies it is another story altogether.

### II. Schizophrenic California

In Sunnyvale, Calif., the Lockheed Missile and Space Co.—a division of the Lockheed Aircraft Corp. which had substantial layoffs in the past year—now wants

to hire 100 to 200 men for computer systems evaluation, design, guidance and control, and for ground-support systems. Varian Associates, of Palo Alto, is hiring again for microwave tube work and circuit design. The Hewlett-Packard Co., also in Palo Alto, wants 50 to 75 engineers for circuit and product design. At the Semiconductor division of the Fairchild Camera and Instrument Corp., in Mt. View, a spokesman says, "Our demand for device engineers is now greater than it has been at any time."

Sounds rosy, doesn't it? But Prof. R. P. Loomba of San Jose State College, who has made a survey of engineering employment, reports that there are still 300 to 400 unemployed engineers in the Bay area. One reason is that many engineers just don't have the backgrounds that the companies are seeking. A California company official puts it a little less politely. He says today's tight competition

### Jobs at a glance

Here is an area-by-area summary of the employment trends for electronics engineers:

West Coast—Mass layoffs ended, some hiring under way, but hundreds of engineers still unemployed.

Midwest—Outlook for electronics companies good, but hiring slow because of the influx of engineers from California.

Southwest—Companies with NASA contracts hiring.

Southeast—Cape Kennedy hiring primarily recent graduates.

New England—Apparently on the upswing.

New York—Outlook poor except for those with strong experience.

demands that "nonperformers" be weeded out. Further, he says, men who have not kept up with the technology have become obsolete.

**On the mend.** In Southern California, the worst appears to be over. The number of engineers applying for unemployment insurance has declined steadily, if slowly, since July. The Douglas Aircraft Co. placed a full-page ad in the Los Angeles Times recently for aircraft engineers to work on growth versions of the DC-8 jetliner and on the C-5A military heavy logistics transport study. The company's Southern California divisions expects to hire 500 engineers in 1965. The Aerojet-General Corp. isn't hiring, but it isn't firing either. The Space Technology Laboratories division of Thompson Ramo Wooldridge, Inc., at Redondo Beach, which has won some good contracts, will add 25 engineers to bring its staff back to its 1963 strength of 175. A year ago, the staff was 153.

Autonetics, a division of North American Aviation, Inc., is hiring engineers to work on avionics systems, but laying off engineers who have not kept up with technical advances.

### III. Back home in Illinois

Where do California engineers go when they are laid off? Many head for the Midwest, where consumer and industrial electronics manufacturing outweighs the military three to one. This reverse migration has tightened the market in the Chicago area. Still, Jim Belmont, electronics counselor for Cadillac Associates, an employment agency, reports a definite up-

swing in employment there. Echoing his California colleagues, he says "We are looking for people who have had specific experience."

Some companies are taking pains to keep their good people. The Grumman Aircraft Engineering Corp. in Bethpage, N. Y., avoids hiring engineers for a specific project: under its "section team effort" program, engineers are hired by disciplines or technical specialties, and the company tries to keep them steadily employed in their specialties. As projects phase out, they are reassigned. And Texas Instruments, Inc., in Dallas, says that if a man has a specialty, the company is broad-based enough to find a spot for him. TI particularly wants men experienced in solid state, field radar and antenna design.

#### IV. The eyes of Texas

Electronics and aerospace companies in the Dallas-Fort Worth area are looking for engineers, but as on the West Coast, they must be experienced. Ling-Temco-Vought, Inc., currently employs about 15,000 persons—down 2,000 from the peak of two to three years ago—of whom roughly 4,000 are engineers or scientists. It wants to hire 125 to 150 more engineers with 3 to 10 years experience.

In Houston, aerospace companies near the National Aeronautics and Space Administration's Manned Spaceflight Center were optimistic about hiring, although NASA itself has no plans to increase its engineering staff of 500. The Philco Corp. plans to hire 35 electronics engineers in 1965 and 60 more in 1966; it now employs 120 on its \$54-million contract with the space-flight center. Lockheed Aircraft has four support contracts with the center. It hired 100 engineers last year, and plans to hire more this year and next. Lockheed particularly wants men with experience in telemetry, instrumentation, guidance and control, circuit design, power distribution and communications. At least two companies in the area are bidding on another space flight contract, for general electronic, instrumentation and engineering support, which will require another 250 men.

#### V. Rocket to the moon

As the Saturn-5 moon-shot pro-

gram gets into gear in Huntsville, Ala., engineers will be added. The Boeing Co., holder of a \$600-million contract for production of the S-1C booster for Saturn 5, and for Saturn 5 integration, wants both electronics and electrical engineers. Boeing employs 3,000 people at Huntsville, of whom 1,500 are professional. The International Business Machines Corp., which has a \$175-million contract for the instrument units on Saturn 1B and Saturn 5, is also recruiting.

The General Electric Co.'s Missile and Space division is hiring men experienced in cryogenics, instrumentation and control systems for the Mississippi Test Operation of the Saturn program. The salary range is \$8,000 to \$13,000, and there are 40 openings. Mississippi Test is an expanding program; GE expects its payroll to go from 520 to 1,700 within a year, and North American Aviation, Inc., sees a rise from 30 to 400.

NASA's glamor post, Cape Kennedy, has a less optimistic outlook for 1965. The Cape is about at full strength, and at the moment is concentrating on bright young graduates—the top third of the class. The only hiring contemplated is to compensate for normal attrition.

#### VI. New England rebounds

A Federal Reserve Bank analyst says flatly: "Electronics employment in New England bottomed out about June of 1964. It now shows signs of strengthening." The volume of prime government con-

tracts is a significant index in this government-oriented area, and in this respect the trend was apparent as early as last summer. During the first quarter of the current fiscal year—July through September—New England's share of prime contracts was up 12% while the national total was down 12%.

The area's largest electronics employer, the Raytheon Co., is down in total employment from 31,000 in March, 1964, to 28,000, mostly because of deceleration of the Hawk missile program. It is, nevertheless hiring for work on radar, sonar, and space systems. "We're crying for guys; we need 100 right now," says an executive in the company's Space and Information Systems division.

**Wonderful town?** New York has too many engineers, principally because of the drop in defense and NASA contracts. Still, the skilled and experienced man is in demand. The Lockheed Electronics Co. in Plainfield, N. J., wants men experienced in airborne and field-radar systems, transistor circuit design and microwave antennas. Long Island is overstocked with engineers, and more are being fired than hired. The Sperry Gyroscope Co., a division of the Sperry Rand Corp., and the American Bosch Arma Corp. are cutting down; the Republic Aviation Corp. has leveled off at 5,000 employees of all types, down from 15,000 a few years ago. Grumman Aircraft, Kollsman Instrument Corp. and Airborne Instrument Laboratories are hiring.

---

## Avionics

# Array radar in the air

Air Force plans to build a terrain-avoidance radar with 604 phased beams that will be generated by microcircuits

**An airborne phased-array** radar system, with hundreds of beams generated, steered and received by monolithic integrated circuits, will be built as part of a major research program being sponsored by the Air Force.

The main goal of the new program is the development of integrated circuits that can generate at least one watt of power at frequencies millions of cycles a second higher than any integrated circuits yet made.



That development is expected to lead to the design of computer-controlled, all-integrated-circuit radar systems without tubes or moving parts, so that airborne radars can be made smaller, lighter and more reliable than the types now used in military aircraft.

To provide a "research vehicle"—an experimental system to prove out design concepts—Texas Instruments Inc. will spend the next two or three years designing and developing the phased-array terrain-avoidance radar. The airborne radar will operate at a frequency of about 9 gigacycles, in the X-band of radar frequencies.

TI began preliminary design work about four months ago and has just submitted its first report to the molecular electronics branch of the Electronics Technology Laboratory of the Avionics Laboratory at Wright-Patterson Air Force Base, Ohio.

The report looks so promising, says R. D. Alberts, head of the molecular electronics branch, that the project will be given the green light. "We have now defined the problems and none seem insurmountable," Alberts says.

### I. Terrain avoidance

Terrain-avoidance radars allow aircraft to fly at tree-top level at high speeds by searching ahead for hills and other obstructions so the plane can be guided around them [Electronics, Feb. 21, 1964, p. 10]. Such radars are already on board some attack planes and will be used in new planes such as the F-111 tactical fighter.

The radar continually looks at the landscape in front of the plane. Some types have a fixed antenna, but most systems now in use require an antenna that is moved electromechanically, so the beam can keep a continuous watch on the terrain as the plane dodges and weaves.

Some of the new systems are both terrain-avoiding and terrain following. That is, they can avoid a crash into a hill by going around the hill, or by following the slope of the terrain and rising above the hill. In advanced designs, the radar warnings are fed to flight control systems so the plane flies itself around obstructions.

The set that Texas Instruments

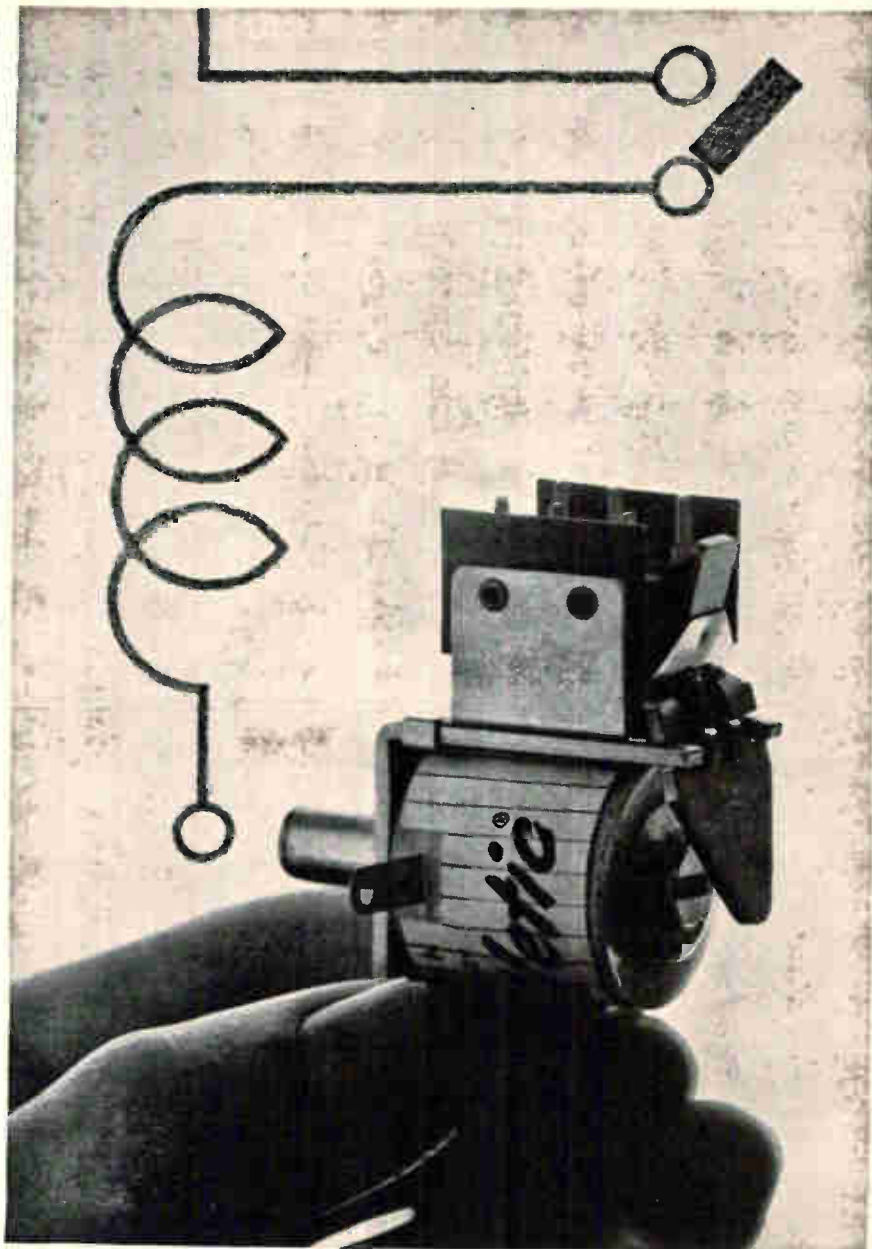

## WHY USE TWO IF ONE WILL DO?

The Heinemann Type B Time-Delay Relay can double as its own load relay. It's got a continuous-duty coil. Once actuated, it can remain locked-in indefinitely. This, combined with DPDT snap-action switching at up to 5 amps, can obviate the need for a separate slave relay in many applications.

Yours might be one of them. Here's a quick rundown of the Type B's specs:

**Standard Timings:** ¼, ½, 1, 2, 3, 4, 5, 8, 10, 15, 20, 30, 45, 60, 90, 120 seconds.

**Contact Capacity:** 5 amperes at 125V or 250V AC; 5 amperes at 30V DC, resistive; 3 amperes at 30V DC, inductive.

**Coil Voltages:** 60 cycles AC: 6, 12, 24, 48, 110, 115, 120, 208, 220, 230, 240 volts; DC: 4, 6, 12, 24, 28, 48, 64, 110, 120 volts. (Others available.)

For more detailed specifications on the Type B (and on all the other time-delay relays in the Heinemann line), write for Bulletin 5005.



**HEINEMANN**  
ELECTRIC COMPANY  
2600 Brunswick Pike, Trenton 2, N. J.

SA 2578

# NEED TO MONITOR IN-FLIGHT VIBRATION?

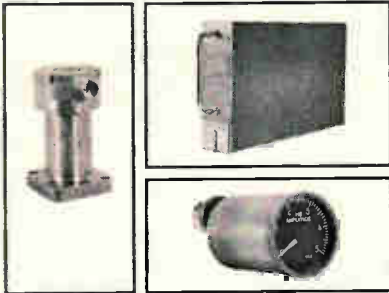

CEC's Airborne Vibration Monitoring System is the accepted standard of the industry — and a "must" for airlines concerned with cost reduction of engine maintenance. So efficient is the system, it frequently pays for itself in less than a year. Reason: the advanced design of the system's three basic components.

**CEC 4-125 Vibration Transducers** — one to three per engine — will operate continuously at 700°F, are impervious to shock, and are virtually maintenance-free. Special gold palladium bearing rings eliminate the need for lubricants.

**CEC solid-state amplifiers** — up to four per module with a single power supply — are easily accessible for inspection, and are physically and electrically interchangeable.

**CEC's precision indicator** — continuously displays the vibration level being measured on a given engine. The indicator is available with a choice of scale graduations and integral lighting to match other instrument panel instruments.

For full details, call or write CEC for Bulletins in Kit #7027-X3.

**CEC**  
Transducer Division

**CONSOLIDATED ELECTRODYNAMICS**  
A SUBSIDIARY OF BELL & HOWELL/PASADENA, CALIF. 91109  
INTERNATIONAL SUBSIDIARIES: WOKING, SURREY, ENGLAND  
AND FRIEDBERG (HESSSEN), W. GERMANY

is to build will get rid of the moving antenna by using an electronically steered array of 604 beams. Changing the relative phases of the beams will change their direction, causing a pencil beam composed of groups of individual beams to sweep the terrain in front of the plane.

"The project would not be feasible without an integrated-circuit computer," Alberts declares, because of the complexity of adjusting and controlling many beams simultaneously. Eventually, tiny airborne computers may be made by interconnecting hundreds of circuits on single slices of silicon. Such computers are being developed under other Air Force projects.

**Reliability.** "We can get rid of the power-hogging, mechanically swept antenna and the magnetron of the conventional radar," Alberts says. The electromechanical parts and the magnetron cause 75% of the failures in present terrain-avoidance radars, he adds.

Besides, he points out, the use of many beams means the set's performance doesn't depend on a few critical parts. If a few of the 604 elements of the array failed, only a small percentage of the system's total effectiveness would be lost.

The proposed system could also solve some knotty problems in radome design. Usually, aircraft radomes are a compromise between the designs that least distort the beam and those that least affect the aircraft's aerodynamic performance. Electronic steering of the beam could be adjusted to offset beam distortion, allowing the use of ideal aerodynamic design for the radome.

**50 kilowatts.** In terrain-avoidance radar, a peak power of about 50 kilowatts is required. Magnetrons are generally used as transmitter tubes.

The integrated-circuit array will be designed to obtain an effective peak beam power of 50 kilowatts, even though the total power of all the beams will be only around 600 watts.

The difference will be made up by using pulse-compression. This is a technique for raising the effective peak power of the return pulse received by the radar set, by com-

pressing the energy distribution of a transmitted pulse into a narrow band. Plans are to use a pulse-compression ratio of 100 to 1 in the experimental system.

## II. Transmitter design

The beams would be emitted by the 604 slot elements of the fixed antenna. Each element would have its own signal generator, just as in the large shipboard and ground-based phased arrays [Electronics, Nov. 15, 1963, p. 29, and June 1, 1964, p. 91].

Two stages of circuits will be used in the new system's transmitter. The first will probably be a transistor oscillator and amplifier that will take a direct-current input and step its frequency up to 2.25 gigacycles. The power output of this stage would be 2 watts. The next stage, a harmonic generator, would multiply the frequency by four, at the expense of 50% of the power, providing a 1-watt output at 9 gigacycles.

It is still too early, Alberts says, to tell exactly what kind of integrated circuits will be used. The most likely possibility seems a construction similar to the microwave stripline circuits now made with discrete components. The monolithic circuits would probably be made of gallium arsenide crystal grown on top of a silicon-crystal substrate.

Texas Instruments is already making harmonic-generator transistors, with a frequency range of 1 to 10 gigacycles, out of epitaxially grown gallium arsenide.

Alberts is not ruling out more advanced approaches, such as the use of lasers.

**Gunn effect.** Also, it may be possible to employ the effect discovered by J. B. Gunn, of the International Business Machines Corp. The Gunn effect is the basis for the generation of coherent, continuous-wave oscillations by the application of a d-c field to a gallium-arsenide crystal. The Bell Telephone Laboratories recently reported a Gunn-effect device with a c-w output of 15.5 milliwatts and pulsed output of 1.83 watts at about 4.5 gigacycles [Electronics, Feb. 22, 1965, p. 176].

The power of such devices is not yet sufficient for radar, though, Alberts says.



**For the best possible color-TV picture...**

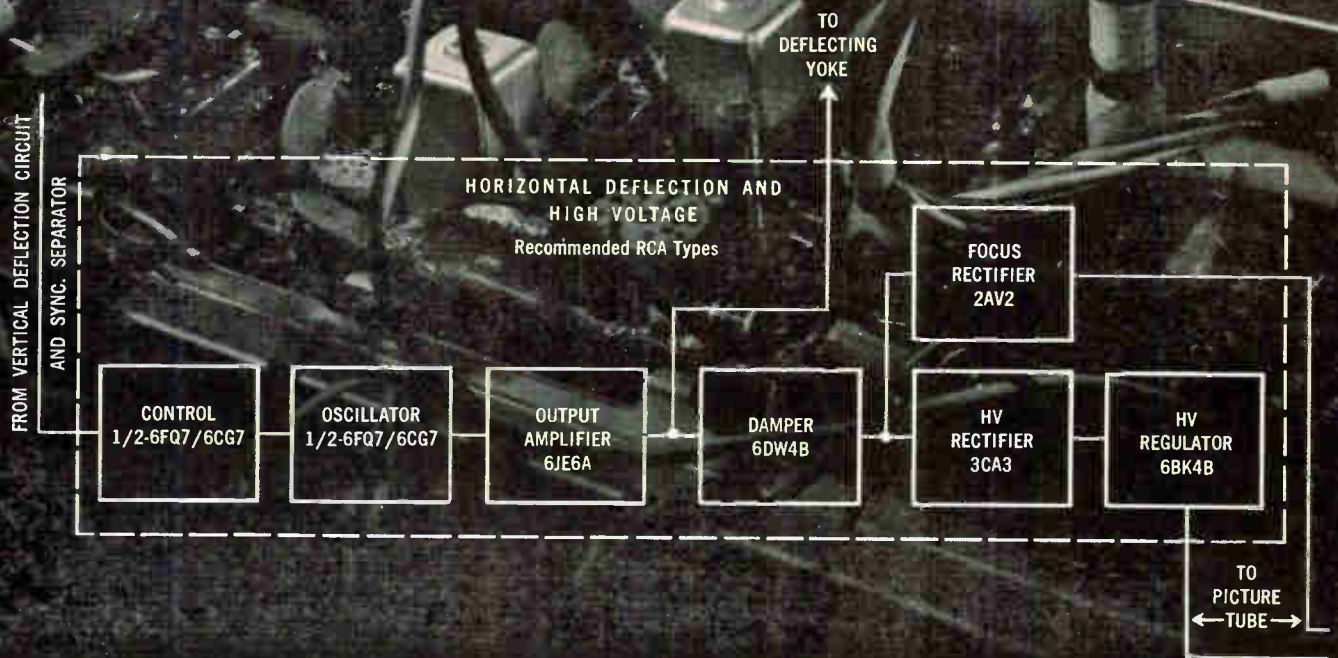

**these horizontal-deflection and high-voltage circuits need color-TV receiving tubes by RCA**

Here's where you really can benefit from the knowledge and experience that RCA accumulated during the developmental stage of color TV. This background enables RCA to design and select tubes that offer the color-set manufacturer the best combination of price, performance and reliability on the market today.

Take these tubes for example:

- RCA-6JE6A NOVAR Beam Power Tube for the Horizontal-Deflection-Amplifier socket of color-TV receivers using "B" supply voltages from as low as 270 volts to as high as 400 or more volts. No "snivet" problems with this tube—a new special plate construction eliminates "knee" discontinuities in the zero-bias  $E_b$ - $I_b$  characteristic. Other benefits of the 6JE6A are: maximum plate dissipation rating of 30 watts; maximum grid no. 2 input of 5 watts and a high plate-current to screen-current ratio.

- RCA-6BK4B Beam Triode for the High-Voltage Regulator socket. New materials technology has permitted an increase in the maximum plate dissipation rating to 40 watts with no danger of glass electrolysis failure at the plate seal. Dark Heater provides cooler tube operation—important for long tube life and reliability.

- RCA-6DW4B NOVAR Half-Wave Vacuum Rectifier for the Damper circuit. Recently modified to lower overall height by bottom exhaust construction, the 6DW4B features low voltage-gradients and high permeance. RCA's Dark Heater and

Bonded Cathode contribute to long, dependable performance.

As part of our persistent effort for perfection, each of these tube types is subjected to extensive tests, in actual color-TV receivers, in our Tube Reliability Laboratory. This testing is standard procedure for all of RCA's COLOR-TV RECEIVING TUBES and each sample lot must meet rigid QUALITY standards before its associated production lot is released to the warehouses.

For more information on RCA's COLOR-TV RECEIVING TUBES, call your nearest RCA District Office or write to RCA Commercial Engineering, Harrison, N. J. 07029.

RCA Electronic Components and Devices, Harrison, N. J.



**The Most Trusted Name in Electronics**



# Early Bird watching in downtown Washington

Comsat will operate its overseas communication satellite from a command and control center in the capital

Soon, a Washingtonian walking down L Street may decide to slow down a minute, press his nose against a window, and look at some flashing lights. He'll be following the flight of the world's first commercial communications satellite.

The control room for the Communication Satellite Corp.'s Early Bird is on the street floor of the building at 2100 L Street in Washington, D. C. From downtown Washington, Comsat will direct Early Bird into synchronous orbit, keep tabs on it on a 24-hour basis, and coordinate operations with Canada, England, France, Germany, and Italy.

Early Bird is to be orbited in April. After about two months of tests, the satellite is to begin handling up to 240 overseas telephone calls simultaneously. It will also be

capable of relaying live television from overseas.

Operators monitoring or controlling satellite operations sit at a large console and view a massive display board on which lights continuously indicate orbital position, status of ground stations, technical data on instrumentation, and other pertinent information. The elaborate board, made by Blair, Inc. of Alexandria, Va. can be viewed either from the street or from a small room where visitors may sit in comfort and watch operations.

**Man in charge.** A 32-year-old graduate of Princeton, who received his master's degree in engineering from the University of Maryland, was responsible for setting up the control center. He is Robert D. Briskman, head of Comsat's Command and Control



Robert D. Briskman, standing, set up the control center.

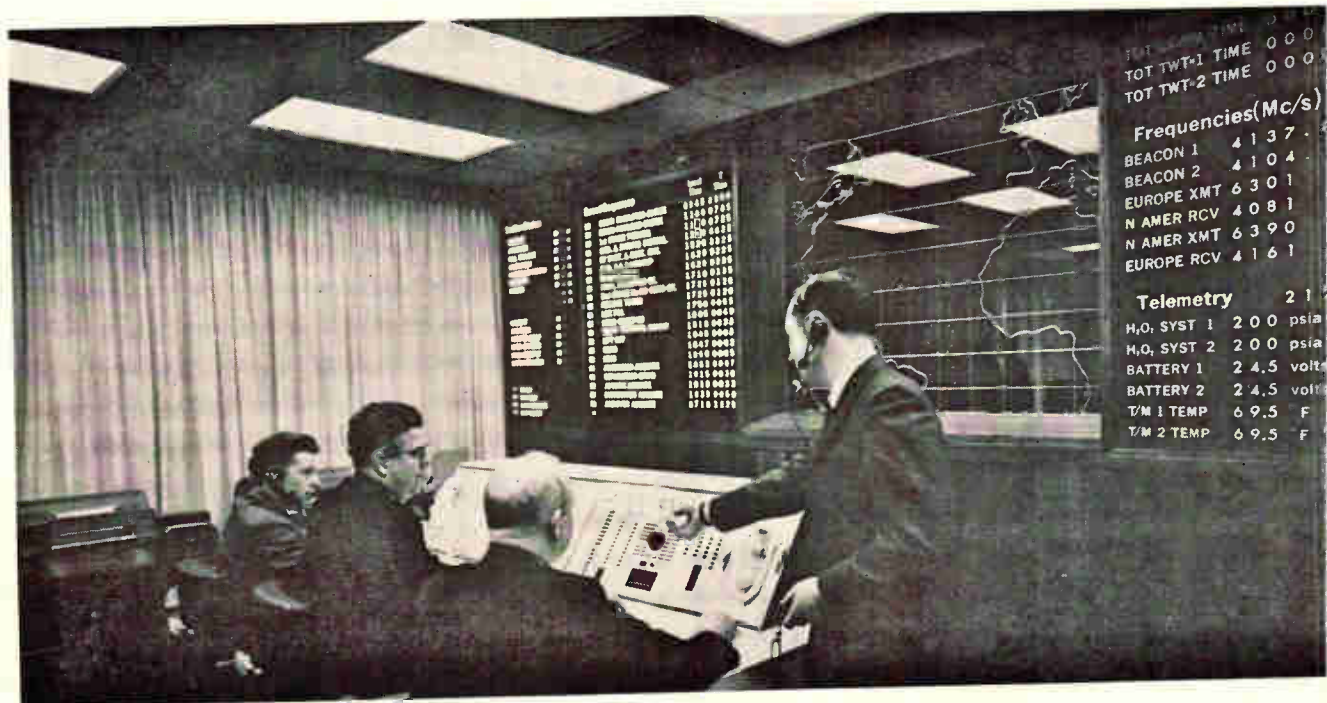

At the console, operators direct satellite and ground stations and monitor display board.



Department.

**Kick in the apogee.** Comsat will take over control of Early Bird some 28 minutes after it is launched by the National Aeronautics and Space Administration with a three stage thrust augmented Delta rocket.

Early Bird at this point will be in an elliptical orbit with its apogee 22,300 miles above the Equator. Using an IBM 7040 digital computer, the technical staff finds exactly when the satellite's apogee motor must be fired to put it into synchronous orbit. The computer also tells how much thrust is needed for what the staff calls a "kick in the apogee."

Comsat is shooting for an inclination no more than four or five degrees on either side of the Equator. If the orbit is highly circular, a 15° swing above and below the equator can be tolerated without passing out of range.

**Sharing the Early Bird.** Commands from the control center go by cable to the American Telephone & Telegraph Co.'s ground station in Andover, Me. Stations sharing use of Early Bird will be linked with the control center, via the satellite, by an "order wire." This is one voice channel and one teletype channel that transmit instructions for locking on the satellite and using it.

Early Bird does not have multiple-access capability and must work with only a pair of ground stations at a time. A sharing arrangement, now being negotiated by Comsat and the foreign participants, is expected to allow each station to work with the satellite for periods of up to one week.

**Good bet.** Comsat wants experience with Early Bird's synchronous system before deciding on what type of system will comprise the global operation to be working by 1968. Its contract with the Hughes Aircraft Co. is for two Early Bird Satellites, and it's a good bet that the second will also be orbited this year, perhaps over the Pacific.

The eventual operational system will include multiple access by several stations. The thinking now is that each ground station will need a receiver for every other ground station, with each location transmitting on a slightly different frequency.

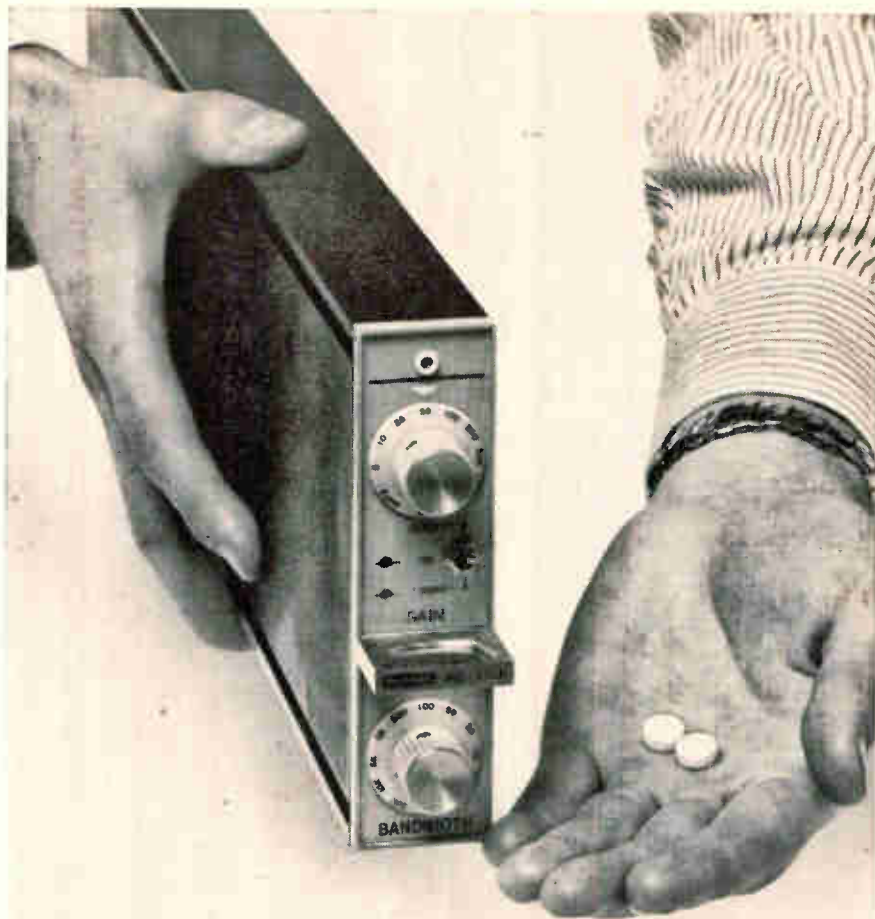

## Get permanent relief from amplifier headaches without system upset

For \$350 you can buy 200,000 aspirin tablets — enough to fight 100,000 headaches. For the same money you can get *permanent* relief from data-system problems with the Beckman AMPLEXER™ Differential Amplifier. It amplifies, filters, multiplexes, and has options for 11 switchable gains and 9 bandwidths. □ Taking 200,000 aspirins could be unsettling. The AMPLEXER Amplifier settles in as little as 100 microseconds, depending upon the filter—and there are 184 to choose from! Also, your aspirin may not be buffered, but the AMPLEXER is. The 3 simultaneous outputs—commutated, filtered, and wideband—are fully isolated from the input. What else? It's wideband (dc to 50 kc), linear to  $\pm 0.005\%$ , and has gain accuracy to 0.01%, and gain stability of 0.005% for six months. □ Write today for full details. Compare the performance and cost-per-channel of the exciting new AMPLEXER with other units—then use it in your next data system. Save the aspirin for non-users.

**Beckman®**

INSTRUMENTS, INC.

BERKELEY DIVISION

RICHMOND, CALIFORNIA • 94804

INTERNATIONAL SUBSIDIARIES: GENEVA, SWITZERLAND; MUNICH, GERMANY;  
GLENROTHES, SCOTLAND; PARIS, FRANCE; TOKYO, JAPAN; CAPE TOWN, SOUTH AFRICA

# AMPERITE

## Thermostatic DELAY RELAYS



**Delays:  
2 to 180 seconds**

Actuated by a heater, they operate on A.C., D.C., or Pulsating Current . . . Being hermetically sealed, they are not affected by altitude, moisture, or climate changes . . . SPST only—normally open or normally closed . . . Compensated for ambient temperature changes from  $-55^{\circ}$  to  $+80^{\circ}$  C. . . Heaters consume approximately 2 W. and may be operated continuously . . . The units are rugged, explosion-proof, long-lived, and—inexpensive!

PROBLEM? Send for Bulletin No. TR-81

TYPES: Standard Radio Octal, and 9-Pin Miniature.  
List Price, \$4.00



Individual inspection and double-checking assures top quality of Amperite products.

## AMPERITE BALLAST REGULATORS

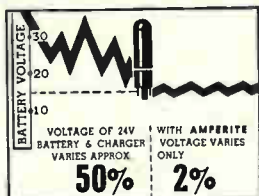

Hermetically sealed, they are not affected by changes in altitude, ambient temperature ( $-50^{\circ}$  to  $+70^{\circ}$  C.), or humidity . . . Rugged, light, compact, most inexpensive.

List Price, \$3.00

Write for 4-page Technical Bulletin No. AB-51



# AMPERITE

600 PALISADE AVE., UNION CITY, N.J.

Telephone: 201 UNion 4-9503

In Canada: Atlas Radio Corp., Ltd.,  
50 Wingold Ave., Toronto 10

Advanced technology

## More light on lasers

Researchers sound a warning on harmful effects of laser irradiation and urge users to take safety measures

"Right now we're at the same state of knowledge about the laser as we were in the early days of x-rays. At that time a technician would hold his hand behind a fluoroscope to see if it was working. It wasn't until his fingers started dropping off that he realized he was doing something dangerous."

Donald E. Rounds, director of the department of cellular biology at the Pasadena Foundation for Medical Research, was sounding a warning about the possible harmful effects of laser beams. He continued, "I am vitally concerned about the uncontrolled use of lasers on and by human beings before we have thoroughly studied the latent dangers."

His concern is shared by a number of researchers across the country who are also investigating the effects of laser irradiation of biological systems. Industry, less vocally, acknowledges the inherent danger of the laser. However, there are differing views as to the safety precautions required.

Behind the curtain. "We are certainly aware of the dangers and

take definite precautions to avoid accidental irradiation of the eyes or other parts of the body," says Theodore Maiman, the developer of the ruby laser.

Maiman, president of the Korad Corp., a subsidiary of the Union Carbide Corp., described the safety measures used at Korad. "When it's practical, we keep the laser behind a curtain or a shield similar to the kind used in arc welding. Before using the laser, we draw the shades on the outside windows. We require all personnel to wear protective goggles and to count down in a loud voice. We try to prevent any exposure to direct or reflected beams."

Look away. But Dr. Samuel Fine of Northeastern University isn't putting his faith in the protection afforded by goggles. His advice is succinct: don't look. Some researchers at industrial laboratories share Fine's view.

At Northeastern, Dr. Fine and his colleagues avoid exposure to laser irradiation by using a closed-circuit television system for close-up visual observation. Fine is both

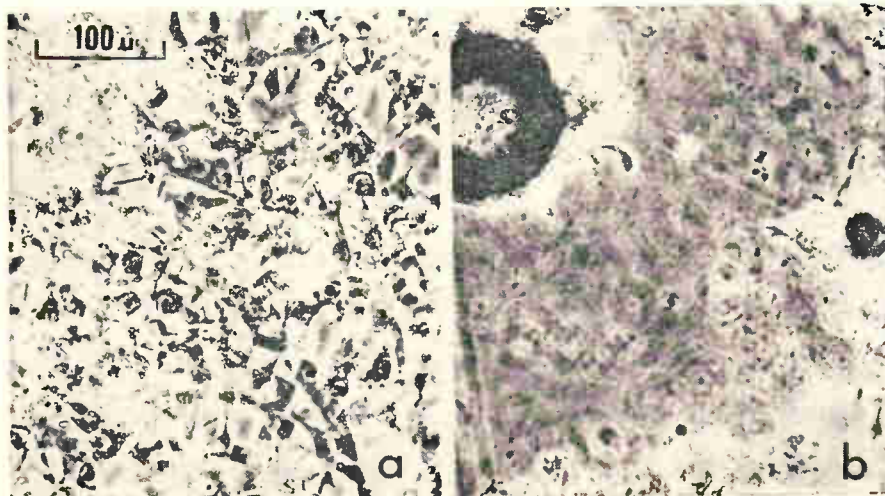

Pigmented cells before and after exposure to a laser concentration of about 25 joules per square centimeter for one microsecond. The black ring at the upper left of picture B is a collection of charred pigmented cells. There was no evidence of damage to nonpigmented cells.



**ANOTHER APPROVAL FOR EL-MENCO...**

BELL TELEPHONE LABORATORIES  
 INCORPORATED  
 463 WEST STREET, NEW YORK 14, N. Y.  
 AREA CODE 212  
 CH 3-1000

September 13, 1962

W. P. H. STEVENS  
 PURCHASING AGENT

A NOTE OF APPRECIATION  
 I take pleasure in sending you an advance copy of a

You will note that you are listed as one of the companies which helped us make Telstar a success. In behalf of Bell Laboratories, I would like to take this opportunity to express again our appreciation for your cooperation in this important endeavor.

Sincerely,



a  
**star performer-**  
**TELSTAR,**  
**we mean**

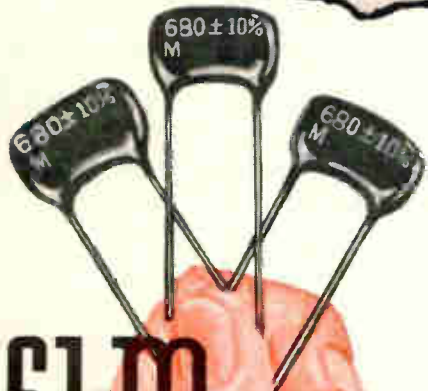
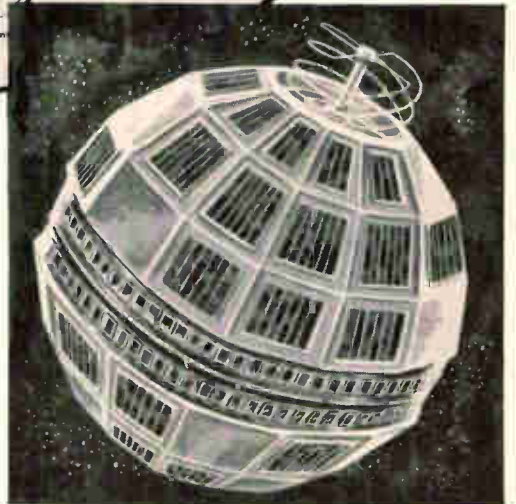

**El-Menco**  
**were selected**  
**for**  
**TELSTAR**

**MICA CAPACITORS**

In the words of the Bell Telephone System, El-Menco was chosen "because of its competence in its field for the job required." At El-Menco we believe that competence in our work of designing and building the best practical capacitors will instill your confidence in our product. This philosophy has resulted in our producing capacitors which have a high order of *quality, reliability, and availability.* Hence the selection of El-Menco mica capacitors for many important missile and satellite programs. Still widely discussed is the RCA test evaluation of El-Menco high reliability dipped mica capacitors in which enough actual test unit-hours were accumulated at *elevated temperature and with 225% of the rated voltage applied* to verify failure rates on the order of 0.0001% and 0.00004% at a 90% confidence level.

\*The El-Menco high reliability dipped mica capacitors are being supplied to the Radio Corporation of America for a high reliability military ground electronics project.

**THE ELECTRO MOTIVE MFG. CO., INC.**  
 WILLIMANTIC, CONNECTICUT



*Dipped Mica • Molded Mica • Silvered Mica Films • Mica Trimmers & Padders  
 Mylar-Paper Dipped • Paper Dipped • Mylar Dipped • Tubular Paper*

**ARCO ELECTRONICS, INC.,**  
 Community Drive,  
 Great Neck, L. I., New York  
 Exclusive Supplier to

Jobbers and Distributors in the U. S. and Canada

West Coast Manufacturers Contact:

**COLLINS & HYDE CO.,**  
 1020 Corporation Way  
 Palo Alto, California

5380 Whittier Boulevard, Los Angeles, California

Write for reliability study and technical brochures.

# HOW TO BUY POWER SUPPLIES AND SAVE MONEY

Over the years, Acme Electric has designed and supplied DC regulated power supplies in substantial quantities to some of the largest electronic equipment builders.

A number of these **Custom Designed** units have specifications and performance features that make them uniquely suited for standard industrial and laboratory use.

If you have an application in which one of these custom designed power supplies would be acceptable, the probability is that you can save money and at the same time obtain greater value represented by improved performance parameters.

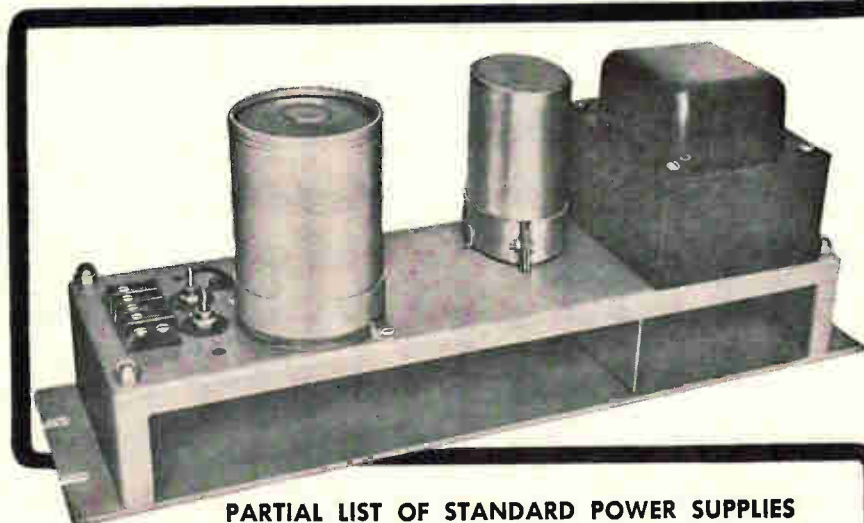

## PARTIAL LIST OF STANDARD POWER SUPPLIES

INPUT: 110-130 Volt, 50/60 cycles

LINE REGULATION:  $\pm 1\%$  for  $\pm 13\%$  line voltage change

LOAD REGULATION:  $\pm 2\%$  for load change between 50% and 100%

TYPE	DC VOLTS	DC AMPS	PANEL SIZE
PS-41922	24	2	19 x 3 $\frac{1}{2}$ x 7
PS-41423	24	6	19 x 5 $\frac{1}{4}$ x 9 $\frac{3}{4}$
PS-47173	24	25	19 x 7 x 9 $\frac{3}{4}$
PS-41424	48	4	19 x 5 $\frac{1}{4}$ x 9 $\frac{3}{4}$
PS-47519	48	10	19 x 7 x 9 $\frac{3}{4}$
PS-41425	125	2	19 x 5 $\frac{1}{4}$ x 9 $\frac{3}{4}$
PS-41428	250	1	19 x 5 $\frac{1}{4}$ x 7 $\frac{3}{4}$

RIPPLE: 1% RMS MAXIMUM

For full details covering component features, operating performance and price, write for Bulletin 175.

**Acme Electric**

**Engineers and Builders of...**

313 WATER STREET, CUBA, NEW YORK

Canadian Representative: Polygon Services, Ltd.  
50 Northline Rd., Toronto 16, Ont.

REGULATED POWER SUPPLIES  
STATIC POWER RECTIFIERS  
VOLTAGE STABILIZERS  
VOLTAGE REGULATORS

SAA-3767-3075

a medical doctor and an electrical engineer. His work, like Rounds' at Pasadena, is being sponsored by the Surgical Research Branch of the Army Medical Research and Development Command, Surgeon General's office.

### I. Research

Almost all of the research on the hazards of lasers, certainly 85% of it, is supported by the command. Lt. Col. John Kovaric monitors the work of the research groups and says that over the last year and a half about \$750,000 has been spent on a handful of projects. Initially, Kovaric says, the interest was in surgical applications for the laser, now emphasis has also been placed on laser safety research.

"It became apparent," declares Kovaric, "that many people were using lasers for a variety of things from radar to communications and that they could be subject to many kinds of hazards."

Among the hazards is damage to the eye. Kovaric says this effect of irradiation by laser might not be known to do-it-yourselfers or high school and college level experimenters.

**A question of interest.** Industry is more interested in the use of the laser than in research, according to Kovaric. He says industry doesn't see "any gain in putting research into protective goggles that might not work anyway." An optical instrument manufacturer disputes this interpretation, pointing out that industry would be inadequate to the task of performing the medical, biological and technical research involved.

There is considerable evidence that industry is vitally interested in the research being conducted. That interest grows as laser output power grows and new applications are sought for the laser's intense, beam of light.

Rounds, at Pasadena, attributes the heightened attention to the biological effects of the laser, by both the scientific and industrial communities, to the fact that more information is becoming available. He discounts the view, advanced in some quarters, that there's a scare program afoot. He says the increased concern and enlarged research stems from a better understanding of what's happening,



rather than from increased fear.

## II. The dangers

Information is still fragmentary, conclusions are tentative, and interpretations differ as the light of research is concentrated on the laser. However, no one contests the view that laser beams are a hazard to sight.

"Two potential hazards, in my opinion," says Rounds, "are the immediate injury to the retina of ciliary muscles of the eyes and the long range possibility of cancer induction."

Last year, at the First Annual Conference on the Biological Effects of Laser Radiation held at the Armed Forces Institute of Pathology in Washington, a number of scientists from various disciplines discussed their work on the effects of the laser. Among the most provocative findings were these:

- Irradiation of the eyes of albino mice by beams in the 100-joule range resulted in severe damage. In the case of black mice, the ocular orbit was destroyed.

- When the foreheads of the mice were irradiated with a 100-joule laser, 75% of the mice exposed died within 24 hours.

- Irradiation of the skin of humans caused tissue destruction. The magnitude of the damage depended on the type of laser, the exit energy and the size of the area irradiated.

**Don't know.** Some researchers point out that while little is known about exposure to a single laser flash (a target is "irradiated" or "flashed" by the laser), even less is known about possible cumulative effects over long periods, and about backscattered energy.

Dr. Fine says: "Initially it was thought that backscattered radiation would not be concentrated sufficiently on any one target to be harmful. This is not necessarily true. We just don't know. I would want definitive information that it is not harmful before drawing any such conclusion."

**Lens muscles.** There have been some serious eye injuries as the result of accidental exposure to relatively high power laser beam concentrations, according to researcher Rounds. One accident, apparently from a laser beam that struck the eye at an angle, without

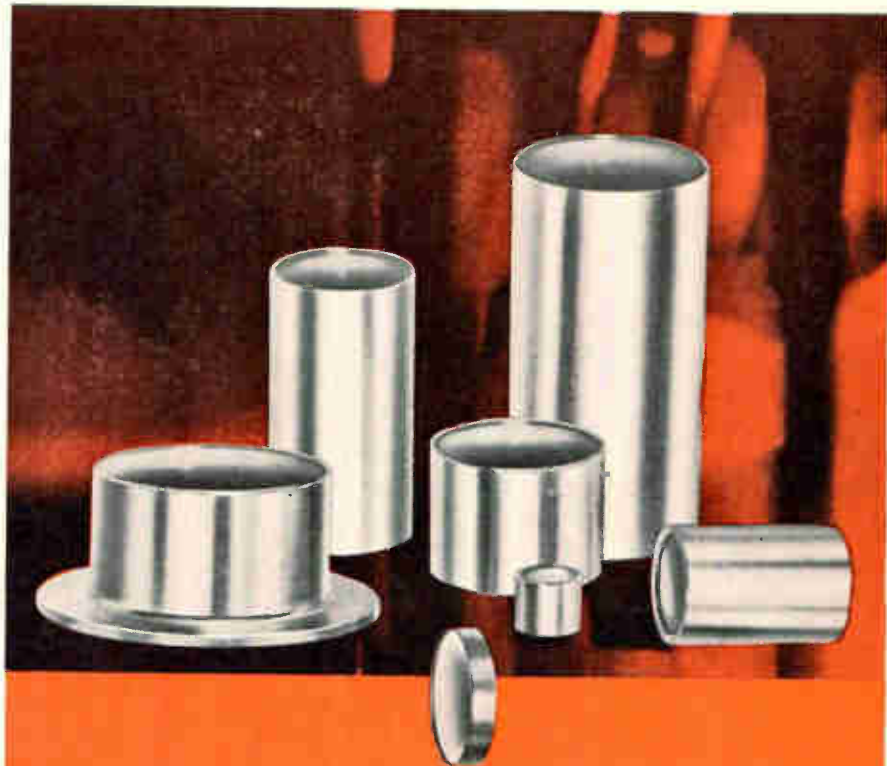

## high temperature, high reliability **SAPPHIRE-TO-METAL WINDOWS ... off the shelf!**

Sapphire-to-metal windows manufactured by Ceramics International meet the most exacting requirements of military and aerospace applications. The techniques developed at CI produce a sapphire window with unsurpassed flatness and clarity, and rugged enough to withstand the most severe environmental conditions. At CI we are producing, faster and cheaper, sapphire-to-metal windows of superior quality for the broadest range of standard and special applications.

### Applications include:

- Detector windows for military infrared guided equipment.
- Optical windows in high pressure or high temperature systems.
- Satellite thermionic converters for converting sunlight directly to electricity.
- Windows for transmission of ultraviolet and X-rays.
- Output windows for microwave tubes such as klystrons or magnetrons.
- Internal supports for vacuum tubes, insulators, and low leakage detectors.

We also make ruby-to-metal seals to the standards required for laser application.

Our seal is guaranteed to leak less than  $10^{-10}$  std. cc/helium sec. All our parts are hydrogen brazed with OHFC copper, fine silver or BT solder—72% Ag. 28% Cu Eutetic.

For further details write for our new bulletin #S110.



**CERAMICS INTERNATIONAL CORP.**  
MAHWAH, NEW JERSEY

HIGH TEMPERATURE CERAMIC-TO-METAL PRODUCTS FOR THE AEROSPACE AND ELECTRONICS INDUSTRIES

See us at the IEEE Show, Booth #2340

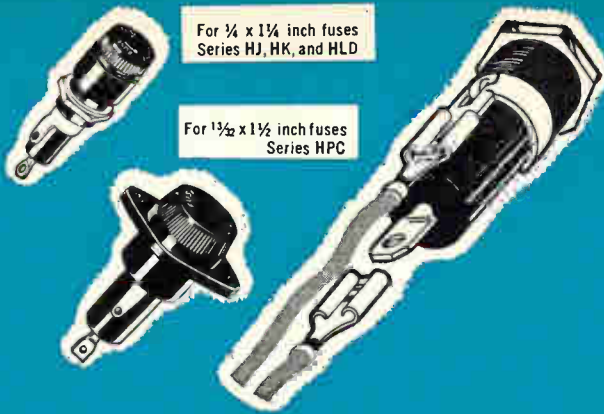

## Save Assembly Time with Quick-Connect Terminals on BUSS Fuseholders

Eliminates soldering. Permits use of pre-assembled harness. Reduces assembly time.

# BUSS

Write for BUSS Bulletin SFB

BUSSMANN MFG. DIVISION, McGraw-Edison Co., St. Louis, Mo. 63107

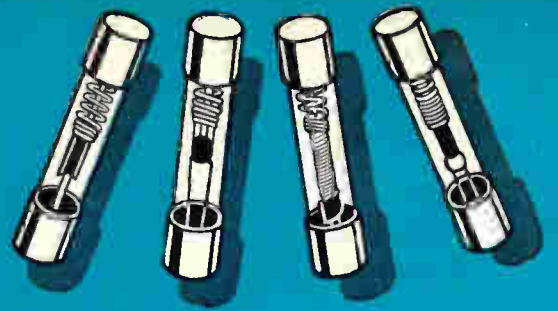

## FUSETRON dual-element Fuses

*time-delay type*

"Slow blowing" fuses that prevent needless outages by not opening on motor starting currents or other harmless overloads—yet provide safe protection against short-circuits or dangerous overloads.

# BUSS

Write for BUSS Bulletin SFB

BUSSMANN MFG. DIVISION, McGraw-Edison Co., St. Louis, Mo. 63107

# BUSS®: The Complete Line of Fuses.

Circle 133 on reader service card

## They look alike... yet they're different!



## One\* operates on 44% less power!

These DPDT half-micro relays look like twins. Both conform to MIL-R-5757D. Their specifications read alike. But the fact that one\* requires 44% less power than the other means greater circuit sensitivity, less heat generated, and smaller power supplies. One\* can also be used in close proximity to other relays and remain unaffected by magnetic interference, permitting greater design versatility and component density.

The reason for such performance is that one\* is manufactured with the unique Adjustaweld process (patent pending)—all components are automatically adjusted, precisely aligned, and welded in a single operation.

Three series are available: 100 mw, 300 mw, and sensitive latching.

\*The one on the right; a Welch, of course. Write for complete data.



**WELCH RELAY COMPANY**  
1871 South Orange Drive  
Los Angeles, California 90019  
Telephone (213) 933-9541

Circle 132 on reader service card

Circle 133 on reader service card

### Reprint order form

Send to: Electronics Reprint Dept.  
330 West 42nd Street  
New York, N. Y. 10036

For listing of reprints available see the reader service card.

To help expedite mailing of your reprints please send cash, check or money order with your order.

For reprints of the latest special report:

### International Color Television

Send me . . . reprints of key no R-70 at 25¢ each.

For reprints of previous special reports fill in below:

Send me . . . reprints of key no.(s) . . . at . . . ¢ each.

For prices see the reader service card.

Name . . . . .

Number & Street . . . . .

City, State . . . . .

Zip code . . . . .



impinging directly on the retina, caused a loss in the ability to focus on near objects. Rounds thinks that there may have been damage to the muscles controlling the lens. Body muscles seem to be well protected by the skin layers.

**Pigment difference.** Cells and tissues, grown between glass plates, have been irradiated directly and not through covering layers of skin and bone. This exposure is far more severe than in any envisageable situation but it offers scientific controls not otherwise available.

One important finding of Rounds' research is that pigmented cells are susceptible to damage where nonpigmented cells are not. The photograph on page 128 shows pigmented cells before and after exposure to laser irradiation. The lack of damage to nonpigmented cells may be valuable in the treatment of certain types of highly pigmented cancer. One reason, according to Rounds, that detached retinas can be welded back in place is that they are pigmented. Experi-



Donald E. Rounds, of the Pasadena Foundation for Medical Research, warns of the danger of lasers.

ments are being started at Pasadena to determine the effects of differing wavelength laser beams on various pigmented cells.

**Cell structure.** Experiments on red corpuscles have been carried out at the National Transfusion Center in France. There, a laser beam concentrated on a small area within a single cell caused the cell to explode. Rounds, in experiments with less concentrated beams over a group of cells, has observed some coagulation of the cells. If this bunching-up effect occurred in the blood stream it would produce a clot. However, Rounds believes that the surface protection given veins and arteries by layers of skin will prevent such damage. But, he says, this may apply only to the present laser power levels.

**Common sense.** Since there is so little positive information available at this time it makes sense, warns Rounds, to take precautions against possible injury. Users of lasers, and researchers should avoid exposure to laser beams.

## of Unquestioned High Quality...



*Actual Size*  
Only 1-5/8 inches long...  
Extends just 29/32 inch  
behind front of panel

### BUSS Space Saver Panel Mounted Fuseholder

- Fuseholder takes 1/4 x 1 1/4 inch fuses. Converts to 9/32 x 1 1/4 inch fuses simply by changing screw type knob. Holder is rated at 30 ampere for any voltage up to 250.
- Also available in military type which meets all requirements of MIL-F-19207A.

# BUSS

Write for BUSS  
Bulletin SFH-10

BUSSMANN MFG. DIV., McGraw-Hill Co., ST. LOUIS, MO. 63107

Circle 133 on reader service card

### THE NEWEST DEVELOPMENTS IN ELECTRICAL PROTECTION

will be shown at the



*If you can't make the show, but have a problem in electrical protection, our staff of fuse engineers is at your service to help you solve it. In any event, be sure to get latest information BEFORE final design is crystallized.*

# BUSS

JUST CALL  
OR WRITE

BUSSMANN MFG. DIVISION, McGraw-Hill Co., St. Louis, Mo. 63107

Circle 133 on reader service card

*"Here's the First  
Reliable Family of  
High-Density  
Connectors..."*



*Roger Bowen  
Director of Engineering  
Connector & Cable Products*

"We call these multi-pin connectors the New Generation. They're the smallest, high-performance circular connectors in the high-density packaging field—61 crimp contacts in an insert the size of a dime. Our smallest models save as much as 61% in weight and 54% in panel space compared to conventional connectors—and without sacrificing performance.

"This newest MARC 53 connector I have here in my hands is a 'high rel' version of our standard 43 series. The MARC 53 features 'Posilock', a push-pull coupling design that allows mating the highest density con-

nectors with only your finger tips. And it's a dual positive locking action...so there's no chance for accidental disconnect. Also, the MARC 53's 'Posiseal', is the first multiple, environmental sealing system to provide an environmental integrity never before possible.

"The New Generation also includes the only all-crimp hermetic high-density connectors...in both the MARC 43 and MARC 53 series. Since no soldering iron is ever used with these hermetic versions, there is no danger of damage to the glass seal—no problem of leaking glass seals.

"The MARC 53 series has been designed to comply with the applicable requirements of the latest Air Force specification, MIL-C-38300 Revision A. It's the finest subminiature circular connector you can use.

"The MARC 43 series, which is the standard push-pull type for normal requirements, meets all applicable specifications. And it's the only high-density circular connector that has a push-pull, positive-locking coupling device with low engaging and separating forces, that will meet the high performance require-



## **MICRODOT INC.**

220 Pasadena Avenue, South Pasadena, Calif.  
Overseas: S.A. Microdot—Varec N.V. (Brussels)



ments of MIL-C-38300. Mil Specs to match our all-crimp hermetic version haven't been written yet. But deviation requests have been successfully initiated by subcontractors who want—and need—this highly advanced connector.

"See why we call these connectors a New Generation?

"We've been doing a lot of other things, too. For instance, we offer an exclusive mil mating connector—MICRO-MIL—that references MIL-C-22557A. Additionally, we have the 'Golden Crimp', which is a 100% crimp version of our famous coax line, and MICROCRIMP, a commercially priced crimp-style connector available in over 100 designs.

"In our coax cable product line, we're introducing 'Shield-ax', a flexible metallic coated cable that achieves 100% shielding without the disadvantages of solid tubing. Within the 'Lerco' hardware line, we're offering greatly improved service in terminals, knobs, and related hardware. It's an inter-related capability—connectors, cable, 'Lerco' hardware, and custom assemblies.

"Write me personally with any questions about the New Generation of connectors, and about putting this total capability to work for you. Or check the reader service card for latest data sheets."



See us at IEEE  
Booths 1208-1210



# these semi-conductors:

*single-sided glassivated, silicon controlled switches,  
dual diodes and transistors.*

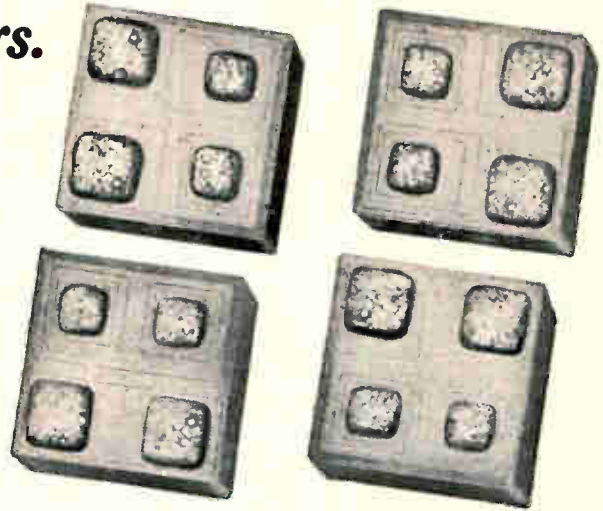

# make these hybrid circuits

*the most practical approach to many micro-circuit applications*



3 STAGE AMPLIFIER



SCS FLIP-FLOP



DECODER LATCH



RESISTOR DIODE-NETWORK

*because they are low cost, flexible and available.*

New Burroughs single-sided semiconductors represent one of the most significant component package advances in the history of micro-circuit development. Unique design and fabrication techniques have introduced drastic cost reductions which make hybrid circuits the most reliable and lowest cost approach to many micro-circuit applications.

A "super" glassivation technique and a single-sided metal contact system have completely eliminated several costly procedures previously necessary in semiconductor manufacture. And the new low cost glassivation process effects a highly superior hermetic seal which insures permanence and stability of device characteristics.

Burroughs single-sided semi-conductors are available as discrete components—or mounted on ceramic substrates in hybrid circuits to specification.

For complete information, write today.



**Burroughs Corporation**

**ELECTRONIC COMPONENTS DIVISION  
PLAINFIELD, NEW JERSEY**

# If you know one of our Sales Engineers, you know what's most important to know about synchros.



Now you know. One of our Sales Engineers can help you with *any* synchro problem. Including those you've almost given up on. He represents the most complete line of synchros in the industry, and his knowledge about them stays as up-to-date as today.

That's why he's one of the few people around who doesn't break out

into a sweat when customers ask about those new high-temperature synchros that can take up to 800 degrees F.

How about synchros resistant to nuclear radiation? Space and missile applications? He knows, he knows. All about the new line of military and Autosyn® synchros, too. So, if you're

up against a tough synchro problem, get in touch with one of our Sales Engineers. He's just the man to help you solve it. Phone 717 278-1161, Montrose, Penna.

Send for new catalog.



**Montrose Division**





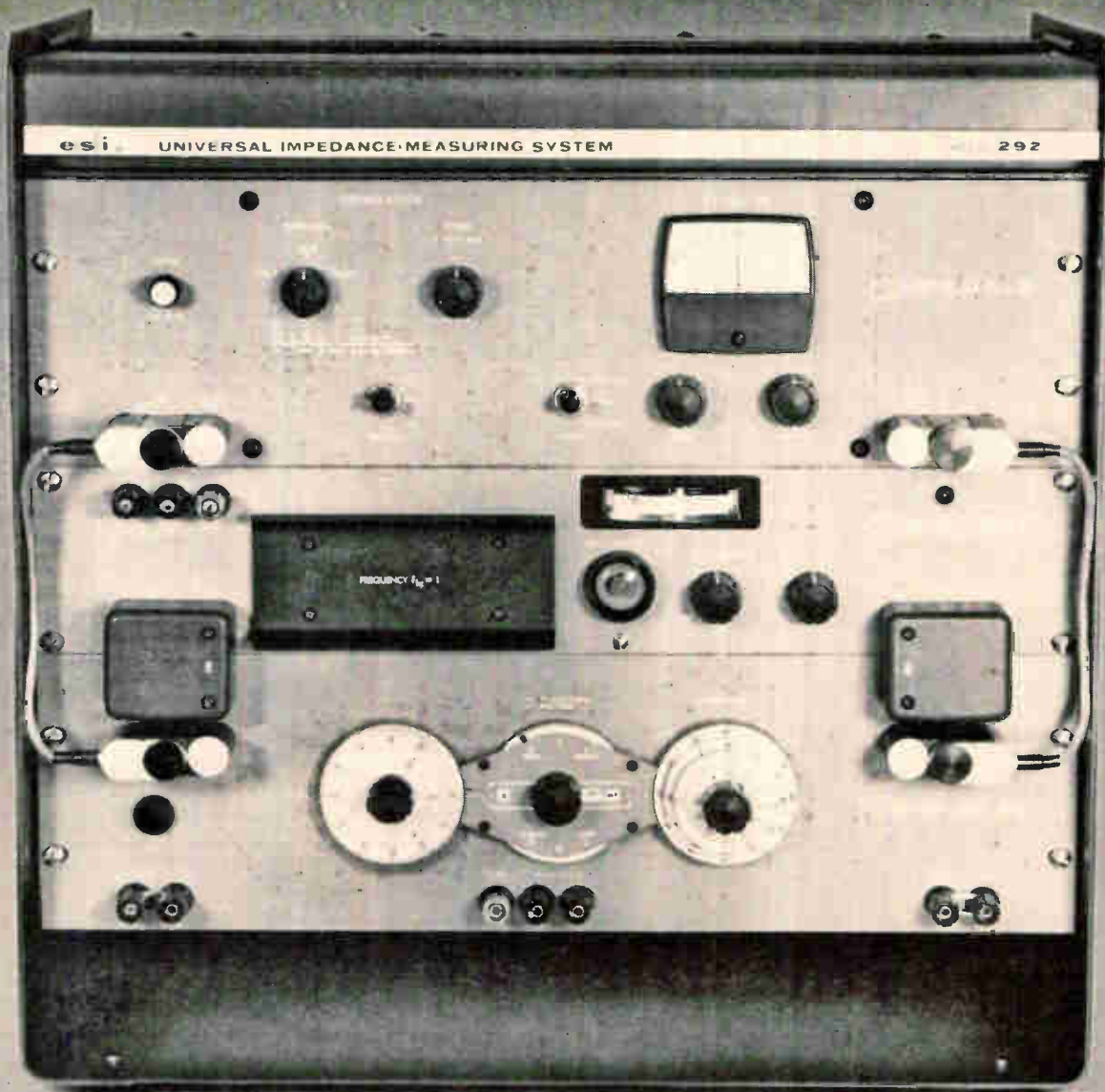

## “Bring me your resistors, your capacitors, your other component parts.

(And I will lead you to a measurement accuracy of 0.05%.)”

Let our new model 292 usher you into the promised land of high accuracy impedance measurement. Here in one system you have the capabilities to measure resistance and conductance to  $\pm 0.05\%$ , inductance and capacitance to  $\pm 0.1\%$ .

We've designed it to give you easy access to each circuit element for individual use and ease of calibration. This package “laboratory” of six high accuracy bridge circuits will handle 99% of the measurement requirements of the average inspection, quality control or calibration department. It's so easy to operate you don't need an instruction manual (although one is provided for those who like to read!)

Earlier models of this system have been living up to specifications for eight years now. If you haven't heard about the ESI Impedance Measuring System before this, remember: it took Moses 40 years to discover *his* promised land. ESI®, 13900 NW Science Park Drive, Portland, Oregon (97229).

### Model 292 Universal Impedance Measuring System

#### Resistance and Conductance

Range: 0 to 1200 kilohms—(R)  
0 to 1200 milliohms—(G)

Accuracy:  $\pm 0.05\%$  + 1 dial division

#### Capacitance and Inductance (Series & Parallel)

Range: 0 to 1200 microfads—(C)

0 to 1200 Henrys—(L)

Accuracy:  $\pm 0.1\%$  + 1 dial division

#### Sensitivity:

DC—5 microvolts      AC—20 microvolts

Frequency: 1 KC supplied (others available)

Price: \$1285

Note: For related capability in a proven, portable design, inquire about our Model 250 DA at \$495.

Electro Scientific Industries

**esi**®

Visit Booths 3015-17-19 at the IEEE Show

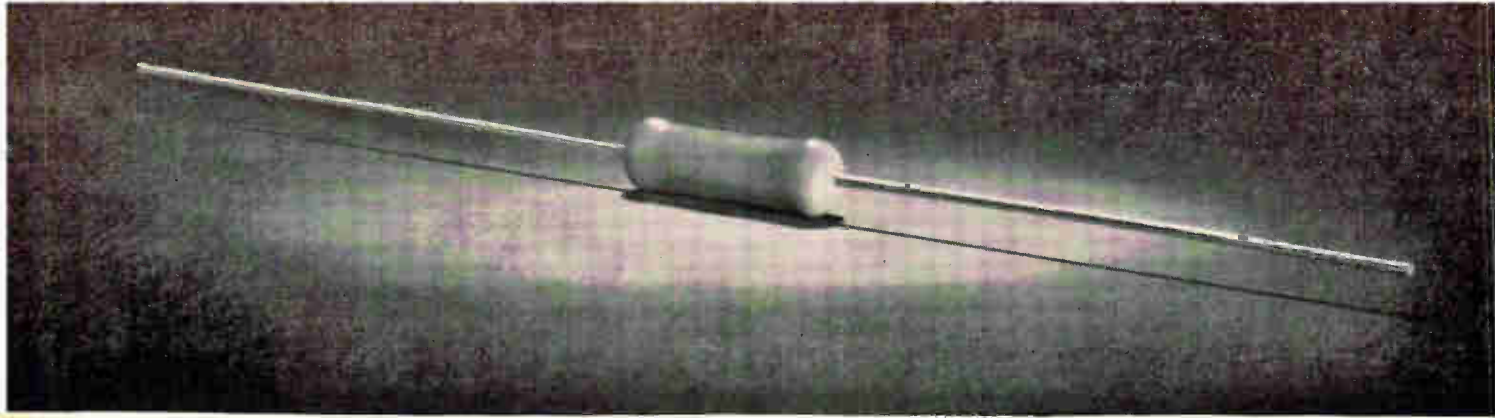

**If you can find one resistor  
that's best for all precision applications**

**...buy it**

**We don't think you will.**

**That's why we make all these different types ... can recommend without bias.**

 <p><b>MOLDED DEPOSITED CARBON</b> Low cost, most popular MIL-R-10509</p>	 <p><b>COATED DEPOSITED CARBON</b> Industry's first precision film, MIL-R-10509</p>	 <p><b>MOLDED METAL FILM</b> Best MIL-R-10509 performance, hi-rel option</p>	 <p><b>COATED METAL FILM</b> Smallest size resistor for MIL-R-10509</p>
 <p><b>ULTRA RELIABILITY METAL FILM</b> MIL-R-38101, Minuteman .0001%/1000 hr.</p>	 <p><b>HIGH RELIABILITY METAL FILM</b> MIL-R-55182, 4 sizes, glass-hermetic</p>	 <p><b>LOW COST METAL FILM</b> 100 ppm T.C. Molded or coated types</p>	 <p><b>MINIATURE METAL FILM</b> Saves space, 1/20 watt, 1% tolerance</p>
 <p><b>PRECISION POWER WIREWOUND</b> Miniature, 1/2 to 15 watts, 25 ppm T.C.</p>	 <p><b>ENCAPSULATED WIREWOUND</b> MIL-R-93, humidity and shock resistant</p>	 <p><b>UNENCAPSULATED WIREWOUND</b> Instrument grade, low cost Wirewound stability</p>	 <p><b>MATCHED METAL FILM</b> Matched to 3 ppm T.C. and/or .02% tolerance</p>

*Write for Precision Resistor Selection Chart... complete data in handy 11" x 17" size.*



**INTERNATIONAL RESISTANCE COMPANY**

PHILADELPHIA, PA. 19108



# Ultrastable co-ax transmits at 5Gc

Flexible, low-loss line uses Teflon tape as main dielectric in 8-layer waveguide

A new ultrastable coaxial cable is expected to have a significant impact on microwave equipment design and application. It can replace waveguide at frequencies up to five gigacycles.

Tentatively designated RG-326/U, the cable exhibits an attenuation factor of only 10.0 db per 100 feet at 5 Gc, and a nominal vswr of only 1.2 at that frequency. It is as flexible as present coaxial cables of an equivalent 3/4-in. diameter.

The company says the new cable is more than twice as efficient as RG-281/U, the best production microwave cable previously available. It also has higher power and corona ratings than its predecessor. Price is about \$7.50 per foot.

RG-326/U is made in eight layers: the center conductor, 19 plated copper wires, each 0.0378 in. in diameter; the main dielectric, perforated Teflon tape to approximately 3/8 in. radius; a wrapping of unperforated Teflon tape; a gap-spaced layer of spirally wound, silver-plated copper foil; a high-density braid of silver-plated copper wires; two nylon tensioning layers; and an environment-resistant polyurethane jacket.

Perforated Teflon tape acts as a semisolid dielectric because of the many air spaces trapped inside the layers. Teflon was chosen over conventional polyethylene because its dielectric constant is lower—2, compared with 2.26 for polyethylene—and because Teflon's dissipation factor is about half that of polyethylene. In addition, perforated Teflon tape offers greater resistance to mechanical deformation by external forces.

One of the most significant features of the new cable is the design of the foil and braid shield, which combine to offer a braid coverage of nearly 100%. The layers were designed to reduce contact resistance to an absolute minimum. The spirally wound, gap-spaced foil

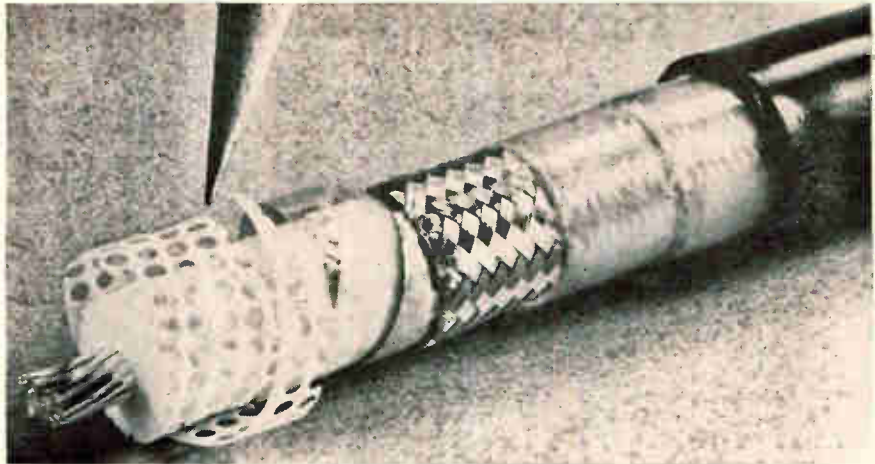

covers large areas of the cable with a solid shield, yet does not significantly affect flexibility. Wrapping the foil with gaps between each turn prevents changes in contact resistance due to shorting during flexing. The braid layer offers the shielding required to cover gaps in the foil. To assure the electrical stability of the braid-to-foil-to-dielectric contact, a double layer of nylon fabric compresses the outer conductors firmly against the dielectric layers. This compression reduces outer conductor contact resistance to a minimum, resulting in the low attenuation and vswr

factors of the coaxial cable.

The tough polyurethane jacketing is more than four times as abrasion-resistant as polyethylene or polyvinyl chloride. In addition, the jacket remains flexible over a range of  $-55^{\circ}$  to  $+90^{\circ}$ C.

Originally developed for use with new Army mobile radar vans, the cables are expected to find important commercial applications. The manufacturer reports interest in coaxial techniques among solid-state and connector manufacturers.

Amphenol-Borg Electronics Corp., 6235 S. Harlem Ave., Chicago, Ill.  
Circle 349 on reader service card

## Hermetically sealed zener diodes

A new series of 1-watt flangeless zener diodes, rated from 3.9 to 33 v, is now in production. These alloyed junction devices, intended for applications where sharp knees, low zener impedance, small size and ease of mounting are important, are said to be particularly valuable in production lines using automation. The 1ZF series is hermetically sealed to insure stable, long term



operation. Operating temperature range is  $-65^{\circ}$ C to  $+165^{\circ}$ C, and units may be obtained in 5, 10 and 20% voltage tolerances.

International Rectifier Corp., 233 Kansas St., El Segundo, Calif. [350]

# WHAT DO YOU NEED IN TOGGLE SWITCHES?

**Control Switch has it!**



**World's smallest cylindricals.** Overall lengths as small as  $\frac{7}{32}$ " , diameters as small as  $\frac{1}{16}$ ". Life of 25,000 to 100,000 operations, depending on switch type and load. 1,150 types, 2- and 3-position, maintained and momentary, 1- or 2-poles, rated from  $\frac{1}{4}$  to 10 amp at 28 VDC or 115 VAC.

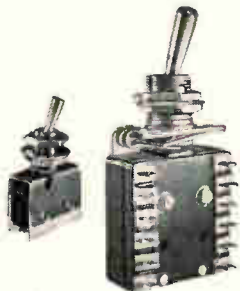

**1 to 6 circuits.** Ratings to 40 amps, single- or simultaneous double-break actions, maintained or momentary contact, 4-way action, holding coils, special toggle shapes. Name it, Control Switch probably has it right now.



**Moistureproof.** A complete line of internally sealed, moisture-proof types as small as  $\frac{1}{16}$ " diameter by  $\frac{7}{32}$ " long overall. Momentary or maintained, 2-position, 2-circuit contact arrangements handle loads up to 3 amps at 28 VDC or 115 VAC. There's a moistureproof toggle switch to suit your exact needs—from us or from leading electronic parts distributors throughout the country.

**CONTROLS COMPANY OF AMERICA**

CONTROL SWITCH DIVISION  
1420 Delmar Drive, Folcroft, Pennsylvania 19032

## New Components and Hardware

### Vidicon enhances tv camera design

A hybrid vidicon has been developed that will permit the design of smaller, lighter, high-resolution tv cameras for military, space, industrial and commercial use. Employing a new method of magnetic focusing and electrostatic deflection—called focus projection and scanning (FPS), the new pickup tube is particularly adapted for such space applications as star trackers and tv guidance for missiles and for portable tv cameras for battlefield surveillance. Commercial uses could include color tv cameras and educational tv. The FPS design greatly reduces the vidicon's power requirements, a critical factor in any portable or airborne equipment. It requires only 5 w—one-half the power needed by a typical all-magnetic vidicon. Compared with a typical 6-in., all-magnetic vidicon, the new FPS tube measures only 4 in. in length, excluding pins, and 1 in. in diameter. This combination of small size and magnetic focusing eliminates potential problems caused by magnetic interactions of the beam in space. Despite its small size, the FPS tube has a resolution of 800 tv lines with only 750 v beam acceleration. It also has



better center-to-edge resolution than tubes with electrostatic deflection. The tube is approximately 25% lighter than comparable magnetic vidicons. Usable target diameter is 0.58 in. maximum. The tube's unique design for focusing and deflection consists of a new crossed-field system, employing a transverse electrostatic field for deflection. This field is immersed with an axial magnetic field that focuses the electrons. Other hybrid vidicons employ electrostatic focusing and magnetic deflection.

General Electric Co., Schenectady, N. Y. [351]

### Subminiature relay handles 1-amp loads

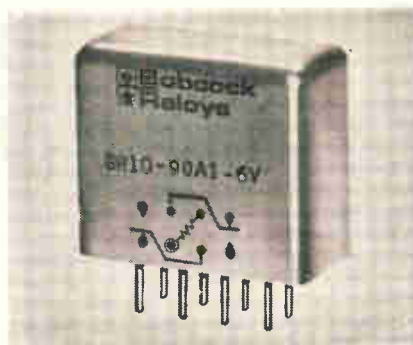

A new relay,  $\frac{1}{16}$  crystal can size, has been developed for low profile, printed circuit mounting. Designed

to meet the requirements of Mil-R-5757D, this dpdt relay will switch dry circuit to 1-amp loads over a temperature range of  $-65^{\circ}$  to  $+125^{\circ}$ C. It has a rated life of 150,000 operations at 0.5 amp, 28 v d-c resistive at  $125^{\circ}$ C. Other specifications include: vibration—30 g, 40-3,000 cps; operate and release time, 3.5 msec max; pull in power, 100 mw max; size, 0.505 in. by 0.405 in. by 0.230 in.; weight 0.15 oz; price, approximately \$16 depending on quantity and special features. Designated the BR-10, the relay features the manufacturer's exclusive Vycor getter to adsorb outgassed organic materials. Self-wiping AgMgNi alloy contacts optimize performance under load and minimize low-level contact resist-



**You've just  
decided to use  
a lighted  
pushbutton,**



**instead  
of a  
toggle  
switch.**



**Are you going to have to switch SWITCH suppliers?**

Well, if you have been considering one of the 3,150 toggle switches we have at Control Switch, you can quietly stay right where you are and start considering one of our 1,800 lighted pushbutton switches.

Same salesman. Same distributor. Same supplier. Same superior engineering for applications where you can't afford to have a switch goof, even after a hundred thousand actuations.

You can stay with us just as easily, too, for leaf and lever, interlock and limit, hermetically-sealed and environment-free switches.

*For an idea of what Control Switch has in toggle switches alone, see the column at left.*



**CONTROL SWITCH DIVISION**  
1420 Delmar Drive, Folcroft, Pennsylvania 19032

**NOW! TRANSMIT LIGHT  
IN FLEXIBLE CURVES...**

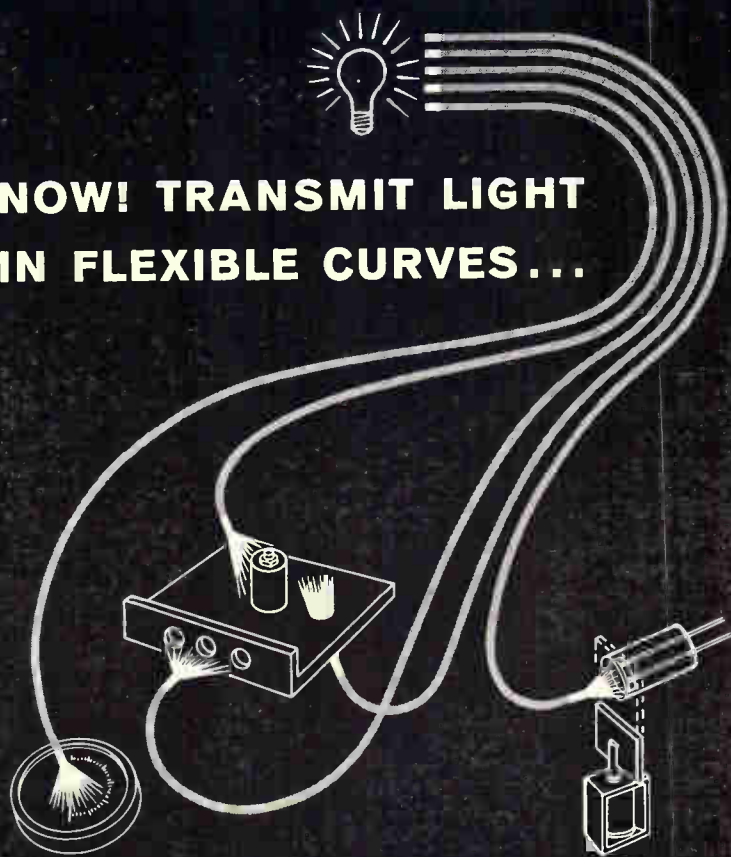

## **NEW Bausch & Lomb LIGHT WIRES**

**Your first low-cost source for production-run incoherent fiber optics!** Out of the "high-priced, laboratory stage" . . . and into your hands to be designed and engineered into your products and systems as a practical economical tool. That's the big news from Bausch & Lomb, leaders in fiber optics research.\*

Thin glass fibers, each about 15 microns in diameter, are made to transmit light by a process of total internal reflection. Each fiber is clad in a coating of lower refractive index than itself . . . bundles of these high optical quality fibers are clustered together into flexible "wires" . . . the ends are bonded, ground and polished . . . and you have Bausch & Lomb LIGHT WIRES! They can be specified by known parameters . . . and ordered by diameter and length . . . to fit your design problem.

LIGHT WIRES transmit light and light impulses efficiently around flexible curves and into inaccessible areas. As flexible as electrical wires, they can be bent and twisted around corners, harnessed together by butt-contact splicing and fed through conduits, to move light signals or illumination from one point to another. Applications in illuminating, signaling, monitoring, and actuating are virtually unlimited . . . where higher efficiency, reliability, space reduction, potential fire and explosion, lower cost, and inaccessibility are design problems.

Write for complete information Catalog D-2045, Bausch & Lomb Incorporated, 62315 Bausch Street, Rochester 2, New York.

\*Another Bausch & Lomb first in fiber optics . . . "The FLEXISCOPE" . . . a great new tool for production and quality control, which transmits images from inaccessible areas. Catalog D-2042 available on request.

**BAUSCH & LOMB** 

In Canada, write Bausch & Lomb Optical Co., Ltd., Dept. 614, Scientific Instrument Division, 16 Grosvenor St., Toronto 5, Canada

### **New Components**

ance. Unitized construction adds to over-all reliability by reducing the number of moving parts. The BR-10 is available in solder or welded enclosure and with a variety of terminal styles. Spdt or radiation hardened models are available on special order.

Babcock Relays, a division of Babcock Electronics Corp., 3501 Harbor Blvd., Costa Mesa, Calif. [352]

### **Photoresistive spst switches**

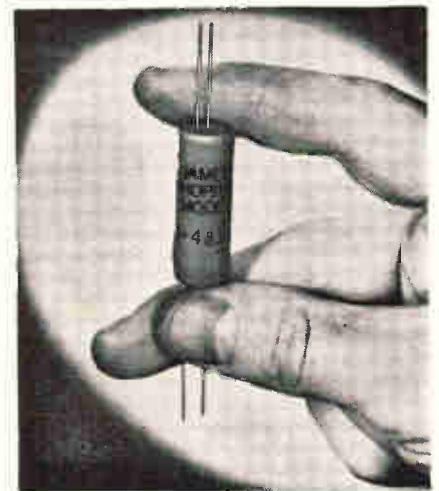

Four single-pole, single-throw Photocom photoresistive switches are being introduced. The miniature series 4820 switches, composed of a photoresistive cell driven by a neon lamp, offer solid-state design, low electrostatic, magnetic and thermal noise in an encapsulated package to withstand extreme environmental conditions. Model 4820 has a resistance of 50,000 ohms in the operate condition and 100 megohms in open circuit. For model 4821, resistances are 500,000 ohms and 1,000 megohms; model 4822—60,000 ohms and 100 megohms; model 4823—250,000 ohms and 1,000 megohms. Operate time for models 4820 and 4821 is 2 msec, nominal; for models 4822 and 4823, 15 msec, nominal. Release times are approximately equal to operate times. The low-level switches will find application as series or shunt modulators in operational d-c amplifiers, pH meters, electrometers, servo control, and other equipment



where a reliable, solid-state, low-noise switch is required. The neon lamp requires 120 v rms drive and the photoresistive cell delivers 50 mw of switching power, in all models. Efficiency is 98%, with source impedance = 0 and load impedance =  $10^6$  ohms at 60 cps and 25°C. All models of the encapsulated switch measure 1½ in. long by ¼ in. diameter. Silver leads provide input to the neon lamp and gold leads are used for output. Prices range from \$9 each for samples and \$6 each for 100 lot quantities. Sample delivery is one week, and four to five weeks for production quantities.

James Electronics, Inc., 4050 North Rockwell Ave., Chicago, Ill. [353]

### Solid electrolyte tantalum capacitors

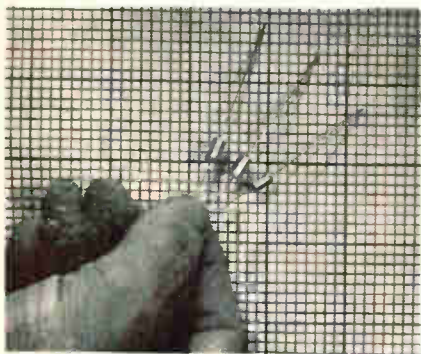

The Econotan line of polarized, solid tantalum capacitors has been designed for commercial applications. Major features are small size with 0.020-in. diameter, tinned nickel leads suitable for automatic insertion; and reliable operation without degradation from -55°C to +85°C. Solid electrolyte eliminates leakage of electrolyte and provides indefinite shelf life. The new capacitor is available in 29 standard ratings. The metal case can be supplied with insulating polyester sleeve. The smallest of the three case sizes is 0.240 in. long by 0.090 in. diameter. It is available in ratings from 0.068  $\mu$ f at 20 wvdc to 10  $\mu$ f at 2 wvdc. The largest case size is only 0.345 in. long by 0.180 in. diameter. It is available in ratings from 6.8  $\mu$ f at 20 wvdc to 68  $\mu$ f at 2 wvdc. The 1,000 price for a 1.0  $\mu$ f, 20 wvdc unit is 22 cents, and shipments of

# NEED INDUCTORS FOR PRINTED CIRCUIT BOARD MOUNTING?

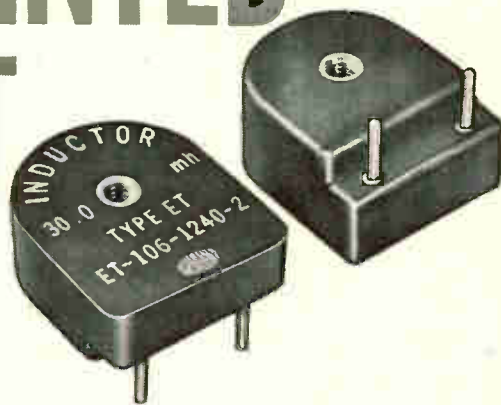

Sangamo offers 72 hour delivery on all prototype encapsulated inductors.

With Sangamo encapsulated inductors, your assembly time is shortened. There's no need to solder individual

wire leads to terminals. Mount the Sangamo inductor onto the card and dip solder—that's all.

**SIZE:** The type ET is a miniaturized toroidal inductor. Dimensions, shown on diagram, make it ideal for mounting on circuit boards where spacing is critical. Any custom inductance value from 1.00mh to 2.50h is available at no additional cost.

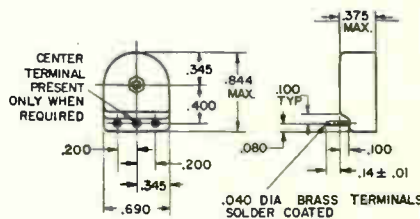

**CONFIGURATION:** The design of the ET-1 provides an excellent wash area for easy flux removal after soldering. Units are available with a third terminal to provide a tapped inductor.

**FEATURES:** Vacuum encapsulated units assure a void-free envelope. Inductors are impervious to moisture and have extremely stable electrical and temperature characteristics, plus exceptionally high Q values. Send for Engineering Bulletin 2721A.



EC 65-2

**SANGAMO ELECTRIC COMPANY** • P.O. BOX 359 • SPRINGFIELD, ILLINOIS 62705

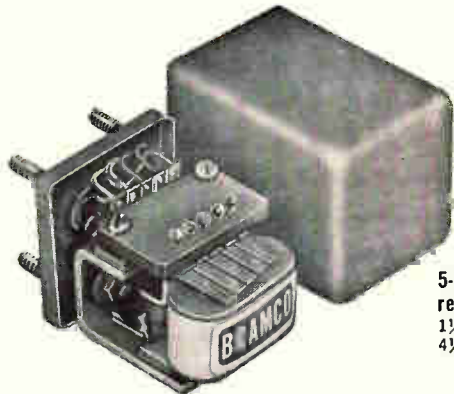

5-channel resonant reed relay  
 $1\frac{1}{2} \times 1\frac{3}{4} \times 2$ ,  
 4½ oz.

## REMOTE CONTROL SWITCHING WITH AUDIO SIGNALS

An audio tone can be generated by an electronic oscillator or resonant reed encoder circuit, then transmitted by wire or radio. The tone activates a resonant reed relay to perform a control function.

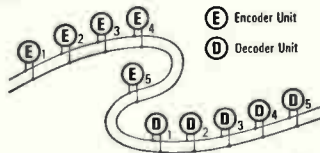

A single pair of wires, or a leased telephone line, can carry the audio signals for a complete control system.

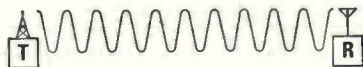

For inaccessible areas or mobile installations, a radio transmitter and receiver system can carry the signals.

Bramco reeds permit over 50 selective control frequencies within the 67 to 1600 cps spectrum. This is assured by: (1) the narrow response bandwidth of about 1% for decoders and (2) the high accuracy of Bramco reed encoders (1/10 of 1% of design frequency).

A big advantage of reeds in control switching is that they are ideally suited for simultaneous and sequential coded tone systems. The actual number of control functions possible in such a system is virtually unlimited. For example, over 3300 individual control functions are possible with only 16 frequencies coded sequentially in groups of three.

Compared to other types of tone filters, resonant reeds are small and inexpensive. They give more control functions per spectrum, per size, per dollar.

If you work with controls that select, command, regulate, or indicate, you should know about how it can be done with audio signals. We custom design and stock a broad line of encoder/decoder components and modules.

For literature write Bramco Controls Division, Ledex Inc., College and South Streets, Piqua, Ohio, or call 513-773-8271.



BRAMCO CONTROLS DIVISION, LEDEX INC.  
 College and South Streets, Piqua, Ohio 45356

## New Components

production quantities can be made in two weeks.

Components, Inc., Smith St., Biddeford, Me. [354]

## Crimp-type phono plug for easier stripping

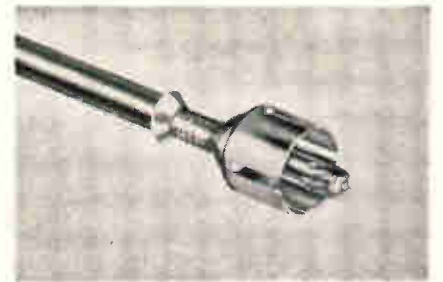

A crimp-type coaxial phono plug has been introduced in strip form for automatic machine application. The new A-MP plug simplifies cable stripping requirements and eliminates time-consuming solder operations. It can be terminated by automachine at a rate of up to 1,000 per hr. Two crimps are applied simultaneously—one directly over the exposed braided conductor, the other on the pin and center conductor. The primary insulation extrudes into the shell as the braid is crimped, eliminating the possibility of shorting. The second crimp on the pin end creates a voidless contact with the center conductor. The new phono plug is expected to lower applied cost in producing many coaxial interconnections. It is available in a variety of sizes and pin lengths to accommodate standard cables and jack types.

AMP Inc., Harrisburg, Pa. [355]

## Telephone-type relay plug-in sockets

Series ETP plug-in sockets accommodate telephone-type relays and provide for dual taper pin connections to the circuit on the back of the socket. The dual taper pin feature of the socket provides extra advantages for the relays. More than one wire can be attached to





**"Follow the man from Schiller Park.**

**He's showing a new Portable  
Dynograph® Recorder at IEEE.  
It's priced under \$1,300.  
You ought to see it!"**

Visit Booth 3407. Learn how you can save \$500 or more on your next 2-channel direct-writing recorder. It's available with ink curvilinear, ink rectilinear or heat rectilinear recording media. It weighs less than 40 pounds,

provides millivolt sensitivity, extreme ruggedness and maximum operator convenience. If you can't see it at IEEE contact your local Offner Division Sales Engineering Representative or write for Data File 718.

**Beckman®**

INSTRUMENTS, INC.

OFFNER DIVISION

SCHILLER PARK, ILLINOIS • 60176

INTERNATIONAL SUBSIDIARIES: GENEVA, SWITZERLAND; MUNICH, GERMANY;  
GLENROTHES, SCOTLAND; PARIS, FRANCE; TOKYO, JAPAN; CAPE TOWN, SOUTH AFRICA



# CUT CONSTRUCTION TIME...

Make card circuitry *and cheaper*  
 the **FASTER, EASIER, WAY**  
 with **VECTOR PLUGBORDS**

Ideal for prototypes and moderate production. Easily adapted to printed circuits.



**1** Select a pre-punched plugboard from a large variety of sizes, patterns and materials.

Choose a card connector with "Edgepin," ELCO's "Varicon" or etched contacts.



**2** Lay out your circuit while you breadboard. Push in "Mini-klip" terminals to grip component leads. Transistor leads slip in easily on "Jedec" grid holes. Tube socket mounts also available.



**3** Snap in and solder components leads; cross-connect, and a finished plug-in circuit card is ready for operation.

Send for complete literature

**VECTOR ELECTRONIC CO., Inc.**

1100 Flower Street, Glendale 1, California • Phone: CHapman 5-8971

IEEE Show Booth 1513

Circle 203 on reader service card

## New Components

each terminal. The connection does not deteriorate with extensive removals and reinsertions (if any change occurs at all, it is improvement in contact resistance). Programming possibilities are increased and made easy. Danger from inadvertent grounds and shorts between adjacent connectors is eliminated. The socket accommodates the regular sizes of the manufacturer's Class E relays and clear plastic covers as used on the EIN series. Automatic Electric Co., Northlake, Ill., 60164. [356]

## Coil bobbins achieve faster, easier winding



Latest developments in precision engineered thermoplastic coil bobbins result in faster and easier winding, mounting and assembly of coils plus improved electrical and mechanical properties. A wide range of high quality bobbins made by the single-cavity injection molding technique are available, including stock shapes and sizes down to subminiature dimensions, International cup cores and "c" cores, variations of stock shapes, and special bobbin designs with details such as lead-in grooves, appendages and lugs. As molded, features of the bobbins include smooth, flash-free surfaces; radii on flanges to prevent snagging during winding; thin, dense walls for uniform dielectric characteristics and more winding area; a high degree of dimensional accuracy and uniformity from part to part. Among the many interesting designs available is a nylon double bobbin, consisting of a single molding of two bobbins that are connected at the flange by

## Switch to the Best

- 6000 volt peak flashover at 60 cps
- 20 ampere current carrying capacity
- Current carrying members heavily silver plated
- Low loss silicone impregnated steatite stators and rotors

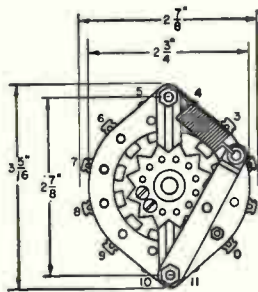
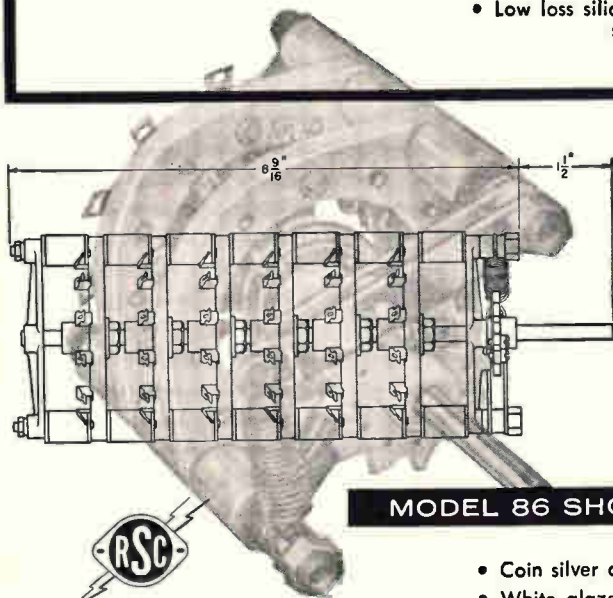

### MODEL 86 SHORTING SWITCH

- Coin silver contact shoes
- White glazed steatite spacers
- Nylon detent wheel
- Black anodized aluminum die cast support brackets
- Stainless steel detent arm



FOUNDED 1933

**RADIO SWITCH CORPORATION**

MARLBORO, NEW JERSEY  
 Telephone: HOpkins 2-6100



a thin nylon strip. This permits the bobbins to be folded back to back and wound at the same time, saving material, labor and assembly time. Gries Reproducer Corp., New Rochelle, N.Y. [357]

## Receptacle-type p-c connectors



Printed circuit connectors with single-sided design are announced. The series 600-132 units are available with 34 or 16 contacts and accept a  $\frac{3}{32}$ -in. p-c board. The 34-contact connector illustrated was designed for critical missile applications. Bifurcated contact construction provides exceptional reliability under the most adverse operating conditions. Glass reinforced diallyl-phthalate molding has integrally molded reinforcing center gusset. Center-to-center spacing of 600-132-34 is 0.150 in.; 600-132-16 is 0.125 in. Contact material is gold plated beryllium copper.

Continental Connector Corp., 34-63 56th St., Woodside, N.Y., 11377. [358]

## Crystal can relays operate on 100 mw

Series JW is a 0.2 in. grid spaced, crystal can relay that requires only 100 mw of power. It combines sensitivity, low volume and high environmental specifications. The device features all-welded construction. Temperature range is  $-65^{\circ}\text{C}$  to  $125^{\circ}\text{C}$ ; dielectric strength, 1000 v rms, 500 v rms between contacts; insulation resistance, 1000 megohms, minimum; contact arrangement, 1 or 2 pole, double throw; contact resistance (max), 0.05 ohm initial, 0.10 ohm after rated life; contact rating, 2 amps resistive, 4 amps overload; vibration is 30 g from 5 to 3,000 cps; shock is 150 g for 11 msec; operate time is 10 msec max; release time, 10 msec max. Delivery is 45 days. Filtrons, Inc., East Northport, N.Y. [359]

# HERE'S WHY\*

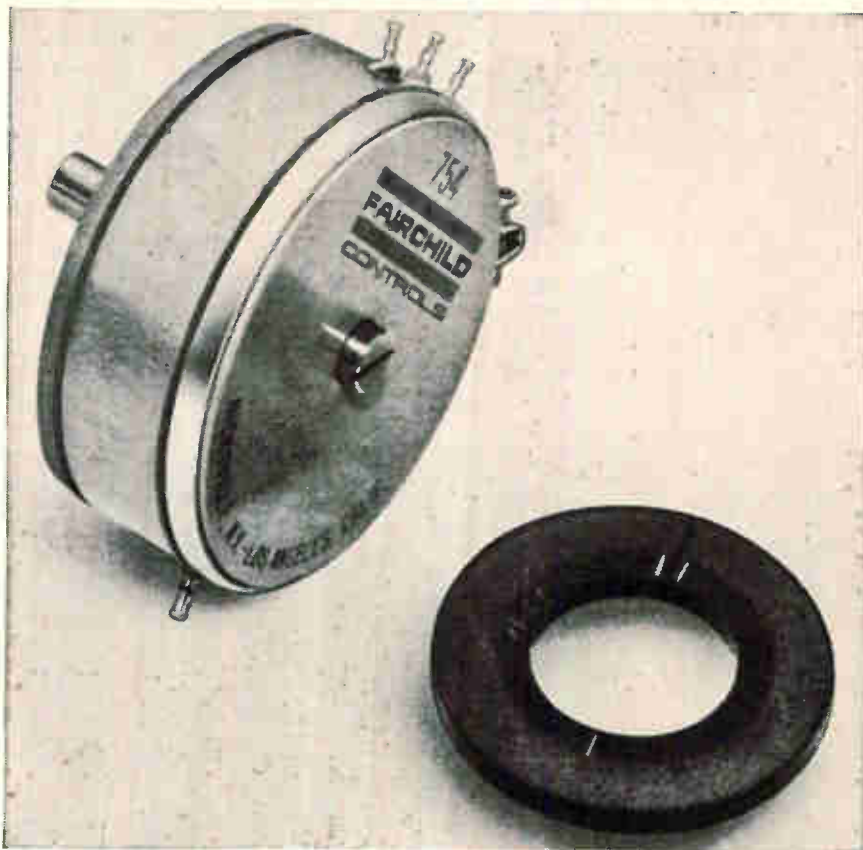

## FAIRCHILD CONDUCTIVE PLASTIC POTENTIOMETERS ARE BETTER!

- \* Over 20 years experience making precision linear and non-linear potentiometers.
- \* Exclusive co-molding process using proprietary materials and methods assures superior life, low noise, HIGH HUMIDITY PERFORMANCE, extreme temperature operation, radiation proof—
  - Life—1/4 billion revolutions at 600 rpm
  - Low Noise—Exceeds MIL-R-39023 requirements over life
  - Humidity—95-100% RH at  $+71^{\circ}\text{C}$  for 240 hours
  - Temperature—Can sustain  $-320^{\circ}\text{F}$  and  $+300^{\circ}\text{F}$  for 50 hours and cycling, without failure or degradation
  - Radiation—Integrated fast thermal neutron flux ( $E > .3\text{MEV}$ ) for 100 hours—no substantial degradation of performance
- \* Exceptional physical environmental characteristics—
  - Vibration—15 G's, 10-2000 cps; Acceleration—50 G's;
  - Shock 50 G's, 11 ms
- \* Complete line availability—linears, non-linears, sine-cosines, standard and ultra-short cup lengths. Sizes from  $7/8$ " through 3".

Whether you're designing a new system or seeking a replacement potentiometer, you can be assured of a BETTER potentiometer—Wirewound or Conductive Plastic, from FAIRCHILD.

Send for complete data today and for test reports, please write on company letterhead.

**FAIRCHILD**  
**CONTROLS**  
 A DIVISION OF FAIRCHILD CAMERA AND INSTRUMENT CORPORATION  
 225 PARK AVENUE, HICKSVILLE, L. I., NEW YORK  
 TELEPHONE: (516) 938-5600 • TWX: (516) 433-9146  
 CABLE: FAIRCON-HICKSVILLE, NEW YORK, U. S. A.



## **ENGELHARD** Thermometal<sup>®</sup> and contacts give this Briles circuit breaker "fire-and-ice" reliability

With two Hound-Dog missiles tucked snugly under its wings, the Boeing B-52 Stratofortress represents one of America's most potent jet-age weapons . . . a modern arsenal in flight capable of operating successfully in extremes of heat and cold.

And it is precisely in such extremes that Engelhard is making significant contributions to aerospace technology.

Engelhard metallurgical trail-blazing produced the Thermometal and contacts for this circuit breaker made by Briles Products, El Segundo, California — performing perfectly as the B-52 encounters extreme temperature environments at high and low altitudes.

Blazing new trails is just one more aspect of Engelhard metallurgical activities. For information write to Technical Service Department.

96





Some other  
**ENGELHARD**  
products

**GOLD COATING** on printed circuits, knobs and other parts is simple and effective with Atomex® Solution. 24K gold is deposited by ionic displacement in a thin, dense, uniform protective layer. Atomex is the first practical gold coating solution with no free cyanide.

**FUSED QUARTZ** components are fabricated in all sizes and shapes for electronic use. For example: coil forms, vacuum furnace chambers, lamp bodies and high-voltage insulators. One millimeter thickness provides absolute protection against 10,000 volts. Transparent, translucent and optical grades available.

**THIN WIRE AND FOIL** are produced by Engelhard's Baker Platinum Division to meet rigid electronic design requirements. Both extruded and Taylor Process thin wire are available in diameters as small as .001". Thin-gauge foil is supplied in sheets up to 8" x 18".

**PLATINUM-CLAD MATERIALS** are custom produced for a wide variety of electronic applications. Clad thickness is held uniform to close tolerances. True metallurgical bond to base material prevents flaking and blistering under heat. Cladding is 100% dense.

**SILVER PLATING** with Silva-Brite® Solution protects components, increases conductivity. Plating is quick, easy, and non-critical at current densities from 10 to 40 amps. Operation at normal room temperature minimizes fumes and bath decomposition.



Circle 149 on reader service card

## New Instruments

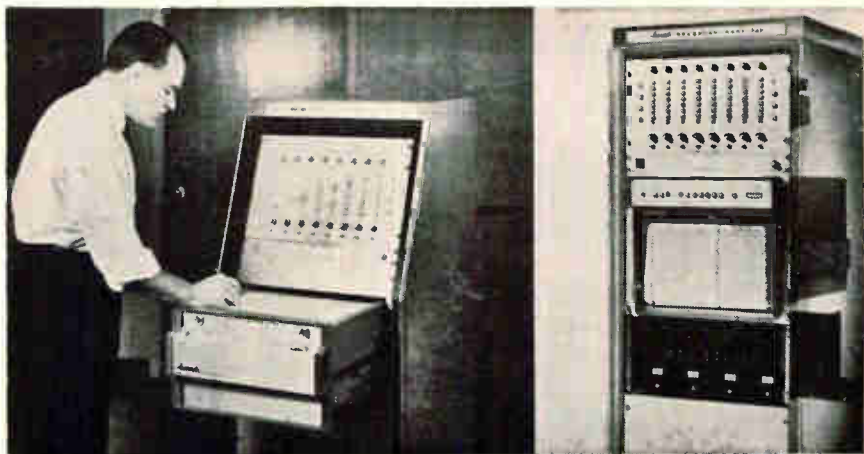

### Direct-writing system uses modules

A new concept in the assembly of multichannel, direct-writing recording systems is claimed for the Mark 200 series 1707 units. Hundreds of recording system configurations can be made up at high speed and accuracy from all-solid-state subsystems to suit the specific needs of any application in laboratory, production, aerospace and medical research. Subsystem modules include the following: 1) three types of oscillographs including flush-mounted vertical, pull-out horizontal, and wide-view 30-in. display; 2) three types of penmotor/amplifier writing modules—dual-channel 40 mm units, single-channel 80 mm penmotors, and eight-channel multimarker event marker blocks; 3) 17 types of preamplifiers ranging from 1  $\mu$ v to 50 mv sensitivity, a high-voltage preamplifier, strain and demodulator units. Wide flexibility is offered through the combination of modules and a unique cabling setup for interconnecting them. A

positive keying arrangement insures that subsystems are properly interconnected. Over-all system accuracy of any combination of subsystems can be as high as 0.5%. A typical system may contain all three types of recordings—40 mm analog, 80 mm analog, and bipolar digital event traces. A new universal chart paper accommodates any recording system combination. Chart speeds in 12 steps are electrically controlled by push buttons. Speeds are shifted instantaneously without step-progression. A single 2-oz charge of writing fluid provides sufficient ink for an average of six months. Ink is pressurized by a solenoid-operated pump. Penmotor stiffness has been increased to 18 grams per inch—more than 100 times higher than d'Arsonval movements. Price is approximately \$900 per channel depending on type of input.

Brush Instruments, division of Clevite Corp., 37th and Perkins, Cleveland 14, Ohio. [381].

### Automatic bridge measures resistance

An automatic wheatstone bridge is being introduced to keep pace with automated production techniques for thin film and monolithic integrated microcircuits. Model 125A wheatstone bridge will scan up to

seven resistances on a single ceramic substrate at the rate of 50 msec per measurement. Accuracy is  $\pm 0.05\%$ . The same principles can be extended to test up to 28 resistors on single substrate. The measurement process is simple. A multiple contact head is placed over the microcircuit to be tested. In the head, two wires are brought

# ENGRAVE EVERYTHING FROM 6 FT. PANELS TO TINY NAMEPLATES

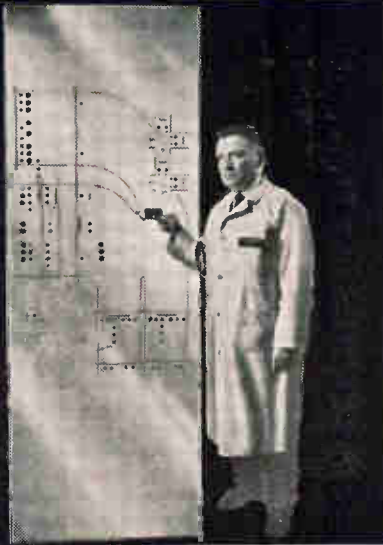

Tracer-guided arm guides the worker —  
makes everyone a skilled engraver.

**Convenient**—It's right in the plant when and where you need it.

**Accurate**—Positive depth of cut with automatic depth regulator. 15 accurate ratios.

**Speedy**—Self-centering work holder cuts set-up time in half.

Ask for complete, illustrated catalog EE-14

*new hermes engraving machine corp.*

154 WEST 14th ST., NEW YORK 11, N. Y. Chicago, Atlanta, Dallas, Los Angeles, Montreal

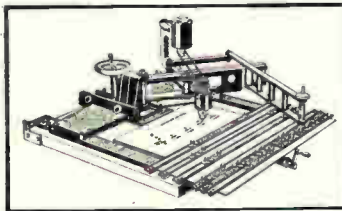

## New Instruments

into contact with each resistor to make the measurement. The scanner takes sequential readings from the pairs of leads in the measuring head. Any number of identical circuits can be tested using the same head. On the control panel, dials are set for the specified resistance of from one to seven resistors, with values between 10 ohms and 10 megohms and three-digit resolution. Tolerance limits for each can be set from zero to  $\pm 11\%$  with two-digit resolution. Settings for resistance value and tolerance are completely independent for each resistor. The results of each resistor test are displayed on the front panel by red, yellow and green lamps indicating high, low and go, respectively. Resistors that test low can be reworked to bring up their value of resistance. Resistors that test high lead to a rejection of the entire circuit. The instrument considers its findings and then, with a green or red lamp, indicates whether to accept or reject the circuit as a whole. Totals of the numbers of circuits accepted and rejected are maintained on digital counters. The instrument employs logic circuits to control the switching, set the limits and trigger the proper counter. The entire system, including the resistance reference, comparator unit and control unit stands about two feet high and is priced at \$5,850. Delivery time is 8 to 10 weeks.

Boonton Electronics Corp., Parsippany, N.J. [382]

## Laser attenuator improves radiometer

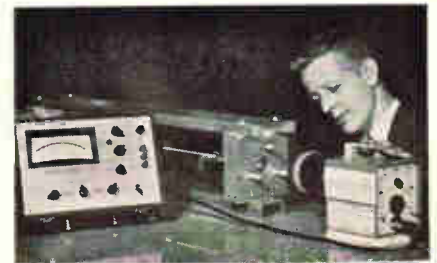

A narrow beam adapter/laser attenuator has been developed for use with the versatile 580 radiometer system. With the new, easily-

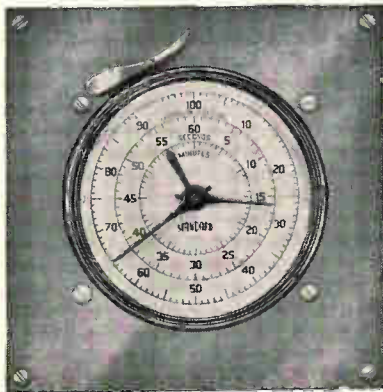

## THE ONE TIMER WITH ALL THE FEATURES

- Portable, Panel or Wall Mounting
- Scale Divisions from 1/1000 sec. to 1/5 sec.
- Totalize from .360 sec. to 60 min.
- Accuracy range from  $\pm .0002$  to  $\pm .1$  sec.

Since 1932 Standard Electric Time Company has been developing and manufacturing units for the precise measurement of elapsed time. Accuracy, rugged construction and long life are Standard features.

For full details request free 20 page catalog No. 257.

Model	Scale Divisions	Totalizes	Accuracy
S-100	1/5 sec.	6000 sec.	$\pm .1$ sec.
S-60	1/5 sec.	60 min.	$\pm .1$ sec.
SM-60	1/100 min.	60 min.	$\pm .002$ min.
S-10	1/10 sec.	1000 sec.	$\pm .02$ sec.
S-6	1/1000 min.	10 min.	$\pm .0002$ min.
S-1	1/100 sec.	60 sec.	$\pm .01$ sec.
MST-100	1/1000 sec.	6 sec.	$\pm .001$ sec.
MST-500	1/1000 sec.	30 sec.	$\pm .002$ sec.

## THE STANDARD ELECTRIC TIME COMPANY

89 LOGAN STREET • SPRINGFIELD, MASSACHUSETTS



# BRUSHLESS D.C. MOTORS Can you use them? Should you?

You may have wondered what to expect from a brushless d.c. motor. In its simplest form a brushless d.c. motor is an a.c. motor with a transistor inverter that changes d.c. to square wave or sine wave a.c., and thus avoids the brushes and commutator. The main advantage of the idea is that the motor will have an extremely long and reliable life because there won't be any brushes to replace or brush dust to reduce bearing life. Side benefits include superior high altitude performance and improved dielectric strength; no brushes mean no arcing, and hence less radio noise. A good brushless d.c. motor may operate continuously for more than 10,000 hours; a conventional d.c. motor under the same conditions will operate for considerably less time before the brushes need changing.

## low vs. high price

Brushless d.c. should not be thought of as an automatic solution to all problems. You need more hardware to do the same job when you use the brushless concept and so the price includes performance loss as well as money.

■ From our experience we find that the increased price ranges from \$10 to \$100 per unit, with \$15 a good average. For a given frame size, the brushless d.c. motor is capable of less torque than a permanent magnet motor of the same size, particularly for motors up to 1/10 HP.

■ Another point should be made in all fairness. The semiconductor circuits range from extremely simple, refined and dependable units to complex filtered circuits that are protected against incoming high voltage transients, and outgoing radio noise. The power transistors in the miniature inverter do generate radio noise when they switch, although this noise is easy to filter. However, the more sophisticated the circuit, the higher the price.

## motor heat vs. transistor junctions

At Globe we use two basic mounting configurations for the inverter. When used with a motor alone we put the inverter in its own package (3½ cubic inches) separate from the motor to keep temperatures within reason. On axial blowers the best place for the inverter is integral with the motor, a location that permits cooling in the blower's airstream. Motors make a notoriously poor heat sink when they are operating, so you do need caution before you specify an integral inverter.

## speed variations

A small potentiometer wired into the winding can be used to change the frequency, and thus to change

the speed of the motor. This vernier-type of adjustment may be useful where you need to set the speed to match other components. The potentiometer won't make an infinitely variable drive out of the motor, but a reasonable range may be useful. By using a toroid in the winding, refinements may be made in this technique.

## exclusive speed control

Here is another development, different in function, but related in hardware: at Globe we have a unique solid state circuit that not only gives brushless d.c. performance, but holds an exact speed within 0.5% at any variation in the range from 22 to 32 v.d.c. and from -55°C to 75°C. Virtually synchronous performance from d.c. is now possible under variable environments.



A 3" blower may operate more than 10,000 hours on d.c. using an inverter that adds 1½" to motor length.

## Globe is headquarters

Thus, we have separate inverters, integral inverters, and a black box speed control that works beautifully. All three of these are potted for maximum vibration resistance and environment protection.

■ Globe is the largest builder of precision miniature motors, and we have spent years refining the brushless d.c. motor from a laboratory development to a practical product. If you are interested in the benefits of brushless d.c. motors, we invite you to talk with us. We have positive, constructive suggestions to give you the quality product you need. Our background can help you to stay in perspective on brushless d.c. motors. Request Bulletin BDC.

Globe Industries, Inc., 2275 Stanley Avenue, Dayton 4, Ohio

Visit us at  
Booth 1100  
IEEE Show



## New Instruments

attached accessory, the radiometer detector head can directly monitor the output of a solid, gas, or diode laser for fast, accurate measurement of energy, power and pulse shape characteristics. Absolute attenuation is completely calibrated as a function of wavelength. With the attenuator attached, the radiometer system's indicator unit provides direct meter readout of average power of steady state light and integrated energy of pulsed light. When used with an external oscilloscope, measurement can be made of peak power and wave shape of pulses having rise times down to 1 nsec. Applications requiring the new accessory encompass any light laboratory project involving measurement of laser and other narrow beam light sources.

Edgerton, Germeshausen & Grier, Inc.,  
160 Brookline Ave., Boston, Mass.,  
02215. [383]

## Precise, economical! frequency synthesizers

Lower-priced versions of the manufacturer's 5100A frequency synthesizer are being introduced. The 5100A costs \$15,000 whereas the 5102A and 5103A are priced at \$8,500 and \$9,000 respectively. They retain all the important features of the more expensive instrument—high precision coupled with unusual purity of the output wave shape—but have a more limited frequency range. The 5102A operates to 1 Mc and the 5103A to 10 Mc. The units use the direct synthesis principle to translate the basic stability and purity of a single quartz crystal-controlled oscillator into any one of 19 million instantly selectable discrete frequencies. The model 5102A allows incremental changes as small as 0.01 cps. The 10-Mc unit permits frequency selection in increments of 0.1 cps. The output frequencies are selected digitally by front-panel push buttons or remote control, or a combination of the two. Additional versatility is provided by an L-C search oscillator. This permits continuous tuning in any selected column of frequencies represented by

Type	UCSV 250
Capacity	125 to 250 PF
Voltage	10 KV PK
Current (16 mc)	40 Amps RMS
Type	JCSF 80
Capacity	80 PF
Voltage	10 KV
Current (16 mc)	30 Amps RMS
Type	CVDA 1000
Capacity	25 to 1000 PF
Voltage	7.5 KV
Current (16 mc)	125 Amps RMS
Type	UCSX 1000
Capacity	25 to 1000 PF
Voltage	7.5 KV
Current (16 mc)	45 Amps RMS

## NEW H-F MULTICOUPLER USES JENNINGS VACUUM CAPACITORS TO ACHIEVE HIGH Q

Jennings vacuum capacitors are used in the reactive filter network of Granger Associates Model 520F multicoupler. The multicoupler connects two h-f transmitters to a single broadband antenna, permitting both to transmit simultaneously without interference or interaction and without significant insertion loss. The high frequency range of 2 to 32 megacycles is divided into two channels, separated by an extremely narrow open band, to accommodate each transmitter. Jennings capacitors provide the low dissipation factor and high Q characteristics which make this close channel operation possible.

In addition the vacuum capacitors offer extra high voltage and current ratings at high ambient temperatures to provide a very comfortable margin of safety.

A high degree of reliability was required because the capacitors are used under oil in a sealed enclosure. Jennings vacuum capacitors met these requirements with ease. No field problems have ever occurred which could be related to either electrical or mechanical fault in the Jennings capacitors.

This proven application is only one of the hundreds in which Jennings vacuum capacitors have solved difficult circuit design problems. For any capacitive problem involving high power rf generating devices examine the advantages of Jennings capacitors. They have an unequalled record of exceptional performance in all sections of high power transmitters, dielectric heating equipment, antenna phasing equipment, electronic equipment from cyclotrons to electron microscopes.

At your request we will be happy to send more detailed information about our complete line of vacuum capacitors.

RELIABILITY MEANS VACUUM | VACUUM MEANS

**Jennings**<sup>®</sup>

JENNINGS RADIO MFG. CORP., 970 McLAUGHLIN AVE., SAN JOSE 8, CALIF., PHONE CYpress 2-4025



## IBM permissive-make relays give you high-speed operation —with virtually no bounce

To design this kind of a relay, we turned to a computer for help.

The result was a unique contact spring configuration as a basis for assembly.

We call this relay "permissive-make."

Its bounce is less than 50 microseconds. Its speed is as fast as 2.0 milliseconds. What's more, this relay has an exceptionally long, *adjustment-free* life—over 400 million operations.

Because they minimize expensive integrating networks, the permissive-make relays are especially suitable for interfacing

relay logic and transistor circuitry.

Where high-speed and low bounce are important, permissive-make relays are well worth considering—for counting, logic switching, switch registers and timing circuits.

Applications include numerical control, communications, test equipment, process control, data processing, supervisory control systems—and many others.

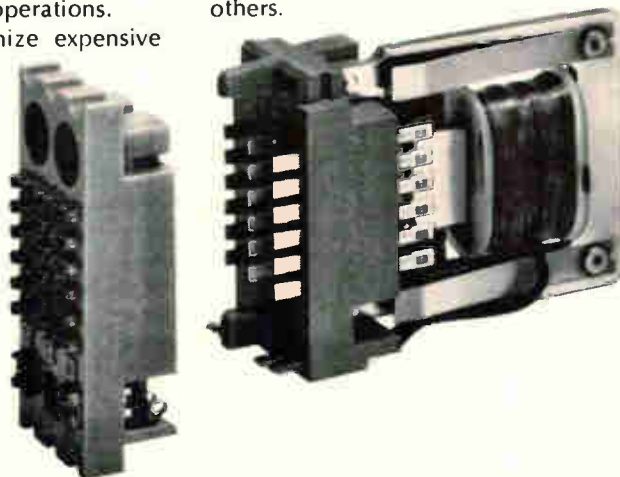

The cost: \$7.75 for 6-pole, Form C permissive-make relays (shown below actual size); \$6.50 for the 4-poles.

Incidentally, IBM permissive-make relays minimize maintenance time and costs. That's because they're pluggable—just like our wire contact relays.

Next time your switching requirements call for specifications normally found only in more expensive relays (mercury-wetted or reed relays), consider IBM permissive-make relays.

For illustrated literature, write: IBM Corporation, Industrial Products Division, 1000 Westchester Avenue, White Plains, New York 10604.

See us at IEEE, N. Y. Coliseum  
Booth 4528-30-32-34-35

an  
ordinary  
(for Manson)  
1 mc  
crystal  
oscillator



Disassembled view of FFO-144A oscillator with case

- 1 part in  $10^8$  per day stability\*
- 64,000 hour mean time between failure
- Less than 1w average power consumption
- Withstands severe shock and vibration
- Virtually undetectable oven switching
- Continuous monitoring of oven cycling
- 4-7/16" L. x 1-11/16" Diam.—
- 10 oz. Weight
- Off the shelf delivery

At Manson, the unusual in crystal control is commonplace. Compact, lightweight and unmatched in reliability, this 1 mc Oscillator has found wide application as a frequency source for Communications, Telemetry, Navigation, Missile Systems and Test Equipment. Write for full information on this ordinary (for Manson, that is) Crystal Oscillator. We'll also send you engineering data on some of our extra-ordinary equipment. (For example: 2 parts in  $10^8$  per day stability from a crystal frequency standard.)

\*The FFO-159 Oscillator, identical to the FFO-144A described above is available with a stability of 5 parts in  $10^9$  per day.



Manson Laboratories division

77 Danbury Rd., Wilton, Connecticut  
Tel.: (203) 762-8301

New Instruments

the push buttons. The operator may search any significant column from 100 kc to 0.01 cps either manually by a front-panel control, or remotely by a suitable external voltage. An internal precision quartz oscillator is provided for use as a frequency standard; or an external 1- or 5-Mc source can be used. The variable output frequency is synthesized directly from this single frequency source. Since no phase-locked loops are involved in the synthesizing procedure, switching from one output frequency is rapid. Less than 1 msec is required to change output frequencies. A very clean output over the entire frequency range is essential. The synthesizers keep spurious signals 90 db below the selected output. Modular construction enhances the serviceability since the modules are interchangeable from one instrument to another. The manufacturer says the new units will find broad application among users requiring high stability, precision switching of increments and maximum signal-to-noise ratio. The output purity also makes these units attractive in communications systems; they can be used as a transmitter master oscillator or a receiver local oscillator. The outputs can be used as standards in measuring phase stability of critical circuits. Other possibilities are in production testing at specific calibration points of frequency-sensitive devices. First deliveries are scheduled for May. Hewlett-Packard Co., 1501 Page Mill Road, Palo Alto, Calif. [384]

Solid state counter  
meets military specs



The CMC 880 is claimed to be the first all-solid state frequency counter to meet military specifications. It offers major specification advantages over the AN/USM26,

NEW  
FROM PATWIN



This indicator  
operates  
without decoders  
or drive circuits

If your output data is coded 2 out of 5, you can use the new MAGNELINE 26000 Series digital indicators without drive circuits or decoders. This new series also has these MAGNELINE features: long life, reliability, inherent memory, and excellent readability in all kinds of light.

SEE IT AT  
BOOTH 3050  
IEEE SHOW

PATWIN®

ELECTRONICS

A DIVISION OF  
THE PATENT BUTTON COMPANY

WATERBURY, CONN. 06720



a vacuum-tube device that has been the military's only standardized counter for the past seven years, according to the manufacturer. The 880 weighs 38 lbs. compared with 118 lbs. for the AN/USM26, draws 1/6 of the power and has 10 times the direct counting range—up to 100 Mc. Range can be extended with a frequency extender plug-in available from the manufacturer. Time-base stability of the 880 is one part in  $10^8$  per week, compared with five parts in  $10^8$  per week for the current military counter, the company says. The new counter has built-in capacity for time-interval and multiple-period measurements, and uses a self-contained plug-in unit for reference frequency.

Computer Measurements Co., 12970 Bradley Ave., San Fernando, Calif., 91342. [385]

### Solid-state meter monitors kilowatts



A series of wattmeters feature a new generation of power-indicating devices. Using the inherent multiplying ability of semiconductor elements, this solid-state Hall-multiplier circuit converts instantaneous load voltage and current inputs into a metering voltage that is proportional to the product of these two inputs. The entire indicating assembly is ruggedized and sealed and meets the applicable requirements of MIL-M-10304. The manufacturer offers a wide selection of standard power ranges in addition to readily available special ranges and accuracies.

WacLine, Inc., 35 South St., Clair Street, Dayton, Ohio. [386]

## For Printed Circuits to meet any requirement...

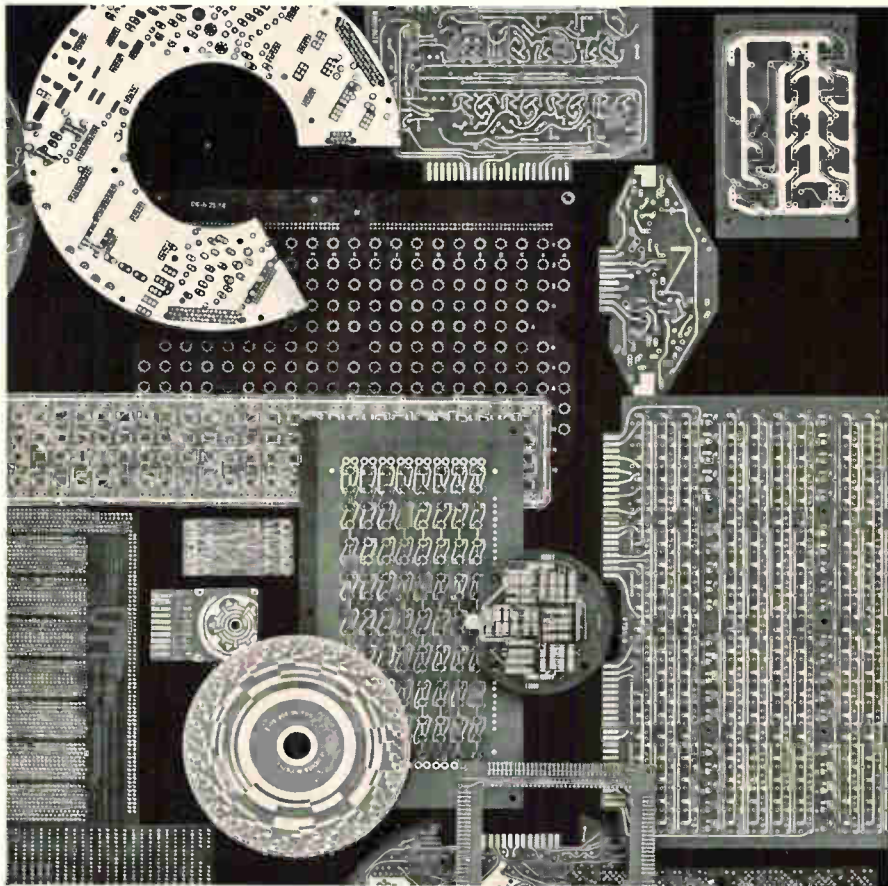

### ...Specify Cinch-Graphik



You name it... big as a card table or tiny as this:  ...one of a kind or millions... single or multilayer (30 layers or more!)... Cinch-Graphik can do! The multilayer cross-section photo shows some of the details of Cinch-Graphik's precision production techniques: Uniform thickness of the plated thru-hole and the complete interface bond between the individual circuit layers and the plated wall. This type of matchless craftsmanship is found in all Cinch-Graphik circuits regardless of type or application. For satellites or stereo, computers or communications, there are no finer printed circuits than Cinch-Graphik. To learn more about our unique capabilities, write for our new brochure.

**CINCH-GRAFIK**  
DIVISION OF UNITED-CARR

200 South Turnbull Canyon Road, City of Industry (Los Angeles), Calif. 91744 • Phone (213) ED 3-1201. Offices in 22 Principal Cities throughout United States, Canada, England and Australia listed under Cinch Mfg. Co. or United-Carr Incorporated • Cinch • Cinch-Monadnock • Howard B. Jones • Ucinite • Palnut



**DRESS UP YOUR  
SYSTEMS  
ANALYSIS**



**SERVO  
STYLE**

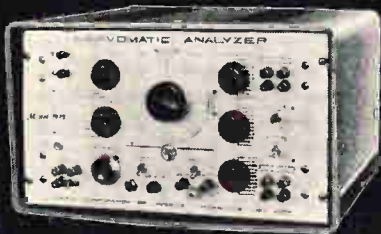

**Model 1995  
SERVOMATIC® Analyzer**

What's so much better about today's latest model SERVOMATIC Analyzer? First, there's a "built-in bow-tie" display—use it anytime—especially for low speed analysis and get that extra CRT persistence. Next, a DC offset with independent signal control which allows system response measurement at just the right bias displacement. Cleaner and better waveforms make phase and amplitude response plotting in varied frequency a snap with this new SERVOMATIC Analyzer. A multiple function generator, calibrated phase shifter and precision amplitude control combined...it's just the right ensemble to apply in many measurement areas...you're sure to find yours in the list below:

- Transfer function of open and closed loops
- Phase angle measurements
- Amplitude measurements
- Transfer function of damping and filter networks
- Frequency response of portions of systems
- Response of servo amplifiers
- Transient response
- Locating sources of non-linearities
- Servomotor time constants
- Response of magnetic amplifiers

Details available on request



**SERVO  
CORPORATION  
OF AMERICA**

111 New South Rd., Hicksville, L. I., N. Y.  
516 WE 8-9700

**New Semiconductors**

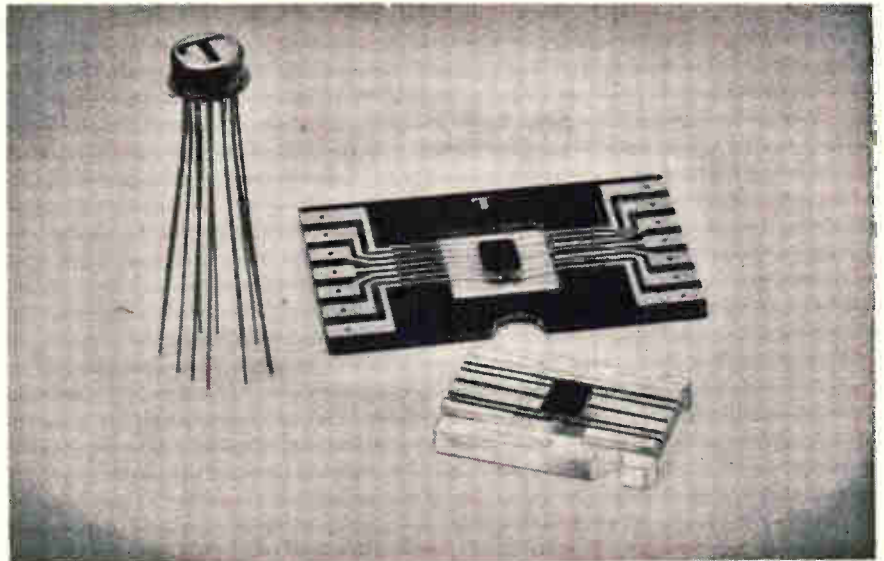

**Integrated circuit J-K flip-flop**

This is claimed to be the industry's first single-phase, d-c coupled flip-flop capable of operating at 20 Mc in the counting mode. It is a general purpose J-K flip-flop with the basic circuit design of the HLTTTL (high - level transistor - transistor logic) family. Utmost flexibility has been achieved through the master-slave design that makes these circuits ideal for use as shift register element, J-K flip-flop, counter stage, and set-reset flip-flop. They exhibit typical outstanding performance in: high speed, 20 Mc counting; noise rejection, 600 mv; high fanout, 20; and capacitive line driving capability, 300 pf. An inverting buffer has been incorporated in the element for use as: a clock line buffer, reducing clock line load to one unit load; a signal inverter, when no signal complement is available; and

for use in an asymmetric mode. The asynchronous inputs can be activated at any point in the timing cycle independent of the condition of the clock line. The introduction of these flip-flops has opened the way for general use of the HLTTTL product line, the company says. The circuits are packaged both in TO-5 and flatpacks. The flatpack used by the manufacturer is 0.250 in. long by 0.175 in. wide package with 14 leads. The 0.014 in. wide and 0.004 in. thick Kovar flat leads are arranged seven on a side on 0.050 in. centers. The package header is constructed with a Kovar mounting platform and glass-ceramic material for the body of the package, to give the package superior dissipation capabilities.

Transitron Electronic Corp., 168 Albion St., Wakefield, Mass. [371]

**Compression-bonded scr  
handles more current**



A 175-ampere silicon controlled rectifier features forward blocking voltage and peak reverse voltage to 1,000 v. Type 220 scr offers designers 17% greater half-wave and rms current capability and 33% greater surge current capability (4,000 amps) than the 150-amp scr currently used in many designs. These higher ratings permit greater



# When you need the ultimate in dependability specify JFD ultra high stability and reliability electronic components

**JFD precision trimmer capacitors offer highest reliability . . . in the industry's broadest product line—over 500 standard models.**



Model VC 23G  
Actual Size

**Exclusive JFD design advantages:**

- Widest choice of seven drive mechanisms
- Versatile choice of five dielectric materials
- Matched metalizing—homogeneous bond with dielectric
- Industry's most comprehensive and advanced construction
- High level shock and vibration resistance
- Highest reliability is assured through industry's most exacting quality control program

Meet or exceed MIL-C-14409B  
SEND FOR JFD CATALOG C-64

**JFD High Q Uniceram fixed capacitors provide exceptional stability in smallest size.**



Model UY01  
Actual Size

Uniceram High Q ceramic fixed capacitors offer a previously unobtainable combination of small size and exceptional stability. High Q model UY01, shown actual size, provides 62.0 pf . . . up to ten times more capacitance per unit volume than competitive units . . . and at competitive prices.

**Note these advantages:**

- 160 models . . . capacitance values from 0.5 to 10,000 pf.
- Extremely high ratio of capacitance to unit volume
- Built-in stability . . . remains constant through voltage, frequency and temperature variations.
- Meet or exceed MIL-C-11272B

**UNICERAM HIGH K SERIES** • Uniceram High K ceramic capacitors with greatly increased capacitance per unit volume . . . up to 1 mfd . . . meet or exceed MIL-C-11015C specifications.

SEND FOR BULLETIN UNM 64-2

**JFD Modutrim ceramic variable capacitors give you . . . widest  $\Delta C$  . . . highest stability . . . smallest size**

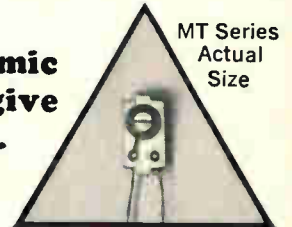

The new MT 100 and MT 200 Series of Modutrim micro-miniature ceramic variable capacitors offer micromodule and hybrid circuit designers a choice of wide delta Cs in extremely small and ultra stable units.

- $\Delta C$  is extended to as high as 5-50pf.
- Highest stability results from the use of both a special ceramic material (developed in JFD's own Glass and Ceramic laboratories) and a unique monolithic rotor.
- Smallest available standard unit size is only 0.208 in. x 0.401 in. x 0.120 in. thick for the MT 100 Series; and 0.208 in. x 0.281 in. x 0.120 in. thick for the MT 200 Series.

Meet or exceed MIL-C-81A  
WRITE FOR BULLETIN MT-65-1

**JFD offers most complete and versatile line of LC Tuners, Inductors, and Tank Circuits.**



Model LC 303

JFD LC Tuners combine, in a single unit, a precision variable piston capacitor with a precision fixed metalized or air core inductor to provide a compact tuneable LC circuit, offering space-conscious design engineers more circuitry in less space with a stability and reliability level never attainable before.

**Design advantages:**

- Low temperature coefficient of inductance
- Low distributed capacitance
- Single resonating frequency
- Reliable antibacklash tuning mechanism

Meet or exceed MIL-C-14409B.  
WRITE FOR CATALOG TI-73

**Components Division**

JFD ELECTRONICS CORPORATION, 15th Ave. at 62nd St., Brooklyn, N. Y. 11219  
JFD NORTHEASTERN, Ruth Drive, P. O. Box 228, Marlboro, Mass. 07152  
JFD NEW YORK-NORTHERN, Damiano Pl., P. O. Box 96, New Hartford, N. Y. 13503  
JFD MID-ATLANTIC, P. O. Box 5055, Philadelphia, Pa. 19111  
JFD MID-ATLANTIC-MARYLAND, P. O. Box 7676, Baltimore, Md. 21207  
JFD MIDWESTERN, 6330 W. Hermione St., Chicago, Ill. 60646  
JFD MIDWESTERN-OHIO, P. O. Box 8086, Cincinnati, Ohio 45208  
JFD WESTERN, 9 Morlan Place, Arcadia, California 91006  
CANTRONICS, LTD., P. O. Box 296, Downsview, Ontario, Canada  
HANS W. BRIEGER SALES CO., 5253 Decarie Blvd., Montreal, Quebec, Canada  
JFD ISRAEL LTD., Industrial Area B, Bldg. 23, Azor, Israel  
DUCON CONDENSER PTY., LTD., Christina Road, Villawood, N.S.W., Australia  
LCC STEAFIX, 128 Rue de Paris, Boite Postale 51, Montreuil-sous-Bois, Seine, France  
MURATA MANUFACTURING CO., LTD., Nagaoka Otokuni, Kyoto, Japan  
STANDARD TELEPHONE & CABLES LTD., Footscray, Sidcup, Kent, England  
JFD ELECTRONICS, EUROPE S A, 7 Rue de Rocroy, Paris, 10, France

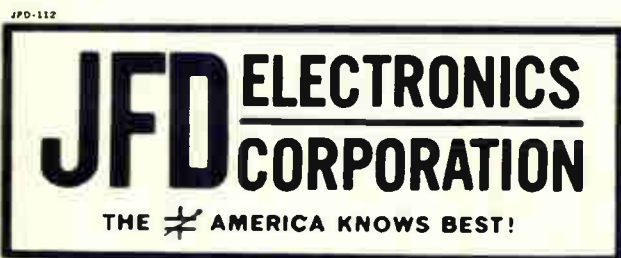

Variable Trimmer Piston Capacitors ■ Metalized Inductors ■ LC Tuners ■ Ceramic Fixed and Variable Capacitors ■ Fixed and Variable Distributed and Lumped Constant Delay Lines

## A one-way street to utter isolation

(80-100 db's worth)

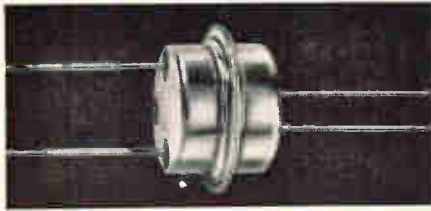

We're talking about a photon-coupled isolator for electro-optical relays. For signal transfer functions requiring high isolation and unidirectional signal flow. You name them.

Construction? A gallium arsenide infrared emitter and a planar silicon photo detector, coupled by infrared radiation over a short light path. Electrostatically shielded to reduce the parasitic coupling capacitance to a very low value. Isolation

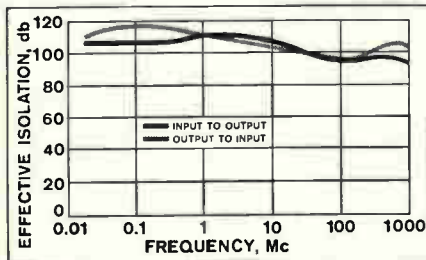

levels exceed 80 db and are typically greater than 100 db — from DC to 1 Gc frequency range. (For a bare outline, see chart.) Package is hermetically sealed.

In addition to high isolation levels at signal processing speeds in tens of megacycles — is there any other reason why we should hope to interest you in the Philco L4450 Photon-Coupled Isolator?



Well, by utilizing this isolator, we are able to offer a complete Signal Line Isolation Switch (the P650B)—a compact, low-cost unit with micro-electronic circuitry to process and regenerate high-speed data and timing signals.

If you'll take a moment to check through this most incomplete list of applications, you should discover whether there's anything in it for you:

Secure communications, high-speed telegraphy, isolation probes, DC and isolation amplifiers, modulators, commutators, digital circuitry. The slightest tingle of interest should initiate a prompt inquiry.

For prompt technical help call, write or wire Russ Wright, or at least circle the bingo card! (Phone 215-855-4681.)

### SOLID-STATE PRODUCTS OPERATION

**PHILCO**  
A SUBSIDIARY OF Ford Motor Company,  
LANSDALE DIVISION • LANSDALE, PA.  
In Canada, Don Mills Road, Don Mills, Ontario, Canada

## New Semiconductors

design flexibility and safety margins. Additional features claimed for the type 220 include a unique, internal, compression-bonded construction that eliminates thermal fatigue by eliminating solder joints. Low thermal impedance, glazed ceramic headers, and hermetically weld-sealed cases insure dependable operation under severe application conditions. Suggested prices of the type 220 to makers of original equipment vary from \$59.50 to \$355.50 (in quantities of 1 to 24), and \$52 to \$309.50 (in quantities of 25 to 99).

Westinghouse Semiconductor division, Youngwood, Pa. [372]

## Silicon transistors for uhf oscillators

A line of 2-Gc silicon transistors is announced for uhf oscillator applications. Capable of outputs greater than 25 mw at 2,000 Mc, the devices, designated as K2501, K2502 and K2503, are packaged in TO-18, TO-46 and TO-50 outlines, respectively. Working at 15 v, these transistors now allow circuit designers to operate many uhf local oscillators and other signal sources without varactor multipliers.

Kmc Semiconductor Corp., Parker Road, R.D. 2, Long Valley, N.J. [373]

## High capacitance varactor diodes

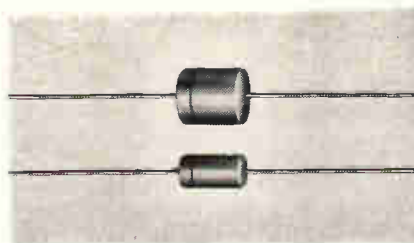

Twenty-one new voltage-variable capacitors (varactor diodes) range from 65 to 500 pf capacitance in 1 and 2 watt packages. Maximum d-c voltage ratings of 25 to 200 v may be selected for the 65 pf units, while d-c voltages of 50 or 100 may be selected for units with capacitances of 100 pf or greater.



**ZELTEX**

MODEL 131

Differential Operational Amplifier with

**FIELD EFFECT TRANSISTORS!**

- Input Impedance—500 megohms!
- Input Current—1 nanoamp maximum!

Zeltex introduces the Model 131 differential operational amplifier—the first of its kind to employ field effect transistors to achieve exceptionally high differential and common mode input impedance with low current. Utilizing silicon transistors for highest reliability, Model 131 is offered in a small encapsulated model with machined connecting pins to facilitate etched circuit card mounting.

### Key Specifications:

- Gain: 100,000.
- Gain-Bandwidth Product: 1 mc.
- Offset Voltage: Adjustable to zero with internal potentiometer; 20  $\mu\text{v}/^\circ\text{C}$  and 50  $\mu\text{v}/8$  hr stability.
- Input Current: 1 nanoamp maximum.
- Temperature coefficient of 0.1  $\text{na}/^\circ\text{C}$  ( $0^\circ\text{C}$  to  $+40^\circ\text{C}$ ).
- Input Impedance: 500 megohms.
- Output:  $\pm 10$  volts,  $\pm 4$  ma, frequency for full output of 80 kc.
- Temperature Range:  $0^\circ\text{C}$  to  $+60^\circ\text{C}$ .
- Power Requirement: 15 vdc.
- Price: \$125.

Call ZELTEX today. A complete source for amplifiers and computer elements.



**ZELTEX, INC.**

2350 Willow Pass Road  
Concord, California



Minimum Q's of the units vary from 45 to 150 at 50 Mc and from 300 to 1,000 at 10 Mc. Units are hermetically sealed in insulated cases and meet all environmental requirements of MIL-S-19500. Applications are in electronic tuning, harmonic generation, parametric amplifiers, voltage variable delay lines, and self-balancing bridge circuits.

Soliton Devices, Inc., 256 Oak Tree Road, Tappan, N. Y., 10983. [374]

## Microelectronic diode logic networks

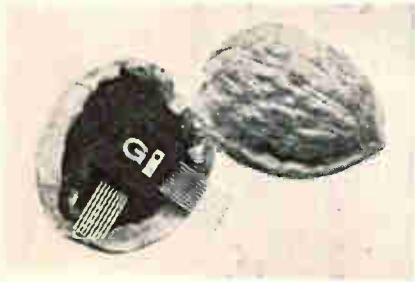

New microcircuit silicon diode arrays perform logic functions. Small enough to fit in half a walnut shell, the networks are used in data processing systems including counters, multiplexing operations, machine control and monitoring systems among others. The arrays allow the circuit designer a high degree of flexibility, since logic or counting function is changed by simply rearranging the diode pattern, with the external circuitry remaining the same in many cases. Costs are held to a minimum—standardized leads and package size simplify packaging, external connections are minimized and assembly costs are reduced. At the same time, reliability is increased and since the matrices are ruggedly constructed, they are said to be unusually resistant to shock and vibration. A wide range of electrical parameters are available including: high peak inverse voltage (300 v); low reverse leakage (less than  $1 \mu\text{a}$  at 25 v and less than  $5 \mu\text{a}$  at 75 v); high forward conduction (greater than 50 ma at 1 v); switching speeds from  $2 \mu\text{sec}$  to 50 nsec; power dissipation of 1 w. Two configurations are available: square flat pack— $\frac{1}{2}$  in. on a side by  $\frac{1}{8}$  in. high and rectangular array— $\frac{1}{2}$  in. long by  $\frac{1}{8}$  in. wide and high.

Gulton Industries, 212 Durham Ave., Metuchen, N.J. [375]

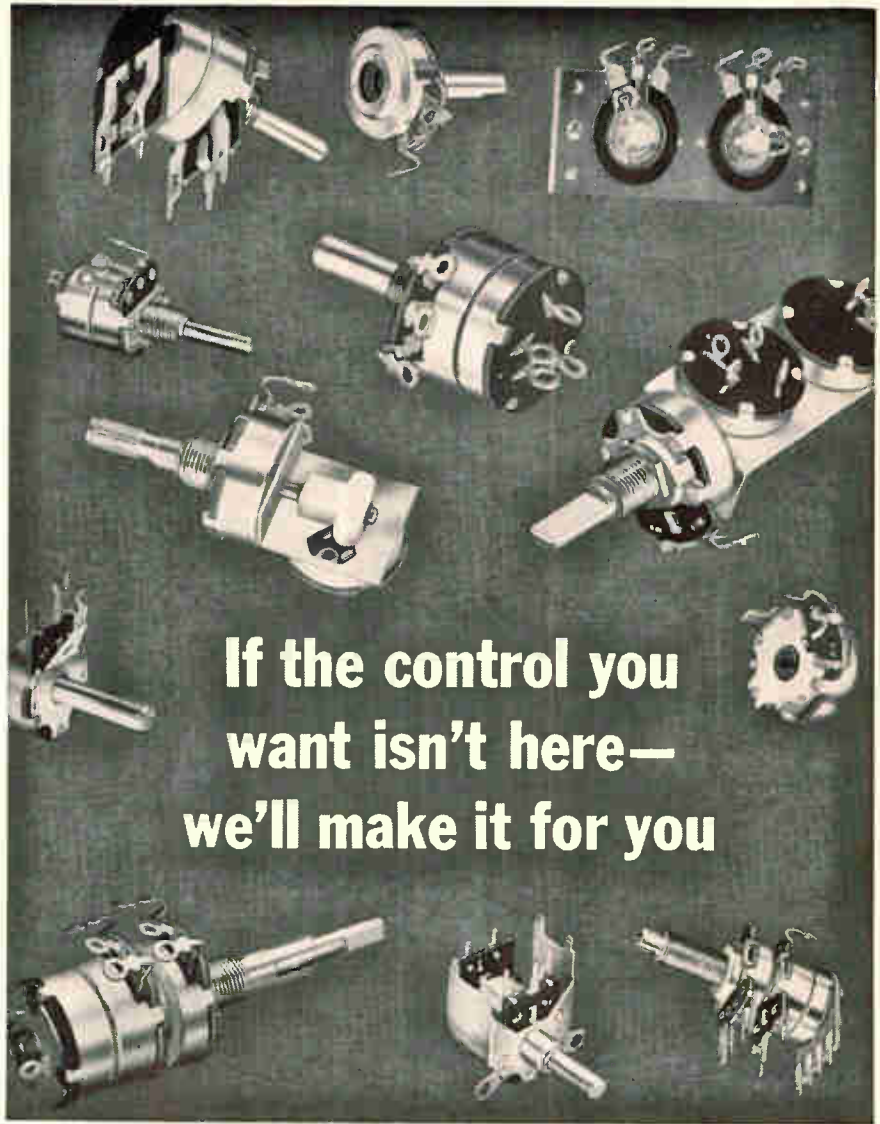

**If the control you  
want isn't here—  
we'll make it for you**

Our standard control line includes just about any model you might need. Singles; duals, tandem and concentric; miniatures; printed circuit types; economy-priced strip controls. With rotary, push-pull, push-push, or momentary action switches. In linear, audio, modified and special tapers, single and double taps; low end-resistance for transistor circuitry. Every mounting configuration imaginable. All of them with the famous long-life, high-stability Mallory resistance element.

And if you need a special design, we'll be glad to design and manufacture it for you. We've saved many dollars for many people with our value-conscious engineering.

Write today for a copy of our Bulletin 98-51. And let us have the opportunity of quoting on your next order. Mallory Controls Company, a division of P. R. Mallory & Co. Inc., Frankfort, Indiana 46041.

**MALLORY**



Did you say

## BROADBAND MIXERS?

LEL offers the widest selection of multiple-octave coax and full waveguide range mixer models. Take LEL's 12-18 Gc Mixer, for instance. This tiny mite measures a mere 2 cu. inches but delivers top performance with highest isolation . . . lowest noise figure. It's one of more than twenty broadband mixer models covering the entire spectrum, from 100 Mc to 18 Gc.

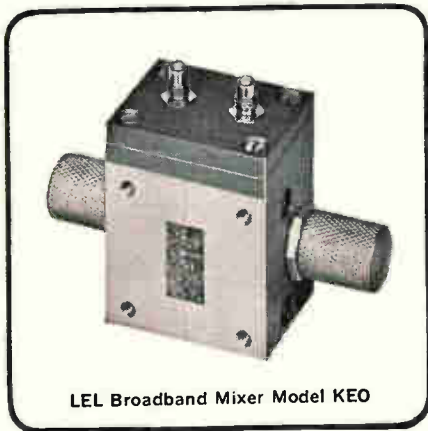

LEL Broadband Mixer Model KEO

**For all your receiver requirements... call on LEL capability!**

Send for your **FREE** copy of LEL's Catalog

See us at IEEE Show, N. Y. Booth Nos. 2106-8



**LEL** DIVISION  
VARIAN associates

AKRON ST., COPIAGUE, L. I., NEW YORK 11726  
(516) AMityville 4-2200/(516) PYramid 9-8200  
TWX Code 516-691-5085

## New Subassemblies and Systems

### Electrometer-grade d-c amplifiers

Two new solid-state, differential d-c amplifiers have input current measured in picoamperes and fractions of picoamperes, common-mode input impedance in the millions of megohms, fully floating differential inputs with common-mode rejection better than  $10^6$ , and voltage noise measured in microvolts. Models P2A and SP2A may be used with virtually any gain in the measurement of voltage or current from high impedance sources, as integrators or sample-and-hold circuits having exceptional holding ability, as wide-range logarithmic amplifiers, and for precise differential amplification. These amplifiers are designed for feedback applications and are stable for nearly all closed-loop applications. The amplifiers are characterized by typical open-loop d-c gain of 25,000, input common-mode range of  $\pm 200$  v, output range of  $\pm 10$  v at 2.0 ma, small-signal open-loop unity gain-bandwidth of 100 kc, full output to 1.0 kc, typical offset current of  $\frac{1}{2}$  picoamp, noise current less than 100 femtoamps, ad-



justable voltage offset drifting randomly less than  $20 \mu\text{v}$  per hour typically, voltage noise less than  $1 \mu\text{v}$  rms, temperature sensitivity less than  $100 \mu\text{v}/^\circ\text{C}$ , differential input impedance typically greater than 500 megohms. Price of either unit is \$227 in small quantity (1-4). Philbrick Researches, Inc., Allied Drive at Route 128, Dedham, Mass. [401]

### Power supply offers wide range of outputs

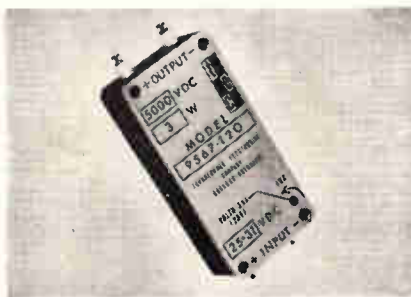

The 9567 miniature 3-watt power supply series has been developed to satisfy voltage conversion requirements for a broad range of applications. Special features claimed are a wide range of available output voltages, advanced miniaturization and packaging techniques, and high reliability at

minimum cost. Typical applications are: high voltages for photomultiplier tubes and similar devices; intermediate voltages for telemetry equipment and solid state detectors; low voltage and complementary plus and minus voltages for pulse circuitry, differential, and operational amplifiers; and a-c voltages for chopper drivers and a-c filaments. Input is  $28 \pm 3$  v d-c (output regulated to  $\pm 0.25\%$ ). Outputs are: 1.5 v to 5,000 v d-c (21 models);  $\pm 15$  v d-c to  $\pm 100$  v d-c (4 standard models); 1.5 v a-c to 1,000 v a-c (peak square wave approximately 3 kc). Operating temperature is  $-50$  to  $+100^\circ\text{C}$  (approximately  $0.01\%/^\circ\text{C}$  temperature coefficient). The package consists of an extruded anodized aluminum frame with components completely encapsulated in silicone rubber. The new supply measures 3.0 in. by



## SENIOR OPENINGS FOR SPACE SYSTEMS COMMUNICATIONS

The positions will involve the development of the state-of-the-art in communications systems for future spacecraft.

A thorough understanding of the fundamentals of communications systems and a detailed familiarity with the capabilities of communications systems components are required. In addition, systems engineering and hardware experience would be helpful. Specific experience in such areas as command & control systems, telemetry systems, secure systems, high processing gain systems, high data rate systems and satellite relay systems, would be most pertinent.

Since the positions are so directly concerned with the development of the state-of-the-art, an open-minded and imaginative approach is of critical importance. A personality which would assure acceptance in contract proposals is a consideration.

Requirements include: M.S. or Ph.D. degree from an accredited university, U. S. citizenship and several years of experience.

For additional details about these exceptionally challenging opportunities, please airmail your resume to:

**MR. ROBERT A. MARTIN**  
Head of Employment  
HUGHES Aerospace Divisions  
11940 W. Jefferson Blvd.  
Culver City 37, Calif.

**HUGHES**

HUGHES AIRCRAFT COMPANY  
AEROSPACE DIVISIONS

An equal opportunity employer

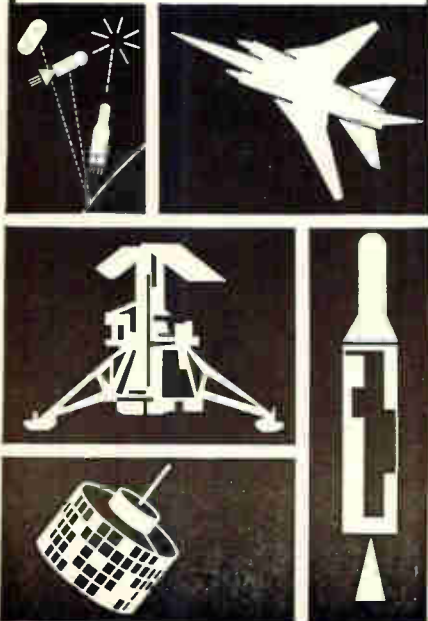

1.5 in. by 0.6 in; and weighs 4 oz average. Price is from \$150 per unit. Delivery is off the shelf to two weeks.

Transformer-Electronics Co., Boulder Industrial Park, Boulder, Colo. [402]

### D-c motor operates from -300 to +350° F



Type SU 414 stainless steel, 28 v d-c motor has been tested for operation and storage at -300°F to +350°F. It is 7/8 in. in outside diameter by 1.368 in. long, is rated at 0.3 oz in. at 5,000 rpm, and has stainless steel frame, dry bearings, and other construction features to minimize effects of high and low temperatures. Units are also available for operation at 6 to 50 v d-c, 8,000 to 18,000 rpm at 0.004 h-p and with special shafts, mountings, etc., to suit application. Life is 500 hours plus, depending on load and environmental conditions.

Globe Industries, Inc., 1784 Stanley Ave., Dayton, Ohio, 45404. [403]

### Operational amplifier has tough package

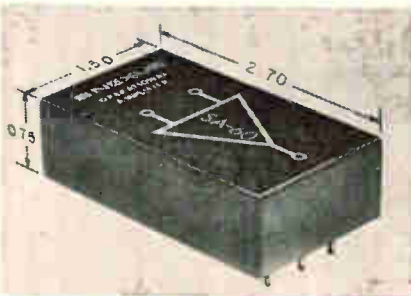

A new 60-v operational amplifier, the SA-60, is available in a compact encapsulated package said to be unique for analog modules with comparable output capability. This package permits use in environments where high shock, vibration, or high humidity may be encountered. The high stability chopper-

To  
serve  
you  
better...

**LEL**

a  
division  
of

**VARIAN**  
ASSOCIATES

**LEL** DIVISION  
VARIAN associates

AKRON ST., COPIAGUE, L. I., NEW YORK 11726  
(516) AMityville 4-2200 / (516) PYramid 9-8200  
TWX Code 516-691-5085

# Telemetry Receiving Station

## Complete... IN 1 CU. FT.

(33 LBS.)

Everything you need for on-site checkout of airborne or sled-borne radio-link telemetry systems is all wrapped up in this highly portable, fully compacted 14-channel package.

It's Genisco's new A-186 FM/FM Telemetry Checkout Package, designed for airborne power or battery pack operations. The miniature FM receiver, tuning 215 MC. to 260 MC., is sensitive to 1 microvolt signals. Discriminator outputs are  $\pm 2.5$  volts.



Write today for specifications and information on Genisco's telemetry checkout packages and receivers or our broad line of band pass filters and discriminators.

**Genisco** | TECHNOLOGY CORPORATION | 

INSTRUMENTS DIVISION  
9036 Winnetka Avenue, Northridge, California

Circle 206 on reader service card

## New Subassemblies

less circuit avoids many problems inherent in chopper stabilized amplifiers, such as recovery from overload or overdrive. In addition to input signal overdrive protection, the SA-60 is designed to withstand short-circuit faults of signal input and output terminals to ground or to all power supply leads. Supply voltage is  $\pm 75$  v. Supply current at full output is  $\pm 25$  ma. Open-loop gain at d-c is 100,000 min. Current (open signal) at 25°C is  $\pm 5$  na typical; change in current (open signal)/change in temperature ( $-25^\circ\text{C}$  to  $+55^\circ\text{C}$ ), 1 na/ $^\circ\text{C}$  max; change in voltage (open signal)/change in temperature ( $-25^\circ\text{C}$  to  $+55^\circ\text{C}$ ), 10  $\mu\text{v}/^\circ\text{C}$  typical; output voltage,  $\pm 60$  v; output current,  $\pm 10$  ma. Price for 1 to 4 units is \$175; for 5 to 9, \$170; for 10 to 24, \$161.

Nexus Research Laboratory, Inc., Neponset Valley Industrial Park, 480 Neponset St., Canton, Mass., 02021. [404]

## Constant current power supply



Model 1024 constant current supply is a solid state device that delivers a precision 25 ma dc. The standard unit operates on 115 v a-c, 60 cps. The maximum output current deviation allowed due to input line changes of  $\pm 10\%$  and load changes from 100 ohms to 1,000 ohms is  $\pm 0.05\%$ . Output current should vary no more than  $\pm 0.05\%$  due to an environmental tempera-

## CHRONO-LOG DIGITAL CLOCKS

ELECTROMECHANICAL OR SOLID STATE



Chrono-log SOLID STATE Clocks are available with time resolutions down to one microsecond. Versatile control features allow their use in real-time, elapsed time or count-down applications. Digital outputs can be either parallel or serial. Plug-in card construction with "worst-case" circuit design insures high reliability and ease of maintenance.

Chrono-log ELECTROMECHANICAL Digital Clocks are low-cost units with time resolutions down to one second. Multiple, parallel, decimal and binary-coded-decimal outputs allow the Clocks to be used in all types of digital systems.

Chrono-log Digital Clocks have been operating reliably in the field in a wide variety of applications and environments for over eight years. They provide digital outputs of the time and also the date or day of the year. Many special designs and features are available to meet exact customer requirements.

There is a Chrono-log Digital Clock to fit your digital timing requirements. For complete information, contact:

 **CHRONO-LOG CORP.**  
2583 W. CHESTER PIKE, BROOMALL, PA.

## COMINCO high-purity metals

Available forms in 99.999% and/or 99.9999% purities	ALUMINUM	ANTIMONY	ARSENIC	BISMUTH	CADMIUM	COPPER	GOLD
	BARS	X	X	X	X	X	X
SHEETS	X				X	X	X
WIRE	X				X	X	X
POWDER		X	X	X	X		
SHOT		X		X	X	X	
ROD	X			X	X	X	
RIBBON							
PREFORMS	X				X	X	X
SALTS					X		
Available forms in 99.999% and/or 99.9999% purities	INDIUM	LEAD	SILVER	TELLURIUM	THALLIUM	TIN	ZINC
	BARS	X	X	X	X	X	X
SHEETS	X	X	X			X	X
WIRE	X	X	X			X	X
POWDER	X	X	X	X	X	X	X
SHOT	X	X	X			X	X
ROD	X	X	X			X	X
RIBBON	X	X				X	
PREFORMS	X	X	X			X	X
SALTS	X						

### COMINCO PRODUCTS, INC.

ELECTRONIC MATERIALS DIVISION  
818 West Riverside Ave., Spokane, Wash. 99201  
Phone 509 747-6111 Telex 032 610

5609

TWX 509-328-1464

Circle 207 on reader service card



ture change from 30°F to 120°F.  
Viking Industries, Inc., 21343 Roscoe  
Blvd., Canoga Park, Calif. [405]

## Photometer system has modular design

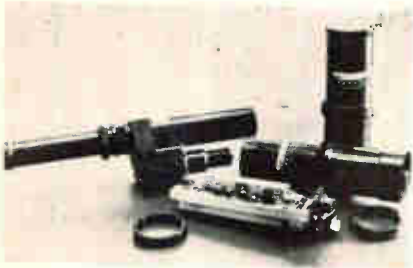

A new modular photometer system has been developed for a wide variety of sounding rocket experimental applications. The RD-100 rocket photometer system detects light energy with a photomultiplier tube, amplifies it and converts it to an electrical output signal for direct readout or transmission by telemetry. A wide variety of ultraviolet, visible and near infrared detection systems can be assembled for special experiments using standard modules — photomultiplier, amplifier, power converter and filter wheel. Basic system components include a photomultiplier tube, a low-noise logarithmic d-c amplifier and a voltage regulator-command control module. Each module is sealed to allow for pressurization when necessary to prevent high voltage arcing in low atmospheric pressure environments. The RD-100 system has threshold sensitivity of  $10^{-13}$  w/cm<sup>2</sup>, and output to telemetry of 0 to 5 v d-c. Power requirement is 56 v d-c, approximately 4 w per channel. Weight is approximately 1.85 lb for each photomultiplier and associated electronics. Typical environmental specifications include vibration of 20 g up to 3,000 cps, shock of 20 g, 11 msec duration and temperature of -10°C to 50°C. Accessories available include multilayer interference filters in the wavelength range from 3,000 to 18,000 angstroms, a filter wheel that holds 5 filters, mounting structures for multiple systems, sun-shades and field restricting baffles, interconnecting cables and ground control unit.

Spectrolab, Division of Textron Electronics, Inc., 12484 Gladstone Ave., Sylmar, Calif. [406]

## TRYLON VLP T2-8 LOG PERIODIC ANTENNA

Two-curtain, vertically-polarized,  
for 3 to 30 mc. 65° azimuth beamwidth;  
13 db/iso gain; VSWR: less  
than 2:1; power to 50 kw.

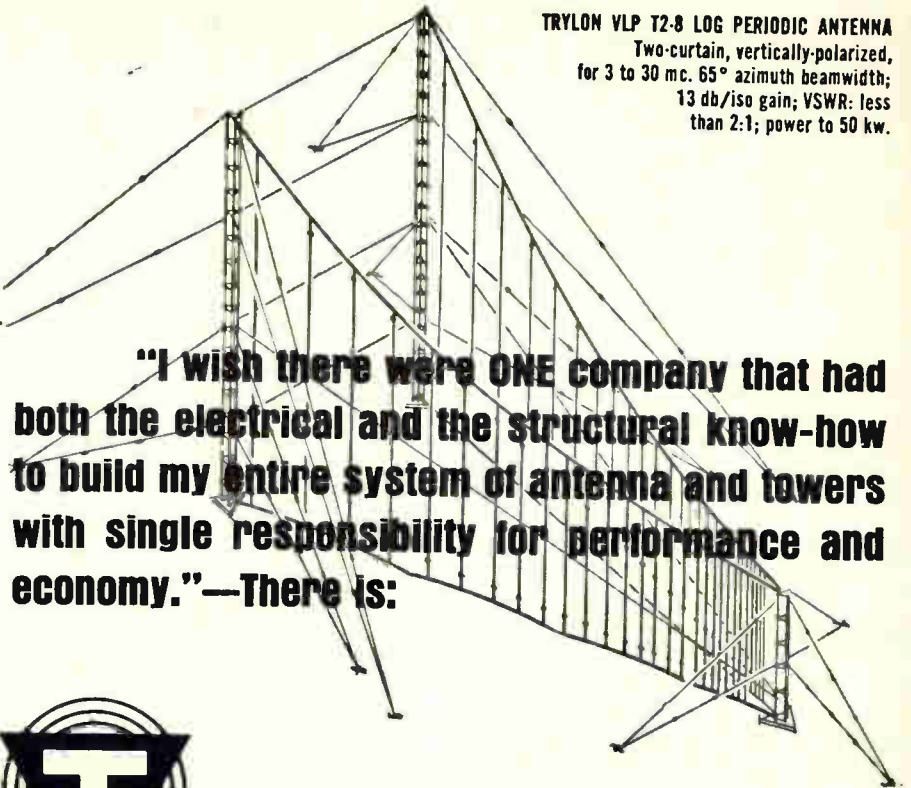

**"I wish there were ONE company that had both the electrical and the structural know-how to build my entire system of antenna and towers with single responsibility for performance and economy."—There is:**



Elverson, Pa. 19520 (215) 942-2981 — International Division, 750 Third Avenue, New York, N.Y. 10017, U.S.A.

Circle 208 on reader service card

## BREAKTHROUGH BY COWECO

*Announcing a Coil Winder  
Years Ahead of its Time!*

MODEL WH

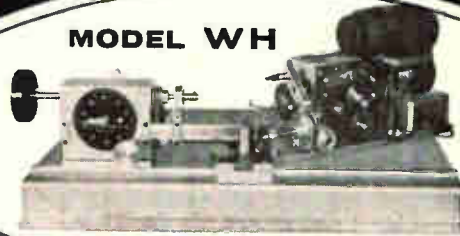

The advanced thinking and technical skill of COWECO engineers created this revolutionary new machine. Patterns resembling lattice and progressive universal windings are produced with winding angles and electrical characteristics heretofore unavailable. The Model WH is rated at 6000 rpm and has made coils at 9000 rpm. This machine is especially suited to wind radio-frequency coils.



**COIL WINDING EQUIPMENT CO.**

OYSTER BAY, L.I., NEW YORK • (516) WAInut 2-5660

SEE THE MODEL WH IN ACTION AT BOOTHS 1902-04, COLISEUM, NEW YORK

# Lepel

## INDUCTION COUPLED PLASMA DEVICE



*a controlled high temperature heat source for*

- CRYSTAL GROWING
- SPHEROIDIZING PARTICLES
- HEATING FLUIDS & GASES
- LABORATORY RESEARCH

The new Lepel inductively coupled plasma device is a low cost unit designed to permit laboratories and research departments to conduct experimental work within a modest budget. It can readily be mounted on existing laboratory fixtures or directly on the induction generator. The plasma unit can be supplied with either a single-walled quartz tube or a double-walled water cooled quartz tube. The adjustable water cooled feeder tube provides for passage of solid particles through the plasma.

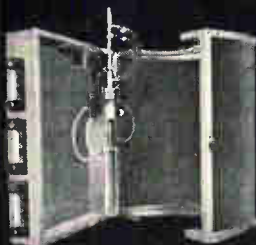

Enclosure for plasma device includes hinged protective shield of tinted plexiglas and flow meters.

**Lepel** HIGH FREQUENCY LABORATORIES, INC.

55th ST. & 37th AVE., WOODSIDE 77, N. Y. C.

## New Microwave

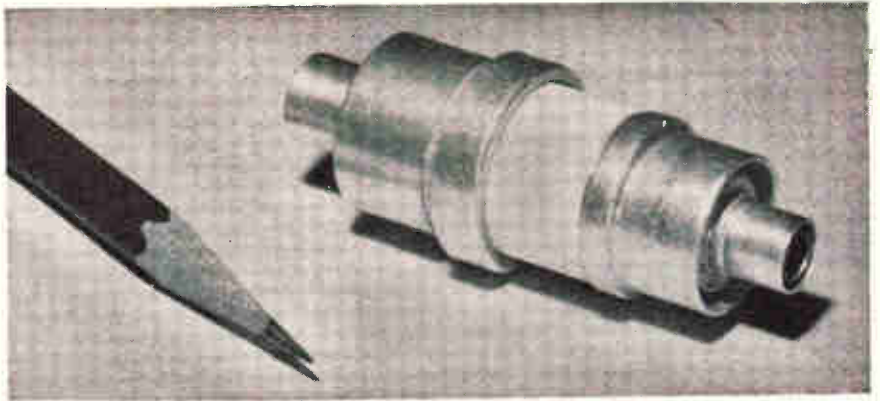

### Metal-ceramic triode for transponder use

A coaxial, metal-ceramic triode has been designed to meet the stringent, high-performance military transponder requirements of the new AIMS program for air traffic control and identification of aircraft. The requirements placed on the new microminiaturized transponder equipment by the AIMS (Air traffic control radar beacon systems, Identification friend or foe, Military security Systems) program include altitude-reporting capability, positive aircraft identification, 4096 codes, smaller size, longer life and increased reliability. Basic performance requirements of the application are understood to include a peak power output of 1,000 w, a duty cycle to 0.01, and an equipment mean time between failures to 1,000 hours. The new

triode, designated ZP-1061, operates at a center frequency of 1,090 Mc. Its major advantages are internal feedback which greatly simplifies oscillator cavity design and operation; a large cathode which greatly increases life and reliability; grid-pulsed operation for simple modulator requirements; substantially improved r-f performance, life and reliability in a comparable or smaller tube-cavity package than those previously used. The tube also has high voltage hold-off capability because of the wider and less critical internal spacing achieved with coaxial construction. Maximum steady state voltage is 2.5 kv although only 1.8 kv is needed for 1 kw of peak power output.

General Electric Co., Schenectady, N. Y. [421]

### C-band multiplier delivers 200 mw

A new C-band, solid state multiplier provides stable, broadband operation. The VFM-105C delivers 200 mw minimum power output, with a 5% instantaneous bandwidth within the 4.5 to 4.9 Gc frequency range. The completely passive unit offers a frequency multiplication factor of 18, and is comprised of a cascade of two triplers

and a doubler. The compact and rugged package makes it suitable for the stringent shock and vibration tests of military specifications for airborne equipment. Power stability,  $-20$  to  $+70^{\circ}\text{C}$ , is  $\pm 1.5$  db; nominal output frequency, 4.7 Gc; nominal input frequency, 260 Mc; flatness over 5% bandwidth,  $\pm 0.5$  db; input power, 7.0 w; minimum spurious response below signal, 30 db; weight, 1.5 lb. Delivery is in 90 days.

Solid State Products, Varian Associates, Salem Road, Beverly, Mass. [422]



# An oscilloscope picture in 10 seconds: any longer is a waste of time.

Polaroid Land films don't make you wait to see if your trace zigged when it should have zagged.

They let you know in ten seconds.

They give you an oscilloscope picture you can study, attach to a report, send as a test record with a product shipment, or file for future reference.

You have a choice of 5 films for oscilloscope recording.

The standard film has an A.S.A.

equivalent rating of 3000. It comes in both roll film [Type 47] and pack film [Type 107]. They both give you 8 pictures  $3\frac{1}{4} \times 4\frac{1}{4}$  inches. This emulsion is also available in 4 x 5 sheets [Type 57].

For extremely high-speed recording, there's Polaroid PolaScope Land film [a roll film, Type 410]. It has an A.S.A. equivalent rating of 10,000.

It can take pictures of traces too fleeting for the human eye: such as a scintillation pulse with a rise time of less than 3 nanoseconds.

One thing all these films have in common is a sharp, high-contrast image that's easy to read. Because the films are so sensitive, you can use small camera apertures and low-intensity settings.

To put these films to work on your scope, you need a camera that will take a Polaroid Land Camera Back.

Most oscilloscope camera manufacturers have one. For instance: Analab, Beattie-Coleman, BNK Associates, Fairchild, EG&G, General Atronics, Hewlett-Packard, and Tektronix.

You can get complete information by writing to Polaroid Corporation, Technical Sales Department, Cambridge, Massachusetts 02139, or by writing to one of the manufacturers mentioned above.

It will probably take a little longer than 10 seconds, but we promise the information won't be a waste of time.

"Polaroid" and "PolaScope"®

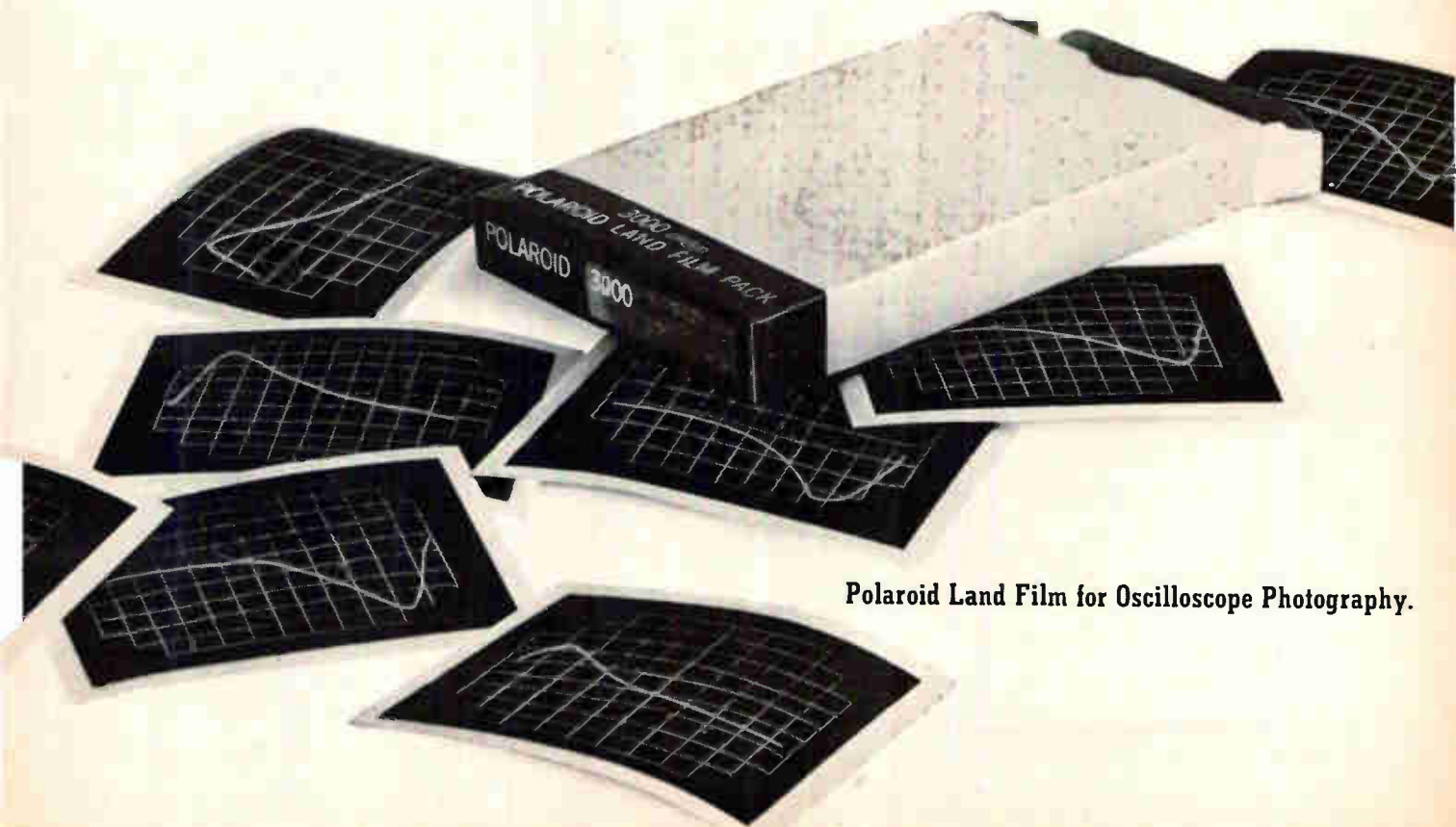

Polaroid Land Film for Oscilloscope Photography.

**Well Known  
by Reputation**



**Now for Printed  
Circuit Boards**



**LOW NOISE LEVEL  
TWIN CONTACT RELIABILITY  
LONG LIFE**

**AC Drive Models  
DC Drive Models  
SPDT or DPDT  
MBB or BBM**

Request  
Catalog No. 515



**STEVENS  
INCORPORATED  
ARNOLD**

QUALITY SINCE 1943

7 ELKINS ST., SOUTH BOSTON 27, MASS.

S/A-32-1/3

## New Production Equipment

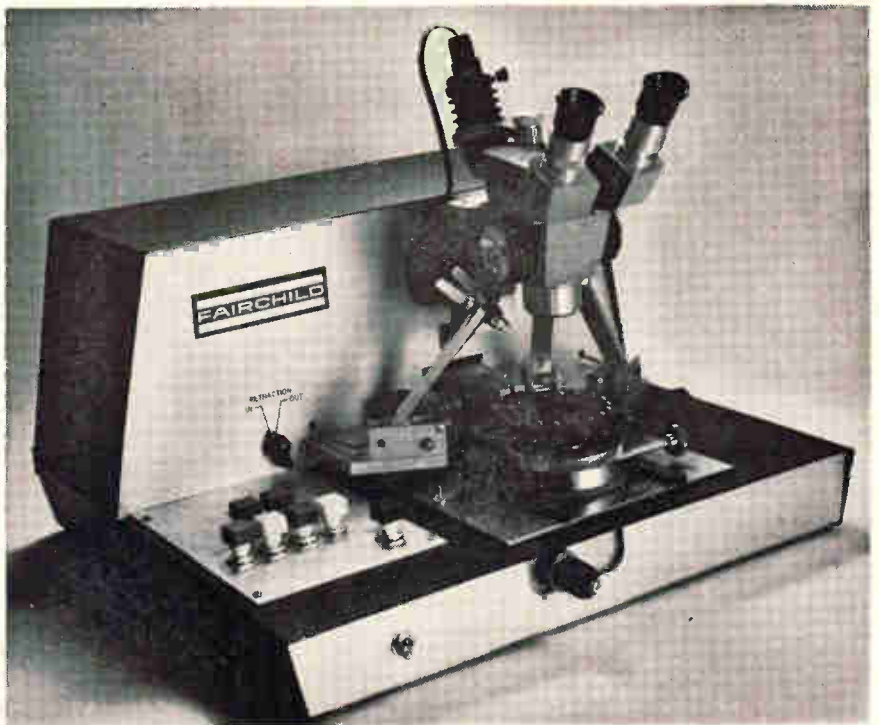

### Automatic device sorts wafers and dice

This manufacturer's first commercial entry into the semiconductor production equipment market is the model 1000 wafer and die sorter. The automatic device makes it possible to perform electrical tests on transistor and integrated circuit dice before they are separated from the master processing wafer. Heart of the model 1000 is an assembly of 18 probes on interchangeable rings that are adjustable in all three planes, each with its own pressure setting. The probe head cycles from die to die, feeding test signals back to the test console. Four separate ink markers are triggered according to preprogrammed instructions, to indicate the performance of each device tested. No particular operator skill is required to run the model 1000. The test console itself interprets the results and causes push buttons to light; the operator merely presses the illuminated buttons as they flash. Mechanical features of the model 1000 include: 1) a rotary vacuum chuck to hold dice slices, with coarse and fine rotary adjustments (the chuck slides out toward the operator for fast reloading); 2) a precision 2 in. by 2 in.

microscope stage for setup and monitoring; 3) positive cam and motor control, coupled with removable lead screw cartridge and 180° detent; 4) optional optics in 10×, 20× and 40× powers, optional additional probe rings, and optional completely automatic inking operation controlled by the test console program. Price of the basic model 1000 is \$3,350 and delivery is 30 to 45 days after receipt of order. Fairchild Semiconductor, 313 Fairchild Drive, Mountain View, Calif. [451]

### Sputtering unit features high speed

The SS-10 high-speed sputtering unit features a 6-in. diameter cathode and sputtering rates on the order of 150 angstroms per minute. The unit comes with a 6-port vacuum collar and micrometer adjusted leak valve. Tested and proven, the SS-10 is available for fast delivery at a price of \$1,084. Evaporation Apparatus, Inc., PO Box 217, San Marino, Calif. [452]



# SWEPT FREQUENCY MEASUREMENT, 5Mc TO 12.4Gc

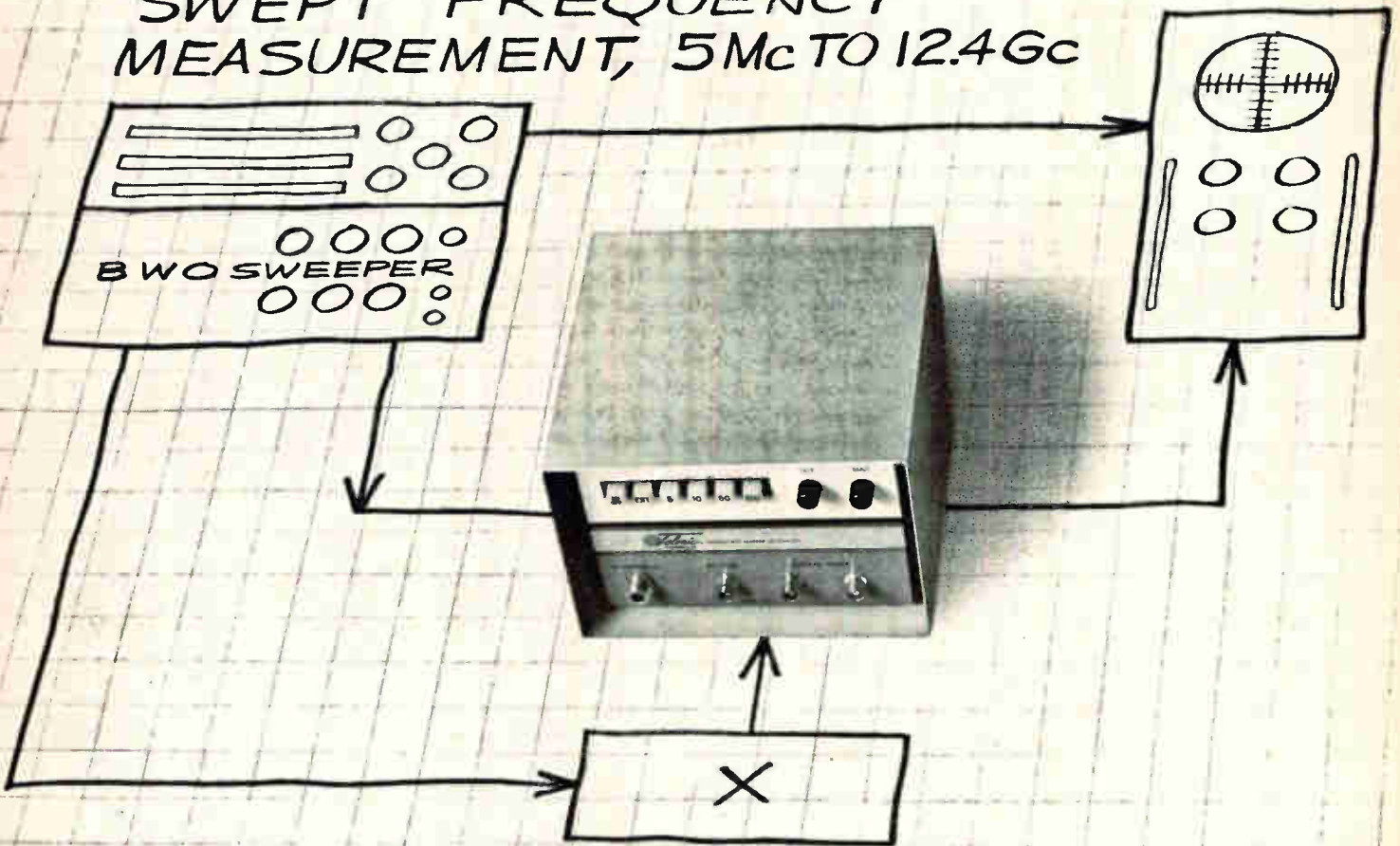

## ACCURACY, (.001%) STARTS WITH A SINGLE TMS-1

Telonic's new TMS-1 Microwave Marker Generator makes a .001% system out of any BWO Sweep Generator. That's an improvement in accuracy of about 100X for a frequency range extending from 5 Mc to 12.4 Gc. Test results can be obtained much more quickly and reliably, with a low investment in instrumentation.

Now, you can determine swept frequencies with accuracies approaching that of a frequency counter but at a fraction of the price. What's more, only one TMS-1 Generator is needed to cover this entire band rather than a costly series of .1% wave meters.

The TMS-1 provides sharply defined Birdy-type markers on the scope trace (even on steep slopes) every 5, 10, 50, or 100 Mc, selected by convenient push-buttons. Provision is also made for connecting an external oscillator for any frequency from 2 Mc to 200 Mc if other intervals are desired. An extra push button and an RF connector are available for this purpose.

If you would like to see the new TMS-1 in action contact your local Telonic representative for a demonstration, or write direct for complete details and specifications.

### GENERAL SPECIFICATIONS

FREQUENCY RANGE	5 Mc to 12.4 Gc
STANDARD MARKER INTERVALS	5, 10, 50, 100 Mc
ACCURACY	.001%
POWER REQUIREMENTS	115V, 60 cycle
CONNECTIONS	Sample In, External Oscillator, Marker Adder In, Marker Adder Out
DIMENSIONS	.6" high x 8" wide x 10½" deep
WEIGHT	15 lbs.



ENGINEERING CO.

DIVISION OF TELONIC INDUSTRIES, INC.  
480 Mermaid Street, Laguna Beach, California  
Phone (714) 494-7581, TWX 714-673-1120

Representatives in all principal cities

# PEERLESS IS THE BEST



## STANDARD DIFFERENTIALS

QUALITY  
PRECISION  
RELIABILITY  
EXPERIENCE

BACKED BY MORE THAN

# 25

YEARS OF CONTINUOUS LEADERSHIP  
IN THE ELECTRONICS INDUSTRY.

WRITE FOR NEW CATALOG  
& COMPLETE TECHNICAL SPECIFICATIONS.

## PEERLESS

PEERLESS INSTRUMENT CO., INC.  
90-15 CORONA AVE., ELMHURST, L. I., N. Y.  
TELEPHONE 212 RI 6-1100

## New Materials

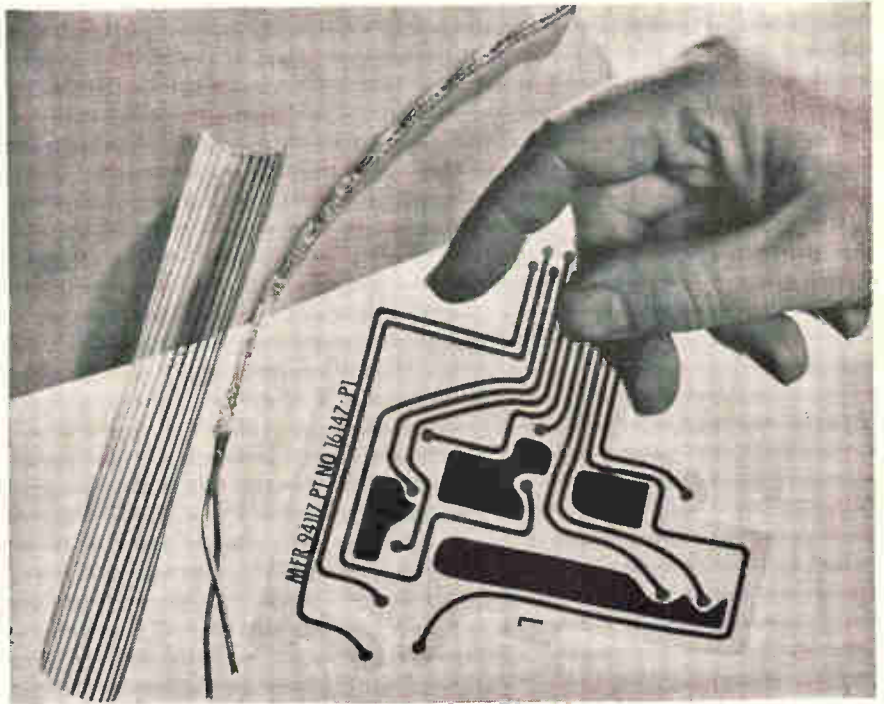

## New polyimide film tops Mylar

Development of a new film called Kapton has been announced. This is a polyimide, resulting from the polycondensation reaction between an aromatic tetrabasic acid and an aromatic diamine. It has been used successfully in applications where the temperatures have been as low as  $-269^{\circ}\text{C}$  and as high as  $400^{\circ}$ . At room temperature, the properties of Mylar polyester film and Kapton polyimide are similar. However, as the temperature is increased or decreased the properties of Kapton are less affected than those of Mylar. Kapton's ultimate tensile strength at  $-195^{\circ}\text{C}$  is 35,000 psi; at  $25^{\circ}\text{C}$ , 25,000 psi; and at  $200^{\circ}\text{C}$ , 17,000 psi. Its dielectric strength at

$-195^{\circ}\text{C}$  is 10,800 v; at  $25^{\circ}\text{C}$ , 7,000 v; and at  $200^{\circ}\text{C}$ , 5,600 v. A flame resistant material, Kapton begins to char above  $800^{\circ}\text{C}$ . There is no known organic solvent for the film, and it is infusible and does not melt. Applications for Kapton include wire and cable wrap, motor slot liners, formed coil wrap, transformers, capacitors, flexible printed circuits, magnetic and pressure sensitive tapes, and hose and tubing. At elevated temperatures, the material is resistant to radiation and to chemicals. Kapton will be available commercially after July.

E. I. duPont deNemours & Co., Inc.,  
Wilmington, Del., 19898. [441]

## Silicone rubber tape insulates cables

A new silicone rubber cohesive tape is announced for both primary and secondary insulation of cables, coils, and cable harness assemblies as well as electronic and electrical units particularly where potting is impractical. Wrapped on itself, it

bonds into a homogenous mass within 24 hours at room temperature. The advantages include: a dielectric strength of 500 v/mil; it is serviceable at temperatures of  $-130^{\circ}\text{F}$  to  $500^{\circ}\text{F}$ , and it can be wrapped at temperatures as low as  $0^{\circ}\text{F}$ . The cured material has excellent ozone, corona, and aging properties.

Ronthor Reiss Corp., U.S. Route 46,  
Little Falls, N.J. [442]



**Electronic Fittings & Components Division's new series of Sub-Miniature Connectors have exclusive CURTAC<sup>®</sup> design features and crimp removable, rear insertion, rear release contacts. □ Also, with standard sized contacts, these new connectors are interchangeable, in the field, with our Series 5040 connectors and all other conventional Sub-Miniature solder cup type connectors!**

## Series 15 Sub-Miniature Connectors from



Here's a completely new series of Sub-Miniature Connectors — now available with either patented CURTAC contacts or standard #20, .040" diameter contacts.

With exclusive CURTAC contacts, these connectors withstand shock and vibration up to 250g's and 3,000 cps. CURTAC construction gives reliable electrical characteristics — low voltage drop, high current capability and low noise generation. Closed entry construction — with low insertion and withdrawal forces.

To replace solder cup connector inconvenience with crimp removable features, Series 15 Connectors are also furnished with standard .040" diameter contacts, and will mate with and are interchangeable, in the field, without changes in mountings, with Series 5040 and other makes of conventional solder cup connectors!

Available in sizes to accommodate 7 to 104 contacts, spaced on .125" centers. Meet or exceed MIL-C-8384.

**During IEEE, visit us at Booth 2122-2124**

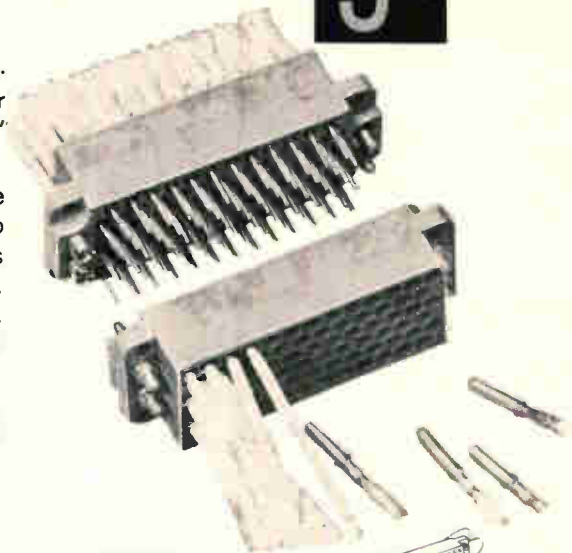

### INSERTION

Crimped contacts are inserted manually, without tools.



### REMOVAL

Simple tool ejects contact and wire, from rear of connector, for fast and easy on-the-spot replacement.



For complete information, write or call:

**ELECTRONIC FITTINGS & COMPONENTS DIVISION**

**CURTISS-WRIGHT CORPORATION**

29 Sugar Hollow Road • Danbury, Connecticut • Phone (203) 744-2000

## ASSEMBLE YOUR OWN ALL-TRANSISTOR

# Schober ELECTRONIC ORGAN



3 NEW MODELS  
Recital \$1500  
Console II 850  
Spinet 550

This is the new, all-transistor Schober Console II...the most luxurious

"home-size" organ available today.

Full 61-note manuals, 17 pedals, 22 stops and coupler, 3 pitch registers, and authentic theatre voicing leave little to be desired. Comparable to ready-built organs selling from \$1800 to \$2500.

The pride and satisfaction of building one of these most pipe-like of electronic organs can now be yours...starting for as low as \$550. The Schober Spinet, only 38 inches wide, fits into the smallest living room. The all-new, all-transistor Schober Recital Model actually sounds like the finest pipe organ; its 32 voices, 6 couplers, 5 pitch registers delight professional musicians...making learning easy for beginners.

AND YOU SAVE 50% OR MORE BECAUSE YOU'RE BUYING DIRECTLY FROM THE MANUFACTURER AND PAYING ONLY FOR THE PARTS, NOT COSTLY LABOR.

It's easy to assemble a Schober Organ. No special skills or experience needed. No technical or musical knowledge either. Everything you need is furnished, including the know-how. You supply only simple hand tools and the time.

You can buy the organ section by section...so you needn't spend the whole amount at once.

You can begin playing in an hour, even if you've never played before—with the ingenious Pointer System, available from Schober.

Thousands of men and women—teen-agers, too—have already assembled Schober Organs. We're proud to say that many who could afford to buy any organ have chosen Schober because they preferred it musically.

Send for our free Schober Booklet, describing in detail the exciting Schober Organs and optional accessories; it includes a free 7-inch "sampler" record so you can hear before you buy.

IN OUR 10TH YEAR

THE Schober Organ CORPORATION

43 West 61st Street, New York, N. Y. 10023

Also available in Canada, Australia, Hong Kong, Mexico, Puerto Rico, and the United Kingdom

THE SCHOBER ORGAN CORP., DEPT. EL-7  
43 West 61st Street, New York, N. Y. 10023

- Please send me FREE Schober Booklet and FREE 7-inch "sampler" record.
- Enclosed find \$2.00 for 10-inch quality LP record of Schober Organ music. (\$2.00 refunded with purchase of first kit.)

Name \_\_\_\_\_

Address \_\_\_\_\_

City \_\_\_\_\_ State \_\_\_\_\_ Zip. No. \_\_\_\_\_

## New Books

### Solid state

Semiconductor Network Analysis and Design  
Vasil Uzunoglu  
McGraw-Hill, Inc.  
1964, 372 pp., \$12.50

The intention of the author is to apply techniques of network analysis to semiconductor networks. This is a significant step forward. As modern circuit designs become more and more sophisticated and especially as the use of computer designed circuits and systems becomes more and more prevalent, the need for a comprehensive understanding of semiconductor networks is essential.

Many of the design techniques used by the author have never been presented comprehensively before.

With the advent of integrated semiconductor networks the chapter on distributed parameters is especially interesting. This technique lends itself to computer design of discrete semiconductor networks and discrete devices which can be analyzed as distributed parameter devices.

The chapters on low and high frequency amplifiers, stability considerations, feedback, broadbanding techniques, etc. are the first complete treatment of these subjects using semiconductor components. These chapters fill a very big void. In this respect, this book could replace material based solely on vacuum tubes.

One criticism of the book as a whole should be mentioned. The techniques introduced are extremely powerful design tools with tremendous significance but the author does not carry these conclusions and implications far enough. It is almost essential to follow up the explanation of such techniques with a discussion of a real situation.

Over-all, the book is well thought out and well documented. There is certainly enough material presented to generate a dozen more books. It should prove to be a starting place for future work.

James F. Kane

Motorola Semiconductor Products, Inc.  
Phoenix, Ariz.



SEE IT...



SHOOT IT...



HAVE IT...

WITH SCOPE CAMERAS BUILT BY THE LEADER...FAIRCHILD

Available from the industry's most complete line of high precision scope cameras are models for high speed atomic research, radio astronomy, medical observations and general lab work. Prices start at \$350. Application assistance is available from your local Fairchild Field Engineer. Call him, or write for details, then compare design features. Fairchild Scientific Instruments, 750 Bloomfield Ave., Clifton, N. J.

**FAIRCHILD**

DU MONT LABORATORIES  
SCIENTIFIC INSTRUMENT DEPARTMENT



# NEW

## 120A EXPANDED SAMPLING OSCILLOSCOPES

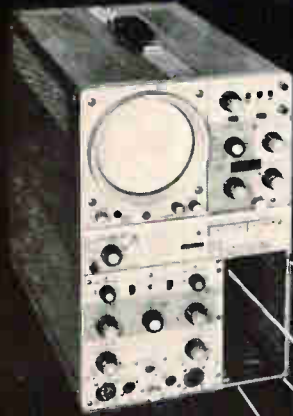

- 0.35 or 0.1 ns RT
- exceptional RF triggering to over 4 Kmc
- stable at rep. rates as low as 1 cps
- modular construction for ease of maintenance
- auxiliary attenuated trigger input

with the  
**3rd plug-in**  
series of nanosecond instruments

Model 2202  
Variable Delay  
plug-in shown

### NEW UNIQUE 100 PS RT SAMPLING UNIT

... remote, feedthru sampling head reads 100 ps RT at your circuit because hook-up cable distortion is eliminated



### READ AREA UNDER SAMPLED WAVEFORM

Model 2430 Automatic Area Integrator... 3rd Plug-in for the 120A Sampling Oscilloscope... reads area directly under any portion of the display... for fast measurement of diode stored charge, magnetic memories... plots H.F. B-H loops

### NANOSECOND PULSERS

... 3rd Plug-ins or separate instruments

Model 2305  
Pre-trigger Pulser

to 100 Kc, <math>\leq 1</math> ns RT,  
variable to  $\pm 20V$ ,  
variable trigger delay

Model 2303  
Sub-Nanosecond  
Pulser

0.3 ns RT,  $\pm 100V$ ,  
remote programming,  
280 cps, mercury reed  
type

1 mc and 20 mc pulsers also available



### AUTOMATIC TIME READOUT IDEAL FOR INTEGRATED CIRCUITS

Model 2440 Automatic Waveform Readout... a 3rd Plug-in for the 120A Sampling Oscilloscope... reads time or amplitude... completely programmable... compact for semi-automatic switching time testing... test points can be set independent of the signal for I.C. testing.

**Lumatron** nanosecond instruments manufactured by GASL  
**General Applied Science Laboratories, Inc.**  
Merrick and Stewart Avenues — Westbury, L. I., N. Y.  
Telephone Area Code 516 — ED 3-6960



**SIEMENS**

## Siemens surge voltage protectors

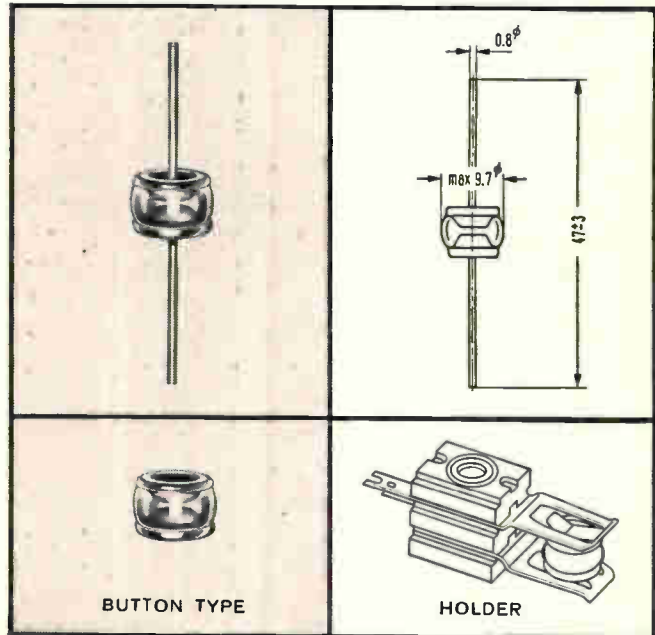

BUTTON TYPE

HOLDER

The cost of surge voltage damage to delicate equipment runs high. Telecommunications and signaling apparatus, the entire range of solid state circuitry are completely vulnerable to uncontrolled surges, causing immediate damage. Due to short circuits, lightning flashes, electrical overloads or static charging, surge voltages may range from 200 to several thousand volts. In a community wide test, up to 600 surge voltages were recorded in a 10,000 hour period.

Low cost surge voltage protectors developed by Siemens give instant reaction—in .4 microseconds! Protectors shown here cost under one dollar in quantity. All fully protect valuable equipment and do a job that cannot be done by air gap or carbon block protectors.

These gas-filled glass protectors, installed between supply line and equipment, not only absorb the surge but reset automatically for continuous protection. In this price range the only proven arc-suppressors with a current carrying capacity up to 5,000A. Low capacitants (2 p F) for HF use. Standard models have a nominal DC striking voltage of 230V to 800V.

Immediate delivery from stock in White Plains, N.Y. 14 standard models available. Custom-designed also for particular applications.

Write now for full information on Surge Voltage Protectors

SIEMENS AMERICA INCORPORATED

350 Fifth Avenue, New York, N.Y. 10001

A Corporation of THE SIEMENS GROUP IN GERMANY  
Berlin • Munich • Erlangen

In Canada:

SIEMENS HALSKE SIEMENS SCHUCKERT (CANADA) LTD.  
407 McGill Street, Montreal 1, P.Q.



# Ultra-sensitive relays

## HELPFUL DATA FOR YOUR CIRCUITRY IDEA FILE

The circuit drawing below indicates just one of the hundreds of ways many manufacturers utilize Micropositioner® polarized relays to solve complex control problems.

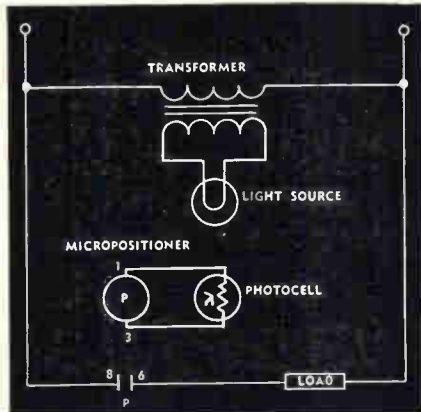

### PHOTOELECTRICITY APPLICATION

Many stages of electronic amplification in photoelectric controls can be completely eliminated with a Barber-Colman Micropositioner, since a current generating photocell alone provides sufficient power to operate this relay directly.

A Micropositioner operating on 50 micro-watt input (with fine silver contacts rated at 1 ampere, 110 volt 60 cycle, resistive load) is essentially a tubeless amplifier capable of two million times amplification.

Among the many applications for this simplified, nonelectronic photocell control are punch press safety controls . . . emergency lighting controls . . . door openers . . . burglar alarms . . . level controls . . . packaging, sorting, filling, and materials handling controls . . . plus many other automation functions.

If you are developing an application calling for photocell control, why not make a test with a Micropositioner designed for circuits similar to that shown above? Write for technical bulletins.

### BARBER-COLMAN MICROPOSITIONER® POLARIZED D-C RELAYS

Operate on input power as low as 40 microwatts. Available in null-seeking and magnetic-latching "memory" types of adjustment. Also transistorized types with built-in preamplifier. Write for our latest catalog with full information on polarized relays.

**BARBER-COLMAN COMPANY**  
Electro-Mechanical Products Division  
Dept. C, 1259 Rock Street, Rockford, Illinois



## Technical Abstracts

### Balanced microwave amplifier

Balanced transistor amplifiers for precise wideband applications

K. M. Eisele, R. S. Engelbrecht and K. Kurokawa  
Bell Telephone Laboratories Inc.  
Murray Hill, N. J.

A new type of transistor amplifier is suitable for precision receivers in the low microwave range. Two amplifiers were built, one operating in L-band (390-1,550 Mc) and another operating in S-band (1,550-5,200 Mc). Each amplifier consists of a pair of closely matched transistors. The input and output signals of the transistors are each combined by 3-db directional couplers. When a signal is applied to the input port of the input coupler, it divides, with half the power going to one transistor, and half to the other transistor. Gain of the amplifier is the gain of one transistor. The fourth port of each directional coupler is terminated in an appropriate load, and reflections from the transistor inputs or outputs are absorbed in these terminations. Thus, the input and output ports are well matched.

Noise originating in the terminating resistor of the input coupler is amplified, but is absorbed by the termination at the fourth port of the output coupler. Noise performance, therefore, is not degraded by the presence of the terminating resistors.

Stages can be cascaded without interactions since input and output are well matched and because of the bias circuit design. Two four-stage amplifiers, one L-band and one S-band were designed in printed circuit form. The L-band unit exhibited 20-db gain and the S-band unit had 12-db gain, both over a bandwidth of 600 Mc.

An experimental, single-stage amplifier for L-band was built on a ceramic substrate. The d-c biasing circuit was laid down using thin film techniques. Nichrome film was deposited for the resistors, and alumina or silicon monoxide was used as the dielectric for the capacitors with aluminum as the counter electrode. Transistors were inserted in holes in

## NEW! and NOW!

### IRRADIATED

### Polyolefin Shrinkable Tubing PENNTUBE<sup>†</sup> V

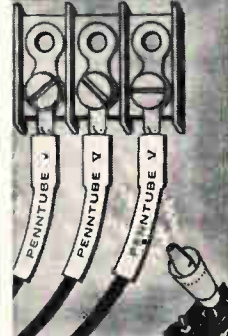

from  
**PENNSYLVANIA  
FLUOROCARBON  
COMPANY**

2:1 shrink ratio.  
Meets  
all applicable  
specifications.

Write for product data  
sheet and free sample  
NOW!



### PENNSYLVANIA FLUOROCARBON CO., INC.

Holley Street & Madison Ave.,  
Clifton Heights, Pa.  
Phone: (215) MADison 2-2300  
TWX: 215-623-1577

Export Dept. Room 5710 Empire State Bldg. N.Y. 1, N.Y.

One source for:

TEFLON\* TFE  
Shrinkable  
(Penntube-I-E)

TEFLON FEP  
Shrinkable  
(Penntube-II-SMT)

IRRADIATED  
Polyolefin Shrinkable  
(Penntube V)

\*Du Pont Reg. T.M.

†Penna. Fluorocarbon Reg. T.M.

Circle 210 on reader service card



## NEW! ELECTRONICS SLIDE RULE WITH INSTRUCTION COURSE

Professional, all-metal 10" slide rule . . . designed specifically for engineers and technicians. Comes with four lesson AUTO-PROGRAMMED Instruction Course. Carries special scales to speed solution of reactance and resonance frequency problems. Has handy decimal point locator plus widely use formulas and conversion factors not found on any other rule. Can be used for conventional computation, too. Made to our rigid specs by Pickett, Inc. Rule, AUTO-PROGRAMMED Instruction Course and top-grain leather case . . . just \$14.95. Satisfaction warranted or your money back. Cleveland Institute of Electronics, 1776 E. 17th St., Dept. E-103, Cleveland, Ohio 44114.

### SEND COUPON TODAY

### Cleveland Institute of Electronics

1776 E. 17th St., Dept. E-103, Cleveland, Ohio 44114

Send Electronics Slide Rule with Instruction Course and leather case. I'm enclosing \$14.95.

Send descriptive brochure only . . . without obligation.

Name \_\_\_\_\_

Address \_\_\_\_\_ County \_\_\_\_\_

City \_\_\_\_\_ State \_\_\_\_\_ Zip \_\_\_\_\_

**A leader in Electronics Training . . . since 1934**

Circle 211 on reader service card



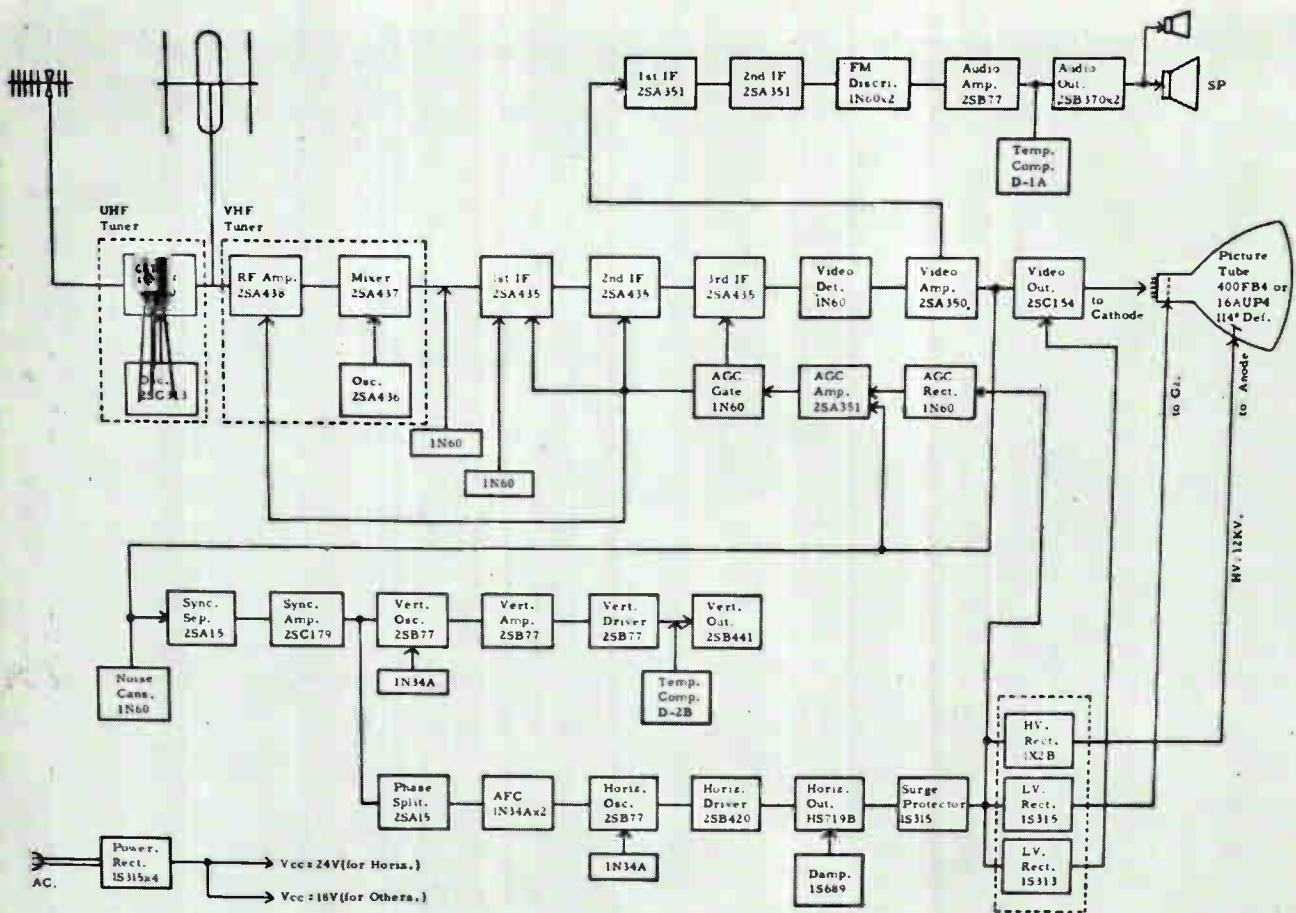

**WE'VE DESIGNED AND PRODUCED THIS TRICKIER TRANSISTOR. AND NEARLY ALL THE REST BESIDES. NOW THERE'S HARDLY ANYTHING IN AN HITACHI TV THAT HITACHI DOESN'T MANUFACTURE.**

For many years now Hitachi has been producing practically every transistor they need for their large TV range. All, that is, except one. The trickier one. But, now Hitachi is even producing this. It's called the Ultra High Frequency transistor. So, now the circuits are almost complete. Nearly all 100% Hitachi. Nearly every transistor... diode... and picture tube is designed... developed... and produced within the confines of Hitachi. The advantages in quality control, reliability and price must be distinctly apparent. For full details of all Hitachi transistors, please write to the addresses below:

HITACHI SALES CORPORATION: 333, N. Michigan Avenue, Chicago 1, Ill., U.S.A. Tel: 726-4572/4 / 666, 5th Avenue, New York, N.Y. 10019, U.S.A. Tel: 581-8844 / 12715, S. Daphne Avenue, Hawthorne, Calif., U.S.A. Tel: 757-8143 / HITACHI, LTD., DUESSELDORF OFFICE: Graf Adolf Strasse 37, Duesseldorf, West Germany Tel: 10846

 **Hitachi, Ltd.**  
Tokyo Japan

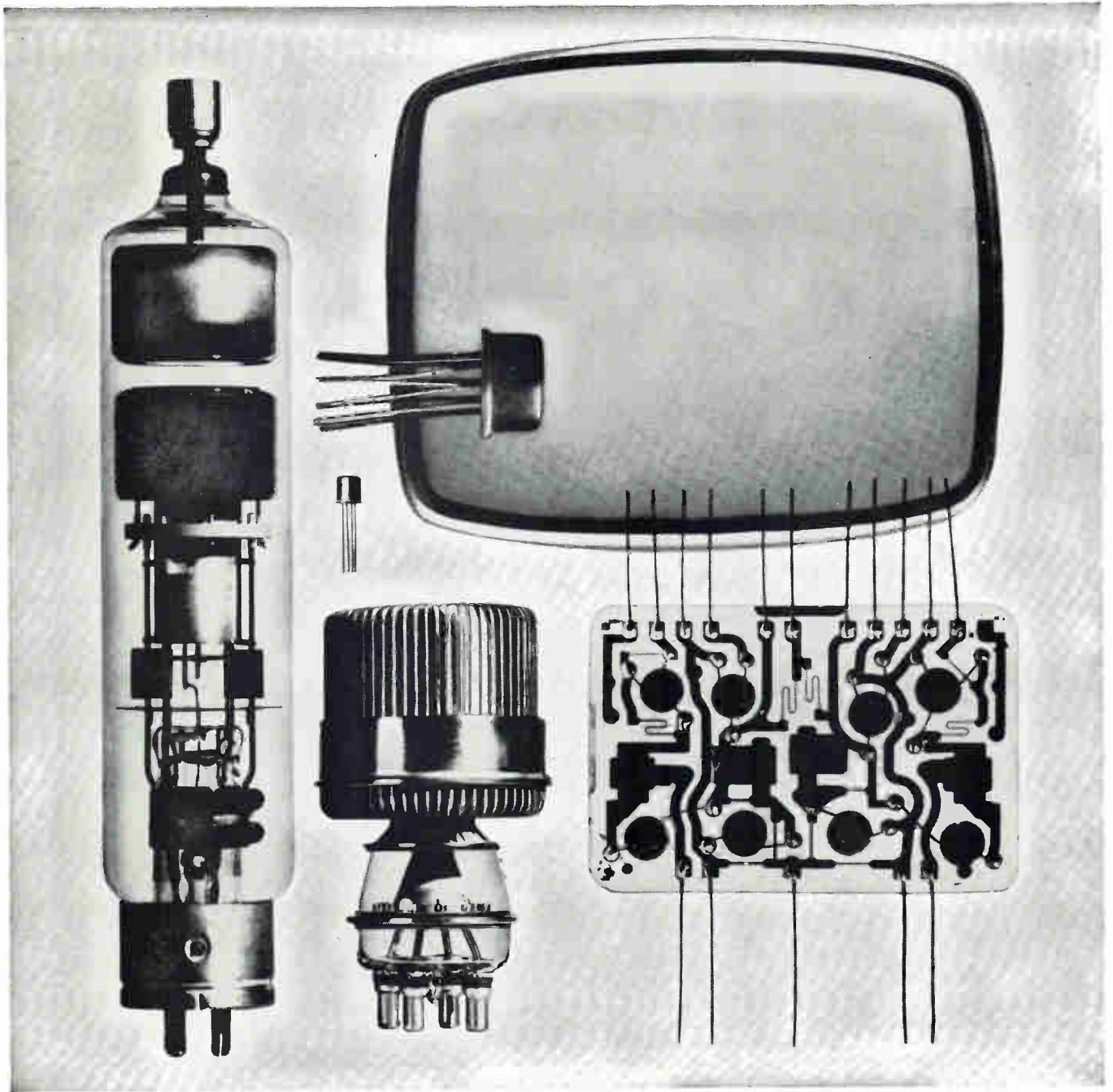

## the product is only part of the deal

To the equipment manufacturer it is not the components alone which are all-important. He sees them only as part of a transaction which should provide him with research and applications know-how, technical data and assistance in many forms, and an assurance of dependability which can only come from exceptional experience in production and quality control. This is the kind of support that goes with Mullard products, and with emphasis on quality and performance. The plants in which the products are made are

purpose-built; much of the intricate machinery and test gear is designed and engineered on the spot; even glass is specially made and metals processed from the basic raw materials so that quality may be controlled from the earliest stage.

Fourteen separate plants, twenty thousand employees, serving the Electronics Industry . . . if we are not serving your Company already, please let us know if we can help you.



# Mullard

MULLARD LIMITED · MULLARD HOUSE · TORRINGTON PLACE · LONDON · W.C.1 · ENGLAND



## Technical Abstracts

the ceramic board. Two coupled r-f conductors, one deposited on the main ceramic board and the other deposited on a smaller board, separated by a sheet of mica, make up the 3-db couplers. Characteristics of the amplifier were about the same as the printed circuit version, with stage gain of 5 db.

Presented at the International Solid-State Circuits Conference, Philadelphia, Feb. 17-19.

### Microwave power source

Solid-state 1-watt f-m source at 6 Gc  
E. A. Murphy, W. Posner and  
D. Renkowitz  
General Telephone and Electronics  
Laboratories, Bayside, N. Y.

A six-stage varactor multiplier has a frequency-modulated output of one watt. Previous techniques have used modulation at low levels before frequency multiplication. This device has demonstrated the feasibility of using solid state techniques for high-power modulation after the multiplication is accomplished. A five-stage transistor source supplies 36 watts at 93.75 to 187.5 megacycles to the input of the multiplier. Each varactor multiplier stage doubles frequency to achieve the final output of 3 to 6 gigacycles.

Single stud-mounted varactor diodes were used in lumped element circuits for the first three doublers. Experimental microwave varactors were used in the three distributed element doublers operating from 750 Mc to 6 Gc. The final doubler has a coaxial input and a waveguide output. Unmodulated power output is 2 watts.

Modulation of the 6-Gc carrier is by an upper-sideband up-converter using a single varactor diode. The 6-Gc carrier is combined with an f-m 70-Mc pump signal which results in the upper sideband at 6.07 Gc. Operating the up-converter at a conversion efficiency of 50 percent gives the 1 watt f-m output at 6.07 Gc. Use of the 70-Mc pump frequency permits the converter to be pumped directly from a 70-Mc i-f amplifier as a nondemodulating repeater.

Presented at the International Solid-State Circuits Conference, Philadelphia, Feb. 17-19.

## ELECTRICAL / ELECTRONIC ENGINEERS

DESIGN · ANALYSIS · TEST

BSEE, plus appropriate experience in any of the following areas:

- Communications
- Computer Software
- AGE Systems
- Field Engineering
- Circuits/Systems
- Electro-optics
- Microwaves
- Power Systems
- Propulsion
- Instrumentation
- Guidance & Controls
- Batteries

Write: Lockheed Missiles & Space Company,  
Professional Placement Staff, Suite 462, 599  
North Mathilda Avenue, Sunnyvale, California.

**LOCKHEED**  
**MISSILES & SPACE COMPANY**  
A GROUP DIVISION OF LOCKHEED AIRCRAFT CORPORATION  
AN EQUAL OPPORTUNITY EMPLOYER

## NEW MAGNETIC



## COMPONENTS

It's New ...  
LV SERIES

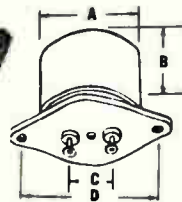

### VARIABLE INDUCTORS

Specially designed for accurate inductance where close tolerances are required for final tuning of equipment. Unique parallel gap construction provide the following advantages.

1. Negligible distortion.
2. Up to core saturation — very low changes of (L) inductance with increased D.C. (See charts above.)
3. Exceptionally high Q for the size units.
4. Wide frequency band 0-100 KC.
5. Wide Inductance ranges.

EXAMPLE: Part No. 20 LV 121 has a max. of .12 henries, Cv of .024 therefore at 400 CPS maximum applicable voltage which should be used is  $400 \times .024 = 9.6$  Volts. To determine the max. permissible current for linear inductances at .2 turn rotation would be (see table)  $630 \times .2 + 16 = 142$  m.A. at .2 turns we have 25% of L max. = .03 henries. The AC current =  $V / 2\pi fL = 9.6V / 6.28 \times 400 \times .030 = 127$  m.A. A.C. The total permissible current for maximum temperature rise is determined by the sum of the square of the AC and DC current. Therefore  $(.127^2 + .142^2) \times 22 \text{ ohms} = .8$  watts, which is adequate for this unit (2.5 watt max.). Curve under 20 LV Series shows Q = 38 at .2 turns and 1000 cps. To estimate the Q at 400 cps it may be shown as  $Q_{400} = 400 \div 1000 \times Q_{1000}$  or  $Q = 400 / 1000 \times 38 = 15.2$ .

Other windings obtained on request.

Series No.	A	B	C	D
10 LV	.82	.63	.37	1.00
20 LV	1.25	1.25	.60	1.56
30 LV	1.80	1.25	0.9	2.06

Size of unit a direct function of ...

A. Maximum permissible voltage is the given constant Cv times frequency or 400 V RMS — whichever is lower. B. Q — changes with rotation and frequency (see appropriate curves).\* C. Max. permissible DC for the reactor to be linear. This is a function of rotation, size, and part number (see table)\*  $Cdc \times \text{Rotation} + a$  constant. D. Maximum permissible heat dissipation (see table)\*  $= (I^2dc + I^2ac) \times Rdc \text{ lac} = V / wL = V / 6.28 fL$

\*To understand the direct functions and to follow the example shown send for I.T.C. Magnetic Components Catalog.

## INDUSTRIAL TRANSFORMER CORP.

GOULDSBORO, PENNSYLVANIA • Tel.: (717) Victor 2-2111 • New York (212) Walker 5-9860

## SPECIAL INTRODUCTORY OFFER

# FREE

Because electronic and control engineers have a lot of questions that need current, quick, clear answers and because books written by specialists in various branches of electronic and control engineering have those answers, the Electronics and Control Engineers' Book Club has been organized. It brings to your attention outstanding books in your field that you might otherwise miss.

### OUTSTANDING SELECTIONS AT SUBSTANTIAL SAVINGS.

Possibly just one idea from one of these books could mean more to you in actual dollars and cents than many times the cost of the book. By taking advantage of this special introductory offer you will receive absolutely FREE a copy of *Design Manual for Transistor Circuits*, together with your choice of any one of these twelve books as your first selection—at the special club price. (If you already have Carroll's work, you may take another of the books listed in the coupon as your gift copy.)

Selections cover the sound, hard core of electronic and control engineering practice. These books suggest the quality of the volumes that are available to you as a Club member. All books are chosen by editors and specialists whose thoroughgoing understanding of the standards and values of technical literature is your guarantee of authoritativeness.

### FOR EXAMPLE — SEE COUPON.

The Club will describe all forthcoming selections to you. Periodically you will receive free of charge *The Electronics and Control Engineers' Book Club Bulletin*, as issued. This gives complete advance notice of the next main selection as well as a number of alternate selections.

From this point on, the choice is yours. If you want the main selection you do nothing; the book will be mailed to you. If you want an alternate selection or if you want no book at all for that particular period, you notify the Club by returning the convenient card enclosed with your *Bulletin*. We ask you to agree only to the purchase of four books in two years. Certainly out of the large number of books in your field offered during this time there will be at least four you would buy in any case. By joining the Club you will save, in cost, about 15 per cent from publishers' prices.

### —YOUR NO-RISK GUARANTEE—

Remember, the goal of this economical technical reading program is your satisfaction. We ask you to take no risk whatever. If you are not delighted with the volumes you receive for this introductory offer, return the books within ten days and your membership will be cancelled without further obligation. So while this offer is in effect, put your coupon in the mail today!

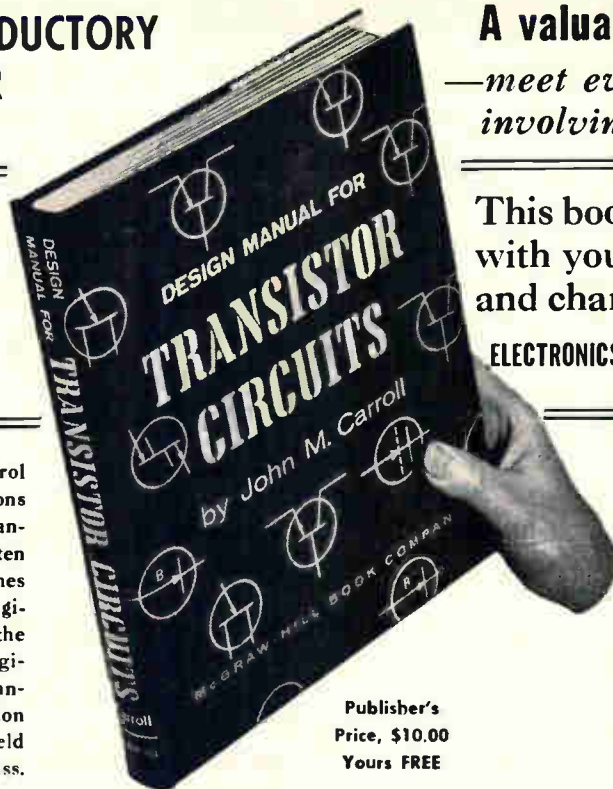

Publisher's Price, \$10.00  
Yours FREE

A valuable guide to help you  
—meet everyday design problems  
involving transistors

This book will be given to you  
with your first selection  
and charter membership in the  
ELECTRONICS AND CONTROL ENGINEERS' BOOK CLUB

Design Manual  
for  
Transistor Circuits  
By John M. Carroll

Author, *Modern Transistor Circuits, and Transistor Circuits and Applications;*  
Managing Editor,  
*Electronics*

Here's a wealth of practical information to help you meet everyday design problems involving the use of transistors and other semiconductor devices. Conveniently arranged for easy use, this information—in the form of articles, design charts, nomographs, and actual ready-to-use circuits—covers a wide range of applications—from simple one-transistor "push-pull" amplifiers . . . to complex computer switching circuits.

### MAIL ENTIRE COUPON FOR FREE BOOK AND SELECTION

The Electronics and Control Engineers' Book Club  
330 West 42nd Street, New York, N. Y. 10036

Please enroll me as a member of the Electronics and Control Engineers' Book Club. I wish to take as my first selection the book checked below:

- |   |  |
|---|--|
| <input type="checkbox"/> <b>Electronic and Radio Engineering</b> , 4th Ed.,* by F. E. Terman. Publisher's Price, \$16.00. Club Price, \$13.00.                      | <input type="checkbox"/> <b>Information Transmission, Modulation, and Noise</b> by Mischu Schwartz. Publisher's Price, \$12.50. Club Price, \$10.65.                       |
| <input type="checkbox"/> <b>Mathematics for Electronics with Applications</b> by H. M. Nodelman and F. W. Smith, Jr. Publisher's Price, \$7.00. Club Price, \$5.95. | <input type="checkbox"/> <b>Digital Computer and Control Engineering*</b> by R. S. Ledley. Publisher's Price, \$14.50. Club Price, \$12.35.                                |
| <input type="checkbox"/> <b>Electronic Designers' Handbook*</b> by R. W. Landee, D. C. Davis, and A. P. Albrecht. Publisher's Price, \$18.50. Club Price, \$15.75.  | <input type="checkbox"/> <b>Electronic Measuring Instruments</b> by Harold E. Soisson. Publisher's Price, \$7.50. Club Price, \$6.40.                                      |
| <input type="checkbox"/> <b>Magnetic Tape Instrumentation</b> by G. L. Davies. Publisher's Price, \$9.50. Club Price, \$8.10.                                       | <input type="checkbox"/> <b>Electrical Engineering for Professional Engineers' Examinations</b> by John D. Constance, P.E. Publisher's Price, \$10.00. Club Price, \$8.50. |
| <input type="checkbox"/> <b>Electronic Switching, Timing, and Pulse Circuits</b> by J. M. Pettit. Publisher's Price, \$8.95. Club Price, \$7.60.                    | <input type="checkbox"/> <b>Adaptive Control Systems*</b> , Edited by Eli Mishkin and L. Braun, Jr. Publisher's Price, \$17.50. Club Price, \$14.95.                       |
| <input type="checkbox"/> <b>Transistor Circuit Design*</b> by the staff of Texas Instruments Incorporated. Publisher's Price, \$15.00. Club Price, \$12.75.         | <input type="checkbox"/> <b>Control Engineer's Handbook*</b> , Edited by J. C. Truxal. Publisher's Price, \$25.50. Club Price, \$19.95.                                    |

I am to receive FREE with the book checked above a gift copy of *Design Manual for Transistor Circuits* or an alternate gift copy\* of

Bill me for my first selection at the special Club price, plus local tax, and a few additional cents for delivery costs. Forthcoming selections will be described to me in advance and I may decline any book. I need only take 4 books in two years of membership. All further selections I choose will be at the member's special price.

\* Titles marked with an asterisk carry an extra \$1.00 charge.

(Print) Name .....

Address .....

City ..... State ..... Zip Code .....

1-3-22



## QUALIFICATION FORM FOR POSITIONS AVAILABLE

### ATTENTION: ENGINEERS, SCIENTISTS, PHYSICISTS

This Qualification Form is designed to help you advance in the electronics industry. It is unique and compact. Designed with the assistance of professional personnel management, it isolates specific experience in electronics and deals only in essential background information.

The advertisers listed here are seeking professional experience. Fill in the Qualification Form below.

#### STRICTLY CONFIDENTIAL

Your Qualification form will be handled as "Strictly Confidential" by Electronics. Our processing system is such that your form will be forwarded within 24 hours to the proper executives in the companies you select. You will be contacted at your home by the interested companies.

#### WHAT TO DO

1. Review the positions in the advertisements.
2. Select those for which you qualify.
3. Notice the key numbers.
4. Circle the corresponding key number below the Qualification Form.
5. Fill out the form completely. Please print clearly.
6. Mail to: Classified Advertising Div., Electronics, Box 12, New York, N. Y. 10036.

COMPANY	PAGE #	KEY #
ATOMIC PERSONNEL INC. Phila., Pa.	177	1
COLUMBIA UNIVERSITY Nevis Laboratories Irvington-On-Hudson, NY	177	2
DOUGLAS AIRCRAFT CORP. Missile & Space Systems Div. Santa Monica, Calif.	195*	3
GENERAL ELECTRIC CO. Apollo Support Dept. Daytona Beach, Fla.	178	4
IBM CORP. Armonk, NY	213*	5
IBM CORP. Poughkeepsie, NY	215*	6
NATIONAL CASH REGISTER Electronics Div. Hawthorne, Calif.	171*	7
U. S. NAVY Electronics Maintenance Engineering Center Norfolk, Virginia	179*	8

\* These advertisements appeared in the March 8th issue.

(cut here)

(cut here)

## Electronics WEEKLY QUALIFICATION FORM FOR POSITIONS AVAILABLE

(Please type or print clearly. Necessary for reproduction.)

#### Personal Background

NAME .....

HOME ADDRESS .....

CITY ..... ZONE ..... STATE .....

HOME TELEPHONE .....

#### Education

PROFESSIONAL DEGREE(S) .....

MAJOR(S) .....

UNIVERSITY .....

DATE(S) .....

#### FIELDS OF EXPERIENCE (Please Check)

32265

- |  |  |                                       |
|--|--|---------------------------------------|
| <input type="checkbox"/> Aerospace           | <input type="checkbox"/> Fire Control        | <input type="checkbox"/> Radar        |
| <input type="checkbox"/> Antennas            | <input type="checkbox"/> Human Factors       | <input type="checkbox"/> Radio-TV     |
| <input type="checkbox"/> ASW                 | <input type="checkbox"/> Infrared            | <input type="checkbox"/> Simulators   |
| <input type="checkbox"/> Circuits            | <input type="checkbox"/> Instrumentation     | <input type="checkbox"/> Solid State  |
| <input type="checkbox"/> Communications      | <input type="checkbox"/> Medicine            | <input type="checkbox"/> Telemetry    |
| <input type="checkbox"/> Components          | <input type="checkbox"/> Microwave           | <input type="checkbox"/> Transformers |
| <input type="checkbox"/> Computers           | <input type="checkbox"/> Navigation          | <input type="checkbox"/> Other .....  |
| <input type="checkbox"/> ECM                 | <input type="checkbox"/> Operations Research | <input type="checkbox"/> .....        |
| <input type="checkbox"/> Electron Tubes      | <input type="checkbox"/> Optics              | <input type="checkbox"/> .....        |
| <input type="checkbox"/> Engineering Writing | <input type="checkbox"/> Packaging           | <input type="checkbox"/> .....        |

#### CATEGORY OF SPECIALIZATION

Please indicate number of months experience on proper lines.

	Technical Experience (Months)	Supervisory Experience (Months)
RESEARCH (pure, fundamental, basic)	.....	.....
RESEARCH (Applied)	.....	.....
SYSTEMS (New Concepts)	.....	.....
DEVELOPMENT (Model)	.....	.....
DESIGN (Product)	.....	.....
MANUFACTURING (Product)	.....	.....
FIELD (Service)	.....	.....
SALES (Proposals & Products)	.....	.....

CIRCLE KEY NUMBERS OF ABOVE COMPANIES' POSITIONS THAT INTEREST YOU

1 2 3 4 5 6 7 8 9 10 11 12 13 14 15

### EMPLOYMENT

ADDRESS BOX NO. REPLIES TO: Box No. Classified Adv. Div. of this publication. Send to office nearest you.  
NEW YORK, N. Y. 10036: P. O. Box 12  
CHICAGO, Ill. 60611: 645 N. Michigan Ave.  
SAN FRANCISCO, Cal. 94111: 255 California St.

#### SELLING OPPORTUNITY WANTED

Belgian National, vast experience import-export sales & excellent contacts in common market with aeronautical, radio, electronic industries supplying armed forces, wishes set up & manage fast delivery export division for American manufacturer/distributor. Specifics exchanged in confidence. RA-6258, Electronics.



**E. E.'s**  
for FEE-PAID Positions  
**WRITE US FIRST!**  
Use our confidential application for professional, individualized service... a complete national technical employment agency.  
**ATOMIC PERSONNEL, INC.**  
Suite 1207L, 1518 Walnut St., Phila. 2, Pa.

#### Your Inquiries to Advertisers Will Have Special Value . . .

—for you—the advertiser—and the publisher, if you mention this publication. Advertisers value highly this evidence of the publication you read. Satisfied advertisers enable the publishers to secure more advertisers and—more advertisers mean more information on more products or better service—more value—to YOU.

### ELECTRONIC ENGINEER

An opportunity for a highly competent, design orientated engineer in the stimulating field of Fundamental Particle Physics Research in the academic atmosphere of one of the leading University laboratories of the world in beautiful Westchester surroundings. Benefits include tuition exemption plan.

Projects include interfacing analog or digital experimental equipment with digital computers, and design of a broad spectrum of special purpose circuits and systems. Experience is required in circuit design, and is desirable in ultra high speed circuitry.

Send resume with salary requirements to Mr. A. E. Straus

#### COLUMBIA UNIVERSITY

NEVIS LABORATORIES

P. O. BOX 137

IRVINGTON-ON-HUDSON, N. Y.

An equal opportunity employer.

# THE ASD RECRUITER

# IMMEDIATE OPENINGS

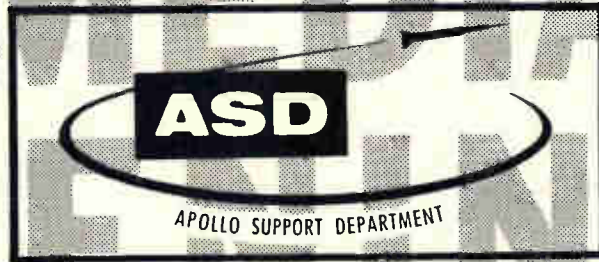

## HUNTSVILLE, ALABAMA

### Experience required in the following areas:

<b>Systems Design Engineer</b> BSEE	Conceptual, functional and preliminary design of electrical subsystems and hardware of ground support equipment for launch vehicles. Should include computer applications, digital circuitry or control systems design.
<b>Component Engineer</b> BSEE	Design tests for use in evaluation and qualification of electrical component parts. Monitor performance of tests and compile results.
<b>Systems Engineers-Power</b> BSEE	Analysis of power requirements of stage and missile systems and/or launch complex areas. Power systems; conceptual, functional, and preliminary design of GSE equipment as applied to the launch missile stages.
<b>Systems Interface Engineers</b> BSEE	Experience in design and evaluation of complex electrical GSE with interface coordination experience. From available documentation analyze, formulate, and document the various interfaces (vehicle/GSE, GSE/GSE) and formulate functional circuit schematics.
<b>Electrical Engineer-Reliability Analysis-BSEE</b> (Also for Cocoa Beach, Fla.)	Design, test or analysis of electrical systems, with at least two years in failure mode and effects analysis, determination of criticality numbers, or development of math models. Coordinate analytical effort with design and test personnel.

## HOUSTON, TEXAS

### Experience required in the following areas:

<b>Crew Systems Engineer</b> BSAE, ME	Analysis of systems required for support and operational use of spacecraft crew; in development of specifications, test plans and requirements for crew systems; and knowledge of crew capabilities and limitations.
<b>Senior Simulation Analysis Engineer</b> BSAE	Simulation of spacecraft systems, in centrifuge operations and in instrumentation; also in closed-loop digital, analog or hybrid simulation programs and set ups to determine crew-vehicle compatibility. Flight experience desirable.
<b>Engineer-Cryogenics Fuel Cell</b> BSME/ChE.	3 to 5 years experience in work involving Cryogenics, Fuel Cells and associated systems. This should include systems design and analysis. Provide technical assessment of design of Apollo SC systems emphasizing reliability.

## COCOA BEACH, FLORIDA

### Experience required in the following area:

<b>Documentation Specialists</b> College Degree-Preferably BSEE (Also for Daytona Beach, Fla.)	Analyze, determine & define Apollo Engineering Documentation Standards & Practices requirements necessary to achieve Department objectives. Five years in Engineering Documentation; familiarity and experience in DOD policies; contract; specifications and technical manuals, regulation and writing; plus actual knowledge of large systems preferably missile and/or aircraft.
--	---

## DAYTONA BEACH, FLORIDA

### Experience required in the following area:

<b>Engineer-Operational Analysis</b> BSME, AE, CE, IE	Develop systems management procedures and system analysis in field of launch facilities and equipment. Minimum 2-3 years experience preferably in similar aerospace program. Must deal with customers, and know and be able to document all functions, authorities, responsibilities of organization and information flow. Require familiarity with AFSC 375 series systems and government documents.
--	---

*contact*

MR. D. D. SMITH/PROFESSIONAL & TECHNICAL RESOURCES  
G.E./Apollo Support Dept./Room 1107-M/Box 2500/Daytona Beach, Fla.

GENERAL  ELECTRIC

An equal opportunity employer



# BAYNTON SPECIALS

## TEKTRONIX

- 53B High Gain Wide Band Plug-in..... \$78.50
- 121 Wide-Band Preamp gain 0.01 to 100..... \$165.00
- 190A Constant-Amplitude Sig. Gen., 350KC to 50 MC..... \$190.00
- 313D 3" Lab. type oscilloscope..... \$390.00
- 511A Wide Range Oscilloscope..... \$195.00
- 511AD Wide Range Oscilloscope..... \$255.00
- 512A OC Coupled Oscilloscope..... \$355.00
- 513D High-Sensitivity-Wide Range..... \$695.00
- 513AD Laboratory Oscilloscope..... \$395.00
- 521AD Television Oscilloscope, DC to 10MC. \$575.00
- 521D Television Oscilloscope..... \$475.00

## BOONTON RADIO COMPANY

- 160A Q Meter, measures Q..... \$350.00
- 202B FM Signal Generator, 54MC to 216MC. \$485.00
- 260 A Q Meter, C & L Measures Q, C, and L. \$675.00

## HEWLETT-PACKARD

- 151A. High Gain Amp—Plug-in for 150A Scope \$118.00
- 200B. Audio Oscillator 20 cps. to 20 KC. \$109.50
- 200ABR. Audio Oscillator—20 cps. to 40KC. \$115.00
- 202A. Low Frequency Function Generator. \$425.00
- 205AG. Audio Sig Gen—5W. 20 cps. to 20 KC. \$340.00
- 206A. Audio Sig. Gen.—20 cps. to 20KC. \$355.00
- 211A. Square-Wave Generator, 1 cps. to 1MC. \$225.00
- 212A. Pulse Generator..... \$320.00
- 100C. RMS V.T.V.M., 10 cps. to 4MC. \$99.50
- 410B. V.T.V.M., 20 cps. to 700MC. \$149.00
- 115A. Standing-Wave Indicator..... \$99.50
- 116A. Ratio Meter, Reflection coefficient..... \$360.00
- 119A. Traveling Wave Tube Amplifier, 2 to 4KMC. \$675.00
- 509A. Frequency Meter, Direct reading..... \$95.00
- 524A. Frequency Counter, Counts to 10MC. \$895.00
- 510A. Transfer Oscillator, 10MC to 5GC. Extends range of 524 to 124GC. \$435.00
- 510B. Transfer Oscillator, 10MC to 124GC. \$475.00
- 616A. Digital Recorder, Prints 11 digit..... \$845.00
- 616B. Signal Generator, 1.8 to 4.2KMC. Pulse, CW, or FM modulation. \$1175.00
- 624A. Sig. Gen. "X" band, 8.5 to 10KMC. \$695.00
- 624B. Signal Generator "X" band, 8.5 to 10KMC. \$995.00
- Output 3 w.
- 670HM. Swept Freq. Oscillator, 7 to 10KMC. \$490.00
- 670JM. Swept Freq Oscillator, 5.85 to 8.2KMC. \$190.00
- 711A. Lab Power Supply, 0 to 500V @ 100ma. \$125.00
- 712B. Lab Power Supply, 0 to 500V @ 200ma. \$260.00
- 717A. Klystron Supply, 800 to 1000V @ 25ma. \$180.00

## GENERAL RADIO

- 561D. Vacuum Tube Bridge..... \$395.00
- 820A. Heterodyne Freq Meter 300KC to 300MC. \$275.00
- 631BL. Stroboscotac (Stroboscopic Tachometer)..... \$145.00
- 650A. Impedance Head..... \$75.00
- 120A. Heterodyne Freq Meter, 10 to 3000MC. \$279.00
- 726A. RMS Voltmeter..... \$58.50
- 736A. Wave Amplifier..... \$825.00
- 740B. Cap Bridge, 5 mfd. to 1100 mfd. \$190.00
- 801C. UHF Signal Generator, 8MC to 300MC. \$325.00
- 801A. Standard Sig Gen, 16KC to 15MC. \$850.00
- 805C. Standard Sig Gen, 16KC to 50MC. \$1395.00
- 1106B. Frequency-Transfer Unit, 1 to 10MC. \$580.00
- 1106C. Frequency-Transfer Unit, 10 to 100MC. \$620.00
- 1107A. Interpolation Oscillator, 0 to 5000 cps. \$620.00
- 1301A. Beat Frequency Oscillator, 20 cps. to 20KC. \$235.00
- 1481K. Standard Inductor 1h ± 0.25%..... \$19.50
- 1632A. Resistance Limit Bridge..... \$295.00

## BERKELEY

- 554 E-Put Meter, counts to 100KC..... \$325.00

## SUPER-SPECIAL VECTRON

- SA25 Microwave Spectrum Analyzer with 20X Plug-in Unit. (X Band)..... \$695.00

## WESTERN ELECTRIC

### TRANSMISSION TEST EQUIPMENT

- 2B Noise set (Similar to Daven 34B and C)..... \$695.00
- J-64030A Transmission Measuring Set..... \$895.00
- J-61031BL Transmission Measuring Set..... \$875.00

### POWER SUPPLIES KEPCO

- KR6M 195 to 325V @ 600ma. 0.1% reg. (metered) Rack mount..... \$149.00
- KR11M 0 to 150V @ 125ma. 0.1% reg. (metered) Rack mount..... \$105.00
- 315 0 to 300V @ 150ma. and 150V Bias @ 5ma. Bench model..... \$85.00

## LAMBDA

- 25 200 to 325V @ 100ma. Bench model..... \$35.00
- 32 200 to 325V @ 300ma. Rack mount..... \$72.50
- 35 100 to 200V @ 300ma. Bench model..... \$95.00
- 62M 245 to 305V @ 600ma. Rack mount..... \$145.00
- 64M 100 to 200V @ 600ma. Rack mount..... \$135.00
- 65M 0 to 100V @ 50-600ma. Rack mount..... \$185.00
- C861 125 to 325V @ 800ma. Rack mount..... \$175.00
- 1541 275 to 325V @ 0-1500ma. 0.25% reg. Rack mount..... \$295.00
- C1581M 125 to 325V @ 0-1500ma. 0.25% reg. Rack mount..... \$345.00

This is just a sample listing—send for free 48 page catalog.

### WE GUARANTEE QUALITY

We overhaul and painstakingly lab-test and calibrate every piece of equipment before it leaves our warehouse. We maintain one of the most up-to-date test equipment maintenance shops and standards labs, to be positive that our equipment meets original factory specifications.

## BAYNTON ELECTRONICS CO.

2918 NORTH 16th ST., PHILADELPHIA, PA. 19132  
AREA CODE 215 Baldwin 9-9800

CIRCLE 959 ON READER SERVICE CARD

## WESTON SENSITROLS



Stationary contact is a small powerful permanent magnet and movable contact is an iron "rider" mounted on the pointer which travels over relay scale. Operating torque moves pointer into magnetic field of stationary contact which draws movable contact and holds it firmly. Contacts remain closed until reset. Will operate directly from a photocell or a group of thermocouples.

Double contact with Solenoid Reset; Sensitivity: 7.5 Microamps, 50 ohm coil; Makes contact on increasing or decreasing values; Reset coil: 6-24 VDC or 24 VAC; Contacts: "Twintacts"; Capacity: 100 ma at 120 volts; Nickel plated, Brass Cover; WESTON MODEL 705 TYPE 6; #R560 10.00

Same as #R560 but with Glass Face; WESTON MODEL 705 TYPE 6; #R561 12.50

Same as #R560 with glass face and flange for panel mountings in 3" hole. WESTON MODEL 705, TYPE 6. #R5375 15.00

WESTON MODEL 723: Similar to 705 but in hermetically sealed flanged case for panel mount in 3" hole; Sensitivity: 5 microamps; 2000 ohm coil. Reset coil: 115VAC. "Twintacts" 100 ma capacity. #R5401 35.00



"Satisfaction is on the other end of your telephone"

# Universal RELAY CORP.

42 WHITE ST., NEW YORK 13, N. Y. • Walker 5-6900

CIRCLE 951 ON READER SERVICE CARD

## INDUSTRIAL—RECEIVING SPECIAL PURPOSE TUBES

BEST QUALITY—LOWEST PRICES  
Semiconductors—All Types

FREE CATALOG—write

ROBERT G. ALLEN CO.

P.O. Box 1882 Dept. E-1, Beverly Hills, Calif. 90213  
Phone (213) 657-1583

CIRCLE 954 ON READER SERVICE CARD

## free catalog

### POTTING APPLICATORS MANUAL AND DISPOSABLE

6cc 12cc 30cc

FOR POTTING, ENCAPSULATING, AND SEALING OF MINIATURE COMPONENTS

PHILIP FISHPAN COMPANY  
7 CAMERON ST., WELLESLEY 81, MASSACHUSETTS

CIRCLE 955 ON READER SERVICE CARD

## Antique

### TELEPHONES

As is complete, decorative purpose \$17.50. Working order, inter-comm. \$19.50. Ext. on dial \$24.50, talking circuit only. Write for complete list. All shipments FOB, Simpson, Pa.

TELEPHONE ENGINEERING CO.  
Dept. E-3225 Simpson, Pa.

CIRCLE 956 ON READER SERVICE CARD

## PUNCHED TAPE PHOTO-ELECTRIC READER AND TRANSPORT

Potter Model 807C transistorized perforated photo-electric tape reader. 600 digits per second. Unused. Original cost \$8,182.00. Best Offer.

EL-TRONICS, INC.

Beaty Building, Warren, Pennsylvania

CIRCLE 957 ON READER SERVICE CARD

RAOAR AUTO-TRACK & TELEMETRY ANTENNA PEDESTALS 3 & 10 CM. SCR 584 AUTOTRACK RADARS, M-33 RADAR TPS-ID SEARCH, APS-45 TPS-10D HT. FINDERS, WX RADARS. FPN-32GA APS-10 APS-15B APS-27 (AMT) SEARCH. ■ ■ ■ APN-102 DOPPLER, DOZENS MORE, CARCINOTRONS PPN'S. 25-5-1-2-3-6 MEGAWATT PULSE MODULATORS, CAVITIES, PULSE TRANSFORMERS, IF STRIPS, WAVEGUIDE, BENDS 200 MC. 1 KMC, 3 KMC, 6 KMC, 9 KMC, 24 KMC, RF PKGS.

RADIO RESEARCH INSTRUMENT CO.  
550 5TH AVE., NEW YORK 36, N. Y. JU 6-4691

CIRCLE 958 ON READER SERVICE CARD

## RELAYS BY UNIVERSAL

Highlighted here are just a few of over 2,000,000 in 20,000 different types in stock. . . Most makes. This permits immediate delivery of production quantities. We are equipped to assemble, adjust and test any type of relay.

Average shipment made within 48 hours.

Orders requiring coil and frame assembly, special testing or adjustment are shipped within one week to ten days.

Send for latest 60-page free illustrated catalog #E which describes the largest inventory of relays in the world.

## ARROW LIFSCHULTZ FREIGHT FORWARDERS

FASTEST COAST TO COAST

5th & 6th DAY EAST COAST TO CAL., ARIZ., NEV., ORE. and WASH.

7th DAY TO EAST COAST from CAL., ARIZ., NEV., ORE. and WASH.

Specialists in Shipment of Electronics Products  
Call for information

NEW YORK — PHILADELPHIA  
BALTIMORE — BOSTON — NEW JERSEY  
HOLYOKE — NEW HAVEN — PROVIDENCE  
LOS ANGELES — SAN FRANCISCO — SEATTLE

CIRCLE 952 ON READER SERVICE CARD

## FREE Catalog OF THE WORLD'S FINEST ELECTRONIC GOV'T SURPLUS BARGAINS



HUNDREDS OF TOP QUALITY ITEMS — Receivers, Transmitters, Microphones, Inverters, Power Supplies, Meters, Phones, Antennas, Indicators, Fillers, Transformers, Amplifiers, Headsets, Converters, Control Boxes, Dynamometers, Test Equipment, Motors, Blowers, Cable, Keyers, Chokes, Handsets, Switches, etc., etc. Send for Free Catalog—Dept. E-5.

FAIR RADIO SALES  
2133 ELIDA RD. • Box 1105 • LIMA, OHIO

CIRCLE 953 ON READER SERVICE CARD



**IT'S OPEN HOUSE! . . . TO IEEE SHOW VISITORS**

COME TO AMERICAN RELAY, ELECTRONICS DIVISION, IT WILL BE WORTH YOUR TIME TO SEE THE VALUES THAT AWAIT YOU (TAKE 8th AVE SUBWAY, INDEPENDENT LINE, FROM THE COLISEUM TO CANAL ST. STATION. WALK ONE BLOCK EAST) AND SEE . . .

**ONE HUNDRED MILLION DOLLARS (ORIGINAL COST) IN DIVERSIFIED ELECTRONIC, ELECTRO-MECHANICAL AND TEST EQUIPMENT . . . TERMINATED INVENTORIES**

- DIGITAL VOLTMETERS
- DIGITAL OHMMETERS
- ACCELEROMETERS
- POWER SUPPLIES
- PRESSURE TRANSDUCERS
- PREC. POTENTIOMETERS
- SCOPES
- GYROS
- TUBES
- VARIACS
- AUTOSYNs
- SWITCHES
- RELAYS

FREE . . . COMPLETE CATALOG  
STOP IN AND PICK ONE UP . . .  
OR WRITE TODAY.

*"When you think electronics,  
Think American"*



HP 185A 500MC OSCILLOSCOPE  
WITH 187A DUAL TRACE AMPLIFIER  
ORIGINAL COST . . . \$3000.00  
SPECIAL PRICE . . . 1590.00

ONLY 4 AVAILABLE

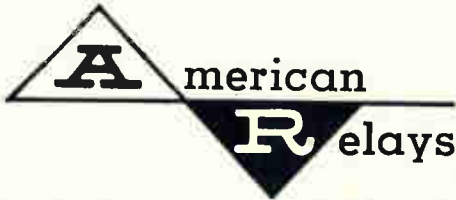

**Electronics  
Division**

39 LISPENARD ST. NEW YORK, NY, 10013  
(212) WO 6-5650

CIRCLE 960 ON READER SERVICE CARD

**SEMICONDUCTORS  
MAJOR BRANDS**

INTERGRATED CIRCUITS • DIF. AMPS DAR-  
LINGTONS • POWER DIODES & TRANSISTORS  
• SPECIAL DEVICES

Write for Catalog S-1

SEMICONDUCTOR SALES OF CALIF.  
1063 Perry Annex Whittier, Calif.  
(213) 696-7544

CIRCLE 963 ON READER SERVICE CARD

**MINIATURIZATION  
IN UNUSUAL SEMI-  
CONDUCTOR TYPES**

SCR's, TRANSWITCHES,  
PHOTO TRANSISTORS,  
100 VOLTS SILICONE  
TRANSISTORS IN TO-5 CASE

WRITE FOR LATEST FREE CATALOG

Transistors Unlimited Company  
462 JERICHO TURNPIKE, MINEOLA, N. Y.  
516 PI 7-7221

CIRCLE 964 ON READER SERVICE CARD

**"SEARCHLIGHT"  
Can Help You!**

When you want to buy or sell  
used or surplus new equipment  
and/or accessories, or have  
other business wants—advertise  
them in the SEARCHLIGHT SEC-  
TION for quick, profitable results!

**SPECIAL SALE!  
TEST EQUIPMENT**

**GENERAL RADIO**

541-B Megohm Bridge 0.1 to 1,000,000 Megohms	\$195
648-A Auxiliary Light Source (Strobolux)	\$95
724-B Precision Wavemeter, 16ke to 50 mc	\$75
1304-B Beat Freq. Audio Generator	\$350
1432-N Resistor Decade, Total 1,111,000 ohms	\$65
1432-Q Resistor Decade, Total 1,111,000 ohms	\$65
1490-B Decade Inductor, 11.11 h (0.001 steps)	\$145
1521-A Graphie Level Recorder 20 cps to 200 kc	\$695
1521-P10 Drive Unit, used with above recorder	\$50
1521-P14 Link Unit, couples 1521-A to 1304-B	\$15
532-B Strobolum Hi-Intensity Light Source	\$125
1570 Automatic AC Voltage Regulator	\$195
1700-B Motor Speed Control Variac Type	\$85

**HEWLETT-PACKARD**

151A High Gain Amplifier, DC to 10 mc/s	\$65
200 CDR Wide Range Audio Oscillator	\$160
330B Distortion Analyzer, 20 to 20,000 cps	\$295
S380A Calibrated Variable Attenuator	\$65
400D V.T.V.M. 10 cycles to 4 megacycles	\$145
400HR V.T.V.M. 10 cycles to 4 megacycles	\$175
450A Stabilized Laboratory Amplifier	\$95
520A High-Speed Cecade Scaler	\$195
521C Electronic Counter, 1 cps to 220 kc	\$450
612A UHF Signal Generator, 450 to 1230 Mc/s	\$895

**KEPCO TRANSISTORIZED SUPPLIES**

SC-18-1M: 0-18V, 0-1A (Orig. \$180)	\$165
SC-32-5: 0-32V, 0-5A (Orig. \$800)	\$185
SC-32-10: 0-32V, 0-10A (Orig. \$950)	\$225
SC-32-15: 0-32V, 0-15A (Orig. \$1100)	\$275
SC-150-1: 0-150V, 1A (Orig. \$790)	\$185
25C-32-1.5: Dual 0-32V, 0-1.5A (Orig. \$990)	\$225
25C-100-0.2: Dual 0-100V, 0-0.2A (Orig. \$750)	\$185
SR-12-50: 5-13V, 0-50A (Orig. \$1950)	\$495
SC-3672-0.5: 36-72V, 0-0.5A (Orig. \$380)	\$125
SC-3672-1M: 36-72V, 1A (Orig. \$625)	\$175
PSC-10-2: 7.5-12.5V, 2A (Orig. \$395)	\$125
PSC-20-2: 17.5-22.5V, 2A (Orig. \$395)	\$125

**LAMBDA DC POWER SUPPLIES**

28: 200-235V, 0-100MA, 6.3 @ 3A, 1%	\$35
28M: Same as above but metered	\$45
29: 100-200V, 0-100MA, 6.3 @ 3A, 1%	\$40
C-2B1: 125-325V, 0-200MA, 6.3 @ 10A, 0.25%	\$45
C-181M: 125-325V, 0-100MA, 6.3 @ 5A, 0.25%	\$45
50R: 0-500V, 0-500MA, 6.3(2) @ 5A, 0.5%	\$195
LA50-03A: 0-34V, 0-5A, Transistor'd, 0.05%	\$185
LT-2095M: 0-32V, 0-2A, Transistor'd, 0.15%	\$135
LT-2095AM: 0-32V, 0-2A, Transistor'd, 0.15%	\$175

**TEKTRONIX**

53-51K Fast Rise, Hi-Gain Plug-in Unit	\$95
107 Square-Wave Generator, 400 kc to 1 mc	\$115
112 Differential DC-Coupled Amplifier	\$75
161 Pulse Generator Unit	\$55
162 Waveform Generator Unit	\$55
570 Characteristic Curve Tracer	\$675

**MILITARY TEST SETS**

AN/PRM-10 Grid Dip Osc., 2 to 400 mc/s	\$95
AN/UPM-10 Radar Test Set	\$275
AN/UPM-11 Radar Range Calibrator	\$165
AN/URM-43B RF Power Meter, 30 to 600 mc/s	\$95
AN/URM-79 Freq. Mtr. 100 kc to 20 mc, .001%	\$495
AN/USM-24 Oscilloscope 1.5 cps to 8.5 mc/s	\$175
OS-8E U Oscilloscope, portable 2 mc b'dwidth, 1 1/2"	\$125
TS-17 A/R Test Oscillator, 40 to 500 mc/s	\$50
TS-731/URM Summation Bridge, 1 to 4 kmc/s	\$50

**RECORDING INSTRUMENTS**

BARNES DEV. CO: Type 4 Data Recorder	\$250
BRUSH ELECT: BL-262 with 2-chan BL-530	\$495
CONS. ELEC: 5-114P3, 18 Channels	\$350
SANBORN: 356-5480W, 6 Channel	\$975
Esterline Angus: Model AW, 5-0-5 Ma	\$95

**MISCELLANEOUS ITEMS**

BALLANTINE: 300E VTVM, 300uv to 300V, 2%	\$125
BECKMAN: 5914 In-Line, 4 Digit Readout	\$145
BECKMAN: 5630-37 Predetermined Counter	\$75
BEHLMAN: 161-C-2, 400 cy. 1PH. Power Source	\$295
BEHLMAN: 253-D-3F, 400 cy. 3PH. Power Source	\$395
BOONTON: Model 260A "Q" Meter	\$675
BRUEL & KJAER: 2603 Microphone Amplifier	\$395
DUMONT: 304H Oscilloscope, 5" CR tube	\$95
ELECTRO INSTS: DXM-031 Digital Clock	\$345
ELECTRO INSTS: A-12 DC Amplifier	\$165
ELECTRO PULSE: 2120A Pulse Generator	\$175
ELECTRO PULSE: 4120A Pulse Generator	\$95
ELECTRO SCIENTIFIC: 250DA Imped. Bridge	\$295
ELIN CO: DK-106R-13, 400 cy Prec. Osc	\$125
EMPIRE DEVICES: AT-106 MB Attenuator	\$145
FREEBORN: 1010-V Comparison Unit Bridge	\$125
GERTSCH: Model PT-IR Ratiofran	\$145
HARRISON: 700A Power Supply, 0-315V, 1.5A	\$165
HICKOCK: 1700 Laboratory Tube Analyzer	\$450
KINTEL: 301R DC Voltage Standard	\$395
KINTEL: 451 Digital Voltmeter System	\$750
KINTEL: 453 Scanner Programming Device	\$695
KROHN-HITE: 340A Servo Design Filter	\$85
PANORAMIC: LP-1 Sonic Analyzer	\$350
PANORAMIC: G-2 Sonic Response Indicator	\$125
SERVO CORP: Model 1100C Servo Analyzer	\$475
SORENSEN: Type 1000S AC Voltage Regulator	\$125
SORENSEN: FCD3P 1000-MI 400 cy Pwr. Source	\$795
STATHAM INSTS: TC-5B-2-3 Temp. Chamber	\$175

Write for complete listings. We buy your excess test equipment, or will trade.

**ELECTRONICRAFT, INC.**

P.O. BOX 13, BINGHAMTON, N.Y. 13902

Phone: 607-724-5785

**ELECTRONIC TUBES  
EQUIPMENT, COMPONENTS  
ONE OF A KIND SPECIALS**

YOU ARE CORDIALLY INVITED  
TO VISIT

**BARRY ELECTRONICS**

SEE THOUSANDS OF  
ELECTRONIC ITEMS.

A DREAM FOR PURCHASING AGENTS,  
ENGINEERS, HAMS, EXPERIMENTERS,  
ETC.

FROM THE COLISEUM, TAKE THE  
BROADWAY DOWNTOWN BUS TO  
SPRING STREET . . . OR TAKE  
THE SUBWAY (Independent Line to  
Broadway/Lafayette Station then  
walk 3 blocks downtown) Or, go  
with a few fellows and take a cab  
—(fare approx. \$1.30)

See you at

**Barry's**

512 BROADWAY—NYC

(between Spring and Broome Street).

WALKERS 5-7000. If you can't come,  
write for "Barry's Green Sheet"

CIRCLE 961 ON READER SERVICE CARD



## New Literature

**Mixer-preamplifiers.** RHG Electronics Laboratory Inc., 94 Milbar Blvd., Farmingdale, N.Y. Bulletin 1218 illustrates and describes a line of integrated microwave mixer-preamplifiers.

Circle 461 on reader service card

**Rtv silicone rubber compounds.** General Electric Co., Waterford, N.Y. A single-page selector guide, CDS-597, describes all the rtv silicone compounds giving applications and complete property listings. [462]

**Constant-voltage transformers.** Sola Electric Co., 1717 Busse Road, Elk Grove Village, Ill., has published a 12-page manual CV-225, containing engineering and design data on its constant-voltage transformers. [463]

**Multicomputer control.** Bailey Meter Co., Wickliffe, Ohio, 44092. A 20-page brochure entitled "Power Plant Automation" describes the company's 700 multi-computer control. [464]

**Bidirectional counter.** Atec, Inc., P.O. Box 19426, Houston, Tex., 77024. A catalog sheet describes the model 5AS06, a general-purpose reversing counter with a frequency range of 2 cps to 250 kc. [465]

**Plastic products.** Griffith Plastic Products Co., Nobex Division, 1027 California Drive, Burlingame, Calif., offers a catalog on thermoplastic control knobs and precision molded plastic parts for the electronic industry. [466]

**Test console components.** Theta Instrument Corp., Saddle Brook, N.J., 07663, announces publication of its 1965 catalog entitled "Dial Assemblies, Voltmeters and Phase Generators for Test Consoles." [467]

**Silicon solar cells.** Datasensors Inc., 318 Interstate Road, Addison, Ill., has released a four-page brochure illustrating a new line of silicon solar cells. [468]

**Wire and cable.** Continental Wire Corp., 322 North Cherry St., Wallingford, Conn., offers a catalog on switchboard and rheostat wire and cable for industrial and military use. [469]

**Centrifugal blowers.** Globe Industries, Inc., 1784 Stanley Ave., Dayton, Ohio, 45404. Bulletin C-1206 gives performance and dimensions of type LC and YC centrifugal blowers rated at 200 cfm and 85 cfm, respectively, at zero back pressure. [470]

**Broadcast tubes.** The Penta Laboratories, Inc., 312 N. Nopal St., Santa Barbara, Calif., 93102. A fact sheet describes nine power tubes ranging from 65 to 1,000 w plate dissipation, and

also includes information on beam pentodes suitable for use in the design of new broadcast equipment. [471]

**Tunnel mixers.** Aertech, 250 Polaris Ave., Mountain View, Calif. A technical data sheet illustrates and describes low l-o power and low i-f resistance tunnel mixers. [472]

**Cut-off attenuator.** PRD Electronics, Inc., 202 Tillary St., Brooklyn, N.Y., 11201, offers a two-page data sheet describing the model 1904 ultraprecision, 30-Mc cut-off attenuator. [473]

**Waveguide isolators.** Raytheon Co., 130 Second Ave., Waltham, Mass., has available a 12-page short-form catalog tabulating the principal specifications of 114 low and medium power waveguide isolators. [474]

**Miniature composition potentiometers.** Centralab, The Electronics Division of Globe-Union Inc., P.O. Box 591, Milwaukee, Wisc., 53201, has issued a new eight-page catalog on miniature composition potentiometers. [475]

**Bonding equipment.** General Electric Co., Schenectady 5, N.Y. A four-page bulletin, GED-4975A, details features of the Square Pulse bonder for uniform surface bonding of leads to microminiature circuitry. [476]

**Power supplies.** Technipower Inc., a subsidiary of Benrus Watch Co., Inc., 18 Marshall St., South Norwalk, Conn. Catalog No. 651 lists nine new product lines, and consists of 76 models of laboratory and systems power supplies, and over 3,700 models of modular power supplies for a-c/d-c, d-c/d-c and d-c/a-c operation. [477]

**Semiconductor materials.** Dow Corning Corp., Hemlock, Mich., 48626, has available data sheets describing boron polycrystalline rods and powder, single crystal tellurium, and single crystal gallium arsenide. [478]

**Battery products.** Sonotone Corp., Elmsford, N.Y., has released a new product facility brochure on the history and capability of its rechargeable nickel-cadmium batteries. [479]

**Vlf receiver/comparator.** Electronic Engineering Co. of California, 1601 E. Chestnut Ave., Santa Ana, Calif. An eight-page brochure describes model 880A, a new electronic servo vlf receiver/comparator. [480]

**D-c amplifiers.** Taber Instrument Corp., 107 Goundry St., N. Tonawanda, N.Y., 14120. Bulletin P-64215 presents the new Teledyne series 215 differential/single-ended d-c amplifiers. [481]

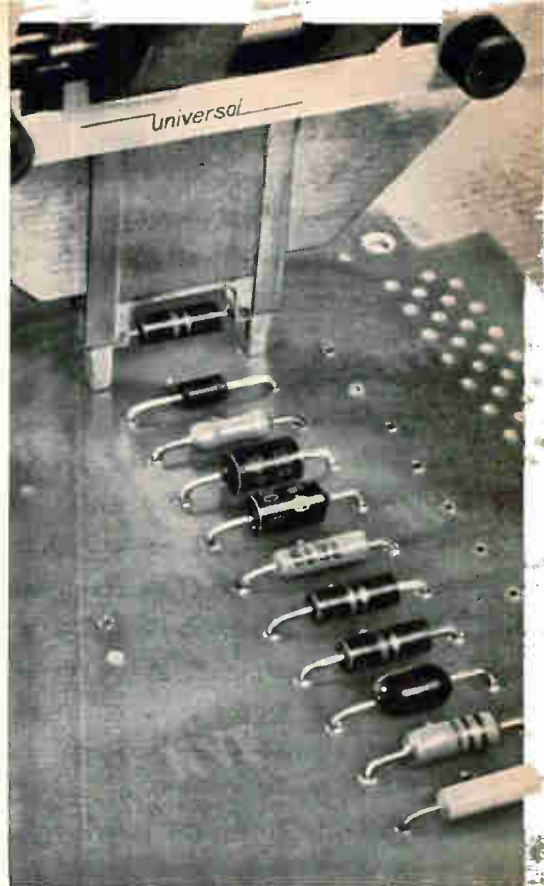

# 4000

printed circuit board  
insertions per hour  
from one head

Universal's new numerically controlled Model 6010 Insertion Machine inserts 4,000+ axial lead components an hour at lowest initial cost, lowest operating cost, and with reduced rejects and customer proven reliability. Even inserts sequenced axial lead components of varying physical size. Insertion heads to handle micro miniature diodes and transistors are also available.

Send for complete  
technical information.

See It  
Demonstrated At  
NY-IEEE Show  
Booth 1900



# Universal

INSTRUMENTS CORPORATION

139 E. Frederick St., Binghamton, N. Y.

607-722-1244 • TWX: 607-772-0243

# A FULL OCTAVE SWEEP WIDTH



## TELONIC OFFERS THE VR-50M . . . THE FIRST SOLID STATE SWEEP GENERATOR TO COVER A FULL OCTAVE

The Telonic VR-50M is the first solid state plug-in head sweep generator to cover a full octave of sweep width without a BWO or heterodyned output. It operates over the frequency range of 500 to 1000 mc, and can be swept manually at variable rates from 1 c.p.s. to 100 c.p.s. It is provided as a plug-in head for the SM-2000 control chassis. With this important new design, you get high reliability, low maintenance cost and infinite marking capability.

Still another plus feature—ECONOMY! The VR-50M equals the performance of BWO sweep generators at half the cost, and maintenance is minimal. For example, the VR-50M's unique oscillator design employs inexpensive but extremely reliable transistors. Other sweep generators which are capable of sweeping frequencies in this range employ expensive ceramic tubes, voltage tuned magnetrons, or backward wave oscillators, therefore resulting in high maintenance costs. Contact your Telonic representative today for complete information on the VR-50M.



**60 North First Avenue, BEECH GROVE, INDIANA**  
Phone (317) State 7-3231/TWX 317-635-4748

DOMESTIC SALES OFFICES: Baltimore, Boston, Chicago, Cleveland, Dallas, Dayton, Denver, Huntsville, Indianapolis, Los Angeles, New York City, Orlando, Philadelphia, San Francisco, Seattle, St. Louis, Syracuse • OVERSEAS SALES OFFICES EUROPEAN: Vienna, Austria; Brussels, Belgium; Humlebaek, Denmark; London, England; Paris, France; Helsinki, Finland; Gennep, Holland; Milan, Italy; Oslo, Norway; Madrid, Spain; Barcelona, Spain; Motala, Sweden; Onex-Geneva, Switzerland; Munich, W. Germany • OTHER: Buenos Aires, Argentina; Sao Paulo, Brazil; Montevideo, Uruguay; Sydney, Australia; Auckland, New Zealand; Wellington, New Zealand; Tel-Aviv, Israel; Bombay, India; Manila, Philippines; Tokyo, Japan; Osaka, Japan.

TELONIC—INTERNATIONAL LEADER IN FREQUENCY MEASUREMENT



# Electronics Abroad

Volume 38  
Number 6

## Great Britain

### Correcting tv color

On the eve of Wednesday's international color-television meeting in Vienna [see p. 97], British scientists have rectified one disadvantage in the United States' NTSC system—its susceptibility to color distortion when transmitted long distances over Europe's microwave network.

A color corrector, developed at the Post Office Research Station, has been demonstrated successfully between London and Brussels, London and Rome, and more recently in Moscow using a 3,750-mile distribution link.

**Backing U. S.** Encouraged by the improvement contributed by the color corrector, Britain's Postmaster General has swung his country more solidly behind NTSC. The U. S. system is vying with two European methods—France's Secam and West Germany's PAL—at a meeting of the International Radio Consultative Committee (CCIR) of the International Telecommunications Union. Any color system recommended by CCIR is likely to be adopted for most of Europe.

A spokesman for the British Broadcasting Corp. is more specific. "With this innovation," he says, "we believe NTSC to be superior to the other systems on technical grounds. Fringe-area reception is better than with Secam, and the receiver is simpler and cheaper than both Secam's and PAL's."

George H. Brown, vice president of research and engineering at the Radio Corp. of America, says Soviet scientists "could not help but be favorably impressed" by the superiority of the NTSC picture over a "noisy" Secam version in the long-distance tests. The color corrector is unnecessary in the U. S., he adds, because of the Bell

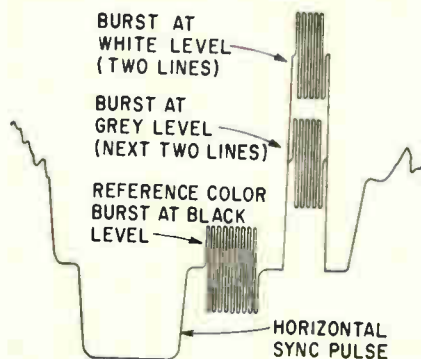

Short subcarrier bursts, alternately at white and grey levels, are added during horizontal blanking period in British technique for correcting distortion introduced in long-distance color transmission of NTSC signals.

System's high-quality, broad-band microwave links. RCA has been NTSC's strongest advocate in Europe.

**Why distortion.** To understand the principle of the color corrector, consider the cause of distortion. The color subcarrier rides on the luminance signal which may be at a black level, a white level or at any grey level. The subcarrier's amplitude determines color saturation; its phase, relative to that of the reference burst transmitted during the blanking period, determines color hue.

Theoretically, if the broadcast equipment shifts the phase of the subcarrier, it shifts the phase of the reference burst by the same amount, so there is no hue distortion. Likewise, any attenuation of the subcarrier's amplitude results in a corresponding attenuation of the burst, so that no color is desaturated more than another. However, in broadcast equipment that is not completely linear, the phase of the burst transmitted at the black level does not shift the same amount as the subcarrier at a white or grey level. This is known as differential phase distortion. Similarly, in differential gain dis-

tortion the subcarrier's amplitude is changed by different amounts at the black, grey and white levels.

**The remedy.** These distortions are usually small and imperceptible; however, in long studio-to-transmitter links involving dozens of microwave relays, cumulative distortions may render the picture objectionable.

In the British technique to correct this distortion, a short burst of subcarrier is added to the signal after the reference burst on the back porch of the horizontal blanking period. But where the reference burst is at the black level, the additional short burst alternates position every two lines between a white level and a grey level (50% of maximum white). This is shown in the figure on this page.

At the color corrector, a circuit compares the phase and amplitude of the reference burst with those of the white burst then with the grey. The circuit then generates difference signals, which correspond to the distortions at the white and grey levels. These signals are applied in a feed-back circuit to a distortion corrector. It is assumed that the distortion is a smooth parabolic curve so that, with distortion known at the three levels—reference black, white and grey—all levels can be corrected by interpolation.

The white and grey bursts are added to the video signal at the studio; they are removed after color correction in the last tv distribution link before broadcast. If the bursts at white and grey were not removed, they would appear on the screen during the retrace periods. Hence, this technique cannot be used in its present form to remove distortion that is introduced between the transmitter and the receiver.

The color-correction circuitry was developed by I.G. MacDiarmid of the Post Office Research Station, in conjunction with the BBC design department. The technique was

suggested by N. W. Lewis, director of research at the research station.

### Tonic for computer firms

Britain's beleaguered computer industry received a dose of government encouragement this month and its confidence chart turned upward sharply.

Frank Cousins, the minister for technology, announced plans to establish the world's first nationwide public library of computer programs. He also pledged more government-sponsored research into computer techniques and development of hardware.

The program also calls for a five-year plan for acquiring computers for universities and research institutions, and for creating a panel within the ministry to give information about computers to potential users who operate with public funds. The adequacy of existing computer facilities in universities has been criticized.

**Jubilation.** In a gratified computer industry, the most jubilant member is International Computers and Tabulators, Ltd. The company has received a \$15-million, interest-free loan toward further development of its modular KCT 1900 system, a direct competitor of the Series 360 offered by the International Business Machines Corp.

ICT will put up \$45 million more for this research by 1970.

British computer makers have been the target of stiff competition recently from IBM and Honeywell, Inc., two United States concerns.

**Breakthrough.** The most dramatic step could be the program library. "If the center develops converter programs to sort out the incompatibilities among British machines," says one industry official, "this could start a real breakthrough."

Details about the program center are still skimpy. It is known, however, that Cousins envisions the purchase of existing programs and the commissioning of new ones for use with British computers. The

center would be operated jointly by industry and government.

**A first.** The idea of a nationwide library of computer programs is not new, but no main country has one yet. The nearest thing to it is a worldwide network operated by IBM for its customers.

Formed 10 years ago, the IBM library contains about 2,300 programs available on cards, punched paper tape, magnetic tape and direct-access diskpacks. Several computers are used to keep track of the programs, which are loaned from IBM libraries in White Plains, N. Y.; Toronto, Canada; Tokyo; Sydney, Australia; and Caracas, Venezuela. The Caracas library is being moved to Buenos Aires.

The programs are supplied by IBM customers and by IBM employees who have helped to set up procedures. However, a customer can keep a program secret if he's worried about its finding its way into a competitor's data processor.

### Millimeter-wave laser

A laser that operates far into the infrared region with peak power of 10 watts has been developed at the National Physical Laboratory in Teddington.

The device, designed by H. A. Gebbie, puts out one milliwatt average power at a wavelength of 0.337 milliwatts. Vernon Fowler, a laser expert at the General Telephone and Electronics Corp. laboratories in Bayside, N. Y., notes that the British device produces frequencies "an order of magnitude above present millimeter sources. The best you can do with comparable power is 100 Gc; this one is 1,000 Gc," he explains.

The British laser is continuously pumped. Fowler says this is the first time, to his knowledge, that this has been accomplished at such a high frequency.

**Done with mirrors.** In its experimental form, the device consists of a simple glass tube about one meter long and 10 centimeters wide. At each end of the tube are plain glass mirrors, each with an

aluminized coating. One mirror is of smaller diameter than the glass end plate of the tube; this end emits the electric spark.

Acetonitrile vapor is pumped continuously through the tube, and a high-voltage, high-energy pulse is applied to electrodes near each end of the tube. This pulse causes the discharge between the electrodes and results in a breakdown of the acetonitrile vapor.

One mirror is adjustable so that the path length within the tube can be made a multiple of the output wavelength, creating a resonant cavity. The repetition rate is 10 pulses a second, with pulse length of 2 to 3 microseconds. Some runs have been made with pulse rates up to 40 a second. Output is a single frequency with a line width so small that it's difficult to measure.

**Other frequencies.** Output frequency depends solely on the type of gas injected into the tube. Experiments are under way to test other vapors for emissions at different wavelengths.

The device is expected to be used in machine shops, for distance measurements. The wavelength of a unit for this purpose is 0.013 inches. Some form of interferometer could be used to count wavelengths traversed.

---

## Czechoslovakia

---

### One-piece networks

Monolithic resistor-capacitor networks are reported to be in pilot production in Czechoslovakia.

The devices, said to be only a few millimeters long, have been developed at the A. S. Popov Research Institute of Radio Communications in Prague. R. Wasyluk, a scientist at the institute, says the one-piece networks are as easy to manufacture as disk capacitors, and much less expensive than conventional RC networks made with resistors and capacitors.

According to Tibor Vasko, scien-



tific attache of the Czech Embassy in Washington, the Czechs plan to use the devices in radio and television sets. He did not say when this might be done.

**Inductances too.** The networks are made of high-loss dielectrics such as semiconductors, oxides, niobates, tungstates and ferrites. The dielectrics' properties are modified by doping and diffusion. Grain size and oxygen content are altered by firing and other processes.

In a paper by Wasyluk that Vasko read for him at the International Solid-State Circuits Conference in Philadelphia last month, it was said that devices could be made with capacitances of 10 picofarads to 3 microfarads and with resistances of 1 ohm to 10 megohms. Wasyluk said networks with inductances also could be made. Subsystems could be built up, he added, by sticking the devices and dipping the resulting block into molten solder.

He said that field-effect devices should be suitable as the active devices in such assemblies.

---

## West Germany

### Satellites for Bonn

West Germany, until now an exporter of space experts, is about to put its talent to use at home. The Bonn government plans to have its first space satellite early in 1967. It is already conducting informal negotiations with the United States' National Aeronautics and Space Administration, which would launch the satellites.

The first satellite project, labeled 625-A, would consist of two sets of experiments in space. Ultimately, NASA would launch a third vehicle for Germany. As with proposed British, Canadian and Italian satellites, the U. S. agency would also provide tracking and other ground facilities. In return, the Germans would supply data from the experiments, primarily on radiation.

**Role for U. S. firms.** American



Model of German satellite in laboratory

companies have stakes in the \$12-million German program. Three German aerospace concerns have prepared proposals for the satellite; all are believed to have agreements with companies in the U. S.

Boelkow GmbH works closely with the Boeing Co. The other two candidates for Bonn's satellite business are Dornier Systems and Development Group North, a joint venture of Vereinigte Flugtechnische Werke GmbH (VFW) and Hamburger Flugzeugbau GmbH.

The Boelkow design calls for a 154.3-pound cylindrical vehicle, 29.5 inches in diameter and 15.75 inches high; the payload would weigh 44 pounds.

**Eccentric orbit.** The satellite would be spin-stabilized on a spin axis accurate to  $\pm 1^\circ$  in relation to the sun. But because an eccentric orbit is planned—with apogee of 17,400 miles and perigee of 143 miles—several passive stabilization methods would also be utilized.

To regulate the 120-rpm spin rate, and to reorient the satellite after unexpected disturbances, a double system of gas jets similar to that used in the Syncom satellite would be included. Spin regulation and reorientation signals for the gas jets would be initiated by a solar sensor system, also in duplicate.

**500 bits a second.** The one-watt transmitter has a planned frequency of 136 megacycles. A reserve transmitter can be switched in automatically if the first should

fail. On the basis of storage capacity and pickup duration, the information flow during the transmitting period should be about 500 bits a second. This corresponds to a high-frequency bandwidth of about seven kilocycles, since frequency modulation is to be used for the main carrier.

Commands would be transmitted through a longitudinally modulated audio frequency, modulated on a 120-Mc carrier frequency. The system is designed to transmit 40 eight-bit commands. To increase the reliability of command transmission, parallel redundancy is to be used for both the decoder and the receiver.

Antennas would be laid out in crossed dipole form, allowing uninterrupted communication independent of the satellite's position. A diplexer would make it possible to receive at 120 Mc simultaneously with transmit at 136 Mc.

---

## France

### Components show

When the gates of the Parc des Expositions are thrown open April 8, visitors from all over the world will see Europe's biggest electronics show and the latest components offered by about 800 manufacturers.

The six-day International Electronic Components Show is expected to have 120,000 visitors, up from 100,000 last year; 30,000 are expected from abroad, compared with 18,000 in 1964. These estimates come from Robert Foucault, the show's general commissioner.

On April 5, three days before the exhibition hall is opened, presentation of 80 technical papers will begin at symposiums on components and memory systems. Attendance at each symposium will be limited to 1,000 a day for six days.

**Hybrid subsystems.** Companies have been reluctant to discuss their exhibits before the show; least reticent have been the British. Fer-

**PORTABLE LONG-TERM  
RECORDER HAS  
REAL-TIME PLAYBACK**



Model 17373  
LT/FM\*  
Recorder/  
Reproducer

Weighing only 35 pounds, Geotech's Model 17373 Recorder/Reproducer provides highest quality recording for laboratory or field applications. This suitcase-size LT/FM\* unit records 7 channels of low-frequency data on a 14" reel of 1/2" tape continuously for 10 days. Operating speed is IRIG-standard 15/160 ips.

Real-time playback at ultra-slow speeds, an LT/FM exclusive advantage, permits monitoring while recording and makes possible exact signal reproduction. Dynamic range equal to that obtained in audio frequencies is produced by this unique flux-responsive playback system. Because drift compensation is not required, all channels are available for recording on a full-time basis.

All electronics are solid state. Power requirements: 24 volts dc, center tapped; ac optional.

PRICE: \$8,750, FOB Dallas.

**SPECIFICATIONS**

Model	17373
(1) Tape Speed	15/160 ips
Channels	7
FM Data Frequency Range	dc-17 cps
FM Center Frequency	84.4 cps
Recording Time	10 days
(2) Playback Channels	1
(3) Dynamic Range	40 db
(4) Power Consumption	9 watts

- (1) Speeds from .03 through 0.1 ips available on special order.
- (2) Switchable to any recorded channel.
- (3) RMS basis, without compensation.
- (4) 7 channel record, 9 watts; 7 channel record and 1 channel playback, 12 watts.

\* Long-Term/Frequency Modulation

**THE GEOTECHNICAL CORPORATION**

DEPT. 45 • BOX 28277  
DALLAS, TEXAS 75228  
PHONE 214 • BR 8-8102



"Geotech Serves  
the Sciences"

ranti, Ltd., says it will show its new concept in hybrid subsystems, called Multilin.

Standard Telephones and Cables, Ltd., a British subsidiary of the International Telephone and Telegraph Corp., reportedly will introduce a range of transistors and chip circuits. STC is known to be changing its production line at Foot's Cray, Kent, to use a manufacturing process developed by the Fairchild Camera and Instrument Corp. in the United States.

Another British concern, the Obund Electronics Co., will show precision oscilloscopes. One model, the RO-55, designed for single- or multiple-trace work, has a rise time of only 21 microseconds and bandwidth of 16 megacycles, the company says. Another model offers 160-nanosecond signal delays and rise time of 10 nanoseconds; its bandwidth is 32 megacycles.

**From France.** La Radiotechnique, a French subsidiary of Philips Gloeilampenfabrieken N. V. of the Netherlands, will offer a line of photomultipliers. It includes the 56-TVP tube that the French observatory at St. Michel used in January to measure the distance (over 900 miles) to the U. S. satellite Explorer 22. Using a laser beam, the observatory measured the distance precisely to 8.7 yards.

La Radiotechnique also will show a silicon npn planar-epitaxial transistor, type 84-BF, for use as an amplifier in the vhf stages of a television set. At 200 Mc the device has a 17-decibel gain and a noise figure less than 5 decibels.

**Crackdown**

At the "suggestion" of President de Gaulle, the Sperry Rand Corp. has sold its control of a French electronics concern, Société de Fabrication de Instruments de Mesure (SFIM).

Sperry's 47% ownership gave the United States company control of the French concern because the remaining shares were spread among many stockholders. This control was distasteful to Paris officials because most of SFIM's \$9 million annual business comes from mili-

tary contracts. The company makes airborne equipment including automatic pilots and radar sets.

**Bankers in control.** Sperry sold 20% of SFIM's shares to the Rivaud group, a French banking house, for a reported \$600,000. Rivaud now is said to exercise control of SFIM. Sperry retains a big interest, however; besides its 27% ownership, the U. S. company owns many licenses under which SFIM operates.

The government crackdown, backed by an implicit threat of withdrawing contracts, seems to conflict with other recent actions. One of these is government approval of plans for a Fairchild Camera and Instrument Corp. factory in Rennes, Brittany, near the Armanents Ministry's proposed electronics laboratory. Fairchild will make transistors and integrated circuits, many for military use.

**Japan**

**Fast printer**

It would take a good typist more than 10 minutes to copy this page. A new computer printer, developed by Hitachi, Ltd., is said to print in one minute enough characters to fill 100 pages.

The electrostatic printout device writes up to 6,000 lines per minute, with up to 128 characters to the line, Hitachi says. It will be commercially available late this year. The price has not yet been decided.

The closest counterparts in the United States appear to be IBM's 1403 series of impact printers that, according to the International Business Machines Corp., range from 600 to 1,400 lines a minute, and the electrostatic SC 4020, a 3,600-line-a-minute printer made by the Stromberg Carlson division of the General Dynamics Corp.

**128 alphabets.** The Hitachi printer employs a printing drum, carrying 128 alphabets of 128 characters each and rotating at 3,000 readouts a minute opposite a row of electrodes. Each alphabet, actu-



ally two 64-character alphabets around a circumference of the drum, prints one position in a line.

The electrodes are pulsed by a control system that determines which characters will be printed in the line. Paper passes between the electrodes and the printing drum; it slides over the hard, wear-resistant electrodes but does not come into contact with the drum.

During a half-revolution of the drum, the paper moves about one-sixth of an inch, or the height of a single line of print.

When the character to be printed reaches the proper position, a 3-microsecond 1,000-volt pulse is generated at the electrode; this causes the paper to become electrically charged. The paper holds the charge long enough to attract a toner—a dark powder—that is then bonded firmly to the paper by heating. After the letters and numbers are printed, a cut mark is also printed electrostatically. As the printed paper leaves the machine, the cut mark is sensed photoelectrically, and the paper is cut into single sheets and stacked.

### Around the world

**Hong Kong.** The International Telephone and Telegraph Corp. plans to manufacture transistor radios in Hong Kong late this year. G. L. Warner, president of Far East, Ltd., an ITT affiliate, says the sets will be for export to the United States and Europe.

**Canada.** While many countries fret about inroads by United States electronics companies, a new Canadian concern is competing for business in Washington, London, Paris and Bonn. The two-year-old firm Simtec, Ltd., makes silicon lithium-drift detectors of nuclear particles—alpha, beta and gamma rays.

Its founder is Sidney Wagner, former research director at the RCA Victor Co., a Montreal subsidiary of the Radio Corp. of America, which also makes particle detectors. Customers include the U. S. Navy and the National Aeronautics and Space Administration.

## High Reliability STYROFLEX® Capacitor Film

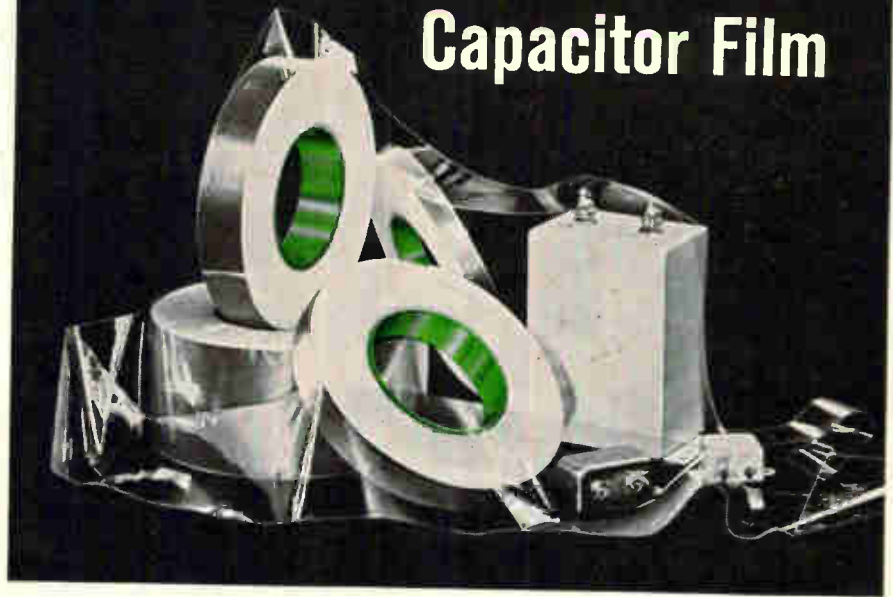

- Controlled Orientation
- Ultra High Purity
- Greater Dielectric Reliability
- Far Greater Yields
- Reduced Manufacturing Costs

Now you can manufacture close tolerance capacitance units with greatly improved yields. For new techniques permit more accurate measurement and closer control of the degree of orientation imparted to Styroflex capacitor film. In addition, as a result of highly improved raw material selection techniques, Styroflex gives capacitors truly exceptional insulation resistance values. These improvements plus continued exacting quality control procedures and the use of the latest radioactive thickness gauges produce an improved product in all respects. You will find Styroflex film is easier to use and gives you a better product at substantially lower manufacturing costs. Styroflex® is available in thicknesses from 0.00025" to 0.006" and widths from 1/2" to 10".



**Natvar CORPORATION**

201 Randolph Avenue, Woodbridge, New Jersey 07095

Tel.: 201 388-8800 • TWX: 201-381-8056

Cable Address: Natvar, Rahway, New Jersey

Circle 212 on reader service card

### NEWELL LABORATORIES, inc.

introduces the

#### MILLIMINIATURE CRYSTAL CONTROLLED OSCILLATOR

without ovens

POWER DRAIN: 75 MW

1 × 1 × 1/3 = 1/3 cu. in. 30 MC to 125 MC

1 × 1 × 1/2 = 1/2 cu. in. 3 MC to 30 MC

10 parts per million from -55° to +125°C

2 parts per million from -40° to +70°C



ACTUAL SIZE

FOR THE SOLUTION OF YOUR OSCILLATOR PROBLEMS CONTACT:

**NEWELL LABORATORIES, INC.**

ELDRIDGE (DAVENPORT), IOWA 52748  
TELEPHONE 319/285-4452

# NEW!

## Type "V" Miniature Air Variable Capacitors

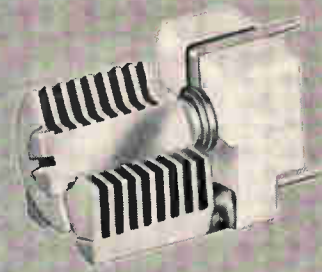

Available in Printed Circuit  
and Panel Mount types

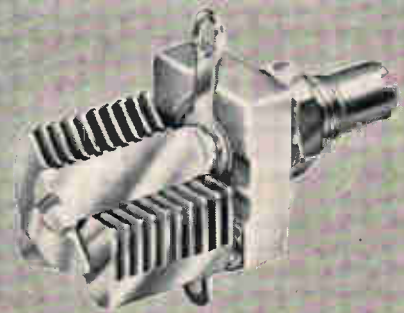
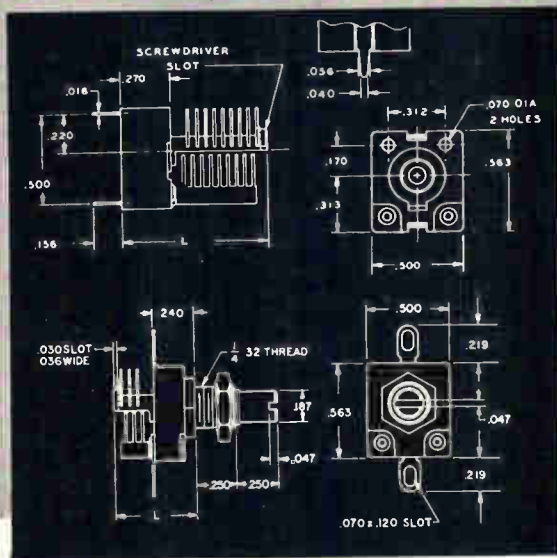

## Precision machined for outstanding uniformity and electrical stability—low in cost!

The Type "V" Miniature delivers more capacity in less space — occupies less than 0.3 square inch for printed board or panel mounting. Rotors and stators are precision machined from one piece of solid brass — unique construction gives you high reliability and outstanding mechanical stability at modest cost! Series offers high "Q" (more than 1500 at 1 Mc.) . . . low temperature coefficient (plus  $50 \pm 20$  PPM/°C) . . . and exceptionally uniform delta C and voltage characteristics. All metal parts silver-plated — ceramic is steatite grade L-423 or better. Voltage breakdown ratings to 650 Volts DC. Provides absolute freedom from moisture entrapment found in trimmers of the enclosed or solid dielectric type. Slotted rotor or shaft extension accommodates screwdriver or alignment tool for convenient adjustment.

### Sub-Miniature Panel Mount "U" Variables and "U-LC" Tuners!

**TYPE "U"** Slightly smaller in size than the Type "V". Replaces costly glass piston capacitors — offers high reliability and excellent mechanical stability at a fraction of the cost.



**"U-LC" TUNER** Combines precision machined "U" capacitor with air-wound silver-plated inductor. Low cost, compact, tuneable "L-C" circuit with excellent "Q" and temperature stability.



**WRITE FOR CATALOG 984!**  
Complete specification and  
prices on all Johnson electronic  
components.



**E. F. JOHNSON COMPANY**

3008 Tenth Ave. S.W. • Waseca, Minnesota 56093



# Electronics advertisers

March 22, 1965



■ AMP Incorporated Garceau, Hargrave & McCullough Inc.	109	■ Electro Motive Mfg. Co. Inc., The Cory Snow Inc.	129	Machlett Laboratories Inc. The Fuller & Smith & Ross Inc.	9
■ Acme Electric Corporation Scheel Adv. Agency	130	Electro Scientific Industries Nadler & Larimer Inc.	137	Mallory & Company, Inc. P.R. The Aitkin-Kynett Company	119, 159
Air Express Div. of REA Express Ketchum, MacLeod & Grove Inc.	57	Electronic Fittings & Components Div. of Curtiss Wright Corp. Ray Ellis Advertising Inc.	169	Manson Laboratories Ted Peck Inc.	154
Amperite Company H. J. Gold Company	128	Engehard Industries Inc. Keyes, Martin & Company	148, 149	McDonnell Electronic Equipment Division John Patrick Starrs Inc.	27
■ Amphenol-Borg Electronics Corp. Connector Division Marsteller Inc.	66, 67	Estertine Angus Instrument Company Inc.	68	McGraw-Hill Book Company Inc.	176, 190
■ Andrew Corporation The Fensholt Advertising Agency	116	Caldwell, Larkin & Sidener Van Riper Inc.		Mechatrol, A Div. of Teledyne Inc. Lewis, Hunt & Harland Associates	8
				Microdot Inc. Jones, Maher, Roberts Adv.	134
Barber-Colman Company Howard H. Monk Associates Inc.	172	Fairchild Controls Dunwoodie Associates Inc.	147	Motorola Inc. Military Electronics Div. Charles Bowes Advertising Inc.	60, 61
Bausch & Lomb Inc. Wolff Associates Inc.	142	Fairchild Dumont Laboratories The Poner & Wilbur Co. Inc.	170	■ Mullard Ltd. Marsteller Inc.	174
Beckman Instrument Inc. Berkeley Division Erwin Wasey, Ruthrauff & Ryan Inc.	127	Fluke Mfg. Co. Inc. John Bonfield Associates Inc.	11		
Beckman Instrument Inc. Offner Division Erwin Wasey, Ruthrauff & Ryan Inc.	145	Flying Tiger Line Cole Fischer Rogow Inc.	42	Natvar Corporation The Sanger-Funnell Inc.	187
■ Bendix Corporation, Montrose Division MacManus, John & Adams Inc.	136	General Applied Science Laboratories Inc. Samuel H. Goldstein Advertising	171	Newell Laboratories Communications Incorporated	187
Bendix Corporation, Scintilla Division MacManus, John & Adams Inc.	32	General Radio Company K.E. Moranq Company	2nd Cover	New Hermes Engraving Machine Corporation Doner-Harrison Inc. Advertising	150
■ Brush Instruments, Div. of Clevite Corp. Carr Liggett Adv. Inc.	3rd Cover	Genisco Technology Corporation Getz and Sandborg Inc.	162	North Atlantic Industries Inc. Murray Heyert Associates	39
Buchanan Electrical Products Corp. Keyes, Martin Company	53	Geotechnical Corporation Evans, Young & Wyatt Adv.	186		
Burroughs Corporation Conti Advertising Inc.	135	■ Globe Industries Inc. Odiorne Industrial Adv. Inc.	151	Patwin Electronics Company Graceman Advertising Inc.	154
■ Bussmann Mfg. Co. Div. of McGraw-Edison Co. Henderson Advertising Company	132, 133	Gudebrod Bros. Silk Co. Inc. Lee Ramsdell & Co. Inc.	30, 31	Peerless Instrument Co. Inc. Mark Snyder Incorporated	168
				Pennsylvania Fluorocarbon Company Ernest William Greenfield, Inc.	172
Cambridge Thermionic Corporation Chirurg & Cairns Inc.	112	Heinemann Electric Company Thomas R. Sundheim Inc.	123	Philco Corporation Lansdale Division Batten, Barton, Durstine & Osborn Inc.	158
Ceramics International Conti Advertising Agency	131	■ Hewlett-Packard Company Lennen & Newell Inc.	2, 54, 55	Polaroid Corporation Doyle, Dane, Bernbach Inc.	165
Chrono-Log Corp. Albano Advertising	162	Hewlett-Packard Company, Moseley Division Lennen & Newell Inc.	1		
Cinch-Graphik Div. of United Carr Reach, McClinton & Company	155	Hitachi Ltd. Dentsu Advertising Inc.	173	■ Radiation Inc. G.M. Basford Company	110, 111
Cleveland Institute of Electronics Carr Liggett Advertising Inc.	172	Hughes Aircraft Company Foote, Cone & Belding Inc.	161	Radio Corporation of America Al Paul Lefton Company	125, 4th Cover
■ Clifton Precision Products Co. div. of Litton Industries Ivey Adv. Inc.	16			Radio Engineering Laboratories Arthur Falconer Associates Corp.	115
■ Coil Winding Equipment Company J. J. Coppo Company Inc.	163	■ IBM Corp. Industrial Products Div. Marsteller Inc.	153	Radio Switch Corporation George Homer Martin Associates	146
Cominco Products Inc. McKim Productions Limited	162	Industrial Transformer Corp. International Resistance Company Arndt, Preston, Chapin, Lamb & Keen Inc.	175 138	Raytheon Company, Industrial Components Div. Fuller & Smith & Ross Inc.	52
Consolidated Electrodynamics Corporation Hixson & Jorgensen Inc.	50, 124	ITT Components Group, Electronic Tube Division West, Weir & Bartel Inc.	43 to 46		
Controls Company of America The Harry P. Bridge Company	140, 141			Sangamo Electric Company Winius-Brandon Company	143
		■ JFD Electronics Corporation Michel Cather Inc.	157	Schober Organ Corporation J.B. Rundte Incorporated	170
Daven, Div. of McGraw-Edison Keyes, Martin & Company	114	■ Jennings Radio Manufacturing Corp. L.H. Waldron Advertising	152	Servo Corporation Snow & Depew Advertising	156
Defense Electronics Inc. GLM Associates Inc.	65	Jerrold Electronics Corp. Irving Gould Advertising Inc.	10	■ Siemens American Inc. Mann-Wesley Inc. Advertising	171
■ Delco Radio Division of General Motors Corporation Campbell-Ewald Company	59	Johnson Company, E.F. Firestone Advertising Inc.	188	Sigma Instruments Inc., The McCann-Marschalk Company Inc.	48, 49
Di-Acro Corporation Charles E. Brown Adv.	40			■ Signalite Incorporated Armand Richards Advertising Agency	41
■ Digital Equipment Corporation The Rumrill Company Inc.	28	LEL Division of Varian Associates Snow & Depew Advertising	160, 161	Silicon Transistor Corporation A.D. Adams Advertising Inc.	29
DuPont de Nemours & Co. Inc. E.I. Batten, Barton, Durstine & Osborn Inc.	47, 120	■ Lambda Electronics Corporation Michel Cather Inc.	37	Sorensen Inc. Fuller & Smith & Ross Inc.	113
		Ledex Inc. Yeck and Yeck	144	Spectrol Electronics Corporation Bonfield Associates Inc.	117
Eastman Kodak Company The Rumrill Company Inc.	58	Lepel High Frequency Laboratories Inc. Apex Graphic Company	164	Speer Carbon Company Hazard Advertising Company	56
■ Electro Instruments Inc. Teawell Inc. Advertising	118	Lockheed Missiles & Space Company Hal Stebbins Inc.	173	Sprague Electric Company The Harry P. Bridge Company	5, 6

Executive, editorial, circulation and advertising offices: McGraw-Hill Building, 330 West 42nd Street, New York, N.Y., 10036. Telephone Area Code 212-971-3333. Teletype TWX N.Y. 212-640-4646. Cable: McGraw-Hill, N.Y. Officers of the Publications Division: Shelton Fisher, President; Vice Presidents: Joseph H. Allen, Operations; Robert F. Beger, Administration; John R. Callahan, Editorial; Ervin E. DeGraff, Circulation; Donald C. McGraw, Jr., Advertising Sales; Angelo R. Venezian, Marketing. Officers of the Corporation: Donald C. McGraw, President; Hugh J. Kelly, Harry L. Waudell, L. Keith Goddard, Executive Vice Presidents; John L. McGraw, Treasurer; John J. Cooke, Vice President and Secretary. Title R registered U.S. Patent Office; © copyright 1964 by McGraw-Hill, Inc. All rights reserved, including the right to reproduce the contents of this publication, in whole or in part.

# FIELD-EFFECT TRANSISTORS

By Leonce J. Sevin, Jr.  
Senior Engineer  
Texas Instruments Incorporated

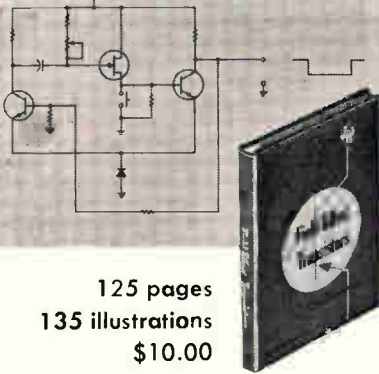

125 pages  
135 illustrations  
\$10.00

TEXAS INSTRUMENTS ELECTRONICS SERIES

This book fully explains the theory, characterization, and application of field-effect transistors. The presentation of physical theory is based on Maxwell's equations applied to the motion of charged particles in a semi-conductor. From this theory a lumped linear model or equivalent circuit is developed and used to describe the electrical interaction of the device and its electrical environment. The book describes in detail the physical behavior of field-effect transistors . . . electrical characteristics of field effects important in circuit applications . . . FET in low level linear, non-linear, and power circuits . . . unipolar and MOS FET's applied to integrated circuits . . . and much, much more.

BUY THIS BOOK AT YOUR BOOKSTORE  
OR MAIL THIS COUPON

McGraw-Hill Book Co., Dept. 23-L-322  
330 West 42 Street, New York, N.Y. 10036

Send me Sevin's FIELD-EFFECT TRANSISTORS for 10 days on approval. In 10 days I will remit \$10.00 plus a few cents for delivery costs, or return book postpaid. SAVE MONEY: We pay delivery costs if you remit with coupon; same examination and return privilege.

NAME (print) \_\_\_\_\_

ADDRESS \_\_\_\_\_

CITY \_\_\_\_\_

STATE \_\_\_\_\_ ZIP CODE \_\_\_\_\_

For price outside U.S., write McGraw-Hill Int'l., N.Y. 10036 23-L-322

## Electronics advertisers

March 22, 1965



■ Stevens-Arnold Inc. Meissner & Company Inc. Sylvania Electric Products Inc. Kudner Agency Inc.	166 19 to 26
■ Telonic Engineering Company Jansen Associates Telonic Industries Inc. Burton Browne Advertising Texas Instruments Incorporated Industrial Products Group Robinson-Gerrard Inc.	167 182 7
TEXAS INSTRUMENTS INCORPORATED Semiconductor-Components Division Don L. Baxter Inc.	12, 13
■ Trylon Inc. George Moll Adv. Inc.	163
Ultra Carbon Corporation Church & Guisewite Advertising Inc.	38
Union Carbide Electronics Hal Lawrence Incorporated Unitrode Corporation Chirurg & Cairns Inc.	62 51
■ Universal Instruments Corporation Caroe Marketing Inc.	181
Vector Electronic Company Inc. Van Der Boom, McCarron Inc.	146
Welch Relay Company M.R. Crossman Company Winston Research Corp. Sub. of Fairchild Jordan Farrell Advertising	132 14
Zeltex Inc. Sturges and Associates	158

## Advertising sales staff

Gordon Jones [212] 971-2210  
Advertising sales manager

Atlanta, Ga. 30309: Gus H. Krimsier, Michael H. Miller, 1375 Peachtree St. N.E., [404] TR 5-0523

Boston, Mass. 02116: William S. Hodgkinson McGraw-Hill Building, Copley Square, [617] CO 2-1160

Chicago, Ill. 60611: Robert M. Denmead, 645 North Michigan Avenue, [312] MO 4-5800

Cleveland, Ohio 44113: Paul T. Fegley, 55 Public Square, [216] SU 1-7000

Dallas, Texas 75201: Richard P. Poole, The Vaughn Building, 1712 Commerce Street, [214] RI 7-9721

Denver, Colo. 80202: John W. Patten, David M. Watson, Tower Bldg., 1700 Broadway, [303] AL 5-2981

Houston, Texas 77025: Kenneth George, Prudential Bldg., Halcombe Blvd., [713] RI 8-1280

Los Angeles, Calif. 90017: Ashley P. Hartman, John G. Zisch, 1125 W. 6th St., [213] HU 2-5450

New York, N.Y. 10036: Donald R. Furth [212] 971-3615 Frank LeBeau [212] 971-3615 George F. Werner [212] 971-3615 500 Fifth Avenue

Philadelphia, Pa. 19103: William J. Boyle, Warren H. Gardner, 6 Penn Center Plaza, [215] LO 8-6161

San Francisco, Calif. 94111: James T. Hauptli, 255 California Street, [415] DO 2-4600

London W1: Edward E. Schirmer, 34 Dover Street, Hyde Park 1451

Frankfurt/Main: Gerd Hinske, 85 Westendstrasse Phone: 77 26 65 and 77 30 59

Geneva: Michael R. Zeynel, 2 Place du Port 244275

Paris VIII: Denis Jacob, 17 Avenue Matignon ALMA-0452

Tokyo: Nobuyuki Sato, Shiba, Minato-ku (502) 0656

Osaka: Kazutaka, Miura, 163, Ume-gae-cho, Kita-ku [362] 8771

Nagoya: International Media Representatives, Yamagishi Bldg., 13, 2-Chome, Oike-cho Naka-ku

Hugh J. Quinn: [212] 971-2335  
Manager Electronics Buyers' Guide

David M. Tempest: [212] 971-3139  
Promotion manager

Milton Drake: [212] 971-3485  
Market research manager

Richard J. Tomlinson: [212] 971-3191  
Business manager

Theodore R. Geipel: [212] 971-2044  
Production manager

■ For more information on complete product line see advertisement in the latest Electronics Buyers' Guide

## Classified advertising

F.J. Eberle, Business Mgr. Employment opportunities	177-178
Equipment (Used or Surplus New) For Sale	179-180

## Classified advertisers index

Allen, Co., Robert G.	179
■ American Relays	180
Arrow Freight Forwarders	179
Atomic Personnel Inc.	177
■ Barry Electronics	180
■ Bayton Electronics	179
Columbia University Nevis Laboratories	177
El-Tronics Inc.	179
Electronicraft Inc.	180
■ Fair Radio Sales	179
■ Fishman Co., Philip	179
General Electric Co. Apollo Support Dept.	178
■ Radio Research Instrument-Co.	179
Semiconductor Sales of Calif.	180
Telephone Engineering Co.	179
■ Universal Relay Corp.	179



# Electronics reader service

Use these handy post cards for more detailed information on: products advertised, new products, new literature.

Circle the number on the Reader Service post card that corresponds to the number at the bottom of the advertisement, new product item, or new literature in which you are interested.

Please print clearly. All written information must be legible to be efficiently processed.

If someone has beaten you to the post cards, you may obtain the needed information by writing directly to the manufacturer, or by sending your name and address, plus the reader service number, to Electronics reader service department.

All foreign inquires that cannot reach Electronics before the expiration dates noted on the Reader Service post card, must be mailed directly to the manufacturer. The manufacturer assumes all responsibilities for responding to inquiries. Electronics merely provides and clears requests for information from inquirer to manufacturer.

Correct amount of postage must be affixed for all foreign mailings.

### To subscribe to or to renew Electronics

Fill in the "For Subscriptions" area on the card if you desire to subscribe to or renew your present subscription to Electronics. Send no money. Electronics will bill you at the address indicated on the Reader Service post card.

### Multi-product advertisements

For information on specific items in multi-product advertisements which do not have a specific Reader Service number indicated write directly to manufacturer for information on precise product in which you are interested.

6 March 22, 1965 Card Expires May 22, 1965 14

Name \_\_\_\_\_ title \_\_\_\_\_

Company \_\_\_\_\_

Address \_\_\_\_\_

For Subscriptions

new  renewal

3 years \$12.00

1 year \$6.00

1	20	39	58	77	96	115	134	153	172	191	210	229	248	267	286	305	324	343	362	381	400	419	438	457	476	495	514	962
2	21	40	59	78	97	116	135	154	173	192	211	230	249	268	287	306	325	344	363	382	401	420	439	458	477	496	515	963
3	22	41	60	79	98	117	136	155	174	193	212	231	250	269	288	307	326	345	364	383	402	421	440	459	478	497	516	964
4	23	42	61	80	99	118	137	156	175	194	213	232	251	270	289	308	327	346	365	384	403	422	441	460	479	498	517	965
5	24	43	62	81	100	119	138	157	176	195	214	233	252	271	290	309	328	347	366	385	404	423	442	461	480	499	518	966
6	25	44	63	82	101	120	139	158	177	196	215	234	253	272	291	310	329	348	367	386	405	424	443	462	481	500	900	967
7	26	45	64	83	102	121	140	159	178	197	216	235	254	273	292	311	330	349	368	387	406	425	444	463	482	501	901	968
8	27	46	65	84	103	122	141	160	179	198	217	236	255	274	293	312	331	350	369	388	407	426	445	464	483	502	902	969
9	28	47	66	85	104	123	142	161	180	199	218	237	256	275	294	313	332	351	370	389	408	427	446	465	484	503	951	970
10	29	48	67	86	105	124	143	162	181	200	219	238	257	276	295	314	333	352	371	390	409	428	447	466	485	504	952	971
11	30	49	68	87	106	125	144	163	182	201	220	239	258	277	296	315	334	353	372	391	410	429	448	467	486	505	953	972
12	31	50	69	88	107	126	145	164	183	202	221	240	259	278	297	316	335	354	373	392	411	430	449	468	487	506	954	973
13	32	51	70	89	108	127	146	165	184	203	222	241	260	279	298	317	336	355	374	393	412	431	450	469	488	507	955	974
14	33	52	71	90	109	128	147	166	185	204	223	242	261	280	299	318	337	356	375	394	413	432	451	470	489	508	956	975
15	34	53	72	91	110	129	148	167	186	205	224	243	262	281	300	319	338	357	376	395	414	433	452	471	490	509	957	976
16	35	54	73	92	111	130	149	168	187	206	225	244	263	282	301	320	339	358	377	396	415	434	453	472	491	510	958	977
17	36	55	74	93	112	131	150	169	188	207	226	245	264	283	302	321	340	359	378	397	416	435	454	473	492	511	959	978
18	37	56	75	94	113	132	151	170	189	208	227	246	265	284	303	322	341	360	379	398	417	436	455	474	493	512	960	979
19	38	57	76	95	114	133	152	171	190	209	228	247	266	285	304	323	342	361	380	399	418	437	456	475	494	513	961	980

**Business reply mail**  
No postage stamp necessary if mailed in the United States

Postage will be paid by

**Electronics  
Reader service department  
Box 444  
Hightstown, N.J. 08520**

First class  
Permit no. 42  
Hightstown, N. J.

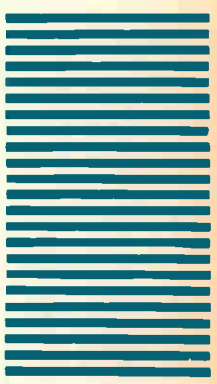

6 March 22, 1965 Card Expires May 22, 1965 14

Name \_\_\_\_\_ title \_\_\_\_\_

Company \_\_\_\_\_

Address \_\_\_\_\_

For Subscriptions

new  renewal

3 years \$12.00

1 year \$6.00

1	20	39	58	77	96	115	134	153	172	191	210	229	248	267	286	305	324	343	362	381	400	419	438	457	476	495	514	962
2	21	40	59	78	97	116	135	154	173	192	211	230	249	268	287	306	325	344	363	382	401	420	439	458	477	496	515	963
3	22	41	60	79	98	117	136	155	174	193	212	231	250	269	288	307	326	345	364	383	402	421	440	459	478	497	516	964
4	23	42	61	80	99	118	137	156	175	194	213	232	251	270	289	308	327	346	365	384	403	422	441	460	479	498	517	965
5	24	43	62	81	100	119	138	157	176	195	214	233	252	271	290	309	328	347	366	385	404	423	442	461	480	499	518	966
6	25	44	63	82	101	120	139	158	177	196	215	234	253	272	291	310	329	348	367	386	405	424	443	462	481	500	900	967
7	26	45	64	83	102	121	140	159	178	197	216	235	254	273	292	311	330	349	368	387	406	425	444	463	482	501	901	968
8	27	46	65	84	103	122	141	160	179	198	217	236	255	274	293	312	331	350	369	388	407	426	445	464	483	502	902	969
9	28	47	66	85	104	123	142	161	180	199	218	237	256	275	294	313	332	351	370	389	408	427	446	465	484	503	951	970
10	29	48	67	86	105	124	143	162	181	200	219	238	257	276	295	314	333	352	371	390	409	428	447	466	485	504	952	971
11	30	49	68	87	106	125	144	163	182	201	220	239	258	277	296	315	334	353	372	391	410	429	448	467	486	505	953	972
12	31	50	69	88	107	126	145	164	183	202	221	240	259	278	297	316	335	354	373	392	411	430	449	468	487	506	954	973
13	32	51	70	89	108	127	146	165	184	203	222	241	260	279	298	317	336	355	374	393	412	431	450	469	488	507	955	974
14	33	52	71	90	109	128	147	166	185	204	223	242	261	280	299	318	337	356	375	394	413	432	451	470	489	508	956	975
15	34	53	72	91	110	129	148	167	186	205	224	243	262	281	300	319	338	357	376	395	414	433	452	471	490	509	957	976
16	35	54	73	92	111	130	149	168	187	206	225	244	263	282	301	320	339	358	377	396	415	434	453	472	491	510	958	977
17	36	55	74	93	112	131	150	169	188	207	226	245	264	283	302	321	340	359	378	397	416	435	454	473	492	511	959	978
18	37	56	75	94	113	132	151	170	189	208	227	246	265	284	303	322	341	360	379	398	417	436	455	474	493	512	960	979
19	38	57	76	95	114	133	152	171	190	209	228	247	266	285	304	323	342	361	380	399	418	437	456	475	494	513	961	980

# Reprint service

All Electronics editorial matter available in reprint form:

For reprints of special reports and feature articles see list on right side of this page. Send your order to Electronics Reprint Department at the address indicated. To expedite mailing of your order for single reprints please send cash, check or money order with your order.

Bulk reprints of editorial matter can be ordered from current or past issues. The minimum quantity is 100 copies. The higher the quantity ordered, the more economical the cost per copy. Prices quoted on request.

To order reprints or for further information, please write to: Electronics Reprint Department, 330 West 42nd Street, New York, N.Y. 10036. Telephone: Area code 212 971-3140.

Prices for the below listed reprints unless otherwise specified are 1-10 copies 50¢ each; 11-24 copies 35¢ each; 25-99 copies 25¢ each; price for 100 or more is 20¢ each.

Key No. R-70 International Color Television  
8 pages. 25¢

Key no. R-69 1964 Complete Electronics Index Catalogs all technical articles — newsletter items, Electronics Review, Electronics Abroad, and Probing the News stories, manufacturers mentioned in these articles plus a complete advertisers index.  
40 pages. \$1.00

Key no. R-68 Designing Against Space Radiation, 18 pages.

Key no. R-67 Electronics Markets 1965.  
24 page forecast report with 6 page foldout chart.

Key No. R-66 Field Effect Transistors, Part III  
16 pages.

Key No. R-65 Field Effect Transistors, Part II  
24 pages.

Key No. R-64 Field Effect Transistors, Part I  
24 pages.

Key no. R-62 Electronic Telephone Switching,  
16 pages.

Key no. R-61 Direct Digital Control In Industry, 24 pages.

Key no. R-60 Transistor Heat Dissipators,  
32 pages.

Key no. R-58 Oceanography, 15 pages.

Key no. R-57 Magnetics, 24 pages.

Key no. R-53 Digital Instrumentation, 16 pages.

Key no. R-48 Modern Electronic Packaging, 16 pages.

Key no. R-45 Today's Semiconductors, 24 pages.

Key no. R-40 Tunnel Diodes, [4 part series]  
26 pages.

Key no. R-38 Family Tree of Semiconductors, [22" x 11" foldout chart].

Key no. R-31 1962 Electromagnetic Spectrum Chart, [22" x 30" foldout chart].  
\$1.00

Key no. R-30 Graphical Symbols For Electronic Diagrams, [29" x 11" foldout chart].

Key no. R-26 Lasers Devices and Systems, [1961 4 part series] 23 pages:  
\$1.00

First class  
Permit no. 42  
Hightstown, N. J.

## Business reply mail

No postage stamp necessary if mailed in the United States

Postage will be paid by

Electronics  
Reader service department  
Box 444  
Hightstown, N. J. 08520



6	March 22, 1965 Card Expires May 22, 1965																																								14
Name _____	_____																																								title _____
Company _____	_____																																								
Address _____	_____																																								
1	20	39	58	77	96	115	134	153	172	191	210	229	248	267	286	305	324	343	362	381	400	419	438	457	476	495	514	562	For Subscriptions												
2	21	40	59	78	97	116	135	154	173	192	211	230	249	268	287	306	325	344	363	382	401	420	439	458	477	496	515	963	<input type="checkbox"/> new <input type="checkbox"/> renewal												
3	22	41	60	79	98	117	136	155	174	193	212	231	250	269	288	307	326	345	364	383	402	421	440	459	478	497	516	964	<input type="checkbox"/> 3 years \$12.00												
4	23	42	61	80	99	118	137	156	175	194	213	232	251	270	289	308	327	346	365	384	403	422	441	460	479	498	517	965	<input type="checkbox"/> 1 year \$6.00												
5	24	43	62	81	100	119	138	157	176	195	214	233	252	271	290	309	328	347	366	385	404	423	442	461	480	499	518	966													
6	25	44	63	82	101	120	139	158	177	196	215	234	253	272	291	310	329	348	367	386	405	424	443	462	481	500	900	967													
7	26	45	64	83	102	121	140	159	178	197	216	235	254	273	292	311	330	349	368	387	406	425	444	463	482	501	901	968													
8	27	46	65	84	103	122	141	160	179	198	217	236	255	274	293	312	331	350	369	388	407	426	445	464	483	502	902	969													
9	28	47	66	85	104	123	142	161	180	199	218	237	256	275	294	313	332	351	370	389	408	427	446	465	484	503	951	970													
10	29	48	67	86	105	124	143	162	181	200	219	238	257	276	295	314	333	352	371	390	409	428	447	466	485	504	952	971													
11	30	49	68	87	106	125	144	163	182	201	220	239	258	277	296	315	334	353	372	391	410	429	448	467	486	505	953	972													
12	31	50	69	88	107	126	145	164	183	202	221	240	259	278	297	316	335	354	373	392	411	430	449	468	487	506	954	973													
13	32	51	70	89	108	127	146	165	184	203	222	241	260	279	298	317	336	355	374	393	412	431	450	469	488	507	955	974													
14	33	52	71	90	109	128	147	166	185	204	223	242	261	280	299	318	337	356	375	394	413	432	451	470	489	508	956	975													
15	34	53	72	91	110	129	148	167	186	205	224	243	262	281	300	319	338	357	376	395	414	433	452	471	490	509	957	976													
16	35	54	73	92	111	130	149	168	187	206	225	244	263	282	301	320	339	358	377	396	415	434	453	472	491	510	958	977													
17	36	55	74	93	112	131	150	169	188	207	226	245	264	283	302	321	340	359	378	397	416	435	454	473	492	511	959	978													
18	37	56	75	94	113	132	151	170	189	208	227	246	265	284	303	322	341	360	379	398	417	436	455	474	493	512	960	979													
19	38	57	76	95	114	133	152	171	190	209	228	247	266	285	304	323	342	361	380	399	418	437	456	475	494	513	961	980													

First class  
Permit no. 42  
Hightstown, N. J.

## Business reply mail

No postage stamp necessary if mailed in the United States

Postage will be paid by

Electronics  
Reader service department  
Box 444  
Hightstown, N.J. 08520





# New Brush Mark 842

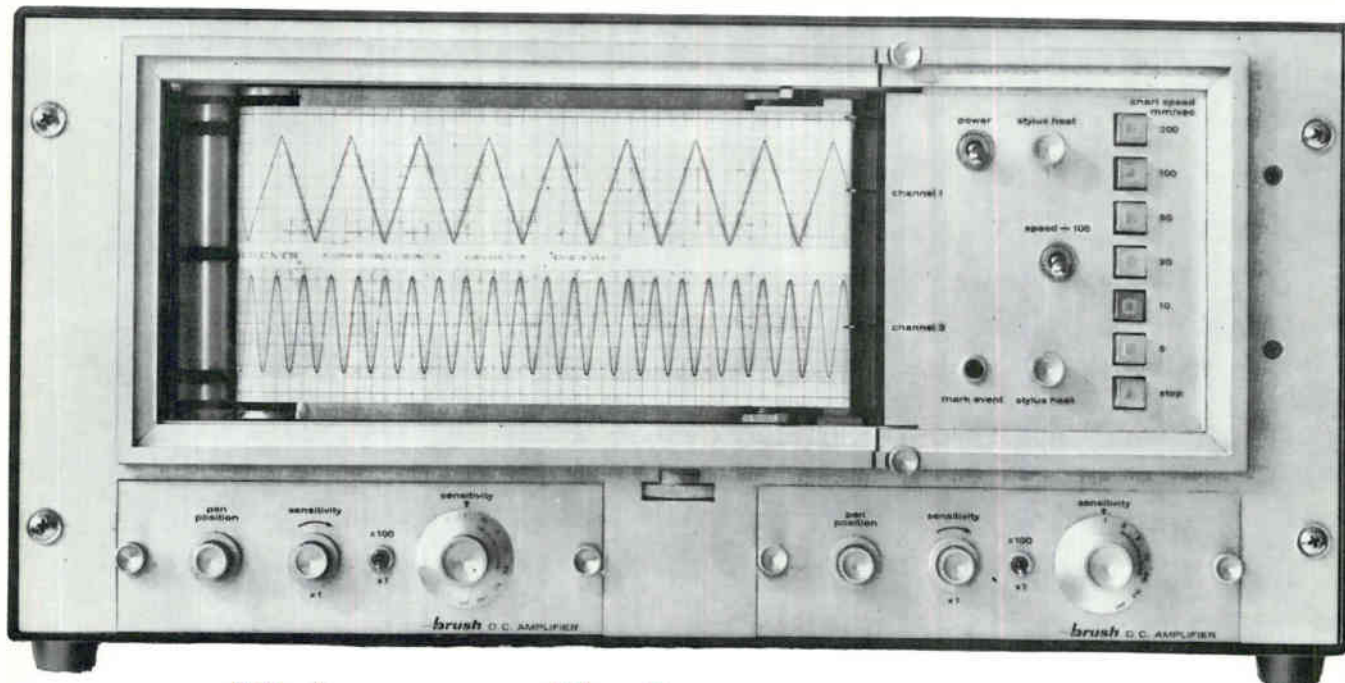

**Highest useable frequency response  
of any direct writing recorder**

**Here's the Recorder some people thought was years away . . .** a completely self-contained system for general purpose or specialized requirements.

Useable frequency response . . . 75 cps full scale; flat to 150 cps at reduced amplitude.

$\frac{1}{2}\%$  Linearity . . . assured by *tangent-correction*.

Plug-in preamplifiers . . . design your own recorder.

Complete simplicity . . . push a button and it's "go".

All solid state electronics. And new high-torque penmotors permit greater stylus pressure without loss of accuracy . . . assure uniform accurate recording of high speed transients. Rugged styli deliver crisp, clear traces on heat sensitive paper. Wide "off-the-shelf" selection of plug-in modular preamplifiers, lets you match a Mark 842 system to your specific recording requirements. Variety of mounting possibilities, including RETMA standard. Simple, reliable, flexible

. . . designed to fill your needs for years to come. Complete details on request. Brush Instruments Division, Clevite Corporation, 37th & Perkins, Cleveland, Ohio 44114.

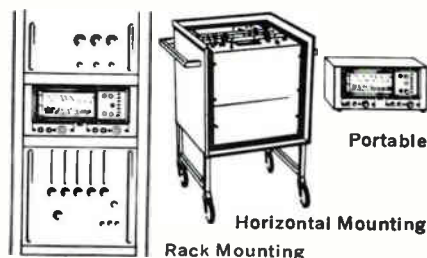

**CLEVITE**  
INSTRUMENTS DIVISION

**brush**

Circle 901 on reader service card



# First 8-Amp-Optimized SCR

(only the price is economized)

Take a "top-notch" SCR design. Optimize every parameter for a standard TO-3 case. Use a stamped-metal base. No weld rings. No gild—no gold or silver wires. Result: The RCA 2N3668 with 8 full amps (average) designed for your mass-produced line-operated consumer and industrial products.

Now automatic sensor-actuated, stepless controls are priced within reach of applications such as: motor speed "feed", electric heater regulators, commercial light dimmers, line regulators, power control and switching applications requiring line blocking capabilities up to 400 volts and forward current capabilities of 8 amp (avg) and 12.5 amps (RMS) at a case temperature of 80°C.

If cost has kept you from designing with silicon controlled rectifiers, take another look! RCA's family of SCRs is available in types to handle forward currents ( $I_{FRMS}$ ) from 2 to 12.5 amps for 120- and 240-volt line operation.



Optimize your designs with RCA types in this low-cost group of SCRs. Application engineering assistance is available. For technical bulletin, write: RCA Commercial Engineering, Section RN 3-4, Harrison, N. J.

**AVAILABLE FROM YOUR RCA DISTRIBUTOR**

RCA Electronic Components and Devices



**The Most Trusted Name in Electronics**

	TO-8		TO-66		NEW! IN TO-3			
								
	2N3528	2N3528	2N3228	2N3525	2N3668	2N3669	2N3670	
Standard A-C Supply	120	240	120	240	Low Voltage Supply	120	240	volts
PRV Repetitive $V_{RM}$ (rep)	200	400	200	400	100	200	400	volts
Peak Forward Blocking Voltage $V_{FBM}$ (rep)	600	600	600	600	600	600	600	volts
Avg DC Forward Current $I_{FAV}$	1.3	1.3	3.2	3.2	8	8	8	Amp
	$(T_{FA}=25^{\circ}\text{C})$		$(T_C=75^{\circ}\text{C})$		$(T_C=80^{\circ}\text{C})$			
			w/heat sink		w/heat sink			
RMS Current $I_{FRMS}$	2.0	2.0	5.0	5.0	12.5	12.5	12.5	Amp