

electronics®

SPECIAL
REPORT

MATERIALS FOR
SPACE-AGE
ELECTRONICS



10
C 1
ROLAND KESSLER
966 MC
NEEDS TIME WASH

the Making of a Standard

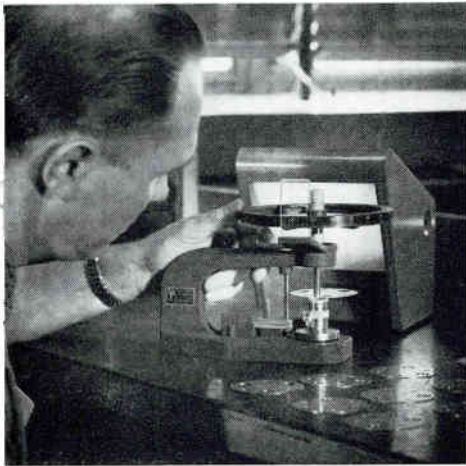

Plates for the 1404 Reference Standard Capacitor are made of low-temperature-coefficient Invar alloy, precision lapped and checked on a light-wave micrometer for flatness. Each plate must be absolutely flat. To insure this, the plates are first heated and stress relieved at high temperature in a neutral atmosphere. Following this annealing process, the plates are hyperlapped to a thickness that is held to better than ± 0.00025 of an inch. In addition, special Invar spacers are fabricated to within ± 0.0001 of an inch.



The capacitor is carefully assembled from parts that are one-hundred-percent inspected. The stacks of lapped Invar plates are mounted on six Invar posts separated by six Invar spacers and mounted on a thick Invar baseplate. By using one low-temperature-coefficient material throughout, the capacitor's final value is made more reproducible, since differential drift caused by use of dissimilar metals is eliminated. Temperature coefficient of the unit is that of Invar, or about $+2$ ppm/ $^{\circ}$ C.



Following inspection and measurement, the capacitor is mounted in a hermetically-sealed heavy brass enclosure. All connections are made through glass-to-metal seals. The unit is then evacuated, purged to remove water vapor, refilled with high-purity, dry nitrogen gas and sealed. Sealing in an invariant atmosphere insures that both capacitance and dissipation factor will be virtually independent of environmental changes in pressure, altitude, and humidity.



After assembly and sealing, each capacitor is subjected to a number of hot and cold cycles of temperature to stabilize the structure and to determine temperature coefficient and magnitude of hysteresis. Test procedure requires heating the unit to 150° F — measuring; cooling to room temperature — remeasuring; cooling to 0° F — measuring; reheating to return the capacitor to its value prior to heating, and remeasuring to determine the retracability of the cycle. Test limits are ± 5 ppm on retracability; capacitance change must not exceed 20 ppm for these hot and cold cycles. Typical change from hysteresis is less than 10 ppm.



The capacitor is adjusted with a trimmer to bring it close to nominal value. This is done with a precision of better than ± 1 ppm. Adjustment is made at a temperature of $23^{\circ} \pm 1^{\circ}$ C and frequency of 1000 cps to a value of 5 ppm above nominal with respect to reference standards whose values are traceable to NBS standards. The adjustment above nominal (e.g. 1000.005 pf) is made because it is more convenient to use than a standard adjusted to below nominal value (e.g. 999.995 pf).

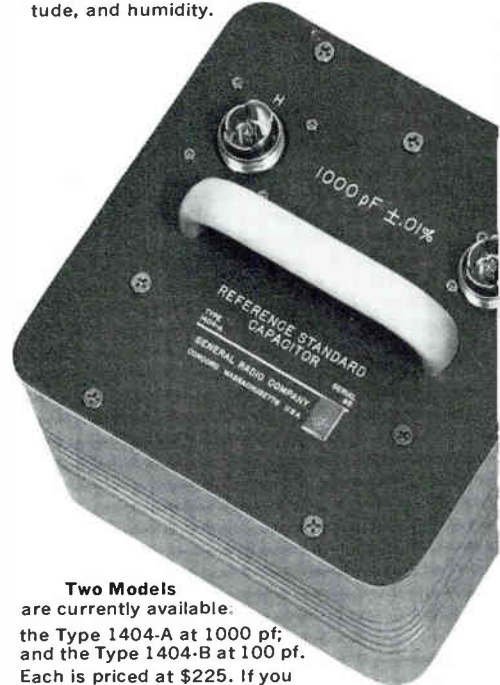

Two Models are currently available.

the Type 1404-A at 1000 pf; and the Type 1404-B at 100 pf. Each is priced at \$225. If you would like more information, please write. General Radio also manufactures a complete line of R-L-C standards.

Type 1404 Reference Standard Capacitors show very little change with orientation. Typical change is less than 5 ppm as the capacitor is turned in all possible directions. These capacitors are relatively free from microphonics. They do not have to be coddled. Sample units have been through 50g shock for 11 milliseconds and have shown capacitance changes of less than 50 ppm. Drift rate is well below 20 ppm per year. Losses are very low — almost immeasurable. Dissipation factor is less than 10 ppm at 1 kc.

Write for Complete Information

GENERAL RADIO COMPANY

WEST CONCORD, MASSACHUSETTS

IN CANADA: Toronto 247-2171, Montreal (Mt. Royal) 737-3673
IN EUROPE: General Radio Overseas, Zurich, Switzerland

NEW YORK, N. Y., 964-2722
(Ridgefield, N. J.) 943-3140

CHICAGO
(Oak Park) 848-9400

PHILADELPHIA, 424-7419
(Abington) 887-8486

WASHINGTON, D. C.
(Rockville, Md.) 946-1600

SYRACUSE
454-9323

DALLAS
FL 7-4031

SAN FRANCISCO
(Los Altos) 948-8233

LOS ANGELES
469-6201

ORLANDO, FLA.
425-4671

CLEVELAND
886-0150

CIRCLE 900 ON READER SERVICE CARD

electronics

A MCGRAW-HILL WEEKLY 75 CENTS

W. W. MacDONALD, Editor
Telephone Area Code 212 (971-2645)

J. M. CARROLL, Managing Editor (2293)

SENIOR EDITORS

Samuel Weber (2371)
George W. Sideris (3444)

SENIOR ASSOCIATE EDITORS

Michael F. Wolff (2600)
John F. Mason (2666)

ASSOCIATE EDITORS

Michael F. Tomaino (2071)
William P. O'Brien (2297)
George J. Flynn (2188)
George V. Novotny (3151)
Leon H. Dulberger (3446)
Alexander A. McKenzie (2685)

ASSISTANT EDITORS

Stephen B. Gray (2245)
Barry A. Briskman (2306)
Dan Smith (2467)
Joel A. Strasser (2127)

REGIONAL EDITORS

Harold C. Hood,
1125 W. 6th St., Los Angeles 90017, Calif.
(213-482-5450)
Laurence D. Shergalis,
John Hancock Bldg., 255 California St.,
San Francisco 94111, Calif. (415-362-4600)
Thomas Maguire
McGraw-Hill Bldg., 607 Boylston St.,
Boston 02116, Mass. (617-262-1160)
Cletus M. Wiley,
Blair Bldg., 645 N. Michigan Ave.,
Chicago 60611, Ill. (312-664-5800)

ART DIRECTOR

Howard R. Berry (2430)

ASSISTANT ART DIRECTOR

John C. Wright, Jr. (3430)

EDITORIAL ASSISTANTS

Lorraine Rossi, Virginia T. Bastian,
Lynn Emery, Ann Mella, Lorraine Werner,
Alice M. O'Brien, Sharon Parks,
Claire Benell, Kay Fontana

FOREIGN NEWS BUREAU

DIRECTOR, John Wilhelm, (2532);
Lawrence Mihlon (2997), Alyne Elias
(2998)

LONDON—John Shinn, Derek Barlow,
Nicholas Landon, 34 Dover St., London
W.1, England

BONN—Bruce Bendow, Richard Mikton,
Silke McQueen, Mittelstrasse 39, Bad
Godesberg, Germany

BRUSSELS—27 Rue Ducarle, Brussels,
Belgium

PARIS—Robert Farrell, Arthur Erikson,
17 Ave. Matignon, 3rd Fl., Paris 8,
France

MILAN—Marc A. Messina, Via Manzoni
No. 12, Milan, Italy

MEXICO CITY—Wesley Perry, Jr.,
Lafragua 4-314, Mexico 1 D.F. Mexico

RIO DE JANEIRO—Leslie Warren, Rua
Mexico 3-S/1507 1509, Rio de Janeiro,
Brazil

MOSCOW—Stewart Ramsey,
Kutuzovsky Prospekt 19, Apt. 28-29,
Moscow, USSR

TOKYO—Richard Halloran, Charles Cohen,
John Yamaguchi, Toranomon Sangyo
Bldg., 1 Kotohiracho Shiba, Minato-Ku,
Tokyo, Japan

CIRCULATION MANAGER

Hugh J. Quinn (2310)

C. C. RANDOLPH, Publisher (2016)

EUROPIUM chelate molecule EuTTA (europium trifluoro thenoyl acetate) is one of the newer members of the growing family of laser materials. This and similar molecules have made it possible to produce stimulated emission in liquids and plastics. *Pumping energy is absorbed in the organic portion of the molecule and transferred into the central europium atom to produce the characteristic emission from the rare-earth ion (N. E. Wolff, RCA Laboratories). See p 37*

COVER

BUGS AND ANTIBUGS. At this month's Valachi hearings, lawmen pushed for legalization of electronic "investigative tools." But despite legal posers, development and sales of snooping devices reflect a demand that is already large. *Here's an up-to-date look at this rarely illuminated corner of the electronics industry* 10

MOLECULAR AMPLIFICATION. This isn't a circuit term—it's an emerging process for vapor-depositing microcircuits. *An electron-beam modulation system controls deposition by scanning a diagram with a tv camera* 26

ELECTRONICS IN THE MIDWEST. Next week's National Electronics Conference will consider advanced production techniques for microelectronics, laser micromachining and drilling, thin-film counters for laser rangefinders and infrared tracking systems. *One microcircuit fabrication process uses fluorescent dye to trigger electron-beam welding* 31
By C. M. Wiley

AVALANCHING TRANSISTOR GENERATES MICROWAVES. A transistor relaxation oscillator operating in the avalanche-switching mode at about 100 Mc generates almost 16 microwatts of power at X-band and even higher. Resonant cavity selects the desired harmonics in the oscillator output. *Generator is useful as a laboratory microwave source.* 35
By R. J. Vilmur and K. Ishii, Marquette Univ.

SPECIAL REPORT: MATERIALS FOR SPACE-AGE ELECTRONICS. Fabrication of electron devices and components is now becoming an exact science based on atomic physics and crystal chemistry. Materials are tailored to order, starting with the atoms and winding up with the device. *This report summarizes present technology, highlights accomplishments and indicates directions for the future.* 37
By M. F. Tomaino

REFERENCE SHEET: SELECTING TUBES FOR WIDE BANDWIDTH. Comprehensive table permits the designer to select quickly a tube and compensating network that provide the performance characteristics he is looking for in either a wide-band amplifier or nanosecond pulse circuit. *Table lists four compensating networks; characterizes and gives design data on 88 tubes.* 53
By L. M. Dyson, Chem-ionics Corp.

Published weekly, with Electronics Buyers' Guide as part of the subscription, by McGraw-Hill Publishing Company, Inc. Founder: James H. McGraw (1860-1948).

Title ® registered U.S. Patent Office; © copyright 1963 by McGraw-Hill Publishing Co., Inc. All rights reserved, including the right to reproduce the contents of this publication, in whole or in part.

Executive, editorial, circulation and advertising offices: McGraw-Hill Building, 330 West 42nd Street, New York, N. Y., 10036. Telephone Area Code 212 971-3333. Teletype TWX N. Y. 212-640-4646. Cable McGrawhill, N. Y. PRINTED IN ALBANY, N. Y.; second class postage paid at Albany, N. Y.

OFFICERS OF THE PUBLICATIONS DIVISION: Shelton Fisher, President; Vice Presidents: Joseph H. Allen, Operations; John R. Callahan, Editorial; Ervin E. DeGraff, Circulation; Donald C. McGraw, Jr., Advertising Sales; Angelo R. Venezian, Marketing.

OFFICERS OF THE CORPORATION: Donald C. McGraw, President; Hugh J. Kelly, Harry L. Waddell, L. Keith Goodrich, Executive Vice Presidents; John L. McGraw, Treasurer; John J. Cooke, Vice President and Secretary.

Subscriptions are solicited only from those actively engaged in the field of the publication. Position and company connection must be indicated on orders. Subscription rates: United States and Possessions and Canada, \$6.00 one year, \$9.00 two years, \$12.00 three years. All other countries \$20.00 one year. Single copies, United States and Possessions and Canada 75¢. Single copies all other countries \$1.50.

THE PUBLISHER, UPON WRITTEN REQUEST TO OUR NEW YORK OFFICE FROM ANY SUBSCRIBER, AGREES TO REFUND THAT PART OF THE SUBSCRIPTION PRICE APPLYING TO COPIES NOT YET MAILED.

Subscribers: Please send change of address notices, subscription orders or complaints to Fulfillment Manager, Electronics, at the address below. Change of address notices should provide old as well as new address, including postal zone number if any. If possible, attach address label from recent issue. Allow one month for change to become effective.

Postmaster: Please send Form 3579 to Fulfillment Manager, Electronics, P. O. Box 430, Hightstown, New Jersey, 08520.



Audited Paid Circulation

Contents continued

UNIUNCTION TRANSISTOR SIMPLIFIES VOLTAGE-FREQUENCY CONVERTER. This linear voltage-controlled variable-frequency oscillator can be used to adapt a standard recorder for recording low-frequency f-m signals. *Linearities of two percent have been measured for small-signal inputs.*
By J. Schwartz, Sage Instruments, Inc. 56

POLARIS' NEW FIRE CONTROL. Advanced packaging and standardized modules raise the Mark 84's maintainability and efficiency while cutting production costs. *This report discloses how the system works, as well as how it is put together* 61

AIRCRAFT DATA PROCESSING. Expensive flight delays are causing airlines to look to computers for efficient flight plans. *And FAA will push installation of its systems ahead of testing them* 66

ELECTRET MICROPHONE. Improved version of capacitor microphone exhibits high stability and flat frequency response. *It can be connected directly to a conventional transistor amplifier* 68

DEPARTMENTS

Crosstalk. Mixed Blessing 5

Comment. Value Engineering 6

Electronics Newsletter. Microcircuits Increase Compatibility Problems 17

Meetings Ahead. Radio Meteorology World Conference 18

Washington This Week. Minimum Wages for Tube and Parts Workers May Be Raised 20

Research and Development. SSB System Goal is 20-Year Life 75

Components and Materials. Accurate Gyro Balancing 81

Production Techniques. Laser Welds Copper Leads 88

New Products. Recorders Use Capstan and Tape-Speed Control 96

Literature of the Week 112

People and Plants. At NEC: Hall Makes Experiments Pay Off 114

Index to Advertisers 122

our stock answer is

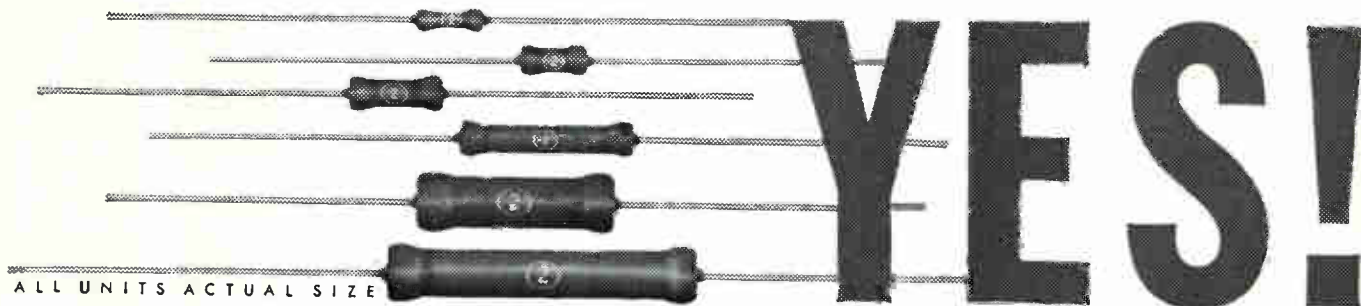

ALL AXIAL LEAD BLUE JACKET RESISTORS

*in 1, 2, 3, 5, 7 and 10-watt power ratings are carried in
factory stock for immediate delivery. Place your order now with your
nearest Sprague Industrial District Office or Sales Representative.*

Key Sprague Industrial Distributors carry most popular ratings in local stocks.

S P R A G U E S A L E S O F F I C E S

Ariz.	Phoenix, Sprague Electric Co., 3550 N. Central Ave., 279-5435	Mo.	St. Louis, Sprague Electric Co., 3910 Lindell Blvd., JE 5-7239
Cal.	Los Angeles, Sprague Electric Co., 12870 Panama St., UP 0-7531 or EX 8-2791	N. J.	Camden, Sprague Electric Co., 545 Cooper St., WO 6-1776
	San Francisco, W. J. Purdy of Calif., 312 7th St., UN 3-3300	N. M.	Albuquerque, Bowen & Carlberg Co., 222BA San Mateo Blvd., N.E., AM 5-1579
Colo.	Denver, R. G. Bowen Co., Inc., 721 S. Broadway, RA 2-4641	N. Y.	New York, Sprague Electric Co., 50 E. 41st St., OR 9-1195
D.C.	Washington, Sprague Electric Co., 2321 Wisconsin Ave., N.W., 338-7911		Great Neck, William Rutt, Inc., 123 Middle Neck Rd., HU 2-8160
Fla.	Clearwater, Sprague Electric Co., 1152 Cleveland St., 446-3119	N. C.	Winston-Salem, Sprague Electric Co., 92B Burke St., 722-5151
Ill.	Chicago, Sprague Electric Co., 5942 W. Montrose Ave., MU 5-6400	Ohio	Chagrin Falls, Sprague Electric Co., 24 N. Main St., CH 7-6488
Mass.	North Adams, Sprague Electric Co., Marshall St., 664-4411		Dayton, Sprague Electric Co., 224 Leo St., BA 3-9187
	Newton, Sprague Electric Co., 313 Washington St., WO 9-7640	Tex.	Dallas, Sprague Electric Co., 3603 Lemmon Ave., La 1-9971
Mich.	Detroit, ABM Sales Co., 10116 Puritan Ave., UN 2-1300	Utah	Salt Lake City, R. G. Bowen Co., Inc., 463 E. 3rd St., S. EM 3-4528
Minn.	Minneapolis, H. M. Richardson & Co., Inc., 9 E. 22nd St., FE 6-4078	Wash.	Seattle, Sprague Electric Co., 4601 Aurora Ave., ME 2-7761

*For application engineering assistance write:
Resistor Division, Sprague Electric Co., Nashua, New Hampshire.*

SPRAGUE COMPONENTS

RESISTORS	PULSE TRANSFORMERS	CERAMIC-BASE PRINTED NETWORKS
CAPACITORS	PIEZOELECTRIC CERAMICS	PACKAGED COMPONENT ASSEMBLIES
TRANSISTORS	PULSE-FORMING NETWORKS	BOBBIN and TAPE WOUND MAGNETIC CORES
MICROCIRCUITS	TOROIDAL INDUCTORS	SILICON RECTIFIER GATE CONTROLS
INTERFERENCE FILTERS	ELECTRIC WAVE FILTERS	FUNCTIONAL DIGITAL CIRCUITS



'Sprague' and '®' are registered trademarks of the Sprague Electric Co.

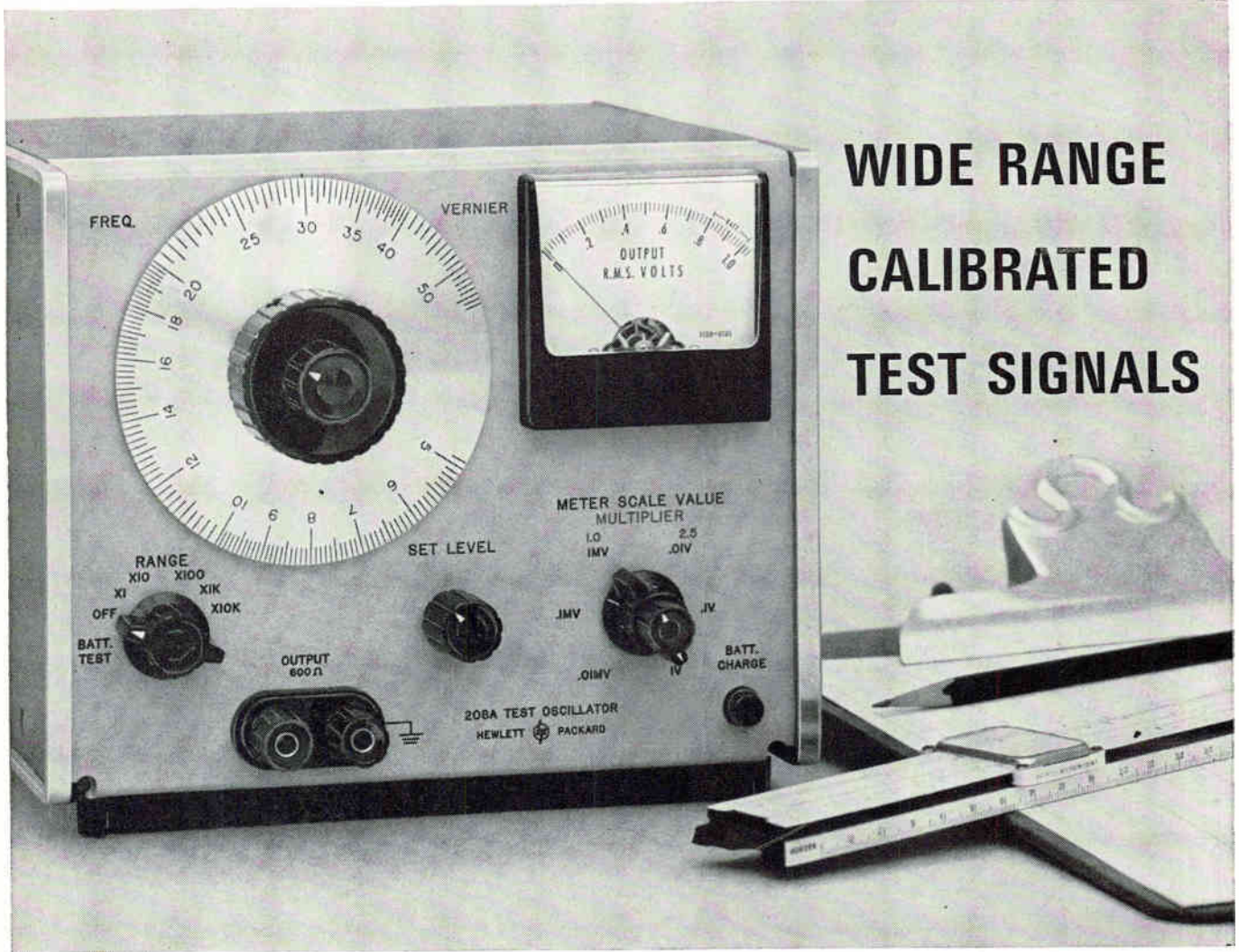

WIDE RANGE CALIBRATED TEST SIGNALS

5 cps to 560 kc, 5 μ v to 2.5 v into 600 ohms

SPECIFICATIONS

- Frequency range:** 5 cps to 560 kc, 5 ranges
- Dial:** logarithmic calibration, $\pm 3\%$ accuracy
- Frequency response:** $\pm 3\%$ into rated load
- Output:** 10 mw (nominal 2.5 v rms into 600 ohms)
- Output impedance:** 600 ohms
- Output attenuator:** 6 position, 10:1 steps from 0.01 mv to 1 v; times 2.5 multiplier gives 10:1 steps from 0.025 mv to 2.5 v
- Output monitor:** transistor voltmeter monitors level at input to attenuator and after set level
- Set level:** continuously variable attenuator with 10:1 (20 db) minimum range
- Distortion:** less than 1%
- Hum and noise:** less than 0.05%
- Power:** four rechargeable batteries (furnished), recharge during ac operation; 30 hours per charge, more than 500 recharges
- Size:** 6½" high, 7¾" wide, 8" deep, 8¼ lbs.
- Price:** hp 208A, \$525

Data subject to change without notice. Prices f.o.b. factory.

Also available: Model 208A-DB for audio, communication system testing. Model 208A-DB, same as 208A except that output is calibrated in dbm, has a 110 db attenuator calibrated in 1 and 10 db steps. Price: \$535.

New hp 208A Test Oscillator

Solid state and operated from a rechargeable battery pack or ac line, the 208A can be used anywhere to provide stable, accurate signals that are calibrated with a built-in attenuator and voltmeter. The precision attenuator adjusts the output in 20 db steps from 0.01 mv to 1 v or from 0.025 mv to 2.5 v. A metered set level control provides continuous adjustment between 20 db steps. Output is calibrated into 600 ohms, single ended.

While operation on rechargeable battery pack makes the 208A ideal for field use, battery operation is also useful in general lab work, providing isolation from power line ground to avoid hum and ground loop problems. The long-life nickel-cadmium batteries recharge automatically while the oscillator is operated from the ac line so that the 208A is always ready for portable use. Output is flat within $\pm 3\%$; frequency stability is typically better than 5 parts in 10^4 .

This portable source of stable, wide range, calibrated test signals can save you time and trouble. Call your hp field sales office today for a trial on your bench.



HEWLETT-PACKARD COMPANY

1501 Page Mill Road, Palo Alto, Calif. 94304, (415) 326-7000. Sales and service in all principal areas. Europe, Hewlett-Packard S.A., 54 Route des Acacias, Geneva, Switzerland; Canada, Hewlett-Packard (Canada) Ltd., 8270 Mayrand St., Montreal, Que. 8636

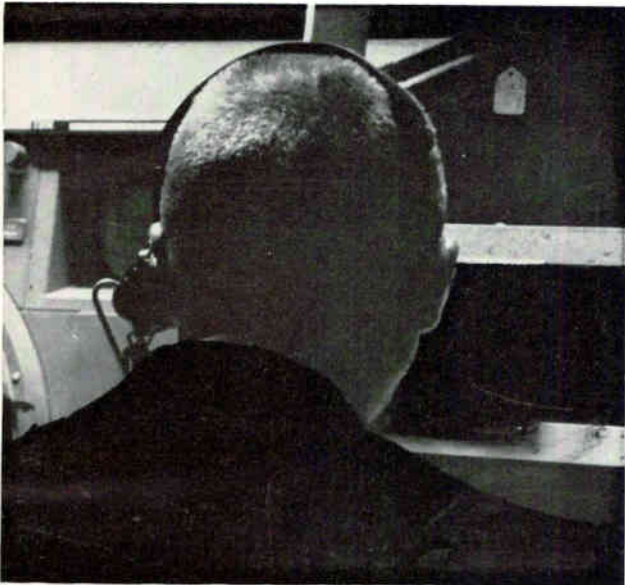

Mixed Blessing

SNOOPING DEVICES, both in space and on earth, are becoming more and more sophisticated. Electronic eavesdroppers, "bug," or whatever one calls these gadgets, have now been developed to the point where more control by law may be needed.

In California some are specifically mentioned in the new penal code signed by Governor Brown in August. Penalty for intentionally intercepting confidential communications without the consent of the sender, by means of any electronic amplifying or recording device, is a jail term of one year and \$1,000. The California Attorney General wants all of them registered under a Federal law.

Experts say that development of still newer electronic devices makes old-fashioned wire tapping obsolete. Microminiature self-contained transmitters can be easily planted in a room and broadcast up to several hundred feet. Often they are just abandoned when the batteries go dead, especially if they are being used illegally.

The problem then, boils down to this: Do we hamstring legitimate enforcement agencies? If not, how do we insure the basic right of privacy? What about industrial espionage and other spying?

Lawmakers are worried about the increasing manufacture and sale of many devices it is almost impossible to detect in use.

COSA NOSTRA, NO. One of the contributors to this week's article on snooping devices (p 10) sent us this memo along with data on a device to detect hidden microphones:

"Hal Hood asked me to send you the enclosed dope on our Bug Detector (Survey Receiver . . . please).

"If you mention our company by name please include the note that we sell only to law enforcement and corporate security types. No Mafia or Cosa Nostra need apply. Another thing, we are putting in for a patent on the "positive identify" feature, which might be called to your readers' attention, although how we would go about enforcing our patent position on the competition is something that hasn't been settled.

"Up to now we've concentrated on satellite instrumentation . . . we feel that with this venture we're . . . slipping Big Brother's schedule into the fall of 1985 . . ."

Coming In Our November 1 Issue

THE CONFERENCE TRAIL. This week's issue, you'll note, contains several articles previewing next week's National Electronics Conference in Chicago. In the November 1 issue, we journey to Boston for a look at the Northeast Electronics Research and Engineering Meeting's offerings the following week.

While the journey is figurative (Thomas Maguire, our regional editor, has been in Boston all the time—in fact, he was born in the land of bean and cod), the preview is not. If you've been wondering whether to make the trip to Boston, read the preview. We've just seen it, and it contains enough hard news to renew even a jaded wanderlust.

Other articles you'll want to read next week include:

- A mechanically steerable zoom antenna composed of glass-fiber rods. One reason the Army likes it is that its silhouette is nonmetallic

- Field-effect device that provides broadband gain. This metal-oxide-semiconductor device is called the p-MOST

- Simplified design for memories. The technique combines advantages of thin-film and closed-flux types.

OUR CONFERENCE PROCEEDINGS

The conference on the Impact of Microelectronics conducted by electronics and IIT Research Institute in June presented highly qualified speakers on a subject of vital interest to the industry.

Its success can be judged by the overwhelming response by those who attended, and requests for Proceedings from many more who couldn't.

The printed record, now available, is a 120-page volume filled with marketing and technical information. Price, \$3.50.

To order, write to

electronics
Reprint Department
330 West 42nd Street
New York, N. Y. 10036

or use the order form on p 105



a new and important SOLID STATE SWITCH

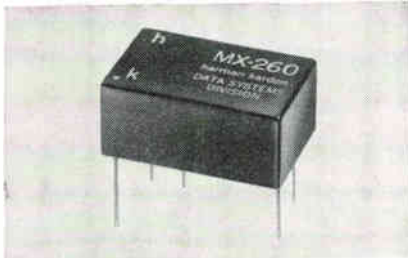

High precision! High speed solid state analog switch (MX-260) offering full reliability at an economical price! The perfect relay replacement! Switching speed from D.C. to 10,000 cps (synchronous or asynchronous) with complete isolation between drive and switching circuits! Offset voltage, over an operating temperature from -30° to $+70^{\circ}$ C. will be less than 100uv maximum; estimated mean time to failure—100,000 hours! Series contact resistance—36 ohms max.; leakage current— $3\mu\text{a}$ max. at room temperature. Designed to requirements of MIL-E-5272C!



a new high speed 20 channel SOLID STATE MULTIPLEXER



More features! More performance! More value! Frequency variable, D.C. to 10,000 cps! Programmable channel skip—internally and externally! Built around the precision performance of the H-K 100,000 hour solid state switch—the MX-260! Expandable design provides for future growth applications! Send for full description of Model 902.

Data Systems Division, Desk E-10
HARMAN-KARDON, INC.
Plainview, L.I., N.Y.

Please send me full information on
the new MX-260 and H-K Multiplexer.

Name _____
Company _____
Address _____
City _____ State _____

harman kardon

HK-91

A subsidiary of THE JERROLD CORPORATION

COMMENT

VALUE ENGINEERING

I agree with your editorial (p 5, Sept. 27). In fact, I believe Value Engineering is a very timely subject. It has some good points, but its promotion has been highly emotional. I feel its broad-brush panacea-type application to military products may be running away with reason at times.

I have heard Larry Miles' speech, I have read his book, and I have been through the one-week Value Engineering Seminar at the University of Michigan. One cannot help noting that Larry Miles, Bob Gillespie and others prominent in the field continually stress that the technique is broadly applicable to almost any manufactured item, and to a great extent to services. However, one also notes that essentially all of the great number of examples used in Miles' book could be classified as simple mechanical items where quantities are generally high.

My point here is that the professional value engineer seems to run into trouble when the product is beyond the level where everybody is an expert; i.e., a simple mechanical device. Above this level the only solution is, as you suggest, to increase the awareness of the design engineer and his supervision to this aspect of his job. . . .

DONALD J. NIGG

Prairie Village, Kansas

VALUE ENGINEERING

Your *Crosstalk* about Value Engineering (p 5, Sept. 27) has caused some raised eyebrows among those who have the task of implementing VE programs in accordance with the directives of DOD. ELECTRONICS holds too high a position in the engineering profession for editorial comment such as yours to be treated lightly.

There is not much room for argument with your definition of an engineer. The same thing can be said many different ways. We will also agree with you that the scientist is primarily interested in adding to our knowledge of the world about us. However, cost becomes a factor when the engineer applies the results of the scientist's efforts to providing a piece of hardware that will perform a desired function at a predetermined level of reliability.

Engineers in the last 25 years have done a fantastic job of meeting functional needs in all fields of human endeavor with the result that many laymen look upon the engineer as someone separate and apart from normal mortals. You and I know this is not so.

The engineer is fundamentally like everybody else. He gets a great deal of satisfaction out of creating things and he is proud of his accomplishments. He grudgingly accepts the fact that his tasks must be completed within specified time limits, but when it comes to cost, he'd rather not be bothered.

Let's take a look at the education of the average engineer. Where in the curriculum of an engineer is he told that the application of all the mathematics, physics and chemistry he studies so intently must be applied at the lowest possible cost? If we go one step back, we can ask, "What knowledge or experience does the engineering teacher have about the relation of cost to function?" A close look will show that our engineering students do not get exposed to the idea of cost during their learning years. They must acquire cost consciousness on the job if they don't have it instinctively.

When they go to work in commercial fields, the pressure of competition forces them to become cost conscious in their engineering or their employers are unable to keep them on the payroll. If they go into military product jobs, there has been so much emphasis on function and schedule that it is impossible for an engineer to avoid any consideration for cost altogether.

It is true that value engineering is just good engineering and every engineer should be a value engineer. But what recourse do we have when we find that most engineers are actually not value engineers—and what is worse—refuse to let anyone take a second look at their designs to try to improve its value?

The answer is simple. We must create a strong value program that will convince the engineers, buyers, manufacturing and reliability people that cost is just as important as function and schedule.

If you will admit that good engineering doesn't happen by itself, then you must agree that some agency must be established in an organization to see that it does happen. That's why Value Engineering is here to stay and is doing a creditable job of getting DOD more hardware for less dollars. We would like to enlist your help to convince the engineer that he can become a better engineer if he will understand VE and cooperate with its objectives.

DAVE FRAM

Great Neck, New York

NANOSECOND PULSE FROM NEW RAULAND ULTRAFAST SCAN CONVERTER STORAGE TUBE

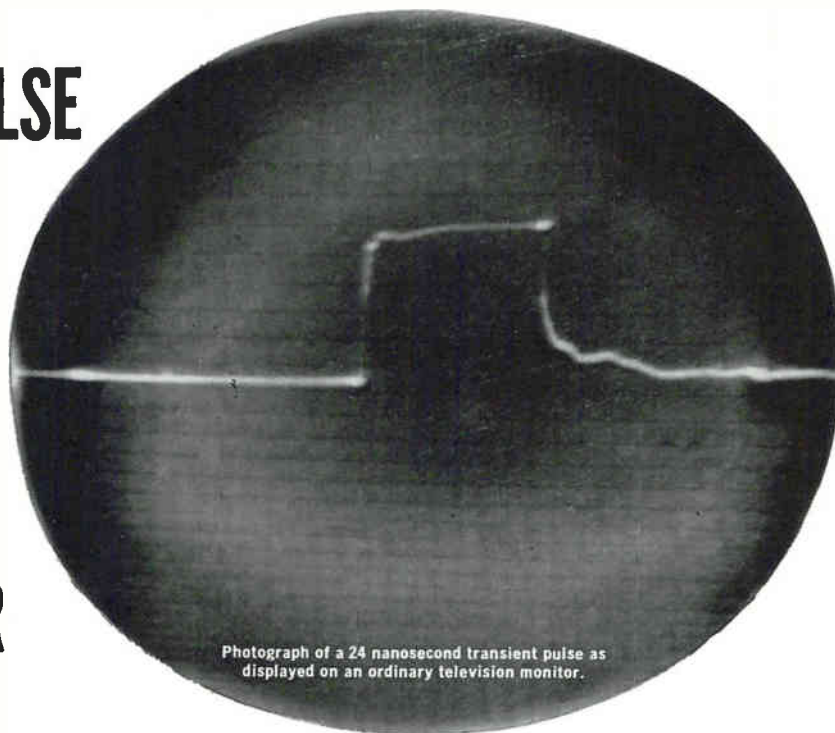



Photograph of a 24 nanosecond transient pulse as displayed on an ordinary television monitor.



Rauland has developed an ultrafast Scan Converter Storage Tube that records and stores transient phenomenon with pulse rise times in the range of a nanosecond or less. The unique design of the new Rauland R6253 tube permits slow scanning techniques to be used for the relay of transient pulse data over narrow band systems of 100 KC bandwidth or less. The pulse may also be recorded by conventional means—on magnetic tape, transmitted over inexpensive telemetry links, over communication cables, displayed on an ordinary television monitor and photographed using “box camera” exposure time. When displayed on a monitor, the tube

further allows unaided visual observation of extremely fast phenomenon for a period of several seconds. Relay or recording of pulses can be simultaneous with visual observation. The tube, consisting of separate writing and reading electron guns, is approximately 27 inches long and is 4 inches at its largest diameter. It utilizes a distributed deflection system for the writing side and either magnetic or electrostatic deflection for readout of high speed phenomenon. The tube is available with characteristic impedances of 50 or 125 ohms. The deflection system, being a continuous transmission line, allows the operation of several tubes in series.

 <p>SCAN CONVERTER STORAGE TUBES</p> <p>Resolution Capability of 1000 TV lines. Erase Capability of 2 seconds or less. Any combination of electrostatic or magnetic deflection is available.</p>	 <p>FLAT FACE DISPLAY TUBES</p> <p>Rauland's flat face tubes (16", 22", 24") minimize parallax error. Resolution capability of 1000 TV lines at a brightness of 100 foot-lamberts. We will suit your specific requirements with any type of radar display tube in any size with any type phosphor or gun.</p>	 <p>HIGH-RESOLUTION, HIGH-BRIGHTNESS TUBE</p> <p>Round 21" high voltage CRT will resolve at least 1000 TV lines at a brightness of 300-500 foot-lamberts. For displays under high ambient light conditions. Write or phone...</p>
---	---	---



The RAULAND Corporation

5600 JARVIS AVENUE
CHICAGO 48, ILL.
MULberry 5-5000

A subsidiary of



Radio Corporation
Chicago, Illinois

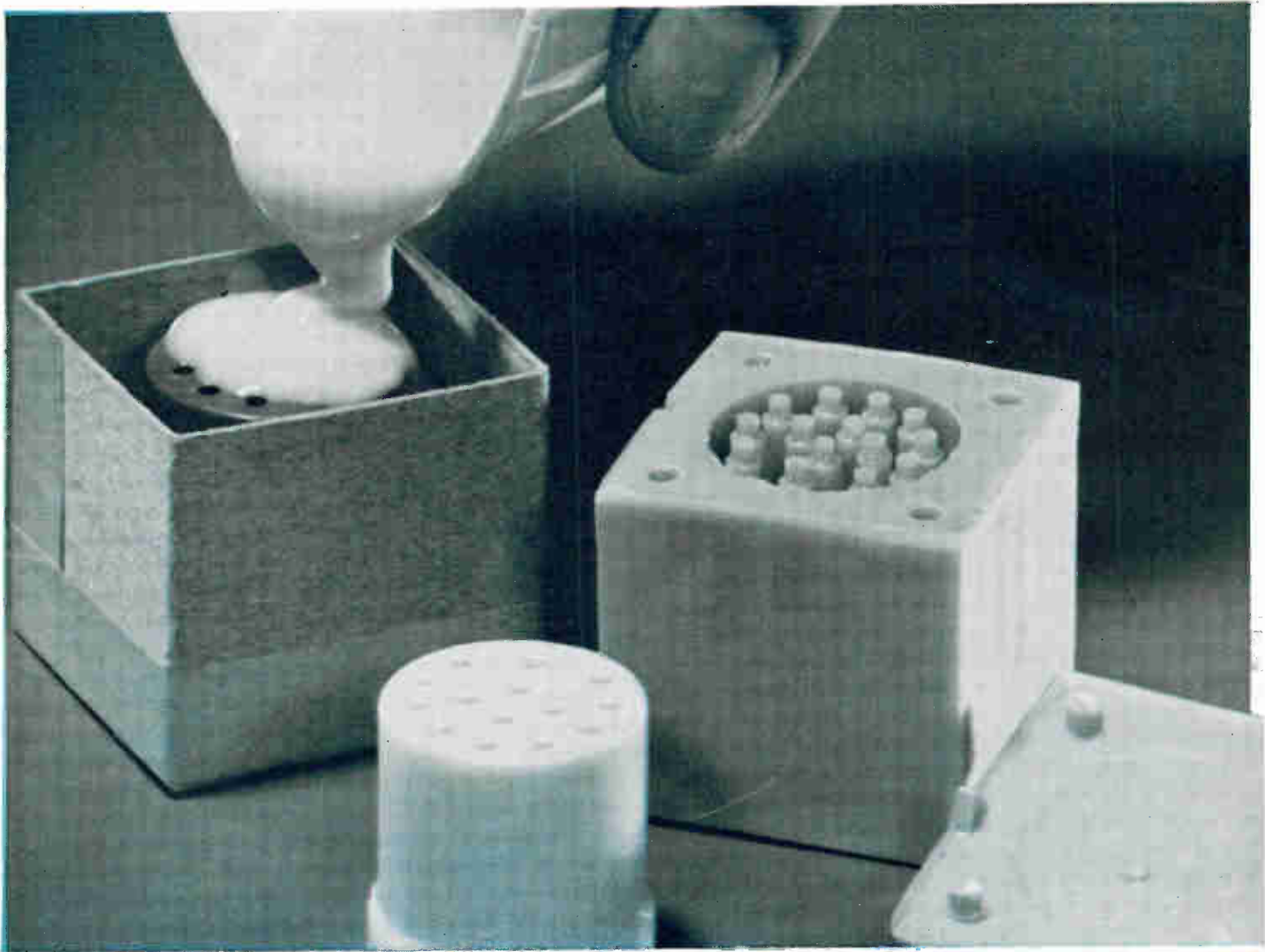

News Briefs

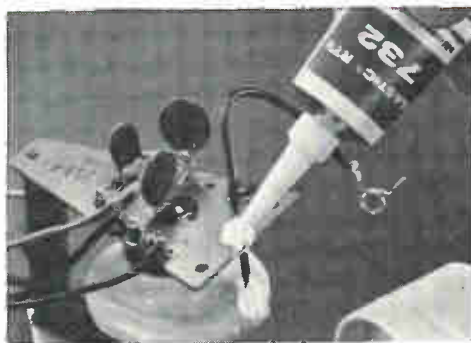

Hold it — bond it — seal it with Silastic® 732 RTV rubber. For bonding or sealing—try this ready-to-use Dow Corning silicone rubber adhesive/sealant. Tack free in one hour, solid rubber in 24 hours, it cures at room temperature, stays flexible from —100 to 300 F and higher, retains flexibility indefinitely. Used to bond metal, glass, plastics, rubber and many other materials, it waterproofs, insulates and calks. Resistant to corona, Silastic 732 RTV rubber is shown being applied to the high voltage lead of a fly back transformer.

CIRCLE No. 290 ON READER SERVICE CARD



Resist heat, moisture, pressure with silicone impregnating varnish. Dow Corning® 997 impregnating varnish is specified by most manufacturers of silicone-insulated equipment. The solenoid coil shown here is part of an electronic device that perforates oil well casings and is exposed to extreme pressure and heat, as well as salt water. Its dependable performance is assured by vacuum impregnation with Dow Corning 997 varnish. Use this varnish to seal, bond, insulate . . . to protect components or entire systems against environmental extremes.

CIRCLE No. 291 ON READER SERVICE CARD

For prototypes or production... new Silastic® RTV silicone rubber makes tough, deep-section molds

Now, cast prototypes quickly and easily in flexible molds made from this versatile new material. Silastic 885 RTV rubber duplicates fine detail, cures in any thickness at room temperature. Molds made from this tougher material retain their size and shape despite frequent use or extended storage . . . and they are easy, and economical to make.

Silastic brand RTV silicone rubber is supplied as a low-viscosity fluid. You simply add catalyst, mix and pour over your model. It cures completely within 24 hours regardless of confinement, configuration or thickness of sections. Then start casting exact duplicates in plastics or alloys with casting temperatures up to 500 F. Silicone rubber molds release easily, cleanly from most materials.

You'll find reproduction of even the finest detail is exceptionally true. And you'll find

this new silicone rubber particularly good for making prototype and shortrun production molds where delicate undercuts, thin sections and free-standing cores exist.

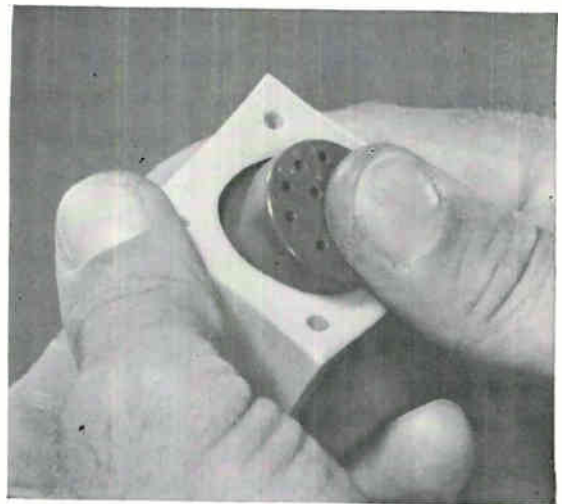

CIRCLE No. 289 ON READER SERVICE CARD

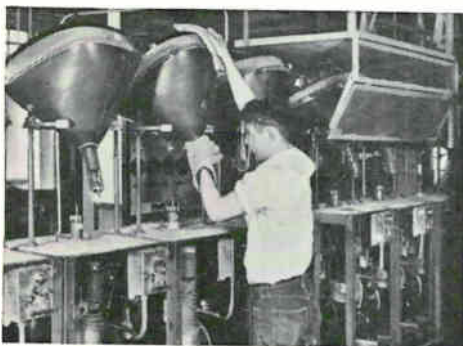

Fast pumpdown to high vacuum! The heat stability and rapid recovery characteristics of Dow Corning® diffusion pump fluids speed production rates and allow long runs without maintenance. Ultrahigh vacuum to 2×10^{-10} torr can be reached without refrigeration. Exceptionally low vapor pressure reduces backstreaming and vapor migration rates. Pump vacuum can be released without first cooling the boiler . . . hot fluid does not decompose when exposed to air. Specify Dow Corning brand diffusion pump fluid for high vacuum, low vapor pressure, quick pumpdown.

CIRCLE No. 292 ON READER SERVICE CARD

If you want to mold fast . . . hold fast . . . resist heat or assist vacuum — there's a Dow Corning silicone product to help do it better. For full information on these or other silicone applications, write Dept. 3922, Electronic Products Division, Dow Corning, Midland, Michigan.

Dow Corning

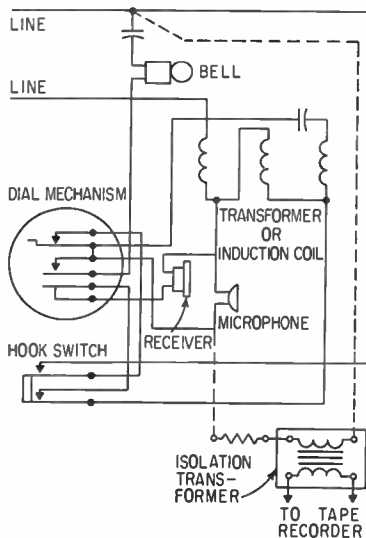
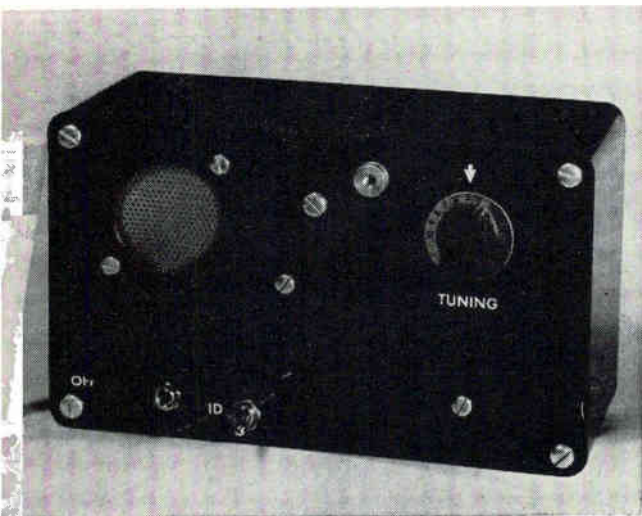

BUG DETECTOR (left) squawks when it locates hidden transmitter. Later models will be disguised as transistor radios, Y-Lab says

TELEPHONE TAP (diagram). This is a typical scheme. Dotted lines indicate connections to be made

Bugs and Antibugs: New Designs for

Despite legal questions, snoopers become more sophisticated, sales spurt

LOS ANGELES — During this month's tv spectacular starring song-bird Joseph Valachi, one official stated that 4 law enforcement men armed with telephone taps and other surreptitious listening devices can do the work of 400 unequipped men.

This statement was aimed at getting legalized the police use of electronic "investigative tools." They are also used by government agencies, plant security personnel and private detectives. The trouble is that it is hard to keep the devices from undesirables who also appreciate the advantages of "electronic spying"—nobody knows for sure how many of the devices eventually wind up in the hands of commercial spies and underworld types.

Manufacturers of this little-publicized equipment report that sales have noticeably spurted in the past few years. Producers of counter-eavesdropping gear are also chalking up healthy sales. Said one: "For every bug sold, there are probably 10 people worried about being bugged."

One source told **ELECTRONICS** that, nationwide, there are probably 10 firms, each with a half-dozen employees, making miniature surveillance transmitters and allied

gear, and innumerable telephone company employees and renegade police technicians moonlighting telephone-tapping devices for private detectives. The legitimate companies, he stresses, "are doing a conscientious, ethical job in the field."

He identifies the three major companies as Mosler Research Products, of Danbury, Conn.; Fargo Police Equipment, of San Francisco, and Tracer Electronics, of Newport Beach, Calif. He guesses that they account for 50, 20 and 15 percent, respectively, of the total market.

Before a plant fire, Solar Research, of Oakland Park, Fla., claimed the "most complete design and manufacturing facilities for intelligence equipment" in the free world. The company expects to rebuild and be back in business by December.

Taps and R-F Bugs—For intercepting telephone conversations, taps or miniaturized, microphone-equipped r-f transmitters called "bugs" are generally used. Taps are of either the induction variety or the strip-and-tape, direct-contact type.

Most r-f bugs transmit at 50 to 100 Mc. Snoopers with limited funds can adapt readily available f-m receivers for pick-up. Some bugs "borrow" power from the telephone equipment in which they are secreted; others use hearing-aid

batteries. Most have a power drain of 2 to 3 mw while emitting a 1-mw signal.

The more sophisticated have three r-f stages: an oscillator, a buffer and a final amplifier, are fixed-tuned, and have little drift. Audio systems are generally two-stage and use a reactance stage or Varicap as the frequency modulator. Few are crystal-controlled. The better devices have about 5 transistors and measure roughly 1-inch square and ½-inch high. Probably the simplest device is a single-transistor oscillator. Hooking it to a pipe, bedspring or other metal boosts antenna area.

Sugarlump Transmitter — Tracer Electronics markets two "sugarlump" transmitters, for \$65 and \$95. Their 8.4-v mercury battery lasts up to 100 hours and range is about one city block. One attaches to a telephone line; the other has its own microphone, and can be hung by the tip of its 12-inch antenna in the folds of drapery, or secured to cornices or furniture.

For \$150, Tracer sells a wearable transmitter with neckcord-antenna. James Swallow, of Santa Ana, who sells for Tracer, says it is ideal for vice-squad and narcotics-squad operators, being 1/20 the size of the smallest tape recorder. Another device, for listening in an automobile, draws power from the cigarette lighter wire and transmits over the

SCRAMBLER made by Delcon makes telephone conversation unintelligible except to listener with matching unscrambler. Battery-powered sets sell for \$250 a pair. It works against taps, not nearby r-f bugs

TRICKS OF THE TRADE

R-F bugs are considered expendable. One informant says no private eye in his right mind would retrieve a bug when its batteries run down. But the industrial spy may do just that, making him vulnerable to bug detectors. One gambit is to bug your own briefcase, "forget" it when visiting a conference room, eavesdrop or record outside, rush back to claim the briefcase

Hidden Ears

By HAROLD C. HOOD
Regional Editor, Los Angeles



car's radio antenna.

To pick up transmitter signals, the company has a tuneable vhf receiver that measures $5 \times 6 \times 2$ inches and will tune 20 Mc at 20 db. For tape-recording the signal, Tracer adapts American Concer-tone's all-transistor model 400.

Who Buys Them—Swallow estimates Tracer has sold well over 2,000 "sugarlump" transmitters.

"It's almost impossible to determine into what groups all our customers fall," he says. "Plant security officers use our bugs in remote areas of company buildings to warn against intruders. We sell to law-enforcement groups, and to private detectives. I imagine a certain number end up being used for industrial spying. Some companies in the business claim they sell only to government agencies, police departments and security forces, but that's a lot of bunk."

He feels that the beneficent uses of his equipment far outnumber the deleterious. "I can think of no cases where our products have been used to the detriment of society. On the other hand, many crooks have been apprehended and considerable swindling prevented."

Bug Detectors—Metal detectors, essentially miniature mine detectors, may be used to "sweep" a room for microphones concealed in wood, plaster and other materials. Mosler

Research claims the audible signal from one can indicate location, contour and approximate mass of the object detected.

However, such devices pick up nails, bolts and pipes as well as bugs, and cannot be conveniently used, for example, to detect listening devices in briefcases once a conference is underway. Field-strength instruments, such as one Mosler makes, use probes that can be concealed in the coat sleeve for discreet searches. Proximity of hidden transmitters can be indicated visually or audibly.

An agent might not want to tip his hand by letting the other side know he's located a bug implanted in a wall. Mosler also—among others—makes a device that will merely make a bug inoperative.

R-F Detector—Y-Labs, of Huntington Beach, Calif., now sells for \$250 an r-f detector. The device is dial-tuned from 15 Mc to several hundred Mc to locate an r-f bug. A modulator transforms the received c-w signal into an audible 400-cycle tone. When the "identify" switch is flipped, an audio filter is cut in. If the signal comes from a bug, acoustic feedback causes a squawk like an improperly tuned PA system. Y-Labs anticipates wide acceptance among the nation's 100,000 corporate security officers.

Spike Mikes—In many states, evi-

dence obtained by eavesdropping devices is inadmissible in court. In others, attorneys frequently resort to antitrespassing rulings to throw incriminating evidence out of court. The "Spike Mike" combats such legal tactics. Mosler Research and C. H. Stoelting Co., of Chicago, sell versions of this device. Pointed metal probes attached to contact microphones are driven into walls, doors or panels which act as "sounding boards," so rooms can be monitored without entering them.

New-Fashioned Spying—CIA and FBI sources don't want to discuss the gear used by intelligence and counterintelligence agents, but they hint that private-eye equipment is crude by comparison.

That famous decorative shield presented to the American Embassy in Moscow contained a spring-steel vibrator attached to a U-shaped piece of metal. A sensitive radar across the street picked up the reed's movement as people talked in the room. The bug put out no r-f signal, nor did it require battery replacement. Another Soviet trick, mentioned during the Valachi hearings, is to "read" the vibrations induced in window panes by conversations.

Then there's the story about the American attache in Moscow who found an r-f bug in his martini olive, but that one is supposed to be pure myth.

REDUCE CIRCUIT SIZE AND WEIGHT

*...with miniaturized
IGC ferrites*

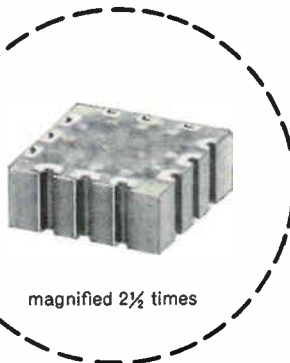
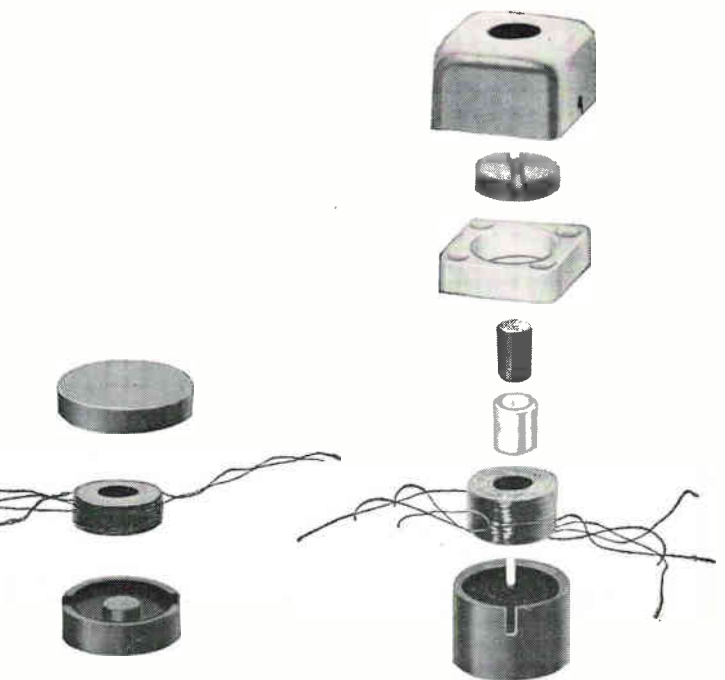



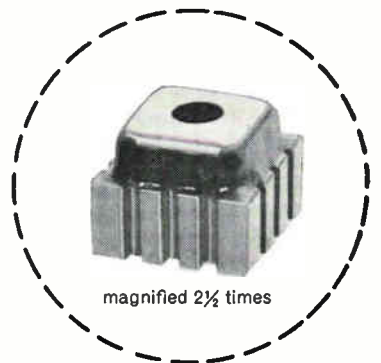

COLLINS RADIO COMPANY



TRW ELECTRONICS' RADIO INDUSTRIES, INC.

Extensive research by IGC engineers has resulted in a tenfold miniaturization of ferrite parts for the U. S. Army Signal Corp/RCA Micromodule Program. Typical of IGC's achievements are ferrite parts for fixed and adjustable inductor assemblies shown above. The adjustable inductor microelement, produced by TRW Electronics' Radio Industries, Inc., operates over a frequency range of 400 KC to 15 MC . . . has a tuning capability of 10% . . . a temperature range of -55°C to 85°C . Miniature ferrite cup cores with a Q of 100 to 115 over a frequency range of 200 to 1500 KC are supplied to Collins Radio Company for the fixed inductor assembly. ■ **MAGNETISM IS OUR BUSINESS.** IGC linear temperature coefficient ferrite materials are ideally suited to miniaturization because they combine the advantages of high Q and low loss with predictable change in inductance over a wide temperature range. For information, write to Indiana General Corporation, Electronics Division, Keasbey, N. J.

INDIANA GENERAL

 Toroids	 E. & I. Cores	 Inductors	 Transformer Cores	 Antenna Rods
--	--	--	--	---

SANBORN® DC DATA AMPLIFIERS



For precise control of low level signals from thermocouples, strain gages and resistance bridges, other millivolt-output transducers

Low noise and drift, high linearity and freedom from ground loop problems are a few of many distinct advantages these stable, all-solid-state Sanborn amplifiers offer your low-level DC signal instrumentation. Typical inputs include millivolt signals from thermocouples and strain gages. Amplifier outputs can be connected to scopes, meters, magnetic tape, oscil-

lographs, computers, and for high current output models, high frequency optical galvanometers. This choice from Sanborn lets you select the performance characteristics you need in your data acquisition system — you pay for only what you need. *And the specs hold true in practice as well as on paper.*

■ Consult Sanborn on your instrumentation requirements — your local Sanborn Sales-Engineering Representative will be glad to work out the details with you . . . and a phone call will get immediate action. Offices throughout the U.S., Canada and foreign countries.

	"FIFD" 860-4000	WIDEBAND 860-4200	NARROW BAND 860-4300
Bandwidth	DC — 10 KC within 3 db	DC — 50 KC within 3 db	DC — 100 cps within 3 db
Linearity	±0.1% of 10 V f.s. at DC	±0.01% of 10 V f.s. at DC	±0.03% of 5 V f.s. at DC
Gain	1000, 500, 200, 100, 50. Smooth gain control covers intermediate ranges	1000, 500, 200, 100, 50, 20, 10. Does not phase invert	1000, 500, 200, 100, 50, 20, 10. (Gain of 10 to 20,000 in 12 fixed steps available on special order)
Overload Recovery	For 20 V, 1 ms to 1% of f.s. output		For ±10 v, 200 ms to within 25 mv of original output
Drift	±2 uv ref. to input. ±0.01% of f.s. at output at constant ambient for 40 hours	±0.02% of f.s. at constant ambient for 40 hours	±2 uv ref. to input. ±0.1 mv. ref. to output for constant ambient for 40 hours
Noise	5 uv rms, DC-10 KC (ref. to input at gain of 1000)	7 uv rms, DC-50 KC (ref. to input)	1 uv p-p, DC-20 cps (ref. to input, at gain of 1000)
Input	Isolated from gnd. and output. Impedance 100 meg. min. at DC in parallel with 0.001 mfd.	Impedance 100 meg. at DC in parallel with 0.001 mfd.	Isolated from gnd. and output. Impedance 500K
Output	Isolated from input and ground. ±10 V at 10 ma. (4000P has grounded output, ±10 V at 100 ma.)	±10 V at ±100 ma. Sustained short across output will not cause damage to amplifier.	Isolated from input and ground ±5 V at ±2.5 ma. Part or all of internal 2K in parallel with 25 mfd. may be removed, connected externally.
Common Mode Characteristics	120 db rejection at 60 cps, 160 db rejection at DC (1000 ohms in either input lead). Tolerance ±300 V DC or peak AC.	Amplifier floats with respect to chassis. Isolation impedance is greater than 3000 megohms in parallel with 5 pfd.	130 db rejection at 60 cps, 160 db rejection at DC (1000 ohms in either input lead). Tolerance ±300 V DC or peak AC
Price (F.O.B. Waltham, Mass.)	\$825 (860-4000P \$900)	\$600 (including internal power supply)	\$425



INDUSTRIAL DIVISION
SANBORN COMPANY
 WALTHAM 54, MASS.
 A Subsidiary of Hewlett-Packard Co.

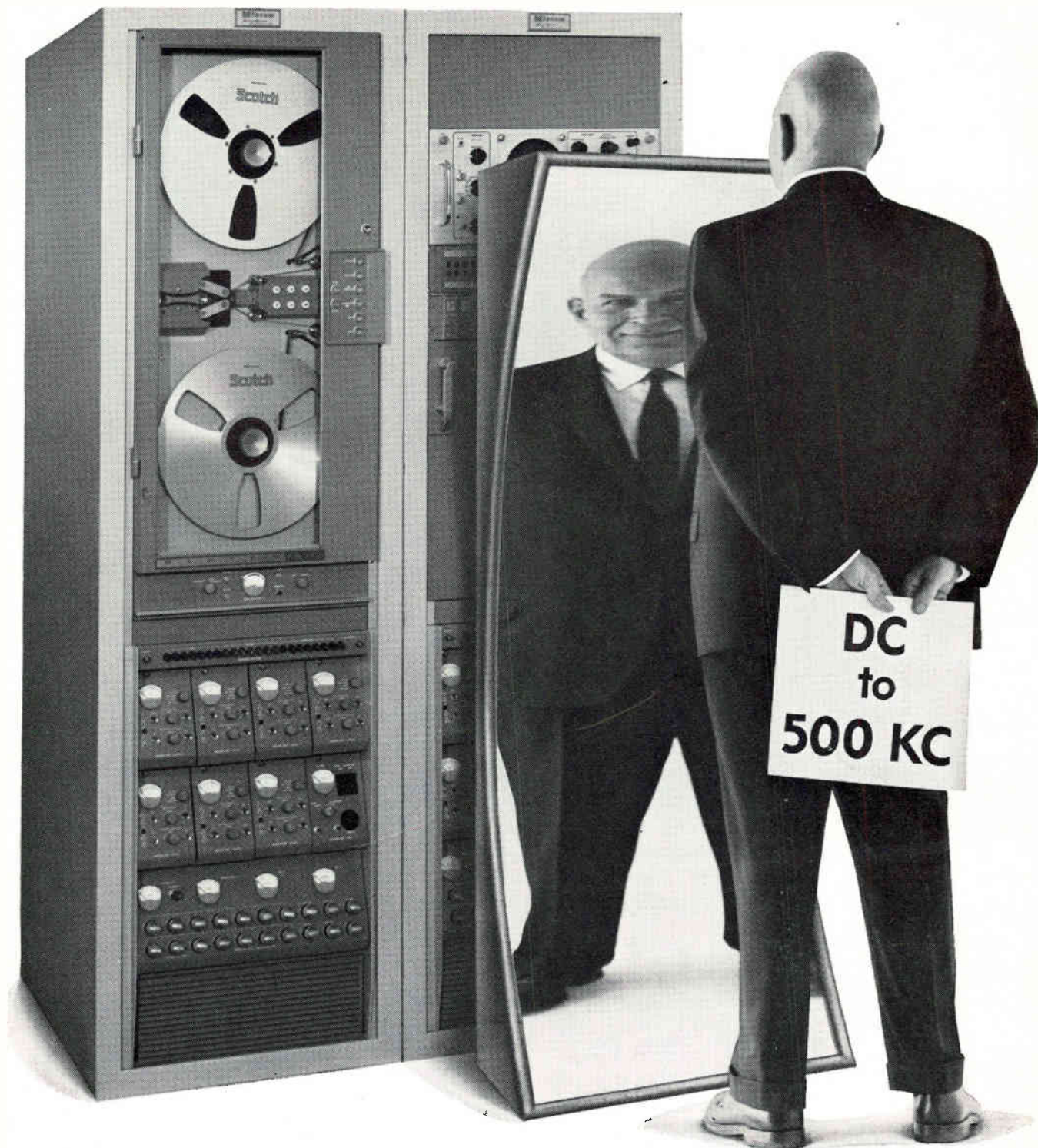

WIDEBAND FM recording, using 1.5-megacycle analog techniques to attain an improved frequency response of DC-500 kc, is Mincom's latest telemetry development. Heart of the new system is the standard Mincom 1.5-mc CM-114 Recorder/Reproducer. The extended FM responses enable telemetry facilities to record simultaneously the most complex narrow-band and wideband signals in PCM, PCM/FM, PDM, and FM/FM modulation. More advantages: Extended low frequency response, excellent linearity, seven or fourteen recording tracks, versatility without modification, greater dynamic range, dropout reduction virtually to zero. Write today for details and complete specifications.

Mincom Division **3M**
COMPANY
2049 South Barrington Avenue, Los Angeles 25
425 13th Street N. W., Washington 4, D. C.

Microclad^(TM)

FLEXIBLE PRINTED WIRING MATERIALS FROM SPAULDING

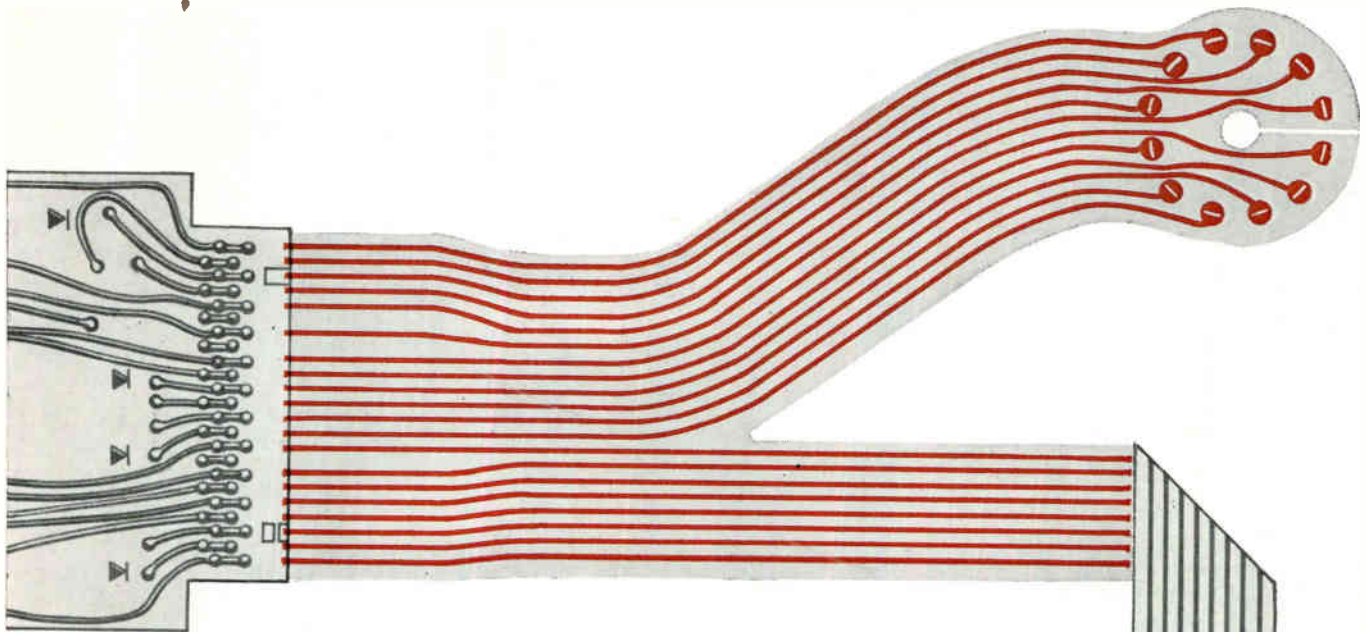

Flexible laminate for etched wiring, harnesses and other electronic applications to reduce space, weight and cost while broadening your design parameters.

Available in combinations of copper, nickel or Kovar† foils laminated to Mylar* or Teflon* films. Write for details.

†Westinghouse registered trade name

*duPont registered trade names

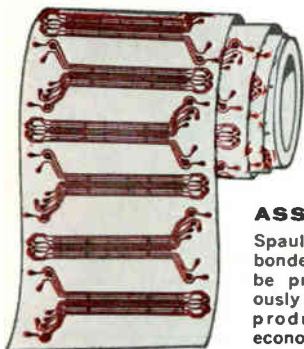

ASSURED RELIABILITY

Spaulding Microclad-metallic foils bonded to insulating films—may be printed and etched continuously thereby guaranteeing reproducibility coupled with economy.

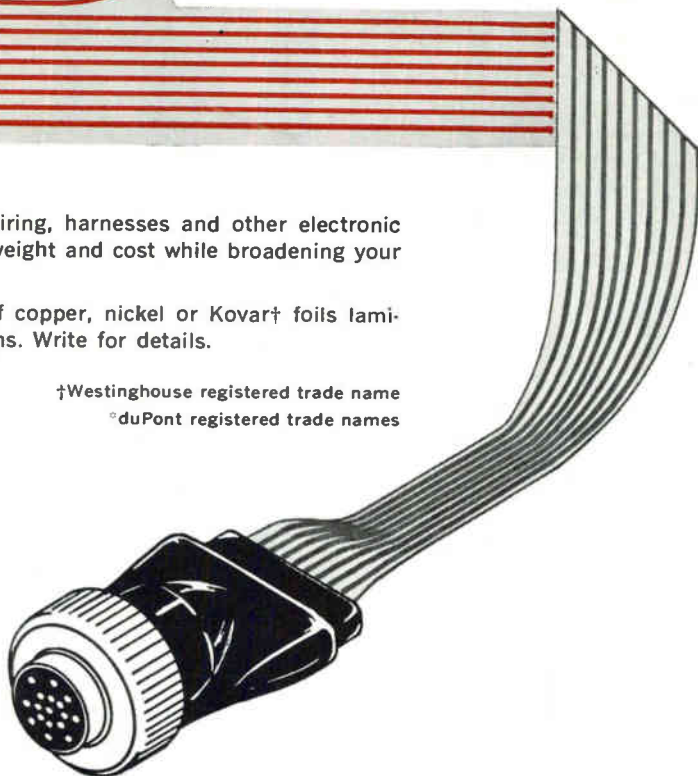

SPAULDING FIBRE COMPANY, INC. • 471 Wheeler Street/Tonawanda, N. Y.

NOW!

Famous "VY" Porcelain Capacitors are available with ZERO and NEGATIVE Temperature Coefficients

(as well as standard +105 ppm/°C)

THE NEW
VY[®] "0"

Solid State Capacitor

Here's a capacitor designed to pull its own weight in tuned circuits, rf, and high frequency applications. This new "VY" capacitor has a temperature coefficient of 0 ± 25 ppm/°C. Axial-radial lead configuration saves board space . . . gives greater flexibility to circuit wiring. Offers the exceptional electrical and physical characteristics inherent in all "VY" Capacitors.

THE NEW
VY[®] "-65"

Solid State Capacitor

This new unit offers the same capacitance and temperature range and same voltage ratings as the zero TC Capacitor. Temperature coefficient is -65 ± 25 ppm/°C. Axial-radial lead configuration is provided in the same body sizes as the zero TC unit.

Send for data sheet containing complete specifications

© Vitramon, Inc. 1963

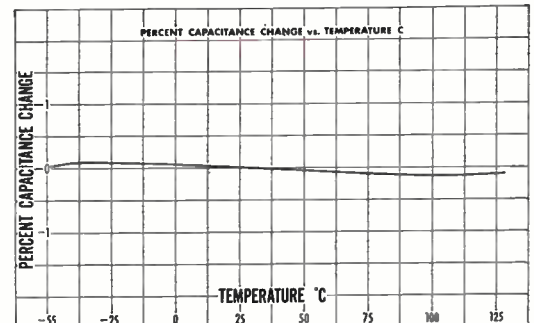

- * Conforms with MIL-C-11272
- * 10 to 1000 pf
- * -55°C to 125°C operation
- * 300 and 500 vdc

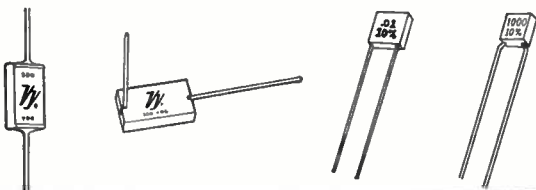
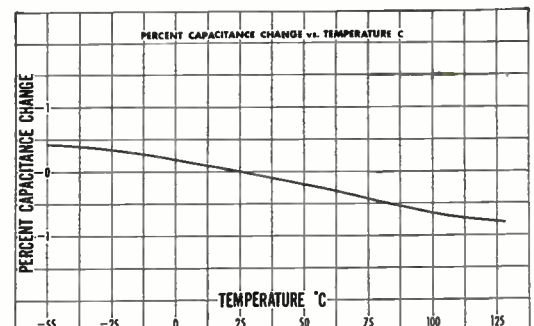

Vitramon
INCORPORATED
BOX 544 • BRIDGEPORT 1,
CONNECTICUT, U.S.A.

In United Kingdom contact:
Vitramon Laboratories
Limited
45 Holloway Lane
Harmondsworth, Middlesex
England

RFI: Another Microcircuit Problem

CHICAGO—Brig. Gen. Allen Stan-wix-Hay, of the Army Electronics Material Agency, last week posed this problem for designers of micro-circuits: as circuits get smaller and simpler, can their ability to reject and suppress spurious responses and emissions be retained? The chal-lenge, he said at the ninth Electro-magnetic Compatibility Conference, is to simplify microcircuits without sacrificing radio-frequency-interference control. Interacting microcir-cuits (p 28, June 14) are increas-ingly a source of rfi, he indicated.

Several speakers updated earlier reports on the Electromagnetic Compatibility Analysis Center (see p 20, Aug. 17, 1962, and p 28, Nov. 16, 1962).

J. B. Scott, of ECAC, described a new prediction program that can find interference-to-noise ratios be-tween 45 transmitters and 45 re-ceiver in a problem area within 6 minutes, using a digital computer and the ECAC data base.

J. Iseli, of ECAC, discussed a computer profile generator capable of covering 1 mile/msec. Aim of the project is automatic generation of terrain profiles and extraction of in-formation required for rfi or propa-gation analysis.

Reliable Earth Sensor Described by NASA

BALTIMORE—Development of the Reliable Earth Sensor for orienting a spacecraft toward earth using in-frared techniques without any mov-ing parts was disclosed Wednesday at the East Coast Conference on Aerospace and Navigational Elec-tronics by Barbara Lunde, of NASA Goddard Space Flight Center.

Designed for operational weather and communications satellites, RES uses $\frac{1}{10}$ the electronics required for OGO's ir horizon scanner and has a 90 percent probability of operat-ing for three years, apparently meet-ing the Weather Bureau's longevity requirement. Space Technology Laboratories is building the sensor under a \$200,000 contract. First test flight has been scheduled for June, 1965.

RES is an ir optical system that images the earth and the surround-ing space on a detector array. Out-put of opposite heat detectors is compared and amplified. Difference in temperature between elements determine the offset angle. Special region of 12 to 20 microns will be used.

Project Orion May Die: Blame Test-Ban Treaty

WASHINGTON—Some observers here say the nuclear test-ban treaty will be used as an excuse to kill Project Orion, although others predict Orion will be con-tinued for the time being as a study project. Under the Orion scheme, large spacecraft would be propelled by exploding small nuclear bombs against an abla-tive plate behind the rear of the craft. The test-ban treaty is not expected to affect other nuclear propulsion programs.

Laser Scanning Study Aimed at Display Use

PERKIN-ELMER this week announced it has a \$97,500 Air Force contract to study scanned-laser display tech-niques. It is expected that non-mechanical techniques for modulat-ing and scanning light will lead to the use of c-w gas lasers for gener-ating high-resolution displays.

System requirements include a modulation frequency range of 30 cps to 30 Mc, a minimum of 1 mil-lion resolvable elements, and a scan rate permitting the presentation of all resolvable elements in 30 msec. Techniques for both internal and ex-ternal laser output beam modulation are being considered.

NASA Electronics Center—Where?

WASHINGTON—NASA has named a special panel to study possible loca-tions for a \$50-million space electronics center. Before any funds authorized by Congress can be spent, NASA must say why the center is needed and why it should be located at a particular site. NASA's original proposal to put the center in the Boston area has been criticized as politically motivated, for the benefit of Sen. Edward Kennedy. (D-Mass.) However, the Boston area has not been ruled out of consideration.

Francis B. Smith of NASA's Langley Research Center will head the com-mittee. Other members: Wendell H. Pigman, Dr. G. Allen Smith, and C. R. Morrison, all of NASA, and Dr. B. Richard Teare Jr., dean of engineering and science, Carnegie Institute of Technology.

LEM Guidance Contracts Awarded—\$60-Million Worth

WASHINGTON—NASA has awarded contracts, expected to exceed \$60 million, to MIT, AC Spark Plug, Raytheon, Kollsman Instruments and Sperry Gyroscope, to build and test the guidance and navigation system for the Apollo lunar excu-rsion module. The companies were

previously under contract for similar work on the command and service modules.

AC Spark Plug will supply the inertial measuring unit, including precision gyros, navigation base, power and servo assembly and the coupling display unit. It will also assemble the complete system. Kollsman will supply the scanning telescope, and the map and visual display unit; Raytheon, the on-board computer; Sperry, the pulse integrating pendulum accelerometer. MIT Instrumentation Lab will direct the overall development, and Grumman will integrate the system into LEM.

No-Bounce ILS Antenna May Take to the Hills

NUTLEY, N. J.—ITT hopes a glide-slope antenna it is developing under a \$127,000 FAA contract will minimize rough-ground problems that bother present ILS setups. The 72-foot, 28-dipole antenna will not

need smooth terrain for a reflector because it will send out its beam directly. Systems now in use form vertical lobes by bouncing the beam off the earth. Although the cost of the new antenna will be relatively high, some airports will find it cheaper than flattening the surrounding land, ITT said.

Russians Visiting Britain Shown Nucleonic Devices

LONDON—Eighteen firms of the British Scientific Instrument Makers Association have organized a display of nucleonic instruments for a visiting delegation of Soviet isotope specialists. The Soviets are touring the United Kingdom Atomic Energy Authority establishment at Harwell. British interest in expanding export markets in the Communist bloc was also reflected last November at an exhibition of scientific instruments and industrial controls in Peking. The display was staged by the Sino-British Trade Council.

Microcircuit Projections Called Too Optimistic

PHILADELPHIA—Industry may be overestimating the market potential for microcircuits, says Walter W. Slocum, president of International Resistance Co. Slocum, speaking before the Financial Analysts of Philadelphia, said IRC sees total markets of \$150 million for hybrid and \$450 million for integrated circuits by 1972. Estimates by industry sources run as high as \$190 million and \$790 million respectively.

Space Drive May Shift, Marketing Manager Warns

GE MARKETING executive last week warned that significant shifts in the U. S. space program may be in the wind for the 1965 fiscal year. Budget cuts may also result in a "serious reduction in work," said John L. Galt, manager of advanced marketing for GE's Missile and Space Division. He spoke before the Philadelphia chapter of the National Security Industrial Association.

MEETINGS AHEAD

NATIONAL ELECTRONICS CONFERENCE, IEEE, IIT, Northwestern University, University of Illinois; McCormick Place, Chicago, Ill., Oct. 28-30.

ELECTRON DEVICES MEETING, IEEE; Sheraton Park Hotel, Washington, D. C., Oct. 31-Nov. 1.

17TH NORTHEAST ELECTRONICS RESEARCH-ENGINEERING MEETING, New England Sections IEEE; Commonwealth Armory and Somerset Hotel, Boston, Mass., Nov. 4-6.

RADIO FALL MEETING, IEEE, EIA; Hotel Manger, Rochester, N. Y., Nov. 11-13.

FALL JOINT COMPUTER CONFERENCE, AFIPS, IEEE, ACM; Las Vegas Convention Center, Las Vegas, Nev., Nov. 12-14.

MAGNETISM-MAGNETIC MATERIALS ANNUAL CONFERENCE, AIP, IEEE-PTGMTT; Chalfonte-Haddon Hall, Atlantic City, N. J., Nov. 12-15.

MEASURE TESTING-CONTROL AUTOMATION INTERNATIONAL EXHIBITION, MESUCORA; Palais de la Defense, Paris, France, Nov. 14-21.

TECHNICAL WRITING WORKSHOP, University of California Extension Center; San Francisco, Calif., Nov. 18-19.

ENGINEERING IN MEDICINE AND BIOLOGY ANNUAL CONFERENCE, IEEE, ISA; Lord Baltimore Hotel, Baltimore, Md., Nov. 18-20.

VEHICULAR COMMUNICATIONS NATIONAL CONFERENCE, IEEE-PTGVC; Adolphus Hotel, Dallas, Texas, Dec. 5-6.

FALL URSI MEETING, IEEE Seattle Section, URSI, Boeing Scientific Research Laboratories; University of Washington, Seattle, Wash., Dec. 9-12.

FIRST MICROELECTRONICS CONFERENCE, EIA; Irvine Auditorium, University of Pennsylvania, Philadelphia, Penn., Dec. 10-11.

AMERICAN ASSOCIATION FOR THE ADVANCEMENT OF SCIENCE MEETING, AAAS; Cleveland, Ohio, Dec. 26-30.

ADVANCE REPORT

RADIO METEOROLOGY WORLD CONFERENCE, URSI, UGGI, NBS, American Meteorological Society; Boulder, Colo., Sept. 14-18, 1964; Dec. 1 is deadline for submitting titles, suggestions to Mr. J. W. Herbstreit, Program Committee, 1964 World Conference on Radio Meteorology, Central Radio Propagation Laboratory, National Bureau of Standards, Boulder, Colo. Some possible topics: microwave propagation in or through the troposphere; radar observations of precipitation, cloud, lightning, dielectric inhomogeneities of the air.

Seismic Net Points Way To A-Blast Monitor

BOSTON—A seismic data network has been established in New England to help develop an operational system for seismometer detection of underground nuclear explosions. Data from four unmanned stations has been successfully transmitted over special telephone lines to visual and tape recording devices at Weston Observatory in Weston, Mass., says Air Force Cambridge Research Labs. The stations are in Caribou, Machias and Milo, Me.; and Berlin, N. H., the farthest being 365 miles from Weston. The network will be used to study methods of overcoming the No. 1 problem in detection of underground explosions: separating signals of interest from other noises.

Low-Cost Data System Will Connect Computers

NEW YORK—Univac introduced a low-cost, high-speed data communications system at the opening of a data-processing center here last week. The system adds to the Univac 1004 card processor a data-line terminal that links the 1004 to a standard Bell System Data Phone. This enables the 1004 to communicate with another 1004 or a Univac 490 or 1107. Transmission rates are 342 or 285 characters a second over private or toll lines, respectively.

Punched-card data is read into the 1004's 931-character core memory, whose time is 8 μ sec. Then digital bits are transferred serially from the memory to the Data Phone for transmission. Parity bits are added to each 6-bit character and longitudinal parity bits are added also to enable the receiving terminal to detect errors. The terminal also detects line failures. The 1004 can edit data and perform "housekeeping" chores. The 1004 costs \$54,000 to \$74,000 and rents for \$1,350 to \$1,700 a month.

Univac officials estimated the entire data-processing-center business now stands at \$220 million a year, and will reach $\frac{1}{2}$ billion by 1968. They expect the rental market for data communications gear to reach \$1 billion a year by 1968. Univac now has centers in 32 cities.

Field-Effect Transistors Highly Stable, Test Shows

SUNNYVALE, CALIF.—Unipolar field-effect transistors, in two-million-hour life tests by Siliconix here, showed better stability than bipolar injection transistors, the firm told ELECTRONICS this week. Double-diffused FET's followed the normal decreasing slope of the Weibull distribution, indicating low failure rates after a short burn-in time—making FET's eligible for high-reliability applications.

Tests on 1,000 unipolar FET's at 150 C ambient with all *p-n* junctions reverse biased to 80-percent

rated breakdown voltage, showed electrical parameters resist drift. The firm attributes this to the fact that FET performance relies on the majority-carrier conduction mechanism: carrier lifetime is unimportant. Control action in bipolar transistors is directly affected by the base region minority-carrier lifetime—which apparently changes with temperature cycling and operating life.

Anisotropic Media Studied For Microwave Generation

RAYTHEON'S Research division will study a method of microwave generation using anisotropic media as "structures" to support electro-magnetic waves. Media to be investigated are plasmas and pyrolytic graphites. The feasibility of using pyrolytic graphite for application in microwave tubes will also be considered. The electron beam interaction with various forms of anisotropic and isotropic plasma columns will be weighed as a possible means of generating microwaves and millimeter waves with easy electronic tuning and simple construction. The study will be conducted for USAEDRL, Fort Monmouth.

Disk File Stores Billion Characters

IBM last week introduced its 1302 disk storage unit, which has twice the read-write speed and four times the capacity of the IBM 1301 disk file. The 1302 reads and writes 184,000 characters a second. Some 117 million six-bit alphanumeric characters can be stored on the 1302, model 1, a single module file, and twice that many on the model 2, a double module. As many as five 1302 disk files can be operated through a 7631 file-control unit, making a maximum of over a billion characters of random-access storage that can be used with any of nine IBM computers, including the 1401, 7074 and 7090. The 7631 control unit allows 1302 units to be shared by any two of these IBM systems.

IN BRIEF

PRODUCTION has started at General Micro-Electronics on the company's first set of semiconductor integral logic-circuit elements. The seven basic circuits — silicon planar epitaxial devices — are designed for medium-speed, low-power applications.

SYLVANIA has developed a mathematical technique for forecasting the probable success of a space flight at any time during a mission.

CONTRACTS worth \$11,604,300 for R&D on an advanced integrated flight control system—most likely for use in the X-20 Dynasoar program—have been awarded by the Air Force Systems Command. Litton gets \$9,509,300 for a control data system, Leer Siegler \$1,995,000 for advanced flight instruments and Bell Aerosystem \$100,000 for a reentry energy management system.

REPUBLIC AVIATION reports fabrication of a solar-flare alarm system using video digital techniques for use with solar-oriented scientific spacecraft and ground-based solar observatories. In the lab, the system has detected flares with intensities only 1.5 to 2.0 times that of the background solar disc.

FIRST MILITARY microelectronic computer (p 26, Feb. 15) has been completed by North American Aviation. The production scale D37B will be part of the Air Force Minuteman's new X17 inertial guidance system.

AMPEX has acquired Mandrel Industries

BOTH TWIN VELA satellites (p 57, Oct. 18) last week went into orbit to detect high-altitude nuclear blasts and measure space radiation.

CONTROL DATA CORP. has acquired principal assets of the Control Systems Division of Daystrom Inc. in return for Control Data stock.

VARIAN has developed an optically pumped solid-state laser that operates in the orange range at 5,985 A, using praeosodymium ions dissolved in an optically clear crystal of lanthanum trifluoride.

TEXAS INSTRUMENTS, under a \$194,000 NASA contract, will devise gear to obtain scientific information and ground samples once an Apollo team lands on the moon.

RCA is now supplying sample active thin-film devices.

Minimum Wages For Tube and Parts Workers May Be Raised

Labor Department is considering raising the minimum wages that producers of tubes and component parts must pay. The present minimum of \$1.23 for component parts was set July 26, 1961. The tube industry rates—\$1.35 for solid-state semiconductors and \$1.42 for all other products—were set January 7, 1961. A minimum of \$1.52 has been in effect since May 4, 1963, for electronic equipment.

On another Walsh-Healey front, Bureau of Labor Statistics has just begun a study of what happens to the wage structure in an industry after federal minimum wage rates are established under the Walsh-Healey Act. What the impact actually is has long puzzled both government and management economists. One unknown is whether pay differentials are maintained when the lowest salaries are raised.

BLS hopes to get answers within a year from studies of the office computing and accounting machines and manifold business forms industries. It will study the wage situation for a period just before and just after the minimums became effective in each case. For office computing machines, a \$1.55 minimum was imposed in March 1962; for business forms, \$1.39 was set in September, 1961.

Pentagon To Double Check Its R&D Bills

Defense Department will look more closely at the bills it gets from contractors for independent research work. When they are asked to share costs of continuing R&D efforts, officials will want to examine total company costs, for private as well as government business. The objective is to make sure costs are shared in fair proportion and to prevent the subsidizing of large R&D staffs in industry. Pentagon contracting officers feel some firms are unnecessarily hoarding personnel. In a few weeks, contractors will get the details of a uniform system for determining how research costs are to be fixed.

Space Station Aided by Pact

Joint agreement between NASA and the Pentagon to coordinate efforts for a manned space station has two significant meanings: initially, it boosts the program's chances by reducing military-civilian in-fighting; and it reflects the ascendancy of the military role in space as NASA struggles to retain its domination of the program. The station may cost as much as \$4 billion.

Navy Gets Set To Build Autec

Project Autec's prime contractor will likely be picked within the next few weeks. RCA, ITT, GE, Lockheed and Raytheon have entered proposals for the \$100-million Atlantic Underwater Test and Evaluation Center. Instrumentation, to be anchored or suspended from buoys, is to be bought competitively. With the signing on Oct. 11 of a formal agreement between Britain and the U. S. for establishment of Autec near Andros Island in the Bahamas, Navy will move rapidly to get the base underway. Plans now call for putting Autec in operation in two years.

Funds for PhD Program Cut

Presidential Science Advisor Jerome B. Wiesner is fighting to save funds for a new National Science Foundation program to support graduate education in mathematics, engineering and the physical sciences. The House of Representatives cut \$266 million from the NSF budget, and banned new programs. Wiesner wants to see 7,500 new doctorates a year in these fields by 1970, compared with 3,000 a year now.

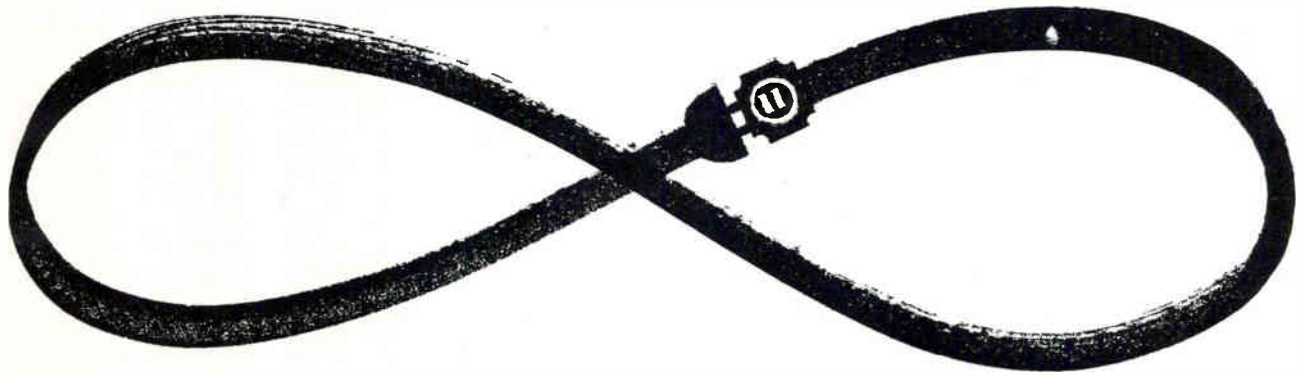

ELECTRIC POWER FOR SPACE

TRW Space Technology Laboratories is building electric power systems using electrochemical, photovoltaic and nuclear techniques. They are being used on America's major space programs, including OGO, Air Force 823 Program and Mariner. Engineers and scientists interested in energy conversion technology, transistor circuit design, electrochemistry and power system engineering should contact STL Professional Placement, One Space Park, Redondo Beach, Calif. Dept. G-10. TRW is an equal opportunity employer.

TRW / **SPACE TECHNOLOGY LABORATORIES**
 a subsidiary of Thompson Ramo Wooldridge Inc.
ONE SPACE PARK • REDONDO BEACH, CALIFORNIA

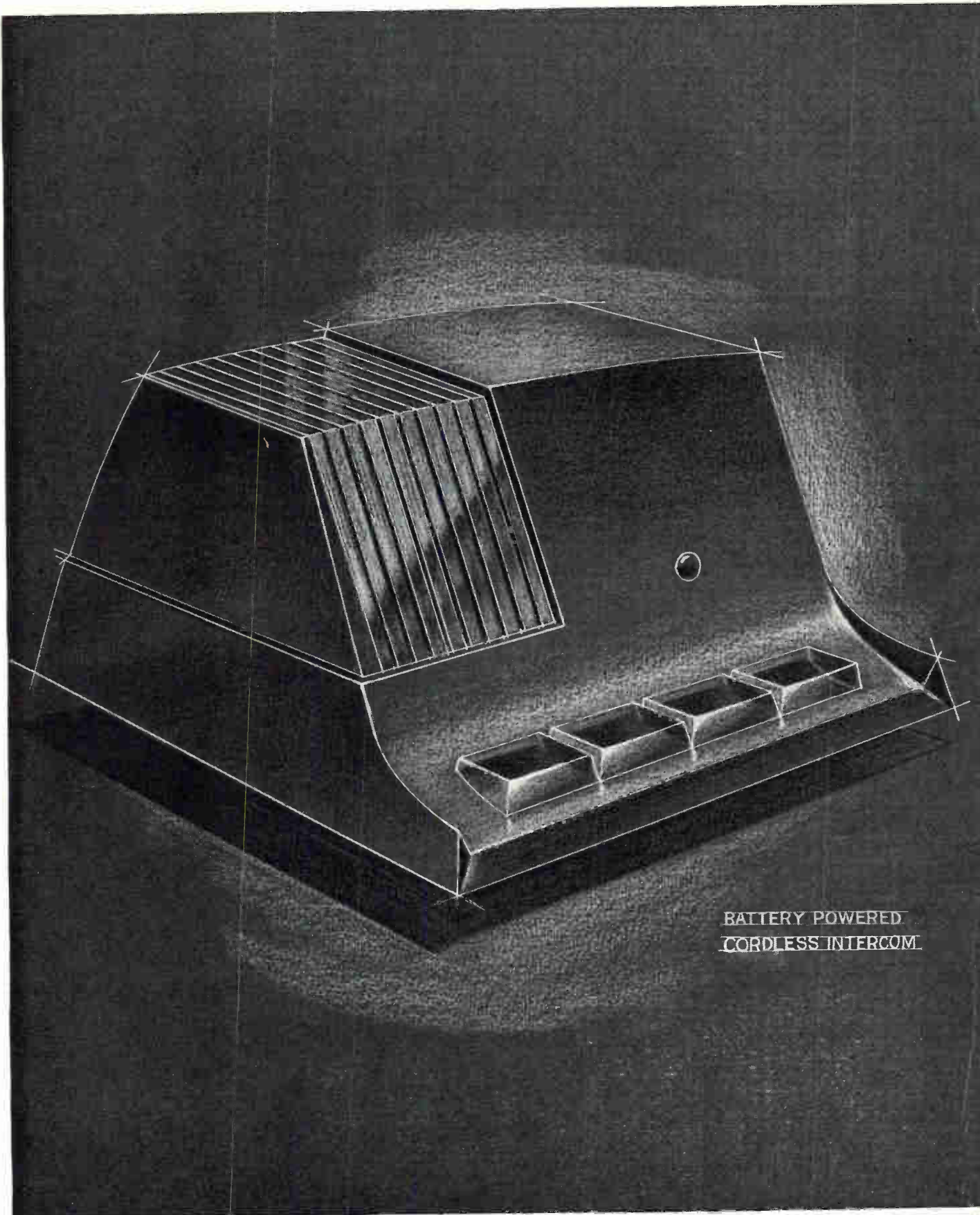

BATTERY POWERED
CORDLESS INTERCOM

When *your* design calls

Mallory—best source for answers to battery problems for more than 20 years.

No envelope or postage

MALLORY BATTERY CO.
 A Division of
P. R. Mallory & Co., Inc.
 60 Elm Street
 N. Tarrytown, N. Y.

Attn: Application

Jim - need lots of battery capacity in minimum size - lets call Mallory! WAT.

Gentlemen:

Please recommend the Mallory Mercury Battery or Cell most suitable for the requirements outlined below. We understand that our inquiry will be treated confidentially, and that we shall not be obligated in any way.

Nature of Application: Military _____ Commercial _____ (please check)

Type of equipment (specify motor, transistor, etc.): _____

Type of Battery Required: Primary _____ Rechargeable _____

Electrical requirements:

Maximum no-load voltage _____ V
 Starting voltage under load _____ V
 Resistance or cut-off voltage _____ V
 Resistance of load _____ V
 Current drain (average) _____ OHMS
 Peak current (if any) _____ MA
 Duration of peak current _____ SEC.
 Is battery operation continuous? _____ If intermittent, time on _____ time off _____

Physical and environmental requirements:

Overall battery size limitations:
 Length _____ Width _____ Height _____ or Diameter _____ Height _____

Type terminals _____ Locations of Terminals _____

If battery has more than one section, are negative terminals common? _____

Operating temperature range from _____ to _____ °F.
 Storage temperature range from _____ to _____ °F.
 Vibration or shock conditions (describe): _____

Other unusual conditions: _____

Name _____ Position _____
 Company _____
 Street Address _____
 City _____ Zone _____ State _____

Battery Application Data

1-404 2/63

for battery power . . . call
 Mallory Battery Company, Tarrytown, New York — a division of P. R. Mallory & Co. Inc.



NEW → 'The Mercury' SERVOMATIC® ANALYZER

WAVESHAPES AVAILABLE: Sine, Triangle, Square, Modulated Sine, Modulated Triangle, Modulated Square (see selected specifications below)

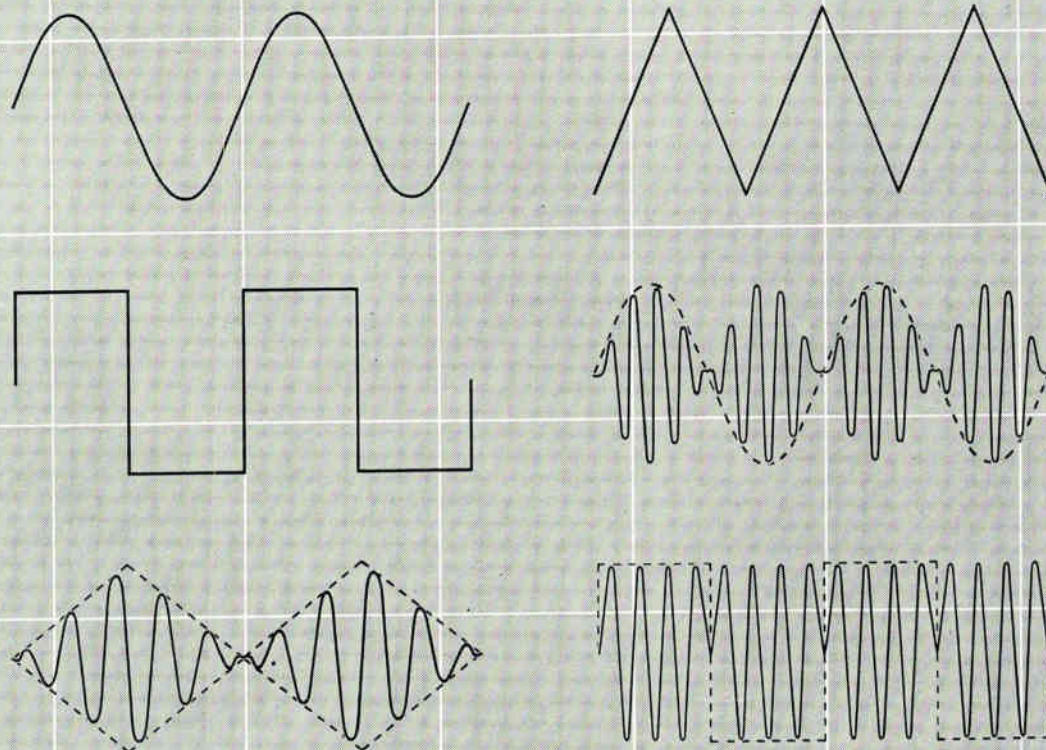

Model 1990

Also available: Model 1990X with CRT indicator and Model 1990R for rack mounting; other models available for specific applications with dc-only servo systems.*

*Lower prices on models in this series.

Servo's new SERVOMATIC® Analyzers are the standards for comprehensive servo system test and analysis. Write for complete specifications and arrange a demonstration from your local representative.

SELECTED SPECIFICATIONS FOR MODEL 1990

Frequency range 0.005-1,000 cps, cont. var. in 5 ranges for all waveshapes
Eleven available signal outputs:

- 0° and 90° sine wave and mod. sine wave 0-40 v, p-p min.
- Square wave and mod. square 0-40 v, p-p min.
- 0° and 90° triangular wave and mod. triangular 0-35 v, p-p min.
- Synchronized sweep 7 v min.
- Synchronized pulse 3 v pos; 9 v neg
- Carrier acceptance 50-10,000 cps (ext); 1 watt, 26 v / 115 v terminals provided
- Phase measurement 0°-360° dial; 0° and 90° reference points
- PRICE (U.S.A.) \$3,450.00



SERVO CORPORATION OF AMERICA

111 New South Road, Hicksville, L.I., N.Y., WE118 8-9700 • Sales and service offices coast to coast.

10 WATT - 100 MC POWER TRANSISTOR

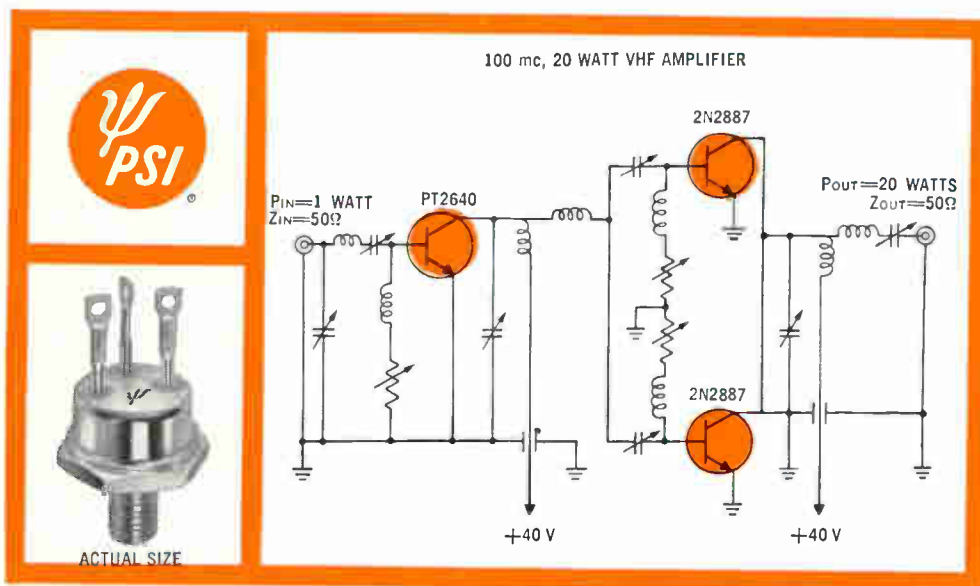

PSI DOUBLE-ENDED
POWER PACKAGE
WITH ISOLATED COLLECTOR

20 WATT-100MC VHF POWER AMPLIFIER

2N2887 now 1/3 its former price!

One of the most popular VHF Power Amplifiers in the PSI Communications Transistor line is now available at one-third its former price...\$44 at the 100 level!

The 2N2887* gives you a full 10 watts output at 100 mc with 9 db gain at 45 volts. It is furnished in a highly efficient double-ended power package, with isolated collector to reduce heat sink requirements.

There's no problem getting sufficient drive for this remarkable amplifier...just specify the new PT2640 which furnishes 3 watts drive at 100 mc, 8 db gain at 28 volts.

Both types available off-the-shelf from PSI authorized distributors. Write TRW Electronics/Pacific Semiconductors for complete technical details.

*2N2887 was formerly designated DPT-657

TRW
electronics / *Pacific Semiconductors*

THOMPSON RAMO WOOLDRIDGE INC.
14520 AVIATION BOULEVARD, LAWNSDALE, CALIFORNIA

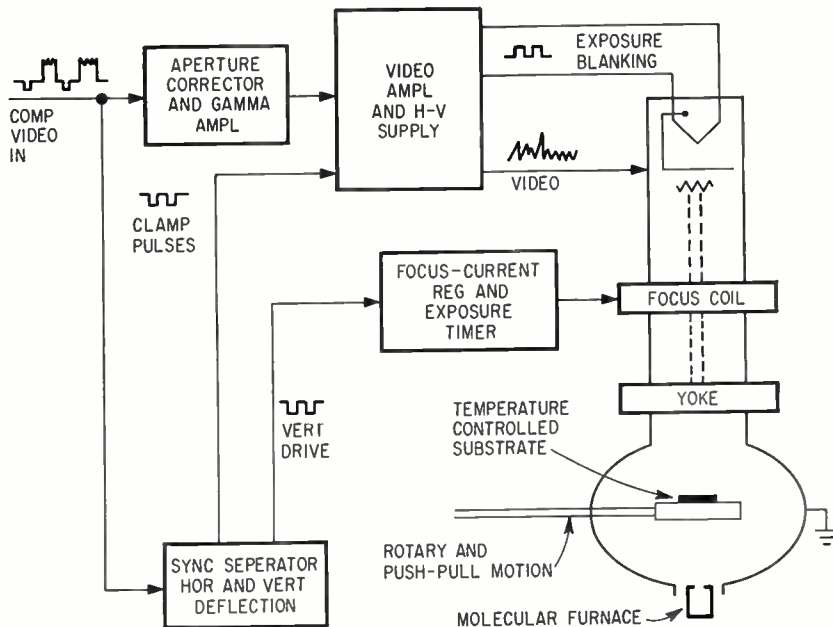

VAPOR-DEPOSITION pattern is controlled by modulating the electron beam with video signal obtained by scanning a pattern, or from stored information. This experimental system is used by Erie for process studies

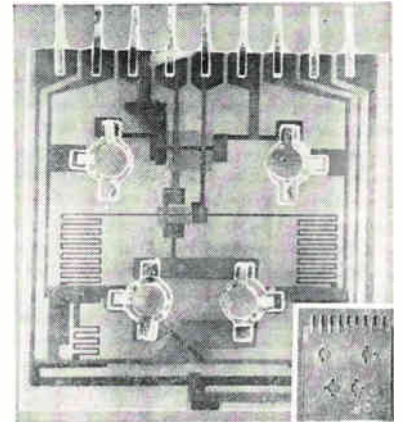

PLANAR CONNECTIONS to active devices on thin-film substrates are provided by Telefunken technique of inserting metal bars in slots. Substrate is shown at right before connecting paths are deposited and, magnified at left, afterwards

Modulated Beams Build Microcircuits

Pattern scanned by tv controls the selective deposition of materials

By **THOMAS MAGUIRE**
Regional Editor, Boston

BOSTON — Molecular amplification, or selective deposition by manipulation of surface energies, is under investigation for microcircuit fabrication.

At the 10th National Vacuum

Symposium last week, A. F. Kaspaul and E. E. Kaspaul, of Erie Technological Products, reported on production of passive and active circuits and thin-film devices using modulated electron and ion beams to form latent images on preconditioned substrates.

A processing step called nucleation is followed by maskless development of three-dimensional monoplanar structures using molecular beams and vapor-phase deposition.

The Kaspauls reported that diagrams, drawings, images and stored

information can be transformed directly into circuits and devices.

Molecular Amplification — This process, known in other applications for many years, describes the mechanism by which nuclei surround themselves, during the exposure to material vapor, to a much larger number of atoms and molecules than they contain themselves. Thus, invisible nucleation centers containing about 10^{13} atoms/cm² become visible by collecting about 10^{17} atoms/cm². This means that each atom in a nucleus has captured at least 10,000 atoms from the molecular beams.

Among techniques to generate nuclei on a variety of substrates, the Kaspauls cited nucleation by molecular beam, by ion beam and by electrons.

Beam Technique—In the molecular-beam technique, materials such as silver, nickel and chromium are vaporized and directed toward the substrate. A thin mask located between the vapor source and the substrate controls the distribution of the deposit. This method has the advantage of producing nucleation patterns of defined boundaries so

AT NEC, SIDESHOWS GO UNDER THE BIG TOP

CHICAGO—Company-sponsored technical and new products seminars will be an integral part of the National Electronics Conference next week.

The show's management expects this format to avoid the distraction of competing sessions in downtown hotels (see *ELECTRONICS*, p 3 and p 29, Aug. 9) while providing a fuller program for an estimated 23,000 conferees.

The format, an innovation at last year's NEC, is still experimental, says Hansford Farris, program chairman. But, he points out, the "high-quality technical content" of the company seminars deserve maximum exposure to conference goers.

Of 500 exhibitors (a new record for NEC), 16 will take part in new products seminars. Motorola and Texas Instruments Inc. are sponsoring sessions on reliability, integrated circuits and advanced semiconductors

that the resolving power of the nucleation development process can be evaluated.

In the ion-beam method, a material such as tantalum or chromium is vaporized with the assistance of an electron beam. The ionized material vapor is then injected into the electro-optical system of the ion-beam unit and impinges in controlled manner onto a substrate.

Electrons and noble-gas ions are generally unsuitable for producing effective nucleation sites at impact on alumina substrates. But the pre-deposition of a monomolecular film of a halide will provide a reservoir of possible nucleation centers which are activated on impingement by the electrons and noble-gas ions.

Scanning System—To study electron-beam nucleation and subsequent development, the scanning electron-beam system diagrammed has been developed by the Kaspauls. Drawings, transparencies or photos about 12 × 22 inches in size are viewed by a high-resolution tv camera and set into a video processor which controls the electron beam. Spot sizes are 10 microns. With the resolution of this 729-line system, substrates as small as ¼-inch square can be scanned.

Thin-Film Connections—A novel method of connecting leads and thin films was disclosed by a team from Telefunken Research Lab, Germany. Metal bars are brazed or soldered into metalized slots in a ceramic or glass substrates, then ground down to provide an essentially planar connection. Thin films are then sputtered or evaporated on the substrate (see photo).

The method is applicable to plug, solder or wrapped-wire connections, shows high mechanical stability, no mechanical or thermal stress during connection of the thin films, low contact resistance and high reliability, it was reported.

The authors, J. J. Schuetze, H. W. Ehlbeck and G. G. Doerbeck, also gave data on properties of tantalum thin films. They said resistivity and temperature coefficient of sputtered films are heavily dependent on sputtering voltage, but not on sputtering time and current.

UNIQUE MACHLETT DP-30 FOR... SWITCH TUBE OR PULSE AMPLIFIER



as switch tube:
30kw switch
at 0.0033 d

OR

as pulse amplifier:
20kw peak pulse
at 1Gc

The unique DP-30 planar triode does double duty as an rf pulse amplifier (or oscillator), or modulator/switch tube. Typical performance as an rf amplifier: 20kw peak pulse power at 1Gc, 0.001 d. Typical performance as a switch tube: 5a x 6kv for 30kw switch power at 0.0033d. ■ For data write: The Machlett Laboratories, Inc., Springdale, Connecticut. An affiliate of Raytheon Company.

MACHLETT

ELECTRON TUBE SPECIALIST

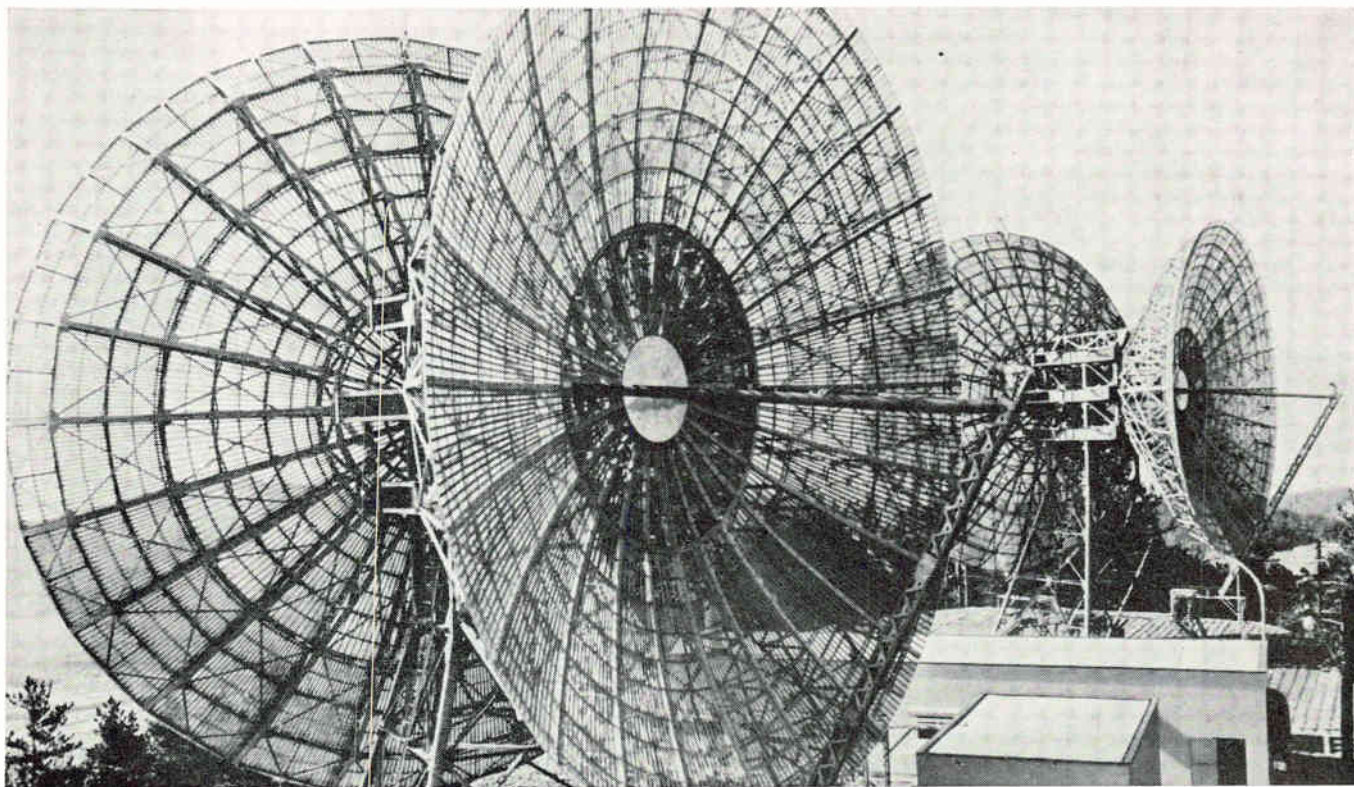

U.S. Forces O/H installation in Japan supplied by NEC

How to design and install a long-hop multiplex telecommunications link . . .

- ... over mountains, oceans, jungles
- ... in the shortest possible time
- ... with the greatest assurance of reliability

Examine NEC's O/H microwave system. For example, excellent results have been obtained for a 60-channel O/H system which succeeded in spanning two points 580 kilometers (approx. 360 miles) apart. This popular and versatile 2000-Mc O/H equipment is capable of providing up to 120 telephone channels, each with a frequency range of 300—3400 cps.

Four outstanding features of this system are:

1. NEC's *original* high-sensitivity receiver with compandor, employing a negative feedback phase detection system, improves S/N ratio and threshold level by 10 db over conventional FM receivers. This has the same effect in link design as a tenfold increase in transmitter power. (Patents have been obtained in such major countries as U.S.A., United Kingdom and West Germany.)
2. NEC's *newly refined* low-noise parametric amplifier improves noise figure to 3 db.
3. NEC's *newly perfected* angular diversity system halves the number of antennas required by conventional systems, resulting in great savings in both equipment and installation costs.
4. NEC's *newly designed* pre-detection ratio-square combiner improves S/N ratio and decreases distortion in telephone and television relays over conventional combiner.

Components with special features

abound in NEC's O/H systems; e.g.:

1. Constant impedance branching filter with hybrid circuits and filters.
2. Parallel push-pull hybrid circuit, which provides four excitation inputs for simultaneous combination after amplification.
3. Circulator, which is a type of non-reciprocal device using ferromagnetic materials; and a permanent magnet that transmits microwaves cyclically in a fixed direction.
4. Oil-filled high-voltage power supply.
5. Ceramic-sealed high-power lighthouse tubes with unique characteristics.

6. A variety of high-power klystron tubes.

NEC O/H communications systems summarized

SYSTEM	O/H 2000	O/H 900	O/H 900V	O/H Tr 2000 (transistorized and transportable)
Channel Capacity	120 ch	120 ch	TV 1 ch	120 ch
Frequency Band	1700—2300 Mc	700—950 Mc	700—950 Mc	1700—2300 Mc
Relaying System	Base band	Base band	heterodyne	Base band
Output Power	100W, 400W 1kW, 10kW, 15kW	500W	500W	1 kW
Order of Diversity	Dual, quadruple, octuple			
Diversity System	Frequency, space, angular			
Noise Figure	3 db with parametric amp.; 7.5 db without parametric amp.	3.5 db with parametric amp.; 7.5 db without parametric amp.	3.5 db with parametric amp.; 8 db without parametric amp.	5 db with tunnel diode amp.

NEC O/H equipment now installed covers a total of 218, 404 channel-miles. **Patent Numbers Granted:** U.S.A.—3,001,068 & 3,069,625 Canada—653,856 & 640,291 West Germany—1,071,160 United Kingdom—833,390 & 911,495 France—1,209,602 & 1,222,053 Other countries—pending

For complete details on NEC's latest advances in O/H microwave technology, send for illustrated brochures.

Nippon Electric Company Limited
P.O. Box 1, Takanawa, Tokyo, Japan

NEC

Nippon Electric New York Inc.
Pan American Bldg., 200 Park Ave., New York 17. Tel: MO 1-3420

affiliate of
ITT

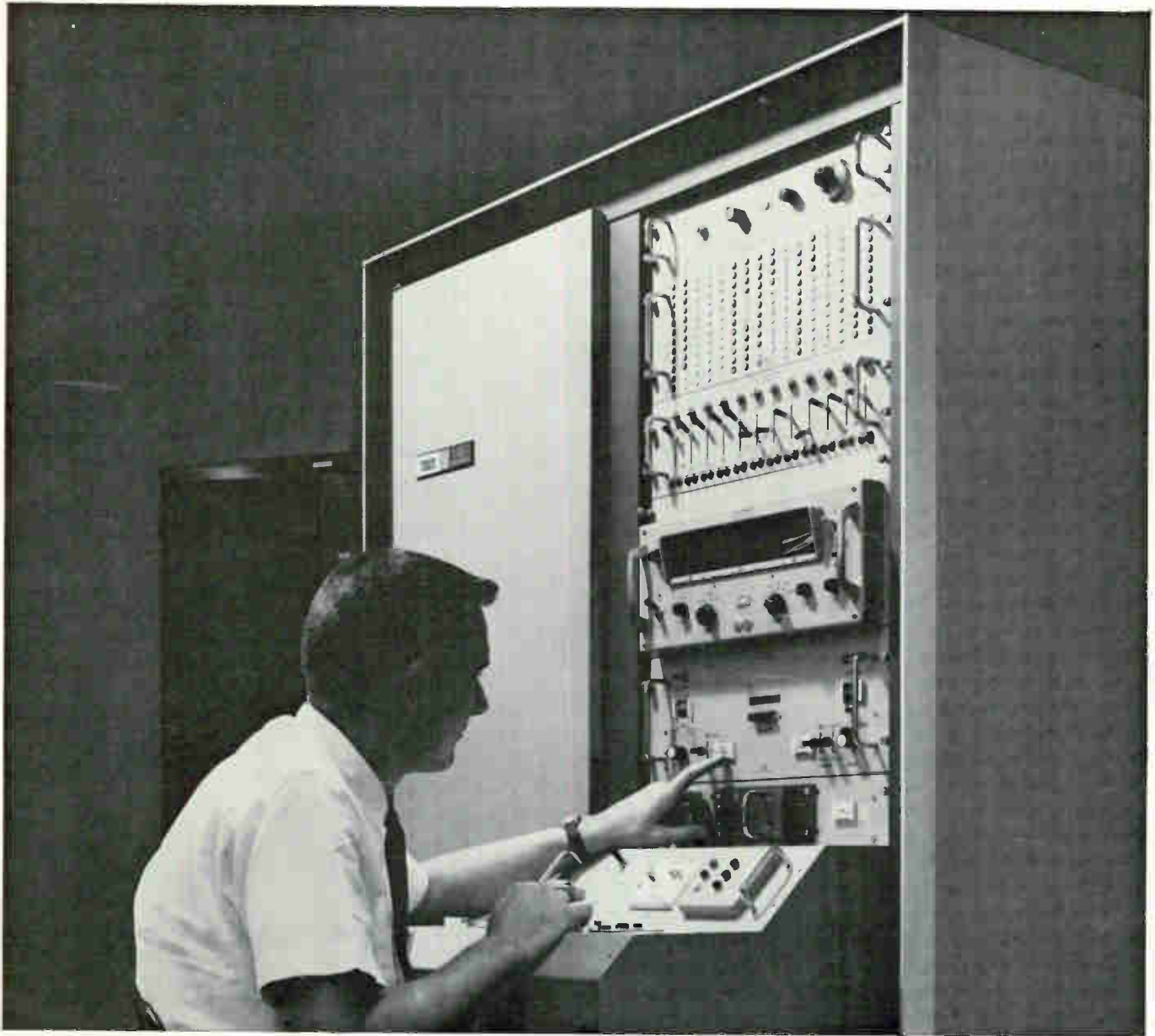

Save Device Handling Time

add switching time measurements to your **tact*** system

The Switching Time Measuring Unit, added to your TACT system, can cut your device handling at least 50% because all tests are made in a single socket . . . you do not have to change units from one socket to another. You do not need additional scopes or pulse generators. Switching time measurements on semi-conductors can be intermixed in any order with other parameters. And with TACT, automatic data

recording will increase your savings. Digital card programming eliminates set-up and operating errors, assures repeatability. Standard switching time parameters, t_{d1} , t_{r1} , t_{on} , t_s , t_f , t_{off} may be measured within the range of 1 nanosecond to 10 microseconds. Performance circuits are precisely matched to your requirements . . . the desired circuit selectable by the program card. The switching time measuring unit is

another planned advancement of the ever-expanding TACT system. Since its introduction in 1960 with d-c capability, the Transistor And Component Tester has continuously expanded with pulse, h-parameter, h_{FE} , low-current measurements, and environmental tests. Now switching time can be added to every TACT system, new or old. Let a TI engineer show you how to save by using the TACT system.

*Trademark of Texas Instruments Incorporated

INDUSTRIAL
PRODUCTS
GROUP



TEXAS INSTRUMENTS
INCORPORATED

P. O. BOX 66027 HOUSTON 6, TEXAS

NOW

1

WITH
THE
ADDITION
OF

4 NEW
MINIATURE
SIZES



Precision **POWER RESISTORS** From **MEPCO**

- Minimum size vs power ratio
- Cooler operation and more stable performance
- All-welded terminal to terminal construction
- Low noise factor
- Resists moisture, salt spray and cleaning fluids
- Average TC ± 15 ppm
0.1 Ω to 75 K at 0.05%
0.5 to 15 watts at 25 C
including MIL types

APPLICATIONS:

- Micro-Circuitry
- High wattage dissipators
- Reference resistors for precision power supplies
- Ballast resistors with special ± 5000 PPM T/C
- Voltage dividers

For detailed specifications and performance characteristics, write or call MEPCO distributors and representatives.



MEPCO, INC.,
MORRISTOWN, NEW JERSEY

DEFECTIVE HEARTS may be detected by automatic analysis of their sounds in system being developed at Northwestern University, one of four midwestern universities that will participate in an NEC session on interdisciplinary approaches to biomedical engineering

By CLETUS M. WILEY
Regional Editor, Chicago

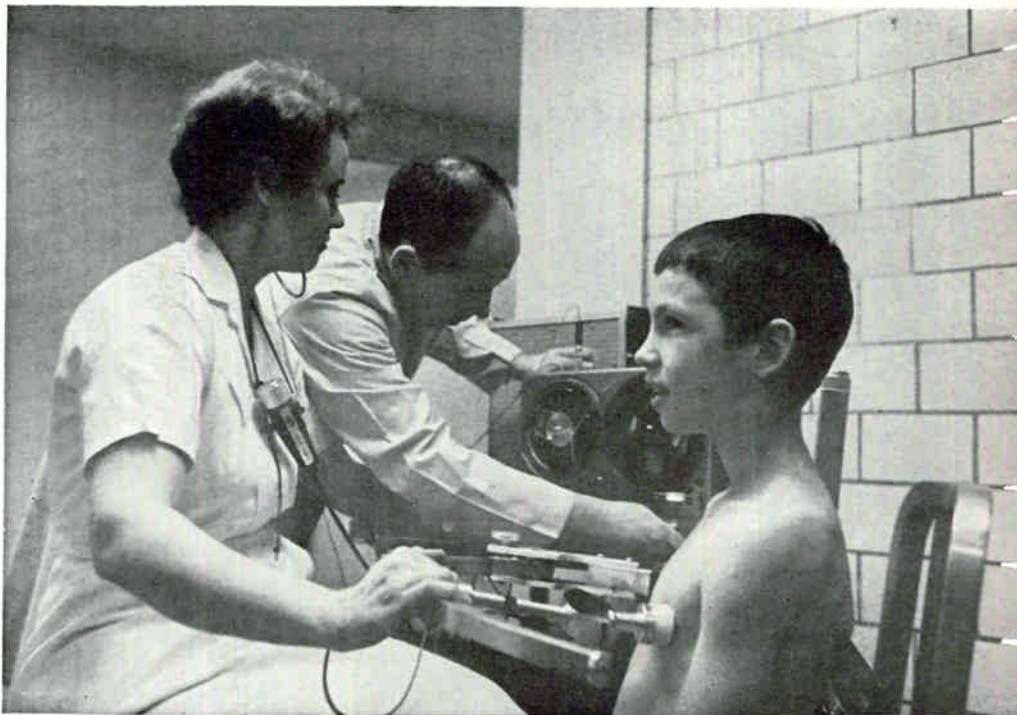

ELECTRONICS IN THE MIDWEST

Next week's National Electronics Conference will highlight new production techniques for microelectronics, laser machining, infrared tracking, and applications of the dielectric rod antenna among other advances

CHICAGO—When the expected 23,000 engineers and scientists show up at next week's National Electronics Conference, they may be getting a look at the next generation of production techniques for electronic devices and circuits. For among the technical highlights will be two sessions dealing solely with applications of energy beams as working tools.

These sessions will include papers on advanced production techniques for microelectronics and the potentialities of laser machining. While economics will most likely determine how and when such techniques will actually be used, exotic production methods have been receiving increasing attention in the past several months, particularly among companies in the microelectronics business. A sampling of the highlights of these and others among the 200-odd papers to be presented Oct. 28-30 follows.

Laser Micromachining—Lasers already offer micro-

precision machining and drilling that is far deeper than that possible with arc-limited particle beams, according to Jerome Rothstein, of Laboratory For Electronics.¹ Specialized laser welding and soldering should ultimately compete with, and perhaps surpass, particle beams for localized heating of fine leads on miniature electronic components, he says.

Laser beams can drill deeper than particle beams because the vapor that expands from the drilled spot is transparent to the laser beam. The coherence properties of the beam are such that it may be possible to extend laser working depths to feet or yards. A series of lenses would be used to reduce the diameter of the beam to that required for the particular drilling application while keeping the beam collimated. Practical limits to the micromachining would then be imposed by such factors as melting, surface tension and gravity.

It may be possible to drill holes smaller than the

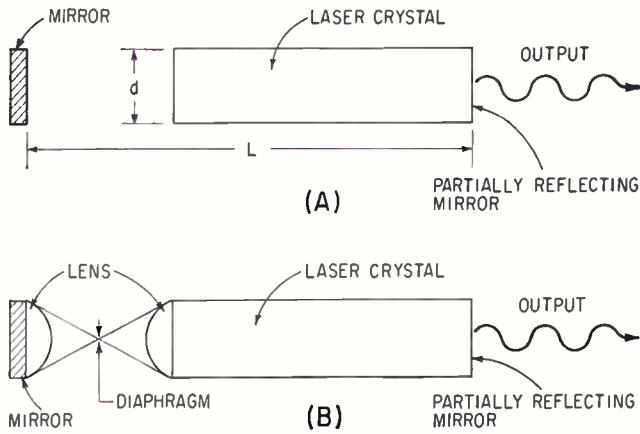

RESONANT CAVITY incorporating a distant mirror off-axis-modes suppressor (A) and a pin-hole off-axis-modes suppressor (B)—Fig. 1

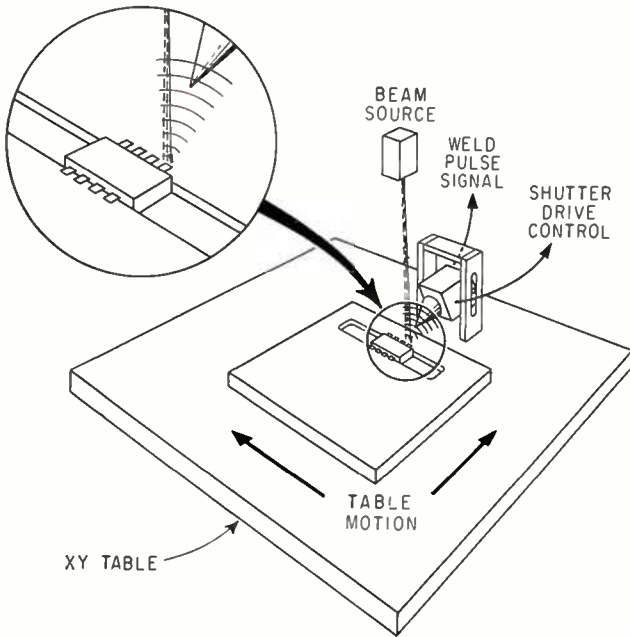

ADAPTIVE POSITIONING control triggers microcircuit welding when beam strikes tab lead coated with fluorescent dye—Fig. 2

THIN-FILM COUNTER for laser ranger displays range to target directly in meters—Fig. 3

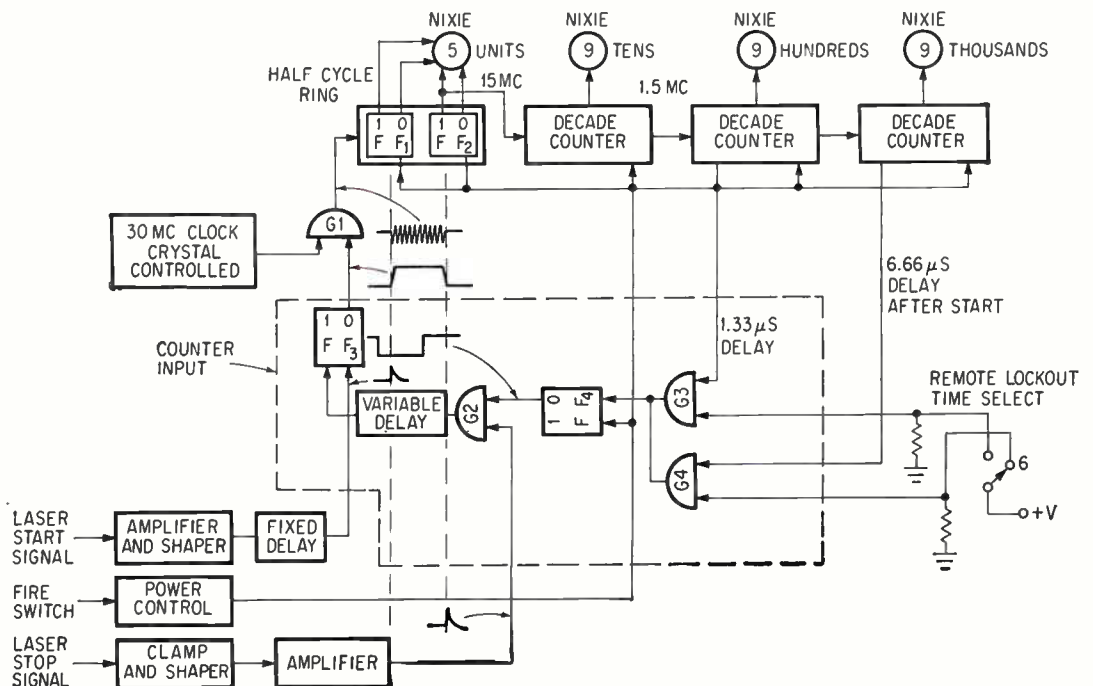

laser's nominal diffraction limit by peripheral spot cooling, which restricts high rates of evaporation to the central region of the hole. Also we may be able to make use of surface tension effects for controlling the diameter of the hole. Surface tension tends to re-close a drilled hole but when more is known about how to precisely control and program the energy per spike, it may be possible to exploit surface tension for precisely controlling hole diameter.

The same beam-material interactions that favor micromachining interfere with welding and soldering, Rothstein points out. Welding and soldering with high-peak-power pulsed lasers is presently limited to joining thin sheets and to applications where local pitting is not objectionable. This will change, however, as lasers with high average powers become available.

Intriguing laser possibilities for the future include local alloying of even the most refractory materials, and the possibility of alloying in the vapor phase.

Although no theoretical upper limit has yet been found for laser power density, densities on the order of billions of watts per square centimeter have been reported. Many sources may cohere with each other when locked to a common signal.

Nevertheless, electron-beam machines, which have a higher efficiency, are not likely to be completely displaced soon, if ever, he says. And laser beams may never approach the diffraction limit of the shorter wavelength particle beams.

C. M. Adams, Jr., of MIT, who will also speak at this session, sees immediate operational use of laser welding in electronics (see p 88).

Drilling—Laser drilling will be discussed by D. V. Missio, of Raytheon's Laser Advanced Development Center.² Experiments show that a laser beam can be controlled for the production of holes a few microns in diameter in thin sheets and for holes more than six millimeters deep in brass.

In both cases control of the off-axis radiation is the most important prerequisite for achieving these results, Missio says. One technique for suppressing off-axis modes is based on the so-called distant mirror arrangement shown in Fig. 1A. However, it can be shown that for a 1-cm transmitting aperture the distance L necessary to give the diffraction limited beam angle will be over 100 meters for a ruby laser. The setup in Fig. 1B is widely used to obviate such long resonators.

Typical examples of work done at Raytheon include penetrating 0.25 inch of brass with 130 joules and perforating 2-mil-diameter wire with a few millijoules to make a hole 0.2 mil in diameter. No problems are anticipated in drilling small-diameter holes across plates more than 0.5 inch thick with 350-joule lasers.

Microcircuit Fabrication—An automated electron-beam fabrication, interconnection and packaging system for integrated devices will be introduced by D. J. Garibotti, of United Aircraft's Hamilton Standard division and E. H. Miller, of Manufacturing Technology Lab, USAF Aeronautical Systems division.³

Tape programmers and function generators control the etching of thin-film resistors, capacitors and planar conductor patterns in tenths to tens of mils diameters on 25-mil grid matrices (ELECTRONICS, p 45, Feb. 15). The system is also capable of micro-welding leads and ribbons, and hermetically sealing microcomponents and circuits.

Before the microcircuits or components are loaded into the machine, tab leads are coated with a fluorescent dye. A low-level electron beam is then programmed to advance digitally through the areas containing the leads to be welded. When the beam encounters a coated tab (Fig. 2) fluorescence is sensed by a photocell which moves the beam to the center of the tab and triggers the welding process; a-c deflection welding is used. This produces more reliable welds than would be possible with a stationary,

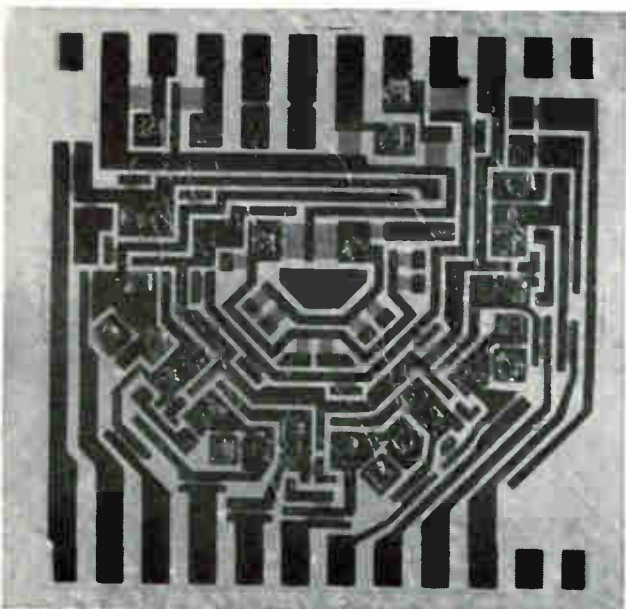

RING COUNTER substrate is one of 13 packaged in a volume 3 by 6 by 0.5 inch—Fig. 4

FOR DESIGNERS

TWO of the NEC reports that should be of particular interest to circuit and equipment designers are presented in detail in this issue of *Electronics*. On p 35 you'll find an article by Richard J. Vilmur and Koryu Ishii, of Marquette University, on a simple method for generating microwave energy with a regular high-speed switching transistor. Avalanche switching characteristics of a low cost, germanium transistor are used to generate microwave signals as high as 12 Gc.

The high-frequency single-sideband transceiver being described by Robert Trachtenberg, of RCA, is the subject of a report on p 75. The transceiver uses metal-oxide-semiconductor transistor integrated circuits, is expected to have a 20-year useful life with performance exceeding that of present equipments

undeflected beam.

When the weld cycle is completed, beam intensity drops back to scan level. Offset current and a-c deflection patterns are discontinued and the taped program directs the beam to resume its search for the next tab.

A matrix packaging system is being evaluated in parallel with development of the machine, as a production assembly structure compatible with either analog or digital circuits. Vertical and horizontal interconnection patterns are formed in ceramic substrates coated with beryllium.

Integral devices and functional blocks of various geometries and varieties may be bonded and interconnected on the grooved substrates by means of horizontal conductors and vertical feedthroughs. Beryllia members within the multilayer structure have high thermal dissipation and serve to dissipate the concentrated thermal energy that results from the dense packing. Additional active and passive elements may be added or interconnected as required.

Laser Counter—Details of a thin-film counter for a laser rangefinder developed at the Orlando division of Martin-Marietta will be described by John Winkler.⁴ Use of thin films reduced counter volume 96.7 percent, making it possible to construct a man-portable laser rangefinding device. The system was designed and demonstrated for Frankford Arsenal's laser rangefinder program.

The high-frequency counter uses hybrid thin-film logic, reads the range to targets directly in meters on a Nixie display in a separate package. As shown in Fig. 3, the display is driven from four decades which are driven by a crystal controlled clock set at approximately 30 Mc. The highest frequency counter switches at a 60-Mc rate derived from alternate half-cycles of the clock.

The counter contains 921 parts and requires 3.6 watts of power. It occupies nine cubic inches and weighs six ounces. The equivalent printed circuit would occupy 266 cubic inches and weigh 7.1 pounds, according to Winkler. Figure 4 shows the thin-film substrate of the divide-by-ten ring counter.

Several advantages of this technique are cited by Winkler. They include:

- High-frequency performance of a transistor is not

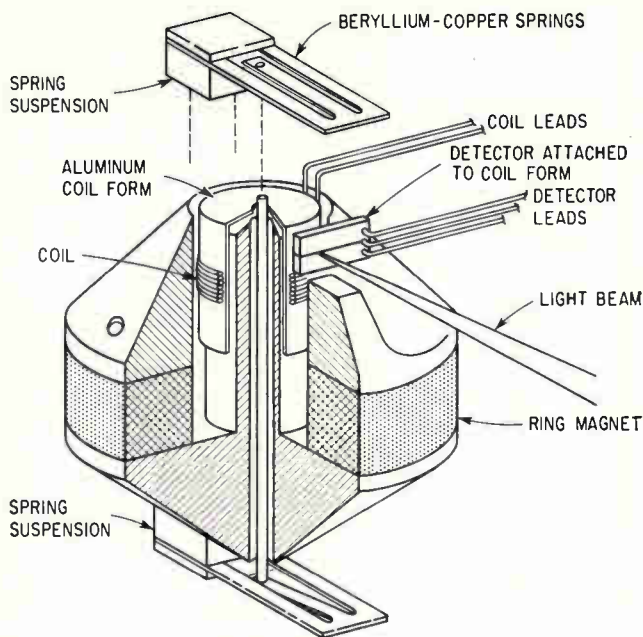

SERVO POSITIONER is heart of a motorless infrared tracking system whose applications range from precision machining to space rendezvous—Fig. 5

degraded by close proximity of passive components as in semiconductor integrated circuits

- High-frequency characteristics are enhanced over those achievable with printed circuits because transistor headers are removed and critical circuit components can be mounted close together
- Distance between functional blocks or substrates is small, minimizing line losses and noise pickup
- Single plane construction of the substrate allows it to be tested and maintained down to the component level

UHF Transceiver—Another example of the application of thin-film hybrid microcircuit fabrication techniques will be provided by Thomas T. Hill, of Sylvania's microelectronics laboratory.⁵ He will describe a uhf transceiver being developed by Sylvania for the Avionics division of the U. S. Naval Bureau of Weapons.

The thin-film hybrid transceiver transmits and receives on the 243-Mc emergency frequency and is intended for use in locating and rescuing downed aviators. Upon bail-out the unit automatically sends out a beacon signal until the operator desires to listen or transmit voice. The complete transceiver, including built-in battery and antenna, is about the size of a king-size pack of cigarettes.

Infrared Tracker—A motorless infrared tracker whose applications range from microprecision machining to space rendezvous over hundreds of miles will be described by Hans Heyck, of Martin-Marietta's electronic systems and products division.⁶

Optical tracking is reportedly superior to radar and ultrasonic sensing for short-range, high-resolution applications such as missiles, automatic aircraft landing systems, and tracking and guidance of ground vehicles. Primary use of the Martin tracker has been with cooperative targets fitted with zirconium or

xenon arc beacons. The device may also be equipped with a light modulator to track noncooperative targets, according to Heyck. Time sharing switching would make it possible to track two or three targets simultaneously.

Heart of the system is the electromagnetic servo positioner shown in Fig. 5. A lead sulfide detector is mounted on the movable coil of a light-spot follower located in the center of the tracker's focal plane.

The detector is precisely divided into halves which are connected as a bridge. When the target image falls across the gap between the halves, the detector output is zero. An off-target beam falls on either the upper or lower segment of the detector, producing a difference signal. This signal is preamplified, demodulated and power amplified to drive the coil of the light-spot follower until the detector gap lines up with the center of the image spot and the signal is nulled.

High resolution, quick response, less than 5-watt power requirements 0.578-cubic-foot size and 10-15 pound weight lend themselves to airborne, space vehicle and man-portable applications. Accuracy is reported to be one foot in 10,000 from a 20-degree field.

Dielectric Rod Antenna—Use of the dielectric rod antenna as an unusually effective radar reflector will be discussed in a paper by Dean D. Howard and N. A. Thomas, of U. S. Naval Research Laboratory.⁷

As a radar reflector, all that is required is a cylindrical rod of dielectric with a single taper which is coated with conducting material at the large-diameter end. Thus, the rod provides a simple, rugged and conveniently shaped reflector with unusually high efficiency in terms of the ratio of the equivalent flat plate area to the physical nose-on cross-section, the authors claim. This ratio is 100 or greater, while in conventional radar reflectors it is less than unity.

The dielectric rod antenna is considered particularly useful where scattering cross-sections of up to tens of square meters are needed. The single element, for a given frequency, is limited in scattering cross-section, but double interconnected rods can be used to increase cross-section while maintaining a broad beamwidth. These configurations can use Van Atta array techniques as well as conventional linear arrays.

Effective scattering cross-section could also be increased by terminating the reflector in a single-port amplifier such as the tunnel diode or parametric amplifier. The tunnel-diode amplifier would be particularly useful because it is simple, but the power levels are considered too high for presently available diodes. However, it is expected they could provide a simple and useful reflector amplifier in the near future.

REFERENCES

1. All papers prepared for the 1963 National Electronics Conference, Chicago.
- (1) Jerome Rothstein, Some Dynamic Aspects of Theoretical Laser Micromachining Limitations.
- (2) D. V. Missio, Energy Effects of Laser Beams.
- (3) D. J. Garibotti and E. H. Miller, Versatile Interconnection System for Integral Electronics, Using Electron Beam Techniques.
- (4) John Winkler, Thin Film Laser Counter.
- (5) Thomas T. Hill, Thin Film Hybrid Transceiver.
- (6) Hans Heyck, MIRTRAK, A Precision Motor-less Infrared Tracker.
- (7) Dean D. Howard and N. A. Thomas, The Dielectric Rod Antenna as an Unusually Effective Radar Reflector.

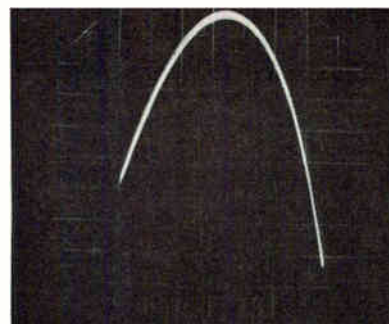
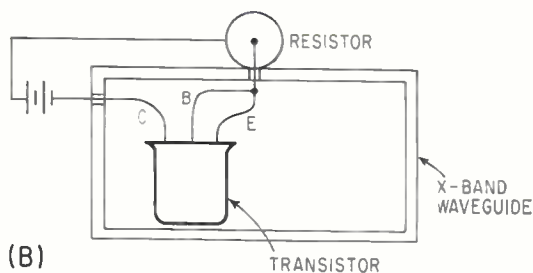
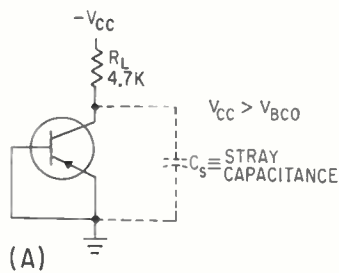

(A)

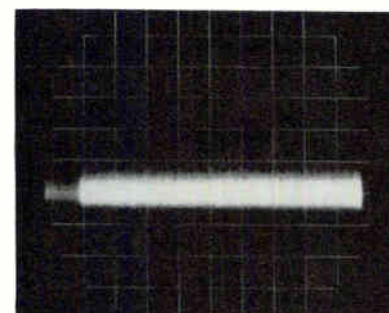
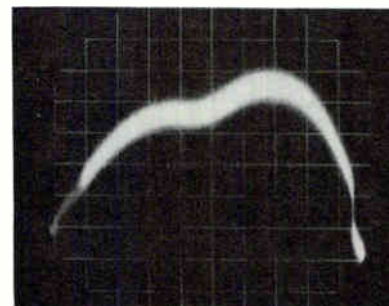
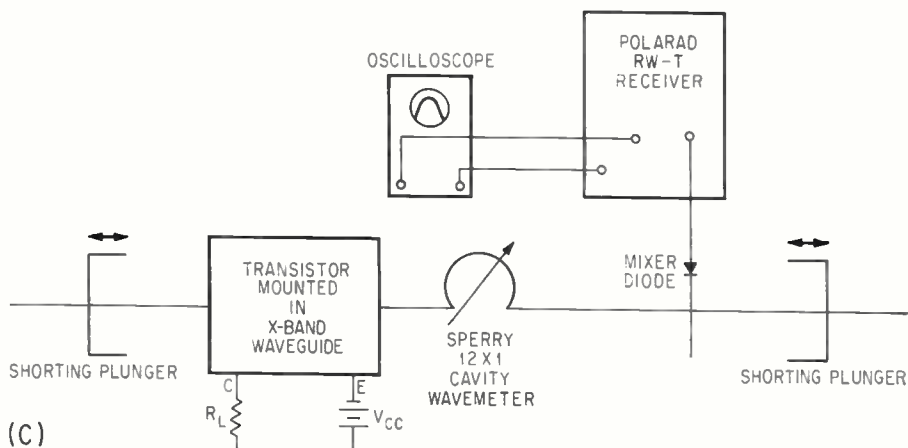

(B)

CIRCUIT (A) and waveguide mounting (B) for relaxation oscillator circuit for producing microwaves to 12 Gc. Detection circuit (C) uses cavity wavemeter—Fig. 1

OUTPUT OF 2N965 at 9.086 Gc (top) with $R_L = 4,000$ ohms and $V_{cc} = 39$ v. Middle trace is output of 2N955A at 9.020 Gc, showing dip caused by cavity wavemeter. Bottom trace (9.020 Gc) is with 35 db attenuation in circuit—Fig. 2

Avalanching Transistor GENERATES MICROWAVES

Tie the base and emitter of a switching transistor together, add a collector resistor, and generate signals to 12 Gc. Simple relaxation circuit provides enough power for laboratory experiments

By RICHARD J. VILMUR and KORYU ISHII, Marquette University, Milwaukee, Wisconsin

THE NIBBLER

Ever onward and upward goes the transistor as the circuit designer keeps pushing it to higher and higher frequencies. Now the transistor is nibbling seriously at the Gc band and may even be said to biting hunks out of it. After all, 12 Gc is only an order of magnitude away from the 100 Gc fortress of the vacuum tube.

Will the transistor ever make it all the way on its own? Maybe that's not the right question. Maybe it should be: When will the transistor make it?

MICROWAVE SIGNALS to 12 Gc can be produced with a high-speed switching transistor. The circuit is a free-running relaxation oscillator and is shown in Fig. 1A. Avalanche switching characteristics of the transistor are used to produce a relaxation oscillation with a repetition rate up to 100 Mc. A 2N965 transistor has produced as high as 15.8 microwatts at 11.153 Gc in the circuit,

which is enough for an experimental laboratory source.

Main advantages of the microwave generation technique are simplicity, low cost (transistors used cost less than five dollars), and extremely wide bandwidth. Frequencies from the high kilocycle range out to a measured 12.205 Gc have been obtained, using both the fundamental and the harmonics produced by avalanche switching. The upper limit of this method of microwave generation has not yet been determined. Circuit packaging determines output frequency range.

Other methods of producing microwave energy from solid-state de-

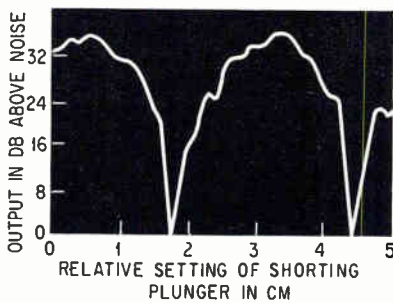

WAVEFORM at 9.020 Gc as shorting plunger nearest the mixer diode is moved—Fig. 3

vices are expensive because of the elaborate supporting equipment that they use.^{1, 2}

Operation—When V_{cc} is applied to the circuit of Fig. 1A, the collector-base junction is reverse biased, the voltage across stray capacitance C_s begins to build up, and the emitter-base junction is held at approximately zero bias. The collector-base voltage continues to increase, as C_s charges until avalanche breakdown voltage is reached.^{3, 4} When this happens, I_{CB} becomes much higher than I_{CBO} causing a voltage drop across the internal base resistance, which forward biases the emitter-base junction. Holes then diffuse across the base until they reach the collector-base depletion layer where the high field causes avalanche multiplication; C_s begins to discharge and avalanche multiplication ceases when the collector-emitter breakdown voltage is reached.

Because of the excess electrons in the base due to the avalanche multi-

C_s is discharged or until the number of excess electrons is insufficient to keep a high enough forward bias on the emitter-base junction to supply the current necessary to keep up the voltage drop across R_L . When one of these conditions occurs, the emitter-base junction is again cut-off and C_s begins to recharge. The cycle repeats until V_{cc} is lowered below the avalanche breakdown voltage of the collector-base junction of the transistor. If R_L is too small, the voltage from the collector to the emitter will fall only to the collector-emitter breakdown voltage and stay there. This may destroy the transistor through excess power dissipation.

The result of the relaxation oscillation is a series of less than one nanosecond rise-time current pulses that contain a substantial amount of microwave energy. It was decided at the start of the research to try to obtain generation in the X-band. To be able to detect this X-band energy, the transistors are mounted inside an X-band waveguide as shown in Fig. 1B; load resistor and power supply are outside the waveguide. The circuit used to detect the X-band output is shown in Fig. 1C. The best output obtained so far has been with the 2N965, a *pn*p, germanium, diffused junction, epitaxial mesa, switching transistor. All transistors of this type that were tried produced microwave output; some typical results are shown in the table.

The frequencies given in the table are those that were detected with certainty using a cavity wavemeter. These data were taken for fixed

Representative Results for a 2N965 Transistor

Frequency in Gc	Output in dbm
8.605	-36
8.918	-24
9.060	-52
9.310	-30
9.840	-53
10.105	-53
10.560	-52
11.153	-18
11.967	-44
12.030	-34
12.205	-40

Resistor $R_L = 4,700$ ohms, repetition rate = 37.5 Mc and $V_{cc} = 37$. Shorting plungers were set for maximum output at 11.153 Mc

shorting plunger settings set for highest output at 11.153 Gc. The output does not follow a normal smooth fourier power spectrum because the impedance of a fixed microwave circuit varies with frequency.

Results — Output waveforms at 9.086 Gc are shown in Fig. 2A. The repetition rate was 43.2 Mc and the shorting plungers were set for maximum output. Output of the 2N955A transistor at 9.020 Gc is shown in Fig. 2B. The dip in the top trace is caused by a cavity wavemeter. The bottom trace shows the lack of output when 35 db attenuation is placed in the microwave circuit. The top trace represents an output of -55 dbm. The bandwidth of all the traces is approximately 20 Mc. A graph showing the standing-wave pattern generated by the shorting plunger nearest the mixer diode is given in Fig. 3 for the 2N955A at a repetition rate of 34.5 Mc. Output was 9.020 Gc. The graph gives an indication of the change in impedance of the microwave circuit with plunger setting.

The circuit in its most elementary mounting position, Fig. 1A, is a multifrequency source that is almost completely insensitive to mismatching in the microwave circuit. A mismatch to one harmonic frequency can be a match at another. If the supply voltage is modulated, the repetition rate of the relaxation oscillator will vary widely, with the modulation turning the circuit into a microwave noise source.

Undesired harmonics can be filtered out by packaging the transistor relaxation oscillator in a resonant cavity. Packaging in the cavity to reduce stray capacitance variation will stabilize the circuit enough to make it a practical microwave source.

The authors thank S. Krupnik, Jr., J. A. Stefancin, J. E. Billo and E. Starr for their assistance.

REFERENCES

- (1) J. L. Moll, A. Uhlir and B. Senitsky, Microwave Transients from Avalanche Silicon Diodes, *Proc IRE*, 46, p 1306, June, 1958.
- (2) D. Leenov, J. W. Rood, UHF Harmonic Generation with Silicon Diodes, *Proc IRE*, 48, p 1135, July, 1960.
- (3) J. R. A. Beale, W. L. Stephenson and E. Wolfendale, A Study of High-Speed Avalanche Transistors, *Proc Inst EE*, 104, Part B, p 394, July, 1957.
- (4) G. M. Ettinger, Some Circuit Applications of Avalanche Devices, *Proc Inst EE*, 108, Part B, p 563, Sept., 1961.

MATERIALS FOR SPACE-AGE ELECTRONICS

By MICHAEL F. TOMAINO, Associate Editor



REPRINTS AVAILABLE
SEE READER SERVICE CARD

"They (atoms) move in the void and catching each other up jostle together, and some recoil in any direction that may chance, and others become entangled with one another in various degrees according to the symmetry of their shapes and sizes and position and order, and they remain together and thus the coming into being of composite things is effected".

Simplicius, 6th Century A.D.

Dance of the Atoms

and the SEARCH

THE CAPABILITY WE SEEK

"As electronics people we must necessarily embrace all materials, both organic and inorganic, that have even a remote chance of being useful for performing electronic functions.

"An emphasis is put on the interdependence of materials, an understanding of phenomena, fabrication techniques, and device design.

WE START with the atoms and, hopefully, end up with the device.

The device performs electronic functions—in tubes, transistors, silicon blocks, passive elements, thin-film wafers, and combinations of these. These units will amplify, detect, oscillate, switch signals, and otherwise perform to our requirements.

Our team includes chemists, physicists, metallurgists, electronics engineers.

We learn all we can about the atoms and molecules, their arrangement, and how they move and spin and interact. We learn how the atoms vibrate, turn, shift, and change their partners. We try to understand how electrons and protons behave, and how they can be manipulated.

It is difficult to classify us as chemists, physical chemists, physicists, theorists, and electronics engineers. We often work as a team and are trained in interdisciplines. Many of us think of materials first.

We use high-purity materials. Impurities come in parts per million and we hope for even better purification techniques. We make crystals of these materials and tailor them with special impurities. We learn

how to arrange atoms in special ways to do the job.

We Try to understand all aspects of the dance of the atoms, and how to make the atoms perform for us. Materials, electronic effects, techniques for fabrication and design of the device are closely interrelated in our task. We are theorists, and craftsmen of the electronic device.

Our knowledge gives us an understanding of how the atoms and molecules can be arranged, and how they behave. We take measurements, try to understand what the data means, and determine how to construct the device.

We study the relationship between our materials, the circuit elements, and the circuit functions.

We have developed a highly sophisticated technology for the fabrication of our devices. Our industry has invested many millions, in manpower and machines, in the study and construction of these devices.

We have, for example, perfected complex devices based on silicon, its compounds and the materials that are compatible with it.

Many of us do not know the end-point use of many of the devices we have made possible. Information about them is confidential. Application of our burgeoning solid-state materials technology to

"Efforts in these areas of interest must be pursued concurrently to achieve the potential offered by the molecular engineering concept.

"Our aim is to perfect a technology based on the synthesis of material with tailored electronic properties.

"All the disciplines of science must be utilized to solve our technical problems and attain the necessary breakthroughs.

"The coordinated efforts and results of basic and applied research, electrical and electronics engineering, and device and system design are required to provide the capability we seek."

ELIZABETH H. TARRANTS
Molecular Electronics Branch
Electronic Technology Division
Wright-Patterson Air Force Base,
Ohio

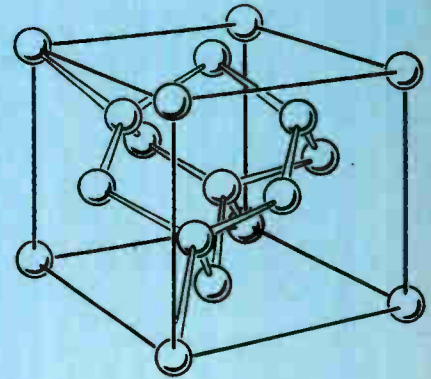

BASIC UNIT cell of silicon or germanium—a diamond structure, prototype of elements in Group IV (Texas Instruments)

for the DEVICE

commercial equipment has been barely touched.

Our technology is yet to be fully exploited—in medicine, in industry, for our comfort and for our social needs.

Our whole silicon technology and the role of silicon-based devices will get even bigger. The cost of these devices will come down and they will be commonplace in our offices, our factories, in our kitchens and in our living rooms.

We do not stand still, waiting for all this to happen. Our present demands—for the moon and the planets and the regions of interplanetary space—are pushing us into new explorations.

New Technology is directed towards development of devices capable of operating at still higher frequencies, and at still higher temperatures. We are extending the spectrum of our capabilities in both directions. We need smaller sizes, higher current densities, higher-power dissipation capabilities for many applications.

Silicon alone cannot be relied upon for future improvements in some important areas we wish to pursue. Although we have yet to explore the full potential of this material, we seek further knowledge of other materials, and other phenomena.

A tremendous effort is now being put into these new explorations. We delve further into the phenom-

ena of luminescence. This is one of our oldest phenomena, and still not completely understood. We are exploring magnets, dielectrics, lasers, modulator materials, insulator physics.

We are going into new areas. But we are also going back into old ones. We are taking another good look at some of our older materials, like germanium, that have been around a long time. And we find that alloys of older materials can do things we haven't thought of before.

We are pushing into higher band gap materials (Band gap, usually expressed in electron volts, measures the energy separation of the valence and conduction bands in a semiconductor.), but we are also going back in the other direction—to lower band gap materials—towards the metals. Here we now find completely miscible alloys and compounds for semiconductors and thermoelectrics.

We have been producing new large single crystals of elements and compounds, by new techniques. But we are also reappraising our older techniques. We are going back into tiny single crystals and we are constructing heterogeneous structures. We are looking for clues to superconductivity—materials that will pass electricity with no electrical resistance.

We work on, hoping to understand what really goes on within the atoms.

deg K and 77 K. This extends the operating range of semiconductor masers further into the infrared. Workers at Lincoln Laboratory have observed a large shift of the radiation spectrum of incoherent indium-arsenide diodes to shorter wavelengths in a magnetic field. Here we may have the attractive possibility of a tunable maser. The emission wavelength can be changed by selecting the cavity mode by a magnetic field.

A gallium-indium-arsenide system is completely miscible, and the band gap varies continuously with composition. Thus the ground has been laid for fabricating coherent infrared sources. Suitably proportioned gallium-indium-arsenide compounds can cover the entire wavelength range between 0.84 μ to 1.1 μ .

Metallic indium telluride, a Group III-VI compound, is a superconductor (see p 52) with a transition temperature of 2.18 deg K. The critical magnetic field is about 800 gauss.

BORON NITRIDE

BN. This high-temperature structural material is both a good insulator and a good conductor. Films have been evaluated extensively at Texas Instruments for their dielectric properties, and possible application for precision r-f electrostatic capacitors. National Carbon has produced 14-in. diameter cylinders of boron nitride that are 12-in. long.

BORON PHOSPHIDE

BP. HP Associates reports injection electroluminescence in boron phosphide. Compound is said to have more favorable temperature dependence than gallium arsenide or gallium phosphide electroluminescence.

The compound has been synthesized.

The most advanced effort, carried out at HP Associates, is on boron phosphide, a virtual unknown among the III-V compounds. Company has grown *p* and *n* type boron phosphide and is presently studying injection electroluminescence. Boron-phosphide electroluminescent light emitters indicate a potentially unique combination of optical, electrical, thermal, and mechanical properties. However, their device feasibility has not yet been firmly established. This material still presents technological difficulties yet to be overcome according to HPA's E. E. Loebner.

SILICON CARBIDE

SiC. Here we go back to group IV in the periodic table. Single crystals of this material with sufficient purity, structural perfection and size have been difficult to grow. If we improve the growth problem and get high quality crystals we will be on the road to a higher degree of stability, than for the III-V compounds and can push our operating temperatures up to 500 deg. C.

Tyco Laboratories reports growth of a crystal ($\frac{3}{8}$ -in. long in the *c* direction, and about $\frac{1}{4}$ -in. square) by the traveling solvent method (TSM). Advantages of this method were pointed out in 1961. This technique is characterized by the movement of a solvent zone through both single and polycrystalline source crystals. Tyco used three systems: a platinum-silicon-carbide, silicon-silicon-carbide and chromium-silicon-carbide. Cleanliness of the surface is said to be critical factor. This development may pave the way for a 10-ampere rectifier, that has been sought for a specific application.

Silicon carbide structures can make low-power injection lasers (ELECTRONICS, Sept. 6, 1963, p 6).

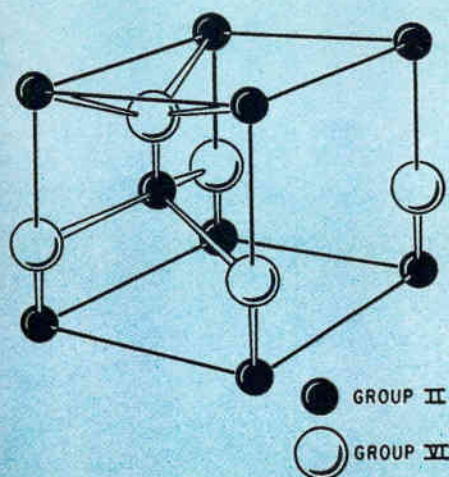

BASIC UNIT cell of cadmium sulfide, a wurtzite structure, prototype of many of the II-VI compounds. It is possible for some II-VI compounds to take a zincblende III-V structure. (Y. T. Sihvonen, Texas Instruments)

INTERFERENCE-MICROSCOPE MEASUREMENT

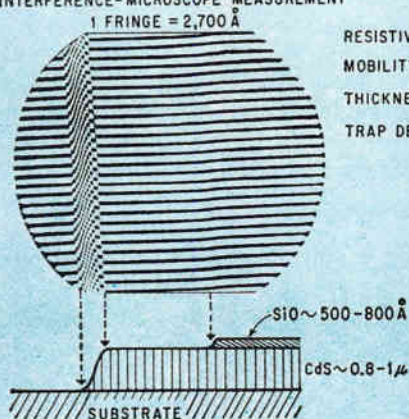

RESISTIVITY: 10^4-10^8 OHM-CM
MOBILITY, μ_e : $10-100$ CM²/VOLT-SEC
THICKNESS: 0.1-30 μ
TRAP DENSITY: $10^{14}-10^{16}$ CM⁻³

THIN FILM properties of cadmium sulfide, interface microscope measurement on deposited CdS film through a metal mask (R. Zuleeg and E. J. Senkovitz, Hughes Aircraft, Electrochemical Society Symposium, April, 1963)

STRUCTURE of silicon carbide (J. W. Faust, Jr. Westinghouse, Silicon Carbide Symposium, Air Force Cambridge Research Center, 1959)

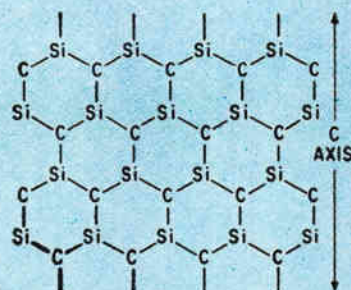

"Efforts in these areas of interest must be pursued concurrently to achieve the potential offered by the molecular engineering concept.

"Our aim is to perfect a technology based on the synthesis of material with tailored electronic properties.

"All the disciplines of science must be utilized to solve our technical problems and attain the necessary breakthroughs.

"The coordinated efforts and results of basic and applied research, electrical and electronics engineering, and device and system design are required to provide the capability we seek."

ELIZABETH H. TARRANTS
Molecular Electronics Branch
Electronic Technology Division
Wright-Patterson Air Force Base,
Ohio

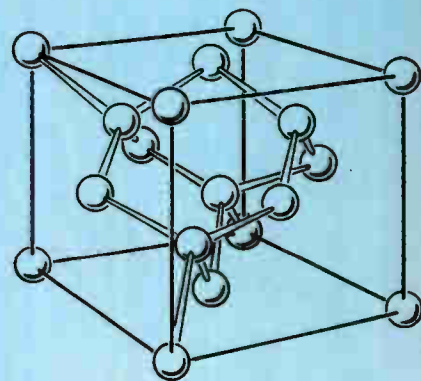

BASIC UNIT cell of silicon or germanium—a diamond structure, prototype of elements in Group IV (Texas Instruments)

for the DEVICE

commercial equipment has been barely touched.

Our technology is yet to be fully exploited—in medicine, in industry, for our comfort and for our social needs.

Our whole silicon technology and the role of silicon-based devices will get even bigger. The cost of these devices will come down and they will be commonplace in our offices, our factories, in our kitchens and in our living rooms.

We do not stand still, waiting for all this to happen. Our present demands—for the moon and the planets and the regions of interplanetary space—are pushing us into new explorations.

New Technology is directed towards development of devices capable of operating at still higher frequencies, and at still higher temperatures. We are extending the spectrum of our capabilities in both directions. We need smaller sizes, higher current densities, higher-power dissipation capabilities for many applications.

Silicon alone cannot be relied upon for future improvements in some important areas we wish to pursue. Although we have yet to explore the full potential of this material, we seek further knowledge of other materials, and other phenomena.

A tremendous effort is now being put into these new explorations. We delve further into the phenom-

ena of luminescence. This is one of our oldest phenomena, and still not completely understood. We are exploring magnets, dielectrics, lasers, modulator materials, insulator physics.

We are going into new areas. But we are also going back into old ones. We are taking another good look at some of our older materials, like germanium, that have been around a long time. And we find that alloys of older materials can do things we haven't thought of before.

We are pushing into higher band gap materials (Band gap, usually expressed in electron volts, measures the energy separation of the valence and conduction bands in a semiconductor.), but we are also going back in the other direction—to lower band gap materials—towards the metals. Here we now find completely miscible alloys and compounds for semiconductors and thermoelectrics.

We have been producing new large single crystals of elements and compounds, by new techniques. But we are also reappraising our older techniques. We are going back into tiny single crystals and we are constructing heterogeneous structures. We are looking for clues to superconductivity—materials that will pass electricity with no electrical resistance.

We work on, hoping to understand what really goes on within the atoms.

deg K and 77 K. This extends the operating range of semiconductor masers further into the infrared. Workers at Lincoln Laboratory have observed a large shift of the radiation spectrum of incoherent indium-arsenide diodes to shorter wavelengths in a magnetic field. Here we may have the attractive possibility of a tunable maser. The emission wavelength can be changed by selecting the cavity mode by a magnetic field.

A gallium-indium-arsenide system is completely miscible, and the band gap varies continuously with composition. Thus the ground has been laid for fabricating coherent infrared sources. Suitably proportioned gallium-indium-arsenide compounds can cover the entire wavelength range between 0.84 μ to 1.1 μ .

Metallic indium telluride, a Group III-VI compound, is a superconductor (see p 52) with a transition temperature of 2.18 deg K. The critical magnetic field is about 800 gauss.

BORON NITRIDE

BN. This high-temperature structural material is both a good insulator and a good conductor. Films have been evaluated extensively at Texas Instruments for their dielectric properties, and possible application for precision r-f electrostatic capacitors. National Carbon has produced 14-in. diameter cylinders of boron nitride that are 12-in. long.

BORON PHOSPHIDE

BP. HP Associates reports injection electroluminescence in boron phosphide. Compound is said to have more favorable temperature dependence than gallium arsenide or gallium phosphide electroluminescence.

The compound has been synthesized.

The most advanced effort, carried out at HP Associates, is on boron phosphide, a virtual unknown among the III-V compounds. Company has grown *p* and *n* type boron phosphide and is presently studying injection electroluminescence. Boron-phosphide electroluminescent light emitters indicate a potentially unique combination of optical, electrical, thermal, and mechanical properties. However, their device feasibility has not yet been firmly established. This material still presents technological difficulties yet to be overcome according to HPA's E. E. Loebner.

SILICON CARBIDE

SiC. Here we go back to group IV in the periodic table. Single crystals of this material with sufficient purity, structural perfection and size have been difficult to grow. If we improve the growth problem and get high quality crystals we will be on the road to a higher degree of stability, than for the III-V compounds and can push our operating temperatures up to 500 deg. C.

Tyco Laboratories reports growth of a crystal ($\frac{3}{8}$ -in. long in the *c* direction, and about $\frac{1}{4}$ -in. square) by the traveling solvent method (TSM). Advantages of this method were pointed out in 1961. This technique is characterized by the movement of a solvent zone through both single and polycrystalline source crystals. Tyco used three systems: a platinum-silicon-carbide, silicon-silicon-carbide and chromium-silicon-carbide. Cleanliness of the surface is said to be critical factor. This development may pave the way for a 10-ampere rectifier, that has been sought for a specific application.

Silicon carbide structures can make low-power injection lasers (ELECTRONICS, Sept. 6, 1963, p 6).

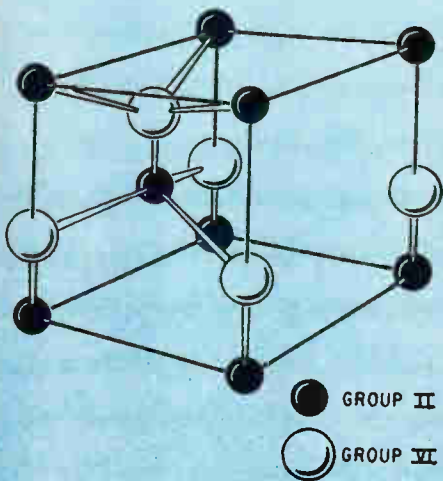

● GROUP II
○ GROUP VI

INTERFERENCE-MICROSCOPE MEASUREMENT

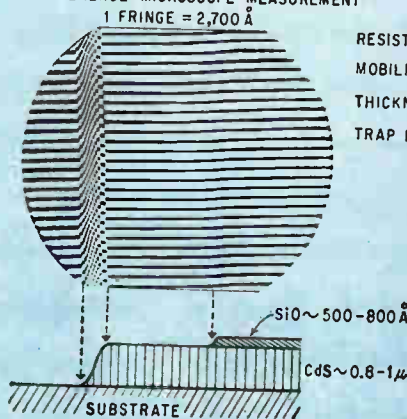

RESISTIVITY: $10^4 - 10^8$ OHM-CM
MOBILITY, μ_e : $10 - 100$ CM²/VOLT-SEC
THICKNESS: 0.1 - 30 μ
TRAP DENSITY: $10^{14} - 10^{16}$ CM⁻³

THIN FILM properties of cadmium sulfide, interface-microscope measurement on deposited CdS film through a metal mask (R. Zuleeg and E. J. Senkovitz, Hughes Aircraft, Electrochemical Society Symposium, April, 1963)

STRUCTURE of silicon carbide (J. W. Faust, Jr. Westinghouse, Silicon Carbide Symposium, Air Force Cambridge Research Center, 1959)

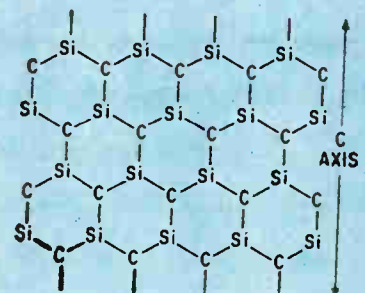

"Efforts in these areas of interest must be pursued concurrently to achieve the potential offered by the molecular engineering concept.

"Our aim is to perfect a technology based on the synthesis of materials with tailored electronic properties.

"All the disciplines of science must be utilized to solve our technical problems and attain the necessary breakthroughs.

"The coordinated efforts and results of basic and applied research, electrical and electronics engineering, and device and system design are required to provide the capability we seek."

ELIZABETH H. TARRANTS
Molecular Electronics Branch
Electronic Technology Division
Wright-Patterson Air Force Base,
Ohio

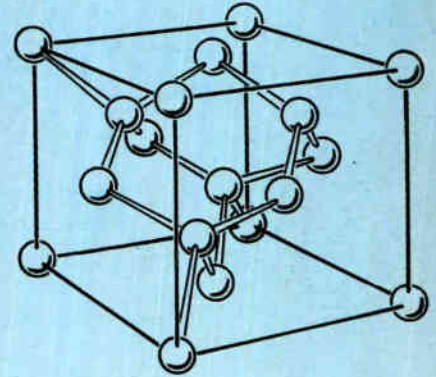

BASIC UNIT cell of silicon or germanium—a diamond structure, prototype of elements in Group IV (Texas Instruments)

for the DEVICE

commercial equipment has been barely touched.

Our technology is yet to be fully exploited—in medicine, in industry, for our comfort and for our social needs.

Our whole silicon technology and the role of silicon-based devices will get even bigger. The cost of these devices will come down and they will be commonplace in our offices, our factories, in our kitchens and in our living rooms.

We do not stand still, waiting for all this to happen. Our present demands—for the moon and the planets and the regions of interplanetary space—are pushing us into new explorations.

New Technology is directed towards development of devices capable of operating at still higher frequencies, and at still higher temperatures. We are extending the spectrum of our capabilities in both directions. We need smaller sizes, higher current densities, higher-power dissipation capabilities for many applications.

Silicon alone cannot be relied upon for future improvements in some important areas we wish to pursue. Although we have yet to explore the full potential of this material, we seek further knowledge of other materials, and other phenomena.

A tremendous effort is now being put into these new explorations. We delve further into the phenom-

ena of luminescence. This is one of our oldest phenomena, and still not completely understood. We are exploring magnets, dielectrics, lasers, modulator materials, insulator physics.

We are going into new areas. But we are also going back into old ones. We are taking another good look at some of our older materials, like germanium, that have been around a long time. And we find that alloys of older materials can do things we haven't thought of before.

We are pushing into higher band gap materials (Band gap, usually expressed in electron volts, measures the energy separation of the valence and conduction bands in a semiconductor.), but we are also going back in the other direction—to lower band gap materials—towards the metals. Here we now find completely miscible alloys and compounds for semiconductors and thermoelectrics.

We have been producing new large single crystals of elements and compounds, by new techniques. But we are also reappraising our older techniques. We are going back into tiny single crystals and we are constructing heterogeneous structures. We are looking for clues to superconductivity—materials that will pass electricity with no electrical resistance.

We work on, hoping to understand what really goes on within the atoms.

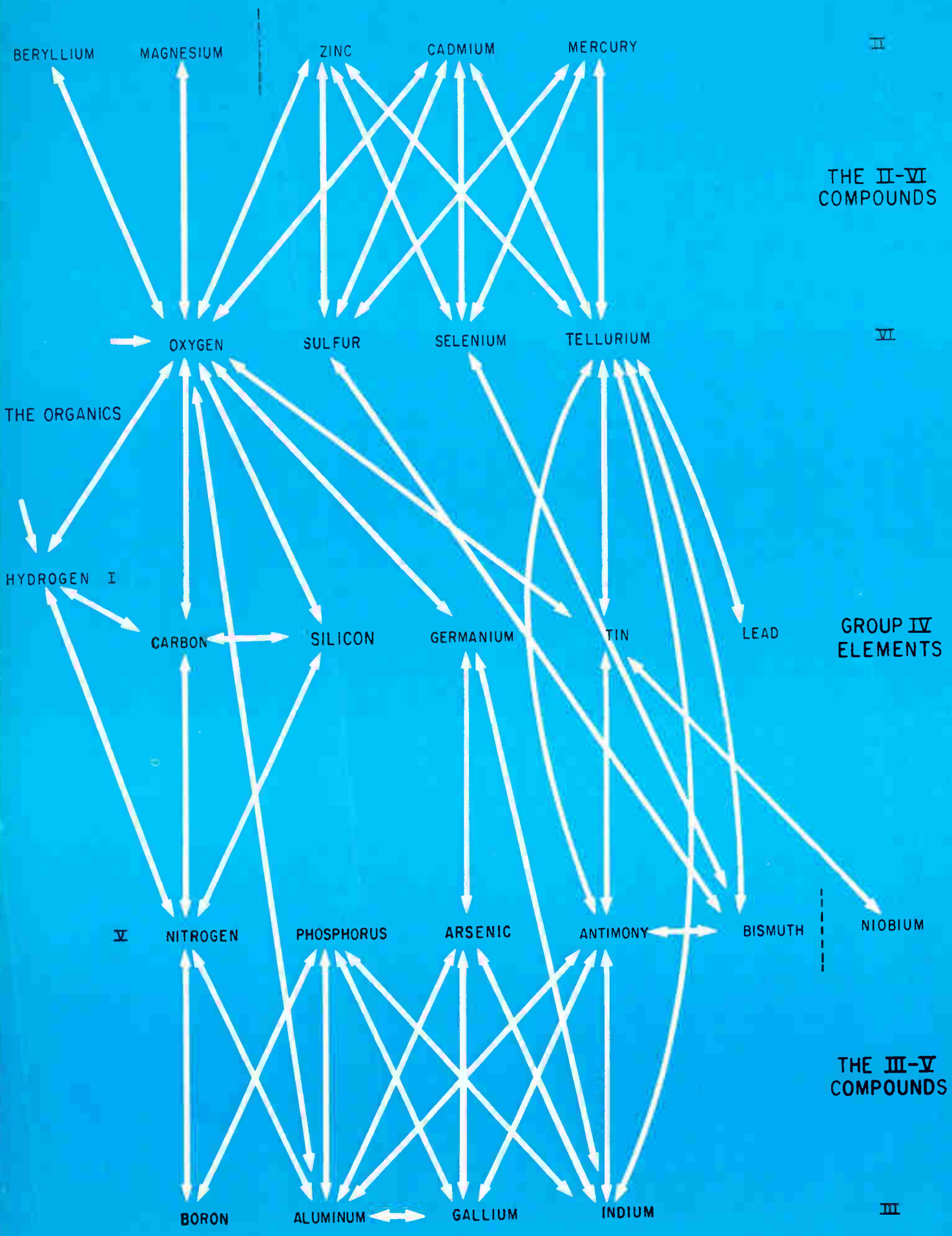

The Big Push Beyond SILICON

Versatile compounds can perform several functions. Success in this area depends, in part, upon how well we can cut through an often bewildering array of techniques in developing procedures for preparation of pure materials

SOPHISTICATED silicon technology may be hard to beat from the standpoint of optimum compromises among reliability, size-weight, cost and automation—within the operational capabilities of silicon.

This technology will continue to grow and will become even more important than it is now.

Complex integrated circuits, based on silicon, can contain scores of components. Constant refinements of techniques will achieve better yields, lower imperfections, less expensive fabrication techniques, and lower costs.

But the search goes on. The present trend is to exploit new materials, new phenomena. Further use will be made of piezoelectric, photoconductive and semiconductive properties to perform functions which cannot, as far as is now known, be accomplished with materials like germanium and silicon.

This is the big coming explosion in electronics. It will supplement silicon technology, not supplant it.

Areas of Hope for new explorations lie in elements and compounds illustrated by the diagram on the opposite page. These important materials offer great promise for new high-temperature semiconductors, ultrasonic amplifiers, electroluminescent devices, c-w injection lasers, piezoelectric devices, optoelectronic devices, opto-electro-magnetic devices, insulating ferromagnets, high-temperature dielectrics, infrared detectors, superconductors and devices that may combine several of these functions. Many of these functions appear to be beyond the scope of silicon alone.

◀ **EXTENDING OUR MATERIALS SPECTRUM**—Important building-block elements are arranged by groups. Links between elements form compounds of high interest

In the diagram, the elements have been arranged by groups. The arrows connecting the elements form compounds of high current interest. Patterns appear to be forming. Other patterns will no doubt evolve. These encompass the rare earths, the organics, high-temperature metals and the hard superconductors.

C. E. Ryan, of Air Force Cambridge Research Laboratories, says we don't know all the rules of the new game as yet. But we are learning. MIT's Arthur R. von Hippel, one of the prime movers of the concept of tailoring materials to our needs, says that we are beginning to understand slowly some fundamental concepts. But it will take time before we can provide all the answers we seek.

One of the most interesting facts about the II-VI and the III-V compounds is that alloys containing varying proportions of these elements have a continuous range of band gaps. Varying the composition of such materials will open up new areas for electronic devices.

New approaches for preparing high-purity single crystals and for mixing these compounds can lead to simpler, less expensive techniques for building devices of all kinds.

Further investigations into these combinations suggest many areas of promise.

The degree of accomplishment with these compounds will depend upon the materials technology and the fabrication technology we can develop for them. This will come with time. At the present, there is still a very limited technology in these areas compared to silicon.

New explorations will stretch the spectrum of materials technology. But silicon-based devices will take care of the bulk of our earth-bound electronic needs for some time to come.

BUILDING BLOCKS for New Functions

Here is why these versatile
compounds show great promise

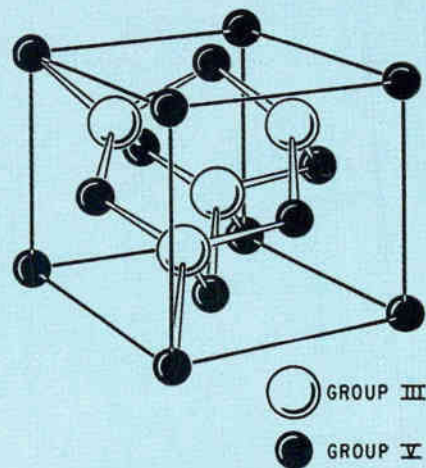

BASIC UNIT cell of gallium arsenide, a zincblende structure, prototype of the III-V compounds. (Texas Instruments)

GALLIUM ARSENIDE

GaAs. This III-V compound shows promise of combining the favorable properties of germanium and silicon, and the best features of both. The technology for the construction of conventional devices is more advanced for gallium arsenide than for other compounds of the III-V family. This compound is most promising in terms of high-frequency, high-temperature performance. High-quality, high-resistivity gallium arsenide is available for investigation.

Despite the potential of GaAs for high-temperature operation, it does have a few limitations. One of these is the major differences between elemental and compound semiconductors: stoichiometry, positive and negative crystal faces, and decomposition of the material during processing. One major limitation is band-to-band carrier recombination. This results in short minority carrier lifetimes.

Gallium arsenide ranks high as a material for the conversion of solar energy by a photovoltaic device, and will probably be the material which gives the highest reliable conversion efficiency.

This material can also provide a truly unique laser which operates by the injection of minority carriers, rather than by optical pumping.

The electrical characteristics of gallium arsenide tunnel diodes are encouraging. Peak to valley current ratios up to 45 have been observed at RCA. Lead inductances are as low as 400 ph. Basic circuit concepts have been conceived for application of tunnel diodes to switches, oscillator amplifiers and down converters.

Dopant diffusions and photolithographic techniques can be applied to gallium arsenide for the construction of power-transistor structures.

One of the most attractive device applications for gallium arsenide is for the generation of infrared light, both as a simple light source and as an injection laser. At low temperatures, a very intense radiation is emitted at about 8,600 angstroms. This wavelength

corresponds to an energy of about 1.47 ev, just a little less than the band gap energy for gallium arsenide.

An optoelectronic approach has been taken at HP associates for the advanced development of functional electronic blocks. Company has been experimenting with gallium-arsenide electroluminescent diodes matched to silicon phototransistors. The highest electroluminescent efficiency of zinc into *n*-type gallium arsenide diffused junction diodes has been measured to be less than one percent at room temperature and 3 to 5 percent at liquid nitrogen temperature. Highest proton flux observed at room temperature was 10^{16} protons/sec when pulsed for about 0.1 microsecond. Rise and decay time falls between 30 and less than 5 nanoseconds. Investigations show the recombination mechanism for the 1.34 ev emission band.

Another type of gallium-arsenide diode was fabricated at HP Associates, using *p*-type gallium arsenide to which a silver-tellurium contact was alloyed.

Diode areas have been limited by fabrication techniques, but larger areas should be possible. The infrared radiation can be modulated at frequencies well above 1,000 cps by simply modulating the diode current. One nanosecond bursts of infrared have been so produced at MIT.

It is believed that silicon or germanium based dopants in *n*-type gallium would improve efficiency several orders of magnitude.

The infrared absorption of gallium-doped germanium has been examined at MIT at about 2 deg K in the range 50 to 200 microns. F. Low of Texas Instruments has used this material as a low-temperature bolometer in the near infrared.

Although the light emitted from gallium arsenide *p-n* junctions is not visible, it is useful for optoelectronic applications. Efficiency and speed of response of light exceeds the best performance of zinc sulfide electroluminescent devices.

HP Laboratory has identified a highly self-absorbed

III-V COMPOUND AND IV ELEMENT SEMICONDUCTOR PROPERTIES

Semi-conductor	Band gap (ev)	Electron mobility $\text{cm}^2/\text{V sec}$	Hole mobility $\text{cm}^2/\text{V sec}$	Max. temp. (usable C)
InSb	0.18	65,000	~ 1,000	- 196
InAs	0.33	> 20,000	~ 200	~ 30
InP	1.25	> 4,000	> 100	~ 300
GaAs	1.35	> 5,000	> 400	~ 400
GaP	2.25	> 100	> 20	~ 650
AlSb	1.52	> 400	> 400	~ 450
Ge	0.67	3,900	1,900	85-100
Si	1.11	1,500	500	150

Prepared by Texas Instruments

BAND STRUCTURE OF GALLIUM ARSENIDE

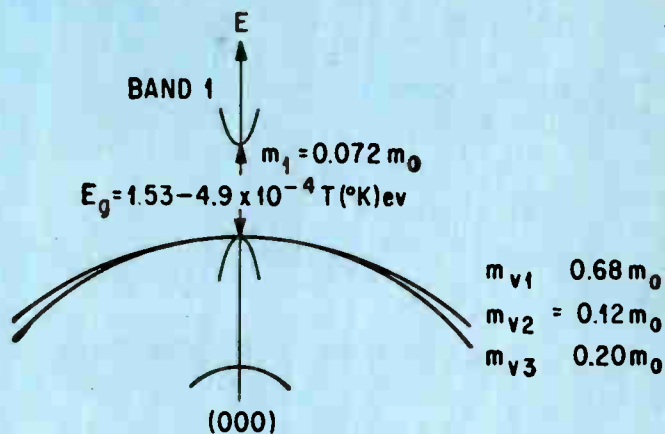

RCA for Air Force Systems Command, 1963

component in the generated radioactive spectrum. The new insight has enabled the company to make gallium arsenide el devices having very high conversion yields at room temperature. These are used in optoelectronic relays and amplifiers with gain bandwidths in the order of a megacycle.

Tyco Laboratories, has reported the growth of single crystals of gallium arsenide from solution by the movement of a solvent zone of gallium through both single and polycrystalline source crystals. The grown crystals are more pure and of a higher degree of crystalline perfection than the source material employed.

The zone movement process is controlled by the diffusion of arsenic across the liquid zone.

A similar system is suitable for the growth of silicon carbide from chromium, gallium phosphide from tin, gallium and indium, and strontium titanate from barium borate.

This system can be applied to the fabrication of homo- and heterojunctions of III-V semiconducting compounds, company says.

GALLIUM PHOSPHIDE

GaP. This translucent compound is a good example of how semiconductor behavior can be blended with luminescent behavior for optoelectronic technology. The material combines functions of semiconduction, insulation and luminescence in one material. The push is for an injection laser. RCA is attempting to grow single crystals by the vertical or Czochralski technique.

Injection electroluminescence has been observed in forward-based gallium-phosphide diodes. This consists of several emission bands. One dominant band is located at 6,300 to 6,400 angstroms at 77 K. This band has variously been ascribed to a phosphorus vacancy, substitutional oxygen or to zinc. Diodes have been prepared at Westinghouse by diffusion of silicon into *p*-type gallium phosphide.

GALLIUM ANTIMONIDE

GaSb. Emission of high-intensity infrared radiation at 1.6 microns has been observed from forward-based gallium-antimonide *p-n* junctions. Radiation seems to come from the junction or close to it. Optical pumping of the base material produces the same spectrum of radiation as *p-n* injection. Radiation may be connected with impurities, since the radiation spectrum is changed by adding a different impurity, according to MIT workers.

INDIUM ANTIMONIDE

InSb. The energy of the band gap for indium antimonide decreases linearly with temperature, and approaches zero at the melting temperature. This property makes InSb interesting to study.

Injection plasmas have been formed in *p*-type indium antimonide at temperatures below 100 deg K as donor traps become saturated by electrons injected through a forward based *n+p* junction. In an appropriate diode, the saturation of traps and the subsequent increase in electron lifetime bring about an abrupt decrease of base resistance. This produces a negative-resistance region in the current-voltage characteristic.

The high mobility of electrons are appreciably deflected and deformed by transverse magnetic fields of the order of 10 gauss. Control of the position of the plasma in a solid by a magnetic field can be utilized in a number of different devices having their input circuits isolated from their outputs. These devices are called madistors. They make use of magnetic field effects on an injection plasma in a semiconductor. Four types have been studied at MIT.

INDIUM ARSENIDE

InAs. Coherent emission has been observed at 3.1 μ from diffused indium-arsenide diodes, both at 4.2

deg K and 77 K. This extends the operating range of semiconductor masers further into the infrared. Workers at Lincoln Laboratory have observed a large shift of the radiation spectrum of incoherent indium-arsenide diodes to shorter wavelengths in a magnetic field. Here we may have the attractive possibility of a tunable maser. The emission wavelength can be changed by selecting the cavity mode by a magnetic field.

A gallium-indium-arsenide system is completely miscible, and the band gap varies continuously with composition. Thus the ground has been laid for fabricating coherent infrared sources. Suitably proportioned gallium-indium-arsenide compounds can cover the entire wavelength range between 0.84 μ to 1.1 μ .

Metallic indium telluride, a Group III-VI compound, is a superconductor (see p 52) with a transition temperature of 2.18 deg K. The critical magnetic field is about 800 gauss.

BORON NITRIDE

BN. This high-temperature structural material is both a good insulator and a good conductor. Films have been evaluated extensively at Texas Instruments for their dielectric properties, and possible application for precision r-f electrostatic capacitors. National Carbon has produced 14-in. diameter cylinders of boron nitride that are 12-in. long.

BORON PHOSPHIDE

BP. HP Associates reports injection electroluminescence in boron phosphide. Compound is said to have more favorable temperature dependence than gallium arsenide or gallium phosphide electroluminescence.

The compound has been synthesized.

The most advanced effort, carried out at HP Associates, is on boron phosphide, a virtual unknown among the III-V compounds. Company has grown *p* and *n* type boron phosphide and is presently studying injection electroluminescence. Boron-phosphide electroluminescent light emitters indicate a potentially unique combination of optical, electrical, thermal, and mechanical properties. However, their device feasibility has not yet been firmly established. This material still presents technological difficulties yet to be overcome according to HPA's E. E. Loebner.

SILICON CARBIDE

SiC. Here we go back to group IV in the periodic table. Single crystals of this material with sufficient purity, structural perfection and size have been difficult to grow. If we improve the growth problem and get high quality crystals we will be on the road to a higher degree of stability, than for the III-V compounds and can push our operating temperatures up to 500 deg. C.

Tyco Laboratories reports growth of a crystal ($\frac{3}{8}$ -in. long in the *c* direction, and about $\frac{1}{4}$ -in. square) by the traveling solvent method (TSM). Advantages of this method were pointed out in 1961. This technique is characterized by the movement of a solvent zone through both single and polycrystalline source crystals. Tyco used three systems: a platinum-silicon-carbide, silicon-silicon-carbide and chromium-silicon-carbide. Cleanliness of the surface is said to be critical factor. This development may pave the way for a 10-ampere rectifier, that has been sought for a specific application.

Silicon carbide structures can make low-power injection lasers (ELECTRONICS, Sept. 6, 1963, p 6).

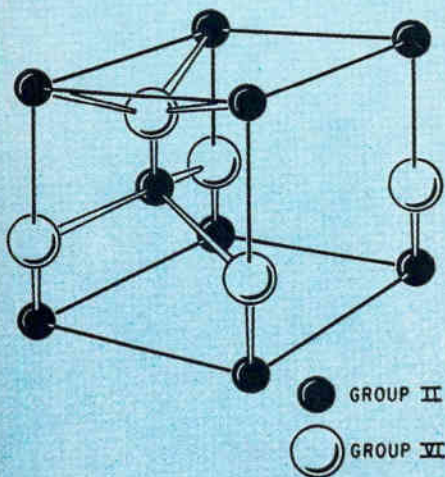

BASIC UNIT cell of cadmium sulfide, a wurtzite structure, prototype of many of the II-VI compounds. It is possible for some II-VI compounds to take a zincblende III-V structure. (Y. T. Sihvonon, Texas Instruments)

INTERFERENCE-MICROSCOPE MEASUREMENT

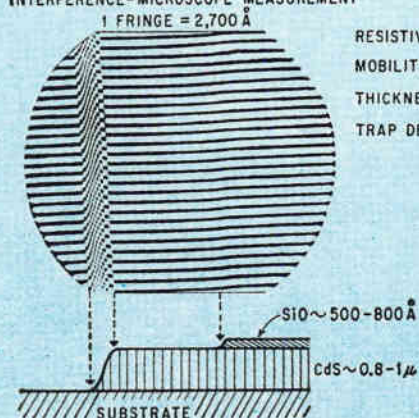

RESISTIVITY: $10^4 - 10^8$ OHM-CM
MOBILITY, μ_e : $10 - 100$ CM²/VOLT-SEC
THICKNESS: $0.1 - 30 \mu$
TRAP DENSITY: $10^{14} - 10^{16}$ CM⁻³

THIN FILM properties of cadmium sulfide, interface-microscope measurement on deposited CdS film through a metal mask (R. Zuleeg and E. J. Senkovitz, Hughes Aircraft, Electrochemical Society Symposium, April, 1963)

STRUCTURE of silicon carbide (J. W. Faust, Jr. Westinghouse, Silicon Carbide Symposium, Air Force Cambridge Research Center, 1959)

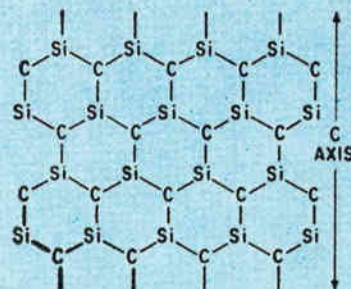

The TSM grown crystals have a higher purity and crystalline perfection than the source material.

DIAMOND

C. This prized gem exhibits thermoluminescence. Blue fluorescent diamonds emit a blue glow at 540 deg K. Two peaks were found, a weak one below 400 deg K, and main peak at 540 deg K. Thermal activation energies are 0.5 and 0.7 ev respectively. Diamonds exhibit a variety of glow peaks throughout the range from 80 to 600 deg K. Two workers, J. Nahum and A. Halpern of Hebrew University of Jerusalem have conducted extensive studies on excitation spectra, activation energies and photoconductivity.

CADMIUM SULFIDE

CdS. This compound may hold the best potential from the II-VI family for a variety of functions. It is available in high-resistivity single-crystal form and has a relatively high electromechanical coupling coefficient. Field effect devices, photocells, and thermal energy converters are all possible applications of this basic compound.

Large boules of cadmium sulfide have been prepared at RCA by sublimation. Gold appears to accelerate the growth process, according to report. Some evidence for *p*-type conductivity in a CdS:Cu boule was obtained. The pure bodies show high conductivity, but one sample contained a high-resistivity region. Cubic cadmium sulfide has been prepared and its photoconductivity measured.

R. Zuleeg of Hughes has described a method for the vapor deposition of cadmium-sulfide films ranging in thickness from 0.1 to 30 microns. The films have a

highly oriented structure which approach single-crystal characteristics. The single-crystal areas are of average diameter in excess of 100 microns.

Large areas of single-crystal thin films will be in the offing by controlling nucleation and providing optimum deposition conditions.

Thin film cadmium-sulfide solar cells, may have maximum efficiency of only 4 to 5 percent compared to 15 percent for silicon cells. But a thin film array potentially can more than compensate for the difference in efficiency by yielding a greater power-to-weight ratio than cells made of single crystal slices of silicon, according to National Cash Register.

At RCA, cadmium sulfide has been prepared by decomposition of cadmium mercaptide. Photoconductivity spectral response indicates a band gap of about 2.1 ev, about 0.3 ev smaller than the band gap of hexagonal cadmium sulfide.

Research in tunnel-cathode materials for microwave tubes at Stanford Research is said to have solved certain problems associated with sprayed CdS films. They report that better techniques are needed for deposition of thin, uniform films.

One of the most successful approaches to thin-film active devices has been taken by Paul K. Weimer of RCA. (ELECTRONICS, June 21, 1963, p 25). He has prepared insulated-gate field-effect devices from evaporated cadmium-sulfide layers. Experimental units using microcrystalline layers of cadmium sulfide have yielded gain band width products greater than 28 mc.

The dominant current control mechanism in the insulated-gate cadmium-sulfide thin-film transistor (TFT) is conductivity modulation in the semiconductor by field effect action of the gate.

Ultrasonic gain has been observed in cadmium sulfide. Gain is about 5 db/mm at 50 Mc. Work at MIT

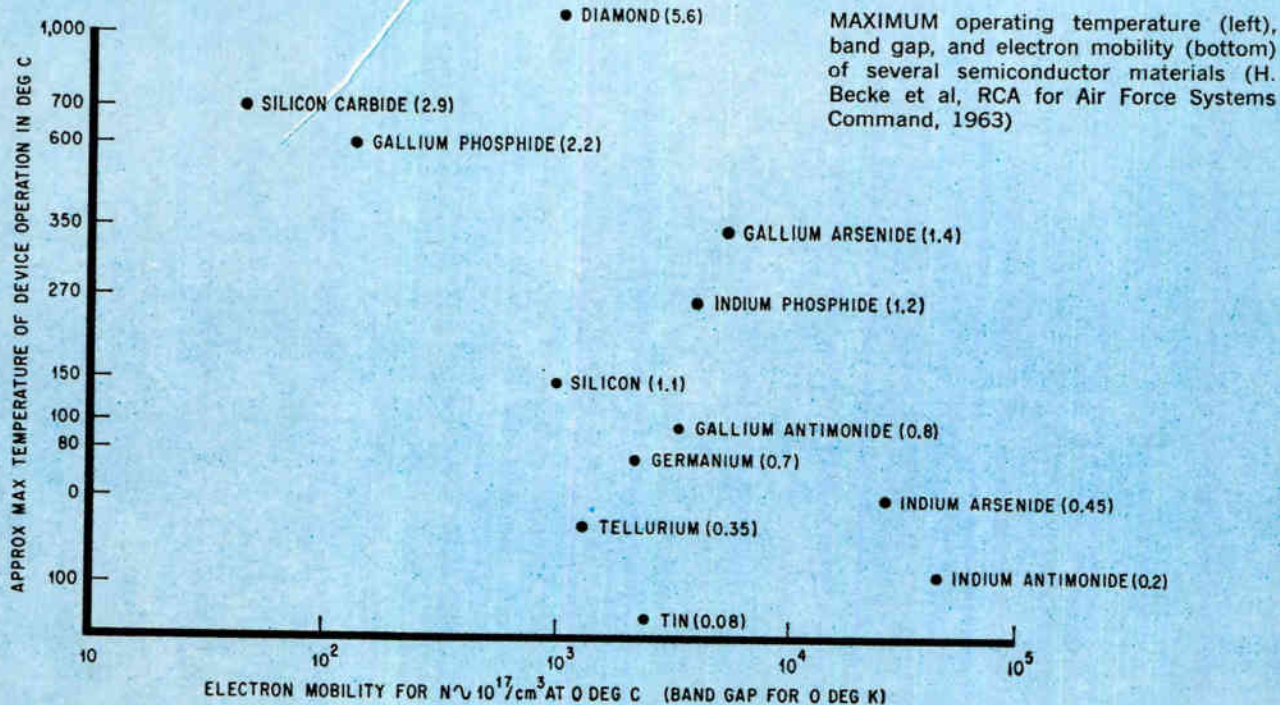

will utilize this effect at several hundred megacycles in an oscillator producing relatively high-amplitude uhf ultrasonic energy for research purposes. Depletion layer transducers are planned which will be resonant in the region of 500 mc. An ultrasonic amplifier incorporating this type of transducer may make possible the construction of such devices as an uhf ultrasonic delay line with negative insertion loss.

Gold-cadmium sulfide-gold structure has been investigated by Stanford Research Institute. They plan to develop a thin-film capacitor cathode for microwave tubes. Reports indicate that better techniques are desirable for depositing the cadmium-sulfide films.

CADMIUM TELLURIDE

CdTe. One of the most interesting techniques proposed for semiconductors by MIT workers is to use a cadmium telluride-mercury telluride system for a device in which a continuous range of band gaps exists. In a system where each photon is absorbed at a point where its energy is equal to the band gap, it should be possible to convert a continuous spectrum of radiation with maximum efficiency. Another interesting feature of such a device, would be the presence of built-in fields due to the inhomogeneity. Thus it is possible that the excess carrier currents in such a device would flow primarily by drift. This may lead to outputs larger than those available for a normal *p-n* junction cell or a normal photoelectro-magnetic cell, in which the excess carriers flow mainly by diffusion.

In the cadmium telluride-mercury telluride system, the energy gap is a function of composition, varying from 1.5 ev in pure cadmium telluride to a band overlap in pure mercury telluride. The transition region between two similar interdiffused semiconductors may be treated as a region of continuously varying band gap, effective mass, mobility, and excess carrier lifetime. Thus it should be possible to make a device with varying band gap by interdiffusing the two compounds.

Some workers have had difficulties in obtaining conductive films of cadmium telluride, and believe that the usefulness of cadmium telluride as a conductor for thin-film device applications may be limited.

ZINC ANTIMONIDE

ZnSb. An important application of this compound is its use as the *p*-type leg against an *n*-type leg in

Approximate resistivities and mobilities of some II-VI compounds

Compound	Band Gap (ev)	Resistivity in ohm-cm		Mobility in cm ² /volt sec	
		n-type	p-type	n-type	p-type
ZnS	3.7	10 ²	10 ⁶	70	5
ZnSe	2.7	1	10 ⁶	400	10
CdS	2.4	10 ⁻²	—	350	—
ZnTe	2.2	—	1	—	100-200
CdSe	1.7	10 ⁻²	—	500-600	—
CdTe	1.5	10 ⁻¹	10	1000	80

MANUEL AVEN, General Electric, Electrochemical Society Symposium, May, 1962

thermionic power generators. There has been little effort to explore the properties of this compound in a systematic way. Fundamental investigation of the thermal and transport properties of this material are being conducted at MIT. Nature and mechanism of the high-temperature instability and the effects of annealing both single crystal zinc antimonide and zinc antimonide alloy systems has not been established. Instability appears when the material is raised to temperatures around 100 C. This phenomena has an important influence on the optimization of ZnSb for higher temperature thermo-electric applications.

ZINC SULFIDE

ZnS. The electroluminescent series in the II-VI compounds consists of zinc sulfide, zinc selenide and zinc telluride. Back in 1957, RCA workers, led by S. Larach, studied the variations in band gap with composition. Families of electroluminescent materials can cover the spectrum from ultraviolet to infrared. The materials can be tailored to any color with the introduction of the proper amounts of donor and activator impurities. These materials can be applied to integrated circuits and thin films in all areas.

Electroluminescent films of zinc sulfide require much lower voltages for equivalent brightness than the more conventional powder phosphor layers, according to Westinghouse. No insulating material need be included. Emission can be exceedingly uniform. Films respond to a-c or d-c excitation, are transparent, and show high resolution. Blue and green emitting ZnS: Cu films are successful, but yellow emitting ZnS: Cu, Mn films have been emphasized at Westinghouse.

Work with ZnS: Cu, Mn, Cl films showed hours of operation at 400 cps to half of initial brightness was about 300 hours, providing atmosphere is dry and the films are coated with plastic or MgF₂. Bare films, humid atmospheres, or low coactivator content leads to much shorter lifetime. Film capacitance is often about 5,000 pf/cm² and increases with voltage and frequency. Capacitance of thinner films has been measured as high as 35,000 pf/cm². Conductance of the films averages about 10 to 15 microhms/cm² at low voltage but can increase by ten or one hundred times with increase in voltage and frequency. Brightness of 100 ft L requires about 25-c d-c. In one case, 50 ft L over a one-inch-square area was obtained by using a 22½-v battery. A thin, plastic insulating coating seemed to make little difference in d-c operation of these films. Maintenance of light emission with d-c operation was found to be much poorer than with a-c operation, the light dropping to half in no more than a few hours. D-c efficiency is so far no better than 0.1 pw and in many cases increases steadily with brightness up to breakdown.

Injection electroluminescence has been reported in Cu₂S-ZnS and Cu₂Se—ZnSe heterojunctions by General Electric workers.

Hot-pressed zinc sulfide and selenide are considered as hosts for either rare earth or transition element impurities.

These materials are being considered at MIT for work on parametric effects and development of lasers in the 10-micron wavelength region.

More Materials of Promise

ALUMINUM OXIDE

Al_2O_3 is being explored as a high-temperature dielectric. A-c dielectric measurements, taken at Westinghouse, indicate an increasing capacitance with temperature up to 500 C, with a greater increase at lower frequencies. The films also showed a dissipation factor (loss angle) maxima as the measurement frequency and temperature were varied.

Failures of dielectric materials used in microwave electronic devices have been a source of great concern. Stanford Research Institute has been studying materials in terms of their properties and factors that control them. Materials are prepared in their most pure form and then changed by modifying composition and structure.

Recent work at GE, connected with fabrication of tunnel-emission cathodes, has been directed towards improving the quality of the anodized aluminum-oxide film through which tunneling occurs. A large improvement in the insulating film current density has been made as a result of processing changes, improved vacuum levels and cleanliness.

Molybdenum-doped aluminum-oxide films that are stable and reproducible have been made at Stanford Research Institute in resistivities ranging from 10 ohm-cm to 10^{-4} ohm-cm. There is no indication that the process is limited to this range. Study has been conducted for thin-film emission tubes.

Synthetic ruby, used in optical masers has the composition $Cr^{3+}: Al_2O_3$. United Aircraft aims to extend the frequency spectrum of solid state masers into the millimeter wavelength region. The efficiency of the ruby laser as an optical pump source for a laser-pumped ruby maser has been demonstrated at 22.4 Gc. Operation at millimeter wavelengths will require only modest refinements of the experimental technique and apparatus. Continuous laser pumped maser operation in ruby appear quite difficult to obtain at present, and other materials may offer a better means of achieving a c-w optically pumped maser.

Output of a ruby crystal laser can rapidly deliver heat to a small surface area. This had led to a high-power system that can weld up to 25-mil thick surfaces. TRG believes that the heating and cooling rates of their system has not been previously achieved in welding.

At MIT a ruby optical maser has been operated in magnetic fields up to 65 kilogauss in a 4-inch bore magnet. Workers there say there may be several advantages of operating optical masers in uniform magnetic fields. These include tunability of the emission and the possibility of simultaneous operation at two or more frequencies, which will give rise to variable sum and difference frequencies when incident on a nonlinear dielectric. At low temperature, the operating threshold may be reduced.

BERYLLIA

BeO Entirely new design concepts can be employed when utilizing beryllia in electronic devices. Brush Beryllium has suggested beryllia for transistor packages, varactor diode packages antenna windows, substrates and external heat sinks. The thermal-electric properties of beryllia ceramics has led to smaller packages. The extremely high thermal conductivity of the dielectric permits conduction cooling at rates equal or greater than those obtainable with other ceramic metals (See ELECTRONICS, Oct. 18, p 75).

BARIUM TITANATE

$BaTiO_3$ Materials have been developed at Linden Laboratories that have optical electrical properties above 300 C. Emphasis was placed on exploring the maximum feasible operating temperature and on developing bodies possessing high dielectric strength, low conductivity and electrical dissipating, and long, reliable operating life at elevated temperatures.

Barium titanate single crystals are being grown at MIT, and measurements of frequency response are being extended into the submillimeter region. New ferroelectric materials that exhibit strong paramagnetism and possibly ferrimagnetism have been synthesized.

Thin films compositions of barium titanate, prepared at General Telephone and Electronics Laboratories, showed dielectric constants at room temperature in the range of approximately 10 to 1,300. Ranges depend upon the relative amounts of barium oxide, titanium oxide and their compounds and under the conditions in which the depositions are carried out.

The resistance of barium titanate can be changed from 10^{-12} ohm-cm to 10^{-1} to 10^5 by impurity additions of certain rare earths. Studies at American Radiator and Standard Sanitary Corp. show that resistances can be controlled by additions of strontium or lead to replace part of the barium.

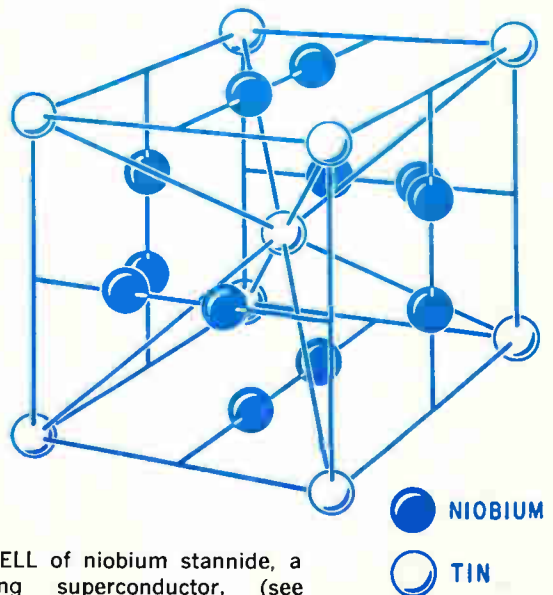

UNIT CELL of niobium stannide, a promising superconductor, (see page 52, Fred Rosi, RCA)

Barium titanate has an excellent permeability-dielectric constant product.

BISMUTH

Bi. Bismuth telluride-bismuth selenide alloys are being investigated at MIT. Attempts are being made to correlate data on electrical conductivity, thermal conductivity, thermoelectric power, and magnetoresistance. Bismuth telluride is also being explored for magneto-optic properties.

A rapid freeze method for growing large striation-free single crystals of bismuth has been developed at MIT. Simple technique is said to grow crystals in a few minutes, even when a seed crystal is not used. Technique, developed by Sidney Fischler of Lincoln Labs is said to be applicable to preparing other elements and compounds. Large boules are possible.

COBALT

Co. Cores of cobalt and cobalt zinc ferrite have been used in the development of ferreeds (ELECTRONICS, Sept. 30, 1960, p 63). These contact switching devices can obtain reed relay control time in microseconds, coincident selection, a memory without holding power, and a smaller and more sensitive unit. Switches using these elements have been in the hands of USARDL for consideration and possible application.

CHROMIUM BROMIDE

CrBr₂ is one of the few insulating ferromagnets. At MIT, a program is investigating the Cr⁵³ nuclear resonance as a function of temperature near the Curie point (37 K).

FOAMED MATERIALS

The use of both rigid and flexible foams has grown because of ease of preparation. Foamed metals, glasses, concretes, ceramics and paper offer low conductivity and light weight. Structural elements with unusual strength can be constructed by separating the foamed materials with thin, usually dense surface sheets. Large enclosures for military equipment may be constructed entirely of foamed materials, formed at site from liquids or formed in sections and joined into shell structures. This can provide a simple thermal or vapor barrier.

GLASSES

Workers at Bell Laboratories say that systems with interesting new electrical characteristics can be constructed using a whole new series of semiconducting glasses of widely-diverse chemical construction. These glasses have been examined in the conductivity range 10⁻² to 10⁻⁸ ohm⁻¹. The following systems have been studied. Low melting glasses As-Ti-I, As-Te-Se, As-Ti-Se; intermediate melting glasses V-P-O, V-P-O-Ba, V-P-O-Pb. High melting glasses Na-B-Ti-O. These compounds are easily prepared by fusing mixtures of either the elements or appropriate compounds.

Electronic effects were first discovered in samples of glasses from the system As-Te-I. Diodes have been formed which are nonpolar and exhibit two regions of widely different positive resistance, and at least one region of negative resistance. Reports are of a preliminary nature and effects are not well understood. The possibility of using these materials in a practical system is yet to be explored.

A new method for preparing electrophoretic screens directly on glass surfaces is said to have important advantages over fine settled screens and over electrophoretic screens deposited on ECG (electrically

HOW TO GET MORE FEEDBACK

The urgent need for information relating to availability of high-purity research materials specimens for electronics has been aided by the establishment of a Research Materials Information Center at Oak Ridge National Laboratory, Tennessee. This Laboratory is operated by Union Carbide Corporation for the U. S. Atomic Energy Commission.

This program was described at an Electrochemical Society Symposium this fall by J. H. Crawford, Jr. The Center now has over 1,000 data sheets on a wide variety of materials.

Information on materials used and desired in electronics is being organized and encoded in an auto-

Experts Appraise

COMPOUNDS NEED BETTER CONTROL

By CHARLES E. RYAN

Air Force Research Laboratories, Cambridge, Mass.

THE ONLY semiconductor materials that are under excellent control from a standpoint of chemical purity and structural perfection are still germanium and silicon.

In general, the techniques of zone purification and pulling from the melt that have proved very successful for the elemental semiconductors are, for a variety of reasons, not effective for III-V and II-VI compounds, with the possible exception of indium antimonide.

If one wants to prepare materials with impurities in the part per billion range rather than in the part per million range, new purification techniques must be developed for both the compounds and their constituent elements. Moreover, new crystal-growth techniques are needed so that the materials will not be degraded in the processing steps.

The preparation of single-crystal films, epitaxially or heterotaxially by vapor transport, chemical decomposition and by variations of high vacuum evaporation techniques are most attractive to us.

The traveling-solvent method of growth (see p 43) has possibilities for extending some of the advantages

conductive glass) coated glass, according to CBS.

Glasses have been produced containing up to 90 mol percent V_2O_5 with electrical resistivities as low as 10^3 ohm cm, well within the range of semiconductors.

Evidence gathered at MIT shows conductivity is electronic rather than ionic, and that it may be of either *n*-type or *p*-type depending upon the composition of the glass.

Glasses can be chemically strengthened to more than three times the strength of physically tempered ware.

matic storage and retrieval system.

It is hoped that this collection can be expanded and updated with the cooperation of all workers engaged in electronic materials investigations.

Workers are asked to notify the center of their work, needs and interests.

The Center will emphasize high-purity inorganic materials such as metals, alloys, semiconductors, compounds, elements, laser and maser materials. Information on structural materials, devices, radiation effects and radioactive and stable isotopes will not be included. These are separately covered by the Defense Materials and Radiation Effects Information Centers of Battelle Memorial Institute, and the Isotope Information Center at the Oak Ridge National Laboratory. Information is solicited on a voluntary basis.

HELIUM NEON

He-Ne is used for gas lasers. When excited with high voltage pulses, this system yields peak power outputs significantly greater than the maximum continuous wave output achieved by more conventional means of pumping. A laser has been constructed at Martin Company which was designed for pulsed operation. This is planned for operation at much longer wavelengths with reduced loss of transmission.

Peak powers of over 50 watts have been achieved. Outputs in the kilowatt range are not far off with the

The Federal Bureau of Mines, Boulder City, Nevada is actively engaged in research for the development of methods for the extraction and utilization of our natural resources.

The Department of Defense has taken vigorous steps to discharge its responsibility in materials research. The Interdisciplinary Laboratory Program of the Advanced Research Projects Agency has broadly-written contracts with universities having large graduate programs in materials sciences, as well as a sampling of universities having more modest programs. Total initial investment has run into many millions of dollars. Millions more are being spent for yearly renewals.

This program has been outlined by Charles Yost of Advanced Research Projects Agency.

Materials TECHNOLOGY

of the floating-zone techniques to compound semiconductors. The lack of available suitable crucible materials is one of the practical limitations of the growth of gallium arsenide and other electronic materials from the melt.

The miscibility of gallium arsenide with gallium phosphide over the entire range permits useful compromises of energy gap and mobility. Furthermore, the fact that the energy band transitions are direct, up to a composition of about 50 percent gallium phosphide, make these two materials the most broadly significant of the III-V compounds. However, to exploit these materials even for tunnel diodes and semiconductor lasers will require substantially better material control.

Potentials—The present state of the material art limits III-V and II-VI compounds to devices that have less stringent requirements of chemical purity and structural perfection or to utilization of phenomena that have no counterpart in germanium and silicon. Hence, majority carrier devices, hot electron devices, semiconductor lasers and heterojunction devices are more attractive than bipolar devices.

Even so, until much better control of materials can be obtained, one must expect severe limitations on the device potentialities of compound semiconductors.

Examples that are well known are degradation effects in tunnel diodes, competing transitions in semiconductor lasers limiting their operation to low temperatures and trapping centers in photoconductors.

Moreover, the potential of compound semiconductors for piezoelectric devices and phonon interaction amplifiers and a wide variety of electro optical devices, in inhibited by the present state of the art for growth of high-quality single crystals of wide band semiconductors.

Thus, to achieve the full promise of wide band semiconductors, we need advances in conventional and unconventional methods of purification, new rapid and nondestructive analyses techniques and much more science in the crystal growing art and better methods of correlating materials parameters with device parameters.

The wide band semiconductors of particular interest to us are silicon carbide and diamond in Group IV, gallium arsenide and gallium phosphide in Group III-V, and CdS, ZnSe and ZnTe in Group II-VI.

The techniques of particular interest to us are concerned with thin-film single crystals.

Among the most interesting devices are the TFT (see cadmium sulfide, p 45) and MOS (metal oxide semiconductor) transistors, semiconductor lasers and hot electron devices.

(more Experts...)

RARE EARTHS

These are members of the periodic table with atomic numbers 57 through 71. At present improved technology and their availability as by products of the atomic energy industry have made rare earths quite common and inexpensive. Binary compounds of rare earths—group V compounds are semiconductors. Unfortunately melting points of these compounds are high and they tend to decompose prior to melting.

REFRACTORY METALS

These metals have melting points that exceed 2,000 C such as niobium, tantalum, tungsten and molybdenum. They are used chiefly for extremely high-temperature, high-density or highly corrosive applications.

Information of interactions between alkali and refractory metals will help the development of more corrosion-resistant alloys for space application.

Thin refractory metal films of niobium, tantalum and tantalum compounds have potential as passive components in electronic systems. Tantalum and niobium films with superconducting properties close to those of bulk metal can be deposited.

SILVER-OXIDE

Cadmium, and silver-oxide-zinc cells as battery power have been launched in probes and satellites. The silver-oxide-cadmium couple has been used as a secondary source. Several flights have incorporated a silver oxide primary as the main power supply. According to NASA spokesmen, the prime interest of these materials was the possibility of fabricating cells entirely free of materials that are essentially non-magnetic so as to eliminate extraneous magnetic signals when used near satellite magnetometers. Evaluation programs have shown that the silver cadmium system is particularly suited as a secondary where orbital periods exceed five hours. The silver cadmium couple offers substantial weight saving over other conventional electrochemical primary systems.

SUPERCONDUCTORS

These materials offer zero resistance. No heat is generated and no large amounts of power are required for continuous operation. Operation is at temperatures near absolute zero. New superconductors compounds are being explored at great lengths. This has been motivated by data processing. Bit density of data processing system using superconductors can be 10^9 with access time of microseconds. A one pound superconductive magnet can produce twice the field strength generated by a twenty-ton conventional electromagnet. Niobium-zirconium alloys, and compounds which remain superconductive in high magnetic fields, have been applied to generating magnetic fields up to 70 kilogauss.

Niobium stannide, Nb_3Sn has the highest known superconducting transition temperature, 18 deg K, and has exhibited the highest current carrying capacity at high magnetic fields, for example, greater than 10^5 amps/cm² at 94,000 gauss. Efforts are now con-

centrated by some workers in finding ways to make superconducting magnets more reliable and durable rather than pushing them towards higher field strengths of which they should be ultimately capable. Uses have been restricted to experimental work with traveling-wave masers, in magnetohydrodynamic energy conversion and biomagnetic studies. Theoretically, any current started in a coil of one of the superconducting alloys will flow indefinitely.

TANTALUM

Ta. Well controlled tantalum film technology has been developed. This basic refractory metal, from group V, can be used for resistors, capacitors and conductors. Techniques are applicable to a broad range of circuits, both linear and digital, according to Philco. Resistor tolerances of ± 5 percent are readily available. The metal is compatible with thin film active devices. One possible solution to the interconnection problem is a combined microcircuit wherein tantalum passive elements are deposited and connected to diffused planar devices. Advanced computer microcircuit application has operation speeds of greater than 50 mc.

Tantalum thin film circuits and components possess high reliability, low temperature and voltage coefficients of resistance and capacitance, ease of fabrication and potentially low cost.

One major disadvantage of tantalum thin film circuits is the nonavailability of a comparable active device.

TIN OXIDE

This compound provides high-value resistors which can be readily etched to fine patterns. Compound makes stable electrical contact to silicon. At elevated temperatures it reacts with aluminum to form an insulating aluminum oxide interface. This results in an open contact. A film of nickel, approximately 1,000 angstroms thick, provides a satisfactory stable interface between tin oxide and aluminum, according to Motorola.

Tin films, prepared by electrodeposition, have been found capable of being utilized for cryogenic switching devices, according to General Electric.

ZIRCONIUM

Zr. Absorbed zirconium coatings are used on tungsten field emitters as a means of altering the emission characteristics. Work at Linfield Research Institute shows that such coatings appear to be easily reproducible, have a work function of less than 3 ev, confine the emission almost wholly to 100 and immediately adjacent surfaces, are capable of emission of current densities of the order of 10^8 amp/cm², and to allow emission without excessive tip heating of higher total current from the zirconium-coated tungsten emitter than are possible from the uncoated emitter.

Zirconia has long been of interest in the field of high-temperature technology because of its refractory properties (m.p. 2,680 C) and resistance towards many chemical agents.

conductive glass) coated glass, according to CBS.

Glasses have been produced containing up to 90 mol percent V_2O_5 with electrical resistivities as low as 10^3 ohm cm, well within the range of semiconductors.

Evidence gathered at MIT shows conductivity is electronic rather than ionic, and that it may be of either *n*-type or *p*-type depending upon the composition of the glass.

Glasses can be chemically strengthened to more than three times the strength of physically tempered ware.

matic storage and retrieval system.

It is hoped that this collection can be expanded and updated with the cooperation of all workers engaged in electronic materials investigations.

Workers are asked to notify the center of their work, needs and interests.

The Center will emphasize high-purity inorganic materials such as metals, alloys, semiconductors, compounds, elements, laser and maser materials. Information on structural materials, devices, radiation effects and radioactive and stable isotopes will not be included. These are separately covered by the Defense Materials and Radiation Effects Information Centers of Battelle Memorial Institute, and the Isotope Information Center at the Oak Ridge National Laboratory. Information is solicited on a voluntary basis.

Materials TECHNOLOGY

of the floating-zone techniques to compound semiconductors. The lack of available suitable crucible materials is one of the practical limitations of the growth of gallium arsenide and other electronic materials from the melt.

The miscibility of gallium arsenide with gallium phosphide over the entire range permits useful compromises of energy gap and mobility. Furthermore, the fact that the energy band transitions are direct, up to a composition of about 50 percent gallium phosphide, make these two materials the most broadly significant of the III-V compounds. However, to exploit these materials even for tunnel diodes and semiconductor lasers will require substantially better material control.

Potentials—The present state of the material art limits III-V and II-VI compounds to devices that have less stringent requirements of chemical purity and structural perfection or to utilization of phenomena that have no counterpart in germanium and silicon. Hence, majority carrier devices, hot electron devices, semiconductor lasers and heterojunction devices are more attractive than bipolar devices.

Even so, until much better control of materials can be obtained, one must expect severe limitations on the device potentialities of compound semiconductors.

HELIUM NEON

He-Ne is used for gas lasers. When excited with high voltage pulses, this system yields peak power outputs significantly greater than the maximum continuous wave output achieved by more conventional means of pumping. A laser has been constructed at Martin Company which was designed for pulsed operation. This is planned for operation at much longer wavelengths with reduced loss of transmission.

Peak powers of over 50 watts have been achieved. Outputs in the kilowatt range are not far off with the

The Federal Bureau of Mines, Boulder City, Nevada is actively engaged in research for the development of methods for the extraction and utilization of our natural resources.

The Department of Defense has taken vigorous steps to discharge its responsibility in materials research. The Interdisciplinary Laboratory Program of the Advanced Research Projects Agency has broadly-written contracts with universities having large graduate programs in materials sciences, as well as a sampling of universities having more modest programs. Total initial investment has run into many millions of dollars. Millions more are being spent for yearly renewals.

This program has been outlined by Charles Yost of Advanced Research Projects Agency.

Examples that are well known are degradation effects in tunnel diodes, competing transitions in semiconductor lasers limiting their operation to low temperatures and trapping centers in photoconductors.

Moreover, the potential of compound semiconductors for piezoelectric devices and phonon interaction amplifiers and a wide variety of electro optical devices, is inhibited by the present state of the art for growth of high-quality single crystals of wide band semiconductors.

Thus, to achieve the full promise of wide band semiconductors, we need advances in conventional and unconventional methods of purification, new rapid and nondestructive analyses techniques and much more science in the crystal growing art and better methods of correlating materials parameters with device parameters.

The wide band semiconductors of particular interest to us are silicon carbide and diamond in Group IV, gallium arsenide and gallium phosphide in Group III-V, and CdS, ZnSe and ZnTe in Group II-VI.

The techniques of particular interest to us are concerned with thin-film single crystals.

Among the most interesting devices are the TFT (see cadmium sulfide, p 45) and MOS (metal oxide semiconductor) transistors, semiconductor lasers and hot electron devices. (more Experts...)

Experts . . .

GREATER GAINS FOR SILICON

By WOLFGANG GAERTNER, CBS Laboratories

Speaking strictly in the field of Micropower Microelectronics, I feel that silicon and silicon oxide should and will be the basic materials into which all solid-state devices will be diffused and alloyed and onto which many different materials will be either grown epitaxially, evaporated, or sputtered for some time to come.

The extreme chemical simplicity and stability of silicon, the already excellent performance of devices built with it, the wide range of technologies to which it may be subjected without resulting in undesirable changes in its properties, and most important, the fact that several orders of magnitude of improvement in device characteristics are still possible by fully exploiting the characteristics of silicon itself, lead me to believe that greater gains can be achieved by more emphasis on the perfection of silicon technology rather than by looking for new basic materials.

TAILORING MATERIALS TO ORDER

By LEONARD E. AMBORSKI, Du Pont, Yerkes Research Lab

Progress in materials for electronics has been phenomenal in the past two decades. Continuation of this pace becomes an increasingly formidable challenge as the demands on materials are intensified.

We have seen improvements in metals, ceramics and polymers in the form of wires, sheets, fibers, films,

new technique, researchers believe. The Martin pulsed gas laser uses helium and neon in a 50 to 1 mixture.

The purity of the frequency of a continuous-wave gaseous optical maser is extremely high. A continuous wave gaseous optical maser may be considered as the most sensitive instrument for detecting minute variations of length, according to MIT reports.

LANTHANUM TRIFLUORIDE

LaF₃. Trivalent crystal matrix is host for rare earth dopants for laser-maser research. Substitution of the entire rare-earth series, over wide concentration range, has been successfully made in optical-grade crystals. Standard dopants are presently neodymium and praseodymium in three concentration ranges. Other rare earth dopants in the LaF₃ matrix can be grown to specifications, according to Varian Associates.

Lanthanum trifluoride crystals should make it possible to construct laser systems which will be more amenable to applications where weight, space and power requirements must be minimized as much as possible, Philco says.

The absorption band for optical pumping of lanthanum trifluoride coincides with the emission band

of gallium-arsenide injection light sources when operating at liquid temperatures. By using the combination as the optical pump, it should be possible to construct very efficient laser systems.

Improvements have been made in liquids and gases as well as solid materials. Much has been learned about the electrical properties of all states of matter, and a vast body of knowledge has been accumulated in correlating electrical behavior of materials and their chemical and physical structure. We are learning much about the forces of atoms and molecules. Basic discoveries of many new phenomena have resulted from research in a wide cross-section of scientific disciplines. Besides general physics, chemistry and engineering, these include the fields of metallurgy, spectroscopy, solid-state physics, electrochemistry, quantum-mechanics, thermodynamics, crystallography, optics and acoustics.

We now have a limited ability to synthesize, modify or process materials to provide the desired electronic functions. Too many gaps exist in our state of knowledge to permit us to achieve the desired end results with a great degree of success, but considerable progress has been made in this direction.

The Ideal is to utilize the atomic constants in assembling the atomic and molecular building blocks into the finished product with all of the desired characteristics and none of the undesirable ones. This concept of tailoring materials is known by many terms but perhaps one of the best known—particularly in the electronic sciences—is that of molecular engineering or molecular electronics.

This concept of molecular engineering involves much more than just bringing into chemical combina-

of gallium-arsenide injection light sources when operating at liquid temperatures. By using the combination as the optical pump, it should be possible to construct very efficient laser systems.

LEAD TELLURIDE

PbTe. Energy band structure of this IV-VI compound is being investigated for magnetic tunneling. A theoretical model of the compound, consistent with its transport and optical properties, is now being worked out by the materials theory group at MIT. Tentative conclusions regarding the symmetry of the energy band structure have been obtained.

NICKEL CADMIUM

Ni-Cd batteries are widely used in many space applications where extremely reliable, completely automatic operation is essential. These cells are relatively new and their performance characteristics are still in the process of being delineated.

Rapid charge Ni-Cd cells are now being manufactured by General Electric, Sonotone, and other firms, with an eye to consumer applications (see *ELECTRONICS*, Oct. 4, 1963, p 49).

tion the correct proportions of the required elements. It entails, also, such variables as the proper crystal structure, orientation, annealing, impurity content and physical form.

The Polymers—The application of molecular engineering has met with considerable success in tailoring polymers with predicted mechanical, thermal, chemical and electrical properties. For example, it has been possible to prepare polymers with high capacitance, by the introduction of polar groups such as the halogens of hydroxyl groups; low loss, by maintaining a high degree of purity and structures without polarizable groups; high insulation resistance at elevated temperatures by the use of highly aromatic and cyclic structures with a high degree of crystallinity such as the aromatic polyesters, polypyromellitimides, and polybenzimidazoles; and moisture insensitive properties by the use of hydrophobic polymers.

Much has been learned about the effects of orientation, crystallinity, plasticizers and impurities on the electrical properties of polymers to permit control of the final properties. The wide acceptance of synthetic organic polymers by the electronics industry is indicative of the virtues they possess. We see alkyds, silicones, polyesters, polyimides, polyolefins, halogenated polyolefins and chlorinated hyphenyls.

Future research on materials for applications as insulators, dielectrics, inductors, magnets, and resistors will involve explorations for operation under high temperatures, cryogenic temperatures, radioactive environments, vacuum and high mechanical stress.

The more we increase our knowledge of molecular and atomic properties as related to macroscopic properties, the more successful we will be able to fabricate materials for space-age electronics.

NICKEL-ZINC-COBALT

This ferrite has been used in making thin-film inductors. The main problem has been control of the composition of the film. Zinc is the most difficult element to control, according to Motorola. Flat spiral coils in combination with two or more bulk ferrite wafers have produced a maximum inductance value of 153 μ h with a value of 20 as measured at 1 mc.

NIOBIUM

Nb. This is a group V superconductor material that is qualitatively similar to superconducting alloys and compounds but structurally simpler and easier to study because of its less critical fields. Well annealed niobium remains superconducting while carrying densities of the order of 10^3 amp/cm² in magnetic fields considerably higher than the bulk critical field H_{cb} , which is 1.5 kilogauss at 4.2 deg K. Cold-worked niobium can carry current densities of about 10^5 amp/cm².

Measurements, now being conducted on niobium at MIT may make it possible to obtain information about the band structure.

Work at Philco shows that anodic films of niobium,

sandwiched between the parent metal film and a thin film counterelectrode of films, has excellent rectification characteristics similar to that of a metal-semiconductor contact. Quantitatively similar behavior has been observed in thin oxide films of tantalum and titanium.

Niobium-thorium eutectic alloy has produced wire capable of carrying 10^4 amperes per sq cm, independent of magnetic field from 20 kilogauss to the highest field used, 82.5 kilogauss. This critical current level may extend to considerably higher fields, according to an MIT report.

ORGANIC MATERIALS

These are compounds of which carbon, nitrogen, hydrogen and oxygen are the main building blocks. Organics have been relatively unexplored in electronics. Insulating films can be prepared so that their thickness, structure and composition are subject to careful experimental control. The unique properties of organics, with their well-defined structural layers will open up a whole range of basic materials for electronic applications, according to Westinghouse spokesmen. (see ELECTRONICS, Oct. 11, 1963, p 51).

Lack of knowledge of the conduction mechanism in organic crystalline materials may hamper their use as minority carrier devices, according to Texas Instruments. At the present time it is difficult to purify the compounds or characterize the impurities.

Many rare earth chelates have been made to emit coherent radiation (see cover). The chelates can be expected to assume a prominent place in optical maser devices. Many organics can be made to emit coherent radiation at 2.90 Gc, for instance. Possibilities of organics exist for inductors and transducers, and there are device possibilities offered for organic photoconductors. Organic devices could be used for modulating light intensity or color by electric fields.

Organics can be tailored to specific properties, lower requirements for purity and simpler fabrication techniques can be used, according to RCA.

Generally, inorganic metallic materials are hard, brittle, stiff, weak while organics are soft, tough, extensible and impact resistant. Desirable properties can be obtained by combining various inorganic aggregates and reinforcing agents with natural synthetic polymers.

The approach to organics should be not to look for semiconductive properties per se, but rather to see how organics can be used to perform electronic functions. Some of the properties that may be useful are piezoelectric, piezoresistive, photochromatic, electrochromatic, dielectric properties, acoustic interactions, infrared transitions. The same mechanisms may or may not apply to organics and inorganics.

POTTING

Potting compounds are being sought for encapsulation of electromagnet elements. Goal is to discover a material with lower expansion coefficient, lower shrinkage and with zero magnetic susceptibility. Gyroscopic components now have need of such materials.

(continued)

RARE EARTHS

These are members of the periodic table with atomic numbers 57 through 71. At present improved technology and their availability as by products of the atomic energy industry have made rare earths quite common and inexpensive. Binary compounds of rare earths—group V compounds are semiconductors. Unfortunately melting points of these compounds are high and they tend to decompose prior to melting.

REFRACTORY METALS

These metals have melting points that exceed 2,000 C such as niobium, tantalum, tungsten and molybdenum. They are used chiefly for extremely high-temperature, high-density or highly corrosive applications.

Information of interactions between alkali and refractory metals will help the development of more corrosion-resistant alloys for space application.

Thin refractory metal films of niobium, tantalum and tantalum compounds have potential as passive components in electronic systems. Tantalum and niobium films with superconducting properties close to those of bulk metal can be deposited.

SILVER-OXIDE

Cadmium, and silver-oxide-zinc cells as battery power have been launched in probes and satellites. The silver-oxide-cadmium couple has been used as a secondary source. Several flights have incorporated a silver oxide primary as the main power supply. According to NASA spokesmen, the prime interest of these materials was the possibility of fabricating cells entirely free of materials that are essentially non-magnetic so as to eliminate extraneous magnetic signals when used near satellite magnetometers. Evaluation programs have shown that the silver cadmium system is particularly suited as a secondary where orbital periods exceed five hours. The silver cadmium couple offers substantial weight saving over other conventional electrochemical primary systems.

SUPERCONDUCTORS

These materials offer zero resistance. No heat is generated and no large amounts of power are required for continuous operation. Operation is at temperatures near absolute zero. New superconductors compounds are being explored at great lengths. This has been motivated by data processing. Bit density of data processing system using superconductors can be 10^9 with access time of microseconds. A one pound superconductive magnet can produce twice the field strength generated by a twenty-ton conventional electromagnet. Niobium-zirconium alloys, and compounds which remain superconductive in high magnetic fields, have been applied to generating magnetic fields up to 70 kilogauss.

Niobium stannide, Nb_3Sn has the highest known superconducting transition temperature, 18 deg K, and has exhibited the highest current carrying capacity at high magnetic fields, for example, greater than 10^5 amps/cm² at 94,000 gauss. Efforts are now con-

centrated by some workers in finding ways to make superconducting magnets more reliable and durable rather than pushing them towards higher field strengths of which they should be ultimately capable. Uses have been restricted to experimental work with traveling-wave masers, in magnetohydrodynamic energy conversion and biomagnetic studies. Theoretically, any current started in a coil of one of the superconducting alloys will flow indefinitely.

TANTALUM

Ta. Well controlled tantalum film technology has been developed. This basic refractory metal, from group V, can be used for resistors, capacitors and conductors. Techniques are applicable to a broad range of circuits, both linear and digital, according to Philco. Resistor tolerances of ± 5 percent are readily available. The metal is compatible with thin film active devices. One possible solution to the interconnection problem is a combined microcircuit wherein tantalum passive elements are deposited and connected to diffused planar devices. Advanced computer microcircuit application has operation speeds of greater than 50 mc.

Tantalum thin film circuits and components possess high reliability, low temperature and voltage coefficients of resistance and capacitance, ease of fabrication and potentially low cost.

One major disadvantage of tantalum thin film circuits is the nonavailability of a comparable active device.

TIN OXIDE

This compound provides high-value resistors which can be readily etched to fine patterns. Compound makes stable electrical contact to silicon. At elevated temperatures it reacts with aluminum to form an insulating aluminum oxide interface. This results in an open contact. A film of nickel, approximately 1,000 angstroms thick, provides a satisfactory stable interface between tin oxide and aluminum, according to Motorola.

Tin films, prepared by electrodeposition, have been found capable of being utilized for cryogenic switching devices, according to General Electric.

ZIRCONIUM

Zr. Absorbed zirconium coatings are used on tungsten field emitters as a means of altering the emission characteristics. Work at Linfield Research Institute shows that such coatings appear to be easily reproducible, have a work function of less than 3 ev, confine the emission almost wholly to 100 and immediately adjacent surfaces, are capable of emission of current densities of the order of 10^8 amp/cm², and to allow emission without excessive tip heating of higher total current from the zirconium-coated tungsten emitter than are possible from the uncoated emitter.

Zirconia has long been of interest in the field of high-temperature technology because of its refractory properties (m.p. 2,680 C) and resistance towards many chemical agents.

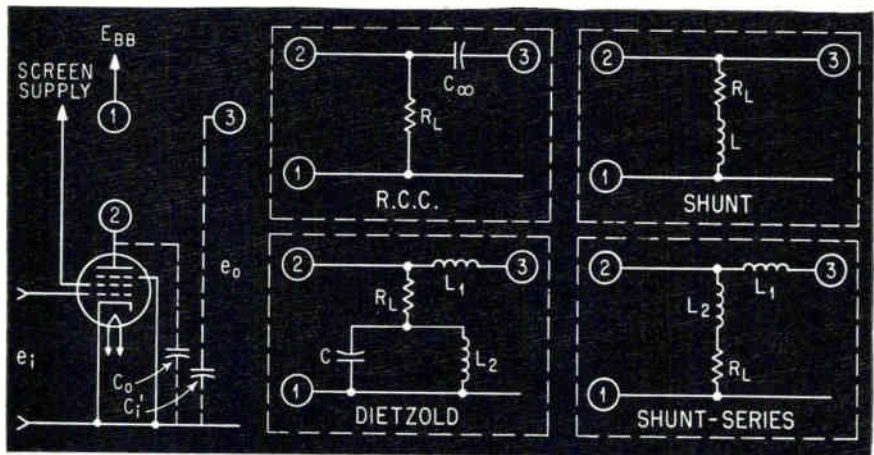

AMPLIFIER tube produces different risetimes and bandwidths when connected to either the resistance-capacitance (R.C.C.) or the compensating networks shown in insets to right

Selecting Tubes for Wide Bandwidth

By LOUIS M. DYSON, Chem-ionics Corp, Seattle 15, Washington

BY USING the table overleaf, a designer can quickly select a tube and/or compensating network (see Figure) that provide the performance characteristics he desires in a wideband amplifier or nanosecond (nsec) pulse circuit.

The capacitances (measured in the cold state and without tube shields) and operating g_m (see Glossary) have been taken from manufacturers' literature. The G - BW (gain-bandwidth) column is used since it is inversely proportional to the rise-time (t_r) formula (Glossary) and the figure-of-merit column (F) is shown because of its common usage and direct relationship to G - BW .

The R.C.C. (R-C coupled) amplifier column (see Table) shows the t_r and f_3 that are obtained for a theoretical amplifier gain (A^0) of 2. When shunt peaking (SH.PK.), Dietzold peaking (DTZ. PK.) or shunt-series peaking (SH.-S. PK.) compensation networks are used with a tube listed in the Table, they provide the t_r and f_3 values shown—again

assuming that the theoretical amplifier gain is 2.

Since the t_r and f_3 values in the table were calculated for an idealized circuit (that is, a circuit having no stray capacitance, with no change in capacitance occurring during operation, no output load capacitance, and no inductance in tube electrodes or components), the t_r and f_3 values that are shown should be increased and reduced, respectively, by a factor

GLOSSARY

- A_o = e_o/e_i Amplifier stage gain
- C_i = Tube input capacitance
- C_i' = Input cap. of following stage
- C_o = Tube output capacitance
- C_L = Load capacitance
- C_s = Stray capacitance
- C_T = Total circuit cap. ($C_i + C_o + C_s$)
- F = Figure of merit
- G - BW = Gain-Bandwidth
- f_3 = Upper 3-db frequency
- f_3'/f_3 = Upper-freq improvement with network
- G_i = Tube input conductance at frequency f
- G_i' = Tube input conductance at f'
- g_m = Tube transconductance
- t_r = Rise-time
- t_{rt} = Total risetime of n stages
- ρ = Rise-time improvement
- R_L = Load resistor
- G - $BW = g_m / (C_i + C_o)$
- $F = g_m / 2\pi (C_i + C_o)$
- $t_r = 2.2 A_o [(C_i + C_o) = g_m]$
- $\rho = t_r / t_r'$
- $BW = f_3 = 0.35 / t_r$
- $t_{rt} = (t_{r1}^2 + t_{r2}^2 + \dots + t_{rn}^2)^{1/2}$
- $G_i / G_i' = (f / f')^{1/2}$
- t_d = time delay (in tube) input to output

Characteristics of Wide Bandwidth Amplifier Tubes ▶

of two when estimating the actual t_r and f_2 that can be obtained in a practical amplifier having a gain of 2; similarly, assume that a practical amplifier will produce the t_r and f_2 values that are shown if its gain is one, that is, if $A_o = 1$.^{1,2}

In deriving the shunt-peaking values, the following parameters were used: $K = R_L (C/L)^{1/2} = 1.71$; $m = 1/K^2 = 0.34$, $\gamma = 1$ percent (overshoot and $\rho = 1.70$). This calculation provides a response having the most constant delay.³ The Dietzold and the shunt-series peaking network

values are derived from a Millman and Taub table.⁴

Other two-pole and four-pole networks are described in the literature.^{5,6,7}

The formula $f_2 = 0.35/t_r$, which is used to compute f_2 , uses a factor of 0.35 because it is assumed that the amplifier(s) have an overshoot of less than 5 percent.³

The formula for t_{rt} (Glossary) can be used to estimate the total risetime of an amplifier of n stages.⁸

When the bandwidth of the calculated amplifier requires gains of less than $A_o = \epsilon^{1/2} = 1.65$, a distributed amplifier may be used.⁹

The grid-voltage column lists the lowest bias voltages that are practical. The a-c and-or step-function signal is superimposed on this bias.

The g_m/I_p , or Economy, column is a guide for comparing power consumption to g_m .

The G_1 column shows the input conductance in μmhos at frequency f (adjacent column). To compute G_1' , the input conductance at a frequency f' , use the approximate relation

$$G_1/G_1' = (f/f')$$

The screen-grid with respect to grid 1 amplification factor (μ) is shown in the G_1-G_2 column.

REFERENCES

- (1) "Broadband Amplifiers Using Amperex 7788 and 8233", Application Bul. T502, T101 and T102, Amperex Electronic Corp., Hicksville, L. I., N. Y., 1962.
- (2) J. R. Whyte, "Choosing Pentodes for Broadband Amplifiers", *ELECTRONICS*, 25, p 150, April 1952.
- (3) G. E. Valley and H. Wallman, "Vacuum Tube Amplifiers", pp 72-83, McGraw-Hill, N. Y., 1948.
- (4) J. Millman and H. Taub, "Pulse and Digital Circuits", Table 3-3 and pp 65-76, McGraw-Hill, N. Y., 1956.
- (5) S. W. Seeley and C. N. Kimball, "Analysis and Design of Video Amplifiers", *RCA Rev.*, 3, p 290, 1939.
- (6) H. W. Bode, "Network Analysis and Feedback Amplifier Design", pp 403-450, Van Nostrand, N. Y., 1945.
- (7) W. W. Hansen, "On Maximal Gain-Bandwidth Products in Amplifiers", *J Appl Phys.*, 16, p 528, 1945.
- (8) A. V. Bedford and G. L. Fredendall, "Transient Response of Multistage Video Frequency Amplifiers", *Proc IRE*, 27, p 277, 1939.
- (9) I. A. D. Lewis and F. H. Wells, "Millimicrosecond Pulse Techniques", p 176, Permagon Press, N. Y., 1959.

TUBE CLASS	TUBE TYPE	MFR (aa)	ELECTRODE C (pF)				
			C_{sp}	C_i	C_o	C_{T^*}	
VOLTAGE AMPL. PENTODES	7721/D3a*	Siemens	0.035	10	2	12	
	E810	Mullard	0.006	14.5	3.5	18.0	
	7788	Amperex	0.04	16.0	3.5	19.5	
	7722/E280F	Siemens	0.035	9.3	2.1	11.4	
	E282F	Siemens	0.05	10	2.6	12.6	
	8233	Amperex	0.091	18	4	22	
	E56L	Mullard	0.11	18	4	22	
	6688/E190F		0.03	7.5	3.0	10.5	
	7737	Amperex	0.03	7.6	3.3	10.9	
	6PS5	GE	0.03	4.8	2.0	6.8	
	6HM6	Westing*	0.031	8.7	2.15	10.85	
	5847/404A & GR-R8	Ericsson	0.03	7.0	2.5	9.5	
	6FG5	Nippon El. GE	0.02	4.2	2.8	7.0	
	6R-R8C	Nippon El.	0.05	7.2	3.2	10.4	
	6EJ7/EF184	Raytheon	0.005	10.0	3.0	13.0	
	6DK6		0.02	6.3	1.9	8.2	
	CK7995	Raytheon	0.035	8.5	2.75	11.25	
	6EA5		0.05	4.5	3.0	7.5	
	6EW6		0.03	10	3.4	13.4	
	6R-P10	Nippon El.	0.05	10.5	2.7	13.2	
	6CB6		0.025	6.5	2.0	8.5	
	Z759	Genelex	0.012	13	3	16	
	12BY7A	Valvo	0.55	11.1	3.0	14.1	
	7054		0.063	10.2	3.5	13.7	
	12DQ7		0.1	10	3.8	13.8	
	6AH6		0.03	10	2	12	
	6AK5		0.02	4.0	2.8	6.8	
	6689/E83F	Amperex	0.015	8.5	3.6	12.1	
	6485		0.02	10	3.6	13.6	
	6686/E81L	Amperex	0.02	11.5	6.5	18.0	
	6AC7		0.015	11	5	16	
	POWER AMPL. PENTODES	6939*		0.15	6.4	1.6	8.0
		6HB6	Raytheon	0.18	13	8	21
		12BV7		0.055	11	3.0	14
		6761	Ericsson	0.4	11	5	16
12DQ7			0.1	10	3.8	13.8	
6DZ7*			0.5	11	5.0	16	
6CL6			0.12	11	5.5	16.5	
7189			0.75	10.8	6.8	17.3	
6216			0.37	12.3	6.7	20.0	
6AN5			0.075	9.0	4.8	13.8	
6CH6			0.25	14.0	5	19	
6EH5			0.05	17	9.0	26	
6CW5/EL86			0.6	12.0	6.0	18.0	
5763		RCA	0.3	9.5	4.5	13.0	
6AG7			0.06	13	7.5	20.5	
7534			2.0	35	17.0	52.0	
6A130L		Amperex					
6550		Siemens	0.85	14	12	26	
829*			0.12	14.5	7.0	21.5	
5686		GE	0.08	6.5	8.5	15.0	
807		0.2	12	7	19		
6AQ5		0.35	7.6	6.0	13.6		
6L6G		0.9	11.5	9.5	20.0		
6005		0.54	8.3	7.5	15.8		
6V6GT/G & 5881*		0.7	9	7.5	16.5		
L. NOISE PENTODE	6AU6	Amperex	0.0035	5.5	5.0	10.5	
	6267/EF86		0.05	3.8	5.3	9.1	
	5879		0.15	2.7	2.4	5.1	
	1608/651G	RCA	0.007	4.6	6.5	11.1	
6084/E80F	Amperex	0.025	5.0	7.3	12.3		
DUAL CONT. GRID HEX.S. & PENTODES	6AS6		0.02	4.0	3.0	7.0	
	6486A		0.035	4.5	3.3	7.8	
	7AK7		0.7	12.0	9.5	21.5	
	6687/E91H	Amperex	0.08	5.4	7.9	13.3	
	6DB6/6954		0.0035	6.0	5.0	11.0	
5915-A		0.08	5.4	7.6	13.0		
6CS6		0.07	5.5	7.5	13.0		
TETRODES & SHIELD GRID TRIODES*	6HA5*	Amperex	0.36	4.3	2.9	7.2	
	6GK5*	Amperex	0.48	4.7	3.3	8.0	
	7150	Ericsson	0.03	16.0	2	18.0	
	A2674	Genelex	15.0	3.5	18.5		
	6FY5*	Amperex	0.50	4.4	3.3	9.0	
6ER5*	Amperex	0.38	4.4	3.0	7.4		
7690*	Amperex	0.15	6.4	1.6	8.0		
6CY5		0.03	4.5	3.0	7.5		
SHIELD GRID PENTODES	7377*	Amperex	0.145	4.5	1.35	5.85	
	6B-R22 & W.E.448A	Nippon E.	0.16	16.4	3.57	19.97	
	6B-P16 & W.E. 418	Nippon E.	0.08	15.9	4.23	20.13	
	6R-R21 & W.E. 455A	Nippon E.	0.03	9.3	2.5	11.8	
SEC. EMISSION PENTODES	E2708			14	7	21	
	7548	Lektro [†]	0.027*	8.0	4.4	12.4	
	6351/Z319	Genelex	0.003*	8.0	3.0	11.0	
	6FP-60	Amperex	0.004*	9.2	6	15.2	
8428*	Tung-Sol		13	70	83		
BEAM TUBES	6BN6*		0.004	4.2	3.3	7.5	
	7360	RCA	0.003	7.5	0.8	8.2	
	6218/E80T*	Amperex	0.02	2.2	2.0	4.2	
	6JH8	Tung-Sol	0.38	4.8*	5.0	9.8	

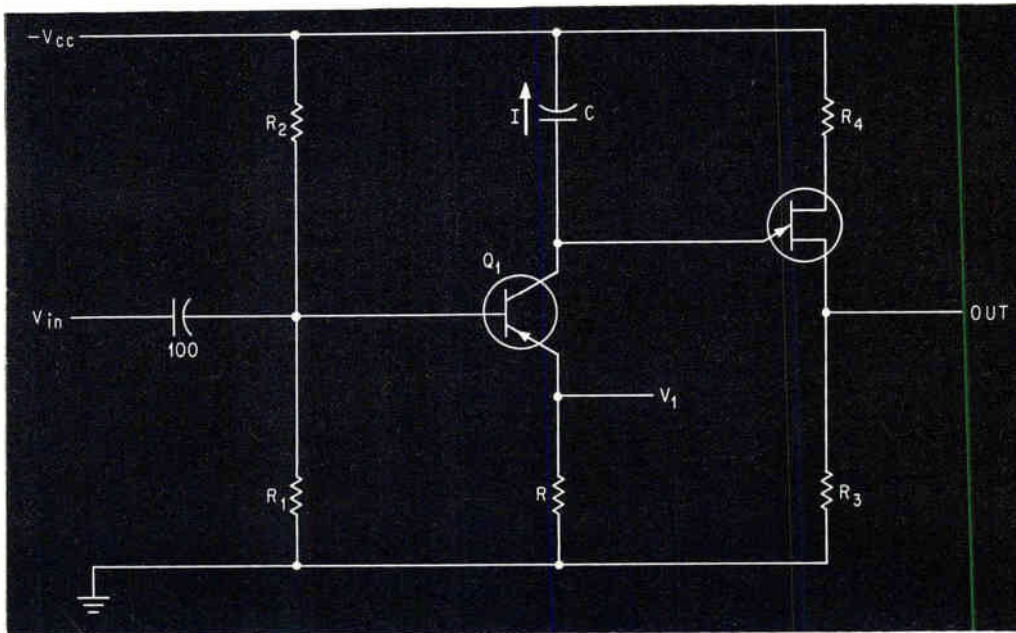

CAPACITOR C is charged with a constant current that varies linearly with the input voltage

UNIUNCTION TRANSISTOR

Simplifies Voltage-Frequency Converter

Linear voltage-controlled variable-frequency oscillator will convert a standard recorder for f-m recording of low frequencies

By JOEL SCHWARTZ, Sage Instruments, Inc., White Plains, New York

THIS CIRCUIT has application as a linear-modulator to convert an amplitude into a frequency. One specific use has been in converting a standard recorder to an f-m recorder so that low-frequency (0.1 to 1,000 cps) signals may be recorded.

Capacitor C is charged with a constant current that is proportional to V_{in} . When the voltage across C exceeds V_p of the unijunction transistor, it fires.

$$I = \frac{V_{in}}{R} + \frac{R_1 V_{cc}}{R(R_1 + R_2)} = \frac{CV}{T}, \text{ where } V = \text{voltage across } C$$

$$f = \frac{1}{T} = \frac{I}{CV_p} \text{ where } V_p = \text{peak point of } Q_2 = \eta V_{cc}$$

$$f = \frac{I}{C \eta V_{cc}} = \frac{R_1 V_{cc} + V_{in}(R_1 + R_2)}{C \eta V_{cc}(R_1 + R_2)R}$$

Thus the circuit will have a frequency (f_o) of

$$\frac{R_1}{C \eta (R_1 + R_2)R}$$

for no input, and the frequency will increase or decrease linearly from this value depending on whether V_{in} is negative or positive.

For $R_1 = 18,000$ ohms, $R_2 = 100,000$, $C = 0.01 \mu\text{f}$, $\eta = 0.6$, $R = 10,000$, $Q_1 = 2N591$, $Q_2 = 2N491$, $V_{cc} = 20$ v, $R_3 = 270$, $R_4 = 270$, f_o is 2.5 kc. The base frequency, f_o , may be conveniently varied by changing C or R. Inputs of up to 2.5 volts give little sign of saturating the circuit.

Linearities of two percent have been measured, for small-signal inputs.

FOR BY-PASSING
COUPLING OR
FILTERING
APPLICATIONS

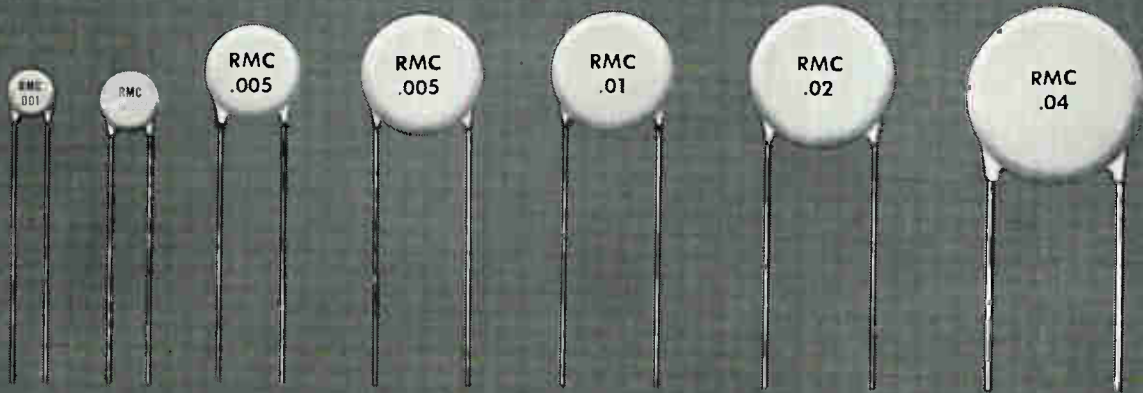

RMC Type B Discaps

Type B DISCAPS meet or exceed all EIA RS-165 specifications for Z5U ceramic capacitors. Manufactured in capacities between .00015 and .04 MFD, Type B DISCAPS are designed for by-passing, coupling or filtering applications.

A heavy ceramic dielectric element provides a safety factor where steady or intermittent high voltages occur. Type B DISCAPS show a minimum capacity change between +10°C and +85°C (see curve).

Type B DISCAPS are rated at 1000 working volts and cost no more than ordinary lighter constructed units.

Write on your letterhead for additional information on RMC DISCAPS.

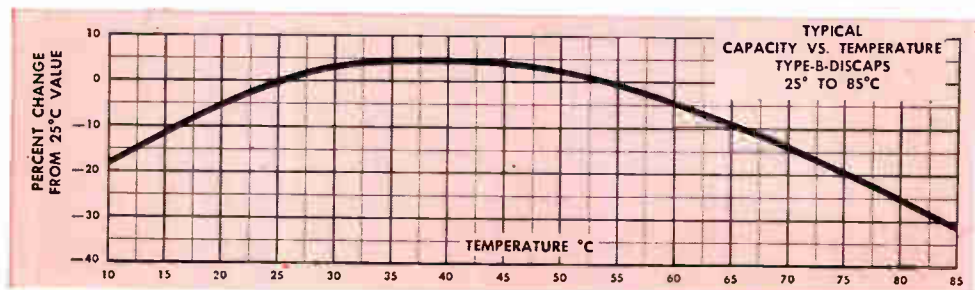

DISCAP
CERAMIC
CAPACITORS

RADIO MATERIALS COMPANY
A DIVISION OF P. R. MALLORY & CO., INC.
GENERAL OFFICE: 4242 W. Bryn Mawr Ave., Chicago 46, Ill.
Two RMC Plants Devoted Exclusively to Ceramic Capacitors
FACTORIES AT CHICAGO, ILL. AND ATTICA, IND.



**A Foreword by
Dr. Walter East**
President, Electro Instruments, Inc.

It has been largely out of a need for precise results that the aircraft, missile and spacecraft industries have taken the lead in the use of electronic measurement and control systems. Industries which have lagged behind in their employment probably have felt the added precision wasn't worth the system's price tag. Many businesses, I fear, have overlooked the fact *speed* alone is often a good dollar-and-cents reason for modernizing measurement and control systems. One of our more interesting "case histories," I think, is the experience of the glass manufacturer whose story is told below. I am continually cautioning our own people not

to use the word "system" too glibly. It sounds like something complex—and expensive. Actually, of course, a "system" for measuring can be quite simple. Witness the clock, the automobile speedometer, your furnace thermostat.

Our Aim—Save You Money!

We manufacture and sell instruments and equipment for measuring everything under the sun. We make simple, inexpensive systems; we make complicated, expensive ones. But you'll find our Sales Engineers are real "down to earth" people. They don't go around recommending systems with costs out of all proportion to the savings they make possible. I mentioned last month that we like to offer the challenge: "You name it, we'll find a way to measure it." Maybe I should have added "on the budget you have in mind"!

Classic Jobs of Measurement

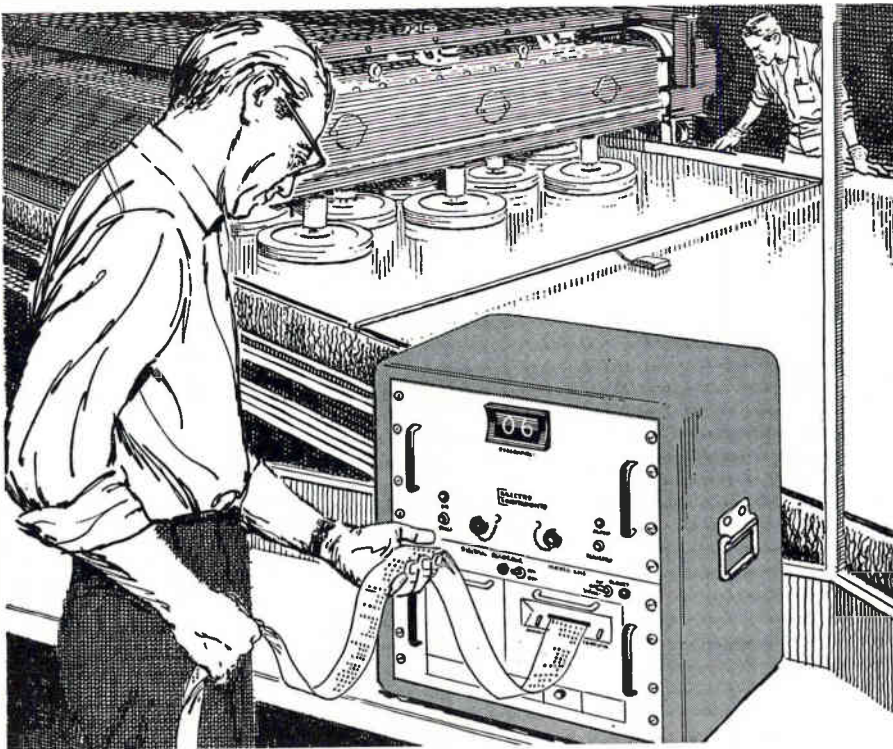

"Heart" of new glass scanning system was Electro Instruments' Digital Recorder.

Unique Use of X-Y Recorder Saves Company over \$20,000

An odd one—involving measuring equipment but no measuring job! Operator at a major plant once had to hand-space ceramic wafers on a processing tray. Bid for automating job was \$24,000. An EI X-Y recorder, with tray mounted to recorder in place of plotting pen, was found to be all that was needed for the job. The enterprising EI Sales Engineer saved the company involved more than \$20,000!

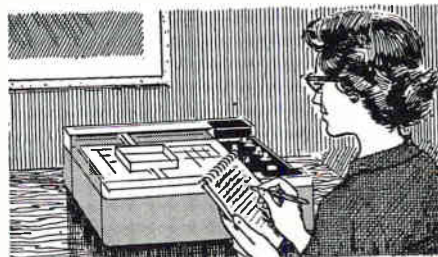

Electro Instruments offers the world's most carefully designed X-Y Recorders.

*Performed by
Electro
Instruments*

Electronic Scanning Slashes Time, Labor of Grading Glass . . . and manufacturer discovers output can be worth more money.

Glass, like steel, is poured and rolled to thickness while molten. After cooling, it is polished. Degree of polish will determine its quality, and will establish its market worth. One manufacturer actually counted pits and blemishes, then determined grade by means of a tedious system of mathematical hand plotting. A consultation with Electro Instruments led to the development of an automatic system, based around a light source and a photosensitive instrument. These could be connected to an EI instrument to count pits electronically, simultaneously compute grade of glass, and visually display results. An additional output allowed information to be automatically graphed by an Electro Instruments' X-Y recorder.

More Accurate Grading, Too!

The whole process of grading glass thus could be drastically speeded up at this manufacturer's plant. A secondary benefit was greater accuracy in grading. Oddly enough, older measurement methods had resulted in substantial output being downgraded, and the glass priced below its true worth!



Electro Instruments, Inc.
8611 Balboa Avenue, San Diego 12, California

ELECTRO INTERNATIONAL, INC., ANNAPOLIS, MARYLAND • TRANSFORMER ENGINEERS, SAN GABRIEL, CALIFORNIA



NASA problem: Apply space-age techniques to navigation

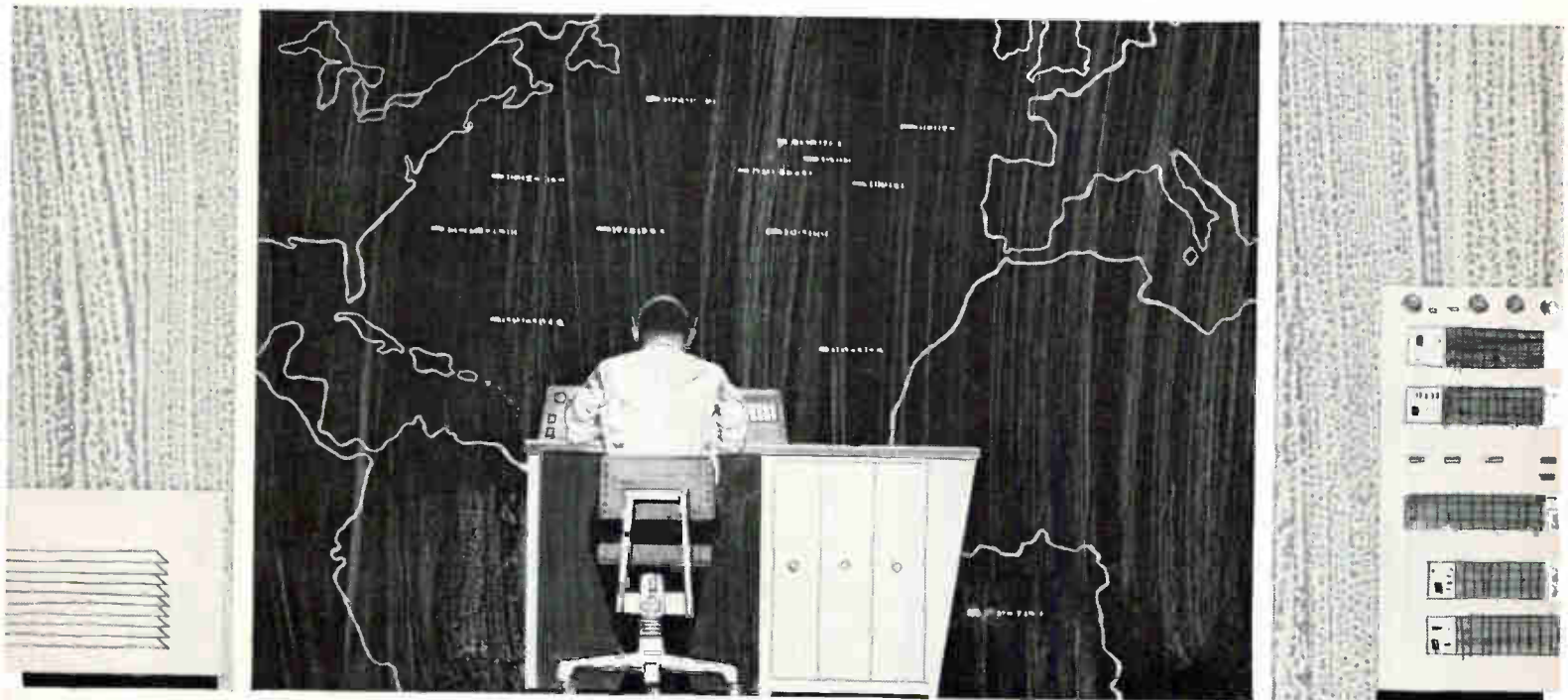

Westinghouse assignment: Define a system to guide ships and planes everywhere

Westinghouse is defining for NASA a system of satellites and ground stations tailored specifically for the navigation and traffic needs of ships and planes.

As now envisioned, here's how the system will operate: A ship or plane will file a flight plan or intended course at the ground traffic center, including instructions to transmit a fix at specified intervals.

The traffic center will fix the craft's position by using a satellite as a navigational reference point. Then, the fix will be transmitted to the craft via the satellite. The complete operation will take only a fraction of a second.

Continuous monitors of appropriate agencies will scan worldwide traffic patterns and, again by satellite transmission,

warn any craft in danger of collision. In the event of disaster, air and sea rescues will be able to get underway without delay.

Westinghouse is evaluating the problem so that such a system can be developed at minimum cost and with maximum benefit to civilian air and sea operations.

You can be sure . . . if it's Westinghouse.

J-02352A

We never forget how much you rely on Westinghouse



PROVEN RELIABILITY—

DC-DC, DC-AC, SOLID-STATE POWER INVERTERS

over 260,000 logged hours— voltage-regulated, frequency-controlled, for missile, telemeter, ground-support, 135°C all-silicon units available now—

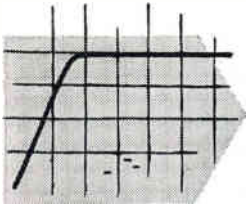
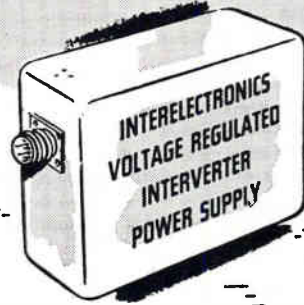

Interelectronics all-silicon thyatron-like gating elements and cubic-grain toroidal magnetic components convert DC to any desired number of AC or DC outputs from 1 to 10,000 watts.

Ultra-reliable in operation (over 260,000 logged hours), no moving parts, unharmed by shorting output or reversing input polarity. High conversion efficiency (to 92%, including voltage regulation by Interelectronics patented reflex high-efficiency magnetic amplifier circuitry).

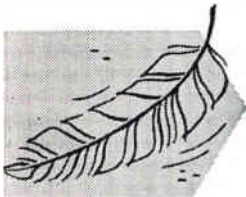

Wide input voltage range (1 to 250 volts DC). Wide input voltage regulation (output voltage maintained with variations up to 50% in input voltage).

Light weight (to 6 watts/oz.), compact (to 8 watts/cu. in.), low ripple (to 0.01 mv. p-p), excellent voltage regulation (to 0.1%), precise frequency control (to 0.2%) with Interelectronics extreme environment magnetostrictive standards or to 0.0001% with fork or piezoelectric standards.

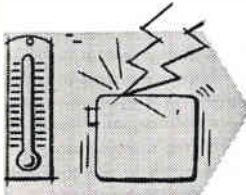

Complies with MIL specs. for shock (100G 11 misc.), acceleration (100G 15 min.), vibration (100G 5 to 5,000 cps.), temperature (to 150 degrees C), RF noise (I-26600).

AC single and polyphase units supply sine waveform output (to 2% harmonics), will deliver up to ten times rated line current into a short circuit to actuate MIL type magnetic circuit breakers or fuses, will start gyros and motors with starting current surges up to ten times normal operating line current.

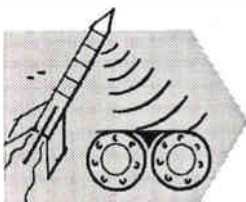

Now in use in major missiles, powering telemeter transmitters, radar beacons, electronic equipment. Single and polyphase units now power airborne and marine missile gyros, synchros, servos, magnetic amplifiers.

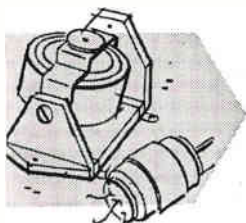

Interelectronics—first and most experienced in the solid-state power supply field produces its own all-silicon solid-state gating elements, all high flux density magnetic components, high temperature ultra-reliable film capacitors and components, has complete facilities and know how—has designed and delivered more working KVA than any other firm!

For complete engineering data, write Interelectronics today, or call LUdlow 4-6200 in New York.

INTERELECTRONICS CORPORATION

2432 Grand Concourse, New York 58, N. Y.

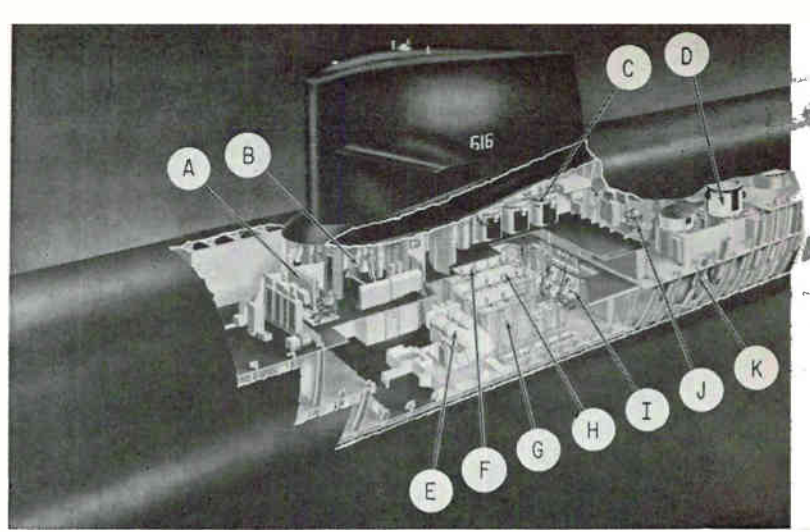
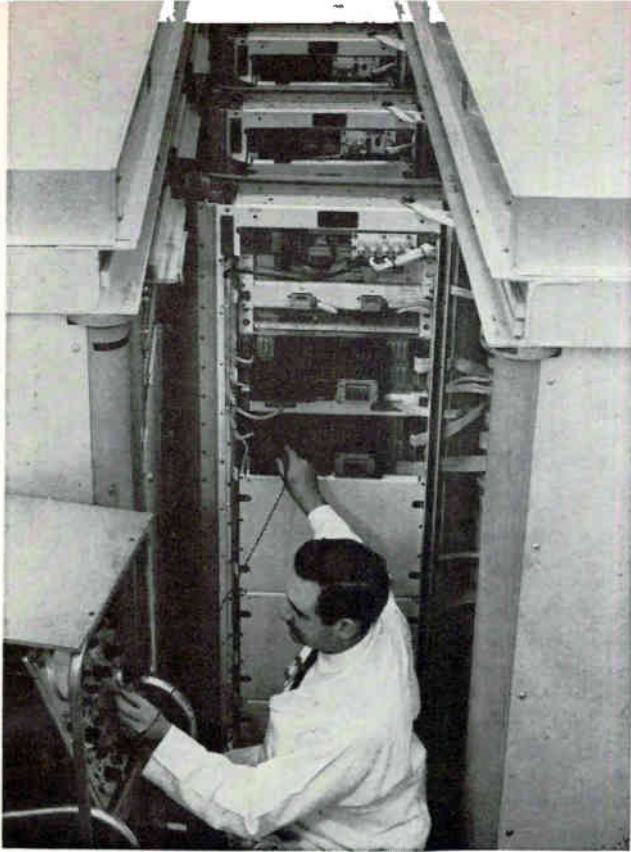

CUTAWAY OF USS LAFAYETTE shows location of major elements in the Mk 84 Fire Control system in relation to other ship stations: (A) ship control, (B) captain's station, (C) inertial element of SINS, (D) Polaris missile, (E) air conditioning for fire control system, (F) test and maintenance, (G) guidance data and control group, (H) digital geoballistic computer, (I) firing console, (J) Mk 1 Polaris guidance capsule on test stand, (K) part of launcher

SWING-OPEN DOORS—designated Type 1 module—facilitate maintenance. System contains more than 10,000 modules designed in standardized groups to perform 147 basic functions

New Techniques Pay Off for Polaris Fire-Control System

Efficiency up, cost down, in production of Mk 84 fire control

By JOHN F. MASON
Senior Associate Editor

PITTSFIELD, MASS.—Details, released this week, of the Mark 84 fire-control system for the new fleet of Polaris submarines—the *USS Lafayette* and beyond—reveal impressive achievements in design and planning that will undoubtedly be useful in developing a wide range of future complex electronic systems.

Advanced—and many new—approaches show gains in the areas of computer application, modular design, installation, maintenance, and components. System cost was reduced and reliability boosted by improved production techniques and wide-scale standardization. Stand-

ardization facilitates maintenance and makes it easier to keep procurement sources alive for essential replacement parts in future years.

Navy's Special Projects Office is responsible for development of the Mk 84, as it was for the Mk 80. General Electric's Ordnance department, here in Pittsfield, designed, developed and built the first Mk 84's—as it did the 10 Mk 80's now

operational in the first-generation Polaris subs. GE and Hughes, as a second source, are now building and delivering Mk 84's to the Navy.

Digital Computer—Task of a ship-based fire-control system for ballistic missiles is formidable compared to that of a stationary site. A submarine's location may be changing in a mixture of directions

Contracts for 11 Mk 84's Expected Soon

Contract for the first 12 Mk 84's (9 for ships, 3 for trainers) was awarded to GE; to create a second source, four of them would be assembled and tested by Hughes.

Competitive bidding has since resulted in contracts to GE for 7 tactical systems and 4 trainers, and to Hughes for 9 tactical systems and 1 trainer.

Before the end of the year, contracts for 11 Mk 84's will be awarded—5 of which will go to the United Kingdom.

Unit cost for one Mk 84 is approximately \$2½ million. Standardization, mass production, design, and competitive procurement, made cost 16 percent lower than for the less-sophisticated Mk 80

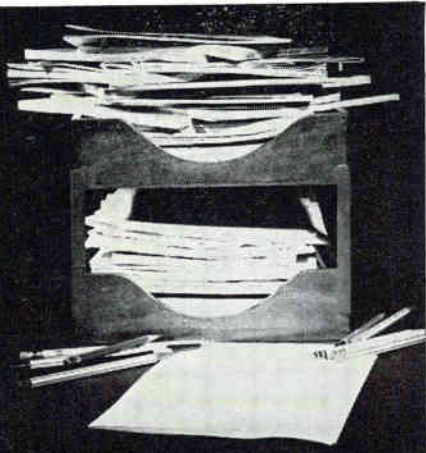

for busy engineers
who must keep
abreast of
advances in
electronics

CREI Extension Programs
fit any schedule

Are irregular hours, travel and family obligations keeping you from attending classes—even though you are fully aware of the danger of technical obsolescence? Check into CREI Special Programs for Engineers. They offer you the opportunity to catch up with new developments in electronics through home study at your own pace, your own schedule. Our free brochure gives full information, details on technical material covered. For your copy, use coupon or write:

CREI, Dept. 3910-A1
3224 16th St., N.W.
Washington 10, D.C.



FREE BOOK

The Capitol Radio Engineering Institute
Founded 1927 Accredited Member of
the National Home Study Council
Dept. 3910-A1, 3224 Sixteenth St.
N.W. Washington 10, D.C.

Please send me free brochure describing CREI Special Program in Electronics for Engineers.

Name _____ Age _____
Address _____
City _____ Zone _____ State _____
Company _____
Title _____

SP-42

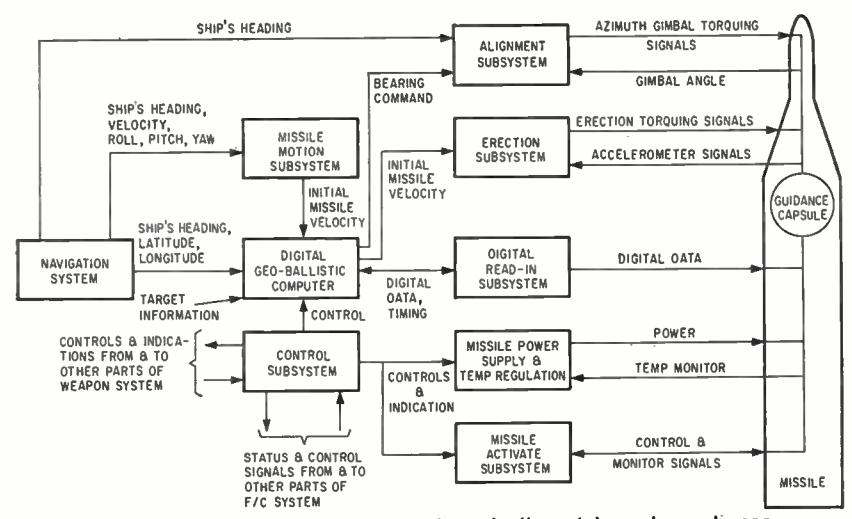

MK 84 FIRE CONTROL system keeps the missiles at launch readiness

all at once—longitude, latitude, pitch, heave, roll, surge, sway and yaw. Using a digital geoballistic computer (DGBC), designed and built for GE by Control Data Corp., the MK 84 correlates data and feeds computed results into each guidance system of the 16 missiles. Each stable platform is erected to local vertical and aligned relative to true north until the instant of firing. The DGBC uses a real-time, multi-level program operating in a cycle mode or under interrupt control.

New targets can be assigned to a missile by manually inserting the new target coordinates. The computer solves the new flight problem instantly and feeds the information to the missile.

The Mk 84 can handle all three Polaris types, A-1, A-2, and A-3. It also automatically checks out each missile's readiness for launch. If one is faulty, it will pass on to the next missile. In the test mode it will quickly isolate an error by pinpointing the location of components which are causing failure.

Hardware—The Mk 84 system is organized into five groups:

- Fire-control computer group

**MODULE TYPE 3
STANDARDIZATION**

Item	Number	Types
Analog.....	2,166	99
Digital.....	5,777	42
Power supply.....	143	2
Relay.....	1,550	11
Switch.....	256	5
Servo, electromech.....	73	21
Servo, electronics.....	172	9
Display.....	1,089	7

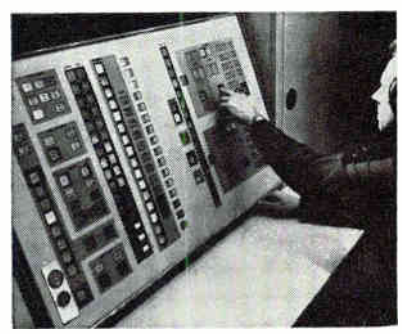

MISSILE fire control console shows status of missile readiness and when the button is pushed, the whole firing sequence

aligns and erects the missiles, computes missile motion and translates all other missile-data inputs. It also contains the master timing for the fire control and sets missile guidance timing

- Alignment group corrects for static and dynamic misalignments of each missile in its launch tube

- Display console and control group monitors and controls the entire system's operations

- DGBC contains two channels. Either channel can provide all the necessary firing information to all 16 missiles aboard. These channels illustrate functional redundancy in hardware. Mk 84 can fire Polaris even when one channel is damaged

- Temperature regulation and missile power units for each missile.

Total weight of the entire system is 65,000 pounds.

Modular Approach—Modularization is carried out in the Mk 84 on three levels. The largest unit, Type 1 module, is a six-foot-high, electronic equipment rack, built as a door that opens and shuts. Four



**Kynar[®] insulation
takes 180° bends
without cutting**

Now you can pull computer hookup wire around tight corners—even stretch it over sharp edges—without danger of insulation cutting through. The secret: Kynar, Pennsalt's vinylidene fluoride resin, a new high-performance fluoroplastic that's *tough!* □ Wire insulation of Kynar offers unmatched mechanical strength and toughness, even in 5-mil sections you may need for miniaturization. It cuts cleanly, strips readily,

won't burn or melt. Dimensionally stable, Kynar doesn't stretch when wires are pulled. Wire insulated with Kynar has ample stiffness yet stays in place when harness is bent to shape. □ Write for our brochure and the names of leading manufacturers who supply wire insulated with Kynar. Plastics Department, PENNSALT CHEMICALS CORPORATION, 3 Penn Center, Philadelphia 2, Pa.

Kynar... a fluoroplastic that's tough!

Kynar is a Registered Trademark of Pennsalt Chemical



POLAROID

CORPORATION

USES

CLAIREX[®]



...AGAIN!

- **FIRST FLASH EXPOSURE CONTROL USING PHOTOCONDUCTIVE CELL**

The world's most advanced camera, the **Polaroid Land Automatic 100**, contains a most advanced photoconductive cell by **Clairex** capable of high speed operation over a ratio of light levels greater than 10,000/1. This cell is a key component—a "light valve"—in the new camera's electronic shutter which permits perfect exposures in both color and black and white under all conditions, including flash operation. Precisely controlled characteristics, as well as speed and reliability, prompted **Polaroid** to rely on **Clairex** photoconductive cells for such an important task . . . a second time!

- **FIRST STILL CAMERA WITH PHOTOCONDUCTIVE CELL CONTROL**

Over four years ago, **Polaroid Corporation** came to **Clairex** and asked it to supply the critical photoconductive cell component for its "Microeye" exposure control device, a "first" for still cameras!

Have you considered the "light touch" . . . in your automation or control problem?

CLAIREX

CORPORATION

The Finest in Photoconductive Cells . . . in and out of This World

New 16 page Photoconductive Cell Manual Free on Request

doors are erected together in a row. There are 70 doors in the complete system: 40 for the fire control, 2 for power switches, 4 for missile compartment switchboard, 10 for test and maintenance of the missiles, 8 spares, and 6 for testing Type 3 modules.

Mounted on the doors are back-panel plug boards called Type 2 modules. These boards, standard in design and differing only in height, feature solderless wrapped-pin connections. There are 446 Type 2 modules in the system.

Almost hiding the boards is a mass of the smallest module, Type 3. Each consists of a circuit-containing, plug-in package. There are 11,226 Type 3 modules (see table).

Standardization — Thousands of parts have been standardized: circuits, switches, shock mounts, pintles, cables and connectors. Of the 197,300 transistors and diodes in the system, only 19 types are used. Large quantities of each type permit economical sample lot testing before acceptance. Multiple-source procurement and large quantities achieve very competitive prices on high-quality and high-reliability units.

To improve reliability, worst case or statistical design is applied to all circuits. Whenever possible, electronic a/d and d/a converters are used instead of electromechanical servos and shaft encoders.

Production and Maintenance—Numerically controlled equipment, including wire-wrap machines, increased production output over conventional methods.

The ship is built to accommodate the system in many respects. Connecting cables that pass through the ship structure and terminate in wiring panels in the Missile Control Center are built in by the shipbuilders. They are ready to be connected to the Mk 84 when it is installed.

Time and money are also saved by first putting the Mk 84 together for system test in the plant. When the ship is built, the system is taken down and set up in the ship, piece by piece. Modular design makes this possible.

Maintenance is facilitated first by built-in redundancy, then by the system's capability to pinpoint the location of a malfunctioning module.

small
change



FOUR-LAYER INTEGRATED CIRCUIT AND LOGIC MODULE CARRIER

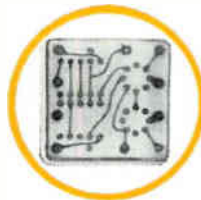

Small change? Yes—but it guarantees big performance. This little board is one sample of our leadership in the field of precision multilayer circuitry. It costs just about what you see here. Why not send us **your** requirements?

CINCH-GRAPHIK

DIVISION OF UNITED-CARR FASTENER CORPORATION



200 South Turnbull Canyon Road, City of Industry (Los Angeles), California • Phone (Area Code 213) 333-1201
Offices in 22 Principal Cities throughout United States, Canada, England and Australia listed under Cinch Mfg. Co.
or United-Carr Fastener Corporation • Cinch • Ucinite • Monadnock Mills • Howard B. Jones • Palnut



RESOLVERS, SYNCHROS PHASE SHIFTERS



STANDARD RESOLVERS

A full line of compensated and uncompensated resolvers in standard BuOrd size 23, 15 and 11 cases. Size 23 series has functional accuracy of 0.05%; resolvers in other two series have accuracy of 0.1%.



HIGH PRECISION SIZE 23 RESOLVERS

New series of extremely accurate resolvers, includes a 0.01% functional accuracy computing resolver with 100% compensation and data transmission resolvers with 20-second accuracy. The ultimate in precision for resolvers of this case size.



20-SECOND SIZE 23 SYNCHROS

These three wire synchros are the most accurate units available in a standard BuOrd size 23 case. Both transmitters and control transformers can be supplied, for either 400-cycle or 60-cycle input.



PRECISION PANCAKE RESOLVERS

0.006% functional accuracy computer resolvers with 100% compensation. 10-second accuracy data transmission resolvers. Integral bearing design permits direct mounting to gimbal structure. Beryllium housings provide stable operation under extreme temperature variation.



BOOSTER AMPLIFIERS

Complete line of vacuum tube and transistorized booster amplifiers, for use in conjunction with compensated resolvers. Transistorized units contain two fully encapsulated amplifiers in a single case.

For data transmission; coordinate transformation and conversion; computer chain; and sweep applications. Write for data file 104.

REEVES INSTRUMENT COMPANY

Division of Dynamics Corporation of America, Roosevelt Field, Garden City, N.Y.

Airlines Look To Computers To End Delays

By MARVIN REID
McGraw-Hill World News

DALLAS—Data-processing systems and other electronic gear will play a big part in improving efficiency as well as control of the nation's rapidly growing air traffic, said speakers at the 8th Annual Air Traffic Control Association Meeting last week.

Some carriers are already finding that computer-plotted flight plans help them to cut as much as \$200 to \$300 off particular route costs, Walter Jensen, of the Air Transport Association (ATA) reported.

Flight delay costs, however, are the most troublesome factor for most carriers. As much as \$67-million may be lost this year through bad-weather delays, diversions, and cancellations. Jensen said ATA is now processing some 375,000 flight cards to learn more about common delay patterns and their possible solutions.

Traffic Control—N. E. Halaby, FAA administrator said that modern data systems will enable a controller to handle 15 or 16 aircraft routinely—twice today's load.

Data-processing systems are being bought or installed now at Indianapolis, Boston, Cleveland, Washington and New York. Remote strip printers and controller updating equipment are now in at New York and will be installed in other centers next year.

Halaby said "a lot of hardware" is under development now for the air traffic control subsystem of the National Airspace System. (For detailed plans, see *ELECTRONICS*, p 37, Dec. 7, 1962; p 46, Dec. 14, 1962; p 92, Jan. 4, 1963.) Assembly and testing of parts will begin early in 1964. Field installation will begin before testing and evaluation is completed, he said, citing as a good example the central data processor.

"The central data processor to be used in centers and metroplex terminal facilities (will be) a general-purpose computer capable of radar tracking, radar beacon processing and later, all manner of flight plan analysis and conflict prediction," Halaby said. "Being general purpose, the equipment can be contracted for now and its programming can be developed and changed as the implementation of the system progresses."

Halaby also mentioned that procurement of an improved headset, a 1.5-ounce piece of equipment similar to that used by astronauts, has been authorized for controller use. He said FAA is working on a cordless microphone, but there are unsolved problems in getting more than one communication channel in the mike.

Raytheon was cited by the Association for its development of the Amplitron tube. ATA said the tube was the first "practical amplifier" for civil air control which provided high reliability. Advanced versions of this tube increased area coverage of enroute radar by 250 percent, ATA said.

The addition of identity and altitude information on radar displays is still a big need for air traffic controllers, several speakers said.

Aerial Road Map



MOVING-MAP display by Computing Devices of Canada Ltd. continuously shows aircraft's position and course on topographic map. Royal Air Force is flight-testing it and USAF will make flight trials

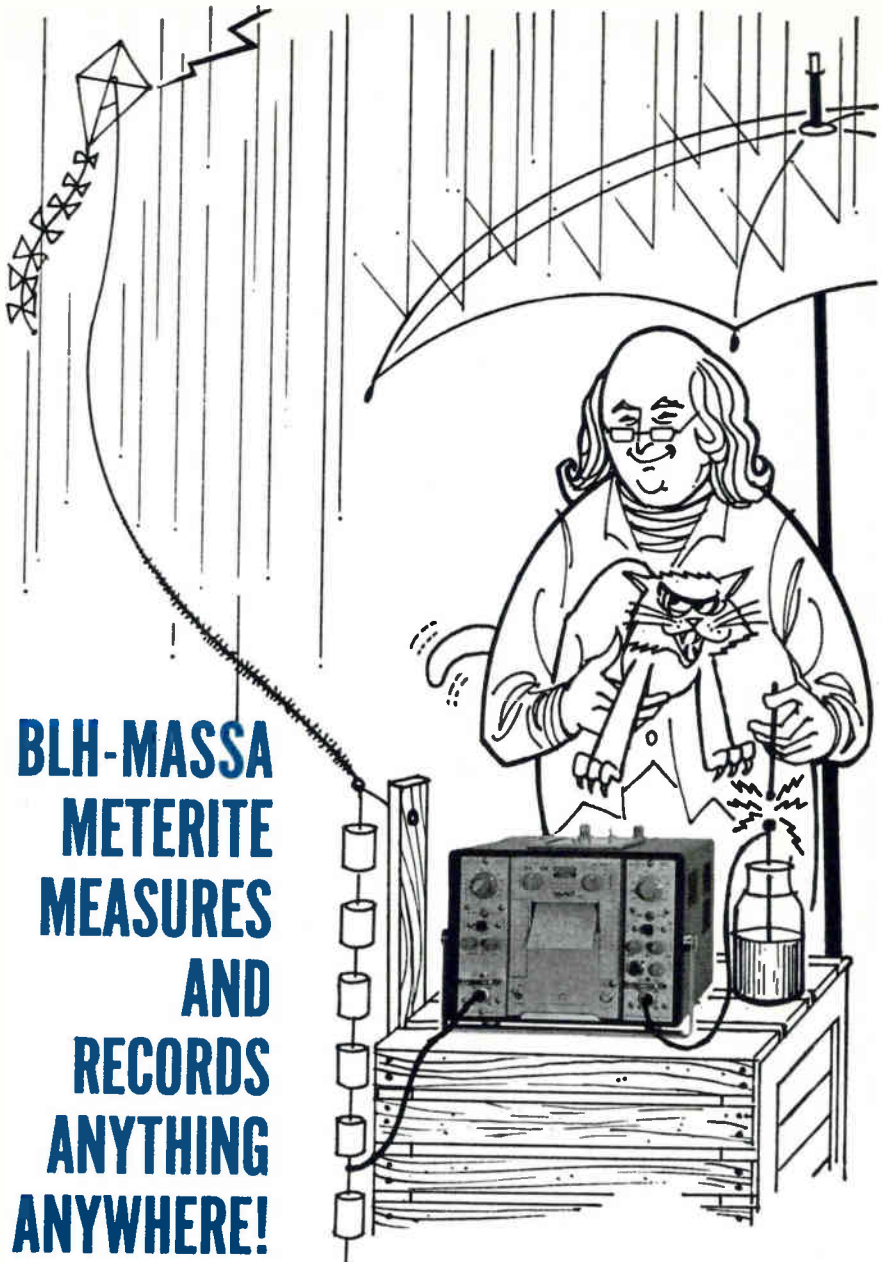

**BLH-MASSA
METERITE
MEASURES
AND
RECORDS
ANYTHING
ANYWHERE!**

If Dr. Ben Franklin had a Massa Meterite Strip Chart Recorder he would have had little difficulty comparing a lightning bolt to the charge from cat's fur! The two signals, recorded in clear undistorted ink or electric traces on the two-channel rectangular coordinate chart, would be written proof of the similarity between lightning and discharging static electricity. The convenient two-channel Meterite can be hand carried and operated almost anywhere there is a signal to be recorded.

While you may not be proving a fundamental physical law, your own strip chart recording may be just as critical. Regardless of your signal source, there is a Massa plug-in preamplifier suited to the job. The Meterite uses any two of the six available Massa preamplifiers. Other Massa recording systems, in groups of four to twelve channels, are packaged in cabinet and standard rack mounting configurations.



**BALDWIN · LIMA ·
HAMILTON**

Write for Meterite booklet
"Pitfalls to Avoid
when Purchasing
Strip Chart Recorders"



ELECTRONICS DIVISION Waltham, Mass. 02154 Tel. (617) 894-6700
Note: On Oct. 1, BLH Electronics Division acquired the Massa line of high speed strip chart recorders and oscillographs from Cohu Electronics, Inc.

PERFORMANCE

and ECONOMY

TELMAG

Tape-wound cores

E, C and TOROIDAL

FOR TRANSFORMERS, CHOKES, PULSE, AND INSTRUMENT
TRANSFORMERS, SATURABLE REACTORS, ETC.

Cost savings with sustained high quality are yours with TELMAG grain-oriented silicon-iron tape-wound cores for all standard and non-standard applications. Available in various grades with core losses as low as 0.82 w/lb. for 12/13 mil cores and low exciting VA... TELMAG cores can be delivered in any size and tape thickness of 1, 2, 4, 6, and 12/13 mil. Cut faces on 12/13 mil cores have lapped finish without extra cost for superior quality.

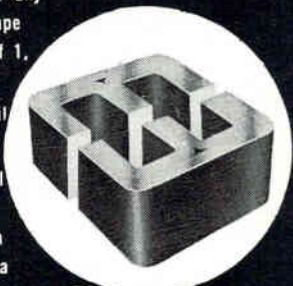

for other applications

Inter-Technical offers a wide variety of TELCON soft magnetic alloys as raw material or as fabricated items (such as laminations, shields, toroids)... and a complete selection of glass-to-metal-seal alloys.

TELCON materials are produced by companies highly specialized in the production of magnetic alloys from the chemical ingredients to the development of the finished product.

Associated with the B.I.C.C., the extensive research of the world's largest user of copper contributes to an extremely high-quality, low-cost product.

Let us quote your specifications

NATIONAL DISTRIBUTORS

914 LY 1 8822

THE INTER-TECHNICAL

P. O. BOX 23 GROUP INC.
IRVINGTON-ON-HUDSON
NEW YORK

Foil Stabilizes Electret Mike

Practical hardware stars at annual review of audio developments

By ALEXANDER A. MCKENZIE
Associate Editor

NEW YORK—An improved capacitor microphone, with high stability, frequency response flat between 50 cps and 15 kc, and with impedance low enough for direct connection to conventional transistor amplifiers, was reported last week at the Audio Engineering Society convention and exhibit. In all, 95 papers were presented.

Microphones—Construction of the capacitor microphone is illustrated. The electret (permanently polarized dielectric) is $\frac{1}{4}$ or $\frac{1}{2}$ -mil Mylar metallized on the outer side which serves as the second electrode. Typical capacitance is 62 pf/cm² (700 pf) about triple that of conventional capacitor microphones.

Because an electret is used, no external d-c bias is required, G. M. Sessler and J. E. West, of Bell Telephone Labs, said. Furthermore, they said, the use of foil overcomes the polarization instability that has been a problem with conventional thick dielectrics. The film is polarized by heating to 120 C and allowing it to cool slowly in a d-c field.

Besides the flat frequency response, sensitivity is as high as -50 dbv with respect to 1 microbar. Tests over a year have shown no degradation in sensitivity. Because of the low impedance, a long cable

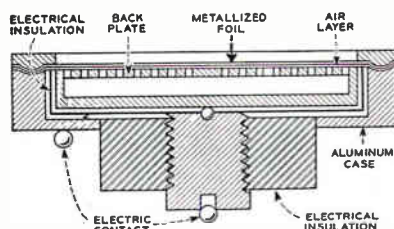

IMPROVED electret-foil capacitor microphone provides a frequency response that is flat within ± 3 db from 50 cps to 15 kc. It can be directly connected to transistor amplifier because of its low impedance

can be used to connect the microphone to an amplifier and no cathode follower is needed. With a transistor amplifier having 65-db power gain, the microphone yields 1 v across 1 kilohm for a sound-pressure level of 10 microbars.

Wireless Microphones—One evening was devoted to special microphone adaptations including the wireless type. Since the use of restricted radiation devices pose legal problems and controversies, R. L. Cutts, representing the Frequency Utilization and Requirements branch of FCC, clarified licensing and requirements for low-power transmitters, including wireless mikes (ELECTRONICS, p 26, June 28). Generally speaking, the unlicensed devices are severely limited in power and can operate only in special frequency bands. The licensed devices qualify under various FCC rules, depending upon the industry or use, but may be subject to far less interference in operation.

Magnetic Tape—Marvin Camras, of IIT Research Institute, summarized progress in magnetic recording, pointing to the increase in recording densities, successful experiments with cartridges (ELECTRONICS, p 18, Oct. 18) experimental work on electron-beam, magnetic modulator and Hall-effect flux-sensitive heads as well as four-track X-field heads requiring very thin tapes.

Loudspeakers—An electrostatic tweeter with 1-watt output to 200 cycles, described by K. O. Johnson, of Ampex, was developed with the help of an electrical circuit analog. The tweeter operates with high efficiency and good linearity. The single-ended electrostatic loudspeaker is made from standard 4 X 5-foot sheet stock and uses a $\frac{1}{4}$ -mil metallized Mylar diaphragm. Angular dispersion of the curved device is 135 degrees.

F. K. Harvey and W. F. Kallensee, of Bell Labs, demonstrated how two small loudspeakers placed behind a person's head can be employed for proximity stereo listening using the generally neglected rear hemisphere.



EL readout and translator sandwiched into 1/2 inch

The problem: design a 4-digit readout to operate from binary coded or decimal output, with readout and integral translator measuring only 4" by 2" by 1/2" deep. Make it rugged, lightweight, reliable, dimmable, and operable from batteries—it will go into a portable laser range finder for field use.

Sylvania has developed just such a unit, using PANELESCENT® EL display and a new sandwich construction. This is how it looks: in front is the display panel with phosphored segments which light up to form numerals. The back layer is an electroluminescent-photoconductive switching matrix, and in between is a flexible Mylar®

sheet with printed wiring, connecting matrix outputs to the corresponding display segments. Total thickness, only 1/2 inch!

A neat, compact construction — made possible by still another Sylvania development, a new low-voltage device for switching the high-voltage AC of the electroluminescent trigger lamps. Our gate is a tiny incandescent lamp encapsulated with a photocell, measuring overall less than 0.1 inch and weighing less than 0.01 gram. It also serves as an ideally simple dimming mechanism, with a life equal to the EL segments themselves.

Life, reliability, compactness, readabil-

ity, low power consumption — Sylvania EL has all this and more. Whether you want to discuss existing EL devices, or our capability to meet your special design problem — contact your Sylvania sales engineer or write to Display Products Manager, Sylvania Electric Products Inc., Seneca Falls, New York 13148.

SOME FACTS OF LIFE

In plant tests, 4,648 Sylvania EL segments have been in a constant lighted condition for more than 220,000 hours. That's more than one billion segment hours without a single catastrophic failure — and they're still going strong.

*Registered Du Pont Trademark

SYLVANIA

SUBSIDIARY OF

GENERAL TELEPHONE & ELECTRONICS



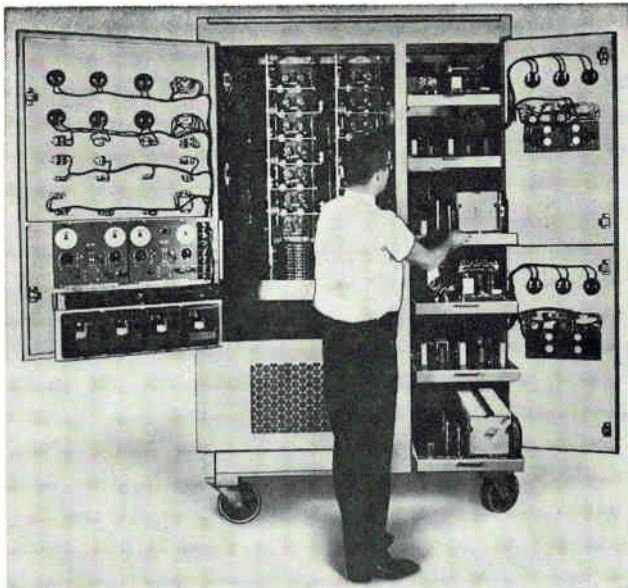

One of a new class of 300 KW DC Regulated Power Supplies, to be installed at Argonne National Laboratory to power the bending and focusing magnets of a Zero Gradient Synchrotron.

Acme  Electric

**builds products that
ENGINEERS talk about**

Call this what you will—a dc regulated power supply or a static power rectifier, it still is a design with features that engineers talk about.

Engineering-wise, this power supply provides performance parameters never before attainable. The two 125 volt, 1200 ampere, filtered direct current outputs are singularly smooth, with a ripple voltage that will average 0.005%. Each output is adjustable from 10% to 100% of rated output current. Precision control is .03%.

An ingenious water cooling system permits full load operating at not over 50°C temperature rise. Weight of the 300 KW unit has now been reduced to less than 33 pounds per KW.

The experience and advantage in technology that Acme Electric has accumulated over the years in building Power Supplies and Static Power Rectifiers is available to you on request.

Acme  Electric

Engineers and Builders of...
3110 WATER STREET, CUBA, NEW YORK
In Canada: Acme Electric Corp. Ltd.
50 Northline Rd., Toronto, Ont.

SAA-3714-3034

REGULATED POWER SUPPLIES
STATIC POWER RECTIFIERS
VOLTAGE STABILIZERS
VOLTAGE REGULATORS

70 CIRCLE 70 ON READER SERVICE CARD

**FAST
DELIVERY**
ANYWHERE

MIDWEC INSTRUMENT GRADE MYLAR* DIELECTRIC

Ca-pac-i-tors

Best Shipping Interval In The Industry—3 Weeks Standard

High Reliability and Quality

Competitively Priced

Specialists In Low Tolerance Units

Approved for use in Talos, Minute Man, Titan, Typhon,
Telephone Companies ■ 100% Test for dielectric strength,
capacitance, insulation resistance and dissipation factor

See the
EBG
Page 55



write for
data sheets
and prices

SALES OFFICE: 601 So. Jason St., Denver 23, Colo.
TWX: 292-3891—Telephone SH 4-3481—DDD 303

*DuPont TM for Polyester Film.

CIRCLE 201 ON READER SERVICE CARD

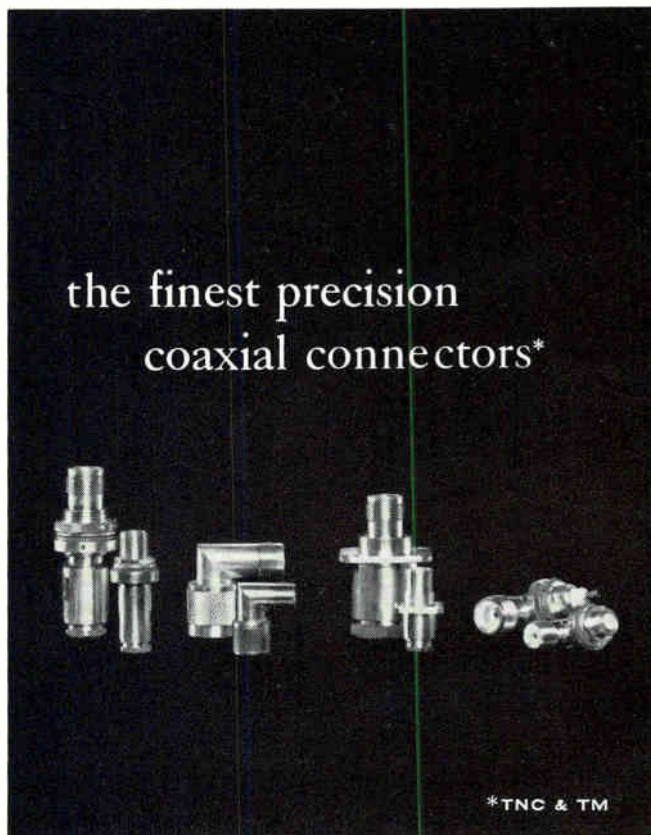

*TNC & TM

General RF Fittings, Inc.

702 BEACON STREET, BOSTON 15, MASSACHUSETTS
Telephone: 617 267-5120

CIRCLE 202 ON READER SERVICE CARD

October 25, 1963 electronics

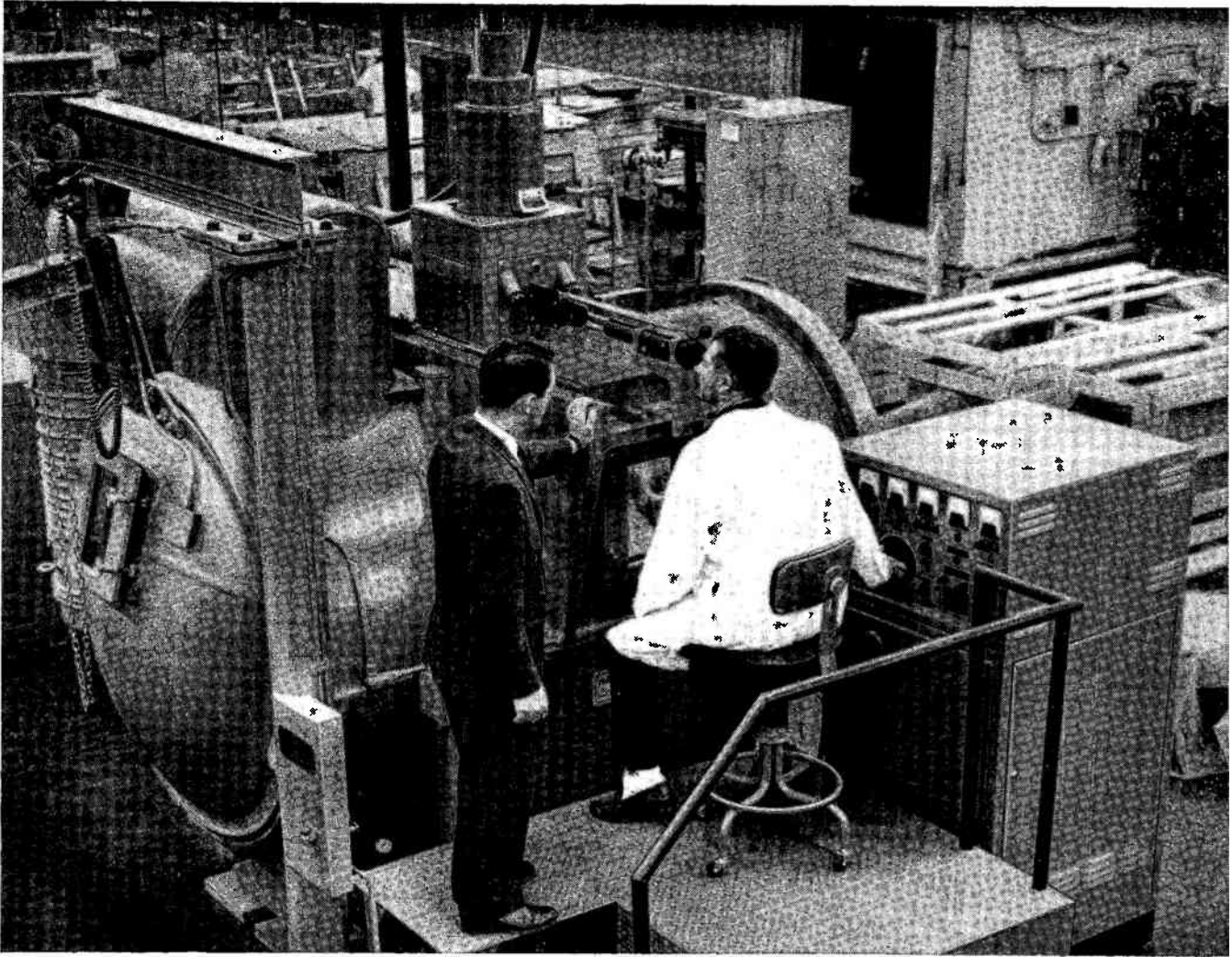

Power and work handling capacity increased in new series of Hamilton Standard Electron Beam Welders

Applications for electron beam welding have been vastly expanded with the introduction of the new Series SW Hamilton Standard Electron Beam Welders.

SW Series machines, with power increased from 3 to 6 kw, are now being supplied with work chambers up to 5½ feet in diameter and 15 feet in length. Gross work table loads up to 3 tons can be accommodated. Weld penetrations of up to 2 inches in steel and aluminum are possible, depending upon the particular alloy.

Other unique features provided in the SW Series:

- Sliding electron gun for lateral welding
- Down-The-Beam Optical Viewing
- Remote Control of work tables, which can be fixtured and loaded externally on run-out platform

For detailed information on models and accessories that comprise the new SW Series, write Sales Manager, Hamilton Standard, Industrial Products Department, Windsor Locks, Connecticut.

**Hamilton
Standard** DIVISION OF UNITED AIRCRAFT CORPORATION
WINDSOR LOCKS, CONNECTICUT

**U
A**

Geometry. Performance. Price.

There are dozens of rack-and-panel connectors that give you either geometry, performance, or price—maybe even two out of three. Only Amphenol Blue Ribbons, though, give you all three. That explains their popularity.

THE THREE BASICS

These are the three fundamental considerations behind every rack-and-panel connector application:

Geometry. The connector must fit the package. It must be small enough to serve unobtrusively in miniaturized equipment; large and rugged enough to handle the heavy duty jobs; and at the same time, accommodate the necessary number of interconnections.

Performance. Not only must a rack-and-panel connector mate perfectly. It also has to carry current with a minimum of resistance. And it must perform again and again in a wide range of environments.

Price. A truly great rack-and-panel connector should be a bargain. That is, the connector should deliver top value per purchase dollar.

LET'S TALK GEOMETRY

Blue Ribbons come in two series . . . small (26 series) and smaller (57 series . . . called Micro-Ribbons). Series 26 units pack 32 contacts into a $3\frac{1}{4}'' \times 3\frac{1}{4}''$ body with 8, 16, and 24 contact units available in proportionately smaller bodies. Micro-Ribbons come with 14, 24, 36, and 50 contacts and are, con-

tact for contact, one-third the size of the 26 series. All are rated 5 amps.

Unlike pins and sockets, Blue Ribbon contacts join with a wedge-like mating action. Once united, resilient spring action binds male and female together.

The advantages are fourfold:

1. Extremely low insertion and withdrawal forces combined with high contact pressure when mated;
2. Remarkably low contact resistance because of large contact surfaces;
3. Self-wiping action of contacts assures a clean mating surface after every insertion; and
4. No pin bending or socket jamming.

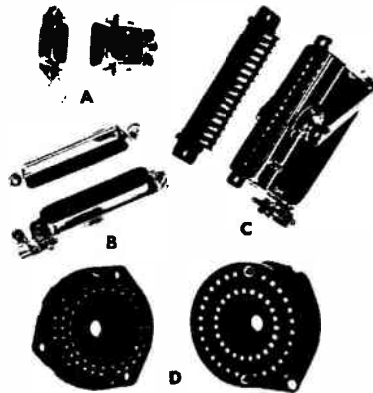

Four Blue Ribbon connector types:

(A) Micro-Ribbon 14-contact pair in cable-to-chassis housing; (B) Micro-Ribbon 50-contact pair with cable-to-chassis housing; (C) Blue Ribbon 36-contact pair in latch-type housing with end cable outlet; (D) Circular Blue Ribbon pair.

14 MILLIVOLTS DROP

Performance? Blue Ribbons behave like champs after thousands of mating cycles in salt spray. Electrical and mechanical changes are barely measurable.

Contact resistance, for example, is normally in the order of 14-millivolts drop at 5 amps.

Reliability? Over 5 billion contacts have been used by the maintenance-conscious telephone industry—without a single reported failure! (Confidentially, we think there must have been a failure someplace, but nobody told us about it.)

ACCEPTANCE

Competition, oversupply, and panic have forced many electronic component prices down, often to profitless levels.

Blue Ribbon prices are down, too. But for a different reason. Blue Ribbon prices have resulted directly from the acceptance that this unique connector has built up since its introduction nearly fifteen years ago.

EASY TO BUY

You can get Blue Ribbon (or Micro-Ribbon) connectors as fast as one of our sales offices or stocking distributors can arrange shipment.

If you'd like to know more about Blue Ribbon connectors, just write to: Dick Hall, Vice President, Marketing, Amphenol Connector Division, 1830 S. 54th Avenue, Chicago 50, Illinois.



Amphenol Division / Amphenol-Borg Electronics Corporation

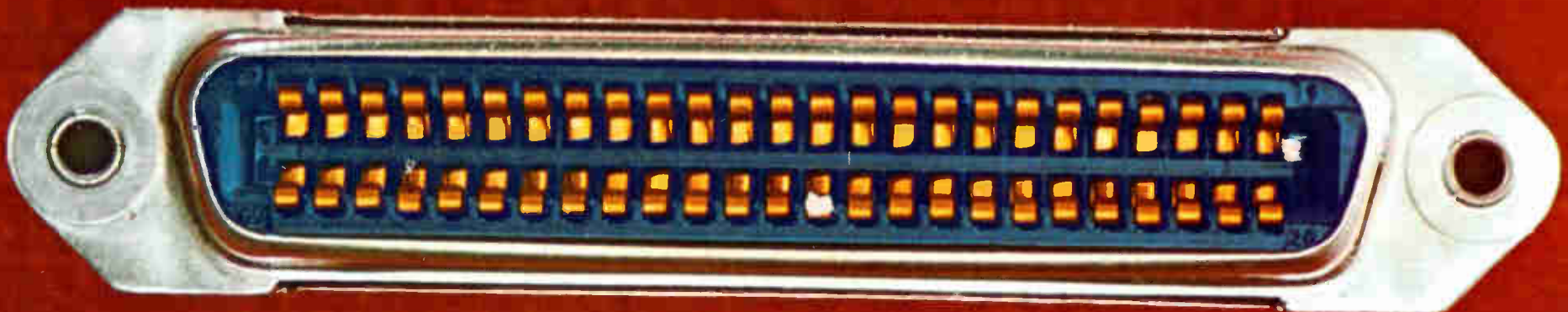

Northern Ireland Electronics Industry Growing Fast

Employment in Northern Ireland's electronic and electrical industry rose 212% in the ten years to 1960; a further gain of 76% will result from plants recently built or now in construction. The extraordinary growth of this thriving industry is especially significant for U.S. companies planning to make quality products abroad to reach out for growing world markets.

Government Assistance Helpful

To encourage new industry (or expansion of older industry) the Government has developed a highly flexible program of assistance. Too lengthy to detail here, it embraces capital grants, new plants on long lease for as little as 2¢ a square foot a month, labor training grants, modern, low-cost employee housing, and generous and accelerated depreciation schedules. All of these factors contribute to low cost production.

Right Kind of Labor Available

Education in Northern Ireland has always been technically oriented. Under the leadership of the well-known Queens University at Belfast, engineering in all its branches has been extended down through the many fine technical schools, with the result that a new company staffing-up should find necessary skills ready at all levels. Especially for the electronics industry and its demand for highly specialized skills, this means shorter training periods, quicker and sustained production, and higher quality output.

Electronics Complex Important, Too.

Whether the company is a producer of finished products such as office equipment, computers, tape recorders, or component manufacturing, it will find the growing complex of electronic and electrical companies in Northern Ireland of greatest importance, either as suppliers or customers. Near at hand are manufacturers of coated wire, cable, motors, generators, switch gear, analog computers, tape recorders, training simulators, automation controls, calculators, record players, and a host of other electronic, electric or electro-mechanical products. Clearly this is a climate in which a new company can flourish.

With Northern Ireland an integral part of the United Kingdom, no trade restrictions exist with the rest of Britain. Manufacturers in Northern Ireland also enjoy the benefits of Commonwealth trade ties

around the world plus a preferential trade area relationship.

For information on Northern Ireland op-

portunities, phone or write Wm. McC. Taylor, British Industrial Development Office, 845 Third Ave., N. Y., N. Y. (10022), PLaza 2-8400.

Produce in **NORTHERN IRELAND** Sell the world-over

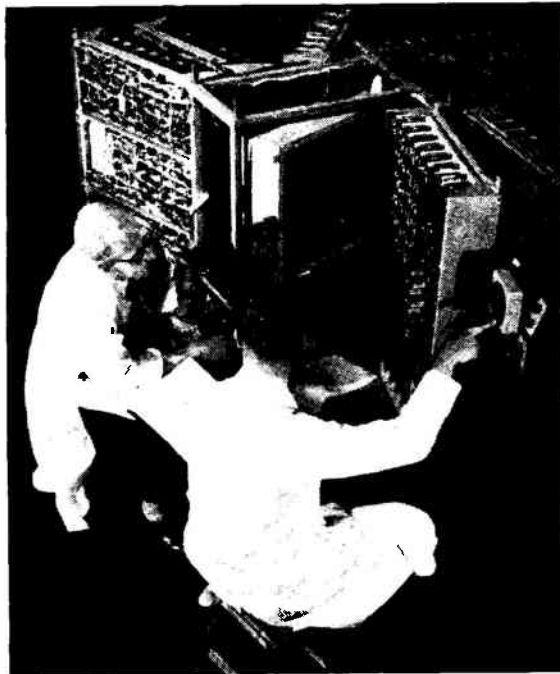

Senior technicians insure quality control through precision testing in a large electronics plant in Northern Ireland.

Costs down—Quality Up That's the Northern Ireland Story for the Electronics Industry

Electronics, electrical, and related industries grow fast in Northern Ireland, and for good reason, too.

- **Production costs are low**, due to direct and indirect Government assistance, new, ready-built plants at low rentals, an abundance of easily-trainable labor available at realistic wage rates.
- **Production quality is high**, due to the inherent skills of the people of this industrialized country, the high level of education for all, the scope and depth of the many technical schools, and the common sense of a people proud to do the job right.

Costs down—quality up—an unbeatable combination to bring your products into world markets—competitively.

Find out why so many important companies have chosen Northern Ireland as the site for their plant to produce complicated electronic equipment. Phone or write Wm. McC. Taylor, British Industrial Development Office, 845 Third Ave., New York, N. Y. (10022). PLaza 2-8400. Ask for our informative brochure, "NORTHERN IRELAND ... Your Answer For Overseas Location."



**UNITED KINGDOM of Great Britain
AND NORTHERN IRELAND**

SSB System Goal Is 20-Year Life

Microcircuit transceiver is built around MOS field-effect transistors

By SAMUEL WEBER
Senior Editor

CAMDEN, N. J.—Advanced design concepts and unique microcircuit techniques are going into an h-f single-sideband transceiver that may start a new trend in military communications equipment.

The radio set, the AN/ARC-104 is being developed here for the Bureau of Naval Weapons by the Communications Systems division of RCA's Defense Electronic Products.

A breadboard model is scheduled to be delivered by spring, with six completely packaged prototypes to follow in about a year. The final package will be about one-half cubic foot in volume and 30 pounds in weight, up to 5 times lighter and 10 times smaller than present operational equipment.

Robert Trachtenberg, the division's chief development engineer, will describe the new equipment at NEC next week. Trachtenberg told ELECTRONICS last week that the development program is in response to increased Navy emphasis on long life and low maintenance. Navy feels that the initial cost of such equipment is only a small part of its total investment and wants to reduce the costs of training and maintenance.

Major features of the AN/ARC-104 include:

- Useful life span of 20 years in the Navy's inventory
- Mean-time-before-failure of 1,300 hours
- Performance exceeding present equipments' in every major characteristic
- Tuning without gears, linkages, motors or other mechanical parts

that characterize conventional equipment for the same application

• Semiautomatic self-testing system to minimize downtime and maintenance.

Fet Circuits—Extensive use of RCA's insulated-gain field-effect transistor or MOS—metal-oxide-semiconductor (ELECTRONICS, Feb. 15, p 52)—makes possible many of the advanced characteristics of the set, according to Trachtenberg. Heart of the transceiver is

the digital frequency synthesizer, which will allow the operator to set up, by an arrangement of digital counters, any frequency for both transmitter and receiver in the 2 to 32-Mc range in steps of 1 kc.

The counters are unique in that the digital circuits are formed by use of multiple interconnected MOS devices without the need for any other electronic components, such as resistors, capacitors or diodes. The MOS has unlimited fan-out capability, and performs well in direct-

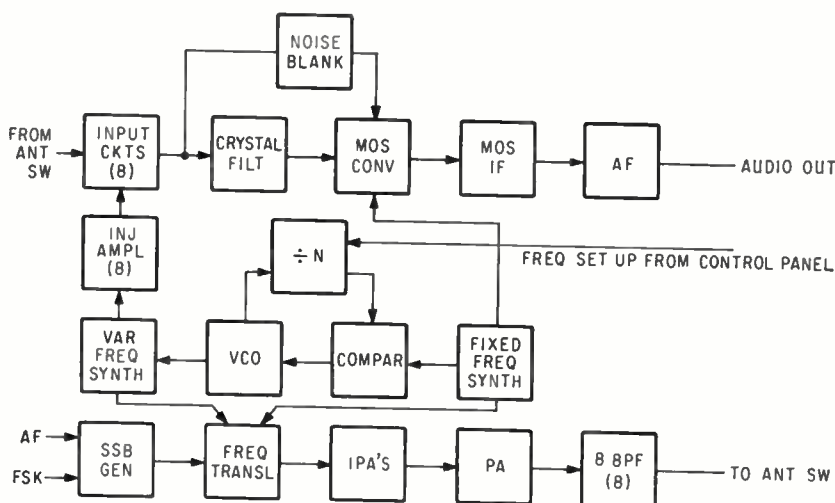

HEART OF SYSTEM is the digital frequency synthesizer. No mechanical parts are required for tuning. Microcircuits comprise 2/3 of system—Fig. 1

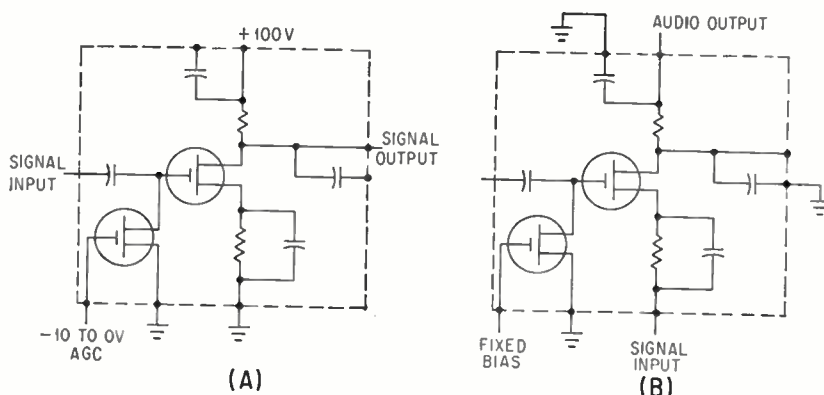

VERSATILITY of the MOS (metal-oxide-semiconductor) is indicated by similarity of the i-f amplifier (A) and product detector (B). Only the input connections are different—Fig. 2

**NOW! TRANSMIT LIGHT
IN FLEXIBLE CURVES...**

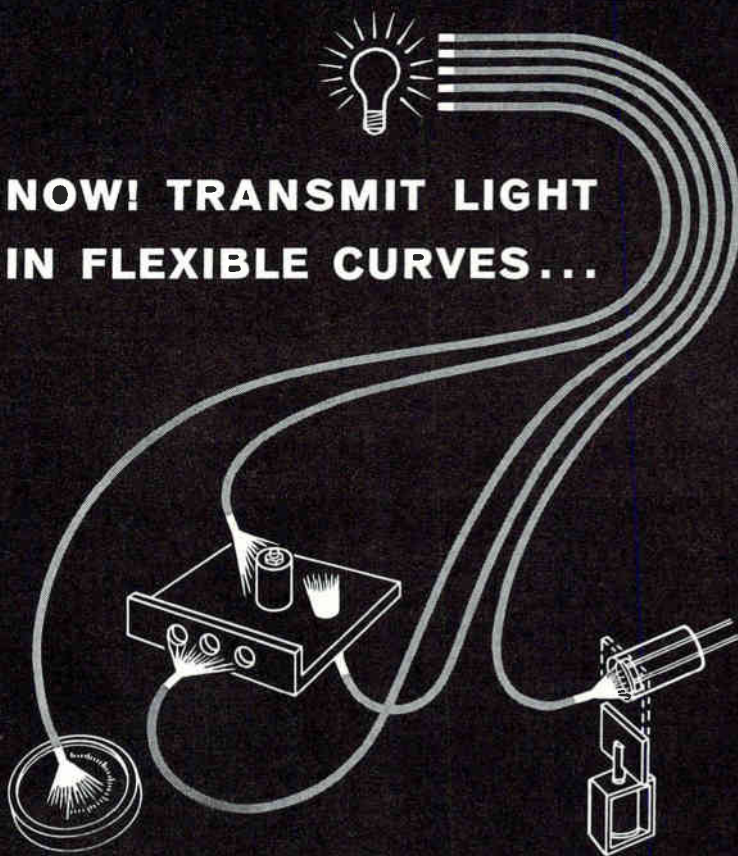

NEW Bausch & Lomb LIGHT WIRES

Your first low-cost source for production-run incoherent fiber optics! Out of the "high-priced, laboratory stage" . . . and into your hands to be designed and engineered into your products and systems as a practical economical tool. That's the big news from Bausch & Lomb, leaders in fiber optics research.*

Thin glass fibers, each about 15 microns in diameter, are made to transmit light by a process of total internal reflection. Each fiber is clad in a coating of lower refractive index than itself . . . bundles of these high optical quality fibers are clustered together into flexible "wires" . . . the ends are bonded, ground and polished . . . and you have Bausch & Lomb LIGHT WIRES! They can be specified by known parameters . . . and ordered by diameter and length . . . to fit your design problem.

LIGHT WIRES transmit light and light impulses efficiently around flexible curves and into inaccessible areas. As flexible as electrical wires, they can be bent and twisted around corners, harnessed together by butt-contact splicing and fed through conduits, to move light signals or illumination from one point to another. Applications in illuminating, signaling, monitoring, and actuating are virtually unlimited . . . where higher efficiency, reliability, space reduction, potential fire and explosion, lower cost, and inaccessibility are design problems.

Write for complete information Catalog D-2045, Bausch & Lomb Incorporated, 62346 Bausch Street, Rochester 2, New York.

*Another Bausch & Lomb first in fiber optics . . . "The FLEXISCOPE" . . . a great new tool for production and quality control, which transmits images from inaccessible areas. Catalog D-2042 available on request.

BAUSCH & LOMB



In Canada, write Bausch & Lomb Optical Co., Ltd., Dept. 623, Scientific Instrument Division, 16 Grosvenor St., Toronto 5, Canada

coupled circuits as switching devices. Since no power is used except during switching, power dissipation in the logic circuits is exceptionally low, it is reported.

Logic Nets—The circuits are built up of groups of MOS's in what RCA calls integrated logic nets, made by diffusion on a small silicon wafer. Interconnections are made by depositing conductors and insulation to permit an overlay of additional conductors. The result is the formation of complex circuits by a process consisting of only a few steps.

Significant reduction in the number of separate parts for even more complex digital equipment is possible by using this technique, RCA says. For example, only seven wafers of integrated logic nets are used in the " $\div N$ " function (Fig. 1) that would otherwise require the use of 142 separate digital microcircuits of types that are now available from various industry sources. More than $\frac{2}{3}$ the entire equipment is microcircuited using only 105 microcircuit wafers of 17 different types in all parts of the transceiver.

Amplifiers—Nondigital portions of the set also utilize the unique characteristics of the MOS. These include an i-f amplifier and a product detector (Fig. 2) that are basically the same circuit with changed connections. MOS microcircuits also serve as audio amplifiers and untuned frequency doublers which can be cascaded for higher order frequency multiplication. The i-f amplifiers exhibit improved intermodulation distortion characteristics, better than attained to date with tubes or conventional transistors, says Trachtenberg.

MOS characteristics are of the same form as those of a pentode tube except that zero bias operation is permissible, and the transfer characteristic is according to a square law. Operation of the MOS below the knee of the drain characteristic can simulate a variable resistance by varying the gate voltage. This is utilized in an automatic-gain-control feature of the equipment.

Dynamic Range—To achieve the unusually high dynamic range of 120 db, the receiver uses 8 broadband input circuits. Noise blanking

is provided and is based on detection of impulse noise ahead of the selective i-f circuits. The transmitter will have a 400-watt peak-effective-power output featuring ssb, fsk and "a-m equivalent" modes. Ssb voice processing provides an average output within a db of the peak transmitter output.

Self-Testing — The self-test feature is implemented by a semi-automatic process controlled by a digital programmer, which exercises various circuits, either simultaneously or in a prescribed sequence. Signal amplitudes are measured throughout the equipment by voltmeter circuits, and the presence or absence of a desired frequency is determined by switching in crystal filters. Signal lights on the panel inform the operator of the condition of the circuit under test. The entire equipment can be checked out in less than one minute.

Electron Bombardment of Materials Studied

ION PHYSICS Corporation is currently initiating a program for the U. S. Air Force to discover the effects of 2-million-volt electron-beam bombardment on materials. IPC will develop testing techniques, choose materials and perform the irradiation with high energy atomic particles and evaluate the results.

A 2-Mev Van de Graaff electron accelerator—manufactured by High Voltage Engineering Corporation—will be used as the radiation source. The machine will deliver extremely powerful pulses of radiation energy capable of causing profound changes both within and on the surface of materials. Initially, aluminum, a low-density metal; tungsten, a high-density metal, and quartz, because of its transparency, will be used as targets.

Electro-Optical Lab Created at Michigan

ANN ARBOR — New electro-optical sciences lab, at the University of Michigan Institute of Science and Technology, will enable graduate students to work with electronic information processing, laser light am-

Brian Clare can show you...



Sales Engineer, North Atlantic Industries

how to match a PAV to tough GSE specs

From its all solid state circuitry to its MIL-type hermetically sealed meter and plug-in amplifiers, every design feature of the Model VM-235 Phase Angle Voltmeter has been selected for rigorous service in Aerospace Ground Equipment.

Your North Atlantic man can quickly demonstrate how this rugged, miniaturized version of North Atlantic's famous PAV provides direct, accurate reading of phase angle, nulls, total, fundamental, quadrature and in-phase voltages—even under the roughest of military field conditions.

The VM-235's ability to meet tough system specs is demonstrated daily in operational and support equipment for USAF and Navy aircraft and missile programs. Its capabilities for complex measurements are shown in the abridged specifications below:

Voltage Range.....	1 mv to 300 v f.s., 12 ranges
Voltage Accuracy.....	±2% f.s.
Phase Accuracy.....	dial: ±1°; meter: ±3% of F.S. degrees
Signal Frequency.....	400 cps
Input Impedance.....	1 megohm
Reference Input.....	26 v or 115 v
Meter scale.....	3-0-3, 10-0-10 linear
Phase Angle Dial.....	2 scales, 90° (elec.) apart
Nulling Sensitivity.....	2 microvolts (phase sensitive)
Harmonic Rejection.....	55db (with filters)
Dimensions.....	8 ¹ / ₁₆ " h. x 8 ¹ / ₂ " w. x 6 ³ / ₁₆ " d.

North Atlantic's field engineering representative in your area has full data on the VM-235, as well as modified versions for specific systems requirements. For his name, call or write today, or request Bulletin VM-235.



NORTH ATLANTIC industries, inc.
 TERMINAL DRIVE, PLAINVIEW, L. I., NEW YORK • Overbrook 1-8600

NEW! HIGH SENSITIVITY

GENERAL PURPOSE 247A

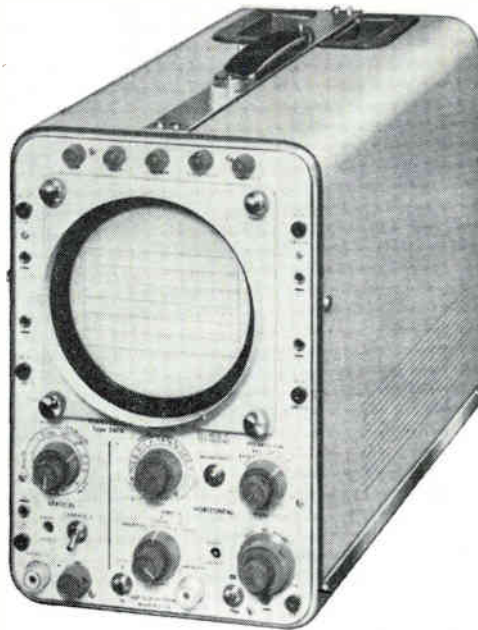

The type 247-A oscilloscope fully qualifies as a universal instrument because its performances and the size (13 cm (5") dia.) of its C.R. Tube authorize accurate measurements and tests in all fields of low-frequency instrumentation. Also, because of its simplicity of operation, the 247-A is ideally suited for practical laboratory work of an educational nature.

TECHNICAL SPECIFICATIONS

Vertical amplifier

1 channel; Frequency range: DC to 1 Mc/s (-3 dB)
Sensitivity: 50 mV/cm

AC: 10 c/s sinewave or 50 c/s square-wave to 100 Kc/s (-3 dB)
Sensitivity: 5 mV/cm

Calibrated attenuator: step-adjustable from 5 mV to 20 V/cm
in 12 positions
Sequence: 1 - 2 - 5 - 10 etc...

Attenuator vernier ratio 1/3
Constant input impedance: 1 M Ω 47 pF

Sweep

Free-running - triggered - single sweep
Duration: 1 s/cm to 0.5 μ s/cm in 20 calibrated positions
Vernier: 1: 3 ratio
x 5 magnification expanding
sweep durations from 3 s/cm to 0.1 μ s/cm

Sync

5 positions: single-sweep, HF, LF, TV-line, TV-frame
Polarity: - or - internal or external
selection of triggering level

Horizontal Amplifier

Frequency range: 0 to 500 Kc/s (-3 dB)

Sensitivity: 1 V/cm or 10 V/cm (switch-selected)
Vernier: 0 to 1
Constant input impedance: 1 M Ω and 47 pF

Cathode-ray Tube

5 ADP 2 or equivalent type
Screen: 13 cm (5") dia.
Deflection factors:
X: 30 V/cm (approx.)
Y: 20 V/cm (approx.)

Direct drive of H and V plates
Acceleration voltage: 3 Kv

MECHANICAL FEATURES

Light-alloy chassis, readily-detachable panel for easy access to circuits.

1) Tube complement

9/ECF80 - 2 NM2L or equivalent types

2) Power supply

105 - 115 - 127 - 220 - 240 V - 50 or 60 c/s

3) Dimensions

Width: 20,5 cm - (8")
Depth: 38,5 cm - (15")
Height: 31 cm - (12")
Weight: 14 kg - (30 lbs)

OTHER INSTRUMENTS

Oscilloscopes

204 A - High speed and fast rise oscilloscope
241 A - 242 A - 243 A, Multi-function osc. with
plug-in preamplifiers.
255 B - Portable oscilloscope
245 A - High performance portable oscilloscope
246 A - High sensitivity low-frequency oscilloscope
248 A - Maintenance oscilloscope.

Sweep frequency Generators

411 A - Laboratory sweep frequency generator
410 B - TV - FM sweep frequency generator
476 A - Radio sweep frequency generator

Signal Generators

405 A - Low frequency RC signal gen. (30 c/s-300 Kc/s)

428 A - HF constant amplitude signal generator
(100 Kc/s-30Mc/s)
458 - Pulse generator (5 c/s - 50 Kc/s).

TV pattern generators

465 C - Portable electronic pattern generator
464 A - Test - pattern generator

Regulated power supplies

117 A - Transistorised regulated power supply
114 A - Regulated power supply

Cameras

1000 A - oscilloscope camera with Polaroid
1001 B - oscilloscope recorder

plification and control, and communications.

Although other universities are researching this field, Michigan believes its "Introduction to electro-optical science," begun this fall, is the first of its kind. The academically oriented research program will be headed by Prof. George Stroke—MIT geometry and physical optics authority until he accepted an appointment to teach the new electro-optical course at Michigan this autumn.

The electro-optical sciences lab will study diffraction gratings, light propagation, speed of light measurements, electro-optical communications and optical electronics.

MIT Laser Detects Meteoric Fragments

USING A LASER as part of an optical radar, scientists at MIT's Research Laboratory of Electronics have detected minute particles—presumably dust from meteoric fragmentation—in the uppermost portions of the earth's atmosphere. The finding adds support to the theory that very small meteors shower into the earth's atmosphere continuously and do not burn up but instead fragment into still smaller particles that eventually settle to earth.

Giorgio Fiocco, assistant professor of geology and geophysics, and Louis D. Smullin, professor of electrical engineering, both researchers at the Research Laboratory of Electronics at the Massachusetts Institute of Technology, reported observation of optical echoes from minute particles at heights of from 60 to 140 kilometers (35 to 85 miles). Concentrations, they say, appeared in two regions—one around 80 kilometers (50 miles) and the other around 120 kilometers (70 miles). They could not say what caused these echoes in the absence of independent methods of observation.

It is tempting, however, to compare the lower echoes (approximately 80 kilometers) with the observed heights of noctilucent clouds. And it may be speculated that the more distant echoes (approximately 120 kilometers) correspond to the region of meteoric break up.

INTER-PLANS

RIBET-DESJARDINS

MEASURE & CONTROL DEPARTMENT, 13-17, rue Périer MONTROUGE/PARIS TEL: ALESIA 24-40
CANADIAN BRANCH: RIBET-DESJARDINS (CANADA) Room 114, 5757 Decelles Avenue - MONTREAL.

Hears more . . .
Holds more . . .
Tells more . . .

In outer, inner, and inbetween space, Leach Tape Recorders hear and tell more for their tiny size and weight than any other recorders. And they work best when the going isn't.

Only seven pounds light, the Satellite Recorder/Reproducer (MTR-2100) withstands launch and re-entry, records for 210 mins. at 1.8 ips and requires the minimum power consumption.

Less than 2 lbs. light (actually only 26 ounces) this smallest Leach Recorder (MTR-362 LT) takes 2000 G's of shock and works in temperatures from -100°F to 180°F .

Only nine pounds light, this Leach Recorder (MTR-800) has a tape capacity of 300 feet of one mil Mylar tape, withstands shock to 750 G's and vibration to 15 G's to 2000 cps. Proved during rocket sled tests.

Only 13 pounds light, this Leach Recorder (MTR-1200) is now used in underground nuclear tests. It has a tape capacity of 720 feet of one mil Mylar tape on up to 16 channels. Takes shock to 750 G's and vibration to 15 G's to 2000 cps.

Leach makes the accessory electronics, too — all interchangeable for selection of record modes between analog, digital and fm.

Off the shelf or off the drawing boards, Leach Tape Recorders will make the toughest job sound easy. For full details write Leach today.

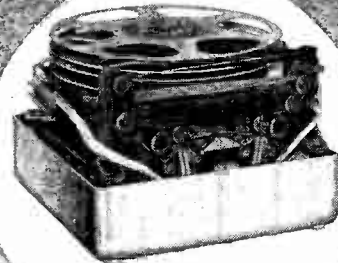

IN ORBIT

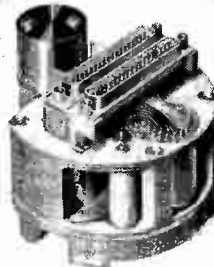

IN THE ATMOSPHERE

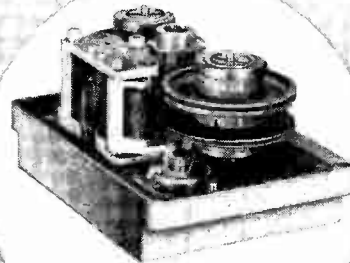

ON GROUND

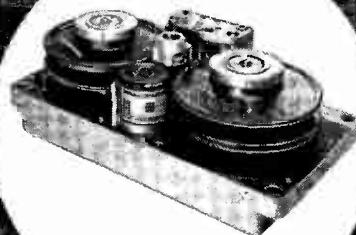

UNDERGROUND

LEACH
CORPORATION

CONTROLS DIVISION

717 North Coney Ave. • Azusa, Calif.

Export: Leach International S. A.

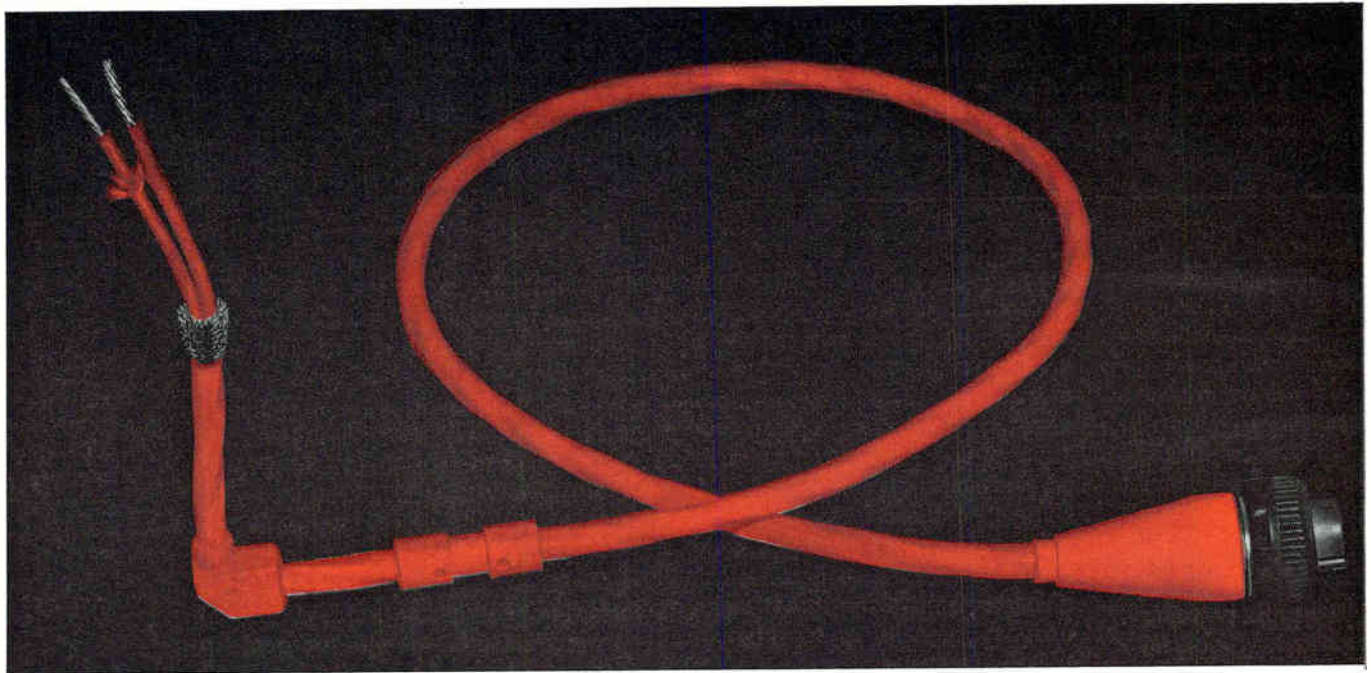
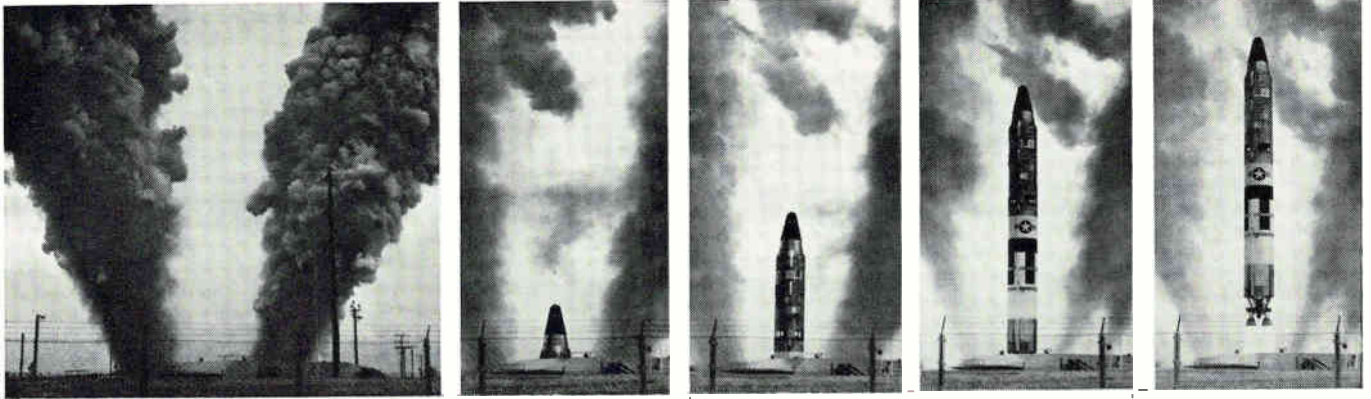

Integrally molded components of **TEFLON® FEP** extend reliability of thermocouple cables in Titan II

A spool at one end of a Titan II thermocouple cable . . . a right-angle bend near the spool . . . a connector boot at the other end—these components are all integrally molded of a Du Pont **TEFLON** FEP-fluorocarbon resin. Why **TEFLON**? Because it is completely inert to all fuels and oxidizers. Why **TEFLON** FEP? Because FEP resins are easily and rapidly molded into complex shapes, eliminating expensive machining and time-consuming assembly jobs. The result is a thermocouple cable that

offers the unmatched reliability of **TEFLON** plus the ease and economy of conventional thermoplastic molding. (As you might expect, **TEFLON** is also used for primary insulation, secondary insulation and jacketing on these cables.)

Melt-processible **TEFLON** FEP resins are being used to solve problems of reliability and efficient manufacture in a wide variety of molded electronic components, and in the form of long, extruded lengths of insulation and jacketing. They offer the

outstanding insulating properties you expect of **TEFLON** resins, the complete inertness to virtually all chemicals—and they are rated for continuous use up to 400°F.

Perhaps they can simplify a design problem for you, too. For more detailed information write to: E. I. du Pont de Nemours & Co. (Inc.), Div. E-1025 63, Room 2526 Nemours Building, Wilmington 98, Delaware.

In Canada: Du Pont of Canada Limited, P. O. Box 660, Montreal, Que.



TEFLON®
FLUOROCARBON RESINS

TEFLON is Du Pont's registered trademark for its family of fluorocarbon resins, fibers and film, including TFE (tetrafluoroethylene) resins and FEP (fluorinated ethylene propylene) resins.

BETTER THINGS FOR BETTER LIVING . . . THROUGH CHEMISTRY

Accurate Gyro Balancing

Electrolytic cells and special power supply solve old gyro problem

By **EDWARD J. MULLARKEY**
President,
Avcon Corporation

ONE of the problems inherent in building extremely precise gyros is the precession due to the interaction between accelerations and a mass shift in the gyro which causes an unbalance. The mass shift occurs when the effective mass of the gyro assembly moves off the sensitive—or spinning—axis of the gyro. Mass shifts equivalent to the movement of the gyro wheel by as little as one-millionth of an inch will produce drift rates—under normal acceleration of one “g”—in the order of two-hundredths of a degree per hour. To compensate a gyro by counterbalancing is an extremely difficult, tedious, and expensive operation; heretofore accomplished by

shifting of the balancing screws of the gyro on a trial and error basis. In the case of fluid-floated gyros it is necessary to resort to extremely complex methods for gaining access to the adjusting screw through fluid medium.

In the case of pendulous integrating gyroscope accelerometers, where an intentional unbalance is created in the gyro rotor, the degree and placement of the unbalance is similarly extremely difficult to accomplish. And, alignment of the accelerometers on an inertial platform presents special difficulties. It had been necessary to position the gyro case in order to achieve alignment with the gimbal axes.

All environmental factors being considered, it is virtually impossible to achieve coherent mass transfer with a battery-type power source. The system, developed by Avcon (ELECTRONICS, p 18, Oct. 4, 1963), for remotely balancing conventional design gyroscopes relies on a special power supply and a tiny electrolytic cell. The system eliminates precision translating weight and screw arrangements with which mass ad-

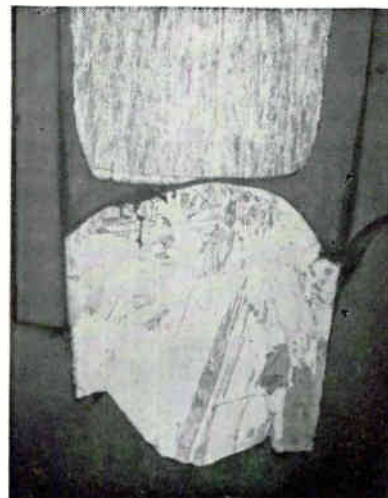

CROSS SECTION of electrolytic cell. Electroplated material—lower section—takes on appearance of crystalline structure

justments are more generally made, access ports into the gyro case and/or float for the purpose of such adjustments, departures from ideal float configurations necessitated by screw and port arrangements, and oversized floats resulting from added buoyancy to counteract the excess weight. The power supplied to the Avcon electrolytic cells, speeds up ion diffusion, eliminating gravitational and diffusional impairments, resulting in coherent plating. The physical characteristics of the plating achieved are rather unique. Instead of being stratified, the electroplated mass takes on the appearance of a single-crystal growth (see figure).

Small electrolytic cells are mounted on the gimbal or float structure (normally, two are required) parallel to the input and spin axes (see figure). Using static motor leads, electrical grounds, and float stops, additional power leads are unnecessary. If an internal receiving circuit were used, the device would require no external leads. When power is applied, atoms are electroplated from one electrode to

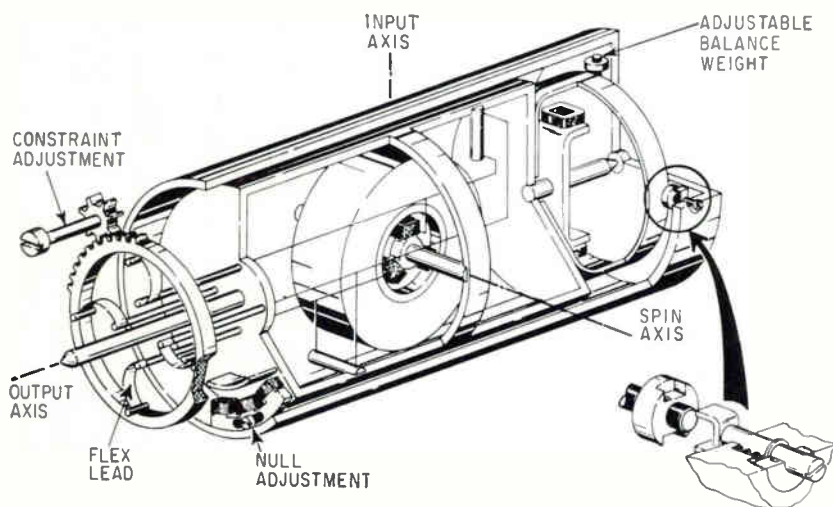

TYPICAL floated gyro. Cells are shown installed parallel to spin axis and input axis. Previous balance system—replaced by cells—is shown at rear of float



Crown

— first choice
of those who
demand the best!

NEW

Solid State

CONTROL CENTER
FOR SERIES 800, 1000
AND 1400 MODELS

DOUBLES former performance

Quarter-Track Record/Play Data

ips	db	cps	s/n
7-1/2	±2	50 — 30,000	56db
3-3/4	±2	30 — 20,000	52db
1-7/8	±3	30 — 16,000	50db
15/16	±3	30 — 10,000	48db

The most complete recording instruments ever designed for stereo use. Audio circuitry, ±1/4 db from 10-100,000 cps; extended range, 5-500,000 cps. Plug-in circuit modules are printed on epoxy and gold plated. Engineered to space craft reliability.



THE HALLMARK
OF CROWN —
SUPERLATIVE
CRAFTSMANSHIP
THROUGHOUT!

INDIVIDUAL PERFORMANCE
RECORD SUPPLIED
WITH EACH CROWN

WRITE DEPT. EL-10



Crown

INTERNATIONAL

1718 Mishawaka Rd. • Elkhart, Ind.

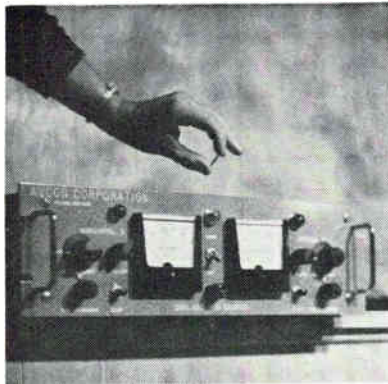

POWER SUPPLY used with electrolytic cells to accomplish gyro balance

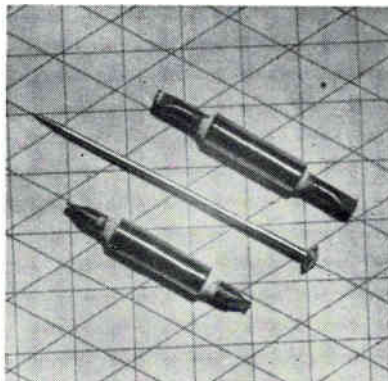

ELECTROLYTIC cells shown alongside straight pin for size comparison

the other. For a given polarity, the relative masses of the electrodes change. The change in mass results in compensating torque—balancing the gyro, one atom at a time; up to 5 dyne/cm in either direction.

The electrolytic cells are built to withstand temperature environments from -65° to +180°F and vacuums from 20 μ to 1¼ atmospheres. Sperry Gyroscope and MIT Lincoln Labs have constructed gyros using the Avcon cells and there are plans to start production. It is expected that the basic system will also find application in fuel cells, and other devices dependent upon electroplating, that must operate in aerospace environments.

Watch Magnets

Find New Uses

A PLATINUM-COBALT permanent-magnet alloy that offers designers minimum size and weight per unit of flux produced, is now available as Placovar from Hamilton Watch

Company. Most permanent-magnet alloys are brittle, but Placovar is ductile and can be used where magnet design is restricted to a small length-to-diameter ratio (2:1 or less).

Containing 50 atomic percent platinum and 50 atomic percent cobalt, Placovar possesses a high coercive force (over 4000 oersteds) and a high energy product (about 9.5 x 10⁶ gauss-oersteds). Although the alloy was known to possess permanent-magnet properties as early as 1936, it remained principally a laboratory curiosity for over 20 years, partly because it is relatively expensive.

Some of the more recent uses, however, include permanent magnets for miniature relays, field bucking and focusing magnets for X-band helix traveling-wave tubes and gyro torquer magnets. Both Relay and Syncom communications satellites contain two traveling-wave tubes, each of which uses platinum-cobalt magnets to supply the magnetic field required for collimation of the electron beam. The use of platinum-cobalt for these magnets has resulted in the highest power-to-weight ratio yet achieved in periodic permanent-magnet focused traveling-wave tubes.

Microelectronics to Kitchen Sink

OSAKA, JAPAN—The second Japan Electronics Show, sponsored by the Electronics Industries Association of Japan (EIA-J), had displays from 189 companies whose products covered the entire spectrum from integrated semiconductor circuits to a kitchen sink—included because it featured a duplex convenience power outlet and an electric garbage disposal.

Yagishita Electric Co. Ltd showed a d-size lead-acid rechargeable storage battery. The lead acid cells are much cheaper than the nickel-cadmium type: export price was 220 yen (60¢).

Matsushita Electric Industrial Company had two new types of capacitors. One type used a sintered niobium anode in place of a sintered tantalum anode. The niobium anode weighs much less than the tantalum anode, with performance

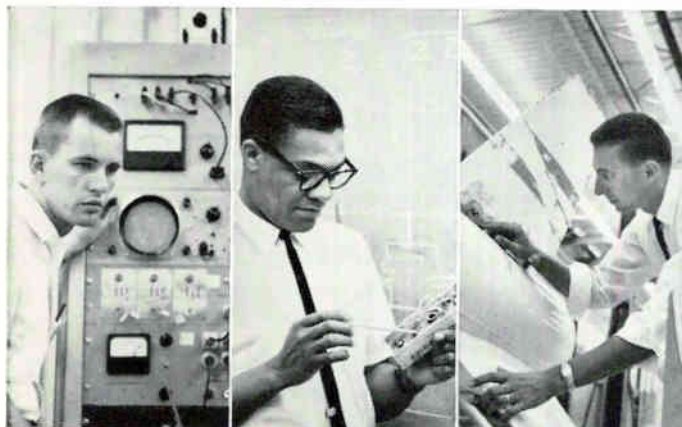

Space- the youthful outlook

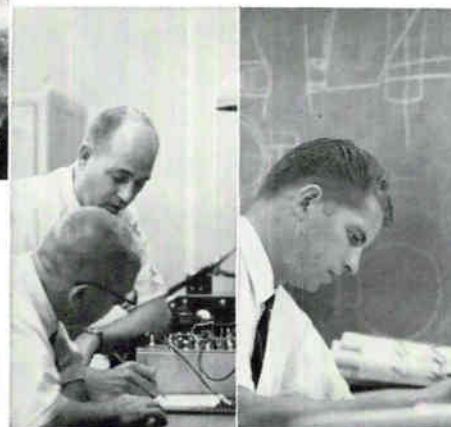

Space-General offers unlimited opportunities for engineers and scientists who want to move ahead quickly in a dynamic young organization dedicated to space projects. ■ Less than three years old, Space-General now has grown to almost 1,200 employees and occupies one of the newest, best-equipped facilities in the industry. Location is ideal...in the San Gabriel Valley, 15 minutes by freeway from downtown Los Angeles. ■ Our current interests are broad: electronics, guidance and control systems, space telemetry, survivable communications, satellite and military systems, space vehicles, lunar and planetary exploration craft, inflatable reentry vehicles, and nuclear detection studies. ■ Our employees tell us they prize Space-General's unusually heavy emphasis on *individual* work and ideas. As a matter of fact, every member of our technical staff is expected to make a creative contribution to the growth of our technological capability.

There are many outstanding career opportunities at Space-General for engineers and scientists with a B.S. degree or higher and at least two years of experience in any of the following fields:

Communication Systems Analysis • Circuit Design • Heat Transfer-Thermodynamics Analysis • Stress Analysis • Trajectory Analysis and Aerodynamics • Hydraulic-Pneumatic Controls Development • Structural Test Analysis • Space Vehicle Design • Guidance and Control Analysis • Advanced Sensor Research • Microwave Research • Nuclear Test Instrumentation • Bio-Sensor Research. ■ Your resume will receive immediate confidential attention. *Send to:* Donald L. Craig, Employment Mgr., Space-General Corp., Dept. No. NP-14, 9200 E. Flair Drive, El Monte, California.

An equal opportunity employer.



SPACE-GENERAL CORPORATION

El Monte, California

A subsidiary of Aerojet-General Corporation



FOR OFHC COPPER COMPONENTS

Call  **JANNEY**

Call **JANNEY** for Forgings,
Extrusions, High Energy Rate Forming

Benefit from JANNEY's extensive experience in forming OFHC* Copper and other high conductivity alloys for electronic applications. We offer:

1. Engineering know-how in this field
2. Flexibility of operation
3. Comprehensive quality controls
4. Machining facilities
5. Capacities: primarily parts weighing between 2 and 6 pounds each and billet sizes ranging between 2½" and 5" in diameter.

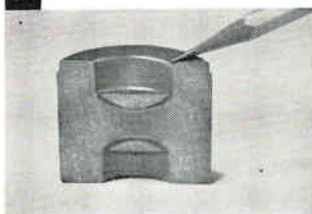

**OFHC COPPER
ELECTRONIC COMPONENT**
(HER Formed for smoother finish, better parts, less metal loss, simpler tooling)



OFHC COPPER
(Ring Forging, Rough Machined)



OFHC COPPER
Components for Electronic Applications



OFHC COPPER
A housing that has been backward extruded and machined. Note solid end.

Challenge us with your problem.
Write, wire or phone.

JANNEY CYLINDER COMPANY

7401 STATE ROAD, PHILADELPHIA 36, PA.
Phone: (215) MAYfair 4-6600

*Reg. Amer. Mtl. Climax, Inc.



which Plastic?

LET FRY'S CATALOG HELP —NEW, MOST COMPLETE

listing of plastics, their uses, characteristics, costs, ever compiled. Every available type listed, most illustrated. Raw stock, shapes, fabrications, adhesives, and fittings shown. Over 200 pages. FREE.



**FRY PLASTICS
INTERNATIONAL, INC.**
8601 SO. FIGUEROA STREET
LOS ANGELES 3, CALIFORNIA

CIRCLE 203 ON READER SERVICE CARD

THE DECI-CAP

New Subminiature Ceramic Capacitor—0.100" Diameter by
0.250" Molded Envelope—24 Hour Delivery

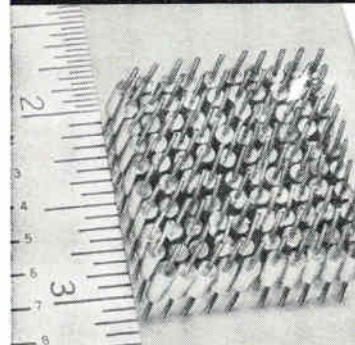

5 pf to 470 pf in 19 values, 200 WVDC

Epoxy molded for highest reliability and performance—less than 7½% capacitance change from -55°C to +125°C

FEATURES:

Standardized size for high density cordwood packaging

Designed to meet all the requirements of MIL-C-11015

10 PER LINEAR INCH,
100 PER SQUARE INCH

The DECI-CAP is the latest addition to Nytronics' DECI Series—a series that does consist of inductors, capacitors and resistors in a uniform envelope to facilitate point-to-point assembly in cordwood, printed circuit and other high density module assemblies.

For complete engineering data, write Dept. WL-33, or phone 201-464-9300.

NYTRONICS, INC.

550 Springfield Ave., Berkeley Heights, N.J.

Design Leaders STANDARD components to meet CUSTOM requirements

CIRCLE 204 ON READER SERVICE CARD
October 25, 1963 electronics

degraded only slightly. The niobium devices sell for much less than the tantalum equivalent. The other capacitor uses anodized coating on aluminum foil as the dielectric. Anodized aluminum foil capacitors are available in capacitances from 1,000 to 50,000 pf. and are operable at frequencies up to 3 to 5 Mc. Matsushita also showed a backward-wave oscillator capable of a 1 to 10 mW output in the 66 to 81 Gc—4.5 to 3.7—range. The tube uses a comb-type delay line with 85 teeth.

Transistor-Zener Device Reduces Drift Problems

DEVICE that functions as a combination transistor amplifier and zener diode—called an integrated reference amplifier—costs less than the two devices it replaces. The GE device can be used as an error voltage amplifier in a regulated power supply, with its own integral reference, either for voltage or current regulation. Maximum power dissipation of any of the ten models presently available is 300 milliwatts. The integrated structure of the devices reduces the effects of long- or short-term drift in reference voltage—common in regulated supplies—according to the manufacturer.

Standards Announced For Solid Tantalum Capacitors

THE DEFENSE Electronics Supply Center, DESC, announces its intention to establish Qualified Products Lists for items manufactured under the following specification: MIL-C-39003, 1 Aug., 1963, Capacitors, Fixed, Solid-Electrolyte, Tantalum, Established Reliability (Navy-SH Preparing Activity).

Companies which have products meeting the requirements of these specifications are urged to contact the Defense Electronics Supply Center, Attn: DESC-EQ, 1507 Wilmington Pike, Dayton, Ohio 45420 for an opportunity to have their products tested. Awards will be made only for such products as have been tested and approved for inclusion in the Qualified Products List.

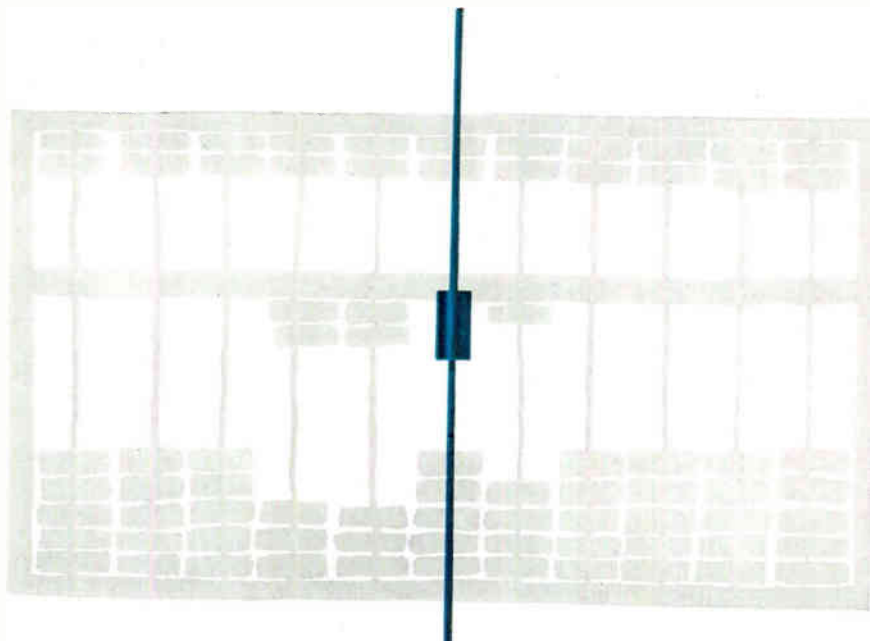

a new addition . . .

to the Paktron® family of molded miniature Mylar® capacitors—the MA-375

Egyptians, Greeks, Romans and Chinese used various forms of movable counters. Quite a difference when you consider today's modern digital and analog computers. Quite a difference, too, between the components of earlier computers. Today's computers demand the small size, high reliability of capacitors such as the Paktron® molded MA-375.

The extended values of the MA-375 are from 220mmf to .01mf at 100v. It's adaptable for printed boards, cordwood techniques and automatic inserting. Size: L—.375 O.D.—.200. Delivery fast. Quality outstanding. Priced competitively.

For complete technical data on the MA-375 axial lead capacitor write:

©DuPont

i t **PAKTRON**
W DIVISION ILLINOIS TOOL WORKS INC.
1321 LESLIE AVENUE • ALEXANDRIA, VIRGINIA



How far can you stretch one salesman?

Not far enough. A recent survey indicates that the average industrial salesman spends 58% of his time travelling, waiting, making reports and attending sales meetings. In the 42% of his workday