

# electronics®

A MCGRAW-HILL WEEKLY

75 CENTS

OCTOBER 4, 1963

## LOGIC FOR MICROCIRCUITS

Here's how six circuit  
types stack up

## RADIATION TROUBLE

Surface effects add to  
space-craft problems

## UPDATING THE NAVY

Ship modifications  
require new gear

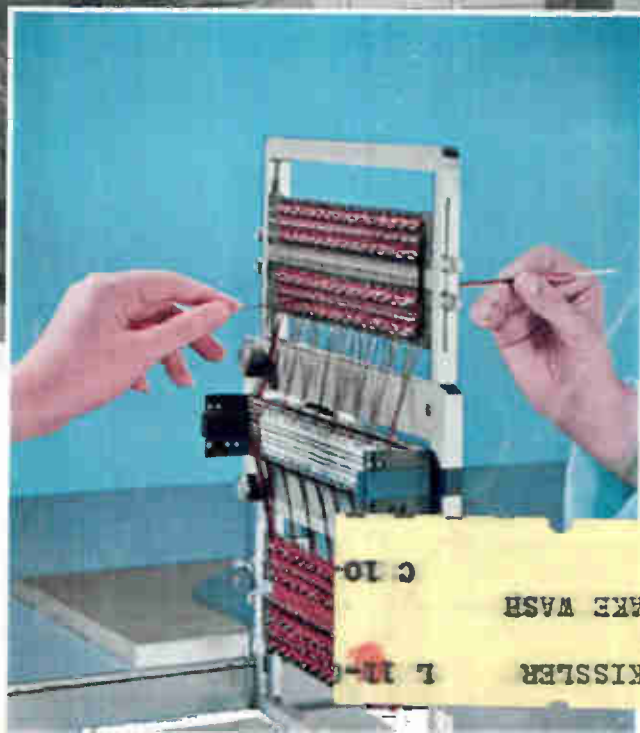
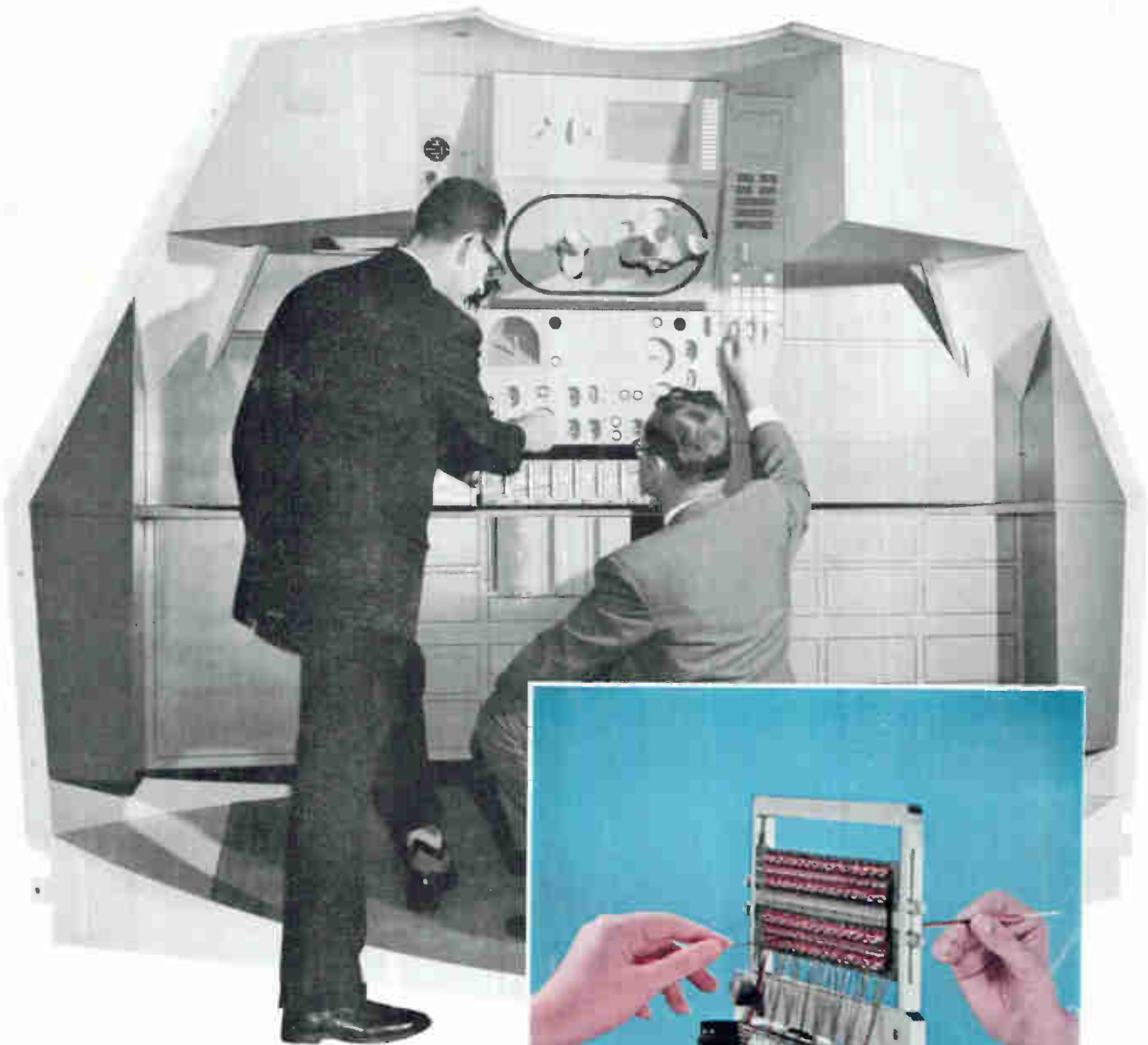

Engineers check instrument panel in mock-up of Apollo vehicle. Rope-memory module is used in guidance and navigation computer

C 10

ROLAND KISSLER  
BOX 956  
MOSES LAKE WASH

## TWO NEW PULSERS FROM hp—WITH TWIN PERFORMANCE INNOVATIONS:



### Custom-designed nanosecond pulses

With the hp 215A: Positive or negative pulses to 10 v into 50 ohms with rise and fall times less than 1 nsec. Width continuously adjustable to 100 nsec. Continuously adjustable internal triggering 100 cps to 1 mc, external 10 cps to 1 mc, with selectable slope and level, single pulse. Trigger output 140 nsec advance to 10 nsec delay with respect to output pulse. Pulse bursts with gated input, 1 v to turn on. Price, \$1875.

**Controlled, specified pulse shape!** No need to monitor the pulse from this new generation of Hewlett-Packard pulsers. Pulse shape is so carefully controlled that it can be specified under all operating conditions!

**Constant 50-ohm source impedance** absorbs reflections from the external load, bans secondary reflections from the pulser. Monitoring is unnecessary.

**Scope-type triggering, pulse gating.** No amplifiers or inverters needed for external triggering—you can select your external trigger slope and level. The gated feature provides pulse bursts for maximum versatility!

*Data subject to change without notice. Prices f.o.b. factory.*

### HEWLETT-PACKARD COMPANY

1501 Page Mill Road, Palo Alto, Calif. 94304, (415) 326-7000.  
Sales and service in all principal areas. Europe, Hewlett-Packard S.A., 54 Route des Acacias, Geneva, Switzerland; Canada, Hewlett-Packard (Canada) Ltd., 8270 Mayrand St., Montreal, Que.



8691

### Power-packed 200 watt pulses

With the hp 214A: Positive or negative pulses to 100 v into 50 ohms (2 amps) at rep rates to 1 mc. Rise times 10 to 15 nsec. Pulse width continuously adjustable to 10 msec. Internal triggering, 10 cps to 1 mc continuously adjustable, external, dc to 1 mc, level and slope selectable. Gated feature for pulse bursts, double pulse, single pulse, square wave capabilities. Ideal for high current applications. Price, \$875.

Ask your Hewlett-Packard field engineer for a demonstration of the pulse generator that will best fit your requirements.

# electronics

A MCGRAW-HILL WEEKLY 75 CENTS

**W. W. MacDONALD, Editor**  
Telephone Area Code 212 (971-2645)

**J. M. CARROLL, Managing Editor (2293)**

**SENIOR EDITORS**

Samuel Weber (2371)  
George W. Sideris (3444)

**SENIOR ASSOCIATE EDITORS**

Michael F. Wolff (2600)  
John F. Mason (2666)

**ASSOCIATE EDITORS**

Michael F. Tomaino (2071)  
William P. O'Brien (2297)  
George J. Flynn (2188)  
George V. Novotny (3151)  
Leon H. Dulberger (3446)  
Alexander A. McKenzie (2685)

**ASSISTANT EDITORS**

Stephen B. Gray (2245)  
Barry A. Briskman (2306)  
Dan Smith (2467)  
Joel A. Strasser (2127)

**REGIONAL EDITORS**

Harold C. Hood,  
1125 W. 6th St., Los Angeles 90017, Calif.  
(213-482-5450)  
Laurence D. Shergalis,  
John Hancock Bldg., 255 California St.,  
San Francisco 94111, Calif. (415-362-4600)  
Thomas Maguire  
McGraw-Hill Bldg., 607 Boylston St.,  
Boston 02116, Mass. (617-262-1160)  
Cletus M. Wiley,  
Blair Bldg., 645 N. Michigan Ave.,  
Chicago 60611, Ill. (312-664-5800)

**ART DIRECTOR**

Howard R. Berry (2430)

**ASSISTANT ART DIRECTOR**

John C. Wright, Jr. (3430)

**EDITORIAL ASSISTANTS**

Lorraine Rossi, Virginia T. Bastian,  
Lynn Emery, Ann Mella, Lorraine Werner,  
Alice M. O'Brien, Sharon Parks,  
Claire Benell, Kay Fontana

**FOREIGN NEWS BUREAU**

**DIRECTOR**, John Wilhelm, (2532);  
Lawrence Mihlon (2997), Alyne Elias  
(2998)  
**LONDON**—John Shinn, Derek Barlow,  
Nicholas Landon, 34 Dover St., London  
W.1, England  
**BONN**—Bruce Bendow, Richard Mikton,  
Silke McQueen, Mittelstrasse 39, Bad  
Godesberg, Germany  
**BRUSSELS**—27 Rue Ducarle, Brussels,  
Belgium  
**PARIS**—Robert Farrell, Arthur Erikson,  
17 Ave. Matignon, 3rd Fl., Paris 8,  
France  
**MILAN**—Marc A. Messina, Via Manzoni  
No. 12, Milan, Italy  
**MEXICO CITY**—Wesley Perry, Jr.,  
Lafragua 4-314, Mexico 1 D.F. Mexico  
**RIO DE JANEIRO**—Leslie Warren, Rua  
Mexico 3-S/1507 1509, Rio de Janeiro,  
Brazil  
**MOSCOW**—Stewart Ramsey,  
Kutuzovsky Prospekt 19, Apt. 28-29,  
Moscow, USSR  
**TOKYO**—Richard Halloran, Charles Cohen,  
John Yamaguchi, Toranomon Sangyo  
Bldg., 1 Kotohiracho Shiba, Minato-Ku,  
Tokyo, Japan

**CIRCULATION MANAGER**

Hugh J. Quinn (2310)

**C. C. RANDOLPH, Publisher (2016)**

**APOLLO INSTRUMENTS.** Ralph R. Gagan, operations manager of Raytheon's Sudbury lab Space and Information Systems division, and Eldon Hall, director of the Apollo Computer division at MIT's Instrumentation Lab, check the instrument panel in a mock-up of the manned lunar vehicle. *Unit shown in the inset is a logic and rope memory module for the craft's guidance and navigation computer. See p 14*

COVER

**NAVY'S SHIP PROGRAM.** Navy has lined up and Congress will soon approve a \$2-billion shipbuilding and conversion program. Electronics' share, Navy estimates, is 40 percent. *Here is a rundown of the ships planned and the electronic equipments they will require*

10

**GAMMA-RAY LASER.** A Soviet academician proposes one that he thinks is feasible. *Basis would be a pure nuclear isomer crystal yielding a single pulse of gamma emission*

11

**GUIDANCE AND NAVIGATION.** Polaris-proven electronic components will guide Apollo spacecraft to the moon. The guidance and navigation system includes a rope-memory. *One technique borrowed from Polaris is pulsed torquing of gyros so they harmonize with digital computers*

14

**CHOOSING LOGIC FOR MICROCIRCUITS.** Six common logic circuits are compared for microcircuit use: direct-coupled transistor logic (DCTL), resistor-transistor logic (RTL), resistor-capacitor-transistor logic (RCTL), transistor-coupled transistor logic (TTL), diode-transistor logic (DTL) and emitter coupled transistor logic (ECTL). Although no scheme is clearly superior each has its peculiar advantages and disadvantages. *Worst-case operating conditions are considered.*

By A. E. Skoures, U. S. Naval Air Development Center 23

**TWO-PHASE OSCILLATOR.** Covering the range from 0.1 to 1,000 cps, this instrument provides an ideal excitation source for measuring the transfer characteristics of automatic control systems. It consists of two cathode-followers each with 45-deg phase shift, a 90-deg amplifier and a 180-deg amplifier. *Use of R-C phase-shifting networks in the first three stages helps eliminate harmonics from the output.*

By Y. P. Yu, Ad-Yu Electronics 27

**RAISING Q WITH THE NRE.** The nonlinear resistance element NRE, a packaged semiconductor circuit, can be used as an efficient Q multiplier. Effectively the circuit raises the Q of a low-frequency resonant tank by paralleling the unwanted resistance with its own negative resistance. *Several formulas for analysis of Q multipliers illustrate the design procedure.*

By C. D. Todd, Hughes Aircraft 30

Published weekly, with Electronics Buyers' Guide as part of the subscription, by McGraw-Hill Publishing Company, Inc. Founder: James H. McGraw (1860-1948).

Title @ registered U.S. Patent Office; © copyright 1963 by McGraw-Hill Publishing Co., Inc. All rights reserved, including the right to reproduce the contents of this publication, in whole or in part.

Executive, editorial, circulation and advertising offices: McGraw-Hill Building, 330 West 42nd Street, New York, N. Y., 10036. Telephone Area Code 212 971-3333. Teletype TWX N. Y. 212-640-4646. Cable McGrawhill, N. Y. PRINTED IN ALBANY, N. Y.; second class postage paid at Albany, N. Y.

OFFICERS OF THE PUBLICATIONS DIVISION: Shelton Fisher, President; Vice Presidents: Joseph H. Allen, Operations; John R. Callahan, Editorial; Ervin E. DeGraff, Circulation; Donald C. McGraw, Jr., Advertising Sales; Angelo R. Venezian, Marketing.

OFFICERS OF THE CORPORATION: Donald C. McGraw, President; Hugh J. Kelly, Harry L. Waddell, L. Keith Goodrich, Executive Vice Presidents; John L. McGraw, Treasurer; John J. Cooke, Vice President and Secretary.

Subscriptions are solicited only from those actively engaged in the field of the publication. Position and company connection must be indicated on orders. Subscription rates: United States and Possessions and Canada, \$6.00 one year, \$9.00 two years, \$12.00 three years. All other countries \$20.00 one year. Single copies, United States and Possessions and Canada 75¢. Single copies all other countries \$1.50.

THE PUBLISHER, UPON WRITTEN REQUEST TO OUR NEW YORK OFFICE FROM ANY SUBSCRIBER, AGREES TO REFUND THAT PART OF THE SUBSCRIPTION PRICE APPLYING TO COPIES NOT YET MAILED.

Subscribers: Please send change of address notices, subscription orders or complaints to Fulfillment Manager, Electronics, at the address below. Change of address notices should provide old as well as new address, including postal zone number if any. If possible, attach address label from recent issue. Allow one month for change to become effective.

Postmaster: Please send Form 3579 to Fulfillment Manager, Electronics, P. O. Box 430, Hightstown, New Jersey, 08520.



Audited Paid Circulation

Contents continued

**EFFECTS OF IONIZING RADIATION.** Effects of ionizing radiation on the bulk properties of semiconductor materials and devices—formation of transient hole-electron pairs and permanent lattice defects—are well known. But surface effects are important also. These result in increased leakage current and reduced gain. *Surface effects can be reduced by sealing the device in an evacuated envelope.*  
By D. S. Peck and E. R. Schmid, Bell Telephone Labs 34

**AUTO ELECTRONICS.** Their reputation for reliability is boosting the use of semiconductor devices in automobiles. *One survey predicts this market will rise as high as \$333 million by 1970* 39

**LASER COMPUTER.** Under investigation is an optical-electrical computer for high-speed solution of equations. A key technique is control of laser-beam phase. *Phaser control depends on coefficients of equation to be solved* 39

**HELICOPTER ILS.** New microwave system puts tracking radar on the helicopter and the beacon on the ground. *Developers say system provides for instrument flight over a 10-mile radius and permits landings in zero-zero visibility* 40

**COLOR-TV PROJECTOR.** New system has three optical units. *Simultaneous, rather than field-sequential, projection lowers bandwidth requirements for closed-circuit use* 42

DEPARTMENTS

**Crosstalk.** People Make Progress 5

**Comment.** Rebalancing the Electronics Business. Transistor Symbols 6

**Electronics Newsletter.** Russians Consider Telepathy for Space Communications 17

**Meetings Ahead.** 1963 Fall URSI meeting 18

**Washington This Week.** Kennedy's Offer of U. S.-USSR Space Trips May Nip NASA Funds 20

**Research and Development.** Optical Radar Uses Xenon Flashtube 44

**Components and Materials.** Battery for Space Finds Consumer Uses 49

**Production Techniques.** Layout Machine Scribes on Glass 52

**New Products.** Variable Delay Line Features Direct Readout 57

**Literature of the Week** 63

**People and Plants.** Siliconix Elects Officers 64

**Index to Advertisers** 68



matched pair

## New hp crystal detector, 10 mc to 12.4 gc

- Frequency response  $\pm 0.5$  db; full band
- High sensitivity, low swr

Here's a unique new crystal detector whose frequency response is so flat that any two are a matched pair. This flat frequency response,  $\pm 0.5$  db from 10 mc to the top of X-band, removes a major source of error in microwave measurement.

This single detector covers the entire frequency range from 10 mc to 12.4 gc, with swr less than 1.5 (less than 1.2 in the important coax range, 10 mc to 4.5 gc). High sensitivity permits low-level measurements, large decoupling factors. The combination of flat response and low swr makes this detector ideal for leveling applications.

The unique features of the 423A are made possible by use of a new hp semiconductor diode, housed in a sealed capsule that is easily replaceable without tools or soldering.

The 423A introduces new simplicity and new accuracy to your microwave measuring work. Ask your hp representative for all the details.

### SPECIFICATIONS

Frequency range:	10 mc to 12.4 gc
Frequency response:	$\pm 0.5$ db over entire range
SWR:	< 1.2, 10 mc to 4.5 gc < 1.35, 4.5 to 7 gc < 1.5, 7 to 12.4 gc
Sensitivity:	High level, < 0.35 mw produces 100 mv output Low level, 0.4 mv dc/ $\mu$ w cw
Output Impedance:	< 15 K shunted by 10 pf
Maximum input:	100 mw
Noise:	200 $\mu$ v p-p, with cw power applied to produce 100 mv output
Output polarity:	Negative; positive available
Connectors:	Type N male input, BNC female output
Size:	$\frac{3}{8}$ " diam., 2 $\frac{1}{2}$ " long, 4 oz. net weight
Price:	\$125

Data subject to change without notice. Price f.o.b. factory

8599

**HEWLETT  
PACKARD  
COMPANY**



1501 Page Mill Rd., Palo Alto, Calif., (415) 326-7000. Sales and service representatives in principal areas. Europe, Hewlett-Packard S.A., 54 Route des Acacias, Geneva, Switzerland; Canada, Hewlett-Packard (Canada) Ltd., 8270 Mayrand St., Montreal, Que.



THE LITTLEST THING THAT COUNTS!

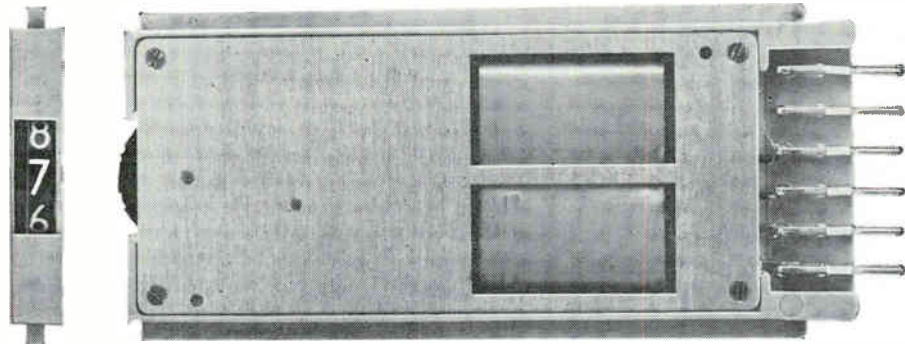

## THE COUNT MODULE

*a new and basic tool for counting,  
controlling, displaying and printing*

- Pencil-thin, these single digit electromagnetic displays build into any kind of counting, registering or printing system . . . with any number of digits. The modular concept extends to both the mountings in the front and the circuitry in the rear.
- Each Count Module is a plug-in unit, may be shifted as needed. The face plates, the frames that house them and the variety of driving circuits that plug in at the rear can be any width up to 19". The digits on all modules are  $\frac{3}{16}$ " high.
- Each module can be equipped with switches for sensing a start position and serial counting by periodic contact closure. Multiple module assemblies can be precisely tailored to particular functions through choice of mounting, circuitry and Count Modules.
- Module wheels are made in 10 or 12 positions (either numerical or alphanumeric), and are designed for either reading or printing. Stepping rate of the low speed module is 40 counts per second. High speed is 80 counts per second. Life is estimated in the hundreds of millions of counts.
- Miniaturization is accompanied by low prices! Data printers and printing counters can be built with these modules at conspicuously lower cost than ever before possible. From the point of view of configuration, as well as dollar savings, Count Modules open the way to new products in a wide variety of fields.
- For further information, write for Bulletin 601A

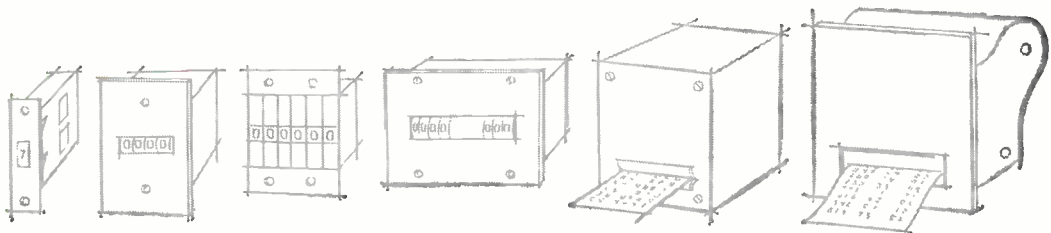

**PRESIN COMPANY, INC.** Box 3245, Bridgeport 5, Connecticut  
Telephone: Bridgeport 333-9491 From New York: WA 5-7960 Telex No.: 096-4217

## People Make Progress

A NEW TECHNOLOGY has mushroomed in the past decade. Beside the usual electronics technology, there is now a subtechnology for coping with megabuck budgets, intricate bidding and procurement regulations, analysis of systems, and application of computers and game theory to costing and scheduling.

As big science gets bigger so does this subtechnology. More and more it seems to preoccupy an industry whose major concern has traditionally been technical progress. More and more it seems that the solution to technical problem is seen only in the spending of money for more equipment and buildings.

It is important to be reminded occasionally that electronics involves people — not large indistinct masses, but individuals of varied backgrounds and talents. Because of this, the solution to technical problems in the field of electronics in particular may frequently be basically a human one. Many problems persist or are made stickier because the human factor is neglected.

Concern with this does exist in the industry. For instance, it was very evident at the recent AIME meeting on advanced electronic materials. The meeting featured a two-hour panel and audience discussion on trends in materials. But only a small portion of the time was actually devoted to materials. After quickly agreeing that the building of useful new devices requires uniting the materials man with the component, circuit and device designer (ELECTRONICS, p 66, Sept. 6), the audience spent the remaining time discussing human problems involved in accomplishing this. For example, progress in developing new solid-state devices will require more understanding of how to control crystal-growing process. Yet, as one scientist asked, how do you get capable people into crystal growing when all the credit may go to the man who puts the crystal into a new device?

The answer that emerged from that particular discussion was essentially this: Don't call the crystal chemist a crystal manufacturer and stick him in an isolated corner of the lab; get him in contact with people who need his work, who can present him with a challenge, and who will appreciate the results.

Obviously human questions are not limited to growing crystals. As one research manager pointed out, they are really part of the whole problem of how to organize research and development. The electronics industry was one of the first to recognize the importance of obtaining close interaction between people and motivating them to communicate their results and problems to one another.

As our technological superstructure gets heavier, let's not forget the importance of personal motivation and appreciation to technological progress.

**LASER COMPUTER.** The news item on p 39 this week describes what could become a significant application for lasers. As components in an optical-electronic computer, they may greatly decrease the time required to solve complex mathematical problems through a light-phasing technique.

Interestingly, while the adaptation of light-phasing to lasers is new, the concept of light-based computations is not. In the early 1930's, we are informed by the people doing the present work, a "photoelectric integrator" was described by T. S. Gray in the *Journal of the Franklin Institute*. Gray was developing at that time one of the early computing machines. His integrator passed a beam of light through two data planes and onto a solution plane to solve certain integral equations—just as the laser computer would do.

For reports on some of the other approaches and work being done on optical computers, we refer you to articles on p 30, Nov. 9, 1962, and p 72, May 3, 1963. The first article starts with this remark: "General-purpose optical digital computers may be nearer than you think."

**AU REVOIR, NRE.** As a result of Carl David Todd's series of articles on the negative resistance element, we have half-coined a new slogan: "Never underestimate the versatility of a new component." His article this week (p 30) on using the NRE for Q multipliers is the last of five articles on this new component (strictly speaking, it isn't a discrete component, but a packaged circuit.)

We frankly hadn't planned on running five articles on the NRE. But some of the analog and digital applications possibilities outlined in the introductory article (p 21, May 31) seemed worth probing further. So there followed reports on the NRE's application to d-c switching (p 32, July 12), free-running multivibrators (p 50, July 26) and monostable multivibrators (p 35, Sept. 13).

The NRE is not of course the only negative-resistance device. For example, in our March 8 issue, Vasil Uzunoglu, of Westinghouse Electric, came up with a whole series of useful negative-resistance circuit configurations. His use of the term "negative resistance," by the way, touched off a controversy on definition that is still going on in our *Comment* page.

## Coming In Our October 11 Issue

**MICROWAVE GENERATORS.** High-power solid-state microwave generators pose some sticky design problems—varactor nonlinearity, for example. Next week, our lead feature article shows step-by-step how to cope with such problems. Among other articles will be:

- Pulse-width modulation circuit that avoids using precision components and power supplies
- How silicon controlled rectifiers help capacitor banks charge and discharge rapidly
- Artificial-limb control that is actuated by the electric potential in the wearer's muscles.

**Only from Sprague!**

**Multi-Advantage  
Construction in a  
Low-Cost  
Film Capacitor!**



- (A) Hard, durable, orange epoxy protective coating.
- (B) Lead firmly welded to metal end cap.
- (C) Fixed diameter of metal end caps insures uniformity of capacitor size.
- (D) Extended-foil capacitor roll inside end cap—every turn of electrode is positively contacted, assuring non-inductive section.
- (E) Metal end cap guards against entrance of moisture.
- (F) Specially selected ultra-thin polyester film dielectric permits dramatic size reductions.

**TYPE 206P for "CORDWOOD" PACKAGING**

Two tiny sizes (.090" D. x .250" long and .138" D. x .390" long) for compatibility with other "cordwood" components supplement the Type 192P ratings in the standard Pacer Capacitor line.

• • •

For complete technical data on Type 192P and Type 206P Pacer Capacitors write for Engineering Bulletins 2066 and 2067, respectively, to Technical Literature Service, Sprague Electric Co., 35 Marshall St., North Adams, Mass.



**COMMENT**

**REBALANCING THE ELECTRONICS BUSINESS**

Regarding your editorial of 9 August (p 3), Is Peace Breaking Out?, I am most disturbed by this and similar writings in the electronics press.

Is it not far better to look *now*, for a realistic solution for the rebalancing of the electronics business on a peacetime basis, rather than create a climate of opinion which must, in spite of itself, resist disarmament for purely economic reasons? Although your editorial may have been intended to make just this point, I feel it trod too lightly on the toes of the all-military electronics suppliers.

BERESFORD SMITH

Princeton, New Jersey

• In context with our editorials of Feb. 22 (p 3, Let's Look at the "Civilian Section") and June 28 (p 3, One Customer Isn't Enough), the August 9 editorial is in fact a strong recommendation that the industry put more effort into developing nonmilitary markets. We know of no other way for the industry to achieve the rebalancing urged by reader Smith. Because the industry cannot patriotically or economically slight defense business, the balance, it seems, must be achieved by building up nonmilitary business.

**TRANSISTOR SYMBOL**

We feel it necessary to protest at the attitude of the editorial headed Defeat in Venice? in your July 12 issue (p 3).

The only conclusion that can be drawn is that, in your view, the only standards are U.S.A. standards. We cannot find one logical argument in the article to favour the "classical" symbol over the proposed symbol, except your first point that the "classical" symbol has been with us for several years.

We can see no reason why the circle is more necessary with the proposed symbol, and the comment on templates is irrelevant. It is worth noting that all transistor schematics in the subject issue of ELECTRONICS used the "classical" symbols *with* circles.

The point about more complex semiconductor devices is particularly weak, since both symbols will accommodate new devices with equal ease or difficulty.

We all have seen symbols improved by evolution, and it is for this reason that we have not written this letter in Gothic script, even though this has also "been with us a long time."

J. A. JONES  
M. F. VINCENT  
J. N. WHITTAKER

London, England

**NEGATIVE RESISTANCE**

I have been following the dialogue on negative "resistance" and offer the following suggestion, based on the discussion on pp 64-68 of "Linear Vacuum-Tube and Transistor Circuits," McGraw-Hill, 1961.

Since it is shown in that reference that a *short-circuit-stable* port (that is, terminal-pair) can be considered as arising from a *transadmittance* controlled source, such a port could be defined as a *negative admittance*. Similarly, the *open-circuit-stable* port could be defined as a *negative impedance*.

Note that such definitions, in less general cases, lead to negative conductance, *negative susceptance* (both short-circuit-stable ports), *negative resistance* and *negative reactance* (the latter pair being open-circuit-stable ports). Each of these four ports yields a fundamentally different response when driven by a generator.

In short, I believe that any definitions proposed for active negative immittances should provide for *all* of the possible two-terminal networks exhibiting "negative" properties.

A. J. COTE, JR.

U. S. Naval Ordnance Laboratory  
Silver Spring, Maryland

**HALL ELEMENTS**

The August 23 issue carried a write-up on . . . thin-film Hall elements (p 48). We appreciate the generous coverage on [our] new component.

The article does contain some information that is not [universal]. . . . The third line, referring to Hall elements, states, "They are constructed of a slab of indium arsenide or indium antimonide on a ceramic or ferrite substrate." This is not applicable to our elements, which are made from a high mobility metal (rather than a semiconductor element) sandwiched between Mylar insulation, and contains copper terminals. . . .

ROBERT M. GITLIN

American Aerospace Controls, Inc.  
Farmingdale, New York



# FASTER AND SIMPLER PRODUCTION-RUN TESTS WITH NEW DIGITAL READOUT OSCILLOSCOPE

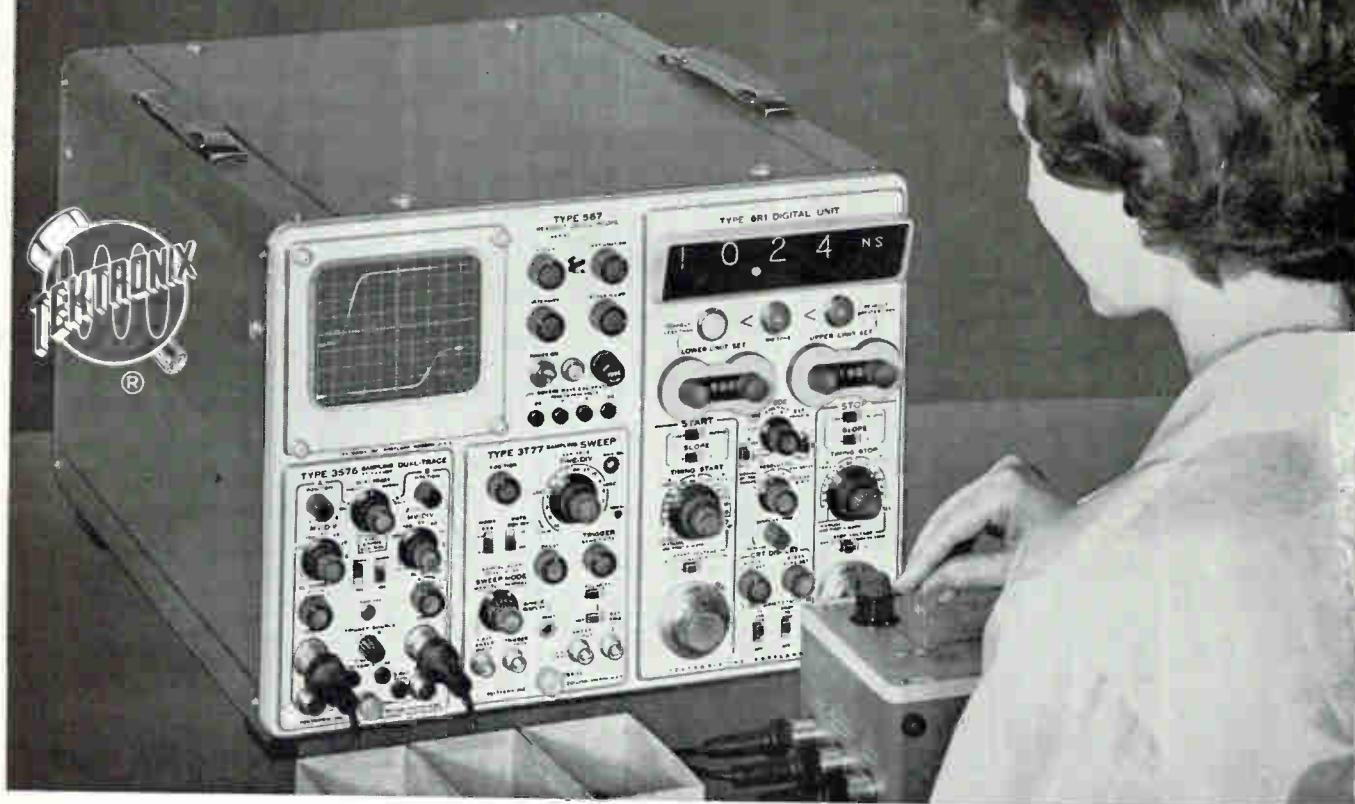

- DIGITAL READOUT** of pulse amplitudes as small as 2 millivolts peak-to-peak
- DIGITAL READOUT** of pulse risetimes as fast as 0.35 nanosecond
- DIGITAL READOUT** of time differences as small as 50 picoseconds up to 100 microseconds

With this new Tektronix Readout Oscilloscope you can measure pulse amplitudes and time increments faster and easier. For, after selecting measurement points on the displayed waveform *once* for all successive similar measurements, you make the tests and read the digital data directly. Indicators light to designate the readout status—whether *in* the preset-limit range, *below* it, or *above* it.

In a typical test application, such as measuring transistor switching times, you can read directly such characteristics as the delay, rise, storage, and fall times; the total turn-on and turn-off times; the width of pulse A and pulse B; and time and amplitude between two selected points on either waveform. You know immediately by the digital presentation and indicator lights whether or not the item tested has met specifications.

Also, the Tektronix Readout Oscilloscope—with digital and sampling plug-in units—can be externally programmed for automatic sequential operation.

On a production line, in a laboratory, or for sustained testing programs, the digital convenience of this Tektronix Readout Oscilloscope can speed up and simplify your measurement applications.

- Type 567 Readout Oscilloscope  
(without plug-ins) . . . . . \$ 700
- Plug-In Units include:*
- Type 6R1 Digital Unit . . . . . \$2500
- Type 3S76 Sampling Dual-Trace Unit . . . \$1100
- Type 3T77 Sampling Sweep Unit . . . \$ 650

U.S. Sales Prices f.o.b. Beaverton, Oregon

**FOR A DEMONSTRATION—  
PLEASE CALL YOUR  
TEKTRONIX FIELD ENGINEER**

**Also Available**—2 new plug-in units to extend digital readout of signal information to low and medium frequency applications.

**Tektronix, Inc.** / P. O. BOX 500 • BEAVERTON, OREGON 97005 / Phone (Area Code 503) Mitchell 4-0161 • Telex: 036-691 • TWX: 503-291-6805 • Cable: TEKTRONIX • OVERSEAS DISTRIBUTORS IN 27 COUNTRIES

Tektronix Field Offices: in principal cities in the United States. Consult Telephone Directory • Tektronix Limited, Guernsey, Channel Islands  
Tektronix Canada Ltd.: Montreal, Quebec • Toronto (Willowdale), Ontario • Tektronix Australia Pty. Limited, Sydney, New South Wales

**COPY**  
**CAT**



**TAPE COPY STATION FOR ATLANTIC MISSILE RANGE**

**Six 1.5-mc Mincom CM-100 Recorder/Reproducers** form the backbone of an extremely complex tape copy station recently delivered to the Atlantic Missile Range, through Defense Electronics, Inc., Rockville, Maryland. Set up at AMR last March, the station makes possible for the first time as many as five first-generation copies of prime data tapes in one operation. In addition to the six CM-100's, it also includes two 600-kc Mincom G-100's, two degaussers, and an advanced monitor alarm system policing forty-two 1.5-mc channels. The station is the result of Mincom's long experience with frequency responses of better than 1 mc—an outstanding reliability record since 1955.

**Mincom Division** **3M**  
COMPANY  
2049 South Barrington Avenue, Los Angeles 25  
425 13th Street N. W., Washington 4, D. C.

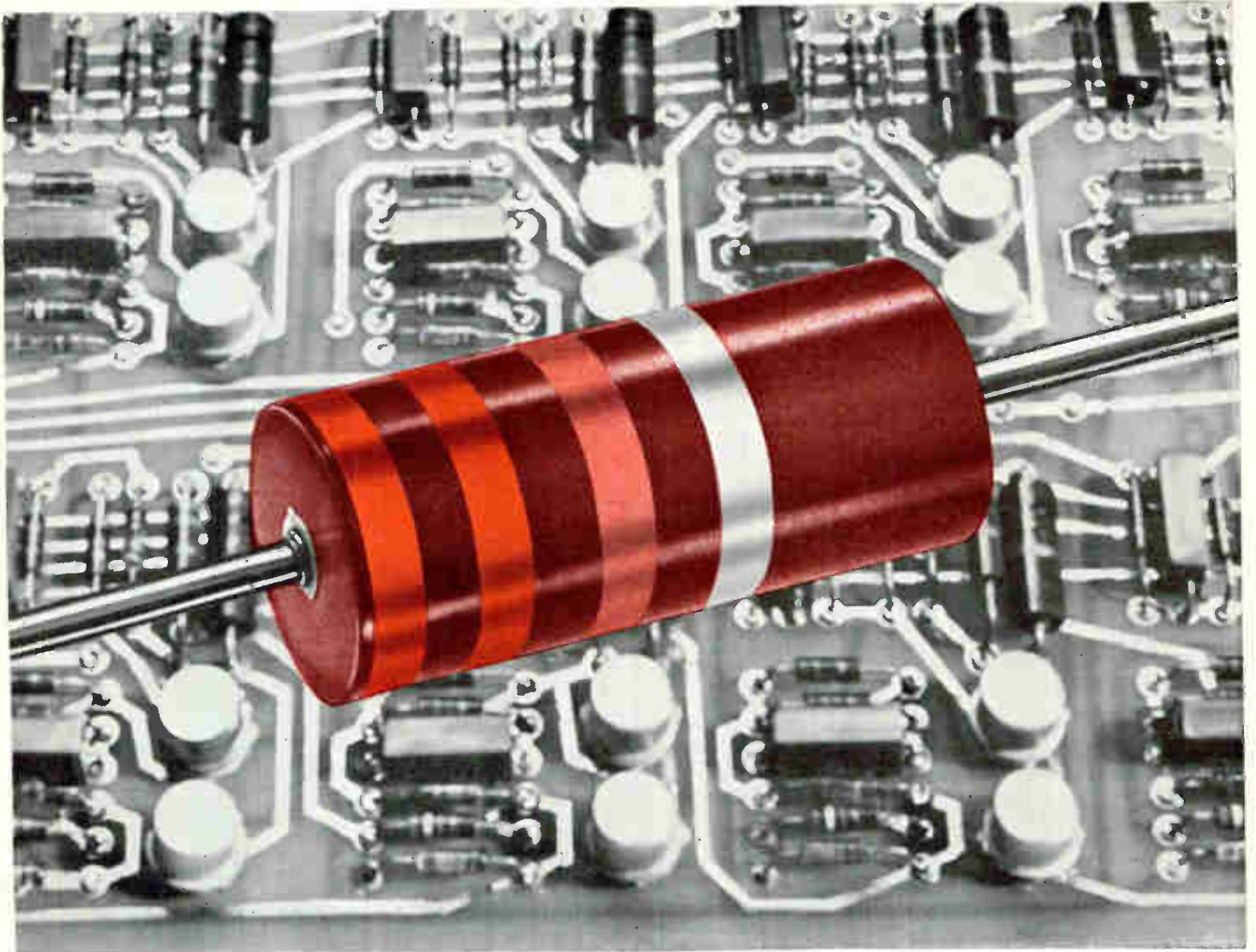

## Why Allen-Bradley hot molding is so important to resistor performance

■ First and foremost, Allen-Bradley's exclusive hot molding provides a uniformity that cannot be matched by any other resistors on the market—a fact with which hundreds of Allen-Bradley customers have become acquainted through their experience for over 30 years. Such history of uniformity in physical dimensions and electrical properties from one resistor to the next . . . from one order to the next . . . has been demonstrated in the production of more than *ten billion resistors*.

In addition, with their stable characteristics and conservative ratings providing an *extra* margin of safety, you can accurately predict long term resistor performance under various circuit conditions—and at all times be certain of *complete freedom from catastrophic failures*.

A unique manufacturing method is the key which

makes all this possible. Allen-Bradley's hot molding technique is unlike anything in the industry, because both the process and the automatic machines—with built-in precision control—were developed and perfected by Allen-Bradley. Here, the resistance material, insulation material, and lead wires are hot molded into one solid integral structure that's mechanically strong—completely free of cracks which might admit moisture.

There are additional reasons why more and more leading electronic manufacturers are standardizing on Allen-Bradley hot molded resistors. Complete specifications are furnished in Technical Bulletin 5050. Please send for your copy, today: Allen-Bradley Co., 110 W. Greenfield Ave., Milwaukee, Wis. 53204. In Canada: Allen-Bradley Canada Ltd., Galt, Ont.

TYPE TR 1/10 WATT		MIL TYPE RC 06
TYPE CB 1/4 WATT		MIL TYPE RC 07
TYPE EB 1/2 WATT		MIL TYPE RC 20
TYPE GB 1 WATT		MIL TYPE RC 32
TYPE HB 2 WATTS		MIL TYPE RC 42



# ALLEN-BRADLEY

QUALITY ELECTRONIC COMPONENTS

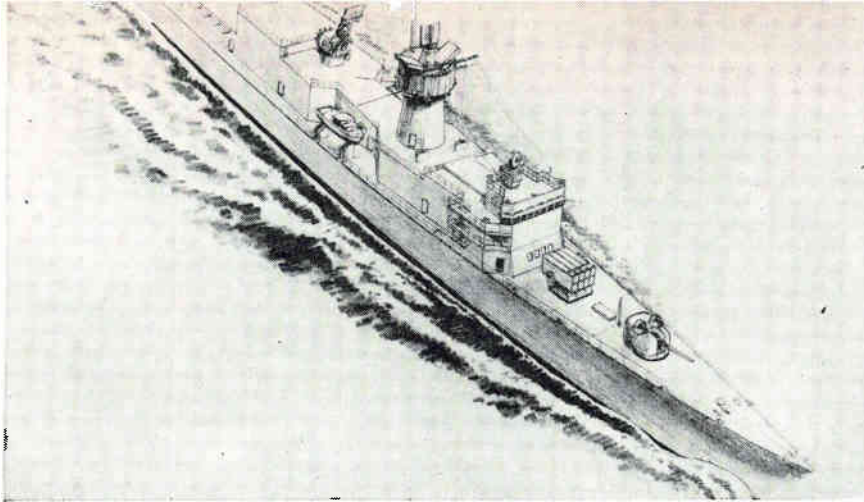

NEW ESCORT SHIP (DE) design treats the ship structure and electronic systems as a package. This approach will ultimately be used in all Navy ships

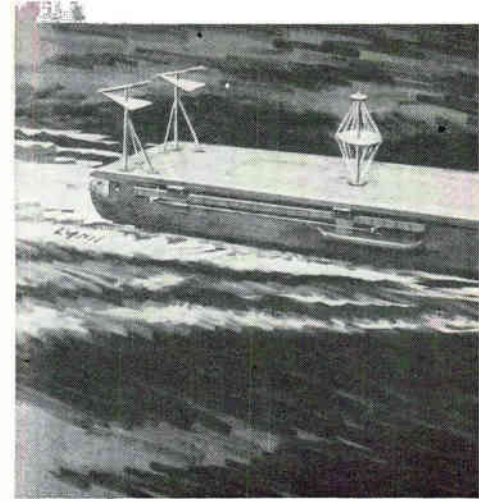

SPECIAL ANTENNA designs will be used (AGMR), programmed to take the place of

# Navy's New Ship Program Calls

Automation and tighter control add new gear to Navy's war ships

**ELECTRONICS INDUSTRY** can expect contracts amounting to more than \$827 million to come from Navy's \$2-billion 1964 shipbuilding and conversion program. This figure is based on Navy's estimate that 40 percent of the cost of a new ship, or conversion of an old one, goes for electronics.

In future years, the percentage for electronics will go even higher. Navy is automating as many ship functions as technology permits, and has already started to implement the new Coordinated Ship Electronic Design (CSED), designing a ship and its electronic systems as a package (ELECTRONICS, p 10 Sept. 13). CSED has been used in the attack submarines, is scheduled for the *Sea Hawk* ASW ship, and will subsequently be used for all Navy ships.

**Polaris Ships** — Approximately \$702.3 million is programmed for construction of six nuclear-powered Polaris subs. Electric Boat division of General Dynamics will build three; Newport News Shipbuilding and Drydock, two; and the Mare Island Naval Shipyard, one.

All ships will be equipped with SINS, ship's inertial navigation system; AN/BQQ-3 sonar classification system; AN/BQS-4 detection and tracking sonar; and an AN/WRT-4 m-f/h-f transmitter.

Also, \$109.3 million will be spent from another budget category for Polaris support equipment, and most of \$669.3 million earmarked for "Polaris and Dash drone helicopters" will go for Polaris missiles.

To support the Polaris subs, a new tender will be constructed and a cargo ship converted. Besides a tremendous amount of electronic test and check-out gear, the tender will probably have SINS, as does the *USS Hunley*. The cargo ship—AK (FBM)—will carry missiles and supplies needed to keep a Polaris sub on station.

**Other Warships** — Approximately \$787 million is programmed to build six nuclear-powered attack subs, modernize 19 destroyers, and convert five destroyers and two frigates to guided-missile destroyers.

Attack subs—SS(N)—will be improved beyond the *Thresher*, including better depth control. The subs will have SINS and AN/BQQ-3 sonar classification gear.

From another budget category, \$682.9 million is programmed for ASW weapons and detection devices—Asroc weapons, submarine and air-launched torpedos, including the

MK 46 torpedo. The MK 46, now under integrated technical evaluation, will require \$31.5 million in 1964. By 1965, the weapon should be ready for competitive bidding by industry.

Nineteen destroyers (DDFRAM) will be modernized with the latest ASW equipment. Some will get the AN/SQS-23 long-range sonar (keel mounted), improved air and surface search radar, sonar, Asroc, improved combat information center, communications capability, and Dash drone helicopters (ELECTRONICS, p 18, April 19).

Five destroyers (DDG) will get Tartar missiles, Dash, and an improved underwater battery fire-control system for the existing advanced sonar installation. Other systems include AN/SPS-39A 3-coordinate air search radar and AN/SPS-29 or -40 air-search radar. After these five conversions, Navy plans 13 more.

Two bigger destroyers (DDG-DL) will have Tartar missiles, Asroc, improved fire-control system for existing Dash and advanced sonar installations.

For existing DLG's, Navy will buy three sets of 3-D air-search radar, AN/SPS-48, built by Gilfillan for \$4.5 million; eight in 1965 for \$12 million; five in 1966 for \$7.5 million. Navy says the radar is so accurate on range, bearing and height that it will be integrated into the

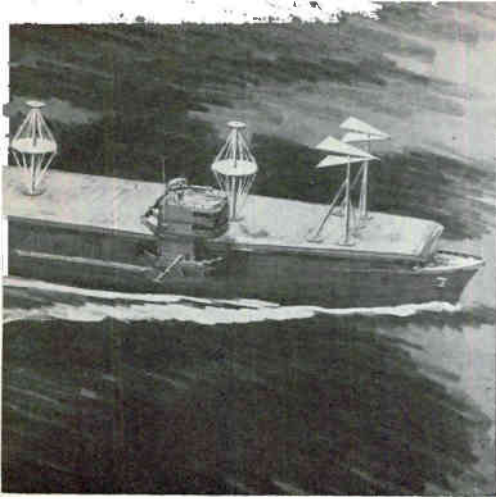

on the major communications relay ship  
a major shore communications station

---

## CONGRESS CUTS SHIPBUILDING BY \$1/4 BILLION

Navy originally requested authorization for 41 new ships and 35 conversions, plus 203 new small craft (32 service craft and 171 landing craft). Estimated cost of the program was \$2,461 million. New obligation authority required was \$2,310 million.

The House slashed the request for new ships down to 32, recommended Navy convert 36 ships and approved the 203 service and landing craft. Money cut amounted to \$229,911,000, leaving \$2,080,089,000.

The Senate last week knocked out one more new ship—leaving 31—and went along with the House recommendations for 36 conversions and 203 service and landing craft. Money recommended was \$2,068,089,000, \$12 million below the House allowance.

The final bill will be drawn shortly in a conference of House and Senate appropriations committees

---

# for More Electronics

By JOHN F. MASON  
Senior Associate Editor

surface-missile system to acquire targets. Hughes is upgrading a similar radar that Navy also may consider. The radars will be used on frigate class (DLG) ships and later on missile and air-control ships.

**Amphibious Ships**—\$141 million is scheduled for construction of three amphibious transport dock ships (LPD) to carry landing craft, helicopters, troops and equipment. They will be equipped with Hicapcom, the high-capacity communications system, and AN/SPS-40 air-search radar.

**Mine Warfare and Patrol**—\$314.4 million will be spent to construct ten escort ships (DE), two motor gunboats (PGM) for counterinsurgency, and to modernize one mine countermeasures ship (MSC).

The escort ships (DE) will have the most advanced ASW detection devices and weapons now available: Asroc, Dash, MK-32 torpedos, and the Sea Mauler when this sea-going version of Army's Mauler becomes operational. All the electronic equipment is in production, except for the AN/SQS-26 sonar and the variable depth sonar (AN/SQS-35) that are in development (ELECTRONICS, p 10, Sept. 13). Other improvements include better signal-processing equipment, less noise, ability to search at higher ship speeds and in worse sea states.

New equipment on the PGM's includes an integrated fire-control system. The MCS will use electronic or sonic mine detectors.

**Auxiliaries and Craft**—\$225.7 million will buy one new destroyer tender (AD), one combat stores

ship (AFS), and two surveying ships (AGS). Conversions include one major communications relay ship (AGMR), three oilers (AO), and three ammunition ships (FAST), and one floating drydock (ARD-FBM). Also, 203 service and landing craft will be built.

## Russia Tries Gamma-Ray Laser

GAMMA-RAY LASERS are feasible, according to B. V. Chirikov of the Nuclear Physics Institute, Siberian Division of the Academy of Sciences, USSR, writing in *Zhurnal Eksperimental'noy i Teoreticheskoy Fiziki*.

His proposal is based on a pure nuclear isomer crystal that yields a single pulse of gamma emission. Restricting his analysis to a first approximation and considering only low-energy flow, he developed theoretical expressions for the cross section of stimulated emission and obtained criteria for amplification of the gamma wave within the crystal. The problem of reflecting the gamma flux and lengthening its path in the active medium is avoided owing to the kinetics of such a gamma-emission system.

Because the time needed to at-

tain a pure isomer crystal is long, the excited lifetime is also long, exceeding the characteristic time of gamma-wave development. This time is expected to be 1 second. With a characteristic length of 1 mm, a crystal several centimeters long will appear virtually infinite and eliminate need for a resonant cavity.

As a first step, Chirikov will attempt some amplification. This is difficult because the Mossbauer line is wider than the narrowest line that can be tolerated. However, a breakthrough is expected soon "in view of the exceedingly intensive research on the Mossbauer effect carried on at this time."

Besides Chirikov's previous work, papers and patent applications for gamma lasers have also been filed by Soviet scientist L. A. Rivlin.

*Amazing new Duocoat process . . .*

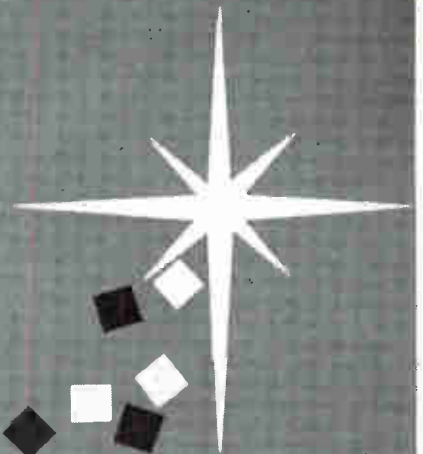

*salts the surface and not the fiber!*

How did we do it? It's a secret. Suffice it to say Duocoat is a miracle of GAF Ozalid chemical wizardry. A unique process that lays sizing and printing surface in *one* application. Pores of the paper are filled so the diazo emulsion goes onto the surface—*not into the fibers*.

The result? You get cleaner, sharper, denser images unclouded by fibrous intrusion. What's more, Ozalid Duocoat gives you the ultimate in color: AVA blue. That's short

for Apex of Visual Acuity, which means it's real easy to see. Use new GAF Ozalid Duocoat Blue-Line White Paper and see the difference in your prints. It's available in 205S and 208S standard weight, rapid speed papers. And they cost no more.

**gaf** **OZALID**  
REPRO PRODUCTS  
GENERAL ANILINE & FILM CORPORATION  
BINGHAMTON, NEW YORK

# Why are we changing our name?

Since its incorporation in 1928, Erie Resistor Corporation has dedicated itself to establishing the finest possible reputation in the electronics industry. One of our main objectives has always been to provide a high degree of product value and service at a fair price for such value and service. Our vision, research, and technology have long since carried us beyond the scope of the resistor business, and "Erie Resistor" no longer accurately describes our company. We are changing our name because —

■ We now design, manufacture, and market scores of electronic products other than resistors.

■ We've greatly expanded our R & D facilities. Several industry-famous scientists have been added to our R & D staff.

■ Creative scientific investigation into exciting new electronic and materials fields has become a way of life in our company.

■ Our plans for the future encompass much more than components for the electronics industry.

## AND

■ Our manufacturing operations all around the world have been expanded, modernized, and reoriented to new concepts in electronics.

The new name . . . Erie Technological Products, Inc., . . . is a much more accurate description of the present and future plans for our company. Don't you agree?

ERIE

TECHNOLOGICAL

PRODUCTS, INC.



644 West 12th Street  
Erie, Pennsylvania

FORMERLY ERIE RESISTOR CORPORATION

WHERE IMAGINATION CREATES VALUE IN ELECTRONICS



PULSED TORQUING in inertial measurement unit makes output of gyros digital. At right, David G. Hoag, Apollo technical director at MIT, inspects mockup of this unit. For view of overall system, see cover. At far right, Michele Sapuppo, of MIT, and John Morgan, of Sperry, work on inertial platform

## Polaris-Proven Electronics to Guide APOLLO

By THOMAS MAGUIRE, Regional Editor, Boston



System, nearly ready for production, includes rope-memory computer

**CAMBRIDGE, MASS.** — A complete flight-type Apollo guidance-navigation (G&N) system, incorporating Polaris-proven components plus unique engineering advances, is expected to be in operation by 1964.

This was disclosed last week by NASA at a press conference at MIT Instrumentation Laboratory, which has primary design responsibility. NASA spokesmen declined to say how much Apollo's guidance-navigation will cost, but to date, contracting is \$85,280,000—including allocations to MIT and the four participating contractors, AC Spark Plug division of General Motors, Raytheon, Kollsman Instrument and Sperry Gyroscope.

"The design is virtually complete—and we are within spitting distance of our original schedule," said Milton B. Trageser, MIT's Apollo project director.

Hugh Brady, of AC Spark Plug, said a manufacturing prototype of the G&N unit is now being assembled at Milwaukee, simultaneous with assembly of another system at MIT. The AC system will soon be ready for checkout and start of manufacturing is "imminent."

**Design Features** — The inertial-celestial system can operate without information from earth, but can also accept information—and commands—from earth. Earth stations will monitor all in-flight data and commands. Apollo astronauts will be able to choose operating modes ranging from almost fully manual to automatic. Peak consumption of the entire G&N system will be several hundred watts.

Design features also include:

- Ultracompact computer using integrated circuits (ELECTRONICS, p 17, Sept. 27).

- Inertial measurement unit whose gyroscopes and accelerometers employ advanced pulsed torquing techniques. The pulsed integrating pendulum accelerometers made by Sperry Gyroscope are adaptations of a basic MIT design for Polaris. Pulsed torquing makes inertial reference integrating gyros digital devices so commands are more easily and reliably handled by a digital computer.

- Optical unit, by Kollsman, will have such advanced capabilities as basing sextant measurements on the illuminated earth or moon, on earth and lunar landmarks, and on the times of star eclipsing by the earth or moon.

The G&N station aboard Apollo will also include an advanced power-servo assembly, a map and data viewer with extremely high information density, and five coupling and display units.

**Computer** — The general purpose G&N computer is specially organized for moon-flight data handling, and unmatched today in power efficiency and compactness.

Basic word length in parallel operations is 15 bits, with an added bit for parity check and with sub-routines for double and triple-precision operations. Memory-cycle time is 11.7  $\mu$ sec, single addition 23.4  $\mu$ sec, double precision multiply sub-routine 780  $\mu$ sec.

Programs and fixed data are stored in a core-rope memory. Variables are stored in a coincident-current ferrite-matrix erasable memory. The core-rope memory and logic use integrated microcircuits supplied primarily by Fairchild Semiconductors. The Micrologic circuits are connected by welding techniques developed by MIT and Raytheon for Polaris.

Raytheon is to supply 13 complete computers, including backup spare modules carried side by side with the operating modular trays.

Because of similarities with the Polaris computer, NASA declined to specify the Apollo G&N computer's designed mtbf.

Ralph R. Ragan, of Raytheon, said state-of-the-art advances have halved the originally contemplated computer size while doubling memory capacity. It sizes less than 1 cu ft and weighs less than 60 lbs. Memory capacity is classified, but for an Apollo-type mission, 10,000 words is a minimum.





**Rope Memory** — In the core-rod memory, a fixed-storage device with nondestructive readout, each rope is divided into two physical sticks. On command, the fixed memory will retrieve one 16-bit word from a stick. Bit density of the fixed-memory portion of the computer, including circuits and interconnections, is 1,550 bits/cu in. One stick contains 512 Permalloy tape-wound cores of  $\frac{3}{8}$ -in. diameter, 128 diodes, 64 resistors and approximately 1,200 feet of 34-gage wire.

To select and sense information, each core of a rope is approached by 128 sense wires (8 words). The bit configuration of the four words in that core is generated by passing the sense wires through or by passing the core. Anytime a core is switched, it generates a pulse on only the sense wires that pass through the core. Diode gating selects one of the four sets of sense lines for an output.

In a complete fixed-memory cycle: (1) the desired core is selected by generating currents that inhibit all other cores; (2) the core's desired word is selected by forward biasing diodes of the 16 sense wires of the selected word; (3) a set current pulse is applied to all cores and the selected core switches (other cores were inhibited); (4) the selected 16 sense wires are sampled and latched in the memory data register; (5) the reset current pulse is driven to clear all cores to the reset polarity.

# our stock answer is YES!

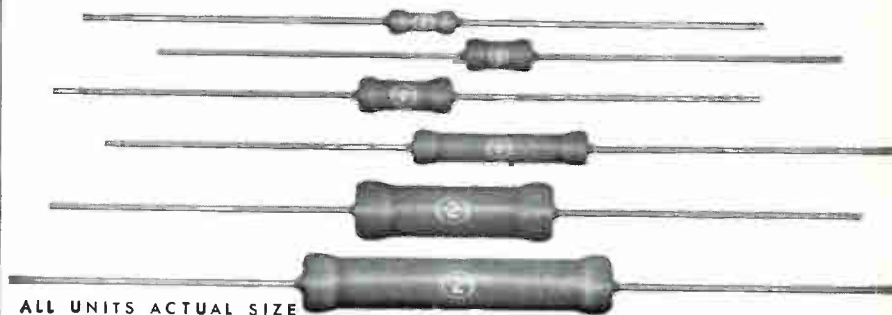

ALL UNITS ACTUAL SIZE

*ALL AXIAL LEAD*

*BLUE JACKET RESISTORS*

*in 1, 2, 3, 5, 7 and 10-watt power ratings are carried in  
factory stock for immediate delivery.*

*Place your order now with your  
nearest Sprague District Office or Sales Representative.*

*Key Sprague Industrial Distributors  
carry most popular ratings in local stocks.*

*For application engineering assistance write:  
Marketing Dept., Resistor Division, Sprague Electric Co., Nashua, New Hampshire.*

## SPRAGUE COMPONENTS

RESISTORS  
MICROCIRCUITS  
CAPACITORS  
TRANSISTORS  
INTERFERENCE FILTERS  
PIEZOELECTRIC CERAMICS

PACKAGED COMPONENT ASSEMBLIES  
FUNCTIONAL DIGITAL CIRCUITS  
MAGNETIC COMPONENTS  
PULSE TRANSFORMERS  
CERAMIC-BASE PRINTED NETWORKS  
PULSE-FORMING NETWORKS



# Here's how Martin Company saves \$16,000/year cleaning safety suits for TITAN II!

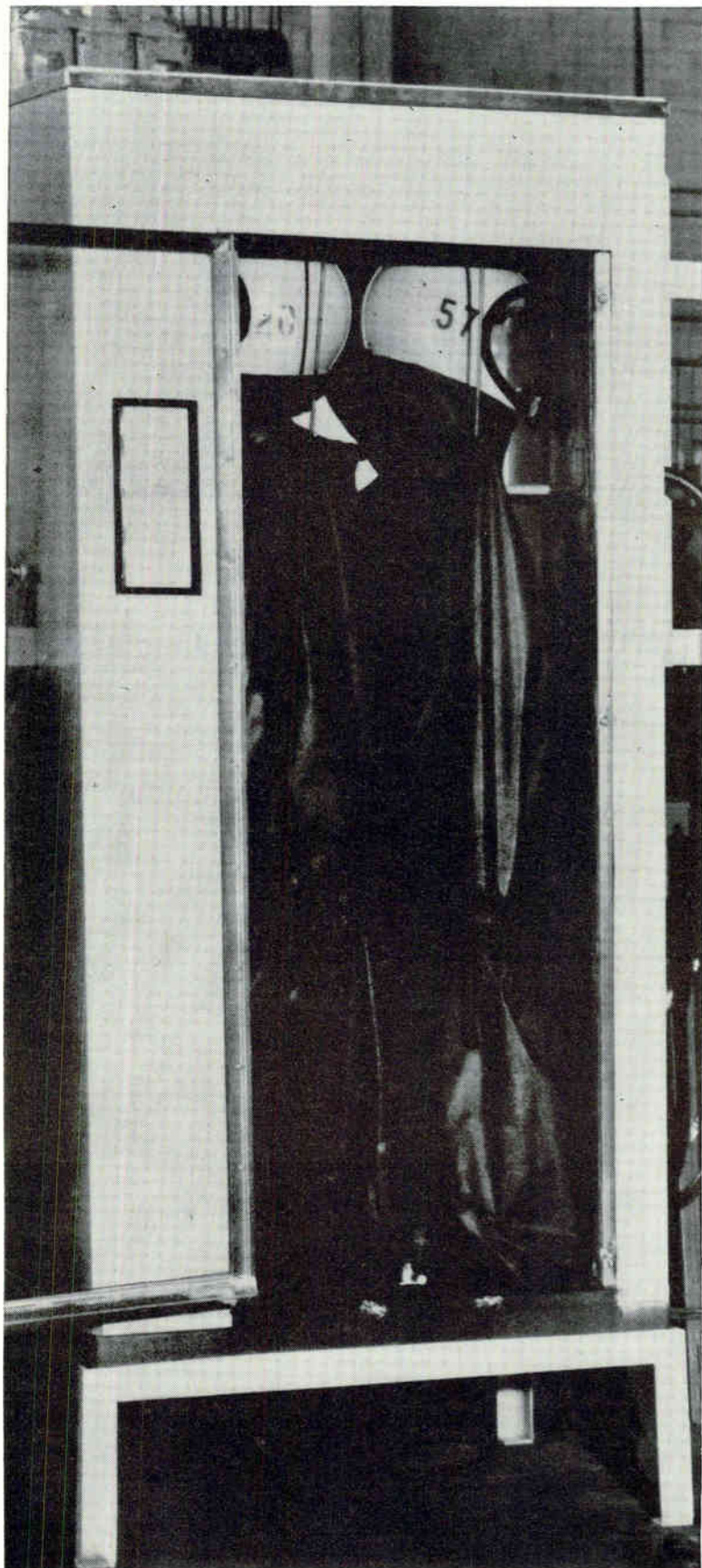

**PROBLEM:** It used to be an expensive and time-consuming job for Martin Company's Canaveral Division to clean these critical safety garments. The suits protect TITAN II launch-stand personnel from toxic propellants during fueling and countdown. They must be cleaned after each wearing for toxicity and sanitation reasons. Formerly, Martin did this laboriously by hand with detergents at \$6.35 per suit.

**SOLUTION:** An entirely new cleaning system based on FREON fluorocarbon solvents. FREON is an efficient *selective* solvent. It quickly removes toxic fuels or vapors, oil, grease and dirt from the suit while not affecting plastic or metal parts in any way.

To clean the suits, Martin uses FREON in a modified shower cabinet, fitted with several nozzles to drench 2 suits thoroughly—both inside and out. Since adopting this system, cleaning time per suit has been cut from 1½ hours to 5 minutes; cost, from \$6.35 to \$1.10. So in one year, with 3,600 safety suits cleaned, that's a saving of \$16,000!

Martin also likes FREON because it is non-flammable, nonexplosive, and has very low toxicity—making it safe and easy for workers to handle. And—extremely important—contaminated FREON is easily purified for reuse over and over again.

Wherever *you* have a critical cleaning problem, components or assemblies, electronic, electrical or mechanical, it's quite possible FREON solvents could improve operations and cut costs. We'd be happy to discuss it with you! First step: send the coupon or Reader Service Card for our new cleaning booklet.

## FREON®

solvents



Better Things for Better Living  
... through Chemistry

### MAIL COUPON FOR NEW BOOKLET ON CLEANING

E. I. du Pont de Nemours & Co. (Inc.)  
FREON Products Division  
N-2420E-10, Wilmington 98, Delaware

Name \_\_\_\_\_ Title \_\_\_\_\_

Company \_\_\_\_\_

Address \_\_\_\_\_

Please send new booklet on FREON solvents for precision cleaning. (Offer good in U.S.A. only.)

I am interested in cleaning \_\_\_\_\_

I would like Du Pont to send a cleaning specialist.

# Telepathy—Boon for Spacemen?

PARIS—Both the U.S. and Russia have started experiments pointed toward developing the ultimate space communications system—telepathy (p 14, March 29). That disclosure highlighted the International Astronautic Congress here this week. NASA's bioastronautics director Eugene B. Konecci said the U.S. believes the Soviets have at least eight centers for energy-transfer research. If experimental results are half as good as the Soviets claim, they probably will be the first to achieve mind-to-mind communications on the moon, he said.

One Soviet researcher thinks the critical experiment could be made with a man in space under longterm gravity-free conditions. Konecci hinted U.S. work in "thought transference" leads to the same conclusion. An ideal platform for the human receiver, he said, would be a manned orbital laboratory operating in the nul region where the gravitational forces of the earth and moon are approximately equal. The human transmitter on the earth would be put under high-gravity forces. Under these conditions, Konecci said, the U.S. would expect to find a most remarkable increase in the interaction of "energy transfers" for direct communications between humans.

## Air Force, NASA Seek All-Purpose Guidance

LOS ANGELES—In about two weeks, Air Force will announce the award of contracts for a study aimed at development of single, standard guidance system for Air Force and NASA. Contractors will study varying types of space missions and space vehicles to arrive at a standard guidance for as many as possible or all missions.

Companies bidding on the contract are IBM with Nortronics, Minneapolis-Honeywell with Hughes and Raytheon, Space Technology Labs with General Precision and Univac, Autonetics and North

## Nuclear Generator Powers Satellite

SATELLITE was launched from Vandenberg Air Force Base recently with a radioisotope generator as its sole source of power, the AEC said Monday. Unofficial reports placed the launch date as last Saturday. The Snap 9-A (System of Nuclear Auxiliary Power) will give a steady 25-watt flow for the next five years from the lump of decaying plutonium 238 it carries. Snap 9-A is the size of a basketball and weighs 27 pounds. Two others were launched previously, the AEC said, but this is the first to power a satellite completely. Martin is principal contractor for Snap.

American, American Bosch Arma, RCA, United Aircraft, Sperry Rand, AC Spark Plug and Litton Industries.

## Inertial System Uses Electrostatic Gyro

HONEYWELL reported last week that it is developing for Air Force an experimental airborne inertial-guidance system whose components include two miniature electrostatic gyroscopes. The \$1.8-million contract calls for delivery of the system in the summer of 1965.

The gyro rotor is a 1½-inch, hollow beryllium sphere initially spun by a magnetic field and suspended by an electrostatic field within a ceramic case. Data is obtained from the rotor by a fiber-optic pickoff. Vacuum within the case is provided by an ion-getter pump.

## ComSat Corp. Timetable: First Launch in 1966

WASHINGTON — Communications Satellite Corp. now hopes to launch its basic satellite system between the first and third quarters of 1966. De-

sign study contracts will go out during the first quarter of 1964. ComSat wants a satellite with only about 1,000 components. During the fourth quarter of 1964, design studies will be due and hardware contracts will be awarded for a medium-altitude or synchronous system, or a combination of both.

## Microelectronics Gaining With Military

CEDAR RAPIDS, IOWA — Microelectronics will be cheaper and account for 77 percent of all military circuits by 1970, predicts Richard DeWitt, of the Secretary of Defense's Directorate of Research and Engineering.

Microelectronics now make up 30 percent of military circuits. DeWitt broke down his predicted increase to 77 percent by 1970 this way: communications, a rise from 1.8 percent this year to 9 percent in 1970; radar, 3 to 90 percent; analog computers, 0.3 to 0.6 percent; digital computers, 25 to 46 percent; control, 1.7 to 11.5 percent; and display, 0 to 1 percent.

DeWitt told the Conference on Communications here that today's \$20 silicon integrated circuits will drop below \$4 by next year and to

*Continued on page 18*

half that within 10 years.

Yields for an experimental decade-counter circuit, using metal-oxide semiconductors (MOS), an RCA speaker said, are in the 99-percent range. MOS yields were 90 percent last winter (p 52, Feb. 15). MOS circuits, RCA said, could be used in precision switching, series-parallel choppers, electronically controllable resistors.

## Dual Radars Will Track Ionized Meteor Trails

BEDFORD, MASS.—A dual radar system designed to exploit the natural tracers provided by ionized meteor trails will be used by Air Force Cambridge Research Laboratories to obtain wind and density information about the atmosphere at altitudes between 20 and 80 kilometers.

Data on density fluctuations in the upper atmosphere are needed to plan aerospace operations.

The meteor-trail radar uses two pairs of yagi antennas, one pair for 4-meter reception, the other for 8 meters. After initial operation at AFCRL, the transportable radar will be moved at six-month intervals to a succession of more southerly locations to obtain data at various latitudes and longitudes. Final measurements will be made in the equatorial regions.

Avcon, of Pelham, N. Y. By electroplating material from one end of the cell to the other, reliable mass-balance adjustments of up to 5 dyne-cm in either direction can be provided, according to E. J. Mullarkey, company president. He said a new power source makes it possible to achieve coherent plating, regardless of the gravity gradient. Similar applications are expected for fuel cells and other components for aerospace environments.

## Electrolytic Cell Balances Gyroscopes

CONVENTIONAL-DESIGN gyroscopes can be balanced by tiny electrolytic cells permanently mounted on the gimbal or float structure, reports

## Japanese Firm Gets Rights to Planar Process

FAIRCHILD CAMERA and Instrument says the Japanese government has approved its licensing agreement with Nippon Electric under which Nippon gets the right to use Fairchild's planar process of semiconductor manufacture. Nippon has exclusive rights in Japan for 10 years, but is required to sublicense the entire Japanese semiconductor industry. Fairchild says it expects first sublicense agreements to be signed shortly

## MEETINGS AHEAD

ELECTROMAGNETIC RELAYS INTERNATIONAL CONFERENCE, IEEE, ICER, IEE, Tohoku University, Science Council of Japan; Sendai, Japan, Oct. 8-11.

ELECTRICAL - ELECTRONICS CONFERENCE, Aerospace Electrical Society; Pan Pacific Auditorium, Los Angeles, Calif., Oct. 9-11.

NATIONAL AEROSPACE CONFERENCE, National Society of Professional Engineers; Lafayette Hotel, Long Beach, Calif., Oct. 10-11.

SOCIETY OF MOTION PICTURE-TELEVISION ENGINEERS CONVENTION, SMPTE; Somerset Hotel, Boston, Mass., Oct. 13-18.

AUDIO ENGINEERING SOCIETY FALL CONVENTION—EXHIBIT, AES; Barbizon-Plaza Hotel, New York, Oct. 14-18.

NEW YORK CONFERENCE ON ELECTRONIC RELIABILITY, IEEE; United Engineering Center, N. Y., N. Y., Oct. 18.

EAST COAST CONFERENCE ON AEROSPACE-NAVIGATIONAL ELECTRONICS, IEEE PTG-ANE; Emerson Hotel, Baltimore, Md., Oct. 21-23.

NATIONAL ELECTRICAL MANUFACTURERS ASSOCIATION ANNUAL MEETING, NEMA; Edgewater Beach Hotel, Chicago, Ill., Oct. 21-24.

NATIONAL ELECTRONICS CONFERENCE, IEEE, IIT, Northwestern University, University of Illinois; McCormick Place, Chicago, Ill., Oct. 28-30.

ELECTRON DEVICES MEETING, IEEE; Sheraton Park Hotel, Washington, D. C., Oct. 31-Nov. 1.

17TH NORTHEAST ELECTRONICS RESEARCH-ENGINEERING MEETING, New England Sections IEEE; Commonwealth Armory and Somerset Hotel, Boston, Mass., Nov. 4-6.

RADIO FALL MEETING, IEEE, EIA; Hotel Manger, Rochester, N. Y., Nov. 11-13.

FALL JOINT COMPUTER CONFERENCE, AFIPS, IEEE, ACM; Las Vegas Convention Center, Las Vegas, Nev., Nov. 12-14.

MAGNETISM-MAGNETIC MATERIALS ANNUAL CONFERENCE, IEEE-PTG-MIT, AIP; Chalfonte-Haddon Hall, Atlantic City, N. J., Nov. 12-15.

ENGINEERING IN MEDICINE AND BIOLOGY ANNUAL CONFERENCE, IEEE, ISA; Lord Baltimore Hotel, Baltimore, Md., Nov. 18-20.

## ADVANCE REPORT

1963 FALL URSI MEETING, IEEE Seattle Section, groups, Boeing Scientific Research Laboratories; University of Washington, Seattle, Wash., Dec. 9-12, 1963; Oct. 21 is deadline for submitting 200-word abstracts in duplicate to Prof. M. G. Morgan, Secretary, U.S.A. National Committee of URSL, Dartmouth College, Hanover, N. H. Subject areas include: radio propagation in non-ionized media, ionospheric radio, magnetospheric radio, radio waves and transmission of information, geoscience electronics, information theory, instrumentation, microwave theory and techniques.

## Woven Magnetic Planes Cut Memory Costs

CANOGA PARK, CALIF.—The Computer division of Thompson Ramo Wooldridge now estimates that the woven-magnetic-plane memories it is developing will sell for 0.01 cent to one cent per bit in a mounted stack (p 59, June 29, 1962). Memories capable of handling as many as 100 million bits of information can be built from them, TRW says.

The systems have undergone temperature tests up to 195 C on small planes and 105 C on large planes. Several 100 g's have also been exerted on a large plane with no damage resulting. The woven-screen planes have been bent and re-straightened, illustrating the absence of sensitivity to severe environments.

## ITU Agenda: Space Frequencies

WHO GETS to use what radio-frequency bands for space communications will be the main order of business at the International Telecommunication Union conference next week in Geneva. Representatives of some 66 countries will act on proposals from at least 14 countries, including the USSR, France, England and the U. S.

Communications Satellite Corp. had previously made known its wants (p 7, June 14). Russia wants provisions for space emergency frequencies. It suggests that distress frequencies allocated for ships and aircraft be increased and extended to outer space. It is one of several countries that mentions the possibility of direct broadcasting from satellites to listeners, and it wants studies in this area speeded up.

The United Kingdom considers "that it would be prudent to plan for a total frequency requirement for satellite communications of approximately 3,000 Mc/s," though it does not expect this requirement to be fully realized until 1975. France supports proposals for a single world-communication-satellite system that additional countries could join the nations "pioneer" the system have it in operation.

### Electron Microscope Checks Out Transistors

NEW YORK—Scanning electron microscope built by Westinghouse can display differences in voltage that exist on a semiconductor surface. "The beam can observe the differences in potential between the various regions of a planar-type transistor and thereby inspect in great detail the quality of the device and of the processes used to make it," said I. M. Mackintosh of Westinghouse Research Labs before the Electrochemical Society this week.

The 0.5-micron electron beam can also substitute for a beam of light in exposing a photosensitive emulsion that coats the surface of a semiconductor material, he said. The fineness of the electron beam yields minute devices believed capable of extremely high-frequency performance.

### \$5 Million Restored For Lance Missile

SENATE RESTORED \$5 million for Army's Lance missile system that the House had cut out. The surface-to-surface missile was formerly known as Missile B. It is in R&D, and is being developed by Ling-Temco-Vought at Warren, Mich. It will replace the Honest John and LaCrosse weapon systems, and perhaps the Little John.

### Bonus Play for Syncom —Tv Transmission

WASHINGTON—Although not designed for television, Syncom II last week relayed satisfactory tv pictures between Fort Dix, N. J. and Andover, Me. Tests were conducted by NASA, Hughes and Bell Labs engineers.

It was found that Syncom II's wide-band transponder, although designed for another purpose, could accommodate video signals to the exclusion of audio.

At AT&T's station at Andover, modifications, including installation of a 2-Gc traveling-wave maser, permitted the station to receive Syncom's 1,815-Mc tv signals. A portable Sony video tape recorder, with a 2.5-Mc video bandwidth capability, was used to record pictures at ITT's station at Nutley, N. J. The recorder was then taken to Fort Dix, where, with tv terminal equipment from the Relay satellite system temporarily installed for the experiment, the signals were sent to Syncom at 7,360 Mc using the station's 20-kw transmitter and 60-foot dish.

## IN BRIEF

**SPRAGUE** says it will double production capacity for electrochemical process transistors at its Concord, N. H. plant. The move follows Philco's announcement (p 17, Sept. 13) that it will discontinue transistor sales.

**GOLD ALLOY** containing one part barium to five parts gold becomes superconducting at 0.7 degree Kelvin, according to four physicists at University of California.

**75-POUND** instrument package, launched by balloon to map solar-system magnetic fields, completed a 12-hour flight successfully last week, rising to 126,000 feet and landing near Paris, Tex.

**NEW HEADQUARTERS** in New York for American Management Association includes tv studio and 41 meeting rooms with closed-circuit tv facilities. System will eventually handle three or four channels.

**BHARAT ELECTRONICS**, owned by the Indian government, is making anti-aircraft radar equipment at its Bangalore plant.

**ELECTRON** microscope by Hitachi Perkin-Elmer has attained 2.35-angstrom resolution. Device uses highly refined objective lens pole piece, made of materials with special magnetic properties, and highly stabilized electronics for electron acceleration and magnetic lens current.

**RYAN** will build hovering indicators for British antisubmarine helicopters under a \$1-million contract.

**\$1.8-MILLION** contract for lightweight solid-state multiplex gear has been awarded Electronic Communications Inc. for helicopterborne troposcatter communications terminals.

**AEC** is seeking design study proposals for a portable nuclear military power plant that would generate 1,000 kw.

**BECKMAN** Instruments, under a \$1-million NASA contract, will build monitoring-recording ground test data system for Apollo command-service modules.

**ELECTRA** Manufacturing has acquired Microelectron Inc. Both make thin film resistors and integrated circuits.

**SINS SYSTEMS** (ship inertial guidance) will be used on Navy carriers for premission alignment of aircraft inertial platforms. Sperry Gyroscope will produce 21 Mark 3 Mod 3 systems for attack submarines, carriers and a missile-launching ship, under a \$14.2-million contract.

## Kennedy's Offer Of U.S.—USSR Space Trip May Nip NASA Funds

**Effects of President Kennedy's** proposal to enter a joint lunar-landing program with the Soviets are beginning to show.

The general feeling prevalent in Congress is that Kennedy took the urgency out of the moon race whether the Soviets accept the joint venture or not. In fact, the quick interpretation of the UN speech as ending the race prompted Kennedy to explain to key legislators that he did not mean that spending for the program should be cut back.

Despite the White House stand, Congress seems even more certain now to pare NASA's budget back to around \$5 billion. A cut of \$362 million had already been made in NASA's \$5.7-billion authorization request. NASA officials also face a morale problem. The space program had already been buffeted by internal management problems, slipping schedules, and congressional criticism. Now, top NASA officials admit, it will be doubly difficult to keep up enthusiasm.

Reacting quickly, NASA administrator James E. Webb has switched themes on support for his program—now he's plugging hard on the military value of space programs, not beating the Russians to the moon.

## More Incentive Contracts for Space Work, Too

**NASA is moving swiftly** toward greater use of incentive contracts in an effort to solve cost and slippage problems. Officials are unhappy with the performance on some cost-plus-fixed-fee contracts.

For its new \$100-million lunar-orbiter program NASA is offering industry up to 10-percent incentives for keeping costs down, and an additional 7 percent for high technical performance. The penalty for cost overrun could be zero profit. In some future contracts NASA may demand that a contractor share cost overruns, so bad performance could mean a contractor loses money.

In the lunar-orbiter program, at least five 830-lb spacecraft will go around the moon photographing its surface. Information will help select the lunar landing site for Project Apollo and may aid in final design of the manned lunar excursion module. A contractor will be selected by the end of the year.

## Up or Down for Defense Budget?

**Defense spending** is apparently reaching a peak. Congress is putting the finishing touches on a fiscal 1964 budget that will be about \$1 billion below the \$48.3 billion of the fiscal 1963 budget (ELECTRONICS, p 20, Sept. 27). Meanwhile, the Department of Defense is preparing its budget request for fiscal 1965. Prospects are that the Pentagon will not make the 1965 request higher than the 1964 one—the first time in four years no increase was sought.

Strategic weapons systems—long range bombers, ICBM's and Polaris submarines—are phasing out. But production of tactical fighters and transport planes is expected to continue rising, Army is modernizing, Navy wants to modernize (see p 10) and there are hints of a more favorable outlook for Air Force space programs. These trends should help keep defense electronics spending firm.

## World's Biggest Environmental Lab

**Air Force has perfected** a technique for multiple satellite launches that will be used in a variety of space projects to research radiation effects and equipment reliability. Air Force has placed two tiny 1½-lb tetrahedral research satellites (TRS) into orbit from a mother spacecraft using an Atlas Agena booster. Ten separate experiments will be conducted by the pair of satellites. Indications are that additional launches can be expected. Dubbed by the Air Force as a test bed to determine the reliability of unproven spacecraft components and subsystems, the satellites were developed by Space Technology Laboratories for \$70,000. Production models cost \$15,000 each.

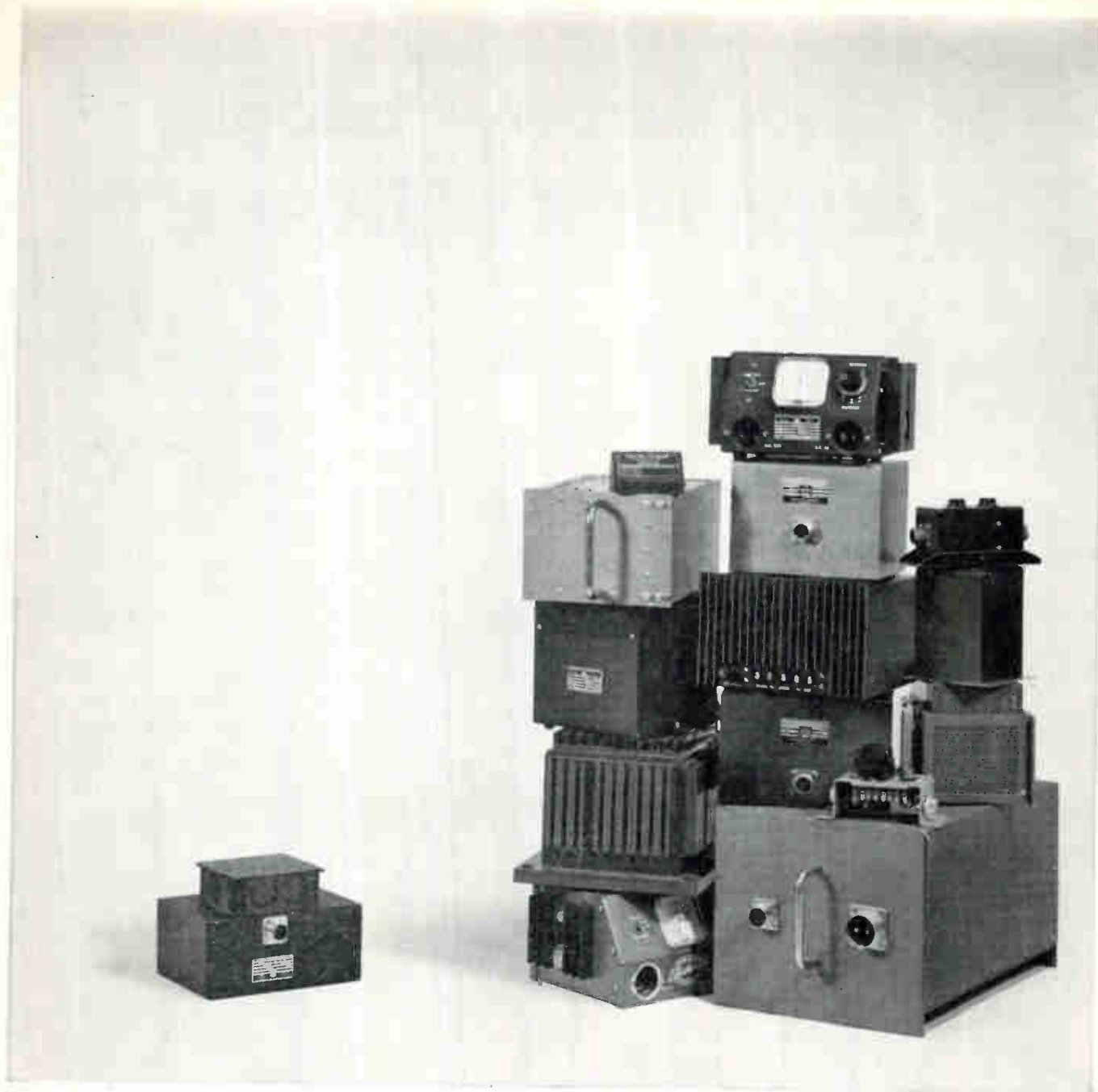

When you make a good inverter . . .

it's hard to stop.

If you're looking for one of the most complete lines of static inverters for military and industrial applications, you'll find it at Hamilton Standard.

From models in production, you can mix a limitless combination of characteristics to match your application—perfectly.

The variables: output rating (from 25 va to 10 Kva), number of phases, wave form, conversion

efficiency, operating temperature range ( $-55^{\circ}\text{C}$  to  $+125^{\circ}\text{C}$ ), size, weight, design life, vibration (10 to 5,000 cps at 30 Gs), overload protection, operating shock performance (10 to 400 Gs).

We'd be glad to send a representative list (complete with specifications) of our static power conversion equipment. Write: Electronics Department, Hamilton Standard, Broad Brook, Connecticut.

**Hamilton Standard** DIVISION OF UNITED AIRCRAFT CORPORATION  
ELECTRONICS DEPARTMENT  
BROAD BROOK, CONNECTICUT

U  
A

# Lambda Environment-Engineered LE Series Power Supplies at Competitive Prices

Note these quality design features

## CONVECTION COOLED

No blowers or filters; maintenance free.

## WIDE INPUT RANGE

Wide input voltage and frequency range—105-135 VAC, 45-66 CPS and 320-480 CPS in two bands selected by switch.

## COMPLETELY PROTECTED

against—short circuit and electrical overload; input line voltage transients; excessive ambient temperatures. No voltage spikes due to "turn-on, turn-off" or power failure.

9 models available

## CONSTANT VOLTAGE CONSTANT CURRENT

by automatic switchover.

## REMOTELY PROGRAMMABLE AND CONTINUOUSLY VARIABLE

Voltage continuously variable over entire range. Programmable over voltage and current range.

## OTHER FEATURES

- All solid state.
- Adjustable automatic current limiting.
- 0°C to + 50°C ambient.
- Grey ripple finish.
- Ruggedized voltmeters and ammeters per MIL-M-10304B on metered models.



## LE SERIES CONDENSED DATA

### DC OUTPUT (VOLTAGE REGULATED FOR LINE AND LOAD)<sup>(1)</sup>

Model	Voltage Range	Current Range	Price <sup>(2)</sup>
LE101	0-36 VDC	0- 5 Amp	\$420
LE102	0-36 VDC	0-10 Amp	525
LE103	0-36 VDC	0-15 Amp	595
LE104	0-36 VDC	0-25 Amp	775
LE105	0-18 VDC	0- 8 Amp	425
LE106	0-18 VDC	0-15 Amp	590
LE107	0-18 VDC	0-22 Amp	695
LE109	0- 9 VDC	0-10 Amp	430
LE110	0- 9 VDC	0-20 Amp	675

<sup>(1)</sup> Current rating applies over entire voltage range.

<sup>(2)</sup> Prices are for nonmetered models. For models with ruggedized MIL meters add suffix "M" to model number and add \$40 to the non-metered price. For metered models and front panel control add suffix "FM" and add \$50 to the nonmetered price.

### REGULATED VOLTAGE:

Regulation

(line and load) . . . . . Less than .05 per cent or 8 millivolts (whichever is greater). For input variations from 105-135 VAC and for load variations from 0 to full load.

Remote Programming . . . . . 50 ohms/volt constant over entire voltage range.

Ripple and Noise . . . . . Less than 0.5 millivolt rms.

Temperature Coefficient . . . . . Less than 0.015%/°C.

AC INPUT: . . . . . 105-135 VAC; 45-66 CPS and 320-480 CPS in two bands selected by switch.

### PHYSICAL DATA:

Mounting . . . . . Standard 19" rack mounting.

Size . . . . . LE 101, LE 105, LE 109 3½" H x 19" W x 16" D  
LE 102, LE 106, LE 110 5¼" H x 19" W x 16" D  
LE 103, LE 107 . . . . . 7" H x 19" W x 16½" D  
LE 104 . . . . . 10½" H x 19" W x 16½" D

SEND FOR LAMBDA CATALOG.



# LAMBDA ELECTRONICS CORP.

515 BROAD HOLLOW ROAD • MELVILLE, L. I., NEW YORK • 516 MYRTLE 4-4200

SALES OFFICES AND REPRESENTATIVES CONVENIENTLY LOCATED IN MAJOR CITIES

CIRCLE 22 ON READER SERVICE CARD



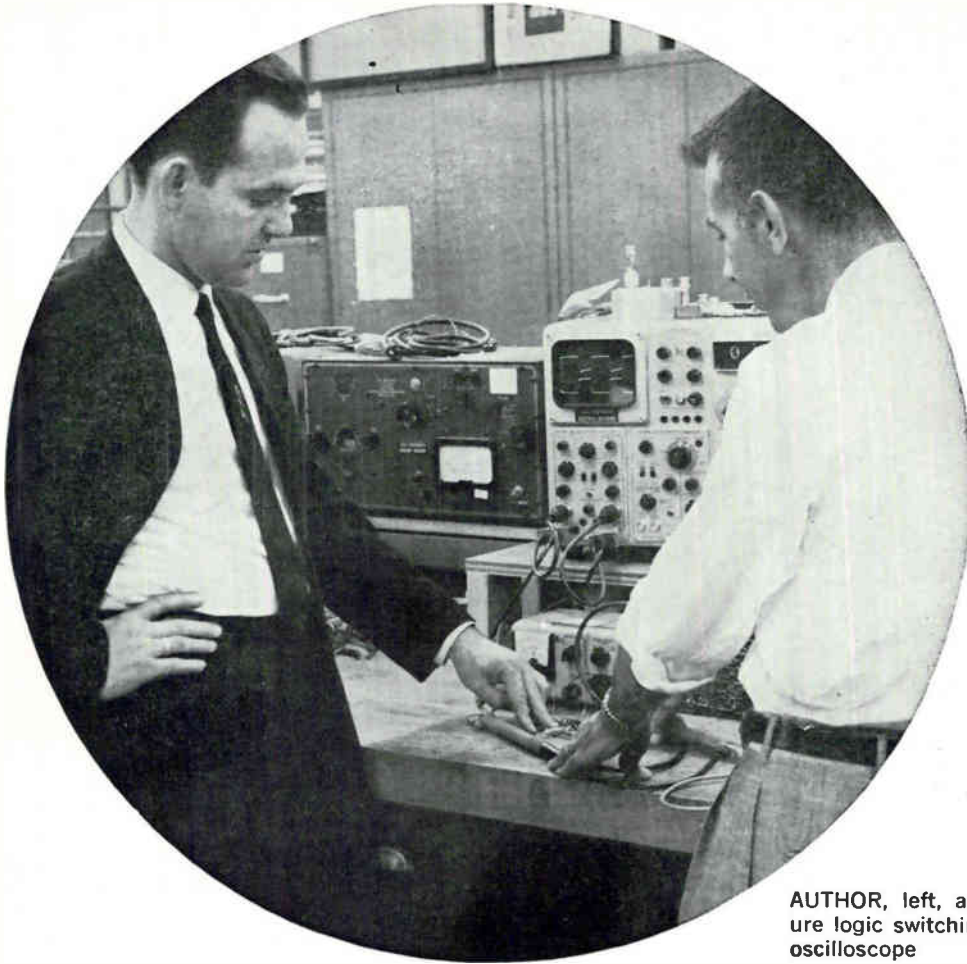

AUTHOR, left, and Joseph Ritz measure logic switching time with sampling oscilloscope

# Choosing Logic for Microelectronics

Engineers make a systematic study of available microelectronic logic. Their conclusion: none is inherently superior

By ALEX E. SKOURES, U. S. Naval Air Development Center, Johnsville, Penna.

**IN SOLID STATE** integrated circuits—those formed principally by diffusion of active and passive components in doped silicon chips—two conditions must be met before a circuit may be successfully fabricated.

- The circuit should function satisfactorily with relatively wide component tolerances. This requirement is basic since it affects both performance and yield.

- The circuit should use relatively few components. This requirement establishes the econom-

ical yield and influences reliability.

Greatest success with solid state integrated circuits has thus far been achieved with digital logic circuits.

Even though many logic schemes may be realizable, several factors must be considered in choosing a logic system for a particular application. The panel (next page) lists the major considerations.

**Logic Function**—The main function of any logic circuit is to arrive at a logical decision and deliver the decision, or its complement, to one

or more loads. In delivering this decision the circuit appears as a signal source supplying power to a load. A typical elementary circuit, Fig. 1A, can also be represented as shown in Fig. 1B.

In the first state ( $I_b = 0$  or  $S$  open) current is supplied to the load through  $R_1$  and load voltage  $V_L$  is derived from the voltage divider action between load and  $R_1$ . In the second state ( $I_b$  large or  $S$  closed)  $V_L$  is zero, or virtually so, and the load is essentially isolated. In each case, however, current

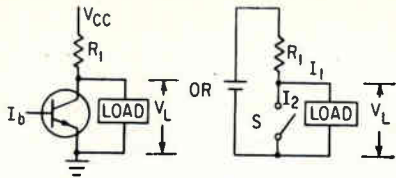

▼ CURRENT FLOWING in  $R_1$  in (A) and (B) when load voltage is zero sets power dissipation limit—Fig. 1

▼ DCTL LOGIC is popular because of simplicity, but small variations in thresholds cause wide variations in load currents, resulting in current hogging—Fig. 2

DCTL NAND/NOR GATE

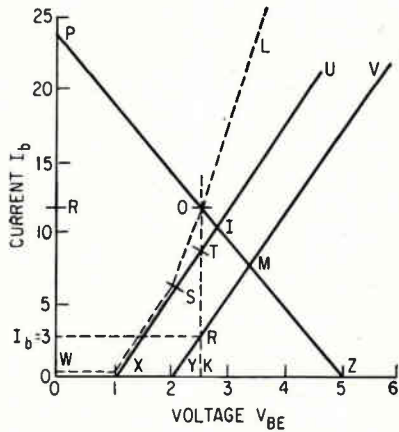
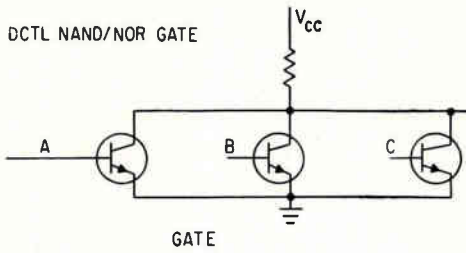

TWO UNEQUAL diode type loads in parallel leads to unequal load currents in DCTL logic. See text for discussion—Fig. 3

### FACTORS TO CONSIDER IN CHOOSING A LOGIC SYSTEM

**Logic Capability**—Fan-in; inversion capability; availability of both normal and complemented outputs

**Maximum Fan-Out**—Number of loads which the logic element supplies.

**Maximum Frequency of Operation**—Determined by rise, fall, delay, storage and recovery times

**Packing Density**—Power dissipation, operating temp., heat sink temp.

**Isolation**—Signal propagation between channels of the same circuit

**Directionality**—Degree of signal propagation from output to input

**Interconnection Interaction**—Signal propagation from one line to another.

**Limiting**—Restandardization of the signal extremities corresponding to logical one or zero

**Threshold Level**—Limits at which circuit amplifies information but rejects certain noise signals

**Stability**—Degree of freedom from errors resulting from regeneration within a circuit

**Signal Amplitude**—Minimum limits of signal level used to communicate from one circuit to another

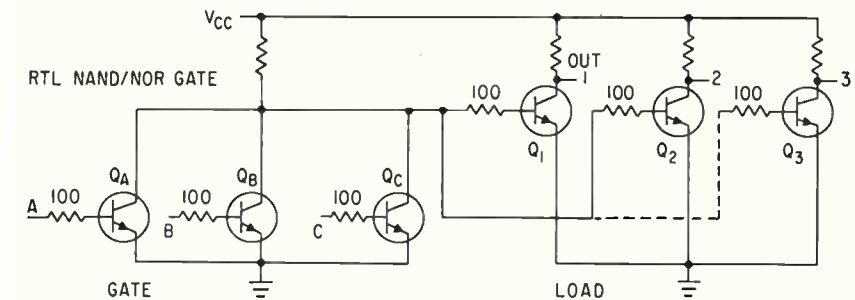
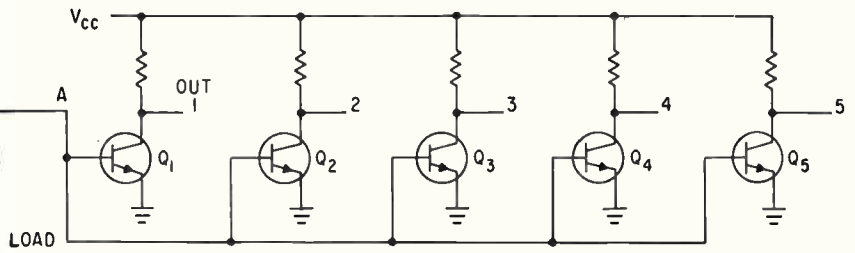

ADDING RESISTANCE in the base changes DCTL logic to RTL, reducing waste current but also speed—Fig. 4

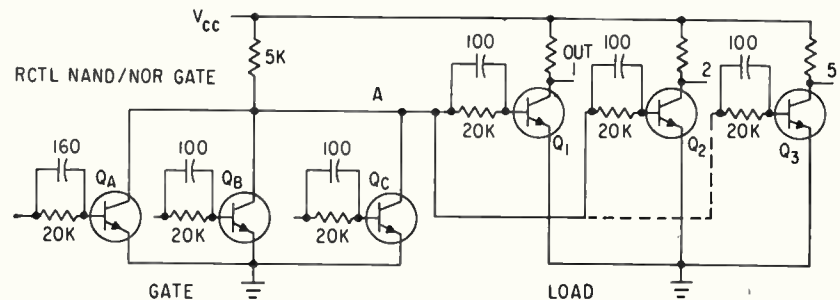

CAPACITORS and resistors in base circuits give relatively high fan-out and low operating power—Fig. 5

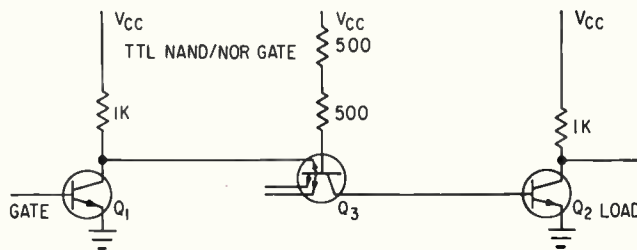

CIRCUIT ACTS to bring transistor out of saturation quickly, thus increasing operating speed—Fig. 6

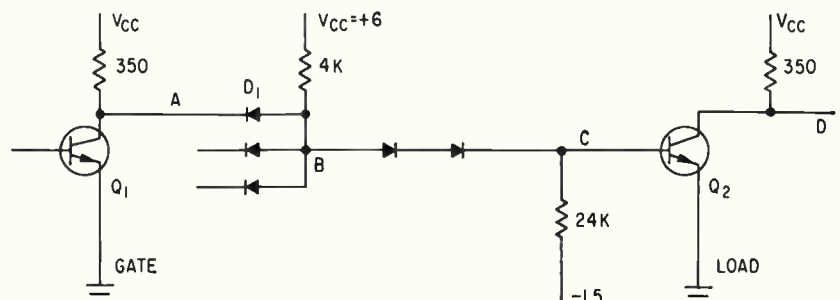

GATE HAS high immunity to noise and no limitation on fan-in—Fig. 7

flows through  $R_1$  and power is dissipated.

This power dissipation is the irreducible minimum and is one of the most important factors in the design. Power dissipation determines the packaging density, and the addition of a cooling requirement will reduce the benefits of microelectronics. The effect of the temperatures resulting from this power dissipation on drift and reliability must also be considered.

An ideal logic coupling network should provide infinite isolation impedance between inverting stages, have zero signal propagation time, and dissipate no power. Furthermore, the use of relatively few component is desirable.

**DCTL**—The Direct Coupled Transistor Logic (DCTL) NAND/NOR gate, shown in Fig. 2, is popular due to its simplicity. The threshold function is achieved through the base-to-emitter V-I characteristic of the load transistors. This characteristic is of the diode type. Whenever any of the inputs of the gate is at a high state, the output, point  $A$ , is low and the output of each of the load transistors,  $Q_1$  through  $Q_5$ , is high. To achieve a logic fan-out, several threshold devices must be connected in parallel. These devices constitute the total load seen by the gate element. The gate element should, ideally, supply the same amount of current to each of the loads. However, relatively small variations in threshold characteristics result in a wide variation in the current supplied to the loads.

The poor distribution of current in the load elements can be understood from Fig. 3. Line  $WXU$  represents the V-I characteristic on an idealized diode type load. Line  $WYV$  represents the V-I characteristic of another diode type load having a different forward voltage drop. The combined characteristic of these devices in parallel is  $WXSL$ . If the signal source must supply a minimum of three units of current to each of the diode loads, the source must supply a voltage represented by  $WK$  (2.5 voltage units) to the combined loads. To meet this condition, and to insure minimum dissipation, the combined diode characteristic must intercept their load line at  $O$ . Total current sup-

plied to the loads is represented by  $KO$  (12 units), with  $KR$  (3 units) being supplied to one load and  $RO$  (9 units) supplied to the other. One load is therefore supplied with three times its required current.

Also, if the minimum current requirement is reduced to near zero, the power supplied to one load approaches zero while that supplied to the other approaches the product of voltage  $WY$  and current  $YS$ .

This current represents waste, and the condition is called current hogging. Current hogging limits the loading capability of DCTL gates and limits their application except where the base-to-emitter characteristics of the load transistors can be closely matched. Figure 2 also shows that when the gate is not conducting, a small negative noise voltage introduced between  $A$  and any of the loads will turn that particular transistor off, since the base-to-emitter voltages are small.

**RTL**—If a small resistance is introduced into the base of each transistor in the DCTL system, the coupling mechanism becomes Resistor-Transistor logic, or RTL. This is shown in Fig. 4. A 100-ohm resistance reduces the spread of the diode type load characteristic, reduces the waste current, and increases the fan-out capability. Noise rejection, however, will still be relatively low. Operating speed is reduced to below that of the DCTL gate, but it is still relatively high. Logic swing is about one volt and power consumption, although less than DCTL, is relatively high per shift.

**RCTL**—If the base circuit is modified to that of Fig. 5, the result is Resistor-Capacitor-Transistor logic (RCTL). The high base resistance greatly reduces the spread of the diode type load characteristic, but also reduces operating speed. The capacitor increases the base current for fast turn on and minimizes storage time by supplying a charge equal to the store base charge. At low temperatures the noise rejection may be reduced. Normal noise rejection is high because of a logic swing of about two volts; there is no current hogging problem. The low base current permits relatively high fan-out and operating power typically is low.

**TTL**—Transistor Coupled Transistor logic (TTL) is shown in Fig. 6. When  $Q_1$  is cut off, the base current of coupling transistor  $Q_3$  is steered into the base of inverting transistor  $Q_2$ . In this condition the emitter of  $Q_3$  sees approximately 500,000 ohms and the current goes through the collector;  $Q_3$  therefore acts as a diode. When  $Q_1$  is saturated, the base current of  $Q_3$  is steered into the collector of  $Q_1$ , clamping the base of  $Q_2$  to a low potential. This cuts off  $Q_2$ , and the emitter of  $Q_3$  is clamped at almost ground potential through saturated  $Q_1$ . In this condition the  $V_{BE}$  of  $Q_3$  is much smaller than the  $V_{BC}$  of  $Q_3$  plus the  $V_{BE}$  of  $Q_2$  so the base current of  $Q_3$  would be steered through the emitter. This gate is capable of high-speed operation; logic swing is about 0.4 volt.

One factor that must be considered with this type of logic is the inverse beta ( $\beta_{in}$ ) of  $Q_3$ ;  $\beta_{in}$  must be low since it is a measure of the leakage current of the input emitter. If each emitter is connected to a different driving source, which could be at different potentials, the high leakage currents become analogous to current hogging and limit fan-out. Also,  $V_{CE(SAT)}$  of  $Q_1$  must be low at high collector currents or noise at any of the inputs of  $Q_3$  could influence operation. For example, if  $Q_1$  is conducting and has a high  $V_{CE(SAT)}$  and  $Q_2$  is cut off, a positive noise introduced between  $Q_1$  and an emitter of  $Q_3$  will turn  $Q_2$  on. For stability in noise

$$(V_{CE(Q_1SAT)} + \text{Noise}) < V_{BC(Q_3)} + V_{BE(Q_3)}$$

**DTL**—The fifth coupling network to be considered is Diode-Transistor logic or DTL, as shown in Fig. 7. If  $Q_1$  is cut off, the voltage at  $A$  is almost equal to  $V_{cc}$ . Current flows from  $V_{cc}$  through the two series diodes and then through the parallel path formed by the 24,000-ohm resistor and the base to the emitter of  $Q_2$ . The voltage at point  $B$  is therefore 6 volts minus the drop across the 4,000-ohm resistor, and the voltage at  $C$  is the voltage at  $B$  minus the forward drops of the two series diodes. The voltage at  $C$ , being well above ground, drives  $Q_2$  into saturation, and the voltage at  $D$  equals  $V_{CE(SAT)}$ .

In this situation a positive noise picked up between  $A$  and  $D_1$  will

not affect the operation of the gate since it will only increase the back bias on  $D_1$ . A negative noise, however, if sufficient to overcome the forward and reverse voltage of  $D_1$ , and the voltage necessary to turn  $Q_2$  off, will affect operation. When  $Q_1$  is conducting and  $Q_2$  is cut off, the voltage at  $B$  is equal to the  $V_{CE(SAT)}$  of  $Q_1$  plus the forward voltage drop of  $D_1$ . The voltage at  $C$  is at or below ground, and the base of  $Q_2$  is back biased. In this situation a positive noise between  $A$  and  $D_1$  must overcome the forward drop of the two series diodes and the base-to-emitter drop of  $Q_2$ .

This gate has a relatively large noise immunity, provides diode isolation, and has no fan-in limitation. It does, however, require two power supplies for a high degree of noise immunity; logic swing is typically 1.7 volt, which is not too high for fast operation nor too low to be affected by noise of less than a volt.

**ECTL**—One logic system available in integrated circuit form but not evaluated is Emitter Coupled Transistor logic (ECTL). The principal advantage of ECTL is that it retains the manufacturing simplicity of DCTL without current hogging. ECTL does, however, utilize more components than DCTL and requires two power supplies. An ECTL AND gate is shown in Fig. 8. The resistances are selected so that with a  $V_{ref}$  of 0.4 volt, and point  $X$  at  $-0.3$  volt,  $Q_D$  will conduct and  $Q_A$ ,  $Q_B$  and  $Q_C$  will be off when any of the inputs at  $A$ ,  $B$ , or  $C$  are 0.2 volt or below. Increasing any of the inputs, say  $A$ , to 0.7 volt will cause  $Q_A$  to conduct;  $Q_A$  will conduct more heavily than  $Q_D$  by virtue of its lower collector resistance (none, versus 3,000 ohms). The relatively large current flowing through  $Q_A$  will increase the voltage at  $X$  from  $-0.3$  volt to zero. This in turn reduces the  $V_{BE}$  of  $Q_D$  from 0.7 to 0.4, which will cut off  $Q_D$  and present a high output voltage.

This gate circuit inherently tends to eliminate current hogging. Assuming the inputs initially are less than 0.2 volt,  $Q_A$ ,  $Q_B$ , and  $Q_C$  are cut off, and  $Q_D$  is conducting. Current  $I_R$  is

$$I_R = \frac{[(-0.3) - (-3.5)]}{(2/3)R} = 1.6 \text{ ma}$$

Current  $I_{CD}$  is

$$I_{CD} = \frac{(V_{CC} - V_C)}{R} = \frac{[3 - (-0.2)]}{3} = 1.07 \text{ ma}$$

Since  $I_c = \beta I_b$ , and in this case  $I_b = I_R - I_{CD}$

$$\beta = I_c / (I_R - I_{CD}) = 1.07 / (1.6 - 1.07) \approx 2$$

Thus a transistor with a  $\beta$  of only two is required.

When any of the inputs,  $A$  for example, is 0.7 volt,  $Q_A$  will conduct and  $I_R$  becomes  $I_{R'}$ .

$$I_{R'} = \frac{V_Q - (-3.5)}{(2/3)R} = \frac{0 + 3.5}{(2/3)3} = 1.75 \text{ ma}$$

Since  $I_{R'} \approx I_c$

$$I_{R'} = \beta I_b, \text{ and } I_b = (1/\beta) I_{R'}$$

The base current required for switching therefore varies inversely with the  $\beta$  of each transistor. This has an effect on the current drawn by each diode type load. From Fig. 8, emitter resistance is  $2/3$  the collector resistance. Base-to-emitter resistance for each diode type load therefore becomes  $(2/3) \times R \times \beta$ . For a transistor with  $\beta$  of 10 the diode type load would be 20,000 ohms, and for a transistor with a  $\beta$  of 5 it would be 10,000. Thus as  $\beta$  increases, the slope of the load line decreases, so the current drawn

by the diode type load varies as  $1/\beta$ .

This means that—unlike DCTL—the base to emitter resistance varies with  $\beta$  and base current varies as  $1/\beta$ . Therefore, the transistor with the high  $\beta$  will take less current from the source than those with low  $\beta$ . This permits a higher fan-out capability than with DCTL. The fact that only one transistor in the gate is driven to saturation, in addition to a small logic swing, makes high speed operation possible. The small logic swing, however, reduces noise immunity.

No one logic type stands out as being inherently superior: each has its advantages and its disadvantages. Table I lists typical worst case operating conditions.

The scope of this article has been limited to solid state integrated logic circuits that have been evaluated by the U. S. Naval Air Development Center. Many of the observations and conclusions thus therefore be considered interim.

The opinions expressed are not necessarily those of the U. S. Naval Air Development Center or the Navy Department.

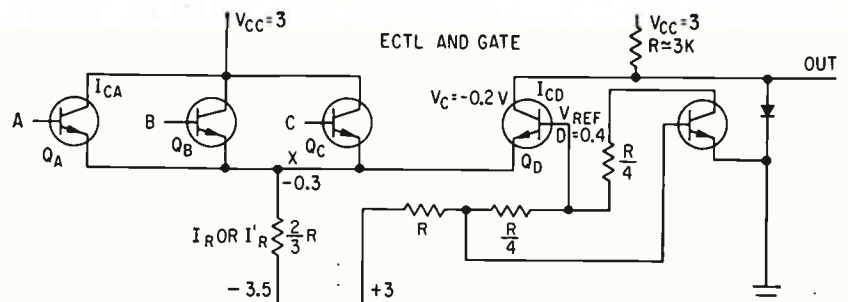

GATE has manufacturing simplicity of DCTL and is free from current hogging but uses two supplies—Fig. 8

### Worst Case Conditions for Logic Gate Types—TABLE I

<b>RTL Gate</b> — $T = 125 \text{ C.}$ Fan-Out ( $N$ ) = 4. $f = 1 \text{ Mc.}$ Propagation Delay ( $T_{pd}$ ) = 40 ns. Rise Time ( $T_r$ ) = 15 ns. Fall time ( $T_f$ ) = 22 ns. Power Dissipation: ( $P_d$ ) = 15 mw per gate and 15 mw per shift register.
<b>RCTL Gate</b> — $T = 125 \text{ C.}$ $N = 5.$ $V_{\infty} = 3\text{V.}$ $f = 0.1 \text{ Mc.}$ $T_{pd} = 200 \text{ ns.}$ $T_r = 0.3 \mu\text{sec.}$ $T_f = 1.4 \mu\text{sec.}$ $P_d$ (for $V_{\infty} = 3\text{v}$ ) = 3 mw per gate and at $V_{\infty} = 6\text{v}$ , 7 mw per shift register.
<b>DTL Gate</b> — $T = 125 \text{ C.}$ $V_{\infty} = 5 \text{ v.}$ $N = 4.$ $f = 7 \text{ Mc.}$ $T_{pd} = 42 \text{ ns.}$ $T_r = 39 \text{ ns.}$ $T_f = 56 \text{ ns.}$ $P_d = 6 \text{ mw per gate and } 23 \text{ mw per shift register.}$
<b>TTL Gate</b> — $T = -55 \text{ C.}$ $V_{\infty} = 4.$ $f = 5 \text{ Mc.}$ $T_{pd} = 55 \text{ ns.}$ $V_{\infty} = 4.$ $f = 5 \text{ Mc.}$ $T_{pd} = 90 \text{ ns.}$ $T_r = 13 \text{ ns.}$ $T_f = 15 \text{ ns.}$ $P_d = 12 \text{ mw per gate and } 60 \text{ mw per shift register.}$

AUTHOR Y. P. YU is shown working with a servo-system developmental setup using the two-phase low-frequency oscillator

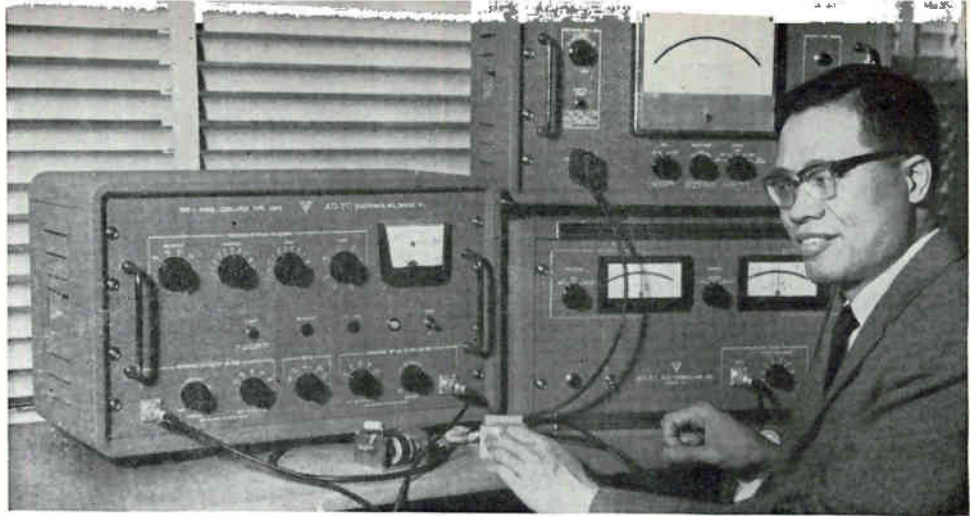

## IDEAL CONTROL REFERENCE

# Two-Phase Oscillator Covers 0.1 to 1,000-CPS

Stable low-frequency oscillator comprises phase-shift stages such that amplifier output can be fed back in phase with its input

By Y. P. YU, President and Chief Engineer, Ad-Yu Electronics, Inc., Passaic, N. J.

**LOW-FREQUENCY** oscillators with a two-phase output are useful excitation sources for measuring the transfer characteristics of automatic control systems. Transfer characteristics are generally determined by measuring in-phase and quadrature responses against frequency. Thus, a two-phase oscillator is an ideal signal source for transfer-function analyzers, Nyquist-diagram plotters and other instruments for evaluating automation systems.

**Instrument Functioning**—Blocks in Fig. 1A show a simplified diagram of the instrument to be described. A phase shift is produced by two 45-degree-shifting cathode followers, a 90-deg amplifier and a 180-deg amplifier. Precision RC networks shift phase in the two 45-deg cathode followers and the 90-deg ampli-

**TWO-PHASE OSCILLATOR (A)** uses phase-shifting technique; its amplifier regulator keeps output amplitudes constant over operating-frequency range. Two stages shift phase by 45 deg (B) and one stage shifts phase 90 deg (C)—Fig. 1

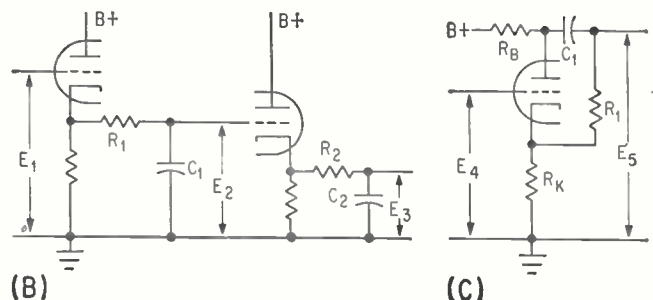
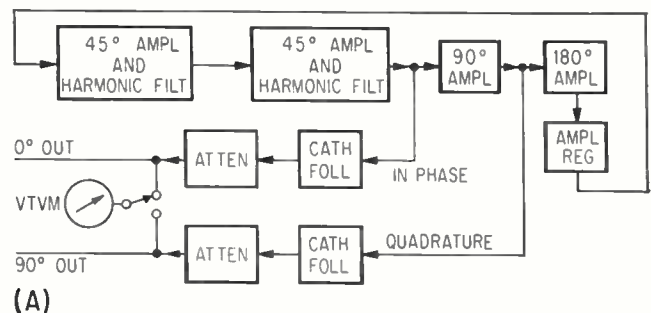

fier. Frequency is varied by changing the value of the resistors and capacitors to produce in-phase feedback to the input of the instrument. A reference and a quadrature voltage output are picked off before and after the 90-deg amplifier. The vtvm, which reads average values, indicates the output voltage.

The simplified circuit in Fig. 1B shows the two-stage 45-deg cathode follower. Signal  $E_2$  is shifted 45 deg with respect to  $E_1$  when  $R_1 = 1/\omega C_1$ , where  $\omega = 2\pi f$ . Signal  $E_3$  is shifted 45 deg with respect to  $E_2$  when  $R_2 = 1/C_2$ . Since the RC network is a low-pass filter, the two stages eliminate harmonics and shift phase from the output.

Figure 1C shows the 90-deg amplifier. The resistance of  $R_B$  is equal to the resistance of  $R_K$ . Thus, the signal at the plate equals the signal at the cathode; these signals are 180-deg apart in phase. When  $R_1 = 1/\omega C_1$ ,  $E_5$  has a 90-deg phase difference with respect to  $E_4$ . Capacitor  $C_1$  also isolates the plate potential.

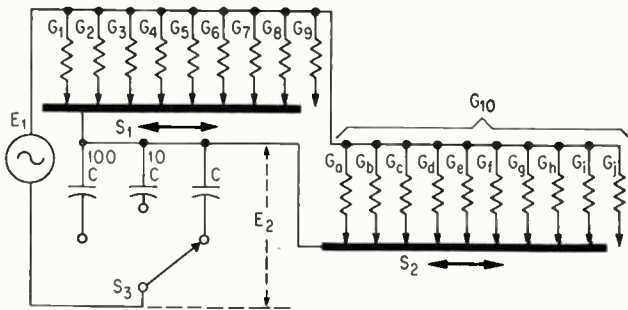

DECADE variation of frequency is accomplished by switching arrangements such as this RC network—Fig. 2

**Frequency**—To vary the frequency in decades in either stage of Fig. 1B, ten different resistors must be used if the resistors are in series. Figure 2 shows an RC network whose corresponding frequency for a 45-deg phase shift between input and output can be varied in decade steps.

The expressions for 45-deg phase shift between  $E_1$  and  $E_2$  and the corresponding frequency  $f$  are

$$2\pi f C = G_1 + G_2 + G_3 \cdots + G_{10}$$

$$f = \frac{G_1 + G_2 + G_3 \cdots + G_{10}}{2\pi C}$$

where  $G$  is the conductance of a resistor; consider conductances  $G_a$  to  $G_j$  in Fig. 2 as comprising a single conductance,  $G_{10}$ . When all  $n$  resistors are equal.

$$f = nG/2\pi C$$

Thus, frequency increases in numerical order as the switch advances from  $G_1$  to  $G_n$ .

To provide second decade of frequency variation, the tenth resistor is divided into ten parallel elements. Thus, each of these ten resistors has a conductance of  $0.1 G$ . Switch  $S_2$  controls the number of resistors in parallel, thereby controlling the frequency for 45-deg phase shift between  $E_1$  and  $E_2$  for the second decade, just as  $S_1$  controls it for the first decade. When

$$G = G_1 = G_2 = G_3 \cdots = G_9$$

and  
then

$$0.1G = G_a = G_b = G_c \cdots = G_j$$

$$f = (nG + 0.1nG)/2\pi C$$

where  $n$  is the number of elements in the first and second decades. A third decade is provided by dividing the tenth resistor of the second decade into ten

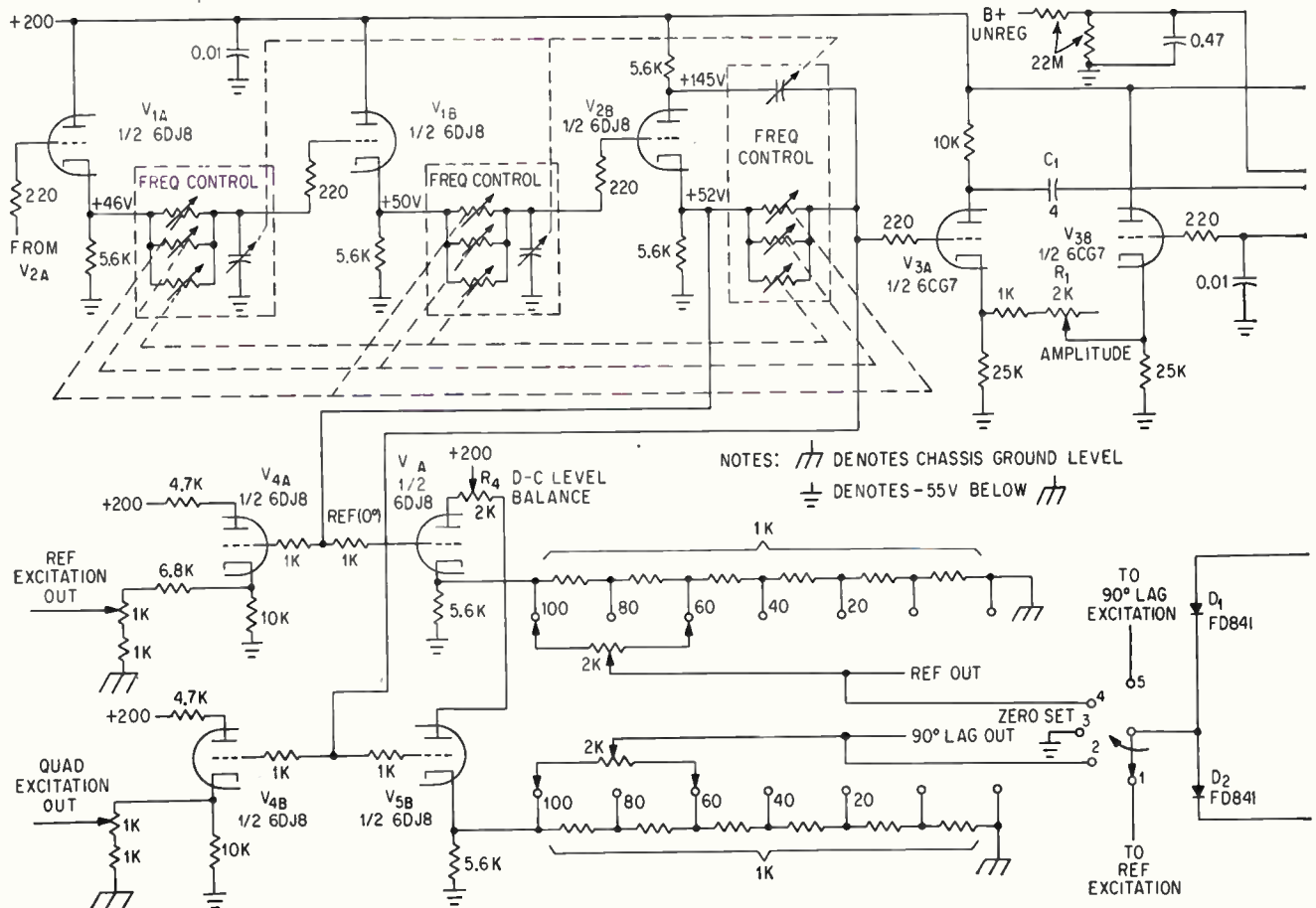

equal conductances. The instrument uses such combinations for each of the two 45-deg phase shifters and the 90-deg phase shifter shown in Fig. 1A.

**Circuits**—In Fig. 3,  $V_{1A}$  and  $V_{1B}$  are 45-deg cathode followers. The frequency-control RC circuits of  $V_{2B}$  shift the output signal 90 deg with respect to the input. Thus, the voltage at the output of the frequency-control network of  $V_{2B}$  lags the input of  $V_{1A}$  by 180 deg. Tube  $V_{3A}$  provides another 180-deg phase shift.

The peak-to-peak swing at the output of  $V_{3A}$  is adjusted by  $R_1$ . The instrument's gain stability requires a slight amount of peak clipping to achieve stable oscillation at low frequencies since the capacitors normally have higher leakage with higher voltages. The amount of clipping is set by establishing a precise operating bias with  $R_2$ , which adjusts the current of  $V_{3B}$ .

Capacitor coupling (by  $C_1$ ) is used at the output of  $V_{3A}$  to lower the d-c level at the output of cathode follower  $V_{2A}$ , whose output is d-c coupled to the grid of  $V_{1A}$ . The low-oscillator frequencies require a very long time constant ( $22 \text{ megohms} \times 4 \mu\text{f}$ ) at the input of  $V_{2A}$ . The ratio of coupling reactance to load resistance must be small since  $\tan \theta = X_c/R$ .

Before the oscillation starts,  $C_1$  must be fully charged. A pushbutton switch is used to short the 22-megohm resistor ( $R_3$ ) momentarily, thereby charging  $C_1$  instantaneously.

The output of  $V_{1A}$  goes to its frequency-control network and then to cathode follower  $V_{1B}$ . The output of  $V_{1B}$  goes to its frequency-control network, then

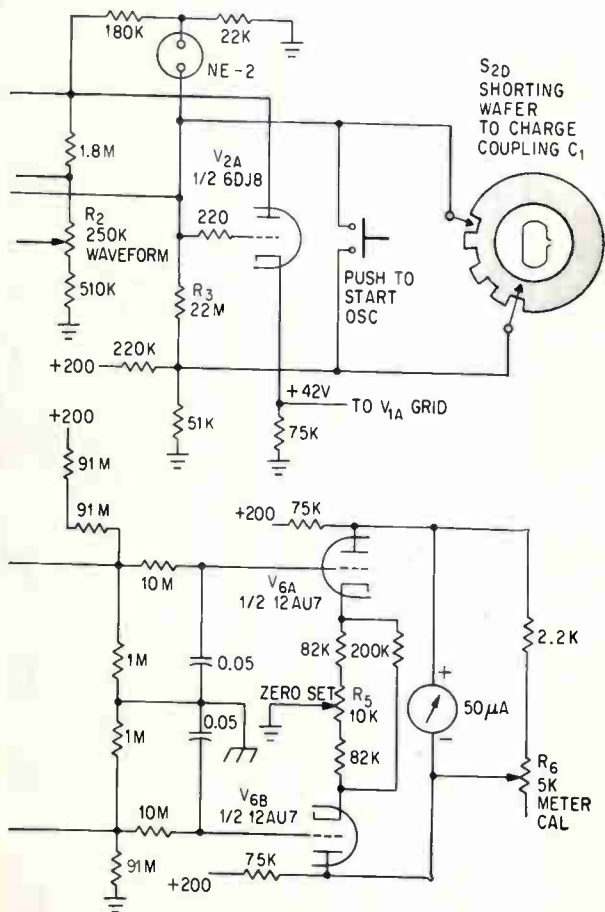

CIRCUIT of two-phase oscillator is complete except for simplified depiction of the phase-shifting networks, and for the regulated power supply, which is not shown—Fig. 3

## INSTRUMENT DESIGN PROBLEMS

Since this low-frequency instrument has to produce two simultaneous outputs that have a 90-deg difference over a frequency range of a fraction of a cps to 1,000 cps, its design created problems that normally are not encountered when designing audio oscillators.

- Direct coupling between stages had to be used to avoid phase error caused by coupling capacitors.
- Negative feedback was used to control amplitude, rather than using such nonlinear elements as incandescent lamps or thermistors.
- Decade controls were used to vary frequency, rather than variable capacitors or potentiometers

through the 90-deg phase shifting amplifier  $V_{2B}$  and its frequency-control network. Amplifier  $V_{3A}$  provides another 180-deg phase shift. Oscillation occurs at the frequency at which total phase shift is 360 deg. This requires the capacitive reactance of each frequency-control network to be equal to the series resistance in the network.

The reference, or 0-deg output voltage is taken from the input of the 90-deg phase-shifting network and the 90-deg lag output is taken from the output of the same network. These outputs go to front-panel terminals after passing through followers  $V_{5A}$  and  $V_{5B}$ . Followers  $V_{4A}$  and  $V_{4B}$  provide an additional pair of output signals.

The d-c levels of the output are set to zero with respect to chassis potential by returning the circuit ground to a potential that is -55 volts below ground. This potential is adjusted with a control in an output d-c level regulator circuit (not shown). Minor differences between  $V_{5A}$  and  $V_{5B}$  are balanced out with  $R_4$ , which is tied to their plates.

In the metering circuit, diodes  $D_1$  and  $D_2$  are arranged in a full-wave rectifier configuration that converts the average value of the a-c output to a d-c potential. Use of an average detector instead of a peak detector is necessary to take readings at low frequencies at the center between two peak swings. This d-c potential is amplified by  $V_6$  and applied to the meter. Resistor  $R_5$  equalizes the cathode currents of each half of  $V_6$  so that the meter reads zero in the absence of any signal. Control  $R_6$  sets the gain of  $V_6$  so that a 5-volt signal at the input of the diodes is indicated by 5 volts on the meter.

**Results**—Oscillator frequency can be varied from 0.101 to 999 cps by using three controls and a four-range multiplier. The three controls vary the conductance of the frequency-control networks and the multiplier varies the capacitance of the frequency-control networks. Frequency accuracy is within  $\pm 2$  percent and stability is within 0.2 percent. Phase angle between the output voltages is constant at 90 deg.  $\pm 2$  deg.

# USING A NEW COMPONENT—Raising

Semiconductor negative resistance elements can be paralleled with tank circuit to neutralize equivalent resistance and produce high  $Q$ 's. Adjusting NRE for infinite  $Q$  leads to sinusoidal oscillations.

## WITCHCRAFT

Getting rid of resistance merely by introducing negative resistance to cancel it seems so obvious as to be unreal. Its like a science-fiction plot to use negative-gravity to hold the spaceship aloft. Yet for tank-circuits it works. The positive resistance disappears, near-infinite  $Q$  is left and the circuit becomes a sinusoidal oscillator

By **CARL DAVID TODD**  
Hughes Aircraft Co.,  
Newport Beach, California

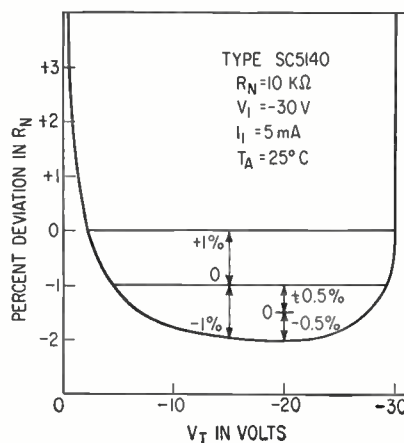
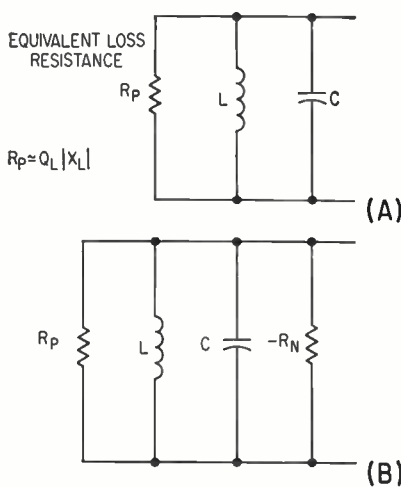

**MANY RESONANT** circuits require a higher  $Q$  than practical  $LC$  components can give. This is especially true for the lower frequencies where relatively large inductances are necessary and where a coil having sufficiently high  $Q$  is often too heavy.

The effective  $Q$  of practical  $LC$  resonant circuits can be increased by using negative resistances to compensate for losses within the resonant circuit. To achieve a stable  $Q$  yielding a constant bandwidth stable negative resistance is needed. Negative resistance elements (NRE) are now available giving excellent stability with time and for variations of supply voltage and temperature. If  $Q$  is infinite, the circuit becomes a simple two-terminal sine wave oscillator. Various formulae for design or analysis of  $Q$ -multipliers are presented using examples to illustrate practical design procedure.

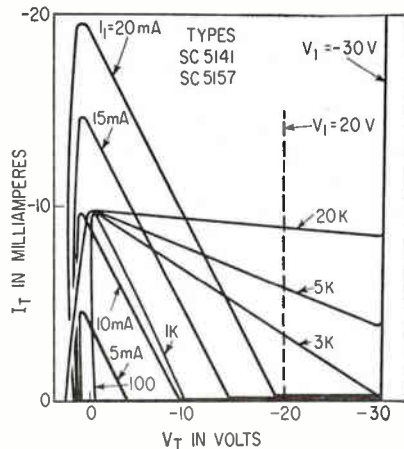
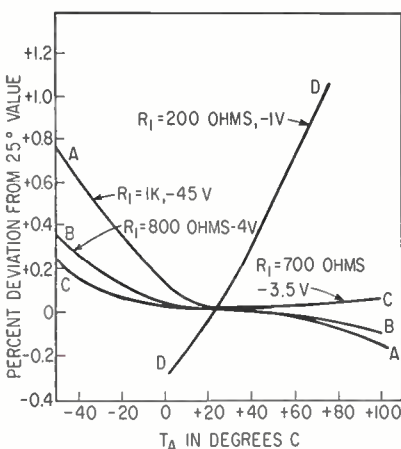

**Q Multiplier**—In using a practical resonant circuit, losses may be considered as an equivalent resistor in shunt with pure reactive elements. Figure 1A illustrates the equivalent circuit for a practical parallel resonant  $LC$  tank circuit. Components  $L$  and  $C$  are assumed to be lossless and  $R_p$  represents all losses in the circuit at the frequency under consideration. The  $Q$  of the circuit is usually dependent on the losses within the inductor and may be expressed as

$$Q = Q_L = R_p / \omega L \quad (1)$$

Where  $R_{p1}$  represents the effective shunt resistance of the inductor at the frequency of interest. For a complete analysis or where the losses of the capacitor may be appreciable, an

(D) **PARALLEL RESISTOR** represents resonant circuit's equivalent resistance (A). Adding negative resistance neutralizes equivalent resistance, gives high  $Q$  (B). Voltage-stability of few tenths percent is possible with stable supplies (C), temperature stability to 0.1 percent can be achieved for 100 C temperature range (D). Negative resistance characteristics are drawn for  $R_n = 1,000$  ohms, also for several values of  $R_1$  (E)—Fig. 1



# Tank-Circuit Q With the NRE

effective loss resistance  $R_{p'}$  is associated with the capacitor. For this analysis, however, the term  $R_p$  will represent the total loss associated with the circuit.

**Negative Shunts**—Suppose that a negative resistance of magnitude  $R_n$  is placed across the tank circuit as shown in Fig. 1B. This combines with the positive resistance,  $R_p$ , to form a new equivalent resistance  $R_{p'}$ .

$$R_{p'} = R_p (-R_n) / (R_p - R_n) \quad (2)$$

The magnitude of  $R_{p'}$  changes rapidly as the value of  $R_n$  approaches  $R_p$ , but its sign remains positive as long as  $R_n$  is greater than  $R_p$ . At the point where  $R_n$  is exactly equal to  $R_p$ , the value of  $R_{p'}$  becomes infinite and the circuit oscillates.

With a modified value of equivalent loss resistance,  $R_{p'}$ , has a new value  $Q'$  where

$$Q' = R_{p'} / \omega L = -R_p R_n / \omega L (R_p - R_n) \quad (3)$$

Taking the ratio of  $Q'$  to the original value  $Q$ , factor  $K$  indicates the increase in  $Q$

$$K = Q' / Q = R_n / (R_n - R_p)$$

**Stability**—Equation 4 shows a graph of the sensitivity of  $K$ , and hence the sensitivity of  $Q'$  to changes in  $R_n$  with respect to  $R_p$ . This is especially pronounced as the value of  $K$  is increased by making  $R_n$  approximately equal to  $R_p$ . Thus, if  $K$  is made only 10, a one percent change in  $R_n$  will produce roughly a ten percent change in  $Q'$ .

If  $Q$  is to be held as high as possible, there will be limitations to the value of  $K$  since slight variations in  $R_n$  could produce unwanted oscillations. Variations of  $Q$  will also produce changes in the resultant bandwidth of the resonant circuit.

Assuming that  $R_p$  remains relatively constant with temperature, then negative resistance must remain stable. Figures 2C and 2D show that the desired stability is available from off-the-shelf negative-resistance elements.

Figure 1C shows that  $R_n$  varies less than  $\pm 1$  percent for terminal

voltages from about 25 to 30 volts. Restricting the terminal voltage excursion will maintain a linearity or stability of  $R_n$  better than a few tenths of a percent.

Figure 1D illustrates the temperature stability of  $R_n$  for the SC-5140, using a wire-wound resistor for the reference. For  $R_n$  values around 700 ohms, stabilities in the order of 5 parts per million per degree centigrade are possible over a temperature range of  $-20$  to  $+100$  C. It is possible to produce negative resistances over a range of values which yield less than 0.1 percent change in value over a 100 degree centigrade temperature span. For values of  $R_n$  much above or below 700 ohms, it may be necessary to use a basic  $R_n$  of about 700 ohms and then use positive resistances to modify it.

**Resistance Tracking**—Although previously  $R_p$  was assumed to remain constant, in a practical case, this will not always hold. To demand a stable value of  $R_n$  would not help

much if  $R_p$  varies greatly. However, it is possible to produce relative tracking of  $R_p$  and  $R_n$  when using negative resistance elements.

The value of  $R_n$  approximates the value of a reference resistor  $R_1$  connected across the input terminals. Hence, if  $R_1$  varies in the same manner as  $R_p$ , then a tracking arrangement is possible in which variation in the difference between  $R_n$  and  $R_p$  is held to a minimum. The required variation in  $R_1$  may usually be achieved by using a network of thermistors of positive and negative coefficients combined with normal resistors.

**Load**—While even the unloaded low frequency tank circuit may have an already inadequate  $Q$ , its  $Q$ -value may be reduced further by source or load resistances. All such losses, whether due to the capacitor, inductor, or source and load resistances, may be included in the one term  $R_p$ . Here again, for  $K$  or  $Q'$  to remain fairly constant, it is necessary for the total  $R_p$  to remain stable

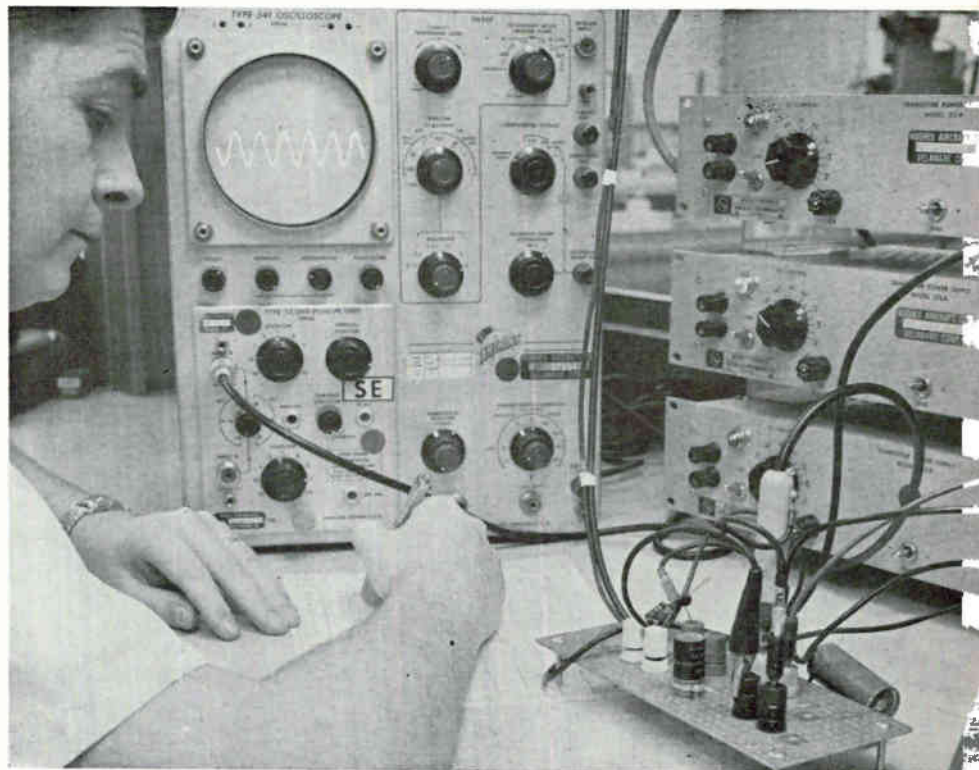

AUTHOR Todd measures performance of breadboard Q-multiplier circuit

as well as  $R_n$ . If the load resistance has some variation, then a compensating variation may be induced in the value of the reference resistor  $R_1$ .

**Biasing**—The typical terminal characteristic curves are given in Fig. 1E for the SC5140 and SC5141. To bias the negative resistance element, a positive current bias,  $I_1$ , and a negative voltage bias  $V_1$ , must be applied. It is necessary, for linear applications, to bias the output terminals with a d-c load line that intersects the characteristic within the negative-resistance region. Circuits for the  $Q$ -multiplier and the two terminal oscillator will be the same. The only difference is in the choice of the value of  $Q$ .

Figure 2A illustrates the fundamental bias requirements for the NRE multiplier or oscillator. Positive voltage supply  $V_2$  and series resistor  $R_2$  comprise a d-c current source for current bias  $I_1$ . The magnitude of  $I_1$  depends upon signal level requirements and other considerations.

A negative voltage supply,  $V_1$  is applied to terminal 3. This determines the terminal voltage,  $V_T$ , at which the current rises sharply as indicated in Fig. 1E.

Finally, a second negative voltage supply,  $V_3$ , is applied through the inductor,  $L$ , to the output terminals of the NRE. For operation as a  $Q$  multiplier or oscillator, it is necessary that the d-c load line, fixed by the d-c resistance of the inductor and  $V_3$ , intersect the output terminal characteristic curve only within the negative resistance region.

For the normal case, where the d-c resistance of the coil is negligible, it is necessary only that  $V_3$  be between zero and  $V_1$ . Signal requirements may impose other restrictions.

A reference resistor,  $R_1$ , must be connected between the terminals. Its value will be determined by circuit requirements. It should have the necessary stability with temperature or, if temperature tracking is desired, must have the appropriate temperature coefficient.

**Two Bias Supplies**—It is always possible to simplify the circuit of Fig. 2A by eliminating the voltage supply,  $V_3$ . This may be done by using

a voltage divider from  $V_1$  if the output resistance is held low enough to give a proper d-c load line. It will be necessary to bypass this point to an a-c ground.

A design approach which improves power-supply economy, yields considerable circuit simplification, and also improves bias point stability, is to derive the supply voltage  $V_3$  from the  $V_1$  source by using a series voltage regulator diode, as shown in Fig. 2B. Supply  $V_3$  must always be less than  $V_1$  and a current must always flow at the output terminal for linear signal operation. Hence, the voltage regulator diode will always be in the breakdown region and will present a low a-c impedance to ground.

Thus, no bypass capacitor will be required.

**One Bias Supply**—However, in some applications it may not be convenient to have both positive and negative supply voltages; however several possibilities exist for biasing the NRE  $Q$ -multiplier with a single source.

One possible circuit is given in Fig. 2C. This is a modified form of Fig. 2B, in which  $V_2$ , ( $I_1$  supply), is generated with a second voltage regulator diode,  $D_2$ . To obtain the necessary polarity, it is necessary to lift the ground points of Fig. 2B to the voltage of  $D_2$ . Supply voltage  $V_1$  must be increased by a voltage equal to that of  $D_2$  to preserve the former bias condition of Fig. 2B. Should it be necessary to keep the tank circuit at d-c ground, configurations of Fig. 2D of Fig 2E may be used. In Fig. 2D a tapped supply provides both  $V_2$  and  $V_1$  bias voltages for the remaining circuit. A voltage regulator diode establishes the actual terminal bias voltage.

Fig. 2E illustrates a configuration in which a single supply may be used for holding the tank circuit at d-c ground. The value of  $I_1$  will now be

$$I_1 = (V_1 - V_{B1})/R_2 \quad (5)$$

Temperature compensation of  $I_1$  in Fig. 2E circuit is possible if the temperature coefficient of  $D_1$  is approximately 2 mv/degree C.

The operating characteristic curve of the basic circuit is shown in Fig. 2F. The d-c load line will have a slope dependent upon the d-c resistance of the coil, which for most

cases is negligible. The d-c resistance load line produced by  $R_L$  will be the parallel equivalent of the source resistance,  $R_G$ , load resistance  $R_L$ , and the equivalent loss resistor,  $R_p$ .

The instantaneous output voltage swing must be between zero and  $V_1$ . Thus, for a maximum output capability, the voltage at the bias point  $Q$  must be half-way between zero and  $V_1$ . That is, at  $V_1/2$ .

**Determination of  $R_n$** —The first design choice will be the determination of  $R_n$ . The value used for  $R_n$  will depend on the desired  $Q'$  plus loading and losses of the tank circuits, and may be expressed

$$R_n = R_L'/(1 - R_L'/LQ') = R_L'/(1 - Q/Q') \quad (6)$$

Where  $R_L'$  is the total parallel equivalent loss resistance, consisting of the generator source resistance, load resistance, and the internal losses of the tank circuit;  $Q$  is the value of  $Q$  obtained before adding the multiplier circuit; and  $K$  is the ratio of multiplication.

The minimum allowable supply voltage for  $V_1$  is equal to the maximum peak-to-peak output voltage and should be made slightly greater to allow for some component tolerance and rift. If low distortion is a severe requirement, it will be necessary to provide a guard band of two or three volts on both the high and low ends, and  $V_1$  should be about four volts higher.

With  $V_1$  and  $R_n$  chosen, the required value of bias current  $I_1$  may be easily computed, as it is nearly equal to  $-I_p$ , the peak current of the NRE. With  $R_n$  fixed and  $V_1$  chosen, an assumed arrangement shown in Fig. 2F yields a value for  $I_p$

$$I_p = V_1/R_n = I_1 \quad (7)$$

Thus  $I_1$  is generated by a voltage source  $V_2$  in series with resistor  $R_2'$ . Source  $V_2$  should be large with respect to 0.8 v to reduce temperature dependence. Ideally,  $V_2$  should decrease approximately 2 mv/degree C.

The remaining variable  $V_3$ , is chosen half-way between zero and  $V_1$  and is

$$V_3 = V_1/2 \quad (8)$$

**Other Bias Schemes**—These above design equations may be extended to other biasing schemes with some

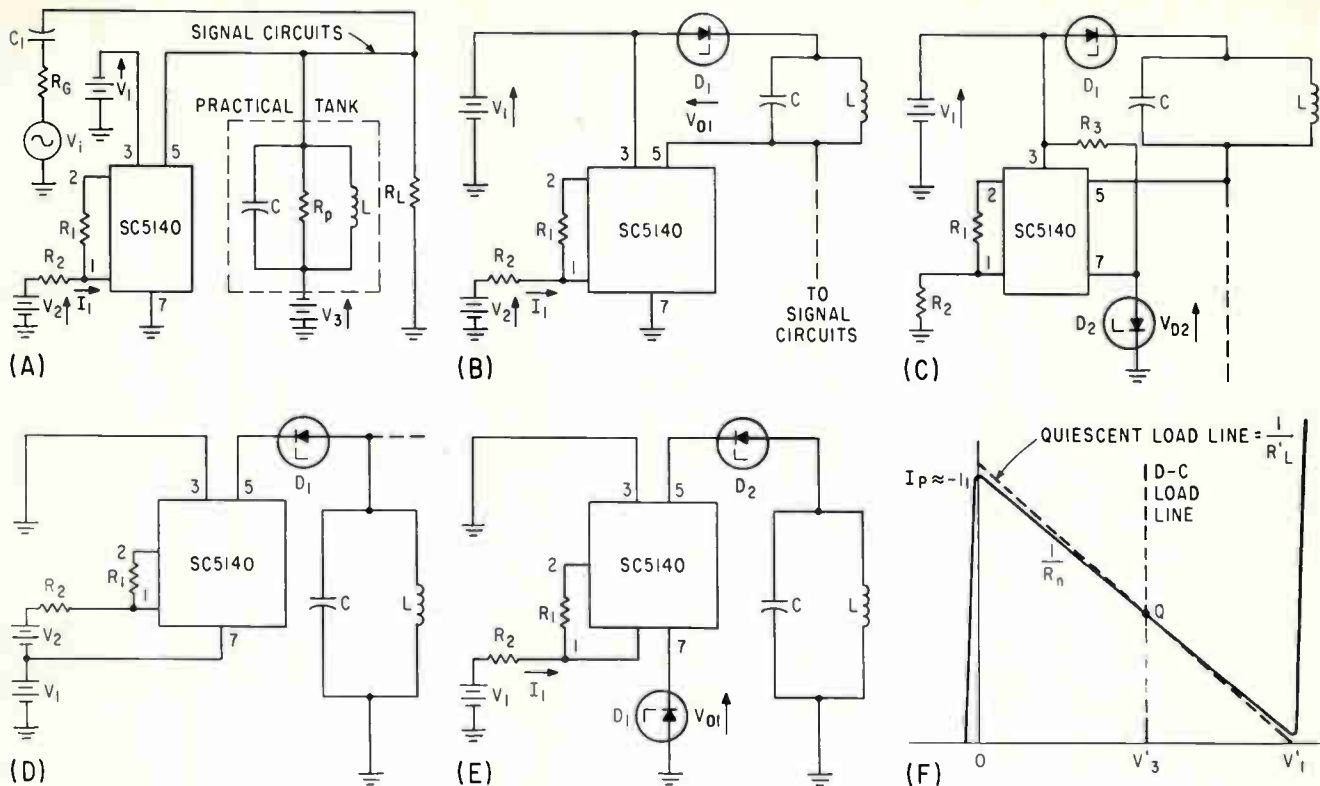

SIMPLEST Q-multiplier involves 3 voltage sources (A), improved circuit eliminates one supply with zener (B), two zeners permit operation on single supply (C). Tapped supply enables tank circuit to be grounded by (D), improved version has grounded tank and one supply (E). Characteristics refer to circuit 2A (F)—Fig. 2

modification. For example, consider the circuit of Fig. 2B. Here, the procedure is exactly the same as given above except a breakdown diode,  $D_1$ , is used to develop the value of  $V_3$  indicated by Eq. 8.

$$V_{D1} = V_1 - V_3 = V_1/2 \quad (9)$$

For Fig. 2C, the design procedure is as before, except  $V_1$  must be increased by an amount equal to the breakdown voltage of  $D_2$  which is usually made 5 volts or slightly less to obtain a slightly negative temperature coefficient for compensation. Also  $V_{D1}$  equals half the value of  $V_1$ , less the breakdown voltage of  $D_2$ .

$$V_{D1} = V_1 - V_{D2}$$

Figure 2D is just a minor rearrangement of Fig. 2B, hence, the same design procedures apply.

The circuit of Fig. 2E requires a slightly different procedure. Here  $V_{D1}$  must equal the voltage required for  $V_1$  in the basic design. For temperature compensation,  $V_{D1}$  should have a temperature coefficient of about +2 mv/degree C;  $V_{D2}$  is then made equal to  $V_{D1}/2$ , and  $V_1$  of Fig. 2E must equal  $V_{D1}$  plus an amount to produce the required value of  $I_1$  through  $R_2$ . Thus

$$V_1 = V_{D1} + I_1 R_2$$

**Design Example**—Assume that a resonant tank circuit consisting of a 1-uf capacitor and a 1-henry inductor, resonating at 159 cps. The unloaded  $Q$  of the inductor is 10, and source and load resistances are each 10,000 ohms.

The value of the equivalent parallel resistance  $R_p$  may be calculated to be 10,000 ohms, then the net value of  $R_p$  including the source and load resistances would be 3,333 ohms for a loaded  $Q$  of 3. Shunting the tank circuit with a 3,600 ohm negative resistance gives a modified  $Q$  or  $Q'$  using Eq. 3 but including loading equal to

$$Q' = \frac{-(3,333)(3,600)}{2\pi(159)(3,333 - 3,600)} = 4.5$$

The loaded  $Q$  has thus been multiplied by 15. To achieve a higher multiplication factor it is necessary only to make the value of  $R_n$  a little smaller. Bias arrangements should be designed next, assuming separate power supplies for  $V_1$ ,  $V_2$  and  $V_3$  in Fig. 2A.

For a single-supply arrangement such as shown in Fig. 10, operating from +24 v,  $V_{D1}$  is made equal to the desired value of  $V_1$ . To set up the same equivalent bias conditions as before,  $V_{D1}$  is set to 15 volts,

and  $V_{D2}$  is made equal to 7.5 volts. Resistor  $R_2$  provides the bias current of 4.2 ma from the difference in  $V_1$  and  $V_{D1}$ .  $R_2$  should be

$$R_2 = (24 - 15)/4.2 \text{ ma} = 2,200 \text{ ohms}$$

To design an oscillator, it is necessary merely to reduce the value of  $R_n$  until it is slightly less than the total positive loss resistance. If low distortion is required, it may be necessary to make  $R_n$  adjustable. Otherwise, it should be some 10 percent lower than  $R_p$ .

If the peak to peak signal swing is 10 volts, then valley voltage for the NRE must be greater than 15 volts for the best linearity. Operating bias point is then chosen to be 7.5 volts, equal to  $V_3$  if the d-c resistance of the coil is negligible.

The valley voltage is approximately equal to the product of  $R_n$  and the peak current,  $I_p$ . With  $R_n$  equal to 3,600 ohms and a valley voltage of -15 volts,  $I_p$  must be -4.2 ma. Current  $I_p$  is controlled by the value of bias current  $I_1$ , hence, if  $V_2$  is 24 volts,  $R_2$  must be approximately 5,600 ohms. The final voltage,  $V$ , must be between -15 volts and a maximum of -30 volts; the value of  $R_n$  is set by a resistor  $R_1$  of 3,600 ohms. (Actually  $R_n$  will be slightly larger.)

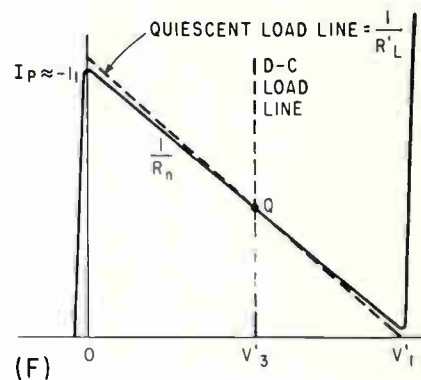

DEGRADATION of diffused silicon transistor sealed in vacuum is much less than that of unit sealed in dry air (A). Model of surface effect phenomena for npn mesa transistor showing channel formation (B). Voltage level in the actual circuit is a large factor in degradation (C)—  
Fig. 1

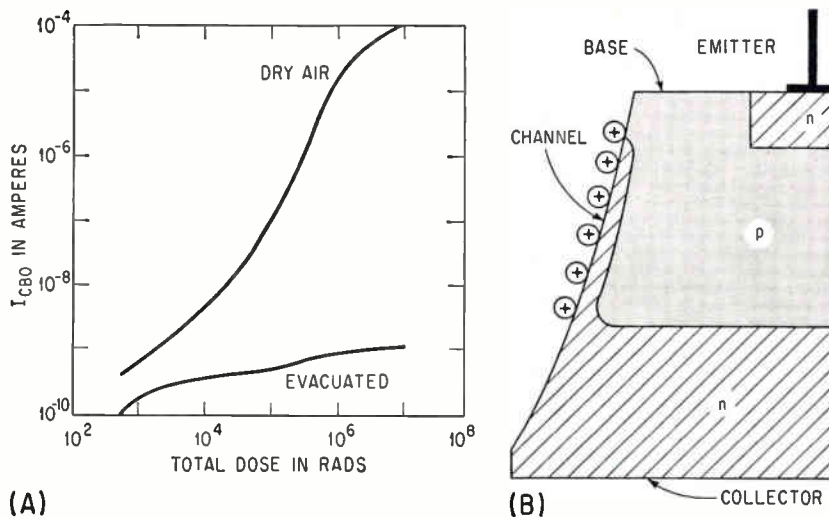

## Surface Effects of IONIZING

By D. S. PECK and E. R. SCHMID, Bell Telephone Laboratories, Inc., Allentown, Pennsylvania

Semiconductors sealed in gas show greater changes when irradiated than those sealed in vacuum. High circuit voltages also contribute to device degradation

**SURFACE EFFECTS** of high-energy radiation—ionizing radiation—on semiconductor devices have only recently been systematically studied and reported, although bulk effects have been studied for years. The failure and later repair of the first Telstar satellite brought the surface-effect problem increased attention, since surface effect experiments on the ground have duplicated the operation of the circuits in the satellite.

Although the present model of the surface-effect mechanism is not

considered complete in all details, it does provide a practical way to evaluate semiconductor devices that are to be used in a radiation environment. In particular, the model is believed to be applicable to the environment of the Van Allen belts.

**Nature**—Surface radiation effects must first be distinguished from the more readily understood bulk effects. A surface effect should cause an increase in reverse junction currents; the reverse collector current in a transistor has been found to be

particularly sensitive to radiation if the transistor is irradiated while under bias. Transistor current gain is also affected, sometimes even if the collector current has not degraded. The effect becomes apparent at radiation doses of  $10^3$  to  $10^6$  rads, depending on the gas inside the transistor envelope and the treatment of the surface prior to encapsulation. Some diffused germanium transistors also exhibit degradation of the reverse collector current, although generally more slowly and gradually than silicon transistors. (A rad is equivalent to the absorption of 100 ergs per gram; one rad produces about  $2 \times 10^9$  ion-electron pairs per  $\text{cm}^3$  in air or about  $40 \times 10^{13}$  hole-electron pairs per  $\text{cm}^3$  in silicon.)

Bulk effects can occur either through the formation of hole-electron pairs by collisions of charged particles with bound electrons, or through lattice defects produced by collisions of particles with the nuclei. The first of these mechanisms is transient since the pairs quickly recombine. The second mechanism produces permanent damage but generally after rather large radiation doses. For diffused silicon devices, permanent bulk damage typically begins at about  $10^8$  rads. For alloyed devices, in

### TRYING TO KEEP AHEAD

When Telstar I conked out just as 1962 was ending, engineers at Bell Labs had already started studying what happens on the surfaces of semiconductors when they are subjected to Van Allen Belt radiation. Like the cavalry in a western they were just in time. Telstar I was restored to working order, mainly by removing the voltages on the affected decoder circuits and letting the transistors recover on their own.

Surface effects are better understood now, and circuit designers who must cope with radiation are a little further out of the woods

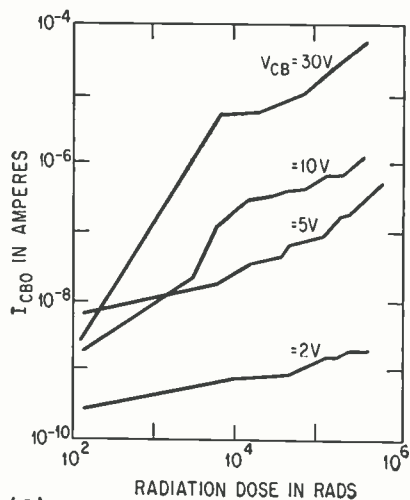

(C)

# RADIATION

which the base region is generally wide, bulk damage begins at low dose levels so that surface effects, if there are any, may be masked.

Figure 1A shows the effects of ionizing radiation on the reverse collector currents of a sensitive silicon transistor sealed in dry air and of a similar type in vacuum. The marked difference in behavior points directly to a surface effect.

All evacuated types are slow to degrade, compared with devices in a gas. However, large variations in the response of devices of the same gas-filled type occur, indicating that subtle differences in surfaces as well as the gas may be playing a role. A simple model<sup>1</sup> of the process is given in Fig. 1B for an *n*pn mesa transistor. The fringing field of a reverse biased collector junction causes ions produced by radiation to be deposited on the *p*-type base. This creates an inversion layer at the surface which in effect extends the collector region over the base. The inversion layer or channel increases the collector current and—if it extends as far as the emitter—adds even more current to the collector. Such channels have been repeatedly observed and are identified by a high emitter floating potential and channel pinch-off. Both these characteristics of channels

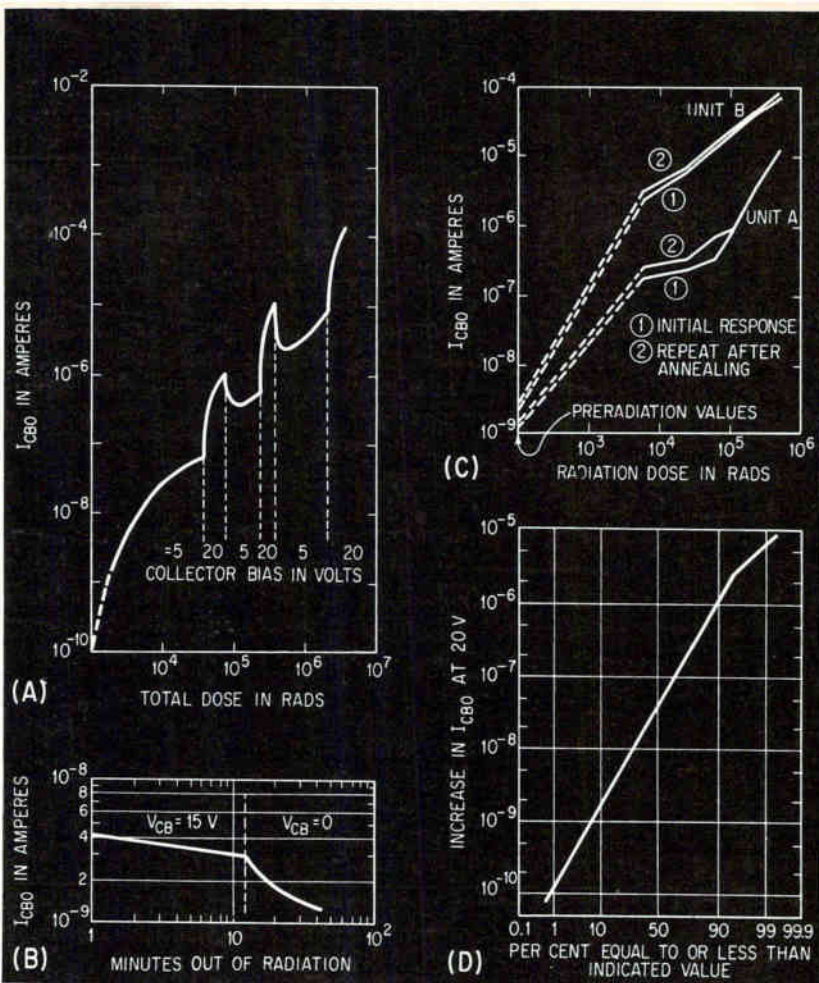

CURRENT  $I_{CBO}$  increases steeply as circuit voltage is raised, recovers slightly when it is lowered (A). Decay of radiation effect with and without bias (B). Transistors return nearly to their original state if they are heat treated after being irradiated (C). Large variation in resistance to radiation of a single type transistor is illustrated in (D); if this device were to be used in radiation, careful selection of individual units would be desirable—Fig. 2

have been verified in connection with radiation effects on silicon transistor surfaces. A possible contributing factor is that the encapsulating can of most transistors is electrically tied to the collector, so the field exists throughout the space surrounding the wafer. This would increase the efficiency of ion collection on the base region.

**Bias Effects**—The model proposed requires the presence of a field and therefore changing the bias voltage should alter the effect, since both the efficiency of charge collection and the extent of the inversion layer depend on the field. For similar transistors at different bias levels, Fig. 1C, current degradation seems to depend strongly on bias up to doses of about  $10^4$  rads. At greater doses the rates of degradation appear to be reasonably independent of bias level.

When the bias is suddenly increased, the current quickly changes, as though the entire dose had been

given at the higher bias. A corresponding readjustment also takes place when the bias is lowered, as shown in Fig. 2A. Collector bias seems to have a strong influence on the arrangement of charges on the surface—this determines the current characteristics of the channel whereas the supply of available charges is a function of the radiation dose.

**Dose Rate**—Initial studies indicated that the degradation of reverse collector current is more a function of total dose than of dose rate. Since devices recover when removed from the radiation field, the observed behavior can not be solely dependent on the total dose. Individual devices have shown shifts in reverse current of as much as two and one-half orders of magnitude when the dose rate was changed from very low to very high. Also, devices that have been degraded at a high dose rate will recover at low dose rates for a time. Thus the simple model, which predicts that

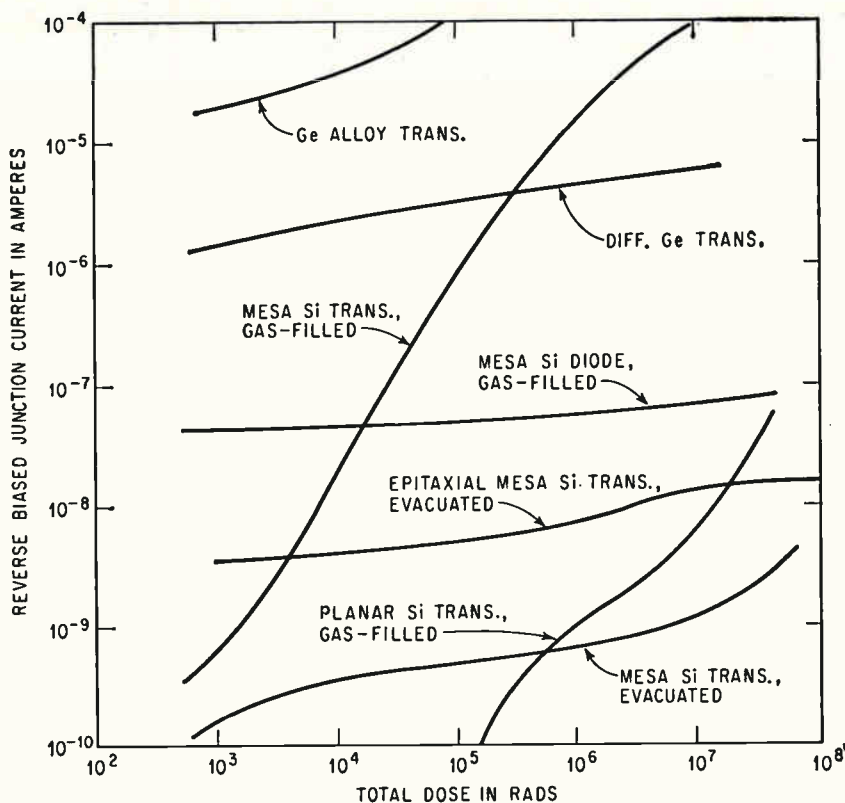

APPROXIMATE effects of radiation on several classes of devices. But great variation, even in units of the same type, is usual—Fig. 3

only the total dose is important, does not always hold.

It appears that degradation is a function of total dose but that large changes in dose rate can cause temporary deviations from expected behavior.

**Memory and Recovery**—Figure 2B shows recovery with and without bias. Removing the bias apparently accelerates recovery because ions are now no longer held by the field but are free to diffuse. Recovery can also be hastened by leaving the devices in the radiation field without bias. Apparently the presence of gas ions contributes to the neutralization of previously produced surface charges.

When a device is allowed to recover and is again irradiated, degradation corresponding to the level previously attained takes place quickly. Even months later, devices that recovered will quickly reestablish their former response when again irradiated. However, this memory effect can be erased, Fig. 2C, by baking the device at an elevated temperature for a few hours.

**Measurements**—Measuring device

characteristics in the presence of ionizing radiation requires great care. Reverse-bias junction currents of silicon transistors are inherently low—often  $10^{-10}$  ampere or less. Radiation produces in leads and sockets currents that are several orders of magnitude larger than device reverse currents.

Even an empty socket can give a response like a relatively insensitive transistor. This problem can be partially overcome by protecting all exposed leads, solder joints and socket pins from ionized gas, either by working in a vacuum, or by covering or potting the test fixtures and devices being tested. This is at best a cumbersome process and not suitable for multi-unit or routine testing. To read low junction currents, it is therefore generally necessary to remove the device momentarily from radiation. Since the devices recover when this is done, measurements must be made as quickly as possible. Because the measurement of low currents requires good instrumentation, the only practical way to experiment with many devices at one time is to use high speed electronic scanning and automatic recording. Thus

a fairly simple measurement must be made with elaborate equipment.

Another serious problem arises in measuring recovery, especially while the device is under radiation and without bias. To measure reverse current a nominal bias voltage must be applied. At the same time, the device must be removed from the radiation field or it would quickly remember its previous degradation and return to it. Two things now happen: the recovery rate is slowed by removal from radiation, and the application of bias brings on the memory effect. The events take place so rapidly it is often not possible to distinguish between meter damping and the onset of the drift. Thus bias should be applied only momentarily and the meter deflection kept small.

**Device Selection**—Different types of transistors have greatly varying responses, with large variations among transistors of the same type. Occasionally an individual device will differ grossly from the type behavior.

Increases in reverse collector current for one type transistor at a dose of  $1.4 \times 10^4$  rads are shown in Fig. 2D, showing the need for a screening procedure if this type transistor is used in radiation. Responses of some device types are shown in Fig. 3, with each curve representative of a broad class of devices. There are large variations between different types within a given class and among individuals within a type.

The experience gained with the first Telstar is that a communications satellite in a low orbit will accumulate a radiation dose of about  $10^6$  rads per year.<sup>2</sup> A radiation tolerance of  $10^7$  rads or more is therefore a reasonable requirement for devices in such applications. Some types of devices do meet the requirement but cannot always be used. When using devices less resistant to radiation, screening can be used to great advantage.

#### REFERENCES

- (1) D. S. Peck, R. R. Blair, W. L. Brown, and F. M. Smits, Surface Effects of Radiation on Transistors, *BSTJ*, 42, No. 1, p. 95, Jan. 1963.
- (2) W. L. Brown, J. D. Gabbe and W. Rosenzweig, Results of the TELSTAR Radiation Experiments, *BSTJ*, 42, No. 4, p. 1505, July 1963.

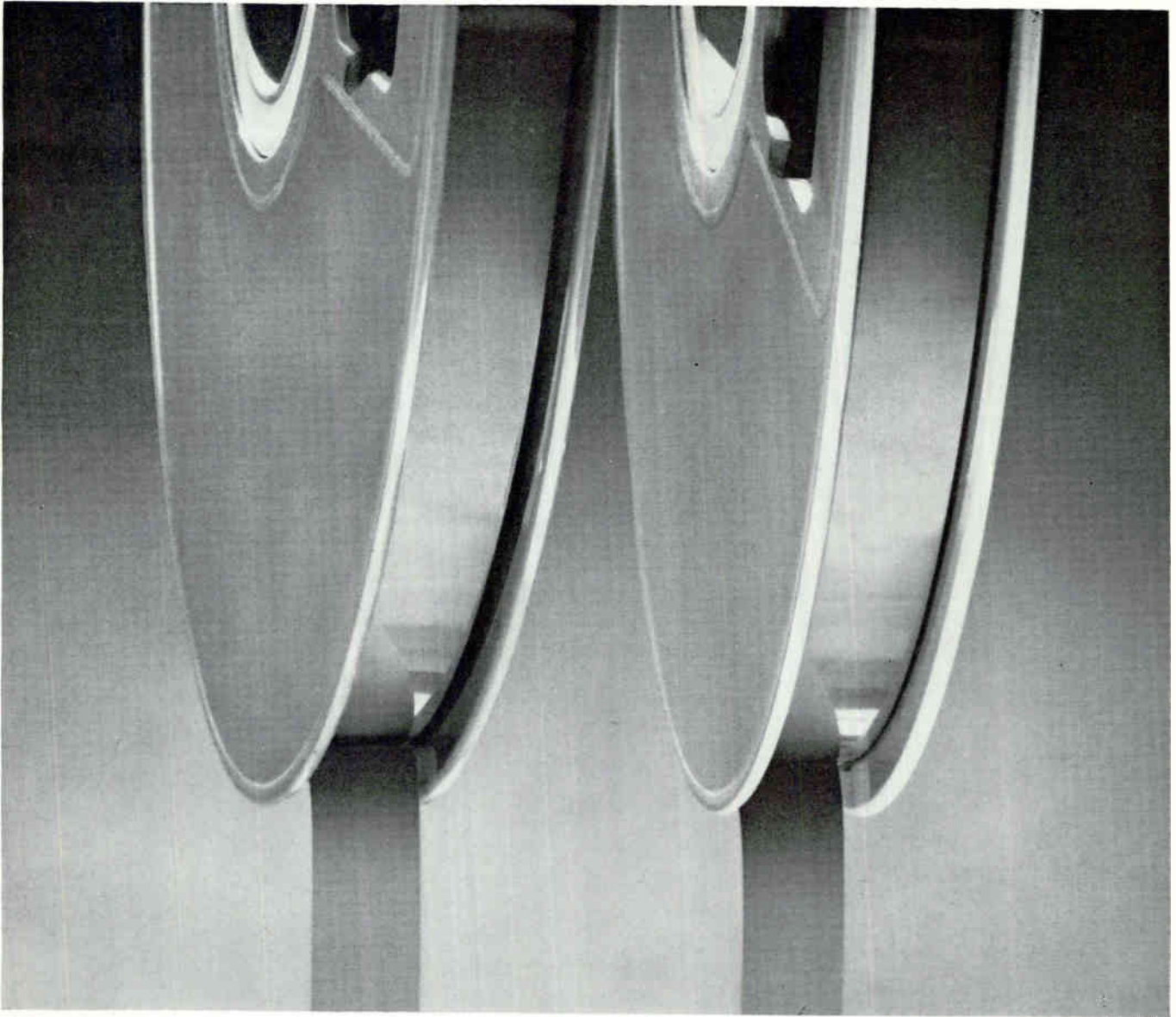

## **BOTH THESE MAGNETIC TAPES HAVE A POLYESTER BASE ...BUT ONLY ONE IS MYLAR® (8 YEARS PROVEN)**

Eight years ago instrumentation tape of Du Pont MYLAR\* polyester film appeared on the scene and set new standards of reliability. Naturally enough, people whose needs called for a magnetic tape of highest performance couldn't risk a tape other than MYLAR. ■ Now, other polyester films are beginning to appear. They are not all the same: MYLAR is a polyester film, but other polyester films are

not MYLAR. In the past you could safely assume you were getting MYLAR when you specified "polyester base". *Today you cannot.* ■ There's only one way to be sure you're getting the MYLAR you've used and trusted for magnetic tapes of proven reliability: specify MYLAR by name. E. I. du Pont de Nemours & Co. (Inc.), 10452 Nemours Bldg., Wilmington 98, Delaware.

\*Du Pont's registered trademark for its polyester film.



BETTER THINGS FOR BETTER LIVING . . . THROUGH CHEMISTRY

electronics October 4, 1963

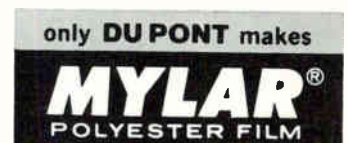

CIRCLE 37 ON READER SERVICE CARD 37

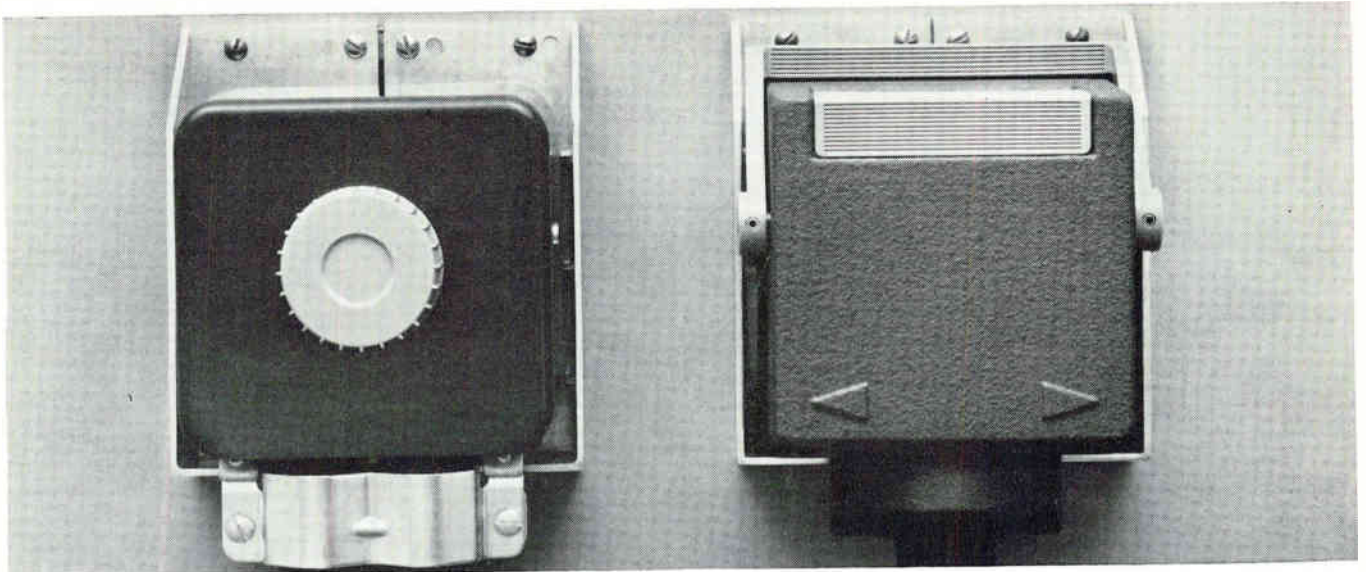

## Lock-up choice . . .

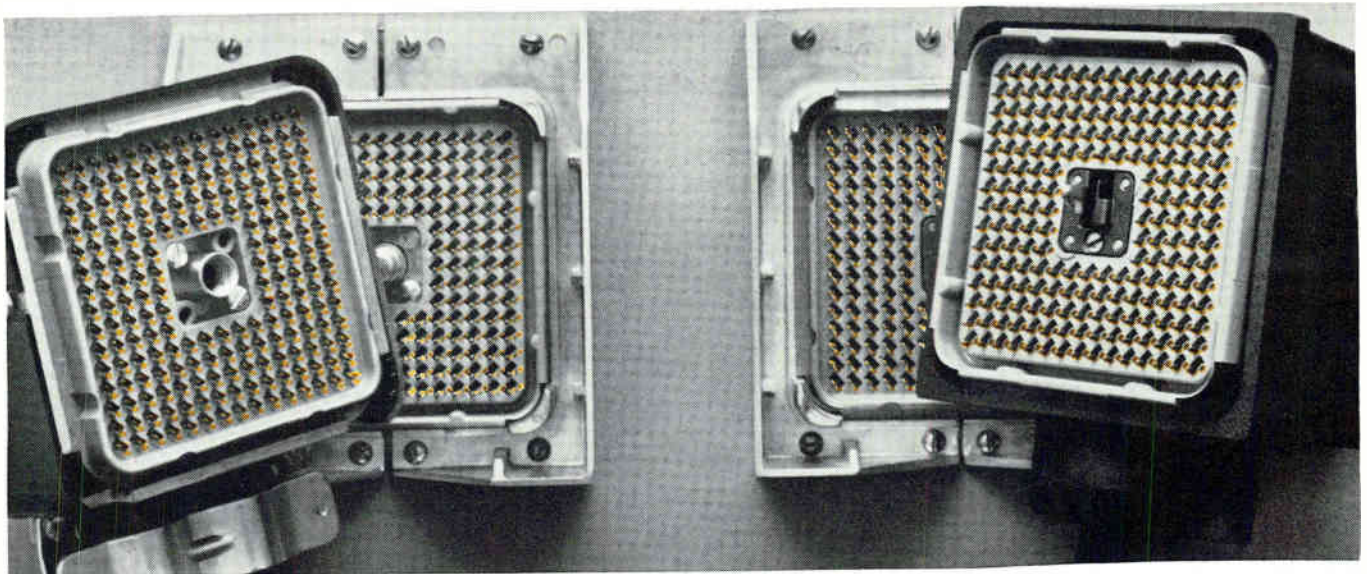

## Locks in reliability

Choose one of two ways to lock in unmatched reliability in the 200-position DUALATCH★ Cable Connector: cam action handle or screw type knob. Either way and with any number of contacts up to 200, you have locked in top performance for even the most complex application.

The DUALATCH Contact tells the reliability story. Out of millions of these contacts now in use not one single operating failure has been reported!

The DUALATCH Contact is hermaphroditic, with a dual, high-conductivity contact area. Aligns and mates perfectly. Has full-sweep self-cleaning wiping action for greater contact redundancy. Benefits from 70% lower engagement and separation forces than most other contacts. And while rated for 2,000 insertions and extractions, it has been successfully tested for 10,000 such cycles without pushouts or degradation of electrical characteristics. In addition:

AMP precisely controlled compression crimping (with matched tooling) adds measurably to both reliability and versatility. And the ease and speed of automatic application—up to 1,500 contacts per hour—results in lowest applied cost. Other advantages:

- available with cable outlet positioned at 45° or 90°
- cost-saving stamped and formed contacts
- can be electrically disengaged without mechanical separation
- AMP standard gold over nickel plating
- exact polarization to assure proper coupling
- voltage rating: 1,000 volts ac, rms; current rating in excess of three amperes
- available in wire sizes #20-24 AWG and #16-18 AWG

Write for additional data.

★Trademark of AMP INCORPORATED.



AMP products and engineering assistance are available through subsidiary companies in: Australia • Canada • England • France • Holland • Italy • Japan • Mexico • West Germany



# Autos Boost Solid-State Devices

One estimate: a market as high as \$333 million for semiconductors by 1970

**EAST LANSING, MICH.** — The reputation for reliability that semiconductor devices enjoy among automakers is boosting future market forecasts by 100 to 200 percent, according to reports at the Industrial Electronics Symposium here September 18 and 19.

"We haven't even begun to use the warranty allowances set aside when semiconductor alternators were adopted a few years ago," reported Martin Cassario, of GM's Delco Radio division.

Autos—the single biggest industrial market for semiconductors—will absorb from \$168.7 million to \$333 million of the devices by 1970, predicted L. J. Giacoletto, of Michigan State University. New totals update a three-year-old MSU survey that forecast an auto market of \$78 million by 1970.

Ignition systems are expected to take \$81 million of the new 1970 total, voltage regulators \$38.5 million, radios \$30.2 million and alternators \$21 million.

Giacoletto expects a 10-percent-a-year increase in the auto market. Wider applications for semiconductors would compensate for overall declines in unit costs.

**Applications**—Pontiac was reported to offer a total of 33 semiconductor devices to the customer who exercises all options: for a-m/f-m radio, voltage regulator and alternator. The symposium also discussed Cadillac's introduction of a heating-cooling comfort center whose "computer" uses three or four semiconductors.

Other possible auto applications for semiconductors include fuel monitoring and metering, sensing and computation for automatic transmissions, in fuel pumps, headlight dimmers, horns, starter relays, electronic clocks—and even computers reporting how many miles your remaining fuel will take you.

---

## THIS CAR IS REALLY LOADED

DETROIT—Cadillac owners can now get gadgets that take almost all the work out of driving.

Besides the usual options, they can have an emergency brake that automatically releases when the car is put in gear, an ignition system that won't work unless all doors are closed tight, and a cruise control that keeps the car running at a preset speed.

The heating and air-conditioning unit has a small computer control, acting on temperature signals provided by thermistors that monitor sun load, outside air temperature and discharge air temperature.

Under consideration is a system to automatically start the car and heat or cool it to taste before the passengers get in

---

**Auto Radar** — Anticollision radar costs are now at the level of automatic transmissions, reported Angelo Merlo, of Bendix. Simplified system would cost about as much as an auto radio, he said. Radar would cost less than \$100 if a hobbyist assembled it himself.

C-w doppler radar offers the minimum number of components and least complexity, with no local-

oscillator control and a conventional speaker delivering an audio signal proportional to closing distances. Transistor circuitry should cut battery drain from 25 to 12 w.

An experimental K-band, reflex-klystron, ssb a-m unit transmits carrier and upper sideband. A five-inch parabola forms a 7½-degree lobe. A 12-inch dish projects a 3 to 4 degree beam 800 feet forward.

## Laser May Accelerate Computer

Electro-optical system will hopefully solve problems 20 times faster

**SILVER SPRING, MD.**—A laser-operated optical electrical computer that can solve one form of integral equation and certain other mathematical problems 10 to 20 times faster than conventional computing equipment is being investigated at the Applied Physics Laboratory of The Johns Hopkins University.

Charles May, supervising the development, said the system is still in the early development stage, Engineers David G. Grant and Adolph M. Chwastyk have had success, however, with electronically

stimulated phase control of laser light, key to the projected computing instrumentation.

**Beam Phasing**—The instrumentation involves phasing an intense and stable helium-neon gas laser beam as it passes one point or data plane and focuses at another point in space called the solution plane. At the latter point, a light-to-electrical converter will capture the solution by electronic means and transform it into voltage so it can be recorded.

Light phase would be controlled by piezoelectric or potassium dihydrogen phosphate crystals, which react upon the passing light when stimulated by a voltage. May explained that phaser control depends upon the coefficients of the equation

# High CAPACITY VACUUM

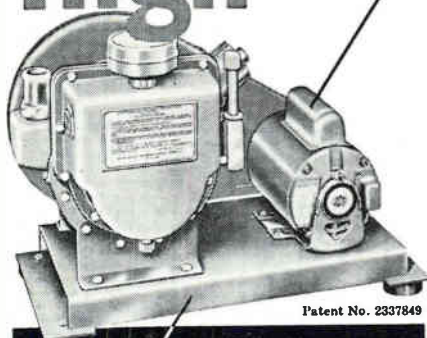

## WELCH DUO-SEAL VACUUM PUMP WITH VENTED EXHAUST

Welch "Duo-Seal" No. 1397 is a two-stage, oil sealed, rotary vacuum pump with a free air capacity of 425 liters per minute and a guaranteed vacuum performance of 0.1 micron or better with the vented exhaust closed . . . 1.0 micron with vent open. The performance is uniformly high over a range to  $1 \times 10^{-4}$  mm Hg (Torr). It is especially suited for application to large systems involving substantial vapor removal.

The 1397's are equipped with vented exhausts to eliminate condensation of vapors which raise the vapor pressure of the sealing oil, contaminate and break down the oil, and corrode the metal parts.

### IMPORTANT FEATURES:

- High pumping speed—425 liters per minute
- Low ultimate pressure— $1 \times 10^{-4}$  mm Hg (Torr)
- Quiet, vibration-free operation
- Compact, rugged design
- Air-cooled
- Vented Exhaust—eliminates condensed vapors, oil filters and separators
- Belt guard
- Trouble-free, low maintenance

Over the years, Welch "Duo-Seal" Vacuum Pumps have gained a world-wide reputation for best performance, greatest reliability and quietest operation. They are available in a wide selection of capacities and ultimate vacuum characteristics, ranging in capacities from 21 to 1400 liters/minute and ultimates from  $2 \times 10^{-2}$  mm Hg (Torr) down to  $1 \times 10^{-4}$  mm Hg (Torr).

WHEN YOU USE A WELCH "DUO-SEAL" VACUUM PUMP, YOU'RE USING THE FINEST!

For complete descriptions, specifications and prices, write for Welch "Duo-Seal" catalog.

**W** SINCE 1880 THE WELCH SCIENTIFIC COMPANY  
foremost manufacturers of scientific equipment  
1515 Sedgwick St. Dept. 906  
Chicago 10, Ill.

to be solved. These problem variables can be introduced by the action of the phase-control crystals.

**Parallel Processing**—With the laser-electronic computing mechanism, a

number of computations will be processed in parallel to obtain 10 to 20 answers in the  $\frac{1}{2}$  msec or less needed by the usual sequential computing equipment to determine a single answer.

## For 'Copters, Microwave ILS?

Radar on helicopter and beacon on ground help helicopters land blind

**FT. WORTH, TEXAS**—Some of the problems confronting the helicopter industry—such as blind flying and landing, training student pilots, and sighting and firing weapons—are beginning to be answered by electronics, an R&D symposium staged by Bell Helicopter Co. here showed.

**ILS System**—Bell provided its Remote Area Instrument Landing System (Rails). This is a microwave basic instrument flight system. The addition of a tracking radar on the helicopter and a beacon on the ground makes it a complete blind (zero-zero) landing system.

Rails can be used for cross-country IFR flight, for high-precision navigation within 10 miles of the beacon, and can give complete programmed information for approach and touchdown to a selected landing spot near the beacon. The system can process and display information from conventional ILS or any polar or rectangular-coordinate type navigation system.

In operation, information from sensors is processed and displayed in symbolic form. The symbols are displayed on two 5-in. cathode ray tubes. A vertical display tube presents attitude, ground velocity, absolute altitude and flight-path steering symbols. A horizontal display tube presents aircraft heading, beacon position, altitude error and cyclic stick steering information.

**Student Trainer**—A by-product of Rails is a student training aid called Hepcat (Helicopter Pilot Control and Training Equipment). Bell claims this is the first such aid of its kind, and that it substantially reduces the time required to train new pilots.

Hepcat is a small indicator on the instrument panel. Horizontal and vertical lines indicate pitch and roll. By keeping the lines at the proper positions, the student gets the "feel" of the craft's controls and can maneuver, land and take-off. The instructor's control processes sensor

## Aris' New Antenna



**COMPACT** antenna engineered by ITT Federal Labs for Air Force's Advanced Range Instrumentation Ships program comprises a remotely tunable helical coil plus top-hat loading. Wire fans are ground plane. Tuning range is 2 to 30 Mc, swr less than 2, efficiency 40 percent at 2 Mc and peak envelope power over 10 kw

## "THIS BETTER BE GOOD!"...

May says the chief efforts now are to strengthen power and stability of the meter-long gas laser, to achieve better phase control, and to adapt the equipment as a functional instrument.

signals and feeds the readout to the indicator.

**Headtracker**—Bell showed another system it calls Headtracker. This is an optical device that monitors movement of a helicopter pilot's head and aligns external armament equipment with the pilot's line of sight. This would enable a pilot to place immediate fire on a target. Polarized light actuates three motion-tracking devices positioned in the cabin near the pilot's head.

Headtracker was developed under an Army contract, and will be turned over to research specialists at the Army's R&D laboratories at Ft. Belvoir, Va.

Bell has also been developing a system to use low-light-level television. The system was produced by General Electric, and Bell says its tests have shown a helicopter pilot can safely maneuver his aircraft by referring to the tv screen. It says the system makes it possible to see objects under dark conditions.

## DYNA-SOAR'S First Guidance System

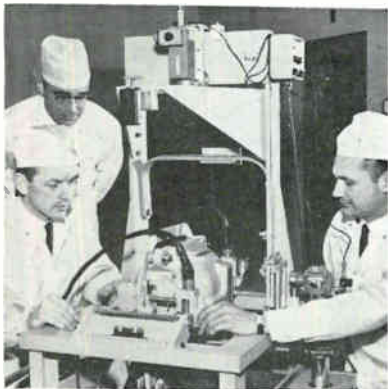

PROTOTYPE of the inertial-guidance system for the Dyna-Soar spacecraft has been delivered by Honeywell to Boeing, the prime contractor

... I wouldn't have taken the time, if Standards hadn't sent you. As I understand it, you sold them an oscillator, which they think can help *me!* Did they fill you in?

*Yes — they tell me the final test on your new line of amplifiers seems to be chewing up a lot more time than you'd like.*

Time? Please! Every time the brass walks through here and sees those unshipped instruments, I get visions of my merit file being stuffed with nasty little notes! Big problem's been in checking for frequency response and harmonic distortion. Just too bloody long on each instrument!



*Take the tests one at a time. Frequency response. Been feeding preset amplitudes at frequency steps, reading amplifier output and comparing? Have to go back to the signal source each time to check and reset its output amplitude at every frequency?*

Sure! Otherwise, I've got oscillator amplitude error in my gain figure.

*OK. You don't have to. The frequency response of the Krohn-Hite 446 oscillator is within 0.01 db up to 20 kc, within 0.05 db all the way from 10 cps to 100 kc. And short-term amplitude stability of 0.01%! So, forget about resetting voltage every time you change frequency.*

Beautiful! Eliminating rechecking the source and re-setting will *really* speed things up.

*Now — what are you doing to the input signal when you measure harmonic distortion of the amplifier? Have to purify the oscillator output?*

Naturally!

*Not at all . . . use the 446 as your source and forget about harmonic distortion — it's less than 0.02% from 400 cps to 5 kc, and only 0.2% at 20 cps and 20 kc. Another thing — the 446 is available fully programmable for automatic check-out — including self-checking, "enable" and "completed" circuits.*

Brother — you've just saved me 8 hours an instrument! I'm going upstairs right now and pinch a 446. We can ship some amplifiers tonight!

*Hold it! They're right in the middle of DVM calibrations with their 446's. But I'll let you buy your own from me.*

Dammit, progress always costs!



**KROHN-HITE  
CORPORATION**

580 Massachusetts Avenue, Cambridge 39, Mass.  
Area Code 617 491-3211

*Pioneering in Quality Electronic Instruments*

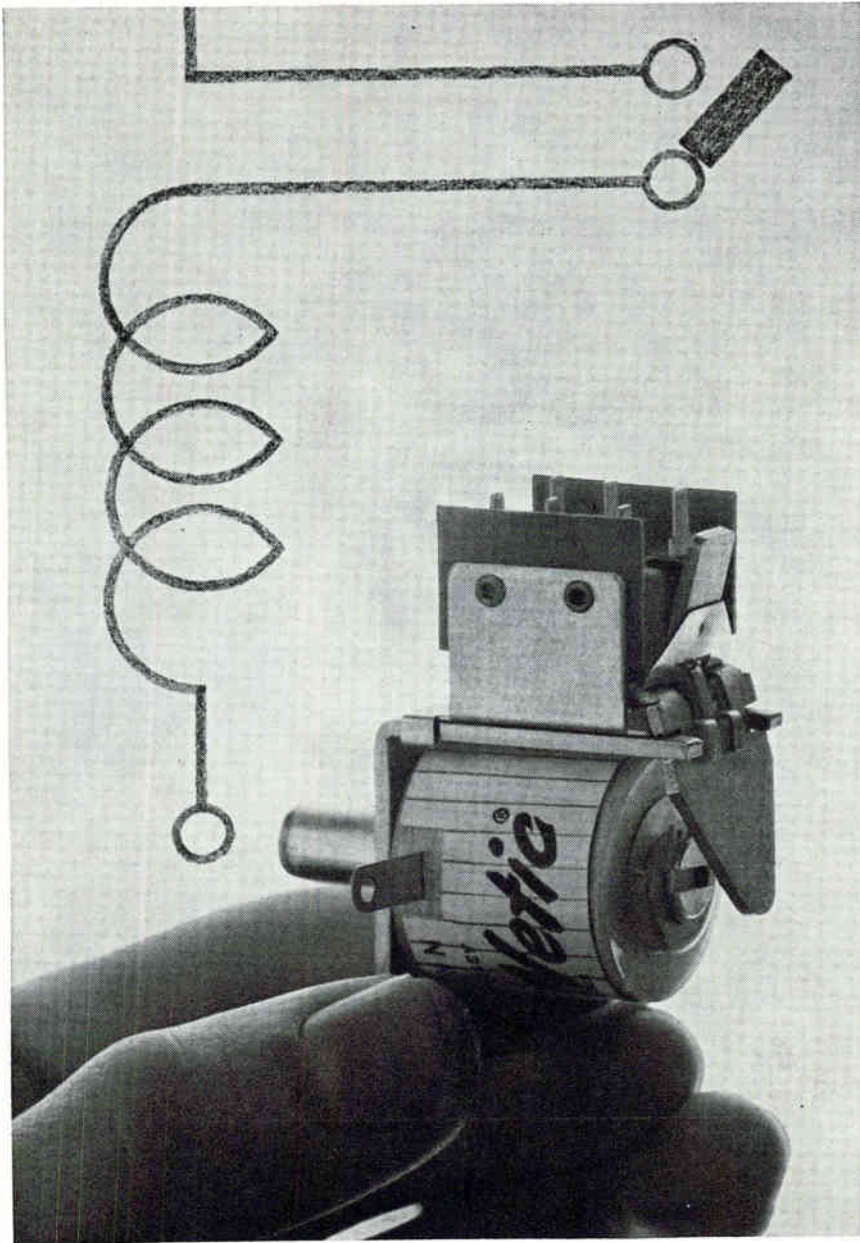

## WHY USE TWO IF ONE WILL DO?

The Heinemann Type B Time-Delay Relay can double as its own load relay. It's got a continuous-duty coil. Once actuated, it can remain locked-in indefinitely. This, combined with DPDT snap-action switching at up to 5 amps, can obviate the need for a separate slave relay in many applications.

Yours might be one of them. Here's a quick rundown of the Type B's specs:

**Standard Timings:** ¼, ½, 1, 2, 3, 4, 5, 8, 10, 15, 20, 30, 45, 60, 90, 120 seconds.

**Contact Capacity:** 5 amperes at 125V or 250V AC; 5 amperes at 30V DC, resistive; 3 amperes at 30V DC, inductive.

**Coil Voltages:** 60 cycles AC: 6, 12, 24, 48, 110, 115, 120, 208, 220, 230, 240 volts; DC: 4, 6, 12, 24, 28, 48, 64, 110, 120 volts. (Others available.)

For more detailed specifications on the Type B (and on all the other time-delay relays in the Heinemann line), write for Bulletin 5005.



**HEINEMANN**  
ELECTRIC COMPANY  
2600 Brunswick Pike, Trenton 2, N. J.

SA 2578

## Tri-Optic System Projects Color Tv

WOODSIDE, N. Y.—The new Eidophor simultaneous color-television system was demonstrated last week. The new closed-circuit system has three separate optical systems and independent controls for color balance and shading, intensity and registration. Basically, it combines three black-and-white Eidophor systems.

Mechanical components are made by Ciba's Swiss subsidiary, Gretag, and the electronics by Philips of the Netherlands. Distributor here is

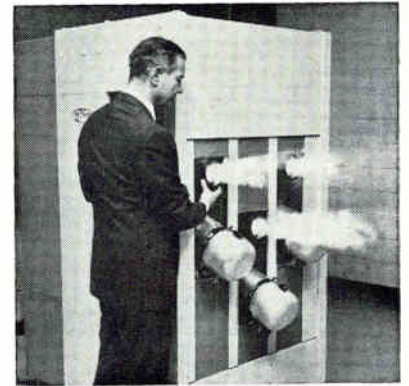

THREE black-and-white Eidophor optical units plus filters make up color-tv projection system

Theatre Network Television (TNT).

The previous Eidophor color system is field-sequential, using a rotating color wheel. It requires high bandwidth for transmissions.

The new simultaneous system can use any standard color-tv camera and color video tape. According to TNT, the new system projects more than 4,000 lumens compared with 250 lumens for the best former system, on screens up to 50 by 38 ft.

Air Force's Rome Air Development Center is using the system's prototype to investigate techniques such as displaying alphanumeric data against a map background. TNT sees applications for the simultaneous color Eidophor in areas such as military command posts, educational tv and theater pay tv and others. TNT plans to reenter theater television programming.

catch up with world-wide developments in electrical & electronics engineering!

# 100,000

## engineers & scientists on 6 continents will read the informative November issue of proceedings—will you?

November's special issue of **Proceedings of the IEEE** is the most important of 1963—it will spell out, in about 25 articles written by world-famous authorities, the electrical and electronics progress being made outside North America. URSI's 50th anniversary will also be reviewed.

100,000 engineers and scientists all over the world will read their subscription copy of November's **Proceedings** with intense interest. If you are not yet a subscriber, make sure you receive your copy of this fact-filled issue—fill out and mail the coupon today!

**Here's a sampling of 5 much-needed articles—**

*Experimental research on behavior of passive repeaters for microwave radio links*

COLAVITO & D'AURIA, ITALY

*Some observations on V.L.F. standard frequency transmissions*

THOMPSON, ARCHER, HARVEY, AUSTRALIA

*Space-charge limited solid state devices*

G. T. WRIGHT, ENGLAND

*Hall effect gyrators, isolators and circulators of high efficiency*

GRUTZMANN, WEST GERMANY

*Low noise non-reciprocal parametric amplifier with power matching at the input and output*

MAURER AND LOCHERER, WEST GERMANY

Remember—November **Proceedings** will carry 20 more!

**The Institute of Electrical & Electronics Engineers, Inc.  
Box A, Lenox Hill Station  
New York 21, N. Y.**

Gentlemen:

Yes, I want to join the 100,000 world-wide electronics engineers and scientists who will be reading the November issue of **Proceedings**.

I am not an IEEE member.

I'm enclosing  check  money order for \$3.

Bill me later.

Please mail my copy of **Proceedings** to (please print)

Name .....

Street & No. ....

City ..... State .....

**I understand your offer is good for a limited time only, as the "World Achievement Issue" may soon be sold out.**

### **Proceedings of the IEEE**

**The Institute of Electrical & Electronics Engineers, Inc.  
Box A, Lenox Hill Station, New York 21, N. Y.**

Boston • Fairfield, Conn. • Demarest, N.J. • Philadelphia • Bath, Ohio  
• Chicago • Minneapolis • Los Angeles • San Francisco • Paris • Tokyo



# Optical Radar For Space Rendezvous

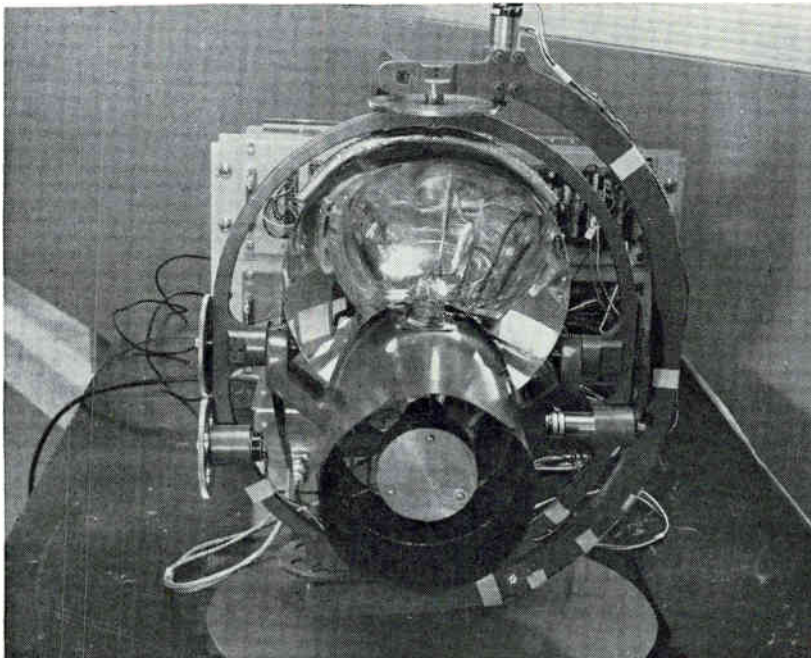

BREADBOARD MODEL as seen from outside of vehicle. Xenon discharge tube and transmission mirror at center, receiver optics with image splitter in larger tube underneath. Electronics are at rear of package

Uses xenon flashtube to guide space vehicles from 50 km to 1 m

**OPTICAL RADAR** for space vehicle rendezvous and docking applications, based on transmission and reflection of noncoherent visible light, was described this week at the Space Electronics and Telemetry Symposium in Miami Beach by E. Kirchoff, R. O. Leighou and R. B. Blizard of Martin Company, Denver, Col.

The system is designed to provide data such as relative range, direction, direction rate and closure rate over a range of 50 km to 1 m. An optical scheme was chosen for its simplicity and lightness; a noncoherent source was used rather than a laser, because of its greater efficiency and convenience.

Using a xenon flash tube and a 7-inch paraboloid reflector, a pulsed light signal is transmitted to a cube corner reflector that returns the light to the receiver in a very narrow beam, obviating the need for an active transponder. Transmitter and receiver are moved mechanically by a servo-operated gimbal system. The corner reflector returns the signal parallel to the incoming beam for angles of  $\pm 45$  deg.

Pulse return time is measured from acquisition (50 km) to 30 meters, to yield range information. Below 30 m, range is obtained from the amplitude of the return signal, since it is difficult to measure pulse return times of less than 0.2 nanoseconds. Range rate is obtained by differentiating the range information.

**Receiver**—The return signal is received through a Cassegrainian mirror system, and split into three equal components, going to three separate multiplier phototubes and

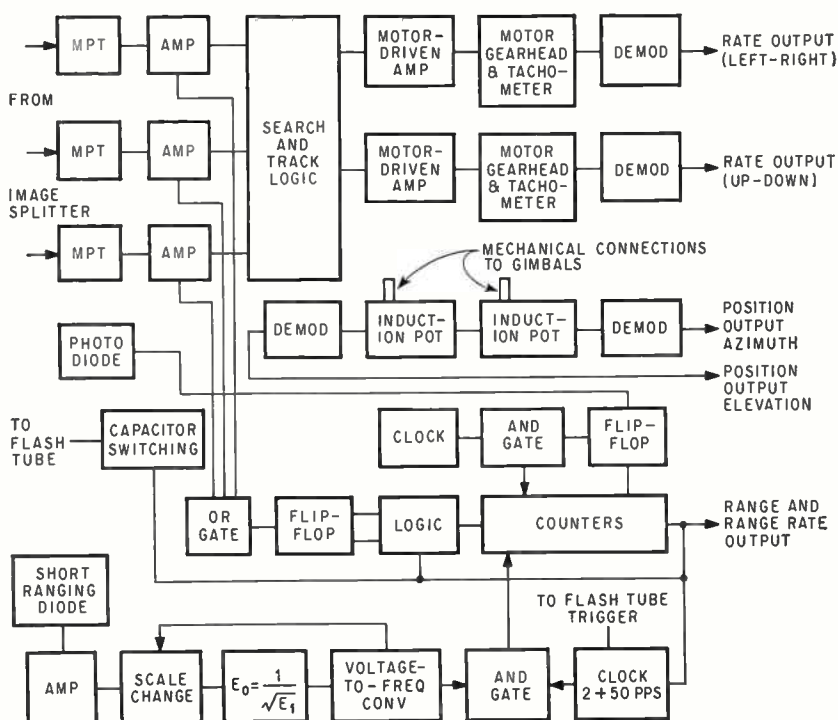

RADAR SYSTEM block diagram shows how relative position, range and direction outputs are obtained from light beam return

# can you use the advantages of Kepco's STATIC MAGNETIC VOLTAGE STABILIZER

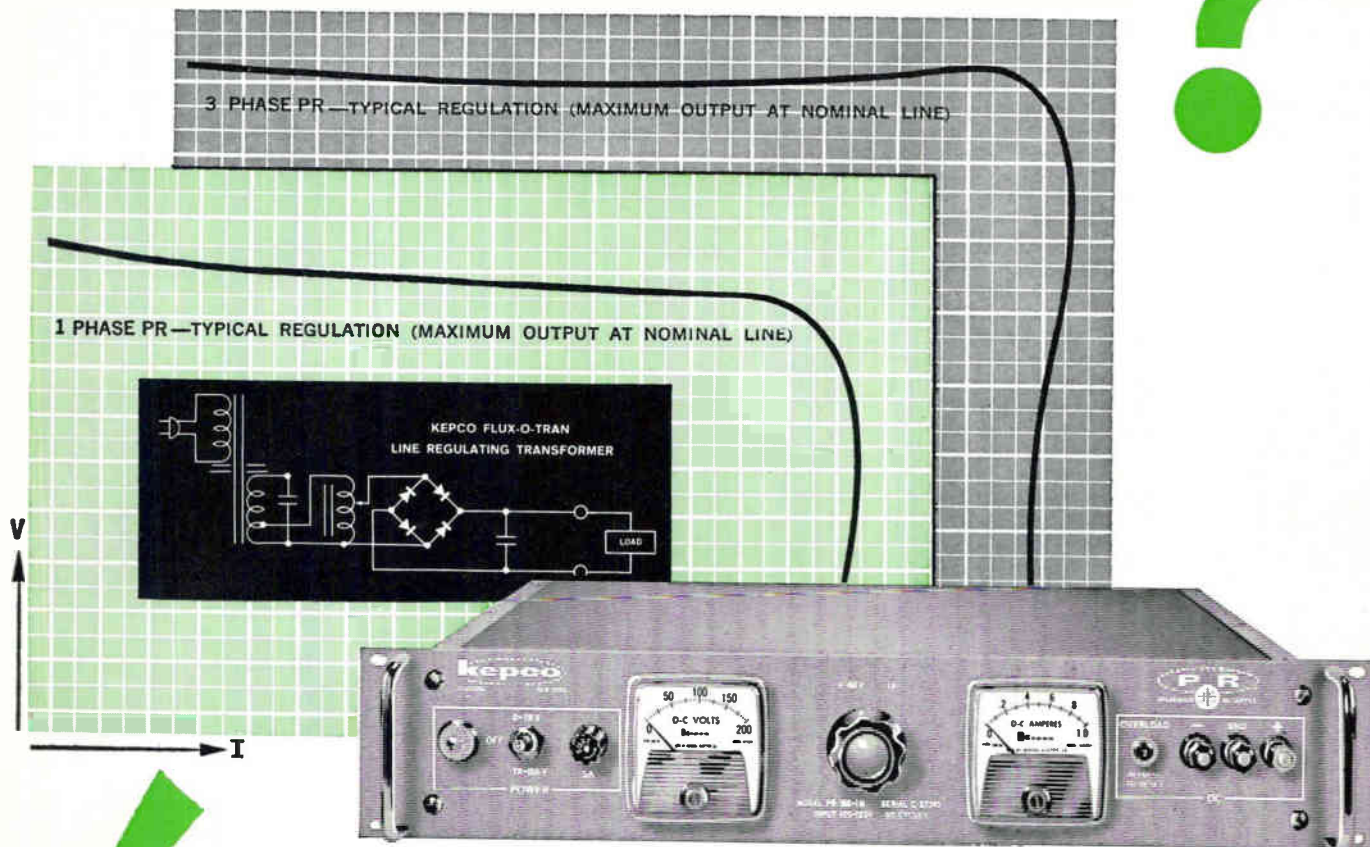

Model PR 155-1M



## KEPCO POWER SUPPLIES

Kepco's **FLUX-O-TRAN** is a ferro-resonant static magnetic voltage stabilizer. Its design characteristics feature:

- output essentially free of line voltage variations
- isolation of line transients
- current limiting protection from current overloads and external short-circuit

The **FLUX-O-TRAN** is the heart of Kepco's PR GROUP of DC Power Supplies. By delivering a squared-waveform to the rectifier, the **FLUX-O-TRAN** increases rectifier utilization and improves the loading characteristics of the filter capacitors. This characteristic

provides a relatively low intrinsic source impedance, improving load regulation and affording a low ripple content. The result is a simple FOOL-PROOF, high efficiency source of regulated DC power in *minimum* space and at *minimum* cost.

The PR GROUP offers a wide choice of *adjustable* output voltage and output ratings with:

- typical ripple values 0.5 to 3%
- overcurrent protection
- no voltage overshoot
- power efficiency typically 50-70%
- reliable, efficient silicon full-wave rectification

	± 1% LINE REGULATION — 105-125 V AC, 60 CPS ± 5% — 1 PHASE										± 2% LINE REGULATION 208/230 V AC ± 10% 60 CPS ± 5% — 3 PHASE		
VOLTS	0-7.5-15	0-15	0-19-38	0-38	0-40-80	0-80	0-78-155	0-155	0-165-310	0-310	0-20	0-40	0-50
AMPS	0-10	0-30	0-5	0-15	0-2.5	0-8	0-1	0-4	0-0.6	0-2	0-100	0-50	0-40
MODEL	PR 15-10M	PR 15-30M	PR 38-5M	PR 38-15M	PR 80-2.5M	PR 80-8M	PR 155-1M	PR 155-4M	PR 310-0.6M	PR 310-2M	PR 20-100M	PR 40-50M	PR 50-40
PRICE	\$345	\$495	\$325	\$475	\$325	\$450	\$325	\$430	\$345	\$430	\$1,125	\$950	\$950

for complete specifications on more than 250 standard models, write for NEW Catalog B-631

See our Catalog in  Sec. 4000



131-38 SANFORD AVENUE • FLUSHING 52, N.Y., U.S.A.  
Phone (212) IN 1-7000 • TWX# (212) 539-6623  
Cable Address: KEPPOWER, NEWYORK



Unique thumb-wheel operation and in-line readout permit ease of setting even under severe field conditions. Sealed switch modules and environment-proof case make these Ratio Boxes ideal for rigorous GSE and commercial applications. In addition to high readability and accuracy in minimum space, they provide previously unavailable design and performance features:

- Four digit in-line readout
- Ratio range to 1.1110
- Accuracy 10 ppm
- Frequency range to 10 kc
- Series impedance as low as 0.8 ohm
- No switching transients
- Splash and drip-proof design
- Meets rugged MIL requirements

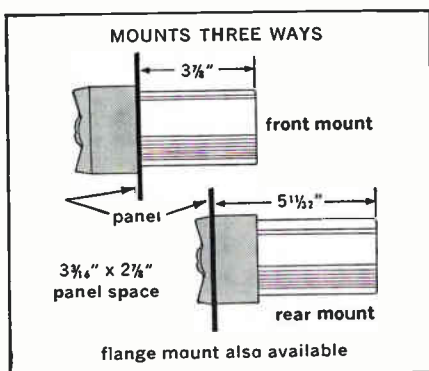

For complete data,  
write today for Bulletin RB520/521

**NORTH ATLANTIC**  
industries, inc.  
TERMINAL DRIVE, PLAINVIEW, L.I., NEW YORK  
Telephone: Overbrook 1-8600

three preamplifiers. An error signal is generated if the three components are unequal; this is used for optical alignment of the receiver and reflector. When the receiver package is aligned on the corner reflector, the reflected transmitter image is focussed on the image splitter, which illuminates all three multiplier phototubes.

The search pattern is  $\pm 15$  deg in azimuth and elevation, with a pattern similar to a tv raster except that vertical scanning is done in small increments at the end of each horizontal scan. Scanning rates are determined by transmitted beam width, prf and receiver field of view. Acquisition occurs when the target image is located within the receiver field of view, and tracking takes place when the target image is centered on the image splitter. The breadboard used digital circuitry because of its simplicity and adaptability to microcircuit techniques.

**Prototype**—The optical radar has been built by Martin in prototype. Using 10 percent of maximum input power, it showed search, acquisition and tracking capability at ranges up to 0.8 mile in the atmosphere during daylight. At short ranges, angular resolution was 1 milliradian, and tracking capability was demonstrated down to 3 feet.

## Picker Has New Semicon Diffraction Unit

CLEVELAND—New kind of instrument that uses x-ray diffraction techniques to orientate single crystals of semiconductor material is being readied for delivery here by Picker X-Ray Corporation's Special Products Division. The \$30,000-instrument is for the Air Force's Semiconductor Laboratory at Hanscom Field, Massachusetts.

Project engineer R. Carlson told Electronics that the instrument, first of its kind, will cut by 100 the time normally required to determine the exact crystal orientation in a semiconductor test specimen. Equipped with a movable x-ray tube and a rotating vernier sample mount, it makes possible the observation of changing Laue diffraction patterns while the specimen is rotated at will. Accuracy of crys-



**OBSERVING** the changing x-ray diffraction pattern of a semiconductor crystal, Picker engineer rotates the specimen by turning vernier dial, in order to locate exact direction of crystal planes

tal-plane location is said to be of the order of  $1/4$  degree, superior to that of etching techniques.

To make the Laue diffraction pattern visible, the unit uses a specially designed image intensifier tube equipped with an 8-inch beryllium front window for lossless x-ray transmission. The system will handle both transmission and backscatter patterns, and is suitable for crystal orientation of materials such as cesium iodide for which no other methods exist.

In addition to the obvious semiconductor component study applications, Carlson said the instrument is suitable for research into the changes produced in diffraction patterns by varying environmental conditions such as temperature.

## Tactile Control Seen In Space Applications

TEL AVIV, ISRAEL—Tactile vibrations—principle employed in a new telephone for deaf-mutes—could apply also to space communication and to drone aircraft, say scientists at Israel Institute of Technology.

Telephone operates by coding vibrations on basis of single or multiple frequency sent and received by the fingers. Equipment, tested experimentally, consists of one apparatus: sensitive vibration-transmitting keys in the sender, vibration-receiving diaphragm in receiver. Duplicate reverse system permits units to exchange function.



exclusively  
for  
industry

free

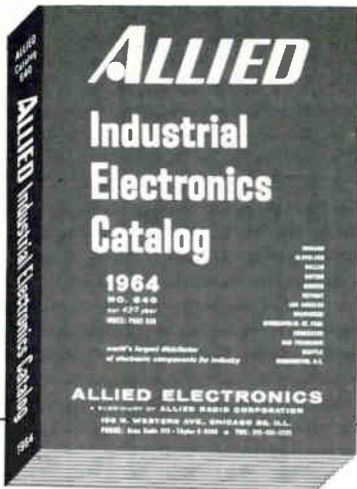

ask for  
your

1964 **ALLIED INDUSTRIAL CATALOG 640**

540 PAGES • COMPLETE INDUSTRIAL ELECTRONICS CATALOG FOR THE SPECIAL USE OF PURCHASING AGENTS AND ENGINEERS

- World's Largest Stocks of Electronic Components
- Same Day Shipment • Factory OEM Prices

for **FREE** copy, check reader service card or write direct

**ALLIED ELECTRONICS**

subsidiary of ALLIED RADIO CORPORATION

100 N. Western Ave., Dept. 80-K, Chicago 80, Ill.

For separate Catalog No. 230 featuring hi-fi, build-your-own kits, home tape recording, ham gear, etc., write directly to Allied Radio, Dept. AX, 100 N. Western Ave., Chicago 80, Ill.

CIRCLE 200 ON READER SERVICE CARD

**LEASE A  
BRAND NEW  
PLANT**



**65¢**  
Sq. Ft.

built for you in the finest  
industrial location in the East

**THE PHILADELPHIA INDUSTRIAL PARK**

651 Acres surrounding the North Philadelphia Airport. Suburban environment with all metropolitan utilities, services, conveniences.

Developer: **TISHMAN INDUSTRIAL PARKS, INC.**

Exclusive Agent:

**BINSWANGER**

**CORPORATION • INDUSTRIAL LOCATION SPECIALISTS**

1420 Walnut St., Phila. 2, Pa. • PEEnypacker 5-0202

CIRCLE 201 ON READER SERVICE CARD

electronics October 4, 1963

**UNDERSTANDING  
SWITCHING TECHNIQUES  
THROUGH KNOWLEDGE**

Janco's understanding of switches lies in the knowledge gained from its experience in making switches that function properly under conditions beyond the normal electrical, mechanical, or environmental standards. This experience provides a comprehensive knowledge of switching techniques. This means that proven performance is inherent in every Janco switch. ■ Janco's continuing research and development programs are dedicated toward meeting tomorrow's requirements today. Years of service with high performance military aircraft and missile systems is conclusive evidence of Janco's superior knowledge and experience.

**JANCO  
CORPORATION**

3111 WINONA AVENUE • BURBANK, CALIFORNIA

Visit Our Booth at The AES SHOW, Los Angeles, Oct. 9-11  
CIRCLE 47 ON READER SERVICE CARD 47

# ES Product of the month: IFF/TACAN DIPLEXER SYSTEM



**ES** is a diversified, dynamic, multi-divisional organization serving defense and industry over a broad range of vital areas with advanced systems, sub-systems, and state-of-the-art components. Major contributions are currently being made in the following:

## ELECTRONIC AND ELECTROMECHANICAL CONTROLS:

gyroscopes, relays, static switching devices, sensors, flashers, regulators, converters, rotary and linear actuators, motors, generators, weapon and camera controls, electromechanical assemblies for aerospace applications.

## COMMUNICATIONS:

antennas, flexible and rigid waveguides, coaxial switches, diplexers, power dividers, filters, radio telescopes, solar furnaces, matching networks, antenna drive motors and controls.

## POWER:

precise power systems, dynamometers, computer power sources, motor - generators, actuators, starter generators, power conversion systems, transmission towers for public utilities.

## SPACE CONDITIONING:

electronically programmed environmental controls and systems for industrial, commercial, and military applications.

## SYSTEMS:

Systems Laboratories conduct research, development and study programs in reconnaissance, electronic countermeasures, interferometer phased array systems, and total energy packages; integrating divisional components, sub-systems, and specialized technical skills.

*For information concerning the corporate systems capability, product line, or research and development programs, write to the Director of Marketing, address below.*

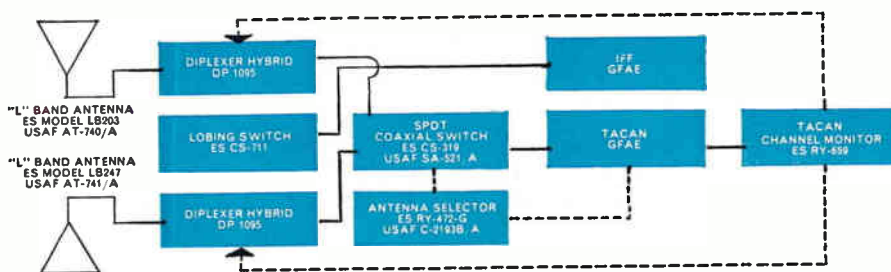

Electronic Specialty recently introduced a new device to solve the attenuation problem found in TACAN channels that are very close to IFF frequencies. Designated the DP-1095, it permits the use of all 126 channels. The device is a combination of a standard IFF/TACAN diplexer in conjunction with a hybrid, a coaxial switching matrix, and a 50 ohm termination. It uses the best features of diplexer on TACAN channels not interfering with IFF (very low insertion loss—less than 0.3 db), and automatically switches to hybrid mode only on TACAN channels close to IFF (limits insertion loss to 3 db). TACAN channel monitor can be installed in interconnecting TACAN cable at either end without tools. For complete information on the Electronic Specialty Non-Interfering IFF/TACAN Antenna Diplexer, write to William Marcy, Director of Marketing, at the address below.



# ELECTRONIC SPECIALTY CO.

5121 San Fernando Road • Los Angeles 39, California

# Battery for Space Finds Consumer Uses

Control electrode allows safe, rapid charging of nickel-cadmium batteries

**RAPID CHARGING** is only one advantage of a new nickel-cadmium battery developed by General Electric. The sealed, maintenance-free cell uses an electrode that determines completion-of-charge by sensing any buildup of oxygen. The electrode thereby prevents any gas buildup in the cell, eliminating the need for a heavy-walled case. A much simpler seal for battery terminals can also be used with the new device.

**New Approach**—The use of an electrode to recombine oxygen is not entirely new. Thomas A. Edison proposed use of a heated platinum or platinum oxide-coated wire to catalyze recombination of hydrogen

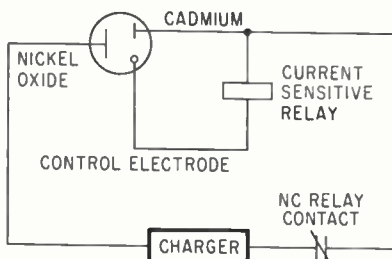

**CONTROL ELECTRODE** produces a signal by electrochemical consumption of oxygen (generated at outset of overcharge) on the electrode surface. The signal operates a current-sensitive relay which opens the normally closed series contact to shut off the charger. The control electrode can be designed over a large range of impedance characteristics as desired to match the control element. Voltage sensitive control elements can also be used

and oxygen in galvanic cells in 1912—making possible the first sealed secondary cell. In the development of the new cell, however, the use of an auxiliary electrode to control charging circuits does represent a new approach.

**Consumers Too**—Although the battery is expected to find widespread applications for space and military, G. L. Haller, vice-president for Advanced Technology Services, predicted that the device would spur development of nearly all kinds of portable, battery-operated electrical tools, appliances, and other consumer items. A sealed battery for a lawnmower, for example, could be charged in less than an hour, whereas conventional batteries require about 15 hours for recharging. The practical result of the new battery is that battery-operated equipment can be designed for continuous use, with only brief periods for recharging, instead of almost the reverse.

**Available**—Units are currently being manufactured with 3, 6, 12, 20, an 40 amp-hour ratings. Price will be dependent upon application, but is expected to be 25 to 30 percent over a conventional aerospace cell.

**In May 1962**, General Electric announced a \$3-million facility primarily for manufacturing nickel-cadmium cells located at Gainesville, Fla. "General Electric entered the (battery) market," according to general manager L. P. Hart, "because the company felt it could make a technical contribution that would lead to a substantial business opportunity." The nickel-cadmium battery market was in its infancy

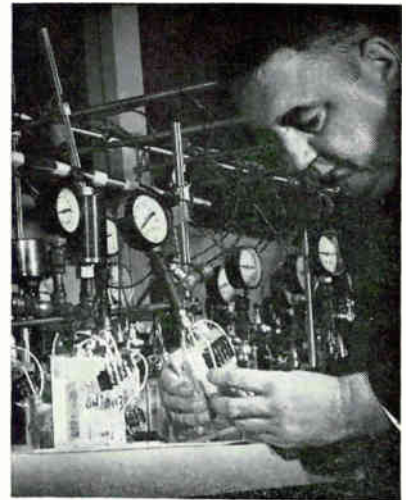

W. N. CARSON of General Electric's Advanced Technology Laboratories checks gas pressure in a laboratory model of the rapid-charge, nickel-cadmium battery

and was expected to see larger gains if certain problems—particularly size and weight—could be overcome, he continued.

## Magnetic Modulation of Light Reported

**EUROPIUM** orthosilicate ( $\text{Eu}_2\text{SiO}_4$ ) has been found nearly ten times as effective as previously known materials in rotating the plane of polarization of light when subjected to a magnetic field. With the advent of lasers, the ability to rotate the plane of polarization of light has become of increased technological interest because it is one way of modulating the laser beam to carry information. The electromagnetic oscillations of plane polarized light occur along one direction only. A change in this direction can be detected, and thus can serve as modulation of the light beam.

The plane of polarization of light can be rotated by a wide variety of materials when they are placed in a magnetic field, but the amount of rotation is extremely small. The discovery of the much stronger rotation in europium orthosilicate provides a material that may be useful

# SPECIFY ARNOLD IRON POWDER CORES... COMPLETE RANGE OF SIZES AND SHAPES FOR YOUR DESIGNS

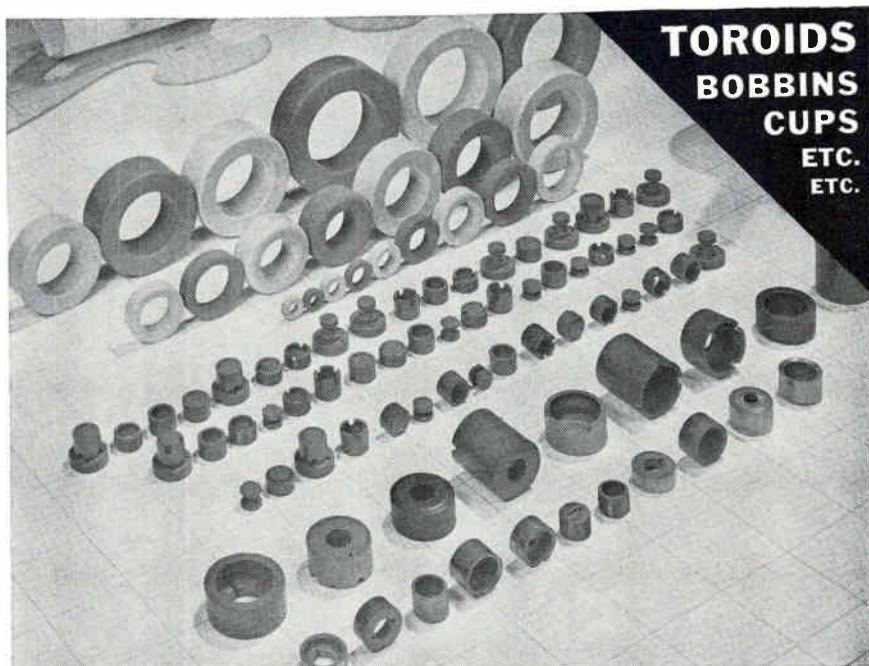

Arnold offers you the widest range of shapes and sizes of iron powder cores on the market.

In addition to toroids, bobbin cores and cup cores—typical groups of which are illustrated above—Arnold also produces plain, sleeve and hollow cores, threaded cores and insert cores, etc., to suit your designs. Many standard sizes are carried in warehouse stock for prompt shipment, from prototype lots to production quantities. Facilities for special cores are available to order.

The net result is extra advantage and

assurance for you. No matter what shapes or sizes of iron powder cores your designs require, you can get them from a single source of supply—with undivided responsibility and a single standard of known high quality.

Arnold's superior facilities for manufacture and test also assure you of dependably uniform cores, not only in magnetic properties but also in high mechanical strength and dimensional accuracy.

● For technical data and other information on Arnold iron powder cores, write for a copy of Bulletin PC-109A.

ADDRESS DEPT. E-10



## ARNOLD

SPECIALISTS in MAGNETIC MATERIALS

THE ARNOLD ENGINEERING COMPANY, Main Office: MARENGO, ILL.  
BRANCH OFFICES and REPRESENTATIVES in PRINCIPAL CITIES

284191A

for modulating laser beams by this method.

Measurements show that its Verdet constant—the rotation per unit of thickness per unit of magnetic field—is 2.5 minutes per oersted per centimeter at room temperature. This is nearly ten times larger than any previously reported value. The material is highly transparent to red and yellow light and is ferromagnetic at low temperatures. The combination of transparency and ferromagnetism is extremely rare, and accounts for the high Verdet constant.

Europium orthosilicate has the practical advantages of being easy to handle and chemically stable in normal use. Previously reported materials with relatively high Verdet constants have lacked transparency, were extremely fragile, or have been subject to deterioration in air.

### Laminated Plastic Withstands 500 F

GLASS-phenolic laminated plastic that withstands continuous temperatures up to 500 F has been introduced by Taylor Corporation. The material—designated by Taylor as Grade G-723—was designed for applications where good thermal and electrical resistance are both required. It is available in 49-inch by

### Power Fieldtron

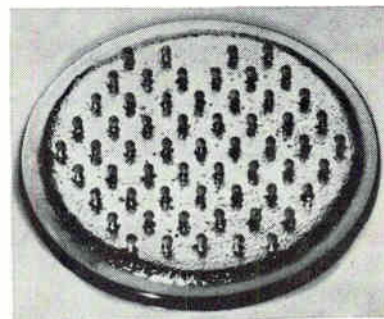

CLOSE-UP of French Technetron (Electronics, p 75, Sept. 6, 1963)—device is capable of switching 15 amp. Two or more may be connected in parallel to handle larger currents. Atlantic Instruments and Electronics of Boston—who plan to market the device in the U. S. under the trade name Fieldtron—foresee widespread use in high-power a-c and d-c switching circuits

49-inch sheets ranging in thickness from 0.015-inch to 0.5-inch. In addition to the high temperature coefficient, the manufacturer also claims that Grade G-723 has good electrical and mechanical properties. For example, flexural strength, flat-wise, condition A of  $\frac{1}{8}$ -th-inch thick sheet is given as 55,000 pounds per square inch (minimum), lengthwise, and 45,000 pounds per square inch (minimum), crosswise. Dielectric strength parallel to laminations is given as 50 kv (minimum) step by step, condition A.

### Preparation of Qualified Products Lists Announced

HEADQUARTERS, Ballistic Systems Division, Norton AFB, California, has announced the intention to establish a Qualified Products List for resistors, fixed, established reliability under Specification MIL-R-38101; capacitors, fixed, established reliability under Specification MIL-C-38102; and semiconductors, established reliability under Specification MIL-S-38103. Companies with products meeting the requirements are urged to contact Cpt. H. E. Mottley, BSRGQ-3, for all necessary information.

Additional qualified manufacturers for relay type RY4LA/B3L01, under Specification MIL-R-5757 (20 Sept. 1960) are desired by the Defense Electronic Supply Center. Companies with products fulfilling the requirements are urged to contact Defense Electronics Supply Centre, Attn.: DESC-EQ, 1507 Wilmington Pike, Dayton, Ohio, 45420.

### New Materials for Thermionic Converters

STUDIES at Martin—under an Air Force Cambridge Research Laboratories contract—may lead to an accurate room-temperature means to evaluate new anode and cathode materials for thermionic converters, the firm said. This in turn, may help simplify design of direct-energy conversion systems. Martin's approach, using a field-emission microscope, involves hunting the cause of pulsations seen in the magnified image of cesium-coated element specimens.

**Hughes  
new 5-digit  
voltmeter—  
worth  
\$1,000 more  
than its price**



The new Hughes Model 5100 Digital Voltmeter is an integrating 5 digit, all solid state instrument priced at \$2695.

We can bring you this new voltmeter, equal or superior to devices costing \$4000 or more, at a low price because of an entirely new concept in circuitry design.

The Hughes 5100 Digital Voltmeter incorporates a new and unique voltage to frequency converter\* as the heart of the machine. This device practically eliminates the use of critical or trouble-making components. The result is a voltmeter offering remarkable reliability, accuracy, ease of maintenance, and high noise rejection.

The Model 5100 can be used with the Model 1100 AC-DC Converter. Precise measurements of AC voltages from 30 cycles to 10 KC can be made simply, with 10 megohms input impedance on all ranges.

We would like to demonstrate the Hughes 5100 Digital Voltmeter and prove to you that it is the best value on the market. Write or call HUGHES INSTRUMENTS, 2020 Oceanside Boulevard, Oceanside, California. For export information write Hughes International, Culver City, California.

**SPECIFICATIONS HUGHES 5100 DIGITAL VOLTMETER:** Ranges:  $\pm 9.9999$  volts,  $\pm 99.999$  volts,  $\pm 999.99$  volts with full 5-digit readout. Accuracy:  $\pm .01\%$ . Linearity:  $\pm .005\%$  of full scale. Resolution:  $100 \mu V$  over entire lowest range. Input impedance: 1000 megohms on  $\pm 9.9999$  volt scale. 10 megohms on higher ranges. Features: Automatic polarity; automatic ranging; 9 readings per second average.

\*Patent Pending

**HUGHES**

HUGHES AIRCRAFT COMPANY  
HUGHES INSTRUMENTS  
OCEANSIDE, CALIF.

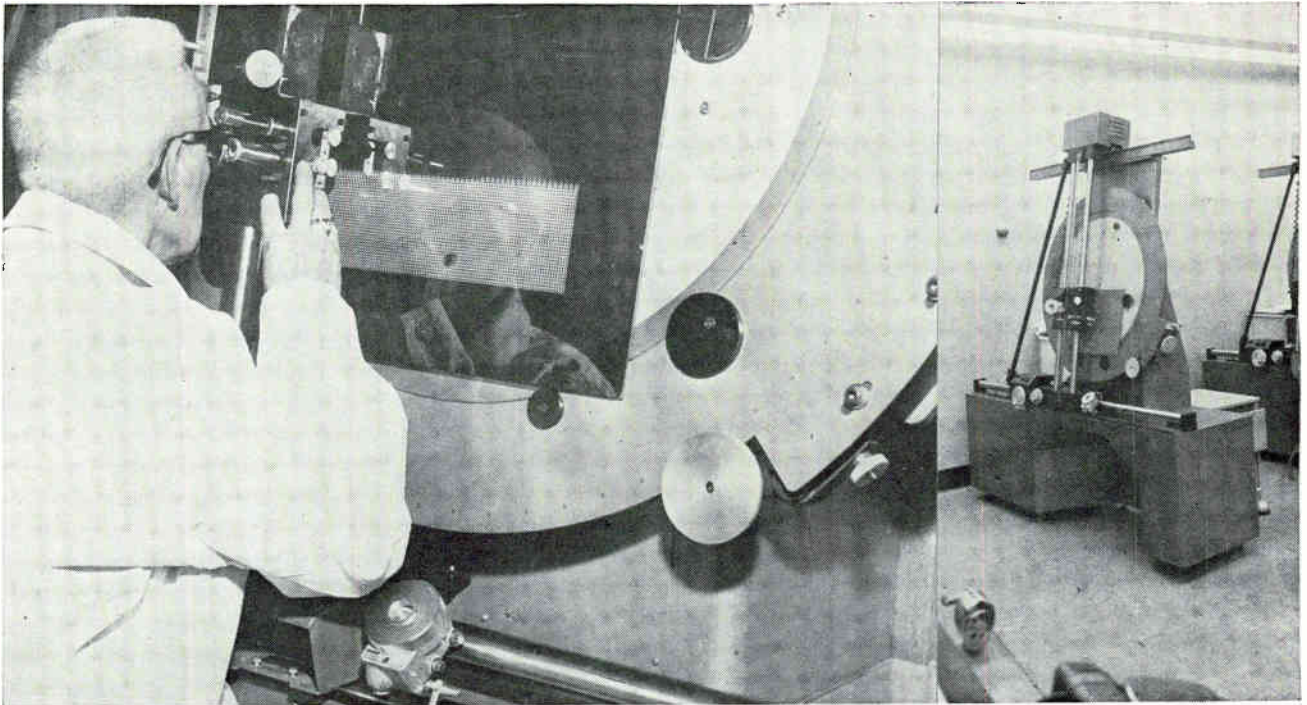

GLASS SCRIBING MACHINE (right) scribes emulsion on glass to produce highly accurate artwork. Precision glass master is scribed with 8,000 spherical lands for IBM circuitry. Accuracy is controlled in 1 to 1 scale to within 0.0005 in (left)

## Layout Machine Scribes on Glass

Photo masters on glass-borne emulsion enhance artwork

By **ALBERT C. BIDWELL**  
Chief Engineer  
Visual Inspection Products  
Lynn, Mass

**ORIGINAL ARTWORK** has been produced more accurately and with smaller scales by the use of an emulsion-scribing technique and machine. Modern integrated and microelectronic circuits have demanded more sophisticated methods than the use of pencil and ink drafting, chart pack tape layout and cut and strip. The introduction by VIP

and acceptance by IBM, Bendix, Raytheon, Sylvania, Pratt & Whitney and Hercules-ABL of scribing on glass through an emulsion to produce exquisite lines with extreme sharpness together with layout machines that can position a stylus, or make a non contact measurement down to 0.0001 inch has facilitated the required artwork.

**Design Features** — Uninterrupted process of layout and vertical attitude of the equipment are paramount advantages. A synchromatic slide block in the scribing head provides scribing and microscopic sighting without removing or interchanging the scope or scribe in performing separate operations. One is in true centrality and alignment to the other, and may be positioned alternately by lowering or raising the slide block. Optical readout heads

and sophisticated scales afford position and readout to 0.0001 inch with complete repeatability. It is entirely operator adjustable, and through a series of systematic checks the equipment is maintained within specified tolerance.

**Tooling**—The precision layout on glass is achieved through various tool designs. Hardened tool steels, carbides, and sapphires are used with cutting edges defined by the work to be processed. Truncated points on tool shafts are flattened to coincide with the line required. Chisel face and hollow ground cutting edges are employed for cutting wide lines in one path, while synthetic stones find usage within workable line limitations. Orientation of the tool to precise tolerances is required when generating miniaturized circuit patterns, so compass-oriented

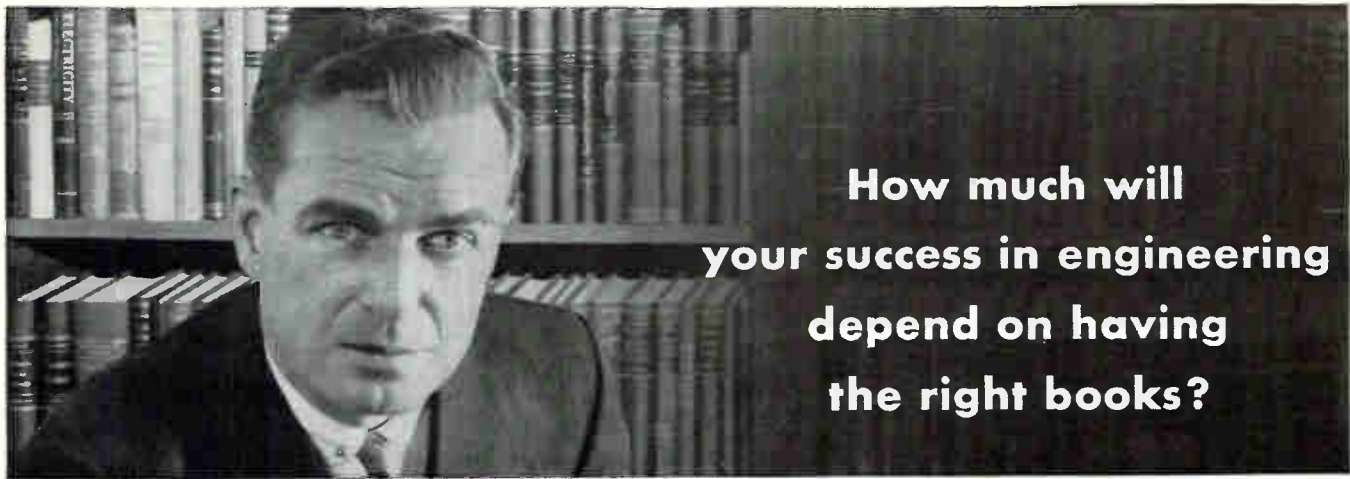

How much will  
your success in engineering  
depend on having  
the right books?

## The Electronics and Control Engineers' Book Club helps you keep ahead in your field . . . at a savings

Start your membership with any of these selections:



Electronic Switching, Timing, and Pulse Circuits by J. M. Pettit. Provides a practical understanding of operation of complex circuits.

Publisher's Price, \$8.50  
Club Price, \$7.25



Information Transmission, Modulation, and Noise by M. Schwartz. A unified approach to communication systems.

Publisher's Price, \$12.50  
Club Price, \$10.65



Mathematics for Electronics with Applications by H. M. Nodelman and F. W. Smith, Jr. Methods for solving practical problems.

Publisher's Price, \$7.00  
Club Price, \$5.95



Digital Computer and Control Engineering by R. S. Ledley. Full coverage from basic electronic design to advanced programming techniques.

Publisher's Price, \$14.50  
Club Price, \$12.35



Modern Transistor Circuits by J. Carroll. Presents almost 200 modern transistor circuits in 101 separate articles.

Publisher's Price, \$10.00  
Club Price, \$8.50



Magnetic Recording Techniques by W. E. Stewart. Full description of magnetic recording methods and devices.

Publisher's Price, \$9.00  
Club Price, \$7.65



Wave Generation and Shaping by L. Strauss. Essential features and techniques of practical wave-generating and shaping circuits.

Publisher's Price, \$12.50  
Club Price, \$10.65

Your engineering career owes a great deal to books. Why not take advantage of this convenient, economical way to have the best professional books available when you need them? THE ELECTRONICS AND CONTROL ENGINEERS' BOOK CLUB brings you the essential technical literature in your field. It also helps you overcome today's high cost of building a professional library by saving you an average of 15% from publisher's prices.

**How the Club Operates.** You regularly receive free of charge *The Electronics and Control Engineers' Book Bulletin*. This gives complete advance notice of the next selection-of-the-month, as well as many alternate selections. If you want the main selection you do nothing; the book will be mailed to you. If you want an alternate selection—or no book at all—you can notify the Club by returning the convenient card enclosed with each *Bulletin*.

**Saves You Time and Money.** You agree only to the purchase of three books in a year. Certainly out of the large number of books in your field offered in any twelve months there are at least three you would buy anyway. By joining the Club you save both money and the trouble of searching.

**Send No Money Now.** Just check the book you want as your first selection on the coupon below. With it you will be sent *Transistor Circuit Design* for only one dollar. Take advantage of this offer and receive two books for less than the regular price of one. (If coupon is detached, write to The Electronics and Control Engineers' Book Club, Dept. L-10-4, 330 W. 42nd St., New York 36, N. Y.

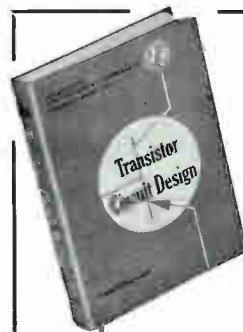

ACCEPT THIS  
BIG, NEW  
\$15.00 BOOK  
with membership in  
The Electronics and  
Control Engineers'  
Book Club

### TRANSISTOR CIRCUIT DESIGN

Prepared by the Engineering Staff  
of Texas Instruments Incorporated

Here's a practical reference that can ease your transistor circuit design work. It brings you a wealth of data and facts prepared by the engineering staff of Texas Instruments, Inc. Reflecting the combined knowledge and experience of 32 expert circuit design engineers, this book makes conveniently available the actual design procedures and circuits most often requested from Texas Instruments.

*Transistor Circuit Design* is typical of the selections of THE ELECTRONICS AND CONTROL ENGINEERS' BOOK CLUB. All books are chosen by qualified editors and consultants. Their thoroughgoing understanding of the standards and values of the literature in your field guarantees the authoritativeness of the selections.

**(NOTE: If you already own this volume, you may substitute any other book on this page as your DOLLAR book. Check two books below and you will receive the higher priced selection for only \$1.00.)**

## CLIP AND MAIL THIS COUPON TODAY

The Electronics and Control Engineers' Book Club, Dept. L-10-4  
330 West 42nd Street, New York 36, N. Y.

Please enroll me as a member of The Electronics and Control Engineers' Book Club. You will bill me for my first selection indicated at right at the special club price and \$1 for *Transistor Circuit Design* (or alternate choice), plus few cents delivery costs. (The Club assumes this charge on prepaid orders.) Forthcoming selections will be described in advance and I may decline any book. I need take only 3 selections or alternates in 12 months of membership. (This offer good in U. S. only.)

### PLEASE PRINT

Name .....

Address .....

City..... Zone..... State.....

Company .....

### NO RISK GUARANTEE:

If not completely satisfied, you may return your first shipment within 10 days and your membership will be canceled.

Send as my first selection: (If more than one book is checked we will send the higher priced selection as your \$1.00 book.)

- Electronic Switching, Timing, and Pulse Circuits, \$7.25
- Information Transmission, Modulation, and Noise, \$10.65
- Mathematics for Electronics with Applications, \$5.95
- Digital Computer and Control Engineering, \$12.35
- Modern Transistor Circuits, \$8.50
- Magnetic Recording Techniques, \$7.65
- Wave Generation and Shaping, \$10.65

*Designed for*

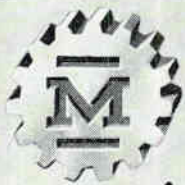

*Application*



90901

**INSTRUMENTATION OSCILLOSCOPE  
One Inch**

Miniaturized basic packaged panel mounting Cathode Ray Oscilloscope for instrumentation use replacing "Pointer Type" meters. Panel bezel matches 2" square meter. No. 90901 uses 1CP1 tube. No. 90911 uses 1EP1 tube. Power supply No. 90202 available where application requires.

**JAMES MILLEN MFG. CO., INC.**

**MALDEN  
MASSACHUSETTS**

CIRCLE 54 ON READER SERVICE CARD

# **HOW TO USE YOUR ELECTRONICS BUYERS' GUIDE**

## *The Two-Way Product Locator*

Most products advertised in the ELECTRONICS BUYERS' GUIDE are listed twice for your convenience. After the Product Heading, advertising page numbers appear where appropriate (when advertisements of one kind are grouped together in the book). Next to the individual product listing, the page number of associated advertising material is cited. Thus you can locate all of the advertisements for a particular product category, or any specific advertisement, quickly, accurately, and conveniently. Keep your ELECTRONICS BUYERS' GUIDE close to your work area at all times.

---

**ELECTRONICS BUYERS' GUIDE**

*A McGRAW-HILL PUBLICATION*



bushings and mating-tool caps are provided.

The emulsion or coating applied to glass plates through which exquisite lines will be scribed is also considered tooling. To facilitate follow-on photographic steps, the emulsion must be opaque and to achieve and meet edge-of-line coherency requirements, must be of butter consistency. This emulsion must maintain its characteristics through nominal shelf-aging, and provide the opportunity for rework and corrective action while maintaining stability.

**Layout Process**—Unique mobile base lines, or the zero reference technique accelerate the process. Without removing or interchanging precision scales as many as four or five zero references may be established when necessary to the processing of a single master layout. This is accomplished by the technician through multi-color coding on unmarked adjustable scales. A sub-master technique reproduces the original master in unlimited quantity and a sub-master is mounted on the layout machine for incorporation of circuit lines, component connections, or other precise art. This technique utilized at IBM-Space Guidance Center solves myriad registration and line placement problems in advanced guidance computers.

**Tolerance**—Realistic consideration is to be given to the apportionment of tolerance. The original art master generation is but one of the many sequential steps to the end product, each step introducing error. It is therefore important to calculate the least common denominator. The percentage tolerance allowable ( $T$ ) can be found by  $T^2 = t^2 + S^2$  where  $t$  is the line width tolerance and  $S$  is the scale. Results will vary depending on the facility and is an individual effort.

**Scaling**—The most significant advantage of this approach is the reduction of scale size of the original master. With increased accuracy and edge of line definition scale sizes have been reduced from 50 to 1 to as small as 4 to 1. Greater scale reductions are possible for such fields as molecular electronics where 250 to 1 and 500 to 1 is commonplace.

# ACCURACY

# 0.00001%

# VDR-106

## PRIMARY STANDARD VOLTAGE DIVIDER

Here's a voltage divider with 1 PPM accuracy. That's an absolute figure you can rely on, not one so submerged in cumulative errors and uncertainties that the resulting instrument may be as much as one order of magnitude less accurate. You'd expect this accuracy from Julie, the company that developed the Julie RATIOMETRIC™ System, a new and revolutionary approach to hyper-accurate DC measurements. The heart of that system is the VDR-106 . . . and it's adaptable to your own measuring system components as well. Check the specifications below.

If accurate instrumentation is your problem, write or call collect for complete data on the VDR-106 and its applications to Ratiometric Calibration in the new Julie System.

#### SPECIFICATIONS

**Range:** Every integral ratio from 0.000000 to 1.000000

**Resolution:**  $10^6$  discrete steps of 0.000001 each yield 1 PPM resolution

**Accuracy:** Ratio indicated is accurate to 0.0001% of full scale (1 PPM) absolute

**Stability:** Within 0.0001%, five years.

## JULIE RESEARCH LABORATORIES, INCORPORATED

211 WEST 61st STREET, NEW YORK 23, NEW YORK • 212 CI 5-2727



© Julie Research Laboratories, Inc., 1963

# The Simplified Angle Counter

**cppe** VS. multiple gears,  
with one Geneva VS. springs and shutters

*-means trouble free operation*

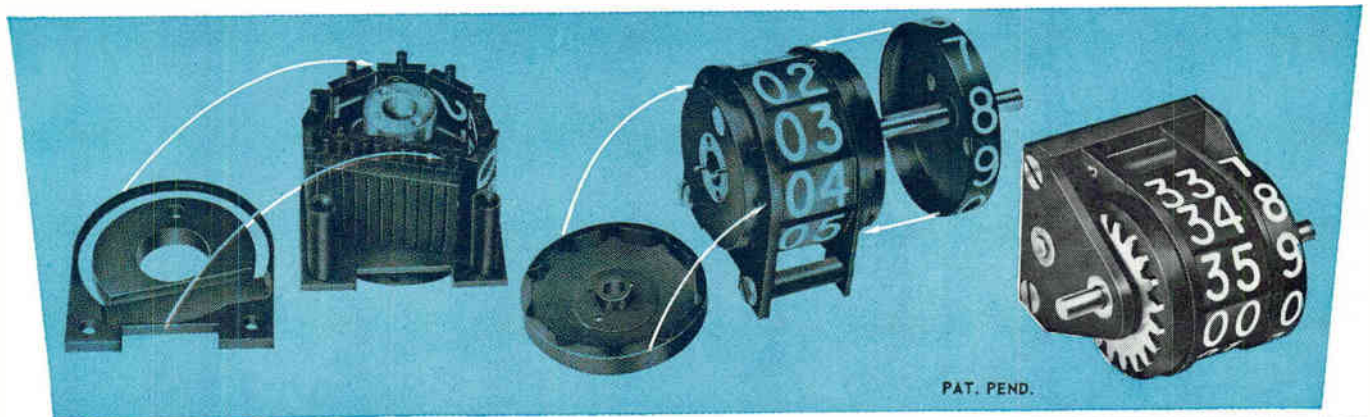

The New Clifton Precision Angle Counters are extremely *simple* (hence reliable), *small* (1.85 cu. in.) *lightweight* (1.5 oz.) and display  $\frac{1}{4}$ " numerals —in addition they are *tested and proven!*

The CPPC Counter uses an extremely simple mechanism as compared to the nested drums and complex gearing of other 360° counters.

The major contributing factor to simplicity and smaller size is the totally new concept used in presenting the 10's and 100's of degrees. Further details of this concept are available upon request.

Due to the elimination of complex gearing, the Clifton counter has a more normal spacing between numbers than other counters — thus requiring a smaller instrument panel opening and providing easier reading.

In the CPPC Counter, the drive shaft is coupled directly to the units counting wheel—hence backlash is eliminated. Shaft extension may be right, left or both.

Rotation is reversible and continuous with clockwise rotation of the input shaft extending right resulting in an increasing readout value.

Because the message units are captively supported and forcibly driven, these angle counters operate in any attitude and are highly resistant to shock and vibration.

For further information: Sales Dept. 5050 State Road, Drexel Hill, Pennsylvania, 215 MA 2-1000, TWX 215 623-6068—or our Representatives.

## SPECIFICATIONS

TYPE AWH-170-001

Numeral Size	.250" high, white on black drums and plates
Torque	1 oz-in max. at 20°C
Input Shaft Speed	450 RPM Continuous 1000 RPM Intermittent
Life	5 million revolutions min.
Operating Temperature	+125°C to -55°C
Weight	1.5 oz.
Mil Spec.	Designed to meet Mil-E-5272 "C"

CLIFTON PRECISION PRODUCTS CO., INC.

**cppe**

Clifton Heights, Pa.  
Colorado Springs, Colo.

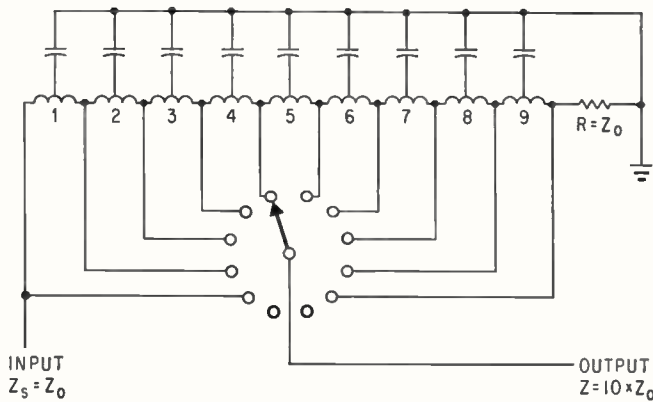

DELAY LINE TAP SWITCHING

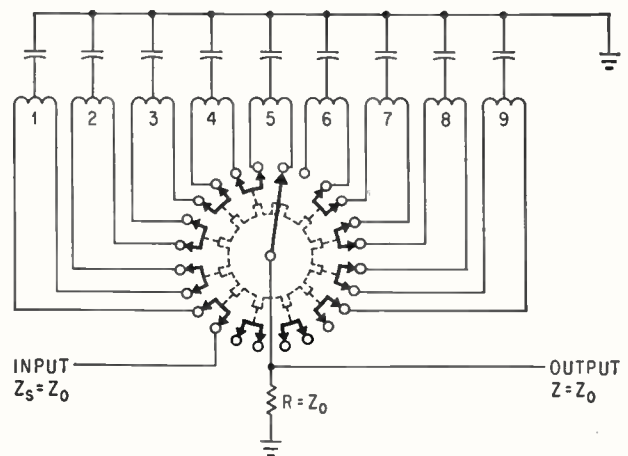

DELAY LINE SECTION INSERTION SWITCHING (V492)

## Variable Delay Line Features Direct Readout

Unit provides delay ranges to 999.9  $\mu$ sec in 0.01- $\mu$ sec steps

**INSTRUMENT** type delay lines provide for selection of desired delay with four decade switches that indicate the setting in a direct-reading in-line display. Units are available with total delays to 999.9  $\mu$ sec having delay increments of 1/10,000 of total range.

Model V-492 shown in the photo operates by switching sections of the line rather than moving a tap point along the line as in most conventional devices (left drawing). The unit shown and others in this series conform schematically to the drawing on the right.

The insertion switching method illustrated has advantages in that every delay setting comprises a complete line with unused portions disconnected from the circuit. This system eliminates undesirable distortion and reflections caused by capacitive or resistive loading at the tap point. Moreover, since each delay setting is a complete line terminated in its characteristic impedance, the unit can be inserted into



a circuit without considering load impedance since the load impedance equals the input impedance (1,000 ohms). Although a tapped line should normally be loaded with a minimum resistance of 10 times the line impedance and zero or mini-

mum capacity, these units represent an advantage since closer tolerance on delay settings can be held without cost increase. Tapped lines are subject to a normal cumulative delay error.

Delay settings are accurate to 1 percent of indicated delay and delay to rise-time ratio at maximum setting is 40:1. Insertion loss is less than 3 db and temperature stability is below 40 ppm/degree C. The unit shown in the photo is only 8 x 5 x 3 inches in size and is priced at \$245. Computer Devices Corp., 6 West 18th St., Huntington Station, N. Y.

CIRCLE 301, READER SERVICE CARD

## Thyratron Develops 100 Megawatts



**CERAMIC** hydrogen thyratron capable of 100-megawatt peak power has an average power capability of 200 kw with a moderate amount of air cooling of anode and grid structures.

According to the manufacturer, the tube called KU275A achieves the highest power ever obtained in a single hydrogen thyratron and, therefore, accomplishes in a single tube what is feasible only with two conventional tubes.

A balanced capacity-gradient grid design gives optimum electrical characteristics and a maximum-

## Acoustical Components of Superior Quality

JAPAN PIEZO supplies 80% of Japan's crystal product requirements.

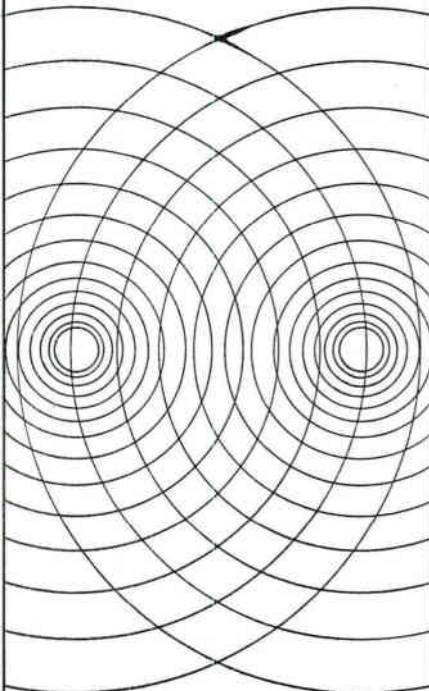

### STEREO CARTRIDGE

Crystal — "PIEZO" Y-130

#### X'TAL STEREO CARTRIDGE

At 20°C, response: 50 to 10,000 c/s with a separation of 16.5 db. 0.6 V output at 50 mm/sec. Tracking force:  $6 \pm 1$  gm. Compliance:  $1.5 \times 10^{-6}$  cm/dyne. Termination:  $1M\Omega + 150$  pF.

Write for detailed catalog on our complete line of acoustical products including pickups, microphones, record players, phonograph motors and many associated products.



**JAPAN PIEZO  
ELECTRIC CO., LTD.**

Kami-renjaku, Mitaka, Tokyo, Japan

area planar cathode assures long life. Maximum ratings are 50 kv peak forward anode voltage, 50 kv peak inverse anode voltage, 4,000 amperes peak anode current and 8 amperes average anode current. The tube is intended for use in high-powered shipboard and ground-based radar systems and linear accelerators. International Telephone and Telegraph Corp., 320 Park Ave., New York 22, N. Y.

CIRCLE 302, READER SERVICE CARD



## Bridge Measures Resistance From 0.3 to 300,000 Ohms

MODEL 4283 Wheatstone Bridge is a portable unit designed to provide rapid, accurate resistance readings where accuracies greater than those obtainable with an ohmmeter are required. Unit is calibrated from 0 to infinity in 6 ranges and features an accuracy and sensitivity of  $\pm 1$  percent of reading for measurements from 0.3 to 300,000 ohms. Auxiliary binding posts permit connection of external standards when making routine comparisons of similar resistances. Moreover, the bridge uses two, 1½-volt D batteries for power and is completely self-contained. Price: \$240. Leeds & Northrup Co., 4901 Stenton Avenue, Philadelphia, Pa. (303)

## Tiny BWO Produces 20 Milliwatts

PM-FOCUSED backward-wave oscillator type SE 303, is tunable over the full X-band range. Unit weighs only 1.5 lb and occupies 1½ x

# FREE TO COMPANY OFFICIALS LOOKING FOR A NEW PLANT SITE

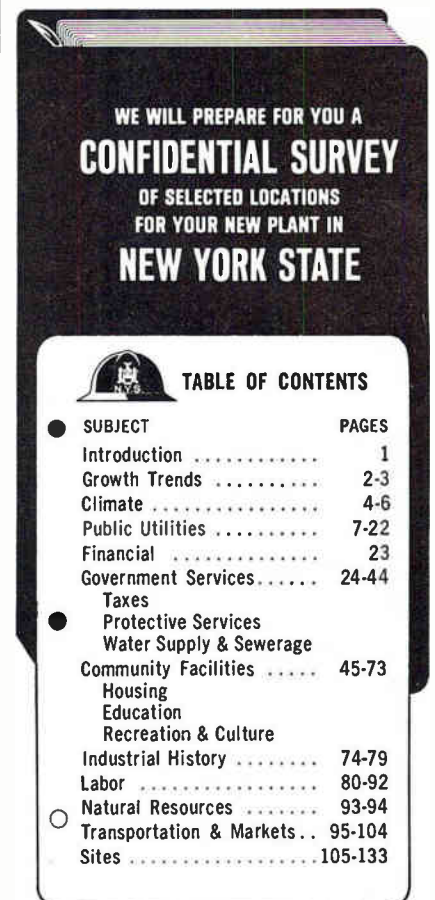

### TABLE OF CONTENTS

SUBJECT	PAGES
Introduction .....	1
Growth Trends .....	2-3
Climate .....	4-6
Public Utilities .....	7-22
Financial .....	23
Government Services .....	24-44
Taxes	
• Protective Services	
Water Supply & Sewerage	
Community Facilities .....	45-73
Housing	
Education	
Recreation & Culture	
Industrial History .....	74-79
Labor .....	80-92
○ Natural Resources .....	93-94
○ Transportation & Markets ..	95-104
Sites .....	105-133

**TAILOR-MADE.** This confidential report is not taken off the shelf. It will be prepared specifically for you, based on the requirements for your new plant as you give them to us. Send these requirements on your business letterhead to Commissioner Keith S. McHugh, N.Y. State Dept. of Commerce, Room 252R, 112 State St., Albany 7, N.Y.

*Keith S. McHugh*

Keith S. McHugh, Commissioner  
New York State Department of Commerce



5 inches of space. Producing a minimum power output of 20 mw, the bwo will soon be available in other waveguide bands. It is intended for airborne and space applications where small size and weight and ability to perform under rugged environmental conditions such as high shock are required. Stewart Engineering Co., Santa Cruz, California. (304)

### Protective Coating Resists Weathering

CONFORMAL polyurethane coating, HumiSeal type 2A59, is recommended for use where the coating remains in contact with nitrogen tetroxide. The range of continuous-use temperature is from -100 F through +250 F. It protects glass components subjected to severe environmental conditions. Used on high-frequency coils, it protects against the solid encapsulant resins. Columbia Technical Corp., 24-30 Brooklyn Queens Expressway W., Woodside 77, N. Y. (305)

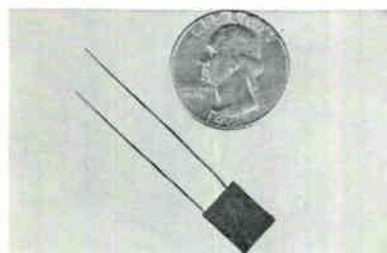

### Miniature Capacitors Have Low Leakage

LINE of Minitan solid tantalum capacitors, the J series, have a case size 0.475 high by 0.375 wide by 0.150 thick. Leads are weldable and solderable tinned nickel, 0.016 in

# NEW

## VERSATILITY IN LIGHT MEASUREMENT

# lite-mike

measures:

MEASUREMENT	MONOCHROMATIC SPECTRUM		CHROMATIC SPECTRUM
	LASER	GALLIUM ARSENIDE	
WAVESHAPE Rise time Fall time Duration Amplitude	Yes	Yes	Yes
Average Power (watts)	Yes	Yes	*
Energy (joules)	Yes	Yes	*

\*Can be calculated within spectral response capabilities.

		RESPONSE RANGE							
		1.13 $\mu$ ————— 0.35 $\mu$							
ANGSTROMS		10 <sup>4</sup>	9,000	8,000	7,000	6,000	5,000	4,000	3,000
	NEAR IR						VISIBLE		NEAR UV
MICRONS		1	0.9	0.8	0.7	0.6	0.5	0.4	0.3



Compact (10" high) and lightweight, the EG&G LITE-MIKE has built-in controls for sensitivity and balancing of ambient light. Head is swivel-mounted for ease of alignment with source.

# NEW

## SD-100 SILICON

### PHOTODIODE offers this

unique combination of advantages

- (1) FAST RESPONSE / Rise time:  $4 \times 10^{-9}$  sec. @ 90v  
Fall time:  $15 \times 10^{-9}$  sec. @ 90v
- (2) WIDE SPECTRUM 0.35 to 1.13 microns (10% points)
- (3) HIGH SENSITIVITY 0.25 microamps per microwatt
- (4) LOW NOISE  $1 \times 10^{-12}$  watts  $\cdot$  (cps) $^{-1/2}$
- (5) WIDE DYNAMIC RANGE 0.1 amp to approx.  $10^{-8}$  amp

Applications: receiving equipment for lasers and injection laser systems; measurements on modulator and pulsed light sources; measurements of light intensity and wave forms, detection of color changes.

For full information on LITE-MIKES and SD-100 photodiodes, contact: Marketing Dept., EG&G, 176 Brookline Ave., Boston 15, Mass.



**EDGERTON, GERMESHAUSEN & GRIER, INC.**

1007

BOSTON • LAS VEGAS • SANTA BARBARA

*Magneline*<sup>®</sup>  
THE INDICATOR WITH INHERENT MEMORY

## NEW DIGITAL INDICATORS FOR DIFFICULT SYSTEMS

### SERIES 14000—FOR SOLID STATE LOGIC

Character Size .....  $\frac{3}{32}$ " x  $\frac{1}{4}$ "  
No. of Characters ..... Up to 11  
Leads ..... 11 plus a common  
Watts ..... 2.4

### SERIES 15000—FOR RELAY LOGIC

Character Size .....  $\frac{5}{16}$ " x  $\frac{1}{4}$ "  
No. of Characters ..... Up to 10  
Leads ..... 5 plus a common  
Watts ..... 1.0 - 1.7

### RUGGED

UNITS MEET OR EXCEED MIL E 5272. HAVE BEEN LIFE TESTED AT 28 MILLION CYCLES. NEED NO MAINTENANCE.

### COMPACT

UNITS REQUIRE ONLY 1.12 CUBIC INCHES, WEIGH ONLY 1.5 OUNCES.

### READABLE

DISTINCT WHITE CHARACTERS STAND OUT AGAINST DULLED BLACK BACKGROUND IN NORMAL ROOM LIGHTING. ILLUMINATED MODELS AVAILABLE.

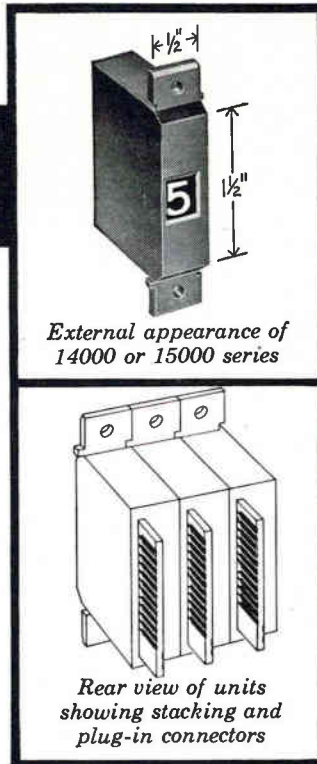

External appearance of 14000 or 15000 series

Rear view of units showing stacking and plug-in connectors

diameter. Available ratings are from 22  $\mu$ f — 20 v d-c to 150  $\mu$ f — 6 v d-c. Leakage current at 25 C will not exceed 9  $\mu$ a. Price range \$1.50 to \$3.00 each, depending on quantities. Components, Inc., Smith St., Biddeford, Maine.

CIRCLE 306, READER SERVICE CARD

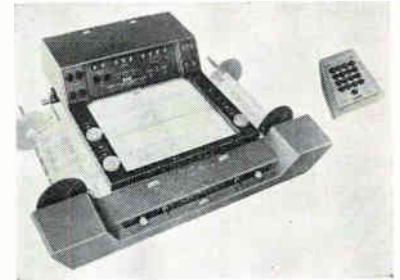

## Data Reducer Is Easily Operated

HIGHLIGHTING new 3-digit readout, this flexible digital data reduction system is designed for easy operation in reducing large or small quantities of recorded data. With only relatively little training, an unskilled operator can reduce X-Y data to point-to-point digital form at the rate of many thousands of tabulations per day. (Full rated machine speed is in excess of 10,000 tabulations per day.) Virtually any kind of oscillogram, graph, drawing or other chart material can be read quickly and easily using the model GDDRS-3B. Flexible output capability is designed to fit the user's particular data-handling system. Typewriter and keypunch are standard. However, paper tape punch, Flexowriter, adding machine, and plotters may also be employed. Gerber Scientific Instrument Co., South Windsor, Conn. (307)



## Rectifiers Provide Fast Switching

FAST-SWITCH rectifiers have recovery times of 200 nsec or less with the average being 120 nsec and 80 nsec devices available for special

Write or phone  
203-756-3636  
for free literature

## PATWIN<sup>®</sup> ELECTRONICS

A DIVISION OF THE PATENT BUTTON COMPANY  
WATERBURY, CONNECTICUT • 06720  
CIRCLE 204 ON READER SERVICE CARD

## WHICH DEFLECTION YOKE FOR YOUR DISPLAY ?

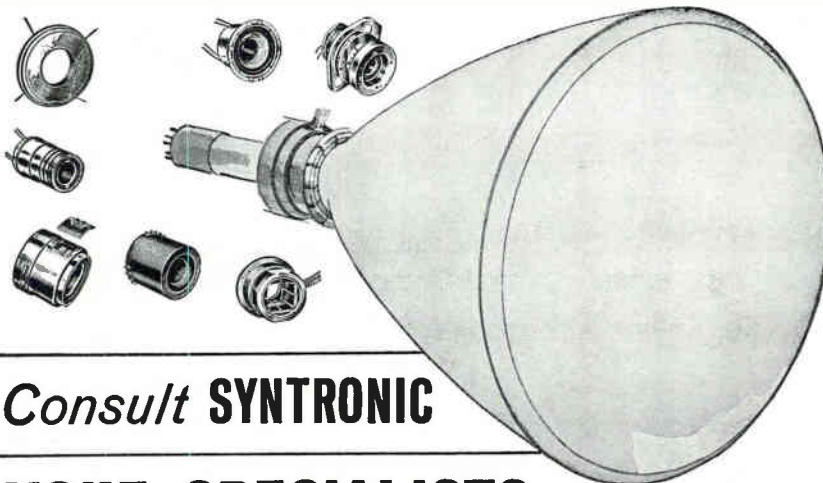

Consult **SYNTRONIC**

## YOKE SPECIALISTS

Syntronic's team of experts knows more about yoke design, engineering and quality control than anyone else. A solid 10-year record of leadership—acknowledged throughout the industry. Benefit from it.

*syntronic* INSTRUMENTS, INC.  
100 Industrial Road, Addison, Illinois  
Phone: Kingswood 3-6444

applications. This recovery capability results in an increase of up to 50 percent in circuit efficiency. Units are available in DO-4, DO-5, DO-10 and DO-11 packages, with current range of 1-30 amp. EIA approved devices are available for immediate delivery. Hughes Semiconductors, Box H, Newport Beach, Calif. (308)

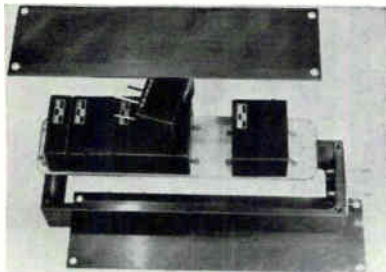

### H-V Converters Feature Functional Modules

PHOTOMULTIPLIER high-voltage supply series is announced. Adjustable output voltages in new series from 750 to 3.5 kv; regulation, 0.05 percent; temperature coefficient, 16 to 65 mv/deg C; efficiency, 45 to 55 percent; power out, 0 to 250 mw; optional d-c inputs available; reflected ripple, 0.5 mv; operating temperature, - 30 to + 70 C; weight, 8 oz; volume, approximately 8 in. cube. Transformer-Electronics Co., Boulder Industrial Park, Boulder, Colo. (309)

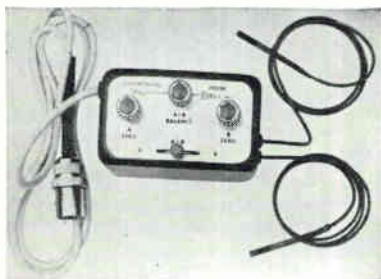

### Differential Probe Uses Two Hall-Effect Devices

DIFFERENTIAL probe uses two ultra-stable Hall-Pak devices with matched characteristics, used independently for absolute measurements and in series opposition for differential measurements. A magnetic field differential between the two devices of only 1 percent of the absolute field provides a full-



(Photo Courtesy of Western Electric Company)

BARBER-COLMAN MICROPOSITIONER®

## Ultrasensitive relays

### CONTROL WELDING ARC LENGTH AUTOMATICALLY AT LOW COST

Here's an idea for combining precise automatic control with low cost. Air Reduction Sales Company uses Barber-Colman Micropositioner polarized tungsten arc welding head to *automatically* maintain a constant arc length . . . for only one-third the manufacturing cost of electronically controlled units.

The Micropositioner serves as an arc-voltage sensing element; actuates a bidirectional stepping motor which positions the electrode for constant arc length. Besides simplifying automatic control, Air Reduction has reduced both size and weight of the welding head.

How many ways can Micropositioners add value to *your* equipment? Ask your Barber-Colman representative, or write for free, 8-page Control Applications Bulletin.

Barber-Colman Micropositioner polarized d-c relays operate on input power as low as 40 microwatts. Available in three types of adjustment: null-seeking, magnetic-latching "memory," and form C break-make transfer. Also transistorized types with built-in preamplifier.



**BARBER-COLMAN COMPANY**

Dept. V, 1259 Rock Street, Rockford, Illinois



**CUT IT,  
WRAP IT!**

**NETIC AND CO-NETIC  
MAGNETIC SHIELDS  
APPLIED  
IN SECONDS**

Guard against performance degradation from unpredictable magnetic field conditions to which your equipment may be exposed. Economical CO-NETIC and NETIC Magnetic Shielding Foils are adaptable to any size or shape components. Simply cut with ordinary scissors. Available in continuous lengths on rolls up to 15" wide. Furnished in final annealed state. Co-Netic and Netic alloys are not affected significantly by vibration or shock, assuring components performance repeatability over a wider range of flux intensities. They are also non-retentive and do not require periodic annealing. When grounded, they shield electrostatic as well as magnetic fields. They have many applications in satellite instrumentation and many other magnetically sensitive devices.

**MAGNETIC SHIELD DIVISION**  
Perfection Mica Co. Phone EVerglade 4-2122  
1322 North Elston Avenue, Chicago 22, Illinois

CIRCLE 205 ON READER SERVICE CARD

**To Manufacturers Who Import Foreign Materials:**

**YOU COULD SAVE 100% IN INCOME TAXES PLUS 66% IN DUTIES BY OPERATING IN PUERTO RICO'S NEW FOREIGN TRADE ZONE. A NEW CUSTOMS RULING CONFIRMS THIS. FILL OUT THIS CONFIDENTIAL COUPON FOR DETAILED INFORMATION . . .**

CONFIDENTIAL . . . CONFIDENTIAL . . .

**Puerto Rico Foreign Trade Zone #7  
c/o Development Counsellors  
International, Box "G"  
20 East 46th Street  
New York, N. Y. 10017**

Give me full facts about possible production, import duty and tax savings for my company in Puerto Rico's new Foreign Trade Zone:

Name: \_\_\_\_\_

Title: \_\_\_\_\_

Company: \_\_\_\_\_

Address: \_\_\_\_\_

Major Product Lines \_\_\_\_\_

CONFIDENTIAL . . . CONFIDENTIAL . . .

## TECHNICAL HEAD DISPLAYS

We have an excellent growth opportunity for a man capable of supervising our activities in the design and development of visual display devices. Responsibilities will include the direction of a technical group developing systems for the display of both graphic and alphanumeric weather information. Source material may be derived from large scale computers via communication circuits. Alphanumeric indicators, CCTV, special cathode ray tubes or hard processors will also be considered for these display systems.

Requirements include an E.E. or Physics degree with emphasis in electronics and eight years of experience.

This position offers an attractive starting salary plus liberal fringe benefits including a fully reimbursed advanced education plan.

We invite you to submit your resume to Mr. R. Fuller, Corporate Systems Center, United Aircraft Corporation, 1690 New Britain Avenue, Farmington, Connecticut — an equal opportunity employer.

**United  
CORPORATE SYSTEMS CENTER  
Aircraft**

scale deflection and a resolution of 1 part in 10,000. Gradients may be measured by separating the two devices by a known distance and measuring the difference across this distance. Magnetic field gradients or differences can be measured over a distance varying from a few thousandths of an inch up to 40 in. and in any direction or plane. F. W. Bell Inc., 1356 Norton Ave., Columbus, O.

CIRCLE 310, READER SERVICE CARD

## D-C Amplifiers Feature Compactness

MODEL CA-650 d-c amplifier is a compact solid-state instrument to provide high-current low-impedance outputs for driving h-f galvanometers to their maximum output, or

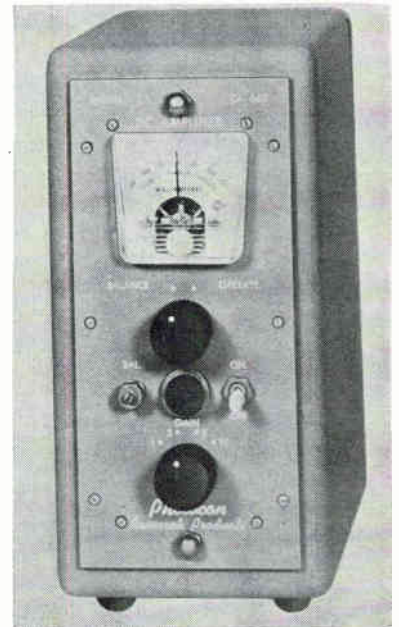

long transmission lines without loss in frequency response from 0 to 20,000 cps. It is basically an impedance translator with a voltage gain slightly less than unity. Model CA-660 has the same output characteristics with the addition of an amplifier stage to give amplifications of 1, 2, 5, and 10. Six of either amplifiers can be mounted in a standard 8¾ in. by 19 in. panel. Photocon Research Products, 421 North Altadena Drive, Pasadena, Calif. (311)



## LITERATURE OF THE WEEK

**OCTAVE-BAND FILTER SET** B&K Instruments, Inc., 3044 West 106th St., Cleveland 11, O. Four-page brochure on the model 1612 1/3 and 1/1 octave-band filter set is available. (312)

**HIGH-VOLTAGE CONNECTORS** The Standard Connector Corp., 201 State St., North Haven, Conn., offers a 4-page folder illustrating a few of its more than 100 different types of connectors, from miniature sealed to high temperature power types. (313)

**SILICON RECTIFIERS** Transatron Electronic Corp., 168 Albion St., Wakefield, Mass. Data sheet gives ratings and specifications on a series of rugged and economical medium-power industrial-type silicon rectifiers. (314)

**RECYCLING TIMER** C. J. Applegate & Co., Inc., 1840-24th St., Boulder, Colo., has published a bulletin on the model 110 recycling timer, a digital timer designed to give a recurring output for the control of research equipment. (315)

**SYNCHRONOUS MOTOR** The Superior Electric Co., Bristol, Conn. Bulletin illustrates and describes type SS1800 Slo-Syn synchronous motor. (316)

**BROADCAST TRANSMITTER** Continental Electronics, Box 17040, Dallas 17, Texas. Brochure describes type 416C 10-kw screen modulation shortwave broadcast transmitter. (317)

**LABORATORY POWER SUPPLIES** Electronic Research Associates, Inc., 67 Factory Place, Cedar Grove, N.J. Catalog supplement No. 130 covers Magitran magnetic/transistor solid-state laboratory power supplies. (318)

**INTEGRATED CIRCUITS** Signetics Corp., 680 W. Maude Ave., Sunnyvale, Calif. An 8-page condensed catalog gives data for 25 integrated circuits available off-the-shelf. (319)

**VOLTAGE REGULATOR** Sola Electric Co., 1717 Busse Road, Elk Grove Village, Ill., Catalog sheet illustrates and describes the compact 1-kva Solatron voltage regulator. (320)

**CAPSULAR RELAYS** General Electric Co., Schenectady 5, N. Y. Bulletin GEA-7627 describes type BA Quadra-Mite four-pole double-throw capsular relays for low-level switching. (321)

**TRAVELING-WAVE TUBES** Raytheon Co., Waltham 54, Mass. Traveling-wave tubes for radar and space applications are described and illustrated in two new 4-page bulletins. (322)

**CIRCULATORS** Sperry Microwave Electronics Co., P. O. Box 1828, Clearwater, Fla. A 4-page brochure illustrates the company's capability in the design and development of circulators. (323)

**PRESSURE TRANSDUCERS** Computer Instruments Corp., 92 Madison Ave., Hempstead, L. I., N. Y. A 16-page catalog features a full line of precision-film pressure transducers. (324)



New, economical  
15/16" dia. 5-watt wirewound  
variable resistors

## Versatile Series AW

**Available with:** 1 Bushing Mounting 2 Twist Tab Mounting 3 Pull-on, Push-off Switch 4 Straight Tandems 5 Concentric Tandems. (The new Series AW wirewound controls can also be used with CTS Series 45 1/16" dia. 1/2-watt carbon control to make any combination of straight or concentric tandems desired.) Series AW can be supplied in L and T pads. Element wire can be soldered to end terminals if required.

**Priced less** than larger diameter lower wattage commercial wirewound variable resistors. Unique high temperature heat resistant winding core and liner permit a 5-watt rating at 25°C, or a 4-watt rating at 55°C derated to no load at 105°C. Resistance range is one ohm through 25,000 ohms, linear taper. The unit is completely enclosed for full protection.

Write for Catalog 2100. (West Coast Inquiries to Chicago Telephone of California, Inc., 1010 Sycamore Ave., So. Pasadena, Calif.)

**CTS OF ASHEVILLE, INC.**  
SKYLAND, NORTH CAROLINA



SUBSIDIARY OF **CTS CORPORATION** • ELKHART, INDIANA



Richard E. Lee



Thomas S. Edwards



Arthur D. Evans

## Siliconix Elects Officers

**ELECTION** of top officers at Siliconix Inc., Sunnyvale, Calif., has been announced. New president is Richard E. Lee. Elected vice presidents were Thomas S. Edwards and Arthur D. Evans.

Lee joined Siliconix as executive vice president and general manager when the company was formed in March 1962. Before that, he was marketing manager, Transistor Products division, manager of semiconductor networks department, and head of circuit development branch, during four years at Texas Instruments.

Edwards will continue as marketing manager, the position he assumed when he joined Siliconix in April 1962. He came to Siliconix after eight years with Texas Instruments where he was branch manager of military systems marketing, Transistor Products division, his final year.

Evans was also one of the original staff members of Siliconix Inc. He will continue to be responsible for engineering of SI's series of unipolar field-effect transistors and integrated circuits. Prior to joining the company, Evans spent 12 years with Texas Instruments Inc., where he was manager of design branch, semiconductor networks department.



### Williams Accepts ITT Executive Post

**APPOINTMENT** of William A. Williams as area general manager-Far East and Pacific for International Telephone and Telegraph Corporation has been announced. He was formerly with Petroleum Refineries (Australia) Pty. Ltd.

Williams also was elected president and a director of ITT Far East and Pacific, Inc. He will initially be located in Melbourne, Australia,

and will be responsible for directing, planning and coordinating all ITT system manufacturing and marketing operations in the area.

### Dorsey Becomes Product Manager

**THE NEWLY CREATED** post of product manager for semiconductor strain gages at the Electronics division of Baldwin-Lima-Hamilton Corp., Waltham, Mass., has been taken over by James Dorsey. He was formerly chief engineer for sensors.

### McDonnell Aircraft Names Peck

**GEORGE A. PECK** has been named general manager of the Electronic

Equipment division of McDonnell Aircraft, St. Louis, Mo.

Before coming to McDonnell, Peck was director of manufacturing operations for International Telephone and Telegraph Federal Laboratories at Nutley, N. J. Prior to that he was president of the S.I.E. division of Dresser Electronics at Houston, Texas. From 1942 until 1962, Peck was with Stromberg-Carlson, serving as vice president and general manager of the Electronics division at Rochester, N. Y., from 1957 until 1962.

### GI Announces Appointments

**THREE** key appointments in the Brooklyn, N. Y., selenium operation of the General Instrument Rectifier division have been announced.

Allie Thorn has been promoted to supervisor of production and material control. He formerly was in charge of material control.

Edward Shomber has joined the selenium operation production department as general foreman, cell process. He was previously with General Bronze Corp.

Robert Everett has been named manager of research and development. He comes to GI from Vickers division of Sperry Rand.



### Tyson Moves Up At LP Associates

**NEWLY** appointed vice president-engineering of LP Associates, Inc., Los Angeles microwave electronics firm, is Owen A. Tyson.

A veteran of over thirty years

# A New Gaussmeter to Measure ABSOLUTE Magnetic Strength

This is a new gaussmeter, made by Oki Electric, which makes use of nuclear magnetic resonance to measure absolute, instead of relative, flux density of magnets. It needs no standard magnet for reference, and precise measurement is assured by a built-in calibrator. Measurement procedures are simplified too. This gaussmeter uses a probe and can be handled just like an ordinary oscilloscope.

Write to Oki Electric for the tech bulletin for Model WX-610.

#### Specifications

Measurement range 1,000 - 20,000 gauss  
(in 6 steps)  
Accuracy  $1 \times 10^{-3}$   
Probe thickness 10 mm  
Power requirements 115 V, 60 cps, 50 VA  
Cathode ray tube 3 inch standard  
Cable extension 10' max. from magnet to indicator

#### Dimensions and weights

Oscillator unit 6 $\frac{3}{8}$ " wide, 6 $\frac{3}{8}$ " high, 8 $\frac{1}{2}$ " deep; 12 lbs  
Indicator unit 7 $\frac{3}{8}$ " wide, 6 $\frac{3}{8}$ " high, 11" deep; 17 lbs 11 oz.

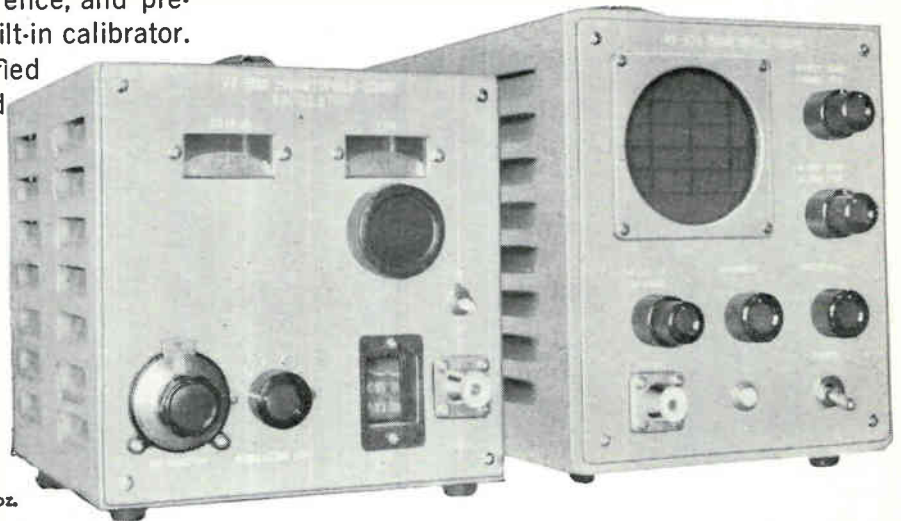

**OKI**  
electric industry  
co., ltd. TOKYO JAPAN

WRITE FOR DETAILED INFORMATION TO:  
SOLE DISTRIBUTOR IN U.S.A.  
**BUTLER ROBERTS ASSOCIATES INC.**  
500 SE 24 St. Ft. Lauderdale, Fla. 523-7202  
202 E. 44 St., N.Y. MU 2-2989

CIRCLE 65 ON READER SERVICE CARD

## TO ORDER REPRINTS

Fill in, cut out coupon below, insert in envelope and mail to:

electronics Reprint Dept.  
330 W. 42nd Street, New York, N. Y. 10036

### REPRINT ORDER FORM

For Listing of Reprints Available See Reader Service Card

(To help expedite mailing of your reprints please send cash, check or money order with your order.)

**For Reprints of the latest Special Report; Radio Frequency Interference**

Send me . . . . . Reprints of Key No. R-39. I—10 copies 75¢ each, II—24 copies 60¢ each, 25 or more 50¢ each.

For Reprints of previous **Special Reports** or **Feature Articles** fill in below:

Send me . . . . . Reprints of Key No.(s) . . . . . @ . . . . .¢ each. (For prices, see Reader Service Card.)

\*For orders of **Bulk Reprints** of other editorial articles in this issue or past issues:

Send me . . . . . Reprints of pages no.(s) . . . . . of issue date . . . . . of article entitled . . . . .

\*Minimum bulk order 100 copies. You will be advised of costs by return mail.

Name . . . . .

Number and Street . . . . .

City, Zone No., State . . . . .

experience in electronics, Tyson joined the LPA organization when it was formed early this year. Prior to that time he was technical director of the microwave laboratory at Quantatron, Inc.

## Beggs to Head Electronics Division

JAMES M. BEGGS has been named general manager of Westinghouse Electric Corporation's electronics division in Baltimore, Md. He succeeds Robert E. Kirby, who was elected vice president, engineering, by the corporation's board of directors.

Beggs had been manager of the Westinghouse systems management department in Baltimore.

## PEOPLE IN BRIEF

**Richard H. Woodward** elevated to v-p, senior scientist, at Pickard & Burns Electronics. **Robert E. Scribner, Jr.**, formerly with GE, appointed g-m of the Light Equipment div. of Ferranti Electric, Inc. **William E. Caulfield** moves up to dept. head in charge of electrical & electronic facility design engineering at Bausch & Lomb Inc. **George H. Balding** promoted to mgr. of advanced development and **Jerold H. Gard** to asst. chief engineer at Kaiser Aircraft and Electronics div.'s Palo Alto plant. **Harold V. Wallace**, with Edgerton, Germeshausen & Grier, Inc., since 1956, elected v-p. **Edward G. Tuttle**, previously with North Electric Co., appointed chief engineer of the Relay div. of Electro-Tec Corp. **Edward S. Seaman** advances to v-p, sales, at Memorex Corp. **Wesley L. McBreen**, ex-Servomechanisms, Inc., named quality control mgr. for Halex, Inc. **D. R. Fewer**, from Texas Research and Electronic Corp. to Schlumberger Well Surveying Corp. as technical asst. to the v-p/technique. **David H. Ransom, Jr.**, formerly with Ransom Research, announces formation of Ransom Electronics in San Pedro, Calif.



**NATIONAL COVERAGE**

### EMPLOYMENT OPPORTUNITIES

The Advertisements in this section include all employment opportunities—executive, management, technical, selling, office, skilled, manual, etc. Look in the forward section of the magazine for additional Employment Opportunities advertising.

Positions Vacant	Civil Service Opportunities	Employment Agencies
Positions Wanted	Selling Opportunities Wanted	Employment Services
Part Time Work	Selling Opportunities Offered	Labor Bureaus

**DISPLAYED**

The advertising rate is \$40.17 per inch for all advertising appearing in other than a contract basis. Contract rates quoted on request.

An advertising inch is measured 3/4" vertically on a column—3 columns—30 inches to a page.

Subject to Agency Commission.

**---RATES---**

\$2.70 per line, minimum 3 lines. To figure advance payment count 5 average words as a line.

Box Numbers—counts as 1 line.

Discount of 10% if full payment is made in advance for 4 consecutive insertions.

Not subject to Agency Commission.

**UNDISPLAYED**

Send **NEW ADS** to **CLASSIFIED ADV. DIV. of ELECTRONICS**, P.O. Box 12, N. Y., N. Y. 10036

## INDUSTRIAL ELECTRONICS

### Design-Development

Chemstrand Company, a leader in the chemical fiber industry, has an immediate opening in its Development Department, Pensacola, Florida, in the field of Electronic Design and Development. Chemstrand is a Division of Monsanto.

Work involves creating and developing circuitry for control and measurement in instrumentation and related fields. Requirements include a BS Degree in Electrical Engineering with emphasis in solid state physics or electronics, and up to three years experience in associated fields.

Qualified applicants are requested to submit a complete resume including salary history in confidence to:

Staff Administrator  
Development Department CL-33

CHEMSTRAND



COMPANY  
P. O. Box 1507, Pensacola, Florida  
An equal opportunity employer

### ENGINEERS/SCIENTISTS\*

BS and/or Advanced Degree

- Radar
- Microwave
- Systems
- Computers
- Circuitry
- Logic

Salaries \$6,000 to \$25,000  
Fee and relocation paid

### SNELLING & SNELLING

\* Scientific Placement Specialists  
581 Boylston St., Boston, Mass. 262-2660

Submit resume in confidence including current salary to Mr. Jerry Bartzoff. Openings at all levels. Offices coast to coast.



### E. E.'s

for FEE-PAID Positions  
**WRITE US FIRST!**

Use our confidential application for professional, individualized service . . . a complete national technical employment agency.

**ATOMIC PERSONNEL, INC.**  
Suite 1207L, 1518 Walnut St., Phila. 2, Pa.

## SEARCHLIGHT

### RADIO RESEARCH INSTRUMENT CO.

AUTO-TRACK & TELEMETRY ANTENNA PEDESTALS  
3 & 10 CM. SCR. 584 AUTOTRACK RADARS.  
AN/TPS-10 SEARCH. AN/TPS-10 HT. FINDERS.  
AN/FPN-32CA. AN/APS-10 NAVIG. & WEATHER.  
AN/APS-15B PRECISION. AN/APQ-35B PRECISION.  
AN/APS-31A SEARCH. DOZENS MORE.  
S-1-2 MEGAWATT HIGH POWER PULSERS.

RADIO RESEARCH INSTRUMENT CO.  
550 Fifth Ave., New York      Judson 6-4691

**RADAR SYSTEMS & COMPONENTS/ IMMEDIATE DELIVERY**

## FOR INFORMATION

about Classified Advertising

contact the McGraw-Hill office nearest you

**ATLANTA**, 30309 I. HILL—R. JOHNSON  
1375 Peachtree St., N.E. 875-0523 (Area Code 404)

**BOSTON**, 02116 J. WREDE  
McGraw-Hill Bldg., Copley Square  
Congress 2-1160 (Area Code 617)

**CHICAGO**, 60611 WM. HIGGINS—G. AMBROZE  
645 No. Michigan Avenue  
Mohawk 4-5800 (Area Code 313)

**CLEVELAND**, 44113 R. HARTER  
55 Public Square  
Superior 1-7000 (Area Code 216)

**DALLAS**, 75201 F. LeBEAU  
1712 Commerce St., Vaughn Bldg.  
Riverside 7-9721 (Area Code 214)

**DENVER**, 80202 J. PATTEN  
1700 Broadway, Tower Bldg.  
255-2981 (Area Code 303)

**DETROIT**, 48226 T. JAMES  
856 Penobscot Building 962-1793 (Area Code 313)

**HOUSTON**, 77025 K. GEORGE  
Prudential Bldg., Holcombe Blvd.  
Riverside 8-1280 (Area Code 713)

**LOS ANGELES**, 90017 R. McGINNIS  
1125 West Sixth Street  
Huntley 2-5450 (Area Code 213)

**NEW YORK**, 10036 D. HAWKSBY—H. BUCHANAN  
500 Fifth Avenue 971-3596 (Area Code 212)

**PHILADELPHIA**, 19103 WM. SULLIVAN—R. LEWIS  
Six Penn Center Plaza  
LOcust 8-4330 (Area Code 215)

**PITTSBURGH**, 15222 4 Gateway Center 391-1314 (Area Code 412)

**ST. LOUIS**, 63105 J. CROWE  
7751 Carondelet Avenue  
Parkview 5-7285 (Area Code 314)

**SAN FRANCISCO**, 9411 J. A. HARTLEY  
255 California Street  
DOuglas 2-4600 (Area Code 415)

CIRCLE 951 ON READER SERVICE CARD

# BREAKING THE TIME BARRIER



Although Rome wasn't built in a day, much less 137 days, the General Dynamics/Electronics SC-760 was. In fact, this highly versatile two-way doppler tracking system was "idea-ed" and delivered within this astonishingly short span of time.

A four and a half month wonder when you consider that our engineers and scientists produced it from scratch and that it is now gathering highly accurate rate information—in digital data form—on cooperative missiles launched from the Pacific Missile Range. Its exceptionally reliable, solid-state phase-lock receiver is highly sensitive—operating at signal levels as low as  $-151$  dbm.

This tracking colossus is just one example of the work being done at General Dynamics/Electronics. Whatever the phase of electronic and communication systems or however complex, our engineers and scientists are busily pushing aside many grey areas in pattern recognition studies, speech analysis, bandwidth compression, single sideband communications, underwater detection systems and in digital communications. Above all, they are creating technology on the move. And...their careers move, too.

Right now an interdisciplinary team is designing and building the equipment to test the most sophisticated electronic equipment for the most advanced tactical aircraft under development today. Each man on the team is becoming thoroughly familiar with a wide sampling

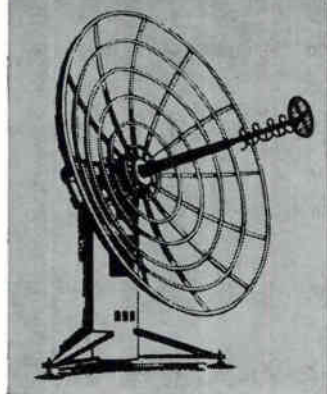

of commercial hardware designed by leaders in their respective fields.

There are openings on this team for graduate EE's with design experience in space communications, RF circuitry, tracking equipment, advanced pulse circuitry, mobile communication sets, doppler systems, navigation aids, reconnaissance/countermeasures, USW/ASW equipment, aerospace ground equipment, IFF equipment and telemetry receivers and transducers.

Additional positions are available in the Space Electronics & Navigation Laboratory where the SC-760 was created. In-house contracts can provide assignments for RF circuit design engineers on TACAN navigation systems (both airborne and ground equipment), advanced telemetry and tracking receiver design, and Doppler and monopulse tracking systems.

While the nature of the work is a star attraction at General Dynamics/Electronics, the Company location provides another source of satisfaction. Rochester, New York has the largest percentage of professional people in the nation for a city in the 500,000 population class...is noted for its cultural and educational advantages, and its proximity to the recreational and vacation areas on Lake Ontario, the Finger Lakes and the Adirondack Mountains.

If you would like to join this professional community within a professional community, send a resume to R. W. Holmes, registered engineer, Dept. 22.

**GENERAL DYNAMICS | ELECTRONICS**

An Equal Opportunity Employer

1400 N. GOODMAN ST., ROCHESTER 1, N. Y.

# INDEX TO ADVERTISERS

• AMP Incorporated . . . . .	38	Janco Corp. . . . .	47	• Tektronix, Inc. . . . .	7
Allen-Bradley Co. . . . .	9	Japan Piezo Electric Co., Ltd. . . . .	58	United Aircraft Corporate Systems Center . . . . .	62
Allied Electronics Sub. of Allied Radio Corp. . . . .	47	Julie Research Laboratories Inc. . . . .	55	Welch Scientific Co., The . . . . .	40
Arnold Engineering Co., The . . . . .	50				
Barber-Colman Co. . . . .	61	• Kepco, Inc. . . . .	45		
Binswanger Corp. . . . .	47	Krohn-Hite Corp. . . . .	41		
• CTS of Asheville, Inc. . . . .	63	• Lambda Electronics Corp. . . . .	22		
• Clifton Precision Products Co., Inc. . . . .	56				
		• Magnetic Shield Division of Perfection Mica Co. . . . .	62		
duPont de Nemours & Co., Inc., E. I. . . . .	16, 37	McGraw-Hill Book Co. . . . .	53		
		Millen Mfg. Co., Inc., James . . . . .	54		
Edgerton, Germeshausen & Grier . . . . .	59	Minnesota Mining & Mfg. Co. Mincom Division . . . . .	8		
Electronic Specialty Co. . . . .	48				
• Erie Technological Products, Inc. . . . .	13	New York State Dept. of Commerce . . . . .	58		
		• North Atlantic Industries, Inc. . . . .	46		
General Aniline & Film Corp. Ozalid Div. . . . .	12				
		• OKI Electric Industry Co., Ltd. . . . .	65		
• Hamilton Standard Div. of United Aircraft Corp. . . . .	21				
Heinemann Electric Co. . . . .	42	Patwin Electronics . . . . .	60		
• Hewlett-Packard Company . . . . .	3	• Perfection Mica Co. Magnetic Shield Div. . . . .	62		
	2nd cover	Presin Co., Inc. . . . .	4		
Hughes Aircraft Co. Instruments Division . . . . .	51	Puerto Rico Foreign Trade . . . . .	62		
Institute of Electrical & Electronics Engineers, Inc. . . . .	43	Radio Corporation of America . . . . .	4th cover		
		Sperry Electronic Tube Div. Sperry Rand Corp. . . . .	3rd cover		
		Sprague Electric Co. . . . .	6, 15		
		• Syntronic Instruments, Inc. . . . .	60		

**CLASSIFIED ADVERTISING**  
F. J. Eberle, Business Mgr. (2557)  
**EMPLOYMENT OPPORTUNITIES 66-67**

**EQUIPMENT**  
(Used or Surplus New)  
For Sale . . . . . 66

## CLASSIFIED ADVERTISERS INDEX

Atomic Personnel Inc. . . . .	66
Chemstrand Co. . . . .	66
General Dynamics/Electronics . . . . .	67
• Radio Research Instrument Co. . . . .	66
Snelling & Snelling . . . . .	66

• See advertisement in the July 25, 1963 issue of electronics Buyers' Guide for complete line of products or services.

This Index and our Reader Service Numbers are published as a service. Every precaution is taken to make them accurate, but electronics assumes no responsibilities for errors or omissions.

## electronics



Audit Bureau  
of Circulation



Associated Business  
Publications

AUDITED PAID CIRCULATION

**JAMES T. HAUPTLI (2210)**  
Advertising Sales Manager

**HENRY M. SHAW (3485)**  
Market Research Manager

### electronics Buyers' Guide

**R. S. QUINT (2335)**  
General Manager

**RICHARD J. TOMLINSON (3191)**  
Business Manager

**THEODORE R. GEIPEL (2044)**  
Production Manager

**NEW YORK TELEPHONE:** Dial Direct:  
971 plus number in parenthesis,  
Area Code 212

## ADVERTISING REPRESENTATIVES

**ATLANTA, GA. 30009**  
Michael H. Miller, Robert C. Johnson  
1375 Peachtree St. N.E.,  
Trinity 5-0523 (area code 404)

**BOSTON, MASS. 02116**  
William S. Hodgkinson  
McGraw-Hill Building, Copley Square,  
Congress 2-1160 (area code 617)

**CHICAGO, ILL. 60611**  
Harvey W. Wernecke,  
Robert M. Denmead  
645 North Michigan Avenue,  
Mohawk 4-5800 (area code 312)

**CLEVELAND, OHIO 44113**  
Paul T. Fegley  
55 Public Square, Superior 1-7000  
(area code 216)

**DALLAS, TEXAS 75201**  
Frank Le Beau  
The Vaughn Bldg.,  
1712 Commerce St.  
Riverside 7-9721 (area code 214)

**DENVER, COLO. 80202**  
John W. Patten  
Tower Bldg., 1700 Broadway,  
Alpine 5-2981 (area code 303)

**HOUSTON, TEXAS 77025**  
Kenneth George  
Prudential Bldg., Halcombe Blvd.,  
Riverside 8-1280 (area code 713)

**LOS ANGELES, CALIF. 90017**  
Ashley P. Hartman, John G. Zisch,  
1125 W. 6th St., Huntley 2-5450  
(area code 213)

**NEW YORK, N. Y. 10036**  
Donald H. Miller (212) 971 3615  
George F. Werner (212) 971 3617  
Donald R. Furth (212) 971 3616  
500 Fifth Avenue

**PHILADELPHIA, PA. 19103**  
Warren H. Gardner, William J. Boyle  
6 Penn Center Plaza,  
LOcust 8-4330 (area code 215)

**SAN FRANCISCO, CALIF. 94111**  
Richard C. Alcorn  
255 California Street.  
Douglas 2-4600 (area code 415)

**LONDON W1:**  
Edwin S. Murphy Jr.  
34 Dover St.

**FRANKFURT/Main:**  
Matthee Herfurth  
85 Westendstrasse

**GENEVA:**  
Michael R. Zeynel  
2 Place du Port

**TOKYO:**  
George Olcott,  
1, Kotohiracho, Shiba, Minato-ku

---

**JOHN R. WHITFORD**  
Division Manager

---

**Performance  
(not promises)  
is what Sperry  
delivers in  
high-power  
CW klystrons**

"The high-power CW klystrons on this table are already in production! They are our SAC-406, SAX-4181 and SAX-418. They cover frequencies from 4.4 to 11 Gc.

"Our unique new 'modular manufacturing' concept has allowed us to customize these production tubes to many different frequencies. At the same time, we have achieved gain as high as 70 db, efficiency as high as 42%, and CW power levels up to 50 kW.

"Delivery? No problem. We'll deliver a high-power CW klystron to your specifications in 120 days, but often we have beaten that. We recently shipped a SAX-418 for plasma investigations in just 10 days, ARO. And a 10 kW, CW broadband klystron for a satellite communications system was completed in just 16 days after receipt of order.

"Do you need high performance from CW klystrons and fast performance from their manufacturer? Then get full details on the hardware in being at Sperry.

"Write Sperry, Gainesville, Florida, or contact your nearby Cain & Co. representative. In Europe, contact Sperry Europe Continental, Paris."



CIRCLE 901 ON READER SERVICE CARD



*1,600,000 Hours of Nuvistor Life Tests DEMONSTRATE:*

**99.53%  
RELIABILITY**

*per 1,000 hours over first 10,000 hours of operation at a*

**95% CONFIDENCE LEVEL**

New data, from continuing tests, substantiate these exceptional reliability figures for RCA nuvistors.

1,600,000 tube hours of actual life tests on the RCA-7586 nuvistor triode have established a failure rate of only 0.47% or less per 1,000 hours—for the first 10,000 hours of operation—at a confidence level of 95%.

Furthermore, during the tests, involving 532 nuvistors, only one tube showed a reduction in transconductance to 50 percent or less of the initial value. The tests also revealed no sustained downward trend in transconductance distribution. Based on these findings, wear-out type failures should be virtually non-existent during the first 10,000 hours of nuvistor tube life.

These facts give you 95% assurance that:

- Of every 200 RCA-7586 type nuvistors in your sockets, 199 will satisfactorily complete each 1,000 hours during the first 10,000 hours of operation.
- Nuvistor characteristics are exceptionally uniform from tube to tube, and remain exceptionally stable throughout tube life.

This outstanding reliability is one more reason why you should specify nuvistors for all applicable circuitry. For technical data on specific types, see your RCA Field Representative or write: Commercial Engineering, RCA Electronic Components and Devices, Harrison, New Jersey.

Nuvistor Life Test Conditions

	Test Conditions =1	Test Conditions =2
Heater volts	6.3	6.3
Heater-cathode volts	100	0
Plate volts	100	—
Plate-supply volts	—	75
Grid volts	-1.85	—
Cathode resistor—ohms	—	*100
Grid-circuit resistance—megohm	0.5	0.5
Metal-shell temperature—°C	150	150
Plate dissipation—watts	1	0.75

FIELD OFFICES—EAST: 32-36 Green St., Newark 2, N. J., (201) 485-3900 • MIDWEST: Suite 1154, Merchandise Mart Plaza, Chicago 54, Ill., (312) 527-2900 • WEST: 6801 E. Washington Blvd., Los Angeles 22, Calif., (213) RAYmond 3-8361 • 1838 El Camino Real, Burlingame, Calif., (415) 697-1620



**The Most Trusted Name in Electronics**