

electronics®

INDUSTRIAL ESPIONAGE

*How much goes on
in our industry, p 22*

EVERY PLANE A WEATHER STATION?

*Versatile weather pod
fits most planes, p 38*

TUNNEL RESISTOR

*Latest solid-state
device, p 42*

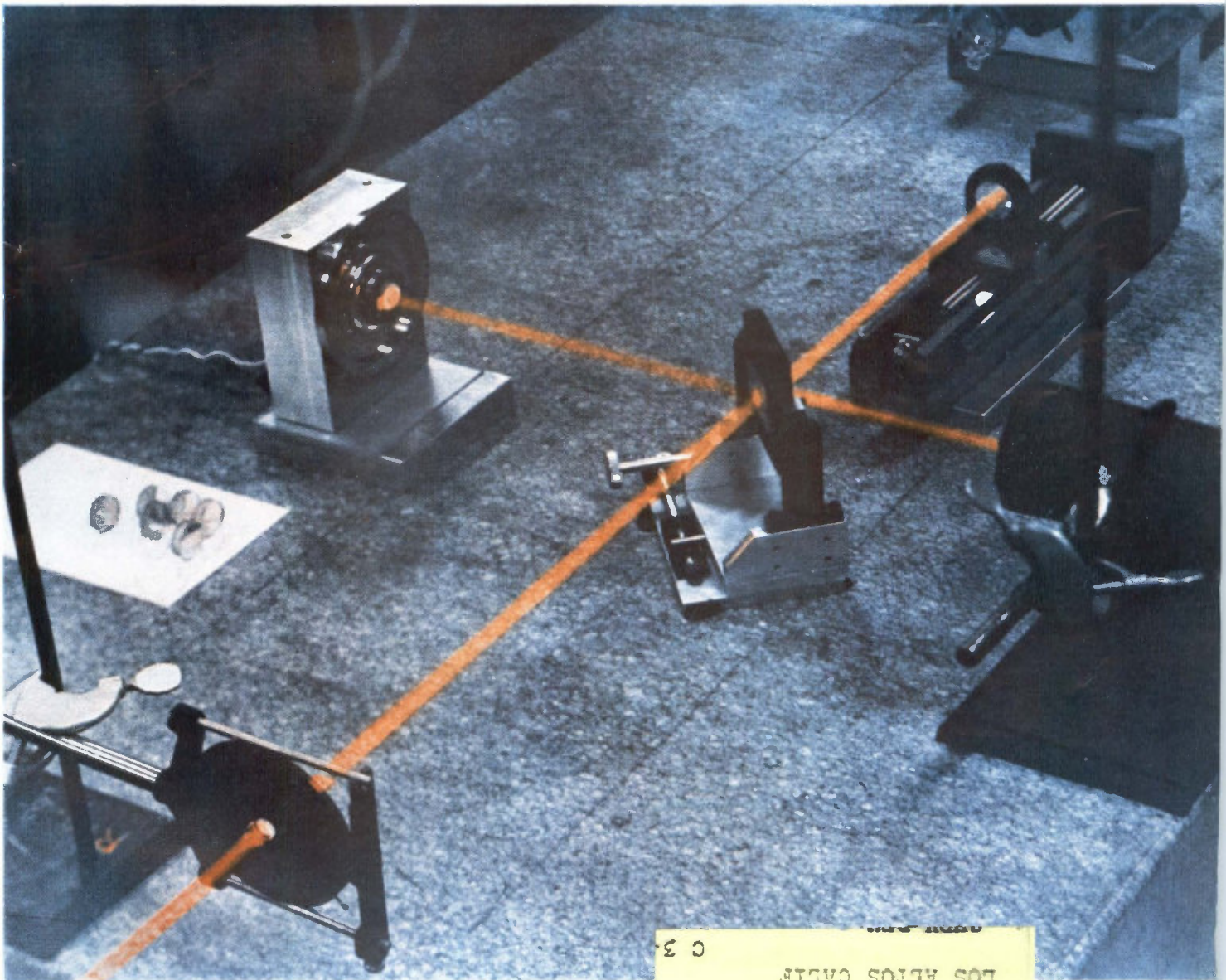

OPTICAL HETERODYNE DETECTION may be the keystone of a s

R D SKINNER
1020 GOVINGTON RD
LOS ALTOS CALIF
C 3
L

CLAMP AROUND THE LEAD:

and measure dc current 0.1 ma to 10 amps, without breaking circuit leads, without loading the circuit.

Pull back the probe flange, the probe opens. Aim it at a lead and let loose. The probe closes. Now you can measure dc current, on a bare or insulated wire . . . and you can read it directly, even in the presence of equally strong ac on the same wire, without breaking a lead and without loading the circuit.

The hp 428B Clip-on DC Ammeter reads dc current directly in 9 ranges by sensing the magnetic flux induced by the dc current. To measure the sum or difference of currents flowing through two separate wires, you simply clamp the probe around them both . . . and read. The standard 428B has a range of 0.1 ma to 10 amps and lets you read dc currents on wires up to $\frac{3}{32}$ " in diameter. A recorder, oscilloscope output is provided on the 428B.

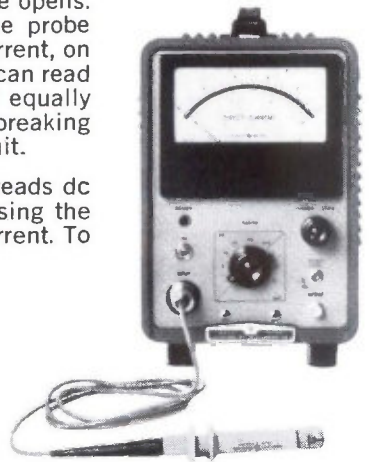

CHOMP!

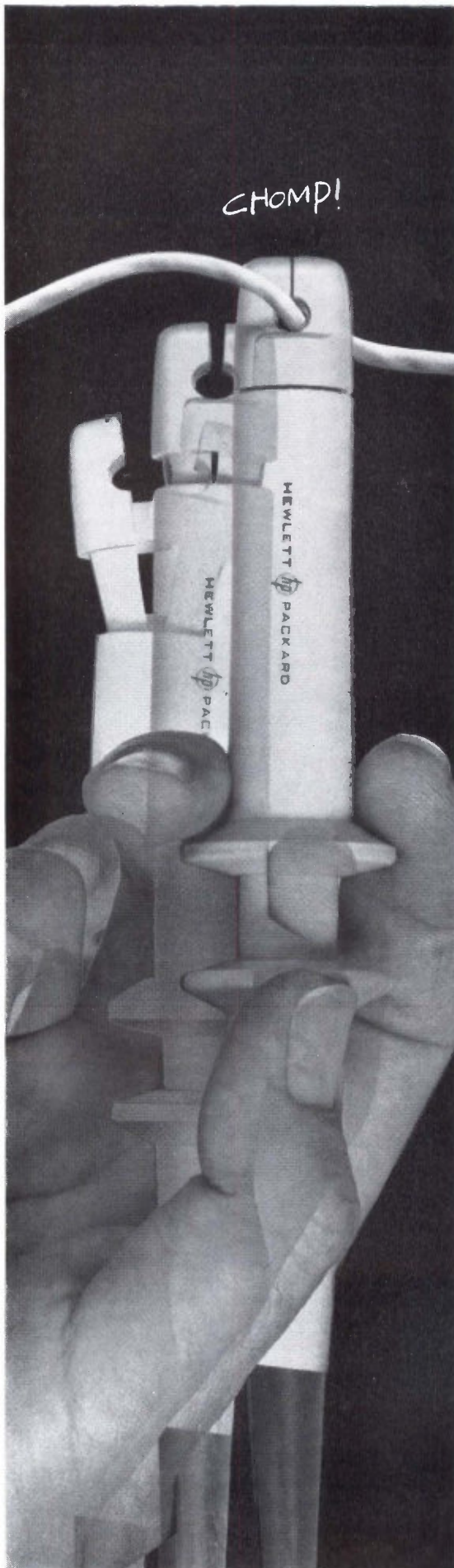

hp 3528A Current Probe

hp 3529A Magnetometer Probe

The hp 3528A Current Probe (\$450 with degausser) lets you measure dc current in conductors up to $2\frac{1}{2}$ " in their maximum dimensions . . . even pipes, multiconductor cables, lead-sheathed cables, microwave waveguide.

The hp 3529A Magnetometer Probe (\$75) is useful in applications ranging from acoustical transducer design to study of the Zeeman effect; it measures the direction or magnitude of any magnetic field with 1 milligauss sensitivity.

Look at the 428B specs, then call your hp field engineer or write direct for a single data sheet which describes all its capabilities.

428B SPECIFICATIONS

- Current Range:** 1 ma to 10 a full scale in 9 ranges
- Accuracy:** $\pm 3\%$, ± 0.1 ma
- Probe Inductance:** $< 0.5 \mu\text{h}$ introduced into measured circuit
- Probe Induced-Voltage:** < 15 mv peak into measured circuit
- AC Rejection:** ac with peak value less than full scale affects meter accuracy less than 2% at frequencies above 5 cps and different from carrier (40 kc) and its harmonics; (on 10 range, ac is limited to 4 a peak)
- Recorder/Oscilloscope Output:** app. 1.4 v across 1400 ohms full scale; frequency response dc to 400 cps
- Probe Insulation:** 300 v maximum
- Price:** hp 428B, \$600 (cabinet); hp 428BR, \$605 (rack mount) (428A also available; same as 428B except range: 3 ma to 1 ampere full scale; no recorder output, \$500)

Data subject to change without notice. Prices f.o.b. factory.

8495

**HEWLETT
PACKARD
COMPANY**



1501 Page Mill Rd., Palo Alto, Calif., (415) 326-7000. Sales and service representatives in principal areas. Europe, Hewlett-Packard S.A., 54 Route des Acacias, Geneva, Switzerland; Canada, Hewlett-Packard (Canada) Ltd., 8270 Mayrand St., Montreal, Que.

electronics

W. W. MacDONALD, Editor (2645)

A McGraw-Hill Weekly 75 Cents

J. M. CARROLL, Managing Editor (2293)

SENIOR EDITORS

Samuel Weber (2371)
George W. Sideris (3444)

SENIOR ASSOCIATE EDITORS

Michael F. Wolff (2600)
John F. Mason (2666)

ASSOCIATE EDITORS

Michael F. Tomaino (2071)
William P. O'Brien (2297)
Sy Vogel (2467)
George J. Flynn (2188)
George V. Novotny (3151)
Leon H. Dulberger (3446)
Alexander A. McKenzie (2685)

ASSISTANT EDITORS

Stanley Froud (2710)
Stephen B. Gray (2245)
Roy J. Bruun (3495)
Barry A. Briskman (2306)
Dan Smith (2472)
Joel A. Strasser (2127)

REGIONAL EDITORS

Harold C. Hood
(Pacific Coast, Los Angeles)
Laurence D. Shergalis
(Pacific Coast, San Francisco)
Thomas Maguire
(New England, Boston)
Cletus M. Wiley
(Midwest, Chicago)

ART DIRECTOR

Howard R. Berry (2430)

ASSISTANT ART DIRECTOR

John C. Wright, Jr. (3430)

EDITORIAL ASSISTANTS

Lorraine Rossi, Virginia T. Bastian,
Lynn Emery, Ann Mella, Lorraine
Werner, Alice M. O'Brien, Sharon
Parks, Patricia Mitchell, Claire
Benell, Kay Fontana

FOREIGN NEWS BUREAU

DIRECTOR, John Wilhelm;
Alyne Elias, Laurence Mihlon
LONDON—John Shinn, Derek
Barlow, Nicholas Landon
BONN—Bruce Bendow,
Richard Mikton, Silke McQueen
BRUSSELS—Peter Forbath
PARIS—Robert Farrell,
Arthur Erikson
MILAN—Marc A. Messina
MEXICO CITY—Wesley Perry, Jr
RIO DE JANEIRO—Leslie Warren
MOSCOW—Stewart Ramsey
TOKYO—Richard Halloran,
Charles Cohen, John Yamaguchi

CIRCULATION MANAGER

Hugh J. Quinn (2310)

W. W. GAREY, Publisher (2016)

NEW YORK TELEPHONE:
Area Code 212. Locally, 971 plus
extensions shown above in parenthesis

CONFIRMING optical heterodyning principles in the lab (TRG).

Beam from helium-neon gas laser enters at lower left. Beam splitter center sends part of beam to phase modulator (left) and part to reflector (top). Reflected beams both go to detector (right) where modulating signal is recovered. *An automatic-frequency-control system now permits separate transmitter and local-oscillator lasers to be used.* See p 29

COVER

ELECTRONIC MUSCLE EXERCISER developed for consumer use is nearing production. The transistor operated instrument generates a pulsed sonic pulse that is applied to muscles via dampened electrodes. *Therapeutic applications abound including weight reduction*

16

ARMY'S UNLIMITED FIREPOWER Now Places Emphasis on Command and Control Research to Provide Needed Techniques for Large and Small Wars. *Army researchers seek to provide quick reaction time and a maximum of field mobility in design formats of advanced equipment*

20

HOW TO SUCCEED in Business on Someone Else's Research. Industrial espionage received a lot of publicity a few years ago when scandals broke in the drug and chemical fields. Gossip has linked these activities to our industry also, but how much really goes on? *While a precise answer to this question is impossible, the records of an investigative firm indicate the amount is substantial*

22

NEW DEVICE LOWERS MEMORY ELEMENT COST. Barium titanate cells the size of a dime can be made cheaper than today's cores. *Readout is nondestructive, and the associated circuits are less sensitive to noise, magnetic fields and radiation*

25

ZIP GOES THE MAIL! With phosphor-coated air mail stamps and ZIP code numbers, the Post Office Department will use ultraviolet detectors and optical scanners to speed the mail through. *POD aims to delay future postal rate increases by mechanizing fast enough to keep up with the annual 3 percent mail increase while holding on to permanent personnel*

26

OPTICAL HETERODYNING Heralds Space Signaling With Lasers. The laser beam affords enormous information capacity that now becomes realizable as familiar radio techniques are demonstrated one-by-one using light. *The optical heterodyning technique offers an advantage over conventional detection with respect to signal-to-noise ratio and handles phase, amplitude or single-sideband modulation.* By S. Jacobs, TRG, Inc.

29

NEGATIVE RESISTANCE ELEMENTS As D-C Switches. New component, recently made available, combines the advantages of mechanical switches with high speed and freedom from contact bounce. *Voltage-stable negative-resistance characteristic of the device is responsible for its advantages.*

By C. D. Todd, Hughes Aircraft 32

Contents Continued

Published weekly, with Electronics Buyers' Guide as part of the subscription, by McGraw-Hill Publishing Company, Inc. Founder: James H. McGraw (1860-1948).

Title ® registered U.S. Patent Office; © copyright 1963 by McGraw-Hill Publishing Co., Inc. All rights reserved, including the right to reproduce the contents of this publication, in whole or in part.

Executive, editorial, circulation and advertising offices: McGraw-Hill Building, 330 West 42nd Street, New York, N. Y., 10036. Telephone Area code 212 971-3333. Teletype TWX N. Y. 212-640-4646. Cable McGrawhill, N. Y. PRINTED IN ALBANY, N. Y.; second class postage paid at Albany, N. Y.

OFFICERS OF THE PUBLICATIONS DIVISION: Shelton Fisher, President; Vice Presidents: Joseph H. Allen, Operations; John R. Callahan, Editorial; Ervin E. DeGraff, Circulation; Donald C. McGraw, Jr., Advertising Sales; Angelo R. Venezian, Marketing.

OFFICERS OF THE CORPORATION: Donald C. McGraw, President; Hugh J. Kelly, Harry L. Waddell, L. Keith Goodrich, Executive Vice Presidents; John L. McGraw, Treasurer; John J. Cooke, Vice President and Secretary.

Subscriptions are solicited only from those actively engaged in the field of the publication. Position and company connection must be indicated on orders. Subscription rates: United States and Possessions and Canada, \$6.00 one year, \$9.00 two years, \$12.00 three years. All other countries \$20.00 one year. Single copies, United States and Possessions and Canada 75¢. Single copies all other countries \$1.50.

THE PUBLISHER, UPON WRITTEN REQUEST TO OUR NEW YORK OFFICE FROM ANY SUBSCRIBER AGREES TO REFUND THAT PART OF THE SUBSCRIPTION PRICE APPLYING TO COPIES NOT YET MAILED.

Subscribers: Please send change of address notices, subscription orders or complaints to Fulfillment Manager, Electronics, at the address below. Change of address notices should provide old as well as new address, including postal zone number if any. If possible, attach address label from recent issue. Allow one month for change to become effective.

Postmaster: Please send Form 3579 to Fulfillment Manager, Electronics, P. O. Box 430, Hightstown, New Jersey, 08520.



Audited Paid Circulation

CONTENTS continued

MISSILE-ANTENNA IMPEDANCE. Measuring It in Flight. It is easy to obtain antenna vswr and phase information in the lab but to measure it out in space you either need to buy a set of angel wings or use this four-probe reflectometer. *The instrument works even during reentry.*
By P. Bohley, R. Caldecott, R. McGown and R. C. Taylor,
The Ohio State University 36

NEW APPROACH TO WEATHER DATA: Every Plane a Station. Data now being gathered by meteorological balloons and rockets can be supplemented by sensors mounted on aircraft but instrumenting a plane can be awkward; this self-powered probe makes it easy. *One novel instrument in the pod is a special dew-point sensor.*
By H. R. Farrah and P. E. Sherr, Bendix 38

TUNNEL RESISTOR: New Device that Speeds up Tunnel Diodes. The tunnel resistor is formed by plating a resistive path across a tunnel-diode junction. Tunnel-resistor biasing has permitted logic functions in a 40-gate system to be performed at 300-Mc shift and count rates. *Monostable stages as fast as 1 Gc seem feasible.*
By M. Cooperman and R. H. Bergman, RCA 42

DEPARTMENTS

Crosstalk. <i>Defeat in Venice</i>	3
Comment. <i>Sideband Reception. Negative Resistance-V</i>	4
Electronics Newsletter. <i>Thermal Effects Aid Micro Circuits</i>	7
Washington This Week. <i>Electronics Gets Major Share of NASA Money</i>	12
Meetings Ahead. <i>Vehicular Communications International Convention</i>	27
Research and Development. <i>Avalanche Transistors Test 10-Nsec Logic</i>	46
Components and Materials. <i>Will British TWT's Make Further Inroads?</i>	50
Reprint Order Form	51
Production Techniques. <i>Laser Welding Experiments Show Promise</i>	54
New Products. <i>Binary Indicator Uses 7 Transistors</i>	58
Literature of the Week	66
People and Plants. <i>RCA Puts \$11.6 Million In New Tube Plant</i>	68
Index to Advertisers	74

Defeat in Venice?

ON JUNE 6, in the venerable city of Saint Mark, technical committee three of the International Electrotechnical Commission took action that may represent a defeat not only for American manufacturers but also for the cause of standardization throughout the world. But final action still requires approval of 80 percent of the 35 members (one vote per nation). The voting will be completed sometime before next May.

For several years the transistor symbols, like the one shown at the left have been a universal standard both here and abroad. But we may very well be headed for a dual standard, which as everyone knows is not a standard at all. The symbol at the right represents the proposed system of semiconductor symbols. It was proposed about a year ago by the Swedes.

At first glance, the symbols might seem to have an advantage of being comforting to engineers who prefer to cling to something more resembling the familiar vacuum tube. However, this Swedish proposal is, in fact, a giant step backwards, especially today when equipment uses many thousands of transistors.

The Swedish symbols require that the circle be used, while the classical symbols do not. It is difficult to draw a great many circles on a single diagram. Furthermore, the more complex semiconductor junction devices will be infinitely harder to draw in the new system. Supporters of the new system plead that it simplifies drafting and this argument appeals to many Europeans who do not generally use templates to the extent we do.

Until recently, the Swedish system was never considered seriously. Not until the French apparently reversed several years of practice in using the classical symbols to support the Swedish system. They were joined by the Italians, Czechs, Swiss and Danes—making enough votes to bring the matter up for debate in the IEC.

At this point the shortsighted economy measures of at least two well-heeled American companies contributed to our defeat as several competent and eloquent specialists in semiconductor symbols were kept at home instead of having their fares paid to join the U. S. delega-

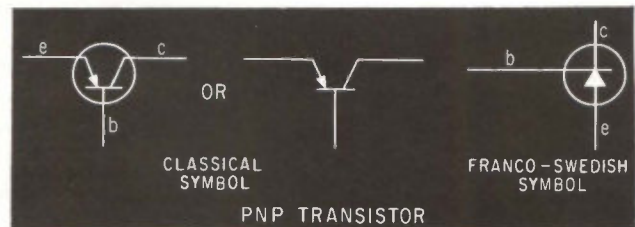

tion to Venice. The sole U. S. delegate, although primarily a power man by training and long experience, gave a masterful presentation of the American position, but he was all but overwhelmed by the opposition. The U. S. delegate was able only to get agreement that the classical system should be designated as the preferred system.

At first we received enthusiastic support from the British, Germans and Dutch. But the British later agreed to use of both sets of symbols. The USSR also advocated use of both sets of symbols.

The committee decision will soon go out for a two-month ballot to all 35 members of the IEC. The trend of the times seems to be running strongly to compromise.

We urge all national committees to vote NO and thus preserve standardization of semiconductor symbols. Only seven negative ballots would be necessary to reinstate the classical system as the sole system.

DIAL US DIRECT

ELECTRONICS New York staff may now be reached by Direct Inward Dialing, without going through our central switchboard.

If you are outside our area, first dial the code number 212. Then dial our "exchange," 971. Then dial the extension shown in parenthesis after the name of the man you want on the first page or the last page of this issue.

To reach anyone else at McGraw-Hill in New York whose extension number you do not know, dial 212 if an area code is needed, then 971-3333

Pulse Network Problems Solved by Experienced Systems Engineers

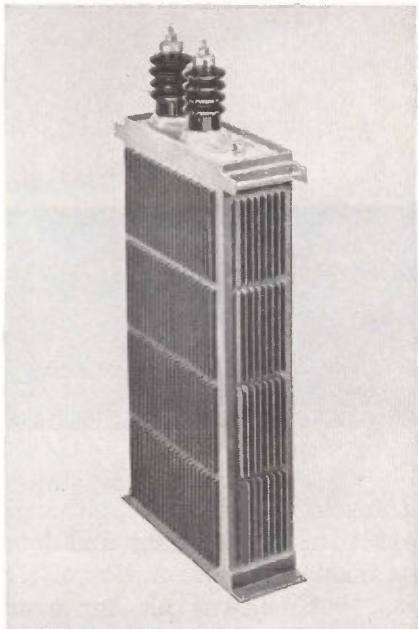

Typical Large Pulse-Forming Network designed by Sprague to meet a specific customer need.

Prompt cooperation on customers' pulse network problems is readily available from Sprague Electric Company's Pulse Capacitor and Network Section.

Sprague has much to offer to designers of radar systems, laser systems, tube testing systems, and other specialized systems. A highly-technical special engineering section devoted exclusively to pulse capacitors and networks includes systems as well as pulse network engineers. *Sprague can help you with your problems because Sprague fully understands your problems!*

But Sprague service does not end here. Following up the design aspect, these specialists can quickly and efficiently estimate pulse network sizes and prices for bidding purposes. They are also equipped to give quick reaction capabilities for your breadboard and prototype units.

A pioneer in pulse networks, Sprague is a major supplier of custom units from less than 1 KV up to 500 KV over a broad range of power levels.

For application engineering assistance, or additional information, write to Pulse Network Section, Sprague Electric Company, 35 Marshall St., North Adams, Massachusetts.

48PN-104-63

COMMENT

Sideband Reception

I am writing for a reprint of the article, Better Superhets For Sideband Reception (p 39, May 10).

This is the first time in any publication that I have seen so complete a summary of the requirements for this type of receiver. It also brought out two new viewpoints about features that I have not seen previously.

I wish to thank you for a very interesting magazine, which I usually see at the library of Michigan State University at East Lansing, Michigan.

C. MCCORMICK

Lansing, Michigan

Negative Resistance V

A comment published in your April 26 issue (p 4) by Wayne T. Sproull on Negative Resistance stimulates this further comment.

I note that "The International Dictionary of Physics and Electronics," D. Van Nostrand Co., Inc., 1956, p 774, defines negative resistance as a negative value of dV/dI . This is a very useful concept for non-linear electron devices whose current and voltage can often be analyzed as having a "d-c" and a "signal" component. (Positive resistance has its share of confusion also.)

Triodes, for example, have among their published parameters that which is known as plate resistance. This is a slope, specifically dV/dI . Sometimes this is called "dynamic" resistance, as for example, the zener region of a zener diode. Whatever we should call it, it is clear that the slope dV/dI is an extremely useful parameter and often tells much more about the behavior of the device than the simple resistance as defined by writer Sproull, namely, V/I .

The muddy thinking which is associated with this difference between dynamic resistance and resistance is exemplified by advertisements for null-type d-c differential voltmeters. Without exception, ads which I have seen for this type of instrument, state that the instrument has infinite input

impedance at null, and therefore, there will be no measurement errors due to circuit loading. This is correct; however, what the user also needs to know is how sensitive is the null-type instrument for the case of measuring voltages which have a high source resistance. To know this, the user must know the dynamic resistance of the null-type instrument.

I suggest that whenever the word *resistance* is applied to an active and/or nonlinear device such as a diode, zener diode, transistor or vacuum tube, that the meaning should always be dynamic resistance. If the preceding is acceptable, the definition that resistance is V/I should only be permitted to apply to a resistor.

F. H. HARRIS

Electron Tubes Branch
U. S. Naval Research Laboratory
Washington, D. C.

Sideband Reception II

The following omissions and corrections to the article, Better Superhets For Sideband Reception (p 39, May 10), are noted.

The graph of Fig. 2, referred to in line 16 of the second column, p 40, was omitted.

The calculation for noise factor in Fig. 1, line 29 of the third column on p 40, should have 0.49 instead of 0.5 within the first pair of parentheses.

In Fig. 2, "24e" should be at the grid side of the tube, next to letter B, rather than on the plate side of the tube, since it represents the voltage at the grid rather than at the plate.

On p 42, seventh line from the bottom, second column, the word should be *multiplies* rather than *multiplies*.

In Table IV, p 43 under column $f_s:f_c$, the third entry should be 2:3 rather than 2:8. This is important because this entry is referred to in the text, lines 18-20, column 3, p 42.

The authors have received a number of favorable comments from their colleagues on the article, which attests to your fine editing as well as the original source of the material.

WARREN BRUENE

EDGAR SCHOENIKE

Collins Radio Company
Cedar Rapids, Iowa

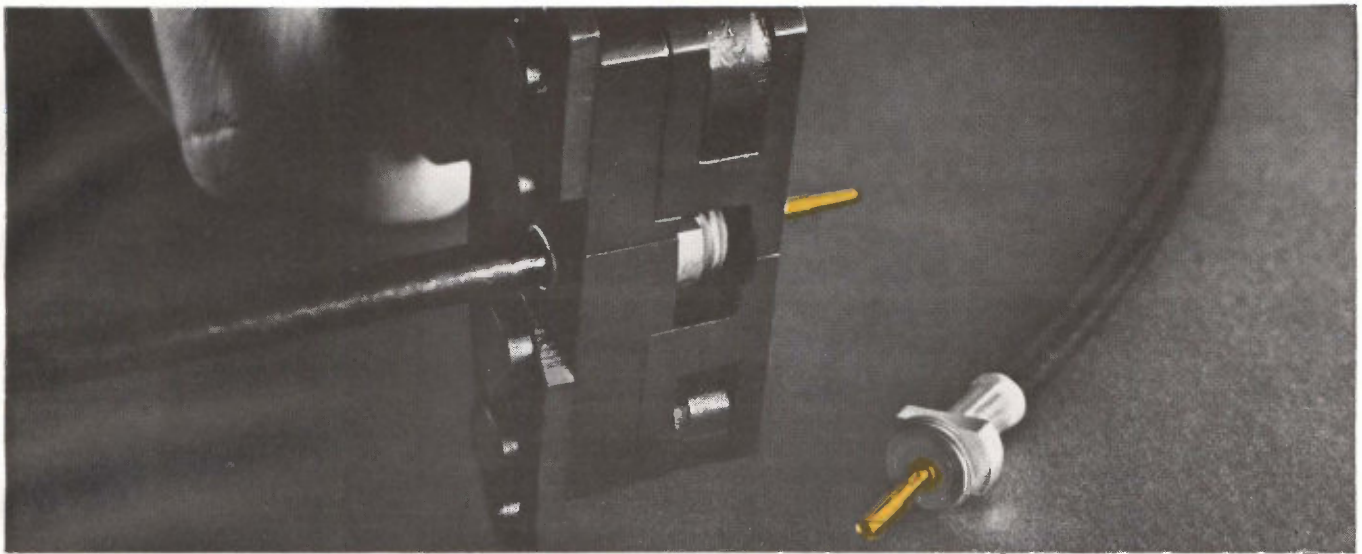

7 seconds . . . done!

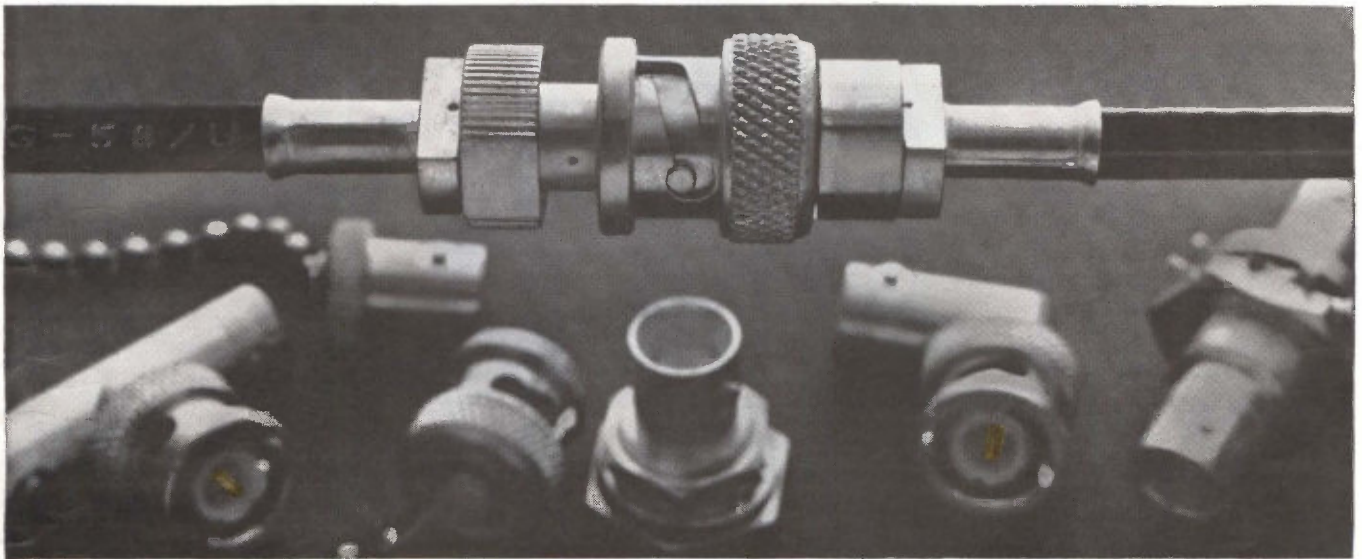

No rejects!

Just one crimp terminates the contact in this new A-MP BNC Series COAXICON* Connector. One crimp terminates inner conductor, outer braid and cable support . . . simultaneously! Result? You save more than 50% in applied costs over other BNC assemblies. And that's just the beginning!

There's never any time loss or hidden costs. Contacts come pre-assembled, ready to crimp. Never any rejects or faulty connections. Controlled cycle crimping tools permit no variance in the connections. Each termination is identical—precision crimped and electrically stable. Each delivers minimum discontinuity for example at 4,000 megacycles, the voltage standing wave ratio is 1.12:1.

Make a match—our BNC Connectors against any others. Ours are fully intermatable with comparable UG/U series connectors. They meet and

exceed all specifications of MIL-C-3608A. They're available in a broad range of RG/U cable sizes, with Right Angle, Tee and Bulkhead adapters to meet every design requirement.

Add up the advantages: quick assembly, stable performance, lowest applied cost. For RF applications in your most advanced electronic equipment choose A-MP BNC Series COAXICON Connectors. They're available now. Send today for complete specifications and test data.

*Trademark of AMP INCORPORATED



AMP products and engineering assistance are available through subsidiary companies in: Australia • Canada • England • France • Holland • Italy • Japan • Mexico • West Germany



TINYMAX 400 CYCLE MINIATURE POWER TRANSFORMERS

TINYMAX

- Range from 1.5 VA to 75 VA with 115V primaries and secondary voltages from 6V to 300V
- Save weight, space and improve performance
- Are hermetically sealed, metal cased and stud mounted
- Are built to meet MIL-T-27A, grade 4, class S requirements
- Special designs up to 2.5 KVA.

DESIGNED
TO YOUR SPECS,
MANUFACTURED AND
SHIPPED WITHIN

24 HOURS

Yes, its true TORWICO achieved the almost impossible. Now within 24 hours from the time you give us your order, TINYMAX, 400 cycle power transformers, will be shipped to your plant. Don't waste costly time — get peak efficiency — let TORWICO experts do the design work.

Wire, call or write for complete bulletin and price list!

TORWICO
ELECTRONICS INC., LAKEWOOD, N. J. • 201-364-1800

Thermal Effects Aid Microcircuits

CHICAGO — Thermal propagation techniques may provide a solution to problems encountered in dealing with low frequencies in microelectronic circuits, according to J. S. Kirby of Texas Instruments. Because of the low capacitance and lack of inductance, microelectronic-type oscillators and low-pass filters in the 30 to 1,000-cps range have been difficult to construct.

Speaking at a conference here sponsored by ELECTRONICS and ITT Research Institute, Mr. Kirby described experiments exploiting the thermal properties of a silicon bar. A thermal pulse was introduced into one end of a thermal bar and a delayed thermal pulse was noted at the other end. Using suitable feedback circuits, stable oscillations in the 30- to 1,000-cps region have been achieved.

A second concept, in which parallel capacitors are commutated at a fixed rate, indicated that with refinements, microelectronic i-f amplifiers could also be constructed for operation in the 30 to 1,000-cps range.

Japan Will Purchase Hughes' 'Sage' System

TOKYO—The Japanese Defense Agency has decided to buy the Hughes' version of the small-scale Sage-type air warning and control system (p 7, March 8). Officials here said reasons for the choice include low initial cost and low operational cost. Hughes' major competitor had been Litton. GE was in the race too, but was eliminated early because of the high price of its system. GE last week lowered its price to equal Litton's, but this move apparently came too late.

The decision was made on the day following the return of the team that had been in the U. S. to inspect the Hughes and Litton systems (p 8, June 21). It reported the Hughes system should satisfy

technical and delivery requirements.

A Japanese-American joint operation study and a system design phase, lasting approximately 4 months, are contemplated. These would be followed by a Japanese-American cost conference and signing of the contract, around October, 1964. Completion of the contract is expected in March, 1967.

Delay Lines Provide "Scratch Pad" Memory

MARTIN has developed superconductor delay lines for use as "scratch pad" memory devices in high-speed computers. The new delay lines give precise delay times from 100 to 2,000 nanoseconds. In computers with clock rates of about 125-Mc, an 800-nanosecond delay line will

provide a 100-bit storage capacity. The delay line occupies a volume of $2\frac{3}{8}$ -inches in diameter, by $1\frac{1}{8}$ -inches in height. Additional uses for the delay lines include radar pulse storage and delay, millimicrosecond and video pulse processing, and pulse comparison.

Philippines Buying Telecommunications Net

EMERGING NATIONS are bypassing conventional wire-type telephone and telegraph systems and going directly to radio relay links. In the latest instance of this, the Philippine Government has contracted with ITT Philippines, Inc. for a \$12-million telephone and telegraph system. The cities of Manila, Cebu, and Cagayan de Oro, on the three major islands, will be connected by

Latest Nurses' Aide



IBM 1710 computer is the heart of a hospital information system that will be installed next spring at Children's Hospital of Akron (Ohio). Terminals at nursing stations and other locations will feed patient information to the 1710, which in return will send the stations schedules for medications, diets, lab tests and x-ray examinations

over-the-horizon radio links using tropospheric scatter.

Microwave links are planned between larger centers on each island, with vhf feeder links to the smaller centers. Training of local personnel in the operation and maintenance of the new equipment has been arranged by the United Nations through the International Telecommunications Union, and is being implemented by the Bureau of Telecommunications of the Philippines.

FAA Wants Low-Cost ILS For Small Airport

WASHINGTON—ITT has been selected by the Federal Aviation Agency to develop a low-cost, complete instrument landing system which would be inexpensive enough for smaller airports with insufficient traffic to justify a full-scale, conventional system.

A regular instrument landing system costs about \$276,000, according to the FAA. The agency wants a system costing about one-third this sum. It says the savings could result from a simplified design, prefabrication of certain components, and a lower power unit. FAA estimates that there are about 200 small airports that would be in the market for the simplified system.

Spy Will Cost Sweden \$200 Million in Repairs

STOCKHOLM—Government observers estimate Sweden must spend at least \$200 million to repair damage to its defense system resulting from espionage committed by Col. Stig Wennerstrom. Colonel Wennerstrom, one of Sweden's disarmament specialists, confessed several weeks ago to having spied for the Russians for 15 years.

Big investments are expected here in electronics for anti-aircraft equipment. Some Swedes fear they will no longer be able to purchase advanced military equipment, especially missiles, from the U.S. and England, thus requiring huge investments in Swedish industries to

produce this material. In Washington, the Pentagon would only say "it is not appropriate at this time to make a comment since the Wennerstrom case is still under study."

Electroluminescence May Light Runways

MADRIGAN Electronics has received an FAA contract to design and develop an experimental runway lighting system using electroluminescent panels. The panels for a system such as this could have been made years ago, but a new power driver developed by Madrigan doubles light output and permits brightness levels almost equal to primary lighting. The electroluminescent panels, measuring eleven inches in diameter and one inch in thickness, are expected to operate under water or ice.

Heart's Magnetic Field Detected, Measured

TWO ELECTRICAL engineers at Syracuse University report detecting the magnetic field about the human heart. Using a device called a magnetocardiograph, Dr. Gerhard Baule and Dr. Richard McFee measured the strength of the field as roughly one millionth of the earth's field. They said it fluctuates according to currents produced in the chest by the heart's electric forces.

The magnetocardiograph uses a pickup assembly consisting of a pair of foot-long coils, each wound with more than two million turns of wire. The instrument was devised to study activity where electrical forces in one side of the heart are opposed by equal and opposite forces in the other side. In such a situation, the electric field is weak but the magnetic field is comparatively strong.

The magnetocardiograph detects types of electrical activity usually not revealed by electrocardiograms and may yield new information about the physiology of the heart. It could also prove more sensitive to certain kinds of heart diseases than the electrocardiograph.

In Brief . . .

LASER may be used to fuse walls out of stone or brick, reports Dr. I. Belinkin of the University of Cincinnati. New method may prove useful for military applications where time is at a premium.

RAYTHEON received a \$6-million Army contract to produce high-power illuminator radars for the Hawk missile system.

THE NORWEGIAN Telegraph Administration has ordered 'Autospec' equipment from Marconi. Autospec reduces radioteletype errors by using a special 10-character teletype code in place of the normal 5-character code.

NASA has awarded \$83,000 to GE and \$40,000 to Martin Marietta for space nuclear electric power studies. Martin has already developed a device for providing a constant 28-v output from the 1-v thermionic SNAP-13 Nuclear generator.

PAN AM received \$128 million from the USAF to operate the Atlantic Missile Range for another year, bringing 11-year total to \$714 million.

BULGARIA plans household semiconductor refrigerators in 1964. Present plans are to produce solid-state refrigerators for medical laboratories, electronic devices, and similar applications.

THOMPSON Ramo Wooldridge was awarded a five-year, \$23.5-million contract from the Army for r&d on tactical automatic data processing systems.

THE ARMY has awarded Western Electric \$20 million for r&d on a multifunction array radar for the Nike X.

MORE THAN 50 percent of Hongkong's transistor radio exports went to the United Kingdom in May. Exports to the U.S., previously Hongkong's best customer, dropped to less than 35 percent.

DIGINAMICS, INC. has been sold to the 3M Co., 3M says.

OVER TEN BILLION A-B HOT MOLDED RESISTORS

and not even one catastrophic failure

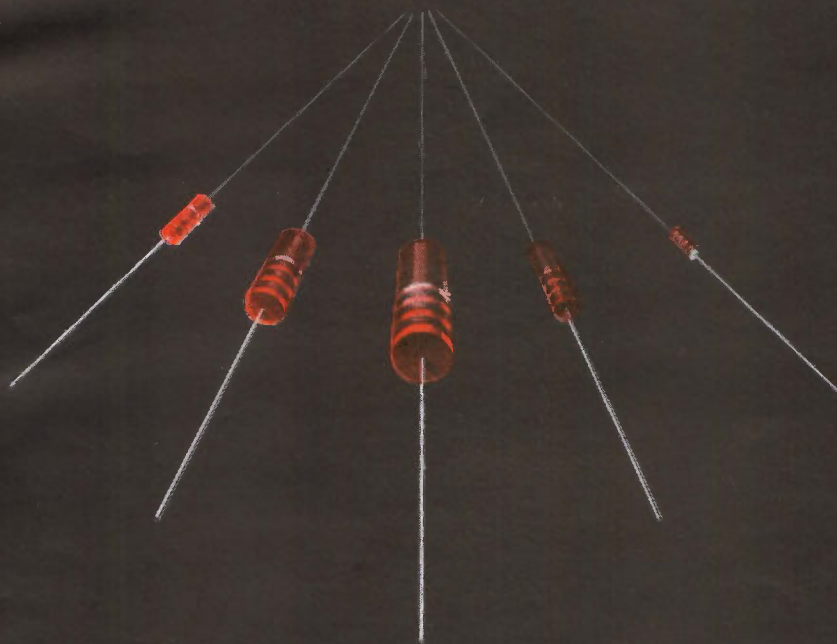

ALLEN-BRADLEY HOT MOLDED FIXED RESISTORS. SHOWN ACTUAL SIZE, ARE AVAILABLE IN ALL STANDARD EIA AND MIL-R-11 RESISTANCE VALUES AND TOLERANCES

■ Such an outstanding record of resistor performance—accumulated over some twenty-five years—clearly demonstrates the all around reliability of Allen-Bradley hot molded resistors. It is more conclusive proof of the total reliability of the A-B resistors than could be produced by any massive testing program. The unique Allen-Bradley hot molding process results in such uniformity from resistor to resistor—year after year—that long term performance can be accurately predicted.

Because the many years of use in the most critical applications have established the reputation of Allen-Bradley hot molded resistors for their stable characteristics and

conservative ratings, they are generally “required” in today’s critical military and industrial electronic circuitry.

Let your own circuitry benefit from the reliability that’s based on more than ten billion field proven resistors—without a single failure. For detailed specifications on Allen-Bradley’s resistors, please send for Technical Bulletin 5050. You also should have Publication 6024, which briefly describes the full line of Allen-Bradley quality electronic components. Allen-Bradley Co., 110 W. Greenfield Ave., Milwaukee 4, Wis.

In Canada: Allen-Bradley Canada Ltd., Galt, Ontario.



ALLEN-BRADLEY

QUALITY ELECTRONIC COMPONENTS

1 DC VOLTS 2 DC CURRENT 3 AC VOLTS 4 OHMS

ELECTRONIC
VOLTMETER

HEWLETT  PACKARD

MODEL 410C

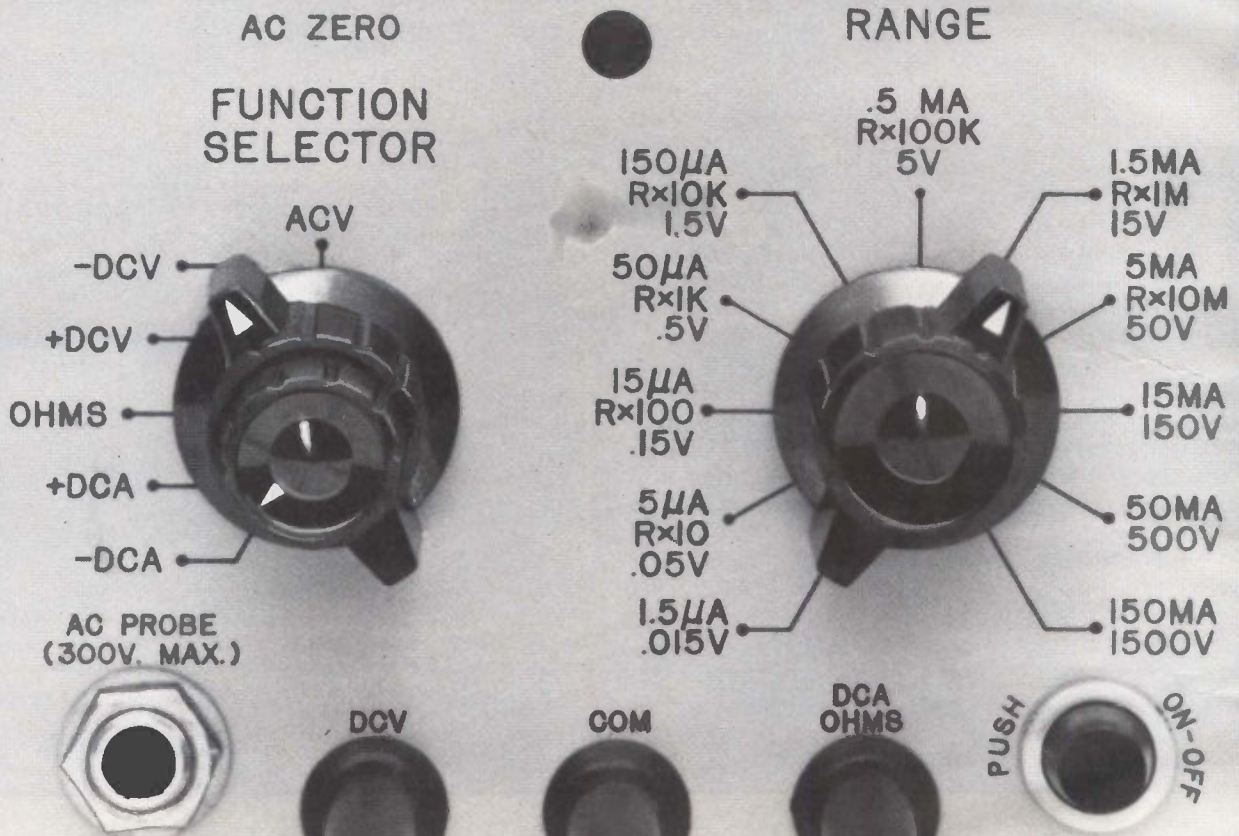

1. dc voltage — 1.5 mv to 1500 v — no zero set
2. dc current — 0.15 nanoamps to 150 ma — no zero set
3. ac voltage — 50 mv to 300 v — to 700 mc
4. resistance — 0.2 ohm to 500 megohms — no zero or ∞ set

MULTIMETER CONVENIENCE— with LABORATORY PRECISION!

hp introduces the 410C Electronic Voltmeter—a compact, wide-range instrument that makes all the measurements of a pocket-size meter with laboratory accuracy!

No single instrument has ever offered the accuracy available to cover this wide range of measurements: dc voltages from 15 mv to 1500 v full scale, direct current from 1.5 μ a to 150 ma full scale, resistance from 10 ohms to 10 megohms center scale and, with an optional plug-in probe, ac voltages at 20 cps to 700 mc from 0.5 v to 300 v full scale. Special current ranges, ± 1.5 , ± 5 and ± 15 nanoamps may be measured on the 15, 50, and 150 mv ranges using the voltmeter probe; 5% accuracy and 10 megohm input resistance.

The compact design and light weight of the 410C make it an ideal multimeter for laboratory, production line and service department.

A neon oscillator and unique photoconductor chopper amplifier combine with the best advantages of vacuum tube and solid state design to provide such features as:

no zero adjustment for dc voltage, current and resistance ranges

100 megohms dc voltmeter input impedance
low resistance recorder output of less than 3 ohms
dc voltage accuracy of $\pm 2\%$ of full scale, current accuracy of $\pm 3\%$ of full scale

Further, the high sensitivity, low drift and low noise of the neon oscillator photochopper amplifier make the instrument ideal as a preamplifier for data logging on analog recorders.

Add to this the optional hp 11036A AC Probe, and the 410C measures ac voltages with 3% accuracy. AC probe responds to positive peak voltage with meter reading in rms.

DC voltage measurements may be made up to 400 v above ground, thus eliminating ground-loop problems, and built-in self protective devices permit recovery in less than three seconds from overloads at up to 100 times full scale!

The individually calibrated taut band meter incorporates a 5:15 scale which permits most measurements to be made on the upper two-thirds of the meter scales.

Call your Hewlett-Packard representative now for convincing demonstration of the 410C on your bench.

HEWLETT PACKARD COMPANY



1501 Page Mill Rd., Palo Alto, Calif., (415) 326-7000. Sales and service representatives in principal areas. Europe, Hewlett-Packard S.A., 54 Route des Acacias, Geneva, Switzerland; Canada, Hewlett-Packard (Canada) Ltd., 8270 Mayrand St., Montreal, Que.

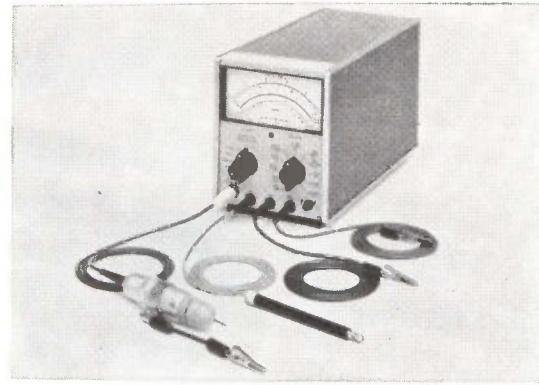

SPECIFICATIONS

DC VOLTMETER

Voltage Ranges: ± 15 mv to ± 1500 v full scale
Accuracy: $\pm 2\%$ of full scale, any range
Input Resistance: 100 megohms $\pm 1\%$ on 500 mv range and above; 10 megohms $\pm 3\%$ on 15 mv, 50 mv and 150 mv ranges

DC AMMETER

Current Ranges: ± 1.5 μ a to ± 150 ma full scale
Accuracy: $\pm 3\%$ of full scale, any range

OHMMETER

Resistance Range: resistance from 10 ohms to 10 megohms, center scale
Accuracy: $\pm 5\%$ of reading at mid-scale

AMPLIFIER

Voltage Gain: 100 maximum
Output: proportional to meter indication; 1.5 v dc at full scale; maximum current 1 ma

AC Rejection: 3 db at $\frac{1}{2}$ cps; approx. 66 db at 50 cps and higher frequencies for signals less than 1600 v peak or 30 times full scale, whichever is smaller

Output Impedance: less than 3 ohms at dc
Noise: less than 0.5% of full scale on any range (p-p)

DC Drift: less than 0.5% of full scale/year at constant temperature; less than 0.02% of full scale/ $^{\circ}$ C

Overload Recovery: recovers from 100:1 overload in less than 3 sec

AC VOLTMETER

hp 11036A AC Probe Required

Ranges: 0.5 v to 300 v full scale, 7 ranges
Accuracy: $\pm 3\%$ of full scale at 400 cps for sinusoidal voltages from 0.5 to 300 v rms; the ac probe responds to the positive read-above-average value of the applied signal.

Frequency Response: $-3\% \pm 2\%$ at 100 mc; $\pm 10\%$ from 20 cps to 700 mc (400 cps reference); indications to 3000 mc

Frequency Range: 20 cps to 700 mc

Input Impedance: Input capacity 1.5 pf, input resistance greater than 10 megohms at low frequencies; at high frequencies impedance drops because of dielectric loss

Meter: peak-above-average responding, calibrated in rms volts for sine wave input

GENERAL

Maximum Input: dc—100 v on 15, 50 and 150 mv ranges; 500 v on 0.5 to 15 v ranges; 1600 v on higher ranges; 100 times full scale or 1600 v, whichever is less ac—100 times full scale or 450 v peak, whichever is less

Power: 115 or 230 v $\pm 10\%$, 50 to 1000 cps, 13 watts (20 watts with 11036A Probe)

Dimensions: 6-17/32" high, 5 $\frac{1}{8}$ " wide, 11" deep behind panel

Price: hp 410C, \$300

Option 01: hp 11036A Probe calibrated with instrument, add \$50 to price of 410C; hp 11036A Probe when sold separately, \$60

Data subject to change without notice. Prices f.o.b. factory.

WASHINGTON THIS WEEK

ELECTRONICS GETS MOST OF NASA MONEY

NASA ESTIMATES THAT electronic components account for over 40 percent of the costs of its space boosters, over 70 percent of the cost of its spacecraft, and over 90 percent of the cost of building tracking and data acquisition facilities. The estimates were made by the Agency's head, James Webb, in a recent letter to Rep. George Miller (D., Cal.), chairman of the House Space Committee.

MORE SKILL NEEDED FOR DEFENSE THAN CONSUMER WORK

THE LABOR DEPARTMENT has compiled figures which show that engineers, scientists, and technicians represent one-third of the work force producing military electronic products, but only about one-tenth the work force making consumer electronic goods. The figures were compiled in a 1962 survey, yet to be published, of occupational patterns in the communications equipment and general electronics manufacturing industries.

Semiskilled and unskilled production workers, according to the new figures, make up only about one-fourth of the military electronics work force, but nearly two-thirds of the consumer electronics work force.

Labor Dept. officials report that employment in plants producing communications equipment totaled 281,000 in 1962, up 44.4 percent over 1958. Total employment in plants making "electronic components and accessories" amounted to 243,200 last year, 35.9 percent more than in 1958.

U. S. FIRMS MAKE NEW INROADS IN EUROPEAN MARKET

U. S. ELECTRONICS producers sold over \$1-million worth of instruments and components in just seven days last month at an exhibit in the Commerce Dept.'s Trade Center at Frankfurt, Germany. Fifty-six firms participated in the exhibit. Exhibitors estimate that potential sales on the European continent "could increase by \$25 million by the end of 1964 as a result of the exhibit," the Commerce Dept. says. Of the 56 U.S. electronics exhibitors, 50 already had European agents or distributors.

HOUSE SCORES SUBCONTRACTING PRACTICES IN ZEUS AND NIKE X

REP. GERALD R. FORD, Jr. (R., Mich.), ranking minority member of the House Defense Appropriations Subcommittee, has complained to the Army about subcontracting procedures on the Nike Zeus and Nike X projects. He objects that Western Electric, the prime contractor, is being allowed to handle components work in-house rather than fostering competition among subcontractors.

His specific complaint involves Lear-Siegler, Inc., which won a competitive award to design the gyro reference platform for Zeus. The Army subsequently authorized Western Electric to build the components in-house.

An Army spokesman told Ford that the Army is making "a maximum effort, within the bounds of the program's time urgency," to obtain competition in development of Nike X components.

A MIGHTY BIG STEP



A MIGHTY IMPORTANT STEP FOR YOU! YOU CAN NOW BUY PRINTED CIRCUITS WITH YOUR CONDUCTOR AND HOLE PATTERN... WITHOUT ARTWORK... WITHOUT QUOTATIONS... WITHOUT TOOL CHARGES, AND IN MOST CASES, AT HALF THE USUAL COST AND IN HALF THE USUAL DELIVERY TIME!

Our new Standard Circuit Division reduces printed circuit manufacturing overhead to the barest minimum by automation and standardization. Mass production techniques drastically reduce costs, delivery time, and improve quality—yet still give you flexibility in board design. Sound exciting? For complete information write today for our 16 page brochure detailing this major printed circuit breakthrough.

Photocircuits

CORPORATION • GLEN COVE, N.Y. • ANAHEIM, CALIF.

*The high-voltage barrier to passivated PNP transistors has finally been broken
—but it took a new manufacturing process to overcome the obstacles.*

Now from MOTOROLA

Epitaxial, Passivated PNP SILICON TRANSISTORS

Made by the Annular* Process

Some new words are being added to the dictionary of semiconductor terms—words like Annular* and Band-Guard†, words that relate to a new manufacturing process which will have a strong influence on transistor design and promises to open new areas for transistor applications. The Annular manufacturing process provides a new degree of freedom from surface effects for semiconductor products.

For years, the industry had been working to design high voltage silicon PNP transistors with the low leakage currents normally associated with NPN types, surface passivated by the planar process. For PNP devices, planar techniques proved inadequate since any attempt to increase voltage ratings beyond approximately 20 volts (through increasing collector material resistivity) induced a phenomenon, called channeling, which actually increased leakage current far beyond tolerable levels.

Channeling is a condition whereby the surface portion of a transistor collector region actually changes polarity and becomes an extension of the base region. The base-collector junction, therefore, rather than coming to the top surface where it is protected from the environment by a silicon oxide coating, extends to the unprotected edges of the transistor where it is subject to contamination and surface damage. This phenomenon circumvents the passivation advantages of planar designs and results in excessive leakage currents.

The formation of channels has been traced to effects of ionized or polarized particles on or within the passivating oxide coating which create an electrical environment that tends to alter the apparent polarity of the material directly

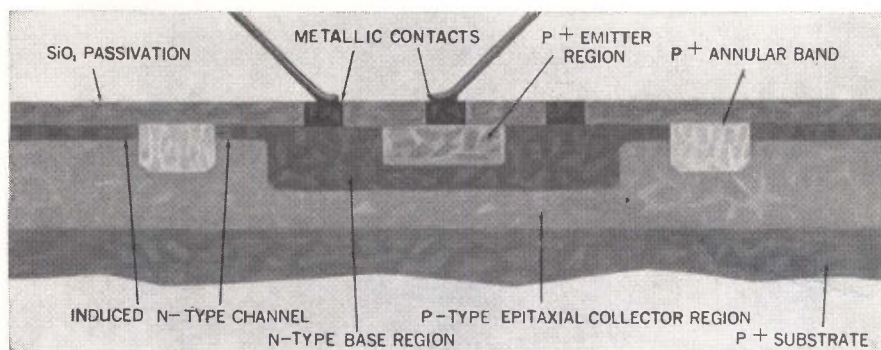

Cross Section of Annular Transistor

beneath the oxide—an effect which is particularly pronounced in lightly doped P-type material. The channels are random in nature and erratic in characteristics, and can be highly sensitive to radiation bombardment.

As a result of channeling, some manufacturers have reverted to earlier silicon mesa structures or have deliberately circumvented the oxide passivation in planar transistors in order to produce high voltage devices. These methods have yielded high voltage ratings but other characteristics of the resulting transistors do not compare favorably with those of surface passivated devices.

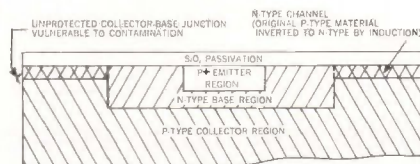

Cross Section of Planar Transistor

Now, Motorola has overcome these obstacles—but it has taken a new manufacturing process to do so. Rather than trying to eliminate the channel, Motorola, in a new series of “Band-Guard” transistors, has deliberately introduced a channel whose controlled characteristics completely overshadow the variable effects of any randomly induced channel, thus providing a high

degree of performance stability. Moreover the controlled channel is terminated close to the base region by a diffused annular band of the same polarity as the collector region but with a resistivity level impervious to channeling. The collector-base junction, therefore, is properly terminated underneath the oxide coating where it is protected against environmentally induced leakage currents. The resultant “Band-Guard” PNP silicon devices, for the first time, combine the low-leakage characteristics of passivated junctions with the high-voltage characteristics of non-passivated, or mesa structures.

And, if theoretical analysis of this process is confirmed by tests now in progress, they will prove to be more resistant to radiation, thus heralding improved performance and greater reliability of space equipment.

Though initially devised for the production of high voltage silicon PNP transistors, there are strong indications that the Annular process yields major benefits for NPN and field effect transistors and other semiconductor devices as well.

In view of these considerations, there is little doubt that the new, Motorola developed Annular process will take its place among the major milestones in the advancement of the semiconductor art.

*Patents Pending

†Trademark of Motorola Inc.

NOW FROM MOTOROLA

HIGH VOLTAGE PASSIVATED

PNP SILICON TRANSISTORS

... made by the new ANNULAR PROCESS

Four new Motorola PNP silicon transistors made by the Annular process and featuring high speed . . . high voltage . . . low leakage . . . and surface passivation and stability, are now immediately available as types 2N2800, 2N2801, 2N2837, and 2N2838. Called "Band-Guard" transistors, the new devices reflect performance advantages inherent in an Annular, oxide-passivated, epitaxially fabricated transistor.

Annular Process — Provides a new degree of freedom from surface effects of adverse environments. Gives a new degree of performance stability by eliminating sub-surface leakage paths to the unprotected edges of the device. Makes possible combined high voltage *and* true silicon oxide passivation.

Oxide Surface Passivation — Prevents contamination of the junction by external agents. Makes possible the low collector leakage current (1/10th that of other PNP units) of Motorola's "Band-Guard" transistors.

Epitaxial Structure — Gives lower saturation voltage ($\frac{2}{3}$ lower) and twice the frequency response (120 mc) of ordinary PNP devices.

Other types supplied as "Band-Guard" units include 2N1132, 2N1132A, 2N1132B, and 2N722.

Motorola passivated, epitaxial "Band-Guard" transistors are immediately available from your Motorola Semiconductor Distributor or District Office. For full electrical specifications write: Technical Information Center, Motorola Semiconductor Products, Inc., Box 955, Phoenix 1, Arizona.

"Band-Guard" Transistor Performance Ratings

Characteristic	2N2800 (TO-5 pkg)	2N2801 (TO-5 pkg)	2N2837 (TO-18 pkg)	2N2838 (TO-18 pkg)	Unit
Collector-Base Breakdown Voltage ($I_c = 10 \mu\text{Adc}$, $I_e = 0$)	50	50	50	50	Vdc
Collector-Emitter Breakdown Voltage ($I_c = 100 \text{ mAdc}$, $I_b = 0$)	35	35	35	35	Vdc
Collector Cutoff Current ($V_{ce} = 25 \text{ Vdc}$, $V_{be} = 0.5 \text{ Vdc}$)	100	100	100	100	nAdc
DC Forward Current Transfer Ratio ($I_c = 150 \text{ mAdc}$, $V_{ce} = 10 \text{ Vdc}$) [*]	30-90	75-225	30-90	75-225	—
Current-Gain — Bandwidth Product ($I_c = 50 \text{ mAdc}$, $V_{ce} = 10 \text{ Vdc}$, $f = 100 \text{ mc}$)	120	120	120	120	mc

*Pulse Test: Pulse Width $\leq 300 \mu\text{sec}$, duty cycle $\leq 2\%$

... also supplied as "Band-Guard" types:

Characteristic	2N1132 (TO-5 pkg)	2N1132A (TO-5 pkg)	2N1132B (TO-5 pkg)	2N722 (TO-18 pkg)	Unit
Collector-Base Breakdown Voltage ($I_c = 100 \mu\text{Adc}$, $I_b = 0$)	50	60	70	50	Vdc
Collector-Emitter Breakdown Voltage ($I_c = 100 \text{ mAdc}$ pulsed)	35	40	45	35	Vdc
Collector Cutoff Current ($V_{ce} = 30 \text{ Vdc}$, $I_e = 0$) ($V_{ce} = 50 \text{ Vdc}$, $I_b = 0$)	1.0 —	— .5	— .01	1.0 —	μAdc
DC Forward Current Transfer Ratio ($I_c = 150 \text{ mAdc}$, $V_{ce} = 10 \text{ Vdc}$)	30-90	30-90	30-90	30-90	—
Current-Gain — Bandwidth Product ($I_c = 50 \text{ mAdc}$, $V_{ce} = 10 \text{ Vdc}$, $f = 20 \text{ mc}$)	60	60	60	60	mc



"new leader in Total Silicon Technology"

MOTOROLA Semiconductor Products Inc.

BOX 955 • PHOENIX 1, ARIZONA • A SUBSIDIARY OF MOTOROLA INC.

CIRCLE 15 ON READER SERVICE CARD

PORTABLE ELECTRONIC MUSCLE EXERCISER

NEARS PRODUCTION

*Pulsed sonic waveform
is applied to muscles
by variable carrier*

A TRANSISTOR INSTRUMENT to exercise muscles by using a low-voltage, pulsed sonic waveform is under study by several physicians at hospitals and rehabilitation centers. Designed for eventual consumer use, the instrument is said to be capable of exercising anything from a human leg to the muscle of the eye.

Developed by Micro Precision Corp., New York, the instrument connects to humans with $\frac{3}{4}$ -inch diameter electrodes dampened and applied to the surface of the skin. No surgery is required. Such electrodes are suitable for muscles as small as those in the human finger. Battery operation of the device is employed to eliminate shock hazards. Nickel cadmium batteries and a trickle charger are used.

Transistors, some having special characteristics, are employed in the design of the instrument. The complete device measures $3 \times 4 \times 1$ inches, approximately the size of two packs of cigarettes. The output waveform is a sonic carrier continuously variable over the range of 20 cps to 4 Kc. It is modulated by a pulse with continuously variable on and off time. Both on and off time may be adjusted from 0.1 second to 7.0 seconds. Output developed across a 1,000 ohm load, which is taken as average body resistance with the electrode techniques used, is 15 volts.

APPLICATIONS — Some physicians and physiotherapists have large electronic muscle exercisers for office use now. And the new transistor portable instrument has

already been used on laboratory animals as well as humans. The low-voltage current passing through the muscle, causes it to contract; cessation of current flow permits the muscle to return to its original state. Applications may include treatment of muscles of bed-ridden patients to improve muscle tone or prevent atrophy. It has been used in therapeutic tests for special eye exercises attempting to correct defects in children afflicted with walleve (pointing out) and cross-eye.

Cerebral palsy patients may benefit from exercise administered by the instrument. The task of manually exercising persons afflicted with this disease is an arduous one, and even with the interest and sympathy of devoted relatives the forty minutes per muscle is hard to accommodate.

In cases of damage to a portion of the brain, which controls certain muscle action, it has been demonstrated that therapeutic ex-

ercise of muscles without control may develop new areas of the brain and permit them to take over control of the immobilized muscles. The technique of brain re-learning is receiving attention and much work remains to be done.

WEIGHT REDUCTION—The possibility of using the new instrument for weight reduction in humans has been advanced. The improvement of muscle tone obtained by applications of the instrument in appropriate areas of the body might provide a slimming effect. A secondary result could be weight reduction.

While the instrument should be available to the general public in time, doctors will probably first supervise their use in therapeutic programs. The variable controls on the device facilitate the doctors' choosing the appropriate signal parameters.

According to Herbert Friedlander, the president of Micro Precision, his firm will manufacture and market the instrument before the end of the year. Several patents assigned to the company are pending. The company predicts that the price of a commercial instrument when it is introduced will be within the economic reach of most people. The eight-year-old firm, headed by an engineer, expects the electronic muscle exerciser to be a major product.

Metal Sheet Memory Operates Independent of Temperature

CURRENT work on memory components at Fort Monmouth is concentrated on a thin-sheet memory of Permalloy, etched to form multi-aperture arrays. This transfluxor-type memory will be used by RCA in small low-power tactical computers for the Army, and will operate independent of temperature.

The holes are etched in a $\frac{1}{4}$ -mil sheet of molybdenum Permalloy, an inch or two square. Copper conductors are deposited by evap-

oration on the holes and out to the edges of the metal sheets for connections.

The sheets are stacked to form a computer memory, with 2-mil copper sheets in between for electrical shielding.

At the present state of R&D, 128 elements can be placed on a sheet one inch square, with a total thickness of 5 mils. Unlike cores, which are sensitive to temperature, the thin-sheet memory operates between -50 and $+125$ C.

NEED MAXIMUM ENERGY STORAGE IN THE SMALLEST SIZE CASE?



D C M
90,000 MFD
10W VDC
539-2627-01
MADE IN U.S.A.
658201



SPECIFY...

SANGAMO

COMPUTER GRADE ELECTROLYTIC CAPACITORS

ELECTROLYTIC



CAPACITORS

If you need high energy content per unit volume . . . if you want exceptionally low ESR . . . if you would like to have capacitors that withstand high ripple currents without overheating . . . get the facts about Sangamo's Type DCM *Computer-Grade* electrolytic capacitors.

These stable, long-lived capacitors are designed for use as energy-storage and filter components in circuits requiring high levels of reliability. They have been used, primarily, where peak power requirements exceed the maximum output of the associated power supply. Standard ratings include capacitances up to 500,000 μ f (at 1.5 WVDC . . . in a 3 1/16" x 6" case), but Sangamo will welcome the opportunity of engineering and producing capacitors to almost any specification you request. Complete information is yours for the asking.



SANGAMO ELECTRIC COMPANY

SPRINGFIELD, ILLINOIS

SANGAMO
SANGAMO

Signal Source!

SANGAMO
SANGAMO
SANGAMO
SANGAMO
SANGAMO
SANGAMO
SANGAMO
SANGAMO
SANGAMO
SANGAMO

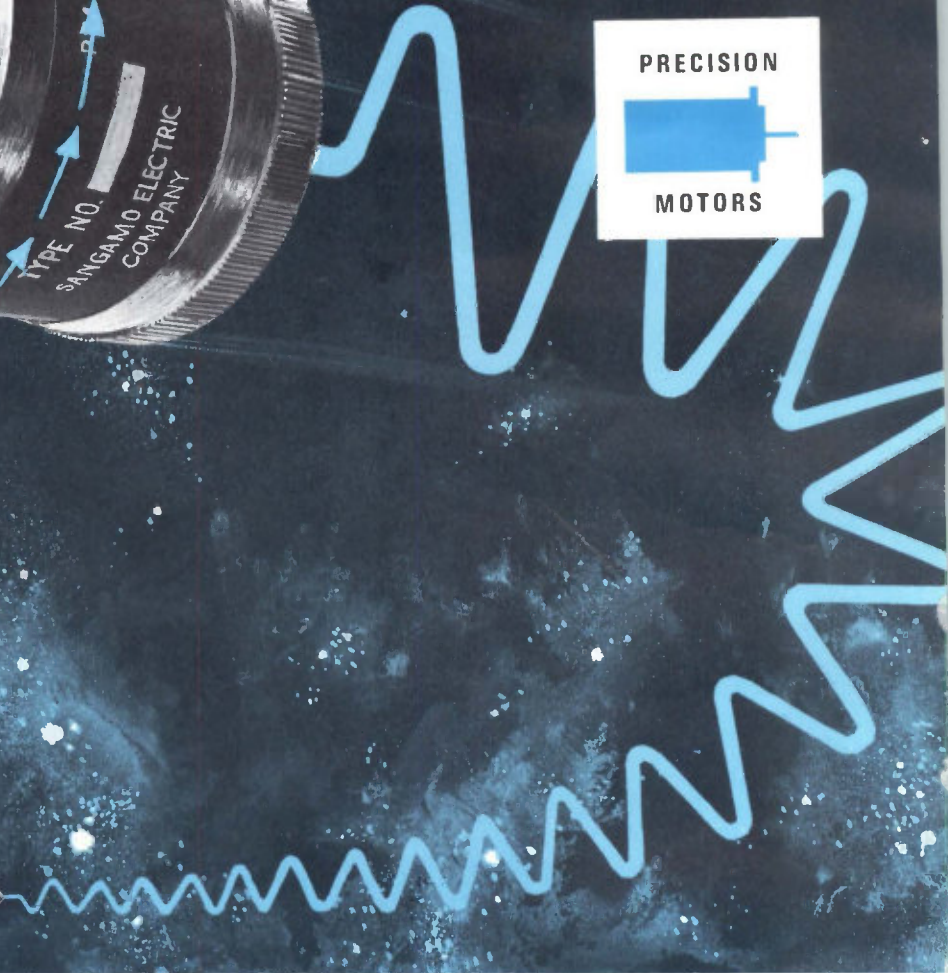
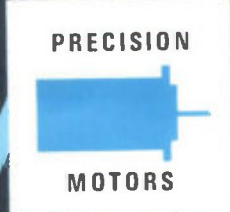
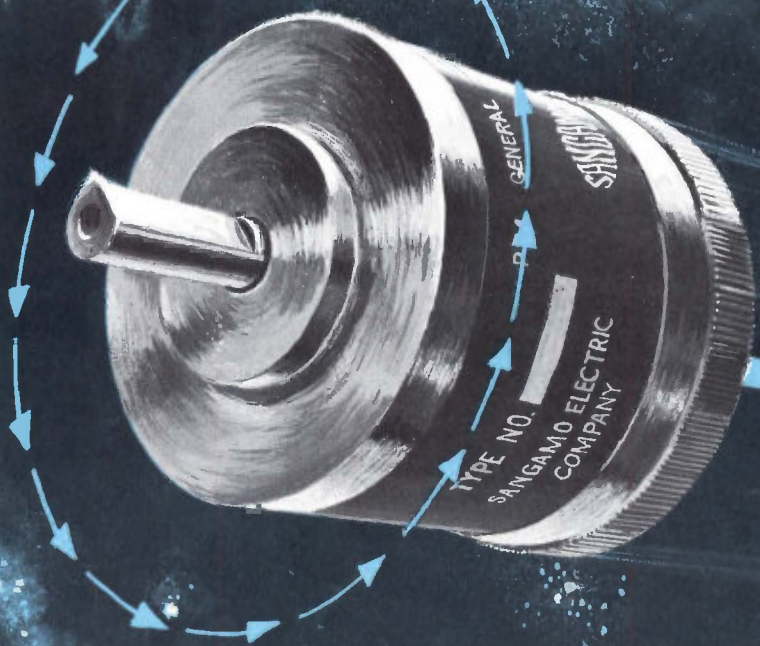

SANGAMO PERMANENT MAGNET GENERATORS... SPEED SENSING... PHASE SENSING... VARIABLE FREQUENCY SOURCE



Size 14 PMG—highly specialized, custom-designed generator for extremely rigid OEM specifications as to electrical characteristics and physical dimensions.

Here are miniature precision generators that provide sinusoidal output signals with frequencies and amplitudes directly proportional to the speed of their permanent-magnet rotors. They can be used as speed-sensing devices based on either output amplitude or frequency, or as a source of variable frequency voltage. The PM generators shown here were originally designed for aircraft tachometer applications, but they have been adapted to many other uses in miniaturized servo systems. Other PM generators are available in frame sizes from 1" to 3½".



Size 25 PMG—aircraft and tachometer generator meets rigid and varied specifications for reliability and mounting flexibility.

Sangamo also manufactures precision servo motors, induction generators, drag-cup motors, synchros, synchronous motors and motor generators in sizes 5 to 25, with integral gearing if required. Most are available in either 60 or 400 CPS. With Sangamo's new stock-inventory program, almost any of our 700 existing designs can be delivered... in quantity... in 4 to 6 weeks, but we will be glad to develop special designs for your particular needs, including packaged servos.



SANGAMO ELECTRIC COMPANY

SPRINGFIELD, ILLINOIS



The day when the designer selected his materials all by his lonesome is past—especially in electronics. Lots of engineers, from many departments, get into the electronics buying act with the design engineer today. Production engineers, for example, feel free to bare their fangs at any specified product they feel would snafu the production line. Procurement people growl for their freedom to respecify for the sake of better prices or delivery. Service engineers, once burned by a faulty component or subassembly, are twice shy and thrice loud about its inclusion in future equipment. And management's oxen are notoriously goreable. That's what makes electronics marketers turn gray. The advertiser today must

teach the design engineer *and* everyone else in electronics engineering. He can do so either through a passel of splinter publications, or through electronics.

Well, that's the price of progress.

electronics is the weekly, contemporary engineering publication of the modern electronics industry. It integrates the interests of 57,000 engineers in all phases and functions of electronics—the people who pass on your products before they are bought. In a field abounding with free publications, these 57,000 engineers pay up to \$6 a year to subscribe to electronics. They need electronics. You need them. Advertise in electronics.

electronics: *your basic buy for electronics advertising* | A MCGRAW-HILL PUBLICATION

330 West 42nd St., New York 36, N. Y.



Army Demands New Electronics Techniques

Communications, airborne gear, surveillance receive researchers' attention

By LEON H. DULBERGER
Associate Editor



ARMY COMMUNICATIONS *without field engineering is major goal*

THIS WEEK in the bitterly contested jungles of South Vietnam, GIs were learning lessons that will shape Army's electronics requirements for years to come. And alert manufacturers were already cashing in on Army's hard-won experience in limited war.

U. S. Army's unlimited fire-power now brings the requirement for increased mobility and control of tactical and strategic forces to the vanguard of the service's operational problems.

New electronic techniques—some radical, others an extension of known principles—are under study to extend command and control over weapons and field missions.

The areas of electronics in which Army seeks technology breakthrough fall generally under command and control. They break down into the generic areas of: communications, such as telephone, radio and exotic; surveillance, such as radar, ir, photography; identification (iff), airborne gear; and data processing.

Often, Army cannot use existing commercial equipment or techniques on military missions because Army's needs are different from industry's needs. Additionally, commercial systems depend heavily on field engineering to achieve operational status. The Army seeks to avoid field engineering by performing all the preengineering possible in the laboratory, thus simplifying field operation.

SURVEILLANCE — The greater area of firepower influence today requires that Army surveillance penetrate to a greater depth and have greater mobility. Evaluation of the vast amounts of data collected in many forms must be done quickly at a single location and interpreted effectively.

All of the various sensor inputs—such as radar, camera, ir, prisoner-of-war interrogations, front-line observers—must speak to evaluators in a common final language. This means the man-machine interface must be designed for quick information transference. Army points out that the interface techniques required cannot be met by commercial means.

The problem of determining the military status of targets under surveillance is receiving much attention. Several techniques are being studied such as:

- Military targets are man-made and generally have angular characteristics of form and structure. Non-military targets are natural in form. Radar and other equipment designed to detect angular characteristics are being developed

- Target movement is a well-known criterion for target identification and the technique is receiving further refinement

- Heat radiating from a target provides important information on its military nature. Devices to measure temperature accurately over great distances are in development

- The texture of the surface of

an object provides indications of its military importance

- Polarization techniques using specially designed radars are under study.

The data gathered from all sensors would ideally be combined to provide as many factors to aid in identification of a single target as possible. This would preferably be accomplished before the final read-out form of surveillance information is assumed, usually a photographic record.

AIRBORNE—The new emphasis on an airborne army to provide increased mobility and quick reaction time leads to extended airborne equipment requirements for the Army. Self-contained beacon systems are needed. Communications breakthroughs and system developments are called for. Army's air-navigation problems are acute. Identification equipment (iff) with instant readout is badly needed to keep pace with improved ability to down an aircraft rapidly.

COMMUNICATIONS—Army's attempts to apply commercial communications equipment to military applications are frustrated by the fact that commercial systems are fixed installations while Army requires mobile facilities. In addition the time-frame in commercial communications is usually hours or days, while Army must handle information in seconds to be militarily useful. Command and control systems developed for Army



AUTOMATED FIRE direction center is example of Army's needs

must be capable of covering both small and large wars, and effect a smooth transition to large scale conflicts growing out of small ones without loss of control.

Army finds that automatic telephone-switching techniques used in commercial communications do not permit changes in switching-center computer programming to be made in minutes. This frustrates the service's short-time response needs.

In a scheme aimed at replacing signaling and routing equipment with simpler gear, Army, in one theoretical approach, is investigating a technique dubbed saturation signaling. In this concept a 1-msec pulse may be sent out over all radio telephone lines, perhaps a thousand of them, and the single telephone corresponding to the coded impulse could hook itself up to the system. If proven successful it would materially simplify the military phone book. All equipment other than the signaling gear could be conventional in design.

JUNGLE PROBLEMS — Jungle communications presents a special problem where the sheath formed by tropical vegetation with heights of the order of 200 feet produce an impenetrable barrier to radio signals. It represents one of Army's most pressing problems because of their present involvement in brush-fire conflicts. A technique which may prove worthy of development involves thrusting an antenna through the vegetation roof.

To obtain high information-carrying capacity in radio communications, wide bandwidth is needed. This demands high carrier frequencies, resulting in line-of-sight limitations on propagation characteristics. Among possible solutions are elevated repeaters such as satellites, mountain-top installations, or the use of chaff.

One concept under consideration by Army is use of a relay balloon designed to hover at 50,000 feet. At this altitude air streams circulating about the earth move just above and below the balloons position, under certain weather conditions and specific areas of the earth. Army points out an enemy seeking to destroy the hovering balloons would require a single missile for each balloon making it a costly counter-operation.

Techniques employing chaff, and scatter communications are also being explored.

Army's data transmission activity is expanding with the need to handle more and more data. In selection of data transmission techniques the question of developing general purpose equipment or special systems for specific applications is under study.

Another technique aimed at avoiding switching centers is Army's Random Access Discrete Address System (ELECTRONICS, p 18, April 5). Army is considering the system, still in the mathematical stage, as a solution to a plethora of field communications problems.

THE POTTER MT-36

digital magnetic tape transport

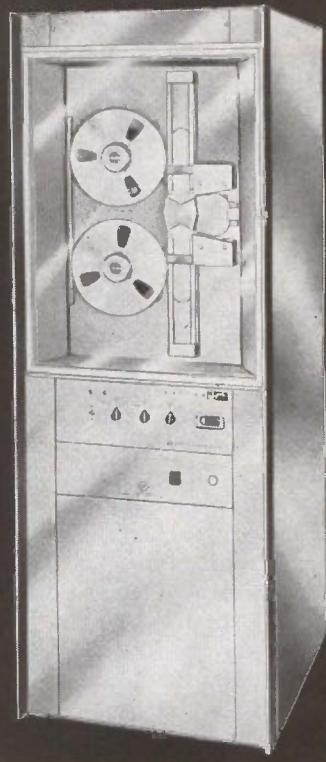

MT-36: THE MOST RELIABLE TRANSPORT in its price range

The Potter MT-36 Digital Magnetic Tape Transport offers maximum reliability for computer systems requiring an economical transport. The Potter MT-36 features:

- **NO PROGRAM RESTRICTIONS...** up to 200 commands per second at 36 ips.
- **SOLID STATE CIRCUITRY...** photo electric sensing minimizes the need for switches and relays.
- **VACUUM TROUGH GUIDES...** provide smooth tape stops.
- **IMPROVED PINCH-ROLLER CIRCUITS...** offer fast tape starts and stops.
- **EASE OF MAINTENANCE...** drive electronics and fully regulated power supply are mounted on individual plug-in boards.
- **RAPID TAPE THREADING...** Just 15 seconds for complete threading.
- **BUILT-IN TAPE CLEANER...** vacuum on trough guide removes all loose oxide and dust.

For full information and specifications on the MT-36 Digital Magnetic Tape Transport, write today.



POTTER INSTRUMENT CO., INC.

TAPE TRANSPORT DIVISION
151 Sunnyside Boulevard • Plainview, New York

How to Succeed in Business On Someone Else's Research

*Industrial espionage
—how much goes on
in electronics?*

By DAN SMITH
Assistant Editor

INDUSTRIAL espionage has been a much-discussed subject since the scandals in the drug and chemical fields several years ago. The electronics industry is included in the gossip and speculation but so far no one has been able to say authoritatively how much goes on.

ELECTRONICS asked the security directors of some of the largest corporations in the industry for their estimates and for the most part received surprisingly complacent replies. "We've never had a case in my firm and I've heard of few others throughout the industry," one said. "If it goes on, we don't know about it," another said. A third admitted his firm's security

program "doesn't amount to much."

Fine—except there was another officer, employed by an organization fully as prosperous and powerful as the others in the survey, who said just the opposite: "Industrial spying goes on all the time and is steadily on the increase." How to fit that opinion into the pattern—for it was bitter and cynical and hinting at dark knowledge. It couldn't be ignored, but there was a catch: the man was unwilling to cite examples involving his firm, although he claimed there had been many. He set us straight on one thing though—we might just as well forget about the electronically sophisticated snooping devices we'd been hearing bits and snatches about for years. Yes, the equipment exists and microminiaturization is making possible newer and more stealthy gadgets all the time, but there is seldom reason to use them. There is a harder-to-detect device available—man. Human spies can be planted in most firms with ease and, easier still, employees on the

payroll can usually be persuaded to steal secrets for pay. Our cynical friend, though, is taking no chances. Periodically, in the wee hours when his firm's office building is otherwise deserted, he 'sweeps' the board room and executive offices for electronic eavesdroppers, a safeguard he feels is too important to be left to subordinates.

UNDERCOVER MEN—So far we had talked to about two dozen security officers and we had little that was solid to show for it. Weeks passed. We talked to others, with much the same results. Clearly, we needed a new approach. We read all we could on the subject, scanned our notes for leads and, finally, without too much hope, went to call on Norman Jaspán Associates, which had been described to us as "a management engineering firm with a twist." The twist, we had heard, was this: before Norman Jaspán suggests organizational changes, it contrives to have operatives hired by the customer firm through normal personnel channels. They might pose as porters or engineers, anything that will get them close to the information they desire. Usually only the highest executives in the firm know of their presence. After several months of surveillance, the operatives write detailed reports of what they have heard and seen. Armed with these, a Jaspán representative sits down with department managers and discusses what is wrong with the company set-up. The Jaspán man, who often knows more about the firm's operations than the managers themselves, usually wins his points. Maybe, we said to ourselves as we set out for our interview, the undercover men learn of other things besides inefficiencies.

CASE HISTORY—We had been talking only a few minutes with the Norman Jaspán man (who, because of the nature of his work, prefers

Cryogenic Memory Stores 16,384 Bits

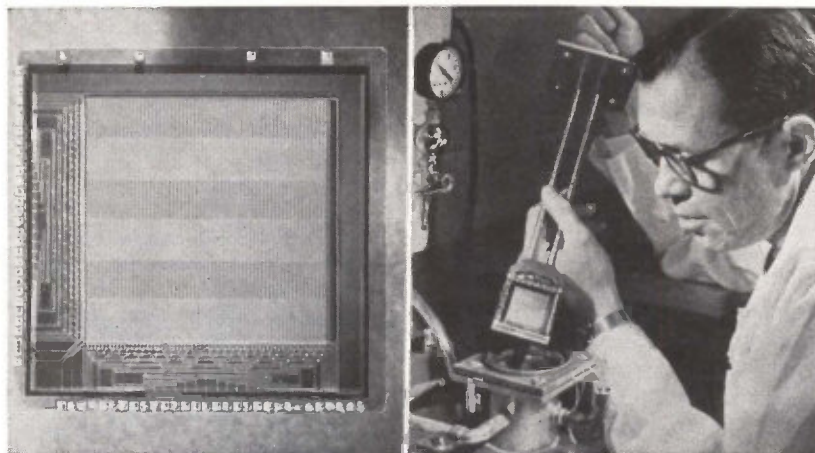

SUPERCONDUCTIVE, THIN FILM memory, shown recently by RCA's Sarnoff Research Center, stores 16,384 bits in 2×2 -inch plate (*ELECTRONICS*, June 28, p. 8). Experimental unit, only 120 millionths of an inch thick (left), accepts all connections on the plate itself—with 32 connections from the first plate and two for each additional. L. L. Burns of RCA Laboratories (right) lowers the memory into 3.6-degree K liquid helium.

to remain anonymous) when he related this anecdote to us, drawn from the files of the approximately fifty electronics firms Norman Jaspan counts among its hundreds of customers.

The research director of a large electronics firm was recently exposed for selling company secrets to a competitor over the course of seven years. He was discovered when a Jaspan agent, working in the mail room, opened a heavy carton from him which was to be sent to a Los Angeles area address. The research director had scrawled "Re-prints" across the carton but inside was found logs, blueprints and original research data that it had taken the company three years to assemble. Upon interrogation, it developed that the research director had been a silent partner in the competitor firm for four years: the first three years he had merely been paid cash for the secrets.

THE RECORD—The Jaspan man reeled off other case histories with ease. Going over the records, we found that in the past year Norman Jaspan Associates filed \$1 million in claims to cover losses incurred by electronics firms from the theft of company secrets. It had filed for approximately the same amount in each of the previous two years; claims filed in any one year of course may be for losses sustained over several years. The \$1 million represents out-of-pocket losses of the victimized firms, the amounts they had spent in labor and materials for research and development. The potential market value of the secrets was not taken into account. And there were other losses not covered by bonding companies.

The \$1 million then is a conservative figure—and for only a portion of the industry. While no one knows precisely how much spying goes on in electronics firms, it is safe to say that the amount is substantial. That even security officers don't know of its extent is not surprising. Rarely are they told that Norman Jaspan Associates is investigating their firm. And the offenses are seldom publicized or prosecuted in court. Firms are usually content to fire the wrongdoers. (*First of two articles*)

The First of its Kind!

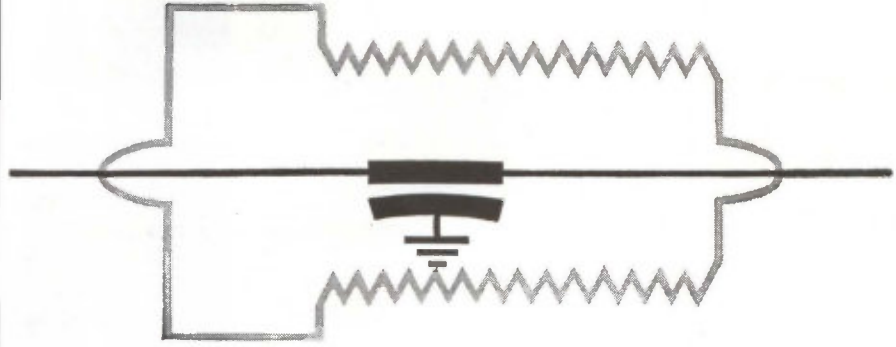

A Solid Tantalum 5-Ampere Feed-thru Capacitor for RFI Suppression

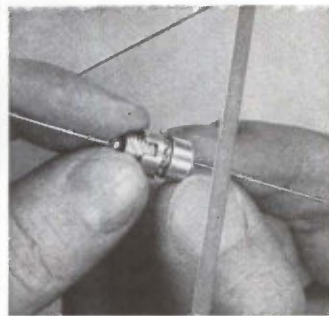

Sprague Type 180D Tantalex Capacitor on transparent panel to illustrate feed-thru mounting.

- Sprague's Type 180D Tantalex® Capacitor is another result of extensive pioneer work in the field of solid-electrolyte tantalum capacitors.
- Three-terminal unit—line current is carried through tantalum section from lead to lead, case is ground terminal.
- Negligible self-inductance, minimum length of internal path for RFI—large values of capacitance in small physical size account for unusually effective elimination of spurious and unwanted signals.
- Completely new case design assures firm metallic contact with mounting surface over a closed path, completely encircling the feed-thru conductor.
- Threaded body and spanner nut of same outside diameter as collar of the case permit close mounting and maximum stacking capacity.
- Corrosion-resistant metal case, hermetically-sealed with glass-to-metal solder seal terminals for maximum protection against severe environmental conditions.
- All units carry 5 amperes thru-current. Capacitance ratings range from 60 μF at 6 volts to 6.8 μF at 35 volts d-c.

For complete technical data, write for Engineering Bulletin 3525A to Technical Literature Section. Sprague Electric Company, 35 Marshall St., North Adams, Mass.



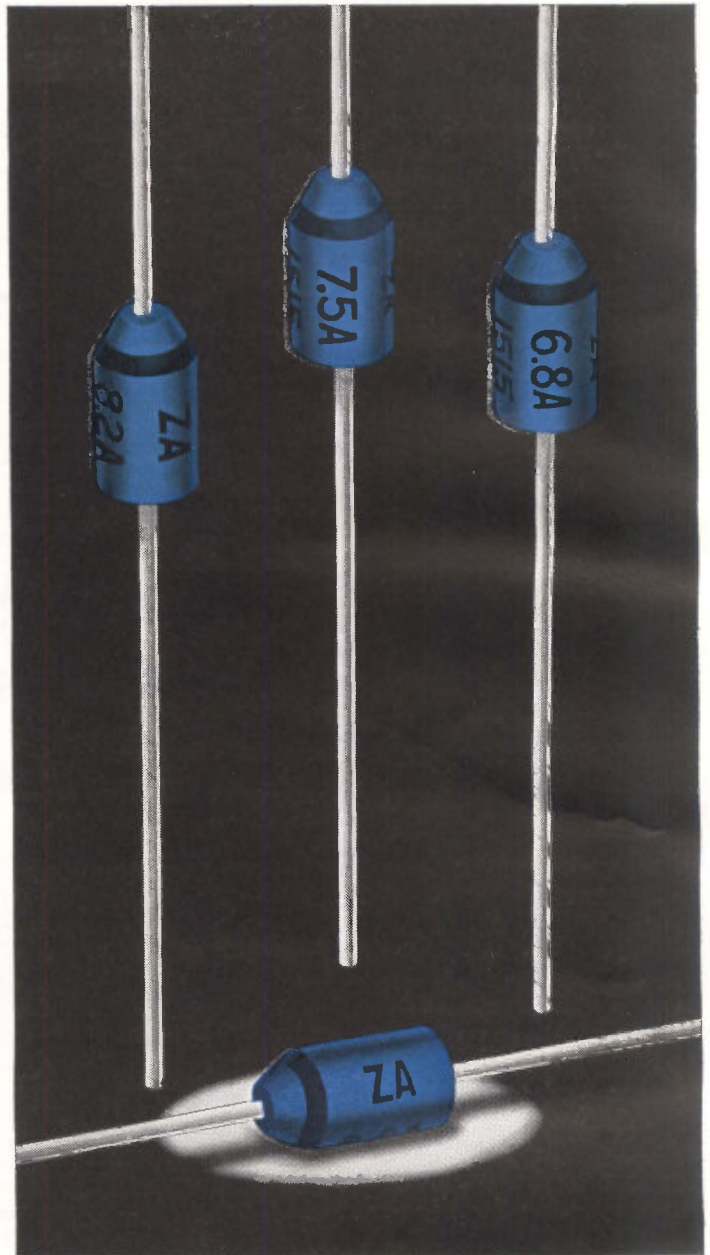
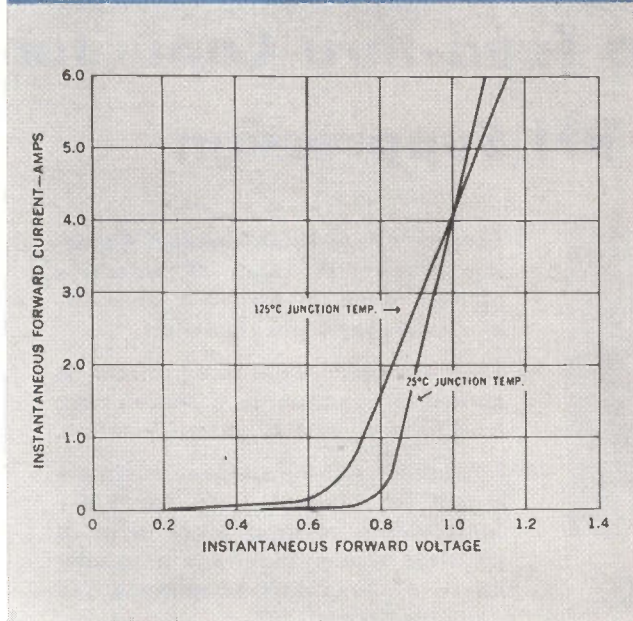
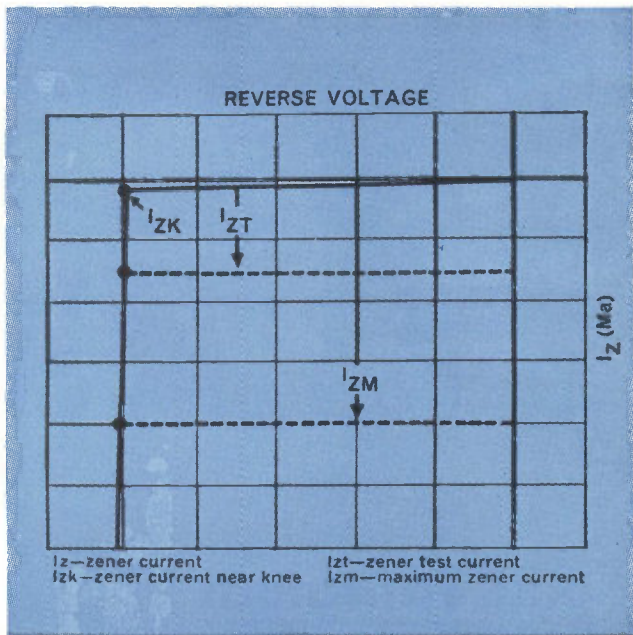

NEW MALLORY ZENER DIODE BREAKS THE QUALITY-PRICE BARRIER

The new Mallory ZA molded zener diode is a new kind of component . . . it gives you military reliability and performance at *half* the cost of hermetically-sealed units. Advanced Mallory production techniques and packaging concepts made this price/performance breakthrough possible . . . brings reliable zener performance to commercial electronics, even home instruments.

This Mallory one-watt zener diode uses the same silicon cell that goes into our types made to military requirements; gives you performance never before found in a low-price zener. And Mallory keeps the price low by using unique production techniques and putting the ZA in a rugged, economical molded plastic case . . . an electrically cold case that shrugs off moisture, takes temperature changes in stride, permits high density packaging.

The Mallory type ZA is available in zener voltage ratings ranging from 6.8 to 200 volts. Write today for literature: Mallory Semiconductor Company, Du Quoin, Ill.

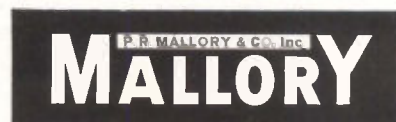

Silicon rectifiers • Packaged rectifier circuits • Zener diodes • Silicon controlled rectifiers

Mallory zener diodes are available from stock at factory prices from Mallory Industrial Distributors

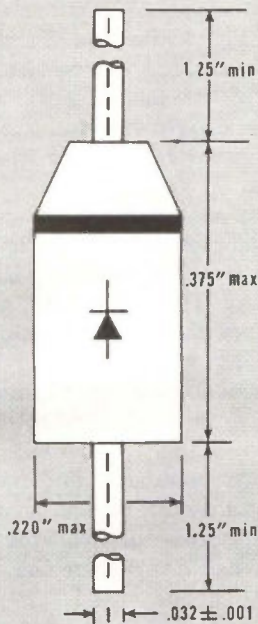

RATINGS AND SPECIFICATIONS

Mallory Part No.	Nominal Zener Voltage @ IZT (VZ) Volts
ZA6.8	6.8
ZA7.5	7.5
ZA8.2	8.2
ZA9.1	9.1
ZA10	10
ZA11	11
ZA12	12
ZA13	13
ZA15	15
ZA16	16
ZA18	18
ZA20	20
ZA22	22
ZA24	24
ZA27	27
ZA30	30
ZA33	33
ZA36	36
ZA39	39
ZA43	43
ZA47	47
ZA51	51
ZA56	56
ZA62	62
ZA68	68
ZA75	75
ZA82	82
ZA91	91
ZA100	100
ZA110	110
ZA120	120
ZA130	130
ZA150	150
ZA160	160
ZA180	180
ZA200	200

Write for the name of the Mallory Distributor nearest to you

Mallory Distributor Products Company
P. O. Box 1558
Indianapolis 6, Ind.

New Device Lowers Memory Element Cost

LOW-COST, miniature barium titanate cells for computer logic and memories were introduced by Alvin Kaufman, Litton Systems, at the recent Joint Automatic Control Conference at the University of Minnesota.

Dime-sized, eight-bit, multi-port cells can be fabricated for less than today's cores, according to Kaufman. The voltage output of these cells permits them to drive multiple logic gates without amplification.

Other advantages include non-destructive readout (which permits elimination of writeback electronics), simplified support equipment, and associated circuits less sensitive to noise pickup and magnetic field interference or to nuclear and space radiation.

Although the memory is already much smaller than the sum of cores required for the same bit-number word, cell density may be further expanded to 20-40 bits, Kaufman said.

The cell is constructed in two parts, from a single piece of ferroelectric material. The central dot electrode is a permanently polarized motor element, across which a pulse

or sinewave of voltage is developed by a sinusoidal or unipolar pulse clock generator, to deliver a sinusoid signal from the eight-bit radial memory portion of the cell.

The polarity of a short pulse, at 35 to 350 volts d-c, applied to memory elements for write-in, determines the phase of the readout signal referenced to the clock. The phase of the readout signal defines the storage of a digital zero or a digital one.

The clock frequency is chosen to operate the memory cell near or at electro-mechanical resonance, where the memory output is shifted to 90 degrees with respect to clock drive. The cells are normally operated above or below resonance, at the point where clock signal and memory output are in phase. Detuning secures the zero phase shift between clock and memory cell.

Alternately and preferably, the clock supply to a logic gate—where the pulse output is used—would be supplied through a delay network so that the cell could be used at resonance, its memory output and a gating pulse being synchronized.

Short-Necked Color TV Tube Is Lighter

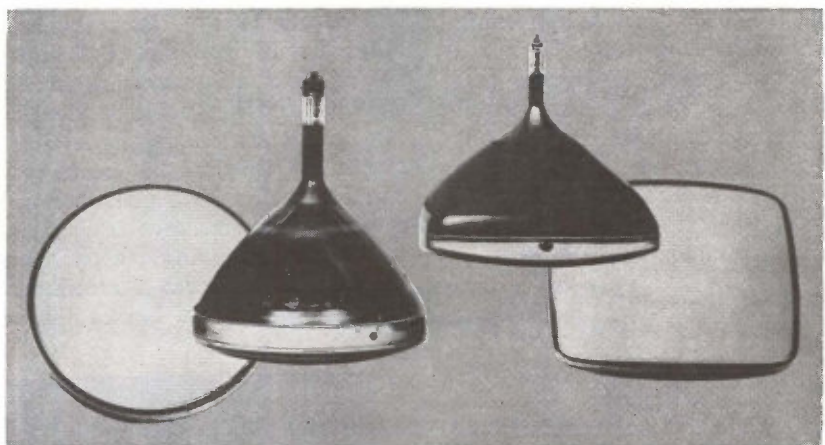

WIDE-ANGLE, 92-degree, 23-inch rectangular color-mask tube (right) demonstrated recently by Motorola weighs about four pounds less than conventional round 21-inch, 70-degree color tube (left). Being produced in quantity by National Video in Chicago, the new tube allows 4½-inch reduction in cabinet depth

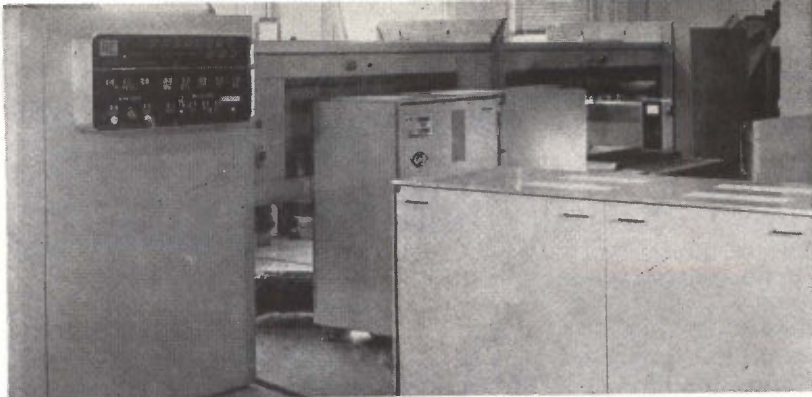

ELECTRONIC ADDRESS READER (right) for scanning ZIP code numbers is coupled to a 90-pocket mechanical sorter (left), made by Rabinow Engineering. Reader optically scans letters automatically while sorter separates mail for 50 states and 100 cities at high speed

ZIP Goes the Mail!

Ultraviolet detectors, optical scanners speed mail, delay rate hikes

By JOEL STRASSER,
Assistant Editor

WASHINGTON — Electronic mechanization will send stamp collectors looking for invisibly-coated air mail stamps within the next weeks and has already sent millions scurrying to put ZIP code numbers on their letters earlier this month as the Post Office Dept. begins implementing a vast program of mail service improvement.

Requests for proposals for optical scanning equipment are due this month and ultra-violet detection equipment begins a field test with phosphorescent "tagged" air mail stamps in Dayton, O. shortly, Edward Harriman, director of POD's research and engineering office told ELECTRONICS.

The end result, Harriman emphasized, is to delay future postal rate increases. The idea is to mechanize fast enough, he said, to keep up with the annual 3 percent mail volume increase while retaining permanent employees.

STAMP TAGGING will begin field tests at Dayton within the next two weeks using equipment of the National Cash Register Co. To separate air mail from regular mail before the cancelling process, an orange phosphorescent material will be applied over the printed surface of air mail stamps. The coating will be visible only to u-v de-

tection equipment and will make possible priority handling of air mail. Cost will be less than \$5,000 per device, according to Harriman.

Green and blue phosphors are also being laboratory tested. Harriman indicated that these and other color phosphors will be used to identify different stamp denominations and special services. Reading of combinations of phosphor stamps is also planned for the future.

ZIP—Early this month, POD introduced the ZIP code (Zone Improvement Plan). This requires using a 5-digit code instead of postal zone numbers on mail throughout the country. For example, "New York 36, N. Y." now is addressed as "New York, N. Y. 10036."

The code will be used with either of two optical scanning devices—one developed by Farrington, the other by Philco. The Farrington device does slit scanning at 24,000 rpm and is capable of identifying characters on envelopes. Resolution is 15 to 20 scans per character. The Philco scanner uses a 5-inch diameter tube to do flying spot scanning. Using a broad beam initially, it conducts a rough scan locating the bottom line of the ad-

dress. It then registers the x-y dimension, rescans with a 3 or 4-mil beam (the fine scan) and seeks out the alphanumeric information. The Philco system seeks out the salient features of the address for further processing, while the Farrington system picks out the vertical characteristics of the address, adjusting for height before scanning. Washington, D. C. has the first scanner.

ZIP is also expected to provide a tool for companies with their own data processing systems. By programming the ZIP code number onto punch cards or magnetic tapes, a company will be able to bypass the POD's first three sorting steps and send its mail straight to the dispatch stage. POD will insert ZIP code numbers on magnetic tapes and punch cards, as well as addressograph plates, for companies that don't own the equipment.

SORTING—For sorting letters, POD is rapidly bringing into use a multiposition letter sorter that is 3 to 6 times as fast as manual sorting. Operated by 12 men at keyboards, the machine is capable of 300 separations at 3 letters per second. Eventually, the machine's keyboards will be replaced with four scanning heads and ZIP code sorting will be done automatically.

The multi-position machines cost the POD \$100,000 each and are expected to pay for themselves within 4 to 6 years. Designed by Rabinow Co., they are being built by Burroughs and Cadillac-Gage. They will replace a single-position, one-man machine that is capable of 50 separations at 1 letter per second.

Mark II facer-canceller, already in use for several years, is the in-between machine to complete the flow. Following the u-v tagging machine and preceding the scanner, the equipment was supplied by Pitney-Bowes at a cost of about \$20,000 each—yielding a return of about 100 percent in 1 year.

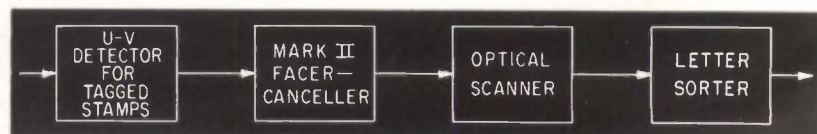

FLOW CHART shows relative position of new equipment in mail-processing chain being implemented by the Post Office. Buffer storage stage separates the facer-canceller from the ZIP code optical scanner

MEETINGS AHEAD

MEDICAL ELECTRONICS INTERNATIONAL CONFERENCE, IFME, University of Liege, Liege, Belgium, July 22-26.

ELECTROMAGNETIC MEASUREMENTS & STANDARDS SEMINAR, National Bureau of Standards; NBS Laboratory, Boulder, Colo., July 22-Aug. 9.

AEROSPACE SUPPORT INTERNATIONAL CONFERENCE & EXHIBIT, IEEE, ASME; Sheraton-Park Hotel, Washington, D. C., Aug. 4-9.

INTERNATIONAL ELECTRONICS CIRCUIT PACKING SYMPOSIUM, University of Colorado, et al; at the University, Boulder, Colo., Aug. 14-16.

WESTERN ELECTRONICS SHOW AND CONFERENCE, WEMA, IEEE; Cow Palace San Francisco, Calif., August 20-23.

DATA PROCESSING NATIONAL CONFERENCE & EXHIBITION, Association for Computing Machinery; Denver Hilton Hotel, Denver, Colo., Aug. 27-30.

AUTOMATIC CONTROL INTERNATIONAL CONGRESS, International Federation of Automatic Control; Basle, Switzerland, Aug. 27-Sept. 4.

MILITARY ELECTRONICS NATIONAL CONFERENCE, IEEE-PTGMIL; Shoreham Hotel, Washington, D. C., Sept. 9-11.

ELECTRICAL INSULATION CONFERENCE, IEEE, NEMA; Conrad-Hilton Hotel, Chicago, Sept. 10-14.

JOINT ENGINEERING MANAGEMENT CONFERENCE, IEEE, ASME, et al; Biltmore Hotel, Los Angeles, Sept. 12-13.

INTERNATIONAL ASSOCIATION FOR ANALOG COMPUTING, AICA; Brighton College of Technology, Lewes Rd., Brighton, England, Sept. 14-18.

INDUSTRIAL ELECTRONICS ANNUAL CONFERENCE, IEEE, ISA; Michigan State University, East Lansing, Mich., Sept. 18-19.

PHYSICS OF FAILURE IN ELECTRONICS SYMPOSIUM, Armour Research Foundation and Rome Air Development Center, Illinois Institute of Technology, Chicago, Sept. 25-26.

ADVANCE REPORT

VEHICULAR COMMUNICATIONS INTERNATIONAL CONVENTION, IEEE-PTGVC; New York City, March 23-26, 1964. Aug. 15 is the deadline for submitting 50-word abstracts to: E. W. Borden, Session Organizer, American Telephone and Telegraph Company, 195 Broadway, New York 7, N. Y. Original papers on any subject of general interest in the field of mobile communications will be considered. Manufacturers of vehicular systems equipment and system users are urged to present new developments and previously unpublished knowledge or experience.

New ac-dc laboratory standard



Speed voltmeter calibration Simplify supply voltage monitoring

±0.03% accuracy of indication. Engelhard's new Differential Thermocouple Voltmeter provides features never before available in a single instrument. Model 35700 DTVM is designed for rapid, high-precision voltmeter calibration, monitoring of supply voltages, and is ideal for critical ac and dc measurements as well. The instrument offers an accuracy of ±0.03% at any voltage from 1 to 1011.1v—either dc or 5cps to 1kc. Accuracy is rated as percent of *actual* reading rather than full-scale deflection.

Model 35700 indicates results directly, without multiplying factors or calculations, and requires only one operation per calibration reading. In addition, all measurements are performed without accessory equipment.

Circuitry is based on a similar design developed by Griffin and Hermach for the National Bureau of Standards. Calibration of the instrument is traceable to NBS, and the DTVM is acceptable for certification by the Bureau.

Exceptional stability permits uninterrupted observation of voltage changes as small as 0.02% over a period of several hours. Zener diodes establish a precise basic reference voltage, while a balanced thermal-converter circuit cancels effects of ambient temperature variations.

Simplified operation speeds measurement and helps eliminate error.

Calibration and monitoring results are indicated directly in *percent* on the DTVM. Voltage readings appear directly in *volts* on the instrument.

SPECIFICATIONS

Range (ac-dc):
Accuracy (±0.03%):
Accuracy (±0.05%):

1 to 1011.1, with overranging
dc and ac from 5 cps to 1 kc,
any voltage rating.
1.0 to 600v (1kc to 30kc)
600 to 800v (1kc to 20kc)
800 to 1011.1v (1kc to 10kc)
19 x 19 x 9
105/125v, 60cps, 10w

Size (Inches):
Power requirement:

Write Engelhard for details on Model 35700 DTVM. We'll send a technical data sheet with full information and specifications.

ENGELHARD
INDUSTRIES, INC.
INDUSTRIAL EQUIPMENT DIVISION
Instruments and Systems Section
850 PASSAIC AVENUE • EAST NEWARK, NEW JERSEY



Hot,



cold,



or in between,

a Heinemann breaker's
ampere rating
won't vary a hair.

Temperature stability is part and parcel of the Heinemann hydraulic-magnetic circuit breaker. The Heinemann breaker's current rating and calibrated trip points don't drift in response to temperature changes. The breaker will carry 100% rated load at any ambient within its overall operating range, and will always trip at the same specified overcurrent values. You don't have to derate.

Reason? Magnetic actuation. No heat-sensing (and heat-sensitive) elements. The breaker's magnetic overload coil couldn't care less what the temperature is: it responds only to actual load currents; never to heat, ambient or otherwise. (With a Heinemann breaker protecting your equipment, you will never hear of a heat-caused power interruption).

And the nice part is, this unshakeable stability is combined, in the Heinemann breaker, with decimal-point-precise current ratings. Heinemann can give you any integral or fractional rating you need—anything from 0.010 amp on up. You don't have to settle for "pretty close."

These specs apply to every breaker that Heinemann makes. Little breakers, like the VP shown above. Big breakers, like our 480-volt EH. Breakers for DC service. Or AC service. For frequencies up to 400 cycles—and beyond. With any of several inverse time-delays. And every single one of them carries a five-year repair-or-replace guarantee. The new Heinemann Engineering Guide, Bulletin 202, will give you detailed technical information. Yours for the asking, of course.

HEINEMANN ELECTRIC COMPANY, 2600 Brunswick Pike, Trenton 2, N. J.

The Optical Heterodyne

Key to Advanced Space Signaling

Frequency control of local oscillator laser and reduction of noise combined with nonlinear photodetection show the direction for successful modulated space communications with coherent light

By STEPHEN JACOBS*, TRG, Incorporated, Syosset, N. Y.

ENORMOUS INFORMATION capacity of optical frequency transmission has been the subject of considerable interest for the past several years. With the advent of the laser, it is now possible to generate highly monochromatic electromagnetic waves at optical frequencies and today, one by one, various radio techniques are being demonstrated with light. These include oscillators, amplifiers, mixers, rectifiers, discriminators, modulators and harmonic generators. The optical heterodyne technique of detection is no different in principle from that of heterodyning in the radio-frequency region, except that it is not preceded by any stages of amplification.

The method of optical heterodyning is described below. A laser local oscillator beam is made spatially and temporally coherent with an incoming signal beam as shown in Fig. 1. Both beams are made to fall on the surface of a radiation detector and a cur-

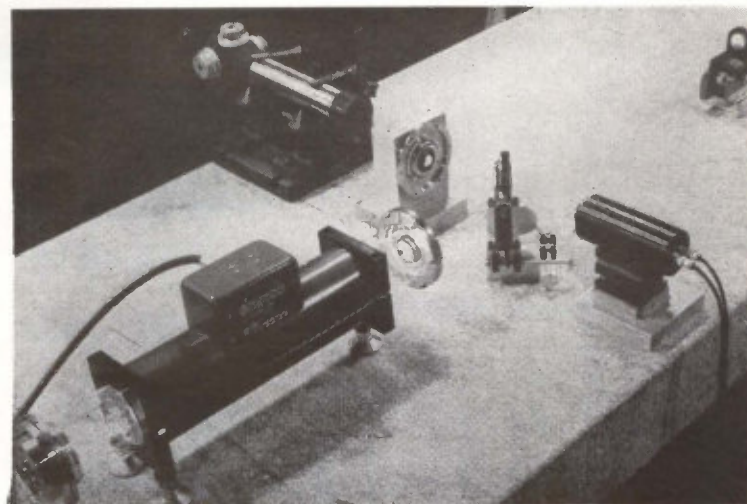

LASER BEAM enters from lower left (note different arrangement of equipment from that on color cover). Beam splitter (center) produces two beams. Phase modulation occurs with piezoelectric mirror (left center). Local oscillator mirror (upper right) and phototube multiplier (lower right) complete setup. Autocollimator (top) is used to align the beam initially

rent, at the difference frequency of the coincident beams, is generated by the nonlinear process of photodetection. This beat current is called the signal current. The effect of mixing the signal beam with a powerful local oscillator beam is both to generate the signal current and to introduce a large amount of shot noise, which becomes the limiting noise of the system. As will be shown, the signal current and the rms shot noise current are both proportional to the square root of the local oscillator power. The signal-to-noise ratio inherent in the signal beam is thus preserved through this amplification process, while the incoherent background noise is submerged with respect to the local oscillator noise.

OPTICAL HETERODYNING processes may be clarified by considering the mixing of two coherent fields on the photosensitive surface of a square-law detector, that is, one that responds in proportion to the square of the interfering fields. All photodetectors are square-law in the sense that i is proportional to E^2 .

Let the field at the photosensitive surface be

$$E = E_L \cos \omega_L t + E_S \cos \omega_S t$$

where

$$E_L = \text{local oscillator field amplitude}$$

$$E_S = \text{signal field amplitude}$$

$$\omega_L, \omega_S = \text{respective angular frequencies.}$$

Assuming E_L and E_S have the same polarization, then the resulting photocurrent is proportional to

$$\overline{E^2} = \frac{1}{2} E_L^2 + E_L E_S \cos (\omega_L - \omega_S) t + \frac{1}{2} E_S^2$$

averaging over a response time, τ , such that

$$(\omega_L - \omega_S) \ll \frac{1}{\tau} \ll \omega_L$$

* This work was supported by the Communications Branch of ASD, by the Advanced Communications Techniques Branch of RADC, and by ARPA through AFOSR.

WHY OPTICAL COMMUNICATION?

In a nutshell, when information is carried on a monochromatic beam of light, optical heterodyning makes it possible to filter out and amplify only the bandwidth of interest—that is, the information bandwidth. Besides this advantage, a laser communications link has extremely narrow beamwidth as contrasted with a radio-frequency system.

More data on optics of real atmospheres will be necessary before optical heterodyne transceivers can be employed for doppler velocity and acceleration applications. But one feasible application is extremely long range, broad-band communications through space

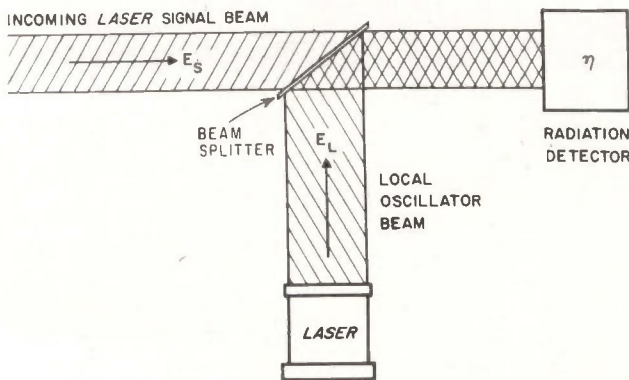

LASER BEAMS from remote source and local oscillator combine for optical heterodyne detection—Fig. 1

The a-c component of the photocurrent at the difference frequency $\omega_L - \omega_S$ is

$$i_{\text{peak a-c}} = 2 \frac{E_L E_S}{E_L^2 + E_S^2} i_{d-c}$$

and if $E_L \gg E_S$

$$i_{d-c} = \eta \frac{P_L}{h\nu} e$$

where η = detection quantum efficiency
 P_L = local oscillator beam power
 e = electronic charge
 h = Planck's constant
 ν = light frequency

Under the above conditions, the a-c signal power is amplified in proportion to P_L

$$\overline{i_{a-c}^2} = 2 \left(\frac{E_S}{E_L} \right)^2 i_{d-c}^2 = 2 \frac{P_S}{P_L} i_{d-c}^2 = 2 \left(\frac{\eta e}{h\nu} \right)^2 P_L P_S$$

where P_S = signal beam power

Finally, the shot noise is given by,

$$i_N^2 = 2 e i_{d-c} \Delta f = 2 \frac{\eta e^2}{h\nu} P_L \Delta f$$

Therefore, if the local oscillator generates only shot noise in the detector, the signal-to-noise ratio

$$\frac{\overline{i_{a-c}^2}}{i_N^2} = \eta \frac{P_S}{h\nu \Delta f} = \eta \left(\frac{\text{signal photon rate}}{\text{frequency bandpass}} \right)$$

One characteristic difference between optical heterodyne detection and conventional detection is that the signal-noise ratio is not limited by the noise equivalent power, nep. Under the condition that the local oscillator shot noise predominates over all other noise in the detector, it is only the detection quantum efficiency that determines the minimum detectable power.

Figure 2 illustrates how signal-noise power ratio depends on signal beam power under the above conditions. It has been demonstrated in this laboratory that power levels two orders of magnitude less than a detector nep can easily be detected with a bandwidth $\Delta f = 1$ cps. Figure 3 shows what happens when, for a given signal beam power, the local oscillator power is allowed to drop below the level where the shot noise is the dominant noise in the detector. Note that there is no improvement in the signal-noise ratio for large local oscillator power.

INTERFERENCE — To avoid interference with transmitted information the laser in a broadband optical heterodyne communications system should transmit a single frequency only. Beyond this consideration of information capacity, the requirements of optical demodulation dictate that the optical heterodyne system be in tune at some frequency. Definite phase relationships must be established to detect sidebands about a certain carrier frequency. It is not generally possible to satisfy these relationships simultaneously for more than a single frequency.

The requirement can be summarized as a need for lasers with high single-mode power. This means more than a single-mode spot on the wall, but also a single temporal, or axial, mode as well. In choosing between lasers of comparable single-mode power, the lowest frequency laser, with the most photons per unit power, gives the best signal-noise ratio for given signal beam power.

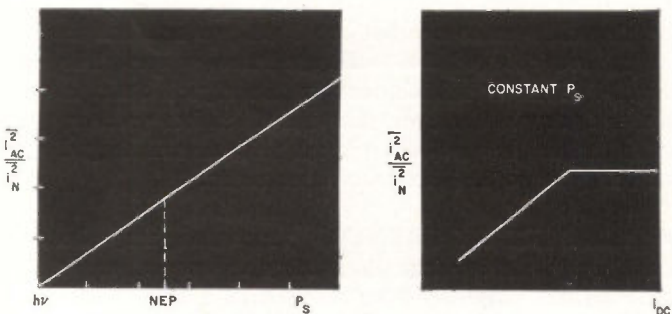

SIGNAL-NOISE power (nep) varies with incident signal beam power assuming $\eta = \Delta f = 1$ —Fig. 2

LOCAL OSCILLATOR beam power shot noise is inadequate to mask background—Fig. 3

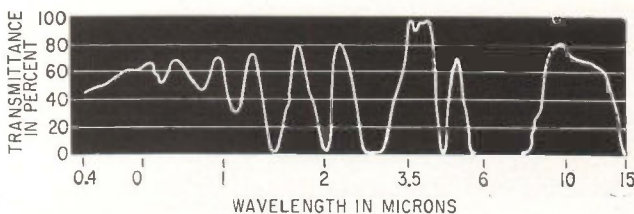

ATMOSPHERIC transmittance through 200 yards of 17-mm precipitable water—Fig. 4

MODULATION—Either phase, amplitude, or single sideband modulation is appropriate for optical heterodyne detection. The modulator must be able to operate on the light beam without seriously disturbing the coherence of the wavefront as it passes through. This requires good optical surfaces and homogeneity.

Especially important in broadband systems is the need to keep modulation power reasonably low. This avoids thermal distortions, and obviates practical limitations of available power, size, weight, and cooling.

The modulation mechanism must not allow distortion of signal owing to nonlinearities and must, of course, be appropriate to the type of the laser being modulated. An example of such light modulation is the electro-optic effect with crystals of KDP.

FIGURE OF MERIT—Fundamental to optical heterodyne detection is the detector quantum efficiency. In addition to the basic relationship between detector speed and information capacity there is a subtle but all-important requirement, imposed by the condition that the laser photocurrent shot noise must exceed all other detector noise.

Fulfilling the above condition involves different considerations for different types of detectors. For example, there is a problem with thermal noise in detectors of low resistance

$$\overline{\delta i^2}_{\text{thermal}} = \frac{4kT}{R} \Delta f$$

Comparing this with the laser-induced shot noise

$$\overline{\delta i^2}_{\text{shot}} = 2ei \Delta f$$

it is required that

$$2ei \gg \frac{4kT}{R} \quad \text{or} \quad V_{\text{signal}} = iR \gg \frac{2kT}{e} = 50 \text{ mV}$$

at room temperature. Thus a low resistance detector may require an intense local oscillator to generate adequate shot noise to mask the thermal noise. This may even bring the detector into an intolerable saturation region.

Other special considerations apply to special detector types, such as the need to overcome bias current noise of a photoconductor, or the need to elimi-

nate signal-dependent noise of an unbiased photovoltaic detector.

TRANSMISSION PATH—Dispersive, turbulent, absorbing atmospheres are problems as yet generally unexplored. The least unknown of these quantities is the transmittance of the atmosphere (Figure 4). Little is known about the variations of refractive index in the atmosphere that cause a coherent laser beam to be changed in direction and phase, as well as displaced in the plane of the receiver. Some references to recent studies are listed.

Even in a perfectly isotropic optical medium, optical dispersion tends to limit the usable information bandwidth. The frequency variation of the refractive index gives rise to differences in transit times for photons of different frequency. The dispersion has not only linear frequency dependence but also higher order terms that are difficult to compensate and that impose a bandwidth limitation. Some of the problems of phase distortion and displacement can be met by techniques of single sideband transmission and double-detection, the details of which are beyond the scope of this paper.

Although the problems associated with real atmospheres presently appear formidable, it is consoling to recall that most of the universe is free from such problems.

FREQUENCY CONTROL—Any optical heterodyne system involving separate transmitter and receiver lasers must maintain either a frequency that is discretely offset or positive frequency control. It has been shown that two He-Ne gas lasers, free-running under ideal isolation conditions, can be kept stable to within 30 cps over a few tens of milliseconds and are resettable to somewhat less than 0.5 megacycle. However, such ideal conditions cannot usually be maintained and frequency feedback control is needed. Utilizing the circuit shown in Fig. 5, the frequency-locking of two lasers has been demonstrated to within several kilocycles under ordinary laboratory conditions. This represents frequency control of one part in 10^{11} and is only a modest beginning. There may be considerable advances beyond this when improved servo systems are developed.

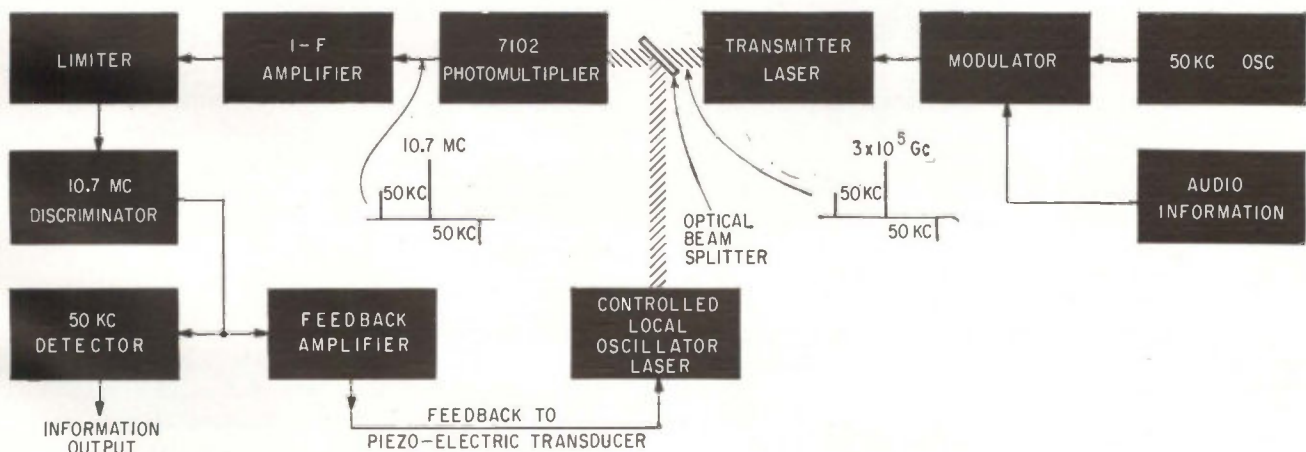

DUAL-LASER setup for demonstrating optical heterodyne detection of frequency modulated light employs a local oscillator—Fig. 5

ADVANTAGES OF THE NRE

The Negative Resistance Element overcomes many of the limitations of other negative-resistance devices or circuits. These limitations include nonlinearity or unpredictability of electrical characteristics, and temperature sensitivity

By **CARL DAVID TODD**

Head of Engineering, Modular Circuits,
Hughes Aircraft Co., Newport Beach, Calif.

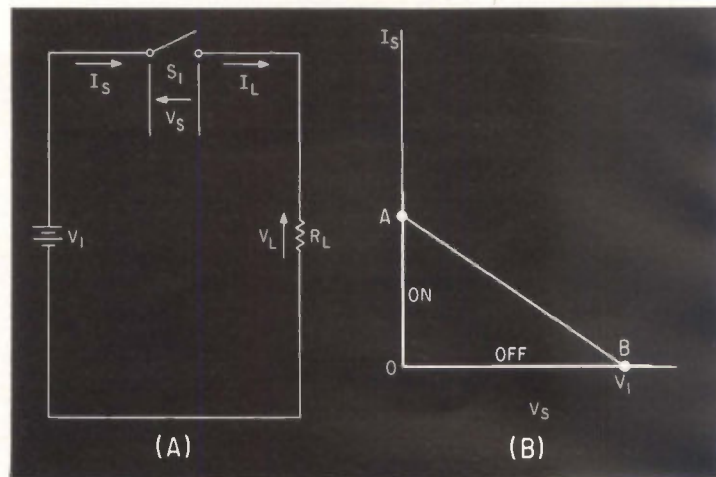

TYPICAL D-C SWITCHING circuit (A); operating characteristics for a mechanical switch (B)—Fig. 1

USING A NEW COMPONENT: Design of D-C Switches

Composite circuit recently made available, provides speed and freedom from contact bounce when used as an electronic switch. Design in switching applications is outlined step-by-step

A TYPICAL CIRCUIT for a mechanical switch is shown in Fig. 1A. Switch S_1 , which connects source voltage V_1 to load resistor R_L , has two possible conditions: open or closed. In closed or ON, the full supply voltage is applied to R_L and the operating point on the load line is at A (Fig. 1B). When S_1 is open or OFF, the operating point must be at point B and little current can flow.

The ideal switch will have zero resistance, and thus zero voltage drop across it, when it is ON. It will have infinite resistance, so that load current will be zero, when S_1 is OFF. The ideal switch is approached even for practical switches of the mechanical form.

A characteristic known as toggle switching may be desired, where the switch remains in the position to which it is set until moved. Thus, it is not necessary to retain the control signal (force applied to the switch handle), to retain either the ON or OFF condition.

Although the mechanical switch approaches the ideal condition for ON and OFF resistance, it lacks the speed and freedom from bounce required for many applications. It is here that electronic switches prove valuable.

NEGATIVE—The Hughes family of negative resistance elements (NRE) (ELECTRONICS, p 21, May 31, 1963) are composite circuits having a voltage-stable

or S-type negative resistance characteristic appearing at the output terminals. Figure 2A is a typical family of electrical characteristics for the SC5141 or SC5157 negative resistance elements.

The shape of the characteristic curve is clearly defined and is highly predictable. Peak current is a direct function of the magnitude of the bias current, I_1 , and is almost equal to it. The polarity of I_r , however, is negative.

The slope of the characteristic curve in the region of negative resistance (region II), where an increase in terminal voltage produces a decrease in terminal current, is approximately $-1/1,000$ ohms or -1 milliohm.

The valley voltage, which represents the boundary between region II and the second positive resistance region, region III, is roughly equal to the product of I_P and R_n , the magnitude of the a-c negative resistance. For the SC5141 and the SC5157, V_V is given by:

$$V_V = I_P R_n = I_P (1,000) \quad (1)$$

Therefore, if I_1 is made equal to 10ma, I_P will be nearly equal to -10 ma and V_V will be -10 volts.

The current I_V that flows for a terminal voltage V_V is small. Typically the value of H , the ratio of I_P to I_V will be 50 or more. The slope of the characteristic curve for voltages just larger than V_V is positive, and is approximately 50,000 ohms. This

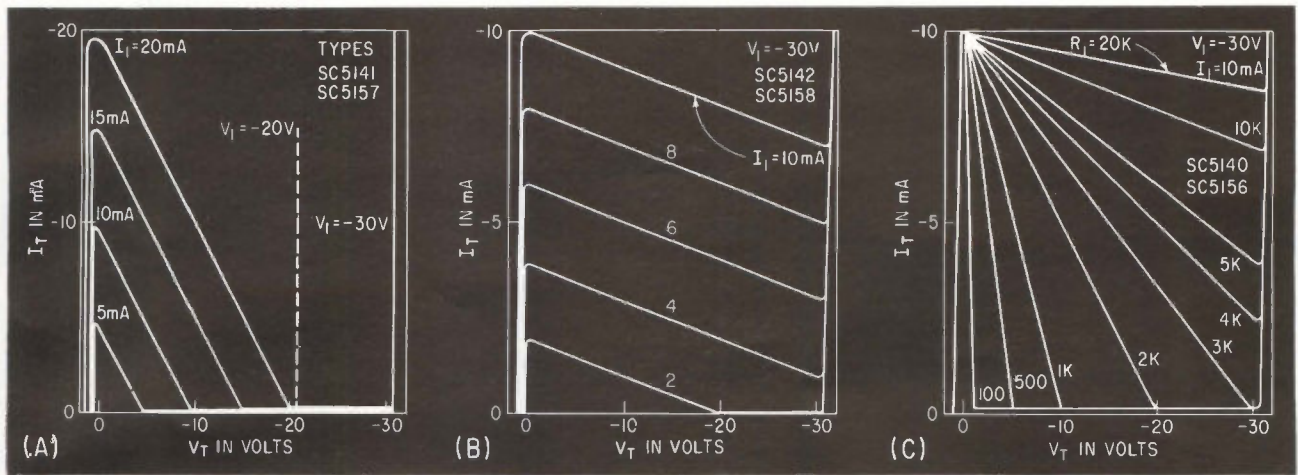

OUTPUT CHARACTERISTICS: for negative resistance elements with $R_n = 1,000$ ohms (A); for an NRE with R_n of 10,000 ohms (B); for several values of R_i (C)—Fig. 2

With Negative Resistance Elements

value varies somewhat from unit to unit, depending upon the source resistance for I_1 .

The terminal voltage, V_K , where the current rapidly increases with a small increase in the V_T , is approximately 0.7 volt larger than the bias voltage, V_1 . The maximum allowable value of V_1 for the types of NRE shown is -30 volts. Should it be desirable to make the value of the knee voltage less than the value of V_1 , a voltage regulator diode may be placed directly across the output terminals to modify the characteristic curve. If more convenient, a diode clamp may be used.

The electrical characteristics for the SC5142 and the SC5158 NRE are given in Fig. 2B; the value of R_n for these two types is 10,000 ohms and the valley voltage is:

$$V_V = I_P (10,000) \quad (2)$$

Other characteristics of the curves will be similar to those of the SC5141 and the SC5158.

A third class of NRE, types SC5140 and SC5156, may be used to produce almost any negative resistance from -50 to $-100,000$ ohms. The value of R_n will be nearly equal to the value of an external resistor, R_i , placed across the input terminals provided. This approximation becomes less accurate for very low or very high values of R_i , or for very low values of I_1 . A typical characteristic family is shown in Fig. 2C for several values of R_i and for an I_1 of 10 ma.

BIASING—An NRE, operated under the load-line conditions of Fig. 3A will have two stable states, points A and B. At point A the voltage across the NRE is typically about 0.5 volt positive and the current through it is relatively high. This corresponds to operating point A in Fig. 1B for the closed or ON switch.

At operating point B the terminal current is much lower than it was at A and practically all of the supply voltage is dropped across the NRE. This condition corresponds to operation at point B in Fig. 1B for the open or OFF switch.

For the circuit of Fig. 3B, a voltage slightly larger than the supply voltage appears across the load when operation is at point A or the switch is ON. The load current when the switch is closed must be less than the peak current of the NRE, roughly equal to I_1 in magnitude.

When operation is at point B in Fig. 3A, most of the supply voltage appears across the NRE and little voltage is impressed across the load. The load current is thus small and corresponds to the condition of an open or OFF switch. Switching is not perfect since the current in the OFF condition is not zero, but this is not a problem in many applications. The value of the knee voltage, V_K , must be larger than the supply voltage. With the arrangement of Fig. 3B, this condition is automatically obtained, since V_K is about 0.7 volt higher than the applied voltage bias.

TRIGGERING—Consider the mechanism for switching from the closed or ON condition to the open or OFF condition and back again. Assume that the conditions are as illustrated by the solid characteristic curve of Fig. 3A and the operating point is at B.

As seen before, the switch is effectively open or OFF. A small trigger current, I_2 , applied to terminal 1 will modify the d-c characteristic curve since it adds or subtracts from the value of I_1 depending upon the polarity of the trigger.

If I_2 is positive or in the direction shown in Fig. 3B, the characteristic curve becomes that illustrated by the dotted line. The load line now intersects the new characteristic curve at only one point, C, very

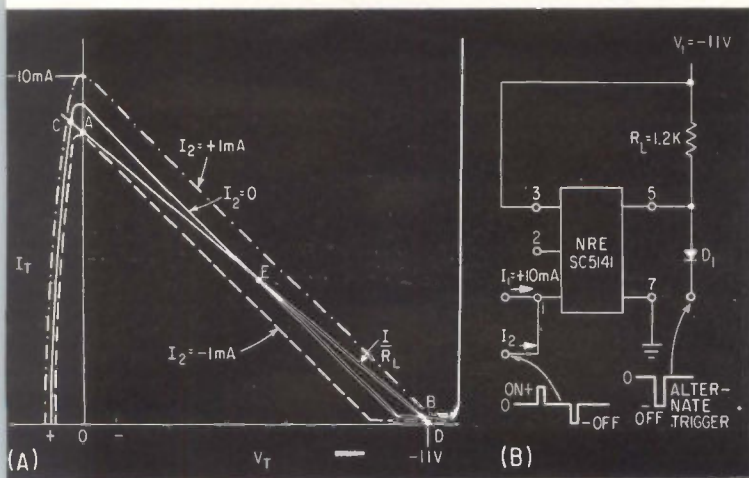

OPERATING CHARACTERISTICS (A) for switch circuit (B) using a negative-resistance element—Fig. 3

near to A and the operating condition must shift to this point. If I_2 is now reduced to zero, the characteristic curve of the NRE will assume its original form. The operating point, however, will remain at A. Thus, by the application of a positive trigger current applied to terminal 1, the switch is turned from OFF to ON.

Consider now what happens upon the application of a negative value of I_2 , with the direction of I_2 being opposite to that indicated in Fig. 3B. The characteristic curve of the negative resistance element now takes the form of the dashed line of Fig. 3A. Again, the load line intersects the modified characteristic curve at only one point, but this time the only permissible condition is D, or a high-voltage state near B. As I_2 is again made zero, the operating point remains at B. Thus, a negative trigger current applied to terminal 1 will cause the switch to change from ON to OFF.

The switch is bistable and, once triggered, will remain in the demanded state until a trigger of the opposite polarity is applied. Thus, a memory function is provided similar to the mechanical toggle switch.

The circuit of Fig. 3B has considerable power gain both for the turn-off as well as for the turn-on conditions. The power required to turn the switch OFF is about 5 microwatts. For turning the switch ON, the required power is quite circuit-dependent, but may be held to around one milliwatt. The power switched in the load is 110 milliwatts.

The switch of Fig. 3B may be turned OFF by the application of a negative voltage pulse applied to the alternate trigger point. The amplitude must be greater than the terminal voltage corresponding to point E on the curve of Fig. 3A before switching takes place. The energy required is much greater than that required at terminal 1, but this method of triggering may be desirable in some applications. The trigger normally must be a pulse of short rise time for decisive triggering.

COMPENSATION—During normal operation of the switch of Fig. 3B, a voltage slightly larger than the

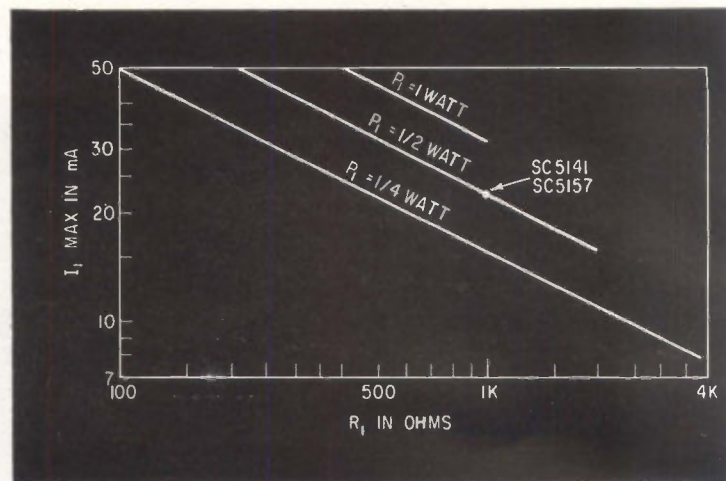

CURRENT LEVEL is limited by the power rating of R_L for switching applications—Fig. 4

value of the supply voltage appears across the load resistor. This is due to the slightly positive voltage at point A and may be compensated for by the insertion of a small resistor R_c in series with load resistor, R_L . For perfect compensation, the voltage drop across R_c when the switch is ON must be exactly equal to the voltage V_A corresponding to point A in Fig. 3A,

$$R_c = \frac{V_A}{I_A} = \frac{V_A}{V_1/R_L} \quad (3)$$

POWER DISSIPATION—The ideal mechanical switch of Fig. 1 dissipates no power since the voltage drop is zero when it is closed and the current through it is zero when it is open. The NRE switch of Fig. 3B approaches this state for most applications and therefore the power dissipation due to the ON voltage or the OFF current will be negligible, or at least within the $V_T I_T$ rating of 250 mw. There are other portions of the internal circuit of the NRE which do consume power that must be dissipated in the form of heat.

The area of major concern is the resistor that generates the effective negative resistance, R_n , whether the resistor is internal as in the SC5141, SC5142, SC5157, and SC5158, or external as with the SC5140 and the SC5156. The power dissipation in this resistor, R_n , is greater when the switch is OFF or operation is at point B in Fig. 3A. The maximum value of I_1 which may be permitted under the general circuit conditions of Fig. 3B may be determined from

$$I_{1\max} = \sqrt{P_{1\max}/R_n} \quad (4)$$

where $P_{1\max}$ is the maximum power dissipation allowed in R_n .

Equation 4 is plotted in Fig. 4 for several possible resistor power ratings. This analysis is limited to the case where V_T of the NRE is less than V_1 . It is not always possible to operate a given resistor up to its rated power because of voltage limitations. Only the switching case has been considered and it is assumed that power dissipation in switching from one state to the other is small.

DESIGN PROCEDURES—Consider the steps neces-

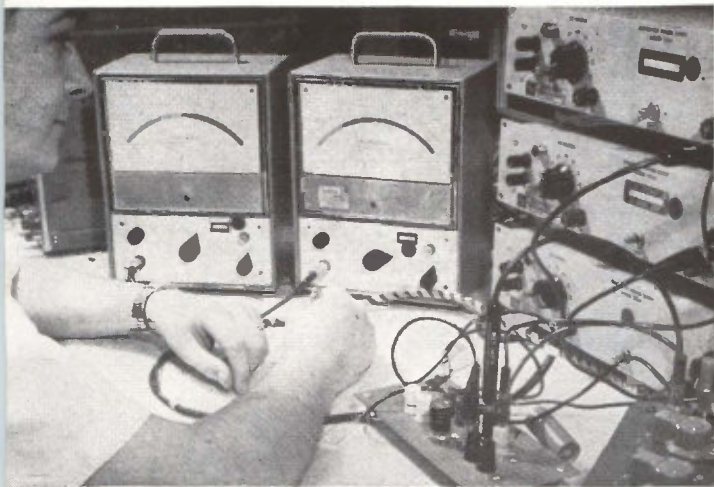

AUTHOR measures the operating parameters of a breadboarded d-c switch

sary to arrive at a final design for a d-c switch circuit like that shown in Fig. 3B. Assume that it is desired to apply or disconnect a given supply voltage, V_1 , to a given load resistor, R_L .

It is necessary that the peak current, I_p of the NRE be larger than the load current, I_L , when the switch is ON. This may be easily accomplished by making I_1 , the applied bias current slightly greater than I_L . A 5 or 10-percent margin is normally adequate:

$$I_1 = I_L (1 + k) = \frac{-V_1}{R_L} (1 + k) \quad (5)$$

where k represents the desired fractional margin.

For a bistable load line, the value of R_n , the magnitude of negative resistance developed by the NRE must be smaller than R_L . To reduce the trigger current required to turn the switch ON, R_n must be as large as practical and yet still be less than R_L . For the same relative stability as before, V_v should be made 5 or 10 percent lower than V_1 . This demands that R_n be made 10 to 20 percent lower than R_L :

$$R_n = R_L (1 - k') \cong R_1 \quad (6)$$

The next step is to determine the power requirements of the resistor R_1 :

$$P_1 = I_1^2 R_1 \quad (7)$$

where P_1 is the actual power dissipation in R_1 when the switch is in the OFF state. Should the switch remain ON most of the time and the duration of the OFF time be relatively short, it may be possible to use a resistor with a smaller power rating than that suggested by Eq. 7. If the switch is to remain OFF for rather long periods, the power rating should be somewhat higher than indicated by Eq. 7.

The NRE used must be rated for a voltage equal to V_1 or higher. In addition, it must be able to withstand the required value of I_1 .

The required trigger current, I_2 , to turn the switch ON or OFF may now be calculated:

$$I_{2\text{ ON}} = \Delta I_P = -\frac{V_1}{R_n} - I_1 \quad (8)$$

$$I_{2\text{ OFF}} \cong -(I_1 - I_L) \quad (9)$$

Thus, a positive current will turn the switch ON

if its value exceeds that indicated by Eq. 8, and a negative current will turn it OFF if its value exceeds that indicated by Eq. 9. Using the recommended margins given above, typical trigger currents will be 5 or 10 percent of the value of I_L .

Should it be desirable to compensate for the positive voltage drop when the switch is ON, the compensation resistor, R_c , may be calculated directly from Eq. 3, repeated here for convenience:

$$R_c = \frac{V_A}{I_A} = \frac{V_A}{V_1/R_L} \quad (3)$$

TYPICAL EXAMPLES—Suppose it is desired to design a switch that may be used to connect a power supply of -11 volts to a 1,200-ohm load resistor. The normal load current under the ON condition will be 9.2 ma. The required value of the bias current may be computed from Eq. 5:

$$I_1 = I_L (1 + k) = 9.2 \times 10^{-3} (1 + 0.1) = 10.1 \text{ ma} \quad (10)$$

Here a margin of 10 percent has been used. A bias current of 10 ma will be assumed.

Next, it is necessary to calculate the required value of R_n . This may be done by using Eq. 6 and assuming the margin k' to be 15 percent:

$$R_n = R_L (1 - k') = 1,200 (1 - 0.15) = 1,020 \text{ ohms} \quad (11)$$

An NRE with a negative resistance of 1,000 ohms may be used. The SC5140 may be used with an external R_1 connected between terminals 1 and 2, or an SC5141 may be used alone.

It is necessary to check that power ratings are not exceeded. Equation 7 gives a requirement of 0.1 watt, which is well within the rating of the SC5141.

Equations 8 and 9 yield the required trigger current level. Thus, a value of I_2 of +1 ma will turn the switch ON and a value of I_2 of -0.8 ma will turn it OFF.

For a second example, assume that it is required to switch a -28 -volt power supply to a load resistance that varies from 1,000 to 3,000 ohms. The load current, therefore, varies from 28 to 9.3 ma.

When the load current varies, it is necessary to design for the maximum value of its range. Therefore, the design will be based on the limiting case where R_L is 1,000 ohms.

Equation 5 will indicate a required bias current, I_1 , of 30 ma using a margin of about 7 percent. From Eq. 6 is determined a value of R_n of 820 ohms using a margin of about 18 percent.

Power in R_1 will be 0.74 watt, so a 1 or 2-watt resistor must be used between pins 1 and 2 on an SC5140 NRE.

The trigger current required to turn the switch ON will be about +3.4 ma. Because the load resistance varies, the trigger current required to turn the switch OFF also varies. As R_L is changed from 1,000 ohms to 3,000 ohms, $I_{2\text{ OFF}}$ varies from -2 ma to -2.7 ma.

The examples indicated are only representative of the many possible applications of the Negative Resistance Element family. The circuits shown are primarily for NRE types designed primarily for use with negative voltage supplies. Types are also available which will allow the use of positive voltage supplies.

By P. BOHLEY, R. CALDECOTT
 R. McGOWN
 R. C. TAYLOR
 Antenna Laboratory,
 Dept. of Electrical Engineering,
 The Ohio State University,
 Columbus, Ohio

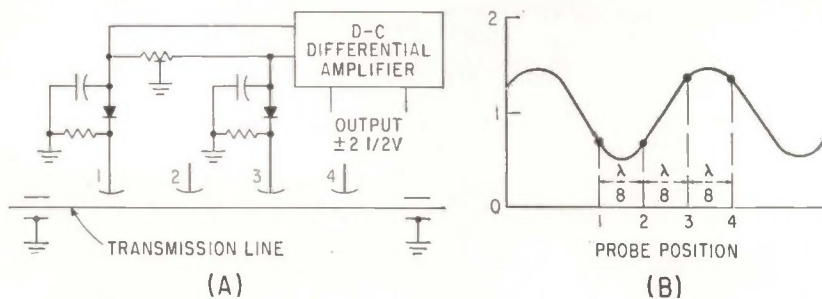

TYPICAL four-probe reflectometer feeding a differential amplifier (A) and probe positions on a standing wave (B)—Fig. 1

Measuring Missile Antenna

Antenna vswr and phase information are easy to obtain in the laboratory where an abundance of test equipment is available. However, getting this data from a missile in flight presents some obvious problems. This instrument makes it possible even during reentry

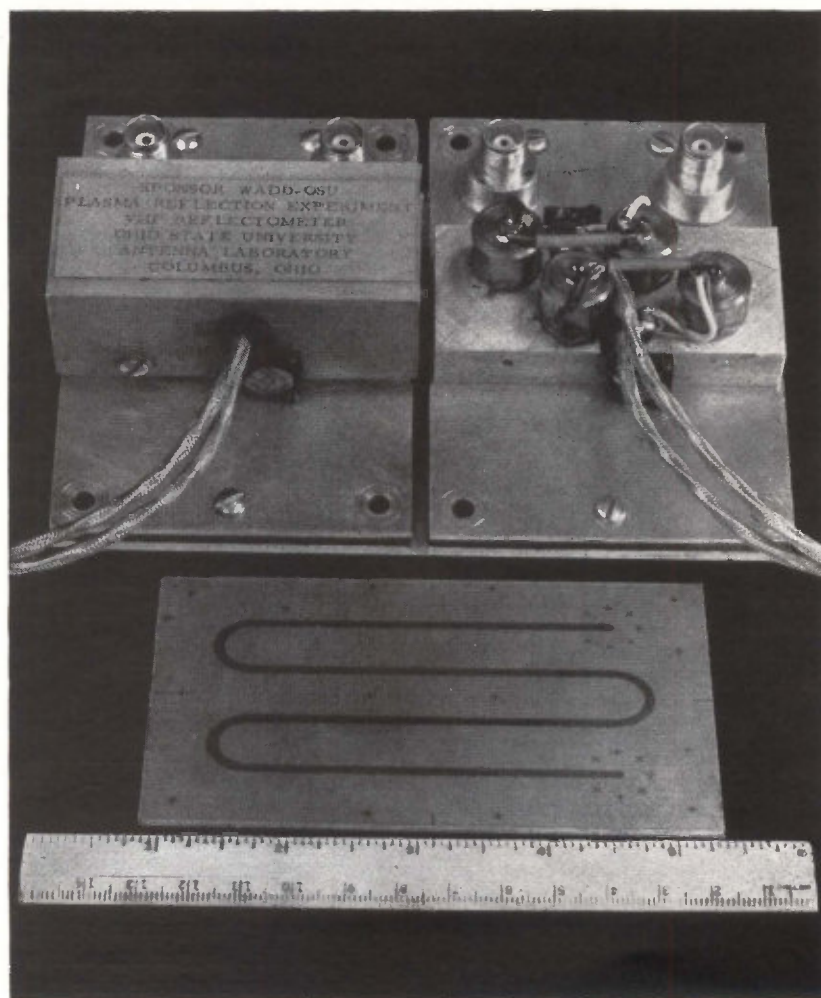

VHF reflectometer represents one configuration of the instrument—Fig. 2

MEASUREMENT of missile antenna impedance during flight requires the use of a light-weight, compact, automatic system with a fast response time. Response time is particularly important during vehicle reentry where available measurement time is only a few seconds, and it is desirable to obtain the variations in impedance of the antenna during this extremely short time interval. Conventional laboratory techniques using slotted lines and bridges usually require an operator and bulky equipment that has slow overall response time. Many systems have been developed for missile applications that will measure the vswr of an antenna; but to measure impedance, which is a more useful quantity, phase information is required.

DESIGN—The design of the instrument is based on a method¹ where probes are spaced one-eighth of a wavelength apart along a transmission line. The probes are capacitance coupled to the transmission line, and each in turn is connected to a crystal rectifier as shown in Fig. 1A. The output voltages from the crystal rectifiers are then fed to two differential ampli-

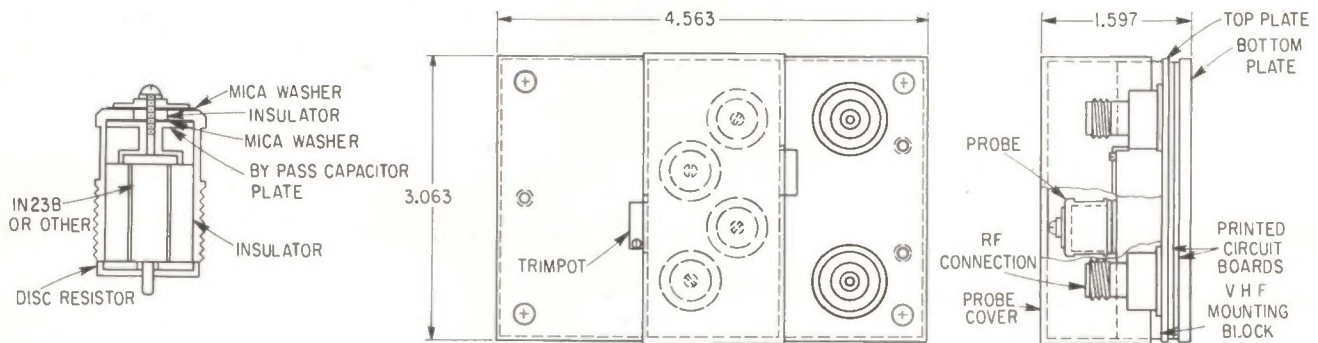

CONSTRUCTION details for a single probe and mounting assembly for four probes—Fig. 3

Impedance In Flight

fiers. The circuit for probes 2 and 4 in Fig. 1A is identical to that shown for probes 1 and 3. A typical standing-wave pattern with an arbitrary location of the four probes is shown in Fig. 1B.

A photograph of the 4-probe network designed to operate at a frequency of 237 Mc is shown in Fig. 2. The transmission line is fabricated using strip-line techniques to reduce physical size and facilitate coupling the probes to the transmission line. The block containing the four probes and crystals is constructed so that the unit can be easily removed and attached to another strip line designed to operate at a different frequency.

The 4-probe network using the strip-line transmission line can be designed to operate over approximately the same range of frequencies as coaxial cable.

Previous difficulties with the 4-probe technique have been principally those of obtaining identical crystals, disturbance of the standing wave by the probes, and the lack of a constant-power signal source. By using balancing po-

tentiometers and variable-gain differential amplifiers, the requirement of identical crystals has been eliminated except for the square-law response. In addition, the probe coupling to the transmission line is adjustable by thin Teflon washers, thus further reducing the requirement for identical crystals. Differential amplifiers allow the probes to be more loosely coupled to the transmission line for a given signal-to-noise ratio, resulting in reduced disturbance of the standing wave. Due to the development of stabilized signal sources, the requirement for constant-power oscillators has been fulfilled, especially if an isolator is used on the oscillator output. Calibration measurements of the instrument have shown a total system error of less than 5 percent.

Calibration of the instrument can be accomplished by placing a sliding short on the r-f output terminals and adjusting until a maximum occurs on one channel; the balancing potentiometer on the other channel is then adjusted for zero output. The process is then repeated for the case of a maxi-

mum on the other channel. The gain of the differential amplifiers is then adjusted so that the maximum voltages on the two channels are the same and equal to 2.5 volts if standard telemetry outputs are required.

The 4-probe network shown in Fig. 2 has been subjected to the following environmental conditions and found to perform satisfactorily: shock test, 20 g; vibration, 15 g; temperature, 200 F; and altitude to 1 mm of pressure.

APPLICATION—Although the 4-probe instrument was developed for a particular missile application, the instrument can be used in various laboratory experiments. The 4-probe method has been satisfactorily used at 3.2 Gc in coaxial cable, and at 10 Gc in waveguide. One waveguide system incorporates a standard slotted guide so that the positions of the probes may be easily adjusted to operate over the frequency range of the waveguide. Other possible applications include error-sensing systems for high-speed impedance matching, and automatic high-speed impedance plotting in shock-tube or pattern range measurements. This work was sponsored in part by the Propagation Division of The Aeronautical Systems Division, Air Force Systems Command, United States Air Force, under Contract No. AF33-(657)-10426.

REFERENCES

- (1) A. L. Samuel, An Oscilloscope Method of Presenting Impedance on the Reflection Coefficient Plane, *Proc IRE*, 35, No 11, p 1279-1283, Nov. 1947.

HIGH-FLYING MEASUREMENTS

Measuring the characteristics of a missile antenna in flight poses several problems. Not the least of these is measuring phase data in very short time periods such as missile re-entry. To accomplish this, the authors have developed a system that has very fast response time. Moreover, the basic device can be applied to a number of configurations in the vhf range

New Approach to Weather Data:

Data now being gathered by radiosonde balloons and rockets can be supplemented with data gathered by pods mounted on aircraft. Improved weather forecasting may result, particularly on the west coast where data over the Pacific Ocean is scanty

By H. R. FARRAH and P. E. SHERR, Bendix Systems Div., Ann Arbor, Michigan

WEATHER RESEARCH and prediction has historically been hampered by a lack of reliable, up to the minute data—especially data about the upper atmosphere. To repair the lack, scientists started taking instruments aloft in balloons in about 1885. At the turn of the century, giant kites with instruments aboard were flown as high as

3 kilometers, controlled by piano wire and machine driven winches.

Even today, with balloon borne radiosondes and Tiros satellites, more weather data is wanted by the forecasters. The west coast particularly, whose weather is made far out over the Pacific ocean, would benefit by a more efficient reporting system.

What could become a help—and has already aroused Federal Aviation Agency and U.S. Weather Bureau interest—is a new meteorological pod that can easily be attached to subsonic aircraft. Small, lightweight, the meteorological pod has been successfully flown and has transmitted useful data over a 1,680 Mc telemetry link to conventional ground meteorological devices (GMD).

The M-9 meteorological pod, shown mounted on a Navion in one of the photographs and disassembled in the other, is a self-contained system designed as an easily mounted external store for drones and light aircraft. Two hours of operation is provided by the integral battery power supply, which is rechargeable.

Measurement of the basic atmospheric parameters of static pressure, total temperature and ambient dewpoint are obtained from the pod as shown in Fig. 1; the sensor complement could be expanded to measure variable atmospheric properties of less common interest such as ozone content and microwave index of refraction gradients.

Static pressure is measured at ports located on the probe extending forward from the nose cone of the pod. The ports are connected to a Giannini Model 451212 high resolution aneroid pressure transducer. A Rosemount Engineering Corporation Model 101 total temperature probe extending well beyond the pod boundary layer is used as a housing for a Bendix thermistor to detect the air temperature.

Dewpoint measurement is made

HOW'S THE WEATHER UP THERE?

The idea of gathering weather data by flying around in an airplane and measuring the items of interest is not new. Usually the sensors were poked through the airplane's skin, powered by the plane's electrical system, and the data recorded in the plane.

But why not build a self-contained, self-powered pod that can be attached to small airplanes and will telemeter data back to the ground? The authors did it. Now the U. S. Weather Bureau is going to attach it to drones and send it into cyclones in Kansas

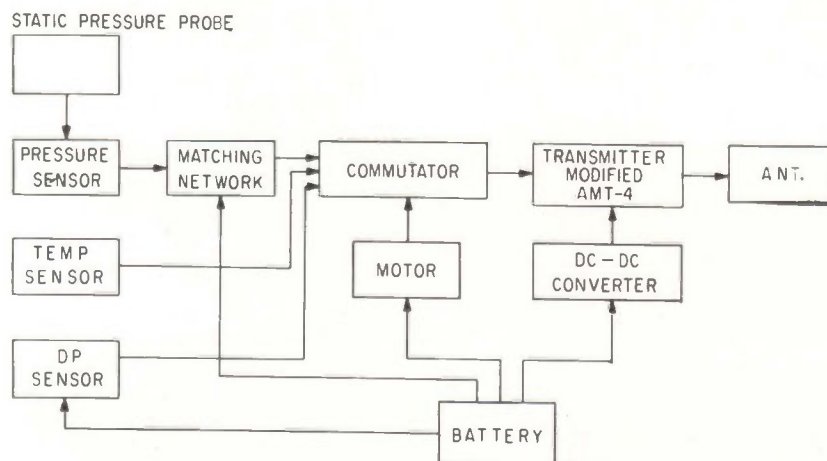

BESIDES sensors shown here, pod could be adapted to measure ozone content and other variables—Fig. 1

Every Plane a Station

with a mirror hygrometer.

All three sensors provide a variable resistance output proportional to the meteorological variable measured. These resistances are used on a time-shared basis to control the repetition frequency of 50-microsecond pulses carried on the 1,680-Mc data link; time-sharing is accomplished by a motor driven commutator. Transmitter circuits are identical with AN/AMT-4 radiosonde transmitter normally used with the GMD ground equipment.

Except for the dewpoint sensor, the system is of conventional design.

DEWPOINT SENSOR — A block diagram representation of the dewpoint sensor appears in Fig. 2. The hygrometer operating technique is to control the temperature of a metallic mirror surface such that a thin film of dew or frost is maintained on this surface with approximately constant thickness. At the equilibrium condition of unchanging thickness, the saturated water vapor pressure over the mirror film is equal to the partial pressure of water vapor in the air sample flowing through the sensor. The mirror surface temperature is then the dewpoint of the air sample.

A photoelectric system, compensation network, chopper, pulse amplifier, demodulator and bistable power stage are used for controlling the mirror temperature to provide a constant reflectance of film thickness.

An ultra-small bead thermistor mounted directly below the mirror surface converts the mirror temperature (dewpoint) to a resistance analog output signal. A copper-constantan thermocouple is also soldered in the mirror rod adjacent to the bead thermistor to calibrate the thermistor.

SERVO—The control method is a bang-bang servo, where the output temperature control has only two stable states, either full on or full off.

Figure 3 is a schematic diagram of the electronic part of the instru-

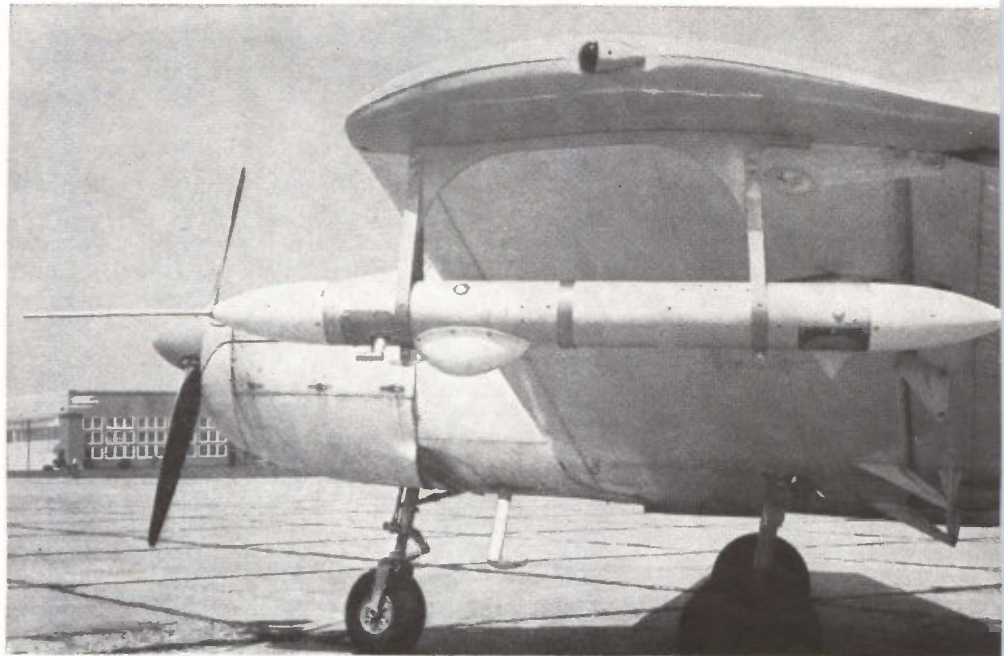

WEATHER DATA telemetry pod mounts to wings of subsonic aircraft. Maneuverability of aircraft, including drones, provides a flexible way to obtain weather profiles at altitudes up to 40,000 feet

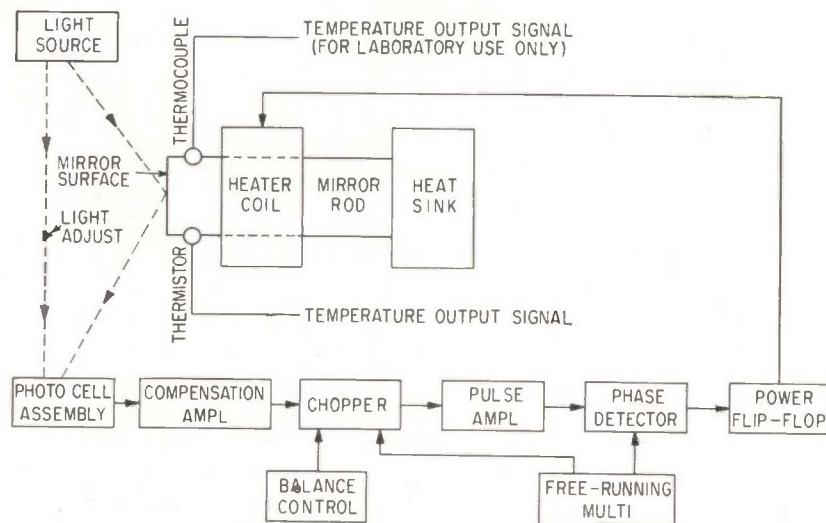

WHEN MIRROR surface temperature is at the dew point, the thickness of the water or frost film on the mirror will stay constant. The servo circuit error signal is developed from the light reflected from the mirror to hold film thickness constant—Fig. 2

ment. The photocell assembly is driven by a regulated d-c voltage supplied by D_1 . The photocells are two arms in a bridge, with the other arms of the bridge consisting of R_2 , R_3 , and R_1 . Bridge balance is accomplished by varying R_3 . In practice the output of the bridge

shows little sensitivity to temperature variations since temperature matched cadmium sulfide cells are used. Analysis^{1,2} reveals that a lead network of the form

$$\frac{(0.25 S + 1)(0.05 S + 1)}{(0.01 S + 1)(0.005 S + 1)} \quad (1)$$

is needed to insure adequate re-

sponse with a small limit cycle.

Because of drift, it is advantageous to chop the d-c signal from the photocells so that an a-c amplifier can be used. The compensation can be introduced in three possible places: d-c compensation can be used either before the signal is chopped, or after the signal is demodulated; an a-c carrier type lead network can also be employed. However, the a-c lead technique would require a drift-free oscillator if an RLC network were used, or would introduce severe noise problems if a synchronous carrier were employed. It was decided to put the lead network prior to chopping the d-c signal for two reasons:

- If saturation occurs in the a-c amplifier, it is desirable to employ lead compensation before the saturation component

- If a lead network is used after demodulation, then a highly filtered demodulator must be employed to filter out the carrier noise.

If a passive lead network is used, a severe d-c attenuation would result that would lower the signal-to-noise ratio in the chopper because

of temperature drift. If an active d-c lead network is used with d-c gain, then drift problems would be encountered.

The compensation scheme finally used is shown in block diagram form in Fig. 4. High frequency gain is provided by the a-c coupled amplifier, while a straight through d-c path is provided for by resistor R_{10} .

FEEDBACK — One complication arose in that the a-c coupled amplifier must have positive gain, which means that R_{10} forms a positive feedback path. Care must be taken in the final design to insure against instability. It is desirable to keep the positive feedback low not only for stability, but also to reduce the effect of chopper noise. The final design of the compensation network, shown in the schematic, Fig. 3, approximates the theoretical compensation required in Eq. 1. Minor changes were also made in the form of the lead compensation after the unit was operating. These optimized changes are also reflected in the schematic.

The chopper and pulse amplifier are of fairly standard design. A free-running multivibrator supplies square wave excitation for the chopper and demodulator at a frequency of approximately 5,000 cps.

The demodulator supplies a train of positive or negative spikes, depending on the phase of the signal at the output of the pulse amplifier. If the output at F is in phase with F_1 , C_8 can discharge rapidly through D_3 , but must charge slowly through R_{22} . The result is a train of negative pulses that will be passed by D_5 . When the signal at F changes phase, it will be in phase with F_2 . Capacitor C_8 can then charge rapidly through D_4 , but must discharge slowly through R_{23} . This will give rise to a train of positive pulses, which will be passed by D_6 ; D_3 and D_6 serve the function of only passing negative and positive spikes respectively. The train of negative and positive spikes are added in R_{26} and applied to the input of the power stage. Because of the logic circuits involved, a positive and negative train of pulses cannot occur at the same time.

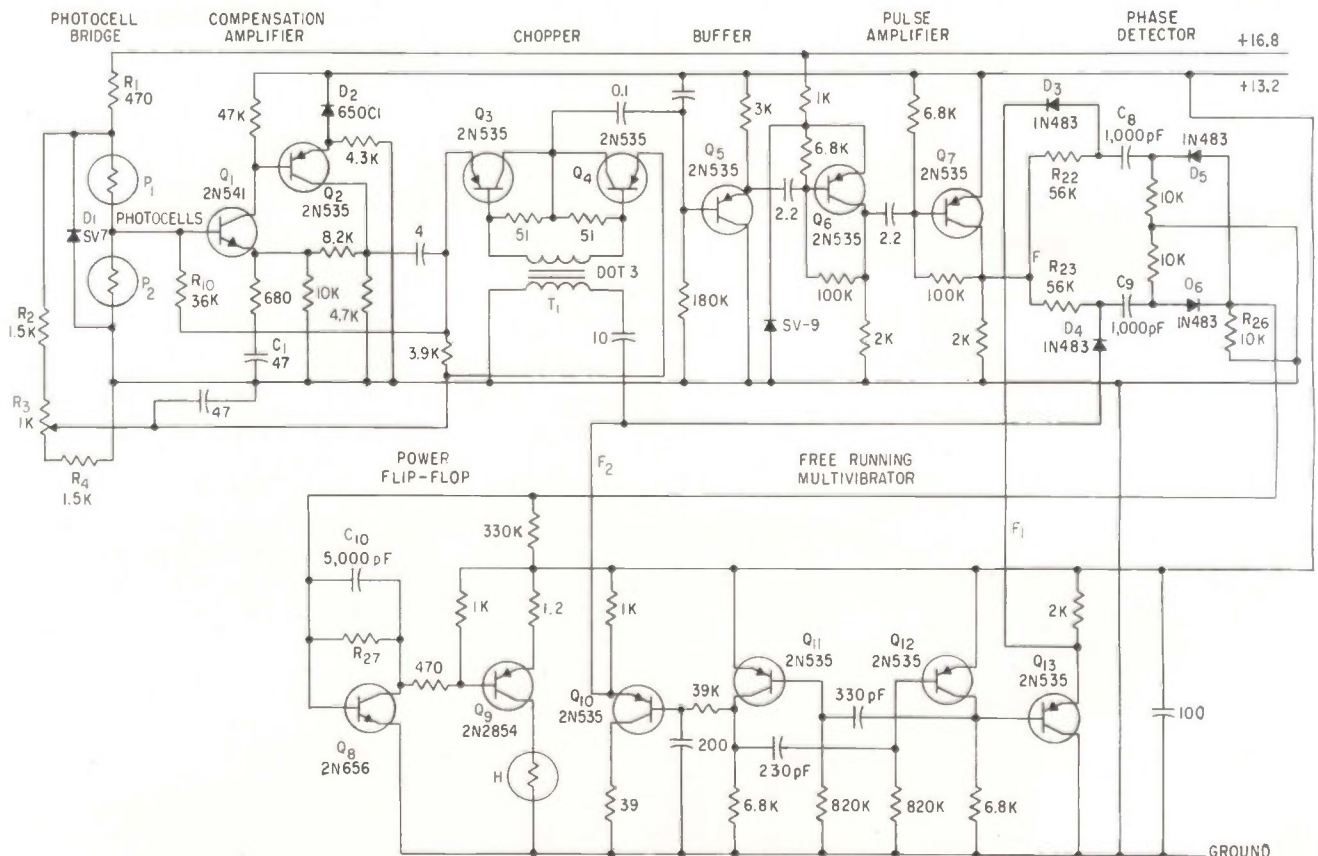

PHOTOCELL bridge circuit develops error signal for the dew point servo system. The heating coil is in the collector circuit of Q_9 —Fig. 3

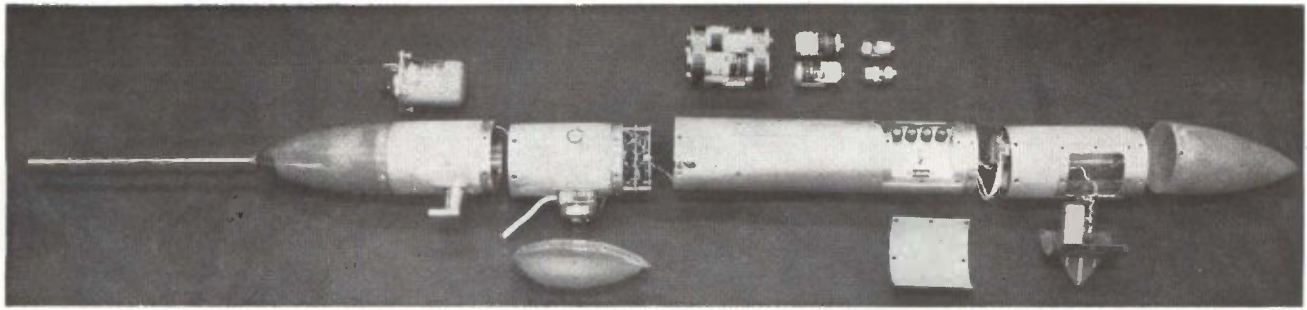

POD is 61½ inches long, weighs 16½ lb, will measure pressure, temperature and dew point for two hour periods with power from its own batteries

OUTPUT—The power stage is a complementary flip-flop. Transistor Q_8 directly drives Q_9 , a power transistor. Positive feedback is provided from the heater (the load for Q_9) through R_{27} to the base of Q_8 , with C_{10} used for speedup. Circuit values are chosen so the positive train of pulses turns Q_8 and Q_9 on while negative pulses turn the stages off. Since Q_9 is operated in the pulse mode, only a small amount of power is dissipated in Q_9 , thereby obviating the need for large cooling fins.

In operation, R_8 is adjusted for proper frost thickness on the mirror

surface. Since a bang-bang system is employed, the mirror temperature oscillates about the correct value, with a maximum excursion less than 0.5 C, increasing to 1.5 C at -80 C.

Oscillation frequency is about 4 cps, changing slightly with dewpoint and air sample velocity. Response of the sensor is good, especially at dewpoints above -40 C. A typical example of the transient response of the sensor is shown in Fig. 5. The response to a 10 C step change is less than 2 seconds, with a 1 second response to the peak.

The latest dewpoint sensor designs use thermoelectric mirror temperature control and more conventional servo design. The model presented in this article was chosen as the topic of discussion because it incorporates some unusual circuit features while embodying all of the general dewpoint sensor characteristics, and because it was the first dewpoint sensor installed in the M-9 meteorological pod. Future versions of this pod will contain the more advanced sensor. Instead of a bang-bang circuit, the new model uses a proportional servo, containing all d-c transistor circuits.³ The drift-free amplifier in the new model has been detailed elsewhere.⁴ In all other respects, the theory of operation of the sensor is the same in the two models and the performance is comparable. Operating times of greater than 2 hours are possible with the new sensor.

The data gathering system is capable of obtaining high performance meteorological data from subsonic aircraft at altitudes up to 40,000 feet.

The authors acknowledge help from the Aerial Reconnaissance Laboratory of WADC and the Meteorological Development Laboratory of AFCRL for sponsoring work leading to the development of the dewpoint sensors.

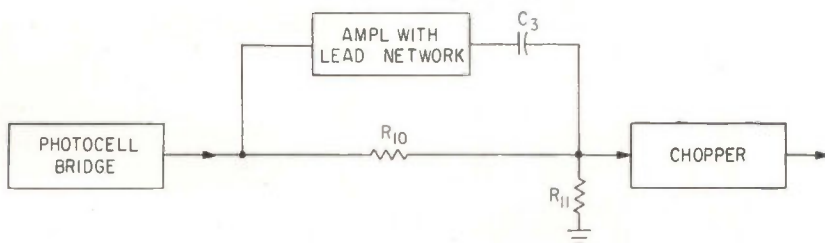

COMPENSATION circuit for dew point servo combines a-c and d-c signals—Fig. 4

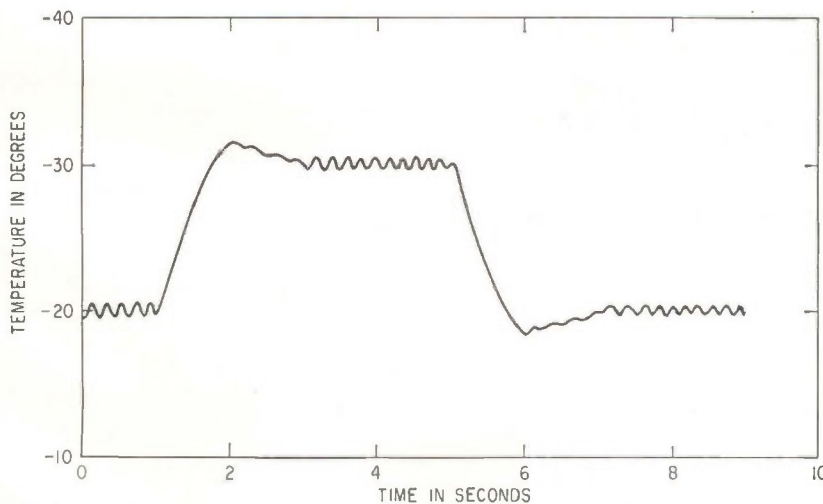

TRANSIENT response of dew point bang-bang servo—Fig. 5

REFERENCES

- (1) "Final Report—AN/AMQ-15 Air Weather Reconnaissance System—Dewpoint Phase I," Bendix Research Laboratories Division Report No. 1319, August 1959, Contract AF 33(600)-37984.
- (2) H. R. Farrah, "A Non-Linear Analysis Technique for an On-Off Servo with Velocity Inputs," *IRE Trans. on Automatic Control*, p 13, Vol. AC-7, No. 2, March 1963.
- (3) Farrah, Vitale, and Young, "Development of a Dewpoint Sensor for Atmospheric Sounding," Bendix Research Laboratories Division, Report No. 2055, March 1962, Contract AF 33(600)-41821.
- (4) P. A. Michaels, "A Low-Level Transistorized D-C Amplifier," *Proc National Telemetry Conference*.

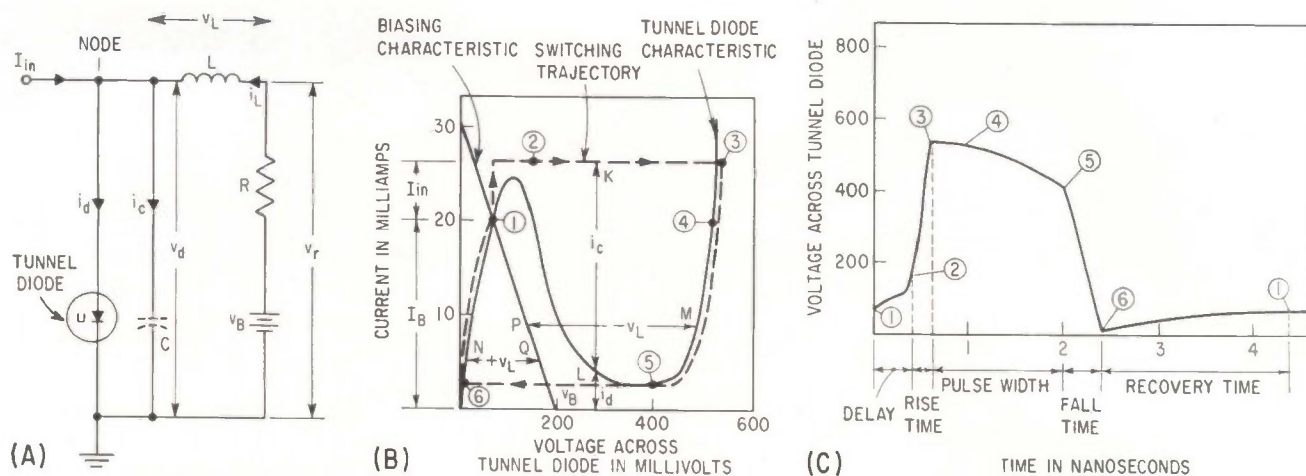

MONOSTABLE CIRCUIT using a tunnel diode (A), with analysis of switching (B) and output waveform (C)—Fig. 1

Tunnel Resistor—New Device

Pulse amplifier gain and speed can be increased with this new tunneling device. A typical pulse amplifier is described

By M. COOPERMAN and R. H. BERGMAN
EDP Advanced Development
Engineering,
Radio Corporation of America,
Camden, New Jersey

MICROWAVE LOGIC?

Tunnel resistor biasing has permitted logic functions to be performed in a 40-gate subsystem at 300 Mc shift and count rates. The authors say that with improved fabrication techniques, it should be possible to increase the speed of a tunnel-resistor monostable stage to 1 Gc

TUNNEL RESISTORS are new tunneling devices that permit circuit design for better use of tunnel-diodes. Specifically, they allow tunnel-diode pulse amplifiers to operate with increased gain, speed, tolerances and reduced power dissipation.

A tunnel diode, operating in a monostable mode, provides a practical way of getting pulse amplification. A simple monostable circuit, Fig. 1A, is analyzed graphically in Fig. 1B. Resistor R and V_B form the biasing characteristic that intersects the tunnel-diode characteristic at point 1 of Fig. 1B. To simplify the analysis, assume that inductance L of Fig. 1A is relatively large, so that there is negligible change of current in R as the diode switches from point 1 to point 3. Under these conditions, when a current step input is applied to node 1 of Fig. 1A, it all goes into the tunnel diode. When the total current into the tunnel diode exceeds the tunnel-diode peak current, the operating point switches to point 3 along the trajectory indicated by the dotted lines in Fig. 1B. The trajectory is a plot of the total current available to the diode versus the voltage across the diode. Thus, during the time that the diode is switching from point 1 to point 3, a current of $I_{in} + I_B$ is available, resulting in a constant-current dynamic load line of this magnitude.

Switching speed from point 1 to point 3 depends on how quickly diode capacitance C can be charged to the new voltage. In general, the instantaneous rate of change in voltage across a capacitor C may be expressed as

$$\frac{dv}{dt} = \frac{i_c}{C} \quad (1)$$

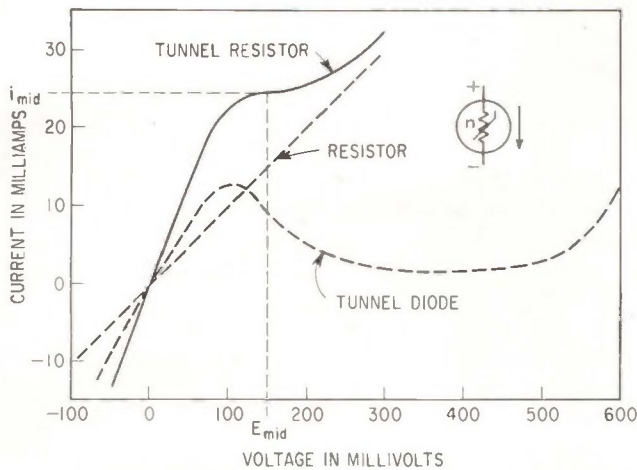

TUNNEL RESISTOR characteristics compared to tunnel diode—Fig. 2

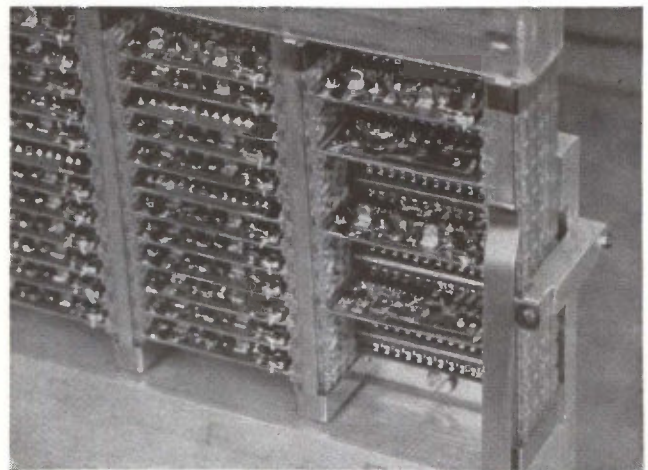

LOGIC SUBSYSTEM built with tunnel resistor biased circuit

to Speed up Tunnel Diodes

where v is capacitor voltage i_c is the charging current, and t is time. In this case, i_c is the difference between the total available current, $I_b + I_{in}$ and the current i_n . The instantaneous charging current, i_c , is shown graphically in Fig. 1B as the distance KL . Thus, for a given diode, the longer the distance KL , the faster the switching.

If the input is removed immediately after the diode reaches point 3, the operating point of the tunnel diode moves to point 4. This is not a stable state, however, and the current in L decays causing the dynamic operating point to proceed toward point 5.

The speed of moving from point 4 to point 5 depends upon how quickly the current in the inductance can change. In general, the instantaneous rate of change of current in an inductance, L , may be expressed as

$$\frac{di_L}{dt} = \frac{v_L}{L} \quad (2)$$

where i_L is the current in the inductance, v_L is the voltage across the inductance, and t is time. In this case, v_L is the difference between the biasing network voltage, v_r , and the tunnel-diode voltage v_d (Fig. 1A). Voltage v_L is shown graphically in Fig. 1B as the distance PM . Thus, for a given inductance, the longer the distance PM , the faster the dynamic operating point moves (relaxes) from point 4 to 5.

When point 5 is reached, the current in L continues to decrease since v_L is not zero. This action takes the diode once again into the negative-resistance region, causing it to switch to point 6 by a mechanism similar to that which caused it to switch from points 1 to 3.

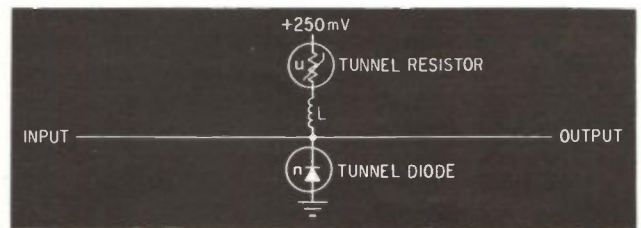

MONOSTABLE STAGE using tunnel resistor—Fig. 3

Point 6 is still not stable since v_L is not zero. Note, however, that v_L has changed sign, which causes the current in L to increase until point 1 is reached. Here again, for a given inductance, the longer the distance QN , the factor the operating point moves (relaxes) from point 6 to point 1. Point 1, the initial operating point, is stable since both v_L and i_c are zero. The voltage, V_o , obtained from the switching trajectory, is shown as a function of time in Fig. 1C. The waveform of the complete cycle is subdivided into time intervals as indicated. The delay, rise time and fall time are functions of i_c/C in their respective regions. The pulse width and recovery time are functions of L/v_L , in their respective regions. Thus, the monostable circuit provides a reshaped voltage pulse and can supply an output current approximately equal to I_b (Fig. 1B) which is several times the magnitude of I_{in} , and current amplification is obtained.

SAVING TIME—For high-speed operation, it is necessary to reduce the total cycle time to a minimum. Most of this time is composed of the pulse

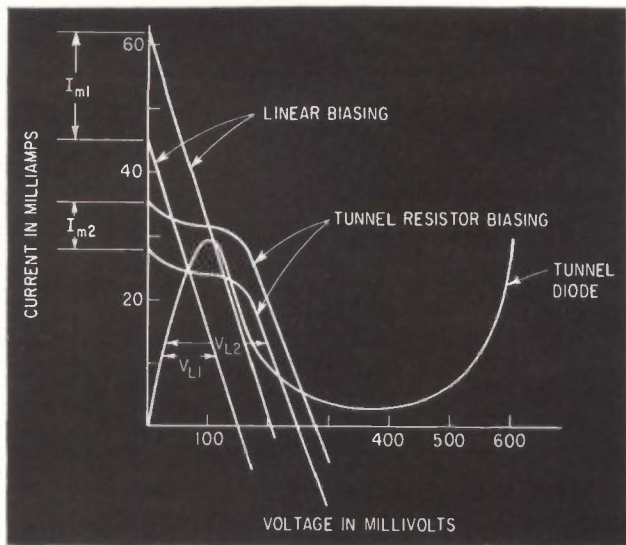

COMPARISON between tunnel resistor and linear biasing—Fig. 4

width and the recovery period, which decrease as the inductance is decreased. When repetition rates of hundreds of megacycles are desired, the inductance has to be made so small (about 5 nanohenries) that it becomes ineffective in blocking the input current from flowing into the biasing network while the tunnel diode is switching over the peak. Thus, a larger input current is required, but that reduces current amplification and usefulness of the circuit.

An ideal answer to this problem is the tunnel resistor. The tunnel resistor is formed by plating a resistive path across a tunnel-diode junction. The two are then mounted in one glass package to form one device. The process of plating and mounting in one package is used in order to keep the stray reactive elements to a minimum, otherwise, the tunnel diode may oscillate, thereby preventing the two elements from acting as one device. The characteristic of a tunnel resistor and the elements from which it is formed are shown in Fig. 2.

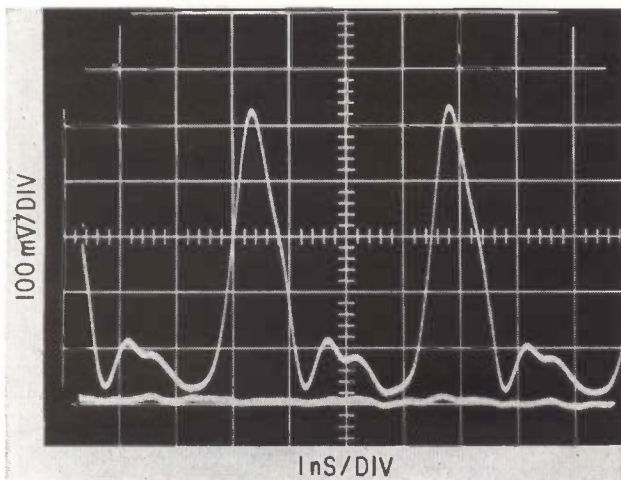

OUTPUT WAVEFORM of tunnel resistor pulse amplifier—Fig. 5

MONOSTABLE STAGE—In a monostable circuit employing a tunnel resistor, Fig. 3, the tunnel resistor merely replaces the resistor of Fig. 1A. The biasing characteristic formed by the tunnel resistor and the supply voltage is shown superimposed on the tunnel-diode characteristic Fig. 4. For comparison, the linear resistor biasing characteristic is also shown.

Assuming L to be so small that it has a negligible effect in delaying the flow of current, then the characteristics must be raised above the peak of the tunnel diode in order for switching to take place. It can be seen that the tunnel resistor provides a desirable biasing characteristic as it is relatively flat when the tunnel diode switches over the peak; it then drops sharply to permit monostable operation. Therefore, the input current (I_{in}) required for switching is considerably less than the input current (I_{in}) in the linear resistor case. Output waveform is shown in Fig. 5.

ADVANTAGES—Tunnel resistor biasing eliminates the need for any inductance as far as switching over the peak is concerned. However, some inductance (about 5 nanohenries) is needed to slow the current decay in the tunnel resistor so that an output current can be supplied to a load. If linear biasing were used, this amount of inductance would still cause a relatively long recovery time. Here again, the tunnel resistor offers an advantage. In accordance with Eq. 2, the recovery time decreases as v_L is increased. It can be seen that, in the recovery region, v_L is larger with Eq. 2, the recovery time decreases as v_L is larger with tunnel resistor biasing, thus resulting in faster recovery for a given inductance.

The tunnel resistor also offers a tolerance advantage which is due to the flat region of its biasing characteristic. For a given tunnel resistor, the biasing voltage may be varied by approximately ± 20 percent with negligible effect on the current bias point.

All these features are obtained with relatively low power dissipation. In this case, the power dissipation is about 5 milliwatts. In general, however, the dissipation is directly proportional to the tunnel-diode peak current. Consequently, by lowering the peak current, the dissipation per stage can be reduced. Power dissipation in the order of microwatts can be realized.

The tunnel resistor monostable stage can be useful in many applications where high speed is required. An immediate application of this stage is found in logic circuits for high-speed digital computers. Using this stage for high-speed amplification with low power dissipation, a logic subsystem, capable of shifting and counting at 300 Mc, was constructed.

The tunnel resistor was proposed by H. Ur, of this activity, and developed in collaboration with J. T. Wallmark, C. W. Benyon and L. Varettoni, of the RCA Laboratories, Princeton, New Jersey. The authors wish to express their gratitude to other colleagues at Pennsauken, Somerville and Princeton, for their support and cooperation. Particular thanks are due R. K. Lockhart and J. N. Marshall for their guidance and support.

7½ TEST YEARS

CUT TO 18 MONTHS FOR

60 MILLION DATA TEST HOURS!

BETTER
MEASURING
FROM 

In determinations of acceleration factors for metal and carbon film resistors for the high reliability MINUTEMAN Program, Electra Manufacturing Company uses an Automatic Resistor Data Logging System designed and built by Electro Instruments.

This system, in conjunction with other test equipment, has accumulated over 60 million resistor hours of data in the last 18 months. *Without this accelerated testing system, 7½ years of test time would have been required!* Most important, the EI system gives Electra the confidence that their products meet stringent government specifications.

As in this EI system created for Electra, EI *all solid state* Digital Multimeters are the basis for *better measuring* at greater speed, higher reliability, significant cost savings and a much lower investment.

Whether your interest lies in spacecraft, electronic components or industrial processes, we can demonstrate to you the advantages of EI digital instruments in measuring DC volts, AC volts, DC ratios, resistance, capacitance, inductance and impedance. Let EI *all solid state* Digital Multimeters or Complete Systems provide swift, accurate, low cost solutions to your measurement and display problems!

For full details on EI's individual digital instruments, or our complete capabilities in the field of measurement, display and recording—write direct to Electro Instruments, Inc.



Technician at Electra Manufacturing Company inserts test resistors in the Automatic Resistor Data Logging System designed and built by Electro Instruments. Over 60 million resistor hours of data were accumulated in 18 months.



Electro Instruments, Inc.
8611 Balboa Avenue, San Diego 12, California

Avalanche Transistors Test 10-Nsec Logic

Three avalanche transistors eliminate delay-line circuit

By ROGER CHARBONNIER,
Rochar Electronique,
Montrouge, Seine, France

PARIS—Three avalanche transistors, driven by a single sawtooth signal, eliminate cumbersome delay lines in a pulse generator developed to test response of 10-nanosecond decade counters to compact groups of two or three pulses.

The generator delivers to a common output recurrent groups of two or three pulses of a few nanoseconds' duration at an individually adjusted delay, following an internally generated synchronizing pulse. Recurrence frequency is not important.

Of a number of transistors tested in development, type 2N706A proved most successful for the avalanche pulsers. This silicon transistor delivered pulses of 8 to

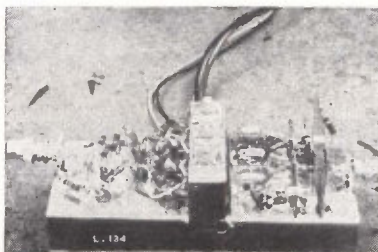

BREADBOARD MODEL of pulse generator that delivers recurrent groups of two or three pulses to common output—Fig. 1

10 volts peak amplitude into a 75-ohm termination, with risetime below 1 nanosecond.

The three independent avalanche pulsers (see Fig. 1, 2) are driven by a sawtooth signal through adjustable bias networks. Transistors Q_1 and Q_2 form an emitter-coupled free-running multivibrator. Sync output from the collector of Q_2 uses a decoupling diode. Transistor Q_3 operates as a sawtooth generator, with a 47-pf integrating capacitor; it drives the emitter follower Q_4 .

Three individually biased ampli-

fiers Q_5 , Q_6 and Q_7 provide for delay adjustment. Each drives one silicon transistor (Q_8 , Q_9 , Q_{10}) working in avalanche mode. Three 100-ohm resistors connect the three transistors to a single output.

H-V SUPPLY—The high-voltage supply uses a 120-v d-c generator and 120-K resistor. The high voltage value is critical and must be adjusted to ± 10 percent. That means the series resistors in the high-voltage circuit must be vari-

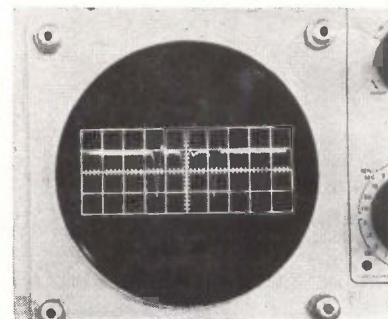

GROUP OF THREE pulses, displayed at 5 nanoseconds/division, illustrate generator output—Fig. 3

able, or the transistors suitably selected.

While no long-run test has been made to determine the life expectancy of the avalanche transistor, performance to date has been stable. Figure 3 shows a typical group of three pulses displayed at a sweep velocity of 5 nanoseconds per unit length.

Author acknowledges the help of Gerard Dao in developing the breadboard circuit.

Physicist Says Baryon, Lepton 2 Basic Particles

THE BARYON and the lepton are the only two basic elementary particles and 30 other so-called "particles" are merely different states of these two, asserts Victor F. Weiss-

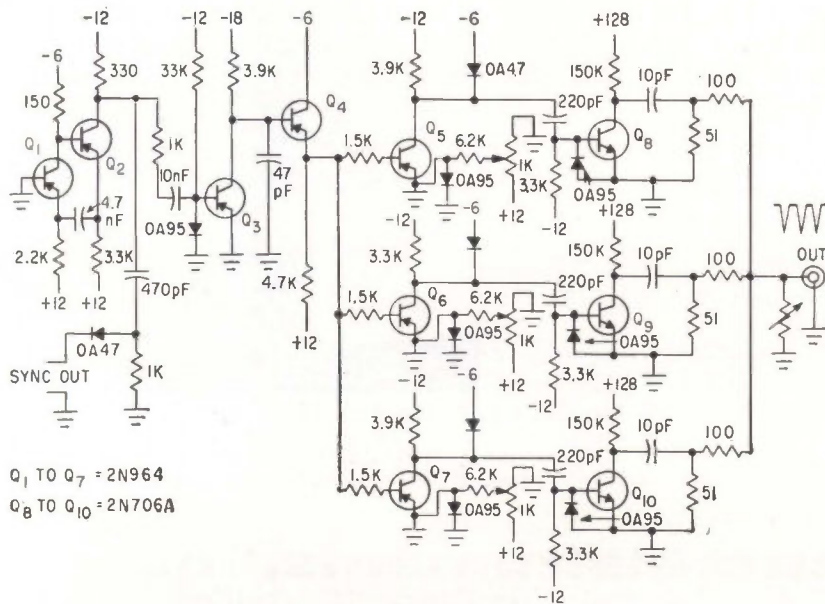

Q_1 TO Q_7 = 2N964
 Q_8 TO Q_{10} = 2N706A

PULSE GENERATOR schematic circuit shows pulse processing—Fig. 2

NEW!

MODE INDICATORS FOR VOLTAGE/CURRENT REGULATED POWER SUPPLIES

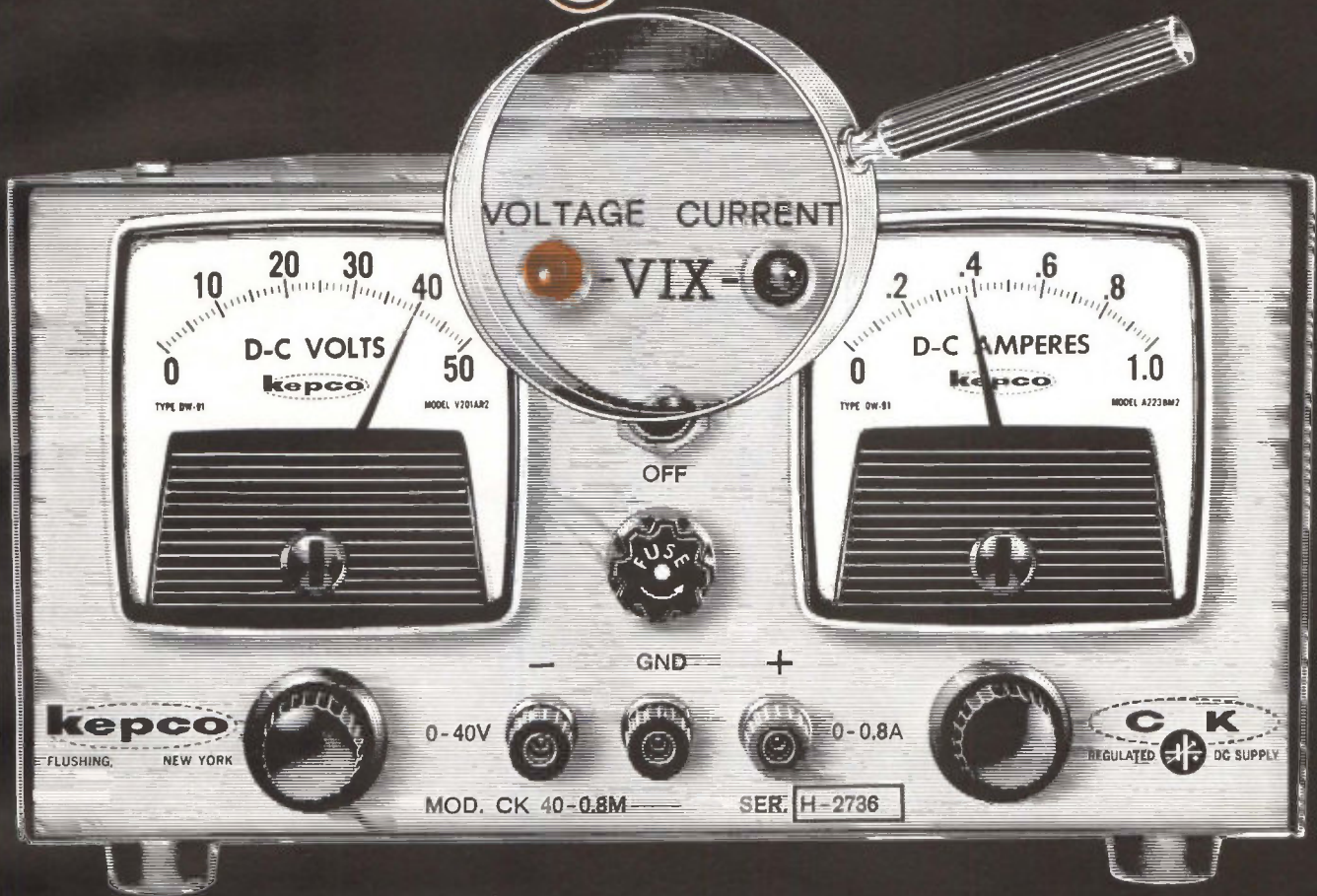

KEPCO TIME-SAVING **VIX*** INDICATORS

Kepco voltage/current regulated power supplies in the CK series now come equipped with voltage/current mode indicators called "VIX".*

Time saving and added utility are provided by these indicators which show at a glance whether the power supply is in its voltage regulating mode or its current regulating mode.

This indication is especially useful in the Kepco CK Models since they have extremely sharp cross-over characteristics.

*VOLTAGE/CURRENT CROSSOVER INDICATORS

Send for complete data on
Kepco CK Models
featuring NEW "VIX" Indicators.



NEW **CK** SERIES
REGULATED DC SUPPLY

0.01% REGULATION and STABILITY

DC OUTPUT RANGE		MODEL	PRICE
VOLTS	AMPS		
0-2	0-8	CK 2-8M	\$330.00
0-8	0-5	CK 8-5M	330.00
0-18	0-3	CK 18-3M	290.00
0-36	0-1.5	CK 36-1.5M	290.00
0-40	0-0.8	CK 40-0.8M	255.00
0-60	0-0.5	CK 60-0.5M	290.00

131-38 SANFORD AVE. • FLUSHING 52, N.Y.
(212) IN 1-7000 • TWX# 212 539-6623
Cable Address: KEPCOPOWER, NEWYORK

"A-OK"

FOR PPM-FOCUSING of TWT's . . . ALNICO VIII from ARNOLD

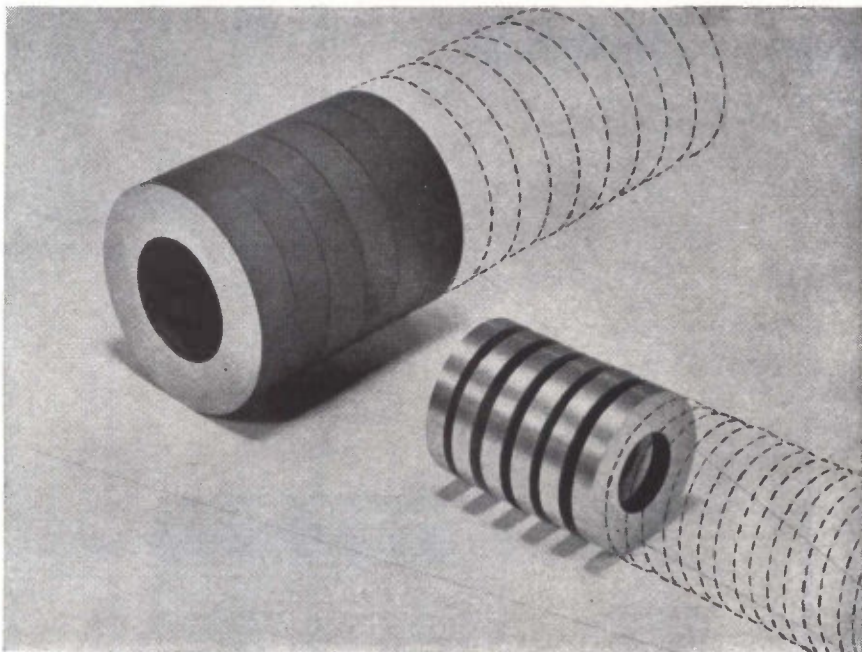

For periodic permanent magnet focusing of traveling wave tubes, Arnold offers you Alnico VIII rings in the finishes you require, as illustrated above, and in sizes as small as 1/2" diameter or less, weighing a fraction of an ounce.

They're characterized by highly uniform magnetic properties from front to back and from piece to piece. You're assured of more constant flux density and more uniform field patterns from end to end of the stack required to accomplish the needs of your structure.

Use Arnold Alnico VIII for its high coercive force (*in excess of 1400 oersteds if required*), for relatively high energy product, and for lowest temperature coefficient

(*you can eliminate temperature-compensating elements and hold down TWT size*). It's available from Arnold in production quantities, and in various shapes and sizes to meet your requirements.

Also use Alnico VIII for other microwave applications, such as tubular-type straight field focusing magnets, and in backward wave oscillators, etc. In addition, Alnico VIII is your logical choice where length is a premium, or where strong demagnetizing fields are encountered—such as in two-pole rotors, motors, generators, and torque transmission through an air gap.

• Let us help you engineer it to your needs. For more information, ask for Bulletin PM-119.

431091A

ADDRESS DEPT. E-7



ARNOLD

SPECIALISTS in MAGNETIC MATERIALS

THE ARNOLD ENGINEERING COMPANY, Main Office: MARENGO, ILL.
BRANCH OFFICES and REPRESENTATIVES in PRINCIPAL CITIES

kopf, MIT physics professor and director-general of CERN.

Writing in "Physics Today", Dr. Weisskopf says: "I contend that the view that there is a large number of particles is based on a misunderstanding which is arrived at because of three practices: each anti-particle of a given particle has been called a new particle; each excited state of a particle has been called a new particle; entities such as the light quantum have been called particles, a point which is perhaps a matter of taste."

The leptons are a class of elementary particles that have a spin of one-half, and mass less than that of the nucleons. Leptons include electrons, positrons, neutrinos and antineutrinos. Baryons are commonly defined as those elementary particles whose mass lies in the interval from the nucleonic mass up to but not including the deuteron mass. Baryons include protons and neutrons.

Color Vision May Be A Waveguide Phenomenon

NEUROLOGICAL CODE that is used by animals and humans in identifying colors is close to solution, according to scientists at Goodyear Aerospace Corporation in Akron, Ohio.

Results of this work may influence control of color in color printing, color television and color photography, said A. J. Cacippo, head of Goodyear's Life Sciences department.

He explained that the retina of the vertebrate eye contains millions of microscopic light receptors, the rods and cones, which receive light as electromagnetic energy and translate it into intensity and color information. The color sorting may be accomplished by a kind of waveguide effect involving all the cones. Previous classical theory postulated three different kinds of cones, each sensitive to only one primary color.

In the research study, scientists recorded the electrical signals from the retinæ of laboratory animals exposed to different colored lights. Results indicate that the color information is carried by the waveform of the response signal. A



WAVEFORM carrying color information from retina of test animal to its brain is intercepted and analyzed on oscilloscope

special network of nerve cells then recognizes each basic waveshape as a specific color.

The work is supported by the development of an analog-computer model of the dynamics of the vertebrate color identification process.

Undersea Weather Forecast By Number Studied

UNDERSEA WEATHER forecasting is the subject of Navy-sponsored research program initiated at Lockheed-California in Burbank, California, under a \$49,000 contract.

Series of mathematical equations, to be developed from existing oceanographic data and theory, will provide numerical models for computer use, to analyze and forecast sea temperature, sound velocity, and currents, analogous to automatic numerical weather forecasting methods.

The models would be applied to various ocean zones to permit rapid automatic area and depth analysis of existing and future data using computers.

The resulting knowledge of short-term variations in undersea conditions is essential to the accurate detection and tracking with sound of objects such as submarines, and could be also used for avoiding enemy sonar signals.

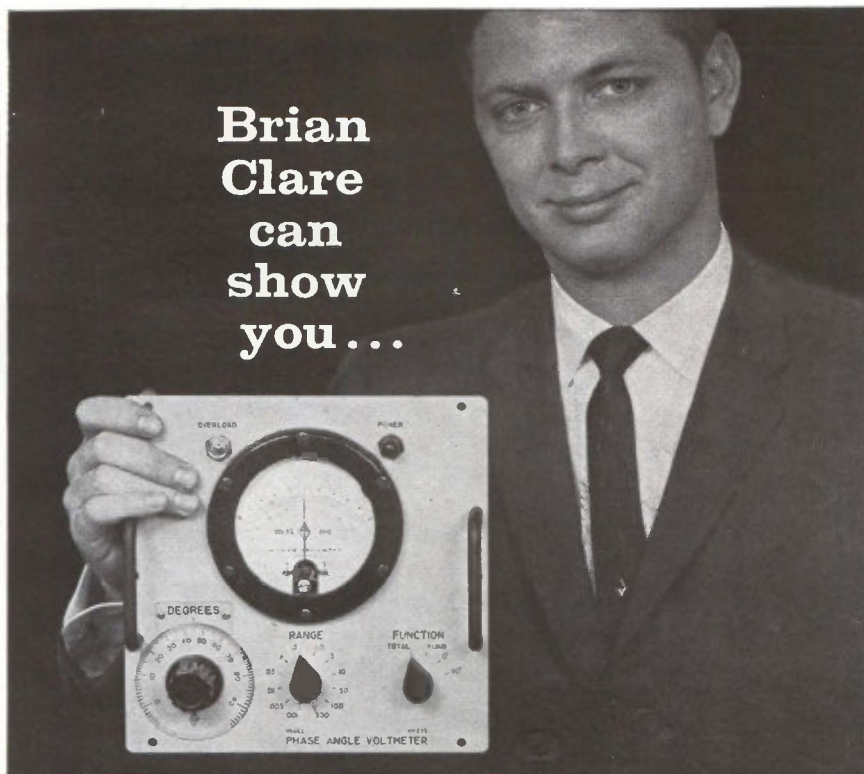

Brian Clare can show you...

Sales Engineer, North Atlantic Industries

how to match a PAV to tough GSE specs

From its all solid state circuitry to its MIL-type hermetically sealed meter and plug-in amplifiers, every design feature of the Model VM-235 Phase Angle Voltmeter has been selected for rigorous service in Aerospace Ground Equipment.

Your North Atlantic man can quickly demonstrate how this rugged, miniaturized version of North Atlantic's famous PAV provides direct, accurate reading of phase angle, nulls, total, fundamental, quadrature and in-phase voltages—even under the roughest of military field conditions.

The VM-235's ability to meet tough system specs is demonstrated daily in operational and support equipment for USAF and Navy aircraft and missile programs. Its capabilities for complex measurements are shown in the abridged specifications below:

Voltage Range.....	1 mv to 300 v f.s., 12 ranges
Voltage Accuracy.....	±2% f.s.
Phase Accuracy.....	dial: ±1°; meter: ±3% of F.S. degrees
Signal Frequency.....	400 cps
Input Impedance.....	1 megohm
Reference Input.....	26 v or 115 v
Meter scale.....	3-0-3, 10-0-10 linear
Phase Angle Dial.....	2 scales, 90° (elec.) apart
Nulling Sensitivity.....	2 microvolts (phase sensitive)
Harmonic Rejection.....	55db (with filters)
Dimensions.....	8 ¹ / ₁₆ " h. x 8 ¹ / ₂ " w. x 6 ³ / ₁₆ " d.

North Atlantic's field engineering representative in your area has full data on the VM-235, as well as modified versions for specific systems requirements. For his name, call or write today, or request Bulletin VM-235.



NORTH ATLANTIC industries, inc.
 TERMINAL DRIVE, PLAINVIEW, L. I., NEW YORK • Overbrook 1-8600

Will British TWT's Make Further Inroads?

They now hold healthy chunk of traveling wave markets. Here's why

By **DEREK BARLOW**
McGraw-Hill World News

OVER 500 microwave repeater stations in North America now use British traveling wave tubes. British spokesmen say that low costs and two technical breakthroughs have captured for Britain around 60 percent of all U.S. and Canadian twt requirements on long-haul microwave communication links.

Market is worth over two million dollars a year.

Presently two British firms, Mullard Ltd. and M-O Valve Company, share this market between them, supplying around 3,000 traveling wave tubes a year to North America.

Directors of both British firms pinpoint lower costs and a different manufacturing philosophy than Stateside firms as the initial reasons for their success. Following hard came two technical developments—lightweight periodic permanent magnet focusing, and later directly replaceable tube elements within the magnet stick.

COST—First British break into the market came in 1957 when costs of British twt's were often one-fifth or even one-tenth those of comparable U.S. twt's. First sale was achieved by M-O Valve for the East Canadian Rimouski link, an order worth \$150,000.

Next big order went in 1960 to Mullard for tubes worth \$2 million. This was the installation that RCA designed for Western Union in the 3,300-mile multichannel transcontinental microwave communications link.

Last year Mullard obtained an



BRITISH firms send over 3,000 traveling-wave tubes a year to North American installations

order, worth half-a-million dollars for the MM600 microwave system built for the Canadian Pacific Canadian National Telecommunications System from Montreal to Vancouver.

Similarly, M-O Valve has been increasing sales to around 1,500 twt's a year in the States with applications on the Alaska Dewline, the trans-Canadian links, and the Maritime-Montreal system. With the aim of even bigger sales, M-O Valve recently set up a special outlet in Toronto to cover North America.

M-O Valve's sales chief, David La Frenais, looks for a twenty-fold increase in sales, spread over the next five years. Peter Britton, general manager for Mullard tubes, pinpoints Britain's success to "the extensive research and development programs that were stimulated by Britain's major stake in this telecommunications field."

TECHNOLOGY—Tight control of production is a must for manufacture of twt's on the scale practiced by Mullard and M-O Valve.

British manufacturers say reasonable profit levels are achieved

by operating close statistical feedback quality control systems that reduce rejects to negligible quantities. The tube comprises an electron gun and a long wire helix mounted in an evacuated precision bore glass tube around which is the magnetic focusing system. Tolerances are down to one-hundredth of a millimeter.

Typical of the diagnostic techniques used at M-O Valve are fault prevention routines of 100-percent measurement on 35 components and a 100-percent x-ray inspection of all gun assemblies. Construction techniques for the helix are another area where company's method differs from present U.S. practices, company says.

Using only simple medium precision machines, company engineers have devised techniques that achieve exact tolerances. Details are not disclosed. Inspection is required only for checking winding pitch at the end of the

Solid-State Pot

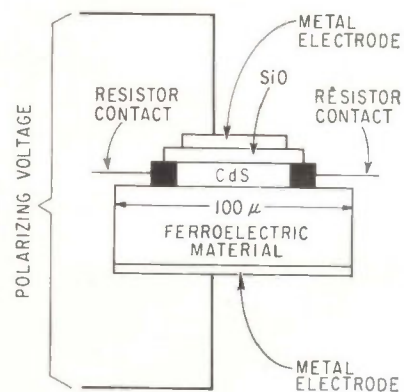

POLARIZING VOLTAGE determines resistance between contacts in new solid-state variable resistor described by Y. Tarui and J. L. Moll of Stanford University (*ELECTRONICS*, p 24, June 21). Experimental potentiometer could be useful in adaptive systems or integrated circuits



**Are you a
COMPLETELY
INFORMED
electronics
engineer?**

Today you may be working in microwaves. But on what project will you be working tomorrow? You *could* have read electronics this past year

and kept abreast of, say, microwave technology. *There were 96 individual microwave articles between July, 1961 and June, 1962!*

But suppose tomorrow you work in some area of standard electronic components, in semiconductors, in systems? Would you be up-to-date in these technologies? Did you read the more than 3,000 editorial pages that electronics' 28-man editorial staff prepared last year?

electronics is edited to keep you current *wherever* you work in the industry, *whatever* your job function(s). If you do not have your own copy of electronics, subscribe today via the Reader Service Card in this issue. Only 7½ cents a copy at the 3 year rate.

electronics



**X-ray
to be
sure**

Now, here's true quality control on transistors and other electronic components. X-ray is an economic and efficient non destructive testing method that assures reliability and provides a film record to prove it. Send samples for free test report or request literature.

X-ray Problem? Ask Balteau About It!



BALTEAU ELECTRIC CORPORATION
10-14 MEADOW ST. • STAMFORD, CONNECTICUT

CIRCLE 201 ON READER SERVICE CARD

TO ORDER REPRINTS

Fill in, cut out coupon below

Insert in envelope and mail to:

electronics Reprint Dept.

330 W. 42nd Street, New York, N. Y. 10036

REPRINT ORDER FORM

(To help expedite mailing of your reprints please send cash, check or money order with your order.)

For Reprints of the latest Special Report:

Rodio Frequency Interference

Send me..... Reprints of Key No. R-39 1-10 copies 75¢ each, 11-24 copies 60¢ each, 25 or more 50¢ each.

For Reprints of previous Special Reports or Feature Articles fill in below:

Send me..... Reprints of Key No.(s).....@.....¢ each.

(For prices, see Reader Service Card.)

*For orders of Bulk Reprints of other editorial articles in this issue or post issues:

Send me..... Reprints of page No.(s).....of issue date.....

of article entitled.....

*Minimum bulk order 100 copies. You will be advised of costs by return mail.

Name

Number of Street

City, Zone No., State

NOW ONLY \$40
WILL BUY A

NEXUS
SGX-3 solid state
operational
amplifier

- Now in production for fast delivery.
- Use G.E.'s new family of 2N2711 transistors for maximum performance per dollar.
- SGX-3 gain 10,000 and input Z 0.1 megohms: \$40 (1-gg).
- SGX-4 gain 100,000 and input Z ¼ megohm: \$60 (1-gg).
- Write for Technical Bulletin SGX (4/63).

NEXUS
RESEARCH LABORATORY, INC.
19 Needham St., Dedham, Mass. 617-326-8414

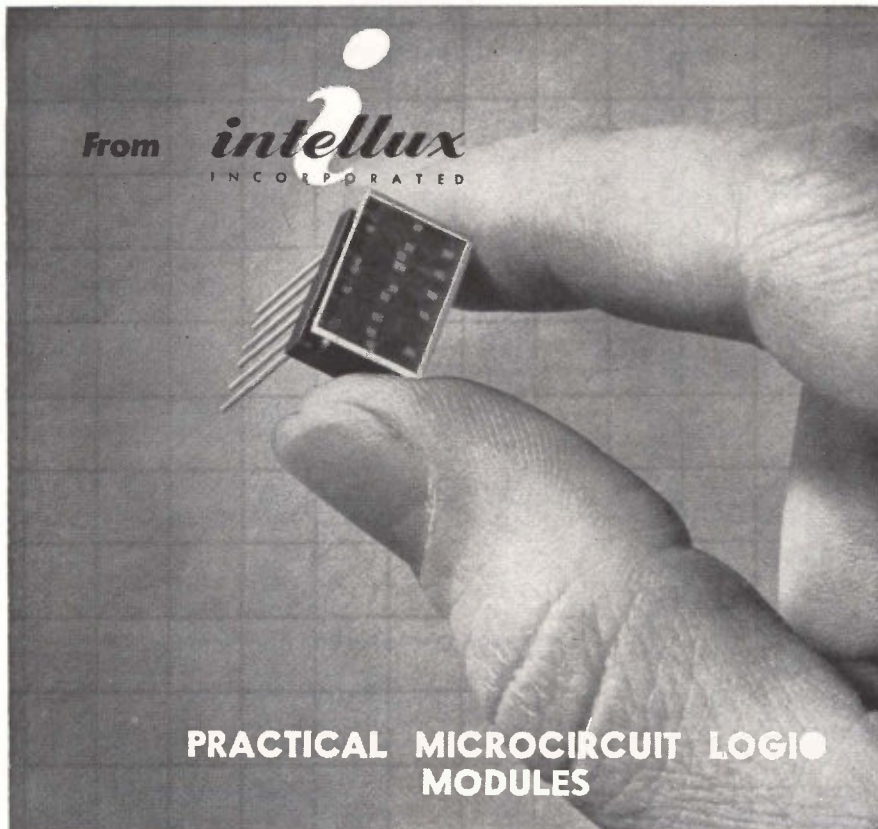

Tired of the "Madison Avenue Pitch" on micro-circuitry? . . . Take a look at **practical** logic modules.

The INTELLUX approach is realistic—it's here today—in any volume (2, 3, 4 or 5,000 per week if you want)—and best of all their use can put profit back in your computer-sales.

Drop us a card for the complete story, but here are the brief facts:

- ▶ Available immediately . . . Flip Flops, Double NOR Gates, Gate Buffers and Free-running Multivibrators.
- ▶ They can be mounted physically adjacent to each other . . . and still be interconnected.
- ▶ Standard semiconductors are married to thin film passive components.
- ▶ Stability of resistors guaranteed to 30,000 hours.
- ▶ Outperforms discrete component modules . . . and on a par with the most sophisticated microcircuits.
- ▶ So rugged in construction they need no special handling—just treat them like any ordinary radio component.
- ▶ Unquestioned economic and reliability advantages.

For complete data and specifications write:

intellux
INCORPORATED

P.O. Box 929, Santa Barbara, Calif.

helix. At all other points the windings automatically maintain a pitch-to-pitch ratio better than 0.005 in.

Permanent magnet focusing, employing staked barium ferrite magnet disks has long been a feature of British traveling wave tubes. Field uniformities of better than one-percent over the ten-inch tube lengths are obtained by adjustment of the 35 individual magnet units. A controlled curie point sheet wrapped around the magnet acts as a variable magnetic path shunt. This compensates for flux variations over a -30 to 69 C temperature range.

Latest improvement is direct tube replacement within the permanent without the need for re-matching the tube to the waveguide system. Tube alignment within the housing is corrected by merely adjusting four screws.

Planar Technology Aims For Consumer Markets

DES PLAINS, ILL.—A large scale use of silicon planar transistors in consumer products was predicted over the next few years by C. R. Gray, manager of commercial engineering at Philco's Lansdale Division.

Opinions were presented at the annual Spring Conference on Broadcast and Television Receivers.

Gray says that the planar devices will soon provide performance equal or nearly equal to germanium units and at a lower cost to consumer product manufacturers.

Circuit design hurdles will keep germanium units in some sockets a bit longer, according to Gray. Interchangeability problems should be minimized as semiconductor manufacturers gain more experience in making planar devices for consumer products, Gray says. Direct-coupled audio circuits are a natural market for silicon transistors because of their low leakage currents. Medium power audio circuits will gain the 3 to 5 watt ratings of silicon units, compared to maximum ratings under one watt provided by germanium transistors. The silicon devices will fill the gap between the 250-mw germanium units and the higher power tran-

sistors, according to Gray. Though high power silicon units are now expensive, compared to germanium, he believes that price breakthroughs are in the offing.

A good bit of the maximum available gain of the silicon devices will have to be sacrificed to achieve the same degree of stability now obtained for germanium devices in broadcast and fm radio circuits.

PRICE FACTOR—Television is the last consumer market open to transistorization. It now hinges only on relative prices of transistors and tubes. Gray notes that either germanium or silicon units are capable of producing a tv set competitive with tube sets in terms of sensitivity. But if silicon devices can be priced right, there is a market here for 125 to 150 million transistors a year.

The video output stage will be a silicon device because of its better combination of voltage, power and frequency. Vertical output will use the lowest price device. And though presently either germanium or silicon can be used for the horizontal output, more design work needs to be done.

For uhf television tuners, Gray claims that present designs using a local oscillator will welcome the power dissipation and frequency performance of the silicon transistor. But he also sees the possibility that the better noise figure and reduced oscillator radiation which results from the addition of an r-f stage may force American manufacturers to adopt the European type of an r-f amplifier/converter tuner circuit eliminating the diode mixer. In this case, he concedes that germanium devices will hold a performance edge for some time. Germanium transistors will also be better if the industry goes to a single combination uhf-vhf tuner which would require an r-f stage, he said.

Solid-State Ignitions

ALREADY installed on Ford's heavy duty trucks, solid-state ignition systems may not be far away for passenger car use, according to Hoffman Electronics. Company says reliability is now proven.

Unusual stability

in miniature, surface-mounted platinum temperature sensors

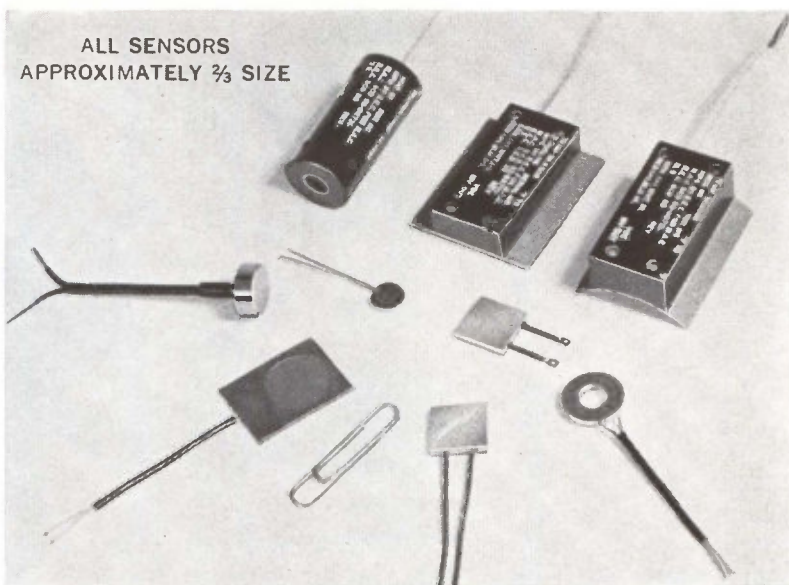

Performance is excellent for such small sensors in the REC line of miniature surface sensors. Range covered is from -435°F. to $+1800^{\circ}\text{F.}$ Repeatability after 10 consecutive shocks from liquid nitrogen at -320°F. to silicon oil at 300°F. is within $\pm 0.1^{\circ}\text{F.}$

The easily attached sensors can be cemented, spot welded or clamped to surfaces. Cylindrical models fit around standard small pipe sizes.

REC surface sensors have elements of highest purity platinum wire, fully annealed and mounted so that the resistance wire is well isolated from any strain in the surface. Outer cases are platinum, stainless steel, epoxy compounds, or ceramic, depending on the model. Some have interchangeable bridge networks to provide a choice of temperature-voltage relationships.

For more details, write for Bulletin 9625, Platinum Resistance Surface Temperature Sensors.

A complete precision line

Rosemount Engineering Company designs and manufactures high quality precision equipment in these lines:

- | | |
|--|--|
| Air data sensors | Surface temperature sensors |
| Total temperature | Pressure sensors |
| Pitot-static tubes (de-iced) | Accessory equipment and aeronautical research |
| Immersion temperature sensors (including cryogenic) | |

For more information please write for the REC catalog. Specific questions on any temperature or pressure problems are welcomed.



**ROSEMOUNT
ENGINEERING
COMPANY**

4900 West 78th Street • Minneapolis 24, Minn.

SPECIALISTS IN TEMPERATURE & PRESSURE MEASUREMENT

Will Lasers Weld Circuit Components?

Power density exceeds requirements. Extended pulse used

By K. W. DUNLAP

D. L. WILLIAMS

Advanced Technology Laboratories
General Electric Co.
Schenectady, N. Y.

SPOT WELDS with adequate penetration can result with the pulsed output of a ruby laser yielding 6943 Angstrom radiation. Work is continuing at GE's Advanced Technology Laboratory (formerly the General Engineering Laboratory) to determine production welding possibilities and required parameters. Improvements are being made in existing experimental equipment.

There is little question that the short, high-power laser pulses delivering energy in the range of tens of joules will be valuable in circuit-component welding. This can be done right now, but laser welding will not be competitive until it can be operated on a continuous basis or at a high repetition pulse rate. While drilling and cutting of material has been popularly demonstrated almost without effort, the process of applying laser beams to welding is proving to be much more difficult.

EXPERIMENTATION — Regulation of the energy-delivering rate required for different welding applications is made by varying pulse life with a pulse-forming network. Such regulation prevents exceeding of the critical power density characteristics of materials. Thus, while power delivered in a 2-millisecond pulse would vaporize a particular material, delivered in a 12-millisecond pulse it would permit much greater dissipation of heat through the material without exceeding fusion temperatures in most of the weld-area.

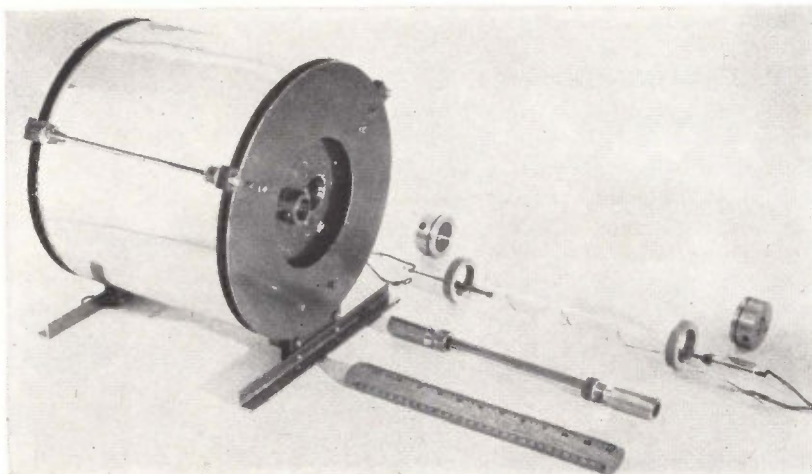

HIGH ENERGY laser head components consist of: cylindrical reflector housing (left), 8 × 0.6-inch ruby rod, linear flash lamp

Schematic diagrams of pulse-forming network hookups are shown in Fig. 1. As shown, pulse duration is varied by using different combinations and inductances in energy storage bank. The two hookups illustrated are for operating with 2 and 12-millisecond pulses.

EQUIPMENT — Pulses generated by network energize the xenon

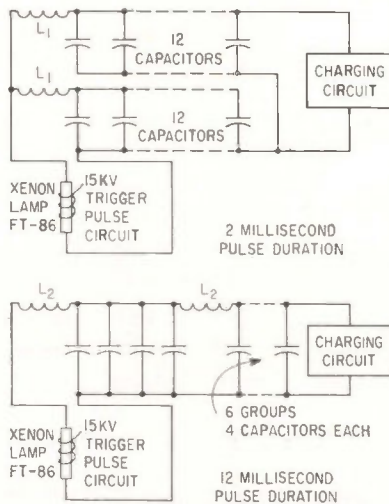

TWO HOOKUPS of pulse forming network give 2-millisecond and 12-millisecond laser welding pulses. The 12-millisecond pulse results in more satisfactory welds—Fig. 1

lamp that optically pumps the ruby rod. Rod is 8 inches long by 0.6 inch in diameter. In addition to having its shaft highly polished, one end of rod has a total-internal-reflecting roof accurate to better than one second of arc to provide 100 percent reflection on one end of the basic cavity. The other end is flat to within $\frac{1}{4}$ wavelength of light emitted by ruby and is coated with a 50-percent reflective dielectric coating.

The highly collimated light generated by this configuration requires only a single element lens for converging it on work area. Since beam divergence with this rod is 1.3 degrees, a 1-inch focus f/1.5 lens could be placed up to 2 feet from laser head in those applications when energy source must be located remote from the work.

The laser head when used with the power supply described below has an overall efficiency of about 0.1 percent. Energizing lamp in head has a nominal rating of 9,000 joules. Thus, when capacitance of power supply is charged to this level, output energy of slightly over 9 joules is generated.

The power supply was constructed by ATL to actually de-

Here's how Martin Company saves \$16,000/year cleaning safety suits for TITAN II!



PROBLEM: It used to be an expensive and time-consuming job for Martin Company's Canaveral Division to clean these critical safety garments. The suits protect TITAN II launch-stand personnel from toxic propellants during fueling and countdown. They must be cleaned after each wearing for toxicity and sanitation reasons. Formerly, Martin did this laboriously by hand with detergents at \$6.35 per suit.

SOLUTION: An entirely new cleaning system based on FREON fluorocarbon solvents. FREON is an efficient *selective* solvent. It quickly removes toxic fuels or vapors, oil, grease and dirt from the suit while not affecting plastic or metal parts in any way.

To clean the suits, Martin uses FREON in a modified shower cabinet, fitted with several nozzles to drench 2 suits thoroughly—both inside and out. Since adopting this system, cleaning time per suit has been cut from 1½ hours to 5 minutes; cost, from \$6.35 to \$1.10. So in one year, with 3,600 safety suits cleaned, that's a saving of \$16,000!

Martin also likes FREON because it is non-flammable, nonexplosive, and has very low toxicity—making it safe and easy for workers to handle. And—extremely important—contaminated FREON is easily purified for reuse over and over again.

Wherever *you* have a critical cleaning problem, components or assemblies, electronic, electrical or mechanical, it's quite possible FREON solvents could improve operations and cut costs. We'd be happy to discuss it with you! First step: send the coupon or Reader Service Card for our new cleaning booklet.

FREON®

solvents



Better Things for Better Living
... through Chemistry

MAIL COUPON FOR NEW BOOKLET ON CLEANING

E. I. du Pont de Nemours & Co. (Inc.)
FREON Products Division
N-2420E-7, Wilmington 98, Delaware

Name _____ Title _____

Company _____

Address _____

Please send new booklet on FREON solvents for precision cleaning. (Offer good in U.S.A. only.)

I am interested in cleaning _____

I would like Du Pont to send a cleaning specialist.



MIL TYPE CRYSTALS

Now Available: New James Knights brochure listing MIL Type Crystals in common use today—for both military and non-military equipment designs. James Knights also manufactures comparable type crystals having increased quality and performance characteristics. Tell us your requirements. Write for latest brochure.

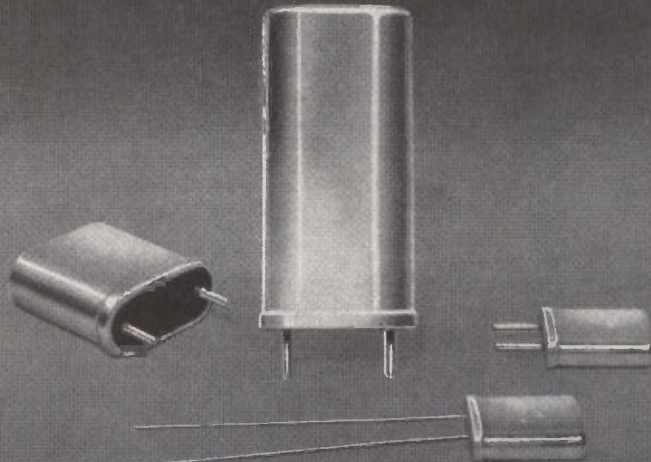

THE JAMES KNIGHTS COMPANY • Sandwich, Illinois

CIRCLE 202 ON READER SERVICE CARD

PRECISION TIMING A PROBLEM?

HERE'S HELP...

New, complete catalog describes full line of Standard precision timers. Various models have scale divisions from 1/1000 sec. to 1/5 sec., totalize from .360 sec. to 60 min., are available in accuracy range from ± 0.002 sec. to ± 1 sec.

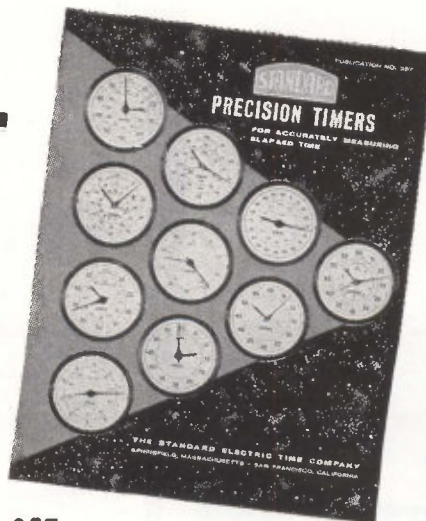

REQUEST Catalog No. 257



THE ONE TIMER WITH ALL THE FEATURES

THE STANDARD ELECTRIC TIME COMPANY

89 LOGAN STREET • SPRINGFIELD, MASSACHUSETTS

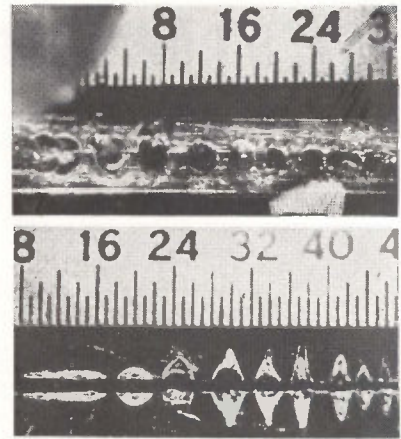

WELDS obtained with 2-milli-second pulse. First three overlapping welds made with focus 5/32-inch inside best focus. Next 5 shots progress to best focus. Next 4 progress beyond best focus—Fig. 2

liver up to 30,000 joules so that it can be used in further high-power laser experiments. Consisting of a charging circuit, energy storage bank and a control circuit, the power supply uses storage capacitors rated at 5 Kv, 100 μ f.

SPOT-WELD CAPABILITY—Production spot-welding capabilities were determined using Zircalloy-2 material $\frac{1}{8}$ -inch thick. This is a highly refractory metal difficult to weld. A GE customer has expressed interest in using it for fuel cell construction.

A 2-millisecond pulse was initially used at a constant energy level of about 25 joules. By varying focus of electrical beam with optical system, varying energy densities were obtained on work surface. Best focus yielded a spot weld having a 0.030-inch diameter and 0.070-inch penetration (depth of cast area, which is surrounded by heat-treated interface lying between it and metal in original state).

However, when optical system was adjusted to $\frac{1}{16}$ -inch inside best focus a greater diameter with less penetration resulted: 0.064-inch and 0.015 inch, respectively. With optical focuses beyond best focus, diameters remain fixed but penetration becomes less.

Fig. 2 illustrates spot welds obtained. Upper view is that of edge rejoined after breaking for examination of interface as shown in lower view.

PULSE EXTENSION—A one-to-one penetration ratio (diameter-to-depth) results when going to a 12-millisecond pulse and best focus as shown in Fig. 3A (welds 1, 2, 3). As can be seen in Fig. 3B (a 50 × section through weld 1), the one-to-one penetration ratio was obtained *only* at best focus. Diameter and depth of weld measured 30 mils.

VAPOR BUBBLE—While getting the desirable one-to-one penetration ratio, a vapor bubble in the cast area indicates that fusion temperatures have been exceeded in the weld's center. Further experimentation will be done to reconcile pulse duration with desired penetration.

Efforts have been made to distribute the heat energy along interface of the joined pieces using a cylindrical optical focusing system. Results are shown in Fig. 3A. While giving promise of being a reasonable approach to controlling energy distribution and minimizing vaporization, satisfactory penetration could not be made.

PLANS—Laser welding characteristics of various materials will be determined. And, though it is felt that spot welding of circuit components can be done right now, future work on welding equipment will involve development of a more complicated optical system, more power, and use of pulses longer than 12 milliseconds.

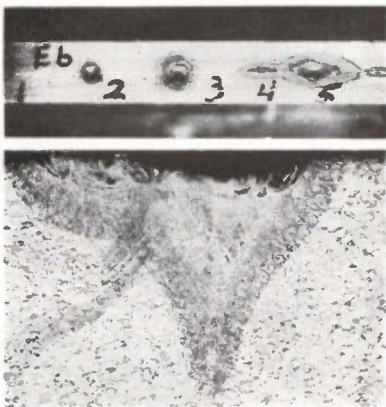

PULSES of 12-milliseconds give welds 1, 2, 3 showing effect of increasing pulse energy (top). Desired penetration of one-to-one is obtained with these welds (bottom). Welds 4 and 5 show heat distribution obtained with use of cylindrical optical system—Fig. 3

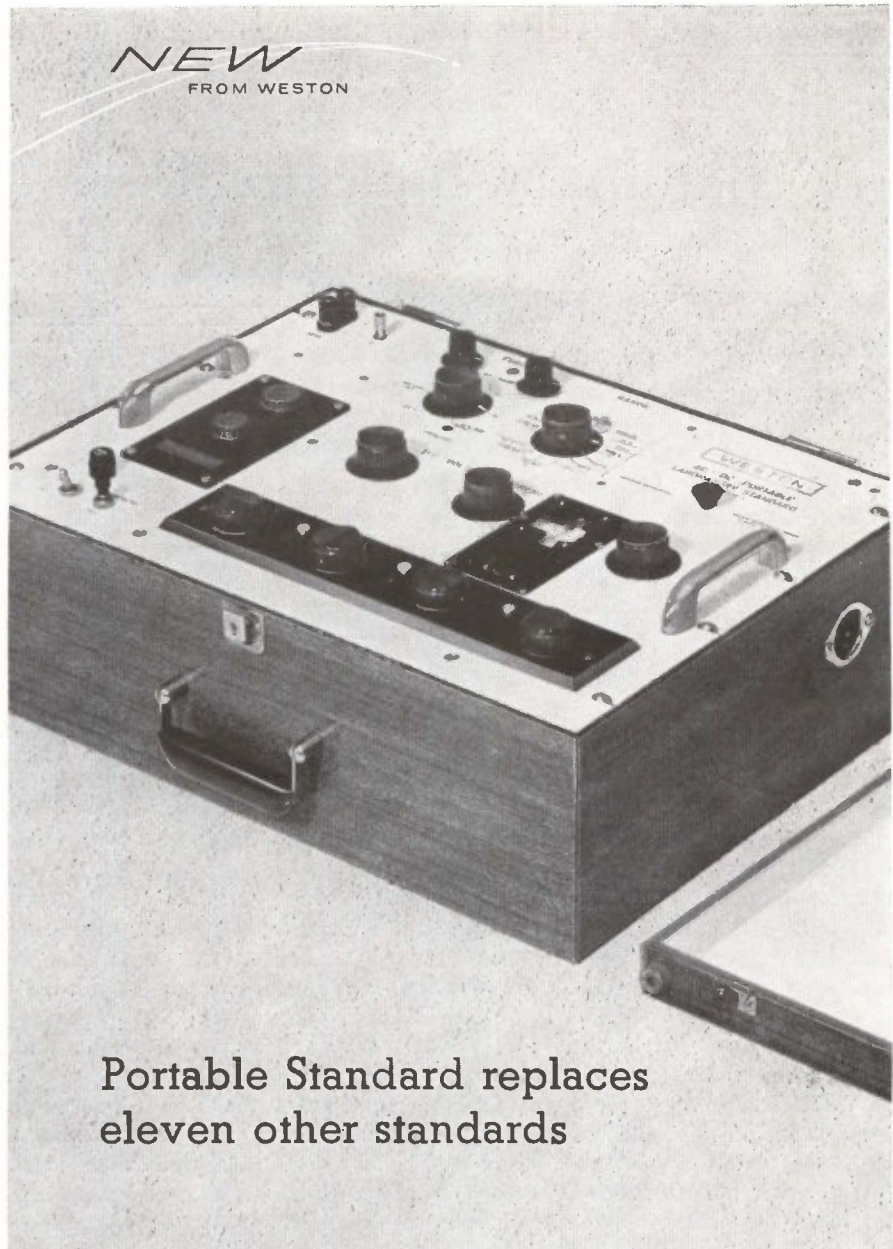

Portable Standard replaces eleven other standards

New Weston Portalab® is an ac-dc portable laboratory voltammeter with unusual features. It combines $\pm 0.05\%$ accuracy of indication, plus light, rugged construction for field and production testing. Truly portable, it performs the measurements of eleven precision instruments, permitting lab accuracy on location.

Direct readout and a movable, lighted decimal point eliminate interpolation, make reading easy. A highly-stable Zener reference source is contained in a temperature controlled oven. The Portalab is designed for use from -10 to $+40^{\circ}\text{C}$, ambient. Fuses and instrument relays protect measuring circuit against overload, and a diode network guards thermo elements against damage.

Range, dc: 0.01 to 1,500v; 100 μa to 1.5 amperes. True RMS response is provided in ac measurements: 1 to 1,200v; and 0.01 to 12 amperes. Frequency span: dc and 50 to 2,500cps (5,000cps to 120v). Input power: 105/130v, 50/440cps. Write for details on Model 1572 Portalab.

WESTON 
Instruments & Electronics

Division of
Daystrom,
Incorporated

614 FRELINGHUYSEN AVENUE, NEWARK 14, NEW JERSEY

Biquinary Indicator Uses 7 Transistors

New numerical indicator tube simplifies driver circuits

FIRST practical biquinary numerical indicator tube recently announced by Amperex Electronic Corp., 230 Duffy Avenue, Hicksville, N. Y., is designed for readout applications in digital voltmeters, calculators, counters and computers.

Designated the ZM1032, the tube has bases of five and two that greatly facilitate biquinary counting and decimal readout. Moreover, it represents increased economy by requiring substantially simplified driver circuits similar to that shown in the schematic where 7 transistors replace the ten required with conventional indicators.

Construction differs markedly from ordinary decade tubes in that the ZM1032 has two separated anodes and is divided internally into two vertical sections by a shield electrode. The rear compartment contains one anode and

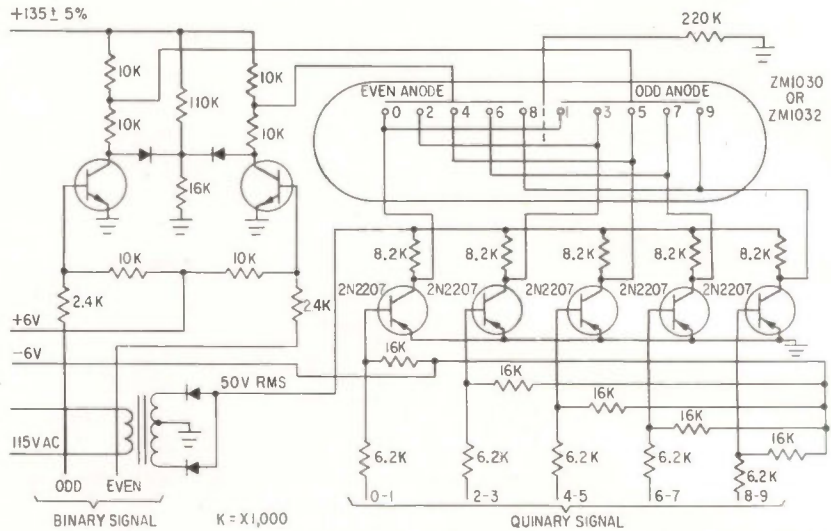

the figures 0-2-4-6-8, while the front section has the second anode and the numbers 1-3-5-7 and 9. Figures are connected electrically in pairs such as 0 to 1, 2 to 3, 4 to 5, 6 to 7 and 8 to 9.

Externally, the tube uses a standard 9-pin miniature socket. Figures are 0.6 inch high and are placed behind each other to provide visibility at the same spot

for in-line readout. They are viewed from the side permitting narrower panel spacing and wide-angle viewing. Type ZM1030 is identical except that its envelope has a translucent external coating of red lacquer to prevent glare. Indicator is priced at \$6.00 in large quantities and will provide 20,000 hours of reliable operation.

CIRCLE 301, READER SERVICE CARD

Synchronizer Locks Klystrons To 1 Part In 10⁸

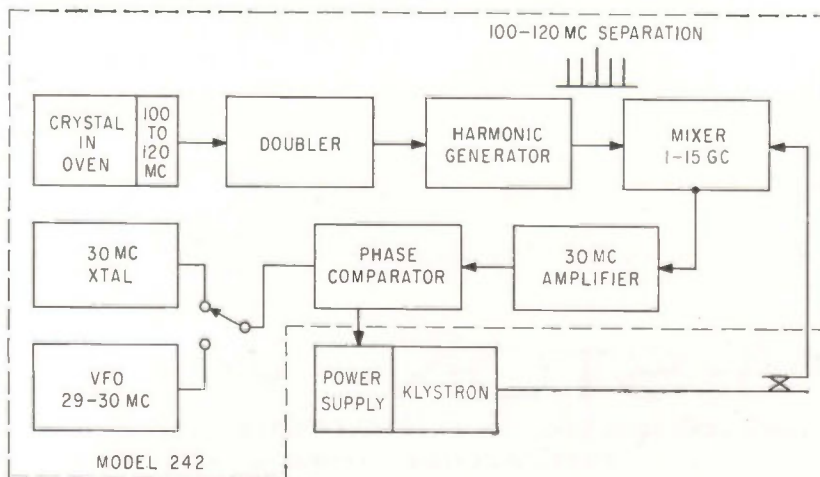

MICROWAVE Oscillator Synchronizer soon to be introduced by the Instrument Division of LFE Electronics, Boston, Mass., can phase lock most reflex-klystron oscillators to at least 1 part in 10⁸ per second. Called the Model 242, the new instrument obtains r-f reference frequency from an integral oven-mounted quartz crystal cut between 100 and 120 Mc, and i-f reference from either an internal 30 Mc crystal or a tunable 29 to 30 Mc vfo as shown in the diagram.

To obtain stability required at these frequencies, the klystron

advanced PRECISION COMPUTING RESOLVERS for Cascaded Resolver Systems

SIZE 8 FEEDBACK WINDING RESOLVERS



These resolvers are designed for use with transistorized "booster" amplifiers in cascaded chains.

Chains of precision size 8 winding compensated resolvers accurately solve the trigonometry of coordinate translation, rotation and conversion.

A chain of five resolvers is typically employed to solve for an unknown side and angle of oblique spherical triangles.

Individual resolvers exhibit functional errors of less than 0.1%

and axis perpendicularity errors of $\pm 5'$ max. In combination with the proper amplifier, the closed loop phase shift is $0.00^\circ \pm 0.01^\circ$

and the transformation ratio is $1.0000 \pm .0005$. The residual null voltage is 1 mv/v max. over a range of 10V, 400~.

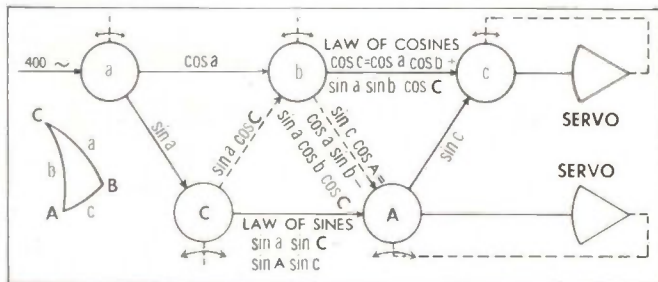

SIZE 11 "BOOSTERLESS" RESOLVERS FOR SERVICE IN REVERSIBLE CHAINS



The frame of these size 11 computing resolvers also houses a matching transformer which simulates a pair of resolver windings at maximum coupling. In a reversible chain of alternately interconnected resolvers (only partially diagrammed), the excitation may be applied to either end of the chain and the outputs taken from the other end.

Quick disconnect allows ease in harnessing. Accuracy: $\pm 5'$ of arc or less; winding perp. $\pm 5'$. Electrical characteristics: Input to EITHER rotor or stator. Input voltage 115v 1600 ~; output voltage 110v with either stator or rotor as primary; phase shift (stator primary) 1.1°; phase shift (rotor primary) 1.9°; Z_{so} (nom.) $990 + j13500$; Z_{ro} (nom.) $1150 + j13500$.

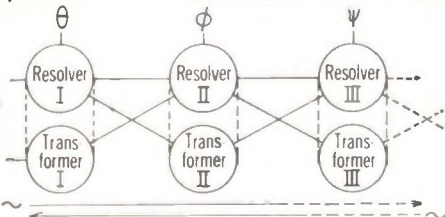
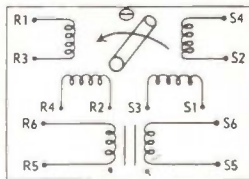

SIZE 11 RESOLVER TRIMMED FOR ZERO PHASE SHIFT CONTAINS ALL COMPENSATION IN 2 1/4" LENGTH

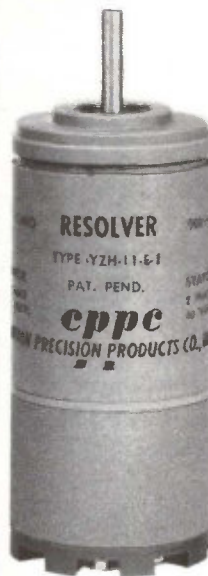

The YZH-11-E-1 precision computing resolver has been developed for use in a cascaded, amplifierless resolver system at 900~.

These units have been trimmed to provide zero phase shift and compensated for transformation ratio stability, under temperature, when working into their iterative impedance.

Accuracy: Functional error .1% or less; winding perp. $\pm 5'$. Electrical characteristics: Input voltage (stator) 40v900 ~; output voltage (rotor) 33.2v; phase shift 0; max. null voltage 1 mv/v.

Also ready for delivery is an equivalent, compatible pancake resolver. By its use, differential information from an inertial platform may be obtained and introduced into the system.

cppe CLIFTON PRECISION PRODUCTS Co., INC.
Clifton Heights, Pa. • Colorado Springs, Colo.
Sales Dept.: 5050 State Rd., Drexel Hill, Pa., MADison 2-1000, TWX 215 623-6068 — or our Representatives



FLEXITE[®]

TUBINGS

for a wide range
of temperature
requirements...

One of these Markel FLEXITE Extruded Tubings will meet your particular needs with economy and reliability for the lifetime of your equipment.

FLEXITE TFE Teflon[®] Tubing combines superior electricals with exceptional heat stability, chemical resistance, and physical strength. Recommended for continuous use from -55°C to 250°C .

FLEXITE SR-200 Silicone Rubber Tubing is extremely flexible, highly temperature stable, and has excellent corona resistance. It meets MIL-R-5847C, and is recommended for use at -70° to 210°C .

FLEXITE FEP Teflon Tubing has most of the outstanding characteristics of TFE, and is recommended for use where high reliability is required at temperatures from -55° to 200°C .

Ask for data sheets, samples and prices

L. FRANK **MARKEL** & SONS

NORRISTOWN, PA.



SOURCE FOR EXCELLENCE

Insulating Tubings and Sleeveings
High Temperature Wire and Cable

*Du Pont Trademark

signal is mixed with a harmonic of an r-f reference to produce an i-f reference that is amplified and phase compared with a stable, fixed-crystal oscillator. The resultant phase difference or error is added in series with the klystron reflector power supply for control and stabilization of the klystron output. In operation, the r-f reference is doubled, simultaneously mixed and applied to a varactor harmonic generator. Useful harmonics are obtained between 1 and 15 Gc resulting in a comb with lines 100 or 120 Mc apart, depending upon crystal frequency selected. These are mixed with the external klystron signal to form lock frequencies that are either 30 Mc above or below the harmonic line.

Provisions are made for stabilizing and measuring long-term drift to one part in 10^6 per week, short-term drift to one part in 10^8 per second and incidental fm of five parts in 10^6 . The Model 242 has an input power of -20 dbm at X band, -10 dbm at 15 Gc, $+10$ dbm maximum; a reflector voltage of 2,000 vdc maximum; reflector current of 50 μ amp maximum; fm deviation rate of 0 to 50 Kc flat between 0 and 20 Kc and deviation sensitivity of 100 Kc per volt into 12,000 ohms. Unit price is \$1,450.

CIRCLE 302, READER SERVICE CARD

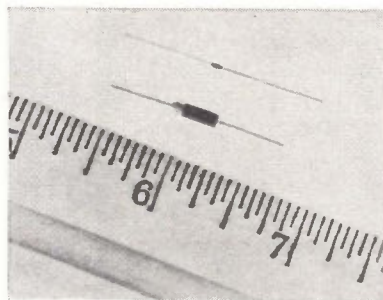

Tiny Diode Handles
1,500 Volts

SHARP breakdown voltage silicon micro diodes now available from MicroSemiconductor Corp., 11250 Playa Court, Culver City, Calif., operate in the 1,000 to 1,500 volt range. Units have low leakage currents in the order of 10 to 20 namp at 1,200 v and can handle currents between 1 ma and 1 ampere. Diodes can be supplied in micro and

Acoustical Components of Superior Quality

JAPAN PIEZO supplies 80% of Japan's crystal product requirements.

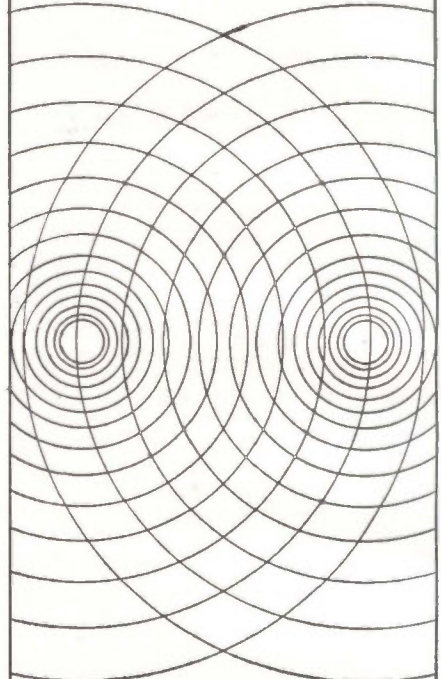

STEREO CARTRIDGE

Crystal — "PIEZO" Y-130
X'TAL STEREO CARTRIDGE

At 20°C , response: 50 to 10,000 c/s with a separation of 16.5 db. 0.6 V output at 50 mm/sec. Tracking force: 6 ± 1 gm. Compliance: 1.5×10^{-6} cm/dyne. Termination: $1\text{M}\Omega + 150$ pF.

Write for detailed catalog on our complete line of acoustical products including pickups, microphones, record players, phonograph motors and many associated products.



**JAPAN PIEZO
ELECTRIC CO., LTD.**

Kami-renjaku, Mitaka, Tokyo, Japan

CIRCLE 203 ON READER SERVICE CARD
July 12, 1963 • electronics

subminiature sizes as shown in the photo; device reliability and performance meet or exceed all applicable MIL-S-19500C and MIL-STD-202B requirements. Prices in quantities of 100 vary between \$2.50 and \$7.50 each. (303)

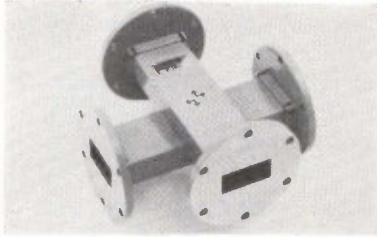

Directional Coupler For X-Band Use

X-BAND cross guide directional coupler covers the frequency range from 5.85 to 18.0 Gc. Vswr is 1.10; directivity, 20 db. All parts are plated rhodium over silver to prevent oxidation and tarnish. Microwave Components and Systems Corp., Monrovia, Calif. (304)

Teflon Capacitors Feature Compactness

PRECISION miniature Teflon capacitors have been announced. A complete range of capacitors from 0.001 μ f and up, in all working voltages is available in standard and custom types. Stability is 0.02 percent from -62 C to 125 C. Capacitance deviation with temperature is ± 0.2 percent from -10 C to 85 C. Insulation resistance is 2×10^9 megohms at 125 C. Component Research Co., Inc., 3019 So. Orange Drive, Los Angeles 16, Calif. (305)

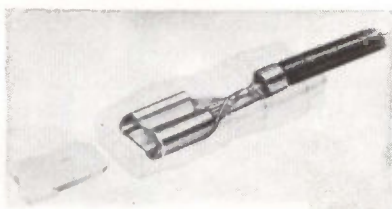

Terminals Furnished In Chain Form

SERIES of terminals for $\frac{1}{8}$ in. male tabs for quick connect/disconnect applications is now available. They are furnished in chain form for

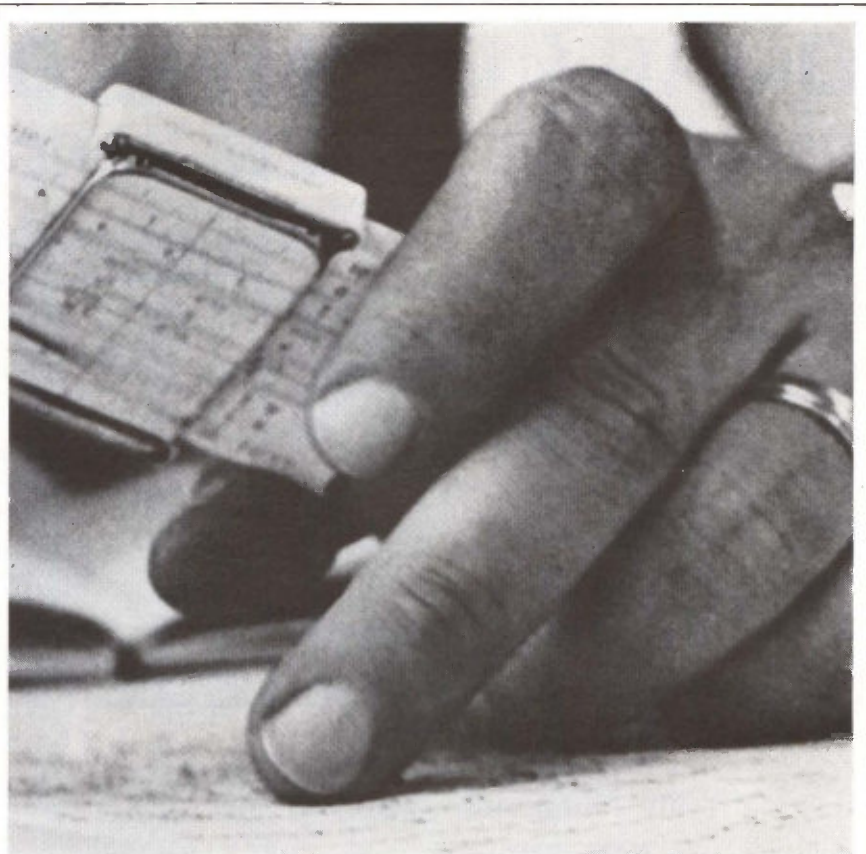

Today, 25 glass zeners replace 841 D.A.T.A.-listed numbers to **simplify circuit engineering!**

The new simpler way to meet maximum design considerations with minimum compromise is by specifying Hoffman Oxide-Passivated zener diodes. Because a mere handful of these high-reliability devices—1N960A through 1N984A*—meets or beats any military, in-house or commercial spec ever written for 9.1 to 91-volt 400 mW zeners. And they work equally well as rectifiers or regulators. So, all you do is choose the right number from among these 25 — rather than puzzle over the countless number of DATA-listed and additional manufacturers' numbers currently offered. When you do, you'll get diodes that deliver stability, temperature confidence and microamp-level voltage regulation equal to or better than any zener — alloy or diffused — you've ever looked at. These 25 uniquely versatile zeners are available—like now!—from your Hoffman salesman or distributor, along with a full interchangeability list.

*US1N962B THROUGH US1N973B AVAILABLE

BASIC EIA TYPE NO.	ZENER VDLTAGE E_z @ I_z (V)	TEST CURRENT I_z (mA dc)	MAX. DYNAMIC RESISTANCE Z_z (OHMS) @ I_z	MAX. REVERSE CURRENT @ 80% of E_z (μ A dc)	25 C	200 C	BASIC EIA TYPE NO.	ZENER VOLTAGE E_z @ I_z (V)	TEST CURRENT I_z (mA dc)	MAX. DYNAMIC RESISTANCE Z_z (OHMS) @ I_z	MAX. REVERSE CURRENT @ 80% of E_z (μ A dc)	25 C	200 C
1N960A	9.1	14	7.5	400	.05	10	1N975A	39	3.2	80	650	.05	10
1N961A	10	12.5	8.5	450	.05	10	1N976A	43	3.0	93	1000	.05	10
1N962A	11	11.5	9.5	450	.05	10	1N977A	47	2.7	105	1000	.05	10
1N963A	12	10.5	11.5	450	.05	10	1N978A	51	2.5	125	1000	.05	10
1N964A	13	9.5	13.0	500	.05	10	1N979A	56	2.2	150	1250	.05	10
1N965A	15	8.5	16.0	500	.05	10	1N980A	62	2.0	185	1250	.05	10
1N966A	16	7.8	17.0	500	.05	10	1N981A	68	1.8	230	1600	.05	10
1N967A	18	7.0	21	500	.05	10	1N982A	75	1.7	270	1600	.05	10
1N968A	20	6.2	25	550	.05	10	1N983A	82	1.5	330	1600	.05	10
1N969A	22	5.6	29	550	.05	10	1N984A	91	1.4	400	2000	.05	10
1N970A	24	5.2	33	600	.05	10							
1N971A	27	4.6	41	600	.05	10							
1N972A	30	4.2	49	650	.05	10							
1N973A	33	3.8	58	650	.05	10							
1N974A	36	3.4	70	650	.05	10							

NOTES: Dynamic resistance is measured by superimposing an A.C. current having an RMS value equal to 10% of the D.C. current on the D.C. current.
*1N960A measured @ .5mA; all others @ .25mA.

Hoffman / ELECTRONICS CORPORATION
Semiconductor Division

4501 N. ARDEN DR., EL MONTE, CALIF. • CUMBERLAND 3-7191 • TWX: 213-442-5633

OMARK® GRAMWELD® PERCUSSIVE STUD WELDING

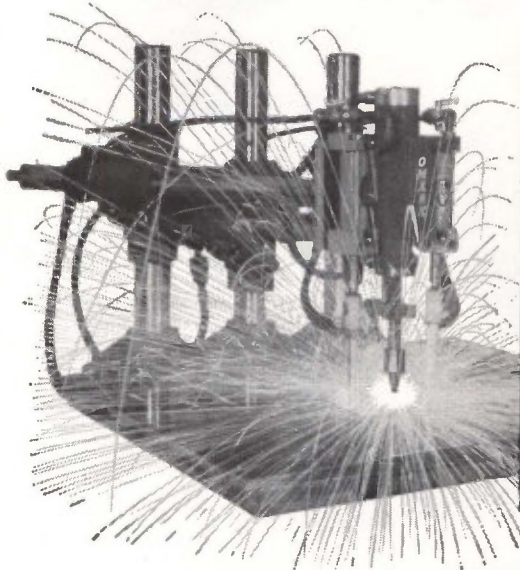

developing
new
concepts
in metal
fastening
for
industry

MANY BIG PROBLEMS HAVE SMALL CORRECT ANSWERS

Not infrequently in metal fastening, the apparent size of the problem obscures the obvious solution. Particularly when the correct answer is a small, readily and economically applied Gramweld stud, such as that shown here. Think about it. Then let's talk about it. You can reach a technically qualified OMARK representative through the yellow pages.



© Copyright 1963 by

OMARK INDUSTRIES, INC.

PORTLAND, OREGON • GUELPH, ONTARIO
AMSTERDAM, HOLLAND • VARBERG, SWEDEN
BRANCHES IN 27 MAJOR U. S. CITIES
CONSULT THE YELLOW PAGES

CIRCLE 62 ON READER SERVICE CARD

**HELP YOUR POST OFFICE
TO SERVE YOU BETTER
BY
MAILING EARLY IN THE DAY
NATIONWIDE IMPROVED MAIL SERVICE
PROGRAM**

rapid machine crimping, thus eliminating costly hand labor and assuring uniform quality. Series 250 Tabon terminals are made with large radii for quick, easy insertion and feature vertical and horizontal spring arm action. They are vibration proof and assure uniform electrical contact over the full length of the mating areas. Insulating sleeves of super high impact polyvinyl chloride can be furnished. Malco Mfg. Co., 4025 West Lake St., Chicago 24, Ill.

CIRCLE 306, READER SERVICE CARD

Tantalum Capacitors Rated 75 and 100 V

SOLID electrolyte tantalum capacitors in 75 and 100 v ratings are available. Capacitor operating temperature range is -80°C to $+125^{\circ}\text{C}$. The 75-v units are available in capacitance values that range from $0.47\ \mu\text{f}$ to $3.3\ \mu\text{f}$ while the 100-v solids are available from $0.47\ \mu\text{f}$ to $2.7\ \mu\text{f}$. Depending upon rating, the 75 and 100-v units will be supplied in standard case sizes of 0.125 in. diameter by 0.250 in. length and 0.175 in. diameter by 0.438 in. length. Mallory Capacitor Co., a division of P. R. Mallory & Co. Inc., Indianapolis 6, Ind. (307)

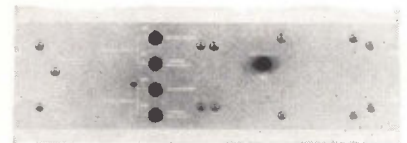

Power Supplies for Computer-Type Systems

TRANSISTORIZED dual power supplies provide plus and minus voltages used in computer-type systems. They are available in any combination of voltages from 6 to 60, and feature all silicon design, only 7 in. deep. Advanced Development Corp., 1134 South Prairie Ave., Hawthorne, Calif. (308)

Voltage Digitizer Features Flexibility

HIGH-SPEED, high-accuracy voltage-to-digital converter features extra flexibility in programming and output format control, as a result of a

novel patchboard and output shift register arrangement. Series VDC is available in both straight binary and binary-coded decimal models, in order to satisfy all user requirements. Internal conversion rate of both models is approximately 2 Kc. Input voltages can be converted with an accuracy of ± 0.05 percent of full scale, $\pm \frac{1}{2}$ v of the least significant digit in the code. The bipolar input voltage ranges of both models are ± 1 v, ± 10 v, and ± 100 v. Electronic Development Corp., 423 W. Broadway, Boston 27, Mass. (309)



Feed-Through Terminal Saves Space

METAL-TO-METAL press fit terminal, designed for 100 grid spacing or other extremely small applications, has been announced. Featuring the Nurl-Loc principle, these feed-through terminals measure only 0.098 in. in diameter. They are available with bifurcated lug for soldering on one end, and with a pigtail lead for soldering, on the opposite end. High temperature diallyl phthalate insulation is actually molded between conductor and eyelet. Metal-to-metal press fit assures the highest possible radial and axial pull out forces. Electronic Molding Corp., 52 Church St., Pawtucket, R. I. (310)



Joint Compound Has High Stability

LOW THERMAL RESISTANT joint compound for use between semiconductor or thermoelectric module and heat dissipator is available. The

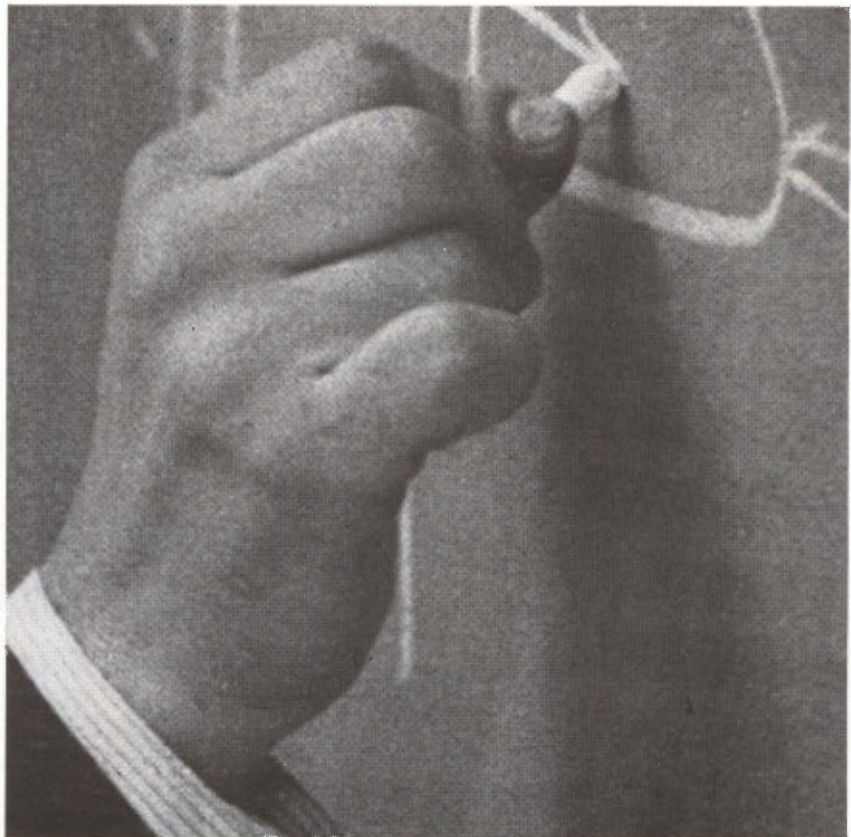

Today, 25 glass zeners replace 841 D.A.T.A.-listed numbers to optimize diode standardization!

Forget the hundreds of in-house numbers not even included in these 841 zener listings. Because you don't need all of them—any more. A mere 25 high-reliability, Hoffman Oxide-Passivated devices—1N960A through 1N984A*—meet or beat any military, in-house or commercial spec ever written for 9.1 to 91-volt, 400 mW diodes. And these work equally well throughout your subsystem as rectifiers or regulators. High reliability? These babies are built to take environmental abuse. Like instant temperature cycling from -190° to $+250^{\circ}\text{C}$... with superb stability, because Hoffman Oxide Passivation literally locks out deteriorative elements so permanently that you can successfully Joy-bomb these zeners without their glass cases. Furthermore, though they're registered as 400 mW, we rate and guarantee them to perform at 600 mW. And just take a look at these knees! Proof that these devices deliver precise voltage regulation even at microamp current levels (permanently!) thanks to a leakage rate less than 1/100th the Mil Spec and extremely low Z_{ZK} . For the full story, including an interchangeability list, check your Hoffman salesman or distributor or write to us direct.

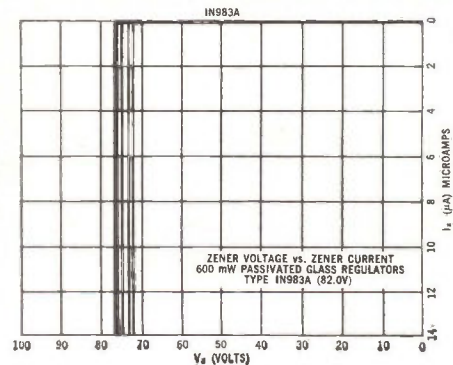

*USN1N962B THROUGH USN1N973B AVAILABLE

Hoffman / **ELECTRONICS CORPORATION**
Semiconductor Division

4501 N. ARDEN DR., EL MONTE, CALIF. • CUMBERLAND 3-7191 • TWX: 213-442-5633

make Springs
in Seconds!

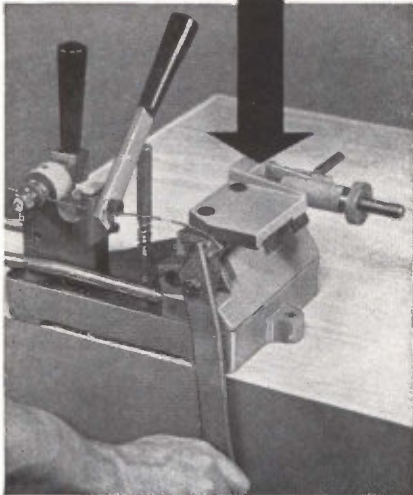

Save Costly Special Orders
With the NEW

DI-ACRO* Spring Winder

This unique machine eliminates costly special spring orders, saves valuable waiting time. Winds compression and extension springs to 1½" O.D. Handles round, flat and rectangular wire to ⅛" dimension. Note exclusive features in the hand operated Di-Acro Spring Winder which assure accurate tension and fast operation without special experience or skill.

new TENSION CONTROL—Simply adjust to desired tension—the control keeps it uniform, for winding one spring or hundreds, and releases when each spring is wound.

new WIRE CUT-OFF—After spring is wound, release tension and use cut-off lever to quickly cut end of spring to desired length.

new CAM LOCK—Simply feed wire under cam, turn handle and wire is securely locked to arbor while spring is wound. No threading required.

FREE ENGINEERING SERVICE



Send us your spring forming problems—samples or dimension sketches—together with sufficient test material, and let us wind some sample springs for you free of charge. No obligation.

Quick Facts Folder gives details on all Di-Acro Precision Machines. Consult the yellow pages of your phone book under Machinery, Machine Tools, for the name of your Di-Acro distributor or write.

*pronounced Die-ack-ro

di-acro
PRECISION
METALWORKING
MACHINES

DI-ACRO CORPORATION
formerly O'Neil-Irwin
Mfg. Co.
437 8th Ave., Lake City, Minn.

No. 120 compound has the low thermal resistance of 0.05 C/w for a film thickness of 0.001 in. over a 1-in. square area, which represents approximately 25 percent of the thermal resistance inherent in silicon grease. It is electrically non-conductive, stable from -40 C to +200 C, and non-toxic. Wakefield Engineering, Inc., 139 Foundry St., Wakefield, Mass.

CIRCLE 311, READER SERVICE CARD

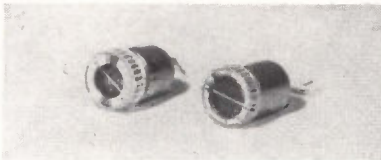

Miniaturized Meters For Indicator Uses

MINIPILOT meter model CFM-11 weighs less than 0.2 oz. It is designed for a variety of indicator applications such as: stereo balance, record level for tape recorders, f-m tuning, power on, signal strength, battery capacity, volume indication, or wherever a relative indication is desired in a small package. Manufactured by Kuwano Electrical Instrument Co. of Japan, it is available in ranges from 200 μ a to 2 ma and in various d-c voltages. Philip Ray Co., 5312 N. Oriole, Chicago 31, Ill. (312)

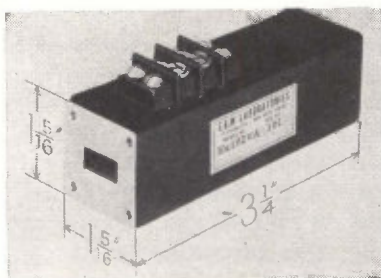

Variable Attenuator Covers Full Ku-Band

MODEL Ku102VA covers from 12.4 to 18.0 Gc, with a maximum vswr of 1.35 and an attenuation that can be varied from 1.2 db to 20 db. Model Ku103VA is indicative of the type of characteristics which are attainable over a narrow bandwidth. This unit covers the 14.0 to 16.0 Gc frequency band with a max vswr of 1.25 and an attenuation that can be varied from 1.0 db to 25 db. Both are designed in UG-419/U wave-

You Get Things Done With Boardmaster Visual Control

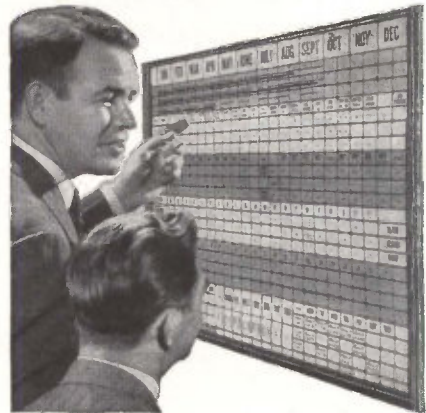

- ☆ Gives Graphic Picture of Your Operations—Spotlighted by Color
- ☆ Facts at a glance — Saves Time, Saves Money, Prevents Errors
- ☆ Simple to operate — Type or Write on Cards, Snap in Grooves
- ☆ Ideal for Production, Traffic, Inventory, Scheduling, Sales, Etc.
- ☆ Made of Metal. Compact and Attractive. Over 750,000 in Use

Full price \$4950 with cards

FREE 24-PAGE BOOKLET NO. C-10
Without Obligation

Write for Your Copy Today
GRAPHIC SYSTEMS
Yanceyville, North Carolina
CIRCLE 204 ON READER SERVICE CARD

FASTENERS FROM



DIE CAST
ZINC ALLOY

Zinc Alloy



Wing Nuts



Cap Nuts



Thumb Nuts

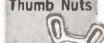

Thumb & Wing Screws



Hex Nuts

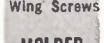

Washers

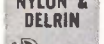

Screws



Screw Insulators

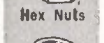

MOLDED
NYLON &
DELRIN

CAP NUTS



EXCLUSIVE WASHER BASE



Widest range of types and
thread sizes FROM STOCK

New exclusive types never before available—standard or full dia. washer base with open or closed ends—no separate washer needed... speed assembly. Also high series with 50% greater thread depth and regular series in open or closed end. 15 hex sizes, threads from #4 to 5/8". ALL GRC CAP NUTS feature rust-proof, corrosion resistant surfaces, uniform accuracy... are completely free of tool marks and cut-off burrs. GRC's exclusive methods—die casting zinc alloy or molding Nylon and Delrin fasteners in one high speed automatic operation—assure high quality at lowest possible cost.

Write, wire, phone TODAY for SAMPLES, prices, your copy of GRC's NEW INDUSTRIAL FASTENER CATALOG

GRIES
GRIES REPRODUCER CORP.
World's Foremost Producer of Small Die Castings
151 Beechwood Ave. • New Rochelle, N. Y.
Phone: (914) New Rochelle 3-8600

guide. The d-c resistance of each is approximately 30 ohms, and less than 200 ma of drive current is required to achieve the specified characteristics. E&M Laboratories, Califa St., Van Nuys, Calif. (313)

Compound Amplifier Offers High Gain

DESIGNED for circuits requiring very high gain, high input impedance and low noise, the Darlington compound amplifier features a d-c current gain of 1,600 to 10,000. Designated the RM3022, it is constructed of two high-gain silicon planar transistors interconnected within a standard TO-18 case. Breakdown voltage is 1000 v, and leakage current is 5 nanoamperes. Raytheon Co., 350 Ellis St., Mountain View, Calif. (314)

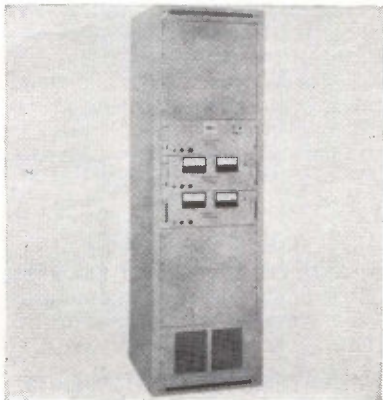

Life Tester for Integrated Circuits

HIGH FREQUENCY operation is featured in the model 8003 integrated circuit life tester. Operating with a fast rise time 100 Kc signal, the system has provisions for life testing of 3000 integrated circuits or functional electronic blocks including: flip-flops, clocked dual NAND gates and shift registers. Modular construction permits life testing in groups of 20 with systems available from 100 to 10,000 positions. Temperature range is -55 C to +150 C for the integrated circuits with voltage and current monitoring facilities included. Available as a complete system including temperature chamber or as a separate electronic system. Micro Instrument Co., 2245 S. Federal Ave., Los Angeles 64, Calif. (315)

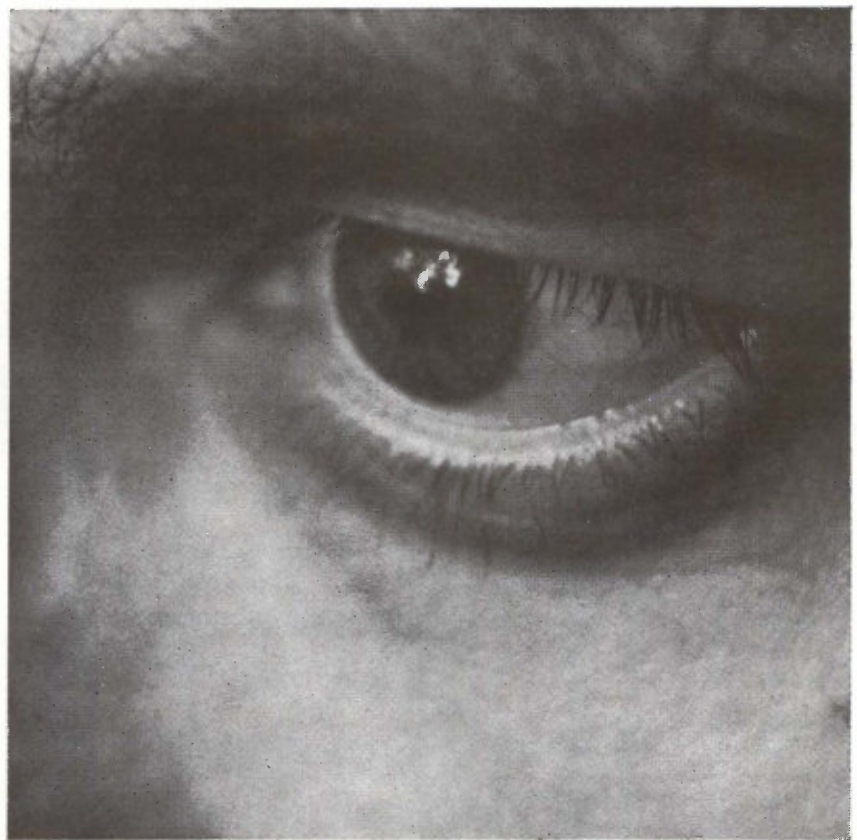

Today, 25 glass zeners replace 841 D.A.T.A.-listed numbers to **maximize diode value engineering!**

There has never been an easier (or safer) way to stretch a procurement dollar or value engineer diode circuitry. Because these Hoffman Oxide-Passivated 1N960A through 1N984A* glass zeners, just 25 numbers in all, meet or beat any military, in-house or commercial spec ever written for 9.1 to 91-volt diodes. And they're yours from a Minuteman-approved vendor who's just invested \$1/2 million more in new equipment to meet present and future demand! So, now you can simplify your inventory with devices that minimize special testing, cut down on prints and in general save countless manhours. Nice. Because they combine stability, voltage regulation at microamp currents and temperature confidence levels the likes of which you've never seen before in one device. And what's more, this makes 'em ideal for rectifying as well as regulation. Best news yet. These Oxide Passivated zeners are priced right down with competition, number for number. And you can get 'em in quantity now—along with a full interchangeability list—from your Hoffman distributor or any of these Hoffman sales offices.

*USN1N962B THROUGH USN1N973B AVAILABLE

<p>EASTERN & CENTRAL REGION</p> <p>Regional Office Metuchen, New Jersey Liberty 9-3500</p> <p>Boston District West Newton, Mass. Woodward 9-8411</p> <p>New York City District Great Neck, L. I., N. Y. HUnter 7-2660</p> <p>Philadelphia District Jenkintown, Pa. WAverly 4-0307</p>	<p>Chicago District Evanston, Illinois UNiversity 9-2400</p> <p>Dallas District Dallas, Texas EMerson 3-6627</p> <p>Dayton District Dayton, Ohio 222-4617</p> <p>Detroit District Detroit, Michigan BRoadway 3-7806</p> <p>Minneapolis District St. Paul, Minn. MI 6-4835</p>	<p>WESTERN REGION</p> <p>Regional Office & Los Angeles District So. Pasadena, Calif. MUrray 2-3741</p> <p>San Diego District Coronado, Calif. HEmpstead 5-9076</p> <p>San Francisco District San Carlos, Calif. LYtel 1-5796</p> <p>EXPORT DEPARTMENT El Monte, Calif. CU 3-7191</p>
--	--	---

Hoffman / ELECTRONICS CORPORATION
Semiconductor Division

4501 N. ARDEN DR., EL MONTE, CALIF. • CUMBERLAND 3-7191 • TWX: 213-442-5633

HELPFUL McGRAW-HILL BOOKS



available by mail
for 10 days'
free examination

INFRARED PHYSICS AND RADIATION

Just Out. Provides a wealth of physics, engineering, and analytical help in designing modern infrared systems. Covers operations analysis, information theory, space filtering, systems sensitivity, etc. By J. Jamieson, R. McFee, R. Grube, and R. Richards, all of Aerojet-General Corp.; and G. Phass, Ford Motor Corp. 680 pp., illus., \$19.00

AN INTRODUCTION TO SEMICONDUCTOR ELECTRONICS

Just Out. This clear treatment of semiconductor devices provides the essential background in solid state physics, and describes how to apply the circuit and device theories. Discusses both the electronics of semiconductor internal behavior and circuit performance. By R. Nanavati, Syracuse Univ. 410 pp., illus., \$12.50

CIRCUITS, MATRICES, AND LINEAR VECTOR SPACES

Just Out. Introduces matrix methods for describing general network situations, and linear vector spaces for effectively analyzing circuits. Shows how to apply both techniques to the analysis and synthesis of all linear lumped circuits. By L. P. Huelsman, Univ. of Arizona. 273 pp., 230 illus., \$10.75

FOURIER SERIES AND BOUNDARY VALUE PROBLEMS

Just Out—2nd Ed. Presents an introduction to Fourier series and their application to the solution of boundary value problems in partial differential equations in engineering and physics. Revised edition includes additional material on important aspects of the subject. By R. V. Churchill, Univ. of Mich. 2nd Ed. 256 pp., illus., \$6.75

TECHNICALLY SPEAKING:

Oral Communication for Engineers,
Scientists, and Technical Personnel

Just Out. Keyed specifically to needs of the technical man—helps you prepare and deliver forceful speeches; give clear instruction; organize and deliver technical reports; converse lucidly about plans, opinions, advice; develop the art of productive listening. By Harold Weiss & James B. McGrath, Jr., both of So. Methodist Univ. 304 pp., \$7.95

10-DAY FREE EXAMINATION direct from McGRAW-HILL

McGraw-Hill Book Co., Dept. L-7-12
327 W. 41st St., New York 36, N. Y.

Send me book(s) checked below for 10 days examination on approval. In 10 days I will remit for book(s) I keep, plus few cents for delivery costs, and return unwanted book(s) postpaid. (We pay delivery costs if you remit with this coupon—same return privilege.)

- Jamieson, et al—Infrared Phys. & Rad., \$19.00
- Nanavati—An Intro. to Semiconductor Elec., \$12.50
- Huelsman—Circ., Matri. & Lin. Vec. Spaces, \$10.75
- Churchill—Fourier Series & Bound. Val. Probs., \$6.75
- Weiss & McGrath—Technically Speaking, \$7.95

Name

Address

City..... Zone..... State.....

Company

Position

For price and terms outside U. S. write
McGraw-Hill Intl. N.Y.C. 36 L-7-12

Literature of the Week

PHASE-SHIFT CAPACITOR Nilsen Mfg. Co., P.O. Box 127, Haines City, Fla. Technical data sheet describes a phase-shift capacitor with screw-driver adjustment and lock. CIRCLE 316, READER SERVICE CARD

DIGITAL MODULES Cambridge Thermionic Corp., 445 Concord Ave., Cambridge 38, Mass. An engineers' catalog covers a line of 18 different families of digital modules, 35 modules in all. (317)

SPEED CONTROL TACHOMETER Electro Products Laboratories, Inc., 6120 W. Howard St., Chicago 48, Ill. Bulletin ET-263 is a guide for selecting the proper model tachometer for measuring speed and providing overspeed/underspeed control. (318)

POTTING APPLICATOR Philip Fishman Co., 7 Cameron St., Wellesley 81, Mass. Bulletin 103 describes No-Drip applicator for sealing, encapsulating, or potting miniature or subminiature components. (319)

PCM DECOMMUTATION SYSTEM Telemetrics, Inc., 12927 So. Budlong Ave., Gardena, Calif. Data sheet 41 describes model 620 pcm decommutation system. (320)

COMPUTING RESOLVERS Theta Instrument Corp., 520 Victor St., Saddle Brook, N. J., has published a 16-page primer for engineers which discusses the characteristics of computing resolvers. (321)

HYDROGEN FILLED TUBES Tung-Sol Electric Inc., One Summer Ave., Newark 4, N. J. A 6-page folder on hydrogen filled tubes and their application to a broad range of high-powered radar and microwave uses is available. (322)

MILITARY-TYPE CAPACITORS General Electric Co., Schenectady 5, N. J. Bulletin GET-2982 covers a line of military-type porous anode Tantalic capacitors. (323)

FREQUENCY SYNTHESIZER Hewlett-Packard Co., 1501 Page Mill Road, Palo Alto, Calif. Brochure illustrates and describes model 5100A-5110A frequency synthesizer that provides an output frequency adjustable from 0.01 cps to 50 Mc in steps as fine as 0.01 cps. (324)

RELAYS AND FUSES Networks Electronic Corp., 9750 DeSoto Ave., Chatsworth, Calif. Two new data sheets, one covering temperature-sensitive relays and one covering temperature-sensitive fuses, are available. (325)

RELIABILITY INDICATORS The A. W. Haydon Co., 232 North Elm St., Waterbury 20, Conn. Data sheet DS-1A covers a-c and d-c subminiature and microminiature elapsed

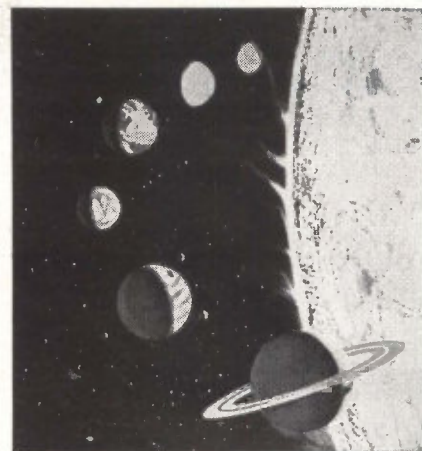

AUTOMATIC CHECKOUT OF MANNED SPACECRAFT

North American Aviation's Space and Information Systems Division is developing a checkout system consisting of unique and highly versatile computer controlled digital command, data acquisition, and data transmission systems. State-of-the-art technologies are being employed with applications toward future requirements where microminiaturization and advanced systems design concepts will require new studies and techniques.

LOGIC DESIGNERS

to perform conceptual analyses and trade-off studies resulting in logic designs of command and data systems.

PCM TELEMETRY ENGINEERS

to develop a PCM System utilized in checkout of the spacecraft systems.

SYSTEMS ENGINEERS

to analyze spacecraft vehicle system characteristics and perform system studies of an automatic digital checkout system.

RF SYSTEMS ENGINEERS

to analyze requirements and establish criteria for RF system checkout equipment.

Send your resume (in complete confidence) to: Mr. P. G. Moseby, Engineering and Scientific Employment, 12214 Lakewood Blvd., Downey, California.

All qualified applicants will receive consideration for employment without regard to race, creed, color, or national origin.

SPACE AND INFORMATION SYSTEMS DIVISION

North American Aviation



time indicators and events indicators for monitoring reliability performance of components and systems. (326)

MAGNETIC TEST EQUIPMENT RFS Engineering Co., 2nd and Westmoreland Sts., Philadelphia, Pa., has published an 8-page brochure describing a line of magnetic test equipment. (327)

SPACE POWER SYSTEMS Electro-Optical Systems, Inc., 300 N. Halstead St., Pasadena, Calif., has published a new brochure on its total space power systems capabilities. (328)

EXPANDED METAL Metalex Corp., P.O. Box 148, Libertyville, Ill., has available a 12-page designers' catalog on expanded metal. (329)

THERMISTORS Victory Engineering Corp., Springfield, N. J., has available a data sheet covering "VECO Thermistors for Flow Measurement." (330)

ISOLATION TRANSFORMER Elcor, Inc., 1225 West Broad St., Falls Church, Va., has released a 6-page descriptive data sheet on a new high-powered line isolation transformer series. (331)

DIPPED MICA CAPACITORS The Electro Motive Mfg. Co., Inc., Willimantic, Conn. Design information covering El-Menco dipped mica capacitors is presented in a 20-page folder. (332)

CARD, TAPE READERS Hoffman Electronics Corp., El Monte, Calif. Three data sheets cover the HSRA-9, -10 and -12—basic products for reading punched holes in paper tapes and cards with tiny solar cells. (333)

SERVO AMPLIFIERS Helipot Division of Beckman Instruments, Inc., 2500 Harbor Blvd., Fullerton, Calif., has available data sheet 63542 on three new models of transistorized servo amplifiers. (334)

MOUNTING STUDS Endeveco Corp., 801 South Arroyo Parkway, Pasadena, Calif. Specification data sheet describes a complete line of mounting studs for use with the company's piezoelectric transducers. (335)

MICROWAVE ROTARY JOINTS Airborne Instruments Laboratory, Deer Park, L. I., N. Y., offers a 4-page brochure describing microwave rotary joints. (336)

ELECTRON BEAM POWER PACKAGE Brad Thompson Industries, Inc., 83-810 Tamarisk St., Indio, Calif. Six-page catalog 1615.1 describes 6 kilowatt power supply for electron beam. (337)

SILICON BRIDGE RECTIFIERS International Rectifier Corp., 233 Kansas St., El Segundo, Calif. Bulletin SR-232 covers miniature silicon bridge rectifiers that provide up to 1.8 amp d-c, 200 to 1,000 v prv. (338)

CAPACITORS Captronics, Inc., 9 Cricket Terrace, Ardmore, Pa. Technical bulletin 403 deals with capacitors designed to surpass requirements of MIL-C-25A, characteristic E. (339)

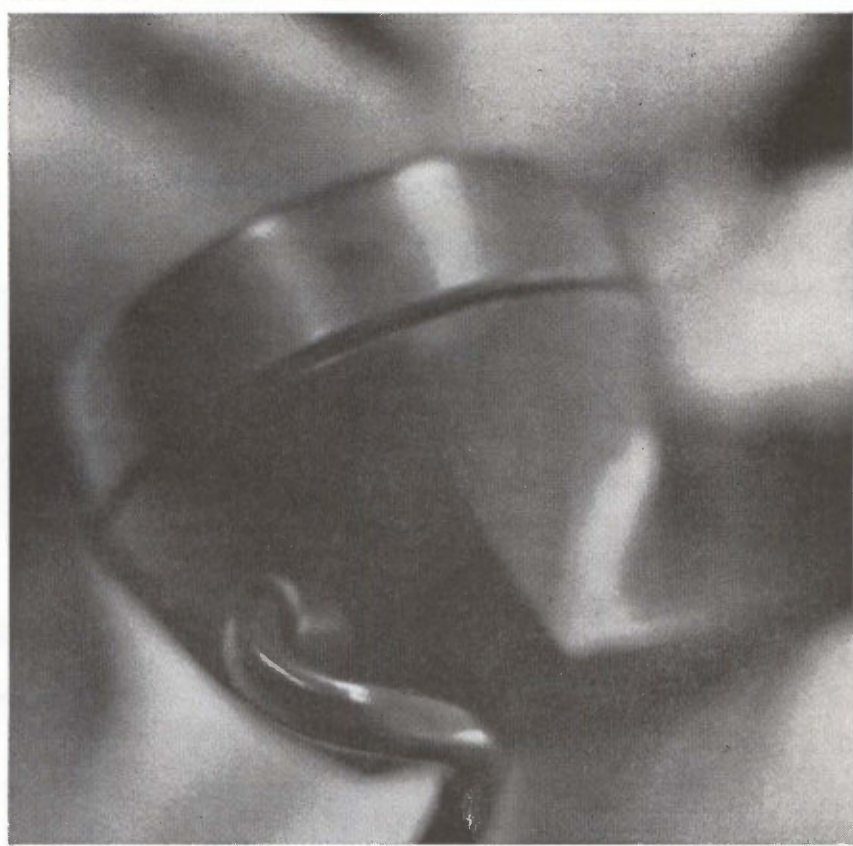

Today, 25 glass zeners replace 841 D.A.T.A.-listed numbers to **uncomplicate diode purchasing!**

At last you can save the strain of reaching for that neat blue book every time the job calls for diodes. Because Hoffman's new Oxide-Passivated series meets or beats any military, in-house or commercial spec ever written for 9.1 to 91-volt glass zeners. All with a mere 25, easy-to-remember numbers: 1N960A through 1N984A*, to be exact. All selling at today's going price for equivalent numbers. All stocked at your local Hoffman distributor in quantities up to 999 for availability—like now! (If you insist on writing a p.o. for more, of course, you'll have to wait a little longer for delivery. Like 48 hours.) Look, you're busy. So we won't bore you with all the exciting technical poop on these things. Just ask your circuit designers, standards people or value engineers. They've already read our other three ads in this magazine and know the whole story. Or check with any of these Hoffman distributors (they've got interchangeability lists, too).

*US1N962B THROUGH US1N973B AVAILABLE

ALAMOGORDO — Kierulff	DETROIT — Newark-Ferguson	OAKLAND — Elmar
ALBUQUERQUE — Kierulff	GLENDALE — Weatherford	ORLANDO — Hammond
ANAHEIM — Weatherford	HOUSTON — Harrison	PALO ALTO — Pencor
ATLANTA — Ack Radio	HYATTSVILLE — Milgray	PHILADELPHIA — Milgray
BUFFALO — Standard Elect.	INDIANAPOLIS — Graham	PHOENIX — Kierulff
CEDAR RAPIDS — Deeco	KANSAS CITY — Esco	PITTSBURGH — Cameradio
CHICAGO — Allied	LOS ANGELES — K-Tronics	SALT LAKE — Standard Supply
Newark	Radio Products	SAN DIEGO — Kierulff
CINCINNATI — United Radio	MILWAUKEE — Allied	Radio Parts
CLEVELAND — Pioneer	MINNEAPOLIS — Lew Bonn	ST. LOUIS — Olive
COLUMBUS — Hughes-Peters	MONTREAL — Cesco	SYRACUSE — Essex
DALLAS — Esco	NEW ORLEANS — South'n Radio	SEATTLE — Western Elect.
DAYTON — Sreppo	NEWTON — Cramer	TULSA — Esco
DENVER — Newark	NEW YORK — Milgray	WALTHAM — Durrell

Hoffman / **ELECTRONICS CORPORATION**
Semiconductor Division

4501 N. ARDEN DR., EL MONTE, CALIF. • CUMBERLAND 3-7191 • TWX: 213-442-5633

RCA Puts \$11.6 Million in New Tube Plant

Management ok's one of largest single requests for any RCA installation

LANCASTER, PA. — Two new buildings, planned here, will provide an additional 46,000 square feet for color-television picture-tube engineering, and 154,000 square feet for conversion-tube manufacturing.

The \$11.6 million plant expansion is said to be the largest single expenditure undertaken by RCA.

Move means that several hundred additional employees will be added to the present RCA work force of 4,200 at Lancaster.

Conversion-tube facilities will be established within the next 21 months. Ground breaking plans for the color-tube engineering section will follow after occupancy of the first addition.

Conversion-tube operations include image orthicon and vidicon camera tubes, image converters, display storage tubes, photo tubes and photomultipliers. These types are widely used in television, space satellites and astronomy, as well as for medical, military and nuclear operations.

COLOR—Company spokesmen say that RCA is, of course, interested in any new development in the color-tv picture-tube field, and anticipate the concept of a tv tube as a picture on the wall—someday. Over the years they have experimented with a variety of rectangular tubes, including 17-in., 21-in., and 23-in. sizes.

"The 21-in., 70-degree round RCA color tube, now in commercial production, is the only one that meets our rigid standards for faithful reproduction of color, as well as black and white reception comparable to the best black and white receiver", company says.

Spokesmen say they will continue their efforts to solve the technical

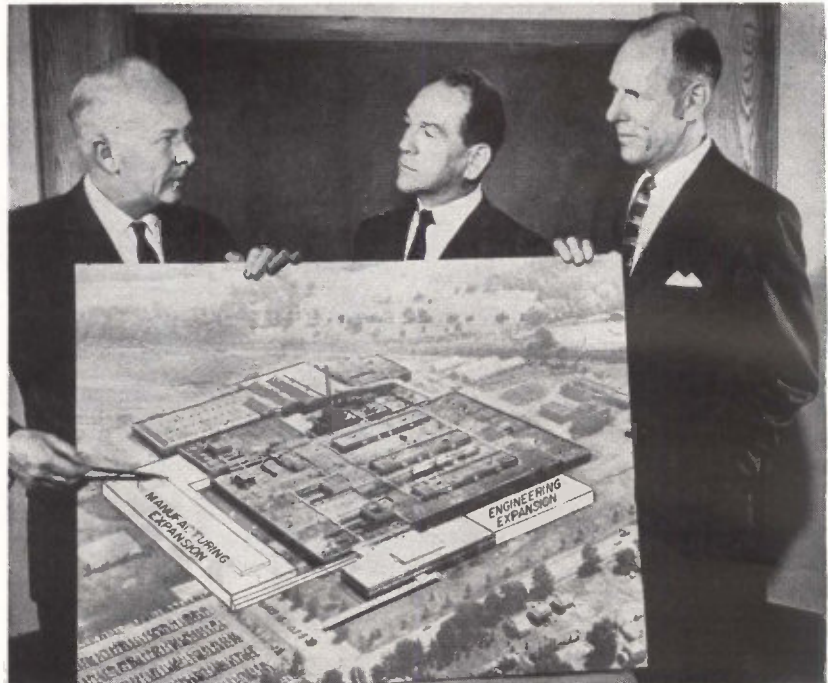

KEY EXECUTIVES of RCA's Electronic Component and Devices Division review expansion plans for Lancaster plant. D. Y. Smith, vice president discusses effect enlarged facilities will have on electron tube market with J. B. Farese, division vice president and Tex Burnett, v-p who worked hard to sell expansion idea to company

problems of other kinds of color tubes to meet the same goals of reliability and acceptance that have been established for the 70-degree tube.

The existing Lancaster plant was built in 1942 with U. S. Navy funds, and was operated by RCA for the Armed Forces during World War II. Between 1942 and 1946, the facility was the largest single supplier of cathode ray and power tubes used for radar, shoran, loran, airborne television and other strategic military systems.

Company purchased the plant from the Navy in 1946 as a base for black-and-white picture-tube production and as a location for power and special-purpose tube engineering and production. With the advent of color tubes in 1954, black-and-white picture-tube production was transferred to RCA's Marion, Indiana plant.

Douglas Y. Smith, vice president,

RCA Electronic Components and Devices, reported that sales of RCA electron tubes rose to an all time high in 1962—20 percent over 1961 levels. Presently company product line consists of over 1,700 electron tube types.



National ResisTronics Names Forman

SAM FORMAN has been appointed manager of the Micro-Module divi-

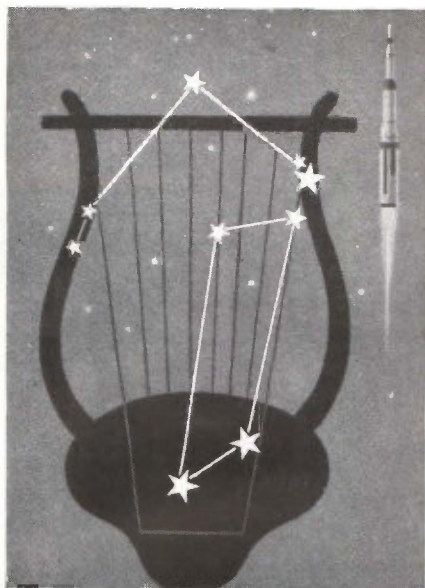

SIMPLICITY

Digital electronics systems and components have been designed and developed by General Time with this single rule in mind—"Keep it simple, while meeting or exceeding performance specifications."

- INCREMAG, the precision electronic counting element counter with a memory
- MU-CHRON, the highly stable magnetic oscillator
- Solid State Delay Switches
- True Rotary Solenoids, no axial motion
- Digital control systems

These General Time units for timing, counting, programming control and memory storage have reliably fulfilled stringent requirements of space, military and industry . . . and now stand as a high point in the state of the art.

Based on solid state and magnetic core principles, General Time equipment offers these advantages:

- Design simplicity—dependability
- Low power consumption
- Minimum size and weight
- Resistant to shock, vibration, thermal stress

General Time digital electronic units are available on an off-the-shelf basis, or can be readily modified to meet specific requirements.

GENERAL TIME CORPORATION

ELECTRONIC SYSTEMS DIVISION
201 Summer Street, Stamford, Conn.



sion of National ResisTronics, Inc., Pearl River, N. Y. He was formerly a reliability engineer for General Transistor.

National ResisTronics specializes in the manufacture of micro-miniature circuits, instrument grade components, precision wire wound resistors, and d-c measuring devices.

Leifer Accepts Sylvania Post

MEYER LEIFER has been appointed director of the Systems Engineering and Management Operation (SEMO) of Sylvania Electric Products Inc., Waltham, Mass.

Leifer, who is rejoining Sylvania after two years as chief engineer of the Video and Instrumentation division of Ampex Corp., formerly was general manager of Sylvania's Microwave Device division.



Cook Electric Promotes Wall

JOHN E. WALL, division factory manager since last December, has been named general manager of Cook Electric Company's Wirecom division, Chicago, Ill.

Wall will direct a marketing, sales, manufacturing, and engineering program to refine and improve Cook's line of precision electronic relays and components.

Hughes Names Two To New Positions

PROMOTION of two laboratory managers to assistant directors of the research and development division

For laboratory or field research applications

MODEL 700/1400 SERIES NEW MAGNETIC TAPE RECORDING SYSTEMS



ACCURATE ± 0.2 linearity for analog data

FLEXIBLE as many data channels as you need from 2 to 14

COMPACT a 7-channel system fits in less than 2 ft. of rack space

LOW COST modest initial cost, true operating economy

MNEMOTRON NEW MODEL 700/1400 SERIES MAGNETIC TAPE RECORDING SYSTEMS record any electrical quantity from DC up to 5000 cps. A uniquely simple pulse-frequency modulation technique insures that data signal intelligence is free from non-linearity due to tape coating or other distortions.

Select as many data channels as you need, up to 14. Choose the tape format you want— $\frac{1}{4}$ ", $\frac{1}{2}$ " in-line, or standard IRIG. If standardization is desired, simply specify 7 channels on $\frac{1}{2}$ -inch tape in the standard IRIG configuration.

Record/Reproduce electronics for each channel are integrated in a single plug-in module featuring unity gain. An integral speed switch permits selection of data conversion for 2, 3 or 4 tape speeds — no additional plug-ins needed. For maximum flexibility, each multi-channel input is isolated. Data can be accepted from unbalanced, differential or push-pull outputs — or different DC levels on input signal ground returns can be preserved. Test points allow monitoring of input during recording, output voltage level when reproducing.

Write for the pleasant details.

MNEMOTRON

Division of
TECHNICAL MEASUREMENT
CORPORATION



Executive Sales Offices:
202 Mamaroneck Ave., White Plains, N.Y.

termination-proof ✱
careers for
Electronic Engineers
in Washington, D. C.

Why let your career hang on the whim of a single defense contract . . . or your professional development be restricted to a single program?



Electronic Engineers at the Navy's Bureau of Ships headquarters activities here in the nation's capital tangle with an unending series of large-scale programs for submarines, surface ships, shore installations, and amphibious craft. If one program is terminated, or fails to live up to its promise, the BuShips engineer simply turns his attention to the six or seven other programs he is concerned with . . . or takes on the next task coming down the pike.

Today this might involve IFF & Electronic Navigation . . . Acoustics . . . Strategic Computers . . . VLF Systems . . . Sonar and Radar . . . Gyros . . . Control & Display Systems . . . IR and Toxic Vapor Detection . . . Antennas . . . Crypto Equipment . . . Communications . . . and many more.

Tomorrow, and in the years ahead, this might involve automation of electronics on all naval vessels in order to reduce the number of personnel required for extended operations . . . quick-reaction tactical data systems for hydrofoil and hydro-skimmer craft capable of speeds of 100 knots . . . high performance radars using pulse-compression techniques . . . revolutionary sonar and noise reduction concepts for deep-diving submarines . . . further subminiaturization of all electronics on operating vessels . . . and many, many more advanced programs.

Electronic Engineers at BuShips headquarters work in one or more of the following categories:

ELECTRONIC-ELECTRICAL DESIGN to provide systems layout and specifications at the very early stages of ship design.

PROJECT ENGINEERING to manage the electronic development programs, and to initiate R & D and/or Production contracts, work with Design people, trouble-shoot fleet technical problems, and recommend future areas of R & D attention.

SHORE ELECTRONICS ENGINEERING to provide systems planning, installation and maintenance for Aeronautical Facilities (communications, radar, nav aids, etc.) . . . Communications Facilities (the worldwide Naval Communications System) . . . and Special Facilities involving highly classified work.

R & D MANAGEMENT — directing BuShips \$200 MILLION PER YEAR research effort into noise reduction, ocean surveillance, advanced warfare systems, and, of course, ASW.

It's all right here in Washington at BuShips headquarters — the interesting jobs, the even more interesting future, and the many useable benefits of Career Civil Service. (Salaries are competitive, by the way, and there's another increase coming in January, 1964.)

Make uncertainties and limitations a part of your past, and the nuclear Navy a part of your future. Get in touch with Mr. L. E. Probst, Code 263R, and find out what you and BuShips can offer each other.

Bureau of Ships Department of the Navy
 Washington 25, D. C.

An Equal Opportunity Employer

of Hughes Aircraft Company's Aerospace Group in Culver City, Calif., is announced.

The new appointments are William A. Craven, Jr., manager of the group's infrared systems and guidance heads laboratory, and Elvin E. Herman, manager of the signal processing and display laboratory.

Both men will continue as managers of their respective laboratories in addition to their new duties.

PEOPLE IN BRIEF

Melvin W. Caquelin promoted by Collins Radio Co. to director of the Components div. The Magnavox Co. advances James T. Smith to director of operations of its Urbana facility. Richard W. Karcher, formerly with GE, appointed director of engineering at Cornell-Dubilier Electronics' Mica div. Donald H. Blouch moves up at General Kinetics Inc. to mgr. of the Magnetic Tape Services div. E. C. Boycks, previously with Abacus, Inc., named product mgr., systems at the Computer div. of Packard Bell Electronics. Ian B. Dickson elevated to g-m of American Micro Devices, Inc. Robert R. Rutherford leaves U.S. Semiconductor Products to join Motorola Semiconductor Products div. as product mgr. of glass diodes. Edcliff Instruments boosts F. Donald Calkins to asst. g-m. J. H. Zeigler raised to plant operations mgr. at Electro Instruments, Inc. Sidney Bass promoted to asst. mgr., Communication and Radar Section, Electronics div., IIT Research Institute. Indiana General Corp. ups Thomas O. Quinn to chief mfg. engineer for the Magnet div. Donald Wahl, ex-GD/Electronics, named v-p of engineering and mfg. at Optics Technology, Inc. R. Dean Eanes advances to director of the engineering department of Leeds & Northrup Co. Norman J. Regnier of RS Electronics Corp. takes the new position of v-p of marketing. Reginald A. Alexander, formerly with RCA, appointed v-p in charge of special assignments at Industrial Electronic Hardware Corp.

electronics

WEEKLY QUALIFICATION FORM FOR POSITIONS AVAILABLE

ATTENTION: ENGINEERS, SCIENTISTS, PHYSICISTS

This Qualification Form is designed to help you advance in the electronics industry. It is unique and compact. Designed with the assistance of professional personnel management, it isolates specific experience in electronics and deals only in essential background information.

The advertisers listed here are seeking professional experience. Fill in the Qualification Form below.

STRICTLY CONFIDENTIAL

Your Qualification form will be handled as "Strictly Confidential" by ELECTRONICS. Our processing system is such that your form will be forwarded within 24 hours to the proper executives in the companies you select. You will be contacted at your home by the interested companies.

WHAT TO DO

1. Review the positions in the advertisements.
2. Select those for which you qualify.
3. Notice the key numbers.
4. Circle the corresponding key number below the Qualification Form.
5. Fill out the form completely. Please print clearly.
6. Mail to: Classified Advertising Div., ELECTRONICS, Box 12, New York 36, N. Y. (No charge, of course).

COMPANY	SEE PAGE	KEY #
ATOMIC PERSONNEL INC. Philadelphia, Penna.	72	1
BUREAU OF SHIPS Department of the Navy Washington, D. C.	70	2
GENERAL DYNAMICS/ELECTRONICS A Div. of General Dynamics Corp. Rochester, New York	57*	3
INTERNATIONAL BUSINESS MACHINES CORP. Space Guidance Center Owego, New York	72	4
SOCONY MOBIL OIL CO., INC. Dallas 21, Texas	72	5
SPACE AND INFORMATION SYSTEMS Div. of North American Aviation, Inc. Downey, Calif.	66	6

* These advertisements appeared in the July 5th issue.

(cut here)

electronics WEEKLY QUALIFICATION FORM FOR POSITIONS AVAILABLE

(cut here)

(Please type or print clearly. Necessary for reproduction.)

Personal Background

NAME

HOME ADDRESS

CITY ZONE STATE

HOME TELEPHONE

Education

PROFESSIONAL DEGREE(S)

MAJOR(S)

UNIVERSITY

DATE(S)

FIELDS OF EXPERIENCE (Please Check)

71263

- | | | |
|--|--|---------------------------------------|
| <input type="checkbox"/> Aerospace | <input type="checkbox"/> Fire Control | <input type="checkbox"/> Radar |
| <input type="checkbox"/> Antennas | <input type="checkbox"/> Human Factors | <input type="checkbox"/> Radio—TV |
| <input type="checkbox"/> ASW | <input type="checkbox"/> Infrared | <input type="checkbox"/> Simulators |
| <input type="checkbox"/> Circuits | <input type="checkbox"/> Instrumentation | <input type="checkbox"/> Solid State |
| <input type="checkbox"/> Communications | <input type="checkbox"/> Medicine | <input type="checkbox"/> Telemetry |
| <input type="checkbox"/> Components | <input type="checkbox"/> Microwave | <input type="checkbox"/> Transformers |
| <input type="checkbox"/> Computers | <input type="checkbox"/> Navigation | <input type="checkbox"/> Other |
| <input type="checkbox"/> ECM | <input type="checkbox"/> Operations Research | <input type="checkbox"/> |
| <input type="checkbox"/> Electron Tubes | <input type="checkbox"/> Optics | <input type="checkbox"/> |
| <input type="checkbox"/> Engineering Writing | <input type="checkbox"/> Packaging | <input type="checkbox"/> |

CATEGORY OF SPECIALIZATION

Please indicate number of months experience on proper lines.

	Technical Experience (Months)	Supervisory Experience (Months)
RESEARCH (pure, fundamental, basic)
RESEARCH (Applied)
SYSTEMS (New Concepts)
DEVELOPMENT (Model)
DESIGN (Product)
MANUFACTURING (Product)
FIELD (Service)
SALES (Proposals & Products)

CIRCLE KEY NUMBERS OF ABOVE COMPANIES' POSITIONS THAT INTEREST YOU

1 2 3 4 5 6 7 8 9 10 11 12 13 14 15

IBM

FEDERAL SYSTEMS DIVISION

SPACE GUIDANCE CENTER

MANAGEMENT AND SENIOR STAFF LEVELS

Candidates with more than five years of professional experience are invited to investigate newly defined positions involving the establishment and design of new programs and new systems—in a fine professional environment.

PRINCIPAL AREAS OF INVESTIGATION

Advanced Computer Organization and Reliability

Reconnaissance Data Acquisition

Reconnaissance Data Processing

Design Automation

Systems Synthesis

Operations Research

Guidance and Control Systems Design

Inertial Guidance Systems and Equipment

Space Navigation

Manned Space Flight

Space Trajectory Analysis

Semiconductor Physics

Thin Film Studies

Aerospace Materials Engineering

Electromagnetic and Optical Sensors

Plasma Physics

Paramagnetic Resonance

PRINCIPAL POSITIONS TO BE FILLED IN

Advanced Systems Research

Applied Research

Operations Analysis

Human Factors

Marketing

Geographic locations are throughout the U. S., primarily Owego, N. Y. (in the Finger Lakes region); Huntsville, Alabama; and Los Angeles, California.

IBM, an Equal Opportunity Employer, offers a far-sighted program of personal and family benefits.

Your letter or wire will receive personal attention.

Arthur E. Cooper, Dept. 554G3

Space Guidance Center Manager

IBM Federal Systems Division

Owego, New York

INTERNATIONAL BUSINESS MACHINES CORPORATION

IBM

SOCONY MOBIL RESEARCH LABORATORY

DALLAS, TEXAS

ELECTRONICS TECHNICIAN

High School Graduate, some college preferred. 5-10 years Electronics training and experience in construction of test equipment and electronic instruments required. Work is non-routine and requires exceptional ability and understanding of electronics components, circuits, layouts, and specifications. Applicants should submit detailed personal resumes including experience and education to J. F. Gleason, Jr., Socony Mobil Oil Company, Inc., Research Department, P. O. Box 900, Dallas 21, Texas.

An Equal Opportunity Employer



E. E.'s
for FEE-PAID Positions
WRITE US FIRST!
Use our confidential application for professional, individualized service . . . a complete national technical employment agency.
ATOMIC PERSONNEL, INC.
Suite 1207L, 1518 Walnut St., Phila. 2, Pa.

Put Yourself in the Other Fellow's Place

TO EMPLOYERS - TO EMPLOYEES

Letters written offering Employment or applying for same are written with the hope of satisfying a current need. An answer, regardless of whether it is favorable or not, is usually expected.

Mr. Employer, won't you remove the mystery about the status of an employee's application by acknowledging all applicants and not just the promising candidates.

Mr. Employee you, too, can help by acknowledging applications and job offers. This would encourage more companies to answer position wanted ads in this section.

We make this suggestion in a spirit of helpful cooperation between employers and employees.

This section will be the more useful to all as a result of this consideration.

Classified Advertising Division

McGRAW-HILL PUBLISHING CO., INC.

330 West 42nd St., New York 36, N. Y.

DISPLAYED RATE

The advertising rate is \$27.25 per inch for advertising appearing on other than a contract basis. Contract rates quoted on request. AN ADVERTISING INCH is measured 7/8 inch vertically on one column, 3 columns—30 inches—to a page. EQUIPMENT WANTED or FOR SALE ADVERTISEMENTS acceptable only in Displayed Style.

The publisher cannot accept advertising in the Searchlight Section, which lists the names of the manufacturers of resistors, capacitors, rheostats, and potentiometers, or other names designed to describe such products.

Send NEW ADS or inquiries to Classified Adv Div. of Electronics P. O. Box 12, N. Y. 36, N. Y.

UNDISPLAYED RATE

\$2.70 a line, minimum 3 lines. To figure advance payment count 5 average words as a line.

BOX NUMBERS count as one line additional in undisplayed ads.

DISCOUNT of 10% if full payment is made in advance for four consecutive insertions of undisplayed ads (not including proposals.)

FREE Catalog

OF THE WORLD'S FINEST
ELECTRONIC GOV'T
SURPLUS BARGAINS



HUNDREDS OF TOP QUALITY ITEMS—Receivers, Transmitters, Microphones, Inverters, Power Supplies, Meters, Phones, Antennas, Indicators, Filters, Transformers, Amplifiers, Headsets, Converters, Control Boxes, Dynamotors, Test Equipment, Motors, Blowers, Cable, Keys, Chokes, Handsets, Switches, etc., etc. Send for Free Catalog—Dept. E-3

FAIR RADIO SALES
2133 ELIDA RD. • Box 1105 • LIMA, OHIO

CIRCLE 954 ON READER SERVICE CARD

ADDRESS BOX NO. REPLIES TO: Box No.

Classified Adv. Div. of this publication.

Send to office nearest you.

NEW YORK 36: P. O. Box 12

CHICAGO 11: 645 N. Michigan Ave.

SAN FRANCISCO 11: 255 California St.

BUSINESS OPPORTUNITY

Leading Puerto Rico electronic parts and equipment wholesaler seeking experienced partner with \$25,000 to invest in expansion. Will stand rigid investigation. Write BO-2542, Electronics.

TUBES & COMPONENT

FREE...CATALOG
BARRY ELECTRONICS

512 BROADWAY 212-WALKER 5-7000
NEW YORK 12, N.Y. TWX-571-0484

CIRCLE 955 ON READER SERVICE CARD

SMALL AD but BIG STOCK

of choice test equipment
and surplus electronics

Higher Quality—Lower Costs
Get our advice on your problem

ENGINEERING ASSOCIATES

434 Patterson Road — Dayton 19, Ohio

CIRCLE 956 ON READER SERVICE CARD

POTTING APPLICATORS
MANUAL AND DISPOSABLE

6cc 12cc 30cc
FOR POTTING, ENCAPSULATING, AND
SEALING OF MINIATURE COMPONENTS
PHILIP FISHMAN CO.
7 CAMERON ST., WELLESLEY 81, MASS.

CIRCLE 957 ON READER SERVICE CARD

AUTOTRACK ANTENNA MOUNT

360 degree azimuth, 210 degree elevation sweep with better than 1 mil. accuracy. Missile velocity acceleration and slewing rates. Ampidyne and servo control. Will handle up to 20 ft. dish. Supplied complete with control chassis. In stock—immediate delivery. Used world over by NASA, ABMA, USAF, USN.

SCR 584 RADARS AUTOMATIC TRACKING
3 CM & 10 CM

Our 584s in like new condition, ready to go, and in stock for immediate delivery. Ideal for telemetry research and development, missile tracking, satellite tracking, balloon tracking, weather forecasting, anti-aircraft defense defense tactical air support. Used on Atlantic Missile Range, Pacific Missile Range, N.A.S.A. Wallops Island, A.B.M.A. Write us. Fully Desc. MIT Rad. Lab. Series, Vol. 1, pps. 207-210, 228, 284-286.

7.5KW PHONE TRANSMITTER

RCA type ET-4750, tunes 2 to 22 mcs. Broadcast quality. Can also be keyed for CW or modified for SSB. Price \$5000.00.

PULSE MODULATORS**MIT MODEL 9 PULSER****1 MEGAWATT—HARD TUBE**

Output 25 kv 40 amp. Duty cycle .002. Pulse lengths .25 to 2 microsec. Also .5 to 5 microsec. and .1 to .5 msec. Uses 6C21. Input 115v 60 cycle AC. Mfr. GE. Complete with driver and high voltage power supply. Ref: MIT Rad. Lab. Series Vol. 5 pps. 152-160.

500KW THYRATRON PULSER

Output 22kv at 28 amp. Rep. rates: 2.25 microsec. 300 pps. 1.75 msec 550 pps. .4 msec 2500 pps. Uses 5C22 hydrogen thyratron. Complete with driver and high voltage power supply. Input 115v 60 cy AC.

2 MEGAWATT PULSER

Output 30 kv at 70 amp. Duty cycle .001. Rep rates: 1 microsec 600 pps. 1 or 2 msec 300 pps. Uses 5B48 hydrogen thyratron. Input 120/208 VAC 60 cycle. Mfr. GE. Complete with high voltage power supply.

15KW PULSER—DRIVER

Biased multivibrator type pulse generator using 3E29. Output 3kv at 5 amp. Pulse lngths .5 to 5 microsec. easily adj. to .1 to .5 msec. Input 115v 60 cy AC. \$475. Ref: MIT Rad. Lab. Series Vol. 5 pps. 157-160.

MIT MODEL 3 PULSER

Output: 144 kw (12 kv at 12 amp.) Duty ratio: 001 max. Pulse duration: 5.1 and 2 microsec. Input: 115 v 400 to 2000 cps and 24 vdc. \$325 ea. Full desc. Vol. 5 MIT Rad. Lab. series pg. 140.

C.E.C. AMPLIFIER-SYSTEM D

c/o 12 channels #1-112C Linear Integrating Amplifiers

1 Oscillator Power Supply #2-105A

1 Amplifier Case

Condition: LIKE NEW. Orig. cost: \$7,000.00

Now: \$2,750.00 complete

Additional 1-112C Amplifiers: \$175.00 ea.

GIL DAGENAIS

1600 Angulus Ave., L.A. 26, Calif.

CIRCLE 952 ON READER SERVICE CARD

ELECTRON TUBES

KLYSTRONS • ATR & TR • MAGNETRONS
SUBMINIATURES • C.R.T. • T.W.T. • 5000-
6000 SERIES

• SEND FOR NEW CATALOG A2 •

A & A ELECTRONICS CORP.

1063 PERRY ANNEX

WHITTIER, CALIF.

AN 92865 OR 943-2829

CIRCLE 953 ON READER SERVICE CARD

MICROWAVE SYSTEMS**300 TO 2400MC RF PKG.**

300 to 2400MC CW. Tuneable. Transmitter 10 to 30 Watts. Output. As new \$475.

AN/TPS-ID RADAR

500 kv 1220-1359 mcs. 160 nautical mile search range P.P.I. and A Scopes. MTI. thyratron mod. 5J26 magnetron. Complete system.

AN/TPS-10D HEIGHT FINDER

250 KW X-Band 60 & 120 mile ranges to 60,000 feet. Complete.

10 CM. WEATHER RADAR SYSTEM

Raytheon, 275 KW output S Band. Rotating yoke P.P.I. Weather Band. 4, 20 and 80 mile range. 360 degree azimuth scan. Supplied brand new complete with instruction books and installation drawings. Price \$975 complete.

AN/APS-15B 3 CM RADAR

Airborne radar. 40 kv output using 725A magnetron. Model 3 pulser. 30-in. parabola stabilized antenna. PPI scope. Complete system. \$1200 each. New.

10KW 3 CM. X BAND RADAR

Complete RF head including transmitter, receiver, modulator. Uses 2J42 magnetron. Fully described in MIT Rad. Lab. Series Vol. 1, pps 616-625 and Vol. II, pps. 171-185 \$375. Complete System. \$750.

AN/APS-27 X BAND RADAR

Complete 100 kv output airborne system with AMTI, 5C22 thyr. mod, 4J52 magnetron, PPI, 360 deg az sweep, 80 deg. elev. sweep, gyro stabilizer, hi-gain rcvr. Complete with all plugs and cables \$2800.

M-33 AUTO-TRACK RADAR SYSTEM

X band with plotting board, automatic range tracking, etc. Complete in 2 van complex incl. 1 megawatt acquisition radar.

AN/APS-45 HEIGHT FINDER

Airborne system, 40,000 ft. altitude display on PPI & RHI. 9375 mcs. 400kw output using QK-172 megatron, 5F22 thyratron.

L BAND RF PKG.

20 KW peak 990 to 1040 MC. Pulse width .7 to 1.2 microsec. Rep rate 180 to 420 pps. Input 115 vac. Incl. Receiver \$1200.

QUARTZ DELAY LINE

500 Microsecs. 30 MC. 1000 OHMS Termination Resistance—with Calib. Curve LFE Type 11445. Price \$275 each.



**Radio-Research
Instrument Co.**

550 5th Ave. New York 36, N.Y.
Tel. JUdson 6-4691

CIRCLE 950 ON READER SERVICE CARD

LIFSCHULTZ

FASTEST...

4th DAY
between
Chicago and
West Coast

2nd DAY
between
Chicago—
Milwaukee and
Eastern
Terminals

Specialists in Shipment of Electronics Products

**LIFSCHULTZ
FAST FREIGHT**

NEW YORK — CHICAGO — PHILADELPHIA — BOSTON
HOLYOKE — BALTIMORE — BLOOMFIELD, N. J.
NEW HAVEN — PROVIDENCE — MILWAUKEE
LOS ANGELES — SAN FRANCISCO

CIRCLE 951 ON READER SERVICE CARD

TO SEARCHLIGHT ADVERTISERS
Your Inquiries Mean OPPORTUNITY!

... not only for the advertiser, or the publisher, but **FOR YOU!** When you mention this publication in inquiries to advertisers, you enable them to value the evidence of your readership... This advertisers' 'satisfaction' means we have an easier time securing more SEARCHLIGHT advertisements — meaning **MORE** information, **MORE** choice of products, **MORE** value — **FOR YOU!**

INDEX TO ADVERTISERS

• AMP Incorporated	5
Allen-Bradley Co.	9
Arnold Engineering Co., The.....	48
Balteau Electric Corp.....	51
Bureau of Ships.....	70
• Clifton Precision Products Co., Inc.	59
Di Acro Corp.	64
duPont de Nemours & Co., Inc. E. I.	55
Electro Instruments Inc.....	45
Englehard Industries, Inc.....	27
General Time Corp.....	69
Graphic Systems, Inc.....	64
Gries Reproducer Corp.....	64
Heinemann Electric Co.....	28
• Hewlett-Packard Company...2nd cover	10-11
Hoffmann Electronics Corp....	61, 63, 65, 67
Intellux Inc.	52
• Japon Piezo Electric Co., Ltd.....	60
• Kepco, Inc.	47
• Knights Company, James.....	56
Mallory and Co., Inc., P. R....	24, 25
• Markel & Sons, L. Frank.....	60
McGraw-Hill Book Co.....	66
Mnemotron Corp.	69

Motorolo Semiconductor Products Inc.	14, 15
Nexus Research Laboratory, Inc..	51
North American Aviation.....	66
• North Atlantic Industries, Inc.....	49
Omark Industries, Inc.....	62
Photocircuits Corp.	13
• Potter Instrument Co., Inc.....	21
• Radio Corporation of America.4th cover	
• Rosemount Engineering Co.....	53
Sangamo Electric Co.....	17, 18
Sperry Electronic Tube Div.	
Sperry Rand Corp.....	3rd cover
Sprague Electric Co.....	4, 23
Standard Electric Time Co., The..	56
• Torwico Electronics Inc.	6
Weston Instruments & Electronics A Division of Daystrom Inc....	57

EQUIPMENT	
(Used or Surplus New)	
For Sale	73

CLASSIFIED INDEX	
• A & A Electronics Corp.....	73
Atomic Personnel Inc.....	72
• Barry Electronics Corp.....	73
• Engineering Associates.....	73
• Fair Radio Sales.....	73
Fishman Co., Philip.....	73
Gagenais, Gil.....	73
• Houde Glass Co.....	73
International Business Machines..	72
Lifschultz Fast Freight.....	73
Radio Research Instrument Co...	73
Socony Mobile Oil Co., Inc.....	72

■

CLASSIFIED ADVERTISING
F. J. Eberle, Business Mgr.

EMPLOYMENT OPPORTUNITIES	72
BUSINESS OPPORTUNITIES	73

• See advertisement in the July 25, 1962 issue of Electronics Buyers' Guide for complete line of products or services.

This Index and our Reader Service Numbers are published as a service. Every precaution is taken to make them accurate, but **electronics** assumes no responsibilities for errors or omissions.

electronics



Audited Paid Circulation
JAMES T. HAUPTLI (2210)
Advertising Sales Manager
DAVID CUNNIFF (3139)
Promotion Manager
HENRY M. SHAW (2751)
Market Research Manager

■

Electronics Buyers' Guide

R. S. QUINT (2335)
General Manager

■

RICHARD J. TOMLINSON (3191)

Business Manager
THEODORE R. GEIPEL (2044)
Production Manager

NEW YORK TELEPHONE:
Area Code 212. Locally, 971 plus extensions shown above in parenthesis

ADVERTISING REPRESENTATIVES

ATLANTA (9):
Michael H. Miller, Robert C. Johnson
1375 Peachtree St. N.E., Trinity 5-0523
(area code 404)

BOSTON (16):
William S. Hodgkinson
McGraw-Hill Building, Copley Square,
Congress 2-1160 (area code 617)

CHICAGO (11):
Harvey W. Wernecke, Robert M. Denmead
645 North Michigan Avenue, Mohawk 4-5800
(area code 312)

CLEVELAND (13):
Paul T. Fegley
55 Public Square, Superior 1-7000
(area code 216)

DALLAS (1):
Frank Le Beau
The Vaughn Bldg., 1712 Commerce St.
Riverside 7-9721 (area code 214)

DENVER (2):
John W. Patten
Tower Bldg., 1700 Broadway,
Alpine 5-2981 (area code 303)

HOUSTON (25):
Kenneth George
Prudential Bldg., Halcombe Blvd.,
Riverside 8-1280 (area code 713)

LOS ANGELES (17):
Ashley P. Hartman, John G. Zisch,
William C. Gries
1125 W. 6th St., Huntley 2-5450
(area code 213)

NEW YORK (36):
Donald H. Miller (3615)
George F. Werner (3617)
Donald R. Furth (3616)
500 Fifth Avenue, Dial 971 plus Nos. in parenthesis
(area code 212)

PHILADELPHIA (3):
Warren H. Gardner, William J. Boyle
6 Penn Center Plaza, LOcust 8-4330
(area code 215)

SAN FRANCISCO (11):
Richard C. Alcorn
255 California Street, Douglas 2-4600
(area code 415)

LONDON W1:
Edwin S. Murphy Jr.
34 Dover St.

FRANKFURT/Main:
Matthée Herfurth
85 Westendstrasse

GENEVA:
Michael R. Zeynel
2 Place du Port

TOKYO:
George Olcott,
1, Kotohiracho, Shiba, Minato-ku

So shake it!

New low-cost reflex klystrons designed to meet the severest environments of vibration and shock are now available from Sperry Electronic Tube Division.

An example is Sperry's SRU-4192. It offers 250 mW minimum output at any frequency you specify between 15.5 and 17.5 Gc. It's trim tunable across a 100 Mc range. It operates at an unusually low voltage. It's available within 30 days from receipt of your order, but with all these advantages it's priced far below comparable tubes.

Sperry has similar capabilities in other areas of the spectrum. If you need a ruggedized reflex klystron anywhere in X, U, K, or V band (8.2 to 40 Gc), Sperry has the answer.

To avail yourself of the outstanding performance of one of Sperry's rugged new reflex klystrons, place your order now. Contact your Cain & Co. representative or write Sperry, Gainesville, Florida. In Europe, contact Sperry Europe Continental, Paris.



CIRCLE 901 ON READER SERVICE CARD

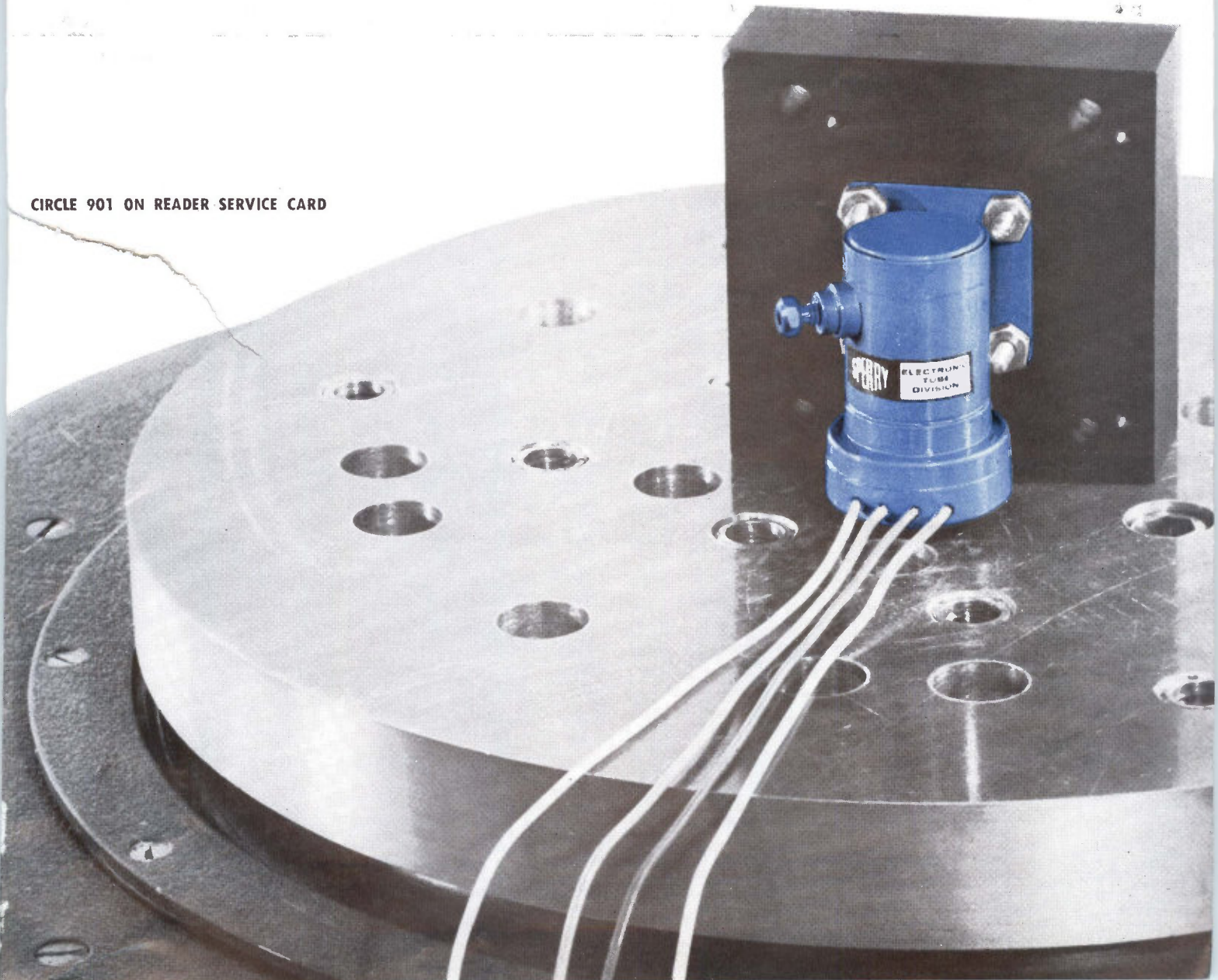

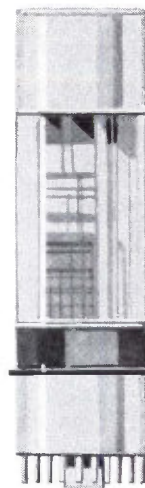

**A MAJOR
ADVANCE
IN LASER
DETECTION**



RCA LASECON

JOINS THE FAMILY OF RCA DETECTORS FOR LASER SYSTEMS



A new electron tube, the LASECON, soon to be available on a sampling basis from RCA, is the industry's most advanced microwave phototube designed for use as a laser signal detector and converter. Capable of handling several hundred television channels simultaneously over a single light beam, the LASECON is also expected to play an important role in the use of lasers for space communications, optical radar, and radar astronomy.

Designated RCA-A1283, the LASECON joins the family of RCA Photomultiplier, Photojunction, and Photoconductive square-law detectors. It is a primary example of how the RCA Electron Tube Division is extending to the optical frequency region its capability in devices for generating, amplifying, modulating, and detecting electromagnetic radiation—to develop even more sophisticated detectors of coherent light.

Many of RCA's square-law detectors meet the major requirements of coherent light detection and mixing devices. They have broad bandwidth, low noise, and fast response.

The LASECON, recently tested under a contract with the U.S. Army Electronics Research and Development Laboratory, has recovered modulation at frequencies ranging from 1,000 to 2,000 Mc. It was employed to recover the beat frequency generated by two modes of a ruby laser which were separated by 1,700 Mc.

For more information on the LASECON and other RCA devices for use in the light portion of the frequency spectrum, write: Manager, Marketing, RCA Electronic Components and Devices, Lancaster, Pennsylvania.

Some Lasers and Recommended RCA Detectors

Laser Type	Approximate Laser Output Wavelength in Å Units	Recommended Detector Units (s)
Gas He + Ne	6,340	C70042A
AL ₂ O ₃ :Cr ³⁺	6,943	C70042A
AL ₂ O ₃ :Cr ³⁺	7,060	C70042A
Solid CaF ₂ :Sm ³⁺	7,090	C70042A
Solid GaAs	8,400	C70102B, C70007A
Gas Ne + O	8,450	C70102B, C70007A
SrF ₂ :Nd ³⁺	10,350	C70102B, C70007A
Solid CaF ₂ :Nd ³⁺	10,600	7467
Gas He + Ne	11,200-12,000	7467
Gas Ar	16,100	7467
Gas Kr	17,000	7467
CaF ₂ :Dy	23,600	C70274
Gas He + Ne	34,000	C70274, C70201
Gas Cs	71,600	C70274, C70201, C70015

Pertinent Data on RCA Laser Detectors

Type and No.	Approximate Usable Spectrum in Å	Response Time in Seconds	Equivalent Noise Input in Watts
Head-on Type Photomultiplier C70007A	4500-10,000	2 x 10 ⁻⁹	2 x 10 ⁻¹² @ 25°C
Head-on Type Photomultiplier C70042A	3000-8000	2 x 10 ⁻⁹	2 x 10 ⁻¹² @ 25°C
Head-on Type Photomultiplier C70102B	4500-10,000	2 x 10 ⁻⁹	N.A.
Photojunction Cell 7467	3500-18,700	1 x 10 ⁻⁹	1.3 x 10 ⁻¹⁰ @ 25°C
Head-on Type Photoconductive Cell C70274	18,000-85,000	1 x 10 ⁻⁶	5 x 10 ⁻¹⁰ @ 77°K
Head-on Type Photoconductive Cell C70201	30,000-135,000	1 x 10 ⁻⁶	3.6 x 10 ⁻⁹ @ 21°K
Head-on Type Photoconductive Cell C70015	30,000-155,000	1 x 10 ⁻⁶	2.7 x 10 ⁻⁹ @ 21°K

RCA FIELD OFFICES:

OEM SALES: Newark 2, N. J., 32-34 Green St., (201) 485-3900 • Chicago 54, Ill., Suite 1154, Merchandise Mart Plaza, (312) 527-2900 • Los Angeles 22, Calif., 6801 E. Washington Blvd., (213) RA 3-8361 • GOVERNMENT SALES: Harrison, N. J., 415 South Fifth St., (201) 485-3900 • Dayton 2, Ohio, 224 N. Wilkinson St., (513) BA 6-2366 • Washington 6, D. C., 1725 "K" St., N.W., (202) FE 7-8500 • INTERNATIONAL SALES: RCA International Division, Clark, New Jersey, (201) 382-1000



The Most Trusted Name in Electronics