

electronics®

INFRARED TRACKING

Finding missile plumes amid bright clouds, p 39

SIMULATING NEW DOPPLER RADAR

Phase-locked klystrons upgrade performance, p 44

BALLOON-BORNE RADIOSONDE

Unit detects x-rays and gamma rays, p 47

LATEST ANTI-SUBMARINE WEAPON. *Drone helicopter packs nuclear punch, p 18*



C 11
HOSES LAKE WASH
BOX 956
ROLAND KISSLER T 11-

MEASURE MILLIVOLTS at 1000 MC

hp 411A RF Millivoltmeter now available. Measure low level radio frequency, radio frequency and intermediate frequency stage gain, and radio frequency in coaxial lines from 500 kc to 1000 mc, 10 mv to 10 volts. Measuring is simple, resolution is high, and thermal drift errors are virtually eliminated with the 411A Voltmeter. This remarkable instrument has true linear operation (no correcting networks) and readings are presented on a large, mirror-backed linear meter. Temperature stability is such that there is virtually no change from 10° to 40° C.

Specifications alongside indicate basic features of this important new, time-saving instrument. Other special features include: matched diodes protected against burnout; probe temperature compensated for low drift; amplifier photochopper eliminating contact noise, guaranteeing high sensitivity and zero-drift freedom; extra probe tips available including a 500 kc to 250 mc UHF tip, 100:1 Capacity Divider tip for measurements up to 1000 v peak, and Type N Tee tip for coax use to 1000 mc. Get a new 411A into action on your bench now!



**HEWLETT
PACKARD
COMPANY**

1501 Page Mill Rd., Palo Alto, California, Area Code 415, DA 6-7000. Sales and service representatives in all principal areas, Europe, Hewlett-Packard S.A., 54 Route des Acacias, Geneva; Canada, Hewlett-Packard (Canada) Ltd., 8270 Mayrand Street, Montreal

SPECIFICATIONS

Voltage Range:

10 mv rms full scale to 10 v rms full scale in seven ranges; full scale readings of 0.01, 0.03, 0.1, 0.3, 1, 3 and 10 v rms

Frequency Range:

500 kc to 1 gc with accessory probe tips; usable indications to 4 gc

Accuracy:

500 kc to 50 mc, $\pm 3\%$ of full scale; 50 mc to 150 mc, $\pm 6\%$ of full scale; 150 mc to 1 gc, ± 1 db using appropriate probe tips

Meter Scales:

Two linear voltage scales, 0 to 1 and 0 to 3, calibrated in the rms value of a sine wave; db scale, calibrated from +3 to -12 db; 0 db=1 mw in 50 ohms

Probe Tip Furnished:

411A-21E BNC open circuit tip, 500 kc to 500 mc; shunt capacity less than 5 pf; max. input 200 v dc; input resistance at 10 mc typically 80K ohms

Galvanometer

Recorder Output:

Proportional to meter deflection, 1 ma into 1000 ohms at full scale deflection

Power:

115 or 230 v $\pm 10\%$, 50 to 60 cps, 35 watts

Dimensions:

Cabinet Mount: 11 $\frac{3}{4}$ " high, 7 $\frac{1}{2}$ " wide, 12" deep
Rack Mount: 6 - 31/32" high, 19" wide, 10 $\frac{3}{8}$ " deep behind panel

Price:

⌘ 411A, (cabinet) \$450
⌘ 411AR (rack mount) \$455

*Data subject to change without notice.
Price f.o.b. factory.*



electronics

A McGraw-Hill Weekly 75 Cents



W. W. MacDONALD, Editor

J. M. CARROLL, Managing Editor

SENIOR EDITORS

Samuel Weber, George W. Sideris

SENIOR ASSOCIATE EDITORS

Michael F. Wolff, John F. Mason

ASSOCIATE EDITORS

Michael F. Tomaino, Sylvester P. Carter, William P. O'Brien, Sy Vogel, Leslie Solomon, George J. Flynn, Laurence D. Shergalis, George V. Novotny, Leon H. Dulberger

ASSISTANT EDITORS

Nilo Lindgren, Stanley Froud, Stephen B. Gray, Roy J. Bruun, Barry A. Briskman

REGIONAL EDITORS

Harold C. Hood (Pacific Coast, Los Angeles), Thomas Maguire (New England, Boston), Cletus M. Wiley (Midwest, Chicago)

ART DIRECTOR

Howard R. Berry

ASSISTANT ART DIRECTOR

John C. Wright, Jr

EDITORIAL ASSISTANTS

Lorraine Rossi, Virginia T. Bastian, Lynn Emery, Ann Mella, Lorraine Werner, Alice M. O'Brien, Sharon Parks, Patricia Mitchell, Claire Benell

FOREIGN NEWS BUREAU

DIRECTOR, John Wilhelm;
Alyne Elias, Charles Obertance

LONDON—John Shinn, Derek Barlow, Nicholas Landon

BONN—Bruce Bendow,
Richard Mikton, Silke McQueen

BRUSSELS—Peter Forbath

PARIS—Robert Farrell,
Arthur Erikson

MILAN—Marc A. Messina

MEXICO CITY—Wesley Perry, Jr

RIO DE JANEIRO—Leslie Warren

MOSCOW—Stewart Ramsey

TOKYO—Richard Halloran,
Charles Cohen, John Yamaguchi

CIRCULATION MANAGER

Hugh J. Quinn

W. W. GAREY, Publisher

TORPEDO-TOTING drone helicopter is Navy's newest weapon against enemy submarines (Gyrodyne Co. of America). It can leave a destroyer's deck, clobber a sub with torpedos or nuclear depth charges and return while the mother ship stands off at a safe distance. *Landing assist device will automatically land the drone even in a 40-knot wind. See p 18*

COVER

ROBOT HELICOPTERS Join Navy's Antisubmarine Arsenal. Navy plans to install the weapons delivery system aboard some 300 ships. *The program may run to \$200 million over the next five years; estimated cost will be \$50 million this fiscal year*

18

SPACECOM: \$100-Million-a-Year Market. Here's a rundown of Air Force plans to upgrade its communications. Facilities include microwave, cable and troposcatter equipment, and point-to-point and ground/aerospace circuits. *The systems will be wide-band, survivable, secure*

22

ION IMPLANTS Forge Tailor-Made Semiconductor Junctions. Particle accelerator precisely puts impurities into crystals. *The technique is now being tried out on solar cells, but the big goal is microcircuits that can be made without masking and photo-etching*

26

MEDICAL LASERS. Team of eye doctors and laser designers develop an ophthalmoscope-laser. *It can weld retinal flaws in 1 msec, without pain to the patient*

30

EUROPE PLANS SATELLITES. Eight countries are asked by 121 firms to join forces in Eurospace program. *First proposals are for communications and navigational satellites. Meteorological satellites will be considered next*

36

NEW INFRARED SYSTEM Tracks Missiles Against Bright Florida Sky. This equipment can distinguish a missile plume even when clouds reflect more energy. *It is useful for short-range tracking when spurious returns make conventional radar ineffective.*

By T. P. Dixon, ITT Federal Labs 39

PHASE-LOCKED KLYSTRONS Simulate Doppler Radar. Obtaining accurate results from simulation tests of modern doppler radar requires higher doppler range, cleaner frequency spectrum and better frequency stability than commonly available. *This crystal-controlled phase-locked system can be applied to carrier frequencies from 1 to 40 Gc.*

By A. Benjaminson, Hewlett Packard 44

RADIOSONDE Measures After Effects of Solar Flares. Balloon-borne instrument uses both scintillation counter and counter telescope to study phenomena in the auroral zone initiated by solar flares. *Equipment has been operated successfully in several flights over polar regions of Europe.*

By E. Waibel, Max-Planck Institut 47

Contents Continued

Published weekly, with Electronics Buyers' Guide as part of the subscription, by McGraw-Hill Publishing Company, Inc. Founder: James H. McGraw (1860-1948).

Title ® registered U.S. Patent Office; © copyright 1963 by McGraw-Hill Publishing Co., Inc. All rights reserved, including the right to reproduce the contents of this publication, in whole or in part.

Executive, editorial, circulation and advertising offices: McGraw-Hill Building, 330 West 42nd Street, New York 36, N. Y. Telephone Longacre 4-3000. Teletype TWX N.Y. 212-640-4646. Cable McGrawhill, N. Y. PRINTED IN ALBANY, N. Y.; second class postage paid at Albany, N. Y.

OFFICERS OF THE PUBLICATIONS DIVISION: Shelton Fisher, President; Vice Presidents: Joseph H. Allen, Operations; John R. Callahan, Editorial; Ervin E. DeGraff, Circulation; Donald C. McGraw, Jr., Advertising Sales; Angelo R. Venezian, Marketing.

OFFICERS OF THE CORPORATION: Donald C. McGraw, President; Hugh J. Kelly, Harry L. Waddell, Executive Vice Presidents; L. Keith Goodrich, Executive Vice President and Treasurer; John J. Cooke, Vice President and Secretary.

Subscriptions are solicited only from those actively engaged in the field of the publication. Position and company connection must be indicated on orders. Subscription rates: United States and Possessions, \$6.00 one year, \$9.00 two years, \$12.00 three years. Canada: \$10.00 one year. All other countries \$20.00 one year. Single copies, United States and Possessions and Canada 75¢. Single copies all other countries \$1.50.

THE PUBLISHER, UPON WRITTEN REQUEST FROM ANY SUBSCRIBER TO OUR NEW YORK OFFICE AGREES TO REFUND THAT PART OF THE SUBSCRIPTION PRICE APPLYING TO COPIES NOT YET MAILED.

Subscribers: Please address change of address notices, subscription orders or complaints to Fulfillment Manager, Electronics, at above address. Change of address notices should provide old as well as new address, including postal zone number if any. If possible, attach address label from recent issue. Allow one month for change to become effective.

Postmaster: Please send Form 3579 to Fulfillment Manager, Electronics, 330 West 42nd Street, New York 36, New York.



Audited Paid Circulation

CONTENTS continued

SWEEP MEASUREMENTS In the Difficult Range. Basic measuring techniques change radically in the 5 to 220-Mc range but this is exactly the range of interest in many applications. *One way to measure is to compare transmission through two paths using oscilloscope display.* By K. Simons, Jerrold Electronics 52

SIMPLE TRANSISTOR TESTER: How to Build One. Here is a quick way to sort out good transistors from bad ones. *The instrument will measure leakage current and common-emitter current amplification.* By G. F. Montgomery, National Bureau of Standards 56

DEPARTMENTS

Crosstalk. *The Beneficent Laser* 3

Comment. *Microminiaturization. Decimal-to-Binary Switch* 4

Electronics Newsletter. *Thresher Probe Key to ASW's Future* 7

Washington This week. *Internal Revenue Service Cracks Down on Trade Associations* 12

Meetings Ahead. *Magnetism and Magnetic Materials Conference* 37

Research and Development. *Packing a Half-Million Bits in a Cubic Inch* 58

Components and Materials. *Miniature Components for Mass Market* 64

Production Techniques. *Thin Film Production Performed Continuously* 70

New Products. *Noise Generator is Drift Free* 76

Literature of the Week. 86

People and Plants. *Hazeltine Reassigns Executives* 88

Index to Advertisers. 98

CROSSTALK



THE BENEFICENT LASER. One of the joys of being a reporter is the occasional awareness of witnessing an event that can alter many lives. That sense of revelation sustains the good reporter through all the intervening humdrum assignments. The other mark of a good reporter is an itch to get into print quickly what has been witnessed.

Of course, there are other reasons for the fourth estate, but more to the point of this page is the story that prompted these remarks on journalistic enthusiasm. When Ed Addeo, of the McGraw-Hill World News Bureau in San Francisco, submitted this week's report on a new ophthalmoscope-laser (p 30), he wrote this preamble:

"In the current excitement over lasers and the potentials thereof, researchers and press agents tend to get a little carried away with the 'death ray' aspects and other awe-inspiring applications. Burning through plate steel and blasting enemy satellites out of the sky are admittedly colossal prospects, but comparatively little heed is being paid to the more gentle and peaceful uses of the laser principle."

Ed's itch to get the story into print was showing, but we were glad to scratch it. In the last few years, we have paid particular heed to the laser application efforts being made by scientists and physicians (such as Drs. H. C. Zweng and Milton Flocks, shown in the photo experimenting on a rabbit with the ophthalmoscope-laser). In fact, one article in our 1961 series on lasers (p 54, Nov. 24, 1961) was devoted pri-

marily to potential scientific and medical applications, including the type of retinal surgery reported this week.

THE PEACEFUL ATOM. Akin to the laser story is the report on ion implantation, by New England Editor Maguire on p 26 this week.

For years, we have reported how atomic radiation damages semiconductors—a problem whose seriousness has been confirmed by the damage to Telstar and other satellites. Now, according to Ion Physics Corp., semiconductor device fabrication may be substantially improved by purposefully bombarding the semiconductor with ions. The bombardment tool is a particle accelerator—one of the breed that has belabored semiconductors in radiation-damage studies.

Appropriately, the component most harrassed by space radiation—solar cells—will probably be the first to benefit from the technique. This story, by the way, is one we have been after for a long time. It was just about two years ago (p 11, April 7, 1961) that we first learned that Ion Physic's parent corporation was working on ion bombardment.

Coming In Our April 26 Issue

FAMILY TREE. If you have found it difficult to keep straight the relationship between the many branches of the semiconductor art—and who hasn't?—you'll want to tack on your wall the three-page foldout chart of the semiconductor family tree we are publishing next week. Prepared by Managing Editor Carroll, it traces the growth and ramifications of semiconductor devices, starting with the discovery of the selenium photocell in 1876. The cover illustration uses the symbols for many modern semiconductor devices.

Another example of the merger of the electrical and electronic worlds is provided next week by an article, by F. Brunetto, of New York Naval Shipyard, on the gate-turn-off switch. This new semiconductor device combines the characteristics of transistors and silicon controlled rectifiers. It promises to find wide use in electrical power control applications.

Other features next week include:

- Target-tracking tv systems
- How r-f interference can be controlled
- High-linearity multivibrator
- Compact new telemetry antenna
- New trigger circuit with low cost and high sensitivity.

↓
**QUICK DELIVERY
 FROM
 SPRAGUE**

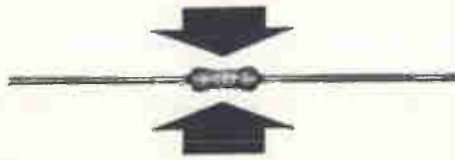

THIS IS A ONE-WATT BLUE JACKET RESISTOR

**P. S. Big brothers available
 up to 11-watts power rating**

**P. P. S. For complete data,
 write for**

Engineering Bulletin 7410 D

Axial-lead Blue Jackets, available in ratings from 1 through 11 watts are specially designed for use with point-to-point wiring or on printed boards in miniature electronic assemblies.

SPRAGUE ELECTRIC COMPANY
 35 Marshall Street, North Adams, Mass.



COMMENT

Microminiaturization

I am presently project leader of project to convert our present printed-circuit boards to miniature module construction. In reviewing the advertisements and articles on microminiaturization, I have found your magazine very useful, and in the future I expect it to be even more useful.

RICHARD W. BURKENPAS
 Montronics, Inc.
 Bozeman, Montana

Decimal-to-Binary Switch

I would like to refer to the article, Contact Arrangement Simplifies Design (p 86, Feb. 8).

We will agree that the switch shown by Mr. Werden is simpler than the two-section switch versions used for decimal-to-binary conversions, but can't help wondering why he makes it so complicated.

The catalog sheet attached shows the layout of a switch wafer that we have had on the market for quite some time which is not only a one-wafer switch but also eliminates the six jumpers used in wiring on Mr. Werden's switch.

L. H. FLOCKEN
 Oak Manufacturing Co.
 Crystal Lake, Illinois

Mr. Werden replies:

The Oak switch is indeed very simple wiring. I would have undoubtedly used it had it been available to me at the time I was designing the circuit and logic requiring decimal-to-binary manual controls.

Laser Navigation

I would like to make the following friendly comment on Laser May Find New Role in Navigation, ELECTRONICS, Feb. 8 (p 7):

This type of laser, suitable for gyro applications, is not necessarily radically new to those who are acquainted with Rosenthal's equation and his concept of the rotating laser cavity with two counter-rotating light beams (A. H. Rosenthal, Regenerative Circulatory Multiple-Beam Interferometry for the Study of Light Propagation Effects, *J Optical Soc of America*, Vol. 52, No. 10, pp 1143-1148, 1962). Based on this principle, the following items had been proposed some time ago within The Boeing Company: a laser compass, a laser gyro, a laser navigation aid to determine geographical latitude and longitude, and a laser rotation detector.

Furthermore, a highly sensitive experiment on the problem of finity or infinity of space had been envisaged: a laser cavity that rests on the earth's surface is surrounded by a heavy cylindrical mass. The hollow cylinder may rotate clockwise, or counterclockwise, at a high angular velocity. Any decrease, or increase, in beat frequency of the two laser beams would indicate that the oblateness of planets is caused by their rotation with respect to the entirety of galaxies, and would manifest that space is finite, according to Mach's ideas (M. von Laue, "Die Relativitätstheorie," edited by F. Vieweg and Son, Braunschweig 1956, Vol. 2, pp 6-7).

THEODORE F. HEITING
 Aero-Space Division
 The Boeing Company
 Seattle, Washington

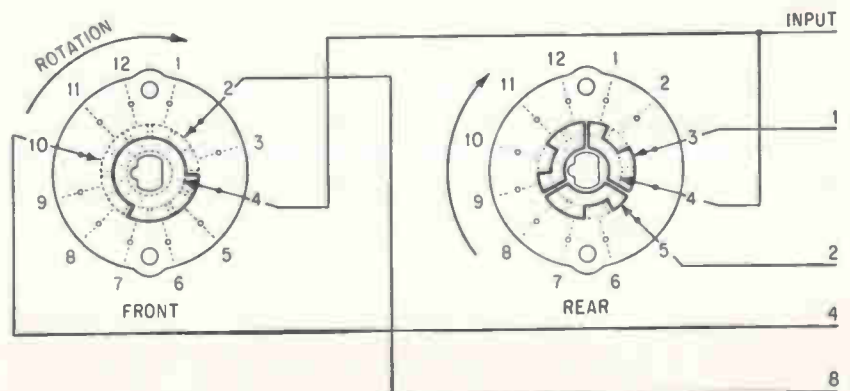



Allen-Bradley
hot molded resistors
help achieve...

**OPTIMUM PERFORMANCE
CONTINUING RELIABILITY**
for Tektronix Oscilloscopes

In designing oscilloscopes to meet the exceptionally high standards for laboratory work, Tektronix demands equally high performance from the components they use. Here, Allen-Bradley fixed and variable resistors are a natural choice.

The exclusive hot molding process—developed by Allen-Bradley—gives A-B fixed resistors such consistently uniform characteristics that their performance can be accurately predicted over long periods of time under various operating conditions . . . and catastrophic failures are unheard of!

Allen-Bradley's famous Type J variable resistors feature a solid resistance element—also made by A-B exclusive hot molding process—that assures smooth control at all times. There are never any abrupt changes in resistance during adjustment as in wire-wound units. Also, the "noise" factor is extremely low initially, and it decreases with use.

You, too, can obtain optimum resistor performance and reliability by insisting on Allen-Bradley. For full details on the complete line of A-B quality components, please write for Publication 6024, today.

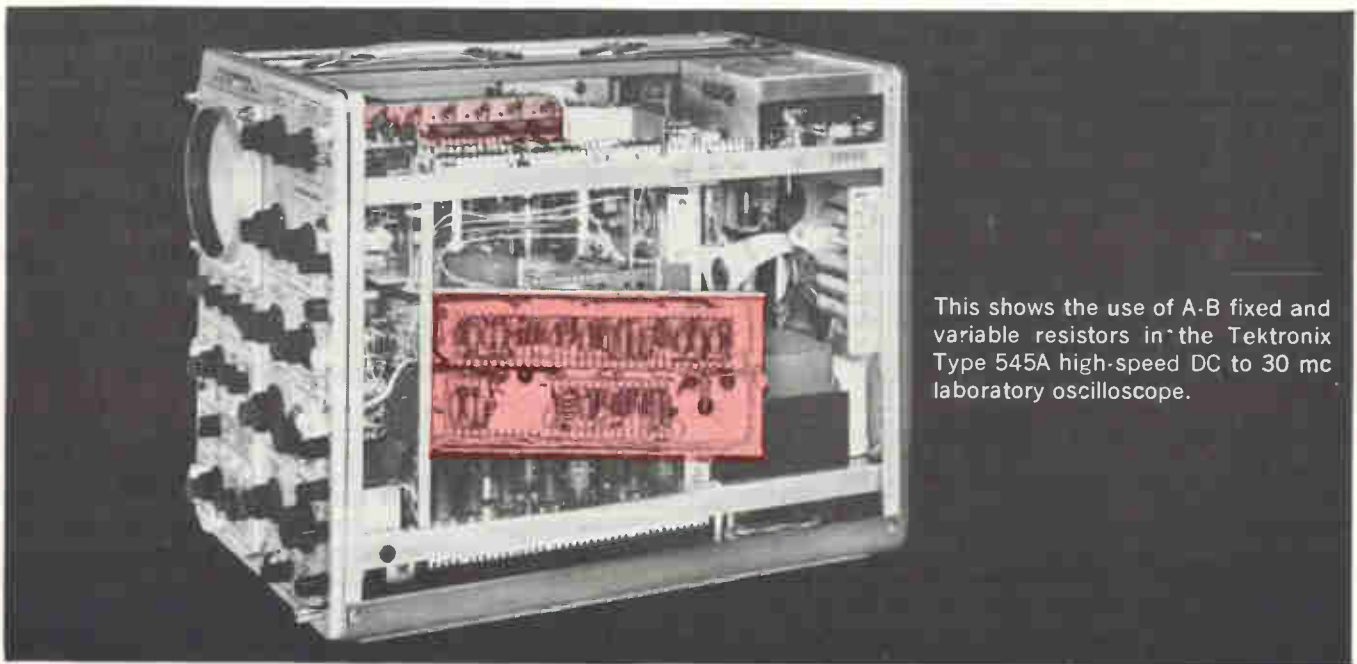

This shows the use of A-B fixed and variable resistors in the Tektronix Type 545A high-speed DC to 30 mc laboratory oscilloscope.

A-B Type J variable resistor actual size, rated 2.25 watts at 70°C. Available in standard tapers and in standard total resistance values to 5 megohms. A-B engineers will be happy also to discuss your needs for special tapers and special, as well as, higher resistance values.



Type TR 1/10 Watt		MIL Type RC 06
Type CB 1/4 Watt		MIL Type RC 07
Type EB 1/2 Watt		MIL Type RC 20
Type GB 1 Watt		MIL Type RC 32
Type HB 2 Watt		MIL Type RC 42

Allen-Bradley hot molded fixed resistors (shown actual size) are available in all standard EIA and MIL-R-11 resistance values and tolerances.

Allen-Bradley Co., 110 W. Greenfield Ave., Milwaukee 4, Wisconsin • In Canada: Allen-Bradley Canada Ltd., Galt, Ontario

ALLEN-BRADLEY / **Quality Electronic Components**

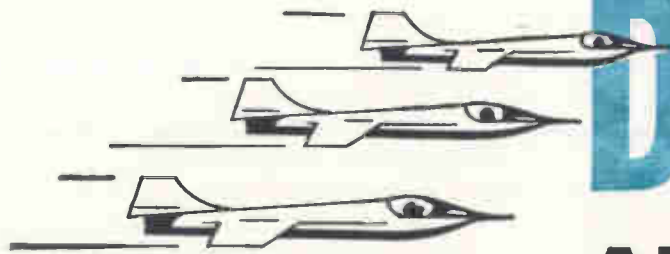

Dunco

AIR FRAME RELAY



Type FC-400

115v AC and 28v DC contacts rated 10 amperes. Coils for 28v DC or 115v, 400 cycles AC. Solder hook terminals standard, others available.

4-pole DT balanced armature type for reliable space age circuit control

This newest addition to Struthers-Dunn's rapidly growing line of relays for critical missile and aircraft uses is made and tested to meet MS-25271-D1 and A1 requirements in accordance with MIL-R-6106C.

The ultimate in contact reliability is obtained by strict quality control; by manufacture in ultra clean, contamination-free surroundings; and by comprehensive production testing.

Modifications designed for electronic and communications equipment as outlined under MIL-R-5757D can be supplied. Write for Bulletin FC-400 to: *Struthers-Dunn, Inc.*, Pitman, N. J., U.S.A.



ANOTHER NOTABLE NEW PRODUCT BY THE MAKERS OF THE WORLD'S LARGEST ASSORTMENT OF RELAY TYPES.

Member, National Association of Relay Manufacturers

Sales Engineering Offices in: Atlanta • Boston • Buffalo • Charlotte • Chicago • Cincinnati • Cleveland • Dallas • Dayton • Denver • Detroit • High Point • Kansas City • Los Angeles • Montreal • New York • Orlando • Pittsburgh • St. Louis • San Diego • San Mateo • Seattle • Toronto. (Export Department: 1505 Race St., Philadelphia 2, Pa., U.S.A.)

Thresher Probe Key to ASW's Future

PORTSMOUTH, N. H.—The future of antisubmarine warfare and the programs to probe the ocean depths—sometimes called inner space or hydrospace—may hinge on the search for the nuclear submarine *Thresher*. Facts learned from the *Thresher* probe are almost certain to affect the crusade by some in the Navy for an all-out effort to explore and exploit the ocean depths.

These factors were in the background this week as the nation's most advanced sonar and oceanographic equipment was being pressed into service to pinpoint the *Thresher's* wreck.

Two research vessels from the Woods Hole oceanographic institution, the *Atlantis II* and the *Gillis*, were mapping the topography of the ocean bottom some 8,000 feet down to pave the way for the bathyscape *Trieste*, which will be lowered to the bottom to photograph the hull.

In addition to sonar, the research vessels have gear to measure underwater current layers, temperature gradients to chart conditions for later dropping of underwater tv cameras and other surveillance devices. The *Atlantis II*, a brand-new 2,300-ton research ship steam-powered to keep background noise at a minimum during underwater acoustic probes, was profiling the ocean floor in the area where oil slicks and debris indicate the *Thresher's* position. The Navy has indicated that it will make every possible effort to locate the *Thresher* and try to determine what happened to this first of a class of deep-diving, high-speed, quiet-running attack subs.

Supporters of an all-out effort to explore the ocean depths contend that Navy subs should eventually be flying through inner space as planes fly through the atmosphere and that advanced sonar would be the eyes and ears of these subs.

Meanwhile, in Washington it was being said that the *Thresher* tragedy pinpoints the difficulties still present in submarine commu-

nications. Before the *Thresher* was lost, the submarine rescue vessel USS Skylark, had difficulty understanding *Thresher's* communications over the underwater sound telephone.

Through ulf stations, the Navy is able to send messages to its submarines at great distances on a one-way basis. However, the submarines cannot transmit back over similar distances without raising antennas above the surface of the water.

Closed-Cycle A-Power Highlight at MHD Parley

BERKELEY, CALIF.—Shift toward closed-cycle nuclear systems for generating MHD power was in evidence at the Fourth Symposium on the Engineering Aspects of Magnetohydrodynamics here last week. Ionization in such systems would be by magnetic induction which has been shown possible by many calculations and a few experiments. Other reports included one from the French Centre d'Etudes Nucleaires on a new type of com-

bustion MHD generator that uses striations of high-temperature gas, and one from Avco showing it may be possible to reduce heat transfer during reentry by causing a shock layer to stand off a body in hypersonic flow. Avco also reported fabricating a 40-Kg superconducting niobium-zirconium coil with a 7-inch inner diameter.

Underwater Tests Show Laser Ranges up to 1,000 ft

EXPERIMENTS in the Navy's Taylor Model Basin reveal that ranges of about 150 feet are possible with a ruby laser operating underwater. Ranging and profiling could be done with high precision using undersea light techniques

Navy scientists used two 5-inch-diameter periscopes to provide an underwater path. Pickup was an infrared-sensitive photodetector on one periscope. Maximum range is estimated at 45 meters. Radiant energy of the laser was 0.07 joule, peak power output roughly 200 w and beam wavelength 6,943 Å.

The ruby rod was removed and

Scanner Is Working on the Railroad

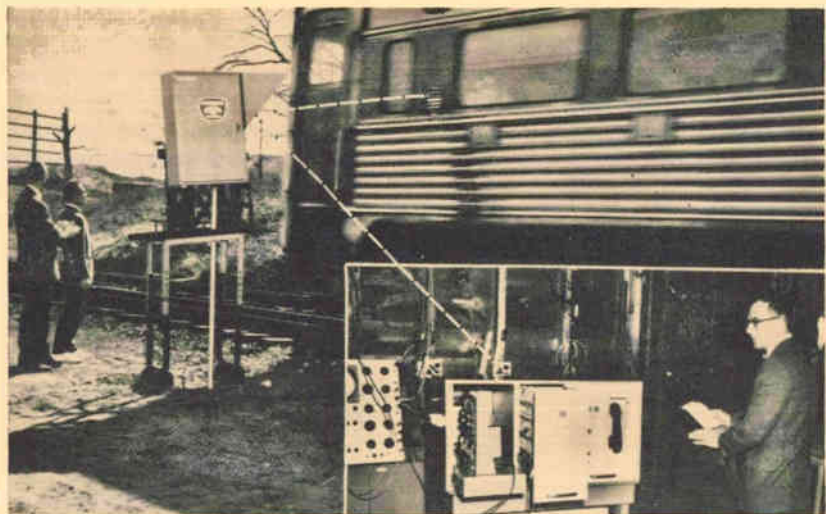

SCANNER developed by Sylvania identifies and records number of moving railroad car. Number is coded on colored, reflective strips on the side of the car. The scanner sends out white light and gets back colored light, which is then converted into electronic impulses. The decoding and printing units are shown in the inset.

a blue-sensitive detector and new filters were employed to measure transmission of incoherent light at 4,900, 5,220 and 5,650 Å, in the green region. Estimated range of a 5,300 Å green laser, if one were available, would be about 300 meters (roughly 1,000 feet).

Why Zeus Won't Go Into Production

PROBABLE REASON Nike-Zeus was not voted into production at the secret Senate session, called by Senator Strom Thurmond last Thursday, was Defense Secretary McNamara's strong argument against it to the Senate Armed Services committee hearings.

Quick deployment of a Zeus system would require use of the existing Zeus discrimination radar, and modification of the Zeus missile to reduce the minimum altitude at which an incoming warhead can be intercepted.

McNamara told the committee that while we could deploy such a system by 1968, the Soviets would be able to introduce into their warheads—if they haven't already done so—the capability to penetrate the system by 1966.

Japan Asks Bids On Small "Sage"

TOKYO—Japan Defense Agency last week asked Litton, Hughes and GE for a third major bid on its proposed air defense control and warning system (p 7, March 8). Contractors must deliver bids by April 27 and a final decision is expected by the end of May. Japan thinks this will be in time for the U.S. to appropriate its share of the cost of the system in the fiscal 1964 budget.

The bid is for the third major configuration of the system, which is somewhat smaller than earlier configurations. The second configuration was based on a projected total of 600 fighter planes in Japan in 1967. The third configuration is designed for 500 planes.

Mojave Station To Link Satellites with Japan

PLANS are under way to convert

NASA's Mojave Station at Goldstone, Calif. for reception and transmission of communication satellite signals with the two Japanese stations now under construction. At present, a satellite would not be in line of sight with Japan and either U.S. station at Andover, Me., or Nutley, N. J. The first Japanese station is scheduled for operation in early 1964.

Higher Reliability Seen for Space Parts

ELECTRONICS INDUSTRY should be able to guarantee one-to-five-year reliability for spacecraft systems, GE said Monday. GE, conducting a study for the Air Force, first screened 14,950 present-day parts thoroughly to make sure they came up to military specifications, then subjected them to design-level vibration tests. Parts that passed this underwent thermal-vacuum tests, simulating space conditions. No failures were reported.

GE forced failures with other parts, analyzed the causes and wrote new specs. When parts were built to these, no failures occurred.

Airliner Electronics Are Passing Military Tests

CHICAGO—Testing of the airliner electronic equipment that will be used in the C-141 has been 90 percent completed by the manufacturers, it was reported last week at the Airlines Electronic Engineering Committee meeting. Only minor debugging problems have occurred.

The jet cargo transport is the first military plane planned from scratch to use Arinc-spec equipment (Arinc—Aeronautical Radio, Inc., Washington, D. C., is the parent organization of AEEC). Object is to provide equipment interchangeability when the plane goes into full production.

Air Force has ordered five C-141's from Lockheed, with the first to be delivered in August. Initial suppliers include: Collins, vhf and marker beacon receiver; Wilcox, vor and glide-slope; Bendix, adf; Sperry/Phoenix, gyro compass; Fairchild Camera & Instrument, flight-data recorder.

In Brief . . .

NEW YORK CITY police are using an IBM 1401 computer to process and search fingerprints, plan to use it to match physical descriptions against rogues gallery files.

TEXAS INSTRUMENTS Incorporated has a \$11-million Air Force contract to develop airborne terrain-clearance radar. Program may lead to multipurpose tactical navigation system.

ADMIRAL Corp.'s Ross D. Siragusa predicts that only a picture-tube shortage can prevent marketing of 700,000 color tv sets this year. Admiral would produce 75,000 to 100,000, he said.

RENAULT is factory-installing electronic gearshift on 1963 Dauphine models. Transistor unit coordinates gear changes, magnetic clutch and acceleration.

SYSTEM ANALYSES for the supersonic transport research program will be conducted by the Cornell Aeronautical Laboratory under a \$399,669 contract from FAA.

RCA WILL SET UP a color tv display at the New York World's Fair.

INDOOR GOLF LINKS that use electronic devices to simulate actual playing conditions will be given a big push soon by Canada's Autofab, Ltd.

MAGNAVOX will build solid-state digital computers that will direct mortars, cannons and tactical guided missiles from forward battlefield positions. Firm received \$4,173,619 contract from the Army.

HONEYWELL received \$16-million contract from the Air Force for additional work on the Dyna-Soar guidance system.

COLLINS RADIO was awarded \$2.6-million Navy contract for high-frequency, single-sideband transceivers for ship-to-ship and ship-to-aircraft communications.

RACK'EM UP!

EFFICIENTLY & INEXPENSIVELY

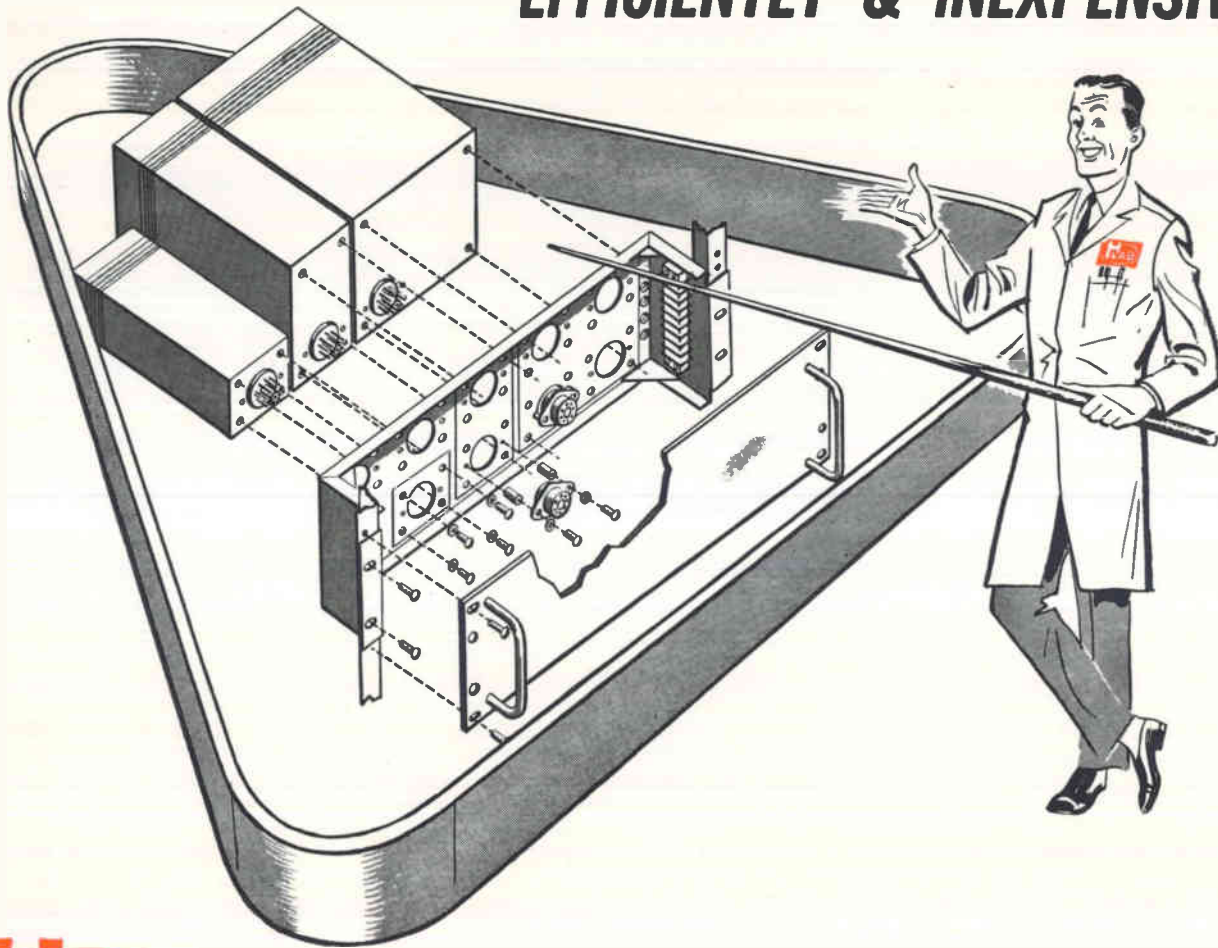

6340 SERIES MODULAR POWER SUPPLIES

CHALK UP H-LABS' NEW MODULAR POWER SUPPLY CONCEPT AS A MUST FOR YOUR SYSTEMS REQUIREMENTS.

Systems requirements for several DC power supplies at different voltages and currents can now be satisfied in a minimum amount of space using H-Labs' new plug-in modular concept. Each of the three modular sizes requires a mounting area exactly twice that of the next smaller module. All input and output power connections plus output voltage control are accomplished through the plug-in terminal connections. These sup-

plies feature the traditionally low H-Lab regulation and ripple figures as well as remote programming, remote sensing, adjustable current limiting and short-circuit-proof operation.

SPECIFICATIONS

MODEL NO.	SIZE	OUTPUT RATING	WEIGHT	PRICE
6343A	A	0-18V @ 0-300 milliamps	5 lb.	\$120.00
6344A	B	0-18V @ 0-1 amp	15 lb.	\$165.00
6345A	C	0-18V @ 0-2.5 amps	25 lb.	\$225.00
6346A	A	0-36V @ 0-150 milliamps	5 lb.	\$120.00
6347A	B	0-36V @ 0-500 milliamps	15 lb.	\$165.00
6348A	C	0-36V @ 0-1.5 amps	25 lb.	\$225.00

SIZE
 A 3"L x 2 1/2"W x 8"D
 B 5"L x 3" W x 9"D
 C 6 1/4"L x 5"W x 9"D
INPUT: 105-125 VAC

LOAD REGULATION: Less than 3 mv or 0.02%
LINE REGULATION: Less than 3 mv or 0.02%
RIPPLE AND NOISE: Less than 1 mv rms
OPERATING TEMPERATURE RANGE: 0°C to 50°C

Contact your local sales rep or write directly to factory for complete specifications on any of H-Lab's complete line of regulated power supplies.

Write for new catalog describing the complete H-Lab line.

HARRISON LABORATORIES

A DIVISION OF
HEWLETT-PACKARD 

45 INDUSTRIAL ROAD • BERKELEY HEIGHTS, NEW JERSEY
 464-1234 • Area Code 201 • TWX-201-464-2117



New generation of Shaped-Beam Tubes makes

by: A. H. Wisdom,
Manager of Research and
Engineering for Data Products

CHARACTRON® Shaped-Beam Tubes produced nearly 10 years ago, many of which are still being used in the display consoles of the SAGE program, have achieved 20,000 hours or more of reliable performance. Today's CHARACTRON Tube represents a new generation of development, offering dozens of major improvements over the original tube. The principle, however, remains essentially the same.

HOW IT WORKS

Heart of the CHARACTRON Shaped-Beam Tube is the stencil-like matrix, a thin disc with alphanumeric and symbolic characters etched through it. This matrix is placed within the neck of the tube, in front of an electron gun. The stream of electrons emitted from the gun is extruded through a selected character in the matrix. When the beam impinges on the phosphor-coated face of the tube, the character is reproduced.

The standard matrix carries 64 characters. However, matrices have been made with 88, 128, and 132 characters. Coupled with new variable character size capabilities, the CHARACTRON Tube offers a wide latitude in symbol generation. The beam is passed through one of the characters by applying the proper voltage to the selection plates. Electrostatic reference plates and/or magnetic deflection are then used to position the beam at any tube face location. In more compact tubes, the entire matrix is flooded with electrons generating a complete array of characters, while only the desired character is allowed to pass through a small masking aperture. A small diameter beam can be used to display data from analog inputs simultaneously with the characters.

NEW GENERATION OF TUBES

Today's CHARACTRON Tube is *not* the same tube built ten years ago. While all major improvements cannot be discussed, following are some of the more significant:

Earlier tubes had some deformation of the characters at the screen edge. The modern tube is sharp to the edge, with much greater resolution. New bright phosphors have been developed including a pastel green which eliminates spot size variation or "bloom-

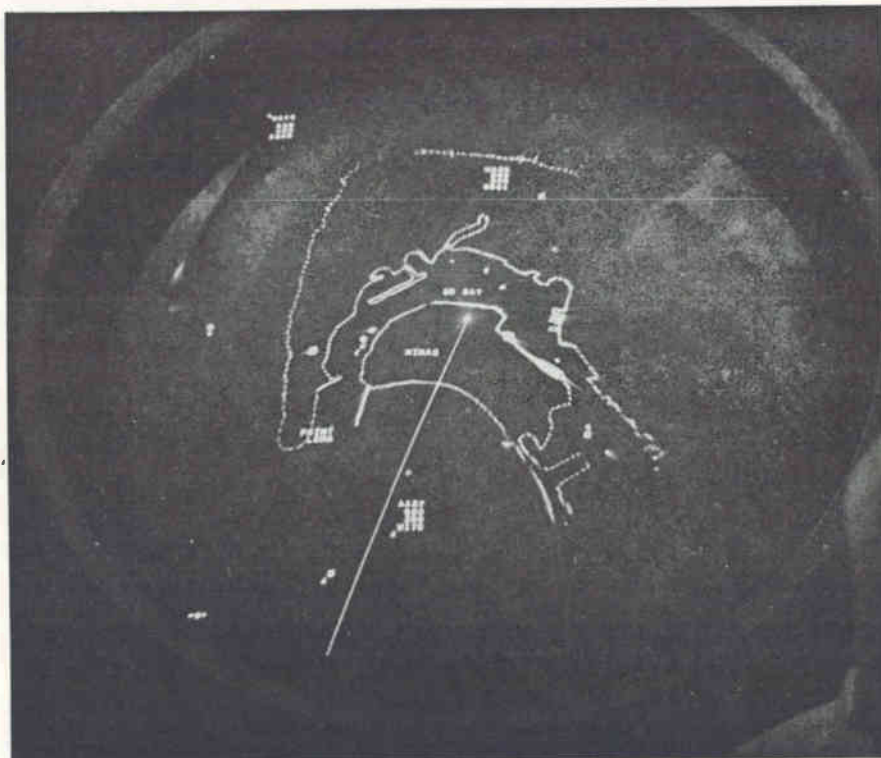

Time-share version of CHARACTRON Shaped-Beam Tube.

ing". When necessary, tube length can now be dramatically decreased. A tube 25 in. long now achieves the same results once requiring a tube 45 in. long.

SPEED

Many optimistic goals have been claimed regarding the speed of character writing tubes. Frequently, however, these claims do not delineate the time required for the positioning of these generated characters but simply state the time necessary for generation. It is a simple matter to blink a character at tremendous speeds at the same place on the tube face. Generating different characters and positioning them in different places on the tube is something else. The shaped-beam principle generates characters in a period of time independent of the complexity of the character. Complex symbols can be generated as simply as a dot. With high speed circuitry, selection can be accomplished at rates equivalent to oscilloscope deflection frequencies.

For example, characters could easily be generated at a million each second. However, today's magnetic deflection yokes require a minimum 5 to 8 microseconds to settle the magnetic domain

in the core and this is the limiting factor in positioning speeds. Using a high speed selection system and allowing five to ten micro-seconds for unblanking, CHARACTRON Tubes can provide realistic writing rates of 50,000 characters per second or more, even using random deflection. Electrostatic deflection tubes now under development promise writing speeds of up to 200,000 characters per second.

ECONOMICS

A CHARACTRON Tube by itself appears to be relatively expensive, but a system using this tube can economically justify itself easily. This is true because the CHARACTRON Tube replaces both the necessary character generator and much of the circuitry required by other systems.

In recent models, alignment procedures have been simplified, and the tube holds alignment longer than other character writing systems. A CHARACTRON Tube can be set up by an experienced man in less than one hour. Tubes are available in a wide range of phosphors with practically any desired color or degree of persistence. Resolution of 1800 TV lines can

advanced techniques possible in data display

be provided, the only limitation being the grain size of the phosphor. CHARACTERON Tubes are no more fragile than any other cathode ray tube. They have been exposed to a 32G shock for 52 milliseconds without harm, and can take just about any shock that does not fracture the glass. In one application, the tube was used in a portable battlefield display console.

PICTURE WINDOW TUBE

Frequently, it is necessary to continuously repeat certain data on the face of a tube while changing other data.

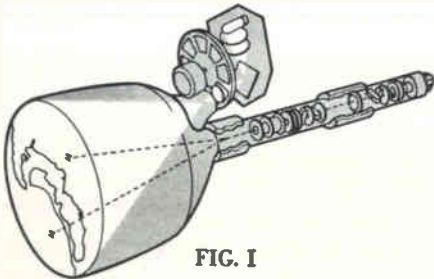

FIG. I

This may be done easily with a new development called the "picture window" concept. In the "window" tube, changing data from computer, radar, or communications link, is presented in the usual manner. Repetitious data are projected through the "window" onto the faceplate using a slide or film projector (Figure I). In a typical application, a geographic map of the area is projected on the face while the computer presents changing data. As the area under surveillance changes, the operator pushes a button to select another map. In another application, business or engineering forms are projected on the tube and filled in with data from the computer. Included in this option is a recording camera. By means of a beam splitting half-silvered mirror, the camera maintains optical access to the entire tube face. A button actuated solenoid operates the camera, recording all data being displayed.

TIME-SHARE TUBE

A new "time-share" version of the tube produces alphanumeric data and at the

same time performs beam writing to draw curves and vectors. In the drawing mode, electrons pass through a special large aperture so that none of the beam is blocked. Brighter beam drawings result. The name "time-share" is derived from the fact that both the alphanumeric and drawing mode share the beam from one cathode for part of the time. This tube is ideal for applications such as long range radar where the antenna may turn at a relatively low speed of six times a minute.

TWO-GUN TUBE

On short range radar requiring high rotation speeds of perhaps 25 times a minute and many hits on small targets to build up an image, there may not be enough time left for forming alphanumeric symbols. With these applications, a two-gun tube (Figure II) is suggested. This tube retains the beam shaping electron gun for producing characters and employs another gun to accomplish the video writing. This second gun, when coupled with video driving circuitry, can be used to generate high resolution TV images including scan converter readout or

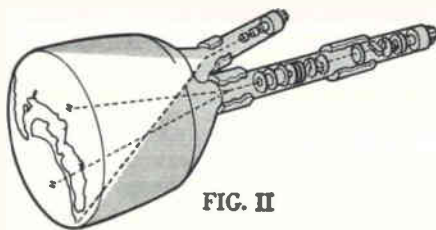

FIG. II

raw radar data. These images, of course, can occur at the same time as and without any effect on the alphanumeric data supplied from the shaped-beam gun.

SYSTEMS

In addition to offering the CHARACTERON Tube as a display or recording character generator, General Dynamics|Electronics has a number of custom and standard display, printing and film recording systems which utilize the tube.

Custom installations include direct-view consoles as well as film recorders which automatically process and project large-screen displays for group viewing.

The S-C 1090 Display console (Figure III) presents alphanumeric, symbolic and graphic data from computers

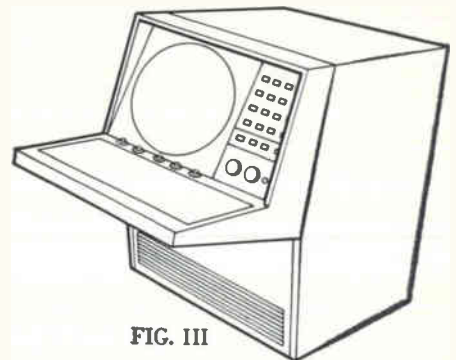

FIG. III

or other sources. It is a complete, "off-the-shelf" display unit. Optional equipment includes internal test routine, input register, level converters, internal storage of complete display frame, vector generator, expansion and off-centering, category selection and various data channel buffers. The console is 66 in. long, 32½ in. wide, and 47 in. high. It is recommended for a variety of applications, including command and control systems, air traffic control, computer readout and data display for any automated process.

The S-C 4020 records the output of large scale computers on film and/or paper at equivalent speeds. Combinations of drawings and alphanumeric data may be recorded in fractions of a second.

The S-C 3070 provides high-speed asynchronous printing without impact on paper for communications or computer output applications.

WRITE FOR MORE INFORMATION

For technical information on the S-C 1090 Display, the S-C 4020 Computer Recorder, the S-C 3070 Electronic Printers, or the new generation of CHARACTERON Shaped-Beam Tubes, write to General Dynamics|Electronics, Department D-14, P. O. Box 127, San Diego 12, California.

GENERAL DYNAMICS | ELECTRONICS **GD** SAN DIEGO

WASHINGTON THIS WEEK

INCOME TAX CRACKDOWN ON TRADE ASSOCIATIONS

TRADE SHOWS, publications and other profit-making activities of trade associations, are the target of a crackdown by the Internal Revenue Service. IRS is stepping up audits of all tax-exempt organizations, from an average of 2,000 a year to 10,000 this year. IRS wants to know whether a show furthers the business as a whole or whether it is clearly a profit-making service. To avoid question, many associations are incorporating their sidelines into tax-paying subsidiaries. Some are being tapped for back taxes. Association publications which earn income are under IRS scrutiny, but the service has not yet set out principles for taxing them.

Members of many associations, too, are finding part of their dues disallowed as a tax deduction as a result of the audits—if IRS finds a “substantial” amount of lobbying activity carried on by an association. Some associations say IRS is being arbitrary.

DOD BUDGET “SAVINGS” DWINDLING

MILITARY SPENDING isn't the only thing being pared down by the Pentagon. Cost-cutting estimates seem to be getting the ax, too. Last month, Defense Secretary McNamara indicated that some \$3.4 billion would be saved out of next year's defense budget (*ELECTRONICS*, p 12, March 29). Then a figure of \$2.7 billion was cited (p 12, April 12). Now, Deputy Defense Secretary Gilpatric predicts the Department of Defense will save—or avoid spending—\$2 billion in fiscal 1964 and that the savings will swell to \$3 billion a year from then on.

DYNA-SOAR SUBSTITUTE IS SOUGHT

AIR FORCE is scrambling to find a replacement project that will maintain Air Force's foothold in space, now that Defense Secretary McNamara has made his negative position on Dyna-Soar abundantly clear (*ELECTRONICS*, p 12, March 22). McNamara is offering Air Force new hope, suggesting that Air Force look at the overall capability being sought in space—to be able to send manned vehicles to detect, inspect and nullify enemy satellites—and come up with a program that would accomplish this.

ALL-CHANNEL IS THE WORD —NOT UHF

EMPHASIS in the promotion of uhf broadcasting is to be on “all-channel,” rather than on “uhf.”

The first action of the executive committee of the new government-industry group for uhf promotion was to drop “uhf” from its name, and adopt “Committee for the Full Development of All-Channel Broadcasting.” The idea is that all-channel is less confusing to the public.

Designated as permanent committee chairmen are: Ben Adler, of Adler Electronics, technical development, and Seymour N. Siegel, of Mutual Broadcasting, station operation.

UNEMPLOYMENT TAX TO DROP

TAX PAID by employers for unemployment compensation programs probably will be lowered this year. The Ways and Means Committee has approved legislation to drop the rate from 0.80 to 0.65 percent on the first \$3,000 of an employee's wages. A Labor Department fund is becoming sufficient to pay off 1961 supplemental program advances.

1963 SAAB... built so well that it has a 24,000-mile/24-month warranty*

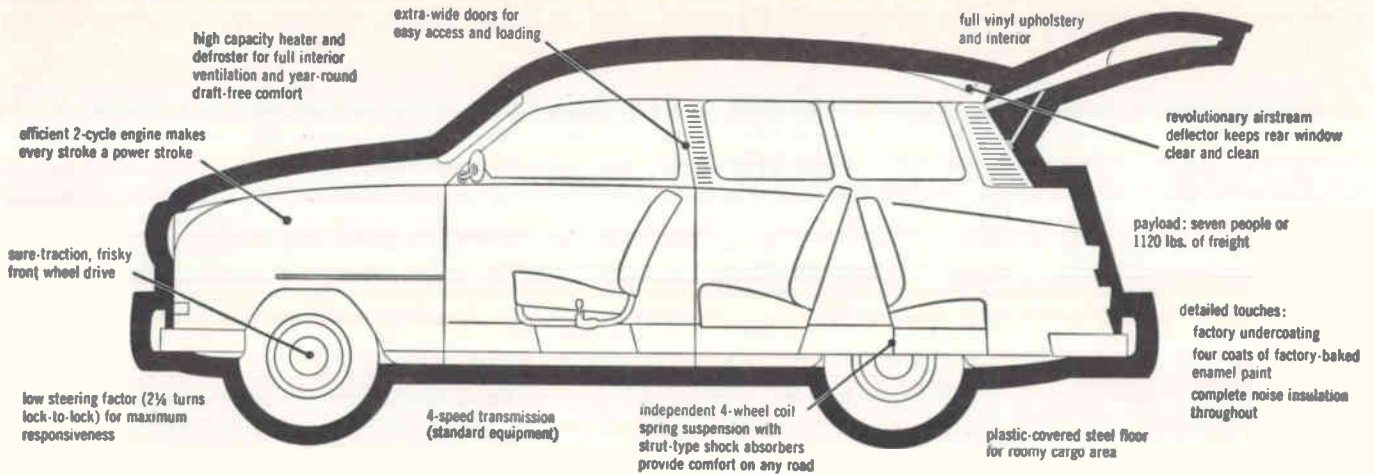

Take a critical look at the new 7-passenger SAAB station wagon

Aircraft reliability and performance standards are blended with an entirely new approach to over-all automotive design in the Swedish SAAB 95 station wagon. This car was built to be better, not different... built by one of Europe's leading aircraft manufac-

urers... built for those who enjoy mechanical excellence, technical uniqueness, and extraordinary craftsmanship.

A critical look at *all* the facts and specifications will prove that the new SAAB 95 is one of the world's best engineered wagons.

*Engine, transmission and differential have a written warranty for 2 years or 24,000 miles.

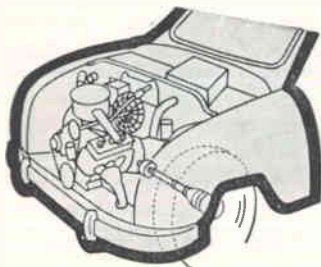

SAAB WAGON PERFORMANCE is the envy of many sedans. Reasons: Simple, effective engine—a quiet, three-cylinder, two-stroke valveless unit—produces all the power of a conventional "6." At high speeds, it operates with gas turbine-like efficiency, yet delivers from 30 to 35 miles per gallon. Front wheel drive; eliminates sway, minimizes skidding, and optimizes over-all stability. Front wheels pull the rest of the car firmly and effortlessly—around curves and corners, over mud, ice, and snow.

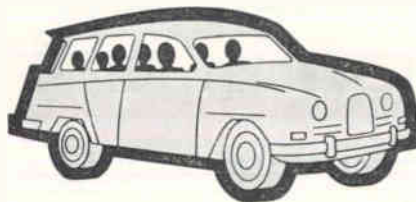

SAAB COMFORT AND CONVENIENCE are extraordinary. You—and six passengers or more than 1/2-ton of freight—ride in total comfort. Sleek aerodynamic design plus full major body panel and firewall insulation virtually eliminate noise. Unique air stream deflector—based on aerodynamic design—keeps rear window clear and clean. Efficient heating and ventilation system provides all-season comfort, keeps all windows fog-free. Bonus: You get \$265 worth of accessories as standard equipment on a SAAB.



SAAB IS SAFETY ENGINEERED. Driver and passengers ride encased by a practically uncrushable steel air-foil on wheels. The rigid unitized body shell utilizes 18- to 20-gauge steel (heavier than most American cars)—throughout. Additional steel panels brace the engine compartment. A built-in crash bar (usually on racing cars only) completely surrounds the windshield, providing tremendous extra strength where you need it most, making SAAB one of the safest station wagons you can drive.



\$2345 P.O.E. (little enough for one of the world's best engineered station wagons)

1ST OVERALL WINNER—MONTE CARLO RALLY, 1962-1963
Arrange a test drive at your nearest SAAB dealer. Or write for more information—and the SAAB North American Road Atlas, a 64-page comprehensive travel guide valued at \$1.00, but yours for only 25¢ to cover postage and handling. SAAB Motors, Inc., Dept. 304, 405 Park Avenue, New York, New York.



SAAB MOTORS, INC.—NEW YORK • NEW HAVEN • JACKSONVILLE • ST. LOUIS
FOR INFORMATION OTHER THAN ROAD ATLAS CIRCLE 299 ON READER SERVICE CARD

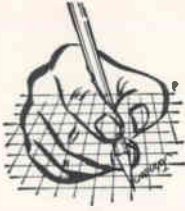

Time after time engineers specify Johnson sockets!

Whatever the choice . . . a miniature 7-pin steatite wafer or a low-loss Kel-F socket for high power transmitting tubes . . . time and time again design and development engineers specify Johnson tube sockets! All sockets have been categorized under a socket standardization program, reducing the number of variations in each socket type. Standardization and immediately available stock shortens delivery cycles—permits fast selection of a Johnson socket for almost any application!

Standard: Commercial grade for general requirements. Bases are glazed porcelain or steatite. Etched aluminum shields or bayonet shells.

Industrial: Superior in quality to "Standard" Grade. Glazed steatite bases, DC-200 treated. Phosphor bronze or beryllium copper contacts .0005 silver-plated. Aluminum shells and shields are iridite No. 14 treated. Fungus resistant cushion washers under contacts.

Military: Top quality to meet military requirements. Glazed L-4 steatite bases, DC-200 treated. Phosphor bronze or beryllium copper contacts heavily silver-plated. Hot tin dipped solder terminals. Brass bayonet shells .0003 nickel-plated. Aluminum shells and shields are iridite No. 14 treated. Fungus resistant cushion washers under contacts. Wafer sockets protected for 200 hour salt spray test.



E. F. JOHNSON COMPANY

2821 TENTH AVENUE S.W. • WASECA, MINNESOTA

KEL-F SERIES—Molded of low dielectric loss-factor Kel-F plastic—designed for use with a wide selection of high power transmitting tubes such as: 4X150A; 4X150D; 4X250B; 4CX250B; 4X250F, 7034; 7035. Basic sockets are available in several designs—with or without screen grid by-pass capacitors, mounting saddles, or steatite chimney to direct air flow through tube cooling fins. Control grid contact "guide" is machined for greater alignment accuracy, and tapped for 6-32 machine screw. All contacts are low resistance silver-plated beryllium copper. Tube pin contacts are heat treated to provide positive contact pressure as well as extended life. Annealed soldering tabs may be easily bent or formed.

BAYONET TYPES—Includes Medium and Heavy Duty Medium, Jumbo and Super Jumbo 4-pin types. For use with tubes such as: 866A or 811A, E.I.A. Base No. A4-10; 872A, 211, and others with E.I.A. Base No. A4-29; and tubes such as: 8008, 5C22, FG104, GL146 and others with E.I.A. Base No. A4-18.

STEATITE WAFER TYPES—Available in 4, 5, 6, 7, and 8-pin standard socket types, as well as Super Jumbo 4-pin for tubes with E.I.A. Base Nos. A4-15, A4-16, and A4-18. Giant 5 and 7-pin models for tubes with E.I.A. Base Nos. A5-19 and A7-17. Septar Sockets for tubes such as the 7094 with E.I.A. Base No. E7-2; and VHF Septar Sockets for tubes such as: 5894, 6524, 6252 with E.I.A. Base No. E7-20; and 826, 832, 4D32 with E.I.A. Base No. E7-2.

MINIATURE TYPES—All steatite, available in Standard Wafer Type or Shield Base Type for 7-pin miniatures such as the: 1RS, 1S5, 6CB6, etc., with E.I.A. Base No. E7-1.

SPECIAL PURPOSE TYPES—Includes sockets for special purpose tubes such as the: 204A and 849; the 833 and 833A; 152TL; 304TL; 750TL; 1500T; 2-2000A; 5D21, 705A and others.

NOTE: Detailed specifications on all Johnson tube sockets have been prepared for engineering department use in Socket Standardization Booklet 536. Should you wish a copy—please make your request on company letterhead.

STANDARD, INDUSTRIAL, MILITARY TUBE SOCKETS

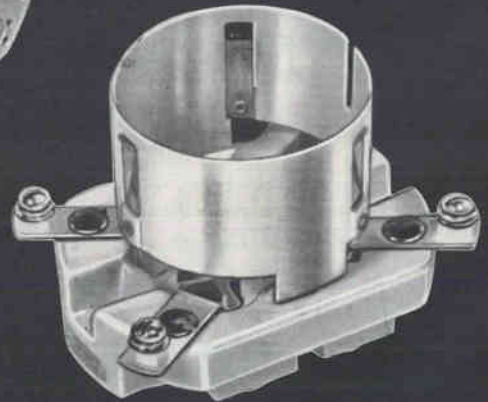
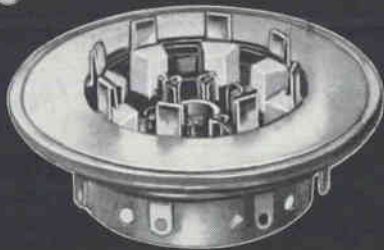
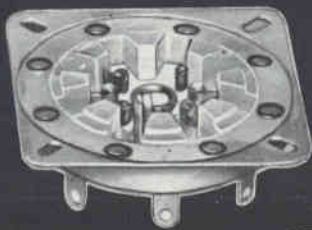

DETAILED COMPONENTS CATALOG AVAILABLE—Write today on company letterhead

• CAPACITORS • TUBE SOCKETS • CONNECTORS • PILOT LIGHTS • INSULATORS • KNOBS AND DIALS • INDUCTORS • HARDWARE

1963 SAAB... built so well that it has a 24,000-mile/24-month written warranty*

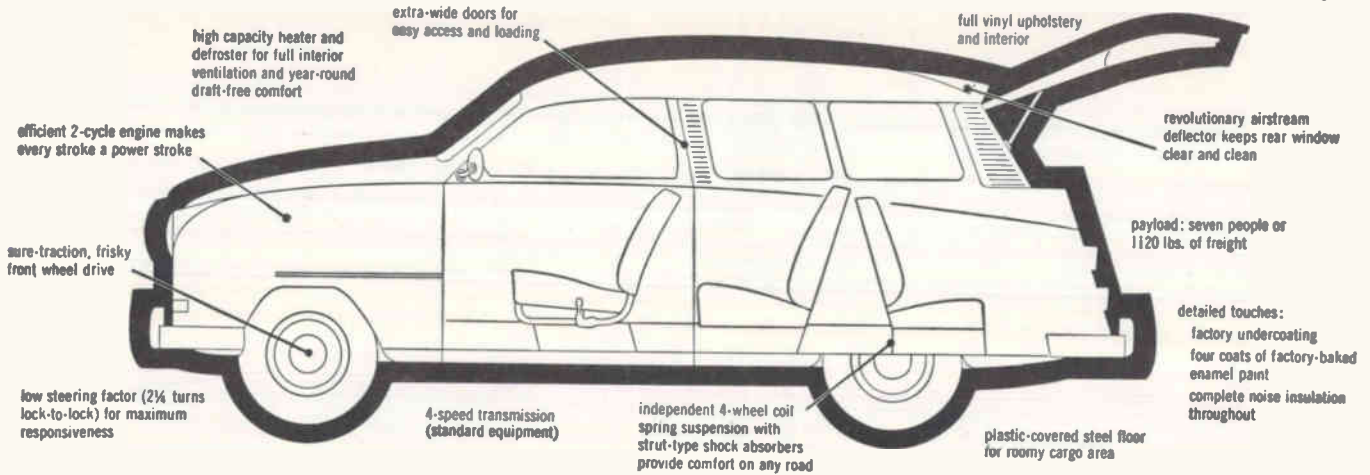

Take a critical look at the new 7-passenger SAAB station wagon

Aircraft reliability and performance standards are blended with an entirely new approach to over-all automotive design in the Swedish SAAB 95 station wagon. This car was built to be better, not different... built by one of Europe's leading aircraft manufac-

turers... built for those who enjoy mechanical excellence, technical uniqueness, and extraordinary craftsmanship.

A critical look at *all* the facts and specifications will prove that the new SAAB 95 is one of the world's best engineered wagons.

*Engine, transmission and differential have a written warranty for 2 years or 24,000 miles.

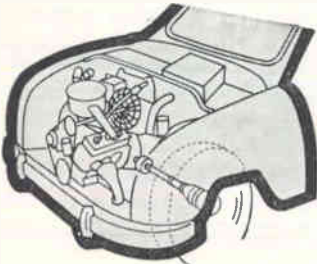

SAAB WAGON PERFORMANCE is the envy of many sedans. Reasons: Simple, effective engine—a quiet, three-cylinder, two-stroke valveless unit—produces all the power of a conventional “6.” At high speeds, it operates with gas turbine-like efficiency, yet delivers from 30 to 35 miles per gallon. Front wheel drive; eliminates sway, minimizes skidding, and optimizes over-all stability. Front wheels pull the rest of the car firmly and effortlessly—around curves and corners, over mud, ice, and snow.

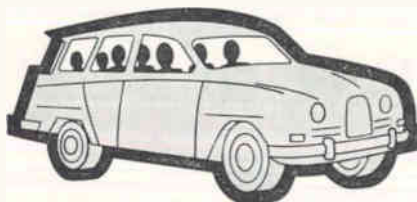

SAAB COMFORT AND CONVENIENCE are extraordinary. You—and six passengers or more than 1/2-ton of freight—ride in total comfort. Sleek aerodynamic design plus full major body panel and firewall insulation virtually eliminate noise. Unique air stream deflector—based on aerodynamic design—keeps rear window clear and clean. Efficient heating and ventilation system provides all-season comfort, keeps all windows fog-free. Bonus: You get \$265 worth of accessories as standard equipment on a SAAB.



SAAB IS SAFETY ENGINEERED. Driver and passengers ride encased by a practically uncrushable steel air-foil on wheels. The rigid unitized body shell utilizes 18- to 20-gauge steel (heavier than most American cars)—throughout. Additional steel panels brace the engine compartment. A built-in crash bar (usually on racing cars only) completely surrounds the windshield, providing tremendous extra strength where you need it most, making SAAB one of the safest station wagons you can drive.



1ST OVERALL WINNER—MONTE CARLO RALLY, 1962-1963

Arrange a test drive at your nearest SAAB dealer. Or write for more information—and the SAAB North American Road Atlas, a 64-page comprehensive travel guide valued at \$1.00, but yours for only 25¢ to cover postage and handling. SAAB Motors, Inc., Dept. 304, 405 Park Avenue, New York, New York.

\$2345 P.O.E. (little enough for one of the world's best engineered station wagons)



SAAB MOTORS, INC. — NEW YORK • NEW HAVEN • JACKSONVILLE • ST. LOUIS
FOR INFORMATION OTHER THAN ROAD ATLAS CIRCLE 299 ON READER SERVICE CARD

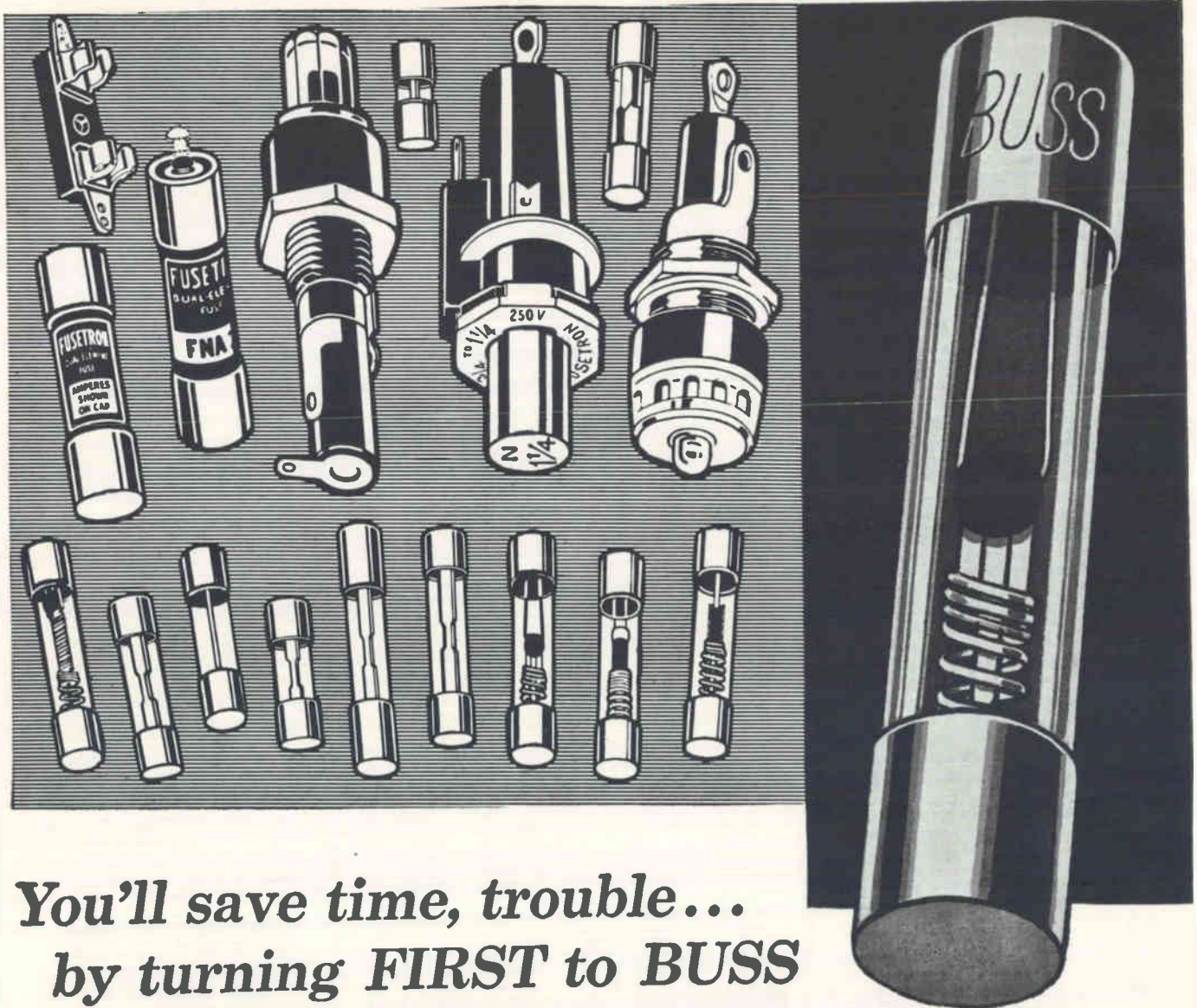

**You'll save time, trouble...
by turning *FIRST* to *BUSS*
for fuses of unquestioned high quality**

By relying on BUSS as your source for fuses, you can quickly and easily find the type and size fuse you need. The complete BUSS line of fuses includes: dual-element "slow-blowing", single-element "quick-acting" and signal or visual indicating types... in sizes from 1/500 amp. up—plus a companion line of fuse clips, blocks and holders.

**BUSS fuses are made to protect—
not to blow needlessly**

When you specify BUSS fuses—users of your equipment receive maximum protection against damage due to electrical faults. And just as important, users are safeguarded against irritating, useless shutdowns caused by faulty fuses blowing needlessly.

A component part that operates as intended helps to maintain the reputation of your equipment for quality and service. That's why it pays to rely on dependable BUSS fuses.

If you should have a special problem in electrical protection... the world's largest fuse research laboratory and its staff of engineers are at your service—backed by over half a century of experience. Whenever possible, the fuse selected will be available in local wholesalers' stocks, so that your device can be easily serviced.

For more information on BUSS and FUSETRON Small Dimension Fuses and Fuseholders... Write for bulletin SFB.

**BUSS: The complete line of fuses and
fuse mountings of unquestioned high quality.**

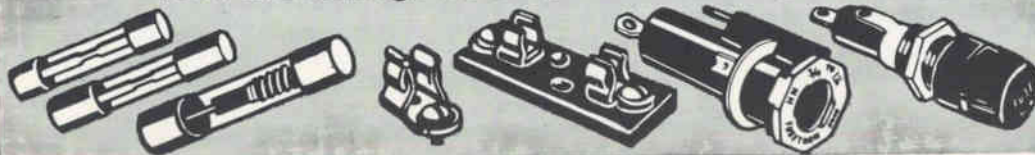

**BUSSMANN MFG. DIVISION
McGraw-Edison Co.
St. Louis 7, Mo.**

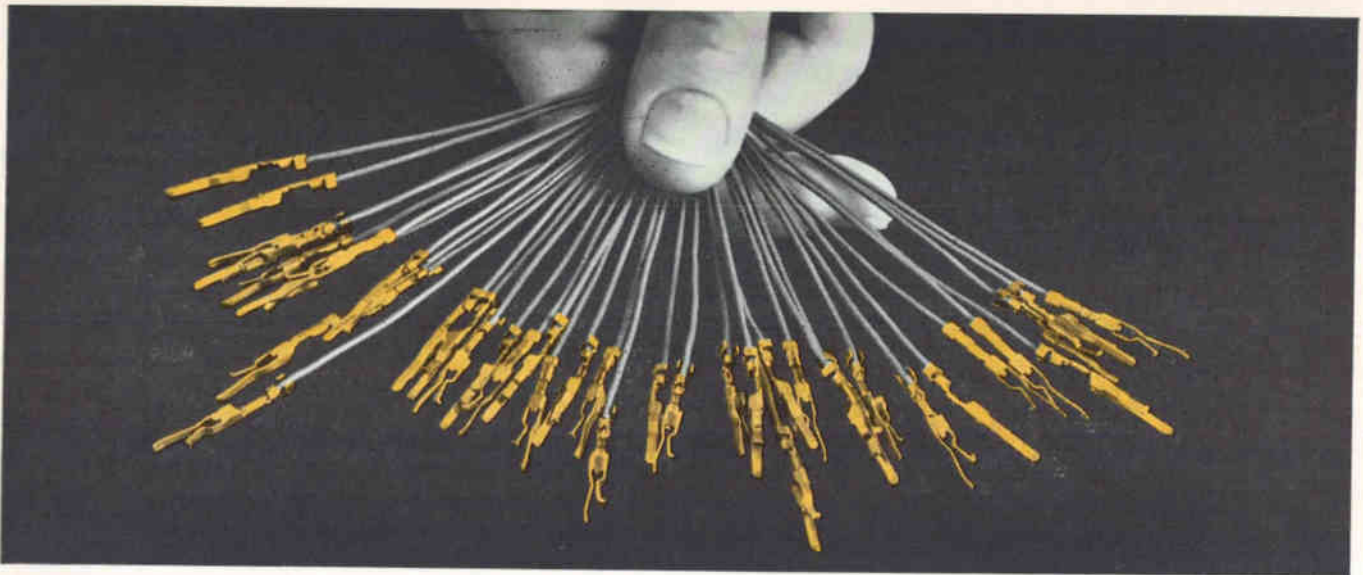

The Greeks had a word for it . . .

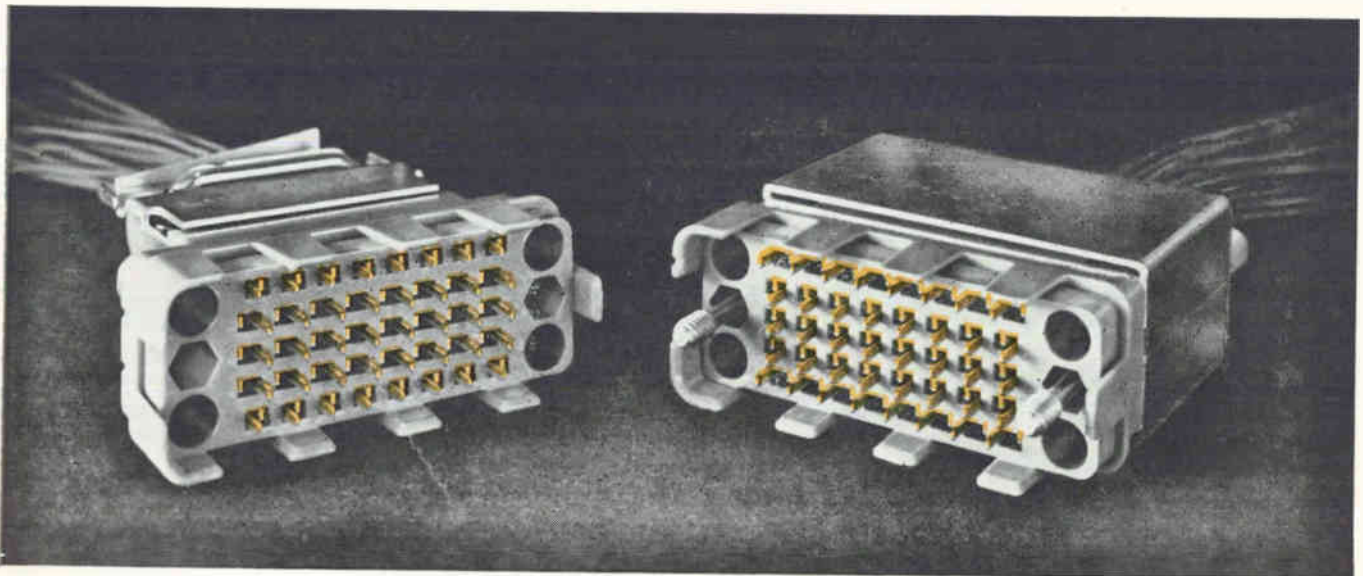

ΕΡΜΑΦΡΟΔΙΤΙΚΟΣ

What this has to do with us is an understandable connection—plainly hermaphroditic and *exclusive* in the new miniature DUALATCH* Connector.

Here's a connector that stacks up against industry need with feature after feature—working features that come as a result of our longtime experience and production know how in solderless termination products and techniques.

In this DUALATCH Connector, the crimped contacts of identical design can be quickly snapped into either half and because the controlled crimping is done on A-MP* Automachines at rates of up to 1500 terminations per hour, you gain three ways—higher density, maximum reliability and lowest possible installed cost. The flat design of the contact gives you additional advantages over conventional connectors—70% lower insertion and withdrawal forces, overall wiping action for

greater contact redundancy and better mating and alignment. Available in 40, 60 and 132 position sizes, the DUALATCH Connector offers these additional features:

- polarized for error-free assembly
- numerous keying possibilities
- cost-saving stamped and formed contacts
- AMP gold over nickel plating
- available for wire size ranges 20-22, 24-26 and 28-32 AWG

Send today for complete information.



AMP products and engineering assistance are available through subsidiary companies in: Australia • Canada • England • France • Holland • Italy • Japan • Mexico • West Germany

*Trademark of AMP INCORPORATED



Time after time engineers specify Johnson sockets!

Whatever the choice . . . a miniature 7-pin steatite wafer or a low-loss Kel-F socket for high power transmitting tubes . . . time and time again design and development engineers specify Johnson tube sockets! All sockets have been categorized under a socket standardization program, reducing the number of variations in each socket type. Standardization and immediately available stock shortens delivery cycles—permits fast selection of a Johnson socket for almost any application!

Standard: Commercial grade for general requirements. Bases are glazed porcelain or steatite. Etched aluminum shields or bayonet shells.

Industrial: Superior in quality to "Standard" Grade. Glazed steatite bases, DC-200 treated. Phosphor bronze or beryllium copper contacts .0005 silver-plated. Aluminum shells and shields are iridite No. 14 treated. Fungus resistant cushion washers under contacts.

Military: Top quality to meet military requirements. Glazed L-4 steatite bases, DC-200 treated. Phosphor bronze or beryllium copper contacts heavily silver-plated. Hot tin dipped solder terminals. Brass bayonet shells .0003 nickel-plated. Aluminum shells and shields are iridite No. 14 treated. Fungus resistant cushion washers under contacts. Wafer sockets protected for 200 hour salt spray test.



E. F. JOHNSON COMPANY

2821 TENTH AVENUE S.W. • WASECA, MINNESOTA

KEL-F SERIES—Molded of low dielectric loss-factor Kel-F plastic—designed for use with a wide selection of high power transmitting tubes such as: 4X150A; 4X150D; 4X250B; 4CX250B; 4X250F, 7034; 7035. Basic sockets are available in several designs—with or without screen grid by-pass capacitors, mounting saddles, or steatite chimney to direct air flow through tube cooling fins. Control grid contact "guide" is machined for greater alignment accuracy, and tapped for 6-32 machine screw. All contacts are low resistance silver-plated beryllium copper. Tube pin contacts are heat treated to provide positive contact pressure as well as extended life. Annealed soldering tabs may be easily bent or formed.

BAYONET TYPES—Includes Medium and Heavy Duty Medium, Jumbo and Super Jumbo 4-pin types. For use with tubes such as: 866A or 811A, E.I.A. Base No. A4-10; 872A, 211, and others with E.I.A. Base No. A4-29; and tubes such as: 800B, 5C22, FG104, GL146 and others with E.I.A. Base No. A4-18.

STEATITE WAFER TYPES—Available in 4, 5, 6, 7, and 8-pin standard socket types, as well as Super Jumbo 4-pin for tubes with E.I.A. Base Nos. A4-15, A4-16, and A4-18. Giant 5 and 7-pin models for tubes with E.I.A. Base Nos. A5-19 and A7-17. Septar Sockets for tubes such as the 7094 with E.I.A. Base No. E7-2; and VHF Septar Sockets for tubes such as: 5894, 6524, 6252 with E.I.A. Base No. E7-20; and 826, 832, 4D32 with E.I.A. Base No. E7-2.

MINIATURE TYPES—All steatite, available in Standard Wafer Type or Shield Base Type for 7-pin miniatures such as the: 1RS, 1S5, 6CB6, etc., with E.I.A. Base No. E7-1.

SPECIAL PURPOSE TYPES—Includes sockets for special purpose tubes such as the: 204A and 849; the 833 and 833A; 152TL; 304TL; 750TL; 1500T; 2-2000A; 5D21, 705A and others.

NOTE: Detailed specifications on all Johnson tube sockets have been prepared for engineering department use in Socket Standardization Booklet 536. Should you wish a copy—please make your request on company letterhead.

STANDARD, INDUSTRIAL, MILITARY TUBE SOCKETS

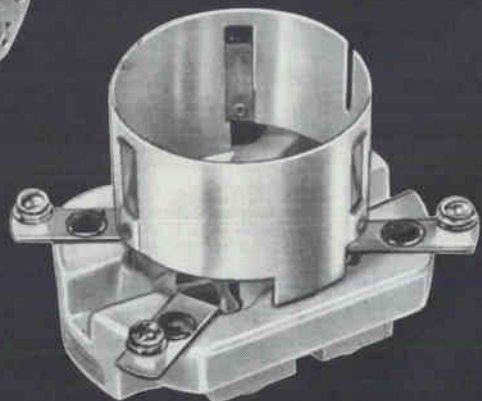
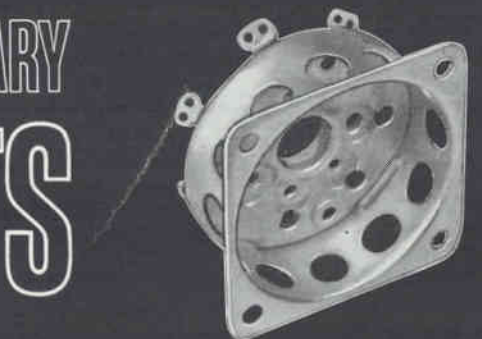
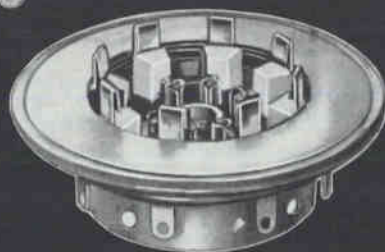
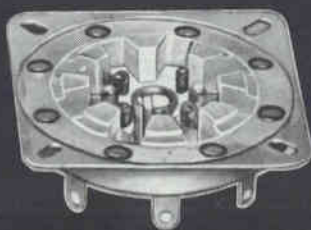

DETAILED COMPONENTS CATALOG AVAILABLE—Write today on company letterhead

• CAPACITORS • TUBE SOCKETS • CONNECTORS • PILOT LIGHTS • INSULATORS • KNOBS AND DIALS • INDUCTORS • HARDWARE

OZALID NEWSLETTER

NEW IDEAS TO HELP YOU WITH ENGINEERING REPRODUCTION AND DRAWING

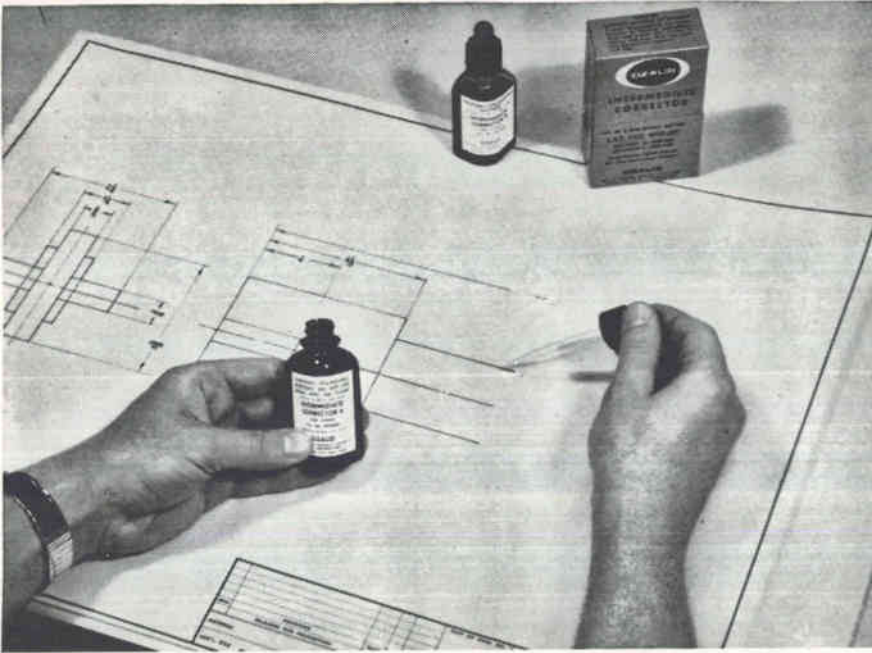

New ITX line of intermediates by Ozalid offers finest-line pick-up and fastest printing speed of any intermediates!

Three new diazo intermediates which fit their performance directly to your reproduction requirements are now available from Ozalid! They require no special equipment or processing and can be exposed on any Ozalid whiteprinter or similar machines.

Unmatched pencil-line pick-up power

The standard (402 ITX) and faster (404 ITX) intermediates reproduce faintest details faithfully. Their "pencil-line pick-up power"—the true measure of a good intermediate—is rated excellent by research and development technicians and by industry experts.

Improved 402 ITX—the standard intermediate in the new line, has greatest density and assures maximum readability in the final print.

All-new 404 ITX is a distinct im-

provement over other sepias and combines fast printing speed with high quality reprints. Its broad covering power results in sharpest images. The new 100% rag, transparentized and blue-tinted base gives faster printback speeds. 404 ITX narrows the gap between printing and reprint speeds; in many cases both speeds are identical.

Fastest intermediate you can get!

406 ITX—another new Ozalid intermediate, is twice as fast as 402 ITX. Density is a trifle less, but the remarkable increases in production, over 100%, offset its slight decrease in covering power.

New, easy-on-the-eyes, readability

The rich mahogany image color of the new ITX series contrasts sharply with the blue-tinted background, providing excellent visual acuity and exceptional readability.

Which to use? 402? 404? or 406?

402 ITX—because of its superior covering power—is of great value to architects, engineers and draftsmen who demand exceptional repro fidelity as well as good printback speed.

404 ITX (Fast Speed) and 406 ITX (Extra Fast Speed) increase productivity of slow speed machines. In production shops where the number of intermediates needed is consistently high, copies may be run off on both these new materials at far faster speeds.

The ITX intermediates, either separately or as a product family, offer important advantages to every diazo user.

Corrections are simple

Dye line eradications can be made quickly and easily with Ozalid® Intermediate Corrector. Special base stock readily accepts pencil and ink additions.

Repeated erasures don't ghost or lose "tooth"

The ITX product line has a 100% rag-tracing vellum stock as a base with a new plastic transparentizer. Even repeated erasures made on the same spot do not destroy the "tooth" or ghost in printbacks.

Get all the facts now!

For complete information about this new family of intermediates, write OZALID, Dept. 102, Binghamton, New York.

OZALID
WE REPEAT
OZALID

General Aniline & Film Corporation
In Canada: Hughes-Owens Co., Ltd., Montreal.

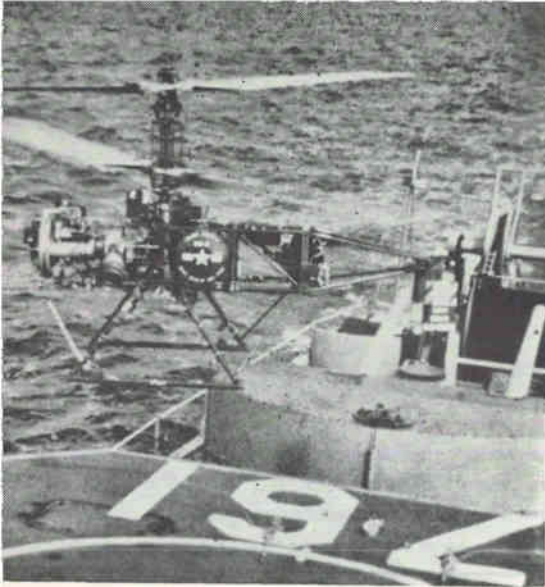

FIRST DRONE delivered to the Pacific Fleet was flown from San Clemente Island to the USS Buck early this year

ROBOT COPTERS

Join Navy's Anti-Sub Arsenal

Dash weapon system, set to go operational, drops torpedos 30 miles away

ROBOT, torpedo-carrying helicopters, Navy's newest weapon against enemy submarines, are set to achieve full operational status in June.

The unmanned drones are remotely commanded to leave decks of destroyers, fly over their targets, deliver torpedos or nuclear depth charges on an enemy submarine and return to their mother ships. The mother ships, meanwhile, remain safely beyond the submarine's retaliatory striking range.

Dash (Drone Anti-Submarine Helicopter) will ultimately be installed aboard approximately 300 Navy ships, mostly destroyers, each having two drone helicopters plus one backup. Government costs will hit \$50 million during this fiscal year, the Pentagon estimates. Other sources indicate that the program

should run well into \$200 million over the next five years. The system has maximum priority, a high-ranking Navy officer told **ELECTRONICS**. Gyrodyne Company of America, Inc. is weapon system manager.

Landing assist device (Lad), newest part of the system, now under development, will automatically land the drone and secure it to the ship's deck on return from its mission under the most adverse weather conditions, including 40-knot winds.

Basic element of the Dash system is a drone, coaxial helicopter (counter-rotating rotor, as opposed to a main-rotor/tail-rotor type). The QH-50C, formerly DSN-3, reportedly has a 100-knot top speed and can be remotely controlled over a 25 to 30-mile radius. It has a 300-hp Boeing engine. Navy selected Gyrodyne's coaxial type for development of the QH-50C because of its stability and maneuverability.

TAKEOFF—Using a control stick

to maneuver the drone in the roll and pitch axes and dial controls for altitude and heading, a deck transmitter control gives the vehicle initial flight information. This sends the drone in the general direction of the target. Digital signals from the controllers are sent to a relay assembly for assignment to an audio-frequency coder. Digital audio command signals are then transmitted by uhf directly to the drone using a line-of-sight antenna.

FLIGHT—Once in flight, vehicle control is transferred to a second shipboard transmitter control at the combat information center. Based on sonar information, the drone is sent over the enemy submarine to await further commands from the center.

The drone receives flight control information over a uhf link. Audio output from the transistor f-m receiver is applied to the drone's decoder. The decoder extracts the digital message from the audio out-

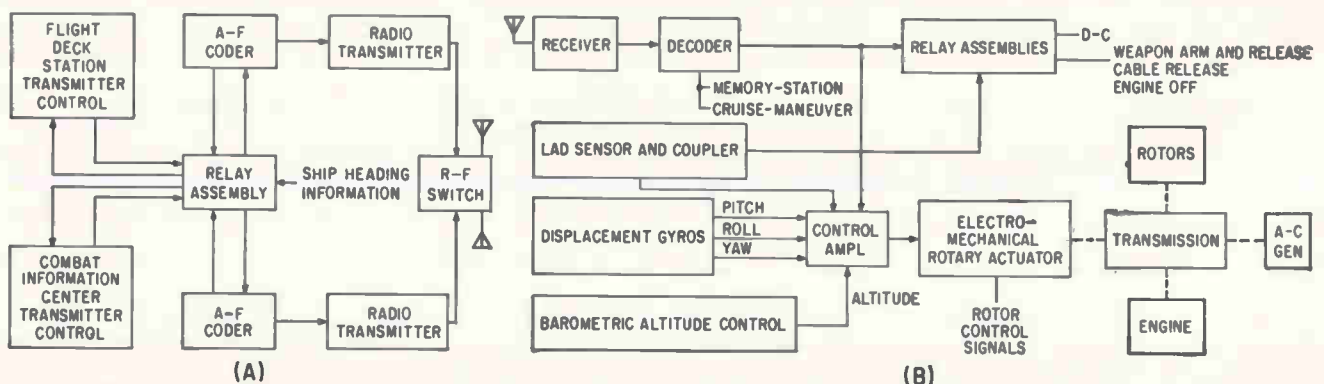

SHIPBOARD CONTROL system (A) guides the drones. Redundancy in coders and uhf transmitters provides reliability. Airborne electronics system (B) converts digital signals to analog for drone control. Amplifier controls attitude and altitude servo clutches of electromechanical actuator in response to commands from decoder and attitude sensors

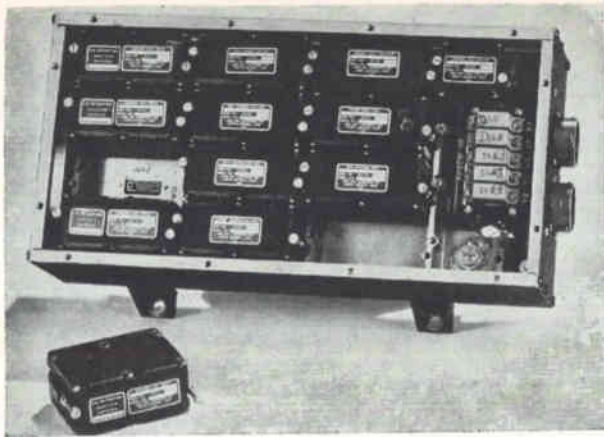

MODULAR control amplifier, built by Lear-Siegler, weighs 12½ lb and is 13 in. long

put of the receiver, decodes the command information, and provides analog output voltages and on-off switch closures for flight control equipment and torpedo-release mechanisms.

These analog voltages together with inputs from roll, pitch and displacement gyros and the altitude control are fed into the electronic control amplifier. The amplifier controls the pitch, roll, yaw and altitude servo clutches of the drone's electromechanical actuator.

The amplifier uses transistor circuits and high-density packaging techniques developed by Astronics division of Lear-Siegler. A new sampling technique in the quadrature-rejection circuit lowers the amplifier time-constant to 2.5 msec. By using a large open-loop gain, closed-loop sensitivity is kept to 10 percent nominally, 20 percent max. Circuits are divided into modules (e.g., preamplifier, discriminator, demodulator) and housed in separate building blocks for convenient maintenance.

LANDING—On conclusion of the mission, the drone is brought back to the ship by remote control from the combat information center and control is transferred to the deck controller for final landing with the help of Lad.

As the drone approaches to within 40 feet of the deck, it drops a cable which is secured to a deck fitting. The drone is then commanded to a higher altitude pulling the cable taut and engaging Lad. Sensors in the drone measure cable tension and angle from the vertical.

This automatically maintains the drone's position over the landing site and causes it to follow the cable during reel-in. The Lad system is being supplied by Electronic Controls, Inc., to Gyrodyne's specifications.

The command control units and digital encoder and decoder are being supplied by Motorola. Babcock Electronics is producing the airborne command receiver.

OTHER USES—Successful use of drone helicopters in the Dash system has provoked interest in other potential applications for drones as unmanned tv reconnaissance helicopters, for contamination studies during nuclear tests or war, as decoys for anti-helicopter weapons testing and for delivering supplies behind enemy lines. Babcock has applied similar guidance techniques to drone missile-target aircraft, including the Navy's KD2R-5, KDB, F6F and F9F.

Japan Hopes to Limit Tv Exports to U. S.

TOKYO—The Japan Machinery Exporters Association says it will try to put a ceiling on the export of tv sets to the United States this year. The ceiling would be 500,000. Japanese manufacturers are being swamped with orders not only from regular U.S. importers but also from leading department stores and jobbers, an association spokesman said. Last year Japan exported 273,604 tv sets to the U. S.

ELECTRONIC COUNTERS, INC. MODEL 960 DIGITAL RECORDER



**provides permanent
measurement records
... INSTANTLY!**

Do you require high speed permanent recording of binary coded information? Do you require both intermittent and continuous operation capabilities? If these are your requirements, the Potter Model 960 Digital Recorder is your answer.

This highly reliable instrument uses the Potter developed 1-2-4-8 coding format to provide an easily read permanent record of measurement data involving micro-second phenomena. Up to 150 eight-digit numbers per second can be permanently recorded—and the visible record is available instantly. No processing is required.

For additional information and detailed specifications write today . . .



**ELECTRONIC
COUNTERS, INC.**

Subsidiary of

POTTER INSTRUMENT CO., INC.

151 Sunnyside Boulevard • Plainview, New York

out of the jumble of electronics buying directories

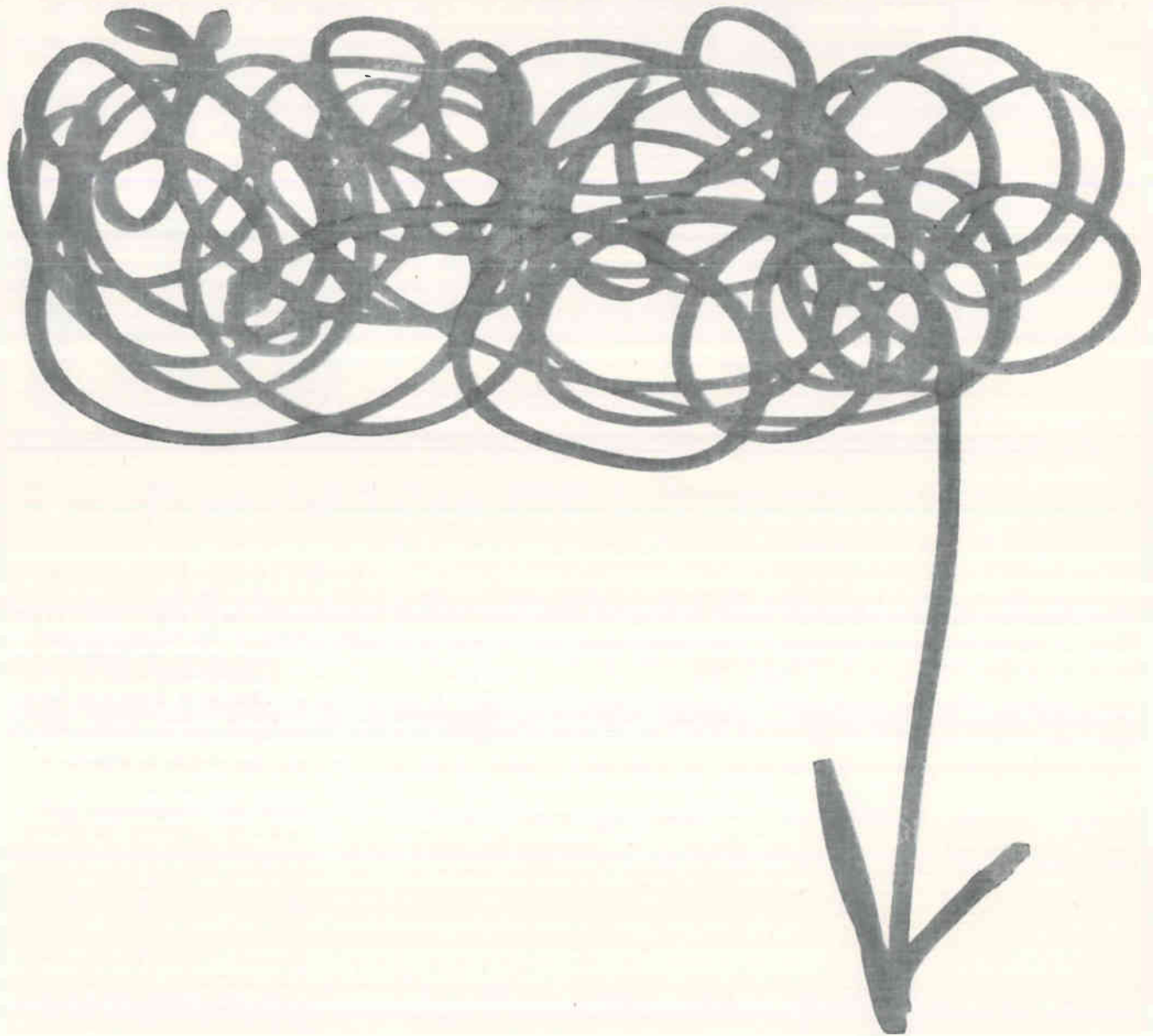

emerges the direct-route directory: **electronics BUYERS' GUIDE**

63,000 electronics engineers and purchasing agents use the electronics Buyers' Guide to specify products, day after day throughout the year. It's the only directory of products they need. And that's all right with them.

There are many, many purchasing directories for the electronics market. Some of them are complicated. The electronics Buyers' Guide is simple to use. Some of them are cryptic. The electronics Buyers' Guide is clear. Some of them force the user to go all around Robin Hood's barn

to find the product he needs. The electronics Buyers' Guide, through sensible product groupings, lets the purchaser "spec-shop" for his product (your product?) quickly.

Closes May 1

The electronics Buyers' Guide closes for plates on May 1. If your electronic product is not already represented in its pages, it should be. Call your nearest electronics Buyers' Guide representative now:

Atlanta: 875-8523; M. H. Miller, R. C. Johnson / Boston: CONgress 2-1180; Wm. S. Hodgkinson, D. R. Furth / Chicago: MCHart 4-5800; H. Wernecke, R. M. Denmead / Cleveland: Stiprior 3-7000; P. T. Fagley / Dallas: Riverside 7-8721; Frank LaBran / Denver: ALpine 5-2961; J. W. Patten / Houston: RIVERSide 8-1280; Joseph Page, Jr. / Los Angeles: HUNting 2-6488; Wm. Gries / New York: LONgacre 4-3000; D. H. Miller, N. M. Shaw, George Werner / Philadelphia: LOcut 8-4338; W. H. Gardner, W. Boyle / San Francisco: DOuglas 2-4800; R. C. Alcorn

going UP are you?

Look at our "rate of climb" since 1960. Need we say more?

We could tell you about the wonderful living conditions in one of the most beautiful suburban areas of Long Island — fishing, bathing and boating on the broad expanse of Long Island Sound — golf courses nearby — our plant setting amidst tall trees and lakes on a 300 acre plot — our air conditioned buildings — BUT we are not building or selling housing developments. We ARE building helicopters, pilotless ones equipped with avionics which operate from the flight decks of Navy destroyers.

We could tell you about our employment and retirement benefits, but these exist in other companies in which competent individuals might be interested. Also, we are not offering in-plant, on-the-job retirement. We expect many years of work and accomplishment from those who join our team.

Make no mistake! We are not a social club but creativity and productive effort are well rewarded.

We invest in people! Are you willing to invest your future with us?

If you have a engineering degree applicable to one or more of the fields listed, why not accept our challenge by exploring our job opportunities? We have a number of senior and intermediate level positions open in each field of specialization. Send a confidential resume to our Personnel Director, St. James, L. I., N. Y.

Systems Engineers: Experienced in integration of equipment with sub-systems, produced by sub-contractors, into airborne and ground control support systems, 5 years experience in any of the following fields: avionics, auto-pilots, flight controls, lorelei, transistor circuitry. Background in digital/analog computers and telemetry devices desirable. EE, ME, AERO or Physics major.

Instrumentation Engineers: Design or establish specification for airborne, ground control and support instrumentation for development flight test activity. Must have background in system design, signal conditioning, transducer calibration, PAM and PDM telemetry and oscillograph recording. EE background.

Flight Test Engineers: For development testing of complete aircraft and components. Full scale flight testing and ground test-rig operations with emphasis on helicopter flying qualities. Minimum of 5 years experience in planning, execution and reporting of complete developmental flight and ground test program. Engineering degree required.

Quality Control Engineers: Electronic Systems reliability, test analysis, statistical sampling, sub-contractor resident liaison programs. Positions available at L. I. Plant, Phoenix, Santa Monica, Cleveland locations. Minimum of 5 years heavy experience and EE degree required.

Structures Engineers: Establish criteria for helicopter design, stress and vibration analysis of structure and mechanical components. Conduct test analysis program. Minimum 5 years experience and ME/AE degree required.

Test Analyst Engineers: Conduct electronic, mechanical, testing programs on all types of components including airframe structures, transmissions, power plant, blades, electronic ground equipment, avionic equipment, etc. Minimum 5 years experience plus Engineering degree.

Transmissions Engineers: Design and layout of complete transmissions, complex mechanisms and high capacity gears (straight and helical spurs — straight and spiral bevels). Prepare assembly procedures, limits charts and service manuals. ME degree and minimum 3 to 5 years experience.

RATE OF CLIMB (1960-1963)

SALES

UP 590%

EMPLOYMENT

UP 321%

FACILITIES

UP 267%

BACKLOG ORDERS

UP 241%

Gyrodyne
COMPANY OF AMERICA, INC.

an equal opportunity employer





ALASKAN SWITCHING system built by Western Electric provides direct dialing without private line and manual switchboards. DCA wants USAF system modified to handle Army, Navy, and FAA



TROPO terminal in Greenland is part of 240-channel Dew East network linking northeast North America with Greenland and Iceland

SPACECOM: \$100-Million-a-Year Market

*Air Force is buying
wideband, survivable
secure communications*

By **JOHN F. MASON**
Senior Associate Editor

HANSCOM FIELD, MASS.—Part of an old Army hospital, a few miles from this Air Force installation, now serves as headquarters for a \$100-million-a-year market for the electronics industry.

The operation is Spacecom, a program to modernize and expand USAF's world-wide Aircom communication system which includes both point-to-point and ground/aerospace circuits. Spacecom, like the Army and Navy communication systems, is part of the integrated Defense Communication System (DCS) managed by the Defense Communications Agency (DCA). Hanscom Field is the Air Force Systems Command's Electronic Systems Division where more than 15 command and control systems ("L" and "M") are being developed.

Spacecom is by far the biggest of the command and control system projects, and is still growing. Last October it was elevated from an "L" system (480L) to the level of Directorate of Communications.

Soon, it will be graduated to the position of Deputy for Communications, equal to such comprehensive offices as Deputy for Advanced Planning and Deputy for Systems Management. Besides headquarters here, Spacecom maintains field offices in Alaska, the West Coast, England, and Germany.

Spacecom, headed by Col. J. A. Plihal, currently manages more than 80 programs. These range from feasibility studies to R&D, to systems acquisition and installation. Approximately 35 of these programs can be considered major efforts—20 of which are already under contract, using more than 100 first-tier subcontractor firms.

Under USAF contract, ITT Communication Systems, Inc. provides system engineering analysis for Spacecom requirements. ITT also supplies DCA with long haul link studies.

SPACECOM'S NEEDS—About 80 percent of Spacecom's work is for long-haul circuits, calling for troposcatter, microwave and cable equipment—in that order. Twenty percent is for special application and for tributaries of long-haul circuits used only by USAF. These portions use l-f, h-f, uhf, and vlf equipment. The long-haul portion, which might be used by all three

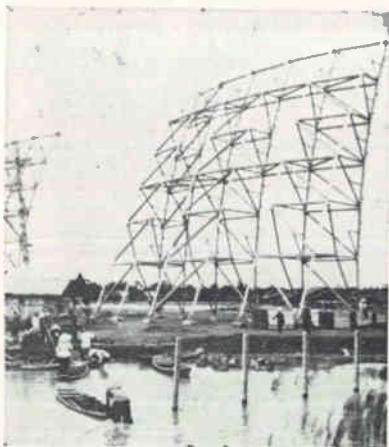

PROJECT BACKPORCH provides tropo system for South Vietnam. Radio Engineering Laboratories (REL) supplied basic f-m radio gear for prime contractor Page Communications Engineers

services is subject to approval by DCA, while the short-range circuits are not.

The new system will stress circuits that are wideband, survivable, and secure. Communication satellites will also be introduced into the system at a later date.

TROPOSCATTER—Over-the-horizon tropo systems now operate in the 400-Mc or the 800 to 1,100-Mc bands. Due to improved klystrons, higher frequency systems are being built. Within three years, Spacecom will have 4.4 to 5-Gc equipment in operation. And while no date has been set for installation of 8 to 10-Gc gear, it is being developed.

Blackout from nuclear detonation is not expected to be a severe problem. If a nuclear explosion occurs in the direct line of tropo communication, five to ten miles high, it could black out reception for two to three minutes. In case of massive nuclear attack this would probably be attempted south of our Ballistic Missile Early Warning System stations in Greenland and Alaska. The undersea cable would probably be cut simultaneously — an exercise Russian "fishermen" continue to find so stimulating when weather permits.

MAJOR PROGRAMS — Biggest efforts over the next two or three years include:

- **486L**—System around the Mediterranean, from Spain to Turkey, and from northern Italy to Libya, will be expanded and integrated to meet DCA requirements. Big Rally II is an interim, transportable tropo system, and Euromed Tropo is the permanent system. Federal Electric Co. is prime for both.

- **490L**—Installation of analog switches in the DCS. Proposals are in from bidders, and the contract will be awarded soon.

- **Buildback** — Air Reserve Recovery Communications System to provide a mobile post attack ground communication system to command airborne aircraft when normal communications are interrupted. Spacecom is putting the system package together, and will issue requests for proposals in the near future.

- **Communications Upgrade** — Modernization of equipment in Europe to meet DCA requirements.

Did you know Sprague makes...?

MAGNETIC LOGIC DEVICES



Core-diode and core transistor magnetic shift registers and magnetic counters for switching and storage applications in computer and logic circuitry.

CIRCLE 277 ON READER SERVICE CARD

MOLDED PULSE TRANSFORMERS

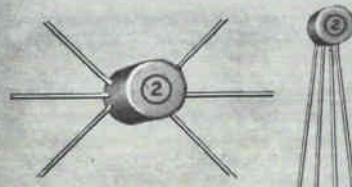

Miniature Pulse Transformers with tough molded cases for increased protection against physical damage and severe atmospheric conditions.

CIRCLE 278 ON READER SERVICE CARD

NANOSECOND PULSE TRANSFORMERS IN TO-5 TRANSISTOR CASES

Special design offers distinct advantages: (1) Mini-fied size. (2) Welded hermetic seal. (3) Increased reliability. (4) Compatibility with transistor mounting techniques.



CIRCLE 279 ON READER SERVICE CARD

SOMETHING NEW IN COUNTING TECHNIQUES

Simple yet versatile, low-cost yet reliable counters available for predetermined (2 to 11) or selectable (5 through 10) counting cycles.



CIRCLE 280 ON READER SERVICE CARD

DYNACOR® BOBBIN CORES



Series "300" Cores with logical flux values in popular physical sizes are stocked in production quantities for fast delivery. They're value engineered for quality with economy!

CIRCLE 282 ON READER SERVICE CARD

HERMETICALLY-SEALED TO-5 ENCASED SWITCH CORES

Designed especially for high-speed, low-power switching up to 100 kc, adaptability with conventional transistor packaging techniques, and performance under MIL-S-21038 environmental conditions.



CIRCLE 281 ON READER SERVICE CARD

ELECTRONIC MODULES TO CUSTOMER REQUIREMENTS



Custom packaging is no novelty at Sprague's Special Products Division, where "specials" are continually being developed and produced with countless variations in electrical characteristics and mechanical configurations.

CIRCLE 283 ON READER SERVICE CARD

For application engineering assistance (without obligation, of course) on any of the above products, write or call the Special Products Division, Sprague Electric Company, 35 Union Street, North Adams, Massachusetts.

485P-111-63

SPRAGUE®
THE MARK OF RELIABILITY

"Sprague" and "S" are registered trademarks of the Sprague Electric Co.

TWO important FIRSTS in Magnetic Field Measurement

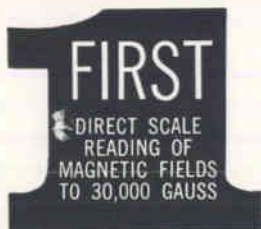

**Model 300
Bell Gaussmeter**

Portable with laboratory accuracy ● 1% to 10,000 gauss or 2½% to 30,000 gauss ● Utilizes the new high linearity "Hall-Pak" probe ● A.C. line or self-contained battery operated.



**Model 350
Bell A.C. Gaussmeter**

For time-varying fields from 10 to 30,000 cps ● .1 to 3000 Gauss F.S. ● Accuracy ±2% ● Magna-probe provides 100 Gamma F.S. sensitivity ● Selectable high and low pass filters ● Provision for spectrum analysis.

Send for complete specifications

BELL
INC.
1356 Norton Avenue
Columbus 12, Ohio
Phone 614-294-4906

Present system was designed to communicate locally. New system must tie in European net with the U.S. More power, better antennas and analog switches are needed. This work will be carried out on an incremental basis, falling under several program categories.

PROPOSED AND UNDERWAY— Other projects include:

- *Wet Wash*—Although no go-ahead has been received yet from USAF, Spacecom would like to tie in the tropo net in South Vietnam (called Backporch, which USAF installed for the Army) with the net in the Philippines. This is a long haul and Spacecom is not sure yet how it should be done. Whatever technique is used, it must be wide-band.

- *Seal Shell* — Tests for feasibility of using ground currents for distances of 500 miles or more are still underway. Best results to date were limited to 40 miles.

- *Haystack*—No news is being released on when this powerful, precision radar might be stoked up again to bounce signals off a Lincoln Labs belt of orbiting needles. The first West Ford package didn't open, and the second was placed in such a perfect, slow-decaying orbit that the box of needles was never commanded to open. Electronics Systems Division paid for Haystack.

- *SLFC*—Survivable Low Frequency Communication for the Strategic Air Command is a point-to-point system. R&D feasibility study is underway at Space General Corp. Contract for system procurement will probably be awarded in fiscal year 1964. This will be a big contract.

- *Pail (490M)*—Post Attack Intercontinental Link is a classified project.

IMPROVEMENTS NEEDED —

Considerable effort is going into providing secure and survivable communications. Although all techniques used for security are classified, Vocom is an important program in this category. Survivability is achieved by redundancy, alternate routes, and hardening.

Spacecom would like new techniques to extend the range of tropo communications, to increase capacity in long-haul equipment, and to provide more solid-state compo-

nents. Spacecom hopes that lasers will solve a number of existing problems.

Versatile Electron Beam System Set

BOSTON, MASS.—Modular electron beam system permits a variety of applications. At fifth Electron Beam Symposium sponsored by Alloyd Electronics Corp., W. C. Nixon, of Cambridge University, England, reported on Intercol, an interchangeable electron beam column system. When used for micro-circuit etching, system operates at 5Kv to 30 Kv and beam currents up to 2.5 ma. Lowest ranges are used for partial etching where it is desirable to remove only a few hundred angstroms from the surface. Point source applications also include X-ray for microscopy or analysis, electron diffraction work and magnifying.

Airborne Blind-Landing System Under Study

AN ALL-WEATHER aircraft approach and landing system that would be completely airborne is being studied by North American under a NASA contract. The company said the system will probably contain a radar altimeter, ranging radar, computer and an inertial sensing device.

Automatic Pharmacy



PREPACKAGED DRUGS are dispensed and the transaction recorded by this machine when plates (identifying the drug desired, the nurse and the patient) are inserted. Some 80 percent of prescriptions can be supplied from stock of 96 drugs. Installation at Providence Hospital, Seattle, by Brewers Pharmacal Co., provides 24-hour control over drugs

NEW!



- 1/2% FM DISTORTION
- SOLID-STATE POWER SUPPLY
- ELECTRONIC VERNIER TUNING
- AUTOMATIC RF LEVEL SET
- SHOCK-MOUNTED RF UNIT

FM-AM SIGNAL GENERATOR

TYPE 202-H

RADIO FREQUENCY CHARACTERISTICS

RF RANGE: 54-216 MC
 RF ACCURACY: $\pm 0.5\%$
 RF OUTPUT RANGE:
 0.1 μv to 0.2 volts*
 *Across external 50 ohm load at panel jack
 ACCURACY:
 $\pm 10\%$, 0.1 μv to 50 K μv
 $\pm 20\%$, 50 K μv to 0.2 volts
 AUTO LEVEL SET:
 Holds RF monitor meter to "red line" over band
 IMPEDANCE: 50 ohms
 VSWR: < 1.2

SPECIFICATIONS

AMPLITUDE MODULATION CHARACTERISTICS

AM RANGE:
 Internal: 0-50%
 External: 0-100%
 AM ACCURACY:
 $\pm 10\%$ at 30% and 50% AM
 AM DISTORTION:
 $< 5\%$ at 30% $< 20\%$ at 100%
 $< 8\%$ at 50%
 AM FIDELITY:
 ± 1 db, 30 cps to 200 KC

FREQUENCY MODULATION CHARACTERISTICS

FM RANGE:
 Internal: 0-250 KC in 4 ranges
 External: 0-250 KC in 4 ranges
 FM ACCURACY: $\pm 5\%$ of full-scale*
 *For sine-wave
 FM DISTORTION:
 $< 0.5\%$ at 75 KC (100 MC and 400 cps modulation only)
 $< 1\%$ at 75 KC (54-216 MC)
 $< 10\%$ at 240 KC (54-216 MC)
 FM FIDELITY:
 ± 1 db, 5 cps to 200 KC
 SIGNAL-TO-NOISE RATIO:
 > 60 db below 10 KC

PULSE MODULATION CHARACTERISTICS

PM SOURCE: External
 PM RISE TIME: $< 0.25 \mu\text{sec}$
 PM DECAY TIME: $< 0.8 \mu\text{sec}$

MODULATING OSCILLATOR CHARACTERISTICS

OSC FREQUENCY:
 50 cps 7.5 KC 1000 cps 15 KC
 400 cps 10 KC 3000 cps 25 KC
 OSC ACCURACY: $\pm 5\%$
 OSC DISTORTION: $< 0.5\%$

PHYSICAL CHARACTERISTICS

MOUNTING: Cabinet for bench use; readily adaptable for 19" rack
 FINISH: Gray engraved panel; green cabinet (other finishes available on special order)
 DIMENSIONS:
 Height: 10 3/8" Width: 16 3/4" Depth: 18 3/4"

POWER REQUIREMENTS

202-H: 105-125/210-250 volts,
 50-60 cps, 100 watts

PRICE — 202-H: \$1365.00
 F.O.B. Rockaway, N. J.



The Type 202-H FM-AM Signal Generator covers the frequency range from 54 to 216 MC and is designed for the testing and calibration of FM receiving systems in the areas of broadcast FM, VHF-TV, mobile, and general communications. The generator consists of a three-stage RF unit, together with a modulating oscillator and power supply, all housed in a single cabinet which may be adapted for rack mounting.

The RF unit consists of a variable oscillator, a reactance tube modulator, a doubler, and an output stage. The modulator is specially designed for minimum distortion and operated in conjunction with the electronic vernier to provide incremental changes in RF output frequency as small as 1 KC. The RF output is fed through a precision, waveguide-below-cutoff variable attenuator; automatic RF level set is incorporated which maintains "red line" on the RF monitor meter over the entire band. The entire RF unit is shock-mounted for minimum microphonism.

An internal audio oscillator provides a choice of eight frequencies which may be used for either FM or AM modulation. A modulation meter indicates either FM deviation or % AM and is calibrated for sine-wave modulation.

A completely solid-state power supply furnishes all necessary operating voltages and may be switched for inputs of either 105-125 or 210-250 volts, 50-60 cps.

Model 202-J is also available for the 215-260 MC telemetering band.

BOONTON RADIO COMPANY

A Division of Hewlett-Packard Company



GREEN POND ROAD, ROCKAWAY, NEW JERSEY

Tel. 627-6400 (Area Code 201) TWX: 201-627-3912 Cable Address: Boonraco

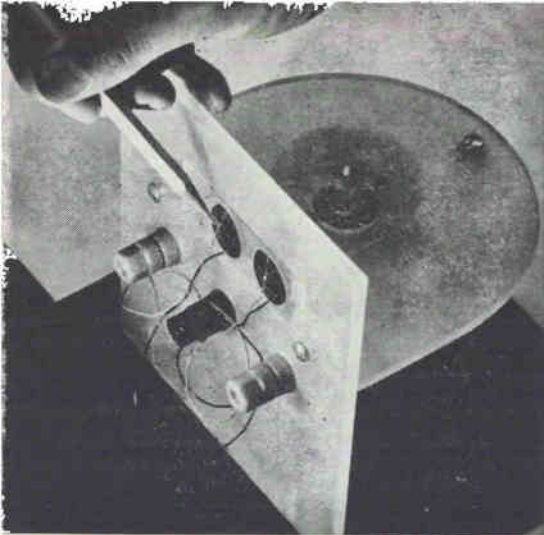

SOLAR CELL fabricated by ion implantation technique drives small fan in demonstration

PINPOINT BOMBING

Bombardment of solids with various ion species at accelerated energies is far from being a shotgun technique. On the contrary, its value lies specifically in the controllability of beam energy, current and irradiation times, plus the discrete-energy feature of ions. Ions can be inserted or implanted at varying depths in a material, and with accurately predetermined impurity concentrations.

It shows promise of specialized benefits—different from those provided by diffusion, evaporation, epitaxy and sputtering. Among primary advantages: thermal effects appear to be virtually negligible. Solar cells have been fabricated in the laboratory and three-layer-device action has been demonstrated, but ion implantation is still in the R&D stage

NEW IN SOLID-STATE

Ion Implants Forge Tailor-Made Junctions

Charged-particle method makes solar cells now; big goal: microcircuits

By THOMAS MAGUIRE
New England Editor

BURLINGTON, MASS.—An extensive program is underway at Ion Physics Corp. to exploit ion implantation for solid-state device and circuit fabrication.

The company, which has been investigating the process for more than a year (ELECTRONICS, p 7, March 8), now has an Air Force Aeronautical Systems Division contract for further development.

Initial goal is forming *p-n* junctions for solar cell panels. Hopefully, the technique will yield more efficient, uniform-quality cells with higher radiation resistance—at the same or lower cost than present methods.

Ion implantation has even more important potentials in microcircuits and radiation detectors, says

W. J. King, director of solid-state physics at Ion Physics. For thin-window detectors ion implantation offers precise control of number of impurities, junction depth and implantation area. It is also a low-temperature process, a useful characteristic in fabricating *pin* detectors with wide depletion regions.

For microcircuits, says King, ion implantation can work through passivated layers. The material need never see the atmosphere until it is time to make external contacts. The circuit would be written on the silicon block—eliminating masking, photoresist and etching processes.

SOLAR CELLS—The initial R&D target is a better solar cell.

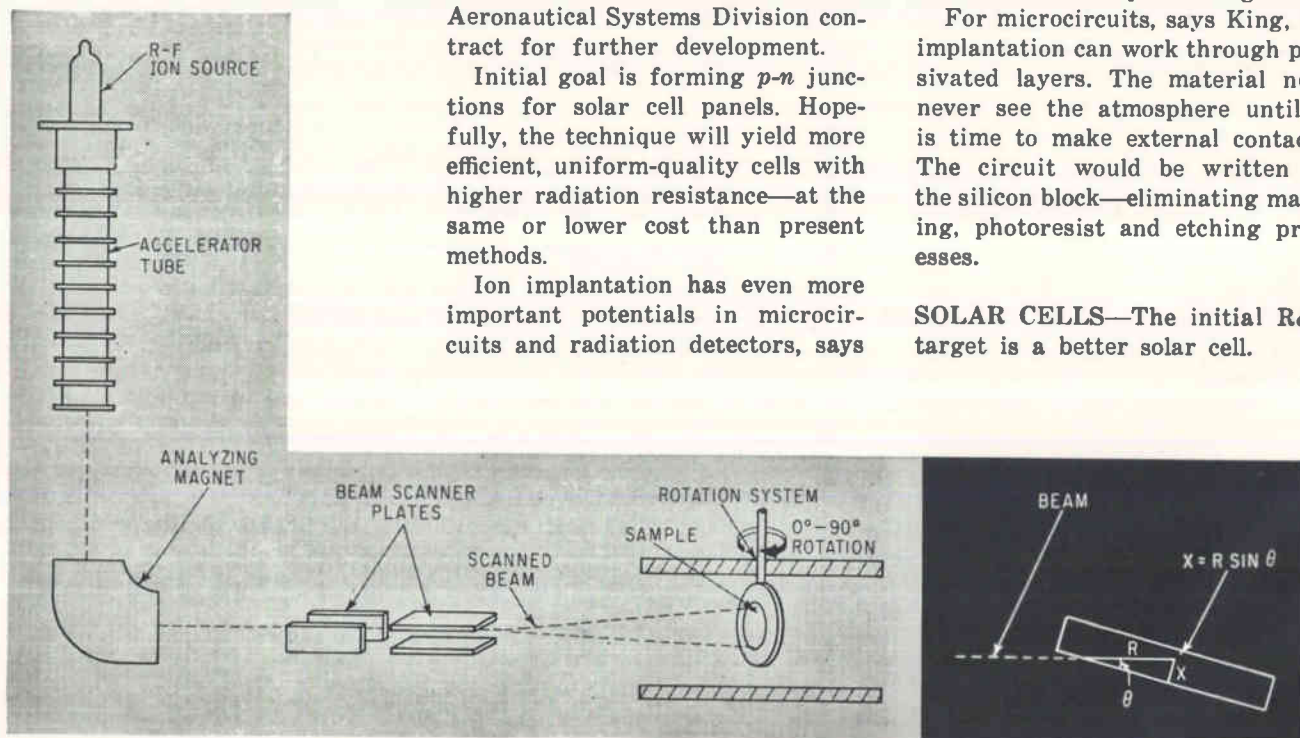

ROTATION SPEED of sample controls integrated flux at predetermined depth below surface

Theoretically, maximum conversion efficiency is 23 percent. King says producers are now getting about 12 percent and 14 in isolated cases. Ion implantation now yields 6 percent, and experimenters hope for 10 to 12 and then 14 to 15 percent—reproducibly.

Because of their superior radiation resistance, *n-on-p* type cells of high efficiency are the long-range goal.

Materials other than silicon will also be used. Gallium-arsenide cells have already been produced with efficiencies approaching those of silicon cells. Plans are to use GaAs as a test material for ion implantation techniques in III-V compounds. Accelerated zinc ions will be used to produce *p*-type, and sulfur ions for *n*-type.

RAISING EFFICIENCY — Substantial gains can be made in optimizing collection efficiency: separation of hole-electron pairs at the junction, before the minority carriers can diffuse away from the junction and recombine at the surface or deep inside the cell.

The impurity gradient yielding the optimum junction profile for collection efficiency should provide a built-in drift field of at least 1 Kv/cm in the *p*-layer; this field should be effective at the cell surface where the recombination velocity is the highest; and the junction depth should be as shallow as possible consistent with low *p*-layer resistivity.

According to King, ion implantation is uniquely capable of the precise tailoring of characteristics required in the semiconductor layer, e.g., a drift field that is highest at the surface and tapers off toward the junction, where it is not required. Energetic heavy ions have discrete ranges in materials, and it is on this property that the accelerated-particle technique depends. In addition, an accelerator like the Van de Graaff permits accurate control of ion energy, ion current, integrated beam current and beam distribution.

LOW TEMPERATURE — King points out that diffusion, at 1,100 C, involves diffusion of "undesirable" impurities also, seriously re-

Fast, foolproof production testing and sorting of 2 and 3 terminal devices

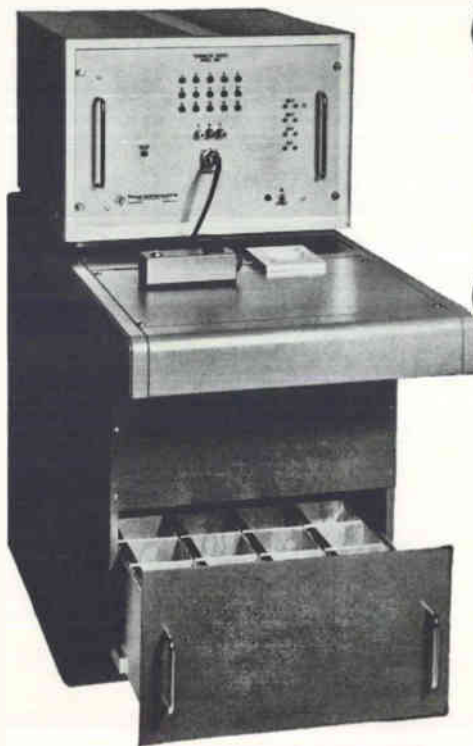

1 Insert Device



2 Press Button



3 Drop in Chute

15 tests in less than
a second

Automatic sorting to
16 categories

No operator decision

Texas Instruments Model 654 Transistor and Diode Tester with 16-Bin Automatic Sorter provides production-speed testing and accurate automatic grouping of two- and three-terminal devices.

Operation requires only three simple manual steps, completely eliminating operator decision. Sorting logic determined by printed plug-in circuit boards in the tester automatically routes the component to the proper bin. At the conclusion of the test, the operator merely drops the device into the entry chute. Sorting logic is held during the testing of the next device.

The Model 654 combines speed and accuracy with flexibility of circuit board programming. The Automatic Sorter and other accessory equipment insure continued maximum effectiveness of the basic instrument.

Write for complete information.

INDUSTRIAL
PRODUCTS
GROUP



TEXAS INSTRUMENTS
INCORPORATED
P. O. BOX 66027 HOUSTON 6, TEXAS

SENSING • RECORDING • TESTING • DIGITIZING INSTRUMENTS
THE INSTRUMENTS OF TEXAS INSTRUMENTS

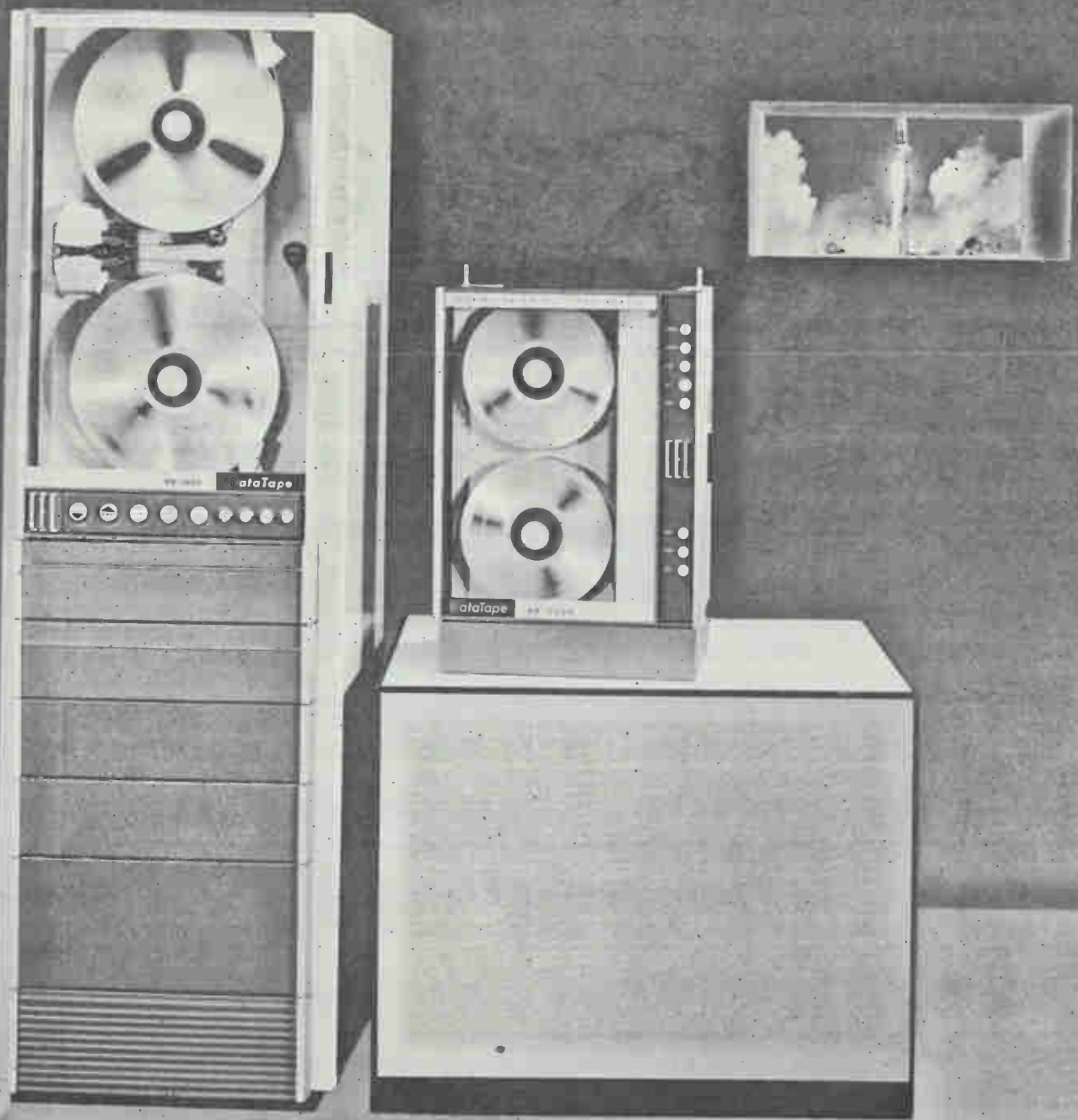

Telemetry won't wait while you change reels

These two recorders give you twice the recording time

CEC's VR-2800 (general lab) and VR-3300 (portable) record 100 kc telemetry at one-half conventional speeds. Thus, recording time of a single reel is doubled—you get top CEC performance at minimum cost... in critical blockhouse, lab, shipboard or van applications.

Bandwidth of direct recording/reproducing is 100 cps to 200 kc; 0 to 20 kc with wideband FM techniques.

CIRCLE 28 ON READER SERVICE CARD

Single cabinets of the VR-2800 and VR-3300 contain full 14-channel record and reproduce systems. Six standard speeds in three pairs (60, 30 ips; 15, 7½ ips, and 3¾, 1¾ ips) are set by means of a simple belt and switch change. Both systems feature solid state electronics for reliability and low power consumption.

Other features: all-metal-surface magnetic heads, plug-in electronics, automatic

end-of-reel stop, and backlighted mode controls.

For complete information and specifications, call your nearby CEC office, or write for Bulletins CEC 2800V-X1 and 3300V-X1.

CEC

Data Recorders Division

CONSOLIDATED ELECTRODYNAMICS

A Subsidiary of Bell & Howell • Pasadena, California

MOST versatile high performance recorder in its class —

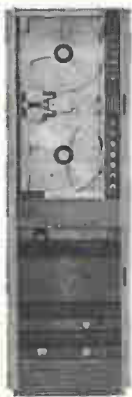

CEC's VR-2600

Working in environmental testing? Structural or transient studies? Radar recording? Telemetry? Consider CEC's VR-2600. Here's a multichannel system offering accuracy, reliability, simplicity, and room to grow into. Handling data in the 400 cps-600 kc range via direct techniques, in the d-c - 80 kc with FM techniques, IRIG PDM via PDM electronics, and 1000 bit/inch/each of 16 parallel tracks via saturation recording/reproducing techniques makes this recorder universally useable in both industrial and military applications. The VR-2600 employs solid state electronics for low power consumption, and full push-button controls. Six speeds, ranging from 1-7/8 to 120 ips are electrically selectable, with no adjustments required. For complete information, call CEC or write for Bulletin CEC 2600-X10.

CEC

Data Recorders Division

CONSOLIDATED ELECTRODYNAMICS

A Subsidiary of Bell & Howell • Posedeno, Calif.

CIRCLE 29 ON READER SERVICE CARD
electronics • April 19, 1963

ducing the lifetime of generated carriers in the bulk region. Ion implantation, on the other hand, is done at room temperature. Heat treatment subsequently anneals out radiation damage, but this temperature never exceeds 800 C, so thermal diffusion of impurities can be avoided.

APPARATUS — Principal components of the ion implantation apparatus are illustrated. Boron ions from an r-f ion source are accelerated to an energy corresponding to the desired range in the silicon. The ion beam is passed through an analyzing magnet to remove impurities, yielding a spectroscopically pure boron beam that is then passed through horizontal and vertical scan plates.

This scanned beam strikes a slice of—typically—0.4 ohm/cm n-type silicon mounted so that it can be rotated continuously from a position normal to the beam to a parallel position. By rotating the sample continuously while the beam energy is held constant, a continuous implantation of ions is obtained from the surface to a depth

corresponding to the maximum range. Beam current is also held constant. Since incident flux decreases as the angle between the incident direction and the cell surface decreases, cam system controls the speed of sample rotation and therefore the integrated flux at any given depth below the surface.

In experimentation, the basic tool is the 2-Mev Van de Graaff made by Ion Physics' parent corporation High Voltage Engineering Corp. Researchers say that 2 Mev is probably not needed except for R&D where a broad range of energies permits a complete evaluation of the technique. Ion Physics, has reduced the energy level in solar cell work to 500 Kev, and theory says that 350 to 400 Kev would be sufficient—and less expensive.

For shallow junctions, ions can be produced by a plasma source such as HVEC's duoplasmatron, capable of delivering ion currents in the 100-ma range. This could reduce implantation times to fractional seconds and permit much greater freedom in studying impurity concentrations and gradients.

Seismic Observatory Opens

FIFTH AND LARGEST seismic observatory built under the DOD's Vela program has gone into operations near Payson, Ariz. The observatories are designed to increase U.S. capabilities in underground nuclear detection. Smaller stations were previously established at Lawton, Okla.; Baker, Ore.; Vernal, Utah, and McMinnville, Tenn. (p 24, Feb. 22, 1963).

United ElectroDynamics designed and produced the equipment. The observatory has more than 60 seismometers of various types, buried in the ground in vaults. Fourteen miles of trails and 400 miles of electrical cable connect the seismometers with the recording and control center.

Concrete piers, resting on solid granite bedrock 41 feet below floor level of the observatory, provide a low-noise-level base for photo am-

plifiers which amplify electric signals from the seismometers to sufficient power to be recorded.

Seismogram Retrieval



SCANNING cameras microfilm seismograms at U.S. Coast and Geodetic Survey's new Data Analysis Center in Washington. Cameras, built by Itek, employ aerial photography techniques to retain detail

new

FM COMMAND SIGNAL GENERATOR

\$1950.

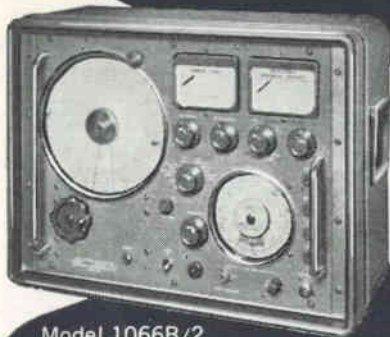

Model 1066B/2

- Frequency Range: 400Mc to 555Mc
- No Subharmonics
- Crystal Check Points Every Mc
- Stability 0.0025%
- Deviations to 300Kc Monitored
- Modulating Frequencies to 100Kc
- External Modulation Compressor Available

Write for detailed catalog sheet.

MARCONI INSTRUMENTS

DIVISION OF ENGLISH ELECTRIC CORPORATION
111 CEDAR LANE • ENGLEWOOD, NEW JERSEY
Main Plant: St. Albans, England

Lasers Fill Medical Need

Ophthalmoscope-laser to weld retinal flaws gets human test soon

By ED ADDEO
McGraw-Hill World News

SAN FRANCISCO—The medical field, ophthalmology in particular, seems to have an inside track in the race for practical uses of laser devices. Latest advance is about to be achieved by Optics Technology, Inc., of Belmont, Calif., and the Palo Alto Medical Research Foundation.

Now being developed under a National Health Institute grant of \$115,000 to the Foundation is an ophthalmoscope with a built-in laser. The device can "weld" shut a retinal flaw in 1 msec (10-nsec devices have been tested), permitting treatment in an ophthalmologist's office with no anesthetic and no pain to the patient.

The ophthalmoscope-laser was designed by OTI to close pinpoint holes that develop in the retina. If left unattended, such holes can lead to complete retinal detachment from the choroid—and blindness. The 2-lb device reportedly offers the control and reliability required for medical use.

Chief investigator in the research is Narinder Kapany, presi-

dent of OTI, and two OTI physicists, Norman Peppers and Norman Silbertrust. Also in on the testing of the device are Drs. Milton Flocks and H. Christian Zweng, of Stanford School of Medicine's Division of Ophthalmology.

Drs. Flocks and Zweng have experimented on hundreds of rabbits with the OTI device and expect to perform the first human tests "within a few months." The device has been described by Prof. Arthur L. Schawlow, of Stanford, co-discoverer of the laser principle, as "probably the first real application of the laser."

OTHER USES—Dr. Zweng sees laser treatment soon developing to the point where lasers will be used to burn tumors and other vascular diseases of the eye, and cure many types of disorders of the iris. In a cataract operation, for example, removal of the cataract often results in the iris being peeled off the eyeball. The laser, in this case, could conceivably "burn" a new pupil into the patient's eye, restoring his sight.

Areas of the retina where treatment is impossible due to the eye's curvature may soon be reached through fiber-optics attachments to the OTI device. Peppers reports that OTI has already developed a fiber optics device, encased in a hypodermic needle, that allows

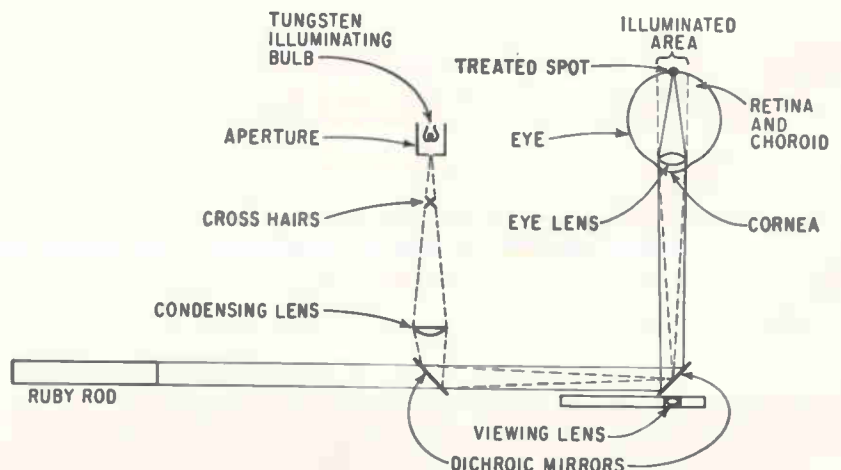

FUNCTIONAL ARRANGEMENT of the instrument. Crosshairs are used to aim the beam at the hole in the eye's retina



FIVE-MAN TEAM demonstrates laser ophthalmoscope on rabbit. From left are Dr. H. C. Zweng, Dr. Milton Flocks, Prof. A. L. Schawlow, Norman Peppers and Norman Silbertrust



LASER - OPHTHALMOSCOPE and its power supply

laser treatment of other areas inside the eye. Work is now under way in curving the needle, so the fiber optics bundle will transmit light to inaccessible areas of the eye.

ACCURATE AIMING—The ophthalmoscope-laser enables a doctor to see inside the eyeball while aiming the beam through cross-hairs exactly at the hole in the retina. The laser, or retinal coagulator, provides a beam of 0.05 joule. Focused by the eye's lens onto the retina, the beam spot-welds the flaw with a heat-produced scar, or lesion.

The OTI instrument uses a synthetic, chromium-doped ruby crystal, $\frac{1}{2}$ by 3 inches, and operates at a wavelength of 6,943 Å. Dichroic mirrors in the device filter the wavelength. Area of treatment can be as large as 3 degrees or as small as 0.5 degree, which represents a $\frac{1}{4}$ -mm-diameter lesion on the retina. Diameter of the lesion is determined by the function:

$$D = f(2a)$$

where f is the focal length of the eye's lens and $2a$ is the full di-

NOW from DEI

Versatile . . . Proven . . . Modular

VHF/UHF Telemetry Receiver

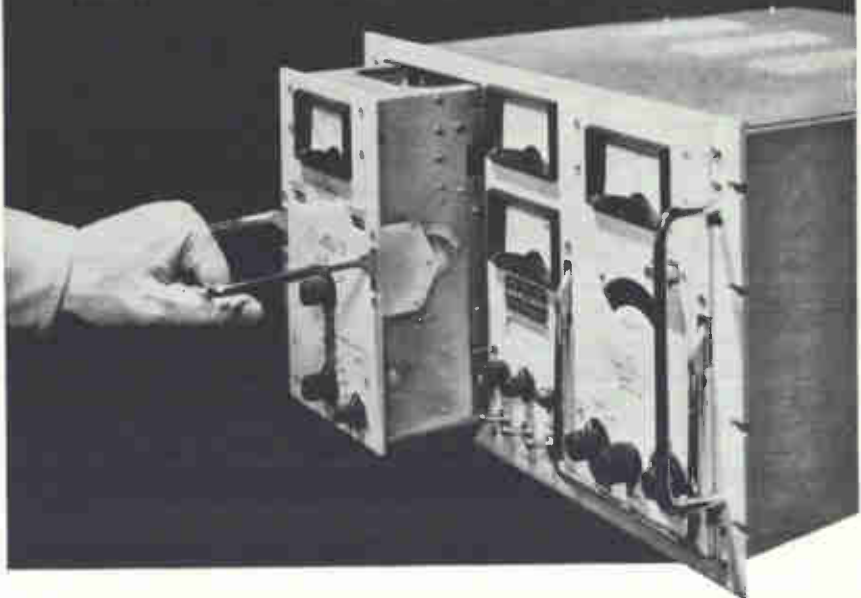

- Video Amplifier Response DC to 1 mc with Impedences Selectable 75 or 600 ohms
- AFC Optional on all RF Heads
- Multiple Bandwidth Front Panel Switchable IF Amplifiers
- Multi-Range Deviation Meter Calibrated Directly in KC

Immediately available from Defense Electronics, Inc. is the versatile, field-proven, completely-modular TMR-5A telemetry receiver.

This reliable unit will currently accept 14 plug-in tuning heads . . . 14 plug-in IF strips and six demodulators . . . any one of which can be easily removed from the receiver in seconds. Additional heads, demodulators and IF amplifiers are available upon request.

Plug-in RF heads can be instantly installed or removed from the receiver to provide the required frequency range by merely using the "single-action" pull out handle.

The video drawer also can be speedily converted by the various plug-in IF strips, ranging from 3 KC to 2.4 MC, and plug-in demodulators for FM, AM, PM and FM phase-lock applications.

This unit is particularly suitable for conical scan antenna tracking, dual diversity combining and predetection record/playback applications.

Write for DEI bulletin TMR-5A . . . or call:



DEI
SERVING
GOVERNMENT
AND INDUSTRY

Defense Electronics, Inc.

Main Office:

5455 Randolph Rd.
Rockville, Md.

Phone: WH 6-2600
TWX: 301-949-6788

Regional Office: Sherman Oaks, Calif. Phone: 873-4322



Electron Tubes

Power grid tubes

for AM and FM radio broadcasting, VHF and UHF television transmitters, and communication and industrial heating equipment. Siemens external anode tubes are available for all classes of service including coaxial based tubes for high frequency operation up to 1000 Mc/s, and vapor cooled tubes with plate dissipation ratings up to 180 kWatts.

Internal anode radiation cooled glass types are available for frequencies up to 600 Mc/s, and plate dissipation ratings up to 1.2 kWatts.

Three widely used ceramic-metal tetrodes are described below.

Type	Application	Max. frequency at full/reduced ratings Mc/s	Power Output Synchron Level kWatts	Maximum Ratings			
				Plate Voltage kV dc.	Plate Dissipation		
					Air Cooled kWatts	Water Cooled kWatts	Vapor Cooled kWatts
RS 1032 C	UHF TV Transmitter	790 960	10 7.5	5.2 4.1	10 10		
RS 1052 C	UHF TV Transmitter	790 960	2.2 1.6	3.8 3.1	3.5 3.5		
RS 1082 C	SSB Transmitter	30 250	20*	10	25 25	30 30	45 45

* single tone power output, zero grid current

For further information and application engineering assistance regarding these electron tubes manufactured by Siemens & Halske AG • Germany, please write to their distributor in the U.S.A.:

SIEMENS AMERICA INCORPORATED

350 Fifth Avenue, New York 1, N.Y. • Tel: LOngacre 4-7674. Telex 01-2070, Cable: siemens newyork

In Canada:

SIEMENS HALSKE SIEMENS SCHUCKERT (CANADA) LTD.

407, McGill Street, Montreal 1, P.Q. • Tel: 849-5783. Telex 012800, Cable: siemenscan



LESION formed on rabbit's retina by OTI laser

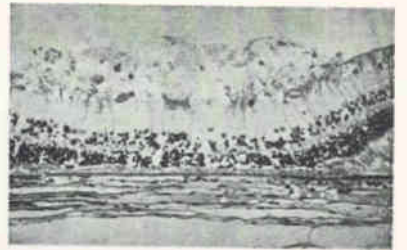

RETINAL cross section showing scar formation

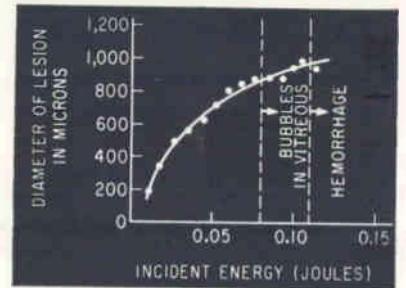

LASER OUTPUT is set to produce a scar large enough to scar over the retinal hole without causing hemorrhaging

vergence angle of the crystal. Lesion diameter is a nonlinear function of incident energy—too high an output would cause hemorrhaging and too small an output would not effectively scar over the retinal hole (see graph).

A safety feature of the device is two isolated capacitors, each 175 μ f, that cannot accidentally discharge together at full power because they are separated by 100-ohm resistors (see diagram p 36).

Price of the instrument, although not being seriously discussed until all testing is completed, will probably be around \$2,000.

MEDICAL NEED — Each year, thousands of persons develop retinal detachment. When the fluid in the
(Continued on p 36)



Siemens Components Center, Munich—Main Offices, Research, Manufacturing and Sales

This is Siemens

Siemens is one of the world's largest business enterprises. The photo shows about one third of the Munich complex devoted exclusively to Siemens electronic components. Other Siemens components plants are located in Heidenheim and Regensburg. New buildings are also under construction at all three locations.

A large proportion of the total production of Siemens components is used in Siemens telecommunication equipment and other Siemens electronic products, world known for their high standards of quality. As a result, unusually complete and exact data is available on Siemens components performance under actual operating conditions.

For general information on Siemens, circle 263 on Reader Service Card

SIEMENS & HALSKE AG · GERMANY

Subsidiary in the U.S.A.:

SIEMENS AMERICA INCORPORATED

350 Fifth Avenue, New York 1, N.Y.

In Canada:

SIEMENS HALSKE SIEMENS SCHUCKERT (CANADA) LTD.

407 McGill Street, Montreal 1, P.Q.

MKH and MKL...

the smallest metallized film capacitors



Siemens MKH and MKL capacitors set new standards for both **small size and high reliability**. Twenty years' experience in making metallized capacitors has resulted in advanced manufacturing techniques which closely control every capacitor property. And these capacitors are almost completely foolproof in service; their "self-healing" ability eliminates the possibility of any voltage breakdown.

TWO SELF-HEALING PROCESSES

1. There is very little probability of an internal voltage breakdown. Whenever it happens, however, the thin metal coatings at the breakthrough point act as a fuse element and vaporize. The resulting gas pressure blows the vaporized metal away from the breakthrough point—interrupting the breakthrough within a few microseconds and eliminating any possibility of its recurrence.

Tests at nominal voltage show that the **average probability is less than one self-healing breakdown per year and per mF**. This value is for the first year. It is even less for following years. (The average total is 15 self-healing breakdowns in 20 years.) At lower than nominal voltages, the probability is far less.

Overload tests (at 2.2 times nominal voltage and at 85°C) show that decrease of capacitance as a result of self-healing is negligible, even after several years.

2. The second process, "electrochemical self healing," starts whenever and wherever insulation resistance decreases in the dielectric material. This process works at any voltage, even at 10 mV. It may continue for several hours or days. Its effect is to change the metal coating at the point of lowest insulation resistance to a non-conductive oxide...thus eliminating the point electrically.

There is practically no change in insulation resistance during or after an electrochemical self heal...or after a self-healing breakdown.

MKH metallized polyester capacitors—small size at low cost.

MKH capacitors are available, with axial or radial leads, in a flat shape. See photo below. A round type will be available soon. Leads are soldered to metallized ends to ensure reliable contact. The dielectric is polyester film widely used for capacitors.

Operating temperatures: -40° to +125°C.

Insulation resistance: At least 20,000 megohms for nominal capacitance up to .022 mF at +20°C. For higher capacitance values: 10,000 megohms × mF (typical values).

Temperature coefficient: Approx. .04%/C° between 0° and 70°C.

Dissipation factor: 0.5% at 1 kc; 1.5% at 10 kc (typical values).

Dimensions (in inches):

Capacitance Values (mF) ⁽¹⁾	Nominal Voltage 250 VDC	Nominal Voltage 400 VDC ⁽²⁾
.01		.21 × .36 × .56
.015	Rated for up to 630V	.25 × .40 × .56
.022		.30 × .46 × .56
.033		.25 × .40 × .56
.047		.21 × .36 × .80
.068	.23 × .38 × .56	.25 × .40 × .80
.10	.26 × .42 × .56	.28 × .44 × .80
.15	.25 × .38 × .80	.25 × .50 × 1.09
.22	.25 × .48 × .80	.30 × .54 × 1.09
.33	.23 × .48 × 1.09	.32 × .70 × 1.09
.47	.25 × .62 × 1.09	.32 × .82 × 1.19
.68	.26 × .76 × 1.09	.40 × .89 × 1.19
1.0	.36 × .74 × 1.09	.52 × 1.01 × 1.19
2.0	.48 × .99 × 1.19	

(1) Usual tolerance: ±20%. Closer tolerances and intermediate values on request. (2) All values from .033 to .22 mF also available at 630V ratings.

MKH capacitors (±20% tolerance and axial leads) are in limited stock in White Plains, N. Y.

MKL miniature metallized lacquer capacitors—smallest film capacitor in mass production.

The dielectric is a 1/10 mil film of lacquer. A recent invention has substantially improved insulation resistance and allowed higher voltage ratings.

MKL standard type B 32110 capacitors are cased in an aluminum tube sealed with epoxy resin. MKL Type B 32120 capacitors are enclosed in a non-magnetic metal can hermetically sealed with glass. For both types, a plastic sleeve provides external insulation.

MKL capacitors are used for all types of circuits requiring high components density.

Operating temperatures: -40 to +85°C.

Insulation resistance: 5000 megohms × mF (typical value). 1000 megohms × mF (minimum value).

Temperature coefficient: Approx. .08%/°C for temperature above 0°C.

Dissipation factor: 1% at 100 cps; 1.5% at 1 kc; 2% at 10 kc. (All at 20°C.)

Dimensions (Type B 32110) in inches⁽¹⁾:

Capacitance Values (mF) ⁽²⁾	Nominal Voltage 50 VDC	Nominal Voltage 100 VDC ⁽³⁾
0.1		.21 × .73"
0.22	.21 × .73"	.25 × .73
0.47	.29 × .73	.29 × .83
1.0	.29 × .83	.37 × .83
2.2	.42 × .83	.42 × .98
4.7	.42 × .98	.46 × 1.34
10.0	.50 × 1.34	.66 × 1.34

(1) Dimensions for Type B 32120 are slightly larger. (2) Usual tolerance: ±20%. Closer tolerances and intermediate values on request.

(3) All values are also available in 160V rating.

MKH and MKL capacitors are distributed by William Brand Electronic Components Inc. Services are available through sales representatives throughout the U. S.

CIRCLE 264 ON READER SERVICE CARD.

Siemens components available: Ferrite pot cores and transfluxors; capacitors (electrolytic, polystyrene, metallized plastic, metallized paper); deposited-film resistors; semiconductors; R. I. meters and screened cubicles.

Distributor for these electronic components:

WILLIAM BRAND Electronic Components, Inc.

220 Ferris Ave., White Plains, N. Y.
Telephone: 914 WH 8-3434

In Canada:
SIEMENS HALSKE SIEMENS SCHUCKERT (CANADA) LTD.
407 McGill Street, Montreal 1, P.Q.

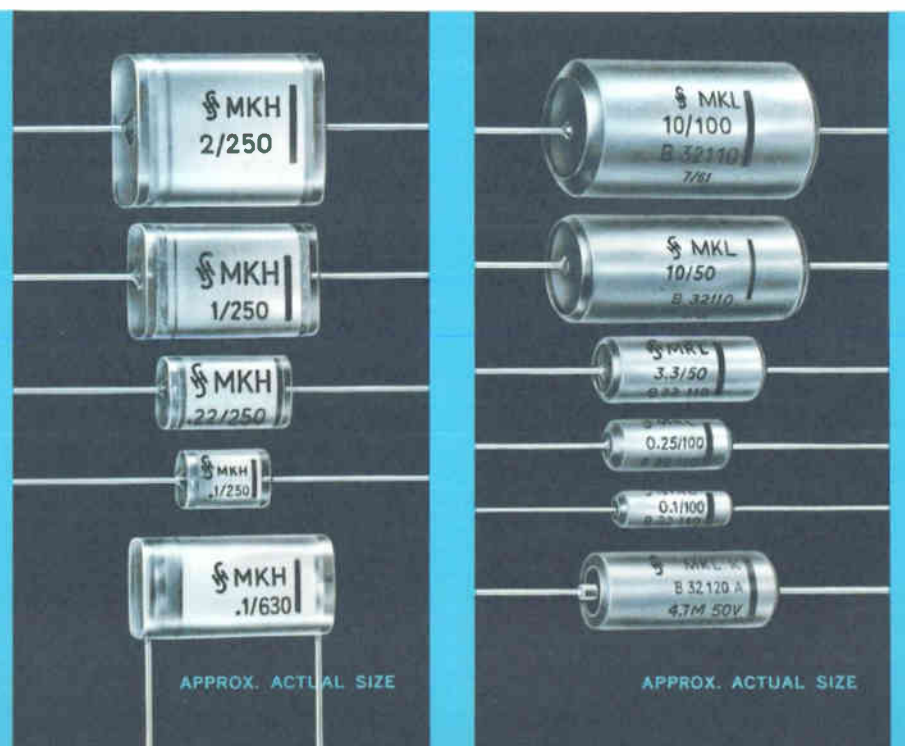

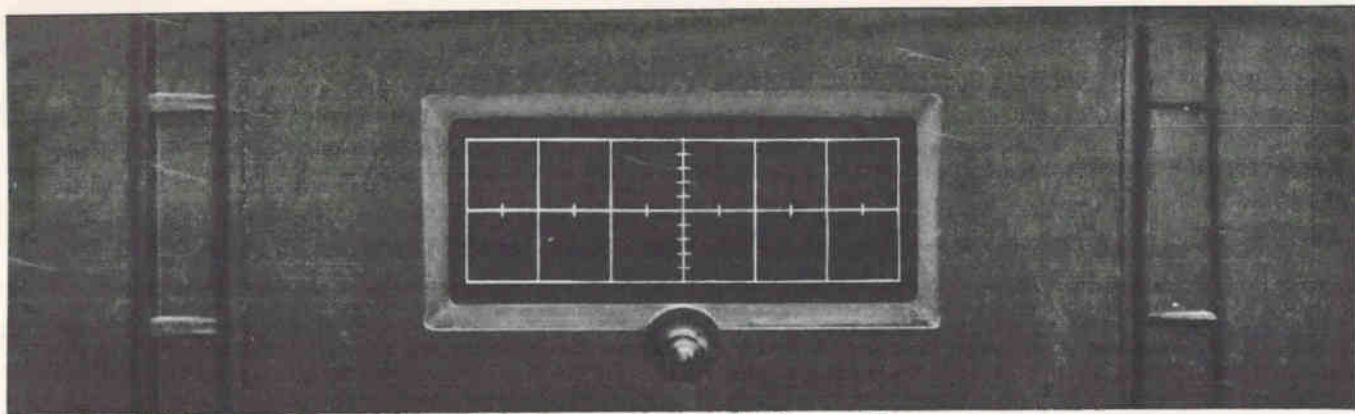

See anything?

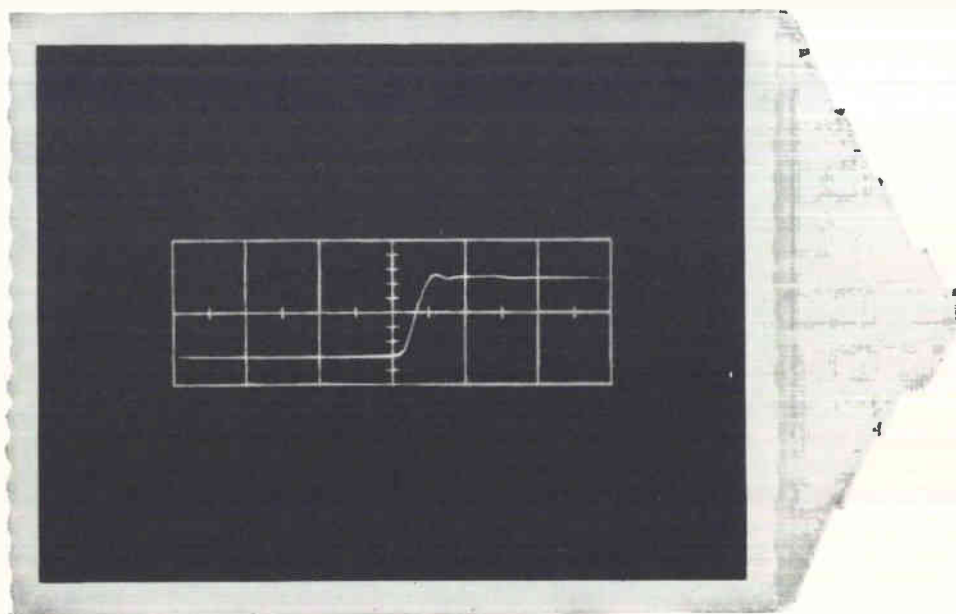

This new film did.

This new film saw something the eye couldn't: the rise time of a single pulse on a Tektronix 519 scope at a sweep rate of 2 nanoseconds/cm. The new film, Polaroid PolaScope Land Film, actually extends the usefulness of existing oscilloscopes by supplying "brightness" that the scope hasn't got!

The reason is that this PolaScope film has an ASA equivalent rating of 10,000, which means it can see things your eye cannot. It has about twice the writing rate of the Polaroid 3000-speed film, currently the standard for

high speed oscilloscope photography. (No other commercially available films come anywhere near the speed of PolaScope film.) And because it's made by Polaroid you get a finished usable print—see above—ten seconds after exposure.

PolaScope film will also give you better shots of slower pulses and stationary waveforms. So little light is required, camera aperture and scope intensity can be reduced considerably, and that's how to get really sharp oscilloscope pictures.

And wherever else light is at a premium—such as photomicrography and Kerr Cell photography—PolaScope film will make new applications possible, old applications more useful.

PolaScope Type 410 Film is packed 12 rolls to the carton. The price is about the same as the Polaroid 3000-speed film. For the name of the industrial photographic dealer nearest you, write to Technical Sales Department, Polaroid Corporation, Cambridge 39, Massachusetts.

POLAROID®

New Polaroid Land 10,000-speed film for oscillography

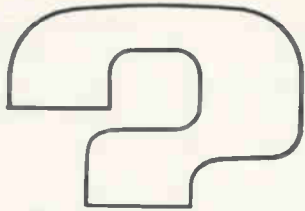

What do you need to know about

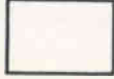

PURE FERRIC OXIDES
MAGNETIC IRON OXIDES



Since the final quality of your production of ferrites and magnetic recording media depends on the proper use of specialized iron oxides—you'll find it mighty helpful to have the latest, authoritative technical data describing the physical and chemical characteristics of these materials. This information is available to you just for the asking. Meanwhile, here are the highlights.

PURE FERRIC OXIDES—For the production of ferrites, both hard and soft, we manufacture a complete range of iron oxides having the required chemical and physical properties. They are produced in both the spheroidal and acicular shapes with average particle diameters from 0.2 to 0.8 microns. Impurities such as soluble salts, silica, alumina and calcium are at a minimum while Fe_2O_3 assay is 99.5+%. A Tech Report tabulating complete chemical analysis, particle shape, particle size distribution, surface area, etc., of several types of ferric oxides, hydrated ferric oxide, and ferroso-ferric oxide is available.

MAGNETIC IRON OXIDES—For magnetic recording—audio, video, computer, and instrumentation tapes; memory drums; cinema film striping; magnetic inks; carbon transfers; etc.—we produce special magnetic iron oxides with a range of controlled magnetic properties. Both the black ferroso-ferric and brown gamma ferric oxides are described in a Data Sheet listing magnetic properties of six grades.

If you have problems involving any of these materials, please let us go to work for you. We maintain fully equipped laboratories for the development of new and better inorganic materials. Write, stating your problem, to C.K. Williams & Co., Dept. 25, 640 N. 13th St., Easton, Pa.

WILLIAMS
COLORS & PIGMENTS

A Subsidiary of Chas. Pfizer & Co., Inc.

*Pigment
Technology
at its
best*

E. ST. LOUIS, ILL. · EASTON, PENNA. · EMERYVILLE, CALIF.

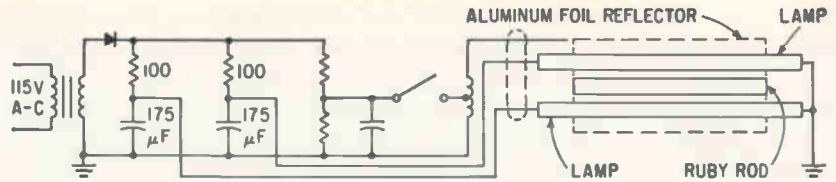

SAFETY FEATURE in the laser system is isolation of the capacitors by resistors so they cannot accidentally discharge together at full power

eyeball—the vitreous humor—seeps through a hole or tear in the retina, the pressure between the retina and choroid can eventually peel off the retina and cause blindness.

Retinal flaws have been treated by surgery, diathermy, or with the Zeiss Photo Coagulator developed in Germany in 1954. The latter focuses light, from a xenon gas tube, on the retina, but requires a treatment time of $\frac{1}{2}$ to 1 second. In this time, the patient might close

or move his eye.

The laser device, according to Dr. Zweng, overcomes this problem by the 1-msec speed—faster than the reflex movement of the eye—and its precise aiming, which eliminates any need for several shots to get the scar in the right place.

Ophthalmologists began examining the laser as an eye treatment tool well over a year ago (ELECTRONICS, p 54, Nov. 24, 1961; p 7, Jan. 5, and p 27, Jan. 26, 1962).

Europe Plans Satellites

Eight countries are asked to join forces in Eurospace program

LONDON—An integrated space program is being proposed to the governments of eight European countries by a consortium of 121 European aviation and electronic firms formed to promote European space efforts.

The two main projects proposed by the Eurospace consortium are a space communication system and a navigational timekeeping satellite.

For both systems European launchers would be used. These would be either the French Diamant system or the European Launcher Development Organization's Eldo launcher comprising a British first stage, a French second stage and a German third stage.

Other projects under consideration include meteorological satellites and space transporters.

TWO SYSTEMS—Two alternative systems are envisaged for the space communications system. One will use twelve station-keeping satellites equispaced in a circular equatorial orbit at an altitude of 7,500 miles. These would give an effective

period of 12 hours between two passes over the same meridian. Each satellite handling 600 communication channels would be attitude-stabilized with respect to the earth with its position controlled in orbit to maintain constant separation between satellites. Cost of this twelve-satellite system is estimated at \$400 million with a continuing annual operating cost of \$60 million.

A cheaper approach of using two stationary satellites rotating at the same angular velocity as the earth is the second Eurospace proposal. In this system communication over 600 channels would use ground stations transmitting single-sideband multiplexed telephone signals. Cost to establish the system is \$185 million with \$24 million annual operating cost.

NUCLEAR POWER—In their report, Eurospace also makes detailed proposals for research programs covering chemical, electric and nuclear propulsion systems.

But Eurospace's proposals have to pass two major hurdles before a European space communication system becomes a reality. First of these is governmental approval on an all-Europe basis for such a space program and secondly the setting up of an all-Europe body to operate the communication system.

MEETINGS AHEAD

QUALITY CONTROL & RELIABILITY CONFERENCE, American Society for Quality Control; Hofstra University, Hempstead, N. Y., April 20.

MOTION PICTURE & TELEVISION ENGINEERS CONVENTION, SMPTE; Traymore Hotel, Atlantic City, N. J., April 21-26.

BIO-MEDICAL ENGINEERING SYMPOSIUM, IEEE, et al; Del Webb's Ocean House, San Diego, Calif., April 22-24.

MANNED SPACE FLIGHT MEETING, NASA, AIAA; Marriott Hotel, Dallas, Texas, April 22-24.

WEATHER RADAR CONFERENCE, American Meteorological Society; International Inn, Washington, D. C. April 22-25.

NATIONAL ELECTROMAGNETIC RELAY CONFERENCE: Oklahoma State University; OSU, Stillwater, Okla., April 23-25.

POWER INDUSTRY COMPUTER CONFERENCE, IEEE; Westward-Ho Hotel, Phoenix, Ariz., April 24-26.

REGION 3 MEETING, IEEE; John Marshall Hotel, Richmond, Va., April 24-26.

VALUE ENGINEERING CONVENTION, Society of American Value Engineers; Americana Hotel, New York City, April 25-26.

PHOTOGRAPHIC SCIENTISTS AND ENGINEERS CONFERENCE, SPSE and Army Research Office; Ambassador Hotel, Atlantic City, N. J., April 29-May 3.

TECHNICAL ASPECTS OF COMMUNICATIONS SATELLITES CONFERENCE, NASA, Illinois Institute of Technology, etc.; at IIT, Chicago, May 2-3.

ELECTRONIC COMPONENTS CONFERENCE, IEEE, EIA; International Inn, 14th & M Streets, N. W., Washington, D. C., May 7-9.

IMPACT OF MICROELECTRONICS CONFERENCE, Armour Research Foundation and *ELECTRONICS Magazine*; Illinois Institute of Technology, Chicago, Ill., June 26-27.

WESTERN ELECTRONIC SHOW AND CONFERENCE, WEMA, IEEE; Cow Palace, San Francisco, Calif., Aug. 20-23.

ADVANCE REPORT

MAGNETISM AND MAGNETIC MATERIALS CONFERENCE, IEEE and American Institute of Physics; Atlantic City, N. J., Nov. 12-15, 1963. Information on submission of abstracts can be obtained from: William D. Doyle, Franklin Institute Laboratories, Philadelphia 3, Pa. Areas of interest include potential engineering applications using recent advances in magnetism including those related to superconductivity.

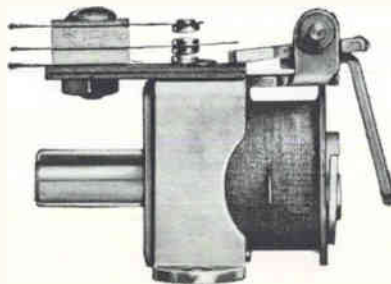

“twofer”

With Heinemann's Type A Silic-O-Netic®, you get two relays for the price of one: a time-delay relay and a load relay. In one small package (shown actual size above), you get a time-delay relay that can double, if you wish, as a load carrier, too. (It's got a continuous-duty coil; you don't have to use auxiliary lock-in circuits or slave relays.)

The Type A tips the scale—barely—at three ounces. It comes with any delay you spec, from a quarter-second to two minutes, can be supplied for use on any one of twenty standard AC or DC voltages. Contact capacities range up to three amps. Maximum power consumption is two watts AC, three watts DC. Switching is SPDT or DPDT. Operating life is somewhere in the millions (the hydraulic-magnetic delay element is hermetically-sealed, fatigue-free).

The Type A (and the entire line of Heinemann time-delay relays) is described in full in our Bulletin 5003. A copy is yours for the asking.

HEINEMANN ELECTRIC COMPANY

2600 BRUNSWICK PIKE



TRENTON 2, NEW JERSEY

SA-2466

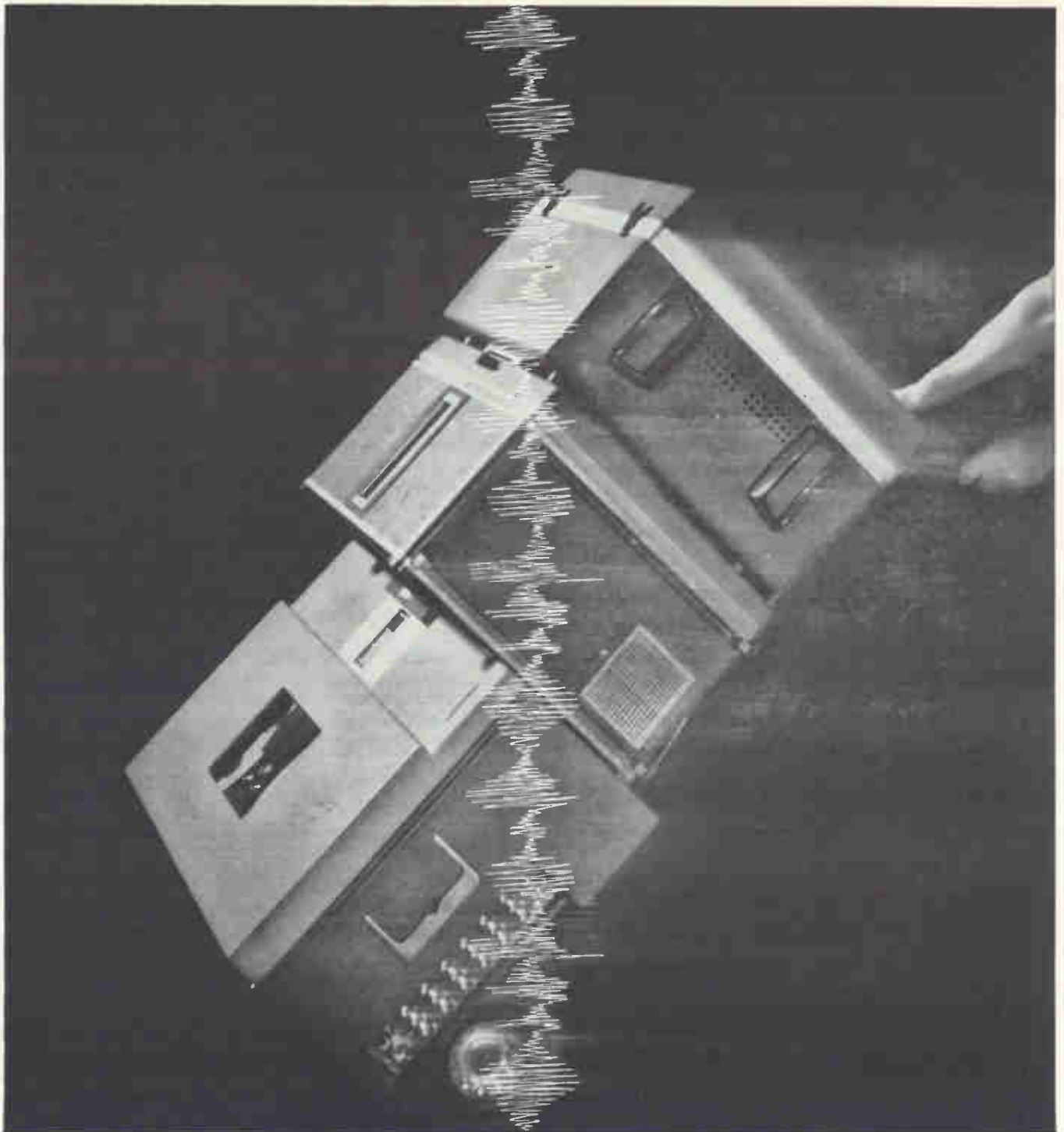

Who can deliver the most complete line of portable instrumentation recorders?

AMPEX

And what a line it is. There's a portable for medical, for industrial, for research applications, for rugged applications — for almost every data acquisition need. And there's a price to fit almost every budget. Behind each recorder stands the name of Ampex — to assure you true instrumentation performance all the time. On the top, above: the low-cost SP-300. It has four speeds, four tracks, push-button selection for FM or Direct recording, plus built-in attenuation, monitoring, calibration and erase. In the middle is the FR-1300. It offers 14 tracks, 300 cps to 300 KC capability on Direct, DC to 20 KC on FM and six speeds precisely controlled by a unique servo-driven capstan. On the



bottom: the rugged CP-100. It records Direct, FM-Carrier and PDM. Has a closed loop drive, six standard speeds, 14 tracks, a frequency response of up to 250 KC on Direct, down to DC on FM. And it operates on almost any source of power—including batteries. In other words, Ampex has a portable line so complete you can pick a recorder to fit your needs instead of having to modify your requirements to fit the recorder. For more information write the only company providing recorders, tapes and core memory devices for every application: Ampex Corp., 934 Charter St., Redwood City, Calif. Term financing and leasing available. Worldwide sales and service.

AMPEX

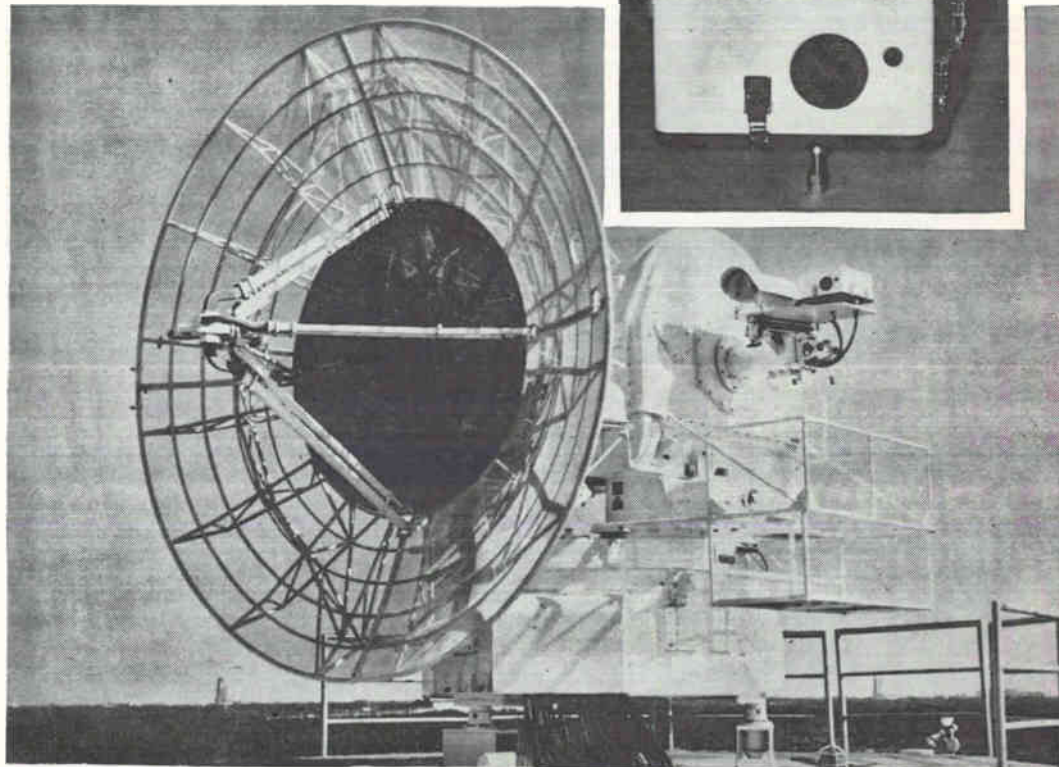
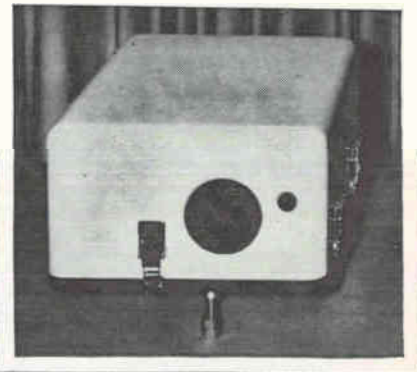

INFRARED OPTICS package mounted on radar bowl's elevation trunnion to the right of bowl's rim and expanded view of optics package

NEW INFRARED SYSTEM TRACKS MISSILES AGAINST BRIGHT FLORIDA SKY

Equipment distinguishes target from clouds even when clouds reflect more energy.

Infrared optics package is mounted on radar antenna trunnion and controls tracking at short range when spurious returns make conventional radar ineffective

By T. P. DIXON, ITT Federal Laboratories, San Fernando, Calif.

THIS INFRARED TRACKER was designed for the early stages of missile launching when ordinary radars suffer from interference due to false echoes. The infrared equipment was mounted on a radar antenna assembly and its signal fed into the existing radar control system. When a newly launched vehicle reaches burnout the same antenna is automatically switched-in to track the vehicle by radar operation rather than infrared.

For this application, high sensitivity is not important because there is sufficient energy from the missile plumes to provide a large signal-to-noise

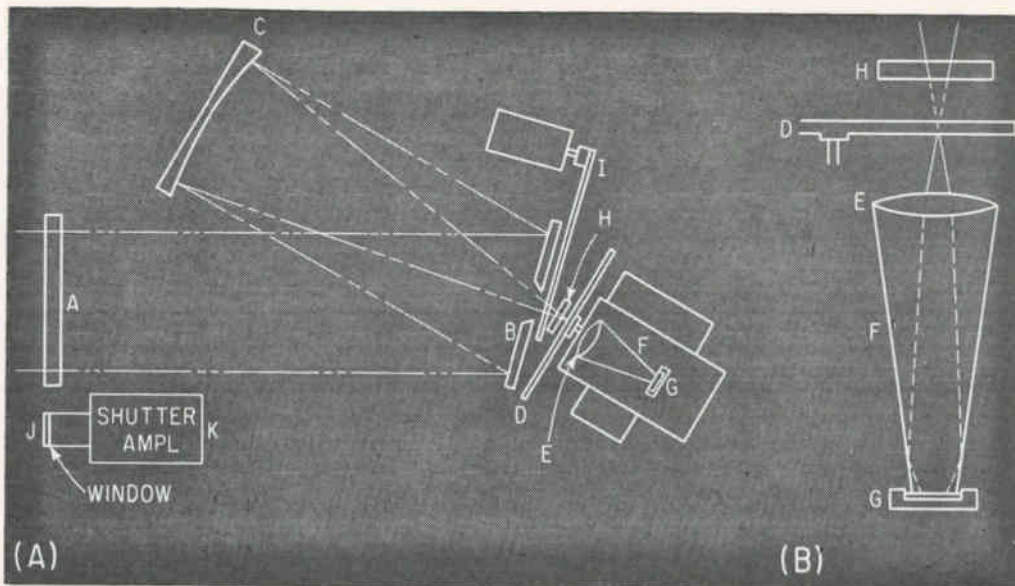

MIRRORS are used in optical system to minimize absorption of infrared energy (A). Final optics stage uses condensing lens to define a 4 degree field of view then a conical mirror to spread the infrared energy over the photocell surface (B)—Fig. 1

ratio. The measured noise equivalent flux density (NEFD) of 10^{-10} watt/cm² has proven adequate. The problem was to provide a large enough tracking field to avoid the loss of close-range high-acceleration targets, and provide sufficient background suppression to permit operation in the brightly lighted cumulus clouds that are common in the Florida area. Also, it was desired to make the instrument simple and reliable, and to require a minimum of adjustment and maintenance. In addition, the tracker required a large dynamic range so that it would track small missiles to great range without needing gain adjustments, and yet would not saturate and lose track on large missiles from nearby launching pads.

These requirements were satisfied by using imaging optics that resolved 0.1 milliradian in a 70×70

milliradian field and which made it possible to use a reticle that provided a high degree of space filtering, by further discriminating against the background with spectral filtering, and by the use of an agc amplifier having a dynamic range of 10^4 . Specifications are given in the table p 42.

EQUIPMENT CONFIGURATION—The electronic unit consists of the control-display panel, signal processing chassis and power supply. The electronic unit is in a cabinet inside the radar building, next to the radar control console. The control-display panel is arranged for easy access by the operator.

The output unit is mounted on the elevation trunnion alongside the boresight camera on the FPS-16 radar. The line-of-sight of the tracker is just outside the rim of the antenna. When precise tracking data are desired from the early launch phase, the $6\frac{1}{2}$ foot azimuth parallax error may be corrected in subsequent data processing.

OPTICAL UNIT—An important design requirement for the optical unit was minimum weight to avoid undue increase in the moment-of-inertia of the radar antenna about one or both axes. It was also necessary to maintain sufficient rigidity to avoid target image movement due to structural flexures when subjected to vibration and acceleration. These requirements were satisfied by mounting all optical elements on 1/2 inch thick aluminum tooling plate that had been "waffled" out on the underside. Approximately 60 percent of the weight was removed with little loss of rigidity in the optical path. Other advantages of the tooling plate are the precisely flat surface for mounting the optical elements, and its freedom from creep or cold flow that is common with other lightweight structural materials.

A simplified schematic of the optical unit is shown in Fig. 1. Infrared energy from the target enters the unit through the sealed Vycor window A. It is reflected by the pierced folding mirror B to the imag-

DIMMING THE FLORIDA SKY

FLORIDA doesn't seem the best spot to locate an infrared tracking system because, according to Murphy's Law, if the sun could possibly interfere with the proceedings, then it will. Consequently, this system's designers have had to devise methods of eliminating interference from the sun's energy, which is drastically more intense than the plume of any target now envisaged.

Direct sunlight is taken care of by an automatic shutter that covers the aperture of the optic inlet. Indirect sunlight—reflections from clouds and so on, are the more troublesome source of interference: radiation from a large bright cloud adds up to much more energy than any missile's plume produces. Yet the infrared system can still distinguish between a missile and a bright cloud which forms the missile's background. The secret lies in the design of the reticle (chopper), which delivers a signal only when a small target is in view

RETICLE distinguishes target from such large area infrared sources as highly reflecting clouds. Missile plume covers optical axis while energy from cloud spans 3 sets of parallel spokes—missile's energy is chopped by the group of opaque spokes but cloud energy is averaged over large area and produces no output signal—Fig. 2

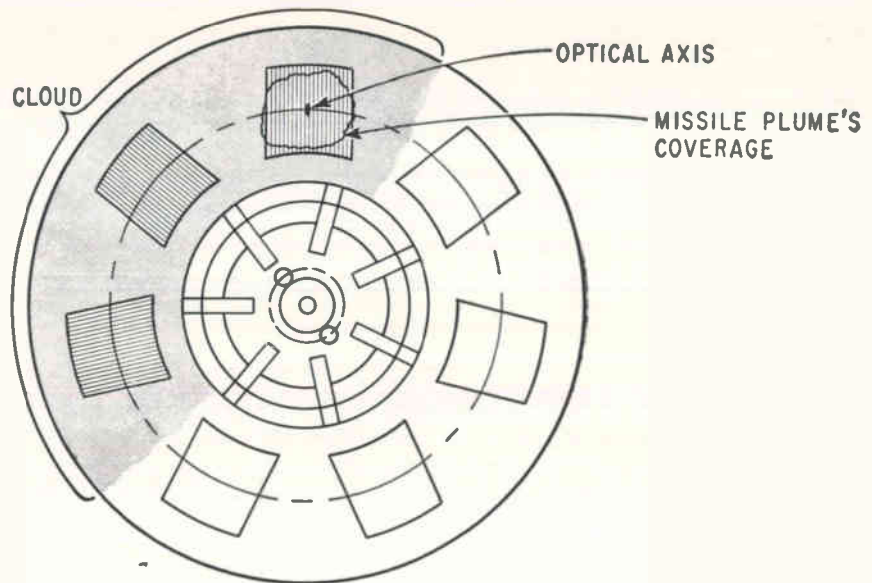

ing spherical mirror *C*. This is a 4½ inch diameter, 9 inch focal length mirror stopped down to $f/3$ by the entrance window that is located at twice the focal length from the spherical mirror. This field-stop makes it possible to maintain a small blur circle over the entire image field. Locating the image plane near the folding mirror improved the optical efficiency by making possible a small obscuration.

The target energy passes through the opening in the folding mirror *B* and forms a real image on the reticle (described in detail later) *D*. The energy transmitted by the reticle is collected by the coated germanium condensing lens *E* that defines the 4 degree total field of view. The energy is further condensed into a small area perpendicular to the optical axis by a gold-plated condensing cone *F*. The use of such a cone increases the efficiency of the $f/3$ primary optics to an effective ratio of slightly better than $f/1$. The scrambled energy leaving the condensing cone strikes the uncooled lead sulfide detector *G*. The signal generated by the cell is carried by a coaxial cable to the signal preamplifier.

A 2.1-micron short-wavelength-cutoff interference filter *H* is placed in the optical path just ahead of the reticle. This filter improves the ratio of target to background energy for the majority of the targets. A sun shutter *I* actuated by a rotary solenoid is placed in the optical path to protect the detector cell when the sun is within the field of view. It is operated in a fail-safe manner—held closed by spring force and opened only when current flows through the solenoid coil; it remains closed when the instrument is turned off. The sun sensor is a silicon solar cell that receives energy through a small entrance window *J*. A two-stage, silicon transistor amplifier driver *K* actuates the rotary solenoid. The sun sensor has a 50 percent greater field of view than the tracker to allow time for the sun-shutter to close before direct sunlight reaches the cell. Using a 6 degree field of view, direct irradiance from the sun is still a large multi-

ple of the reflected energy from bright cloud banks, so that the threshold energy to trigger the sun shutter solenoid driver is not critical, and false alarm closures do not occur.

RETICLE—An illustration of the reticle used in the tracker is shown in Fig. 2. This offset reticle performs two important functions in addition to chopping the energy to permit a-c amplification. It provides an average space filtering of 357 waves per radian to aid in distinguishing the target from the background; it also generates a signal waveform that contains information on the position of the target within the field of view. In an instrument of this type, having a relatively large 4 degree \times 4 degree field of view, the amount of near-ir energy that may be received from sunlit clouds can be much greater than that from the target that is being tracked. Without space filtering, such a cloud entering the field of view would cause the target to be lost.

The basic function of space filtering reticles is the enhancement of those components of the spatial radiance distribution in the scene which coincide with the periodicity of the reticle pattern, and the suppression of those which do not. The ideal reticle for discrimination in favor of a point target might be considered to be of the checkerboard type. This is rarely used, however, because of its inability to chop reliably target images along the boundaries of the checkerboard elements, and also because it is affected with virtually unavoidable phase jumps in the modulated signal whenever the target image moves from one row of elements to any of the neighboring rows. Due to these shortcomings the application of spoke reticles with radial or involute patterns, has become widely accepted wherever high degrees of space filtering are essential.

The problems of background suppression have been studied, and in recent years there have evolved a number of sophisticated reticle designs that offer improved performance for certain applications. The

reticle in Fig. 2 offers a significant improvement in performance with the particularly serious background condition consisting of long, clearly defined boundaries between brightly lighted clouds and a deep blue sky. It employs seven groups of parallel spokes deposited on a Vycor disk and arranged so that the center-line distance between adjacent spoke groups is exactly equal to the width of the groups. The space between the groups is coated to have an ir transmittance of 50 percent. Because of this coating the lead-sulphide (PbS) detector will receive the same average amount of energy from a large area source regardless of whether a group of spokes or the blank space is in the optical path. With the transmittance of the blank areas matched to the integrated transmittance of the spoke areas, there will be no frame-rate signal appearing in the output of the detector.

The center spoke in each group lies along a radial line, while the remainder of the spokes are at progressively increasing angles from radii through their centers. Because of this arrangement, each spoke within a group will chop the image from a slightly different angle. Therefore, if a straight cloud edge should appear in the field of view, regardless of its orientation, only one spoke in each group can chop it completely, while all the other spokes will cut diagonally across it. In this parallel-spoke reticle the degree of background rejection varies directly with the angular deviation of the spokes from radial lines. The limit to which such deviations can be used is imposed by the aspect ratio of the target. When tracking targets having a large vertical aspect—as do missiles in the early launch phase—an increase in the angular deviation of the spokes would cause the reticle to discriminate against the target as well as the background, and would provide no further improvement in the target-to-background ratio. A compromise was reached whereby some target discrimination was permitted during the early launch phase, where the target energy received by the tracker is greatest, to permit still further improvement in background rejection during the later phase when the target aspect ratio approaches unity.

Another function of the reticle is to generate a signal containing information on the position of the target image in the field of view. This reticle makes

it possible to generate azimuth and elevation angle error signals independently with a single detector. Each group of spokes in the reticle contains 25 spokes and 25 spaces. When a target is on the optical axis, its image will be chopped by the spokes, and a signal will be generated by the infrared detector consisting of a group of 25 cycles followed by an equal period of time at constant amplitude. If the target moves up in the field of view, it will be chopped for a shorter period of time and will occupy the blank space between adjacent groups of spokes for a longer period of time. This will result in a signal from the detector having a higher frequency, and with an envelope having a duty cycle of less than 50 percent. If the target should move toward the bottom of the field of view, the target will be chopped for a greater percentage of the reticle rotation, and a smaller percentage of time will be spent in the blank space between groups of spokes. The resulting signal will have a lower frequency, with an envelope having a duty cycle greater than 50 percent. A measurement, therefore, of either the signal frequency or the duty cycle in the envelope is a direct indication of the vertical position of the target within the field of view. If the target moves to the right or left from the optical axis, the frequency and duty cycle will remain unchanged, but the signal will be displaced in phase from a time reference. By using a reference signal generated by a magnetic pickup in the reticle hub, a measurement of phase displacement will give an accurate indication of the horizontal position of the target within the field of view.

SIGNAL PROCESSING—Figure 3 is a simplified block diagram of the circuit. The blocks shown to the left of the dashed vertical line are contained in the optical unit which is mounted on the radar antenna. The blocks to the right are contained in the electronic unit which is mounted inside the radar building.

The signal from the lead sulfide detector is applied to the input of the transistor preamplifier. This preamplifier uses silicon semiconductors and will withstand a 10,000-percent overload without damage or blocking. This overload capacity is desirable to permit operation of the tracker with future high energy boosters at close range.

The pulses from the magnetic pickup are amplified in a similar, but smaller, preamplifier. The signal and reference voltages are connected to the electronic unit through coaxial slip rings on the radar pedestal. The signal is applied to a two-section, high gain, agc amplifier which has a constant output amplitude with a 10' variation in input signal amplitude. By maintaining the peak amplitude of the signal constant with an agc amplifier, the background signals are suppressed rather than accentuated, as with a conventional amplitude limiter.

The constant amplitude signal is rectified and filtered to extract the waveform envelope. At this point the signal is applied simultaneously to three channels. The upper channel Fig. 3, is a duty cycle detector which generates the elevation error signal. When the target is in the center of the field of view, the signal

TRACKING SYSTEM SPECIFICATIONS

Field of view	70 milliradians
Resolution	0.1 milliradian
Tracking accuracy	0.25 milliradian
NEFD (2.1 to 2.65 μ)	10 ⁻¹⁰ watts/cm ²
Dynamic range	10 ⁶ (includes 10 ² limiting in preamp)
Error signal slope	0-2 volts/milliradian
Error signal maximum amplitude	0-10 volts
Weight	{ Optical unit, 17 pounds
	{ Electronic unit, 50 pounds
Size	{ Optical unit, 7 × 11 × 15 in.
	{ Electronic unit, 22 × 19 × 15 in.

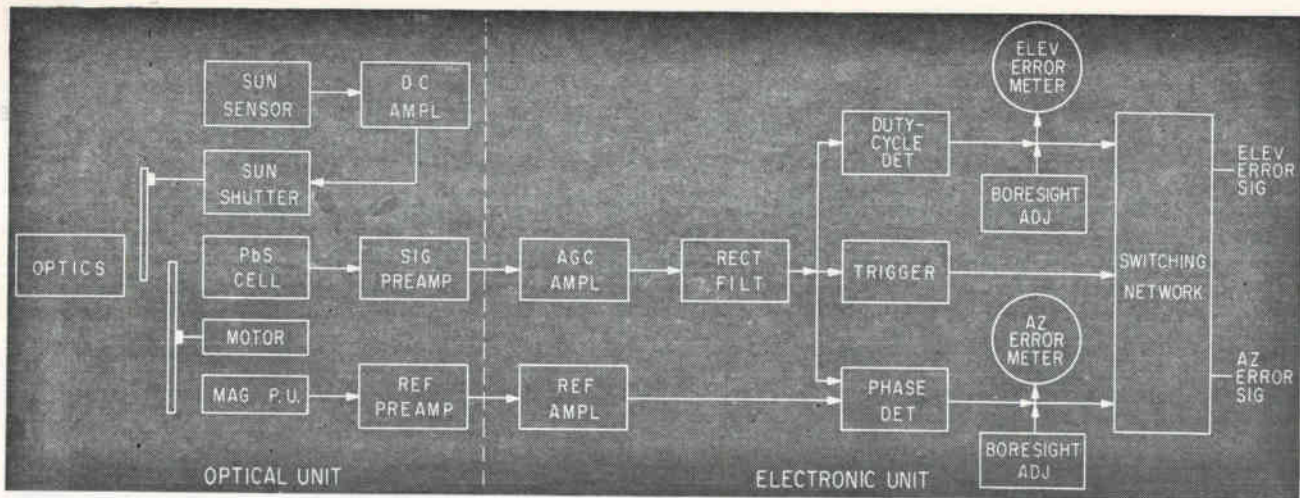

OPTICS package includes clock generator that provides reference signal for elevation and azimuth information. Electronic unit uses agc that accommodates variations in target intensity over 10,000:1 range—Fig. 3

envelope has a duty cycle of 50 percent. A Fourier analysis of this square-wave signal indicates that it contains no even-order harmonics. If this signal is applied to a circuit that extracts only the second harmonic, the output of the circuit will be zero when the target is on center. When the duty cycle of the signal increases or decreases, a second harmonic component will be present in an amount that varies with the deviation of the duty cycle from 50 percent, and of a phase that is determined by the direction of the deviation. A synchronous rectifier operating at twice the fundamental frequency derives a polarity reversible d-c signal from the phase reversible a-c signal. Circuit for extracting the second harmonic from the input signal contains a band-pass filter having a center frequency of twice the fundamental frequency of the signal envelope and a broad top to permit operation with variations in the reticle speed.

The azimuth error signal is generated by a conventional phase detector that uses the reference signal from the magnetic pickup in the optical unit. The azimuth and elevation error signals are indicated on panel meters which are calibrated in milliradians.

The error signals are applied to the radar antenna servos through a switching network that provides for manual and automatic switching. A trigger circuit provides an ENABLE voltage to the automatic portion of the switching network whenever a signal envelope at the fundamental frequency exists at the output of the rectifier-filter with amplitude sufficient to indicate the presence of a target.

In the automatic switching mode, control of the antenna servos is retained by the radar receiver or by other manual or designated sources at the option of the console operator, until the missile plume appears. At this time the switching network is energized automatically, and control of the antenna servos is transferred to the infrared tracker. This control is retained as long as the target produces sufficient irradiance to provide a tracking signal.

If the target is lost by obscuration or due to burn-out, control of the antenna servos switches auto-

matically back to the radar receiver. At any time in the missile's flight, the console operator may press a button and switch manually from infrared to radar tracking. Lighted indicators on the control panel show whether a target is in the field of view, regardless of which tracking mode has been selected. Indications are given also of the selected tracking mode and further indicators show whether the infrared or radar tracker is actually controlling the antenna servos.

The boresight adjustments shown on the block diagram are front panel controls which permit the operator to compensate for any mechanical boresight errors that may exist prior to an operation. Compensation is accomplished by locking the radar tracker onto the boresight tower and adjusting the knobs for zero error signals on the panel meters while the infrared tracker is viewing an infrared lamp mounted on the boresight tower.

SYSTEM INTEGRATION—One of the problems generally encountered in integrating a new piece of equipment into an existing operational system is in providing a match in operating characteristics. This is particularly true when the existing system contains high velocity servos. By analysis and experiment, the critical parameters of volts per milliradian and phase lag of the infrared tracker were matched to those of the radar receiver for error signal rates to approximately twice the resonant frequency of the antenna servos. By making this match, the infrared tracker error signals could be introduced to a point in the radar servo system that permitted the same servo bandwidth control to be used during both radar and infrared tracking.

ACKNOWLEDGEMENTS—The author acknowledges efforts of H. D. Coombes in the design and manufacture of the tracker, and the cooperation and support given by R. L. Carney, Pan American World Airways, Inc., especially in solving the complex infrared-to-radar interface problems. This work was performed under Contract AF08(606)-4621.

By AL BENJAMINSON

Dymec Div. of
Hewlett-Packard Co.,
Palo Alto, Calif

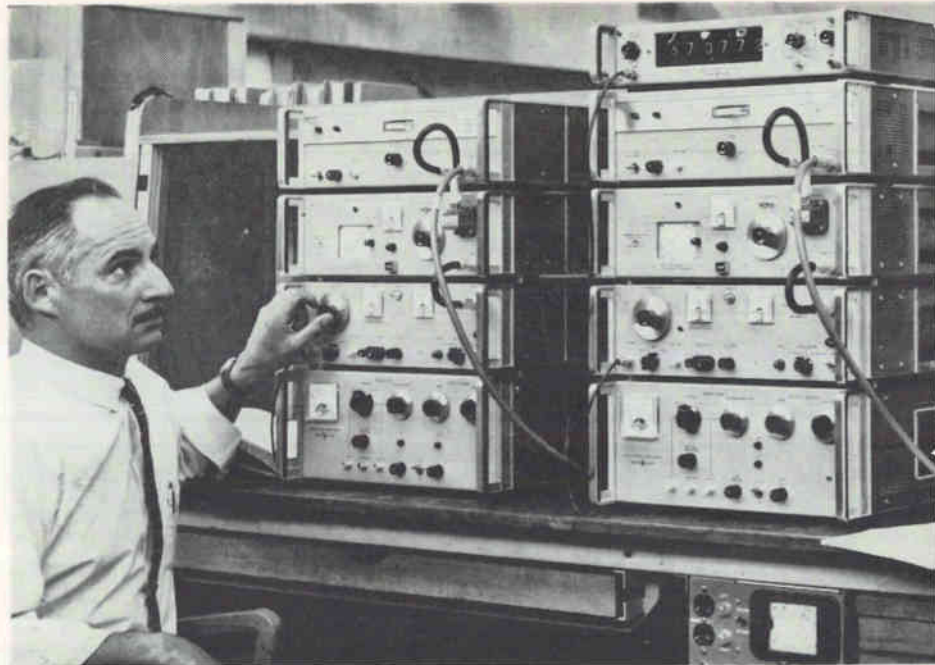

AUTHOR adjusting the simulator in the Dymec laboratory

FILLING MODERN NEEDS Phase-Locked

DOPPLER RADAR is used extensively in missile systems to guide and control the vehicle to the target. The evolution of missiles and targets, with increased ranges, velocities and accelerations, has added to the design burdens of radar system and doppler-simulator system engineers. Resultant parameter changes have raised doppler offset ranges and produced requirements for simulator equipment with cleaner spectrums and higher frequency stability.

The familiar serrodyne technique consists of phase modulating a traveling-wave tube amplifier driven by a reflex-klystron oscillator. The modulation is a sawtooth waveform applied to the helix of the twt, and adjusted to produce a 2π radian phase-shift-per-cycle. This results in an output frequency that is offset from the klystron frequency by the repetition rate of the sawtooth generator; it also creates harmonics and image signal spectral components of the offset frequency that are due to the finite retrace time of practical sawtooth generators and the accuracy to which the 2π radian phase excursion can be held. Present requirements for higher doppler

offset frequencies and tighter specifications on permissible spurious components, makes the serrodyne technique inadequate for most modern applications.

The phase-lock technique employed in Dymec microwave frequency synchronizers and stabilized signal sources can be applied to doppler simulation to overcome many of the inherent limitations of serrodyne modulation systems. The simulator described combines a Dymec DY-2650A Oscillator-synchro-

nizer with other instruments to test the practicality and performance of the approach.

DUAL KLYSTRONS—The oscillator-synchronizer phase locks a reflex-klystron oscillator tube to a harmonic of an r-f reference signal plus or minus a lower frequency i-f reference signal, as shown in Fig. 1. By combining two such systems with separate i-f reference oscillators and a common r-f reference, two crystal-controlled microwave

JUST LIKE THE REAL McCOY

Laboratory simulation of a system must accurately reproduce functional conditions. The author describes a test system that does this for a doppler radar. The method relies on synchronization of two reflex klystron oscillators to the sum of a common reference plus individual offset signals. Stable and spectrally pure carrier frequencies are obtained, also a low-jitter doppler difference virtually free from spurious content.

Doppler offset can be varied at rates from 0 to 100 Kc, while offsets can be adjusted to 4 Mc manually and 2 Mc electrically. Carrier frequency can be within the range of available klystrons from 1 to 40 Gc

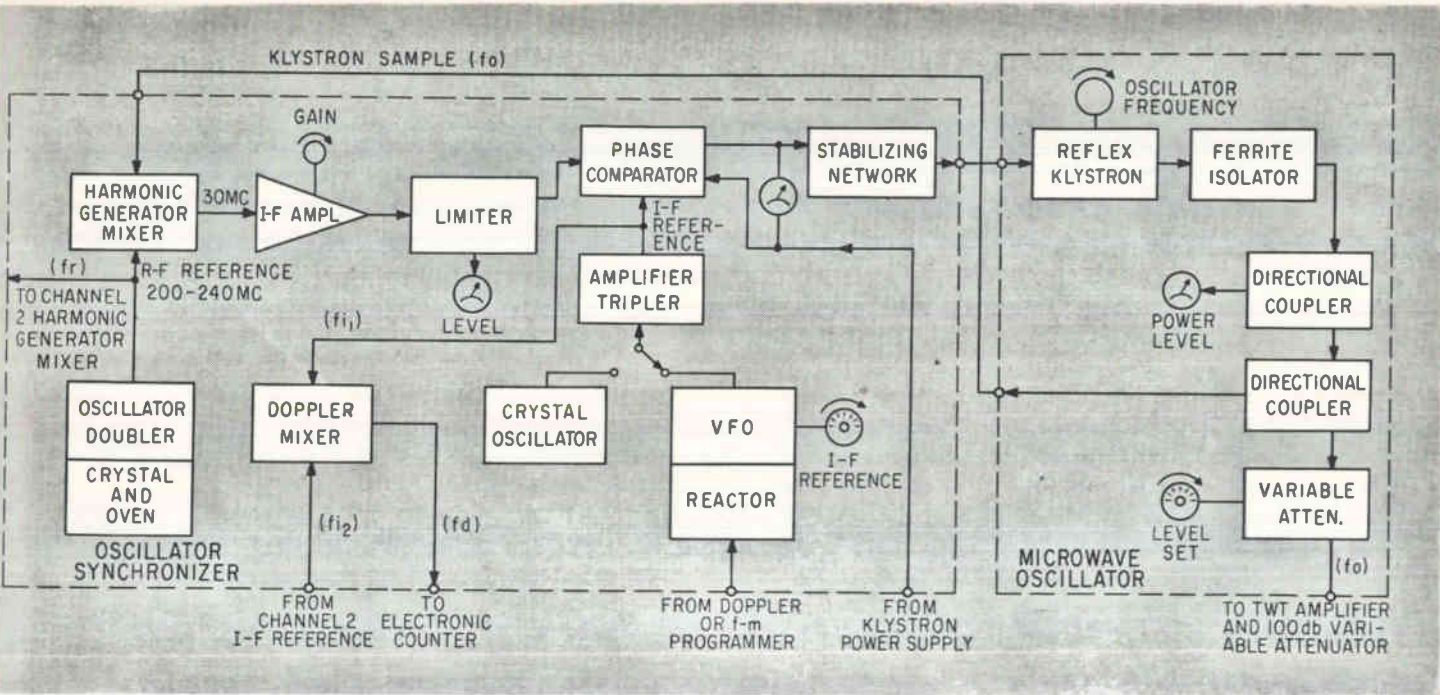

CHANNEL 1 of the doppler-simulator. Channel 2 is identical, except as noted—Fig. 1

Klystrons Simulate Doppler Radar

signals are produced that can be offset from each other by as much as 2 Mc. Each can be individually swept to peak deviations of 0.5 Mc at rates from d-c to 100 Kc.

The individual output frequencies of Fig. 1, are $f_o = Nf_i \pm f_1$, where N is a suitable harmonic, typically 35 to 60 for X-band operation and f_1 can be varied from 29-31 Mc. The doppler frequency is then controlled by $f_d = f_{i1} - f_{i2}$ or $f_{i2} - f_{i1}$, so that either channel 1 or channel 2 can be set to a higher frequency,

and can be fixed or variable with regard to doppler programming.

Because phase-locking is used, the offset between channels is affected only by the frequencies assigned to the i-f reference oscillators, and is not influenced by drift in klystron cavities or other klystron or power supply parameter variations.

The system is shown in the photograph, and the block diagram of the complete simulator appears in Fig. 2. Both channels are identical

in Fig. 2, except for minor modifications that permit either synchronizer's r-f reference to be used for both channels, and provisions for measuring F_d , the difference frequency between the two i-f references (and therefore the two microwave references). Each channel contains a klystron power supply. The reflector supply voltages pass through the oscillator-synchronizers and are modified by the phase-correcting voltages before being applied to the klystron reflectors. A sample of each klystron frequency is fed back to each synchronizer for comparison with the common r-f reference, and through each i-f amplifier for comparison with the i-f reference signals. The difference frequency F_d , was derived for measurement by mixing the two i-f oscillator signals together. The mixer output is coupled to a frequency meter for measurement and control.

SELECTION — The klystron was chosen to suit the system on the basis of power output, life, electronic-tuning range and frequency. Almost any reflex klystron can be used in this or any Dymec phase-locked system, because the tight con-

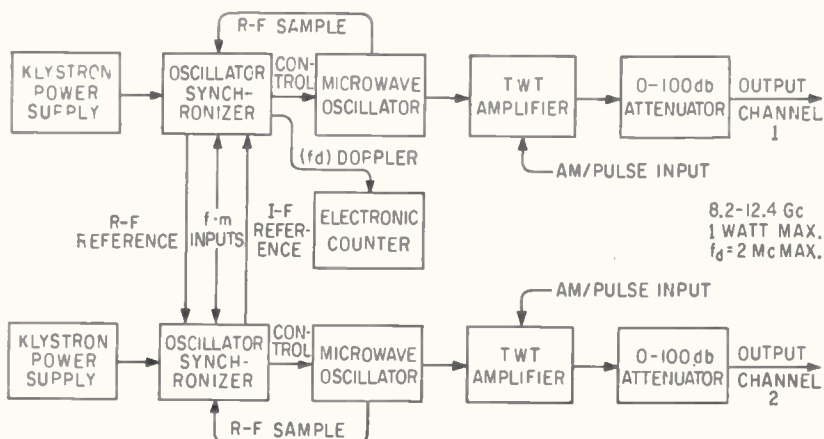

BLOCK diagram of the complete system as shown in the photograph—Fig. 2

trol imposed by the high loop-gain virtually eliminates independent klystron jitter and drift. Warm-up drift is important only if it exceeds the control range of the synchronizer. However, a maximum control voltage of ± 20 volts is available, so few klystrons fail to meet this requirement. The klystrons used in the DY-2655A Microwave Oscillator typically produce outputs in excess of 100 milliwatts over the range 8.2 to 12.4 Gc, and can be controlled over a 20 db range by internal power-set attenuators or external rotary-vane attenuators with a range of 0-100 db.

A twt Amplifier was added to each channel to provide limiting for a-m resulting from f-m, and to introduce an amplitude control program simulating antenna nutation signals and/or noise modulation. The final output levels were at least 1 watt-per-channel.

PERFORMANCE — Tests were performed on the system to determine short-term and long-term stability of the microwave output and doppler offset frequencies.

Doppler-offset drift F_d , was approximately 20 cps rms, averaged over one-second in a normal laboratory environment with normal line voltage fluctuations. After one hour of warm-up, the long-term drift was less than 200 cps-per-hour and was not continuous, but fluctuated in direction and magnitude.

Short-term drift of F_d , was similar to that of the individual oscillators, while long-term drift was considerably improved over the individual units. This is due to the fact that the two i-f reference oscillators are identical in design, although mounted on separate chassis within the same cabinet. Localized temperature changes affect each oscillator separately, while long-term temperature changes are the same for both oscillators.

The drift in F_d , the separate microwave output frequencies, measured at approximately 8.6 Gc is shown in Fig. 3. These recordings were made with i-f reference oscillators in the crystal oscillator mode, and do not show the small additional drift due to the

variations in the vfo's. The variations shown are due entirely to the short-term jitter and oven temperature cycling of the common r-f reference oscillator. The upper recording shows the frequency jitter of the unlocked klystron and the improvement that results when the phase-lock loop is closed.

Changes induced in the klystron spectrum by the wide-band phase lock were also measured by beating the two channel output signals together in a mixer and examining the spectrum around F_c with a frequency discriminator and wave analyzer. Since each spectrum is produced by broad-band white noise, the individual spectrum can be assumed to be only $1/\sqrt{2}$ of the difference spectrum.

The spectrum produced by the phase-lock was measured with a number of different tubes in X-band and showed little variation between tubes. The reversal in noise versus modulation-frequency distribution is typical of phase-locked systems, and is due to thermal or other tube or mixer noises which phase-modulate the klystron within the phase-loop bandwidth. The spectra of the reference oscillators will effect the phase-locked spectrum only in the region close to the carrier. If extended to higher frequencies, the noise deviation will gradually level off and then fall to a low value outside the effective phase-control bandwidth. Since system noise is uniform, it produces a constant phase deviation within the system bandwidth. Frequency deviation, which is equal to the product of phase deviation and modulation frequency, produces an increasing characteristic with frequency.

CONCLUSIONS — Results have shown that doppler simulators with performance superior to that obtained from the serrodyne system, can now be assembled from slightly modified stock instruments, resulting in flexibility of design and selection of operating frequencies. Since standard reflex klystrons and twt Amplifiers (when required) can be used for frequencies from 2 to 18 Gc, the necessity for special serrodyne-type twt's is eliminated.

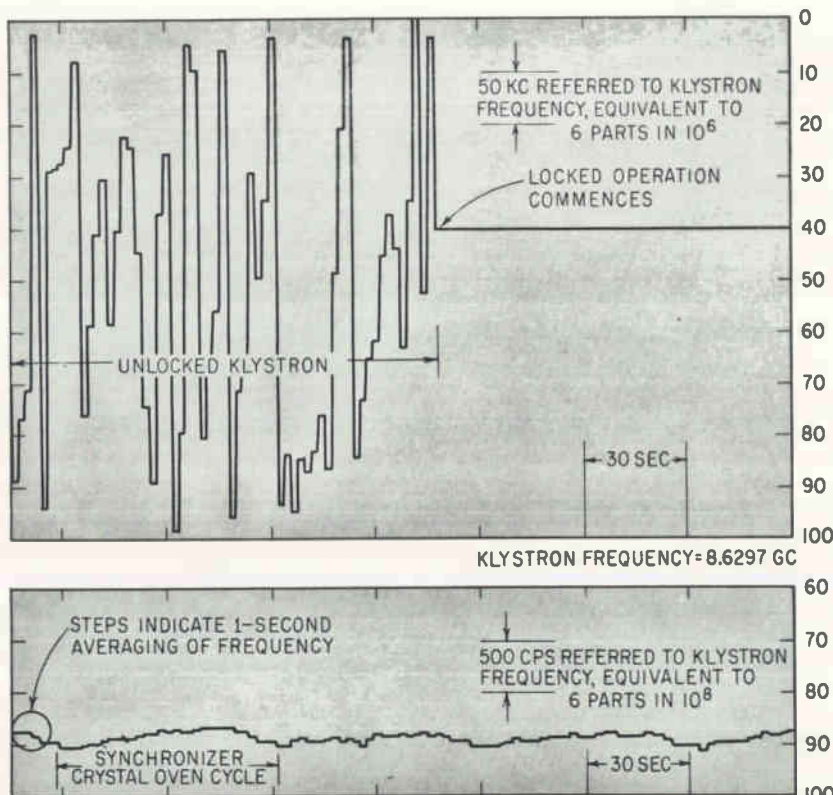

STRIP-CHART recordings show the reduction in klystron frequency jitter when the phase lock is applied—Fig. 3



PREPARATIONS are made for balloon launching of equipment to explore x-rays and particle radiation at high altitudes in the auroral zone

RADIOSONDE

Measures After-Effects of Solar Events

Data on x-rays and particle radiation at high altitudes in the auroral zone are gathered by balloon-borne system.

New and modified circuits are used in versatile, temperature-stable apparatus

By **E. WAIBEL***

Max-Planck-Institut für Aeronomie
Institut für Stratosphären Physik, Lindau/Harz, Germany

COPING WITH ENVIRONMENT

Environmental conditions often make contradictory demands on electronic equipment. A design that adequately meets one requirement may be completely unacceptable because of some other environmental factor. For example, a balloon-borne radiosonde must operate under an unusually difficult combination of conditions. The success of the system described here in meeting these requirements has been demonstrated in flight

A BALLOON-BORNE radiosonde has been developed to explore phenomena initiated by solar events and accompanied by x-rays and particle radiation in the auroral zone. The system distinguishes between photons and charged particles, which is required because both kinds of radiation may occur after strong solar flares.

The equipment, which has operated successfully in several flights over the polar regions of Europe, uses both a scintillation counter and a counter telescope. Because of this combination, the radiosonde can be readily modified for a wide variety of radiation measurements in the upper atmosphere. The system is also easily adjusted and requires little time to make it ready for flight.

Design of the radiosonde was influenced by the conditions under which it would operate. For example, operation of the transistorized system is stable over a wide range of temperatures. The lightweight system is relatively inexpensive, and power requirements are practical for a balloon-borne system. To fulfill these requirements, some conventional circuits could not be used and others had to be modified.

RADIATION DETECTION — The main radiation detector is the scin-

* Now at Physikalisches Technische Bundesanstalt Braunschweig

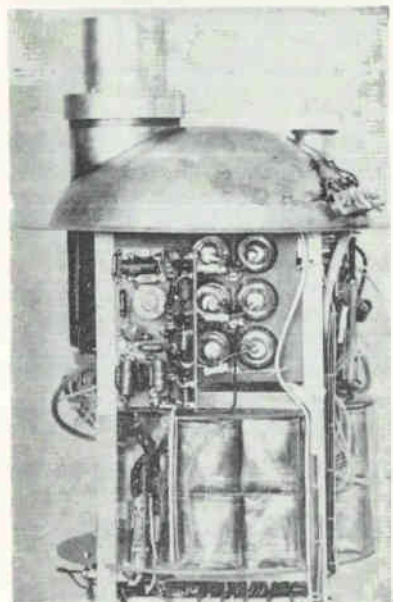
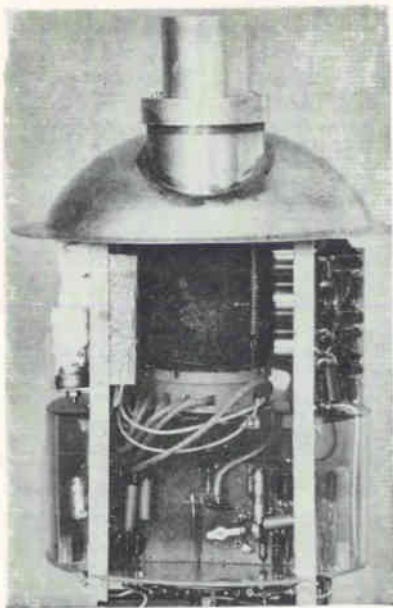

SCINTILLATION counter, counter telescope and input circuits appear at top, while high-voltage supply can also be seen in photo below

tillation counter using a Tl-activated NaI crystal. The counter telescope responds primarily to charged particles only above a predetermined threshold level. The radiation measurements are telemetered to an existing receiving station on the ground by a vhf frequency-modulated transmitter. Only five subcarriers are used to avoid interference among the audio-frequency channels. Because of this limitation, the kind of information that was to be transmitted had to be carefully considered.

It has been observed that x-ray

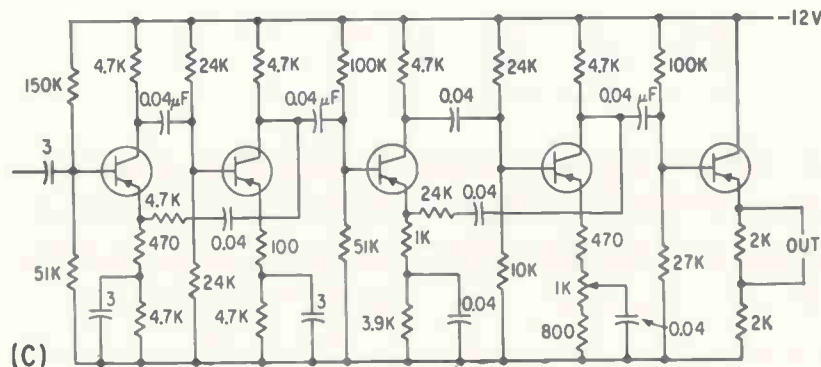
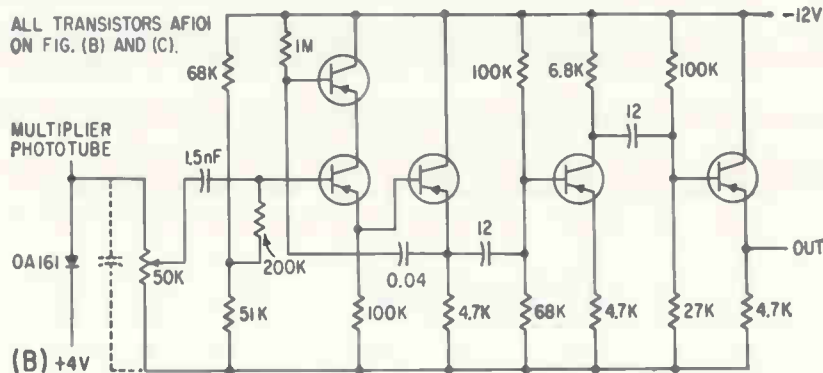
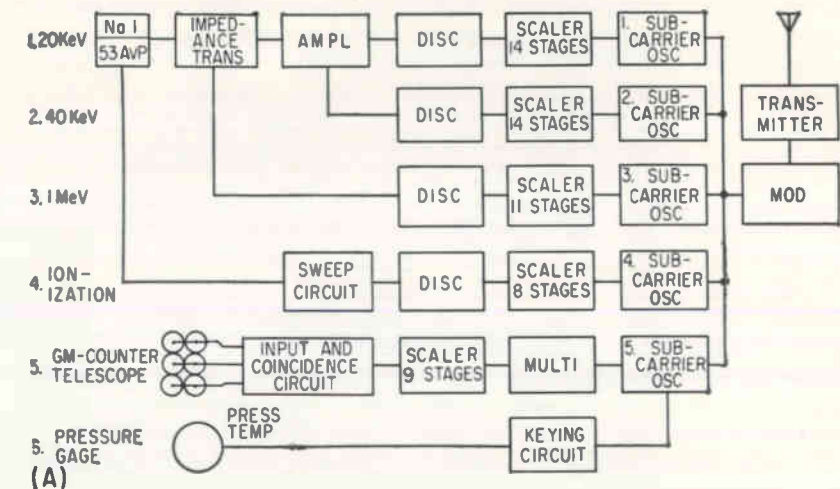

MULTIPLIER phototube output of system (A) is fed to impedance transforming circuit (B) and to amplifier (C) in two channels—Fig. 1

intensity usually decreases rapidly above 100 KeV.¹ Therefore, two channels were provided for transmitting energy losses in the scintillator below 100 KeV. Channel 1 is provided for energy losses of 20 KeV or greater and channel 2 for energy losses of 40 KeV or greater. A third threshold established on channel 3 for energies of 1 million electron-volts or more provides information about gamma rays. The average energy loss in the scintillator is indicated by channel 4. Temperature inside the gondola, air pressure and the coincidence

rate of the counter telescope are indicated by channel 5.

Charged particles can be distinguished from photons because of this selection of information channels. This approach also provides information about the average slope of the energy spectrum of x-rays, the occurrence of gamma rays above energies of 1 MeV and the average energies of the charged particles if the kind of particle is known. This restriction is not considered serious based on present knowledge since usually only protons need be considered in these measurements

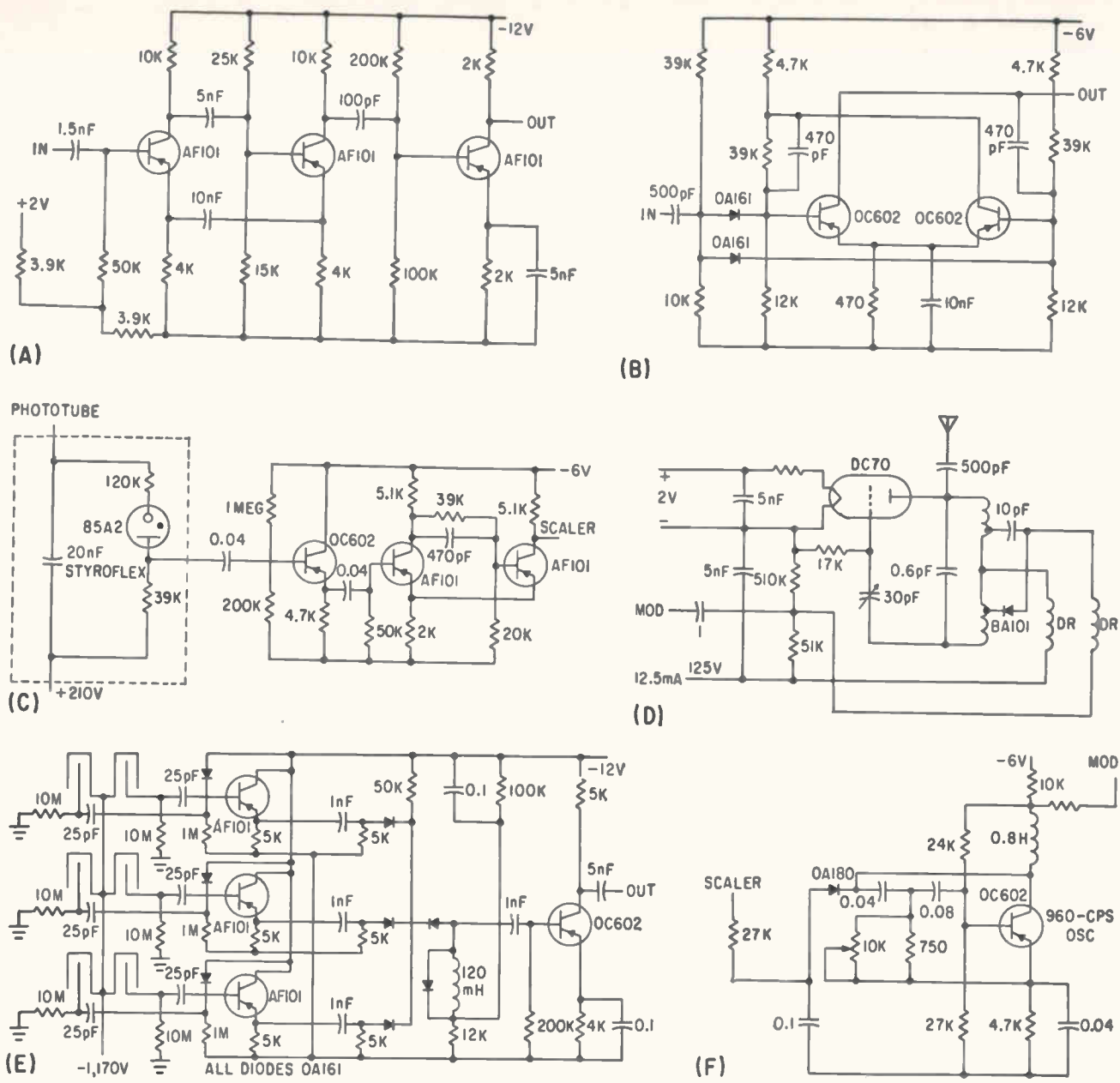

CIRCUITS are shown of discriminator (A) binary scaler stage (B), ionization channel input circuit (C), vhf transmitter (D), counter telescope (E) and subcarrier oscillator (F)—Fig. 2

EQUIPMENT—The radiosonde is shown in Fig. 1A. Pulses corresponding to the different energy losses are fed from the last dynode of the multiplier phototube to an impedance-transforming circuit. Pulses in channel 3 corresponding to energy levels of 1 Mev or more are fed directly to an amplitude discriminator, but those in channels 1 and 2 require additional amplification.

Output from the amplifier shown in Fig. 1C is connected to an attenuator in channel 2. The discriminators are followed by a series of

binary scaler circuits. The number of stages, indicated in Fig. 1A, is chosen in accordance with the expected pulse rates. Mean anode current from the multiplier phototube, which represents mean energy loss in the crystal, is measured by an integrating device. Outputs from the last flip-flops in these four channels control four subcarrier oscillators directly.

Pulses from the counter telescope are fed to the threefold coincidence circuit in Fig. 2E and then to a discriminator and binary scalars. The last stage triggers the monostable

multivibrator in Fig. 3, which keys the fifth subcarrier oscillator on for more than twice the duration of a dash in the Morse signals from the pressure and temperature gage.³ Because of the different keying times, no coincidence signal can be lost. The occasional loss of the slowly varying pressure and temperature signals, which are transmitted every half minute, is not important.

The five audio-frequency signals are fed to a mixer that controls the vhf transmitter. The f-m signals are transmitted to a directional an-

tenna. The vhf receiver on the ground is followed by an audio-frequency amplifier and filter. After demodulation, the a-f signals are recorded by a multichannel pen recorder with time signals.

SCINTILLATOR — Since x-rays with quantum energies as low as 20 Kev must be measured, the crystal casing must be thin. The scintillator was therefore mounted outside of the pressure tank, while the multiplier phototube, high-voltage battery and electronic circuits are inside. The NaI (Tl) crystal is 4 cm in diameter and 4 cm high. The housing consists of aluminum (0.027 g/cm^2) and of silicone paste and MgO (about 0.029 g/cm^2). The surface facing toward the multiplier phototube is covered by a plexiglass disk.

The dynodes of the multiplier phototube (Valvo 53 AV) are connected directly to a series of small batteries shunted by capacitors. Because of the small load, the effect of temperature changes on battery voltage is negligible over a wide temperature range even at low temperatures.

IMPEDANCE TRANSFORMER— Input impedance of the impedance transforming circuit in Fig. 1B is much higher than the load resistance of the multiplier phototube, insuring adequate independence of pulse height and temperature. The circuit is characterized by two transistors in series and is similar to a previously reported hard tube circuit.³ The circuit can be con-

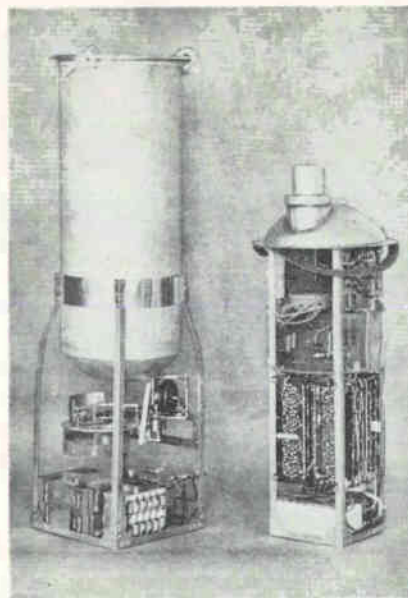

CONSTRUCTION details of the radiosonde—Fig. 4

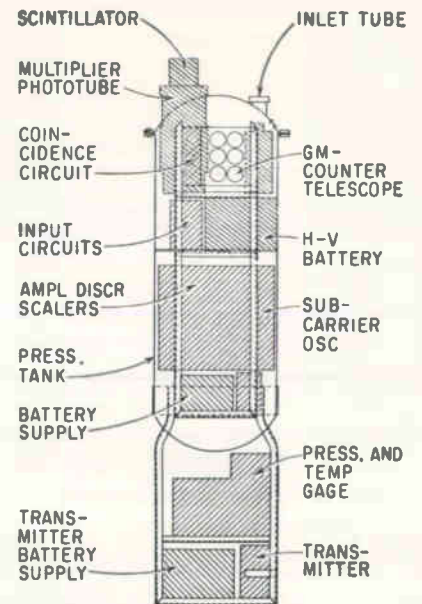

sidered an ideal impedance converter since both emitter and collector potentials follow base potential of the first transistor.

Total capacitance consisting of base-emitter and base-collector capacitances (about 150 pF and 7 pF) is reduced to a fraction of 1 pF. If small base resistors must be used, the circuit can be improved by connecting a capacitor from the emitter to the bottom of this resistor. Depending on input time constant, the circuit has good charge sensitivity (required in this case), or it may be used as an input stage for fast coincidence devices.

A clipping diode at the last dynode limits pulse height to 4 volts, which also reduces the influence of

potential variations on the anode of the multiplier phototube. To achieve good stability in the main amplifier with respect to supply voltage and temperature changes, substantial amounts of d-c and a-c negative feedback are used in the two loops in Fig. 1C.

DISCRIMINATORS—The Schmitt-type discriminator in Fig. 2A is used for the three energy-loss channels. For temperature stability of the threshold, the d-c couplings usually used were replaced by R-C networks, which are particularly helpful in avoiding the effects of drift of the open-circuited transistor. Drift caused by collector leakage current of the biased transistor could be reduced substantially by an additional 1-volt bias for a 1.2-volt threshold.

The scalers inserted between discriminator and subcarrier oscillator consist of improved flip-flops, as shown in Fig. 2B. By using transistor pairs with collector cutoff currents matched within ± 10 percent, the scalers work satisfactorily over the temperature range between -50 and 35 deg C.

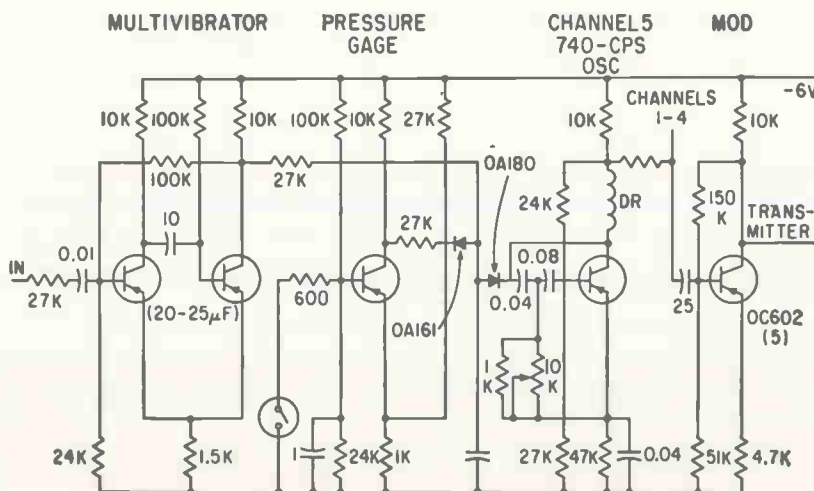

SUBCARRIER oscillator for fifth channel is shown with modulator stage—Fig. 3

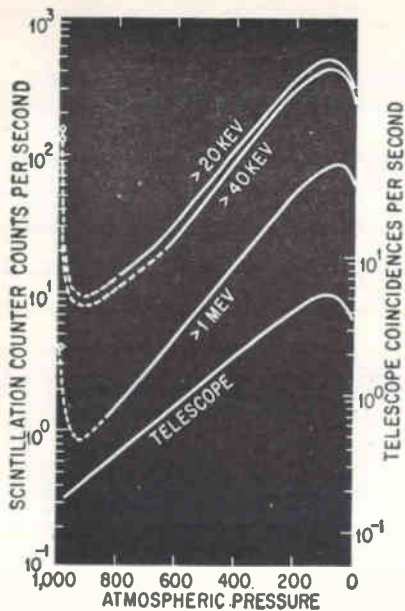

PULSE rates during the first ascent are shown as a function of atmospheric pressure—Fig. 5

In the ionization channel, anode current from the phototube charges a capacitor to the ignition voltage of a shunted neon tube as shown in Fig. 2C. The discharge pulses are then fed to an emitter follower in series with a discriminator and flip-flops.

Interference in the input of the impedance transforming circuit resulting from pickup through interelectrode and wiring capacitances is avoided by flattening the discharge pulses so that the decisive time constants of the channels differ markedly. The capacitor value used limited error in the discharge to 2.4 percent for maximum current pulses of 60 ma.

COUNTER TELESCOPE — The counter telescope consists of pairs of Geiger-Muller counters (20th Century Electronics type G10) in three layers, as in Fig. 2E. For vertically incident radiation, absorber thickness is at least 6.5 mm glass (about 1.55 g/cm²) and 0.85 mm copper (about 0.75 g/cm²). The corresponding kinetic cutoff energies are 42 Mev for protons and at least 3.8 Mev for electrons. Geometry factor of the telescope is 26.9 cm² sterad for the isotropic flux and about 22.4 cm² sterad for cos² θ distribution. High voltage for the counters is taken from the multi-

plier phototube power supply and filtered.

The subcarrier oscillators operating at 740, 960, 1,300, 1,700 and 2,300 cps are switched on and off by the last scaler stages except for channel 5. Essentially the circuits in Fig. 2F and 3 act as R-C generators with substantial d-c and some audio-frequency negative feedback to ensure stability. The audio-frequency signals are fed to the modulator through decoupling resistors. These decoupling resistors are also used to adjust amplitude of the signals.

The vhf transmitter in Fig. 2D operates at 152.3 Mc and provides about 0.6 watt power. The matched antenna consists of a silver-coated spring wire that assumes its natural position after launching and ascent of the balloon.

CONSTRUCTION—Since the high-voltage supply for the multiplier phototube consists of a series of batteries with taps for each dynode and since all parts should be readily accessible (for example, without insulation coatings to prevent corona discharge), as much instrumentation as possible was put in the pressure tank. Only the pressure gage and the vhf transmitter were placed outside the tank. The inside parts were mounted in a frame fixed onto the cap of the tank, as shown in Fig. 4. All of the electronic circuits used in the system were built on printed-circuit boards.

Thermal isolation was obtained by using a casing of 2-cm styrofoam surrounded by a stretched polyethylene foil at a distance of 8 cm from the styrofoam casing. With the styrofoam blackened about 20 percent, the apparatus warmed in day time to 10 deg C. The power supply was designed for an operating period of 30 hours. The complete radiosonde weighs 8.5 kilograms.

ADJUSTMENTS—Since the discriminator thresholds are equal, the amplification factor and input attenuation of the channels for different energy losses need only be fixed accordingly. This adjustment can readily be made with a suitable gamma-ray source such as Cs 13F using the 662-Kev line for refer-

ence. Pulse rate of the ionization channel can be calibrated in terms of mean energy loss in absolute units with the aid of a gamma-ray source.⁴

The equipment was designed to operate over a temperature range of -20 to +40 deg C. Temperature inside the gondola was expected to be above 0 deg C during day time, but in some flights extended through the night it was below -40 deg C. The system operated well, however, because of the large amount of negative feedback used in the design.

Under constant irradiation, pulse rates in channels 1, 2 and 3 decreased less than 5 percent for a temperature change from -22 to 40 deg C. The telescope channel was not affected by a change of -40 to 40 deg C, and the transmitter and subcarrier oscillator operated well. Ionization pulse rate changed not more than 5 percent when temperature was raised from -30 to 0 deg C and decreased about 8 percent from 0 to 40 deg C. However, since temperature was recorded throughout the flight, corrections could easily be made.

Pulse rates during an ascent are shown in Fig. 5. The pronounced decrease near the ground results from its natural radioactivity, which cannot affect coincidence rate. Distinct variations resulting from x-rays appeared in measurements taken during the first flight in the 20 and 40-Kev channel superimposed on the cosmic radiation. Temperature of the balloon-borne equipment during the day remained within the range between 7 and 10 deg. C.

This work was sponsored in part by the Office of Scientific Research, OAR, through the European Office of the Office of Aerospace Research, USAF, and by the Max-Planck-Gesellschaft. The author acknowledges the contributions of Prof. A. Ehmert and G. Pfozter and of G. Spitz.

REFERENCES

- (1) K. A. Anderson and D. C. Enemark, *J Geophys Res.* 65, p 3,521, 1960.
- (2) G. Pfozter, A. Ehmert and E. Keppler, *Mitteilungen aus dem Max-Planck-Institut fur Aeronomie*, 9, 1962.
- (3) A. Ehmert and R. Muehleisen, *Z angew Physik*, 5, p 43, 1953.
- (4) E. Waibel, *Mitteilungen aus dem Max-Planck-Institut fur Aeronomie*, 10, in press.

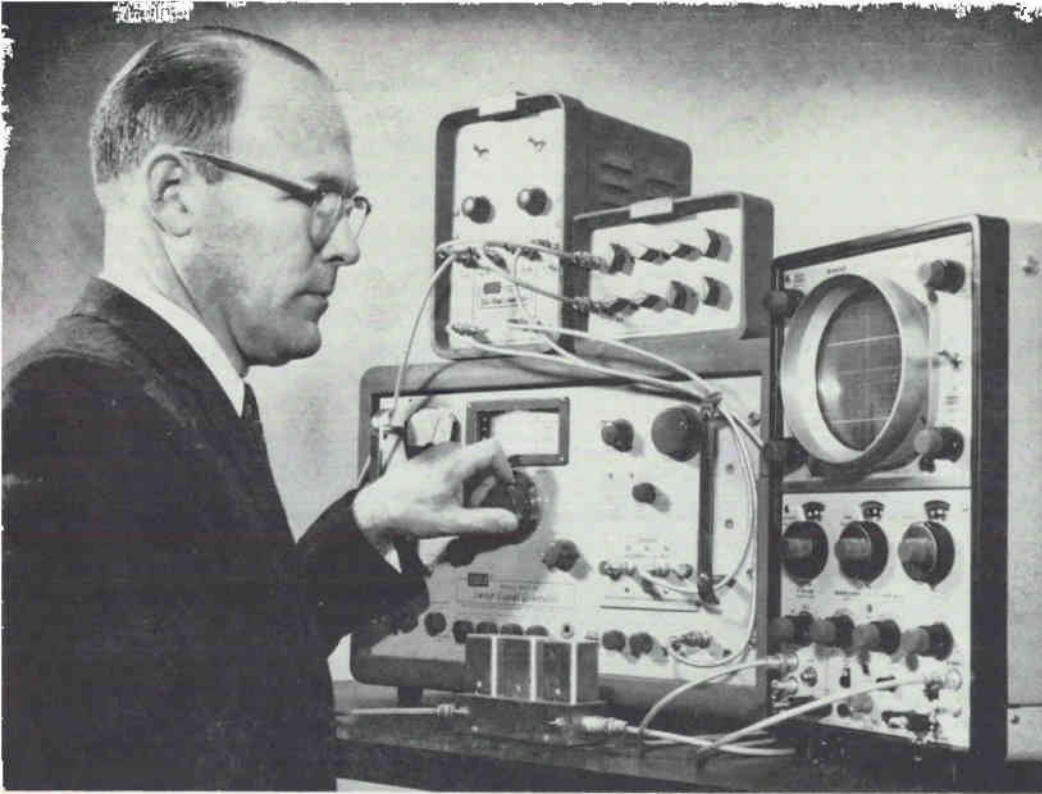

By **KEN SIMONS**
 Chief Engineer,
 Jerrold Electronics Corp.,
 Philadelphia, Pa.

Sweep

*Comparison techniques
 have serious limitations*

CIRCUIT LOSSES can be determined rapidly with a minimum of equipment. One system permits loss to be read directly from a standard attenuator

SWEEP FREQUENCY measurements in the range 5 to 220 Mc can be difficult to make because the upper end of this range is too high for techniques used for low-frequency measurements. Also, the lower end of the range is too high for standing-wave line measurements. A number of techniques have evolved to permit measurements in this awkward area.

COMPARISON CIRCUIT — One basic technique is that of comparing transmission through two paths. A source of test signal and an output indicator are connected to a dpdt switch so that in one position (test), the signal passes through the network under test, while in the second (reference), it is connected through a calibrated variable attenuator. To make a measurement, the switch is thrown back and forth and the attenuator adjusted until the output indicator shows the same reading in both switch positions. The loss of the unknown is then equal to that of

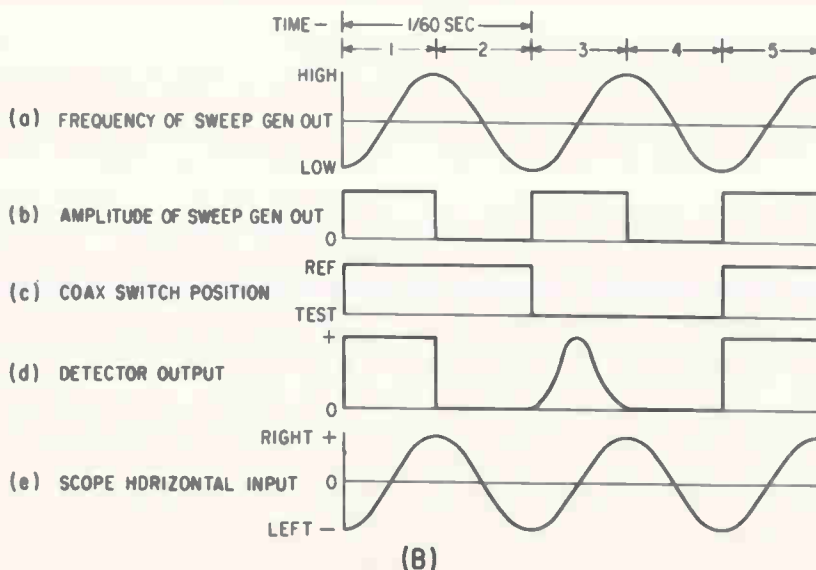
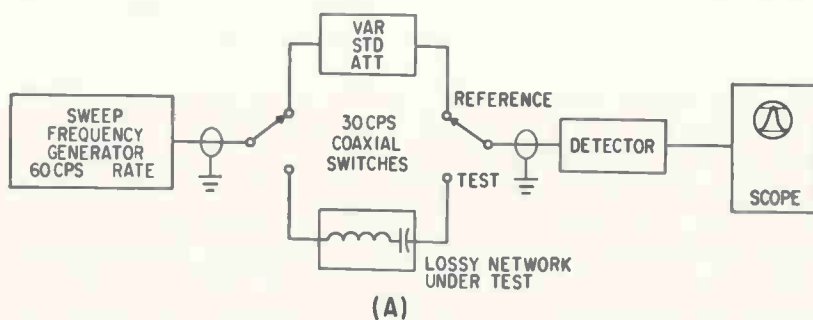

COAXIAL comparison circuit measures high-frequency loss with sweep-frequency display (A); waveforms show how display is generated (B)—Fig. 1

Inherent frequency characteristics and differences in measurement techniques between the high and low ends of the range 5 to 220 Mc often give engineers quite a tussle. The author points out the methods and applications of a simple comparison method that allows accurate and rapid sweep-frequency measurements with a minimum of equipment

Measurements

MAKING THE TOUGH ONES EASY

improve sweep-frequency measurements between 5 and 220 Mc. Conventional methods at either the high or low end of this range

the attenuator and can be read directly from it.

SWEEP DISPLAY — Comparison with sweep display represents a natural approach to sweep-frequency testing over wide bandwidths. Sweep generators and oscilloscopes are good in sensitivity and poor in calibration. Stable and accurate attenuators, however, are common. For high-frequency measurements, coaxial transmission lines require the comparison switch to be coaxial and have an impedance equal to that of the lines. Also, oscilloscopic display of a sweep-frequency response curve requires periodic repetition of the measurement about 60 times a second to let the eye see a single, steady presentation. The switch must also operate periodically so that calibration appears as part of the steady pattern. To achieve periodic switch operation, a high-speed coaxial relay is used. This unit operates at high speed with no bounce and has long life. Switches of this type have withstood full-time lab operation for up to five years with negligible failures.

MEASURING LOSS—The methods used to measure and display the high-frequency loss of a network by the sweep-frequency com-

parison method are shown in Fig. 1A. The output of a generator, swept across the desired band at a 60-cycle rate, is connected to one of two spdt coaxial switches; the other switch mates the input of a wide-band detector. These switches transmit alternately through the network under test and the variable attenuator.

The way the display is generated is shown in Fig. 1B. The frequency of the sweep output varies sinusoidally between an upper and a lower limit at a 60-cycle rate. The output is cut off during the return trace to form a zero trace. The coaxial switches are transferred at a 30-cycle rate allowing development of a full trace in the reference position followed by a full trace in the test position. As a re-

sult, the detector output goes through four conditions during each thirtieth of a second; first indicating reference output, second delivering zero output, third following the loss curve of the unknown and fourth repeating the zero output trace.

When the detector output is applied to the vertical input of an oscilloscope, and a voltage whose instantaneous magnitude is phased to match the instantaneous frequency of the generator is applied to the horizontal input, the scope shows a curve of the variation in the loss of the unknown with frequency, together with a base line showing zero response (infinite loss) and the reference trace showing the loss corresponding to the attenuator setting. The reference trace crosses the test trace at those frequencies where the loss of the unknown precisely equals that of the standard attenuator.

To measure the insertion loss of a triple-tuned band-pass filter, the attenuator was set at 1.0 db, and the point at which the reference trace crosses the response shows a loss of 1.0 db at a 7-Mc band-width centered on 125 Mc as shown in Fig. 2. Accuracy is not affected by the constancy of the sweep output across the band, the flatness of the detector, or by drift or other

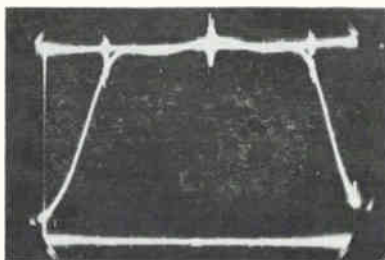

CURVE of the insertion loss of a triple-tuned bandpass filter with center marker at 125-Mc and side markers at ± 3.5 -Mc—Fig. 2

changes in scope gain and centering.

Where small attenuation differences are to be observed, it is convenient to increase the vertical gain and recenter the trace to show a highly expanded view of part of the response pattern. This is illustrated in Fig. 3. A wideband generator was used to sweep between zero and 203 Mc with a short coaxial jumper connected between its output and a detector. The vertical gain of the scope was increased to about four times the level required to show the change from zero to full output, and the centering readjusted to bring the trace onto the screen. The screen showed a change of only 0.2 db per division and the trace showed the sweep output to be constant within ± 0.2 db as shown in Fig. 3A. With the same sweep and scope settings, the sweep output was connected through two coaxial switches transferring between a short jumper and a variable attenuator by two, 2-foot coaxial cables.

Figure 3B compares jumper loss with attenuator insertion loss at zero setting, continuing with the

same expanded vertical scale. The test (upper) trace is slightly down at the high end, indicating that the coaxial switches and short jumper have added about 0.2 db loss at 200 Mc, while the reference (lower) trace shows that the attenuator and its longer cables have added about 0.8 db loss at the high end.

If precise measurements are to be made, it is not essential that either curve be precisely flat. It is essential, however, that the loss on the test side before inserting the unknown be the same as that on the reference side. This was accomplished by inserting additional cable totaling 137 inches on the test side so that the insertion losses in both circuits were nearly identical. The resulting trace shows considerably less than 0.05 db difference between the two circuits over the entire frequency range up to 200 Mc as shown in Fig. 3C. Inserting an additional 0.5 db into the standard attenuator gave the result of Figure 3D, showing that this setup could be used for loss measurements involving small attenuation differences.

This approach was applied to a

practical measuring problem as shown in Fig. 4A. A repeater amplifier for use in cascaded television distribution systems was under evaluation. The amplifier, together with its equalizer, is required to have gain equal as closely as possible to the loss of 2,000 feet of a particular coaxial cable between the frequencies of 5 and 95 Mc. To test this the cable, equalizers and amplifier were connected, each following the other, on the test side of the comparison circuit with a jumper providing a zero-loss reference on the reference side. Figure 4B is the response showing that the combination of cable, equalizer and amplifier had zero loss within about ± 0.25 db between 5 and 95 Mc. The fine-grained ripple is due primarily to variations in the cable's transmission characteristic.

It would take many hours to make this measurement using point-by-point techniques and accuracy would be questionable. Furthermore, refined adjustments of the equalizer and amplifier can be carried out quickly and accurately while observing the display. This is impossible with a point-by-point approach.

MEASURING GAIN — The comparison technique can be used effectively for measuring amplifier gain. By using a jumper as a zero-loss reference and inserting the variable attenuator ahead of the amplifier on the test side, the reference line is made to cross the amplifier response curve at the point where attenuator loss equals amplifier gain.

Figure 5A shows the gain measurement of an amplifier designed to pass television channel 13 for r-f distribution systems. To obtain an enlarged view of the passband response, the scope gain was turned up and the trace recentered to give the result shown in Figure 5B. This shows that amplifier response is within 0.1 db across the band. Neither the measurement nor the alignment that preceded it could be readily carried out by any single-frequency technique.

IMPEDANCE MATCH — In addition to gain and loss measurements, the comparison method can be used

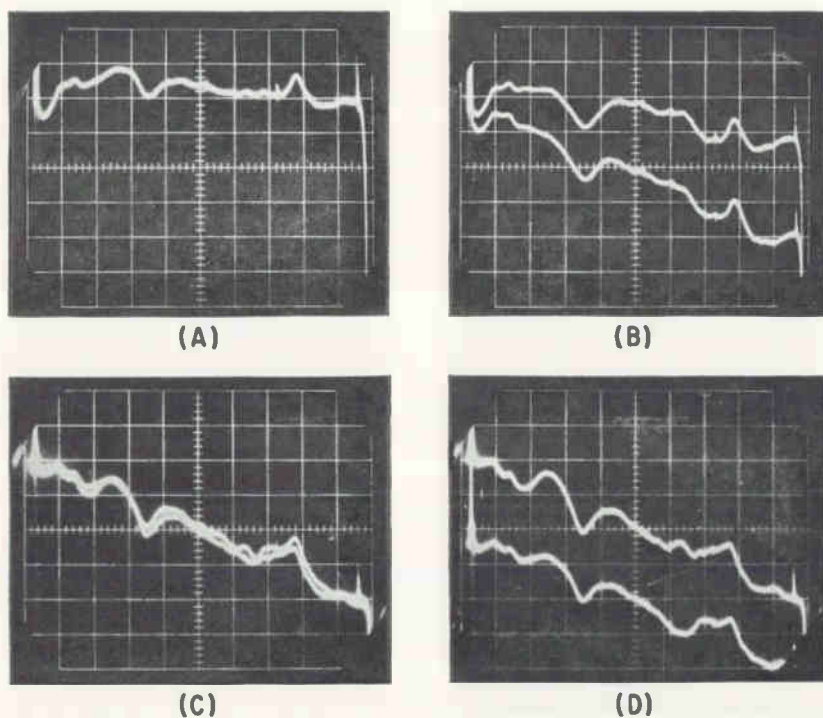

RESPONSE of sweep generator and scope alone (A); output pattern of 0 to 200-Mc sweep through coaxial switch and a short jumper (upper curve) and with attenuator (lower curve) (B); long jumper added on test side equals loss in the attenuator (C) and pattern with 0.5 db loss inserted in attenuator (D)—Fig. 3

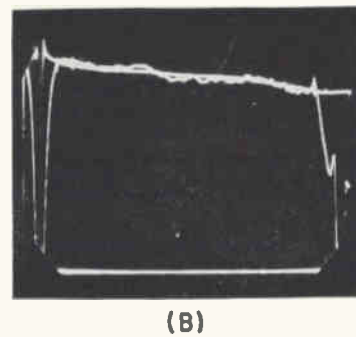
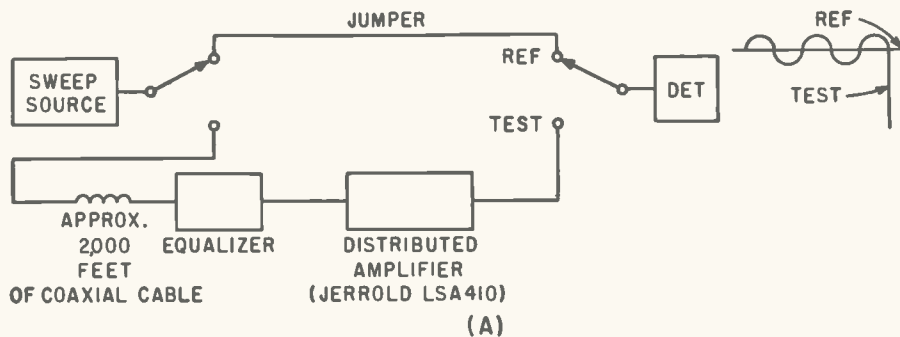

EQUIPMENT SETUP to measure the loss in 2,000 ft of coax cable (A) and response showing that losses in cable and equalizer plus amplifier gain equal 0 ± 0.25 db from 5 to 95-Mc (B)—Fig. 4

with a bridge circuit to provide wide-band display of impedance match characteristics. The technique depends on the characteristics of a high-frequency bridge having six equal arms including the impedance of the source and detector. The insertion loss between the input and output terminals is equal to 12 db plus the return loss of that which is connected to the unknown terminal. Return loss is the ratio of the reflected wave in a coaxial system to the incident wave, expressed in db. When a signal is introduced into the input terminal of the bridge, the output signal is the reflected wave from the unknown, diminished by 12 db. Thus, the bridge makes possible impedance measurements over a wide frequency band by converting impedance variations into loss variations that are then accurately measured by the comparison technique. It is, in effect, a directional coupler giving flat response over a wide band of frequencies in the 5 to 220-Mc range.

For impedance sweeping, the bridge is connected to the test terminals of the comparison switches and a fixed 12-db pad is used with the standard attenuator in the reference leg. To obtain adequate gain for the measurement of small reflections, a wide-band distributed amplifier is inserted before the detector. The reference trace crosses the unknown at a return loss level corresponding to the attenuator setting. The bridge permits measurement of return loss in the range 0 to 40 db, with an accuracy within ± 1 db.

In measuring the input impedance of the band-pass filter shown

in Fig. 6A, the filter was aligned for maximum return loss of 12.5 db, with Tchebycheff or equal-ripple match characteristics. Adjustment and measurement were carried out rapidly with the comparison presentation. Measurement of the structural return loss impedance variations due to minor mechanical irregularities in a 1,000-ft. piece of unusually good coaxial cable shows that the maximum reflection spike at about 150 Mc had a return-loss level of just over 40 db as shown in Fig. 6B. Measurement of such a complex characteristic over this frequency range would be a maddening if not impossible process by any point-by-point technique.

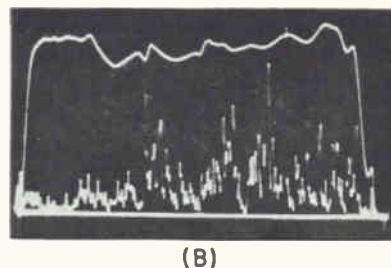
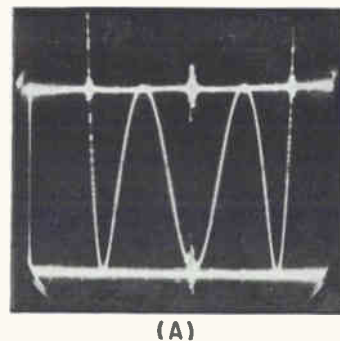
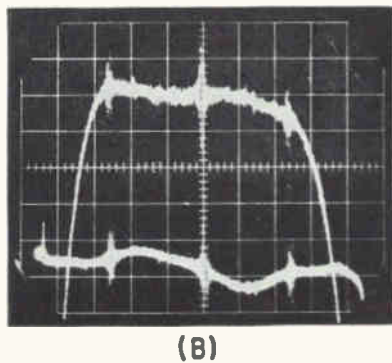
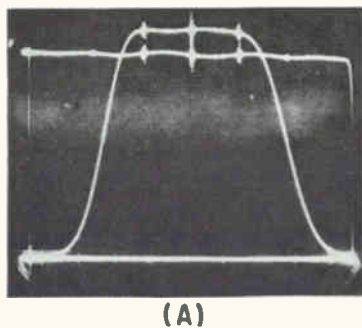

RETURN LOSS of the triple-tuned bandpass filter with 130-Mc center marker and side markers at ± 3.5 -Mc (A) and return loss at one end of a 1,000 ft length of good coax cable between 4 and 100-Mc (B)—Fig. 6

CHANNEL 13 tv amplifier with reference trace at a gain level of 57 db (A) and the identical response with vertical gain expanded 5 times (B)—Fig. 5

SPRING CLEANING TIME

Many engineers have transistors piled up in a corner of their desk drawer, or in cardboard boxes, with nothing known about them but their type numbers. This I_{CEO} and h_{FE} tester, in conjunction with a simple h_{fe} tester (ELECTRONICS, p 198, May 1, 1957) provides means of making parameter tests so that bad ones can be dumped and good ones put into another box. You can write the parameter values on little tags, fasten them to the transistors and have a box of transistors with 3 parameters known

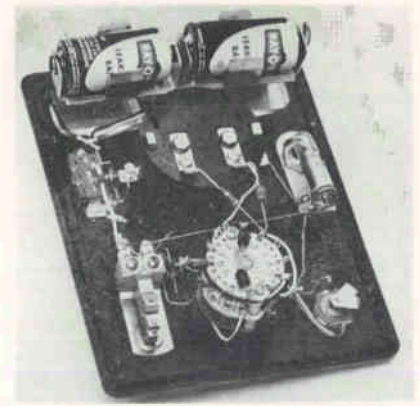

UNIT is clean both above and below the front panel

Building a Simple TRANSISTOR TESTER

Leakage current and common-emitter current amplification of silicon or germanium transistors can be measured on this easy-to-build tester

By G. FRANKLIN MONTGOMERY

National Bureau of Standards, Washington 25, D.C.

IN DIRECT-COUPLED or switching circuits, two important transistor d-c parameters are leakage current I_{CEO} and common-emitter current amplification h_{FE} . An in-

strument for measuring these parameters is a useful complement to equipment for measuring a-c amplification h_{fe} (beta).¹

The d-c tester shown in the schematic is easy to operate, cheap to build and indicates I_{CEO} and h_{FE} of both germanium and silicon transistors on linear meter scales with accuracy sufficient for most circuit development.

THEORY OF OPERATION—The forward drop across two silicon rectifiers in series is used as a reference voltage. This drop is insensitive to small changes in current such as those due to battery aging. The reference voltage is also used as the source of $10\text{-}\mu\text{A}$ base current for the transistor under test. The current is maintained constant by switching the series base resistance to correspond to the transistor type. For a fixed base current, h_{FE} is directly proportional to col-

lector current. In this case, a collector current of 1 ma represents an h_{FE} of 100. If amplification is greater than 100, an additional contact on the h_{FE} switch is used to shunt the meter thus increasing its effective range to 10-ma full scale.

USING THE METER — Set the polarity switch (*npn-npn*) and type (Ge- Si) switch to the appropriate settings. Insert the transistor, depress the I_{CEO} switch and read current directly on the 1-ma meter scale.

Depress the h_{FE} switch to the first stop, note the numerical scale value and multiply by 100 to get h_{FE} . If the meter goes off-scale during this measurement, depress the h_{FE} switch to the lower stop. The increased pressure closes an additional contact that reduces meter sensitivity. The scale value must be multiplied by 1,000 to get h_{FE} .

If the test transistor is short-circuited, the SHORT lamp will light and the meter will read off-scale when either the I_{CEO} or h_{FE} switch is depressed.

The meter is protected against excessive overload by the lamp and a silicon rectifier. A zero-resistance short circuit produces a meter current of approximately 2 ma.

The two flashlight cells used in the device are tested in the BATTERY position of the switch, and a meter reading of half-scale or greater indicates a satisfactory battery.

The author thanks H. D. Kratz for building and testing two models.

REFERENCE

(1) G. F. Montgomery, Transistor Beta Tester, ELECTRONICS, 30, p 198, May 1, 1957.

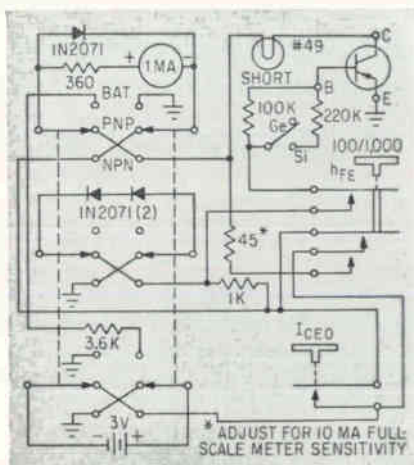

THE h_{FE} push switch has two depth positions. First multiplies meter value by 100. Fully-depressed position multiplies value by 1,000

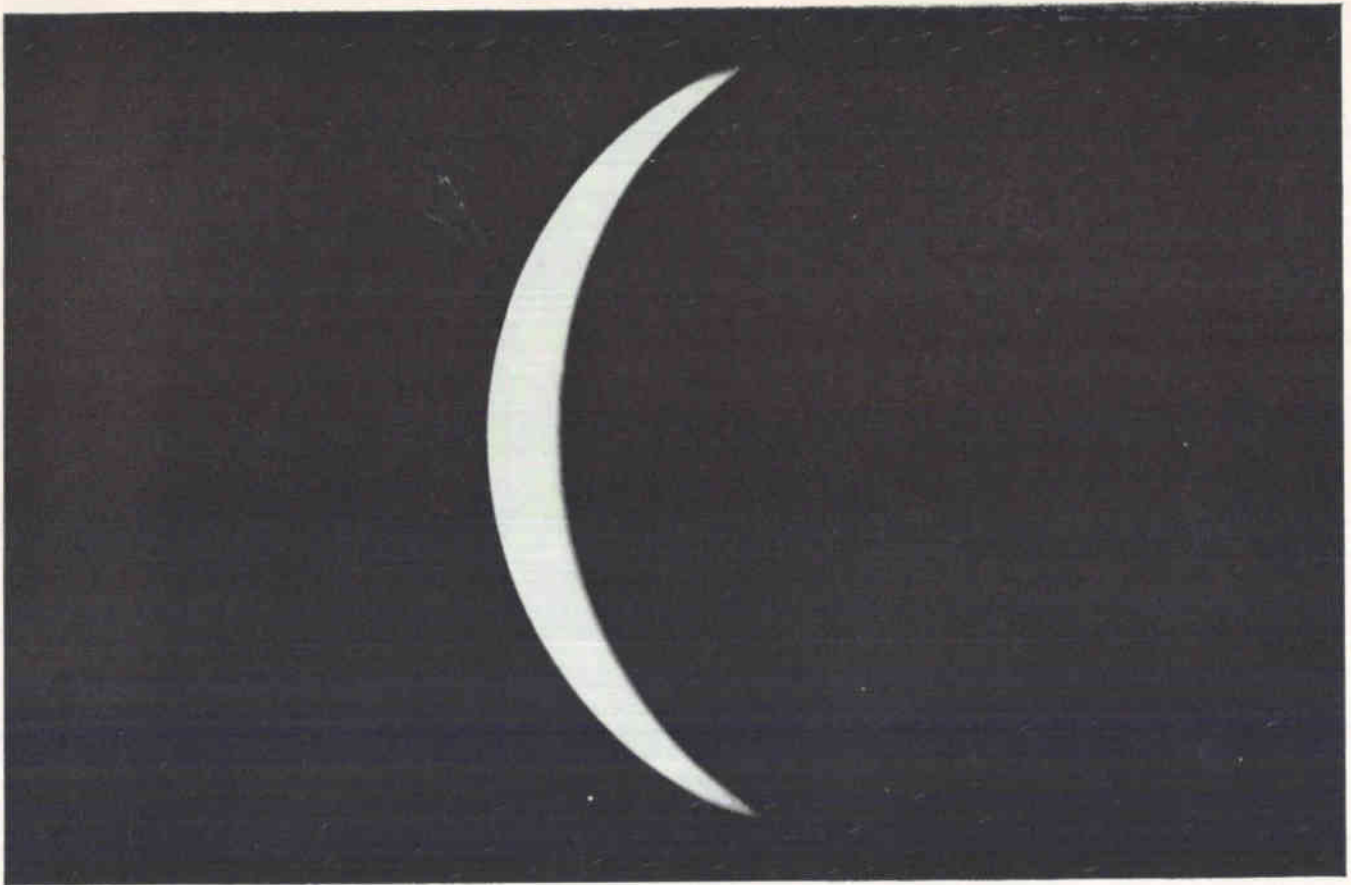

This is Venus

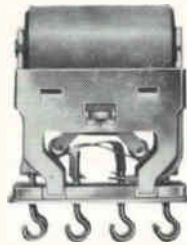

85 of these Sigma Relays went there on Mariner II

Sigma Relays were specified for Mariner II because the designers knew they'd have no second chance. What had to be done, had to be done right the first time. Opening the solar panels, for example. Switching on the scanning devices as Venus was approached. Initiating timing sequences. Sampling data for telemetry. The designers of Mariner II needed assured reliability in spite of adverse operating conditions—both predictable and unpredictable. And they came to Sigma to get it. □ Working together, Sigma Application Engineers and

Mariner's designers specified the Sigma Series 32's and 33's which performed so reliably on the Venus probe.

Come to Sigma when you have switching or controlling problems. The same Sigma reliability and Application Engineering is available to you, whether you're building space vehicles or commercial equipment. Sigma Application Engineers will work with you in selecting the right standard from over 100,000 available. Or, if a standard won't do, we'll create a special for you.

SIGMA DIVISION  **SIGMA INSTRUMENTS INC**
Braintree 85 Mass

Packing a Half-Million Bits in a Cubic Inch

INTERMAG conference shows latest advances in nonlinear magnetics

WASHINGTON, D.C.—Newest international developments in the fields of magnetic logic, memories and recording, silicon controlled rectifiers in combination with saturable magnetic devices, and magnetic amplifiers were presented here this week at INTERMAG (International Conference on Non-linear Magnetics).

A high-bit-density permalloy sheet transfluxor memory stack was described by G. R. Briggs and J. W. Tuska, of RCA Laboratories. The experimental memory stack has a bit density of 30,000 per cubic inch, and planes with a density capability of 500,000 per cubic inch have also been fabricated. The photoetched planes are stacked within one mil of each other, and the complete unit is operated by word-organized inhibited flux logic. The authors said their memory has a minimum practical cycle time of four microseconds, a low-drive current capability and an option of nondestructive readout. Operating temperature range is -70 to 150 deg C. The stack organization is shown for one element in Fig. 1.

The use of magnetic elements for switching of analog signals was discussed in a paper by H. D. Crane and W. K. English, of Stanford Research Institute. The several switching models presented yield high on-off ratios, with a linear transfer function between input and output in the ON state. A balanced switch arrangement, analogous to a vacuum tube circuit, is shown in Fig. 2.

TWISTOR MEMORY — An electrically alterable semi-permanent twistor memory, with nondestructive readout, was described by J. G.

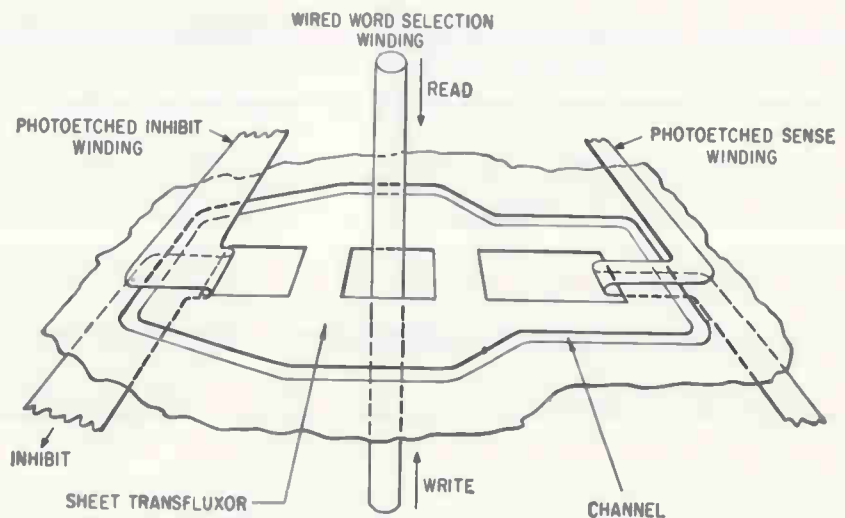

TRANSFLUXOR MEMORY with thin-film elements, described by Briggs and Tuska of RCA, achieves storage densities of up to 500,000 bits per cubic inch—Fig. 1

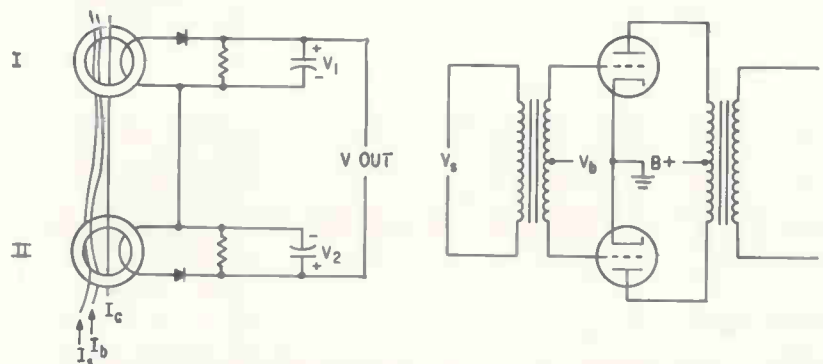

SWITCHING ARRANGEMENT using magnetic elements, is analogous to vacuum-tube circuit (right). Toroids I and II represent two minor apertures of a multiaperture element—Fig. 2

Valassis, of Automatic Electric Co. Nondestructive readout of the twistor elements is accomplished by a set of bipolar solenoid current pulses, and can take place in less than three microseconds. Information is stored in the memory by a novel technique called the "orthogonal impulse write-in scheme", which makes use of the coincidence of what are normally the interrogate solenoid current pulses and the information bipolar digit current through the center conductors of the respective twistor wires.

The essential scheme is shown in Fig. 3. The twistors, together with return paths, are placed between the solenoids and the copper sheet having coded windows punched in it. Spacing is so chosen that the resulting transmission line has the required characteristic impedance. The word solenoids are printed on plastic film. The window-coded copper sheet can uniquely disturb the energizing fields distribution at distinct twistor portions in the solenoid region. Such disturbance is due to the effective amplification

can you use the advantages of Kepco's

AUTOMATIC VOLTAGE-CURRENT CROSSOVER

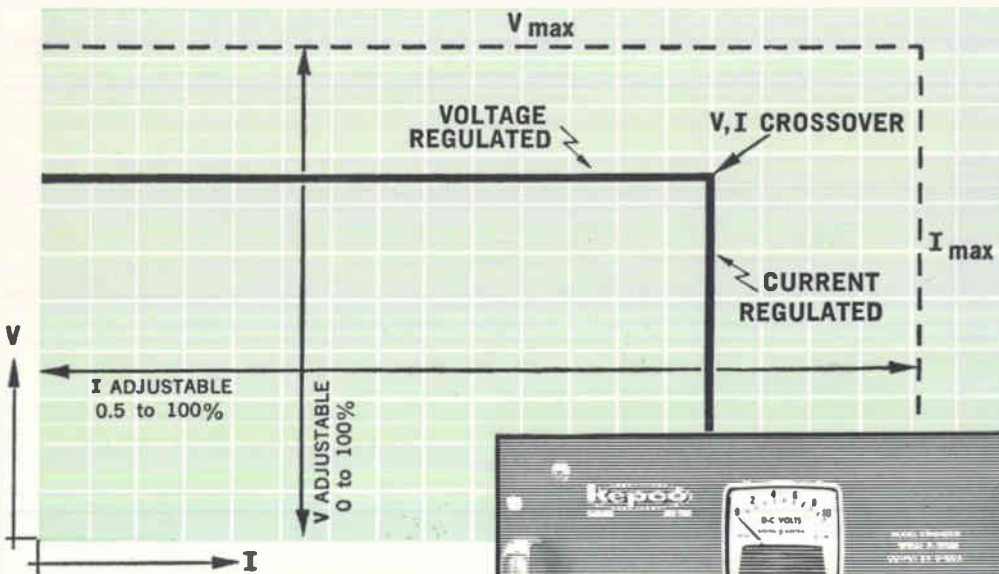

KEPCO POWER SUPPLIES

Automatic Voltage-Current Crossover is the characteristic of a power supply that automatically changes the method of regulation from *constant-voltage* to *constant-current* (or vice-versa), as dictated by varying load conditions. The constant-voltage and constant-current levels can be independently adjusted within their specified voltage and current limits. The intersection of the constant-voltage and constant-current lines is called the crossover point (V,I, as shown in the graph above), and may be located anywhere within the volt-ampere range.

Kepco's KS Group of HIGH-POWER, highly regulated DC power supplies provides two panel control

knobs that allow *automatic crossover* to be set from less than 0.5% to 100% of rated current and 0 to 100% of rated voltage.

- Programming of output voltage
- Programming of output current
- Remote error signal sensing
- High resolution adjustment
- No voltage overshoot

for complete specifications on more than 250 standard models, write for NEW Catalog B-631



0.01% REGULATION and STABILITY	MODEL	DC OUTPUT RANGE VOLTS (AMPS)	PRICE
	KS 8-100M	0-8 100	\$1,395
	KS 18-50M	0-18 50	\$1,295
	KS 36-30M	0-36 30	\$1,195
	KS 60-20M	0-60 20	\$1,295

131-38 SANFORD AVENUE • FLUSHING 52, N.Y., U.S.A.
N.Y. Phone (212) IN 1-7000 • TWX# (212) 539-6623
Cable Address: KEPCOPOWER NEWYORK

SECRET REVEALED!

SECRET OF 100,000 DIGITAL LOGIC COMBINATIONS REVEALED!

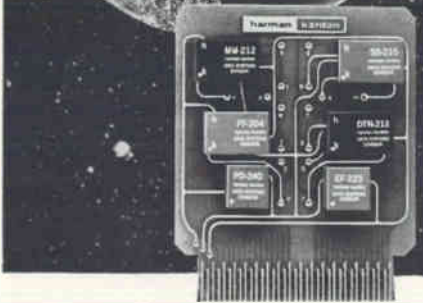

NO BLACK MAGIC HERE! just simple combinational (or is it permutational?) mathematics.

65 different HARMAN-KARDON Logic Modules...19 different HARMAN-KARDON Flexi-Cards...mix and combine to provide 100,000 functional card combinations, delivered immediately and economically, assembled to your requirements. 250kc, 125°C, 5/10mc.



FREE! Send for complete 64-page DIGITAL LOGIC catalog with sections on theory and application and a Boolean algebra guide.

RK-30

Data Systems Division, Desk E-4
HARMAN-KARDON, INC.
55 Ames Court, Plainview, L.I., N.Y.

Please send complete details on Digital Logic.

Name _____
Company _____
Address _____
City _____ State _____

harman kardon

A subsidiary of THE JERROLD CORPORATION

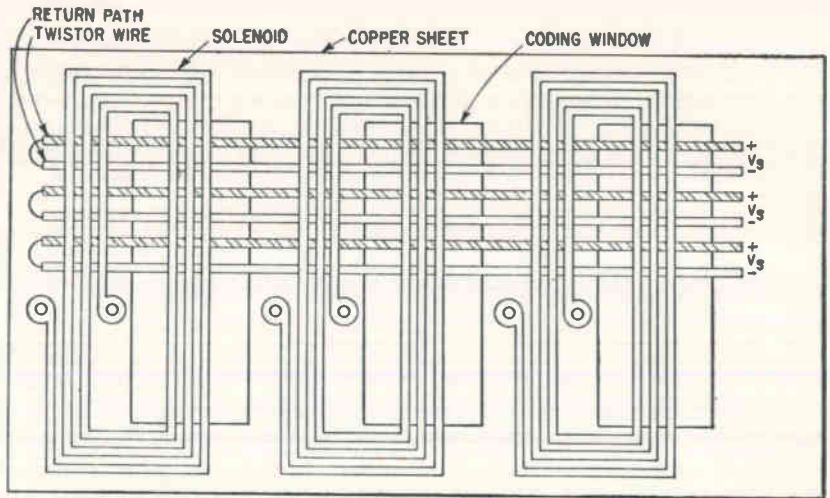

TWISTOR MEMORY PLANE with non-destructive readout, reported by Valassis of Automatic Electric, uses a novel write-in technique—Fig. 3

of the energizing fields resulting from the presence of virtual currents induced in the copper sheet when the solenoids are pulsed; the twistor portions opposite the copper sheet are thus energized with about 50 percent stronger fields than those opposite the windows.

ANGULAR TRANSDUCER — A paper presented by T. E. Hasty and T. C. Penn, Texas Instruments Incorporated described an ultrasensitive angular transducer, using ferromagnetic film resonance, that can measure angles of rotation as small as 10^{-6} radians with respect to a reference plane. This angle corresponds to the thickness of this page seen at a distance of five miles.

The transducer is an application of a high-sensitivity vector magnetometer with excellent directional properties. A magnetometer has a very low output when a static field is applied perpendicularly to its sensitive direction; however, the slightest change of orientation of the magnetometer results in a field component along its sensitive axis, and hence in a significant output.

The magnetic sensor used by Hasty and Penn is a thin magnetic permalloy film. The internal field is measured by observing the low-frequency ferromagnetic resonance of the film. An application seen for this magnetometer is as a readout device for a sensitive seismometer. Instrumentation includes a marginal oscillator, selective amplifier, phase detector, oscillator and power amplifier.

Ruby Laser Demodulator Uses Quartz Crystal



EXPERIMENTAL quartz demodulator for ruby laser is shown with inventor, Kenneth E. Niebuhr, of IBM Federal Systems Division

LASER LIGHT beams can be converted to microwave signals with a new technique developed by International Business Machines Co. Unlike previous schemes which used phototubes or photoconductive devices, the new technique makes use of crystalline quartz or electro-optic materials.

A quartz crystal is coupled to a ruby laser crystal, and converts two different frequencies in the laser beam to an S-band microwave signal by reactive mixing. In this process, the quartz crystal's index of refraction is changed by the intense laser beam. The microwave signal,

VICTOREEN Presents . . .



NEW ULTRA-STABLE INSTRUMENT TO MEASURE FEMTOAMPERES

Victoreen dynamic capacitor electrometer is an ultra-precise transistorized measuring instrument of great stability and ultimate sensitivity. At about $\frac{1}{3}$ of full-scale, the Femtometer measures currents of less than 1 femtoamp (10^{-15} amp.), charges of less than 1 femtocoulomb (10^{-15} C), and voltages from ultra-high-impedance sources. ¶ This remarkable capability makes the Femtometer the ideal measuring instrument in nuclear studies involving ion currents . . . in electronics for measuring transistor base or tube grid currents, and contact

potentials . . . in chemistry for pH and chromatography . . . in physics for serious research applications. ¶ All the most desired deluxe features—unitized plug-in preamplifier for remote operation, multiple switch-selected input resistors, built-in remote shorting switch, etc.—are yours at the attractive base price. ¶ Victoreen representatives will be demonstrating the Femtometer throughout the country this month. Write us on your professional letterhead for a demonstration at your convenience.

A-8049A

CONDENSED SPECIFICATIONS

Ranges: 3 millivolts to 30 volts; 3×10^{-15} . . . 3×10^{-7} amps.
Power Requirements: 115-230v, 50-60 cps; or 4 "D" flashlight batteries. Switches itself on to battery if AC fails. (No batteries needed for AC-only operation.)
Input Connector: Adaptors furnished to fit std. MIL type connectors.
Accuracy: 2% or better on panel meter or potentiometer recorder readout; order of 0.25% with calibrated capacitor and rate of charge measurement with external potentiometer.

WORLD'S FIRST NUCLEAR COMPANY

VICTOREEN

THE VICTOREEN INSTRUMENT COMPANY
5806 HOUGH AVE. • CLEVELAND 3, OHIO

Victoreen European Office: The Hague



CIRCLE 61 ON READER SERVICE CARD



*a pair of pliers is just a pair
of pliers... unless it's*

UTICA

THEN IT'S AN INSTRUMENT

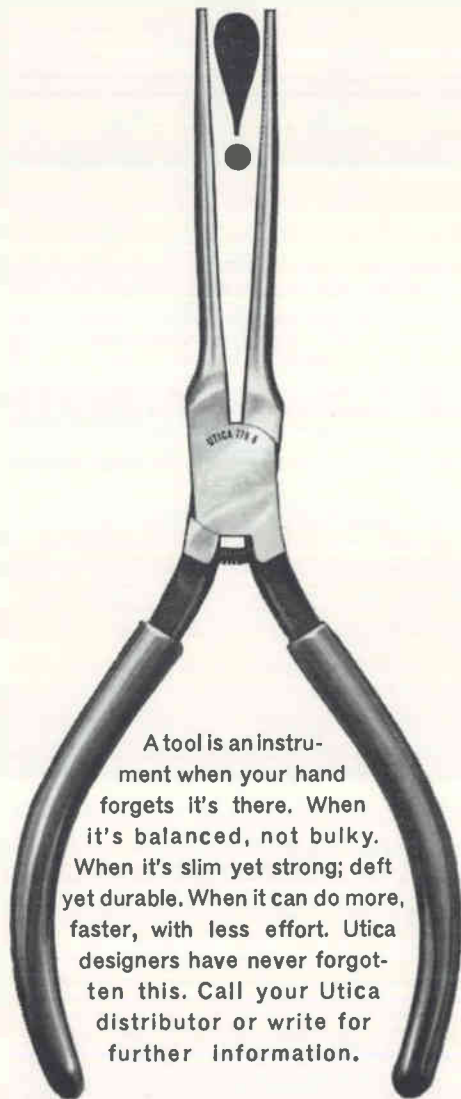

A tool is an instrument when your hand forgets it's there. When it's balanced, not bulky. When it's slim yet strong; deft yet durable. When it can do more, faster, with less effort. Utica designers have never forgotten this. Call your Utica distributor or write for further information.

UTICA

DROP FORGE & TOOL DIVISION • KELSEY-HAYES COMPANY • ORANGEBURG, S. C.

a difference frequency between adjacent modes, is in the millimeter and submillimeter regions of the spectrum, where signals are difficult to generate with existing techniques.

The process is enhanced by placing the quartz crystal inside the ruby laser resonating system. Outer ends of both the quartz and the ruby are coated with reflective material to build up the conversion effect. Conversion efficiency was further increased by matching the microwave phase velocity and the light group velocity.

With the separation of the ruby and quartz reflectors so that adjacent axial Fabry-Perot modes were located about 423 Mc apart and the ruby axis oriented parallel with the quartz X-axis, detected microwave output was at 2.964 Gc.

Do Cells Surrounding Neurons "Bias" Them?

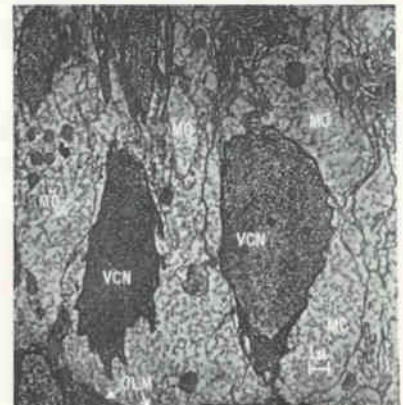

ELECTRON MICROGRAPH of area of frog retina shows how neural elements (VCN—visual cell nucleus and glial elements (MC—Muller cells) are intimately related; OLM is the outer limiting membrane

NEURONS, the information-processing elements of the nervous system, have come under increasing analysis in recent years (see *ELECTRONICS*, Feb. 9, 1962, p 37). Researchers and engineers consider that electronic imitations of them will be important components in future intelligent machines (see *ELECTRONICS*, March 1, p 46). Thus, an understanding of how neurons operate is a prime target of researchers. A new view on how neuron activities may be controlled by glial cells was

brought forward at the 2nd Bionics Symposium at Dayton, Ohio, March 19. It was based on research carried out by Dr. Leo L. Lipetz and Thomas M. Richardson of the Ohio State University.

For a long time, brain researchers have believed that glial cells, which are whitish masses surrounding neurons throughout the nervous system and which form a large bulk of the central brain, were merely the "glue" that held everything structurally together. No function was attributed to them. Then, a few years ago, the suspicions grew that glia might have something to do with long-term memory, a problem which ranks high in the building of artificial intelligence.

Now, experimental evidence is growing that glia may in some way control the sensitivity and firing thresholds of individual neurons. It has been shown that there exists some form of ionic energy exchange between a neuron and the glial cells surrounding it (see photo). When heavy demands are made on an individual neuron, its metabolism increases and the energies of the glial cells around it diminish. Lipetz, who presented the accumulating evidence in favor of this new concept, said that though it had not been proved conclusively as yet, he believed that retinal light adaption (such as we all undergo when we go from a lighted room into relative darkness or vice-versa), which is a long-term process sometimes measured in minutes, is primarily a glial cell process. Some glial cells, which extend over relatively large areas within the retina, can add or difference or average over a spatial extent the activities of a number of neural or receptor circuits.

The new findings, if they prove true, will be especially important in pattern recognition work.

Japanese Government Pumping More into R&D

TOKYO—Japanese government will spend \$2 million on electronics R & D in fiscal 1963 (April, 1963 through March, 1964), a 15 percent increase. Although R & D by electronics firms here tops \$100 million, much of this is applications work while government grants go almost wholly to basic research.

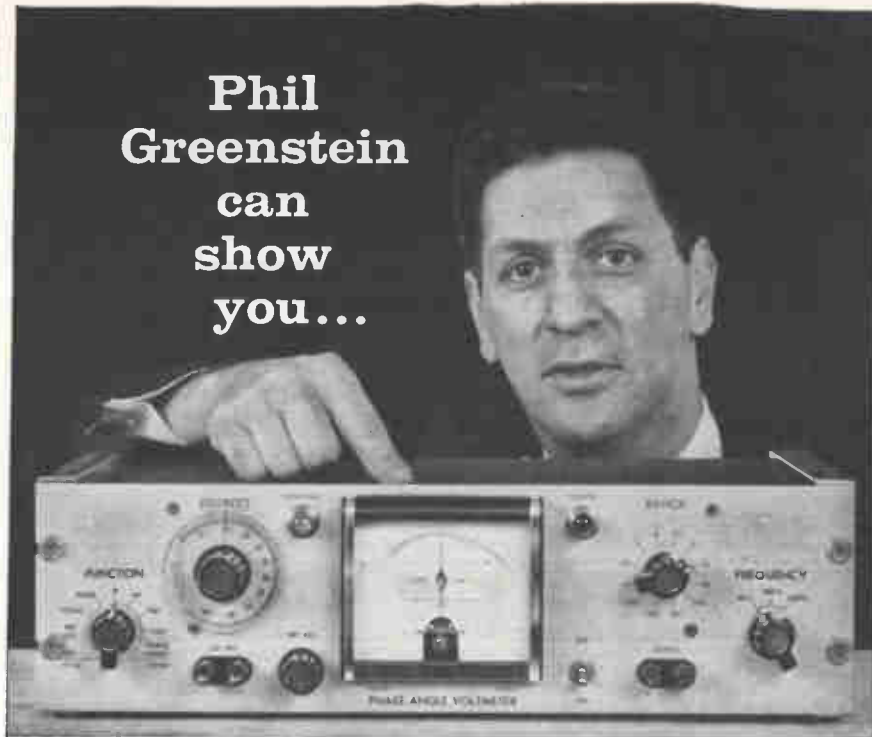

Instrumentation Sales Manager, North Atlantic Industries.

how North Atlantic's Phase Angle Voltmeters* solve tough ac measurement problems ... in the lab or in the field.

Designed for critical tasks in circuit development, production and testing, North Atlantic's Phase Angle Voltmeters provide direct reading of phase angle, nulls, total, quadrature and in-phase voltages—with proven dependability even under field conditions. Your North Atlantic engineering representative can quickly demonstrate how they simplify ac measurement jobs from missile checkout to alignment of analog computers—from phasing servo motors to zeroing precision synchros and transducers.

Shown below are condensed specifications for single-frequency Model VM-202. Other models include high sensitivity, three-frequency and broadband types.

Voltage Range.....	1 mv to 300 v f.s., 12 ranges
Voltage Accuracy.....	±2% f.s.
Phase Accuracy.....	dial: ±1°; meter: ±3% of F.S. degrees
Signal Frequency.....	1 Freq., 30 cps—10 kc
Input Impedance.....	10 megohms
Reference Input.....	100 K, 0.25 v min.
Meter scale.....	3-0-3, 10-0-10 linear
Phase Angle Dial.....	4 scales, 90° (elec.) apart
Nulling Sensitivity.....	2 microvolts (phase sensitive)
Harmonic Rejection.....	55db (with filters)
Dimensions.....	5½" h. x 19" w. x 7½" d.

The North Atlantic man in your area has full data on standard and special models for laboratory, production and ground support. Call today for his name, or request Bulletin VM-202.

**Trademark*



NORTH ATLANTIC industries, inc.
TERMINAL DRIVE, PLAINVIEW, L. I., NEW YORK • Overbrook 1-8600

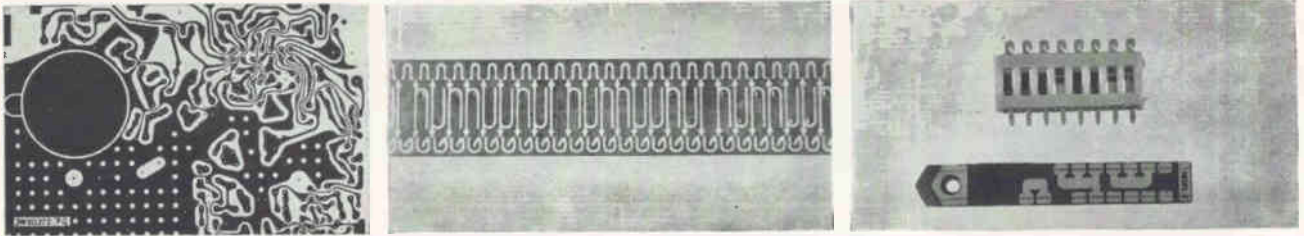

MOTHERBOARD of a-m/f-m radio is considered as multiple female plug (left). Contact springs in waveguide switch are etched out of sheet metal (center). Plug-in waveguide switch (right) has 8 contacts arranged in two rows—Fig. 1

Miniature Components Aimed for Mass Market

Three-waverange pocket radio design proves out design standardization

By J. RODRIGUES de MIRANDA
N. V. Philips' Gloeilampenfabrieken
Eindhoven, Netherlands

EXPERIMENTATION with standardization techniques, proposed by Philips of Eindhoven last fall (ELECTRONICS, Sept. 28, p 86) has led the company to design portable radio sets that can be packed in small cabinets.

Techniques have led to mass production of small a-m, f-m radio set that measures $4\frac{1}{4} \times 3 \times 1\frac{1}{4}$ inches.

Standard components all have same height, and projected surfaces are held to minimum.

TUNING — A capacitive tuning system is used on both a-m and f-m. A special a-m/f-m variable capacitor

was developed which includes 4 trimmers. One set is used for a-m and one set for f-m. Capacitor measures $20 \times 20 \times 18$ mm.

On a-m, the circuit comprises a tuned ferrite aerial, a mixerstage, a two-stage i-f amplifier and a detector leading to the a-f part. On f-m, a telescopic aerial is followed by a high-frequency amplifier, a mixer, a 3-stage i-f amplifier limiter, a radio detector and, of course, the same a-f part as used on a-m.

The latter part consists of an a-f preamplifier and a complementary output stage (npn-pnp pair of transistors). An important part of this system is that no audio frequency transformers are required.

The output power of 70 mw, delivered by the final stage, is fed to a 2-inch loudspeaker. Voice coil of loudspeaker has an impedance of 100 ohms, necessary because of the direct coupling to the power transistors. Battery delivers a working current of 8 to 10 ma.

This complicated circuit could be built in such a restricted volume and is made possible by application of our miniaturization philosophy. Circuit has 24 coils, 30 capacitors, 39 resistors, 8 transistors, 3 diodes, a 3-position wave-range switch with 16 contacts, 260 soldering connections, 160 soldering points.

PRINTED BOARD—Panel is based on the e-grid, with 1/40th of

an inch as unit distance, see Fig. 1. Minimum width of the copper tracks, as well as their minimum distance is 0.32 mm (approx 0.0125 inch). Mass production of boards with that amount of detail necessitated a refined production technique. Photo-etching process is used. A new technique was also developed for soldering.

One difficulty in panel construction was to get small holes in center of soldering pads. Holes are 0.03-in. in diam, minimum diameter for soldering pads is standardized at approx 0.055-in. A close tolerance reference system was developed both for the photographic process and punching the holes. A strip on each side of the panel bears the reference system. Strips are removed before the completed panel is built into the cabinet.

COILS—All coils are consistent with standardization except the high-frequency f-m coils. Standard enclosures of coils measure $\frac{1}{4}$ -in. \times $\frac{1}{4}$ -in. \times $\frac{3}{8}$ -in. Their terminals match the e-grid and are made of normal wire. Because of short length they can be considered as short rods. The metal enclosure, acting as screen, has two tapered feet that fit tightly in the panel holes to ensure proper fit. Quality factor of the coils, Q, can be as high as 140. Ferrite material easily allows for this, but it requires a well-closed magnetic circuit. This means that tolerances in the magnetic properties of the fer-



COMPLICATED circuit of small am/fm radio is packed in $4\frac{1}{4}$ -in. \times 3-in. \times $1\frac{1}{4}$ -in. cabinet. Note ordered arrangement of components in cans—Fig. 2



**Another
Blue Ribbon
Product from**
cppe
II

NEW, IMPROVED SERVO MOTORS to Help Solve Special Servo Problems

Do you have a particular servo motor problem such as Power Consumption? Torque? Starting Voltage? High Temperature? Efficiency? Single Phasing? Length?

Let Clifton Precision help you solve it!

The new Clifton motors feature more torque for considerably less power input. This results in a more efficient and cooler running motor.

Acceleration is increased up to 160,000 rad/sec² at between 2 and 3 watts per phase. This is such an improvement that in certain motor generator requirements a new Clifton motor will now suffice.

Starting voltage in our new motors is now guaranteed to be 1%.

New heat resistant materials and improvements enable these motors to withstand 200°C plus.

Call Clifton for your special or standard servo motor needs!

CLIFTON PRECISION PRODUCTS CO., INC.
Clifton Heights, Pa. Colorado Springs, Colo.

cppe
II

CIRCLE 65 ON READER SERVICE CARD



222 Steps to the first plateau

INDUSTRY'S MOST COMPLETE TANTALUM CAPACITOR LINE



Wet slug types rated up to 200°C, solid electrolyte types up to 50 volts, plain and etched foil types. All in many MIL sizes. Write for data.

Tantalum powder travels a long road until it assumes final form in a solid or wet slug capacitor. A minimum of 222 individual steps are required for complete electrical, chemical and physical evaluation of the powder before it is transformed into its usable capacitor form, the pellet. Someone is watching, measuring or testing . . . before, during and after each operation. When the powder is pressed into pellets only the first plateau has been reached.

Throughout the entire manufacturing process, inspections and tests are conducted and recorded on every production lot of tantalum capacitors. If we seem fanatical about testing, it's because we know from over twelve years experience in making tantalum capacitors that this is essential to consistently high quality. And that's what you're always sure of getting in Mallory tantalum capacitors. They're the product of the most modern tantalum capacitor facility in the world. Visit us and see for yourself. Mallory Capacitor Company, Indianapolis 6, Indiana—a division of P. R. Mallory & Co. Inc.

SOLID, WET SLUG AND FOIL TANTALUM CAPACITORS

CIRCLE 66 ON READER SERVICE CARD

P. R. MALLORY & CO. INC.
MALLORY

Mallory tantalum capacitors delivered from stock at factory prices by these distributors:

Baltimore, Md.
Radio Electric Service

Binghamton, N.Y.
Wehle Electronics

Birmingham, Ala.
MG Electronics & Equipment Co.

Boston, Mass.
Cramer Electronics
DeMambro Radio Supply Co.
Lafayette Radio
QPL House, Inc.

Bridgeport, Conn.
Westconn Electronics

Buffalo, N.Y.
Summit Distributors, Inc.

Chicago, Ill.
Allied Electronics Corp.
Newark Electronics Corp.

Cincinnati, Ohio
United Radio

Cleveland, Ohio
Pioneer Electronics

Dallas, Texas
Engineering Supply Co.
Hall-Mark Electronic Corp.

Dayton, Ohio
Stotts-Friedman Co.

Denver, Colo.
Denver Electronics

Houston, Texas
Harrison Equipment Co., Inc.
Lenert Company

Indianapolis, Ind.
Graham Electronics

Los Angeles, Calif.
California Electronics
Kierulff Electronics, Inc.
Lynch Electronics
Radio Product Sales

Minneapolis, Minn.
Northwest Electronics Corp.

Montreal, Que.
Canadian Electrical Supply Co.

Muskegon, Mich.
Fitzpatrick Electric Co.

Nashville, Tenn.
Electra Dist. Co.

Newark, N.J.
Lafayette Radio

New York, N.Y.
Harrison Radio Corp.
Harvey Radio Co., Inc.
Lafayette Radio
Milo Electronics
Terminal Hudson Electronics

Oakland, Calif.
Elmar Electronics, Inc.

Oklahoma City, Okla.
Radio, Inc.

Orlando, Fla.
East Coast Electronics
Hammond Electronics, Inc.

Ottawa, Ont.
Wackid Radio-TV Lab.

Palo Alto, Calif.
Zack Electronics

Perth Amboy, N.J.
Atlas Electronics

Philadelphia, Pa.
Herbach & Rademan
Philadelphia Electronics

Phoenix, Ariz.
Kierulff Electronics, Inc.

Pittsburgh, Pa.
Radio Parts Co.

Salt Lake City, Utah
Kimball Electronics

San Antonio, Texas
Perry Shankle

San Francisco, Calif.
Kierulff Electronics, Inc.

St. Louis, Mo.
Olive Electronics

Seattle, Wash.
F. B. Connelly Co.

Springfield, N.J.
Federated Purchaser, Inc.

Tampa, Florida
Thurow Electronics, Inc.

Toronto, Ont.
Alpha Aracon Radio Co.
Electro Sonic Supply
Wholesale Radio & Electronics

Tulsa, Okla.
Engineering Supply Co.

Washington, D.C.
Capitol Radio Wholesalers
Electronic Industrial Sales

White Plains, N.Y.
Westchester Electronic Supply Co., Inc.

Winston-Salem, N.C.
Electronic Wholesalers Inc.

rite appear heavily in the properties of the coils. Special ferrites are used to obtain consistent quality.

WAVELENGTH SWITCH — Unit is also consistent with dimensions of other standard parts. Switch, Fig. 1, is designed for mass production. All spring contacts are etched out of sheet metal and kept together by small strips of metal until they are molded in the plastic housing. Connecting strips are then cut away. The slider, in finished form, has two rows of contacts on each side. Adjacent contacts on each side can be connected, and top contacts on one side can be connected with corresponding ones on the other side. In this way, a multitude of switching possibilities are created. Switch measures $5 \times 10 \times 21.5$ mm. With same production tools already set up, switches can be made with up to 2×36 contacts. All contacts are gold-plated and switches can stand at least 15,000 switching op-

erations.

Waveranges for portable radio shown in Fig. 2 are 260-150 Kc, 1,622-517 Kc, and 104-87.5 Mc.

Clean Surface Key To Epitaxial Growth

IN SOME quarters belief existed that epitaxial crystal growth was a highly specialized situation involving a close match of lattice dimensions and a narrow range of deposition temperatures.

Work at Union Carbide shows that epitaxial growth under proper clean conditions is the rule rather than the exception. The poorly controlled factor in early work, apparently, was the surface itself.

A truly clean surface results in crystal growth in an epitaxial manner, providing the temperature of the substrate is sufficiently high enough to allow a free surface mo-

More Precision for Gyro Measurements

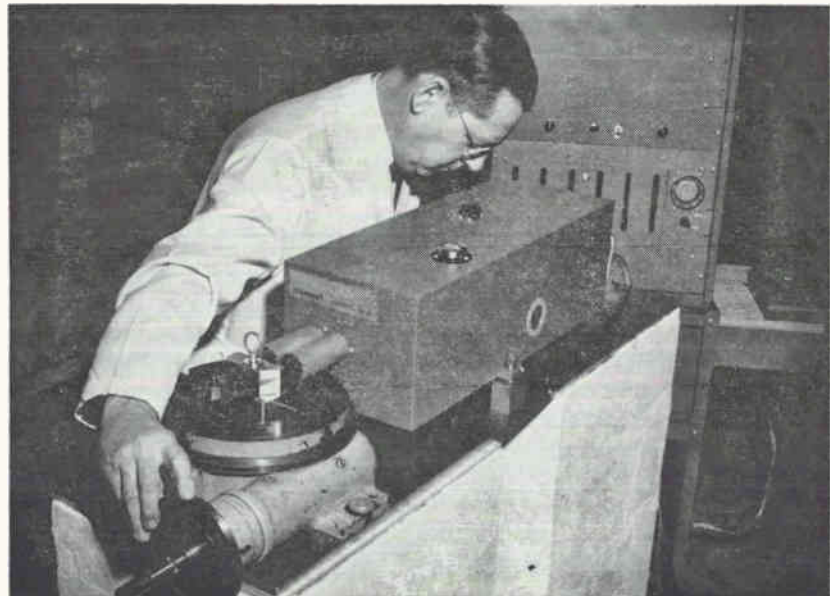

NEW ultra-precise angle measuring instrument, delivered to NASA, was developed by Link Division of General Precision. Electro-optical device, called the Fringe-count Goniometer, is said to measure drift of a gyro with greater precision than previously possible.

Prototype was used by Johns Hopkins to accurately determine

atomic dimensions of crystals.

Future applications include aiming laser beams to specific spots on moon, and lining up telescopes and antennas to send and receive signals from space.

Photo shows R. A. Woodson aligning optical components. Precisely measured angles are read directly from electronic counter.



Who moved "Friendship 7" into the Smithsonian? Bekins, of course!

When it comes to moving electronic equipment—even the most complex and delicate—Bekins engineers take up where yours left off.

A case in point is this recent move in Washington, D. C. during which Bekins electronics specialists transported John Glenn's famous space capsule into the Smithsonian Institute.

How was it done? With a combination of first-class equipment and first-class brains. At Bekins, we're justifiably proud of our vans. We're prouder still of our *men* because we believe it's men who make the big difference.

That's why we carefully train our people in the Bekins School of Certified Service. When they graduate, they're experts in every sense of the word. When they put their training to work, they're as exacting as your own engineers.

Think about it! Doesn't the *moving* of your delicate equipment deserve this kind of brainpower?

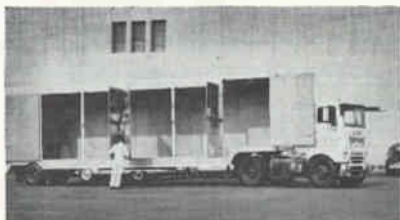

BEKINS WORLD-WIDE MOVING & STORAGE
Bekins offices and agents in all principal cities

bility of the depositing atoms, according to company. The temperature was also found to be dependent on the arrival rate of the deposited material. Theory is that epitaxial growth may be concerned with the energetics of the mechanism of orientation.

Do Voids Cause Microwave Breakdown?

DIELECTRIC materials are prepared in their most pure form, and changed by controlled modification of composition and structure. Aim of work at Stanford Research Institute is to control failures of dielectrics used in microwave devices, a present source of great concern.

High r-f fields can induce ionization of gases within bonds of ceramic dielectrics. This can lead to stresses in the material and consequent breakdown.

Study of the probability of ionization of residual gas in voids of window ceramics indicates there is a high probability of breakdown occurring in microwave fields when voids are 0.010 in. and larger.

There is some doubt whether similar breakdown can occur for smaller voids. Stanford experiments will show if this is true.

New Teflon Capacitors On Production Line

A **LINE** of metallized teflon capacitors, which reduce the volume per microfarad up to one-fourth that of conventional teflon-dielectric foil capacitors has been quality-quantity reproduced on a pilot production basis, according to Dearborn Electronic Labs, Orlando, Florida.

Capacitors have been successfully tested at 200 C for 1,000 hours at 140 percent of rated voltage. Range of values are between 0.001 to 1 microfarad; working voltages from 100 to 1,000-v d-c; operating range between -65 C and 200 C. The minimum product of insulation resistance and capacitance, at 25 C, is 2,500 megohm-microfarads. At 200 C minimum insulation resistance is 500 megohms. Maximum dissipation factor at 25 C is 0.005.

Sample units have been dis-

tributed by Air Force to various military and civilian facilities. Dearborn contract was accomplished under the technical direction of the Electronic Branch, Manufacturing Technology Laboratory, Wright-Patterson Air Force Base, Ohio.

Control Switch Simplifies Portable Recorder Design



SINGLE JOY STICK selector switch (circled in foreground) replaces five push buttons and their associated interlock devices. Small switch is used to control all operating modes of Ampex's new portable television tape recorder.

Five-position switch was developed by General Electric's General Purpose Control Department. Recorder is a low-cost unit, with fully transistorized audio and video circuits. Unit was designed for recording closed-circuit television programs.

Thin-Film Triode To Use Tunneling

STUDY begins at Philco to develop a metal oxide amplifier with a usable power gain that is relatively insensitive to temperature changes.

Thin-film, triode will use tunneling emission of hot electrons into a silver film, and collection over a silver-mixed sulfide barrier of controllable barrier height.

Present work suggest very low collection efficiencies, due to collector barrier height being larger than the hot electron energy.

NOW
FROM WESTON

**Stability, flexibility and
50 mv sensitivity!**

Weston's 20Mc, solid-state Universal Counter-Timer provides outstanding stability and flexibility through a combination of unique features:

- 50 mv sensitivity
- Time base frequency available on front panel
- Powered from 110 or 220 v; 50, 60, or 400 cps
- Standard crystal stability of ± 1 part 10^6 /day
 - Optional extra ± 1 part in 10^6 /day
- Convenience of plug-in circuit cards
- Bright in-line Nixie readout
- Automatic unit and decimal display
- Panel arrangement for ease of operation
- Standard BCD output: 1-2-4-8 code
- Light weight: 30 pounds
- Rack or bench mounting
- Outstanding flexibility through these exclusive accessories:
 - Optional battery operation for field or flight use
 - Direct reading 500 Mc converter
 - Adjustable time base which permits direct readout in transducer input units
 - Decimal divider for longer time base and period measurements

The Universal Counter-Timer offers reliability and dependability typical of fine Weston products. Write for detailed information on this and other Weston electronic test equipment. Our field representatives will be glad to supply a unit for evaluation.

WESTON
Instruments & Electronics



Division of
Daystrom,
Incorporated

614 FRELINGHUYSEN AVENUE, NEWARK 14, NEW JERSEY

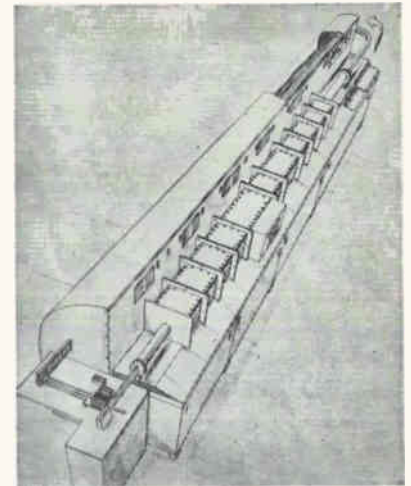

CONTROLS for setting vacuum and temperature in chambers are located at output end of machine. Diagram shows how finished substrates are returned by conveyor to storage table where substrate holders are unloaded and reloaded.

Thin-Film Production Performed Continuously

Multi-chamber arrangement maintains constant vacuum needed for in-line production

CONTINUOUS VACUUM machine now enables uninterrupted production of thin-film circuits at Western Electric's Princeton, N. J. Engineering Research Center as against separate pump-down operation of vacuum evaporators required in batch type operations. Deposition steps for various types of passive thin film circuit elements can be performed using connecting vacuum stations into which substrates

are carried on a special carrier-and-track configuration that minimizes air leaks into each chamber. An automatic pumping system sensitive to very small pressure changes functions to evacuate each chamber, keeping six of them at a pressure of 10^{-6} Torr—the first four chambers step down pressure from normal atmospheric pressure and also preheat substrates.

In fifth chamber evaporation and deposition of thin-film tantalum resistor elements is performed. In seventh chamber, gold conductor elements will be laid-down although presently not used. Remaining 4 chambers gradually bring sub-

strates and deposited films to normal pressure and room temperature.

CALIBRATED LEAKS—Machine deposits tantalum on 2 x 3-inch glass or ceramic substrates that are fitted to slide-holder carriers that continuously ride between top and bottom steel guide rail tracks through all chambers. Clearances between carriers and track are called "calibrated leaks"—they are large enough to allow free movement of carriers but provide sufficient resistance to incoming air flow needed in maintaining vacuum in deposition chambers.

GASES—First four chambers are fitted with iodine-cycle quartz lamps. Specially-built reflectors spread infra-red energy from lamps uniformly across passing substrates. High substrate temperatures obtained by this preheating removes absorbed and adsorbed (adhering) gases and other surface contaminants to provide chemically clean surfaces enabling film purity and adhesion. Preheat temperatures are higher in chambers 3 and 4 than temperature of sputtering (evaporation and deposition) chamber to facilitate contaminant removal. Vacuum is also higher in these two chambers.

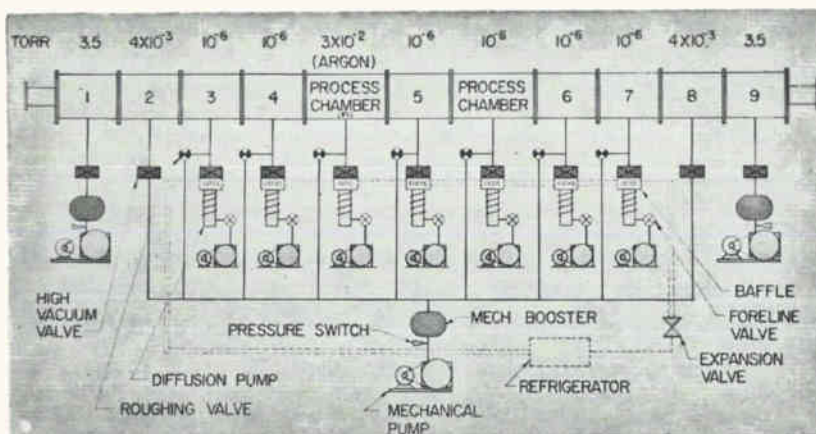

TANTALUM resistors are now being deposited in first process (deposition) chambers. Second process chamber will be used to deposit gold conductors. When in use, pressures in process chambers are higher than in adjoining

sputtering chamber provides inert

CLEANING

A LOOK AT ITS TOTAL COST, NOT JUST THE CLEANING AGENT

Over the past ten years, tightening product specifications and tightening profit margins have made *cleaning* of critical importance in manufacturing operations. This has involved the cleaning of manufactured *products*, in addition to the *machinery* that makes them. As a result, the contribution of the cleaning operation to total manufacturing costs is now mostly a matter of labor, equipment and product expenses—the cleaning agent itself becoming a small part of the total bill. In fact, in many industries today, it's vital to specify the very best cleaning agent available, despite its cost—because the potential losses in rejects, labor and equipment downtime could be far greater than the investment in agent.

.

Our own connection with this new concept stems from the FREON fluorocarbons, already familiar as refrigerants and aerosol propellents. From the same chemical family comes a group of FREON solvents with interesting cost-saving properties—at a price of \$7.50/gallon!

Here are the ways FREON can cut your costs:

Labor Savings—FREON solvents are selective, removing dirt, grease and contaminants but not affecting materials of construction—so complete assemblies can be cleaned whole in FREON without the cost of disassembly.

Also FREON is virtually non-toxic, so you get no downtime due to employee headaches and related complaints.

Investment Savings—Because FREON is non-flammable and virtually non-toxic, you can reduce or eliminate special air-handling facilities in your cleaning operation.

Production Savings—FREON cleans thoroughly and reliably, because of its solvent power and low surface tension. It cuts your rejects for lack of cleanliness way down, can also speed up production rates if cleaning is now your bottleneck.

Solvent Savings—Although FREON costs \$7.50/

gallon, it's so stable that you can recover it and use it over and over again endlessly, for maximum economy. Recovery of the solvent is easy in a simple still or activated charcoal adsorption unit.

The above cost savings have already made FREON solvents popular in the electronic, electrical and aerospace industries. Here's an actual situation in cleaning electric motor stators.

Manufacturer	Solvent	Price/ gallon	Total cleaning cost per stator
A	"Freon"	\$7.50	3.0¢
B	Chlorinated solvent	\$1.80	6.5¢

We think the unique properties of a FREON solvent system might improve cleaning operations and cut costs in your own plant. Write for full details. If you wish, we'll send a specialist to analyze your current cleaning setup. Du Pont Company, FREON Products Div., N-2420E-4, Wilmington 98, Delaware.

FREON[®]
cleaning solvents



BETTER THINGS FOR BETTER LIVING
... THROUGH CHEMISTRY

GO EAST, YOUNG MAN

for a new plant site. This free book tells why

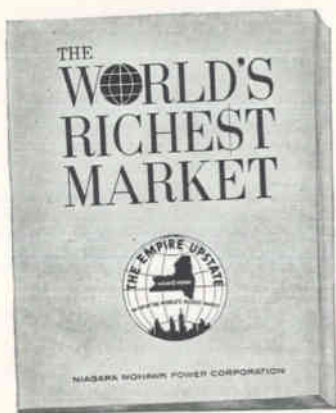

- 45 million customers live within 250 miles of the Empire Upstate.

- This area accounts for 28% of the nation's income.

- It has nearly twice the population and 3 times the population density of the West Coast—and will still have in 1975.

Write for your FREE copy of "The World's Richest Market" on your company letterhead to: Richard F. Torrey, Director of Area Development, Niagara Mohawk Power Corporation, Dept. E-4, 300 Erie Blvd. West, Syracuse 2, N. Y.

NIAGARA MOHAWK

INVESTOR OWNED • TAXPAYING

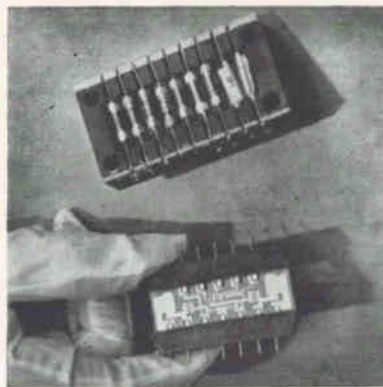

THIN-FILM circuits (bottom) have replaced conventional circuits (top) in Bell System equipment. Thin-film circuits are claimed to be more reliable

shield to protect against contamination during deposition. To argon is added a small amount of nitrogen to impart stable electrical resistance characteristics of tantalum film. A normal argon flow of 23 std. cc per minute is combined with ± 0.03 std. cc per minute of nitrogen.

STORAGE TABLE—A storage table having a controlled atmosphere holds substrates for cleaning and loading carriers before they enter vacuum chambers. After cleaning, and loading, carriers are placed in an indexing mechanism that positions them at entrance of first vacuum chamber. A drive mechanism then pushes them into machine track. A return track enclosed and surrounded by a controlled atmosphere delivers outgoing carriers from end chamber to storage table where processed substrates are removed and carriers reloaded.

Controlled atmosphere at storage table and return track prevent carriers or substrates from contacting any particulate matter. Otherwise small dust particles of 5000 Angstroms would interfere with required continuous deposition of 1000-Angstrom thick film.

ORIENTATION — Carriers hold substrates in vertical position as they pass through preheat, sputtering, and post-sputtering chambers. Tantalum cathode source is also vertically oriented in sputtering chamber. Details giving further relative positional information on cathode and substrates were not made known.

Physical uniformity and thick-

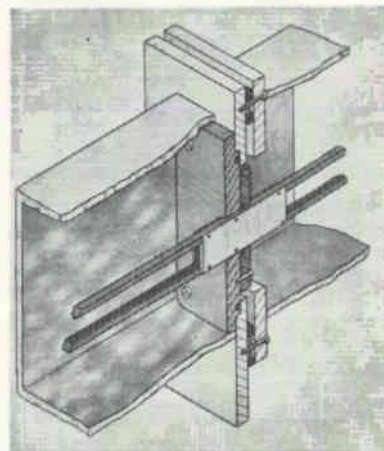
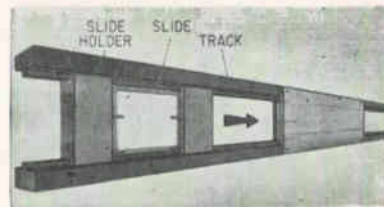

SUBSTRATES (slides) mount vertically in holders that fit in bottom-and-top tracks (top). Track seal arrangement (bottom) permits free movement of holders but retards air flow into chambers

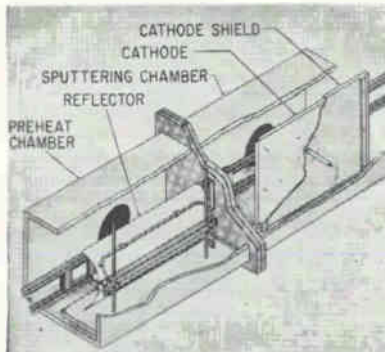

WINDOW shows substrate passing through one of first four chambers. Drawing shows infra-lamp reflector in fourth chamber that directs heat onto substrates; also shown is tantalum source cathode in sputtering (deposition) chamber

8½" X 11" X-Y RECORDER



HR-96-T
\$895

0.25% ACCURACY
10 IN/SEC Pen Speed
1 MV/IN- 10 V/IN
Sensitivity

0.05-2 IN/SEC Time Base
Zener Reference Voltages
Electric Pen Lift

HR96 Without Time Base, Zener
Reference Supply and Pen Lift \$725

LITERATURE AVAILABLE UPON REQUEST



houston instrument
corporation

4950 Terminal Avenue/Bellaire 101, Texas

MOhawk 7-7403/Cable: HOINCO TWX 713-571-2063

CIRCLE 200 ON READER SERVICE CARD

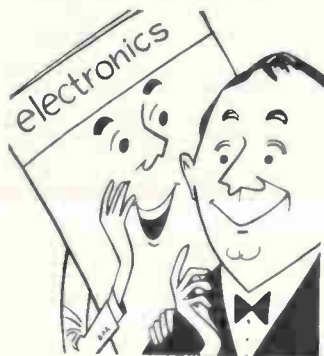

electronics
IS EDITED
TO KEEP YOU
FULLY INFORMED
—a "well-rounded"
engineer

What's your *present* job in electronics? Do you work on computers? (electronics ran 158 articles on computers between July, 1961 and June, 1962!) Are you in semi-conductors? (For the same period, electronics had 99 articles, not including transistors, solid-state physics, diodes, crystals, etc.) Are you in military electronics? (electronics had 179 articles, not including those on aircraft, missiles, radar, etc.)

In all, electronics' 28-man editorial staff provided more than 3,000 editorial pages to keep you abreast of all the technical developments in the industry. No matter where you work today or in which job function(s), electronics will keep you fully informed. Subscribe today via the Reader Service Card in this issue. Only 7½ cents a copy at the 3 year rate.

electronics

electronics • April 19, 1963

FOUR NEW WAYS TO HOUSE MICROFUSES*



Front panel mount (hexagon nut rear of panel). Aluminum body, knurled cap; can be anodized in color. Fungus, shock resistant. Sealing "O" rings in cap, on body.



Rear panel mount (round nut front of panel). Aluminum body, knurled cap; can be anodized in color. Fungus and shock resistant. Sealing "O" rings in cap, on body.



Front panel mount (hexagon nut rear of panel). Molded from dielectric material. Knurled cap. Rugged "Eye" type brass terminals; barrier provides full insulation.



Indicating Microfuse holder —when the fuse blows indicating bulb glows. Serrated, transparent knob. Molded from dielectric material. Voltage ranges, 2½ to 125 volts.

Microfuses achieve low fuse resistance values with high reliability in ultra-fast blowing characteristics. Microfuses can be hermetically sealed, suitable for potting applications. Glass enclosed visible filament. Microfuses available in 1/500 through 5 amps at 125V. Short circuit interrupting capacity 125 V—10,000 amps. DC.

LITTELFUSE

DES PLAINES, ILLINOIS

*Products shown actual size

CIRCLE 73 ON READER SERVICE CARD

73

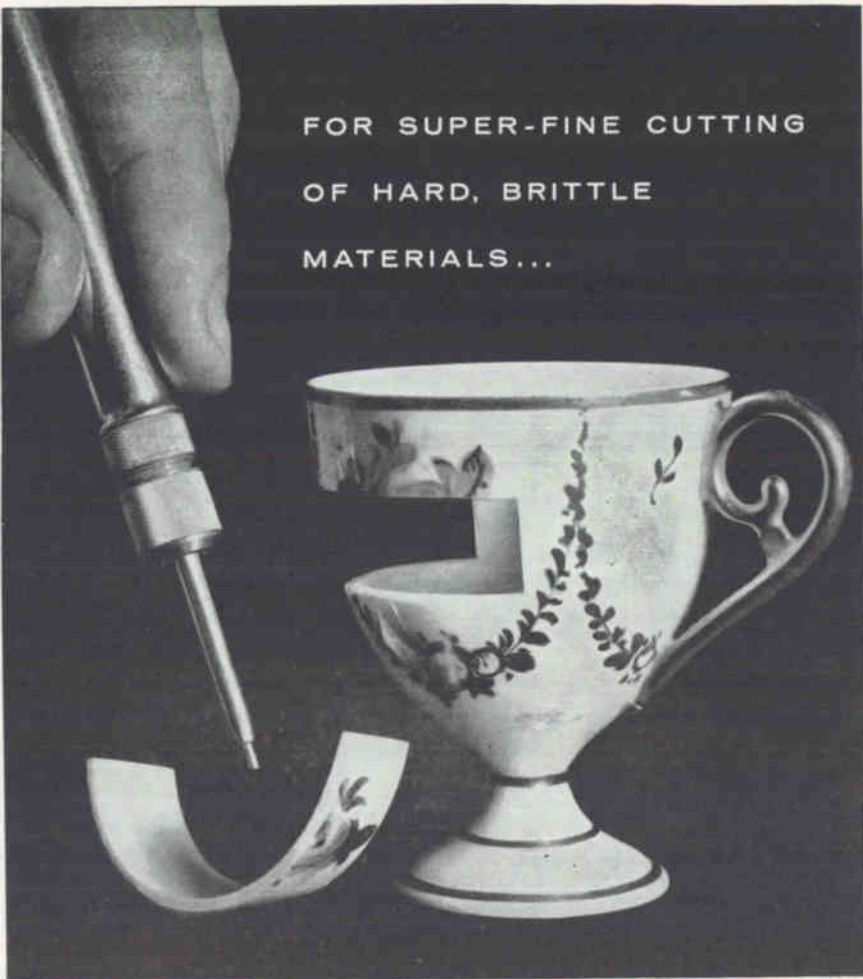

FOR SUPER-FINE CUTTING
OF HARD, BRITTLE
MATERIALS...

THE *S.S. White* Industrial Airbrasive Unit

We don't recommend slicing up the family's fine Limoge China, but this does illustrate the precisely controlled cutting action of the S. S. White Airbrasive Unit. Note how clean the edge is, and how the delicate ceramic decoration is unharmed.

The secret of the Airbrasive is an accurate stream of non-toxic abrasive, gas-propelled through a small, easy-to-use nozzle. The result is a completely *cool* and *shockless* cutting or abrading of even the most fragile hard materials.

Airbrasive has amazing flexibility of operation in the lab or on an automated production line. Use the same tool to frost a large area or to make a cut as fine as .008"! ... printed circuits... shaping and drilling of germanium and other crystals... deburring fine needles... cleaning off oxide coatings... wire-stripping potentiometers... engraving glass, minerals, ceramics. Jobs that, were previously thought impossible are now being done.

Send us samples of your
"impossible" jobs and let us
test them for you at no cost.

WRITE FOR
BULLETIN 6006.
Complete information.



S. S. WHITE INDUSTRIAL DIVISION
Dept. EU, #10 East 40th St., New York 16, N. Y. • Telephone MU 3-3015 collect.

S.S. White INDUSTRIAL AIRBRASIVE



ness of films is measured with a direct-reading mechanical probe applied over various regions of substrate surface—thickness spread has been found to be less than ± 150 Angstroms.

Product of thickness and sheet resistivity, which should be uniform, gives specific resistivity—a measure of film's chemical purity. This has been within ± 23 ohm-cm (one Angstrom equal 10^{-8} cm). A four-point probe measures sheet resistivity.

Balls Provide Problem Solutions

PRECISION balls made in large economic quantities from steel, rare-earth metals and pure elements (platinum, gold, tantalum, tungsten, titanium) may help solve certain electronic production problems. Produced by Industrial Tectonics, diameters of balls range as low as 0.008 inch. Size and sphericity are held within ± 0.000010 inch, and weight or specific gravity are predetermined. A major semiconductor manufacturer is reported to be using two differently sized steel balls in the production of a mesa transistor can and getter assembly. Balls are used to retain getters in transistor assembly and to act as a welding spacers in separating screens from getters and cans: ball is welded to the bottom of can; circular getter is slipped over ball and screen is welded to top of ball. Thus, ball acts as retainer and spacer, keeping getter separated from screen and can bottom. Reportedly, 800,000 balls per week provide assembly-time and cost savings. Diameters of balls for this application are available from 0.040 inch to 0.033 inch. Smaller-sized balls are being used for contact and relay points.

Vibratory Feeders for Micromin Parts

NEW SERIES of electrical vibratory feeder units ranging in size from $3\frac{1}{2}$ inches to $2\frac{1}{2}$ inches, for automatic handling of miniature and sub-miniature parts have been developed by Affiliated Manufac-



THREE MODELS of miniature-parts vibratory feeders are available

turers. Claimed to have been thoroughly tested in production-line use, these feeders—both spiral and straight-line—reportedly can be adapted to feed, orient, and position at rates up to 10,000 parts per hour. Vibratory amplitudes are relative to size of part handled.

Fibreboard Pre-packing Aids Missile Reliability

TECHNIQUE for pre-packaging electronic components and affixing them to fibreboard lengths in order of assembly to circuit boards, is reported to promote missile reliability and to give promise of annual cost savings of \$2 million in missile production. Developed by Lockheed Missiles & Space Company, technique is based on "skinpackaging"—securing of parts by a transparent plastic film to the corrugated fibreboard.

Manager of package handling engineering, Bronson Baker, says the system has been in operation in one manufacturing area at Lockheed for the past few months. He says it has proved highly successful in that one area: projected annual savings is expected to total \$600,000. Application to other electronic manufacturing areas will realize the total \$2 million savings, says Bronson. With the old system, an assembler had to scramble through some 50 plastic bags to select proper components. Engineer D. R. Pieri created the new assembly technique. With the assistance of B. W. Brown, a packaging and handling specialist, he packaged the parts in kits for sequential selection to provide the assembler with the required part at each assembly step. The technique is being used in Polaris production.

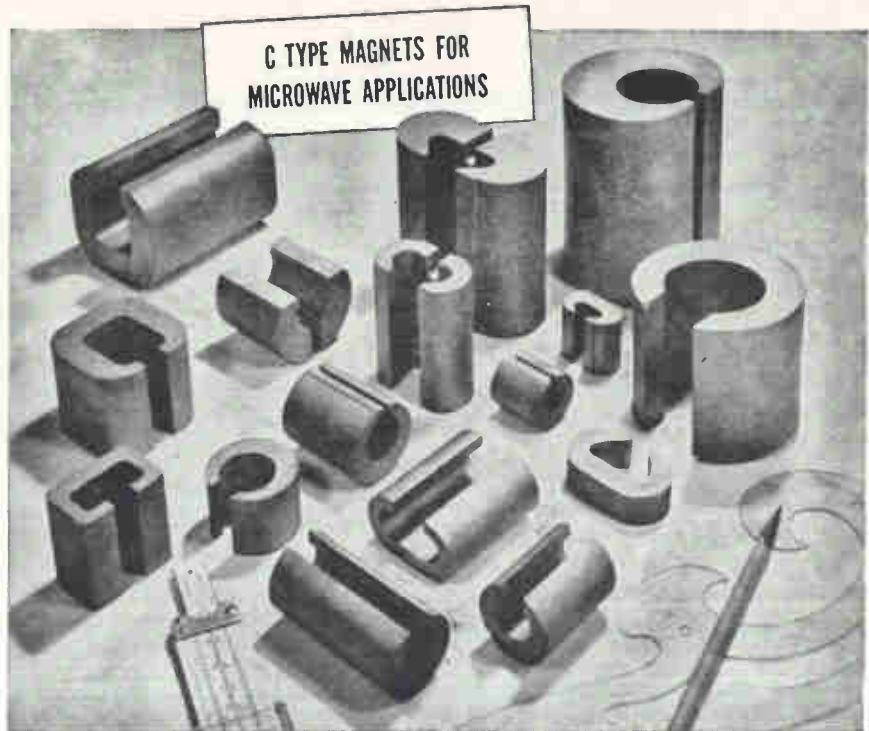

Available in a wide range of sizes to meet your design needs in ★ TRANSVERSE FIELD ISOLATORS ★ DIFFERENTIAL PHASE SHIFTERS ★ DUPLEXERS

Arnold C-type Alnico Magnets are available in a wide selection of gap densities ranging from 1,000 to over 7,500 gauss. There are six different basic configurations with a wide range of stock sizes in each group.

The over-all size and gap density requirements of many prototype designs can be met with stock sizes of Arnold C Magnets on an immediate-shipment basis, or readily supplied in production quantities.

When used in transverse field isolators, Arnold C Magnets supply the magnetizing field to bias the ferrite into the region of resonance, thus preventing interaction between microwave networks and isolating the receiver from the transmitter. These magnets are also used in differential phase shifters and duplexers, and Arnold is prepared to design and supply tubular magnets to provide axial fields in circular wave guides.

A feature of all Arnold C Magnets is the excellent field uniformity along the length of the magnet. Versatility in design may be realized by using multiple lengths of the same size magnet stacked to accomplish the needs of your magnetic structure.

Let us work with you on any requirement for permanent magnets, including high coercive force Alnico VIII for TWT focusing applications. ● For information on Arnold C Magnets, write for Bulletin PM-115. For data on Alnico VIII, ask for Bulletin PM-119.

4369

ADDRESS DEPT. E-4



ARNOLD

SPECIALISTS in MAGNETIC MATERIALS

THE ARNOLD ENGINEERING COMPANY, Main Office: MARENGO, ILL.
BRANCH OFFICES and REPRESENTATIVES in PRINCIPAL CITIES

Random-Noise Generator Is Drift Free

Feedback loop maintains accuracy at ± 0.3 db and stability at 0.5 percent

CALIBRATION of sensitive receivers from 1 to 500 Mc can be made by the model NS-A portable random-noise generator made by Aerospace Research Inc., 130 Lincoln St., Boston 35, Massachusetts. Noise output of the device is presented on a single meter calibrated in noise in db and noise in antenna temperature. Range is 0 to 16 db and 290 to 12,000 K. Output impedance is 50 ohms, accuracy is ± 0.3 db over entire frequency range and stability is 0.5 percent for line-voltage variations of 20 percent and

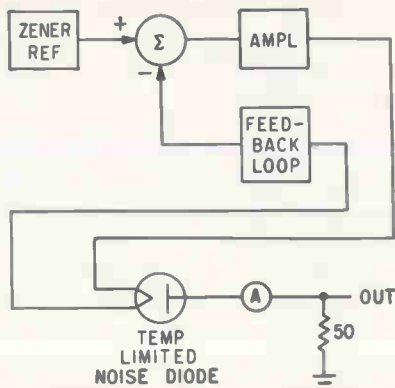

temperature changes of 30 degrees C. The device uses a transistor feedback control circuit that stabilizes the noise diode plate current at a preset level. This level is independent of any physical factors and the feedback loop also compensates for



aging of the noise diode itself. The feedback control also eliminates warm-up drift in output noise level when the device is first turned on. Remote programming is also available.

CIRCLE 301, READER SERVICE CARD

Multiple-Chip Amplifier Has 20-Mc Bandwidth

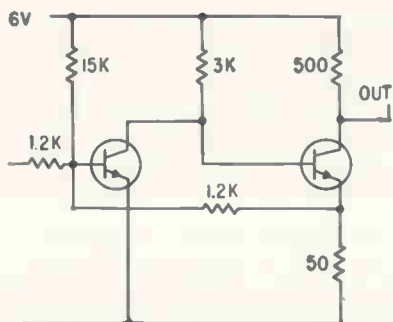

VIDEO AMPLIFIER linear micro-circuit having 20 Mc bandwidth using multiple chips is being manufactured by General Instrument Semiconductor, 600 West John St., Hicksville, L. I., New York. The two-stage PC-101 operates between -55 and $+125$ C with a supply voltage of 6 v, input impedance of 1,200 ohms, output impedance of 500 ohms, voltage gain of 20 db and a current gain of 25 db. Output voltage is 4.5 v peak-to-peak, equivalent input noise with R_L of 500 ohms and

R_L of 1,000 ohms is $10 \mu\text{v}$ rms. Bandwidth at 3 db points is 20 Mc. The NC101 version comes in a JEDEC TO-5 case. Several amplifiers may be cascaded where additional gain is required and the feedback factor can be varied to increase gain at expense of bandwidth. (302)

Fast Switch Includes Semiconductor Protector

FAST-ACTING push-pull or toggle switches combined with semiconductor devices to guard against transient and long-term overvoltages and overcurrents are announced by Metals and Controls Div., of Texas Instruments Inc., 34 Forest St., Attleboro, Massachusetts. Models 8 and 9MC1 of the Klixon protector provide combined overcurrent and overvoltage protection while the 8

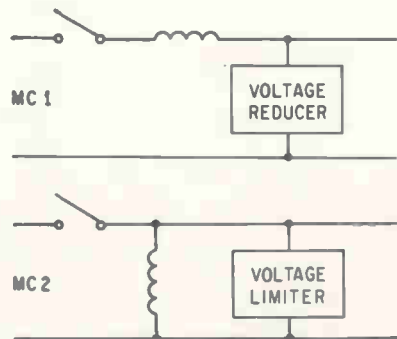

and 9MC2 provide voltage limiting and automatic system recovery for short transients. Ratings for the MC1 are 20 to 60 v d-c, 0.050 to 15 amperes and 115-v a-c. The MC2 is for 6 to 50 v d-c. Ultimate trip hold is 110-percent rating indefinitely with trip at 135-percent of rating within 100 ms. Rupture is 1,000 amperes at 32 v d-c, endurance cycling is 10,000 operations at 100-percent rating. Dielectric strength is 1,500-v minimum and insulation resistance is 100 meg-ohms minimum. Applications include protection of transistorized power supplies, computers, servo controls, mobile communication equipment and other solid-state electronic systems. A diode unit in the MC1 acts as a voltage sensor

IF YOU ARE RESPONSIBLE FOR CIRCUIT DESIGN AND WOULD LIKE TO

1. Reduce Breadboard Time
2. Cut Costs
3. Increase Reliability

here is a new, proven system that can help you!

IT IS CALLED SPARC—(System of Programs for Analysis by Recomp). SPARC has contributed importantly to such highly-complex projects as Minuteman, Saturn IV, Mariner, Polaris, and others. SPARC allows simulation of electronic circuits on a computer... and achieves optimized design with minimum dependence on laboratory experimental work.

SOME SOLUTIONS SPARC CAN GIVE YOU:

D. C. Analysis: Bias Change • Input Impedance • Output Impedance • Open Loop Gain • Closed Loop Gain • Normal and Worst-Case Voltages • Power Dissipation • Temperature Characteristics • Statistical Specification Setting (Tolerance Narrowing).

A. C. Analysis: Frequency Response • Input Impedance • Output Impedance • Stability • Open Loop Gain and Phase Angle • Closed Loop Gain and Phase Angle • Effects of Noise.

Transient Analysis: Open Loop Transient Response • Closed Loop Transient Response • Linear and Non-Linear Third Order Differential Equations.

AND YOU DON'T NEED A COSTLY COMPUTER TO USE SPARC!

SPARC Systems were designed on and for the compact, moderately priced RECOMP® Computers. Three reasons behind their selection were: simplicity of operation, their capabilities, their reliability. Hundreds of engineers, with no previous computer operation experience, have learned how to effectively use SPARC Systems on RECOMP Computers after only two or three days indoctrination.

Here's how you can receive full information on this new, low-cost reliable method of circuit analysis. Just fill in and mail the coupon below. We will promptly send you an interesting, descriptive booklet, "SPARC—Automated Circuit Design Analysis."

RECOMP

Recomp is a product of
Autonetics Industrial Products
Autonetics is a Division of
North American Aviation

Recomp
Dept.S-24, 3400 East 70th St., Long Beach, Calif.

Please send me "SPARC—Automated Circuit Design Analysis."

Name _____

Position _____

Company _____

Address _____

City _____ Zone _____ State _____

Hyperion PRECISION TIME INDEXING and TAPE SEARCHING EQUIPMENT

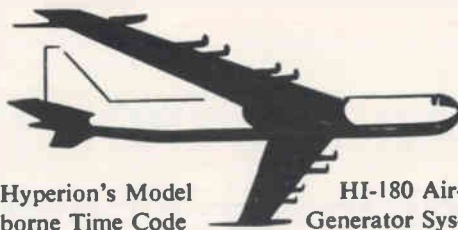

Hyperion's Model HI-180 Airborne Time Code Generator System was designed and manufactured to meet essential functional requirements of MIL-E-5400 Specification. This system ... generates standard time code formats, suitable for recording on magnetic tape, oscillographs and data recording cameras ... has a remote control box for time preset and display in addition to required auxilliary remote displays ... has a time base stability of 1 part in 10^7 ... power input either 28 VDC or 110 VAC, 45 ... 440 cps ... weight 16 lbs. Write for Technical Bulletin 580.

½ ATR Box

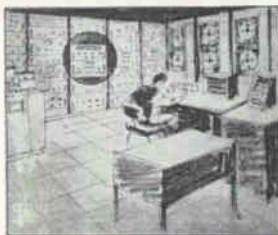
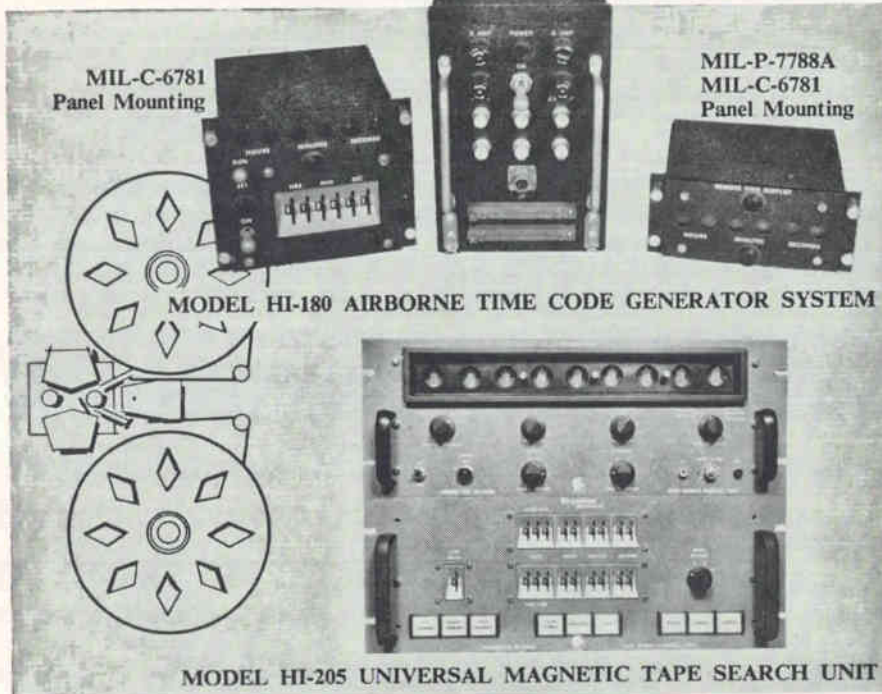

Hyperion's Model HI-205 Universal Magnetic Tape Search Unit ... accepts any range time code format ... searches at uncontrolled tape speeds for modulated code formats ... displays UPDATED time in decimal format... searches for pre-selected start and stop times ... its parallel and serial outputs provide for remote data reduction ... automatically controls any instrumentation tape transport ... compensates for input signal variations over the dynamic range of magnetic tape recording ... all solid state construction. Write for Technical Bulletin 505.

Write or call Hyperion for your precision range time indexing and search requirements.

Hyperion INDUSTRIES, INC.

• DIGITAL PRODUCTS DIVISION

187 COOLIDGE HILL ROAD, WATERTOWN, MASSACHUSETTS
TWXN: WTVN MASS 890 TEL: WA 6-0140

and triggers the electromechanical portion of the protector to de-energize the system and in the MC2, the diode bypasses the voltage transient until the electromechanical portion has time to operate.

CIRCLE 303, READER SERVICE CARD

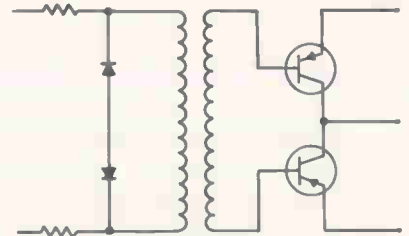

Solid-State Chopper Has Isolated Drive Input

MANUFACTURED by Solid-State Electronics Co., 15321 Rayen St., Sepulveda, California, the model 64 transistorized plug-in line-driven chopper incorporates a transformer-coupled isolating drive network and clipping diodes so it can be driven from a 400 cps source or from a drive source common to the d-c voltage being chopped. Driving voltage can be nominal 10 to 130-v rms sine from 70 cps to 10 Kc, or 40 to 300-v peak-to-peak square from 40 cps to 12 Kc. Driving input impedance is 3,000 ohms, input voltage dynamic range is from a fraction of a mv to more than 10 v, source resistance is less than 100 ohms for minimum noise. (304)

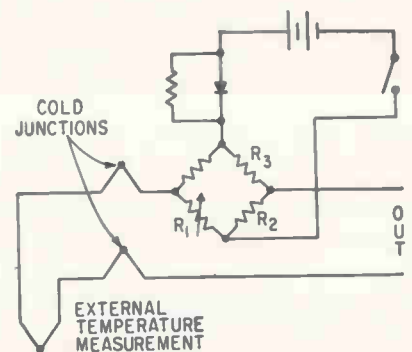

Temperature Reference From -40 to +212 F

REFERENCE temperature within 0.25 F for any specified thermocouple material up to five years within the temperature range from -40 to +212 F is available with the self-powered, high-performance, thermocouple reference junction com-

pensator manufactured by Consolidated Ohmic Devices, 900 Third Avenue, New Hyde Park, N.Y. The unit features instantaneous warm up, total isolation and requires no external power supply. Expanded scale temperature measurements are made possible by selectable hot or cold reference temperature. The device is epoxy encapsulated, has a normal use life of three years and a continuous use life of 10,000 hours. Output impedance is 220 ohms. Basic circuit is shown in sketch (p 78). Here, R_1 is a temperature-sensitive component thermally bonded to the cold junction thermocouples. Resistance/temperature curve of R_1 matches the emf/temperature curve of the thermocouple material. Change in voltage developed across R_1 is equal and opposite to cold junction thermal voltage over wide range of ambient temperature. Ratio $R_2/(R_1 + R_2)$ is adjusted for reference temperature. (305)

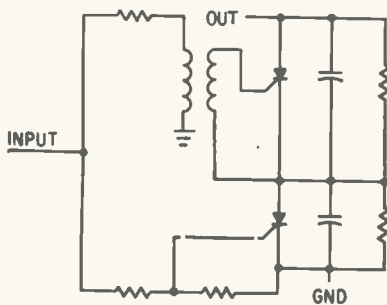

Solid-State Switch For 20-Kw Pulsed Power

SOLID-STATE modulator switch specifically designed to replace thyratrons in applications requiring high voltage at high peak currents is announced by Sectron, Inc., 1 Pingree St., Salem, Massachusetts. The SM1100 can switch 50 ampere pulses at 800 v in 0.2 μ sec and operate at 20 Kc repetition rate at 100 C. The epoxy-encapsulated module is completely insensitive to extreme environments including shock, vibration, temperature altitude and corrosive atmospheres. (306)

Power Gate with Fan-Out of 20

NEW integrated power gate with a fan-out of 20, designed for digital systems operating in the 5 Mc

range, has been announced. It is available in either a modified TO-5 or a modular glass-Kovar flat package. Signetics Corp., 680 W. Maude Ave., Sunnyvale, Calif. (307)



Lamp Operator Is Epoxy Encapsulated

THE Mili-Min No. 1375 lamp operator is a rugged, reliable module which operates a lamp in response to low level signals of either plus or minus polarity. By connecting an external jumper, the module becomes a one shot which extends the duration of a short pulse to give a visual indication. Pulses of less than 200 millisecond are extended to 200 millisecond. (Minimum pulse duration 10 μ sec.) For pulses exceeding 200 millisecond the output persists for the duration of the pulse. An output terminal is also provided to operate an external slave driver. Amtron Inc., 14631 S. Waverly Ave., Midlothian, Ill. (308)



Digital Electrometer Has Infinite Impedance

NOW AVAILABLE is a digital electrometer capable of measuring both high and low d-c voltages without loading its signal source. Instrument uses an electrostatic voltage divider for its 100 v and 1,000 v ranges. This completely eliminates current drain which ordinary 10 meg resistive dividers of digital voltmeters create. An admittance neutralizer is inserted between the null-detecting chopper and the potentiometer-driving error amplifier. The admittance neutralizer's infinite impedance constitutes the key to possible infinite impedance oper-

Hyperion

CUSTOM ENGINEERED

POWER SUPPLIES

Hyperion has "custom engineered" power supplies to MIL Specs for many years. The Airborne Custom MIL Power Supply meets MIL-E-5400, MIL-T-5422 and MIL-I-6181 specifications. The Shipborne Custom MIL Power Supply meets MIL-E-16400 and all its associated specs. Both units are designed and manufactured to MIL-Q-9858 standards.

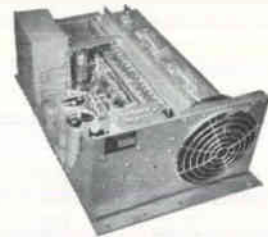

500 VOLT-AMPERE
Regulated Excitation Supply
Input: 120/208 VAC \pm 10%,
60 cps \pm 5%, 3 phase
Output: +250 VDC at 0-2 amps
Regulation: \pm 0.5%
Ripple: 3.5 mv, rms
Temperature: 0°C to +65°C



Airborne Multiple Output
System Supply
Input: 107 VAC to 120 VAC @ 380 cps
to 420 cps, 3 phase
Output: 11 regulated DC outputs from
-50 VDC to +300 VDC,
total output power 3 KW
Regulation: \pm 0.25% including
temperature stability
Altitude: 50,000 ft.
Temp.: -55°C to +55°C

Our power supply capabilities are far ranging, including such diversified fields as satellite, ground support (MIL-E-4158), missile support (MIL-I-983) and other types which include TWT, Klystron, High Voltage, Computer and many others.

Hyperion

INDUSTRIES, INC.

• POWER EQUIPMENT DIVISION

127 COULDS HILL ROAD, WATERTOWN, MASSACHUSETTS
TWX: WTVN MASS 860 TEL: WA 8-0140

Magneline[®]
THE INDICATOR WITH INHERENT MEMORY

Two new series for digital readout,
ideal for multiplex applications

SERIES 14000—FOR SOLID STATE LOGIC
Character Size..... $\frac{9}{32}$ " x $\frac{1}{4}$ "
No. of Characters.....Up to 11
Leads.....11 plus a common
Watts.....2.4

SERIES 15000—FOR RELAY LOGIC
Character Size..... $\frac{5}{16}$ " x $\frac{1}{4}$ "
No. of Characters.....Up to 10
Leads.....5 plus a common*
Watts.....1.3—1.7

*Requires switching of lead in combination with reversal of polarity to change indicator.

Units hold last reading without power. Totally enclosed, self-stacking housing for front or rear mounting. Jewel bearings, only one moving part. Standard voltages 6, 12, 24, or 28 V.D.C. Readability 12 feet at normal room lighting. Options include special voltage, special characters, and internal lighting for dark room applications.

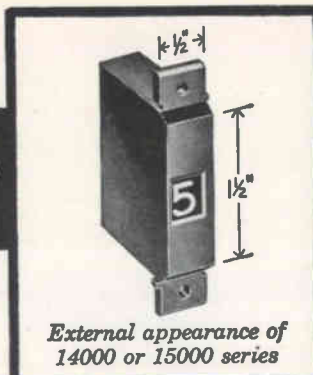

External appearance of 14000 or 15000 series

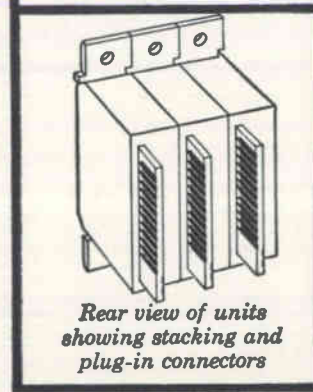

Rear view of units showing stacking and plug-in connectors

Write or teletype
(203-753-9341)
for free literature

PATWIN[®] ELECTRONICS
A DIVISION OF THE PATENT BUTTON COMPANY
WATERBURY 20, CONNECTICUT
CIRCLE 201 ON READER SERVICE CARD



Fastest check for radar dish contour

Barr & Stroud Rangefinder gives $\frac{1}{8}$ -inch accuracy at 22-foot range!

In the application shown, a B. S. 8-inch rangefinder measures the distance of key targets. A simple mount with azimuth and elevation scales simplifies the observation of range measurements.

Easy to operate! No training required. Just sight through eyepiece... turn knob until two images of object coincide... read range directly in feet or yards. No triangulation or computing!

Barr & Stroud Rangefinders, of various base lengths and magnifications, are widely used in surveying, engineering, construction and marine applications. Sold and serviced exclusively in the U. S. by Kollmorgen Corporation. Write for facts today to Kollmorgen Corporation, 347 King St., Northampton, Mass.



ation of the voltmeter. Micronia Amplifier Corp., Box 269, Port Washington, N. Y.

CIRCLE 309, READER SERVICE CARD



S-Band Paramp Has Low Noise Figure

MICROWAVE PHYSICS CORP., 420 Kirby St., Garland, Texas. Coolable S-band parametric amplifier has typical noise figures, including circulator and filter losses, of 1.7 db at room temperature and 0.7 db at liquid nitrogen temperature. It is designed for space tracking, communications or radio astronomy applications and operates over a frequency range of 2.7-3.0 Gc. Bandwidth is 30 Mc at the 3 db points. Gain is 15 db \pm 1 db over 24 hr operation, and phase stability is 5 deg for 24 hr. (310)

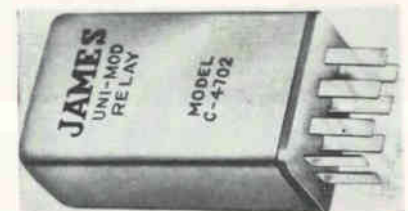

Multiplexing Switch For Low-Level Use

THE Uni-Mods will provide low-cost channel switching for transducer input multiplexing and all types of low-level switching. They feature single, double and triple pole models for single channel switching. Units have extremely low-thermal switching circuitry, electromagnetic and electrostatic shielding and are adapted to high and low impedance circuits. Contacts are of a special gold alloy which provide an op-

erational life in excess of one billion operations. Operating speeds are less than 600 μ sec with stable repeatability and close tolerance between units. James Electronics Inc., 4050 N. Rockwell, Chicago. ((311)

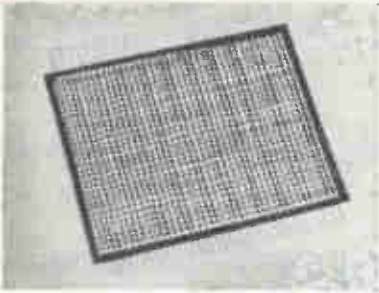

Memory System Has High Speed

A HIGH-SPEED nondestructive memory system has been developed. Method of nondestructive storage is based on the use of a minor loop for storage of the binary digit "1" and the saturated or major loop for the condition "0". To obtain bipolar outputs the scheme is extended to a two-core per bit scheme. Characteristics: word organized, up to 1024 words (modular in 64 word increments); word length, 40 bits; amplitude, ± 25 mv nominal (bipolar); interrogate current, 250 ma (unipolar drive); speed, 1 μ sec cycle time, 0.1 μ sec access time. North Electric Co., Galion, O. (312)



Tunable Loads for VSWR Measurements

TUNABLE LOADS now available provide a very high degree of accuracy in vswr measurements and are highly versatile laboratory instruments. Units feature 1.02 max vswr for a full octave. Two models are offered covering the frequency range of 0.25 to 4 Gc. Power han-

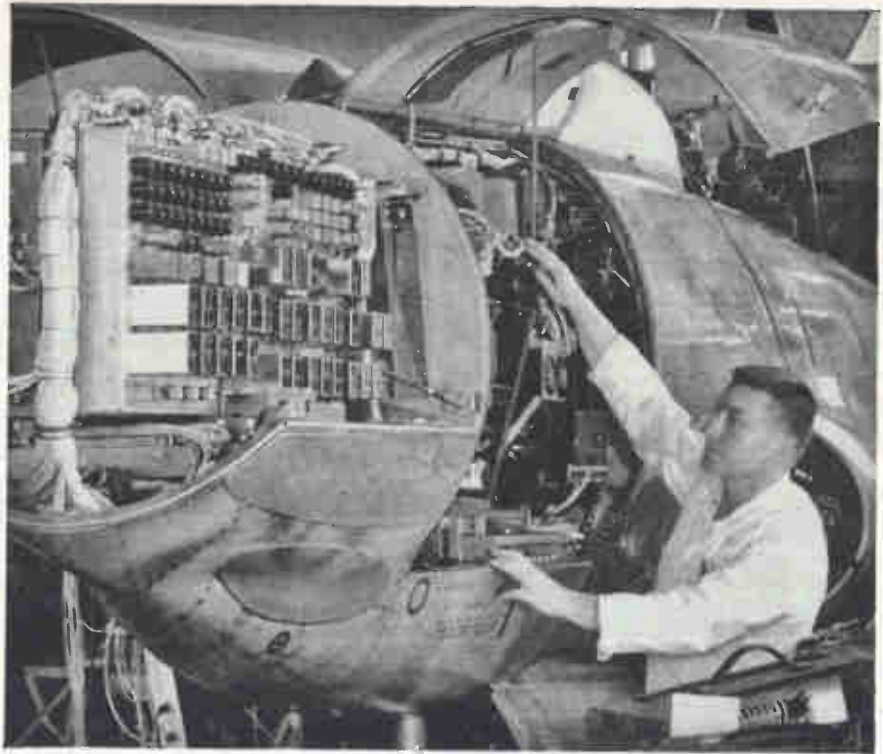

Aircraft flight simulator at Cornell Aeronautical Laboratory puts new aircraft designs through their paces, saving countless dollars of Air Force development costs. Analog computer circuitry can pre-evaluate stability and control characteristics in advance of flight.



Specified for reliability:

Bristol choppers help pre-test tomorrow's aircraft

Finding out just what a new superspeed jet or rocket aircraft will do *before* it leaves the ground—even before it leaves the drawing boards—is the job of the aircraft simulator at Cornell Aeronautical Laboratory, Inc., Buffalo, New York.

This vital equipment, equivalent to a medium size analog computer, employs more than 600 transistors and hundreds of other components connected by more than five miles of wiring . . . among them 46 Bristol Syncroverter* choppers. High reliability, low noise and long life are the qualities that are recommending these choppers to more and more designers of critical circuitry. More than 200 models available. Write for full specifications.

**The Bristol Company,
Aircraft Equipment Division,
152 Bristol Road, Waterbury 20, Conn.**

A Subsidiary of
American Chain & Cable Company, Inc. **ACCO**

*T.M. Reg. U.S. Pat. Off.



10 Bristol Syncroverter* choppers (foreground) are used in this unit which governs "pilot's" instrument display. 1.25

BRISTOL... engineers for precision, builds for reliability

6

GUIDANCE STUDIES REQUIRING ADVANCED THINKING AT HONEYWELL IN FLORIDA!

- Application of geometrical and astronomical fundamentals to practical navigation of manned and unmanned vehicles.
- Derivation and verification of aircraft and missile guidance theories.
- Analysis of control systems, including sampled data processes.
- Simulation of real-time devices.
- Application of digital computers to real-time control of electronic systems.
- Statistical analysis of expected performance of electro-mechanical systems.

TALENT AND EXPERIENCE IN ANY OF THESE AREAS CAN MEAN IMMEDIATE AND REWARDING CAREER ADVANCEMENT AT HONEYWELL'S STEADILY EXPANDING FLORIDA FACILITY.

Our work on projects such as Polaris, Gemini, X-20A (Dyna-Soar), Centaur, plus others not cleared for publication, and our continuing expansion creates permanent assignment openings AT ALL LEVELS for guidance oriented engineers and scientists.

Help solve the precision guidance and space navigation problems of the '70s! Find out now about the challenging professional opportunity awaiting you at Honeywell in Florida. A brief note describing your education, experience and special work interest will receive a prompt, confidential reply. Address L. F. Ericson, Honeywell, 13350 U. S. Highway 19, St. Petersburg, Florida.



Honeywell An Equal Opportunity Employer

"A Good Place to Work . . . A Good Place to Live"

To investigate professional openings in other Honeywell facilities, send your resume to H. F. Eckstrom, Honeywell, Minneapolis 8, Minnesota.

HONEYWELL ENGINEERS ARE DOING THINGS IN FLORIDA

ding is 1 w c-w, 1 Kw peak. Nominal impedance is 50 ohms. Maury & Associates, 10373 Mills Ave., Montclair, Calif.

CIRCLE 313, READER SERVICE CARD



Tiny Soldering Iron Has Long Life

AMERICAN ELECTRICAL HEATER CO., 6110 Cass Ave., Detroit 2, Mich. The American Beauty B-series 3-oz soldering iron features a floating heating element. Core is pure alumina. Windings are resistance wire, finer than human hair, held at constant spacing and surface insulated by an adhesive. Entire element is sealed in steel, almost impervious to accidental damage. B-2000 operates at 22½ w input and provides 700 F heat at the ¼ in. diameter tip. B-2500 provides 850 F at 30 w input; tip is ⅜ in. (314)



T-W Amplifier Fits Small Space

TYPE RW103 medium power, c-w traveling-wave amplifier is designed for higher density applications in test equipment, radio relay links and microwave communications. Frequency characteristics are 1.5 to 3.0 Gc, typical output at saturation 15 w, gain 25 db, helix 1900 v, heater voltage 6.3 v and heater current 1.5 amp. Cathode is indirectly

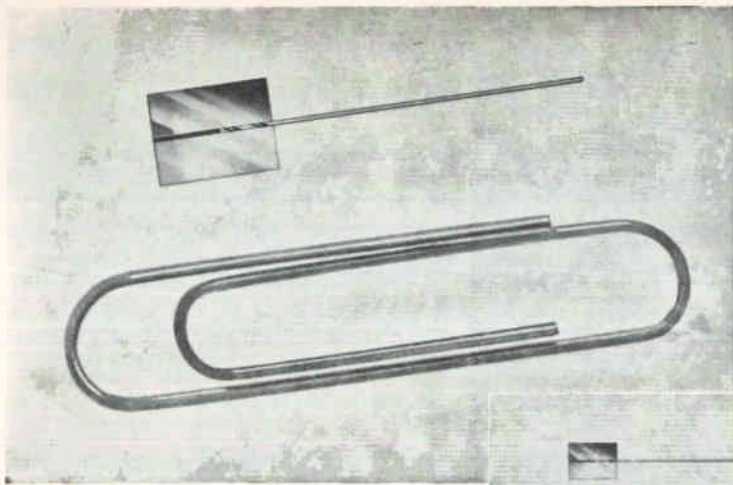

Ideally suited for drilling exceptionally long holes and for drilling through a bushing. For complete information write for Catalog 62.

LEVIN®

LOUIS LEVIN & SON, INC.
3573 Hayden Ave., Culver City, California

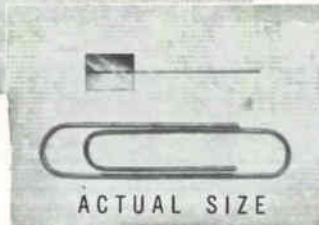

STRAIGHT SHANK MICRO-DRILLS

SPHINX straight shank precision micro-drills are now stocked in the U.S.A. for the first time. These Swiss drills are recognized as the standard of quality wherever fine instrument work is being done.



IN STOCK FOR IMMEDIATE DELIVERY

STRAIGHT SHANK DRILLS15MM — 1.00MM
SPIREC PIVOT DRILLS.....	.10MM — 3.00MM
FLAT PIVOT DRILLS04MM — 1.00MM
SPIREC PIVOT DRILLS—LEFT HAND.....	.10MM — 1.00MM
SPIREC CENTER DRILLS.....	.10MM — .70MM

CIRCLE 83 ON READER SERVICE CARD



Are you a COMPLETELY INFORMED electronics engineer?

Today you may be working in microwaves. But on what project will you be working tomorrow? You could have read electronics this past year

and kept abreast of, say, microwave technology. There were 96 individual microwave articles between July, 1961 and June, 1962!

But suppose tomorrow you work in some area of standard electronic components, in semiconductors, in systems? Would you be up-to-date in these technologies? Did you read the more than 3,000 editorial pages that electronics' 28-man editorial staff prepared last year?

electronics is edited to keep you current *wherever* you work in the industry, *whatever* your job function(s). If you do not have your own copy of electronics, subscribe today via the Reader Service Card in this issue. Only 7½ cents a copy at the 3 year rate.

electronics

Planning to change your address?

Use the form below to indicate a change of address. Because our issues are addressed in advance, please try to allow at least 5 weeks for change of address to become effective. Attach the address label from your most recent issue in the space provided below.

(Please print the following information for proper service)

Title or position.....

Name

Chief Job Responsibility.....

Distributor
Manufacturer

Company and Div.....

Product or Service Approx. No. of Employees

Address

City Zone State or Prov.

Mail to home address below:

Address

City Zone State or Prov.

Mail to: Fulfillment Manager, electronics
330 West 42nd Street, New York City 36, N. Y.

*Paste present mailing label or address
from wrapper or envelope here.

NOW...ON-LINE!

New Correlation Computer System permits on-line auto- and crosscorrelation studies



MNEOTRON's Correlation Computer System (CC-1) consists of the COR-256 combined with the Computer of Average Transients (CAT 400B). This system performs real time auto- and crosscorrelation computations, thereby permitting the study of statistical properties of repetitive signals buried in random noise.

The Correlation Computer generates up to 256 points of the auto- or crosscorrelation functions. On-line

operation eliminates the need for time consuming and costly data analysis. Results computed by the system are immediately available as an oscilloscope pattern. Accessory units make results available as an analog plot or a printed or punched digital readout.

MNEOTRON

Division of
TECHNICAL MEASUREMENT
CORPORATION **TMC**

Executive Sales Offices: 202 Mamaroneck Ave., White Plains, N. Y.

CIRCLE 202 ON READER SERVICE CARD

HERE IS THE WORLD'S SMALLEST MOTOR YET IT'S SO POWERFUL . . .

MITSUMI MICRO MOTOR



MODEL MI-100

Less than 20mm in diameter, the new Mitsumi Micromotor provides a startling efficiency of over 50%, the barrier which miniature motors are not allowed to pass.

A novel construction principle helped to make this accomplishment possible. The form is more simplified by setting all the terminals at one position. Because the entire mechanism is given full protection against irregular revolution and above all, electrical noise is entirely eliminated, you may call this the most perfect micromotor yet devised. Please write for complete information on Mitsumi Micromotor, and we will send you specifications and data.



MITSUMI PARTS

MITSUMI ELECTRIC CO., LTD.

TOKYO • OSAKA • NEW YORK

heated and oxide coated. Compact 13½ in. length, 1¾ in. capsule diameter and 2 lb net weight are possible because focusing is by integral periodic permanent magnets so no electromagnet is needed. Price ranges from \$1,000 to \$1,500 depending on quantity. Warnecke Electron Tubes, Inc., 175 W. Oakton St., Des Plaines, Ill.

CIRCLE 315, READER SERVICE CARD



V-T Voltmeter for Video Range

BALLANTINE LABORATORIES INC., Boonton, N. J. Model 310B vtvm covers from 10 cps to 6 Mc, has a voltage range from 10 μ v to 100 v, or to 1,000 or 10,000 v with optional accessories. Its 3 db bandwidth is 2 cps to 10 Mc. It may also be used as a broad band amplifier, 10 cps to 6 Mc. An indicating meter with logarithmic voltage scales makes it possible to use the full five-inch scale to the same accuracy and precision of reading anywhere on the scale. (316)



Calibration System For Acoustic Devices

SYSTEM is capable of precise directivity and response measurements of underwater hydrophones, transducers and other acoustic devices. It controls pulse length, frequency, bandwidth and receiving gates to prevent distortion of measurement data due to reflections. Specifica-

tions: Frequency range, 500 cps to 150 Kc continuously variable; manual or automatic frequency sweep; dynamic range, 50 db; response recording accuracy, 0.5 db or better; pulsed or c-w operation with variable pulse width from 10 μ sec to 1 sec. Hazeltine Corp., Little Neck 62, N. Y. (317)

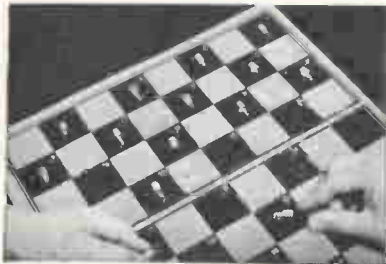

Phono Sockets Offer Long Life

CONNECTOR CORP., 6025 North Keystone Ave., Chicago 46, Ill., announces series 107E, a line of compact long life phono sockets consisting of 3 snap-in printed circuit and 11 single hole mounting types for use with 0.125, 0.093 and 0.040 diameter plugs. Minimum contact resistance and maximum life with mating connector are achieved by emphasis on contact and shell design. (318)



Airborne Antenna For X-band

NOW AVAILABLE is X-band airborne antenna, model X860, with csc² elevation pattern, ± 1.5 db, from 6 to 40 deg; horizontal pattern beam width 13 deg, side lobe level 20 db. Polarization horizontal; gain 22 db; vswr < 1.2 max. Power handling capacity exceeds 100 Kw. Fits in 16 in. cube. Weight 8 lb. Delivery 90 days after receipt of order. TRG, Inc., 400 Border St., East Boston, Mass. (319)

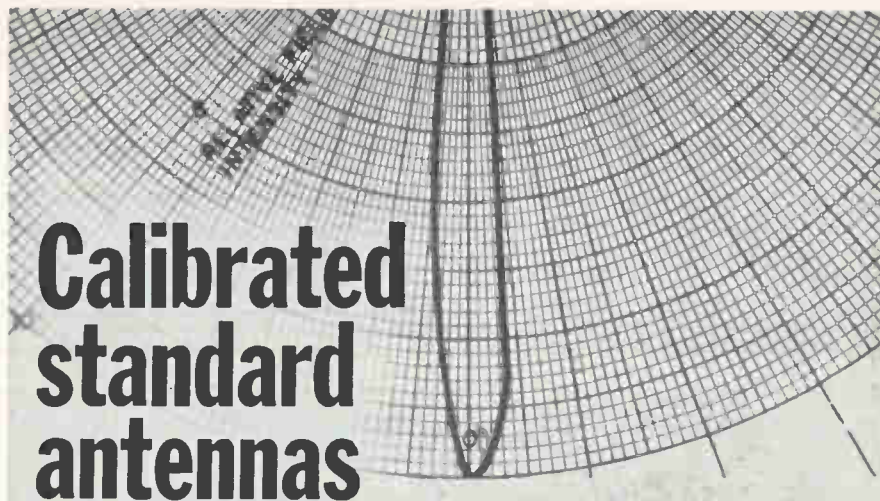

Calibrated standard antennas

nine designs now cover 1-21 KMC!

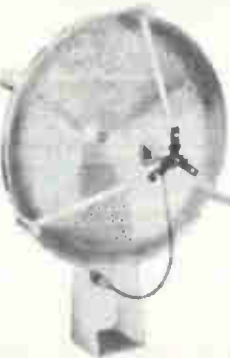

Stable, rugged, portable, accurately-calibrated antennas for every microwave application from precision field intensity, leakage, gain, and directivity measurements to the most demanding communications installation. Teflon windows, MIL fittings, compatible tripods and reflectors. Excellent directivity, high and uniform broadband gain, low VSWR... CA Series.

Call your POLARAD Field Engineer... he is a Microwave Specialist!

POLARAD
ELECTRONIC INSTRUMENTS

POLARAD

A Division of Polarad Electronics Corporation
World Leader in Microwave Instrumentation
34-02W Queens Blvd., Long Island City 1, New York

CIRCLE 203 ON READER SERVICE CARD

30,000 V 8 MA $\pm 0.05\%$ REGULATION OFF-THE-SHELF POWER SUPPLIES



Model PSR30-8

PSR Series offers these important features: 11 Models available • Range 5 to 30 KV, 2 to 30 MA • Regulation $\pm 0.05\%$ • Ripple .1% RMS • Completely Solid State Circuitry • Light Weight • Rack Height 8 $\frac{3}{4}$ " maximum • Dry Insulation • Overload Protection • Reversible Polarity • Simplified Controls; coarse and fine voltage, ON-OFF meter reversing switch • Triple-Range Kilovoltmeter and Milliammeter. Write for New 1963 High Voltage Bulletin.



ELECTRONICS DIVISION

RESEARCH-COTTRELL, INC., SOUND BROOK, NEW JERSEY

RC-264E



PERMAG

24-HOUR DELIVERY from our stock of magnets in all sizes, all shapes, all grades. Magnets also precision engineered and promptly fabricated to your needs.

MAGNETS

PERMAG CORP.

88-06 VAN WYCK EXPRESSWAY, JAMAICA 18, N. Y.
Olympia 7-1818 • TWX: 212 479-3654

PERMAG PACIFIC CORP.

6178 W. JEFFERSON BLVD., LOS ANGELES 16, CALIF.
Vermont 7-4479 • TWX: 213 836-0445

CIRCLE 204 ON READER SERVICE CARD

NUMBER code WIRES and CABLES
**FAST... with NEW LOW COST
DISPENS-O-CODE®**

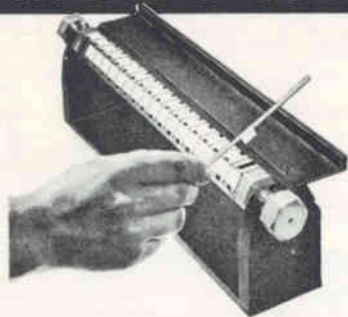

Unskilled Operator can number code 1000 pieces of wire/hr. 120 pieces of tape cut with a flick of the wrist.

Tape sizes range — ¼" to 1" and ¾" to 2¼" long.

Eliminates need of costly stocking of many different colors of wire... Is less expensive than pre-printed, pre-cut pressure sensitive wire markers.

Precision-Built Machine for Efficient, Accurate Operation.

For complete information write to

mask-o-matic Inc.

55 BELMONT AVENUE • PATERSON, N. J.
AREA CODE 201 — 684-5800



Literature of the Week

STATIC SWITCHING CONTROLS The Clark Controller Co., 1146 E. 152 St., Cleveland 10, O. A four-page technical brochure describes the bulletin 1010 transistorized static switching controls.

CIRCLE 320, READER SERVICE CARD

INSTRUMENT SELECTION GUIDE Non-Linear Systems, Inc., Del Mar, Calif. Short form catalog lists the complete line of NLS instruments, accessories and standard systems including their basic specifications and prices. (321)

CERAMICS PROPERTY CHART American Lava Corp., Manufacturers Road, Chattanooga 5, Tenn. Chart No. 631 contains mechanical and electrical properties of AlSiMag ceramics. (322)

VIDEO VTVM Ballantine Laboratories, Inc., Boonton, N. J. Technical bulletin describes model 310B sensitive video electronic voltmeter. (323)

COAXIAL CABLE CONNECTORS Phelps Dodge Electronic Products Corp., 60 Dodge Ave., North Haven, Conn. A 24-page catalog deals with Wirelok and PDE connectors for the company's air dielectric, semi-flexible cables. (324)

WIRE CATALOG The Lewis Engineering Co., Naugatuck, Conn. A line of standard industrial thermocouple wire, thermocouple extension wires and typical multiconductor thermocouple cables is featured in a 10-page booklet. (325)

SWEEPING OSCILLATOR Kay Electric Co., Maple Ave., Pine Brook, N. J., has published a bulletin on the Multi-Sweep 121-A wide band sweeping oscillator. (326)

D-C MICROVOLT METER & AMPLIFIER Cohu Electronics, Inc., KinTel division, 5725 Kearny Villa Road, San Diego 12, Calif. Data sheet 3-12 contains applications and specifications of the 202B d-c microvoltmeter and amplifier. (327)

MEMORY TEST SYSTEMS Digital Equipment Corp., 146 Main St., Maynard, Mass., has available a 20-page report covering a line of memory test systems. (328)

INSTRUMENTATION & CONTROL CABLES Gulton Industries, Inc., 212 Durham Ave., Metuchen, N. J., offers bulletin A101 on radiation-, humidity-, and water-resistant instrumentation and control cables. (329)

POTENTIOMETER ENGINEERING REPORT Clarostat Mfg. Co., Inc., Dover, N. H. Actual test results on the series 62 ten-turn potentiometer are available. (330)

INSTANT GRAPHIC RECORDING Alden Electronic & Impulse Recording Co., Inc., Westboro, Mass., has published a news bulletin (Vol. VII, No. II) describing advances in instant graphic pulse presentation. (331)

REGULATED SUPPLIES Alpha Scientific Laboratories, Inc., P. O. Box 333, Berkeley 1, Calif. Catalog literature describes precision regulated power supplies for magnets and general purposes. (332)

PIEZOELECTRIC ACCELEROMETERS Statham Instruments, Inc., 12401 West Olympic Blvd., Los Angeles 64, Calif. High performance piezoelectric accelerometers and companion amplifiers are described in a 4-page brochure. (333)

PHONO SOCKETS Connector Corp., 6025 N. Keystone Ave., Chicago 46, Ill. Four-page data sheet 22A is devoted to a line of compact long life phono sockets. (334)

ELECTRONIC CONTROL MODULES Sectron, Inc., One Pingree St., Salem, Mass. A new concept in modular electronic circuits for control applications is presented in a booklet. (335)

SYSTEM CAPABILITIES Canoga Electronics Corp., 15330 Oxnard St., Van Nuys, Calif., offers a brochure on its systems capability in radar, telemetry trackers, digital data handling, antennas and pedestals, beacons and feeds. (336)

LIGHT BEAM OSCILLOGRAPHS Brush Instruments, Division of Clevite Corp., 37th and Perkins, Cleveland 14, O. Catalog sheet describes the series 2300 eight or 16 channel light beam oscillographs. (337)

ELECTROLYTIC CAPACITORS Cornell-Dubilier Electronics, Division Federal Pacific Electric Co., 50 Paris St., Newark 1, N. J. Two 17 in. by 22 in. wall charts have been compiled to aid circuit designers select electrolytic capacitors for commercial, industrial and military use. (338)

WAVE ANALYZER Hewlett-Packard Co., 1501 Page Mill Road, Palo Alto, Calif. Vol. 14, No. 5-6 of the *H-P Journal* includes an article on a versatile wave analyzer for the Kc to 1.5 Mc range. (339)

SIGNAL MONITOR Communication Electronics, Inc., 4900 Hampden Lane, Bethesda, Md. Two-page bulletin covers a signal monitor designed for use with communication receivers having an i-f frequency of 500 Kc. (340)

VSWR TEST SET PRD Electronics, Inc., 202 Tillary St., Brooklyn 1, N. Y. Catalog sheet covers an automatic broadband vswr test set. (341)

SOLAR SIMULATOR Tenney Engineering, Inc., 1090 Springfield Road, Union, N. J., has issued a bulletin on a model TIC-01 airborne time code generator. (342)

TIME CODE GENERATOR Correlated Data Systems Corp., 1007 Air Way, Glendale 1, Calif. Data sheet explains model TIM-01 airborne time code generator. (343)



The day when the designer selected his materials all by his lonesome is past—especially in electronics. Lots of engineers, from many departments, get into the electronics buying act with the design engineer today. Production engineers, for example, feel free to bare their fangs at any specified product they feel would snafu the production line. Procurement people growl for their freedom to respecify for the sake of better prices or delivery. Service engineers, once burned by a faulty component or subassembly, are twice shy and thrice loud about its inclusion in future equipment. And management's oxen are notoriously goreable. That's what makes electronics marketers turn gray. The advertiser today must

reach the design engineer *and* everyone else in electronics engineering. He can do so either through a passel of splinter publications, or through electronics.

Well, that's the price of progress.

electronics is the weekly, contemporary engineering publication of the modern electronics industry. It integrates the interests of 57,000 engineers in all phases and functions of electronics—the people who pass on your products before they are bought. In a field abounding with free publications, these 57,000 engineers pay up to \$6 a year to subscribe to electronics. They need electronics. You need them. Advertise in electronics.

electronics: *your basic buy for electronics advertising* | A MCGRAW-HILL PUBLICATION

830 West 42nd St., New York 36, N. Y.

Hazeltine Reassigns Executives



D. M. Stuart

HAZELTINE ELECTRONICS Division of Hazeltine Corp., Little Neck, N.Y., announces the reassignment of D. M. Stuart, vice president, to the Washington, D.C. office of the corporation.

In his new position, Stuart will coordinate the company's activities in civil aviation electronics. For the past four years, he has been vice president and general manager of the division's Technical Development Center in Indianapolis.



J. B. Winningham

The Electronics division also announces the election of J. B. Winningham to the post of vice president. He succeeds Stuart as general manager of the Technical Development Center.

Since joining Hazeltine in 1956, Winningham has served as program manager of several important development and production programs, and his most recent assignment has been as head of the customer liaison department.

Sylvania Expands in Santa Cruz

CONSTRUCTION will soon get underway for 70,000 square feet of electronic manufacturing facilities in Santa Cruz, Calif., for the western operation of Sylvania Electronic Systems, a division of Sylvania Electric Products Inc. The expansion will more than triple Sylvania-owned operating space in Santa Cruz, according to Gordon McClure, manager of the western operation's systems manufacturing plant there. Space will increase from the present 34,000 sq ft to approximately 104,000 sq ft, he said.

Completion of the added facilities is expected by July 1963. McClure said "Employment—now a little over 600—is expected to increase to about 700 by July."

Examples of the role which the Santa Cruz facility plays in national defense are: (1) Production of special-purpose direction-finding equipment, developed in Mountain View under a \$5 million U.S. Navy contract. (2) Production of electronic security systems to aid the U.S. Air Force's Atlas-Titan and Minuteman ICBM programs, under contracts totaling more than \$7 million.

General Technology Promotes Solow

SAMUEL SOLOW has been promoted to chief electronics engineer for

General Technology Corp., Torrance, Calif. As senior engineer for the past two years in the company's electronics engineering group, Solow has headed several frequency control equipment design and development programs.

Lockheed Sets Up New Division

LOCKHEED Missiles & Space Co., Sunnyvale, Calif., has announced formation of a new research and development division, to be headed by E. P. Wheaton, LMSC vice president and general manager.

The R&D division will consolidate several Lockheed groups: the former research and engineering group; certain advanced design groups that have been part of product divisions; personnel from company advanced planning staffs, and the Lockheed Research and Development Center in Huntsville, Ala.

It was also announced that Roy A. Smelt will succeed Wheaton in the space programs division.

Philco Elevates Oscar Simpson

THE BOARD of directors of Philco Corporation has elected Oscar T. Simpson a vice president. He is general manager of the company's WDL division in Palo Alto, Calif.

Simpson has been awarded a patent for a directional antenna system and has numerous applications filed for electrical apparatus, f-m radio, color television and microwave circuitry.

Rawlings Receives Air Force Award

VERNON R. RAWLINGS, vice president at Martin Company's Baltimore facility, has been honored by the Air Force for his "outstanding contribution to the deterrent strength and security of the United States and the Free World by insuring

Systems test engineers for airborne weapon systems

MISSILE SYSTEM TEST AND EVALUATION

Responsibilities: The planning, performance, and evaluation of data resulting from laboratory functional and environmental evaluation and testing of missile systems; the coordination and integration of systems tests with test programs on individual units of the missile system; the engineering solution of design problems arising from the evaluation effort.

Experience: One year or more in one or more of the following fields: System evaluation and test and environmental testing; system engineering involving missile or fire control systems; field engineering on missile or fire control systems; flight testing of missile or fire control systems; radar systems, particularly pulse doppler, electrical power and armament control subsystems, fuze systems, autopilot and control systems and target tracking systems; microwave components and circuit design.

Academic Background: A degree from an accredited university—B.S. in E.E., M.E. or Physics. U. S. citizenship required.

FIRE CONTROL SYSTEM TEST AND EVALUATION

Responsibilities: The planning, performance and evaluation of data resulting from laboratory functional evaluation and testing of complex advanced fire control systems; the engineering solution of design problems arising from the evaluation effort.

Experience: One year or more in one or more of the following fields: System evaluation and test; system engineering involving missile or fire control systems; field engineering on missile or fire control systems; flight testing of missile or fire control systems; radar systems, particularly pulse doppler; microwave components; circuit design; electrical power subsystems; target tracking systems; digital computers, particularly airborne systems; analog computers; inertial components; infrared detection and track systems; aircraft displays and controls; navigation systems.

Academic requirements: B.S. in M.E., E.E., or Physics degree from an accredited university. U. S. citizenship required.

*For immediate consideration,
please airmail your resume to:*

MR. ROBERT A. MARTIN
Head of Employment
Hughes Aerospace Divisions
11940 W. Jefferson Blvd.
Culver City 65, California

Creating a new world with electronics

HUGHES

HUGHES AIRCRAFT COMPANY
AEROSPACE DIVISIONS

An equal opportunity employer.

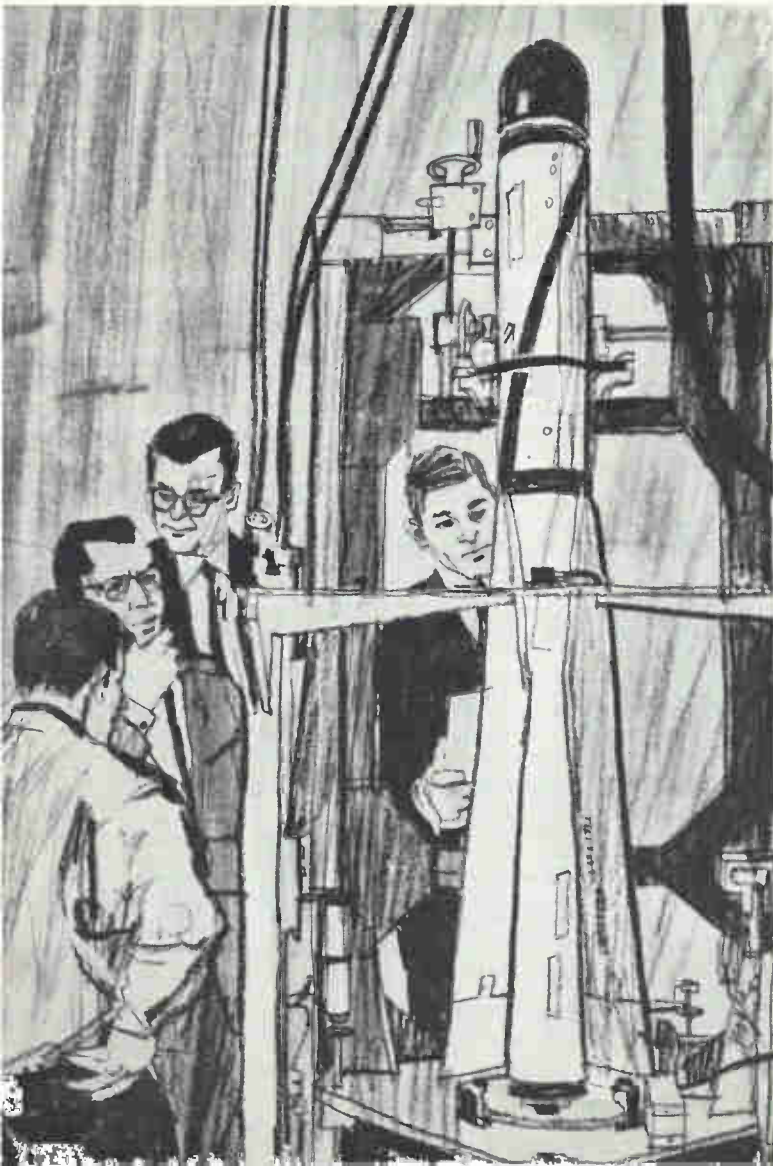

GRC tiny parts

die cast
ZINC ALLOY

molded
PLASTICS

Coil Bobbins
Gears & Pinions



GEAR & PINION GUIDE BOOK

Gives full specs for hundreds of stock combinations of small 1-pc. die cast zinc alloy gears integral with pinions, shafts, spacers, etc., . . . also combinations to specs.

GRC's exclusive techniques give you high quality in small parts of diecast zinc alloy, and engineering thermo-plastics at low cost! Write, for samples and literature. Send prints for quotation

No Minimum Size! Max: Zinc Alloy-2" long, 1/4 oz. Plastic-1 1/2" long, .05 oz.

See us at
the Design
Show—
Booth #624
& 626



GRIES REPRODUCER CORP.

World's Foremost Producers of Small Die Castings
151 Beechwood Ave. • New Rochelle, N. Y.
phone: (941) NEW Rochelle 3-8600

CIRCLE 205 ON READER SERVICE CARD

NIMS

NATIONWIDE IMPROVED
MAIL SERVICE PROGRAM

For Better Service
Your Post Office
Suggests

That You Mail Early
In The Day!

timely activation of the Titan I and Titan II weapon systems."

The award, given by General Bernard A. Schriever, commander of the Air Force Systems Command, is said to be the first conferred in defense contractor ranks.

Under Rawlings' direction, the five Titan I ICBM operational bases—in Colorado, South Dakota, Washington, Idaho and California—were completed and turned over to the Air Force, and the Titan II base program advanced to near-complete status at Arizona, Kansas and Arkansas.



Doorley Moves Up At Permali

PAUL A. DOORLEY has advanced from vice president and general manager to president of Permali, Inc., Mt. Pleasant, Pa. He succeeds A. S. Moseley, who has returned to England as a director of Permali, Ltd., in charge of foreign operations. Doorley will retain the title of general manager.

Permali is a manufacturer and fabricator of high voltage electrical insulating materials and components.



Ace Engineering Appoints Schaller

C. RANDALL SCHALLER has been appointed vice president in charge of

engineering at Ace Engineering & Machine Co., Huntingdon Valley, Pa. He was formerly chief engineer.

Ace Engineering manufactures shielded enclosures for radio frequency interference control. The company is also actively engaged in the design and construction of completely shielded buildings which are used mainly for military purposes.

Intertechnique Grants License to Packard

INTERTECHNIQUE S.A., Boulogne-Billancourt (France) announces conclusion of an agreement with Packard Instrument Co., Inc., La Grange, Ill., whereby Packard will manufacture under license, in the USA, Intertechnique's line of multichannel analyzers of 400, 1024 and 4096 channels.

First deliveries by Packard are expected this spring.



Electronic Crystals Promotes Angove

ROBERT B. ANGOVE has been promoted to the new post of vice president of production at Electronic Crystals Corp., Orlando, Fla., a subsidiary of Systems, Inc. He was formerly crystals production manager.

Electronic Crystals Corporation manufactures a line of quality quartz crystals from 800 Kc to 200 Mc for both military and commercial applications.

Ess Gee Elects Vice President

ALVIN J. HAMMOND has been elected vice president of operations of Ess



Are you a

COMPLETELY INFORMED

electronics engineer?

Today you may be working in microwaves. But on what project will you be working tomorrow? You *could* have read **electronics** this past year and kept abreast of, say, microwave technology. *There were 96 individual microwave articles between July, 1961 and June, 1962!*

But suppose tomorrow you work in some area of standard electronic components, in semiconductors, in systems? Would you be up-to-date in these technologies? Did you read the more than 3,000 editorial pages that **electronics'** 28-man editorial staff prepared last year?

electronics is edited to keep you current *wherever* you work in the industry, *whatever* your job function(s). If you do not have your own copy of **electronics**, subscribe today via the Reader Service Card in this issue. Only 7½ cents a copy at the 3 year rate.

electronics

 ★ 100% Financing! Lowest monthly cost! ★
 ★ **BRAND NEW** ★
 ★ **ONE STORY** ★
 ★ **PLANT** \$ **560** ★
 ★ built for you ★ **5** Sq. Ft. ★
 ★  ★
 ★ in the East's finest industrial location ★
 ★ **THE PHILADELPHIA INDUSTRIAL PARK** ★
 ★ 651 Acres surrounding the North Philadelphia ★
 ★ Airport. Suburban environment with all ★
 ★ metropolitan utilities, services, conveniences. ★
 ★ Developer: **TISHMAN INDUSTRIAL PARKS, INC.** ★
 ★ Exclusive Agent: ★
 ★ **BINSWANGER** ★
 ★ **CORPORATION • INDUSTRIAL LOCATION SPECIALISTS** ★
 ★ 1420 Walnut St., Phila. 2, Pa. • PEnnypacker 5-0202 ★
 ★ *****
 ★ **CIRCLE 206 ON READER SERVICE CARD** ★

Planning to change your address?

Use the form below to indicate a change of address. Because our issues are addressed in advance, please try to allow at least 5 weeks for change of address to become effective. Attach the address label from your most recent issue in the space provided below.

(Please print the following information for proper service)

Title or position.....

Name

Chief Job Responsibility.....

Distributor
 Manufacturer

Company and Div.....

Product or Service Approx. No. of Employees

Address

City Zone State or Prov.

Mail to home address below:

Address

City Zone State or Prov.

Mail to: Fulfillment Manager, **electronics**
 330 West 42nd Street, New York City 36, N. Y.

*Paste present mailing label or address
 from wrapper or envelope here.

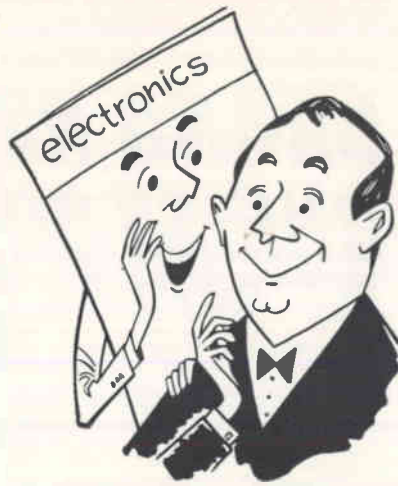

electronics IS EDITED TO KEEP YOU FULLY INFORMED — a “well-rounded” engineer

What's your *present* job in electronics? Do you work on computers? (**electronics** ran 158 articles on computers between July, 1961 and June, 1962!) Are you in semiconductors? (For the same period, **electronics** had 99 articles, not including transistors, solid-state physics, diodes, crystals, etc.) Are you in military electronics? (**electronics** had 179 articles, not including those on aircraft, missiles, radar, etc.)

In all, **electronics'** 28-man editorial staff provided more than 3,000 editorial pages to keep you abreast of all the technical developments in the industry. No matter where you work today or in which job function(s), **electronics** will keep you fully informed. Subscribe today via the Reader Service Card in this issue. Only 7½ cents a copy at the 3 year rate.

electronics

Gee, Inc., White Plains, N.Y.

Prior to joining the company in July 1960 as operations manager, Hammond had been associated with the Trumbull division of General Electric Co., the Philips Electronics Co., and General Precision Laboratory, Inc.

Ess Gee, Inc., designs, develops and fabricates electronics systems and equipment. Much of its business is from government contracts.

PEOPLE IN BRIEF

David Richardson, formerly with Melabs, named mgr. of research for Mitek Corp. Martin Co. promotes John P. Butterfield to exec director of technical operations at its Orlando div. Dan Goor, ex-GE, appointed mgr. of the new Advanced Component Operation at Laboratory For Electronics, Inc. Frank C. Dupre moves up to president of Kollsman Motor Corp. Vilar F. Kelly advances to mgr. of commercial development research on the corporate staff of IBM Corp. Ludwig Luft, formerly with Allied Research Associates, now director of research at Instrumentation Laboratory, Inc. Richard S. Frary, previously with RCA, appointed v-p and mgr. of the Service div. of Ultronic Systems Corp. Joseph Suarez, ex-California Technical Industries, named engineering mgr. of Genisco Systems, a div. of Genisco, Inc. John H. Baldwin leaves Honeywell Controls Ltd. to join Daystrom, Ltd., as president. Joseph Sacco, formerly with RCA Laboratories, becomes mgr. of ferrite mfg. and development at Burroughs' Electronic Instruments div. James J. Mullen, Jr., president of Moloney Electric Co., elected chairman of the board and chief exec officer. Ellis A. Johnson elevated to head of the Case Institute of Technology Systems Research Center. William O'Connor, previously with Southwestern Industrial Electronics Co., named director of mfg. at Hathaway Instruments, Inc. Robert E. Stoffels advances to senior supervisor-industrial systems for Automatic Electric Laboratories. Russel H. Kittel, from Paradyamics Inc. to Aero-Space Avionics, Inc., as v-p.

electronics

WEEKLY QUALIFICATION FORM FOR POSITIONS AVAILABLE

ATTENTION: ENGINEERS, SCIENTISTS, PHYSICISTS

This Qualification Form is designed to help you advance in the electronics industry. It is unique and compact. Designed with the assistance of professional personnel management, it isolates specific experience in electronics and deals only in essential background information.

The advertisers listed here are seeking professional experience. Fill in the Qualification Form below.

STRICTLY CONFIDENTIAL

Your Qualification form will be handled as "Strictly Confidential" by ELECTRONICS. Our processing system is such that your form will be forwarded within 24 hours to the proper executives in the companies you select. You will be contacted at your home by the interested companies.

WHAT TO DO

1. Review the positions in the advertisements.
2. Select those for which you qualify.
3. Notice the key numbers.
4. Circle the corresponding key number below the Qualification Form.
5. Fill out the form completely. Please print clearly.
6. Mail to: Classified Advertising Div., ELECTRONICS, Box 12, New York 36, N. Y. (No charge, of course).

COMPANY	SEE PAGE	KEY #
ARMOUR RESEARCH FOUNDATION Illinois Institute of Technology Chicago, Illinois	96	1
ATOMIC PERSONNEL INC. Philadelphia, Penna.	96	2
COLLINS RADIO CORP. Cedar Rapids, Iowa	104*	3
GENERAL DYNAMICS/ELECTRIC BOAT Groton, Conn.	146*	4
GENERAL DYNAMICS/ELECTRONICS A Div. of General Dynamics Corp. Rochester, New York	145*	5
GENERAL ELECTRIC COMPANY Apollo Support Department Daytona Beach, Florida	95	6
GYRODYNE COMPANY OF AMERICA INC. St. James, L. I., N. Y.	21	7
HONEYWELL St. Petersburg, Florida	82	8
LOCKHEED CALIFORNIA CO. A Div. of Lockheed Aircraft Corp. Burbank, California	135*	9
NORDEN Div. of United Aircraft Corp. Norwalk, Conn.	96	10
PAN AMERICAN WORLD AIRWAYS INC. Guided Missiles Range Div. Patrick AFB, Fla.	94	11
REPUBLIC AVIATION CORPORATION Farmingdale, L. I., N. Y.	97	12

* These advertisements appeared in the April 12 issue.

(cut here)

electronics WEEKLY QUALIFICATION FORM FOR POSITIONS AVAILABLE

(cut here)

(Please type or print clearly. Necessary for reproduction.)

Personal Background

NAME

HOME ADDRESS

CITYZONE.....STATE.....

HOME TELEPHONE

Education

PROFESSIONAL DEGREE(S)

MAJOR(S)

UNIVERSITY

DATE(S)

FIELDS OF EXPERIENCE (Please Check)

41963

- | | | |
|--|--|---------------------------------------|
| <input type="checkbox"/> Aerospace | <input type="checkbox"/> Fire Control | <input type="checkbox"/> Radar |
| <input type="checkbox"/> Antennas | <input type="checkbox"/> Human Factors | <input type="checkbox"/> Radio-TV |
| <input type="checkbox"/> ASW | <input type="checkbox"/> Infrared | <input type="checkbox"/> Simulators |
| <input type="checkbox"/> Circuits | <input type="checkbox"/> Instrumentation | <input type="checkbox"/> Solid State |
| <input type="checkbox"/> Communications | <input type="checkbox"/> Medicine | <input type="checkbox"/> Telemetry |
| <input type="checkbox"/> Components | <input type="checkbox"/> Microwave | <input type="checkbox"/> Transformers |
| <input type="checkbox"/> Computers | <input type="checkbox"/> Navigation | <input type="checkbox"/> Other |
| <input type="checkbox"/> ECM | <input type="checkbox"/> Operations Research | <input type="checkbox"/> |
| <input type="checkbox"/> Electron Tubes | <input type="checkbox"/> Optics | <input type="checkbox"/> |
| <input type="checkbox"/> Engineering Writing | <input type="checkbox"/> Packaging | <input type="checkbox"/> |

CATEGORY OF SPECIALIZATION

Please indicate number of months experience on proper lines.

	Technical Experience (Months)	Supervisory Experience (Months)
RESEARCH (pure, fundamental, basic)
RESEARCH (Applied)
SYSTEMS (New Concepts)
DEVELOPMENT (Model)	020 030 040	000 010 020
DESIGN (Product)	010 020 030	020 030 040
MANUFACTURING (Product)
FIELD (Service)	0:0.....
SALES (Proposals & Products)

CIRCLE KEY NUMBERS OF ABOVE COMPANIES' POSITIONS THAT INTEREST YOU

1 2 3 4 5 6 7 8 9 10 11 12 13 14 15 16 17 18 19 20 21 22 23 24 25

ENGINEERS • SCIENTISTS



CENTRAL CONTROL...CALLING DYNA-SOAR

A practical solution to the problem of communications with the X-20 pilot—during launch and on his orbital path over the Atlantic Missile Range—has already been outlined by the engineers and scientists of PAN AM's Guided Missiles Range Division at Cape Canaveral.

Already a special staff of Engineering Program Managers at GMRD is preparing master plans for range development—encompassing facilities and instrumentation systems for tracking, telemetry and communications support of the X-20 space glider program. Working closely with the Air Force and X-20 contractors, they are tailoring range specifications to match the demanding requirements of orbital rendezvous and docking techniques by a manned space glider.

As contractors for the development, engineering and operation of the Atlantic Missile Range for the Air Force, GMRD presents recommendations for new equipments, then writes the specifications for authorized new instrumentation and facilities, and monitors their development by industry, their installation and acceptance testing.

Staff expansion is under way at GMRD to meet the range technology needs of the next 15 years. You are invited to inquire about career opportunities for:

Systems Engineers—EE's, Physicists capable of assuming complete project responsibility for new range systems.

Instrumentation Planning Engineers—EE's, Physicists to be responsible for specific global range instrumentation concepts.

Advance Planning Engineers—EE's, Physicists to evaluate and project the state-of-the-art in all applications of range instrumentation.

Experience in one or more of these areas: Pulse radar, CW techniques, telemetry, infrared, data handling, communications, closed circuit TV, frequency analysis, command control, underwater sound, timing, shipboard instrumentation.

Why not write us today, describing your interests and qualifications in any of the areas above. Address Dr. Charles Carroll, Dept. 28D-3, Pan American World Airways, Inc., P.O. Box 4465, Patrick Air Force Base, Florida.



GUIDED MISSILES RANGE DIVISION

PATRICK AIR FORCE BASE, FLORIDA
AN EQUAL OPPORTUNITY EMPLOYER

PAN AM is now creating the range technology for launches of DYNA-SOAR, GEMINI, APOLLO, ADVANCED SATURN BOOSTERS



**GENERAL ELECTRIC TO SUPPORT NASA IN
FORMULATING DESIGNS AND EQUIPMENT
FOR CHECKOUT OF THE APOLLO SYSTEM**

The National Aeronautics and Space Administration has assigned to General Electric a major role in designing and developing integrated, automatic checkout and test equipment for the APOLLO program, in addition to supporting NASA in overall reliability of the entire system. High level specialists and systems people are being drawn from many components of the company to contribute to the design and development of computerized semi-automatic and automatic checkout systems. Additional highly qualified engineers and scientists are needed now.

Assignments are at HUNTSVILLE, CAPE CANAVERAL and DAYTONA BEACH

Engineering experience required in
SYSTEMS and SUB-SYSTEMS CHECKOUT and TEST PLANS, DESIGNS and OPERATIONS

Electrical ■ Electronics ■ Mechanical ■ Conversion and Guidance ■ Propulsion ■ Instrumentation and Communications ■ Telemetry ■ Pyrotechnic ■ Vehicle Systems ■ Systems Specifications and Designs ■ Digital Command Systems ■ PCM ■ Computers ■ Display ■ Analog and Digital Simulation ■ Test Simulation ■ Vibration Analysis ■ Space Mechanics ■ Operational Support Systems.

If you have experience in any of the listed areas, write us today (include salary requirements). Your inquiry will be held in strict confidence. Write to: Mr. P. W. Christos, Professional Placement, Section 69-T, Apollo Support Department, General Electric Co., Support Building, Daytona Beach, Florida.

APOLLO SUPPORT DEPARTMENT

GENERAL  ELECTRIC

An Equal Opportunity Employer

ULTRASONIC NONDESTRUCTIVE TESTING SPECIALISTS

The Armour Research Foundation is an independent research organization which conducts research in virtually all of the major scientific disciplines. At ARF, a staff of more than 800 engineers and scientists work on projects sponsored by government, industry and the Foundation itself.

The introduction of new materials and methods of fabrication has created interesting and challenging problems in non-destructive testing. Positions are available for Project Leaders who desire the opportunity of advancing ultrasonic techniques to meet its challenges.

Current Projects Include:

- ULTRASONIC IMAGE CONVERTER DEVELOPMENT
- STUDIES OF INTERMODULATION TECHNIQUES
- STUDIES OF LAMB AND RAYLEIGH WAVE TECHNIQUES
- SCHLIEREN OPTICAL STUDIES
- EXTENSION OF CONVENTIONAL NDT ULTRASONIC SPECTRUM INTO LOW 100 Mc/s REGION

Positions require qualified specialists with the technical, creative and leadership ability to initiate and lead projects from concept through development.

ARF's modern facilities, located at Technology Center with the Illinois Institute of Technology and the John Crerar Library, include UNIVAC 1105 and IBM 7090 computers and, in the Acoustics Section, the finest equipment for ultrasonic research. In combining the best features of academic and industrial research, ARF provides attractive salaries, tuition-free graduate study and liberal fringe benefits and vacation policy.

Write in confidence to Ron C. Seipp. Your inquiry will receive a prompt reply.



**ARMOUR
RESEARCH
FOUNDATION**
TECHNOLOGY CENTER
10 W. 35th St., Chicago 16, Ill.
An Equal Opportunity Employer

RELIABILITY ENGINEERS

Specific opportunities for R & D Reliability Engineers and Managers with the Quality Assurance Section at Norden. Applicants should have a degree or its equivalent and 3-10 years' experience applicable to the areas indicated below. Current expanding programs at Norden encompass computer techniques, display integration, radar and communications systems, special-purpose TV, IR, microelectronics, inertial systems for stabilization and navigation of aircraft and space vehicles, missiles, and marine vessels.

SYSTEM RELIABILITY

Reliability design review, analysis and test of systems and subsystems for approval of designs. Prediction and determination of MTBF and failure effects, including recommendation of design modifications. BS or MS in EE desirable.

COMPONENT RELIABILITY

Application, evaluation, test and selection of components for use on all systems. Authority to approve choice and applications of components on all systems. BS or MS in EE desirable.

ENVIRONMENTAL

Dynamicists, Climatic and Interference Specialists required for R & D reliability reviews, environmental evaluation and test, and qualification tests of systems, subsystems and components. BS or MS in EE or ME desirable.

Please forward your resume to:
Mr. James E. Fitzgerald, Employment Department, Norden, Helen Street, Norwalk, Connecticut.

Norden

**U
A**
DIVISION OF UNITED AIRCRAFT CORPORATION

An Equal Opportunity Employer

WANTED

Ingenious and Ambitious Engineers and Scientists

To form the technical nucleus of a new industrial applied research laboratory. Positions are available for Inorganic Chemists, Physical Chemists, Solid-State Physicists, Electrical Engineers. Opportunities and advantages are:

- 1) Freedom to initiate areas of investigation
- 2) Responsibility for technical programs
- 3) Top salaries for qualified people
- 4) Northern New Jersey location

CALL COLLECT
(201)—HU 5-2100, Ask for Dr. Kaufman



E. E.'s

for FEE-PAID Positions
WRITE US FIRST!

Use our confidential application for professional, individualized service . . . a complete national technical employment agency.
ATOMIC PERSONNEL, INC.
Suite 1207L, 1516 Walnut St., Phila. 2, Pa.

SEARCHLIGHT SECTION

(Classified Advertising)

BUSINESS OPPORTUNITIES
EQUIPMENT - USED or RESALE

DISPLAYED RATE

The advertising rate is \$27.25 per inch for all advertising appearing on other than a contract basis. Contract rates quoted on request. AN ADVERTISING INCH is measured 3/4 inch vertically on one column, 3 columns—30 inches—to a page. EQUIPMENT WANTED or FOR SALE ADVERTISEMENTS acceptable only in Displayed Style.

UNDISPLAYED RATE

\$2.70 a line, minimum 3 lines. To figure advance payment count 5 average words as a line.

PROPOSALS, \$2.70 a line an insertion.
BOX NUMBERS count as one line additional in undisplayed ads.

DISCOUNT OF 10% if full payment is made in advance for four consecutive insertions of undisplayed ads (not including proposals).

RADIO RESEARCH INSTRUMENT CO.

AUTO-TRACK & TELEMETRY ANTENNA PEDESTALS
3 & 10 CM. SCR. 984 AUTOTRACK RADARS
AN/TPS-10 SEARCH; AN/TPS-10 HT. FINDERS
AN/PPN-320CA, AN/APS-10 NAVIG. & WEATHER
AN/APS-15B PRECISION; AN/APQ-35B PRECISION
AN/APS-31A SEARCH; DOZENS MORE
5-12 MEGAWATT HIGH POWER PULSERS.

RADIO RESEARCH INSTRUMENT CO.
550 Fifth Ave., New York Judson 6-4651

RADAR SYSTEMS & COMPONENTS/ IMMEDIATE DELIVERY

CIRCLE 950 ON READER SERVICE CARD

LOOKING FOR USED/SURPLUS ELECTRONIC EQUIPMENT/COMPONENTS?

For an up-to-date listing of such equipment see Searchlight Section of April 12th issue.



ELECTRONICS ENGINEERS & SCIENTISTS:

JOIN US IN GIVING A NEW DIRECTION TO AEROSPACE TECHNOLOGY

SYNCHRONOUS-ALTITUDE METEOROLOGICAL SATELLITE (SMS) – Only One of the Many Space Studies at Republic's Paul Moore Research Center Requiring Advanced Electronics Research.

Republic is conducting broad systems studies for NASA to develop a satellite which will provide high-resolution day and night cloud cover data and IR measurements of the earth's heat budget. Positioning and maintaining the satellite in a 24-hour orbit and acquiring data with the required accuracy provide complex electronic problems to be resolved: high resolution imaging at the 22,240 mi. altitude, dynamic range demands on "night-and-day" sensors, filtering to prevent solar damage to photo sensitive surfaces, precise altitude stabilization controls, power supply, and ground station data links.

On this and other space programs...such as Space Station, Project Fire, Lunar Logistic System, and basic and applied research in many vital areas of space electronics...opportunities are available for capable engineers and scientists at all degree levels.

communications / controls / navigation & guidance / trajectory / power supplies / optics / IR / computers & data processing / radar and radar cross-section / antennas / telemetry / digital circuitry / microwave circuitry / inertial guidance / display components / detector circuitry / solid state components / sophisticated instrumentation concepts for hypervelocity testing (hypervelocity wind-tunnels, ballistic ranges and arc-jet tunnel) / experimental instrumentation (temperature, humidity, gas composition, pressure flow & data acquisition techniques).

Write in confidence to
Mr. George R. Hickman,
Professional Employment
Manager, Dept. 11D-4.
An Equal Opportunity Employer

REPUBLIC
AVIATION CORPORATION
FARMINGDALE, LONG ISLAND, NEW YORK

MOTIONLESS AT 6,872 MPH

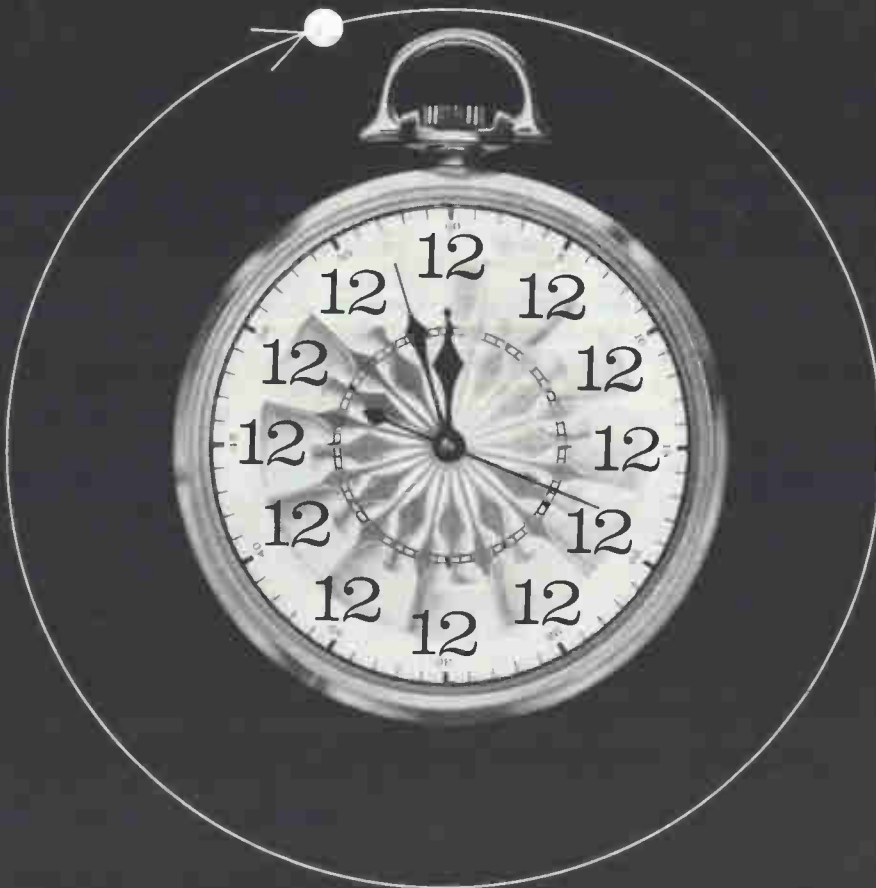

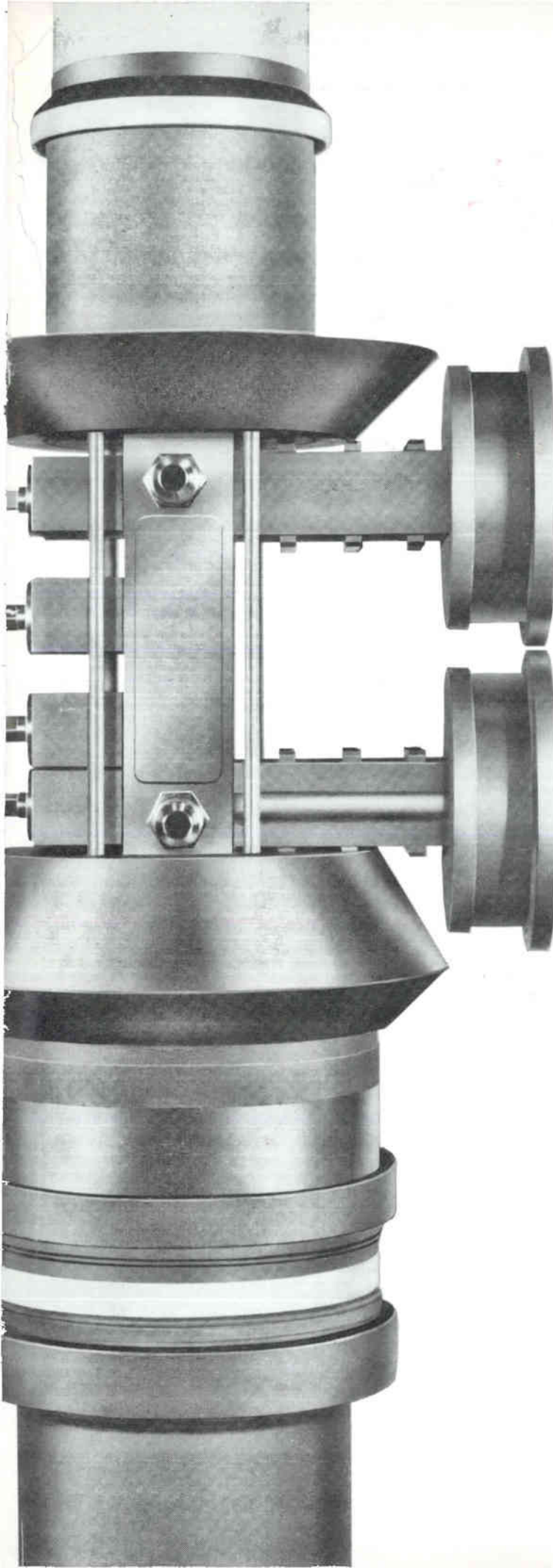

120-DAY DELIVERY
10 TO 50 KW, CW

AT ANY FREQUENCY
FROM 4.4 TO 11 GC

New Super Power Klystrons

SAC-406 SERIES—at any frequency between 4.4 and 6 Gc, 120-day delivery.

SAC-417 SERIES—at any frequency between 6 and 8 Gc, 120-day delivery.

SAX-418 SERIES—at any frequency between 8 and 11 Gc, 120-day delivery.

ALL AT FIXED PRICES

A free technical bulletin is available. Write Sperry, Gainesville, Florida, or contact your nearby Cain & Co. representative. In Europe, contact Sperry Europe Continental, Paris.



SPERRY RAND CORPORATION
GAINESVILLE, FLA. / GREAT NECK, N. Y.

CIRCLE 901 ON READER SERVICE CARD

FREQUENCY VS READOUT

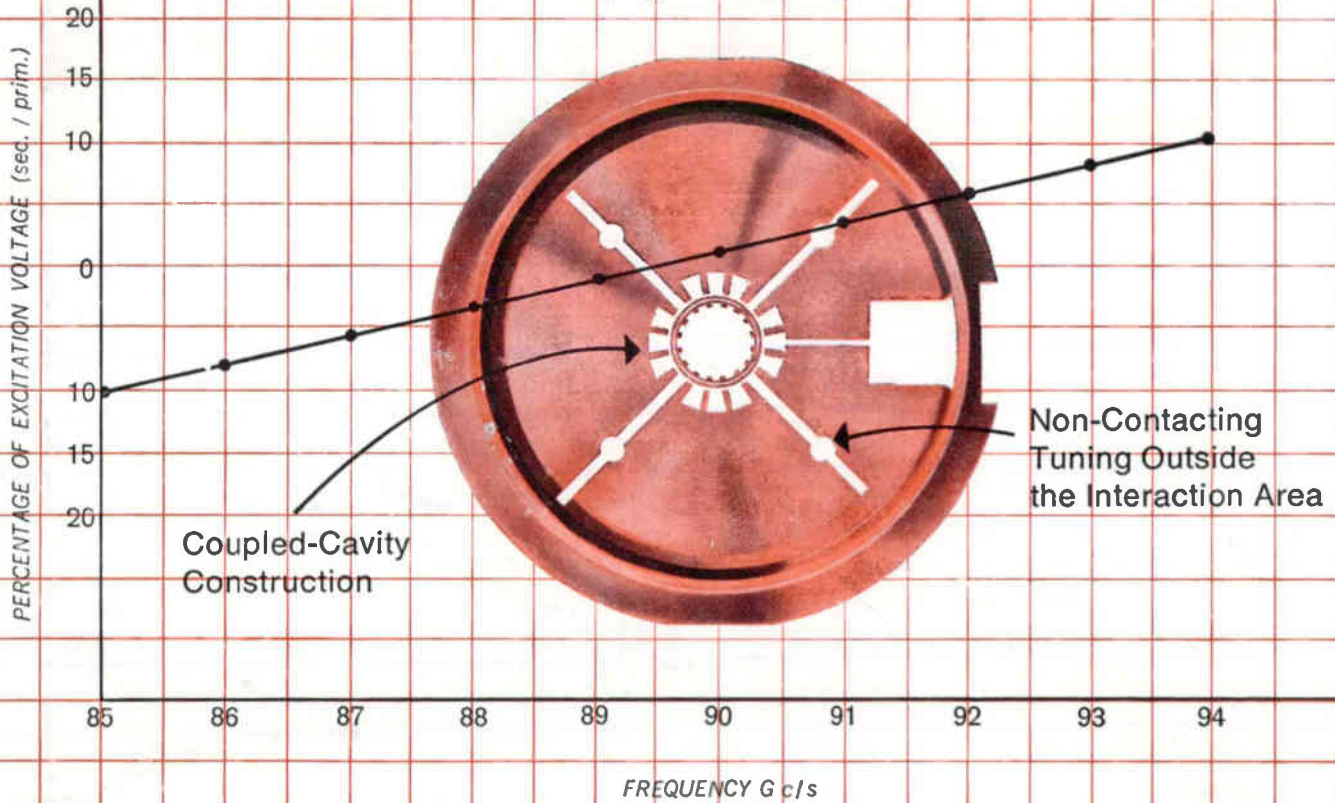

RCA-A1226 - First really stable Hydraulically-Tuned Magnetron Coupled-cavity design means high stability in X band

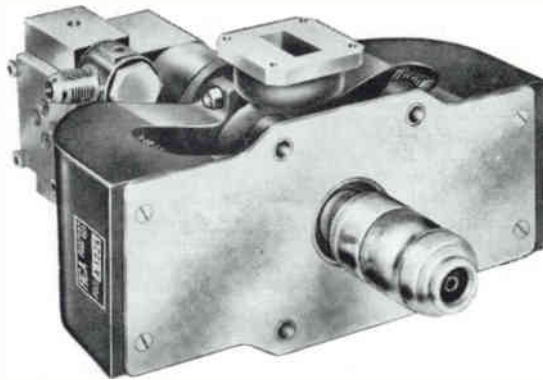

Outstanding performance stability in X band...that's RCA-A1226 Magnetron. Utilizing coupled-cavity construction—exclusive in RCA Magnetron design—RCA-A1226 features exceptionally stable performance characteristics.

RCA-A1226 is hydraulically tunable, with a tuning rate in excess of 100,000 Mc/sec. This rapid tuning is achieved by hydraulically operated, non-contacting plungers located outside the interaction area. High reliability and long life result.

In other respects, RCA-A1226 uses the field-proved electrical design parameters

of the RCA-7008 and RCA-7111 Magnetrons, and is electrically interchangeable with these two types.

Significant features of RCA-A1226 include: low thermal drift, essentially flat power-output characteristics, minimum frequency drift, and low inter- and intra-pulse frequency modulation.

RCA-A1226 is available for Government end-use applications. For information on this hydraulically-tunable magnetron, see your RCA Field Representative, or write: Manager, Microwave Marketing, RCA Electron Tube Div., Harrison, N. J.

Typical Operation of RCA-A1226

Peak Anode Voltage	22 Kv
Peak Anode Current	27.5 Amp
Rate of Voltage Rise	225 Kv/μsec
Peak Power Output	220 Kw
Pulse Width	0.1-2.5 μsec
Duty Cycle	0.001
Frequency Range	8500-9400 Mc
Stability (Missing Pulses)	0.01%
Pulling Figure	9 Mc

INDUSTRIAL TUBE PRODUCTS FIELD OFFICES—
 OEM SALES: Newark 2, N. J., 32-36 Green St., (201) 485-3900 • Chicago 54, Ill., Suite 1154, Merchandise Mart Plaza, (312) 527-2900 • Los Angeles 22, Calif., 6801 E. Washington Blvd., (213) RA 3-8361 • GOVERNMENT SALES: Harrison, N. J., 415 South Fifth St., (201) 485-3900 • Dayton 2, Ohio, 224 N. Wilkinson St., (513) BA 6-2366 • Washington 6, D. C., 1725 "K" St., N.W., (202) FE 7-8500 • INT'L. SALES: RCA International Div., Clark, N. J., (201) 382-1000



The Most Trusted Name in Electronics