

# electronics

A McGraw-Hill Publication 75 Cents

## DOPED-OXIDE THERMAL DEVICE

*generates high voltage in small volume, p 39*

*(photo below)*

## FIELD-EFFECT TRANSISTOR

*shows negative resistance, p 48*

## MAGNETIC ROD MEMORY

*large output and high speed, p 50*



C 10

ROLAND KISSLER  
BOX 956  
MOSES LAKE WASH



# SPECIAL CUSTOM BUILT AUDIO TRANSFORMERS & REACTORS

Exceptional quality and reliability is provided in all UTC designs. Over 30 years of engineering knowledge and experience backed by complete environmental testing and life testing facilities assure the highest standard in the industry. Full analysis and evaluation of materials are conducted in UTC's Material and Chemical Laboratories. Rigid quality control measures coordinated with exhaustive statistical findings and latest production procedures results in the industry's highest degree of reliability. Range covered in Audio Transformers is from 0.1 cycles to 400 MC . . . microwatts to 50 KW.

New designs for both military and commercial types custom built to YOUR specifications for transistor and tube applications.

## SOME TYPICAL AUDIO TRANSFORMERS

- |            |                 |
|------------|-----------------|
| BRIDGING   | METAL CASED     |
| CHOPPER    | MIXING          |
| DRIVER     | MODULATION      |
| HYBRID     | MOLDED          |
| INPUT      | OUTPUT          |
| INTERSTAGE | PRINTED CIRCUIT |
| MATCHING   |                 |

SPECIAL  
CUSTOM BUILT  
IRON CORE  
COMPONENTS  
FOR  
EVERY PHASE  
OF THE  
ELECTRONICS

- ART →
- POWER TRANSFORMERS
  - AUDIO TRANSFORMERS
  - REACTORS
  - PULSE TRANSFORMERS
  - ELECTRIC WAVE FILTERS
  - LUMPED CONSTANT DELAY LINES
  - HIGH Q COILS
  - MAGNETIC AMPLIFIERS
  - SATURABLE REACTORS
  - REFERENCE UNITS

Write for catalog  
of over  
1,000 STOCK ITEMS  
with  
UTC High Reliability  
IMMEDIATELY AVAILABLE  
from  
YOUR Local Distributor



## UNITED TRANSFORMER CORP.

150 VARICK STREET, NEW YORK 13, N. Y.

PACIFIC MFG. DIVISION: 3630 EASTHAM DRIVE, CULVER CITY, CALIF.  
EXPORT DIVISION: 13 EAST 40th STREET, NEW YORK 16, N. Y.      CABLES: "ARLAB"

# electronics

A McGraw-Hill Publication 75 Cents



W. W. MacDONALD, Editor

J. M. CARROLL, Managing Editor  
 SENIOR EDITORS: Samuel Weber, George W. Sideris. SENIOR ASSOCIATE EDITORS: William E. Bushor, Michael F. Wolff. ASSOCIATE EDITORS: Michael F. Tomaino, Sylvester P. Carter, William P. O'Brien, John F. Masan, Thomas Emma, Sy Vogel, Leslie Solomon, M. M. Perugini, George J. Flynn, Laurence D. Shergalis. ASSISTANT EDITORS: Nilo Lindgren, Stanley Froud, Stephen B. Gray, Roy J. Bruun, George V. Novotny, Leon H. Dulberger. REGIONAL EDITORS: Harold C. Hood (Pacific Coast, Los Angeles), Thomas Maguire (New England, Boston), Cletus M. Wiley (Midwest, Chicago). ART DIRECTOR: Harry Phillips; Howard R. Berry. PRODUCTION EDITOR: John C. Wright, Jr. EDITORIAL ASSISTANTS: Gloria J. Meurer, Bernice Duffy, Lorraine Rossi, Virginia T. Bastian, Lynn Emery, Laura W. Smith, Bette H. Snyder, Rosemary Abbruzzese, Judy Haskins. FOREIGN NEWS BUREAU: Director, John Wilhelm, Alyne Elias. London—John Shinn, Derek Barlow, Nicholas Landon. Bonn—Peter Forbath, James Morrison, Silke McQueen. Paris—Robert Farrell, Arthur Erikson. Milan—Gene DiRaimondo. Mexico City—Bruce Bendaw. Rio de Janeiro—Leslie Warren. Moscow—Stewart Ramsey. Tokyo—Richard Hallaron, Charles Cohen, John Yamaguchi.

JAMES GIRWOOD, Publisher

**CERAMIC THERMOELECTRIC** generator using mixed-valency oxides undergoes test at Army's Picatinny Arsenal. Generator puts out 100 v as electric furnace heats it to 2,400 F. *Army may use generator to convert waste heat of rocket exhaust to electricity.* See p 39 COVER

**MILITARY ELECTRONICS.** Here's a sampling of technical news that will be made at next week's IRE National Winter Convention on Military Electronics. *Ground radar that senses space ship attitude, multicolor display and electronic intelligence system are reported* 20

**MISSILE MISS-DISTANCE** Is Indicated by Photon Counter. Compact, low-power system gives three-dimensional monitoring of small, tactical missile accuracy. *Advanced models to evaluate anti-ICBM missiles are underway* 21

**OPTICAL CHARACTER READERS** Use Memories for Increased Versatility. Equipment now in production backs up data processing equipment used by businessmen to cut paperwork. *Even skewed and mutilated type and variable fonts won't throw off the newer systems* 26

**COUNTERMEASURES SIMULATOR** Trains B-52 Crews. Pre-programmed to duplicate hostile r-f functions, it is the first of a new series for SAC. *Punched cards duplicate any antenna pattern* 28

**100-MW AMPLIFIER** Uses Microwave "Flywheel." Circular cavity steps up pulse output from 10 Mw to 100 Mw. *This is first of a series of superpower systems for plasma and radar research* 31

**OXIDE THERMOELECTRIC GENERATOR** With High Voltage Output. One side of alumina ceramic plate is sprayed with platinum by a plasma torch. Doped nickel oxide goes on other side. *Generator withstands high temperature, has high voltage output. However its resistivity is higher than intermetallic generators.* R. D. Fenity 39

**BEAM-DEFLECTION TUBES** Make a Telemetry Diversity Combiner. Control signals from receiver agc outputs are applied to deflection electrodes. Circuit offers wide frequency response and a rapid combining rate. *This system would be especially useful in a spinning, tumbling space ship traveling at many times the speed of sound.* V. A. Ratner 42

**COMBINED OSCILLATOR-AMPLIFIERS** for Tone Transceivers. A single transistor circuit can generate an audio tone during transmission and selectively amplify it during reception. Circuit is transformed by slight change in impedance level of an R-C time constant. *Math developed applies also to oscillators, Q multipliers, notch filters and selective amplifiers.* R. C. Carter 44

Published weekly, with Electronics Buyers' Guide and Reference issue, as part of the subscription, by McGraw-Hill Publishing Company, Inc. Founder: James H. McGraw (1860-1948).

Indexed Annually in Buyers' Guide and Reference issue.

Title ® registered U.S. Patent Office; © Copyright 1962 by McGraw-Hill Publishing Co., Inc. All rights reserved, including the right to reproduce the contents of this publication, in whole or in part.

Executive, editorial, circulation and advertising offices McGraw-Hill Building, 330 West 42nd Street, New York 36, N. Y. Telephone Longacre 4-3000. Teletype TWX N.Y. 1-1636. Cable McGrawhill, N. Y. PRINTED IN ALBANY, N. Y.; second class postage paid at Albany, N. Y.

OFFICERS OF THE PUBLICATIONS DIVISION: Nelson L. Bond, President; Shelton Fisher, Wallace F. Traendly, Senior Vice Presidents; John R. Callahan, Vice President and Editorial Director; Joseph H. Allen, Vice President and Director of Advertising Sales; A. R. Venezian, Vice President and Circulation Coordinator; Daniel F. Crowley, Vice President and Controller.

OFFICERS OF THE CORPORATION: Donald C. McGraw, President; Hugh J. Kelly, Harry L. Waddell, Executive Vice Presidents; L. Keith Goodrich, Executive Vice President and Treasurer; John J. Cooke, Vice President and Secretary.

Subscriptions are solicited only from those actively engaged in the field of the publication. Position and company connection must be indicated on orders. Subscription rates: United States and Possessions, \$6.00 one year; \$9.00 two years; \$12.00 three years. Canada, \$10.00 one year. All other countries \$20.00 one year. Single Copies, United States and Possessions and Canada 75¢. Single copies all other countries \$1.50.

THE PUBLISHER, UPON WRITTEN REQUEST FROM ANY SUBSCRIBER TO OUR NEW YORK OFFICE, AGREES TO REFUND THAT PART OF THE SUBSCRIPTION PRICE APPLYING TO COPIES NOT YET MAILED.

Subscribers: Please address all correspondence, change of address notices, subscription orders or complaints to Fulfillment Manager, Electronics, at above address. Change of address notices should provide old as well as new address, including postal zone number if any. If possible, attach address label from recent issue. Allow one month for change to become effective.

Postmaster: Please send Form 3579 to Fulfillment Manager, Electronics, 330 West 42nd Street, New York 36, New York.

CONTENTS continued

FIELD-EFFECT TRANSISTOR as a Negative-Resistance Device. Voltage-controlled negative-resistance characteristic appears at gate of field-effect transistor when drain-gate distance exceeds channel width and drain is grounded with other electrodes negative. *This field-effect transistor is not unipolar.* T. Niimi and T. Hayashi 48

MAGNETIC-FILM RODS Provide High-Speed Memory. Three-dimensional memory organization reduces crosstalk. Element is used in destructive readout, word-organized memories with 1 to 5-Mc cycle rates. *Present design effort centers on a 128-word, 8-bit-per-word memory with a 5-Mc cycle rate.* D. A. Meier 50

REFERENCE SHEET: Calculating Potentiometer Errors. Presence of a finite impedance in wiper arm of a potentiometer makes output voltage differ from no-load value. *These nomographs help you to calculate errors due to loading, fixed contact resistance and equivalent noise resistance.* H. S. Zablocki 53

DEPARTMENTS

Crosstalk. *Bionics and Electronics* 3

Comment. *More on Electronic Versus Electronics* 4

Electronics Newsletter. *FAA Starts \$500 Million Air Traffic Control Improvements Program* 7

Washington Outlook. *Tax Credit for Communications Purchases. Space Detection Funds Increased* 12

Meetings Ahead. *Western Electronics Show and Convention* 32

Research and Development. *Ferrites Generate Millimeter Waves* 58

Components and Materials. *Specifying Transformers for Special Needs* 62

Production Techniques. *Production Methods for Welded Circuits* 66

New Products Design and Application. *A-C Voltage Standard* 72

Literature of the Week 77

Plants and People. *CMS Ready to Occupy New Facility* 78

Index to Advertisers 85



Audited Paid Circulation

# CROSSTALK

**BIONICS AND ELECTRONICS.** Next week we will publish the first of a series of articles on bionics, the study of functional units of life—or, more accurately, how living organisms function and why they function as they do. In some ways, this study is of direct interest to future developments in electronics. Other aspects are of tangential interest.

The intensive investigation of biological “machines” today stems from a need to improve existing manmade devices. Living creatures are highly efficient and are usually exquisitely designed and organized. Bionics pioneers feel that the operating principles of creatures may well be applied to nonliving systems.

In his first article, Assistant Editor Lindgren describes, for example, a prototype ground speed indicator based on the principles of a beetle’s visual system. Another development, seen in the photographs, is an electronic neuron network, as assembled to test theories of actual neuron behavior. Real neurons, basic building blocks of the brain, are not yet fully understood because they are so complex. These analogs, developed under an Air Force contract by T. E. Bray, of General Electric’s Syracuse Research Labs, grossly represent real neuron behavior. Interest in such devices is high because they can lead to development of artificial intelligence and, in turn, greater capabilities in such systems as computers and automatic control systems.

At first glance, the term *bionics* looks like a combination of biology and electronics. The actual origin is the Greek *bion*, meaning a life unit. Bionics embraces not only electronics, but mathematics, biophysics, biology, chemistry, medicine, applied physics and other fields. Unlike electronics, it has started as a melting pot of the sciences. Electronics (the word, by the way, was coined as a name for this magazine 33 years ago) in its early days was almost entirely concerned with what was known as the radio art. It has since broadened its scope until today it embraces virtually the entire range of applied physics and mathematics. Bionics will bring the life sciences more intimately into the fold.

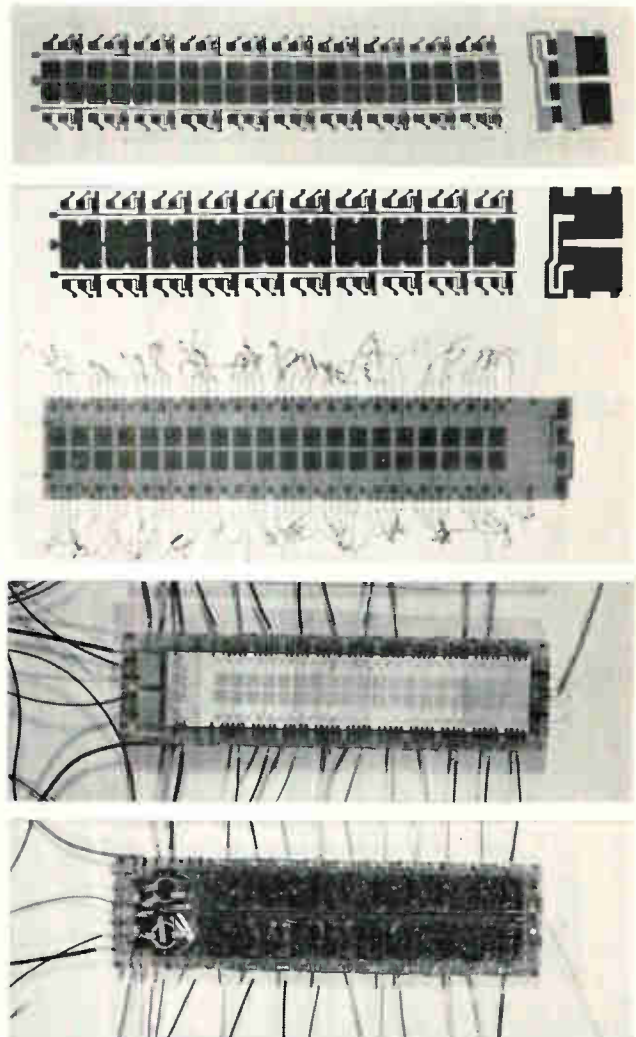

**SEMDECTRON.** This term was coined by Andrzej Ambroziak, of the Polish Academy of Sciences, to describe a solid-state version of a cold-cathode counting tube. Operating principles will be reported next week. The article, incidentally, is one of the few we have accepted from a Communist country in recent years. Not that we haven’t asked for more. We think engineering details on their aerospace equipment in particular would be instructive to Western engineers. But detailed information seems available only for innocuous developments.

**VERY NARROW**

10kc\*

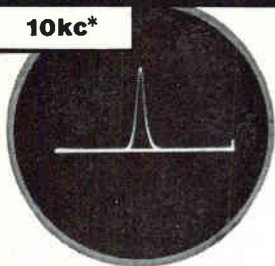

**TO VERY WIDE**

400mc\*\*

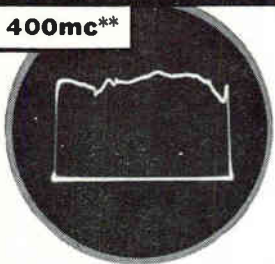

**SWEEP WIDTHS**  
...all in one instrument

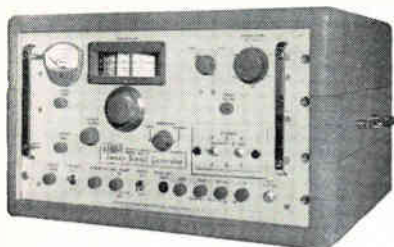

**NEW JERRALD® 900B**  
**SWEEP SIGNAL**  
**GENERATOR**

The new Jerrald 900B is the last word in versatility and precision, the ultimate instrument for all your IF, VHF, and UHF sweep requirements. Bench space requirements and test set-up time are drastically cut because so much is already built in:

- Built-in crystal-controlled harmonic markers at 1, 10, and 100mc intervals.
- Built-in variable-gain dc or ac-coupled 'scope preamplifier with 200X maximum gain.
- Built-in precision attenuator from zero to 50db in 10db steps.

Generating sweeps with center frequencies ranging from 500kc to 1200mc, the 900B offers unusual stability with sweep widths as narrow as 10kc and as wide as 400mc. Write for complete technical data.

**\$1,980.00** f.o.b. Philadelphia

\*Typical communication receiver IF (selectivity approx. 6 kc).

\*\*Frequency response of typical wide-band distributed amplifier (4-216 mc).

**JERRALD®** ELECTRONICS CORPORATION  
Industrial Products Division, Dept. IFE-127  
The Jerrald Building, Philadelphia 32, Pa.  
Jerrald Electronics (Canada) Ltd., Toronto  
Export Representative: Roche International, N.Y. 16, N.Y.

**COMMENT**

**Medical Electronics**

Your series on medical electronics is excellent.

When one profession broadens its outlook to include the field of another profession, it is to be commended. The growth of the electronics field has been remarkable, and it will continue to be so.

Each individual in each laboratory tends to be specialized in his outlook for the problem. Workers in a field talk one language and are lost in the foreign elements of their neighbors' medical lingo. Your series allows a quick panoramic view into the work of different individuals as they progress along the uncharted courses of research or the clinical, diagnostic and therapeutic application of recent breakthroughs in medical discovery. Herein lies the importance in the worthwhileness of your series of articles.

WILLIAM H. HOVER, M.D.  
Upper Montclair, New Jersey

The seven-part medical electronics series appeared on p 49, Jan. 20, 1961; p 46, Feb. 3; p 54, Feb. 24; p 43, June 23; p 63, July 21; p 65, Dec. 15; and p 47, Jan. 19, 1962. We will continue to keep abreast of new developments in this fast-moving field and report them from time to time.

**Electronic Versus Electronics**

When, in 1930, I first began my R&D and patent developments of musical instruments utilizing electrical methods for generating and controlling musical tones, I was in a quandry of the same kind queried by Mr. Rohrer in the issue of Jan. 12 (*Comment*, p 4). This year, as I remember, was the same year that **ELECTRONICS** made its appearance. I soon became convinced that mere reinforcement, by public-address system methods, of sounds already produced, as in guitars, organs, pianos or the like, or by pipe organs with electrically-operated actions, should be classed differently than those in which incidental sound took no part, and where indeed that sound, more often than not, required suppression where it, uncontrollable in harmonic content, only blanketed the electrically-generated

tones having such harmonic content control. Such tone generators as rotating, vibratory, vacuum-tube, etc., with either silent transducers or silent vacuum tubes providing the desired tones in electrical form, required differentiation from the purely acoustic types using a microphone, amplifier and loudspeaker.

The music trade papers constantly confused the two types, both in their news and the advertising content. My solution for this was to call the electrically-amplified acoustic instruments *electrical*, and the new types, *electronic*. This nomenclature gradually took hold in the music instrument industry and is almost uniform today, thirty years later. I say "almost uniform" because there are still a few manufacturers of such instruments as accordions and reed organs, with internal microphones and amplifier-speaker reproducers, who call their instruments *electronic*, where in fact electronics has nothing at all to do with tone *generation*, and only a little to do with control of tone quality.

BENJAMIN F. MIESSNER  
Miessner Inventions, Inc.  
Miami Shores, Florida

**Hitachi, Not Hibachi**

The company referred to in the second paragraph of the *Components and Materials* section of the Dec. 29 issue (p 58) is correctly spelled Hitachi.

*Hibachi* is the wastebasket-shaped utensil, now commonly made of ceramic, in which the Japanese place a few glowing embers for heating purposes. Not just anyone can be warmed by a hibachi: it takes practice, as the glow from the embers is not strong enough to warm the body, but only the soul. This need for practice, in which the young people of Japan today will not persevere, is one more reason that the hibachi is on its way out. Perhaps more important is that the price of charcoal has been steadily rising, the price of kerosene and gas heating appliances steadily decreasing.

Another English-language publication left off the H and wrote it Itachi. *Itachi*, the Japanese word for skunk, is an error in far worse taste.

CHARLES L. COHEN  
Tokyo, Japan

SAVE up to  
**40%**  
 in board space!.....

...with unique design that offers

**TRUE**   
**RADIAL LEAD**  
**CONFIGURATION**

**Plus Provision For**  
**Axial Lead Application**

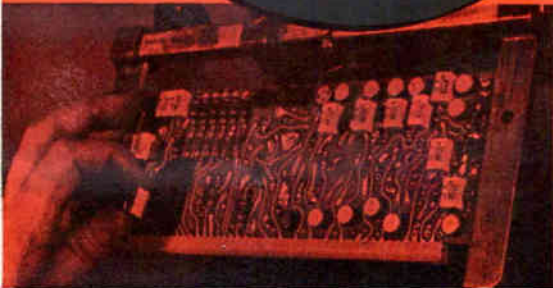
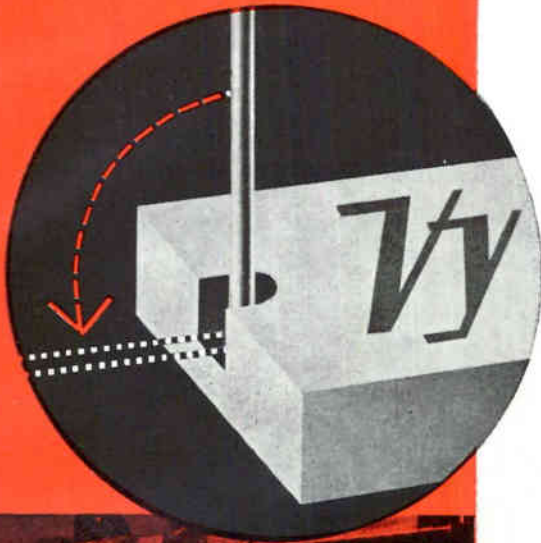

**VY** **Axial-Radial Capacitors**  
 vs. **Axial Lead Capacitors**

$\frac{1}{4}$ " multiplied by the number of capacitors used on your circuit boards is the amount of space you can save by substituting "VY" Axial-Radial Capacitors for the axial units you may now be using.\* Leads are *inboard* the body in radial configuration, yet may be moved to a *straight* axial position when required. Available in four sizes, 0.5 to 5600 mmf, 300 and 500 v ratings.

\*Assuming minimum allowance of  $\frac{1}{8}$ " for lead bend at each end of body for axial capacitors

**CONFORMS TO MIL-C-11272B**

**VY 12 Axial-Radial Capacitor**



Length  $\frac{3}{8}$ "  
 Board Space Required  $\frac{3}{8}$ "  
 (No allowance necessary for lead bend)

**VY 13 Axial Capacitor**



Length  $\frac{3}{8}$ "  
 Board Space Required  $\frac{5}{8}$ "

**Brand "X" Axial Capacitor**



Length  $\frac{11}{32}$ "  
 Board Space Required  $\frac{19}{32}$ "

© VITRAMON, INC., 1961

**Vitramon**<sup>®</sup>  
 INCORPORATED  
 P.O. Box 544 Bridgeport 1, Connecticut

# 2N2297 SILICON PLANAR EPITAXIAL

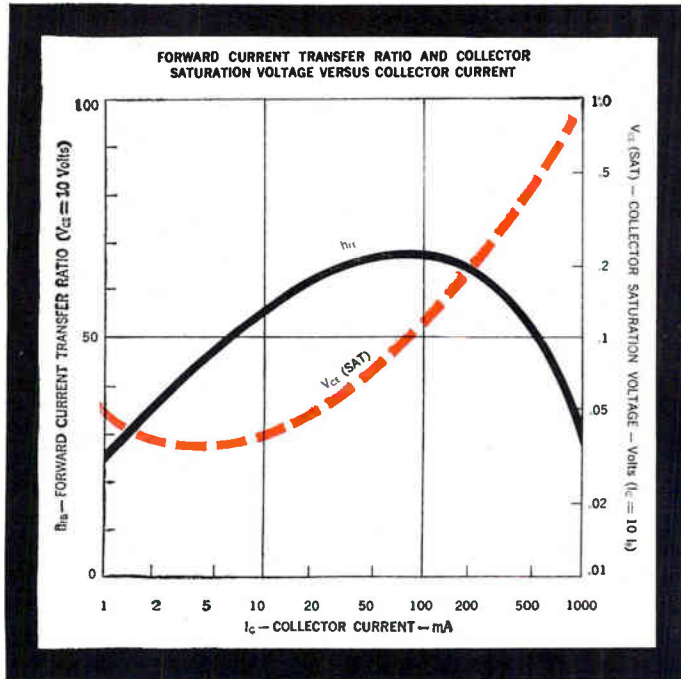

**1 VOLT  
MAX  
V<sub>CE</sub> (SAT)  
AT 1 AMP**

## ELECTRICAL CHARACTERISTICS & RATING AT 25°C UNLESS OTHERWISE NOTED

Storage Temp. —65 to +300°C  
 Operating Temp. 200°C Maximum  
 Power Dissipation 1 watt @ 25°C ambient temp.  
 5 watts @ 25°C case temp.

BV <sub>cbo</sub>	@ 0.1 mA	80 volts MIN
BV <sub>ebo</sub>	@ 0.1 mA	7 volts MIN
LV <sub>ceo</sub>	@ 30 mA	35 volts MIN
h <sub>FE</sub>	@ I <sub>c</sub> = 150mA	40 to 120
	V <sub>ce</sub> = 10 volts	
h <sub>FE</sub>	@ I <sub>c</sub> = 1.0A	15 MIN
	V <sub>ce</sub> = 10 volts	
V <sub>CE</sub> (SAT)	@ I <sub>c</sub> = 1 ampere	1 volt MAX
	I <sub>b</sub> = 0.1 ampere	
V <sub>CE</sub> (SAT)	@ I <sub>c</sub> = 150mA	.2 volts MAX
	I <sub>b</sub> = 15mA	
V <sub>BE</sub> (SAT)	@ I <sub>c</sub> = 1 ampere	2 volts MAX
	I <sub>b</sub> = 0.1 ampere	
C <sub>OB</sub>	@ V <sub>cb</sub> = 10 volts	12 pf MAX
Gain Bandwidth:		
	@ V <sub>ce</sub> = 10 volts	60 mc MIN
	I <sub>c</sub> = 50 mA	
	f = 20 mc	
I <sub>cbo</sub>	@ 60 volts & 25°C	10 nA MAX
	150°C	10 μA MAX

For more detail see data sheet. Available from distributors.

## TYPICAL APPLICATIONS

### MEMORY DRIVERS

T<sub>ON</sub> < 70 n sec  
 T<sub>OFF</sub> < 150 n sec  
 I<sub>c</sub> 1 AMP @ 50 V.

### RF AMPLIFIERS

P<sub>o</sub> 1.3 watts  
 @ 27 mc V<sub>cc</sub> = 12V

### CONVERTERS

**FAIRCHILD**  
**SEMICONDUCTOR**

545 WHISMAN ROAD, MOUNTAIN VIEW, CALIF. • YORKSHIRE 8-8161 • TWX: MN VW CAL 853  
 A DIVISION OF FAIRCHILD CAMERA AND INSTRUMENT CORPORATION



# ELECTRONICS NEWSLETTER

## FAA Awards First Project Beacon Contracts

WORK HAS BEGUN on the Federal Aviation Agency's five-year, \$500 million effort to develop a new air traffic control system. A presidential task force, Project Beacon, recommended late last year (ELECTRONICS, p 14, Nov. 17) that FAA work out a system using radar and altitude-reporting transponders to replace the present pilot reporting system.

FAA's design team is to submit by this summer a draft of a master plan for carrying out the task force's recommendation. A prototype is to begin operating 18 months later at FAA's experimental center in Atlantic City, N. J. A \$2.7 million contract to test and evaluate certain concepts of the system has just gone to the nonprofit Mitre Corp.

Contracts, totaling \$174,000 were awarded Hazeltine Corp. and Transco Products, Inc., for transponder development. They'll be called Slate (Small Lightweight Altitude Transmission Equipment). Hazeltine is to have a 10-lb airborne radar beacon ready in 10 months. Transco has a year to follow another approach expected to make a 5½-lb unit possible.

Transponders are to report altitude in 500-ft increments from 1,000 ft below sea level to 15,000 ft and have a range of 50 to 100 miles. They'll be used in planes weighing less than 12,500 lb. Longer-range equipment will be developed for airliners.

## Magnetic Field Increases Diode Forward Resistance

LARGE INCREASES in forward resistance of indium-antimonide diodes at liquid nitrogen temperatures have been produced by changes of about five gauss in transverse magnetic fields. Reported by I. Melngailis, of MIT Lincoln Lab at the American Physical Society meeting in New York last week, magneto diodes are expected to be useful as four-terminal switches and amplifiers.

H. Riemersma, of Westinghouse Electric, reported achieving a field of 68 kilogauss with a variable composition superconducting solenoid. Designed for 80-Kg field intensity, it has six concentric sections wound

with niobium-zirconium wire. It has 25 percent zirconium on the outside and 50 percent on the inside.

Westinghouse scientists also reported they are researching thin films for magnets. Theoretically, critical current density would be increased by a factor of 10' over wire-wound magnets, permitting thinner windings or possibly higher magnetic fields.

## Discrimination Radar for Nike Zeus Being Built

ARMY DISCLOSED at a press conference in Los Angeles that the first installation of the Nike Zeus discrimination radar is being made now at White Sands, N. M.

Gen. August Schomburg expressed Army confidence in the ability of this controversial link of the anti-ICBM system to perform its function. He told a somewhat skeptical press group that "no contest exists between Nike Zeus and the USAF's Atlas."

Sperry Gyroscope is building the

radar. After brief testing of the initial equipment, it is expected a similar system will be installed on Kwajalein (ELECTRONICS, p 12, Jan. 12).

Schomburg said actual atmospheric testing of Nike Zeus's warhead won't be needed to prove its detonation capabilities.

(A Washington report said work on a discrimination radar at Kwajalein is well advanced and that it would be used during the firing of Atlas nose cones from California.)

## FAA Buying \$114 Million Airport Electronic Gear

FAA ANNOUNCED last week what air traffic control and navigation equipment it will buy with the \$114 million Congress appropriated for fiscal 1962, which ends June 30. Here are major items:

Two long-range radars, \$2.7 million each, for airports at Garden City, Kansas, and San Juan, Puerto Rico; three airport surveillance radars, \$307,400 each; improvements in 16 existing long-range radars, \$129,500 each.

Also, 50 vortac stations, \$392,000 each; 15 radar beacon systems, \$238,600 each; an air route traffic control center at San Juan, \$2.1 million; equipment for seven new air traffic control towers, \$160,000 each; 21 terminal vor stations, \$115,900 each; 90 direction finders, \$27,800 each.

Instrument landing systems at 18

## Information Technology Rivals Farmer's Almanac

CROP FORECASTING, timber inventories, detecting timber diseases, surveying traffic and slums, measuring mountain snows to estimate water reserves—these are some of the fields opening up to information technology by peaceful applications of military aerial reconnaissance techniques and electronic interpretation of photographic data.

Some of these applications are underway in California. Fast and accurate forecasts of grape crop size and quality, for example, permits pacing deliveries to vintners for market and price stability.

The state is working with Itek Laboratories' Palo Alto division. Techniques are like those for detecting underground nuclear blasts in ARPA's Project Vela. Multicamera reconnaissance and electronic data reduction measure changes in the earth's surface color and brightness near the test site

airports, \$163700 each; directional localizers for 12 instrument landing systems, \$163,700 each; 40 visual glide slope lighting systems, \$51,100 each; high intensity approach lights, 45 airports at \$183,400 each. Costs given are estimated averages.

## Addresses—Literally— Operate This Computer

BRITISH Addressograph-Multigraph Co. has developed an addressing machine that used coded address plates as the input for a digital computer. It was designed to process stock dividend checks.

For each shareholder there's a plate on which his share holding is coded in binary form and his name and address are embossed.

As the plates feed into the machine, photoelectric cells detect the share holding. The computer figures gross and net dividends less taxes. Out comes addressed checks at a rate of 100 dividends a minute.

## Air Force Wants Flyable Airport Traffic Controls

AIR FORCE has scheduled for operational use in 1963 an air-transportable, all-weather, emergency air traffic control system. They'll be designed for fast movement to sites without ground-to-air facilities, will be compatible with FAA systems.

Equipment will include search and precision approach radar, communications, Tacan, visual and instrument flight rules towers. Proposals, due Feb. 22, have been invited from 77 companies. A new office—482L—has been set up by the Electronic Systems Division, Hanscom Field, Mass., to manage the program.

## Space Vehicles Will be Tracked with Transponders

HIGH-ACCURACY range and range rate measuring system for spacecraft will be developed for NASA by Motorola. The goal, according to NASA, is a system that can tell the position of a vehicle in near space within a few feet and its velocity within fractions of a foot per

second. This can be done by placing single stations around the world under the expected orbit and by using three stations in a specific region for triangulation. Stations will be in vans so they can be transported by air to accommodate different orbits.

NASA indicated that carrier and side-tone modulation measurement techniques would be used. Motorola added later that transponders would be carried in the space vehicles.

## Oxygen Sensor Provides Its Own Power Supply

FUEL CELL principles are used by General Electric in an experimental oxygen sensor that is its own power supply. It consists of an ion-exchange membrane between two catalytic-platinum electrodes. Hydrogen is supplied to one side and, depending on the amount of oxygen on the other side, oxygen level is read in milliamperes.

GE says an operational instrument, complete with hydrogen supply, for monitoring oxygen levels in spacecraft would weigh about seven ounces. By using oxygen instead of hydrogen as a gas supply, it would become a hydrogen sensor. The sensor could also be used in mines and submarines, GE believes.

## Magnetometer to Forecast Solar Proton Showers

ZEEMAN EFFECT magnetometer is under construction at Air Force's Sacramento Peak Observatory in New Mexico to help predict periods of solar proton showers, perhaps the biggest hazard a space traveler will face. Solar proton radiation is intermittent, cannot easily be predicted over long periods. The observatory, operated by AFCRL, will try to extend the forecast period.

All proton showers so far recorded originated in sunspot groups of 100,000 to 200,000 Km diameter. A sunspot center with a complicated magnetic field averages five times as many flares as a center with a simple dipolar or unipolar field. The magnetometer under construction will permit complete mapping of the longitudinal magnetic field of an active center.

## In Brief...

A-M STEREO broadcasting proposals will be studied by EIA's engineering department in New York City.

HOFFMAN ELECTRONICS has packed a 33 $\frac{1}{3}$ -45 rpm stereo phonograph, a-m and shortwave radio into a portable the size of a cigar box. It lists at \$79.95.

IBM HAS INTRODUCED another large-scale, solid-state scientific computer, the 7094, an expanded 7090. It costs \$3,134,500.

MARTIN MARIETTA has a \$500,000 feasibility study contract for a new Army antitank guided missile called Tow. Hughes and McDonnell Aircraft have similar contracts. Hughes has a follow-on contract of \$750,000 for continued development of guidance for Mauler air defense missile.

QUANTATRON has a Navy contract to apply advanced laser technology to missile guidance problems.

SPERRY GYRO has a \$15 million Navy contract for navigation equipment for the 20th to 29th Polaris submarines. A \$6 million-plus Navy contract to Magnavox covers classified systems including APQ 94 airborne radar systems.

OTHER MAJOR military contracts include \$4 million to Budd Electronics for conversion of 86 Air Force AN/FPS-18 radar to AN/FPS-74; \$1.2 million to Astronautics Corp. of America for jet aircraft horizon situation indicators; \$1 million to Helder Electronics for AN/TRC-24 Army radio set components; \$1 million to National Company for communications equipment and development of a pocket-sized transceiver.

ISOTOPES Development Center has been set up at AEC's Oak Ridge National Laboratory to spur government and private R&D in radioisotope technology.

RCA ANNOUNCES a video recorder with tape speed of 7.5 and 15 ips, said to reduce tape costs. Recorded tracks are five mils wide instead of 10 mils.

TODAY'S  
 MOST RELIABLE  
 SOLID TANTALUM  
 CAPACITORS



**HYREL<sup>®</sup> ST Capacitors, developed and qualified  
 for use in the Minuteman Missile, are  
 NOW available to you in ALL RATINGS!**

- Quality *100 times greater* than that of former high-reliability components! That's the ultra-high-reliability now demanded of electronic parts in the Minuteman missile's intricate guidance and control system.

- An unmatched test history of over 117 million unit-hours backs up the design of HYREL ST Capacitors to withstand the rigorous performance requirements specified for Minuteman components.

- The pioneer in solid tantalum capacitors, Sprague is one of 12 nationally-known manufacturers chosen to participate in the

Air Force's Minuteman Component Development Program of Autonetics, a division of North American Aviation, Inc.

- All of the special processes and quality control procedures that make HYREL ST Capacitors the most reliable in the world can now help you in your military electronic circuitry. A tantalum capacitor engineer will be glad to discuss the application of these capacitors to your missile and space projects. Write to Mr. C. G. Killen, Vice-president, Industrial and Military Sales, Sprague Electric Company, 35 Marshall St., North Adams, Mass.

**SPRAGUE COMPONENTS**

CAPACITORS

RESISTORS

MAGNETIC COMPONENTS

TRANSISTORS

INTERFERENCE FILTERS

PULSE TRANSFORMERS

PIEZOELECTRIC CERAMICS

PULSE-FORMING NETWORKS

HIGH TEMPERATURE MAGNET WIRE

CERAMIC-BASE PRINTED NETWORKS

PACKAGED COMPONENT ASSEMBLIES

FUNCTIONAL DIGITAL CIRCUITS



**SPRAGUE<sup>®</sup>**

THE MARK OF RELIABILITY









"Sprague" and "®" are registered trademarks of the Sprague Electric Co.







# One of these specialized meters is designed for your measuring job

Each of these Hewlett-Packard instruments has its own special usefulness for you. But all of them offer the extra values you expect in an  instrument: Realistic specs which every instrument meets, now and next year. Conservatively designed circuitry that will perform for years, without being overworked. Careful amplifier design featuring high feedback that assures constant performance as tubes age. Cleanliness and ruggedness in design and assembly — packaging that makes routine maintenance simple.

In short, you get  quality and accuracy and the best test instrument value in America today. Now, to the specs below. Choose the instrument designed for your present job and call your  rep for a demonstration.





**COMPLETE COVERAGE,  
UNIQUE VALUE,  
TRUSTED  ACCURACY  
AND DEPENDABILITY**

Instrument	Primary Uses and Features	Frequency Range	Voltage or Current Range	Input Impedance	Price	Instrument	Primary Uses and Features	Frequency Range	Voltage or Current Range	Input Impedance	Price
  403A	Solid state ac voltmeter, battery-operated, portable. Fast, accurate, hum-free ac measurements.	1 cps to 1 MC	0.001 to 300 v 12 ranges	2 megohms 40 pf shunt, low ranges; 20 pf, mid ranges; 15 pf, high ranges	\$275.00	  412A*	Precision VTVM. 1% accuracy; measures voltage, current, resistance; no zero set needed; 1 ohm to 100 megohm center scale for resistance meas., 60 db dc amplifier.	dc	1 mv to 1,000 v 1 $\mu$ a to 1 amp	10 to 200 megohms, depending on range	\$400.00
  400D	Wide range ac voltmeter. High sensitivity, 2% accuracy.	10 cps to 4 MC	0.001 to 300 v 12 ranges	10 megohms 15 pf shunt, high ranges; 25 pf, low ranges	\$250.00	  413A*	DC null meter, dc voltmeter, 60 db dc amplifier. 2% accuracy, floating input, 1 mv end scale sensitivity.	dc	1 mv to 1,000 v 13 ranges	10 to 200 megohms, depending on range	\$350.00

	Similar to 400D, 1% accuracy on extra-large 5" mirror-scale meter.	10 cps to 4 MC	0.001 to 300 v 12 ranges	10 megohms 15 pf shunt, high ranges; 25 pf, low ranges	\$325.00		Automatic digital VM. "Touch and read", direct dc voltage measurements, digital readout. Automatic range, polarity; readout available for printer, system.	dc	0.001 v to 1,000 v (accuracy $\pm 0.2\%$ of reading $\pm 1$ count)	11 megohms	\$850.00
	Logarithmic 400D. Accuracy $\pm 2\%$ constant percentage of reading. For log voltages, linear db measurements.	10 cps to 4 MC	0.001 to 300 v 12 ranges	10 megohms 15 pf shunt, high ranges; 25 pf, low ranges	\$325.00		Microvolt-ammeter reads $\mu\text{v}$ , $\mu\text{a}$ ; 100 db amplifier; measures dc voltages, current as in medical, biological, physical, chemical work.	dc	10 $\mu\text{v}$ to 1 v 11 ranges; 10 $\mu\text{a}$ to 3 ma, 18 ranges	1 megohm $\pm 3\%$ (v) 1 megohm to 0.33 ohms (current)	\$500.00
	VTVM for audio, rf, VHF measurements; dc voltages, resistances. Minimizes circuit loading, low drift, one zero set all ranges.	dc; ac, 20 cps to 700 MC	dc, 1.0 to 1,000 v, 7 ranges; ac, 1.0 to 300 v, 6 ranges	dc, 122 megohms; ac, 10 megohms/ 1.5 pf shunt	\$245.00		Clip-on dc milliammeter, eliminates direct connection, no circuit loading. Measures dc in presence of ac.	dc	3 ma to 1 amp 6 ranges		\$500.00
							Similar to 428A, wider range, recorder output for dc to 400 cps.	dc on meter, dc to 400 cps on recorder	1 ma to 10 amps 9 ranges		\$550.00

## \* LAB STANDARD ACCURACY IN COMMERCIAL VOLTMETERS!

New individual calibration of meter scales gives you today's highest available accuracy in commercial voltmeters. With a servo system, each voltmeter scale is calibrated to the exact characteristics of its individual meter movement. No preprinted approximate scales are used. Scale tracking error is eliminated. What the voltage actually is —you read!

Individually calibrated meter scales are now furnished—at no increase in cost—on these  instruments:  400H Vacuum Tube Voltmeter,  412A DC Voltmeter-Ohmmeter-Ammeter,  413A DC Null Meter,  425A DC Microvolt-Ammeter.

Data subject to change without notice. Prices f.o.b. factory.

# HEWLETT PACKARD COMPANY



1501 Page Mill Road, Palo Alto, California. Area Code 415, DA 6-7000. Sales and service representatives in all principal United States areas; Europe, Hewlett-Packard S.A., Rue du Vieux Billard No. 1, Geneva; Canada, Hewlett-Packard (Canada) Ltd., 8270 Mayrand Street, Montreal.

# WASHINGTON OUTLOOK

**PURCHASES OF ELECTRONIC** equipment by regulated communications utilities such as Western Union, the Bell System and independent telephone companies may be stimulated by a proposed four percent tax credit on investment in equipment.

## TAX CREDIT FOR UTILITIES?

The tax credit plan has received a tentative nod from the House Ways and Means Committee. But help may be a long way off. The committee has a long history of reversing itself on tentative votes made in closed sessions. And besides, any tax bill is subject to many changes before it finally becomes law.

Here's some background: last fall the committee adopted a draft tax revision bill built around an eight-percent investment credit for business. It was designed to stimulate modernization of equipment, but left out utilities.

Now the committee is amending its draft and the utilities are cut in for a four percent credit. It means that utilities would be entitled to reduce their final tax bill for any year by four percent of what they spend on new equipment.

## SPACE DETECTION MONEY

**THE PENTAGON** is less than candid in releasing budget figures about its planned electronics spending. And that's a gross understatement. For example: Defense Secretary McNamara allows as how increased funds have been set aside for the Space Detection and Tracking System (Spadats). He says next year's sum will exceed the "substantial funds" allocated last year.

The additional money will be spent on development of improved radar, other sensing devices, computers and operation of the system's two parts: the Navy's Space Surveillance System (Spasur) and the Air Force's Space-Track System.

## NAVY'S BUDGET

**ALSO IN THE "GUESSING GAME"** category are the figures on Navy's electronics procurement program. That is, electronics buying not related to other weapons systems such as aircraft or missiles. There will be an increase of about nine percent over this year's level of contracting and 19 percent over last year's.

The Marine Corps will buy increased quantities of the AN/PRC-38 tactical radio. This will be initial procurement of the newly developed item. But according to Secretary McNamara it will fulfill "a substantial part of the objective."

## ARMY'S BUDGET

**ARMY GETS \$296 MILLION** for new electronics equipment procurement not associated with other weapons systems. This is slightly under Army's present rate of electronics buying.

Largest item, nearly \$30 million, is for the new AN/VRC-12, a rugged and easily serviced vehicular radio set. Another important item is the AN/PRC-25, a man-portable radio to provide field communications for company-sized units. The budget earmarks \$13 million for this item.

## FLOATING COMMAND POSTS

**AT LEAST TWO MORE** floating command posts may provide additional high-command backup in case the Pentagon is wiped out in a nuclear attack. The Defense Department wants funds from Congress to convert at least two mothballed light carriers into command and control ships. They would be equipped for constant radio communications between joint command headquarters and strategic retaliatory, air defense and tactical warfare commands in the fields.

There are already at least two alternate high command posts. One is the mountain hideout along the Maryland-Pennsylvania border, the other is aboard the Navy's cruiser-command ship *USS Northampton*.

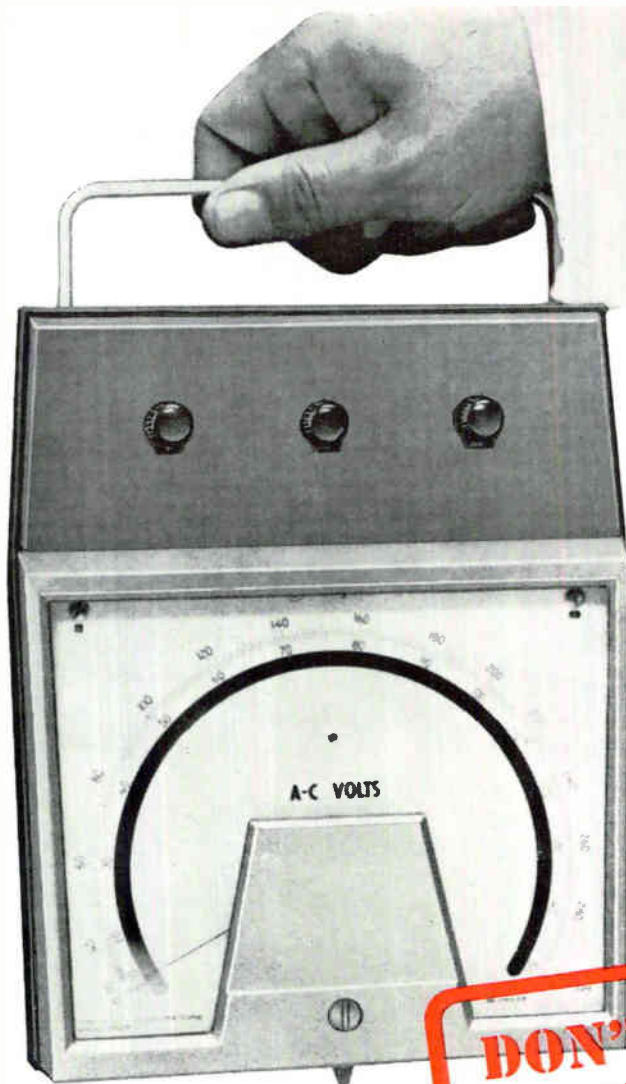

Type 161 TBS Portable Instrument—  
11.2-inch scale

**DON'T HANDLE  
WITH CARE**

**New, rugged Westinghouse portable instruments give long-term accuracy never before possible**

There's no need to treat them gently. These new Westinghouse portable instruments have neither pivots nor jewels. There is no friction in the movement—no wear—nothing to get out of adjustment. The secret is a unique development—Westinghouse Taut Band Suspension. The moving element is suspended between strong metal bands under high tension. These bands carry the current to the coil and provide torsion against rotation.

In the Westinghouse instrument laboratory, this rugged instrument movement has withstood over 200 shock tests of 2400 G's and retained accuracy within 1/2%. After 24 million full-scale deflections, repeatability remained within 1/20 of 1%. By contrast, pivot and jewel instruments, after only one million deflections, will have so much

friction their accuracy will be questionable. Conclusion: Westinghouse *the*\* portable instruments are the toughest precision portables ever made. Maintenance, recalibration and other adjustments are practically eliminated.

Westinghouse TBS portable instruments are available as a-c or d-c ammeters or voltmeters, with single or multi-range scales for practically any precision applications. Full-scale deflection as low as 1 microampere is available. Shatterproof glass window, high impact molded case and insulated retractable handle are standard features. Accuracy rating is 1/2% or 1/4%. All Westinghouse portable instruments meet or exceed the requirements of ASA standard C-39.1. Write for complete specifications and a sample of Taut Band Suspension. Westinghouse Electric Corporation, P.O. Box 868, Pittsburgh 30, Pennsylvania. *You can be sure . . . if it's Westinghouse.*

J-40541

\*Trademark of Westinghouse Taut Band Suspension Instruments

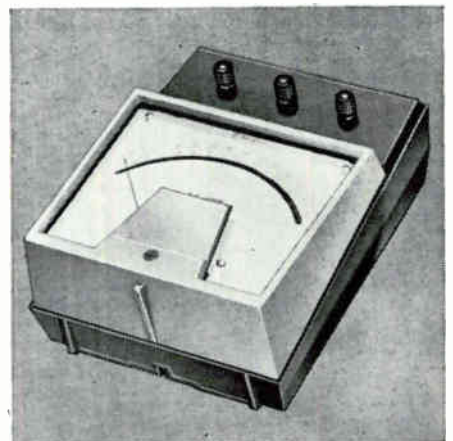

Type 151 TBS Portable Instrument—  
6.0-inch scale

**Westinghouse**



OK...

# LOCKHEED

*Here's what I want*

## ENGINEERS

### *Have YOU Answered This Invitation Yet?*

It appeared in the January issues of Scientific American, Aviation Week, Aero Space Engineering, Aero Space Management, Space Aeronautics and a number of other publications. Answers received so far indicate that we already offer a remarkably high percentage of the advantages desired by the majority of Engineers AND THAT WE CAN PROBABLY TAILOR A POSITION TO FIT THE REQUIREMENTS OF THE EXCEPTIONS. You'll never know how well your own desires and requirements can be satisfied unless you challenge us to meet them by telling us WHAT YOU WANT!

We challenge YOU TO DO IT NOW!

**MAIL TO:**

Hugh L. Gordon  
Professional Employment Manager  
Lockheed-Georgia Company  
834 West Peachtree Street  
Atlanta 8, Georgia Dept. RR-88

THE ENGINEERING CENTER  
**LOCKHEED-GEORGIA COMPANY**  
A DIVISION OF LOCKHEED AIRCRAFT CORPORATION  
AN EQUAL OPPORTUNITY EMPLOYER



Engineers: check your answer and mail today!

- Opportunity for professional advancement: for instance: \_\_\_\_\_
- Opportunity to work on interesting and challenging projects: such as: \_\_\_\_\_
- Long range job security: for instance: \_\_\_\_\_
- Full opportunity to utilize and capitalize on my education: which is: \_\_\_\_\_
- Full opportunity to utilize and capitalize on my experience: which is: \_\_\_\_\_
- Year-round recreational facilities: such as: \_\_\_\_\_
- Income: such as: \_\_\_\_\_
- Professionally advantageous associations: such as: \_\_\_\_\_
- Freedom to work with less red tape: for instance: \_\_\_\_\_
- Desirable fringe benefits: such as: \_\_\_\_\_
- Company stability and prestige: for instance: \_\_\_\_\_
- Pleasant Living conditions: such as: \_\_\_\_\_
- Opportunities for further education: for instance: \_\_\_\_\_
- Recognition of personal contributions: such as: \_\_\_\_\_

NAME \_\_\_\_\_  
ADDRESS \_\_\_\_\_  
PHONE \_\_\_\_\_



# VALUE

makes the  
**Tektronix**  
**Type 545A**  
*your best*  
*investment*



## VERSATILITY

... for pulse-sampling applications ... for transistor-rise-time testing ... for semiconductor-diode-recovery-time studies ... for strain-gage and other transducer measurements ... for differential-comparator displays ... for multiple-trace work in general laboratory experiments. ... for single-shot or recurrent or triggered main-sweep presentations ... for either conventional or triggered jitter-free delayed-sweep presentations.

With 16 plug-in units available, the Tektronix Type 545A Oscilloscope holds the capabilities for displaying simply and reliably almost any dc-to-30 mc signal in almost any laboratory application.

And an operational amplifier soon available will even further widen the scope of Type 545A Oscilloscope measurements—through its capabilities for integration, differentiation, amplification, summation, other operations for medium and high-frequency applications.

## RELIABILITY

... from a company that has originated its own designs in over 50 different laboratory oscilloscopes—incorporating many special components designed and made by Tektronix to provide optimum performance and assure continuing reliability.

... from a company that has specialized in manufacturing ONLY laboratory oscilloscopes and associated instrumentation.

... from a company that has emphasized quality in design for quality in performance for 15 years.

## CONTINUING ASSISTANCE

And to maintain high performance, Tektronix backs up every Type 545A Oscilloscope with comprehensive field services from 36 Field Offices and 20 Repair Centers throughout the United States and Canada. For Tektronix believes that a manufacturer's responsibility to the user of his product continues throughout the life of the instrument.

*Type 545A performance characteristics include:* Risetime of 12 nanoseconds—with fast-rise Plug-in Units. Calibrated Sweep Range of 0.1  $\mu$ sec/cm to 5 sec/cm. Calibrated Sweep Delay from 1  $\mu$ sec to 10 seconds.

*Other Tektronix features include:* Single Sweep (for Time Base A). 5X-Magnifier. 10-KV Accelerating Potential. Amplitude Calibrator. Electronically-regulated Power Supplies. Type 545A (without plug-in units) . . . . . \$1550  
 Type CA Dual-Trace Plug-In Unit (as illustrated) . . . . . \$260

U.S. Sales Prices f.o.b. Beaverton, Oregon

Call your Tektronix Field Engineer  
 for a demonstration of the versatile  
 and reliable Type 545A Oscilloscope  
 in your own application.

**Tektronix, Inc.** P. O. BOX 500 • BEAVERTON, OREGON / Mitchell 4-0161 • TWX—BEAV 311 • Cable: TEKTRONIX

**TEKTRONIX FIELD OFFICES:** Allentown, Pa. • Atlanta, Ga. • Baltimore (Towson) Md. • Boston (Lexington) Mass. • Buffalo, N.Y. • Chicago (Park Ridge) Ill. • Cleveland, Ohio • Dallas, Texas • Dayton, Ohio • Denver, Colo. • Detroit (Lathrup Village) Mich. • Endicott, Endwell, N.Y. • Greensboro, N.C. • Houston, Texas • Indianapolis, Ind. • Kansas City (Mission) Kan. • Los Angeles Calif. Area (East Los Angeles, El Segundo, West Los Angeles) • Minneapolis, Minn. • Montreal, Quebec, Canada • New York City Area (Albany, Buffalo, Elmira, Ithaca, New York, Syracuse, Utica) • Philadelphia, Pa. • Phoenix (Scottsdale) Ariz. • Portland, Ore. • Poughkeepsie, N.Y. • San Diego, Calif. • San Francisco, Calif. Area (Lafayette, Palo Alto) • Seattle, Wash. • Syracuse, N.Y. • Toronto (Midvale) Ont., Canada • Washington, D.C. (Annandale, Va.).

**ENGINEERING REPRESENTATIVES:** Herteron H&S, Ltd., Honolulu, Hawaii. Tektronix is represented in twenty-five overseas countries by qualified engineering organizations. European and African countries, the countries of Lebanon and Turkey, please contact TEKTRONIX INTERNATIONAL A.G., Terrassenweg 1A, Zug, Switzerland, for the name of your local engineering representative. Other Overseas areas, please write or cable directly to Tektronix, Inc., International Marketing Department, P. O. Box 500, Beaverton, Oregon, U.S.A. Cable: TEKTRONIX.

# Save 7% of Your electronics BUYERS' GUIDE Advertising Costs ACT NOW!



Order your advertising for the 1962 electronics BUYERS' GUIDE now. Study these exceptional discounts. You can earn up to 10% in discounts. You will see four distinct ways to save money. Here is how the "Early Bird" discount structure works:

In addition to volume discounts for Multiple Page, run-of-press, advertising, a discount of 7% on the earned rate will be allowed on ads of ½ page or more, provided insertion order is received by February 15, 1962, and plates are supplied to the publisher by April 25, 1962.

In addition to the volume rates for inserts, a discount of 7% of those rates will be allowed providing insertion order is received by February 15, 1962, and inserts are supplied to the publisher by May 25, 1962. See your local advertising representative, listed on the last page of this issue for complete details.

Multiple Page Discounts		discount
2 pages	.....	earn 3%
4 pages	.....	earn 4%
6 pages	.....	earn 6%
8 pages	.....	earn 7%
12 pages	.....	earn 8%
16 pages	.....	earn 9%

Special rates for furnished inserts		per page
2 pages	.....	\$715
4 pages	.....	682
6 pages	.....	654
8 pages	.....	616
12 pages	.....	600
16 pages	.....	583
20 pages	.....	566
24 pages	.....	550
28 pages	.....	533
32 pages	.....	517
over 32 pages	.....	489

(Orders and complete plates to be sent to 330 West 42nd Street, New York 36, N.Y. Inserts to be shipped to National Publishing Co., Lanston Building, 24th and Locust Street, Philadelphia 1, Pennsylvania. Marked: Electronics Buyers' Guide.)

## electronics BUYERS' GUIDE & Reference Issue



A McGraw-Hill Publication / 330 West 42nd Street, New York 36, N.Y.

## Acoustical Components of Superior Quality

JAPAN PIEZO supplies 80% of Japan's crystal product requirements.

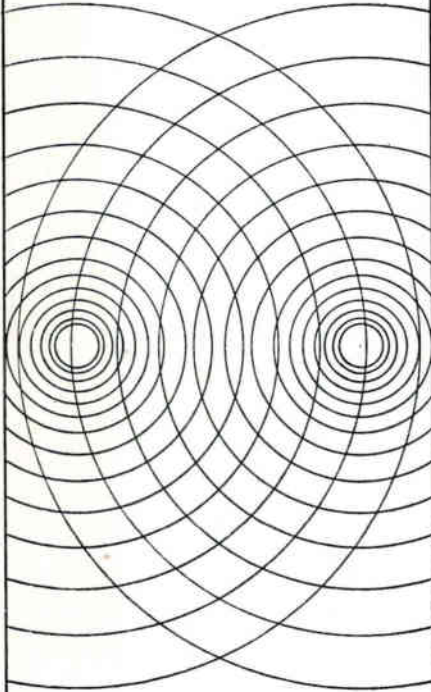

### STEREO CARTRIDGE Crystal — "PIEZO" Y-130 X'TAL STEREO CARTRIDGE

At 20°C, response: 50 to 10,000 c/s with a separation of 16.5 db. 0.6 V output at 50 mm/sec. Tracking force:  $6 \pm 1$  gm. Compliance:  $1.5 \times 10^{-6}$  cm/dyne. Termination:  $1M\Omega + 150$  pF.

Write for detailed catalog on our complete line of acoustical products including pickups, microphones, record players, phonograph motors and many associated products.



## JAPAN PIEZO ELECTRIC CO., LTD.

Kami-renjaku, Mitaka, Tokyo, Japan



How's  
your  
Comfort  
Index\*  
this  
month?



**Jack Lightfoot, LOCKHEED staff engineer** working on the Polaris Missile for the Navy, explains why the COMFORT INDEX in Santa Clara County means better living to him. "It doesn't matter whether it's January or July around here — I can take off for the golf course any week end. And, frankly, I feel that I accomplish more on the job in this all-year mild climate."

Both management and employees have a lot to gain from the mild Santa Clara County climate. Productivity goes up as your COMFORT INDEX approaches the ideal level. But you get *more* than exceptional livability. This unique location at the Southern tip of San Francisco Bay places Santa Clara County right in the *market and transportation center* of the West.

First, compare the COMFORT INDEX of each potential industrial site. When you add the other advantages, every fact points to **SANTA CLARA COUNTY** — for maximum *livability* and *productivity*.

\*COMFORT INDEX—One of many terms used to describe the exact point at which the climate of a particular area approaches an ideal combination of moderate temperature, low humidity.



SEND TODAY for these two booklets and bring your plant site research file up to date: "What Do You Mean — COMFORT INDEX?" and "NEW INDUSTRY SPEAKS".

GREATER SAN JOSE  
CHAMBER OF COMMERCE  
Dept. 3B, San Jose 13, California

## SANTA CLARA COUNTY California

GREATER SAN JOSE CHAMBER OF COMMERCE  
DEPT. 3B, San Jose 13, California



# HIGH STABILITY 1MC and 100KC OSCILLATOR

The new Model 18-10 Oscillator has dual oven vacuum insulated construction and dual temperature control operated by a high resolution mercury thermostat to insure a high degree of reliability and stability.

### Specifications are as follows:

- Output frequencies ..... 1 MC and 100 KC @ 1 volt RMS (phase locked)
- Stability, long term ..... 1 part in  $10^6$  per day; 5 parts in  $10^6$  per week
- Stability, short term .....  $\pm 3$  parts in  $10^9$  per 5 minutes
- Input voltage, oscillator ..... +35V to +210V at 15 MA (specify voltage)
- Oven voltage @25°C ..... 6.3V, AC or DC, (floating) at 2.5A; 1A. after 30 min. warmup
- Ambient temperature range (operating) ..... -40 to +55°C
- Frequency change with B+ (+210 volt input) .... approx.  $\frac{1}{2}$  part in  $10^9$  over the range 185 to 235 volts
- Output signal distortion ..... 5% total harmonic distortion
- Trim range ..... 5 parts in  $10^6$  minimum
- Setting resolution ..... On the order of parts in  $10^{10}$ ; 1 part in  $10^8$  per turn of the shaft
- Weight ..... 28 ounces
- Size ..... 6" x  $3\frac{3}{8}$ "

### Other features include:

Oscillator and divider circuits in inner oven	Completely self-contained (except heater and B+ supply)
Frequency adjustment externally available	

PRICE \$295.00



MODEL 18-10

**NORTHEASTERN ENGINEERING INCORPORATED**  
DEPT. 3-C MANCHESTER, NEW HAMPSHIRE  
AFFILIATE OF ATLANTIC RESEARCH CORP.

CIRCLE 201 ON READER SERVICE CARD

# POWER from

**NICAD** NICKEL CADMIUM

## Rechargeable Batteries

### DESIGNED FOR

- Low Maintenance Cost
- Instant Efficient Operation
- Durability

NICAD Sealed and Vented Cells make practical the battery operation of many types of equipment not previously suited to dry, mercury, or lead acid types. Capable of sustained or stable voltage over a wide temperature range these NICAD Cells have extremely long life, require little or no maintenance, and are always ready to operate in any position under even the most adverse operating conditions . . . with POWER to spare.

For the full POWER story, write . . .



NICAD BATTERY DIVISION  
**GOULD-NATIONAL BATTERIES, INC.** E-1403 First National Bank Bldg., St. Paul 1, Minn.  
NICAD is a trademark of Gould-National Batteries, Inc.

### SEALED CELLS



### VENTED CELLS

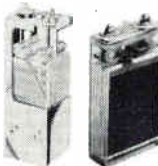

Get the facts on  
**CONTROLLED-LOSS**  
**ECCOSORB<sup>MF</sup>**

For waveguide and coax

A series of plastic rod and sheet designed for waveguide and coaxial cable terminations and attenuators. Providing a 50-to-1 range of attenuation values at any microwave frequency. Non-porous, zero moisture absorption. Usable to 350° F. Easily machined to close tolerances for good impedance match. Dielectric constant 1.0 to 30. Dissipation factor .01 to 1.5. Available from stock in standard rod sizes of 1", 2" and 3" diameter, and in  $\frac{1}{2}$ ", 1" and 2" sheet.

For higher temperatures:  
**ECCOSORB MF 500F** Ask for bulletin 8-2-6A

For complete data, write for technical bulletin 8-2-6



**Emerson & Cuming, Inc.**

Canton, Massachusetts    Gardena (L.A.), California









CIRCLE 202 ON READER SERVICE CARD

electronics



# NOW...

# SINTERED MOLYBDENUM FOR THE

CHEMICAL  ELECTRONIC   
 ELECTRICAL  GLASS   
 METALWORKING   
 INDUSTRIAL HEATING   
 MISSILES  AIRCRAFT 

# I S RIES

**AVAILABLE FROM STOCK IN PRODUCT FORMS TO MEET YOUR NEEDS.** Universal-Cyclops now adds sintered molybdenum mill products to its growing line of refractory metals. A leading producer of arc-cast molybdenum and its alloys, the company's Refractomet Division has adapted its years of experience and technical know-how in this area, to the production of sintered molybdenum.

The only integrated producer of molybdenum mill product forms, Universal-Cyclops now provides imme-

diately delivery of sintered product, as well as arc-cast, in all mill forms—for every application in the chemical, electronic, electrical, glass, metalworking, industrial heating, missiles, and aircraft industries.

For complete information, write Refractomet Division or call your nearest district sales office.



# CY

# AL

STEEL CORPORATION  
EXECUTIVE OFFICES: BRIDGEVILLE, PA.

COLUMBIUM • MOLYBDENUM • TANTALUM • TUNGSTEN  
HIGH TEMPERATURE METALS • TOOL STEELS • STAINLESS STEELS

# Radar Will Measure Space Vehicle Attitudes

LOS ANGELES—IRE's National Winter Convention on Military Electronics has on its agenda for next week 91 papers, including 29 classified confidential. Among topics slated for a big play are antisubmarine warfare, lunar landing systems, radar, communications and reconnaissance systems.

Here is a sampling of some of the reports which the technical program committee, headed by Matthew Brady, lists as certain to attract considerable interest:

A. Reich, of RCA, will describe an attitude sensor for space vehicles which needs no optical system or electromechanical parts. Attitude is determined from measurements made with ground radar equipment, using phase modulation coding of radiation lobes transmitted from the vehicle.

Several radiator configurations will satisfy requirements, Reich feels. A circular wave guide will be

used in initial prototypes. No particularly new techniques are needed to synthesize antenna patterns. System accuracy depends on signal-to-noise ratio and the functions describing the antenna pattern. A cosine-squared pattern makes the direction of cosines directly available at the receiver output without further computation.

## *Multicolor Display*

A mock antisubmarine warfare battle will be fought at session III-D, as L. J. Hines and H. L. Djelland, of National Cash Register, describe their company's multicolor photochromatic display. A single light source provides all the energy needed for writing multiple tracks and alphanumeric, to illuminate cursors, and to project dynamic information and a static background grid on a rear-projection screen.

Tracks and characters are writ-

ten in real time by multiple ultraviolet beams. Lens motion is controlled by x-y input signals. Reversible light-sensitive dyes are used on the screen. The film changes from a transparent to opaque state wherever the light beams strike, then is transparent again. Image persistency can be controlled by temperature variation and light control.

Applications include computer output in command and control systems and for real time display in antisubmarine warfare, air traffic control, missile range surveillance and other systems handling continually changing information. Production for a classified Navy torpedo weapon system will begin in mid-1962.

## *Reconnaissance System*

A heretofore unannounced reconnaissance system for electronic intelligence will be described in two papers by ITT Federal Labs personnel. It reportedly has demonstrated remarkable speed, accuracy and ability to detect unusual signals in actual flight tests.

Called Pirate, the system incorporates superheterodyne sensitivity with broad spectrum coverage without sweeping and a simple but all-encompassing form of logic which detects anomalous time- or frequency-domain behavior by signals.

Multiple traveling-wave tubes are used in the polydigital receiver for high sensitivity. Several wide r-f bands are heterodyned into a wide-band microwave i-f. Supposedly unique mix-based techniques for encoding received carrier frequencies into a three-digit code partially account for the high traffic capabilities reported. New methods for identifying input bands in both c-w and pulse sections are used.

Video measurement and recording circuitry, the company claims, instantaneously detect, measure and store voltage analogs of pulse parameters such as carrier frequency pulse width, polarization, time of intercept, and signal strength. A direction finding system computes absolute bearing of received pulse signals.

## Message Tape Cuts Government Red Tape

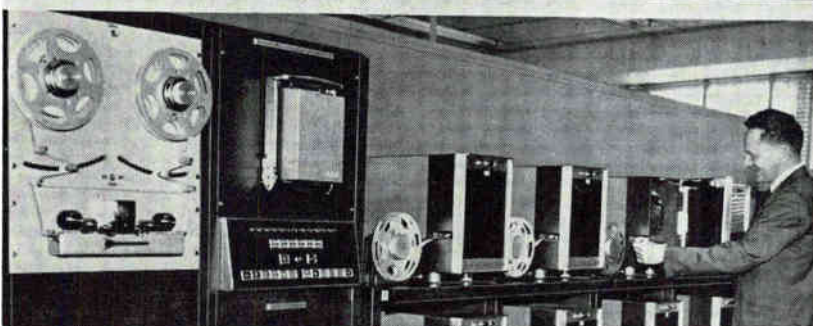

*Social Security Administration is installing a data communications system between its computer center in Baltimore and 600 district offices. Processing of some three million claims annually will be speeded by eliminating typing, mailing and punched card preparation for computer input. Top photo shows Digitronics Corporation's Dial-O-Verter system magnetic and paper tape transmission units. At bottom, in one of six control centers, is equipment which sorts messages according to information concerned and routes them between computer center and offices. Bell Telephone's Data-Phone system is incorporated in the network*

*Designed for*



*Application*



**MAGNETIC SHIELDS**

Illustrated are a few of the stock mumetal or nicaloy magnetic shields for multiplier photo tubes and cathode ray tubes. Stock shields are available for all popular tubes. Custom designed shields are made for special applications.

**JAMES MILLEN MFG. CO., INC.**

**MALDEN  
MASSACHUSETTS**

**CIRCLE 203 ON READER SERVICE CARD**

*Success is often the "Summation of" sound Ideas and Communication efficiency*

See **BUDELMAN**

*...for reliable, economical\**  
**COMMUNICATIONS SYSTEMS**  
Carrier • Microwave • Paging  
For Common Carrier, Industrial, Public Safety, Transportation and Business Applications  
We invite your inquiry for free BEC Spec File or Systems Engineering assistance.

375 Fairfield Avenue • Stamford, Conn.

\*Because Budelman equipment performs better, costs less to buy and maintain.

**NEED  
65-80 db  
ISOLATION  
BETWEEN  
TRANSFORMER  
WINDINGS?**

You do if your project involves very low signal levels. This was the case recently when a major transistor manufacturer specified EIC custom transformers with 65 db isolation between windings, from 60 cycles to 10 kc. (We can give you 80 db if required.) Insulation resistance specified (winding to winding and winding to case) was 300,000 megohms. Send us your complete specifications for prompt price and performance quotations.

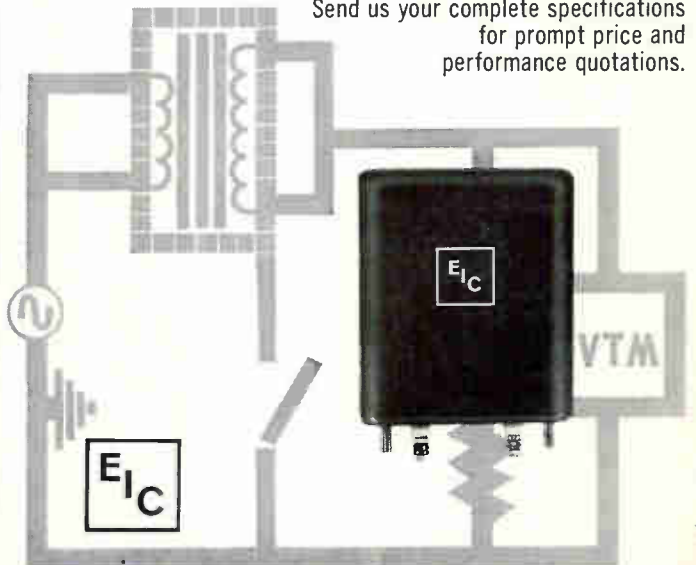

**ELECTRODYNAMIC INSTRUMENT CORPORATION**

*Subsidiary of Reed Roller Bit Company*  
JA 6-3761 • 1841 Old Spanish Trail • Houston 25, Texas  
**CIRCLE 204 ON READER SERVICE CARD**

electronics

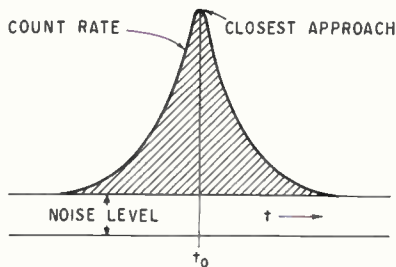
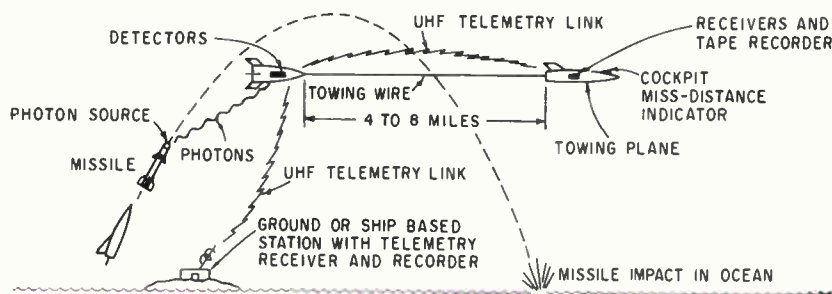

▲ This is how prototype system evaluates small tactical missiles

► Impulse data from detector in target may also be telemetered to ground

◀ Count rate at detector as a function of time and approach distance

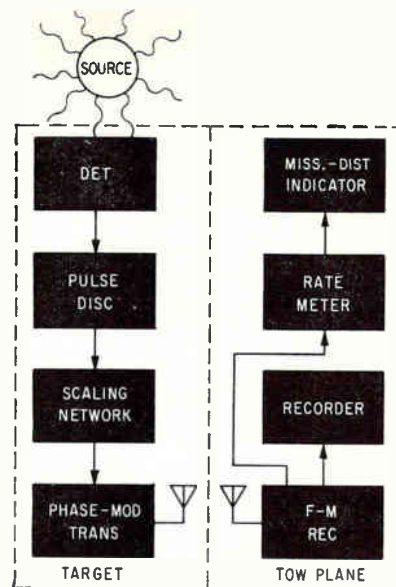

## Photon Count Tells Missile Miss-Distance

MISSILE MISS-DISTANCE indicator, allied in concept to the photon altimeter reported two weeks ago (ELECTRONICS, p 26, Jan. 19), has been developed by Giannini Controls Corp.

In the Photon Target Scoring System, the radioisotope source and the photon detector are two separate units. One is located in the intercepting missile and the other in the target. Miss-distance is calculated from the number of photons detected.

Prototype systems for evaluating such tactical missiles as Sidewinder and Sparrow are being used at the Pacific Missile Range. These systems typically require only about one-half watt of input power.

More sophisticated systems are underway, Giannini says, for evaluating anti-ICBM missiles. Among the reported advantages is that unlike r-f signals, radiation energy propagation is affected little by ionized shock waves which develop around missiles during reentry. Also, source units are physically small, don't alter missile characteristics, don't interfere with r-f apparatus and provide three-dimensional indication of miss-distance.

The source used on small tactical missiles is Ta 182, a high-energy gamma ray emitter, mounted in a ring configuration. If desirable, the source could be placed in the target and the detector in the interceptor.

The detector is a plastic scintil-

lator coupled to a multiplier phototube. The tube amplifies impulses by a factor of one million or more.

Output pulses have a rise time on the order of 10 nsec. They are further amplified, shaped and passed through a pulse discriminating network. This network, essentially a bandpass filter in the energy spectrum, rejects most of the cosmic ray background.

A scaling network matches the pulse repetition rate of the detector to the limited bandwidth of the telemetry system. Pulses modulate the f-m—f-m carrier and are transmitted to the data processing subsystem.

Equipment in the towing aircraft converts the pulse data to display miss-distance in feet and also records the information. Data can also be recorded by a ground station. Future systems may improve accuracy by using digital computers and curve fitting techniques.

### Magnetometer Finds Snow-Buried Skiers

NEXT WEEKEND, two members of the National Ski Patrol will be buried under a simulated avalanche at the Soda Springs ski area in northern California. They'll be testing a new way of finding lost skiers.

Each skier will carry a small per-

manent magnet. Searchers will use a Varian Associates M-49 portable magnetometer.

Boots fitted with heel magnets have been located in a few minutes. Tests have been made in Switzerland, where the technique was proposed by Harry Weaver and Attilio Melara, of Varian, and Franz Schaerer, a Swiss Army avalanche and rescue expert.

The two Americans, on a ski holiday, heard of a skier being lost 30 days under an avalanche as rescuers tried to find him using conventional probe rods. From 30 to 300 people are buried each year in Switzerland.

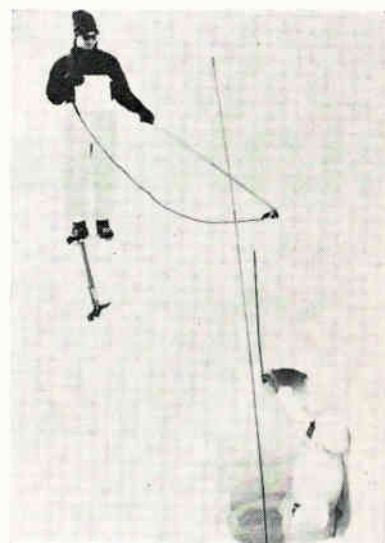

Hole in snow was location of ski boot found by magnetometer



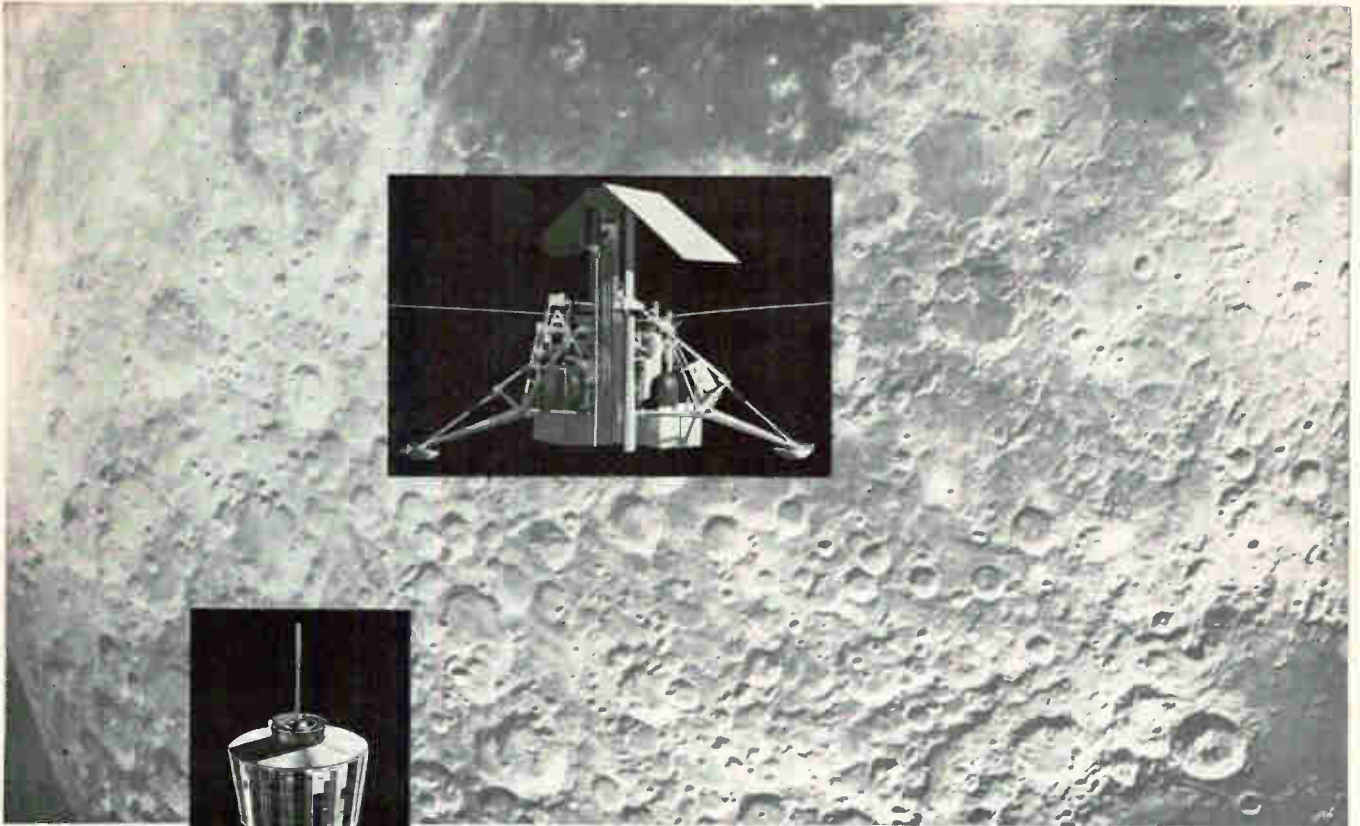

# systems analysts:

**Quantify the complex on important projects at Hughes!**

SURVEYOR (soft lunar landing spacecraft), SYNCOM (synchronous communications satellites), ARPAT (terminal anti-ballistic missile defense system), BAMBI (anti-ballistic missile defense feasibility study). These are a few of the many important and complex projects under design, development and study at Hughes.

Because of these projects and others important to the nation's defense, preparedness and space effort, Hughes offers more opportunities to Systems Analysts than ever before.

Involved with these positions are the consideration of many basic problems such

as: the proper mix of manned vs. unmanned satellites; the requirements of manned space flight; IR systems requirements for high speed strike reconnaissance systems or unmanned satellites; analysis of weapon systems from conception through development, test and customer use; and many others.

**Inquire today.** If you are a graduate engineer or physicist from an accredited university, a U. S. citizen, and believe that you can contribute to and benefit from the important projects at Hughes, contact us today. Airmail your resume to:

**Mr. Robert A. Martin,  
Supervisor of Scientific Employment  
Hughes Aerospace Divisions  
11940 W. Jefferson Blvd.,  
Culver City 42, California**

We promise you a reply within one week.

An equal opportunity employer.

Creating a new world with ELECTRONICS

**HUGHES**

HUGHES AIRCRAFT COMPANY  
AEROSPACE DIVISIONS

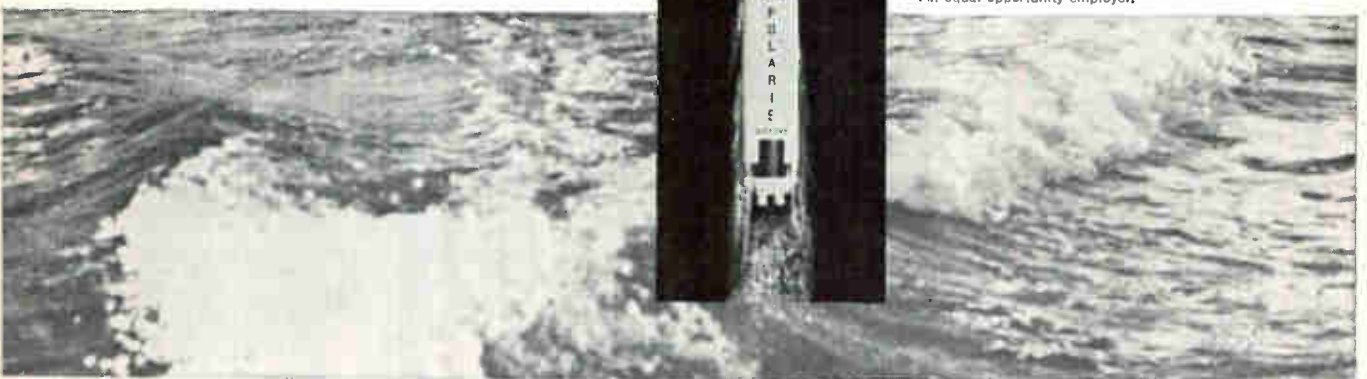

1962 FEBRUARY 1962							1962 MARCH 1962						
S	M	T	W	T	F	S	S	M	T	W	T	F	S
			1	2	3					1	2	3	
4	5	6	7	8	9	10	4	5	6	7	8	9	10
11	12	13	14	15	16	17	11	12	13	14	15	16	17
18	19	20	21	22	23	24	18	19	20	21	22	23	24
25	26	27	28				25	26	27	28	29	30	31

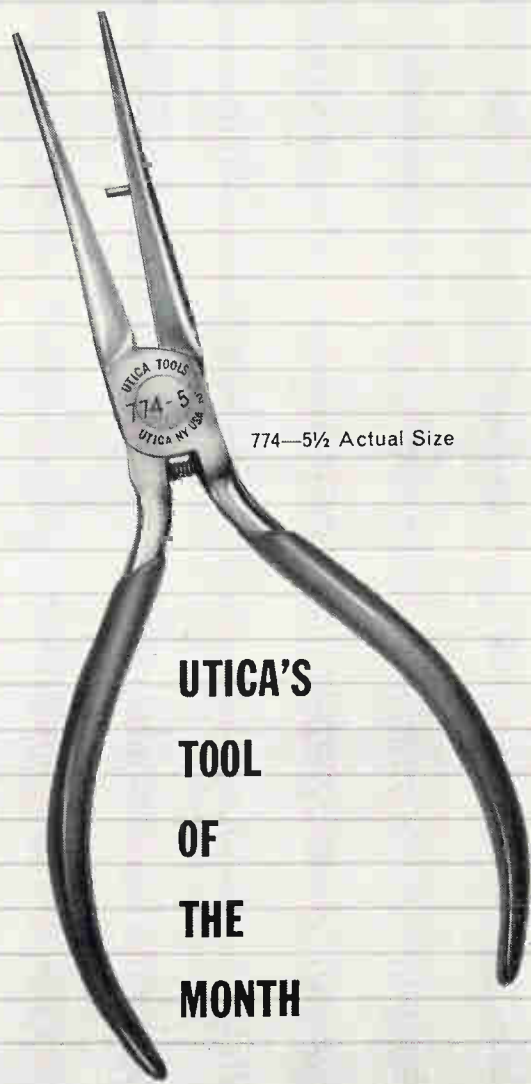

774-5 1/2 Actual Size

**UTICA'S  
TOOL  
OF  
THE  
MONTH**

Utica does it again with a special tool-of-the-month designed to meet the increasingly demanding needs of the electronic industry. The 774-5 1/2 Electronic Pick-up and Wiring Plier features a dowel pin located in the jaws to assure perfect alignment and positive gripping control for looping, twisting and bending. And the finely tapered nose . . . only 1/16" at the tip . . . will pick-up and hold the finest wire used in electronic production work. Covering a wide range of wiring applications, this new plier is especially useful in handling delicate work in restricted work areas. The Bauer-type grip release spring and heavy plastisol grips offer ease of handling . . . increased production line efficiency.

**UTICA TOOLS • DIVISION OF KELSEY-HAYES COMPANY, UTICA 4, NEW YORK**

# UTICA



**PUTS THE BEST IN  
CREATIVE ELECTRONICS  
INTO YOUR HANDS**



Send for  
**FREE**  
Catalog

**28 pages of professional electronic equipment in kit and wired form—for Lab . . . Line . . . Home**

EICO, 3300 N. Blvd., L.I.C. 1, N. Y. E-2A  
 Send free 32-page catalog & dealer's name.  
 Send new 36-page Guidebook to HI-FI for which I enclose 25¢ for postage & handling.

Name \_\_\_\_\_  
 Address \_\_\_\_\_  
 City \_\_\_\_\_ Zone \_\_\_\_\_ State \_\_\_\_\_

**EICO** 3300 N. Blvd., L.I.C. 1, N. Y.  
 Export Dept., Roburn Agencies  
 431 Greenwich St., N. Y. 13, N. Y.

**CIRCLE 205 ON READER SERVICE CARD**



### Operational guidance for buyers

That's what your 1961 electronics Buyers' Guide and Reference Issue gives you . . . this year more than ever before.

Your EBG is bigger and better this year than ever . . . and more helpful than ever . . . with more new exclusive features than ever. Keep it close at hand, you'll find it's useful day in and day out.

**electronics  
BUYERS' GUIDE  
and Reference Issue**

The Basic Buying Guide  
in Electronics *since 1941*



**Grabbe-Ramo-Wooldridge (Eds.):  
HANDBOOK OF AUTOMATION,  
COMPUTATION, AND CONTROL,**

**Vol. 3: Systems and Components.** Outlines in detail the modern approach to systems engineering, with typical industrial examples. Describes classes of control components and shows how they are combined to form complete systems. 1961. 1194 pages. \$19.75. Vol. 1: Control Fundamentals. 1958. 1020 pages. \$18.50. Vol. 2: Computers and Data Processing. 1959. 1093 pages. \$18.50

**Kruse-McGlauchlin-McQuistan:  
ELEMENTS OF INFRARED TECHNOLOGY.**

Generation, transmission and detection, plus the nature of infrared radiation and performance of components. 1962. 472 pages. \$10.75

**Meyerhoff (Ed.):  
DIGITAL APPLICATIONS OF  
MAGNETIC DEVICES.**

Electrical, logical, system design for developing digital systems using the toroidal magnet or magnetic core as basic circuit element. 1960. 604 pages. \$14.00

**Pitman (Ed):  
INERTIAL GUIDANCE.**

Covers all aspects including instruments, components, design, systems for cruise vehicles and space navigation. 1962. Approx. 496 pages. Prob. \$18.50

**Louisell:  
COUPLED MODE AND  
PARAMETRIC ELECTRONICS.**

First to apply the coupled mode approach to space charge waves, parametric amplifiers, and related devices. 1960. 268 pages. \$11.50

**Polydoroff:  
HIGH-FREQUENCY MAGNETIC MATERIALS.**

First comprehensive guide to ferromagnetic materials and their applications, with tests, measurements, examples. 1960. 220 pages. \$9.00

**Schlicke:  
ESSENTIALS OF  
DIELECTROMAGNETIC ENGINEERING.**

Facts of the possibilities and limitations of magnetically soft ferrites and high-permittivity dielectric polycrystalline ceramics. Examples, case histories. 1961. 242 pages. \$9.50

**Bundv-Hibbard-Strong (Eds.):  
PROGRESS IN VERY HIGH  
PRESSURE RESEARCH.**

Pivotal topics are equipment, methods, structure and behavior of materials formed under very high pressure. 1961. 314 pages. \$12.00

**Murphy:  
ELEMENTS OF NUCLEAR ENGINEERING.**

Concepts and principles necessary for an engineering understanding of nuclear transformation and radiation. 1961. 213 pages. \$7.50

**Harris:  
INTRODUCTION TO FEEDBACK SYSTEMS.**

Covers all areas of application in electronics, communications, and control systems. 1961. 363 pages. \$10.50

**Hurley:  
TRANSISTOR LOGIC CIRCUITS.**

Includes both theory and practice, with examples to point up basic ideas. 1961. 363 pages. \$10.00

**Fano:  
TRANSMISSION OF INFORMATION**

A statistical presentation of communication, covering foundations and major results of information theory. An M.I.T. Press Book. 1961. 400 pages. \$7.50

**Rose-Clark:  
PLASMAS AND CONTROLLED FUSION.**

Outlines the present state of the art and indicates what remains to be done. 1961. 493 pages. \$10.75

**Seifert-Brown:  
BALLISTIC MISSILE AND  
SPACE VEHICLE SYSTEMS.**

Presents design principles of missiles and space vehicles resembling each other in everything but trajectories followed. 1961. 526 pages. \$12.00

**Peterson:  
STATISTICAL ANALYSIS AND  
OPTIMIZATION OF SYSTEMS.**

Gives the analytical foundations, computation procedures, and numerical results of specific examples. 1961. 190 pages. \$9.75

**Romanowitz:  
FUNDAMENTALS OF SEMICONDUCTOR  
AND TUBE ELECTRONICS.**

Uses the engineering viewpoint and reviews pertinent physical theory to bring out "whys" of basic concepts and principles. 1962. Approx. 584 pages. Prob. \$8.25

**Lafuze:  
MAGNETIC AMPLIFIER ANALYSIS.**

Gives systematic procedure for analyzing magnetic amplifier circuits in general. Uses equivalent circuit approach plus block diagrams of basic servo theory. 1962. Approx. 264 pages. \$9.75

**Wozencraft-Reiffen:  
SEQUENTIAL DECODING.**

A probabilistic treatment, showing how terminal equipment of reasonable complexity can provide essentially error-free communication. An M.I.T. Press Book. 1961. 80 pages. \$3.75

**Peterson:  
ERROR-CORRECTING CODES.**

Stresses types of codes embodying mathematical structure. An M.I.T. Press Book. 1961. 285 pages. \$7.75

**Eckman (Ed.):  
SYSTEMS: RESEARCH AND DESIGN.**

Covers analysis and synthesis in very large systems: manufacturing, military, economic—and systems involving both men and machines. 1961. 310 pages. \$8.50

**Lafferty (Ed.):  
SCIENTIFIC FOUNDATIONS OF  
VACUUM TECHNIQUE,**

Second Edition. By the late Saul Dushman. Retains original aims and now includes all important progress of the past twelve years. 1962. 806 pages. \$19.50

**PLUS . . . Battelle: SEMICONDUCTOR ABSTRACTS,** Vol. V (1957 issue), 1960, 449 pages, \$12.00. Vol. VI (1958 issue), 1961, 528 pages, \$14.00 . . . Hallen: **ELECTROMAGNETIC THEORY,** 1962. In Press . . . Hennie: **ITERATIVE ARRAYS OF LOGICAL CIRCUITS,** 1961, 242 pages, \$4.95 . . . Thourel: **THE ANTENNA,** 1960, 407 pages, \$12.50 . . . Gibson-Burgess-Kroger: **PROGRESS IN SEMICONDUCTORS,** Vol. V, 1961, 316 pages, \$11.00 . . . Clarricoats: **MICROWAVE FERRITES,** 1961, 260 pages, \$8.00 . . . Tillman-Roberts: **INTRODUCTION TO THE THEORY AND PRACTICE OF TRANSISTORS,** 1961, 340 pages, \$8.00

SEND NOW FOR YOUR  
ON-APPROVAL COPIES

**JOHN WILEY & SONS, Inc.**

440 PARK AVENUE SOUTH,  
NEW YORK 16, NEW YORK

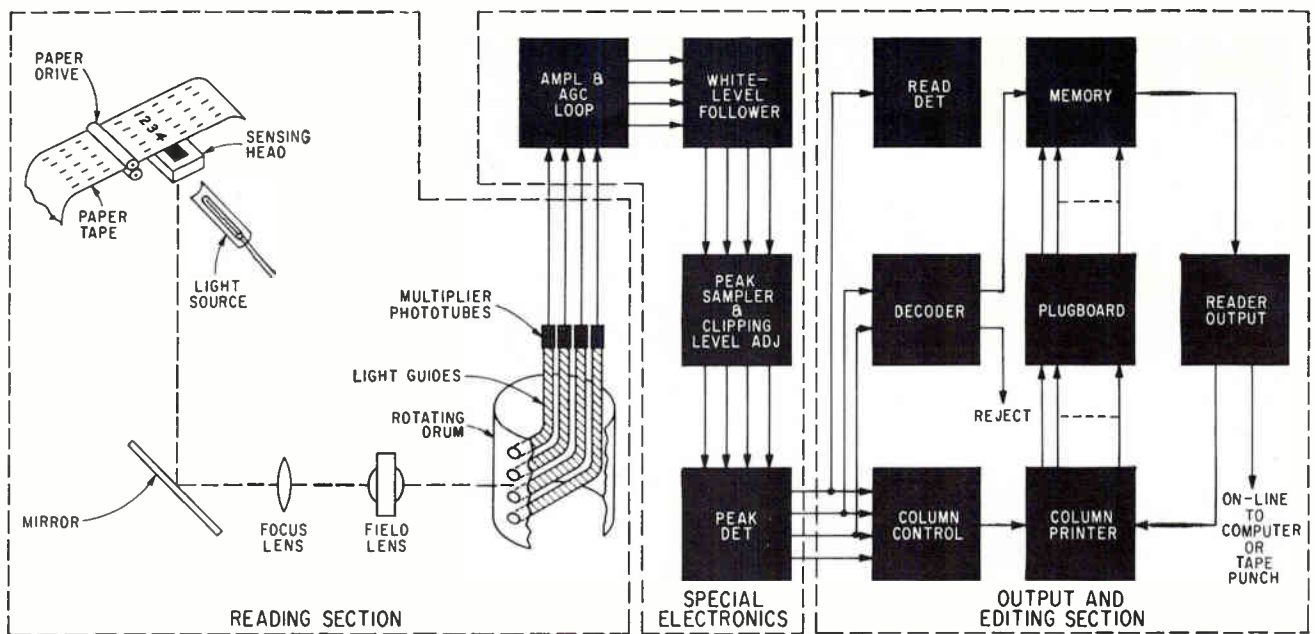

Reading section of NCR's 420 optical reader moves next line into place after line being read is accepted

## Optical Character Readers Use Memory Drums, Matrices to Increase Versatility

By WILLIAM E. BUSHOR  
Senior Associate Editor

WASHINGTON — Businessmen confronted with ever-mounting stacks of paperwork can take heart from availability of optical reading machines able to swiftly feed printed information into data processing systems. Some recent systems are selective in what they read, tolerant of faulty printing and able to read varying type styles.

Several such systems were described here at a symposium sponsored late last month by the Office of Naval Research and National Bureau of Standards.

Business machine journal tape characters can be recognized by National Cash Register's Bi-code system even if they are skewed 7.5 degrees. The system also has a memory and can be instructed to edit and rearrange data read.

Top and bottom sections of characters are each assigned five zones. Vertical stroke in a zone produces a binary ONE; absence, a binary TWO. A 10-bit binary word represents stroke location.

As the tape moves over the read-

ing head, the print image is periodically reflected through optics (see figure) so it periodically coincides with one of 18 four-aperture sets around the rotating drum. The sampled image is ducted by light guides to multiplier phototubes. Tube output corresponds linearly to white level, delineating ink strokes.

An amplifier and agc loop take care of variations in lamp intensity, paper reflectivity, aperture area and power supply voltage. "White level" circuits allow only ink stroke waveforms into peak sampling and clipping level circuits. Feedback from the peak detector establishes a new clipping level for subsequent peaks.

The peak detector's shaped pulse output goes to a column counter that steps with the right-hand edge of each character. One memory position is assigned each character. Plugboard wiring determines which column is stored in which memory position. The lower reading phototube and the memory control the decoder.

Farrington Electronics showed its Selected Data Page Scanner, which can be instructed what to

read on such documents as invoices. Instruction selectors are interchangeable panels that can be wired to any reading mode and to arrange data as desired. Switches, counters and an individually addressable 32-position accumulator can also be used to control the data.

A reader that will tolerate some print mutilation and up to a 10-degree character tilt was developed for the Signal Corps by Control Instrument division, Burroughs Control Corp. It reads pages of double-spaced elite type at a rate of 75 characters a second.

An automatic handling system moves the document about a rotating drum. A flying spot scanner generates a signal whose level is proportional to reflected light. Each character is read as a particular pattern of 96 black or white points, which are compared with a stored library of patterns.

To compare, the serially-generated video data is converted to parallel form so signals for a character are all presented at one time. This is done by passing video signals through delay lines with 96 parallel output taps. Each tap has twin

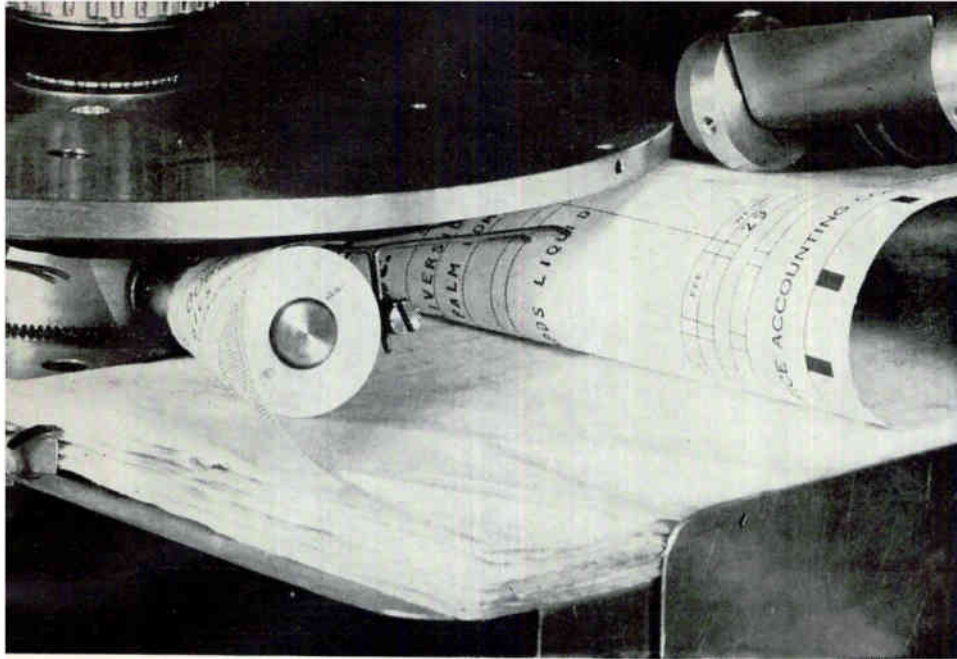

*Cycloid paper pickup developed by Rabinow handles flimsy papers*

leads for black and white points.

Each lead connects to a magnetic core, which is set to a ONE state by a pulse from the lead. Wires are threaded through the cores in a character recognition pattern. The pulse generated in each wire is proportional to the number of switched cores through which it is threaded. This voltage is matched against reference voltages representing each character and the one with least mismatch is read out as a five-unit teletype code.

Rabinow Engineering made three developments public: two experimental readers and a cycloid paper pickup mechanism.

One machine uses a full retina of photocells to examine characters, identifying them by correlation matrices. The second uses multiple curve tracing to examine such characters as handwritten numerals. As long as line quality and size are kept within reasonable limits, numbers can be read even though written without restraint.

The paper pickup handles flimsy paper at rates up to 20 documents a second, reportedly more than double previous speeds. This narrows the gap between input feed rates and scanning speed, which at present is up to 25 times faster.

A timing gear rotates a disk carrying 12 to 15 cone shaped vacuum pickups. As a cone whirls around, it picks up a corner of a document, rolls it to the disk and releases the vacuum. Rollers then pull the docu-

ment along in the usual way.

Among feasibility models reported was an RCA multifont machine for automatic language translation or autoabstracting. One approach is to use a photographic matrix mask for memory and recognition by optical correlation. A second technique is electronic page scan with automatic line and character location.

### Faraway Weather Data Gathered by Photometer

OZONE DISTRIBUTION in Arctic regions has been measured at the Naval Ordnance Test Station in China Lake, Calif. UCLA and Navy researchers made the readings with a two-color photoelectric photometer, using the Echo satellite as a sunlight reflector. The photometer measures the ratio of light intensity, in blue and orange, as Echo enters the earth's shadow.

The technique could provide weather information from other inaccessible regions. Daily variation of ozone content indicates atmospheric movements. Ozone distribution at altitudes above 30 Km may provide clues on the relationship of solar radiation and surface weather. An installation similar to that at China Lake is being planned to cover the Antarctic. It will probably be in Chile.

### Exhaust Probes Monitor Helicopter Rotor Icing

SOLID-STATE aircraft deicing control system developed by Cook Electric is reported to be small enough for private planes and helicopters.

It weighs only 12 pounds, occupies about one-sixth the volume of electromechanical systems and improves deicing reliability, says Daniel Shevelenko, executive engineer.

In a typical two-engine helicopter installation, one differential air pressure probe is placed in each engine duct, providing redundancy should one engine fail. When the probe is blocked by ice, a pair of electrical contacts close so that the probe is deiced.

Icing pulses are counted by a binary network while a transistor timer measures intervals between pulses. Output goes to a latching relay memory which decides when icing on rotors is hazardous.

Four icing pulses within intervals of 30 seconds or less cause a pulse generator to trigger a deicing program. The deicing time required at a given ambient temperature is determined by a thermistor sensor and a resistive network.

Rotor blades are deiced, a section at a time, by heating a strip on the leading edges. A binary counter monitors this operation. Engine deicing follows after a half-minute overhang and windshields after two minutes.

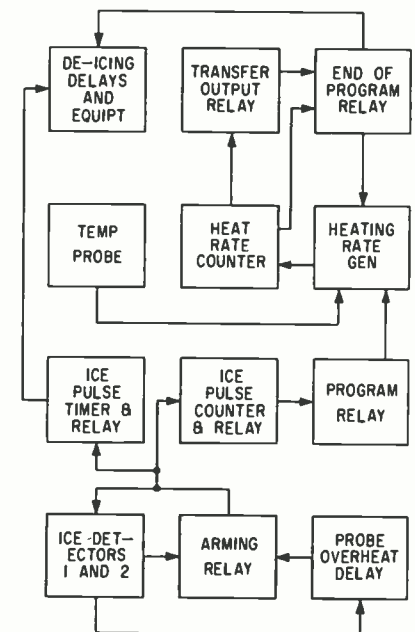

*Simplified diagram of deicer*

# System Simulates B-52 Countermeasures

By JOHN F. MASON  
Associate Editor

ELECTRONIC COUNTERMEASURES simulator delivered to the Air Force can duplicate existing or predicted r-f environments that a bomber flying over enemy territory might encounter.

Although bought by USAF to train electronic warfare officers of B-52 bombers, the simulator, designated T-4, can be adapted for ecm training on other current or projected aircraft.

The T-4 is the first of a new series of electronic mission training systems being built for the Strategic Air Command by Reflectone Electronics, Inc., a subsidiary of Universal Match Corp. The \$11.8 million contract was awarded by the Aeronautical Systems Division of the Air Force Systems Command, Wright-Patterson AFB, Ohio. The simulator was developed under the engineering cognizance of ASD's Bombing, Navigation and Ecm Branch, Director of Aerospace Ground Equipment Engineering Deputy for Engineers.

The new system differs from Reflectone's B-58 Defense Systems Operator simulator (ELECTRONICS, p 26, Apr. 7, 1961) in that the B-52 training device simulates only ecm. The older plane undoubtedly requires more sophisticated ecm gear than the newer B-58 since it is slower and will spend more time over enemy territory in a jamming, enemy radar, missile-attacking environment.

T-4 provides all countermeasures equipment an electronic warfare officer (EWO) must operate to detect and take action against hostile signal transmission. It can duplicate practically all types of signals in the r-f spectrum over a very wide range.

The T-4 includes a signal generation section of nine cabinets, a systems simulation section with seven cabinets (providing signals to simulate operation of student station equipment), an instructor's station and a student's station. The latter

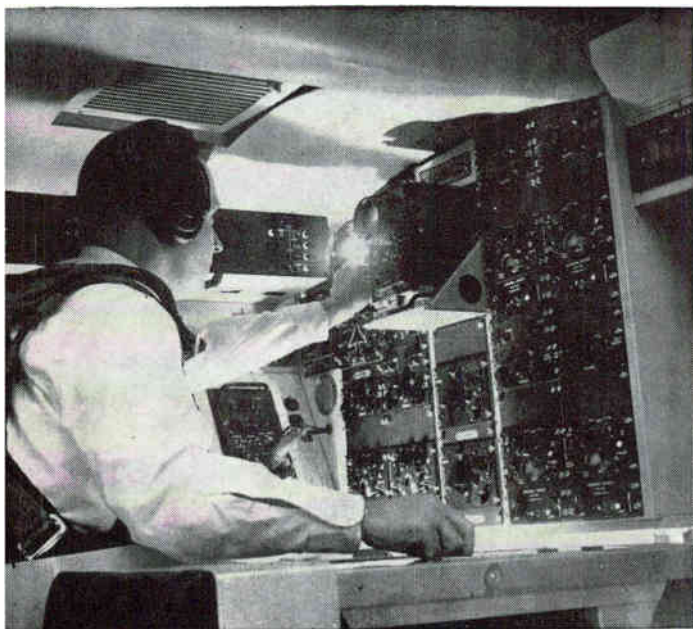

*Ecm simulator provides electronic warfare officer all equipment found in the B-52 for detecting and taking action against hostile signal transmission*

*Instructor inserts punch card in signal generation section to simulate radar signal from enemy station*

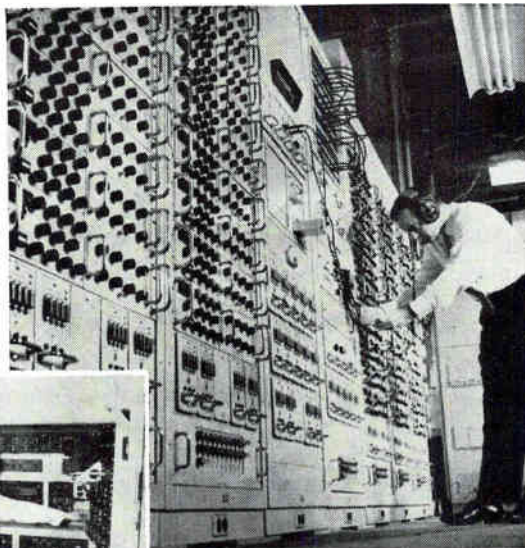

*Instructor (left) monitors student electronic warfare officer's technique in coping with enemy signal transmission*

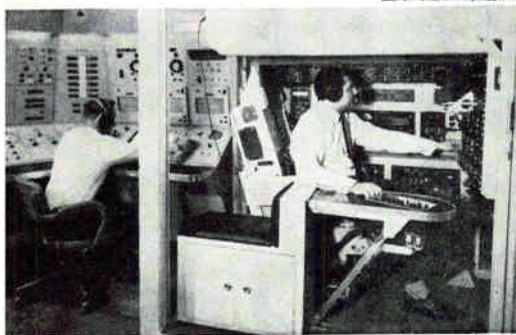

*B-58 ecm simulator, already in operation over a year, provides space for instructor not available in airborne training*



is essentially a physical duplication of the operational EWO portion of the B-52. The trainer fits into an area 30 ft by 28 ft.

A large number of radar or communication stations can be simulated simultaneously. New stations can be introduced by leap-frogging back to use those no longer in the mission problem.

The simulator duplicates r-f transmission by preprogramming 19 functions. These include such signal characteristics as frequency, pulse repetition frequency (prf), pulse width, polarization and pulse mode. Other parameters include radar range, detection range, geographic position and the particular action an enemy station takes when it detects the B-52 and when the B-52 jams it. After detecting a target, the enemy radar may change from a search mode to a tracking mode. It may for a time go off the air. Back-up radars may come on when the target is fully in range. To counter jamming, a radar station may slide or jump to a different frequency. It may also change, for example, from a fixed frequency to varying modulation.

Any antenna pattern can be duplicated. The resulting signal is recorded on one channel of a continuous-loop, 50-channel tape recorder, which preprograms up to 50 different antenna signal characteristics. A semi-automatic punch card system selects the desired antenna characteristic and combines it with the appropriate video-audio signal to provide complete simulation of any radar or other r-f signal.

Project Engineer, Major P. Fasules, estimates that the cost of airborne training that can be accomplished in the simulator during one four-month period equals the cost of the simulator.

The B-58 ecm trainer has been in operation at SAC's Carswell AFB, Texas, for about a year. In one training period, 30 students averaged about 27 hr each, "flying" 497 missions totaling some 800,000 miles.



15 Mw Modulator Power  
3.0 Mw R-F Power  
**ML-7560**  
Ceramic Triode

Coaxial terminal, thoriated-tungsten cathode ML-7560 provides:

**15 Mw Pulsed Modulator Power Capability at 1% duty . . .**

DC Plate Voltage Max 50 kv

Pulse Cathode Current Max 550 amps

**3.0 Mw R-F Pulsed Power capability at 5% duty . . .**

Peak Plate Pulse Supply Voltage Max 40kv

Pulse Cathode Current, Max 550 amps

Send for 74 page brochure, "Hard Pulse Modulator Tubes", containing useful information for Radar Design Engineers and others.

**MACHLETT**

**The Machlett Laboratories, Inc.**  
A Division of Roytheon  
**Springdale, Connecticut**

# SPRAGUE PIEZO- ELECTRIC CERAMIC ELEMENTS

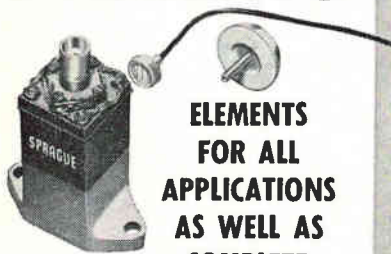

**ELEMENTS  
FOR ALL  
APPLICATIONS  
AS WELL AS  
COMPLETE  
TRANSDUCER ASSEMBLIES  
FOR MOST APPLICATIONS,  
SUCH AS UNDERWATER  
SOUND AND  
VARIOUS ORDNANCE AND  
MISSILE DEVICES.**



Sprague-developed mass production and quality-control techniques assure lowest possible cost consistent with utmost quality and reliability. Here too, complete fabrication facilities permit prompt production in a full, wide range of sizes and shapes.

Look to Sprague for today's most advanced ceramic elements—where continuing intensive research promises new material with many properties extended beyond present limits.



**YOUR INQUIRIES  
ARE INVITED**

**WRITE FOR  
LITERATURE**

**SPRAGUE ELECTRIC COMPANY**  
35 Marshall Street, North Adams, Mass.

**SPRAGUE®**  
THE MARK OF RELIABILITY



*Amplifier is big enough to fill three-room apartment. This is control display*

## “Flywheel” Pumps Pulse Power

MICROWAVE POWER amplifier, capable of attaining a peak pulse power of 100 Mw at a frequency of 5.5 Gc, went into operation late last month at the Polytechnic Institute of Brooklyn's Long Island Graduate Center, Farmingdale, N. Y.

The amplifier was designed and built by the Sperry Electron Tube division of Sperry Rand Corp. It delivers pulses with a peak power of 10 Mw. A “microwave flywheel”—something like a cyclotron—steps up power to 100 Mw. The amplifier is coupled to a circular, 500-ft-long pipe. Energy is multiplied as it circulates around in the cavity.

Brooklyn Poly will use the output to observe the reaction of gases and solid materials under high peaks of electrical power. Studies of super-power microwave materials, plasma conductors of high-frequency, high-energy power, and aerodynamic shock tube studies are among research applications. The research program is sponsored by Air Force Systems Command. Sperry plans a line of such amplifiers.

### Racetrack Computer Totes Payoff Odds

RACING FANS around the country will be getting the good news a few minutes earlier at tracks equipped with computers which figure payoffs as soon as the race is completed. American Totalisator Co. is

starting to equip its wagering systems with small digital computers to increase speed and accuracy. The company services some 150 jockey clubs and associations in 24 states, using 60 systems to equip 40 tracks at one time.

Totalisator inaugurated service with its new system at Santa Anita Racetrack recently, after testing reliability at five tracks. A second system has been completed and four others are being built at the company's plant in Baltimore. Oscar Levy, vice-president, expects use by 15 to 20 major tracks.

The computer is a modified Clary Corp. DE-60. It is portable, operates on line power and doesn't require special air conditioning. Tracks are equipped with basic cabling and housings, so systems can be transported from track to track overnight.

Pooled figures on the Tote board are scanned, recorded and translated into the numerical system used by the DE-60. While the horses are running, state and track percentages are deducted. When winners are announced, win, place and show prices are calculated and displayed. This takes about 84 seconds, about 1.5 minutes less than manual methods. The computer is programmed for more than 30 payoff variations.

Error factor is estimated at 0.0003 percent, a figure compiled from the \$3.75 billion registered by Totalisator machines in 1960.



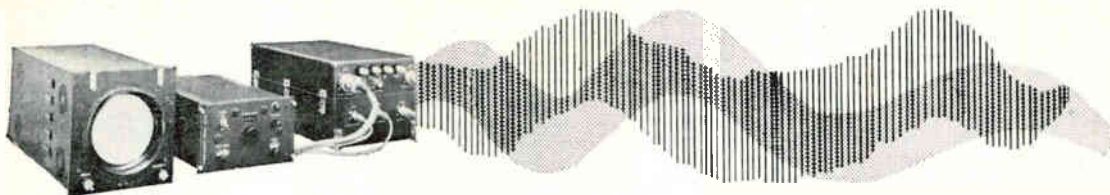

**This ELECTRICALLY TUNED  
RECEIVER that fits  
in any odd space  
on planes or on ships  
that lets you look at  
a signal you hear  
on a companion receiver  
that should be kept near  
that has no moving parts  
that sweeps the full band  
or shows on expanded mode  
a signal just scanned  
comes from the house  
-that TRAK built**

**TRAK PANORAMIC RECEIVER TYPE PAN 1-F**

Frequency range: 100-150 MC. Dynamic range: 60 db.  
Scan rate: 22 sweeps/second. Measures frequency  
to 0.2%. Tangential sensitivity .25 microvolt.



RECEIVER TYPE PAN 1F

**TRAK AUTOMATIC ACTIVE COUNTERMEASURES SYSTEM**

Electrically tuned receiver searches, stops,  
listens, evaluates. Transmitter automatically  
tunes to target frequency and jams for predetermined interval.



COUNTERMEASURES SYSTEMS

**TRAK MODEL 2887 ANTENNA SWITCH**

Allows signals from two, three, or four antennas  
to be displayed simultaneously on a single  
panoramic receiver. Electrically switched.  
No moving parts. 90-160 MC.



MODEL 2887

The Communications and Reconnaissance Dept. of Trak  
Electronics designs and manufactures on a quantity  
or single basis, completely within their own plant.  
This permits "package cost" quotation at your design  
conception stage. Our Engineering Section will be  
glad to offer design and specification assistance if requested.

Simply write 59 Danbury Road or telephone POrter 2-5521.



## PRODUCT APPLICATION

HANSEN  
**SYNCHRON**  
TIMING MOTORS

Hansen  
**SYNCHRON**  
motors,  
the "heart"  
controlling  
the split-second  
timing of  
Schulmerich  
Carillonic  
Bells

Schulmerich  
electro-mechanical

# CARILLONIC BELL

systems . . .

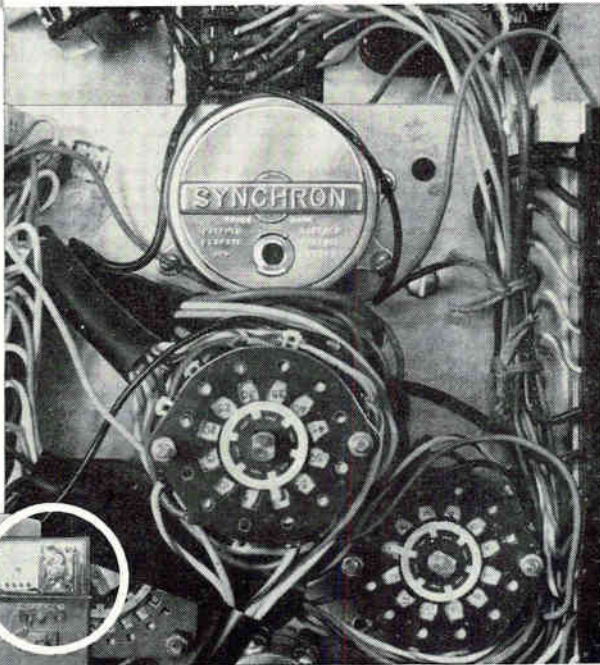

SCHULMERICH CARILLONS, INC., world's largest manufacturer of electro-mechanical carillons, uses Hansen SYNCHRON Timing Motors to drive the program clock governing the all-automatic operation of these precision, perfect-tone instruments. Clock programming is offered at 15-minute intervals, 24 hours a day, 7 days a week. Scheduled to play at specified times, exactly to the minute — there is no allowance for plus or minus variation.

HANSEN SYNCHRON TIMING MOTORS were selected as an integral part of Schulmerich Carillonic Bells because they outperformed all other motors tested. Carefully controlled testing was based on four specifications: (1) instantaneous starting, (2) no time loss or gain, (3) absence of malfunction, and, (4) reliable, continuous operation for periods of a year or more. Depending on installation, motors operate at either 110 or 220 volts — 50 or 60 cycles.

SEND TODAY for informative folder containing specifications and technical data on all Hansen SYNCHRON motors and clock movements.

#### HANSEN REPRESENTATIVES:

##### THE FROMM COMPANY

5150 W. Madison, Chicago, Illinois

##### H. C. JOHNSON AGENCIES, INC.

Rochester, N. Y. — Buffalo, N. Y. — Syracuse, N. Y.

Binghamton, N. Y. — Schenectady, N. Y.

##### ELECTRIC MOTOR ENGINEERING, INC.

Los Angeles, Calif. — (OLive 1-3220)

Oakland, California

##### WINSLOW ELECTRIC CO.

New York, N.Y. — Essex, Conn. (SOuth 7-8229)

Philadelphia, Penn. — Cleveland, Ohio

Sweet's Product  
Design File



## MEETINGS AHEAD

REDUNDANCY TECHNIQUES FOR COMPUTING SYSTEMS, Office of Naval Research; Dept. of Interior Aud., Wash., D. C., Feb. 6-7.

MILITARY ELECTRONICS, PGMIL of IRE; Ambassador Hotel, Los Angeles, Feb. 7-9.

SOLID STATE CIRCUITS, Internat. Conf., PGCT of IRE, AIEE; Sheraton Hotel and U. of Penn., Philadelphia, Pa., Feb. 14-16.

APPLICATION OF SWITCHING THEORY TO SPACE TECHNOLOGY Symp., USAF, Lockheed; at Lockheed, Sunnyvale, Calif., Feb. 27-Mar. 1.

SCINTILLATION AND SEMICONDUCTOR Counter Symp., PGNS of IRE, AIEE, AEC, NBS; Shoreham Hotel, Washington, D. C., Mar. 1-3.

MISSILES & ROCKET TESTING Symp., AF Com. & Electronics Association Coca Beach, Fla., Mar. 6-8.

EXTRA-HIGH VOLTAGE COMMUNICATION, CONTROL & RELAYING, AIEE; Baker Hotel, Dallas, Tex., Mar. 14-16.

IRE INTERNATIONAL CONVENTION, Coliseum & Waldorf Astoria Hotel, New York City, Mar. 26-29.

QUALITY CONTROL Clinic, Rochester Soc for Q.C.; U. of Rochester, Rochester, N. Y., Mar. 27.

ENGINEERING ASPECTS OF MAGNETO-HYDRODYNAMICS, AIEE, IAS, IRE, U. of Rochester; U. of Rochester, Rochester, N. Y., Mar. 28-29.

SOUTHWEST IRE CONFERENCE AND SHOW; Rich Hotel, Houston, Texas, April 11-13.

JOINT COMPUTER CONFERENCE, PGEC of IRE, AIEE, ACM; Fairmont Hotel, San Francisco, Calif., May 1-3.

HUMAN FACTORS in Electronics, PGHFE of IRE; Los Angeles, Calif., May 3-4.

ELECTRONIC COMPUTERS Conference, PGCP of IRE, AIEE, EIA; Marriott Twin Bridges Hotel, Washington, D. C., May 8-10.

NATIONAL AEROSPACE ELECTRONICS Conference, PGANE of IRE; Biltmore Hotel, Dayton, Ohio, May 14-16.

MICROWAVE THEORY & TECHNIQUES National Symposium, PGMTT of IRE; Boulder, Colo., May 22-24.

SELF-ORGANIZING INFORMATION Systems Conference, Off. Nav. Rsch., Armour Rsch. Fd.; Museum of Sci. and Ind., Chicago, May 22-24.

## ADVANCE REPORT

WESTERN ELECTRONICS SHOW AND CONVENTION, WESCON: at Los Angeles in the California Memorial Sports Arena and Statler-Hilton Hotel, August 21-24, 1962. Authors should submit the following materials by April 15 to WESCON Business Office c/o Technical Program Chairman, 1435 S. La Cienega Blvd., Los Angeles 35, Calif.: (1) 100 to 200 word abstract including title of paper, name and address of author; (2) 500 to 1,000 word summary of paper; (3) indication of technical field in which paper falls using IRE professional group classification.



Super Squaremu "79" is a new high-purity alloy of closely controlled composition, an exclusive development of Magnetic Metals. When used in Centricore tape-wound cores, it assures the magnetic amplifier designer the ultimate in core performance and consistent reproducibility of his designs.

Compared with conventional alloys of the same nominal composition, Super Squaremu "79" offers these advantages: ■ High flux density ■ Greater gain ■ Increased

linear range ■ Greater thermal stability ■ Improved uniformity of performance

Centricores made of Super Squaremu "79" deliver the same consistently high performance from core to core and lot to lot, as proved through production quantity runs. They're now available in a new hermetically sealed case, in all standard sizes and shapes. Write or call today for complete specifications. MAGNETIC METALS COMPANY, Hayes Avenue at 21st Street, Camden 1, N. J.

## NEW HIGH PERFORMANCE ALLOY



***... makes Centricores<sup>®</sup>  
the most uniform of all  
tape-wound cores!***

transformer laminations • motor laminations • tape-wound cores • powdered molybdenum permalloy cores • electromagnetic shields

**M**MAGNETIC  
**M**METALS

CIRCLE 33 ON READER SERVICE CARD

CIRCLE 34 ON READER SERVICE CARD →

## The Oak Approach



# When must contact be "Good as Gold"?

*When time means harmful tarnish!*

Of course gold is a *natural* wherever rotary or push-button switches must remain in any one position for months-on-end. Simply because it assures *perfect, lasting contact without care* where switches are operated infrequently.

Under other circumstances, however, contact "good as gold" may call for radically different construction, different selection of metals, as you well know. All the picky considerations so familiar in switch design are thoughtfully gone over in full *each time OAK develops a switch recommendation*. Common, ordinary silver plate may be best of all. (Generally gives outstanding results where 10,000 cycles use-life is sufficient . . . and then provides

brass-to-brass contact up to 200,000 cycles of operation where a bit of circuit noise can be tolerated.)

Then, perhaps, that "good-as-gold" answer will be OAK CMS-202 high-temperature alloy . . . or simply a more familiar silver alloy. OAK recognition of countless significant details helps you save by preventing over-engineered switches — as well as by safeguarding performance.

So let OAK unravel the tedious details: choice of contacts . . . make-up of metals . . . proper insulators and frame design. Creating superior switches and complete switching subassemblies is our full-time business — probably the best reason of all for making OAK *your switch-engineering "right arm."*

## Where creativity pays practical dividends

OAK ideas cut cost of switches for countless applications — Good switch-engineering, as you know, doesn't mean designing the most expensive item to do the job, under all conditions, for a hundred years. It means creating the *lowest-cost component that can handle the job and provide proper use-life*. Be it push-button, rotary, lever or slide switch — send your performance and application data along when you order.

Although you may have been dealing with us for years — you can enable us to do a still better job for you. As a switch specialist, OAK can spot needless costs in mechanical and electrical specifications and help control or eliminate them.

OAK assemblies can cut production costs ... free-up manufacturing facilities — Given circuit data and opportunity, OAK will also build complete subassemblies, and can often combine switches with related circuitry to produce cost-saving "package" plug-ins. Sometimes we can even eliminate expensive components such as relays.

OAK-built components and subassemblies all are life-and environment-tested. Products subject to MIL SPECS (including 3786-A) are checked for performance under vibration, shock, salt spray, humidity, high altitude and temperature extremes.

You'll find OAK engineers eager to assist with problems. We urge that you take full advantage of their unique capabilities.

OAK schedules help speed your production efforts — Need a prototype fast? Order it from OAK; generally it's completed in 3 days! And compare our new, faster production cycle — now insured by expanded plant capacity.

Layout sheets are readily available at no cost, to help in diagramming your switch requests. For specific information, products, or prototype service, contact your OAK representative, or OAK directly.

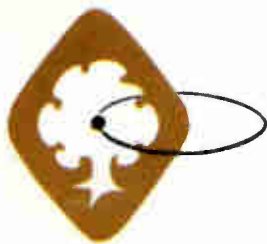
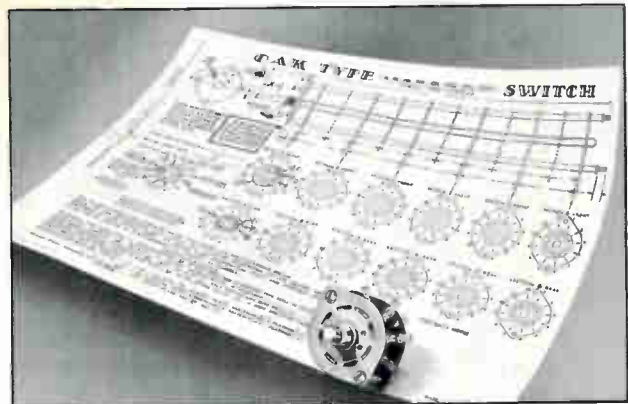
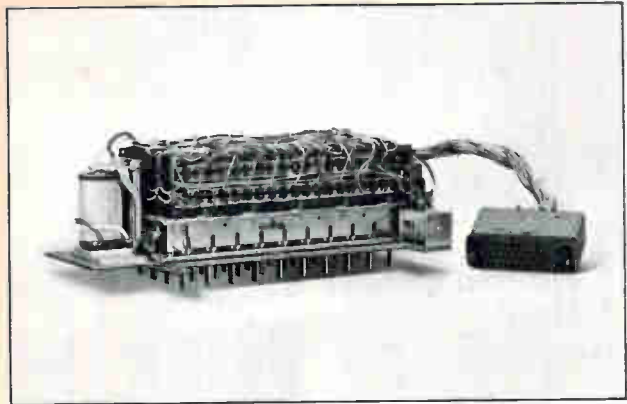
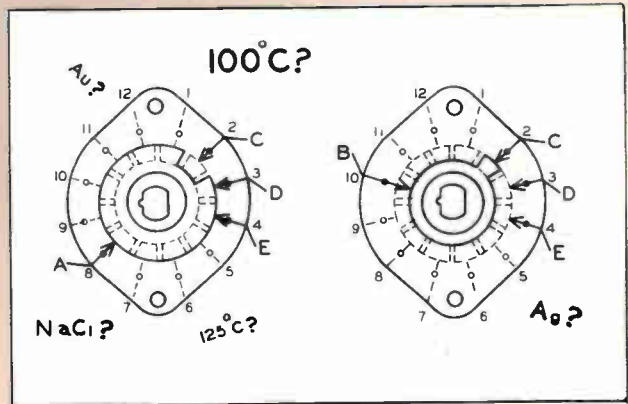

## OAK MANUFACTURING CO.

CRYSTAL LAKE, ILLINOIS • Telephone: Area Code 815; 459-5000; TWX: CRYSL LK 2350-U;  
Cable: Oakmanco. • Plants in Crystal Lake, Illinois • Eikhorn, Wisconsin

Subsidiaries: OAK ELECTRONICS CORP., Culver City, Calif. • McCOY ELECTRONICS CO., Mt. Holly Springs, Pa.  
ROTARY AND PUSHBUTTON SWITCHES • TELEVISION TUNERS • VIBRATORS • APPLIANCE  
AND VENDING CONTROLS • ROTARY SOLENOIDS • CHOPPERS • CONTROL ASSEMBLIES



**TDMS  
IN THE  
LINE  
KEEPS  
FAILURE  
OUT!**

**Unique monitoring system  
anticipates trouble spots in communications networks**

Radiation's Telegraph Distortion Measurement System effectively reduces costly downtime in wire or radio telegraph and data links. A compact, self-contained unit, TDMS provides continuous on-line monitoring—and alerts even the non-technical operator when a circuit is deteriorating.

TDMS offers additional advantages which increase the efficiency of communication systems. It transmits perfect telegraph test signals, for example, permits adjustment of

telegraph relays during operation, and tests start-stop mechanisms. It can also replace most equipment needed for teleprinter terminal maintenance and monitoring.

TDMS (and other Radiation commercial equipment) owe their advantages to Radiation's unequalled experience in advanced aero/space communication systems. To find out how TDMS can service your network, write Dept. EL-22, Radiation at Orlando, 5800 McCoy Road, Orlando, Fla.

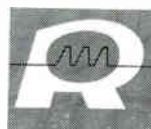

**RADIATION**  
*at Orlando*

# SEEBAKIS



"SEE IT BIG  
AND KEEP IT SIMPLE"...

an engineering byword  
and a mnemonic well worth  
remembering. Take Varian  
power klystrons, for example.

Varian internal cavity design  
minimizes maintenance.  
Absence of sliding joints and  
contacts eliminates RF leakage  
and cuts down self-oscillation.  
Tube and circuits are an integral  
structure, ready for transmitter  
installation. Tubes are self-centering  
in electromagnets. Non-critical  
magnetic focusing requires no physical  
adjustment. High density metal cathodes  
permit automatic fault recycling at full  
power. Input and output couplings are pre-  
set to optimum for flat transmission lines  
(again, there's no need for adjustment).

Just connect coolants, cathode terminals,  
RF input and output lines, and tubes  
are ready to operate.

If you need such long-lasting,  
reliable klystrons, Varian has (or  
can design) the ideal tube for you.  
Contact Tube Division.



**VARIAN** associates

PALO ALTO 1, CALIFORNIA



NOTHING  
REPLACES  
A PHILCO MADT®

A replacement is not a replacement, if it offers only some of the original product's benefits. Philco MADT's give you MORE device per dollar than any germanium "replacement" transistor: ■ MADT delivers higher  $h_{FE}$ ; ■ MADT offers better emitter-base diode stability; ■ MADT types offer higher frequency capability; ■ MADT types offer higher current capability; ■ MADT process-controlled geometry assures tighter parameters; ■ MADT types are optimized for specific applications; ■ MADT is inherently avalanche-free in practical switching circuits.

For top switching capability, use the world's most popular germanium transistor, with uniformity assured by industry's only fully-automatic transistor production. Insist on Philco MADT. For complete data on MADT circuit benefits, write Dept. E2262.

**THESE PHILCO MADT's OFFER OPTIMUM VALUE FOR SPECIFIC NEEDS**

**2N768:** Optimum performance at low power.  $f_T=170$  mc at 1v, 1 ma. **2N1499A†, 2N2048:** High frequency performance at low cost.  $V_{CES} = -20V$ . **2N501A†, 2N1500†, 2N779B:** High speed logic transistors. **2N976:** World's fastest switch,  $f_T=900$  mc. **2N1204A:** High power, low speed. Max.  $I_C=500$  ma.  $f_T=400$  mc.  $P_T=200$  mw. **2N1494A:** High power, low speed. Max.  $I_C=500$  ma.  $f_T=400$  mc.  $P_T=400$  mw.

LANSDALE DIVISION  
**PHILCO**  
A SUBSIDIARY OF *Ford Motor Company*  
LANSDALE, PENNSYLVANIA



\*Micro Alloy Diffused-base Transistors.  
†Military types.



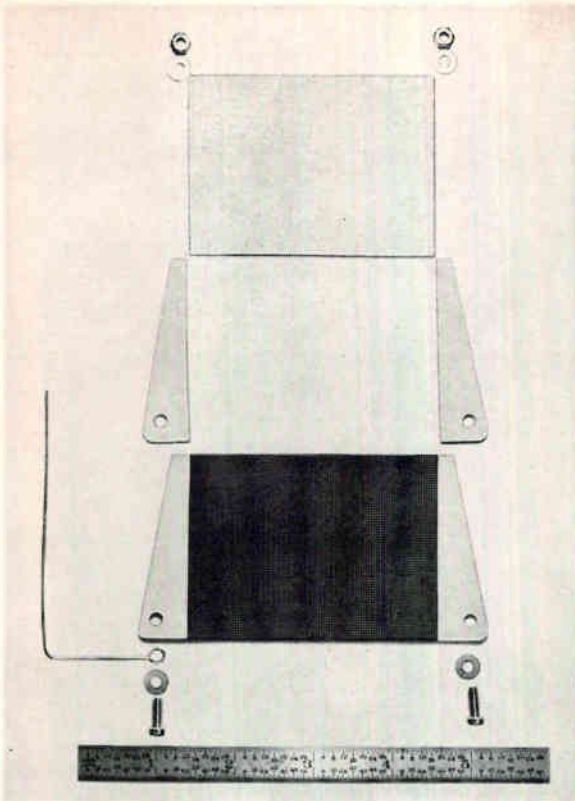

FIG. 1—Exploded view of individual plate (above) with assembled thermoelectric package undergoing tests (right)



HIGH VOLTAGE  
OUTPUT WITH

# Oxide Thermoelectric Generators

*Ceramic technology is used to produce an experimental thermoelectric generator capable of producing 100 volts in a twenty cubic inch package heated to 2,400 degrees F*

By R. D. FENITY  
Minneapolis-Honeywell  
Research Center,  
Hopkins, Minnesota

THIS CENTER has been engaged for about four years in the investigation and development of oxide semiconductors and devices based on their properties. Recently, Picatinny Arsenal supported a program on the use of these materials as thermoelectric generators. The first portion of the sponsored work in-

involved a survey of the thermoelectric properties of a limited number of materials and the initiation of a study of the mechanisms involved. The second phase of this program required the design and fabrication of a generator using the best materials found in the first phase. This resulted in a device capable of generating 100 volts and occupying a space of only twenty cubic inches. This generator was designed to obtain high voltage output in a

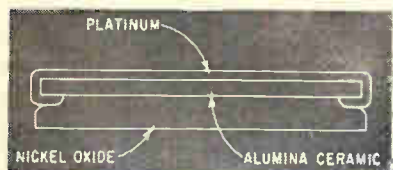

FIG. 2—Cross section of one plate

small volume without regard to current. These design ends were met by an unusual physical construction using ceramic technology. An exploded view of the device is shown in Fig. 1. It consists of an alumina ceramic plate to which has been applied a platinum layer which overlaps the opposite side. A plasma flame sprayed layer of doped nickel oxide is applied to the second side as illustrated in cross section in Fig. 2.

Each plate was then spirally cut with a 0.006-in. thick diamond saw to produce one hundred platinum-nickel oxide junctions in a series connection. The plates were then connected in series to produce 100 volts. Cold-end cooling on this generator was limited to normal losses through radiation, convection and conduction. Figure 1 also shows the generator in its final form.

As can be seen from Fig. 3A, output voltage versus the temperature differential between the hot and cold end, a substantial differential had to be established before appreciable voltage was generated

and there was a tapering off of this voltage starting at a differential of about 500 C. The latter effect has been shown to be due to leakage through the ceramic substrate that proved to have appreciable conductivity at about 1,000 C. The low-temperature effect is attributed to a modification of the properties of the oxide semiconductor that occurred when exposed to the extreme temperatures of the plasma flame torch. Both of these effects can be overcome with a resulting improvement of a factor of four in performance.

Figures 3B and 3C illustrate the voltage and current characteristics of this generator with varying load impedance. The power output peaked at 650,000 ohms load, the generator internal impedance.

Oxide semiconductors used for thermoelectric generation are oxides of the transition metals that are doped by the mixed-valency principle to yield properties similar, but not identical to, the normal band conduction semiconductors. An example of the doping reaction is

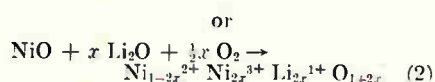
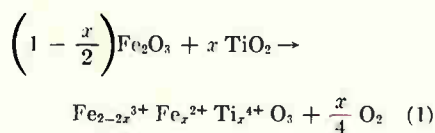

In both of these cases, the doping agent ( $\text{TiO}_2$  or  $\text{Li}_2\text{O}$ ) enters the lattice of the host material creating a charge imbalance that must be corrected. The balance is restored by a valence change in an equivalent number of the host ions. Now ions of different valencies of the same element occupy equivalent positions in the lattice and electron or hole transfer can occur between these positions resulting in semi-conduction.

The vast majority of thermoelectric research at present is being concentrated on the intermetallic compounds. Perhaps the best known of these materials is lead telluride. As a basis for evaluation, some of the properties of this material are shown in Table I along with the properties of doped iron oxide and doped nickel oxide.

The thermoelectric properties described in this table are greater than those exhibited by the generator. This is due to a number of factors but most importantly denotes a decided improvement in these materials since the generator was completed.

Lead telluride can be machined with difficulty and is not easy to fabricate due to extreme brittleness and poor strength. The oxides can be fabricated by normal ceramic methods and are considerably stronger. Parts can be machined with diamond tools. Oxides may be operated at much higher tempera-

TABLE—COMPARISON BETWEEN PbTe AND DOPED  $\text{Fe}_2\text{O}_3$ -NiO THERMOELECTRIC GENERATOR MATERIALS

	PbTe		$\text{Fe}_2\text{O}_3$		NiO	
	N	P	N	P	N	P
Machinability	Not advisable	Not advisable	Possible <sup>a</sup>		Possible <sup>a</sup>	
Operating temperature ( $T_H$ )	594 C <sup>b</sup>	594 C <sup>b</sup>	1,300 C		1,300 C	
Resistivity at 24 C	$5 \times 10^{-4}$ ohm cm	$3.8 \times 10^{-4}$ ohm cm	$6 \times 10^{-1}$ ohm cm		$6 \times 10^{-2}$ ohm cm	
“ at $T_c$ <sup>c</sup>	$4 \times 10^{-4}$ ohm cm	$3 \times 10^{-4}$ ohm cm	$8 \times 10^{-2}$ ohm cm		$1.9 \times 10^{-2}$ ohm cm	
“ at $T_H$ <sup>d</sup>	$5.6 \times 10^{-3}$ ohm cm	$5.8 \times 10^{-3}$ ohm cm	$7.2 \times 10^{-2}$ ohm cm		$1.6 \times 10^{-2}$ ohm cm	
Density	8.15 g/cc	8.15 g/cc	5.2 g/cc		6.3 g/cc	
Thermal expansion coefficient	$18 \times 10^{-6}/^\circ\text{C}$	$18 \times 10^{-6}/^\circ\text{C}$	$13 \times 10^{-6}/^\circ\text{C}$		$12 \times 10^{-6}/^\circ\text{C}$	
Thermal conductivity	0.02 watt/cm/ $^\circ\text{C}$	0.02 watt/cm/ $^\circ\text{C}$	0.02 watt/cm/ $^\circ\text{C}$		Not available	
Design $\Delta T$	556 C	556 C	600 C		600 C	
Voltage/junction	125 mv	135 mv	228 mv		120 mv	

<sup>a</sup> Requires diamond tools

<sup>b</sup> Requires nonoxidizing atmosphere

<sup>c</sup> 10 C for PbTe and 600 C for oxides

<sup>d</sup> 594 C for PbTe and 1,200 C for oxides

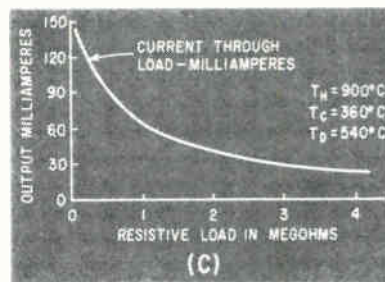
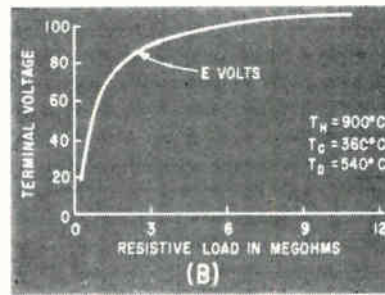
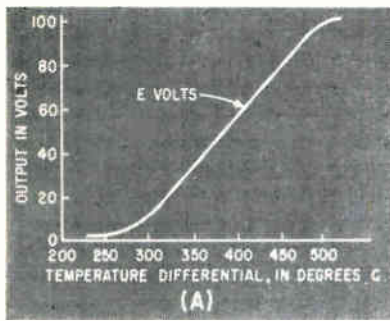
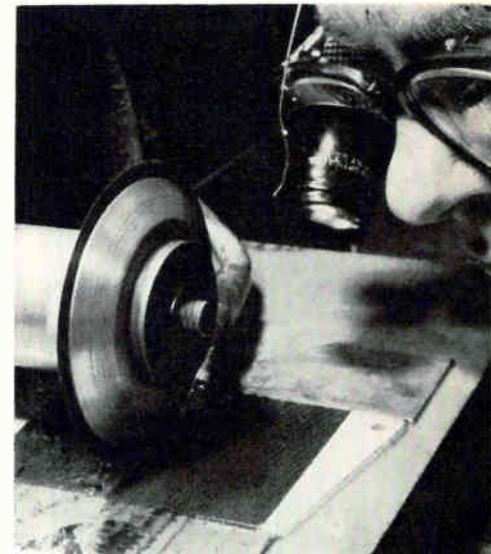

FIG. 3—Output voltage versus temperature differential (A), terminal voltage versus load impedance (B) and output current versus load impedance (C)



Each plate is spirally cut with a 0.006-in. diamond saw

tures, an advantage from a thermal efficiency standpoint. The telluride must be protected from oxidation whereas the oxides may be operated at quite elevated temperatures in air.

The primary disadvantage of the oxides is in their relatively high resistivities. The oxides have between  $10^2$  and  $10^3$  times the resistivity of lead telluride at room temperature. However, due to the large negative coefficient of resistance, this difference decreases to ten to one hundred times at operating temperatures.

The oxides have a density about thirty percent less than lead telluride and this may be of importance in airborne applications. The thermal expansion coefficient of the oxides is lower, which should contribute to better thermal shock resistance. The thermal conductivity of doped iron oxide has been measured and is approximately the same as lead telluride. The thermal conductivity of doped nickel oxide is not available but is expected to be in the same range.

Both the potential temperature differential and the thermoelectric voltage are greater in the oxides and, under the design conditions specified in the table, the total voltage per junction from the oxides is greater than that from the tellurides. It should be pointed out that to some extent this is a matter of design. Combinations of

doped nickel and iron oxides have been measured at greater than  $1,000 \mu\text{V}$  per degree C, and, if operated between room temperature and  $1,300 \text{ C}$ , would generate more than one and one-fourth volts per junction. This, however, would be at a relatively high resistance and little power would be obtained. Since the resistivity of these oxides decreases exponentially with temperature while the Seebeck voltage decreases linearly with decrease in the differential temperature, power output increases rapidly as the cold end temperature is raised, assuming a constant hot-end temperature.

To indicate the order of thermal efficiency presently available, a calculation can be made from recent test data using  $T_h = 1,473 \text{ K}$  (hot-end temperature),  $T_c = 873 \text{ K}$  (cold-end temperature),  $\alpha = 580 \mu\text{V}$  per degree C (open circuit),  $\rho_p = 0.017 \text{ ohm cm}$ , and  $\rho_n = 0.076 \text{ ohm cm}$ . The latter two are average resistivities over operating range  $T_h - T_c$ .

Assuming that the doped nickel oxide has approximately the same thermal conductivity as the doped iron oxide ( $0.019 \text{ watt/cm sec}$ ), the zeta factor and thermal efficiencies can be calculated.

From Ioffe, the Z factor is

$$Z = \frac{\alpha^2}{(\sqrt{K\rho_p} + \sqrt{K\rho_n})^2}$$

Where  $\alpha$  is the open circuit Seebeck voltage,  $K$  is the thermal conduc-

tivity, and  $\rho$  the resistivity. Then

$$Z = \frac{(5.80 \times 10^{-4})^2}{(\sqrt{0.019 \times 0.017} + \sqrt{0.019 \times 0.076})^2 - 1.07 \times 10^{-4} \text{ per deg C}}$$

With this, calculate thermal efficiency  $N$ :

$$N = \frac{1}{2} \frac{\Delta T}{T_h + \frac{2}{Z} - \frac{1}{2} \Delta T}$$

$$= \frac{1}{2} \frac{600}{1473 + \frac{2}{1.07 \times 10^{-4}} - \frac{1}{2}(600)}$$

$$= 0.015$$

This indicates that 1.5 percent of the thermal energy introduced into the hot end of this material is converted into electrical energy. This figure can be compared with 7.85 percent reported for lead telluride.

It is not the purpose of the above comparison to imply that in the present state of knowledge, oxide thermoelectric materials can compete from a thermal efficiency standpoint with intermetallics. The purpose is to suggest that they may be useful in applications requiring greater voltage output, better oxidation resistance and superior physical properties.

It is also suggested that a further study of these materials as thermoelectrics and a better understanding of the mechanisms involved in conduction and thermoelectricity in oxides could lead to considerable improvement in the efficient generation of power in these materials.

# Telemetry Diversity Combiner

## USES BEAM DEFLECTION TECHNIQUE

*Circuit responds to high-frequency fading and has wide bandwidth.*

*Control voltage goes to beam-deflection plates*

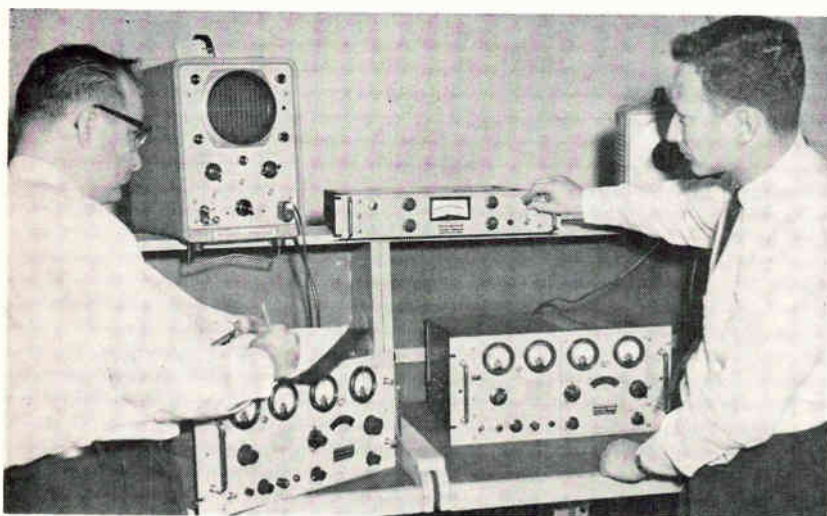

*Small size of the combiner enables flexibility in installation*

By V. A. RATNER

Director, Systems Engineering,  
Defense Electronics, Inc.,  
Rockville, Md.

DIVERSITY RECEPTION techniques applied to radio telemetry place some unusual requirements on the art of diversity combining. Most conventional communications systems need only be responsive to relatively slow fading rates and be capable of handling relatively narrow bandwidths. A tumbling, spinning, missile or spacecraft traveling at several times the speed of sound however, may exhibit fades occurring at rates up to several kilocycles. In addition, high bit-rate rcm and other types of telemetry modulation systems require base-band frequency responses from a few cps to over one megacycle. The problems are even further complicated by the fact that a single installation may be required to operate with several

different bandwidths from day to day, and subsequent data storage and data processing equipment usually have limited dynamic ranges and require that the diversity system have a nearly constant level output.

Conventional noise sampling combiners have proven impractical because signals of differing bandwidth must be accommodated, and full utilization of bandwidth allows no unused spectrum from which to derive a sample of noise that is free of signal energy. Receiver agc has therefore been selected as an analog of signal strength and hence signal-to-noise ratio, for use as a combiner control signal. Agc in most telemetry receivers is an approximately logarithmic function of signal strength. A control amplifier may be designed with a transfer function to give the ratio-squared combining law, which has been

proven optimum for post-detection combining. Post-detection combiners using agc control have been designed using both the expander-compressor technique and the common cathode circuit configurations. Both types however, have suffered from limitations of over complexity, poor fading response, inadequate frequency response, critical balancing controls, and the presence of control voltage variations in the combined output.

A different approach to the problem has resulted in a new type of basic circuit using beam-deflection tubes as combiner elements. This configuration automatically results in ratio-squared combining, and suffers from none of the limitations of previous methods. The circuit of the complete two-channel combiner, Fig. 1, has only five active tubes and is packaged in a 3½-in. standard relay rack space.

The circuit uses the RCA type 7360 beam-deflection tube. This tube, intended for use in single-sideband balanced-modulator applications, has the property of providing output currents that are functions of the product of two input signal voltages. It contains a single cathode, control grid, and screen grid, a pair of deflecting electrodes, and two plates arranged so that a voltage differential impressed across the deflection electrodes causes the beam current to be unequally divided between the plates and proportional to the deflecting potential difference.

The basic combiner circuit consists of two 7360 tubes with corresponding deflection electrodes tied together and opposite plates connected together sharing a common

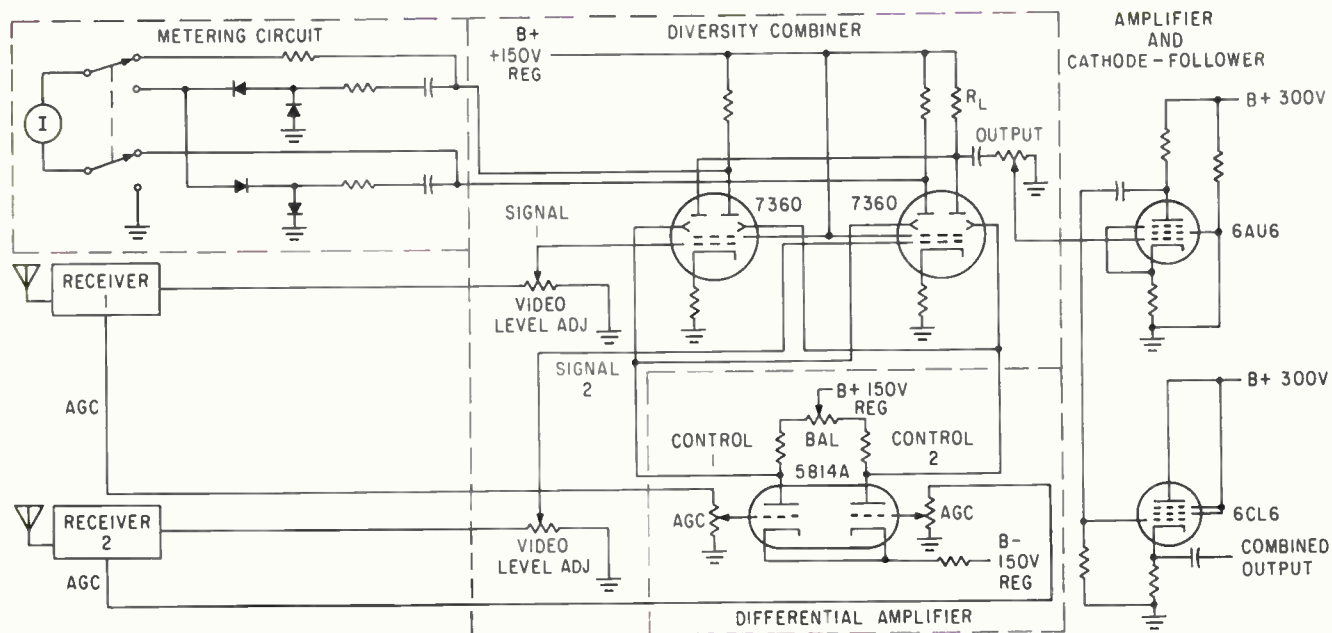

FIG. 1—System consists of four major circuits. Two type 7360 beam deflection tubes in the combiner circuit are the heart of the device

load resistor. The video signals to be combined are fed directly to the grid of each tube individually while the control voltages are applied to the respective deflection electrodes, Fig. 1. Then as the control voltages vary, the total current in the common plate load  $R_L$  remains the same but the relative proportion contributed by each video signal changes. The combined output, taken as signal voltage across the common plate load, will not vary in amplitude as long as the two video inputs are of equal amplitude and in-phase. This is normally accomplished by adjusting the attenuators in the video input line and is critical for rejection of control signal variations. Thus, the variations in control voltage do not appear in the output signal.

The required linear control signal for application to the deflection electrodes is derived from the receiver age outputs. Standard telemetry receivers have age output voltages that are a nearly logarithmic representation of the r-f input levels, and hence signal-to-noise ratio. A direct-coupled differential amplifier is incorporated in the combiner. By applying the receiver age voltages (through variable attenuators) to each of the differential amplifier inputs, an exponential transfer function is attained, which establishes an approximately

linear relationship between control signals. Use of the differential amplifier accomplishes one other important function—the maintaining a constant mean potential between the deflection electrodes and the cathode of the 7360 to preserve balance and prevent nonlinear operation due to distortion of the beam symmetry.

The circuit is superior to the common cathode combiner in both video frequency response and maximum combining rate. This is because a push-pull arrangement is not necessary to cancel control voltage variations in the combiner output. Video transformers or phase splitters with their attendant time constants and balancing controls are not required.

Since the combiner requires that the video inputs as well as the age control voltages be closely balanced, both video and age metering provisions have been incorporated. Earlier combiner designs used individ-

ual meters in each channel and were difficult to adjust due to interaction between channels and variations in meter calibration. The metering circuit in the beam deflection combiner however, uses the unused pair of plates in a bridge type of circuit, Fig. 1. A single zero-center microammeter, Fig. 2, indicates the actual ratio of plate currents, which corresponds directly to the combining ratio. The meter is calibrated in db and gives a more meaningful indication of the combining operation than do individual channel meters. Positive adjustment of the beam deflection combiner with this type of metering may be accomplished within a few seconds, in contrast to the trial and error procedure required of conventional combiners.

The beam deflection combiner, for which a patent application has been filed, may also be incorporated into other communications systems for improved diversity reception.

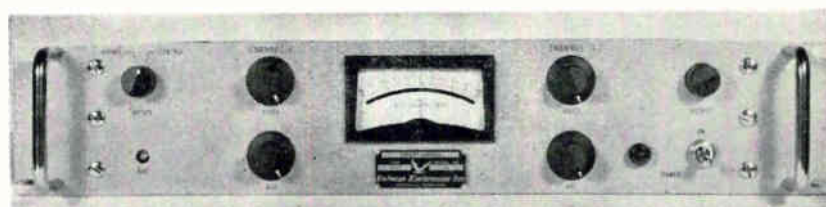

FIG. 2—Control panel illustrates operational simplicity. Built-in metering circuit provides for quick adjustment

# Combined Oscillator-Amplifier

*How to design cascaded common-base and common-collector stages that can be transformed from an amplifier to an oscillator by changing impedance level of an R-C time constant*

By R. C. CARTER, Texas Division, Collins Radio Co., Dallas, Texas

IN TRANSCEIVERS, if one circuit can generate a tone during transmission and selectively amplify that frequency while receiving, the circuit will have advantages over other circuits that may be used for the same application. Such a dual circuit operating at 170 cps has been developed.

One advantage is the smaller number of components in the dual circuit: four frequency determining elements, two transistors and two biasing resistors. Another advantage is that the only transistor parameters that gain and frequency stability depend upon are the grounded-base current gain, and the grounded-collector voltage gain. Both these parameters are stable. Also, practical design equations for the circuit are simple.

The circuit is transformed from a band-pass amplifier to an oscillator by a slight change in the impedance level of an R-C time constant. Using the generalized circuit of Fig. 1A a whole family of circuits can be described. The family includes various oscillators, Q multipliers, notch filters and band-pass, low-pass and high-pass amplifiers. The Butler oscillator may be considered as a member of this group.

Open-loop gain will be considered first by breaking the circuit at point X of Fig. 1A and redrawing as in Fig. 1B

$$i_b = G_i i_1 = \alpha i_1 \cong i_1 \quad (1)$$

where  $G_i$  is the current gain of a common-base stage. Voltage at the output of  $Q_2$  is

$$e_4 = G_v e_3 \quad (2)$$

where  $G_v$  the voltage gain of a common collector stage, is

$$G_v = \frac{r_L}{r_e + r_b(1 - \alpha) + r_L} \cong 1 \quad (3)$$

if  $r_L \gg r_e + r_b(1 - \alpha)$  voltage  $e_4$  can be expressed as

$$e_4 = i_2(Z_1 + R_{in}) \cong Z_1 i_2 \quad (4)$$

if it is assumed  $R_{in} \ll Z_1$ . Point B of Fig. 1B will eventually be returned to point A where  $R_{in}$  becomes the input impedance of  $Q_1$ . Since the input impedance is usually less than 50 ohms, Eq. 4 may be easily satisfied. At the input to  $Q_2$

$$e_3 = Z_2 i_3 \quad (5)$$

It is assumed  $i_{b2} \ll i_b$ . This will be true so long as

$$r_{b2} + \beta_2(r_e + Z_1) \gg Z_2 \quad (6)$$

Combining Eq. 1, 2, 4 and 5

$$G_o = i_2 / i_1 = G_i G_v Z_2 / Z_1 \cong Z_2 / Z_1 \quad (7)$$

where  $G_o$  is the open-loop current gain. From feedback theory, the relationship between closed-loop ( $G_c$ ) and open-loop ( $G_o$ ) gain (for positive feedback) is

$$G_c = G_o / (1 - G_o) \quad (8)$$

Combining Eq. 7 and 8 gives

$$G_c = \frac{1}{\frac{Z_1}{Z_2 G_o} - 1} \cong \frac{1}{\frac{Z_1}{Z_2} - 1} \quad (9)$$

Consider  $Z_1$  a series  $R_1$  and  $C_1$  and  $Z_2$  a parallel  $R_2$  and  $C_2$  thus

$$Z_1 = R_1 + \frac{1}{sC_1} = \frac{sR_1C_1 + 1}{sC_1} = \frac{T_1s + 1}{sC_1} \quad (10)$$

$$Z_2 = \frac{R_2 sC_2}{R_2 + \frac{1}{sC_2}} = \frac{R_2}{sR_2C_2 + 1} = \frac{R_2}{T_2s + 1} \quad (11)$$

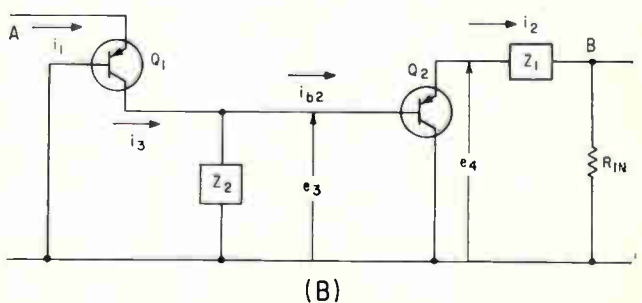
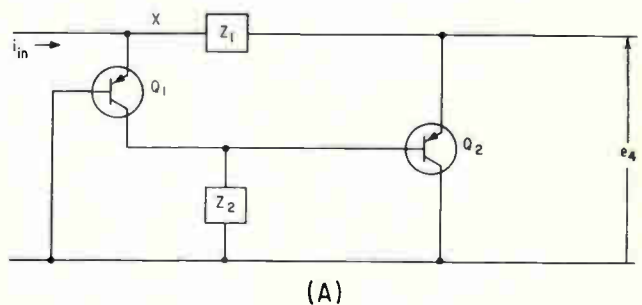

FIG. 1—Circuit (A) is redrawn (B) to provide basis for design equation derivation

# for Tone Transceivers

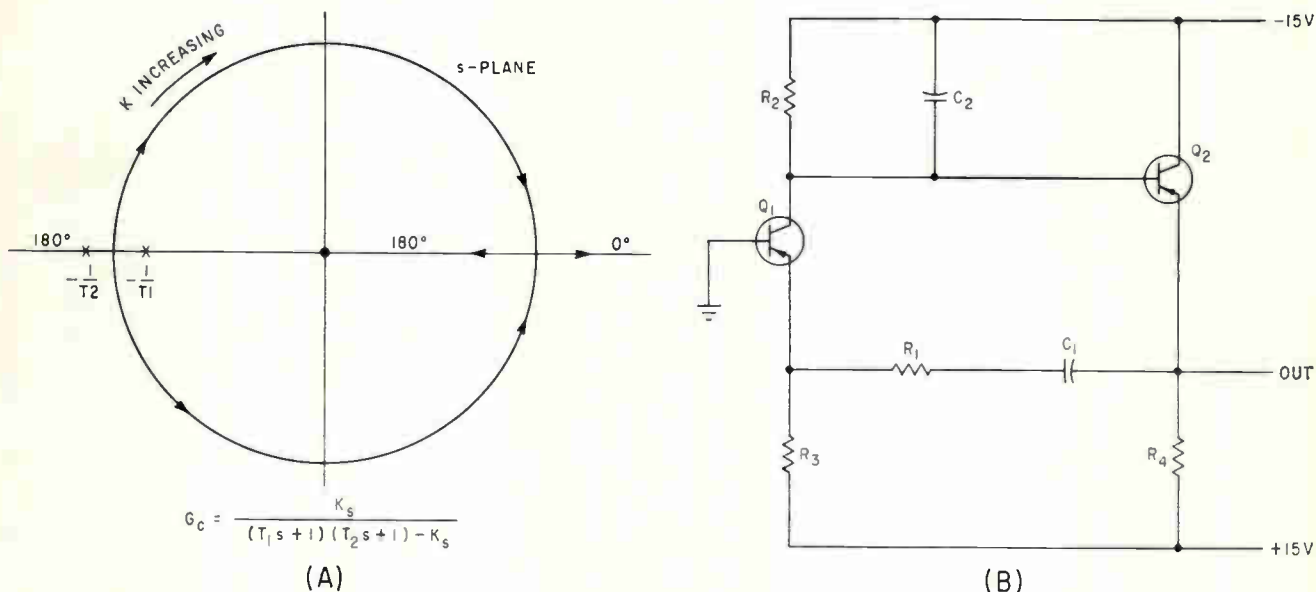

FIG. 2—Root-locus plot of loop gain (A). Circuit for band-pass amplifier and oscillator (B)

where

$$T_1 = R_1 C_1 \quad T_2 = R_2 C_2 \quad (12)$$

$$\text{and } s = j\omega. \quad (13)$$

Combining Eq. 9, 10 and 11

$$G_c = \frac{G_1 G_2 R_3 C_1 s}{(T_1 s + 1)(T_2 s + 1) - G_1 G_2 R_3 C_1 s} \quad (14)$$

$$G_c = \frac{K s}{(T_1 s + 1)(T_2 s + 1) - K s} \quad (15)$$

$$= \frac{K s}{T_1 T_2 s^2 + (T_1 + T_2 - K) s + 1}$$

where

$$K = G_1 R_3 C_1 \quad \text{and} \quad G_1 = G_1 G_2 \quad (16)$$

Equation 15 may be analyzed by the root-locus method if  $K$  is considered as a gain factor. Note, however, that  $K$  may be varied only by varying  $R_3$  or  $C_1$  (Eq. 16), this would also vary the time constant  $T_1$  or  $T_2$  which would be inconvenient. Time constants  $T_1$  and  $T_2$  may be made independent of  $K$  provided two, rather than one, elements are varied. If  $K$  is increased by increasing  $R_3$ ,  $T_1$  may be maintained constant by decreasing  $C_1$ .

The root locus of Eq. 15 may be determined as shown in Fig. 2A. The two poles and one zero of the closed-loop response are as shown. Poles of the closed-loop response approach the open-loop poles if  $K$  approaches zero and proceed along a certain locus to the zeros of the open-loop response as  $K$  approaches infinity. For more on Root Locus see W. R. Evans, Graphical Analysis of Control Systems, *Trans AIEE*, 67, p. 547. Also W. R. Evans "Control System Dy-

namics" and J. G. Truxal, "Automatic Feedback Control System Synthesis," both McGraw-Hill Book Co., N. Y.

As  $K$  increases from zero the poles of the closed-loop response break away from the real axis between  $-1/T_1$  and  $-1/T_2$  and eventually reach the imaginary axis. At this point the circuit has enough gain to just break into oscillation.

The value of  $K$  at this point may be determined by observing that  $K$  must have a value that renders the denominator of Eq. 15 to be purely imaginary. The coefficient of the  $s$  term must be equal to zero. Thus the requirements for oscillation is

$$K = T_1 + T_2 \quad (17)$$

If Eq. 17 is satisfied, the frequency of oscillation is

$$\omega_o = 1 / \sqrt{T_1 T_2} \quad (18)$$

It is convenient to let

$$T_1 = T_2 = T_o \quad (19)$$

Then

$$\omega_o = 1 / T_o \quad (20)$$

Combining Eq. 12, 13, 16 and 17

$$R_3 G_1 R_2 = R_1 \quad (21)$$

$$C_1 G_1 R_2 = C_2 \quad (22)$$

The relations in Eq. 18, 19, 20, 21 and 22 determine the parameters for designing an oscillator. For a practical oscillator, however,  $R_1$  should be slightly smaller than  $R_3 G_1 R_2$  so the circuit is definitely unstable. Too great a decrease in  $R_1$  results in waveform distortion.

For a band-pass amplifier,  $K$  is reduced to make

circuit stable. An equation that expresses the relationship of  $Q$  and the circuit parameters may be developed by comparing the denominator of Eq. 15 to the characteristic equation for a series RLC circuit

$$LCs^2 + RCs + 1 = 0 \quad (23)$$

Since

$$Q = \omega_o L / R = 1 / R \omega_o C \quad (24)$$

Equation 23 may be rewritten

$$\frac{T_s^2}{1 + \frac{1}{4Q^2}} s^2 + \frac{T_o}{Q} s + 1 = 0 \quad (25)$$

where  $1/\sqrt{LC} = \omega_o = 1/T_o$ , which is the resonant frequency in radians per second.

Comparing the denominator of Eq. 15 to Eq. 25

$$T_1 + T_2 - K = T_o / Q \quad (26)$$

$$\text{and } T_1 T_2 = \frac{T_o^2}{1 + \frac{1}{4Q^2}} \cong T_o^2 \text{ if } Q > 5 \quad (27)$$

If  $T_1 = T_2 = T_o$ , Eq. 26 becomes

$$Q = 1 / (2 - G_p R_2 / R_1) \quad (28)$$

A typical value for  $G_p$  would be 0.98. For a desired  $Q$  of 20,  $R_2$  would be  $R_2 = 1.99 R_1$ .

For an amplifier, the gain must be related to frequency and circuit parameters. One way of using Fig. 2B as an amplifier is to inject a constant-current source input to the emitter of  $Q_1$ , and considering the emitter voltage of  $Q_2$  as the output.

Under these conditions it is desired to determine the transresistance  $R_{21}$  as a function of frequency

$$R_{21} = \frac{e_4}{i_{in}} = \frac{Z_1 i_2}{i_1 - i_2} = \frac{Z_1}{i_1 / i_2 - 1} \quad (29)$$

Combining Eq. 29 and 7

$$R_{21} = \frac{Z_1}{\frac{1}{G_p} \left( \frac{Z_1}{Z_2} \right) - 1} \quad (30)$$

where  $G_p = G_1 G_v$

Comparing Eq. 30 to 9

$$R_{21} = G_p Z_1$$

Thus where  $Z_1 = (T_1 s + 1) / s C_1$  and  $Z_2 = R_2 / (T_2 s + 1)$

$$R_{21} = G_p R_2 \frac{T_1 s + 1}{T_1 T_2 s^2 + (T_1 + T_2 - K) s + 1} \quad (31)$$

Using Eq. 26 and 27 and setting  $T_1 = T_2 = T_o$

$$R_{21} \cong G_p R_2 \frac{T_o s + 1}{T_o^2 s^2 + \frac{T_o}{Q} s + 1} \quad (\text{for } Q > 5) \quad (32)$$

Setting  $s = j\omega$  and taking the absolute value

$$|R_{21}(\omega)| = G_p R_2 \sqrt{\frac{1 + T_o^2 \omega^2}{(1 - T_o^2 \omega^2)^2 + \left(\frac{T_o \omega}{Q}\right)^2}} \quad (33)$$

Equation 33 is shown in Fig. 3 for  $Q = \infty$  and 10. Note that the value of  $Q$  virtually has no effect upon the response at frequencies more than about 10 percent away from  $1/T_o$ .

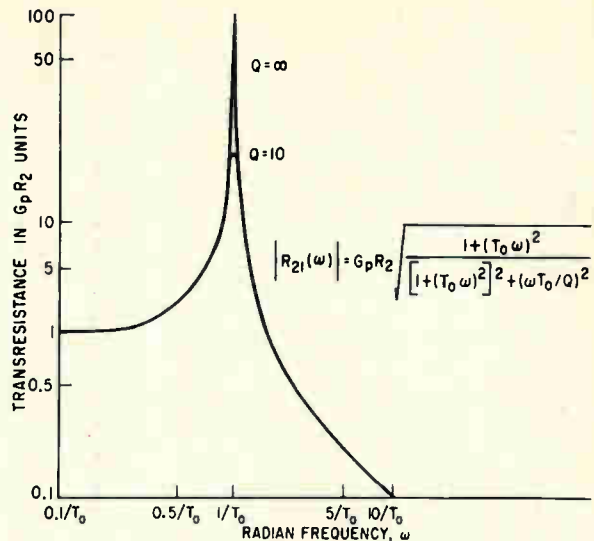

FIG. 3—Effect of  $Q$  on transresistance

Setting  $s = j/T_o$  in Eq. 32

$$R_{21} = G_p R_2 Q (1 - j) \quad (34)$$

and the absolute value

$$|R_{21}| = \sqrt{2} G_p R_2 Q \quad (35)$$

Equations 34 and 35 give the gain at the point of maximum response. At  $\omega = 1/T_o$ , the phase shift is  $-45$  degrees and the gain is a direct function of  $Q$ . For a typical oscillator application: assume it is desired to design an oscillator at a resonant frequency of 100 cps and the power supplies are  $+$  and  $-15$  v. Refer to Fig. 2B. To obtain maximum output before limiting, the quiescent operating collector voltage of  $Q_1$  should be  $-7.5$  v. A good operating current for  $Q_1$  is 1 ma, therefore,  $R_2 = 7.5 \text{ v} / 1 \text{ ma} = 7.5$  kilohms.

Selecting  $R_2$  fixes the values of  $R_1$ ,  $C_1$ , and  $C_2$ . Using Eq. 18, 19, 21 and 22:  $C_2 = 0.212 \mu\text{f}$ ,  $R_1 = 3.674$  kilohms,  $C_1 = 0.424 \mu\text{f}$ , assuming  $G_1 G_v = 0.98$ .

The values of  $R_2$  and  $R_1$  (Fig. 2B) are determined only by operating-point considerations. Thus, if both  $Q_1$  and  $Q_2$  are to be operated at one milliampere, then  $R_2 = 15,000$  ohms and  $R_1 = 22,500$  ohms.

It is desirable to adjust the values of the capacitors to RETMA values:  $C_2$  could be  $0.2 \mu\text{f}$  and  $C_1$  could be  $0.39 \mu\text{f}$ . It is not absolutely necessary that  $T_1$  be exactly equal to  $T_2$ , but for oscillation  $K$  must be equal to or slightly greater than  $T_1 + T_2$ .

From Eq. 21 and 22

$$R_1 = R_2 (G_p - C_2 / C_1) \quad (36)$$

which may be used to determine the relation between resistances when capacitors are arbitrarily chosen.

The frequency of oscillation will be

$$\omega_o = \frac{1}{T_2 (G_p C_1 / C_2 - 1)^{1/2}} = (G_p C_1 / C_2 - 1)^{1/2} / T_1 \quad (37)$$

For a typical bandpass amplifier application: assume it is desired to design a bandpass amplifier with a center frequency of 100 cps and a  $Q$  of 20. It is desired to have at least a 5-v peak-to-peak output voltage swing from a signal source to 100  $\mu\text{amps}$  p-p at



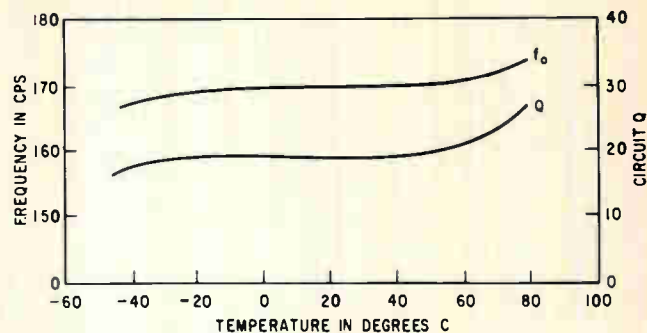
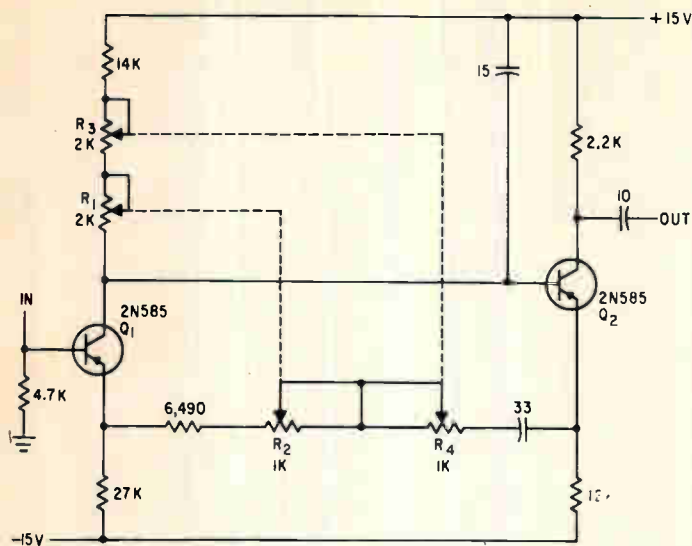

FIG. 5—Variation of Q and center frequency of amplifier with center frequency of 170 cps

FIG. 4—Band-pass amplifier with center frequency of 0.66 cps and Q of 20

center frequency. Power supplies available are + and -15 volts.

$$\text{From Eq. 35, } R_2 = \frac{|R_{21}|}{\sqrt{2}G_p Q} = \frac{5 \cdot 10^{-4}}{(\sqrt{2})(0.98)(20)} = 3.54K$$

This value of  $R_2$  will give the required gain. To put the collector of  $Q_1$  at 7.5 volts, which allows symmetrical clipping on strong signals, the current required would be

$$i = 7.5 / 3.54K = 2.12 \text{ ma}$$

This is a good operating point for  $Q_1$ , however, if more gain is not objectionable,  $R_2$  may be 7.5 K as in the last example.

Resistance  $R_1$  is then given by Eq. 28

$$R_1 = \frac{G_p R_2}{2 - \frac{1}{Q}} = \frac{(0.98)(7.5)10^3}{2 - \frac{1}{20}} = 3.77K$$

and by Eq. 20, 12 and 13,  $C_1 = 0.422 \mu\text{f}$  and  $C_2 = 0.212 \mu\text{f}$ .

For arbitrarily chosen capacitors and a given Q then relation between resistors is

$$R_1 = R_2 \frac{C_2}{C_1} \left[ G_p \frac{C_1}{C_2} + \frac{1}{2Q^2} - 1 + \frac{1}{Q} \left( G_p \frac{C_1}{C_2} + \frac{1}{4Q^2} - 1 \right)^{1/2} \right] \quad (38)$$

However, in the practical case,  $C_1$  and  $C_2$  are chosen to the closest RETMA values as determined by Eq. 20, 12 and 22 and  $R_1$  and or  $R_2$  are trimmed to give the required Q. To maintain the same center frequency while varying Q, resistors  $R_1$  and  $R_2$  must be varied in the opposite directions according to

$$\Delta R_2 = (-)2 \Delta R_1 \quad (39)$$

To maintain a constant Q while varying center frequency, resistors  $R_1$  and  $R_2$  must be increased or decreased together according to

$$\Delta R_2 = 2 \Delta R_1 \quad (40)$$

Resistors  $R_3$  and  $R_4$  in Fig. 2B are determined as before and are 15 K and 22.5 K respectively.

Figure 4 shows a typical application of the band-pass case where the center frequency and Q are adjusted by separate and independent controls. Center frequency is nominally 0.66 cps and Q is nominally 20. Resistors  $R_1$  and  $R_2$  are ganged so that increasing  $R_1$  decreases  $R_2$ . This is the Q control (and controls gain). Resistors  $R_3$  and  $R_4$  are ganged so that they vary together to control frequency.

The input is introduced to the base of  $Q_1$ , rather than the emitter. This raises the input impedance and allows easier driving. No modification of the design equations is necessary since in Eq. 4 it is assumed that  $Z_i \gg R_n$ , where  $R_n$  is the impedance looking into the emitter of  $Q_1$ . This is still true in spite of the added base resistance.

The output may be taken from either the emitter or collector of  $Q_2$ . Although the impedance level is low at the  $Q_2$  emitter, no appreciable power may be taken off at this point without adversely affecting the circuit characteristics. If the load is constant, the circuit may be readjusted after adding the load. It is usually best to couple into the circuit with an emitter follower at the  $Q_2$  emitter. If the output is taken from across a resistor in the collector circuit of  $Q_2$  no adverse loading effects will be noted, but this reduces the dynamic range for a given supply voltage.

Figure 5 shows how Q and center frequency vary with temperature for an amplifier having a center frequency at 170. No temperature compensation techniques were used other than selecting stable components. In this case 2N338 silicon transistors, deposited carbon resistors, and polystyrene dielectric capacitors were used.

It can be shown that the percentage change in the transresistance will be 2Q times the percentage change in  $G_p$ . Although  $G_p$  is temperature stable, it is best not to try for too high a Q in one circuit. A nominal Q of 20 will give stable gain over a large temperature range. Larger values of Q may be used if the temperature range is limited or temperature compensation is used.

Variation of mechanical configuration  
of field-effect transistor  
produces a device with various  
negative-resistance characteristics

By TATSUYA NIIMI  
TOSHIYA HAYASHI

Electrical Communications Laboratory, Tokyo, Japan  
Nagoya Institute of Technology, Nagoya, Japan

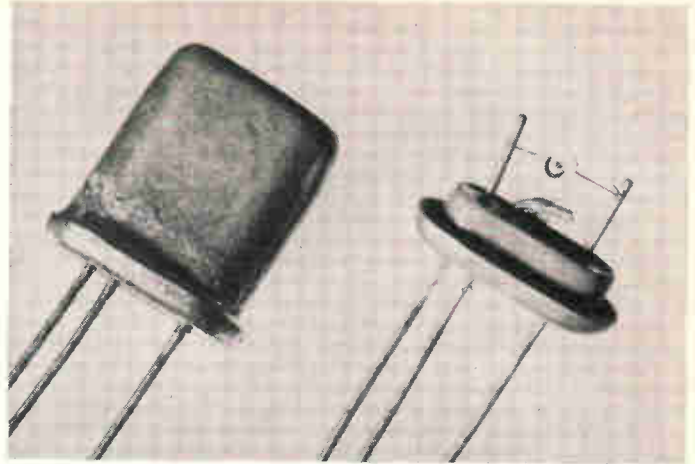

Field-effect transistor resembles a conventional alloy-junction transistor

# Field-Effect Transistor as a

FIELD EFFECT transistors have a negative resistance characteristic at their gate.<sup>1</sup> In recent work on various geometrical configurations of field-effect transistors, a new form was developed, also with a negative resistance characteristic. Results of efforts to improve this characteristic have been disclosed.<sup>2, 3</sup>

Configuration of this field-effect transistor, Fig. 1, is similar to an alloy-junction transistor with a ring base electrode. The base material is *n*-type germanium, but the base width is much narrower than those of conventional transistors. Two electrodes, labeled gate and drain, Fig. 1A form the *p-n* junction with the base material. The third electrode, source, makes resistive contact with the base.

To operate the device successfully, the distance  $W_5$  between the drain and gate must be larger than the channel width  $W_1$ . Channel width  $W_1$  corresponds to the base width of a conventional alloy transistor.

Figure 1B shows a typical operating schematic. The drain is connected to ground, and the other two electrodes are biased negatively. Two batteries supply drain voltage  $V_d$  and gate voltage  $V_g$ . If gate voltage  $V_g$  is reduced to zero, two *p-n* junctions at the drain and the

gate become biased in the forward direction and drain current  $I_d$  flows from the drain to the source through the channel. Similarly, gate current  $I_{g1}$  flows from the gate to the source.

Under operating conditions, however, gate voltage  $V_g$  is not zero, so the *p-n* junction at the gate is biased in the reverse direction. Current  $I_{g2}$ , instead of  $I_{g1}$ , Fig. 1B, will flow in the gate circuit. Increasing voltage  $V_g$  makes the space charge layer widen into the deeper interior of the channel. This increases the resistance of the channel region. Since an increase in the channel resistance results in a larger voltage drop at the channel, an increase in  $V_g$  will reduce the forward bias voltage of the drain *p-n* junction. Currents  $I_d$  and  $I_{g2}$  also decrease. When gate voltage  $V_g$  reaches a pinch-off voltage  $V_p$ , drain current  $I_d$  and gate current  $I_{g2}$  become zero. Therefore, a voltage-controlled negative-resistance characteristic appears at the gate circuit.

This field-effect transistor is not a unipolar transistor since minority carriers play an active role in its operation. Frequency characteristics can be considered the same as a conventional transistor.

The most important parameters

are the pinch-off voltage  $V_p$ , maximum gate current  $I_{g1}(\text{max})$  and cut-off frequency  $f_c$ . Pinch-off voltage determines the voltage operating region of the device. It can be calculated by applying the resistivity of the base material and the channel width  $W_1$ ,

$$V_p = \frac{q(N_d - N_a)}{2k\epsilon_0} W_1^2 \quad (1)$$

where  $k\epsilon_0$  is the dielectric constant of germanium,  $q$  is the charge,  $N_d$  the donor density and  $N_a$  the acceptor density in the base material.

Equation 1 becomes Eq. 2 when type *n* germanium with a resistivity of 10 ohms cm at room temperature is used for the base material and the width  $W_1$  of the channel is

## SPECIFICATIONS OF TYPICAL FIELD-EFFECT TRANSISTOR

Pinch-off voltage	5 v
Width $W_1$	0.1 mm
Width $W_4$	0.007 mm
Width $W_5$	0.04 mm
Radius $r_1$	0.1 mm
Radius $r_2$	0.15 mm
Radius $r_3$	0.4 mm

Base material is type *n* germanium with resistivity of 10 ohms per cm at room temperature

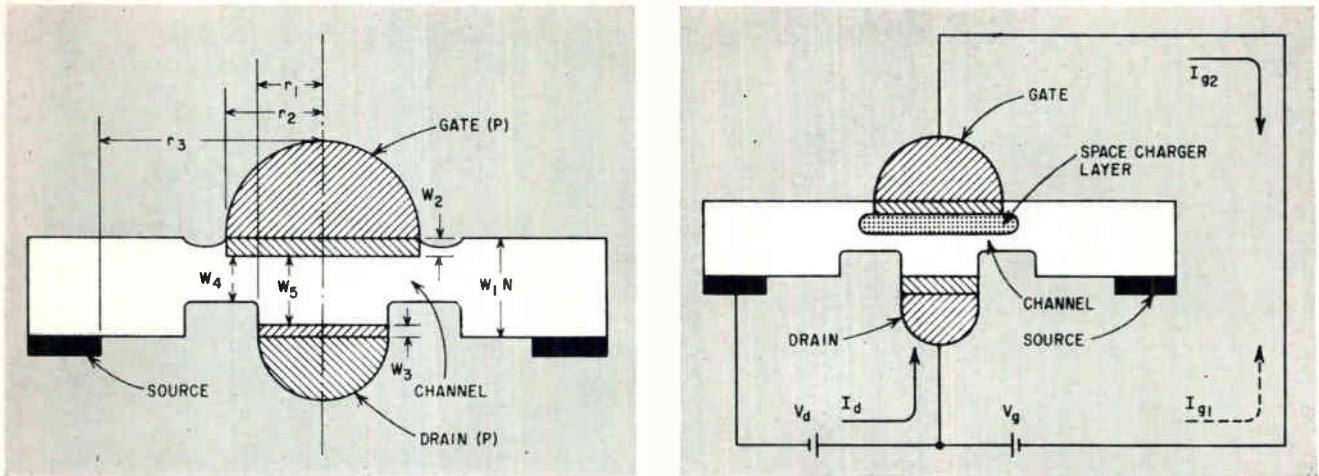

FIG. 1—Width of the channel is the most important dimension in determining the operating characteristics of the field-effect transistor (A) and how the space-charge layer affects the channel resistance (B)

# Negative-Resistance Device

given in microns

$$V_p = 0.098 W_c^2 \quad (2)$$

Assume a channel width of 7 microns. Then voltage  $V_p$  will be 5 v. Best performance of the device was obtained using the type  $n$  germanium as base material. The requirements of good electrical characteristics with sufficient mechanical strength dictated the choice of this base material. Also to successfully form a channel using electrolytic etching, a type  $n$  germanium material is necessary.

Cutoff frequency  $f_c$  is about the same or slightly lower than that of an alloy transistor. Maximum gate current is about the same order as the saturation current of an alloy transistor operating with a grounded emitter. The accompanying table lists the physical parameters of this example. Figure 2 illustrates the static characteristic of a transistor with these dimensions at room temperature. From the curves, pinch-off voltage is 5 v for various values of drain voltage. Maximum gate current never rises above 4 ma.

In the fabrication of a field-effect transistor with negative resistance characteristics, the alloying processes are substantially the same as for conventional transistors except

that alloying temperatures are about 600 C. This is necessary to obtain a wide recrystallized region  $W_c$ , Fig. 1A, to assure adequate mechanical strength.

Electrolytic etching equipment, Fig. 3, etches the channel to the proper width. Electrolyte is 10 percent potassium hydroxide. The cathode is a platinum plate and the anode is the germanium wafer being etched. Variable resistance  $R_1$  adjusts drain current which is read by ammeter  $MA_2$ . Gate voltage is set by variable resistance  $R_2$ . Ammeter  $MA_1$  reads electrolytic current.

In etching, a gate voltage equal

to the desired pinch-off voltage is applied. The drain current decreases during etching. The gate voltage must be held constant. When the drain current reaches zero, the channel for the pinch-off voltage has been formed.

Pinch-off voltage can be set at will, and the on-off ratio of the gate current is 1,000 or more.

## REFERENCES

- (1) G. C. Dacey, I. M. Ross, *Proc IRE*, 41, 8, p 970.
- (2) T. Hayashi, *The Journal of the Institute of Electrical Communication Engineers of Japan*, 43, 3, p 298, (1960).
- (3) T. Niimi, T. Hayashi, Y. Sunohara, *The Journal of the Institute of Electrical Communication Engineers of Japan*, 44, 5, p 811, (1961).

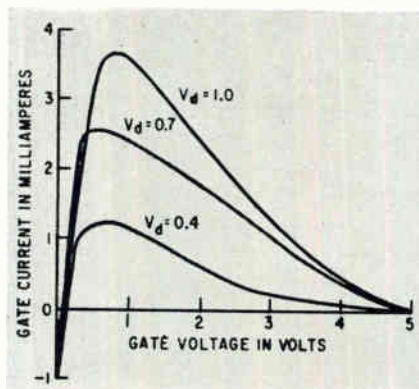

FIG. 2—Current-voltage characteristic of the gate circuit for various values of drain voltage

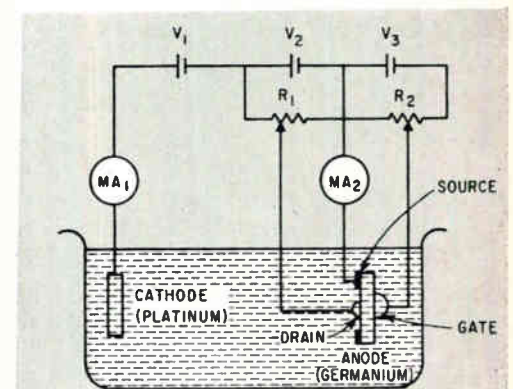
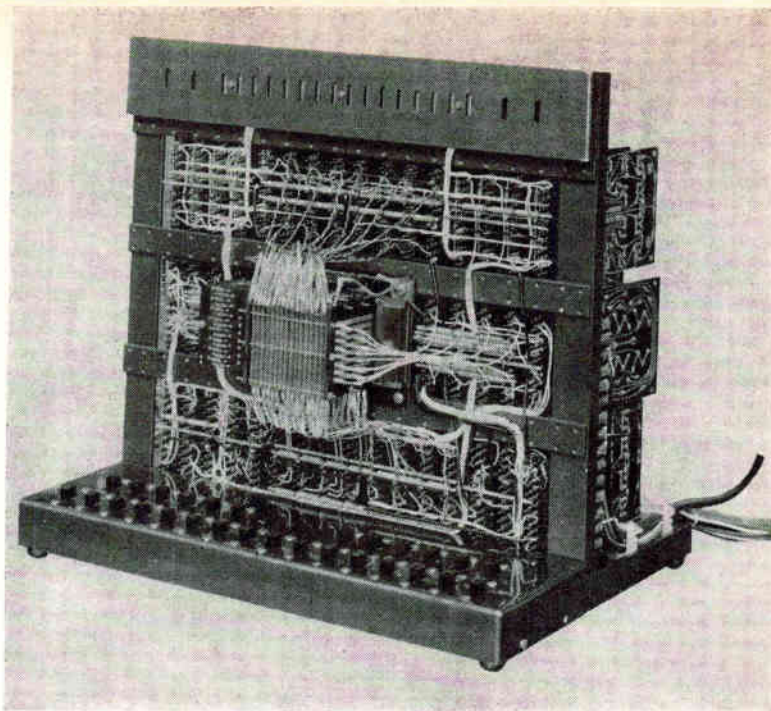

FIG. 3—Connection of electrolytic etching equipment for formation of the channel

*Practical high-speed memories can be achieved using cylindrical elements that make effective use of thin magnetic films and permit memory organization that reduces crosstalk. Large outputs are provided that reduce other system requirements and semiautomatic fabrication can be used*



*First destructive-readout, word organized memory using magnetic rods has been operating continuously for more than two years*

## Magnetic-Film Rods Provide

By D. A. MEIER

Electronics Div.,  
The National Cash Register Co.,  
Hawthorne, Calif.

HIGH-SPEED MEMORIES have been proved practical using cylindrical thin magnetic film elements. The rods permit effective use of thin magnetic film properties and a three-dimensional memory organization that limits crosstalk. The memory elements provide outputs that reduce requirements for noise cancellation and gain-bandwidth of sense amplifiers. The small size of the rod elements limits line inductances and propagation delays in high-speed memory systems.

Higher operating speed is a continuing goal of many designers of digital systems, and component designers are striving to provide faster memory elements to satisfy this desire. New elements having high speeds are announced almost every week, many of which look promising. However, these elements are often described only by switching speeds and have not been thoroughly analyzed to determine their suitability for use in high-speed memories. A memory element ca-

pable of 1-nsec switching may not be practical for use in computers.

To evaluate a memory element realistically for its ultimate application, many factors must be considered. It should be reproducible and capable of providing long life. The environment required for its operation must be considered, and the device must be compatible with other components and practical for system applications. Physical and electrical characteristics of the element as well as its cost must be considered, and it must comply with requirements of the firm using it. Finally, it must do the job better than any other element.

If a memory element does not fulfill even one of these requirements, it sometimes must be rejected. However, even if all these requirements are satisfied, it cannot be assumed that a new memory element will function adequately when used in large numbers in systems. Although no attempt will be made to rate the magnetic rod element in accordance with these criteria, presentation of these considerations indicates some of the tests to which a new element may

be subjected before acceptance.

The rod element' comprises a cylindrical thin magnetic film electrodeposited over a conductive substrate, as shown in Fig. 1A. Silvered-glass rod and a BeCu wire have proved satisfactory.

The magnetic material is 97 percent Fe and 3 percent Ni and thickness is about 4,000 Angstroms. The hysteresis loop is square, which is required in remnant flux storage applications to provide good signal-to-noise ratio and a threshold for which no switching occurs. The material is also relatively insensitive to variations in ambient temperature, as shown in Fig. 2.

The cylindrical shape of the element reduces some of the problems of thin magnetic films. It permits tight coupling between windings and magnetic material, producing typically 30 to 40 mv per turn, and it facilitates multiple-turn windings that provide large uniform switching fields with reasonable currents. The small diameter solenoids also limit winding inductances.

The rod is a continuous magnetic medium, and a single bit is designated by the location of the solenoid

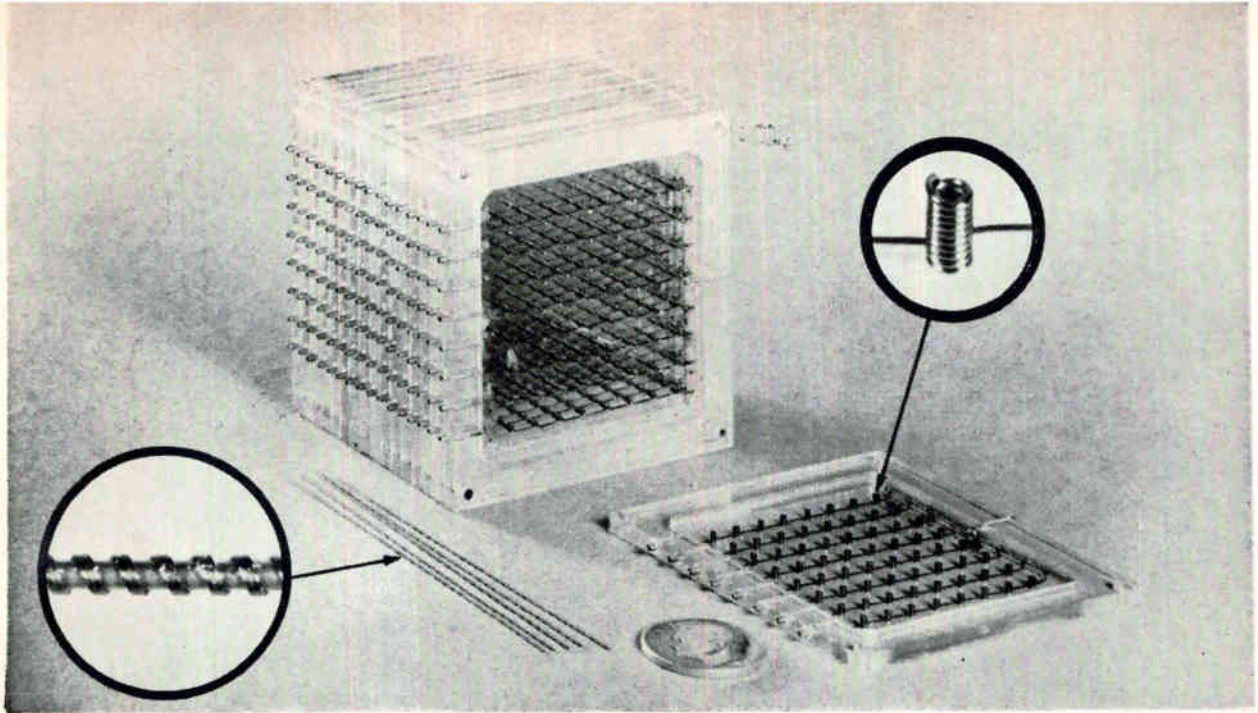

Coaxial winding is shown enlarged on rod of partly assembled memory module, while word windings, like the one also enlarged, are prefabricated on solenoid and rods inserted later

# High-Speed Memory

winding along its length. Solenoid length and the space between adjacent solenoids determine linear bit density of the rod, which should be as high as possible to limit propagation delays.<sup>2,3</sup> A 10-mil diameter rod that stores 10 bits per linear inch is typical. Each bit usually has switching characteristics like those in Fig. 3, where  $\tau_s$  is switching time,  $\mu V_1$  is undisturbed ONE,  $dV_1$  is disturbed ONE, and  $dV_2$  is disturbed zero output voltage.

The axial-switching mode results in an open flux path element in which the return path for the magnetic flux leaves the magnetic film at one end of the solenoid and returns through the air to the other end. With this arrangement, the element is sensitive to stray magnetic fields, and the demagnetizing field produced by the discontinuity limits minimum physical length. Both effects can be limited by using a magnetic material for the mem-

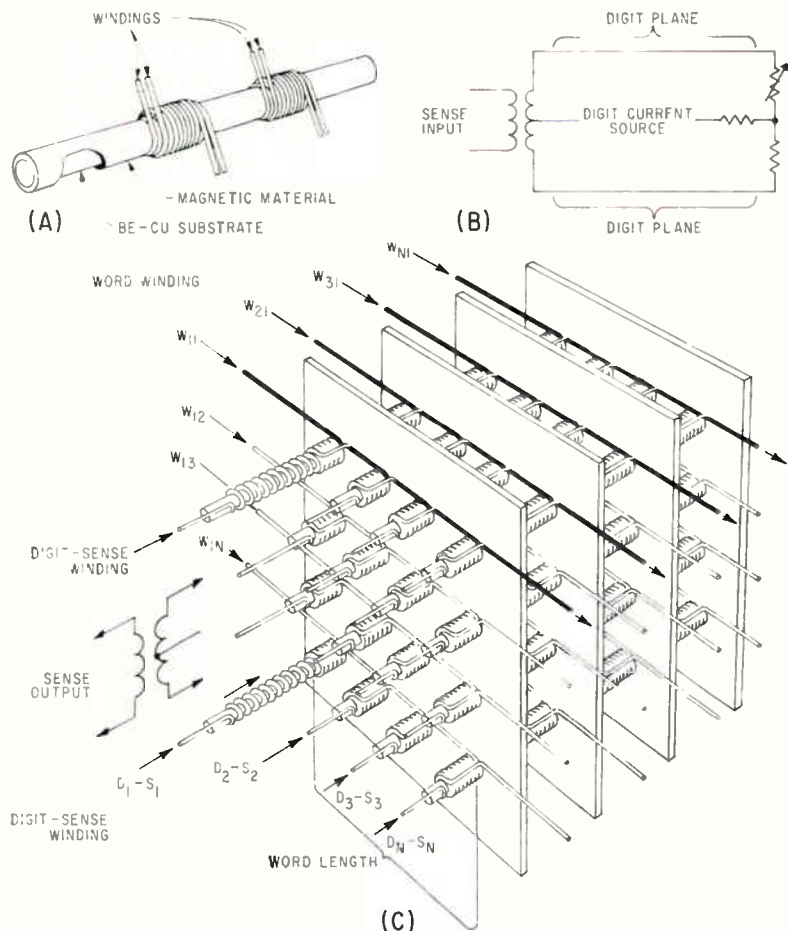

FIG. 1—Rod structure with solenoid windings is shown at (A), shared sense-digit winding bridge at (B) and memory organization at (C)

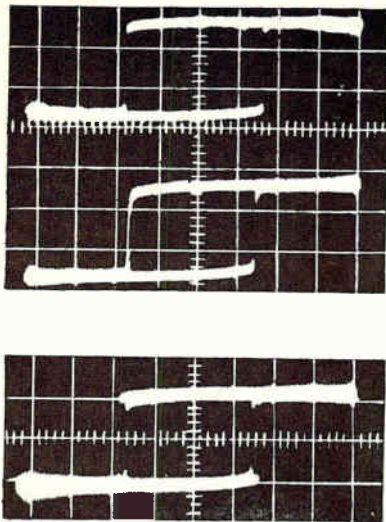

FIG. 2—Top photo shows rod B-H loop at 75 C in upper trace and at 125 C in lower trace. Two traces are superimposed in lower photo

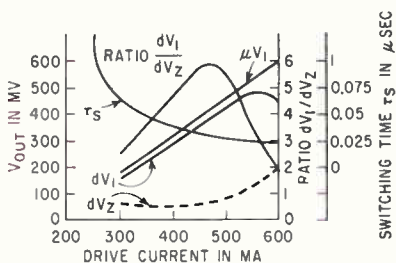

FIG. 3—Switching characteristics for typical rod element

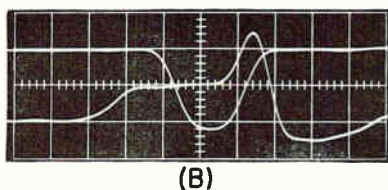
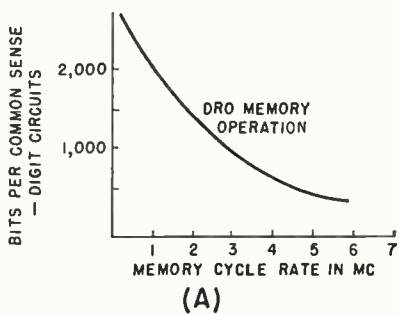

FIG. 4—Number of bits that can share sense-digit circuits is shown at (A) for various cycle rates. Word access time for 5-Mc memory is shown at (B) with sense amplifier output on upper trace and word line voltage on lower trace. Large horizontal divisions are 0.02 usec and large vertical divisions are 2 volts

ory elements having higher coercivity.

The large coercive force of the rod material (15 oersteds) makes special shielding from stray magnetic fields unnecessary and contributes to the nanosecond switching time because of the large excessive fields that can be used. Although the large coercivity requires a large switching field, it can be provided by the small multiple-turn solenoids with reasonable currents.

In a tightly coupled memory module, crosstalk, noise and recovery transients can arise from many sources. Capacitive coupling must be uniform and balanced, and inductive coupling must be limited. Machine winding techniques have been developed that provide sufficiently uniform windings, and the rod element facilitates a three-dimensional memory organization with orthogonal winding that minimizes crosstalk. Typical packing density of present rod modules is 1,000 bits per cubic inch, and an increase to 4,000 bits per cubic inch is planned for the near future.

A two-winding word-organized memory is shown in Fig. 1B and C, and a memory module ready for assembly is shown photographically. A shared sense-digit winding is used in a bridge arrangement that has proved effective in high-speed operation. The word windings are prefabricated on solenoid planes and the rods inserted later. Both coaxial and solenoid plane windings are machine wound.

Significance of the rod element is its use in destructive readout (DRO), word-organized memories with cycle rates of 1 to 10 Mc. (Cycle rate includes word-addressing time and read-restore or clear-write time.) In any memory, economics requires that many bits share sense and digit circuits. However, fewer bits can share circuits as cycle rate increases, more because of propagation and recovery effects than switching time of individual elements. This limit to sharing is generally true of any high-speed DRO memory. Bit-sharing capability at different cycle rates is shown in Fig. 4A. For a balanced 1,000-bit sense winding, propagation time can be reduced to 0.04 nsec per bit for a delay time of about 20 nsec.

The first DRO word-organized memory<sup>2</sup> using the magnetic rod and shown in the photograph has been operating continuously for more than two years with no degradation in operating characteristics noted. It has 64 words of 16 bits per word and a design cycle rate of 1 Mc, although it was bench-tested at a 2-Mc rate. Required word driver current is 260 ma, digit current is 260 ma, and read d-c bias is 130 ma. Sense-winding output voltage produced across 50 ohms by a word-current with a 0.1 μsec rise time is 125 mv.

Maximum potential speed of thin-film rod DRO memories using the many new and more promising high-speed semiconductor components now available is being studied. Present design effort centers around a 128-word, 8-bit-per-word memory with a 5-Mc cycle rate. Using a rod with slightly lower coercivity has reduced switching current requirements sufficiently to make practical a 5-Mc rate using single-transistor drivers.

The time between the voltage change on a selected word line and sense-amplifier output is about 50 nsec, as shown in Fig. 4B. This time includes driver current rise time, time for the rod to switch to the same amplifier voltage threshold, and propagation and delay time of the sense line and sense amplifier. Sense amplifier gain-bandwidth is about  $3 \times 10^9$  cycles.

This work demonstrates that the rod element is practical for high-speed memories. Driver-current requirements are reduced, making megacycle repetition rates practical for semiconductor components. In addition, the rod element permits continuous fabrication and testing and the use of automated windings.

The author acknowledges the assistance of A. J. Kolk, I. Richman, R. Clinehens, E. Ostroot, R. Winfield, L. Douglas and the many others who contributed to the program.

## REFERENCES

- (1) D. A. Meier, Millimicrosecond Magnetic Gating and Storage Element, *Jour App Phys*, 30, p 122, Jan. 1959.
- (2) D. A. Meier, Magnetic Rod Memory, *Proc 1960 Electronic Components Conf*, p 122, May 1960.
- (3) D. A. Meier and A. J. Kolk, The Magnetic Rod—A Cylindrical Thin Film Memory Element, *Symposium on Large Capacity Memory Techniques for Computing Systems*, May 1961, sponsored by Information Systems Branch, Office of Naval Research, to be published by MacMillan Co.

## CALCULATING

## Potentiometer Errors

*Nomographs speed calculation of potentiometer errors caused by resistance loading and by contact and equivalent-noise resistance of wiper circuit*

By HENRY S. ZABLOCKI  
Markite Corp., N. Y., N. Y.

POTENTIOMETER requirements usually dictate linearity, noise and other specifications. Sometimes overlooked are a number of additional potentiometer errors that can result from the installation itself. These errors include general mechanical errors resulting from mounting and coupling, that is, angular displacement and misalignment, and electrical errors that occur when a finite load impedance is present in the wiper circuit.

The presence of a finite impedance in the wiper circuit of

any potentiometer, linear or non-linear, influences the output voltage so that it differs from its no-load value. Consider the total error to consist of loading error, fixed contact resistance error and equivalent noise resistance error.

Loading error is due to the internal resistance of the potentiometer. The equivalent-Thevenin-theorem internal resistance is the resistance (excluding contact resistance) between the potentiometer wiper and ground or reference point, with all battery supply points shorted. The internal resistance and resistance in the wiper circuit form a voltage divider that causes the output voltage to be less than the open-circuit voltage at the wiper point. The loading error varies from point to point.

$$D_L = \frac{S^2(1-S)}{L + S(1-S)}$$

where  $D_L$  = loading error (expressed as voltage ratio),  $S$  = wiper position in fractional resistance at the wiper point, and

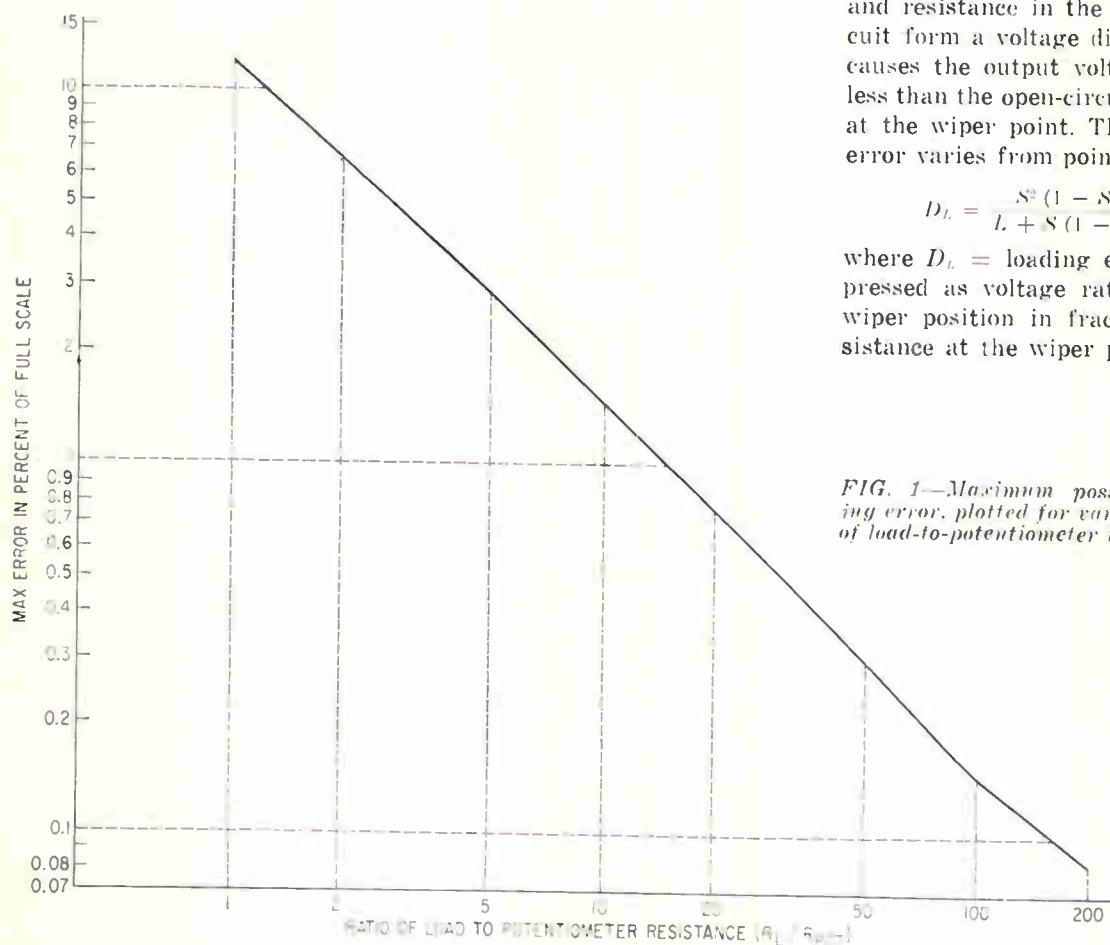

FIG. 1—Maximum possible loading error, plotted for various ratios of load-to-potentiometer resistances

$L$  = the ratio of load resistance to potentiometer track resistance (load ratio).

The maximum loading error occurs at approximately 67 percent of the total resistance (66.7 for  $L \rightarrow \infty$ ; 68.9 percent for  $L = 1$ .) Figure 1 presents this maximum error effect as a function of the load ratio ( $L$ ). The loading error can be compensated for during manufacture of the potentiometer by tailoring the resistance element to take into account the droop in output caused

by load resistance.

The presence of actual or apparent contact resistance in the wiper circuit results in a voltage dividing action between it and the load. Thus, if a potentiometer is compensated for loading error only, an error could still occur because of voltage drop in the contact resistance. This error is a fixed percentage of the output voltage and can be compensated for by adjustment of system gain. The magnitude of this error can be determined from Fig. 2

$$D_c = \frac{NR_c}{R_c + R_L}$$

where:  $D_c$  = error in voltage ratio due to contact resistance;  $N$  = nominal voltage ratio at the wiper point under load if no contact resistance were present (expressed as a fraction of applied voltage);  $R_c$  = apparent contact resistance in ohms; and  $R_L$  = load resistance in ohms.

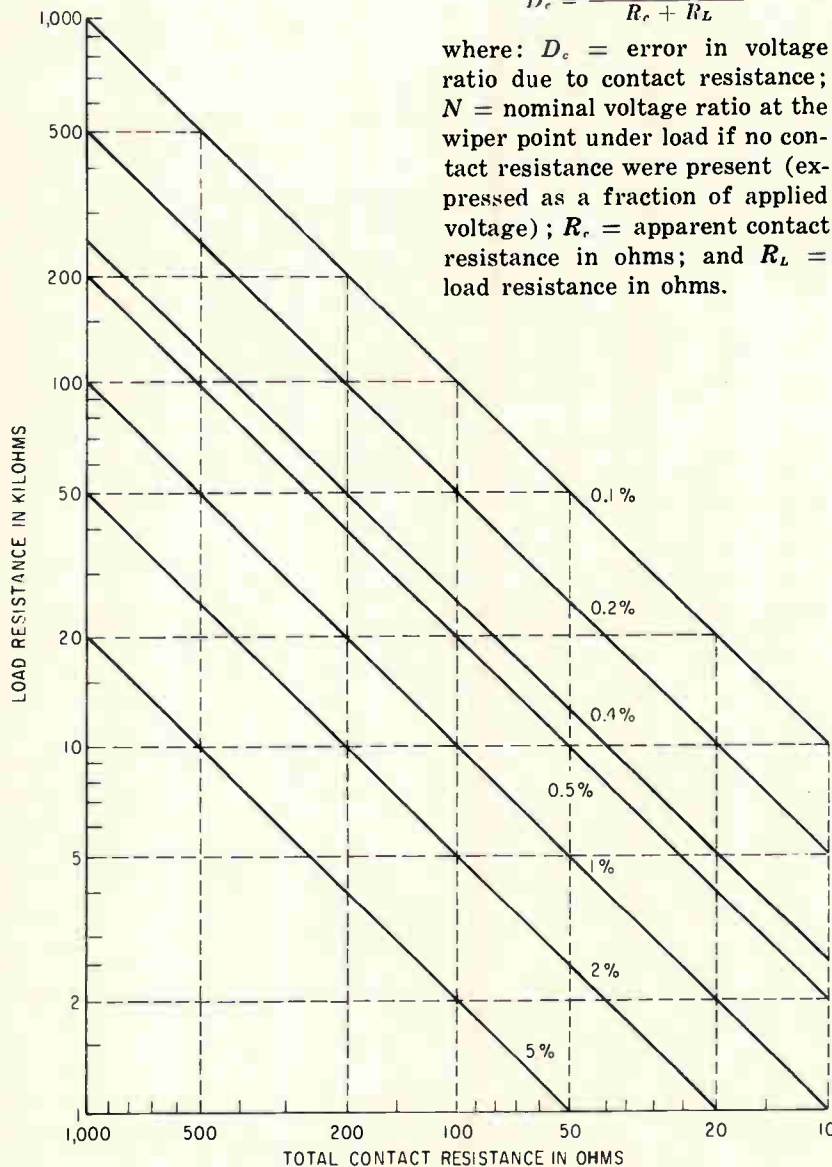

FIG. 2—Error resulting from contact or equivalent-noise resistance and load resistance, expressed in percent of nominal full-scale output voltage

A wiper circuit also has an equivalent resistance that varies with wiper position. This equivalent noise resistance also forms a voltage divider with the load resistance, and causes the output voltage to differ from the ideal. The magnitude of this error is also determined from Fig. 2

$$D_N = \frac{NR_n}{R_n + R_L}$$

where  $D_N$  = error in voltage ratio due to equivalent noise resistance and  $R_n$  = noise resistance. With conductive plastic potentiometers, repeatable noise caused by definite variations in apparent contact resistance can be compensated during manufacture.

Consider a potentiometer with these parameters: track resistance is 10,000 ohms; contact resistance is 200 ohms; equivalent noise resistance is 100 ohms; and load resistance  $R_L$  is 50,000 ohms. Thus,  $L = 50,000/10,000 = 5$ .

From Fig. 1, maximum loading error is 2.9 percent of full scale. This occurs at about 67 percent of full output voltage.

In Fig. 2 the 50,000-ohm load resistance and the 200-ohm contact resistance lines intersect at a full-scale error of 0.4 percent. Therefore, the contact resistance error at the maximum loading error point is  $0.67 \times 0.97 \times 0.4$  percent = 0.26 percent.

In Fig. 2, the 50,000-ohm load resistance and the 100-ohm contact resistance lines intersect at a full-scale error of 0.2 percent. Therefore, the equivalent noise resistance error at maximum loading error point is  $0.67 \times 0.97 \times 0.2$  percent = 0.13 percent.

Thus, the total error at the 67 percent point that is caused by wiper circuit impedance is (in percent):

$$2.9 + 0.26 + 0.13 = 3.2$$

Note that this analysis must be applied to each section of the resistance network in a potentiometer that generates non-monotonic functions.



# 3 New NATVAR Special-Purpose INSULATIONS

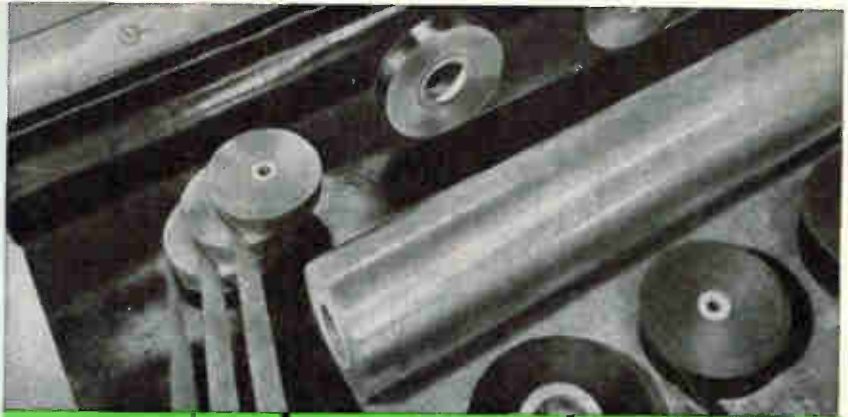

	ACRYLIGLAS**	ISOTERAGLAS**	EPOXY COATED GLASS
 <b>MAXIMUM OPERATING TEMPERATURE</b>	130°	155°	155°
 <b>BASE FABRIC</b>	 Straight Cut Fiberglas*	 Dacron Warp Glass Filler	 Straight Cut Fiberglas*
 <b>COATING</b>	Fully Cured Acrylic Resin	Elastomeric Isocyanate Type for Maximum Conformability	Fully Cured Epoxy Resin
 <b>APPLICATIONS</b>	Suitable for slot liners, phase separators and layer insulation in all acrylic systems. Combines toughness and high moisture resistance with low extractable content.	For motors, generators, heavy duty relays and other types of equipment requiring high electrical protection and toughness under stretch. Stays flexible under heat.	For ground, layer and barrier insulation in dry type transformers, slot, phase and field insulation in motors and generators where high dielectric strength, toughness and compatibility is required.
 <b>FORM</b>	Sheets, Rolls, Tapes .005", .007", .010" and .012"	Sheets, Rolls, Tapes .008" and .010"	Sheets, Rolls, Tapes .003", .007" and .010"



## Natvar Products

- Varnished cambric—sheet and tape
- Varnished canvas and duck—sheet and tape
- Varnished silk and special rayon—sheet and tape
- Varnished papers—rope and kraft—sheet and tape
- Varnished, silicone varnished and silicone rubber coated Fiberglas\*—sheet and tape
- Slot cell combinations, Aboglas®
- Teraglas®
- Acryliglas\*\* sheets, rolls, tapes
- Isoteraglas\*\* sheets, rolls, tapes
- Epoxy coated glass sheets, rolls, tapes
- Isoglas® sheet and tape
- Isolastane® sheet, tape, tubing and sleeving
- Vinyl coated and silicone rubber coated Fiberglas tubing and sleeving
- Extruded vinyl tubing and tape
- Styroflex® flexible polystyrene tape

\*TM (Reg. U.S. Pat. Off.) OCF Corp.  
\*\*Trademark Reg. Applied For.

We will be very happy to supply information on any of our products on request.

These three new Natvar insulating materials will solve production problems for many manufacturers of electrical and electronic equipment. They were developed to take advantage of the latest technological advances in the manufacture of synthetic varnishes and resins. As a result, finished products can be improved, and, in many cases, with significant savings.

Natvar quality is maintained through systematic and rigorous quality control, to assure uniform excellence. And the Natvar research program means that new materials are constantly being tested and evaluated and utilized to give you improved insulations.

Natvar flexible insulations are available from your distributor's stocks or our own. Samples on request.

# NATVAR CORPORATION

FORMERLY THE NATIONAL VARNISHED PRODUCTS CORPORATION

Telephone

TWX

Cable Address

Area Code 201—FULTON 8-8800

RAHWAY, N.J., RAH 1134

NATVAR: RAHWAY, N.J.

201 RANDOLPH AVENUE • WOODBRIDGE, NEW JERSEY



# Mallory tantalum foil capacitors..even

Mallory tantalum foil capacitors consistently exceed capacitance stability, leakage and power factor requirements of MIL-C-3965B. Choose from plain or etched foil types, polarized or non-polarized, in hundreds of ratings, and with or without a Mylar\* insulating sleeve.

### Widest selection available anywhere

Unmatched for variety and completeness, the Mallory line of tantalum capacitors includes wet slug, solid electrolyte, miniature, microminiature, and high temperature (to 200°C.) types. For our latest literature, or to arrange a consultation, write Mallory Capacitor Company, Indianapolis 6, Indiana.

Type	Mallory Designation	Temp. Range	Case Style
PLAIN FOIL	Type TAF	-55°C to 85°C	CL34, CL35
	Type TAG	-55°C to 125°C	CL30, CL31
			CL32, CL33
ETCHED FOIL	Type TBF	-55°C to 85°C	CL24, CL25
	Type TBG	-55°C to 125°C	CL20, CL21
			CL22, CL23

Supplied in all military case styles and all ratings.

\*Du Pont trademark

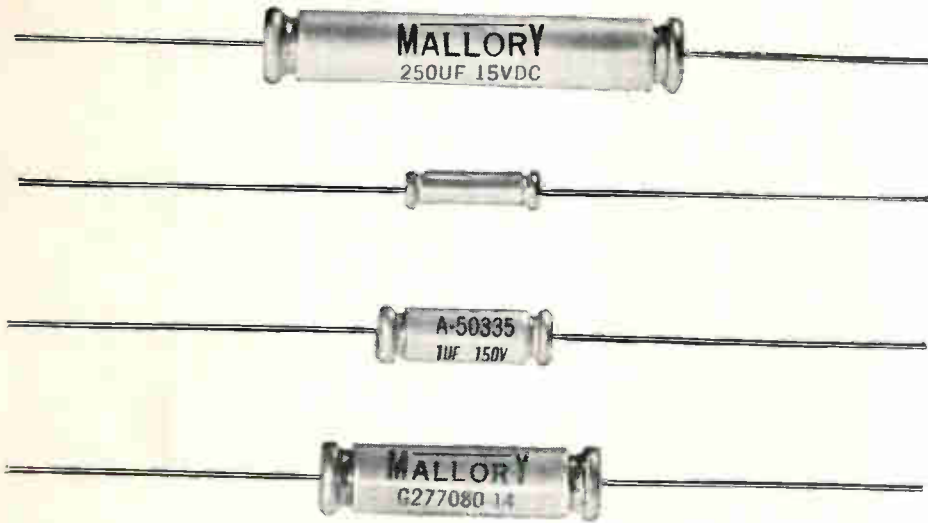

# better than MIL specs!

	MIL-C-3965B Limits	Typical Test Values: Mallory Type TAF (160 mfd 15 VDC)
After 2000 hour life test at 85°C:		
Leakage Current	48 $\mu$ a	0.4 $\mu$ a
Change in Capacity	$\pm 25\%$	-5%
Power Factor	19.5%	3.8%
25°C:		
Leakage Current	48 $\mu$ a	0.2 $\mu$ a
Power Factor	15%	4.5%
-55°C:		
Change in Capacity	-35%	-12%
Impedance	14.0 ohms	7.0 ohms
85°C:		
Leakage Current	240 $\mu$ a	6.5 $\mu$ a
Change in Capacity	-0 +15%	+4.8%
Power Factor	15%	4.5%

Delivered from stock at factory prices by these distributors:

- Baltimore, Md.  
Radio Electric Service
- Binghamton, N.Y.  
Federal Electronics
- Boston, Mass.  
Cramer Electronics  
DeMambro Radio Supply Co.  
Lafayette Radio
- Bridgeport, Conn.  
Westconn Electronics
- Buffalo, N.Y.  
Wehle Electronics
- Chicago, Ill.  
Allied Electronics Corp.  
Newark Electronics Corp.
- Cincinnati, Ohio  
United Radio
- Cleveland, Ohio  
Pioneer Electronics
- Dallas, Texas  
Engineering Supply Co.
- Dayton, Ohio  
Allied Supply Co.
- Denver, Colo.  
Denver Electronics
- Houston, Texas  
Harrison Equipment Co., Inc.  
Leneit Company
- Indianapolis, Ind.  
Graham Electronics
- Los Angeles, Calif.  
Allied Radio of California  
California Electronics  
Kierulff Electronics, Inc.  
Radio Product Sales
- Minneapolis, Minn.  
Northwest Radio
- Monrovia, Calif.  
Lynch Electronics
- Montreal, Que.  
Canadian Electrical Supply Co.
- Mountainside, N.J.  
Federated Purchaser, Inc.
- Nashville, Tenn.  
Electra Dist. Co.
- Newark, N.J.  
Lafayette Radio
- New York, N.Y.  
Harrison Radio Corp.  
Harvey Radio Co., Inc.  
Lafayette Radio  
Milo Electronics  
Terminal Hudson Electronics
- Oakland, Calif.  
Elmar Electronics, Inc.
- Orlando, Fla.  
East Coast Electronics
- Ottawa, Ont.  
Wackid Radio-TV Lab.
- Palo Alto, Calif.  
Zack Electronics
- Perth Amboy, N.J.  
Atlas Electronics
- Philadelphia, Pa.  
Herbach & Rademan  
Philadelphia Electronics
- Pittsburgh, Pa.  
Radio Parts Co.
- Salt Lake City, Utah  
Kimball Electronics
- St. Louis, Mo.  
Olive Electronics
- Seattle, Wash.  
F. B. Connelly Co.
- Tampa, Florida  
Thurow Electronics, Inc.
- Toronto, Ont.  
Alpha Aracon Radio Co.  
Electro Sonic Supply  
Wholesale Radio & Electronics
- Tulsa, Okla.  
Engineering Supply Co.
- Washington, D.C.  
Capitol Radio Wholesalers  
Electronic Industrial Sales
- White Plains, N.Y.  
Westchester Electronic Supply Co., Inc.
- Winston-Salem, N.C.  
Dalton-Hege Inc.



Complete line of aluminum and tantalum electrolytics, motor start and run capacitors



# Millimeter Waves Are Generated With Ferrites

HARMONIC generation using ferromagnetic resonance has produced 60 watts output at 70 Gc and comparable output is expected at 140 Gc. Carefully engineered apparatus and growth of a low-loss single crystal with planar anisotropy promise further improvements. The work was done at the Defense Research Telecommunications Establishment, Electronics Laboratory, Ottawa, and described in a paper by G. W. Williams and A. W. Smith at the Canadian Electronics Conference.

A free electron in a magnet field precesses about the direction of the field at a frequency equal to the product of the field and the ratio of magnetic moment to angular momentum. This ratio is 2.8 Mc per oersted so resonant frequency is in the X band with a 3,600-oersted field. Resonance can be driven by a microwave field circularly polarized in a plane perpendicular to the d-c field. Individual electron spins in the ferromagnet in Fig. 1 are aligned by exchange interaction, producing domains of magnetization. An external field simply aligns the domains. The sample can be represented by a magnetization vector that is the sum of the spins, with resonance determined by the whole sample.

If the sample is driven by a circularly polarized magnetic field, the vector precesses about the magnetic field direction. Resonant frequency is determined by the internal magnetic field and the angle by sample loss (line width). With the linearly polarized field in Fig.

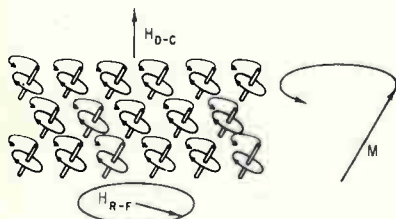

FIG. 1—External field aligns domains in ferromagnet and magnetization vector represents entire sample

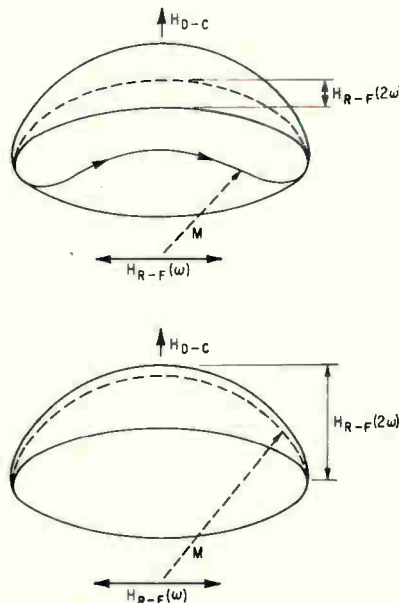

FIG. 2—Linearly polarized driving field causes vector path to deviate from circle to ellipse in upper drawing. Increased amplitude finally produces arc below

2, the vector relaxes toward the d-c field direction, and the path of the vector on the sphere containing it becomes an ellipse instead of a circle.

A second harmonic in the path provides second harmonic power with amplitude proportional to the square of driving field amplitude. In the limiting case of completely damped motion, the vector is just driven in an arc. The second harmonic component is maximum but most input power is consumed in sample loss and conversion efficiency is low.

Sample shape also causes the magnetization vector to deviate from a circular path. In a disk magnetized in the plane, precessing the magnetization out of the plane generates an internal demagnetizing field that opposes vector motion, forcing it into an elliptic path. This approach promises good conversion efficiency since it does not depend on sample loss but limits sample volume because the disk must be thin.

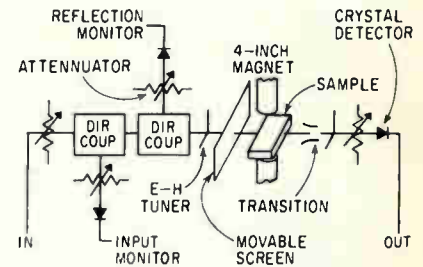

FIG. 4—Mounting positions used fed by magnetron to test samples

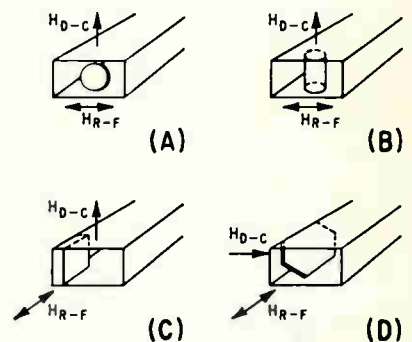

FIG. 3—Microwave circuit was for different type samples

Most ferrites have a cubic structure with an anisotropy field below 50 gauss, but hexagonal ferrites may have fields of tens of kilogauss. If the anisotropy coefficient is positive, the crystal has an easy axis of magnetization. By applying an external field at an angle to the axis, the magnetization has an equilibrium position between the two directions that can enhance harmonic generation as in a thin disk. If the anisotropy constant is negative, the crystal has an easy plane of magnetization. Applying the field in this plane confines the vector to the plane, producing a large second harmonic.

With either type of anisotropy, low loss materials can be used and volume is not limited. Also with high anisotropy materials, the field is added to the internal field resulting from the external applied field. Thus requirements on the magnet at high frequencies are reduced.

The waveguide test section is a tapered transition from input to harmonic frequency guide. The out-

# HOLD IT!

THERE'S NO SUBSTITUTE FOR AN  
**ELECTRONIC MEASUREMENTS**  
CONSTANT-CURRENT POWER SUPPLY



## what every engineer knows about **constant-current** power supplies . . .

How do you check the peak inverse voltage rating of a solid state junction? the breakdown voltage of a reference diode at a specified current? the dynamic impedance of a reference diode? and the many other parameters that are so easily checked with constant-current power supplies?

It's an easy matter to convert some voltage-regulated power supplies to current-regulated operation. At least it's easy with an E/M® Regatron Programmable Power Supply. But for true constant-current performance, there's no substitute for a power supply specifically designed for constant-current operation.

Take Electronic Measurements' Model C635A shown here. It's an easy matter to set the current control to any value desired—from a few microamperes up to 100 ma—manually or programmably. And there's no juggling with makeshift, extra circuitry. Then you can adjust the voltage compliance to any value from 0 to 1500 V. There's no fear that the voltage may be

too great or not enough; the voltage control sets the upper limit.

Here are some additional features of the C635A: Output impedance is  $10^4$  megohms at  $0.5 \mu\text{a}$  to 0.5 megohms at 100 ma. Above  $2.2 \mu\text{a}$ , regulation is better than 0.15%, line or load, Ripple is less than  $0.01\% + 1 \mu\text{a}$  rms. A modulation input is provided.

But to get back to the point; to check the peak inverse voltage rating of a solid state junction, simply set the output current control of an E/M Constant-Current Power Supply at the specified current. Connect the output to the junction, turn the power supply on, and measure the voltage drop across the junction. What could be easier? And other measurements can be made almost as easily.

For a complete discussion of constant-current power supplies with ratings up to 1A, ask for Specification Sheet 3072B. It lists all the models and specifications, too.

®Registered U. S. Patent Office. Patents Issued and Pending.



**ELECTRONIC**  
**MEASUREMENTS**  
COMPANY, INCORPORATED  
EATONTOWN · NEW JERSEY

# Pick any pulse for spectrum analysis

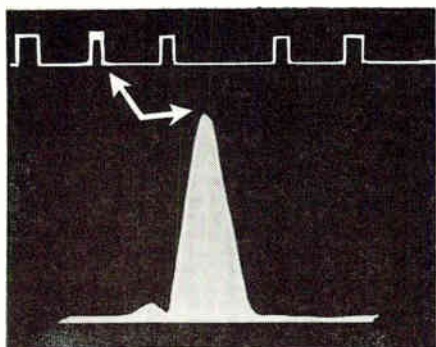

Spectrum Analyzer Display, showing 2nd pulse in a train of 5, isolated by Spectrum Selector SD-1.

Polarad's Multipulse Spectrum Selector, Model SD-1, is the *only* instrument that permits a spectrum-analyzer examination of any individual pulse within a multipulse train.

The spectrum selector automatically gates a spectrum analyzer during the interval of pulse analysis and can be used with any analyzer with an IF of 160 mc (140 mc available on special order).

Pulse selection and gating are visual. The entire pulse group is displayed on the instrument's CRT, and any one pulse in the group is brightened to indicate its selection for analysis. A group of pulses up to 180 microseconds (350 microseconds on special order) in length can be accommodated. Sweep expansion permits detailed examination of closely spaced pulse groups.

For complete specifications, write Polarad or call your local Polarad Representative (he's listed in the Yellow Pages).



**POLARAD**  
ELECTRONICS CORPORATION  
43-20 34th Street, Long Island City 1, N.Y.

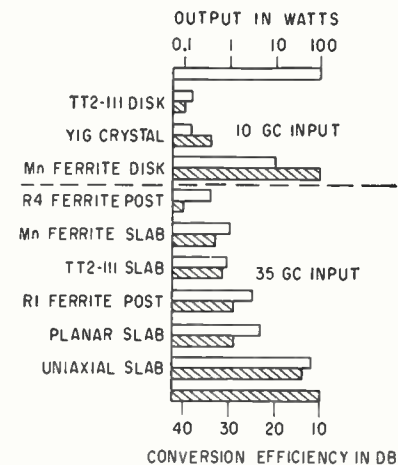
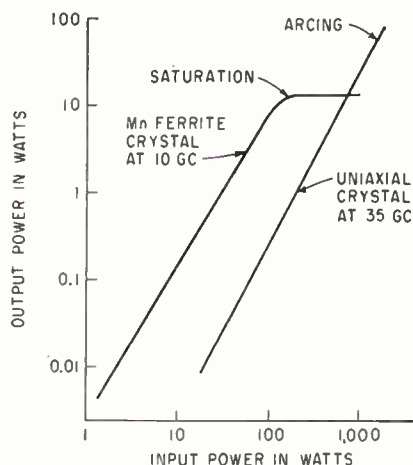

FIG. 5—Harmonic power of two best samples is shown at left, while output and conversion efficiency for all samples is shown at right

put guide is rotated 90 degrees because the second harmonic is generated orthogonally to the driving field. The taper acts as a short, reflecting fundamental power back toward the sample. The sample is mounted an even or odd number of quarter wavelengths from the short, depending on the drive field required. A movable screen of wires parallel to the broad face matches the sample to the transition. It passes fundamental power and reflects the second harmonic.

A magnetron provides 1-usec pulses at 50 Kw peak power. Variable repetition rate is generally set at 50 pps to avoid heating effects. A directional coupler and attenuator in Fig. 3 monitor power incident on the test section. Another coupler samples reflected power and is used to adjust the E-H tuner and the magnetic field to sample resonance.

### Mounting Ferrite Samples

The mounting positions of samples are shown in Fig. 4. The disk (A) is mounted across the guide with the d-c field in the plane. The post (B) is centered in the guide with the field along the cylindrical axis. The slab (C) is mounted on the narrow wall. The slab (D) is at 45 degrees to the narrow wall. It was used for a uniaxial crystal since the field had to be inclined 45 degrees from the perpendicular to the crystal plane.

Variations in second harmonic with input power are shown in Fig. 5 for the two best samples. Saturation in low-loss samples of a man-

ganese ferrite disk occurred in the X band. This single crystal with resonance line width of 25 gauss saturates at 100 watts. All samples followed a square law below saturation and best conversion efficiency was -10 db.

At 35 Gc input, the uniaxial crystal slab had wide line width. Power input was limited at nearly 2 Kw only by arcing. Conversion efficiency was -14 db and maximum power output was 60 watts.

### Sample Performance

Sample TT2-111 in Fig. 5, a ceramic nickel-zinc ferrite for K-band isolators, is fairly lossy. The YIG crystal, grown at the laboratory, was left as a raw crystal to raise saturation level. Samples R1 and R4 (Ferramic), ceramic magnesium manganese ferrite, are quite lossy. The planar ferrite is an oriented ferrite but was too lossy to provide the expected performance of a planar ferrite.

The single crystal hexagonal ferrite, probably barium ferrite was obtained from A. O. Smith Corp. It has an anisotropy field of 14 kilogauss, which would give zero field resonance at 51 Gc. It was operated at a resonance at 3,500 gauss, where domain structure must be retained. Harmonic output was enhanced by the test position, but existence of domain structure makes an explanation of the high efficiency difficult. This crystal will be operated at a high enough field to saturate it, Gc. It is expected to deliver quite useful power at a frequency of 140 Gc.

# 10MC COUNTER INTRODUCES ELECTRO- LUMINESCENT READOUT

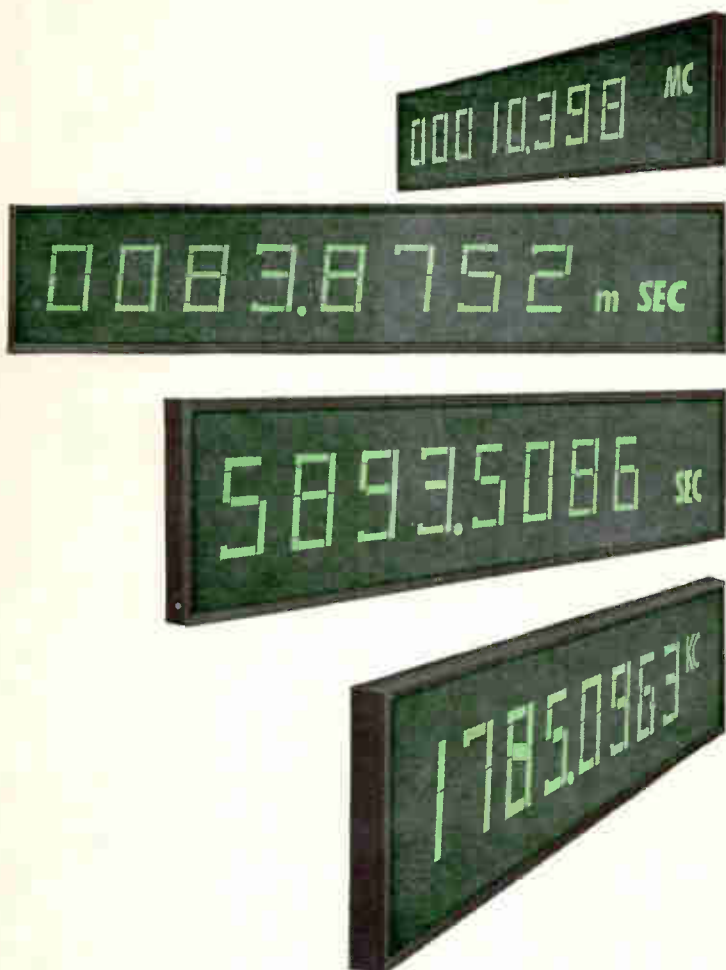

The Beckman® 8370 Universal EPUT® and Timer—the most widely accepted 10MC counter-timer—now offers a totally new *concept* in digital readout. . . . *Electroluminescent display.*

EL digits are in-line and *in the same plane*—assuring fast, accurate readings from extreme angles without the confusion of “stacked” digits. The soft green illumination is uniform and highly legible—no glare to cause eye fatigue.

The 8370 also offers the plus features of automatic decimal point and MC, KC, mSEC, or SEC in the EL display for complete recognition of measurements even at a distance.

Beckman's application of solid-state EL follows 2½ years of close collaboration with Sylvania Electric Products, Inc. during which Beckman research engineers perfected a digital configuration and logic circuitry that capitalize fully on the significant advantages of Sylvania Panelescent® electroluminescence.

This EL feature is also available in other Beckman digital counters.

**Beckman**®

INSTRUMENTS, INC.

BERKELEY DIVISION  
RICHMOND, CALIFORNIA

T-46 PANELESCENT is a registered Trade Mark of Sylvania Electric Products, Inc.

See Us At IRE Booths 3515-17



Equipment designer takes ten minutes to determine size and style of special transformer, and to forward complete specifications to manufacturer

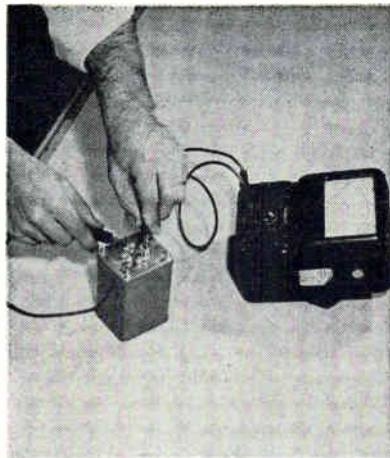

Transformer manufacturer builds, and tests custom-type transformer to meet required parameters. Standard parts are used for cores and cases

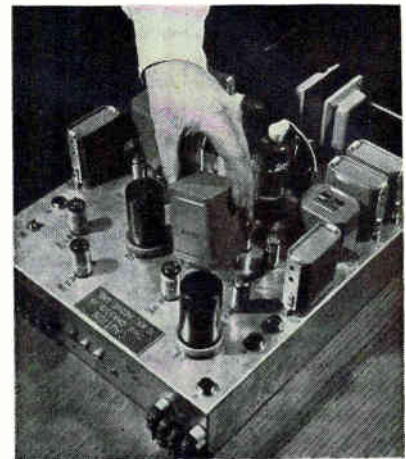

Special unit is ready for circuit within three weeks. Mechanical design integrates electrical requirements, relates volt-amperes to case size

## Specifying Transformers for Special Needs

By R. QUIMBY

E. PODSIADLO

Raytheon Company, Microwave and Power Tube Division, Magnetics Operations, Waltham, Mass.

WHILE IT IS POSSIBLE to quickly and economically obtain reliable standard components such as tubes, resistors and capacitors, the range of electrical requirements for transformers is so great that only representative types are usually listed in manufacturers catalogs. And this often creates a specification problem for equipment design engineers who seek special transformers.

The fact that standard electronic components are fixed mechanically simplifies the problem of chassis layout, size and weight estimating, and manufacturing for both the component supplier and the equipment manufacturer. The military recognized the advantage of standard case sizes for cased, hermetically-sealed transformers when it specified standard Mil Cases in the replacement of Jan T-27 with the now well-known MIL-T-27A specification some years ago.

Raytheon's standardization program is currently confined to 60 and 400 cycle power transformers, but will include other transformer

types such as audio, pulse, signaling transformers, etc. Development of a line of minimum weight, premium grade aircraft transformers to meet all military requirements using wound cores and encapsulated for full moisture protection is presently underway. Each basic line of standard sizes will include cased-hermetic designs, encapsulated core and coils, and open varnish-treated core and coils. The first two are designed to meet MIL-T-27A grade 4 or 5 and temperature classes R and S. A more limited line of silicone encapsulated units are available for Class T requirements and cased-hermetic designs in the Class U range for a maximum temperature of 325 C.

It is possible to anticipate possible combinations of electrical characteristics required by the equipment designer in advance, and to design prior to receiving an inquiry. This technique also enables the manufacturer to prepare data from which the user can determine the size of component that meets his requirements.

The user selects the style of transformer he needs based on environmental conditions and then calculates the total load in volt amperes (LI<sup>2</sup> for inductors). Derating

factors for voltage, frequency, and number of load circuits are then applied to this figure to determine the power output under a particular set of electrical requirements. A graph is consulted which shows power output and regulation for various package sizes and values.

The following example illustrates the method for specifying transformers:

A class R, cased, hermetically-sealed transformer is to be specified with the electrical requirements shown in Fig. 1. Ambient temperature is 65 C, allowable time rise is 40 C, and regulation is 4 per cent. The total *va* output is calculated,

$S_1 = 100 \text{ va}$ ,  $S_2 = 100 \text{ va}$  for a total of 200 va.

Electrical requirements complicated by lower frequency, voltage input taps, high test voltages and rectifier loads are adjusted by

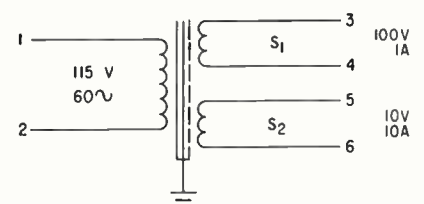
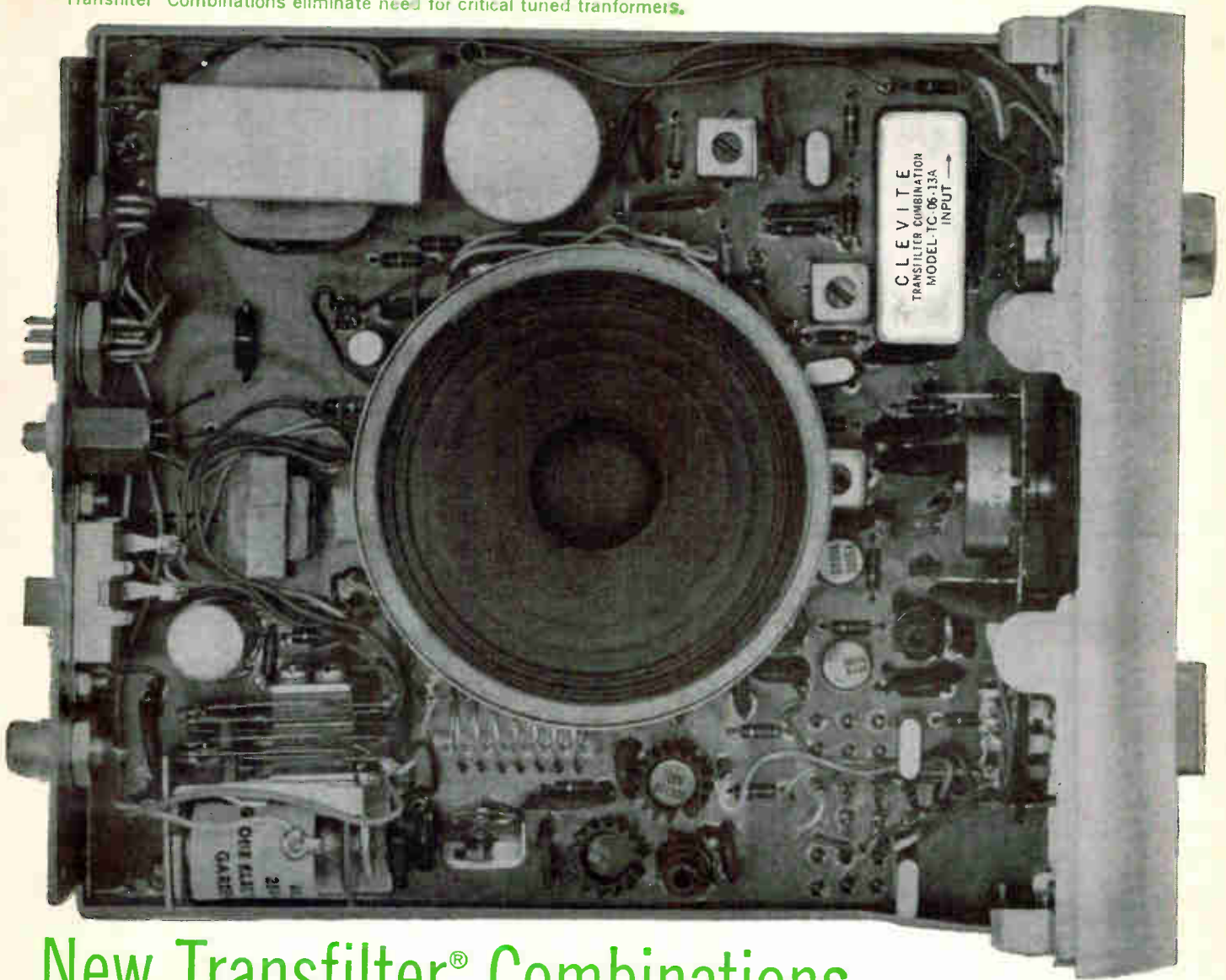

FIG. 1—Electrical requirements of transformer in example



Compact chassis of Osborne 100 CBT Citizens Band Transceiver.  
"Transfilter" Combinations eliminate need for critical tuned transformers.



## New Transfilter® Combinations

### Greater selectivity in a miniature package

... and increased stability at a decreased cost. Further, magnetic shielding can be eliminated as well as the necessity for factory and field alignment. That's why CLEVITE'S ceramic i-f filters are rapidly replacing conventional components in today's mobile or high quality commercial receivers. Basic component of these rugged fixed-tuned devices is the CLEVITE piezoelectric "Transfilter" developed especially for great stability of resonant frequency with respect to time and temperature. Cascading and coupling these resonators provide excellent selectivity at desired bandwidths. Size, 1½" x ¾" x 2.0" high; Center Frequency, 455 kc; Shape Factor (60/6db), 3:1 to 6:1; Bandwidth, 4 to 20 kc; Insertion Loss, 6 to 12 db max. (depending on bandwidth); Impedance, 2700 ohms in and out; Temperature Range, -20°C to +90°C. Call, write or wire for complete details.

#### CLEVITE ELECTRONIC COMPONENTS

232 Forbes Road, Bedford, Ohio / Division of **CLEVITE** Corporation



# NOW A family of Precise Thermistors

YSI produces a family of precise thermistors which match standard Resistance-temperature curves within  $\pm 1\%$ .

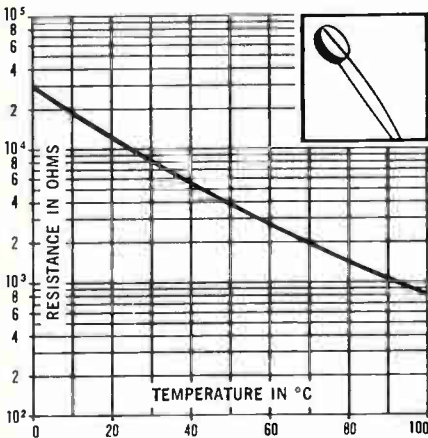

Resistance Temperature Characteristics - Partial Range—YSI #44006 Thermistors (10K).

You can now use stock YSI thermistors interchangeably as components in any temperature transducer or compensator circuit without individual padding or balancing.

## DATA

Base resistances at 25° C. of:  
 100  $\Omega$     1 K    10 K  
 300  $\Omega$     3 K    30 K  
                   100 K

- Each family follows the same RT curve within  $\pm 1\%$  accuracy from  $-40^\circ$  to  $+150^\circ$  C.
- Cost under \$5.00 each, with substantial discounts on quantity orders.
- Quantities under 100 available from stock at YSI now.
- YSI can produce precise thermistors with different base resistances and beta's where design requirements and quantities warrant.

For complete specifications and details write:

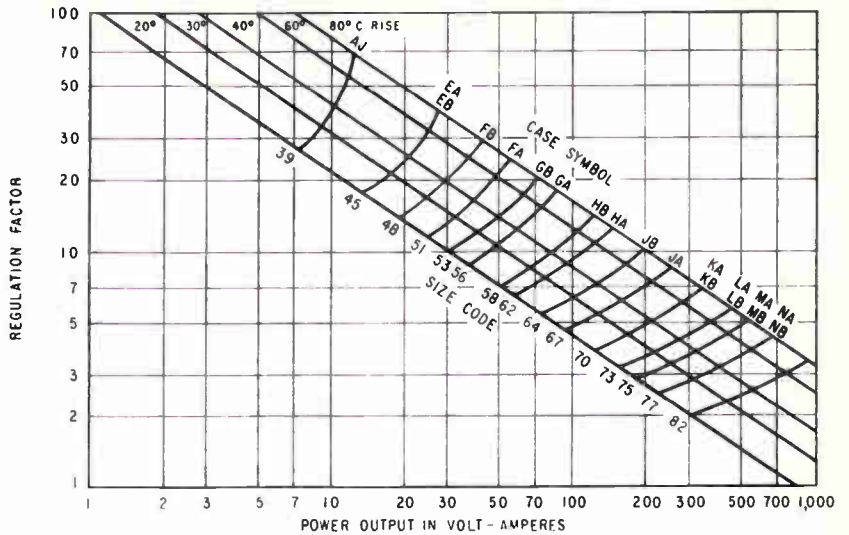

FIG. 2—Basic power curve used in selecting transformer size

simple conversion methods to *va* values which can be applied to the basic power curve.

The size of the unit is selected from the basic power curve in Fig. 2.

Note that the LB case must be used to get 4 per cent regulation. Temperature rise will be only 30 C. The KB case could be used if regulation requirement is relaxed to 5 per cent. Assume that the KB case is selected.

The terminals are selected from chart in Fig. 3. Using operating voltage and current ratings, the fol-

lowing selections are made:

Terminal Numbers	Selections Made
1 & 2	P1
3 & 4	P1
5 & 6	P2

The terminal areas are checked from the chart. If it is desired to have terminals in the center area of the case, KA must be used.

This concept of standardization integrates mechanical design with electrical output by relating volt-amperes to case size, and ensures most of the advantages of both catalog and custom design approaches.

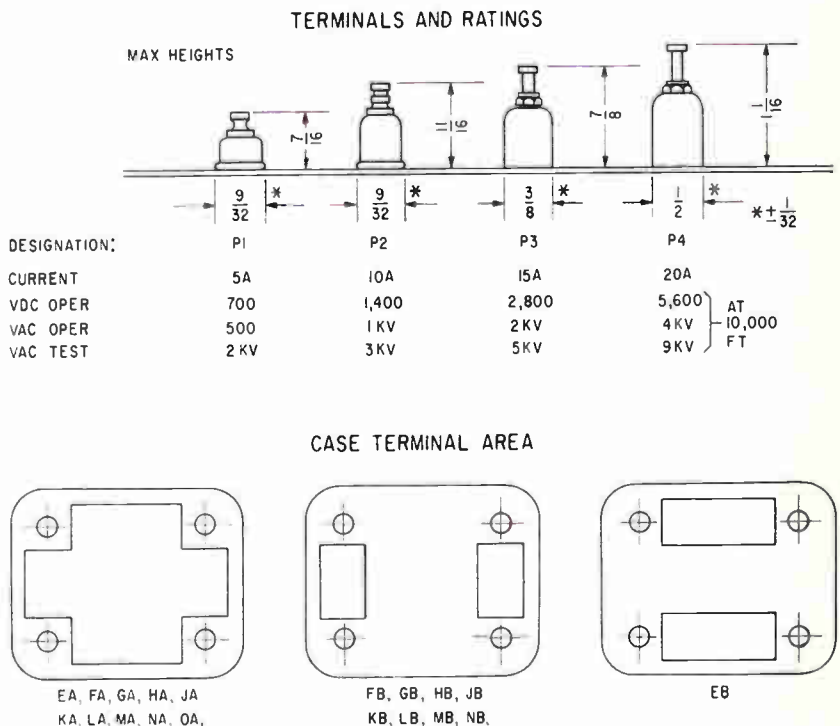

FIG. 3—Terminals and terminal layout guide



Type SC torques  
to 300 oz. in.  
1.07" dia.

Type MC torques  
to 1000 oz. in.  
1.25" dia.

## MINIATURE A.C. GEARMOTORS

Globe Type SC and MC motors with planetary or spur gearheads provide more than 101 standard ratios, even and odd. Custom winding and gearing provide all in-between speeds for the exact speed-torque you need—up to 1000 inch ounces. SC and MC motors are hysteresis-synchronous or induction types, 115 to 208 v.a.c., 60 or 400 cycle or variable frequency, weigh 2½ and 6½ oz. respectively; gearheads add 1¾ to 6 oz. depending on type and ratio of gearing. MIL specs are routine. Ask about commercial versions and check us if you need larger or smaller gearmotors. Please specify your speed; many prototypes shipped in one day, larger quantities soon after. Bulletin SMG. Globe Industries, Inc., 1784 Stanley Avenue, Dayton 4, Ohio.

GLOBE

GLOBE  
INDUSTRIES,  
INC.

CIRCLE 206 ON READER SERVICE CARD

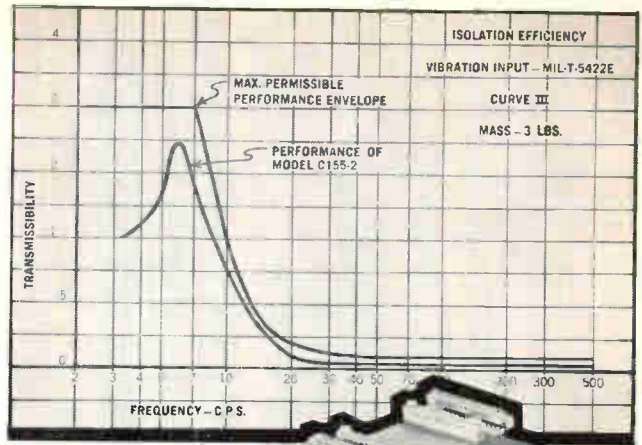

ACHIEVE  
\* **90%**  
ISOLATION

with maximum transmissibility of less than 3, on electronic equipment subjected to the vibration of a helicopter environment exceeding MIL-T-5422E (ASG) requirements.

\*Listed in the VSMF microfilm catalog file.

For information on how we can solve your particular vibration problem write to Dept. BL-30

**AEROFLEX LABORATORIES**  
INCORPORATED

48-25 36TH STREET • LONG ISLAND CITY 1, N. Y.

CIRCLE 207 ON READER SERVICE CARD

20 to 1500 mcs  
PASSIVE  
BROADBAND

**Applied Research inc.**

76 South Bayles Avenue, Port Washington, N. Y.

## MULTICOUPLER

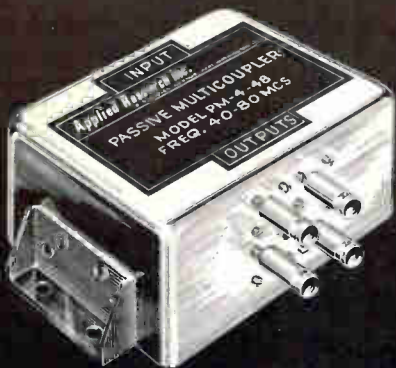

- OCTAVE BANDWIDTH
- HIGH OUTPUT ISOLATION
- MINIMUM LOSSES
- BI-LATERAL ● 2 to 8 OUTPUTS

Applied Research, Inc.—76 S. Bayles Avenue—Port Washington, N.Y.—Phone 516—PO 7-8707—Integrated RF Components and Sub-Assemblies, VLF thru C Band. Octave Amplifiers to 1100 mc; Band Pass Filters; Low Noise Amplifiers; Frequency Multipliers.

CIRCLE 208 ON READER SERVICE CARD

## WEE LINES

SOLVE YOUR  
DELAY LINE PROBLEMS  
FAST!



Wee Lines are unique sectional, custom-fabricated delay lines shipped from the factory to you 24 hours after the order is received. Do away with costly waiting for other types of delay lines. Save time, money and still achieve extra high performance. Design with sectionalized Wee Lines. Available with delay times of 10 nanoseconds to 100 nanoseconds in 10 nanosecond increments. Sections are also available with 200 nanoseconds delay.

For complete descriptive literature, write to Dept. WL-2, or phone 464-9300.

**NYTRONICS, INC.**

550 SPRINGFIELD AVENUE, BERKELEY HEIGHTS, N. J.

CIRCLE 65 ON READER SERVICE CARD

65

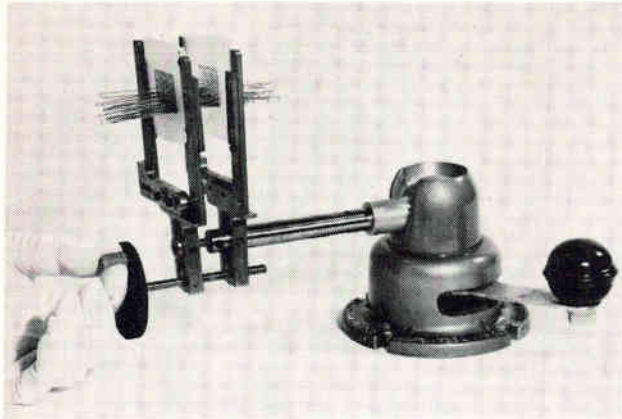

Butterfly assembly fixture is one of many special fixtures that can be designed to improve welds

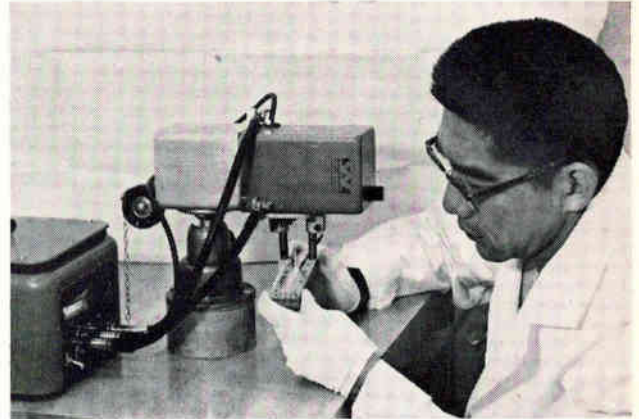

Special fixture has been designed for holding connecting pins during the welding operation

## Production Methods for Welded Circuits

By LLOYD ARMSTRONG  
Space Technology Labs.,  
Los Angeles, Calif.

FABRICATION methods and practices, equipment and personnel selection, and inspection and quality control procedures have been investigated at STL as part of a study of welded modules. The information developed has proved useful in the Titan and Minuteman programs and can be applied to commercial and industrial electronics production.

For prototype and pilot production, each welding station is supplied with one or two welding heads equipped with treadle type switches, a five-power magnifying glass and an adjustable lamp. Most lead and wire materials can be welded with miniature capacitance discharge d-c

welders. Their short welding times prevent heat damage to sensitive components and help prevent shorts through components, as previously discussed (ELECTRONICS, p 72, Sept. 22, 1961). An a-c welder with a thyatron contractor and heat program timer is used for certain types of welds, such as copper-to-copper, or when it is desirable to approach an anneal process for the metals welded.

Electrode materials depend on the materials being welded. In each case, the best compromise between high thermal conductivity, low specific resistivity, wear resistance and strength should be selected. Lead materials with high conductivity require electrodes or electrode tips of higher resistance and vice-versa. Different upper and lower

electrodes can be used to weld dissimilar metals. Electrodes recommended for various materials are shown in the table.

Typical electrode configurations are shown in Fig. 1. Shanks can be coated with polyurethane to help prevent shorts. Color-coding the coating simplifies storage and identification and the color also helps show coating wear and peeling.

Redressing of electrodes by the operator should be avoided, especially if tips are tapered or welding schedules are critical. A supply of freshly dressed electrodes may be supplied. Any redressing on the machine should be minimal and should be done lightly with fine emery paper on a paddle. Offset electrodes are needed to reach into confined spaces. Their alignment should be checked with a triangular tool.

A variety of accessories, tools, jigs and fixtures have been developed. Some of these are shown in the photos. The butterfly jig, for example, facilitates the construction of wafer board modules. The plastic end wafers are held apart at a distance convenient for component insertion, after which the wafers are brought together. Spacers can then be inserted between the plates or can be built into the fixtures.

Special jigs and molds can be devised for any module design. For

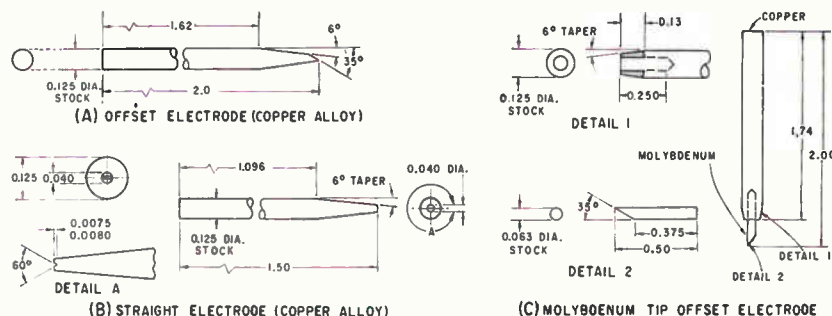

The right electrode for each weld depends on such factors as the diameter of the wire being welded, accessibility of the weld area, flexibility of component leads, and pressure-energy requirements of the weld schedule

for communications engineers:

# 2 problems in magnetic design SOLVED BY PIC

**1:** An instrument for calibrating ILS equipment needed these unusual filters . . .

**TRUE INSERTION LOSS:**  
3.5 db  $\pm$  0.15 db

**OPERATING TEMPERATURE:**  
-20° C to +50° C

Z in: 2000 ohms.  
Z out: 18,000 ohms, CT, isolated.

Attenuation:	Filter #1	Filter #2
< 0.15 db	90 $\pm$ 1 cps	150 $\pm$ 1.5 cps
< 1 db	90 $\pm$ 3 cps	150 $\pm$ 5 cps
> 30 db	54 and 150 cps	90 and 250 cps

Dimensions: 1 3/4" x 1 3/4" x 2 3/4"

### SOLUTION:

Borrow this filter for your own tests—samples can be made available if required.



**2:** Communications engineers asked for this filament regulating magnetic amplifier . . .

Input: 200 V  $\pm$  7%, 3 $\phi$ , 400 cps  $\pm$  5%

Output: 6.4 V dc, 5-30 amps.

Regulation:  $\pm$  0.125 V for any combination of line, load, frequency and temperature.

RIPPLE: 20 mv rms max.

Operating Temperature: -55° C to +85° C

Size: 3" x 3 1/2" x 12"

### SOLUTION:

Borrow this magnetic amplifier for your own tests—samples can be made available if required.



Send us your next "tough" problem in magnetic design . . . PIC is willing to gamble that it can design the magnetic component you have been looking for. Better yet, phone direct to our Custom Design Department — its number is BR 9-4660.

PIC

**POLYPHASE**  
Instrument Company  
Bridgeport, Pa.

TRANSFORMERS • FILTERS • MAGNETIC  
AMPLIFIERS • DELAY LINES • NETWORKS

# RUGGED: HONEYWELL METERS

Honeywell's sealed, ruggedized panel instruments are about as tough as meters can get. They shrug off all kinds of shocks, vibrations, stresses and strains. They're immune to dust, moisture and ordinarily troublesome climatic and atmospheric conditions. They're not affected by magnetic panels because of the special plated steel case. ■ A three-point rubber mounting cushions internal shock. New fastening techniques and materials prevent magnet fracture, increase shear resistance, and minimize whipping and collision between the dial and pointer assembly. High torque-to-weight ratios permit larger radius pivots and reduce the load on bearings. Special beryllium copper hairsprings reduce zero shift, raise the fatigue point, and reduce deformation. ■ For a catalog describing the full line of Honeywell meters (including ruggedized models) write to Honeywell Precision Meters, Manchester, New Hampshire.

MS2Z (2 1/2 inch sealed, ruggedized meter) illustrated. Built to conform to MIL-M-10304B.

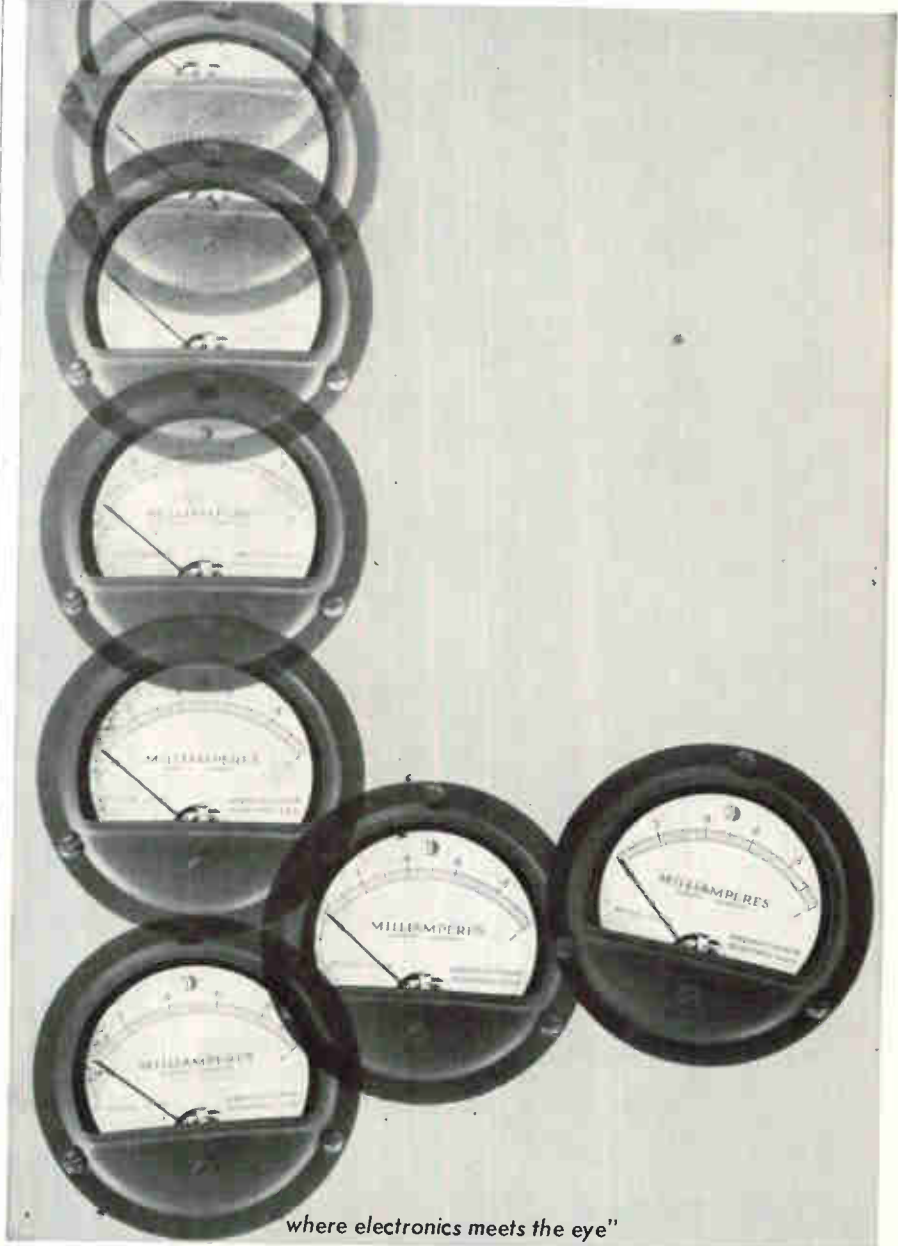

where electronics meets the eye"

# Honeywell



Precision Meters

# Q. HOW THIN CAN METAL TUBING WALLS BE?

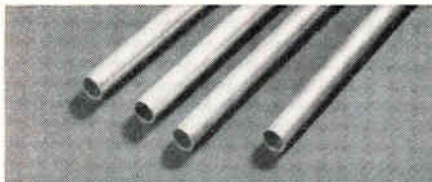

# A. AS THIN AS 0.0005 INCHES!

It's a fact . . . fine seamless tubing with wall thicknesses as *ultra-thin* as 0.0005 inches! This is precision tubing drawn to any specified O.D. from 0.010" to 0.375" within tolerances of  $\pm 0.00005$  inches.

Techniques for redrawing tubing so thin and within such close tolerances were developed in response to many requests for lightweight tubing with the properties of the many common metals and alloys. Accordingly, *ultra-thin* tubing is available in 304, 310, 316, 321 and 347 stainless steels, Monel, Inconel, Nichrome V, Tophet A, nickel, copper, beryllium copper and glass-sealing alloys.

*Ultra-thin* tubing is available cleanly cut to any specified length up to six inches. And speaking of light weight—500 feet of *ultra-thin* 304 SS tubing with an O.D. of 0.375" and a wall thickness of 0.0005" *weighs only one pound!* Rigid quality control assures you that every bit of *ultra-thin* tubing falls within the close tolerances.

If you need fine precision tubing with all the inherent properties of a particular metal or alloy listed above and must have the added advantage of light weight, investigate UNIFORM *ultra-thin* tubing by phoning or wiring the numbers below. Ask, too, about UNIFORM's proved abilities for fabricating tubular parts to exacting specifications. UNIFORM specializes in craftsmanship and fast delivery for fine tubing in most alloys and precious metals.



**UNIFORM TUBES,  
INC. COLLEGEVILLE 2, PA.**  
HUxley 9-7276 TWX-CGVL 1044

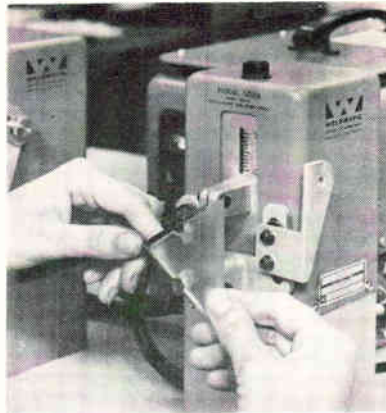

*Electrode alignment tool helps insure standard practices*

example, a diode matrix required some 600 parts; these are inserted in a preformed, three-ply, laminated plastic block before welding. Tooling included a Silastic mold for the block and an aluminum pattern for exact placement of the diodes.

### *Production Control*

An assembly line technique is recommended for weld reliability. Each machine is set to the proper weld schedule and is not changed. Work is passed from machine to machine. The operator has no other job except to place the proper two wires between two electrodes and press the foot pedal. Therefore, a thorough dexterity test is one of the most important personnel evaluation tools.

Inspection stations are equipped with 30-power binocular microscopes for weld inspection. Stress testing of welds in modules is likely to impair reliability while radiography yields little information on resistance weld strength. The best quality assurance is rigid control of equipment, process and materials variables, and the establishment of correct weld schedules. Employees should be thoroughly trained and impressed with the need for reliability. Visual aids can continually emphasize proper technique.

The human element can be minimized by following such general rules as: limit the operators' responsibility for changing pressure and energy settings; group and standardize electrodes for families of welds; redress and maintain electrodes in the machine shop; use fixtures and jigs to support modules during welding; use alignment tools to position electrodes; lay out

### TABLE—RECOMMENDED FACING ELECTRODE FOR VARIOUS TYPES OF METAL

1. Aluminum, Magnesium, Nichrome, Platinum: Resistance Welders Manufacturer's Association #1.
2. Alnico, Brass (yellow), Bronze (phosphor), Constantan, Beryllium, Gold, Iridium, Iron, Novar: RWMA #2.
3. Molybdenum, Monel, Nickel, Nickel Silver, Palladium, Steel, Stainless Steel, Tantalum, Tungsten: RWMA #2.
  1. Brass, Copper, Silver: RWMA #3 or Molybdenum.
  5. Osmium: Molybdenum.

modules so weld positions are easily accessible in sequence; and attach risers or extension leads at test points so they can be clipped off after electrical tests.

Destructive tests can be made on coupons furnished for each different weld at regular intervals. Information should be quickly fed back to the production shop. Machine pressure and force should be periodically calibrated. Changes indicate the frequency of calibration required and will also indicate preventive maintenance needed.

Since it is difficult to rework welded modules, 100 percent testing of components before assembly is recommended. Circuit performance should be tested before potting and again after potting.

### *Inspection Procedure*

The leads of components should be inspected as part of incoming inspection. Variations in lead coating, thicknesses, consistency and composition must be controlled.

The inspection procedure recommended is to clip 12 leads from one side of parts in lots of 100 or less. The samples are welded to an interconnecting lead material according to a previously developed weld schedule for that material. Eleven of the weld samples are tensile tested to failure and the results compared with the strength established for that material. If discrepancies are slight, a metallographic examination is made of the twelfth sample and compared with data used in developing the original weld schedules.

If variations are excessive, the lot must be rejected or a new weld schedule developed.

# IRE SHOW

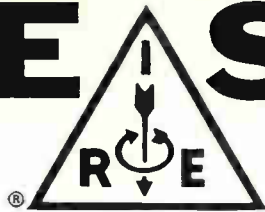

presenting

## "THE GOLDEN AGE OF ELECTRONICS"

March 26-29, 1962

The New York Coliseum

... part of the

International Convention of the IRE

The Institute of Radio Engineers

1 East 79th Street • New York 21

Members \$1.00. Non-members \$3.00. Age limit: over 18

CIRCLE 210 ON READER SERVICE CARD

Routine or rush,  
specify Delta Jet Freight

## NEXT STOP: THE MOON



Space helmets to propulsion units, first fly Delta Jet before they zoom to outer space. Delta Air Freight is always faster, often cheaper than surface transportation for routine or rush shipments. Delta has next day nationwide delivery plus connections to every international destination.

EXAMPLES, DOOR-TO-DOOR:  
100 lbs. Los Angeles to Canaveral \$29.85  
300 lbs. Miami to Chicago \$28.95

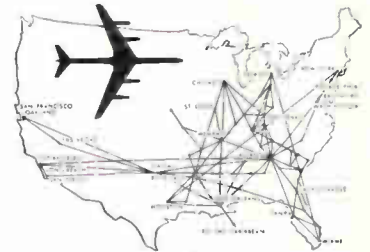

### DELTA

the air line with the **BIG JETS**

GENERAL OFFICES: ATLANTA, GEORGIA

Since 1901



## ELECTRO-PLATED WIRES



### Quality at Moderate Cost

Long experience, technical know-how and specially built equipment enable us to plate wire of uniformly high quality at moderate cost... One application is the Gold plating of Nickel wire. This combines the desirable characteristics of the base metal with the corrosion-resistance of Gold... In our process of continuous electroplating, adherence and quantity deposited are precisely controlled.

Send us details of your specific requirements

**SIGMUND COHN**

Mfg. Co., Inc.

121 South Columbus Ave.  
Mount Vernon, N.Y.

SIGMUND COHN CORP. OF CALIFORNIA • 151C North Maple Street, Burbank, California

CIRCLE 211 ON READER SERVICE CARD

# DESIGN AND APPLICATION

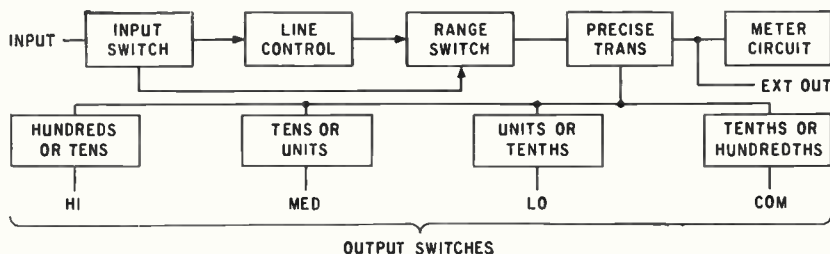

opening the switch and the discharge of the capacitor through the diode and load. The battery is stored in a short-circuited condition and is indifferent to this short circuiting.

**CIRCLE 302 ON READER SERVICE CARD**

## A-C Voltage Standard

ACCURACY TO  $\pm 0.05$  PERCENT

WILK INSTRUMENTS, 3700 South Broadway, Los Angeles 7, California recently announced Model P-4, a new instrument designed for rapid and accurate calibration of a-c voltmeters, ammeters, wattmeters, power-factor meters, phase-angle meters and for use as a precision a-c supply and current transformer. The unit can operate between 50 cps and 5 Kc supply frequency and has output ranges from 0 — 1,511 v in 0.1 v increments and 0 — 151.1 v in 0.01 v increments. The heart of the calibration unit is a precision tapped transformer having 42 separate windings spe-

cially positioned to insure minimum capacitance effect and leakage reactance to maximize frequency response of the system. A special expanded-scale, high-accuracy voltmeter with an accuracy of  $\pm 0.05$  percent of the center-scale value between 50 cps and 5 Kc is used. The meter is calibrated for rms reading of a sine wave. As shown in the sketch, output is determined by four switches with associated dial indications. An illuminated decimal point is automatically positioned by the range switch.

**CIRCLE 301 ON READER SERVICE CARD**



## Salt Spray Chamber

MULTIPURPOSE DESIGN

STANDARD CABINET CO., INC., 56 Washington Ave., Carlstadt, N.J. Line of moderately priced salt spray, salt fog, high relative humidity test chambers feature heavy gage steel construction with rubber composition liner. Chambers meet MIL requirements. Standard sizes range from 2.6 to 22.5 cu ft of work space. Temperature range is ambient to +160 F; humidity range 95 percent,  $\pm 5$  percent.

**CIRCLE 303 ON READER SERVICE CARD**

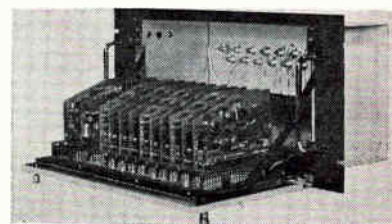

## High Speed Converter

ANALOG-TO-DIGITAL

RAYTHEON CO., 1415 Providence Highway, Norwood, Mass. Model AD-10A operates at up to 500,000

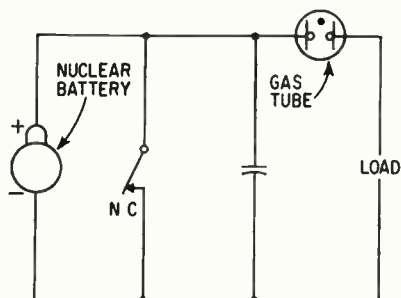

## Nuclear Battery

USEFUL LIFE OF 10 YEARS

RECENTLY announced by Leeson Moos Laboratories, 90-28 Van Wyck Expressway, Jamaica 18, New York is a nuclear battery using Krypton 85, an inert gas which is not metabolized by the body. The battery can produce voltages in excess of 10,000 v, charging linearly to 1,000

v and is essentially a constant-current device with a current capability of 1,000  $\mu$ amps. A small glass ampoule is filled with this gaseous isotope with the filling tube serving as the positive electrode. A copper coating plated on the outside of the glass is the collector or negative electrode. High-energy electrons from the radio isotope cross the glass dielectric and are collected thus creating a potential difference. Because Krypton-85 has a half-life of 10.4 years, the battery has a minimum useful life of ten years. If a capacitor is connected in parallel with the nuclear battery, as shown in the sketch, and then through a cold-cathode diode to the load, the value of the capacitor and the breakdown of the diode will determine the time delay between



# NEW 7-INCH VOMs AT \$49<sup>95</sup>

By *Simpson*

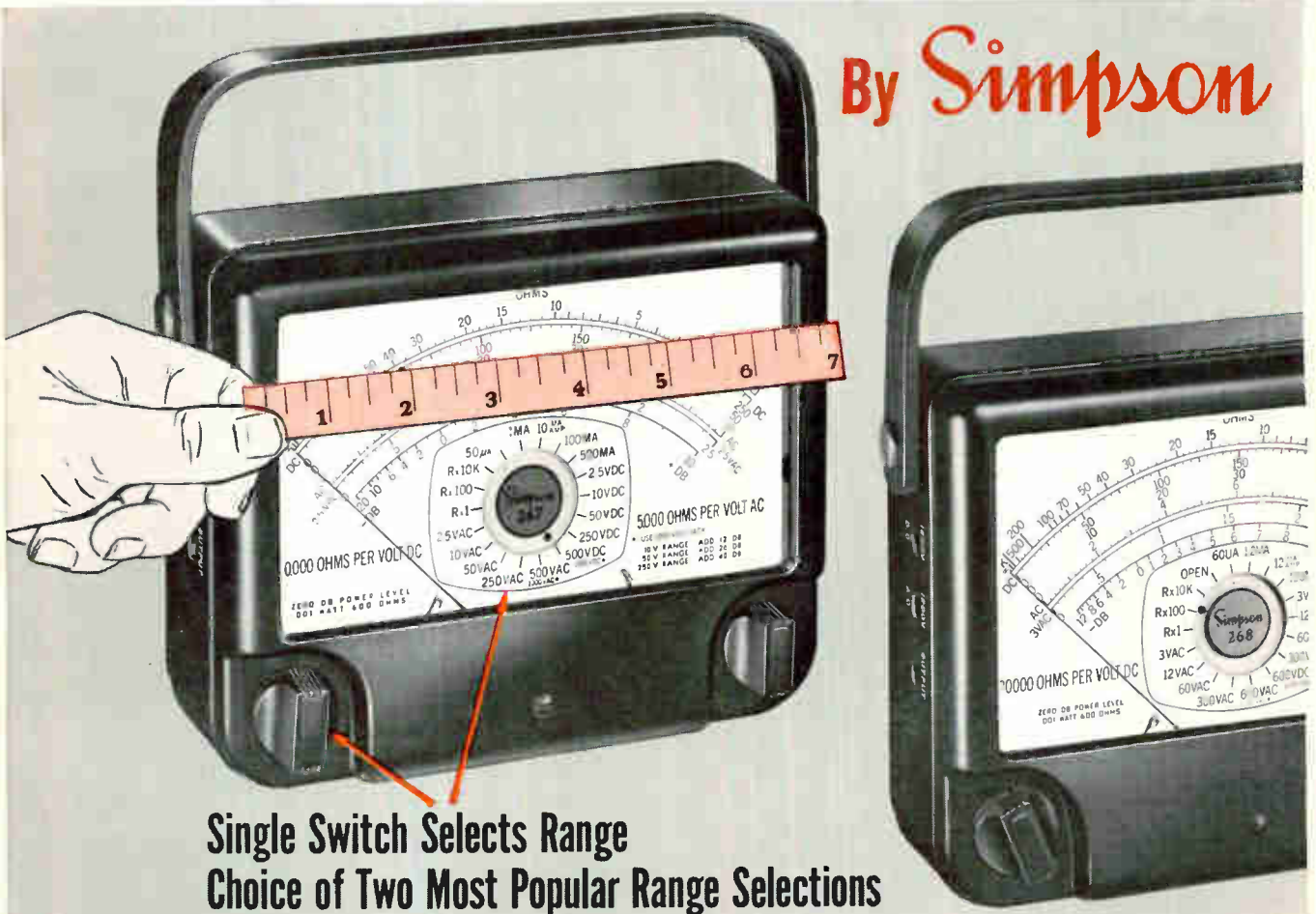

**Single Switch Selects Range  
Choice of Two Most Popular Range Selections**

From whom but Simpson (makers of the world famous 260 Volt-Ohm-Milliammeter) could you expect testers like Models 267 and 268?

Although their price tags fall in the same area as other makes with small 4½" meters, Models 267 and 268 give you big, easy-to-read 7" meters plus quality features such as: *self-shielding*, core-type movements with spring loaded jewels . . . single-switch range selection . . . black and red scales that are spread out for close repetitive reading . . . Adjust-A-Vue handles . . . plus all the rugged, stay-put accuracy that you *expect and get from Simpson*.

Vital statistics for Models 267 and 268 are: DC sensitivity, 20,000 ohms per volt; AC, 5000 ohms per volt. Accuracy: DC volts, ±3% of full scale; AC volts, ±5% of full scale.

*Have your distributor bring one out for trial.*

**Simpson**

**SIMPSON ELECTRIC COMPANY**  
5203 W. Kinzie St., Chicago 44, Illinois  
Phone: EStebrook 9-1121 (Area Code 312)  
In Canada: Bach-Simpson Ltd., London, Ontario

## Choice of 250 or 300 Volts

	Model 267	Model 268	
DC VOLTS	0-25/2.5/10/50/250/500/1000	0-3/12/60/300/600/1200	
AC VOLTS	0-2.5/10/50/250/500/1000	0-3/12/60/300/600/1200	
DC MICROAMPERES	0-50	0-60	
DC MILLIAMPERES	0-1/10/100/500	0-1.2/12/120	
DC AMPERES	0-10	0-12	
DB SCALE	-20 to +10 DB 1 MW in 600 ohms	-12 to +11 DB 1 MW in 600 ohms	
OUTPUT RANGES	AC Volt ranges to 250 V with 1 mfd condenser in series	AC Volt ranges to 300 V with .1 mfd condenser in series	
OHMS			
Ranges	Rx10K	RX100	RX10K
Ctr. Scale Value	12	1200	120,000

Also Available: carrying cases, high-voltage multipliers, and special types of test leads.

**Model 267 or 268  
complete with test leads  
and operator manual . . . . .**

**\$49<sup>95</sup>**

See Your Distributor Also  
For Simpson's Famous 260.  
Outsells All Other VOMs Combined.  
Still Only \$43.95



Famous around the world...260<sup>®</sup> VOM

# SILICONTROL®



## THE ONLY COMPLETE PHASE SHIFT CONTROL PACKAGE FOR SILICON CONTROLLED RECTIFIERS

(SOLID STATE THYRATRONS)

THE ALL-IN-ONE PACKAGE CONTROL  
FOR THE SYSTEM DESIGNER

CHECK THESE  
IMPORTANT ADVANTAGES...

1. One Silicontrol fires one or two silicon controlled rectifiers in back-to-back arrangement or bridge circuit. No added circuitry needed.
2. Eliminates matching of silicon controlled rectifiers. No need to select similar impedance values. Fires any two SCRs of any rating or manufacture.
3. Failsafe feature built-in. Prevents destruction of SCRs and load components through a wide range of overload conditions. Linear control from zero to maximum output. Can shift gate pulse more than 180°.
4. No bias needed; loss of control signal turns off unit.
5. Immune to voltage transients on supply bus resulting from adjacent switching or relay operations. Prevents SCR pulses from interfering with other circuits.
6. The only unit providing all of the above features.
7. SILICONTROLS are available from stock.
8. Both 60 cps and 400 cps models available.
9. Military packaging as required.

Send for Engineering Bulletin No. 2000

★ ★ ★ ★ ★ ★ ★ ★

# VecTroL®

ENGINEERING, INC.

A Subsidiary of Sprague Electric Company  
85 MAGEE AVE., STAMFORD, CONN.

complete 10-bit conversions per sec. Output is either serial or parallel straight binary on all units. Serial output is 5 million bits per sec while parallel output is up to 500,000 words per sec. Accuracy is 0.097 percent  $\pm \frac{1}{2}$  the least significant bit. The unit can be operated internally or externally for sampling command. Price is about \$6,800 complete with power supply.

CIRCLE 304 ON READER SERVICE CARD



### Six Pole D-T Relay HIGH CONTACT PRESSURE

ELECTRO-TEC CORP., 1 Henderson Drive, West Caldwell, N. J. Mark II type 1000 Wedge-Action relay meets requirements of MIL-R-5757D for 125 C operation. It employs a powerful plunger type solenoid to actuate the six moving contacts. These movable contacts are positioned between two rigidly mounted stationary contacts. In either the energized or de-energized position, contact pressure increases between the moving contact and the fixed contact. Contact resistance is 0.015 ohm.

CIRCLE 305 ON READER SERVICE CARD

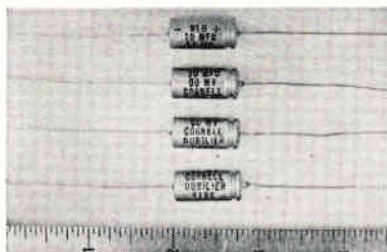

### Miniature Capacitors COMPUTER-GRADE

CORNELL-DUBILIER ELECTRONICS, 50 Paris St., Newark, N. J. Type NLH Computamite electrolytic capacitors are available in ratings of 1 to 300  $\mu$ f at 3 to 150 v d-c working. They are  $\frac{1}{8}$  in. diameter by  $\frac{1}{4}$  in. long in lower ratings and  $\frac{3}{8}$  in. by  $1\frac{1}{2}$  in. long in higher ratings; are designed for an operating range of -40 C to +85 C. High gain etching and forming of 99.99 percent purity

aluminum foil yields up to twice the capacitance of previous techniques with no detrimental changes in dissipation factor or leakage current.

CIRCLE 306 ON READER SERVICE CARD

### Lock-Nut

UNLIMITED RE-USE

DYNALOC FASTENERS, INC., 977 Mt. Read Blvd., Rochester 6, N.Y. The Dynaloc self-locking nut is easy starting, free spinning and locks in last turn. Features: unlimited re-use; it will not strip, gall, shear or otherwise damage mating part; compression action creates no residue; and vibration resistance is very high. Company says nut exceeds government standards on all torque requirements by more than 200 percent. It is available in standard sizes starting at 4-40.

CIRCLE 307 ON READER SERVICE CARD



### Soft Tube Modulator THREE PULSE WIDTHS

THE NARDA MICROWAVE CORP., Plainview, L.I., N.Y. Model 11040 soft tube modulator provides peak power outputs up to a maximum of -33 Kv at 33 amp. It is furnished with three standard pulse widths of 0.5, 1.0 and 2.5  $\mu$ sec, the pulse repetition rate being continuously variable from 200 to 2,000 pps. Price is \$9,650.

CIRCLE 308 ON READER SERVICE CARD

### Radio Altimeter TRANSISTORIZED

INTERCONTINENTAL ELECTRONICS CORP., 300 Shames Drive, Westbury, L. I., N. Y. The AM-220 transistorized radio altimeter features zero to 1,000 ft range. A guaranteed accu-

racy of  $\pm 3$  ft under 50 ft and  $\pm 6$  percent above 50 ft is claimed over the full range of temperature and operating conditions. Also featured are modular construction for easy maintainability, compact size, and a total system weight of 18.6 lb.

**CIRCLE 309 ON READER SERVICE CARD**

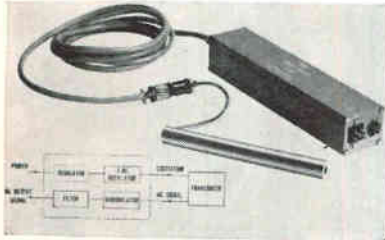

### Transducer Converters THREE MODELS

SANBORN CO., 175 Wyman St., Waltham 54, Mass. Series of transducer converters permits use of differential transformer-type transducers with 28 v d-c and 115 v a-c power sources. They produce d-c signals proportional to the input, ready for monitoring or recording with a general-purpose d-c amplifier. No carrier amplification is needed. Two models that accept 28 v d-c contain a 5 Kc oscillator, demodulator and filter. Third model accepts 115 v  $\pm 10$  percent, 60-cycle a-c.

**CIRCLE 310 ON READER SERVICE CARD**

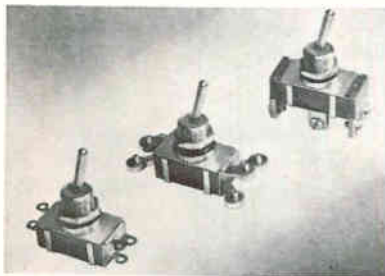

### Toggle Switches SHOCK RESISTANT

ELECTROSPACE CORP., 12 Morris Ave., Glen Cove, N. Y. Line of toggle switches has electronic circuit switching engineered for aircraft, missiles, ground handling equipment and other applications. Units are military approved and meet applicable requirements of MIL-S-3950. Electrical ratings: 10 amp at 125 v a-c, or 30 v d-c. Endurance: greater than 10,000 cycles at +85 C. Dielectric strength: over 1,000 v, 60 cps a-c. Insulation resistance: over 1,000 megohms.

**CIRCLE 311 ON READER SERVICE CARD**

# MEASURE RF MILLIWATTS 30 TO 500 MC

**B**ird's new TERMALINE RF Milliwattmeter provides direct, simple and inexpensive absorption measurement of RF power at milliwatt levels in coaxial systems. No calibration charts. No adjustments. No calculations. No batteries or auxiliary power required.

#### Specifications: Bird Model 6254

- Power Ranges:** Any one of six standard scale ranges of 25, 50, 100, 250, 500 and 1000 milliwatts. Specify scale range desired.
- Frequency:** 30-500 mc
- Impedance:** 50 ohm nominal
- VSWR:** Less than 1.15
- Accuracy:**  $\pm 5\%$  of full scale
- Input Connector:** Female BNC
- Weight:** 2.2 pounds
- Size:**  $5\frac{7}{8}$ " x  $4\frac{1}{4}$ " x  $3\frac{3}{8}$ "
- Price:** \$85.00, F.O.B. Factory

Contact us for further information on this instrument and other Bird products.

**Bird Model 6254  
TERMALINE RF Milliwattmeter**

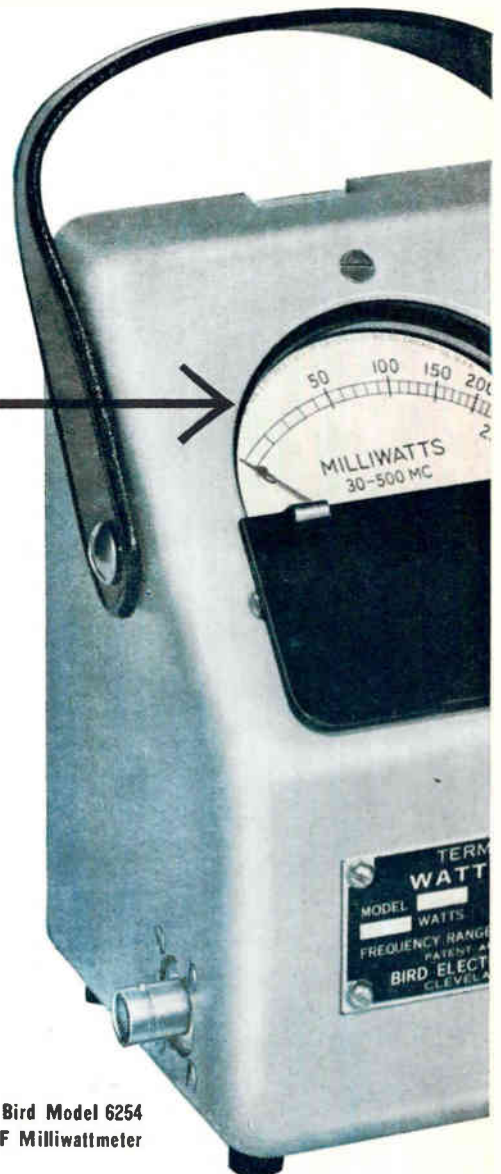

# BIRD

**ELECTRONIC CORPORATION**  
30303 Aurora Rd., Cleveland 39 (Solon), Ohio  
CHurchill 8-1200 TWX CGN FS 679  
Western Representative:  
VAN GROOS COMPANY, Woodland Hills, Calif.

TOWER FOOTING  
INSULATORS FOR  
SELF-SUPPORTING  
RADIATORS

**LAPP**

## **ANTENNA TOWER INSULATORS**

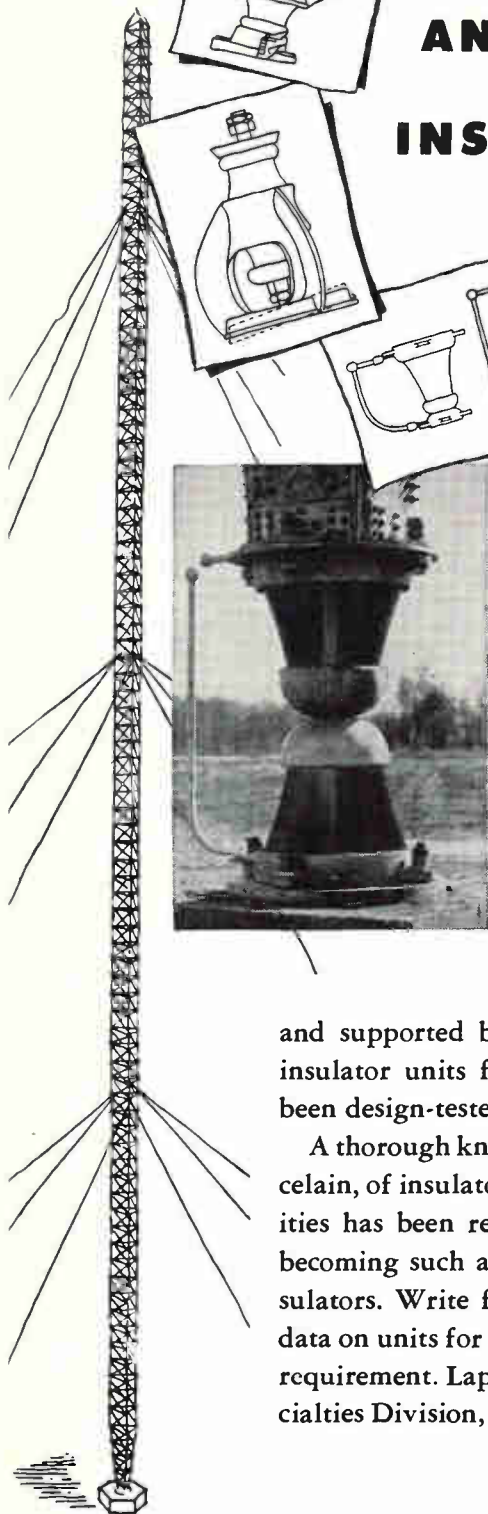

MAST BASE  
INSULATORS

RADIO GUY  
INSULATOR

We at Lapp are mighty proud of our record in the field of tower insulators. Over 30 years ago, the first insulated broadcasting tower was erected—on Lapp insulators. Since then, most of the large radio towers in the world have been insulated

and supported by Lapp insulators. Single base insulator units for structures of this type have been design-tested to over 3,500,000 pounds.

A thorough knowledge of the properties of porcelain, of insulator mechanics and electrical qualities has been responsible for Lapp's success in becoming such an important source of radio insulators. Write for description and specification data on units for any antenna structure insulating requirement. Lapp Insulator Co., Inc., Radio Specialties Division, 188 Sumner Street, LeRoy, N. Y.

# Lapp

### PRODUCT BRIEFS

**VARIABLE DELAY LINE** for radar range calibrators. Andersen Laboratories, Inc., 501 New Park Ave., West Hartford 10, Conn. (312)

**COMPACT POWER SUPPLY** wide range. Electronic Research Associates, Inc., 67 Factory Place, Cedar Grove, N.J. (313)

**PHYSIOLOGICAL STIMULATOR** applies electronic pulse. Theratron Corp., 263 Griggs-Midway Bldg., St. Paul 4, Minn. (314)

**TANTALUM FILM CIRCUITS** in various form factors. Texas Instruments Inc., 13500 North Central Expressway, Dallas 22, Texas. (315)

**TRANSISTORIZED COUNTING STRIP** modular design. The Victoreen Instrument Co., 5806 Hough Ave., Cleveland 3, O. (316)

**COAXIAL HYBRID COUPLER** with crossover feature. Dielectric Products Engineering Co., Inc., Raymond, Maine. (317)

**SURFACE ANALYZER SYSTEM** repeatable recording. Brush Instruments, Div. of Clevite Corp., 37th and Perkins, Cleveland 14, O. (318)

**CIRCUIT TRIAL CASE** self-contained unit. Cambridge Thermionic Corp., 445 Concord Ave., Cambridge 38, Mass. (319)

**VARIABLE ATTENUATOR** high-power, zero-loss. Merrimac Research & Development, Inc., 517 Lyons Ave., Irvington 11, N.J. (320)

**LOW POWER WATTMETER** rack-mounted. Voltron Products, Inc., 1020 South Arroyo Parkway, Pasadena, Calif. (321)

**POWER SUPPLY** high filter. Dynatech Corp., 471 N.E. 79th St., Miami, Fla. (322)

**VARIABLE TRANSFORMER** 40-volt unit. The Superior Electric Co., Bristol, Conn. (323)

**RECORDER/REPRODUCER SYSTEM** all solid-state. Consolidated Electrodynamics Corp., 360 Sierra Madre Villa, Pasadena, Calif. (324)

**BROADBAND VHF AMPLIFIER** low-cost. Motorola Inc., 8330 Indiana Ave., Riverside, Calif. (325)

## Literature of the Week

**DISK INTEGRATOR** Disc Instruments, Inc., 3014B S. Halladay, Santa Ana, Calif. Illustrated 4-page booklet details performance capabilities of the series 200 disk integrator. (326)

**POWER RESISTOR DECADES** Clarostat Mfg. Co., Inc., Dover, N.H. Catalog contains electrical and mechanical specifications for power resistor decades. (327)

**AUTOMATIC CONTROL** Zenith Electric Co., 152 W. Walton St., Chicago 10, Ill. A 64-page catalog provides complete information and prices on electromagnetic controls and timing devices. (328)

**SERVO RECORDERS** Houston Instrument Corp., P.O. Box 22234, Houston 27, Texas. Four-page folder contains illustrated description, ordering information and prices for T-Y moving pen recorders. (329)

**MODULAR POWER SUPPLIES** MicroPower, Inc., 20-21 Steinway St., Long Island City 5, N.Y. Data and selection guide for a line of modular power supplies for microwave tubes is available. (330)

**D-C VOLTAGE REFERENCE** Binary Electronics, Inc., 30-48 Linden Place, Flushing 54, N.Y. Bulletin describes a precision, dual-channel, d-c voltage reference, featuring electrical program ability through specially designed binary-coded decimal, Kelvin-Varley resistive dividers. (331)

**STAND-OFF TERMINALS** Standard Plastics Co., Inc., 62 Water St., Attleboro, Mass. Three technical data sheets offer complete information on custom molded Standite series A, B and C miniature insulated stand-off terminals. (332)

**FRACTIONAL H-P MOTORS** Motordyne, Inc., 2221 Barry Ave., Los Angeles, Calif. Catalog is devoted to p-m and wound fractional h-p d-c motors, as well as centrifugal blowers, and axial fans. (333)

**COMPOSITION RESISTORS** Ohmite Mfg. Co., 3694 Howard St., Skokie, Ill. Bulletin 140 describes Little Devils molded composition resistors available in resistance values as low as 2.7 ohms in the  $\frac{1}{4}$  and 1-w sizes. (334)



## P. I. tape recorder secret is an open book

A unique stacked-reel tape magazine is one of many space-saving secrets which enable Precision instrumentation recorders to out-perform conventional magnetic tape instruments many times their size. Other design secrets are push-button selection of function and speed, light beam end-of-tape sensing, front panel calibration and testing, interchangeable tape loop magazines, and all-solid-state plug-in electronics.

All the secrets of these recorders are unveiled in detailed new brochure 55B. Write for your copy today.



P. S. - Here's an installation secret - two complete 14-channel analog (or 16-channel digital) recorders mount in only 5 1/2" of vertical rack space.

**14-CHANNEL  
PRECISION RECORDER**  
Loaded magazines can be  
interchanged in 5 seconds.



P. I. Invites inquiries from senior engineers seeking a challenging future.  
**PRECISION INSTRUMENT COMPANY**

1011 Commercial Street • San Carlos • California  
Phone LYtell 1-4441 • TWX: SCAR BEL 30

REPRESENTATIVES IN PRINCIPAL CITIES THROUGHOUT THE WORLD

# ENGINEERS SCIENTISTS MANAGERS

New long term diversified development and design contracts create unusually attractive opportunities at the Link Division of General Precision, Inc. Qualified men, proficient in broad systems and equipments

engineering, will be interested in these commercial and military projects. Both aircraft and space vehicle systems are involved. Excellent salaries and ideal living in the Binghamton, New York area will attract the qualified professional man or manager seeking advancement opportunity and challenging work.

**PROJECT MANAGER** — laboratory precision measurement, visual displays and special projects including G.S.E., simulators and checkout equipment. **PROJECT MANAGER** — electro-optical precision measurement systems. **MANAGER PRODUCT SUPPORT** — 12-15 years mechanical design, electronic packaging, model shop construction, and department supervision in military programs. Direct product design department, model shop, product programs and advanced development.

## PRINCIPAL ENGINEER

— visual systems projects.

**OPTICS** — optical, electro-optical measuring, inspection and scanning systems. **OPTICS** — periscopic, projection and relaying lens, analysis of optical problems, laboratory proposals.

**DIGITAL** — transistor circuits, switching circuits, computer logic, "NOR" logic, direct-coupled transistor logic, proposals.

**DISPLAYS** — electronic systems project responsibility. Supervise design, test and verification of prototype model and preparation of engineering data.

**SIMULATION** — analog computing devices, audio systems, transistorized amplifiers, radio aids, radio navigation, aircraft communications.

**DESIGN** — program digital computers, digital systems design.

**MECHANICAL** — systems design of servos, hydraulics, missiles, life support systems.

**MECHANICAL** — systems design of mechanisms, structures, hydraulics, electro-mechanical packaging, materials, plastics.

**AERONAUTICAL** — simulation, project responsibility for computation of equations, defining motion and engine performance of aircraft, specification interpretation, concept determination, data search and liaison, data analysis and processing, test guide inception and computation.

**AERONAUTICAL** — process raw aerodynamic coefficient data and engine data into equation form for electronic simulation, engine performance calculations, test guide to check simulator.

**ELECTRONIC SCIENTIST** — airframe and spacecraft performance, stability and control, engine performance, analog simulation and digital computations.

All positions require an appropriate degree—advanced degree is highly desirable for managerial and senior positions. Minimum experience required is 4 years—an additional 4 years experience is required for managerial and senior positions.

Qualified men are invited to phone collect (RAYmond 3-9311) or write Mr. James T. Gibbons. An equal opportunity employer.



LINK DIVISION  
GENERAL PRECISION, INC.

Binghamton, New York

# SENIOR & JUNIOR ENGINEERS

DEVELOPMENT - DESIGN - ANALYSIS

VISUAL

formerly with Amerac Inc.

J. F. Lane is president of AML; Alden Matsubara is product manager; and Ray Fuller, engineering manager.

Featured line of microwave devices includes oscillators, amplifiers, and multipliers using planar or pencil triodes, and klystrons for either c-w or pulse applications. The company develops complete microwave front-end assemblies utilizing mixers, preselector filters and duplexers in addition to the cavity energy sources.



## Electronics Capital Appoints Root

DONALD E. ROOT has joined Electronics Capital Corp., San Diego based small business investment company, as senior management services officer. Previously, he was associated from 1953 to 1961 with Cubic Corp. of San Diego, where he was general manager of that company's industrial instrument division.



## Mazzaresse Joins Digital Equipment

APPOINTMENT of Nick J. Mazzaresse to the post of computer applications engineer at Digital Equipment Corp., Maynard, Mass., is announced.

Prior to joining Digital, Mazzaresse was an engineer at Hazeltine

# Message printer combines reliability and high speed

The S-C 3070 message printer utilizes an electrostatic process to produce highly legible, permanent copy. The printer is designed to operate at speeds up to 3000 words per minute using standard computer or communications codes over telephone, telegraph and microwave links. ■ Compact dimensions and quiet operation make the S-C 3070 ideal for offices and communications or command centers. Multiple copies of S-C 3070 printer output can be easily obtained by using the original as a litho offset master or by standard office copying methods. ■ Reliable, unattended operation in the S-C 3070 results from the unit's non-impact printing concept and field proven electronic circuitry. Ease of maintenance is assured through modular design and readily replaceable printed circuit boards. Replacement paper rolls can be loaded into the S-C 3070 without interrupting operation or interfering with message transmission. The S-C 3070 finds many applications in military, government, and commercial communications systems — and in the data processing field. ■ For additional information on the S-C 3070, write to Department C-25, General Dynamics | Electronics, P.O. Box 2449, San Diego 12, Calif.



GENERAL DYNAMICS | ELECTRONICS **G ||| ||| D** SAN DIEGO

# WASHINGTON OUTLOOK

EIA'S OPPOSITION to S.2109, the FCC-sponsored bill requiring production of only all-channel uhf-vhf tv receivers (p 12, Feb. 23), was delivered to the Senate Communications Subcommittee last week.

L. M. Sandwick, staff director of EIA's consumer products division, claimed the bill would penalize set manufacturers and consumers with "dubious" results. Buyers would have to pay an average of \$30 more a set, plus antenna costs. Set sales might plunge as much as 14 percent.

The industry will produce all the uhf-equipped sets the public wants, Sandwick said. Shortage of buyers caused uhf set output to drop to a new low, 370,000 last year, against 1.5 million in 1953, he said.

Sandwick cited examples to indicate that uhf station failures were not due to lack of uhf receivers but to programming and other difficulties. Among examples were a uhf station that couldn't compete with vhf network programs, uhf stations that succeeded with network programs, and one that made the grade through "salesmanship" and vigorous competition with vhf programs in the same area.

As an alternative to legislation, he offered the industry's voluntary cooperation in promoting uhf and in solving technical problems. The bill, he protested, could lead to further FCC regulation of set design and might logically be extended to a requirement for f-m in all radio sets.

GOVERNMENT SALARIES under President Kennedy's proposed new scales would range up to \$28,000—almost \$10,000 more than top government scientists and engineers get now. Increases would be most significant in top and near-top levels, where turnover is greatest now. The four top pay grades (\$15,030, \$16,295, \$17,570 and \$18,500) are 20 to 50 percent below comparable private levels.

Proposed increases range from \$6,000 to \$6,500 by 1965, plus two new top classifications which would add another \$3,500 to potential top annual pay. Object is to attract more trained men into government service.

ELECTRONICS INDUSTRY interest in the trade expansion bill will probably focus on the "zero list." The President could reduce to zero the tariffs on all product categories on the list. Products go on the list if the U.S. and European Common Market Countries control 80 percent of world trade.

Computers, for example, will likely be among electronic products on the list. The administration maintains that if Americans and Europeans drop computer tariffs, U.S. manufacturers would be faced with increased imports, but exporters of some lines would have a field day.

Key to the President's trading authority is what base year is selected for exports and imports. The year chosen could put as many as 50 products and categories on or off the list. This question will probably be cleared up after the House Ways and Means Committee begins hearing March 12.

LATEST LABOR DEPARTMENT survey shows employment in aircraft and missile plants rose 3.4 percent in the year ending August, 1961. Employment totaled 982,400. Moderate increases were expected through this February. Employment was up 9.9 percent in the missiles sector of the aircraft industry and up nine percent among missile producers in the electrical machinery (including electronics), ordnance and other industry groups. Missile contractors in industries other than aircraft were expected to account for three-fourths of the additional hiring through this February.

INDUSTRY  
GROUP  
OPPOSES  
TV BILL

FEDERAL  
PAY TO  
JUMP UP

TARIFF  
HEARINGS  
NEXT  
MONTH

MISSILE  
HIRING  
HEALTHY



## Literature of the Week

**DISK INTEGRATOR** Disc Instruments, Inc., 3014B S. Halladay, Santa Ana, Calif. Illustrated 4-page booklet details performance capabilities of the series 200 disk integrator. (326)

**POWER RESISTOR DECADES** Clarostat Mfg. Co., Inc., Dover, N.H. Catalog contains electrical and mechanical specifications for power resistor decades. (327)

**AUTOMATIC CONTROL** Zenith Electric Co., 152 W. Walton St., Chicago 10, Ill. A 64-page catalog provides complete information and prices on electromagnetic controls and timing devices. (328)

**SERVO RECORDERS** Houston Instrument Corp., P.O. Box 22234, Houston 27, Texas. Four-page folder contains illustrated description, ordering information and prices for T-Y moving pen recorders. (329)

**MODULAR POWER SUPPLIES** MicroPower, Inc., 20-21 Steinway St., Long Island City 5, N.Y. Data and selection guide for a line of modular power supplies for microwave tubes is available. (330)

**D-C VOLTAGE REFERENCE** Binary Electronics, Inc., 30-48 Linden Place, Flushing 54, N.Y. Bulletin describes a precision, dual-channel, d-c voltage reference, featuring electrical program ability through specially designed binary-coded decimal, Kelvin-Varley resistive dividers. (331)

**STAND-OFF TERMINALS** Standard Plastics Co., Inc., 62 Water St., Attleboro, Mass. Three technical data sheets offer complete information on custom molded Standite series A, B and C miniature insulated stand-off terminals. (332)

**FRACTIONAL H-P MOTORS** Motor-dyne, Inc., 2221 Barry Ave., Los Angeles, Calif. Catalog is devoted to p-m and wound fractional h-p d-c motors, as well as centrifugal blowers, and axial fans. (333)

**COMPOSITION RESISTORS** Ohmite Mfg. Co., 3694 Howard St., Skokie, Ill. Bulletin 140 describes Little Devils molded composition resistors available in resistance values as low as 2.7 ohms in the  $\frac{1}{4}$ ,  $\frac{1}{2}$  and 1-w sizes. (334)



## P. I. tape recorder secret is an open book

A unique stacked-reel tape magazine is one of many space-saving secrets which enable Precision instrumentation recorders to out-perform conventional magnetic tape instruments many times their size. Other design secrets are push-button selection of function and speed, light beam end-of-tape sensing, front panel calibration and testing, interchangeable tape loop magazines, and all-solid-state plug-in electronics.

All the secrets of these recorders are unveiled in detailed new brochure 55B. Write for your copy today.

*P. S. - Here's an installation secret - two complete 14-channel analog (or 16-channel digital) recorders mount in only 51" of vertical rack space.*



**14-CHANNEL  
PRECISION RECORDER**  
Loaded magazines can be  
interchanged in 5 seconds.

*P. I. Invites inquiries from senior engineers seeking a challenging future.*



**PRECISION INSTRUMENT COMPANY**  
1011 Commercial Street • San Carlos • California  
Phone LYtell 1-4441 • TWX: SCAR BEL 30

REPRESENTATIVES IN PRINCIPAL CITIES THROUGHOUT THE WORLD



## CMS Ready to Occupy New Facility

CLEVELAND METAL SPECIALTIES CO. will move into its new plant on Cleveland's southwest side, on April 1. The plant, located on a one-acre site, is designed for rapid expansion. Even before occupancy, a 2,000-sq-ft addition was built, making total space 9,000 sq ft.

The 55-year-old company entered the electronics field several years ago. It produces photoengraved printed circuits, partial and complete subassemblies, system subassemblies and packaging, and microminiature product design and assembly.

Roger Middlekauff, president,

says the company provides complete printed circuit services, from conversion of schematics to artwork, through production.

CMS, which recently acquired prime contractor status from Army Ordnance Corps, is now engaged in a classified warhead fuzing program. It recently designed and packaged, with Diamond Ordnance Fuze Laboratories, a miniature arming programmer-timer that has had five successful test flights.

The company's industrial and commercial nameplate and jewelry divisions will also be housed in the new plant.



### DATA-tronix Corp. Elects V-P

ELECTION of David N. Dry as vice president and director of DATA-tronix Corp., Norristown, Pa., has been announced. DATA-tronix is a recently formed telemetry components and systems company.

Before joining the firm, Dry was chief engineer of Sonex, Inc., Philadelphia, Pa. He was formerly supervisor of the analog telemetry group, American Bosch Arma-

Corp., with responsibilities for both airborne and ground station component design. While with Philco Corp., Dry also designed and developed circuits for new compact portable tv units.



### General Electric Elevates Schwartz

NATHAN SCHWARTZ has been appointed manager of application en-

gineering at the General Electric Company's Electronics Laboratory, Syracuse, N. Y.

Schwartz was formerly a consultant-advance planning and analysis at the laboratory. Since joining the lab in 1953, he has been concerned with the application of solid-state physics to electronic devices and equipment.

### Daystrom Appoints Eric Weiss

ERIC WEISS was recently appointed to a staff position as technical advisor for Daystrom, Inc., Control Systems Division, LaJolla, Calif. He had been one of the division's original members when it was established in 1956.

Most recently Weiss was general manager of Rheem Advanced Technology Laboratory, LaJolla, which became the LaJolla Division of United ElectroDynamics, Inc.



### Babcock Electronics Hires Dressel

D. W. DRESSEL recently joined Babcock Electronics Corp., Costa Mesa, Calif., in the new position of manufacturing manager.

Prior to joining Babcock, Dressel served as factory manager with the Astronics division of Lear Inc.

### Set Up New Company In Microwave Field

AMONG newest entries in the field of microwave components and subsystems is Applied Microwave Laboratory Inc., of Wakefield, Mass.

The company, which emphasizes design and manufacturing of devices employing cavities, was founded in October 1961 by a group which included five engineers

# IRE SHOW



## presenting "THE GOLDEN AGE OF ELECTRONICS"

March 26-29, 1962  
The New York Coliseum  
... part of the

*International Convention of the IRE*

**The Institute of Radio Engineers**  
1 East 79th Street • New York 21

Members \$1.00. Non-members \$3.00. Age limit: over 18  
CIRCLE 212 ON READER SERVICE CARD



### FOR PRINTING of ELECTRONIC COMPONENTS of almost any shape: **REJAFIX MARKING MACHINES**

Hand-operated, semi-automatic and fully automatic models.  
Why not send us samples of your products. They will be test-printed and returned to you for your examination!

Est. 1922

**POPPER & SONS, INC.**  
300 Park Ave. South New York 10, N. Y.  
CIRCLE 213 ON READER SERVICE CARD

Is your advertising selling the same four key buyers your salesmen call on? Competition demands it! Only advertising in electronics reaches and sells the electronics man *wherever he is: in Research,*

## TODAY YOU MUST SELL ALL FOUR!

*Design, Production, and Management.* Put your advertising where it works *hardest...*

in **electronics**

February 2, 1962

## HIGHEST PURITY PRECISELY DEFINED

to meet critical  
electronic manufacturing  
needs

### J. T. Baker **ELECTRONIC CHEMICALS**

'Baker Analyzed' Reagents

SEMI-CONDUCTOR CHEMICALS



FERRITE AND  
THERMISTOR CHEMICALS



EMISSION CHEMICALS



J. T. Baker electronic chemicals offer you the highest standards of purity in the industry — proved by the Actual Lot Analysis and Actual Lot Assay on the label. Your variables are minimized... rejections are fewer... product performance is improved.

**IMPORTANT.** 'Baker Analyzed' Reagents have consistently met or exceeded the requirements of the electronics industry. Through a continuing program of establishing additional and more stringent specifications, the 'Baker Analyzed' label consistently defines a degree of purity so high that special electronic labeling is unnecessary.

### YOURS FOR THE ASKING—

*Important Guide to Electronic Chemicals*

Describes J. T. Baker chemicals of exceptional purity for semi-conductors, vacuum tubes, ferrites, thermistors, etc. Also includes specification sheets that define the high standards for 'Baker Analyzed' Reagents. Write for your copy today.



**J. T. Baker Chemical Co.**  
Phillipsburg, New Jersey

CIRCLE 79 ON READER SERVICE CARD

79

# ENGINEERS SCIENTISTS MANAGERS

New long term diversified development and design contracts create unusually attractive opportunities at the Link Division of General Precision, Inc. Qualified men, proficient in broad systems and equipments

engineering, will be interested in these commercial and military projects. Both aircraft and space vehicle systems are involved. Excellent salaries and ideal living in the Binghamton, New York area will attract the qualified professional man or manager seeking advancement opportunity and challenging work.

**PROJECT MANAGER** — laboratory precision measurement, visual displays and special projects including G.S.E., simulators and checkout equipment. **PROJECT MANAGER** — electro-optical precision measurement systems. **MANAGER PRODUCT SUPPORT** — 12-15 years mechanical design, electronic packaging, model shop construction, and department supervision in military programs. Direct product design department, model shop, product programs and advanced development.

**PRINCIPAL ENGINEER** — visual systems projects. **OPTICS** — optical, electro-optical measuring, inspection and scanning systems. **OPTICS** — periscopic, projection and relaying lens, analysis of optical problems, laboratory proposals. **DIGITAL** — transistor circuits, switching circuits, computer logic,

# SENIOR & JUNIOR ENGINEERS

**DEVELOPMENT · DESIGN · ANALYSIS** "NOR" logic, direct-coupled transistor logic, proposals. **VISUAL DISPLAYS** — electronic systems project responsibility. Supervise design, test and verification of prototype model and preparation of engineering data. **SIMULATION** — analog computing devices, audio systems, transistorized amplifiers, radio aids, radio navigation, aircraft communications. **SIMULATION** — program digital computers, digital systems design. **SIMULATION** — define problems, program and solve equations of flight simulation, specify components, initiate requirements for design and configuration of electronic and electro-mechanical systems. **MECHANICAL** — systems design of servos, hydraulics, missiles, life support systems. **MECHANICAL** — systems design of mechanisms, structures, hydraulics, electro-mechanical packaging, materials, plastics. **AERONAUTICAL** — simulation, project responsibility for computation of equations, defining motion and engine performance of aircraft, specification interpretation, concept determination, data search and liaison, data analysis and processing, test guide inception and computation. **AERONAUTICAL** — process raw aerodynamic coefficient data and engine data into equation form for electronic simulation, engine performance calculations, test guide to check simulator. **ELECTRONIC SCIENTIST** — airframe and spacecraft performance, stability and control, engine performance, analog simulation and digital computations.

All positions require an appropriate degree — advanced degree is highly desirable for managerial and senior positions. Minimum experience required is 4 years — an additional 4 years experience is required for managerial and senior positions.

Qualified men are invited to phone collect (RAYmond 3-9311) or write Mr. James T. Gibbons. An equal opportunity employer.



LINK DIVISION  
GENERAL PRECISION, INC.

Binghamton, New York

formerly with Amerac Inc.

J. F. Lane is president of AML; Alden Matsubara is product manager; and Ray Fuller, engineering manager.

Featured line of microwave devices includes oscillators, amplifiers, and multipliers using planar or pencil triodes, and klystrons for either c-w or pulse applications. The company develops complete microwave front-end assemblies utilizing mixers, preselector filters and duplexers in addition to the cavity energy sources.



## Electronics Capital Appoints Root

DONALD E. ROOT has joined Electronics Capital Corp., San Diego based small business investment company, as senior management services officer. Previously, he was associated from 1953 to 1961 with Cubic Corp. of San Diego, where he was general manager of that company's industrial instrument division.



## Mazzaresse Joins Digital Equipment

APPOINTMENT of Nick J. Mazzaresse to the post of computer applications engineer at Digital Equipment Corp., Maynard, Mass., is announced.

Prior to joining Digital, Mazzaresse was an engineer at Hazeltine

Electronics in New York City, Sylvania Electric in Needham, Mass., and Instrument Associates in Arlington, Mass.

## George Harmon Co. Expands Facilities

THE GEORGE HARMON CO., INC., Northridge, Calif., announces expansion of facilities to handle a \$4 million backlog of commercial and military electronic products. Manufacturing floor space has been increased from 5,500 to more than 11,000 sq ft, and engineering and production personnel have been added.

Proprietary products currently in production include an automatic crash locator beacon for aircraft, a personnel locator beacon, and several types of impact and pressure switches for military applications.

### PEOPLE IN BRIEF

**Morris Cohen** leaves Loral Electronics Corp. to rejoin PRD Electronics, Inc., as microwave dept. head of the Products and Components div. **James W. Hart** from Motorola, Inc., to Mark Products as mgr. of the Microwave div. Three v-p's of Dunn Engineering Corp. are elected to the board of directors—**Conrad E. Bloom, Jr.**, **Paul R. Likins**, and **Sydney Minault**. **William L. Quine**, previously with U.S. Dynamics Inc., named mgr. of thermistor and solid state switch development for Hydro-Space Technology, Inc. **Robert Bollen**, formerly of Allen B. Dumont Laboratories, appointed field engineering supervisor for Visual Electronics Corp. **Col. Charles G. Patterson**, U.S. Army, Ret., is elected a director and v-p of Belock Instrument Corp. **John F. McCole**, ex-Sylvania, now with the applications engineering staff of Watkins-Johnson Co. **John D. Lovely**, from Rediffusion Inc. to the engineering staff of Benco Television Associates Ltd. **William B. Harris**, ex-AEC exec, joins the engineering staff of Del Electronics Corp. **Leonard Pincus**, v-p and director of Quantatron's microwave laboratory, elected to firm's board of directors.

## No other 10-amp relay like it

A good heavy-duty relay that will dependably switch 5- or 10-amp loads is not as easy to find as you might think. By "good" we mean one actually *designed* for commercial equipment such as machine tool control panels and ground-based military equipment — not just an existing open-frame type repackaged in the familiar square plastic case with an octal plug-in base. (The practice, while common, is like putting a suit of armor on a midget and then sending him out as St. George.)

About a year ago we decided we'd try to correct these sins of the relay industry (and our own) and deliberately design a relay for this unglamorous but deserving application. We did, it's the AC or DC DPDT Series 46, and it will switch one-amp loads at least 10 million times and 10-amp loads 500,000 times. Here are some of the reasons it will work dependably in your "heavy-duty" application, and how it differs from many competitive types:

—Parts are rugged, few in number, and not fastened to phenolic boards with rivets, screws, etc. Each part does several jobs to make the best use of the space available. This leaves room for a big coil with substantial safety margins in operating power, contact force and heat dissipation. The frame is completely independent of the enclosure so the latter can't get hot and melt or give you a shock.

—Moving contacts are mounted on unusually long, U-shaped spring strips, so that the flexing stresses of several million

operations will be distributed over large areas. These springs, the contacts, and other conducting members are all big enough to prevent heavy currents from heating the parts.

—Design and construction of the base effectively get around many of the drawbacks often found in this type of relay. All electrical connections (except coil leads) are made by fastening parts *directly* to rigid, *solid* base pins. (Ordinary tube bases were meant for tubes, and are not rated to carry anything like 10 amps.) This helps reliability by reducing the total number of connections and eliminating all solder joints but two. The base aligning plug is also solid — so much so, in fact, that you have to clamp it in a vise to break it off. Molded barriers between parts and recessed holes for base pins provide good insulation resistance.

Just think of it — all this, with "industry standard" wiring so you can plug it right into sockets in existing equipment — at a regular *competitive* price. That's Designsville, man!

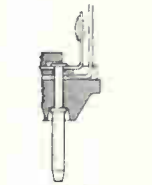
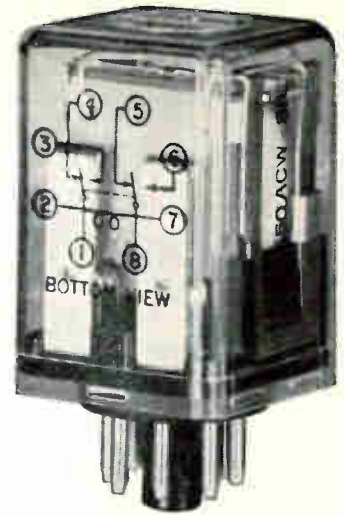

# SIGMA

SIGMA INSTRUMENTS, INC.  
62 PEARL ST., SO. BRAINTREE 85, MASS.

# electronics

## WEEKLY QUALIFICATION FORM FOR POSITIONS AVAILABLE

### ATTENTION: ENGINEERS, SCIENTISTS, PHYSICISTS

This Qualification Form is designed to help you advance in the electronics industry. It is unique and compact. Designed with the assistance of professional personnel management, it isolates specific experience in electronics and deals only in essential background information.

The advertisers listed here are seeking professional experience. Fill in the Qualification Form below.

#### STRICTLY CONFIDENTIAL

Your Qualification form will be handled as "Strictly Confidential" by ELECTRONICS. Our processing system is such that your form will be forwarded within 24 hours to the proper executives in the companies you select. You will be contacted at your home by the interested companies.

#### WHAT TO DO

1. Review the positions in the advertisements.
2. Select those for which you qualify.
3. Notice the key numbers.
4. Circle the corresponding key number below the Qualification Form.
5. Fill out the form completely. *Please print clearly.*
6. Mail to: D. Hawksby, Classified Advertising Div., ELECTRONICS, Box 12, New York 36, N. Y. (No charge, of course).

COMPANY	SEE PAGE	KEY #
DALMO VICTOR COMPANY Div. of Textron, Inc. Belmont, California	116*	1
EITEL-McCULLOUGH INC. San Carlos, California	84	2
ESQUIRE PERSONNEL SERVICE INC. Chicago, Illinois	116*	3
GRUMMAN AIRCRAFT ENGINEERING CORP. Bethpage, L.I., New York	83	4
LINK DIVISION General Precision Inc. Binghamton, New York	80	5
LOCKHEED CALIFORNIA CO. A Div. of Lockheed Aircraft Corp. Burbank, California	84*	6
LOCKHEED-GEORGIA CO. Div. of Lockheed Aircraft Corp. Atlanta, Georgia	14	7
MICROWAVE SERVICES INTERNATIONAL INC. Denville, New Jersey	116*	8
MINNEAPOLIS HONEYWELL Boston Division Boston, Massachusetts	102*	9
REMINGTON RAND UNIVAC Div. of Sperry Rand Corp. St. Paul, Minnesota	77*	10
UNION CARBIDE NUCLEAR CO. Oak Ridge, Tennessee	84	11
P-7950	84	12

\* These advertisements appeared in the 1/26/62 issue.

(cut here)

(cut here)

### electronics WEEKLY QUALIFICATION FORM FOR POSITIONS AVAILABLE

**Personal Background**

NAME .....

HOME ADDRESS .....

CITY ..... ZONE ..... STATE .....

HOME TELEPHONE .....

**Education**

PROFESSIONAL DEGREE(S) .....

MAJOR(S) .....

UNIVERSITY .....

DATE(S) .....

#### FIELDS OF EXPERIENCE (Please Check)

2262

<input type="checkbox"/> Aerospace	<input type="checkbox"/> Fire Control	<input type="checkbox"/> Radar
<input type="checkbox"/> Antennas	<input type="checkbox"/> Human Factors	<input type="checkbox"/> Radio-TV
<input type="checkbox"/> ASW	<input type="checkbox"/> Infrared	<input type="checkbox"/> Simulators
<input type="checkbox"/> Circuits	<input type="checkbox"/> Instrumentation	<input type="checkbox"/> Solid State
<input type="checkbox"/> Communications	<input type="checkbox"/> Medicine	<input type="checkbox"/> Telemetry
<input type="checkbox"/> Components	<input type="checkbox"/> Microwave	<input type="checkbox"/> Transformers
<input type="checkbox"/> Computers	<input type="checkbox"/> Navigation	<input type="checkbox"/> Other .....
<input type="checkbox"/> ECM	<input type="checkbox"/> Operations Research	<input type="checkbox"/> .....
<input type="checkbox"/> Electron Tubes	<input type="checkbox"/> Optics	<input type="checkbox"/> .....
<input type="checkbox"/> Engineering Writing	<input type="checkbox"/> Packaging	<input type="checkbox"/> .....

#### CATEGORY OF SPECIALIZATION

Please indicate number of months experience on proper lines.

	Technical Experience (Months)	Supervisory Experience (Months)
RESEARCH (pure, fundamental, basic)	.....	.....
RESEARCH (Applied)	.....	.....
SYSTEMS (New Concepts)	.....	.....
DEVELOPMENT (Model)	.....	.....
DESIGN (Product)	.....	.....
MANUFACTURING (Product)	.....	.....
FIELD (Service)	.....	.....
SALES (Proposals & Products)	.....	.....

CIRCLE KEY NUMBERS OF ABOVE COMPANIES' POSITIONS THAT INTEREST YOU

1 2 3 4 5 6 7 8 9 10 11 12 13 14 15 16 17 18 19 20 21 22 23 24 25

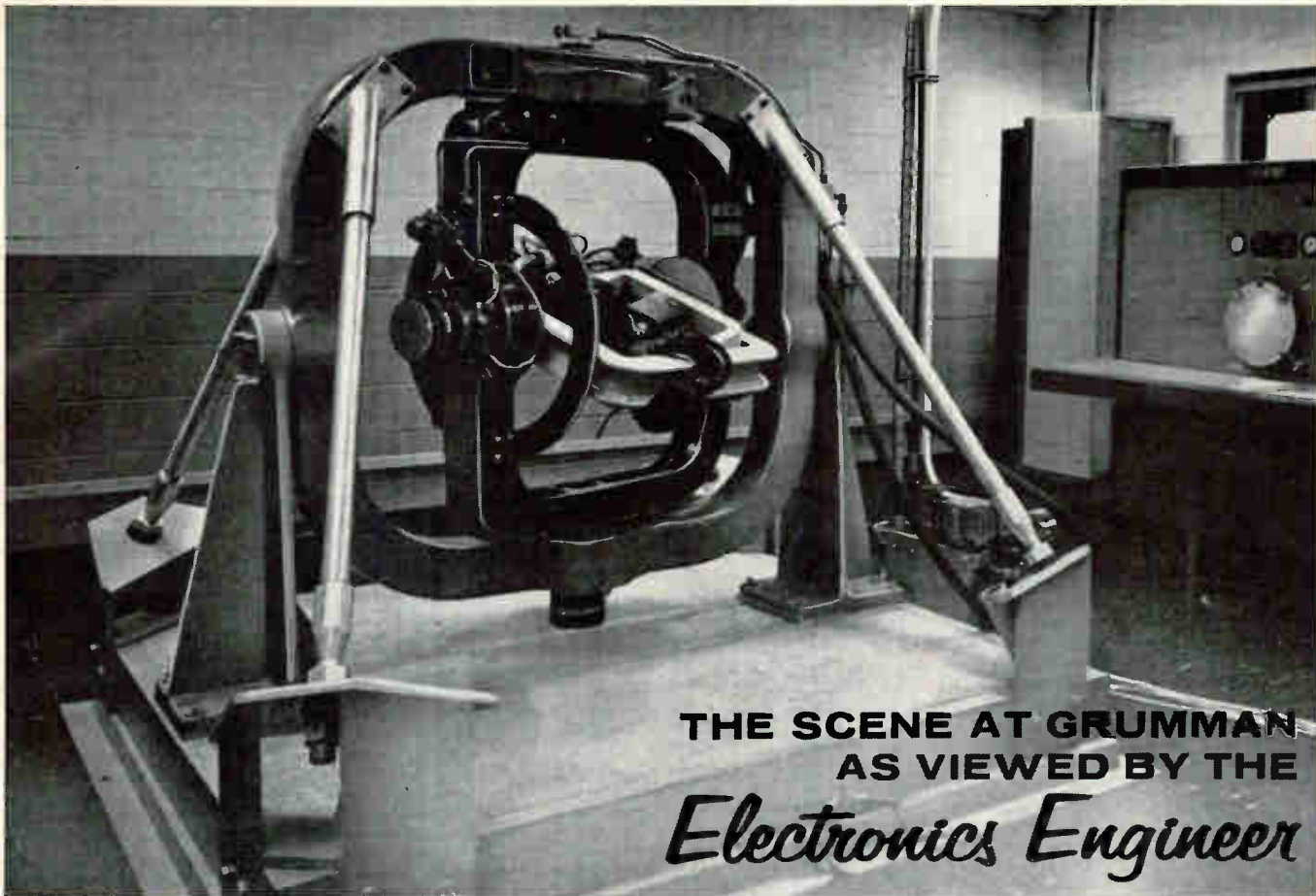

THE SCENE AT GRUMMAN  
AS VIEWED BY THE  
*Electronics Engineer*

*...Tilt*

Complete aircraft guidance and control system hardware evaluation and testing is done before flight at Grumman. Our three-axis flight simulator furnishes the "tilt." Used with pressure simulators and one of our analog computer facilities, the three-axis table imparts to the attitude and angular motion sensors of a guidance system the same dynamic motions encountered in the flight of an actual high performance aircraft or missile. Accurate evaluation of the system behavior is possible under controlled laboratory conditions. Thoroughly tested on this facility, the guidance and control hardware for Grumman's new Hawkeye (AEW) and Intruder (Attack) aircraft proved an outstanding success.

Developing advanced electronics equipments in the pre-flight evaluation of both aircraft and space hardware is just one of the many stimulating work situations that confronts the electronics engineer at Grumman. Qualified individuals with a similar bent are urged to consider the following immediate positions:

**Digital Computer Systems Engineer**—BSEE with a minimum of 4 years experience in the analysis design and development of digital computers. Will participate in the integration of digital computer into a complex weapons system. A significant part of the effort will be devoted to extensive laboratory and flight development programs.

**Systems Engineer**—BS or advanced degree, experienced with digital computers and their applications to the mechanization and control of weapons systems. Working knowledge of the components which comprise these systems such as radars, inertial platforms, air data units, star trackers, and displays is desirable. Will be responsible for conceiving, developing, integrating and system engineering complex weapons delivery and reconnaissance systems involving aircraft, missiles and space vehicles.

**Data Processing Engineers**—Background in digital data processing, logic circuit design, memory devices, R-F modulation techniques and related digital techniques required. Opportunity to participate in advanced design of systems concepts and hardware development. BSEE or BS in Physics with a minimum of 3 years' applicable experience is required.

**Laboratory Equipment Engineers**—BSEE with 5-10 years experience in laboratory test programs of airborne electronics equipment. A working knowledge is required in a majority of the fields of airborne communication radar, navigation and digital computers. Work will be conducted in our new Electronics Systems Center with the finest facilities and equipment available. Applicants must be willing to extend their technical capabilities to new challenging areas ranging from DC to microwaves.

To arrange an immediate interview, send your resume to Mr. W. Brown, Manager Engineering Employment, Dept. GR-76 (U.S. citizenship required)



**GRUMMAN**

AIRCRAFT ENGINEERING CORPORATION  
Bethpage · Long Island · New York

All qualified applicants considered regardless of race, creed, color or national origin.

## MICROWAVE COMMUNICATIONS ENGINEERS

Ankara - Teheran - Karachi  
Bangkok - U. S.

Work involves engineering, supervision of installation, operation and maintenance of microwave communications systems.

College Degree Mandatory

## MICROWAVE COMMUNICATIONS TECHNICIANS

Must be qualified by education and experience to inspect installation, operate and maintain microwave communications systems to insure quality and performance standards.

Technical or trade school training mandatory.

Families May Accompany  
Usual Overseas Benefits  
Send detailed resumes to:

P-7950, Electronics  
645 N. Michigan Avenue, Chicago 11, Ill.

### POSITION VACANT

**E.E.—Audio circuitry.** Design of commercial high fidelity phonograph & AM-FM tuner circuitry. Responsible for overall equipment performance, components, evaluation and follow-through. Transistor circuitry experience desirable. Generous salary and benefits. Call or write: Mr. R. D. Sommer, Westinghouse Television-Radio Division, Metuchen, N. J. LI 8-5000. Ext. 262. An equal opportunity employer.



## MANUFACTURERS' REPRESENTATIVES

IN THE ELECTRONIC INDUSTRY

### SAMUEL K. MACDONALD, INC.

manufacturers representatives over 25 years  
1531 SPRUCE STREET, PHILA. 2, PA.

Territory:	Other Offices:
Pennsylvania • New Jersey	Pittsburgh
Delaware • Maryland	Baltimore
Virginia • West Virginia	Washington, D.C.
District of Columbia	

## MFRS. REPS:

DID YOU KNOW THAT . . .

when you advertise in the electronics BUYERS' GUIDE we reprint your advertising and mail it to over 3,500 Sales Managers of electronic equipment manufacturing companies?

THIS IS COVERAGE BEYOND OUR BUYER'S GUIDE SUBSCRIBERS . . .  
ADVERTISE IN THE 1962 EBG AND GET THIS EXTRA COVERAGE

## Electronic Instrument Technicians The Oak Ridge National Laboratory Operated by UNION CARBIDE NUCLEAR COMPANY at Oak Ridge, Tennessee Has openings for

Highly skilled electronic instrument technicians to work with electronic engineers in the development, installation and maintenance of electronic systems. Digital data handling, transistorized pulse height analyzers, analog and digital computer systems are only a few examples.

Minimum high school education, with additional training in electronics and at least three years' experience in installation and maintenance of complex electronic systems. Entrance rate \$3.10 per hour; \$3.16 per hour after six months. Reasonable interview and relocation expenses paid by Company.

Excellent Working Conditions  
and

Employee Benefit Plans  
An Equal Opportunity Employer

Send detailed resume to:

Central Employment Office  
UNION CARBIDE NUCLEAR COMPANY  
Post Office Box M Oak Ridge, Tennessee

## ACCESSORY PRODUCTS FOR TUBES

Accessories Products Division with responsibility for design and manufacture of klystron hardware, waterloads, sockets, cavities and coils has immediate openings for:

### PRODUCTION DEPARTMENT HEAD

Requires ability to plan, schedule and manage all production activities integrating assembly departments with production control and production engineering. Also must establish and meet quality and quantity standards. Must have at least 7 years' related manufacturing experience.

### SENIOR EE

Must plan and carry out development and production refinement projects on electrical accessories related to tubes. Requires BSEE plus 5 or more years' related design experience involving cavities and sockets for high power tubes.

Send resume to: DONALD K. SMITH

EITEL McCULLOUGH, INC.  
301 Industrial Way, San Carlos, California  
AN EQUAL OPPORTUNITY EMPLOYER

an engineer...  
with the talent to prove it...  
Reach him... Recruit him...

electronics  
he reads:

A McGRAW-HILL PUBLICATION  
CLASSIFIED ADVERTISING DIVISION  
POST OFFICE BOX 12 NEW YORK 36, NEW YORK





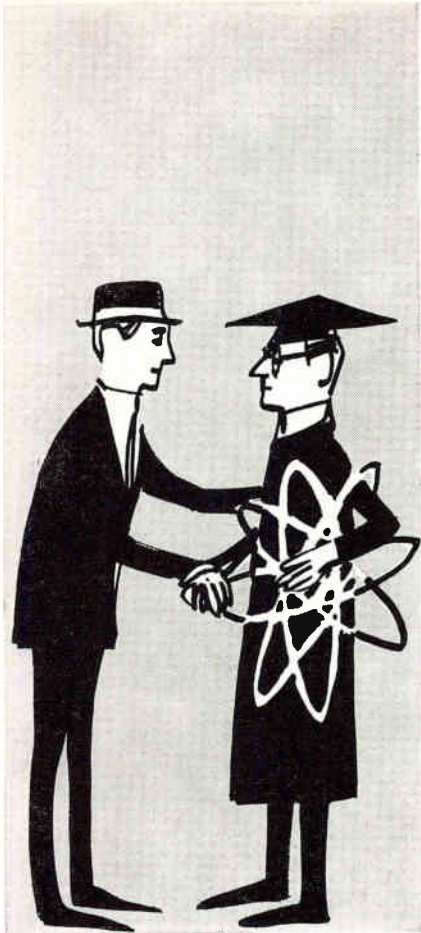

## Pre-production Training of a Work Force at No Cost to You

This is a time-tested and proved-in-use plan in WESTern PENNSylvania by which employees will be trained in whatever skills are needed for YOUR particular operation at no cost to you. For details on labor and training . . . and for complete information on 100% financing of plant space at low, low interest rates . . . and WESTern PENNSylvania's favorable tax climate, wire or call collect or mail coupon below today.

### WEST PENN POWER an operating unit of ALLEGHENY POWER SYSTEM



Now available: Shell buildings at \$2.95 to \$3.25 a sq. ft. can be completed to your specs in 60-90 days. Or select from 200 other industrial properties.

WEST PENN POWER Phone: Temple 7-3000  
Area Development Department (Area Code 412)  
Greensburg, Pennsylvania EL 2-5-2

Please send me data on:  Pre-production Training  
 Taxes  100% Industrial Plant Financing  
 Industrial Properties

Name \_\_\_\_\_

Title \_\_\_\_\_

Company \_\_\_\_\_

Address \_\_\_\_\_

City \_\_\_\_\_ State \_\_\_\_\_ Zone \_\_\_\_\_

State \_\_\_\_\_ Phone \_\_\_\_\_

# electronics



Audit Bureau  
of Circulations

Associated Business  
Publications

## Audited Paid Circulation

**JAMES T. HAUPTLI**

Advertising Sales Manager

**R. S. QUINT:**  
Assistant Publisher Buyers' Guide and  
Business Manager  
**FRED STEWART:**  
Promotion Manager  
**B. ANELLO:**  
Marketing Service Manager

**RICHARD J. TOMLINSON:**  
Production Manager  
**GEORGE E. POMEROY:**  
Classified Manager  
**HUGH J. QUINN:**  
Circulation Manager

## ADVERTISING REPRESENTATIVES

**NEW YORK (36):**  
Donald H. Miller, Henry M. Shaw, George  
F. Werner  
500 Fifth Avenue, OXford 5-5959

**BOSTON (16):**  
William S. Hodgkinson, Donald R. Furth  
McGraw-Hill Building, Copley Square,  
Congress 2-1160

**PITTSBURGH (22):**  
David M. Watson  
Four Gateway Center, Express 1-1314

**PHILADELPHIA (3):**  
Warren H. Gardner, William J. Boyle  
6 Penn Center Plaza, LOcust B-4330

**CHICAGO (11):**  
Harvey W. Wernecke, Robert M. Denmead  
645 North Michigan Avenue, Mohawk 4-5800

**CLEVELAND (13):**  
Paul T. Fegley  
55 Public Square, Superior 1-7000

**SAN FRANCISCO (11):**  
R. C. Alcorn  
255 California Street, Douglas 2-4600

**LOS ANGELES (17):**  
Peter S. Carberry, Ashley P. Hartman  
1125 W. 6th St., Huntley 2-5450

**DENVER (2):**  
J. W. Patten  
Tower Bldg., 1700 Broadway, Alpine 5-2981

**ATLANTA (9):**  
Michael H. Miller, Robert C. Johnson  
1375 Peachtree St. N.E., Trinity 5-0523

**HOUSTON (25):**  
Joseph C. Page, Jr.  
Prudential Bldg., Holcomb Blvd.,  
Jackson 6-1281

**DALLAS (1):**  
Frank Le Beau  
The Vaughn Bldg., 1712 Commerce St.  
Riverside 7-9721

**LONDON W1:**  
Dennis McDonald  
34 Dover St.

**FRANKFURT/Main:**  
Stanley R. Kimes  
85 Westendstrasse

**GENEVA:**  
Michael R. Zeynel  
2 Place du Port

## "Headquarters for Business Information"

### McGraw-Hill Technical and Business Publications

American Machinist, Metal-  
working Manufacturing  
Aviation Week and Space  
Technology  
Business Week  
Chemical Engineering  
Chemical Week  
Coal Age  
Construction Methods and  
Equipment  
Construction Daily  
Control Engineering  
Electrical Construction  
and Maintenance  
Electrical Merchandising Week  
Electrical Newsletter  
Electrical West

Electrical Wholesaling  
Electrical World  
Electronics  
Engineering Digest  
Engineering and Mining Journal  
E & MJ Metal and Mineral  
Markets  
Engineering News-Record  
Factory  
Fleet Owner  
Industrial Distribution  
National Petroleum News  
Nucleonics  
Nucleonics Week  
Platt's Oilgram News  
Platt's Oilgram Price Service  
Power

Product Engineering  
Purchasing Week  
Science Week  
Textile World

Overseas only:  
Automobile International  
(English, Spanish)  
Ingenieria Internacional  
Construccion (Spanish)  
International Management  
(English, Spanish)  
Portuguese editions)  
Metalworking Production  
(Great Britain)

Available by subscription only — to qualified persons actively engaged in the field of the publication. For subscription rates and information describing the editorial coverage of any of the above publications, write to: Subscription Manager, Circulation Department, McGraw-Hill Publishing Company, 330 West 42nd Street, New York 36, N. Y.

**AVEN/GENERAL MILLS**  
...Blazing new trails in component reliability!



***Available Immediately from Distributors!***

## **87 adjustable stop switches replace 2,001 standard types!**

**D**aven revolutionizes switch availability by putting the equivalent of 2,001 standard types on your local selected distributor's shelf, ready for immediate delivery. That's 97% of all your switch needs brought right to your door, usually within 24 hours.

Daven does it by designing the characteristics of 2,001 switches into 87 easy-to-stock, easy-to-use adjustable stop switches. The result: instant availability and **maximum flexibility** (you can change the number of switch positions at any time). The cost is the same, **or less**, than its standard counterpart.

Daven adjustable stop switches are built in **square** configuration, in 1 $\frac{3}{4}$ " and 2 $\frac{1}{4}$ " sizes. Like all Daven switches, their metal parts are fabricated from corrosion-resistant materials . . . plastics are heavily filled with non-organic fibres and are capable of withstanding high temperatures . . . switch contacts and rotor arms are solid silver alloy. Daven's patented knee action, tamper-proof rotor is standard. All applicable paragraphs of MIL-S-3786 and MIL-E-5272 are met and exceeded.

For your new switch catalog, with details on the new adjustable stop switches and a complete Replacement List, write today!

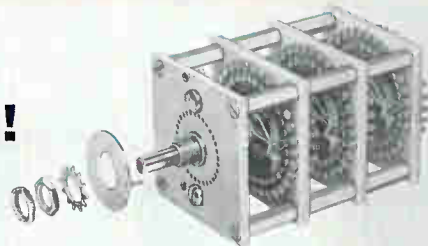

A SUBSIDIARY OF  
GENERAL MILLS

General  
Mills

**THE DAVEN COMPANY, Livingston, New Jersey**

**SWITCHES**

TODAY, MORE THAN EVER, THE DAVEN © STANDS FOR DEPENDABILITY

Another RCA First

# Light INTENSIFICATION to 100,000 X ... with RCA Cascaded Image Tubes

RCA, world leader in photoelectronics, now offers a wide choice of Cascaded Image Tubes for light detection at very low levels of light.

Completely at home even in near darkness, RCA Cascaded Image Tubes can deliver the ultimate in accurate images of scenes with as little as  $10^{-9}$  foot candle illumination on the tube. In astronomy, for example, these tubes are used in the spectroscopy of very faint stars. Stars many light years away can be photographed in 1/100th of the time normally required.

RCA Cascaded Image Tubes also provide a new tool for study of the atom and its nucleus. The Cascaded Image Tube provides a means for improved identification of particles by permitting photography of selected nuclear events within 1 microsecond of the time of occurrence.

### RCA can design and make the Cascaded Image Tube you need

RCA can design and build Cascaded Image Tubes with very high sensitivity—out to the threshold of absolute darkness—for operation in various regions of the spectrum.

Talk over your needs with your RCA Industrial Tube Representative. He can help you draw upon the same research and development capabilities that have made RCA photo-multipliers, phototubes, and other photoelectronic devices famous for a generation. Or, write: Marketing Manager, RCA Industrial Tube Products, Lancaster, Pennsylvania.

RCA ELECTRON TUBE DIVISION



The Most Trusted Name in Electronics

#### INDUSTRIAL TUBE PRODUCTS FIELD OFFICES:

OEM SALES: Newark 2, N. J., 744 Broad St., HU 5-3900 • Chicago 54, Ill., Suite 1154, Merchandise Mart Plaza, WH 4-2900 • Los Angeles 22, Calif., 6801 E. Washington Blvd., RA 3-8161 • Burlingame, Calif., 1838 El Camino Real, OX 7-1620. GOVERNMENT LIAISON: Harrison, N. J., 415 South Fifth St., HU 5-3900 • Dayton 2, Ohio, 224 N. Wilkinson St., BA 6-2366 • Washington 7, D. C., 1725 "K" St., N.W., FE 7-8500.

The development of RCA Cascaded Image Tubes follows the development and production of the RCA-6914 and the RCA-6929 single-stage Image Converter Tubes shown at right.