

electronics

A McGraw-Hill Publication 75 Cents

Photo at right

DANGLING SATELLITE

*Project relay gets
final checkout, p 46*

PREVIEW OF NEC PAPERS

*Highlights of next
week's meeting, p 39*

DIODE EMITS INFRARED

*New communications
carrier source, p 44*

WAVEGUIDES WITH RIDGES

*Latest compendium of
broadband parts, p 50*

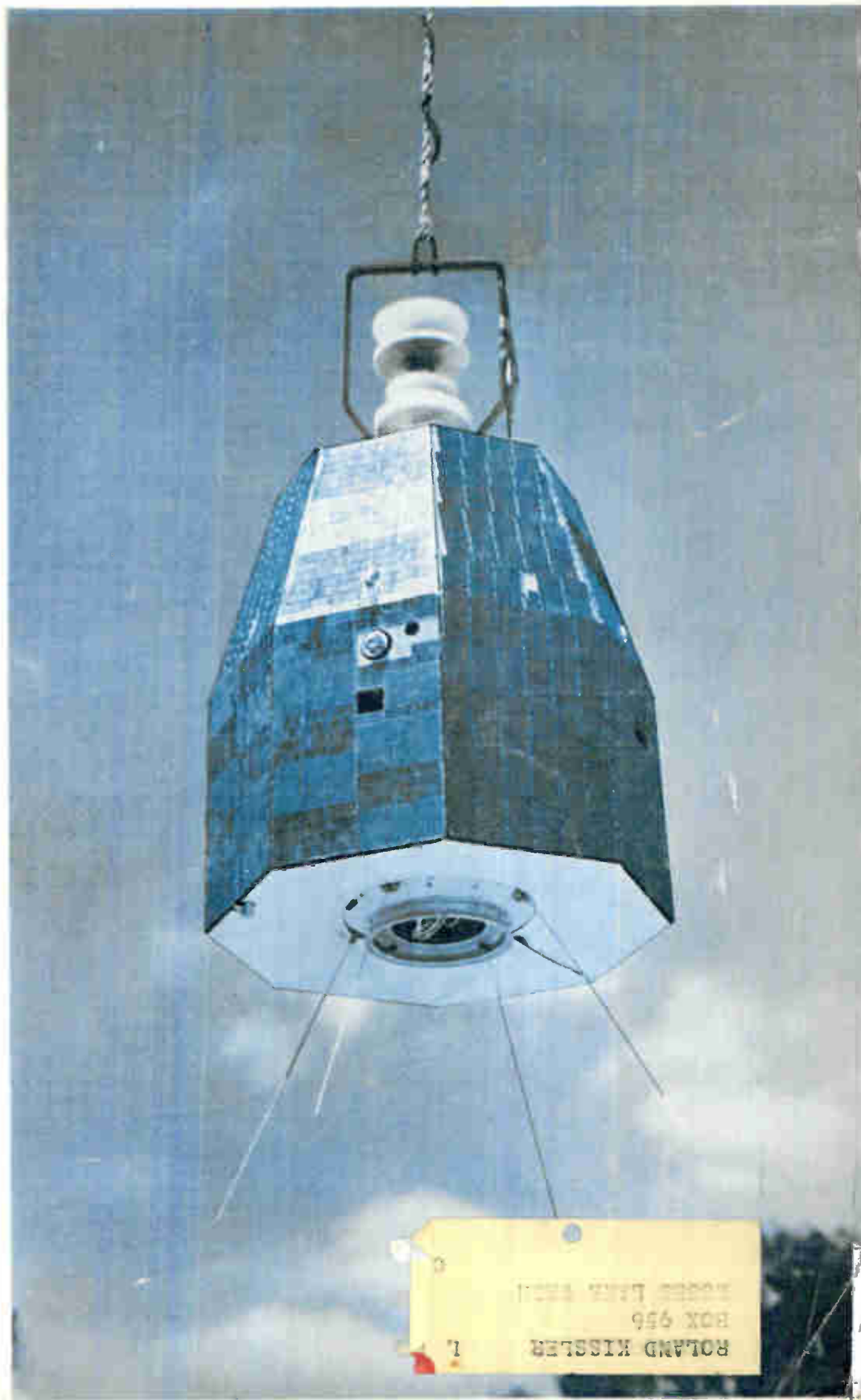

Resistive Decades



✓ *Designed for Accuracy*

✓ *Built for Long Life* ✓ *Trustworthy*

Type 1432

Decade Resistors

A Type 1432 Decade Resistor is an assembly of the well-known Type 510 Decade-Resistance Units. These decades, manufactured by General Radio since 1915, have undergone many changes during the ensuing years to improve accuracy, stability, and appearance, as new materials and techniques were developed. They find extensive use as laboratory standards, ratio arms for dc and ac bridges, and in circuits requiring a wide range of resistance values. Four-, five-, and six-dial decade assemblies are available in 10 models with ratings ranging from 111.1 ohms total to 1,111,100 ohms total. Accuracy is $\pm 0.05\%$ per step for most units, and many models are useful well into the radio-frequency range.

Prices range from \$95.00 to \$160.00

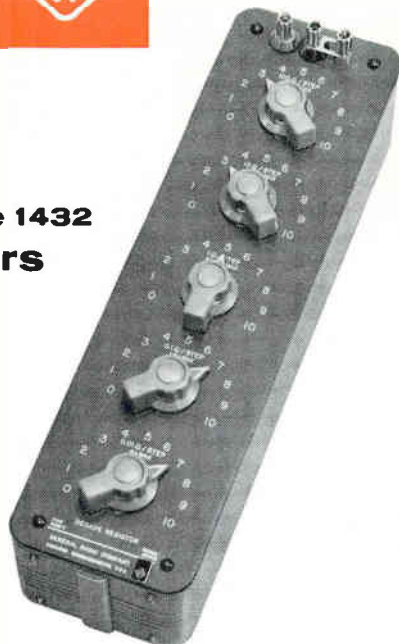

Type 1450

Decade Attenuators

The Type 1450 Decade Attenuator provides a wide range of attenuation values in small steps, and maintains a high degree of accuracy even at low radio frequencies. Each decade consists of four T-pads series-connected by cam-operated switches that have positive detents. Each pad is completely shielded, and a shield is interposed between the input and output series elements of each pad. Each decade has eleven positions, 0 to 10 inclusive, so the decades overlap. There are no stops on the 0.1- and 1-db-per-step decades, permitting quick return from full to zero attenuation when making adjustments. Switches are arranged for break-before-make operation to prevent "blasting" and meter damage.

Type	Range	Price
1450-TA	110 db in steps of 1 db	\$285.00
1450-TB	111 db in steps of 0.1 db	390.00

Type 1454

Decade Voltage Dividers

These Decade Voltage Dividers provide voltage ratios from 0.0001 to 1.000 in steps of 0.0001, with an accuracy of $\pm 0.04\%$ of the panel reading. The decade assembly is comprised of four Type 510 Decade-Resistance Units connected in a Kelvin-Varley circuit. Voltage drop in switches and wiring is compensated by a resistor so that accuracy is maintained down to the lowest settings. The high input impedance, high resolution, and high accuracy of these voltage dividers make them valuable laboratory accessories for both d-c and audio-frequency measurements.



Type	Input Resistance	Price
1454-A	10,000 ohms	\$160.00
1454-AH	100,000 ohms	160.00

All Calibration Traceable to the National Bureau of Standards

Decade capacitors and inductors are also available.

For information, write for our RLC Standards and Components Bulletin.

GENERAL RADIO COMPANY

WEST CONCORD, MASSACHUSETTS
TELEPHONES: (CONCORD) 617-369-4400; (BOSTON) 646-7400

General Radio
(Overseas)
Zurich, Switzerland

NEW YORK, N. Y., 964-2722
Ridgefield, N. J., 943-3140

CHICAGO
(Oak Park) 848-9400

PHILADELPHIA, 424-7419
Abington, 887-8486

WASHINGTON, D.C.
(Rockville, Md.) 946-1600

SYRACUSE
454-9323

SAN FRANCISCO
(Los Altos) 948-8233

LOS ANGELES
HO 9-6201

ORLANDO, FLA.
425-4671

IN CANADA
(Toronto) 246-2171

electronics

A McGraw-Hill Publication 75 Cents



W. W. MacDONALD, Editor

J. M. CARROLL, Managing Editor
 SENIOR EDITORS: Samuel Weber, George W. Sideris. SENIOR ASSOCIATE EDITORS: Michael F. Wolff, John F. Mason. ASSOCIATE EDITORS: Michael F. Tomaino, Sylvester P. Carter, William P. O'Brien, Sy Vogel, Leslie Salomon, George J. Flynn, Laurence D. Shergalis. ASSISTANT EDITORS: Nilo Lindgren, Stanley Froud, Stephen B. Gray, Roy J. Bruun, George V. Novotny, Leon H. Dulberger. REGIONAL EDITORS: Harold C. Hood (Pacific Coast, Los Angeles), Thomas Maguire (New England, Boston), Cletus M. Wiley (Midwest, Chicago). ART DIRECTOR: Harry Phillips; Howard R. Berry. PRODUCTION EDITOR: John C. Wright, Jr. EDITORIAL ASSISTANTS: Gloria J. Meurer, Lorraine Rossi, Virginia T. Bastian, Lynn Emery, Rosemary Abbruzzese, Ann Mella, Lorraine Werner. FOREIGN NEWS BUREAU: Director, John Wilhelm, Alyne Elias. LONDON—John Shinn, Derek Barlow, Nicholas Landon. BONN—Peter Forbath, Silke McQueen. PARIS—Robert Farrell, Arthur Erikson. MILAN—Marc A. Messina. MEXICO CITY—Bruce Bendow. RIO DE JANEIRO—Leslie Warren. MOSCOW—Stewart Ramsey. TOKYO—Richard Halloran, Charles Cohen, John Yamaguchi.

JAMES GIRDWOOD, Publisher

DANGLING from a cable outside RCA's Astro-Electronics Division plant, Princeton, N. J., is Relay I, the government's low-altitude communications satellite. Larger and more powerful than AT&T's Telstar, Relay is scheduled for launching late this year. *For a description of its electronic systems, see p 46 COVER*

HELICOPTER CONTROLS Turn to Transistors. Solid-state stability augmentation systems are lighter, make flying easier. *This new equipment is now being used in commercial and anti-submarine-warfare aircraft* 20

TECHNICIANS: There Aren't Enough to Meet Industry's Needs. Some employers think that the shortage has become critical. *One estimate: there is less than one technician for each engineer* 28

AIRBORNE RADAR Transmits Images to Ground. Army awards contract for models of system that fits in light plane. *The system was designed for mobile use in limited wars* 28

NATIONAL ELECTRONICS CONFERENCE. Universities will outline R&D projects that can stimulate electronics in the Midwest. *Part of the program provides a forum for industry-education cooperation* 30

AIR BATTLE SYSTEM Going Operational. Mobile 412 L system is being installed at two air bases in the U.S., will also be used in Europe and the Pacific. *It can be transported and set up within four hours* 31

NATIONAL ELECTRONICS CONFERENCE: Technical Preview of Next Week's Meeting. Engineers will discuss ultrasonic modulators for lasers, use of lasers in welding, a submarine compass using the Hall effect, underwater telemetry, ultrasonic image conversion and a microwave system for laser heterodyne detection. *Use this article as a guide to technical sessions or let it be your NEC in print.* By C. M. Wiley 39

INFRARED COMMUNICATIONS Using Gallium-Arsenide Diodes. Semiconductors are well established as detectors of energy, including infrared, but here a gallium-arsenide diode generates modulated infrared. *The resulting system can transmit high-quality television pictures.*

By R. H. Rediker, R. J. Keyes, T. M. Quist, M. J. Hudson, C. R. Grant and R. G. Burgess, Lincoln Lab, MIT 44

PROJECT RELAY: First Design Details of Communications Satellite. This government-owned satellite will be launched into a low orbit late this year. It features a unique antenna design and high-powered traveling-wave tube. *Opposing circular polarizations help main antenna transmit and receive simultaneously without interference.* By Paul Cherecwich 46

Contents Continued

Published weekly, with Electronics Buyers' Guide and Reference Issue as part of the subscription, by McGraw-Hill Publishing Company, Inc. Founder: James H. McGraw (1860-1948).

Title ® registered U.S. Patent Office; © copyright 1962 by McGraw-Hill Publishing Co., Inc. All rights reserved, including the right to reproduce the contents of this publication, in whole or in part.

Executive, editorial, circulation and advertising offices McGraw-Hill Building, 330 West 42nd Street, New York 36, N. Y. Telephone Longacre 4-3000. Teletype TWX N.Y. 212-640-4646. Cable McGrawhill, N. Y. PRINTED IN ALBANY, N. Y.; second class postage paid at Albany, N. Y.

OFFICERS OF THE CORPORATION: VISION: Nelson L. Bond, President; Shelton Fisher, Wallace F. Traendly, Senior Vice Presidents; John R. Callahan, Vice President and Editorial Director; Joseph H. Allen, Vice President and Director of Advertising Sales; A. R. Venezian, Vice President and Circulation Coordinator; Daniel F. Crowley, Vice President and Controller.

OFFICERS OF THE CORPORATION: Donald C. McGraw, President; Hugh J. Kelly, Harry L. Waddell, Executive Vice Presidents; L. Keith Goodrich, Executive Vice President and Treasurer; John J. Cooke, Vice President and Secretary.

Subscriptions are solicited only from those actively engaged in the field of the publication. Position and company connection must be indicated on orders. Subscription rates: United States and Possessions, \$6.00 one year, \$9.00 two years, \$12.00 three years. Canada: \$10.00 one year. All other countries \$20.00 one year. Single Copies, United States and Possessions and Canada 75¢. Single copies all other countries \$1.50.

THE PUBLISHER, UPON WRITTEN REQUEST FROM ANY SUBSCRIBER TO OUR NEW YORK OFFICE, AGREES TO REFUND THAT PART OF THE SUBSCRIPTION PRICE APPLYING TO COPIES NOT YET MAILED.

Subscribers: Please address change of address notices, subscription orders or complaints to Fulfillment Manager, Electronics, at above address. Change of address notices should provide old as well as new address, including postal zone number if any. If possible, attach address label from recent issue. Allow one month for change to become effective.

Postmaster: Please send Form 3579 to Fulfillment Manager, Electronics, 330 West 42nd Street, New York 36, New York.



Audited Paid Circulation

CONTENTS continued

ULTRAHIGH-IMPEDANCE AMPLIFIER for Precise Measurements. Unloading circuit is a bridge-balanced vacuum-tube amplifier with cathode feedback and a free grid. *No expensive electrometer tubes are required.*
By J. Morrison, English Electric 49

DOUBLE-RIDGED WAVEGUIDE COMPONENTS for Electronic Countermeasures. Establishes design criteria and discusses fabrication methods for double-ridged waveguide components for use in broadband systems. *More than a dozen important components are described.*
By P. Lubell, Dorne and Margolin, and P. Levine, Empire Devices 50

REFERENCE SHEET: Calculating Transmission-Line Resonant Frequency. Method simplifies calculation of resonant frequency of capacitance-loaded transmission line. *Curve is used to approximate the solution of a transcendental equation.*
By R. C. Morwood, Eitel-McCullough 56

DEPARTMENTS

Crosstalk. <i>One, Not Two. Midwest Rebirth</i>	3
Comment. <i>Lux et Veritas. Ear and Brain Versus Electronics</i>	4
Electronics Newsletter. <i>AT&T Undecided about Launching Telstar II</i>	7
Washington Outlook. <i>Latest Pentagon Statistics on Military Electronics Procurement</i>	12
Meetings Ahead. <i>Electronic Components Conference</i>	34
Research and Development. <i>Tristable Cores Detect Errors in Binary Data</i>	60
Components and Materials. <i>Designing Circuits on Alumina Substrates</i>	68
Production Techniques. <i>Epoxy Used for Short Run Production Parts</i>	72
New Products Design and Application. <i>Solid-State Phase-Lock Loop Discriminator</i>	76
Literature of the Week	85
People and Plants. <i>Rauland Purchases Another Building</i>	86
Index to Advertisers	96

One, Not Two

INSTEAD OF establishing a governmental Department of Science, we have suggested strengthening the National Academy of Sciences (*Crosstalk*, *ELECTRONICS*, p 3, Sept. 14). One way to do this might be to expand the NAS into a National Academy of Science and Engineering.

Such an expansion might be dovetailed with a movement to establish a National Academy of Engineering that is presently gaining momentum. Backers claim that present NAS membership is largely made up of research scientists, and feel the need for a source of advice to the government on engineering considerations in national affairs and policy.

A proposal was adopted last November by the Board of Directors of the Engineers Joint Council that an engineering academy be established in cooperation with the NAS. It would be a private, nonprofit corporation. The proposal suggested that rather than establish a separate academy the NAS charter be modified to provide for a related organization. This, we feel, is a crucial point.

We favor the idea of giving engineers a more effective voice in national affairs. However, because of the increasing interrelationships between electronics engineering and the physical and life sciences, we feel that two separate academies would not be best for the country.

We would like to see engineering included within the framework of one National Academy of Science and Engineering.

MILLIMETRICS—Research on millimeter waves has a parallel in medical electronics where researchers must be knowledgeable in two diverse fields. Since the millimeter waves span the frequencies between microwaves and infrared—in fact, the lower millimeter range overlaps the quasi-optical spectrum—researchers must be familiar with both the radio and optical arts.

The bench setup illustrated, a Michelson interferometer at General Telephone and Electronics Labs, is typical of the electronic-optical equipment required for millimeter-wave research. Used for measurement of relative dielectric constant, the setup has an electronic signal source, but what could be more optical than the lens, prism and mirrors?

This aspect of millimeter wave research, and the applications, problems and progress, equipment and experiments made at laboratories here and abroad

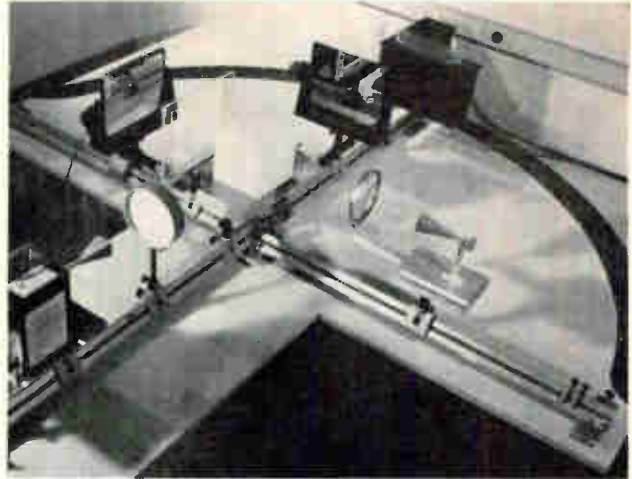

will be detailed next week in a 10-page special article by Associate Editor Shergalis. For a good, long look at a portion of the radio spectrum that is almost uncharted and unused—though probably not for long—we recommend the article.

MIDWEST REBIRTH—To the Midwest's credit—and almost certainly to its eventual profit—the area's electronics spokesmen have not tried to hide its shortage of R&D projects, facilities and personnel. Instead, they have publicized the problem. The result has been a rapid fermenting of concern and a redoubling of efforts to solve the problem.

The Midwest is, and has traditionally been, an industrial giant. But in proportion to population it has the lowest rate of military prime R&D contracting (\$9,000 per million) of any region in the U.S., ties with the South for lowest in military contracting (\$70,000 per million), and has the fewest scientists (7.5 per million).

Against this background, the National Electronics Conference is playing an unusual role for a national technical meeting. As Midwest Editor Wiley's preview indicates this week (p 30), the conference is actively assisting the region's efforts to catch up with the rest of the country.

This is not the first time that NEC has been a forum for grappling with the Midwest's problem (see p 22 and 26, October 6, 1961). More than a year ago, NEC in cooperation with Chicago-area companies financed a study of the area's R&D and recommended some solutions (p 33, March 30, 1962). What NEC is working for now is greater R&D interplay between electronics manufacturers and educational institutions in the area. This should help get the ball rolling again.

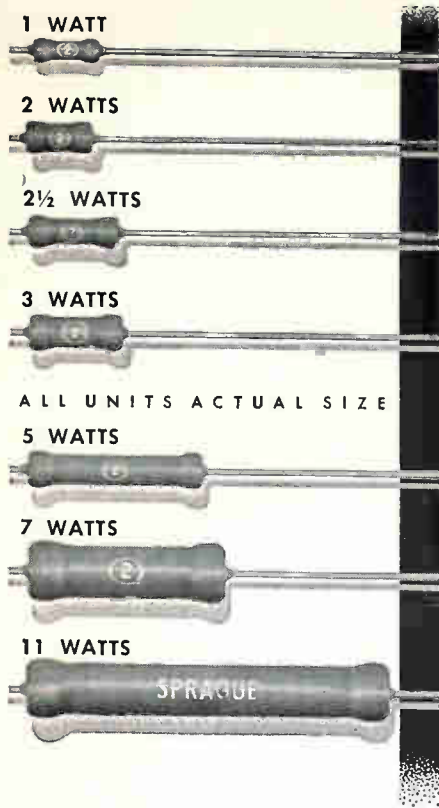

NEXT TIME ... USE TINY *Blue Jacket*[®] WIREWOUND RESISTORS

Sprague builds reliability... efficiency... economy right into minified Blue Jackets with these important features:

- * All-welded end-cap construction with special vitreous-enamel coating for total protection against humidity, mechanical damage, heat, corrosion gives long-term dependability under severe environmental conditions
- * Available in resistance tolerances as close as $\pm 1\%$
- * Low in cost... quick and easy to install

Tiny axial-lead Blue Jackets are specially designed for use with conventional wiring or on printed boards in miniature electronic assemblies. Write for complete technical data in Sprague Engineering Bulletin 7410B.

SPRAGUE ELECTRIC COMPANY
35 Marshall Street, North Adams, Mass.



COMMENT

Lux et Veritas

My high regard for the truth, and my interest in the early history of the incandescent lamp, both impel me to correct a misstatement on p 4 of the Sept. 7th issue, in a letter from Mr. C. E. Hoover.

The lamp base described, and illustrated at the bottom of that page, was made by the Thomson-Houston Electric Company, which began manufacturing lamps in 1884. Their first bases were a similar design made with plaster-of-paris insulation and a brass outer shell. The plaster of paris was later changed to fiber, and around 1900 the porcelain base, as shown, was developed.

The first lamp base, which appeared on the Edison lamp in 1879, consisted of a turned wooden stand, having an ordinary binding post on either side for connections. Shortly after this, a wire-terminal base was used. This base had two narrow copper strips attached to the lead wires, and held to the neck of the lamp by string wrapped around the bulb neck. This base had a mating wooden socket with a thumbscrew which was tightened to hold the lamp into the socket and apply pressure to the copper strip contacts.

In 1880 the original screw base appeared. This base had a screw shell and a metal ring above the shell for the electrical connections. The base insulation and the socket were wood. Early in 1881, a slightly smaller base was developed, which had a cone-shaped ring and plaster-of-paris insulation. It was found that when this was screwed firmly into a socket, the insulation was loaded in tension, and soon failed. Around the middle of 1881, the base was redesigned to load the insulation in compression by moving the contact to the end of the base.

LEROY G. LEIGHTON
General Electric Company
Cleveland, Ohio

Ear and Brain versus Electronics

The *Comment* letter on Ear and Brain versus Electronics (p 4, Aug. 3) has sensible material, but one question is somewhat vague.

The comment that the human ear-

brain combination is capable of extracting any one of a plurality of simultaneous messages, is true. Then a question is asked whether anyone knows how, or can devise a way, to extract a binaural voice message under the given conditions for further amplification. This question relates to human intelligence, and cannot be answered in terms of systems and apparatus, without understanding the function of the brain in performing it.

The condition in which the ear-brain combination can extract a singular spoken message from plural ones is a process of sampling at random rates. To understand this process, first realize that part of the selected message will be destroyed, but it will be reconstructed by the brain for intelligibility. If a selected spoken word is partly destroyed, then the brain must scan within, and find the missing part (imagination) for reconstructing it. If a whole word is completely destroyed, then the brain must find within (imagination) a word that fits the interpreted sentence.

All phonetic sounds (not phonemes), whether they are long vowels, consonants, or plosives, consist of at least one group, two groups, or a series of replica groups of complete information-bearing wave components. Each of these groups has a phonetic value and a quality value. For the brain to interpret these sounds, it selects, or samples, these groups of waves *step by step*, and recognizes both the quality and phonetic values during each step, rather than during its entire spoken time period.

Now assume that several words are spoken simultaneously by voices of different qualities. There will occur random time periods within which complete information-bearing groups of waves will arrive at the ear, without destruction by other spoken words. If extraction of any message is to be from a voice of a particular quality, then the brain will interpret by sampling that group, and either accept or reject by further analysis of the quality value. Thus, there will be random sampling periods within which the brain can interpret and reconstruct the spoken words for intelligibility.

MEGUER V. KALFAIAN
Los Angeles, California

MR. RELAY by Allied Control

1. GRACIOUS TO MULTIPOLE!
YOU MEAN I'M A
FATHER AGAIN!



2. YOU'VE LATCHED ONTO QUITE A
BABY. HE'S SMALLER AND
LIGHTER AND... BOY!...
CAN HE TAKE SHOCK.



3. THAT'S FINE
BUT WILL HE FIT
IN ANY "CRIB"?



4. HE'S JUST MADE FOR CHASSIS
AFTER CHASSIS. FACT, I THINK
YOU OUGHT TO CALL HIM
"INTERCHANGEABLE!"



Yes, sir, Mr. Relay has another "heir" . . . and he's quite a baby. The MP polarized magnetic latching relay is just a mite . . . only 1.124" high—a 1/4" shorter than similar relays—thus saving 18% in volume. And this "featherweight" scales in at 2.2 ounces, trimming 7 pounds per bank of 100 relays. When you look at the MP closely, you'll see its all-welded internal construction and precision one-piece die cast armature assembly. Note, too, the captive slot actuator which securely holds the movable contact arms. It's only one of the secrets of the MP's outstanding vibration, shock, and bounce performance. Want application data? Write for Catalog Sheet MP.

©1962 BY ALLIED CONTROL COMPANY, INC.



OPERATING CONDITIONS	
Contact Rating: (at nominal coil voltage)	2 amperes resistive at 29 volts d-c
Contact Arrangement:	Two, four and six pole double throw
Shock:	100g operational
Vibration:	5 to 55 cps at 0.195 inch double-amplitude 55 to 2000 cps at a constant 30g
Latch in Time: (at +25°C)	10.0 milliseconds maximum at nominal coil voltage
Reset Time: (at +25°C)	10.0 milliseconds maximum at nominal coil voltage
Terminals:	Plug-in (with index pin) or hook-type solder terminals

ALLIED CONTROL COMPANY, INC.

2 EAST END AVENUE, NEW YORK 21, N. Y.



AL-228-MP

October 5, 1962

CIRCLE 5 ON READER SERVICE CARD

5

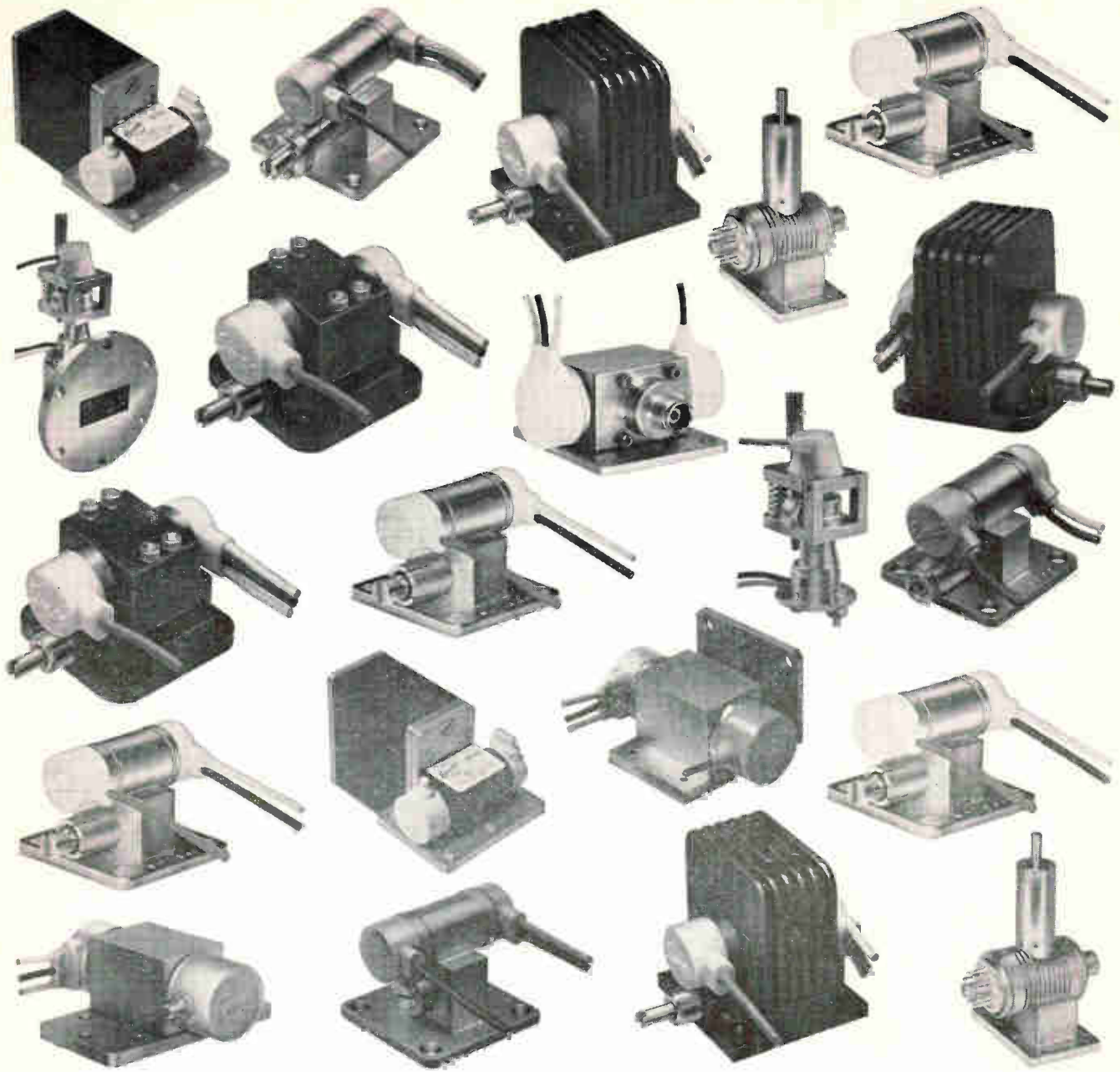

We've made 21 types of reflex klystrons. If there isn't one among them to meet your needs, we'll make it 22.

If you want more, we'll make 24, 28 — as many types as you need. The 21 Eimac reflex klystrons you see above operate at frequencies from 4 to 14 Gc. Power outputs: 20 milliwatts to 1 watt. And some of these tubes are tunable. Some trimmable. Some can take shocks up to 80 g and unlimited altitudes. There's even a new kind of tube called an iso-klystron — an Eimac developed factory-mated isolator and reflex klystron. What are your power and frequency requirements? Eimac can develop a tube to meet them. And every Eimac reflex klystron is always designed to provide superior performance even under severe environments. You can keep your eye on Eimac for advanced microwave tubes, high power klystrons, power grid tubes, accessories. Eitel-McCullough, Inc., San Carlos, California. Subsidiaries: Eitel-McCullough, S. A., Geneva, Switzerland; National Electronics, Geneva, Illinois. **KEEP YOUR EYE ON**



ELECTRONICS NEWSLETTER

Telstar II Goes Back upon the Shelf

TELSTAR II's launching has been postponed, an AT&T spokesman confirmed late last week. The company has agreed to make the booster that was to have been used available to NASA for launching a new satellite that will probe the artificial radiation belt (p 7 and 28, Sept. 21). This move would push the Telstar II launch back to December at the earliest. The launch had been tentatively set for October.

AT&T is reportedly undecided whether the expense of a second launch is warranted at this time since Telstar I successfully demonstrated the feasibility of the program. Also, waiting would increase chances of the program being assumed by the satellite communications corporation recently authorized by Congress.

Another reason is that more information would be gained by launching the next satellite in a 6,000-mile-high orbit instead of the 600 to 3,500 miles used for Telstar I. The higher altitude is favored for communications satellites.

Last week, in a summary of radiation and solar cell damage measurements received from Telstar I, Bell Telephone Labs reported that high-energy protons are a major cause of solar cell damage. Protons diminish with altitude, leading Bell Labs to infer that an altitude of 6,000 miles would be safe. The satellite's radiation-resistant solar cells have lost only 15 percent of their initial power output.

Piezojunction Transistor —Amplifying Transducer

BOSTON—Study of transistor defects at Raytheon has led to development of tiny transducer based on pressure-sensitivity of junctions. Lab models of piezjunction transistors built by W. Rindner respond to 0.01 cps to 120 Kc vibrations.

A stylus attached to a diaphragm over a chip of semiconductor transmits pressure to the junction. This modifies the output signal from the biased semiconductor. Sensitivity can be increased by increasing stylus point pressure or using a shallower junction.

Applications are seen in pres-

sure-sensing diodes and pressure-amplifying transistors for a wide variety of systems and in miniature microphones, pickups, strain gages, accelerometers, medical sensors and other transducers.

New England Is Pushing For More Space Work

BOSTON—Boston area industry leaders were to announce plans this week for organization of a nonprofit management corporation which would seek large NASA prime contracts. Work would be farmed out to the numerous small firms which make up the bulk of the scientific-engineering competence of New England. The move was spearheaded by the Greater Boston Chamber of Commerce after the area lost the Apollo center bid to Houston. Regional protests have been mounting steadily in the past year over the small amount of NASA funds allocated here compared to California, Texas and Florida.

NASA is opening a Northeastern

office to monitor contracts and aid industry seeking NASA awards. The head, Franklyn Phillips, told the local AFCEA chapter that NASA has spent \$150 million in New England and would like to bring the Northeast more into the space program.

Japanese Demonstrate Three-Color X-Ray System

TOKYO—Shown for the first time last week was an experimental color X-ray system by Saburo Sasao, of Hayakawa Electric Research Lab.

Color is obtained by a field sequential system. Soft, medium and hard X-rays provide blue, green and red outputs on the monitor's three-gun cathode-ray tube. A rotating filter sharpens the three X-ray wavelengths obtained sequentially by changing accelerating voltage on a conventional X-ray tube. The filter and power supply are synchronized.

The system still has not been tried on a human body, but preliminary experimental results are reported as extremely encouraging. Effects of selective X-ray absorption of salts of barium, tin, lead and iodine in body should increase contrast of the monitor image.

Ariel's Alive and Finds New Ionospheric Layer

LONDON—Birmingham University researchers headed by Prof. J.

Optical Frequency Vacuum Tube Developed

VACUUM TUBE that produces visible light—some of it coherent—was to be shown and described this week at the Optical Society of America meeting in Rochester, N. Y., by W. W. Salisbury, chief scientist of Varo, Inc.

Salisbury said the color (frequency) of the tube can be continuously controlled, by varying electron accelerating voltage. It can be amplitude or frequency modulated with low power. Some coherency has been observed, he said, and it is expected that the amount can be improved with further work.

The operating principle, Salisbury says, should be applicable to microwave and millimeter-wave regions as well as ultraviolet, infrared and visible light. He sees its use in applications heretofore considered for lasers. The tube has immediate applications, he said, in light beam communications and has been used for a-m and f-m voice communications in the lab.

The principle—that the interaction between an electron beam and a metallic diffraction grating will generate light—is covered in a 10-year-old patent now issued to Salisbury, he said. The project described was sponsored by Varo and the Air Force ARDC

Sayers believe that an ionospheric ledge exists above the F1 and F2 layers. It appears to lie at a geocentric altitude of 700 Km by day and 1,000 Km by night.

Almost unassailable proof of the ledge was obtained by analysis of data from the Anglo-American satellite Ariel. Further information is expected from the satellite. Ariel was assumed dead from solar cell damage (p 28, Sept. 21), but to "everyone's surprise" is sending back reliable data after prolonged exposure to sunlight.

The ledge would explain why a topside sounder launched last year at Wallops Island recorded scatter echoes at altitudes of 700 to 1,000 Km. However, the sounder operated at frequencies far above the layer's critical frequency of 1 to 2 Mc.

Sayers sees no practical applications for the layer. It has a very low ionization density and any radio waves near the critical frequency would not be powerful enough to penetrate the E and F layers.

Thermoelectric Generator Made of Silicon Alloy

TOKYO—Nippon Electric Co. is developing a thermoelectric generator for the U. S. armed forces, it was disclosed last week to *ELECTRONICS* Editor MacDonald by Masatsugu Kobayashi, senior managing director of NEC. The generator, using silicon alloyed with cobalt and manganese and other materials, is good to 1,000 C, he said.

Kobayashi also said his company is independently developing automatic depth control for submarines, employing water pressure and gyros to hold a constant distance below the surface. It does not avoid bottom obstacles or contours, but these are detected and avoided by existing sonar and other means.

UHF Converter Uses Backward Diode Mixer

TOKYO—Sony Corp. has developed an uhf converter for its five-inch transistor tv set. The converter, small enough to mount on the set, tunes continuously over the entire uhf band. Sony officials said announcement of the converter as a commercial item is not far off.

The converter uses germanium mesa transistor oscillator and if booster, and a germanium backward-diode mixer. The mixer is one of a series of circuits Sony is developing for consumer products using the Esaki diode family of semiconductor devices (Sony engineers say the Esaki diode patent includes backward diodes as well as negative resistance diodes).

Sony is also working on vhf and uhf oscillator circuits using tunnel diodes, for tv tuner use. Advantages attributed to these include ease of assembly because of simplified wiring and better noise figure.

FAA Buys 66 More Airport Radar Systems

TEXAS INSTRUMENTS has received a \$10-million contract from the Federal Aviation Agency to build 66 airport surveillance radar systems for Air Force bases. FAA will operate 23 of the radars and the Air Force the other 43. Delivery will begin next July. The systems will be modified versions of ASR-4 units, purchased by FAA in the past for various U. S. airports (TI has sold 36 here and abroad).

A major improvement is the use of parametric amplifiers to make the radars more sensitive to weak echoes. Range is to be 60 miles at altitudes to 40,000 feet. Moving target indication will reduce stationary target clutter and an improved antenna will allow two close-together planes to be seen as distinct blips. The new units are also self-monitoring.

New Satellite Will Check Space Weather

SATELLITE equipped to report on "space weather" is to be launched soon—perhaps this week—NASA reported last week. It is to be placed in an orbit carrying it from an altitude of 185 miles to 53,000 miles every 31 hours. Six radiation and magnetic experiments are to report on energetic particles, magnetic fields, solar particles and winds and other phenomena. Data will be telemetered continuously by a pfm time-division multiplex system transmitting at a frequency of 136.44 Mc.

In Brief . . .

INERTIAL guidance navigation for civil airliners will be tested by FAA. Litton Systems will modify a military system for testing in Pan American DC-8 jets.

FIGURES reported last week (p 8, Sept. 28) on six-month exports of transistors from Japan to Hong Kong were not correct. The Finance Ministry says the correct figure is 4,043,906.

INLAND STEEL is installing a computer-controlled hot strip mill. Westinghouse Electric will supply the computer controls.

LOCKHEED is modifying three F-104A fighters so they can fly to 120,000 to 130,000 feet for re-entry experiments.

MAGNAVOX is entering the office systems field with a low-cost graphic information storage and retrieval system that can call up and reproduce any one of 100 million or more documents within one minute.

NASA HAS AWARDED grants for research facilities—the first of their kind—totaling \$6.4 million to the Universities of California, Chicago and Iowa, Stanford University and Rensselaer Polytechnic Institute.

SIGNAL CORPS has awarded the University of Texas a \$39,800 contract for research in superconductive frequency control devices.

MARTIN CO. and NATO have signed agreements for production of Bullpup missiles in Europe (p 7, March 30 and p 8 May 4).

COLLINS RADIO will build a 806-mile microwave and wire-line communications system for Syria under a \$2.7-million contract.

MERGER plans have been announced by General Railway Signal Co. and Edwards Co. Lapp Insulator has purchased Ceramaseal, Inc. Jamieson Industries has acquired Chicago Electronics Engineering and its subsidiary, Chicago Magnetic Control. Loral Electronics plans to acquire Astrex, Inc.

C _{is} - Input Capacitance - pf	25			2N2609
	12		2N2608	
	7		2N2607	
	4	2N2606		
g _m -μmhos: 150		450	1,350	3,600
I _{DSS} -ma: -0.15		-0.45	-1.35	-3.60

THESE FOUR NEW SILICONIX UNIFETS (UNIPOLAR FIELD-EFFECT TRANSISTORS) REPLACE A WHOLE HANDFUL OF CONVENTIONAL TYPES. ■ EACH HAS ITS OWN GEOMETRY. ■ EACH IS PRODUCED TO EXACT TOLERANCES. ■ EACH IS AVAILABLE IN QUANTITY. ■ PLANAR P-CHANNEL CONSTRUCTION. ■ PINCH-OFF: 2 VOLTS. ■ INPUT RESISTANCE: 100 MEGOHMS. ■ GATE-DRAIN BREAKDOWN: 30 VOLTS. ■ TO-18 PACKAGE. ■ WRITE FOR DATA, APPLICATIONS ASSISTANCE. ■



Siliconix incorporated



1140 West Evelyn Ave. • Sunnyvale 33, Calif. • Telephone 245-1000 • Area Code 408

ONE FOR EVERY JOB

meters to measure dc voltage
ac voltage
dc current
resistance

One of these Hewlett-Packard meters is designed for your measurement job. Each offers performance according to specs, long life, simple operation, conservatively designed circuitry, easy routine maintenance and, above all, value. Each proves that your best instrument buy is Hewlett-Packard. Ask your  representative to demonstrate them on your bench.

Data subject to change without notice. Prices f.o.b. factory.

Today's highest accuracy in commercial meters is assured on many of the  volt-meters, with individual calibration of their meter scales. Each scale is photographically created to match its individual meter movement. No preprinted or approximate scales are used. This accuracy is yours, at no increase in cost, on the  400H, 412A, 413A and 425A.

HEWLETT PACKARD COMPANY

1501 Page Mill Road, Palo Alto, California, Area Code 415, DA 6-7000
Sales and service representatives in all principal areas; Europe,
Hewlett-Packard S.A., 54-54bis Route des Acacias, Geneva; Canada,
Hewlett-Packard (Canada) Ltd., 8270 Mayrand Street, Montreal

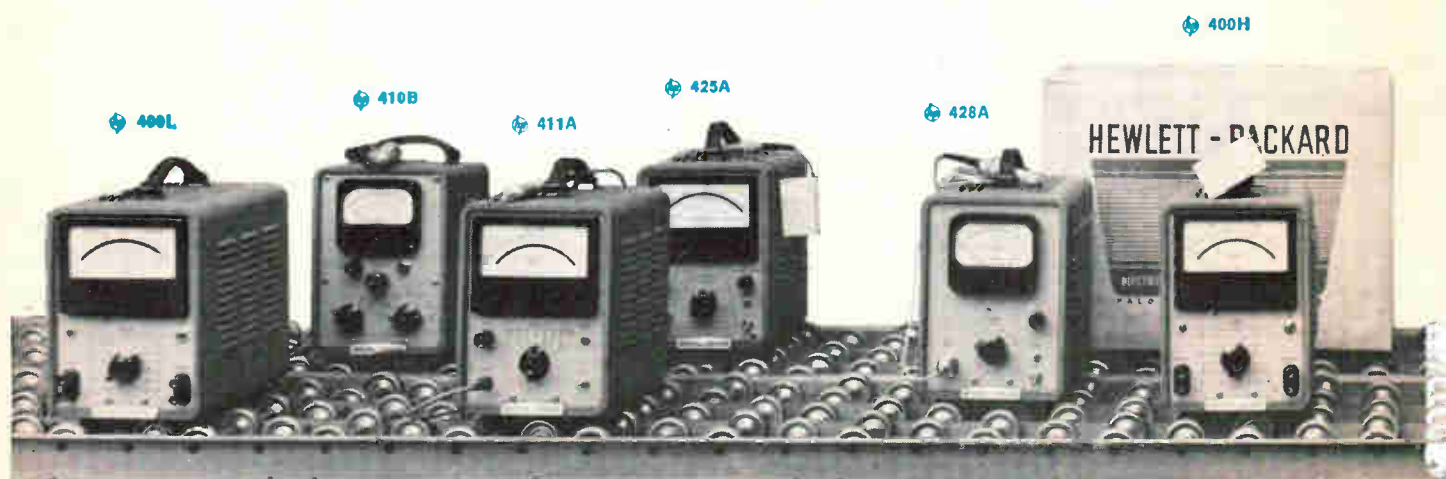

hp Model	Primary Uses and Features	Frequency Range	Voltage or Current Range	Input Impedance	Price
400D	Wide range ac voltmeter. High sensitivity, 2% accuracy.	10 cps to 4 MC	0.001 to 300 v fs. 12 ranges	10 megohms 15 pf shunt, high ranges; 25 pf, low ranges	\$250.00
400H	Similar to 400D, 1% accuracy on extra-large 5" mirror-scale meter.	10 cps to 4 MC	0.001 to 300 v fs. 12 ranges	10 megohms 15 pf shunt, high ranges; 25 pf, low ranges	\$325.00
400L	Logarithmic 400H, log voltages, linear db scale. Accuracy $\pm 2\%$ constant percentage of reading.	10 cps to 4 MC	0.001 to 300 v fs. 12 ranges	10 megohms 15 pf shunt, high ranges; 25 pf, low ranges	\$325.00
403B	Solid state ac voltmeter, ac and rechargeable battery operated, portable. Fast, accurate, hum-free ac measurements.	5 cps to 2 MC	0.001 to 300 v fs. 12 ranges	2 megohms 40 pf shunt, low ranges; 20 pf, mid ranges; 15 pf, high ranges	\$310.00
410B	VTVM for audio, rf, VHF measurements; dc voltages, resistances. High input impedance minimizes circuit loading.	DC; ac, 20 cps to 700 MC	DC, 1.0 to 1,000 v fs.; ac, 1.0 to 300 v fs., 1.0 ohm to 100 megohms	DC, 122 megohms; ac, 10 megohms/1.5 pf shunt	\$245.00
411A	RF voltmeter. Millivolt, db readings, 2 linear scales.	500 KC to 1 GC	10 mv to 10 v fs. 7 ranges	Depends on probe tip, frequency and input voltage; typically 200 K ohms at 1 MC and 1 volt	\$450.00
412A	Precision VTVM. 1% accuracy; measures voltage, current, resistance; no zero set needed; 1 ohm to 100 megohm center scale for resistance measure, 60 db dc amplifier.	DC	1 mv to 1,000 v fs. 1 μ a to 1 amp fs. 0.1 ohm to 1,000 megohms	10 to 200 megohms, depending on range	\$400.00
413A	DC null meter, dc voltmeter, 60 db dc amplifier. 2% accuracy, floating input, 1 mv end scale sensitivity.	DC	1 mv to 1,000 v fs. 13 ranges	10 to 200 megohms, depending on range	\$350.00
425A	Microvolt - ammeter reads μ v, μ μa; measures dc voltages, current as in medical, biological, physical, chemical work. 100 db amplifier.	DC	10 μ v to 1 v fs. 11 ranges; 10 μ μa to 3 ma fs. 18 ranges	1 megohm $\pm 3\%$ (v) 1 megohm to 0.33 ohms (current)	\$500.00
428A	Clip-on dc milliammeter, eliminates direct connection, no circuit loading. Measures dc in presence of ac.	DC	3 ma to 1 amp fs. 6 ranges	Loading of measured circuit negligible	\$500.00
428B	Similar to 428A, wider range, recorder output for dc to 400 cps.	DC on meter, dc to 400 cps on recorder	1 ma to 10 amps fs. 9 ranges	Loading of measured circuit negligible	\$600.00
405CR	Automatic digital VM. "Touch and read", direct dc voltage measurements, digital readout. Automatic range, polarity; has 10-line readout for printer, system.	DC	0.001 v to 1,000 v (accuracy $\pm 0.2\%$ of reading ± 1 count)	11 megohms	\$925.00

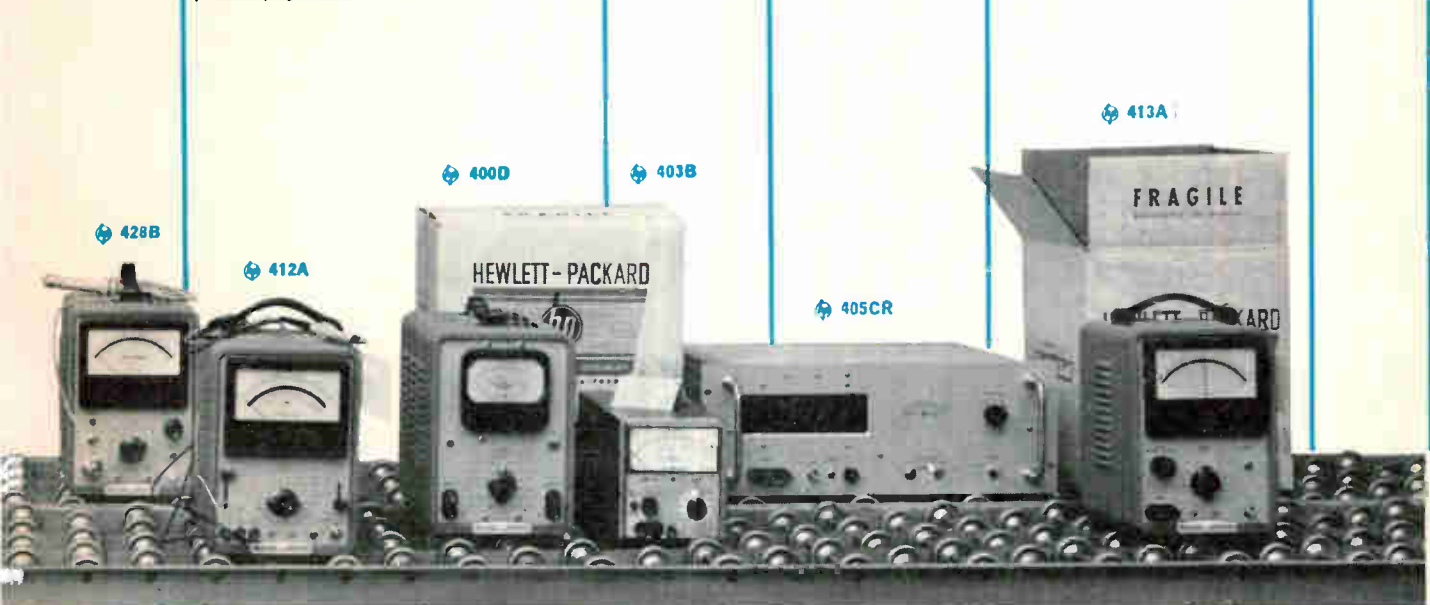

WASHINGTON OUTLOOK

**PENTAGON LOGS
\$1½ BILLION IN
ELECTRONICS
ORDERS IN '62**

LATEST PENTAGON STATISTICS show that the military services awarded \$1.5 billion worth of new orders for procurement of electronics and communications equipment in fiscal year 1962 which ended June 30, a record peacetime rate. At that date, the Defense Department also had \$437.5 million in "unobligated balances" on its books—that is, funds from previous appropriations (not counting the new appropriation for fiscal 1963) earmarked for additional electronics and communications contracts.

**BUT MILITARY
REALLY BOUGHT
\$5.9 BILLION**

THE FIGURES ABOVE cover only so-called "pure" electronics production—ground radar, communications, and the like—not identified with other weapon systems. This is the only electronics identification in the Pentagon's budget. When electronics R&D and airborne, ship-board, and missile electronics production are added in, it is estimated that at least \$5.9 billion worth of orders were placed last year. Contracts amounting to at least \$6.3 billion are anticipated for the current fiscal year, which began this past July 1.

**AND IN 1964
WILL BUY NEAR
\$7 BILLION**

THE OUTLOOK for fiscal 1964, starting next July 1, is for total new electronics contracting of close to \$7 billion. This will be covered in the budget now being prepared by the Pentagon and which goes to Congress in January. In terms of "expenditures," reflecting the rate of shipments, the latest figures show \$1.2 billion in "pure" electronics and communications. The Pentagon's records as of June 30 also show \$1.6 billion in "unpaid obligations"—funds to cover payment for equipment already on order.

**MORE BUSINESS
FROM NASA:
A BIG, NEW
TEST CENTER**

THE ELECTRONICS INDUSTRY will get a sizable chunk of some \$500 million the National Aeronautics and Space Administration will spend initially to build the Mississippi Test Facility near Gainesville, Miss. In addition, operation of the facility will mean a continuing market for electronics for years to come.

Work on the facility will start this year and continue for three to four years. Static test firings of Saturn boosters for the manned space program will be conducted at the 13,500-acre site. The boosters will be transported over a labyrinth of canals from a network of service buildings to test stands.

The boosters will be assembled at Michoud, La., some 35 miles from the Mississippi test center.

All operations at the center will be controlled from a central tower with personnel in touch with all operations by radio and closed-circuit television. Support units will include engineering, acoustical and electronics and instrumentation labs, as well as basic electronics equipment needed to run the facility.

Eventually, the facility will be expanded to handle the giant Nova vehicle now envisioned for use in interplanetary space missions after 1970. Long range, NASA expects the center to become one of its major facilities where all future big boosters will be subjected to intensive testing before they reach the launch pad for use on actual space missions.

Analab ANNOUNCES

a dual-trace **STORAGE** **OSCILLOSCOPE** and all-electronic x-y recorder

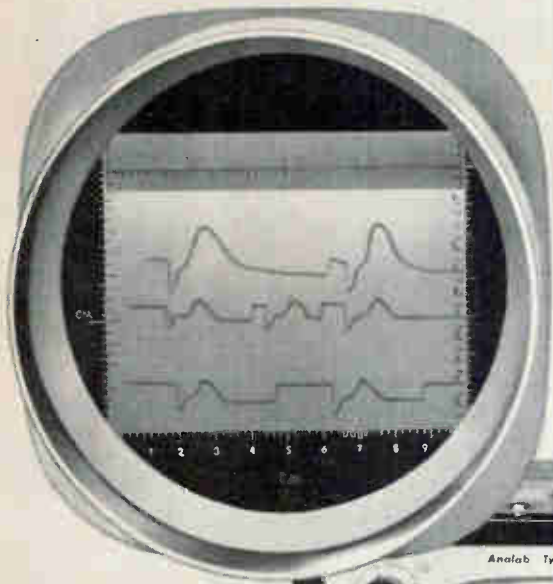

Typical solid-state ↑
power-supply turn-
off transient.

Illustration shows
Type 1220 main
frame with Type 700
plug-in.

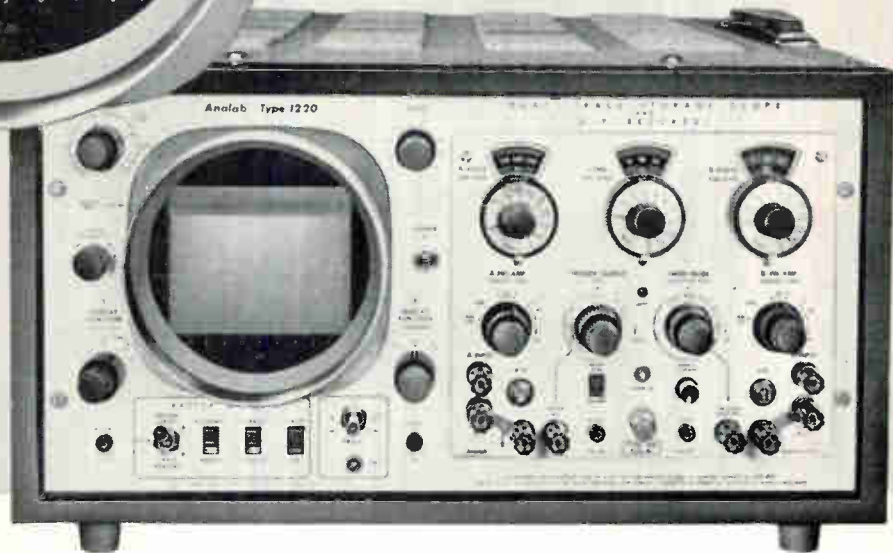

A major advance in precision oscilloscopes

From ANALAB, makers of specialized 'scopes and plug-ins of better than $\pm 2\%$ system accuracy for the most demanding aerospace, medical, and industrial applications, comes this remarkable new instrument which offers up to 20 minutes' recording time with the convenience of indefinite image retention or fast erase. The Type 1220 Storage Scope features an exclusive "preview" target which permits "scratch-pad" observations of signals before recording. Type 1220 allows 1, 5, and 10-track automatic or manual programming.

Save measurement time, achieve greater accuracy, eliminate ink and paper with the Type 1220 Scope and a choice of plug-ins. Call, write, or wire for a demonstration in your laboratory.

TYPICAL APPLICATIONS

- Editing magnetic tape
- Plotting antenna patterns
- Plotting Smith charts
- Alignment of crystal filters
- Shock and vibration testing
- Readout for sampling scopes
- Observation of power-supply transients
- Readout integration of repetitive signals through very high noise levels
- Plotting hysteresis effects not achievable with mechanical x-y recorders

Analab

INSTRUMENT CORPORATION

Cedar Grove, N.J.

A subsidiary of THE JERROLD CORPORATION

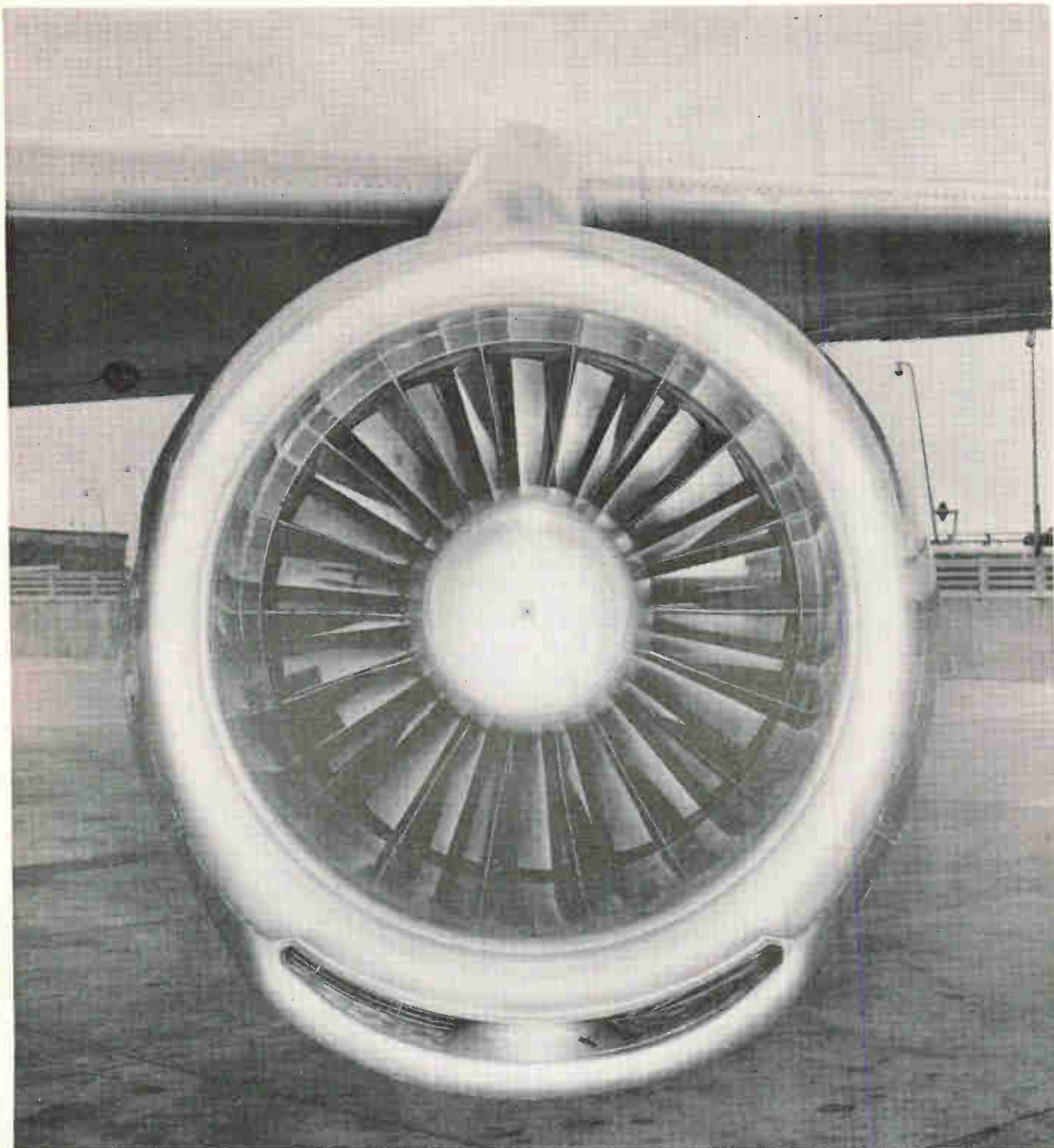

Say, "Ahhhh!"

Be "AnSCO-sure" . . . Aircraft radiography demands AnSCO Superay H-D® — the first, ultra-fine-grain American X-ray film for pinpointing the smallest manufacturing defects or stress fatigue. Besides its critical definition, this film's high contrast records more minute details—which would only show up marginally on conventional films.

For radiography—it's AnSCO best by definition

AnSCO—America's first manufacturer of photographic materials . . . since 1842

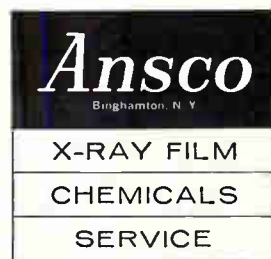

*Mindpower and Manpower...
shaping the future in*

INTEGRATED CIRCUIT APPLICATIONS

SCIENTISTS AND ENGINEERS: Today Motorola is pacing a scientific revolution in electronics with a disciplined approach to integrated circuit applications. Under the personal leadership of Dr. Daniel E. Noble, the men of the Military Electronics Division are synthesizing the process technology and device design capabilities of Motorola's Semiconductor Products and Solid State Systems Divisions with military and space requirements. This coordinated effort, unique in the electronics industry, is yielding a new breed of reliable integrated circuit devices resulting from Motorola's broad range of jointly funded contracts with each of the three services, JPL/NASA and other government agencies. To implement programs such as these, marrying the frontier processing techniques of diffusion, epitaxial growth, electronic ceramics and thin films to practical electronic hardware applications, we can offer immediate opportunities to both systems and equipment design engineers experienced in the following areas.

Specification of design constraints imposed by integrated circuits, trade-off analyses for integrated electronic implementation, and electronic systems specification and optimization. Micro-miniature transistor circuit design, special solid state and semiconductor device utilization, computer-aided circuit design, and subminiature packaging techniques, including thermal considerations or basic training in the solid state sciences.

We are particularly interested in programs from which your experience was obtained and the extent of your technical responsibility.

Please address detailed information to our Manager of Engineering at the location of your choice for immediate and confidential attention.

An equal opportunity employer



MOTOROLA

Military Electronics Division

SCOTTSDALE, Arizona, 8201 E. McDowell Road

CHICAGO 51, Illinois, 1450 N. Cicero Ave. / RIVERSIDE, California, 8330 Indiana Ave.

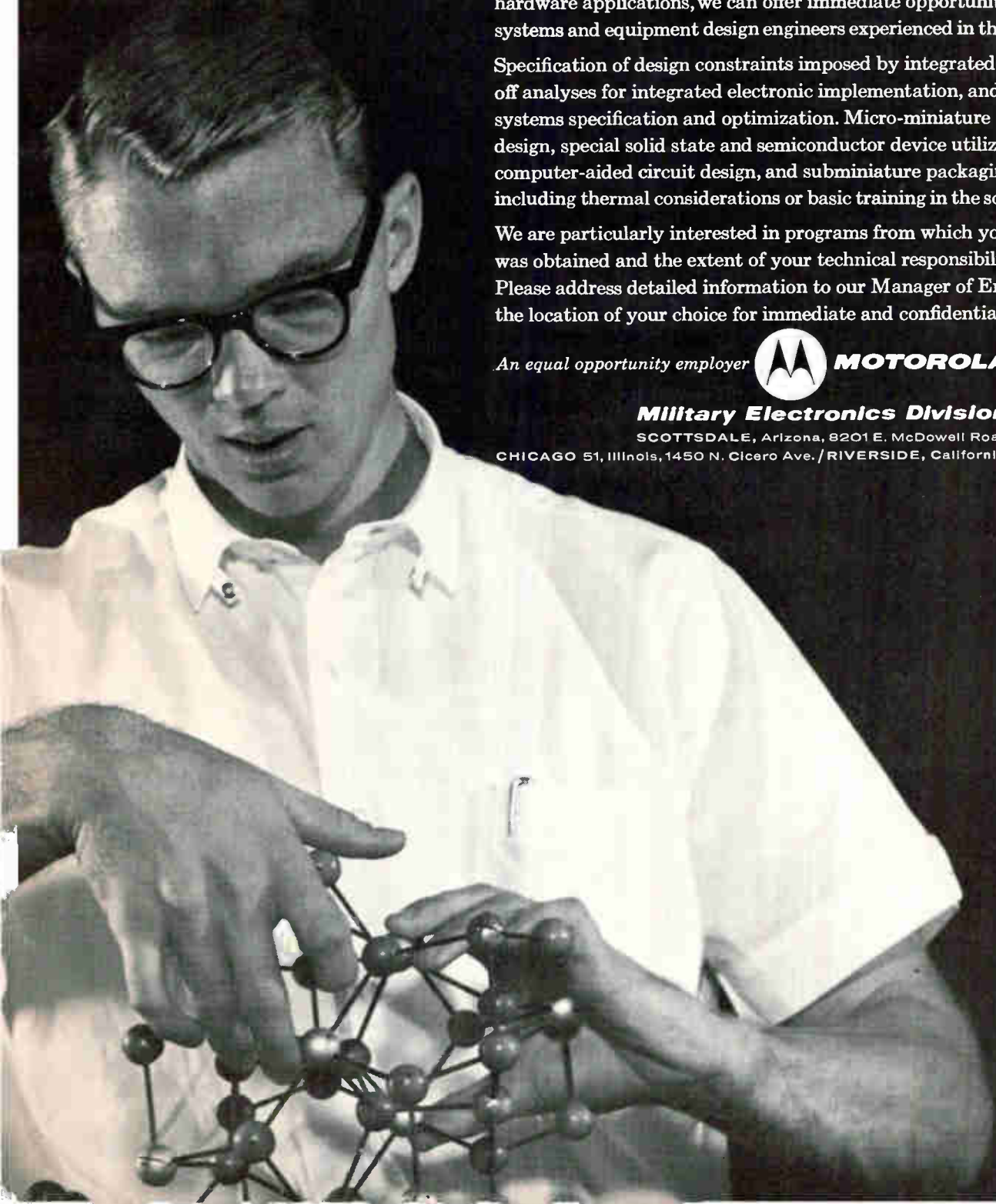

Of interest to engineers and scientists

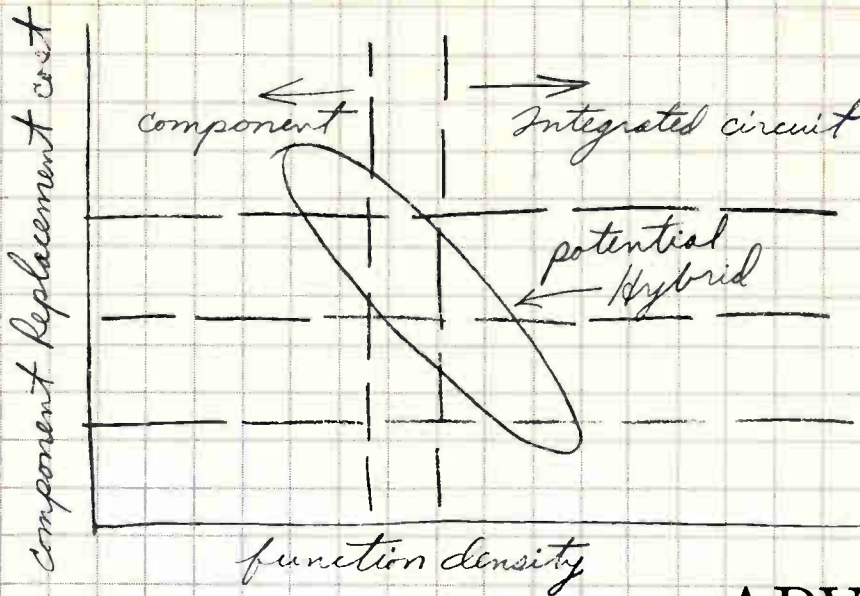

ADVANCED ELECTRONICS PACKAGING

... one of more than 500 R&D programs under way at Douglas

Douglas is studying new design techniques related to miniature electronic systems that must function under conditions more severe than any previously encountered.

These electronic packages must operate perfectly at sound levels up to 168 decibels; at accelerations up to 120G; and in vacuum environments of less than 10^{-10} Torr. They must be impervious to shock loading of hundreds of G's.

Considerable progress has been made toward these goals. Great promise is being shown by hybrid systems which combine discrete components with integrated circuits.

Of career interest to engineers and scientists

Electronics has become a major factor in almost every aspect of Douglas missile and space programs. Assignments include some of the most interesting and advanced work in the communi-

cations, control and computer fields. By accepting a position at Douglas, you can be assured of the rapid professional advancement your ability warrants.

This applies not only to those qualified in electronics, but also to engineers and scientists in many of the wide variety of disciplines related to aerospace and defense programs.

Send us your resume or fill out and mail the coupon. Within 15 days from the receipt of your letter, we will send you specific information on opportunities in *your* field at Douglas.



MISSILE & SPACE SYSTEMS DIVISION

An equal opportunity employer

Mr. F. V. Edmonds F-10
Missile and Space Systems Division
Douglas Aircraft Company
3000 Ocean Park Boulevard
Santa Monica, California

Please send me full information on professional opportunities in my field at Douglas.

Name _____
Engineering or scientific field _____
Address _____
City _____ State _____

Tansitor Electronics Announces NEW DISC-TYPE TANTALUM CAPACITORS FOR MICROMODULES

FLAT-SIDED UNITS ARE EASILY STACKED -

Designed especially for micro-module electronic equipment, these new tantalum capacitors have extremely high volumetric efficiency, can be stacked like pancakes to save space in a circuit.

They shrug off moisture too. In tests at TANSITOR, they showed only 1% change in capacitance compared to 5% permitted in method 106 of MIL-STD-202A.

Compared to many standard miniature solid tantalums, disc-type units provide savings up to 33% in length and 10% in thickness — an important factor in computers, air-borne or space electronic equipment.

CHECK THESE CHARACTERISTICS

Voltage Range	3 - 35
Capacitance Range	0.12 - 160 u.f.
Capacitance Tolerance	±20%
Operating Temperature Range	-80 to 125 C
Polar-Type (black end denotes + lead)	

SELECT THE RIGHT TANTALUM CAPACITOR FOR YOUR CIRCUIT

Tansitor's line of tantalum capacitors includes over 2200 different sizes and types.

TANSITOR
ELECTRONICS INCORPORATED

Where Reliability Comes First

Tantalum Capacitors

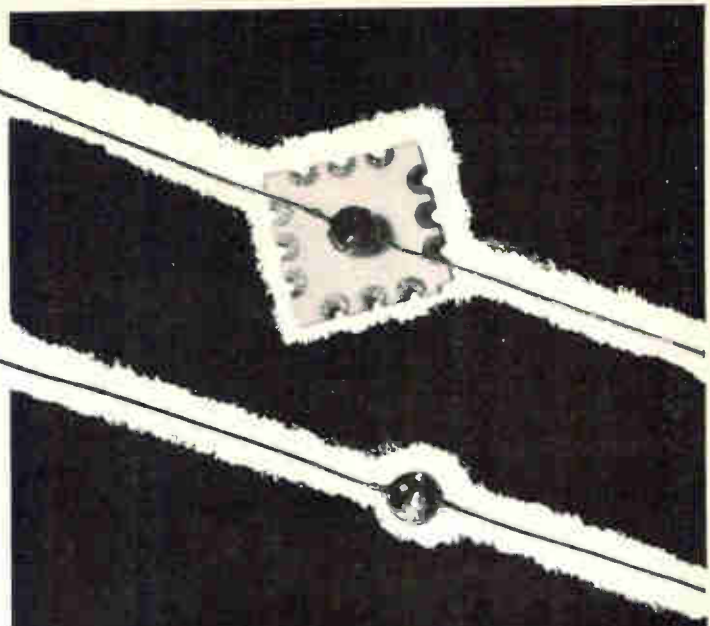

- EASILY ASSEMBLED WITHIN WAFERS

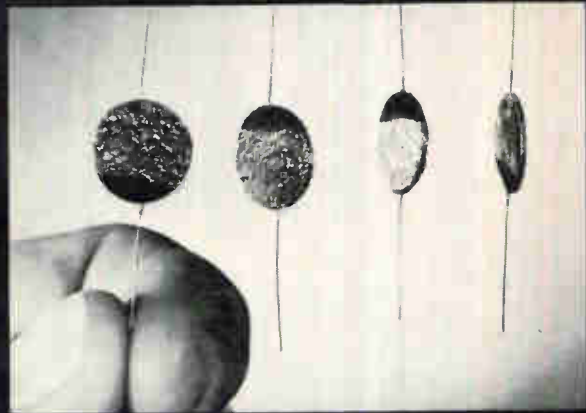

- Foils — MIL-C-3965B type, 85°C and 125°C operation
- Foils up to 1 farad capacitance • Foils for 200 to 300 volts operation • Wire anode types • Solids — dry electrolyte • Solids — wet electrolyte

MORE INFORMATION?

Technical data and evaluation quantities of these revolutionary new capacitors are available on request. Contact your TANSITOR technical representative or write to TANSITOR ELECTRONICS, INC., West Road, Bennington, Vt.
TEL. Area Code 802-442-5473 TWX BENN 468-U

THE MOST WELL BALANCED STOCK OF MICRO-DRILLS IN THE U.S.A.

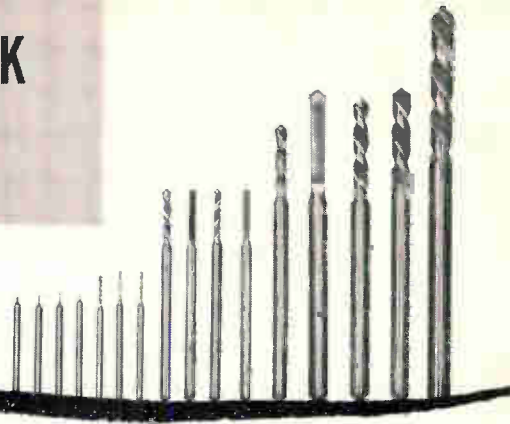
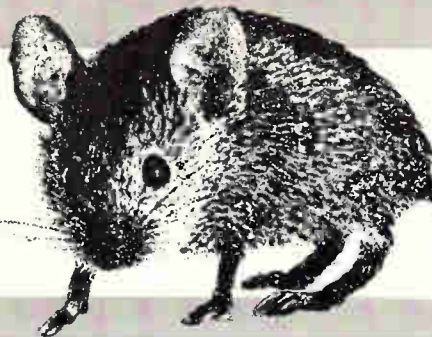

IN STOCK FOR IMMEDIATE DELIVERY

TYPE	STYLE	STOCK SIZES
Spirec Pivot Drills	Right Hand	0.10mm to 3.00mm by 0.01mm increments
Flat Pivot Drills	Right Hand	0.04mm to 1.00mm by 0.01mm increments
Spirec Pivot Drills	Left Hand	0.10mm to 1.00mm by 0.01mm increments
Spirec Center Drills	Right Hand	0.10mm to 0.70mm by 0.05mm increments

Other sizes and styles available on special request.

SPHINX known the world over as the symbol of the finest in micro-drills. Insist on them by name. Your best assurance of quality and precision.

SEND FOR COMPLETE DRILL CIRCULAR

LEVIN®

LOUIS LEVIN & SON, INC.
3573 Hayden Ave., Dept. E - Culver City, California

CIRCLE 200 ON READER SERVICE CARD

free

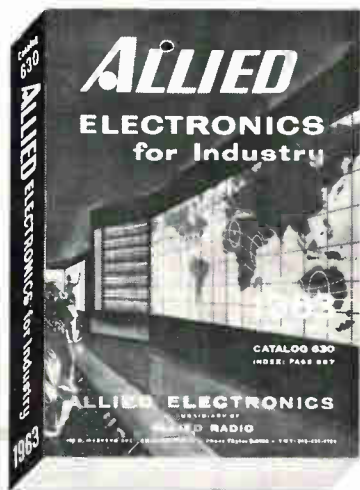

ask for

your 1963 **ALLIED** INDUSTRIAL CATALOG

672 pages IT'S THE COMPLETE CATALOG FOR ALL ELECTRONIC COMPONENTS DIRECT FROM THE WORLD'S LARGEST STOCKS AT FACTORY OEM PRICES

For FREE copy, check reader service card or write direct

ONE ORDER TO ALLIED FILLS THE WHOLE BILL

ALLIED ELECTRONICS
industrial subsidiary of
ALLIED RADIO
100 N. Western Ave., Dept. 922-K, Chicago 80, Ill.



new low cost
decade counter module

Anadex research now makes available an all solid-state, plug-in decade counter module featuring a completely new and unique circuit. Can be interconnected to perform counting and totalizing operations. Compact design permits use in 1 3/4" rack panel. Unit Price \$94.00 including Nixie. Write Anadex Instruments, Inc., 7617 Hayvenhurst Ave., Van Nuys, Calif.

MODEL DC-100

SIZE:
1 3/4" x 1 1/4" x 6 1/2"

COUNTING RATE:
0 to 100 KC

POWER:
Requires only one unregulated power supply voltage

READOUT:
1" ultra long-life wide-angle Nixie

Mounting panels, input amplifier, and electrical readout available.

Anadex

CIRCLE 201 ON READER SERVICE CARD
electronic

What 200 V/ μ sec dV/dt can do for you

In any switching application or where high line transients exist, false firing of low dV/dt SCR's is possible. This makes high dV/dt capability extremely important for circuit reliability.

For example, in inverter circuits, high dV/dt capability permits smaller commutating capacitors which improves the overall circuit reliability. The possibility of both devices being turned on by high line transients when the line switch is closed is no longer a problem with Texas Instruments guaranteed 200 V/ μ sec dV/dt SCR's.

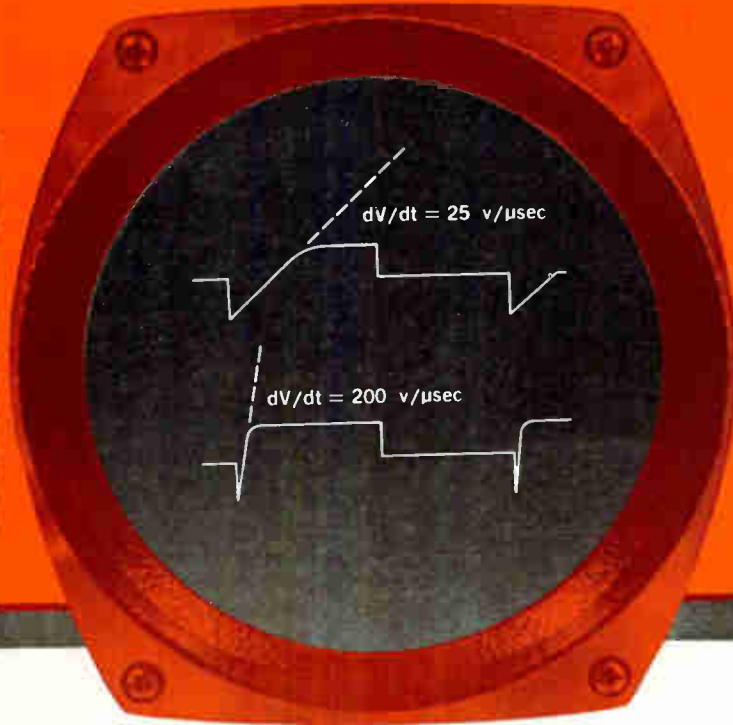

HIGH RELIABILITY SILICON CONTROLLED RECTIFIERS

dV/dt ratings represent the capability of an SCR to resist "false" firing due to transients or pulses in the anode-to-cathode voltage. The possibility of turning an SCR "on" *without an applied gate signal and without exceeding the Forward Breakdown Voltage* exists in any circuit where transients are experienced, where supply voltage may be applied rapidly, or where fast fuses are used in the circuit.

Texas Instruments SCR's eliminate "false" firing by giving you guaranteed 200 V/ μ sec dV/dt @ 100°C for high reliability, long life and low cost control circuits. Other TI SCR's are rated above 50 V/ μ sec, exceeding industry's average rating... giving you added safety.

For information on TI Silicon Controlled Rectifiers, write for the new application tip "dv/dt Considerations in SCR Circuit Design." Address your correspondence to Texas Instruments Incorporated, Semiconductor-Components division, Department 573, P. O. Box 5012, Dallas 22, Texas or circle reader service number.

Rating	TI-116 Series	TI-136 Series	2N1595 Series	2N1929 Series	2N1600 Series	TI-40A Series	2N681A Series	TI-150 Series	2N1770 Series
Voltage	200-400	200-400	50-400	25-300	50-400	50-400	25-400	50-400	25-400
dc Current	1.3 amp	4 amp	1.3 amp	1.1 amp	4 amp	4 amp	25 amp	35 amp	7 amp
V/ μ sec dV/dt	>200†	>200†	>50*	>50*	>50*	>50*	>200†	>50*	>50*

† Guaranteed @ 100°C @ rated voltage * Typically greater than 50V/ μ sec.

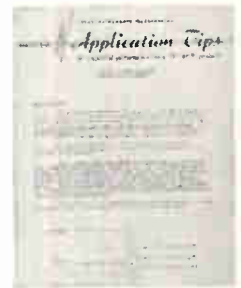

SEMICONDUCTOR-COMPONENTS
DIVISION



TEXAS INSTRUMENTS

INCORPORATED
13500 N. CENTRAL EXPRESSWAY
P. O. BOX 5012 • DALLAS 22, TEXAS

CIRCLE 19 ON READER SERVICE CARD

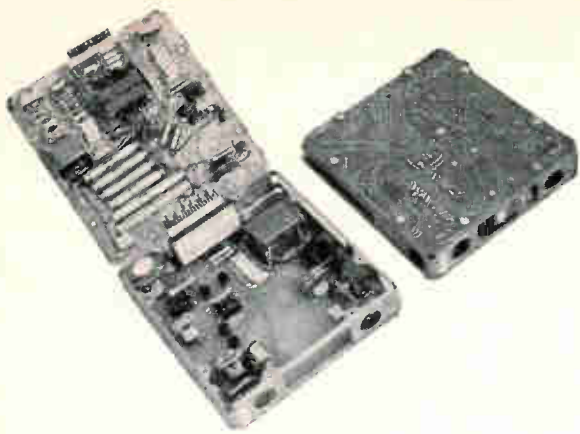

NOW— TRANSISTOR SYSTEMS FOR PRECISION HELICOPTER FLYING

AMPLIFIER MODULE used in Sikorsky ASE is assembled in sandwich form, closed in by p-c boards

By LAURENCE D. SHERGALIS
Associate Editor

Commercial, Asw aircraft get new lightweight systems

HELICOPTER CONTROL in flight, complicated by the inherent instability of the aircraft, will be improved by newly designed, all-solid-state stability augmentation systems.

Vertol division of Boeing Airplane Co. and Sikorsky Aircraft use transistors in their basic systems to reduce weight and increase reliability. Boeing's Stability Augmentation System (SAS) is in operation in the Boeing Vertol 107, and Sikorsky's Automatic Stabilization Equipment (ASE) is used in the Navy HSS-2 helicopter. Sikorsky proposes to modify their equipment for use in the Sud Aviation (France) Super Frelon antisubmarine-warfare (ASW) helicopter.

Both systems allow greater pilot flexibility during flight, reduce pilot fatigue, make marginal weather flying easier and permit

greater precision on ASW missions and in landing in small areas.

While the Boeing and Sikorsky systems differ in certain respects, they operate on the principle of detecting helicopter motion and transmitting corrective signals into the control system. Both systems use a differential type input in which the aerodynamic control surfaces are moved without any motion of the pilot's controls.

BOEING SAS—Designed for both the military and commercial versions of the Vertol 107 Model II helicopters, this system is a dual, three-axis, all-solid-state system using plug-in printed boards and is self-checking without test equipment. The entire unit weighs 8.5 pounds, not including the hydraulic actuators.

Three rate gyros detect roll, pitch and yaw. The three servo loops are nearly identical. Outputs of the rate gyros, 400-cps signals, are fed to full-wave, phase-sensitive demodulators (see diagram) using two center-tapped transformers with

diode rectifiers, and arranged with the primaries in series and the secondaries paralleled. Thus, the resulting 800-cps ripple will not appear as a spurious signal when combined with the 400-cps output of the modulator. The rectified outputs from each half of the paralleled secondaries are filtered. The difference between these two d-c voltages is the output signal.

In the pitch and roll axes, the gyro signals are processed in capacitor-resistor shaping networks and then modulated for injection into the servo amplifiers.

YAW SERVO—Four signals go into the yaw servo loop. One is the yaw rate signal from the yaw rate gyro. Another is a lagged roll rate from the roll demodulator. This signal tends to cancel any yaw rate signal during turn entry so that turns may be well coordinated. A simple RC circuit provides the necessary lag. Since the cancellation lasts only during entry into a turn, that is, during a change in turn rate, the yaw gyro signal is

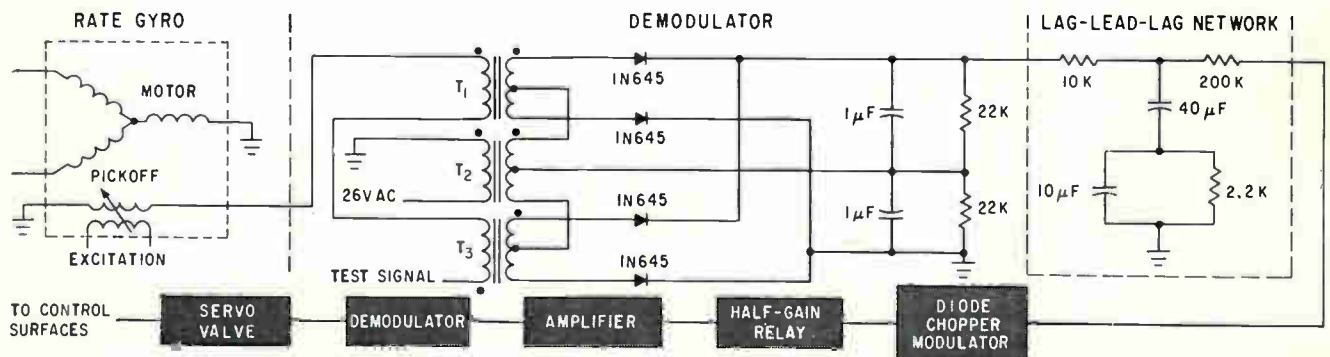

PITCH CONTROL circuit of Boeing's SAS. Roll and yaw circuits are similar

fed to the servo amplifier through a large series capacitor (called a washout) to eliminate any steady state signal.

The third signal fed into the yaw loop is sideslip and is detected by a differential pressure transducer. Gain of the transducer is a function of airspeed and is set for best stability at all airspeeds. A fourth signal goes into the loop from the rudder pedals to insure precise turning control during hover.

D-c control signals for all three axes are modulated by diode chopper modulators, then amplified by two-transistor servo amplifiers. Output of each servo amplifier is fed to a demodulator to provide d-c to the torque motors of the differential hydraulic actuators that position the control elements. Actuator position is sensed by a feedback potentiometer and a voltage is fed back to the servo amplifier. Actuator displacement is then proportional to the signal voltage applied to the amplifier.

In the Vertol 107 system, the SAS is duplicated for additional reliability. A half-gain position is provided in the signal input to each amplifier so that both units may operate simultaneously, each at half gain. In case of failure of one of the loops, the effect on the overall performance will be slight. Also, in case of failure, there are no sudden movements of the aircraft.

SIKORSKY ASE—One of the major uses for Sikorsky's automatic

stabilization equipment is to improve all-weather capabilities of ASW helicopters. Now in use aboard the Navy HSS-2, helicopter, this new system is completely transistorized, weighs 20 pounds and includes inputs from doppler radar, sonar cable angle transducers, hydrostatic altitude sensors, as well as the conventional transducers for flight control. Automatic approach to hover is included in the system to eliminate the difficult manual approach to hover.

Four channels—pitch, roll, yaw and altitude—have their own power supplies and are isolated so that a malfunction will effect only a single channel. The equipment is designed fail-safe and override forces are low. A malfunction will result in control movements that are only a small fraction of the pilot's authority. Thus, there is no danger of the system throwing the aircraft out of control.

ASW TECHNIQUES—On antisubmarine-warfare missions, sonar search is facilitated by the addition of a cable angle control and a cable altitude control. The sonar cable can be held vertically within 20 degrees without pilot effort. More accurate control is possible using a manual trim system. Cable altitude provides an extremely accurate control by sensing the difference between the length of the sonar cable and the depth of the sonar transducer. The resulting signal maintains altitude during search.

COMMERCIAL VERSION of Boeing 107 Helicopter using a stability augmentation system will be modified for Air Force long-range logistics



"Nothing is impossible to diligence and skill"
Samuel Johnson

These are the trademarks of some of our customers—each an important contributor to a dramatically growing industry. We at Potter pledge our diligence and skills to this growth through a constantly expanding program of research and development.

POTTER

**Model LP-1200
High Speed
Printer adds
new versatility**



to modern computer systems. This high-performance, extremely reliable printer provides speeds of 1000 lines per minute with a maximum of 160 columns. An optional Format Control feature permits multi-page forms or books to be printed with completely flexible horizontal or vertical format and up to five carbons.

The Potter LP-1200 reflects the engineering-knowledge gained from extensive experience and research in high-speed printing. Solid-state modular electronics enhance reliability and sturdy, simple mechanical design readily adapts to meet customer requirements.

Three models are available: LP-1200-160 (160 columns), LP-1200-132 (132 columns) and LP-1200-80 (80 columns). Write for specifications.



- Manufacturers of:
- Digital Magnetic Tape Systems
 - Perforated Tape Readers
 - High Speed Printers
 - Data Storage Systems

POTTER INSTRUMENT CO., INC.
Sunnyside Boulevard • Plainview, New York

HIGH RESOLUTION/0.1-nsec Risetime

with the new Tektronix Type 4S2—vertical plug-in unit for the Type 661 Sampling Oscilloscope

RESOLVES fastest present switching transistor risetimes, including commercially available avalanche types (usually limited by the transistor or the transistor case).

RESOLVES most tunnel diode switching times. (Only diodes with better than 3 ma/pf are faster.)

RESOLVES stored charge in switching diodes to the 0.01 picocoulomb/milliampere region (generally limited by diode capacity and turn-on capability).

RESOLVES 0.1% system discontinuities as reflectometer with centimeter separation capability (limited by external pulse generators, delay lines, attenuators).

RESOLVES fractions of a degree of relative phase shift to over 1 gigacycle frequency with lissajous-mode operation (usually limited by harmonic content or residual reflections to a few degrees absolute).

RESOLVES millivolts of information on top of signals hundreds of millivolts in amplitude (not limited by the usual amplifier overload problem).



Additional Ways You Can Use the 661

- • • display repetitive signals on 16 calibrated equivalent sweep rates from 1 nsec/cm to 100 μ sec/cm, accurate within 3%. Magnifier provides display expansion from 2 to 100 times . . . time per dot remains the same for digital readout.
- • • change the probes' signal source without affecting the dot transient response.
- • • reduce time jitter and amplitude noise, if needed, on the more sensitive vertical ranges and faster sweep rates by means of a smoothing control.
- • • calibrate with amplitude and timing signals available at the front panel.
- • • show lissajous patterns in addition to single and dual-trace displays and signals added algebraically.
- • • drive X-Y plotters or similar readout accessories.
- • • drive external equipment, with fast delayed-pulse output.
- • • add plug-in units as they come along.

Type 661 Oscilloscope (without plug-ins) . . . \$1150
 Type 5T1 Timing Unit
 (required to provide time base) . . . \$ 750
 50 Ω Dual-Trace Sampling Units
 (at least 1 required):
 Type 4S2 (0.1-nsec risetime) . . . \$1600
 Type 4S1 (0.35-nsec risetime) . . . \$1430

Currently available, the general-purpose Type 4S1 Unit, with delay lines and internal triggering, permits 661 operation much like a conventional oscilloscope.

Probes:
 Type P6032 Cathode-Follower Probe . . . \$ 160
 Type P6034 Miniature Passive Probe . . . \$ 35
 Type P6035 Miniature Passive Probe . . . \$ 35
 Both miniature passive probes have input capacitance of 0.7 pf \pm 0.1 pf from 1 to 1000 Mc.

U.S. Sales Prices f.o.b. Beaverton, Oregon

Type 4S2 Dual-Trace Sampling Unit—used with a Type 5T1 Timing Unit in a Tektronix 661 Oscilloscope—makes possible a new degree of time resolution. This new vertical plug-in unit retains most features of the general-purpose Type 4S1, except for delay lines and internal triggering.

Type 4S2 is expected to be available during first quarter 1963. Keep in touch with your Tektronix Field Engineer for latest availability information.

Tektronix, Inc.

P. O. BOX 500 · BEAVERTON, OREGON / Mitchell 4-0161 · TWX-503-291-6805 · Cable: TEKTRONIX

TEKTRONIX FIELD OFFICES: Albuquerque, N. Mex. • Atlanta, Ga. • Baltimore (Towson) Md. • Boston (Lexington) Mass. • Buffalo, N.Y. • Chicago (Park Ridge) Ill. • Cleveland, Ohio • Dallas, Texas • Dayton, Ohio • Denver, Colo. • Detroit (Lathrup Village) Mich. • Endicott (Endwell) N.Y. • Greensboro, N.C. • Houston, Texas • Indianapolis, Ind. • Kansas City (Mission) Kan. • Los Angeles, Calif. Area (Encino • Orange • Pasadena • West L.A.) • Minneapolis, Minn. • New York City Area (Albertson, L.I., N.Y. • Stamford, Conn. • Union, N.J.) • Orlando, Fla. • Philadelphia (Bala-Cynwyd) Pa. • Phoenix (Scottsdale) Ariz. • Pittsburgh (Monroeville) Pa. • Portland, Ore. • Poughkeepsie, N.Y. • San Diego, Calif. • San Francisco, Calif. Area (Lafayette • Palo Alto) • Seattle, Wash. • Syracuse, N.Y. • Washington, D.C. (Arlington, Va.).

TEKTRONIX CANADA LTD: Montreal, Quebec • Toronto (Willowdale) Ontario.

TEKTRONIX OVERSEAS DISTRIBUTORS: Kentron Hong Kong Ltd., Hong Kong, Hawaii. Tektronix is represented in twenty-seven separate countries by qualified engineering organizations.

European countries and the countries of Lebanon, Syria, and Algeria, please contact TEKTRONIX INTERNATIONAL A.G., Terrassenweg 1A, Zug, Switzerland, for the name of your local overseas distributor.

Other Overseas areas, please write or cable directly to Tektronix, Inc., International Marketing Department, P. O. Box 500, Beaverton, Oregon, U.S.A. Cable: TEKTRONIX.



Call your Tektronix Field Engineer for additional information on this compact sampling oscilloscope or any other sampling equipment manufactured by Tektronix.

CIRCLE 22 ON READER SERVICE CARD

advanced PRECISION COMPUTING RESOLVERS for Cascaded Resolver Systems

SIZE 8 FEEDBACK WINDING RESOLVERS



These resolvers are designed for use with transistorized "booster" amplifiers in cascaded chains.

Chains of precision size 8, winding compensated resolvers accurately solve the trigonometry of coordinate translation, rotation and conversion.

A chain of five resolvers is typically employed to solve for an unknown side and angle of oblique spherical triangles.

Individual resolvers exhibit functional errors of less than 0.1%

and axis perpendicularity errors of $\pm 5'$ max. In combination with the CPPC RESOLVERAMP, the closed loop phase shift is $0.00^\circ \pm 0.01^\circ$

and the transformation ratio is 1.0000 ± 0.0005 . The residual null voltage is 1 mv/v max. over a range of 10V, 400~.

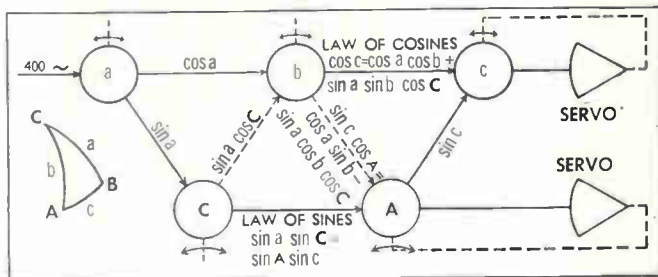

SIZE 11 "BOOSTERLESS" RESOLVERS FOR SERVICE IN REVERSIBLE CHAINS



The frame of these size 11 computing resolvers also houses a matching transformer which simulates a pair of resolver windings at maximum coupling. In a reversible chain of alternately interconnected resolvers (only partially diagrammed), the excitation may be applied to either end of the chain and the outputs taken from the other end.

Quick disconnect allows ease in harnessing. Accuracy: $\pm 5'$ of arc or less; winding perp. $\pm 5'$. Electrical characteristics: Input to EITHER rotor or stator. Input voltage 115v 1600 ~; output voltage 110v with either stator or rotor as primary; phase shift (stator primary) 1.1°; phase shift (rotor primary) 1.9°; Zso (nom.) $990 + j13500$; Zro (nom.) $1150 + j13500$.

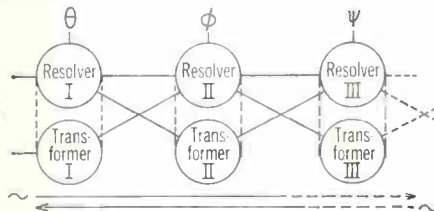
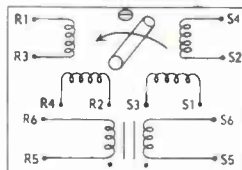

SIZE 11 RESOLVER TRIMMED FOR ZERO PHASE SHIFT CONTAINS ALL COMPENSATION IN 2 1/4" LENGTH



The YZC-11-E-1 precision computing resolver has been developed for use in a cascaded, amplifierless resolver system at 900~.

These units have been trimmed to provide zero phase shift and compensated for transformation ratio stability, under temperature, when working into their iterative impedance.

Accuracy: Functional error .1% or less; winding perp. $\pm 5'$. Electrical characteristics: Input voltage (stator) 40v 900 ~; output voltage (rotor) 33.2v; phase shift 0; max. null voltage 1 mv/v.

Also ready for delivery is an equivalent, compatible pancake resolver. By its use, differential information from an inertial platform may be obtained and introduced into the system.

cppe CLIFTON PRECISION PRODUCTS Co., INC.
CLIFTON HEIGHTS, PENNSYLVANIA
Sales Dept.: 5050 State Rd., Drexel Hill, Pa., MADison 2-1000, TWX LNSDOWN 1122 (U) — or our Representatives

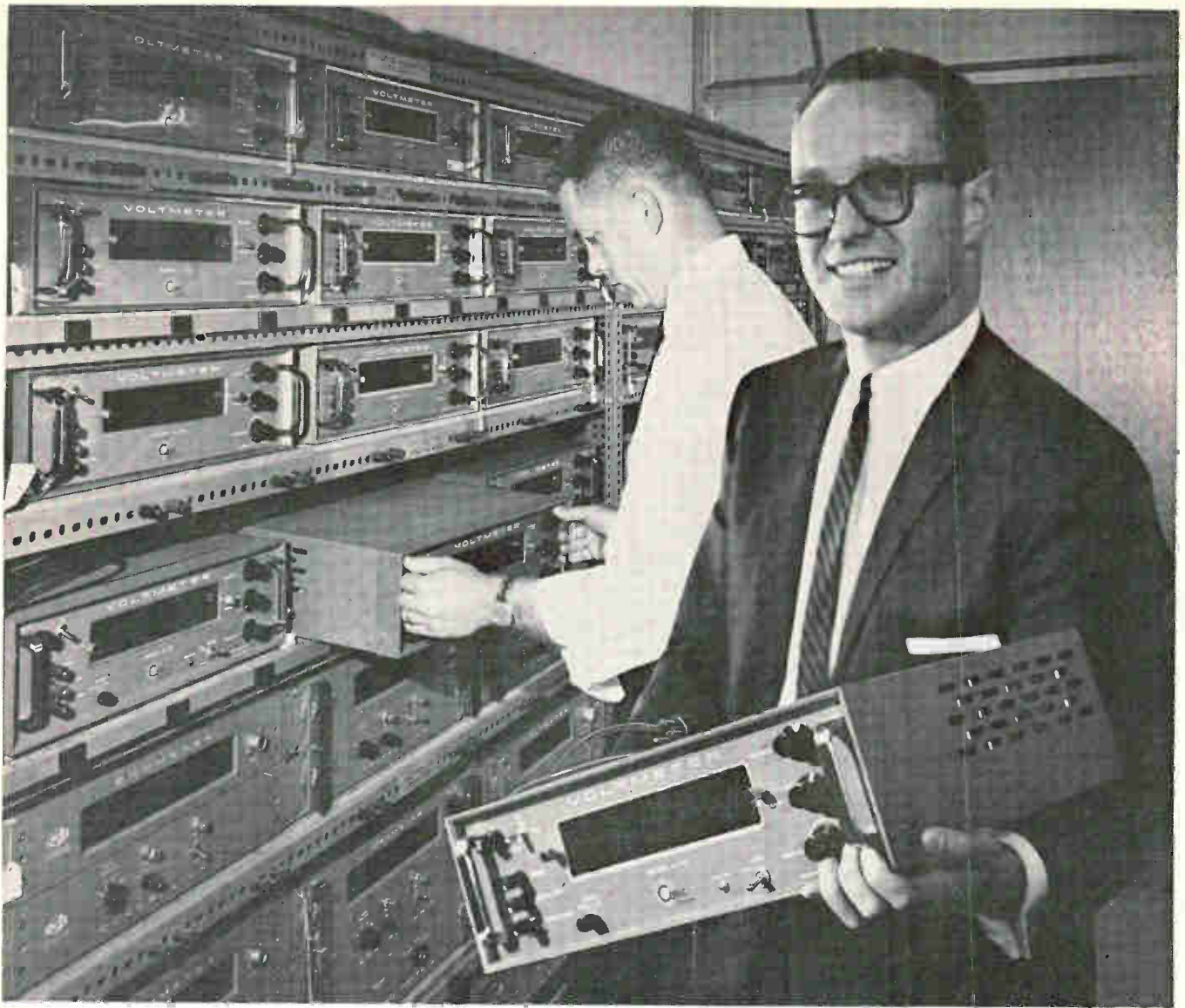

Now! Immediate delivery on Cubic Digital Voltmeters!

Now you can be using your new Cubic Digital Voltmeters and accessories during the period when you would be waiting for delivery on many other brands. You can get immediate delivery right off the shelf on virtually all Cubic instruments. And when you specify Cubic, you can be sure you are getting instruments that offer you the *most* in accuracy, dependability, long life and reasonable prices. Here are the Cubic instruments available for immediate delivery:

V-45 DIGITAL VOLTMETER – Laboratory accuracy at low cost. \$940.

V-46 DIGITAL VOLTMETER – V-45 with automatic ranging and polarity. Price \$1190.

V-70 DIGITAL VOLTMETER – Long life reed relays. Price \$1580.

V-71 DIGITAL VOLTMETER – V-70 with automatic ranging and polarity. Price \$2200.

V-41 DIGITAL VOLTMETER – Meeting highest standards of sensitivity and accuracy. Four digit. Price \$1200. Uses Control Unit C-1. Priced at \$1400.

V-51 DIGITAL VOLTMETER – Five digit version of V-41. Price \$1700. Uses Control Unit C-1. \$1400.

S-71 DATA SYSTEM – Monitors 100 channels. Visual and printed readout. Automatic ranging and polarity. Price \$5270.

AC-45 A-C CONVERTER – Use with any voltmeter to read AC. \$590.

AC-2 A-C CONVERTER – Use with V-51 Voltmeter to read AC. \$1200.

For more details, write to Dept. A-169, Cubic Corp., San Diego 11, Calif., or Cubic Europa S.p.A., Via Archimede 181, Rome, Italy.



INDUSTRIAL DIVISION
SAN DIEGO 11, CALIFORNIA • ROME, ITALY

OTHER OFFICES AND REPRESENTATIVES IN PRINCIPAL U.S. AND CANADIAN CITIES

Watch carefully...
no sleeves...

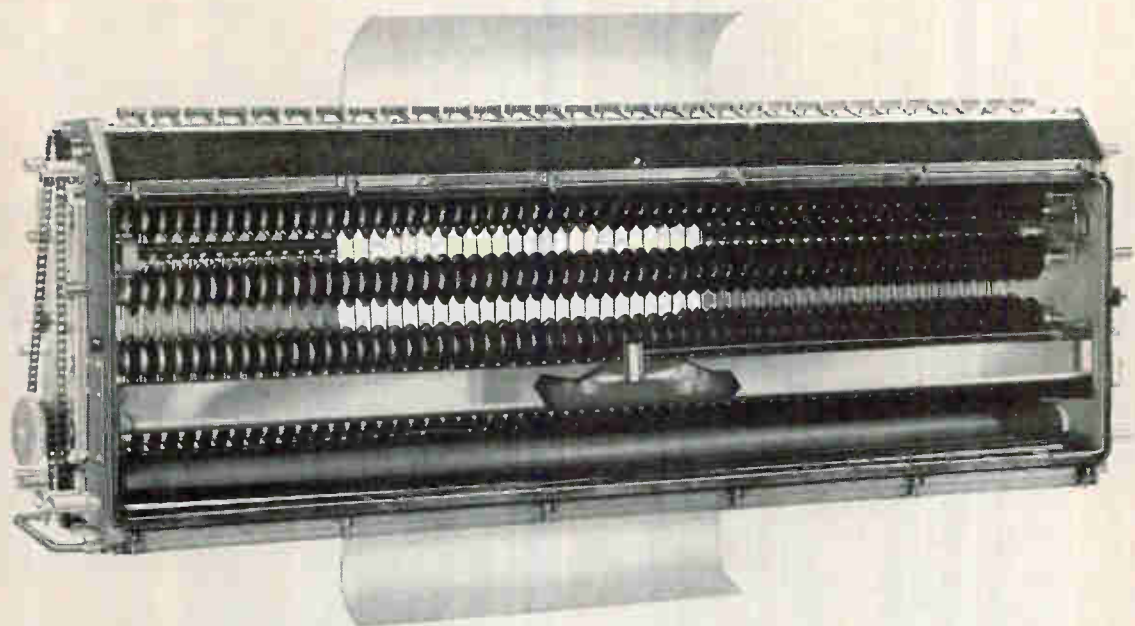

NOW OZALID GIVES YOU FRICTIONLESS, DUAL-SIDED, WHITEPRINT DEVELOPING IN ONE PASS!

The new Printmaster® 900 whiteprinter gives you an amazing OZALID exclusive; a revolutionary developer system with no sealing sleeve, no slip screen, no perforated rollers to clog. Sealing sleeve servicing and replacement are ended. Ammonia is saved.

One pass completely develops double-coated materials. Vapors permeate both sides of prints right down to the base. No under-developed images to fade or discolor. Power-driven discs guide prints straight through the heart of the developer. No print curl or buckle.

The 900's speed (to 75 fpm), hi-intensity 100 or 150 wpi lamp, balanced cooling and simplified speed control assure unparalleled reproduction versatility. Send coupon for full details.



Most machine for the money on the market! All these extras at no extra cost: lamp intensity control, instant reversing device, automatic exhaust timer, enclosed roll holders, automatic feed safety mechanism, instant-start variable speed control, remote ammonia supply attachments.

OZALID
WE REPEAT
OZALID

Division of General Aniline & Film Corporation

In Canada: Hughes-Owens Co., Ltd., Montreal.

OZALID, Dept. 187
Johnson City, New York
Send complete details on the
new PM 900.

NAME _____

FIRM _____

ADDRESS _____

CITY _____ ZONE _____ STATE _____

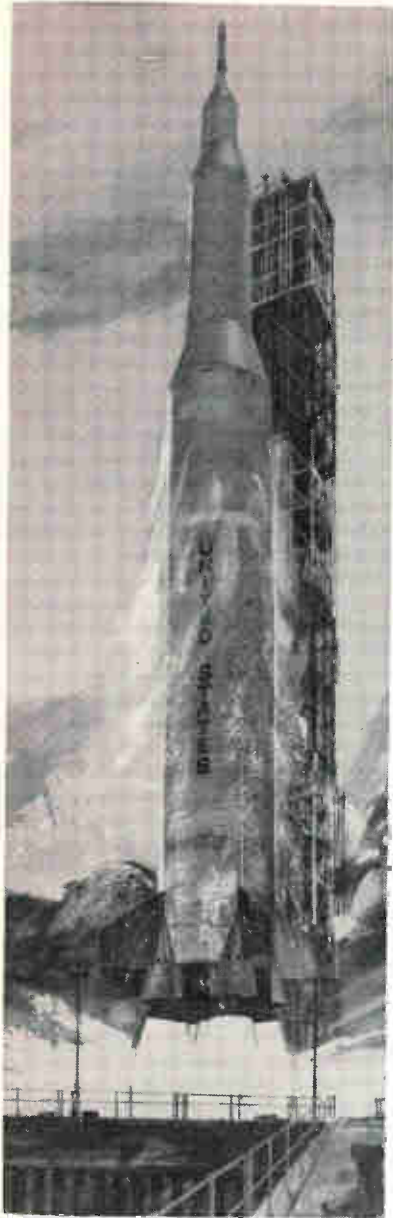

Saturn Launch Vehicle



Dyna-Soar Space Glider



U.S. Science Pavilion at Seattle World's Fair



Fly-casting on Skykomish River near Seattle



Beautiful homes line Seattle's 200 miles of shore

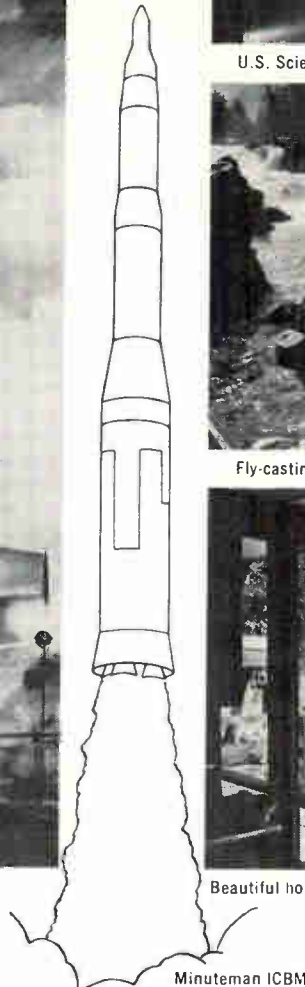

Minuteman ICBM

Advanced Boeing openings for Engineers and Scientists

You will find career excitement in many of the challenging programs at Boeing's Aero-Space Division. Some of these programs—the advanced Saturn S-IC first-stage booster, for example—are under the management of newly-formed divisional organizations that can offer you unique ground-floor opportunities.

Other openings with rapid-advancement potential are immediately available on the Dyna-Soar space glider program and the solid-fuel Minuteman ICBM. Assignments are available in many fields of activity, including Research and Development, Design, Manufacturing and Test.

In addition to professionally stimulating

careers, these Boeing openings can offer you—and your family—a wide variety of living advantages, including geographic locations such as the uncongested Pacific Northwest, Florida resort areas and historic New Orleans.

Salaries are commensurate with education and experience. Minimum requirements are a B.S. degree in any applicable scientific discipline. Boeing pays moving and travel allowances to newly-hired engineers.

Send your resume today to Mr. Lawrence W. Blakeley, The Boeing Company, P. O. Box 3822, ECO, Seattle 24, Washington. Boeing is an equal opportunity employer.

Assignments are available for:

- Structures Engineers
- Electronic/Electrical Engineers
- Mechanical Engineers
- Industrial Engineers
- Manufacturing Engineers
- Propulsion Engineers
- Aeronautical Engineers
- Cryogenicists
- Base Installation Engineers
- Physicists
- Mathematicians

BOEING

Divisions: Military Aircraft Systems • Transport • Vertol • AERO-SPACE • Industrial Products—Boeing Scientific Research Laboratories

**MODEL CFI
TRANSISTORIZED
CALIBRATED
MICROWAVE
FIELD-INTENSITY
(RI/FI) METER
—1,000 to 10,000 MC.**



Category A Air-Force Approval For MIL-I-26600 and MIL-I-6181. Transistorized, portable, compact, ruggedized.

Combines an impulse calibrator, field-intensity meter, and calibrated antenna system. Provides accurate measurements of the frequency and the absolute power level of conducted or radiated microwave energy. Choice of 12V battery or line-power operation.

FEATURES: UNIDIAL® tuning; Direct-reading digital frequency dial; ±1% frequency accuracy; Choice of 3 impulse bandwidths — 1 MC, 5 MC, wide band; Direct reading output level, microvolts, db above 1 microvolt and db above 1 microvolt per MC; Image and spurious response rejection better than 60 db; Max. RF input, 3 volts. Audio, video, recorder outputs. AM, FM, CW, and Pulse Reception Capability. Four interchangeable plug-in tuning units cover 1,000 - 2,040; 1,900 - 4,340; 4,200 - 7,740; and 7,300 - 10,000 MC.

**MODEL FIM-2
CALIBRATED
MICROWAVE
FIELD-INTENSITY
(RI/FI) METER
—1,000 to 10,000 MC
(Extension to 21,000 MC
nearing completion)**



Category A Air-Force Final Approval For MIL-I-26600 and MIL-I-6181. Widest frequency range ever offered in a microwave RI/FI meter!

Combines internal CW signal generator, field-intensity meter, and calibrated antenna system. Provides accurate absolute power level and frequency measurements. The signal level indication is in microvolts, db above 1 microvolt, and db above 1 microvolt per MC.

- Only microwave Field Intensity Receiver with self-contained CW signal generator which calibrates entire system under test at any level.
- First single microwave test system to determine radiated r-f interference and susceptibility.
- Front-panel meter directly reads average, peak, slide-back peak or quasi-peak value of r-f signals.
- Six interchangeable tuning heads cover 1,000 to 21,000 mc.
- Outputs for video, audio and recorder.
- Single UNIDIAL® tuning control simultaneously tunes the receiver and signal generator.
- Calibrated antenna system includes an omni-directional broadband antenna and separate directional antennas to match each tuning unit.
- Frequency Dial Accuracy: ±1%.
- Maximum RF Input: 3 volts
- Sensitivity: -81 dbm minimum
- Impulse Bandwidth: 5 mc
- Image and Spurious Response Rejection: Better than 60 db
- Attenuation: 0 to 80 db in steps of 1 db

HAVE YOU MADE RESERVATIONS YET?



Polarad's new "Project Mohammed" will be bringing the "Mountain" (our new Mobile Microwave Calibration Laboratory) to "Mohammed" (your microwave instruments) starting next month. Be sure to take advantage of this opportunity to have your gear checked — at your doorstep. Save weeks of delay and needless expense. Call your Polarad field engineer for details and schedules!

How To Select An RI/FI Meter

In noise-and-field-intensity measurement, Polarad has three major competitors. They are all competent. They build good equipment. Give or take an adjective, they describe and rate their equipment accurately. We respect their designs, their equipment, and their integrity as manufacturers. We believe they return that respect.

As an engineer, you know that no two design groups ever produce exactly the same instrument for a specific purpose. Experience and backgrounds differ. Approaches differ. Even basic concepts differ. Then, too, each group has its own view of the needs of the user. In a complex design, one approach will favor sensitivity over bandwidth, or, perhaps, cost over durability. We all must draw the line somewhere, in reaching each design decision. In an RI/FI meter, there are dozens of such decisions. The final "mix" of characteristics is, at best, an intelligent compromise . . . never the ultimate.

We believe that the two instruments described on this page represent by far the best "mix" of performance, economy, and versatility for the majority of applications.

You don't buy an RI/FI meter every day. Once you buy it, however, you may use it every day, for many years. Therefore, we urge you to consider the "mix" carefully. Limited range or restricted utility may seem tolerable now, but what about next month, or next year? Initial cost may dominate your thinking now, but how much does an extra man-hour a day (or one questionable result a week) cost . . . over five years?

Consider the "mix". We think you'll choose Polarad.

We can't resist listing the outstanding features of our "mixes", below — but don't decide until you have the complete technical data in front of you.

Call your Polarad Field Engineer.

- CFI "mix"**
- Portable, Rugged, Compact
 - Battery and AC Operation
 - Direct Reading without Charts
 - Directly Calibrated Long-Life Impulse Calibrator
 - Digital Frequency Display
 - -85 dbm Minimum Sensitivity
 - 70 db Dynamic Range
 - Standard Calibrated Horn Antennas
 - Air Force Approved

- FIM-2 "mix"**
- Integral CW Generator for Accurate Calibration & Direct Substitution Measurements
 - Separate Generator Output for Susceptibility Measurements
 - Direct Reading without Charts
 - -81 dbm Minimum Sensitivity
 - Standard Calibrated Horn Antennas
 - Air Force Approved

Which one is just right for you?

POLARAD

Polarad Electronics Corporation

World Leader in
Microwave Instrumentation
43-20 34th Street
Long Island City 1, New York

TECHNICIANS:

One estimate: less than one technician for each engineer

IS THERE a critical shortage of electronics technicians?

That there is a shortage of electronics technicians is generally acknowledged by key personnel in manufacturing, research groups and technical institutes.

Some employers think that the shortage has already become critical. So does Congressman John Brademas, sponsor of the proposed Technical Education Act.

Good electronics technicians are reported to be in extra-short supply in areas with a concentration of electronics manufacturing and re-

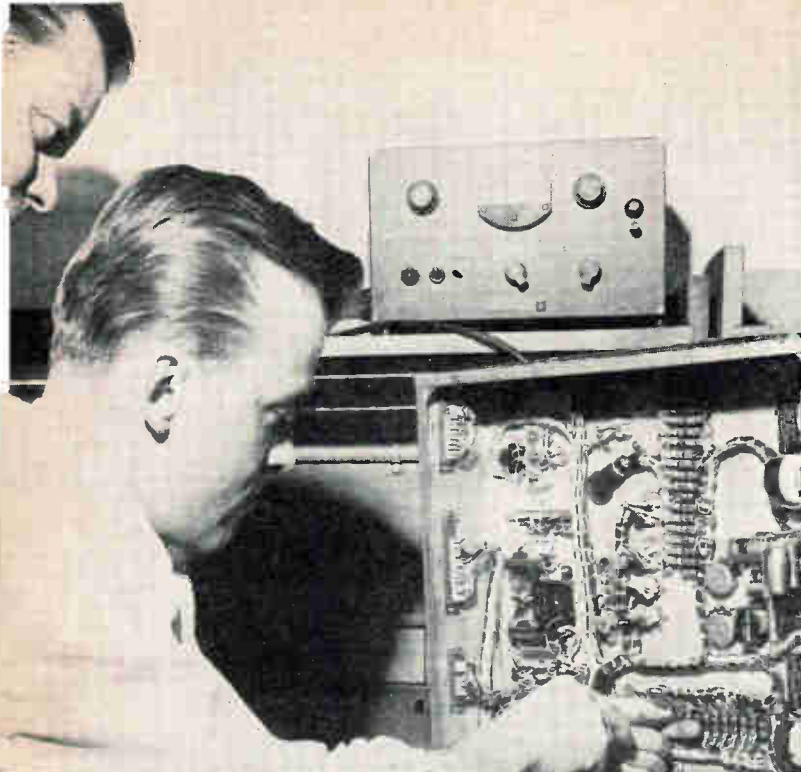

TECHNICIAN TRAINING programs are sponsored by most large electronics companies. Here, at the Kollsman training center, instruction is given in assembly skills

Radar Airborne, Viewers on Ground

System installed in light plane transmits image to field set

SIDE-LOOKING RADAR set that will transmit radar images from a light plane to the ground is being built for the Army by Motorola's Military Electronics division.

The radar, Motorola says, is of a type the Army has long wanted for limited warfare operation. It is the result of four years of R&D by the company, working with Army Signal Research and Development Laboratory.

Motorola has two contracts. One, for \$7½ million, is for models of the AN/APS-94 radar, which is one segment of AN/UPD-2, the overall airborne radar surveillance system. A support contract, \$3½ million, is for test equipment, spare parts and modules for the data transfer portion of the system and for spare radar units.

AN/UPD-2 is comprised of the

AN/APS-94 airborne unit, a recorder-processor-viewer and a data transfer system which sends the image to ground for real-time viewing.

The data transfer portion includes the AN/AKT-16 airborne radar data transmitting set and the AN/TKQ-1 radar data receiving and viewing set.

AIRBORNE PORTION of system is checked out in Army Mohawk aircraft and data receiving set is tested atop 10,000-foot-high peak in Arizona



There Aren't Enough to Meet Industry's Needs

search, especially Massachusetts, New York and California. The only parts of the country reporting an adequate supply of technicians are areas that are sparsely populated and that have a minimum of industry.

STATISTICS—Exact statistics on the supply of technicians are not available.

Government figures do not treat electronics as a specific industry and do not report many field personnel, such as tech reps. Many electronics technicians that work under nonelectronics job titles, such as plant electricians, are also excluded from official tallies. Moreover, electronics technicians with the armed services or those employed by government agencies are not reported in most overall figures.

One estimate, based on the government figures, is that the number of electronics technicians in the United States and at U. S. facilities around the world totals just under 100,000—including those in non-electronics industries.

Within the electronics industry, according to another estimate, there are only seven electronics technicians for every 10 graduate engineers—a ratio two or three times lower than what the industry in general thinks is desirable.

The overall number of technicians is rising, but the ratio of technicians to engineers is decreasing. Although general employment in the electronics industry is increasing rapidly, the number of persons graduating from technical schools and institutes is declining at about 11 percent a year, and many electronics technicians are moving up to fill engineering positions.

By comparison, the USSR is reported to have some 220,000 electronics technicians and a ratio of three to five technicians for each graduate engineer. The Soviets' semiprofessional graduation rate is increasing by 14 percent a year.

IMPACT ON INDUSTRY—Research and development organizations report the greatest need for

electronics technicians.

Since R&D usually requires technicians with fairly good theoretical education and experience, the shortage often forces the use of graduate engineers in positions that could be filled by technicians. This causes some job dissatisfaction and diverts into supporting functions men needed as engineers.

The lack of technical manpower is reported to influence many phases of our industry. For example, it is said to hinder the adoption of industrial electronics equipment because many potential users fear inadequate maintenance. Some firms are afraid that they will not derive full benefit from equipment in the field.

Government agencies find themselves competing—often at a disadvantage in salary levels—with private industry for technicians. An official of one national laboratory remarked that he sometimes feels he is running a training school for pulse technicians in his area.

LEGISLATION—A Technical Education Act (HR 10396) has been sponsored in the House of Representatives by Rep. Brademas (D.-Ind.). But so far, one investigative session has been held (in August) and the date for further discussion is indefinite. The bill's future hangs on the administration's entire educational program.

The bill would aid states to make inventories of engineering, scientific and technical education programs. Funds would be provided for surveying requirements for technicians, developing state plans for the expansion, establishment and improvement of technical education programs, and for assisting in these plans.

The bill would make \$2 million available for state investigations approved by the U. S. Commissioner of Education and provide another \$40 million a year for five fiscal years to get technical education programs under way.

TRAINING—There are now about 50 technical schools and institutes

at which a technician can obtain basic electronics background up to a semiprofessional level. These schools usually require a high-school diploma and a knowledge of algebra, geometry and physics. Courses commonly take from 6 to 30 months, depending on scope and technical level. Most schools help graduates get a job.

Most of the larger electronics companies have in-plant training programs to break in new technicians. These supplement technical school training. Many firms share the tuition expenses of employees studying for an engineering degree. Labor unions, such as the IBEW, also offer technician training programs.

Salaries for electronics technicians vary between \$60 and \$145 a week, depending on education and experience. Men who have received training in military service or have amateur radio experience can often compete with technical institute graduates for employment as technicians.

Three-Hop Tv Relay Uses Three Different Frequencies

MICROWAVE relay that uses a different frequency for each of its three hops has been installed by RCA between KRCA, Los Angeles, and KOGO-TV, San Diego. The system uses frequencies in the 2 Gc, 7 Gc and 13 Gc bands to offset adverse signal conditions in the intercity path.

Outbound from Los Angeles, 13 Gc is used for 17 miles to Mt. Wilson, to avoid congestion at 7 Gc in the area. Next, a repeater relays the tv signal for 108 miles, of which 40 miles is over water. This leg uses 2 Gc to overcome signal propagation characteristics created by the distance spanned and by surface reflections from the water.

At Mt. Soledad, 12 miles from San Diego, the incoming signal is further reinforced through the use of space diversity. The station uses 19-foot and 10-foot dishes. The final leg is at 7 Gc.

NEC'S NEW HOME, McCormick Place, on Chicago's lakefront. More than 500 manufacturers will exhibit products here next week

Universities to outline R&D that can stimulate electronics in Midwest

NATIONAL ELECTRONICS CONFERENCE: Forum for Industry-Education Cooperation

By CLETUS M. WILEY
Midwest Editor

CHICAGO—Greater cooperation between industry and education, to foster electronics progress in the Midwest, will be stressed at the National Electronics Conference next week.

This year's NEC—the 18th—will be held in the new McCormick Place hall. More than 18,000 engi-

neers are expected to attend, a gain of 20 percent over last year's attendance. There will be 39 technical sessions and 125 papers presented.

The hall will contain more than 500 manufacturers' exhibits. New products seminars in a special area—a first this year—will help manufacturers introduce developments.

CONFERENCE GOALS—Goals of this year's conference will be to

show how area universities can stimulate the expansion of Midwest electronics and to develop a sharper awareness by industry of the services that universities and government agencies can contribute.

Ten universities will outline their most important R&D activities during two special sessions. Universities will also display their new developments. At a third session, industry spokesmen will point out special needs.

Luncheon speakers are expected to shed light on why the Midwest has been getting a proportionally lower share of advanced electronics work (see *ELECTRONICS*, p 33, March 30, and p 8, Aug. 3).

The speaker on Monday will be Governor Otto Kerner, who recently went with Chicago officials, scientists and educators to Washington to impress legislators and the administration with the Midwest's importance as an electronics center. The speaker on Tuesday will be Henry Heald, Ford Foundation director, long an advocate of cooperation between education and industry for technological progress. At the windup luncheon on Wednesday, Jerome Wiesner, special scientific advisor to the President, is expected to enlarge on "intellectual vacuum" aspects of the Midwest in explaining why it hasn't

Reactor Powers Mountaintop Radar



AIR FORCE last week dedicated nuclear power plant for the Sage radar (left) at Sundance, Wyo. In the next two years, it will provide 1 megawatt of power, equivalent to output of 2 million gallons of diesel oil. The plant, built by the Martin Co., can be monitored by one man at the control-console (right). It was airlifted and trucked in sections to the site.

won its share of government electronics research.

SESSIONS—Advanced technical sessions (see p 29, this week) will discuss such topics as energy beams as working tools, infrared applications, hydrospace, aerospace and navigational electronics, and medical electronics.

A unique preview session will provide 10-minute presentations of developments breaking too late for inclusion in the regular program. Reports will include an instrument for studies of repetitive, pseudo-transient signals such as speech, from the University of Illinois, research at Purdue on automata and artificial intelligence, computer simulation at Marquette of the human respiratory system, and Zenith's d-c pulse defibrillator.

About a third of the sessions will be tutorial. In addition, there will be workshops, demonstrations and technical sessions especially designed for students, including a day-long computer course, microwave and satellite communications and microwatt control of megawatt systems.

Among panel discussion topics are satellite and space astronomy projects, university assistance available to industry, implications of the European Common Market, reliability, and the consultant's role in R&D. One panel, including Patrick Haggerty, of Texas Instruments, W. R. Hewlett, of Hewlett-Packard, and John Haanstra, of IBM, will discuss the role of R&D in future profits.

All-Electronic Telephone Exchange Put in Service

COMPLETELY electronic telephone exchange has been put in operation in Yonkers, N.Y., by a subsidiary of the General Telephone Corp. The exchange, made by General Dynamics Communications, can provide extended service for up to 100 subscribers.

The exchange employs time-division multiplexing to transmit 100 conversations on one channel. General Dynamics has previously used this complexing principle in other systems.

New Pulse Transformer Assortment Facilitates "Bread-Board" Designs



The 100Z41 Pulse Transformer Assortment offers the circuit designer a versatile selection of miniature pre-molded pulse transformers. Developed by the Sprague Electric Company, this experimental assortment is suitable for a wide range of requirements and designs in either electron-tube or transistorized circuitry.

Provides 58 Combinations

This assortment contains 12 specially-selected type 32Z miniature pulse transformers which permit 58 turns-ratio and primary inductance combinations. With proper choice of terminal windings and connections, these transformers provide primary inductances ranging from 160 microhenries to 43 millihenries, and turns-ratios from 1:5 step-up to 6:1 step-down.

Permits Frequent Re-Use

The potted, pre-molded case construction of these pulse transformers facilitates bread-board wiring and permits frequent re-use.

The assortment is packaged in a clear, hinged-lid plastic case, complete with simple instructions. A printed table inside the lid indicates all turns-ratios, inductances, windings, and connections.

Specific Designs Available

When the required transformer characteristics are determined, production quantities to exact requirements can be easily obtained from Sprague's broad line of hermetically sealed or encapsulated pulse transformers.

For fast delivery or additional information on the 100Z41 Pulse Transformer Assortment, contact the nearest Sprague Products Co. Industrial Distributor, or write Sprague Electric Company, 35 Marshall Street, North Adams, Massachusetts.

411-470

When You Need ELECTRIC WAVE FILTERS Depend on Sprague for

✓ SERVICE
✓ DELIVERY
✓ RELIABILITY



Sprague Electric Wave Filters for use in telemetry, telephony, and various types of communications systems and laboratory equipment which require selection and/or rejection of specific frequencies are now being designed by *Modern Network Synthesis*, which assures exact matching of wave filter characteristics to application requirements for Low Pass, High Pass, Band Pass, and Band Rejection filters.



Drawing on Sprague's long experience in component manufacture, wave filter engineers are able to employ capacitor, inductor and resistor production facilities for particular sizes, shapes, and materials best suited for specific filter applications. Unlike most filter manufacturers, Sprague is not dependent upon other component suppliers, therefore faster deliveries can be provided.



To further Sprague capabilities, wave filter design and field engineering offices as well as pilot production facilities are maintained in North Adams, Mass.; Vandalia, Ohio; and Los Angeles, Calif. Specialized mass production facilities are located at Visalia, Calif. and North Adams.

For additional information on Sprague Electric Wave Filters, write for Engineering Bulletin 46000 to Technical Literature Section, Sprague Electric Company, 35 Marshall Street, North Adams, Massachusetts.



45-444



COLLAPSIBLE HUTS house electronic equipment. These two huts are part of a test installation at Watertown, N. Y.

Air Battle System Going Operational

Limited war version of Sage being installed at two Air Force bases

INSTALLATIONS of the Air Force's Air Weapons Control System 412 L are now underway at Myrtle Air Force Base, S. C., and Seymour-Johnson AFB, N. C. Installations are scheduled for a number of permanently hardened facilities in Western Europe. The system will also be used in the Pacific and by the Tactical Air Command.

Unlike Sage, the 412 L system is automatic rather than semiautomatic and is mobile. Designed to direct air battles during limited wars, it can be transported and set up within four hours of arrival at

a new site. Off-the-shelf modules will provide for hurried assembly. General Electric is the systems engineer.

Some \$150 million has reportedly been invested in the system since its inception more than three years ago (ELECTRONICS, p 29, April 17, 1959). The system, designed for use with existing radars and with radars now under development, consists of four subsystems: data acquisition, data subsystem and display, communications, and an ancillary system including power, grounding and other equipment.

Two operational test installations have been set up at Watertown and Verona, N. Y. The first tracking runs earlier this year showed that the system met performance requirements, GE said.

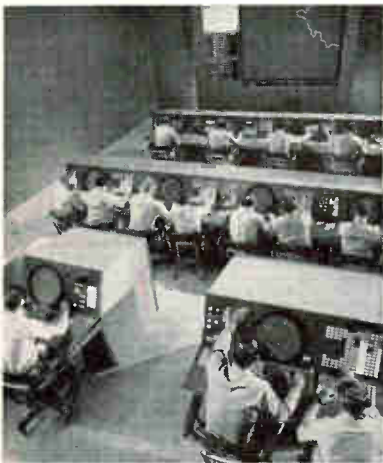

COMMAND POST. These prototypes and models are used for training personnel



TECHNICIAN checks out 412 L system using control panel inside collapsible hut

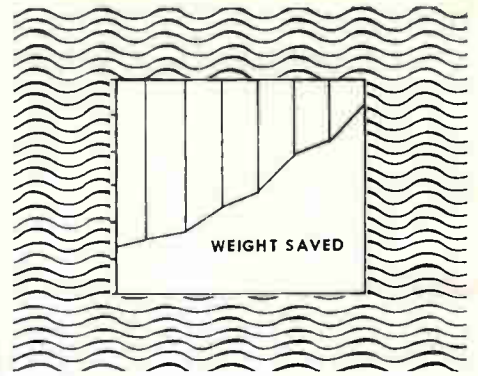

**lightest...
by far**

WEIGHT SAVINGS

Weight is costly, whether you are shipping a car from Europe to the U.S. by sea or a package of highly sensitive instruments around the world by space. Wire and cable components in sophisticated design often get left until the last and are simply a "necessary evil" to complete circuitry. Suddenly weight and size become important and Raychem Corporation is often called upon to consult in these matters.

The weight comparison is based upon Rayolin N and Teflon insulated wires of exactly the same diameters as detailed in MIL-W-16878D/NAS 703. The difference lies in the selection of base polymers used in the construction of these high temperature insulated wires. The fluorocarbon resins, with a specific gravity of 2.2, are approximately twice the weight of irradiated, modified polyolefin systems, (specific gravity 1.1).



**RAYCHEM
CORPORATION**

CIRCLE 33

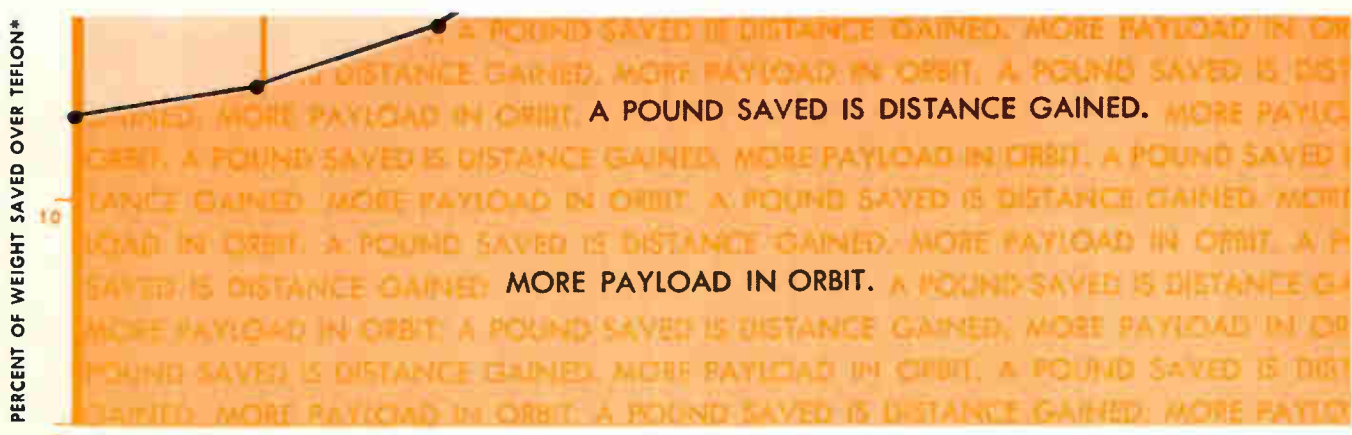
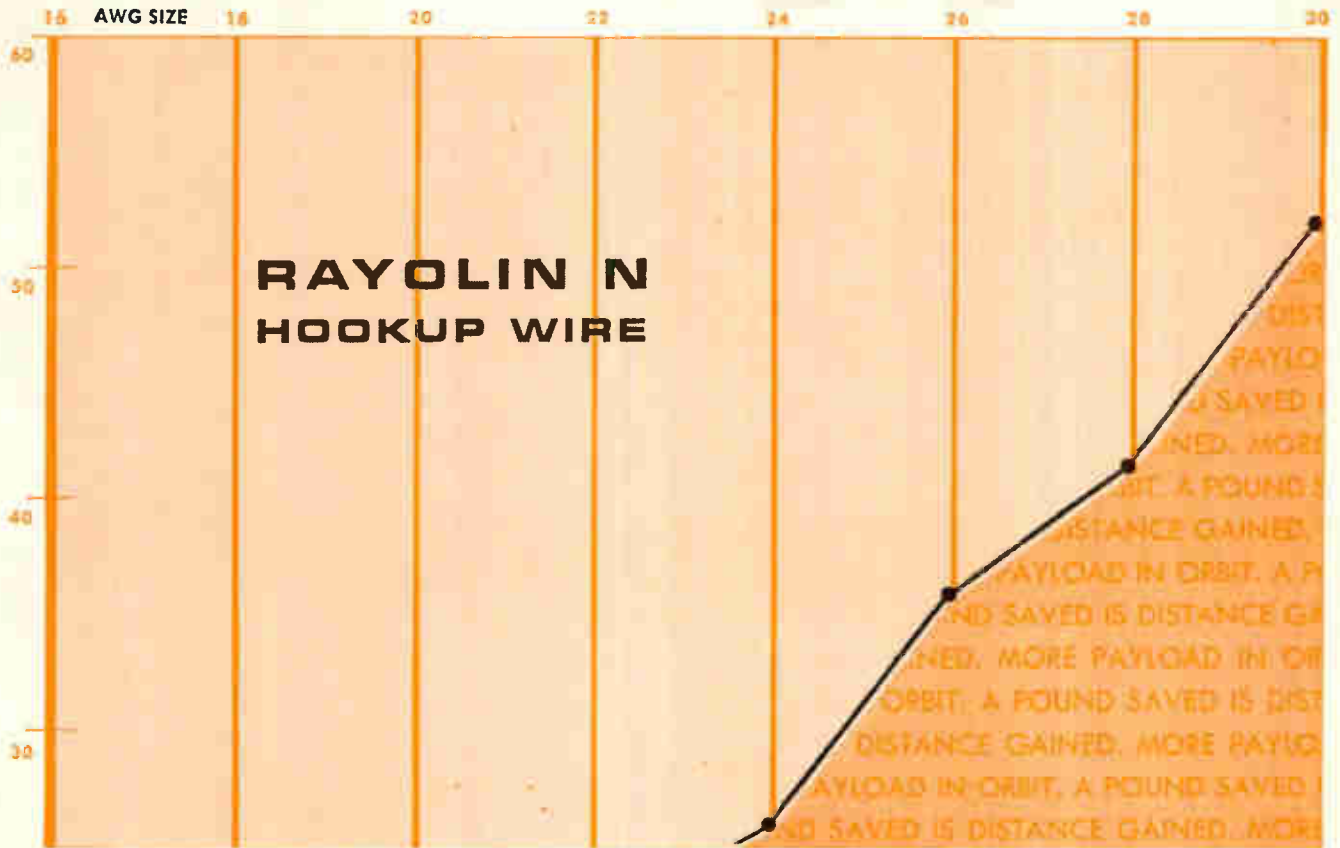

exc
at E.
Indepe.
dial offic
namics/Telc
provide una
to 2,500 subsi
The system
multiplexing t
versations over
eral Dynamics
employed the multi,
in military switchbo.

lightest...by far

**ER IN RADIATION CHEMISTRY
LECTRONIC WIRE AND CABLE**



**RAYCHEM
CORPORATION**

The Big Switch in Power Supplies... TRYGON's New Half-Rack

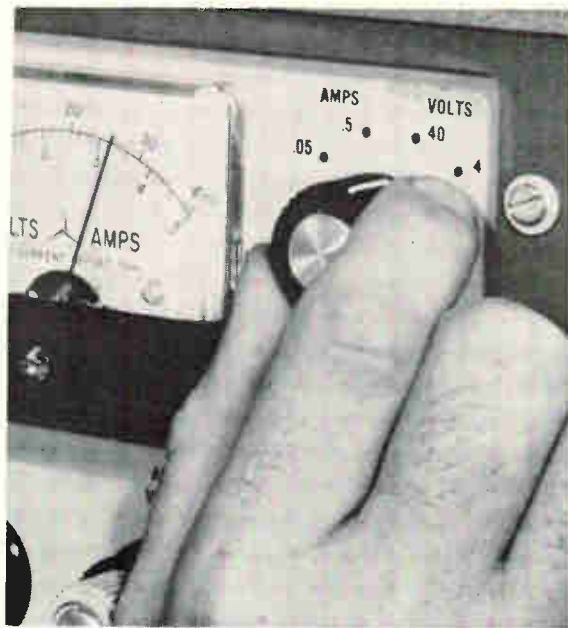

With Single Switch. Hi-Lo Meter Range

The single switch, providing Hi-Lo meter ranges from 0 to 4 or 0 to 40 volts, and 0 to 50 or 0 to 500 milliamps, is only one of the reasons why more and more users will recognize Trygon's new Half-Rack as tops among transistorized power supplies for performance and operational reliability. Here's a unit that proves itself time and again with such Trygon exclusives as hand-wired circuits, and remote sensing which automatically corrects the slightest variation in voltage at the load.

There are other exciting features too:

- Constant Voltage Operation with Adjustable Current Limiting
- Constant Current Operation with Adjustable Voltage Limiting
- Remote Programming and Remote Voltage Sensing
- Parallel and Series Operation
- Highest Quality: Lower Price than any comparable supply

Add all these up and it's easy to see why the big switch is to Trygon, for the ultimate in transistorized half-racks that deliver more performance in less space than any other similar units available.

Output:

Model HR40-500 0-40 VDC @ 0-500 ma
 Model HR20-1.5 0-20 VDC @ 0-1.5 Amp.

Ripple:

Model HR40-500 250 microvolts max. RMS
 Model HR20-1.5 500 microvolts max. RMS

Regulation:

Load 0.05% or 10 mv, NL to FL
 Line 0.01% or 2 mv, 105-125 VDC input

Recovery Time:

Better than 50 usec to recover within 10 mv for 100% step change in rated load

Stability:

0.05% or 10 mv for 8 hours after initial warm-up

Temperature Coefficient:

0.02%/°C

Price:

Model HR40-500 \$149.00
 Model HR20-1.5 \$159.00

Send today for complete details on the extensive Trygon line of transistorized D.C. Power Supplies.



Model HR40-500 (illustrated) and Model HR20-1.5 are available for rack or bench use.



TRYGON

ELECTRONICS, INC.

... THE TRUSTED SOURCE FOR TRANSISTORIZED POWER

111 Pleasant Ave., Roosevelt, L.I., N.Y. — 516-FR 8-2800

MEETINGS AHEAD

ELECTRICAL ENGINEERS FALL GENERAL MEETING, AIEE; Pick-Congress Hotel, Chicago, Oct. 7-12.

NATIONAL ELECTRONICS CONFERENCE, IRE, AIEE, et al; Exposition Hall, Chicago, Ill., Oct. 8-10.

AUDIO ENGINEERING SOCIETY ANNUAL FALL CONVENTION; New York, N. Y., Oct. 8-12.

AIR FORCE SCIENCE & ENGINEERING SYMPOSIUM, AF Systems Command and Office of Aerospace Research; Houston, Texas, Oct. 9-11.

MAGNETOHYDRODYNAMICS CONFERENCE, Michigan State University; at the University, East Lansing, Mich., Oct. 10-11.

AEROSPACE ELECTRICAL/ELECTRONICS EQUIPMENT & SYSTEMS DISPLAY, Aerospace Electrical Society; Pan Pacific Auditorium, Los Angeles, Oct. 10-12.

URSI-IRE FALL MEETING, URSI, IRE-PGAP, et al; Ottawa, Canada, Oct. 15-17.

SPACE PHENOMENA & MEASUREMENTS SYMPOSIUM, IRE; Statler-Hilton Hotel, Detroit, Mich., Oct. 15-18.

INSTRUMENT-AUTOMATION CONFERENCE AND EXHIBIT, Instrument Society of America; Coliseum, New York City, Oct. 15-19.

ELECTRONIC RELIABILITY CONFERENCE, IRE PGRQC, PEP, CP; Stevens Instit. of Tech., Hoboken, N. J., Oct. 19.

MOTION PICTURE AND TELEVISION ENGINEERS Convention and Equipment Exhibit; Drake Hotel, Chicago, Oct. 21-26.

AEROSPACE & NAVIGATION ELECTRONICS EAST COAST CONF., IRE-PGANE; Baltimore, Md., Oct. 22-24.

NORTHEAST RESEARCH AND ENGINEERING MEETING, IRE; Somerset Hotel and Commonwealth Armory, Boston, Mass., Nov. 5-7.

IEEE INTERNATIONAL CONVENTION, Institute of Electrical and Electronic Engineers; Coliseum and Waldorf-Astoria Hotel, New York, N. Y., March 25-28.

ADVANCE REPORT

ELECTRONIC COMPONENTS CONFERENCE, AIEE, EIA, IRE; Washington, D. C., May 7-9, 1964. Nov. 1 is the deadline for submitting a 500 word summary to: Chief, Bureau of Ships, Department of the Navy, Washington, 25, D.C. Attn: Code 681A2C (E. J. Kaputa). Papers will cover new development in components, component processing techniques, component evaluation, and component materials. Areas of interest include: capacitors, space environments and effects; connectors, connections, and interconnections; protective devices; inductors and transformers; insulating materials for components; microwave parts; microminiaturization printed wiring; reliability and testing techniques; relays and switches; resistors and potentiometers; filters and delay lines; conductors and cables.

MORE VERSATILE THAN EVER

"SPEEDIVAC"

MULTIPLE VAPOR SOURCE



VACUUM COATING UNIT

Following are listed some of the special features supplied as standard fittings in the EDWARDS 19E6 evaporator.

Stainless Steel Bell Jar, Viton Gasketing, Six Position Vapor Source, Substrate Heater, Motor Driven Rotary Substrate Holder, Glow Discharge Cleaning, Ultimate Vacuum with LN^2 trap 2×10^{-7} Torr.

Fast reliable pump downs are, of course, a feature of all EDWARDS evaporators.

Write for your free technical reprints, written by members of our research staff on "Thin Films and Ultra High Vacuum Techniques."



MICRO-CIRCUIT JIG AND MASK CHANGER

The micro-circuit jig is complete with a six-position vapor source, enabling six 2" square substrates to be coated with six different materials using six different masks.

The jig is also provided with two substrate heaters, one to preheat the substrate to 150°C. and the second to raise the temperature of the substrate in the evaporation position to 300°C. Resistance monitor pick-up points are provided and separate resistance monitor and automatic source shutter can be provided.

Standard EDWARDS patented glow discharge cleaning rings are supplied with the jig, along with the rotating six-position vapor source.

The accuracy of registration of each successive mask in contact with a given substrate is within ± 0.001 ".



ELECTRON BOMBARDED VAPOR SOURCE

Designed as an inexpensive vapor source for depositing thick films of material containing Ni, Fe or Co. The source is complete with a wire feed mechanism and handwheel assembly for continuous controlled evaporation by feeding wire to the vapor source from the handwheel mounted externally on the coating unit. A complete power supply to operate the source is also available complete with interlocks to the vacuum system.



MARK II MODULATED BEAM PHOTOMETER

The "Speedivac" Modulated Beam Photometer provides a method of controlling the optical thickness of films deposited by evaporation or sputtering by indicating the changing optical characteristics of the films as their thickness increases. The instrument measures the reflection from or the transmission through coated glass surfaces as a function of wavelength. Both these quantities can be measured alternately if two light sensing elements are used.



CRYOGENIC CIRCULATING UNIT

The unit has been designed primarily for use with the coil trap fitted to the 19E series evaporators. It provides continuous circulation of liquid gas with minimum loss.

The system consists of a liquid gas circulation pump with variable speed control and a 12 litre Dewar mounted on a mobile trolley. Valves are fitted for convenient introduction of a dry gas.

EDWARDS HIGH VACUUM INC. / 3279 GRAND ISLAND BLVD., GRAND ISLAND, N.Y.
MANUFACTURERS OF THE MOST COMPLETE LINE OF HIGH VACUUM COMPONENTS AND SYSTEMS

22 WAYS TO GET OHMS AT OHMITE

■ Like the proverbial iceberg, what shows here is only the smaller part of Ohmite's variety in MIL and commercial resistors. However, the 22 families illustrated do give some idea of scope, and incidentally, are a partial survey on the state of the art. As far as we know, Ohmite resistors form the largest selection available anywhere today—innumerable "specials", and thousands of standard units available from factory stock or distributors everywhere. This selection, combined with top engineering service, can provide unexcelled solutions to your procurement problems.

Write on Letterhead for Catalog and Engineering Manual 58

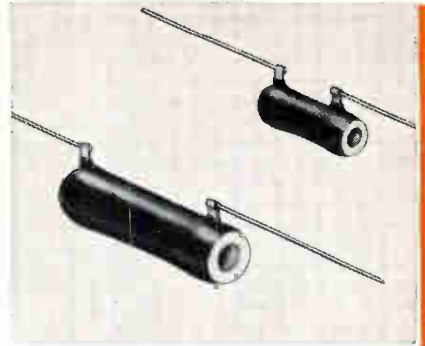

BROWN DEVIL®: Vitreous Enameled; Wire-Wound; 5, 10, 20 Watts

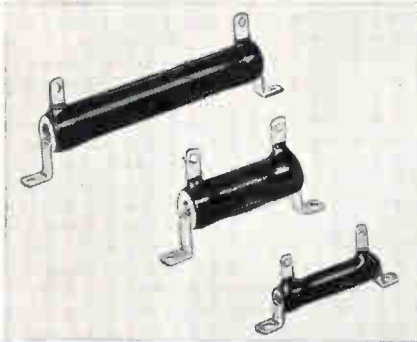

PRECISION, POWER: Wire-Wound; Vitreous Enameled; In Most Styles



HIGH CURRENT: Corrib®; Low Resistance; Up to 1500 Watts

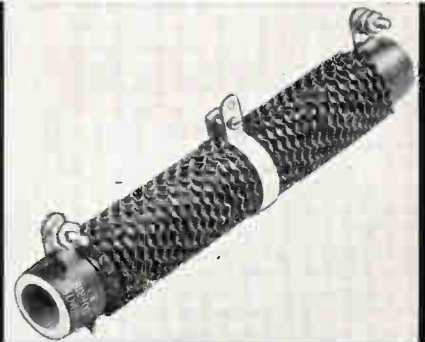

ADJUSTABLE HIGH CURRENT: Corrib®; Low Resistance

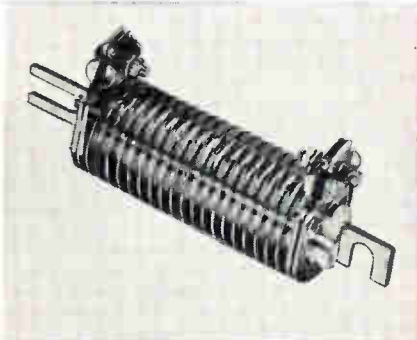

HIGH CURRENT: Powr-Rib®; Low Resistance; Up to 100 Amps

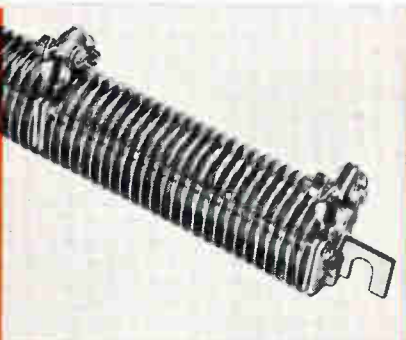

ADJUSTABLE HIGH CURRENT: Powr-Rib®; Low Resistance

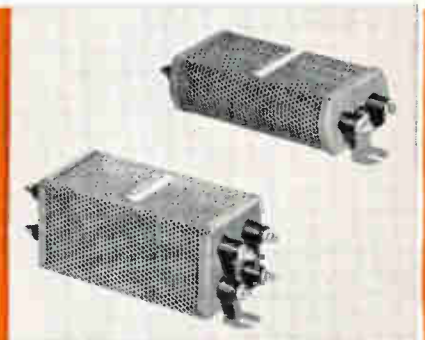

IN CAGES: Terminal Type, Line Voltage Reducer, and Others



NON-INDUCTIVE: Vitreous Enameled; Wire-Wound; 10, 50, 100, 160 Watts



FERRULE MOUNTING: Four Styles; Up to 200 Watts



EDISON SCREW BASE: Up to 215 Watts

WORLD'S LARGEST SELECTION

RHEOSTATS • POWER RESISTORS • PRECISION RESISTORS • VARIABLE TRANSFORMERS • TANTALUM CAPACITORS

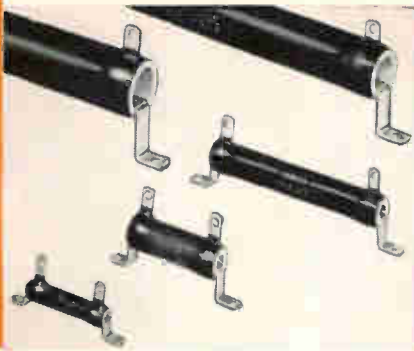

LUG TYPE: Vitreous Enameled; Wire-Wound; 10, 25, 50, 100, 160, 200 Watts

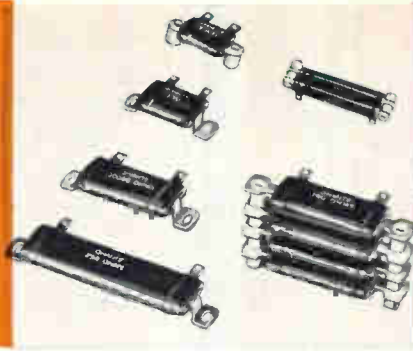

THIN TYPE: Vitreous Enameled; Wire-Wound; 10, 20, 30, 40, 55 Watts

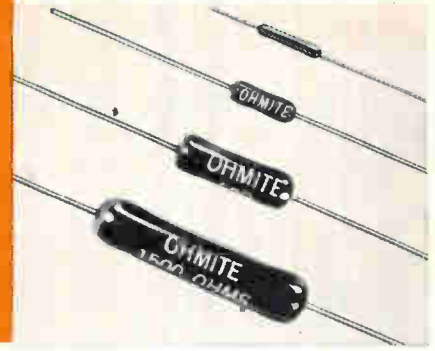

AXIAL LEAD: Vitreous Enameled; Wire-Wound; 1, 3, 5, 10 Watts

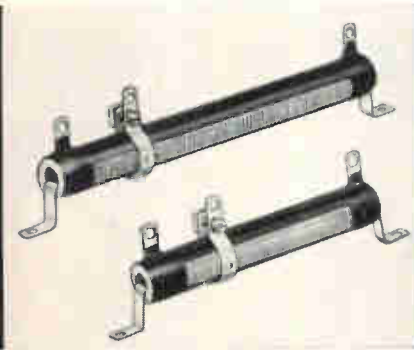

ADJUSTABLE: Dividohm®; Vitreous Enameled; Wire-Wound; 10, 25, 50, 75, 100, 160, 200 Watts

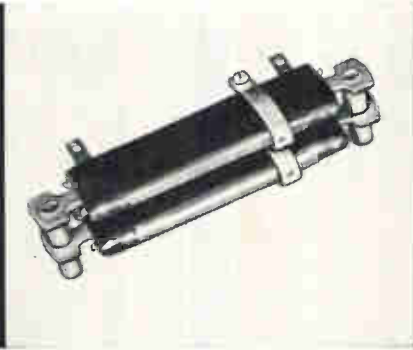

ADJUSTABLE THIN TYPE: Vitreous Enameled; Wire-Wound; 10, 20, 30, 40, 55 Watts



INSULATED: Wire-Wound; Molded; Precision Power; 1, 3, 5, 7, 10 Watts

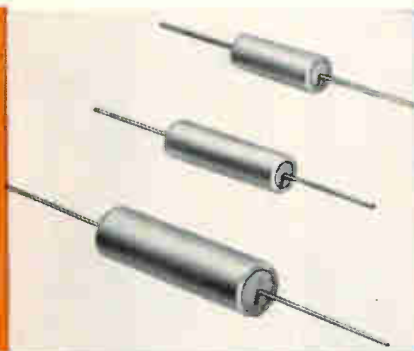

INSULATED: Tubeohm® Style; Wire-Wound in Sealed Ceramic Tube; 5, 10, 25 Watts



MIL-R-26C (FIXED): All Sizes; Tubular, Flat*, Axial Lead*, Insulated*, Ceramic Jacketed*
*Not illustrated

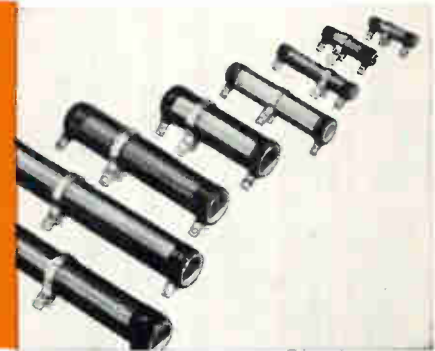

MIL-R-19365C (ADJUSTABLE): Wire-Wound; Vitreous Enameled; All Eight MIL Sizes

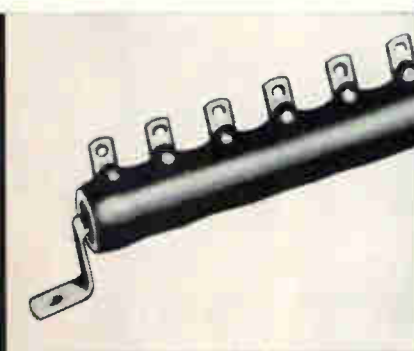

TAPPED: Available in Any Terminal Style or Combination



NON-TURN: Notched or Fluted Cores Prevent Turning on Brackets; Fixed, Adjustable, Tapped



PUSH-ON CONNECTOR TERMINALS: For Lug Type Resistors Up to 10 Amps Current Rating

OF RESISTORS

TAP SWITCHES • RELAYS • R.F. CHOKES • GERMANIUM DIODES

OHMITE

OHMITE MANUFACTURING COMPANY
3610 Howard Street, Skokie, Illinois



**Bell Laboratories—Designed
Western Electric—Made**

HIGH-SPEED SWITCHING DIODES

Bell Telephone Laboratories scientists and Western Electric engineers worked together as a team to develop and produce the USN 1N696 and USN 1N697 diffused silicon switching diodes. Both are ideal for high-speed computer applications and have proven their versatility in the guidance systems of Titan and Hercules.

USN 1N696 CHARACTERISTICS				USN 1N697 CHARACTERISTICS			
	Typical	Max.	Units		Typical	Max.	Units
t_{rr} ($I_F = I_R = 10$ mAdc)	1.5	5	nsec	t_{rr} ($I_F = I_R = 100$ mAdc)	27	100	nsec
C ($V_R = 0$)	2.7	4	pf	C ($V_R = 0$)	16	25	pf
I_S ($V_R = 20$ Vdc)	8.0	15	nAdc	BV ($I_R = 5$ uAdc)	214	120 (min)	Vdc
BV ($I_R = 5$ uAdc)	49	40 (min)	Vdc	V_F ($I_F = 400$ mAdc)	0.83	1.1	Vdc
V_F ($I_F = 10$ mAdc)	0.79	1	Vdc	I_S ($V_R = 100$ Vdc)	0.15	2.0	uAdc
Z_f ($I_F = 10$ mAdc)	16	40	Ω				
MAXIMUM RATINGS AT 25°C				MAXIMUM RATINGS AT 25°C			
Forward Current, Steady State		50 mAdc		Forward Current, Steady State		400 mAdc	
Power Dissipation		100 mw		Power Dissipation		400 mw	

The USN 1N696 and USN 1N697 are available in quantity from Western Electric's Laureldale Plant. For further information, price and delivery on these and other W.E.-Laureldale devices, write to Sales Dept., Room 102, Western Electric Co., Inc., Laureldale, Pa. Or call... Area Code 215-929-5811.

LAURELDALE PLANT
MAKER OF ELECTRON PRODUCTS



HALL EFFECT is used by magnetic compass. NEC Author Keller (right describes the compass, which is designed for undersea operation

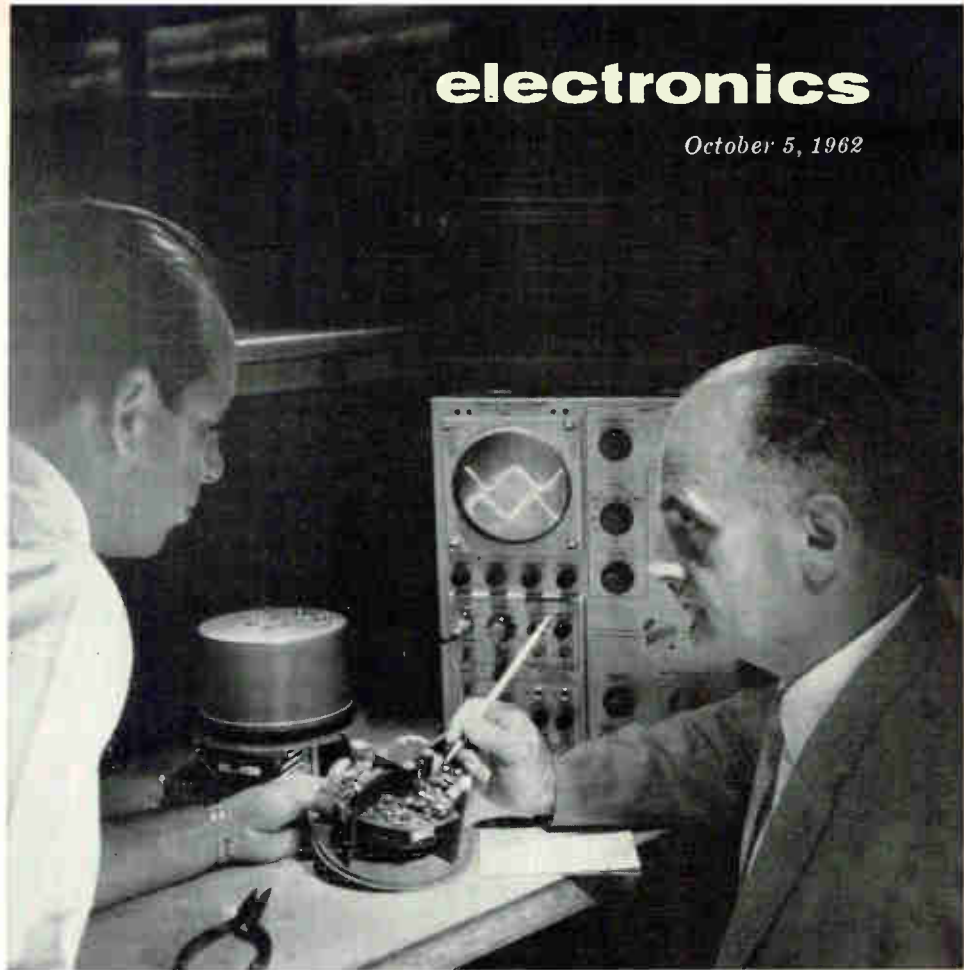

Laser welding, hydrospace electronics and microelectronics will be featured at next week's National Electronics Conference. Here are highlights of some of the most important papers that will be presented

TECHNICAL PREVIEW OF NEXT WEEK'S

National Electronics Conference

By **CLETUS M. WILEY**
Midwestern Editor

LASER fabricating tools, hydrospace electronics, infrared applications and a trend towards standardizing basic microelectronic functions are among the topics described in 125 papers that will be presented at the National Electronics Conference (Chicago, Oct. 8 to 10).

USING LASER BEAMS—Control of laser energy for welding, cutting and metal evaporation can be achieved by selection of an optical focusing system and adjustment of the laser-firing energy, according to Bahun and Engquist of Hughes.

Pulsed-output lasers, which deliver outputs ranging from about 100 w to 10^7 w, are useful for materials fabrication. Pink ruby has thus far delivered the highest power output of all laser materials. Active glasses such as neodymium-doped glass also show promise of being high-power lasing materials.

The laser system used in Hughes' experiments consisted of an 8,000-joule power supply, xenon flash-lamp, $7\frac{1}{2}$ inch long by $\frac{3}{8}$ inch diameter ruby rod with a fully silvered opaque end and an uncoated output end. Cooled by forced air at room temperature, the ruby had an output energy of six joules in a total pulse time of 1,300 μ sec. Focusing

the laser burst with a 4-cm focal length lens produced an energy density of about $2\frac{1}{2}$ million calories/cm².

Dramatizing the extreme care that must be exercised in joint preparation and fit-up for successful welding: steel samples vaporized deeper than expected, aluminum didn't melt as deeply and the melted zone of copper samples didn't even closely approach the expected depth.

Further research should be directed to optical focusing systems and surface absorption characteristics. Bahun and Enquist believe that lasers will be capable of achieving fusion temperatures in all

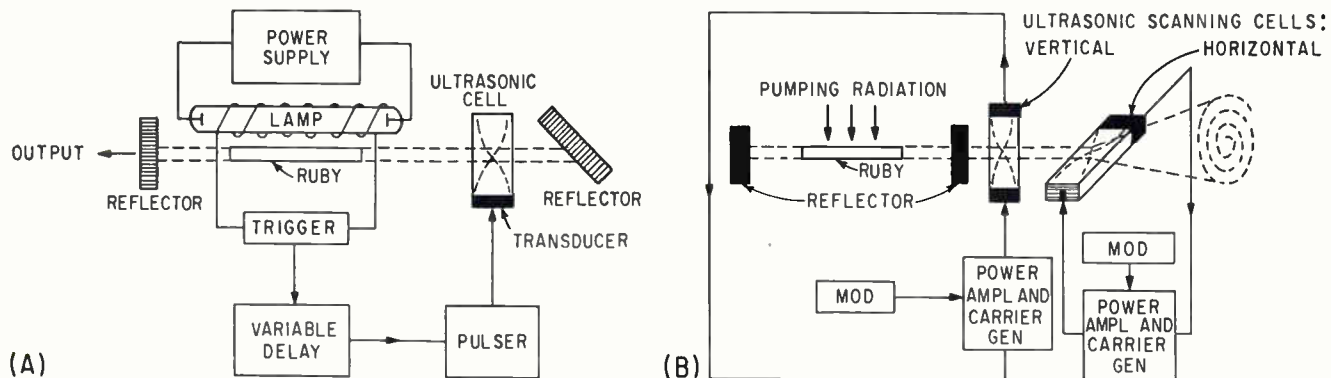

LASER CONTROL by ultrasonics. Ultrasonic energy acts as a shutter (A) to obtain a giant output pulse from the ruby laser; and ultrasonic energy moves the laser output beam in desired scanning pattern for machining (B)—Fig. 1

metals.

Advantages of laser tools include their ability to operate in almost any atmosphere—for example, external to a dry box or vacuum chamber with the laser beam focused through a glass port upon the workpiece—and accurate focusing by optical means to a small diameter spot. Lasers make it practical to machine small close-tolerance holes in metals and alloys that ordinarily possess poor machining characteristics.

Laser microwelding and cutting machines will probably be a complementary tool to electron-beam machines because the overall efficiency of an electron beam is better than 50 percent, compared to 2 percent, the best laser efficiency reported thus far.

ULTRASONIC CONTROL OF LASERS will be described by Schwarz and DeMaria of United Aircraft. When a light beam is passed through a medium acted on by an ultrasonic field, the alternating compressions and rarefactions of the medium produced by the ultrasonic field can cause diffraction, focusing and refraction of the light beam. Figure 1A shows a setup that uses the refraction effects produced by the ultrasonic cell to produce giant output pulses from the ruby laser. The cell is placed between the ruby and one of the end reflecting mirrors of the laser. This reflector is sufficiently off parallel with the other reflector to prevent normal lasing action. Thus, the ability of a pumping pulse from the lamp to increase the population of the upper-energy-level atoms is greatly enhanced since lasing action only begins when

the ultrasonic cell is pulsed. The ultrasonic field refracts the light from the ruby so that enough axially directed light goes back into the ruby to initiate laser action. The laser output pulses that are so generated have an estimated power of over 1 Mw, a rise time of less than 30 nsec and a pulse duration of 75 nsec.

Figure 1B shows a technique for using ultrasonics to control the direction of a laser beam. The two cells are perpendicular to each other. Driving the cells at identical carrier frequencies that are amplitude-modulated produces the spiral scanning action shown. Varying the power, frequencies and phases of the signals supplied to the cells would cause other complicated beam scans that could be used in complex drilling and welding.

HYDROSPACE ELECTRONICS—Small dimensions and rapid response time make Hall-effect compasses particularly well suited as azimuth-reference devices for remotely operating oceanographic instruments and undersea detection devices, according to Ernest Keller of Motorola.

Azimuthal reference will be essential for evaluation of telemetered data from research vessels that may use laser beams to explore the topography of ocean depths, from remote controlled prospecting devices or from miniature robot submarines.

Special-purpose asw instruments require fast reaction to small changes in direction of magnetic fields. They must deliver error-free bearings even while their instruments may be rotating several hundred rpm.

Motorola's compass, shown in the photo, uses two indium-arsenide Hall transducers inserted between four bat wing flux directors, forming an orthogonal detection system. The flux directors increase magnetic-flux density a hundred times. Thus the compass can detect a horizontal component of 0.01 gauss in high latitudes or 0.4 gauss near the magnetic equator.

Hall compasses also look promising for applications in unmanned space vehicles exploring weak magnetic fields of the moon or other planets.

An ultrasonic electronic image converter with possible applications in imaging deep-sea submarines will be discussed by Roy Whymark, Armour Research Foundation. The converter (Fig. 2) produces crt displays of sound fields. The image converter, which is pumped continuously, has a piezoelectric quartz detecting plate at one end of the evacuated metal tube. The sound field to be imaged is incident at the outside surface of the plate while the plate's inner surface is scanned by a beam of primary electrons. Secondary electrons scattered from the quartz are collected at a ring-shaped collector electrode close to the interior surface of the plate. The piezoelectricity of the quartz produces a potential distribution over the inner surface that is an exact replica of the incident sound-pressure distribution. Collector current varies with this distribution, since it is dependent upon the potential difference between the collector electrode and the inner quartz surface. The video signal from the collector is processed through conventional circuits to produce an

image on a cathode ray tube.

Clear visual images have been obtained of 10-mil diameter metal wires at 7-Mc ultrasonic frequencies. Replacing the quartz transducer with thick ceramic plates extends converter operation to the upper end of the sonar frequency spectrum.

An airborne bathythermograph system (Fig. 3) that collects and records the vertical distribution of ocean-water temperatures to a depth of 1,000 feet will be discussed by DeLombard, Gruner and Luempert, Sparton Electronics.

The expendable transmitting subsystem, housed in a standard sonobuoy case for launching from conventional dispensing apparatus, telemeters information to its launching aircraft. When the subsystem hits the water, a quarter-wave antenna is erected from the top of the transmitter buoy. The bottom plate falls free, releasing a sensing probe that dangles from a restraining cord for about 75 seconds, while sea-water batteries activate primary power and temperature-sensing thermistors reach equilibrium. After 75 seconds, the sensing probe starts a free-fall descent of 5 ft per sec and begins its audio modulation of the f-m transmitter in the buoy. The probe performs analog-to-analog conversions of temperature to an audio-frequency signal related to the temperature of the surrounding water. The one-volt audio output from the probe is carried over a two-conductor cable to the surface where it modulates a 160-170 Mc f-m carrier broadcast by the floating section. The transmitter, which radiates 250 mw, has a useful range of more than 25 miles.

Signals are received by a standard sonobuoy receiver equipment. Audio output is passed on to a signal data converter system that converts audio frequency to temperature, measures time elapsed from the onset of the audio signal and converts this information to indicate depth.

Reference information can be inserted into the tape by a telephone dial. The system requires only pre-selection of a radio channel and manual entry of auxiliary data.

INFRARED APPLICATIONS—
Infrared hotbox detectors—a major

UNIVERSITIES AND RESEARCH IN THE MIDWEST

The 1962 National Electronics Conference illustrates an increasing trend towards industry-university cooperation in the Midwest.

Of 125 papers to be presented at the NEC, 46 carry the byline of authors affiliated with a college or a lab operated by a college, and 25 of these colleges are in the Midwest.

Three sessions and a panel discussion have been allocated to symposia on the role of universities in the electronics industry

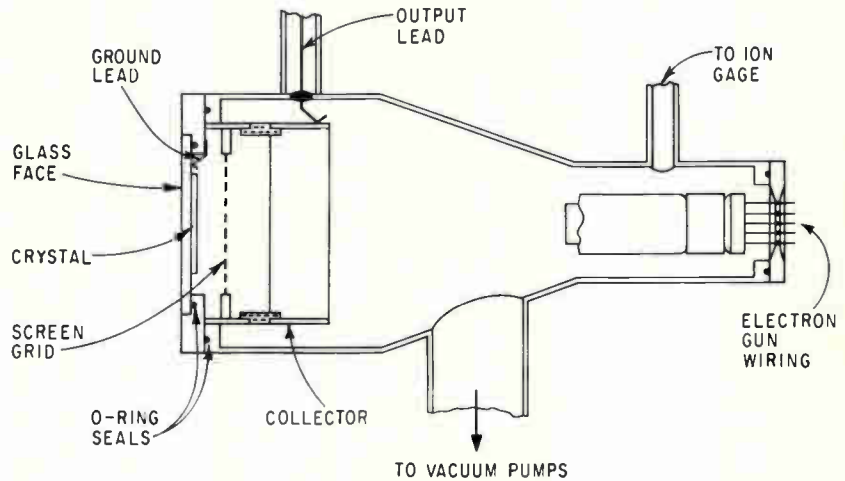

UNDERSEA IMAGE tube converts the pattern presented by ultrasonic energy impinging on tube's face to a picture of the undersea scene—Fig. 2

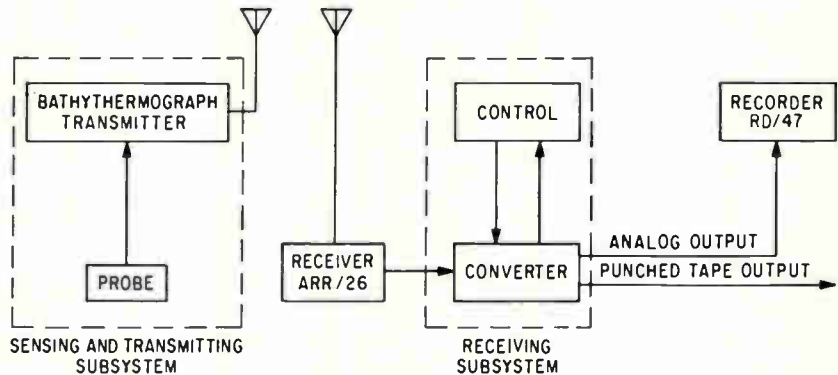

OCEANWATER TEMPERATURES are sensed and transmitted by subsystem at left to receiving subsystem, right—Fig. 3

commercial use of ir detection systems—are detecting overheated bearings on about 30 major American railroads, William Pelino, Servo Corporation will report. Over 400 hotbox detectors are now in use.

A hotbox detector consists of two scanners, one on each side of the track onboard at tie level but close to the rails. Each scanner is tilted 25 degrees to the horizon and toes in about 10 degrees toward the rails. The bottom of a freight car presents a quiescent background against which a heated journal may be measured. The ir optics include an arsenic trisulfide meniscus lens,

a thermistor bolometer cell and a preamplifier having a gain of about 200.

The 4-ms time constant of the gree. Approximately 1 in.² of the journal surface is projected onto a 1-mm² thermistor bolometer flake. This flake and another identical flake are arranged in a bridge.

The f-ms time constant of the (exposed) flake is adequate for the highest train speeds encountered.

The bolometer cell has a silver-chloride window coated with silver sulfide to cut off short wavelengths at about 2 microns. Since the arsenic lens cuts off at 12, transmis-

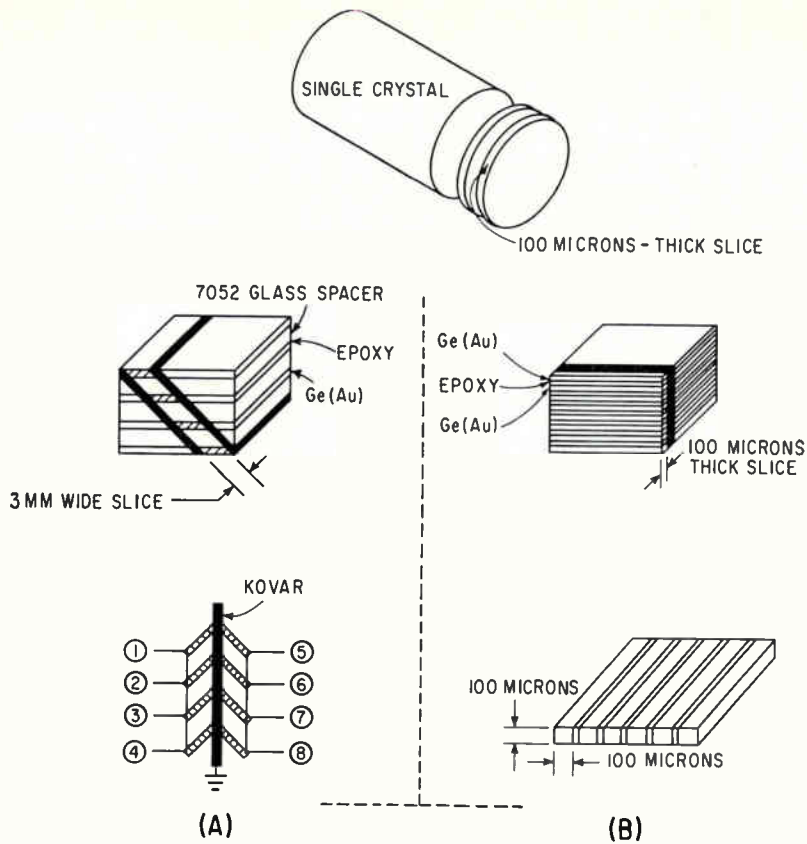

INFRARED DETECTOR ARRAYS shown at bottom: a V-shaped array (A), and a close-spaced array (B), are fabricated from gold-doped germanium slices obtained from single-crystal germanium (top)—Fig. 4

sion is about 70 percent between 2 and 12 microns.

Signals are fed to an instrument case at the wayside for additional amplification and processing. Recorders are hooked up to the instrument cases by direct wire if the observation points are within five miles. Carrier communications are used for greater distances.

Field effect transistors (FET), which offer high input impedance and low noise levels, promise to eliminate the need for vacuum tubes in ir amplifier input stages, according to F. G. Whelan (Martin). Reports of good FET performance, not only at room temperature but also at liquid nitrogen temperatures or below, suggest that first preamplifier stages can probably be built into detector dewars, permitting the FET to be cooled by the detector's refrigerant, to minimize both pick-up and transistor noise.

Whelan also described an ir detector that provides good noise discrimination and relative immunity to sources of sharp input gradients such as cloud edges. It consists of two long and narrow V-shaped de-

tectors. Due to the separation between the detectors, cloud edges cannot produce a pulse resembling a target pulse in both detector elements.

The assembly of miniature ir detector arrays will be discussed by Jack Lennard of Martin (Fig. 4).

Interest in 8.5 to 13.5-micron detectors has been accelerated by possible applications in countermeasures for icbm's, orbiting reconnaissance satellites, submerged submarines and for space navigation and communication, high-precision horizon seekers and outer-atmospheric guidance devices. Cadmium and mercury-doped germanium detectors prepared with time constants less than 1 microsecond are especially useful for detection of radiations in the 8.5 to 13.5-micron atmospheric window.

MICROELECTRONICS—Expressing the operating requirements of a system in a set of basic multipurpose electronic functions is a challenge to electronic engineers, according to a paper prepared by Mitsutomi and DeBoice, Autonetics

division of North American Aviation.

Additional papers from Lockheed, Martin and Hughes show that fewer types of basic electronic functions can meet more system requirements, leaving only a small number of requirements to be satisfied by nonstandard electronic functions.

Five standard functions handle all but 15 percent of the electronic requirements of a molecular and thin film platform control amplifier built by Autonetics.

One function is supplied by the general-purpose amplifier (gpa) (ELECTRONICS, June 1, p 18 and July 6, p 37). The original application of the gpa used negative-feedback adapting circuits of various gain-setting values. A new gpa application uses a positive-feedback adapting circuit that permits bistable triggering. This is useful in analog-to-digital encoders, power-supply regulators and other applications requiring a voltage level sensor. This device may also be used to mechanize agc, amplitude control and signal multiplication.

Other standard electronic functions developed by Autonetics include a synchronous switch, power gate, flip flop and logic gate.

The synchronous switch is used for either suppressed carrier modulation or demodulation in servo amplifiers and other signal channels.

The power gate includes a high-speed, low saturation resistance power transistor, together with current amplification and coupling circuits, and is capable of 100-Kc operation at 90 to 95 percent efficiency from zero to full output.

Only the gpa, synchronous switch and power gate are used in a servo system platform amplifier. The gpa

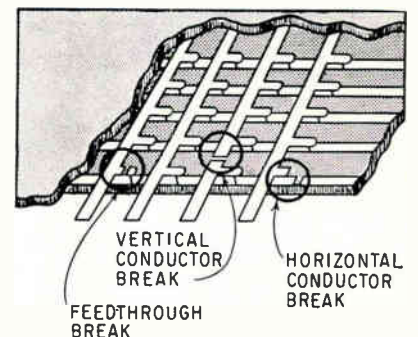

MICROELECTRONIC interconnection system for Hughes' thin-film computer—Fig. 5

LASER BEAM DETECTION system produces an r-f output (f_2) from a conventional detector by beating a local oscillator microwave signal (f_1) with microwave modulation ($f_1 + f_2$) impressed on the laser beam—Fig. 6

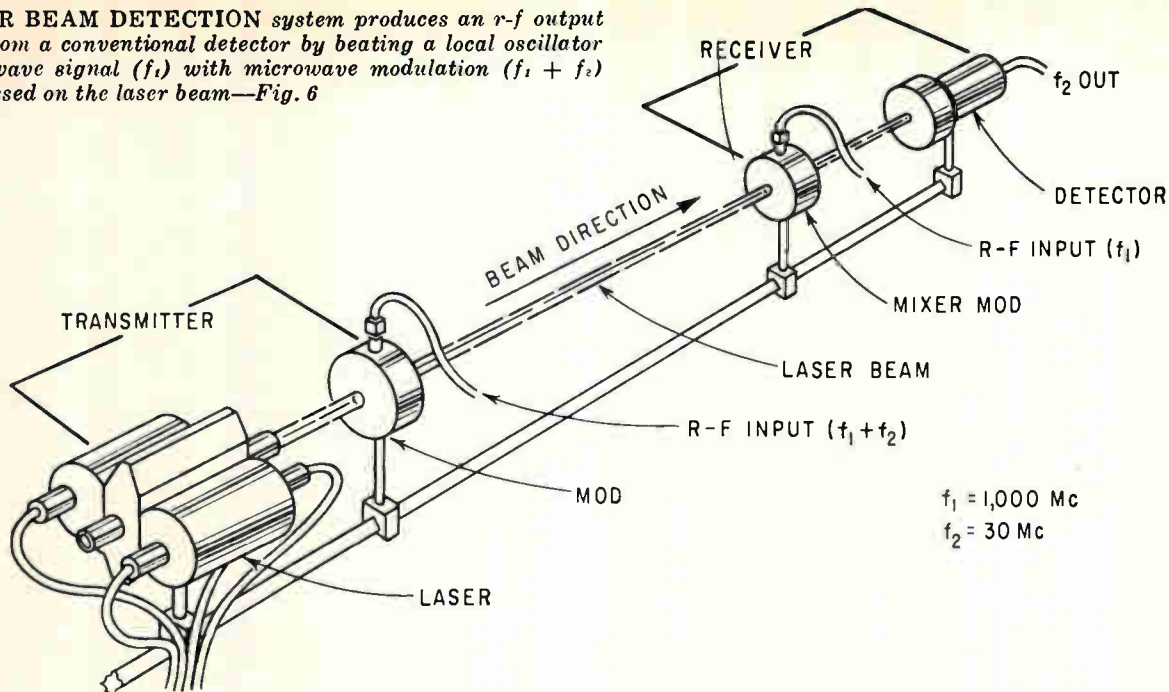

is used both for a-c and d-c signal amplification and as a pulse-width modulator. The synchronous switch provides phase-sensitive detection of a suppressed-carrier input signal. The power gate controls output power to a d-c servo motor.

Three flip flops and gates designed and fabricated as thin-film integrated components for a 4 and 16-channel sequencer will be discussed by Nichols and Fuller, Lockheed. Combining conventional active devices with thin-film passive circuits has reduced interconnections, to achieve a packing density of 444 components a cubic inch.

Martin's Automatic Rapid Test And Control (MARTAC) computer for ground equipment checkout, using only three integrated logic circuits—a nor gate, half shift register and flip flop—will be discussed by Lloyd Thane.

Designed as a missile oriented ground checkout the MARTAC system also looks promising for nuclear reactors, chemical operations, pilot plants, electronic manufacturing assembly and subassembly checkout.

A flexible interconnection technique that solved one of the major stumbling blocks to effective thin-film construction of a complex thin-film digital computer will be discussed by M. M. Dalton, Hughes.

One side of a three-by-four inch

photoceramic substrate carries circuits interconnecting vacuum-deposited thin-film passive elements and multiple component chips while the reverse side carries its interconnection system. Nearly any wiring configuration can be achieved by selective etching of upper or lower interconnecting layers.

The interconnection grid (Fig. 5) consists of 80 horizontal wires crossed by 64 vertical wire sets, formed by vacuum deposition and separated by a layer of insulating material. Feedthrough connections provide continuity at the desired intersection points. A selective etch cuts horizontal and vertical wires at the required locations to open undesired interconnections. Interconnection grids are thus wired to connect circuits on the wafers and to provide the necessary input-output connections.

More than 5,000 interconnection points are provided within a two-by-two inch area by this interconnection grid. Interconnecting wafers that make up the company's HCM-202 computer have been simplified by the ability of the interconnection grid on each wafer to provide the optimum arrangement of signals on the wafer connector.

Circuit wafer arrangements need not be completed until the wafers are nearly through their fabrication cycle.

LASERS — Modulation and detec-

tion of intelligence transmitted over a light beam will be explored by Melvin Watkins of Aircraft Armaments. Mr. Watkin's paper presents a method by which conventional photodetectors may directly detect microwave modulation of a laser beam.

Figure 6 shows the method. Not shown are two polarizers at the transmitter, one on each side of the transmitter modulator. This modulator consists of a basal section of a uniaxial crystal of potassium dihydrogen phosphate (KDP) whose optical axis is oriented parallel to a strong electric field. Peak transmitted light intensity is a function of r-f power absorbed by the crystal.

The receiver's first detector consists of a mixer modulator, operating at a frequency separated from the transmitting modulation frequency by 30 Mc. This 30-Mc difference frequency is low enough to be detected by a conventional low-frequency photodetector. The mixer uses the same type of KDP crystal as the modulator, but its cavity has a resonant frequency that is 30 Mc below that of the modulator cavity.

A variation of this technique requires addition of a third optical polarizer before the mixer crystal and orthogonal to the originating light, which is linearly polarized. This provides for more selectivity and increases the signal-to-noise ratio.

Gallium-Arsenide Diode Sends

Semiconductor device is source of infrared radiation that can be modulated at above 100 Mc to transmit intelligence

By R. H. REDIKER, R. J. KEYES, T. M. QUIST,
M. J. HUDSON, C. R. GRANT, and R. G. BURGESS,
Lincoln Laboratory, Massachusetts Institute of Technology, Lexington, Mass.

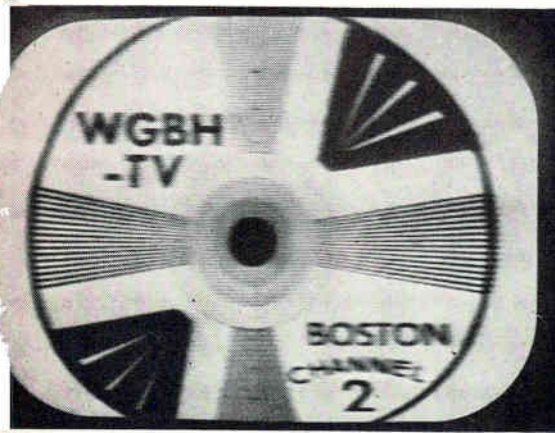

TV SENT BY INFRARED
Test pattern of Boston station WGBH-TV as received after transmission on the infrared beam over a 50-foot path. The transmitting diode was operated at room temperature, and the effective power at the receiver was down by a factor of 500 from what it would be if the transmitting diode had been at 77 deg K. The quality of the tv picture was equal, in every respect, to the quality when the two halves of the split tv receiver were connected and the ir loop not used

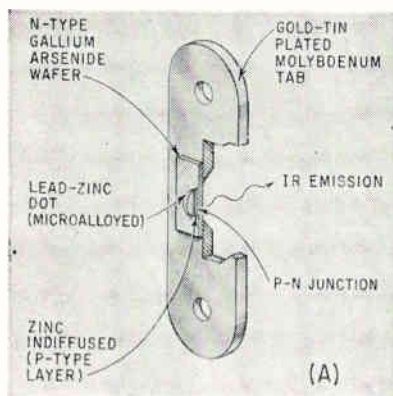

CONSTRUCTION of the GaAs infrared sources (A) with base tab length of 0.28 inch; video driver (B) for the GaAs diode. Although the diode bandwidth is above 100 Mc, the driver bandwidth is 4 Mc, sufficient for transmission of a high-quality tv picture—Fig. 1

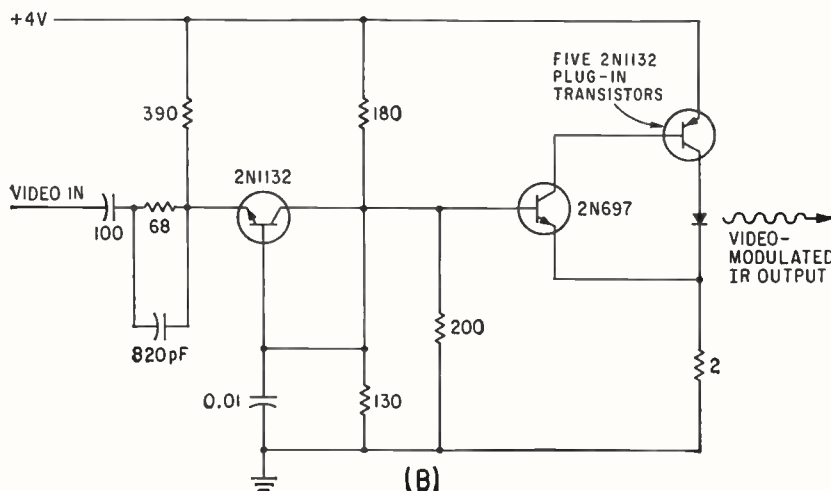

GALLIUM-ARSENIDE diodes have been fabricated, which, when operated at 77 deg. K and biased in the forward direction, may be as high as 85 percent efficient in the conversion of injected carriers into infrared radiation in a narrow range of energy only 0.017 e-v wide about 1.45 e-v (0.85 micron).¹ Figure 1A shows such a diode.

Infrared output power above a watt has been obtained from diodes with active areas about 10^{-3} sq cm. This infrared output can be modulated at frequencies up to and above 100 Mc by simply modulating the diode current. Thus these gallium-arsenide diodes can be used to transmit intelligence on an infrared light beam with a bandwidth well above 100 Mc.

MODULATION—To demonstrate the communications possibilities of these diodes, both audio and video signals have been transmitted by modulating the diode current and consequently the infrared output of the diode. This output was received at a multiplier phototube where it was detected and the video or audio amplified and displayed.

Figure 2 (bottom) is a block diagram of the video transmitter and receiver, which were located 275 feet apart at opposite ends of the roof of the laboratory. The video signal, either from the tuner of a tv receiver or from a vidicon tube, was fed into a specially built video driver (Fig. 1B) that modulates diode currents up to 500 ma.

The infrared output from the diode was focused by a lens with an optical gain of about 1,000 and aimed at the multiplier phototube. The type 7102 multiplier phototube (which is sensitive in the region of 0.85 micron) was placed

Television By Infrared Beam

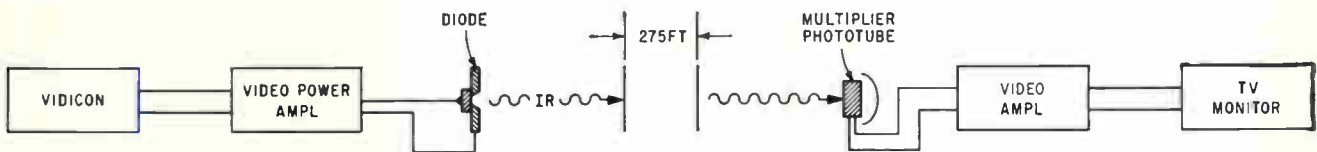
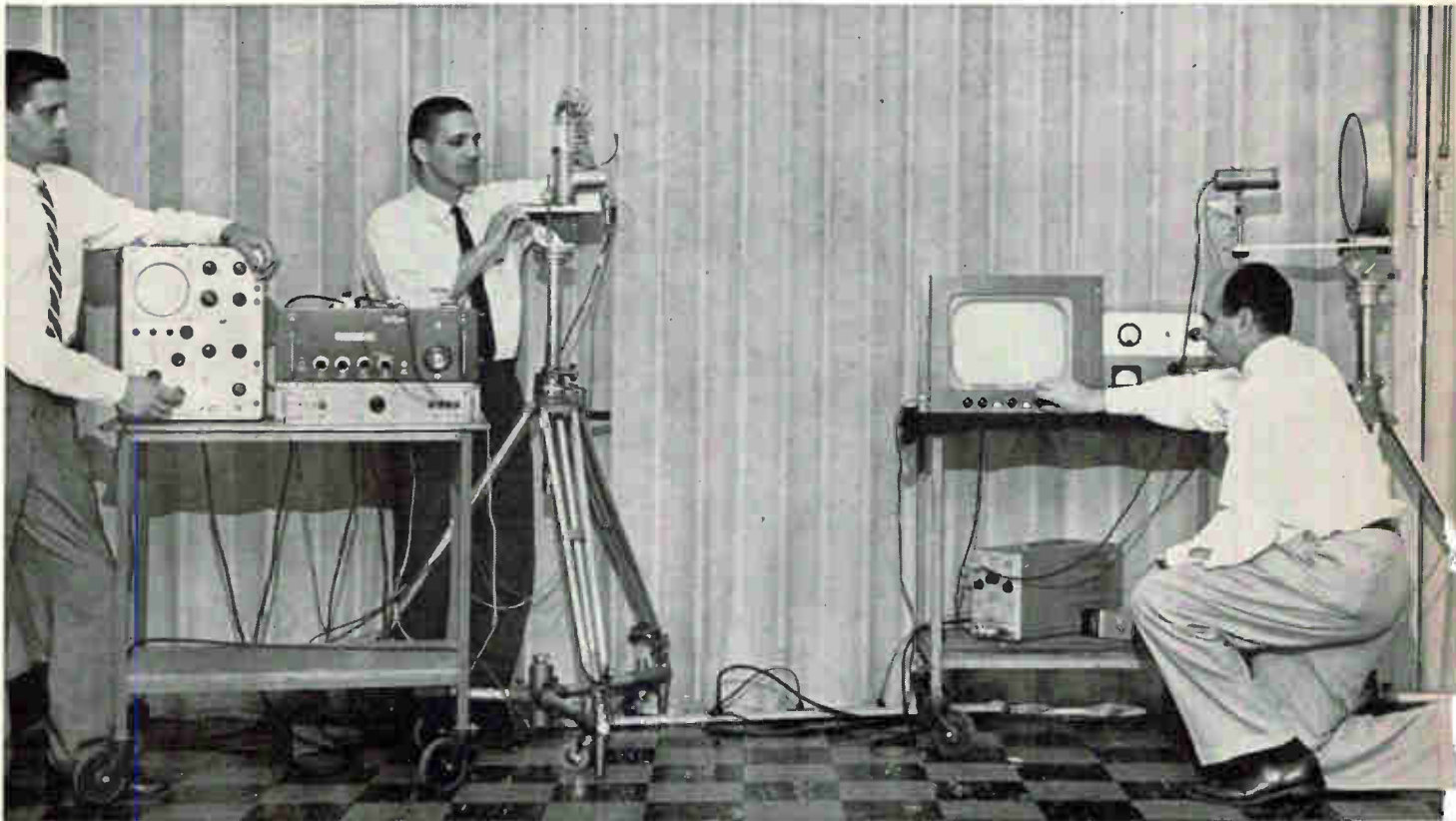

VIDEO transmitter (left) and receiver (right). Photo of laboratory setup shows authors Keyes, Quist and Rediker adjusting, respectively, the monitoring scope, diode position and tv monitor—Fig. 2

at the focal point of a 12-inch diameter parabolic mirror aimed at the transmitter. The output of the multiplier phototube was fed to a Tektronix type 1121 video amplifier and then displayed on a video monitor. The quality of the television picture so displayed was excellent, and equaled the quality when the ir transmission was not used.

RESULTS—While the infrared transmissions have been made at night or late afternoon, communication by this infrared link will be possible in bright daylight, with an appropriate filter to cover the multiplier phototube. Transmission yielding excellent quality television

pictures was also made with the transmitter lens removed.

Because the radiation is in an atmospheric window, the experiments with the lens removed indicate that line-of-sight communication links of 30 miles or more should be easily realized. Equipment is now being assembled to demonstrate such a video communication link.

While infrared transmission may be weather-dependent it should not be affected by ionized plasma.

It should be emphasized that the transmission of one television channel with 4-Mc bandwidth does not at all demonstrate the bandwidth capabilities of over 100 Mc of the

GaAs diode infrared source. While the radiation from this source is incoherent, it is in a spectral band only 100 Å wide, and intensities in this narrow spectral band above 1 Kw per sq cm are possible. Thus the gallium-arsenide diode infrared source should make possible the early realization of many of the communication applications recently proposed for the optical maser.

This project was operated with support from the U.S. Army, Navy and Air Force.

REFERENCE

- (1) R. J. Keyes and T. M. Quist, Recombination Radiation Emitted by Gallium Arsenide, *Proc IRE Corresp*, 50, No. 8, p 1822, Aug. 1962.

FIRST DESIGN DETAILS... Project

Government-owned communications satellite has novel antenna design and uses high-power amplification.

NASA rockets will launch it into a low orbit late this year

By PAUL CHERECWICH, Troy, New York

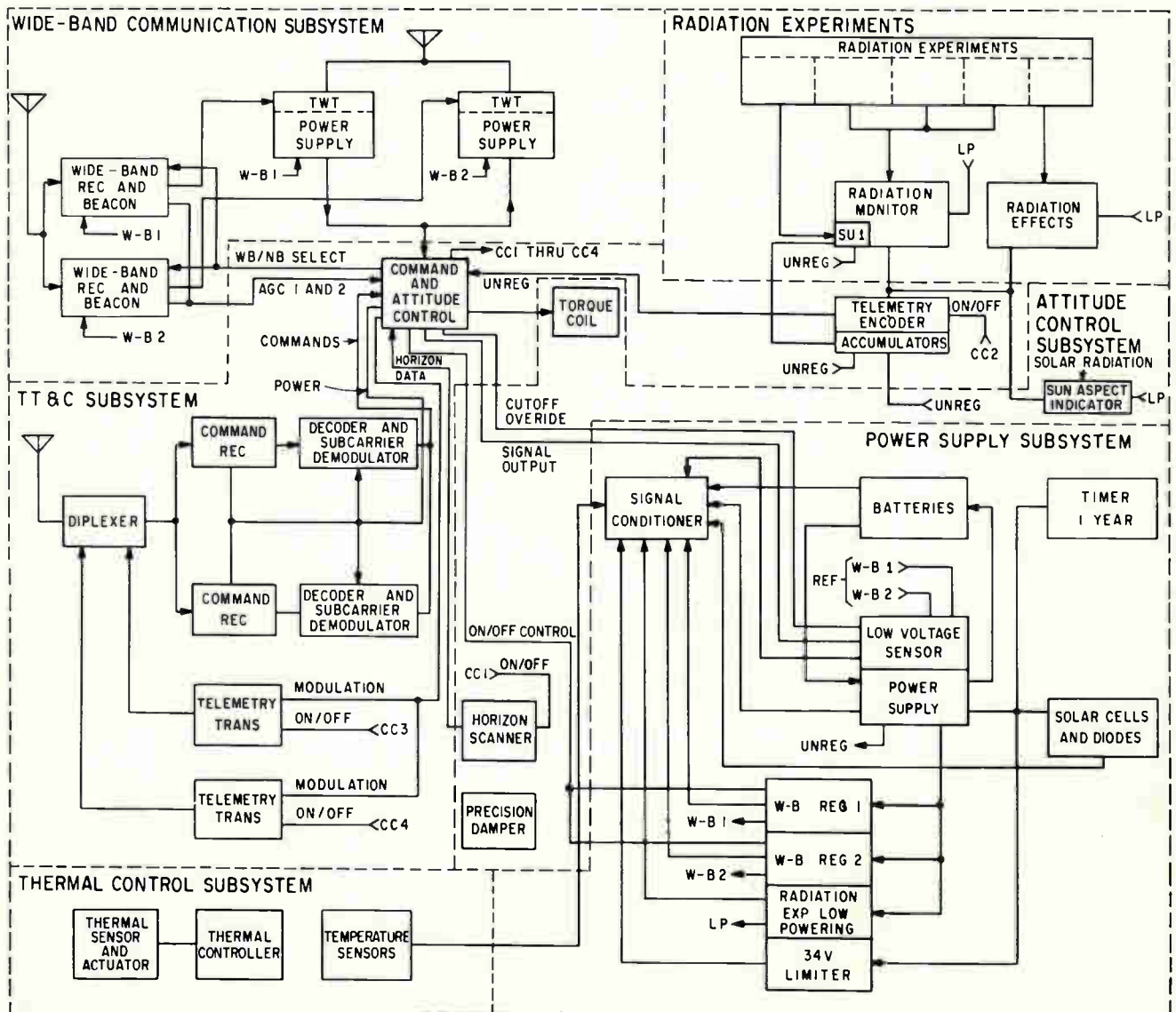

REDUNDANCY of many of Relay's electronics systems prevents failure of a major subsystem from causing the whole satellite to malfunction—Fig. 1

Relay Communications Satellite

A UNIQUE ANTENNA DESIGN and two specially designed high-power traveling-wave tubes (twt) are incorporated in Relay, the government-owned active communications satellite. Seven of the satellite's electronic systems are redundant, so that malfunction of a major component will not affect satellite performance. See Fig. 1.

ANTENNA DESIGN—Relay's 1.8-pound main antenna, which will be

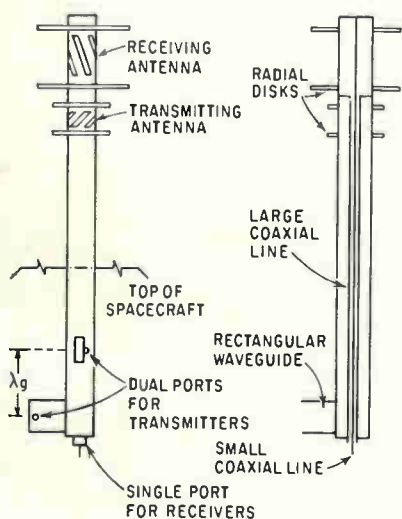

ANTENNA MAST for Relay acts as a dual transmission line—Fig. 2

pointed toward the earth when the satellite is in its low or nonsynchronous orbit, is capable of receiving and transmitting simultaneously without interference. A single mast acts as a dual transmission line, Fig. 2.

The 1,725-Mc wide-band receiving antenna is right-hand circularly polarized, the 4,170-Mc wide-band transmitting antenna is left-hand circularly polarized. The circular polarization enables the antenna to radiate in a doughnut-shaped pattern, so that ground stations will receive a constant signal from the satellite even though it will be spinning at 150 rpm.

Eight slots are located around the antenna for both the transmitting and receiving portions. Circular polarization is obtained through the use of the slots and flat aluminum fins. The fins, covered with foam for support, act as a waveguide for the horizontal portion of the signal vector.

Internally, the transmitting antenna propagates a TE_{11} circular waveguide mode; the receiving antenna propagates a TEM mode. The outer boundary of the receiving antenna acts as the inner boundary of the transmitting antenna.

Telemetry, tracking and command antennas are four monopole whip antennas located on the opposite end of the satellite from the receiving and transmitting mast. They are also circularly polarized, Fig. 3.

TWT—Designed specifically for Relay, the twt in the transmitting circuit will radiate 10 w. It features a special cathode design for long life. Minimum weight is achieved with a platinum cobalt magnet. Vibration effects are minimized by floating the tube in foam with an outer cocoon (see photo). Total weight of the tube, when adapted with heat sink and mounting supports, is 3½ pounds.

Basic tube characteristics are: range, 4,050 Mc to 4,250 Mc; gain at 11 w, 33 db minimum; overall

RELAY READY TO LAUNCH

Late this year a three-stage Delta launch vehicle will blast off from Cape Canaveral carrying into low orbit NASA's active communications satellite, Relay. Although similar in nature and purpose to AT&T's Telstar, (ELECTRONICS, p 28, July 13; p 26, Aug. 17), Relay is more powerful and incorporates several design innovations.

The satellite, shown on this week's cover, is nearing completion at RCA's Astro-Electronics Division plant in Princeton, N. J. NASA has earmarked \$19.1 million for the Relay flight program in fiscal 1963 (ELECTRONICS, p 30, July 20).

Relay, represents one of NASA's approaches to the communications-satellite problem. Another is Syncom, an active communications satellite scheduled to be launched next year into a high orbit synchronized with the earth's rotation. Syncom is under development at Hughes Aircraft

efficiency, 21 percent minimum; estimated mean time before failure, 58,000 hours; basic weight, 2½ pounds.

EXPERIMENTS—High data-rate communication, multiple voice communication and live television communication between countries will be attempted. Mutual visibility between the U.S. and Europe is expected to average 33 minutes an orbit. However, useful transmission time will be only about 15 minutes an orbit.

Other experiments will measure the effects of Van Allen belt radiation on various types of solar cells and other solid-state components. These experiments are supplied by NASA and integrated into the spacecraft by RCA. Continuous information from these experiments will be stored by Relay, then telemetered to earth on command.

COMMUNICATIONS—Two 1,725-Mc receivers and two 4,170-Mc

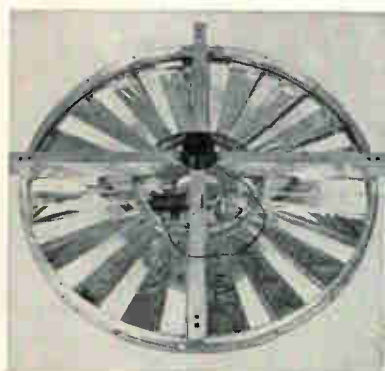

ALUMINIZED Mylar vanes open or shut to dissipate or hold heat in Relay

transmitters are used in Relay. The transmitters, heterodyne repeaters, each have a twt amplifier associated with the circuit. Each transmitter has a circuit capacity of one television channel, one way, 300 voice channels, one way, and 12 voice channels, two way.

The receivers operate in both a wide-band and narrow-band mode. Bandwidth in the wide-band mode is 30 Mc to the 3 db points. The 4.5-Mc-bandwidth channels in the narrow-band mode are separated by 10 Mc. Varactors are employed

in the crystal-controlled circuit, which has a frequency stability of 0.002 percent. The receiver noise figure is 14 db at an input of 1,725 Mc, with a dynamic range of 40 db. Weight is 13 pounds. Modulation is phase-shift keying.

TELEMETRY—Relay has two 136-137-Mc crystal-controlled telemetry transmitters and one telemetry encoder (see Fig. 4). The transmitters are phase modulated. Each weighs 0.65 pound, has a 250-mw output and a 28-v d-c input. Over

200 different telemetry items will be transmitted on command. See Fig. 4.

A signal conditioner is used to convert signals for the 128-channel telemetry encoder. The encoder is low bit-rate pulse-code modulated.

COMMAND—Two subcarrier demodulators and decoders, each weighing 1.5 pounds, accept and convert ground signals into discrete command pulses. The two command receivers, originally designed for the Tiros weather satellite series, operate on vhf and have a 330-mw power input.

The decoder operates on NASA's standard code. The 20 command signals are composed of different combinations of 3 bits out of a 6-bit signal. In this code, each command signal, before it is accepted, must have the correct number of pulses, 3, of the proper bandwidth and frequency.

TRACKING—Two beacon oscillators will emit a continuous wave signal at 4,080 Mc. Countries that will have ground stations participating in Project Relay include Great Britain, France, Brazil, Germany, Italy and the U.S. In the U.S., ITT and AT&T will participate in ground station operations. Proposed orbit for Relay is: time for one orbit, 2½ to 3 hours; apogee, 3,000 miles; perigee, 800 miles.

OTHER SYSTEMS—The solar-cell power supply will have an average power of 45 w at 32 C. Relay has 8,215 fused-quartz-covered solar cells. Sixty nickel-cadmium batteries, in sets of three connected in parallel, are integrated in the circuit.

A glass-fiber oil-filled ring will be used to dissipate precession. Attitude control will be by spin stabilization, and a magnetic torquing system successfully used in the Tiros satellites. A fraction of a watt current through wires outside the satellite will set up a magnetic field to orient the spin axis. Ground command signals will be employed.

A semiactive heat control system will be used. A shutter system of aluminized Mylar vanes will open to dissipate heat, close to retain heat (see photo p 47).

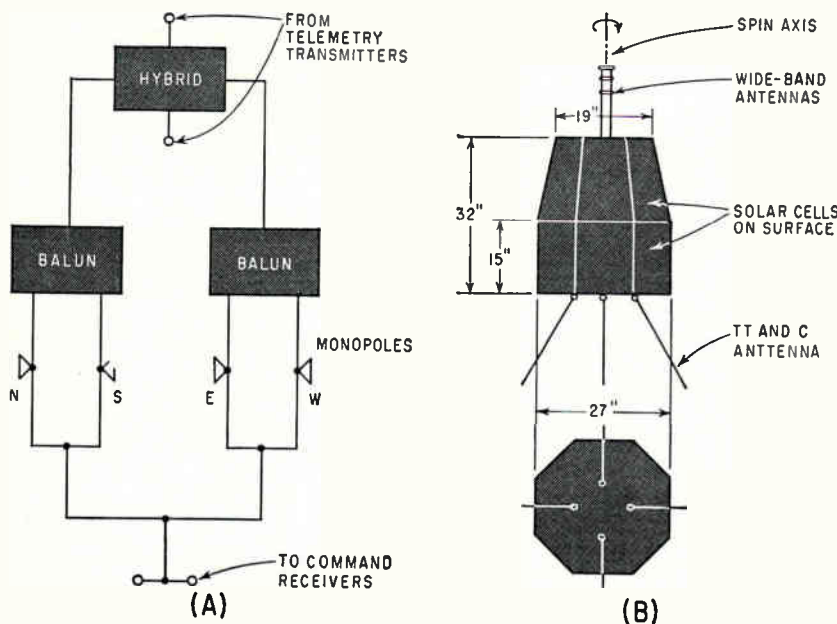

TRACKING, command and telemetry antennas are connected to receivers and transmitters with this diplexer (A). Transmitted signal will be radiated as shown above (B)—Fig. 3

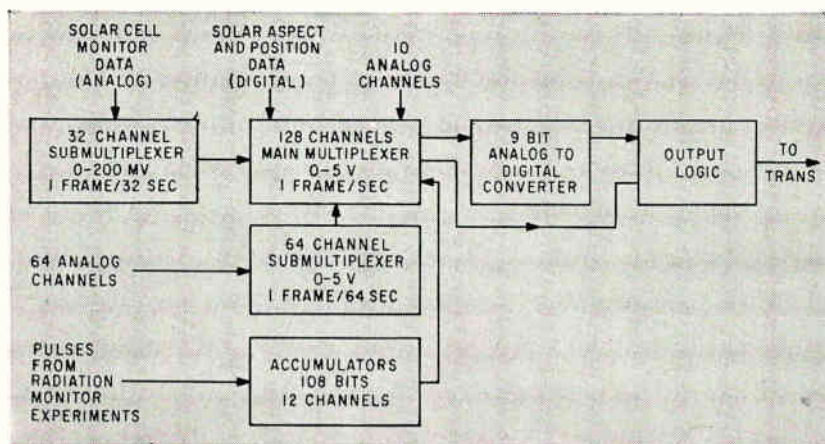

TELEMETRY ENCODER selects the information to be transmitted to earth at any given time—Fig. 4

For Electronic Countermeasures

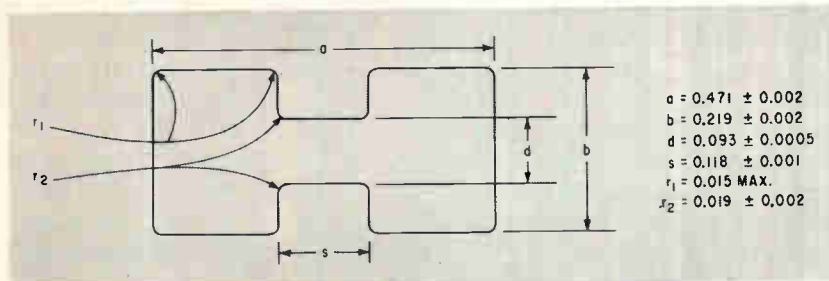

CONFIGURATION for 11.0-26.5 Gc ridge waveguide—Fig. 1

obtained showing the effect of ridge width on theoretical bandwidth, power handling and attenuation.

From the bandwidth curves, the maximum bandwidth for a given ridge height (d/b value) occurs for a ridge width of about one-quarter guide width ($s/a = 0.25$). A similar maximum appears on the power-handling curve when bandwidth is held constant and s/a is roughly 0.25. The attenuation curve shows that for fixed bandwidth, minimum attenuation occurs at s/a of approximately 0.25.

An optimum design for rigid guide has an aspect ratio about 2:1, ridge-to-guide width ratio of 0.25.

To substantiate the theoretical analysis, components were designed and fabricated in an optimum designed double-ridge guide having a theoretical bandwidth of 2.4:1, and operating in the range from 4.75 to 11.0 Gc.⁸ This size, designated D109, double-ridge waveguide with a dimension of 1.090 inches, was chosen for initial development because a non-optimum design, D19, operating over the same frequency range, was available for comparison. The D109 was shown to be superior in power-handling capability, maximum gap-spacing and minimum attenuation for the same bandwidth.

Once the optimum design had been established, attention was given to the development of components for operation above 11 Gc, where the wideband performance of ridged guide is particularly important. With the lower operating

frequency determined, and the b/a and s/a ratios determined by the optimum design, the first consideration is the choice of bandwidth to determine the normal ridge height and d/b value. Optimum designs were available with bandwidths of 2.4 and 3.6:1. The relative power handling capability of the 3.6:1 design is roughly 20 percent of that of the 2.4:1 design. Thus a 50-percent increase in bandwidth incurs an 80-percent reduction in power-handling capability. Therefore, the 2.4:1 design, D47, was chosen as a compromise between bandwidth and power handling. This bandwidth yields a range of operation from 11.0 to 26.5 Gc. This range covers the portion of the microwave spectrum where swept sources are available and where coaxial or other TEM lines are too lossy. This range is presently covered by three standard rectangular waveguide bands: RG-52/U: 11.0 to 12.4 Gc; RG-91/U: 12.4 to 18.0 Gc; and RG-53/U: 18.0 to 26.5 Gc. A comparison between the D47 ridge guide and these waveguides in attenuation and power handling is shown in Fig. 2. The trade-off of power handling and attenuation for bandwidth is apparent.

Development of components in ridge guide was complicated by the unusual geometry.

TOLERANCES—A major problem in the fabrication of ridge waveguide is holding dimensions to close tolerances. The major portion of the electric field is between the

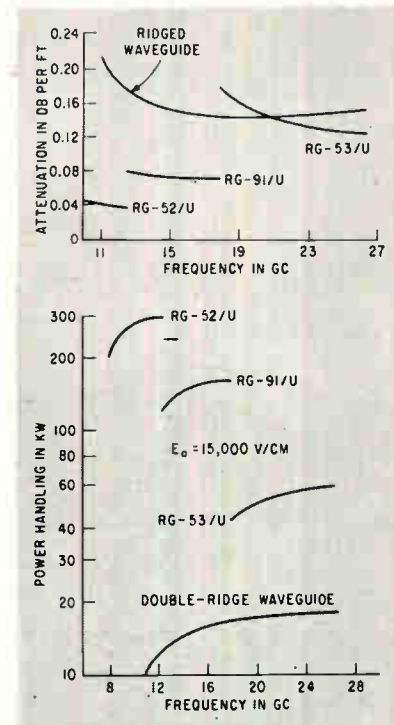

ATTENUATION (top) and power-handling capacity (bottom) for double-ridge and rectangular waveguides—Fig. 2

ridges in ridge guide. Thus the impedance, by the voltage-power definition, is determined to a much greater extent by the d dimension than the b dimension. Since the d dimension is smaller than the b and guide impedance is directly proportional to the b dimension in rectangular guide, tighter tolerances must be held on d for the same proportional change in guide impedance; ± 0.0005 for standard double-ridge guide d and ± 0.002 for extruded. Additional factors affecting ridge-guide impedance, not present in rectangular guide, are ridge width and centering. Ridge-width tolerance is the same as for d .

FABRICATION—The fabrication of rectangular waveguide is generally done by extrusion. In the ridge guide of interest, the best tolerances anticipated by commercial ex-

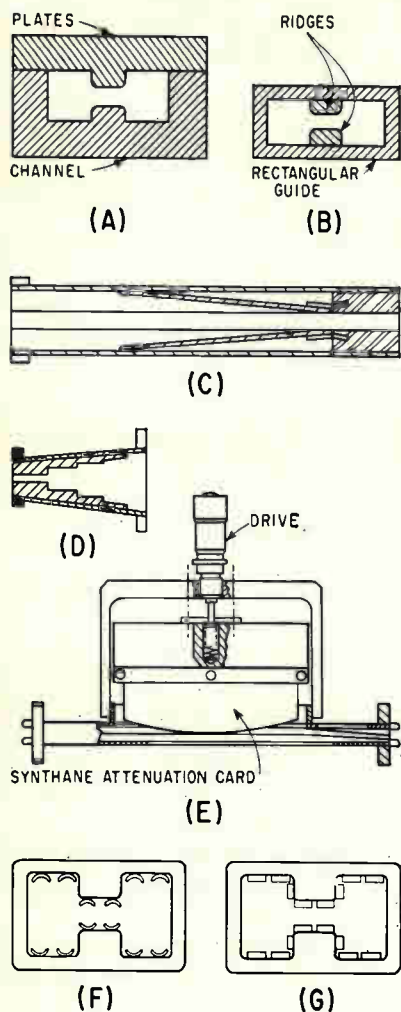

FABRICATION METHODS: *precision machining (A); composite (B). Sliding matched termination (C); waveguide adapter, double-ridge to rectangular (D); double-ridge guide attenuator (E). Tunable waveguide short, with commercial spring fingers (F) and final design (G)—Fig. 3*

trusion firms are ± 0.002 . At the limits of these tolerances, a large mismatch might result between mating guides. Casting and electroforming methods were considered too costly for the quantities involved, although these methods might be applicable on a production basis.

Two fabrication methods were decided upon. Components used as standards such as slotted lines and terminations require a low residual vswr. They were precision machined from solid stock. The ridge-guide configuration was formed from a ridged U-channel and a ridged plate, screwed together as shown in Fig. 3A. The second fabrication method was the extru-

sion of rectangular guide to the same a and b dimensions as the ridge guide. Separate ridges were screwed or soldered on to the broad wall as shown in Fig. 3B. The latter method may be used for precision components if the ridges are custom machined to the b dimension of the guide to fix the d dimension. Care must also be taken at assembly to insure centering of the ridge and good contact between ridge and waveguide wall. This method is convenient where the ridges must be tapered or stepped. No method of fabrication was found to produce to the required tolerances lengths of double-ridge guide of this size for systems use.

COMPONENTS—Several components were made for the 11.0- to 26.5-Gc double-ridge guide.

(1) Sliding termination: Two lossy Synthane cards tapering from the narrow walls of the guide in to the center ridge (Fig. 3C) resulted in a termination with a maximum residual vswr of 1.02.

(2) Transitions to rectangular guide: These were made by stepping down the ridge height to obtain guide impedances determined by a Tchebyscheff distribution and tapering the a and b dimensions of the ridge guide to the rectangular guide size (Fig. 3D).

The impedance for each section is determined from the guide dimensions by calculation from transmission line equations or from graphs^{1,4}. The length of each section is determined by the guide wavelength. This is calculated from the cutoff wavelength, which is determined by the guide configuration, which is in turn determined by the impedance required. Thus a step-by-step trial and error or graphical solution is necessary. Both the cutoff and impedance is determined by the b/a ratio, which varies between the ridge and rectangular guide. The graphs are based on standard b/a ratios so that a correction factor must be used at each step. A correction for $\lambda_{c/a}$ is given in the reference. The impedance may be corrected for the b/a ratio by multiplying the impedance for a standard b/a value by the ratio of the required b/a to the standard b/a .

Transitions to RG-52/U (11.0 to 12.4 Gc), RG-91/U (12.4 to 18.0 Gc), and RG-53/U (18.0 to 26.5 Gc) each gave a maximum vswr of 1.08.

(3) Variable attenuators: To attain a target attenuation of 40 db minimum across the band, it was necessary to insert an attenuating element almost as wide as the ridge into the broad wall of the guide (Fig. 3E). One ridge was tapered down and the other up to give a single ridge configuration having the same electrical characteristics of the double-ridge guide. The lossy Synthane card inserted through the unridged wall gave the 40-db minimum attenuation. Insertion loss was 1.5 db maximum and the maximum vswr was 1.30.

(4) Tunable crystal-bolometer mount: The mount consists of a slide-screw tuner in front of a coaxial detector mount, 1N26 crystal or physically equivalent bolometer. An integral coaxial line to double-ridge waveguide transition was used in the detector mount, as the 1N26 case cannot be mounted directly in the guide.

The transition was matched by varying the back cavity length with a 1N26 matched-load cartridge inserted in the mount in place of the 1N26 crystal. Since the impedance of the crystal varies widely with frequency, the tuner must be used to obtain a good match. A tuned vswr of 1.06 may be obtained over the band with either a crystal or bolometer.

(5) Tunable waveguide short: A noncontacting choke short was rejected in this ridge-guide band because of mechanical problems and the difficulty of making an effective choke short over a large bandwidth. Commercial rounded contacting finger shorts (Fig. 3F) were unsuitable for this guide size. When flatter fingers (Fig. 3G) that gave more contact area were used, a short with a minimum reflection coefficient of 0.97 resulted.

(6) A 20-db directional coupler: Several approaches were investigated to avoid coupling by holes in the broad wall from one ridge guide to another since this method is frequency sensitive. Distortion due to the ridges disturbs the coupling field in rectangular guide, so that

optimization of the coupling-response against frequency characteristic for a multihole coupler is not possible in a double-ridge guide. But other approaches were eliminated, because of mechanical and electrical reasons.

Fabrication of the coupler was difficult mechanically because of the unavailability of waveguide tubing. The secondary line bend was difficult since the ridge had to be machined in a curve and follow the curve of the waveguide wall. The final design gave a coupling of 19.85 ± 3.55 db across the band. Directivity was a minimum of 29 db and vswr was 1.07 or less in both lines.

(7) Precision slotted section: The slotted section (Fig. 4, left) consists of a double-ridge main line containing a slot with tapered ends, probe section and secondary double-ridge waveguide output section containing a slide-screw tuner. A detector mount is connected to the secondary line. The probe, a 0.006-inch diameter Teflon-coated wire, is extended into the main line field by a screw drive (Fig. 4, right). The energy coupled to the probe from the field in the main line is conducted through a short coaxial section into the secondary guide. The slide-screw tuner matches the detector mount to the probe transition section of the secondary guide. A dial indicator measures carriage travel for precise impedance measurements. The

narrowest mechanically practical slot width was used to keep the residual vswr under 1.04 over the band.

Empirical methods were needed to determine the configuration of a probe transition section to provide adequate coupling without excessive probe insertion. Results gave a minimum coupling of 19 db down from the main line for negligible pulling, or distortion of the main line field.

(8) E-H tuner: The tuner was built as a four-port junction of double-ridge waveguide E and H plane tee sections (Fig. 5A). Because of the geometry of the junction, continuity of the double ridge can be preserved in one plane only. It was decided to preserve the ridge continuity in the E-plane for mechanical reasons and because the introduction of an H-plane ridge at right angles to the main line would create a large discontinuity in the transmission path. The ridges in the H-plane arm were terminated at the side wall of the main-line guide. However, the coupling to the H-plane was not tight enough for satisfactory tuning. A coupling structure had to be designed to compensate for this weak coupling. A number of thin metal plate coupling structures from the lower ridge in the side arm to the lower main-line ridge were designed and tested to improve H-arm coupling. The final form (Fig. 12) allows a minimum vswr of 11:1 to be tuned

out over the band, with 20:1 possible over most of the range.

(9) Rotary Joint: The joint consists of double-ridge input and output arms with transitions to a rotary coaxial section (Fig. 5B). The dimensions of the coaxial line are limited, since the outer diameter must pass through the ridge and the center conductor must be heavy enough to withstand torsional stress. A 50-ohm line with a 0.082-inch outer diameter and a 0.032-inch diameter was decided upon. The ridges in each arm were tapered from the standard ridge-guide impedance to a cross section with a 50-ohm characteristic impedance to obtain a match to the coaxial line. Since the ridges were tapered, the arms were fabricated by screwing the ridges into rectangular guide. Because of the high operating frequency and large bandwidth, it was found that rotary-joint choke designs were not applicable. So contacting graphite bearings were used at rotational surfaces. The optimum results for a double-ridge to coaxial-line transition in this frequency range is 1.6:1 vswr. Since two transitions are needed, the overall vswr might be $1.6 \times 1.6 = 2.56$. This would give a reflected loss of 0.76 db. Adding this to the insertion loss of the coaxial section, 0.31 db at 26.5 Gc, gives a possible insertion loss of 1.07 db. Measured results give a maximum vswr of 2.5:1 and a maximum insertion loss of 1.5 db. This indicates that the results were close to the optimum for a double-ridge guide rotary joint in the 11.0 to 26.5-Gc frequency range.

(10) Balanced mixer: For broadband operation a balanced mixer must have a balanced feed for the signal and local oscillator that is *inherently frequency insensitive*. A septum across the middle of the broad dimension of the guide will split power equally over the band if it is thin and long enough so that no resonances occur. A T-bar coupling device may also be well matched over a large bandwidth. Thus a reversed phase-mixer was constructed (Fig. 5C) using an H-plane septum as the in-phase power splitter in the signal circuit, and an E-plane coaxial tee tuned to provide reversed-phase, equal-

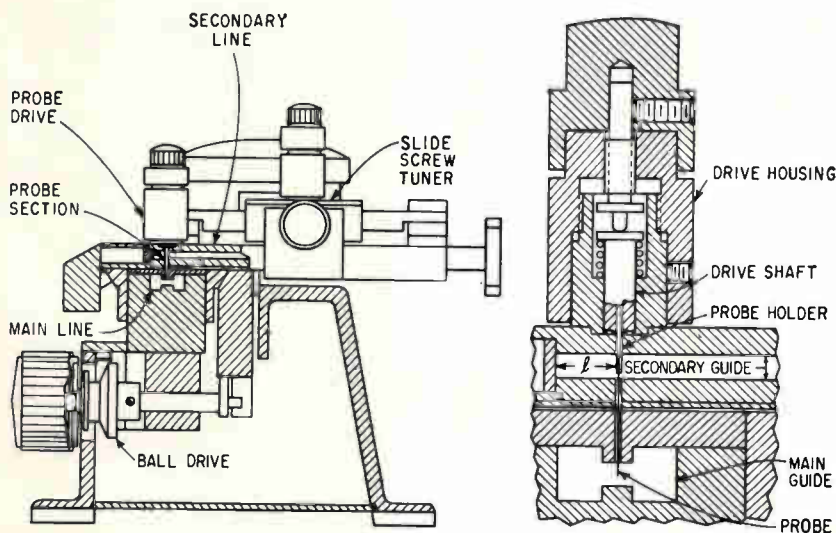

SLOTTED SECTION (left), with probe details (right)—Fig. 4

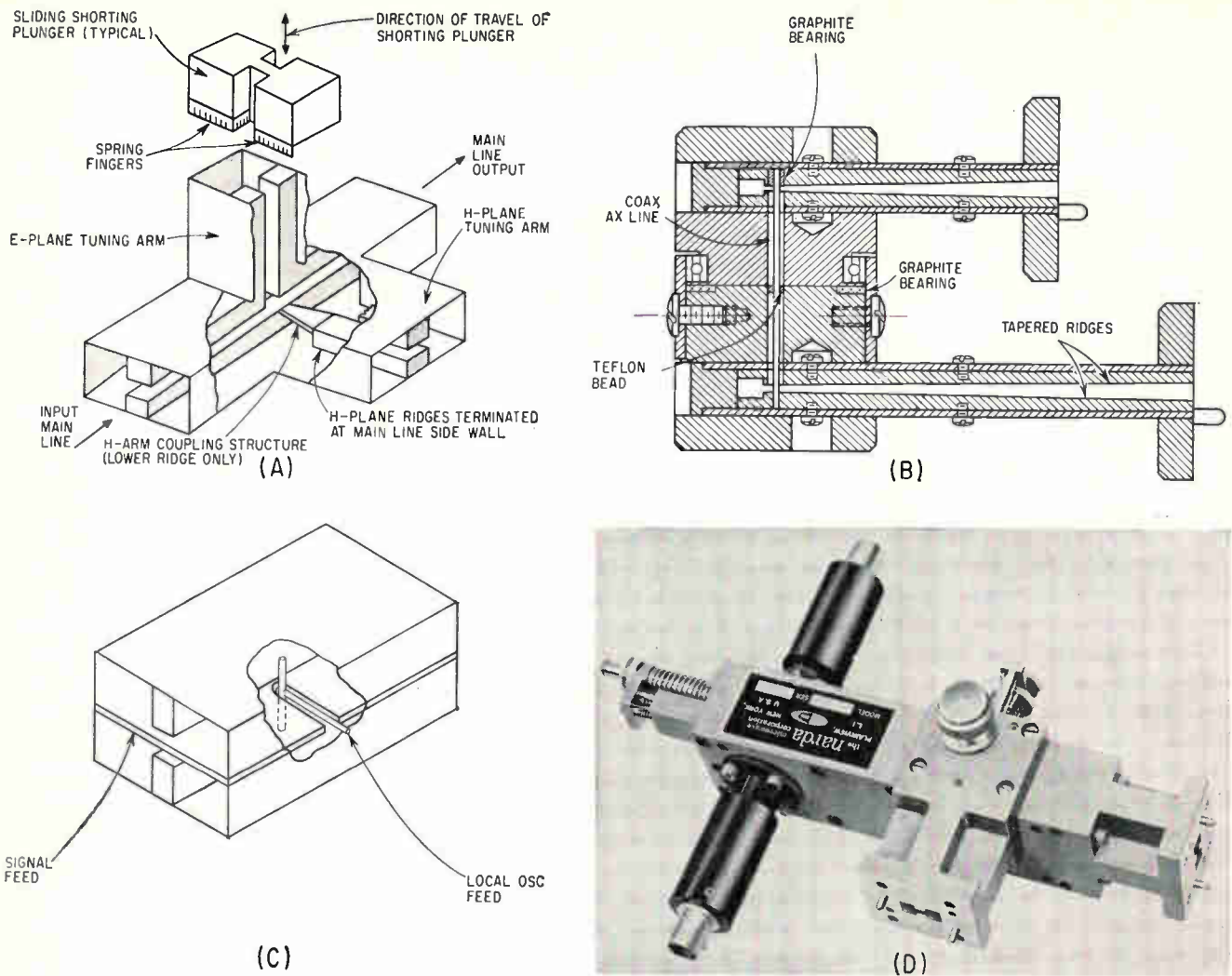

VIEW of E-H tuner showing H-arm coupling (A); double-ridge guide rotary joint (B); coupling section of reversed phase-mixer showing signal and local-oscillator power splitters (C); balanced mixer (D)—Fig. 5

power signals from the local oscillator. The local oscillator feed is in coaxial line and a transition to ridge guide provides a waveguide input. The crystals are fed from the coaxial end of integral waveguide to coaxial transitions in the main line. The diodes are connected so that the in-phase voltages from the local oscillator cancel while the out-of-phase components from the mainline signal add; thus the output of the mixer does not contain extraneous information due to noise components in the local oscillator. Due to symmetry, sidebands of the input signal at the local oscillator frequency are also cancelled.

Tuning adjustment of the waveguide to coaxial transitions in the crystal mounts and the local oscillator input and the local oscillator tee-bar feed are provided for opti-

imum performance (Fig. 5D). The mixer was found to be operable across the band although the results obtained are far from optimum. Additional empirical modification of the local oscillator feed should improve performance. The results were good crystal balance with a minimum sensitivity of 0.55-ma crystal current for 0.75 mw of power input per channel, and a minimum isolation of 20 db. Good isolation was expected because of the geometrically symmetrical nature of the power splitters in both the local oscillator and signal circuits. Local oscillator coupling was a minimum of -20 db. Vswr was a maximum of 5.8:1 at the signal port and 10:1 at the local oscillator port.

The results obtained on most of the components in the 11.0 to 26.5

Gc double-ridge guide band are comparable to results achieved with similar components in rectangular waveguide. It is, therefore, suggested that this particular waveguide would be ideal for ecm applications in this frequency range.

The research described in this article was performed at the Narda Microwave Corp. under contract to the U. S. Army Signal Corps.

REFERENCES

- (1) Broadband Ridge Waveguides and Components, Final Report—Contract No. DA-36-039-SC-78187, Dec. 1958-July 1959, U. S. Army Signal Engineering Laboratories.
- (2) T. Anderson and L. Kent, Standardization of Ridged Waveguides, *Microwave Journal*, 4, No. 4, April 1961.
- (3) *Ibid.*, footnote 2.
- (4) S. Hopper, The Design of Ridged Waveguides, *IRE Trans, MTT-3*, No. 5, Oct. 1955.

RENDEZVOUS ROUTE OR COLLISION COURSE?

A QUESTION OF SUPREMACY:

Pilots of U. S. Navy fighting planes will shortly be able to rendezvous or fly in formation with greater security under a wider range of conditions... for they'll know exactly how far they are from each other. ■ Air-to-air ranging will be added to their present TACAN sets with the General Dynamics/Electronics—Rochester SC-704 modification kit. No bigger than a "best seller," lighter than the circuits it replaces, it permits as many as 5 planes to judge their distances from a sixth, such as a group leader or air tanker. Conversion time? Negligible—only 3 fast hours. And the SC-704 actually improves the

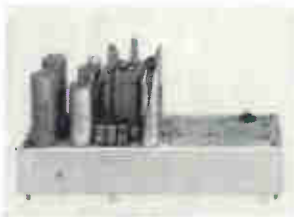

reliability of the air-to-ground function of the TACAN set because the vacuum tube modulator is replaced with a new, completely solid-state modulator. ■ Proficiency in

air and missile-borne ranging equipment comes naturally to a division of General Dynamics, where the B-58 Hustler and Atlas ICBM were born and bred; General Dynamics/Electronics—Rochester is today's seed-bed of advanced ideas in the technology of navigational equipment and radar beacons. ■ Every product we make started with a question. We solicit yours. Write 1420 North Goodman St., Rochester 1, New York.

GENERAL DYNAMICS | **ELECTRONICS — ROCHESTER**

CONVENIENT WAY TO CALCULATE Transmission Line Resonant Frequency

Graphical method simplifies calculation of capacitance-loaded transmission line resonant frequency if line characteristics are known

By ROBERT C. MORWOOD

Advanced Development Group
Power Grid Tube Laboratory
Eitel-McCullough, Inc.
San Carlos, California

SHORT LENGTHS of transmission line make convenient vacuum-tube tank circuits at high frequencies. In dealing with such circuits it is relatively easy to find a length of a line which will resonate at a desired frequency. However, calculation of the resonant frequency when line dimensions are known is more difficult. If line characteristics are known, finding the resonant frequency requires solving a transcendental equation which can be done only by approximate methods. A curve has been prepared as one method of finding resonant frequency of a line of known characteristics.

DERIVATION—The relation between resonant frequency, length, characteristic impedance, and tube capacitance in a quarter-wavelength, capacitance-loaded line is

$$X_c = \frac{l}{2\pi f C}$$

$$X_L = Z_o \tan \frac{2\pi f l}{c}$$

where

- X_c is the capacitive reactance of the tube in ohms
- f is the resonant frequency in cycles per second
- C is the tube capacitance in farads
- Z_o is the line characteristic impedance in ohms
- X_L is the reactance of a line of length l in ohms
- l is the length of the line in meters
- c is the velocity of light, 3×10^8 meters per second

The first relation gives the capacitive reactance of the tube as seen by the line. The second relation gives the reactance of a transmission line of length l and characteristic impedance Z_o .

At resonance the two reactances are equal, yielding the following equation

$$\frac{1}{2\pi f C} = Z_o \tan \frac{2\pi f l}{c}$$

This equation can be solved exactly for C , Z_o , or l . Frequency, however, can only be found by approximate methods; for instance, by a graphical method. The accompanying curve is a graphical aid to solving the foreshortened transmission line problem. If θ is the electrical length of the transmission line, then

$$\theta = \frac{2\pi f l}{c} = \frac{2\pi l}{\lambda} \text{ radians}$$

$$\theta = \frac{360 l}{\lambda} \text{ degrees}$$

$$\text{then } 2\pi f = \frac{\theta c}{l}$$

This expression for $2\pi f$, given in terms of physical and electrical length of the line, can be substituted in the expression for the capacitive reactance of the tube

$$X_c = \frac{1}{2\pi f C} = \frac{l}{c\theta C}$$

Equating capacitive reactance of the tube to the reactance of the line gives

$$\frac{l}{c\theta C} = Z_o \tan \frac{2\pi f l}{c} = Z_o \tan \theta$$

which may be rearranged to give

$$\theta \tan \theta = \frac{l}{cCZ_o}$$

If the line length and characteristic impedance, and the tube capacitance, are known, the factor l/CcZ_o may be found. From the value of this factor, which is equal to $\theta \tan \theta$, the approximate value of θ may be found from the curve. The approximate resonant frequency is then

$$f = \frac{c\theta}{2\pi l}$$

Although the curve is useful for finding resonant frequency of a line of known dimensions, it is not convenient for finding the length of a line to resonate at some desired frequency.

EXAMPLE—Find the resonant frequency of a 50-ohm line 1.6 cm long and loaded by a tube with 2 mmf capacitance.

$$\begin{aligned} C &= 2 \text{ mmf} \\ Z_o &= 50 \text{ ohms} \\ l &= 1.6 \text{ cm} \end{aligned}$$

1. $\theta \tan \theta = \frac{l}{cCZ_o}$
 $= 33.3 \frac{1.6}{2 \times 50}$
2. from curve,
 $\theta \tan \theta = 0.533$
 $\theta = 0.671$
3. $f = \frac{c\theta}{2\pi l}$
 $= 4.77 \frac{\theta}{l}$
 $= 4.77 \frac{0.671}{1.6}$
 $f = 1.97 \text{ Gc}$

(continued on p 58)

FREE REPRINT

Single copy of this article available free by simply checking the READER SERVICE CARD

WEIGHT - 3 grams

OUTPUT - 300 mv full scale

- *You are reading about the remarkable new
Amelco Diffused Silicon Pressure Transducer*

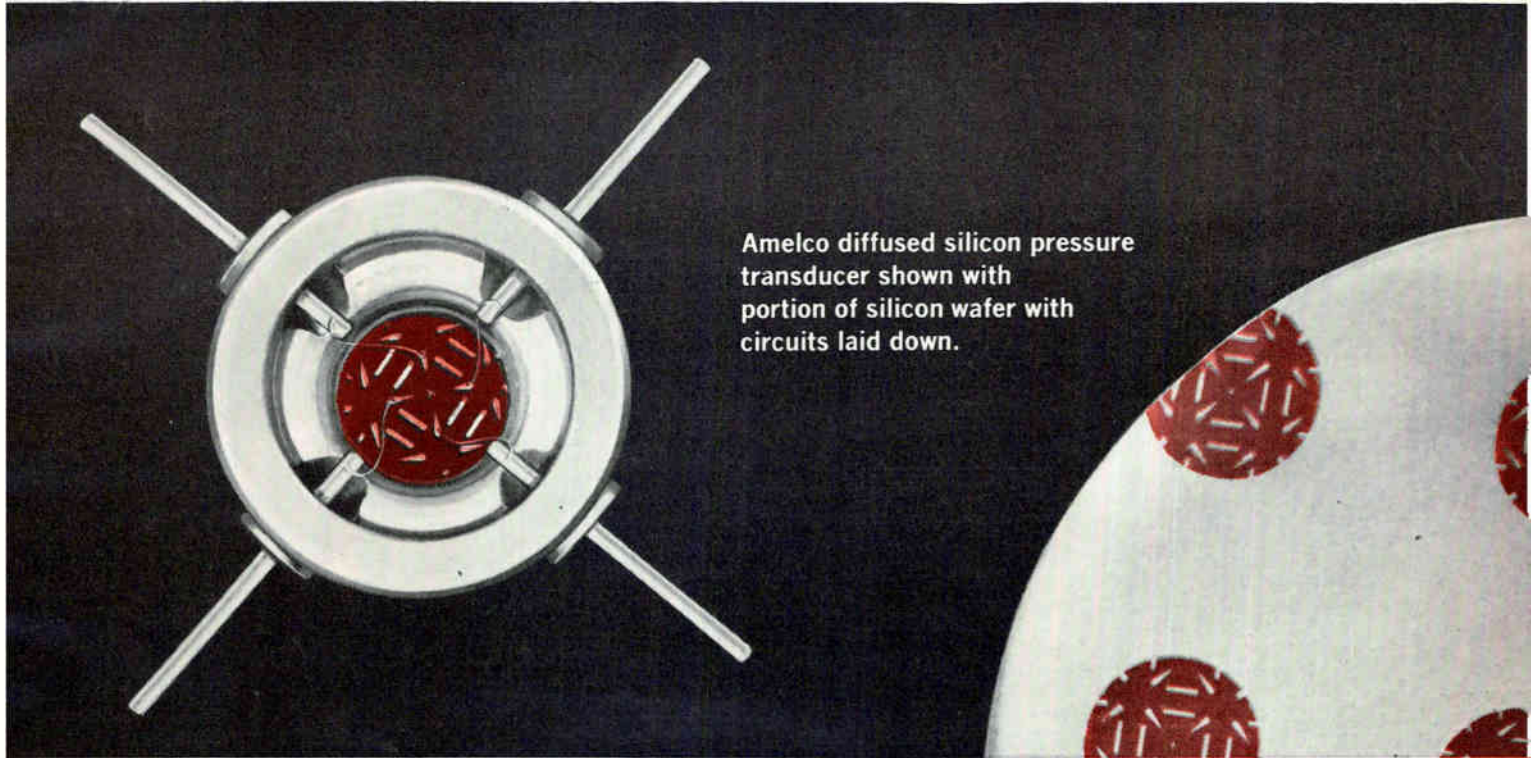

Amelco diffused silicon pressure transducer shown with portion of silicon wafer with circuits laid down.



ACTUAL SIZE

The microminiature Amelco pressure transducer combines a rugged silicon piezoresistive bridge in a simple flush diaphragm design providing an output equally suitable for both dynamic and static measurements with no loss of accuracy.

Consisting of only six parts, none of them moving, the Amelco APG 101 is fabricated using the latest planar diffusion methods. All arms, adhesives, bindings, mechanical linkages and so forth, which cause inaccuracy and degrade reliability have been eliminated.

Full information including price and delivery on the Amelco APG 101 is yours by writing AMELCO, INC., Electron Devices Division, 341 Moffett Blvd., Mountain View, California, phone, 739-0851, TWX: MN VW 852.

AMELCO, INC.
MOUNTAIN VIEW, CALIFORNIA

OTHER SPECIFICATIONS: RANGE: 0-50 psig (additional ranges will be available in the near future). MAXIMUM PRESSURE: 150% fs. THERMAL SENSITIVITY SHIFT: 0.02%/°F from 0°F to 150°F. THERMAL ZERO SHIFT: 0.04%/°F from 0°F to 150°F. NATURAL FREQUENCY: 25 kc. ACCURACY: 1% fs. HYSTERESIS: 0.5%.

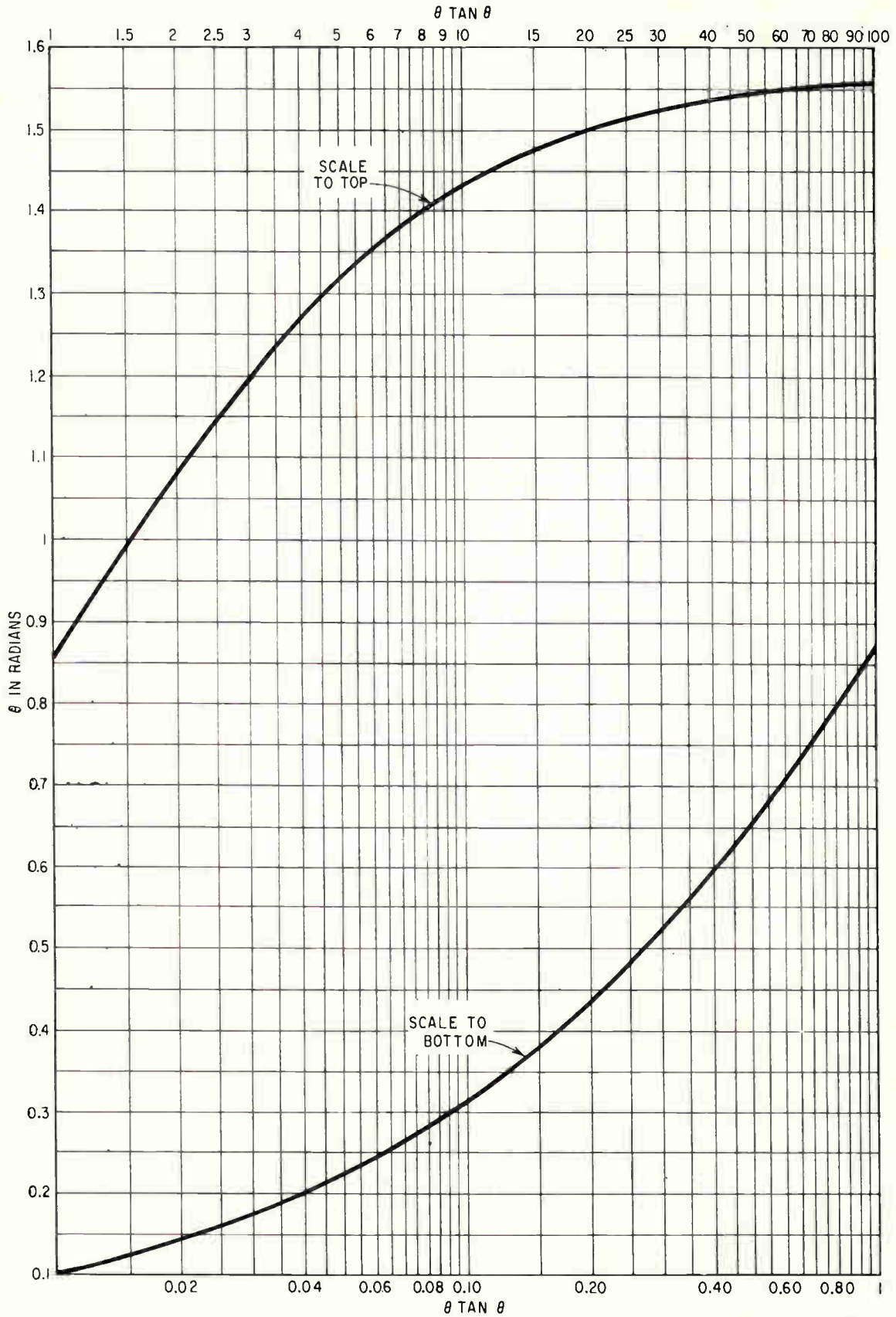

RESONANT FREQUENCY calculations for a capacitance-loaded transmission line are greatly simplified when this curve is used to approximate the solution of a transcendental equation

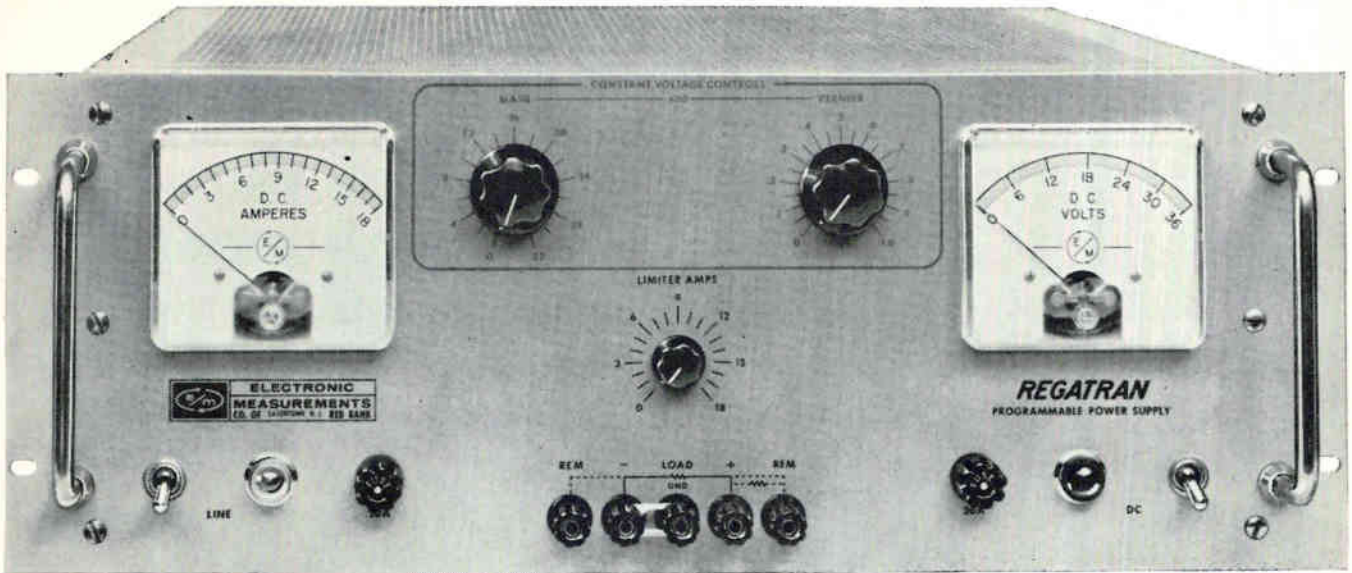

another first from Electronic Measurements

NEW "PV" Series Power Supplies

BRIEF SPECIFICATIONS

BASIC MODEL NO.	DC OUTPUT		DIMENSIONS IN INCHES		
	VOLTS	AMPERES	PANEL HEIGHT	PANEL WIDTH	DEPTH BEHIND PANEL
PV32-5	0-32	0-5	3½	19	17¼
PV32-10	0-32	0-10	5¼	19	16½
PV32-15	0-32	0-15	7	19	15¾
PV32-30	0-32	0-30	8¾	19	16¼
PV36-5	0-36	0-5	3½	19	17½
PV36-10	0-36	0-10	5¼	19	16½
PV36-15	0-36	0-15	7	19	15¾
PV36-30	0-36	0-30	8¾	19	16¼
PV60-2.5	0-60	0-2.5	3½	19	17¼
PV60-5	0-60	0-5	5¼	19	16½
PV60-7.5	0-60	0-7.5	7	19	15¾
PV60-15	0-60	0-15	8¾	19	16¼

- 0.01% or 2 millivolts regulation
- All solid-state with SCR input
- Programmable over the entire voltage and current range
- Long-line remote sensing
- Continuously variable current limiting
- Slaved series or parallel operation
- Up to 44% reduction in panel height

request specification sheet 2020



ELECTRONIC

MEASUREMENTS

COMPANY OF RED BANK
EATONTOWN • NEW JERSEY

Tristable Cores Detect Errors in Binary Data

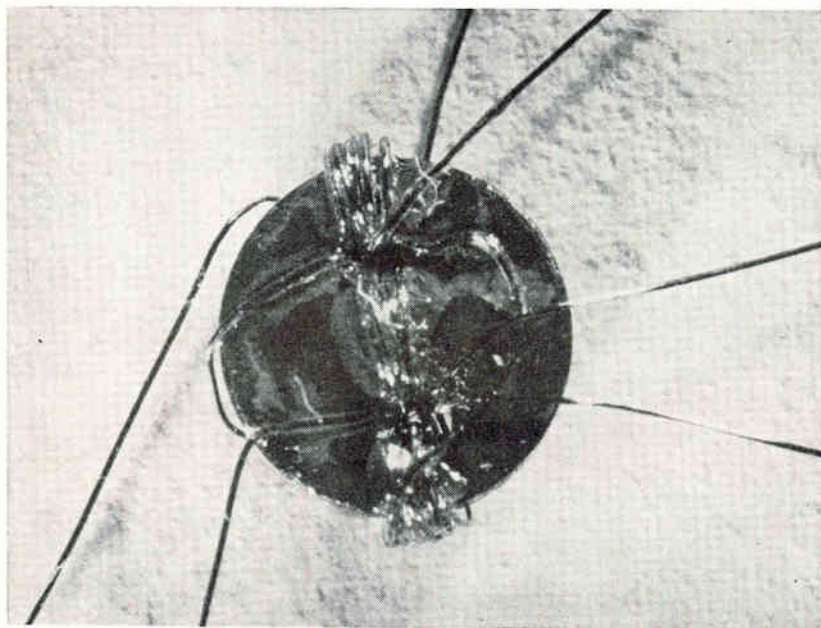

MULTIAPERTURE magnetic core with suitable winding arrangements can remain in any one of three different operating states

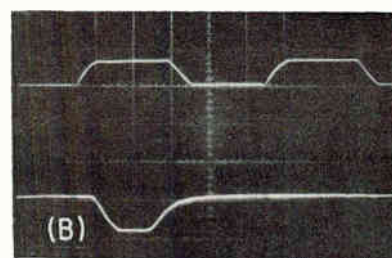
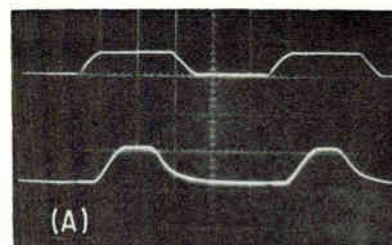

READOUT drive current in upper waveform of each crt display is shown with sense amplifier output for successive ONES (A) and for alternating ZEROES and unknown bits (B)

Multiaperture magnetic cores can store any one of three information bits

By M. PADALINO
IBM Data Systems Div.
Poughkeepsie, N. Y.

MULTIAPERTURE magnetic cores connected for tristable operation have been developed and tested successfully. The feasibility of their use in a system for continuous and automatic storage and readout of any one of three different bits of information has been established by an experimental model.

Magnetic cores have gained acceptance for a variety of electronics applications because they provide a highly reliable component at relatively low manufacturing cost that can remain in either of two stable states without consuming power. Similar advantages can be obtained

from multiaperture magnetic cores, and they can provide three stable states.

Tristable magnetic cores could be useful in a variety of applications. For example, tristable elements could be used in error correction circuits for communications systems that use binary coding. When received pulse information is so degraded that it cannot be recognized as either ONE or ZERO, this third unknown condition could be detected by a tristable magnetic core. Recognition of the condition could be used to activate correction circuits that would initiate retransmission of the pulse information.

Tristable elements could also be used for correcting timing errors between channels in multiple-track recording systems. They could function as a deskewing device in a buffer storage to determine one of three possible conditions of each bit of information. Numerous other examples exist in which it

would be desirable to represent one of three possible conditions.

OPERATION—The core geometry and winding arrangement of a two-aperture magnetic core connected for tristable operation are shown in Fig. 1A and B. A current pulse supplied to the reset or readout winding sets the core in its neutral condition.

A ONE is represented by supplying a current pulse to input winding A that switches the ferrite material around aperture X. A current pulse supplied to the reset winding restores the core to its original condition, which produces a voltage pulse across the output winding. Similarly, a current pulse provided to input winding B switches the ferrite material around aperture Y, and a current pulse in the readout winding resets the core and results in a voltage pulse appearing at the output winding. However, the output voltage

KEPCO PIONEERS THRU RESEARCH and DEVELOPMENT!

Kepeco knows that progress begins with critical analysis, research and development. Guided by a practical approach, the creative minds of Kepeco's engineers are able to supply the leaders of industry with consistently better equipment. Many of Kepeco's original techniques and concepts have become prevailing practice in the manufacture of regulated power supplies.

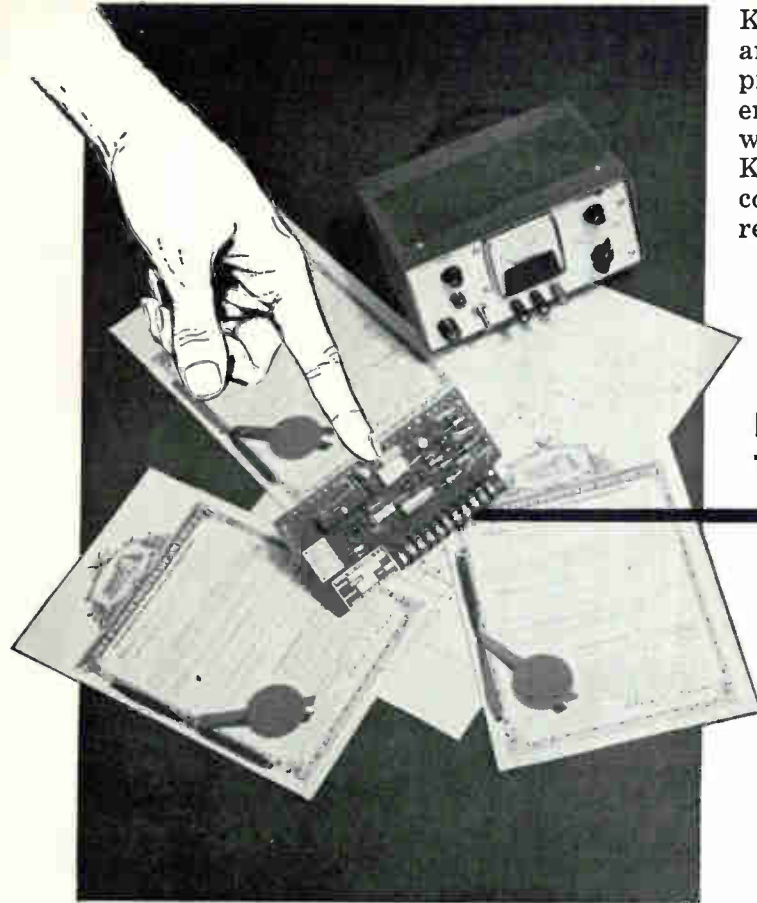

CHECK KEPCO

ENGINEERING CONTRIBUTIONS TO THE POWER SUPPLY FIELD!

- *The Voltage Comparison Bridge Regulator*
- *Full Voltage Range Regulation*
- *Short Circuit Protection by Current Limiting*
- *Remote Programming*
- *Remote Error Sensing*
- *Wide Range Magnetic Regulators*
- *Hybrid Regulators*
- *Voltage Correcting Systems*
- *Proportional Control of Multiple Supplies*
- *High Efficiency Lateral Cooling*

KEPCO **KS** HIGH-CURRENT, DUAL PRECISION REGULATION



an example of Kepeco's creative engineering and research...

ADJUSTABLE CURRENT LIMITING over the full range of current with automatic crossover from constant voltage to constant current.

PROGRAMMING OF OUTPUT VOLTAGE by resistance or voltage.

PROGRAMMING OF OUTPUT CURRENT by resistance or voltage.

ERROR SENSING at remote load assures regulation at the load.

HIGH-RESOLUTION ADJUSTMENT with 10-turn voltage control and 10-turn current limit control.

NO VOLTAGE OVERTHOOT from turn-on, turn-off or power failure.

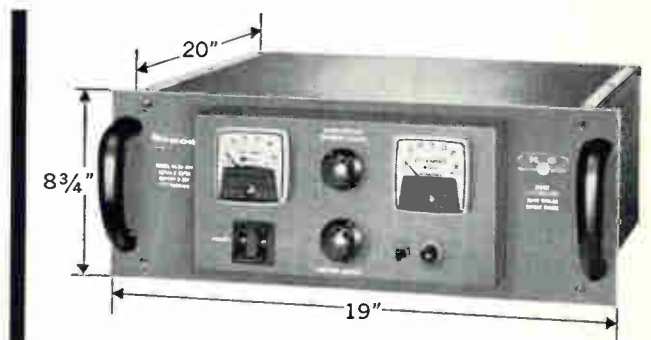

- **REGULATION:** 0.01% LINE/LOAD
- **STABILITY:** 0.01%
- **COMPLETELY PROGRAMMABLE**

MODEL	DC OUTPUT RANGE		REGULATION		STABILITY %	OUTPUT IMPEDANCE			RIPPLE RMS	INPUT WATTS MAX.	INPUT AMPS. MAX.*	PRICE
	VOLTS	AMPS	% LINE	% LOAD		0-1KC	OHMS MAX. 1KC-10KC	10KC-100KC				
KS 8-100M	0-8	100	0.01	0.01	0.01	0.0002	0.02	0.1	1 mv	1400	24	\$1,395.00
KS 18-50M	0-18	50	0.01	0.01	0.01	0.0004	0.02	0.1	1 mv	1400	24	1,295.00
KS 36-30M	0-36	30	0.01	0.01	0.01	0.0006	0.03	0.1	1 mv	1400	24	1,195.00
KS 60-20M	0-60	20	0.01	0.01	0.01	0.001	0.05	0.1	1mv	1500	26	1,295.00

*At 125 volts input



Over 250 standard models available from stock—write for new catalog B-621
 131-38 SANFORD AVENUE • FLUSHING 52, N.Y., U.S.A. • Phone (212) IN 1-7000
 TWX# (212) 539-6623 • Cable Address: KEPCOPOWER NEWYORK

ROYAL "FOAMAX" CABLES

Maximum reliability is built into every foot of "Foamax" — Royal's new Foam Dielectric Cable, manufactured to meet highest quality and performance standards. Write for a sample length and technical data.

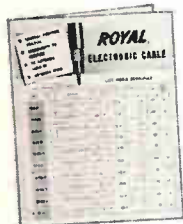

ROYAL ELECTRIC CORPORATION
301 Saratoga Avenue
PAWTUCKET • RHODE ISLAND

ROYAL
ELECTRIC
... an associate of

pulses produced by resetting each aperture are of opposite polarity.

The third condition of the tristable magnetic core is represented by the presence or absence of a current pulse in both input windings. The presence of such a pulse switches the ferrite material around both apertures, while the core remains in its original condition in the absence of a pulse to both input windings. In neither case does voltage appear at the output winding as a result of resetting the core.

The winding arrangement in Fig. 1B is only one possibility among several, which can be selected on the basis of the type signal provided in the particular application. For example, if instead of a two-level signal the input signal were a three-level voltage (positive voltage for a ONE, negative voltage for a ZERO and no voltage for the unknown bit), the wiring arrangement in Fig. 1C could be used. The two input windings are connected in series so a current pulse supplied to the series input winding would switch flux around one aperture but would reinforce the existing condition around the other aperture.

READOUT—As required for temporary storage, the information is destroyed during readout. However, polarity of the output voltage can be used as the basis for rewriting the original information if required. Nondestructive readout is also possible using bias restoration.²

The block diagram in Fig. 2 shows the laboratory model constructed to determine feasibility of continuous and automatic storage and readout of any one of three different bits of information. The square-wave generator with two cascaded binary triggers and a diode matrix generates four sequential pulses to activate the write and readout drivers. Key waveforms throughout the system are shown in Fig. 3.

The two-aperture magnetic core, which was connected as shown in Fig. 1C, is of copper-manganese ferrite material. Characteristics of the magnetic device include H_c of 2 to 2.3 oersted, B_s of 3,320 gauss

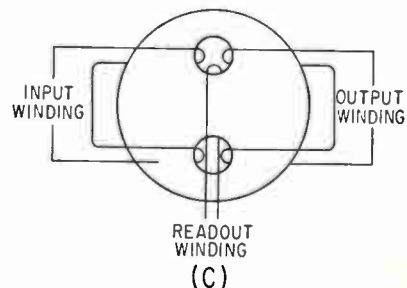
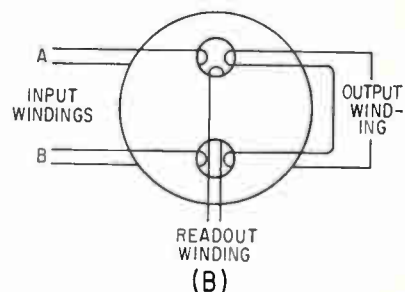
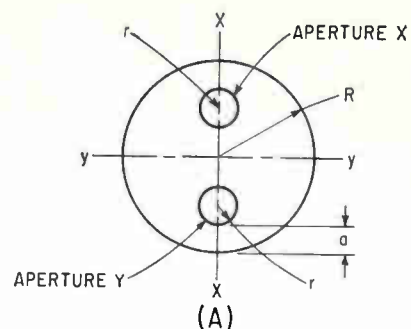

TRISTABLE operation can be obtained from multiaperture core (A) using wiring arrangement (B) for two-level inputs or series connected input winding (C) for three-level input signal—Fig. 1

and B_r of 2,180 gauss. The input winding consists of eight turns around each external leg of the core, the readout winding is made up of eight turns around the center leg, and the output winding comprises a single turn around each external leg. Using the symbols shown in Fig. 1A, dimensions include 20 mils for r , 100 mils for R and 14 mils for a .

PERFORMANCE — Write-read repetition rate has been varied between 10 and 500 Kc, the upper frequency limit being imposed by the square-wave generator used. The output waveforms, which are shown in the photograph, suggest that repetition rate could be increased to 2 Mc.

The project has established by the successful tests that a tristable core can store any one of three pos-

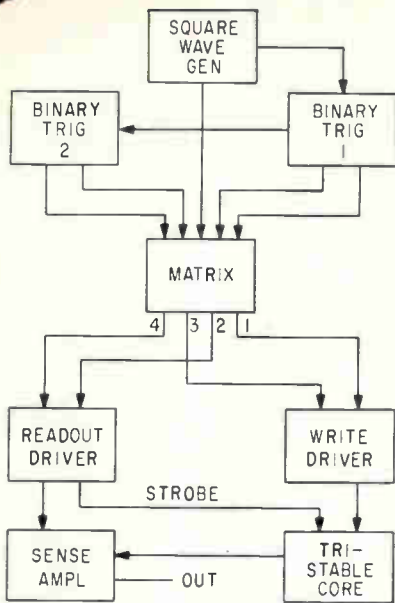

STORAGE and readout of any one of three different information bits is provided by experimental system—Fig. 2

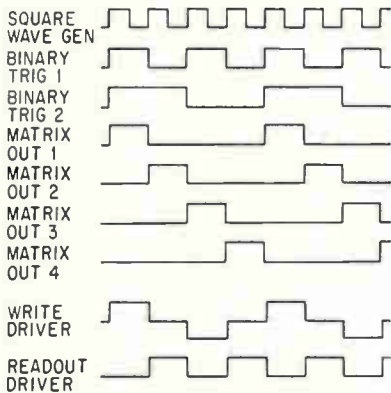

WAVEFORMS are shown at key points of laboratory model—Fig. 3

sible levels of information. Also, application of such a device for error correction in a multiple-track recording system or a multichannel data transmission system is feasible. However, incorporating tristable magnetic covers operational equipment must be justified on the basis of lower costs or space savings in equipment. Evaluation of the tristable magnetic core in terms of these criteria is planned for the near future.

REFERENCES

(1) M. Teig and J. R. Kiseda, A toroidal Nondestructive Readout Memory Element Using Bias Restoration, *Proc. 1961 Nonlinear Magnetic Conf.*

October 5, 1962

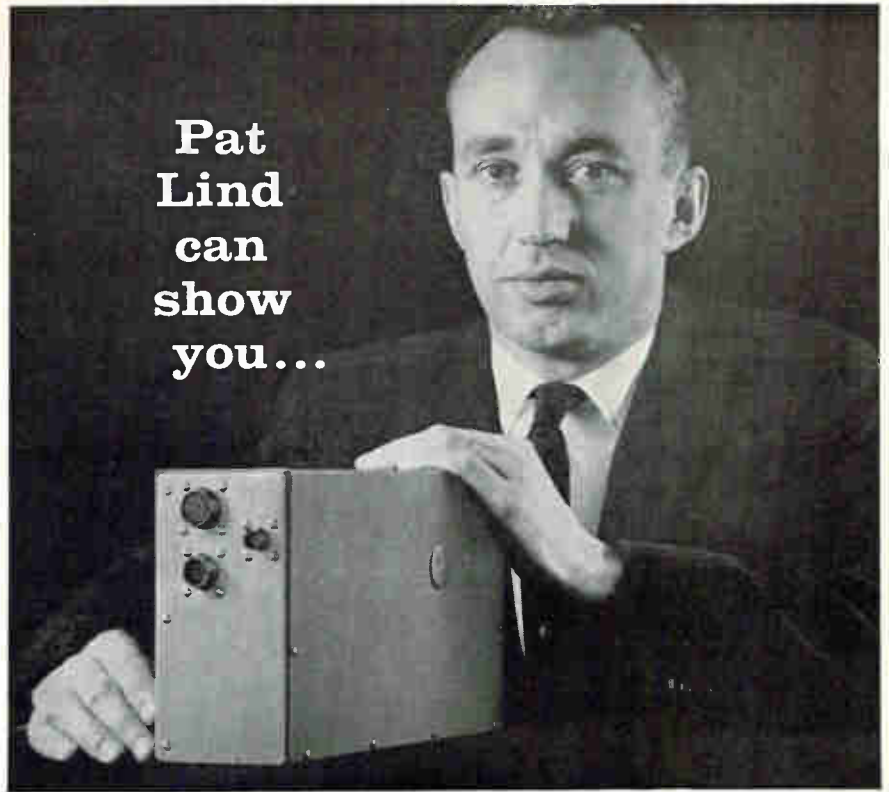

Pat
Lind
can
show
you...

Sales Engineer, Pat Lind Electronics Co.

how to measure in-phase and quadrature with 0.1% accuracy—in milliseconds

Previously unobtainable accuracy and millisecond response are only two of the reasons why NAI's Phase Sensitive AC-to-DC Converters meet the most critical requirements in computer, recording, automatic test and digital display systems.

Unlike conventional converters, these all solid state modules measure not only total signal—but quadrature, in-phase and fundamental components as well. DC output is proportional to selected input component, yet unaffected by harmonics. A wide range of manual and relay-actuated models permits selection and programming of function, range and frequency to suit test or system requirements.

Specifications of relay-programmed models are given in the table. Data on manually switched models PSC-415 and -416 upon request.

	PSC-410/411	PSC-420/421
Voltage Range	(410 & 420)	1 v f.s. to 300 v f.s., 4 ranges
	(411 & 421)	10 mv f.s. to 300 v f.s., 6 ranges
Frequency Range	(phase sens.)	1 frequency*
	(total volts)	60 cps - 20 kc
Linearity	0.1% f.s.	0.1% f.s.
Functions	E_{ϕ} , E_{θ} , E_{in} and E_{q}	
Output Voltage	0-10 v dc. into 10 k load, for all functions	
Input Impedance	1 megohm	1 megohm
Response Time	0.1 sec	

*any frequency between 60cps and 10kc.

The North Atlantic man in your area can quickly show you how the PSC-410 and -420 simplify AC measurement jobs from GSE to production test of transducers, networks and amplifiers. Call today for his name, or request Bulletin PSC-1.



NORTH ATLANTIC industries, inc.
TERMINAL DRIVE, PLAINVIEW, L. I., NEW YORK • Overbrook 1-8600

CIRCLE 63 ON READER SERVICE CARD 63



Electronic Switching, Timing, and Pulse Circuits, by J. M. Pettit. Publisher's Price, \$8.50, Club Price, \$7.25



Information Transmission, Modulation, and Noise, by M. Schwartz. Publisher's Price, \$11.75, Club Price, \$9.95

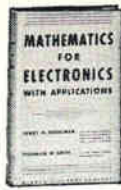

Mathematics for Electronics with Applications, Nodelman & Smith. Publisher's Price, \$7.00, Club Price, \$5.95



Digital Computer and Control Engineering, by R. S. Ledley. Publisher's Price, \$14.50, Club Price, \$12.35



Modern Transistor Circuits, by J. Carroll. Publisher's Price, \$9.00, Club Price, \$7.65



Magnetic Recording Techniques, by W. E. Stewart. Publisher's Price, \$9.00, Club Price, \$7.65

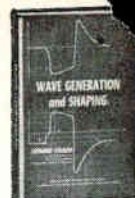

Wave Generation and Shaping, by L. Strauss. Publisher's Price, \$12.50, Club Price, \$10.65

SPECIAL INTRODUCTORY OFFER

Take **ANY ONE \$1.00** for only

To NEW MEMBERS of the **Electronics and Control Engineers' Book Club**

SAVINGS UP TO \$21.50



Electronic Designers' Handbook, Landee, Davis, & Albrecht. Publisher's Price, \$17.50, Club Price, \$14.95



Control Engineers' Handbook, ed. by J. C. Truxal. Publisher's Price, \$22.50, Club Price, \$19.10



Elements of Servomechanism Theory, by G. Thaler. Publisher's Price, \$9.50, Club Price, \$8.10



Instrumentation in Scientific Research, by C. S. Lion. Publisher's Price, \$9.95, Club Price, \$8.45



Basic Feedback Control System Design, by C. J. Savant, Jr. Publisher's Price, \$10.50, Club Price, \$8.95

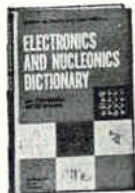

Electronics and Nucleonics Dictionary, Cooke & Markus. Publisher's Price, \$15.00, Club Price, \$12.75



Electronic and Radio Engineering, by F. Terman, 4th Ed. Publisher's Price, \$15.50, Club Price, \$13.25



Management for Engineers, by R. C. Heimer. Publisher's Price, \$7.50, Club Price, \$6.40

How many of these books do you wish you had at Club savings?

Select one for JUST A DOLLAR! Choose from *Electronic Designers' Handbook*, *Modern Transistor Circuits*, *Magnetic Recording Techniques*, *Wave Generation and Shaping*, and eleven other valuable books . . . your introduction to membership in the *Electronics and Control Engineers' Book Club*.

If you're missing out on important technical literature, if today's high cost of reading curbs the growth of your library—here's the solution to your problem. *The Electronics and Control Engineers' Book Club* was organized for you, to provide an economical technical reading program that cannot fail to be of value to you.

All books are chosen by qualified editors and consultants. Their thoroughgoing understanding of the standards and values of the literature in your field guarantees the authoritativeness of the selections.

HOW THE CLUB OPERATES

You regularly receive free of charge *The Electronics and Control Engineers' Book Bulletin*. This gives complete advance notice of the next main selection, as well as a number of alternate selections. If you want the main selection you do nothing; the book will be mailed to you. If you want an alternate selection . . . or if you want no book at all for that two-month period notify the Club by returning the postpaid card enclosed with each *Bulletin*.

SAVES YOU TIME AND MONEY

We ask you to agree only to the purchase of three books in a year. Certainly out of the large number of books in your field offered in any twelve months there will be at least three you would buy anyway. By joining the Club you save yourself the bother of searching and shopping, and save in cost about 15 per cent from publishers' prices. Send no money now. Just indicate any two books you want—one for only \$1.00 and one as your first Club selection—in the coupon below. Take advantage of this offer now, and get two books for less than the regular price of one.

CLIP AND MAIL THIS COUPON TODAY

The Electronics and Control Engineers' Book Club, Dept. L-10-5
330 West 42nd Street, New York 36, N. Y.

Show 2 numbers: #1 for dollar book and #2 for Club selection

Please enroll me as a member of the Electronics and Control Engineers' Book Club. I am to receive the two books I have indicated below. You will bill me for my first selection at the special club price and \$1 for my new membership book, plus a few additional cents for delivery costs. (The Club assumes this charge on prepaid orders.) Forthcoming selections will be described to me in advance and I may decline any book. I need take only 3 selections or alternates in 12 months of membership. (This offer good in U. S. only.)

- Elec. Switch., Tim., & Pulse Cir., \$7.25
- Info. Trans., Mod., & Noise, \$9.95
- Math. for Elec. with Appl., \$5.95
- Dig. Comp. & Ctl. Engr., \$12.35
- Modern Transistor Circuits, \$7.65
- Magnetic Recording Techniques, \$7.65
- Wave Generation and Shaping, \$10.65
- Elec. Designers' Hdbk., \$14.95
- Elem. of Servomech. Theory, \$8.10
- Basic Feedback Ctl. Sys. Des., \$8.95
- Electronic & Radio Engr., \$13.25
- Control Engineers' Hdbk., \$19.10
- Instrumentation in Sci. Res., \$8.45
- Elec. & Nucleonics Dict., \$12.75
- Mgmt. for Engineers, \$6.40

PLEASE PRINT

Name

Address

City..... Zone..... State.....

Company

NO RISK GUARANTEE:

If not completely satisfied, you may return your first shipment within 10 days and your membership will be canceled. L-10-5

MAIL COUPON AT RIGHT TODAY

Another New High Order of Reliability!

El-Menco

*MYLAR-PAPER DIPPED CAPACITORS

TYPE MFD

ASSURE A LOW FAILURE RATE OF
Only 1 Failure in 7,168,000 Unit-Hours for 0.1 MFD Capacitors*

14,336,000

Setting A New High Standard Of Performance!

Life tests have proved that El-Menco Mylar-Paper Dipped Capacitors — tested at 105°C with rated voltage applied — have yielded a failure rate of only 1 per 1,433,600 unit-hours for 1.0 MFD. Since the number of unit-hours of these capacitors is inversely proportional to the capacitance, 0.1 MFD El-Menco Mylar-Paper Dipped Capacitors will yield ONLY 1 FAILURE IN 14,336,000 UNIT-HOURS.

CAPACITANCE AND VOLTAGE CHART

• Five case sizes in working voltages and ranges:

200 WVDC —	.018 to .5 MFD
400 WVDC —	.0082 to .33 MFD
600 WVDC —	.0018 to .25 MFD
1000 WVDC —	.001 to .1 MFD
1600 WVDC —	.001 to .05 MFD

SPECIFICATIONS

- **TOLERANCES:** 10% and 20%. Closer tolerances available on request.
- **INSULATION:** Durez phenolic, epoxy vacuum impregnated.
- **LEADS:** No. 20 B & S (.032") annealed copper clad steel wire crimped leads for printed circuit application.
- **DIELECTRIC STRENGTH:** 2 or 2½ times rated voltage, depending upon working voltage.
- **INSULATION RESISTANCE AT 25°C:** For .05MFD or less, 100,000 megohm-micrarads. Greater than .05MFD, 5000 megohm-micrarads.
- **INSULATION RESISTANCE AT 105°C:** For .05MFD or less, 1400 megohms minimum. Greater than .05MFD, 70 megohm-micrarads.
- **POWER FACTOR AT 25°C:** 1.0% maximum at 1 KC

These capacitors will exceed all the electrical requirements of E. I. A. specification RS-164 and Military specifications MIL-C-91B and MIL-C-25C. Write for Technical Brochure

MINIMUM LIFE EXPECTANCY FOR **1.0 MFD *MYLAR-PAPER DIPPED CAPACITORS AS A FUNCTION OF VOLTAGE & TEMPERATURE

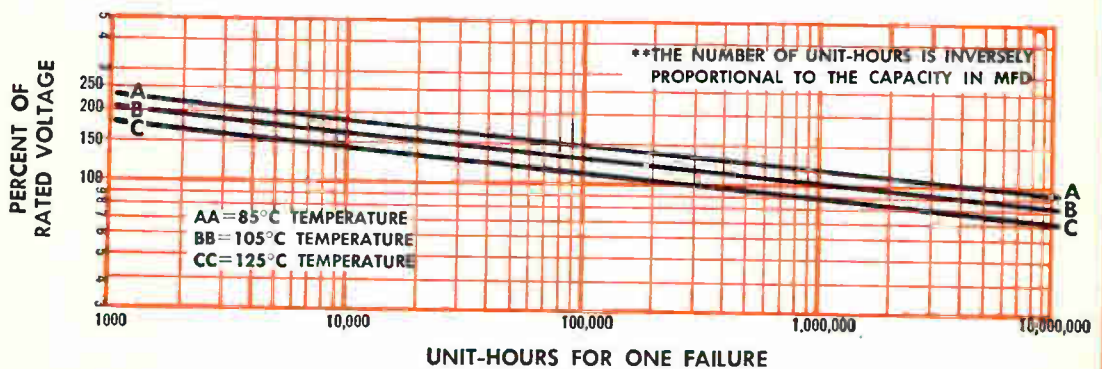

*Registered Trade Mark of DuPont Co.

THE ELECTRO MOTIVE MFG. CO., INC.
WILLIMANTIC, CONNECTICUT

Dipped Mica • Molded Mica • Silvered Mica Films • Mica Trimmers & Padders
Mylar-Paper Dipped • Paper Dipped • Mylar Dipped • Tubular Paper

ARC® ELECTRONICS, INC., Community Drive,
Great Neck, L. I., New York
Exclusive Regional Sales and Distributors
in the U.S. and Canada

West Coast Manufacturing Center
DILLINS & HYDE CO., 535 Woodfield Road,
Palo Alto, California
5380 Whittier Boulevard, Los Angeles, California

MANUFACTURERS OF
El-Menco
Capacitors

Designing Circuits on Alumina Substrates

Same technique may be applied when advanced concepts are developed

MICROCIRCUITS use miniature components and capabilities or constructing a number of circuits on one or more substrates. Alumina substrates are used by one fabricator because of their high thermal conductivity.

Gold-platinum conductive patterns are used for adherence to alumina, and also the alloys' non-migratory nature.

Individual substrates can be connected to the mother substrate with printed conductive patterns. This method of joining the substrates also helps to dissipate heat. When functional blocks become available, these same techniques would still be adaptable, according to Aerovox spokesmen.

Resistive soldering concentrates the soldering heat at the direct point of contact between the component termination and the conductive path.

Company thinking has been directed toward reducing cost, and may reach the point where the entire module is replaced, instead of the individual component.

The temperature characteristic of printed carbon resistors (on small substrates) is less than 200 parts per million per deg C for resistance values of 1 K to 100 K, 600 ppm per deg C or less from 100 K to 1 meg, and 1,200 ppm per deg C or less from 1 meg to 6 meg. By optimizing circuit structure for maximum heat dissipation, actual changes in resistance value can be kept quite small.

DATA OBTAINED—Changes in resistance during temperature cycling will be less than one per cent and will stabilize at 0.2 per cent or less after five cycles. The load life characteristics of 30 resistors after

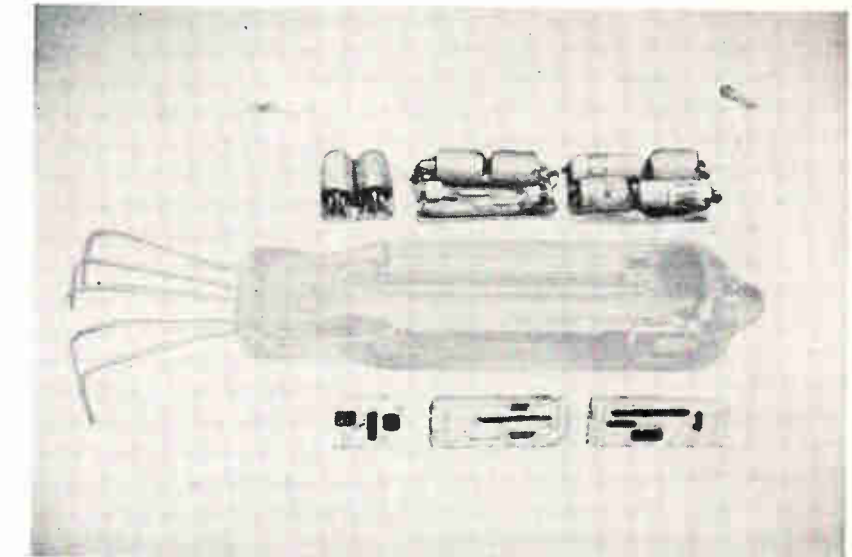

BINARY indicator employs 11 components on alumina substrates, top. Tiny lamps connect to circuit. Density is 2,000 parts per cu. in. Scale is shown by subminiature vacuum tube—Fig. 1

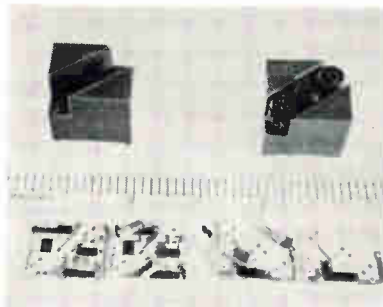

SERVO preamplifier contains 14 components. Triangular sections on each side of transistors are utilized for mechanical protection—Fig. 2



RECTANGULAR WAVE power supply for d-c chopper amplifier, built up on alumina substrates. Unit has 24 components—Fig. 3

4,200 hours had an average change of 0.54 per cent and a max change of 1.2 per cent; the load density was 13 watts per sq in at ambient. This data was obtained on 15 alumina substrates, 0.3 in. × 0.3 in. × 0.010 in., with two 0.50 × 0.150 in. resistor on each substrate. Substrates were coated with a 0.030-in. epoxy material for humidity protection.

Similar resistors, subject to humidity cycling (MIL-R-11), showed a max change of 2 per cent. No change was noted in moisture cy-

cling. Voltage coefficients were well below 0.05 per cent per volt.





Considerable progress has been made towards developing a premium metal frit (cermet) composition resistor, 50 ohms to 1 meg, with superior performance characteristics.

The approach allows the customer to engineer the complete circuit design, followed by a physical design by Aerovox. Flexibility allows the customer to change resistors and capacitors, as well as cir-

what's so special about GRC's tiny zinc die castings and thermoplastic moldings?

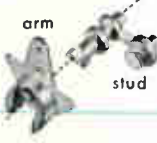
You get benefits no other method can match through GRC's single cavity technique. In one automatic, high speed operation, GRC's exclusive special die casting and molding machines turn out precision intricate die cast and molded parts, completely trimmed...with an unequalled degree of uniformity and preciseness. *They give you wider design latitude...* GRC's special techniques provide shortcuts to economy and quality that permit original design, or redesign, of small parts for greater value improvement. *They lower your end-use cost...* GRC's exclusive HIGHER VALUE methods deliver parts with a high part-to-part uniformity which reduces assembly costs, helps make automated assembly possible. **HERE ARE A FEW EXAMPLES:**

THIS!

GRC customer	part description (plus end product use)	material & processes used	how GRC provides HIGHER VALUE
STEWART WARNER	Coil Carrier for Electric Speedometer 	Automatically molded in Nylon	Precise, intricate 1-pc. molding 1) retains coil, dynamic balance pin, pivot shaft, 2) provides mount for counter-balance weight, assures uniform multi-function part, simpler assembly.
CLAROSTAT	Mated Rocker Arm & Stud for Volume Control 	Automatically die cast in Zinc Alloy	Pre-GRC: 2 screw machine parts + stamped arm + forming operation. GRC die casts 2 studs as 1 part; integral lug of stud mates with locking slot in arm. Lowers assembly cost and inventory, improves product performance.
RONSON	Mated Inner Cutter Bearing & Trunion for Electric Razor 	Automatically molded in Delrin	Precise snap-fit of trunion & inner cutter bearing—fit held to 0.001"—assures bind-free rotation during 14,400 cpm reciprocating motion of bearing (cutter bar attached to it). Design allows replacement of worn cutter head only, not entire shaving head. Makes competitive product advantage possible.
DICTAPHONE	Taper Pin Receptacles for Dictating Machine 	Automatically die cast in Zinc Alloy	Quickly, efficiently establishes electrical contact, eliminates soldering assembly step, provides easy connect and disconnect. Simplifies field service, speeds assembly.
LIONEL	Coupler for Model Railroad Train 	Automatically molded in Delrin	Pre-GRC: spring + casting + assembly. GRC molding with integral leaf spring design costs less, eliminates extra assembly, simplifies major coupling problem. Reduces parts, assembly, inventory costs, improves performance.
IBM	Plug Nose for Data Processing Machine 	Automatically die cast in Zinc Alloy	Design with GRC plug nose makes patch cord removal from program board easy, yet resists accidental pull-out; allows automatic assembly of patch cord (former stamped part did not). Automates assembly, improves in-use reliability.

Parts shown actual size

Find out about GRC's unusual and complete services, and write for several significant guides to help you in designing simple and intricate small parts.

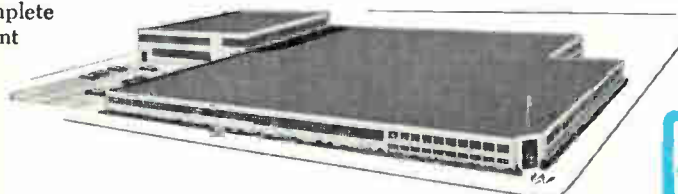

Maximum sizes:
zinc alloy: 2" long; 1/2 oz.
plastics: 1 1/4" long; 05 oz.
no minimum

G R I E S R E P R O D U C E R C O R P .

world's foremost producer of small die castings & plastic moldings / 151 Beechwood Ave., New Rochelle, N. Y. • (914) NEW Rochelle 3-8600



TRANSISTOR . . .

small signal "h" parameters



Model 1803A

Write for information about industry's most complete line of standard and custom designed instruments for semiconductor testing.

DYNATRAN

electronics corporation

178 HERRICKS ROAD
MINEOLA, NEW YORK
Pioneer 1-4141

CIRCLE 211 ON READER SERVICE CARD

Measure
MILLIVOLTS
. **NANOAMPERES**
accurately at low cost
with **DYNATRAN's** . . .



Model 1829

SENSITIVE
DC
VTVM

Write for complete information about this and other quality instruments for laboratory, production, incoming inspection and quality control.

DYNATRAN

electronics corporation

178 HERRICKS ROAD
MINEOLA, NEW YORK
Pioneer 1-4141

circuit configuration for breadboard use.

Component densities of 2,000 parts per cubic inch is achieved in digital circuits, see Fig. 1. Through the use of smaller components, such as Cerol and Cerafil capacitors, printed resistors, tantalum capacitors, dot diodes and dot transistors in this circuit configuration, density can be increased by a factor of three.

Company thinking has been directed towards reducing cost of microcircuits. As demand increases, various individual microcomponents may reach the point where the entire module is replaced, instead of the individual components, see Fig. 2 and Fig. 3.

Tiny Spheres Used As Semiconductor Junctions

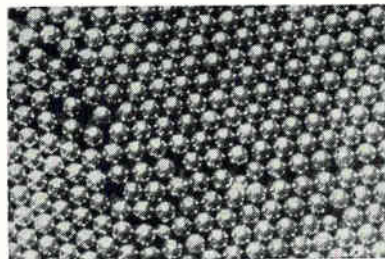

WORLD smallest manufactured parts?

A DIFFICULT problem in manufacturing microwave tunnel diodes is the extremely small size dictated by circuit impedance considerations. For a useful tunnel diode amplifier or oscillator device at the 10,000-Mc range, both the capacity of the diode and the circuit inductance must be kept small. Since the capacity of the diode is determined principally by the area of the semiconductor junction, size of the junction is critical.

Technique used by Microwave Associates—to reproducibly manufacture high-density tunnel diodes with low series resistance and resistive cutoff frequencies in excess of 30 gc—is to use as junctions semiconductor spheres 0.0015-in. in diameter. Company says little etching is required, claims series resistance is lowered and good mechanical strength is achieved.

Semiconductor spheres as small as 0.0003-in. diameter are mass pro-

duced by Anchor Alloys. Company says sorting techniques assure consistency, in the case of 0.0003-in. spheres, to a range of 0.0001 inch.

Spheres, used as doping agents and junctions in the manufacture of transistors and other electronic components, are made of indium, bismuth, antimony, palladium, silver and gold.

Organic Resin Meets Insulation Requirements

NEW CLASS of thermosetting resins have been derived from diphenyl oxides by modifying the aryl or the aromatic shape of the rings in the resin structure. Westinghouse claims this new family of insulating materials maintains bond strengths over 3,000 hours at 250 deg C. Varnished rotating equipment has been subjected to a force of 6,000 G's at temperatures exceeding 150 deg C in oil without effect. Brush wear tests show brush life is extended up to ten times that of brush life in other class H insulation atmospheres, according to company spokesmen.

The coating is available as a varnish, or varnish-treated cloth. Coating is said to maintain a mechanically solid finish in tests up to the 300 deg C range, under chemical, alkali, or solvent attack. Development comes at a time when more demands are being put for electrical equipment that can operate at higher voltages, higher ratings of manageable size, and more exacting reliability.

Some 25 companies are presently testing and making pilot runs using the material in a broad range of applications from automotive to electrical transmission equipment. In test shown in photograph, lam-

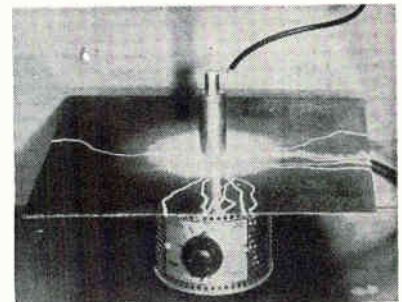

ELECTRICAL surges up to 100,000 volts failed to damage 1/16-in. thick coated laminated board

inated board withstood electrical field of 37 Kv with repeated surges of up to 100 Kv with no effect.

Trade name Doryl, represents an abbreviation of diphenyl oxide and the aryl rings in the resin structure.

Floating Bearing For Space Guidance

A WORKING MODEL of a magnetic bearing, which eliminates friction by free-floating a rotating shaft in a magnetic field has been built at Armour Research Foundation of Illinois Institute of Technology.

Magnetostatic system uses permanent magnets requiring no external power source or controls. Laboratory model employs Indox V ceramic magnet materials, which are light in weight, have high electric resistance, and resist de-magnetizing forces.

One problem confronting designers of high-speed rotating mechanisms, such as the gyroscopes used in modern navigational systems, is the proper selection of shaft bearings. Magnetic bearing is based on the principle that perfect equilibrium in one plane of a magnetic field can be achieved, provided that in the direction perpendicular to this plane there is a restriction to physical displacement. For a magnetic-centered shaft the plane of equilibrium is radial—the direction in which it revolves. Movement along the perpendicular plane, along the axis of the shaft, is restricted in the model because the ends of the shaft abut against end-stones.

The assembly consists of two concentric ring-shaped magnets, placed to repel one another. The smaller ring centers itself inside the larger, and maintains that position as long as it is held in the same plane as the larger ring. This is accomplished when the inner ring is mounted on a shaft which is abuted at both ends. The larger ring is held in place by the frame of the assembly.

The air gap maintained between the two rings by the magnetic force prevents friction when the shaft is turned. In a vacuum, or outer space environment, friction is further reduced by the absence of air drag.

ARNOLD: WIDEST SELECTION OF MO-PERMALLOY POWDER CORES FOR YOUR REQUIREMENTS

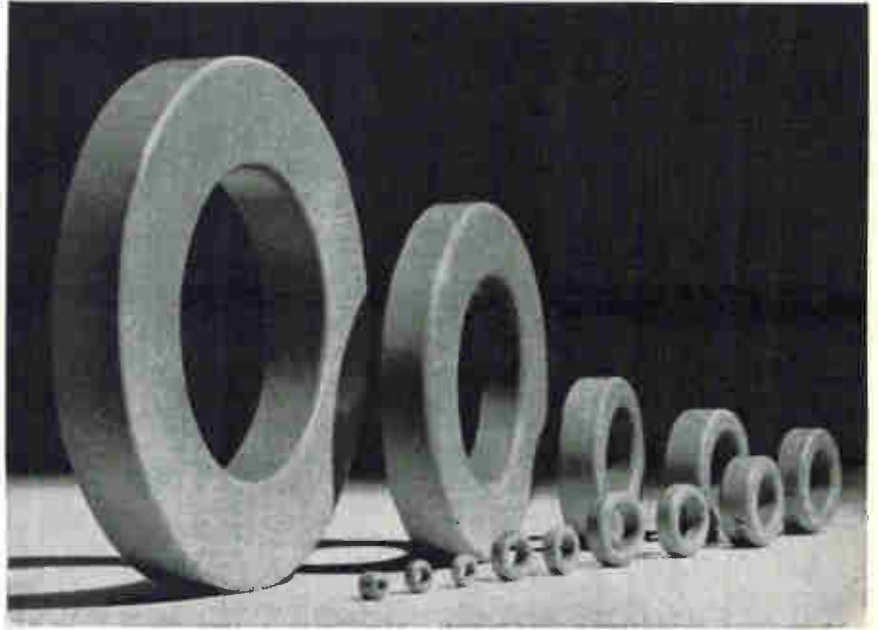

For greater design flexibility, Arnold leads the way in offering you a full range of Molybdenum Permalloy powder cores . . . 25 different sizes, from the smallest to the largest on the market, from 0.260" to 5.218" OD. Standard permeabilities are 14, 26, 60 and 125 Mu, and the high permeability range includes cores of 147, 173 and 205 Mu.

In addition to pioneering the development of the cheerio-size cores, Arnold is the exclusive producer of the largest 125 Mu core commercially available. A huge 2000-ton press is required for its manufacture, and insures its uniform physical and magnetic properties. This big core is also available in 14, 26 and 60 Mu.

High-permeability cores up to 205 Mu are now available in most sizes. These cores are specifically designed for low-frequency applications where

the use of 125 Mu cores does not result in sufficient Q or inductance per turn. They are primarily intended for applications at frequencies below 2000 cps.

Most sizes of Arnold M-PP cores can be furnished with a controlled temperature coefficient of inductance in the range of 30 to 130° F. Many can be supplied temperature stabilized over the MIL-T-27 wide-range specification of -55 to +85°C . . . another special Arnold feature.

Graded cores are available upon special request. All popular sizes of Arnold M-PP cores are produced to a standard inductance tolerance of + or -8%, and many of these sizes are available for immediate delivery from strategically located warehouses.

Let us supply your requirements for Mo-Permalloy powder cores (*Bulletin PC-104C*) and other Arnold products.



ADDRESS DEPT. E-10
ARNOLD
SPECIALISTS in MAGNETIC MATERIALS

THE ARNOLD ENGINEERING COMPANY, Main Office: MARENGO, ILL
BRANCH OFFICES and REPRESENTATIVES in PRINCIPAL CITIES.
DISTRICT OFFICE: 610 E. Palisade Ave., Englewood, N. J.
Telephone: ENterprise 6374

118710

Epoxy Used for Short Run Production

Epoxy can be used both as mold material and for finished parts

By WAYNE GILMAN
Motorola Military Electronics Div.,
Chicago, Ill.

EPOXY FABRICATIONS are suitable not only for tooling but for actual production parts as well. Prototype models and even limited quantity production runs of cases for radios, precision cam shafts, and gear plates are being made of epoxy at this division.

Not only is fabrication speeded but costs are cut as much as 50 percent, even for items that must meet stringent military requirements. Tight contract schedules are more easily met because of the elimination of time-consuming hogging-out of parts. Control and flexibility of the process allow design changes to be made quickly.

Because of the minimum capital investment and the reduction in labor with epoxy fabrication, savings can run into thousands of dollars a year. Models, dies, mock-ups, complete cabinets, and small component parts are fabricated at this division in a small, special department.

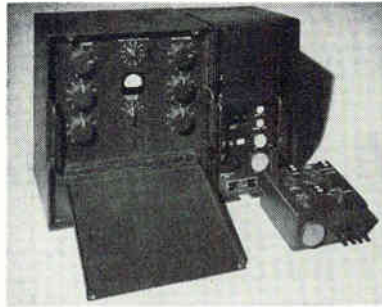

RADIO MOCK-UP was made of alternate layers of epoxy and glass cloth. Plaster mold for case was made from a wood pattern

An example of the kind of work possible is the radio mock-up shown. The cases were made by laying up alternate layers of epoxy and glass cloth. Knobs, switches, and meter blocks are also of epoxy although actual hardware can also be used. Interestingly, the same epoxy material is used for both molds and parts.

On another application, six cases and covers for test models of a pocket carried radio were required and four fabrication methods were considered. The cost to machine the cases from raw aluminum was estimated at \$2,600. The cost to make a pattern, prepare plaster molds from which six sets of castings could be made, then machine holes and threads, and fit to size, was

estimated at \$3,000. To make a steel mold for making die cast parts, cast six parts and add drill and tapping operations was estimated to cost \$5,500. The method adapted was to re-work the original machined engineering model incorporating engineering design changes, then cast an epoxy mold from this model and cast the required six sets of parts in the epoxy mold. All holes and threads were incorporated in the parts through the use of machined steel inserts; no machining was required since fitting dimensions are held to sufficiently close tolerances. The parts shown were made at a total cost (including molds) of \$1,225, a saving of over \$1,300 over the cheapest alternative. In addition there was a 50 percent saving in fabrication time.

CAM SHAFTS—Miniature precision cam shafts can also be made with epoxy. The original cam shaft (see photo) used in the engineering model was made in the model shop. It was made from flattened shaft over which were slipped nylon cams and spacers, with end spacers pinned in place. The cams were all different with respect to flat and high point.

In the quantity required for service test models, the cam shafts

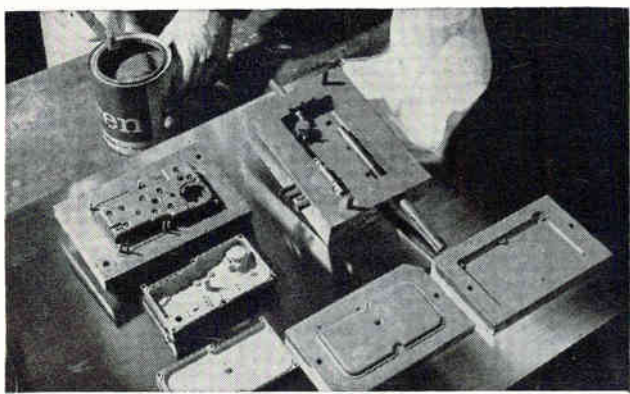

CASE AND COVER (left) for small radio were made from high temperature epoxy using epoxy molds and glass cloth reinforcing. Machined aluminum models were used for making casting molds



EPOXY CAM SHAFTS with cam heights held to ± 0.001 inch are molded on knurled center shafts instead of using nylon cams on flattened shaft. Molds were cast from a cold pouring silicone rubber



...a TV set
operating under water?

That's not water... that's FREON® fluorocarbon solvent

And we'll bet this is the cleanest electronic system at the NEC show! Because it will play, while completely immersed, for the duration of the show.

This demonstration is possible because "Freon" is an excellent dielectric and a selective cleaning agent. There is no arcing, even in the TV set's high-voltage circuitry. "Freon" thoroughly removes dust, grease, lint and chips from components or entire assemblies—without harm to delicate parts, finishes, elastomers or insulation. "Freon" has a uniquely low surface tension that lets it penetrate minute openings. There it wets and displaces soils other solvents cannot.

And "Freon" is *safe* for production people because it's nonexplosive and virtually nontoxic. It leaves no residue and can easily be recovered for use over and over again for maximum economy.

So don't miss this one at NEC! If you're not going to the show, write for complete technical information, and, if you wish, the services of a Du Pont technical man. Du Pont Company, 2420E01 Nemours Building, Wilmington 98, Delaware.

Freon® solvents

Better Things for Better Living... through Chemistry



SEE THIS DEMONSTRATION IN BOOTH # 401 AT NEC!



Mr. RAFRIN* Got You in the Dumps?

Electro • International's quick reaction time can dispose of your RAFRIN problem — fast! We can meet the Spectrum Signature Program requirements proposed for all future Government contracts, (measurements from 20 cycles/sec. to 15,000 megacycles/sec.). To find out more about RFI Control — and how EARLY consultation can save you money — write for an Electro • International Capabilities brochure.

*RAFRINTM Frequency Interference



ELECTRO INTERNATIONAL
Box 391, Annapolis, Md., CO.3-2661
Subsidiary of Electro Instruments, San Diego, Cal.



GEAR PLATES, made from aluminum filled epoxy, work well for normal temperature range but thermal expansion can cause trouble if temperature variation is too wide.

were estimated to cost approximately \$12 each. With slight redesign, and using a knurled center shaft, the cam segments plus the added feature of serrated end for indexing were cast onto the shaft at a cost of about \$3.50 per shaft. Total saving on this part was in excess of \$3,200. The split molds used were made of cold molding rubber cast into a brass tube to maintain the accuracy required in the casting of cam bosses. After curing, the rubber mold is removed from the tube and is snapped off finished parts. The cams are then ready for use. Accuracy of ± 0.001 on cam height was maintained.

The epoxy gear plate shown was made from a jig-board master with inserted pins made from standard ground precision stock. To obtain rigidity in the gear plate a sheet of metal or glass epoxy board with large punched clearance holes is dropped over the pins and centered. The stiffening board around which the epoxy is molded is spaced away from the master plate by spacers of sufficient thickness to position it in the center of the finished cast plate. Precision bearings (oilite or other) are next dropped over ground shafts. A temporary frame is set up around the plate and the mold is ready for pouring. Epoxy material is poured into the mold until it rises to the level of the top of inserts. After curing, the top face of the cast plate is machined off and it is ready for assembly.

In tests, gear plates made by this method have proven highly successful except in cases where they are exposed to temperatures in excess of 140 F. Cost savings over machined gear plates was greater than 50 percent.

In addition to the items men-

tioned, aluminum filled epoxy has been used to make mold cores for instrument housings, and the housing itself has been made of cast epoxy. Epoxy has also been used for molds for injection molded, nylon switch parts.

Electron Beams Make Insulating Films

TECHNIQUE for forming extremely thin, uniform layers of insulation on solid surfaces has been developed by chemists of IBM at the Thomas J. Watson Research Center, Yorktown, N. Y. The process involves polymerization of an organic gas, butadiene, into a solid insulating layer by bombardment with an electron beam.

The technique may make possible thinner, more reliable insulating films than can be obtained with other techniques. Such films would be highly desirable for a number of electronic devices including capacitors and various types of thin film circuits.

Polymerization of butadiene occurs initially in an adsorbed layer on the surface of the substrate and continues by reaction of adsorbed gas with active sites on the polymer surface. The fact that the reaction occurs entirely on the surface could be significant for making insulating films in microcircuits since fine lines of insulating film could be drawn on a surface with an electron beam.

The reaction rate was found to be independent of the pressure of butadiene gas above about 10^{-4} mm Hg, and independent of current in the electron beam above a certain value.

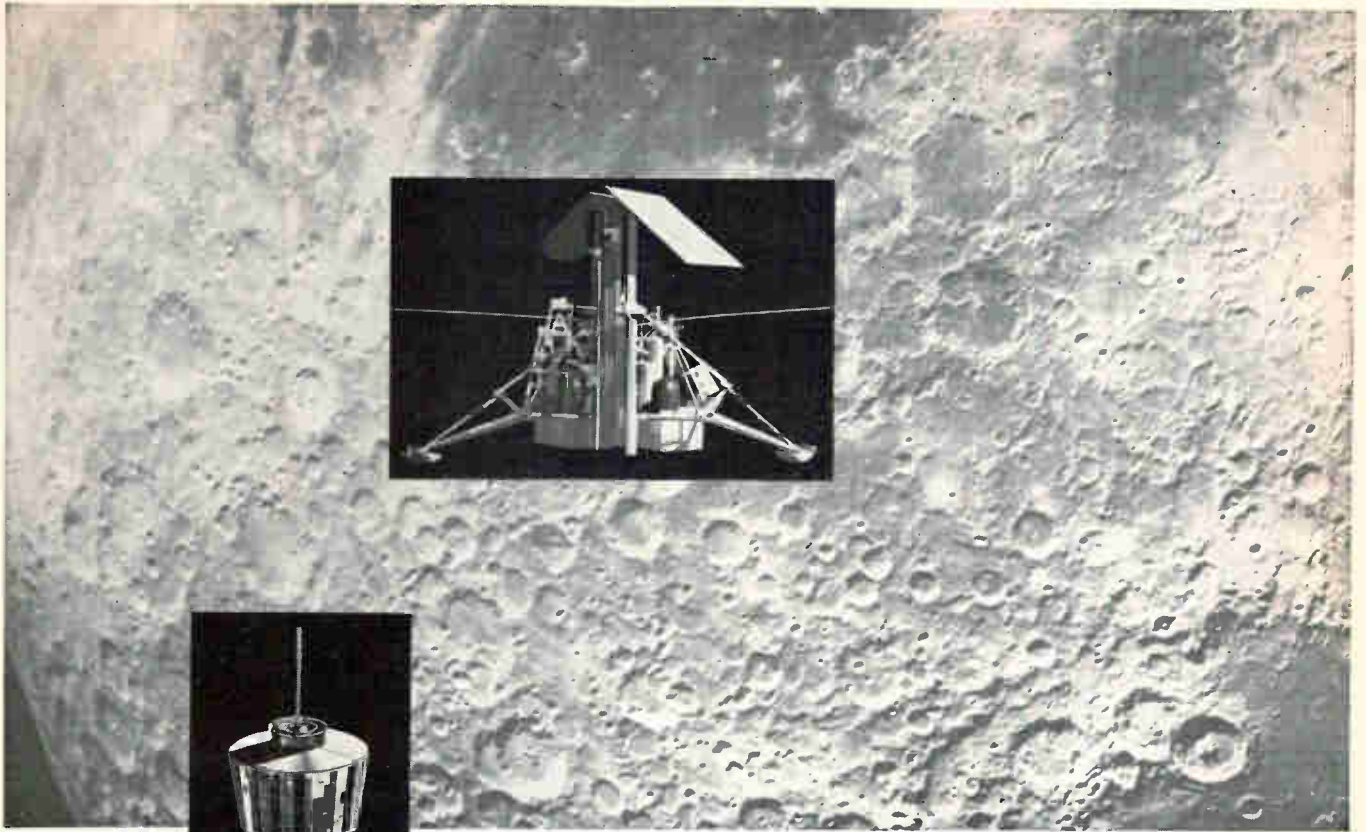

systems analysts:

Quantify the complex on important projects at Hughes!

SURVEYOR (soft lunar landing spacecraft), SYNCOM (synchronous communications satellites), VATE (automatic test equipment), anti-ballistic missile defense systems (boost-intercept, mid-course, terminal)—these are a few of the many important and complex projects under design, development and study at Hughes.

Because of these projects and others important to the nation's defense, preparedness and space effort, Hughes offers more opportunities to Systems Analysts than ever before.

Involved with these positions are the consideration of many basic problems such

as: the proper mix of manned vs. unmanned satellites; the requirements of manned space flight; IR systems requirements for high speed strike reconnaissance systems or unmanned satellites; analysis of weapon systems from conception through development, test and customer use; and many others.

Inquire today. If you are a graduate engineer or physicist from an accredited university, a U. S. citizen, and believe that you can contribute to and benefit from the important projects at Hughes, contact us today. Airmail your resume to:

**Mr. Robert A. Martin,
Head of Employment
Hughes Aerospace Divisions
11940 W. Jefferson Blvd.,
Culver City 65, California**

We promise you a reply within one week.

An equal opportunity employer.

Creating a new world with ELECTRONICS

HUGHES

HUGHES AIRCRAFT COMPANY
AEROSPACE DIVISIONS

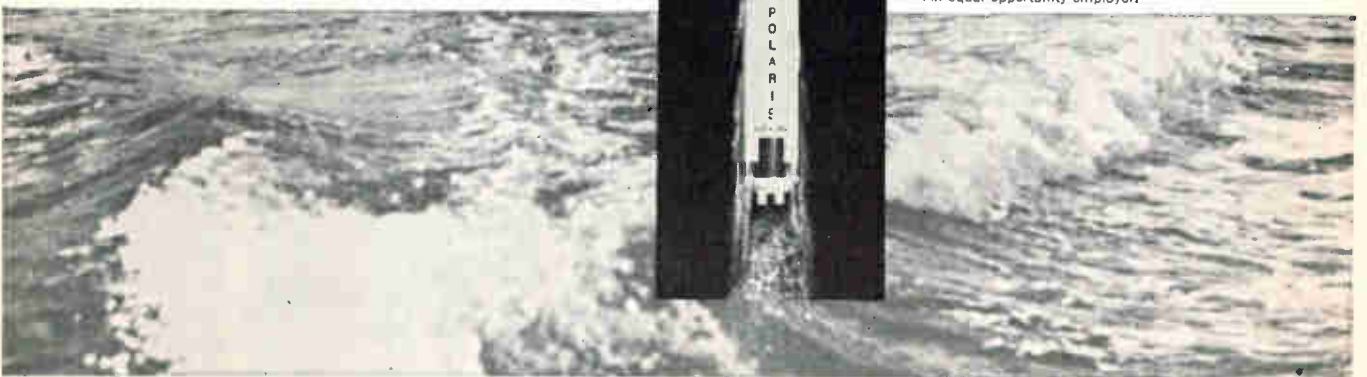

DESIGN AND APPLICATION

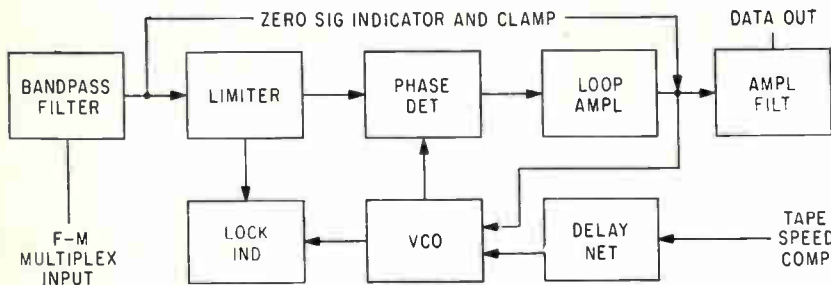

Solid State Phase-Lock-Loop Discriminator

Accepts IRIG channels and frequencies between 300 cps and 300 Kc to 18% deviation

RECENTLY released by Electro-Mechanical Research, Inc., Box 3041, Sarasota, Florida, the model 210 solid state phase-locked-loop discriminator accepts all IRIG channels or any other frequency between 300 cps and 300 Kc with deviations between 2½ percent and 18 percent of the frequency. The new module has a dynamic input signal range between 10 mv and 10 v without adjustment, linearity of ±0.05 percent of bandwidth, noise less than 0.05 percent of bandwidth, 60 db rejection of adjacent channel modulating signal when adjacent channel carrier is 16 db greater in amplitude than desired channel, a 20 db step on input amplitude causes peak transient of less than 0.5-percent of bandwidth and harmonic distortion is less than 0.3 percent of bandwidth. Calculated mthf is nearly 16,000 hours. Power required is less than 13 w per discriminator. The input filter input impedance increases rapidly at frequencies out of the



passband. An active element is not used here, thus noise is not introduced at low signal levels and extremely large peak signal level capability is provided to virtually eliminate crosstalk due to non-linear amplification. The output amplifier is stabilized against drifts due to temperature and time by a solid-state nonmechanical chopper operating at 6 Kc. This enables use of a power source between 47 and 420 cps to eliminate intermodulation distortion due to beats between chopper and intelligence frequency.

CIRCLE 301, READER SERVICE CARD

Multiplying Modulator Has Unlimited Life

ANNOUNCED by General Magnetics, Inc., 135 Bloomfield Ave., Bloomfield, N.J., the Mag-Mod series of miniaturized magnetic modulators deliver an analog output voltage which is a continuous product of

two variable input voltages. One of these is an excitation voltage varying over a predetermined range, and the other is a variable bi-polar d-c current also varying over a predetermined range. The a-c output

voltage is in phase with the variable excitation or fixed reference when the variable amplitude d-c signal is positive and 180-degrees out of phase when the d-c signal is negative. The sketch shows the relation

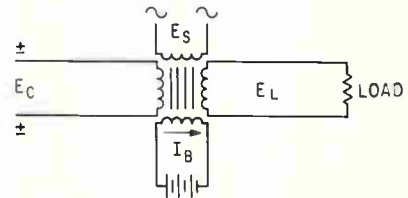

between alternating supply voltage E_s , variable d-c current control signal E_c and alternating load voltage E_L having a sinusoidal waveshape denoted by $E_L = \text{Constant} \times E_s \times E_c$. This expression defines the fundamental principle of the four-quadrant modulator. (302)

D-C to D-C Amplifier In One Cubic Inch

MANUFACTURED by Acromag, Inc., 15360 Telegraph Rd., Detroit 39, Michigan, the model 840 d-c to d-c amplifier has two isolated input signal windings and delivers ±5 v d-c output into a 2,500-ohm load for 50 μa (35 mv) of d-c control sig-

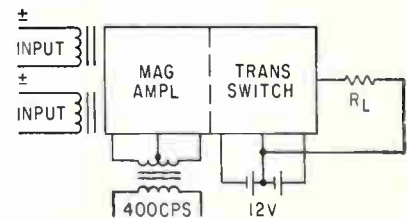

nal. Power consumption is 300 mw. It is designed for applications where a push-pull magnetic amplifier cannot be used due to large size and weight. The unit combines transistor and magnetic amplifier techniques in which a small input magnetic amplifier provides multiple isolated inputs and develops output pulses in response to d-c input pulses. These pulses drive a push-pull transistor output stage. The transistors act as switches not as linear amplifiers hence d-c drift

Exceeds Adjustment Life Requirements of Mil-C-14409A by 600%

CANADIAN PATENT #604,810
U.S. PATENT #2,922,093

new
from
JFD



PRECISION PISTON CAPACITOR

■ IT IS HERE...a new kind of capacitor that combines the precise tuning capability of a piston trimmer, the long-lived adjustment of an air variable—and the rugged Max-C construction with its triple range. ■ THE REASON: A new ultra reliable anti-backlash adjustment mechanism with full-thread engagement. ■ THE PROOF?—Virtually no thread wear after 500 cycles of adjustment. Mil-C-14409A specifications call for 75 cycles. ■ Other Super Max-C capacitor advantages are: 1. MULTI-TURN instead of 180 degree rotation of air variables. 2. FACTORY PRESET TORQUE at any value between 1 and 8 inch ounces can be supplied upon special request. 3. HIGHER SHOCK AND VIBRATION RESISTANCE. 4. KNOB CONTROL possible when panel mounted because of the fixed position of the adjustment screw throughout the tuning range. 5. EXTENDED CAPACITANCE RANGE of 300 per cent beyond that of conventional precision piston trimmers due to proven Max-C embedded electrode construction. 6. COMPLETELY SEALED INTERIOR CONSTRUCTION locks out humidity and other atmospheric elements (greatly exceeds salt spray and humidity cycling requirements of Mil-C-14409A). 7. ULTRA-LINEAR TUNING—absolute repeatability. 8. Q FACTOR IS: 500 guaranteed minimum at 1 MC. 9. INSULATION RESISTANCE is 10^6 megohms. 10. DC working voltage is 1000 VDC. 11. LOW temperature coefficient of capacitance. 12. LOW inductance and low loss for higher frequency use. 13. No derating from -55°C to $+125^{\circ}\text{C}$.

14. Rugged shock and vibration resistance. 15. Dielectric strength is 2000 VDC. 16. New JFD plating for excellent RF conductivity and noise-free tuning protects all metal parts from corrosion and improves life of adjustment.

Write today for detailed Bulletin MCD-62
or see your JFD component distributor.

JFD ELECTRONICS CORPORATION

JFD WESTERN JFD MIDWESTERN
909 So. First Ave. 6330 Hermione St.
Arcadia, Calif. Chicago 46, Ill.
Phone: Hillcrest 6-0312 Phone: 775-5424-25

JFD MIDWESTERN-OHIO
7415 Montgomery Rd.
Cincinnati 36, Ohio

JFD NORTHEASTERN
Ruth Drive, P. O. Box 228
Marlboro, Mass.
Phone: Huntley 5-7311

JFD CANADA
51 McCormack Street
Toronto, Ontario, Canada
Phone: RQgers 9-1129

Main Office, Components Div., 6101 16th Ave., Brooklyn, N. Y. Phone DEwey 1-1000 • TWX-NY 25040
SEE WHAT'S NEW FROM JFD IN BOOTH 823 AT THE NEC

Compact View of "Diamond H" Relays



SERIES R&S Miniature, Hermetically Sealed.

4PDT. Contact ratings from micro-ampere to 10 amps. Meet or exceed MIL-R-5757D. A-c coil version available.



SERIES P High Speed Polarized.

SPDT. Operating response to 200 microseconds. No contact bounce.



SERIES W General Purpose.

DPDT, double break, a-c, d-c relays. Plug-in type or quick-disconnect terminals. Rated up to 25 amps, yet more compact than most 10 amp relays. Holding contact available.

For complete information write to:

The **HART**

Manufacturing Company

202 Bartholomew Avenue

Hartford 2, Connecticut

Phone: 525-3491



caused by changing transistor beta and I_{co} leakage are eliminated. As long as the transistors are in saturation, transistor parameters have

negligible effect on overall performance.

CIRCLE 303, READER SERVICE CARD

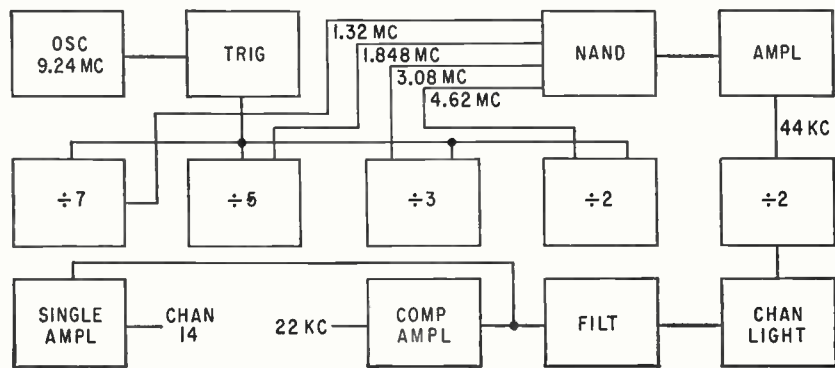

IRIG Calibrator Has 1½% Deviation Steps

NEW from Calenco Industries, 2925 East Foothill Blvd., Pasadena, California, the model FC-11 telemetry calibrator generates calibration signals for all IRIG channels simultaneously with three or eleven deviation points in each channel. Deviation switching is a pyramid function in which frequencies increase in 1½-percent increments from the lower frequency to the upper band edge then decrease in the same steps to the lower frequency. Limiting increments to 1½-percent steps provides better calibration signal for recorders and

decommutators, particularly phase-lock loop discriminators, as a large step can cause a recorder to overshoot and a discriminator to lose synchronization. The unit produces a simultaneous signal for each IRIG channel but the composite signal is limited only to the channels selected by front-panel switching. Gain for each channel is variable. The sketch shows typical channel frequency generation. All frequencies are crystal controlled and the count-down circuits are silicon transistors and diode logic modules. Mounted on individual boards. (304)

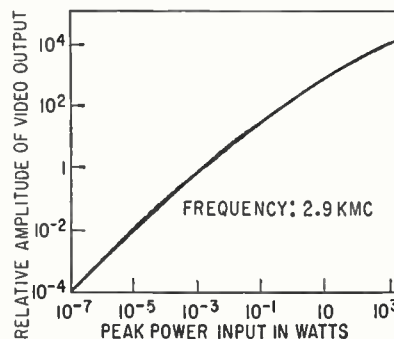

Broadband Diode Detector Has 100 Db Dynamic Range

RECENTLY announced by Cascade Research, 5245 San Fernando Rd. West, Los Angeles 39, California, is a new diode detector having 100 db dynamic range between 100 Mc and 11 Gc. Packaged in a mount approximately 5 inches long by one inch diameter, the device has been tested at peak powers of 1 Kw and average powers of 12 w with no

change in performance characteristics. A sensitivity of 150 mv per mw at S-band makes it ideal for a power detector in all types of microwave equipment. Having excellent square-law characteristics and response time of better than 0.5 μ s allows use as pulse detector. The 100 db dynamic range permits detection of high and low average and peak powers without burnout, change in impedance, reduction in sensitivity or increase in noise level. The chart shows typical performance at 2,900 Mc. (305)

Multiplex Switch Priced at \$60

HARMAN-KARDON, INC., Plainview, N. Y. The MX-260 is completely encapsulated, enabling it to surpass many of the severe environmental conditions imposed by military requirements on digital multiplexing

or scanning systems. Switching speeds from d-c to 10 Kc with operating temperature range of -30 C to $+71\text{ C}$ are offered in this 0.5 cu. in. package, which is capable of being stacked to any desired number of channels. (306)

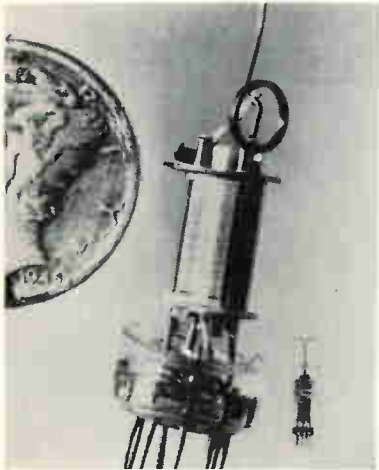

Frame Grid Tube Designed as H-F Probe

AMPEREX ELECTRONIC CORP., 230 Duffy Ave., Hicksville, L. I., N. Y., announces a frame grid tube designed and constructed for use as a h-f probe tube in oscilloscopes. The 8254/EC1000 is a subminiature triode with its control grid brought out through the top of the tube. It is characterized by high transconductance—14,500 μmhos at 14 ma; high gain bandwidth—385 Mc; and extremely low capacitances— $C_{in} = 5.4\text{ pf}$, $C_{out} = 0.5\text{ pf}$. Used as a probe it has a frequency response that is flat from d-c to 300 Mc with an output impedance of 75 ohms. (307)



Differential Voltmeter Measures A-C and D-C

JOHN FLUKE MFG. CO., INC., P.O. Box 7428, Seattle 33, Wash. Model 803B measures a-c and d-c to 500 v

Combine True System Compatibility, Cost Saving Simplification... and Improved Reliability...

1 NEW
LOW
COST

DIGINAMICS DIGITAL TRANSDUCERS

Now... Diginamics Corporation, the leading manufacturer of digital transducers, offers you digital techniques to measure flow as well as temperature, shaft position and pressure.

These techniques offer a low cost method for digital control and data logging never before available.



Gage Pressure to Digital Transducer
Type 2012



Temperature to Digital Transducer
Type 3012



Shaft Position to Digital Transducer
Types 4012 and 4013



Serializer (Parallel to Serial Converter)
Type 5012

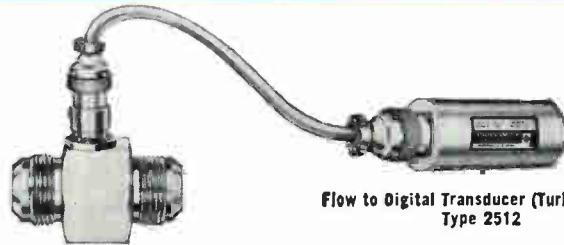

Flow to Digital Transducer (Turbine Type)
Type 2512

Digital Multiplexer
Type 6012

- Completely solid state
- Basic unit accepts 15 inputs
- Additional inputs may be added up to 255
- Input and output levels adjustable



SEE US AT **ISA SHOW** BOOTH NO. 2008

Write today for your copy of
"WHAT? WHY? HOW? DIGITAL TRANSDUCERS"

For specifications and prices, write

**DIGINAMICS
CORPORATION**



DIGITAL INSTRUMENTATION
DIGITAL TRANSDUCERS
DIGITAL CONTROL SYSTEMS

2525 E. Franklin Ave. Dept. K Minneapolis 6, Minn.

KEARFOTT

LOW COST-LOGIC CIRCUITS IN TO-5 CASES

The all welded construction of Kearfott's MicroFunction Circuits, in Standard TO-5 cases, permits 16:1 volumetric reduction of conventional digital circuit design.

Through the use of pre-tested, close tolerance components, high density circuits of unlimited flexibility handling high power can be supplied quickly, at low cost, to match any system requirement.

Kearfott's Germanium or Silicon Transistors may be specified; dependent on temperature requirements. Also available are dual matched pairs within a TO-5 case. A number of available circuits can be provided in TO-18 cases on special order.

DEVICE	SYMBOL	GERMANIUM	SILICON
INVERTER		11 INVG	11 INVS
NOR		TO 5 21 NRLG	TO 5 21 NRLS FAN IN FAN OUT
EMITTER FOLLOWER (BUFFER)		TO 5 21 EFG	TO 5 21 EFS
OR		TO 5 21 ORG	TO 5 21 ORS
AND		TO 5 TO 18 41 DLG	TO 5, TO 18 41 DLS
FLIP FLOP		2 TO 5 INVERTED 2 TO 5 PIGGY BACK 22 FFG	2 TO 5 INVERTED 2 TO 5 PIGGY BACK 22 FFS
MATCHED PAIRS (TO 5)		TO 5 TO 18 22 MPG	TO 5 TO 18 22 MPS
DARLINGTON		TO 5 TO 18 21 DARG	TO 5 TO 18 21 DARS
DELAY		2 TO 5 INVERTED 2 TO 5 PIGGY BACK 21 DELG	2 TO 5 INVERTED 2 TO 5 PIGGY BACK 21 DELS

For complete data write Kearfott Semiconductor Corp., West Newton, Massachusetts.



GENERAL PRECISION

with basic accuracies of ± 0.05 percent of d-c input and ± 0.2 percent of a-c input. D-C input impedance is infinite at null from 0 to 500 v, eliminating source loading error.

CIRCLE 308, READER SERVICE CARD

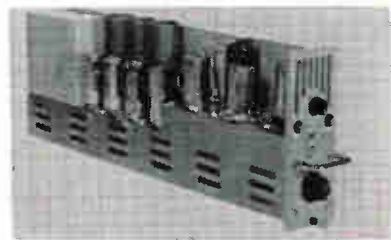

Wideband Amplifier Features High Gain

COMPUTER ENGINEERING ASSOCIATES, 350 North Halstead, Pasadena, Calif. Designed to amplify low-level signals, model A1233C d-c amplifier features continuously adjustable gain between 1 and 10,000. Noise is low— $10 \mu\text{v}$ to 40 Kc, $5 \mu\text{v}$ to 5 Kc. Input impedance of 100,000 ohms is maintained over the entire bandwidth. Output capability of ± 50 v at ± 50 ma provides ample drive. Common mode rejection of 140 db at d-c; rejects up to 200 v from signal source and long input lines. (309)

Soldering Machine

DEE ELECTRIC CO., 1708 W. Belmont Ave., Chicago 13, Ill. Machine comprised of a fluxing unit, pre-heater, dual solder wave fountain, conveyors and control systems, is designed for the automatic soldering of printed circuits. (310)

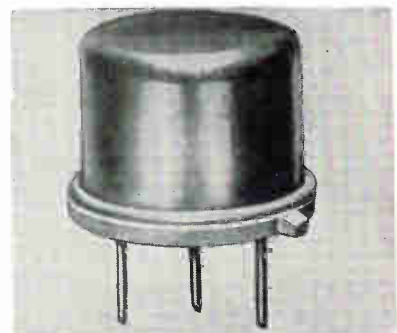

Power Transistor Rated at 4.5 W

CLARK SEMICONDUCTOR CORP., Walnut Ave., Clark, N.J., offers a power transistor for operation at 130 Mc. Rated at 4.5 w, it has a collector

efficiency of 55 percent minimum. Type SN-109 is a triple diffused *npn* mesa device available in TO-5 and other packages. It is suitable for telemetry, mobile communications and similar applications. (311)

Pulse Generator

RADIATION INSTRUMENT DEVELOPMENT LABORATORY, INC., 4501 W. North Ave., Melrose Park, Ill. Pulse generator features a rise and fall time of less than 0.5 nsec; pulse widths of 0.5 to over 1,000 nsec with 4 internally calibrated pulse widths provided; pulse height 0 to 100 v, positive or negative settable to 0.1 percent. (312)

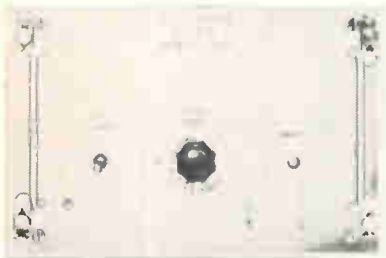

Plug-In Prescaler Used With Counters

NORTHEASTERN ENGINEERING, INC., Manchester, N. H. Model 14-40 is a 100 Mc prescaler plug-in unit designed to work in conjunction with counters. It provides the basic 10 Mc counter with a 100 Mc direct counting capability. It can provide a pulse resolution of better than 10 nsec. (313)



Time Delay Relay Contains No Tubes

G. C. WILSON & CO., Huntington, W. Va. Transistorized model 662 can be furnished for any d-c voltage from 12 v to 220 v; can also be furnished for a-c voltages. Time delays can be fixed or adjustable. Illustrated is unit with time delay adjustable by means of control on top. Standard time range is 0.1 to 15 sec. Time recycles, when power is removed, in 50 millise. Timing is not affected by normal variations



YES	NO
Wheatstone Bridge?	<input type="checkbox"/> <input type="checkbox"/>
Kelvin Bridge?	<input type="checkbox"/> <input type="checkbox"/>
Resistance Decade?	<input type="checkbox"/> <input type="checkbox"/>
Self-Contained Galvanometer?	<input type="checkbox"/> <input type="checkbox"/>
Portable?	<input type="checkbox"/> <input type="checkbox"/>
Separate Current and Potential Terminals?	<input type="checkbox"/> <input type="checkbox"/>
Over 5260 Ohm?	<input type="checkbox"/> <input type="checkbox"/>

The first six questions can be answered "yes" and the last one "no" only for the Shallcross 638R Bridge. This combination of utility and price is the BIG reason why thousands of engineers have determined this their best all-purpose bridge buy. A wide resistance range (.001 ohm to 11.11 megohms), $\pm .2\%$ certified accuracy, and a reputation for quality also contribute to the popularity of the 638R. Hundreds of percent limit, percent deviation, high accuracy Wheatstone and special purpose bridge models are available to satisfy the critical or special purpose application. *Twenty-four hour delivery.* Write direct or mark reader service card for complete information. Shallcross Manufacturing Company, Selma, North Carolina, Specialists in Precision resistance for over 3 decades.

Shallcross
SHALLCROSS MANUFACTURING CO. / SELMA, N. C.
INSTRUMENTS | RESISTORS | SWITCHES | ATTENUATORS | DELAY LINES

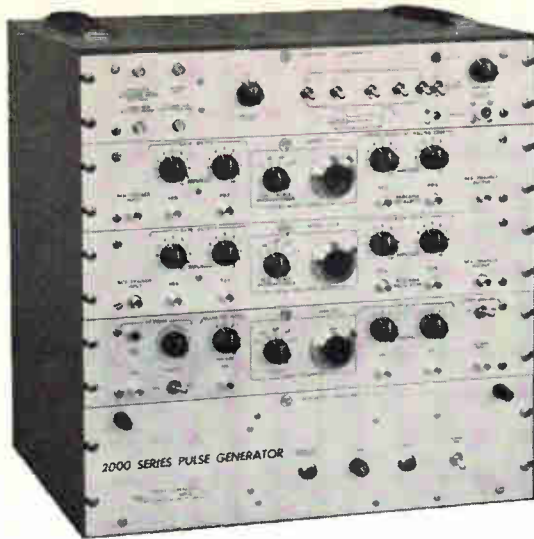

Here's Maximum Pulse Generator Precision and Flexibility

- 0.5% Accuracy ■ 0.02% Jitter ■ 0.02 μ sec Rise Time
- Rep Rate 10 cps to 100 kc ■ Delay to 10,000 μ sec
- 0.1 to 1,000 μ sec Duration ■ Fully Calibrated Controls

The 2000 Series SERVOPULSE™ precision pulse generators are broadly applicable to testing and design in a variety of systems from digital computation to microwave. All the instruments in this series provide accurate, highly controllable pulses from either single-shot pushbutton, internal oscillator, or external sync. Pulse rep rates, duration, delay, and waveform are variable over a wide range. Both positive and negative modes of operation are provided for.—The SERVOPULSE 2000 Series pulse generators are modular in construction and, therefore, allow for extensive secondary applications, interconnecting with other equipments on a module basis, and operation of a single module or different groups of modules in combination. This offers a flexibility and versatility to meet pulse requirements.—Send for the new brochure on SERVOPULSE 2000 Series Pulse Generators.



SERVOPULSE™ PRODUCTS
SERVO CORPORATION OF AMERICA
 111 New South Road • Hicksville, L.I., N.Y. • WELLS 8-9700

MODULE 110A Variable Frequency Unit

Provides standardized variable rep rate from single-shot pushbutton, external signals, or internal. 10 cps to 100 kc oscillator.



MODULE 211A Pulse Width Control Unit

Generates neg. gate and trailing edge trigger inputs.



MODULE 210A Time Delay and Gate

Generates precision time delay and gate widths from external neg. triggers. Neg. triangle output also provided.



MODULE 300A Pulse Forming Unit

Generates fast rise time high power pulses.



in supply voltage and has a repeatability of ± 2 percent. Price is \$22.75 with quantity discounts.

CIRCLE 314, READER SERVICE CARD



Voltage Calibrator Sells for \$295

TENSOR ELECTRIC DEVELOPMENT CO., INC., 1873 Eastern Parkway, Brooklyn, N. Y. Model 7065, which can be used as a source of precise a-c or d-c voltage, has an output impedance of 3,000 ohms max (0.1 ohm at 100 v). Output is continuously variable from 0 to 100 v (a-c or d-c) in four ranges. Input is 115 v 60 cps, 65 w and output frequency is a built-in 60 cps and d-c. It has provision for external frequency of 50 cps to 7.5 Kc. Accuracy is 0.15 percent of reading on d-c or 0.2 percent of reading on a-c. (315)



Non-Overload Amplifier Has Gain of 70,000

GENERAL NUCLEAR CORP., 538 East Central Park Ave., Anaheim, Calif. Model 108 is a high gain amplifier for nuclear counting applications. It has a gain of 70,000 with 0.1 percent linearity. It will accept 4,000 times overload at the input with no distortion of output pulse. It is available with a discriminator and single channel analyzer. (316)

Transistor Size Relay

BABCOCK RELAYS, a div. of Babcock Electronics Corp., 1645 Babcock Ave., Costa Mesa, Calif., offers a low cost relay, rated at $\frac{1}{2}$ amp at 32 v d-c and housed in a 0.200 by 0.400 by 0.600 in. can. (360)

PRODUCT BRIEFS

FREQUENCY RESPONSE ANALYZER operates over a range of 0.01 to 1,000 cps. It uses Fourier analysis to accomplish the frequency response determination. Boonshaft and Fuchs Inc., Hatboro Industrial Park, Hatboro, Pa. (317)

TIME DELAY RESISTORS designed to prevent logic circuit error. Nominal resistance is 1000 ohms. California Resistor, 1631 Colorado Ave., Santa Monica, Calif. (318)

COAXIAL CONNECTORS are of the semi-rigid type. They feature Collet clamp construction. General RF Fittings, Inc., 702 Beacon St., Boston 15, Mass. (319)

PLUG-IN SWEEP OSCILLATORS cover uhf to 3,000 Mc. The devices employ tuned-line circuitry and are swept by a voice coil-driven wobulator. Telonic Industries, Inc., Beech Grove, Ind. (320)

VACUUM BOOSTER for environmental simulation. It is capable of vacuums of 5×10^{-4} torr in four hours. Ultek Corp., 920 Commercial St., Palo Alto, Calif. (321)

PLANETARY GERMOTOR develops as high as 300 oz-in. torque. It measures $\frac{3}{8}$ in. in diameter. Globe Industries, Inc., 1784 Stanley Ave., Dayton 4, Ohio. (322)

CRYSTAL OSCILLATOR is voltage-controlled. It generates 4 mw at 75 Mc with ± 50 Kc deviation. Itek Electro-Products Co., 75 Cambridge Parkway, Cambridge, Mass. (323)

PULSE MODULATOR with peak power of 1.2 Mw. Price, \$16,500. Radiation at Stanford, Palo Alto, Calif. (324)

MINIATURE COAXIAL CONNECTORS are a 3-pin bayonet coupling style. Voltage is a maximum 1,500 v rms at 60 cycles. Kings Electronics Co., Inc., 40 Marbledale Road, Tuckahoe, N.Y. (325)

D-C AMPLIFIER designed for ion engine instrumentation. Accuracy is better than 1.0 percent. Acromag, Inc., 15360 Telegraph Rd., Detroit 39, Mich. (326)

SOLID STATE SWITCH is a phase controlled device. Sensitivity is $0.1 \mu\text{w}$ at 60 cps. Solar Electronics Co., 5909 Melrose Ave., Hollywood 38, Calif. (327)

MICROMINIATURE SWITCH weighs 0.006 oz. It is available in both spst and spdt configurations. Telex Inc., 3054 Excelsior Blvd., Minneapolis 16, Minn. (328)

ULTRASONIC CONSOLE CLEANERS for industrial and laboratory use. Units are of the three chamber type. National Ultrasonic Corp., 95 Park Ave., Nutley 10, N.J. (329)

SOLID STATE CONVERSION KIT for instrumentation recorders. Each kit

TRIPLETS

BORN TO THE HARCURE FAMILY OF EPOXY FLEXIBILIZERS

HARCURE A enjoys an established reputation as a unique epoxy flexibilizer, imparting excellent thermal shock and good high temperature electrical properties to cured epoxy formulations.

NOW HARCHEM ANNOUNCES A TRIO OF NEW FLEXIBILIZERS

HARCURE C

A low melting analogue of Harcure A that allows the properties of Harcure A to be "built into" a polymeric anhydride which can be formulated into a room temperature flowable recipe with a liquid epoxy resin.

HARCURE D

Medium priced liquid flexible anhydride that imparts excellent thermal shock properties to cured epoxy resins.

HARCURE DIMER 870

Dimer-trimer mixture providing a low price flexibilizer for both conventional and peracetic types of epoxy resins.

Write for Bulletin and Samples

**HARCHEM
PRODUCT DEVELOPMENT
DEPARTMENT**

HARCHEM®

WALLACE & TIERNAN, INC.
25 MAIN STREET, BELLEVILLE 9, NEW JERSEY

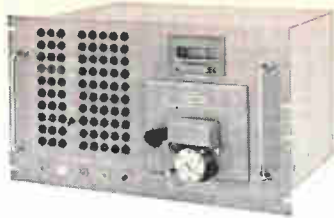

HOW TO INCREASE YOUR READING CAPACITY

EECO's block, punched-tape reader can digest 80, 96, 120 or 160 bits of information at a step (depending upon the model you select). It's better designed for applications like machine tool control and automatic checkout and tests. For instance, it offers a complete test per block; identification of data function by position in block; elimination of data storage records and address decoding circuits. Straight-forward programming by blocks. Standard units read 80, 96, 120, 160 bit blocks. In modular or standard 19" rack mounting units. Takes 1", 8-level paper or mylar tape punched on 0.1" centers. Reader head designed for either forward or reverse reading. Most models are bi-directional. Write for data sheets.

CIRCLE 203 ON READER SERVICE CARD



Automation Division

Electronic Engineering Company
of California

1601 E. Chestnut Avenue • Santa Ana, California
Phone: 547-5501, P.O. Box 58 • Representative in
Western Europe and Israel: Electronic Engineering
S.A., C.P. 142 Fribourg, Switzerland. EE 2-50



you get fine tubing and parts faster from Uniform Tubes

Seamless tubing is drawn to your specifications at commercial or precision tolerances — down to ± 0.00005 " in special cases. O.D.'s from 0.375" to 0.005". Wall thicknesses from 0.050" to as thin as 0.0005".

Tubing is available in ductile metals and their alloys including columbium, tantalum, palladium and glass-to-metal sealing alloys. Composite tubing and coaxial cable is formed to specification by drawing seamless tubing over other tubing, solid conductors or insulated wire.

A complete fabrication service for tubular parts is also offered starting with fine seamless tubing and assuming full responsibility for finished parts. All tubing and parts must pass rigid quality controls covering every aspect of production from alloy analysis to final inspection.

For complete details, see Bulletin 61.



**UNIFORM
TUBES,
INC.**

20 7th Avenue,
Collegedale 2, Pa.
HUXley 9-7293
TWX-CGVL 1044

includes complete electronics and heads. Pacific Electro Magnetics Co., 942 Commercial St., Palo Alto, Calif.

CIRCLE 330, READER SERVICE CARD

MINIATURE TEST POINT CONNECTOR for dip solder and surface mounting. It has five contacts. Lionel Electronic Laboratories, Inc., 1226 Flushing Ave., Brooklyn 37, N.Y. (331)

FERRITE CIRCULATORS are four-port units. They are designed for C- and S-band use. ACF Electronics division, ACF Industries, Inc., 11 Park Place, Paramus, N.J. (332)

NONDEGENERATE AMPLIFIER for C-band use. It has a tuning range from 5.4 to 5.9 Gc. Sperry Microwave Electronics Co., P.O. Box 1828, Clearwater, Fla. (333)

BOLOMETER-THERMISTOR MOUNT designed for coaxial line qualifications. It is useful from 500 Mc to 10,000 Mc. Coax Devices, Box V, Chelsea 50, Mass. (334)

D-C AMPLIFIER designed to measure currents in the range 10^{-13} to 10^{-6} amp. Price is \$266. General Radiological Ltd., Honeypot Lane, Stamford, Middlesex, England. (335)

SILICON MASTER SLICE WAFERS for Solid Circuit semiconductor networks. Many customized circuits are thus made possible. Texas Instruments Inc., P.O. Box 8012, Dallas 22, Texas. (336)

RADIOSONDE SENSORS and ground receptor equipment. They are designed for meteorological applications. General Time Corp., 201 Summer St., Stamford, Conn. (337)

F-M TELEMETRY TRANSMITTER of solid state design. It operates within 215-260 Mc band. Telemetry Corp. of America, 8345 Hayvenhurst Ave., Sepulveda, Calif. (338)

SILICON CIRCUIT MODULE contains three Schmitt trigger circuits on a single etched circuit card. It operates from 0 C to + 100 C. Scientific Data Systems, Inc., 1542 15th St., Santa Monica, Calif. (339)

TIME DELAY RELAYS are hermetically sealed. Standard units operate under vibrations of 500 cps at 10 g. A. W. Haydon Co., 232 North Elm St., Waterbury, Conn. (340)

DUAL ALTITUDE SWITCH in very small size. Weight is 12 oz and set range 1,500/75,000 ft. Speidel Corp., Warwick, R. I. (341)

STRAIN GAGE PRESSURE TRANSDUCERS with 1-v output. They offer natural frequency over 50 Kc at 3,000 psi. Micro Systems Inc., Agostino Road, San Gabriel, Calif. (342)

PAPER TAPE READER reads 5 through 8 channel tape at speed of 600 characters/sec. Price is \$4,750. Autometrics Industrial Products, 3400 E. 70th, Long Beach, Calif. (343)

Literature of the Week

TOROIDS Hi-Q Div., Aerovox Corp., 1100 Chestnut St., Burbank, Calif. Brochure provides technical data and product ordering information for CTL toroids. (344)

TRANSISTOR HEAT SINK Thermalloy Co., 4417 N. Central Expressway, Dallas 5, Texas. Bulletin describes a transistor heat sink for high density circuit board applications. (345)

ENCAPSULATED TOROID Sangamo Electric Co., Springfield, Ill., offers a bulletin on an encapsulated toroid for p-c board mounting. (346)

VOLTAGE DIVIDER Trio Laboratories, Inc., Plainview, L. I., N. Y. Bulletin describes model EX-1 programmable voltage divider. (347)

HIGH POWER AMPLIFIER H. H. Scott, 111 Powder Mill Road, Maynard, Mass., offers an applications/specifications brochure on a 300-w amplifier. (348)

MICROWAVE SWITCHES Consolidated Microwave, a division of Antenna & Radome Research Associates, 27 Bond St., Westbury, N. Y. One-page bulletin describes two solid state microwave switches. (349)

DIFFUSION FURNACES Lindberg Engineering Co., 2443 W. Hubbard St., Chicago 12, Ill. Bulletin details furnace equipment for use in basic research, pilot plant studies and in semiconductor production. (350)

COMPACT INVERTER Microdot Inc., 220 Pasadena Ave., South Pasadena, Calif. Catalog sheet describes a solid state static inverter operating in the 5 Kva range. (351)

THERMAL TIME DELAY RELAYS G-V Controls Inc., 101 Okner Parkway, Livingston, N.J. Bulletin contains selection data for sealed thermal time delay relays. (352)

SYRINGES AND APPLICATORS Philip Fishman Co., 7 Cameron St., Wellesley 81, Mass. Bulletin 102 describes potting syringes and applicators for sealing, encapsulating, or potting miniature or subminiature components. (353)

MICROWAVE TEST EQUIPMENT PRD Electronics, Inc., 202 Tillary St., Brooklyn 1, N.Y. Bulletin introduces 10 microwave and electronic instruments and 25 wave-guide and coax components. (354)

SERVO COMPONENTS Diehl Mfg. Co., Somerville, N.J., has published a catalog covering its line of a-c and d-c servo components. (355)

EVENT RECORDING SYSTEM Sanborn Co., Waltham 54, Mass. Catalog sheet illustrates and describes model 360 which records up to 120 channels of ON/OFF events as brief as 1.3 millisecond.



LINT-FREE!

Dependably lint-free uniforms with

DACRON® or NYLON

POLYESTER FIBER

Precision operations like those at The Barden Corp. require rigid lint-free quality standards. Uniforms of 100% "Dacron"® polyester fiber or 100% Du Pont Nylon dependably fulfill such quality-control requirements. Smooth-surfaced *filament* "Dacron" or *filament* Nylon do not generate lint! Even under the most exacting conditions of White Room cleanliness, "Dacron" and Nylon perform with outstanding lint-free efficiency.

Uniforms of "Dacron" or Nylon wear exceptionally well, stay fresh longer. And they can be successfully handled in commercial laundries. Doesn't the efficiency of your plant call for lint-free uniforms of Du Pont Nylon or "Dacron"?

FOR SPECIAL ADVICE ON UNIFORMS, write: Uniform Counseling Service, E. I. du Pont de Nemours & Co. (Inc.), Textile Fibers Dept., Centre Road Bldg., Wilmington 98, Del.



Better Things for Better Living . . . through Chemistry

*"DACRON" IS DU PONT'S REGISTERED TRADEMARK FOR ITS POLYESTER FIBER. DU PONT MAKES FIBERS, NOT FABRIC OR UNIFORM

strong background in management of complex electronic weapons systems."



Rauland Purchases Another Building

THE RAULAND CORP., wholly-owned tube-manufacturing subsidiary of Zenith Radio Corp., has purchased a 100,435-square-foot building on 8 acres of land in Niles, Ill. The site is contiguous to an 18.1-acre plot purchased by Rauland earlier in the year to provide ample space for future expansion.

The new acquisition will be used to house enlarged research laboratories, and for production of specialized tubes and electronics products for military, medical, scientific, industrial applications, and other similar research products, which represent a growing percentage of the company's business. Rauland's general headquarters will be moved to the new building.



Hoffman Announces New Top Management

STANLEY W. HORROCKS (picture), formerly executive vice president of Autonetics division of North

This move will release a substantial area in the Rauland factory in Chicago required for large-scale manufacture of color tv tubes and for expanded production of black and white tv tubes.

Further space required for color tube production is provided by a 51,000-square-foot addition to the Chicago plant now nearing completion, and by a nearby 45,000-square-foot plant purchased earlier this year.

Among the specialized electronic products scheduled for expanded production and diversification at the Niles plant is a growing family of image intensifier tubes which, the company says, have found wide application in diverse fields.

American Aviation Inc., has been elected president of Hoffman Electronics Corp., Los Angeles, Calif. At the same time, the board elected the company's founder and president, H. Leslie Hoffman, board chairman. Horrocks was also elected as a director of the company.

In announcing the board's action, Hoffman said he will continue to be active in the company's affairs, and added: "Formation of this new top management team is a key step in the company's plan for expanding its participation in the various aerospace programs, since it brings into the company a man with a

List, LeBaron Named To Head Departments

H. J. WISSEMANN, vice president of Texas Instruments Apparatus division Government Products Group, Dallas, Texas, recently announced the appointment of two new department heads following reorganization of the Missile and Space department.

Named to head the Space Systems department is B. H. List, while the Electro-Optics department will be under the guidance of I. Milton LeBaron. Both men formerly were with TI's Central Research and Engineering.



Lockheed Board Elects Gribbon

DANIEL J. GRIBBON, an aerospace executive with Lockheed Aircraft Corp., has been named president of Lockheed Electronics Co. with headquarters in Plainfield, N.J. He succeeds David F. Sanders, resigned.

The directors also elected Gribbon a vice president of the corporation.

Announce Formation of New Company

A NEW FIRM, Angstrom Precision, Inc., Hollywood, Calif., has been formed to engage in the development, manufacture and sale of custom components and test instruments for the electronics industry.

The company, organized by three former International Resistance Co. officials, will operate under a licens-



Complete Catalog Data

on TURBO Fixed Delay Package Waveguide Systems

Just off the press — a 28-page working tool for microwave engineers. Gives complete mechanical and electrical specifications on inventoried items. Shows photographs and dimension drawings.

- Half-X, K_u, Turbine, Large X (X_L), X-Band, Half X_L.
- Bends, twists, flanges, transitions, and single elements.

Catalog and price list sent on request.

TURBO

TURBO MACHINE CO.
LANSDALE, PA.
Phone: Area Code 215, Ulysses 5-5131

CIRCLE 204 ON READER SERVICE CARD



Are you a COMPLETELY INFORMED electronics engineer?

Today you may be working in microwaves. But on what project will you be working tomorrow? You *could* have read electronics this past year

and kept abreast of, say, microwave technology. *There were 96 individual microwave articles between July, 1961 and June, 1962!*

But suppose tomorrow you work in some area of standard electronic components, in semiconductors, in systems? Would you be up-to-date in these technologies? Did you read the more than 3,000 editorial pages that electronics' 28-man editorial staff prepared last year?

electronics is edited to keep you current *wherever* you work in the industry, *whatever* your job function(s). If you do not have your own copy of electronics, subscribe today via the Reader Service Card in this issue. Only 7½ cents a copy at the 3 year rate.

electronics

October 5, 1962

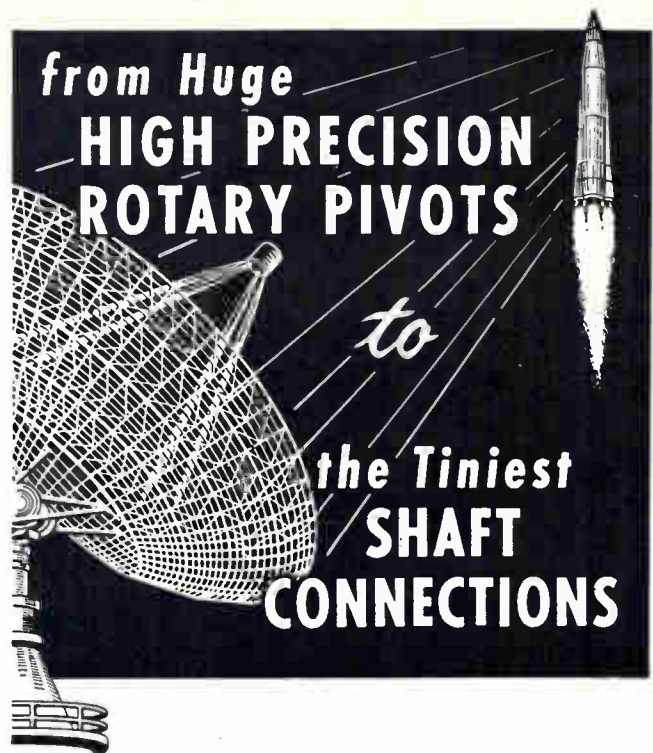

THOMAS FLEXIBLE COUPLINGS

are indispensable for reliable power and motion transmission.

Designed especially to meet critical operating requirements, Thomas Flexible Couplings offer many important advantages plus long life, reliability and a wide range of styles and sizes to meet the particular requirements of your application. Special materials may be specified where high temperatures, corrosive atmospheres or other unusual conditions exist. For detailed information write for Engineering Catalog 60.



THOMAS FLEXIBLE COUPLING CO.
A Subsidiary of Koppers Company, Inc.
WARREN, PENNSYLVANIA, U.S.A.

CIRCLE 87 ON READER SERVICE CARD

87

TELEMETRY BY TELE-DYNAMICS

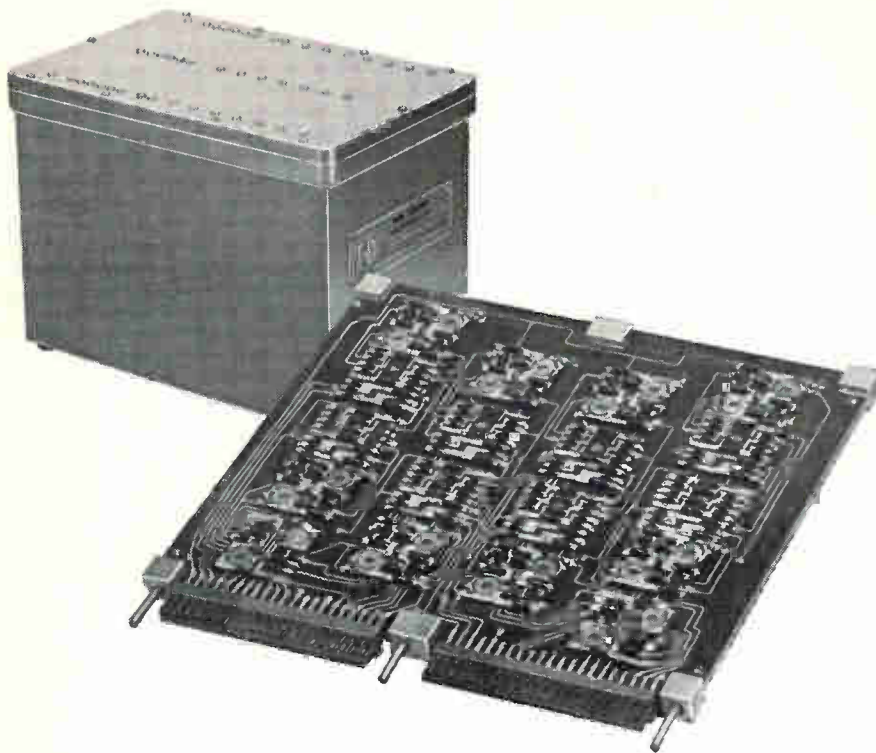

HIGH PERFORMANCE

PCM SYSTEMS

Tele-Dynamics' pulse code modulation telemetry techniques make possible the assembly of PCM systems to meet high-performance requirements. Any number of single or double ended input channels can be accommodated. Bit rate flexibility and commutator programmability are also provided. These unique features make the Tele-Dynamics' PCM system directly applicable to adaptive telemetry requirements. Utilization of microminiature circuitry in the control portions of the system results in substantial reductions in size, weight, and power requirements. Write for complete information and specifications.

TELE-DYNAMICS

DIVISION

AMERICAN BOSCH ARMA CORPORATION

5000 Parkside Avenue, Philadelphia 31, Pa.

6917

ing agreement with IRC covering three specific patents.

Leo J. Jacobson, president, was director of engineering for IRC.

Henry A. Schumer, vice president of operations, had been IRC's assistant director of engineering.

Benjamin Solow, vice president of research & engineering, was formerly manager of IRC's West Coast Engineering.



LFE Names Lawrence Executive V-P

HENRY W. HARDING, president of Laboratory for Electronics, Inc., Boston, Mass., has announced the election of William Lawrence to the new office of executive vice president of the corporation. Lawrence will direct and coordinate the activities of all LFE operating divisions—LFE Electronics, Eastern Industries, Automatic Signal, Tracerlab and the Keleket X-Ray Corp.

Before coming to LFE, Lawrence was with General Dynamics Corp., where he was general manager of both the military Products and Information Technology divisions in San Diego, Calif.



Name Donald Reiser A.G.A. Vice President

DONALD REISER has been promoted to vice president for instrumenta-

**UNITED SYSTEMS
CORPORATION**

Offers...

**A NEW LOW COST
D.C. DIGITAL VOLTMETER**
DIGITEC MODEL 200



With These FEATURES

- 0.2% FULL SCALE ACCURACY
- D.C. RANGES FROM .001 TO 1020 V
- 2 MEGOHMS INPUT IMPEDANCE
- SMALL (5 1/2" x 8" x 7") SIZE
- 7 LBS. TOTAL WEIGHT—PORTABLE
- MANY PLUS FEATURES

WRITE OR WIRE FOR DEMONSTRATION



CIRCLE 220 ON READER SERVICE CARD

SHOCK IT, DROP IT SHAKE IT... EVEN! DRILL IT!

NETIC & CO-NETIC MAGNETIC SHIELDINGS PERMANENTLY PROTECT YOUR COMPONENTS . . . never require rejuvenation . . . have negligible residual magnetism . . . make your sensitive components impervious to outside magnetic disturbances.

Because of their proven reliability, both are widely used in satellites and missiles as well as on the ground to protect recording tapes, components or systems. The proprietary characteristics of these alloys enable you to design compactly and to improve overall performance.

The Magnetic Shield Division has the industry's widest choice of magnetic shields for components and structures, ranging from micromodules to mobile shielded rooms. Tell us your shielding requirement and let us help solve it.



MAGNETIC SHIELD DIVISION

Perfection Mica Company / Everglade 4-2122

1322 N. ELSTON AVENUE, CHICAGO 22, ILLINOIS

ORIGINATORS OF PERMANENTLY EFFECTIVE NETIC CO-NETIC MAGNETIC SHIELDS

CIRCLE 205 ON READER SERVICE CARD

ELECTRONIC *Water Welder* for PENCIL POINT WELDING

Now you can weld, melt, heat, fuse, solder and braze with distilled water as your primary fuel. This instrument handles wire in thickness up to .050 in., and sheet metal up to .025 in. Gives you work piece temperatures up to 6,000 degrees F. Welds stainless steel in the 300 and 400 series, also other nickel base alloys. Torch tips are slip-on 23 gage hypodermic needles. Only distilled water and electricity are needed to run the instrument without the Booster. Wt. 30 lbs. Plugs in any 110-120 V.A.C. Operating cost .01c per hr. Price \$249.00 F.O.B. Phoenix. Write for literature.

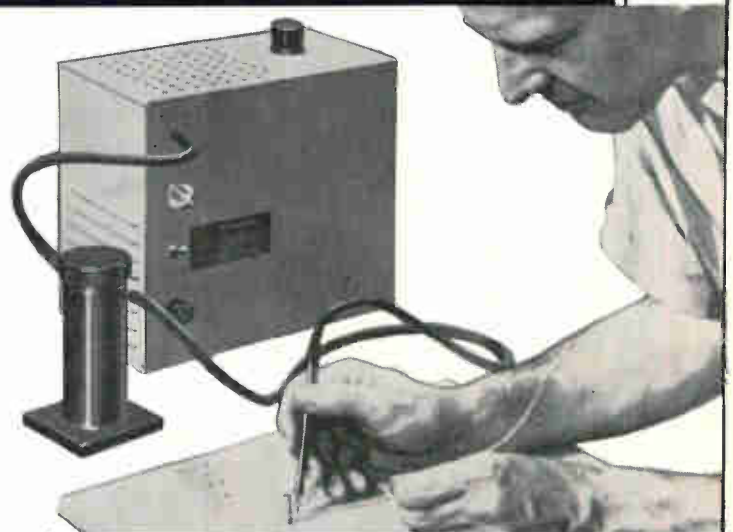

- Work Piece Temperatures Up To 6000 Degrees.
- Primary Fuel is Distilled Water

• COMPACT SIZE 10 1/4 X 9 1/4 X 6

HENES MANUFACTURING CO.
4302 E. Madison St., Phoenix 34, Arizona

PW Assembly Costs Running HIGH?

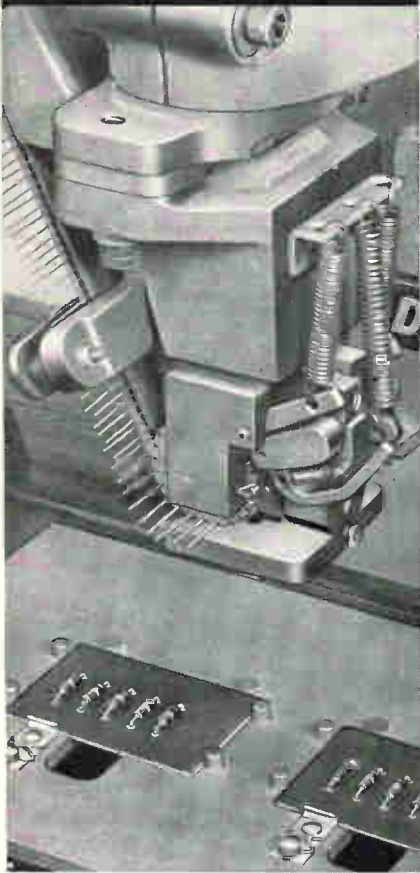

Let DYNASERT® CUT COSTS, SAVE TIME!

The Dynasert Component Inserting Machine will pay for itself in a year or less in direct labor savings. It feeds, cuts, forms, inserts and clinches a wide range of axial lead components — up to ten times faster than by hand assembly.

And with the new Pantograph Positioning Table you get even greater economies. For use where multiple components of the same size are to be inserted in parallel positions.

Find out more. Write or call Mr. D. R. Knight, Dynasert, United Shoe Machinery Corporation, Boston 10, Massachusetts. Area Code 617, LI 2-9100.

United
DYNASERT®

Try it for Yourself

See us at Booth #922 at the NEC

tion at Aero Geo Astro Corp., Alexandria, Va.

Reiser, who was previously director of the Instrumentation division, has been with A.G.A. since 1960 and has been responsible for the design and production of many missile and satellite instruments.

PEOPLE IN BRIEF

L. Frank Robinson, Jr., promoted to mgr. of quality control at GE's Electronic Specialty Capacitor operation. Floyd D. Shipley, ex-Texas Instruments, joins the engineering and development staff of Decibel Products, Inc. Graham Smith, formerly with Sperry Rand Corp., named director of Government Systems at The Teleregister Corp. Francis V. Wagner from North American Aviation to Informatics Inc. as director of plans and programs. John K. O'Sullivan, previously with Consolidated Electrodynamics, appointed quality control mgr. at Montronics, Inc. Howard M. Margowsky moves up to president of Remanco, Inc. James S. McLeod advances to director of engineering at Page Communications Engineers, Inc. Menke Drewes, Jr., leaves Bendix Laboratories to become chief engineer at Conrad, Inc. Edward Kingman, ex-Beckman & Whitley, now v-p and chief engineer of recently established Climet Instruments Inc. Frank B. DeArmond, formerly with North American Aviation, Inc., appointed v-p and g-m of Radiatronics, Inc. Robert F. Tucker, recently retired from U.S. Navy, joins the engineering staff of Electronic Systems div. of Antenna Systems Inc. Walter G. Johnston, formerly with Shafford Electronics, now president and g-m of the newly formed Sperex Corp. Paul Harton promoted to mgr. of data acquisition systems for Pan American Airways' Guided Missiles Range div. Burton S. Ritter from Bendix-Pacific to Lockheed Electronics' Avionics and Industrial Products div. as mgr., advanced systems for telemetry and space communication. Leighton Rama, previously with John Fluke Mfg. Co., named director of engineering of Holt Instrument Laboratories.

Angelica's SUPER IV CLEAN ROOM UNIFORMS "Packaging People to Protect Products"



Angelica's engineer-designed uniforms meet Air Force recommendations... prevent Clean Room contamination and insure product reliability. Static-free, non-linting, acid resistant. Coveralls, smocks, head covers, gloves, boots, wiping cloths.

Contact your nearest Angelica office for help in determining your garment needs... or write for FREE CATALOG.

Angelica®

Uniform Co.

1427 Olive St., St. Louis 3, Mo.
107 W. 48th St., New York 36, N. Y.
445 N. LaSalle St., Chicago 10, Ill.
1900 W. Pico Blvd., Los Angeles 6, Calif.
317 Hayden St., N. W., Atlanta 13, Ga.

CIRCLE 206 ON READER SERVICE CARD

MEGOHMMETER



for INSULATION TESTS

self-powered VIBROTEST®

Model 201... direct reading resistance measurement, ranges of 200 megohms and 2000 ohms... plus a-c and d-c ranges of 0-150, 300 and 600 v. Built-in 500v power supply is operated by flash cells. Order direct. Your satisfaction fully warranted. Net price, fob factory.... **\$136.50**

Write for
New Manual T-75 on
Insulation Testing

2-35.6

ASSOCIATED RESEARCH, Incorporated

"Electrical Testing Instruments Since 1936"

3781 W. Belmont Ave., Chicago 18, Illinois

CIRCLE 207 ON READER SERVICE CARD

electronics

electronics

WEEKLY QUALIFICATION FORM FOR POSITIONS AVAILABLE

ATTENTION: ENGINEERS, SCIENTISTS, PHYSICISTS

This Qualification Form is designed to help you advance in the electronics industry. It is unique and compact. Designed with the assistance of professional personnel management, it isolates specific experience in electronics and deals only in essential background information.

The advertisers listed here are seeking professional experience. Fill in the Qualification Form below.

STRICTLY CONFIDENTIAL

Your Qualification form will be handled as "Strictly Confidential" by ELECTRONICS. Our processing system is such that your form will be forwarded within 24 hours to the proper executives in the companies you select. You will be contacted at your home by the interested companies.

WHAT TO DO

1. Review the positions in the advertisements.
2. Select those for which you qualify.
3. Notice the key numbers.
4. Circle the corresponding key number below the Qualification Form.
5. Fill out the form completely. Please print clearly.
6. Mail to: D. Hawksby, Classified Advertising Div., ELECTRONICS, Box 12, New York 36, N. Y. (No charge, of course).

COMPANY	SEE PAGE	KEY #
ATOMIC PERSONNEL INC. Philadelphia, Pennsylvania	130*	1
BELL AEROSYSTEMS CO. Division of Bell Aerospace Corporation A Textron Co. Buffalo, New York	94	2
BENDIX CORP. Field Engineering Div. Owings Mills, Maryland	130*	3
BRISTOL COMPANY Waterbury, Connecticut	94	4
CALIFORNIA SAN DIEGO UNIVERSITY OF LaJolla, California	94	5
DOUGLAS AIRCRAFT CO. Missile & Space Systems Division Santa Monica, California	16	6
ESQUIRE PERSONNEL Chicago, Illinois	130*	7
GENERAL ELECTRIC Defense Systems Dept. Syracuse, New York	93	8
JET PROPULSION LABORATORY Pasadena, California	94	9
LINK DIVISION General Precision Inc. Binghamton, New York	118*	10
MARTIN MARIETTA Orlando Div. Orlando, Florida	130*	11
MICROWAVE SERVICES, INC. Denville, New Jersey	94	12
MOLONEY ELECTRIC CO. St. Louis 20, Missouri	94	13
REPUBLIC AVIATION CORPORATION Farmingdale, L.I., N.Y.	92	14
VITRO LABORATORIES Division of Vitro Corp. of America Silver Spring, Maryland	92	15
P-942B	94	16

*These advertisements appeared in the Sept. 28, issue.

(cut here) **electronics WEEKLY QUALIFICATION FORM FOR POSITIONS AVAILABLE** (cut here)

(Please type or print clearly. Necessary for reproduction.)

Personal Background

NAME

HOME ADDRESS

CITY ZONE STATE

HOME TELEPHONE

Education

PROFESSIONAL DEGREE(S)

MAJOR(S)

UNIVERSITY

DATE(S)

FIELDS OF EXPERIENCE (Please Check)

10562

- | | | |
|--|--|---------------------------------------|
| <input type="checkbox"/> Aerospace | <input type="checkbox"/> Fire Control | <input type="checkbox"/> Radar |
| <input type="checkbox"/> Antennas | <input type="checkbox"/> Human Factors | <input type="checkbox"/> Radio-TV |
| <input type="checkbox"/> ASW | <input type="checkbox"/> Infrared | <input type="checkbox"/> Simulators |
| <input type="checkbox"/> Circuits | <input type="checkbox"/> Instrumentation | <input type="checkbox"/> Solid State |
| <input type="checkbox"/> Communications | <input type="checkbox"/> Medicine | <input type="checkbox"/> Telemetry |
| <input type="checkbox"/> Components | <input type="checkbox"/> Microwave | <input type="checkbox"/> Transformers |
| <input type="checkbox"/> Computers | <input type="checkbox"/> Navigation | <input type="checkbox"/> Other |
| <input type="checkbox"/> ECM | <input type="checkbox"/> Operations Research | <input type="checkbox"/> |
| <input type="checkbox"/> Electron Tubes | <input type="checkbox"/> Optics | <input type="checkbox"/> |
| <input type="checkbox"/> Engineering Writing | <input type="checkbox"/> Packaging | <input type="checkbox"/> |

CATEGORY OF SPECIALIZATION

Please indicate number of months experience on proper lines.

	Technical Experience (Months)	Supervisory Experience (Months)
RESEARCH (pure, fundamental, basic)
RESEARCH (Applied)
SYSTEMS (New Concepts)
DEVELOPMENT (Model)
DESIGN (Product)
MANUFACTURING (Product)
FIELD (Service)
SALES (Proposals & Products)

CIRCLE KEY NUMBERS OF ABOVE COMPANIES' POSITIONS THAT INTEREST YOU

1 2 3 4 5 6 7 8 9 10 11 12 13 14 15 16 17 18 19 20 21 22 23 24 25

ELECTRONICS ENGINEERS
& PHYSICISTS

JOIN US IN
GIVING A
NEW
DIRECTION
TO
AEROSPACE
TECHNOLOGY thru
RESEARCH & DEVELOPMENT in

aerospace electronics

Republic's Paul Moore Research & Development Center is the most sophisticated and integrated research complex in the East. Advances made here in many critical aerospace problem areas have brought Republic a diversity of new and follow-on R & D contracts leading to next-generation space and re-entry vehicles, satellites, space power and communication systems.

Electronics Engineers and Physicists are invited to consider the challenging opportunities to make important contributions on these programs in the areas of:

SPACE CRAFT COMMUNICATION — B.S., M.S.
Design and develop space vehicle communications systems including telemetry, command and on-board data handling.

DATA HANDLING (ASGSE) — B.S., M.S.
Design and develop ground station and on-board data handling systems for re-entry and space vehicle applications.

COMMUNICATION TECHNIQUES — B.S., M.S.
Develop advanced communications techniques for aerospace and space craft, includes communications theory and network synthesis.

ADVANCED SPACE RADARS — B.S., M.S.
Develop concepts and components for advanced space radar including rendezvous, mapping, acquisition and tracking applications.

RADAR INTEGRATION — B.S.
Develop specifications, install and integrate advanced radar in hypersonic and space vehicles, including antennas, transmitters, receivers, displays, power supplies, controls.

ANTENNA DESIGN — M.S.
Design and development of antennas for re-entry vehicles. Knowledge of wind effects and general re-entry radiation blackout problems.

RADAR TEST (GSE) — B.S.
Test, checkout and maintain ground radar systems. Make required circuit modifications including range gating circuits, modulators. No travel.

RE-ENTRY INSTRUMENTATION — B.S., M.S.
Design instrumentation for specific re-entry and space vehicles including telemetry systems.

MATHEMATICAL ANALYSIS CONTROLS — Ph.D.
Theoretical analysis of noise effects and non-linear mechanisms on automatic controls. Includes optimal control theory and generalized stability criteria.

ELECTRONIC INSTRUMENTATION — B.S., M.S.
Develop instrumentation for space vehicles. Knowledge of system integration and telemetry desirable.

SPACE GUIDANCE SYSTEMS — M.S., Ph.D.
Develop and analyze navigation and guidance systems using inertial and Doppler techniques and advanced nuclear gyros.

ECM REQUIREMENTS — B.S., M.S.
Mathematical analysis of ECM requirements for advanced aerospace and space craft, and specification of equipment.

FLIGHT CONTROL DESIGN — M.S.
Automatic flight controls, servo systems, nonlinear dynamic systems for space craft.

PYROTECHNIC CIRCUIT DESIGN — B.S., M.S.
Develop pyrotechnic missile circuits including safe arm, squib ignition and RFI elimination devices.

EXPERIMENTAL PHYSICIST — Ph.D.
Conduct experimental studies of the application of nuclear or electron resonance to gyroscopics.

ENVIRONMENTAL TESTING — B.S., M.S.
Undertake test programs to estimate component and system reliability using AGREE type methods; monitor offsite testing.

DESIGN REVIEW — B.S., M.S.
Perform mechanical or electronic design reviews, failure analyses, quantitative analyses and reports. Includes circuit analysis, component selection.

STATISTICAL ANALYSIS — B.S., M.S.
Apply statistical theory and method to prediction and analysis of aerospace component performance.

IDEP PRISM PROCEDURES — B.S., M.S.
Participate in "Interservice Data Exchange Programming" and "Program Reliability Information Systems for Management."

Interested applicants are invited to write in confidence to: Mr. George R. Hickman, Technical Employment Manager, Dept. 11H-1

REPUBLIC AVIATION CORPORATION

FARMINGDALE, LONG ISLAND, NEW YORK

An Equal Opportunity Employer



ENGINEERS:
Systems, Design,
Development
PHYSICISTS

opportunity
and
advancement
are

'GO'

at VITRO!

DYNAMIC EXPANSION CREATES NEW CAREER POSITIONS

Vitro Laboratories is expanding on all fronts . . . missile systems engineering . . . design and development . . . analysis . . . research and study. We are stretching the parameters of knowledge in space, in the air, on the ground and underseas. We invite you to enter the "go" climate of Vitro.

Vitro is a good place to work. Here you will find a professional atmosphere conducive to original and imaginative thinking. Skilled clerical and technical support frees you to concentrate on the creative aspects of your assignments, and salaries are at a level worthy of your attention. You will advance as fast as your talents allow.

Career appointments are available immediately in the following areas:

MISSILE SYSTEMS ENGINEERING

Polaris, Typhon, Talos, Tartar

DESIGN & DEVELOPMENT

Digital equipment
ASW equipment
Underwater vehicles
Simulators • Torpedoes
Electro-mechanical launching equipment

ANALYSIS

Radar and IR systems
Digital and analog equipment
Fire control systems

RESEARCH & STUDY

Reliability and feasibility studies
Basic and applied research
Weapons systems analysis
Acoustic studies
ASW studies

WRITE OR PHONE COLLECT for details:
Manager, Professional Employment

VITRO LABORATORIES

Division of Vitro Corporation of America
Dept. 244, 14000 Georgia Ave.
Silver Spring, Maryland
(Residential suburb of Washington, D. C.)
Phone: WHitehall 2-7200
An equal opportunity employer

SURVEILLANCE IDENTIFICATION

WEAPONS CONTROL

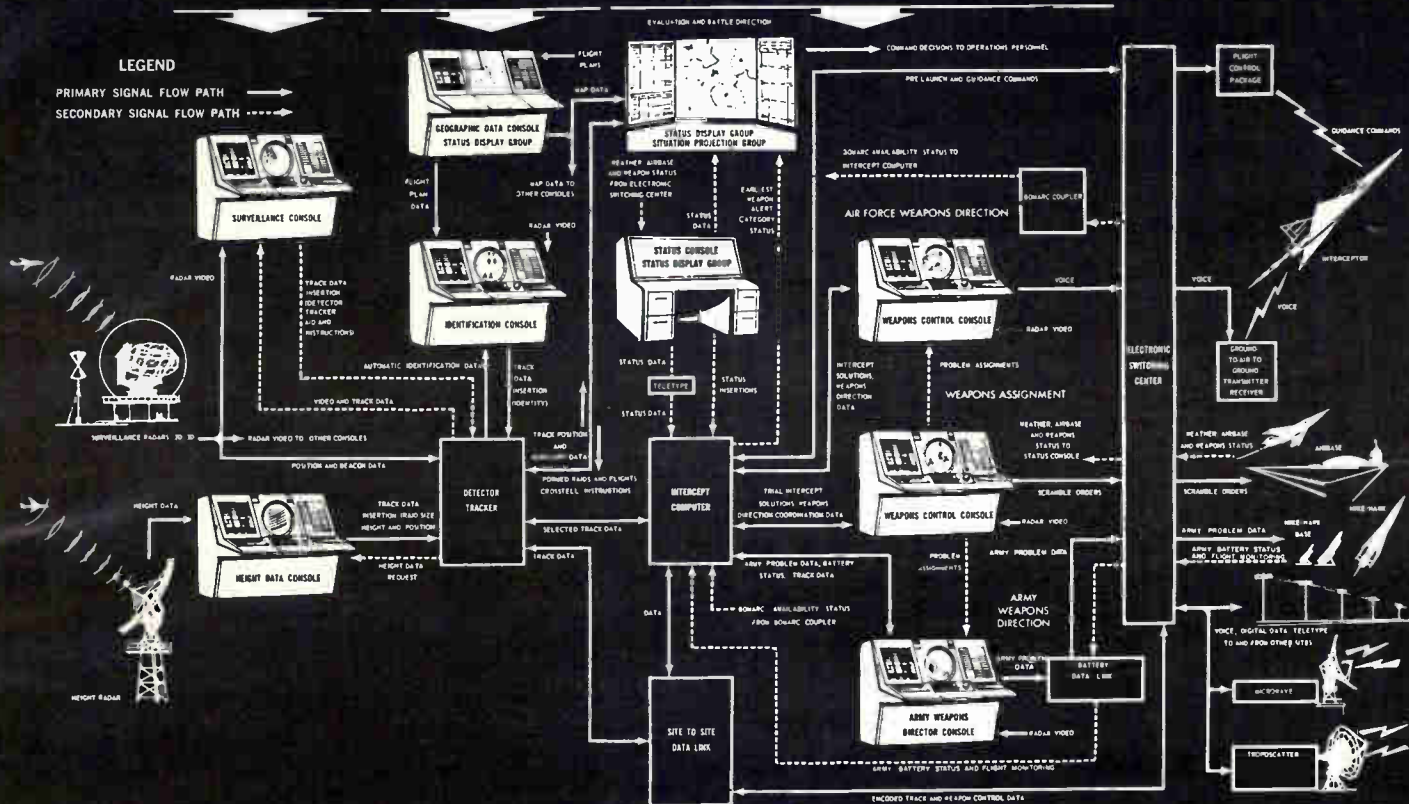

A big loop to close...

Your next job? It depends on what you're seeking... a compatible increment in salary... or a no-holds-barred chance to wrestle with problems of an entirely new magnitude. An example of the latter lies between the lines of the diagram above. □ Superficially, the schematic traces the data flow at a hypothetical Control and Reporting Center of the Air Weapons Control System 412-L. In the over-all mosaic of a fully integrated 412-L System, such a Control and Reporting Center is a key element. □ We are managing the integration and implementation of the 412-L program under the direction of the U.S.A.F. Electronic Systems Division, from system concept and development, through the installation and checkout of complete operating equipments. If you'd like more information about this program, and the calibre of opportunities it offers, send us an outline of your education and experience. Your personal reply will include a technical brochure describing the entire system. There's no obligation.

These are the general areas of immediate opportunity: Communication Systems / Applied Mathematics / Materials Engineering / Microminiature Electronic Packaging / Semiconductor Circuits Design / Computer Systems Applications / Electronic Liaison-Production Engineering / Microminiature Mechanical Design / Operations Analysis / Systems Equipment Analysis / Telecommunication Systems Design / Project Integration Engineering / Equipment Evaluation.

Address your inquiry in confidence to Mr. P. W. Christos, Div. 69-WN, Defense Systems Department, General Electric Company, Northern Lights Office Building, Syracuse, New York.



DSD DEFENSE SYSTEMS DEPARTMENT
A Department of the Defense Electronics Division

GENERAL ELECTRIC

Northern Lights Office Building — Syracuse, New York

An Equal Opportunity Employer

ADVANCED SYSTEMS RESEARCH ADVANCED SYSTEMS ENGINEERING

NEW DEPARTMENTS NOW BEING ESTABLISHED AT BELL AEROSYSTEMS

Known for such "firsts" as HIPERNAS, the most accurate, pure inertial, self-compensating navigation and guidance system known, Bell is increasing its Company-sponsored R&D and further expanding its programs in Avionics. Interesting new investigations are about to start in such varied areas as controls for a lunar landing "bug" or module, learning machines, development of advanced mathematical theorems for quick, accurate measurement of reliability, and new concepts in battlefield surveillance systems and air traffic control.

POSITIONS ARE IMMEDIATELY AVAILABLE FOR:

SR. PHYSICISTS & ELECTRONIC ENGINEERS

MS or PhD with 5 years experience in physics, radar, optics and guidance. To work in company-sponsored R&D programs on microminiaturization, lasers, learning machines, new guidance and control techniques for space vehicles.

CONTROL SYSTEMS & SIMULATION ENGINEERS

Supervisory and senior level positions for assignment to automatic feedback control systems, aerospace vehicles, automatic throttle systems, control systems for simulators and autopilots, closed circuit TV and circuit design. BS or advanced degree in EE plus 3 to 8 years analytical experience related to servo analysis involving hydraulic and electronic control systems, feedback theory, analog computers, simulators and autopilots.

SR. ELECTRONIC SYSTEMS ENGINEERS

BS to PhD in EE with minimum 5 years experience. For synthesis and analysis work involving air traffic control, target locators, space, radar, command and control, visual simulators and feedback control systems.

SR. ENGINEERS & PROJECT MANAGERS

BS or advanced degree in EE plus 10 years analytical experience. Radar and antenna experience desirable. For development of pulse command, navigation and data link systems with specific assignment on such projects as nano-second pulse transmitters and receivers, precision radio distance measuring equipment, rapid frequency diversity techniques, and increasing the power, range and sensitivity of radio command and communication systems.

Your inquiries are invited. Please send resume to Mr. T. C. Fritsch, Dept. G2.

 **BELL AEROSYSTEMS Co.**
DIVISION OF BELL AEROSPACE CORPORATION - A **Textron** COMPANY
An Equal Opportunity Employer P.O. Box #1, Buffalo 5, New York

jpl needs

SCIENTISTS AND ENGINEERS

for
JPL's Lunar and Planetary Programs

with experience in any of the following areas:

- Celestial Mechanics
- Orbit Determination
- Space Navigation Theory
- Trajectory Studies
- Systems Analysis

Openings are now available in both theoretical and project positions.

Send complete resume to
PERSONNEL DEPT.

JET PROPULSION LABORATORY

Operated by California Institute of Technology for
the National Aeronautics & Space Administration
4814 OAK GROVE DR. • PASADENA, CALIF.

"An equal opportunity employer"

Engineering or Science Graduates to be trained as INSTRUMENT SALES ENGINEERS with

The Bristol Company

Leading manufacturer of automation equipment and control systems requires men, preferably 25 to 35 years old, to sell high quality, nationally accepted products to wide variety of industrial markets. Openings in various areas of the country. Successful applicants take comprehensive three-months course at headquarters. Salary and expenses. All replies confidential; every inquiry answered. Write: Charles F. Johnson, Mgr. of Sales Training

The Bristol Company

Waterbury 20, Conn.

An equal opportunity employer

COMMUNICATIONS APPLICATION ENGINEER Analysis of advanced electronic communication systems including radio, carrier, telephone, microwave:



Must have design and marketing experience with commercial and military users.

EE degree, 5 yrs. exp. min.
Send Resume to:

Microwave Services, Inc.

Consulting Engineers
Route 46 Denville, N. J.

RESEARCH SCIENTIST

Leading manufacturers of guidance instruments and control devices in Southern California needs imaginative scientists with background in microelectronics. Must have ability to write engineering proposals and to present new product ideas to customers. Requires Phd in Physical Sciences. Minimum 5 years experience. Salary open.

ASSOCIATE SCIENTIST

M.S., E.E. Minimum 5 years solid state design. Salary open.

SENIOR ENGINEER

B.S., M.E. or E.E. Min. 5 years instrument design experience.

Santa Monica Bay area

P-9428, Electronics

255 California St., San Francisco 11, Calif.

An equal opportunity employer.

UNIVERSITY OF CALIFORNIA SAN DIEGO

DIRECTOR—Experimental Services for School of Science and Engineering. Degree plus proven experience in some areas such as semiconductor materials preparation, electro-mechanical gadgets, research shops, high vacuum, optics, electronic components manufacturing, etc. Must be capable of developing a facility which will perform advanced state-of-the-art research services. Salary comparable to industry. Extra benefits. An equal opportunity employer. Please send resume immediately to

Mr. S. J. ADAMS

Department of Physics

UNIVERSITY OF CALIFORNIA, SAN DIEGO,
La Jolla, California

ELECTRONICS ENGINEERS

With experience in components or system design for high power radar or communications.

Send Complete Resume
Including Salary Requirement

D. F. Winter, Vice President

MOLONEY ELECTRIC COMPANY
5390 Bircher Blvd. St. Louis 20, Mo.

EMPLOYMENT OPPORTUNITIES

The advertisements in this section include all employment opportunities — executive, management, technical, selling, office, skilled, manual, etc. Look in the forward section of the magazine for additional Employment Opportunities advertising.

— RATES —

DISPLAYED: The advertising rate is \$40.17 per inch for all advertising appearing on other than a contract basis. Contract rates quoted on request.

An advertising inch is measured 1/8" vertically on a column—3 columns—30 inches to a page.

Subject to Agency Commission.

UNDISPLAYED: \$2.70 per line, minimum 3 lines. To figure advance payment count 5 average words as a line. Box numbers—count as 1 line.

Discount of 10% if full payment is made in advance for 4 consecutive insertions.
Not subject to Agency Commission.

SEARCHLIGHT SECTION

(Classified Advertising)

BUSINESS OPPORTUNITIES
EQUIPMENT - USED or RESALE

DISPLAYED RATE

The advertising rate is \$27.25 per inch for all advertising appearing on other than a contract basis. Contract rates quoted on request. AN ADVERTISING INCH is measured 7/8 inch vertically on one column, 3 columns—30 inches—to a page. EQUIPMENT WANTED or FOR SALE ADVERTISEMENTS acceptable only in Displayed Style.

UNDISPLAYED RATE

\$2.70 a line, minimum 3 lines. To figure advance payment count 5 average words as a line. PROPOSALS, \$2.70 a line an insertion. BOX NUMBERS count as one line additional in undisplayed ads. DISCOUNT OF 10% if full payment is made in advance for four consecutive insertions of undisplayed ads (not including proposals).

FOR RESEARCH — DEVELOPMENT & EXPERIMENTAL WORK

Over 10,000 different electronic parts: waveguide, radar components and parts, test sets, pulzers, antennas, pulse xmfrs, magnetrons, IF and pulse amplifiers, dynamotors, 400 cycle xmfrs, 584 ant. pedestals, etc.
PRICES AT A FRACTION OF ORIGINAL COST!
COMMUNICATIONS EQUIP. CO.
343 CANAL ST., N. Y. 13, W.O. 6-4045
CHAS. ROSEN (Formerly at 131 Liberty St.)

CIRCLE 950 ON READER SERVICE CARD

OVER 2,000,000

RELAYS

IN STOCK!

Send for Catalog 55

Universal RELAY CORP.
42 WHITE ST., N. Y. 13, N. Y. • Walker 5-6900

CIRCLE 951 ON READER SERVICE CARD

AUTO-TRACK & TELEMETRY ANTENNA PEDESTALS
X & S SCR 584 & M 33 AUTOTRACK RADAR
AN/TPS-1D SEARCH, AN/TPS-10 HT. FINDERS,
AN/FPN-32GCA, AN/APS-10 NAVIG. & WEATHER,
AN/APS-15 B, AN/APS-23 & 31 SEARCH
S & X BEACONS, VA 800 KLY, CARCINOTRONS,
.25-.5-1-2-3-6 MEGAWATT PULSERS,
MICROWAVE PULSING—TEST EQUIP.
LARGEST RADAR STOCK IN U.S.A.
RADIO RESEARCH INSTRUMENT CO.
550 Fifth Ave. New York Tel: Judson 6-4691

RADAR SYSTEMS & COMPONENTS / IMMEDIATE DELIVERY

CIRCLE 952 ON READER SERVICE CARD

Searchlight Equipment Locating Service

No Charge or Obligation

This service is aimed at helping you, the reader of "SEARCHLIGHT," to locate Surplus new and used Electronic equipment not currently advertised. (This service is for USER-BUYERS only).

How to use: Check the dealer ads to see if what you want is not currently advertised. If not, send us the specifications of—the equipment wanted on the coupon below, or on your own company letterhead to:

Searchlight Section Locating Service

Classified Advertising

c/o ELECTRONICS

P. O. Box 12, N. Y. 36, N. Y.

Your requirements will be brought promptly to the attention of the equipment dealers advertising in this section. You will receive replies directly from them.

Searchlight Equipment Locating Service

Classified Advertising

c/o ELECTRONICS

P. O. Box 12, N. Y. 36, N. Y.

Please help us locate the following equipment components.

NAME

TITLE

COMPANY

STREET

CITY10/5/62

NOW: MEASURE FREQUENCY TO PARTS PER 10¹¹!

Use the new VLF transmissions and a Textran Phase-locked VLF Receiver

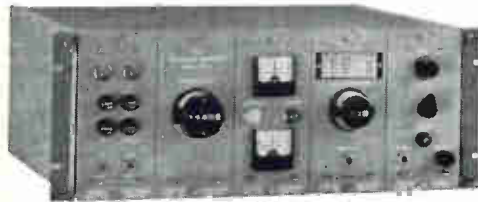

- Tunes full range 12-25 kc
- 0.01 microvolt sensitivity
- 0.2 microsecond resolution on direct-reading output
- Calibrated chart-recorder output
- Blanking and coherent AGC for severe-noise operation

Write for full information on how to use VLF equipment. Ask for "Calibration Data"

TEXTRAN

A Division of **TRACOR** Inc.

1701 GUADALUPE ST., AUSTIN 1, TEXAS

CIRCLE 208 ON READER SERVICE CARD

Military and government field stations, laboratories, educational groups, standards labs, Q/C facilities, test departments, metrology labs—if you need to determine frequency or its inverse, time, to an accuracy of several parts in 10¹¹—several orders of magnitude better than usual WWV or WWVH reception—use the new VLF transmissions and a Textran VLF receiver.

Field evaluation by two leading government agencies confirmed the Textran receiver to be the best available. A phase-comparator and servo-driven phase-shifter yield automatic phase-locked operation. The receiver, with an external local frequency source, becomes a complete and integrated time/frequency measuring system—nothing else to buy or attach.

WWV tracking GUARANTEED anywhere in Continental U.S.

Good parts work best!

Intermediate Frequency Transformer IFT



POLYVARICON Variable Capacitor



The high standards of MITSUMI electronic components are insured by a fully-automated assembly system, and double-checked by rigid quality controls. Mitsumi Electric Company is Japan's largest manufacturer of components for radio, television and communications equipment.

MITSUMI PARTS

MITSUMI ELECTRIC CO., LTD.

Komae, Kitatama, Tokyo



electronics



Audit Bureau
of Circulations



Associated Business
Publications

Audited Paid Circulation

JAMES T. HAUPTLI

Advertising Sales Manager

R. S. QUINT:
Assistant Publisher Buyers'
Guide and Business Manager
FRED STEWART:
Promotion Manager
B. ANELLO:
Market Services Manager

RICHARD J. TOMLINSON:
Production Manager
GEORGE E. POMEROY:
Classified Manager
HUGH J. QUINN:
Circulation Manager

ADVERTISING REPRESENTATIVES

ATLANTA (9):
Michael H. Miller, Robert C. Johnson
1375 Peachtree St. N.E., Trinity 5-0523
(area code 404)

BOSTON (16):
William S. Hodgkinson, Donald R. Furth
McGraw-Hill Building, Copley Square,
Congress 2-1160 (area code 617)

CHICAGO (11):
Harvey W. Wernecke, Robert M. Denmead
645 North Michigan Avenue, Mohawk 4-5800
(area code 312)

CLEVELAND (13):
Paul T. Fegley
55 Public Square, Superior 1-7000
(area code 216)

DALLAS (1):
Frank Le Beau
The Vaughn Bldg., 1712 Commerce St.
Riverside 7-9721 (area code 214)

DENVER (2):
J. W. Patten
Tower Bldg., 1700 Broadway,
Alpine 5-2981 (area code 303)

HOUSTON (25):
Joseph C. Page, Jr.
Prudential Bldg., Halcombe Blvd.,
Riverside 8-1280 (area code 713)

LOS ANGELES (17):
Peter S. Carberry, Ashley P. Hartman
1125 W. 6th St., Huntley 2-5450
(area code 213)

NEW YORK (36):
Donald H. Miller, Henry M. Shaw,
George F. Werner
500 Fifth Avenue, LO-4-3000
(area code 212)

PHILADELPHIA (3):
Warren H. Gardner, William J. Boyle
6 Penn Center Plaza, LOcust 8-4330
(area code 215)

SAN FRANCISCO (11):
R. C. Alcorn
255 California Street, Douglas 2-4600
(area code 415)

LONDON W1:
Edwin S. Murphy Jr.
34 Dover St.

FRANKFURT/Main:
Matthée Herfurth
85 Westendstrasse

GENEVA:
Michael R. Zeynel
2 Place du Port

"Headquarters for Business Information"

McGraw-Hill Technical and Business Publications

American Machinist/Metal-
working Manufacturing
Aviation Week and Space
Technology
Business Week
Chemical Engineering
Chemical Week
Coal Age
Construction Methods and
Equipment
Construction Daily
Control Engineering
Electrical Construction
and Maintenance
Electrical Merchandising Week
Electrical Newsletter
Electrical West

Electrical Wholesaling
Electrical World
Electronics
Engineering Digest
Engineering and Mining Journal
E & MJ Metal and Mineral
Markets
Engineering News-Record
Factory
Fleet Owner
Industrial Distribution
National Petroleum News
Nucleonics
Nucleonics Week
Platt's Oilgram News
Platt's Oilgram Price Service
Power

Product Engineering
Purchasing Week
Science Week
Textile World

Overseas only:
Automobile International
(English, Spanish)
Ingenieria Internacional
Construccion (Spanish)
International Management
(English, Spanish
Portuguese editions)
Metalworking Production
(Great Britain)

Available by subscription only — to qualified persons actively engaged in the field of the publication. For subscription rates and information describing the editorial coverage of any of the above publications, write to: Subscription Manager, Circulation Department, McGraw-Hill Publishing Company, 330 West 42nd Street, New York 36, N. Y.

October 5, 1962

HOW do you want to record your TRACES?

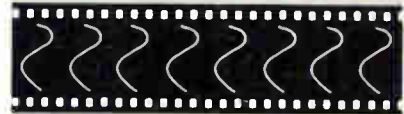

Continuous Flow?

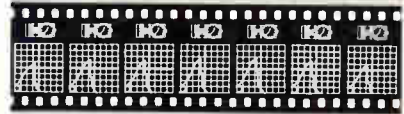

Single Frame?



Polaroid® Prints?

The new Beattie-Coleman KD-5 Oscillotron is a most versatile 'scope camera. Available with continuous-flow 35mm electric magazine, 35mm electric pulse magazine or Polaroid back for 10 sec. prints. Dichroic mirror for simultaneous, parallax-free viewing. Rotates 90° for vert. or horiz. format. Hinged mounting for easy focusing.

RECORD DATA, TOO
Written data, counter
and 24 hr. clock can all
be recorded on same
frame as trace. Write
for information on the
full Oscillotron line.



**BEATTIE-
COLEMAN
INC.**

1004 N. OLIVE ST., ANAHEIM, CALIFORNIA

CIRCLE 97 ON READER SERVICE CARD

97

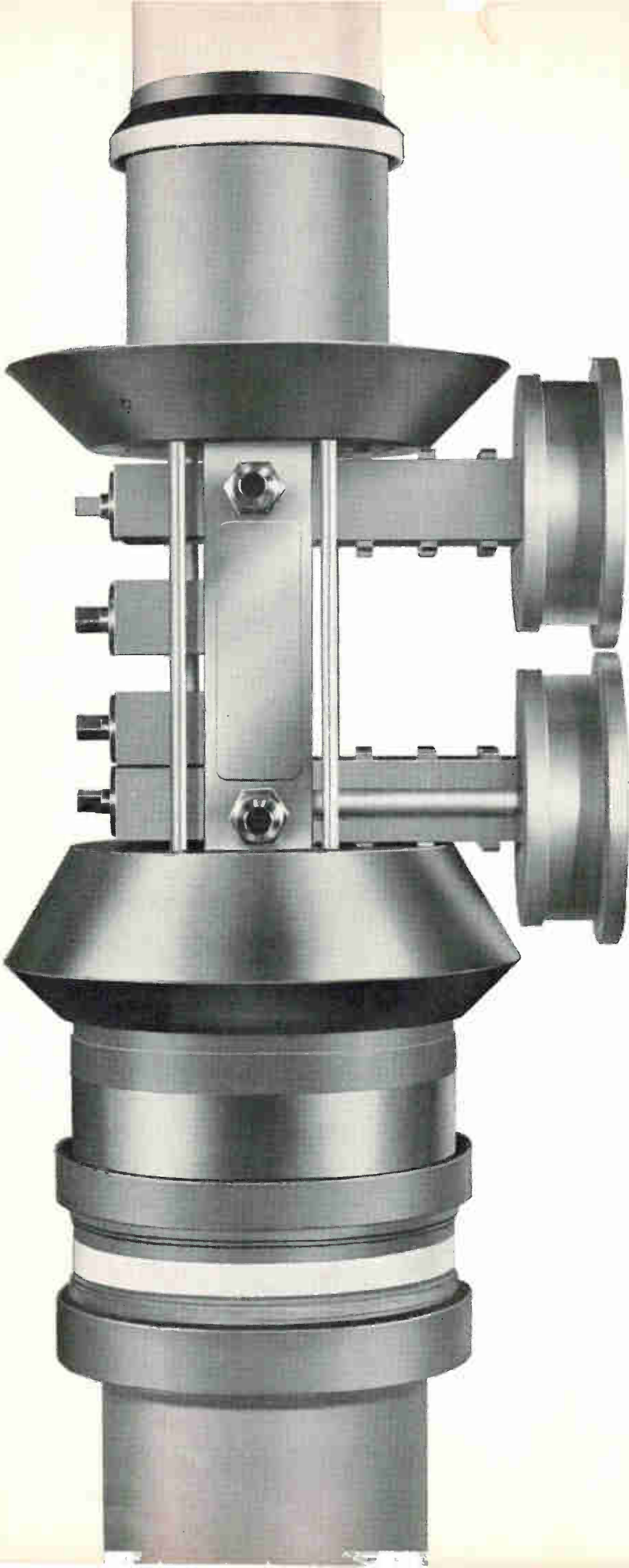

10 TO 50

120-DAY

KW • CW • 4.4-10.5 GC

DELIVERY



SPERRY RAND CORPORATION
GAINESVILLE, FLA. / GREAT NECK, N. Y.

New Super Power Klystrons

SAC-406 SERIES—4.4 to 6 Gc, 120-day delivery.

SAC-417 SERIES—6 to 8 Gc, 120-day delivery.

SAX-418 SERIES—8 to 10.5Gc, 120-day delivery.

ALL AT FIXED PRICES

A free technical bulletin is available. Write Sperry, Sec. 162, Gainesville, Florida, or contact your nearby Cain & Co. representative.



Super-clean area of the "White Room," where every TWT assembly operation is performed.

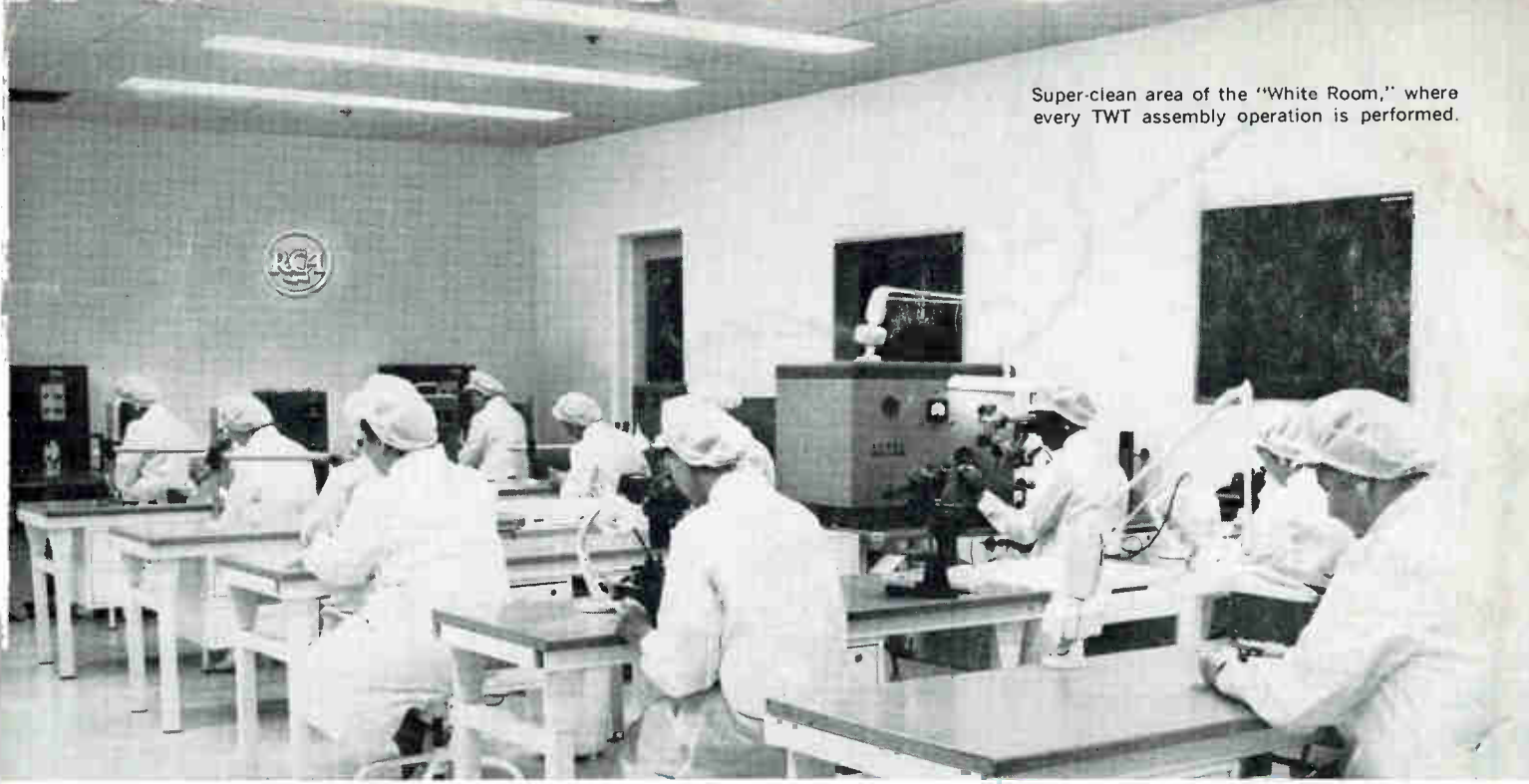

OPERATION TWT



Automatic magnetization and stabilization eliminate operator variability, ensuring required field characteristics.



All helices are inspected to a tolerance of ± 2 microns on a Helix Pitch Error Resolver.



X-ray techniques are used for control of critical sub-assembly spacing and tolerance.

RCA'S MODERN PRODUCTION CAPABILITY SUPPORTS THE ADVANCE OF TRAVELING-WAVE TUBE TECHNOLOGY

Reliability and tube-to-tube uniformity in Traveling-Wave Tubes depend on skillful engineering design and modern production techniques. RCA has both. Backed by development at the David Sarnoff Research Center, RCA produces a variety of Traveling Wave Tube types for a wide range of frequencies. Assembly work is done in a "white room", under controlled conditions of temperature and humidity. Even air is filtered to limit dust particle size to .3 micron!

Many RCA Traveling-Wave Tubes produced in the "white room" were developed on contract for important industrial and defense projects. Tubes are subject to four levels of quality control. No wonder that there are reports of many tubes with 20,000 hours of service. It is no wonder, too, that RCA is the largest producer of TWTs for ECM applications.

If you have a problem in TWT research or development requiring the most recent concepts in TWT state-of-the-art; or require high production resources and capabilities, consult the leader in both areas—RCA.

For information, write: Manager, Microwave Marketing, RCA Electron Tube Division, Harrison, N. J.



A typical example of an RCA ruggedized TWT for ECM applications.

INDUSTRIAL TUBE PRODUCTS FIELD OFFICES

OEM SALES: Newark 2, N. J., 744 Broad St., HU 5-3900 • Chicago 54, Ill., Suite 1154, Merchandise Mart Plaza, WH 4-2900 • Los Angeles 22, Calif., 6801 E. Washington Blvd., RA 3-8361 • Burlingame, Calif., 1838 El Camino Real, OX 7-1620 • GOVERNMENT LIAISON: Harrison, N. J., 415 South Fifth Street, HU 5-3900 • Dayton 2, Ohio, 224 North Wilkinson Street, BA 6-2366 • Washington 7, D. C., 1725 "K" Street, N.W., FE 7-8500 • INTERNATIONAL SALES: RCA International Division, Clark, N. J., FU 1-1000.



The Most Trusted Name in Electronics