

electronics

THIN-FILM CIRCUITS

*Comprise staircase
generator, p 37*

INCREMENTAL COUNTER CORES

*Reach saturation
in 16-steps, p 40*

MICROWAVE FLYWHEEL

*Power source for
plasma work, p 46*

Applying phosphor solution to 21-inch storage tube

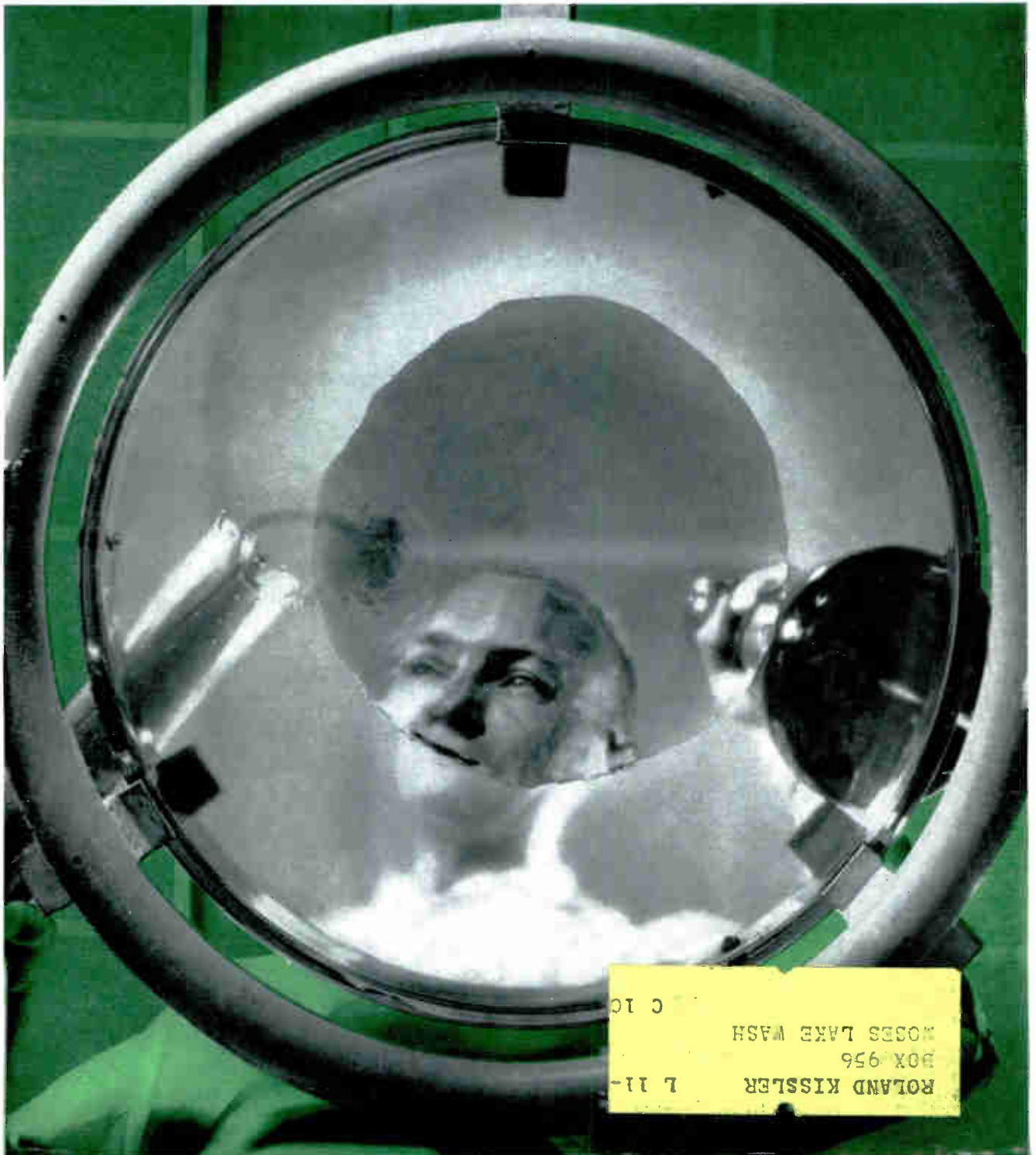

ROLAND KISSLER
BOX 956
MOSES LAKE WASH
L 11-
C 10

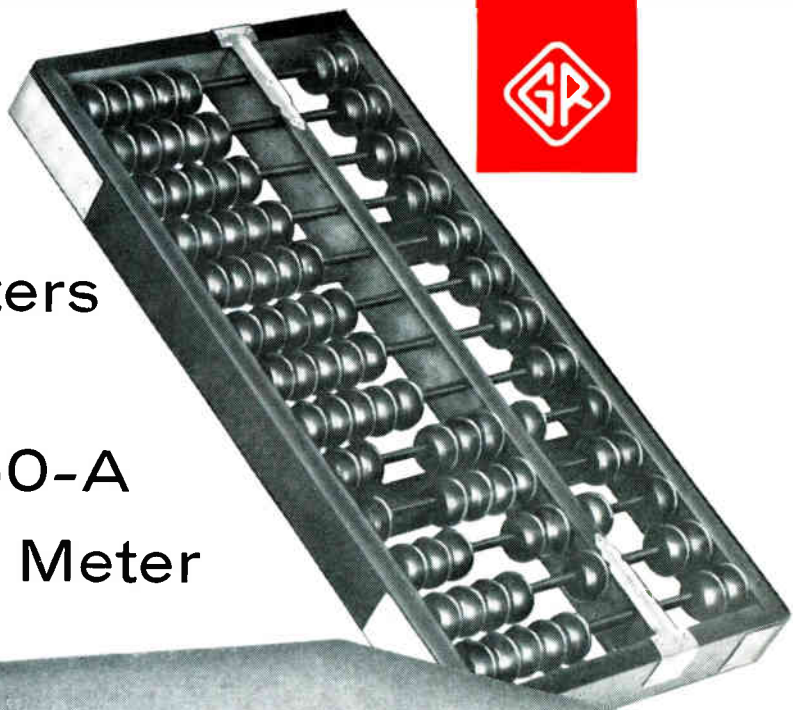

One of the few
 "Solid-State" Counters
 that costs less
 than the **NEW** 1150-A
 Digital Frequency Meter



Type 1150-A
 Digital Frequency Meter . . . \$915

- Totalizes events or measures frequency to 220 kc.
- New, brilliant, always in focus, NUMERIK* in-line display. 120° viewing angle . . . 5000-hour lamp life in counting service.
- Fail-safe ring counting circuits eliminate fussy feedback codes and critical voltage levels.
- *Oven-controlled* 100-kc crystal oscillator with 1/2 ppm stability. Temperature stability better than 5 ppm over an ambient range of 0° to 50°C.



Write for **NEW**
 1150-A Counter Bulletin

*TRADE MARK

GENERAL SPECIFICATIONS

- Frequency Range:** 10 cps to 220 kc
- Accuracy:** ±1 count ± time-base stability
- Time Base:** Internal 100-kc crystal oscillator with 1/2 ppm stability. Provision for external 100-kc time base
- Sensitivity:** Better than 1 volt, peak-to-peak. For pulses, duty ratio should be between 0.2 and 0.8. Input impedance is 0.5 MΩ shunted by less than 100 pf.
- Gate Times:** 0.1, 1, and 10 seconds. Also manual start/stop
- Reset:** Automatic or manual
- Display Time:** Adjustable from 0.1 to 5 seconds, or infinite
- Self Check:** Has provision for counting own 100-kc frequency
- Small Size:** Only 3 1/2" x 19" x 10"

GENERAL RADIO COMPANY
 WEST CONCORD, MASSACHUSETTS

NEW YORK, Worth 4-2722 District Office in Ridgefield, N. J. Whitney 3-3140
 CHICAGO Oak Park Village 8-9400
 PHILADELPHIA Abington HANcock 4-7419
 WASHINGTON, D. C. Silver Spring JUNiper 5-1088
 SYRACUSE Syracuse GLenview 4-9323
 SAN FRANCISCO Los Altos WHITEcliff 8-8233
 LOS ANGELES Los Angeles HOLlywood 9-6201
 ORLANDO, FLA. Orlando GARDen 5-4671
 IN CANADA Toronto CHerry 6-2171

CIRCLE 900 INSIDE BACK COVER

electronics

A McGraw-Hill Publication 75 Cents



W. W. MacDONALD, Editor

J. M. CARROLL, Managing Editor
SENIOR EDITORS: Samuel Weber, George W. Sideris. **SENIOR ASSOCIATE EDITORS:** William E. Bushor, Michael F. Wolff. **ASSOCIATE EDITORS:** Michael F. Tomaino, Sylvester P. Carter, William P. O'Brien, John F. Mason, Thomas Emma, Sy Vogel, Leslie Solomon, George J. Flynn, Laurence D. Shergalis. **ASSISTANT EDITORS:** Nilo Lindgren, Stanley Froud, Stephen B. Gray, Roy J. Bruun, George V. Novotny, Leon H. Dulberger. **REGIONAL EDITORS:** Harold C. Hood (Pacific Coast, Los Angeles), Thomas Maguire (New England, Boston), Cletus M. Wiley (Midwest, Chicago). **ART DIRECTOR:** Harry Phillips; Howard R. Berry. **PRODUCTION EDITOR:** John C. Wright, Jr. **EDITORIAL ASSISTANTS:** Gloria J. Meurer, Bernice Duffy, Lorraine Rossi, Virginia T. Bastian, Lynn Emery, Bette H. Snyder, Rosemary Abbruzzese, Judy Haskins, Ann Mella. **FOREIGN NEWS BUREAU:** Director, John Wilhelm, Alyne Elias. **LONDON—** John Shinn, Derek Barlow, Nicholas Landon. Bonn—Peter Forbath, Silke McQueen. Paris—Robert Farrell, Arthur Erikson. Milan—Marc A. Messina. Mexico City—Bruce Bendow. Rio de Janeiro—Leslie Warren. Moscow—Stewart Ramsey. Tokyo—Richard Halloran, Charles Cohen, John Yamaguchi.

JAMES GIRDWOOD, Publisher

TWENTY-ONE-INCH STORAGE TUBE. Bombardment-induced-conductivity tube can write, hold or erase a picture. A dual-effect dielectric in the storage surface allows it to present and store both light and dark-trace writing. *Similar tubes may be used for interplanetary television in connection with fly-bys to Venus and Mars. See p 64*

COVER

NAVY PLANS PROCUREMENT of More Than \$7 billion in 1963. Major budget categories include \$3 billion for aircraft and missiles, \$2.9 billion for ships. *In addition to gear for new vessels, \$339 million is earmarked for electronic modernization*

20

DISPLAYS Are Key to Apollo Control by Crew. The men manning the first lunar spacecraft will probably make the critical flight decisions, based on a dozen different classes of flight and control data. *Control system details aren't set, but it is expected to operate independently of earth stations*

28

BIOCHEMICAL FUEL CELLS Produce Power from Bacteria, Enzymes and Nutrients. Possibilities of converting wastes and other organic matter into electricity intrigues researchers. *Historical note: while this is considered a new field, a yeast battery was tried back in 1911*

30

SPEECH PROCESSOR Types and Talks. It listens in one language and talks in another. But this early system has only a kindergarten's vocabulary. *Byproduct may be improved communications systems*

32

THIN-FILM STAIRCASE GENERATOR for Space Applications. This 64-step voltage staircase generator was built using uncased transistors and thin-film resistors, conductors and capacitors. *It consists of an R-C clock, six binary counters and summing network on three tiny substrates.*

By E. E. Eberhard, Motorola, Inc. 37

INCREMENTALLY MAGNETIZED CORES as Counting Elements. Multipulse magnetic counter uses technique of adding increments of magnetism to square-loop core until core is saturated. Typical cores count up to 16 pulses. *Counters are stable over wide ranges of temperature and voltage, have shown high reliability in missiles and space applications.*

By J. D. Freeman, General Time Corp. 40

WIDEBAND INTEGRATOR for Magnetic Probes. Instrument is used in plasma research to study magnetic-field distributions. It is a compensated R-C circuit similar to bootstrap integrator. *With a voltage gain of three, it has an 18-Mc bandwidth without overshoot.*

By S. Berglund and S. Westerlund, University of Uppsala 44

Published weekly, with Electronics Buyers' Guide and Reference issue, as part of the subscription, by McGraw-Hill Publishing Company, Inc. Founder: James H. McGraw (1860-1948).

Indexed Annually in Buyers' Guide and Reference issue.

Title ® registered U.S. Patent Office; © copyright 1962 by McGraw-Hill Publishing Co., Inc. All rights reserved, including the right to reproduce the contents of this publication, in whole or in part.

Executive, editorial, circulation and advertising offices McGraw-Hill Building, 330 West 42nd Street, New York 36, N. Y. Telephone Longacre 4-3000. Teletype TWX N.Y. 1-1636. Cable McGrawhill, N. Y. PRINTED IN ALBANY, N. Y.; second class postage paid at Albany, N. Y.

OFFICERS OF THE PUBLICATIONS DIVISION: Nelson L. Bond, President; Shelton Fisher, Wallace F. Traendly, Senior Vice Presidents; John R. Callahan, Vice President and Editorial Director; Joseph H. Allen, Vice President and Director of Advertising Sales; A. R. Venezian, Vice President and Circulation Coordinator; Daniel F. Crowley, Vice President and Controller.

OFFICERS OF THE CORPORATION: Donald C. McGraw, President; Hugh J. Kelly, Harry L. Waddell, Executive Vice Presidents; L. Keith Goodrich, Executive Vice President and Treasurer; John J. Cooke, Vice President and Secretary.

Subscriptions are solicited only from those actively engaged in the field of the publication. Position and company connection must be indicated on orders. Subscription rates: United States and Possessions, \$6.00 one year; \$9.00 two years; \$12.00 three years. Canada, \$10.00 one year. All other countries \$20.00 one year. Single Copies, United States and Possessions and Canada 75¢. Single copies all other countries \$1.50.

THE PUBLISHER, UPON WRITTEN REQUEST FROM ANY SUBSCRIBER TO OUR NEW YORK OFFICE, AGREES TO REFUND THAT PART OF THE SUBSCRIPTION PRICE APPLYING TO COPIES NOT YET MAILED.

Subscribers: Please address all correspondence, change of address notices, subscription orders or complaints to Fulfillment Manager, Electronics, at above address. Change of address notices should provide old as well as new address, including postal zone number if any. If possible, attach address label from recent issue. Allow one month for change to become effective.

Postmaster: Please send Form 3579 to Fulfillment Manager, Electronics, 330 West 42nd Street, New York 36, New York.



Audited Paid Circulation

CONTENTS continued

HIGH-POWER MICROWAVE SOURCE Uses Parallel Klystrons and Flywheel. Another plasma instrument. This apparatus will provide 100 megawatts of peak pulse power at C band with a duty cycle of 0.001. *Major units will be a 20-megawatt klystron system feeding a modified ring resonator or microwave klystron.*
By L. D. Shergalis 46

DIODE RECOVERY TIME: How to Measure It Accurately. Setup using pulser, delay line, pad and sampling oscilloscope measures forward and reverse recovery time independently of test-circuit recovery time. *It is used to test new double and triple diodes in common-cathode connection.*
By D. R. Gipp, Radio Corp. of America 50

ANALOG COMPARISON MULTIVIBRATOR Is Temperature Stable. Voltage on timing capacitor in multivibrator is compared to reference voltage by two transistors connected as a differential amplifier. *Achieves low temperature coefficient over -25 C to 75 C range and operates from one cycle per 100 sec to 100,000 cps.*
By J. D. Long, Space-General Corp. 53

DEPARTMENTS

Crosstalk. <i>Youngest Laserman? Adding with Cores</i>	3
Comment. <i>Capacitor Nomenclature. Numerical Prefixes</i>	4
Electronics Newsletter. <i>Short-Necked Color-Tv Tubes</i>	7
Washington Outlook. <i>Army and Navy Want Surveillance Satellites, Too</i>	12
Meetings Ahead	34
Research and Development. <i>Orbiting Wire-Mesh Passive Reflectors</i>	56
Components and Materials. <i>Cathode-Ray Tubes Open New Dimensions</i>	62
Production Techniques. <i>Soldering and Shielding with Conductive Plastics</i>	70
News Products Design and Application. <i>Tunable Microwave Stable Oscillator</i>	72
Literature of the Week	87
People and Plants. <i>Perkin-Elmer Opens Research Center</i>	88
Index to Advertisers	95

CROSSTALK

YOUNGEST LASERMAN? Scanning the exhibits at an MIT meeting of the New England Section of the Optical Society, one of our editors came upon a 15-year-old student demonstrating a pulsed ruby laser which the youth had built. Questioning Charles E. Wiggin, a 10th grade student at Wellesley, Mass., High School, the editor learned that the boy's interest had been triggered by the series, "Lasers: Devices and Systems," by Associate Editor Vogel and Assistant Editor Dulberger (*ELECTRONICS*, p 39, Oct. 27, 1961; p 40, Nov. 3, 1961; p 81, Nov. 10, 1961, and p 54, Nov. 24, 1961).

The boy's father, an *ELECTRONICS* subscriber, had clipped the articles for suggested perusal by his son, who is a licensed ham. The boy wrote to some of the laboratories and companies mentioned in the articles, got reprints and other literature on lasers, and received some technical advice from companies in the Boston area, but built the device on his own. At the Optical Society meeting, demonstration of his homemade laser was sponsored by the Valpey Crystal Corp. "to encourage companies to seek out and assist young people who show interest in optics and electro-optics."

Young Wiggin tells about a visitor to his exhibit a couple of months ago at the State Science Fair, also held on the MIT grounds. After asking a few questions and witnessing a demonstration of the laser, the visitor congratulated the student and introduced himself: "My name is Townes. I built the first maser."

IT ALL ADDS UP. Timing is one of those technical functions taken for granted—like the power supply to a workbench. If timing is critical, divide down a stable oscillator's frequency. If many inputs are needed, use a motor to drive cam-controlled switches. If power is limited, drive with springs.

But what happens when all three criteria must be met at once, in a satellite, for example, where cameras, recorders, motors and control circuits must all be timed highly accurately? A satellite's power supply is limited and the wide temperature ranges mean clockwork timers will lack the precision needed.

The job can be done by a solid-state binary dividing chain driven from a highly stable oscillator and using silicon transistors. But what if two dozen binary counting stages are necessary?

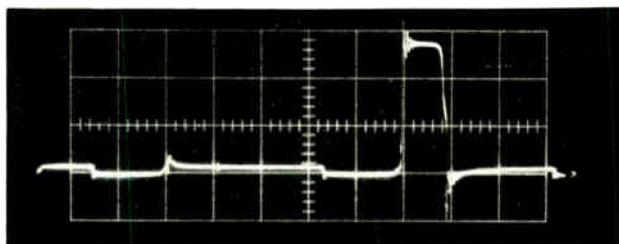
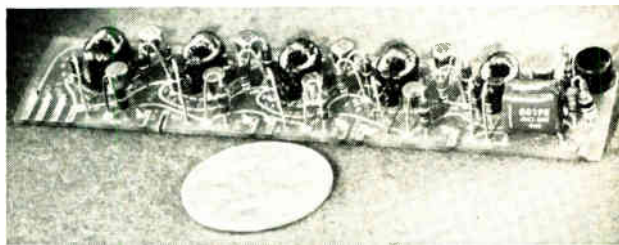

One transistor in each pair is always conducting, so there is a power drain of several milliamps. And the large number of components needed creates a reliability problem.

Another timing method has been evolved for the Tiros satellites. This is the incrementally magnetized magnetic core, which becomes saturated after receiving a definite number of input pulses. The state of this relatively new art is such as to permit the core to operate reliably at 100 Kc over a temperature range of -55°C to 100°C and to discriminate between as many as 16 input pulses. It takes a pretty reliable blocking oscillator to do that when fed at a fixed frequency, yet a core counter will accept pulses at the rate of one an hour or one a day.

We have published several articles recently on the use of cores as counters, dividers and memory elements (p 50, March 17, 1961; p 62, June 16, 1961, and p 23, March 23, 1962), but in these the cores handle at most one bit each.

This week, John D. Freeman, of General Time Corp., describes a magnetic multipulse counter for the Tiros series of space vehicles. Besides accepting random counts, the cores act as memories without consuming power. A chain of counters can be preset to saturate on receipt of the complement of the stored figure. The counter uses little power when counting and relatively few components. Much of it is plain wire—generally more reliable than active elements.

The upper photo shows a four-stage unit that can count to 10^4 . The oscillogram shows a core receiving its ninth and tenth (final) pulses. Reset-to-zero action is triggered (tall pulse) by the tenth pulse.

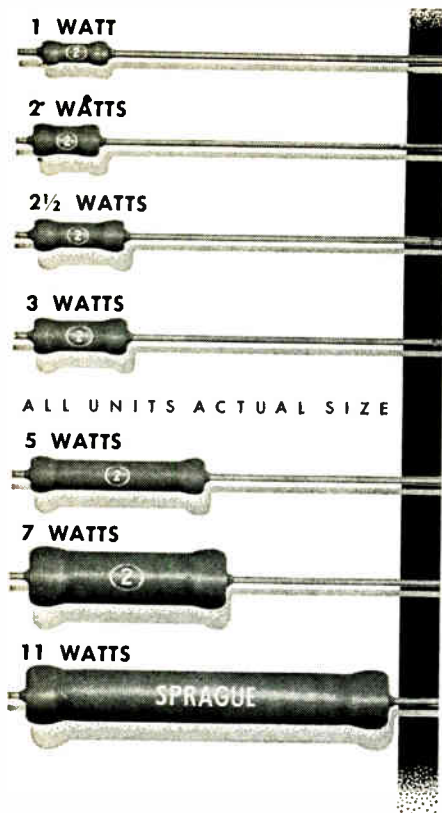

NEXT TIME ... USE TINY Blue Jacket® WIREWOUND RESISTORS

Sprague builds reliability... efficiency... economy right into minified Blue Jackets with these important features:

- * All-welded end-cap construction with special vitreous-enamel coating for total protection against humidity, mechanical damage, heat, corrosion gives long-term dependability under severe environmental conditions
- * Available in resistance tolerances as close as $\pm 1\%$
- * Low in cost... quick and easy to install

Tiny axial-lead Blue Jackets are specially designed for use with conventional wiring or on printed boards in miniature electronic assemblies. Write for complete technical data in Sprague Engineering Bulletin 7410B.

SPRAGUE ELECTRIC COMPANY
35 Marshall Street, North Adams, Mass.



COMMENT

Capacitor Nomenclature

I would like to propose (if this hasn't already been done) that the electronics industry adopt a standard method of capacitor nomenclature that would reduce inventory and manufacturing costs. At present, there are two ways of designating values under one microfarad, either by fractions of a microfarad or by whole numbers followed by mmf or pf.

This double method produces anomalies in the sizes of capacitors. For example, part of one manufacturer's series of standard values includes 3900 mmf, 4000 mmf, 4700 mmf, etc. One could well ask what the 4000 mmf is doing there when it is so close to the 3900 size. The answer is that the capacitors in this range are sometimes designated in microfarads and that 0.001, 0.002, 0.003, 0.004, etc., are all standard values.

One method of gradually eliminating this irregularity would be to adopt the mmf (or picofarad) designation for all capacitors under one microfarad. These could then be standardized, as resistors already are, so that a ± 10 -percent tolerance decade would contain 1000, 1200, 1500, 1800, 2200, 2700, 3300, 3900, 4700, 5600, 6800 and 8200 mmf values. Other decades would, of course, be multiples of ten of this decade. It appears that this standard would eventually eliminate the unnecessary sizes, with subsequent benefit to both capacitor manufacturers and customers.

A. HEMEL

The Hallcrafters Company
Chicago, Illinois

Numerical Prefixes

The February 16 *Crosstalk* column (p 3) mentions the use of a new unit of frequency, the teracycle. This is all a very nice invention—but is all the resultant confusion really worth it?

It is suggested that we do away with all the kilo's mega's, micro's, nano's, and others. They all just stand for certain powers of ten. We might just as well use the powers of ten.

As a test to see which is easier

for the engineer to use, let us try a test. Let us calculate the reactance of a capacitor, first using one system, and then the other.

Prefix System: frequency = 137 Tc; capacitance = 64.8 nf; $X_c = 1/2\pi (137 \text{ Tc}) (64.8 \text{ nf}) = 1/(0.558 \times 10^6 \times 10^{12} \times 10^{-9}) = 1.8 \times 10^{-8} = 180 \mu\text{ohms}$.

Power-of-Ten System: frequency = 1.37 (14) cps; capacitance = 6.48 (8) f; $X_c = 1/2\pi 1.37 (14) 6.48 (8) = 1/55.75 (6) = 1.8 (8) \text{ ohms}$.

It is so much easier using the simple powers of ten. And there is no need to remember the meaning of any prefixes.

The one argument in favor of the prefixes is that it is easier to say "teracycles per second" than it is to say "times ten to the sixth cycles per second." However, if we shorten the latter to "circle twelve," then the advantage disappears.

R. O. WHITAKER

Rowco Engineering Company
Indianapolis, Indiana

Another argument in favor of prefixes is that they are easier to print. Until any new symbol becomes standard and new typefaces have become readily available, it takes time and money to make up special symbols. To make the circles used above, first the type was set without them, the four lines were printed from the type slug, the circles inked in, and then a photoengraving was made from the four lines.

The same problem arises with powers of powers and similar configurations. With the typeface currently used for this magazine, it is not possible to set a superscript to a superscript, nor a subscript to a subscript.

Foreign Tax Proposals

This is a belated note of thanks to ELECTRONICS staffers for keeping readers informed of developments in our industry's fight against the Federal Administration's foreign tax proposals. The *Washington Outlook* lead item, Industry Fights Overseas Tax (p 12, May 4), was particularly welcome.

EDWARD J. GERRITY, JR.
International Telephone and Telegraph Corporation
New York, New York

ARNOLD PULSE TRANSFORMER CORES... INDIVIDUALLY TESTED UNDER ACTUAL PULSE CONDITIONS

The photograph below shows a big Silectron 4-mil pulse transformer core on test in the Arnold plant, before shipment for use in the missile program.

It also illustrates a special Arnold advantage: a 10-megawatt pulse-testing installation which enables us to test-prove pulse cores to an extent unequalled elsewhere in the industry.

For example, Arnold 1 mil Silectron "C" cores—supplied with a guaranteed minimum pulse permeability of 300—are tested at 0.25 microseconds, 1000 pulses per second, at a peak flux den-

sity of 2500 gauss. The 2 mil cores, with a guaranteed minimum pulse permeability of 600, receive standard tests at 2 microseconds, 400 pulses per second, at a peak flux density of 10,000 gauss.

The test equipment has a variable range which may enable us to make special tests duplicating the actual operating conditions of the transformer. The pulser permits tests at .05, .25, 2.0 and 10.0 microsecond pulse duration, at repetition rates varying anywhere from 50 to 1000 pulses per second.

This is just another of Arnold's facilities for better service on magnetic materials of all description. • Let us supply *your* requirements. For design information on Arnold Silectron Cores, write for Bulletin SC-107A. Address *The Arnold Engineering Company, Marengo, Ill.*

ADDRESS DEPT. E-6



ARNOLD
SPECIALISTS in MAGNETIC MATERIALS

BRANCH OFFICES and DISTRIBUTORS in PRINCIPAL CITIES
Find them FAST in the YELLOW PAGES

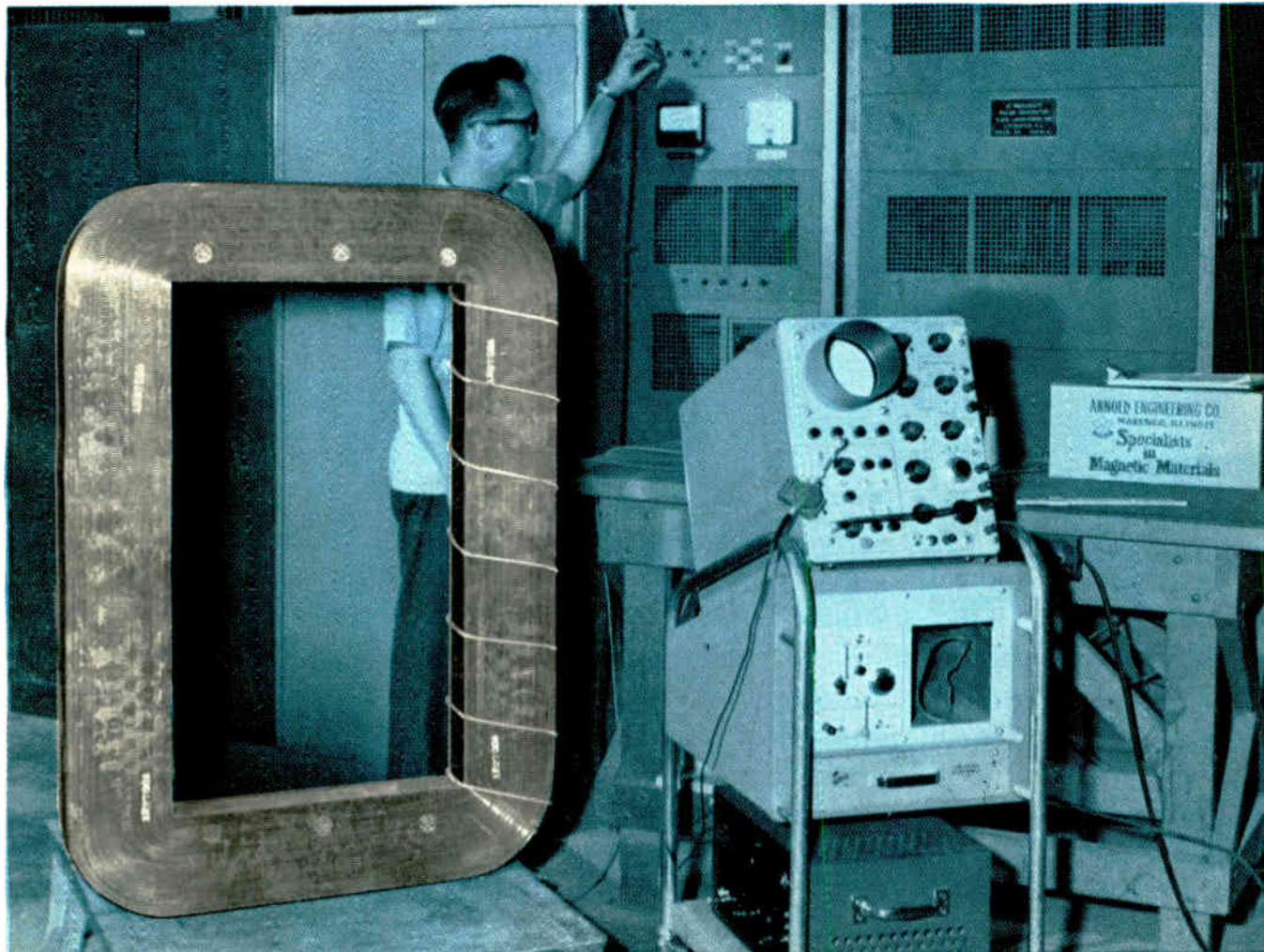

11-4321

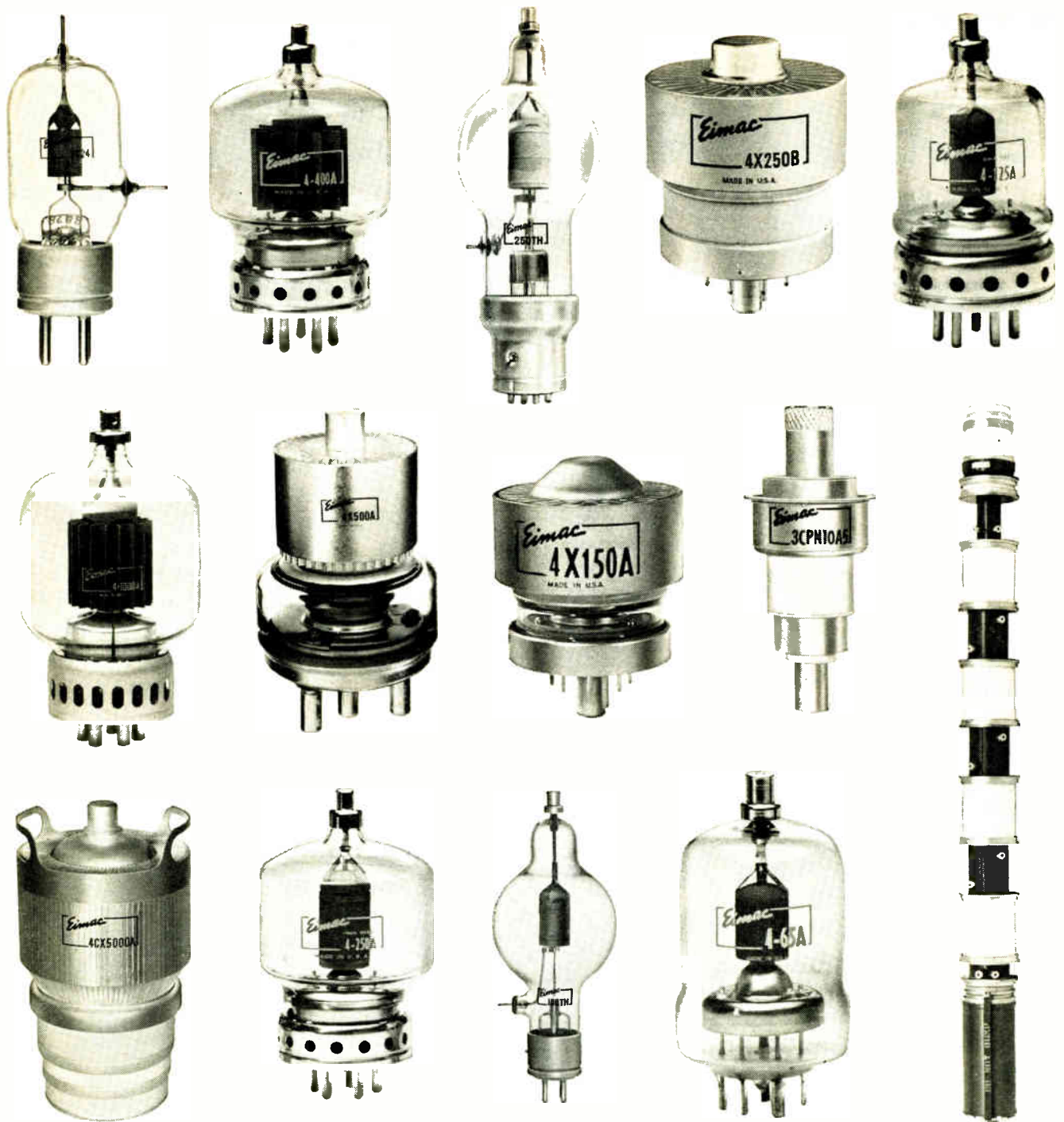

If imitation is the sincerest form of flattery, these Eimac tubes should blush.

The tubes you see above were designed, developed and first delivered by Eimac. Today, they are seen here. There. Everywhere. But then it's natural for Eimac to be a primary source of new tube technology. The reason? Eimac's experience, research and development programs, inventive superiority. That's why Eimac is able to bring you the most imitated power tubes in the world today. (One thing that can't be copied: Eimac's dependability.) Another reason to keep your eye on Eimac for the most advanced power grid tubes, high power klystrons, microwave devices and accessories. Eitel-McCullough, Inc., San Carlos, California. Subsidiaries: Eitel-McCullough, S.A., Geneva, Switzerland; National Electronics, Geneva, Ill. **KEEP YOUR EYE ON**



ELECTRONICS NEWSLETTER

Color Tv Sets Getting Shorter-Necked Tubes

CHICAGO—Convinced long-necked 70-degree color tubes are on the way out, Motorola plans to stay out of the color tv market until it can offer its own chassis built around its own 23-inch, rectangular, 92-degree tube within the coming year. Edward Taylor, executive vice president, indicated at the company's annual dealer meeting last week.

Motorola announced the tube last year, offering its know how (p 145, Sept. 29, 1961) to the tube industry, but with no takers. National Video will supply the tubes for Motorola sets, has already produced 200 tubes.

Consumer sets will be ready a month or two after RCA's 90-degree tube becomes available, Taylor said. RCA is introducing a six-inch shorter, 21-inch, 90-degree tube, but with a round face.

Color tv market may reach 300,000 units during 1962, Taylor estimated, "but the industry has the capacity to produce two to three times that many." Taylor said the 1963 color tv market may reach 450,000 units.

Heat Pipes May Warm Tube Cathodes in Space

ELECTRO-OPTICAL SYSTEMS has received a \$99,380 Air Force contract for R&D on spacecraft thermal radiation guides. The company will investigate the transmission of radiant energy through tubes with highly reflective internal walls, to see if the energy can be transmitted directly to thermal consuming devices such as ion-engine emitters, electron-tube cathodes or vapor-cycle refrigeration devices. Successful adaptation of this technique would avoid converting heat into electricity to perform such functions and also reduce weight of heat-transfer loops now used.

Retrieval System Stores Records in Random Order

LOS ANGELES—Houston Fearless Corp. is fabricating an experimental model of an automatic record

storage and retrieval device for Rome Air Development Center. Basic storage capacity is 10,240 film chips or unit records. Average retrieval time is 4.8 seconds for an individual record and less than 2.5 minutes for a group of 64. Capacity may be extended to over one million records with retrieval of units within 10 seconds and of groups in 5 minutes.

Identified by a human and machine-readable, seven-digit, alphanumeric code, each record is stored at random during filing. Its address is recorded in a magnetic-drum memory. Upon request by identification number, individual records or groups of 64 can be retrieved automatically through an input keyboard. Requests from a paper-tape reader or computer buffer are also accepted. Retrieval records are supplied in requested sequence in an output magazine.

Slosh Filter Improves Rocket Control System

LOS ANGELES—Development of a control system technique expected to improve response characteristics of large rocket boosters has been announced by Space General Corp.

Very low frequency structural bending or fuel sloshing is a problem in large boosters. In the system, called Host (Harmonically Optimized Stabilization Technique), a simple nonlinear filter element is inserted in the autopilot loop. It allows control command signals to pass with little attenuation, but attenuates by a large amount the bending or sloshing motion of the booster as sensed by the control system gyroscopes.

Overall system response reportedly is greatly improved over what can be accomplished with the linear control system. Performance on an

analog simulator indicates improvement in response time and settling time of better than a factor of two.

Army Loses the Last of Its Satellite Programs

WASHINGTON—Department of Defense has switched Army's last major space program, the Advent communications satellite, to the Air Force. Because of booster development and weight problems (p 12, June 1), launch date had been pushed back from 1963 to 1966. Air Force is expected to cut the satellite's weight from about 1,300 pounds to 500 pounds, launch it with an Atlas-Agena in 1964.

Administration Still Plans To Hold Down RS-70 Work

WASHINGTON—Despite Senate Appropriations Committee approval of a \$491-million RS-70 aircraft program for next year, the administration still plans to hold back spending on the project until the technical feasibility of the plane's electronic subsystems can be demonstrated.

The \$491-million sum was proposed initially by the Air Force to speed development work and begin production. Congress has approved this figure under a procurement authorization, but the House Appropriations bill earmarks only \$223.9 million for the RS-70.

The final appropriations figure is likely to be closer to the Senate committee's \$491 million than to the House level. But the administration is expected to spend only a little more than the \$171 million it planned to spend, and this increment will go into development work on the electronics subsystems.

Diamond Transistors No, Diamond Thermistors Yes

PARIS—Diamonds in Industry Congress was told that semiconductor diamonds could make possible transistors with temperature limits to 1,000 C. But commercial devices are nowhere in sight.

Natural diamonds with semicon-

ducting properties are scarce, said Jan F. H. Custers, of the Johannesburg Diamond Research Lab. Further, all the known natural semiconductor diamond is *p*-type and impurity diffusion attempts have been unsuccessful. Experiments with lithium vapor at 900 C, for example, produced only a surface effect.

One practical application is as a high temperature thermistor (p 72, Aug. 26, 1960). P. J. Kemmey, of the laboratory, reported irradiation improves the useful temperature limit. A representative specimen's limit of 800 C was boosted some 200 degrees by irradiating for 10 minutes at 1.5 Mev with a beam current density of 50 μ a per sq cm. Irradiation also predictably increases resistivity of diamond.

Electronic Stethoscope Isolates Heart Sound

BELL AEROSYSTEMS reports it has developed an electronic stethoscope that can isolate any portion of the acoustic human heart cycle for immediate analysis or later study.

The instrument permits three means of studying the heartbeat cycle or any portion of it. Output can be fed into conventional earphones or a loudspeaker for audio analysis; to an oscilloscope for visual display or to an electrocardiograph to provide a permanent record of the heart sounds. All three outputs can be employed simultaneously.

The stethoscope has been used for analysis of heart sounds in children with congenital heart defects. It weighs 20 ounces and is powered by mercury batteries.

Speech Analyzers May Detect Throat Cancer

BOSTON—Air Force experiments suggest waveform analysis of human speech signals can aid detecting cancer of the larynx. Development is a byproduct of speech compression program at Air Force Cambridge Laboratories, specifically, analyses of the waveform concerned with the pitch component of speech. Study by Lt. Philip

Lieberman on recorded speech samples of 32 speakers with known diseases of the larynx showed that diagnosis can be made with high degree of reliability. It was found that growths or polyps on or near the vocal cords result in larger or more prolonged variations in pitch periodicity, and these pitch perturbations can be plotted by computer analysis.

Another International Space Program Underway

MELBOURNE—Under a recently signed agreement, Australian research equipment will be launched in NASA space vehicles. Equipment is part of the Commonwealth Scientific Industrial Research Organization's research into the upper atmosphere. Main purpose is to discover the influence of the sun on earth's radio communications.

The first flight will be in an Aerobee rocket, scheduled for launching on Wallops Island, Va., later this year. If results are good, equipment will be orbited in a Scout satellite. The instruments, designed to detect and transmit low-frequency radio noises in the upper atmosphere, have been flown only in high altitude balloons of the Royal Australian Navy.

Observatory Satellite Runs Out of Power

ORBITING SOLAR OBSERVATORY stopped transmitting useful information after 77 days in orbit, NASA reports. A malfunction in the spin control system (p 8, March 2) prevents the servo system from orienting the scientific instruments and solar cells towards the sun. The servo system, in attempting to orient the solar-cell array, is using too much power. Batteries are continually discharged.

OSO observed and measured more than 75 solar flares and sub-flares, mapped the sky in gamma radiation, examined energetic particles in the lower Van Allen region, monitored the sun in a broad region of x-ray and gamma radiation and performed surface erosion studies of various materials.

In Brief . . .

FAA HAS SUBMITTED to Congress a list of 3,388 airports it would like built or improved over the next five years. Of the 514 new airports, 86 would be for air carriers (66 in Alaska) and 428 for general aviation.

KEARFOOT has a \$172,000 Air Force contract to build a feasibility model of a star-angle comparator that would determine aerospace vehicle attitude on demand.

SIX BENDIX divisions will participate in a long-range company program to develop solar, thermionic, thermoelectric, fuel cell and other space power sources.

ARMED SERVICES Electro-Standards Agency, Fort Monmouth, announces it will expand qualified products lists for coaxial switches, and a variety of tubes, capacitors, resistors and semiconductor devices.

SPERRY GYROSCOPE reports another \$6 million in orders for its Marine Corps 3-D radar, bringing total to \$39 million.

LIBRASCOPE will produce nine automatic navigation computers for C-141 aircraft under \$1.9-million Air Force contract.

ARMY gave Hughes Aircraft a \$500,000 contract to develop a light-weight, wire-guided anti-tank missile, Tow.

POWER CONVERSION components for Snap nuclear power sources are to be developed by AiResearch under \$200,000 contract.

PAKISTAN launched a Nike-Cajun rocket near Karachi, beginning a cooperative program, with NASA, of upper-atmosphere research.

SAAB AIRCRAFT, Sweden, will sell an electronic data processing system based on its D2 digital computer. It handles more than 65 input-output channels and has an information exchange capacity of 125,000 words a second.

RCA HAS A NASA contract of \$71,658 to study proton damage to semiconductor devices in space.



shake it!

We pulled one of our standard 1N2929 tunnel diodes off the line and tied it to the business end of a jackhammer for a bit of jouncing and jarring. It not only survived this beating but went on to pass its 1000-hour life test—at voltages in excess of V_F —without deterioration of peak-to-valley ratios.

No wonder. We build these diodes to exceed the vibration fatigue requirement of MIL-S-19500C. That's 20g's at frequencies to 2000 cps. What's more, they're built to store or operate for 1000 hours at temperatures from -65°C to $+175^{\circ}\text{C}$. They're rugged and reliable, like all Hoffman semiconductors.



We specialize in devices for control, regulation and power. You can buy them with confidence that they'll work and keep on working. Confidence that they'll be available when and where needed. That's why so many of the most successful electronics designers keep coming back to Hoffman—again and again and again. Chances are you'll do the same. Try us. Call your nearest Hoffman distributor or sales office today.

Hoffman / **ELECTRONICS CORPORATION**
Semiconductor Division

4501 N. Arden Dr., El Monte, Calif. • Cumberland 3-7191 • TWX El Monte 9735

CIRCLE 9 ON READER SERVICE CARD

a pleasure
to measure
with these...



5512A, 300 KC



5532A, 1.2 MC

4 NEW SOLID STATE

Measure frequency, period, ratio, quickly, accurately. Compact, easy-to-use instruments provide continuous display, no "blinking"! Solid-state dependability! 0.1 volt

All the advantages of solid-state design are now yours in these new Φ solid state counters—offered at prices comparable to those of today's vacuum tube counters. And you get the *plus* advantages of greater readability, faster measurements, easier routine maintenance, rack-and-stack convenience of the new Φ universal module instrument cabinets.

Offered in four models, these new counters have maximum counting rates of 300 KC or 1.2 MC, with a choice of Nixie or columnar readouts. The high-intensity neon readouts are stacked in compact columns for faster, easier reading. On the in-line readouts, Φ -pioneered standard incorporation of the new long-life, wide-viewing Nixies gives you many extra hours of lamp life and heretofore unknown readability even at extreme angles. Polarized screen provides maximum readout brilliance with freedom from reflections.

A unique display storage feature of these new counters produces a continuous visual readout of the most recent measurement, even while the instrument is making a new measurement. Only if the new count differs from the previous count will the display change, in which case it will shift directly to the new reading. The fatigue and error possibility of a "blinking" display is eliminated. The storage feature may be disabled with a rear panel switch.

The counter's "inactive time" (when not making a new measurement) is independent of gate time and adjustable from 0.2 to 5.0 seconds, thus permitting a higher sampling rate.

Counter	Max. Counting Rate	Registration	Period and Multiple Period	
			Range	Accuracy
5212A	300 KC	5 digits columnar	2 cps to 300 KC	\pm one count \pm time base accuracy \pm trigger error/period averaged
5512A	300 KC	5 digits Nixie		
5232A	1.2 MC	6 digits columnar	2 cps to 1.2 MC	\pm 1 μ s \pm time base accuracy \pm trigger error/periods averaged
5532A	1.2 MC	6 digits Nixie		

High sensitivity permits low level measurement without accessories, and multiple period average measurement (to 100,000 periods) gives higher ac-

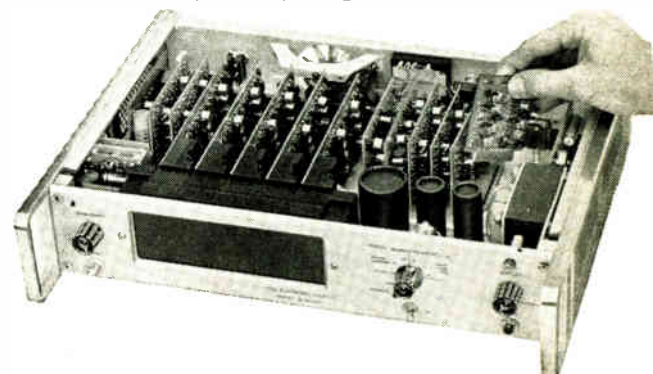

Note clean, compact, easy-to-service physical arrangement of new Φ solid-state counters.

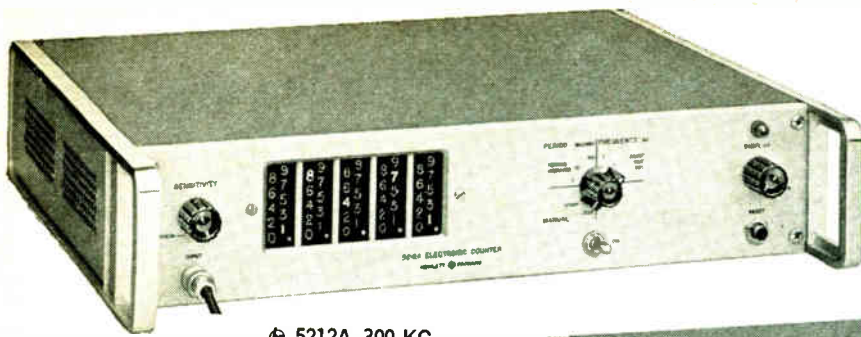

⊕ 5212A, 300 KC

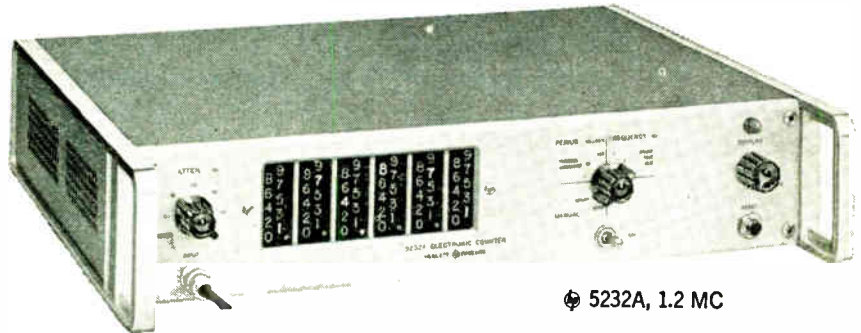

⊕ 5232A, 1.2 MC



COUNTERS!

sensitivity! Higher sampling rate! Unique low frequency accuracy! Operation -20° to $+65^{\circ}$ C! Prices comparable to vacuum tube counters!

Average Measurement		Frequency Measurement				Ratio Measurement			Price
Reads in	Periods Averaged	Range	Accuracy	Reads In	Gate Time	Reads	Range	Accuracy	
Milli-seconds or microseconds with positioned decimal	1, 10, 10 ² , 10 ³ , 10 ⁴ , 10 ⁵	2 cps to 300 KC	± 1 count \pm time base accuracy	KC with positioned decimal	10, 1, 0.1, 0.01 sec.	$(f_1/f_2) \times$ period multiplier	f ₁ : 100 cps to 300 KC (1 v rms into 1,000 ohms) f ₂ : same as period	± 1 count of f ₁ \pm trigger error of f ₂	\$ 975.00
		2 cps to 1.2 MC					f ₁ : 100 cps to 1.2 MC (1 v rms into 500 ohms) f ₂ : same as period		1,175.00
									1,300.00
									1,550.00

accuracy in lower frequency ranges, even for noisy signals. Self-check is provided for both frequency and period measurement modes.

Only 3 1/2" high, these counters are housed in the new hp modular cabinets ideal for both bench use and easy rack mounting. Routine maintenance is simple with snap-out decade/readout units and circuit cards. Readout drive directly from photoconductors eliminates a complete stage of complex circuitry, to effect genuine cost and reliability advantages. Compact design and construction and servicing ease are illustrated at the left.

Solid state design and construction gives you the advantages of low heat dissipation with minor heating effect on adjacent equipment, fast warm-up, low power consumption and new standards of reliability.

The new counters include a four-line BCD code output. This output, with assigned weights of 1-2-2-4 ("1" state positive with respect to "0" state), is available for systems use or to operate devices such as the hp 562A Digital Recorder. Controls include Input Attenuation, Display, Reset and Function.

Call or write your hp representative or call us today for information and a demonstration!

Data subject to change without notice. Prices f.o.b. factory.



HEWLETT-PACKARD COMPANY

1051 Page Mill Road Palo Alto, California, U.S.A.
Cable "HEWPACK" DAVenport 6-7000

Sales representatives in all principal areas

HEWLETT-PACKARD S. A.

Rue du Vieux Billard No. 1
Cable "HEWPACKSA"
Geneva, Switzerland
Tel. No. (022) 26. 43. 36

7061

CIRCLE 11 ON READER SERVICE CARD

WASHINGTON OUTLOOK

MILITARY TO EXPAND SATELLITE PROGRAMS

MORE MILITARY communications and surveillance satellite programs are likely to be approved in the next six months or so. Army, Navy and Air Force have succeeded in convincing Defense Secretary McNamara of their military value.

Air Force successes with Midas, the infrared satellite for detecting Soviet rocket firings, and with Samos, the picture-taking satellite, are leading Army and Navy to press for similar systems. The Navy, for example, sees ocean surveillance system doing the job of several hundred ships and planes. The Army points to the tactical advantage of detecting troop and logistics movements deep behind enemy lines.

In communications, the three services want a satellite system flexible enough for use by ships, planes and field units. Army's Project Advent, a worldwide communications system, won't fill all three needs. Three separate systems may be required. Separate military weather satellite systems are also being considered.

Military space spending, of course, will continue to climb. It's running about \$1 billion this year, will rise to \$1.5 billion in fiscal 1963, and will probably reach \$2 billion in fiscal 1964.

MISSILE WARNING REVIEW

MASSIVE SHAKEUP of the Defense Department's missile warning system may be coming. McNamara has ordered a comprehensive staff study to assess the effectiveness of currently planned warning systems. He wants to know what improvements can be made and what their cost would be. McNamara ordered the evaluation in terms of "amount of warning time, reliability of warning, and value of actions that can be taken on the basis of warning."

DOD WANTS FIVE-YEAR PROGRAM

ECONOMIC EFFECTS of defense contracting are the subject of another long-range study called for by McNamara. Five-year budget projections will be translated "into a five-year production program for defense industries and research organizations." A related analysis will appraise the five-year defense R&D program's impact on "the availability, distribution and utilization of scientific and engineering manpower" to anticipate effects of changes in procurement and R&D.

TRADE BILL TARIFF RELIEF TIGHTENED

RELIEF FROM THE EFFECTS of import competition may be easier for individual firms to get, but harder for entire industries under a last minute change in the trade expansion bill made by the House Ways and Means Committee. The Tariff Commission would have to consider a firm's injury claim in relation to the economic health of the company's industry. If the firm is being hurt, but the industry isn't, the commission could rule for trade adjustment assistance (loans and technical aid), and turn down tariff increases for the industry. At present, few companies get any relief on claims for tariff increases, and there is no adjustment assistance alternative.

The House is expected to debate the trade bill late this month and vote it as passed by the Ways and Means Committee. After the July 4 holiday, the Senate Finance Committee will go to work on it. Final Senate-House passage is now expected by the end of August. Protectionist effort will center on eliminating adjustment assistance and building in tighter mandatory tariff relief through the escape clause.

$$W = \frac{1}{2} CV^2$$

$$R > 2\sqrt{L/C}$$

$$2\sqrt{L/C} > R$$



$$2\sqrt{L/C} \gg R$$

$$i = \frac{V\sqrt{C/L}}{\epsilon} \sin 2\pi ft$$

L-M Offers Specialty Energy Storage Capacitors For Every Application

Regardless of the application, L-M is prepared to assist you in determining your requirements for capacitors. We have designed specialty energy storage capacitors to meet the requirements of various Government and private agencies, universities and industries.

Line Material Industries, a division of McGraw-Edison Company, is one of the nation's leading manufacturers of capacitors for power-factor correction. L-M capacitor engineers have at their disposal the complete facilities of the Thomas A. Edison Short Circuit Current and High Voltage Surge laboratory at Franksville, Wisconsin, and McGraw-Edison Laboratory for Basic Research at West Orange, New Jersey.

Send For Bulletins

Send for bulletins TSC-100, TSC-101 and TSC-102 today. Mail the coupon or check the Reader Service Card. Line Material Industries, Specialty Capacitors, Milwaukee 1, Wisconsin.

APPLICATIONS

Light & Heavy Duty Energy Storage Capacitors

L-M can supply capacitors for applications like these:

- SHOCK WAVE GENERATORS • INTENSE MAGNETIC FIELDS
- ELECTRO-HYDRAULIC METAL FORMING • PLASMA RESEARCH
- WIND TUNNELS • PARTICLE ACCELERATION • FLASH TUBES
- RADAR PULSE FORMING • FILTERS • CAPACITOR WELDING

LINE MATERIAL® Industries



MCGRAW-EDISON COMPANY

Specialty Capacitors



DISTRIBUTION TRANSFORMERS • RECLOSERS, SECTIONALIZERS AND OIL SWITCHES • FUSE CUTOUTS AND FUSE LINKS
LIGHTNING ARRESTERS • POWER SWITCHING EQUIPMENT • PACKAGED SUBSTATIONS • CAPACITORS • REGULATORS
OUTDOOR LIGHTING • LINE CONSTRUCTION MATERIALS • PORCELAIN INSULATORS • FIBRE PIPE & CONDUIT

SEND COUPON TODAY

Line Material Industries, Milwaukee 1, Wisconsin
Please send me your bulletins on Specialty Capacitors.

Name _____

Title _____

Company Name _____

Address _____

City _____ State _____

FOR THIN FILM RESEARCH APPLICATIONS

VERSATILE MULTIPLE VAPOR SOURCE

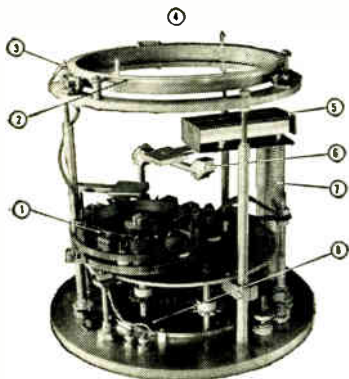
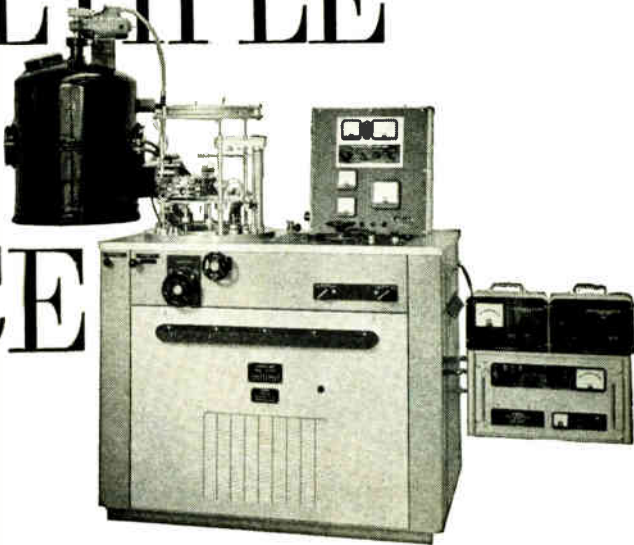

- 1 MULTIPLE VAPOR SOURCES
- 2 ROTATING WORK HOLDER
- 3 SUBSTRATE TEMPERATURE THERMOCOUPLE
- 4 SUBSTRATE HEATER (not shown)
- 5 SPUTTERING CATHODES
- 6 FILM THICKNESS MONITOR
- 7 ION BOMBARDMENT CLEANING
- 8 CIRCULATING LIQUID NITROGEN TRAP

FOR COMPLETE INFORMATION
ON EACH OF THESE SPECIFIC MODELS
WRITE FOR BULLETIN E321-8.

"SPEEDIVAC" VACUUM COATING UNIT

The versatile model 19E6 production unit for evaporated micro-circuits, resistors, and capacitors features fast pump downtime and selection of accessories for almost any evaporation job. The proven Edwards design principles incorporated in this series assures fast, reliable evacuation and many years of dependable operation.

In addition to the many accessories included as standard items such as motor driven rotary work holders, multiple vapor sources, substrate heaters; optional accessories such as electron bombarded vapor sources, circulating LN² traps and film thickness monitoring are provided. Special jigs for the production of micro-circuitry and coated tubular resistors can also be provided to fit this highly versatile coater.

Four separate models make up the 19E series, each using a pumping system, power supply, cabinet and instrumentation common to all.

EDWARDS HIGH VACUUM INC. / 3279 GRAND ISLAND BLVD., GRAND ISLAND, N. Y.
MANUFACTURERS OF THE MOST COMPLETE LINE OF HIGH VACUUM COMPONENTS AND SYSTEMS

ALL SOLID STATE—BUDGET PRICED AT \$1975

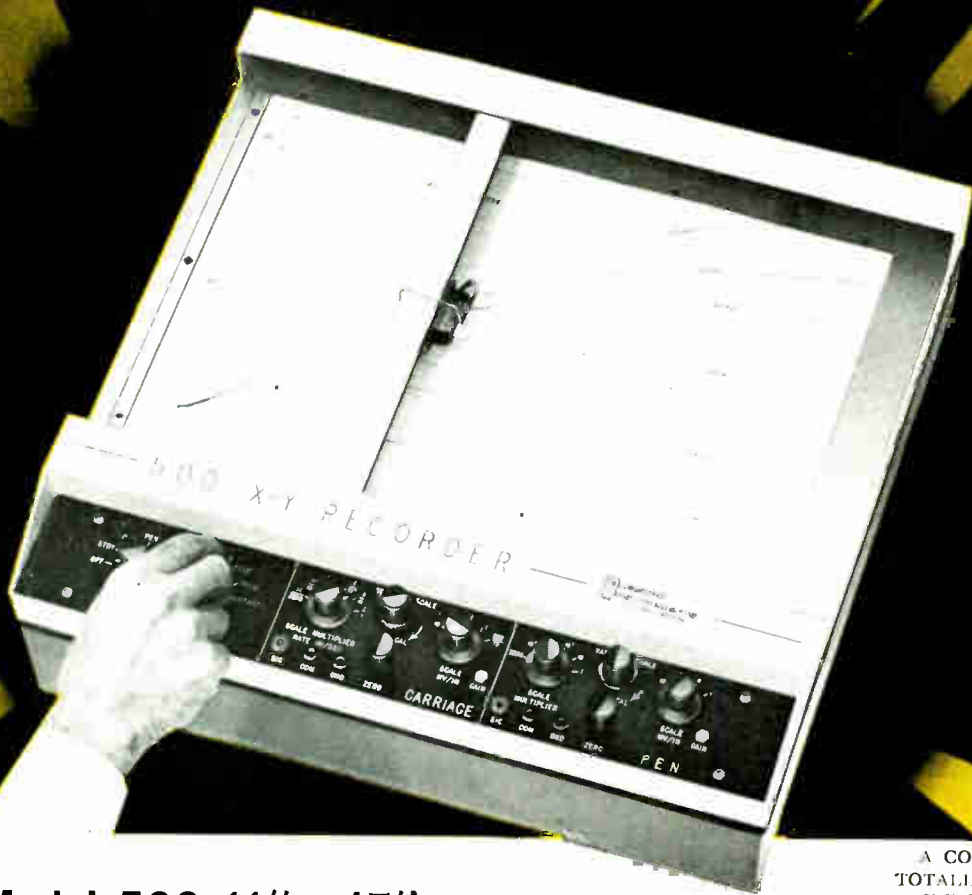

NEW EI Model 500 11" x 17" X-Y RECORDER has unparalleled performance and specifications

Place the new Model 500 alongside any competitive 11" x 17" X-Y Recorder. Check them for ease of operation, reproducibility, absence of jitter, speed of response, input sensitivity, time base accuracy, overall mechanical design and any other performance feature you need in a recorder. It's the only way we know to point up the significant design advances provided in the new 500 that will not be found in any competitive instrument. What's more, the 500 is the only totally transistorized 11" x 17" X-Y Recorder available at this low price—just \$1975, f.o.b. San Diego, Calif.

Brief specifications: 25"/sec. slewing speed, both axes; 0.15% full scale accuracy; 1 meg-ohm input impedance, all ranges; 20 input scales from 0.5 mv/in. to 100 v/in.; integral time base; and measures 17½" x 19" x 5"; weighs only 32 pounds. May be easily rack mounted without additional fixtures.

You would be wise to get complete information on this newest addition to the only complete line of all solid state X-Y Recorders. Your EI field engineer will be happy to tell you all about it. Call him today.

A COMPLETE LINE OF
TOTALLY TRANSISTORIZED
X-Y RECORDERS AND
ACCESSORIES



SERIES 300—A small, lightweight 8½" x 11".

SERIES 400—11" x 17" recorders with plug-in function modules for maximum flexibility.



Engineers: Challenging opportunity now available. Contact Mr. Harvey Fleming.

Electro Instruments, Inc.

8611 BALBOA AVENUE, SAN DIEGO 11, CALIFORNIA



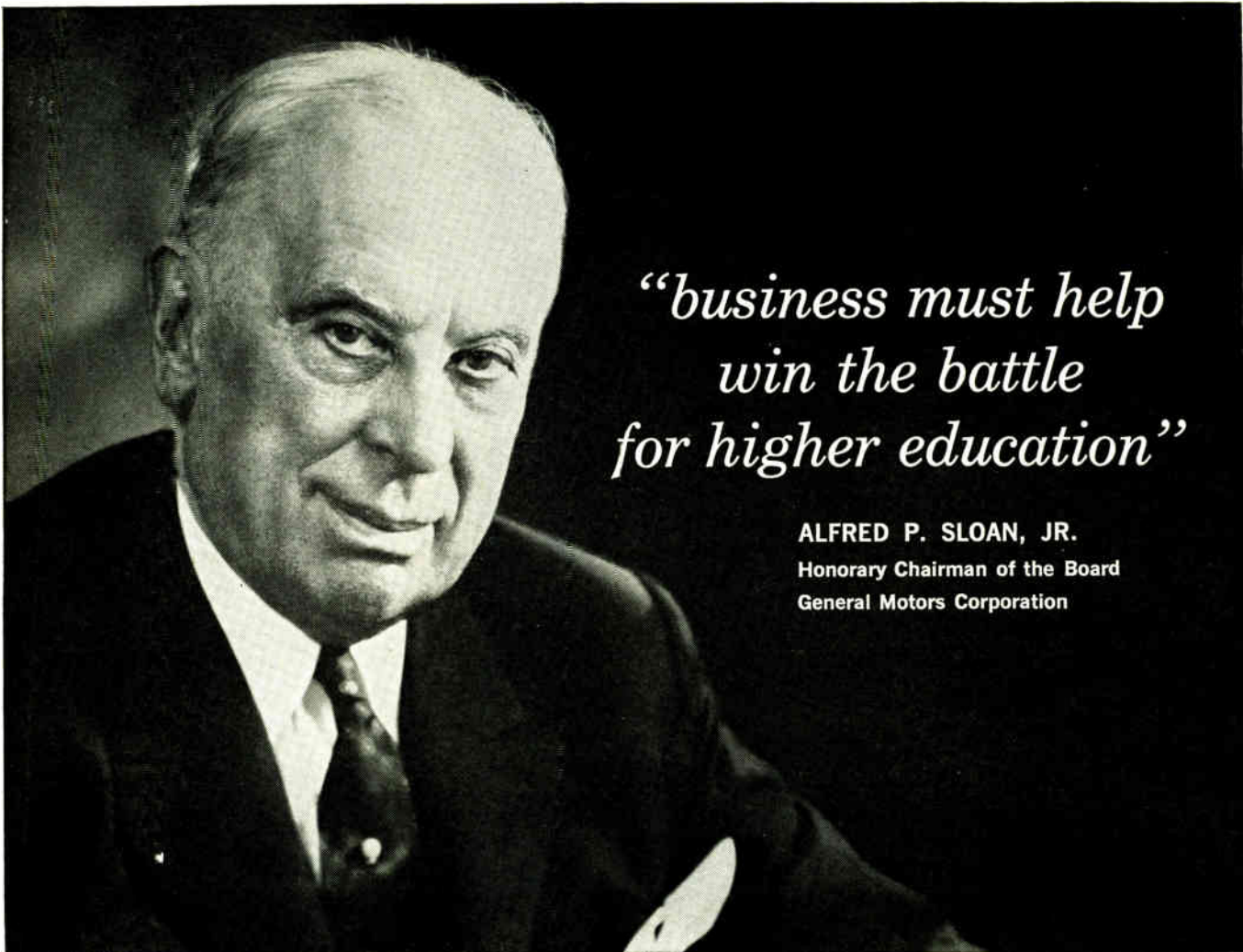

*“business must help
win the battle
for higher education”*

ALFRED P. SLOAN, JR.
Honorary Chairman of the Board
General Motors Corporation

“Regardless of the strengths and attributes our nation possesses, if we fall behind in the field of education, we will fall behind as a world power.

“Our scientific, cultural and economic growth—and our political strength—will depend largely upon the educational facilities we make available to our youth. We owe it to ourselves as a nation; we owe it to our young people who will inherit this nation to provide the financial aid that will make our institutions of higher learning second to none in the world. This is of vital importance to our business community.

“Business must put its support on the line to help win the battle for higher education.”

Today many of our colleges are overcrowded. In ten years, applications will have doubled and we will be faced with an even more serious crisis in our institutions of higher learning. We will need more and better college classrooms, many more well-equipped college laboratories and thousands more of the most dedicated and well-trained professors.

Only increased financial aid will provide our young people with the best college facilities. Only increased financial aid will keep our finest minds from leaving the teaching profession.

For additional information on the crisis faced by higher education write to: Higher Education, Box 36, Times Square Station, New York 36, N. Y.



Published as a public service
in cooperation with The Advertising Council and
the Council for Financial Aid to Education



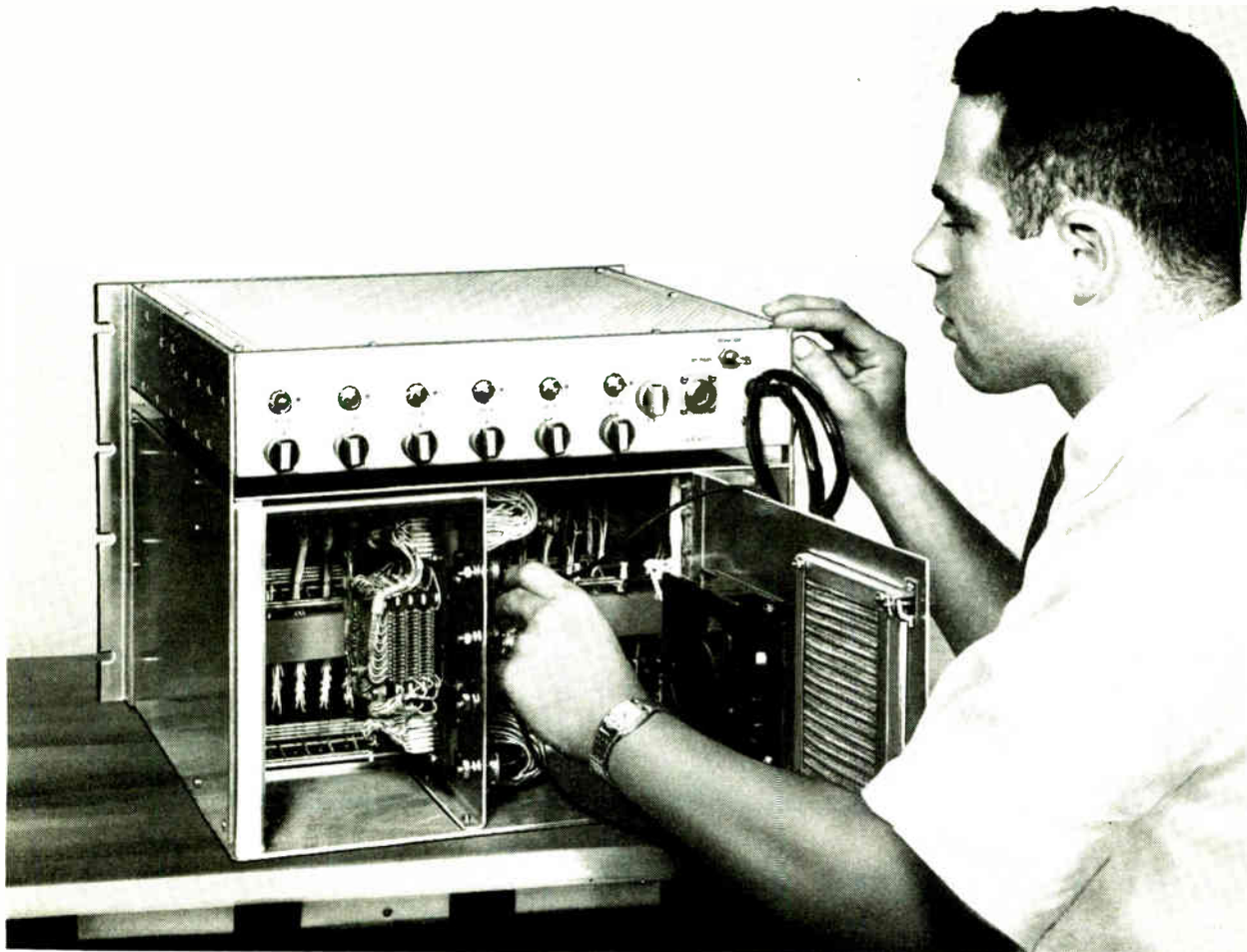

Here's Custom Memory Flexibility in a Standard Package RCA 5 μ SEC MODULAR MEMORY SYSTEM

Compact, high-capacity systems now available with the word lengths you specify—available for quick delivery

Now you can bring a new standard of operating efficiency, servicing flexibility and plug-in convenience to your computer designs with RCA's complete modular memory system. It utilizes new, compact modular design throughout. All circuits and elements, as well as the complete system plug in for easy maintenance and reduced computer down-time.

This rugged RCA memory system, encased in an aluminum cabinet, has a capacity of 256 to 2048 words and up to 20 bits per word. It incorporates RCA ferrite memory cores and planes, with specified wide margins of operation... up to $\pm 8\%$... to cope with broad variations of voltage levels over a wide temperature range.

All RCA Complete Memory Systems are available in a broad range of standard types and custom designs. RCA is ready, willing, and able to meet the most stringent custom requirements for voltage, current, temperature range, and speed of operation to make the memory system fully compatible with your equipment.

Here are some of the outstanding features of complete RCA Memory Systems:

- Specified Wider Margins of Operation... Up to ± 8 per cent... to cope with broad variations in voltage levels.
- Custom Design Service... RCA's engineering staff will custom-design a memory system to your specifications.
- Complete Information Retention... even in case of primary power loss.
- Wide Temperature Range... 0°C to 50°C .

Systems Engineering Service—Your local RCA Semiconductor and Materials Division Field Representative is prepared to provide a completely coordinated application service, covering transistors, semiconductor diodes, ferrites and memory systems. For further technical information, write RCA Semiconductor and Materials Division, Commercial Engineering Division, Section F-N-6-3, Somerville, N. J.



The Most Trusted Name in Electronics

RCA SEMICONDUCTOR & MATERIALS DIVISION FIELD OFFICES... EAST: Newark, N. J., 744 Broad St., HU 5-3900 • (Camden-Philadelphia Area) Erlton, N. J., 605 Marlton Pike, HA 8-4802 • Syracuse, N. Y., 731 James St., Rm. 402, GR 4-5591 • Baltimore, Md., EN 9-1850 • NORTHEAST: Needham Heights 94, Mass., 64 "A" St., HI 4-7200 • SOUTHEAST: Orlando, Fla., 1520 Edgewater Dr., Suite #1, GA 4-4768 • EAST CENTRAL: Detroit 2, Mich., 714 New Center Bldg., TR 5-5600 • CENTRAL: Chicago, Ill., Suite 1154, Merchandise Mart Plaza, WH 4-2900 • Indianapolis 5, Ind., 2132 East 52nd St., CL 1-1405 • Minneapolis 16, Minn., 5805 Excelsior Blvd., WE 9-0676 • Denver 11, Colorado, Continental Terrace Bldg., Suite 301, 2785 N. Speer Blvd., 477-1688 • WEST: Los Angeles 22, Calif., 6801 E. Washington Blvd., RA 3-8361 • (San Francisco Area) Burlingame, Calif., 1838 El Camino Real, OX 7-1620 • Seattle 4, Wash., 2250 First Ave. S., MA 2-8816 • SOUTHWEST: Dallas 7, Texas, 7905 Carpenter Freeway, ME 1-9720 • GOV'T: Dayton, Ohio, 224 N. Wilkinson St., BA 6-2366 • Washington, D. C., 1725 "K" St., N.W., FE 7-8500 • **RCA INTERNATIONAL DIVISION**, 30 Rockefeller Plaza, New York 20, N. Y. Cable Address: RADIOINTER, N. Y.

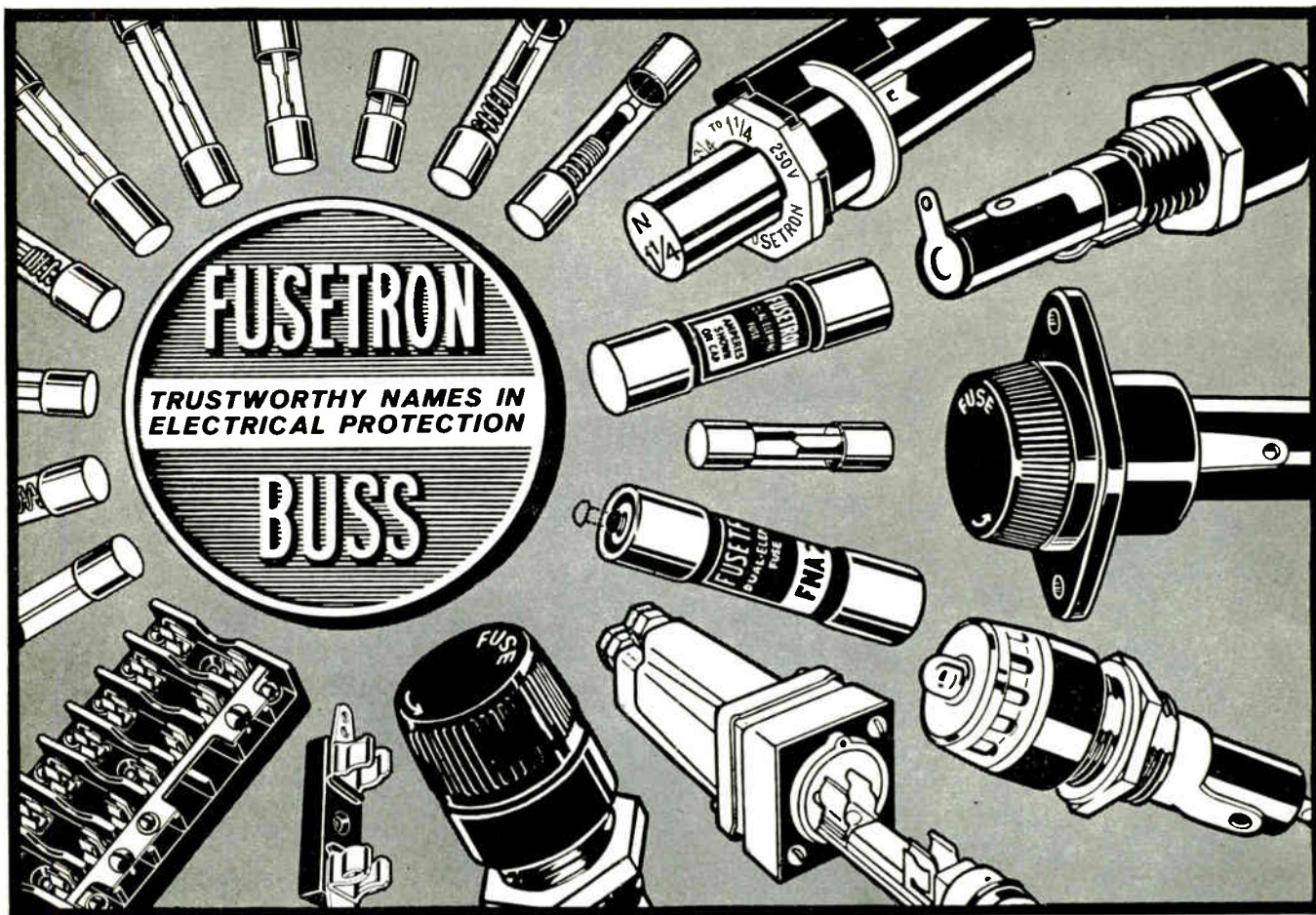

Save Time and Trouble by standardizing on BUSS Fuses—You'll find the right fuse every time...in the Complete BUSS Line!

By using BUSS as your source for fuses, you can quickly find the type and size fuse you need. The complete BUSS line of fuses includes: dual-element "slow-blowing", single-element "quick-acting", and signal or visual indicating types . . . in sizes from 1/500 amp. up—plus a companion line of fuse clips, blocks and holders.

BUSS Trademark Is Your Assurance Of Fuses Of Unquestioned High Quality

For almost half a century, millions upon millions of BUSS fuses have operated properly under all service conditions.

To make sure this high standard of dependability is maintained . . . BUSS fuses are tested in a sensitive

electronic device. Any fuse not correctly calibrated, properly constructed and right in all physical dimensions is automatically rejected.

Should You Have A Special Problem In Electrical Protection . . . BUSS fuse engineers are at your service—and in many cases can save you engineering time by helping you choose the right fuse for the job. Whenever possible, the fuse selected will be available in local wholesalers' stocks, so that your device can be serviced easily.

For more information on the complete line of BUSS and FUSETRON Small Dimension Fuses and Fuseholders, write for BUSS bulletin SFB.

BUSS: The complete line of fuses and fuse mountings of unquestioned high quality.

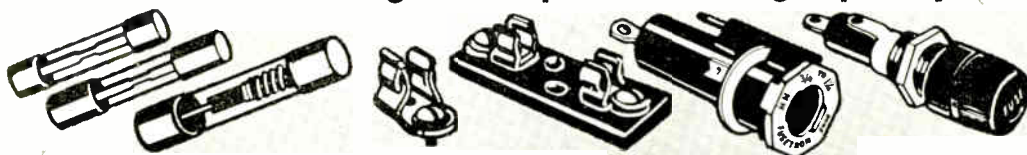

BUSSMANN MFG. DIVISION
McGraw-Edison Co.
St. Louis 7, Mo.



KYNAR[®] insulated wire . . . new standard in performance and production

Wire and cable insulated with Kynar—the new fluorocarbon resin from Pennsalt Chemicals—delivers premium performance in your product and on your production line. Kynar-insulated hook-up wire has high dielectric strength and resistivity . . . strips cleanly, won't tear or cut-through in automatic assembly equipment. Kynar has a useful temperature range of -80° to $+300^{\circ}\text{F}$. and Kynar-insulated wire forms strong, tight seals with epoxy-base potting compounds. As a jacketing material, Kynar offers superior resistance to abrasion, corrosion, weathering, and radiation . . . extrudes readily over single or multi-strand constructions as well as vinyls, PTFE and metallic shields. It can be pigmented and striped to identify circuits. Typical

properties of 10-mil Kynar insulation extruded over AWG 24 solid soft copper conductor:

Dielectric strength, volts.....	10,000
Insulation Resistance, meg-ohm/M.....	> 1,000
Cold bend, $\frac{1}{2}$ " dia., 1 lb. weight at -70°F , volts.....	8,000
Abrasion Resistance, Janco Tester grade 400 alumina, inches of tape.....	50
Cut through, anvil at 90° , 350 gm. hours at 270°F	> 500
Soldering test, flare back.....	None
Flammability.....	self extinguishing

Kynar-insulated wire is available from Surprenant Mfg. Co., Clinton, Mass.; Revere Corp. of America, Wallingford, Conn.; L. Frank Markel, Norristown, Pa.; Hitemp Wires Co., Westbury, L.I.; and Brand-Rex, Concord, Mass. Write to us for details. Plastics Department, PENNSALT CHEMICALS CORPORATION, 3 Penn Center, Phila. 2, Pa.



Navy's 1963 Procurement Plans Go

By JOHN F. MASON
Associate Editor

DESPITE CHANGES the Senate might make in the House-approved appropriations for Navy procurement for 1963, the shopping list will remain essentially the same. Navy's plans for 1963 as outlined to the House Subcommittee on Appropriations are:

Procurement of aircraft and missiles, \$3,007,970,000; shipbuilding and conversion, plus certain long-leadtime items for the fiscal year 1964 program, \$2,907,200,000; other procurement, including capital and collateral gear as well as ordnance items, \$901,700,000; and for the Marines, \$256,000,000. Total: \$7,072,870,000.

Fleet Ballistic Missile (FBM), \$2,016 million. Shipbuilding and conversion (\$888.8 million) provides for construction of six FBM subs, an FBM tender, advance procurement for 1964 shipbuilding program, and conversion of a supply ship and a floating drydock.

Procurement of aircraft and missiles (\$420.7 million) provides for production of operational missiles for shipfill, support, and special purpose, and related production support activities. A-2 missiles will cost \$33 million (at about \$1 million each); A-3's, \$290 million; pro-

duction support, \$83 million; and replenishment procurement, \$13.5 million. This includes equipment for missile handling, checkout and test, production facilities, special tooling, shipping and storage containers, training gear, and modifications to support facilities.

Other procurement (\$114.47 million) provides funds for modernizing ships with launching and handling gear, fire control and navigation and training equipment; and spares and components.

RDT&E for Polaris amounts to \$380 million. Of this, \$271 million will go for development of the A-3 missile; \$33 million for an undisclosed effort that "will benefit all three versions of Polaris"; \$25 million for development of improved communications; and \$51 million for fire control, navigation and other subsystems.

The A-1 Polaris missile (1,200 nautical miles range) is now operational and deployed, the A-2 (1,500 n mi) will go into operation this year and the A-3 (2,500 n mi) will be ready in two years. Present goal is 41 subs, all retrofitted with A-3 missiles. Studies are underway to determine the need for an A-4 version.

Operation and maintenance (\$72.9 million) for operating and

modernizing support vessels, maintenance of equipment and components, crew training, logistics services. This covers repair of launching and fire control, missile and guidance, navigation and test operations, and support. An additional \$74.7 million will be spent by BuShips for support of deployed subs and tenders.

Procurement of Aircraft and Missiles, \$3,008 million. The House approved procurement of 899 new aircraft of 14 different types (Navy had asked for 887 at a cost of \$1.9 billion) along with guided missiles and support gear for the Navy and Marine Corps. Aircraft types include the close support jet attack plane A4D Sky Hawk, A2F Intruder, and the F4H Phantom II jet fighter-bomber. The Army Iroquois helicopter will be bought for the Marines.

For antisubmarine warfare use, the HSS-2 helicopter, the S2F Tracker carrier-based, fixed-wing plane, and the P3V Orion land-based turbo-prop patrol bomber will be purchased.

The A3J-3 Vigilante program was approved with the stipulation that approximately 50 A3J-1 or A3J-2 versions would be modernized in place of that many new planes. Navy requested \$60 million

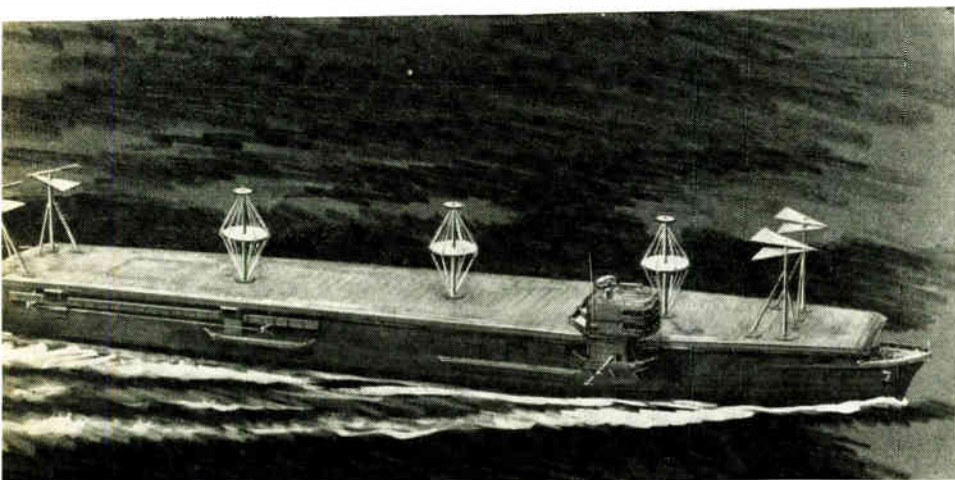

Artist's conceptions of two carriers being converted as sea-going electronics centers. The major communications relay ship (left) will be capable of supplying communications services in any area of the world. At right is a command ship that will provide strategic direction of operations in any area or worldwide. Facilities will include communications, data processing, storage and display. Communications antennas for both ships are being specially designed

Over \$7 Billion

for updating fleet aircraft.

Besides Polaris, the House approved funds to continue buying Terrier, Tartar, and Talos surface-to-air missiles; Sparrow and Sidewinder air-to-air; and Bullpup air-to-surface missiles. The antisub missile-torpedo, Subroc, will remain on the list, and the new Shrike air-to-ground missile will go into production.

Navy requested \$431 million for guided missiles besides Polaris. Target drones will require \$45 million of this. The asw drone helicopter needs \$36 million. Satellites and boosters for navigational satellite Transit will cost \$14.3 million.

Shipbuilding and Conversion, \$2,907 million. The House approved construction of 37 ships and conversion of 35. The attack aircraft carrier will be conventionally-powered, about the size of the *Forrestal*, but with improved electronics. Included are: a high capacity communications system (Hicapcom), the Naval Tactical Data System (NTDS) (ELECTRONICS, p 30, Sept. 16, 1960), and an aircraft automatic landing system.

Twenty-four destroyers will be converted with 1963 funds; a total of 79 destroyers are slated for eventual conversion. They will get new asw equipment including long-

range sonar, Asroc, Dash helicopters, radars and ecm gear. Getting the same gear are five escort ships, the new guided missile frigate (plus the Typhon missile), and the guided missile escort ships (plus Tartar).

The Major Communications Relay Ship will provide a boost to land-based communication systems and be able to move into specific areas when needed.

Other Procurement, \$901.7 million. Navy requested \$361 million for expendable ordnance, which includes rockets, bombs, torpedos and sonobuoys. More than half the program is for asw.

Modernization, calling for \$339.6 million, includes radars, sonars, communications receivers and transmitters, aviation ground electronic gear, cryptographic equipment, fire control, test and checkout, display, simulators and data processing. Ship's electronic gear accounts for \$137 million of this amount; shipboard ordnance and aviation ground electronic programs, \$43 million; catapults and landing aids, \$23 million.

Marine Corps Procurement, \$256 million. The Marine Corps will continue to buy the Hawk missile and will begin buying Redeye. The three-year procurement of the TPS-

SHIP BUILDING PLANS

New Construction

Attack aircraft carrier (CVA) ..	1
Guided missile frigate (DLG(N))	1
Submarine (SS(N))	8
Fleet ballistic missile submarine (SSB(N))	6
Amphibious transport dock (LPD)	4
Amphibious assault ship (LPH)	1
Escort ship (DE)	5
Guided missile escort ship (DEG)	3
Motor gunboat (PGM)	2
Oceanographic research ship (AGOR)	2
Submarine tender (ASC(FBM))	1
Fast cargo support ship (AOE) ..	1
Cargo ship (MSTS)	1
Surveying ship (AGS)	1
Total	37

Conversion

Major communication relay ship (AGMR)	1
Command ship (CC)	1
Destroyer (DD(FRAM))	24
Mine countermeasure support ship (MCS)	1
Oiler (AU(Jumbo))	2
Guided missile test ship (AVM) ..	1
Ammunition ship (AE(Fast)) ..	2
Cargo ship (AK(FBM))	1
Technical research ship (AGTR)	2
Total	35

34 radar will be finished this year, and the TPS-32 will be initiated. The Marine Tactical Data System will also be bought for the first time. The currently used ssb radio will be continued, and two new types initiated.

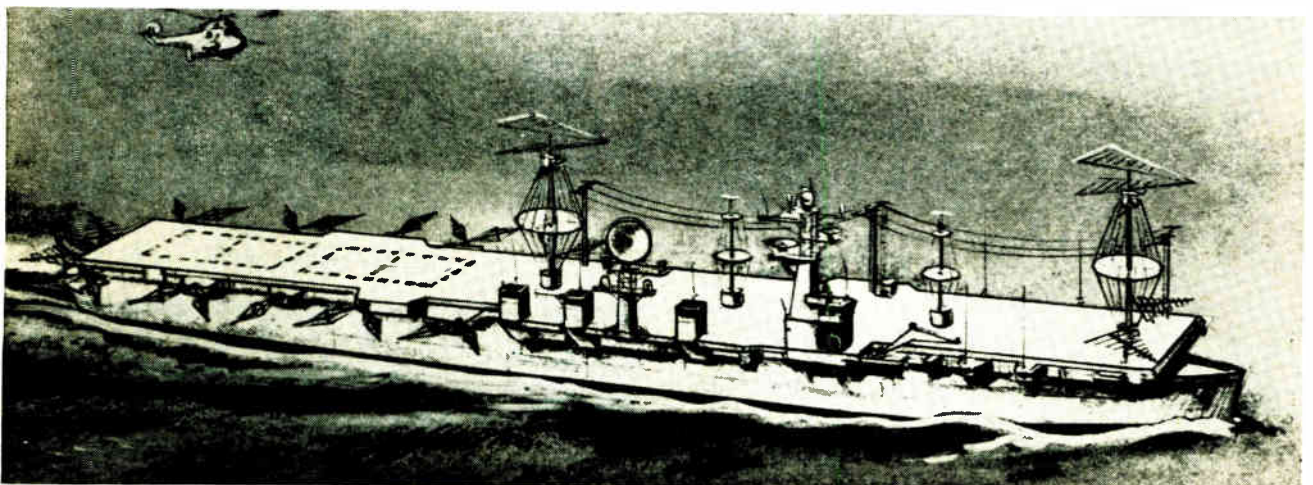

This is the PERFECT "Dust-free" Laboratory

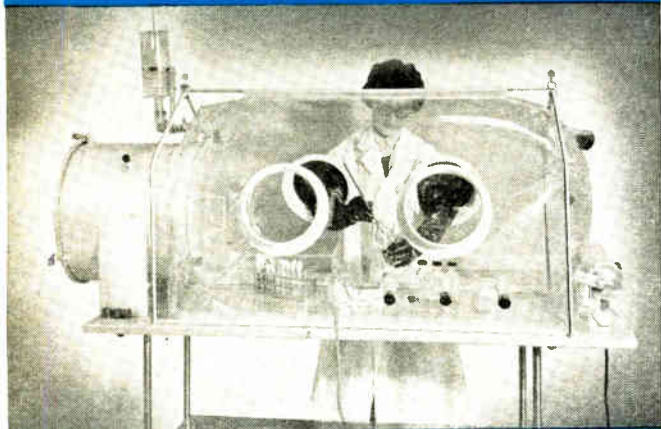

AMSCO Flexible Film Laboratory Dry Box

This low-cost, transparent "self-contained laboratory" is designed for laboratory or production procedures demanding a controlled, isolated atmosphere . . . whether it be dust-free, moisture-free, toxic compound confining, inert gas atmosphere . . . an almost endless list.

Amsco's disposable Flexible Film Dry Box is ideal for delicate transistor and diode assembly, experimental metallurgy, missile sub-assembly work, instrument assembly . . . even Alpha radiation studies. The clear plastic canopy enables technicians to work comfortably and swiftly with no eye strain.

When not in use the "envelope" may be collapsed into a compact package for convenient storage. Upon completion of certain studies, the canopy may be disposed of and replaced quickly and economically. The chamber size is 48" long x 26" wide x 28" high and is provided with four "working" ports, a large interchange lock for introducing parts and several tubular ducts for service lines. Complete air filtration system is optional.

Won't this low-cost, disposable Dry Box fit into your laboratory or production plans? An Amsco man will be happy to discuss the matter in detail . . . or write for bulletin IC-607.

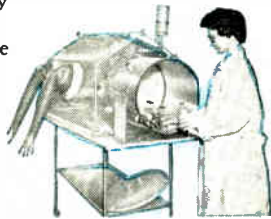

SCIENTIFIC AND INDUSTRIAL DEPARTMENT



**AMERICAN
STERILIZER**

ERIE • PENNSYLVANIA

World's largest designer and manufacturer of Sterilizers, Surgical Tables, Lights and related technical equipment for hospitals, industry, research

RELIANCE DEVELOPS ADVANCED COMMERCIAL FREQUENCY-CONVERTED D-C POWER SUPPLY

Facts book now ready covering data processing and communications equipment



Converting from 60 to 3000 cycles before rectifying to d-c. this new Reliance D-C Power Supply brings you these major advantages:

1. High frequency A-c. distribution — multiple rectifiers at point of use.
2. Low cost, compact, high frequency components.
3. Maximum protection against line voltage and frequency disturbance.
4. Simplicity in maintaining high quality D-c. voltages.

Talk to our people about this new Reliance development . . . and be sure to get the booklet with all technical facts. Write today. Reliance Electric and Engineering Co., Dept. 83-6, Cleveland 17, Ohio. Canadian Division: Toronto, Ontario.

K-1711

RELIANCE ELECTRIC AND
ENGINEERING CO.
CIRCLE 200 ON READER SERVICE CARD

10MC FREQUENCY COUNTER/STANDARD

A NEW CONCEPT IN PRECISION MEASURING

The Model 14-20C 10MC Frequency Counter/Standard combines features of a precision counter and a high stability frequency standard into an advanced design unit.

- Simultaneous and independent use of both frequency standard and counter.
- Stability of 1×10^8 per day and 5×10^8 per week.
- Nine standard decade output frequency from 0.1cps. Gate time from 1 millisecond to 100 seconds.
- Counts any one of nine decade frequencies from 0.1cps to 10MC for period and time interval measurements.
- Self checks counting and gate circuits at any of these frequencies in all combinations of available gate times.
- Operates within -20° C to $+55^\circ$ C.
- Operates from an external 100KC or 1MC reference frequency.

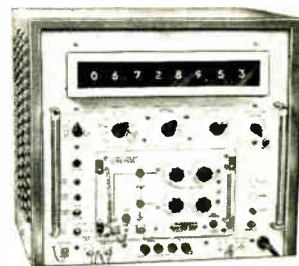

\$2,200

WESCON BOOTH #3245

**NORTHEASTERN
ENGINEERING INCORPORATED**
AFFILIATE OF ATLANTIC RESEARCH CORPORATION

DEPT. 2A MANCHESTER, NEW HAMPSHIRE

Employment Opportunities Open At All Levels

CIRCLE 201 ON READER SERVICE CARD

electronics

Latest Tests Prove—

EVEREADY® CATHODIC ENVELOPE BATTERIES GIVE UP TO 3 TIMES MORE SERVICE, LOWER OPERATING COST!

Comparison of "Eveready" No. 2762 and Six "D" Size Flashlight Cells

Battery Voltage	9	9	9	9
Schedule	2 hours/day to 4.8 volts	2 hours/day to 4.8 volts	4 hours/day to 4.8 volts	4 hours/day to 4.8 volts
Typical Starting Current (Milliamperes)	50	15	25	15
"Eveready" No. 2762 Hours Service Cost per hour	375 hours \$.0073	1250 hours \$.0022	700 hours \$.0039	1325 hours \$.0020
6 "D" Size Cells Hours Service Cost per hour	125 hours \$.0096	355 hours \$.0033	245 hours \$.0048	420 hours \$.0029

Look
at
these
Results!

New Design Permits Greatest Efficiency and Economy!

New "Eveready" Brand Cathodic Envelope Energizers were designed especially to meet the requirements of modern transistor radios and other electronic devices. They provide more energy, longer life, and lower operating cost than conventional battery construction.

In addition, they offer the radio set manufacturer cost savings, such as elimination of contacts needed when round cell batteries are used. Compact construction gives engineers new freedom in design.



GUARANTEED LEAKPROOF

Union Carbide Consumer Products Company offers a guarantee which reads: "If this battery is defective through fault of the manufacturer, satisfactory adjustment will be made within the limits of the value of the electronic device."

Available in Variety of Sizes!

Write for complete technical information on "Eveready" Energizers.



"Eveready" and "Union Carbide" are registered trade-marks for products of
UNION CARBIDE CONSUMER PRODUCTS COMPANY • Division of Union Carbide Corporation • 270 Park Avenue, New York 17, N. Y.

NEW Openings for EEs & MEs in Product Design and Development

Delco Radio's continuous search for new and improved electronic products provides challenging opportunities—in several areas—for capable engineers; specifically:

MOBILE COMMUNICATIONS (Automobile Radiotelephone) EQUIPMENT—

EEs—3-5 yrs. Exper—for design of and production assistance with 150 and 450 mc receiver transmitters; transistorization, packaging, duplex operation and dial mobile. Desire experience or interest in mobile communications equipment, private system or telephone link.

Project Engineers—work includes supervising type tests and FCC qualification testing of automotive radiotelephone equipment. Must audit designs for field reliability.

SUBMINIATURE MILITARY COMMUNICATIONS EQUIPMENT—

EE or ME—for assignment to development group designing all-transistor portable transmitters and receivers, operating in 2-100 mc range. FM—AM—FSK—CW—SSB modulation.

AUTOMOTIVE RADIO DESIGN AND DEVELOPMENT—

EE—to work with Senior Engineer on advanced development of auto radios and other entertainment devices, including FM-AM, miniaturized circuitry and components.

ME—for design of small electronic mechanisms, including FM-AM, Signal Seeking and push-button tuners, and components modules.

EE or ME—for packaging of auto radios and associated tuners, solenoids, etc. Required to make some engineering contacts with automobile manufacturers.

DIGITAL CIRCUITS AND SYSTEMS—

includes card, module and digital systems design, and production liaison involving components and special purpose systems operating from 200 kc to 10 mc.

Project Engineer—to direct efforts of design engineers and technicians in designing

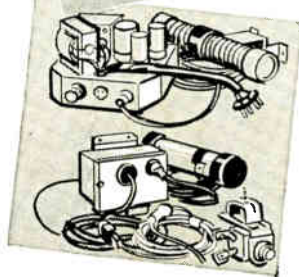
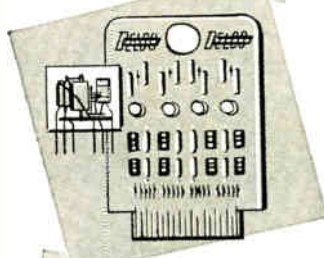
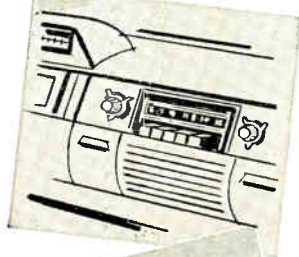

and releasing digital circuits for production. Supervisory experience highly desirable.

EEs—for design and development testing and packaging of transistorized digital switching circuits from 200 kc to 10 mc.

RELIABILITY ASSURANCE—

Project Engineer—to handle tests and evaluations of transistorized systems and components, both power and small signal type. Must evaluate results and associated statistical data. Also includes failure analysis work with suppliers and production.

EE—for design and development work on test equipment for semiconductors and special products, such as radiotelephone.

AUTOMOTIVE ELECTRONICS—non-entertainment automotive electronic development including radio control for Garage Door Operators; other transistor applications in automobile, usually involving electromechanical transducers—

ME—for advanced development work in electromechanical systems used in automotive field.

EE—for design and development of transistorized automobile equipment.

EE or ME—with electromechanical interests for development of electronic equipment for the automotive service market.

● If your interests and experience fall in the above areas and if you're looking for an opportunity to fully exercise your personal competence . . . among men of like talent . . . in unmatched facilities . . . then let's talk. Send your resume today to the attention of Mr. Carl Longshore, Supervisor Salaried Employment.

An equal opportunity employer

solid state electronics ●



DELCO RADIO DIVISION OF GENERAL MOTORS
KOKOMO, INDIANA



Why Fish Around

for Fast Deliveries?

... Hook Up with

Need resistors *on the double* for small runs, military prototypes, production emergencies, or hurry-up design and engineering projects? Get them from Stackpole Distributors—in 24 hours or less!

Today's handsomest resistors, Stackpole Coldite 70+ are just as good as they look. Performance meets and beats latest MIL-R-11 requirements—pays extra load-life and moisture-resistance bonuses. And exclusive solder-coated leads stay tarnish free for fastest soldering. Order Coldite 70+ Fixed Composition Resistors in 2-watt (RC-42), 1-watt (RC-32), and 1/2-watt (RC-20) sizes—in all standard values and tolerances—right from Distributors' stocks.



Available in 24 hours or less

... from these Leading Distributors!



ALABAMA
 OPELIKA—Southern Electronics Corp.

CALIFORNIA
 GLENDALE—R. V. Weatherford, Co.
 LONG BEACH—Deans Electronics
 LOS ANGELES—Rising's, Inc.
 OAKLAND—Brill Electronics
 PASADENA—Wesco Electronics

COLORADO
 DENVER—Denver Electronics Supply Co.

CONNECTICUT
 WATERBURY—Bond Radio Supply Co., Inc.

DISTRICT OF COLUMBIA
 WASHINGTON—Electronic Wholesalers, Inc.

FLORIDA
 MELBOURNE—Electronic Wholesalers, Inc.
 MIAMI—Electronic Wholesalers, Inc.
 TAMPA—Thurrow Electronics, Inc.
 WEST PALM BEACH—Goddard Dist. Inc.

GEORGIA
 ATLANTA—Specialty Dist. Co., Inc.

INDIANA
 INDIANAPOLIS—Radio Dist. Co.

KANSAS
 WICHITA—Interstate Elect. Supply Corp.

KENTUCKY
 LOUISVILLE—P. I. Burks Co., Inc.

MARYLAND
 BALTIMORE—Electronic Wholesalers, Inc.
 Kann-Ellert Electronics, Inc.

MASSACHUSETTS
 BOSTON—Sager Electrical Supply
 WATERTOWN—Northeast Elect. Dist., Inc.
 N. WILBRAHAM—Industrial Comp. Corp.
 NEWTON—Cromer Electronics

MICHIGAN
 BATTLE CREEK—Electronic Supply Corp.

MISSOURI
 ST. LOUIS—Interstate Ind. Electronics, Inc.

NEW JERSEY
 MOUNTAINSIDE—Federated Purchaser, Inc.
 WHIPPANY—State Electronics Parts Corp.

NEW YORK
 BROOKLYN—Electronic Equipment Co., Inc.
 Quad Electronics, Inc.
 BUFFALO—Summit Dist., Inc.
 HEMPSTEAD—Hempstead Electronics
 LYNBROOK—Peerless Radio Dist. Co.
 MINEOLA—Adelphi Electronics, Inc.
 Arrow Electronics, Inc.
 NEW YORK—Electronics Center, Inc.
 Harvey Radio Corp.
 Mita Electronics Corp.
 Sun Radio & Elect. Co., Inc.

ROCHESTER—American Electronics, Inc.
SYRACUSE—Harvey Elect.—Syracuse, Inc.
 Morris Electronics of Syracuse

WHITE PLAINS—Westchester Electronic Supply Co., Inc.

WOODSIDE—Bora Electronics, Inc.

NORTH CAROLINA
 WINSTON-SALEM—Elect. Wholesalers, Inc.

OHIO
 CLEVELAND—Pioneer Electronic Supply Co.
 CINCINNATI—Herrlinger Dist. Co.
 COLUMBUS—Hughes-Peters, Inc.

OREGON
 PORTLAND—Lou Johnson Co., Inc.

PENNSYLVANIA
 PHILADELPHIA—Almo Radio Co.
 Philadelphia Elect., Inc.

SCRANTON—Fred P. Pursell

SOUTH CAROLINA
 FLORENCE—Southern Electronics, Inc.

TEXAS
 DALLAS—Wholesale Electronic Supply

VIRGINIA
 ROANOKE—Peoples Radio & TV Supply Co.

WASHINGTON
 SEATTLE—C & G Electronics Co.
 TACOMA—C & G Electronics Co.

56 Distributors—PLUS . . . and G-C/STACKPOLE, TOO!

Attractively packaged by G-C Electronics for service replacement uses, Coldite 70+ Resistors are also available through over 800 G-C distributors.

MICRO DRILL PRESS

FOR VERY *SMALL* HOLES
DOWN TO
1/1000 INCH
and **SMALLER**



LEVIN® MICRO DRILL PRESSES are *sensitive* because there are no sliding quills and splines to cause drag. They are *accurate* because the precision preloaded ball bearing spindle is made to hold Levin WW Style Collets. For drilling holes from 1/8th inch down to 1/1000 inch and smaller look to Levin for the finest in Micro-Drilling equipment.

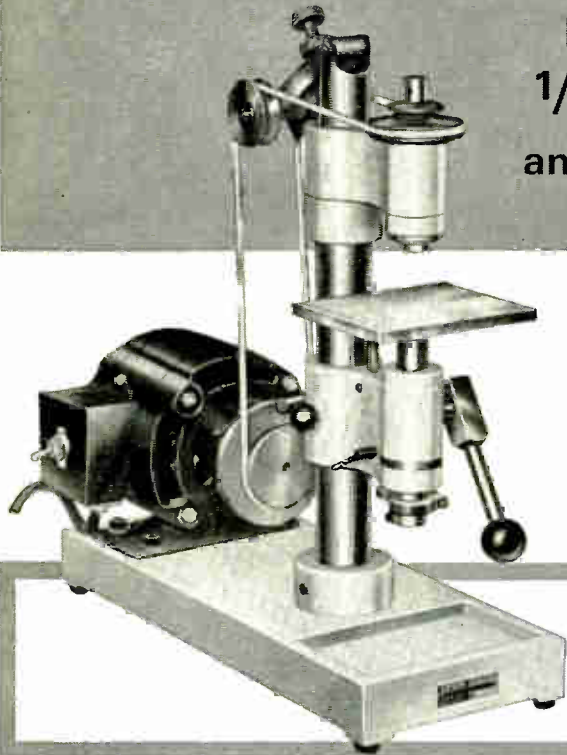

Send for Drill Catalog Today

LOUIS LEVIN & SON, INC.

3573-1 Hayden Avenue • Culver City, California

CIRCLE 202 ON READER SERVICE CARD

TANSITOR'S NEW WET SLUG TANTALUM CAPACITORS MINIMIZE LEAKAGE CURRENT, SAVE SPACE

- Operate from -55 to +85C, up to 125 volts
- Low power factor
- Polar construction
- Long shelf life at -65C
- Insulated or uninsulated

These new W-type wet slug capacitors have one of the lowest leakage current ratings of all TANSITOR tantalums. Usually shorter and thicker than standard tantalum foil capacitors, they can frequently be used where space prevents use of foil units.

Axial leads and clean shoulderless shape simplify installation on printed circuit boards. Ideal for low voltage transistor applications such as filtering or energy storage for guided missiles, computers, navigation, communication and control equipment.

FOR COMPLETE DETAILS
write or 'phone TANSITOR
ELECTRONICS, INC.,
Dept. 24C





miniature o-rings!

A new manufacturing technique now enables Parker Seal Company to offer miniature o-rings that are far superior dimensionally and in quality of finish.

These amazingly near-perfect o-rings can be made in nearly all our standard compounds for usage in a wide variety of fluids and gases, and covering a temperature range from -85° to $+400^{\circ}$ F.

If the products you manufacture or design require very small seals let us tell you about our miniature o-rings.

Just send for Bulletin # 142

Incidentally, there are 351 o-rings this size • behind that dime!



Parker SEAL COMPANY

Culver City, California and Cleveland, Ohio

Fly's eye camera would be able to look through a wide angle and track different celestial objects independently

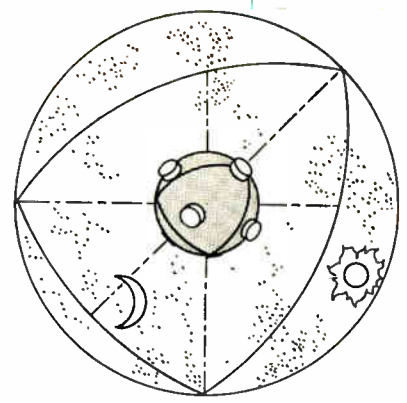

DISPLAYS ARE KEY TO Apollo Control by Crew

By ROY J. BRUN, Assistant Editor

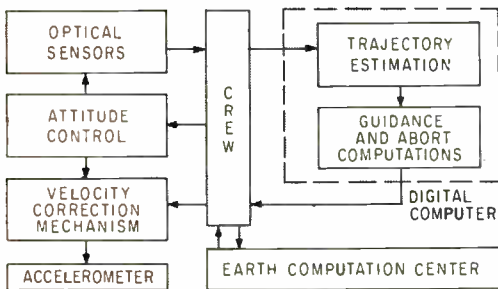

Velocity correction system is directed by the crew. Earth-based computing facility backs up on-board system

NASA IS STILL keeping under wraps specific information on electronic systems design approaches for Project Apollo, the program to land a three-man crew on the moon during 1967-1970. However, equipment needs are indicated by information from one of the successful bidders and by conference papers delivered by NASA personnel.

Contracts have been let for some of the basic systems (see table) re-

quired for earth orbital trials. No contracts have been given for systems needed in later phases. These include rendezvous, abort capability (return to earth in case of trouble) and navigation between earth and the moon.

While work on these systems will probably not be withheld long, implementation will depend on results of earth-orbital trials. North American Aviation, as prime contractor, and NASA will determine who the subcontractors will be.

Northrop, one of the firms now working with North American, indicates that the three-man crew will be the primary "control element." The crew will need flight data presentations that will enable them to maintain orientation, speed and course. Display information would include:

- Attitude. Factors that have to be continuously checked are random oscillations, tumbling, rolling, pitching and yawing.
- Velocity. This is critical to

navigation.

- Thrust vector. Maneuvering may be by a variable-thrust exhaust.

- Propulsion system temperature. Needed to gage propulsion performance.

- Tracking. A concise method of showing the vehicle's actual track and course drift variation is considered essential.

- Distance measuring. Needed for pilot decisions, it should show time elapsed and time to go, at any point in the flight.

- Course monitoring and checking. This would give instantaneous and continual data on any departure from true course.

- Launch monitoring. Would assure conformity with predetermined launch sequence, on takeoff and return to earth.

- Provisions. This would show how much fuel, stores and other supplies are available.

- De-orbit map. On this, the pilot could see his position, predicted ground track on earth, possible landing areas if the vehicle should de-orbit at any time, and communications stations.

- Reentry. Displays would show predicted, optimum and safe limits of reentry angles and position relative to earth topography.

On-board and self-contained navigation systems using optical celestial sensing techniques are essential for nearly all future space systems, according to K. N. Satyendra, Northronics director of research. Such systems would work

APOLLO CONTRACTOR LINE-UP

Prime Contractor: North American Aviation

Communications, television, telemetry: Collins Radio
Flight control and stabilization: Minneapolis-Honeywell
Environmental system: AiResearch
Recovery System: Northrop (Radioplane division)

Integration analysis, reliability and check out system: General Electric

Initial navigation-guidance system: MIT Instrumentation Lab

Inertial platform, associated electronics, guidance ground support and checkout system: General Motors (A.C. Spark Plug)
On-board guidance system digital computer: Raytheon
Optical sub-systems (navigation display equipment, etc): Kollsman
Accelerometers: Sperry Gyroscope

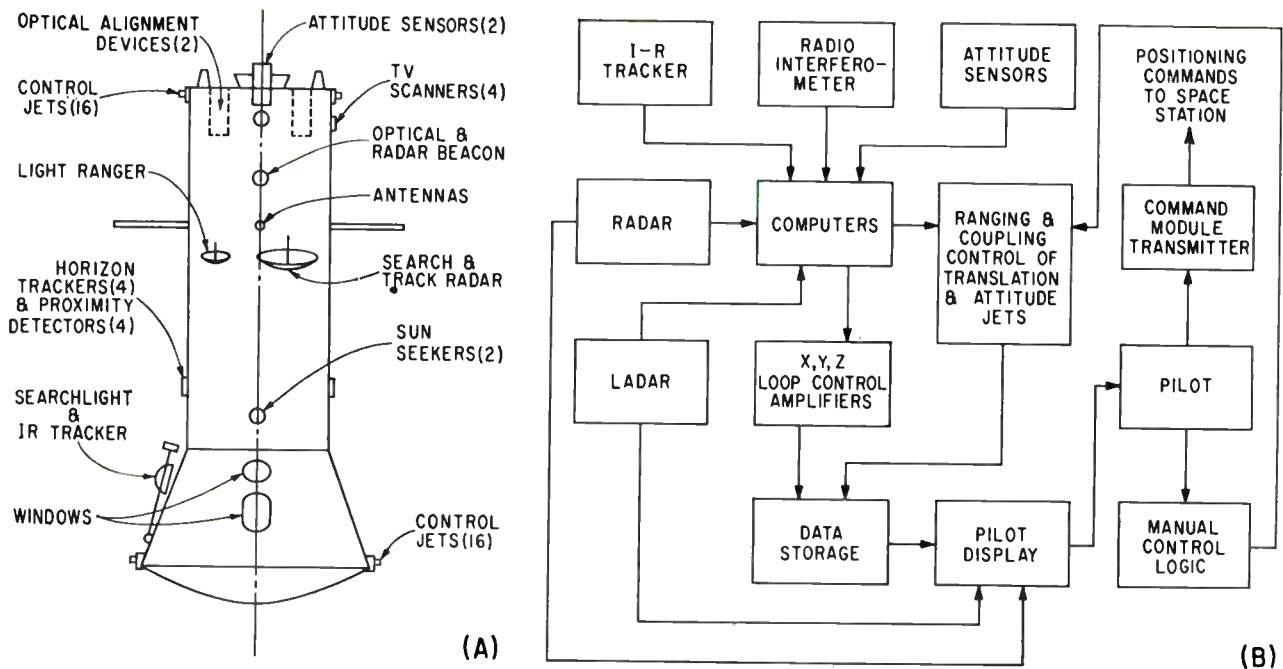

Space rendezvous homing and docking system proposed by Northrop. Sensors on manned capsule (A) would provide data for automatic and pilot control systems (B)

with, but have little dependence on ground equipment. With thousands of objects likely to go into orbit in the next decade, earth-based systems face tracking and communications jams.

Satyendra feels the trend is toward nonradiating, fully integrated systems, rather than the heterogeneous systems being used in early space programs. An integrated system would include an astro-inertial platform, earth, moon and star trackers, radio altimeter and computer-clock. Navigational accuracy would be obtained by using statistical techniques.

Among optical techniques offering increased accuracy and reliability with reduction in size, weight and power is the nonrotating sensor or "fly's eye camera." A mosaic array with a memory of the stars and solar system could provide navigational data. Satyendra also says that laser-doppler techniques for distance measurement in space are becoming feasible. These could improve landing distance and velocity measurement accuracy.

C. L. Smith and J. D. McLean, of NASA's Ames Research Center, say that midcourse navigation to the moon will require complete and versatile on-board capability, but that this should be thoroughly

backed up with ground tracking and computation.

Tracking, computation, display and control features of the system would be under direct control of the crew. Tracking data from optical sensors would be computed on-board and also transmitted to earth for computation there.

The crew would check on-board computation against computation transmitted back from earth, then decide on velocity corrections. If taken, corrective action would be measured by integrating accelerometers and fed back into the on-board computer. Abort, representing a large velocity correction, would be handled the same way.

Smith and McLean say simulation studies show that a lunar mission could be handled with just the on-board system. The redundancy of the earth system would minimize errors and provide emergency operating capability.

The pilot displays listed above would also be needed for spacecraft rendezvous with an orbiting space station. A tracking network on earth, augmented by an on-board tracking system, would be used to determine orbital launch and burnout locations and the ballistic trajectory to the moon.

Northrop's Norair division has

designed a system for rendezvous homing and docking that would use radar, ladar (light tracking and ranging) and photoelectric systems. It would be an automatic system with pilot override.

As the manned capsule approaches the space station, closing velocity and rate would be automatically controlled through radar data. At a distance of 250 feet, the main engines would shut off and low-thrust jets be used.

If the pilot did not take over docking, the automatic system would bring the capsule to within 50 feet of the station and hold it there. Alignment between the two vehicles would be handled by a radar interferometer with polarized antennas. The ladar would serve as a redundant alignment system.

Position error signals for docking are provided by an infrared tracker that detects an ir source on the space station. The tracker points a searchlight at photoelectric sensors on the station. These sensors and photoelectric attitude sensors on the capsule provide error signals for final position correction.

Radar and optical data are presented to the pilot on displays. The pilot can also transmit positioning instructions to the station.

Bacteria and Enzymes Produce Power in

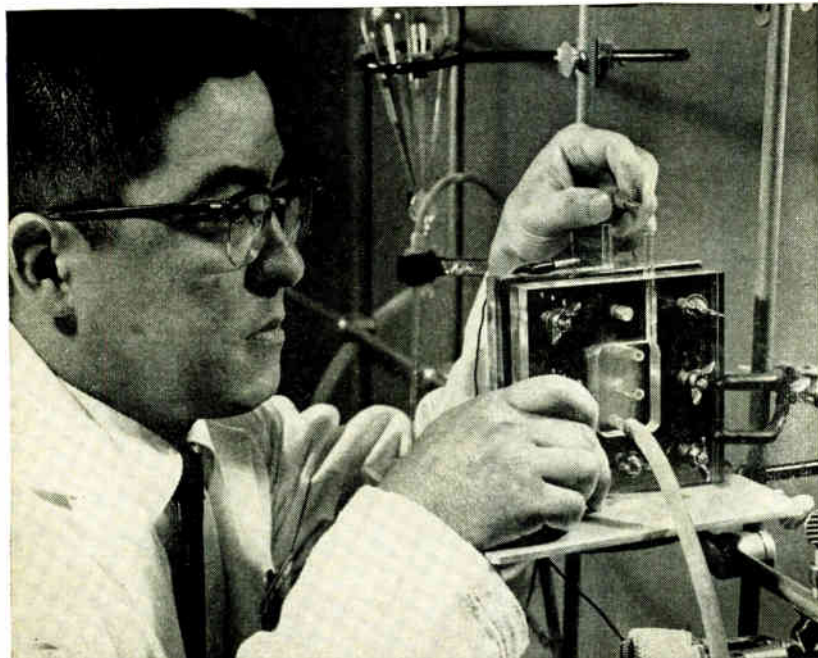

Biochemical fuel cell is prepared for test in chemical research laboratory at Electro-Optical Systems, Inc.

By **MICHAEL F. WOLFF**
Senior Associate Editor

NEWEST EYECATCHER among power sources is the biochemical fuel cell, or biocell. Several companies are actively researching biocells and batteries. Army Signal R&D Labs is asking for bids on a biobattery.

Biocells use biological substances as catalysts. As in other fuel cells and batteries, conversion of chemical energy into electrical energy occurs through the transfer of electrons from the fuel at the anode to the oxidant at the cathode.

Because biocells can operate on materials like sea water, human waste and decaying vegetation, specialized applications can be foreseen—spacecraft ecological systems, sewage conversion systems, buoy power sources and propulsive power for ships, to name a few. However, the biocell is now an experimental device with relatively low power density. Further understanding of basic biological mechanisms is sought, to guide selection of the proper materials and con-

figurations for practical biocells.

At the recent 16th Annual Power Sources Conference (ELECTRONICS, p 27, June 8) G. H. Rohrback, of Magna Corp., said the most promising fuels for biocells include hydrocarbons, fatty acids, alcohols, carbohydrates and urea. Promising oxidants include nitrate, sulfate and carbonate anions. Useful biological substances are micro-organisms, including bacteria, and enzymes. Current densities of the order of amps per square foot have

been achieved, he reported.

Biocells may be divided into two types: those using indirect reactions and those using direct reactions. In the former, the biochemical and electrochemical reactions are separate and the cell operates on a stable intermediate, such as hydrogen or oxygen, produced by the biological process. In the example illustrated, the biochemical reaction occurs in a separate fuel generator, producing electroactive fuel. The remainder of the system acts as a normal fuel cell.

In the direct biocell, the active intermediate has a transitory existence and both reactions occur in contact with the electrode. As illustrated, fuel is put into the fuel chamber with a catalyst such as bacteria or enzymes. The catalyst starts producing the electrochemical reaction when the fuel is wetted.

Magna Corp., much of whose work is Navy-sponsored, has worked out techniques for directly oxidizing fuels such as sugar at an electrode. Magna has also operated a multiwatt magnesium sulfate cell, designed to operate in the ocean where sulfate is plentiful, and a urea battery. Solar biocells using photosynthetic organisms are under study.

General Scientific Corp. researchers report that micro-organism and enzyme cells have powered a transmitter and a model boat operated in sea water. Covering the electrodes with micro-organisms

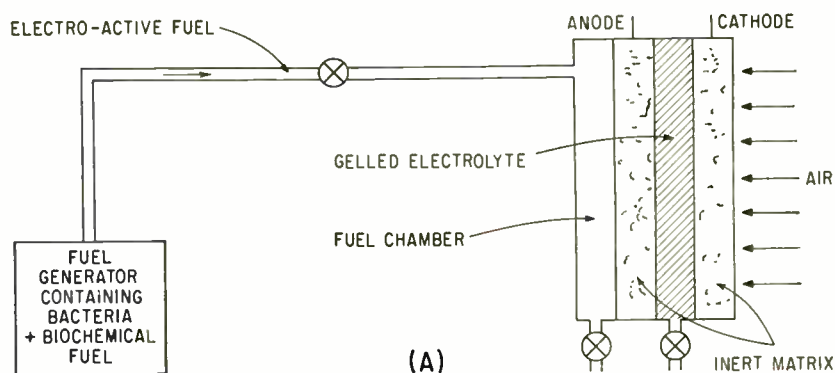

Conceptual drawings of indirect (A) and direct (B, on facing page) cells

New Biocells

HISTORICAL NOTE

WHILE biological processes to promote useful electrode reactions have been actively studied only recently, biological batteries are apparently not new. W. Van Der Grinten, of GE, reports that in 1911 a University of Durham botany professor, M. C. Potter, described (*Proceedings of the Royal Society Series B, Vol. 84*) how a battery of six yeast cells with carbon electrodes connected in parallel gave 1.25 ma. B. Cohen, of the Johns Hopkins Medical School, reported on a 2-ma "bacterial battery" in 1931 (*Journal of Bacteriology, Vol. 21*)

increases current densities. As long as the organisms are fed with a nutrient, current flows and no polarization occurs. According to Robert Sarbacher, micro-organism reaction rate is increased by intimate association with the electrical circuit at the electrode.

GE's Missile and Space Vehicle department is investigating biocells for spacecraft ecological systems processing human waste into hydrogen and oxygen for drinking water and air supply, as a space power source and for modifying wastes as in sewage disposal.

Flow Labs has operated biocells using bacteria and naturally occurring nutrients from the sea. J. A. Welsh said this was a continuation of work previously reported (*ELECTRONICS*, p 10, April 28, 1961).

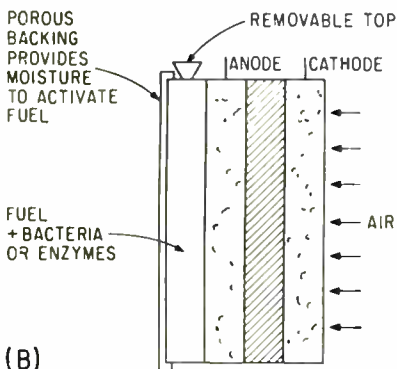

(B) under study at Magna Corp.

Well-known, Widely-used MADT[®] Logic Transistors Now in Smaller Size

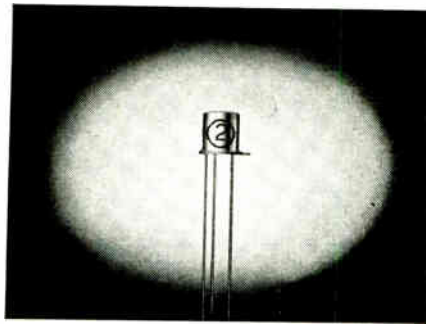

TO-18 Version of Popular Low Cost 2N1499A Now Available

The new Sprague Type 2N979 transistor has solved size, cost and dependability problems for logic circuit designers. This unit is electrically identical to the well known 2N1499A MADT logic transistor and offers the TO-18 package size advantage. The low cost 2N979 is designed to meet the requirements of MIL-S-19500.

High-Frequency switching speeds

Designed for use in saturated switching circuits, the Type 2N979 Transistor is capable of switching at frequencies in excess of 10 megacycles. Ideal for logic circuits, it offers low storage time, low saturation voltage, and high beta. Here are some key parameters:

- I_{CBO} 3 μ a max.
- BV_{CES} 20V min.
- BV_{CEO} 15V min.
- f_T 100 mc min.

Dependable performance

In addition to good electrical characteristics, the 2N979 Transistor has a hermetically-sealed TO-18 case which is cold welded to insure greater reliability.

Attractively priced

Available in production quantities, the 2N979 is a first-run device, not a "fall-out". Produced on FAST (Fast Automatic Semiconductor Transfer) lines with direct in-line process feedback, high production yields make possible its lower cost.

Engineering assistance available

For application engineering assistance, write Transistor Division, Product Marketing Section, Sprague Electric Company, Concord, N.H.

For complete technical data, write for Engineering Bulletin 30,226A to Technical Literature Section, Sprague Electric Company, 35 Marshall St., North Adams, Mass. @ T.M. Philco Corp.

HPB 45-413

CIRCLE 212 ON READER SERVICE CARD

Now! For the first time...

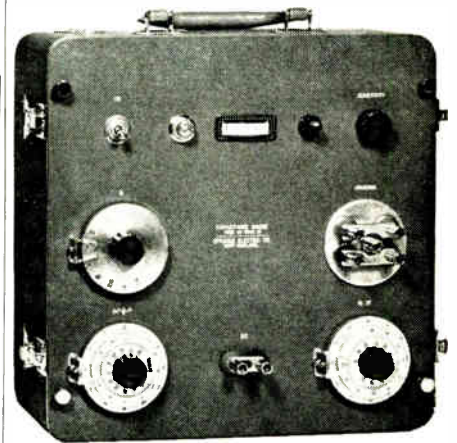

YOU CAN TEST ELECTROLYTIC CAPACITORS

Safely . . . Accurately . . . Simply!

The Sprague Model 1W1 Capacitance Bridge incorporates the best features of bridges used for many years in Sprague's own laboratories and production facilities. Unlike many conventional bridges, the 1W1 will not cause degradation or failure in capacitors during test, since the 120 cycle a-c voltage applied to capacitors never exceeds 0.5 volt!

SPECIFICATIONS

- Capacitance**
Range: 0 to 120,000 μ F at 120 cps
Accuracy: \pm 1% of reading +10 μ F
Sensitivity: \pm 0.1% of reading +10 μ F
- Dissipation Factor**
Range: 0 to 120% at 120 cps
Accuracy: \pm 2% of reading +0.1% DF
Sensitivity: \pm 0.2% of reading +0.05% DF
- Maximum Voltage to Unknown**
A-C: 0.5v RMS at 120 cps
D-C: 0-600v (external)
- Null Detection**
Built-in Galvanometer to Indicate Bridge Balance
- Power Input**
105-125v, 60 cps, 15w
(Also available in 115v and 230v, 50 cps models)
- Case**
Sturdy Aluminum Cabinet with Blue Textured Finish, Grey Panel
- Dimensions**
12" Wide x 12" High x 9" Deep

For complete technical data, write for Engineering Bulletin 90,010 to Technical Literature Section, Sprague Electric Company, 35 Marshall St., North Adams, Massachusetts.



45-430

CIRCLE 31 ON READER SERVICE CARD

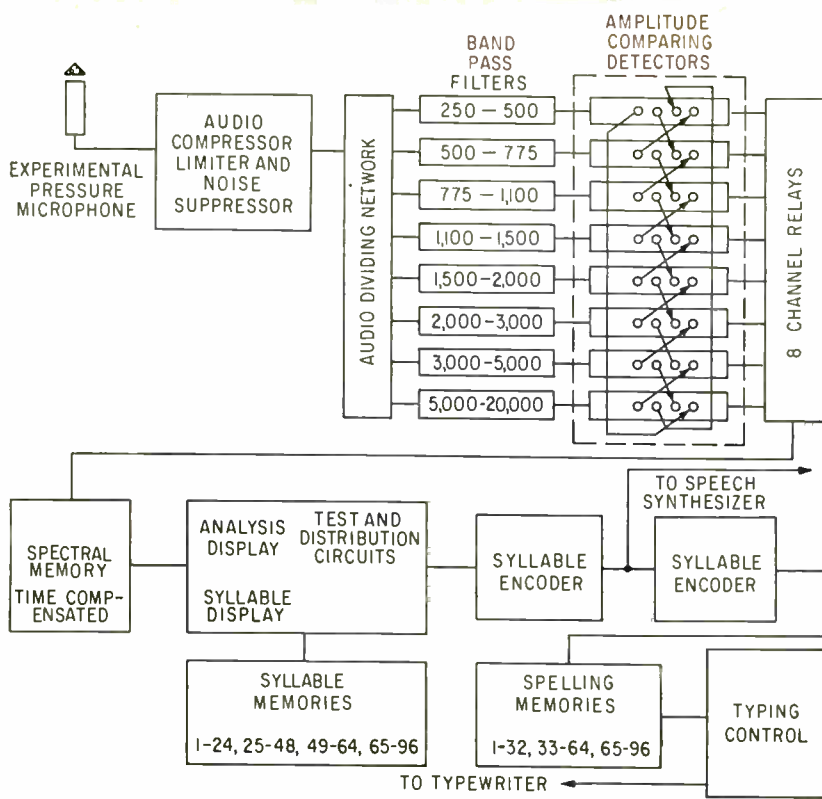

Speech input to microphone is analysed and converted into syllable code for operation of coded typer. RCA system types out words in real time

Speech Processor Types and Talks

SPEECH PROCESSING system able to convert monosyllabic speech into a syllable code, provide language translation, and speech synthesis plus typewriter output was demonstrated by RCA's Princeton Labs.

The equipment understands 52 monosyllabic words, 46 in English and 6 in French, can store up to 96 syllables, and operates in real time.

Printed output is 62 monosyllabic words, 48 in English and 14 in French, German and Spanish. Speech from the voice synthesizer is 50 words in three languages.

System operation begins with voice input to an experimental microphone. Syllables or monosyllabic words are compressed and limited. Low level noise effects are reduced in this amplitude-normalizing system. Eight band-pass filters—each a 10-section, high-pass, low-pass, constant-K design—separate the signal's frequency components and feed them to amplifier-rectifier units.

Each output d-c voltage, proportional to the signal envelope, is quantized to specify the second derivative of the frequency-spectrum-contour curve. Output of all channels gives spectral information,

amplitude-quantized for each syllable.

A time-compensated spectral memory permits various talking speeds and transfers spectral information to the frequency spectrum display.

Output of the memory goes to a syllable encoder for transmission to syllable decoders in various output systems. Printed output is provided by the code typer with its spelling memories and the typing control unit. Final typed output must be rewritten by a human, if words with similar sound but different spelling must be differentiated.

Maximum speaking rate is 11 words in 10 seconds, with a 60-ms delay before each syllable. A speech synthesizer may be connected as parallel output.

A language translation machine is inserted before any of the syllable decoding operations if desired.

The system requires only 23 bits per second bandwidth for coded transmission of normal speech, indicating communications uses.

The system is under development by Harry F. Olson, Herbert Belar and Ricardo de Sobrino. Continuing work will be funded by RCA and the Signal Corps.

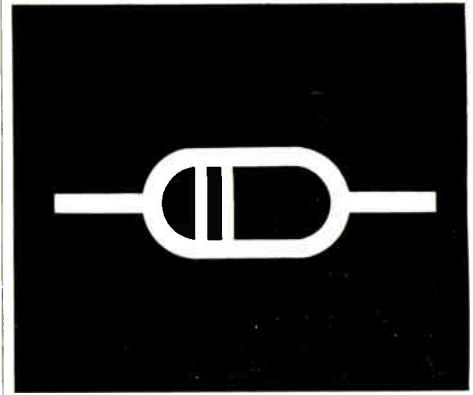

DELAY-LINE

Raychem coaxial delay line cables are pre-eminent in a field where technical excellence is the salient consideration. Specifically, these coaxial delay lines offer the most reliable performance for broad-band applications at microwave frequencies. This superior performance is the result of three distinctive features characteristic in Raychem coaxial delay lines.

- Lowest attenuation per nano-second of delay.
- Greatest attenuation stability over a wide temperature range (-55°C to 125°C).
- Lightest weight.

After all aspects have been considered, Raychem delay lines — with attenuation that is characteristically lower than other available delay lines — is the performance leader; and they weigh up to 30% less.



RAYCHEM
CORPORATION

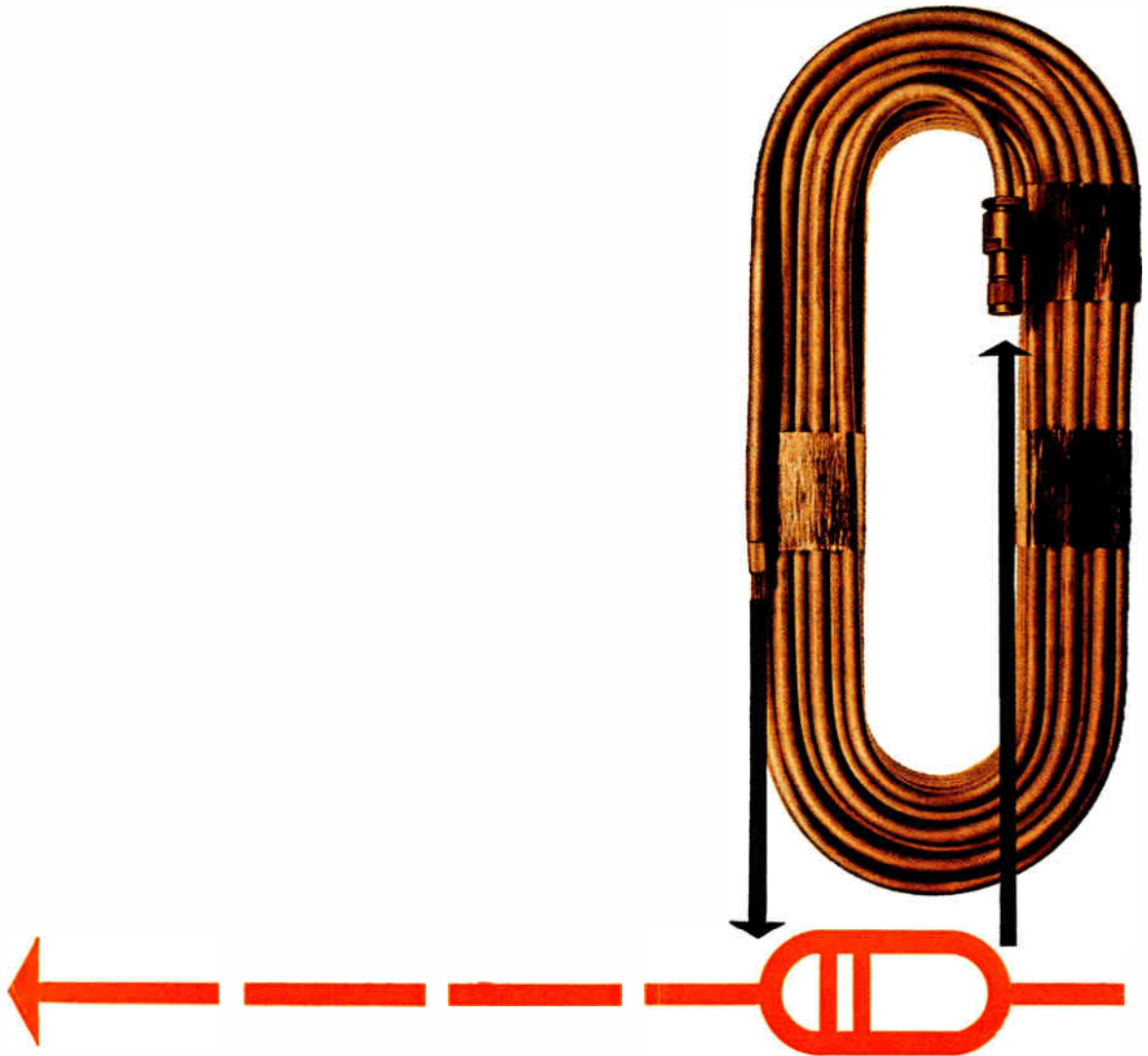

- LOWEST ATTENUATION PER NANOSECOND OF DELAY.
- GREATEST ATTENUATION STABILITY OVER A WIDE TEMPERATURE RANGE (-55°C TO 125°C).
- LIGHTEST WEIGHT.

DELAY-LINE

COAXIAL CABLE

LEADER IN RADIATION CHEMISTRY
FOR ELECTRONIC WIRE AND CABLE



RAYCHEM
CORPORATION

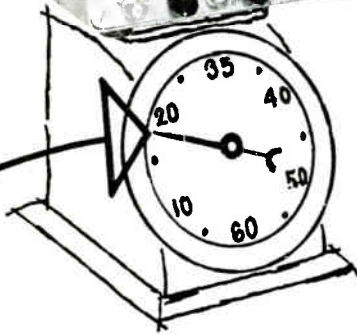
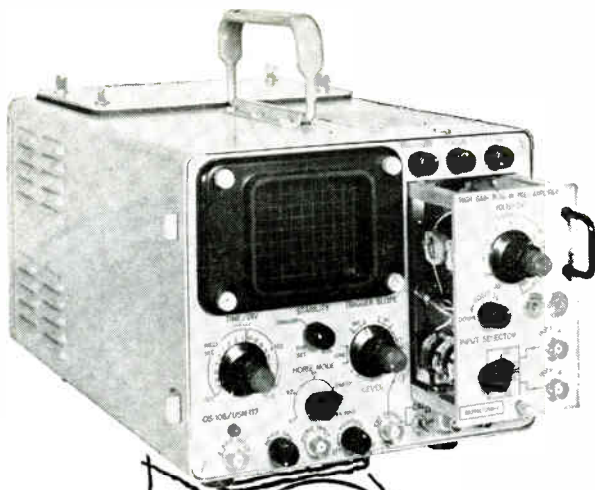

**THE
FIRST!**

ALL-TRANSISTOR MILITARIZED OSCILLOSCOPE

TO MIL-E-16400

ONLY 18 POUNDS

Draws less than
25 watts
DC to 6 mc
bandwidth
Plug-in
pre-amplifiers
(single or
dual trace)
100%
transistorized
(except CRT)
Fits in 1/2
cubic foot



MODEL K-106

The first all-transistor oscilloscope to meet MIL specs, the versatile K-106 packs 18 pounds of rugged dependability and high performance into an 8 $\frac{3}{4}$ " by 6 $\frac{1}{2}$ " by 14" carrying case. It can be hand carried for field or bench use, rack mounted without chassis modification for lab activities, or utilized as a systems component wherever space is at a premium. Full technical and performance data on the Model K-106 and all accessories are available upon request.

Model K-106 illustrated with optional probes, accessories and removable front cover.

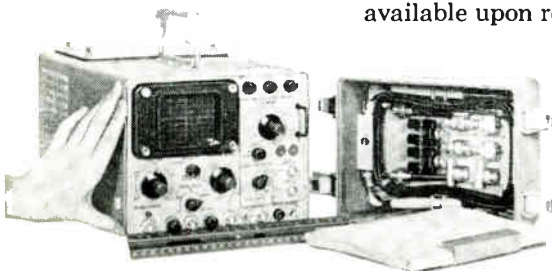

electronic tube & instrument division

of General Atronics Corporation

1200 E. MERMAID LANE, PHILADELPHIA 18, PENNA.

(formerly Electronic Tube Corporation)

MEETINGS AHEAD

AEROSPACE TRANSPORT, AIEE; Denver-Hilton Hotel, Denver, Colo., June 17-22.

BROADCAST & TELEVISION RECEIVERS CONFERENCE, IRE; O'Hare Inn, Chicago, Ill., June 18-19.

MILITARY ELECTRONICS 6TH NATIONAL CONVENTION, IRE-PGMIL; Shoreham Hotel, Washington, D. C., June 25-27.

ELECTROMAGNETIC THEORY & ANTENNAS SYMPOSIUM, Tech. Univ. of Denmark, et al; Copenhagen, June 25-30.

COMPUTER & DATA PROCESSING SYMPOSIUM, Denver Research Instit.; Estes Park, Colo., June 27-29.

AUTOMATIC CONTROL JOINT CONFERENCE, IRE-PGAC, AIEE, ISA, ASME, AICHE; N. Y. Univ., NYC. June 27-29.

RADIO PROPAGATION COURSE, National Bureau of Standards and University of Colorado; NBS Boulder Laboratories, Boulder, Colo., July 16-Aug 3.

RELIABILITY TRAINING CONFERENCE, IRE, ASQC; Princeton Inn, Princeton, N. J., July 9-13.

ENERGY CONVERSION PACIFIC CONFERENCE, AIEE; Fairmount Hotel, San Francisco, Calif., Aug. 13-16.

LUNAR MISSIONS MEETING, ARS; Pick-Carter and Statler-Hilton Hotels, Cleveland, Ohio, June 17-19.

MEDICINE & BIOLOGY DATA ACQUISITION AND PROCESSING, IRE-PGME, AIEE, ISA; Strong Memorial Hosp., Rochester, N. Y., July 18-19.

INTERNATIONAL SOUND FAIR, Institute of High Fidelity Manufacturers, Magnetic Recording Industry Assoc., et al; Cobo Hall, Detroit, July 25-29.

PRECISION ELECTRONIC MEASUREMENTS INTERNATIONAL CONFERENCE, IRE-PGI, NBS, AIEE; NBS Boulder Labs, Boulder, Colo., Aug 14-16.

CRYOGENIC ENGINEERING CONFERENCE, University of California; at UCLA, Los Angeles, Calif., Aug. 14-16.

ELECTRONIC CIRCUIT PACKAGING SYMPOSIUM, U. of Colorado, et al; at U. of Colorado, Boulder, Colo.; Aug. 15-17.

AIRCRAFT & MISSILES JOINT WESTERN REGIONAL CONFERENCE, ASQC; Benjamin Franklin Hotel, Seattle, Wash., Aug. 16-18.

APPLICATIONS & RELIABILITY SYMPOSIUM, Precision Potentiometer Manufacturer's Assoc.; Statler-Hilton Hotel, Los Angeles, August 20.

WESTERN ELECTRONICS SHOW AND CONFERENCE, WEMA, IRE, Los Angeles, Calif., Aug. 21-24.

METALLURGY OF SEMICONDUCTOR MATERIALS CONFERENCE, the American Institute of Mining, et al; Ben Franklin Hotel, Philadelphia, Pa., Aug. 27-29.

BALLISTIC MISSILE & SPACE TECHNOLOGY SYMPOSIUM, U. S. Air Force and Aerospace Corp.; Statler Hilton Hotel, Los Angeles, August 27-29.

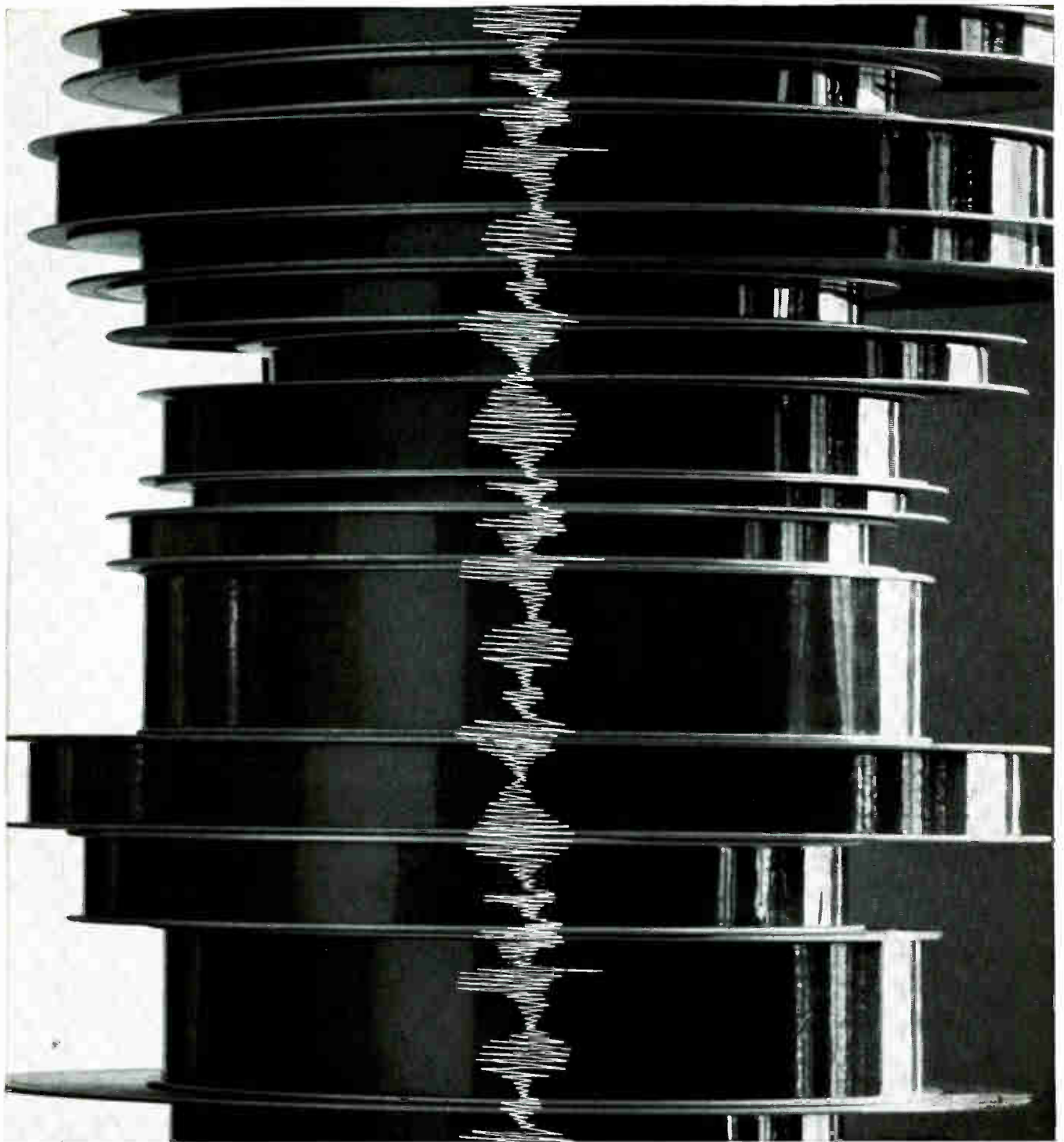

Who knows enough about instrumentation to make tapes for every need? **AMPEX.**

If you'd care to count, you'd find over 153 instrumentation tapes at Ampex. The result: Ampex can offer you a tape for every application. Not just an ordinary tape, but one that insures precise performance — every time. Then, it's only natural the finest instrumentation tape comes from Ampex: the company that makes the largest line of instrumentation recorders, the company that pioneered magnetic recording. Each reel

of tape is based upon this advanced magnetic technology. And it's backed by an extensive application engineering program to give you assistance whenever needed. Ampex instrumentation tape is available almost anywhere. For details write the only company providing tape and recorders for every application: Ampex Corporation, 934 Charter St., Redwood City, California. Sales and service engineers throughout the world.



Announcing the newest member of
Western Electric—Laureldale's Family
of Coaxial Magnetrons:

8123 KU-BAND COAXIAL MAGNETRON

Tunable
16 to 17 Gc

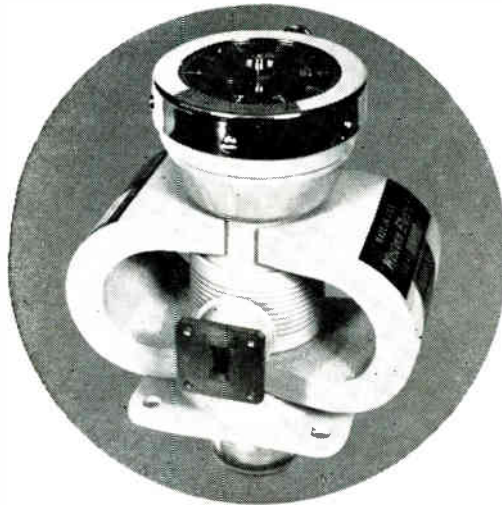

Weight
8¼ Pounds

HIGHLY STABLE FOR AIR-BORNE MTI APPLICATIONS

The 8123 magnetron is the latest addition to the coaxial family of magnetrons produced by the Laureldale Plant of Western Electric. Designed by Bell Telephone Laboratories, this tube is ruggedized to minimize vibration-induced frequency modulation and frequency shifts due to atmospheric pressure changes. The power output variation across the band is typically ± 0.25 db with an average operating efficiency of 40 per cent.

TYPICAL 8123 COAXIAL MAGNETRON CHARACTERISTICS

Peak Power Output kw	Pushing Factor Mc/A	Pulling Factor Mc	r.m.s. Jitter			Missing Pulses %
			Fj kc	Vj db	tj nsec	
70	0.06	6	13	0.02	1.5	< 0.001

Another ruggedized coaxial magnetron, the 7208B, is also available. This tube tunes the frequency range of 15.5 to 17.5 Gc with a peak power output of 130 kw.

Coaxial magnetrons may be purchased from Western Electric's Laureldale Plant. For technical information, price and delivery, address your request to Sales Department, Room 102, Western Electric Company, Incorporated, Laureldale, Pa. Telephone—Area Code 215—929-5811.

LAURELDALE PLANT
MAKER OF ELECTRON PRODUCTS



Latest Thin-Film Circuit Techniques

Application of thin-film techniques to relatively complex electronic circuit shows advantages of this type of construction and miniaturization

By **EVERETT E. EBERHARD**

Solid State Systems Division, Motorola Inc., Phoenix, Arizona

INTEGRATED ELECTRONICS has much to offer in increased systems reliability, reduction of size and weight and in lower equipment manufacturing costs. Research and intensive investigation into this field have already yielded sufficient success to warrant optimistic predictions and, in missile systems, computers and personal communications, the techniques of integrated circuits are expected to influence design philosophies in the future.

An example of recent work is an integrated thin-film version of a 64-step voltage staircase generator. The generator consists of an R-C clock, six binary counters and a summing network. A flexible printed wiring board provides interconnections between submodules.

Purpose of the development was to demonstrate the advantages offered by this manufacturing method to space electronics. Accordingly, the circuits were de-

signed to have smallest weight, least volume and lowest power consumption consistent with high reliability, producibility, accessibility and cost. Additionally, individual components were made easy to reach, and the thin-film submodules capable of replacement without damage to themselves or the printed wiring board.

The circuit was a conventional staircase generator with electrical characteristics including an output of a repetitive staircase waveform having 64 equally spaced potential steps between and including the minimum and maximum voltages. A clock signal (used to initiate each step) was produced by a free-running astable multivibrator with a frequency of about 40 cps. Six binary counters and clamp circuits were used to sum the voltages obtained from a zener diode voltage reference using a resistor network.

Figure 1A is a schematic of the

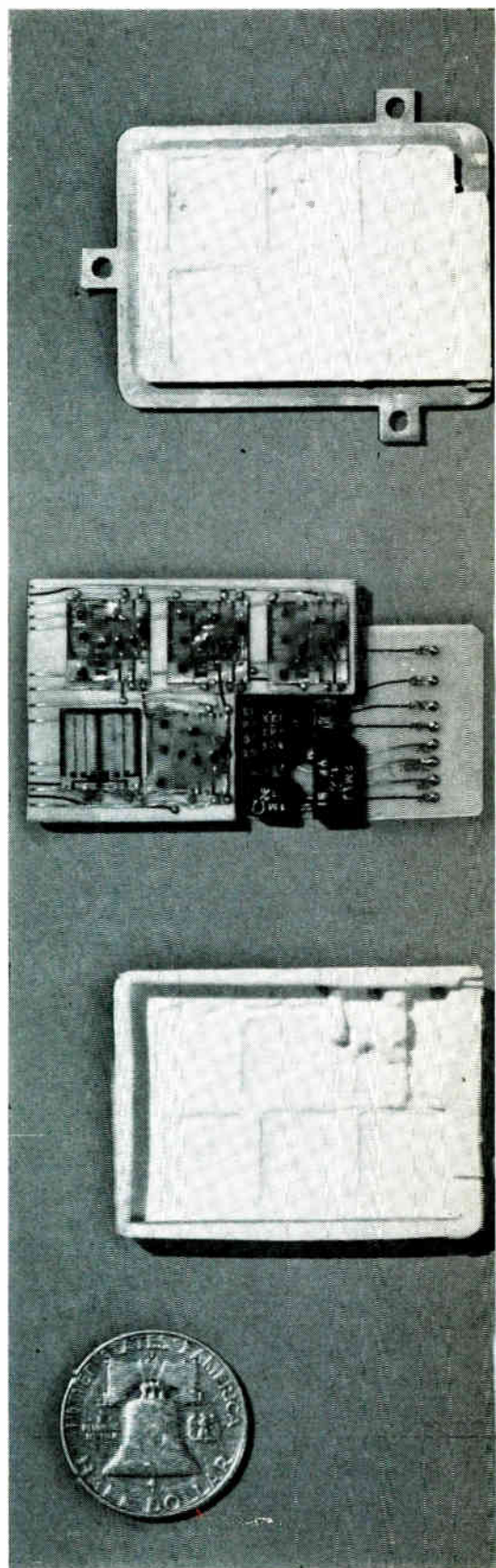

Disassembled view of the staircase generator shows the case, printed-board assembly and the two silicone rubber shrouds

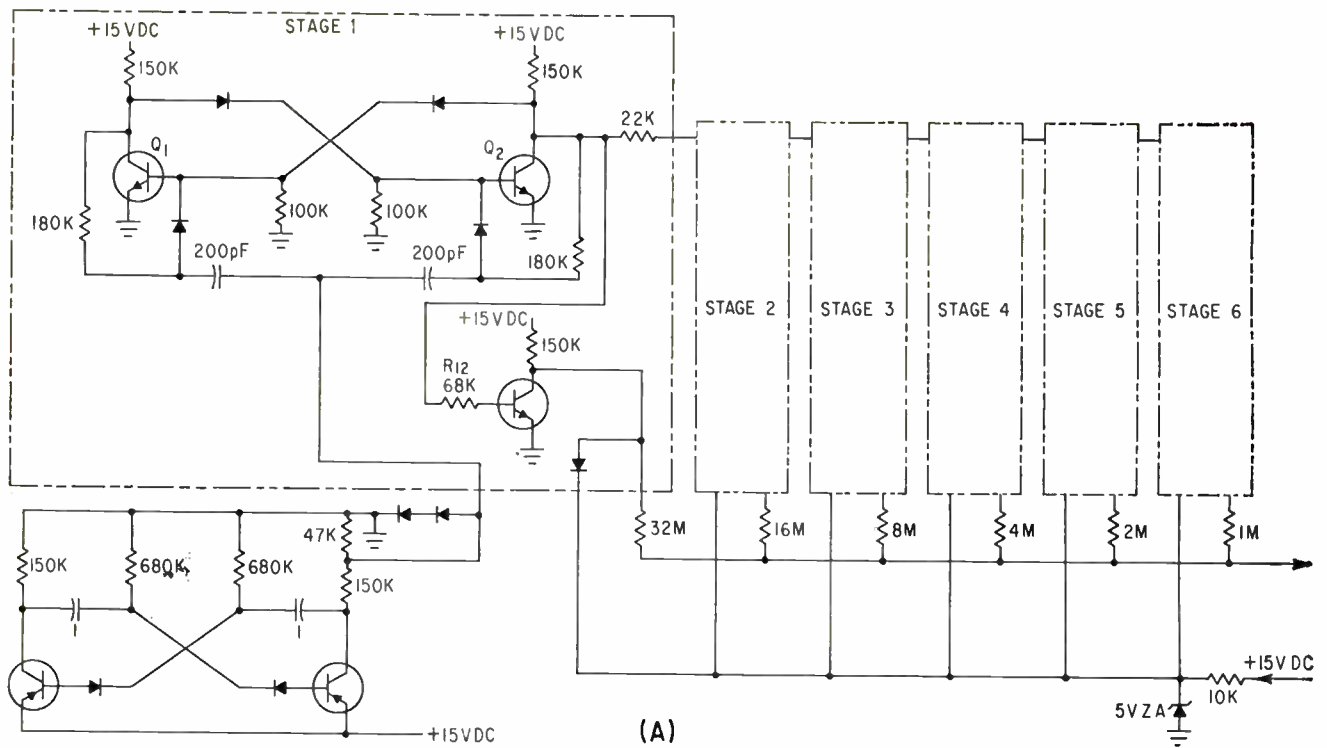

FIG. 1—Original circuit of the staircase generator before modification for thin-film construction (A), and modified

circuit. Figure 1B is the same circuit with modifications to improve the producibility of a thin-film equivalent. These modifications include dropping the supply voltage from 15 to 6 volts, thus reducing power drain by nearly 50 percent. The lower reference voltage permits a substantial reduction in the summing resistor network values, thus reducing the size and weight of these elements. Another modification was the substitution of *npn* silicon transistors for *pnp* units; *pnp* uncased transistors were not readily available when the circuit was in development.

A breadboard of the modified circuit of Fig. 1B was constructed using conventional components and was evaluated to determine component center values and tolerances. The circuit operated satisfactorily over a temperature range of -20 to $+55$ C.

During the next design phase, the circuit of Fig. 2 was divided into functional submodules, thin-film layouts of the submodules made, active elements chosen and test procedures established.

The voltage staircase generator consists of nine submodules with a basic clock astable multivibrator circuit (minus the timing capacitors) placed on one substrate; clock timing capacitors on one sub-

strate to set the clock frequency; six binary counters and clamp circuits, each on one substrate; a 4 and an 8 megohm resistor on one substrate.

The summing resistors and zener reference diode are conventional components.

The resistors were formed by first coating the substrate with a thin film of tin oxide, followed by etching to delineate the resistor pattern. A film resistance of 5,000 ohms per square was used for all resistors. A conductor pattern was created on a substrate by vacuum evaporation of chrome-gold alloy through a metallic mask.

Tantalum film capacitors were used because they provide a large

capacitance value per unit substrate area. These were constructed by the anodization of a vacuum-deposited tantalum film and the deposition of a gold counterelectrode.

The submodules were designed for Pacific Semiconductor PD101 microdiodes and Fairchild Semiconductor FSP-42-1 uncased transistors. These transistors have similar characteristics to type 2N697. A saturation voltage of less than 0.2 volt at the test current was acceptable. A test circuit providing 100 microamperes for the collector and 10 microamperes for the base was used to check the saturation characteristic. These circuit components were used to convert the breadboard to thin-film integrated

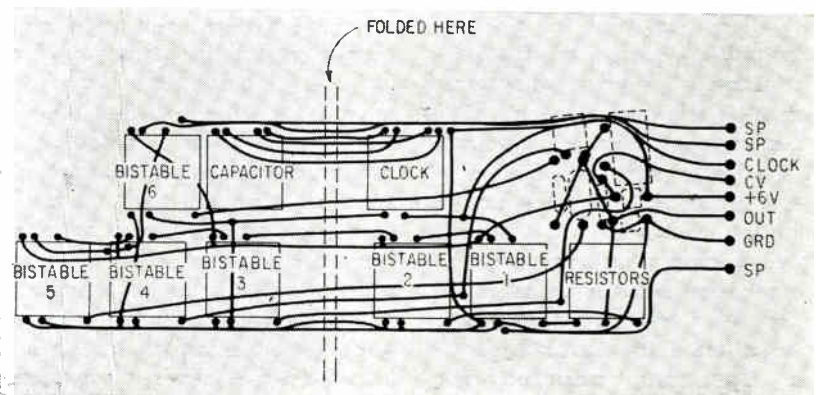
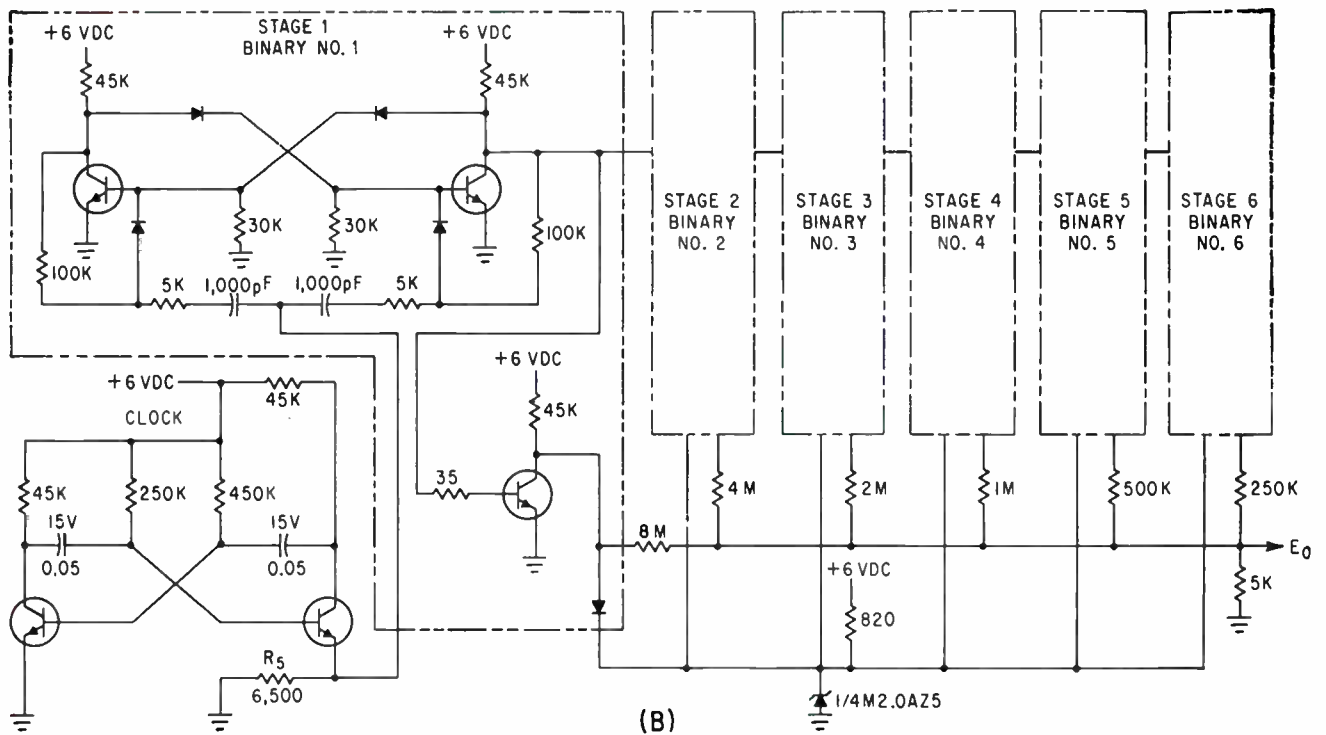

FIG. 2—Layout of the flexible printed board



version of the generator circuit (B). Power-supply voltage has been lowered to 6 volts to reduce component sizes

circuit layouts.

Each submodule was constructed on a ceramic substrate $0.5 \times 0.5 \times 0.020$ inch. One face was used for the thin-film components and active elements, with the edges utilized for the interconnection of submodules. Solder connection tabs were provided to facilitate the installation of diodes and transistors on the submodules. Submodules were provided with leads for connection to the flexible wiring board.

The resistance films were first checked for value of ohms per square. After fabrication of the passive components, a complete electrical test was made to determine the value of all resistors and

capacitor and the leakage and dissipation factor of each capacitor. These were all probe measurements. Each diode and transistor was tested prior to installation.

Each submodule was tested by itself before a complete set was assembled as a staircase generator. Measurements such as square-wave input amplitude, output, saturation voltage at the collectors of bistable and clamp transistors and rise times were made on each bistable submodule.

To provide accessibility and flexibility, the module was fabricated with a flexible printed wiring board made of 10-mil epoxy-glass fiber laminate folded 180 degrees over a center Silastic core.

Nine submodules were attached to the outside surface of the board, and seven conventional electrical components were attached to the underside at one end of the board. The opposite end of the board is cut away to allow access to the conventional components from both sides after the flexible board is folded. Figure 2 shows the layout of the flexible printed wiring board supporting and interconnecting the submodules and Fig. 3 is an assembly sketch of the complete module. Input and output are provided on a tab extension.

The set of submodules was fastened to the flexible printed circuit board with a silastic adhesive and the external leads were soldered to points on the printed circuit pattern. This adhesive can be stripped from the board so that entire submodules can be replaced.

The circuit board assembly was then encapsulated in a shell of silicone rubber within the outside metal case. Figure 4 shows the disassembled module consisting of metal cover, base plate with silicone rubber, silicone rubber shroud and printed circuit board assembly. The process permits disassembly without damage to the encapsulation. When assembled in its metal case, the unit is protected from shock and vibration.

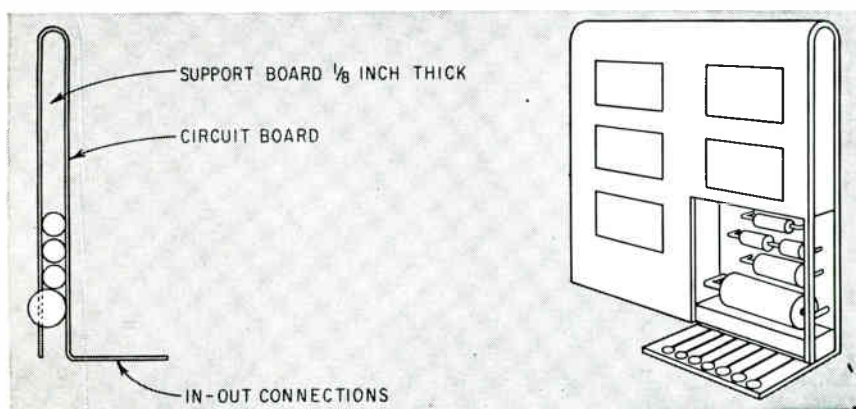
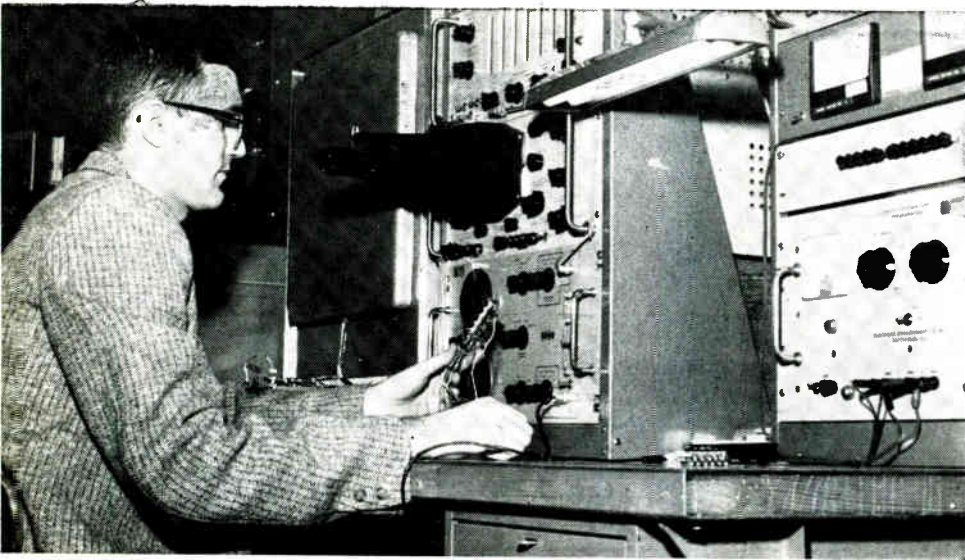
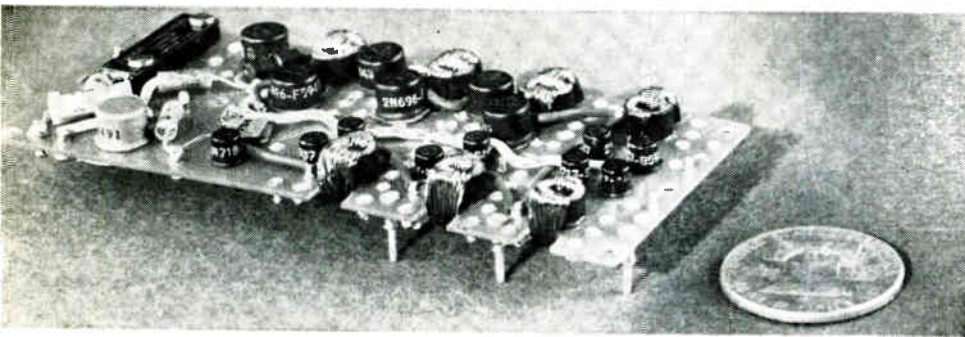

FIG. 3—Method of folding flexible board over the Silastic core

New Idea In Counting:



Technician checks unit using four counter stages and one pulse forming element. The four cascaded stages count up to 10^4



Timer-programmer designed for satellite application uses incrementally magnetized cores. Reliability is excellent

MULTI-PULSE MAGNETIC COUNTERS are now developed to the point where they have distinct advantages over conventional components in many applications. In the area of digital computing and control, the handling of information in binary form has become almost universal. This is because until recently, most circuits available for digital applications have been bistable in operation.

The multi-pulse magnetic counter is a circuit element in which a single core of square hysteresis loop material is driven in a number of discrete steps from one saturated state to the opposite state. For example, where a 10 to 1 count is required a circuit consisting of a single core and one or two transistors will provide an output pulse after receiving 10 input pulses. It can therefore do the work

of four binary elements (Eccles-Jordan multivibrators) requiring eight transistors. Some other inherent advantages of this circuit element are storage without power applied, zero standby power drain and compactness.

This article describes the Incrementag, a multi-pulse magnetic counting element which has proven itself in some of the most rigorous missile and space applications¹. Stable pulse counts up to 16 are obtained over wide ranges of temperature and supply voltage using a single core.

While the general principle of this device has been known for some time²⁻⁶, recent improvements have increased the reliability and operating range over those previously obtained with multi-pulse magnetic counters.⁷

A typical counting stage and its

By J. D. FREEMAN
General Time Corporation,
Stamford, Conn.

pulse forming circuit are shown in Fig. 1. The counter consists of a single toroidal core of square-loop magnetic material wound with a number of turns of fine wire. Two transistors and four resistors complete the circuit. The magnetic core may be thought of as a bucket which will hold a fixed quantity of flux. The bucket is filled by an integral number of ladles of flux of constant magnitude. To ensure constant-volume ladles the counter stage is driven by another counter stage, or from a pulse forming circuit that provides this constancy. In either case, successive pulses of constant volt-second area (representing ladles) are applied to the core winding. When the required number of these pulses have been applied, the core will be driven to positive saturation. Figure 2 shows the resulting incremental magnetization of the counter's core.

The fall of the last input pulse is arranged to trigger a second transistor in the circuit, which then drives the core out of positive saturation, and back to negative saturation. When negative saturation is reached, the circuit is at its initial state. Taking the core from one saturated state to the other, provides a pulse of fixed volt-second area in the output winding.

The output pulse from each counting stage may therefore be used as a ladle of constant volt-second area to fill another counter. As many stages as desired may be cascaded to provide a train of any desired count. The first counter stage in such a train must be supplied by a pulse former, which provides the required constant volt-second pulse regardless of the characteristics of the input pulses. The pulse former consists of a core (identical to the counter cores) with tapped windings, two transistors, and four resistors; the pulse former is therefore essen-

Incrementally Magnetized Cores

Single magnetic core counts up to 16 input pulses before saturating, can replace 4 pairs of binary transistor counters. Magnetic core retains count with supply removed; power consumption when operating is very low

tially the same as a count-of-one In-cremag. The input transistor of the pulse former is in the common emitter configuration, providing a high input resistance to the signal.

In any multi-pulse magnetic counter, means must be provided to deliver an output pulse when the required number of input pulses have driven the core to saturation, and to reset the core to the opposite state of saturation when the correct number of pulses have been received. For the counter to be stable under all conditions, the circuit must accurately sense the saturated state of the core and still not be triggered into resetting by a flux condition near saturation.

Figure 2 shows an idealized ϕ - H loop for a typical magnetic counting core. In the quiescent condition, the core is at negative remanence $-\phi_r$, designated by point

a on the ϕ - H loop. When a negative pulse is applied to gate transistor Q_1 of the counter, the integral of the impressed voltage with respect to time causes a flux change described by points a b b' , with flux ending up at a' when the pulse is completed. The next pulse leaves the core at condition a'' and the following one at condition a''' . The fall of the impressed input pulse occurs in time t_r .

Because of the deviation of the ϕ - H loop from a rectilinear shape, a small change in flux $\delta\phi_{ns}$ occurs during time t_r as indicated by the slope of lines $b'a'$, $b''a''$, and so on. This change in flux gives rise to a voltage pulse opposite in polarity to the input voltage. Applying Faraday's Law $V_{a''''''} = (N_1 + N_2 + N_3) \delta\phi_{ns}/t_r$

When the core has received a number of input pulses such that

$n (V_p t_i) \geq (N_1 + N_2 + N_3) 2 \phi_M$, it reaches the so-called saturated condition. Because of the deviation of the ϕ - H loop from a rectilinear shape however, there is a small but finite increase in flux as further magnetizing force is applied. If, for example, half of input pulse n is sufficient to bring the core to point d , Fig. 2, then during the remainder of this pulse, the core is driven to point e owing to core saturation. The sudden saturation of the core has reduced the impedance of the circuit to the sum of the saturation resistance of transistor Q_1 and the copper resistance of the windings. The magnetizing force therefore increases suddenly to H_s .

When the n th pulse falls to zero, the core is brought to the positive remanent $+\phi_r$ condition shown as point f in Fig. 2. This sudden decrease in flux $\delta\phi$, from point e to

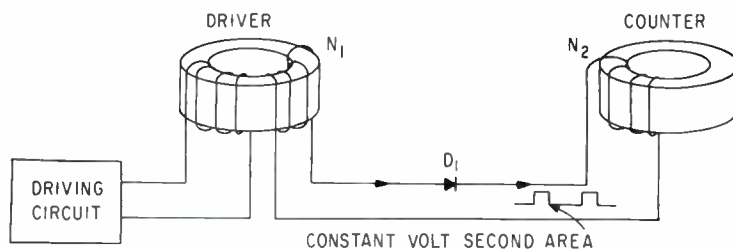

(A)

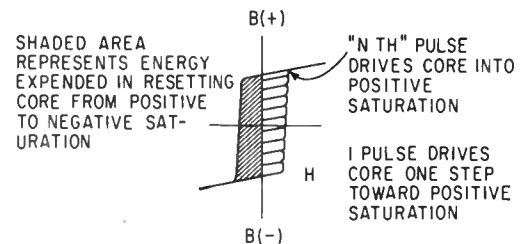

INCREMENTAL MAGNETIZATION OF COUNTER'S CORE

(B)

SATURATING BY SMALL DOSES

The multipulse magnetic counter uses the relatively new technique of adding increments of magnetism to a square-hysteresis loop core until the core is saturated. The number of pulses necessary to drive the core to saturation represents the count produced by that core. Typical cores will count up to 16 pulses; readout is initiated by the final pulse that produces saturation.

Counting cores may be cascaded to produce lengthy dividing chains. The basic requirement for such a chain is a source of constant volt-second-area driving pulses, plus a method of resetting each core when it reaches saturation. In the basic circuit (A) the driver stage generates a pulse of constant volt-second area every time it is switched from saturation of one polarity to satura-

tion of the other. Thus, switching between the limits of core saturation affords the necessary constancy to the drive pulses. The diode D , between driver and counter ensures that only pulses of one polarity reach the counter, as shown in (B).

Operating speed of the counter goes up to 100 Kc, while at the other end of the speed range, the core may receive one pulse per hour or per day without loss of precision. Output pulses up to 0.1 watt are available; normal output is a $1\frac{1}{2}$ -volt pulse of 2-3 microsecond duration. Power consumption depends upon frequency, most of the power being absorbed by the driver stage; typical consumption of one type counter chain when operating at 100 Kc is around 250 milliwatts

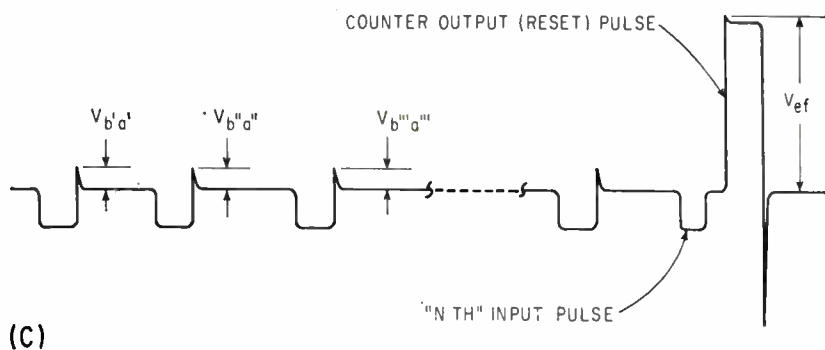
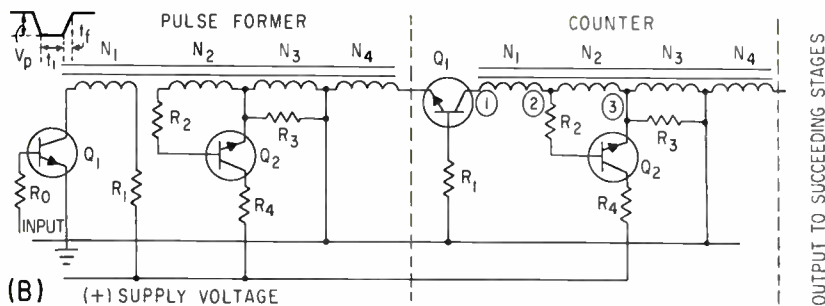
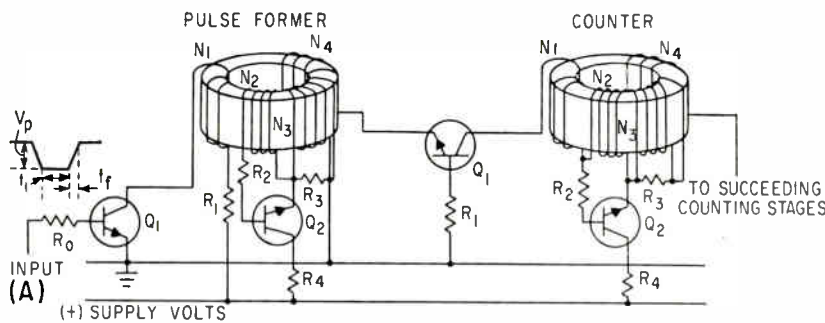

FIG. 1—Schematic circuit shows pulse shaper and first stage of a counting chain (A); redrawn circuit shows arrangement of blocking oscillator used to reset core (B); final saturating input pulse triggers blocking oscillator and produces output waveform (C)

power supply should not limit i_s to a value appreciably lower than indicated. Actually resistor R_s in parallel with winding N_s will lower the total resistance of the circuit, but with the core saturated this effect is negligible.

The ratio of V_{r1} , the required reset triggering voltage, to a typical intermediate pulse voltage such as $b''' a'''$ that must not trigger the Increment's reset action is approximated as follows

$$\frac{V_{r1}}{V_{b''' a'''}} = \frac{\delta\phi_s}{\delta\phi_{n3}} = \frac{H_s}{H_c} = \frac{i_s}{i_n}$$

$$= \frac{V_s - (V_{CE})_{Q1 SAT}}{r_N} \times \frac{4\pi(N_1 + N_2 + N_3)}{10Hl}$$

It is apparent this ratio must be made high to ensure stable counting operation of the Increment.

Figure 1C shows the relative values of these voltages as they occur in driving the core to saturation with square pulses of constant volt-second area. The magnitude of the undesirable voltage spikes V_{ba} , $V_{b'a'}$, and so on, appear to be increasing slightly as the core approaches saturation. This indicates deviation of the actual ϕ - H loop from a rectilinear shape.

The remotely set timer application, Fig. 4, provides an output pulse occurring at a precise time after a start command, where this time interval must be remotely set.

Suppose for example that intervals from 1 second to 1 hour are desired. A 10 Kc oscillator applies pulses through AND gate A to a frequency dividing train. This train consists of pulse former PF₁ and counters K₁ thru K_n, each having counts of 10 so that the total frequency division is 10,000. Pulses at a rate of 1 pps are therefore applied to the storage unit consisting of PF₂ and counters K₁ through K_n. The storage unit, which has a total count of 3,600, may also receive set pulses up to 100,000 Kc through OR gate OR₁. The time interval is obtained by applying (3,600- n) set pulses where n is the time interval in seconds. (Set pulses are applied prior to counting and are retained in the storage unit).

For example, if a time interval of 1,546 seconds is desired, 3,600-

point f induces a voltage across the core windings expressed by $V_{r1} = (N_1 + N_2 + N_3) \delta\phi_s / t_r$.

Figure 1C shows the voltage waveform appearing across the windings of the counter circuit. The difference in amplitude between the small positive voltage spikes V_{ba} , $V_{b'a'}$, etc., and the large voltage spike V_{r1} is of prime importance. Voltage V_{r1} is used to trigger the reset or blocking oscillator circuit consisting of transistor Q₂, windings N_2 and N_3 , and resistors R_2 and R_3 . Voltages V_{ba} , $V_{b'a'}$, $V_{b''a''}$, must not be permitted to trigger the reset circuit. Dividing $V_{r1} / V_{b''' a'''}} = \delta\phi_s / \delta\phi_{n3}$.

Experiments show that because of the nearly equal slopes of lines ef and $b''' a'''$ for certain core materials $\delta\phi_s / \delta\phi_{n3} \approx H_s / H_c$.

The value of the coercive magnetizing force H_c may be obtained from typical B-H loops, though its

value will be determined by applied magnetizing force as a function of time. When a reasonably square voltage pulse is applied to the winding of a typical square-loop toroidal core, and the average current in the winding measured as the core is driven from point b to point d , it follows the relationship $i_n = 10 H_c l / 4\pi (N_1 + N_2 + N_3)$ where l = mean length of the core. Coercive force H_c , approximates the value obtained from the 60 cycle sine current loop of the given core.

It may be assumed that the magnetizing force H_s is limited only by saturation resistance of transistor Q₁, plus the resistance of core windings $(N_1 + N_2 + N_3)$. The current driving the core to the flux condition of point e is therefore $i_s = V_s - V_{CE} / r_N$ where r_N is the resistance of windings and V_{CE} applies to Q₁ in its saturated condition. The output impedance of the

1,546 — 2,054 set pulses are applied to the storage unit in advance of counting. At the desired time the start pulse sets FF_1 , which in turn enables gate A and starts the time interval. When 1,546 pulses (at the 1 pps rate) have been applied to the storage unit by the frequency divider, the storage unit has received its total capacity of pulses (2,054 set pulses plus 1,546 timing pulses = 3,600 pulses), and therefore K_8 delivers an output pulse. This marks the end of the timed interval.

The output pulse from K_8 is applied to FF_1 to reset it, and thereby stop the system. All counters are empty at this instant, with their cores at negative remanence. The system is ready to be set for another time interval when desired.

A decimal coded storage built around the Incremag is shown functionally in Fig. 4. In this application, random pulses of any nature may be counted and stored indefinitely. Upon command, the number of pulses stored may be read out in decimal coded form without destroying the storage. The system shown in Fig. 4A has a maximum storage of 10^4 pulses, but this may be increased by adding further stages. For example, assume that a series of 8,473 pulses representing some measured variable or count have been applied to and stored in the system. Upon command, the circuit will deliver a series of 8 pulses, then 4 pulses, then 7, and then 3 pulses with marker pulses interspersed between them as shown in Fig. 4B.

With clock train pulses supplied at the 100,000 pps rate, read-out time will be approximately 110 microseconds per stage. For the 4-decade system of Fig. 4A the total read-out time will be 440 microseconds.

REFERENCES

- 1) J. D. Freeman, The Tiros I Timer, Astronautics, June 1960.
- 2) R. I. Van Nice, and L. C. Lyman, Pre-determined Scaler Utilizing Transistors and Magnetic Cores, Proc. National Electronics Conference 1955, p 859, 11, 1956.
- 3) J. R. Horsch, A Highly Reliable Pulse Scaler of Arbitrary Order, Proc. National Electronics Conference 1955, p 870, 11, 1956.
- 4) J. R. Bacon and G. H. Barnes, Quantized-Flux Counter, IRE Wescon Convention Record, p 246, 1957.
- 5) G. F. Pittman, Jr., Time-Delay Device Using Transistors, Electrical Engineering, 74, p 498, June 1955.
- 6) A. J. Meyerhoff, ed. "Digital Applications of Magnetic Devices," John Wiley and Sons, New York, 1960.
- 7) Neitzert (General Time Corporation) Patent No. 2897380 and other patents pending.

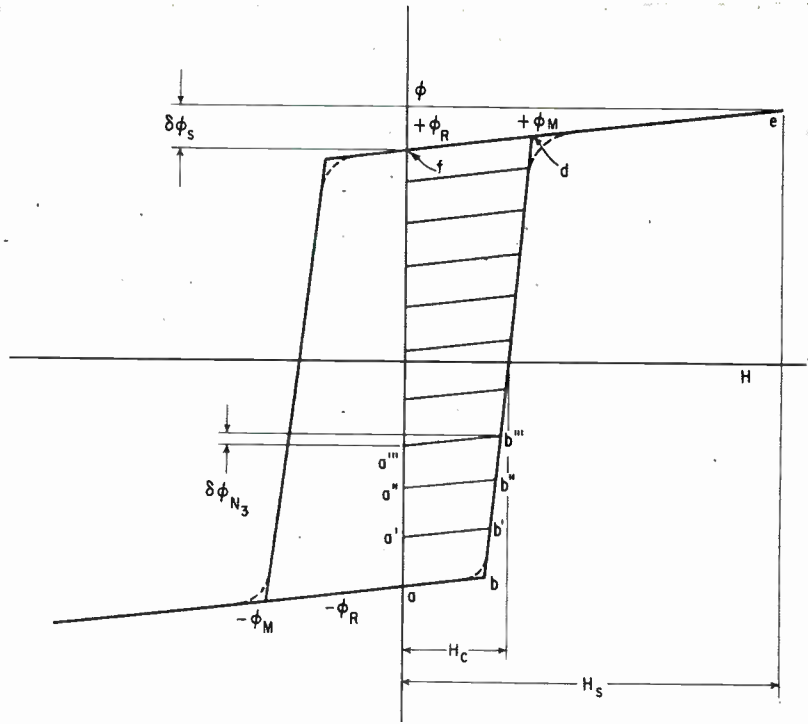

FIG. 2—Hysteresis loop shows this core is saturated by tenth input pulse. For given core, external circuit resistance and other parameters are adjusted to insure correct count. Adjustable counting is available with some cores; maximum count is 16

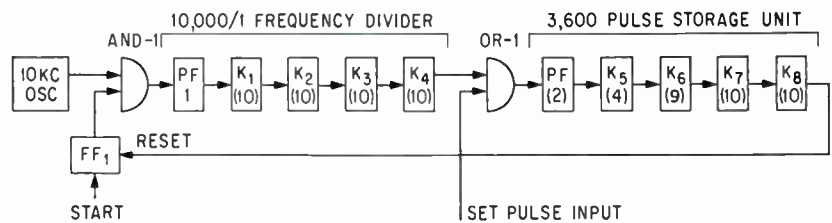
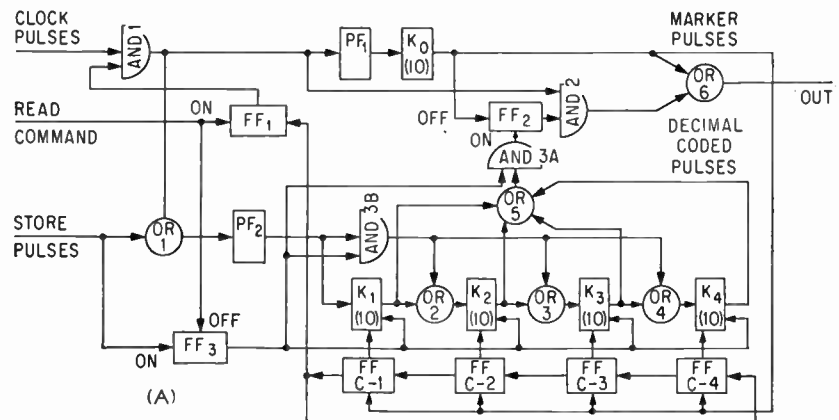

FIG. 3—Divider chain delivers output pulse after preset number of seconds when driven by 10 Kc oscillator. Storage unit is partly filled (saturated) before counting; delivers output when last stage reaches saturation. Information may be stored for days without deterioration



EXAMPLE:
8473 IS NUMBER OF PULSES STORED AND THEN READ OUT.
8 4 7 3
MARKER PULSES
READ-OUT TIME $\approx 440 \mu$ SEC

FIG. 4—Circuit counts random number of pulses, stores them, then reads out content when required (A). Counts held in each storage stage are read out independently (B). Read out occurs nondestructively

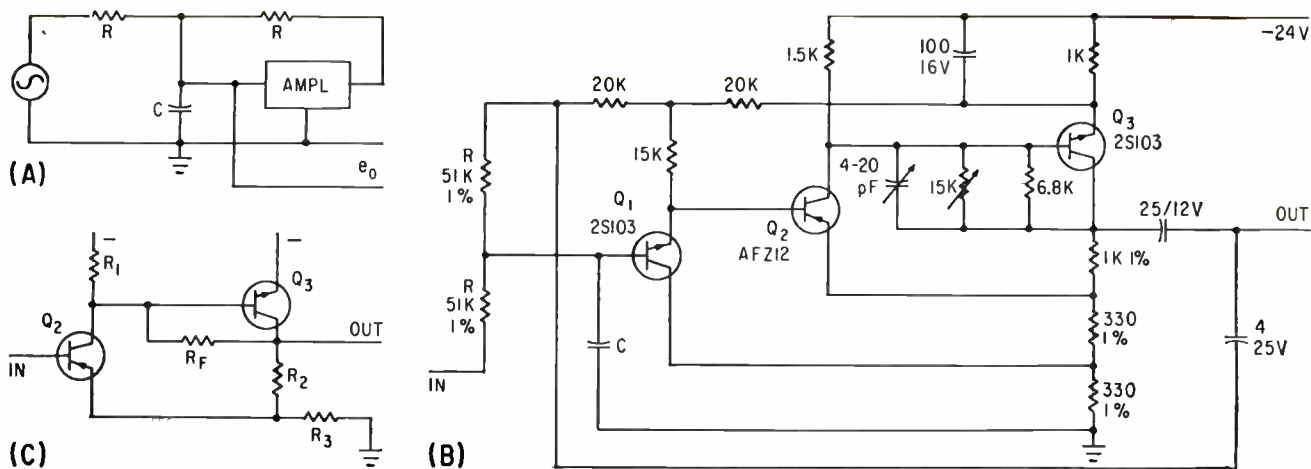

FIG. 1—Basic integrator (A); complete integrator circuit (B); simplified circuit of feedback pair (C)

Probes for Plasma Research

Compensated R-C circuit for plasma research has less than 2-percent

By S. BERGLUND and S. WESTERLUND
 Dept. of Physics, University of Uppsala, Sweden

IN PLASMA RESEARCH, magnetic probes, which are small coils placed outside the plasma or in some way inserted into it, are frequently used to study magnetic field distributions and field diffusions. Since the induced voltage is proportional to the rate of change of magnetic flux through the coil winding, the signal is normally integrated with respect to time before it is displayed on an oscilloscope. The bandwidths required for the integration may be large, stretching from the low frequency of some quasi-stationary stabilizing field up to the wide frequency spectrum of erratic magnetic-field fluctuations.

The integrators normally chosen are the simple R-C circuit or the Miller integrator. However, the former has a poor output-input ratio and the latter has an inherent limitation in its high-frequency response, although there are a number of means of extending its bandwidth by auxiliary circuits.¹

This integrator is based on a compensated R-C circuit, similar to the bootstrap integrator² or circuits reproduced by Puckle³ and Holbrook.⁴ Its principle is shown in Fig. 1A. Neglecting the effects of input and output impedances of the amplifier:

$$\frac{e_o}{e_i} = \frac{1}{j\omega RC + (2 - A)}$$

If the amplification is $A = 2$ without phase shift, the transfer function becomes $e_o/e_i = 1/j\omega RC$, and the circuit is an ideal integrator⁴ with an infinite R-C time. The integrated signal is taken from the amplifier input.

In practice the input impedance of the amplifier cannot be infinitely large nor can the amplification be exactly equal to 2. Assuming a resistive amplifier

input impedance equal to R_{in} and putting $R/R_{in} = \epsilon$ and $(2 - A) = \delta$, the response of the circuit becomes

$$\frac{e_o}{e_i} = \frac{1}{j\omega RC' + \epsilon + \delta}$$

and the effective R-C time is $RC/(\epsilon + \delta)$.

From this expression, the amplifier should have a high input resistance, that is, much larger than the integrator resistance R , and a constant gain without phase shift in the lower part of the passband. Its bandwidth, on the other hand, could be limited, if the integrated signals were to be taken at the amplifier input, since at higher frequencies ωRC becomes large in comparison to $(\epsilon + \delta)$. The amplifier is, however, most generally used for both integration and amplification and its bandwidth must be large enough to handle the whole frequency spectrum of interest.

Figure 1B shows the circuit of the integrator, where the integrator resistances R form a part of the bias stabilization network. The high input impedance of the emitter follower Q_1 , can then be fully utilized. Transistors Q_2 and Q_3 are common-emitter stages in a feedback pair combination. As the circuit must be a compromise between the need for a stable gain at low frequencies and a large bandwidth with small overshoot for pulse signals, considerable local feedback is introduced: series feedback to Q_2 and parallel feedback to Q_3 , resulting in a high input and a low output impedance for the pair. This approach is carried further by the overall feedback of about 14 db from the collector of Q_3 to the emitter of Q_2 , which reduces the voltage gain to 2. The gain is adjustable by the collector-base potentiometer of Q_3 .

In a low-frequency analysis of the circuit (see Fig. 1C) the internal collector-base feedback resistance of the transistors can be omitted without introducing error, as the load impedance of Q_2 is low and

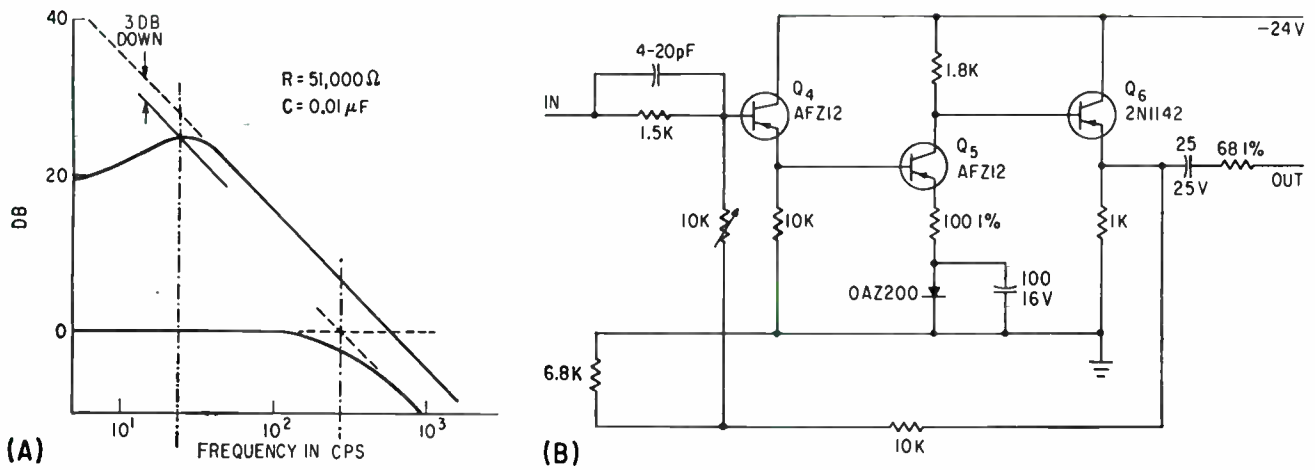

FIG. 2—Measured low-frequency response of integrator (A); line-driving amplifier (B)

With Wideband Integrators

overshoot at the 3-db-down point of 20 Mc

the coupling of Q_3 gives this transistor a low external feedback impedance from collector to base. Supposing the base current of Q_2 to be i_b , the collector current is $\beta_2 i_b$ and flows almost entirely into the third stage, as the input impedance of this is low compared to R_1 . If the current through the collector-base feedback chain of Q_3 is denoted by i_F , the collector current of Q_3 becomes $i_3 = \beta_3 (\beta_2 i_b - i_F)$. Then the following equations for the feedback pair are valid in the low-frequency region:

$$\begin{aligned} e_i &= e_{be2} + R_3[\beta_3(\beta_2 i_b - i_F) - i_F + (\beta_2 + 1)i_2] \\ e_o &= (R_2 + R_3)[\beta_3(\beta_2 i_b - i_F) - i_F] + R_3(\beta_2 + 1)i_2 \\ e_o &= i_F R_F (1 - 1/A_{r3}) \end{aligned}$$

Here the small base-emitter voltage e_{be2} of Q_2 and the quotient $1/A_{r3}$, which is the inverse of the voltage gain of Q_3 , can be omitted. The voltage gain is then

$$\begin{aligned} \frac{e_o}{e_i} &= \frac{R_F}{R_3} \cdot \frac{R_2 \beta_2 \beta_3 + R_3(\beta_2 \beta_3 + \beta_2 + 1)}{R_F(\beta_2 \beta_3 + \beta_2 + 1) + R_2(\beta_2 + 1)(\beta_3 + 1)} \\ &\approx \frac{R_F}{R_2 + R_F} \cdot \frac{R_2 + R_3}{R_3} \end{aligned}$$

The input resistance of the feedback pair is

$$\begin{aligned} R'_{in} &= \frac{R_3[R_F(\beta_2 \beta_3 + \beta_2 + 1) + R_2(\beta_2 + 1)(\beta_3 + 1)]}{R_F + (R_2 + R_3)(\beta_3 + 1)} \\ &\approx \beta_2 \beta_3 \frac{R_3(R_F + R_2)}{R_F + \beta_3(R_2 + R_3)} \approx \beta_2 \frac{R_3(R_F + R_2)}{R_2 + R_3} \end{aligned}$$

The input impedance of Q_1 (Fig. 1B) is kept high by using a silicon transistor with a high current amplification factor and by positive feedback from the amplifier output to the 15,000-ohm resistance that loads the emitter of Q_1 , in parallel with the feedback pair input. The shunting effect of the internal collector-base impedance of Q_1 is also lowered by connecting the collector to an in-phase signal. Assuming $\beta_1 = \beta_2 = \beta_3 = 50$ gives a minimum input impedance of the amplifier $R_{in} = 5$ megohms.

The pulse response and bandwidth of the amplifier are adjusted by the variable capacitor in the local feedback chain of Q_3 . With the 3-db-down point at 20 Mc, the overshoot is less than 2 percent.

Adjustment of the amplifier low-frequency response is best done in the integrator. A positive value of δ is chosen that is large enough to ensure stability and the amplification is adjusted so that the response is 3 db down from the ideal at $\omega = (\epsilon + \delta)/RC$. See Fig. 2A, where the low-frequency response is shown for $R = 51,000$ ohms and $C = 0.01$ μ f.

The lower curve in the figure shows as a comparison the response of an ordinary R-C circuit with the same values of R and C . To yield the same output-input ratio and effective R-C time, such a circuit would have to be followed by an amplifier with a voltage gain of more than 20, and the difficulties of obtaining a large bandwidth and low noise would be

The integrator input impedance is equal to R at high frequencies but diminishes at low frequencies; in an ideal integrator according to Fig. 1A, it would be zero at the limit of zero frequency.

A cable-driving amplifier loaded by a 185-ohm cable follows the integrator (Fig. 2B). To give the best loading conditions to the integrator, this amplifier is d-c coupled. With a voltage gain of three, it has a bandwidth of 18 Mc without overshoot for pulse signals. When some overshoot can be tolerated, the bandwidth can be extended by adjustment of the variable capacitor 4-20 pf at the amplifier input.

REFERENCES

- (1) G. Upham and F. Bennett, Improved Feedback Integrators, Controlled Thermonuclear Conference, Washington, 1958, TID-7558.
- (2) M.I.T. Radiation Laboratory Series, 20, p 302.
- (3) O. S. Puckle, "Time Bases," Chapman and Hall Ltd., p 93, 1944.
- (4) J. G. Holbrook, "Laplace Transforms for Electronic Engineers," Pergamon Press Ltd., p 136, 1959.

Microwave power amplifier design enables single or parallel operation of up to four klystrons at C-band and will feed a modified ring resonator to provide up to 100 megawatts output

By LAURENCE
D. SHERGALIS

Associate Editor

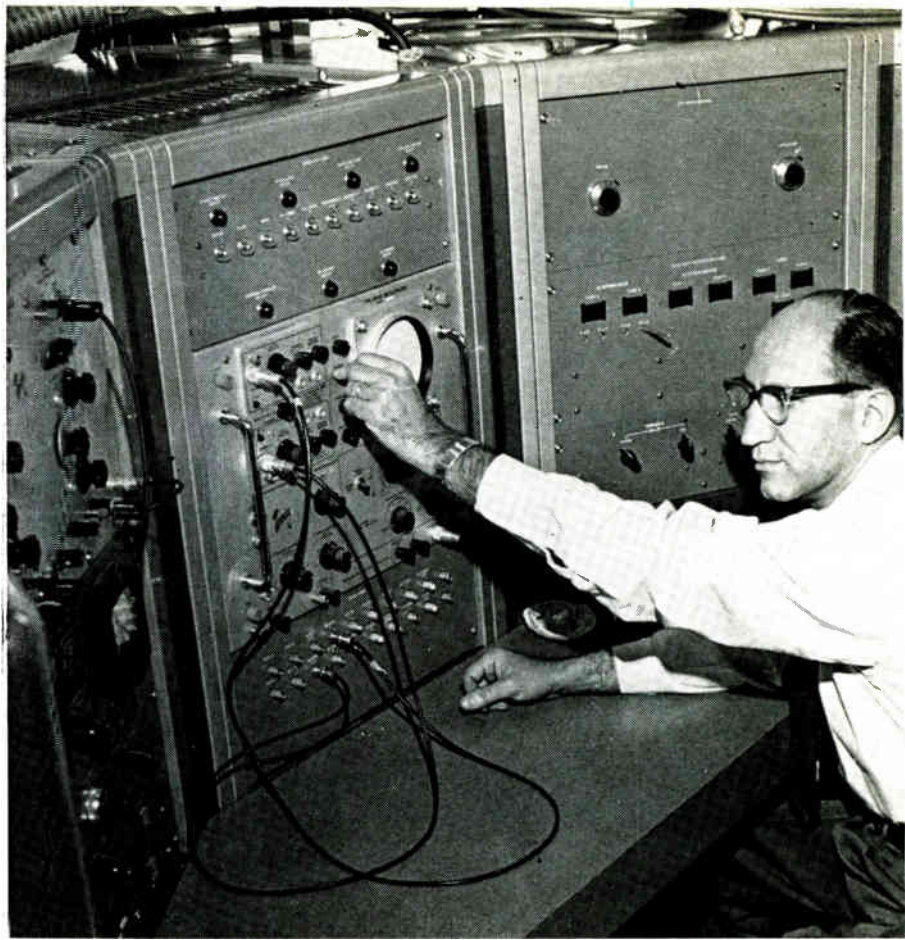

Prof. Saul W. Rosenthal, Polytechnic Institute of Brooklyn, at the control console of the high-power klystron C-band amplifier at which all operating, monitoring and control functions are located

High-Power Microwave Source Uses

HIGH POWER microwave sources are vital to plasma research and to the studies of behavior of microwave components at super powers. In addition, studies of reactions of gases and solids at high power densities require a power source capable of providing several megawatts at microwave frequencies.

An installation being completed at the Polytechnic Institute of Brooklyn graduate center at Farmingdale, N. Y. will ultimately provide up to 100 megawatts of peak pulse power at C-band at a duty cycle of about 0.001. The system will provide variation of r-f power output, pulse width from $\frac{1}{2}$ to 10 microseconds, frequency from 5 to 5.8 Gc and repetition rate consistent with the duty cycle. It will also be possible to sweep the frequency.

Two major units will compromise the complete system: the C-band klystron system and a proposed

modified ring resonator, or microwave flywheel.¹ Power output of the klystron system will be up to 20 megawatts and will be fed into the flywheel, which will enhance the power to provide a peak output of 80 to 100 megawatts to the test cell.

The C-band r-f system, Fig. 1, designed and built by Sperry Electronic Tube division, Great Neck, N. Y., consists of a high-voltage d-c power supply, control console including an r-f drive assembly, two soft tube modulators and two klystron power amplifiers. Power output from each klystron will be combined in a run of waveguide and coupled to the flywheel. It can be terminated in any type of load; however, for test purposes, a water load is used.

Power to the modulator is supplied from a 16.8 Kv, 10-amp d-c source. Input line voltage is fed to a circuit breaker then to a three-

phase variable voltage transformer that is capable of raising or lowering the line voltage 66 percent. From the transformer, three-phase power is fed to the primary of a delta-wye transformer. The transformer secondary supplies the three-phase full-wave bridge rectifier. Six type GL-869B mercury arc rectifier tubes comprise the rectifier and are air cooled to insure that each tube will function up to 20 Kv peak inverse voltage.

Rectified, unfiltered d-c is fed to a filter which includes a 3-h choke and capacitors rated at 20 Kv and 8 μ f total. As a safety precaution, the capacitors remain shorted until the high-voltage circuit is energized. Two line-type beam modulators, Fig. 1, supply a series of power pulses of about 50 megawatts to each of the klystrons. Each modulator functions independently and is controlled from the console.

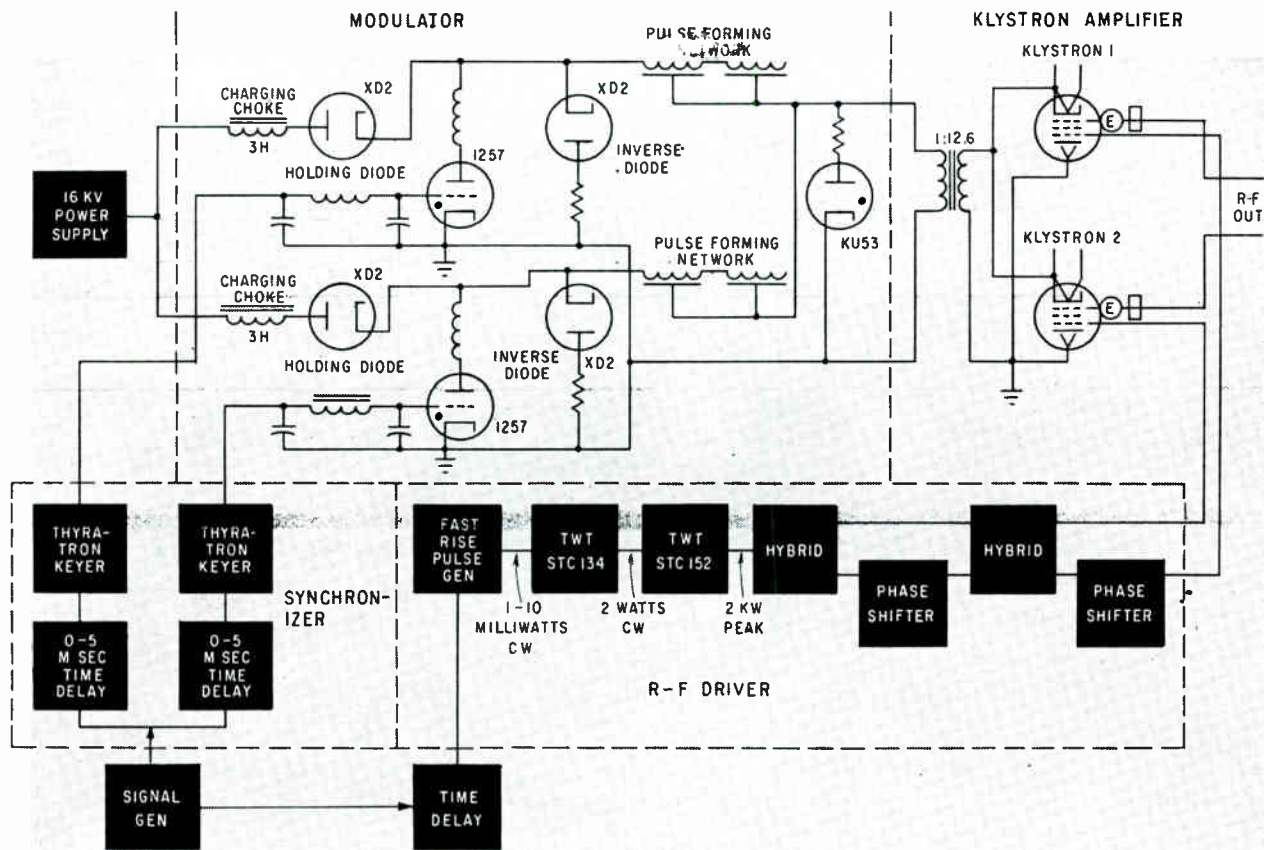

FIG. 1—Time delays in the modulator circuit and phase shifters in the r-f circuit synchronize beam and r-f pulses to permit parallel operation of the klystrons

Parallel Klystrons and Flywheel

In the modulator circuit, a 3-h charging choke provides resonant charging of the E-type pulse-forming network at 400 pps when a 3-microsecond beam pulse is used. This pulse-forming network was designed using a computer and achieves a flat-top pulse with a maximum ripple of 1 percent.

Employed as a holding diode, a type XD2 diode immediately follows the charging choke. In the actual circuit, two XD2's are used in parallel for improved charging efficiency and greater reliability. The switch tube is a type 1257 hydrogen thyatron and the inverse circuit consists of a type XD2. Again, in the operating circuit, two XD2's are used in parallel for lower inverse circuit impedance and greater reliability.

A tail-clipping circuit consisting of a type KU-53 hydrogen thyatron and its plate load reduces back-

swing of the pulse transformer to a maximum of 20 percent of the main beam voltage. The dual keyer provides the required trigger pulses to switch the type 1257 hydrogen thyatron forward switch tubes on at the desired repetition rate. The repetition rate is controlled by the operator and the trigger pulses originate at a signal generator in the control console.

The complete power amplifier will eventually contain four klystrons, and its power output will be 5, 10 or 20 megawatts maximum, depending upon whether one, two or four klystrons are operating in parallel. Modified versions of a military-type klystron are used in the amplifier. These tubes are processed at higher than average power to achieve the specified output. In the amplifier, ion pumps are permanently attached to each klystron. Because the tubes are being oper-

ated above their design specifications, it is necessary to out gas, or process, the tubes whenever the gas pressure rises above a specified value. This is done automatically using a vacuum-ion power supply, which continually monitors klystron internal gas pressure.

Coupling the modulator to the power amplifier is a pulse transformer with a turns ratio of 1 to 12.6. The two pulse-forming networks are operated in parallel and tied to the primary of the pulse transformer. The pulse transformer turns ratio and the pulse-forming network characteristic impedance were designed to match the impedance of the klystrons. This was a design problem since the klystrons are operated both singly and in parallel with a beam pulse width of 12 microseconds at 125 Kv, or over a range of 3 to 6.5 microsecond pulse width at 145 Kv. Figure

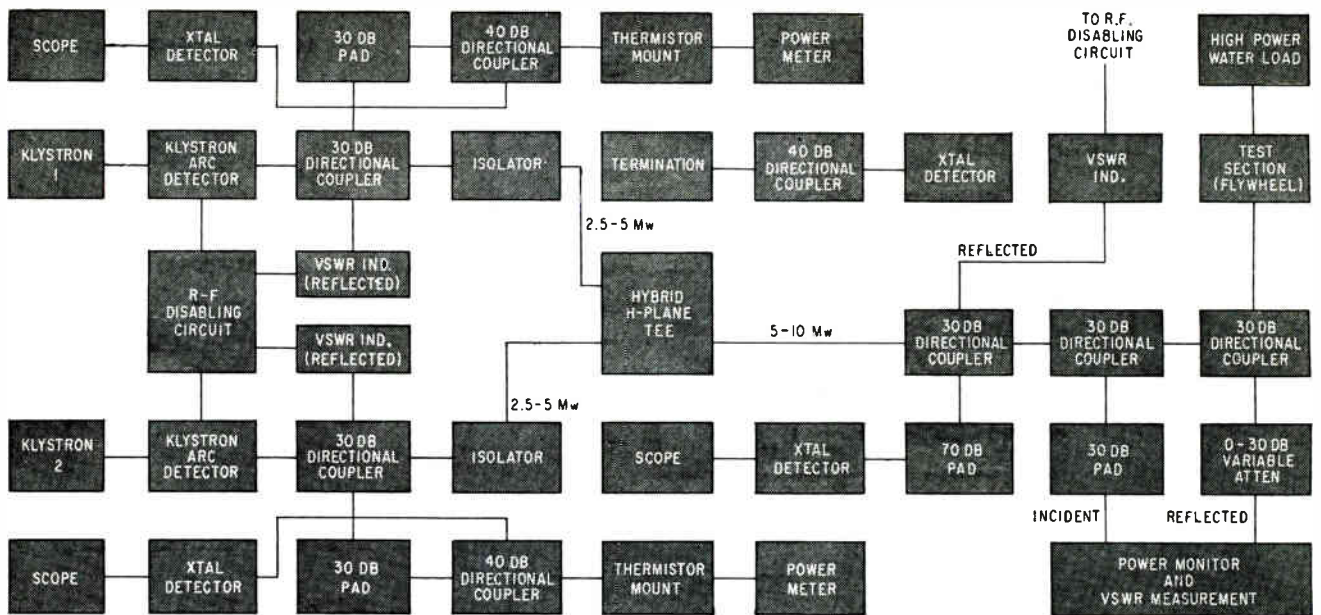

FIG. 2—R-F output circuit combines output of each klystron in a high power hybrid. Monitoring and protective circuits are shown

1 shows how the two tapped pulse forming networks and the pulse transformer are used in the final design.

The transformer secondary is connected to switches that enable the modulator to be connected to one klystron, two klystrons in parallel, to one klystron and a dummy load, or to the dummy load. Use of the dummy load permits system troubleshooting and eliminates the klystrons as a source of trouble.

Parallel operation of the klystrons is accomplished by first synchronizing both klystron beam pulses, then synchronizing the r-f pulses with the beam pulses. Next, amplitude and phase of the two r-f pulses are adjusted to be equal at the klystron amplifier output. Three synchronizing pulses are generated in the console—two pulses go to the modulator thyatron keyers and one to the r-f trigger. Timing of all of these pulses may be controlled by adjustable time delays built into the equipment.

Two adjustable zero to five-millisecond time delays just ahead of each thyatron keyer take care of inherent delays in the switch tube triggering circuits. Each delay is adjusted until the beam pulses to each klystron are synchronized.

Next, the r-f pulses are adjusted until they fall within the beam pulses. The r-f pulses are narrower and have faster rise and fall time

than the beam pulses. The r-f pulse source is a milliwatt c-w oscillator. The signal is amplified by two traveling-wave tubes in series and the output is a 2-Kw pulse signal, which is fed into a folded hybrid H-plane magic tee. This magic tee consists of waveguides in shunt and series with a colinear guide at the same point. When a signal is fed into the shunt arm, and the colinear arms are terminated in matched loads, power divides equally. Because of the symmetry of the hybrid, there is no coupling between the series and shunt arms and no signal will be fed into the series arm. If the load impedances of the two colinear arms are unequal, symmetry will be destroyed and there will be energy transfer between the shunt and series arms. To prevent this, two phase shifters are provided to vary relative phase and amplitude of one pulse with respect to the other, thus insuring proper power division of the two unequal load impedances (klystrons).

Power outputs of the klystrons are combined in a high-power hybrid magic tee, Fig. 2. The signal in the nonpreferred arm of this hybrid is minimized by adjustment of the phase shifter at the input to the klystron. Output of the klystron amplifier may be fed to a water load, the microwave flywheel or any one of a number of devices. Maximum power output from two kly-

strons is 10-megawatts. From four klystrons in parallel, power output will be 20 megawatts.

To achieve the high power necessary for planned test programs, a relatively new type of device is proposed with the klystron power amplifier. Called a microwave flywheel, the device is a reentrant transmission line coupled to another transmission line through a directional coupler, Fig. 3A. A microwave flywheel differs from a ring resonator in that a test device is not inserted in the ring, thus permitting an uninterrupted run of guide. A pulse is fed into the ring, from the power source. A portion of the signal is coupled into the ring, the remainder being absorbed by the load. Power is built up in the ring, then switched out.

Pulses are fed into the ring continuously and in phase with the energy at the directional coupler. Power in the ring is therefore reinforced and, if the physical parameters of the ring are properly chosen, power will build up to relatively high values.

Pulse power of a given peak intensity is converted into shorter pulses of a much higher peak intensity. Input pulses are of constant amplitude and of long duration relative to the time required for the energy to travel once around the ring. There is a build up period in which the energy from

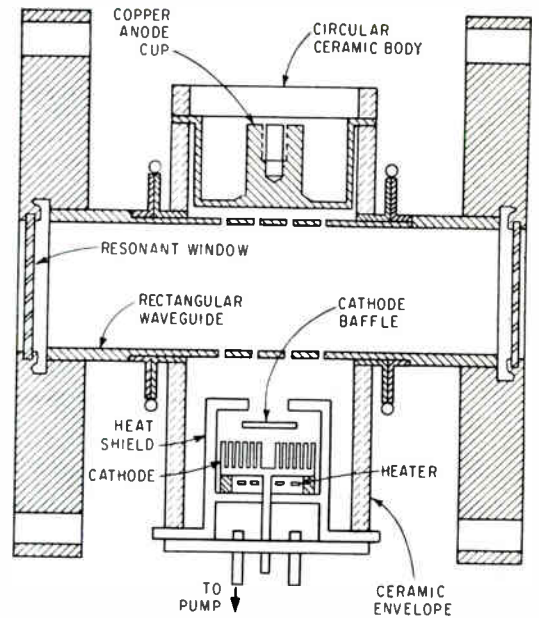
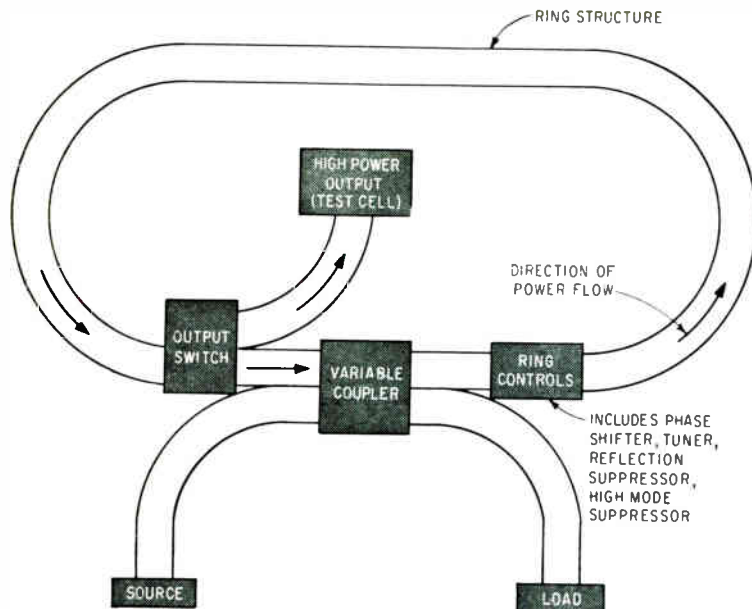

FIG. 3—Pulses are fed into the microwave flywheel (A) from the source in phase with the energy in the ring. Proposed low pressure arc-discharge gaseous-shutter output switch (B) is made as part of a waveguide section

the source is partly stored in the ring as a traveling wave of increasing amplitude. It is only partly dissipated in both the terminating load and in wall and other losses normally associated with the one-way attenuation of the ring. In the absence of reflections or discontinuities, the ring will be resonant when its length is exactly an integral number of guide wavelengths. Power magnification of the ring resonator decreases with an increase in attenuation and therefore would decrease with an increase in length of the ring. Width of the pulse is also a function of the length of the ring.

Use of oversize waveguide in a ring 537 feet long is planned for C-band operation of this installation. Energy conversion efficiency is calculated to be about 41 percent, attenuation about 0.58 db overall, and the capability to produce a 0.55-microsecond output pulse for an 8.5-microsecond input pulse.

Oversized waveguide was chosen to be compatible with the power requirements of the system. Attenuation is estimated to be about 1% that of standard waveguide when the waveguide used is 10 times the area of standard C-band guide.

Rectangular instead of square waveguide was chosen to minimize the number of TE_{mn} modes generated, since power buildup in the ring is sensitive to phasing, mak-

ing higher modes a problem. Filtering of TE_{mn} modes relative to the dominant TE_{10} mode is difficult. Most probably, the wave guide to be used will be EIA 975 (RG-204/U) which is 12.38×24.76 cm. A waveguide of 10×26.81 cm cross section was found to admit the least number of TE_{mn} modes, but is a non-conventional guide and would have to be specially fabricated.

Frequency stability is another problem, and to maintain a power magnification of 95 percent maximum, frequency must be held to within ± 0.01 Mc in 5,650 Mc. This is better than 2 parts per million. An afc system will be used that will involve injecting low power pulses between the high power pulses to determine departure from the ring resonant frequency and to correct the driver frequency. Dimensional stability of the waveguide structure, another engineering problem, will be attacked by burying the entire ring, thereby minimizing mechanical variation caused by ambient temperature changes.

Design of an output switch for switching power out is in progress.² Several approaches have been considered: gas discharges, ferrites, ferroelectrics and the use of the multipactor effect. The phenomena of gas and multipactor discharge are being pursued as the most promising methods. Under development is a low pressure arc-discharge

gaseous shutter, Fig. 3B. Requirements include a switching time of less than 30 nanoseconds, cold insertion loss of less than 1 db, and a microwave holdoff power of 1 megawatt peak. The switching action is performed by rapid ionization of low pressure gas filling the waveguide section. Sufficiently high electron density is created which converts the ionized gas into a medium incapable of propagating electromagnetic energy. Permittivity of the gas becomes negative, and the discharge region has the properties of a beyond-cutoff waveguide. Thus, the incident wave is almost completely reflected. The rectangular waveguide itself, perforated, serves as a control grid for this gas-filled thyatron.

Besides being coupled into the proposed microwave flywheel, the system will also be used in conjunction with ordinary traveling wave rings. These will provide a gain of 5 to 10 times for the testing of some devices and components. In addition, the system will be used to interact with the output of a high mach shock tube presently being constructed by the aerospace department of the graduate center.

REFERENCES

- (1) Peter Sferrazza, Microwave Power Multiplier, U.S. Patent No. 2,875,415, Feb 24, 1959, assigned to Sperry Rand Corp.
- (2) John W. E. Griemsmann, Technical Note on High Power Microwave Electronics, Polytechnic Institute of Brooklyn, Report PIBMRI-9-17-61, Oct. 2, 1961.

NEW WAY TO MEASURE Diode Recovery Time

Useful recovery-time values may be obtained with simple test equipment provided test conditions are considered

By D. R. GIPP, Semiconductor and Materials Division, Radio Corporation of America, Somerville, N. J.

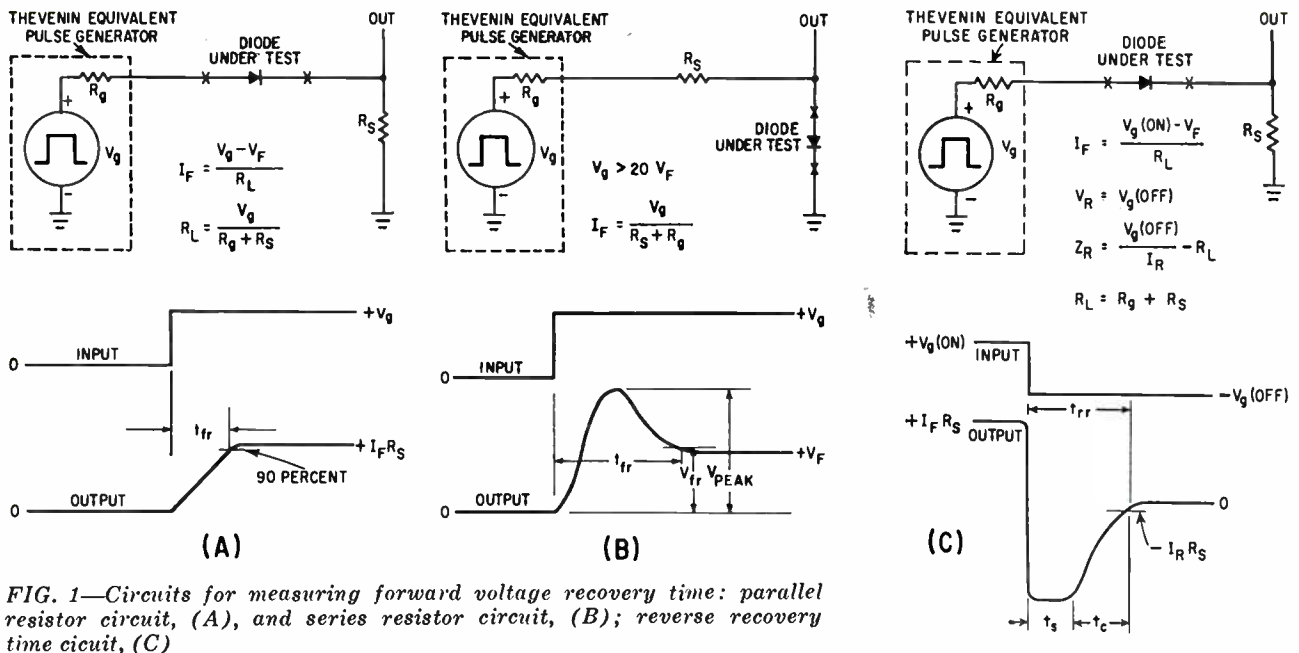

FIG. 1—Circuits for measuring forward voltage recovery time: parallel resistor circuit, (A), and series resistor circuit, (B); reverse recovery time circuit, (C)

FORWARD RECOVERY TIME and reverse recovery time indicate the ultimate speed of diodes in switching or computer applications and represent important diode characteristics. However, switching speeds of diodes are frequently misinterpreted because of the effects of test conditions and recovery-time test circuits. As a result, a relatively fast diode may appear to be slow in certain recovery circuits.

Forward recovery time is the time required for a diode to attain a steady-state forward-bias condition when suddenly switched from zero or reverse bias. The two methods of measuring forward recovery time are shown in Fig. 1A and 1B.

The forward-current recovery-time circuit in Fig. 1A measures the time for the diode to reach 90 percent of its final conduction when

a step voltage is applied to the diode and series-resistance combination. Because the forward recovery time is mainly a result of the effective inductance of the diode, the loop impedance R_L is a principal factor in determining the recovery time. If R_L is small, the recovery time is short; if R_L is large, the re-

covery time is long. Hence, forward recovery time is determined by the test circuit.

The forward-voltage recovery-time circuit in Fig. 1B measures the time required for the diode to attain forward-voltage equilibrium when a step of current is applied to the diode. This test circuit is the

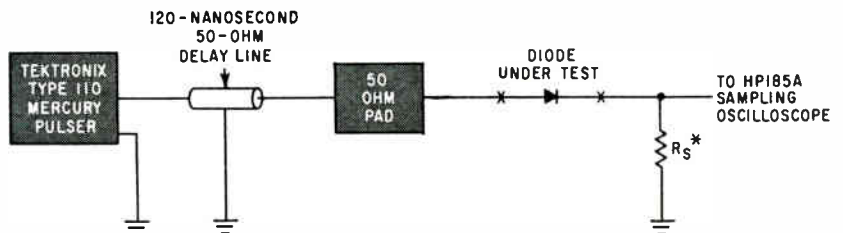

* $R_S = R_L - 50$ OHMS
RESULTS: $t_{fr} < 1$ NANOSECOND FOR VALUES OF R_L UP TO 2,000 OHMS AND I_F UP TO 20 MILLI-AMPERES.

FIG. 2—Actual circuit used for recovery time measurements on multiple diodes 3DG001 and 2DG001

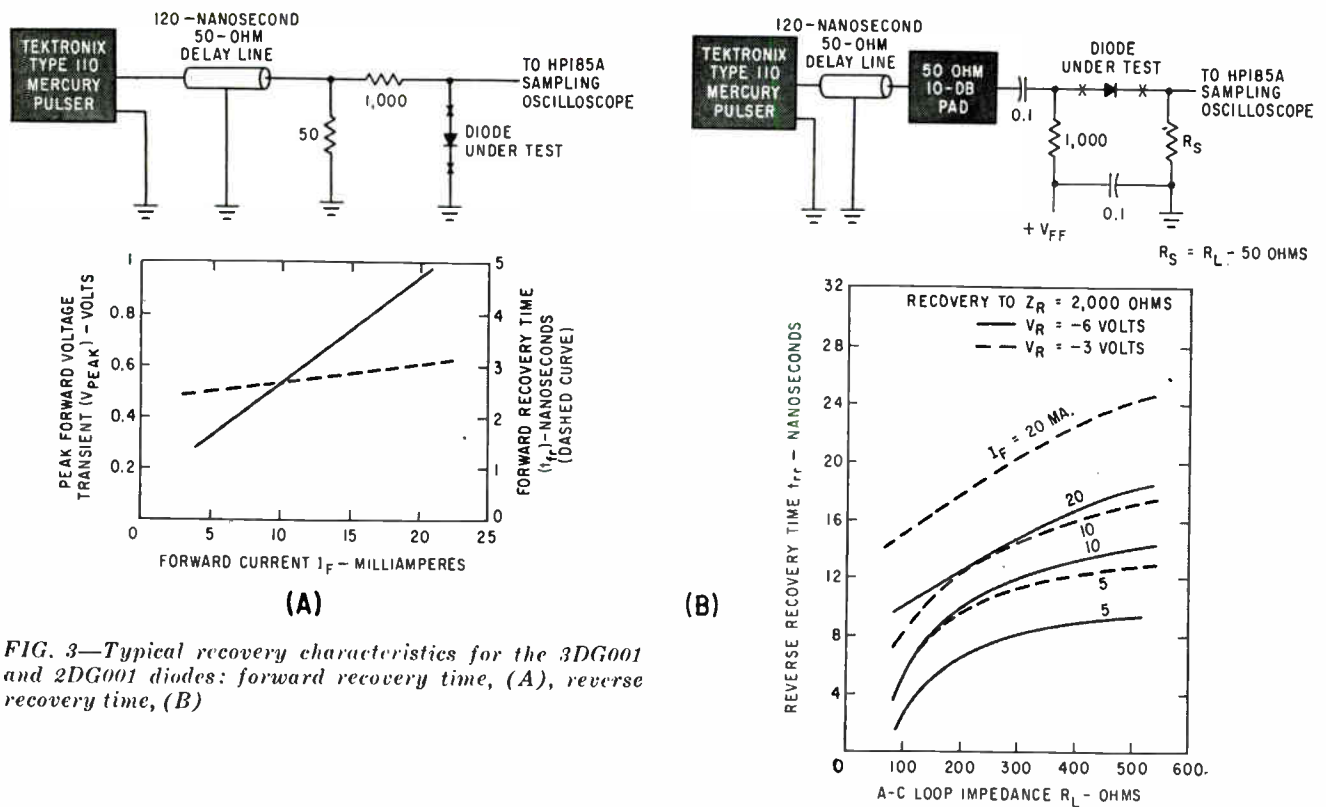

FIG. 3—Typical recovery characteristics for the 3DG001 and 2DG001 diodes: forward recovery time, (A), reverse recovery time, (B)

accepted standard for forward-voltage recovery-time measurements. Either the forward-recovery time, t_{fr} , or the forward-voltage peak, V_{peak} , or both, may be given in this test. In this test circuit, a step of forward current is applied to the diode, and, consequently, the only factor affecting t_{fr} is the magnitude of the applied current. Increasing the forward current provides both larger V_{peak} and longer t_{fr} because forward voltage recovery is also a result of the effective inductance of the diode.

In each of these methods of measuring forward recovery time, the initial bias condition on the diode is conventionally zero. However, an initial reverse d-c bias can also be used.

Reverse recovery time is the time required for a diode to attain steady-state reverse bias when suddenly switched from forward-bias. The reverse-recovery-time circuit is shown in Fig. 1C.

The specification of reverse recovery time requires the initial forward current I_F ; the final value of reverse-bias voltage V_R ; the reverse impedance Z_R to which the diode must recover, and the a-c loop impedance R_L of the recovery-time test circuit. These conditions are completely specified in the circuit of Fig. 1C. The reverse recovery

time t_{rr} is the sum of two components: the storage time t_s required for the stored charge within the diode to recombine or be swept out by reverse current and the capacitive recovery time of the diode t_c resulting from its inherent junction capacitance.

The reverse recovery time t_{rr} is dependent upon the a-c loop impedance R_L . This impedance determines the maximum reverse current through the diode and, therefore, directly affects storage time t_s . Quantity R_L also determines the length of the capacitive recovery time t_c because the time constant of diode-junction capacitance and R_L determines t_c . Therefore, for specified values of I_F , V_R and Z_R , large values for R_L result in long reverse recovery time and small values of R_L result in short recovery time.

The initial forward current I_F and the reverse voltage V_R also affect reverse recovery time. For a given R_L , Z_R and V_R , larger values for I_F result in longer recovery times because of increased storage in the diode. Therefore, the t_s component of the recovery time is increased and t_c is relatively unaffected. For given values of R_L , Z_R and I_F , larger values of V_R result in shorter recovery times because of larger initial reverse current I_R

and, therefore, decreased storage time t_s ; t_c is again unaffected.

Reverse recovery time is also a function of the reverse impedance Z_R to which the diode must recover. For given values of I_F , V_R and R_L , a low Z_R specification yields short recovery times; high Z_R specification results in long recovery times.

RCA multiple diodes types 3DG001 and 2DG001 have been tested in the forward and reverse recovery-time circuits under varying conditions. The results of these tests, together with the actual test circuits, are shown in Fig. 2 to 4.

As shown in Fig. 2, the forward-current recovery time t_{fr} for values of R_L up to 2,000 ohms and I_F up to 20 milliamperes is faster than the 1-nanosecond response of the test circuits. These results indicate that the 3DG001 and 2DG001 diodes have low effective series inductance.

As shown in Fig. 3A, the forward-voltage recovery time of the diodes is also fast, but some recovery time is measurable. As expected, neither t_{fr} nor V_{peak} change appreciably with forward current.

Figures 3B and 4 show the two reverse-recovery-time circuits used to obtain a wide variety of reverse-recovery-time measurements. Circuit 3B is used to obtain extremely fast recovery-time measurements

TABLE—ELECTRICAL CHARACTERISTICS OF EACH DIODE UNIT OF DOUBLE AND TRIPLE SEMICONDUCTOR DIODES TESTED

Parameter	Conditions	Min.	Typical	Max.	Units
V_F —Forward Voltage	$I_F = 5$ milliamperes		0.35	0.4	volts
V_F —Forward Voltage	$I_F = 9$ milliamperes		0.4	0.55	volts
BV_R —Reverse Breakdown Voltage	$I_R = -200$ microamperes	-20	-30		volts
I_R —Reverse Current	$V_R = -10$ volts, $T_A = 55$ deg C		20	75	microamperes
t_{rr} —Reverse Recovery Time	$I_F = 20$ milliamperes, $V_R = -6$ volts, $Z_R = 35,000$ ohms, $R_L = 2,000$ ohms		160	250	nanocrosecond

when values of R_L up to 500 ohms and values of Z_R less than 6,000 ohms are specified. Circuit 4A is used to obtain slower reverse-recovery-time measurements when values of R_L of 500 ohms and greater, and values of Z_R greater than 6,000 ohms are specified. The only significant difference between the two circuits is the reference diode in circuit 4A to reduce the peak-to-peak output-voltage swing. This prevents the monitoring oscilloscope from being overdriven severely, especially when it must be sensitive enough to measure the low reverse currents required in

high- Z_R specifications. At the same time the reference diode must be fast enough so that its reverse recovery does not affect the measurement. The reference diode used in these tests had no measurable reverse recovery time in circuit 4A.

Figures 3B and 4 show, as predicted, that reverse recovery time increases significantly with R_L . Considerable increase in t_{rr} also results with increasing I_F , V_R or Z_R . The important fact is that recovery times ranging from 3 to 160 nanoseconds were obtained on the same diode, depending on the test conditions and test circuit specifications.

Although the diode units in the RCA 3DG001 and 2DG001 appear to have slow switching speeds from the recovery time listed in the Table, the data shows that in reality the devices have high speeds. Forward-voltage recovery times of 3 nanoseconds at 10 milliamperes and reverse recovery times of 5 nanoseconds at 10 milliamperes and -6 volts are typical. The important consideration is that recovery times, especially reverse recovery times, depend on the test conditions and test circuits. Hence, a comparison of the relative recovery times of two different diodes must consider the recovery-time test circuits and test conditions.

The data presented indicates that a measurement circuit and test conditions giving recovery times in the range of 50 to 100 nanoseconds will ensure that the diode is fast in a high-speed test circuit. At the same time, more economical test equipment may be used in measurements. In addition, a more useful value of reverse recovery time is obtained for practical applications because, in general, practical applications do not meet the optimum conditions for recovery times of a few nanoseconds.

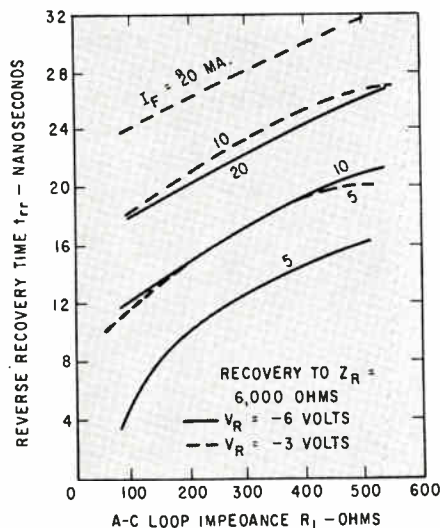
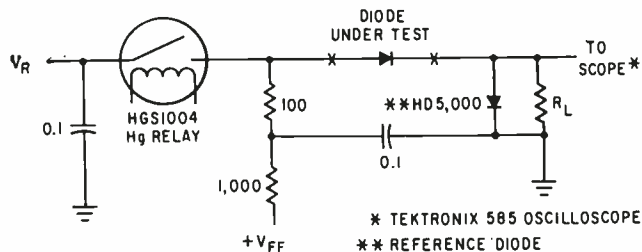
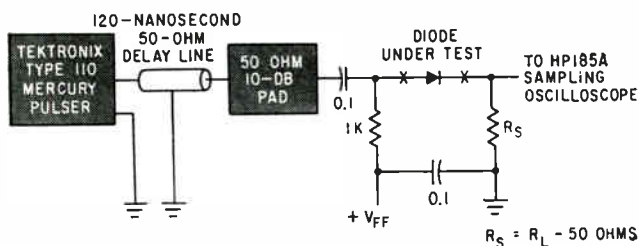

(A)

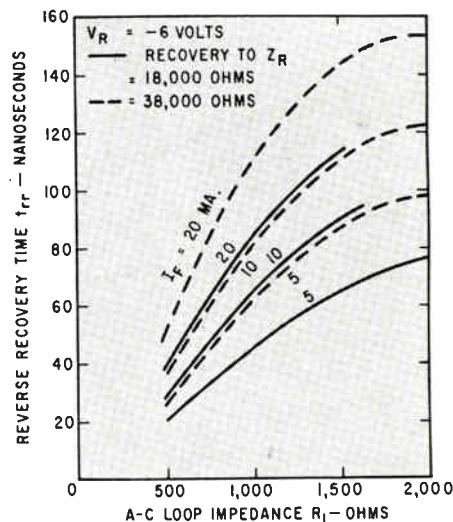

(B)

FIG. 4—Reverse recovery characteristics for 3DG001 and 2DG001 diodes, with different circuit parameters

Novel Differential Amplifier Stabilizes Multivibrator

Voltage on timing capacitor in multivibrator circuit is compared to reference voltage by two transistors connected as a differential amplifier. Temperature coefficients as low as ± 0.0015 percent/C are possible from -25 to 75 C

By JAMES D. LONG
Space-General Corp.,
Glendale, Calif.

A MAJOR PROBLEM with stable, low-frequency oscillators or clock-pulse generators is the temperature dependence of the output frequency. The circuit in Fig. 1 was designed for a temperature dependence not exceeding ± 0.0015 percent/C.

When the circuit is first turned on, the bi-stable multivibrator (Q_4 and Q_5) will set to one of its two stable states, and one of the two timing capacitors, C_1 or C_2 , will begin to charge. The voltage across this capacitor will be compared by

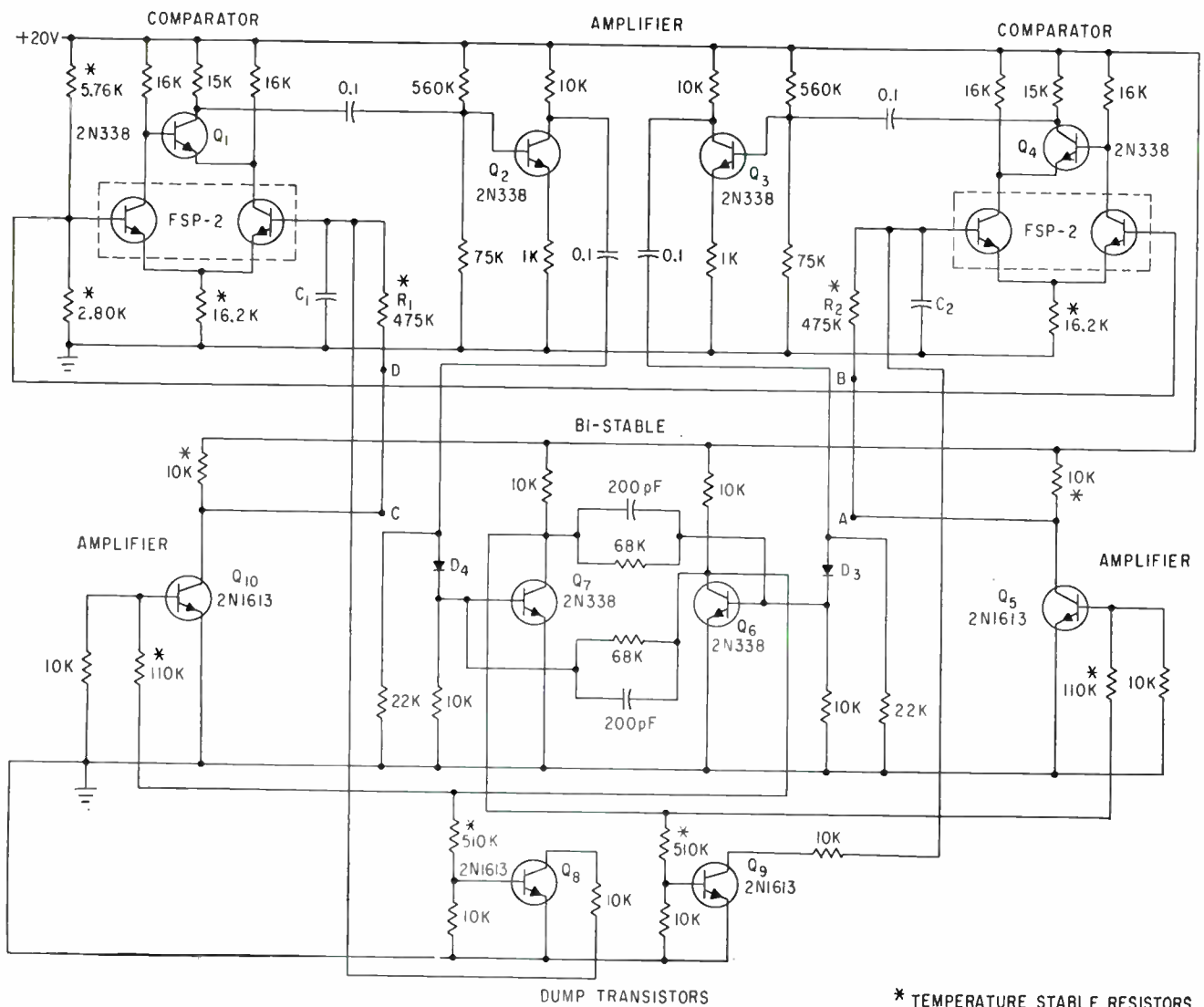

FIG. 1—Temperature stable resistors aid in reducing temperature coefficient

* TEMPERATURE STABLE RESISTORS

a comparator (Q_1 or Q_2) to a fixed reference voltage. When the capacitor voltage is equal to or slightly greater than the reference voltage, the comparator exhibits an output signal that sets the bi-stable multivibrator to its opposite state. When this occurs, the capacitor will be discharged by a reset circuit (Q_2 or Q_1). While the one capacitor is being reset, the other one is charging. The required reset time is much less than the charging time, so that one capacitor is completely discharged when the second comparator exhibits an output pulse to set the bi-stable multivibrator to its original state. The cycle is then repeated.

One significant difference between this method and a conventional multivibrator is in the comparison of the capacitor voltage. In an ordinary multivibrator, the capacitor voltage is compared by a single transistor at its base-to-emitter junction. The base-to-emitter voltage (V_{be}) is temperature dependent, and, therefore, the single transistor cannot make a temperature independent comparison. In the present method, two transistors (in a single case) are used in a differential amplifier connection. Variations of the base-to-emitter voltage of each transistor are very nearly equal, and because of the differential amplifier connection, the effects of these variations tend to cancel. If silicon transistors, such as the FSP-2, are used, the effects of variations in I_{co} are small enough to be ignored.

The circuit has been tested from -55 C to 100 C , and the over-all temperature coefficient was .0034 percent/C. However, the timing capacitors which were used varied considerably at the temperature extremes. The temperature coefficient from 25 C to 75 C was -0.002 percent/C, and the percentage error in frequency at 75 C was 0.1 percent. This was at 4 cps with $0.68\mu\text{f}$ timing capacitors and 475,000 ohms charging resistors.

If the variations in the RC product are excluded, the temperature dependence of a conventional multivibrator (uncompensated) is about -0.02 percent/C. The temperature dependence of this circuit (again excluding variations in the RC product) is -0.002 percent/C. Two transistors, Q_2 and Q_1 , are used to dump or discharge the two timing capacitors after each charge cycle. If the variation caused by temperature dependence of these two transistors is subtracted, the resulting temperature coefficient for the rest of the circuit (excluding the RC) is -0.00068 percent/C. The saturation voltage of the two dump transistors changes by about 5 mv from 25 C to 75 C . This causes a temperature coefficient of -0.0014 percent/C. However, better transistors than the type used can be obtained for this particular application. In addition, a latching relay could be used at low frequencies for not only the dumping requirement but also for the flip-flop requirement. Thus, a complete circuit coefficient (excluding the RC product) of

0.0007/C can be obtained.

Temperature dependence of the RC product is due primarily to variations in the capacitor. Manufacturers have indicated that they can supply capacitors with a given temperature coefficient, and that this coefficient will be constant, within narrow limits, from lot to lot. This indicates some form of compensation might be effective. The technique illustrated in Fig. 2 cancels the timing capacitor variations by making use of two capacitors identical to the timing capacitors. Laboratory results have shown a 50 percent improvement by the addition of the compensating capacitors, and indications are that better cancellation may be possible. The best results obtained with the complete circuit (including the RC) was a temperature coefficient of ± 0.0015 percent/C over a temperature range from -25 C to $+75\text{ C}$.

A single 20-volt supply was used, and there was a 0.02 percent variation in the multivibrator period for a 10 percent variation in the supply. The device operates at frequencies as low as 1 cycle per 100 seconds and as high as 100,000 cps.

The author acknowledges the help of R. E. Wessel in design and development.

BIBLIOGRAPHY

- J. R. Moore, Multivibrator Type Oscillator, Patent 2,540,539
- H. H. Hoge et al., Zener Diode Cross Coupled Bistable Triggered Circuit, Patent 2,879,412.
- T. P. Sylvan, Multivibrator Circuit Having a Bistable Circuit Driving and Triggered by a Relaxation Circuit, Patent 2,997,665.

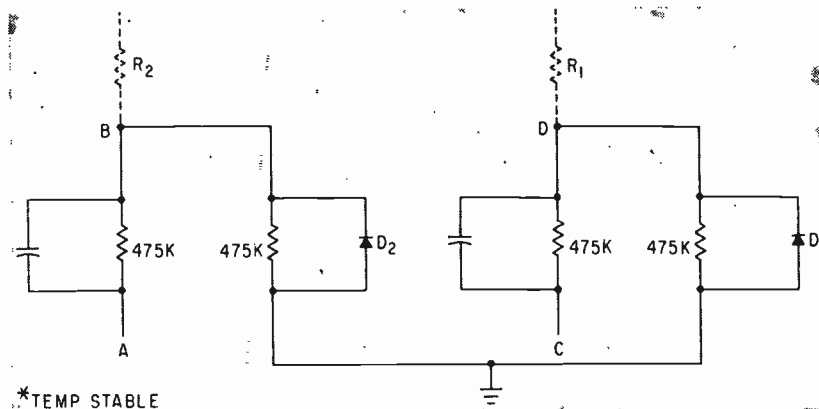
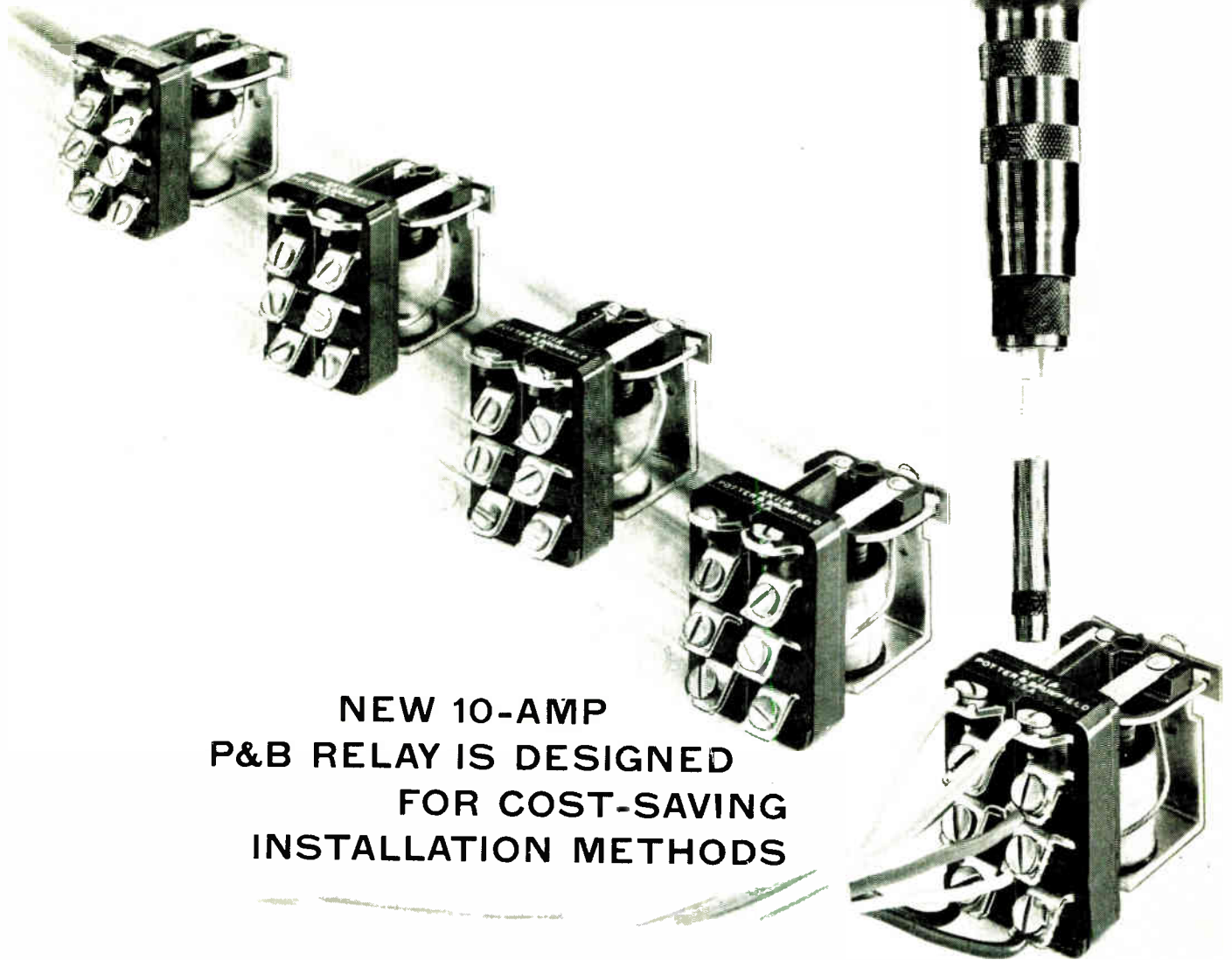

FIG. 2—Temperature compensation for the timing capacitors is obtained by inserting this circuit between AB and CD of Fig. 1



**NEW 10-AMP
P&B RELAY IS DESIGNED
FOR COST-SAVING
INSTALLATION METHODS**

Fast, labor-saving power screwdrivers can be used to hook up lead wires to the extra stout screw terminals of our new AK Series relays. Thus you save time and money on your production lines.

This new relay is sturdy throughout: its expected mechanical life is 3 million operations and the 1/4" diameter contacts are rated at 10 amps at 115V AC non-inductive. Available for either AC or DC power.

Get all the facts today from your P&B representatives or call us direct.

ENGINEERING DATA, AK SERIES

GENERAL:

Insulation Resistance: 100 megohms min.
Breakdown Voltage: 1500 V. rms between all elements.
Temperature Range: AC and DC, -55°C. to +45°C.
Weight: Approx. 5 ozs.
Pull-in:
AC 78% of nominal voltage.
DC 75% of nominal voltage.
Terminals: Heavy-duty screw type.

CONTACTS:

Arrangements: Up to DPDT.
Material: 1/4" dia. silver.
Rating: 10 amps @ 115 volts or 5 amps @ 233 volts, AC non-induc.
COILS:
Resistance: 35,000 ohms max.
Power: 6.4 volt amps (AC), 2.0 watts (DC).
Duty: Continuous AC or DC (DC coils will withstand 6 watts at +25°C.



AB SERIES

SIMILAR RELAYS HAVE U/L & CSA LISTING

The AB and the ABC have 1/4" quick-connect terminals which can be used for printed circuits. Screw terminal adapters available. U/L and CSA listed for 10 amps at 115V 50/60 cycles.



ABC SERIES

P&B STANDARD RELAYS ARE AVAILABLE AT YOUR LOCAL ELECTRONIC PARTS DISTRIBUTOR



POTTER & BRUMFIELD

DIVISION OF AMERICAN MACHINE & FOUNDRY COMPANY • PRINCETON, INDIANA
IN CANADA: POTTER & BRUMFIELD, DIVISION OF AMF CANADA LIMITED. GUELPH, ONTARIO

Orbiting Wire-Mesh Passive Reflectors

REFLECTING SURFACES can be achieved that are at least an order of magnitude lighter per unit area than the 1-mil mylar membrane used in the Echo balloon. The surfaces consist of an open mesh of fine spring wire. The advantages of this type of orbiting passive reflector were described at the recent Spring URSI Meeting in a paper by William E. Bradley, Associate Director of Research, Institute for Defense Analyses.

Studies of passive communications satellites have dealt with three general classes of reflectors. Metalized spherical plastic balloons are intended for use in low altitude orbits. More complex nonstabilized devices, such as the spherical array of corner reflectors, attempt to attain higher gain without stabilizing apparatus. Finally, stabilized structures such as the oriented flat plate have higher gain but are so mechanically complex that the gain may not be significant compared to an active satellite.

For a wire mesh reflector, the finest spring wire commercially

available is about 1/1000 inch in diameter. A square mesh of such wire with half-inch spacing weighs less than 1/12 as much as 1-mil mylar per square meter. At wavelengths greater than about 20 times the spacing between wires, the mesh reflects almost as well as solid metal, although it is a poor reflector when wire spacing exceeds about 0.1 wavelength.

Advantages of Wire Mesh

In space, mesh spheres would keep their shape by elastic forces. Drag would be two or three orders of magnitude lower than a plastic film balloon. Because of the reduced weight, spheres could be made so large that signal strength at a receiver would be comparable to many proposed active satellite systems. In the radiation of the sun and the Van Allen belt, metal wire can be expected to last for decades. Plastic films tend to shrink, become brittle and wrinkle because of radiation-induced cross-bonding of the organic chain molecules.

Micrometeorite impacts or other

disturbances would not deform the sphere. No stabilization is needed. The spherically symmetrical structure permits two-way communications with very high antenna gain required at only one ground station because effective transmission gain varies as the product of the antenna areas at the terminals. With active satellites, no advantage results from greatly increasing antenna size at one ground terminal. Mesh reflectors are effective over a very wide frequency range and are completely linear. The cost per year for such satellites should be quite small.

No known studies have been directed toward the difficult problem of folding and erecting in space such large fine mesh structures.

Quantitative Comparison

To compare plastic film with wire mesh quantitatively, assume that wires have a diameter d and density ρ_2 , while the plastic film has thickness t and density ρ_1 . For a square mesh with spacing a between adjacent parallel wires, wire length per unit area of mesh is $2/a$, and mesh mass per unit area is $(\pi d^2/4)(2/a)\rho_2 = m_2$. For a membrane, mass per unit area is $t\rho_1 = m_1$. The ratio of membrane to mesh mass for the same area is $m_1/m_2 = (2/\pi)(\rho_1/\rho_2)(at/d^2) = 1/10(at/d^2)$. For typical metals and membranes, the ratio ρ_1/ρ_2 is about 1/6 so that the ratio of membrane to mesh mass is about 1/10 (at/d^2) .

For example, if $t = 2.5 \times 10^{-4}$ inch, $a = \frac{1}{2}$ inch, $d = 10^{-3}$ inch, then $m_1/m_2 = 12.5$. Hence, area can be 12.5 times for the same mass.

Essential mass of a 1,000-ft diameter sphere is $\pi D^2 m_2$, where D is sphere diameter and m_2 is mass per unit area of the wire net or $m_2 = (\pi d^2/2a)\rho_2$. If ρ_2 is 0.3 lb/cu in., $m_2 = (\pi/2) \times 10^{-6} \times 0.3 \times 2 = 9.4 \times 10^{-7}$ lb/sq in. or 1.35 lb/sq ft. Essential mass would be $\pi \times 10^6 \times 1.35 \times 10^{-4} = 424$ lb.

The coefficient of power reflection of a grating of fine parallel

Measuring Roundness of Parts

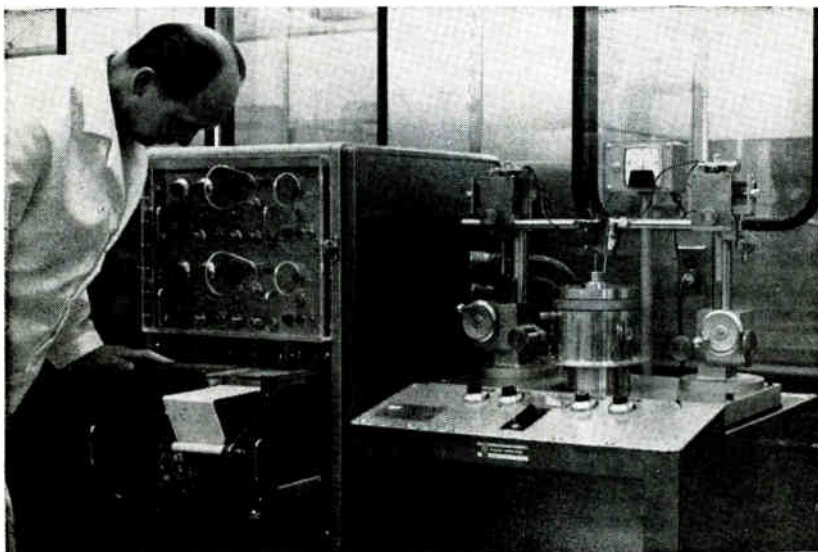

Movement of feeler arm is detected electrically as part is rotated to measure roundness within two-millionths inch using General Motors Roundrecorder at AC Spark Plug Division standards laboratory

for highest quality
**REGULATED
 POWER SUPPLIES**
 at lowest cost . . .

CHECK KEPCO

Kepeco's reputation for outstanding product performance is achieved by rigid **QUALITY CONTROL**—from raw material to finished product.

100% inspection and testing is an integral phase of the entire manufacturing process *before . . . during* and at the completion of all production stages.

Kepeco's quality products are recognized for their outstanding performance.



KEPCO'S PACK MORE VALUE...

RELIABLE:

Unique design uses transistorized reference and amplification circuitry for optimum regulation, stability and long life; plus tube series pass elements for reliable high voltage operation.

EXCEPTIONAL PERFORMANCE:

Conservative specifications give a true picture of operating characteristics.

ECONOMICAL:

Long trouble-free operating life eliminates costly downtime.

COMPACT:

3½ inch panel height, rack mountable.

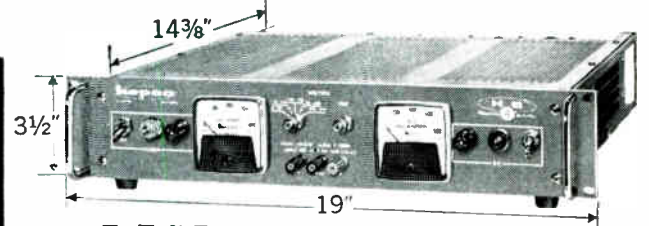

- Full Range Regulation: 0-70 - 130 - 195 - 255 - 325v dc/800ma
- Programming over full voltage range
- Remote output voltage control
- Constant current operation
- No voltage overshoot
- Remote DC on-off
- Series connection

AVAILABLE FROM STOCK!

REGULATION	0.1% LINE / LOAD				0.01% LINE / LOAD			
VOLTS	0-325							
MILLIAMPS	0-200	0-400	0-600	0-800	0-200	0-400	0-600	0-800
MODEL	HB 2M	HB 4M	HB 6M	HB 8M	HB 20M	HB 40M	HB 60M	HB 80M
RIPPLE	less than 1 mv rms				less than 1 mv rms			



Over 200 Standard Models to choose from . . . WRITE FOR NEW CATALOG B-621
 © 131-48 SANFORD AVENUE • FLUSHING 52, N. Y. • Area Code 212 IN 1-7000 • TWX # NY 4-5196

* Mountainous region southeast of the crater Albategnius

Raytheon laser hits moon

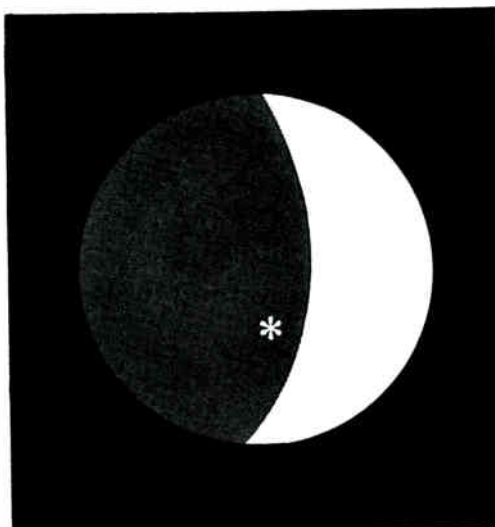

On Wednesday, May 9th, a team of Massachusetts Institute of Technology scientists illuminated the moon's surface and detected and recorded the reflection. The new first was accomplished with 13 bursts of 6934-angstrom light from a 50-joule, 4-barreled Raytheon ruby laser. The new Raytheon laser is the most powerful yet reported. Raytheon is currently investigating laser systems in the areas of communications, ranging, detection, space vehicle guidance, weapon systems, and medicine.* Write for further information to Martin B. Curran, Raytheon Company, Lexington, Massachusetts.

*For those interested in pursuing basic laboratory investigations, Raytheon is now offering a complete laser head for \$975.

RAYTHEON

For new laser fact folio, fill out and mail coupon on page 66

The sky is not your limit



The Advanced Development Laboratory of Raytheon's Surface Radar & Navigation

Operation (suburban Boston) seeks additional skilled and imaginative technical talent—Advanced Systems Engineers and Physicists—for the kind of free-wheeling, no-holds-barred research that led to laser's spectacular moonshot success.

Our prime function is exploring and developing electronics capabilities. In addition to the continuous laser program, typical Advanced Development Laboratory projects include Matched Filter Correlation Systems, theoretical and experimental work on Spherical Plasmoids, investigation into High Level Microwave Energy Absorption by Gases, techniques for extracting information from raw signal data.

Your investigations are carried to a point where capability exists for one of the Engineering Departments to embark on delivery of the item. The results of your participations in such projects will frequently be of sufficiently high level to warrant publication.

The Laboratory provides sufficient assistance from service groups to enable you to pursue theoretical and experimental work free from the problems of production, administration and red tape. The well-equipped experimental facilities include a computer in full-time service.

If you are qualified and would like to join this select group of key technical personnel, please forward your resume to Mr. William Gallagher, Management and Professional Recruiting, Department 127, Equipment Div., Raytheon Co., P. O. Box 520, Waltham, Massachusetts.



An Equal Opportunity Employer

wires is reflected power/incident power = $1/[1 + (2a/\lambda) \log (a/2\pi r)^2]$. Thus it can be seen that loss of reflectance can become serious if spacing a of parallel wires is greater than about 0.1λ if wire radius is about $10^{-3}a$. This loss results from inductance of the wire grating. A square mesh has the same reflection coefficient as a parallel wire grating with its wires parallel to the electric field because any other field orientation can be resolved into two components polarized with the field parallel to each set of wires of the square mesh.

A shallow bowl-shaped surface of wire mesh with its convex side facing the earth would greatly enhance the reflected signal since it should approximate the reflecting properties of an entire sphere representing the continuation of the spherical surface of the bowl. Attitude might be maintained by passive gravitational stabilization if such means are found practical.

Construction, packaging and erecting in space a large mesh structure raise difficult mechanical engineering problems. However, the reliability, long life, versatility and performance capabilities seem to make the effort worthwhile.

Voiceprints Proposed for Identification System

SPEECH RECOGNITION study indicates that the human voice may provide a means of identification that is more difficult to change than fingerprints. The highly individualistic characteristics of human speech, which have been a major problem in development of speech-recognition equipment, could be the basis for a nation-wide identification system. These characteristics, which seem to change little with age or with removal of teeth, tonsils or adenoids, cannot easily be disguised. And they would be considerably more difficult to alter surgically than removal of fingerprints.

A project directed toward voiceprint classification was reported to the Acoustical Society of America in a paper by L. G. Kersta of Bell Telephone Laboratories. Voiceprints or voice spectrograms are patterns of one spoken word showing voice energy at various levels

of pitch. The spectrograms used provide a quantized voiceprint resembling a contour map and are adaptable to computer techniques.

During tests, voiceprints were made of the same word uttered several times by different persons. Cards on which each voiceprint was separately recorded were shuffled and given to trained subjects to classify in groups representing each voice. Of about 25,000 decisions, the correct choice was made 97 percent of the time.

An expert might be able to identify a speaker from millions of

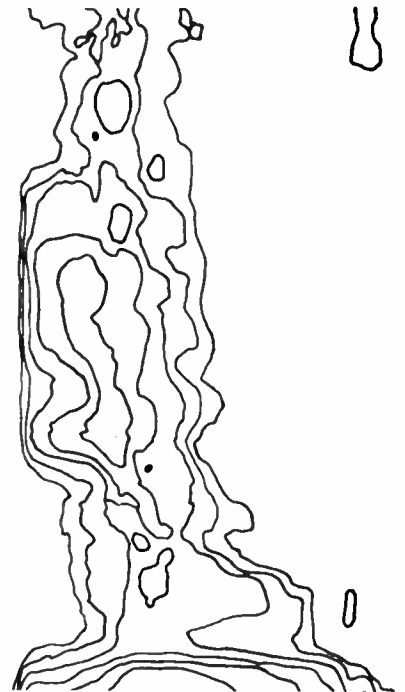

Voiceprint shows frequency vertically, time horizontally and intensity by peaks

other voices with enough different word samples. The natural shape and size of the mouth, throat and nasal cavities cause voice energy to be concentrated into bands of frequencies. Although the exact configuration may change, the patterns of these bands remain essentially the same even if the speaker attempts to disguise his voice. The pattern is only slightly modified by loss of teeth, tonsils or adenoids or even filling the mouth with marbles.

The fundamental patterns revealed by voiceprints seem to be more readily discernible to the eye than to the ear. These wide variations have been known for some time and have been a major prob-

NEW DIMENSIONS IN RELIABILITY

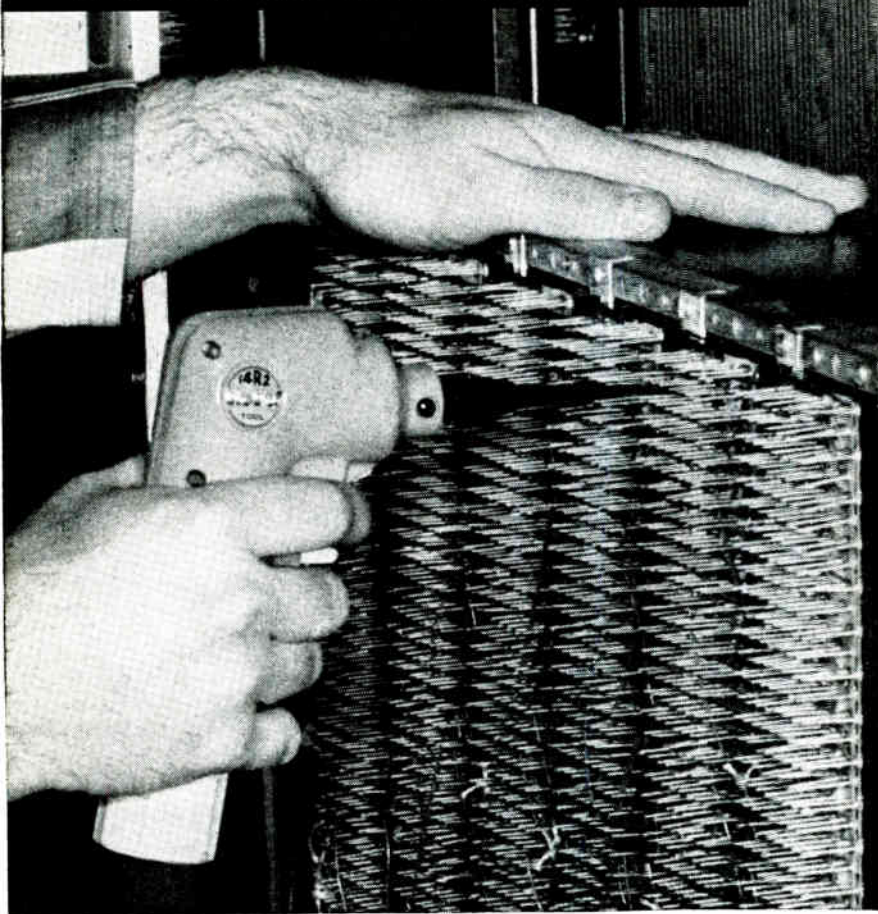

Make terminal connections anywhere without external power supply

For service or production, Gardner-Denver "Wire-Wrap"® tools make permanent, solderless electrical connections anywhere—without compressed air or electric power. Battery-powered tools, hand-squeeze and manual wrapping and unwrapping tools operate entirely free of cords or air hose. The installation or serviceman is not restricted in any location.

Solderless-wrapped connections are permanent connections. Resist corrosion and vibration. Proof of reliability? More than 15 billion connections without a reported failure.

Other "Wire-Wrap" tools include air- and electrically-powered tools, and automatic "Wire-Wrap" machines. Consult a Gardner-Denver engineer, or write for bulletins.

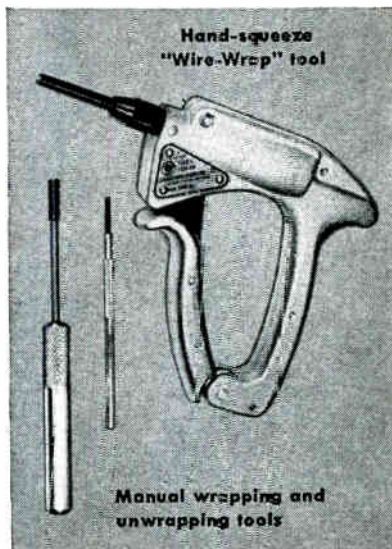

lem in the development of speech recognition equipment. The present research is aimed at taking advantage of this variation by associating the unique characteristics with each voice.

Many more voice samples must be analyzed before the accuracy of voiceprint identification can be established. For example, it is believed that the pattern of an adult is substantially unchanged with age. To evaluate this belief, it is planned to study samples of broadcasters, entertainers and other voices that have been recorded over a period of years. Kersta believes that voice identification will eventually achieve accuracy somewhere between that of fingerprints and handwriting identification.

Identification Method

To identify a single voiceprint from among millions would require trained experts and development of an efficient classification system. Voiceprints might be analyzed and coded by digital computer. The code of an unidentified voice could then be matched with files of voiceprints. As in fingerprint identification, the process would not be completely automatic.

Fingerprint experts to identify one person from a large number often need prints of most of the fingers, almost certainly more than one or two. The same technique is proposed for identifying voiceprints using the ten most commonly used words of the English language: it, me, you, the, on, I, is, and, a, and to.

The technique for making voice spectrograms was invented and explored 17 years ago at Bell Labs. During World War II, it was suggested that enemy radio voices might be identified by spectrogram to detect movements of units. However, less was known about voices, and the type of identification proposed was very tedious.

More is known about the voice now and a new kind of spectrogram was devised in 1960. It provides a quantized voiceprint that resembles a contour map and is more readily adaptable to computers. The use of a computer for analysis, coding and general classification would be an essential part of voiceprint identification on a national scale.



EQUIPMENT TODAY FOR THE CHALLENGE OF TOMORROW

GARDNER - DENVER

Gardner-Denver Company, Gardner Expressway, Quincy, Illinois

In Canada: Gardner-Denver Company (Canada), Ltd., 14 Curity Ave., Toronto 16, Ontario

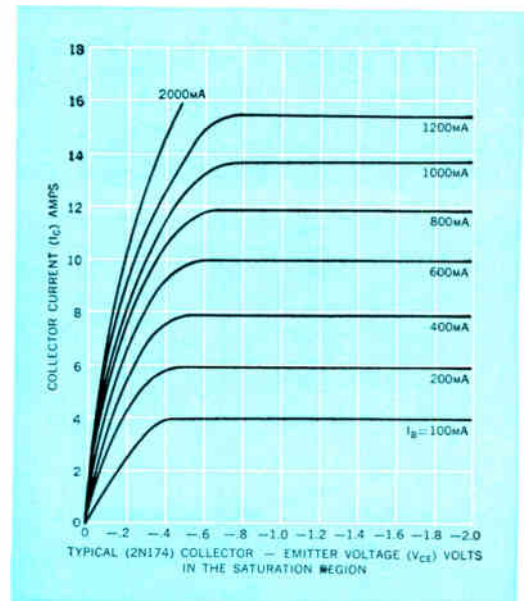
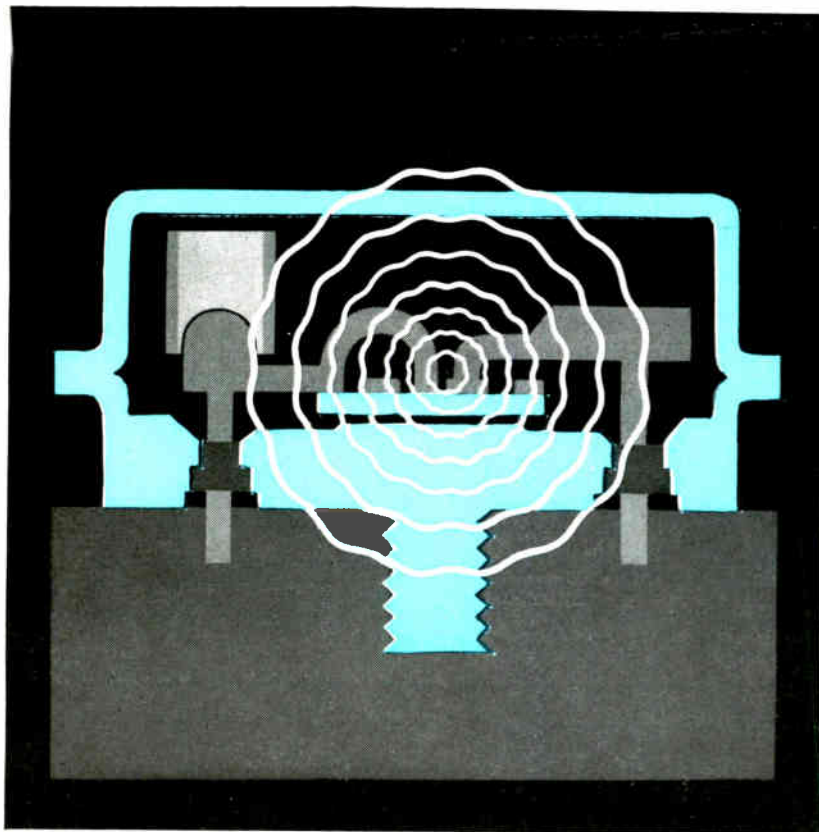

Saturation voltage $V_{CE}(\text{sat})$ is an extremely important transistor characteristic. When the collector to base voltage of a transistor is either zero or in the forward direction and the emitter to base voltage also is in the forward direction the transistor is said to be in saturation. Low saturation voltage improves circuit efficiency and reduces transistor dissipation in applications in which the transistor is driven into saturation. This results in lower junction temperature and improved temperature stability.

TUNG-SOL MINIMIZES $V_{CE}(\text{sat})$

TO PRODUCE POWER TRANSISTORS THAT DELIVER FULL POWER

Power transistors can be rated by at least a score of characteristics. For most of these, the ratings of an ordinary transistor may be equivalent to the ratings of a Tung-Sol transistor—under optimum conditions.

But Tung-Sol engineers have long recognized that power transistors are rarely operated under the so-called optimum conditions. Circuit requirements vary widely and so do operating environments. A better measure of power transistor quality and capability are the characteristics which contribute to transistor reliability and performance under less-than-optimum conditions.

One such characteristic is saturation voltage. Tung-Sol transistors are designed with the lowest possible saturation voltage consistent with other performance requirements.

Low saturation voltage results in lower transistor dissipation and lower junction temperature. This reduces the variation of the temperature dependent parameters of the tran-

sistor with resultant improvement in circuit and operational stability. Low saturation voltage decreases internal resistance and temperature and increases useful power-handling. Therefore, a low saturation voltage becomes increasingly important as the transistor is operated closer to its maximum power or in a high-temperature environment.

Low saturation design is typical of the care taken by Tung-Sol to provide the industry with transistors that reliably deliver full power. Ratings, based on stringent environmental and electrical tests, are given for junction temperatures of 110°C . Thermal resistance is low, while breakdown voltages are high.

Two more power pluses are Cold-Welded copper cases, for better heat dissipation and prevention of contamination, and flat-ground mounting surfaces, for full contact with heat sinks. Talk to Tung-Sol about your transistor problems. Tung-Sol Electric Inc., Newark 4, N. J. TWX: NK193.



TUNG-SOL® FULL POWER
POWER TRANSISTORS

Wide Choice of Tektronix Oscilloscopes for

Basic Specifications of Tektronix Rack-Mount Oscilloscopes

Rack-Mounts that accept Plug-In Units:

Type	Calibrated Deflection Factor	Vertical Passband	Signal Delay	Fastest Sweep (Magnified)	Slowest Sweep (Calibrated)	Calibrated Sweep Magnifier	Sweep Delay	CRT Volts	Vertical Scale	Price (without Plug-In Units)
RM45A	5 mv to 2 v/cm— 3 c to 24 mc					5X	1 μ sec to 10 sec	10 kv	4 cm	\$1650
RM43A						2X, 5X, 10X, 20X, 50X, 100X	None			1400
RM41A	with Type L Plug-In		Yes	20 nsec/cm	5 sec/cm	5X	1 μ sec to 10 sec			1325
RM35A	5 mv to 2 v/cm 3 c to 15 mc .05 to 20 v/cm cc to 15 mc with Type L Plug-In					5X	1 μ sec to 10 sec	10 kv	6 cm	1500
RM33A						2X, 5X, 10X, 20X, 50X, 100X	None			1225
RM31A						5X				1095
RM561	.05 to 20 v/cm dc to 4 mc with Type 67 Time-Base Unit and Type 75 Ampli- fier Unit.		None	.2 μ sec/cm	5 sec/cm	5X	None	3.5 kv	8 cm	465

Rack-Mounts that do not accept Plug-In Units:

RM15	.05 to 20 v/cm— dc to 15 mc			40 nsec/cm	2 sec/cm	5X	None	4 kv	6 cm	950
RM17	.01 to .05 v/div— 2 c to 10 mc .1 to 50 v/div— dc to 10 mc	Yes		40 nsec/div	2 sec/div					9 kv
RM503	1 mv to 20 v/cm— dc to 450 kc			1 μ sec/cm	5 sec/cm	2X, 5X, 10X, 20X, 50X*	None	3 kv	8 cm	655
RM504	5 mv to 20 v/cm— dc to 450 kc	None			5 sec/cm	None				550

U. S. Sales Prices I.o.b. Beaverton, Oregon

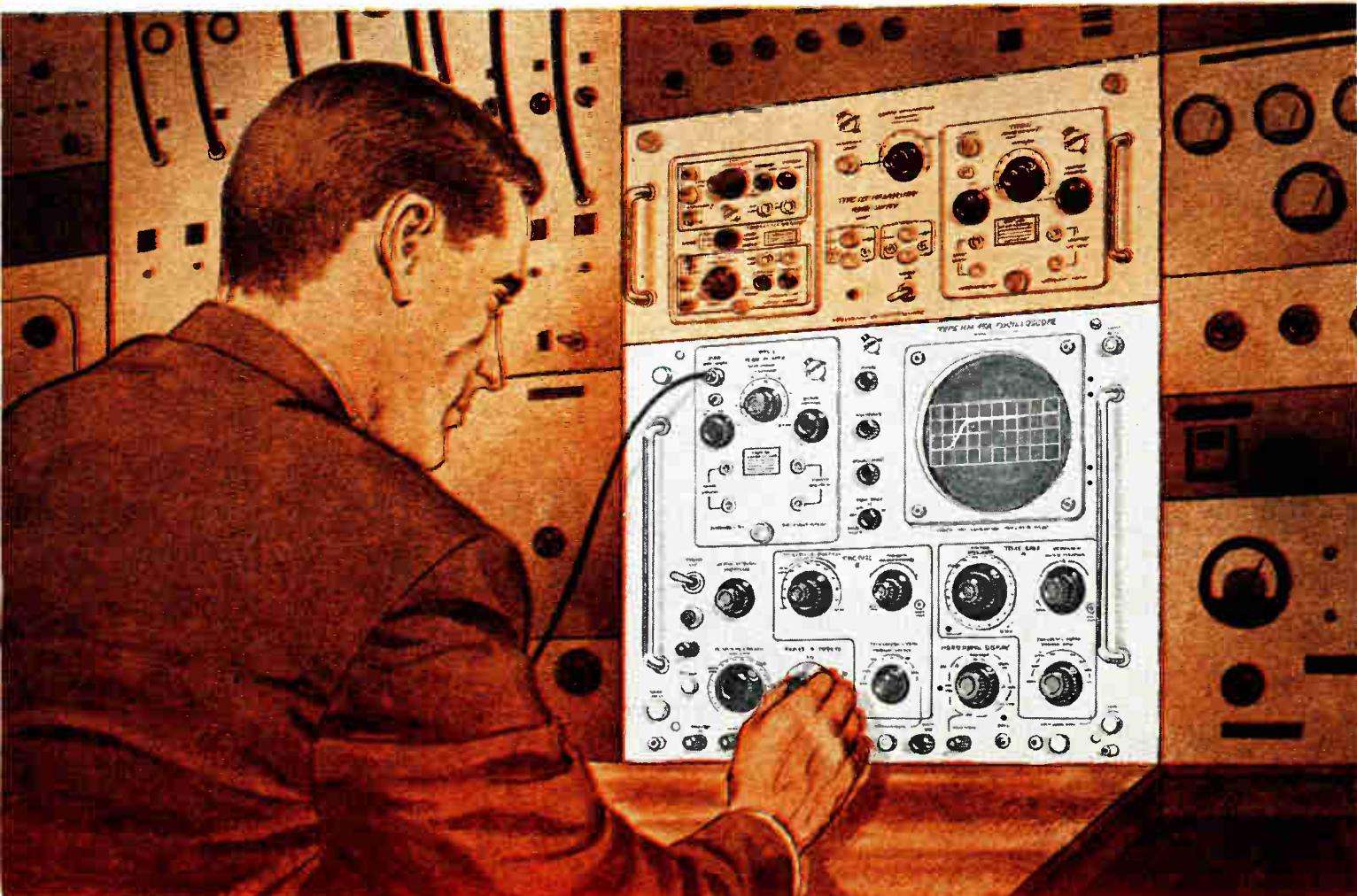

Rack or Console Applications

Tektronix offers 11 rack-mount models of its conventional laboratory oscilloscopes.

Each fits into a standard 19" rack.

Each incorporates the same high-performance features found in the conventional counterpart.

Each performs simply and reliably—for accurate time and amplitude measurements in the many laboratory applications within its capabilities.

Mechanical Features

Type	Plug-In Compartment	Rack Mounting	Rack Height (inches)	Rack Depth (inches)	Approx. Weight (pounds)
RM45A	Vertical Channel accepts one of 16 "letter-series" plug-in units.	Mounts with Slide-out Tracks in a cabinet that mounts to the rack—oscilloscope can be pulled forward, tilted, locked in one of 9 positions.	14	22½	85
RM43A					81
RM41A					79
RM35A					83
RM33A					79
RM31A					79
RM15	None	Mounts with Slide-out Tracks to the rack—otherwise, same as above.	8¾	23	57
RM17					40
RM503					27
RM504					25
RM561	Both Channels accept "number-series" plug-in units.	Type RM561 can be ordered with Slide-out Tracks at additional costs.	7	18	31

For a demonstration of the characteristics and capabilities of any one of these rack-mount oscilloscopes—or information on other Tektronix rack-mount instruments available—please call your Tektronix Field Engineer.

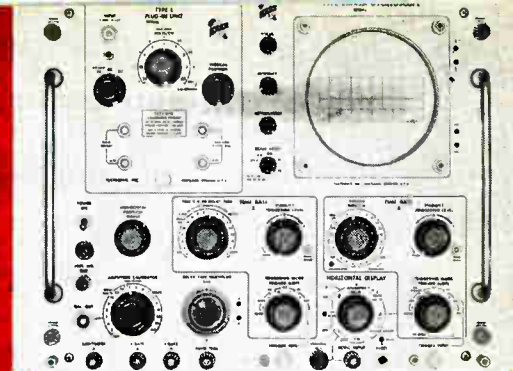

TYPE RM45A DC-TO-30 MC SWEEP-DELAY OSCILLOSCOPE with Type L Fast-Rise, High Gain Plug-In Unit.

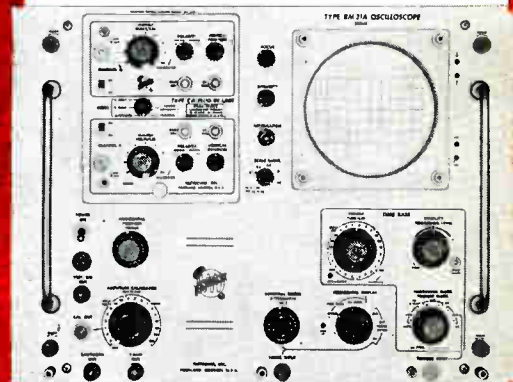

TYPE RM31A DC-TO-15 MC OSCILLOSCOPE with Type CA Dual-Trace Plug-In Unit.



TYPE RM17 DC-TO-10 MC OSCILLOSCOPE with 3-inch crt, 9-kv accelerating potential.

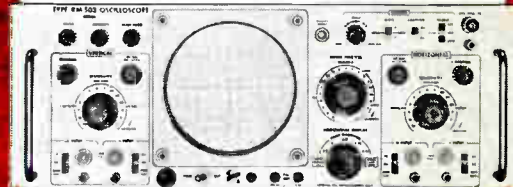

TYPE RM503 DC-TO-450 KC X-Y OSCILLOSCOPE

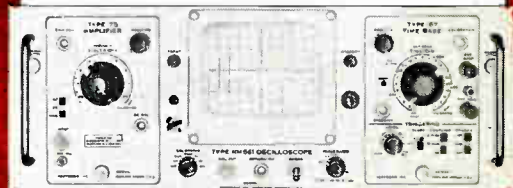

TYPE RM561 OSCILLOSCOPE—accepts plug-in units in both channels.

Tektronix, Inc. P. O. BOX 500 · BEAVERTON, OREGON / Mitchell 4-0161 · TWX—BEAV 311 · Cable: TEKTRONIX

TEKTRONIX FIELD OFFICES: Albuquerque, N. Mex. • Atlanta, Ga. • Baltimore (Towson) Md. • Boston (Lexington) Mass. • Buffalo, N.Y. • Chicago (Park Ridge) Ill. • Cleveland, Ohio • Dallas, Texas • Dayton, Ohio • Denver, Colo. • Detroit (Lathrup Village) Mich. • Endicott (Endwell) N.Y. • Greensboro, N.C. • Houston, Texas • Indianapolis, Ind. • Kansas City (Mission) Kan. • Los Angeles, Calif. Area (East Los Angeles • Pasadena • West Los Angeles) • Minneapolis, Minn. • New York City Area (Alberton, L.I., N.Y. • Stamford, Conn. • Union, N.J.) • Orlando, Fla. • Philadelphia, Pa. • Phoenix (Scottsdale) Ariz. • Portland, Ore. • Poughkeepsie, N.Y. • San Diego, Calif. • San Francisco, Calif. Area (Lafayette • Palo Alto) • Seattle, Wash. • Syracuse, N.Y. • Washington, D.C. (Annandale, Va.)

TEKTRONIX CANADA LTD: Montreal, Quebec • Toronto (Willowdale) Ontario.

ENGINEERING REPRESENTATIVES: Kentron Hawaii Ltd., Honolulu, Hawaii. Tektronix is represented in twenty-five overseas countries by qualified engineering organizations.

European and African countries, the countries of Lebanon and Turkey, please contact TEKTRONIX INTERNATIONAL A.G., Terrassenweg 1A, Zug, Switzerland, for the name of your local engineering representative. Other Overseas areas, please write or cable directly to Tektronix, Inc., International Marketing Department, P. O. Box 500, Beaverton, Oregon, U.S.A. Cable: TEKTRONIX.

CIRCLE 63 ON READER SERVICE CARD

New Horizons in Image Displays

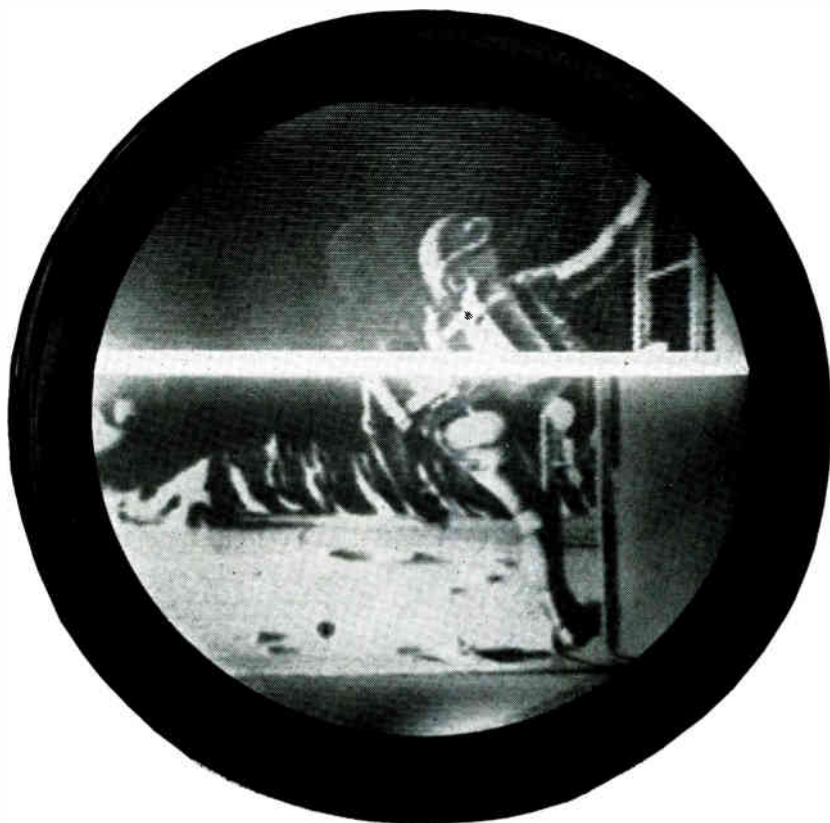

Man-on-moon rehearsal is simulated view of what a tv camera on the moon would send, by narrow band transmission, back to storage tube displays on earth. Advantage of new multi-mode tubes in this application is that persistence and rate of image display can be controlled. Lower part of photo was stored from previous scan

WHILE SIZE REDUCTION is in order for the vast majority of electronic components and circuits, larger and brighter displays loom up for direct view storage tubes—electron tubes into which information is introduced as an electric signal, and read out at a later time as visible output corresponding to stored information.

Manufacturers have increased available sizes from 5-inch diameters up through 7-inch and 10-inch tubes, and even 21-inch versions (see cover).

Hughes Research Laboratories have developed a bombardment induced conductivity (BIC) tube, an electronic blackboard that can write, hold, or erase a picture—that has widespread applications to a number of systems. And recent

innovations suggest even wider applications. The Hughes BIC tube has been a key feature of the Taran Tactical Attack Radar and Navigator System, also developed by Hughes, that enables a fighter-bomber to fly hedge-hopping missions in adverse weather and to avoid detection by darting in below a radar cover. In Taran, the BIC tube provides a pilot with a continuous radar map. The erase feature makes it possible to replace the pilots cockpit map piece by piece. As new information comes in, stored information is erased spot by spot, while the continuous map is being refreshed.

As described by Hughes' George F. Smith, the BIC tube has two mechanisms which serve as chalk and eraser, and as it erases spot

by spot by charging down, it leaves the remainder of the picture unchanged. The tube permits writing white on black and black on white.

Widest application of improved display tubes is in airborne weather radar. Main use of larger tubes that have been developed are for shipboard radar and air traffic controls.

More Tubes Needed

Increased demands for direct viewing display storage tubes include air traffic control for both military and commercial applications, large area oscillographic displays for simultaneous comparison of several parameters in seismologic exploration such as "hole shooting" oil fields. Airborne applications burgeon where weather radar, terrain avoidance, ranging, and tracking information are to be displayed in one tube. Other applications widen in sonar displays, space telemetry, where slow-scan tv transmission of space vehicle data is used. And in various types of fire control systems.

With most high-performance displays, it has been desirable to maintain flat viewing surfaces to avoid distortions which impair accurate readings. In trying to achieve these flat surfaces, tube manufacturers have been faced with the problem of trading off flat glass panels against the needs for mechanical strength.

At sizes above 10 inches in diameter, the glass envelopes' internal vacuum begins demanding either doming of the faceplates, or thickening of the glass. Neither alternative is entirely satisfactory, and as a consequence there is presently no satisfactory storage tube available in the size range between 10 inches (flat-faced) and 21 inches (domed).

Tube manufacturers are making progress in improving the quality and amount of display information available. Improved resolution, greater availability of tubes with

System-Engineered Transformers: Transformers designed and engineered by Triad to the special characteristics and requirements of a specific system. Take, for example, the .N3 Inertial Navigation System in the Lockheed True World F-104 Starfighter. For this system alone, Triad designed 25 different types of transformers ranging from audios to small powers. The largest is a power unit with a cross section of just $\frac{1}{2}$ " x 3". The smallest is the Grade V, Class S miniature with dimensions of .500" x .544" x .466" as shown. This compact, amazingly durable transformer has been submitted to over 100 temperature cycles without failure. Total harmonic distortion is within 2.5% maximum. Frequency response is ± 2 db. Miniature or larger transformers offering exceptional performance characteristics like these are possible because Triad works closely with the customer to design the transformer to system parameters. And frequently, the parameters of an experimental or developmental electronic system are far more stringent than those indicated in standard transformer specifications. Ask for information on the complete line of Triad miniatures. Triad also offers over 1000 off-the-shelf models known for their excellence of construction and performance. Contact your distributor for fast deliveries or write 4055 Redwood Ave., Venice, Calif., or 305 N. Briart St., Huntington, Ind.



TRIAD TRANSFORMER CORP. A DIVISION OF LITTON INDUSTRIES

SEND COUPON FOR THIS...

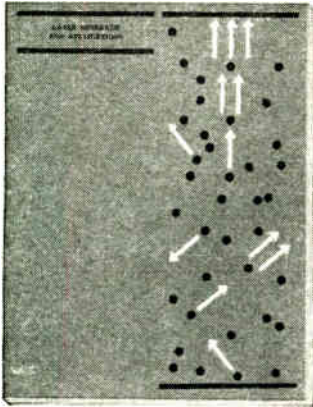

Free Laser Fact Folio

SEE RAYTHEON AD ON PAGE 58

RAYTHEON

MR. MARTIN B. CURRAN
RAYTHEON COMPANY, LEXINGTON, MASSACHUSETTS

■ Please send my copy of "Laser Research and Applications" by return mail.

I am primarily interested in:
 laser systems
 \$975 laboratory head
 (Specify application, if possible)

NAME _____
 TITLE _____
 COMPANY _____
 ADDRESS _____
 CITY _____ STATE _____

large 10-inch display areas, and other novel techniques which improve display legibility are three major approaches being used.

The new BIC tubes introduced by Hughes employ a dual-effects dielectric material in the storage surface. Tubes present and store not only bright trace writing, but dark trace writing, previously mentioned. Non-store displays can also be presented simultaneously with stored displays. Non-store operation permits cathode-ray type information such as reference markers, grid lines, or maps to be superimposed on the stored display with no serious degradation to the latter.

Special Dielectric Used

Inclusion of these features into direct display half-tone storage tubes has not previously been practical because of the nature of secondary emission effects on which writing and erasing of stored information are based. Limitations imposed by secondary emission effects are now surmounted by a special storage surface dielectric.

One general advantage in viewing outer space missions from the earth is that information is seen as it comes in. With conventional equipment there is a lapse of as much as ten seconds, which can be critical in space applications, as seen in the recent delay of Scott Carpenter's retro-rocket firing.

The dark-writing beam has found principal use in ways other than originally contemplated. Rather than being used to rove about, selectively obliterating brightly stored information, this capability has been most commonly received to increase both the resolution and duration of stored displays.

The normal writing beam is first used to prime and store the entire viewing area completely bright. If the priming beam is made to immediately precede the erasing beam, then the entire display area will be stored brightly from scan to scan. Smearing of previously stored information is completely eliminated and only the space between the two beams—a fraction of an inch—contains no information. This is a contrast to a conventional cathode-ray tube used in slow-scan modes, where information fades immediately following the beam sweep, or with conventional storage tubes

which employ a controlled persistence less than the period of the scan to permit fading in time to show a slow-scan smearing.

Man-on-moon rehearsal photo shows a slow-scan presentation in which the lower portion is stored from a previous scan, while the upper portion contains updated information. The entire display is at full brightness.

An added benefit is that the higher potentials at which the dark-writing beam operates provides a smaller spot and hence improved resolution. Thus, storage tube displays of 100 to 120 shrunken raster lines per inch are now possible, delivering more than twice the display information previously obtained.

Slow-scan tv monitors will probably be used to view a tv camera, sent on planetary and interplanetary missions to the moon, or to Venus or Mars, and transmitted by narrow band back to storage displays on earth.

Technical details on the family of Hughes storage tube types—Tonotron, Memotron and Typotron—are available from Hughes Aircraft Company, Vacuum Tube Products Division, Oceanside, California.

Improved Image Intensifier Uses Thin-Film Emitters

By NORMAN SLARK

Calvert Electronics, Inc., N.Y.C.

A HIGH-GAIN image intensifier tube, designed for direct viewing or photographic recording at extremely low light levels, can increase brightness of a weak optical image by at least 100,000 times. The tube has low noise and gives

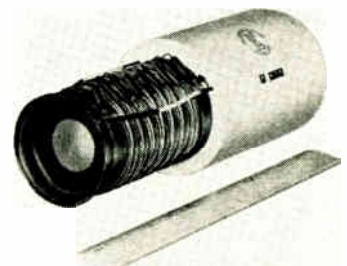

Magnetically focused image intensifier with encapsulation partially sectioned

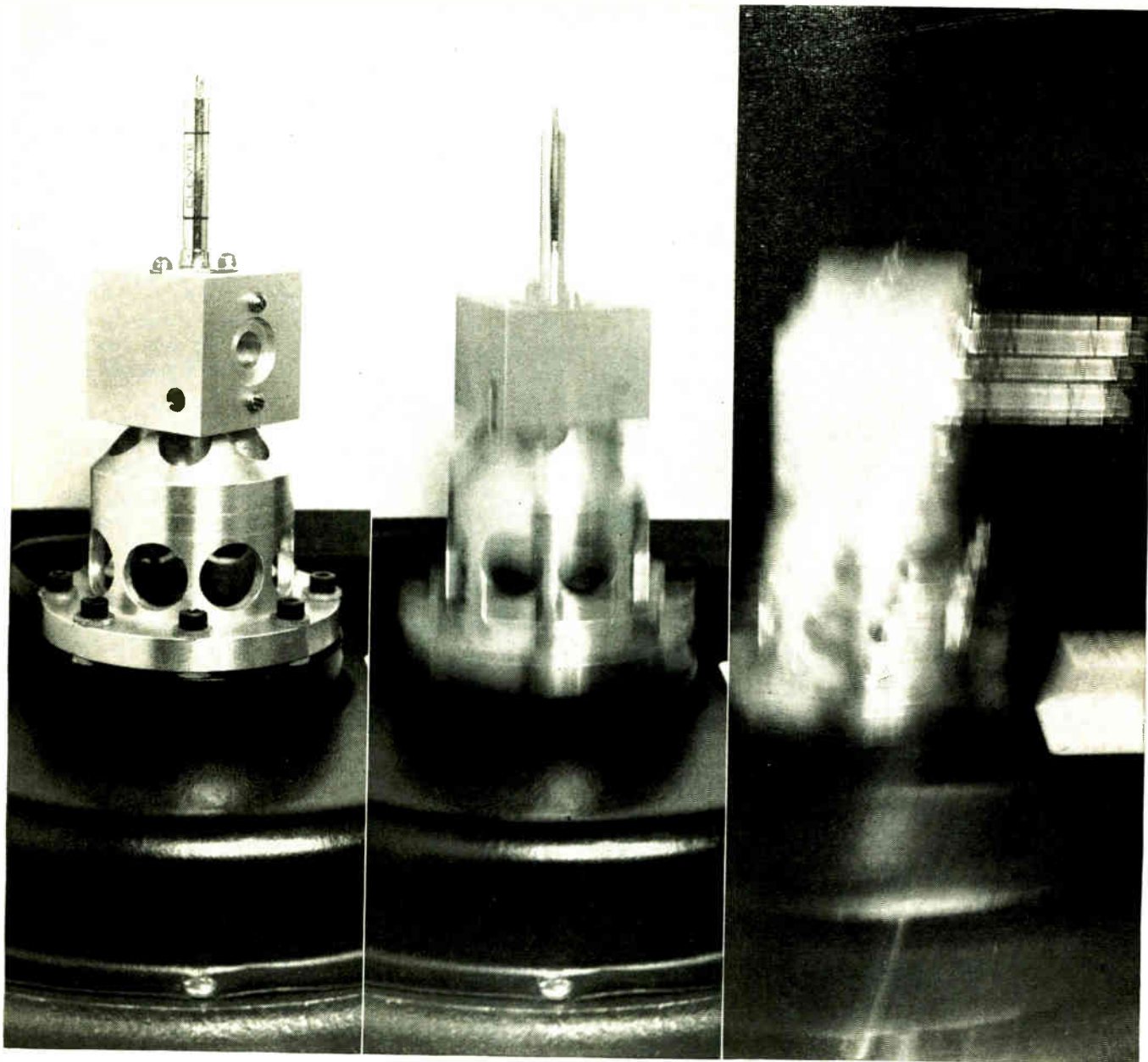

Specify proven stability



with CLEVITE Ceramic Filters

Does your i-f filter maintain center frequency under vibration and shock? It does if it's a Clevite ceramic ladder filter. Center frequency shift is negligible after MIL 202B shock and vibration tests*. ■ Stability like this is worth considering whether your next receiver is ground or airborne. Clevite now stocks 455 kc and 500 kc ladder filters in 12 bandwidths from 2 kc to 50 kc. Standard models pack 80 db stopband rejection into a 0.1 cu. in. package. ■ Write or phone the nearest Clevite office for immediate information, prices and delivery on Clevite ceramic ladder filters.

*actual test plots on request.

Field Sales offices: New York, New York/Chicago, Illinois/Denver, Colorado/Inglewood, California.

**CLEVITE
ELECTRONIC
COMPONENTS**
DIVISION OF CLEVITE CORPORATION
232 FORBES ROAD, BEDFORD, OHIO

June 15, 1962

CIRCLE 67 ON READER SERVICE CARD 67

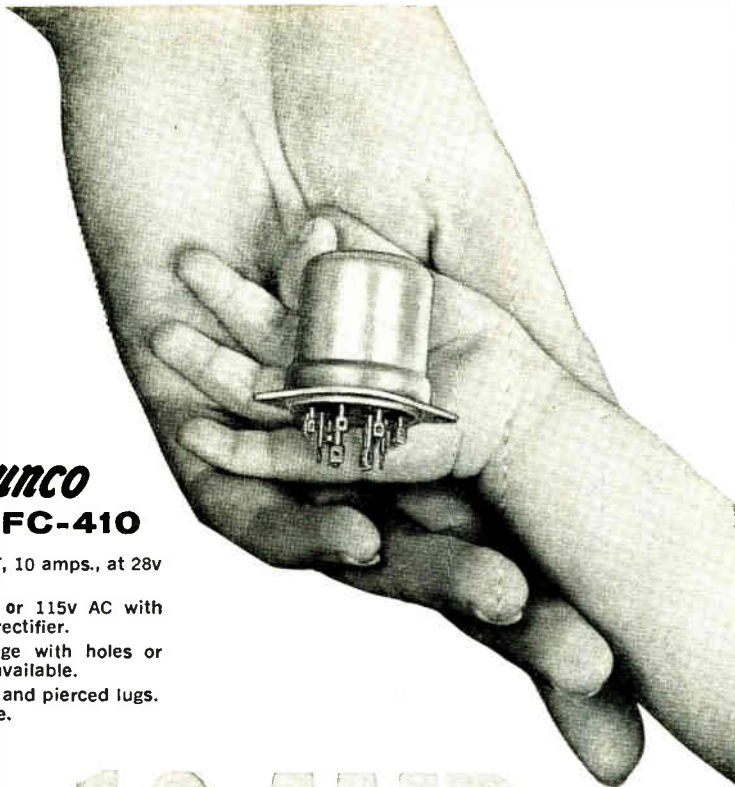

Dunco **TYPE FC-410**

Contacts: 4P-DT, 10 amps., at 28v DC or 115v AC.

Coil: 26.5v DC or 115v AC with self-contained rectifier.

Mounting: Flange with holes or studs. Others available.

Terminals: Flat and pierced lugs. Others available.

10 AMP PERFORMANCE

... 2 AMP RELAY SIZE

Scarcely larger than conventional 2 ampere military relays, the Dunco FC-410 handles a full 10 amperes at 28 volts DC or 115 volts AC. Packed into its tiny hermetically sealed case are a rotary armature and four Form C contacts capable of 100,000 reliable operations at ambient temperatures up to 125°C. Designed to MIL-R-5757D specifications, the FC-410 withstands 50G shock and 20G vibration to 2,000 cycles per second.

Unequaled as a power relay for electronic equipment, the FC-410 is one of several recent Dunco relays that pace the reliability and size requirements of critical ground support and airborne equipment designs. Slightly larger 10 ampere relays for air frame applications under MIL-6106C are also available as the Dunco FC-400 Series. Write for Data Bulletin FC-410 to *Struthers-Dunn, Inc., Pitman, N.J.*

STRUTHERS-DUNN

WORLD'S LARGEST SELECTION OF SMALL RELAYS

Member, National Association of Relay Manufacturers



Sales Engineering Offices in: Atlanta • Boston • Buffalo • Charlotte • Chicago • Cincinnati • Cleveland • Dallas • Dayton • Denver • Detroit • High Point • Kansas City • Los Angeles • New York • Orlando • Pittsburgh • St. Louis • San Diego • San Francisco • Seattle. Canadian Licensee: Renfrew Electric Co., Toronto, Ontario, Canada. Export Department: 1505 Race St., Philadelphia 2, Pa., U.S.A.

good resolution, and may be used as a shutter tube with exposures of one microsecond by pulsing the front section between the photo-cathode and the first multiplying dynode.

Tube employing magnetic focus have been made, but so far have only been available as two-stage tubes having gains much less than 100,000.

However these tubes require the manufacture of many photo-cathodes in the tube envelope which is extremely difficult and therefore makes these tubes difficult to manufacture.

The new device, type P829, achieves intensification of the electron image by focusing the electrons leaving the first photo-cathode onto a thin transmission, secondary emission multiplying film.

The image leaving the fifth film is accelerated onto a phosphor where the output image is produced. Thus the optical image is intensified without the need of producing more than one photo-cathode and, as the secondary emitting films are easier to make than photo-cathodes, construction is simplified.

The photo-cathode features tri-alkaline S-20, minimum sensitivity 80 microamps per lumen. Resolution is 20 line pairs per millimeter minimum, up to 30 line pairs. Operating potential is 35 to 40 Kv max., magnetic field is 260 gauss. The useful photo-cathode and phosphor diameter is one inch. The tube, manufactured by English Electric Valve Co., Ltd., is available here through Calvert Electronics.

Future developments will include a version with a silica face plate, to increase spectral range of sensitivity to cover 2,000 to 8,000 angstroms. A demagnifying front stage is also under development to allow a larger area of the photo-cathode to be used.

The presently available P829 is finding uses in nuclear physics for observation of particle tracks in scintillation material, or for detection of Cerenkov rings to measure particle velocities. In astronomy, the tube reduces the exposure time required to detect weak stars. Military applications include methods for maintaining observations in limited light, spectographic analyses, or where ability to record faint images is advantageous.

MUMETAL

IS THE ANSWER TO YOUR
MAGNETIC SHIELDING PROBLEMS

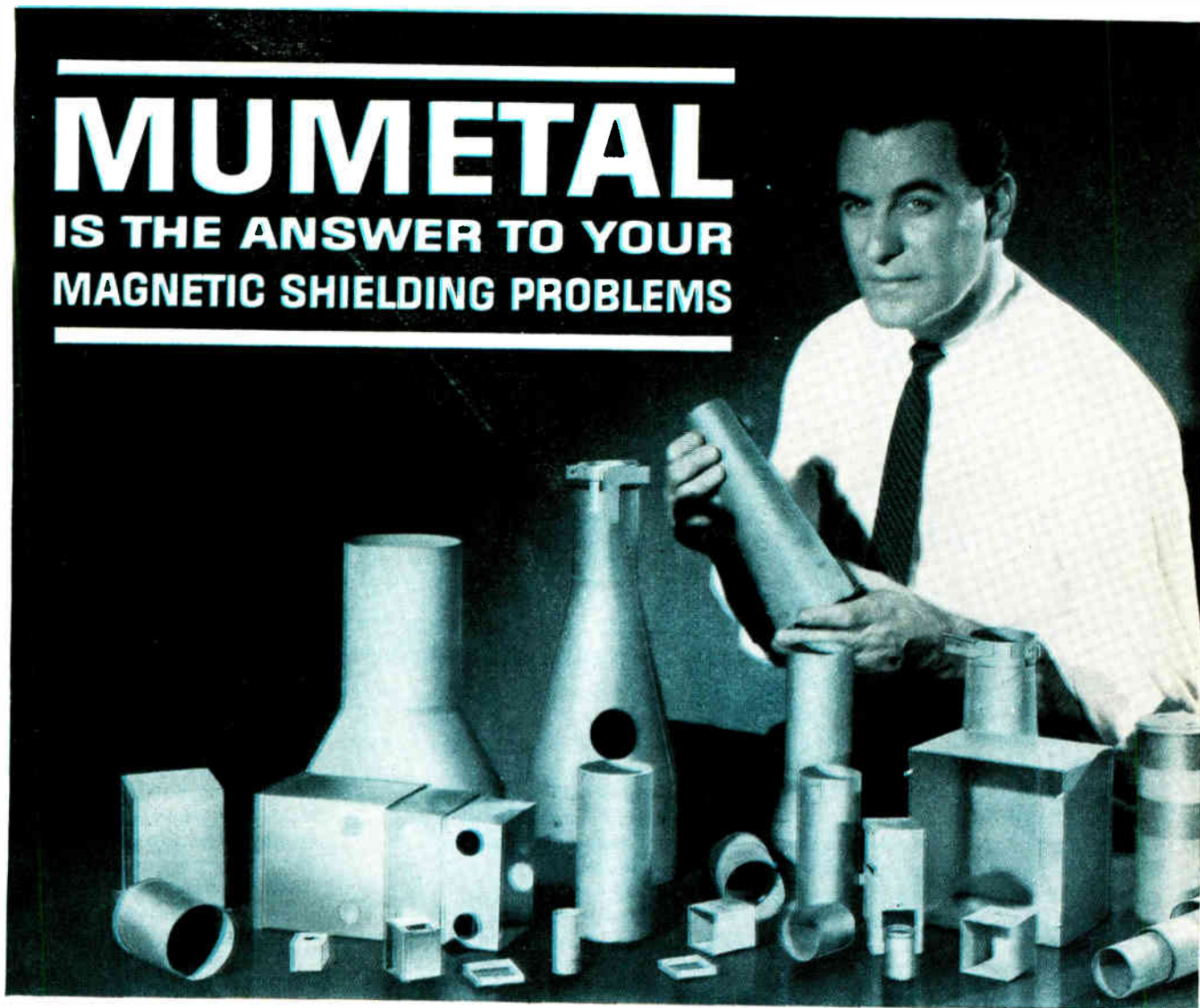

Instant relief to interference caused by extraneous magnetic fields is the net result of shields made of Allegheny Ludlum's Mumetal. These shields protect components against stray external fields or prevent neighboring parts from being affected by a field-generating component inside the shield. In electronics, Mumetal and shielding are practically synonymous terms.

To develop its optimum shielding properties, Mumetal must be properly annealed in a pure, dry, high temperature hydrogen atmosphere after fabrication. When properly annealed, Mumetal has extremely high permeability and is capable of attenuating stray fields to negligible proportions.

In general, high permeability, shielding excellence and strain sensitivity go hand in hand. In the optimum condition, Mumetal is relatively soft. Shields in this condition should be

handled with care in order to preserve optimum shielding efficiency.

In many applications, fabricating or field conditions are encountered which make it impossible to avoid straining the material after the high temperature hydrogen anneal. Even when strained, Mumetal shields remain extremely effective.

The inherent ductility of Mumetal offers fabricating advantages in forming, drawing, and spinning operations.

For all your shielding requirements, insist on Allegheny Ludlum Mumetal. And for more information, ask for a copy of EM12, a 20 page technical Blue Sheet describing Mumetal, its properties, annealing details, etc. Write *Allegheny Ludlum Steel Corporation, Oliver Bldg., Pittsburgh 22, Pa., Address Dept. E-6*



ALLEGHENY LUDLUM

PIONEERING on the Horizons of Steel



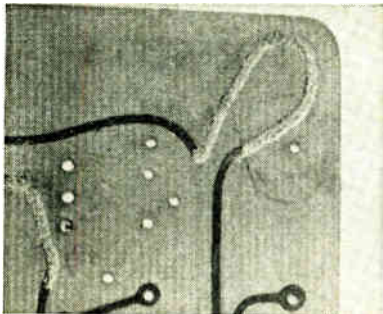

Printed circuit board is repaired with epoxy strip and metal particles



Triode is shielded with 8-mil coat of high conductivity



Lead is attached to capacitor with bonding technique

Conductive Plastic Solders and Shields

A TWO-STEP technique has been developed by Chomerics, Inc. of Cambridge, Mass., for forming low cost, highly adhesive and electrically conductive plastic joints, lines and coatings. The technique can be used to replace metal soldering, metalized coatings and braided wire shielding. Typical resistivities of the coatings are 0.01 to 0.001 ohms per square, depending on thickness.

Materials for the process, which is called Cho-bonding, are about one-third the cost of conventional silver filled resins. A thin film or a small drop of a specially formulated resin binder, usually an epoxy, is deposited on the surface is then coated with one of several special metallic powders by dusting, spraying or immersion. Excess powder not absorbed by the resin film is recovered and the resin binder is cured, freezing the metal particles in place.

Soldering Method

When the technique is used for soldering, a drop of a low viscosity epoxy resin is applied to the lead by a syringe. The wet spot of resin is dusted with metal powder and the excess powder is poured off and recovered. The joint is then heat-cured. A strong, moisture resistant bond is obtained since the low viscosity resin has an opportunity to wet and penetrate the surface before absorbing the powder.

Coatings can be obtained by an extension of the soldering technique, and surfaces of any size and

TABLE—APPLICATIONS OF BONDING TECHNIQUE

Terminal and lead connections	Stenciled printed circuits
Electrical grounding	Extruded r-f cable shielding
Prototype assemblies	Molded r-f connector bodies
Antistatic coatings	RFI shielded rooms and containers
Molded pots—variable resistors	Wave guide gaskets
Printed circuit jumping—repair	Molded electroplating forms
Wave guide tuning and repair	Flexible body electrodes
Electroplating tabs	RFI static closure gaskets
Cast connectors and bases	Radar reflecting coatings
Bonding to semiconductors	Hand applied shielded tape
Electroluminescent and fluorescent lamps	RFI blankets
Capacitor solder slug replacement	

shape can be coated. In one coating application, a glass triode tube had an 8-mil shielding coat applied. The tube was dipped in resin, then dusted with conductive powder. The viscosity of the resin was low enough to prevent sagging of the dusted film during curing.

The coatings can be used on complicated shapes and for covering extended areas, as in the manufacture or repair of parabolic radar antennas. In the manufacture of radar antennas, the technique eliminates the need for flame spraying metal coatings on the plastic substrate. Difficult to reach interior surfaces can also be coated satisfactorily.

Another application is the preparation of shielded cable. The coating is applied in this case over the inner insulating plastic layer of the cable. First the liquid resin binder is applied by dipping or extrusion

and then the conductive particles are applied by dusting or by pulling the cable through a fluidized bed of the particles. The resin binder is thereafter cured. If a flexible resin binder is used the cable can be bent without destroying the coating. Cables so treated have a tight, uniform coating.

Board Repair

Printed circuit boards can be manufactured and repaired with the technique. A line of resin is laid down, either by hand or by silk-screening or offset printing, then dusted with powder and cured.

The conductive powders used are coarse, free flowing metal particles that form electrically conductive paths when maintained in particle-to-particle contact in a suitable plastic binder. Volume resistivities of plastics filled with these conductive powders are uniformly below

How Denison Precision-Cleans .0002" Tolerance Parts Weighing 180 Lbs.!

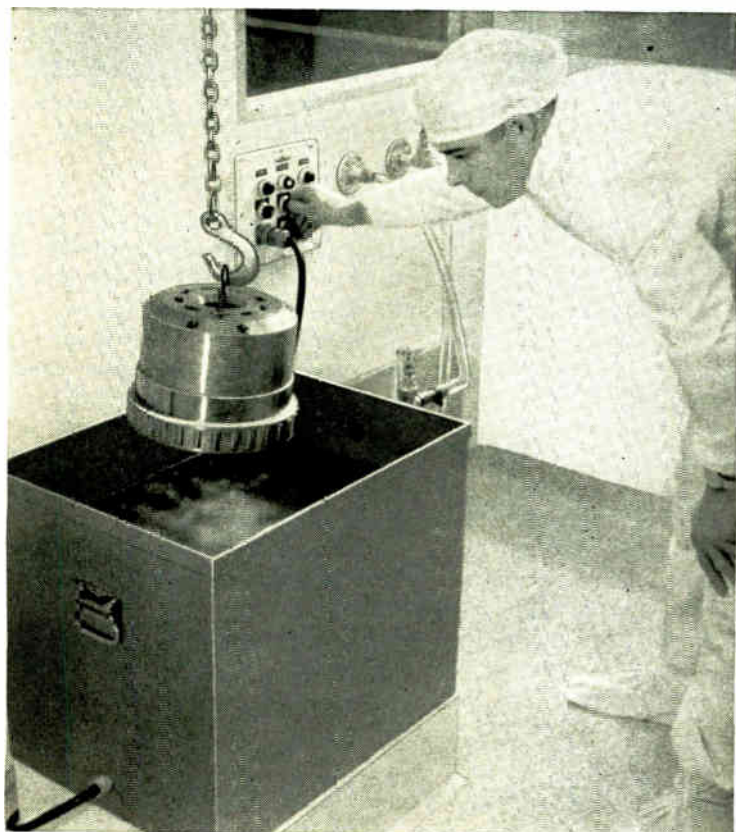

PROBLEM: Denison Engineering Div., American Brake Shoe Co., needed reliable precision-cleaning of metal hydraulic components for missile-ground-support equipment they manufacture. Clearances down to .0002 in. had to be maintained, yet cleaned. A familiar situation . . . except that these components weigh up to 180 lbs.!

SOLUTION: They constructed an ultra-modern new White Room using "Freon" fluorinated solvents. "Freon" is an excellent selective solvent, yet is non-flammable and of extremely low toxicity. So it's perfectly safe and practical to work with the relatively large amount of solvent needed for total immersion of these bulky components. Denison needs no hoods or blowers to vent the solvent!

In the photo, one of these hydraulic components, a 65-lb. pump-cylinder barrel is lowered into an ultrasonic bath of "Freon" solvent at Denison's new White Room. According to Denison, the "Freon" has so low a surface tension, it easily penetrates the tiny openings involved. There it washes away atmospheric or process contaminants such as dust, lint or chips, without harming critical metal surfaces.

Denison has found "Freon" dries quickly, leaves no residue on parts, gives better cavitation than previous solvents. And, most important, they can get 90% recovery of the solvent in a simply constructed still. Since using "Freon", they've never had a hydraulic component rejected for cleanliness!

• • •
We'll be glad to give you help in selecting "Freon" solvents for use in your own White Room. Just write on your letterhead to Du Pont, 2420E6 Nemours Bldg., Wilmington 98, Del.

FREON[®]
solvents



BETTER THINGS FOR BETTER LIVING...THROUGH CHEMISTRY

ADJUSTABLE PRECISION POLYSTYRENE CAPACITORS

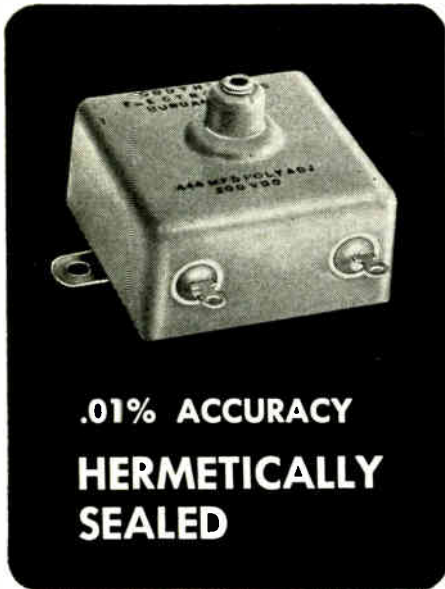

**.01% ACCURACY
HERMETICALLY
SEALED**

**1st choice for
Critical Applications**

SOUTHERN ELECTRONICS hermetically sealed precision adjustable capacitors are being used for many applications in analog computers, network tuning circuits, differential analyzers, and similar circuitry requiring the utmost in accuracy and reliability.

SEC has pioneered in the design and manufacture of hermetically sealed adjustable capacitors, and this experience has resulted in a .01% accuracy standard, and a degree of in-circuit reliability not previously available. **SEC** adjustable capacitors incorporate features proven to be years ahead of any comparable product now available.

GENERAL SPECIFICATIONS

Adjustment Range: $\pm 1\frac{1}{2}\%$
Dielectric Absorption: 0.02%
Available from .01 mfd. to 10 mfd.
Accuracy: .001%
Long Term Stability: 0.03%
Temperature Coefficient: -100 PPM per °C
Temperature Range: -40°F to +140°F



Write today for complete specifications and general catalog.

**SOUTHERN
ELECTRONICS**
Corporation

150 West Cypress Ave., Burbank, California

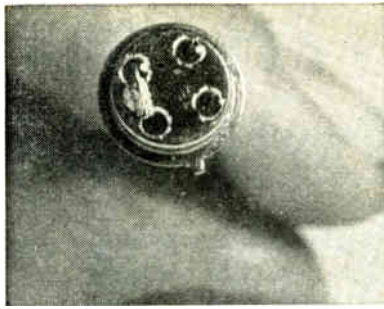

Transistor lead is grounded to header

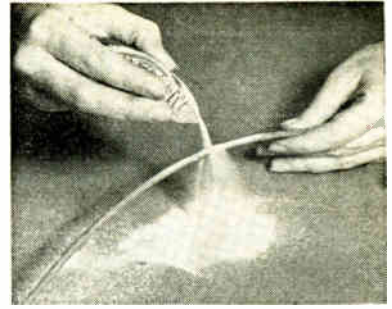

Conductive powder can be applied by pouring, dusting, spraying

0.01 ohm-cm and usually approach 0.001 ohm-cm.

The size of the metal particles, 1 to 3 mils, and their shape, roughly spherical, are such that they readily penetrate and sink into the resin film. The amount of the metal powder a resin will accept in this manner is 85 to 90 percent by weight, which assures high and uniformly reliable conductivities.

The conductive powders are conductive in loose form and will not degrade. They, and plastics filled with them, have been maintained for periods of several weeks at 400 F in an oxidizing atmosphere with

no loss in conductivity. Soldered leads have withstood humidity life tests of 100 percent relative humidity at 100 F for 1,000 hours.

A series of six bonding systems has been developed. One system cures at room temperature and is suitable for horizontal or substantially horizontal surfaces. Other systems cure at elevated temperatures and are designed for various applications, with temperature ratings when in use of up to 300 C.

The table indicates the types of applications in which the technique can be used.

X-Rays for Semiconductor Inspection

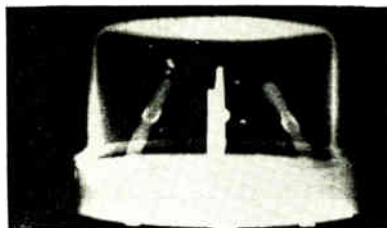

Transistor at left is rejected because of loose solder globules, bent leads, crimped whiskers. Device at right is acceptable

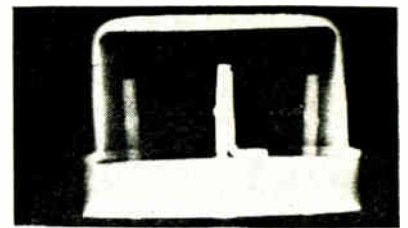

RADIOGRAPHIC INSPECTION of semiconductors is being provided by X-Ray Engineering Co. through its Western Inspection Services Division in Santa Clara, Calif.

The application of micro-radiography to the nondestructive testing of small parts has proved to be a fast method for testing semiconductors to high reliability specifications.

The exposure technique is unusual and is not typically used by experienced radiographers. The focal distance used is 220 to 1, whereas the average focal distance used in normal applications is 18

to 1. Alignment of the X-ray tube is accomplished with a concave shooting table, which conforms with the focal length radius so that all parts are positioned in identical relationship to the focal point.

Because of the small size of the semiconductors, it is necessary to evaluate the film of each item individually with a 20-power microscope. The most important defects are the inclusion of foreign particles (detectable as small as 0.0001 inch), poor crystal mounting, broken or split whiskers, and distorted lead or semiconductor elements.

In Electronic Components,
The Least Costly
Can be Vital!

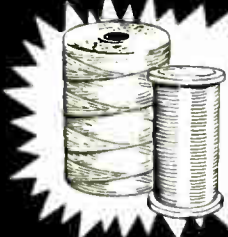

**USE LTCO
LACING CORDS and TAPES**
The Largest Line...The Most Advanced Types



Valuable Literature! New Linen Thread Company catalog, "Lacing Cords and Tapes for Electronics," can help you save money, eliminate hazards. It tells you how to save up to 500% with LTCO X-Type Nylon Lacing Cord, gives data you need on other Specification Lacing Cords and Tapes made by LTCO in Nylon Linen, Teflon, Cotton, Dacron.

Write Dept. 16F for your copy



THE LINEN THREAD CO., INC.
Blue Mountain, Alabama • Est. 1784

CIRCLE 203 ON READER SERVICE CARD

**NEW 1962
catalog**

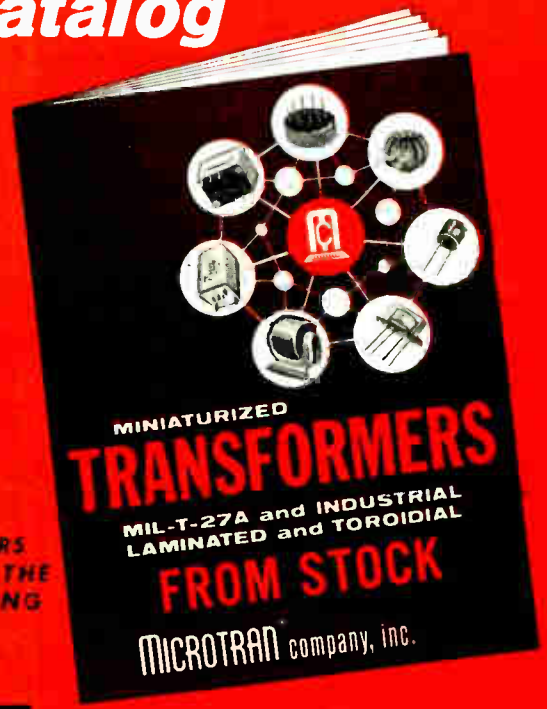

YOURS FOR THE ASKING

**MINIATURIZED
TRANSFORMERS**
MIL-T-27A and INDUSTRIAL
LAMINATED and TOROIDIAL
FROM STOCK
MICROTRAN company, inc.



MICROTRAN company inc.
145 East Mineola Avenue, Valley Stream, New York

"See us at the WESCON Show—Booth #2019

CIRCLE 204 ON READER SERVICE CARD

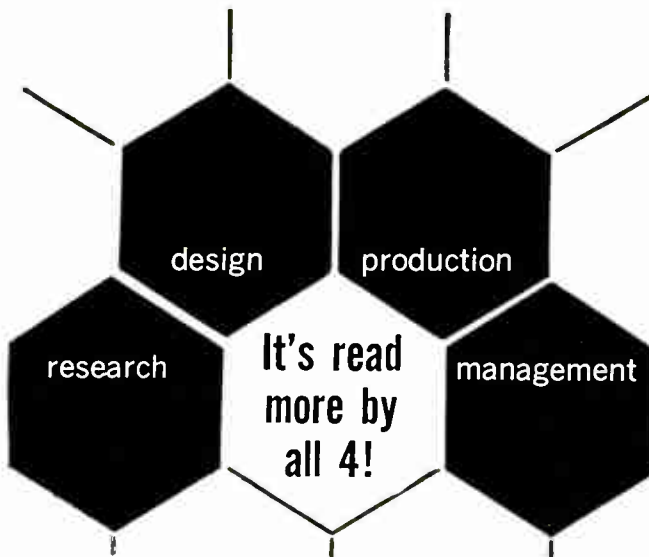

There's more data in **electronics**, the magazine that gives you the latest technical and engineering information every week *plus* business and government trends. Subscribe now. Mail the reader service card (postpaid) to **electronics**, the magazine that helps you to know and to grow! Rates: three years for \$12, one year \$6, Canadian, one year for \$10; foreign, one year for \$20. Annual **electronics** BUYERS' GUIDE included with every subscription.

subscribe today to **electronics!**

Eisler A NAME TO REMEMBER IN MACHINERY FOR ELECTRONICS

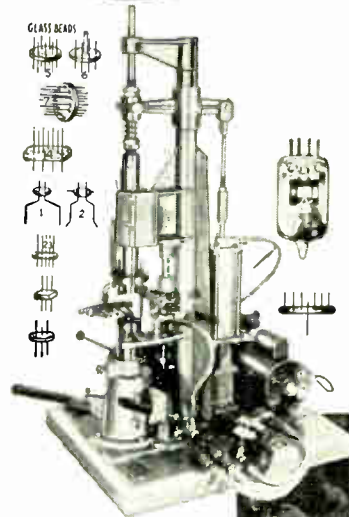

At left: No. 105-BST1 Single position Button Stem and Wafer making machine—Fully automatic. Designed for small production runs on special tube parts or for laboratory use. Produces button stems up to 1 1/4" diameter. Machine can be supplied with up to 24 positions.

Illustrated below: An Eisler precision Vertical Spot Welder designed exclusively for welding of electronic components. Available in sizes from 1/2 to 7 1/2 KVA.



Write us today for full particulars!

EISLER ENGINEERING CO., INC.

Charles Eisler Jr., President

751 So. 13th St., Newark 3, N.J.

CIRCLE 73 ON READER SERVICE CARD

DESIGN AND APPLICATION

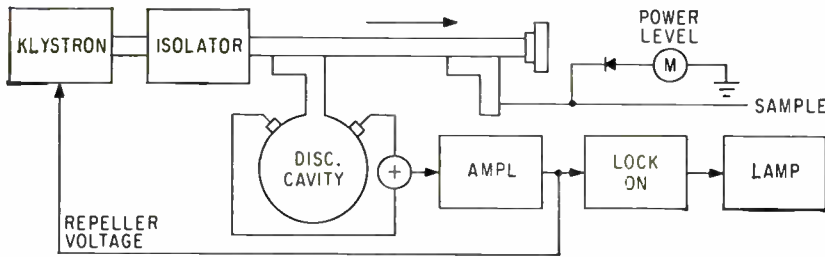

ing circuits, a manual frequency selector switch and a series of decade scalars. No monitoring or adjustment is necessary. The instrument can be used for calibration of tachometers and flow meter instrumentation, timing circuits, calibration of laboratory frequency measuring equipment and as a source of reference frequencies for check-out and system testing.

CIRCLE 302 ON READER SERVICE CARD

Tunable Microwave Stable Oscillator

SECONDARY STANDARD

ON THE MARKET from Frequency Engineering Labs., P.O.B. 504, Asbury Park, N. J., the G120X-1R ultrastable oscillator is tunable over a frequency range of 8.5 to 9.6 Gc with a short-term stability of 5 parts in 10^8 (10 msec) and a long term stability of 1 part in 10^6 (eight hours). Dial accuracy is ± 0.01 percent, power stability is ± 1 db and power output is 500 mw. The oscillator (see sketch) consists of a tunable klystron controlled by a stabilizing feedback loop consisting of a dual-mode cavity discriminator and a wide-band chopper-stabilized d-c amplifier. Klystron reflector voltage and cavity are ganged to one knob for tuning. A separate knob tunes the discriminator to the desired frequency and the klystron is tuned until the sta-

bilization indicator lamp comes on. A sample signal is taken after the load isolator by crossguide coupler and fed to the dual-mode cavity discriminator. A matched pair of forward and reversed crystals are used as the cavity detectors. Output of each detector is fed to a summing junction where an error signal is developed (provided that the klystron frequency is within the operating range of the discriminator). The error signal is amplified and applied to the klystron reflector, completing the feedback loop. Ripple in klystron high voltage is less than $500 \mu\text{v}$ and d-c is used on the filament. Freedom from spurious reference frequencies in the output makes this unit useful in coherent radar applications.

CIRCLE 301 ON READER SERVICE CARD

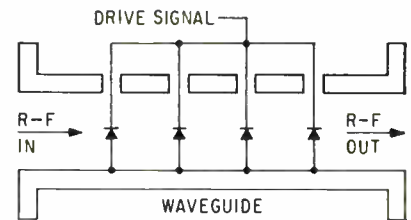

Ultra High Speed Switch

BROADBAND DIODE

ANNOUNCED by Scope Inc., 121 Fall-fax Drive, Falls Church, Virginia, this single-pole, single-throw germanium microwave switch has a bandwidth of 3 Gc at X-band, a switching speed of 1 nsec, driving power less than 60 mw and a minimum isolation of 50 db. It can be used as a pulse modulator for very-narrow, fast-rise pulses, an antenna switching device for low-power signals and an r-f gate in wideband receiver circuits. Using the switching characteristics of germanium diodes, r-f energy is transmitted through the switch with one level of bias on the diodes, and is reflected when another level is applied (see sketch). Driving bias voltages depend on level of r-f to be switched. Bias of -1 v can provide 50 db isolation with 1 mw of power incident on switch. With forward bias of $\frac{1}{2}$ v, diode impedance closely matches that of waveguide and incident power is transmitted with an approximate loss of 5 db. High isolation is achieved over a broadband by critical spacing and

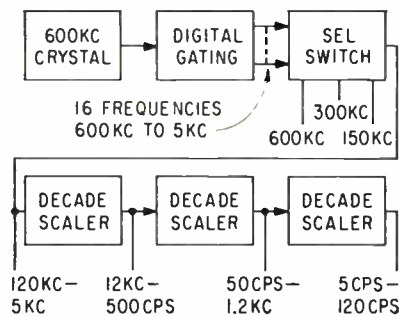

Frequency Generator

CRYSTAL CONTROLLED

MANUFACTURED by Anadex Instruments Inc., 7617 Hayvenhurst Ave.,

Van Nuys, California, the model CU-1 crystal-controlled digital frequency generator provides discrete frequencies ranging between 5 cps and 600 Kc with an accuracy of 0.0005 percent. Output voltage is a square wave with amplitude adjustable to 20 v peak. Both single-ended and balanced outputs are provided. The CU-1 is designed for calibration and test use wherever precision frequencies are needed and eliminates both the variable oscillator and frequency counter normally used in such cases. The unit (see sketch) uses a 600 Kc temperature-regulated crystal, digital gat-

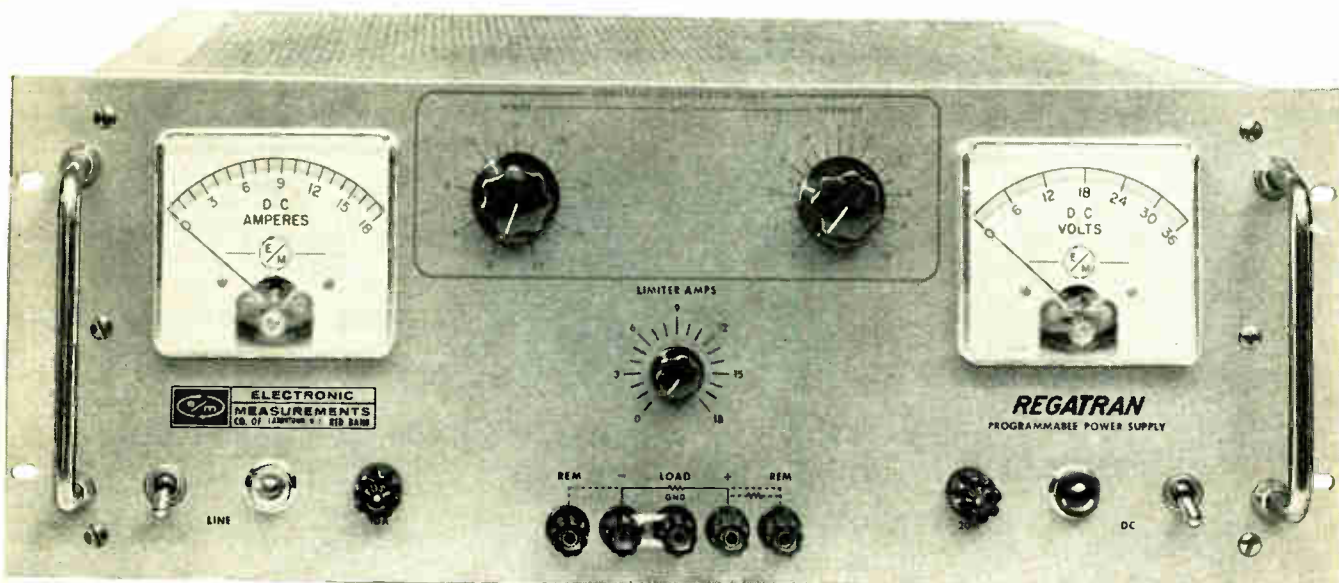

another first from Electronic Measurements

NEW "PV" Series Power Supplies

BRIEF SPECIFICATIONS

BASIC MODEL NO.	DC OUTPUT		DIMENSIONS IN INCHES		
	VOLTS	AMPERES	PANEL HEIGHT	PANEL WIDTH	DEPTH BEHIND PANEL
PV32-5	0-32	0-5	3½	19	17¼
PV32-10	0-32	0-10	5¼	19	16½
PV32-15	0-32	0-15	7	19	15¾ ₁₆
PV32-30	0-32	0-30	8¾	19	16¼
PV36-5	0-36	0-5	3½	19	17½
PV36-10	0-36	0-10	5¼	19	16½
PV36-15	0-36	0-15	7	19	15¾ ₁₆
PV36-30	0-36	0-30	8¾	19	16¼
PV60-2.5	0-60	0-2.5	3½	19	17¼
PV60-5	0-60	0-5	5¼	19	16½
PV60-7.5	0-60	0-7.5	7	19	15¾ ₁₆
PV60-15	0-60	0-15	8¾	19	16¼

- 0.01% or 2 millivolts regulation
- All solid-state with SCR input
- Programmable over the entire voltage and current range
- Long-line remote sensing
- Continuously variable current limiting
- Slaved series or parallel operation
- Up to 44% reduction in panel height

request specification sheet 2020

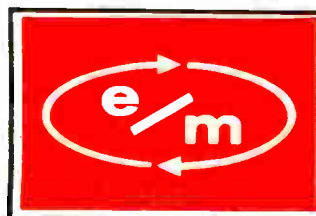

**ELECTRONIC
MEASUREMENTS**
COMPANY OF RED BANK
EATONTOWN • NEW JERSEY

WESTINGHOUSE ULTRASONICS

A reliable production tool . . . cleans almost anything better.

Do you need absolute cleaning of metal, glass, ceramic or plastic parts or assemblies? Westinghouse ultrasonic cleaning can do it. It's fast. Production-line dependable, too: generators are solid-state, transducers are long-life Magnapak and—for insurance—Westinghouse supplies local maintenance and service. Write: Westinghouse Electronic Equipment Department, 2519 Wilkens Ave., Baltimore 3, Md. You can be sure...if it's

Westinghouse

J-3519

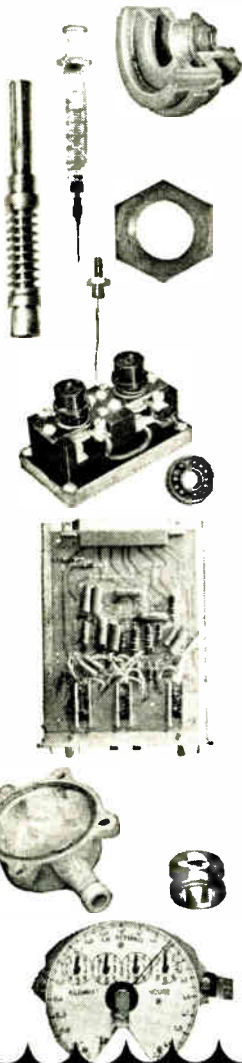

impedance matching of diodes. Switching speeds of 1 nsec can be achieved with less than 60 mw of driving power.

CIRCLE 303 ON READER SERVICE CARD

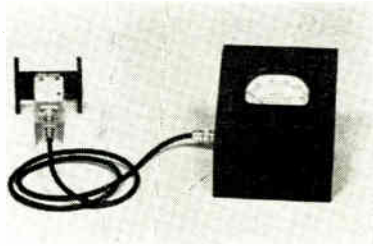

Microwave Wattmeter

COMPLETELY DRY

MANUFACTURED by MSI Electronics Inc., 116-06 Myrtle Ave., Richmond Hill 18, N. Y., the model 511 Calorimistor is an insertion-type non-directional microwave wattmeter for the direct measurement of r-f power ranging between 2.6 and 12.4 Gc with a vswr of 1.1, insertion loss of 0.1 db, response time less than 15 seconds, and power range up to 250 watts with an accuracy of 10 percent. Temperature range is between -28 C and +65 C. The unit contains a thermoelectric sensor integral with the waveguide whose output is fed to an indicating meter calibrated in watts of average power. Providing duty cycle is known, peak microwave power can be determined. By using one sensor at the transmitter and another at the antenna, switching the meter shows actual power being delivered at the antenna compared with transmitter power. It can also be used as a calorimeter if properly terminated.

CIRCLE 304 ON READER SERVICE CARD

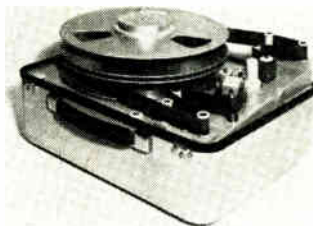

Digital Recorder

STEPPING TYPE

DIGI-DATA CORP., 4908 46th Ave., Hyattsville, Md. With the DSR-1250 digital stepping recorder it is

possible to have the density, reliability and convenience of magnetic tape with the asynchronous operation commonly associated with paper tape and card punches. Major use of the unit is envisioned as being the preparation of standard computer tape directly. Sophisticated design has made possible asynchronous operation at speeds up to 300 discrete steps per sec. Up to 32 tracks can be recorded on 1 in. tape.

CIRCLE 305 ON READER SERVICE CARD

Decade Counter Board

ELECTRONIC MODULES CORP., 1949 Greenspring Dr., Timonium, Md. Board is provided to perform the divide by ten function to facilitate pulse counting where the binary coded decimal format is required as an output. The four flip-flops act as ripple through counter and the necessary gating for the reset and output is provided.

CIRCLE 306 ON READER SERVICE CARD



Power Supply

ADJUSTABLE PARAMETER

NJE CORP., 20 Boright Ave., Kenilworth, N. J., announces an adjustable parameter addition to CR and QR transistor-regulated power supplies. The Vari-Reg feature eliminates overspecification. Regulation may be smoothly adjusted between ± 0.005 percent and ± 10 percent. Ripple is accurately and smoothly adjustable between 3 and 200 mv peak to peak.

CIRCLE 307 ON READER SERVICE CARD

F-M/F-M Transmitters

FOR TELEMETRY USE

TELEMET CORP., Amityville, L. I., N. Y., announces two solid-state f-m/f-m transmitters for telemetry applications in the 215 to 260 Mc range. Model 3001A is a pressurized unit with a power output of 2 w into a 50-ohm load. Model 3005A

is a nonpressurized unit with a power output of 4 w into a 50-ohm load. Frequency stability is ± 0.01 percent. Frequency response is ± 2 db from 10 cps to 100 Kc. The 3001A measures 3.5 in. in diameter by 2.5 in. high. The 3005A is 4 1/2 by 2 1/2 by 1 1/2 in.

CIRCLE 308 ON READER SERVICE CARD

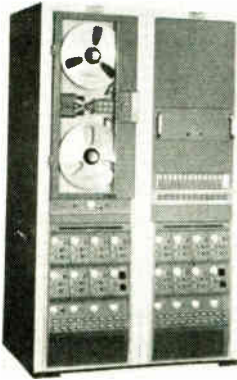

**Recorder/Reproducer
WIDE BAND SYSTEM**

MINCOM DIV., Minnesota Mining and Mfg. Co., 2049 S. Barrington Ave., Los Angeles 25, Calif. A wide band f-m record/reproduce system has a frequency response from 1 cps to 400 Kc, for use with 1 or 1.2 Mc tape operation. Unit provides 7 or 14 track record and playback capability at 120 ips and extended l-f response. The same reduction in the effects of tape drop-outs, over direct recording systems, that result from the use of other f-m systems are applicable.

CIRCLE 309 ON READER SERVICE CARD



**Cathode Follower
HIGH TEMPERATURE**

ENDEVCO CORP., 161 E. California Blvd., Pasadena, Calif. Model 2619 operates in a temperature range of -65 F to $+500$ F and may be mounted alongside those Endevco piezoelectric accelerometers which are designed to operate up to $+500$ F. It is 1 in. by 1 in. by 2.5 in. plus mounting flanges; shock resistant (internal shockmount) 100 g 6 mil-

HICKORY BRAND

**TEFLON*
INSULATED
Multi-Conductor
Cables**

Constructions designed to meet your specific requirements



**HICKORY BRAND
TEFLON***

200°C HOOK-UP WIRE

Long, continuous lengths! Immediate delivery!

• Type E-600V—Type EE-1000V
(meeting all requirements of MIL-W-16878D)

• 26 AWG through 16 AWG • Every reel 100% Tank Tested

This quality hook-up wire has extruded Teflon* insulation over stranded, silver-coated copper conductor. (260°C Hook-up Wire has nickel-coated copper conductor.)

Basic color-coded insulated wire is available with braided shield or shielded and jacketed with Nylon, PVC, wrapped TFE.

*Reg. DuPont trademark



For prompt quotations, call or write

**HICKORY BRAND
Electronic Wires and Cables**

SUPERIOR CABLE CORPORATION

P. O. Box 480-A • Hickory, N. C.

6096

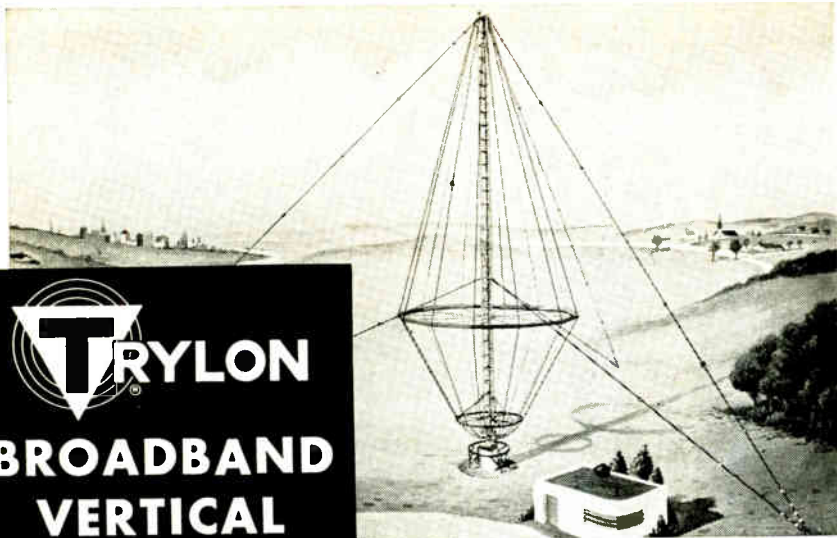

TRYLON BROADBAND VERTICAL RADIATORS

for frequency ranges from 2 to 6 mc.
4.5 to 13.5 mc.—11 to 33 mc.—or similar ranges

A multi-frequency service radiator requiring no matching equipment

ADVANTAGES

- Extremely constant input impedance over a wide frequency range.
- Power handling capacity to 150 kw. or more.
- Radiation performance equal to, or better than a conventional radiator without the need of impedance matching equipment.

Write, wire or phone for information or application to your requirements.

WIND TURBINE COMPANY WEST CHESTER, PA.

Phone: OWen 6-3110

TRYLON TOWER AND ANTENNA SYSTEMS

- RESEARCH
- MANUFACTURE
- DEVELOPMENT
- INSTALLATION

CIRCLE 205 ON READER SERVICE CARD

lisc sawtooth; provides linear output of 5 v (rms) 0.5 ma; operates over frequency range of less than 2 to 20,000 cps ± 2 percent with 100,000 ohm load.

CIRCLE 310 ON READER SERVICE CARD



Electrolytic Pots

GRAVITY SENSING

HAMLIN, INC., Lake Mills, Wisc., announces the EP100 series of gravity sensing electrolytic potentiometers. The proper selection from this family of 8 different ratings offers a system for use in gyroscope correcting mechanisms and many other devices or control requiring a gravity reference or tilt indication. The glass tube of the EP108 illustrated is 1 1/2 in. long, with a diameter of 3/8 in.

CIRCLE 311 ON READER SERVICE CARD

Lock Type Holder

INSULATED HANDLE

TECHNI-TOOL, INC., 1216 Arch St., Philadelphia 7, Pa., offers a lock type holder, with a two position snaplock that will not slip. Device with its insulated handle provides safety in h-v applications and a cushion feel to prevent fatigue. The slim serrated jaws provide an excellent heat sink and clamp for the soldering of transistors, thermistors and diodes. Available straight or curved.

CIRCLE 312 ON READER SERVICE CARD

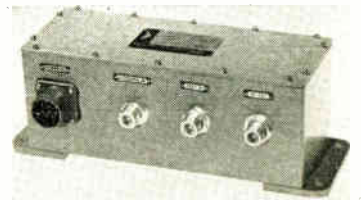

Amplifiers

SOLID STATE

HRB-SINGER, INC., P. O. Box 60, Science Park, State College, Pa., offers amplifiers for rugged military applications. They are equipped with self-contained power supplies, and



**WORLD WIDE
HEADQUARTERS FOR . . .**

LASER SINGLE CRYSTALS

The largest variety and sizes of LASER Crystals, doped with rare earths and transition elements are available at SEMI-ELEMENTS, INC., where 90% of the world's LASER Crystals are produced.

Most LASER Crystals are available from stock in "As Grown" Boules or Finished Rods.

**SINGLE CRYSTAL CHIPS
\$15.00 to \$40.00 each**

Ask us about these newest promising LASERS

STRONTIUM MOLYBDATE
CESIUM MOLYBDATE
BARIUM MOLYBDATE
LEAD MOLYBDATE
STRONTIUM TUNGSTATE
CESIUM TUNGSTATE
ZINC TUNGSTATE
GLASS LASERS
PLASTIC LASERS
LIQUID LASERS

Send for comprehensive literature

SINGLE CRYSTAL DIVISION

Semi-Elements, Inc.

Saxonburg Blvd. • Saxonburg, Pa. USA
DIAL 412-352-1548

electronics

Editorial Opportunity

IT DOESN'T HAPPEN OFTEN, but electronics, "bible of the industry" and a McGraw-Hill publication, has an opening for an Assistant Editor.

Ideally, the man we are looking for and to whom a post on our New York staff could be a long-term challenge, would have an electrical engineering degree or technical equivalent, practical experience in our field and a demonstrated aptitude for editing, writing, reporting. He probably lives somewhere in the metropolitan area and therefore would have no relocation problem.

Write The Editor, electronics, 330 W. 42nd St., New York 36, stating experience, aspirations and past earnings. Mark the envelope "Confidential" and it will be kept that way.

COMPUTER RESEARCH ENGINEERS & LOGICAL DESIGNERS

Rapid expansion of the Computer Laboratory at Hughes-Fullerton has created several attractive professional opportunities for qualified Computer Research Engineers and Logical Designers. These positions require active participation in broad computer R & D activities in connection with Army/Navy computer systems and new large-scale, general-purpose computers. These multiple processor computers utilize advanced solid-state circuitry, gating and resolution times in the millimicrosecond regions; combine synchronous and asynchronous techniques for maximum speed and reliability.

These professional assignments involve broad areas of logical design, programming and system conception. Fields of interest include:

- Distributed computers
- Advanced arithmetic processing techniques
- Mechanized design
- Asynchronous design techniques
- Utilization of parametrons in computers
- Studies in the utilization of multiple processor computers.

These professional assignments involve such R & D areas as:

- Solid state digital circuitry involving millimicrosecond logic
- Microwave carrier digital circuits
- Sub-microsecond core memory
- Thin film storage techniques
- Functional circuit concepts
- Micro-miniaturization concepts
- Tunnel diodes
- Microwave parametrons
- Circuit organization for maximal-speed computing.

Located in Southern California's Orange County (the nation's fastest growing electronics center), Hughes-Fullerton offers you: a stimulating working environment; private or semi-private offices; long-term stability.

CALL COLLECT TODAY!

For complete information on these challenging assignments, call us collect today! Ask for:

Mr. J. E. TENNEY at:
TRojan 1-4080, ext. 3741.

Or, airmail resume to: HUGHES-FULLERTON R & D, P. O. Box 2097, Fullerton 1, California.

An equal opportunity employer.

HUGHES

HUGHES AIRCRAFT COMPANY

are watertight and pressurized. The amplifiers are useful for broadband applications at vhf frequencies, and have a typical noise figure of 5 db. They function at their maximum over a range of operating temperatures from -54°C to $+71^{\circ}\text{C}$.

CIRCLE 313 ON READER SERVICE CARD

Coating Resin

FOLTIN ENGINEERING CO., 20-61 29th St., Long Island City 5, N. Y. Folenco HiDi insulating compound, with its high dielectric strength of 1,200 v per mil, finds application as a coating resin for the rapid repair of coated wires and potted systems.

CIRCLE 314 ON READER SERVICE CARD

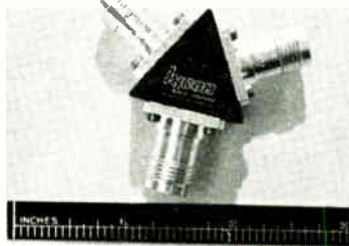

Y-Circulator

FOR AIRBORNE USE

HYCON MFG. CO., 700 Royal Oaks Drive, Monrovia, Calif., has developed a Y-circulator less than 1 in. on a side and only 3/4 in. in height. It is made of aluminum, weighs less than 1 oz, and is designed to meet rugged environmental conditions. Specifications: choice of center frequency from 5.4 to 11 Gc, isolation of 20 db min, insertion loss of 0.5 db max, minimum bandwidth of 6 percent and vswr of 1.3 max.

CIRCLE 315 ON READER SERVICE CARD



Coaxial Switch

WIDEBAND, RUGGEDIZED

E&M LABORATORIES, 15145 Califa St., Van Nuys, Calif. Model SC110SC

For widest frequency selection and smallest size

SPECIFY

Collins Crystal Filters

Your circuits will benefit now from the industry's widest frequency range, sharpest selectivity, and smallest size when you specify Collins Crystal Filters.

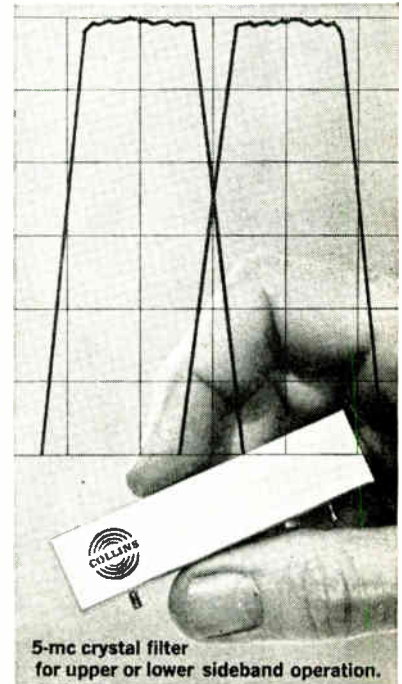

▲ For example the new Collins 5 mc Sideband Crystal Filter with a 1.71 shape factor has 5:1 improvement in selectivity with 2 to 1 reduction in size. This filter will perform at temperature ranges from -40°C to $+85^{\circ}\text{C}$ and at altitudes up to 50,000 feet with a frequency shift of less than $\pm 0.05\%$.

Other characteristics: 25 db carrier rejection, maximum 9 db insertion loss, minimum spurious response attenuation of 60 db.

And approximately the same characteristics have been applied to a standard 1.75 mc filter for critical single sideband applications.

Take maximum advantage of these filter capabilities by contacting Collins at the design stage for units that will best fit your specifications.

For complete information about all Collins Crystal Filters, call or write for Data File 203, Collins Radio Company, Components Division, 19700 San Joaquin Road, Newport Beach, California.

CONTACT



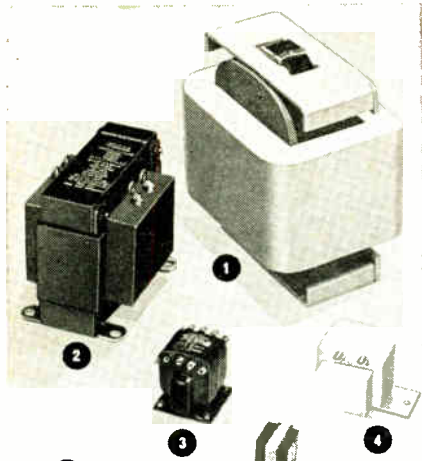

Stancor transformer encapsulations meet mil specs for flammability, humidity, temperature

Stancor Electronics offers the industry's widest range of encapsulation techniques and materials—many developed in our own encapsulation laboratory and available only from Stancor.

Substantial reduction in size and weight without sacrifice of reliability or environmental characteristics can be achieved through the use of Stancor designed and encapsulated transformers.

For help with your transformer design problems, write for the address of our nearest engineering sales office.

- 1 Filter Reactor with epoxy molded coil meets MIL-T-27A, Grade 5, Class R.
- 2 Epoxy molded dual filter reactor, flame retardant material—meets MIL-T-27A, Grade 5, Class R.
- 3 Epoxy dipped filament transformer, 105°C operating temperatures.
- 4 Silicone rubber encapsulated power transformer, 200°C operating temperature.
- 5 MIL-T-27A Filter Reactor with "Scotch Cast" impregnated coil. Entire unit epoxy molded.



Since 1955, Stancor Electronics, Inc., has been operating continuously under RIQAP, the U. S. Army Signal Corps' Reduced Inspection Quality Assurance Plan. When you specify Stancor transformers, delivery time is reduced and incoming inspection is at a minimum. You are assured of the highest quality units for military application.

RIQAP

Factory and product approval has been received from leading military prime contractors.

For Immediate Delivery—Stancor makes available the most extensive line of stock transformers in the industry—through Stancor Industrial Distributors. For a detailed listing of these units, write for Catalog CS-101.

STANCOR

ELECTRONICS, INC.

3502 W. Addison Street • Chicago 18, Illinois

coaxial switch employs features that permit it to function where extreme accelerations, gaussian and sinusoidal vibrations and high temperatures are normal. Over the frequency range of 0 to 6.0 Gc the switch has a maximum insertion loss of 0.3 db, a maximum vswr of 1.25, and a minimum isolation of 20 db.

CIRCLE 316 ON READER SERVICE CARD

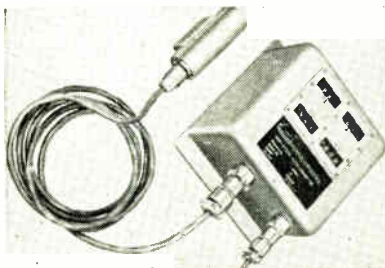

Accelerometer
COUNTING TYPE

GIANNINI CONTROLS CORP., 1600 S. Mountain Ave., Duarte, Calif. Applications for model 2432 include aircraft load survey records and shock recording on missile transporters. Accelerometer portion of the instrument is hermetically sealed, viscous damped with minimum crosstalk error and maximum output sensitivity. Frequency response is flat to 3 cps \pm 4 percent. Operating temperature is -54 C to $+125$ C. Life expectancy is 250,000 counts.

CIRCLE 317 ON READER SERVICE CARD

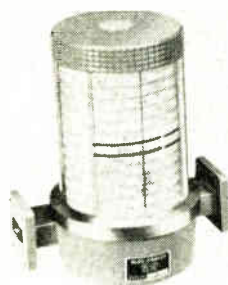

Frequency Meter
DIRECT READING

BUDD-STANLEY CO., INC., 175 Eileen Way, Syosset, Long Island, N. Y. Model X1301A covers from 8.2 to 12.4 Gc. Meter uses a TE₀₁₁ resonant cavity coupled to WR-90 waveguide with a dip of approximately 1 db in the transmitted power at resonance. Frequency can be read directly from the scale with an overall accuracy of 0.08 percent. The high Q

Miniature connectors with minimum voltage drop



drop

...Less than 3 mv at 5 amps. is the average voltage drop across the snap-in contacts of CEC's 500C miniature electrical connectors. This low contact resistance makes these rectangular connectors ideal for dry circuit applications. Designed to exceed MIL-C-8384A requirements, they are available in a range of 14 to 200 contacts—with mounting hardware for flush or surface installation, right-angle or straight cable entrance and guide pin or jackscrew mating. ■ For more data, call your nearby CEC office or write for Bulletin CEC4010-X2.

CEC

Data Recorders Division
CONSOLIDATED ELECTRODYNAMICS
PASADENA, CALIFORNIA
A SUBSIDIARY OF BELL & HOWELL
CIRCLE 206 ON READER SERVICE CARD

electronics

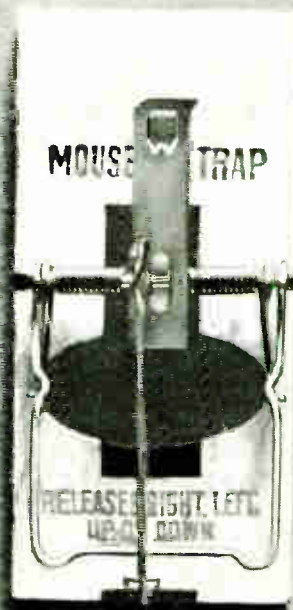

9 billion dollars to build a better one.

We're living in a needful, buying, growing America—a time for new and improved products and services—the creation of new jobs. More than ever, a businessman with an idea, with the urge for something better will move ahead with our expanding economy.

But after the idea, what follows can be a costly period of research and development. Not necessarily—if you use the immense 9-billion-dollar fund of research and patent information that's available at your U.S. Department of Commerce. Think of the saving—in time and money.

For example: there are reports on extensive research by your Government in new products and processes. A trans-

lation of data on inventions and discoveries abroad—information on over 3 million patents—a fortune in patents owned by your Government. All this is yours—for your use and your benefit.

Take advantage of the many ways in which your business can grow. In developing new products and services. In the lucrative foreign markets. In new U.S. markets. In attracting new industry to your local community. Just phone or write the U.S. Department of Commerce Office of Field Services in your city, or Washington 25, D.C. Your U.S. Department of Commerce is always ready to help you grow with America!



NOW'S THE TIME TO GET GROWING IN A GROWING AMERICA!

Good parts work best!



Write for our catalogue

Intermediate Frequency Transformer IFT



POLYVARICON Variable Capacitor



The high standards of MITSUMI electronic components are insured by a fully-automated assembly system, and double-checked by rigid quality controls. Mitsumi Electric Company is Japan's largest manufacturer of components for radio, television and communications equipment.

MITSUMI PARTS

MITSUMI ELECTRIC CO., LTD.
Komae, Kitatama, Tokyo



CIRCLE 207 ON READER SERVICE CARD

cavity is tuned by means of a choke plunger and no sliding contacts are used. A precision lead screw spring loaded to prevent backlash provides a resetability of 0.01 percent.

CIRCLE 318 ON READER SERVICE CARD

Waveguide Load

VSWR BETTER THAN 1.02

MARCONI'S WIRELESS TELEGRAPH CO. LTD., Chelmsford, Essex, England. Type F1210, designed to give a good match over the 2.6 to 3.95 Gc range, is a tapered section of carbonyl iron and araldite molded in the waveguide, with a plain flange as standard fitting.

CIRCLE 319 ON READER SERVICE CARD

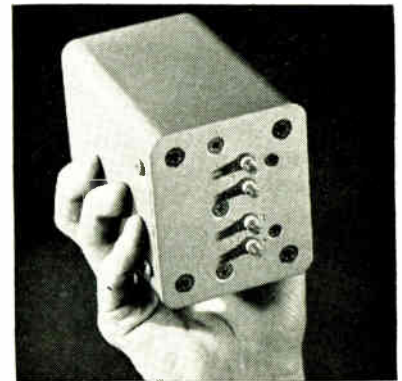

D-C Power Supplies TRANSISTORIZED

RAYTHEON CO., Sorensen Products, Richards Ave., South Norwalk, Conn. Extending the existing QM series, ranging in output down to 3 v, these units have a max output rating of 30 w with voltage regulated to ± 0.05 percent against line and load variations. Insensitive to input frequency variations, they operate on 50, 60, or 400 cps.

CIRCLE 320 ON READER SERVICE CARD

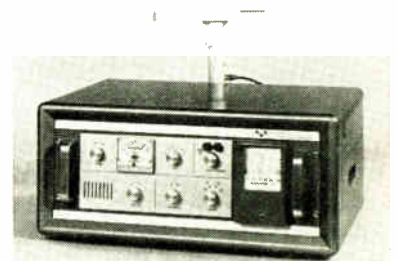

Receiver/Comparator

VERY LOW FREQUENCY

RMS ENGINEERING, INC., 486-14th St. N.W., Atlanta 13, Ga., has de-

MUST YOU MEET SHORT-RUN LABELING?

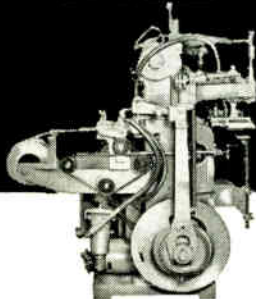

If short runs and a wide variety of labels are part of your labeling problem, this machine can help you. Industry has found that *roll labeling without glue* offers matchless control, efficiency and convenience • New Jersey Machine Corp. offers the economies of roll labels, the ability to imprint valuable data within a master label, and a quick-start no-glue labeling operation. Write today for full information.



Labeling, Cartoning, Paper Box Machinery

NEW JERSEY MACHINE CORPORATION

MAIN OFFICE AND PLANT • 16TH ST. AND WILLOW AVENUE, HOBOKEN, N. J. • OLOFIELD 9-0483
FACTORY SALES AND SERVICE BRANCHES: 325 W. HURON ST., CHICAGO 10, ILLINOIS, 2500 W. 6TH ST., LOS ANGELES 57, CALIFORNIA

**first
choice of
all 4**

research

design

production

management

Because the **BUYERS' GUIDE** satisfies the buying and specifying needs of all four segments of the industry! Gives more information in less space. Easier to use. Only the **BUYERS' GUIDE** has been screened for usefulness over a 20 year period . . . comes to you compact, complete and accurate.

gives more to all 4!

**electronics
BUYERS' GUIDE**
and REFERENCE ISSUE

veloped an ultrasensitive vlf receiver/comparator that determines the frequency error of a local standard by comparison with Standard National Signals of NBA and WWVL. The solid state, self-contained system is designed for standardizing the frequency of local frequency standards having drift rates from 1 part in 10^7 per day to less than 1 part in 10^{10} per day.

CIRCLE 321 ON READER SERVICE CARD

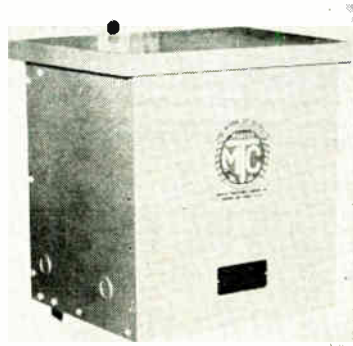

**Voltage Stabilizer
AUTOMATIC**

MARCUS TRANSFORMER CO., INC., Rahway, N. J., offers a line of automatic voltage stabilizing transformers. Line voltage variations as high as 20 percent above normal and 20 percent below normal are stabilized to within ± 1 percent of a fixed voltage on the output side. Stabilizers are currently available in sizes up to and including 100 Kva, single phase, and 3 phase and in all standard or non-standard line voltage ratings to 600 v.

CIRCLE 322 ON READER SERVICE CARD

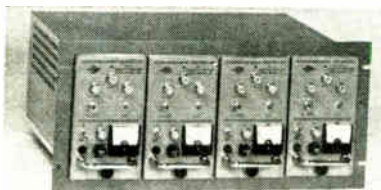

**Bridge Balance
AND POWER SUPPLY**

DETROIT ELECTRONIC CORP., 13000 Capital Ave., Oak Park, Mich. Combined bridge balance-power supply unit is designed for use in conjunction with strain gage transducers of the half or full bridge type. It eliminates complicated external circuitry and cabling. Bridge balance



**Employment opportunities
with **PAN AM**
at Cape Canaveral**

- | | |
|---------------------------|------------------------|
| Scientific Advisory Staff | Program Management |
| Advanced Planning | Operations |
| Range Instrumentation | Facilities Planning |
| Planning & Systems Design | Facilities Engineering |

Pan American, as prime contractor to the U.S. Air Force, has fulfilled the responsibility for planning, engineering, operating and maintaining Cape Canaveral and the Atlantic Missile Range since 1953.

Pan American scientists and engineers have participated intimately in all stages of the national programs since early V-2 tests through Project Mercury's series of manned space flights.

With Pan American, technically respected people have freedom to choose career positions with unlimited opportunities for professional development.

In addition to normal company benefits, Pan Am offers the unique advantage of a 90% world-wide air-travel discount.

You are invited to send your resume in confidence to David I. Bruner, Personnel Manager, Guided Missiles Range Division, Pan American World Airways, Inc., P.O. Box 4336, Patrick Air Force Base, Florida.

An Equal Opportunity Employer.



GUIDED MISSILES RANGE DIVISION
CAPE CANAVERAL, FLORIDA

DYNAMICS

INSTRUMENTATION AMPLIFIERS

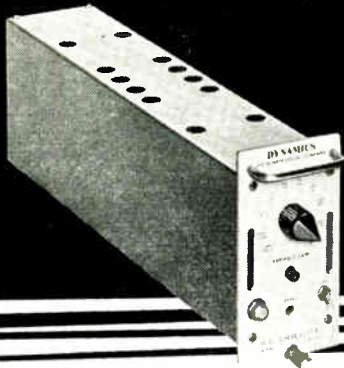

—designed for
system flexibility
and highest quality
operation—where the
ultimate in perform-
ance is essential

Model 6050—differential dc amplifier. Designed specifically to meet the system engineer's requirements, unit incorporates the following features:

Wide bandwidth: DC to 10 kc.

Dual outputs (simultaneous): $\pm 10v$ at 100 ma and $\pm 10v$ at 10 ma.

High common-mode rejection with 1000-ohm input line unbalance: Withstands 117 VAC common mode voltage between input and output ground.

Isolation: Input and output are completely isolated from each other—from rack cabinet, and power line. Small size: 2 $\frac{7}{8}$ " W x 5 $\frac{1}{4}$ " H x 16 $\frac{1}{2}$ " D.

Dynamics manufactures many types of instrumentation amplifiers—guarded, insulated, and isolated. Write for literature on the Model 6050, or the entire line.

DYNAMICS

INSTRUMENTATION COMPANY

583 Monterey Pass Road, Monterey Park, Calif.
Phone: CUmberland 3-7773

CIRCLE 208 ON READER SERVICE CARD

unit consists of balance controls, adjustable calibration resistor, calibration push-button, range control and polarity switch. Power supply is completely transistorized.

CIRCLE 323 ON READER SERVICE CARD



Termination

HIGH POWER

HEWLETT-PACKARD CO., 1501 Page Mill Road, Palo Alto, Calif. Model X913A waveguide termination dissipates 500 w average power without forced air or liquid cooling, and is only 9 $\frac{1}{2}$ in. long and 4 in. in diameter. If desired, the termination can be force cooled for greater dissipation. The termination is not damaged by severe overload, and can handle 100 Kw peak power using only convection cooling. Maximum swr is 1.05. Price is \$100.

CIRCLE 324 ON READER SERVICE CARD

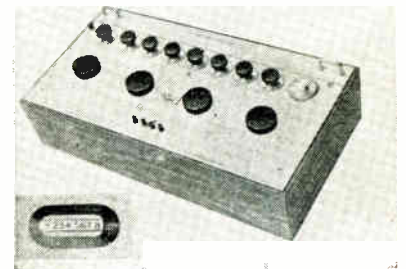

D-C Potentiometer

PRECISION UNIT

SENSITIVE RESEARCH INSTRUMENT CORP., New Rochelle, N. Y., announces the type 9120, a 4 dial 7 figure precision d-c potentiometer with single window readout and resolution of 1 part in 20 million. Total measuring span of 2.099,999.9 v is achieved without a change of range. Manufactured by Guildline Instruments, Ltd., of Canada, the potentiometer is designed for use as a general purpose high accuracy measuring instrument with special emphasis on simplicity of operation and readability.

CIRCLE 325 ON READER SERVICE CARD

IMMEDIATE DELIVERY ANYWHERE IN THE NATION

COSMIC

ELECTROLYTIC AND PAPER TUBULAR CONDENSERS

"35 YEARS OF PROVEN DEPENDABILITY"

COSMIC CONDENSER CO.
853 WHITTIER STREET, BRONX, N. Y.
LUdlow 9-3360

84 CIRCLE 84 ON READER SERVICE CARD

FASTENERS FROM GRC

DIE CAST ZINC ALLOY

- Wing Nuts
- Cap Nuts
- Thumb Nuts
- Thumb & Wing Screws

MOLDED NYLON & DELRIN

- Screws
- Hex Nuts
- Washers
- Screw Insulators

NYLON SCREWS AND NUTS

also available in Delrin

MACHINE SCREWS from miniature #0 thru $\frac{1}{4}$ " in wide range of lengths and head types. Also SET SCREWS, NUTS from #2 thru $5\frac{1}{16}$ ".

GRC's exclusive methods—die casting zinc alloy or molding Nylon and Delrin fasteners in one high speed automatic operation—assure high quality at lowest possible cost.

Write, wire, phone TODAY for SAMPLES, prices, your copy of GRC's NEW INDUSTRIAL FASTENER CATALOG

GRIES REPRODUCER CORP.
World's Foremost Producer of Small Die Castings
151 Beechwood Ave. • New Rochelle, N. Y.
Phone: (914) NEW Rochelle 3-8600

CIRCLE 209 ON READER SERVICE CARD

electronics

PRODUCT BRIEFS

BLOCK-TAPE READER/HANDLER with isolated contacts. Chalco Engineering Corp., 15126 S. Broadway, Gardena, Calif. (326)

PIN AND SOCKET CONNECTOR 50-position, subminiature. AMP Inc., Harrisburg, Pa. (327)

COATING MATERIAL for axial lead semiconductors. U. S. Semiconductor Products, Inc., 3540 W. Osborn Road, Phoenix 10, Ariz. (328)

D-C/D-C CONVERTER militarized. Electronic Development Corp., 423 W. Broadway, Boston, Mass. (329)

INDUSTRIAL TYPE MOTOR 1.4 w output. Daystrom, Inc., Transicoil Division, Worcester, Pa. (330)

CONTINUOUSLY VARIABLE ATTENUATORS broad band. Cossor Radar & Electronics Ltd., The Pinnacles, Harlow, Essex, England. (331)

SILICON CARTRIDGE RECTIFIERS high voltage, axial lead. Electronic Devices, Inc., 50 Webster Ave., New Rochelle, N. Y. (332)

MICROMINIATURE CONNECTORS for severe environments. Hermetic Seal Corp., 4232 Temple City Blvd., Rosemead, Calif. (333)

DIGITAL FREQUENCY METER gives an accuracy of ± 1 count. Avtron Mfg., Inc., 10409 Meech Ave., Cleveland 5, O. (334)

SOLID-STATE COMMUTATOR low drift, high accuracy. General Electric Co., French Road, Utica, N. Y. (335)

WIDEBAND AMPLIFIERS solid state, silicon. Scientific Data Systems, Inc., 1542 Fifteenth St., Santa Monica, Calif. (336)

SILICON H-V REGULATOR DIODES low noise characteristics. Micro Semiconductor Corp., 11250 Playa Court, Culver City, Calif. (337)

MULTIPOLE CERAMIC SWITCH withstands temperatures of -200 to $+600$ F. Unidynamics, a div. of Universal Match Corp., St. Louis, Mo. (338)

STRIP CHART INTEGRATORS three new models. Disc Instruments, Inc.,



NEW GAS DISCHARGE INDICATION TUBE FOR SMALL SIGNALS

Designed specifically for display indicator use in transistorized electronic equipment, the TG121A glow discharge tube offers important advantages over neon indicators and miniature incandescent lamps. Of prime importance is the fact that it can be switched on and off by an input signal of a few volts and thus can be operated directly by ordinary transistor output voltage without amplification. Since it is a cold cathode device there is no heating problem such as is encountered with miniature lamps, even when many are used. This advantage coupled with its small size (length 18mm, diameter 8mm) makes it ideal for miniaturized equipment. Characteristics are stable and life is practically limitless. Detailed specifications and application information are available from our representatives listed below.



FUJI TSUSHINKI SEIZO K.K.,

TOKYO, JAPAN

Represented by:

■ The Nissho American Corporation □ New York 5, 80 Pine St., WH 3-7840 □ Chicago 3, 140 S. Dearborn St., CE 6-1950 ■ The Nissho Pacific Corporation □ San Francisco 4, 120 Montgomery St., YU 2-7901 □ Los Angeles 14, 649 S. Olive St., MA 7-7691

CIRCLE 85 ON READER SERVICE CARD



Did you swipe this magazine?

Only 7½ cents a week is the easy way! (\$6 one year, \$9 for two years, \$12 three years.) Just fill in the handy "For subscriptions" section of the Reader Service Card in this issue . . . and you'll get instant subscription.

electronics: 330 West 42nd St., N. Y. 36.

for maximum
reliability

SPECIFY BIRTCHER PCB-TAINERS®



NEW— LOW COST SPRING CLIPS TO RETAIN PRINTED CIRCUIT BOARDS

PROVIDE EXCELLENT GROUND AND THERMAL PATHS

Birtcher PCB-Tainers simplify design and production, provide important cost savings. PCB-Tainers are tested to retain printed circuit boards under more than 30Gs, vibration up to 2000 cps. Material is beryllium copper for excellent electrical ground and thermal path. Standard lengths for 3/32-in. and 1/16-in. boards.

Available from
authorized distributors



Send for new technical
data sheet with
drawings, test report,
complete details.

THE BIRTCHER CORPORATION

INDUSTRIAL DIVISION

745 S. Monterey Pass Rd. • Monterey Park, Cal.

TUBE/TRANSISTOR/COMPONENT
RETENTION AND COOLING DEVICES

3014 B South Halladay, Santa Ana,
Calif. (339)

SPECTRUM ANALYZER and measuring
set. Panoramic Electronics, Inc.,
520 S. Fulton Ave., Mount Vernon,
N. Y. (340)

PRECISION POWER RESISTOR sub-
miniature. Omtronics Mfg., Inc.,
P.O. Box 1419, Peony Park Station,
Omaha 14, Neb. (341)

TELEMETERING SYSTEM pipeline
data. Datex Corp., 1307 S. Myrtle
Ave., Monrovia, Calif. (342)

ACCELERATION SWITCH small unit.
Humphrey, Inc., 2116 E. Central
Ave., Wichita, Kansas. (343)

MULTICAVIDITY LASER 50 joule output.
Raytheon Co., Waltham Ind. Park,
Waltham, Mass. (344)

SILICON DIODE RECTIFIERS for indus-
trial use. Marcus Transformer Co.,
Inc., Rahway, N. J. (345)

SERVO-METER-POT MODULE accuracy
to 0.25 percent. Computer Instru-
ments Corp., 92 Madison Ave.,
Hempstead, L. I., N. Y. (346)

TRANSISTORIZED POWER SUPPLY low-
cost, compact. Garwin, Inc., Wich-
ita, Kansas. (347)

ADJUSTABLE CAM SWITCH 1 1/8 in.
diameter. Precision Mechanisms
Corp., 44 Brooklyn Ave., Westbury,
L. I., N. Y. (348)

TRANSMITTING MULTICOUPLER four-
channel device. Granger Associ-
ates, 974 Commercial St., Palo
Alto, Calif. (349)

TRANSMITTER-RECEIVING ANTENNA
features low side lobe levels.
Temec, Inc., 7833 Haskell Ave.,
Van Nuys, Calif. (350)

THERMISTORS glass-enveloped. Fer-
roxcube Corp. of America, Sauger-
ties, N. Y. (351)

PHASE/VOLTMETER transistorized.
Acton Laboratories, Inc., 533 Main
St., Acton, Mass. (352)

DIRECT-COUPLED PREAMPLIFIER wide-
band. Hexem, Inc., P.O. Box 636,
Los Gatos, Calif. (353)

MAGNETIC TAPE TRANSPORT for use
with computers. Control Data Corp.,
8100 34th Ave. South, Minneapolis
20, Minn. (354)

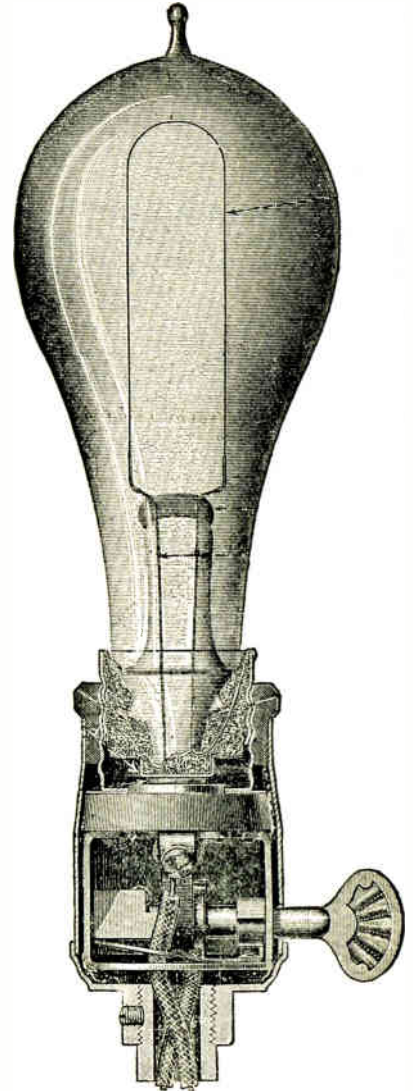

Is it ancient history
by the time you see
electronics?

Get the facts while they're new. Don't
wait for **electronics** on a route slip.
Look in this issue for the Reader Service
Card. Fill out and mail the "for subscrip-
tions" section. Only 7 1/2 cents a week.

electronics

A McGraw-Hill Publication, 330 West 42nd St., N. Y. 36

Literature of the Week

MODULAR POWER PACKS Electronic Research Associates, Inc., 67 Factory Place, Cedar Grove, N. J. Technical bulletin supplement describes the 500 ma series solid-state modular power packs. (355)

ENERGY DATA Yardney Electric Corp., 40-52 Leonard St., New York 13, N. Y. Data book enables the user of high energy conversion systems to determine the type of system best suited to his needs. (356)

ELECTRICAL INSULATION General Electric Co., 1 Campbell Road, Schenectady 6, N. Y. A 20-page brochure describes a line of electrical insulation materials. (357)

D-C POWER MODULES Technipower, Inc., 18 Marshall St., South Norwalk, Conn. Catalog 362 reflects an expanded line of miniature solid state d-c power supplies. (358)

FACILITIES Dynaco Mechanisms, Inc., 175 Dixon Ave., Amityville, N. Y., offers a precision mechanical and electromechanical assembly capabilities brochure. (359)

NOISE FIGURE SLIDE RULE Airborne Instruments Laboratory, Deer Park, L. I., N. Y. A noise figure measurement slide rule is available on receipt of letterhead request.

MAGNETIC SHIELD Magnetic Shield Div. Perfection Mica Co., 1322 No. Elston Ave., Chicago 22, Ill., offers a data sheet on magnetic shield with large length to diameter ratios. (360)

HIGH PERMEABILITY FERRITE Kearfott Div. General Precision Inc., Little Falls, N. J. Advance data sheet describes type MN-60 high permeability ferrite. (361)

SILICON COMPUTER DIODES National Transistor Mfg., Inc., 500 Broadway, Lawrence, Mass. Two catalogs describe an improved line of silicon double diffused computer diodes. (362)

VOLTAGE REFERENCE ELEMENTS Henry Engineering Co., 3625 W. Pacific Ave., Burbank, Calif., has published engineering data for two miniature Zener d-c reference elements. (363)

INVESTIGATE GREATER ATLANTA'S

DYNAMIC DEKALB COUNTY

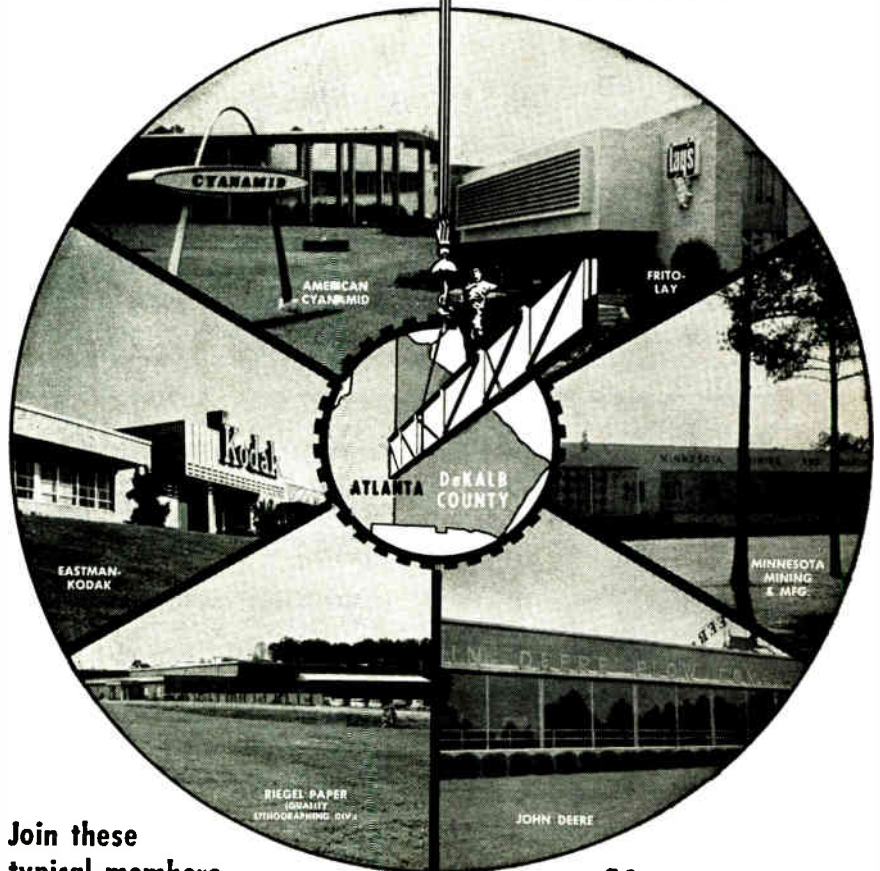

Join these
typical members
of DeKalb-Atlanta's
diversified industrial family:

General Electric
Armour Agricultural
Chemical Co.
General Foods
Singer Sewing Machine
General Motors
(Buick, Oldsmobile, Pontiac Assembly)
Kraft Foods
DuPont Paints
Ralston Purina
Southeastern Ford Tractor

**10 OUTSTANDING
INDUSTRIAL DISTRICTS
NOW READY!**

- PRIVATE FINANCING AVAILABLE
- CHOICE BUILDINGS FOR LEASE

45¢ — 65¢ Square foot per year
(20,000 square feet or more)

**Big-City transportation and commu-
nications, with room for your busi-
ness to grow and prosper**

INQUIRIES CONFIDENTIAL

**SEND FOR FREE
FULL COLOR BROCHURE**

Write, wire or phone

F. WM. BROOME, Manager,
DeKalb Industrial Committee of 100
P. O. Drawer 759, Atlanta 22, Ga.
Telephone 378-3691

Name _____
Title _____
Company _____
Address _____
City & State _____

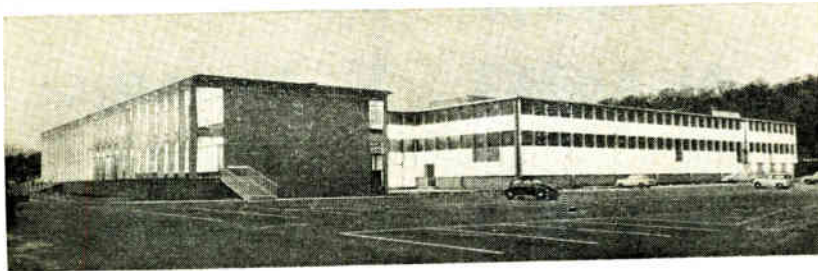

Perkin-Elmer Opens Research Center

ELECTRO-OPTICAL research and engineering center was recently opened by Perkin-Elmer Corp. on a 17-acre tract in Wilton, Conn.

The 100,000-square-foot facility consists of an office building at the front, housing the administrative staff, and a two-story structure at the rear, containing the engineering and advanced research and development departments. The two units are connected by an isthmus section with a cafeteria, library and computer room.

At the formal opening, Richard S. Perkin, founder and chairman of the board of Perkin-Elmer, told the assembly that technology has become the weight which swings or maintains the balance of world power between nations or groups of

nations. As an indication of how swiftly technology has advanced, Perkin commented that while less than a year ago the company considered optics for lasers that had a surface flatness within 1/50th of a wave of light as an achievement in precision, "now, only months later, we are producing optics with a surface that is flat within 1/200th of a wave."

Occupied by the company's Electro-Optical division, the new center will be used for the development of advanced precision optics and electronic-optical systems. Major development areas will include space astronomy, optical masers, reconnaissance and metrology for applications in U. S. space and national security programs.

manager at the Jet Propulsion Laboratory of CIT and as consultant to the Electromechanical Laboratories division of White Sands Proving Ground.



Bradford Joins Mincom Division

APPOINTMENT of Robert Spencer Bradford as research manager of Mincom division, Minnesota Mining and Mfg. Co., Los Angeles, Calif., is announced.

Formerly with Space General Corp., Bradford also served as research group supervisor and project

LFE, Inc. Announces Corporate Changes

TWO major corporate organization changes have been announced by LFE, Inc., Boston, Mass., involving the naming of new presidents for LFE Electronics and Tracerlab divisions.

Richard K. Mosher, former vice president, Systems division, LFE Electronics, has been appointed president of LFE Electronics.

Richard C. Sorensen, former director of manufacturing for LFE

Electronics, has been named president of Tracerlab, a division of LFE, Inc., and of the Keleket X-Ray Corp., LFE's wholly-owned subsidiary.

Monitor Systems Inc. Elects Two V-P's

LUIS A. FERNANDEZ-RIVAS has been elected vice president of engineering and William S. Rumpf, vice president for manufacturing at Monitor Systems Inc., Fort Washington, Pa.

Rivas was formerly chief engineer and technical director, and Rumpf, manager of production engineering for MSI.



N. W. Aram Moves Up At Zenith Radio

NATHAN W. ARAM has been appointed vice president-chief engineer by the board of directors of Zenith Radio Corp., Chicago, Ill.

Aram has been assistant vice president and chief engineer since 1958.



Leelsona Moos Names Senett

FORMATION of a new advanced technology group to probe well beyond the state-of-the-art and advance

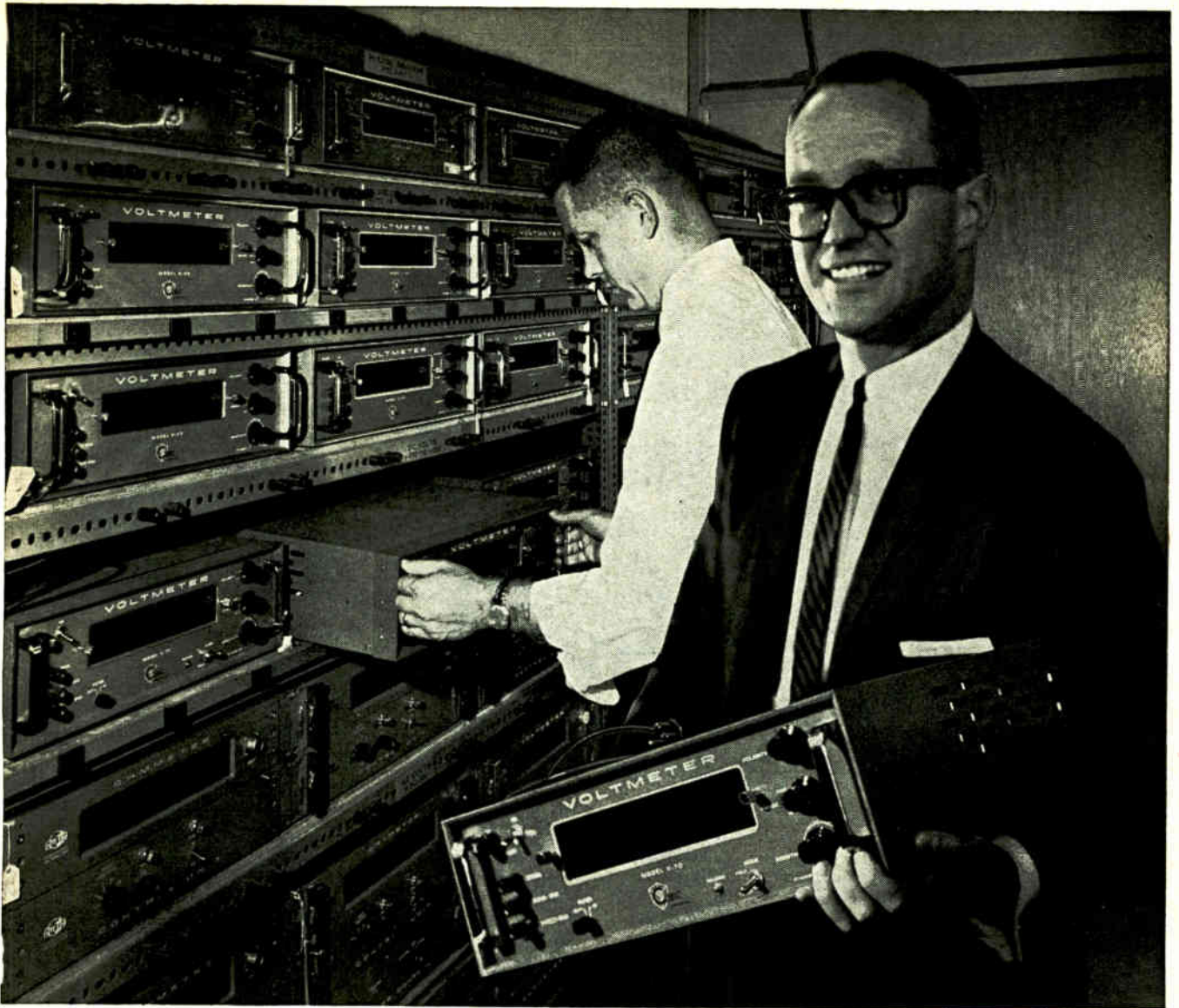

Now! Immediate delivery on Cubic Digital Voltmeters!

Now you can be using your new Cubic Digital Voltmeters and accessories during the period when you would be waiting for delivery on many other brands. You can get immediate delivery right off the shelf on virtually all Cubic instruments. And when you specify Cubic, you can be sure you are getting instruments that offer you the *most* in accuracy, dependability, long life and reasonable prices. Here are the Cubic instruments available for immediate delivery:

V-45 DIGITAL VOLTMETER – Laboratory accuracy at low cost. \$940.

V-46 DIGITAL VOLTMETER – V-45 with automatic ranging and polarity. Price \$1190.

V-70 DIGITAL VOLTMETER – Long life reed relays. Price \$1580.

V-71 DIGITAL VOLTMETER – V-70 with automatic ranging and polarity. Price \$2200.

V-41 DIGITAL VOLTMETER – Meeting highest standards of sensitivity and accuracy. Four digit. Price \$1200. Uses Control Unit C-1. Priced at \$1400.

V-51 DIGITAL VOLTMETER – Five digit version of V-41. Price \$1700. Uses Control Unit C-1. \$1400.

S-71 DATA SYSTEM – Monitors 100 channels. Visual and printed readout. Automatic ranging and polarity. Price \$5270.

AC-45 A-C CONVERTER – Use with any voltmeter to read AC. \$590.

AC-2 A-C CONVERTER – Use with V-51 Voltmeter to read AC. \$1200.

For more details, write to Dept. A-142, Cubic Corp., San Diego 11, Calif., or Cubic Europa S.p.A., Via Archimede 181, Rome, Italy.



INDUSTRIAL DIVISION
SAN DIEGO 11, CALIFORNIA • ROME, ITALY

OTHER OFFICES AND REPRESENTATIVES IN PRINCIPAL U.S. AND CANADIAN CITIES

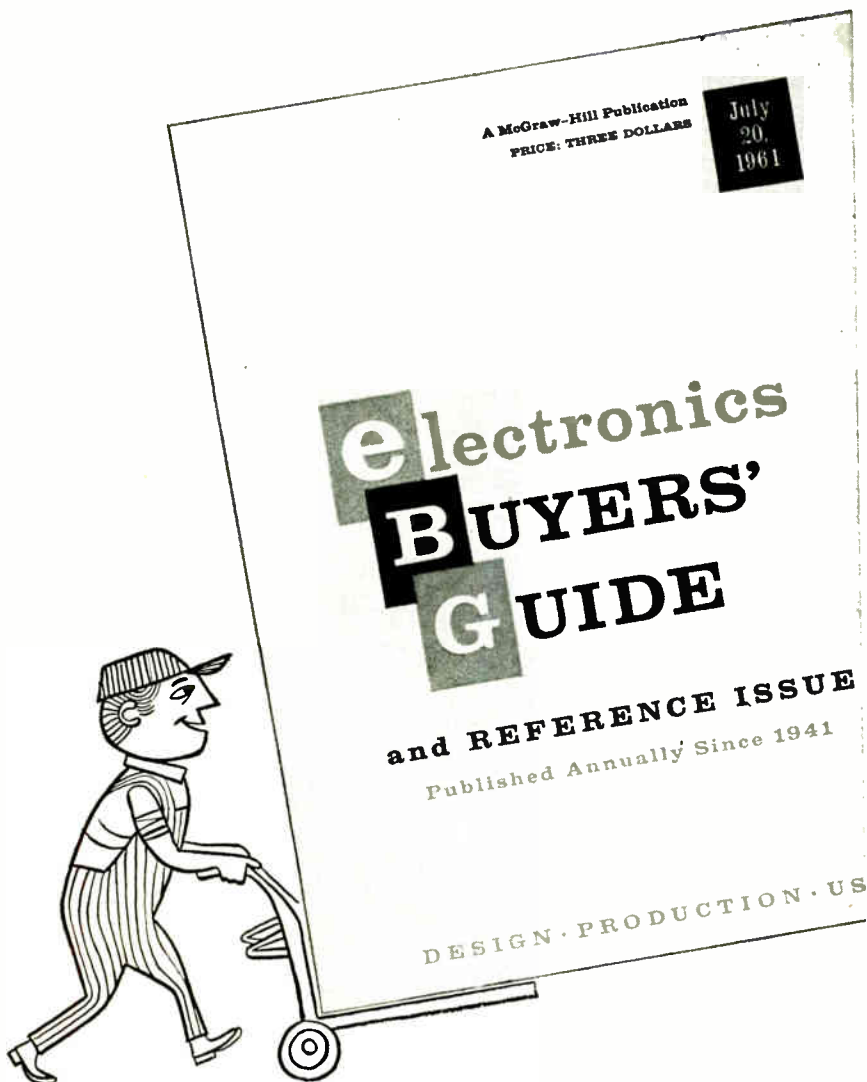

Big book for buyers in electronics

... and for sellers, too. Whether you want to buy or sell in the electronics industry, chances are that information in **electronics Buyers' Guide** and Reference Issue will help you do it better, more easily, more efficiently, or more profitably.

EBG puts key facts at your fingertips, by: Indexing more than 4,700 manufacturers; Listing all up-to-date products, components, materials, services; Giving you company statistics, such as dollar volume of business, number of employees, number of engineers; Giving you the name of the actual man in each company to call for prices, delivery dates, specifications, etc.

Complete information like this puts EBG away ahead in the electronic catalog league. It pays you to know and use the EBG.

electronics BUYERS' GUIDE and Reference Issue



The Basic Buying Guide in Electronics *since 1941*

basic disciplines in various fields of scientific endeavor has been announced by Leeson Moos Laboratories, Jamaica, N. Y.

Named as director of advanced technology is William P. Senett, formerly principal scientist with the Electronics division of General Dynamics.



Varian Associates
Elects Malter V-P

LOUIS MALTER has been elected a vice president of Varian Associates, Palo Alto, Calif., and will report directly to Varian's president H. Myrl Stearns.

Malter, who currently heads the company's Vacuum Products division, came to Varian in 1958 as director of research.



Research-Cottrell
Promotes Willison

RALPH E. WILLISON has been named manager-engineering and development of the new Electronics division of Research-Cottrell, Inc., Bound Brook, N. J. He was formerly the company's chief electrical engineer.

The Electronics division has been formed to design and manufacture custom high-voltage, high energy power supplies, controls, and related equipment, for such applica-

NEED AC-OPERATED MILITARY RELAYS?

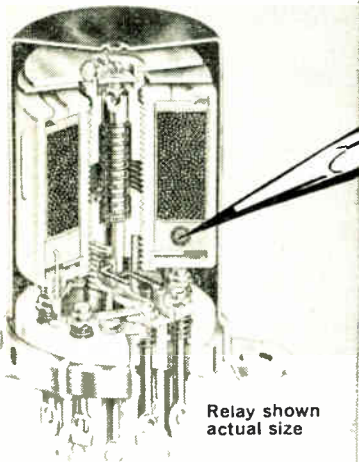

Rectifier circuits . . . full-wave bridge and half-wave . . . use highest quality miniature silicon diodes. Note potted construction.

For reliable switching . . . try "Diamond H" Series RA and SA relays with a-c coils

These relays for 400 cps and 60 cps operation are identical in size and weight to Hart's widely specified Series R and S d-c relays and meet the same specifications*. They provide the same shock resistance (to 50G), the same vibration resistance (to 20G-2000 cps), and the same performance under temperatures ranging from -65°C to $+125^{\circ}\text{C}$. Contact ratings from dry circuit to 10 amps, 115 volts a-c resistive and 30 volts d-c resistive.

The "Diamond H" line includes hundreds of standard models and special variations are possible. Ask for literature and specification list.

*Like the R and S series, they meet the requirements of MIL-R-5757C. Models are also available to fill the requirements of MIL-I-6181.



THE HART
MANUFACTURING COMPANY
 202 Bartholomew Avenue
 Hartford 2, Conn.
 Phone Jackson 5-3491

CIRCLE 211 ON READER SERVICE CARD
 June 15, 1962

tions as radar, electron-beam processing, plasma and ion propulsion research, and missiles and space vehicles.

Sealectro Completes Plant Expansion

SEALECTRO CORP., Mamaroneck, N. Y., manufacturer of a diversified line of military and industrial electronic equipment, has increased working space at its main plant from 15,000 to 20,000 sq ft.

Sealectro has two other plants in Mamaroneck, and one in Great Britain.

PEOPLE IN BRIEF

Winsor Soule Jr. promoted to chief engineer, electronic products, for Marchant div. of Smith-Corona Marchant Inc. Richard M. Whitehorn leaves Varian Associates to join RF Systems div. of Radiation at Stanford as chief engineer. Julius Leonhard, from Itek Laboratories, to Page Communications Engineers, Inc., as R&D consultant. John W. Scholz advances to production head for transistor products at Hughes Aircraft Co. semiconductor div. Frederick J. Milford moves up to asst. director of technical development for Battelle Memorial Institute. Unidynamics ups Max E. Norman to manager of the St. Louis operations. William W. Seifert elevated at MIT to asst. dean of the school of engineering. Dr. Alfred N. Goldsmith, senior technical consultant to RCA, elected an honorary v-p. Joseph McManus, ex-Chemonics Corp. and Hoffman Electronics, named chief engineer at Hopkins Engineering Co. Irving Koss, formerly with Motorola, Inc., appointed g-m of E. F. Johnson Co. George M. Ryan of Benson-Lehner Corp. elected president, succeeding Bernard S. Benson, who advances to board chairman. Walter B. Helms, g-m of Giannini Controls Transducer div., elected v-p of the corporation. Charles W. Newhall Jr., previously with Flight Refueling, Inc., appointed asst. to the president of The Marquardt Corp. Frederick L. Hedblom elevated to v-p/works manager of Zenith Radio Corp.

LAYOUT SHEETS TWICE AS FAST



with
New Di-Acro Lokator Layout Machine

Here's a fast low cost method for laying out sheets and plates without individual use of squares, scribes, scales, punches and hammers. New sliding secondary scales on the primary transverse and longitudinal scales permit direct reading of all locations whether dimensioned from material edges or from each other.

Any bench mechanic can make layouts to $\pm .005"$ accuracy on the new Di-Acro Lokator Layout Machine—in half the time it takes by hand.

Permanent magnets hold the work sheet to the layout machine base under calibrated sliding scales. A sheet up to $18" \times 24" \times 1"$ can be handled in one layout. By re-locating, sheets up to $36"$ wide by any length can be processed. Etched and plated satin finish steel scales read through magnifiers for maximum accuracy. Choose any of three models: calibrated in increments of $1/64"$ from 0 at base line on left side and bottom, $1/64"$ from 0 at center of sheet and $.001"$ from 0 at base line on left side and bottom.

Satin finish hard chrome plating for non-rust, non-glare surface on all parts—punch point hardened to 60-62 Rockwell C. Slides are precision ground to maintain parallel surfaces. All bearings are bronze, adjustable for wear and squareness.

For complete details consult the yellow pages of your phone book under Machinery/Machine Tools for the name of your nearest Di-Acro distributor or use coupon below.



PRECISION METALWORKING EQUIPMENT

DI-ACRO CORPORATION

436 EIGHTH AVENUE LAKE CITY, MINN.

Please send information on the following:

<input type="checkbox"/> Di-Acro Lokator Layout Machine	<input type="checkbox"/> Punch Presses
<input type="checkbox"/> Press Brakes	<input type="checkbox"/> Punches and Dies

Name _____

Address _____

City _____ State _____

CIRCLE 91 ON READER SERVICE CARD 91

electronics

WEEKLY QUALIFICATION FORM FOR POSITIONS AVAILABLE

ATTENTION: ENGINEERS, SCIENTISTS, PHYSICISTS

This Qualification Form is designed to help you advance in the electronics industry. It is unique and compact. Designed with the assistance of professional personnel management, it isolates specific experience in electronics and deals only in essential background information.

The advertisers listed here are seeking professional experience. Fill in the Qualification Form below.

STRICTLY CONFIDENTIAL

Your Qualification form will be handled as "Strictly Confidential" by ELECTRONICS. Our processing system is such that your form will be forwarded within 24 hours to the proper executives in the companies you select. You will be contacted at your home by the interested companies.

WHAT TO DO

1. Review the positions in the advertisements.
2. Select those for which you qualify.
3. Notice the key numbers.
4. Circle the corresponding key number below the Qualification Form.
5. Fill out the form completely. Please print clearly.
6. Mail to: D. Hawksby, Classified Advertising Div., ELECTRONICS, Box 12, New York 36, N. Y. (No charge, of course).

COMPANY	SEE PAGE	KEY #
AMERICAN ENKA CORP. Enka, North Carolina	82*	1
ATOMIC PERSONNEL INC. Philadelphia, Pennsylvania	82*	2
BOEING COMPANY Seattle, Washington	22*	3
BRISTOL COMPANY Waterbury, Connecticut	82*	4
OELCO RADIO Div. of General Motors Corp. Kokomo, Indiana	24	5
GENERAL ELECTRIC CO. Defense Systems Dept. Syracuse, New York	83*	6
INTERNATIONAL BUSINESS MACHINES CORP. Space Guidance Center Owego, New York	82*	7
LOCKHEED CALIFORNIA CO. Div. of Lockheed Aircraft Corp. Burbank, California	51*	8
MELPAR, INC. Sub. of Westinghouse Air Brake Co. Falls Church, Virginia	82*	9
MICROWAVE SERVICES INTERNATIONAL, INC. Oenville, New Jersey	94	10
MOTOROLA, INC. Chicago, Illinois	84*	11
NORTHROP CORP. Norair Div. Hawthorne, California	73*	12
NORTHROP CORP. Space Laboratories Hawthorne, California	75*	13
PAN AMERICAN WORLD AIRWAYS INC. Guided Missiles Range Div. Patrick AFB, Florida	83	14
PHILCO WESTERN DEVELOPMENT LABS. Palo Alto, California	85*	15

CONTINUED ON PAGE 94

(cut here)

electronics WEEKLY QUALIFICATION FORM FOR POSITIONS AVAILABLE

(cut here)

(Please print or type)

Personal Background

Education

NAME

HOME ADDRESS

CITY ZONE STATE

HOME TELEPHONE

PROFESSIONAL DEGREE(S)

MAJOR(S)

UNIVERSITY

DATE(S)

FIELDS OF EXPERIENCE (Please Check)

61562

- | | | |
|--|--|---------------------------------------|
| <input type="checkbox"/> Aerospace | <input type="checkbox"/> Fire Control | <input type="checkbox"/> Radar |
| <input type="checkbox"/> Antennas | <input type="checkbox"/> Human Factors | <input type="checkbox"/> Radio—TV |
| <input type="checkbox"/> ASW | <input type="checkbox"/> Infrared | <input type="checkbox"/> Simulators |
| <input type="checkbox"/> Circuits | <input type="checkbox"/> Instrumentation | <input type="checkbox"/> Solid State |
| <input type="checkbox"/> Communications | <input type="checkbox"/> Medicine | <input type="checkbox"/> Telemetry |
| <input type="checkbox"/> Components | <input type="checkbox"/> Microwave | <input type="checkbox"/> Transformers |
| <input type="checkbox"/> Computers | <input type="checkbox"/> Navigation | <input type="checkbox"/> Other |
| <input type="checkbox"/> ECM | <input type="checkbox"/> Operations Research | <input type="checkbox"/> |
| <input type="checkbox"/> Electron Tubes | <input type="checkbox"/> Optics | <input type="checkbox"/> |
| <input type="checkbox"/> Engineering Writing | <input type="checkbox"/> Packaging | <input type="checkbox"/> |

CATEGORY OF SPECIALIZATION

Please indicate number of months experience on proper lines.

	Technical Experience (Months)	Supervisory Experience (Months)
RESEARCH (pure, fundamental, basic)
RESEARCH (Applied)
SYSTEMS (New Concepts)
DEVELOPMENT (Model)
DESIGN (Product)
MANUFACTURING (Product)
FIELD (Service)
SALES (Proposals & Products)

CIRCLE KEY NUMBERS OF ABOVE COMPANIES' POSITIONS THAT INTEREST YOU

1 2 3 4 5 6 7 8 9 10 11 12 13 14 15 16 17 18 19 20 21 22 23 24 25



NEXT STOP

CAN ONLY BE UP

At Sylvania Electronic Systems the opportunities are nothing less than outstanding. The work is exciting and the advantages of living but thirty minutes from San Francisco speak for themselves. Challenging positions are now available for engineers who want to join us today and be with us at our next stop tomorrow.

SYSTEMS ENGINEERS for reconnaissance systems and subsystems, human factors engineering, operations research and system performance analyses. Five years' experience and background in communications or data processing systems.

DESIGN ENGINEERS for all levels with backgrounds in transmitting and receiving equipment, recording techniques, telemetry, antennas, DF and conversion equipment or computers. Opportunities are now available for both technical specialists and supervisors.

SENIOR RELIABILITY ANALYSIS ENGINEERS for test design, effectiveness studies and systems analysis. BS in EE or Physics with knowledge of calculus or probability. Four years' senior responsibility in associated programs.

SYLVANIA ELECTRONIC SYSTEMS
Government Systems Management
for **GENERAL TELEPHONE & ELECTRONICS**



Write in confidence to

Roger Harlan

SYLVANIA ELECTRONIC SYSTEMS • WEST

Box #188 • Mountain View, California
An Equal Opportunity Employer

7866

Electronics Engineers

JOIN US IN GIVING A
**NEW
DIRECTION**

TO AEROSPACE TECHNOLOGY

Join staff conducting 9 new R&D contracts at Republic's Paul Moore Research & Development Center. Investigations involve instrumentation and antenna design for space craft and re-entry vehicles. Facilities in the Center's Electronics Laboratory include: anechoic chamber providing optimum reflectivity reduction; shielded room with electromagnetically clean environment; standards room with full complement of electronic standards instruments.

ELECTRONIC INSTRUMENTATION. BS, MS. Develop instrumentation for space vehicles. Knowledge of systems integration and telemetry highly desirable.

ANTENNA DESIGN. MS in Physics or EE. Design and development of antennas for re-entry vehicles. Knowledge of window effects and general re-entry radiation blackout problems.

**REPUBLIC
AVIATION CORPORATION**

FARMINGDALE, LONG ISLAND, NEW YORK

An Equal Opportunity Employer

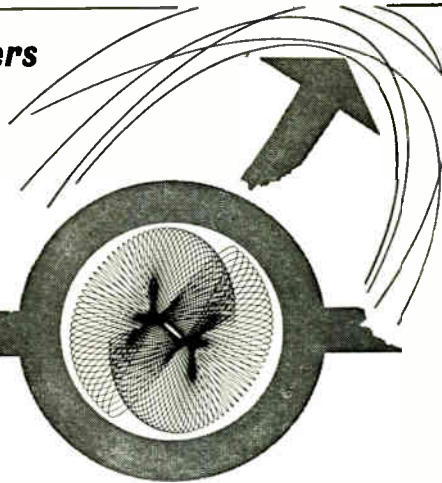

Write to
Mr. George R. Hickman
Technical Employment Manager,
Dept. 11F-3

electronics

WEEKLY QUALIFICATIONS FORM FOR POSITIONS AVAILABLE

(Continued from page 92)

RAYTHEON COMPANY Equipment Division Waltham, Massachusetts	59	16
REPUBLIC AVIATION CORPORATION Farmingdale, L. I., New York	94	17
SCOPE PROFESSIONAL PLACEMENT CENTER Waltham, Massachusetts	94	18
SEARCH ASSOCIATES Philadelphia, Pennsylvania	94	19
SYLVANIA MOUNTAIN VIEW OPERATIONS Mountain View, California	93	20
P-9063	92*	21

* These advertisements appeared in the 6/8/62 issue.

5 UNIQUE POSITIONS

Selected from our client organizations

DIRECTOR OF ENGINEERING

EE with strong systems or equip bkgd for antenna systems company. Sal to 25,000

CHIEF RF ENGINEER

Antennas or R F components. Sal to 15,000

COMMUNICATIONS SYSTEMS

#2 man in new grow group. Sal to 13,000

STRESS ANALYSIS

For excel antenna systems co. Sal to 15,000

CIRCUIT DESIGN

#2 man in rapidly growing commum & microwave company. Sal to 13,000

Our fees, of course, are paid by client company.

L. Bollag, BSEE,

SEARCH ASSOCIATES

300 Penn Sq. Bldg., Phila. 7, Pa. LO-3-7814

COMMUNICATIONS APPLICATION ENGINEER
Analysis of advanced electronic communication systems including radio, carrier, telephone, microwave.
Must have design and marketing experience with commercial and military users.
EE degree, 5 yrs. exp. min.
Send Resume to:
Microwave Services International Inc.
Consulting Engineers
Route 46 Denville, N. J.

POSITION VACANT

Communications Engineer — To supervise technical assistance to schools participating in the Midwest Program on Airborne Television Instruction. Desire graduate Electronic or Electrical Engineer with experience in UHF TV reception or UHF air-ground communications. Send resume and salary requirements to DeW. Schatzel, Director of Engineering, MPATI, Memorial Center, Purdue University, Lafayette, Indiana.

"Put Yourself in the Other
Fellow's Place"

TO EMPLOYERS

TO EMPLOYEES

Letters written offering Employment or applying for same are written with the hope of satisfying a current need. An answer, regardless of whether it is favorable or not, is usually expected.

MR. EMPLOYER won't you remove the mystery about the status of an employee's application by acknowledging all applicants and not just the promising candidates.

MR. EMPLOYEE you, too, can help by acknowledging applications and job offers. This would encourage more companies to answer position wanted ads in this section. We make this suggestion in a spirit of helpful cooperation between employers and employees.

This section will be more useful to all as a result of this consideration.

Classified Advertising Division

McGraw-Hill Publishing Co., Inc.

330 West 42nd St., New York 36, N. Y.

SCIENTISTS/ENGINEERS

Career opportunities in:

- DESIGN
- RESEARCH
- DEVELOPMENT
- SALES
- MARKETING
- APPLICATION

Submit resume in confidence to:

- Alan Glou Technical/Scientific
- Sid Hohner Sales/Marketing

Specialists in the personalized placement of Electronic Engineers and Scientists, on a national basis, who have a BS or advanced degree. Client companies assume fee and relocation costs.

SCOPE

PROFESSIONAL PLACEMENT CENTER
1277 MAIN ST. WALTHAM, MASS.

SEARCHLIGHT SECTION

(Classified Advertising)
BUSINESS OPPORTUNITIES
SPECIAL SERVICES

FOR RESEARCH — DEVELOPMENT & EXPERIMENTAL WORK

Over 10,000 different electronic parts: waveguide, radar components and parts, test sets, pulsers, antennas, pulse xmfrs, magnetrons, IF and pulse amplifiers, dynamotors, 100 cycle xmfrs, 584 ant. pedestals, etc.
PRICES AT A FRACTION OF ORIGINAL COST!
COMMUNICATIONS EQUIP CO.
313 CANAL ST., N. Y. 13, WO 6-4045
CHAS. ROSEN (Formerly at 131 Liberty St.)
CIRCLE 460 ON READER SERVICE CARD

OUR BUSINESS IS CUTTING



Manufacturers of small electrical or mechanical units, however intricate, with high labor content will find our cost-cutting services interesting.

Our complete overseas facilities in Japan, Hong Kong, etc., provide unlimited services by skilled workers, under trained supervision, for the manufacture of complete units or sub-assemblies to your most rigid specifications. All transactions held in strictest confidence.

Submit sample or blueprint for firm quotation. Get the facts about our cost-cutting services — save dollars and build profits!

OVER 25 YEARS EXPERIENCE IN ELECTRONICS

INTERCONTINENTAL INDUSTRIES, INC.
555 W. Adams Street Chicago 6, Illinois
Established 1938

CIRCLE 461 ON READER SERVICE CARD

INDEX TO ADVERTISERS



Audited Paid Circulation

Allegheny Ludlum Steel Corp.	69	Parker Seal Co.	27
American Machine & Foundry Co., Potter & Brumfield Div.	55	Pennsalt Chemicals Corp.	19
American Sterilizer Co.	22	Potter and Brumfield, Div. American Machine & Foundry Co.	55
Ampex Corporation	25		
• Arnold Engineering Co., The.	5	• Radio Corporation of America, 4th Cover, 17	
		Raychem Corp.	32, 33
• Bircher Corporation, The.	86	• Raytheon Company.	58, 59, 66
• Busmann Mfg. Co.	18	Reliance Electric & Engineering Co.	22
• Clevite Electronic Components A Div. of Clevite Corp.	67	• Semi Elements, Inc.	78
Collins Radio Co.	79	• Southern Electronics Corp.	72
Consolidated Electrodynamics Corp.	80	Sperry Electronic Tube Div., Sperry Rand Corp.	3rd Cover
• Cosmic Condenser Co.	84	Sprague Electric Co.	31
• Cubic Corp.	89	Stackpole Carbon Co.	25
		• Stancor Electronics, Inc.	80
DeKalb Industrial Committee of 1900.	87	Struthers-Dunn.	68
Delco Radio.	24	Superior Cable Corp.	77
Dr. Aero Corp.	91		
duPont de Nemours & Co., Inc., E. I.	71	• Tansitor Electronics, Inc.	26
Dynamics Instrumentation Co.	81	Tektronix, Inc.	62, 63
		Triad Transformer Corp.	65
Edwards High Vacuum Inc.	14	• Tung-Sol Electric, Inc.	61
Easler Engineering Co., Inc.	73	Union Carbide Products Co.	23
Enel-McCullough, Inc.	6		
Electro Instruments, Inc.	15	Western Electric, Lanredale Plant.	26
Electronic Measurements Co.	75	Westinghouse Electric Corp.	76
Electronic Tube & Instrument Div. of General Atomics Corp.	34	• Wind Turbine Company.	78
• Fuji Tsushinki Seizo K.K.	85		
Gardner-Denver Company.	60		
General Radio Co.	2nd Cover		
Gries Reproducer Corp.	84		
• Hart Manufacturing Co.	91		
• Hewlett-Packard Company.	10, 11		
Hoffmann Electronics Corp.	9		
Hughes Aircraft Co.	79		
• Keeco, Inc.	52		
Levin and Son, Inc., Louis.	26		
Line Material Inc.	13		
Linen Thread Co., Inc., The.	73		
• Microtran Co., Inc.	73		
• Mitsumi Electric Co., Ltd.	82		
New Jersey Machine Corp.	82		
• Northeastern Engineering, Inc.	22		
Pan American World Airways.	83		
Panoramic Electronics Inc.	95		

CLASSIFIED ADVERTISING

F. J. Eberle, Business Mgr.

EMPLOYMENT OPPORTUNITIES. 93, 94

SPECIAL SERVICES. 94

EQUIPMENT

(Used or Surplus New)

For Sale. 94

INDEX TO CLASSIFIED ADVERTISERS

• Communications Equipment Co. 91

Intercontinental Industries Inc. 91

Microwave Services International Inc. 94

Republic Aviation Corporation. 94

Scope Professional Placement Center. 94

Search Associates. 94

Sylvania Mountain View Operations. 93

• See advertisement in the July 20, 1961 issue of Electronics Buyers' Guide for complete line of products or services.

This Index and our Reader Service Numbers are published as a service. Every precaution is taken to make them accurate, but ELECTRONICS assumes no responsibilities for errors or omissions.

LOW COST HIGH PERFORMANCE SPECTRUM ANALYZER

10 mc - 43 kmc

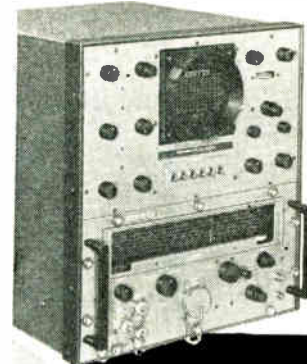

WITH
ONE
TUNING
HEAD

PANORAMIC
MODEL
SPA-10

Model SPA-10 provides sensitive broad-band spectrum analysis through Ka band in a single, low cost, compact unit. With such outstanding features as high sensitivity, wide dispersion range, and adjustable selectivity the easy to use SPA-10 complements Panoramic's unmatched array of widely accepted exceptionally reliable RF and microwave analyzers. Many SPA-10 modular sections are derived from the highly regarded, ultra sensitive model SPA-4a.

CHECK THESE FEATURES

High sensitivity (see table below). • Dispersion adjustable to 80 mc. • Selectivity adjustable 1-80 kc. • Calibrated dispersion marker with modulation provision to measure narrow band dispersions accurately. • Bright, easily read 5" CRT display with calibrated linear, 40 db log and power amplitude scales. • Single knob tuning control with illuminated slide rule scale, accurate within 1%. • Crystal controlled $\pm 0.01\%$ markers (optional) check signal frequency calibrations over entire SPA-10 range. • Single tuning head includes coaxial and waveguide input mixers, plus noise-free non-contacting klystron cavity shorts. • Adjustable smoothing filter simplifies noise analysis.

FREQUENCY	SENSITIVITY*
10 — 640 mc	— 95 to — 105 dbm
0.56 — 1.4 kmc	— 87 to — 97 dbm
1.0 — 2.24 kmc	— 79 to — 89 dbm
2.0 — 3.04 kmc	— 71 to — 81 dbm
2.9 — 6.0 kmc	— 90 to — 100 dbm
6.0 — 12.2 kmc	— 80 to — 95 dbm
12.1 — 24.4 kmc	— 70 to — 85 dbm
21.3 — 43.0 kmc	— 40 dbm nominal

*2:1 deflection ratio—CW signal; noise; 50 ohm input

For detailed information on models SPA-10 as well as SPA-4a, write—wire—phone



Panoramic
electronics, inc.



Formerly Panoramic Radio Products, Inc.
530 South Fulton Ave. • Mt. Vernon, N. Y.
(914) OWens 9-4600 • TWX-MT-V-NY-5229
Cables: Panoramic, Mt. Vernon, N. Y. State

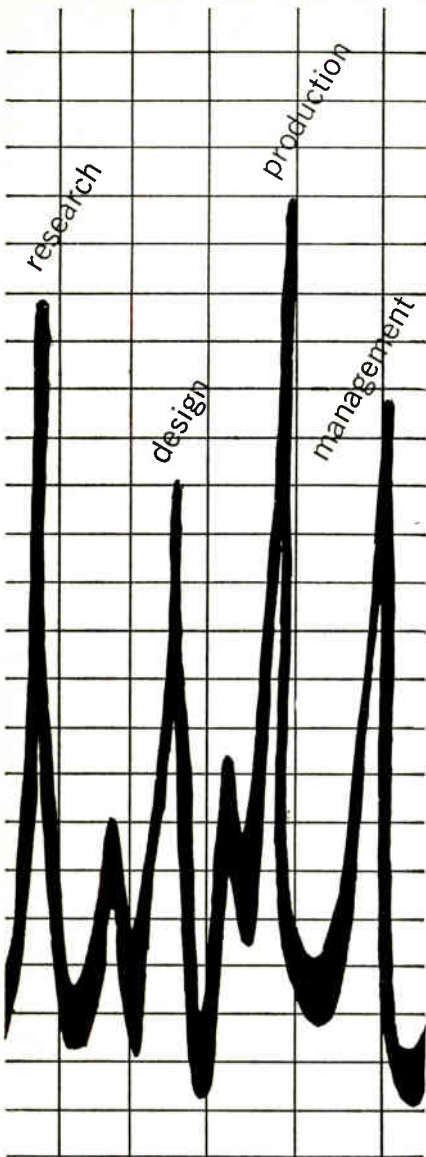

**IT'S READ MORE
BY ALL 4!**

electronics magazine interprets electronics for electronics men every week. The latest components, economic trends, military applications. Technical data you'll want to file and keep. Get the facts first with a personal subscription (don't be low man on a routing slip). Mail the reader service card (postpaid) to **electronics**, the magazine that helps you to know and to grow! Rates: three years for \$12, one year for \$6; Canadian, one year for \$10; foreign, one year for \$20. Annual **electronics** BUYERS' GUIDE included with every subscription.

subscribe today to
electronics

electronics



Audit Bureau
of Circulations



Associated Business
Publications

Audited Paid Circulation

JAMES T. HAUPTLI

Advertising Sales Manager

R. S. QUINT:
Assistant Publisher Buyers'
Guide and Business Manager
FRED STEWART:
Promotion Manager
B. ANELLO:
Market Services Manager

RICHARD J. TOMLINSON:
Production Manager
GEORGE E. POMEROY:
Classified Manager
HUGH J. QUINN:
Circulation Manager

ADVERTISING REPRESENTATIVES

NEW YORK (36):
Donald H. Miller, Henry M. Shaw,
George F. Werner
500 Fifth Avenue, LO-4-3000
(area code 212)

BOSTON (16):
William S. Hodgkinson, Donald R. Furth
McGraw-Hill Building, Copley Square,
Congress 2-1160 (area code 617)

PHILADELPHIA (3):
Warren H. Gardner, William J. Boyle
6 Penn Center Plaza, LOcust 8-4330
(area code 215)

CHICAGO (11):
Harvey W. Wernecke, Robert M. Denmead
645 North Michigan Avenue, Mohawk 4-5800
(area code 312)

CLEVELAND (13):
Paul T. Fegley
55 Public Square, Superior 1-7000
(area code 216)

SAN FRANCISCO (11):
R. C. Alcorn
255 California Street, Douglas 2-4600
(area code 415)

LOS ANGELES (17):
Peter S. Carberry, Ashley P. Hartman
1125 W. 6th St., Huntley 2-5450
(area code 213)

DENVER (2):
J. W. Patten
Tower Bldg., 1700 Broadway,
Alpine 5-2981 (area code 303)

ATLANTA (9):
Michael H. Miller, Robert C. Johnson
1375 Peachtree St. N.E., Trinity 5-0523
(area code 404)

HOUSTON (25):
Joseph C. Page, Jr.
Prudential Bldg., Holcomb Blvd.,
Riverside 8-1280 (area code 713)

DALLAS (1):
Frank Le Beau
The Vaughn Bldg., 1712 Commerce St.
Riverside 7-9721 (area code 214)

LONDON W1:
Edwin S. Murphy Jr.
34 Dover St.

FRANKFURT/Main:
Matthée Herfurth
B5 Westendstrasse

GENEVA:
Michael R. Zeynel
2 Place du Port

"Headquarters for Business Information"

McGraw-Hill Technical and Business Publications

American Machinist/Metal-
working Manufacturing
Aviation Week and Space
Technology
Business Week
Chemical Engineering
Chemical Week
Coal Age
Construction Methods and
Equipment
Construction Daily
Control Engineering
Electrical Construction
and Maintenance
Electrical Merchandising Week
Electrical Newsletter
Electrical West

Electrical Wholesaling
Electrical World
Electronics
Engineering Digest
Engineering and Mining Journal
E & MJ Metal and Mineral
Markets
Engineering News-Record
Factory
Fleet Owner
Industrial Distribution
National Petroleum News
Nucleonics
Nucleonics Week
Platt's Oilgram News
Platt's Oilgram Price Service
Power

Product Engineering
Purchasing Week
Science Week
Textile World

Overseas only:
Automobile International
(English, Spanish)
Ingenieria Internacional
Construccion (Spanish)
International Management
(English, Spanish,
Portuguese editions)
Metalworking Production
(Great Britain)

Available by subscription only — to qualified persons actively engaged in the field of the publication. For subscription rates and information describing the editorial coverage of any of the above publications, write to: Subscription Manager, Circulation Department, McGraw-Hill Publishing Company, 330 West 42nd Street, New York 36, N. Y.

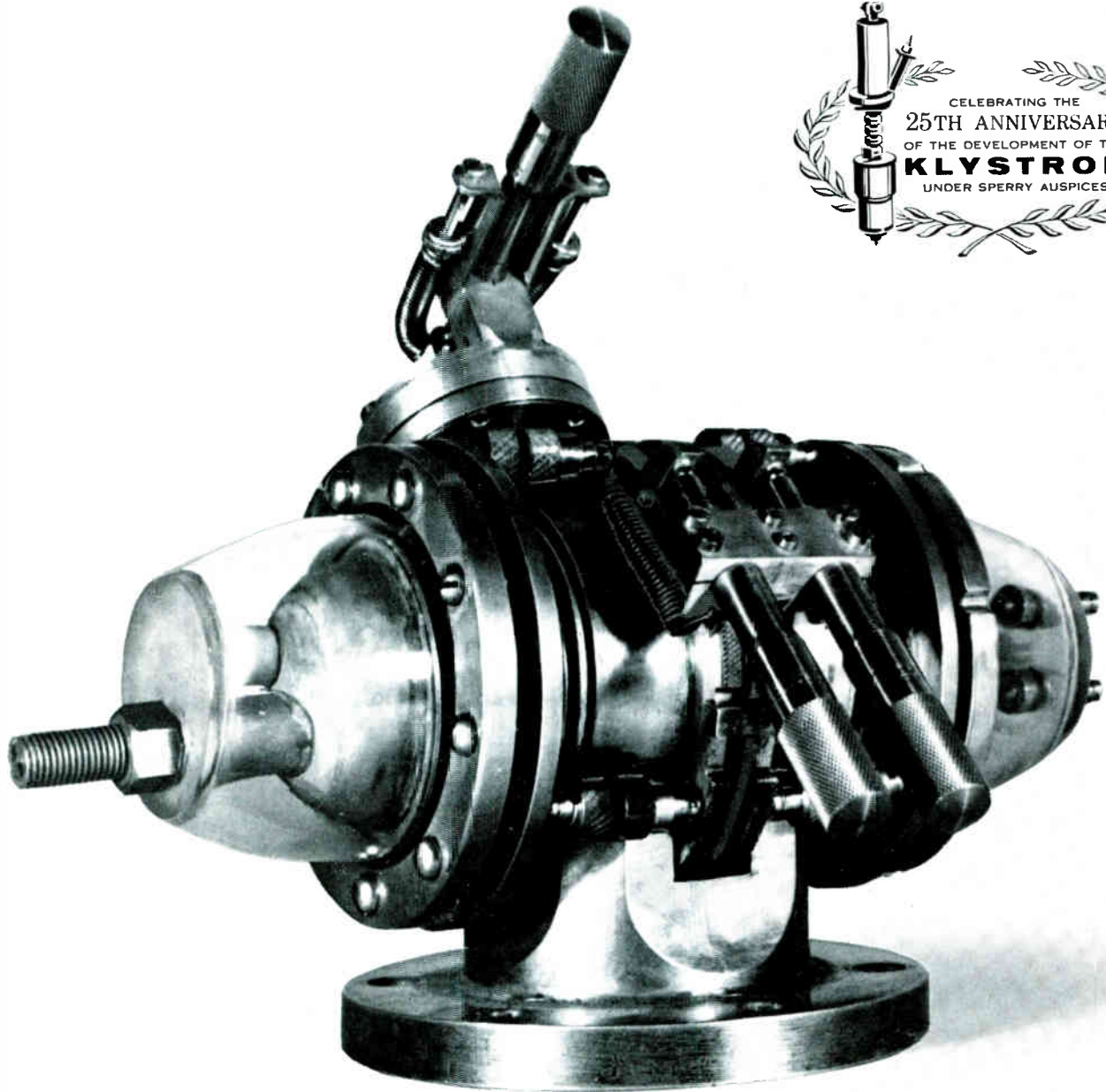

Early klystrons delivered only 5 to 10 W across a relatively narrow bandwidth. Today's Sperry klystron family blankets the spectrum at outputs from milliwatts to megawatts.

EXPERIENCE: how Sperry sets the pace in microwave tube competition

The invention that built a \$110 million-a-year industry

This year is the 25th anniversary of the klystron. In 1937 the klystron became a reality under the auspices of Sperry research. Since that time, new Sperry developments have constantly expanded the microwave tube family's usefulness.



SPERRY RAND CORPORATION
GAINESVILLE, FLA. / GREAT NECK, N. Y.

CIRCLE 901 INSIDE BACK COVER



New from RCA... Developmental **LONG-LEAD NUVISTORS** for applications requiring solder-in components

RCA is now developing a series of long-lead nuvistor types designed to be soldered directly into printed circuit boards . . . without sockets. This simplification can:

- cut assembly cost and time
- save space
- eliminate the undesirable loading effects sometimes encountered with sockets in high-frequency applications.

Nuvistors are a perfect choice for high-frequency solder-in applications because of their high reliability and long life. (Recent tests proved the reliability factor of RCA-7586 nuvistors to be only 0.36% or less failures per thousand hours with a 95% confidence level.)

The table at right indicates the long-lead nuvistor types now in development.

Developmental Number	Commercial Prototype	Developmental Long-Lead Nuvistors Description
A-15212	RCA-7586	General-purpose industrial medium- μ triode
A-2702	RCA-7587	General-purpose industrial sharp-cutoff tetrode
A-15321	RCA-7895	Industrial high- μ triode
A-15319	RCA-8056	Medium- μ triode for low B+ and HYBRID equipment applications
A-15320	RCA-8058	Double-ended high- μ rf power amplifier triode for UHF applications
A-15317		Triode for low-level Class C service
A-15318		Double-ended triode for low-level Class C service
Following types offer EXTRA low failure rates in early life periods, for applications where the primary objective is high and reliable performance for periods up to 100 hours: e.g., sonobuoys, minibuoy, rocketsondes, weathersondes.		
A-2707		Tetrode for oscillator-multiplier applications through 100 Mc
A-15307		Triode for oscillator-multiplier, and amplifier applications through 200 Mc
A-15309		Triode for low B+ and HYBRID equipment applications

Still other nuvistor types are in early stages of development—including a nuvistor with a 13.5-volt heater for low B+ and HYBRID equipment applications in mobile communications. These long-lead nuvistor types constitute another dramatic step forward in the rapidly expanding field of nuvistor receiving tube design. For details about specific types, talk with your RCA Field Representative.



The Most Trusted Name in Electronics

RCA ELECTRON TUBE DIVISION FIELD OFFICES . . . EAST: 744 Broad Street, Newark 2, New Jersey, HUmboldt 5-3900 • MIDWEST: Suite 1154, Merchandise Mart Plaza, Chicago 54, Illinois, WHitehall 4-2900 • WEST: 6801 East Washington Boulevard, Los Angeles 22, California, RAymond 3-8361; 1838 El Camino Real, Burlingame, California, OXFord 7-1620.