

# electronics

**SPECIAL** *New Power Sources and Energy Converters*

*Below: close up view of mirror and support structure for solar thermionic energy conversion system. See p 35*

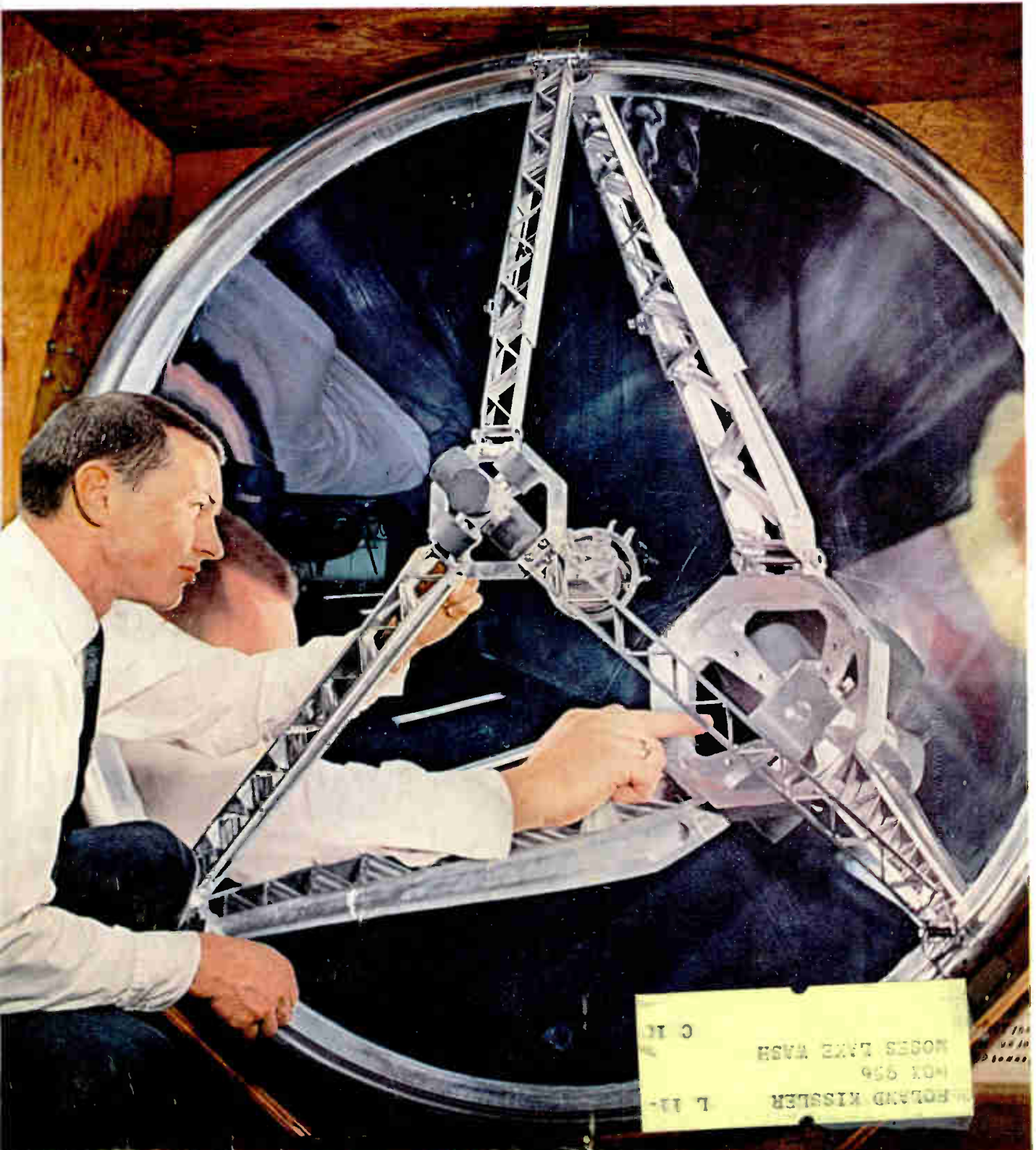

Now you can have a universal oscilloscope with dual trace vertical bandwidth capacity greater than 40 MC—with no sacrifice in sensitivity. Seven separate vertical and horizontal plug-in units give the new  $\text{hp}$  175A the greatest versatility ever offered in a general purpose 50 MC scope. Available are dual-channel, single-channel and high-gain vertical plug-ins, plus these horizontal plug-ins: auxiliary, time mark generator, display scanner and sweep delay generator.

The new  $\text{hp}$  developed 12 Kv CRT presents an easy-to-measure 6 x 10 cm calibrated display without distortion or defocusing. The front panel astigmatism control common to other scopes is no longer necessary. In addition, phosphor and graticule are on the same plane—thus eliminating CRT

parallax error. The front panel is engineered for the simplest possible operation.

$\text{hp}$  175A features simplified circuitry for more reliable performance and easy maintenance. Simple triode circuits (6DJ8 tubes) are used in the vertical amplifier. Complicated distributed amplifiers are not employed. In addition, an  $\text{hp}$  developed cable delay line eliminates still more adjustments. Only 6 tube types and 5 transistor types are used throughout.

The  $\text{hp}$  175A Universal Oscilloscope is housed in the new  $\text{hp}$  modular cabinet . . . a single instrument for both bench use and rack mount. Cover, bottom and sides are easily removed for simple servicing and routine maintenance. The  $\text{hp}$  175A is as easy to service as it is to use!

### These Plug-ins Give Utmost Versatility to the $\text{hp}$ 175A OSCILLOSCOPE:

#### Vertical plug-ins

##### $\text{hp}$ 1750A 40 MC Dual Channel Amplifier (pictured in 175A opposite)

Permits viewing of two phenomena simultaneously, bandpass dc to 40 MC, rise time 9 nsec, sensitivity 50 mv/cm. Differential input for common mode rejection. \$285.00



##### $\text{hp}$ 1752A High Gain Amplifier

Provides 5 mv/cm sensitivity dc to 18 MC with differential input for high common mode rejection. \$225.00

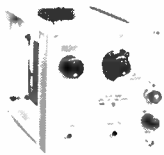

##### $\text{hp}$ 1753A 40 MC Single Channel Amplifier

Bandpass dc to 40 MC, rise time 9 nsec, sensitivity 50 mv/cm. \$155.00

#### Horizontal plug-ins

##### $\text{hp}$ 1780A Auxiliary Plug-In (shown in 175A opposite), normal and single sweep, \$25.00

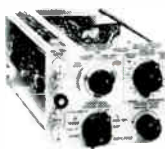

##### $\text{hp}$ 1781A Sweep Delay Generator

For detailed examination of complex signals or pulse trains. Permits viewing expanded waveform segment while still retaining presentation of earlier portions of the waveform. Delay time 1  $\mu$ sec to 10 sec.; delaying sweep, 2  $\mu$ sec/cm to 1 sec/cm. \$375.00

##### $\text{hp}$ 1782A Display Scanner

Provides output to duplicate on X-Y recorder any repetitive wave appearing on scope. Resolution with permanent records higher than CRT or photograph. (Available soon)

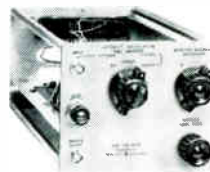

##### $\text{hp}$ 1783A Time Mark Generator

Permits easy time measurements by providing intensity modulated time markers on scope trace. Range, 10  $\mu$ sec, 1  $\mu$ sec and 0.1  $\mu$ sec intervals,  $\pm 0.5\%$ . \$130.00

## SPECIFICATIONS $\text{hp}$ 175A

### Sweep Generator

**Internal Sweep:** 0.1  $\mu$ sec/cm to 5 sec/cm,  $\pm 3\%$ ; vernier extends slowest speed to 15 sec/cm

**Magnification:** x1 and x10

**Triggering:** Internal, from vertical input signal causing 2 mm or more vertical deflection, or from power line. External, from signal 0.5 v p-p or more

**Triggering Point:** On positive or negative going signal; on external signal, level adjustable —10 to +10 v

### Horizontal Amplifier

**Bandpass:** DC to 500 KC

**Sensitivity:** 0.1 and 1 v/cm

### Vertical Amplifier

**Bandpass:** Main amplifier, dc to more than 50 MC

### General

**Power Requirements:** 115/230 v ac  $\pm 10\%$ , 50-60 cps. Maximum of 425 watts, depending on plug-ins used

**Weight:** Maximum of 70 lbs., depending on plug-ins used

**Price:** \$1,325.00

*Data subject to change without notice.*

*Prices f.o.b. factory.*

# HEWLETT-PACKARD COMPANY



1501 Page Mill Road, Palo Alto, California, Area Code 415, DA 6-7000

Sales and service representatives in all principal areas;

Europe, Hewlett-Packard S.A., Rue du Vieux Billard No. 1, Geneva;

Canada, Hewlett-Packard (Canada) Ltd., 8270 Mayrand St., Montreal

# ACTUAL SIZE

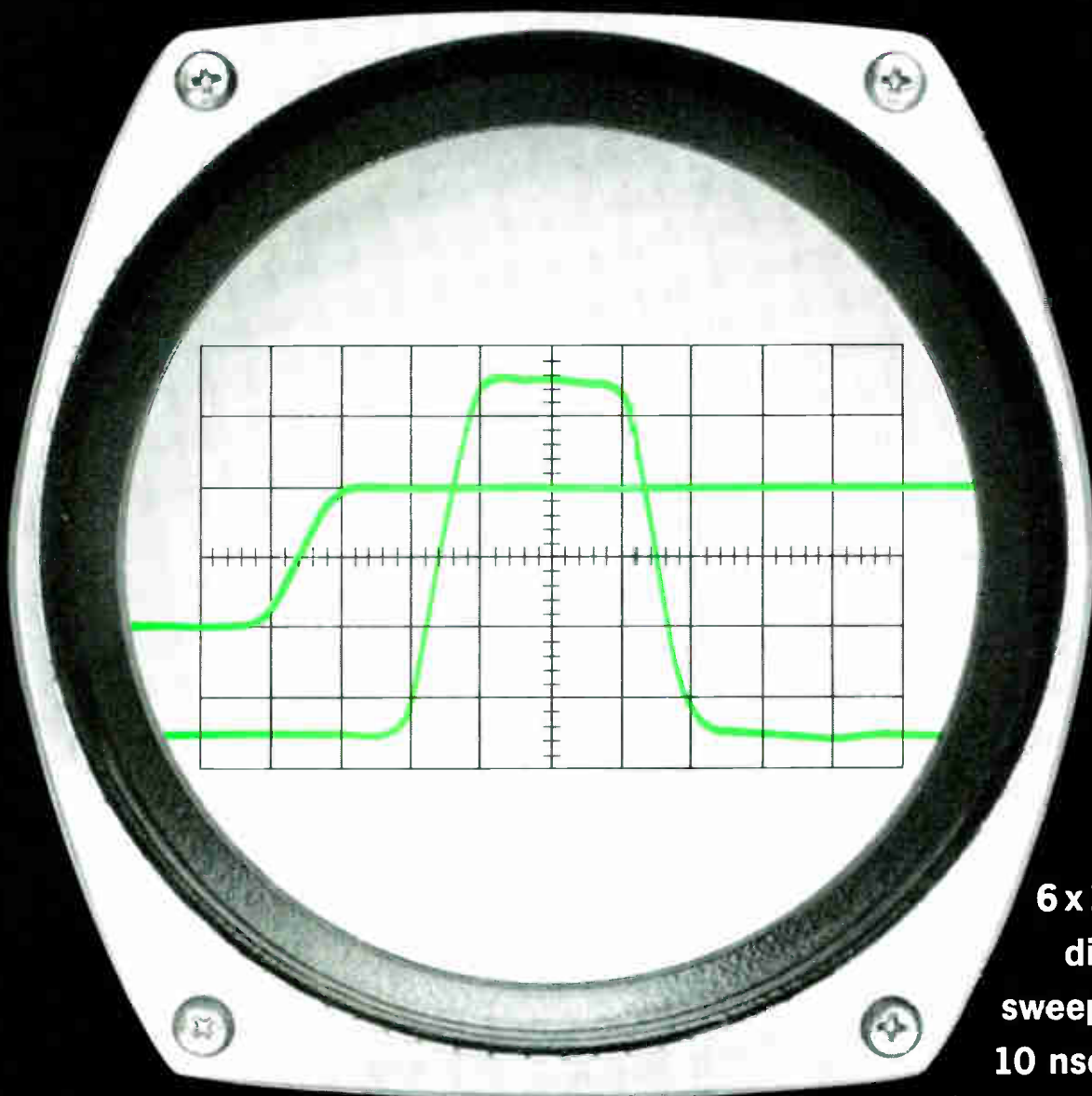

6 x 10 cm  
display;  
sweep time  
10 nsec/cm

## DUAL TRACE FAST PULSE DISPLAY *on the* *New* **50 MC** UNIVERSAL OSCILLOSCOPE

*Turn the page for details!*



**THIS  
IS  
THE  
NEW**



**175A 50 MC Universal Oscilloscope  
with 1750A Dual Channel Amplifier,  
1780A Auxiliary Plug-in installed.**

# 175A 50 MC OSCILLOSCOPE

- Bright, 6 x 10 cm display with no parallax, reflections or astigmatism
- Over 50 MC main vertical amplifier
- Dual trace, dc to 40 MC vertical plug-in
- Horizontal and vertical plug-ins for specific applications
- Easier to calibrate and maintain—no distributed amplifiers
- Positive preset syncing over entire bandwidth

# electronics

A McGraw-Hill Publication 75 Cents



W. W. MacDONALD, Editor

J. M. CARROLL, Managing Editor  
 SENIOR EDITORS: Samuel Weber, George W. Sideris. SENIOR ASSOCIATE EDITORS: William E. Bushor, Michael F. Wolff. ASSOCIATE EDITORS: Michael F. Tomaino, Sylvester P. Carter, William P. O'Brien, John F. Mason, Thomas Emma, Sy Vogel, Leslie Solomon, George J. Flynn, Laurence D. Shergalis. ASSISTANT EDITORS: Nilo Lindgren, Stanley Froud, Stephen B. Gray, Roy J. Bruun, George V. Novotny, Leon H. Dulberger. REGIONAL EDITORS: Harold C. Hood (Pacific Coast, Los Angeles), Thomas Maguire (New England, Boston), Cletus M. Wiley (Midwest, Chicago). ART DIRECTOR: Harry Phillips; Howard R. Berry. PRODUCTION EDITOR: John C. Wright, Jr. EDITORIAL ASSISTANTS: Gloria J. Meurer, Bernice Duffy, Lorraine Rossi, Virginia T. Bastian, Lynn Emery, Laura W. Smith, Bette H. Snyder, Rosemary Abbruzzese, Judy Haskins, Ann Mella. FOREIGN NEWS BUREAU: Director, John Wilhelm, Alyne Elias. LONDON—John Shinn, Derek Barlow, Nicholas Landon. Bonn—Peter Forbath, James Morrison, Silke McQueen. Paris—Robert Farrell, Arthur Erikson. Milan—Gene DiRaimondo. Mexico City—Bruce Bendow. Rio de Janeiro—Leslie Warren. Moscow—Stewart Ramsey. Tokyo—Richard Halloran, Charles Cohen, John Yomaguchi.

JAMES GIRDWOOD, Publisher

**SOLAR ENERGY CONVERTER** by Electro-Optical Systems weighs 25 lb. A 5-ft concentrator focuses solar energy into a cavity to heat several cesium-vapor thermionic diodes. The diodes change heat into current. *Designed for Mariner-class interplanetary probes, the system will generate 135 watts in the vicinity of Mars. See p 35* COVER

**ELECTRON ACCELERATOR** Starts Up. New 6-Bev research tool is nearly ready for full-power operation. *Among design features are a series of 16 resonant r-f cavities and energy storage choke* 18

**100,000,000-BEV ACCELERATOR FEASIBLE?** Designer at national laboratory thinks it can be done. *Size can be kept down by using superconducting magnets* 18

**COMPONENTS STAR AT IRE SHOW.** Manufacturers go all-out to provide the industry with smaller building blocks. *Emphasis in instrumentation is toward faster, more versatile equipment* 26

**LOW-POWER MICROWAVE** Sends Computer Data over Mountains. Experiments indicate knife-edge diffraction can reduce data transmission costs. *Technique can extend one-hop range to hundreds of miles* 28

**INDUSTRIAL ELECTRONICS** Is Fastest-Growing Market. IRE president says it will triple in next 10 years. *But the big money-makers will still be military and space electronics in 1972* 30

**SPECIAL: NEW POWER SOURCES** and Energy Converters. This state-of-the-art survey deals with chemical batteries, fuel cells, photovoltaic converters, thermal energy conversion and nuclear-energy systems. *Here's how the future looks in part: photovoltaic devices up to 1 Kw, solar-thermal systems from 100 w to 10 Kw and reactor systems for higher levels.* By D. Linden 35

**TUNNEL-DIODE PARAMETERS** Measured With Simple Test Set. The tunnel-diode characteristic curve completely defines the unit's performance but tracing curves can be unduly time consuming in production operations. *This set conveniently measures peak-point and valley-point current and peak-to-valley ratio.* By C. D. Todd 43

Published weekly, with Electronics Buyers' Guide and Reference issue, as part of the subscription, by McGraw-Hill Publishing Company, Inc. Founder: James H. McGraw (1860-1948).

Indexed Annually in Buyers' Guide and Reference issue.

Title ® registered U.S. Patent Office; © Copyright 1962 by McGraw-Hill Publishing Co., Inc. All rights reserved, including the right to reproduce the contents of this publication, in whole or in part.

Executive, editorial, circulation and advertising offices McGraw-Hill Building, 330 West 42nd Street, New York 36, N. Y. Telephone Longacre 4-3000. Teletype TWX N.Y. 1-1636. Cable McGrawhill, N. Y. PRINTED IN ALBANY, N. Y.; second class postage paid at Albany, N. Y.

OFFICERS OF THE PUBLICATIONS DIVISION: Nelson L. Bond, President; Shelton Fisher, Wallace F. Troendly, Senior Vice Presidents; John R. Callahan, Vice President and Editorial Director; Joseph H. Allen, Vice President and Director of Advertising Sales; A. R. Venezian, Vice President and Circulation Coordinator; Daniel F. Crowley, Vice President and Controller.

OFFICERS OF THE CORPORATION: Donald C. McGraw, President; Hugh J. Kelly, Harry L. Waddell, Executive Vice Presidents; L. Keith Goodrich, Executive Vice President and Treasurer; John J. Cooke, Vice President and Secretary.

Subscriptions are solicited only from those actively engaged in the field of the publication. Position and company connection must be indicated on orders. Subscription rates: United States and Possessions, \$6.00 one year; \$9.00 two years; \$12.00 three years. Canada, \$10.00 one year. All other countries \$20.00 one year. Single Copies, United States and Possessions and Canada 75¢. Single copies all other countries \$1.50.

THE PUBLISHER, UPON WRITTEN REQUEST FROM ANY SUBSCRIBER TO OUR NEW YORK OFFICE, AGREES TO REFUND THAT PART OF THE SUBSCRIPTION PRICE APPLYING TO COPIES NOT YET MAILED.

Subscribers: Please address all correspondence, change of address notices, subscription orders or complaints to Fulfillment Manager, Electronics, at above address. Change of address notices should provide old as well as new address, including postal zone number if any. If possible, attach address label from recent issue. Allow one month for change to become effective.

Postmaster: Please send Form 3579 to Fulfillment Manager, Electronics, 330 West 42nd Street, New York 36, New York.



Audited Paid Circulation

CONTENTS continued

- FOOTBALL-HELMET TRANSMITTER Telemeters Injury Data. Sports-equipment research is helped by f-m/f-m telemeter mounted in football helmet. Piezoelectric accelerometer modulates voltage-controlled subcarrier oscillator; vhf transmitter is crystal-controlled. *The transmitting dipole antenna is painted on outside of helmet.* J. S. Aagaard and J. L. DuBois 46
- ELECTROMETER INPUT Circuit Uses Vibrating Capacitor. Electrometer amplifiers are used to detect extremely low level currents developed across a high input resistance. Choppers or vibrating capacitors are used at the input to achieve zero stability. *This article tells how to design the vibrating-capacitor input for optimum performance.* V. J. Caldecourt 48
- REFERENCE SHEET: Frequency-Independent Voltage Dividers. Equations and curves are derived for arranging two two-branch series R-L-C circuits in series and generalized to *n* inductances in parallel. *Formulas make possible design of voltage dividers that are independent of frequency.* C. L. Conner 52

DEPARTMENTS

- Crosstalk. *New Spectrum Chart. Delay Lines* 3
- Comment. *The Retina. Field Effect Transistor* 4
- Electronics Newsletter. *Nike Zeus Scores Again* 7
- Washington Outlook. *Air Force Weighs Plan for Competition Through Project Design Phases* 12
- Meetings Ahead. *National Electronics Conference* 32
- Research and Development. *Brushless D-C Motor Uses Hall Effect Devices* 58
- Components and Materials. *Indicator Tube for Transistor Circuits* 64
- Production Techniques. *Winding Inductors to Exact Turns Count* 72
- New Products Design and Applications. *Electron-Beam Evaporator for Thin Film Deposition* 78
- Literature of the Week 92
- People and Plants. *Components Producer in New Plant* 94
- Index to Advertisers 102

# CROSSTALK

**SPECTRUM CHART.** Next week we will publish a new and—we think—uniquely useful spectrum chart, measuring 30 by 22 inches. Conventional spectrum charts published in this country give only the U. S. frequency allocations. We are going to show International Telecommunications Union allocations throughout the world.

Actually, it will be five spectrum charts in one. Parallel bands for each frequency range show the international allocations in Region I (Europe, Africa and the USSR), Region II (North and South America), Region III (Asia and Australia), U. S. government and U. S. non-government allocations. Basic classes of allocations are shown in eight contrasting colors, with key initials for each subclass. The chart also shows all secondary uses for each band.

This arrangement will help engineers quickly locate allocated frequencies for virtually any kind of electronic equipment, anywhere.

One of the important bonuses of using five parallel charts is that equipment designers or users can tell at a glance whether one type of equipment may face interference from another type of equipment at a specific frequency. Here are a few of the conflicts apparent:

In the United States and abroad assignments for fixed and mobile land communications are made at 4.75 to 4.995 Mc. But a double check should be made before this equipment is sent overseas. Under international allocations, this band is also available to broadcast stations, although FCC does not authorize such use in the U. S. Foreign broadcasters could even interfere with communications here under certain conditions.

Or, take the U. S. allocations at 75 to 100 Mc for tv channels 5 and 6 and the adjacent f-m band; Alaskans and Hawaiians can use these bands for fixed communications. The U. S. has maritime communications around 2 Mc.; but go to Europe and you'll find these frequencies used for land communications.

Of course, the chart has the virtue of any new spectrum chart: catching up with all the recent changes in national and international allocations.

Radio allocations aren't the only spectra on the chart. There's also a picture of the use-

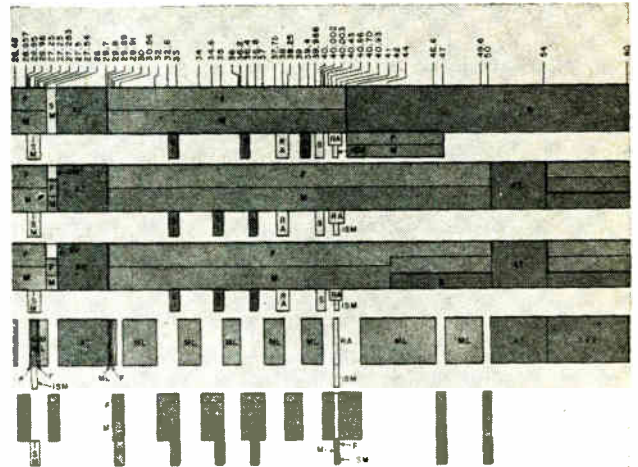

ful optical spectrum, packed with such information as the frequencies of masers and lasers, wavelengths for infrared sources and detectors, optical materials, and so on. And we've included the entire electromagnetic spectrum, the sound spectrum, the range of musical instruments (did you know that the frequencies of black keys on a piano are 1.059 the frequency of the next lower white key?) and a world map of the ITU regions.

The chart was prepared by Associate Editor Solomon and our art department. Solomon did the digging, into the most recent ITU Radio Regulations, FCC rulings, and publications by such government agencies as Office of Emergency Planning. The art department did an excellent job of humanengineering, to make everything clear and legible.

**CLARIFICATION.** When a systems designer needs a specialized component, he often gives the specialist a specification that lists input and output characteristics. Magnetostrictive delay lines, for example, are increasingly used in sonar, radar, data processing and many other applications. If you've been wondering how they really work and what makes one kind different from another, next week read the article by A. Rothbart and A. J. Brown, of Airborne Instrument Labs. They discuss design, operation and commercially available lines, in a really practical roundup of the subject.

## New Nanosecond\* Pulse Transformers for Ultra-miniature, Ultra-high Speed Applications

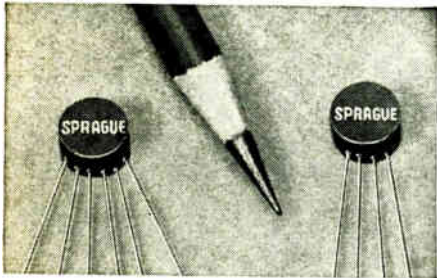

Digital circuit designers will find the new Sprague Type 43Z Nanosecond Pulse Transformers of considerable interest. These tiny transformers have been carefully designed for the all-important parameter of minimum rise time at high repetition rates up to 10 mc.

The new Type 43Z series is comprised of a broad line of 72 pulse transformers in 10 popular turns ratios. They are Sprague's latest addition to the most complete listing of pulse transformers offered by any manufacturer for use in digital computers and other low-level electronic circuitry.

Type 43Z Pulse Transformers are designed so that the product of leakage inductance and distributed capacitance is at a minimum. They are particularly well suited for transformer coupling in transistor circuits since transformers and transistors are very compatible low impedance devices. Nanosecond transformers are equally suitable for transmission line mode of operation, in twisted-pair transmission line coupling, and in regenerative circuits.

The epoxy-encapsulated "pancake" package is excellent for both etched wire board or conventional chassis mounting. To simplify etched-board design, these ultra-miniature pulse transformers are available with leads terminating at the side or the bottom of each unit.

For complete technical information on Type 43Z Nanosecond Pulse Transformers, write for Engineering Data Sheet 40235 to Technical Literature Section, Sprague Electric Co., 35 Marshall St., North Adams, Mass. \*millimicrosecond

## COMMENT

### The Retina

The letter from A. J. Reynolds in the March 23 issue (p 4) is not noteworthy for the closeness of its reasoning, but is noteworthy for classically illustrating a pathetic fallacy. Mr. Reynolds *feels* strongly that there are no such things as photochemicals, and has permitted this feeling to interpose between him and the truth. Actually, his body—and the whole world of nature—are full of photochemicals: chlorophyll, haemin and melanin, to name three familiar ones; rhodopsin and iodopsin to get closer to the point. All five of these substances are porphyrin complexes, of which the body produces many kinds. Porphyrins are known to be conductors or semiconductors (depending on how you look at them), and temporary sodium or potassium chelates of the basic porphyrin ring may be generators of the electrical impulses which are read by the brain as sensory impressions. Porphyrins are variously photosensitive, as one would expect from conductors.

Rhodopsin and iodopsin are two of the several light-sensitive (and color-specific) pigments in the retinal structure, and both were recently demonstrated by Harvard University physiologists to be capable of triggering a reaction that starts with photon impact, produces an interlocked and self-restoring chain of chemical responses, and ultimately sends an electrical signal down the optic nerve to the brain. If that doesn't permit them to be classified as photochemicals, the word needs a new definition.

FRANK LEARY

New York, N. Y.

The letter from reader Reynolds denied the existence of any photochemical action in the retina, and instead set forth his theory that the retina is purely electromagnetic in action, whereby each cone can be regarded as a quarter-wave stub with an associated rectifier and capacitor.

### Field-Effect Transistor

The article, Field-Effect Transistor as a Negative-Resistance De-

vice, in your Feb. 2 issue (p 48) was quite interesting, although at first reading I found it quite confusing. The confusion arose because it was not made clear at the beginning of the article that the device under consideration was not the conventional field-effect transistor, but rather a *pn<sub>p</sub>* transistor modified to make use of the field effect. Still further confusion resulted from the use of source, drain and gate, which is the terminology adopted for the conventional single-junction field-effect transistor.

However, once it is realized that the device is actually a modified *pn<sub>p</sub>* transistor, then it is fairly easy to understand how the depletion region extending from the collector (gate) effectively disconnects the base (source) from the emitter (drain), causing transistor action and collector current to cease. The result is the negative-resistance collector characteristic illustrated in Fig. 2 of the article.

WILLIAM E. EARL

The Foxboro Company  
Foxboro, Massachusetts

### Television Ratings

There is a reference omitted in the article, Flying Spot Inspects Tv Rating Records (p 31, March 2), concerning a previous article that describes the general system.

IRA KAMEN

New York, N. Y.

The reference, in the first column of the article, is to A. C. Lewis Brown, Recording and Tabulating the Radio-Tv Audience, *Electronics*, p 126, Jan. 1955.

### Electron-Beam Parameters

In the Reference Sheet, Design Chart for Calculating Electron-Beam Parameters (p 50, Feb. 16) there are some minor misprints that may mislead readers.

The left side of Eq. 1 should read  $r_s/r_i$ ,  $Z$ , should read  $z$ , throughout, and in the paragraph following Eq. 3,  $kT/eV$  should read  $kT/e$ .

F. J. LEHANY

National Standards Laboratory  
Commonwealth Scientific and  
Industrial Research Organization  
Chippendale, N.S.W., Australia



# TUNG-SOL SUBMINIATURES

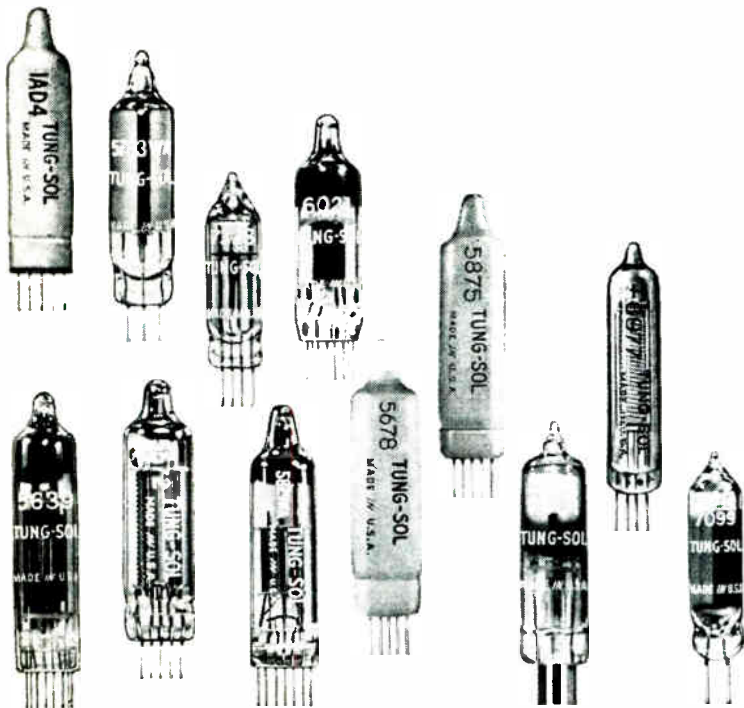

---

**RUGGED, RELIABLE SUBMINIATURES** meeting the most stringent military and industrial specifications are a Tung-Sol specialty. Most of the subminiature tubes in the military preferred and guidance lists (Mil-Std-200F) are available from Tung-Sol.

---

**TUNG-SOL SUBMINIATURES** are available as diodes and twin diodes, triodes and twin triodes, indicator triodes for transistor circuit read-out, pentodes, voltage regulators and references, and thyratrons.

---

**TUNG-SOL SUBMINIATURES** are supplied for almost every kind of portable, wearable, airborne, missile and space equipment: communications receivers and transceivers, telemetry, instrumentation and computers, radar and video, radiosondes and transponders.

---

**TUNG-SOL SUBMINIATURES** are used in all modern circuits: power supply, amplifier, gating, logic, control, oscillator, mixer, detector, read-out, converter, counter, trigger, switching, pulse generation, relay and multiplier.

---

**TUNG-SOL SUBMINIATURES** operate over a wide range of frequencies: d-c, a-f, i-f and r-f; wideband or narrow band, HF, VHF and UHF.

---

**WRITE FOR CATALOG** containing detailed characteristics and applications information about Tung-Sol subminiature tubes. Tung-Sol Electric Inc., Newark 4, N. J. TWX: NK 193. Sales Offices: Atlanta, Ga.; Columbus, Ohio; Culver City, Calif.; Dallas, Texas; Denver, Colo.; Detroit, Mich.; Irvington, N. J.; Melrose Park, Ill.; Newark, N. J.; Seattle, Wash. CANADA: Abbey Electronics, Toronto, Ont.

---

 **TUNG-SOL®**



Bi-directional Power Monitors, 2-1000 MC, 1-1000 W  
Termination Wattmeter, 20-1000 MC, 0-500 W



### SIERRA MODEL 164

#### Bi-Directional Power Monitors

For intermittent or continuous measurement of incident and reflected power

Accuracy:  $\pm 5\%$  of full scale

Insertion VSWR: Less than 1.08, 5 watt - 1 kw ranges;  
less than 1.15, 1 watt range

Price: \$110.00 (Type N connectors)

#### PLUG-IN ELEMENTS FOR 164 POWER MONITORS

Full scale ranges 1, 5, 10, 50 watts		
Model	Frequency Range	Price
180-52	25-52 MC	\$110.00
180-148	50-148 MC	\$110.00
180-470	144-470 MC	\$110.00
180-1000	460-1000 MC	\$110.00

Full scale ranges 10, 50, 100, 500 watts		
Model	Frequency Range	Price
181-250	25-250 MC	\$75.00
181-1000	200-1000 MC	\$75.00

Full scale ranges 50, 100, 500, 1000 watts		
Model	Frequency Range	Price
270-30	2-30 MC	\$170.00
270-75	10-75 MC	\$115.00
270A-470	70-470 MC	\$115.00

### SIERRA MODEL 194A-A

#### Peak Power Monitor

Direct-reading rf Peak Power Monitor, reads both incident and reflected power

Frequency range: 200-1215 MC

Peak power ranges: 0-1/3/30 kw full scale

Accuracy:  $\pm 10\%$  of full scale

Insertion VSWR: 1.15 max.

Price: \$780.00



### SIERRA MODEL 185A

#### Average Reading Wattmeter

Especially useful for terminating rf coaxial transmission systems, measuring power

Frequency range: 20 to 1000 MC

Accuracy:  $\pm 5\%$

VSWR: 1.20 to 1 (max.)

Power range: 100FN, 0-30 w, 1-100 w;

500FN, 0-150 w, 0-500 w

Price: 185A-100FN, \$260.00; 185A-500FN, \$375.00



## SIERRA ELECTRONIC CORPORATION

A Division of Philco Corporation

7696A Bohannon Drive, Davenport 6-2060 (Area Code 415)

Menlo Park, California

# ELECTRONICS NEWSLETTER

## Nike Zeus Intercepts Another Target

DESPITE the cloud over Nike Zeus' future (p 12, March 23), tests of the system are continuing. The Army last week announced that a Nike Zeus successfully intercepted a Nike Hercules missile at the White Sands Missile Range, N. M. This was at least the second Hercules intercept by Zeus—another was announced last December.

Operational tests for the Western Electric-developed system (p 24, Jan. 13, 1961) are planned for this summer in the Pacific, at facilities previously set up at Kwajalein (p 20, April 21, 1961). Live nuclear warheads may be used if a decision is made to resume atmospheric testing (one purpose of atmospheric nuclear bombs tests is to determine if radar or computers will black out, it was reported last week).

The target tracking radar used in the Nike Zeus system has also been given a workout on Ascension Island. In one trial last year, it tracked an Atlas ICBM fired from Cape Canaveral. The radar employs a narrow beam of high-power pulses, emitted by a Sperry Gyroscope transmitter. Range and accuracy of the radar are classified, but aircraft were warned of damaging radiation within 15 miles of the test site.

## Russians Make Radar Antenna from Cement

MOSCOW publication *Yunyy Tekhnik* says that a cloud observation radar of the Hydrometeorological Service has a 20-meter paraboloid reflector made of reinforced concrete plated with zinc.

The fixed antenna is said to cost hundreds of times less than a metal antenna. It is part of a 3.2-cm, narrow-beam system used to evaluate cloud moisture content and movement of cloud droplets and crystals. Vertical range is reported 10 Km.

In another science report, Tass said that decameter (10 to 30-meter) radiotelescopes are being built at Kharkov to explore distant constellations. A special antenna is used to avoid interference from broadcasting stations. Antennas are said to consist of 128 elements re-

sembling television aerials.

Astronomers at a Yalta observatory report they have determined by spectrographs that the upper atmosphere of Venus contains oxygen molecules, indicating life may exist on the planet. They also found evidence of nitrogen. It has already been determined that Venus' atmosphere contains carbon dioxide.

## Air Force to Contract Alaskan Command System

BOSTON—Air Force Electronic Systems Division, Bedford, will receive proposals April 25 for the Alaskan Air Command data-processing and display system, AN/FYQ-9. The system (416L) will provide early warning information to NORAD and reduce time needed for transmission and display of air situation and weapons status at Norad's Alaskan regional combat center and subordinate operations. Some 43

## IRE Show Sets Record

NEW YORK—Attendance at what may be the final IRE Show broke all records last week. Registrations reached 73,479, some 3,500 over advance estimates.

This may well have been the last of the IRE shows. IRE and AIEE members are to vote this summer on the proposed merger of the two societies. IRE members attending a symposium on the merger last week indicated they were in favor by a large majority.

If the merger is consummated by January 1 as planned, a combined convention would be staged, probably in New York next spring. Attendance of 100,000 is anticipated

companies will get a bidders' briefing next Tuesday at Rome Air Development Center. Sage program office at Bedford is systems manager.

## Air Force Lab Gets Bargain in Diamonds

BOSTON—Air Force Cambridge Research Laboratories, which has been making synthetic diamonds as part of a study of high-temperature semiconductors, now has \$250,000 in natural gems for its experiments.

U. S. Customs Service gave the labs a half pound of forfeited smuggled diamonds. The labs paid \$7.50 in court costs.

Relatively few natural gems have the desired semiconducting properties (p 78, Aug. 26, 1960), but they can be used for optical measurements and to study irradiation effects and other properties.

AFCRL researchers may also try to diffuse impurities into the stones under high pressure.

## Norweigan Company Will Make NATO'S Bullpup

PARIS—United Kingdom, Denmark, Norway and Turkey have agreed to final details of a NATO-sponsored European production program for the Bullpup air-to-ground missile (p 7, Mar. 30). The agreement is reported to include selection of a Norwegian company as prime contractor. NATO Council is expected to give its formal approval shortly and will then create an agency to deal with European contractors. The U. S. will probably buy some of the European production; the missile now in operation with the U. S. Navy.

## Magnetic Field Improves Thermoelectric Cooling

POSSIBILITY of lowering thermoelectric cooling temperatures by applying a magnetic field to semi-metal elements was reported by Raymond Wolfe and G. E. Smith, of Bell Telephone Labs, at the Ameri-

can Physical Society meeting in Baltimore last week.

They attained a figure of merit  $Z$  of  $8.6 \times 10^{-3}/\text{deg K}$  in an alloy of 88Bi-12Sb at a temperature of 100 K in a field of 1 kilogauss. The field, available with a small horseshoe magnet, is applied perpendicularly to current flow in single-crystal material.

At room temperature, applying a 17-kilogauss field raises figure of merit for this material from 1.2 to  $2.9 \times 10^{-3}/\text{deg K}$ . In a two-stage device, with a 12-kilogauss field applied to the second stage, the second stage attained a temperature 105 C below room temperature. The principle is applicable to other thermoelectric materials.

## Computer Being Built For Parallel Operation

BENDIX CORP. last week announced some details of the large-scale G-21 computer it is developing for military and other applications. It will use three central processors linked to a 57,344-word core memory. Each processor will also have an exclusive 8,192-word memory, for a total capacity of 81,920 words.

A self-adapting executive program will assign problems to the processors automatically in order of importance. The processors will operate in parallel on elements of the same problem, or on different problems. Operation will be on-line in real time. Minimum cost for a basic system will be \$1½ million.

## Disarmament Inspection Study Contract Given

BOSTON—Raytheon's Missile and Space division has been given a \$125,000 study contract to work out details of the zonal inspection system proposed by Secretary of State Rusk at the Geneva disarmament conference. A report is due in six months to the U. S. Arms Control and Disarmament Agency.

Method for reliable verification of disarmament will presumably include electronic techniques, but Raytheon declines comment. The study will include proposed ways of drawing zones in various countries,

extent to which inspection stations would be needed and methods for preventing secret arms movement.

## Transatlantic Tv Trials May Start This Summer

TELSTAR, Bell Telephone Laboratories' private communications satellite (p 26, Feb. 16), may inaugurate live transatlantic tv in late June. The satellite is tentatively scheduled for launching late in May. Programs would be produced jointly by the three American tv networks and the United States Information Agency. Signals would be beamed to and from the satellite via the U. S. station at Andover, Me., and the British station at Goonhilly Downs. First show would probably be only 10 or 12 minutes long.

## U. S.-French Company to Make Microwave Tubes

VARIAN ASSOCIATES and Compagnie Francaise Thompson-Houston, of Paris, are planning a jointly owned microwave tube company to take advantage of the growing European microwave market, now estimated at \$50 million a year.

A plant to manufacture and distribute microwave tubes will be located in Paris. It will start operations July 1 with 275 employees. Varian and CFTH have been working together six years under a cross-licensing arrangement.

## Reentry Spacecraft to Probe Radio Blackout

NASA is giving the Project Fire (p 8, Feb. 23) contract to Republic Aviation. The contract to be negotiated will amount to about \$5 million for two reentry spacecraft. It will be the first major space contract for the Long Island, N. Y., company, recently hit by a cutback in F-105D fighter-bomber production. The spacecraft will be equipped with instrumentation and telemetry to provide data on—among other things—loss of communications at reentry speeds.

## In Brief . . .

TWO-COLOR PERCEPTION theory work at Sylvania Labs (p 9, Oct. 27, 1961) has won a \$44,000 Air Force contract. Object is to develop mathematical formulation of human visual mechanism.

OTHER STUDY contracts include \$100,000 to Emerson Research and White Electromagnetics, initial phase of study on aerospace communications jamming avoidance; and \$100,000 to Norair, advanced missile electro-optical guidance.

AUTONETICS has selected Minneapolis-Honeywell as additional source for two-axis, gas-bearing gyros used in Minuteman. Initial order is \$1 million.

ELECTRONIC ASSOCIATES is supplying \$900,000 in instrumentation to NATO's missile test range on Sardinia. Packard Bell Computer has \$300,000 award for 64-channel data systems for U. S. Atlantic Range ships.

RAYTHEON gets three more missile contracts: another \$5.6 million for Tartar fire control radars and \$1.7 and \$4 million for Hawk equipment.

NAVY has awarded Edo a \$2 million order for scanning sonar systems, and Alden Electronics \$1 million for 205 facsimile weather map recorders.

CUBIC CORP. will supply telemetry trackers, based on Agave system, to locate and recover satellites landing west of Hawaii. Contract is for \$800,000.

PAGE Communications Engineers is participating in \$5.5 million contract for Minuteman communications at Ellsworth AFB. Page also got \$915,000 contract to maintain and operate Army's Pacific Scatter Communications System.

INSTRUMENTATION contracts include \$2 million to GPL, components and test equipment for doppler radar; \$1.2 million to Mine Safety Appliances, gas detectors for Titan II missile bases.

# New from Sprague!



TO-9  
CASE

*The Most Widely-Used Logic Transistor,  
Type 2N1499A, Now Has a Smaller Brother...*

# TYPE 2N979



TO-18  
CASE

## LOW-COST LOGIC TRANSISTOR

Here is a new Sprague Transistor that is smaller in size, yet identical in performance with the well-known 2N1499A Logic Transistor.

Designed for use in saturated switching circuits, this low-cost, hermetically-sealed MADT® Transistor is capable of switching at frequencies in excess of 10 megacycles.

In addition to computer applications, this rugged transistor is ideally suited for data processing and instrumentation equipment.

There are two major reasons why The Sprague 2N979, as with the 2N1499A, is earning a high level of acceptance:

**1. DEPENDABLE PERFORMANCE**— Specifically designed with parameters intended for logic

circuits, these transistors consistently show low storage time, low saturation voltage, high beta, high switching speed. Their cases are cold welded to insure reliability.

**2. ATTRACTIVE PRICE**— Available in production quantities, these transistors are first-run devices, *not* “fall-outs”. They are produced on FAST (Fast Automatic Semiconductor Transfer) lines with direct in-line process feedback, especially programmed to insure high production yields.

Here are some key parameters:

$I_{CBO}$ .....	1 $\mu$ a typ.
$BV_{CBO}$ .....	20V min.
$BV_{CES}$ .....	20V min.
$f_T$ .....	100 mc min.

*For application engineering assistance without obligation, write Transistor Division, Product Marketing Section, Sprague Electric Co., Concord, New Hampshire.*

*For complete technical data, write Technical Literature Section, Sprague Electric Company, 35 Marshall Street, North Adams, Mass.*

© T. M. Philco Corp.

### SPRAGUE COMPONENTS

TRANSISTORS  
CAPACITORS  
MAGNETIC COMPONENTS  
RESISTORS

INTERFERENCE FILTERS  
PULSE TRANSFORMERS  
PIEZOELECTRIC CERAMICS  
PULSE-FORMING NETWORKS

HIGH TEMPERATURE MAGNET WIRE  
CERAMIC-BASE PRINTED NETWORKS  
PACKAGED COMPONENT ASSEMBLIES  
FUNCTIONAL DIGITAL CIRCUITS



\*Sprague' and '@' are registered trademarks of the Sprague Electric Co.

# NEW!

TWO DIGITAL INSTRUMENTS WITH  
HIGH-QUALITY FEATURES AND  
LOW-BUDGET PRICE TAGS

1. NLS 484A Digital Voltmeter-Ratiometer With Printer Connection and Built-In Automatic Print Control

\$1,460, F.O.B. Destination in U. S. A.

2. NLS 784 Digital Ohmmeter With Printer Connection and Built-In Automatic Print Control

\$1,460, F.O.B. Destination in U. S. A.



Both the 484A and 784 feature plug-in stepping switches.

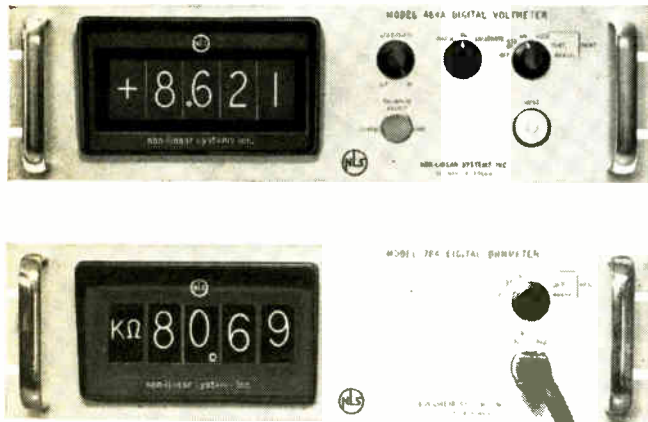

The blue tag indicates that the 484A and 784 are NLS "off-the-shelf" instruments. See demonstrators in action today or take delivery on your own instruments within 10 to 30 days.

These new NLS instruments eliminate the need to sacrifice versatility, accuracy, reliability or servicing ease in purchasing a digital voltmeter or ohmmeter in the \$1000-1600 price range. ■ Consider versatility, for example. Some low-priced DVMs don't measure DC voltage ratio, don't have automatic range and polarity changing, and don't provide output and automatic control for printers. The completely automatic 484A *does*. With it, you can measure both DC voltage and DC voltage ratio with  $\pm 0.01\%$  accuracy . . . make measurements faster and easier than with any meter having manual ranging — without the danger of over-loads . . . plug in a printer for data logging . . . plug in accessories to measure AC or low-level DC or for go/no-go testing. With a 784 digital ohmmeter and a printer, you can measure and record resistance automatically and accurately from 0.1 ohm to 10 megs. ■ Or consider the factors that contribute to the basic reliability of the 484A and 784: simple, time-proven design (thousands of earlier models of the same basic design are in use today) . . . quality construction . . . and use of quality components such as heavy-duty plug-in stepping switches and a precision oven for the Zener reference. ■ Then consider servicing. When it's eventually required, servicing can often be handled right on the spot with electronic parts available in most stockrooms. Plug-in stepping switches can be replaced in minutes and 1000-hour-life readout bulbs even faster without use of tools or soldering or opening the instrument. Contact NLS for complete data, a demonstration, or engineering aid for special applications.

**BRIEF SPECS:** 484A — ranges: DC voltage  $\pm 9.999/99.99/999.9$ , DC voltage ratio  $\pm 99.99\%$  . . . accuracy:  $\pm 0.01\%$  of f. s. on each range . . . measuring time: 1 sec. average . . . automatic range and polarity changing . . . input impedance: 10 megs for volts, 1000 megs for ratio . . . AC or low-level DC with accessories . . . automatic control for data logging.

784 — ranges:  $9999./999.9/99.99/9.999/9.9999$  kilohms . . . accuracy  $\pm 0.05\%$  of reading  $\pm 1$  digit ( $\pm 0.1\%$  of reading above 5 megs) . . . automatic range changing . . . measuring time: 1 sec. average . . . automatic control for data logging.



Originator of the Digital Voltmeter

**non-linear systems, inc.**

DEL MAR, CALIFORNIA

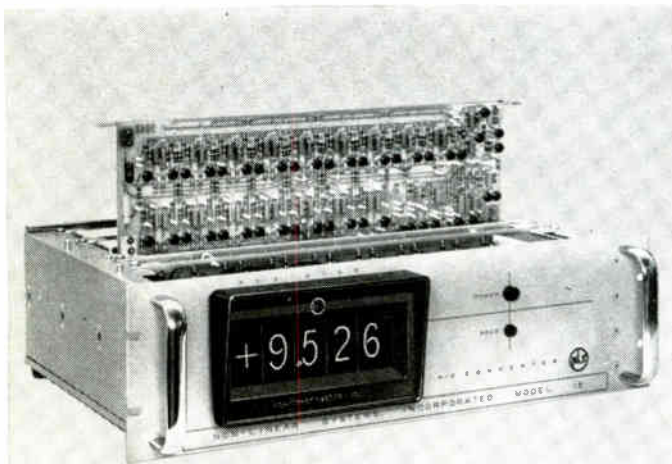

All circuits are easily accessible.

#### BRIEF SPECIFICATIONS

**Range:** Any one fixed range from  $\pm 9999$  v to  $\pm 99.99$  v. (4 decimal digits - auto polarity).  
**Total Digitizing Time:** 67 microseconds; 15,000 completely independent measurements per second.

**Over-all Accuracy:**  $\pm 0.01\%$  of full scale  $\pm 1$  digit for all error sources from  $0^\circ$  to  $40^\circ\text{C}$ . Full scale is defined as 9,999 counts.

**Input Impedance:** 62.5 kilohms for 100 volt range (625 ohms per volt). 50 megohms with Model 142 accessory amplifier.

**Clock:** Internal or external. External clock rate can be from 0 to 250 kc.

**Digital Output:** 0 v. = binary "0" (10 ma. max. hold-down current); -12 v. = binary "1" (680 ohm source impedance). Short circuit does no damage. True bipolar output.

**Dimensions:** 5 $\frac{1}{4}$ " high, 15 $\frac{1}{4}$ " deep, 19" wide.  
**Weight:** Approx. 26 lbs.

**Price:** 15 or 15B - \$6,985 F.O.B. destination in U.S.A.

# NEW!

## NLS A/D CONVERTER BRINGS HIGH ACCURACY TO HIGH-SPEED MEASURING

*Model 15 Makes 15,000  
Measurements Per Second  
With Over-all Accuracy of  
 $\pm 0.01\% \pm 1$  digit*



Now you can specify an A/D converter that provides high accuracy and outstanding versatility in addition to high measuring speed. That's NLS Model 15, a completely transistorized instrument designed for uses such as missile checkout, computers, process control, data reduction, wind tunnel research, and telemetering. ■ Over-all accuracy of Model 15 - all error sources included - is  $\pm 0.01\% \pm 1$  digit from 0 to full scale from 0 to  $40^\circ\text{C}$  - best in its speed range of 15,000 measurements per second. Also, there's no first reading error and no overload error up to twice full scale at full speed. ■ Versatile features that make it the most useful A/D converter include: true bipolar digital output in 8-4-2-1 code (not 1's or 9's complements) . . . digital readout for rapid calibration . . . high output current for versatility in driving external circuits . . . constant input impedance during entire conversion process . . . automatic polarity selection . . . operation from internal clock or from external clock from 0 to 250 kc. ■ Another version, Model 15B, provides straight binary output (14 bits and sign). Other adaptations include: decimal output instead of B-C-D, voltage peak measurements, resistance measurements, and digital to analog conversion. Contact NLS for complete data, a demonstration, or engineering aid for special applications.



Originator of the Digital Voltmeter

**non-linear systems, inc.**

DEL MAR, CALIFORNIA

*The tag indicates the 15 is an NLS "off-the-shelf" instrument. See a demo, today or take delivery on your own within 30 days.*

# WASHINGTON OUTLOOK

## WEIGH NEW R&D PROCEDURE

AIR FORCE is considering a "dual development source procedure" to provide competition beyond preliminary engineering of major development projects. Contractors would compete until firm specifications were written into a definitive contract. Two or three bidders would be paid to make more detailed engineering studies. The winner's contract would spell out specifications when possible, not broad technical objectives. He would take on more risks but could make higher profits under incentive contracts.

Air Force normally awards a letter contract after preliminary design proposals. Some officials complain this gives the selected company the upper hand in negotiations for a firm contract.

## CONTRACTS TO LABOR SURPLUS REGIONS?

DEFENSE DEPARTMENT is experimenting with a new plan to channel more defense work into labor surplus areas on fixed-price procurement by advertised bidding. If the contracting agency finds 50 percent of the production subcontractable, and if there are potential subcontractors in labor surplus areas, the low bidder would have to subcontract half the order to such firms. If the low bidder refuses, the next low bidders will get a chance to match the initial low bid—with priority for next lowest bidder in labor surplus areas. Firms in labor surplus areas must match low bid prices.

## SCIENCE OFFICE SET UP

PRESIDENT KENNEDY has, under power of the Reorganization Act of 1949, established an Office of Science and Technology (OST) and beefed up certain functions of the National Science Foundation (NSF). Generally, OST will advise him on developments much as his present science adviser does, but will be staffed to delve deeper into government-wide scientific programs than the science adviser could. Federal Agency programs will be coordinated by OST instead of NSF.

The shift of the coordinator to the executive office will give it added authority. The move is viewed as a compromise with Congress, which wanted a new agency to handle all federal research. Congress is expected to accept the White House's new approach.

## SATELLITE COMPROMISE OFFERED

SENATE AERONAUTICAL and Space Sciences Committee has a compromise bill on communications satellite system ownership. It appears to reconcile basic administration, industry, and congressional differences on the issue. Adoption of a bill by Congress acceptable to the administration now seems likely.

The committee made these amendments to the administration's ownership plan (ELECTRONICS, p 12, Feb. 16): one class of stock, \$100 a share, will be offered, half to communications companies and the rest to the public.

Capitalization would be set by an 18-member board of directors. Company investment in stock cannot be used to fix rate bases, but nonvoting securities may be offered by the satellite corporation. Companies buying these securities can use them in fixing international rate bases.

Ground stations can be owned by the corporation or communications companies. The corporation could not be dominated by any communications company and would make competitive purchases of electronic equipment.

## SOMETHING FOR B-70

CHANCES ARE that as a token gesture Defense Secretary McNamara will earmark some of the extra B-70 money—probably less than \$75 million—for additional electronic subsystem development on the reconnaissance-strike version. Congress wants McNamara to spend \$320 million more (ELECTRONICS, p 12, March 30).



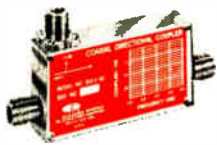

• coax and waveguide couplers • attenuators • mounts •



• bolometers • isolators • detectors • frequency meters •



• r. f. probes •

**UHF to 90 Gc!**  
**NARDA**

• klystron mounts •

can supply you with more than 600  
PRECISION microwave instruments,  
components and hardware!



• thermistors •

Write for  
your free  
catalog!

• tuneable shorts •



• ridged waveguides •

• ferrite circulators •



• waveguide adapters & accessories • stands • horns •

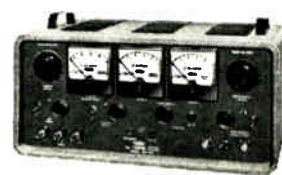

• hybrid junctions • instruments and modulators •

**SEND FOR FREE CATALOG TODAY!**

Address: Department E-1-13



the **narda** microwave corporation

PLAINVIEW, L. I., NEW YORK • AREA CODE 516 GE 3-9000

# OZALID NEWSLETTER

NEW IDEAS TO HELP YOU WITH ENGINEERING REPRODUCTION AND DRAWING

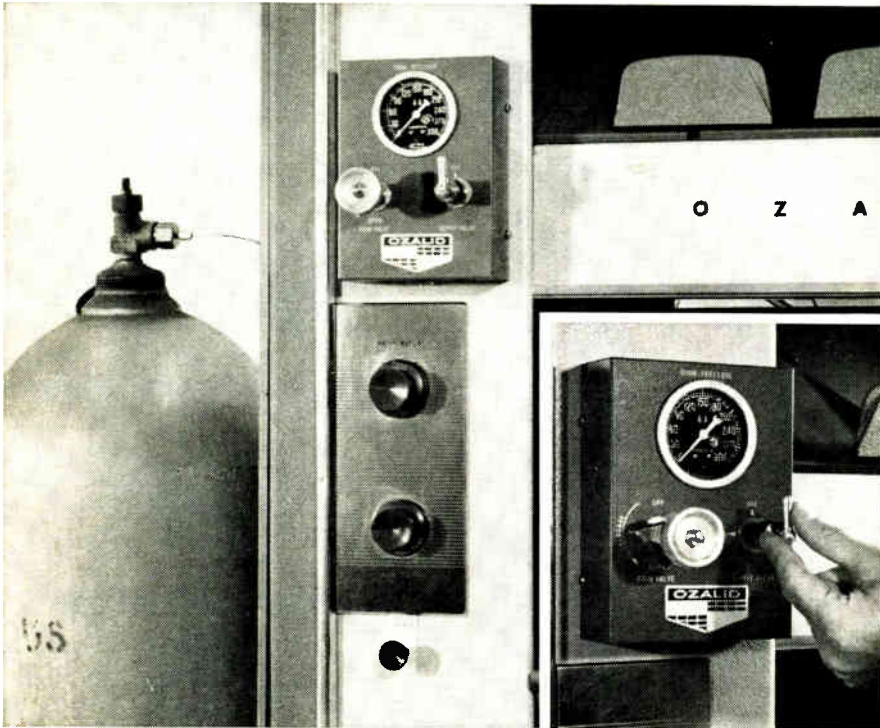

Ozalid® Anhydrous Ammonia System consists of control box mounted on machine and tubing to connect equipment with anhydrous ammonia cylinder, which may be remotely located. Developer handling becomes simply, "valve on, valve off."

## New anhydrous ammonia gas system provides ultimate convenience, cuts developer costs up to 50%, gives from 2 to 6 months developing from a single cylinder!

A simplified, completely safe Ozalid Anhydrous Ammonia Kit brings the convenience of pressurized ammonia gas development to your dry-developing diazo whiteprinter. Depending on machine use intensity and model, the unit saves enough on ammonia costs to pay for its initial expense in as short a time as a year.

A low price tag is only the first of several reasons you should consider using Ozalid Anhydrous Ammonia in your diazo installation. Contents of a single cylinder give up to six months of developing, reducing developer handling to a minimum.

Heater rods, sealing sleeves, and other vital parts in the developer section have longer life because corrosive action is lessened. Machine

warm-up time is shorter. Improved employee morale results in increased production. What's more, chances are you'll see an improvement in print quality.

The Ozalid Anhydrous Ammonia Kit is specifically engineered to meter anhydrous ammonia in the simplest, most efficient method for use with diazo machines. Units have been proved in the field, and are already giving a high degree of customer satisfaction.

Conversion Kits fit all Ozalid dry diazo machines and can be easily installed on practically all others regardless of make. Price of the kit is \$175.00. For information ask your Ozalid man, or write Ozalid, Johnson City, N. Y., Dept. 183.

## New fast reprinting, erasable sepia intermediate

Here's a highly transparent intermediate with a specially prepared paper base that makes reprints faster, yet is easily erasable. Ozalid 402 IZE is its name, has a dark sepia image (but you can rub it out with an ordinary abrasive eraser), has an ideal matte surface for pencil and ink additions, picks up fine line detail beautifully, has excellent covering power, yet is surprisingly low priced. Drafting room comments include, "like see-through"... "excited about erasable feature"... "excellent for overlay work." Ask your Ozalid man for samples and demonstration.

## Crease and crumple this tracing paper. Then, make a print! Surprise!

New Ozaclear isn't called "clear" for nothing. This tracing paper permits only a hint of fracturing from creases and crumpling ever showing up on a print. Ozaclear is 100% rag, with an excellent surface for pencil and ink. But it's that "no bruising" quality that makes it stand out. Its exclusive Ozalid-perfected transparentizer holds its own against heavy pencil pressure, leaving no trace of ghosting when these lines are erased. Want more details about permanent, non-yellowing, high strength Ozaclear? Ask your Ozalid representative or write Ozalid, Johnson City, N. Y., Dept. 243.

## Lennox gives branches up-to-the-minute changes on reproducible masters!

With eight scattered branches and factories, Lennox Industries (Marshalltown, Iowa) uses Ozalid diazo intermediates to get out new product drawings and drawing changes quickly and maintain perfect standardization among plants.

Single duplicate originals are sent to each plant, the plant, in turn, making as many clear, sharp prints as needed. Simple, fast, error-proof!

*Ozalid, A Division of General Aniline & Film Corporation. In Canada: The Hughes-Owens Co. Ltd., Montreal*

## Microminiature Coaxial Connectors



Microdot's microminiature connectors—including the world's smallest 50-ohm coax connectors—are available in over one million combinations. Plugs are available in straight or angle screw types and slide-on versions. Receptacles include printed circuit and bulk-head feed-thru types. Only highest quality materials are used. Conductors are of silver-plated copperweld or cadmium bronze, center contacts are of gold-plated coin silver. Housings are silver-plated brass to assure minimum electrolysis with aluminum panels. "Teflon," "Kel-F," polyethylene, and neoprene are used as dielectrics, jackets, bend relief caps, and pin protectors.

Microdot Inc., 220 Pasadena Avenue, South Pasadena, California  
CIRCLE 200 ON READER SERVICE CARD

## Crimp-type Connectors



These solderless, coaxial connectors are available in a variety of mounting configurations, including snap-locking versions. Male and female connectors may be mounted interchangeably. Mated length is 1 $\frac{3}{16}$ ". Working voltages: 1,000 V. maximum, at sea level; 500 V. maximum, at 60,000 feet. VSWR; less than 1.2 up to 2,000 mc. Life; 5,000 matings, minimum, without electrical deterioration. Tensile strengths of the crimps exceed the breaking strength of the cable. Hard gold plated Beryllium copper and TFE plastic are extensively used to assure optimum reliability.

Microdot, Inc., 220 Pasadena Avenue, South Pasadena, California

CIRCLE 201 ON READER SERVICE CARD  
CIRCLE 15 ON READER SERVICE CARD →

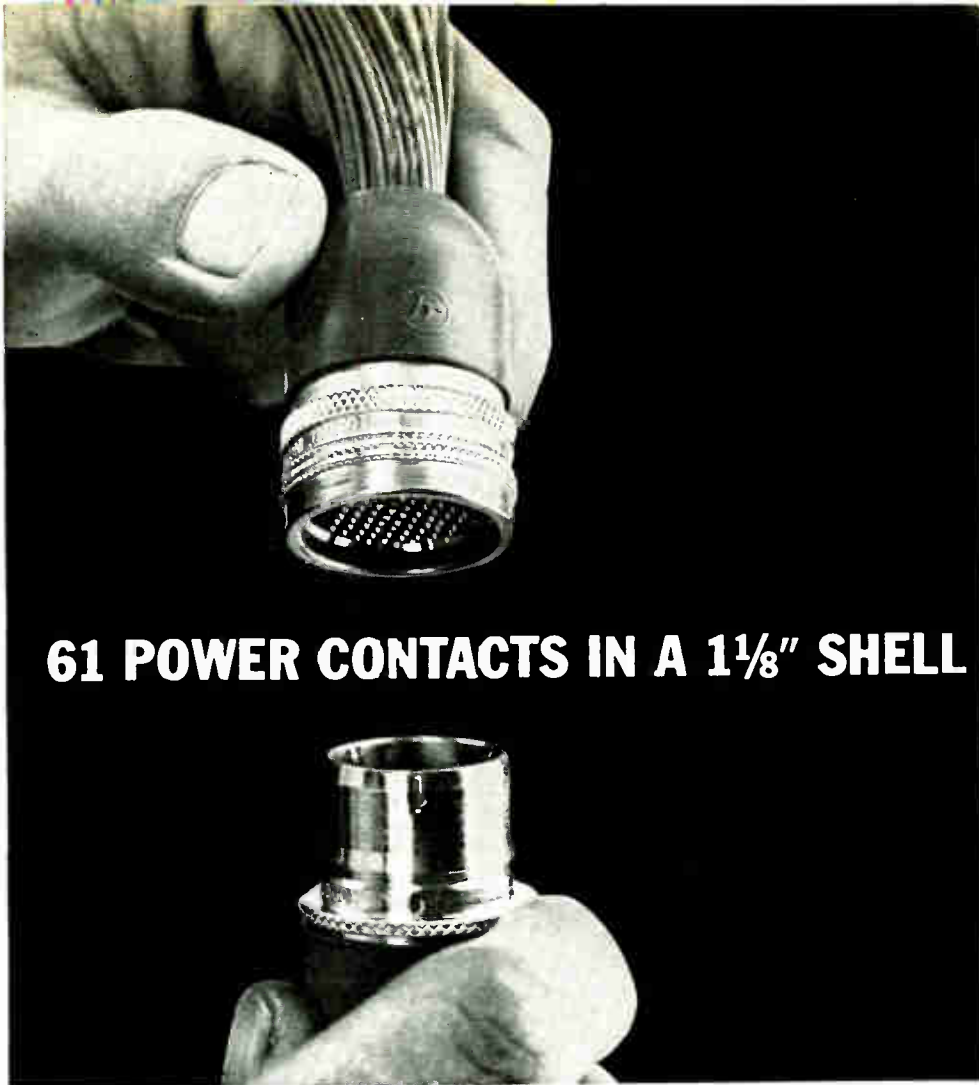

## 61 POWER CONTACTS IN A 1 $\frac{1}{8}$ " SHELL

### NEW MICRODOT MICROMINIATURE MULTI-PIN CONNECTORS

These rugged, reliable "43" Series Microdot Microminiature Multi-pins are only  $\frac{1}{4}$  the size,  $\frac{1}{3}$  the weight of previously available miniature multi-contact connectors. Yet performance equals or exceeds MIL-C-26482 and applicable paragraphs of MIL-C-26500. Ready now for advanced applications, these connectors pack up to 61 power contacts—or 19 coaxial contacts—or a combination of both—into a shell the diameter of a quarter.

Improved three-keyway design of the "43" Series prevents pin engagement with insert face, permits 14 alternate positions for each insert layout by "clocking" shell keyways rather than inserts. Inserts come in a variety of straight power, straight coaxial, and combination power-coaxial layouts. The Multi-pin design accommodates a mix of male and female contacts in either plug or receptacle without changing inserts, allowing hot or cold leads to either side. Closed-entry, crimp or solder contacts are gold-plated pure coin silver to resist wear, maximize ampere ratings and conductivity, minimize temperature rise and resistance. Positive, push-pull, quick-disconnect coupling eliminates need for safety wire. Operating force is always in direction of plug travel.

With all parts interchangeable, the "43" Series Microdot Microminiature Multi-pins are available now in disassembled kit form (for bench assembly or on-the-spot field circuit design), or factory assembled (as basic connectors) or as complete assemblies (with Microdot cable). Write today for illustrated, detailed Bulletin MP-0.



Microdot Multi-pin Connector Kit

SIZE DESIGNATION	PLUG O.D.	NO. OF COAXIAL CONTACTS	NO. OF POWER CONTACTS
A	$\frac{3}{4}$ "	up to 7	up to 19
B	$\frac{1}{2}$ "	up to 12	up to 37
C	$\frac{1}{8}$ "	up to 19	up to 61

## MICRODOT INC.

220 Pasadena Avenue, South Pasadena, Calif.

MUrray 2-3351 SYcamore 9-9171



something new in sensitivity

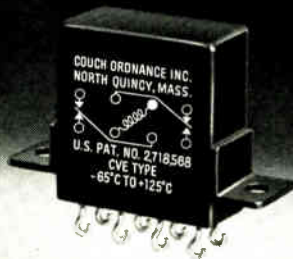

COUCH ORDNANCE INTRODUCES  
A MICROMINIATURE RELAY  
WITH A CHOICE OF THREE  
SENSITIVITIES IN ONE SIZE CASE

40 mw    ···    100 mw    ···    250 mw

WRITE FOR DATA SHEET #6

*Couch*

**ORDNANCE, INC.**

A subsidiary of S. H. Couch Company, Inc.

3 ARLINGTON STREET, NORTH QUINCY 71, MASS. Tel-Boston CYPRESS 8-4147

*exploding bridgewire  
electro/ordnance*



# SOLVE THE PYROTECHNIC PROBLEM

WITH ITT/McCORMICK SELPH  
ELECTROEXPLOSIVE FIRING MODULES

for: Engine Ignition  
Stage Separation  
Thrust Termination  
Missile Destruct  
Wherever positive and  
accurate bursts of igniter  
energy are required

ITT for greater safety, dependability.



ITT Model 2783 Typical Exploding  
Bridgewire Firing Unit.

Modular XBS consists of Power Sup-  
ply, Cabling, Ordnance Component.  
Eliminates bulky central power and  
firing systems for XBS.

For further information write  
for Data File E-1815-1.

# ITT

**Industrial Products Division**  
International Telephone and Telegraph Corporation  
15191 Bledsoe Street • San Fernando, Calif • Empire 7-6161

# SIMPLIFY DATA HANDLING

*with a low cost, flexible system*

*that provides*

- *fast, accurate measurement*
- *variable measurement rate and range*
- *typewritten, printed, punched tape or punched cards*

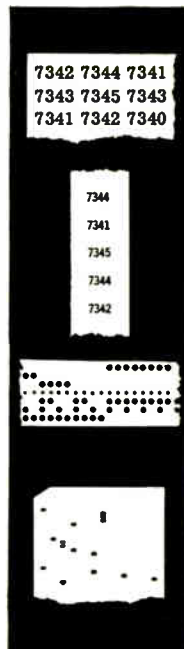
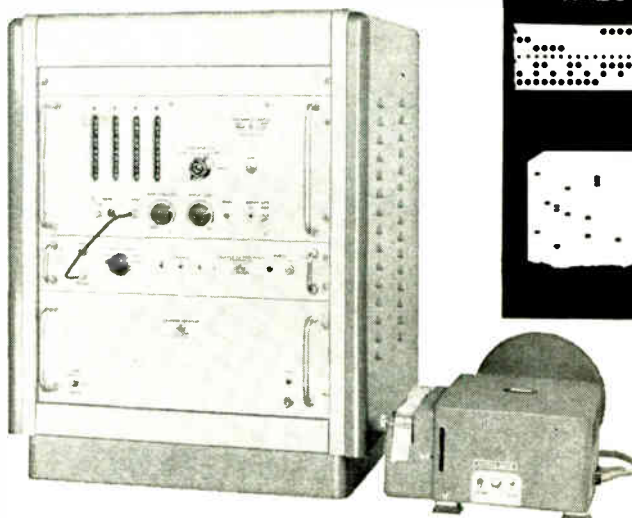

Dymec Model DY-5552 Data Processing System is a remarkably versatile tool for quickly accumulating data on a wide variety of physical, mechanical and electronic processes. Any phenomenon of nature or science that can be converted to a usable voltage or frequency can be measured and recorded through the DY-5552. Digital output can be in any form or combination of forms needed for further machine processing, visual analysis or transmission over any standard communication system. Applications are limited only by the imagination.

The moderately priced Dymec system consists of a voltage-to-frequency converter and electronic counter to convert input information to digital form, plus a scanner/coupler, which transfers this digital data and is capable of providing output for electric typewriter, Flexowriter, serial-entry adding machine and serial entry card punch or tape punch. In many cases two of these recording devices can be operated simultaneously. In addition, the system can drive a digital printer, such as the Hewlett-Packard 560A.

This is one of many Dymec Data Processing Systems which can be assembled from basic "building block" instruments. Versatile, flexible input scanners, counters, digital voltmeters, output couplers/translators meet a wide range of needs for speed, multiple input application, programming.

BRIEF SPECIFICATIONS	
Input Ranges:	0 to 1 v dc, 0 to 10 v dc, 0 to 100 v dc, 0 to 1,000 v dc (30% overrange permissible except on 1,000 v range; either polarity measured without switching). Frequency inputs, 1 cps to 120 KC. Gate times, 0.1 sec., 1 sec.
Accuracy:	DC inputs, .06%, $\pm 1$ count Frequency inputs, .01%, $\pm 1$ count
Operating Speed:	Controlled by Display Time Setting (variable from .1 to 15 sec. or indefinitely), maximum operating speed of 5 full scale readings per second.
Approximate price:	\$3,600.00 (as pictured, including tape punch).

Data subject to change without notice.

Prices f.o.b. Palo Alto

*Describe your requirement today to your Dymec/Hewlett-Packard representative, write Dymec for further information or call Dymec direct. Extension 223 or 224.*

## DYMEC

A DIVISION OF HEWLETT-PACKARD COMPANY



7044

Dept. E-4, 395 Page Mill Road, Palo Alto, Calif. • Phone Davenport 6-1755 (Area Code 415) TWX-117-U

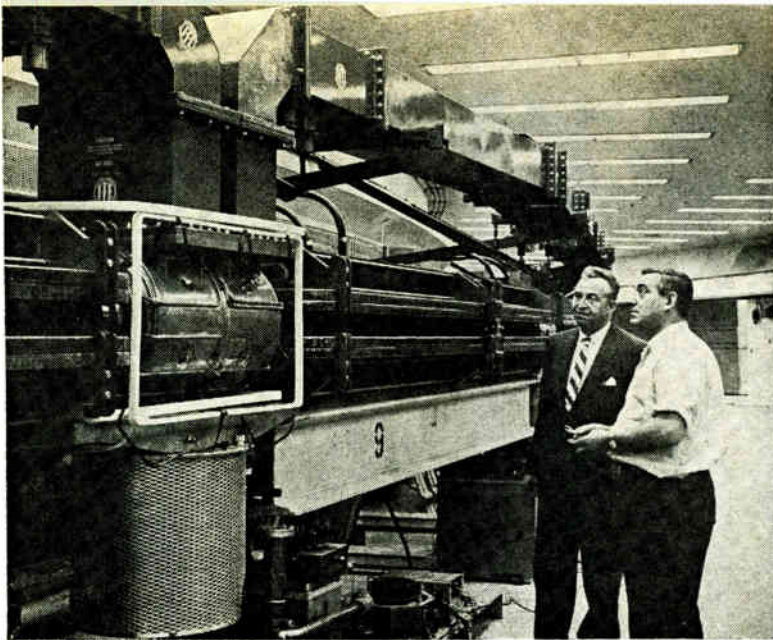

Diameter of circular orbit is 236 ft. At left is one of the 16 resonant r-f cavities which, with waveguide, are tuned to 475.83 Mc

*Harvard-MIT research tool has 16 resonant r-f cavities tuned to one frequency, a choke for magnetic energy storage and other features*

By THOMAS MAGUIRE  
New England Editor

## Six-Bev Electron Accelerator Starts Up

BOSTON—In the world's highest-energy electron synchrotron, acceleration is provided by perhaps the most extended system of high-Q series-resonant circuits ever built to operate in a single mode.

The Cambridge Electron Accelerator at Harvard reached a record electron energy level of 2.2 Bev this month and is expected to achieve its top level of 6 Bev within a couple of months. This will represent an energy five times higher than previous electron accelerators.

A 6-Bev electron synchrotron is

under construction in Erevan, Soviet Armenia, and the West Germans are building one in Hamburg.

The \$11.6 million CEA, designed and built by an MIT-Harvard committee with AEC funds, will permit experimenters to explore a new range of phenomena in particle physics, including electron scattering experiments which had been beyond the limits of existing equipment.

The acceleration system for CEA consists of 16 resonant r-f cavities located in field-free regions between

magnet sectors and connected by waveguide links to form a circular loop 240 ft in diameter. Cavities and links are tuned to 475.83 Mc.

Since the r-f system includes 32 half-wave resonators and 16 waveguide links, there are at least 48 possible modes of oscillation. But for acceleration of electrons it is essential to have identical phases in all cavities, and this necessitates one mode only. The  $TE_{10}$  mode, 10 bandwidths wide in frequency, is selected by precise tuning of all components.

The 475-Mc power supply consists of a power amplifier (transmitter) employing a high-frequency RCA superpower triode as the output stage. Peak power output is 225 Kw and average power 60 Kw for the acceleration interval. The master oscillator which excites the transmitter determines frequency.

Electronic techniques designed into CEA range from a massive resonant circuit for the magnet power supply to nanosecond circuitry and logic, including tunnel diodes, for particle detection. Electronic aids measure parameters of the various components, provide basic sensing and timing mechanisms and power units, and extract output information.

Length of the path traversed by

## 100,000,000-Bev Accelerator Feasible?

CHICAGO—Lee Teng, newly appointed director of Argonne National Laboratory's particle accelerator division, told ELECTRONICS that he sees no reason why an accelerator could not be built to produce particles with energies up to  $10^{17}$  electron volts.

One of his present interests is feasibility and design studies of accelerators with energies in the range of 300 to 1,000 Bev.

He is considering superconducting magnets, which would keep

magnet size down.

Teng was responsible for most of the design work on Argonne's \$47 million zero gradient synchrotron, under construction. Its preinjector, power supply and controls are finished and 10 of the 134 magnets have been delivered. The schedule now calls for completion in 1963.

Three experiments for ZGS have been accepted so far. These are studies of neutrino-induced reactions, K-meson reactions and an anti-proton experiment.

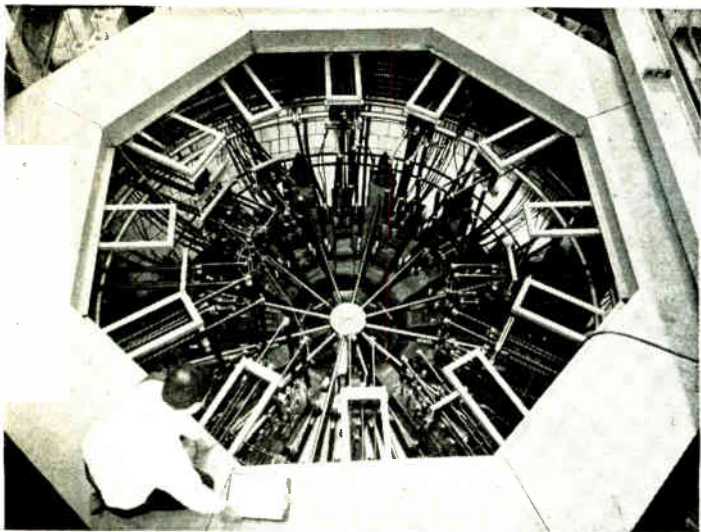

*Toroidal inductor acts as choke to store energy for magnet power*

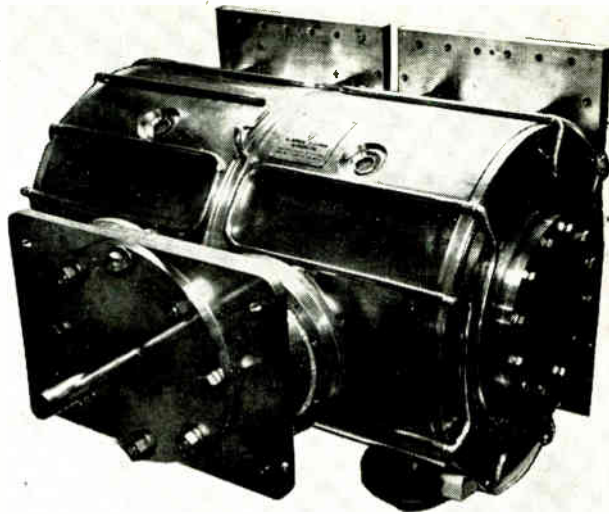

*Each cavity consists of two half-wave resonators coupled by an inductive slot in the center wall*

the electrons imposes strict requirements on location of the magnets and on the shape as well as the value of the magnetic field, since slight inhomogeneities would excite oscillations of linearly increasing amplitude. The important task of observing nondestructively the electrons in orbit is performed by 16 sets of coils which pick up the magnetic field component of the accelerated electron. One type of pickup coil developed at CEA measures the intensity of the circulating electron beam. Another coil produces signals which are proportional to the vertical or horizontal displacement of beam center-of-charge from the ideal orbit.

Sensitivity of this system is limited by signal-to-noise ratio and corresponds to about 0.1 in. displacement at a circulating charge of  $10^{11}$  electrons. The signals from the pickup coils are integrated and amplified in 17 Mc bandwidth video amplifiers and brought to the control room. They are displayed on oscilloscopes as a visual guide to the synchrotron operator in his adjustments of optimum injection parameters.

CEA, like other synchrotrons, operates on the principle of phase-stable synchronous acceleration at constant radius, analogous to the synchronous electric motor. Particle follow a circular orbit in a strongly focused, alternating gradient magnetic field and gain energy

in varying amounts from r-f electric fields applied at accelerating gaps around the orbit.

The 25-Mev preaccelerator is a traveling-wave linac, manufactured by Applied Radiation Corp. This injector operates at a frequency of 2,855 Mc and consists of two 10-foot sections of S-band, iris-loaded waveguide, each powered by a pulsed klystron tube of 5 Mw peak pulse rating. It emits a pulse of 1

$\mu$ sec duration at a 60 cps repetition rate in a slender, well-collimated beam which is inflected into the orbit by an auxiliary magnetic field in one of the spaces between magnets. The auxiliary field is maintained just long enough to fill one turn of the orbit with electrons and is then pulsed off very quickly (0.1  $\mu$ sec) so as not to distort the orbit of electrons completing their first turn.

## Microwaves and Crystal Modulate Light Beam

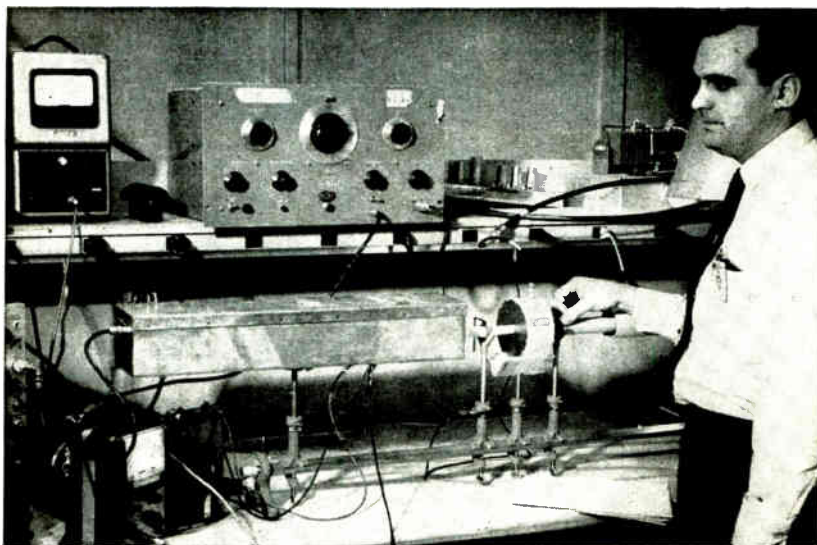

*Aircraft Armaments, Inc., reports it has modulated a light beam by using the Pockels effect in an electro-optical crystal. Refractive properties are changed by applying an electrical field. Crystal, placed in a microwave cavity, is driven by a pulsed, 700 to 1,200-Mc, 20-watt source. Estimated depth of modulation is 10 to 30 percent. Device, solid-state analog of the Kerr effect, is an approach to laser modulation*

# 83% of the answers Stressed *YEAR ROUND* Recreational Facilities We've Got Them —

## FOR INSTANCE . . .

— lakes for motor boating, fishing, swimming, sailing and water skiing — mountains for climbing, camping, and fishing streams — ocean beaches — year round golf courses — tennis — bowling — softball — horseback riding — ample facilities for practically every participating and spectator sport.

If you want year round recreation for happier, healthier living — write us today!



THE ENGINEERING CENTER  
**LOCKHEED-GEORGIA COMPANY**  
A DIVISION OF LOCKHEED AIRCRAFT CORPORATION  
AN EQUAL OPPORTUNITY EMPLOYER



Where, we find,  
there's **MORE** of what **MORE** Engineers want **MORE** of.

OK...  
LOCKHEED  
Here's what I want

- Opportunity for professional advancement
- Opportunity to work on challenging projects
- Long range job security
- Full opportunity to capitalize on my education
- Full opportunity to utilize my experience
- Year-round recreational facilities
- Income
- Professionally advantageous associations
- Freedom to work with less red tape
- Desirable fringe benefits
- Company stability and prestige
- Pleasant living conditions
- Opportunities for further education
- Recognition of personal contributions

NAME \_\_\_\_\_  
ADDRESS \_\_\_\_\_  
PHONE \_\_\_\_\_

## ENGINEERS Have YOU Answered This Invitation Yet?

It has appeared in recent issues of Scientific American, Aviation Week, Aerospace Engineering, Aerospace Management, Space Aeronautics and a number of other publications. Answers received so far indicate that we already offer a remarkably high percentage of the advantages desired by the majority of Engineers AND THAT WE CAN PROBABLY TAILOR A POSITION TO FIT THE REQUIREMENTS OF THE EXCEPTIONS. You'll never know how well your own desires and requirements can be satisfied unless you challenge us to meet them by telling us WHAT YOU WANT!

We challenge YOU TO DO IT NOW!

*Tell us what  
you want*

Write to:  
Hugh L. Gordon  
Professional Employment Manager  
Lockheed-Georgia Company  
834 West Peachtree Street  
Atlanta 8, Georgia Dept. AAA-88





## A New Performance Dimension in Digital Frequency Meters

Already recognized as having the broadest range ever offered at its low price, the Model 8175 110 Mc Digital Frequency Meter now provides an added performance dimension: **the legibility of ELectroluminescent readout.** Displayed in-line and **in the same plane**, EL digits are easily read from extreme angles. EL's glareless, even illumination and automatic display of decimal point and Mc assure greater accuracy by minimizing human error.

Broad range (10 cps to 110 Mc) and readability are only two important advantages of the Model 8175. Accuracy of 0.00004% or better from 1 Mc to 110 Mc exceeds FCC requirements. Frequencies are measured with a flick of a switch — no "tuning." With this simplified operation, a measurement can be accurately made in about 15 seconds, even by personnel with limited technical experience.

Occupying only 8¾" of vertical space in a 19" rack, Model 8175 is small and light enough to be moved about easily when used on the bench. Price is just \$2095. Write for Technical Product Bulletin 8175/7175, which also describes the Model 7175 with decade-columnar readout for \$1895.

**Beckman**®

INSTRUMENTS INC.

BERKELEY DIVISION  
RICHMOND, CALIFORNIA

T-47



**THE**  
**CONTROLLED**  
**RECTIFIER**

For complete technical information, call your G-E Semiconductor Products District Sales Manager. Or write Rectifier Components Department, Section 16D62, General Electric Company, Auburn, New York. In Canada: Canadian General Electric, 189 Dufferin Street, Toronto, Ontario. Export: International General Electric, 159 Madison Avenue, New York 16, N. Y.

## A revolutionary advance in power semiconductors

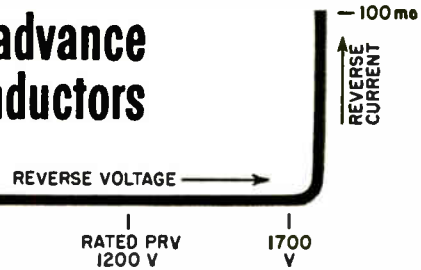

# AVALANCHE

## A NEW 12 AMPERE RECTIFIER WITH PEAK REVERSE RATING OF 1200 VOLTS, AND A SELF-PROTECTIVE REVERSE "AVALANCHE" POWER DISSIPATION RATING UP TO 3900 WATTS

The most important step forward in rectifier technology since General Electric introduced the SCR, the ZJ218 Controlled Avalanche Rectifier is the first of a new generation of G-E power semiconductors which eliminate a fundamental silicon rectifier limitation. Carefully controlled non-destructive internal avalanche breakdown across the entire junction area protects the junction surface, eliminates destructive local surface heating that permanently impairs or destroys the conventional rectifier's reverse blocking ability. In effect, ZJ218 has built-in "zener" diode protection, even well beyond 1200 volts. 600, 800, 1000 and 1200 PRV types are now available . . . all with these outstanding features:

SELF-PROTECTION AGAINST VOLTAGE TRANSIENTS		
PRV	AVALANCHE VOLTAGE @ 25°C	
	Min.	Max.
1200	1500	1930
1000	1250	1550
800	1000	1290
600	750	1030

- self-protection against voltage transients...dissipates up to 3900 watts peak power in reverse direction
- new high reliability standards at PRV's up to 1200 volts (as well as lower voltages)
- protection of other circuit components (including transformers) from overvoltage through rigidly spec'd max./min. avalanche characteristics
- simplified rectifier series operation in high voltage applications . . . eliminates need for shunt resistors
- permits continuous operation in avalanche breakdown region at high voltage . . . unharmed by hi-pot and megger tests

**GENERAL**  **ELECTRIC**

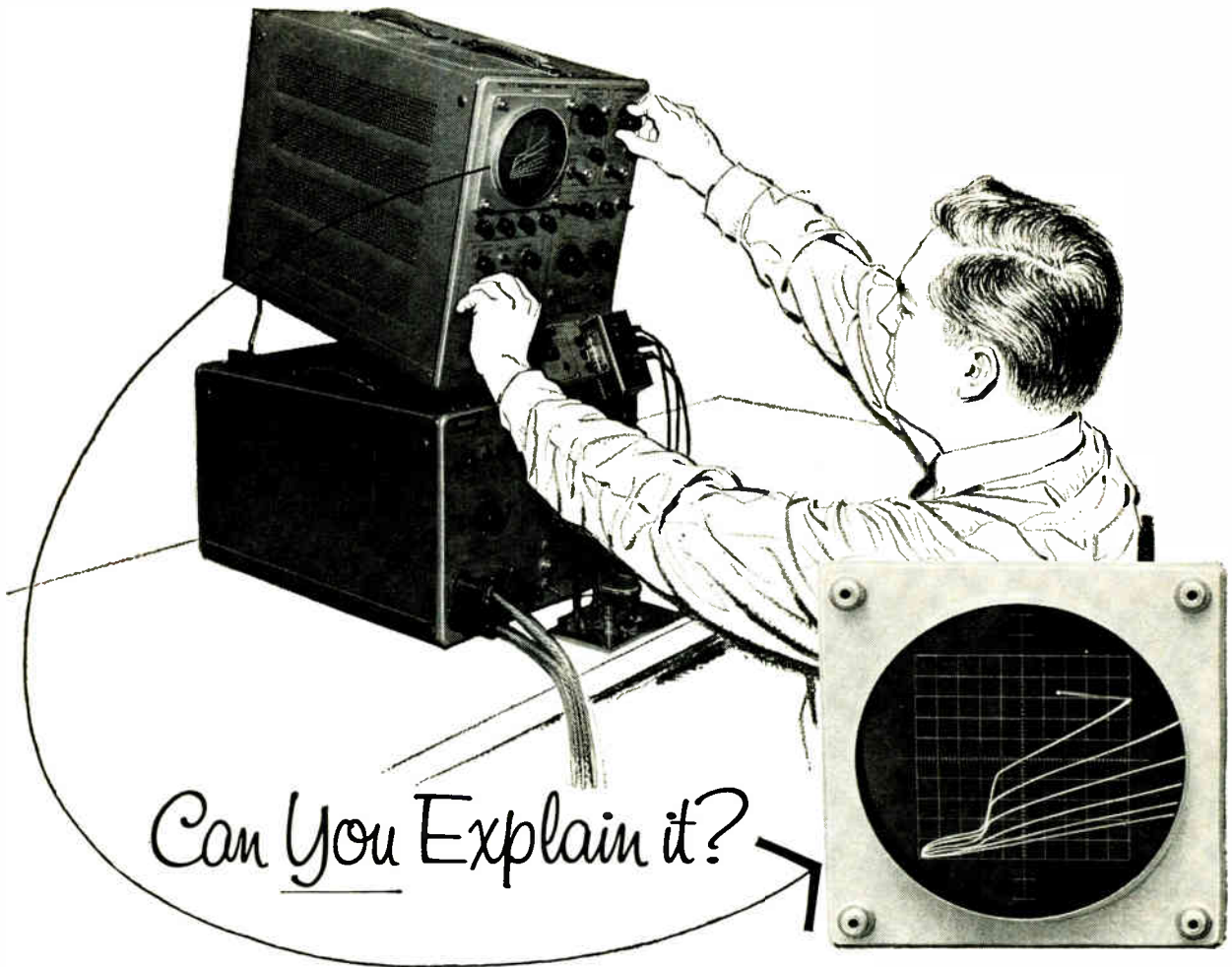

When a transistor performs like this on a curve tracer, we like to know why. Sometimes the answer is obvious. Then again, we may find it not so easily explained. This our semiconductor device people like. They enjoy sinking their teeth into a knotty problem and sticking with it till they shake out the answer—and it usually doesn't take long at Delco.

Why? Easy.

When you toss a problem to a group of talented men . . . provide the necessary research tools . . . in an environment that encourages personal initiative and achievement . . . you can't help getting results. This combination has helped build a position of leadership for Delco in the development and production of semi-conductor devices.

We intend to keep it that way—through expanding facilities and fresh talent.

Our new R&D center—125,000 sq. ft.—houses laboratories equipped with the latest in sophisticated research facilities. Our new semiconductor manufacturing center—226,000 sq. ft.—scheduled for operation this June, will provide an expanded capability in the production of silicon rectifiers. All of which adds up to new opportunities in research, development and production of silicon rectifiers.

solid state electronics ●



DELCO RADIO DIVISION OF GENERAL MOTORS  
KOKOMO, INDIANA

• **SEMICONDUCTOR DEVICE DEVELOPMENT—**  
BS in Physics, Metallurgy or Electrical Engineering; minimum of 2 yrs. experience in high current silicon rectifier development; must be capable of developing these devices and maintaining technical responsibility through pilot production.

• **PHYSICISTS, CHEMISTS AND METALLURGISTS**  
For semiconductor device development; experience in encapsulation, alloying and diffusion, chemistry of semiconductor devices, materials (to lead a program on metallurgical research of new semiconductor materials).

• **ELECTRONIC ENGINEERS—**  
Experienced in machine controls (relay and/or static) to assist in the development and application of static transistorized controls.

• **TRANSISTOR PROCESS ENGINEERS—**  
EEs, MEs, and IEs to develop and create new processes for manufacturing germanium and silicon semiconductor devices and to develop automatic and semi-automatic fabrication equipment. Experience preferred.

If you're looking for an opportunity to fully exercise your personal competence . . . among men of like talent . . . in unmatched facilities . . . then let us hear from you. Send your resume today to the attention of Mr. Carl Longshore, Supervisor Salaried Employment, Dept. 102.

*An equal opportunity employer*



# ASSEMBLE IT TODAY SELL IT TOMORROW ANYWHERE IN THE U.S.A WITH



The products you make, like the ones you buy, move fastest and safest when you specify "via AIR EXPRESS." Door-to-door delivery overnight to 23,000 communities in the U.S., Puerto Rico and Canada, at rates that are lower than you think. For example, 25 lbs. fly 1,000 miles for only \$8.12. So always be sure to insist on AIR EXPRESS for your shipments in and out. It's the only air shipping service with priority on all 36 scheduled U. S. air lines — served by 13,000 REA Express Trucks that are always as near as your telephone. **CALL YOUR LOCAL REA EXPRESS OFFICE FOR AIR EXPRESS SERVICE**

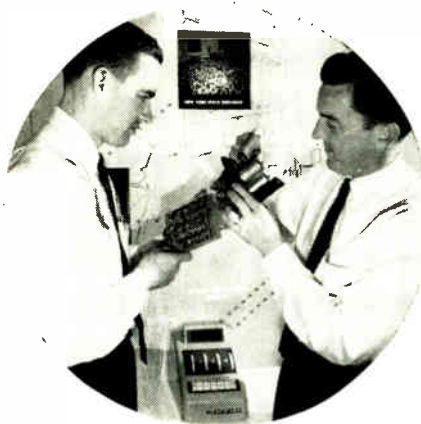

*Two Burroughs men demonstrate Ultronic's stock quoting system (it uses Burroughs' Nixie and beam-switching tubes for display circuit)*

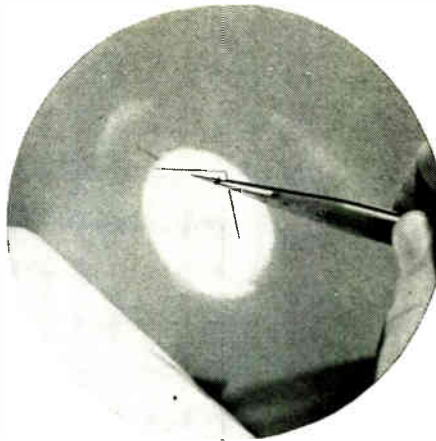

*Eight of Martin Company's thin-film triodes can go on a one-inch-square wafer. Each has cathode, grid and collector electrodes, like vacuum tubes*



*Radical design of Raytheon Amplitron, which has single magnet, cuts weight to 16 oz. It delivers 25 watts at S band, has 60 percent efficiency*

## Components Star at IRE Show

NEW YORK—Two dominant trends in electronic hardware seemed evident last week at the IRE Show: new components are getting smaller, tend increasingly to multi-component modules; instruments are getting bigger, faster, more versatile.

The magic words at the show this year were masers and lasers, although there was little that had not been reported during the past year. Here's a sampling of some of the new products not described in our IRE preview issue (ELECTRONICS, p 22, 32 and 144, March 9):

It looked like every major semiconductor device manufacturer was jumping on the integrated semiconductor circuit bandwagon. Those that weren't showing models were expected to have them ready soon. Among present manufacturers are Fairchild Semiconductor, General Instrument, International Rectifier, Motorola, Pacific Semiconductors, Philco, RCA, Signetics, Sperry Semiconductor and Texas Instruments.

There were also numerous thin-film circuits. Advanced Microelectronics was offering three 1-Mc logic modules from stock, a flip-flop, multivibrator and dual inverter, all measuring 1.1 by 1.1 by 0.2 in. The line is to be extended to eight 1-Mc and eight 10-Mc mod-

ules. These have deposited passive elements, inserted transistors and diodes.

A line of miniaturized digital logic modules was shown by a subsidiary of Curtiss-Wright, Advanced Miniaturized Electronics. Operating from d-c to 250 Kc, these 1 by 1 by 0.6-in. welded and encapsulated modules include two flip-flops, two multivibrators, a blocking oscillator, OR and AND gates, a pulse amplifier and an emitter follower.

McAllister and Associates showed an engineering prototype of a 4 by 2 by 1-in. analog-to-digital converter. The three-digit BCD converter has a resolution of 2 mv and an accuracy of 0.2 percent.

Epsco's ADS-1 wideband d-c amplifier will soon be joined by three more models, all chopper-stabilized and using silicon transistors. For low noise and drift, the amplifiers are stabilized for operation with a wide variety of inputs and feedback networks. The minimum gain of the ADS-1 model is  $2 \times 10^7$ .

A microminiature chopper measuring  $\frac{1}{4}$  by  $\frac{2}{3}$  by  $\frac{1}{4}$  inch and hermetically sealed in an inert atmosphere is available from Collins Electronics, Inc. Three models are available, for 60, 400 and 1,000-cycle operation.

Leach showed a number of minia-

ture systems and components, including a half-size crystal can relay that weighs  $\frac{1}{2}$  oz.

Corning Glass showed several new processes for cathode-ray tubes. One is a photographic process for making graticules within the tube's face glass. The graticule can be edge-lit and eliminates parallax by allowing the viewer to align himself with any graticule line.

Another anti-parallax development reported by Corning is a graticule that is put inside the tube bulb. This places the scale on the same surface as the trace. The company also has a ceramic glass frit coating said to increase bulb strength 30 to 100 percent.

A mechanical switching module with applications in multiplexing was exhibited by Beardow, Inc. Its maximum switching speed is 1,000 cps. Switching is clean with a 10  $\mu$ v signal. Company claims module life is over 100 million cycles. Any number of modules can be combined in a cam-operated multiplexer.

Allen-Bradley showed a ferrite-ceramic filter designed for broadband filtering to eliminate interference in tv tuners. While more expensive than conventional tubular and discoidal type filters, the unit is claimed to be 13 db more effec-

tive in suppressing vhf and uhf spurious radiations.

A microminiature timer unit, adapted from a military version, was shown by ITT Federal Laboratories. The transistor unit uses flip-flop and counter circuits to time from 5 sec to 50 min with 0.01 percent accuracy, giving a current pulse at the end of each cycle. Unit is crystal controlled.

#### Counter Memory

An electronic memory device for operating Nixie tubes was shown by Electronics Division of North Electric. The unit is mounted on a single circuit board 2½ by 3½ inches, acts as a locking memory with a reset to clear all digits.

Bausch & Lomb exhibited safety eyeshields for laser experimenters. Made of absorbing plastic and a dichroic mirror, the shields have 97 db attenuation at near invisible red light wavelengths, but only 6.6 db at visible light.

A switching time tester, able to provide visual display of nanosecond response times of transistors, diodes and circuit networks was introduced by Hewlett-Packard. The plug-in tester is designed for use with the firm's 1,000-Mc sampling oscilloscope. It includes a less than 1 nsec rise time driving-pulse generator, 0.45 nsec rise time pulse amplifier and two bias supplies. Tests possible include rise and fall times of transistors, forward switching and reverse recovery times of diodes.

#### High-Frequency CRO

Hewlett-Packard also had a d-c to 50-Mc oscilloscope which does not use distributed amplifier techniques in the vertical channel design, providing easier adjustment and maintenance.

Plug-in units available include dual trace d-c to 40 Mc, and high gain d-c to 20 Mc, 5 mv/cm vertical amplifiers; and sweep delay and time mark generator units for use with the horizontal sweep.

A klystron oscillator synchronizer for phase locking to a frequency standard was shown by Dymec. The instrument accepts signals up to 12.4 Gc. The firm claims that precise phase and frequency control of the output of a reflex klystron can be obtained.

A pulse generator with rise time

of under 0.25 nsec was shown by Tektronix, Inc. The instrument can generate pulses of various widths, ranging from 0.5 nsec to 40 nsec at full repetition rate, and up to 300 nsec at half rep rate. Output amplitudes from zero to 50 volts in three decade ranges, all calibrated and continuously variable are provided. Pulse polarity can be positive or negative.

Perkin-Elmer introduced a potentiometer linearity tester that simulates dynamic conditions. It will test pots of up to 30 turns at rotational speeds of 10 to 0.1 rpm. P-E says that by incorporating a special Vernistat a-c pot with stepless output, problems such as noise, drift, gearing precision and adjustment of test pots are eliminated.

#### Camera Image Converter

An image converter for camera studies of plasma physics, chemical kinetics and hypervelocity experiments was shown by STL Products, a division of Space Technology Laboratories, Inc. Exposure time is less than 3 nsec.

Four plug-in units are provided, for standard speed or high speed and for frame or streak photographs. In frame operation, three frames are exposed at times of 5 to 200 nsec, with intervals independently adjustable from 0.05 to 10  $\mu$ sec. In streak operation, the writing times are from 50 nsec to 10  $\mu$ sec.

The optical image is focused on a photocathode, which transforms it into an electron image, so that shuttering and amplification can be performed electronically. A focusing electrode assures a distortion-free image as the electron image passes through the deflection plate. The electron image is focused on



Corning uses photosensitive glass to form graticule inside the glass viewing surface of crt



Engineer holds exciter-multiplier module of ITT S or C band transmitter. Compact, solid-state, 1-Kw system has only one tube, a klystron

the photoanode, where it is again converted, to a higher-intensity optical image.

Circuit welding equipment was much in evidence. In a weld station set-up displayed by Weldmatic division of Unitek, the operator can select by push button any of five preset weld energy-electrode force combinations. Preset weld schedules meet needs of most welding operations, even a relatively complicated weld schedule.

W. H. Brady Co. brought out an imprinter for special nameplates. The machine is a manually-operated stamper that fills in model numbers, frequency data and other information on partially finished metal plates, or prints complete dials, serially numbered.

Weller Electric showed a temperature-controlled soldering iron. A thermo-magnetic plug in the tip of the iron is attracted to a magnet as long as its temperature is below a critical temperature. A switch activated by this motion supplies heating current to the soldering tip. When operating temperature is reached, contact is broken—SBG, GVN, LHD, GF, GS

# Low Microwave Power Sends Data Over

*Experiments indicate knife-edge diffraction can reduce data transmission costs*

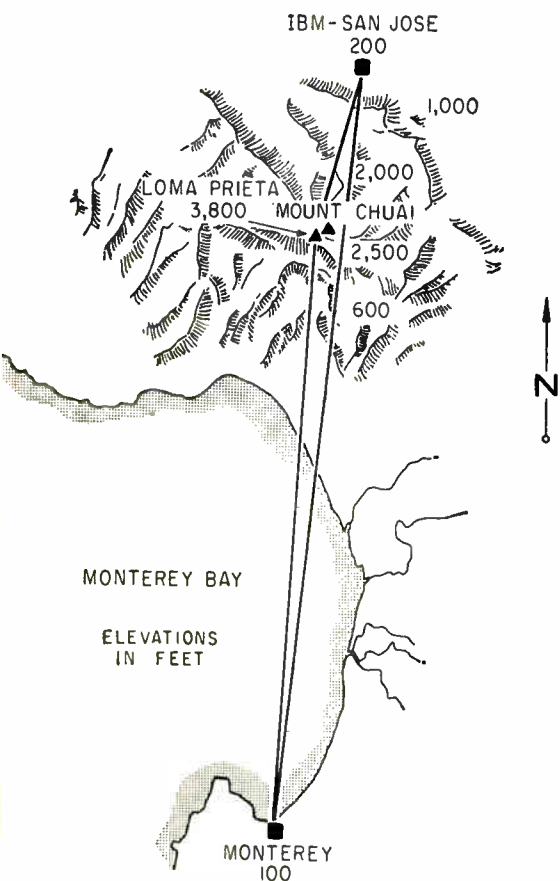

*San Jose-Monterey transhorizon microwave path over 3,800-ft peak*

SAN JOSE, CALIF.—IBM's Advanced Systems Development division has demonstrated experimentally that knife-edge diffraction may be used for transhorizon data transmission with low-power microwave equipment. Signals are diffracted down the other side of a mountain when they strike a ridge.

Using a 15-watt transmitter, signals were sent between Monterey and San Jose, a 45-mi path, by aiming them at an intervening ridge 3,789 ft high. Data rates reached as high as 500,000 bits/sec, IBM said.

With suitable low-power equipment, IBM thinks data could be sent up to a few hundred miles at rates up to a million bits/sec. If a 30-watt transmitter and scatter propagation were used, range might be 1,000 mi.

It was pointed out that the transmitter and receivers used were designed for multichannel telephony, not data transmission. Binary data transmission will tolerate more distortion and signal-to-noise ratios as low as 10:1.

J. P. Vinding, who prepared a report on experiments, listed these

potential advantages of knife-edge diffraction over line-of-sight relay: two stations could be used instead of three to eight; stations would be more easily accessible for maintenance; only one frequency is required for each direction, saving spectrum space.

IBM reportedly has no plans to sell such systems, but wants to interest communications firms in their installation. It hopes that this would lower transmission costs—or make communications economical where none is now available—to reduce overall cost of computer communications systems. This could be a deciding factor in some computer sales.

The basic equipment was developed by Nippon Electric, of Japan. It consists of a 15-watt transmitter operating at 1,855 Mc, two f-m receivers with a sensitivity of about -100 dbm, and a diversity combiner. Antennas have 10-ft parabolic reflectors.

Nominal baseband is 6 to 264 Kc; however, 108 to 120 Kc is reserved for noise measurement. Basic transmission loss over the path is 203 db.

The receivers are placed about 80 ft apart on a line nearly perpendicular to the direction to the transmitter. There is short-term, independent fading of the two received signals, usually 10 to 15 db. The largest received signal was about -83 db.

The receiving system uses double conversion. The demodulator has a phase-locked loop design. There is a variable gain amplifier in each input of the diversity combiner. Gain is adjusted according to noise measured in the band 108 to 120 Kc. Outputs of the two amplifiers are added and amplified to provide a combined output. Data is recovered from the received signal by filters, equalizer and regenerator.

IBM added, for the experiments, a data generator at the transmitter

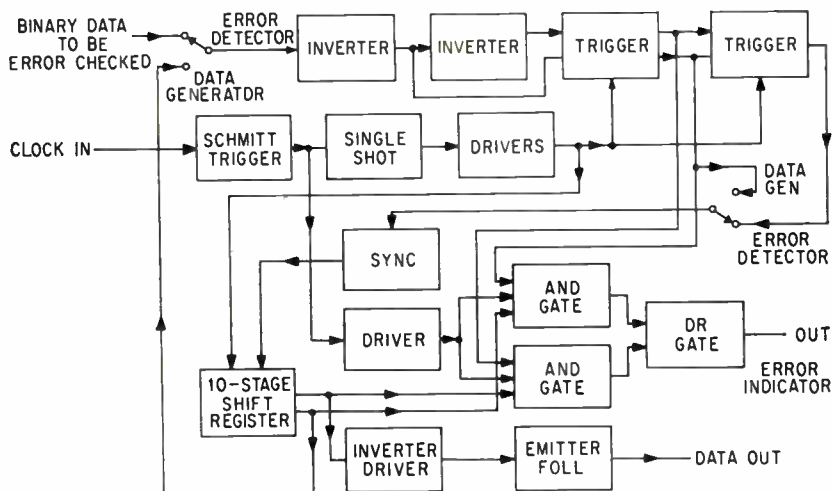

*Binary data generator and error detector. These units are the same, but adjusted to perform each function*



# Mountains

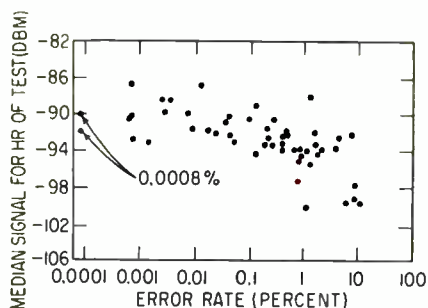

*Average error rate versus median received signal for one hour of transmission daily during six weeks*

and an error detector at the receivers. These are identical units, developed by L. Provazek, that are adjusted to perform each function. They can produce up to 2 million binary bits/sec.

An up level (ground potential) is considered a binary ONE and a down level (-6 v) a ZERO. The shift register produces a 10-bit repetitive pattern. Character switches allow the operator to choose any pattern. A d-c reset puts the character into the register, and when the reset switch is released the 10-bit character recirculates in the register.

The register can also produce two pseudo-random patterns of 127 bits and 889 bits, for test purposes.

Synchronous pulses are developed by a single-shot circuit driven by the data and an AND gate. Gate output is a single pulse coincident with the last ONE of a data string. The pulse can be used to synchronize an oscilloscope and to reset the register.

A synchronous pulse can be extracted from the data as long as the data is repetitive and has a uniquely long sequence of ONES during its period. This condition, also required for error-checking, is satisfied by the 127-bit and 889-bit patterns.

When the unit operates as an error detector, a clock synchronized with the data drives the detector. The detector is set to produce data identical with incoming data. If a difference is found on comparison, a pulse is produced.

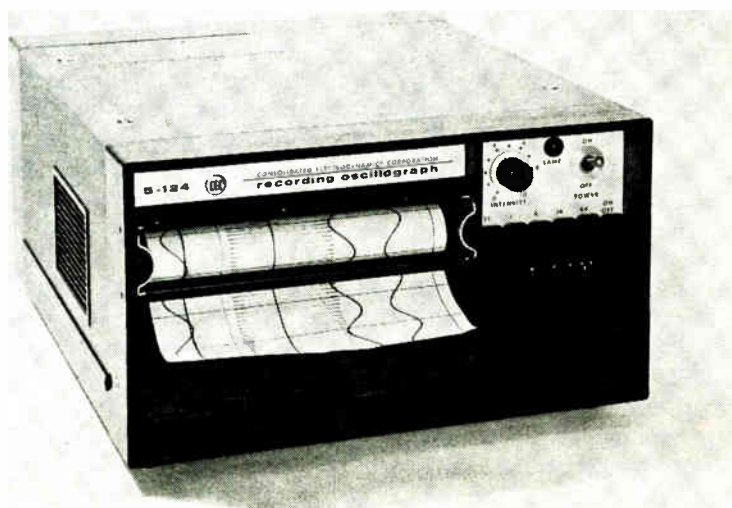

**Beauty...with a purpose**

## **5-124 Oscillograph: design simplicity boosts reliability**

It's simple in design and simple in operation... pushbutton-easy... and seldom in need of maintenance. Plenty of work hours... minimum down time... with CEC's 5-124 Recording Oscillograph. When there's need for parts adjustment or replacement, a few twists - strip off the single-piece cover - and all four basic modules are exposed for easy handling. ■ Little (7 $\frac{3}{8}$  - 12 - 15 $\frac{1}{4}$ ; 40 lbs.), it tells all, too... recording on 18 channels and producing all record parameters at writing speeds up to 50,000 ips. Get full details. Call your nearby CEC sales and service office or write today for Bulletin CEC 5124-X41.

# CEC

Data Recorders Division

**CONSOLIDATED ELECTRODYNAMICS**  
PASADENA, CALIFORNIA • A SUBSIDIARY OF BELL & HOWELL

# FILMISTOR®

**METAL FILM RESISTORS  
OFFER 5 TEMP. COEFFICIENTS  
TO MEET ALL CIRCUIT  
REQUIREMENTS**

**RUGGED END-CAP  
CONSTRUCTION  
FOR LONG TERM  
STABILITY**

**EXCEPTIONAL  
RESISTANCE TO  
MOISTURE AND  
MECHANICAL DAMAGE**

**SURPASS MIL-R-10509  
PERFORMANCE  
REQUIREMENTS**

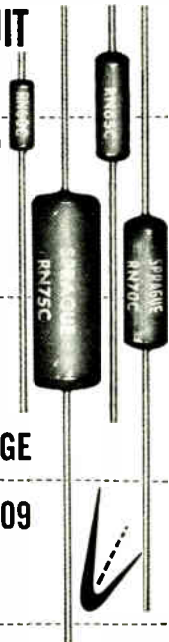

Providing close accuracy, reliability and stability with low controlled temperature coefficients, these molded case metal-film resistors outperform precision wirewound and carbon film resistors. Prime characteristics include minimum inherent noise level, negligible voltage coefficient of resistance and excellent long-time stability under rated load as well as under severe conditions of humidity.

Close tracking of resistance values of 2 or more resistors over a wide temperature range is another key performance characteristic of molded-case Filmistor Metal Film Resistors. This is especially important where they are used to make highly accurate ratio dividers.

Filmistor Resistors, in 1/8, 1/4, 1/2 and 1 watt ratings, surpass stringent performance requirements of MIL-R-10509D, Characteristics C and E.

Write for Engineering Bulletin No. 7025 to: Technical Literature Section, Sprague Electric Co., 35 Marshall Street, North Adams, Mass.

For application engineering assistance, write: Resistor Div., Sprague Electric Co., Nashua, New Hampshire



'Sprague' and '®' are registered trademarks of the Sprague Electric Co.

## 1972 Market: \$20 Billion

VOLUME OF OVER \$20 billion for electronics markets in 1972 was predicted by P. E. Haggerty, president of IRE and Texas Instruments, at the opening of the IRE Convention last week. This is almost double the 1961 volume of \$11.7 billion, which was 2.2 percent of the gross national product. The 1972 volume will be an appreciably larger percentage of GNP, Haggerty added.

The government market, including military and space, will continue to account for a major portion of the output, going from \$6.9 billion in 1961 to \$10 billion in 1972. But the industrial market will become the fastest growing, rising from \$1.9 billion in 1961 to \$5.4 billion in 1972—from 16 percent to 27 percent of the total electronics market. Consumer electronics will go from \$2 billion to \$3.4 billion, he said.

Haggerty attributes the industrial electronics growth to increased application of technologies and products developed for the military. He sees as the most promising fields during the next ten years: direct conversion of fuels to electrical energy; development of masers to light intensities required for inter-

planetary communications, chemically-pure welding, microsurgery, microscopy, precision industrial etching, precision control of machinery, and positioning and maneuvering of satellites in space; application of integrated circuits to a wide variety of consumer, industrial, and military equipment.

Alfred M. Goldsmith, an IRE founder, said plasma power generation, computer technology, space-travel communications, medical electronics and military defense electronics will be the big contributors of electronics in the near future.

### Japanese Plan Survey of Computer Market Here

TOKYO—The Japan Electronic Industry Development Association expects to contract with Stanford Research Institute for study of the U. S. computer market. Ostensible purpose of the survey is to obtain background material for expansion of the computer industry in Japan.

The proposed survey will deal heavily with economic problems. Emphasis will also be given programs and other software, and the tendency of computer users to centralize or decentralize business operations.

An association officer stated that survey was not for purpose of selling computers in the U. S. market. He said that the present high prices of Japanese Computers and lack of software make consideration of sales in the U. S. unrealistic.

### Name Contractor for International Satellite

NASA is negotiating a contract, estimated at \$1,066,000, with Westinghouse Electric, for spacecraft for the S-52 project. S-52 is one of two scientific satellites jointly sponsored by the U. S. and Britain. NASA will handle launching, tracking and data acquisition, the British will prepare instrumentation and do the data analysis.

### Sealed Gas Laser



Sylvania plans to offer commercially a helium-neon gas laser. Sealed quartz tube needs no vacuum station or gas-filling gear, has Brewster angle windows and external optical system

NOW...  
INDUCTANCES  
UP  
TO  
100 $\mu$ h

IN  
THIS  
TINY  
CASE  
SIZE!



### Jeffers Type 09 Mini-Stab Inductors

Jeffers' new Type 09 MINI-STAB Inductor provides inductance values from 0.10 $\mu$ h to 100 $\mu$ h in a case only 0.250 + 0.010 in length and diameter of 0.095 ± 0.003.

Jeffers' popular line of MINI-STAB Inductors has been extended to afford you new opportunities for miniaturization – without sacrificing stability or reliability!

Here are the standard Jeffers features that deserve your special notice:

**MINIATURIZATION** – achieved through more efficient use of coil-winding space.

**STABILITY** – features an open magnetic circuit with carefully selected coil forms.

**QUALITY** – guaranteed through Jeffers' exceptional quality control and inspection system for proving inductor performance under unusual extremes of temperature, humidity, vibration, shock and stress.

**TESTING** – Jeffers' Laboratory includes equipment necessary to perform all tests on molded inductors to assure full compliance with the requirements of MIL C 15305.

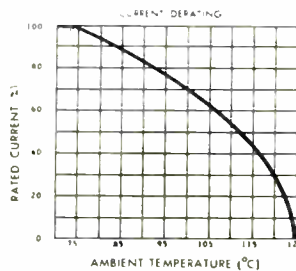

\*Rated Current is based on a 90°C ambient, and 35°C temperature rise.

Write today for assistance with your inductor design problems.



Jeffers Part No	L $\mu$ h ± 0%	Test Freq. (MC)	Q Min.	SRF Min. (MC)	DCR 25°C Ohms	DC Max. Current (MA)	DC * Rated Current (MA)	2nd	3rd	COLOR	CODE
1116-1	0.10	25.0	34	680	0.08	1550	GLD	BRN	BLK		
1116-2	0.12	25.0	34	610	0.09	1560	GLD	BRN	RED		
1116-3	0.15	25.0	34	600	0.10	1480	GLD	BRN	GRN		
1116-4	0.18	25.0	34	550	0.12	1360	GLD	BRN	DFY		
1116-5	0.22	25.0	32	510	0.14	1250	GLD	RED	RED		
1116-6	0.27	25.0	30	460	0.16	1175	GLD	RED	VLT		
1116-7	0.33	25.0	28	410	0.22	1000	GLD	ORG	ORG		
1116-1	0.39	25.0	35	350	0.30	860	GLD	ORG	WHT		
1116-2	0.47	25.0	35	325	0.34	810	GLD	YEL	VLT		
1116-3	0.56	25.0	34	310	0.40	740	GLD	GRN	BLU		
1116-4	0.68	25.0	33	280	0.54	635	GLD	BLU	GRY		
1116-5	0.82	25.0	32	260	0.63	600	GLD	GRY	RED		
1116-6	1.00	25.0	32	240	0.74	545	BRN	GLD	BLK		
1116-1	1.20	7.9	32	150	0.18	1100	BRN	GLD	RED		
1116-2	1.50	7.9	32	140	0.22	1000	BRN	GLD	GRN		
1116-3	1.80	7.9	32	125	0.28	885	BRN	GLD	GRY		
1116-4	2.20	7.9	32	115	0.38	760	RED	GLD	RED		
1116-5	2.70	7.9	40	100	0.55	635	RED	GLD	VLT		
1116-6	3.30	7.9	45	90	0.80	495	ORG	GLD	ORG		
1116-7	3.90	7.9	45	82	1.00	470	ORG	GLD	WHT		
1116-8	4.70	7.9	45	75	1.20	430	YEL	GLD	VLT		
1116-1	5.60	7.9	50	67	1.50	380	GRN	GLD	BLU		
1116-2	6.80	7.9	50	60	1.80	350	BLU	GLD	GRY		
1116-3	8.20	7.9	60	55	2.40	300	GRY	GLD	RED		
1116-4	10.00	7.9	60	50	3.10	265	BRN	BLK	PLK		
1116-1	12.00	2.5	40	40	2.40	300	BRN	RED	BLK		
1116-2	15.00	2.5	40	35	2.70	285	BRN	GRN	BLK		
1116-3	18.00	2.5	45	30	3.00	270	BRN	GRY	BLK		
1116-4	22.00	2.5	45	26	3.30	255	RED	RED	BLK		
1116-5	27.00	2.5	45	22	3.60	245	RED	VLT	BLK		
1116-1	33.00	2.5	45	28	2.80	280	ORG	ORG	BLK		
1116-2	39.00	2.5	45	24	3.10	265	ORG	WHT	BLK		
1116-3	47.00	2.5	45	22	4.40	220	YEL	VLT	BLK		
1116-4	56.00	2.5	45	20	5.70	195	GRN	BLU	BLK		
1116-5	68.00	2.5	50	18	6.50	180	BLU	GRY	BLK		
1116-6	82.00	2.5	50	16	6.70	175	GRY	RED	PLK		
1116-7	100.00	2.5	50	14	7.50	165	BRN	BLK	BRN		

JEFFERS ELECTRONICS DIVISION □ SPEER CARBON COMPANY, INC. □ DUBOIS, PENNSYLVANIA

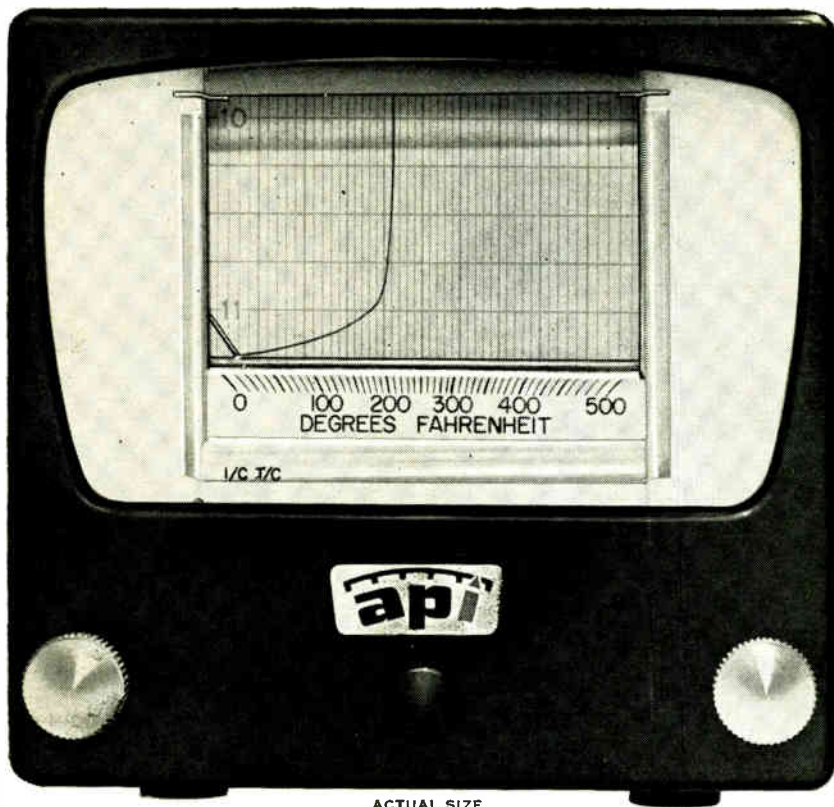

ACTUAL SIZE

## NEW Temprint and Versaprint RECORDERS

Most sensitive recorders of their type

TEMPRINT is API's new temperature recorder; VERSAPRINT is the counterpart for any electrically transduceable variable. Both offer full-scale sensitivities down to 2 microamps or 2 millivolts; temperature ranges narrow as 300°F. with cold junction and copper error compensation.

API recorders are inkless. They record on pressure-sensitive paper. Every five seconds the pointer is clamped against the chart producing a continuous, permanent record.

High sensitivity is made possible by the taut-band meter movement. This movement is frictionless . . . has no hysteresis. Moreover, the taut-band movement is extremely rugged, withstands shock and vibration; it's non-destructible in anywhere near normal usage.

High or low limit control or alarms are optionally available.

### BRIEF SPECIFICATIONS

Accuracy:  $\pm 2\%$  of full scale.

Chart Width:  $2\frac{1}{4}$  inches.

Chart Speed: Standard, 1" per hour (31 days);  $\frac{1}{4}$ ", 2", 3", 4" per hour available.

Mounting: Table or panel.

Depth Dimension:  $6\frac{1}{2}$ " (Behind panel: 6").

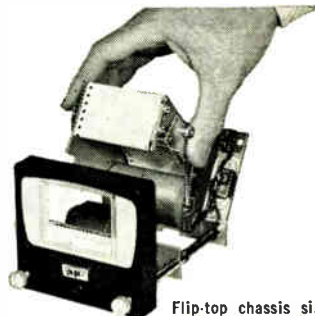

Flip-top chassis simplifies chart replacement. Hinged viewing window permits chart notations.

WRITE FOR BULLETIN 31



**ASSEMBLY PRODUCTS, INC.**

CHESTERLAND 4, OHIO

SA 2580

## MEETINGS AHEAD

CHEMICAL & PETROLEUM INSTRUMENTATION SYMPOSIUM, Instrument Soc. of America DuPont Country Club, Wilmington, Delaware, April 9-10.

NONDESTRUCTIVE TESTING CONVENTION, Society for Nondestructive Testing; Pick-Carter Hotel, Cleveland, Ohio, April 9-13.

PLASMA SHEATH SYMPOSIUM, AF Cambridge Research Labs; New England Mutual Hall, Boston, April 10-12.

SOUTHWEST IRE CONFERENCE AND SHOW; Rich Hotel, Houston, Texas, April 11-13.

AEROSPACE SYSTEMS RELIABILITY SYMPOSIUM, IAS; Salt Lake City, Utah, April 16-18.

HIGH SPEED COMPUTING & MATHEMATICAL RESEARCH SYMPOSIUM, Assoc. for Computing Machinery and American Mathematics Society; Chalfonte-Haddon Hall Hotel, Atlantic City, April 16-18.

FREQUENCY CONTROL SYMPOSIUM, U.S. Army Signal Research and Development Laboratory; Shelburne Hotel, Atlantic City, N. J., April 25-27.

WESTERN SPACE AGE INDUSTRIES & ENGINEERING EXPOSITION/CONFERENCE, sponsored by various business and governmental organizations; Cow Palace, San Francisco, April 25-29.

PULP & PAPER INSTRUMENTATION SYMPOSIUM, Instrument Soc. of America; Jacksonville, Fla., April 26-27.

MANNED SPACE FLIGHT SYMPOSIUM, IAS; Chase Hotel, St. Louis, Mo., April 30-May 2.

INSTRUMENTAL METHODS OF ANALYSIS SYMPOSIUM, Instrument Society of America; Daniel Boone Hotel, Charleston, W. Va., April 30-May 2.

SPECTROSCOPY SYMPOSIUM, Society for Applied Spectroscopy; Conrad Hilton Hotel, Chicago, April 30-May 3.

MOTION PICTURE & TELEVISION ENGINEERS CONVENTION AND EQUIPMENT EXPOSITION, SMPTE; Ambassador Hotel, Los Angeles, April 29-May 4.

JOINT COMPUTER CONFERENCE, IRE-PGEC, AIEE, ACM; Fairmont Hotel, San Francisco, Calif., May 1-3.

NATIONAL AEROSPACE ELECTRONICS CONFERENCE, IRE-PGANE; Biltmore Hotel, Dayton, Ohio, May 14-16.

WESTERN ELECTRONICS SHOW AND CONFERENCE, WEMA, IRE; Los Angeles, Calif., Aug. 21-24.

### ADVANCE REPORT

NATIONAL ELECTRONICS CONFERENCE, AIEE, IRE, et al; McCormick Place, Chicago, Oct. 8-10. May 1 is the deadline for submission of 150-word abstracts (original plus 4 copies) to: Dr. Thomas W. Butler, Jr., E. E. Department, The University of Michigan. Topics will include all scientific and engineering aspects of electronics. Papers of both a tutorial and synoptic nature may be submitted.

# COLLINS FILTERS . . . for selectivity from 10kc to 65mc

**1** When your circuit demands steep-skirted selectivity in the 60-600kc range, specify **Collins Mechanical Filters**



▲ Only Collins mechanical filters provide steep-skirted selectivity approaching the theoretically-perfect. This selectivity comes from a series of resonating dime-size nickel-alloy discs with Qs of 8,000 to 12,000 . . . up to 150 times more than conventional filter elements. Collins mechanical filters are packaged in cases as small as  $\frac{1}{3}$  cubic inch. They're electrically and mechanically stable and don't age, break down, or drift as a result of extreme temperature or long, continuous service. Frequency shift, for example, can be held between 1.5 and 2 ppm/°C over a -25°C to +85°C range.

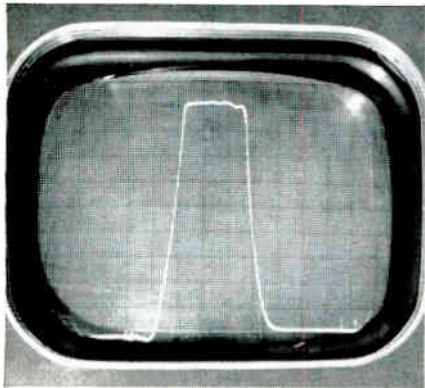

▲ You can select center frequencies from 60 to 600 kc with a wide choice of bandwidths and case styles. All filters display shape factors (ratio of 60db bandwidth to 6db bandwidth) of 2 to 1 or less and have minimum ripple and low transmission loss. And filters with new ferrite transducers show flatter passband response, even lower transmission loss and greater physical strength for missile and other demanding application.

More than 100 standard types of mechanical filters are already catalogued, and the *only* mechanical filter design group in the country is ready to help you with special filtering requirements.

**2** Widest frequency range . . . 10kc to 50mc . . . and smallest size . . . down to less than 1 cubic inch . . . **Collins Crystal Filters**

You're closer to finding the right crystal filter for your circuit when you contact Collins because the 10kc to 50mc range will take care of almost any imaginable application. Choosing Collins for crystal filters will also help with your high-density packaging problems. For example, there's a series of filters from 4-20mc in cases well under 1 cubic inch, a 2 to 1 size reduction from what you'd normally expect.

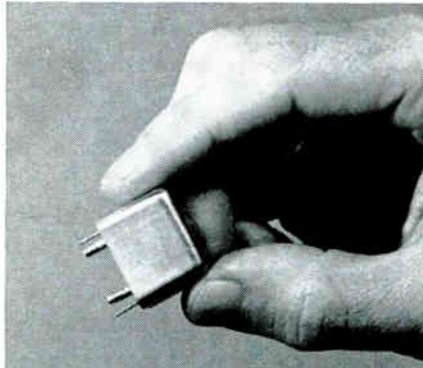

▲ Engineering help at the circuit design stage and rapid development of special prototype filters are other reasons why so many project and design engineers are checking with Collins for crystal filter requirements. In addition, Collins offers the consultation of its design engineers, if required, as well as special application data sheets to help you detail specifications so that we can submit a design and price proposal. If your circuit requirements can be met by one of the many crystal filters whose designs have already been standardized, you can expect deliveries from stock — 90-day deliveries on production quantities.

Besides meeting your specs for center frequency, bandwidth, impedance and size, Collins makes certain your filters will perform under severe operating conditions. As an illustration, Collins filters in the 1-30mc range show a frequency shift of less than .005% from -55°C to +90°C. Below 1 mc, filters have a frequency shift of less than .01% from -40°C to +80°C.

**3** With **Collins LC filters** the catalog is only part of the story . . . it's capability and speed that count most.

You may find exactly what your circuit needs among the hundreds of proven LC filter designs for low pass, high pass, band pass, telegraph tone, aircraft navigation and other applications already on file. But if you don't, we have the capability to design, produce and deliver what you do need.

Through the sub-audio to 65 mc range, we consistently push the state-of-the-art for our customers by delivering filters which meet conditions previously considered impractical or impossible. In temperature stability, in resistance to humidity, in size, in method of packaging, we are filling new and special requirements every day.

What's more, you get reliability and performance in the same package with the hardware. Your own inspection and test procedures will prove that Collins filters are the result of a quality assurance program that never lets up.

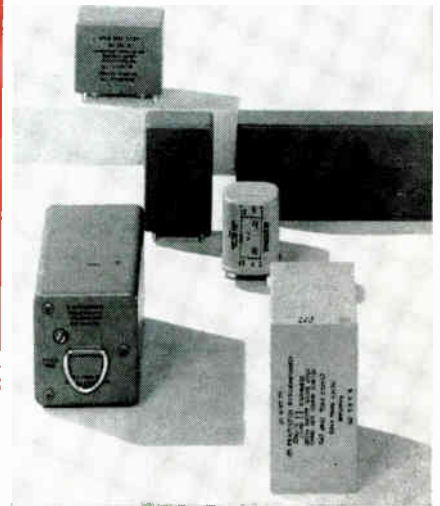

CONTACT



For more information about our capabilities and products, call or write today; ask for Data File 201. Collins Radio Company, Components Division, 19700 San Joaquin Road, Newport Beach, California. Engineering representatives in principal cities.

RENDEZVOUS ROUTE OR COLLISION COURSE?

## A QUESTION OF SUPREMACY:

Pilots of U. S. Navy fighting planes will shortly be able to rendezvous or fly in formation with greater security under a wider range of conditions... for they'll know exactly how far they are from each other. ■ Air-to-air ranging will be added to their present TACAN sets with the General Dynamics/Electronics - Rochester SC-704 modification kit. No bigger than a "best seller," lighter than the circuits it replaces, it permits as many as 5 planes to judge their distances from a sixth, such as a group leader or air tanker. Conversion time? Negligible - only 3 fast hours. And the SC-704 actually improves the



reliability of the air-to-ground function of the TACAN set because the vacuum tube modulator is replaced with a new, completely solid-state modulator. ■ Proficiency in air and missile-borne ranging equipment comes naturally to a division of General Dynamics, where the B-58 Hustler and Atlas ICBM were born and bred: General Dynamics/Electronics - Rochester is today's seed-bed of advanced ideas in the technology of navigational equipment and radar beacons. ■ Every product we make started with a question. We solicit yours. Write 1400 North Goodman St., Rochester 1, New York.

**GENERAL DYNAMICS** |

ROCHESTER 1, N.Y.

—

Circle 34 on Reader Service Card

# New Power Sources and Energy Converters

*Sources range from chemical batteries to nuclear systems. Silicon solar cells, proved reliable in satellites, are being redesigned for higher power*

By DAVID LINDEN

U. S. Army Signal R&D Lab., Ft. Monmouth, N. J.

OVER the past five years, portable electrical power sources have received much attention and many advances have been made. But, with the exception of satellites, application of these power sources has been slow. Development effort has failed to produce hardware that approaches either claims or potentialities.

Many of the new power-source investigations reported on three years ago<sup>1</sup> are still important and are under extensive study. Several, such as photogalvanic, photoemissive or pyroelectric devices, have since shown limitations. Recent progress is reported here and the characteristics and capabilities of the new power systems are compared.

Methods for converting the three prime sources of



*Nuclear reactor power sources appear most satisfactory for space requirements. This space craft uses a medium power (1 Kw-100 Kw) system consisting of a thermal reactor coupled to a turboelectric converter*

energy (chemical, solar and nuclear) into electrical energy are summarized in Fig. 1. The chemical battery and the rotating heat engine, are in wide use today. The others, while promising, require further development to achieve performance characteristics, reliability and low cost essential for general use.

## *Chemical Batteries*

Chemical batteries are used in short-term applications (up to 100 hours), with proven performance, high-power-to-weight ratio and relatively low cost. They can be built to readily meet severe mechanical requirements (shock, vibration, etc) as well as outer space environment. They have the disadvantage of

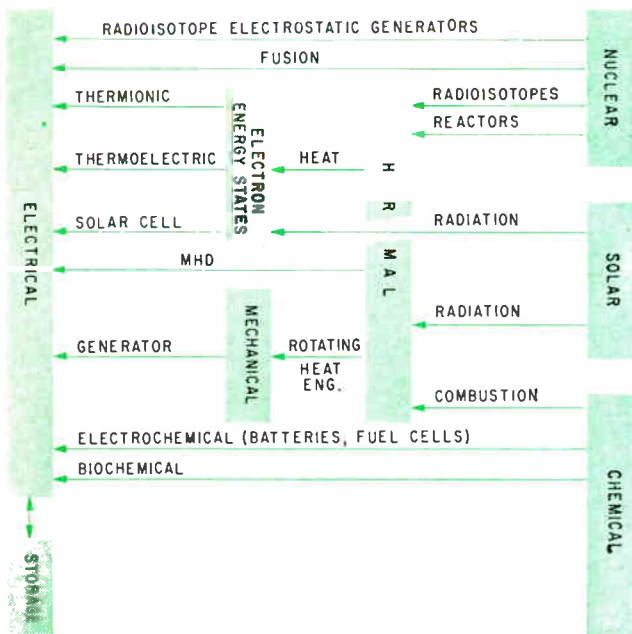

FIG. 1—Three prime energy sources and methods of conversion

a high weight-to-energy ratio and may never exceed a maximum of about 125-150 watt-hours per pound. Batteries operate satisfactorily only within a narrow temperature range. Their shelf-life, too, is short, although this can be overcome by reserve batteries or storage at low temperatures.

The Leclanche or zinc (Zn)-manganese dioxide ( $MnO_2$ ) dry battery is widely used because of its low cost and generally reliable and acceptable performance. For commercial applications, its shelf-life is adequate, but for long-term storage, it must be refrigerated. The magnesium (Mg)- $MnO_2$  battery, soon to be available in production quantities, will fulfill the need for a long-life, nonperishable, portable power source. It has twice the capacity of the conventional zinc battery and a storage life in excess of four years under normal temperatures (70-80 deg F). With organic depolarizers (in place of the heavier manganese dioxide), up to 100-125 watt-hours per pound may be obtained under moderate drain and temperature by 1965. These batteries are gradually coming into military use and may compete in the commercial market when costs are reduced.

For special uses, alkaline dry battery systems have advantageous characteristics. The zinc-mercuric oxide battery has good shelf life and the highest capacity of commercial dry batteries, although its low temperature performance is poor and its cost high. It is used in critical commercial and military operations, such as hearing aids, air-sea rescue equipment and satellites. Recently, a zinc-alkaline-manganese dioxide cell of moderate cost, designed for high rate (3-10 hour rate) continuous duty service, has been introduced and should find wide application. Batteries with built-in heating devices and vest batteries (worn under outer clothing) have also been designed and are among the methods for achieving performance at low temperatures (Fig. 2A).

Power requirements of missiles and rockets have

led to the development of a series of reserve batteries. The automatically activated zinc-silver oxide battery reported in 1958<sup>2</sup> (Fig. 2B) is used in a large number of DOD missiles. It is activated just before use. The battery is kept warm by resistance heating to insure performance regardless of the ambient temperature. Future designs will incorporate chemical heaters. For lower power and pulse applications, the thermal battery has proved effective.

For lower drain (2-20 hour rate applications), the water-activated battery is useful. Capacity is relatively high, up to 20 watt-hours per pound. Once activated, the reaction is exothermic and supplies enough heat to keep the battery warm down to -65 deg F. This battery is excellent for radiosonde use, as a low-temperature battery for radio equipment and in sea-water operations. A liquid ammonia system is also under study as a reserve battery, because of its promising low-temperature performance.

Interest in storage batteries has increased. New power systems have been introduced which require a secondary battery for energy storage and for handling peak power loads. Concurrently, new battery types have become available, with increased capacities and hermetic seals, which have reduced maintenance problems. This has also led to the use of storage batteries in applications which heretofore had used primary batteries almost exclusively, giving an advantage of reduced operating costs.

The lead-acid battery is the most widely used secondary battery. It provides reliable performance under moderate operating conditions at reasonable cost. It should maintain this good competitive position in automotive and industrial applications. The lead-acid battery, however, may not become important in the new developments.

The nickel-cadmium battery, particularly the sintered-plate construction, minimizes many of the limitations of the lead-acid battery. It is noted for its high cycle life, good shelf life, reliable performance and rugged construction, although its capacity is not outstanding. It is easily recharged, capable of being maintained on trickle or float charge, amenable to overcharge and can withstand long periods of storage. In the vented construction, the nickel-cadmium battery has been substituted for lead-acid and nickel-iron batteries in critical commercial and military applications such as aircraft, missiles, communication and surveillance equipment. Offering greater potential is the sealed nickel-cadmium battery, which can be operated with little maintenance, provided some means of regulated charging is provided. These sealed cells have the same characteristics as the vented cells, but must be more carefully charged. Hermetically sealed cells, on a 10-percent discharge cycle, have furnished thousands of cycles and have given over 2½ years of performance in the Explorer VII satellite. Deeper discharges will, however, reduce the cycle life. They are now available in a variety of sizes up to 100 ampere hours and may spark the introduction of many battery-operated devices in commercial, industrial and military uses.

The cadmium-silver oxide battery is attractive because its capacity is about double that of the nickel-cadmium battery, although its cycle life and perform-





(A)

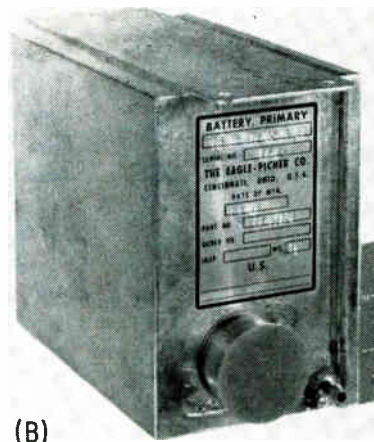

(B)

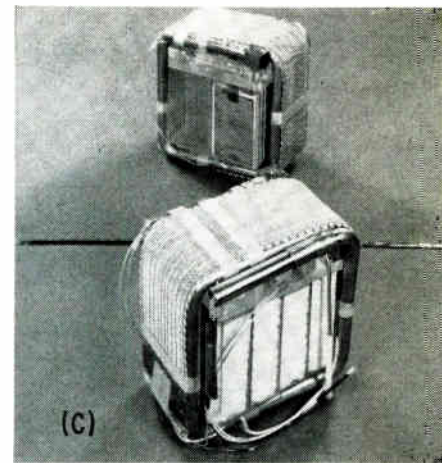

(C)

FIG. 2—Vest battery for radio set AN/PRC-6 (A). External (B) and internal (C) views of automatically activated zinc-silver oxide battery used in many missiles

ance reliability are inferior. This system is being investigated, too, in a sealed construction and will be more competitive with the nickel-cadmium battery in several years as its reliability and performance characteristics are improved. However, its higher cost will limit its use to those applications where small size and weight is a prime requisite.

The zinc-silver oxide battery also is available in a rechargeable design as well as a "wet" primary battery. Its advantage is its high capacity (three times that of nickel-cadmium) but its cycle life is 30-100 cycles, and then only under controlled conditions. A rechargeable version of the zinc-MnO<sub>2</sub> alkaline system is available. It, too, is limited in cycle life, but its cost will be low for a rechargeable system.

#### Fuel Cells

The fuel cell or continuously fed battery is the subject of extensive research and development in many government and commercial laboratories, although its wide application is not yet warranted.

Fuel cells operate like batteries. Fuel and oxidant are fed into the cell when electrical energy is required and an electrochemical reaction produces electricity. No moving parts are required except for auxiliary functions. This gives a capability for quiet operation, long life, and minimum maintenance. Since the fuel cell converts chemical energy directly into electricity, it is not Carnot cycle limited, and offers the possibility of fuel conversion efficiencies of 70 percent or better, and theoretical capacities (based on hydrogen and oxygen as the only active materials) as high as 1,600 watt-hours per lb.

Fuel cell is a generic term, covering a variety of electro-chemical systems and operations. Primary fuel cells can be considered in three categories: The low-temperature system operating between 60-90 deg C at normal pressures; the elevated-temperature system operating at 200-260 deg C and the high-temperature systems operating at 500-1,000 deg C.

The portable type most advanced is the low-temperature cell. This uses hydrogen as fuel and oxygen or air as the oxidant and water is the reaction product. This fuel cell should become competitive with other power systems in low-power applications from

50 watts to several kilowatts. One design employs metal electrodes and an ion-exchange membrane electrolyte. Another design uses catalyzed carbon electrodes and a liquid alkaline electrolyte.

A complete 200-watt air-breathing power source Fig. 3, is one of several experimental units. A 50-watt unit is being tested under Project Hope to determine its space flight capability and others are being considered for future manned space flights. The potential of the fuel cell has been demonstrated, but further development is required before it is practical. Its limitations are heavy weight (300 lb/Kw), large volume (10 cubic feet per kilowatt), the unsolved problems associated with water and heat balance for operation over a wide range of temperature and environmental conditions, and the need for designs to handle ancillary functions and meet mechanical conditions. Within two years, the desired minimum acceptable levels of 6 watts/lb and 200 watts/cubic foot with a 1,000-hour cell life should be reached.

The performance of the low temperature fuel cell can be increased by using pure oxygen instead of air. However, for ground applications, there is no advantage as the gain is minimized by the need to supply oxygen. For space applications values up to 500 watt-hours/lb have been predicted if operation exceeds 1,000 hours. This considerably exceeds the capabilities of primary batteries, but fuel cells for this application are as yet unproved and assumptions in the estimate may be unattainable.

The supply of hydrogen remains a problem. It can be supplied in tanks under pressure but this type of storage is heavy (50-100 lb of storage equipment for 1 pound of hydrogen giving about 10,000 watt-hours at 100 percent conversion efficiency). Using hydrides as fuels, which are decomposed to hydrogen with water or acid, the weight (including the generating system) can be reduced to 20 pounds, or with cryogenic storage to 5 pounds. Ultimately, it will be most desirable to use conventional carbonaceous fuels as a hydrogen source.

Alcohols have recently been considered as a fuel in low temperature systems. A number of experimenters have reported the ability to oxidize methanol elec-

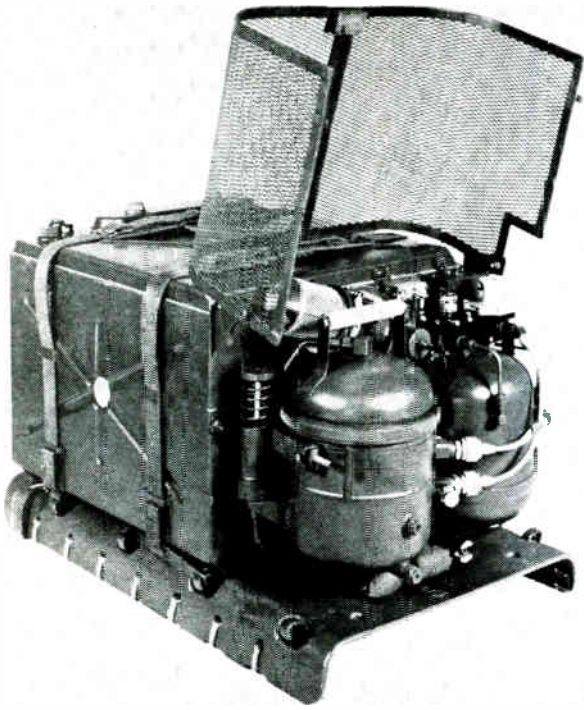

FIG. 3—Portable 200-watt fuel cell power source developed by GE

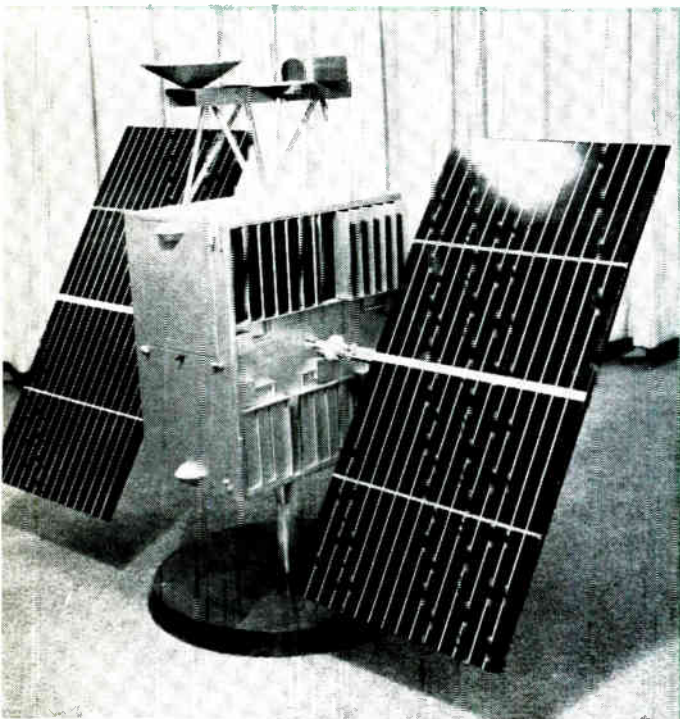

FIG. 4—Advent communication satellites will use solar cell panels that constantly orient to the sun

trochemically both in alkaline and acid electrolytes. Recent investigations are concentrated on acid electrolytes because of the deleterious effects of carbon dioxide absorption and reaction product formation in alkali. With acid electrolytes, the lower potentials and lower efficiency coupled with the present problem of achieving anodic oxidation of the fuel at practical current densities and low polarization will necessitate considerable R&D effort before application can be considered. The solution to these problems must precede the direct electrochemical combustion of hydrocarbon fuels.

The elevated-temperature cell offers higher power per unit weight and volume. The cell uses pure hydrogen and oxygen. It is not attractive as an economical primary system because of high cost of pure fuels and will probably not be satisfactory in sizes below 0.5 to 1 Kw.

High-temperature cells are promising for the direct conversion of carbonaceous fuels. Because the direct carbon cell has been demonstrated as infeasible, efforts are now directed towards hydrocarbon fuel gases and secondary fuels such as water-gas. Calculations based on the use of activated hydrocarbons as fuels show the possibility of achieving efficiencies up to 75 percent. These high-temperature cells, however, are at least a decade away from application. Even then, their use will be limited to large fixed stations and they will not be suitable for portable applications.

Many of the fuel cells reported are regenerative systems. In these cells, the reaction product is maintained in a closed system and reconverted to the original reactants by an external energy. This regeneration can be accomplished using electrical, thermal, light, chemical and radio-chemical energies.

The most common type of electrolytically regenerated fuel cells is the  $H_2-O_2$  cell in which the reaction product, water, is electrolyzed to yield hydrogen and oxygen. These regenerative cells fulfill the same role as a storage battery, although they are now inferior to secondary batteries. If suitable gas storage systems and mechanical designs can be developed, the electrically regenerated systems could be superior for applications requiring long discharge periods.

The thermally regenerative fuel cells are heat engines and their efficiency is limited by Carnot cycle consideration. System analyses indicate that the thermally regenerative fuel cell will not be competitive with other heat engines (Rankine cycle, thermoelectric, thermionic) now being considered for space and ground applications. Photochemically, radiochemical and chemical (redox cells) methods have also been studied for the regeneration of fuel cells, but results to date have not been promising.

Other techniques are being considered for the conversion of chemical to electrical energy. For short durations, high speed gas turbine engines are being developed as a secondary power system for missiles, using solid propellants, ethylene oxide or hydrogen peroxide as the fuel. The turbines are extremely compact and can deliver a regulated output (10-30 watt-hours per pound) over a wide temperature range. For most missile applications, the turbine has not received as wide an acceptance as the auto-

matically activated battery.

The use of bacteria and other simple organisms to produce power has been publicized recently. In these systems, bacteria acts as catalysts, to generate the fuel and oxidant necessary for electrochemical reactions from sea water, vegetation, wastes or other such indigenous materials. Many devices utilizing this principle can be foreseen. An experimental bio-ocean battery, has been built for the Navy by Magna Products, Inc., using a metal fuel and bacteria which derives the oxidant from sea water. Its energy density is low and it cannot be considered for portable applications, but if a suitable environment is available, such as sea-water, this battery may be useful for long-life requirements such as buoys, signal lights—or ultimately, in the conversion of sewage to useful energy.

#### *Photovoltaic Converters*

Solar energy is a free and inexhaustible source of energy that is available for the taking. Solar energy reaching the earth under conditions of full sunlight is about 1,000 watts per square meter and about 1,400 watts per square meter (2 calories/cm<sup>2</sup>/min) just above the earth's atmosphere.

At present, a satisfactory and simple means for converting solar energy into electrical energy is the silicon solar cell. Cells vary from one-half to several square centimeters in size, the most common one being 1 cm × 2 cm. They have an operating voltage of about 0.4 volt at optimum load and are connected in series-parallel to provide the required power. Although the theoretical efficiency of the silicon solar cell has been calculated at about 22 percent, the efficiency of cells in production has leveled off to 10 to 12 percent, with some going as high as 14 percent. Thus, at full sunlight on the earth's surface, the output of present-day solar cells is about 10 mw/cm<sup>2</sup> or about 40 watts per pound. However, they cannot be designed for the full output power because of degrading factors. These include variations of the incident energy, angle of the incident radiation, temperature, and, for space applications, the erosion by micrometeorites, the type and duty cycle of orbit and satellite orientation. Correcting for these factors and providing the necessary mechanical structure, the output power of most satellite supplies is designed at about 8 mw/cm<sup>2</sup> and at 2 w/lb unoriented. Silicon solar cells are now a reliable energy source for satellites. A silicon solar cell power supply placed on the Vanguard satellite and launched on March 17, 1958 is still operating after four years of service. Many other satellites have successfully used solar cells, including Pioneer V, Explorer VI and VII Transit, Tiros and Courier. Designs up to 600 watts are now under consideration for Advent and other larger systems (Fig. 4).

The use of solar energy on the ground has not progressed as rapidly, mostly because of the less predictable solar energy on the ground and because of the high cost of solar cells—approximately \$5 for a 1 × 2-cm cell with an 8-9-percent efficiency. Most ground applications are limited to experimental studies. A transistorized radio operating with solar cells is being marketed and the U. S. Army has con-



FIG. 5—Experimental solar powered battery charger for photoflash gun

sidered using a solar package for recharging small batteries and, in larger sizes, for remote unattended operation. Figure 5 shows an experimental solar-powered battery charger for a photoflash gun.

Work is under way to improve the operating characteristics of the silicon solar cell and to develop photovoltaic materials. One improvement in the solar cell was the use of a gridded contact on the surface of the cell to reduce its internal series resistance. Because of this decreased resistance, the optimum operating voltage of the cell is higher than the nongridded cells and increases the conversion efficiency by about 2 percent. Concentrators to obtain higher intensities of illumination and increase the power output of the solar cell are also under consideration. Drop-off in efficiency is slow with increasing intensity and a fairly uniform increase in power output is obtained with increasing intensity. Simple flat-plate concentrating devices could give a four-fold increase in power output and result in an overall cost reduction of 50 or 75 percent. Filters applied to the cell surfaces can also effectively reduce the operating temperature of the cell, thus increasing efficiency, and provide protection against mechanical damage, surface contamination, micrometeorite erosion, etc. Recently, the development of the blue cell was announced, suited to space environment by its greater response in the blue region, giving a 10-15 percent increase in output power. It is also expected to have a longer useful life because the shallower junctions have a higher nuclear radiation resistance. Another approach is the phosphorus diffused *n-p* silicon solar cell. This cell is even more resistant when exposed to radiation than the boron diffused *p-n* cell. These radiation-resistant cells have about the same efficiency as the *p-n* cell but should be useful for satellite applications and radiation environments.

The development of large-area solar cells made by depositing the photovoltaic material directly on a base material by vapor deposition or other techniques also will be important in reducing solar

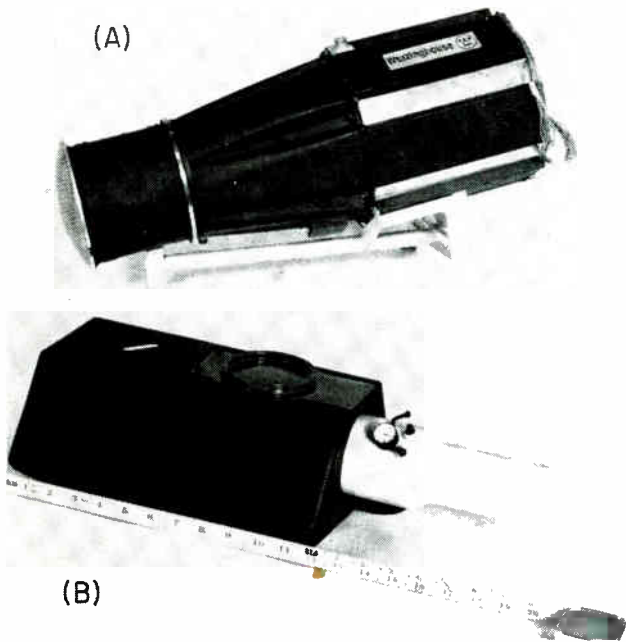

FIG. 6—Thermoelectric generators: 35-lb, 250-watt propane-fired generator (A); and model of 45-watt leaded-gasoline powered generator (B)

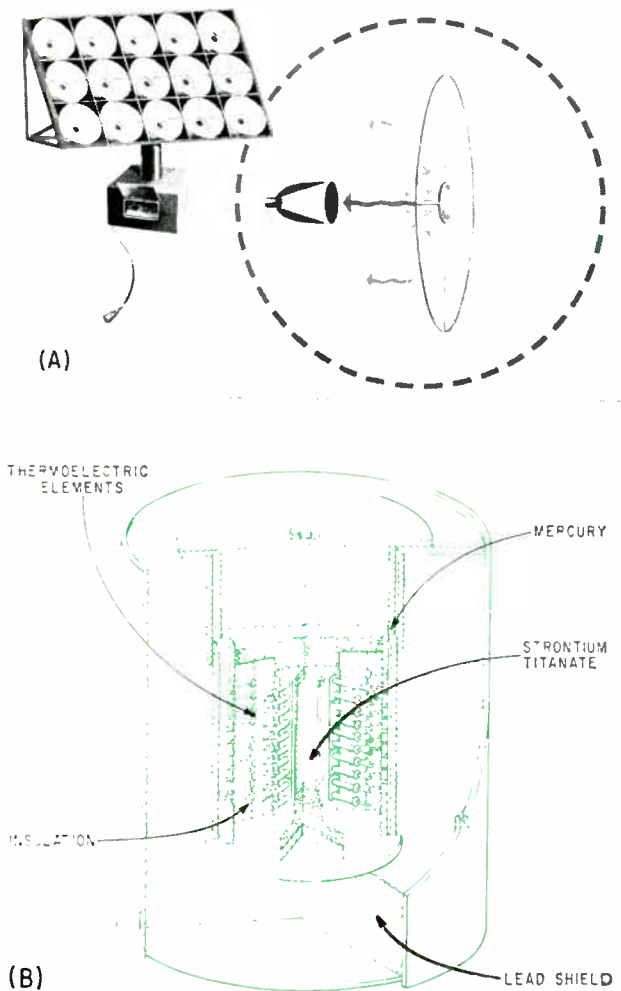

FIG. 7—Design of typical solar-thermionic energy source (A); and portable nuclear-powered electrical energy source (B) used in weather station near North Pole

cell costs. Techniques are being studied for depositing such thin films of silicon or other photovoltaic materials with the hope of achieving conversion efficiencies of 5 to 10 percent. Development of such a low-cost flexible mechanically-sound device would increase the opportunities for exploitation of solar energy on the ground. Forecast for the future is an inexpensive blanket-type converter that can be folded into a small, easily handled package and opened and exposed to the sun to obtain electrical power. Conceivably, up to 100 watts of electrical power could be obtained with a square yard of thin sheet solar converter. Other semiconductor materials under investigation for solar energy conversion include cadmium sulfide, gallium arsenide, gallium telluride and even multienergy-gap materials which ultimately may lead to conversion efficiencies in the order of 20 percent.

#### Thermal Energy Conversion

It is possible that production of electrical power will continue to rely chiefly on thermal conversion systems, although they will be completely different from the rotating types of today. The heat sources will be radioisotopes, solar concentrators or chemical sources for the lower power levels and nuclear reactors for higher power outputs. Conversion devices will be thermoelectric and thermionic generators with competition from Stirling or vapor Rankine cycle heat engines. Regenerative fuel cells will probably not be important. The magnetohydrodynamic (MHD) generator may become an important system for high power outputs, but it is in its infancy today.

Two important thermal energy conversion devices for the low power or portable range, are the thermoelectric and thermionic converters. Technologically, the thermionic converter is not as advanced as the thermoelectric device. However, its conversion efficiency should be considerably higher than the thermoelectric generator because it operates at a higher temperature, thus giving a higher Carnot efficiency.

Efforts in the thermoelectric field have resulted in the development of new materials with conversion efficiencies up to 12 percent and the construction of experimental units up to the five kilowatt size. Typical of recent units using new materials is a 35-lb, 250-watt propane-fired generator built for the Navy (Fig. 6A). Overall efficiency of the unit was about 1.4 percent, although the individual thermocouples had an efficiency of 4.4 percent. Lead telluride was used for the *n*-leg and germanium bismuth telluride for the *p*-leg. The unit operated at a hot-junction temperature of 450 deg C. with a cold-junction temperature of 130 deg C.

The Army is developing a leaded-gasoline powered generator for forward area applications, to provide 45 watts, with a weight of 10 lb, including fuel for 12 hours operation (Fig. 6B). The unit is expected to have a thermocouple life of 1,000 hours. The Air Force is sponsoring a program on a solar power thermoelectric generator for space application, having a power density of 20 watts per lb.

Thermoelectric generators that promise lower weight and smaller size are technologically ahead of other new systems under investigation and will prob-

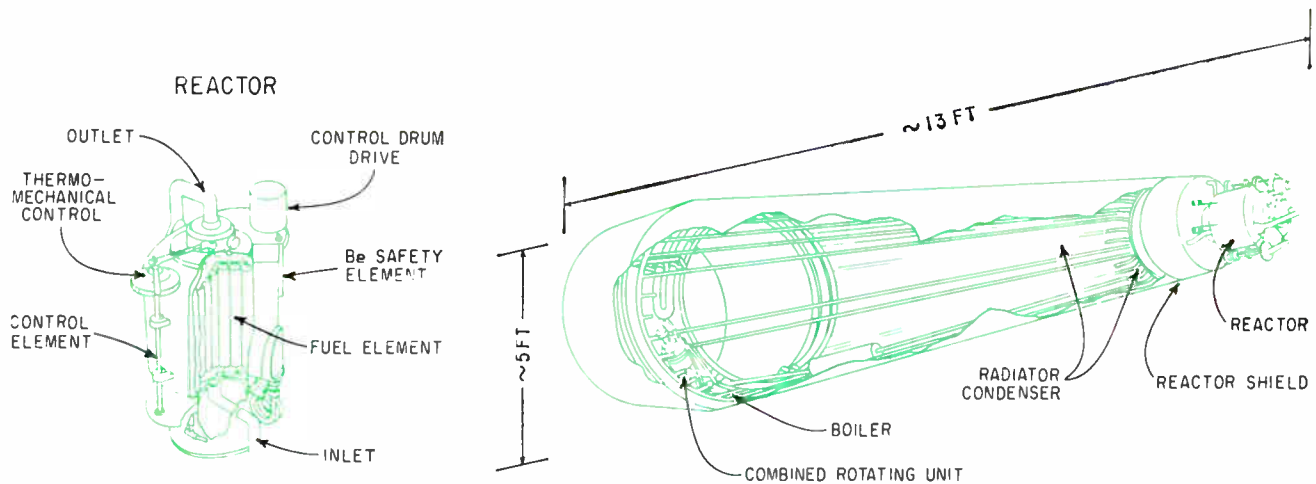

FIG. 8—SNAP 2 (Systems for Nuclear Auxiliary Power) electrical power source, with electrical power output of 3,000 watts, is scheduled for demonstration flight in 1963-64

ably be among the first used in practical applications. Testing of experimental models has brought to the forefront a number of problems (poor contact design and high resistance degradation and sublimation of materials during use, inadequate mechanical strength). These must be overcome before the system requirements of reliability, long life and high material efficiencies can be obtained. Initially thermoelectric generators will operate at low conversion efficiencies, but overall performance will be adequate so that they should be in use within two to three years.

The thermionic converter promises high conversion efficiency and power density. There are two major types of thermionic converters, each offering a different solution to the elimination of space charge that forms around the cathode and limits the performance of the thermionic diode. In the earlier or vacuum type, the spacing between the anode and cathode surface is kept small (about 0.5 mil) to reduce the space-charge effect. In the newer approach, an ionized vapor, such as cesium, neutralizes the space charge, increasing the flow of electrons and useful electrical output. Cathode-to-anode spacing in the cesium thermionic converters is about 10 mils, simplifying the mechanical structure and giving a five-fold improvement in performance over the vacuum converter. Efficiencies of 15-17 percent at a cathode temperature of 1,500 deg C have been reported.

The feasibility of the thermionic converter has been established. Work is continuing to increase power levels and efficiency, to find materials and designs compatible with the high operating temperatures, to achieve required long life and reliability and to develop practical structures in combination with the desired energy source. The thermionic converter is being considered for space applications as it is less susceptible to radiation than some of the other devices and can operate at high levels of radiation and high temperatures without serious damage. A typical solar-thermionic energy source is shown in Fig. 7A. An assembly of thermionic converters, mounted in suitable solar energy concentrators, can be used on an orientation pedestal to provide power

for a satellite or remote ground station. The thermionic converter is also being considered for portable ground applications, fired by gasoline, propane or other conventional fuels. A 45-watt, 10-lb gasoline-fired unit is being developed for the Army. Experimental models of other portable units, in sizes up to 200 watts, will be available for test and evaluation within two years.

The solar-Stirling engine systems and solar turbo-generator systems also are being studied. They may have advantages at the higher power levels, but the trend is towards the static converters for the medium and lower power level applications.

#### Nuclear Energy Systems

Nuclear energy provides a source of electrical energy in a compact form capable of yielding over 1,000 times the energy of a chemical source of the same weight. It is an important energy system for high power unattended or long-life operation.

There are two types of nuclear power sources, those using the energy released in the decay of radioactive isotopes and those employing a reactor. Although some low-power batteries employing direct conversion of nuclear energy have been developed, recent emphasis has been on the conversion of nuclear thermal energy into electrical energy, using both solid-state and dynamic heat engines.

Actual use of a portable nuclear-powered electrical energy source occurred in June 1961 when a plutonium-238 radioisotope fueled generator weighing 4.6 pounds was launched in the Transit IVA satellite and provided 2.7 watts of continuous power. In the summer of 1961 an atomic-powered weather station (Fig. 7B) was established about 700 miles from the North Pole. This Snap 7C unit, weighing 55 pounds (plus 1,600 pounds of shielding) used heat produced from radioactive decay of Strontium-90, and produced 10 watts of electricity by lead telluride thermocouples. Another similar device (Snap 7A) is being designed for a Coast Guard navigation buoy and is predicted to have a 10-year life.

The Snap (Systems for Nuclear Auxiliary Power) program has been responsible for most of the develop-

ment of nuclear-powered electrical power sources. This program is investigating both the radioisotope and the reactor powered devices, as well as solid state and dynamic engine converting devices.

Radioisotope units have a disadvantage in that the power production of the fuel is not constant, decreasing to one-half the original output in a half-lifetime. As most of the useful radioactive materials, with the exception of strontium-90, have lifetime of under one year, the life of these units is limited and the excess energy given off as heat during the early life of the unit must be dumped. Strontium-90 has a half-life of 25 years and provides a relatively constant power over the useful life of an energy converter, but heavy shielding must be provided and generator designs have to be established to provide protection. These characteristics will seriously limit the usefulness of radioisotope devices for other than remote applications.

The nuclear reactor power sources will probably be most satisfactory for achieving the high power requirements of space as well as certain terrestrial applications.

Reactor systems for the space program are Snap 10A and Snap 2. Each uses a compact uranium-hydride fueled reactor. In Snap 10, the reactor is coupled to a thermoelectric converter to produce 500 watts of electricity and will weigh about 525 pounds unshielded. In Snap 2 (Fig. 8), higher power is achieved by coupling the system to a small mercury-vapor turboalternator. The system has a thermal power of 50,000 watts and a designed electrical power output of 3,000 watts and weighs 750 pounds unshielded. The Snap experimental reactor, a prototype to demonstrate the feasibility of the Snap 2

project, operated for over 4,000 hours before the test was discontinued in November 1960. Demonstration flights of Snap 10 and Snap 2 are scheduled for 1963-64.

Snap 8, scheduled for 1965, is a scaled-up version of Snap 2. It is rated at 30 Kw, but has a reactor capable of driving two conversion systems to produce 60 Kw. The unshielded 30 Kw system will weigh about 1,500 lb., the 60 Kw system 2,500 lb. Higher power reactor-electric systems in the 300-Kw and 10-megawatt range using thermionic converters integrated into the reactor core or high temperature Rankine systems are also under consideration.

### Conclusions

Although progress in the development of portable electrical power sources has not been as rapid as expected, a number of new power systems will be available to the equipment designer within a few years. This wide variety of systems will be needed to satisfy new requirements. It is impossible to eliminate any of the major types of power systems from consideration as each will find a useful role.

A single ideal power source capable of fulfilling every requirement will not be obtained. Selection of the one most suitable for a specific application, therefore, represents a compromise among many factors.

A comparison of the power output of the different power systems as a function of service time (projected to the 1965-70 period when the newer systems should be available) is given in Fig. 9. The curves show typical performance, but a wide variation in performance is to be expected, depending on the power level, the specific electrical requirements, shielding, environmental requirements, space or ground applications, and other design factors. The chemical systems show up well for the short duration requirement or, as a secondary battery, for energy storage or for handling peak load requirements. The fuel cell and chemical-thermal systems will fulfill requirements in the medium life range. The solar and nuclear reactor systems are good for long periods of operation. The photovoltaic devices will be important at the lower power levels up to 1 kw, the solar-thermal systems from 100 w to 10 kw, and the reactor systems for the higher power levels.

These generalizations and broad comparisons cannot, of course, cover all of the factors involved in the selection of a suitable power source. More detailed information on the performance of the power source under the operating requirements of the equipment should be obtained before any final selection is made.

The author acknowledges the assistance of the members of the Power Sources division, U. S. Army Signal Research and Development Laboratory, and the industrial organizations who supplied information and photographs used in this article.

The views of the author do not reflect the position of the Department of the Army or Signal Corps.

### REFERENCES

- (1) D. Linden and A. F. Daniel, New Power Sources for Space-Age Electronics, *ELECTRONICS*, p 43, March 20, 1959.
- (2) D. Linden and A. F. Daniel, New Batteries for the Space Age, *ELECTRONICS*, p 59, July 18, 1953.

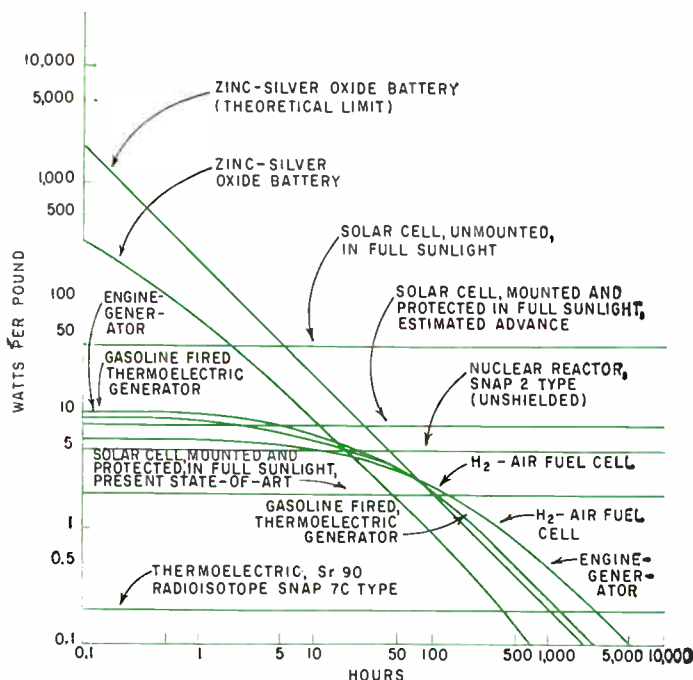

FIG. 9—Comparison of power output for different power systems. For solar and nuclear systems, fuel weight is zero

# Simple Test Sets Measure

## TUNNEL-DIODE PARAMETERS

*Important parameters can be determined with enough accuracy for most applications without actually tracing the diode curve*

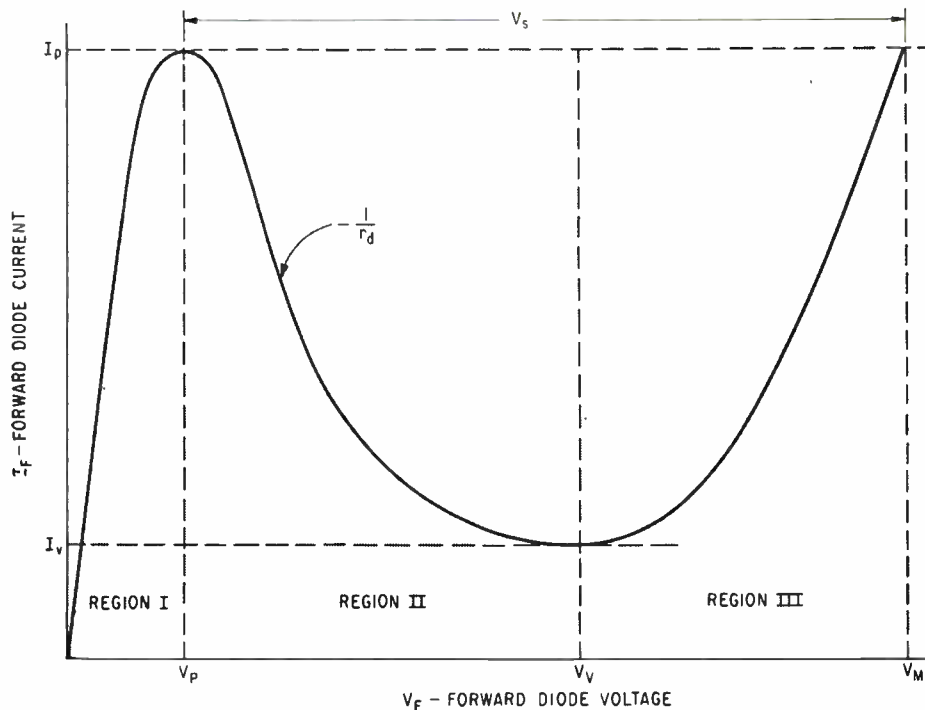

FIG. 1—Forward d-c characteristic curve for the tunnel diode

By CARL DAVID TODD Electronic Products Division, Hughes Aircraft Company, Newport Beach, California

AS TUNNEL DIODES become more common in electronic circuits, the need for measuring techniques and equipment assumes greater importance. Much can be learned from a study of the tunnel diode's static characteristic curve<sup>1, 2</sup>; however, this procedure becomes time consuming for large quantities of tunnel diodes.

Thus, certain d-c parameters are used to characterize tunnel-diode operation. These can be defined with the help of the static operating characteristic curve, shown in Fig. 1.

The curve has been divided into three operating regions. Region I is the first region entered as forward voltage  $V_F$  increases from zero. Current here is due primarily to quantum-mechanical tunneling; the slope of the characteristic, and hence the small-signal resistance, is positive.

As applied voltage  $V_F$  increases, current enters Region II; here the current decreases for an increasing voltage. Current flow here is due primarily to tunneling and the so-called excess current effect.

Finally, region III is entered as the slope changes from negative to positive. The current now consists of the excess, present also in region II, with an added current due to minority carrier injection as encountered in  $p-n$  junction diodes.

The peak tunneling current,  $I_P$ , is the maximum value of forward current the major portion of which may be attributed to tunneling. It is the highest value of current for which the value of equation  $dI/dV$  is zero.

Valley current,  $I_V$ , is the minimum forward current that will sustain operation in any other than the lowest voltage region (II). It is the lowest current for which the

value of  $dI/dV$  is zero.

Peak to valley current ratio,  $H = I_P/I_V$ , is the ratio of the peak tunneling current to the valley current. For a perfect diode without the presence of an excess current, the ratio would be almost infinite. For germanium tunnel diodes, values of 3 to 15 represent the normal spread.

Reverse diode current  $I_R$  is the current flowing when the tunnel-diode junction is negatively biased by a reverse voltage  $V_R$ .

Junction power dissipation  $P_J$  is the steady-state power dissipated by the junction, or the product of  $I_F$  and  $V_F$  if operation is in the forward region, or of  $I_R$  and  $V_R$  if operation is in the reverse current region.

Maximum voltage  $V_M$  at  $I_F = I_P$  is the forward voltage necessary to cause a current flow greater than the peak tunneling current  $I_P$  by

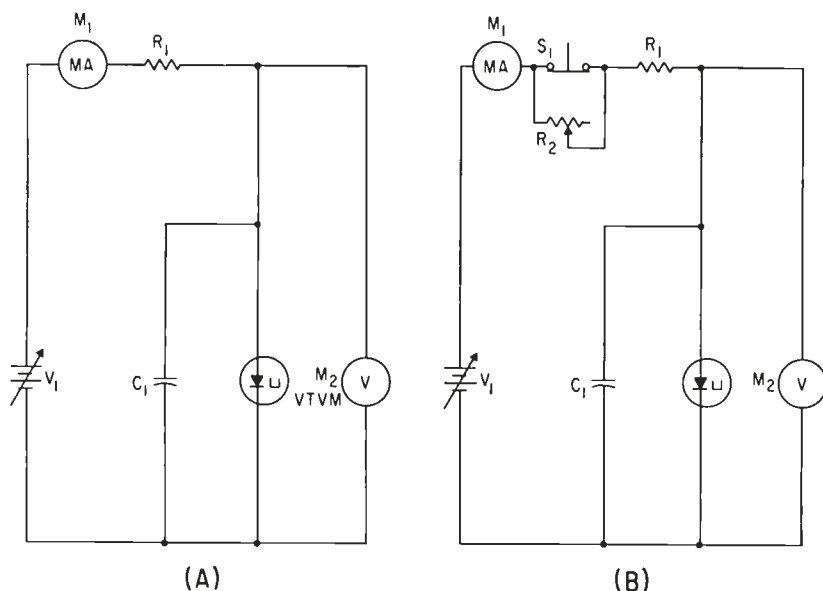

FIG. 2—Two simple test circuits: for measuring currents  $I_p$  and  $I_v$ , (A); for measuring ratio  $H$ , (B)

an infinitesimal amount. It is also the theoretical maximum voltage that may exist across a tunnel diode with an infinite-resistance load line chosen for bistable operation.

Voltage at the peak tunneling current,  $V_p$ , is the forward voltage that causes the maximum tunneling current to flow. Voltage  $V_p$  defines the boundary between regions I and II in Fig. 1. For a voltage less than  $V_p$ , by an infinitesimal amount, the small-signal a-c resistance is positive and for a voltage greater than  $V_p$ , by an infinitesimal amount, the small-signal a-c resistance is negative.

Voltage swing  $V_s$  is the maximum voltage swing for an ideal bistable condition having two stable voltages  $V_p$  and  $V_v$ ;  $V_s$  is the difference between  $V_v$  and  $V_p$ .

Valley voltage  $V_v$  is the forward voltage necessary to cause the valley current,  $I_v$ , to flow, yet with  $dI/dV$  equal to zero. This voltage defines the boundary between regions II and III. For a voltage slightly below  $V_v$ , the small-signal a-c resistance is negative and for a voltage greater than  $V_v$ , the small-signal a-c resistance is positive.

A simple test circuit for measuring the current parameters  $I_p$  and  $I_v$  is shown in Fig. 2A. The tunnel diode is inserted in the test socket and voltage  $V_1$  is slowly increased from zero until a sudden increase occurs in the forward volt-

age of the tunnel diode as indicated by vacuum-tube voltmeter,  $M_2$ . The current measured by meter  $M_1$ , just before the tunnel diode switches is the peak current of the tunnel diode. If  $V_1$  is large compared to  $V_v$ , of the tunnel diode, then the current indicated by  $M_1$  will be the same before and after switching has occurred. Capacitor  $C_1$  prevents premature switching of the tunnel diode due to transients.

If voltage  $V_1$  is much greater than peak voltage  $V_p$ , the value of  $I_p$  may be determined by dividing the value of  $V_1$  by the value of the series resistor,  $R_1$ .

The tunnel diode has switched from region I to region III along a constant current load line. If  $V_1$  is now decreased slowly, the tunnel diode will switch back to region I as the current is decreased below the value of  $I_v$ . Again this switching action may be noted by observing  $M_2$ . The value of  $I_v$  is that current indicated by  $M_1$ , just prior to the switching action. If the value of  $V_1$  is high enough with respect to the valley voltage, no change in current will be noted.

In either measurement, voltage  $V_1$  could have been held constant and the value of the series resistor  $R_1$  varied to increase or decrease the current as desired.

The circuit of Fig. 2B is similar to that of Fig. 2A with the addition of switch  $S_1$ , and the variable

resistance  $R_2$ . If, as before,  $V_1$  is slowly increased from zero until meter  $M_2$  indicates a switching action, the current flowing is equal to  $I_p$  and, in terms of the circuit constants, is  $V_1/R_1$ , assuming  $V_1$  is much greater than  $V_v$ . Now if  $V_1$  is kept constant, switch  $S_1$  depressed, and resistor  $R_2$  increased, the current through the tunnel diode will decrease. When the current drops to an amount equal to  $I_v$ ,  $M_1$  will again indicate a switching action. The value of the valley current

$$I_v = \frac{V_1}{R_1 + R_2} \quad (1)$$

The value of the ratio of  $I_p$  to  $I_v$  is

$$H = \frac{V_1/R_1}{V_1/(R_1 + R_2)} = \frac{R_1 + R_2}{R_1} \quad (2)$$

Note that the ratio obtained is independent of the supply voltage  $V_1$ , although for accurate results,  $V_1$  must be much greater than  $I_v$ . Furthermore, a dial attached to resistor  $R_2$  may be linearly calibrated directly in  $H$ .

If the test circuit of Fig. 2A is used to measure the quantitative values of the tunnel diode forward voltage  $V_p$  just prior to and immediately after switching from region I to region III, the values of  $V_p$  and  $V_v$ , respectively are obtained. The voltage swing  $V_s$ , is the difference between  $V_v$  and  $V_p$ .

The voltage indicated by meter  $M_2$  just prior to switching caused by a sufficient increase in  $R_2$  is the value of the valley voltage,  $V_v$ .

The shape of the tunnel diode characteristic curve makes it difficult to obtain accurate measurement of  $V_p$  and  $V_v$  by this technique although the results will be adequate for most uses. Should an accurate measurement of  $V_v$  and  $V_p$  be necessary, a technique is available for measuring the slope to indicate operation at the peak or valley points.<sup>2</sup>

A test circuit that will allow the measurement of most of the d-c parameters is shown in Fig. 3. It consists of a variable current source whose output is indicated by a multiturn dial and a provision for measurement of the forward diode voltage,  $V_p$  by the use of an external vtvm.



No effort has been exerted to stabilize the tunnel diode and hence it will not remain in the negative resistance region (II, Fig. 1) but will proceed to either a low voltage state, region I, or a higher voltage state, region III. By noting the reading of the d-c vtvm, the state of the device may be determined.

The value of  $I_p$  is obtained by noting that value of current which just causes switching from region I to region III. If the current is adjusted to a value less than  $I_p$ , momentarily depressing switch  $S_1$  (RESET) will cause the tunnel diode to remain in region I. The current is then slowly increased until the reading of the d-c vtvm increases sharply and the value of  $I_p$  may be read from  $R_1$ . Should the dial be turned too far, it should be turned back a little at a time until that current is reached, which will allow steady reset back to region I on the momentary depression of  $S_1$ .

Current  $I_v$  is found by determining the value of current that just demands switching from region III to region I. If the tunnel diode is not in region III, a momentary depression of switch  $S_2$  (SET) will shift the operating point into that region;  $I_v$  may also be determined as the maximum value of current that will allow self-resetting after  $S_2$  has been momentarily depressed.

Two current ranges are provided for  $I_v$ ; one covers a range from about 50 microamperes to 1 ma, the other from 0.5 ma to 10 ma.

The voltage drop across the tunnel diode is approximately 300 to 400 mv greater for region III than for region I (for germanium units). To compensate for this voltage difference and retain the same calibration, a diode ( $D_1$ ) with approximately 350 mv forward drop is placed in series with  $R_3$  when making  $I_v$  measurements. For other measurements, when the tunnel diode is in region III, the diode is shorted out. This compensating voltage as well as the  $V_{BE}$  drop of the transistor can be provided by a voltage drop across  $R_2$ . This voltage is adjusted by changing  $R_2$  until the dial reads correctly at some low-scale reading.

The measurement of  $H$  is a two-step procedure. The peak current is measured in a normal manner leav-

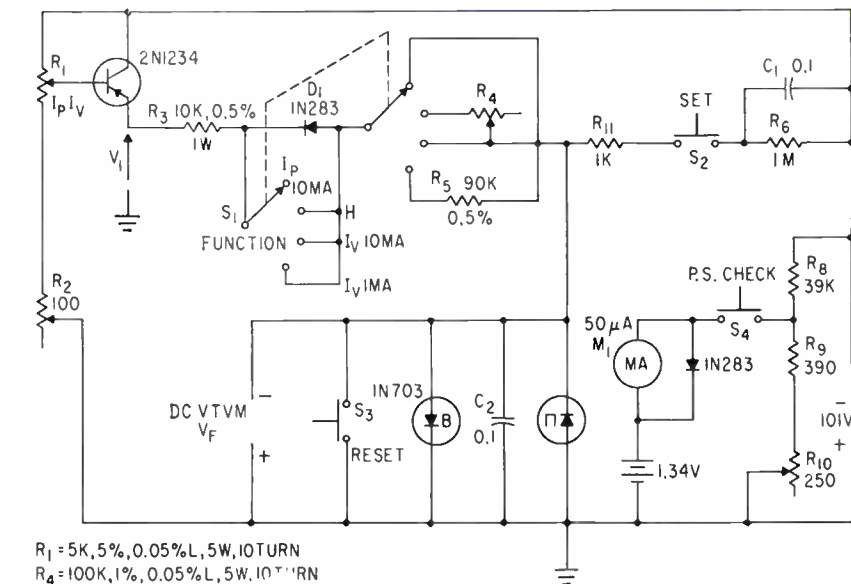

FIG. 3—Test set for quantitative measurement of all d-c parameters of the tunnel diode

ing the tunnel diode in region III but with a forward current equal to  $I_p$ ; FUNCTION switch  $S_1$  is then placed in the position marked H and potentiometer  $R_1$  is slowly increased until switching from region III to region I is noted on the vtvm. The ratio may then be read from the dial of  $R_1$ . Here again, if  $R_1$  is turned too far, it may be backed off by a small amount at a time until a momentary depression of  $S_2$  leaves the tunnel diode in region III.

The value of  $I_v$  is approximated by the value  $V_1/R_3$ . For  $I_v$  measurement

$$I_p = \frac{V_{1P} - V_{F1}}{R_3} \quad (3)$$

$V_{F1}$  is drop across  $D_1$ ,  $V_{1P}$  is  $V_1$  with dial set to  $I_p$ . Performing the steps for  $I_p/I_v$  measurement, the voltage  $V_1$  is the same but the current (equal to the value of  $I_v$ ) is given by

$$I_v = \frac{V_{1P} - V_{F1}}{R_3 + R_4} \quad (4)$$

If the forward drop across diode  $D_1$  is approximately equal to the valley voltage of the tunnel diode, the value of  $H$  reduces to:

$$H = \frac{R_3 + R_4}{R_3} \quad (5)$$

The dial of  $R_1$  may be displaced by one turn to allow direct reading if the total value of  $R_1$  is made ten

times the value of  $R_3$ .

The peak voltage,  $V_p$ , may be read on the vtvm just before the peak current is reached and the tunnel diode switches into region III.  $V_v$  is the voltage indicated by the vtvm just after switching into region III occurs.

The valley voltage  $V_v$  may be obtained by reading the vtvm just before switching back to region I occurs. Forward voltages less than  $V_p$  may be read with  $S_1$  in the  $I_p$  position, the dial of  $R_1$  indicating the value of  $I_p$ . Voltages greater than  $V_v$  may likewise be read with  $S_1$  in one of the  $I_v$  positions with the dial of  $R_1$  again indicating the value of  $I_v$ .

For ease of calibration, a mercury cell reference and meter comparator has been included. Resistor  $R_{10}$  is adjusted during initial calibration. This eliminates the necessity of measuring the supply voltage with an external meter.

The test set of Fig. 3 is intended primarily for reasonably accurate measurement of quantitative values. For production tests, a much simpler set must be used.<sup>3</sup>

#### REFERENCES:

- (1) H.G. Doll and M.R. MacPherson, Tracing Tunnel Diodes, *ELECTRONICS*, **33**, p 62, Aug 5, 1960.
- (2) C.D. Todd, Measurement of Tunnel Diode Negative Resistance, *Review of Scientific Instruments*, **32**, p 338, March 1961.
- (3) C.D. Todd, Tunnel Diode Parameters *IRE Trans on Instrumentation*, **1-10**, p 57, Sept 1961.

# Telemetry

*In this novel application of telemetry to sports-equipment research, a miniature transmitter in the helmet of a football player radios data on impacts that helmet—and player—receive. Equipment on sidelines receives and records data*

By JAMES S. AAGAARD  
JOHN L. DuBOIS,  
Dept. of E. E., Northwestern U.,  
Evanston, Ill.



Authors and two associates look over the helmet that has the transmitter. Receiving equipment is in foreground

INJURIES AND DEATHS among football players, particularly in high schools, have caused increasing concern in recent years. Although the helmet itself is a possible cause of injuries, there is a lack of information concerning its function and how much protection it must supply. Figure 1 shows a system that provides such information, telemetering impact data from the inside of a helmet (Fig. 2) while the wearer plays football.

This f-m/f-m system carries only a single channel of acceleration data. Although multiplex techniques are not necessary for a single channel, they were used for two reasons. The first is that more channels may be used eventually. The second reason is that the sub-carrier oscillator can be constructed in such a way that it is much more immune to shock and vibration than the main-channel oscillator. This prevents extraneous output signals being produced by vibration of the transmitter.

Because of the limited space in

the helmet, a simple design was chosen. Although commercial systems are available that do not occupy any more volume than the one

constructed, they do not meet size and shape requirements. The equipment is limited in thickness to a half inch or less and is located entirely in the crown area of the helmet. Sufficient space is left so there is no danger of the player's head coming on contact with any equipment.

The entire assembly is encapsulated in two sections in a silicone rubber potting material, and attached to the helmet shell with nylon screws. A 12-volt 10-hr mercury battery pack is used.

The transmitter accelerometer (Fig. 1A and Fig. 3) is a piezoelectric unit having a capacitance of 500 pf. To maintain response down to a few cps, the amplifier ( $Q_1$  to  $Q_4$ ) preceding the voltage-controlled subcarrier oscillator ( $Q_5$  to  $Q_n$ ) must have an input impedance of 100 megohms or more. This impedance is obtained by using a combination of positive and negative feedback in  $Q_1$  to  $Q_n$ .

Subcarrier oscillator  $Q_5$  to  $Q_n$  is an astable multivibrator that runs

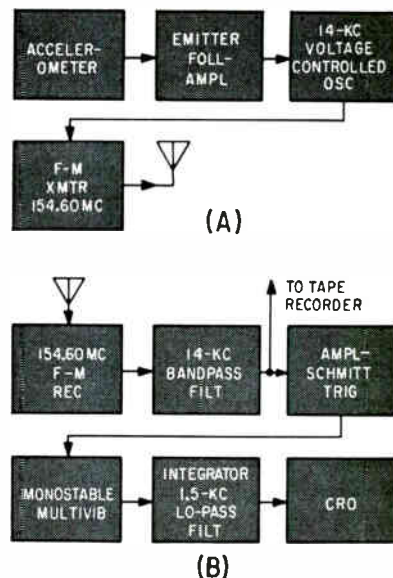

FIG. 1—Helmet transmitter (A) sends data to receiver (B) on sidelines

# Impact Data from the Football Field

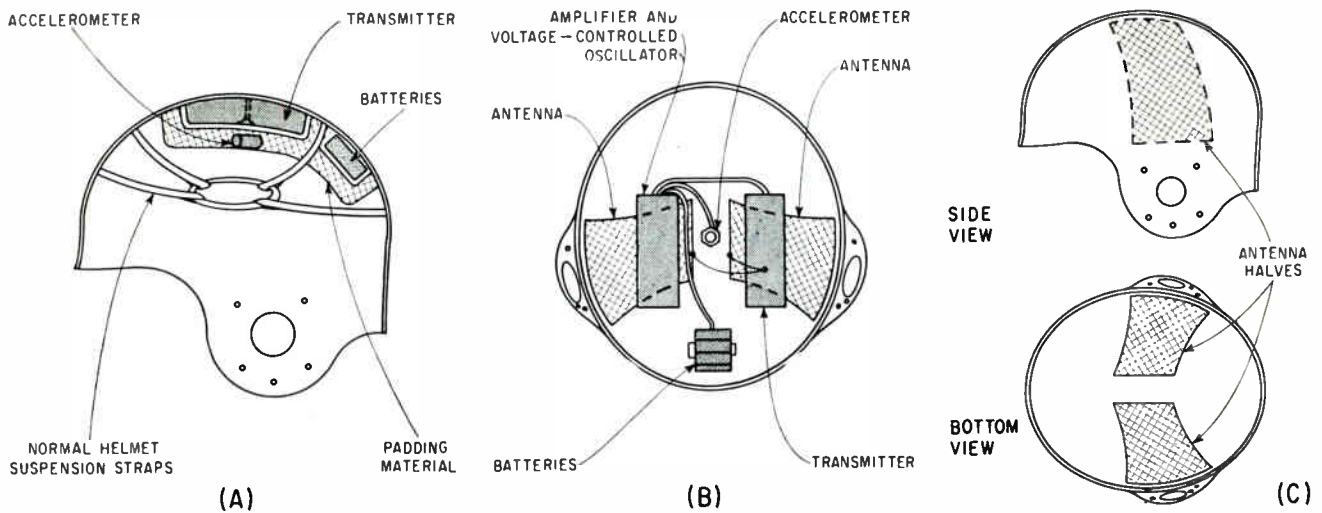

FIG. 2—Section (A) through side of helmet. In (B), view is looking into bottom of helmet, with padding material removed to disclose equipment. Views in (C) show antenna halves, which consist of conducting paint

at 14 Kc. Charging current to timing capacitors  $C_1$  and  $C_2$  is controlled by the input signal. A band-pass filter removes the higher harmonics from the rectangular output of the multivibrator. Maximum subcarrier deviation is 2 Kc.

The crystal-controlled oscillator ( $Q_6$ ) uses the third overtone of the 51.55-Mc crystal. Oscillator frequency is varied plus or minus 7 Kc by the subcarrier, which is applied to the base of  $Q_6$ . The oscillator is inductively coupled by  $T_1$  to a tripler ( $Q_{10}$ ). Transformer  $T_2$  couples  $Q_{10}$  to amplifier  $Q_{11}$ . A pi-network couples  $Q_{11}$  to the antenna, which consists of two areas of conducting paint on the inside of the helmet (Fig. 2B). Output frequency is about 150 Mc and power is about  $\frac{1}{2}$  mw.

The receiver uses a yagi-type antenna in which the plane of the directors rotates around the boom. This tends to reduce the effects of changes in polarization of the transmitted signals as the player moves. An f-m communications receiver is used, followed by a band-pass filter and a pulse-counting type of subcarrier detector. A low-pass filter removes the ripple from the output. Maximum information frequency is about 1 Kc. During use of the equipment at a game,

the subcarrier is recorded on magnetic tape for later analysis.

The waveshapes in the inset of Fig. 3 show a comparison of the telemetered output from the system using an accelerometer in the helmet with the output from a di-

rect connection to an accelerometer mounted in a dummy head (broken lines).

Funds for this work have been provided by Evanston Hospital and the Northwestern University Medical School.

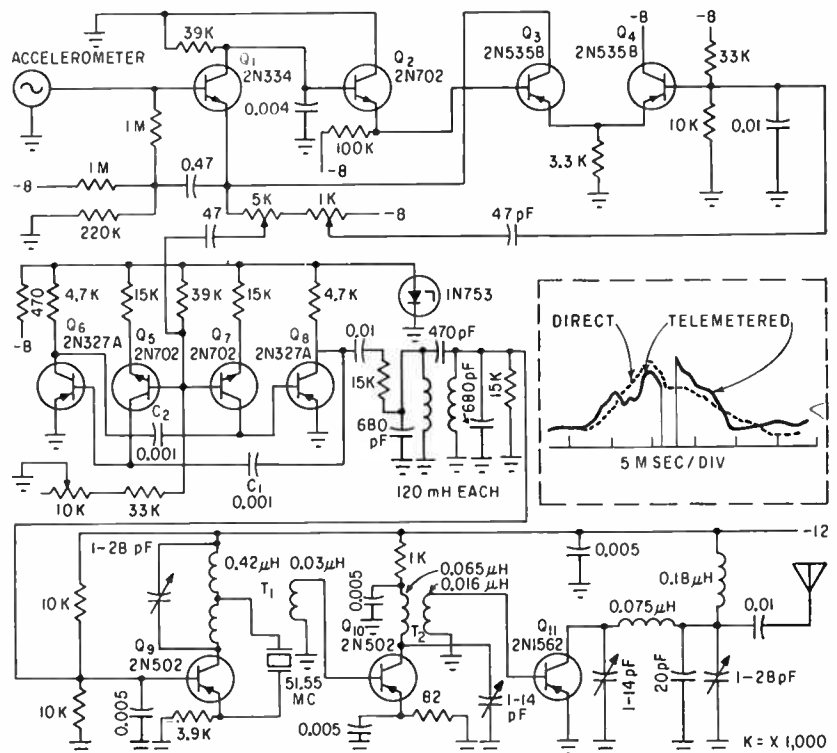

FIG. 3—Helmet f-m transmitter transmits impact data sensed by accelerometer. Inset compares telemetered waveshape with a test waveshape

# Using a Vibrating Capacitor as

*Instead of using a conventional chopper to convert a d-c input signal, the author uses a vibrating capacitor as the conversion element of an electrometer. He shows how to optimize parameters of the vibrating capacitor and of the associated circuit components*

By V. J. CALDECOURT

Chemical Physics Research Laboratory  
The Dow Chemical Co.,  
Midland, Michigan

MEASURING the output of phototubes, ionization chambers, mass spectrometers and many other scientific instruments involves the measurement of currents as small as  $10^{-12}$  ampere or less. This is commonly done by passing the measured current through a high resistance,  $10^{11}$  ohms or more, and amplifying the voltage drop. Since the input impedance is so high an electrometer amplifier is required.

One simple electrometer amplifier uses a low-grid-current tube with a  $10^{11}$  ohm resistor in its grid circuit; the tube is followed by a d-c amplifier. Such amplifiers have attained a high degree of perfection using balanced circuits. However, they are difficult to make with long-term zero stability, that is, with drift rates as low as fractions of a millivolt per day, noncumulative. Long-term zero stability is desirable because it allows unattended operation and long integrating times; lengthening integration time

lowers the minimum current level that can be detected.

Chopping a d-c current to produce a-c, amplifying the a-c signal with an a-c amplifier, and then converting back to d-c with a synchronous detector is a well known way of providing d-c amplification with excellent zero stability. This approach is used in the electrometer shown in Fig. 1, where a vibrating capacitor is used, rather than a chopper. The vibrating capacitor provides a power gain while performing this function.<sup>1</sup>

However, the vibrating capacitor and associated parts add appreciable capacitive loading to the input circuit. This can result in a loss in information. If a pulse change in current occurs, the resulting voltage change is attenuated and the signal-to-noise ratio reduced. The loss in output signal can be compensated by using a feedback amplifier<sup>1</sup> but this will not restore the signal-to-noise ratio. Thus, designing a vibrating-capacitor circuit centers around two concepts: (1) the total shunt capacitance should be held to a minimum; (2) capacitances  $C_1$

(the vibrating capacitor) and  $C_2$  in Fig. 1 are a compromise between the requirements of the first statement and the need for good d-c to a-c conversion efficiency.

Consider the conversion problem first. The capacitance combination of  $C_2$ ,  $C_3$ , and  $C_4$ , dictates much of the design. For good conversion efficiency, vibrating capacitor  $C_1$  must have a maximum capacitance large compared to this capacitance combination. Residual capacitances  $C_2$  and  $C_3$  can be minimized by layout and choice of amplifier tube. Capacitance  $C_2$  is chosen to provide good signal transfer to the grid of  $V_1$ .

In addition to these capacitances, the total shunt capacitance includes  $C_5$ , which comprises the source capacitance plus the shielded conductor to the source. The source capacitance is usually determined by other design factors and can not be easily changed. The shielded conductor can contribute excessively to the total capacitance if long leads or a high-capacitance coaxial conductor is used. This frequently causes a significant loss in signal-to-noise ratio.

These qualitative statements can be expressed mathematically by deriving the peak-to-peak voltage output in the parameters shown in Fig. 1. The design equations are developed in peak-to-peak voltage since expressions for the complete waveshape are complex. The waveform is not a simple sine wave.<sup>2,3</sup>

In Fig. 1 circuit components are shown by solid lines and the significant stray capacitances are

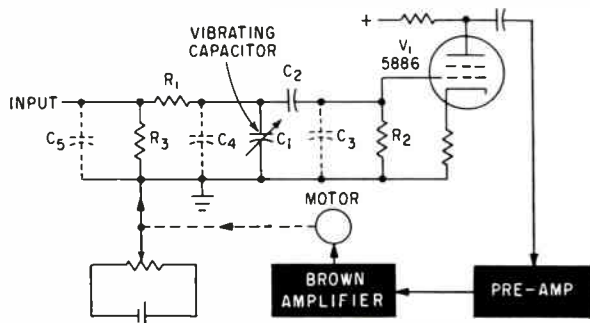

FIG. 1—Simplified circuit shows how vibrating capacitor  $C_1$  is used in the front end of an electrometer

# an Electrometer Input

shown by dotted lines. Leakage resistances can usually be made negligible in comparison to the resistance values.

When considering the output of the converter at the carrier frequency (the vibration frequency of  $C_1$ ), resistors  $R_1$  and  $R_2$ , can readily be chosen so that they become unimportant. This will be true if  $R_1 C_1 > 1/f$  and  $R_2 C_2 > 1/f$ , where  $f$  is the carrier frequency. For simplicity the capacitances can be grouped:

- $C_N$  = minimum value of  $C_1$
- $C_M$  = maximum value of  $C_1$
- $C_R$  (a residual capacitance)
- $= C_3 + C_2 C_3 / (C_2 + C_3)$
- $E$  = d-c input voltage
- $\Delta E$  = peak-to-peak a-c voltage out.

For a given charge in  $C_1$ ,  $Q$ , which will remain essentially constant during a period of vibration because of  $R_1$ ,

$$\Delta E = \frac{Q}{C_N + C_R} - \frac{Q}{C_M + C_R}$$

$$= Q \frac{C_M - C_N}{(C_N + C_R)(C_M + C_R)}$$

which can be rearranged\*

$$\frac{\Delta E}{E} = [(C_M C_N)^{1/2} + C_R] \times$$

$$\left[ \frac{C_M - C_N}{(C_N + C_R)(C_M + C_R)} \right]$$

In practical electrometers  $C_M \gg C_R$  and  $C_M \gg C_N$ . Hence

$$\Delta E/E = [(C_M C_N)^{1/2} + C_R] / (C_N + C_R) \quad (1)$$

Since efficiency is highly dependent on the  $C_R$  term in the denominator,  $C_R$  should be made small.

For a given  $C_M$  and  $C_N$ , there is an optimum value  $^1$  for  $C_N$

$$C_N = [-C_R + (C_R^2 + C_M C_R)^{1/2}] C_M^{1/2} \quad (2)$$

As an example, let  $C_M = 30$  pf and  $C_R = 8$  pf; then  $C_N = 2.95$  pf, for an optimum amplitude.

Capacitor  $C_2$  couples the a-c voltage generated by  $C_1$  to the grid of  $V_1$ . At first glance it would appear that  $C_2$  should be made large compared to  $C_3$  to obtain maximum carrier signal transfer to the grid. However,  $C_2$  significantly affects the response time at low frequencies, that is frequencies less than  $\frac{1}{10}$  the carrier frequency, because  $R_2$

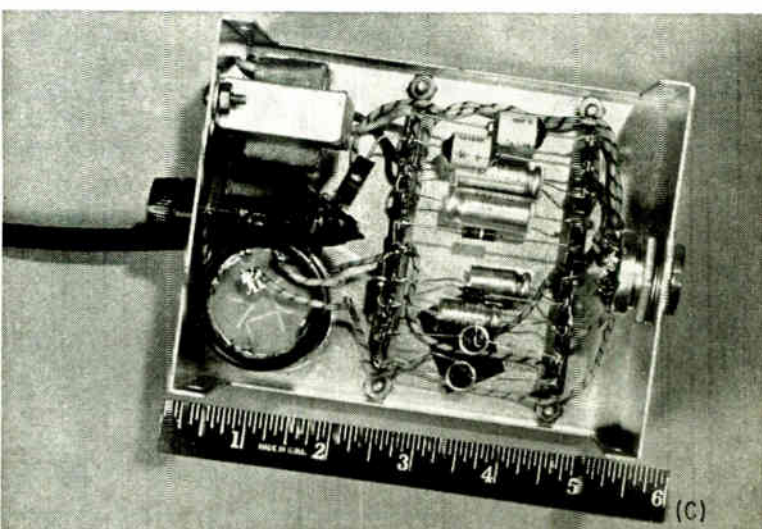
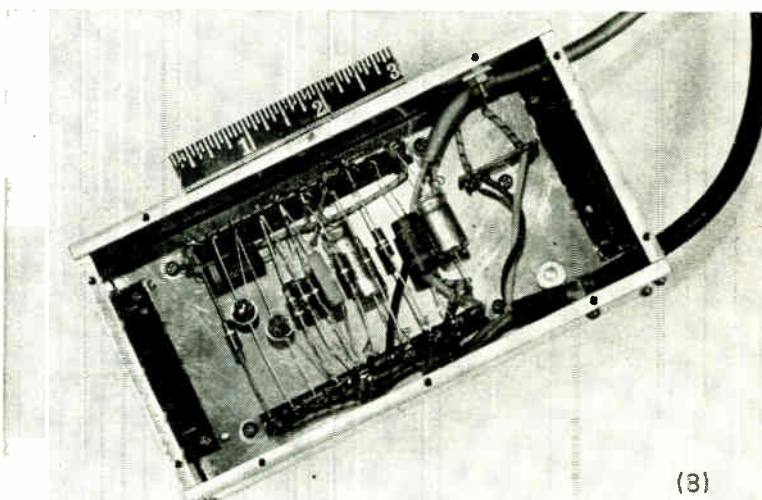
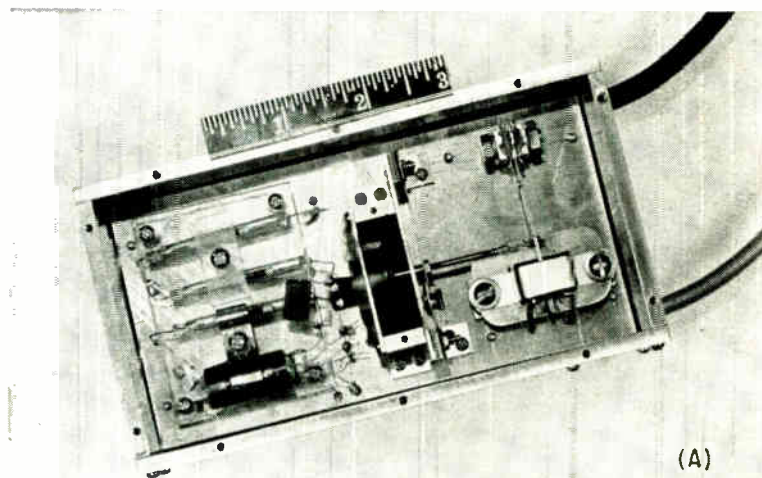

FIG. 2—Vibrating-capacitor assembly (A) is on one side of the electrometer case and preamplifier (B) is on the other. Power supply (C) is in a separate unit

acts as a short circuit and  $C_2$  contributes to the total capacitance sharing the available charge. The optimum value for  $C_2$  is

$$C_2 = [C_3 (C_{nv} + C_1 + C_5)]^{1/2} \quad (3)$$

where  $C_{nv}$  = average capacitance of  $C_1$  when vibrating.<sup>4</sup> The optimum value of  $C_2$  is small. For example if  $C_n = 4$  pf,  $C_1 = 5$  pf,  $C_{nv} = 10$  pf and  $C_5 = 25$  pf,  $C_2$  should be 12.6 pf. Values of  $C_2$  larger than the optimum will reduce the signal-to-noise ratio.

Figure 2 shows a vibrating-capacitor converter designed to the criteria of Eq. 1, 2 and 3. This converter replaced the Brown converter used in a Brown recorder. The vibrating capacitor and preamplifier are mounted in a separate box mounted close to the signal source to minimize  $C_5$ .

Note the low-capacitance construction used in Fig. 2. The first-stage electrometer pentode introduces about 3 pf input capacitance. Parts are mounted well away from the metal chassis to minimize wiring capacitance. The vibrating electrode of the vibrating capacitor is mounted on a parallelogram leaf spring arrangement so that a large amplitude of electrode movement can be attained. The wiring plus the stray capacitance of the vibrating capacitor adds 5 pf, bringing the total residual capacitance to 8 pf. When the  $\frac{3}{8}$ -inch-diameter moving electrode is 0.002 inch from the stationary electrode,  $C_v = 30$  pf. When the electrode separation is 0.02 inch,  $C_v = 3$  pf. Using Eq. 1 above  $\Delta E/E = 1.13$ .

Another advantage of the parallelogram spring mounting is that it provides a mechanical mounting

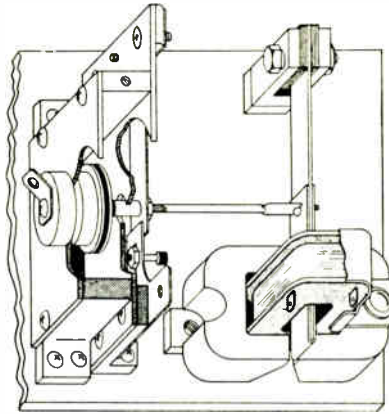

FIG. 3—Drawing shows mounting of vibrating capacitor  $C_1$ .

resistant to motion in modes other than the one it is designed for and therefore is less subject to extraneous vibrations (see Fig. 3).

The surfaces of the vibrating capacitor are coated with Aquadag and lightly polished with a lintless cloth. Residual contact potentials are less than 20 mv and stable. Drift rates of  $\pm 0.2$  mv per day, noncumulative, are typical. A small response, less than 1 mv, has been observed to changes in absolute humidity. This could be stabilized by hermetically sealing the unit.

The drive unit—vibrating leaf, drive coil and permanent magnet—are parts from a Brown converter. These parts were used partly for convenience and partly because they provided a simple way to secure a converter whose phasing would be compatible with the Brown amplifier. The Brown drive unit will provide about 40 to 60 mils of electrode travel.

A mechanical stop is on the outside of the vibrating capacitor housing (Fig. 2A). This prevents

hammering of the electrodes when starting up. The transient occurring when the drive is first turned on causes an overshoot which tends to drive the electrode beyond its normal range.

No interaction of the magnetic field of the drive coil or microphonics from the vibrating capacitor are visible on the output of the electrometer pentode.

Figure 2B shows the opposite side of the electrometer case. The circuit elements for the electrometer preamplifier and the compound-emitter-follower output stage are mounted on terminal strips. The preamplifier shows a gain of 7 to 10. Thus, the peak-to-peak output is 7 to 10 times the d-c input. The emitter follower provides low output impedance to drive the Brown amplifier's input transformer. Figure 2C shows the power supply.

The circuit diagram of the electrometer preamplifier and its power supply is shown in Fig. 4. A 6-v transformer ( $T_1$ ) supplies power to the drive coil of vibrating capacitor  $C_1$  and to the d-c supply. The low voltage d-c (11 v) supplies the transistors and the electrode potentials and the filament voltage of  $V_1$ .

## REFERENCES

1. H. Palevsky, R. K. Swank and R. Grenchik, Design of Dynamic Condenser Electrometer, *Rev Sci Instr.* 18, p 298, May, 1947.
2. J. R. Anderson and A. E. Alexander, Theory of the Vibrating Condenser Converter and Application to Contact Potential Measurement, *Australian J. Appl Sci.* 3, p 201, Sept., 1952.
3. J. R. MacDonald and D. E. Edmondson, Exact Solution of a Time-varying Capacitance Problem, *Proc IRE.* 49, No. 2, p 453, Feb., 1961.
4. Derivation available on request to author.

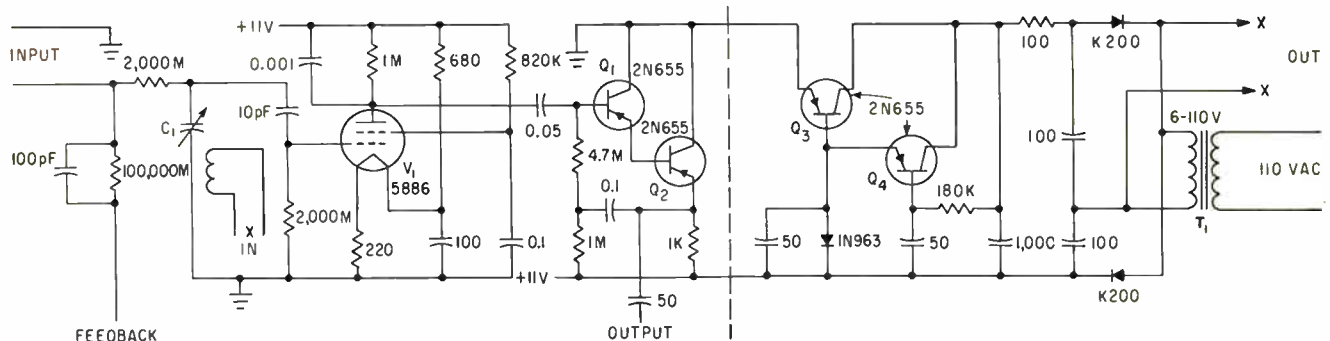
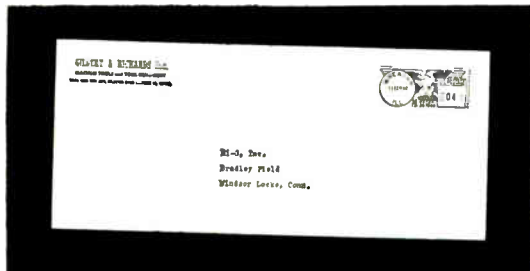

FIG. 4—Output of the electrometer, which is taken from  $Q_1$  of the preamplifier, goes to an amplifier (not shown) that is source of feedback signal

# we've been getting ALL KINDS of complaints



Hi-G's Complaint Department had been purring along in great style, filing nails, brewing coffee, pasting green stamps in books for the girls in the office, when suddenly the complaints began to trickle in. Then seep in. Then POUR in.

"How come you delivered two weeks early. Our production line didn't expect your relays until . . ."

"Your invoice does not agree with your quotation. Your final billing is much lower than your quote. Our Accounting is simply furious at the extra paper work you have caused . . ."

"Who's the wise guy at Hi-G? We specifically specified a relay which would perform 100,000 times without failure. Our 77th Destructive Testing Group is exhausted after 150,000 performances of your Model . . ."

Please. If you are a chronic complainer like this, don't call us. We just happen to have here a list of competitive manufacturers who . . . . .

**RELCOIL**

DIVISION OF HI-G, INC.

**Hi-G**  
INC.

WINDSOR LOCKS, CONN.

**CIG**

DIVISION OF HI-G, INC.

# Frequency-Independent Voltage Dividers

By CLINTON L. CONNER, Defense Electronics Products, Radio Corporation of America, Moorestown, N. J.

FREQUENCY-INDEPENDENT current dividers have been discussed in a previous article. A similar technique can be used to design frequency-independent voltage dividers.

The RLC series circuit shown in Fig. 1A is a voltage divider, which acts as a pure resistance, provided a resonant condition exists. The ratio of output to input voltage is

$$\frac{e_o}{e_i} = \frac{R_1 + j\left(\omega L_1 - \frac{1}{\omega C_1}\right)}{R_1 + R_2 + j\left[\omega(L_1 + L_2) - \frac{1}{\omega}\left(\frac{1}{C_1} + \frac{1}{C_2}\right)\right]} \quad (1)$$

The condition for resonance requires that  $\omega L_1 - 1/\omega C_1 = 0$  and that

$$\omega(L_1 + L_2) - \frac{1}{\omega}\left(\frac{1}{C_1} + \frac{1}{C_2}\right) = 0.$$

If the conditions for resonance are imposed on the circuit in Fig. 1A, then Eq. 1 reduces to a simple ratio so that  $e_o/e_i = R_1/(R_1 + R_2)$ .

Now, is the resonant condition the only method by which we can cause the circuit to act as a simple resistance voltage divider? Let the condition of being independent of frequency be the only initial restriction placed upon the circuit. Assume that  $Z_1 = R_1 + ja$  and  $Z_2 = R_2 + j\beta$ , then the voltage ratio becomes

$$\frac{e_o}{e_i} = \frac{R_1 + j\alpha}{R_1 + R_2 + j(\alpha + \beta)} \cdot \frac{R_1 + j\alpha}{R_1\left(\frac{R_1 + R_2}{R_1}\right) + j\alpha\left(\frac{\alpha + \beta}{\alpha}\right)} \quad (2)$$

If  $(R_1 + R_2)/R_1 = (a + \beta)/a$ , then the voltage ratio will reduce to  $e_o/e_i = R_1/(R_1 + R_2)$ . We know that the ratio  $R_1/(R_1 + R_2)$  is not dependent upon frequency. The other ratio  $a/a + \beta$  is in general dependent upon frequency. If the ratio is rewritten in terms of inductances and capacitances, then

$$\begin{aligned} \frac{\alpha}{\alpha + \beta} &= \frac{\omega L_1 - \frac{1}{\omega C_1}}{\omega L_1 - \frac{1}{\omega C_1} + \omega L_2 - \frac{1}{\omega C_2}} \\ &= \frac{\omega L_1 - \frac{1}{\omega C_1}}{\omega L_1\left(\frac{L_1 + L_2}{L_1}\right) - \frac{1}{\omega C_1}\left(\frac{1}{C_1} + \frac{1}{C_2}\right)} \quad (3) \end{aligned}$$

Impose the condition  $\frac{L_1 + L_2}{L_1} = \frac{1}{C_1} + \frac{1}{C_2}$  upon Eq. 3, then

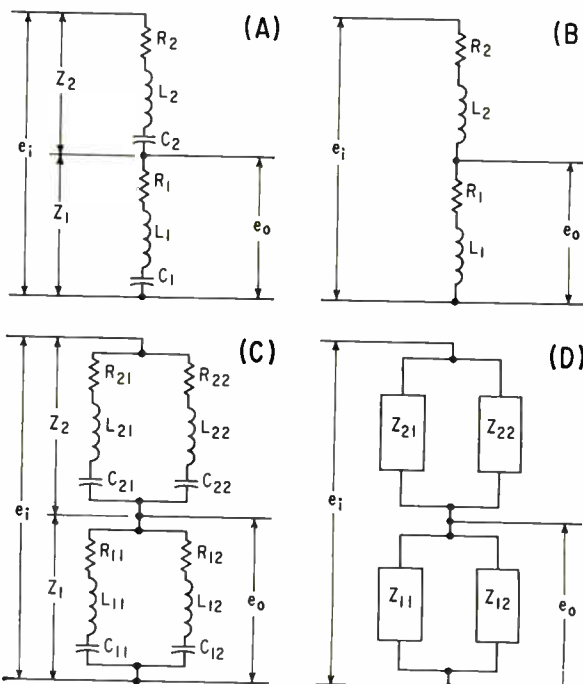

FIG. 1—Simple RLC voltage divider acts as a pure resistance at resonance (A). Inductance-resistance voltage divider that is independent of frequency if the conditions of Eq. 5 are met (B). Conditions for making this two-branch voltage divider independent of frequency may also be extended to any number of parallel branches (C). Generalized voltage divider showing parameters used in the table (D).

$$\frac{\alpha}{\alpha + \beta} = \frac{L_1}{L_1 + L_2} = \frac{\frac{1}{C_1}}{\frac{1}{C_1} + \frac{1}{C_2}}$$

Results of this investigation show that the voltage divider in Fig. 1A will respond as a simple resistance voltage divider and be independent of frequency when

$$\frac{R_1}{R_1 + R_2} = \frac{L_1}{L_1 + L_2} = \frac{\frac{1}{C_1}}{\frac{1}{C_1} + \frac{1}{C_2}} \quad (4)$$

Note that, if  $a$  and  $\beta$  consist only of inductive reactances,  $a/a + \beta = L_1/(L_1 + L_2)$ . The condition for an inductance-resistance voltage divider to be independent of frequency is that

$$R_1/(R_1 + R_2) = L_1/(L_1 + L_2) \quad (5)$$

Refer to the inductance-resistance voltage divider shown in Fig. 1B to determine the meaning of the condition of Eq. 5.) Assume that

$$\begin{aligned} L_1 &= L_2 = R_1 \\ R_2 &= KR_1 \text{ or } K = R_2/R_1 \end{aligned}$$



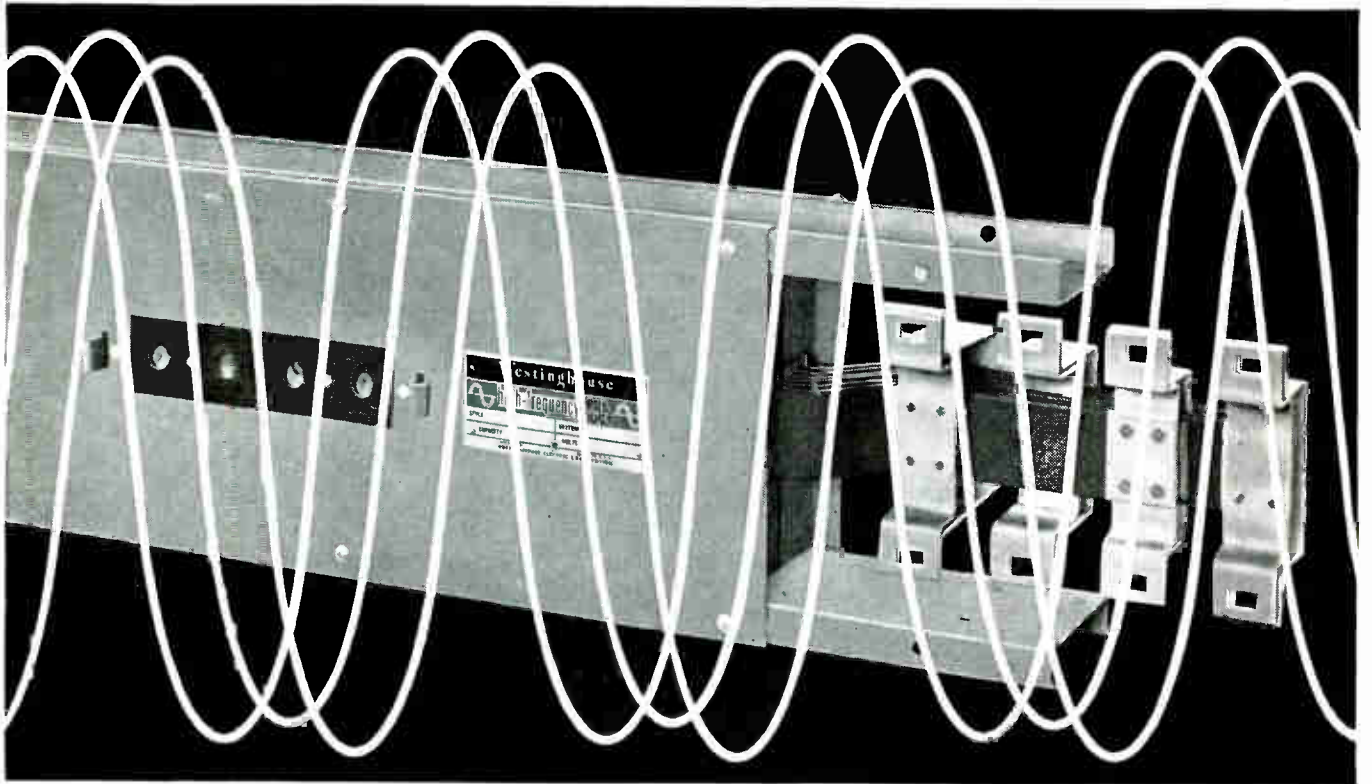

# 400-CYCLE BUS DUCT

## less than 1 volt drop per 100 ft.

Here's the economical, efficient way to put high frequency exactly where you want it—at rock-bottom power loss. Westinghouse High Frequency Bus Duct is designed particularly for 400 to 20,000 cps systems, and distributes power over long runs more efficiently at 400 cycles than most systems do at 60 cycles. Gone are the expense, mess and big voltage drops of multi-run cable and conduit schemes. Gone is the need for special at-the-site power supplies.

Other advantages of Westinghouse High Frequency Duct: small size, light weight, power

taps every 30 inches over the entire duct length, easily relocated and easily installed.

High Frequency Bus Duct is available now . . . and only from Westinghouse. Call your local Westinghouse salesman or write Standard Control Division, Westinghouse Electric Corporation, Beaver, Pa. Ask for booklet B-7326. *You can be sure . . . if it's Westinghouse.*

**Westinghouse** 

The voltage ratio becomes

$$\frac{e_o}{e_i} = \frac{R_1 + j\omega L_1}{R_1 + R_2 + j\omega(L_1 + L_2)} = \frac{1 + j\omega K}{(1 + K) + j2\omega}$$

and

$$E = \left| \frac{e_o}{e_i} \right| = \frac{1 + \omega^2}{\sqrt{(1 + K)^2 + 4\omega^2}} \quad (6)$$

A plot of Eq. 6, where  $E$  is the ordinate and  $\omega$  the abscissa would show that there is only one value of  $K$ ,  $K = 1$ , which gives a curve which is constant with frequency. If  $K = 1$ , then  $R_1 = R_2$  and  $L_1/(L_1 + L_2) = R_1/(R_1 + R_2) = 1/(1 + 1) = 1/2$ .

Having found a method to make the series circuit voltage divider independent of frequency, determine if this is possible with the parallel circuit voltage divider shown in Fig. 1C. The ratio of output to input voltages is

$$\frac{e_o}{e_i} = \frac{Z_1}{Z_1 + Z_2}, \text{ but } Z_1 = \frac{Z_{11}Z_{12}}{Z_{11} + Z_{12}}, \text{ and } Z_2 = \frac{Z_{21}Z_{22}}{Z_{21} + Z_{22}}$$

The voltage ratio becomes

$$\frac{e_o}{e_i} = \frac{Z_{11}Z_{12}}{Z_{11} + Z_{12}} \cdot \frac{Z_{21} + Z_{22}}{Z_{11}Z_{12}(Z_{21} + Z_{22}) + Z_{21}Z_{22}(Z_{11} + Z_{12})}$$

PARAMETER RATIOS FOR FREQUENCY-INDEPENDENT VOLTAGE DIVIDERS

$Z_{11}$	$Z_{21}$	$Z_{12}$	$Z_{22}$	For voltage ratio $E = \frac{e_o}{e_i}$ , set $E$ equal to:
$R_{11}$	$R_{21}$	0	0	$\frac{R_{11}}{R_{11} + R_{21}}$
$j\omega L_{11}$	$j\omega L_{21}$	0	0	$\frac{L_{11}}{L_{11} + L_{21}}$
$-\frac{j}{\omega C_{11}}$	$-\frac{j}{\omega C_{21}}$	0	0	$\frac{1}{\frac{1}{C_{11}} + \frac{1}{C_{21}}}$
$R_{11} + j\omega L_{11}$	$R_{21} + j\omega L_{21}$	0	0	$\frac{R_{11}}{R_{11} + R_{21}} = \frac{L_{11}}{L_{11} + L_{21}}$
$R_{11} - \frac{j}{\omega C_{11}}$	$R_{21} - \frac{j}{\omega C_{21}}$	0	0	$\frac{R_{11}}{R_{11} + R_{21}} = \frac{1}{\frac{1}{C_{11}} + \frac{1}{C_{21}}}$
$j\left(\omega L_{11} - \frac{1}{\omega C_{11}}\right)$	$j\left(\omega L_{21} - \frac{1}{\omega C_{21}}\right)$	0	0	$\frac{L_{11}}{L_{11} + L_{21}} = \frac{1}{\frac{1}{C_{11}} + \frac{1}{C_{21}}}$
$R_{11} + j\left(\omega L_{11} - \frac{1}{\omega C_{11}}\right)$	$R_{21} + j\left(\omega L_{21} - \frac{1}{\omega C_{21}}\right)$	0	0	$\frac{R_{11}}{R_{11} + R_{21}} = \frac{L_{11}}{L_{11} + L_{21}} = \frac{1}{\frac{1}{C_{11}} + \frac{1}{C_{21}}}$
$R_{11} + j\omega L_{11}$	$R_{21} + j\omega L_{21}$	$R_{12} + j\omega L_{12}$	$R_{22} + j\omega L_{22}$	$\frac{R_{11}}{R_{11} + R_{21}} = \frac{R_{12}}{R_{12} + R_{22}} = \frac{L_{11}}{L_{11} + L_{12}} = \frac{L_{12}}{L_{12} + L_{22}}$
$R_{11}$	$R_{21}$	$j\omega L_{12}$	$j\omega L_{22}$	$\frac{R_{11}}{R_{11} + R_{21}} = \frac{L_{12}}{L_{12} + L_{22}}$
$R_{11} - \frac{j}{\omega C_{11}}$	$R_{21} - \frac{j}{\omega C_{21}}$	$R_{12} - \frac{j}{\omega C_{12}}$	$R_{22} - \frac{j}{\omega C_{22}}$	$\frac{R_{11}}{R_{11} + R_{21}} = \frac{R_{12}}{R_{12} + R_{22}} = \frac{1}{\frac{1}{C_{11}} + \frac{1}{C_{21}}} = \frac{1}{\frac{1}{C_{12}} + \frac{1}{C_{22}}}$
$j\left(\omega L_{11} - \frac{1}{\omega C_{11}}\right)$	$j\left(\omega L_{21} - \frac{1}{\omega C_{21}}\right)$	$j\left(\omega L_{12} - \frac{1}{\omega C_{12}}\right)$	$j\left(\omega L_{22} - \frac{1}{\omega C_{22}}\right)$	$\frac{L_{11}}{L_{11} + L_{21}} = \frac{L_{12}}{L_{12} + L_{22}} = \frac{1}{\frac{1}{C_{11}} + \frac{1}{C_{21}}} = \frac{1}{\frac{1}{C_{12}} + \frac{1}{C_{22}}}$
$R_{11} + j\left(\omega L_{11} - \frac{1}{\omega C_{11}}\right)$	$R_{21} + j\left(\omega L_{21} - \frac{1}{\omega C_{21}}\right)$	$R_{12} + j\left(\omega L_{12} - \frac{1}{\omega C_{12}}\right)$	$R_{22} + j\left(\omega L_{22} - \frac{1}{\omega C_{22}}\right)$	$\frac{R_{11}}{R_{11} + R_{21}} = \frac{R_{12}}{R_{12} + R_{22}} = \frac{L_{11}}{L_{11} + L_{12}} = \frac{L_{12}}{L_{12} + L_{22}}$ $= \frac{1}{\frac{1}{C_{11}} + \frac{1}{C_{21}}} = \frac{1}{\frac{1}{C_{12}} + \frac{1}{C_{22}}}$

$$= \frac{Z_{21}(Z_{12} + Z_{22})}{Z_{12}} + \frac{Z_{22}(Z_{11} + Z_{21})}{Z_{11}} \quad (7)$$

Let  $\frac{Z_{12} + Z_{22}}{Z_{12}} = \frac{Z_{11} + Z_{21}}{Z_{11}}$ , then Eq. 7 will become

$$\frac{e_o}{e_i} = \frac{Z_{11}}{Z_{11} + Z_{21}} = \frac{Z_{12}}{Z_{12} + Z_{22}} \quad (8)$$

Equation 8 is the relationship required for two impedances in series to form a divider. From Eq. 4, relations for a series divider are known. The relations for the parallel divider are

$$\frac{R_{11}}{R_{11} + R_{21}} = \frac{R_{12}}{R_{12} + R_{22}} = \frac{L_{11}}{L_{11} + L_{21}} = \frac{L_{12}}{L_{12} + L_{22}}$$

$$= \frac{1}{\frac{1}{C_{11}} + \frac{1}{C_{21}}} = \frac{1}{\frac{1}{C_{12}} + \frac{1}{C_{22}}} \quad (9)$$

Having shown that Eq. 9 is valid for a two-branch parallel impedance voltage divider, the same concept can be extended to three impedances in parallel. Then by mathematical induction, the case for  $n$  impedances in parallel can be proved.

Results are summarized in the table. Figure 1D is used as a reference with the table.

# MUMETAL

IS THE ANSWER TO YOUR  
MAGNETIC SHIELDING PROBLEMS

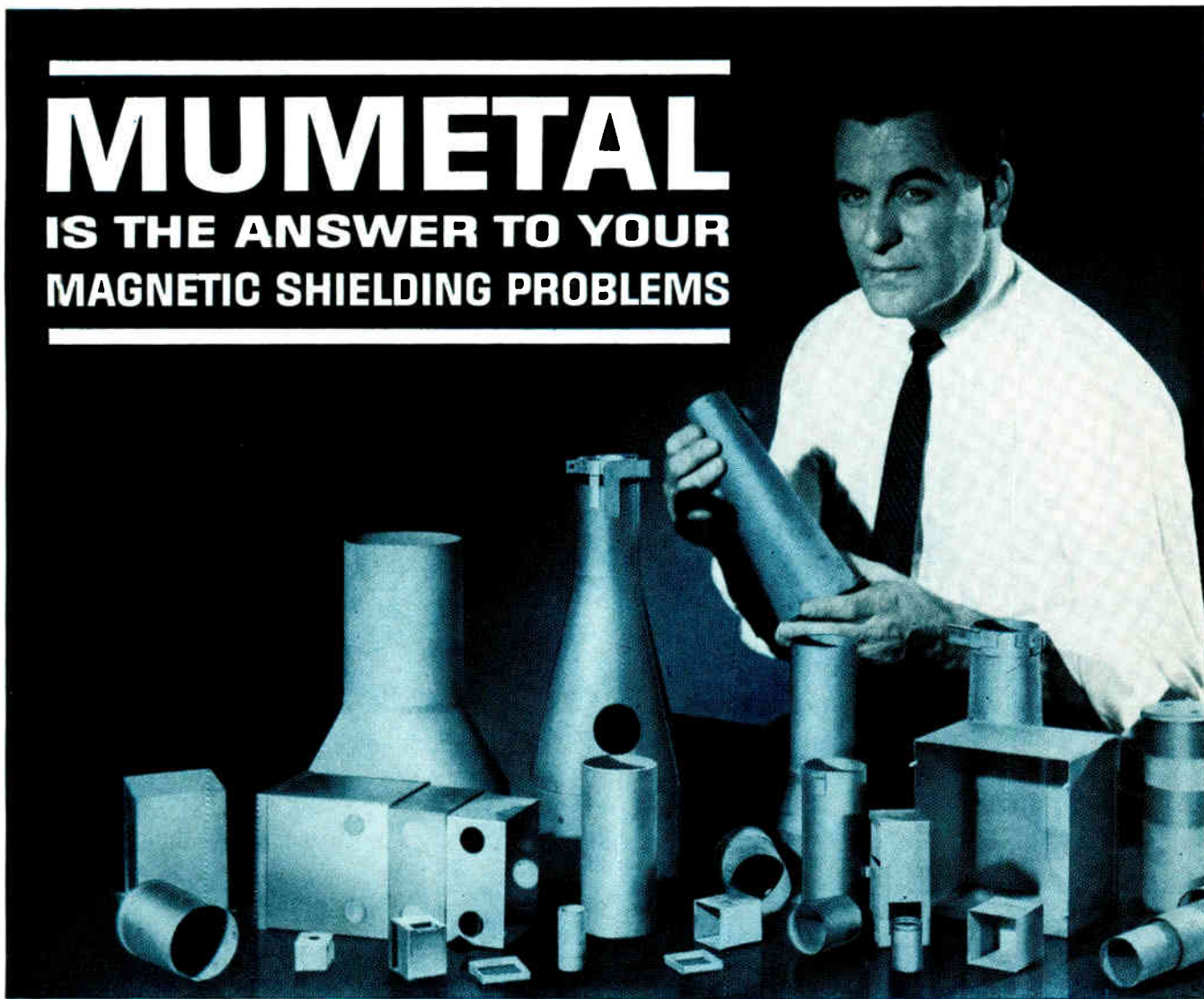

Instant relief to interference caused by extraneous magnetic fields is the net result of shields made of Allegheny Ludlum's Mumetal. These shields protect components against stray external fields or prevent neighboring parts from being affected by a field-generating component inside the shield. In electronics, Mumetal and shielding are practically synonymous terms.

To develop its optimum shielding properties, Mumetal must be properly annealed in a pure, dry, high temperature hydrogen atmosphere after fabrication. When properly annealed, Mumetal has extremely high permeability and is capable of attenuating stray fields to negligible proportions.

In general, high permeability, shielding excellence and strain sensitivity go hand in hand. In the optimum condition, Mumetal is relatively soft. Shields in this condition should be

handled with care in order to preserve optimum shielding efficiency.

In many applications, fabricating or field conditions are encountered which make it impossible to avoid straining the material after the high temperature hydrogen anneal. Even when strained, Mumetal shields remain extremely effective.

The inherent ductility of Mumetal offers fabricating advantages in forming, drawing, and spinning operations.

For all your shielding requirements, insist on Allegheny Ludlum Mumetal. And for more information, ask for a copy of EM12, a 20 page technical Blue Sheet describing Mumetal, its properties, annealing details, etc. Write *Allegheny Ludlum Steel Corporation, Oliver Bldg., Pittsburgh 22, Pa., Address Dept. E-4*



**ALLEGHENY LUDLUM**

PIONEERING on the Horizons of Steel



A108

# NEW FROM SORENSEN

## QM 48 VOLT SERIES

COMPACT,  
TRANSISTORIZED  
DC SUPPLIES  
±0.05% REGULATION  
(LINE AND LOAD)



### STANDARD RATINGS AND SIZES

Nominal Output Volts	2		4		8		15		30	
	Amp.	Size	Amp.	Size	Amp.	Size	Amp.	Size	Amp.	Size
3.0	0.66	1	1.3	2	2.6	3	5.0	5	...	..
4.4	0.45	1	0.9	2	1.8	3	3.5	5	...	..
6.3	0.32	1	0.64	2	1.28	3	2.4	4	4.00	5
9.0	0.22	1	0.44	2	0.88	3	1.7	4	3.00	5
12.0	0.16	1	0.32	2	0.64	3	1.25	4	2.56	5
16.0	0.13	1	0.25	2	0.50	3	0.94	4	1.87	5
21.0	0.10	1	0.19	2	0.38	3	0.71	4	1.43	5
28.0	0.07	1	0.14	2	0.28	3	0.53	4	1.07	5
36.0	0.06	1	0.11	2	0.22	3	0.43	4	0.83	5
48.0	0.04	1	0.08	2	0.16	3	0.31	4	0.62	5

Size	A	B	C	Approx. Weight
1	3 <sup>1</sup> / <sub>32</sub>	3 <sup>3</sup> / <sub>32</sub>	5	
2	4 <sup>3</sup> / <sub>16</sub>	3 <sup>1</sup> / <sub>16</sub>	5 <sup>1</sup> / <sub>16</sub>	5 lbs.
3	4 <sup>1</sup> / <sub>16</sub>	4	6 <sup>1</sup> / <sub>8</sub>	6 lbs.
4	4 <sup>1</sup> / <sub>16</sub>	4	6 <sup>1</sup> / <sub>8</sub>	7 lbs.
5	5 <sup>3</sup> / <sub>32</sub>	4 <sup>1</sup> / <sub>32</sub>	6 <sup>1</sup> / <sub>16</sub>	10 lbs.

QM miniaturized DC supplies combine excellent regulation and extremely low ripple (less than 1mV RMS) with maximum reliability. These completely transistorized units are ideal for use with semiconductor circuitry.

Rugged QM supplies, recommended for a wide variety of "built-in" applications, are designed to resist damage from momentary overloads or output shorts. Intermediate voltages and power levels are available. Consult factory or local representative for complete specifications.

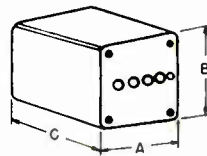

A UNIT OF RAYTHEON COMPANY

RICHARDS AVENUE • SOUTH NORWALK • CONNECTICUT

# NEW FROM SORENSEN



## QM VOLTAGE SELECTOR SERIES CUSTOM OUTPUTS... STANDARD DESIGN

TYPICAL RATINGS

Chassis Size	Maximum Wattage	Number of QM Units*	Watts Per Unit	Volts Per Unit	Panel Dimensions (In.)		
					W	H	D**
A	8	1-4	2	3 to 48	19	3 1/2	7 5/8
B	16	5-8	2	3 to 48	19	3 1/2	14 7/8
C	30	2	2	3 to 48	19	5 1/4	7 1/8
		2	4	3 to 48	19	5 1/4	7 1/8
		2	8	3 to 48	19	5 1/4	7 1/8
		2	15	3 to 48	19	5 1/4	7 1/8
D	35	1	30	3 to 48	19	5 1/4	7 1/8
		4	2	3 to 48	19	5 1/4	11 3/8
		4	4	3 to 48	19	5 1/4	11 3/8
		4	8	3 to 48	19	5 1/4	11 3/8
		2	15	3 to 48	19	5 1/4	11 3/8
E	40	1	30	3 to 48	19	5 1/4	11 3/8
		6	2	3 to 48	19	5 1/4	14 7/8
		6	4	3 to 48	19	5 1/4	14 7/8
		5	8	3 to 48	19	5 1/4	14 7/8
		2	15	3 to 48	19	5 1/4	14 7/8
		1	30	3 to 48	19	5 1/4	14 7/8

\* Any combination of watts per unit (up to maximum wattage) available on C, D, & E chassis at no extra charge.  
\*\* Depth behind panel.

OPTIONAL FEATURES AVAILABLE:

- M1. Pilot light, switch, fuse.
- M2. Pilot light, switch, fuse, voltmeter.
- M3. Pilot light, switch, fuse, voltmeter, front panel pot adjust.

Here's real power supply flexibility. Design to your own requirements. Select up to eight different voltage outputs, or up to six different wattage-voltage combinations, in a single installation.

Sorensen's new QM Voltage Selector Series, with rack-mount features, offers scores of power combinations, each with the precise regulation and ripple characteristics of standard QM supplies. As many as eight different (or identical) QM supplies can be mounted on a single chassis (see table), with eight voltage outputs preset. The use of standard QM models assures prompt delivery at low prices.

Standard QM Voltage Selectors are shipped without panel controls (each unit is individually adjustable on chassis through pot adjust hole). See table for optional features.

A UNIT OF RAYTHEON COMPANY

RICHARDS AVENUE • SOUTH NORWALK • CONNECTICUT



CIRCLE 57 ON READER SERVICE CARD

# Brushless D-C Motor Uses Hall-Effect Devices

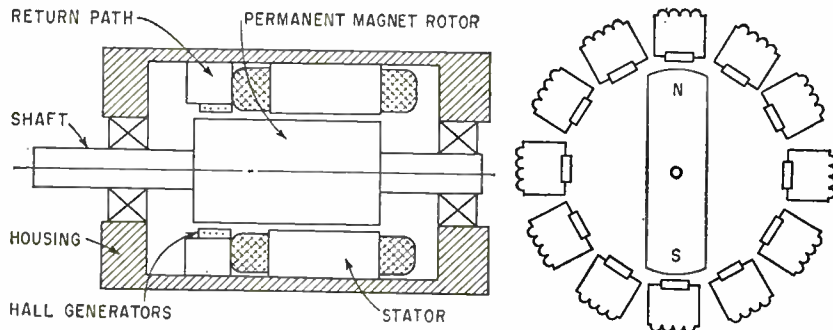

FIG. 1—Brushless d-c motor construction is shown at left while Hall generator and coil arrangement is represented at right

EXPERIMENTAL brushless d-c motor promises high reliability and high torque-to-weight ratios. It has a linear speed-to-torque characteristic that can be controlled by a low-power signal. Solid-state circuits are used for commutation in the machine described at the 1962 IRE Conference in a paper by G. Bauerlein, Kearfott Div., General Precision, Inc.

The field for the brushless d-c motor at the left in Fig. 1 is provided by a permanent magnet rotor. The twelve Hall generators surrounding the rotor at the right are each connected to a coil placed in a stator slot. As Hall-generator output excites each coil, it produces a field displaced 90 degrees from the associated Hall generator and 90 degrees ahead of the rotor. Rotation is produced by the rotor attempting to align with the stator field produced by the armature coils.

As the rotor poles pass Hall generators, the field reverses, reversing polarity of output from the particular generator. As a result, the associated coil is switched, so that a stator field is always provided 90 degrees ahead of the rotor. Since maximum torque is provided for this condition, high torque-to-weight ratios should be possible. Reversing control current to the Hall generators reverses direction.

Among the advantages of Hall generators for armature switching is their small size, which permits them to be placed in the air gap of

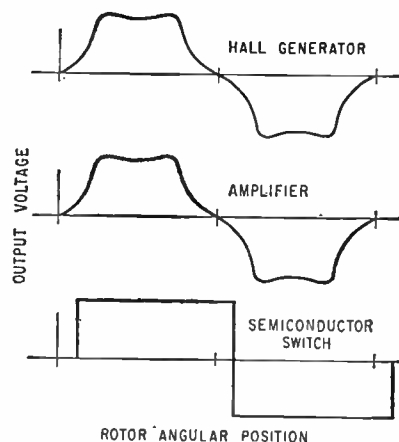

FIG. 2—Hall generator output at top can be amplified as at center or used to control semiconductor switch providing signal at bottom to stator winding

a magnetic circuit. They also provide output even at standstill because they sense magnitude of magnetic flux rather than its rate of change. For the same reason, maximum output, about 100 mv, is not excessive at high speed.

A basic problem with the Hall generator, which is basically a resistive device, is its low efficiency in transferring power. Estimates of efficiency are 10 to 20 percent in a 10-Kg field for high-mobility materials like InAs and InSb. Maximum field for a practical Hall generator commutator is 4 Kg. Efficiency of a typical InAs Hall generator operating into a matched load is  $P_{out}/P_{in} = (V_{ho}^2/4R_h)/I_c^2 R_c = 1.86$  percent, where control cur-

rent  $I_c$  is 0.4 amp, control resistance  $R_c$  is 1.4 ohms, open-circuit Hall voltage is 0.52 v/4Kg and Hall resistance  $R_h$  is 1.4 ohms.

An experimental motor did not operate because of low efficiency, but the armature generated a rotating field when it was mechanically driven. The problem of low efficiency can be overcome using the Hall generators to sense rotor position and provide low-power signals to either semiconductor switches or amplifiers, depending on requirements. Outputs of a Hall generator, amplifier and switch circuit are shown in Fig. 2. Adding a one-transistor amplifier to 3 of the 12 Hall generators in the experimental motor provided sufficient power to maintain rotation.

Transistor switches (or silicon controlled rectifiers in larger units) are used where efficiency is the most important factor, since they are either full on or off. Lower power transistors with heat sinks and smaller Hall generators can be used.

Amplifiers are used if speed must be controlled with a low-power signal or if a smooth torque-position characteristic is needed. Output depends on magnitude and polarity of both commutator field and control current as well as amplifier gain. Amplifiers can reduce complexity in multipole machines where most of the Hall generators supply redundant information. In a ma-

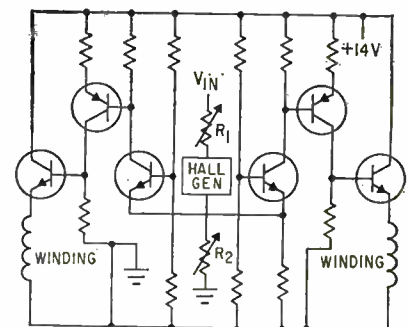
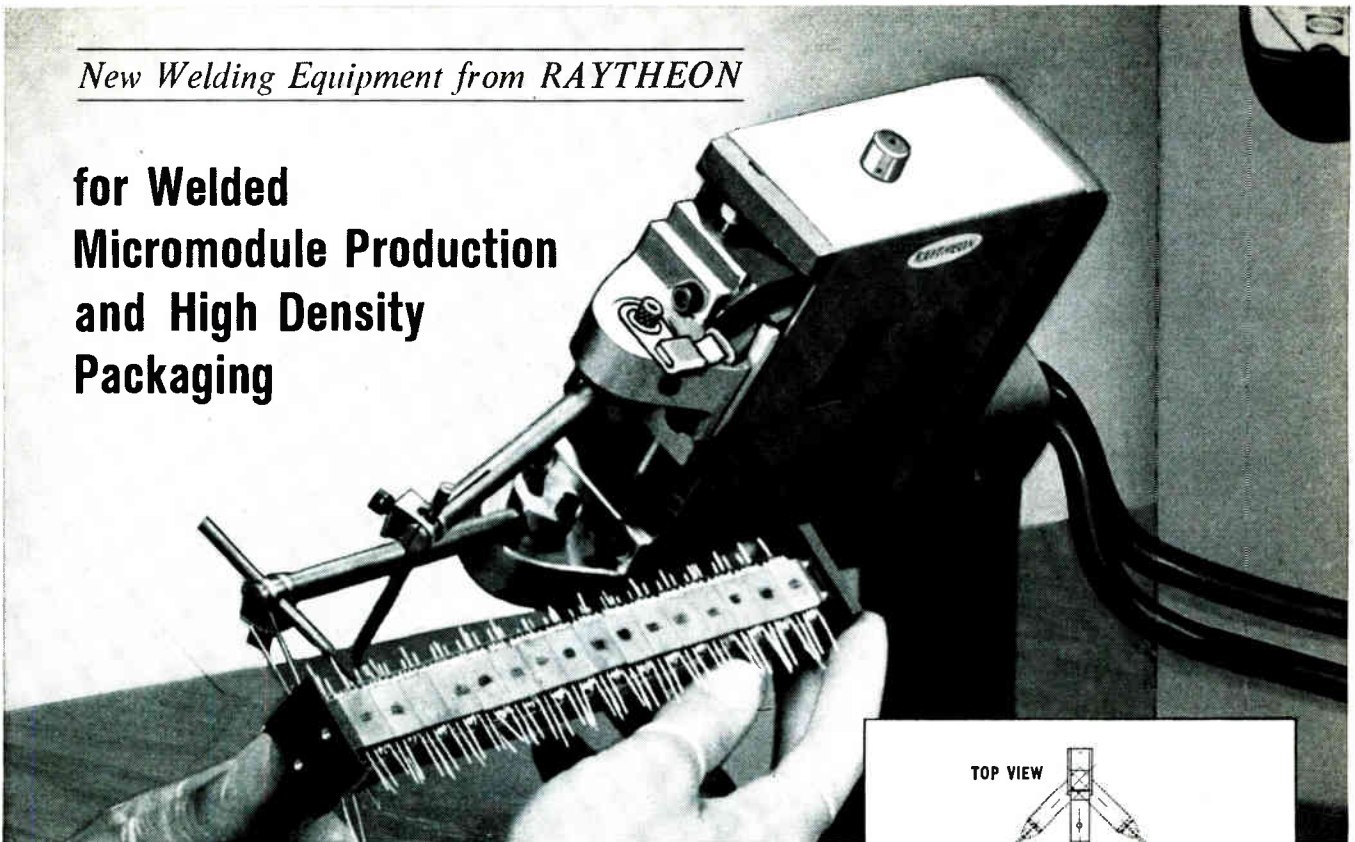

FIG. 3—Potentiometers in d-c amplifier balance lack of symmetry in dividing Hall resistance in control direction

*New Welding Equipment from RAYTHEON*

**for Welded  
Micromodule Production  
and High Density  
Packaging**



Raytheon's noteworthy new precision Miniature Welding Heads are the most versatile in today's demanding market . . . specifically designed to speed accurate, high-speed production welding of micromodules, high density packaging, miniature electronic components, small parts and sub-assemblies. This series (O/OA/OB) offers the highest acceleration of any commercial head now available.

Exceptionally versatile, models OA and OB heads tilt, tip and swivel — lock at intermediate positions — with electrode arms that rotate and swing to suit difficult work configurations and confined space. Throat depth effectively unlimited to accommodate long modules. In-line or "pincer" type electrode motion provided. Model OB incorporates air accessory to minimize operator variables.

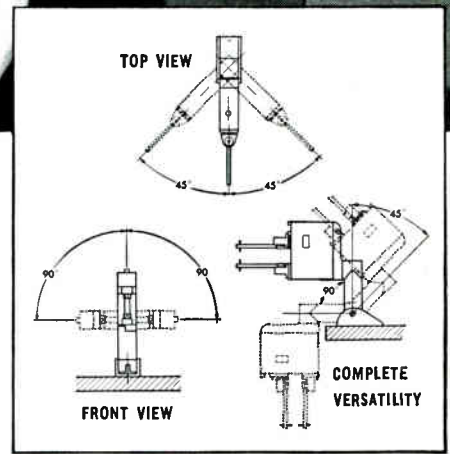

**New — Precision RAYTHEON Welding Accessories**

**New Weldpower Calibrator  
Model 2-250**



Fully transistorized, self-contained, portable. Accurately measures output (welding current-peak and integrated values) to check weld pulse amplitude and length. Helps maintain uniform weld pulses, duplicate welder output and establish iso-strength diagrams in high reliability welding. Compatible with DC and AC welding systems, regardless of manufacturer.

**New Dual Range Force Gauge  
Model 2-245**



Indicates force exerted by electrodes when head is actuated. Essential for obtaining weld repeatability, this precision gauge embodies color-coded scales of 0 to 15 and 0 to 50 lbs., saves cost of 2 separate gauges. Finish — polished stainless steel.

**New DC Welding Power Supply  
Model 60C**

Features adjustable pulse length selection and 100% electronic operation (no relays to stick). MAXIMUM STORAGE CAPACITY: 63 watt-seconds/MULTIPLE CAPACITOR SELECTION: 14, 28, 56 mfd ranges/PRECISION OIL FILLED CAPACITORS/PATENTED VOLTAGE REGULATION/COMPLETE SAFETY PROTECTION/THREE-SCALE POWER LEVEL INDICATOR for accurate heat adjustment/RATED for continuous commercial service.



You saw them at the IRE Show! Now get the full story—please write Raytheon Company, Production Equipment Department, 225 Crescent Street, Waltham 54, Massachusetts.

COMMERCIAL APPARATUS & SYSTEMS DIVISION

Waltham, Massachusetts



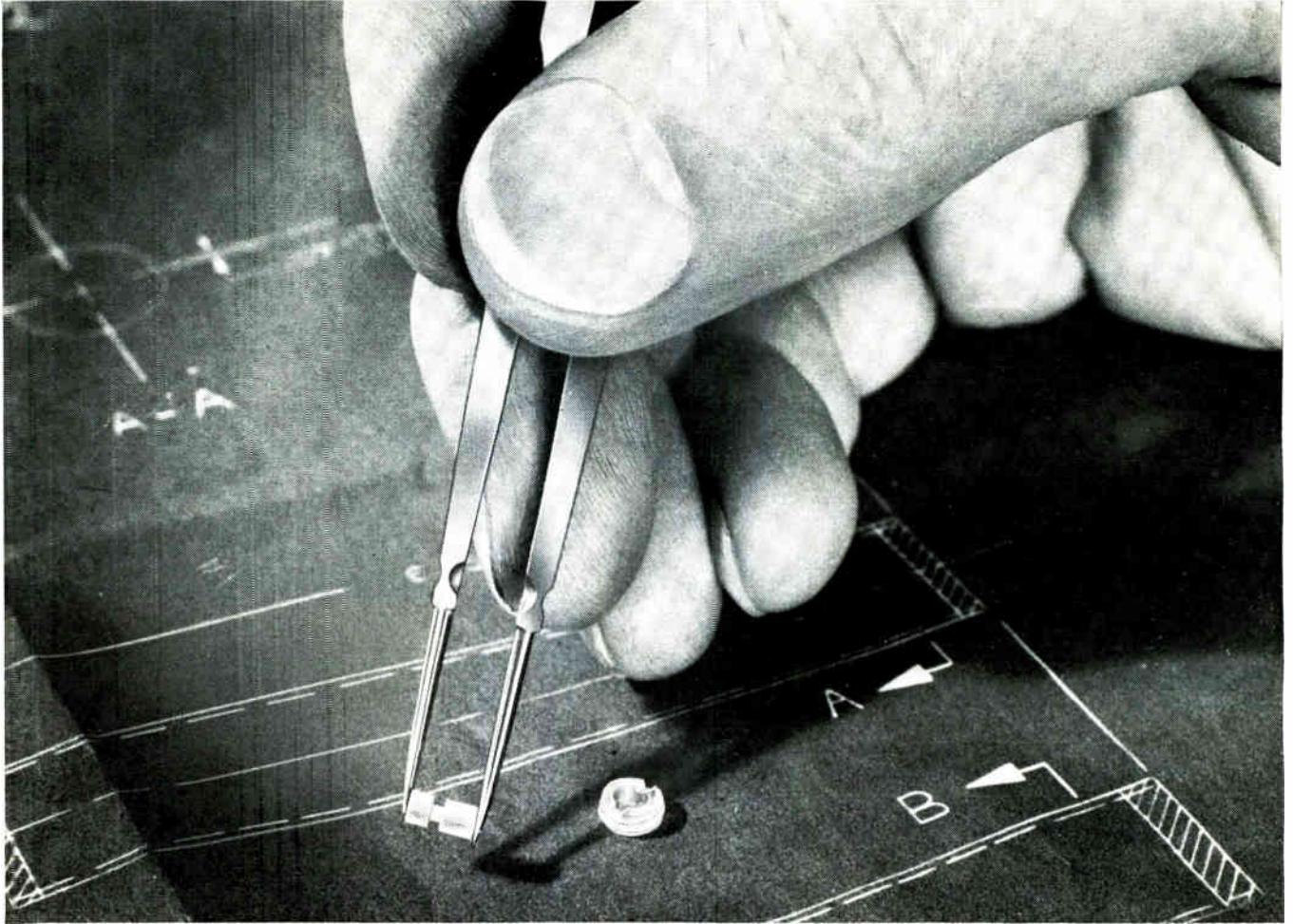

## MACHINABILITY (and 8 other BRAND KEL-F 81 Plastic merits) .... allows wall thickness tolerances of $\pm .005''$

Complexly designed small parts made with KEL-F 81 Brand Plastic achieve fine precision, dielectric stability, *plus* the stamina to stand off extreme environments and destructive attacks of many kinds.

In the hands of an authorized processor, KEL-F 81 Plastic can be heat-treated and machined into close-tolerance components such as the insulating electronic parts, above, with wall thickness tolerances of  $\pm .005''$ . The uniformity, strength and high melt temperature of this material provide machining characteristics comparable to brass. This plastic may be turned, bored, drilled, threaded, *and* tapped . . . it can be milled, sawed, punched, buffed and sanded to achieve minute dimensional accuracy, useful in a variety of applications.

### 8 STAMINA-MAKING KEL-F 81 PLASTIC FACTS!

1) *Electrical insulation* . . . provides high dielectric strength, arc resistance greater than 360 seconds! 2) *Zero moisture absorption* . . . minimizes surface flash-over, makes high humidity behave! 3) *Chemical inertness* . . . resists practically all corrosive media! 4) *800-degree range* . . . has useful temperature range from -400 to +400°F! 5) *Physical strength* . . . combines high tensile, flexural, compressive strengths, excellent abrasion resistance! 6) *Radiation resistance* . . . retains great strength, even after severe exposure! 7) *Infrared transmission* . . . can be fabricated with amazing clarity in thin sections, other optical advantages! 8) *Uniformity* . . . makes possible parts with consistently high molecular weight, high ZST ratings!

Read the column at right for two examples of machined KEL-F 81 Plastic parts, as well as for the list of authorized processors of this material.

\*\*KEL-F\*\* IS A REG. TM OF 3M CO.

MINNESOTA MINING & MANUFACTURING CO. **3M**



## KEL-F 81 Plastic

BRAND

... in typical applications



**NEEDLE VALVE COMPONENT**, made by *Bonny Manufacturing Corporation*, is used in glassware equipment that handles toxic and corrosive chemicals. Shaft and knob, both of KEL-F Plastic, are made separately to conserve material, then threaded together.

**GEARS** are machined from KEL-F Plastic to provide small electric motors with noiseless performance and eliminate lubrication. KEL-F Plastic was selected because of toughness, dimensional stability, good frictional properties.

**FOR MORE DATA** about KEL-F 81 Plastic for applications requiring close-tolerance machinability, contact the 3M Chemical Division Branch Office in Chicago, Cleveland, Los Angeles or Ridgefield, N.J.

### AUTHORIZED PROCESSORS FOR KEL-F 81 PLASTIC

Adam Spence Corp.,  
963 Frelinghuysen, Newark, N. J.  
Allied Nucleonics Corp.,  
2421 Blanding Ave., Alameda, Calif.  
Auburn Plastics, Inc.,  
511-5th Ave., New York  
Bonny Manufacturing Corp.,  
146 Main St., Maynard, Mass.  
Booker & Wallstead, Div. of Thermotech Industries, Inc.,  
3336 Gorham Ave., Minneapolis 26.  
Carmer Industries, Inc.,  
122 N. 26th St., Kenilworth, N. J.  
The Fluorocarbon Company,  
1754 Clementine, Anaheim, Calif.  
Fluorulon Laboratories, Inc.,  
Box 305, Caldwell, N. J.  
G-W Plastic Engineers, Inc.,  
Bethel, Vt.  
Gries Reproducer Corp.,  
125 Beechwood Ave., New Rochelle, N. Y.  
Modern Industrial Plastics, Div. of Duriron Company, Inc.,  
3337 N. Dixie Dr., Dayton 14, O.  
Moxness Products, Inc.,  
1914 Indiana Ave., Racine, Wis.  
Penn-Plastics Corp.,  
100 Fairhill Ave., Glenside, Pa.  
Plastic Molded Parts, Inc.,  
1350 Fifth Ave., East McKeesport, Pa.  
Pli-D-Seal Mfg. Co., Sub. of Zero Mfg. Co.,  
1010 Chestnut St., Burbank, Calif.  
Raybestos Manhattan, Inc., Pacific Div.,  
1400 Orangethorpe, Fullerton, Calif.  
L. W. Reinhold Plastics, Inc.,  
8763 Crockier St., Los Angeles.  
Saunders Engineering Corporation,  
3012 Spring St., Redwood City, Calif.  
W. S. Shamban Co.,  
11617 W. Jefferson Blvd., Culver City, Calif.  
Timely Technical Products, Inc., Industrial Plastic &  
Engineering Div., Verona, N. J.  
U. S. Gasket Co., Inc., Plastic Div., Garlock, Inc.,  
608 N. 10th St., Camden, N. J.

For general technical information about KEL-F 81 Plastic, write Chemical Division, Dept. KAX-42, 3M Company, St. Paul 1, Minn.



CIRCLE 61 ON READER SERVICE CARD

April 6, 1962

chine with  $n$  poles,  $(n - 1)/n$  Hall generators can be eliminated.

One machine was designed to drive an inertia wheel for satellite attitude control. Speed would be controlled by an attitude error signal in a closed loop. Amplifiers were used for accurate speed control and smooth torque. A d-c amplifier with differential input was chosen to limit the number of components and maintain low drift.

Amplifier design was complicated because a Hall generator input circuit is resistively coupled to its output circuit and only one side of the input or one side of the output can be grounded. In the amplifier in Fig. 3, lack of symmetry in dividing Hall generator resistance in the control direction ( $R_c$ ) is balanced by  $R_1$  and  $R_2$ . This amplifier, operating from d-c to about 1 Kc, has a voltage gain of 120 and a power gain of 250,000.

The linear speed-torque characteristic is shown at the top of Fig. 4. However output does not increase linearly with control current, partly because some amplifiers were not correctly balanced and clipping occurred sooner in some amplifiers. All amplifiers were clipping when control current reached 0.165 amp.

Overall efficiency shown at the

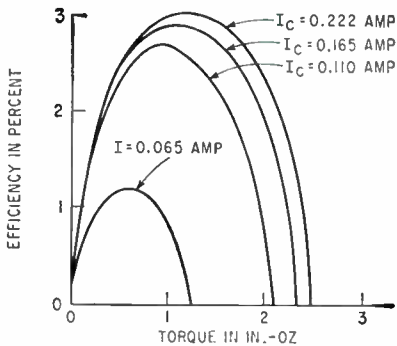
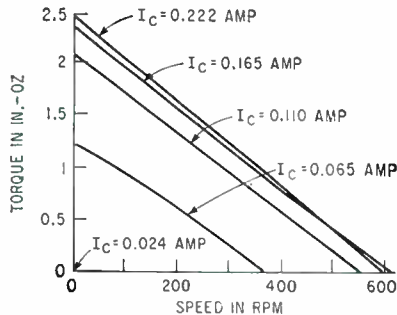

FIG. 4—Linear torque-speed relationship for given control current is shown above, while overall efficiency is shown in lower graph for various control current levels

bottom of Fig. 4 might be improved by refinements in the amplifier circuit. Also, intensive research with both Hall generators and transistors currently underway could provide devices that would significantly improve performance.

## Aircraft Altitude Is Controlled by F-M Radar

AUTOMATIC ALTITUDE control system maintains aircraft altitude within one foot. Drones controlled by the system have been flown reliably at altitudes as low as 50 feet and at speeds approaching Mach 1.

The altitude control system, developed by M. ten Boesch, Inc., permits pilots to make safer blind landings and to fly smoothly through air pockets and turbulence. Extensive flight testing of U. S. Navy low-flying drones has been successfully completed. The equipment can be used in any type aircraft with a single adjustment.

Key to system performance is the use of frequency-modulated radar to sense altitude. Transmitter frequency is swept in frequency at a known rate. The difference between transmitted and reflected frequency indicates altitude directly, eliminating the time required for processing rate information. The reduction in overall system response time contributes to its ability to control high-speed low-altitude flight. Eliminating the computation step also increases system accuracy.

Aircraft altitude is kept at a preselected level independently of load, speed or shape. The system accommodates a wide range of aerodynamic parameters, including bank angles up to 70 degrees.

Several adjustable limit settings prevent dangerous aircraft climb or dive angles or undesirable altitudes. Circuits monitor the overall system continuously. If deviation from the prescribed altitude or altitude rate exceeds the predetermined limit, the equipment disengages and safe flight conditions are maintained.

Provisions are incorporated into the system for absolute calibration of altitude. Altitude calibration is maintained for many months without requiring readjustment.

# NOW - 1000 MC MEASUREMENT WITH FREQUENCY COUNTERS

The model 14-26c, a 1 KMC Frequency Converter, is a plug-in unit for use with the Northeastern Engineering Model 14-20c Frequency Counter/Standard, and counters of other manufacturers.

Technical specifications:

- Frequency range ....200 MC to 1 KMC
- Input voltage (min.) .....100 millivolts RMS
- Input impedance ....50 ohms, approx.
- Accuracy ..... $\pm 1$  count,  $\pm$  accuracy of counter
- Power requirements .....furnished by counter
- Weight .....5 pounds

I.R.E. SHOW

Booth #3232

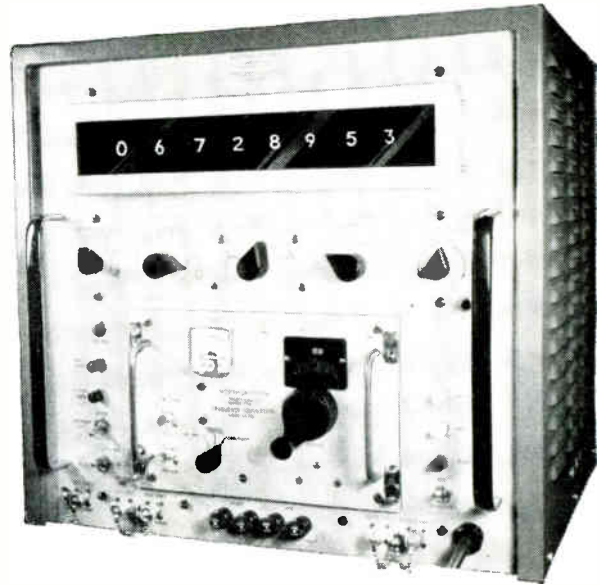

## NORTHEASTERN ENGINEERING INCORPORATED

DEPT. 5C, MANCHESTER, NEW HAMPSHIRE  
AFFILIATE OF ATLANTIC RESEARCH CORP.

CIRCLE 203 ON READER SERVICE CARD

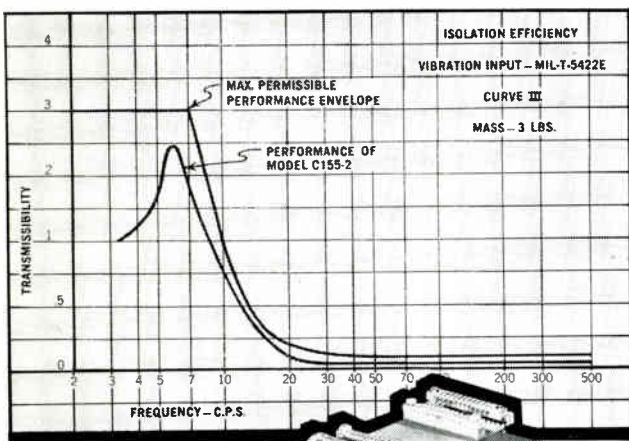

ACHIEVE  
\* **90%**  
ISOLATION

with maximum transmissibility of less than 3, on electronic equipment subjected to the vibration of a helicopter environment exceeding MIL-T-5422E (ASG) requirements.

For information on how we can solve your particular vibration problem write to Dept. BL - 31

**AEROFLEX LABORATORIES**  
INCORPORATED

48-25 36TH STREET • LONG ISLAND CITY 1, N. Y.

\*Listed in the VSMF  
microfilm catalog file.

## POWER from NICAD NICKEL CADMIUM Rechargeable Batteries

DESIGNED FOR

- Low Maintenance Cost
- Instant Efficient Operation
- Durability

NICAD Sealed and Vented Cells make practical the battery operation of many types of equipment not previously suited to dry, mercury, or lead acid types. Capable of sustained or stable voltage over a wide temperature range these NICAD Cells have extremely long life, require little or no maintenance, and are always ready to operate in any position under even the most adverse operating conditions . . . with POWER to spare.

For the full POWER story, write . . .



NICAD BATTERY DIVISION

**GOULD-NATIONAL**

BATTERIES, INC. E-1403 First National  
Bank Bldg., St. Paul 1, Minn.

NICAD is a trademark of Gould-National Batteries, Inc.

SEALED CELLS

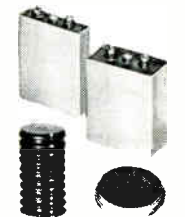

VENTED CELLS

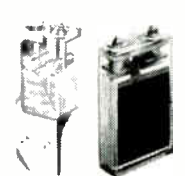

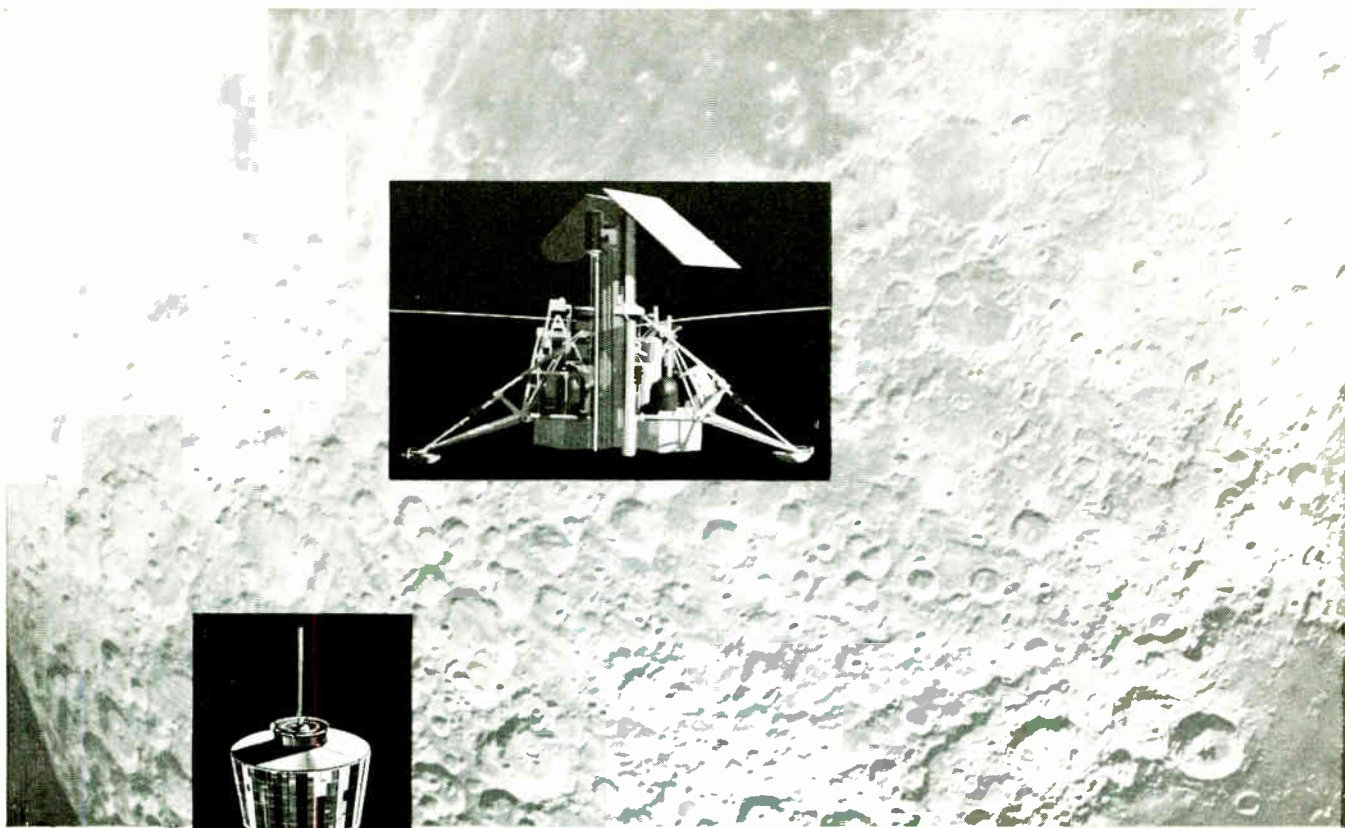

# systems analysts:

Quantify the complex on important projects at Hughes!

SURVEYOR (soft lunar landing spacecraft), SYNCOM (synchronous communications satellites), ARPAT (terminal anti-ballistic missile defense system), BAMB (anti-ballistic missile defense feasibility study). These are a few of the many important and complex projects under design, development and study at Hughes.

Because of these projects and others important to the nation's defense, preparedness and space effort, Hughes offers more opportunities to Systems Analysts than ever before.

Involved with these positions are the consideration of many basic problems such

as: the proper mix of manned vs. unmanned satellites; the requirements of manned space flight; IR systems requirements for high speed strike reconnaissance systems or unmanned satellites; analysis of weapon systems from conception through development, test and customer use; and many others.

**Inquire today.** If you are a graduate engineer or physicist from an accredited university, a U. S. citizen, and believe that you can contribute to and benefit from the important projects at Hughes, contact us today. Airmail your resume to:

**Mr. Robert A. Martin,  
Supervisor of Scientific Employment  
Hughes Aerospace Divisions  
11940 W. Jefferson Blvd.,  
Culver City 6, California**

We promise you a reply within one week.

An equal opportunity employer.

Creating a new world with ELECTRONICS

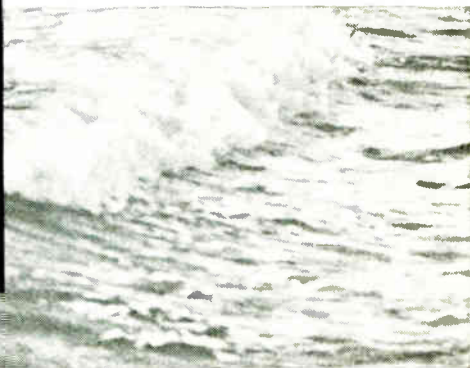
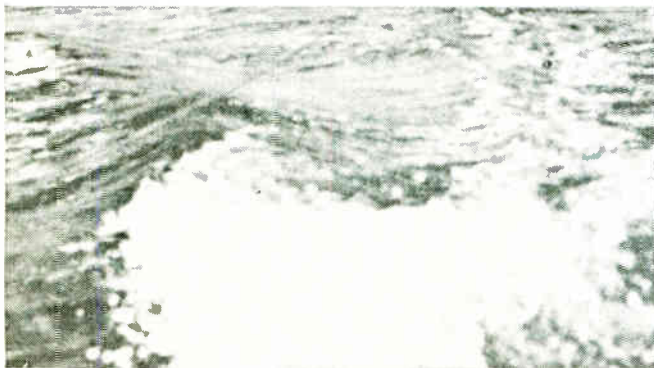

# Indicator Tube for Transistor Circuits

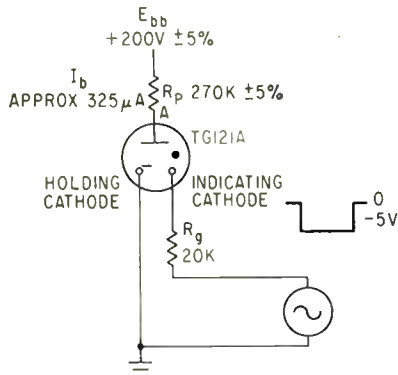

FIG. 1—Standard test circuit for glow indicator tube

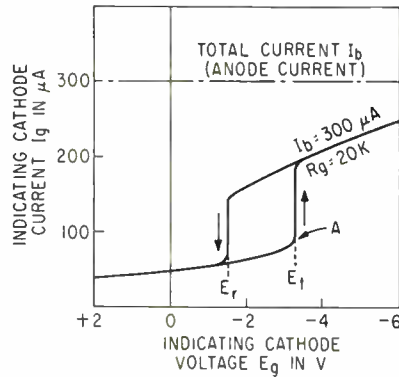

FIG. 2—Indicating current voltage characteristic

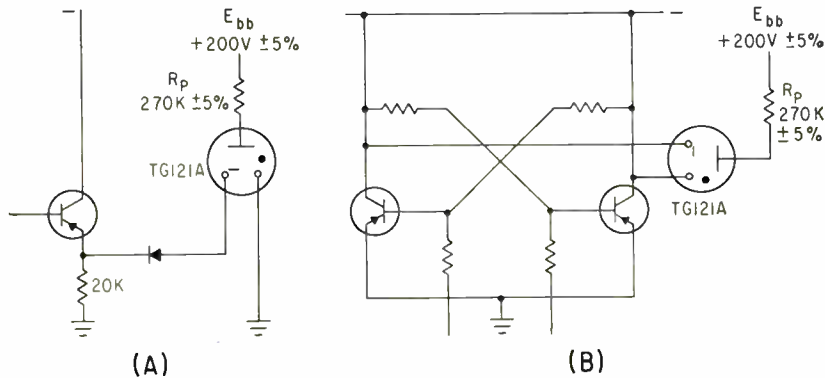

FIG. 3—Application of indicator tube with transistor and emitter follower (A); and with transistor flip-flop. (B)

By YUKIO FUKUKAWA  
TOSHIHIKO NAKAJO  
Fuji Tsushinki Seizo KK, Tokyo, Japan

A DEVICE for providing visual indication of the state of transistor switching circuits economically now requires only a small driving signal. Size (18 mm × 8 mm) is comparable to that of the transistors with which it is used and driving signal requirements are compatible with transistor circuits. Less than five volts signal input will turn an OFF tube ON.

The tube developed by Fuji Tsushinki, has two cathodes, a holding cathode and an indicating cathode (see Fig. 1). Both cathodes operate in the glow region. Signal voltage merely varies the relative amount of glow associated with each cathode; total anode cur-

rent does not vary.

The TG121A can be used in counters, and allows more digits to be shown on the same width panel than conventional displays of decade tubes. It can be mounted directly on printed circuit boards in computers, to show if a particular flip-flop or gate is operating correctly. The tube can also be used with AND gates, OR gates, and other industrial circuits to show the circuit state at any given time. Another use suggested is as a control element of a photoconductive relay. A variation of this application would be use in photoconductive coding or decoding matrixes.

Ordinary neon lamp indicators require a signal voltage about two orders of magnitude higher than the operating voltage of high speed transistor switching circuits. This

necessitates additional amplifier stages. Tungsten lamps bright enough to be seen in a well lighted room have excess power dissipation and shorter life than the associated switching circuits.

Glow indicator action is based on the current transfer between two cathodes. The breakdown voltage is of no importance in the indicating process, and the tube uses a d-c power supply, which is extremely easy to regulate and cannot cause interference in adjunct small signal circuits.

Tube anode is made of pure nickel, the holding and indicating cathodes are both made of pure molybdenum. Pure metal electrodes in a neon and xenon gas mixture provides extremely stable characteristics. Life testing has not been completed, but no changes in operating characteristics or brightness have been observed in tubes on life test for more than 20,000 hours.

Close spacing of the cathodes makes it possible for the glow transfer, which is in reality a current transfer, to occur with a small voltage difference between cathodes. This arrangement also enables the tube to reset itself. That is, the major portion of the anode current returns to the holding cathode after the indicating cathode signal returns to zero. Reset is positive, even after sustained indication.

In the design of the tube it was difficult to meet the contrary requirements of close electrode spacing for small signal operation and wide electrode spacing for ready visual discrimination of on and off states. The electrode geometry developed for the tube made it possible to satisfy both requirements. Improved processing methods made it possible to solve problems encountered in cathode sputtering, desirable for stabilizing tube characteristics.

The indicator tube with standard test circuit is shown in Fig. 1. Anode current is supplied

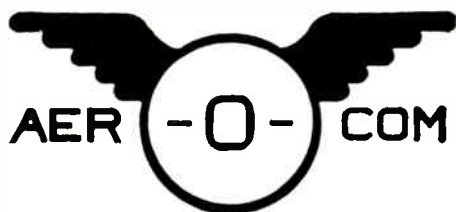

## **DEFINITELY DEPENDABLE!**

# **Aerocom's Dual Automatic Radio Beacon**

Reliability is built into every part of this dual 1000-watt aerophare unit. Ruggedly constructed and conservatively rated, it provides trouble-free unattended service, and at truly low operating and maintenance cost. It operates in the frequency range 200-415 kcs, using plug-in crystal for desired frequency.

Uses single phase power supply, nominal 220 volts, 50 or 60 cycles. Consists of two 1 kw transmitters with 2 keyers, automatic transfer unit and weatherproof antenna tuner. Each transmitter housed in separate fan ventilated rack cabinet, with controls in center rack cabinet.

Nominal carrier power is 1000 watts.

High level plate modulation of final amplifier is used, providing any desired level of modulation up to 100%. P-T switch interrupts tone, permitting voice operation. Operates in ambient temperatures from -35°C to 55°C, humidity up to 95%.

Standby transmitter is placed in operation when main transmitter suffers loss (or low level) of carrier power or modulation, or continuous (30 sec.) tone, or carrier frequency change of 5 kcs or more. Audible indication in monitoring receiver tells when standby transmitter is in operation.

Antenna may be either vertical tower or symmetrical T type.

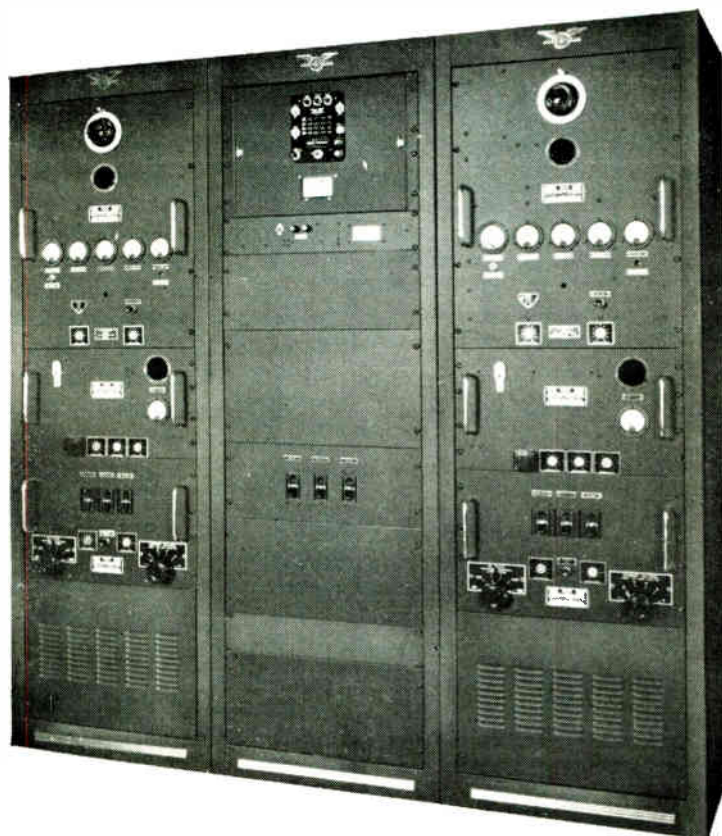

Also available in  
50 WATT  
100 WATT  
400 WATT  
and  
4 KILOWATT  
models

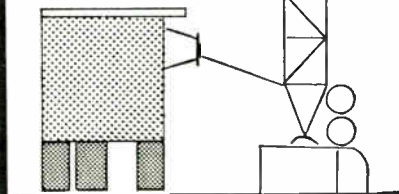

A-101

3090 S.W. 37th AVENUE • MIAMI, FLORIDA

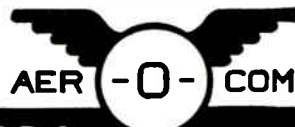

# a new concept

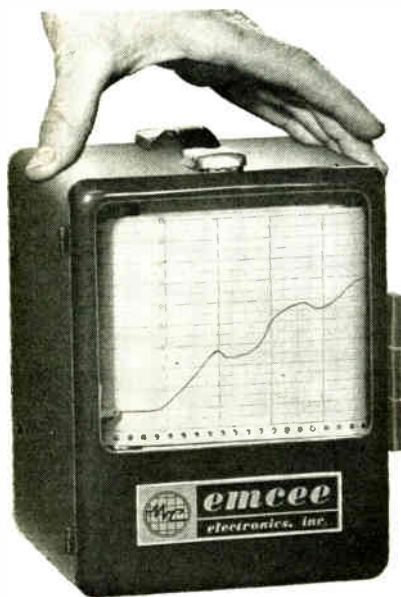

## IN NULL BALANCE STRIP CHART RECORDING

- **COMPLETELY PORTABLE OPERATION** with rechargeable self-contained battery
- **CHARGING CIRCUIT** for recharging and for AC operation
- **LIGHTWEIGHT**—only 8 lbs.
- **VERSATILE** — standard plug-in ranges available or special plug-ins to customer's specs.
- **AVAILABLE WITH ANY SPAN AND ZERO SUPPRESSION**
- **PULL-OUT CHASSIS** for easy accessibility
- **VARIABLE CHART SPEEDS**—motors changed in seconds

Send for descriptive  
brochure today!



Ph. TU 7-2136

**emcee electronics,  
inc.**  
P. O. Box 36  
Glenside, Penna.

through the series resistance and flows into the cathodes. Resistance,  $R_g$ , in the indicating cathode circuit is small enough to allow the electrode to operate in the normal glow region even when the input voltage is zero. But the voltage drop across  $R_g$  keeps the glow small enough that it remains in the masked section of the tube, and no glow can be observed. Most of the anode current flows to the holding cathode.

The proportion of the anode current flowing to the indicating cathode can be increased by applying a negative voltage to the indicating cathode. Indicating cathode current does not increase gradually, but in a step as shown in Fig. 2. Glow then surrounds the portion of the indicating cathode visible through the window of the tube, and the tube is said to be *on*. Upon removal of the signal voltage, the tube returns to its *off* condition.

Application of the indicator tube to transistor circuits is extremely simple. Figure 3A shows the tube connected to an emitter follower. The emitter also functions as the

cathode resistance of the glow tube; the diode prevents the transistor from shorting the resistor. Diode requirements are not severe and almost any diode can be used.

When the tube is used with a transistor flip-flop or other balanced circuit, the simplified circuit of Fig. 3B can be used. The tube then operates from a balanced signal of  $\pm 3$  volts. A tube is easily mounted on a flip-flop circuit board.

The tube, which has an inductive input impedance, caused no noticeable affect on any of the high speed circuits tested.

The indicator tube can be driven by a positive voltage applied to the holding cathode. If necessary, a-c signal voltages of frequencies up to several kc can also be used. And in the region beyond the normal anode current, the tube can provide self-sustaining indication when triggered by short pulses of about 1 msec.

Authors wish to express their appreciation to Takuma Yamoto, Seliichi Tabuchi, Kazuo Toyoda, Daijiro Kobayashi, and Sumio Yamamoto.

## Fiber Optics Crt Shown in London

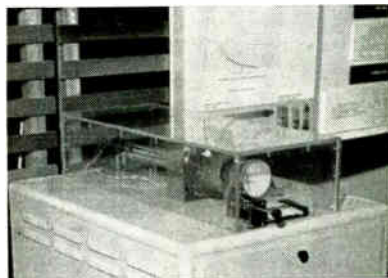

*Prototype fiber optic crt was demonstrated at an Electronics Conversazione held by the Electronics Department of Ferranti at the Mayfair Hotel, London*

A WORKING DEMONSTRATION of a three-in. circular fiber optic cathode ray tube was given in London by Ferranti Ltd. In this tube, which is 19-in long, the normal glass face plate was replaced by a fiber optics one. This causes the image formed on the blue ultra short phosphor to be transmitted through the glass giving a focused image on the front of the tube. Direct optical printing at high speeds can now be achieved.

In the demonstration, direct print out paper was used to obtain prints directly from the face of the tube. The tube has a spot size of 0.0005 in., and a definition of 6,000 lines. It can be operated from 8-20 kv and still give the same resolution, the brightness increasing with increasing voltage.

The light gathering efficiency is approximately 100 times better than an f2.8 lens on a 1 : 1 magnification ratio. The tube has potential application on print out readers, airborne radar devices and film scanning. Electromagnetic focusing and deflecting is employed. Heater voltage is 6.3 volts and current 0.3 amps.

## Optic Photoconductors Obtain High Sensitivity

DIRECT CHEMICAL IMMERSION of stable infrared-sensitive lead sulfide photoconductors onto high-refractive-index optical materials, result-



Over **20 different image orthicon tubes** are in production at Westinghouse—for all applications from standard TV broadcast to highest sensitivity types for low-light level viewing. Outstanding examples of Westinghouse leadership in image orthicon tube developments include: ■ **WX 4299**—(illustrated) image intensifier orthicon combines the highest known sensitivity with good resolution; ■ **WL 7611**—performance-proved for long life and high reliability; ■ **WL 7198**—ruggedized image orthicon with outstanding reliability proven in military applications; ■ **WL 22724**—ruggedized, highly sensitive; special S 20 photocathode provides extended red response. Thin film metal oxide target permits long picture storage or picture integration. ■ **WL 22726**—offers broad spectral response from ultra-violet to near infra-red with extremely high resolution. To meet your immediate requirements, most Westinghouse image orthicon tubes are available from stock. For more information and for ordering—call

or write: Westinghouse Electric Corporation, Elmira, N.Y. *You can be sure . . . if it's Westinghouse.*

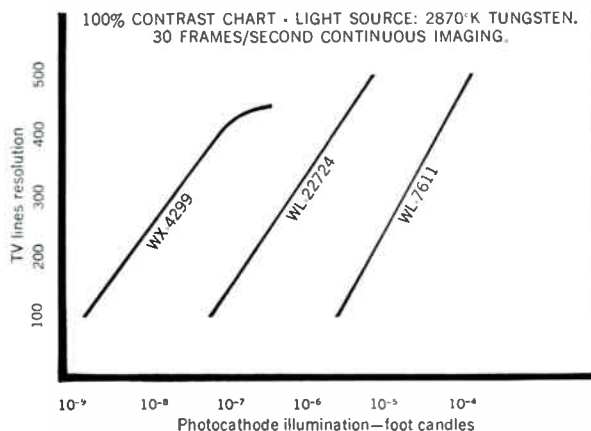

# HICKORY BRAND TEFLON\* HOOK-UP WIRE

*Long, Continuous Lengths!  
Immediate Delivery!*

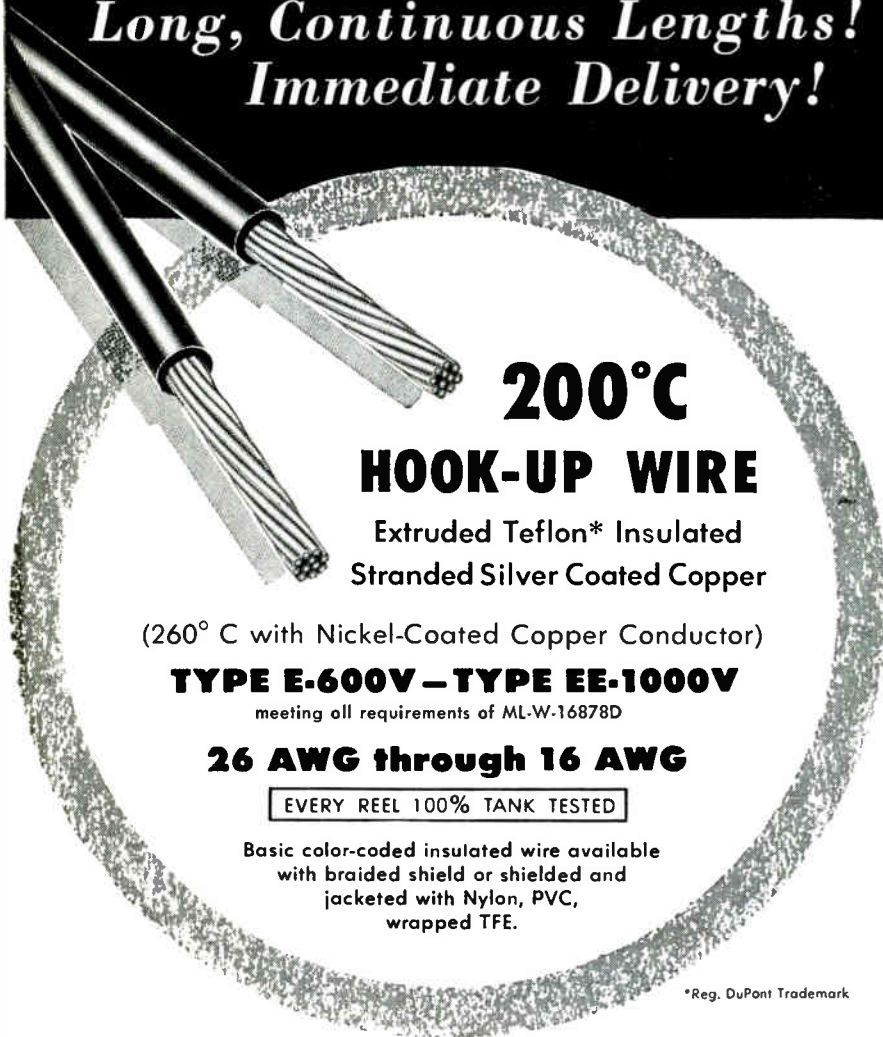

**200°C**

## HOOK-UP WIRE

Extruded Teflon\* Insulated  
Stranded Silver Coated Copper

(260° C with Nickel-Coated Copper Conductor)

### TYPE E-600V - TYPE EE-1000V

meeting all requirements of ML-W-16878D

### 26 AWG through 16 AWG

EVERY REEL 100% TANK TESTED

Basic color-coded insulated wire available  
with braided shield or shielded and  
jacketed with Nylon, PVC,  
wrapped TFE.

\*Reg. DuPont Trademark

**Multi-conductor Cable Constructions  
Designed to Meet Your Specific Requirements**

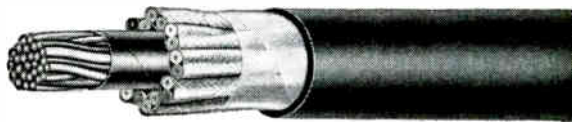

For prompt quotation, call or write  
**HICKORY BRAND**  
**Electronic Wires and Cables**

SUPERIOR CABLE CORPORATION  
P. O. Box 480-A • Hickory, N. C.

5805

68 CIRCLE 68 ON READER SERVICE CARD

ing in simpler electro-optical system design and increased detector sensitivity, has been announced by Infrared Industries' Photoconductor Division.

The immersion technique has been demonstrated on such optical substrates as sapphire, strontium titanate, rutile and moldable IRTRAN I and II, according to W. E. Standing, vice president and manager of the division. Advantages come from increased angular coverage and optical gain attained through lens design, ability to select lens material for optimum refractive index and transmission characteristics, and the reduction of reflection losses at high-low refractive index interface boundaries.

#### *High Sensitivity Gain*

Standing said that, depending on the optical material, sensitivity gains as high as 85 percent can be attained by replacing a conventional plate-type photoconductor with a reduced-area photoconductor immersed on a simple hemispherical lens. The reduction in sensitive area, and correspondingly enhanced signal-to-noise, is a function of the refractive index of the lens material as well as lens configuration. Lenses can be anti-reflection-coated to maximum transmittance.

The IRI immersion technique takes advantage of the capability of IRTRAN (refractive index 2.3) to be production-molded into large lenses, often permitting simplification of an optical system and considerable cost saving, along with increased optical efficiency.

#### **New Silicone Rubber For Flexible Molds**

ELECTRON micrographs show that a new, special room-temperature silicone rubber for making flexible molds will reproduce details in gratings at 15,000 lines per inch.

The mold, supplied in fluid form that flows readily may be used for producing parts cast from epoxies, polyesters and other plastics, and low-melting metals. The fully cured material withstands temperatures up to 500 F.

Dow Corning adds this Silastic RTV 885, as the newest member of their silicone rubber family.

electronics



**WOOD ELECTRIC**

**CIRCUIT BREAKER SPECIALISTS**



**MAGNETIC**

*The CB-4300 trips in milliseconds making it ideal for the positive protection of circuits requiring millisecond action. Features a unique auxiliary switch circuit and dual contacts. Ratings 1/2 to 25 amperes. Size 1 7/8 x 1 x 1 7/8 inches.*

Manufacturing techniques, test methods and equipment used in producing most Wood Electric circuit breakers satisfy the most stringent military requirements. Our confidence in their performance is reflected in a one-year guarantee, based on more than 20 years of experience in the production of fine circuit breakers. For catalog write Dept. D

*Circuit breakers for critical applications*



**WOOD ELECTRIC CORPORATION**  
244 Broad Street, Lynn, Mass., Area Code 617 LY8-5313

**CIRCLE 205 ON READER SERVICE CARD**

**WHAT DO THESE ITEMS HAVE IN COMMON?**

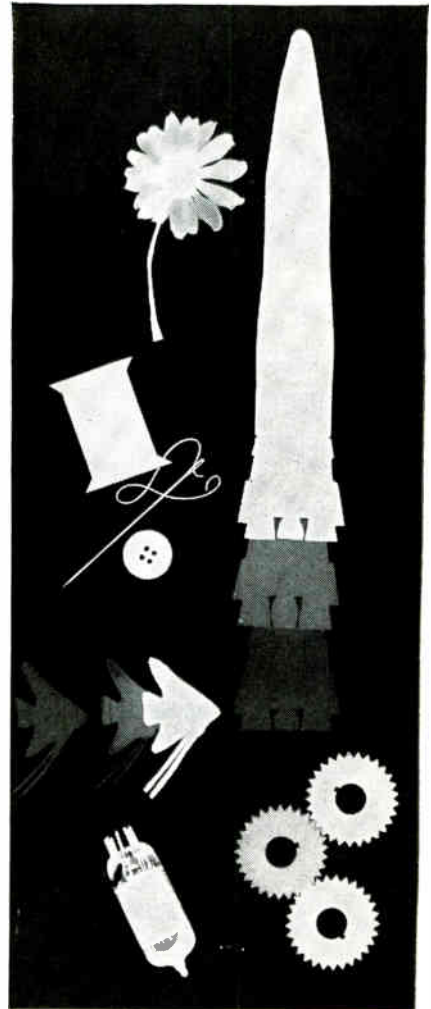

All are rushed to destinations by Delta Air Freight; get nationwide next day right-to-the-door delivery. Thousands of commodities speed daily with Delta dependability. For your next shipment, check how little by Delta — always faster, often cheaper.

EXAMPLES, DOOR-TO-DOOR:  
100 lbs. Los Angeles to Canaveral \$29.85  
200 lbs. New Orleans to New York \$29.50

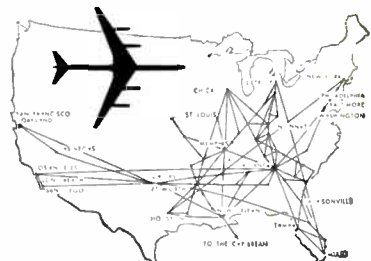

**DELTA**  
the air line with the *BIG JETS*  
GENERAL OFFICES: ATLANTA, GEORGIA.



*Write for our catalogue*

**Good parts work best!**

Intermediate Frequency Transformer IFT



POLYVARICON Variable Capacitor



The high standards of MITSUMI electronic components are insured by a fully-automated assembly system, and double-checked by rigid quality controls. Mitsumi Electric Company is Japan's largest manufacturer of components for radio, television and communications equipment.

**MITSUMI PARTS**

**MITSUMI ELECTRIC CO., LTD.**  
Komae, Kitatama, Tokyo



**CIRCLE 206 ON READER SERVICE CARD**



## MINIATURE PANEL METERS

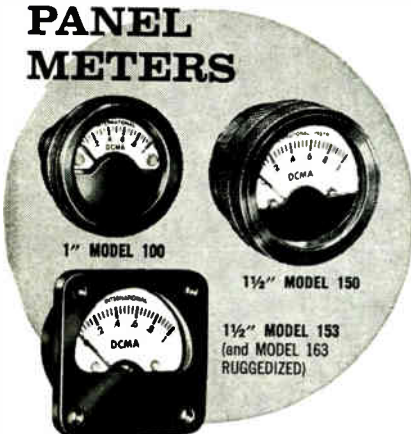

These rugged, yet accurate, meters can do a big job for you. They are available in a wide variety of standard ranges and with special scales, ranges, sensitivities, resistances, cases and other modifications to your special requirements.

ILLUMINATED MODELS can also be supplied.

PARTIAL SPECIFICATIONS			
	1" Models	1 1/2" Models	1 1/2" Ruggedized
Weight	2 oz.	4 oz.	4.2 oz.
Accuracy	± 3% of full scale for DC ± 5% of full scale for AC		
Scale Length	.760"	1.300"	1.000"

Available as DCUA, DCMA, DCA, DCMV, DCV, ACV, with zero at center, left or right. Also VU and Db meters.

International has pioneered in the development of miniature and sub-miniature meters ideally suited for military, aero-space and geophysical devices and other high-demand applications.

**WRITE FOR ENGINEERING DATA SHEETS** on our complete line of panel meters, side indicators, Electronic Control Meters, miniature multimeters, high-torque and flag-type instrument mechanisms.

**INTERNATIONAL PRODUCTS** are made in our new plant in Orange, Connecticut. It incorporates features permitting precision manufacture equal to the most exacting demands of space-age technology.

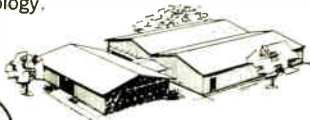

**ii** MINIATURIZATION HEADQUARTERS  
**international  
instruments inc.**  
88 Marsh Hill Road, Orange, Conn., Cable: "INTERINST"



## How to grow a beard...

Sit back and wait for your copy on that routing list. Okay if you like beards. Otherwise, look in this issue for the Reader Service Card. Fill in the "for subscriptions" section. Mail. Only 7 1/2 cents a week.

**electronics** A McGraw-Hill Publication, 330 West 42nd St., N. Y. 36

## MAGNETICO



### MINIATURE SERVO AMPLIFIERS

TRANSISTOR AND OR MAGNETIC

Call Us / WITH YOUR  
REQUIREMENTS

516 AN 1-4502

Or Write / FOR STANDARD  
LISTING



## MAGNETICO INC.

516 AN 1-4502

6 RICHTER CT. E. NORTHPORT, N. Y.

## PRODUCTION TOROIDAL WINDING

MAG - AMPS • TRANSFORMERS



INDUCTORS

FILTER COILS

DELAY LINE COILS



## MAGNETICO

CIRCLE 208 ON READER SERVICE CARD

## electronics

### Editorial Opportunity

IT DOESN'T HAPPEN OFTEN, but electronics, "bible of the industry" and a McGraw-Hill publication, has an opening for an Assistant Editor.

Ideally, the man we are looking for and to whom a post on our New York staff could be a long-term challenge, would have an electrical engineering degree or technical equivalent, practical experience in our field and a demonstrated aptitude for editing, writing, reporting. He probably lives somewhere in the metropolitan area and therefore would have no relocation problem.

Write The Editor, electronics, 330 W. 42nd St., New York 36, stating experience, aspirations and past earnings. Mark the envelope "Confidential" and it will be kept that way.

## GLASS CAPILLARY

REDRAW

Friedrich & Dimmock glass capillary tubing redraw for electronic components is available in a range from .020" to .125" OD in mill lengths up to approximately 36" or cut to specification.

Can be made from S/F, N/C Flint, KG-33, KG-12, and EN-1 Glasses.

Also available in other types of glass. Call or write for further information.



**FRIEDRICH & DIMMOCK, INC.**

Redraw Dept. P.O. Box 230  
Millville, N.J. TAYlor 5-0305

CIRCLE 209 ON READER SERVICE CARD

# if you have your eye on an exciting future . . . . .

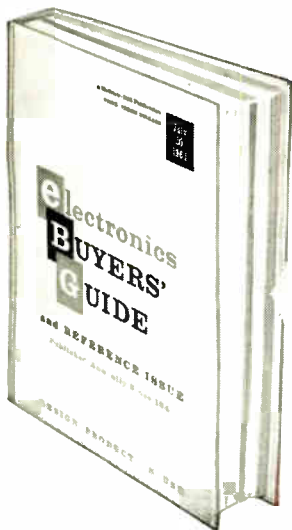

Seen  
the new  
**IDEA  
INDEX  
IN EBG?**

The INDEX to the editorial articles in electronics magazine, previously published annually in a December issue, now appears ONLY in the EBG. Another original EBG idea that saves time and trouble for users! Keep your EBG copy on your desk!

### EXTRA!

Also in the EBG are condensed ABSTRACTS of all the editorial feature articles which have appeared to date in 1961. Another reason why EBG is used more by all four — men in research, design, production and management.



McGraw-Hill Publication,  
330 West 42nd St., New York 36, N. Y.



■ ■ ■ ■ ■ exciting things are happening at Eimac. Who's the world's foremost developer and manufacturer of electron power tubes? Eimac—with a long line of firsts in the field. The first modern beam magnetic optics. The first practical matrix cathode. The first metal-ceramic tubes. The first modulating anode.

Eimac tubes have powered the first satellite bounce communication. The longest command-response achieved by man. The first radar contact with the moon. Venus. And the sun.

Tomorrow: not even the sky's the limit.

You can make this exciting future your future. Each of our development laboratories has openings for microwave tube or power grid tube development engineers. If your forte is developing new higher power, higher frequency tubes, or cavities or test equipment. Or if you have a flair for solving tube production problems and advancing production techniques and equipment, there are exciting challenges to investigate at Eimac. You'll work in an area renowned for its concentration of electronics industry, sunny weather, fine schools and pleasant living conditions. If you can qualify, write: Mr. C. F. Gieseler, Department B, Eitel-McCullough, Inc., San Carlos, California. An equal opportunity employer.

## KEEP YOUR EYE ON



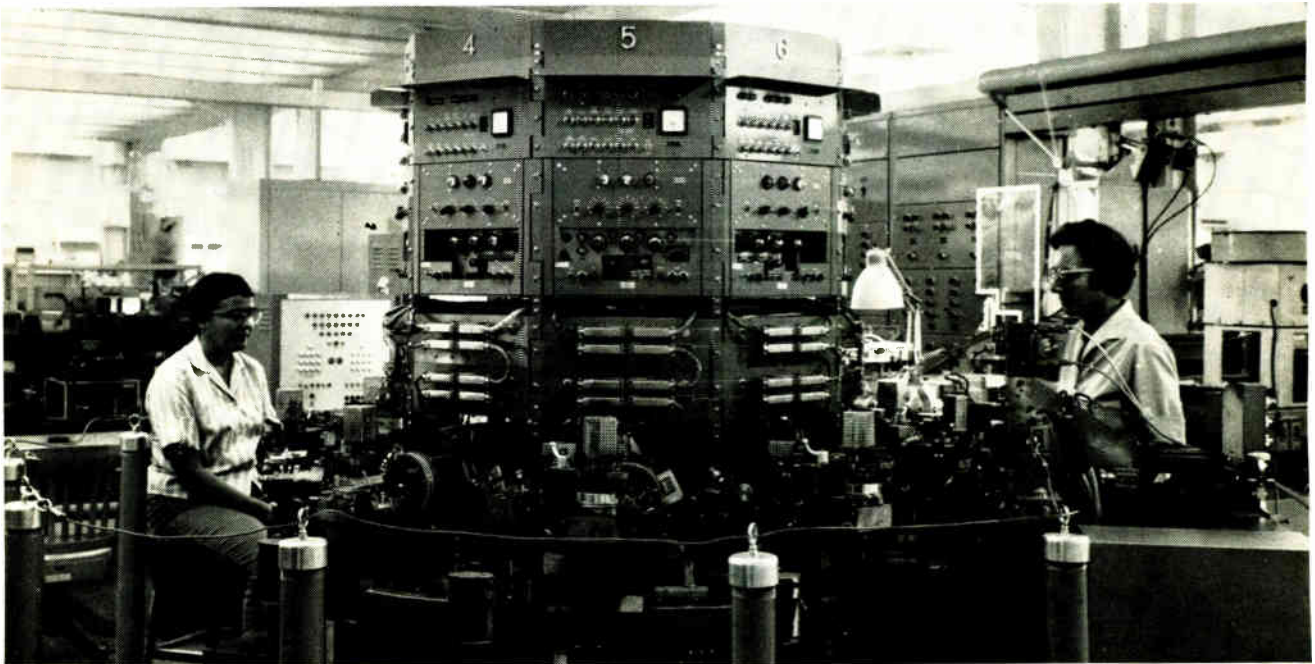

*Multistation toroid winding machine in carousel arrangement winds precision inductors automatically*

## Winding Inductors to Exact Turns Count

By JOHN COFFIN  
TOM MAYNE

Lenkurt Electric Co.,  
San Carlos, Calif.

ECONOMICAL PRODUCTION of precision electrical filters is obtained with a special toroid winding machine developed by Lenkurt Electric Co. In a highly integrated production operation, both capacitors and inductors are manufactured to tolerances better than 1 percent, then matched to yield filters with

the desired performance.

Cores are made from pressed and annealed nickel-iron powder (Lecalloy) having low loss and good temperature characteristics. The temperature coefficient of the cores is approximately equal and opposite to that of the polystyrene dielectric used in the capacitors.

Successful automatic winding of precision toroids requires individual core permeability measurement, computing the number of turns for

each core, and programming the winding head control unit.

To measure permeability, a reference inductance, part of a tuned circuit, is inductively coupled to the core under test. Core permeability affects tank circuit impedance and therefore oscillation frequency.

Usually the coupling between the core under test and the reference inductance is the equivalent of a single shorted transformer turn. The chief limitation of permeameters using single-turn coupling is the difficulty of maintaining constant contact resistance between the upper and lower cup sections. Variations in contact resistance can equal the variations in impedance caused by permeability differences.

If the turns are increased to provide a reactance about four times as great as contact resistance, resistance variations are effectively masked.

A special permeameter was developed with a 36-turn coupling element, providing a sensitivity nearly seven times greater than a single turn unit. In operation, the core to be measured is positioned

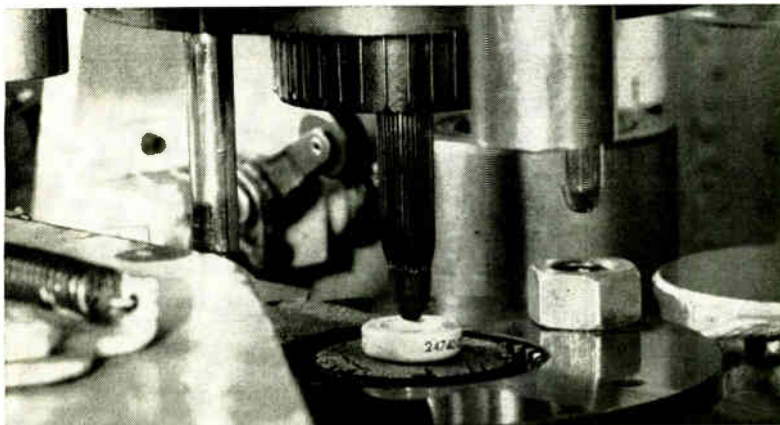

*Multi-turn permeameter used in core testing*

GET PROVEN  
COMPONENT RELIABILITY...  
**USE PHILCO  
PROVED-IN-USE  
EQUIPMENT**

... IN COMPONENT PRODUCTION



**400°C. HARD-VACUUM OVEN**

Industry's finest. Stainless steel muffle. Precise primary and secondary temperature control. Flat profile. Available in 2 sizes: 8" x 8" x 18" and 13" x 14" x 20"

**NEW LOW-COST 250°C. VACUUM OVEN**

Outstanding quality at a budget price. New Philco vacuum bake-out oven features hard vacuum—down to the  $10^{-5}$  range. Dimensions: 10 $\frac{3}{4}$ " diameter (equivalent to 8" x 8" cross-section), 18" depth.



**NEW PHILCO DRYBOXES**

Industry's most hermetically reliable dry-boxes. Available in your choice of stainless steel or aluminum.

External coupling of units, unobstructed internal working surface and plug-in compatibility with ovens and other equipment—all these Philco features assure industry's highest standard of atmosphere control.

... IN COMPONENT TESTING



**NEW PHILCO  $h_{fe}$  TESTER**

A new low-cost way to check transistor current gain. Tester is continuously tuned to process 50kc to over 200mc transistors.



**NEW PHILCO SPA<sup>®</sup>**

**Inspects Incoming Transistors Automatically**

Philco Single-Position Automatic Tester, shown in photo, enables you to plug-in 10 different parameter tests. Can be programmed to test 10 different transistor types—simultaneously. Protects transistors from outside electrical influences during tests. Contains Philco-designed-and-built solid state comparator.

For facts on Philco production and testing equipment, and capabilities for custom equipment, telephone (collect) UL 5-4681 (area code 215). Ask for Mr. E. J. Greenholt. Or write Dept. E4662E.

Equipment Development and Manufacturing Operation

**PHILCO<sup>®</sup>**

A SUBSIDIARY OF *Ford Motor Company*

LANSDALE DIVISION, LANSDALE, PENNSYLVANIA

CIRCLE 73 ON READER SERVICE CARD

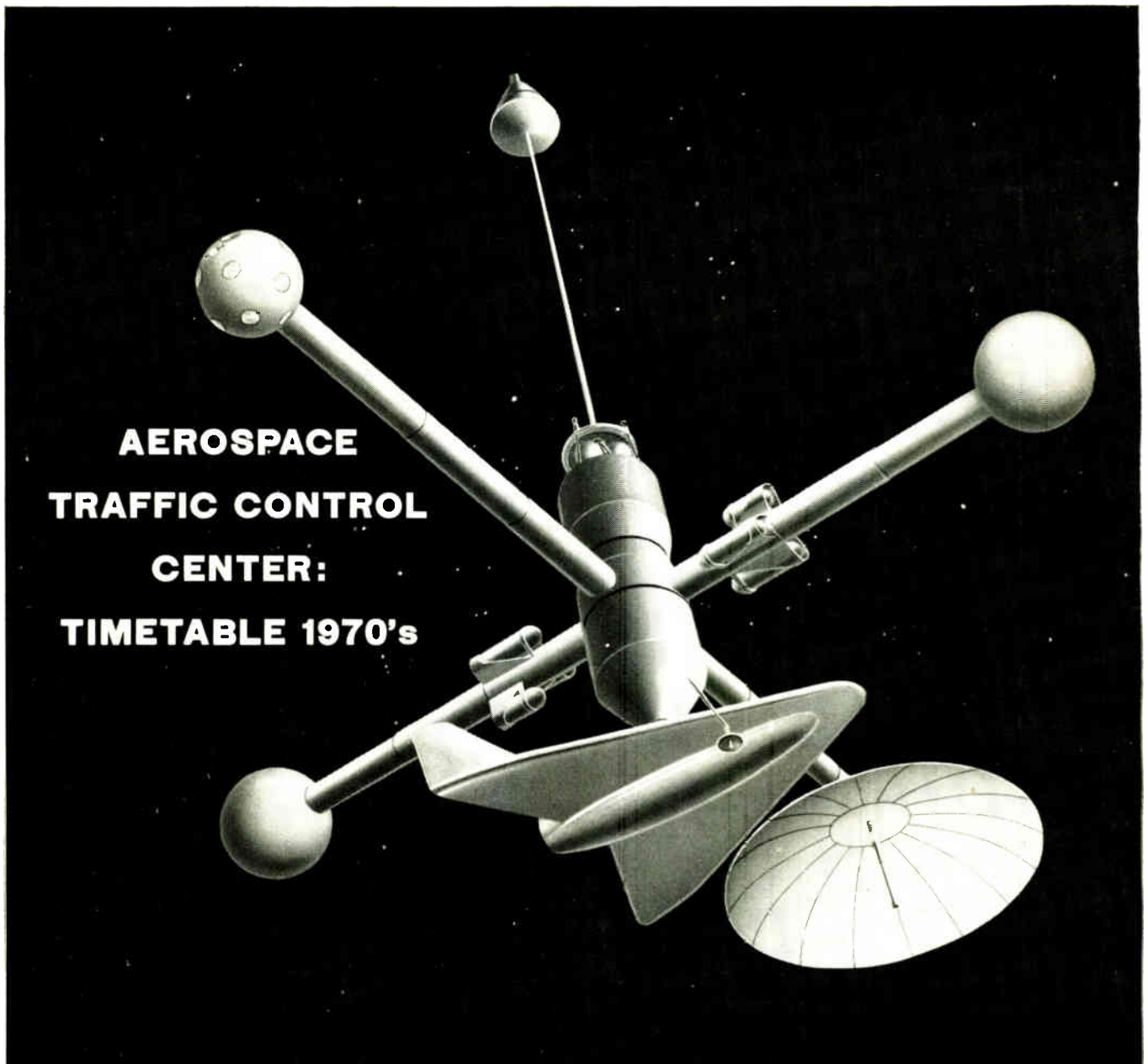

**AEROSPACE  
TRAFFIC CONTROL  
CENTER:  
TIMETABLE 1970's**

*A typical example of advanced design by Lockheed-California Spacecraft*

Will command centers based in space be an outstanding development in the ten-year span from 1967 to 1977?

The answer at Lockheed-California Company's Spacecraft Organization is—Yes. Proof: the Spacecraft design pictured here. It reflects the maturity developed in our thinking about manned space systems.

The station—aeroscope traffic control center of the 1970's—will be assembled in orbit in a series of pieces brought together by rendezvous techniques. Included: Command center; living quarters; maintenance station; radar and infrared sensing devices; nuclear power supply; communication links with the earth and other space vehicles. As now planned, 12 people will man the vehicle. Their tour of duty will be measured in weeks.

For four years Lockheed-California Spacecraft has concentrated on the needs of man in space. Activities embrace all fields pertaining to development of such complex spacecraft, as well as related supporting technologies: Space physics (radiation hazards); astrodynamics (rendezvous); biophysics (human engineering); metallurgy and manufacturing processes (materials and structures).

**Scientists and engineers** of outstanding talent and training are needed to develop the new Spacecraft, Aircraft, ASW concepts of Lockheed-California. If your capabilities lie in the fields listed at right, write: Mr. E. W. Des Lauriers, Manager, Professional Placement Staff, Dept. 1504, Lockheed-California Company, 2408 N. Hollywood Way, Burbank, California. An equal opportunity employer.

**LOCKHEED** CALIFORNIA COMPANY

A DIVISION OF LOCKHEED AIRCRAFT CORPORATION

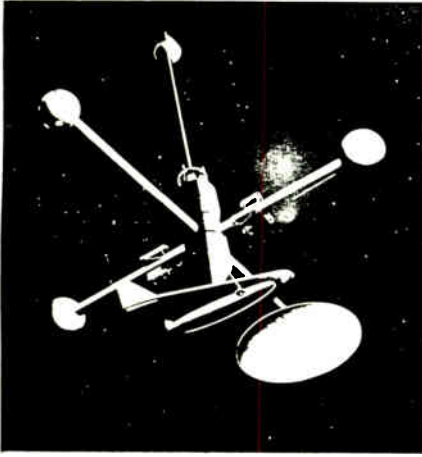

## SCIENTISTS & ENGINEERS

are needed by Lockheed-California to develop new Spacecraft, Aircraft, ASW concepts.

If you are qualified by training and temperament for work in the following fields—we suggest you contact Lockheed at once.

Human Factors  
 Physics (theoretical, plasma, high-energy, solid state, infrared, optics, nuclear)  
 Thermodynamics  
 Servosystems  
 Reliability  
 Physical or Bio-Chemistry  
 Quality and Reliability Assurance  
 Guidance and Control  
 Dynamics  
 Electronic Systems  
 Aerospace Ground Equipment  
 Auxiliary Power  
 Bioastronautics  
 Communications  
 Systems Integration and Trade-Off  
 Space Mechanics  
 Sub-Systems Synthesis and Analysis  
 Telemetry  
 Hypersonic Re-entry  
 Inertial Guidance  
 Navigation  
 Nuclear, Electric and Liquid Rocket Propulsion  
 Electronics Research  
 Hydrodynamics

Send resume to: Mr. E. W. Des Lauriers, Manager Professional Placement Staff, Dept. 1504, 2408 N. Hollywood Way, Burbank, California. An equal opportunity employer.

**LOCKHEED** CALIFORNIA COMPANY  
 A DIVISION OF LOCKHEED AIRCRAFT CORPORATION

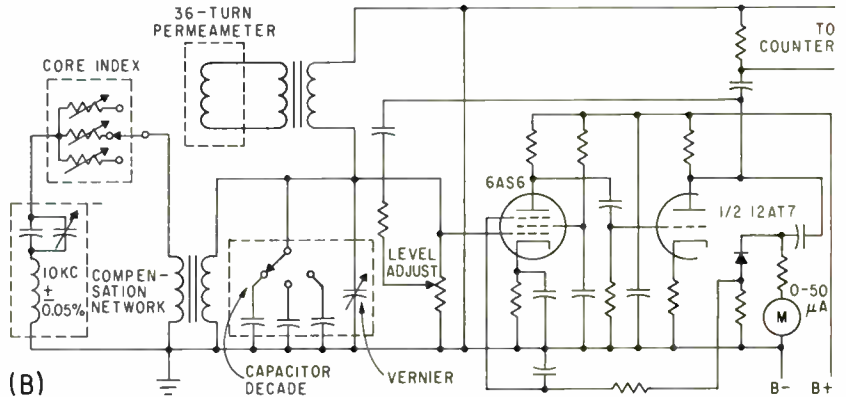
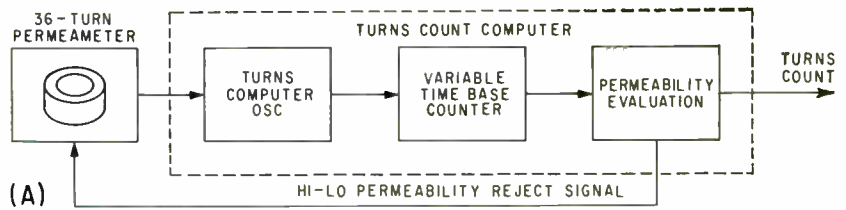

FIG. 1—Turns count is determined by the oscillator frequency when core is in the tank circuit

by a mechanical arm, and the upper rep is lowered through and around the toroidal core; connections are made as indicated in Fig. 2.

The number of turns required by each coil is calculated by the integrated permeameter-turns-computer circuit, as shown in Fig. 1.

Oscillation frequency is converted into a winding turns count in the computer by counting cycles in a controlled time interval. Oscillator frequency is an inverse function of core permeability, thus the lower the permeability, the higher the oscillator frequency and the greater the counts in the fixed time interval. Thus, although each core has slightly different characteristics, the correct number of turns for the desired inductance value is determined and programmed.

The oscillator is always set at a nominal 10 Kc with a reference test core before each production run. Since the coil is actually wound in two operations, the actual turns count developed is one-half the final count.

Rejection of out-of-tolerance cores does not mean they are unusable, since most will be used when requirements are different. The permeability evaluation unit also records the number of cores graded and the number with high- and low-tolerance.

The turns count for each core is

stored in one of two digital repeaters. The digital repeaters store the turns information on a given core until it is loaded into a winding head, then transfers it to the winding head memory.

Turns count information is stored on ten-position stepping switches, one switch being used for each decade of the turns count. The switch shafts are also brought out to the face of the winding head control unit for manual control of the turns count, if desired.

Nine independent winding heads are mounted around the circumference of the machine turntable. Each head indexes, in turn, to the loading station, where finished coils are removed and new cores inserted.

As in hand-winding machines, a split shuttle is used. Wire loading, a time consuming operation in hand winding, is completely automatic. The first few turns are wound slowly and then the shuttle accelerates to a loading rate of about three thousand feet per minute, slowing down just before the proper length is reached.

During winding, an electronic counter records the number of turns wound on the core and the count is displayed on glow transfer tubes. Thirty turns short of the desired turns count the shuttle is slowed to creep speed. When the precise number of turns is reached, a pair of fingers intercept the re-

# INSPECTION PROBLEMS?

This booklet is for you!



This comprehensive, elaborately illustrated booklet provides practical information on the use of the famous A. C. M. I. Bore-scope in various industries, for the inspection of interior areas or surfaces not otherwise visible—together with full data on the types of Bore-scope available, and on their care and maintenance. Have you received your copy?

Free on request

Fill in and mail today

To *American Cystoscope Makers, Inc.*

8 PELHAM PARKWAY

PELHAM MANOR, N. Y.

Gentlemen: Please send me without obligation a copy of your booklet on Borescopes.

Name \_\_\_\_\_

Firm \_\_\_\_\_

Address \_\_\_\_\_

City \_\_\_\_\_ State \_\_\_\_\_

CIRCLE 76 ON READER SERVICE CARD

the "root" of the profit\* problem rests squarely on Better Communications by

# BUDELMAN

• Carrier • Microwave      A SUBSIDIARY OF GENERAL RAILWAY SIGNAL CO.  
 • UHF and Multiplex Radio      375 Fairfield Ave. Stamford, Conn.  
 • Systems Engineering

Write for free BEC Spec File Today!

\* Because Budelman equipment performs better, costs less to buy and maintain.

CIRCLE 210 ON READER SERVICE CARD

## 125,000 Shares CTS Corporation

Common Stock  
(without par value)

Price \$23.50 Per Share

*Upon request, a copy of a Prospectus describing these securities and the business of the Company may be obtained within any State from any Underwriter who may regularly distribute it within such State. The securities are offered only by means of the Prospectus, and this announcement is neither an offer to sell nor a solicitation of any offer to buy.*

Goldman, Sachs & Co.

Eastman Dillon, Union Securities & Co.

Glore, Forgan & Co.

Hornblower & Weeks

Kidder, Peabody & Co.  
Incorporated

Lazard Frères & Co.

Carl M. Loeb, Rhoades & Co.

Merrill Lynch, Pierce, Fenner & Smith  
Incorporated

Smith, Barney & Co.  
Incorporated

Wertheim & Co.

March 30, 1962.



### How to grow a beard...

Sit back and wait for your copy on that routing list. Okay if you like beards. Otherwise, look in this issue for the Reader Service Card. Fill in the "for subscriptions" section. Mail. Only 7½ cents a week.

**electronics**

A McGraw-Hill Publication,  
330 West 42nd St., N. Y. 36

electronics



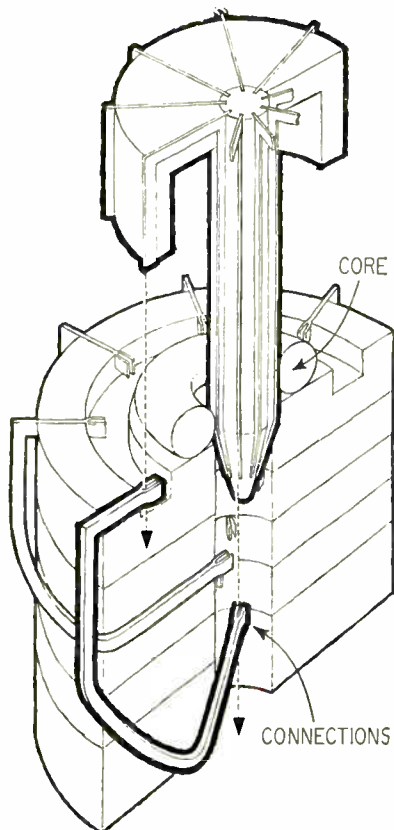

FIG. 2—Connections of multi-turn permeameter are made in three layers of contacts. Only a nine turn unit is shown here

maining wire before it is tightened into a winding turn. At the unloading station a cutter snips and extracts the excess wire and discards it. Because the cores are wound in two operations, the finished coil always has an even number of turns; when necessary, one turn is removed manually.

From 1,400 to 2,200 coils can be wound in an 8-hour shift, with winding rates from 1,800 to 3,000 turns per minute. The machine requires two full-time attendants and a maintenance technician.

A cost savings greater than 50 percent has been achieved in the production of filters, due mainly to reduction in rework. In addition, the actual cost of producing toroidal coils has been reduced to less than 1/3 that of hand-wound coils.

The machine is ideal for long runs of standard toroidal coils, but is less suitable for small quantities. For this reason, it has reduced but not eliminated manually-operated winders. Training programs were initiated with the cooperation of the production workers union to enable displaced workers to be transferred to other production operations.

# Bristol choppers help U.S. Astronaut maneuver Friendship 7 spacecraft

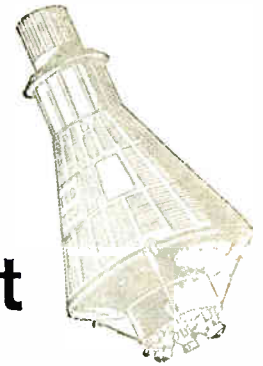

Four Bristol Syncroverter\* choppers formed a vital part of the infrared horizon sensors manufactured by Barnes Engineering Company, Stamford, Conn., and carried aloft in NASA's FRIENDSHIP 7 spacecraft by the first U. S. astronaut to orbit the earth.

The Bristol choppers function as sensitive phase detectors in the sensors as they establish a horizontal reference plane for the vehicle.

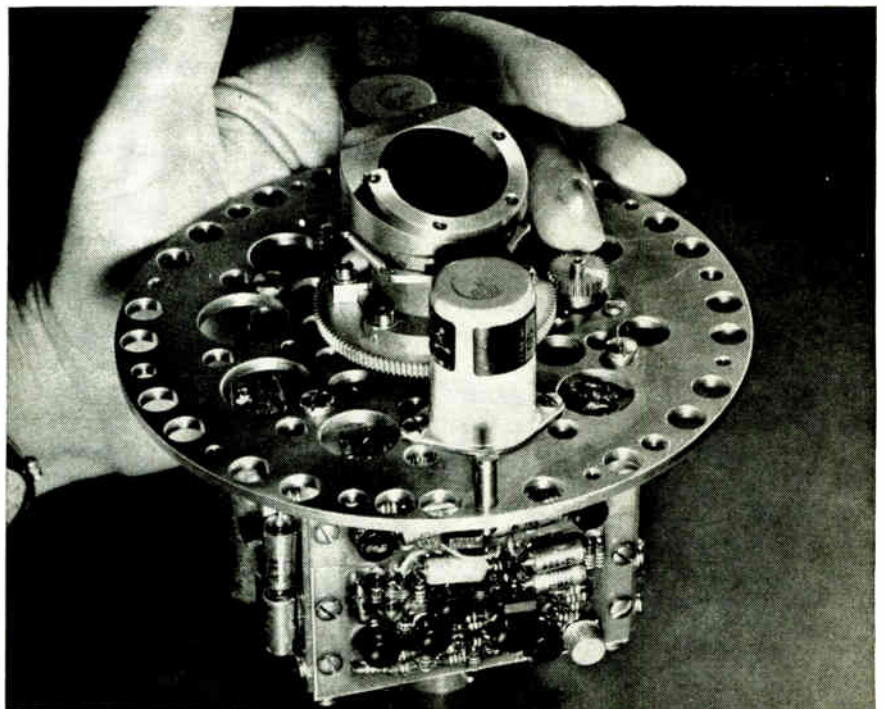

Infrared Horizon Sensor undergoes rigorous optical, mechanical, and electrical checks at Barnes Engineering Co. One Bristol chopper is located in foreground, in front of gear.

**Bristol Syncroverter\* choppers**, noted for low noise, long life and high reliability, are finding a vital place in more and more missile guidance systems, as well as in analog computers, d-c amplifiers, and test equipment for industrial applications. More than 200 models available. Write for complete details.

**The Bristol Company, Aircraft Equipment Division,  
150 Bristol Road, Waterbury 20, Conn.**

A Subsidiary of American Chain & Cable Company, Inc.

\*T.M. Reg. U.S. Pat. Off. 2.22



**BRISTOL...engineers for precision, builds for reliability**

# DESIGN AND APPLICATION

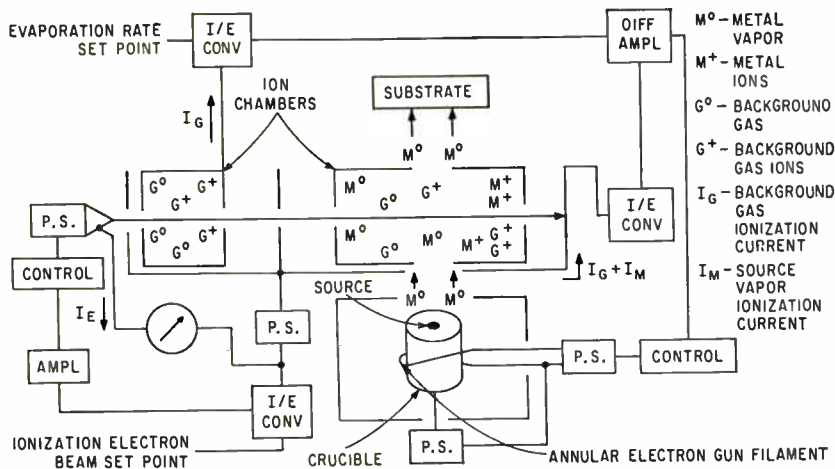

## Electron Beam Evaporator FOR THIN FILM DEPOSITION

ANNOUNCED by Alloyd Electronics Corp., 37 Cambridge Pkwy, Cambridge 42, Mass., the CR-1 controlled rate electron beam evaporator can be used in the fabrication of thin films for memory cores, capacitors, integrated circuits, deposition of optical device coatings and in multiple units it can lay down a controlled composition alloy film. As shown in the sketch, the electron gun tungsten filament and encircling tantalum crucible shoot a beam through the source vapor and ionizes a portion of the atoms going up to the substrate. Atoms that escape collision and ionization are deposited on the substrate and current resulting from ionized

atoms in source vapor is detected and amplified. This current is a measure of evaporation rate and is fed back to power source to control current and rate of evaporation. A separate gun and ionization chamber remove effect of current due to ionization of background gas. This current is subtracted so only ion current from vapor source is detected and used for control. Operating at maximum voltage of 3 Kv at 300 ma, the gun will handle vapor pressures between  $10^{-5}$  and  $10^{-2}$  mm Hg between 800 and 2,000 C. Evaporation rates can be controlled from 0.2 to 150 micrograms per  $cm^2$  per second.

CIRCLE 301 ON READER SERVICE CARD

slow sweep speeds will assist filter designers. Markers are generated (see sketch) by comparing the system ramp voltage generator output to an accurate d-c level determined by a ten-turn potentiometer. When the ramp voltage agrees with the preset voltage level, a pulse generator fires to deliver the marker.

CIRCLE 302 ON READER SERVICE CARD

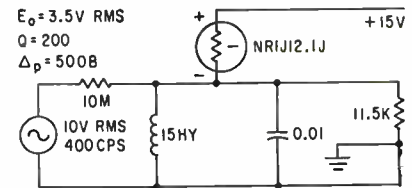
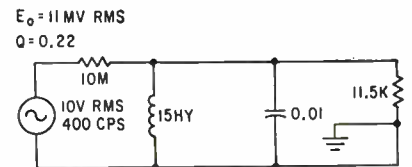

## Negative Resistance Unit SHORT CIRCUIT STABLE

CIRCUITDYNE Corp., 480 Mermaid St., Laguna Beach, California, announces the Negistor series of short-circuit stable negative resistance devices. The significant difference between the Negistor and the tunnel diode is better linearity of negative resistance exhibited by this new device. This linearity makes practical its use in a wide variety of applications where the non-linear characteristics of the tunnel diode is unacceptable. Ratings are: region of linear negative resistance (typical) 3.9 to 25 v, (guaranteed) 5 to 20 v; peak voltage 2.8 v; valley voltage 32 v; shunt capacitance at 15 v is 70 pF; and temperature coefficient of negative resistance at 15 v is 0.07 percent per degree C. Forward voltage is 35 v max, reverse voltage is 30 v max, power dissipation is 350 mw and operating temperature is -55

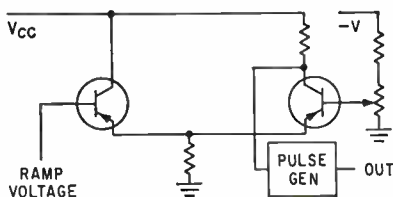

## Video Sweep Generator 100 CPS TO 10 MC $\pm 1$ DB

MANUFACTURED by Teletronics, Inc., 23-27 Main St., Nashua, New

Hampshire, the S-100 video sweep generator is completely solid state and incorporates a marker generator and detector. Four overlapping bands between 100 cps and 10 Mc can be swept in increments between 50 ms and 100 seconds with a sweep linearity of 3 percent. The unit has true zero line retrace blanking and an internal detector having 93-ohms input, linear from 0.1 to 10 v rms with a d-c output into 5,000 ohms. The extremely

# NEW MEASUREMENT EFFICIENCY

WITH THIS TEKTRONIX DIGITAL READOUT OSCILLOSCOPE

**DIGITAL READOUT**  
of time differences as short  
as 50 picoseconds.

**DIGITAL READOUT**  
of pulse risetimes as fast  
as one-half nanosecond.

**DIGITAL READOUT**  
of pulse amplitudes as small  
as 2 millivolts peak-to-peak.

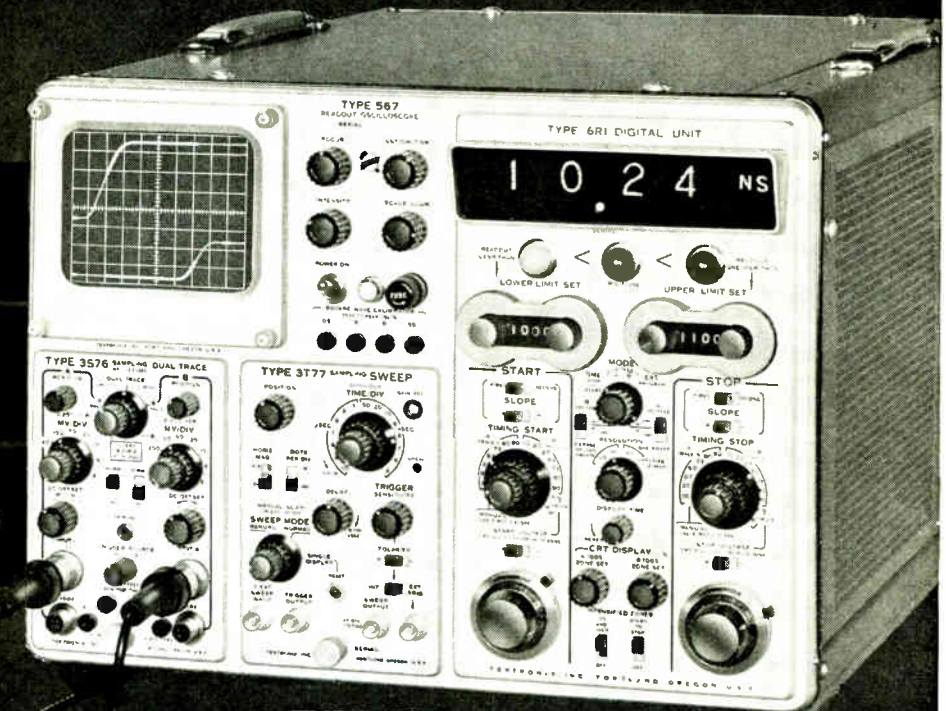

TYPE 567



A Tektronix Readout Oscilloscope enables you to make precision measurements faster and easier—for simultaneously with the analog display on the 5-inch crt, you have a digital presentation on the automatic computing programmer.

You set the program *once* for all successive similar measurements.

For each measurement, you merely read the up-to-4-digit decimal units of actual measurement.

Indicators light to designate the readout status—whether in the preset-limit range, *below* it, or *above* it.

In a typical application such as transistor-switching-time measurements, you can read directly such characteristics as the delay, rise, storage, and fall times; the total turn-on and turn-off times; the width of pulse A and pulse B; and time and amplitude between two selected points on either or both waveforms. You know immediately by the digital presentation and indicator lights whether or not the item tested has met specifications.

To achieve this faster and simpler approach to precision measurement, the Type 567 incorporates many features *new* to an oscilloscope. In the automatic computing programmer, for example, some of these new features include: position-

able measurement-reference zones, automatic normalization, zone-intensity markers, automatic and manual start-timing and stop-timing systems, preset-limit selector and indicators, provision for external programming. These features—and others in the two sampling plug-in units and the oscilloscope itself—enable the new Type 567 to greatly increase your measurement proficiency.

On a production line, in a laboratory, or for sustained testing programs, the digital readout convenience of a Type 567 can speed-up and simplify measurement of pulse amplitudes and time increments between percentages of selected amplitude levels *on an absolute or relative basis*. In addition, you can also measure pulse amplitudes and time increments on differential signals between A and B inputs.

Type 567 Readout Oscilloscope (without plug-ins) . . . . . \$ 700

Plug-In Units include:

Type 6R1 Digital Unit (Automatic Computing Programmer) \$2500

Type 3S76 Sampling Dual-Trace Unit . . . . . \$1100

Type 3T77 Sampling Sweep Unit . . . . . \$ 650

U.S. Sales Office, P.O. Box 500, Beaverton, Oregon

**For complete information about the characteristics and capabilities of this new Digital Readout Oscilloscope, please call your Tektronix Field Engineer.**

**Tektronix, Inc.** P. O. BOX 500 • BEAVERTON, OREGON / Mitchell 4-0161 • TWX—BEAV 311 • Cable: TEKTRONIX

**TEKTRONIX FIELD OFFICES:** Albuquerque, N. Mex. • Atlanta, Ga. • Baltimore (Towson), Md. • Boston (Lexington), Mass. • Buffalo, N.Y. • Chicago (Park Ridge), Ill. • Cleveland, Ohio • Dallas, Texas • Dayton, Ohio • Denver, Colo. • Detroit (Lathrup Village), Mich. • Endicott (Endicott), N.Y. • Greensboro, N.C. • Houston, Texas • Indianapolis, Ind. • Kansas City (Mission), Kan. • Los Angeles, Calif. Area (East Los Angeles Encino • Pasadena • West Los Angeles) • Minneapolis, Minn. • Montreal/Quebec, Canada • New York City Area (Albany, N.Y. • Stamford, Conn. • Union, N.J.) • Orlando, Fla. • Philadelphia, Pa. • Phoenix (Scottsdale), Ariz. • Portland, Ore. • Poughkeepsie, N.Y. • San Diego, Calif. • San Francisco, Calif. Area (Alameda • Palo Alto) • Seattle, Wash. • Syracuse, N.Y. • Toronto (Willowdale), Ont., Canada • Washington, D.C. (Annandale, Va.).

**ENGINEERING REPRESENTATIVES:** Kentron Hawaii Ltd., Honolulu, Hawaii. Tektronix is represented in over 75 overseas countries by qualified engineering organizations. European and African countries, the countries of Lebanon and Turkey, please contact TEKTRONIX INTERNATIONAL A.G., Terrassenweg 1A, Zug, Switzerland, for the name of your local engineering representative. Other Overseas areas, please write or cable directly to Tektronix, Inc., International Marketing Department, P. O. Box 500, Beaverton, Oregon, U.S.A. Cable: TEKTRONIX.

# "WE WILL BUILD AROUND TOP-GRADE TECHNICAL TALENT"

E. G. UHL, President,  
Fairchild Stratons Corporation

Can a simple, straightforward statement capture the spirit of a complex and dynamic situation? We believe it can.

Today, the revitalized divisions comprising Fairchild Stratons are not static, crusted organizations. They are living, growing, achieving forces of human thought and energy. There is a new and growing boldness and vision, a deep personal involvement, and a basic sense of "becoming". Across many disciplines, through each location, in a sound diversity of important programs, there are these common hallmarks:

- True technical excellence which comes from talented individuals and small elite groups rather than massive mediocrity.
- Involvement of technically insightful management at primary points of decision, day to day.
- Recognition and reward of top individual contributors who are challenged and stimulated to truly professional creativity.
- Aggressive program direction, evaluation and control.

This is Fairchild Stratons. A growing and dynamic complex of talented individuals. Fully integrated, small-to-medium sized divisions, large enough for major primes, small enough for state-of-the-art subs. The result is a whole that is greater than and different from the sum of its parts.

**FAIRCHILD STRATONS**  
HAGERSTOWN, MD.

#### Divisions:

#### Aircraft-Missiles

Hagerstown, Md.

#### Aircraft Service

Saint Augustine, Fla.

#### Electronic Systems

Wyandanch, L.I., N.Y.

#### Stratons

Bay Shore, L.I., N.Y.

to +85 C. The upper sketch, p 78, shows a loaded circuit fed from a high impedance source. Center frequency is 400 cps and the 3 db bandwidth is 1,800 cps. The lower sketch shows the same circuit using the new device. Here, the 3 db bandwidth is 2 cps, indicating a Q of 200 while the power output has increased by 50 db.

**CIRCLE 303 ON READER SERVICE CARD**

## Static Inverters

### MEET MILITARY SPECS

ASTRO-SPACE LABORATORIES, INC., 2104 Memorial Parkway, S.W., Huntsville, Ala. Type DSI-10 digital static inverters supply poly-phase 400-cycle a-c from standard d-c supplies. They synthesize sinusoidal waveforms with  $\pm 1.0$  v regulation on balanced or unbalanced loads. Using all-silicon switching transistors and digital circuitry, their efficiency is better than 80 percent on full loads. Models are available from 250 to 5,000 v-a.

**CIRCLE 304 ON READER SERVICE CARD**

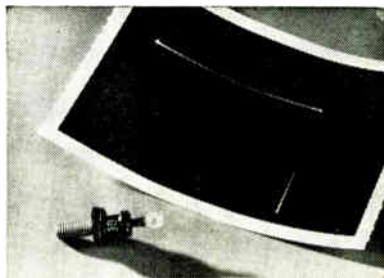

## Rectifier

### CONTROLLED AVALANCHE

GENERAL ELECTRIC CO., West Genesee St., Auburn, N. Y., has introduced the controlled avalanche rectifier, a semiconductor which protects itself against damaging transient voltages. Pictured is the 12 ampere unit known as the ZJ218. The oscillogram depicts the sharp reverse avalanche characteristic at 1260 v of a typical 800 prv controlled avalanche rectifier. The ZJ218 can dissipate up to 3,900 w peak power in the avalanche region.

**CIRCLE 305 ON READER SERVICE CARD**

## Wirewound Resistors

DALE ELECTRONICS, INC., Columbus, Neb. Type MRS miniature resistors

with molded coating are available with ratings of  $\frac{1}{2}$  w and  $\frac{1}{4}$  w at 125 C ambient temperature; max continuous operating temperature for both, 275 C.

**CIRCLE 306 ON READER SERVICE CARD**



## RMS Meter

### HIGH SENSITIVITY

GREIBACH INSTRUMENTS CORP., 315 North Ave., New Rochelle, N. Y. This meter features use of precision wire-wound resistors, true rms—no amplifiers, and a design that excludes the use of current-limiting thermocouples. The simple, virtually foolproof unit uses a solid state transducer instead of a thermocouple, resulting in higher sensitivity, greater over-load capacity, and less current consumption within the meter.

**CIRCLE 307 ON READER SERVICE CARD**

## NPN Semiconductor

### HIGH BETA

WINTRONICS, INC., 1132 S. Prairie Ave., Hawthorne, Calif. The Beta-Pak npn silicon amplifier weighs  $\frac{1}{2}$  oz and is  $\frac{1}{2}$  cu in. in size. Designed for applications requiring high input and low output resistances. Current gain is  $>100,000$ , that is 1  $\mu$ a input will produce 150 ma output with 50-ohm load.

**CIRCLE 308 ON READER SERVICE CARD**



## Capacitors

### ULTRASTABLE

BALCO RESEARCH LABORATORIES, INC., 49-53 Edison Place, Newark, N. J., offers a capacitor for circuit applications requiring constant capacitance with varying operating tem-

peratures. Capacitor variation is  $< \pm 0.05$  percent (approx.) from  $-15$  C to  $+85$  C and  $< \pm 0.5$  percent (approx.) from  $-55$  C to  $+85$  C. High stability holds for both short and long term time intervals. Insulation resistance is  $> 5 \times 10^{10}$  ohms, dissipation factor and dielectric absorption are relatively low.

**CIRCLE 309 ON READER SERVICE CARD**

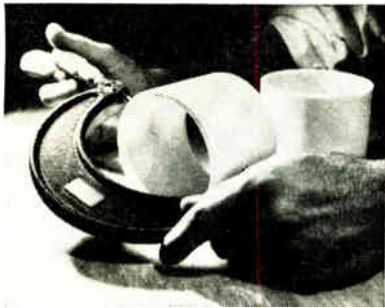

## Beryllium Oxide

### HIGH-PURITY

NATIONAL BERYLLIA CORP., First & Haskell Avenues, Haskell, N. J., announces high-purity beryllium oxide which has the ability to isolate electronic components electrically, while conducting heat away from them.

**CIRCLE 310 ON READER SERVICE CARD**

## P-M Material

WESTINGHOUSE ELECTRIC CORP., P. O. Box 128, Blairsville, Pa. A ductile permanent magnet material called Vicalloy—composed of 52 percent cobalt, 10 percent vanadium and 38 percent iron—is capable of being rolled to thickness of less than one-half of one-thousandth of an inch.

**CIRCLE 311 ON READER SERVICE CARD**



## Transistor Tester

### DIRECT READING

DYNATRAN ELECTRONICS CORP., 178 Herricks Road, Mineola, N. Y. Model 1822 provides direct readings

## MISSILE-SPACE ENGINEERS and SCIENTISTS

**The Aircraft-Missiles Division** needs exceptional talent to spearhead accelerated growth into selected, key aerospace areas such as satellite and reentry systems, reconnaissance-surveillance systems, communications and power for space applications, and advanced missile systems. Basic prerequisites include appropriate degree, plus a minimum of three to four years' applicable experience.

### ADVANCED SYSTEMS ENGINEERING

Requires increasingly more responsible experience in depth in space, reentry vehicle and satellite programs in control systems, guidance systems, sensor systems, communications systems, propulsion systems, data systems, computers (airborne), vehicle systems (reentry and space), recovery systems, command systems, biological and chemical systems.

### SYSTEMS ENGINEERING

Must have had increasingly responsible experience in depth the last several years of which must have been in systems engineering in one or more of the following areas—control systems, guidance systems, sensor systems, communications systems, propulsion systems, data systems, computers (airborne), vehicle systems (reentry and space), recovery systems, command systems, operations research activities, applied mathematics.

### ELECTRONICS ENGINEERING

Requires progressively more responsible experience in depth preferably as related to ballistic missiles, space and reentry vehicles, satellites and associated systems in such areas as data systems, radar, telemetry, tracking equipment, sensor equipment, guidance (command and inertial), control, computers, ground support equipment.

### ENGINEERING TECHNOLOGIES

Must have had increasingly more responsible experience demonstrating ability to handle problems in one or more of the following areas—heat transfer-fluid flow, orbital mechanics, trajectory analysis, aerophysics, magneto hydrodynamics, applied mechanics, aerothermodynamics, space dynamics, numerical analysis, calculus of variations, statistics and information theory, materials engineering—metals and non-metals.

### DESIGN ENGINEERING

Requires progressively more responsible and complex subsystem design experience and demonstrated excellence of capacity in handling such assignments in one or more of the following areas—propulsion, servomechanisms, vehicle structures, space power systems, electrical power and distribution, recovery systems, ground support equipment and environmental control.

For prompt information regarding these openings, inquire of C. A. Webb, Jr., Manager, Professional Relations

**FAIRCHILD  
STRATOS**

AIRCRAFT-MISSILES DIVISION  
HAGERSTOWN 23, MD.

An equal opportunity employer

# UTICA TOOLS

## NEW UA-200

THE VERSATILE  
MULTI-PURPOSE  
POWER CUTTER  
FOR INDUSTRY  
WITH  
INTERCHANGEABLE  
CUTTING HEADS

**B-5 Cutter**  
Standard edge  
diagonal cutting head

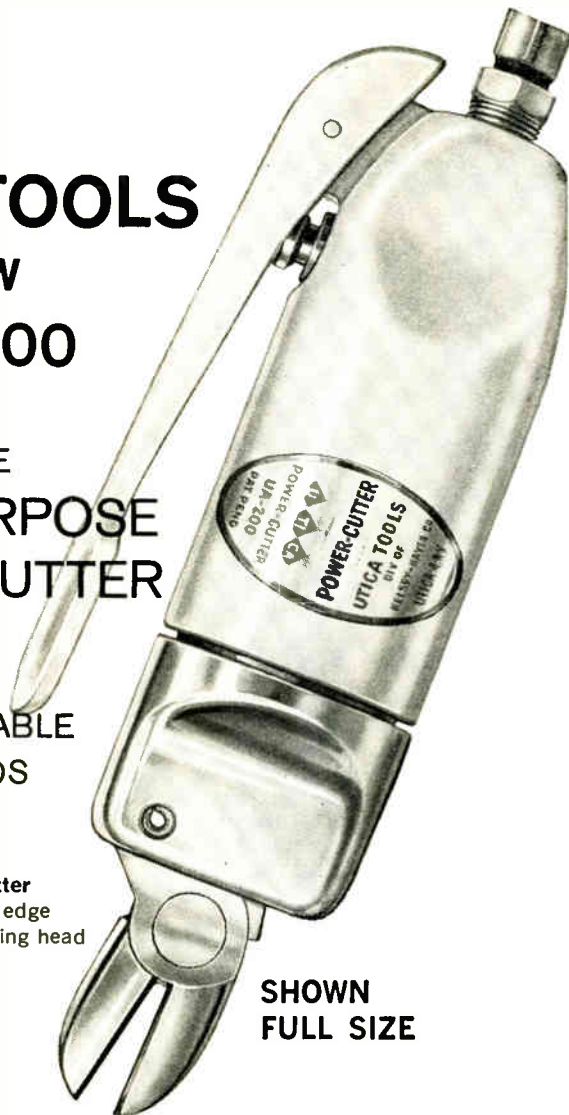

SHOWN  
FULL SIZE

This latest and most versatile addition to the Utica line of production tools is available with four optional, interchangeable cutting heads. Each head is designed for a specific cutting purpose and all have electronically induction hardened jaws. The air cylinder is lightweight, shock-resistant Delrin plastic and the UA-200 is easily operated with a long trigger that fits either hand. And the UA-200 is four times more powerful. Maximum cutting speed with minimum operator fatigue assures higher production in almost any cutting operation. Each UA-200 is equipped with an 8 ft. air hose and your choice of one cutting head. Write for complete information.

### OPTIONAL HEADS FOR VARIED USES



**B-6 Cutter**  
Hairline flush edge  
diagonal cutter head



**B-7 Cutter**  
Cutter-crimper head  
for printed circuits



**B-8 Cutter**  
Diagonal cutting head  
for plastics only

# UTICA

UTICA TOOLS • DIVISION OF KELSEY-HAYES COMPANY, UTICA 4, NEW YORK

of the various d-c parameters of power transistors over a wide range of bias conditions. Parameters are measured by means of a pulsed power circuit which provides peak pulsed power up to the Kw range with collector voltages variable up to 300 v and collector currents up to 100 amp.

CIRCLE 312 ON READER SERVICE CARD



### D-C Power Supply ADJUSTABLE

SPECIFIC PRODUCTS, 21051 Costanso St., Woodland Hills, Calif. Model APS275B Benchpac adjustable power supply offers a better than 1 percent regulation with very low ripple (0.5 v at 50 ma 275 v) in a compact case for mounting where space is at a premium. Price is \$49.

CIRCLE 313 ON READER SERVICE CARD

### Power Transistors

SEMI-ONICS, INC., 4 Broadway, Lowell, Mass., announces three series of *ppp* germanium power transistors in the low-outline TO-36 package. They are designated 2N1518 through 2N1523, 2N2075 through 2N2082, 2N2152 through 2N2159.

CIRCLE 314 ON READER SERVICE CARD

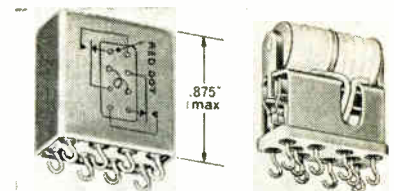

### Matching Relay SUBMINIATURE

C. P. CLARE & CO., 3101 Pratt Blvd., Chicago 45, Ill., offers type LF subminiature magnetic latching relay. Sensitivity of the two-coil models is 150 mw per coil with an operate

time of 5 millisecc at 25 C. Single-coil models are sensitive to 75 mw with an operate time of 8 millisecc at 25 C. Contact load life may be as high as 1,000,000 operations, depending on the type of contact load used.

**CIRCLE 315 ON READER SERVICE CARD**

### Ceramic Capacitors

THE SCIONICS CORP., 7400 Deering Ave., Canoga Park, Calif. The S-Cap series of 200 v d-c subminiature and dip-coated ceramic capacitors are available for miniature modular and printed circuitry.

**CIRCLE 316 ON READER SERVICE CARD**

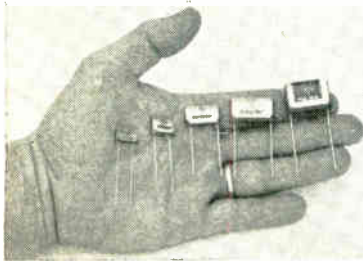

### P-C Capacitors

CLEAR EPOXY POTTED

PRESIN CO., INC., 2014 Broadway, Santa Monica, Calif. The Miniprint vacuum impregnated capacitors are made for insertion into p-c boards by dip soldering, if desired. Normal tolerance is  $\pm 20$  percent of capacitance range up to 2  $\mu\text{f}$  or 630 v operating voltage. Will meet class IV humidity specifications and operate from  $-55$  C to  $+85$  C.

**CIRCLE 317 ON READER SERVICE CARD**

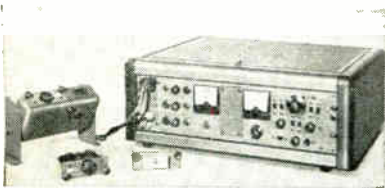

### Semiconductor Test Set PROGRAMMABLE

LUMATRON ELECTRONICS, INC., 116 County Courthouse Rd., New Hyde Park, L. I., N. Y. Model 505 semiconductor test set features automatic programming of test conditions for transistor switching time and diode reverse recovery time measurements in a prepared test

April 6, 1962



## PRECISION GIMBAL ANGLE ENCODER

# Direct Digital Pickoff

**FOR ATTITUDE REFERENCE PLATFORMS  
AND INERTIAL SYSTEMS**



DIGISYN® Type RI-15S optical pancake encoder — 2<sup>15</sup> counts per revolution with rotation sensing and zero reset.



The Wayne-George DIGISYN® Type RI-15S measures gimbal angles in attitude reference, inertial guidance and similar platforms with accuracies to 40 seconds of arc. Associated solid state electronics occupying less than 10 cubic inches provide high-level pulses, one pulse for each 40 seconds of arc, which may be counted to give a direct digital representation of angle. Self-contained direction sensing logic provides pulses on one of two lines depending on direction of rotation. A third line provides a zero index for resetting a reversible counter. The precision, hollow encoder bearing may be used as a gimbal support in most platform applications.

In addition to greater accuracy and reliability, savings in weight and space over synchro-to-digital systems can be realized with the Type RI-15S pancake encoder.

Wayne-George's experience in the design and production of angle encoders and pulse tachometers for a wide variety of applications is available to meet your special requirements.

*Write for Technical Literature*



**WAYNE-GEORGE CORPORATION**

322 Needham Street, Newton 64, Mass.

**CIRCLE 83 ON READER SERVICE CARD 83**



## PACKAGED SERVO ASSEMBLIES

Kearfott packaged servos combine all components (synchros, resolvers, motor-generators, amplifiers, etc.) of typical positioning servos. Available in two basic versions: BuOrd configuration with output shaft, and flat pack in-line configuration without shaft; transistorized amplifier can be built into either. BuOrd size 11 (with two size 5 components), size 15 (with up to four size 5 components), and size 18 (with up to six size 5 components). Flat pack type accommodates up to four wound components. Component complement and precision gearing in a wide range of ratios . . . to your specifications.

For complete data write Kearfott Division, General Precision, Inc., Little Falls, New Jersey.

# KEARFOTT

## HIGHLY RELIABLE



## SHAFT POSITION-TO-DIGITAL CONVERTERS

Resistant to high shock, vibration, and temperature extremes. Applications include latitude, longitude, azimuth, or conventional angular shaft displacement conversion and decimal count conversion. Kearfott's exclusive drum design gives large conversion capacity (typical unit  $2^{15}$ ) in small size. Combination counter-converter assemblies for visual and electrical readout also available.

### CHARACTERISTICS:

Part Number	P1241-11A	P1240-11A	Y1240-11A	Y1241-11A	U1240-11
Code	Cyclic Binary	Binary Decimal			
No. of Drums	5	3	3	2	4
Range	0-32,768 ( $2^{15}$ )	(+)0 to (+)999 (-)999 to (-)0	0 to 359.9	0 to 359	0 to 359.9
Bits per Revolution	16	20	40	40	40
Revolutions for Total Range	2,048	100	90	9	90

For complete data write Kearfott Division, General Precision, Inc., Little Falls, New Jersey.



# GENERAL PRECISION

circuit. It consists of a 0.3 nsec rise time pulse generator, two 500 ma bias supplies and a test jig to hold standard Lumatron transistor and diode test circuit cards.

**CIRCLE 318 ON READER SERVICE CARD**

## Phase Meter

WILTRON CO., 717 Loma Verde Ave., Palo Alto, Calif. Model 305 phase indicator for pulsed microwave signals is an instrument for measuring the r-f phase characteristics during a pulse and between successive pulses. This is important in testing high power microwave tubes.

**CIRCLE 319 ON READER SERVICE CARD**

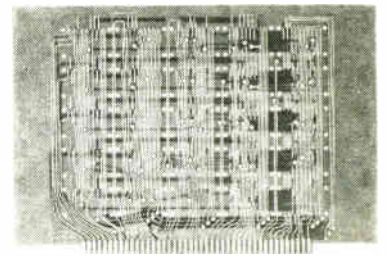

## P-C Board

REDUCED SIZE

PHOTOCIRCUITS CORP., 31 Sea Cliff Ave., Glen Cove, N. Y., announces p-c boards utilizing the Mini-Pad technique which reduces the amount of land or pad area around each circuit hole without sacrificing the strength or reliability of the plated-through interconnection. Use of this process can reduce the required board size by as much as 50 percent.

**CIRCLE 320 ON READER SERVICE CARD**

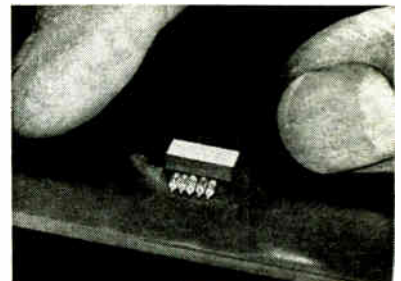

## Packaged Circuits

ENCAPSULATED

CLEVITE TRANSISTOR, Waltham, Mass., employing a milliminiature germanium diode, has developed a line of plastic encapsulated Millipak packaged circuits which will enable



engineers to increase component density on circuit boards by a substantial factor. Company says the milliminiature diode is 1/4th the volume of present subminiature diodes and provides identical circuit performance. MIL-S-19500 specs are exceeded.

**CIRCLE 321 ON READER SERVICE CARD**

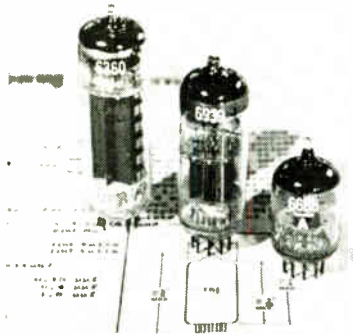

### High Reliability Tubes FOR MILITARY USE

SYLVANIA ELECTRIC PRODUCTS INC., 730 Third Ave., New York 17, N. Y., announces three high reliability tubes—the 6360, 6939 and 6688A, for communications equipment and electronics instrument applications. Very high resistance to temperature, shock and vibration suit them for military applications. Company says each has unusual capabilities in the vhf and uhf ranges.

**CIRCLE 322 ON READER SERVICE CARD**

### Voltage Reference

ELECTRONIC DEVELOPMENT CORP., 423 W. Broadway, Boston 27, Mass. Model VS-11 precision voltage reference source features an accuracy of 0.025 percent of the selected output voltage.  $\pm 250 \mu\text{V}$ .

**CIRCLE 323 ON READER SERVICE CARD**

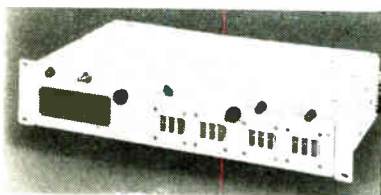

### Counter Timer SEQUENTIAL/INTERVAL

DI/AN CONTROLS, INC., 944 Dorchester Ave., Boston 25, Mass. Model S. I. C.-4/3-25 sequential interval



## SIZE 11 WINDING-COMPENSATED SYNCHRO RESOLVER

Precision, lightweight, high-accuracy components with applications in analog computers and automatic control systems. The compensator winding provides feedback voltage for a resolver isolation amplifier; the feedback loop automatically adjusts to compensate for temperature and frequency variations. Function error of the R980-018 is only 0.1%. A compatible transistorized amplifier, Kearfott number S3100-01A, is available.

Part Number	5R980-41	CR9 0980 001 R980-018
Excitation (volts) (max.)	60	26
Frequency (cps)	400	400
Total Null Voltage (mv)	25	10
Max. Error from E.Z. (minutes)	5	5
Operating Temp. Range (°C)	-55 to +125	-55 to +125

For complete data write Kearfott Division, General Precision, Inc., Little Falls, New Jersey.

# KEARFOTT

## DUAL- CHANNEL TRANSISTORIZED BUFFER AMPLIFIERS



These high-performance units are designed to drive Kearfott's Size 11 R980 winding-compensated synchro resolvers. The amplifier-resolver combination has stable gain characteristics and negligible phase shift through an ambient temperature range of  $-50^{\circ}\text{C}$  to  $+85^{\circ}\text{C}$ . Extremely high resistance to shock and vibration. Meet environmental requirement of MIL-E-5272.

Part Number	S3100-01
Number of Inputs	4 per channel
Input Impedance (ohms resistive at 25°C)	100,000
Voltage Gain	$1 \pm 0.0005$
Phase Shift (rotor output to input at 25°C)	less than 15 min.
Max. Signal Output Voltage	16 volts
Gain Stability Over Operating Temp. Range	$1 \pm 0.05\%$

For complete data write Kearfott Division, General Precision, Inc., Little Falls, New Jersey.



# GENERAL PRECISION

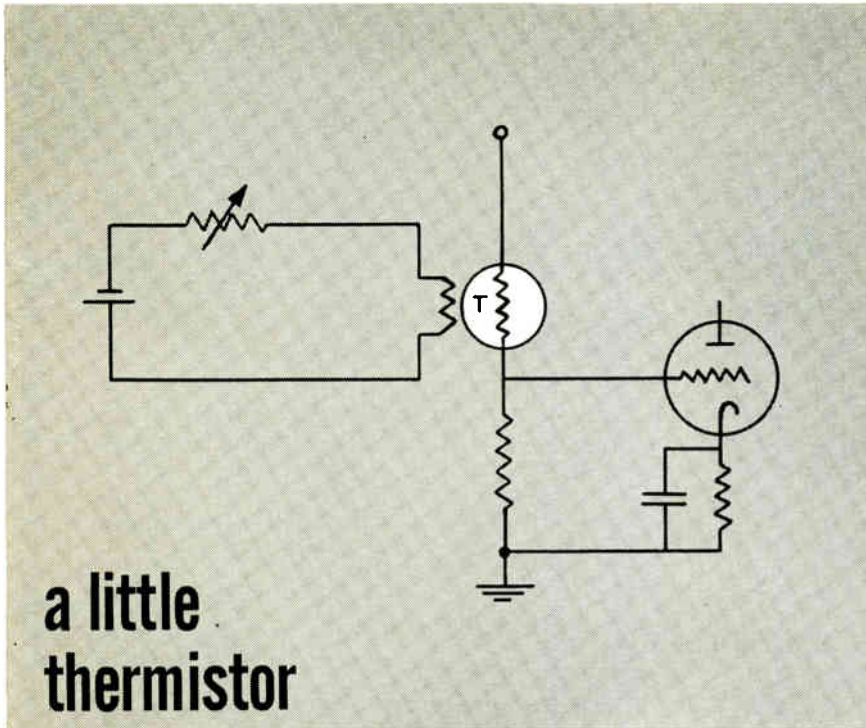

## a little thermistor makes a big difference in remote control applications

This circuit features a little bead thermistor, made with a heater attached and mounted in a vacuum bulb.

When power is applied to the heater, thermistor resistance is lowered. All you have to do is place this unit in the input of a vacuum tube amplifier, for instance, and you have yourself an excellent remote gain control . . . smooth, noiseless, and with no moving parts. And the capacity of the remote transmission line won't affect the amplifier, because capacity between heater and thermistor bead is only a few micro-microfarads.

Thermistors can help to do literally hundreds of jobs better. For instance: temperature control, liquid level measurement, time delay, switching, power measurement, voltage control — or you name it.

**There are just two kinds of thermistors, really:** ordinary, which are good; and FENWAL ELECTRONICS, which are a little bit better. One reason is that FENWAL ELECTRONICS has the edge in experience. We pioneered in this field. Another reason is that we can suit your application exactly — FENWAL ELECTRONICS has the most complete line of thermistors available anywhere.



For details, application assistance, and new Thermistor Catalog EMC 4, write:



63 Fountain Street, Framingham, Massachusetts

THE MOST COMPLETE LINE ANYWHERE . beads and glass probes . discs . washers . rods . probe assemblies . Et matched pairs



counter/timer provides outputs which mark the ends of 4 successive counting cycles. Each cycle is adjustable by decade thumb switches from 0 to 999 counts. An external asynchronous count rate may be used with a maximum limit of 25 Kc. An internal 5 Kc oscillator is provided, as well as a 60 cycle input, so that either of these frequencies may be used as base frequencies to transform the unit into a timer.

**CIRCLE 324 ON READER SERVICE CARD**

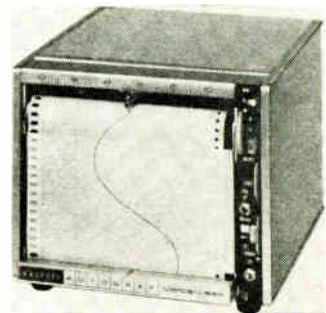

## Strip-Chart Recorders

**HIGHLY ACCURATE**

F. L. MOSELEY CO., 409 N. Fair Oaks Ave., Pasadena, Calif. The Autograf model 680 recorders are servo potentiometer type instruments with fast response and broad versatility. They measure 6 3/4 in. high, 8 in. deep and 7 1/4 in. wide. Accuracy is 0.2 percent full scale and pen speed is 1/2 sec full scale. Recording is made on 100-ft roll charts, 6 in. wide with a 5-in. writing span. Price is \$750.

**CIRCLE 325 ON READER SERVICE CARD**

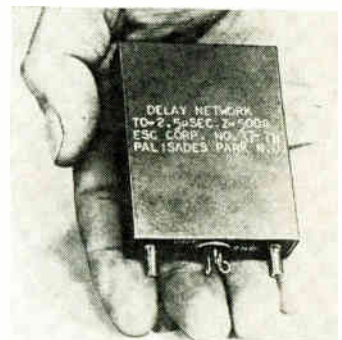

## Delay Line

**MINIATURIZED**

ESC ELECTRONICS CORP., 534 Bergen Blvd., Palisades Park, N. J. Model 37-74 delay line has better than 35 to 1 delay/rise time ratio in a 3 1/2 cu in. case. It features less than

2 db attenuation, temperature operation from -55 to 125 C, and complete uniformity of prototype or production units.

**CIRCLE 326 ON READER SERVICE CARD**

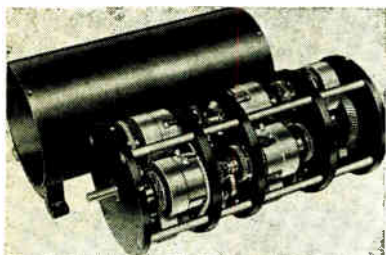

### Transmission MULTI-SPEED

AUTOTRONICS INC., P. O. Box 208, Florissant, Mo. With continuous running input, this transmission delivers 8 binary ratio output speeds in both directions plus an electromagnetically actuated instant brake. Output torque is in excess of 45 lb in. at each speed. With 1,800 rpm input, output speeds are 360, 180, 90, 45, 22.5, 11.25, 5.625, and 2.8 rpm in both clockwise and counterclockwise directions. Speed and/or direction change takes place within 25 millisecc.

**CIRCLE 327 ON READER SERVICE CARD**

### Tape Recorder

CONSOLIDATED ELECTRODYNAMICS CORP., 360 Sierra Madre Villa, Pasadena, Calif., announces a completely integrated magnetic tape recorder/reproducer system capable of recording both predetected and postdetected data simultaneously.

**CIRCLE 328 ON READER SERVICE CARD**

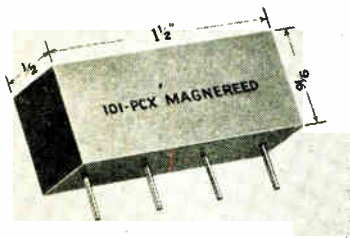

### Miniature Reed Relay ENCAPSULATED

MAGNECRAFT ELECTRIC CO., 5565 North Lynch, Chicago 30, Ill. The 101-PCX Magnareed is positioned in

April 6, 1962

# "ROCKETIZED"

# CRT

**a new concept  
in shock and  
vibration resistant  
cathode ray tubes**

*Probably the most rugged CRT ever built, the ETC Type M1055 is designed especially to withstand the shock of thrust into outer space. Fully potted, shielded, and equipped with flexible leads, integral mounting brackets and shock mounts; the M1055 is tested in accordance with MIL-T-5422C to withstand 1,000 cps vibration at 0.1 inch double amplitude and impacts as high as 15G to 11 ms with peak values at about 5.5 ms. Electrical specifications of this new 5", single-gun, tight-tolerance tube are similar to Type 5AMPL. For details, write for ETC Bulletin M1055.*

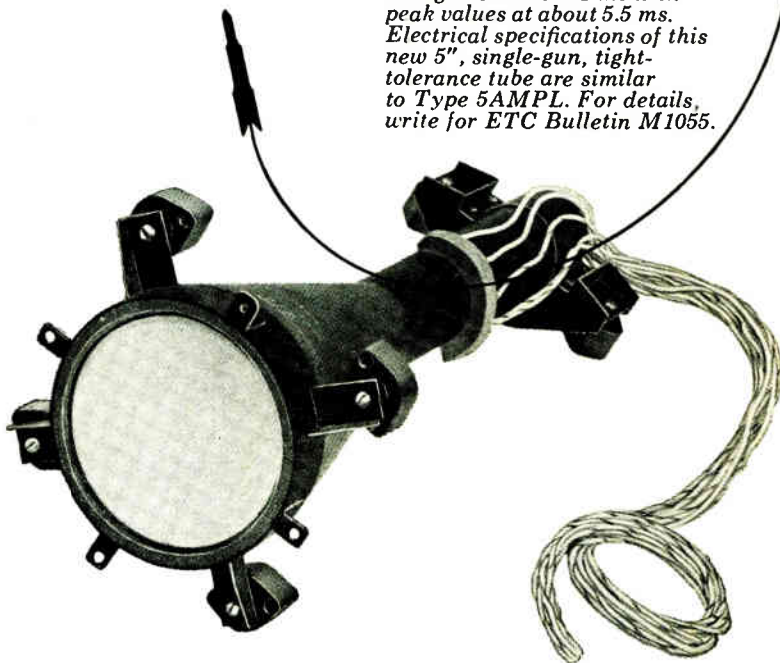

## pacing trends

**IN CATHODE RAY TUBE DESIGN**

**...since 1937**

The Type M1055 is one of many special purpose CR tubes recently developed by ETC that pioneer entirely new concepts in CRT design for jobs that have never been done before. Others incorporate fiber optics, ruggedized construction and other techniques for greatly enhanced defocussing and tracking characteristics. All can be designed with one or more electron guns for special uses. Inquiries for exact requirements will receive prompt attention.

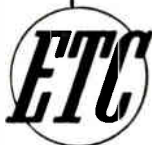

*electronic tube & instrument division*

of General Atomics Corporation

1200 E. MERMAID LANE, PHILADELPHIA 18, PENNA.

(formerly Electronic Tube Corporation)

**CIRCLE 87 ON READER SERVICE CARD**

87

# ENVIRONMENT-PROOF

Honeywell HM and HS series meters are immune to hazardous climatic or atmospheric conditions. True glass-to-metal hermetic sealing makes them completely dust-proof and moistureproof, and plated steel cases provide magnetic and electrostatic shielding. ■ HS series meters, in addition, are ruggedized to withstand exceptional levels of shock, vibration, stress and strain. HS2Z and HS3Z types have external gasket-sealed zero adjusters and conform to the requirements of MIL-M-10304B. ■ For a catalog describing the full line of Honeywell meters, write Honeywell Precision Meters, Manchester, New Hampshire. ■ There's no charge or obligation.

HM3-ET (3 1/2") ELAPSED TIME INDICATOR SHOWN. FULL RANGE OF CURRENT AND VOLTAGE MODELS AVAILABLE.



"where electronics meets the eye"

## Honeywell



Precision Meters

a molded case with tinned round wire terminals brought out through the molded wall which serves as a terminal board. Encapsulation with potting compound rigidizes the p-c terminals and protects the relay from mechanical injury and tampering. Nominal operate time can be less than 1 millisecond; release time can be less than 1/2 millisecond depending on coil operating power.

CIRCLE 329 ON READER SERVICE CARD

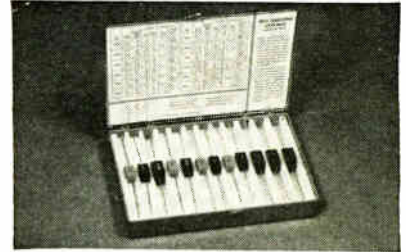

## Pulse Transformers

### VERSATILE SELECTION

SPRAGUE ELECTRIC CO., 35 Marshall St., North Adams, Mass. Type 100Z41 assortment consists of 12 miniature transformers in pre-molded case, each with multiple windings so that the circuit designer using the kit has at his disposal 58 different configurations with primary inductance ranging from 160  $\mu$ h to 43 mh. Complete data on the new kit is given in Engineering Bulletin 40,002, available upon letterhead request.

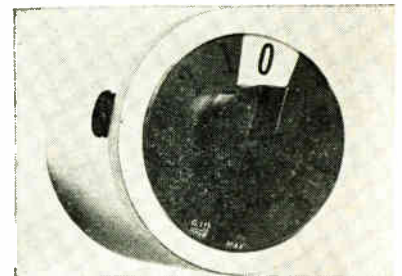

## Decade Resistors

### PANEL-MOUNTED

ELECTRO SCIENTIFIC INDUSTRIES, 7524 S. W. Macadam Ave., Portland 19, Ore., offers model DS-12 Dekastat, panel-mounted, individual decade resistors. Available in standard values of 1 ohm to 100,000 ohms per step and in special order values of 0.01, 0.1 and 1 megohm per step, these 10 step units are designed for use in production test equipment and in other experimen-

tal and permanent equipment where several resistance decades are needed. Accuracy of the units is  $\pm 0.03$  percent (plus 1 milliohm).

**CIRCLE 330 ON READER SERVICE CARD**

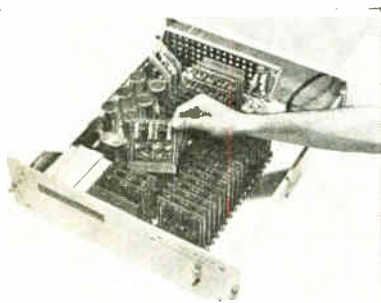

## Silicon Modules

### FOR DATA SYSTEMS

PACKARD BELL COMPUTER, 1905 Armacost Ave., Los Angeles 25, Calif. Line of silicon digital circuit modules will operate over a range from  $-55$  to  $100$  C and will operate without lines of load driving power throughout range from  $0$  to  $55$  C.

**CIRCLE 331 ON READER SERVICE CARD**

## Diffusion Boats

### ULTRAPURE SILICON

ALLEGHENY ELECTRONIC CHEMICALS CO., 20 Leon St., Bradford, Pa., has available diffusion boats made from ultrapure silicon. They afford greatly increased control over the diffusion process because the silicon used in the boats is as pure as that of the wafers being diffused. The silicon boats will not devitrify or warp and will last indefinitely with proper handling. Prices range from  $\$40$  to  $\$180$  each, depending upon sizes required.

**CIRCLE 332 ON READER SERVICE CARD**

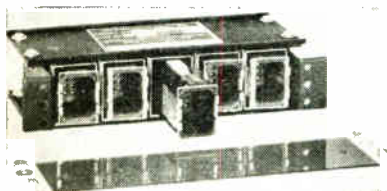

## Miniature Readouts

### FRONT PANEL ACCESS

INDUSTRIAL ELECTRONIC ENGINEERS, INC., 5528 Vineland Ave., N. Hollywood, Calif. Series 130000 plug-in



# DATAPULSE 104 PULSE GENERATOR

### The **DATAPULSE 104 PULSE GENERATOR**

*is designed to accurately and reliably generate the pulses necessary to test this high speed flip flop module.*

*The 104 meets this requirement and many others such as:*

- HIGH SPEED CLOCK GENERATION
- THIN FILM STUDIES
- MAGNETIC CORE DRIVING
- SEMICONDUCTOR EVALUATION
- DIGITAL CIRCUIT DEVELOPMENT
- PULSE TELEMETRY SYSTEM DESIGN
- IMPULSE GENERATION
- KLYSTRON AND TWT PULSE MODULATION
- PULSED DOPPLER RADAR DESIGN
- COUNTERMEASURES DEVELOPMENT

*The 104 provides very short duration, high power pulses at repetition rates to 10 mc, with variable delay and broad pulse width range permitting full general purpose use at lower rates.*

*Review the abbreviated specifications of the 104 Pulse Generator and more detailed information will be forwarded on request.*

### ABBREVIATED SPECIFICATIONS

REPETITION RATE — Variable, 5cps to 10mc, single shot or externally triggered.

AMPLITUDE — Variable to  $\pm 40$ v peak into 50 ohms.

RISE TIME — Variable 10 to 200 nanosec.

PULSE DELAY — Variable 50 nanosec to 10 millisecc.

PULSE DURATION — Variable 20 nanosec. to 500  $\mu$  sec.

DUTY CYCLE — Provide up to 300 ma average output current, with fully automatic overload protection.

SIZE AND WEIGHT — 8 $\frac{3}{4}$ "h x 17" $\frac{1}{2}$  x 15 $\frac{1}{4}$ "d, 45 lbs.

#### Additional Datapulse products

#### 200 DATA GENERATOR

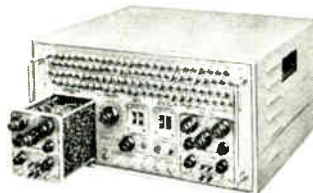

Programmed serial data in 1 or 2 channels  
Cycle length selectable up to 100 bits  
Clock rate variable to 2mc  
Fully controllable output signal characteristics

**DATAPULSE**  
INCORPORATED

509 HINDRY AVE. INGLEWOOD 1, CALIFORNIA  
Data Systems • Pulse Instrumentation  
ORchard 1-7713 ORegon 8-3983

From Aircraft Instruments to Recorders and Indicators...



*Bird* PRECISION  
JEWEL BEARINGS  
are at the heart  
of accurate  
performance

For peak performance in less space, select from a wide range of standard Bird Sapphire and Glass Jewel Bearings, or Complete Jewel Assemblies and Cushion Jewel Assemblies. Or, if you have a special requirement, let our engineers aid you in arriving at the proper solution. Write for your free copy of the Bird catalog, which has complete details on properties and uses of jewel bearings for aircraft, electrical and timing instruments, recorders and indicators.

*Richard H. Bird & CO., INC.*

1 Spruce St., Waltham, Mass.

servicing industry with fine jewels since 1913

readout devices makes it possible to change bulbs from the front panel. It operates on a projection principle with 12 miniature lamps located at the rear of the readout. When one of the 12 lamps is lighted, the lamp projects the corresponding digit or word on the condensing lens through a projection lens onto the viewing screen at the front of the unit. Character size:  $\frac{1}{8}$  in. high standard.

CIRCLE 333 ON READER SERVICE CARD



### Distributed Amplifier WIDE BAND

COMMUNITY ENGINEERING CORP., 234 E. College Ave., State College, Pa. Model 3005 is designed for a frequency response from 5 Kc to 110 Mc. Response flatness is  $\pm 0.5$  db. Noise figure is 7.5 db average. Minimum gain is 45 db, continuously variable, over a 20 db range. Unit measures 4 $\frac{1}{2}$  by 4 by 8 in. overall and weighs 1 lb, 2 oz.

CIRCLE 334 ON READER SERVICE CARD

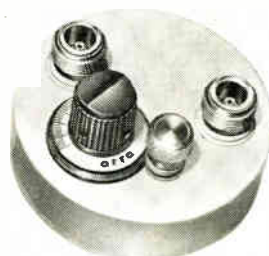

### Attenuators CONTINUOUSLY VARIABLE

ARRA, INC., 27 Bond St., Westbury, L. I., N. Y., offers continuously variable attenuators with the connectors and shaft control on the same surface. This configuration eliminates need for right angle adaptor. Units are being manufactured in S band and C/X band. They are 3 in. in diameter by 1 in. thick and have an attenuation range from 0-20 db.

CIRCLE 335 ON READER SERVICE CARD

SWEENEY MODEL SWE-1125  
STATIC METER

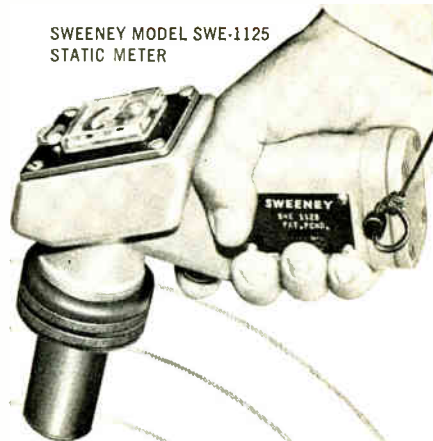

If your target is the detection of **STATIC ELECTRICITY** that exists between improperly grounded or bonded objects, your answer is the

**SWEENEY**

MODEL SWE-1125

**STATIC  
METER**

WRITE FOR AMMUNITION!

**B. K. SWEENEY MFG. CO.  
DENVER 16, COLO.**

CIRCLE 211 ON READER SERVICE CARD  
electronics

## PRODUCT BRIEFS

**ROTARY JOINTS** single, dual channel. Electronic Specialty Co., Kennedy Antenna Div., 155 King St., Cohasset, Mass. (336)

**MAGNETOSTRICTIVE DELAY LINES** low temperature coefficient. Andersen Laboratories, 501 New Park Ave., West Hartford 10, Conn. (337)

**TRANSISTOR HOLDER** eliminates socket. Seaelectro Corp., 139 Hoyt St., Mamaroneck, N. Y. (338)

**MICROWAVE FERRITE DEVICES** X-band. Ferranti Ltd., King's Cross Road, Dundee, Scotland. (339)

**NPN SILICON TRANSISTORS** very low noise levels. National Semiconductor Corp., 4 Thorpe St., Danbury, Conn. (340)

**ANGLED PANEL FAN** saves space. McLean Engineering Laboratories, Princeton, N. J. (341)

**CATHODE RAY TUBE** fiber optic faced. Ferranti Ltd., Hollinwood, Lancs., England. (342)

**MAGNETIC DRUM MEMORY** 2,000,000 bit. Vermont Research Corp., P. O. Box 498, Springfield, Vt. (343)

**SWR INDICATOR** direct reading. Borg-Warner Controls, P. O. Box 1679, Santa Ana, Calif. (344)

**DIGITAL TAPE HANDLER** low cost. Ampex Corp., 934 Charter St., Redwood City, Calif. (345)

**FREQUENCY STANDARD** for low cost commercial usage. Gibbs Mfg. and Research Corp., 456 N. Main St., Janesville 2, Wisc. (346)

**OSCILLATOR** clock-driven. Manson Laboratories, Inc., 375 Fairfield Ave., Stamford, Conn. (347)

**BATTERY CHARGER** scr type. Kearfott Div., General Precision, Inc., 1150 McBride Ave., Little Falls, N. J. (348)

**NUCLEAR SYSTEM** for routine counting and analysis. Hamner Electronics Co., Inc., P. O. Box 531, Princeton, N. J. (349)

**MICROWAVE ANECHOIC CHAMBERS** very high performance. B. F. Goodrich Sponge Products Division, Shelton, Conn. (350)

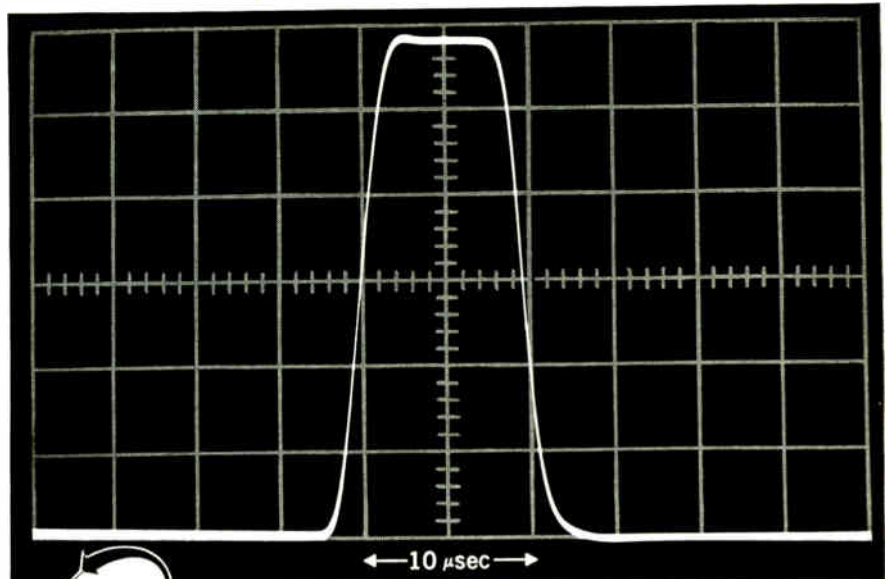

Unretouched Polaroid photograph of a 10- $\mu$ second pulse after processing through DCS' GOV-3 and GFD-4. Subcarrier frequency: 750 kc  $\pm$ 40% deviation. Output filter: 150 kc Gaussian.

## Now! Capture transient events like never before!

### • Virtually no overshoot • Fastest rise time attainable

Want to capture transients that have eluded you up to now? Or, if you are getting them, want them more faithfully? The photo above proves it can be done—providing you use DCS high-frequency FM subcarrier oscillators and discriminators. These new DCS components are based on a high-frequency current switching device, operating with unsaturated transistors in a manner that permits very long recovery periods. Result: faster rise time than ever before possible, with virtually no overshoot!

Components now available for immediate, off-the-shelf delivery:

### DCS High-Frequency VCO (UNIDAP Configuration)

High-frequency VCO plug-in modules for all standard DCS UNIDAP systems. Standard frequencies available: 250, 400, 550, 700 and 850 kc, all  $\pm$ 40 kc. Also 800 kc,  $\pm$ 300 kc. Others available on request. Permits analog intelligence frequencies to 300 kc to be converted to FM subcarriers for both direct tape recording and multiplexing.



Model GOV-3

### DCS High-Frequency Discriminator



Model GFD-4

High-frequency, phase-lock playback discriminator for use with standard DCS UNIDAP and telemetry data systems. Recovers data from all DCS airborne and ground high-frequency VCO's. Also used with standard DCS predetection telemetry recording and standard DCS frequency translation systems. Output intelligence frequencies up to 300 kc.

For more information, complete specifications, etc., write to Dept. E-2-3.



## DATA-CONTROL SYSTEMS, INC.

*Instrumentation for Research*

Los Angeles • Santa Clara • Wash., D. C. • Cape Canaveral  
Home Office: E. Liberty St., Danbury, Conn. • Pioneer 3-9241



## KEITHLEY AC AMPLIFIERS

*ease the search  
for microvolt signals*

The Keithley Model 103 provides the best attainable signal-to-noise ratio for input impedances of either 100 k ohms or 10 megohms. (The equivalent input noise resistance on the low noise position is only 3 k ohms.) Bandwidth of 0.1 cps to 100 kc covers a wide range of uses; eleven high and low frequency cuts permit restricted bandwidths for minimum noise.

Applications include Hall Effect studies, bridge null detection, and semiconductor investigations, as well as such biophysical applications as recording nerve action potentials.

**bandwidth** 0.1 cps to 100 kc using 11 high and low frequency cutoffs.

**input impedance** in the "Normal" mode is 10 megohms; in the "Low Noise" mode, 100 k ohms.

**amplifier gain** either 100 or 1000, adjustable to precise values.

**input** single-ended or differential.

**differential rejection** is at least 80 db.

**power**—from batteries or the Keithley Model 1031, a separate, solid state power supply with noise characteristics equivalent to batteries.

**noise performance** is selected with a "Normal" and "Low Noise" switch. Chart gives noise level of maximum gain from 10 cps with shorted input.

Frequency of high cutoff point	Maximum noise, microvolts RMS referred to input	
	Normal (10 meg impedance)	Low Noise (100 k impedance)
100 kc	3.0	1.9
30 kc	1.9	1.1
10 kc	1.4	0.8
3 kc	0.9	0.6
1 kc	0.7	0.4
300 cps	0.5	0.3
100 cps	0.4	0.25

**prices:** Model 103, \$245; rack, \$255  
1031 Power Supply, \$245; rack, \$255



The Keithley Model 102B amplifier combines a 400-megohm input with high gain and low noise. It is an ideal scope preamplifier, especially for high source impedance signals. The 102B provides accurate signal amplification from piezo-electric devices; it is excellent for noise studies in solid state research, and shock and vibration analysis.

Features of the unit include a driven shield input, decade gains from 0.1 to 1000, selectable bandwidths of 2 cps to 150 kc or 2 cps to 1.7 mc, and a 5-volt, 50-ohm output for scopes and recorders.

**input impedance** over 400 megohms at 3  $\mu\text{f}$ .

**low noise level**, below 10  $\mu\text{V}$  rms from 10 cps to 150 kc at maximum gain, input shorted.

**gain accuracy** of 1% at midband for all gain settings.

**rise time** of 0.3  $\mu\text{sec}$  at highest gain.

**two accessory** low capacitance probes available. **price:** \$335

*send for complete specifications . . .*



KEITHLEY INSTRUMENTS  
12415 EUCLID AVENUE CLEVELAND 6, OHIO

electrometers • micro-microammeters • microvoltmeters • milliohmmeters

## Literature of

**CERAMIC CAPACITORS** Hi-Q Division, Aerovox Corp., Myrtle Beach, S. C., has issued a 40-page catalog on its complete line of ceramic capacitors. (351)

**MAGNETIC CLUTCHES & BRAKES** Fawick Magnetic, Fawick Corp., 9919 Clinton Rd., Cleveland 11, O. Bulletin contains engineering and application information on magnetic clutches and brakes. (352)

**RADIO MULTIPLEX SYSTEM** Lynch Communication Systems Inc., 695 Bryant St., San Francisco 7, Calif. Bulletin covers the type B121R radio multiplex system. (353)

**PRECISION POTS** General Controls Co., 1320 S. Flower St., Burbank, Calif. Catalog No. 608.550 describes a line of precision potentiometers and accessories. (354)

**ULTRASONIC CLEANING TANKS** National Ultrasonic Corp., 95 Park Ave., Nutley 10, N. J., offers an illustrated two-page bulletin on ultrasonic cleaning tanks. (355)

**BIBLIOGRAPHY** Elgenco, Inc., 1231 Colorado Ave., Santa Monica, Calif., offers a bibliography, "The Application of Low Frequency Noise and Statistical Techniques." (356)

**MAGNET WIRE** Hudson Wire Co., 62 Water St., Ossining, N. Y., offers technical literature on Formvar coated magnet wire. (357)

**POWER CONTROLS** Lindberg Engineering Co., 2450 W. Hubbard St., Chicago 12, Ill., has issued a bulletin describing a series of solid-state power controls. (358)

**TEST INSTRUMENTS** Sperry Microwave Electronics Co., Clearwater, Fla. A 112-page catalog covers Microline test instruments. (359)

**PHOTOELECTRIC RELAYS** General Electric Co., Schenectady 5, N. Y. A 2-page bulletin describes versatile, high-speed, low-cost photoelectric relays. (360)

**CARRIER AMPLIFIER** Consolidated Electrodynamics Corp., 360 Sierra Madre Villa, Pasadena, Calif. A 2-page bulletin describes type 1-127 carrier amplifier. (361)

**TRANSDUCER CONVERTERS** Sanborn Co., Waltham 54, Mass., offers a



# the Week

catalog sheet illustrating and describing the 592 series of transducer converters. (362)

**WIDEBAND TRANSFORMER** North Hills Electronics, Inc., Alexander Place, Glen Cove, N. Y., has published a bulletin on the type 0502 wideband transformer. (363)

**CORE MEMORY UNIT** Ampex Computer Products Co., 9937 Jefferson Blvd., Culver City, Calif. An 8-page brochure describes the RQA core memory unit. (364)

**LABORATORY AMPLIFIERS** Gulton Industries, Inc., 212 Durham Ave., Metuchen, N. J. An 8-page technical brochure describes Glennite transistorized laboratory amplifiers (multichannel series). (365)

**FLEXIBLE CABLE** International Resistance Co., 401 N. Broad St., Philadelphia 8, Pa. Multiconductor flat flexible cable is discussed in booklet S-10 (366)

**PRECISE FREQUENCY CONTROL** Lenkurt Electric Co., Inc., San Carlos, Calif. A recent issue of the *Demodulator* has an article on precise frequency control. (367)

**PRESSURE POTENTIOMETERS** Trans-Sonics, Inc., P. O. Box 328, Lexington, Mass. Series of plate mounted miniaturized pressure potentiometers are covered in *Special Product Note 2851*. (368)

**STANDOFF TERMINALS** Electronic Molding Corp., 40 Church St., Pawtucket 15, R. I., announces a 20-page illustrated catalog list of 350 molded insulated standoff terminals available. (369)

**MICROWAVE POWER METER** PRD Electronics, Inc., 202 Tillary St., Brooklyn 1, N. Y. Catalog sheet illustrates and describes the PRD 650-C microwave power meter. (370)

**LVDT DATA** Helipot Division of Beckman Instruments, Inc., 2500 Harbor Blvd., Fullerton, Calif. A data sheet covers linear variable differential transformers. (371)

**TRANSISTOR POWER MODULES** Deltron Inc., Fourth and Cambria Sts., Philadelphia 33, Pa. Bulletin 2029-A-1, -2 and -3 describes the newly revised PI series transistor power modules. (372)

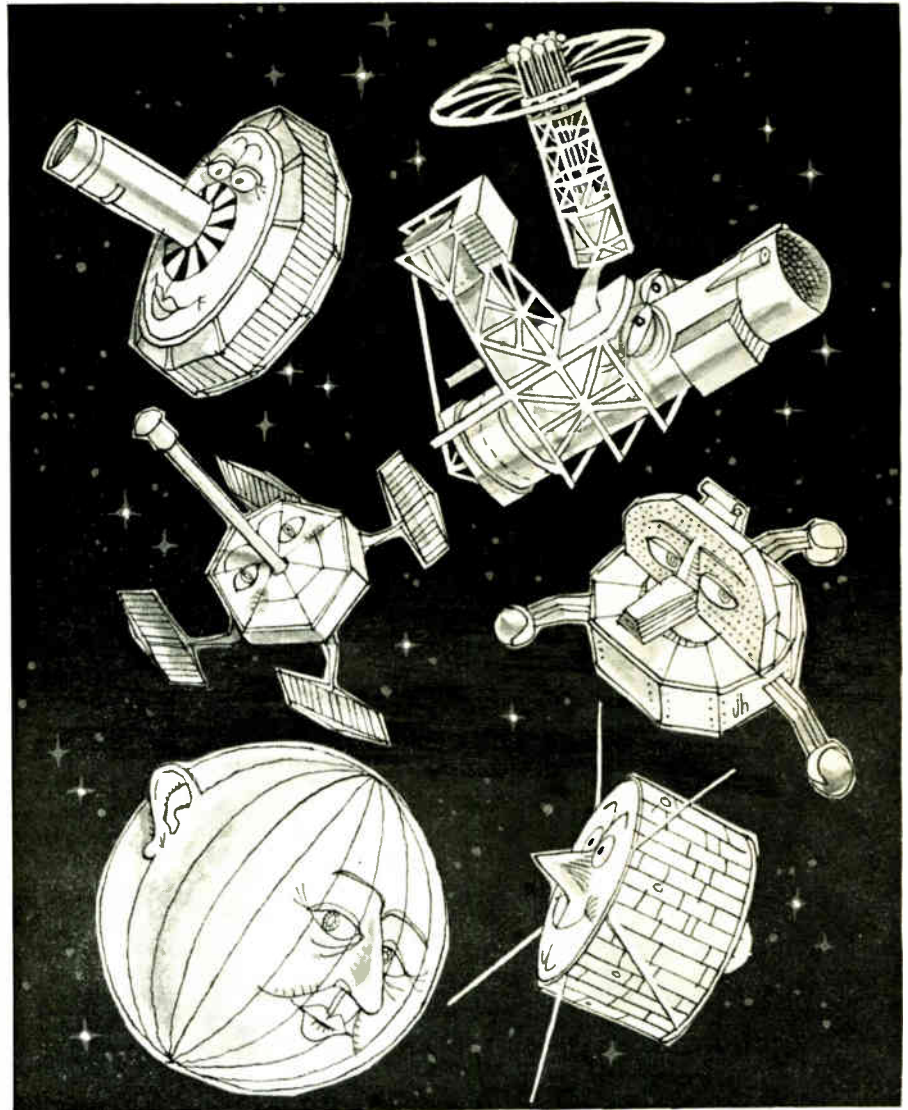

## Six Different Languages... NEMS-CLARKE® 1440 Receiver Interprets Them All!

This hard-working navigational telemetry receiver is already monitoring Transit, Traac, Echo, S3, S16, Stratoscope. It is an exceptionally stable Phase-Lock Receiver with a tuning range of 130-140 mc. The 1440 is particularly suited for the forthcoming S-27 Orbiting Astronomical Observatory.

Nems-Clarke 1440 provides outputs for video, spectrum display, frequency monitor and signal strength recorder. Its four panel mounted meters indicate tuning, output, deviation and signal strength during operation. The receiver is for standard rack mounting.

Write for Data Sheet C-006, Vitro Electronics, 919 Jesup-Blair Drive, Silver Spring, Maryland. A Division of Vitro Corporation of America.

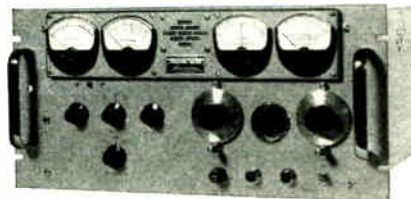

**VITRO ELECTRONICS**

### Specifications:

1. Type of Reception.....FM
2. Tuning Range.....130-140 mc
3. Noise Figure......6 db maximum
4. IF Bandwidth —  
Wide Band ..... 100 kc at 3 db points  
Narrow Band ..... 50 kc at 3 db points
5. Phase-Lock Detector.....linear to better than 1% over bandwidth of  $\pm 50$  kc
6. Video Output .....adjustable
7. Video Frequency Response.....400 cps to 15 kc
8. Sensitivity.....0.3 v peak to peak per kc of deviation, minimum



## Components Producer In New Plant

MARCH DYNAMICS, INC., designer and producer of electronic and magnetic components for control and instrumentation systems, has settled in new 25,000-sq-ft office and plant facilities in Hicksville, N. Y.

More than half of the area is devoted to engineering, production, test and quality control facilities for the company's newly-expanded Magnetics division. The remainder is occupied by sales and administration offices and the Mechanical division which turns out precision mechanical components and sub-assemblies.

Leonard Page, president, said that since November the backlog for rotating components has passed \$70,000. He forecasts sales at the rate of \$1 million a year in magnetic components, mostly for military use, by the end of the first year's operations in the new facilities. The company also designs and produces electromechanical devices

for fire control systems for such missile programs as Polaris and Mars.

The firm was founded in 1955 and recently underwent public financing, through sale of 125,000 common shares in the over-the-counter market. Page said that the public issue and larger facilities "put the company in a strong position to develop a broadened line of products."

Other March Dynamics executives are Anthony Saginario, executive vice president; Joseph Carlstein, vice president and manager, Magnetics division; and Albert Diamond, vice president and chief engineer, Magnetics division.

Prior to joining the company, Carlstein and Diamond both held top engineering posts with the Ketay Department of United Aircraft's Norden Division. Both men are responsible for a number of patents in the magnetics field.

## Announce Formation Of New Company

FORMATION of a new electronics firm, RCF Com-Tronics, Inc., of Pulaski, N. Y., a manufacturer of electronic communication systems and components, is announced by William H. Senior, president. He disclosed that the new firm would soon be in production on its first line of products—a selective paging systems—and predicted more than \$1 million in first year sales.

RCF Com-Tronics was organized by a group of engineers, headed by

Senior, who were formerly associated with the Stromberg-Carlson division of General Dynamics. Other officers of the new firm are Augustus Steele, executive vice president in charge of research and development, and James Murtagh, vice president of manufacturing.

## Summit Completes Scientific Center

THE SUMMIT FINISHING CO., INC., Thomaston, Conn., recently completed a new 2,000-sq ft scientific,

quality-control center. This brings under one centralized department the former research, development, laboratory and visual inspection facilities of the company.

This scientific group and their equipment now work under white-room conditions, where the floors are radiantly heated, the air is filtered, humidified and air conditioned.

Summit produces engineered precision metal finishing for the electronic, aircraft, missile and rocket, computer, guidance system, and general precision manufacturing markets nationwide.

## Howard Zuvers Joins National Electronics

HOWARD E. ZUVERS has joined National Electronics, Inc., a subsidiary of Eitel-McCullough, Inc., as engineering manager of the Ignitron Division in Geneva, Ill.

Zuvers comes to National from the General Electric Co. where he held the positions of senior engineer and engineering supervisor in the Ignitron Department.

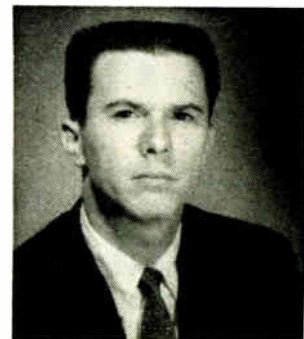

## King Laboratories Names Burthe

APPOINTMENT of Jack H. Burthe as assistant director of research of King Laboratories, Inc., Syracuse, N. Y., has been announced. In this newly created position he will assist Aden J. King, president and director of research, in an expanded research program on getters and other components for electron tubes and transistors. He will also be available for consultation with customers on research and engineering problems.

Burthe was formerly a research

**BLILEY**  
BFN-0100B31

**CRYSTAL FILTERS**  
BULLETIN 524A

**Bliley** ... if you buy quality • BLILEY ELECTRIC COMPANY • ERIE, PENNSYLVANIA

CIRCLE 212 ON READER SERVICE CARD

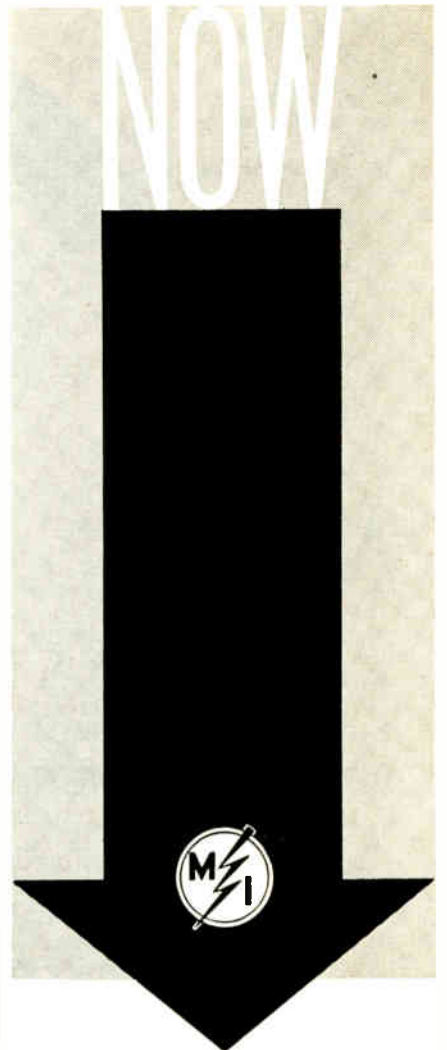

with the NEW  
**AM SIGNAL GENERATOR**  
Model 144H \$1190

WIDER FREQUENCY RANGE  
10 kc to 72 mc

GREATER STABILITY  
0.002%

ELECTRONIC FINE TUNING  
0.01%

HIGHER OUTPUT  
2 v to 0.1 μV, ± 0.5 db  
AND . . . AT LOWER COST

Ask for detailed specifications  
— now.



**MARCONI**  
INSTRUMENTS

DIVISION OF ENGLISH ELECTRIC CORPORATION  
111 CEDAR LANE • ENGLEWOOD, NEW JERSEY  
"Main Plant: St. Albans, England"

CIRCLE 95 ON READER SERVICE CARD 95

# GRC tiny parts

die cast  
ZINC ALLOY



molded  
PLASTICS



Coil Bobbins  
Gears & Pinions



"SMALL ZINC  
DIE CASTINGS"

Get GRC's fact filled brochures. GRC's methods give you quality and accuracy in small parts of die cast zinc alloy, Nylon, Delrin, other engineering thermoplastics. Exclusive single cavity, automatic techniques allow new designs, new production and assembly shortcuts. Write, wire, phone for samples and bulletins. Send prints for quotations.  
NO MINIMUM SIZE! Maximum sizes: Zinc Alloy—2" long, 1/2 oz. Plastic—1 1/4" long, .05 oz.

See us at  
the Design  
Show  
Booth 382



**GRIES REPRODUCER CORP.**

World's Foremost Producer of Small Die Castings  
151 Beechwood Avenue, New Rochelle, New York  
Phone (914) NEw Rochelle 3-8600

CIRCLE 213 ON READER SERVICE CARD  
April 6, 1962

## You Get Things Done With Boardmaster Visual Control

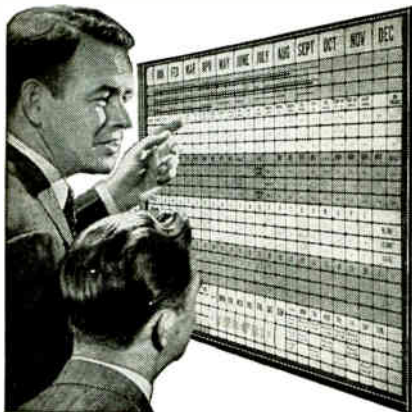

- ☆ Gives Graphic Picture of Your Operations—Spotlighted by Color
- ☆ Facts at a glance — Saves Time, Saves Money, Prevents Errors
- ☆ Simple to operate — Type or Write on Cards, Snap in Grooves
- ☆ Ideal for Production, Traffic, Inventory, Scheduling, Sales, Etc.
- ☆ Made of Metal. Compact and Attractive. Over 750,000 in Use.

Full price **\$4950** with cards

**FREE**

24-PAGE BOOKLET NO. C-40  
Without Obligation

Write for Your Copy Today  
**GRAPHIC SYSTEMS**  
YANCEYVILLE, NORTH CAROLINA

CIRCLE 214 ON READER SERVICE CARD



**"NEW  
NAME"  
IN LOUDSPEAKERS**

*from a 3" tweeter to a 15" woofer*

**PADUCAH, KY. (Special)—**

The name has changed. The world-famous quality has not. The industry's greatest pool of loudspeaker knowledge has been acquired by CTS from Magnavox.

The 106,000 sq. ft. modern Paducah plant makes only loudspeakers—including most of the components for maximum quality control. Facilities comprise the very latest in metal stamping equipment, precision coil winding, plating, assembly and inspection. Precision workmanship produces the closest tolerance between moving coil and magnet.

The respected long-established tradition of excellence will be continued . . . and further enhanced . . . by CTS, a firm with a world-wide reputation for dependable electronic components.

Get the whole story on this exciting "new" name in speakers from your nearby CTS engineer.



Send for Catalog P-101 today. It lists 128 standard loudspeaker models. Others can be "tailored" to your specific requirement.



Founded 1896

**CTS OF PADUCAH, INC.**  
1500 No. 8th Street, Paducah, Kentucky

a subsidiary of  
**CTS CORPORATION**  
Elkhart, Indiana

FORMERLY CHICAGO TELEPHONE SUPPLY CORPORATION

engineer with Westinghouse Electric Corp. in Baltimore, Md.



**Ransom Research  
Hires Deutch**

WYLE LABORATORIES' Ransom Research Division, San Pedro, Calif., has added Joseph Deutch to its staff as assistant to the general manager.

Prior to joining Ransom Research, Deutch was manager of the data processing department at Aeronutronic, a division of Ford Motor Co.



**Dept. of Defense  
Names Puckett**

ALLEN E. PUCKETT, a Hughes Aircraft Co. vice president, has been appointed by the Department of Defense to a four-year term on the Defense Science Board. He also was designated to serve on the advisory group's executive committee.

The Defense Science Board is composed of 28 civilians selected at large for pre-eminence in research and engineering fields.

**Frielich Advances  
At North Atlantic**

NORTH ATLANTIC INDUSTRIES, INC., Plainview, N. Y., has promoted Arthur Frielich to the position of

engineering product manager. He will be responsible for the development and production of several new product programs.

In his former capacity, Frielich served as a staff engineer.



### Paganelli Moves Up At General Electric

THOMAS I. PAGANELLI has been named general manager of the General Electric Co.'s Heavy Military Electronics Department which handles the company's extensive ground and shipboard military electronic business. He was formerly manager of the department's systems operation.

### Defense Electronics Appoints Dent

DEFENSE ELECTRONICS, INC., Rockville, Md., has appointed H. Carlisle Dent as system applications engineer for the Southeast area. Formerly of Dynatronics, Inc., Dent will maintain an office in Winter Park, Fla.



### Melpar Promotes Paul Ritt

PAUL EDWARD RITT, JR., has been named vice president-research,

NEW FROM T/I

# HIGH SPEED A-D CONVERTER

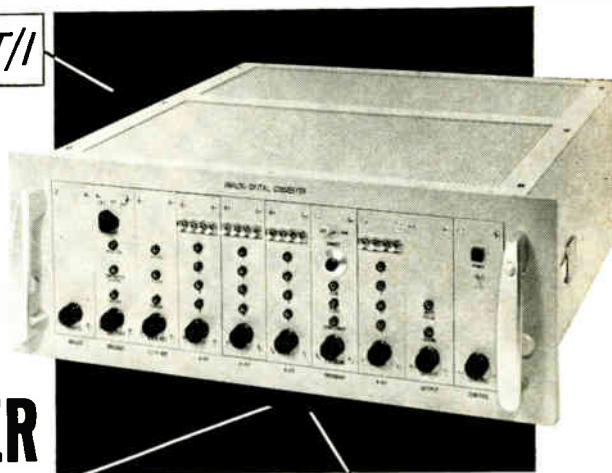

1.5  $\mu$  sec per bit

Automatic Zero Stabilization

Texas Instruments Model 834 Analog-Digital Converter is a versatile, all solid state instrument combining high speed with high accuracy. Basic speed is 25 microseconds per conversion (40,000 12 bit conversions per second); accuracy is  $\pm 0.05\%$  of full scale,  $= 1/2$  the least significant bit. The instrument provides full scale ranges of  $\pm 2.5$ ,  $\pm 5.0$ , and  $\pm 10.0$  volts with an input impedance of 200,000 ohms. Modular construction allows modification of output logic levels and digital code to suit various system requirements.

Write for complete information.

APPARATUS DIVISION  
PLANTS IN HOUSTON  
AND DALLAS, TEXAS



TEXAS INSTRUMENTS

INCORPORATED  
3609 BUFFALO SPEEDWAY  
P. O. BOX 66027 HOUSTON 6, TEXAS

476

CIRCLE 215 ON READER SERVICE CARD

## RECEIVING BALUNS FOR COMMERCIAL APPLICATIONS

Balanced  
to  
Unbalanced

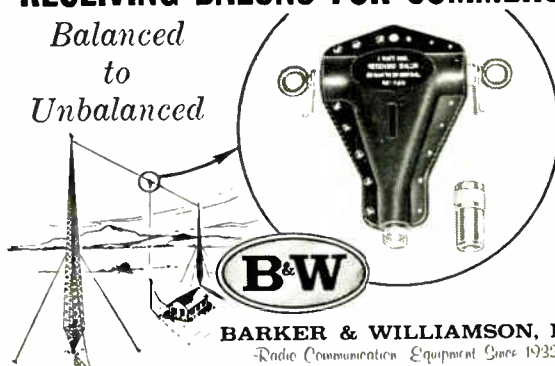

Couples a balanced antenna to unbalanced coaxial cable.

Freq. Range: 2 to 32Mc.

Ideally packaged — acts as a center insulator in a doublet antenna. The coupling transformer is sealed inside a rugged aluminum casting providing shortest possible connections to both antenna and coaxial cable.

Insertion loss less than  $1/2$  db.

Available in twelve impedance transformations.

Drop us a card for "Specs."

BARKER & WILLIAMSON, Inc.  
Radio Communication Equipment Since 1932  
BRISTOL, PENNSYLVANIA • STILLWELL 8-6681

CIRCLE 97 ON READER SERVICE CARD



### Did you swipe this magazine?

Only 7 1/2 cents a week is the easy way! (\$6 one year, \$9 for two years, \$12 three years.) Just fill in the handy "For subscriptions" section of the Reader Service Card in this issue . . . and you'll get instant subscription.

**electronics:** 330 West 42nd St., N. Y. 36.

## for NON-DESTRUCTIVE DIELECTRIC TESTING

Reduce Costs of Testing Transformers, Relays, Capacitors, Complete Assemblies, etc. with...

## ELECTROSPACE MEGPOTS™



**5600 Series**

### MEGPOT MEGOHM-METER & HIGH POTENTIAL TEST SET

Non-destructive testing assured through quick acting relay, cuts current from tested components in milliseconds. Provides for continuously variable current leakage test, with settings from 20 microamperes to 3 milliamperes. Rugged construction.

**Voltage Ranges:** Variable ranges to 0-5000V. Others available.

**Megohm-Meter Ranges:** Up to 4 million megohms at 100 or 200V DC, up to 10 million megohms at 500V DC.

Ask for BULLETIN No. 158

### 650 Series

**Voltage Ranges:** High potential test 0-5000V AC & DC.

**Megohm-Meter Ranges:** Up to 10 million megohms; voltage continuously variable 10-500V DC.

Ask for BULLETIN No. 650



### MEGPOT HIGH POTENTIAL TEST SET - 570 Series

Affords considerable savings in non-destructive testing, by means of its current limiting feature. Provides for a high sensitivity continuously variable test for current leakage, with settings from 20 microamperes to 3 milliamperes. Full scale output with 0.0025 mfd load capacitance.

**Voltage Ranges:** Variable ranges to 0-5000V. Others available. Standard models from 0-3000V or 0-5000V AC rms.

Accuracy:  $\pm 5\%$

Ask for BULLETIN No. 570



ELECTRONICS FOR LAND, SEA & SPACE  
**ELECTROSPACE CORP.**

12 Morris Ave., Glen Cove, L.I., N.Y. • ORiole 1-6100  
MEGPOTS ■ GASEALS ■ ELECTRONIC SUB-SYSTEMS  
TOGGLE SWITCHES ■ HERMETIC SEALING SERVICES

Melpar, Inc., Falls Church, Va.

Formerly Melpar research director, Ritt joined the company as an engineer in the chemistry lab in 1952, and rose steadily to his current position. Under his direction, Melpar's research group grew from 5 to 200 scientists who today make up the Research Division.

### Five Engineers Join Antenna Systems, Inc.

ANTENNA SYSTEMS, INC., Hingham, Mass., announces the appointment of Vaudie W. Vice, Alan G. Williams, Charles R. Sims, Mickey L. Hudspeth, and Hershel Sterling to its systems engineering staff for tracking antennas.

All were formerly associated with Dynatronics, Inc.

### PEOPLE IN BRIEF

A. H. Borbor, formerly with American Systems, appointed a project engineer at Servonic Instruments, Inc. Leonard J. Blumenthal, from Goodyear Aircraft to Melpar, Inc., as mgr. of new reliability dept. Bertram H. Wolf moves up at Lockheed Electronics to director of master scheduling for the military systems group. Siegfried F. Neustadter advances to engineering specialist at the Applied Research Lab of Sylvania Electric Products Inc. Litton Systems promotes Perry A. Luth Jr. to manufacturing mgr. of the Guidance and Control Systems div. National Transistor Mfg., Inc., ups Arthur R. Souldard to production supervisor, silicon products. William O. Baker, v-p research for Bell Telephone Laboratories, Inc., elected to board of directors of The Babcock & Wilcox Co. Clayton C. Farlow, previously with Delcon Corp., joins Alto Scientific Co., Inc., as staff engineer. Bernard Rabinovitch, ex-Fairchild Semiconductor, named mgr. of R&D in magnetic tape and other recording media at the Ampex laboratories. Joseph Kelley, Jr., from Allied Research Associates, Inc., to Telecomputing Corp. as v-p for corporate development. Frederick J. Seufert leaves U. S. Science Corp. to become division mgr. at Sanders Associates, Inc. Henry L. Milo, Jr., promoted to mgr. of The Foxboro Co. engineering div.

## Magneline® ELECTRO-MAGNETIC READOUT INDICATOR

- SILENT
- RELIABLE
- EASY TO READ

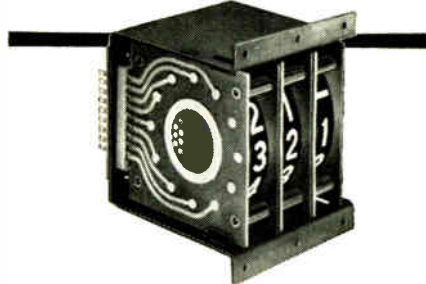

### SERIES 10300 "PLUG-IN"

Modules inserted from front of bracket to make firm connection with circuit block. Twelve characters,  $\frac{5}{16}$ " by  $1\frac{1}{32}$ " high. All MAGNELINE® characters screened white on dull black background, do not glare or fade under normal ambient light. Easy to read at 25 feet.



### SERIES 10200 "MINIATURE"

Outside dimensions, five digit assembly,  $1\frac{1}{8}$ " high x 2" deep x  $2\frac{1}{2}$ " wide. Twelve characters,  $\frac{1}{4}$ " high, distinct at 9 feet under normal room lighting. Weight per digit less than 1 ounce. Meets specs MIL-E-5272 C and MIL-E-5400 D, Class 2.



### SERIES 10100 "STACKING"

$\frac{9}{16}$ " high characters are  $1\frac{1}{16}$ " on center, easy to read at 30 feet under normal room lighting. Stacking gives maximum character size in ratio to valuable panel area. 10 or 12 positions at 6, 12, 24, 28 or 36 volts.

The MAGNELINE® principle insures reliability and long life. A permanent magnet aligns itself with pole and brings specific character into display position. Character is held in position by magnetic detent until next pulse.

**PATWIN**

WATERBURY 20, CONNECTICUT  
A Division of The Patent Button Company

PHONE:  
203-756-  
3636

TWX: WBY 1E3

# electronics

## WEEKLY QUALIFICATION FORM FOR POSITIONS AVAILABLE

### ATTENTION: ENGINEERS, SCIENTISTS, PHYSICISTS

This Qualification Form is designed to help you advance in the electronics industry. It is unique and compact. Designed with the assistance of professional personnel management, it isolates specific experience in electronics and deals only in essential background information.

The advertisers listed here are seeking professional experience. Fill in the Qualification Form below.

#### STRICTLY CONFIDENTIAL

Your Qualification form will be handled as "Strictly Confidential" by ELECTRONICS. Our processing system is such that your form will be forwarded within 24 hours to the proper executives in the companies you select. You will be contacted at your home by the interested companies.

#### WHAT TO DO

1. Review the positions in the advertisements.
2. Select those for which you qualify.
3. Notice the key numbers.
4. Circle the corresponding key number below the Qualification Form.
5. Fill out the form completely. Please print clearly.
6. Mail to: D. Hawksby, Classified Advertising Div., ELECTRONICS, Box 12, New York 36, N. Y. (No charge, of course).

COMPANY	SEE PAGE	KEY #
ALLSTATES DESIGN & DEVELOPMENT CO., INC. New York, New York	100	1
DELCO RADIO Div. of General Motors Corp. Kokomo, Indiana	24	2
EITEL-McCULLOUGH INC. San Carlos, California	71	3
FAIRCHILD STRATOS Aircraft & Missiles Div. Hagerstown, Maryland	80, 81	4
INTERNATIONAL BUSINESS MACHINES CORP. New York, New York	113*	5
INTERNATIONAL BUSINESS MACHINES CORP. Components Div. Poughkeepsie, New York	112*	6
LOCKHEED CALIFORNIA COMPANY Div. of Lockheed Aircraft Corp. Burbank, California	74, 75*	7
LOCKHEED-GEORGIA COMPANY Div. of Lockheed Aircraft Corp. Atlanta, Georgia	20	8
MARTIN COMPANY Orlando Division Orlando, Florida	100	9
MICROWAVE SERVICES INTERNATIONAL INC. Denville, New Jersey	100	10
MOTOROLA, INC. Chicago, Illinois	101	11
SCOPE PROFESSIONAL PLACEMENT CENTER Waltham, Mass.	100	12
SIMMONDS PRECISION PRODUCTS INC. Tarrytown, New York	100	13
SNELLING & SNELLING Boston, Massachusetts	100	14

\* These advertisements appeared in the 3/30/62 issue.

(cut here)

(cut here)

## electronics WEEKLY QUALIFICATION FORM FOR POSITIONS AVAILABLE

**Personal Background**

NAME .....

HOME ADDRESS .....

CITY ..... ZONE ..... STATE .....

HOME TELEPHONE .....

**Education**

PROFESSIONAL DEGREE(S) .....

MAJOR(S) .....

UNIVERSITY .....

DATE(S) .....

### FIELDS OF EXPERIENCE (Please Check)

4662

<input type="checkbox"/> Aerospace	<input type="checkbox"/> Fire Control	<input type="checkbox"/> Radar
<input type="checkbox"/> Antennas	<input type="checkbox"/> Human Factors	<input type="checkbox"/> Radio-TV
<input type="checkbox"/> ASW	<input type="checkbox"/> Infrared	<input type="checkbox"/> Simulators
<input type="checkbox"/> Circuits	<input type="checkbox"/> Instrumentation	<input type="checkbox"/> Solid State
<input type="checkbox"/> Communications	<input type="checkbox"/> Medicine	<input type="checkbox"/> Telemetry
<input type="checkbox"/> Components	<input type="checkbox"/> Microwave	<input type="checkbox"/> Transformers
<input type="checkbox"/> Computers	<input type="checkbox"/> Navigation	<input type="checkbox"/> Other .....
<input type="checkbox"/> ECM	<input type="checkbox"/> Operations Research	<input type="checkbox"/> .....
<input type="checkbox"/> Electron Tubes	<input type="checkbox"/> Optics	<input type="checkbox"/> .....
<input type="checkbox"/> Engineering Writing	<input type="checkbox"/> Packaging	<input type="checkbox"/> .....

### CATEGORY OF SPECIALIZATION

Please indicate number of months experience on proper lines.

	Technical Experience (Months)	Supervisory Experience (Months)
RESEARCH (pure, fundamental, basic)	.....	.....
RESEARCH (Applied)	.....	.....
SYSTEMS (New Concepts)	.....	.....
DEVELOPMENT (Model)	.....	.....
DESIGN (Product)	.....	.....
MANUFACTURING (Product)	.....	.....
FIELD (Service)	.....	.....
SALES (Proposals & Products)	.....	.....

CIRCLE KEY NUMBERS OF ABOVE COMPANIES' POSITIONS THAT INTEREST YOU

1 2 3 4 5 6 7 8 9 10 11 12 13 14 15 16 17 18 19 20 21 22 23 24 25

# EMPLOYMENT OPPORTUNITIES

The Advertisements in this section include all employment opportunities—executives, management, technical, selling, office, skilled, manual, etc. Look in the forward section of the magazine for additional Employment Opportunities advertising



**Positions Vacant**  
**Positions Wanted**  
**Part Time Work**

**Civil Service Opportunities**  
**Selling Opportunities Wanted**  
**Selling Opportunities Offered**

**Employment Agencies**  
**Employment Services**  
**Labor Bureaus**

### DISPLAYED

The advertising rate is \$40.17 per inch for all advertising appearing on other than a contract basis. Contract rates quoted on request.

An advertising inch is measured 7/8" vertically on a column—3 columns—20 inches to a page.

Subject to Agency Commission.

### ---RATES---

\$2.70 per line, minimum 3 lines. To figure advance payment count 5 average words as a line.

Box Numbers—counts as 1 line.

Positions Wanted ads are 1/2 of above rate.

Discount of 10% if full payment is made in advance for 4 consecutive insertions.

Not subject to Agency Commission.

### UNDISPLAYED

Send NEW ADS or Inquiries to Classified Advertising Division of ELECTRONICS, P. O. Box 12, N. Y. 36, N. Y.

Systems Scientists For  
Advanced Programs Staff  
In Orlando, Florida



## Communications

There are staff-level vacancies requiring communications systems engineers who are experienced in circuit design and analysis. Applications include airborne and ground digital data transmission, analog and digital computer systems, pulsed RF/IF amplifiers, and command and control display systems.

Work with the team who developed Pershing, Bullpup, GAM-83, Lacrosse, Racep, Missile Master, and BIRDIE! Join them as they constantly advance the state-of-the-art in missile and electronic systems. Investigate these opportunities by sending your resume, in confidence, to Mr. P. A. Miller, Martin Company, Orlando Division, Sec. 345, Orlando, Florida. (An equal opportunity employer.)

**MARTIN**  
ORLANDO  
A Division of Martin Marietta

## ELECTRONIC ENGINEERS TO \$23,000

Allstates, a national company supplying engineering services to industry, welcomes your inquiry regarding career consulting opportunities in the fields of electronic computer systems and component design.

Expansion in these fields within our organization has created many permanent openings for engineers who are interested in a variety of technical challenges and opportunities for growth in

- Solid State Electronic Systems
- Digital & Analog Logic Circuits
- Semiconductor Mfg Equipment

Apply in person or send resume to

**ALLSTATES DESIGN & DEVELOPMENT CO., INC.**

Affiliate: Allstates Engineering Co.  
55 West 42 St., New York, N. Y.

An equal opportunity employer.

## COMMUNICATIONS & INSTRUMENT ENGINEERS

Immediate openings for experienced engineers to design circuitry for electronic instruments and HF-UHF communications systems. Excellent opportunity for growth with progressive company in ideal surroundings. Send resume to

**Simmonds Precision Products, Inc.**  
Tarrytown, New York

## CIRCUIT DESIGNERS to \$18,720

**SNELLING & SNELLING**  
577 Wash. St., Boston, Mass.

Opportunities in all geographic areas. Submit resume to:

## SCIENTISTS/ENGINEERS

Career opportunities in:

- DESIGN
- RESEARCH
- DEVELOPMENT
- SALES
- MARKETING
- APPLICATION

Submit resume in confidence to:

- Alan Glou Technical Scientist
- Sid Hooper Sales/Marketing

Specialists in the personalized placement of Electronic Engineers and Scientists, on a national basis, who have a BS or advanced degree. Client companies assume fee and relocation costs.



**SCOPE**  
PROFESSIONAL PLACEMENT CENTER  
1277 MAIN ST. WALTHAM, MASS.

## COMMUNICATIONS APPLICATION ENGINEER

Analysis of advanced electronic communication systems including radio, carrier, telephone, microwave:

Must have design and marketing experience with commercial and military users.

EE degree, 5 yrs. exp. min.

Send Resume to:

**Microwave Services International Inc.**

Consulting Engineers  
Route 46 Deenville, N. J.

ADDRESS BOX NO. REPLIES TO: Box No. Classified Ad. Div. of this publication. Send to office nearest you.  
NEW YORK 36: P. O. Box 12  
CHICAGO 11: 615 N. Michigan Ave.  
SAN FRANCISCO 11: 255 California St.

## SELLING OPPORTUNITY WANTED

**Sales Representation—Competent Staff of Professional Engineers** available to represent aircraft & equipment manufacturers in Texas, Oklahoma, Kansas and Missouri. Facilities resume upon request. RA-8515, Electronics.



## MANUFACTURERS' REPRESENTATIVES

IN THE ELECTRONIC INDUSTRY



## Years of Sales Success in Electronics Products

NEW YORK • NEW JERSEY  
PENNSYLVANIA

**KENNETH E. HUGHES Co., Inc.**  
4808 Bergenline Ave., Union City, N. J.

## EMPLOYMENT PROBLEM?

When you are in need of specialized men for specialized jobs, contact them through an employment ad in this publication.



## SEARCHLIGHT SECTION

(Classified Advertising)

BUSINESS OPPORTUNITIES

EQUIPMENT - USED or RESALE

### DISPLAYED RATE

The advertising rate is \$27.25 per inch for all advertising appearing on other than a contract basis. Contract rates quoted on request. AN ADVERTISING INCH is measured 7/8 inch vertically on one column, 3 columns—30 inches—to a page. EQUIPMENT WANTED or FOR SALE ADVERTISEMENTS acceptable only in Displayed Style.

### UNDISPLAYED RATE

\$2.70 a line, minimum 3 lines. To figure advance payment count 5 average words as a line. PROPOSALS, \$2.70 a line an insertion. BOX NUMBERS count as one line additional in undisplayed ads. DISCOUNT OF 10% if full payment is made in advance for four consecutive insertions of undisplayed ads (not including proposals).

## FOR RESEARCH— DEVELOPMENT & EXPERIMENTAL WORK

Over 10,000 different electronic parts: waveguide, radar components and parts, test sets, pulsers, antennas, pulse xmtrs, magnetrons, IF and pulse amplifiers, dynamotors, 400 cycle xmtrs, 584 ant. pedestals, etc.

PRICES AT A FRACTION OF ORIGINAL COST!

Visit or Phone—

### COMMUNICATIONS EQUIP CO.

343 CANAL ST., N. Y. 13, N. Y.  
(Formerly at 131 Liberty St.)  
CHAS. ROSEN, WOrth 6-4045

CIRCLE 460 ON READER SERVICE CARD

### NEW INDUSTRY WANTED

Community Has Cash To Help locate industry in western Kentucky lake area. No gimmick! Plenty of water, labor, sites, gas, power, 100% plant financing. For more details call or write, West Hopkins Industries, Box 245 Dawson Springs, Ky.

## FOR MORE INFORMATION

about Classified Advertising

contract the

McGraw-Hill nearest you.

**ATLANTA, 9** O. Hicks  
1375 Peachtree St., N.E. TRinity 5-0523

**BOSTON, 16** M. Shouylin  
Copley Square COngress 2-1160

**CHICAGO, 11** W. J. Higgins, D. Beran  
645 No. Michigan Avenue MOhawk 4-5800

**CLEVELAND, 13** I. C. Hill  
1164 Illuminating Bldg. SUperior 1-7000

**DALLAS, 7** F. LeBeau  
1712 Commerce St., Vaughn Bldg.  
Riverside 7-9721

**DENVER, 2**  
1700 Broadway—Tower Bldg. ALpine 5-2981

**Detroit, 26** Wm. H. Ginder, Jr.  
856 Penobscot Bldg. WOOdward 2-1793

**HOUSTON, 25** J. Page  
Prudential Bldg., Holcombe Blvd.  
JACKson 6-1281

**LOS ANGELES, 17** Wm. C. Gries  
1125 W. 6th Street HUNtley 2-5450

**NEW YORK, 36** H. T. Buchanan-T. W. Bender  
500 Fifth Avenue LONgacre 4-3000

**PHILADELPHIA, 3** Wm. B. Sullivan-F. W. McCarthy  
Six Penn Center Plaza LOCust 8-4330

**PITTSBURGH, 22**  
4 Gateway Center EXpress 1-1314

**ST. LOUIS, 8**  
7751 Carondelet Avenue PArkview 5-7285

**SAN FRANCISCO, 11** J. A. Hartley  
55 California Street OOuglas 2-4600

# Above all...the creative IDEA

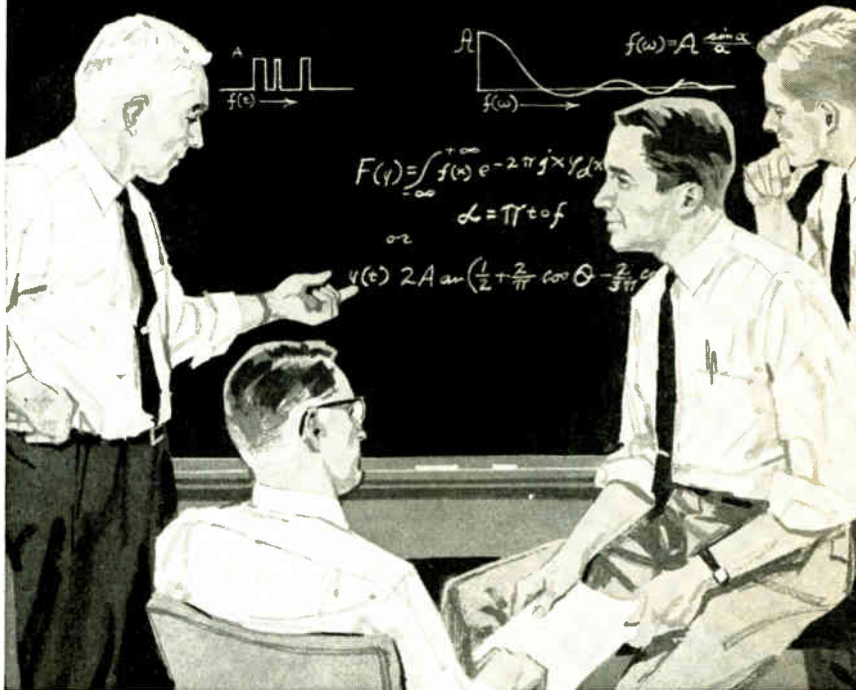

From the very beginning, Motorola has been an "engineer's company"—an organization where every consideration was secondary to the newest technological development. As a result, Motorola has attracted the type of engineer and scientist who is noted, not for his ability to conform—but to create.

In this intellectually rarified atmosphere, the challenges to an engineer are great—but, of course, the rewards are commensurate.

Motorola does *not* need "engineers" per se, but there is always an urgent need for really *good* engineers and scientists—men who are inspired by this dynamic environment rather than afraid of it—men who shun monotony and search for diversified projects. If you are such a man, we would like very much to talk with you.

- Radar transmitters and receivers
- Radar circuit design
- Electronic countermeasure systems
- Military communications equipment design
- Pulse circuit design
- IF strip design
- Device using klystron, traveling wave tube and backward wave oscillator
- Display and storage devices

#### 2-WAY RADIO COMMUNICATIONS

- VHF & UHF receiver
- Transmitter design and development
- Power supply
- Systems engineering
- Antenna design
- Selective signaling

- Transistor applications
- Crystal engineering
- Sales engineering

- Design of VHF & UHF FM communications in portable or subminiature development
- Microwave field engineers
- Transistor switching circuit design
- Logic circuit design
- T.V. circuit design engineering
- Home radio design
- New product design
- Auto radio design
- Mechanical engineering
- Semi-conductor device development
- Semi-conductor application work

MR. W. H. HAUSMANN  
Engineering Personnel Mgr. Dept. D  
4545 Augusta Blvd., Chicago 51, Ill.

AN EQUAL  
OPPORTUNITY  
EMPLOYER



# MOTOROLA inc.

# PROGRESSIVE LEADERSHIP IN *Instrumentation*

Superior design and reliable performance are basic requirements in a wide range of specialized products now in daily use around the world in business, industry, science and defense. Check MI before you buy.

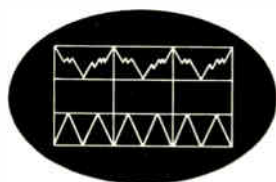

**OSCILLOGRAPHS**



**GALVANOMETERS**

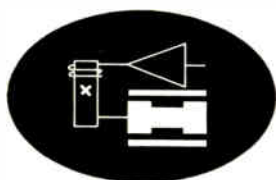

**SERVO VALVES — TORQUE MOTORS**

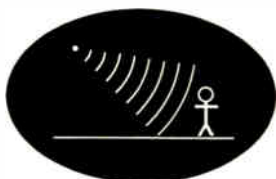

**AMPLIFIERS — TELEMETRY EQUIPMENT**

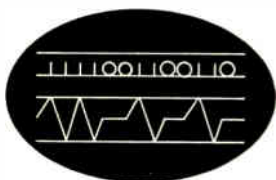

**DIGITAL TAPE HANDLERS**

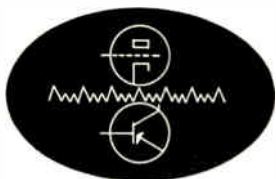

**MAGNECORDER TAPE  
RECORDER / REPRODUCERS**

Write today for Product Digest



**MIDWESTERN INSTRUMENTS**  
P. O. BOX 7509 • TULSA 35, OKLAHOMA

# INDEX TO ADVERTISERS



## Audited Paid Circulation

Aerocom .....	65	• Fenwal Electronics, Inc. ....	86
Aeroflex Laboratories Inc. ....	62	Friedrich & Dimmock, Inc. ....	71
Air Express .....	25		
Allegheny Ludlum Steel Corp. ....	55	General Dynamics/Electronics .....	31
American Cystoscope Makers, Inc. ....	76	General Electric Co. Rectifier Components Dept. ....	22, 23
Assembly Products, Inc. ....	32	Goldman, Sachs & Co. ....	76
		• Gould-National Batteries, Inc. ....	62
		Graphic Systems, Inc. ....	95
Barker & Williamson, Inc. ....	97	Gries Reproducer Corp. ....	95
• Beckman Instruments, Inc. Berkeley Division .....	21		
• Bird & Co., Inc., Richard H. ....	90	• Hewlett-Packard Company .....	Inside Front Cover
• Billey Electric Co. ....	95	Hi-G Inc. ....	51
Bristol Company, The .....	77	Honeywell Precision Meter Division. ....	88
• Budelman .....	76	Hughes Aircraft Co. ....	63
Collins Radio Co. ....	33	• International Instruments, Inc. ....	70
Consolidated Electroynamics Corp. ....	29	ITT Industrial Products Division. ....	16
• Couch Ordnance, Inc. ....	16		
• CTS Corporation .....	96		
Data-Control Systems, Inc. ....	91	• Kearfott Div. General Precision Inc. ....	81, 85
Data Pulse Inc. ....	89	Keithley Instruments, Inc. ....	92
Deleo Radio .....	24	• Kintel, A division of Cohn Electronics Inc. ....	3rd Cover
Delta Air Freight .....	69		
Dymec, A Division of Hewlett Packard Co. ....	17	Lockheed California Co. ....	71, 75
Dynacor, Inc., A Sub. of Sprague Electric Co. ....	103	Lockheed Georgia Co. ....	20
• Eitel-McCullough, Inc. ....	71		
• Electrospace Corp. ....	98		
Electronic Tube & Instrument Div. of General Atomics Corp. ....	87		
Emcee Corp. ....	66		
		• See advertisement in the July 20, 1961 issue of Electronics Buyers' Guide for complete line of products or services.	
Fairchild Stratos .....	80, 81		

Magnetics Inc. ....	70
Marconi Instruments ..... 95	95
Microdot, Inc. ....	15
Midwestern Instruments ..... 102	102
Minnesota Mining & Mfg. Co., Chemical Div. ....	61
• Mitsumi Electric Co., Ltd. ....	69

Wayne-George Corp. ....	53
Westinghouse Electric Corp. ....	67
Wood Electric Corp. ....	69

Narda Microwave Corporation ....	13
• Non-Linear Systems, Inc. ....	11
• Northeastern Engineering, Inc. ....	62

<b>MANUFACTURERS REPRESENTATIVE</b>	
Hughes-Kenneth E., .....	100

**CLASSIFIED ADVERTISING**  
F. J. Eberle, Business Mgr.

Ozald, A Div. of General Electric Film Corp. ....	14
--	----

**EMPLOYMENT OPPORTUNITIES 100-101**

Patwin, Div. of Patent Button Co. ....	98
• Phileo Corporation ....	73

**BUSINESS OPPORTUNITIES ..... 101**

• Radio Corporation of America, 4th Cover	
• Raytheon Company ..... 59	59
Rosemount Engineering Co. ....	104

<b>EQUIPMENT</b>	
(Used or Surplus New)	
For Sale .....	101

• Sierra Electronic Corp. ....	6
• Sorensen ..... 56, 57	56, 57
Speer Carbon Co. ....	31
Sprague Electric Co. .... 4, 9,	30
Superior Cable Corp. ....	68
Sweeney Mfg. Co., B. K. ....	90

**INDEX TO CLASSIFIED ADVERTISERS**

Allstates Design & Development Co., Inc. ....	100
• Communications Equipment Co. ....	101
Martin Company, Orlando Div. ....	100
Microwave Services International Inc.,	100
Motorola Inc. ....	101
Scope .....	100
Simmonds Precision Products Inc. ....	100
Snelling & Snelling .....	100

Tektronix, Inc. ....	79
Texas Instruments Incorporated Apparatus Division .....	97
• Tung-Sol Electric, Inc. ....	5

• See advertisement in the July 20, 1961 issue of Electronics Buyers' Guide for complete line of products or services.

• Utica Drop Forge & Tool Division, Kelsey-Hayes Co. ....	82
--	----

• Vitro Electronics .....	93
---------------------------	----

This Index and our Reader Service Numbers are published as a service. Every precaution is taken to make them accurate, but ELECTRONICS assumes no responsibilities for errors or omissions.



# SQUARE-LOOP TAPE CORES TO MEET YOUR TOUGHEST SPECIFICATIONS

Speed your specs to Dynacor when you want square-loop tape cores to exact requirements—fast! Here you'll find a dependable combination of personnel, experience and facilities—the know-how to deliver parameters to your very tightest tolerance requirements for switching time, flux, and noise.

Dynacor Square-Loop Tape Cores are manufactured with the high permeability alloys—Grain-Oriented 50-50 Nickel Iron, 4-79 Molybdenum Permalloy, and Grain-Oriented 3% Silicon Iron . . . with fully guaranteed uniformity . . . under rigid standards of control and inspection.

Look to Dynacor for reliable production and swift delivery of your tape core requirements. For your convenience a full line of standard units are stocked for immediate off-the-shelf delivery—Send for bulletins DN 2000, DN 2001, DN 2002.



**SPRAGUE®**  
THE MARK OF RELIABILITY

SPRAGUE ELECTRIC COMPANY  
35, MARSHALL ST. • NORTH ADAMS, MASS.

# ACCURATE, RUGGED...

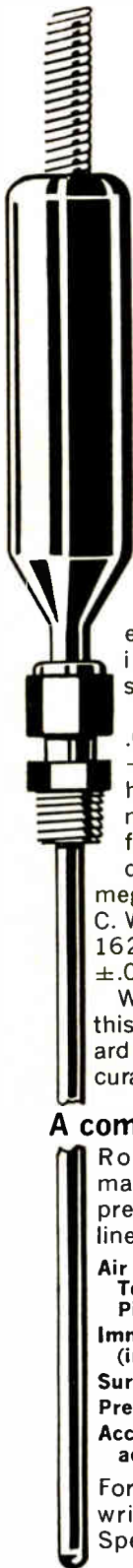

## REC's new temperature standard

The new REC Model 162C platinum resistance temperature standard is so stable and accurate it can be calibrated and certified by the National Bureau of Standards.

Yet it is rugged enough to operate under 2,000 psi pressure and withstands sudden, extreme changes in temperature. The Model 162C's fully annealed, high purity platinum wire resistor is mounted essentially strain free within a hermetically sealed stainless steel well.

Stability is better than .005° C. over a range from -200° to +500° C. Self-heating is only .001° C. at 2 ma. Insulation resistance from element to outside case is more than 1,000 megohms at 100 vdc at 500° C. We will calibrate any Model 162C to an accuracy of ±.015° C.

Write for further details of this new temperature standard that combines great accuracy and ruggedness.

### A complete precision line

Rosemount designs and manufactures high quality precision equipment in these lines:

- Air data sensors
  - Total temperature
  - Pitot-static tubes (de-iced)
- Immersion temperature sensors (including cryogenic)
- Surface temperature sensors
- Pressure sensors
- Accessory equipment and aeronautical research

For more information please write for the REC catalog. Specific questions welcomed.



**ROSEMOUNT  
ENGINEERING  
COMPANY**

4900 West 78th St. • Minneapolis 24, Minn.

## electronics



Audit Bureau  
of Circulations



Associated Business  
Publications

Audited Paid Circulation

**JAMES T. HAUPTLI**

Advertising Sales Manager

**R. S. QUINT:**  
Assistant Publisher Buyers'  
Guide and Business Manager  
**FRED STEWART:**  
Promotion Manager  
**B. ANELLO:**  
Market Services Manager

**RICHARD J. TOMLINSON:**  
Production Manager  
**GEORGE E. POMEROY:**  
Classified Manager  
**HUGH J. QUINN:**  
Circulation Manager

### ADVERTISING REPRESENTATIVES

**NEW YORK (36):**  
Donald H. Miller, Henry M. Shaw,  
George F. Werner  
500 Fifth Avenue, LO-4-3000  
(area code 212)

**BOSTON (16):**  
William S. Hadgkinson, Donald R. Furth  
McGraw-Hill Building, Copley Square,  
Congress 2-1160 (area code 617)

**PHILADELPHIA (3):**  
Warren H. Gardner, William J. Boyle  
6 Penn Center Plaza, LOcust 8-4330  
(area code 215)

**CHICAGO (11):**  
Harvey W. Wernecke, Robert M. Denmead  
645 North Michigan Avenue, Mahawk 4-5800  
(area code 312)

**CLEVELAND (13):**  
Paul T. Fegley  
55 Public Square, Superior 1-7000  
(area code 216)

**SAN FRANCISCO (11):**  
R. C. Aicarn  
255 California Street, Douglas 2-4600  
(area code 415)

**LOS ANGELES (17):**  
Peter S. Carberry, Ashley P. Hartman  
1125 W. 6th St., Huntley 2-5450  
(area code 213)

**DENVER (2):**  
J. W. Patten  
Tower Bldg., 1700 Broadway,  
Alpine 5-2981 (area code 303)

**ATLANTA (9):**  
Michael H. Miller, Robert C. Johnson  
1375 Peachtree St. N.E., Trinity 5-0523  
(area code 404)

**HOUSTON (25):**  
Joseph C. Page, Jr.  
Prudential Bldg., Holcomb Blvd.,  
Jackson 6-1281 (area code 713)

**DALLAS (1):**  
Frank Le Beau  
The Vaughn Bldg., 1712 Commerce St.  
Riverside 7-9721 (area code 214)

**LONDON W1:**  
Dennis McDonald  
34 Dover St.

**FRANKFURT/Main:**  
85 Westendstrasse

**GENEVA:**  
Michael R. Zeynel  
2 Place du Port

### "Headquarters for Business Information"

### McGraw-Hill Technical and Business Publications

American Machinist/Metal-  
working Manufacturing  
Aviation Week and Space  
Technology  
Business Week  
Chemical Engineering  
Chemical Week  
Coal Age  
Construction Methods and  
Equipment  
Construction Daily  
Control Engineering  
Electrical Construction  
and Maintenance  
Electrical Merchandising Week  
Electrical Newsletter  
Electrical West

Electrical Wholesaling  
Electrical World  
Electronics  
Engineering Digest  
Engineering and Mining Journal  
E & MJ Metal and Mineral  
Markets  
Engineering News-Record  
Factory  
Fleet Owner  
Industrial Distribution  
National Petroleum News  
Nucleonics  
Nucleonics Week  
Platt's Dilgram News  
Platt's Dilgram Price Service  
Power

Product Engineering  
Purchasing Week  
Science Week  
Textile World

Overseas only:  
Automobile International  
(English, Spanish)  
Ingenieria Internacional  
Construccion (Spanish)  
International Management  
(English, Spanish  
Portuguese editions)  
Metalworking Production  
(Great Britain)

Available by subscription only — to qualified persons actively engaged in the field of the publication. For subscription rates and information describing the editorial coverage of any of the above publications, write to: Subscription Manager, Circulation Department, McGraw-Hill Publishing Company, 330 West 42nd Street, New York 36, N. Y.

which of these

13

KIN TEL instruments  
does your standards  
lab need?

Used in leading standards labs  
throughout the country, they may  
supply the exact degree of accuracy,  
stability, range, and versatility  
your particular laboratory  
applications demand.

CERTIFIED

#### STANDARDS

**1. DC Voltage Standard (Model 303).** So accurate, so stable, you can use it to calibrate any digital voltmeter. Lets you control output from 0 to over  $\pm 1100$  volts in steps as small as 1 microvolt. Accurate to within 0.01% of the dial setting; stable to within 0.005%. Floating guarded circuit. Price: \$2995.

**2. AC Voltage Standard (Model 601A).** Output is 1 to 501 volts RMS AC, adjustable in 0.1 volt steps and between steps by a multi-turn potentiometer. Voltage accuracy is 0.1%, short term stability is 0.01%. Ideal for calibrating AC measuring instruments, designing servo or gyro equipment, evaluating magnetic properties. Price: \$4500.

**3. DC Voltage Standard and Null Voltmeter (Model 302).** Used by hundreds for rapid, accurate production calibration of precision measuring instruments and DC power supplies; for the design of DC amplifiers and complex circuitry; for computer reference; for precision reference in calibration and measurement laboratories. Measures and supplies DC from 1 to 502 volts with 0.01% accuracy, 0.002% stability. Price: \$1280.

**4. DC Voltage Standard and Null Voltmeter (Model 301).** Has an accuracy of 0.02% and stability of 0.01%. Measures and supplies DC from 1 to 501 volts. Price: \$995.

Write for detailed literature or a demonstration of any of these exceptional instruments. Representatives in all major cities. All prices FOB, San Diego, Calif. 50 cps operation at additional cost.

#### VOLTMETERS

**5. DC Digital Voltmeter (Model 501B).** Four-digit, fifth digit over-ranging. Measures positive or negative DC between 100 microvolts and 1000 volts, with 0.01% (of reading)  $\pm 1$  digit accuracy. Automatic or programmable range; auto polarity. Combines the useful accuracy of a 5-digit voltmeter with the stability, reliability, and price advantage of a 4-digit voltmeter. Price: \$2995.

**6. AC/DC Digital Voltmeter (Model 502B).** Gives you AC accuracy within 0.1% of reading; over-ranging on both AC and DC; automatic ranging and remote (programmable) control. Measures DC between  $\pm 100$  microvolts and  $\pm 1000$  volts, AC from 30 cps to 10 kc between 1 millivolt and 1000 volts. Four-digit readout. Price: \$4245.

**7. AC/DC Digital Voltmeter (Model 502BZ).** Similar to the Model 502B (see above). Circuit is automatically and continually calibrated against a Zener diode reference source instead of against an unsaturated mercury-cadmium standard cell. Price: \$4410.

**8. DC Digital Voltmeter and Ratiometer (Model 507D).** Measures voltages between  $\pm 100$  microvolts and  $\pm 1000$  volts, ratios between  $\pm 0.0001:1$  and  $\pm 999.9:1$  with 0.01% (of reading)  $\pm 1$  digit accuracy. Price: \$3835.

**9. Militarized Digital Voltmeter (Model 412).** Rugged, programmable, differential. Auto range, polarity. Measures AC and  $\pm$ DC potentials between 0.001 and 999.9 volts. Accuracy is 0.01% (of reading)  $\pm 1$  digit for DC, 0.1% of full scale for AC. Designed to MIL-E-4158A. Price: \$10,000.

#### LABORATORY INSTRUMENTS

**10. Meter Calibrators.** Provide voltages and currents calibrated in absolute units, regardless of line or load variations. Long term stability is  $\pm 0.01\%$ . Ideal for fast, accurate production meter or telemetering calibrations. Use as accurate reference, as wide range null voltmeters, as secondary voltage and current standards. Price: \$1150 to \$2995.

**11. Electronic Galvanometer and Amplifier (Model 204A).** A combination DC null detector, linear deflection indicator, microvoltammeter, and inverting DC amplifier. *Functionally equivalent to sensitive suspension galvanometers, yet rugged enough for the test van.* Seven decades ranges provide accurate measurement of voltages from 1 microvolt to 10 volts or currents from 100 microamperes to 1 milliamperes at a constant input resistance of 10,000 ohms. Price: \$425.

**12. DC Microvolt Ammeter and Amplifier (Model 203A).** Provides high sensitivity, drift-free stability, high input impedance. Fifteen voltage ranges cover from 100 microvolts to 1000 volts, full scale; 19 current ranges cover from 1 millimicroampere to 1 ampere, full scale. 3% accuracy. Price: \$750.

**13. DC Microvoltmeter and Amplifier (Model 202B).** Provides high sensitivity, drift-free stability, high input impedance. Fourteen voltage ranges cover from 300 microvolts to 1000 volts, full scale. Measures as little as 10 microvolts. Price: \$500.



5725 Kearny Villa Road  
San Diego 12, California  
Phone 277-6700  
(Area Code 714)

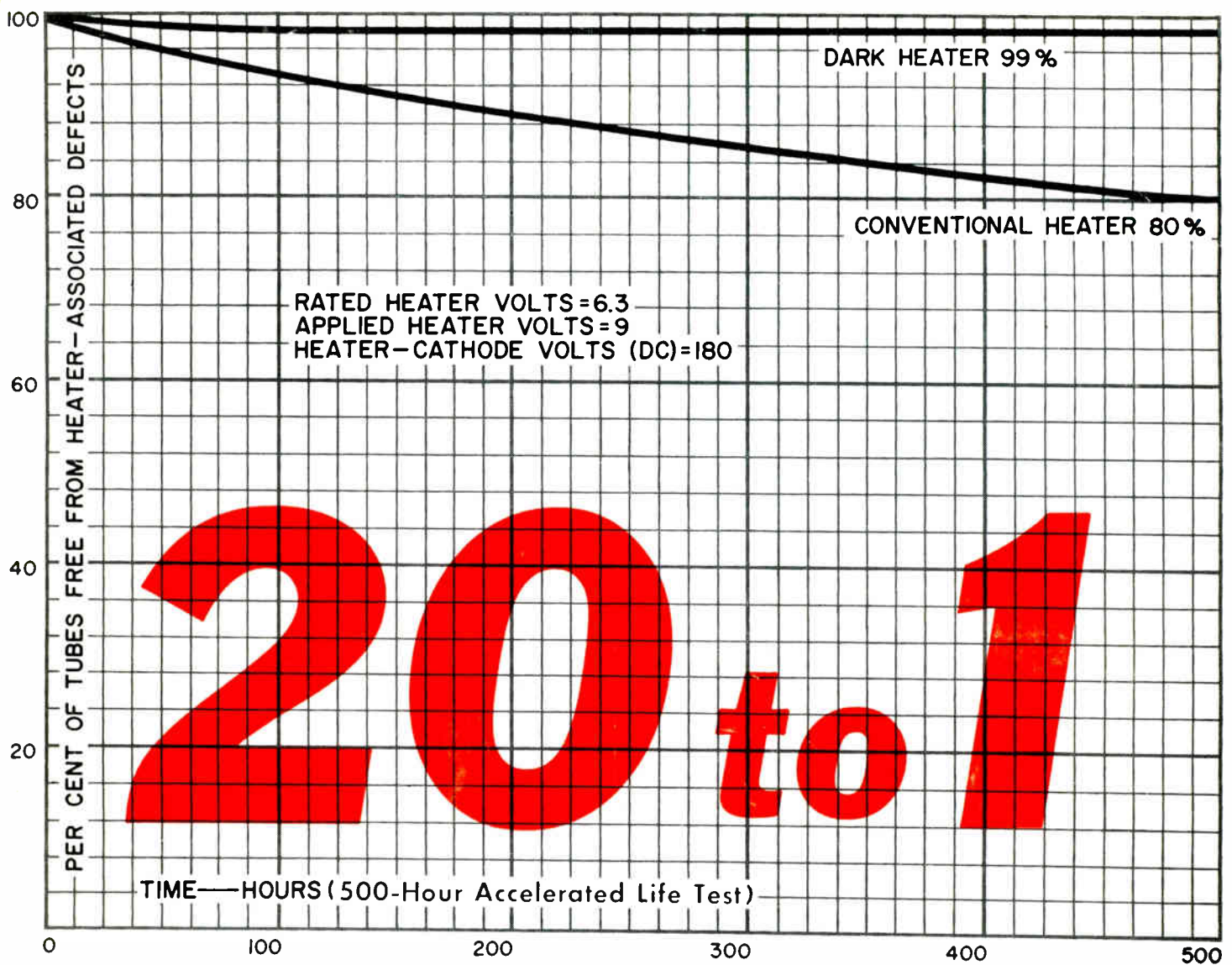

## *reduction in tube failure due to heater-associated defects with revolutionary new RCA "Dark Heater"*



Reduction of tube failures due to heater-associated defects by the amazing factor of 20 to 1 after a 500-hour accelerated heater life cycling test—that's the latest performance triumph chalked up by the revolutionary RCA "Dark Heater".

While tubes with conventional heaters experienced 20 heater-associated defects per 100 tubes, tubes with the "Dark Heater" experienced only one!

Tests were conducted at 143% of rated heater voltage (9 volts for a 6.3-volt type) and at a heater-cathode voltage of 180 volts. Operating cycle was one minute on two minutes off. These 500-hour life tests are the equivalent of operation of a heater for 14,500 hours at normal heater voltage. These tests represented more than a quarter of a million tube hours.

The principle of this remarkable electron tube innovation is quite simple. Since a dark

body emits heat more efficiently than a white body, the "Dark Heater" can operate at about 350°K below the temperature of a conventional heater—yet still produce the required cathode temperature. This means:

- **Longer Heater Life**—as the tests prove, these lower temperatures result in a 50% increase in the ultimate tensile strength of the operating heater wire, and reduce internal stress by 25% during heater "on-off" cycling.

- **Less Chance of Heater Failure.** Reduced operating temperatures and smaller thermal change in cycling minimize tendency toward recrystallization and burnout.

- **Heater-Current Stability on Life.** Conventional heaters often show rising heater current characteristic on life. The "Dark Heater", however, maintains a remarkably stable current characteristic throughout its life.

- **Reduced AC Heater-Cathode Leakage and Hum.** Use of the "Dark Heater" reduces AC leakage and hum particularly "spike" or pulse leakage currents. In addition, lower heater temperature reduces both AC and DC leakage from heater to cathode and heater emission to other tube electrodes.

- **Improved Mechanical Stability.** Cooler operation minimizes changes in heater shape during life, reducing the chance of heater damage or shorts.

- **Greater Safety Margin in H-K Voltage Ratings.** Cooler operation means greater safety margin in present H-K voltage ratings.

Engineering is complete on the inclusion of the Dark Heater in some 200 of the most popular, high-volume OEM RCA receiving tubes—and most are already being delivered. For full information on "Dark Heater" tube types now (or soon to be) available, consult your RCA Field Office.



The Most Trusted Name in Electronics

**RCA ELECTRON TUBE DIVISION—FIELD OFFICES...EAST:**  
744 Broad Street, Newark 2, N. J., HUmboldt 5-3900 •  
**MIDWEST:** Suite 1154, Merchandise Mart Plaza, Chicago  
54, Ill., WHitehall 4-2900 • **WEST:** 6801 E. Washington  
Blvd., Los Angeles 22, Calif., RAymond 3-8361 • 1838  
El Camino Real, Burlingame, Calif., OXFord 7-1620