

# electronics

A McGraw-Hill Publication 75 Cents

8694V

(Photo at right)

## BAKING A KLYSTRON

*14-ft oven outgasses  
tube, activates  
cathode. See p 86*

## CORRELATING NAVIGATOR

*uses microwave  
echoes at several  
antennas. See p 55*

## ELECTRONIC IGNITION

*with thyatron,  
cold-cathode tube  
and transistor, p 62*

## NEW IDEAS IN TUBES

*special cathodes,  
strap frame grids,  
shaped beams, p 60*

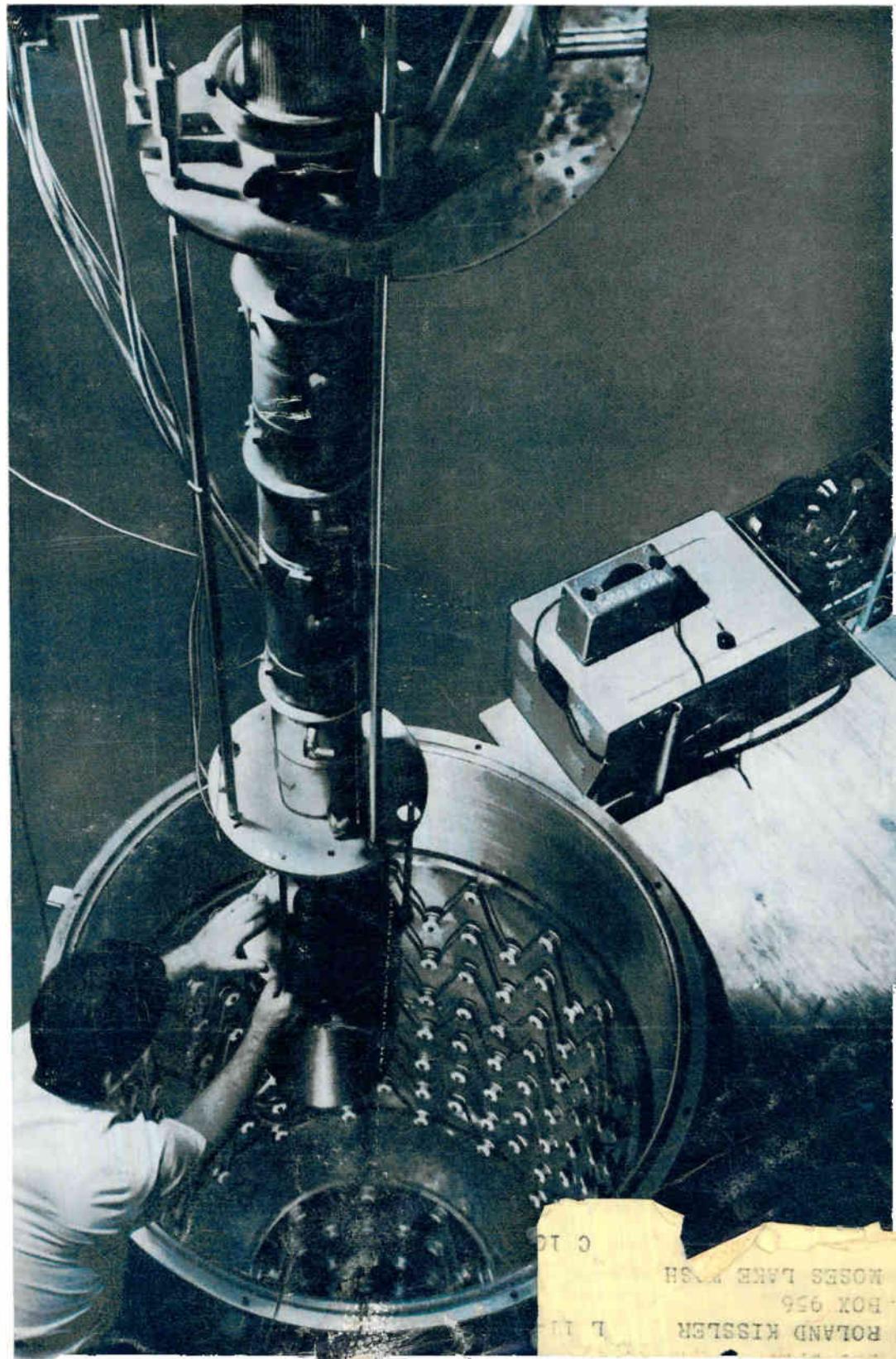

ROLAND KISSLER  
BOX 956  
MOSES LAKE WASH

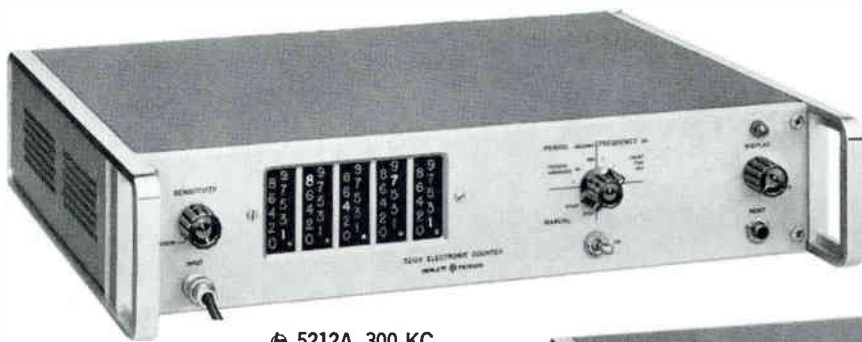

Ⓜ 5212A, 300 KC

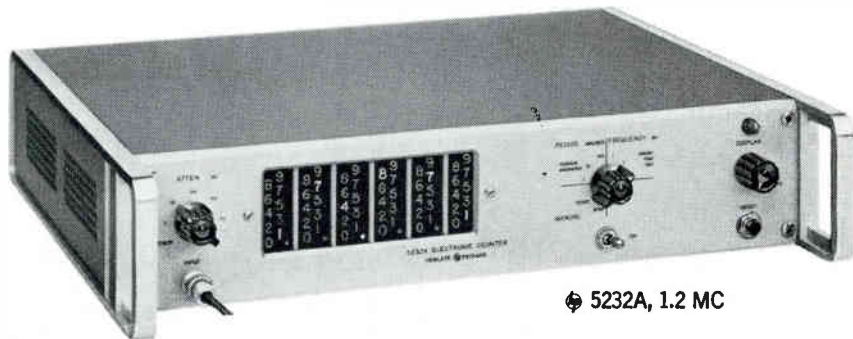

Ⓜ 5232A, 1.2 MC



# COUNTERS!

sensitivity! Higher sampling rate! Unique low frequency accuracy! Operation  $-20^{\circ}$  to  $+65^{\circ}$  C! Prices comparable to vacuum tube counters!

Average Measurement		Frequency Measurement				Ratio Measurement			Price
Reads in	Periods Averaged	Range	Accuracy	Reads In	Gate Time	Reads	Range	Accuracy	
Milli-seconds or microseconds with positioned decimal	1, 10, 10 <sup>2</sup> , 10 <sup>3</sup> , 10 <sup>4</sup> , 10 <sup>5</sup>	2 cps to 300 KC	$\pm 1$ count $\pm$ time base accuracy	KC with positioned decimal	10, 1, 0.1, 0.01 sec.	$(f_1/f_2) \times$ period multiplier	f <sub>1</sub> : 100 cps to 300 KC (1 v rms into 1,000 ohms) f <sub>2</sub> : same as period	$\pm 1$ count of f <sub>1</sub> $\pm$ trigger error of f <sub>2</sub>	\$ 975.00
									1,375.00
		2 cps to 1.2 MC					f <sub>1</sub> : 100 cps to 1.2 MC (1 v rms into 500 ohms) f <sub>2</sub> : same as period		1,300.00
							1,550.00		

accuracy in lower frequency ranges, even for noisy signals. Self-check is provided for both frequency and period measurement modes.

Only 3 1/2" high, these counters are housed in the new modular cabinets ideal for both bench use and easy rack mounting. Routine maintenance is simple with snap-out decade/readout units and circuit cards. Readout drive directly from photoconductors eliminates a complete stage of complex circuitry, to effect genuine cost and reliability advantages. Compact design and construction and servicing ease are illustrated at the left.

Solid state design and construction gives you the advantages of low heat dissipation with minor heating effect on adjacent equipment, fast warm-up, low power consumption and new standards of reliability.

The new counters include a four-line BCD code output. This output, with assigned weights of 1-2-2-4 ("1" state positive with respect to "0" state), is available for systems use or to operate devices such as the 562A Digital Recorder. Controls include Input Attenuation, Display, Reset and Function.

Call or write your representative or call us today for information and a demonstration!

*Data subject to change without notice. Prices f.o.b. factory.*



## HEWLETT-PACKARD COMPANY

1081A Page Mill Road  
Cable "HEWPACK"

Palo Alto, California, U.S.A.  
DAvenport 6-7000

*Sales representatives in all principal areas*

## HEWLETT-PACKARD S. A.

Rue du Vieux Billard No. 1  
Cable "HEWPACKSA"  
Geneva, Switzerland  
Tel. No. (022) 28.43.36





Easier reading continuous display

Higher sampling rate

Multi-period average

Wide temperature range

Low-frequency accuracy

Versatile new modular design

Measurement flexibility, moderate cost

# IN 4 NEW SOLID STATE COUNTERS!

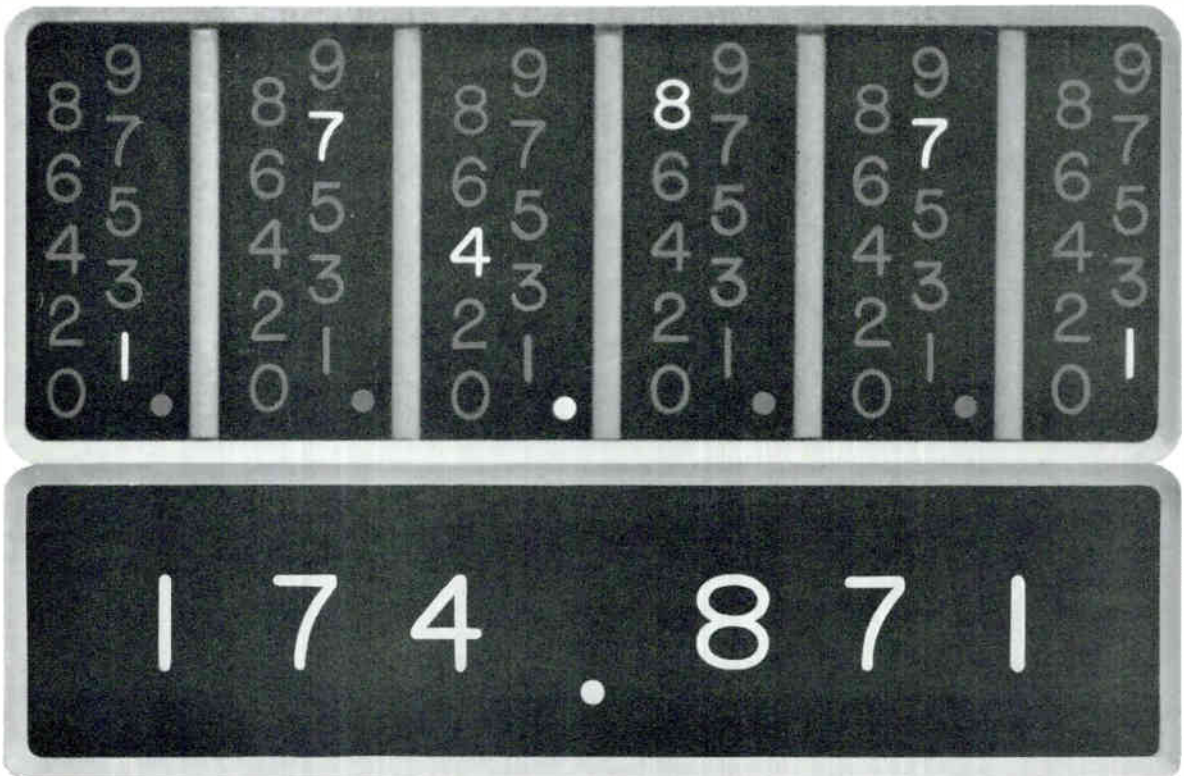

Turn the page to learn about new measuring convenience, dependability from .

a pleasure  
to measure  
with these...





5512A, 300 KC



5532A, 1.2 MC

# 4 NEW SOLID STATE

Measure frequency, period, ratio, quickly, accurately. Compact, easy-to-use instruments provide continuous display, no "blinking"! Solid-state dependability! 0.1 volt

All the advantages of solid-state design are now yours in these new  solid state counters—offered at prices comparable to those of today's vacuum tube counters. And you get the *plus* advantages of greater readability, faster measurements, easier routine maintenance, rack-and-stack convenience of the new  universal module instrument cabinets.

Offered in four models, these new counters have maximum counting rates of 300 KC or 1.2 MC, with a choice of Nixie or columnar readouts. The high-intensity neon readouts are stacked in compact columns for faster, easier reading. On the in-line readouts, -pioneered standard incorporation of the new long-life, wide-viewing Nixies gives you many extra hours of lamp life and heretofore unknown readability even at extreme angles. Polarized screen provides maximum readout brilliance with freedom from reflections.

A unique display storage feature of these new counters produces a continuous visual readout of the most recent measurement, even while the instrument is making a new measurement. Only if the new count differs from the previous count will the display change, in which case it will shift directly to the new reading. The fatigue and error possibility of a "blinking" display is eliminated. The storage feature may be disabled with a rear panel switch.

The counter's "inactive time" (when not making a new measurement) is independent of gate time and adjustable from 0.2 to 5.0 seconds, thus permitting a higher sampling rate.

Counter	Max. Counting Rate	Registration	Period and Multiple Period	
			Range	Accuracy
5212A	300 KC	5 digits columnar	2 cps to 300 KC	± one count ± time base accuracy ± trigger error/periods averaged
5512A	300 KC	5 digits Nixie		
5232A	1.2 MC	6 digits columnar	2 cps to 1.2 MC	± 1 μs ± time base accuracy ± trigger error/periods averaged
5532A	1.2 MC	6 digits Nixie		

High sensitivity permits low level measurement without accessories, and multiple period average measurement (to 100,000 periods) gives higher ac-

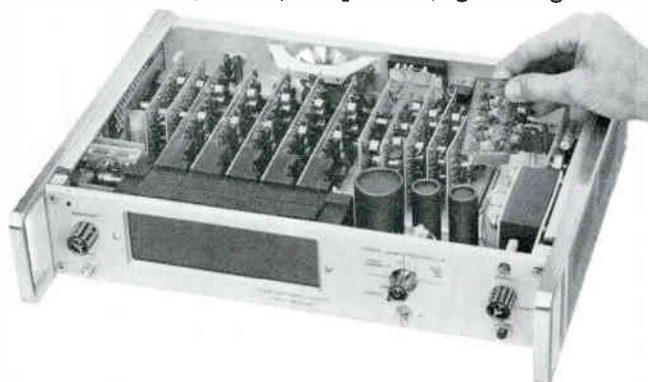

Note clean, compact, easy-to-service physical arrangement of new  solid-state counters.



# electronics

A McGraw-Hill Publication 75 Cents

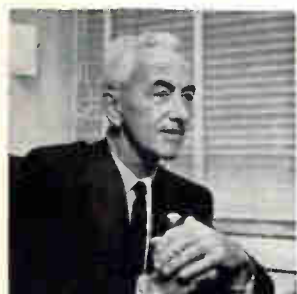

W. W. MacDONALD, Editor

J. M. CARROLL, Managing Editor  
 SENIOR EDITORS: Samuel Weber, George W. Sideris. SENIOR ASSOCIATE EDITORS: William E. Bushor, Michael F. Wolff. ASSOCIATE EDITORS: Michael F. Tomaino, Sylvester P. Carter, William P. O'Brien, John F. Mason, Thomas Emma, Sy Vogel, Leslie Solomon, M. M. Perugini, George J. Flynn, Laurence D. Shergalis. ASSISTANT EDITORS: Nilo Lindgren, Stanley Froud, Stephen B. Gray, Roy J. Bruun, George V. Novotny, Leon H. Dulberger. REGIONAL EDITORS: Harold C. Hood (Pacific Coast, Los Angeles), Thomas Maguire (New England, Boston), Cletus M. Wiley (Midwest, Chicago). ART DIRECTOR: Harry Phillips; Howard R. Berry. PRODUCTION EDITOR: John C. Wright, Jr. EDITORIAL ASSISTANTS: Gloria J. Meurer, Bernice Duffy, Lorraine Rossi, Virginia T. Bastian, Lynn Emery, Laura W. Smith, Bette H. Snyder, Rosemary Abbruzzese, Judy Haskins.

JAMES GIRDWOOD, Publisher

High-power Klystron is lowered into 14-foot high-vacuum bakeout oven at Sperry Electron Tube division. Oven minimizes damage to tube if a leak develops at one of tube's seals. See p 86 COVER

NEW PULSE TRACKERS Readied for Space Ranges. Latest generation of missile range radars is capable of non-ambiguous range measurements of targets as far as 32,000 n. mi 26

Silver Price Jumps Nine Cents. Treasury stops selling metal, important in electronics, at deflated price 28

Thin Film Devices Are Still in Research Stage. Progress report on exploitation of tunneling in supercooled thin-films 30

AIR AND SPACE NAVIGATION Uses Correlation Technique. System reported is more accurate than comparable doppler types. R. J. Miller 55

Latest Developments in Electron Devices. Advances reported at the Radio Fall Meeting. L. Solomon 60

PRACTICAL ELECTRONIC IGNITION With Gas Tubes and Transistor. Thyatron switches high ignition currents around breaker points. H. P. Quinn 62

MEDICAL ELECTRONICS PART VI: Research Instruments. Laboratory equipments implement measurement and visualization of microscopic particles. W. E. Bushor 65

Hybrid Telemeter Detects Avalanches. Tripped wire controls tone-modulated signal. G. Neal and S. A. Stone 72

DEGENERATE PARAMETRIC AMPLIFIER Uses Butterfly Resonators. Suggests possibility of single-control continuous tuning. R. J. Mayer 74

Crosstalk	4	Components and Materials	80
Comment	6	Production Techniques	86
Electronics Newsletter	11	New on the Market	90
Washington Outlook	14	Literature of the Week	104
Meetings Ahead	32	People and Plants	106
Research and Development	76	Index to Advertisers	112

# Get your lead out and test new ozaclear

Transparentized Tracing Paper by OZALID  
with a tough, non-fracturing surface that gets  
clear-as-a-bell prints.

Get your pen out, too! Contact your Ozalid man for samples and see for yourself how well this new Ozalid tracing vellum takes the lead and ink...how well it reproduces *even when abused*. Crease it . . . make multiple erasures . . . then go ahead—crumple it in a ball. Flatten it out and make a reproduction from this much-abused OZACLEAR. Now try the

same thing on your present tracing sheet. Clear-as-a-bell OZACLEAR gives high repro speed, excellent contrast, fine clear-as-a-bell prints. A new companion product to Ozalid Ozatrace® vellum and Duratrace® drafting film. For more information, samples, write: OZALID, Dept. 188, Johnson City, N. Y. In Canada: Hughes-Owens Co., Ltd., Montreal.

**OZALID**  
— WE REPEAT —  
**OZALID**  
DIVISION OF GENERAL ANILINE & FILM CORPORATION



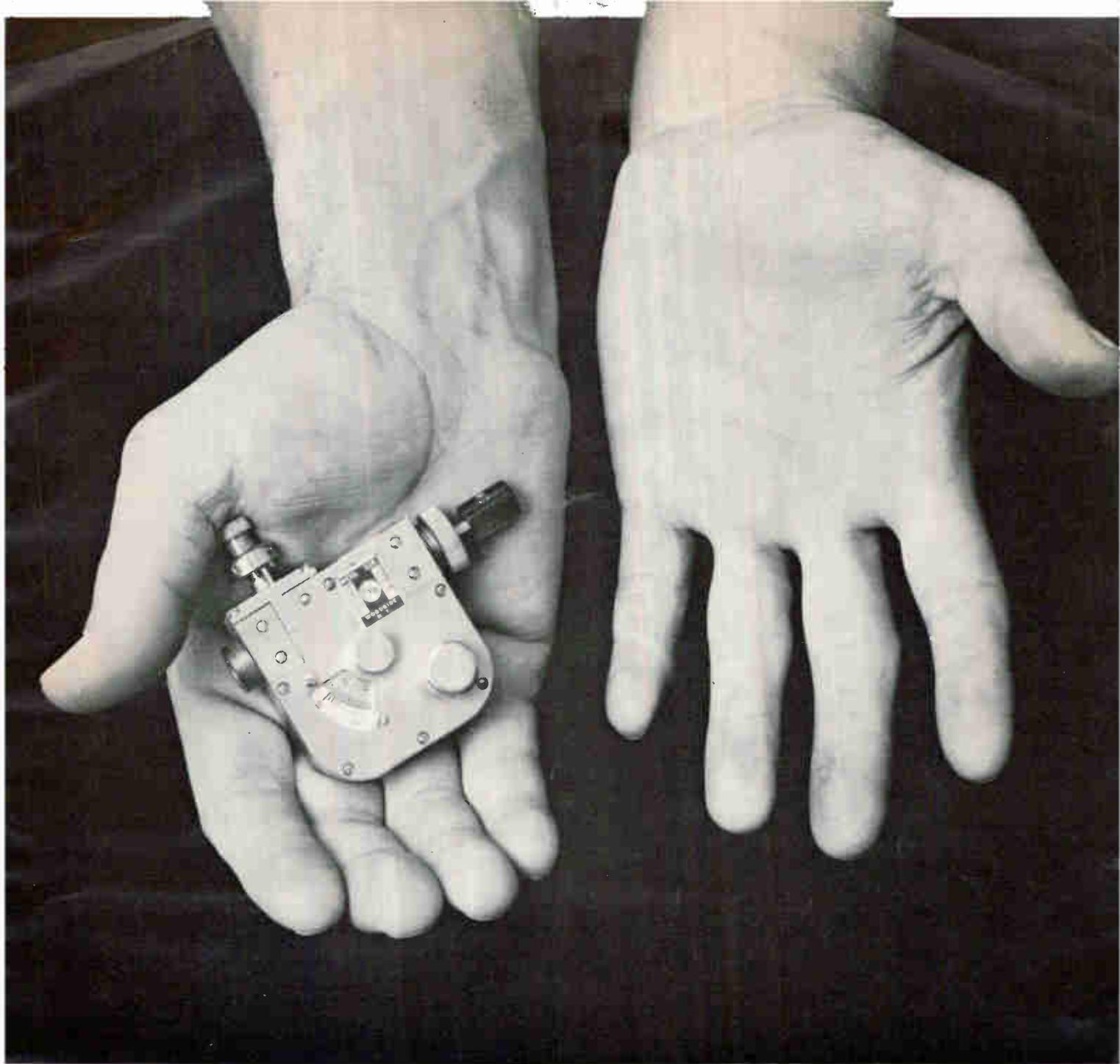

## *Wanted:* 2 & 3 mm oscillators to power FXR's 90 to 220 Gc components

FXR has on hand *today, in stock*, a complete line of microwave components for tomorrow's 2 & 3 mm systems. And by complete line, we mean frequency meters, precision attenuators, E/H tuners, harmonic generators, phase shifters, bends, twists, slotted sections, transitions — in short, everything needed to set up a test system in the 90 to 220 Gc range.

But what about the 2 & 3 mm oscillators needed to drive these test systems? We've the answer to that. While waiting for these 2 & 3 mm oscillators you, too, can use the FXR harmonic generators for test purposes to double and triple the frequencies of existing oscillators. This

design and production availability of 2 & 3 mm components is a further addition to FXR's comprehensive line of microwave components and test instruments.

Staying a band ahead is a point of pride with FXR engineers. FXR's leadership in the mm bands is typical of equally advanced developments in other areas of microwave engineering, including high power electronics. For example, the FXR engineering group which delivered the world's first 50 megawatt S-band trans-

mitter is now producing even more advanced types. Whether in microwave components, test instruments, sub-systems or high power electronics, FXR is known for its ability to *deliver* the last word in microwave technology today.

May we help you in your next microwave project? Write today for literature covering your particular field of interest. FXR, 25-26 50th Street, Woodside 77, New York. Telephone: Area Code 212, Ravenswood 1-9000.

# FXR

THE RF PRODUCTS AND MICROWAVE  
AMPHENOL-BORG ELECTRONICS CORP.

Published weekly, with Electronics Buyers' Guide and Reference issue, as part of the subscription, by McGraw-Hill Publishing Company, Inc. Founder: James H. McGraw (1860-1948).

Title ® registered U.S. Patent Office; Copyrighted © 1961, McGraw-Hill Publishing Company, Inc. All rights reserved, including the right to reproduce the contents of this publication, in whole or in part.

Executive, editorial, circulation and advertising offices McGraw-Hill Building, 330 West 42nd Street, New York 36, N. Y. Telephone Longacre 4-3000. Teletype TWX N.Y. 1-1636. Cable McGrawhill, N. Y. PRINTED IN ALBANY, N. Y.; second class postage paid.

**OFFICERS OF THE PUBLICATIONS DIVISION:** Nelson L. Bond, President; Shelton Fisher, Wallace F. Traendly, Senior Vice Presidents; John R. Callahan, Vice President and Editorial Director; Joseph H. Allen, Vice President and Director of Advertising Sales; A. R. Venezian, Vice President and Circulation Coordinator; Daniel F. Crowley, Vice President and Controller.

**OFFICERS OF THE CORPORATION:** Donald C. McGraw, President; Hugh J. Kelly, Harry L. Waddell, Executive Vice Presidents; L. Keith Goodrich, Executive Vice President and Treasurer; John J. Cooke, Vice President and Secretary.

Subscriptions are solicited only from those actively engaged in the field of the publication. Position and company connection must be indicated on orders. Subscription rates: United States and Possessions, \$6.00 one year; \$9.00 two years; \$12.00 three years. Canada, \$10.00 one year. All other countries \$20.00 one year. Single Copies, United States and Possessions and Canada 75¢; Buyers' Guide \$3.00; Single copies all other countries \$1.50; Buyers' Guide \$10.00.

THE PUBLISHER, UPON WRITTEN REQUEST FROM ANY SUBSCRIBER TO OUR NEW YORK OFFICE, AGREES TO REFUND THAT PART OF THE SUBSCRIPTION PRICE APPLYING TO COPIES NOT YET MAILED.

Subscribers: Please address all correspondence, change of address notices, subscription orders or complaints to Fulfillment Manager, Electronics, at above address. Change of address notices should provide old as well as new address, including postal zone number if any. If possible, attach address label from recent issue. Allow one month for change to become effective.

Postmaster: Please send Form 3579 to Fulfillment Manager, Electronics, 330 West 42nd Street, New York 36, New York.



Audited Paid Circulation

## Shelters Come Second

**FIRST REQUIREMENT** for effective civil defense is warning that an attack is imminent. With any kind of luck the military will know, but it is by no means certain that the warning can be relayed to the bulk of our population fast enough and clearly enough to be effective.

Sirens are fine and relatively foolproof but not everybody hears them. And there have been so many routine tests, as well as drills in which the public is not invited to participate, that they would be initially ignored and heeded only after the first missiles hit. In a saturation attack this might be too late.

Electric alarms installed in homes and elsewhere, triggered over the power lines, are currently under consideration. Such supplementary devices, useful as they would be in spreading warning to people beyond the reach of sirens, have a similar weakness. They would warn the public, but not tell the public why it was being warned and what to do about it. Stating this another way, they would not be able to talk.

We should certainly have a supplementary alarm system, but that system should be operated by radio.

One method by which this might be accomplished has already been demonstrated. It involves incorporating an inexpensive standby circuit in transistor radios, to be operated by a special tone from a broadcast station. Receivers left in the standby position by their users would be automatically turned on, would emit a warning signal, and the station could then go on and tell the public what the warning was all about. This last-mentioned virtue could easily be just as important as the warning itself.

There are inherent weaknesses in any warning system, including radio. But they can be minimized. For example: To what station would the user tune his set? It could be tuned to either one of the two already established broadcast-band Conelrad frequencies. Turning the switch to the standby position could, in fact, automatically insure this. How many people would keep their standby circuits running and draining batteries even if these lasted several months? Sets equipped with the right kind of batteries and simple built-in chargers could be left plugged into the house circuit like clocks, and would continue to operate on the normally-floating batteries even after a power failure.

Think, also, of these virtues of a radio approach: The battery-operated set could be taken to a shelter after the warning to receive further instructions, which is already a recommended practice anyway. A radio system, because it could talk and instruct as well as give warning, could be used in purely local emergencies such as hurricanes. What about reliability of operation of the stations themselves? Many have emergency generators which would permit them to function for at least a little while even if power went out. And, finally, most homes could use another radio in normal times, particularly a portable.

Radio alarms, as a supplement to sirens, should be seriously considered before we plump for bells or buzzers as a matter of national policy.



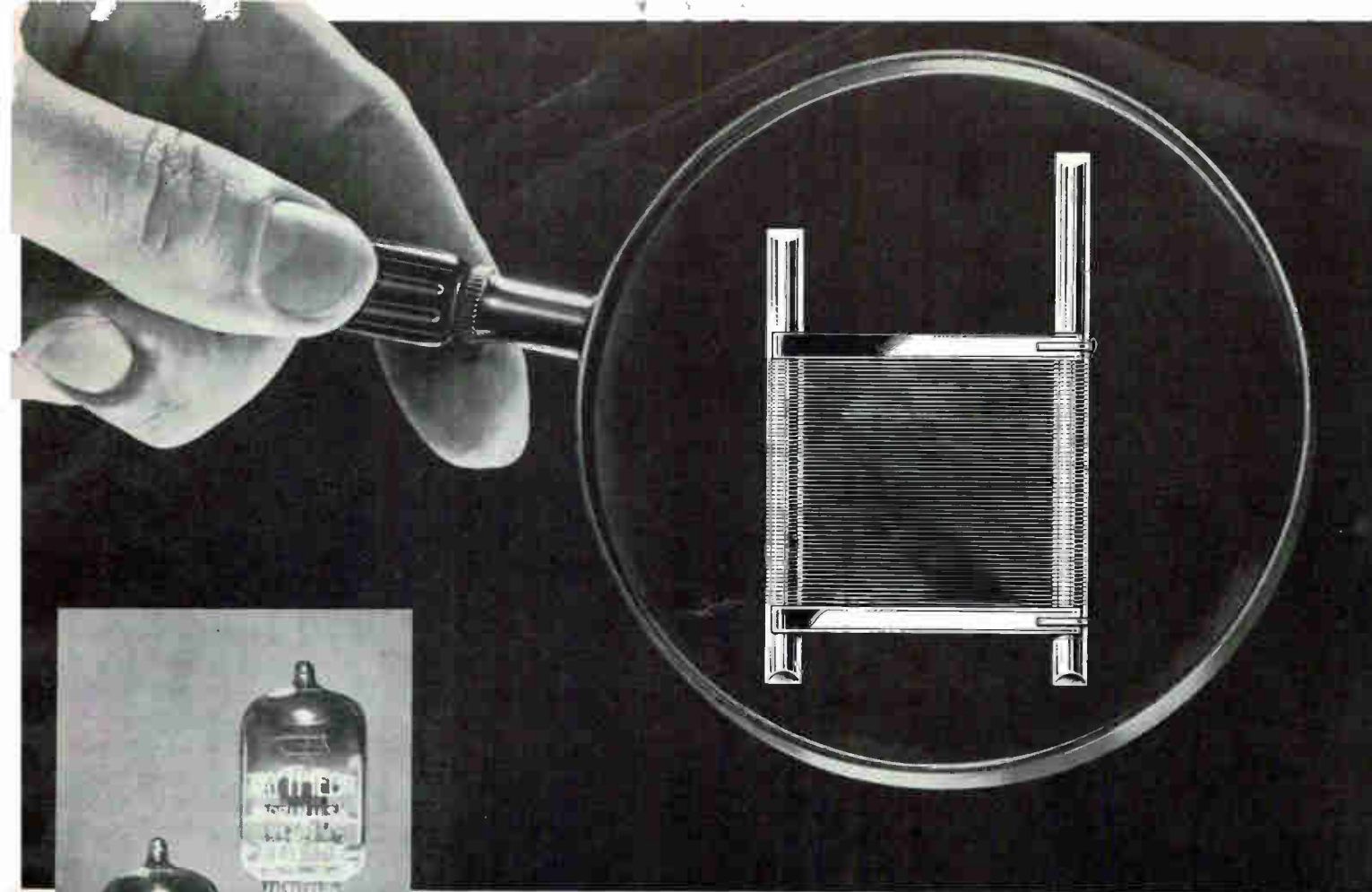

## RAYTHEON FRAME GRID TUBES . . . Outstanding for High Gain Bandwidth Product and Low Noise!

Raytheon frame grid tubes provide your designs with greater performance and reliability—higher gain bandwidth product and lower noise than available from types with conventional grid construction. These tubes feature perfect pitch frame grids with high uniformity of spacing and characteristics, manufactured by the most precise equipment in use today. For example, tolerances are held to an almost unheard of  $\pm 0.0002$ ”!

Rigidity is attained through optimum de-

sign, making the Raytheon frame grid construction highly reliable. The results are better uniformity and a reduced spread of characteristics—important contributions to the improvement of your circuit designs.

Bring to your circuit designs the many important advantages offered by Raytheon's growing family of frame grid tubes. For technical data, please write to Raytheon, Industrial Components Division, 55 Chapel Street, Newton 58, Massachusetts.

Raytheon Frame Grid Types—Gm				
CK5842	CK5847	CK6688	CK6922	CK6939
25,000	13,000	16,500	12,500 per section	10,500 per section

*For Small Order or Prototype Requirements See Your Local Franchised Distributor*

# RAYTHEON COMPANY

INDUSTRIAL COMPONENTS DIVISION



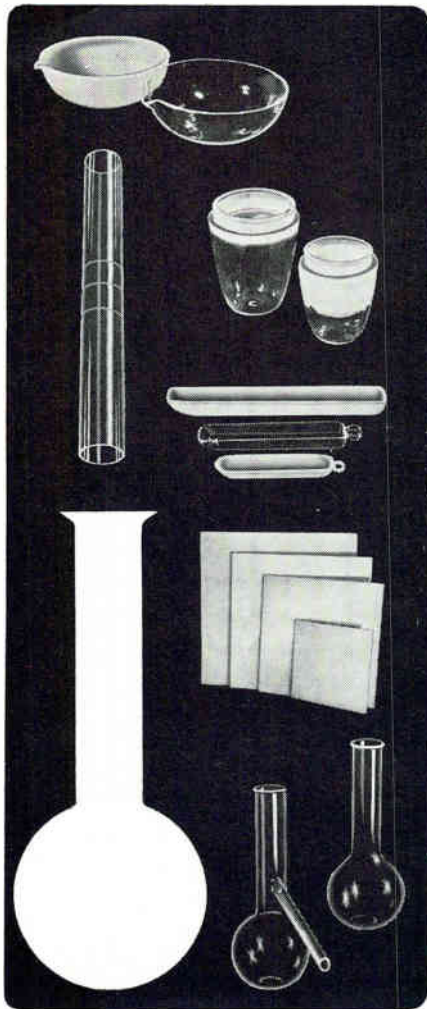

## VITREOSIL® PURE FUSED QUARTZ

**IDEAL FOR ALL SEMI-CONDUCTOR METALS**  
Our unique process enables us to supply semi-conductor quality VITREOSIL to close tolerances in crucibles and special fabricated shapes. Now available Quartz to Metal Seals. Write us about your requirements. See our ad in **Chemical Engineering, Electronic Engineers' Master and Electronic Designers' Catalogues.**

## SPECTROSIL®

**FOR HYPER-PURITY IN SEMI-CONDUCTOR WORK**

**PURITY**—purest form of fused silica

**TRANSPARENCY**—unique optical properties

**HOMOGENEITY**—completely homogeneous and free from granularity

**AVAILABILITY**—block material for lenses, prisms, etc; rod, fiber, wool; hollow ware as tubing, crucibles, and special apparatus.

Write for complete, illustrated catalog.



**THERMAL AMERICAN  
FUSED QUARTZ CO., INC.**  
18-20 Salem St., Dover, N. J.

## COMMENT

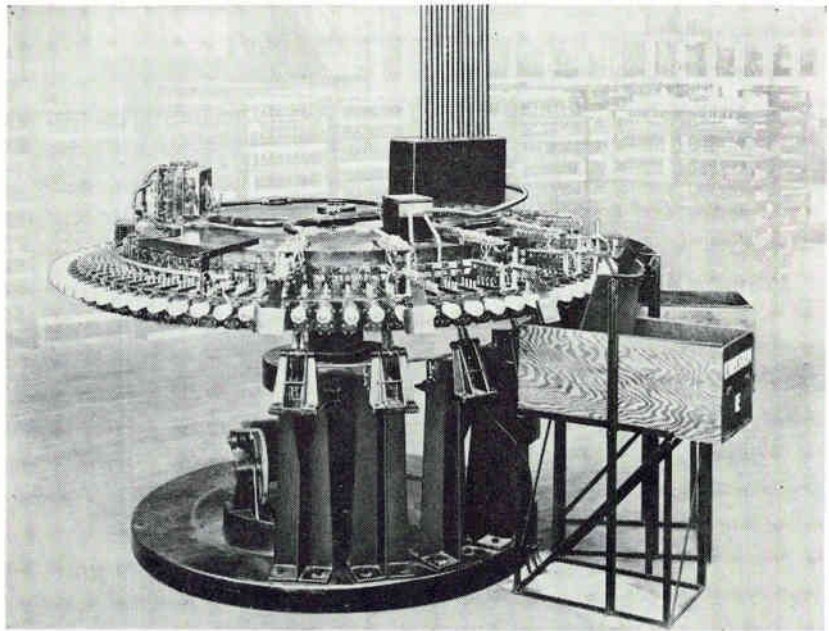

### Automatic Tube Tester

It was with considerable nostalgia that I read the article Automatic Tube Tester in the October 13 issue (p 82). A photograph of the "granddaddy" of all automatic testers is enclosed. It was taken in 1931 at the Majestic Radio Corporation in Chicago.

While the machine shown did not have test functions as elaborate as those shown in the recent article, the tests were sufficient for the tubes being produced at that time. This machine was jointly designed by the writer; Mr. Donald S. Bond, now at RCA in Camden, I believe; and Mr. Linn Sherk, a young and brilliant engineer who passed away long before his time. The foregoing were all reporting to Dr. Marvin Blackburn, also deceased.

The old machine contained some functions not even incorporated in this new one, with the sequence of tests as follows:

(1) Shorts: thirteen different possible combinations, any of which, would cause reject, and the type of short would show up and count at the control operator's desk area (not shown).

(2) Upper and lower plate current: tally upper and lower rejects.

(3) Screen current: tally rejects.

(4) Emission: tally rejects.

(5) Filament current and grid current: differentiate and tally rejects.

The tester also counted the incoming number of tubes, outgoing number of tubes, tallied all rejects and counted the number of empty sockets. It had a speed control on the rotor table to reduce speed, and a patchcord system to cut in a manual meter operation control until the defective control panel could be replaced.

There doesn't seem to be anything new under the sun, does there?

HAROLD E. WEST

Mallory Electromagnetic Company  
Du Quoin, Illinois

### Missiles, Space and Pipe Organs

Congratulations on the fine Missile and Space Electronics report (p 87, Nov. 17).

Nevertheless, I'm glad these topics did not crowd out pipe organs [Noise Generator Helps Create Pipe-Organ Sound Electronically, p 130]. I hope the phrase "have resulted in negative psycho-acoustic responses on the part of listeners" has some Basic English equivalent. No doubt the author wrote it with his tongue in both cheeks.

OTIS N. MINOT

Minot Informatic Devices

Lexington, Mass.

The authors mean that the listeners experienced nonpositive reactions in their neuro-auricular sensory complexes. Or that they didn't like what they heard.



*For Magnetic Forming  
Hypervelocity Wind Tunnels  
Plasma Research  
and many other applications...*

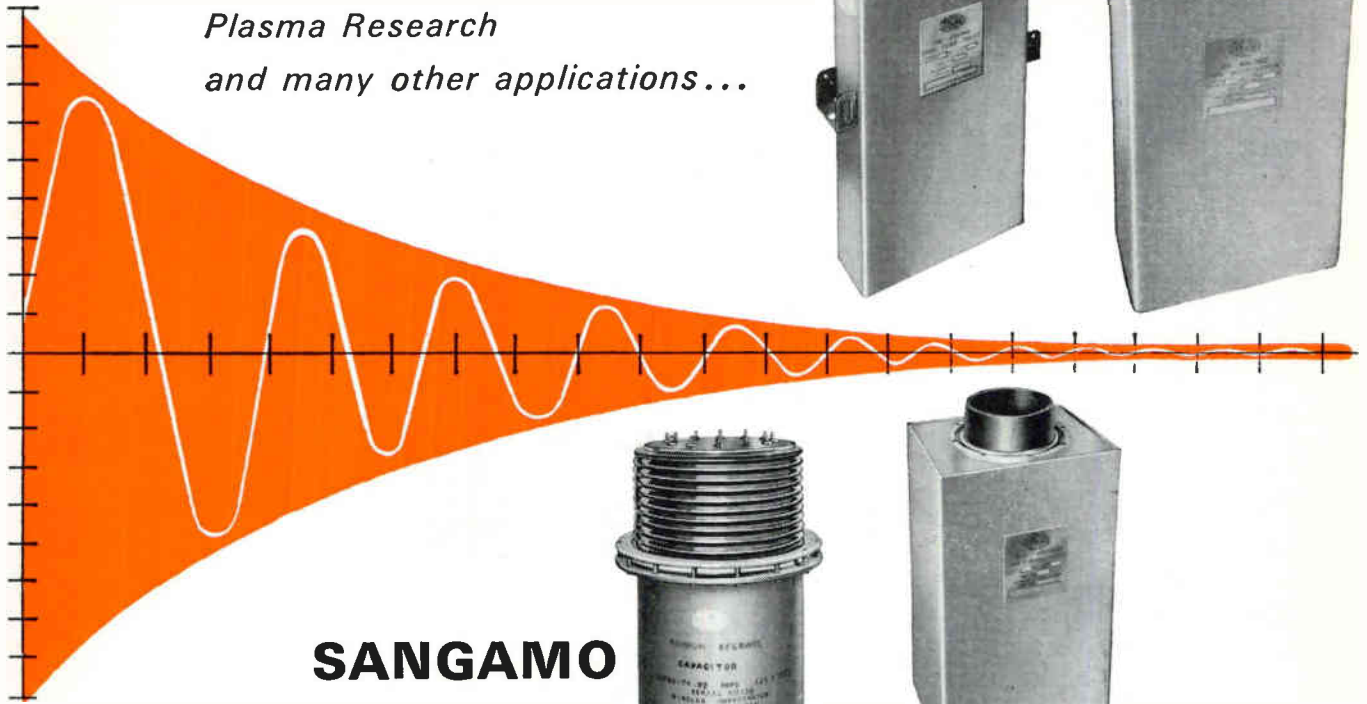
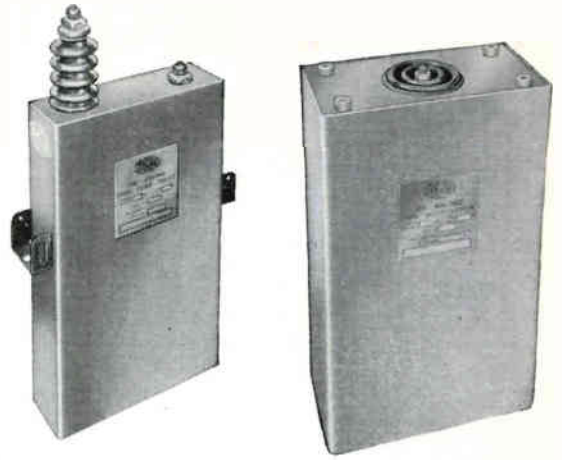

## **SANGAMO ENERGY DISCHARGE CAPACITORS**



**with COMPLEX C<sup>®</sup>**

*meet the most demanding electrical and mechanical design criteria*

Sangamo *knows* energy discharge capacitors and their application—a Sangamo research team has spent years in establishing detailed design criteria to meet the requirements of every conceivable capacitor bank. The energy discharge units developed by Sangamo meet the exact requirements specified, in order to give you the most for your investment in a large energy discharge capacitor bank.

The most significant advance in this field is the development of Complex C (Sangamo's exclusive dielectric impregnant and fill). The use of Complex C, with all other characteristics and circuit conditions being equal, results in a life expectancy 10 to 100 times that previously possible. The exceptional life expectancy of Sangamo Complex C capacitors will give you the most for both your dollar per joule and dollar per shot investment.

**SEND FOR SANGAMO'S BULLETIN TSC-208  
FOR FULL INFORMATION ON THESE CAPACITORS**

The complete story of the design criteria behind Sangamo high voltage, low inductance, energy discharge capacitors is told in detail in this new bulletin. It contains valuable information on possible circuit applications, methods of determining self-inductance of a capacitor, and standard capacitor listings that represent typical values for your energy discharge applications. Your copy will be sent on request. Address:

**SANGAMO ELECTRIC COMPANY**  
SPRINGFIELD, ILLINOIS

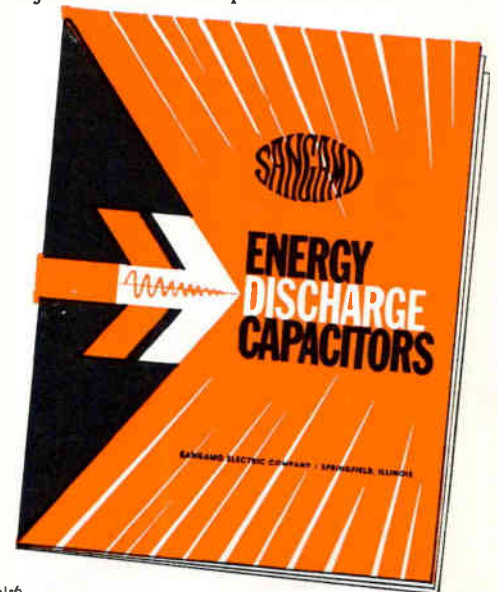

EC61-6



# Mallory tantalum foil capacitors

Mallory can supply tantalum capacitors of etched foil or plain foil types that can meet or exceed requirements of MIL-C-3965B. Use them for your toughest military specifications. All are available as polarized or non-polarized types, in hundreds of ratings, and with or without a Mylar\* insulating sleeve.

## From the industry's widest selection:

Other tantalum capacitors in the comprehensive Mallory line include wet slug, solid electrolyte, miniature, microminiature, and high temperature (to 200°C) types. Write for our latest bulletins and a consultation. Mallory Capacitor Company, Indianapolis 6, Indiana.

Type	Mallory Designation	Temp. Range	Case Style
PLAIN FOIL	Type TAF	-55°C to 85°C	CL34, CL35
	Type TAG	-55°C to 125°C	CL30, CL31 CL32, CL33
ETCHED FOIL	Type TBF	-55°C to 85°C	CL24, CL25
	Type TBG	-55°C to 125°C	CL20, CL21 CL22, CL23

Supplied in all military case styles and all ratings.

\*Du Pont trademark



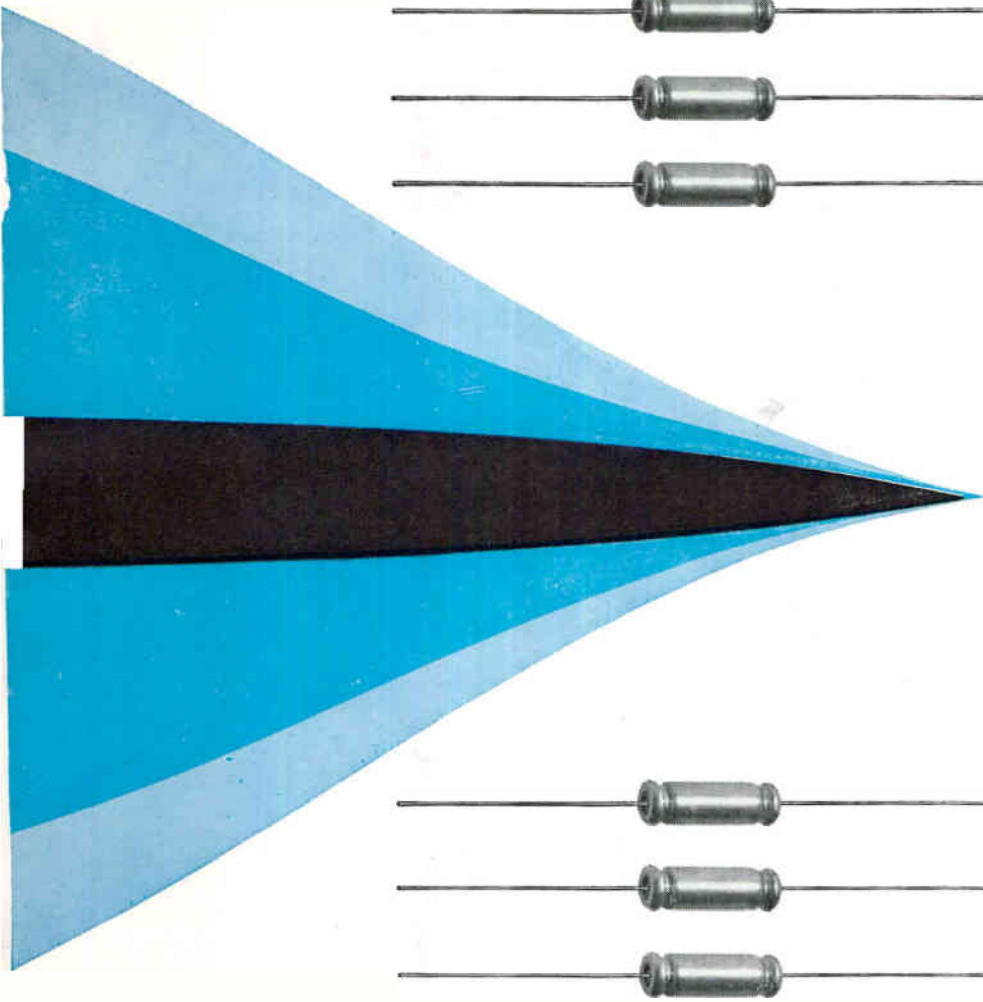

# meet or beat MIL specs

	MIL-C-3965B Limits	Typical Test Values: Mallory Type TAF (160 mfd 15 VDC)
<b>After 2000 hour life test at 85°C:</b>		
Leakage Current	48 $\mu$ a	0.4 $\mu$ a
Change in Capacity	$\pm 25\%$	-5%
Power Factor	19.5%	3.8%
<b>25°C:</b>		
Leakage Current	48 $\mu$ a	0.2 $\mu$ a
Power Factor	15%	4.5%
<b>-55°C:</b>		
Change in Capacity	-35%	-12%
Impedance	14.0 ohms	7.0 ohms
<b>85°C:</b>		
Leakage Current	240 $\mu$ a	6.5 $\mu$ a
Change in Capacity	-0 +15%	+4.8%
Power Factor	15%	4.5%

**Delivered from stock at factory prices by these distributors:**

- Arlington, Va. Rucker Electronic Products
- Baltimore, Md. Radio Electric Service
- Binghamton, N.Y. Federal Electronics
- Boston, Mass. DeMambro Radio Supply Co.
- Lafayette Radio
- Bridgeport, Conn. Westconn Electronics
- Buffalo, N.Y. Wehle Electronics
- Chicago, Ill. Allied Radio Corp.
- Newark Electronics Corp.
- Cincinnati, Ohio United Radio
- Cleveland, Ohio Pioneer Electronics
- Dallas, Texas Engineering Supply Co.
- Dayton, Ohio Allied Supply Co.
- Denver, Colo. Denver Electronics
- Houston, Texas Harrison Equipment Co., Inc.
- Lenert Company
- Indianapolis, Ind. Graham Electronics
- Los Angeles, Calif. California Electronics
- Kierulff Electronics, Inc.
- Radio Product Sales
- Minneapolis, Minn. Northwest Radio
- Monrovia, Calif. Lynch Electronics
- Montreal, Que. Canadian Electrical Supply Co.
- Mountainside, N.J. Federated Purchaser, Inc.
- Nashville, Tenn. Electra Dist. Co.
- Newton, Mass. Cramer Electronics, Inc.
- Newark, N.J. Lafayette Radio
- New York, N.Y. Harrison Radio Corp.
- Harvey Radio Co., Inc.
- Lafayette Radio
- Milo Electronics
- Terminal Hudson Electronics
- Oakland, Calif. Elmar Electronics, Inc.
- Orlando, Fla. East Coast Electronics
- Ottawa, Ont. Wackid Radio-TV Lab.
- Palo Alto, Calif. Zack Electronics
- Pasadena, Calif. Allied Radio of California
- Perth Amboy, N.J. Atlas Electronics
- Philadelphia, Pa. Herbach & Rademan
- Philadelphia Electronics
- Pittsburgh, Pa. Radio Parts Co.
- St. Louis, Mo. Olive Electronics
- Seattle, Wash. F. B. Connelly Co.
- Tampa, Florida Thurow Distributors, Inc.
- Toronto, Ont. Alpha Aracon Radio Co.
- Electro Sonic Supply
- Wholesale Radio & Electronics
- Tucson, Ariz. Standard Radio Parts
- Tulsa, Okla. Engineering Supply Co.
- Union City, N.J. Nidisco—Union City
- Washington, D.C. Capitol Radio Wholesalers
- Electronic Industrial Sales
- White Plains, N.Y. Westchester Electronic Supply Co., Inc.
- Winston-Salem, N.C. Dalton-Hege Inc.



Complete line of aluminum and tantalum electrolytics, motor start and run capacitors



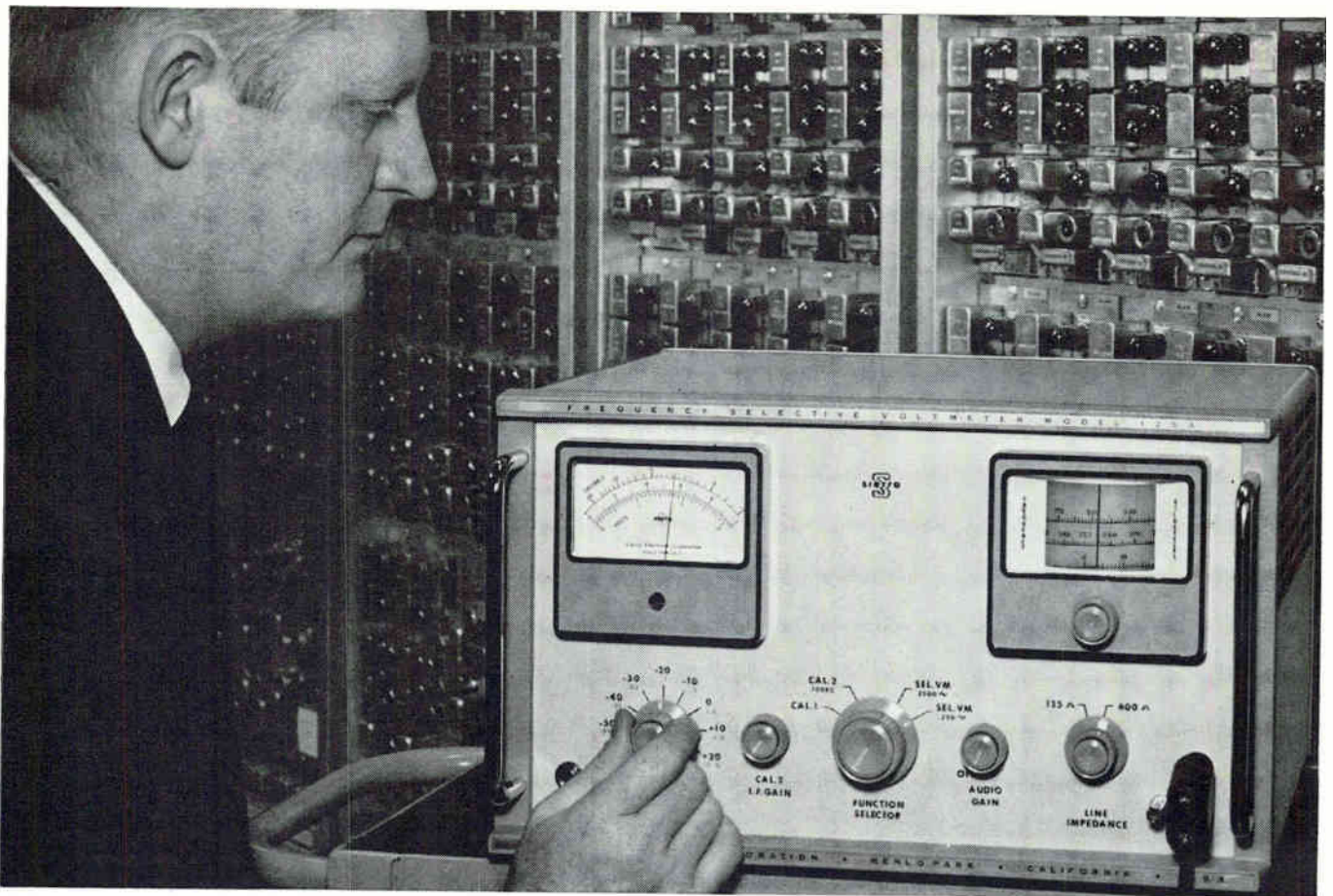

## Why is the Sierra Frequency Selective Voltmeter the standard of the communications industry?

Performance-proved by thousands of users! ● Accepted by all major carrier systems manufacturers, specified by most! ● Uniquely convenient, versatile, dependable for monitoring carrier modulation level!

- Single frequency band, one continuous tuning range—eliminates band switching
- Flat voltmeter section—for accurate measurement, easy detection of spurious signals
- Wide bandwidth—1 to 620 kc—covers 120 channels per L carrier allocation
- Coarse, fine tuning on a single knob—for greater convenience
- Crystal controlled calibration oscillator—for checking both frequency and level
- Domestically produced—for years-ahead engineering, rugged construction
- Dual selectivity—versatility for communications test, wave analysis, general lab use

### SPECIFICATIONS MODEL 125A

#### Frequency Range

Tunable Mode: 3 kc to 620 kc  
Flat Mode: 1 kc to 620 kc

#### Measurement Range

Tunable Mode: -90 dbm to +32 dbm  
Flat Mode: -30 dbm to +32 dbm

#### Selectivity

Narrow: Down 3 db 125 cps off resonance; down 45 db 500 cps off resonance

Wide: Down 3 db 1.25 kc off resonance; down 45 db 5 kc off resonance

Price \$895.00, f.o.b. factory

Call your Sierra representative or write direct. Sierra Model 125B-CR, with upper and lower sideband carrier re-insertion, and Model 125B-Y, with patchcord connections for type "O" and type "N" Western Electric carrier, also available at additional cost.

Data subject to change without notice.



## SIERRA ELECTRONIC CORPORATION

A Division of Philco Corporation

7127A BOHANNON DRIVE • DAVENPORT 6-2060 • AREA CODE 415 • MENLO PARK, CALIF., U.S.A.

Sales representatives in all principal areas.

Canada: Atlas Instrument Corporation, Ltd., Montreal, Ottawa, Toronto, Vancouver.

Export: Frazar & Hansen, Ltd., San Francisco.



# ELECTRONICS NEWSLETTER

## Sage System Buildup Now History

TWENTY-FIRST and final Sage sector in the U.S. was turned over to Air Defense Command today in Sioux City, Iowa. Twenty-second direction center—the only one planned for Canada—will be built in Ottawa and is expected to be ready in two years.

Sage computer techniques are virtually frozen, but AF Electronic Systems Division at Hanscom Field, Bedford, Mass., is updating radar and identification techniques. Frequency diversity radar is being built into detection network for antijamming features, and ID techniques are getting increased channel and power capability. Systems program office at Bedford is also working on a backup system, which could operate even if some sector centers were wiped out by an enemy.

Sage system of coordinating radar data for continental defense against aircraft and airbreathing missiles is oldest of AF command and control systems, dating back to a 1949 study. MIT Lincoln Laboratory, set up in 1951 to design and develop Sage, handled system engineering until about three years ago when this went to Mitre Corp.

Sage-like system will probably evolve for air traffic control. Cost estimates on Sage range as high as \$5 billion.

## Air Force Steps Up 473L System Hardware Purchases

AIR FORCE Electronic Systems Division will brief industry Dec. 21 and 22 at Rome Air Development Center on phase 2 of 473L command and control system (ELECTRONICS, p 24, Apr. 21). The huge, complex system will automatically feed information from AF commands to Washington.

Bids will be invited on a data processing system for the Pentagon and integrated consoles with processing, display and communications controls. Four out of 15 consoles will be bought in this phase. Contracts to date have been largely for analyses and engineering, although Thompson-Ramo Wooldridge has supplied display interface buffer and computer communications con-

soles, to be integrated with an IBM 1401.

In the next phase, financed in fiscal 1963, large panel displays and external message composers to be used at command sources will be bought.

ESD also announced a \$48,000 contract to Sylvania for two prototype electroluminescent data displays for its global weather observation and forecasting system (433L).

## 'Twas Open Season on Big Radome in Maine

A 26-inch snowfall on the Bell Telephone System's nylon dome over the satellite experiment site in Andover, Maine, had local engineers worried. But shotgun slugs fired through the thin covering drained out the water.

Burdick W. Pierce, project engineer at the 13-story high radome, told a Portland men's club that the slug holes posed no problems since the inflatable structure has holes anyway which are covered with flaps to regulate the temperature.

A permanent radome of dacron and synthetic rubber was to be installed shortly. The first experimental satellite transmission of

## Weekly Newsletter Bows

NEW YORK—The McGraw-Hill Publishing Company (publisher of ELECTRONICS) last week announced plans for publication of *Science Week*, a newsletter.

First issue will be published on or about Feb. 1. It will have six pages, 8½ by 11 inches, and be varityped, offset printed and illustrated

telephone and tv signals will be attempted in mid-April. He said the federal government will be paid \$6 million to orbit a three-foot wide satellite into a 1,000-3,000 mile range.

## Supersonic Air Transport R&D Is Ready to Start

RESEARCH on a commercial supersonic transport is expected to get underway shortly, Aerospace Industries Association says. The Mach-3 aircraft could fly from New York to Los Angeles in 90 minutes.

Federal Aviation Agency has asked Air Force to let development contracts. The agency also recommended government participation in development costs, estimated at \$550 million, AIA reported.

Air Force has been assigned contracts administration. FAA has over-all responsibility for the program, NASA and AF are to furnish technical support.

Most of the \$11 million appropriated by Congress to start the project will be contracted for industry research.

## Plug-In Neuron Devices Offered for Bionics R&D

PERCEPTIVE Research Products, of Yonkers, N.Y., reports it is making electronic neuron simulators for use as research and demonstration devices in bionics. The company says the neurons, developed at Bell Labs, closely simulate biological neuron properties of temporal summation, variable threshold and refractory period, inhibition and pulse type output. Two models will be sold, a four-transistor model and a five-transistor version which more closely models the biological neuron.

## ITT Shows Automatic Message Switching Center

AUTOMATIC data/message switching system is being offered industry by ITT Information Systems Division. This is reportedly a commercial version of the high-speed switching centers used in the Air Force 465L global communications network. The



system has a maximum capacity of four million bits per second. It can tie computers together for data exchange in different "languages." Provision is made for translating computer code.

ITT calls the system the ITT 7300 ADX (Automatic Data Exchange System). It operates on line in real time and is essentially a store and forward system.

Data can be dialed in to and out of the system over telephone lines. Other features are a message priority system, multiple addressing and limit to message length. Estimated price for a basic system is \$1 million.

## Rotating Pickup Pulses Auto Ignition System

MOTOROLA has unveiled an electronic ignition system for cars and trucks which uses a small magnetic pickup system instead of breaker points and condenser in the distributor.

The system is comprised of a magnetic pulse generator, a transistorized pulse amplifier and an ignition coil. The pulse generator is a small, spoked or toothed wheel which rotates past a tiny magnet without touching. Since there is no contact, there is no wear, adjustment, nor point chatter, Motorola says. The company announced an electronic alternator system a month ago.

## Future Mercury Astronauts To Rendezvous in Space

NASA NOW PLANS to add \$500 million to the Mercury program, to achieve rendezvous ability in space. Later Mercury vehicles will weigh between two and three tons and carry two men.

Meanwhile, the first manned orbital flight attempt has been postponed until after the first of the year while equipment malfunctions uncovered during the recent chimpanzee flight are cleared up.

Prelaunch problems on that flight included telemetering and communications link difficulties. During the two orbits, a transistor inverter

overheated and an automatic control system failed to operate the hydrogen peroxide control jets, which resulted in the capsule orbiting out of alignment.

NASA said a few days ago that there had been a history of difficulties with the inverters, but that they were considered adequate for the flight. A larger inverter will be used on Lt. Col. Glenn's flight.

## Philco, Now With Ford, Gets New Top Officers

FORD MOTOR CO. took over Philco Corp. as a wholly owned subsidiary on Monday, consummating a \$100 million purchase agreement made in September (ELECTRONICS, p 11, Sept. 22). The new management said it had no plans to cut Philco's product lines.

New top officers were elected for Philco. Charles E. Beck, business planning director of Ford, is the new president and chief executive officer. He succeeds James M. Skinner, Jr., who resigned as Philco president. Irving A. Duffy, a Ford vice president and director, was elected chairman. Other new directors are also Ford executives.

## Weathermen Get System To Measure Raindrops

METEOROLOGISTS who want to find out how big raindrops are can now use a sizer developed by New York University and the Army Signal Research and Development Laboratory. It automatically measures and counts raindrops in 13 sizes.

As the rain falls into the viewing system, images of the drops are projected onto a series of 14 horizontal plastic windows. Each window is separated from the next by a slightly larger gap and is connected to a multiplier phototube. When an image passes a gap as wide or wider than the drop, the size is noted. A memory unit stores the data and records it on punched tape for analysis.

The system may also be used to measure and count other small spherical objects.

## In Brief . . .

NAVY has awarded three more atomic submarine contracts, bringing the total to 32, not including Polaris vessels.

INFRARED acquisition system for the Army's Mauler missile will be developed in Canada by DeHavilland Aircraft. Canada and the U. S. will share costs.

MINNEAPOLIS-HONEYWELL reports development of a 1-Kw transistor audio amplifier for submarine sonar.

COUNTERMEASURES contracts include \$600,000 to Hallicrafters, for Nike Zeus, and \$1.5 million to Loral, for a classified system.

AIR FORCE awards include \$5 million to Lockheed for satellite control development; \$2.3 million to Burroughs for aircraft equipment; \$1 million to Hoffman Electronics for Tacan radio test sets, and \$465,000 to Sylvania for tubes.

POLARIS contracts include a \$4 million gyro production order to Minneapolis-Honeywell, and ground support equipment design, to Seigler, for the new long-range version.

MINUTEMAN ground equipment will be produced by Microlab and Hoover, under \$200,000 and \$135,000 subcontracts.

OTHER MISSILE contracts include \$1 million to Belock Instrument for Hawk training simulators; \$900,000 to Collins Radio for command-control destruct systems; \$363,000 to American Concertone for recorders.

MARTIN-MARIETTA will soon test prototype pneumatic computers under R&D program aimed at low-cost, radiation-resistant, miniature guidance systems able to withstand 2,000 F temperatures. It also has \$149,432 contract to study new intercept guidance techniques for missiles.

GENERAL ELECTRIC contracts for the Army's Advent communications satellite mount to \$56 million with a new \$8 million award.



new from  
**NARDA!**

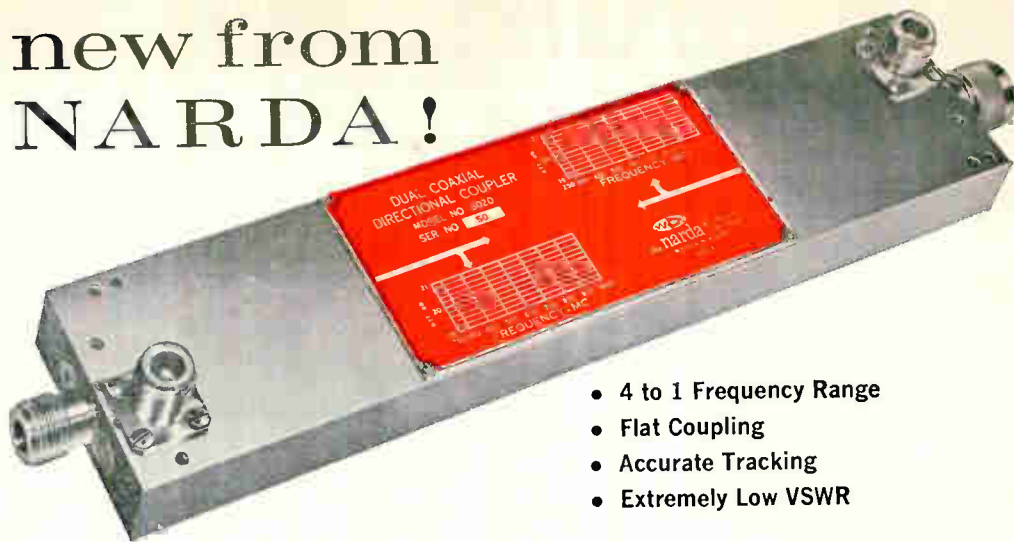

- 4 to 1 Frequency Range
- Flat Coupling
- Accurate Tracking
- Extremely Low VSWR

## high-directivity coax couplers

Specifically designed for  
REFLECTOMETER applications!

- Here are two brand new coax couplers, specifically designed by Narda to provide the extremely high directivity needed in Reflectometer setups. And when we say "extremely high directivity", we mean it! For example: Model 3020 (250 to 1000 mc) has a directivity of 35 db minimum, which means a maximum error in VSWR of only 1.035 can occur as a result of the finite directivity. Main line VSWR is held to 1.05 maximum; secondary line VSWR is 1.10 maximum!
- What's more, each model covers two full octaves; each features extremely accurate tracking (0.3 db maximum change in difference between forward and reverse coupling over the band); each has a power rating of 100 watts CW, 10 kw peak. Check the table for full specifications—and compare with any other units available.
- These are just two examples of the complete line of unusually fine microwave and UHF instrumentation available from Narda. Write today for your free copy of our newest catalog. Address: Dept. E-1-4.

SPECIFICATIONS	MODEL 3020	MODEL 3022
Frequency	250 to 1000 mc	1000 to 4000 mc
Directivity	35db min	30db min
Coupling—both arms	20db nominal	20db nominal
—Frequency sensitivity	±0.6db approx.	±0.6db approx.
Max VSWR—main line	1.05	1.10
Max VSWR—secondary lines	1.10	1.15
Power Rating	100W cw 10kw peak	100W cw 10kw peak
Tracking	0.3db total	0.3db total
Price	\$200.	\$185.



the **narda** microwave  
corporation

PLAINVIEW, L. I., NEW YORK

AREA CODE 516 GE 3-9000

# **B** NEW

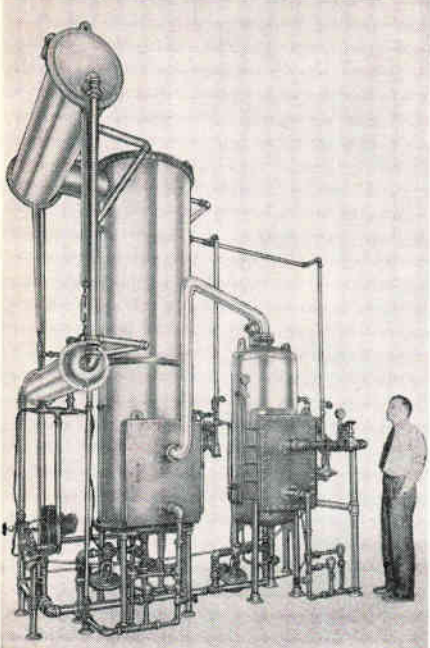

## HIGHER WATER PURITY

NO OTHER STILL  
CAN MATCH  
WITH 50% LOWER  
STEAM COST

### Reports Electronics Manufacturer

Recently installed in a large electronics manufacturing plant, this Barnstead Double-Effect Steam Heated Still not only out-performs an ordinary 200 gallon per hour Still but does it at 50% lower steam cost.

The water produced contains dissolved solids of less than one part in ten million and is free from bacteria, organics and particulate matter. This exceptionally high purity was made possible through the development of NEW Barnstead exclusive patented high purity features.

Full automatic controls not only reduced labor costs to a minimum but also eliminated the incidence of workmen's error. When you bring your water purification problems to Barnstead . . . you profit by 83 years of engineering experience encompassing most fields of manufacturing, processing and research. Write for New High Purity Bulletin #175.

**Barnstead**  
STILL AND STERILIZER CO.

84 Lanesville Terrace, Boston 31, Mass.

## WASHINGTON OUTLOOK

LEGISLATIVE proposal to handle the controversial ownership problem of a worldwide communication satellite system has been prepared by the National Space Council for President Kennedy's approval.

The measure, to go to Congress early next year, will recommend against allowing international communications companies to dominate the system and calls for active public ownership, available to domestic and international interests.

It is now accepted that Congress will make the final decision on ownership of the communication satellite system. Hearings will be held by the Senate Aeronautical and Space Sciences Committee, chaired by Sen. Robert S. Kerr (D-Okla.). No date has been set.

TANTALUM, used in electronics for capacitors and high-temperature alloys, is having its biggest price boom in history. Tantalum ore prices have doubled since last September from \$8.50 per pound, to around \$17 a pound today. Tantalum scrap prices have doubled to \$15 or \$16 a pound, since the first of the year.

Cause of the price jump is primarily psychological, government metal buyers say. The Congo, the main U. S. source, was knocked out as a supplier by its political crisis. Last year, tantalum ore imports from the Congo ran about 31,720 pounds a month. Now, imports are less than 1,900 pounds a month.

The rush for new sources has jacked up the price. Brazil is now coming in as a big tantalum supplier. So are Mozambique and Malaya. Tin slags and columbium ore containing tantalum are being imported in increasing quantities. Prices next year should be more normal.

PENTAGON is putting teeth into its program to increase rate of subcontracting to small businesses. Upcoming policy changes will (1) require subcontractors with orders of at least \$500,000 to use small suppliers as much as possible, (2) require large firms to designate liaison executives to handle inquiries from small business suppliers, and (3) allow the Small Business Administration to check purchasing records of large prime military contractors—but only through channels (the procurement agency)—to check whether major defense producers are actually turning to small business on subcontracting.

But the new rules will not allow SBA the right to prescribe the extent of subcontracting nor to participate in administration of military contracts—provisions proposed by some congressional small business advocates.

TREASURY Department is making engineering studies of six major industries including aircraft (electronics is not specifically designated) to determine whether the legally prescribed useful life of production facilities can be shortened, thus accelerating depreciation for tax purposes. This follows recent decisions to liberalize depreciation policies for the textile industries and to spur new capital investment (ELECTRONICS, p 14, Nov. 3).



From General Ceramics Division of  
**INDIANA GENERAL CORPORATION**

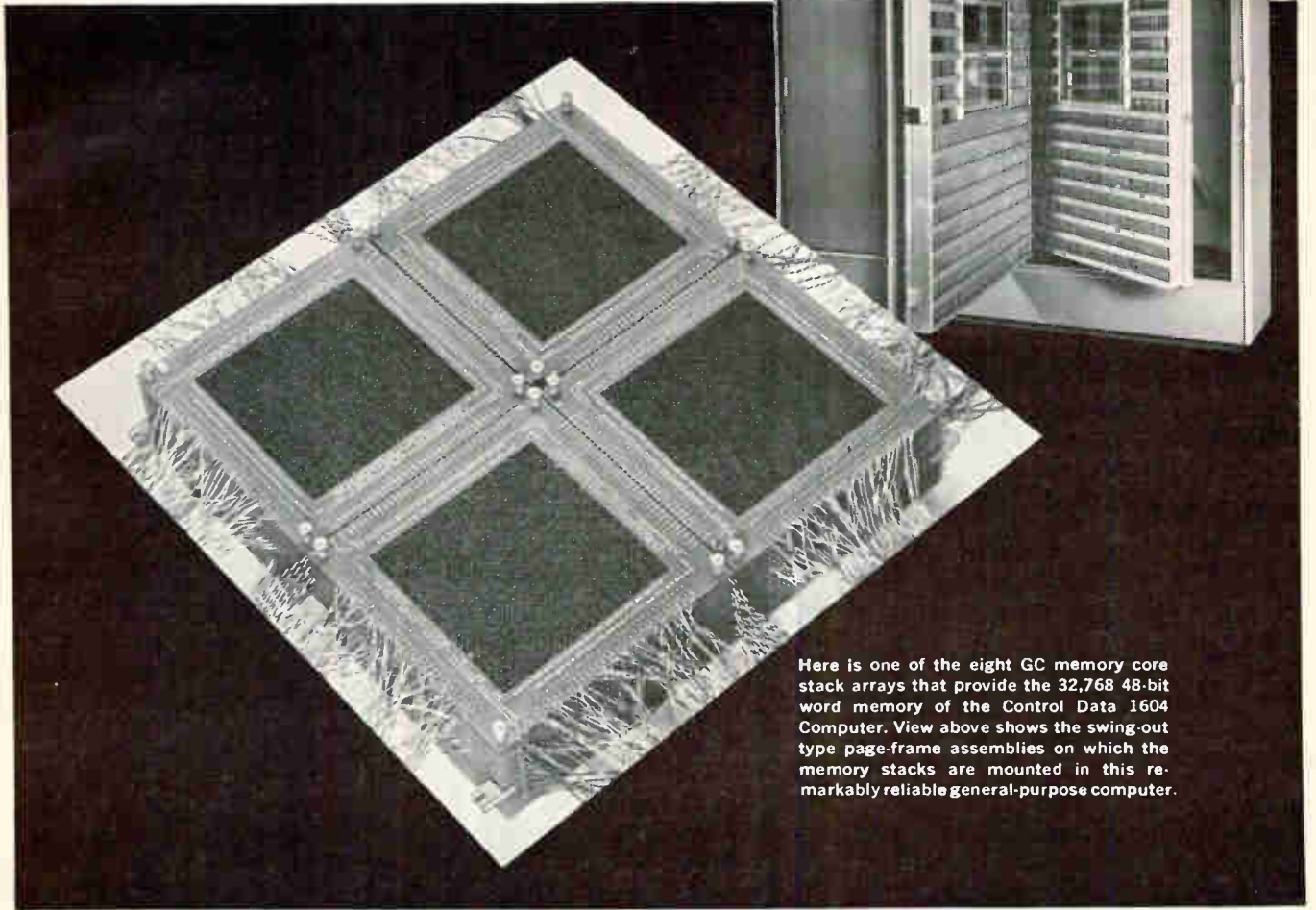

Here is one of the eight GC memory core stack arrays that provide the 32,768 48-bit word memory of the Control Data 1604 Computer. View above shows the swing-out type page-frame assemblies on which the memory stacks are mounted in this remarkably reliable general-purpose computer.

## Reliability that Helps the Control Data 1604 Computer Achieve "UPTIME" RATINGS THAT MEAN PROFIT

General Ceramics, the originator of the square loop ferrite, offers a complete line of job-proven cores, planes, stacks and memory systems — proven in many computer and control system applications where the ultimate in reliability is demanded.

A good example is Control Data's advanced, large-scale, solid state 1604 Computer which has set new reliability standards for the industry, maintaining one of the highest over-all average "uptime" ratings ever achieved for machines in its class. This high performance requires fail-proof output from every component, including the over 1.6 million GC cores wired into the memory stacks of the 1604.

According to W. F. Harrison, Control Data's Manager of Engineering Services, "GC was chosen on the basis of a careful evaluation which included criteria ranging from the supplier's reputation and background through his proven ability to produce required quantities with consistent quality."

General Ceramics reliability is assured through 100% quality control at all levels — beginning with mechanical and electrical testing of each individual core and continuing with both visual and electrical inspections at all stages of assembly. This means, for example, the meticulous microscope-checking of over 175,000 soldered connections alone in the eight banks of stacks used in each Control Data 1604 Computer.

Advanced techniques such as ultrasonic cleaning, automatic 12-per-second core testing and other electronic functional checks performed on specifically designed equipment provide that extra edge of quality which customers, such as Control Data Corporation, have come to expect from General Ceramics.

*Compare GC with your present source — write, wire or phone today.*



APPLIED LOGICS DEPARTMENT

**GENERAL CERAMICS**

Phone VALley 6-5100 • Direct Distance Dialing Code 201

KEASBEY, NEW JERSEY, U.S.A.

TECHNICAL CERAMICS, FERRITES AND MEMORY PRODUCTS

# NEW TRANSISTOR

# 2N1645

- HIGH RELIABILITY ■ ONE WATT POWER OUTPUT AT 100 MC/S
- EFFICIENCY APPROXIMATELY 50%

The 2N1645 is a diffused base germanium mesa transistor for UHF power amplifiers, frequency multipliers, and very high speed, high current switching applications. Typical turn-on and turn-off times under constant voltage drive conditions are less than 5 and 15 nanoseconds respectively. Power output of one-half watt as a doubler may be achieved up to 250 megacycles.

### MAXIMUM RATINGS AT 25°C

Collector Current	300 mA <sub>dc</sub>
Collector Voltage	35 Volts
Emitter Voltage	1 Volt
Junction Temperature	100°C
Power ( $T_A = 25^\circ\text{C}$ )	1 Watt
Power ( $T_C = 25^\circ\text{C}$ )	6 Watts

### TYPICAL ELECTRICAL CHARACTERISTICS

$f_t$	600 mc
$REh_{ie}$ (250 mc)	23 ohms
$C_{cb}$ (dir)	10 pf
$h_{fe}$ (1000 cps)	50
$h_{FE}$ ( $I_C = 100$ mA)	35

### TYPICAL CURRENT GAIN VS FREQUENCY

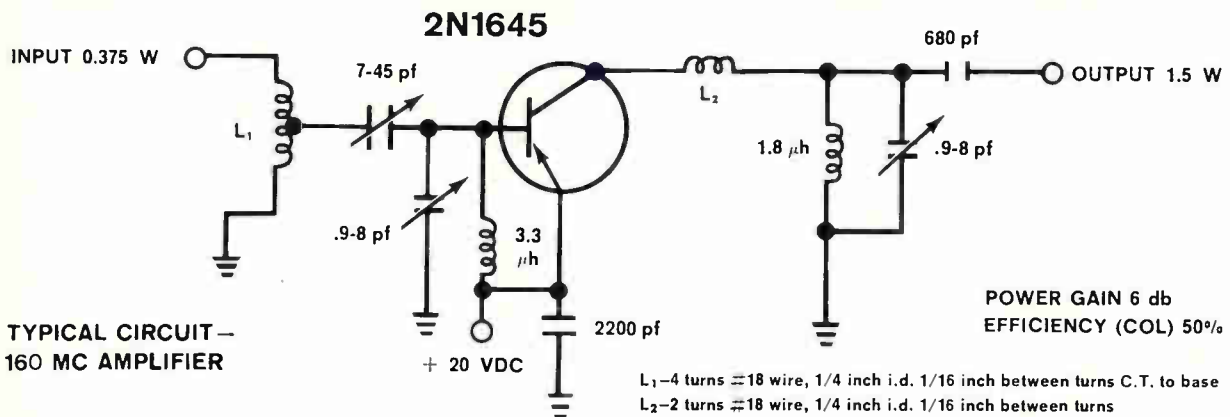
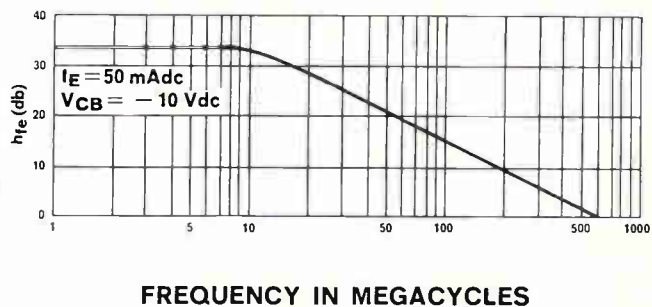

The 2N1645 transistor may be purchased in quantity from Western Electric's Laureldale Plant. For technical information, price, and delivery, please address your request to Sales Department, Room 102, Western Electric Company, Incorporated, Laureldale Plant, Laureldale, Pa. Telephone—Area Code 215—Walker 9-9411.

**LAURELDALE PLANT**

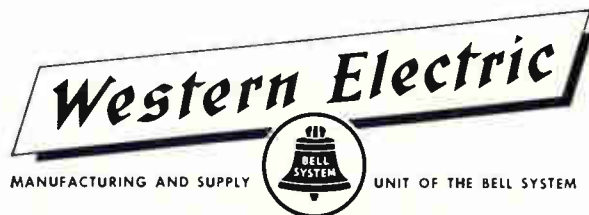



# Project Surveyor engineering openings

Hughes Space Systems Division has immediate openings for Electronic Engineers, Mechanical Engineers, Physicists and Aeronautical Engineers to work on Project Surveyor—a spacecraft which will soft land on the moon. Once there, Surveyor instruments will perform a variety of scientific tests: drills will pierce and analyze the moon's surface; high quality television pictures will be transmitted to earth; other instruments will measure the moon's magnetic and radiation characteristics. ■ To accomplish this step into space, Project Surveyor requires the talents of imaginative junior and senior engineers and scientists to augment its outstanding staff. Experience is preferred but not required. A few of the openings include:

## control engineers

Concerns hydraulics, airborne computers, and other controls related areas for: missiles and space vehicles, satellites, radar tracking, control circuitry, controls systems, control techniques, transistorized equalization networks and control servomechanisms.

## circuit designers

Involves analysis and synthesis of systems for: telemetering and command circuits for space vehicles, high efficiency power supplies for airborne and space electronic systems, space command, space television, guidance and control systems, and others.

## systems analysts

To consider basic problems such as: the requirements of manned space flight; automatic target recognition requirements for unmanned satellites or high speed strike reconnaissance systems; IR systems requirements for ballistic missile defense.

## infrared

Includes systems analysis and preliminary design in infrared activities involving: satellite detection and identification; air-to-air missiles; AICBM, infrared range measurement; air-to-air detection cryogenics and others.

## inquire today

Your reply will be treated with strict confidence. Please airmail your resume to:

### Robert A. Martin

Supervisor of Scientific Employment,  
Hughes Aircraft Company,  
11940 W. Jefferson Blvd., Culver City 61,  
California. WE PROMISE YOU A  
REPLY WITHIN ONE WEEK.

An equal opportunity employer



*Creating a new world with Electronics*

# HUGHES

HUGHES AIRCRAFT COMPANY  
AEROSPACE DIVISIONS

# NEW FROM SORENSEN



Dependable  
Economical



## PRECISION REGULATED TRANSISTORIZED DC SUPPLY

Tubeless circuitry, regulation of  $\pm 0.05\%$  line and load combined and an output voltage range of 4.5 to 9.0 V DC are features of the Sorensen Model Q6-60A. Output current range is 0 to 60 Amps. and ripple is 0.5 MV at nominal output voltage  $\pm 10\%$ .

The Q6-60A is completely self-protected and particularly suitable for critical applications requiring "spike free" output, precise regulation and high currents.

## DC POWER SUPPLY

0 to 40 V DC at 0 to 2 Amps.

The new versatile, fully transistorized OR40-2A DC Power Supply incorporates all the basic features of Sorensen QR Supplies. In addition, it provides regulated current, adjustable current limiting, and programmed output voltage. Provisions for external sensing permit accurate voltage regulation at remote loads. Available for either standard 19-inch rack mounting or in self-contained cabinet, the OR40-2A will easily adapt to your requirements. Write for complete specifications and literature on this dependable, economical power supply.

### SPECIFICATIONS

INPUT VOLTAGE RANGE	105-125 at 50 to 400 cps.
DC OUTPUT VOLTS	0 to 40 V DC
DC OUTPUT CURRENT	0 to 2 Amps. DC
VOLTAGE REGULATION (Line & Load Combined)	$\pm (0.01\% + 1 \text{ MV})$
RIPPLE (RMS) AT 60 CPS.	150 Microvolts
CURRENT REGULATION (Line & Load Combined)	$\pm 0.15\%$
RIPPLE CURRENT	30 Microamps.
RESPONSE TIME	50 Microseconds
CABINET SIZE	17" x 12 1/2" x 5 1/4"
RACK HEIGHT	5 1/2"

A UNIT OF RAYTHEON COMPANY

RICHARDS AVENUE • SOUTH NORWALK • CONNECTICUT



CIRCLE 18 ON READER SERVICE CARD



# NEW FROM SORENSEN



Compact  
Fully Transistorized

## DC POWER SUPPLY

0 to 40 V DC at 0 to .75 Amp.

The compact new Sorensen Model QR40-.75A is one of the latest additions to Sorensen's line of outstanding products. It features extremely low ripple, precise regulation, programmable output voltage, adjustable current limiting and provisions for remote sensing. Typical applications include powering computer circuits, test and instrumentation equipment, and communications equipment. Negligible on-off overshoot provides protection for transistor circuits. Write for complete specifications and literature.

### SPECIFICATIONS

INPUT VOLTAGE RANGE	105-125 V AC at 50-400 cps.
DC OUTPUT VOLTS	0 to 40 V DC
DC OUTPUT CURRENT	0 to .75 Amp.
VOLTAGE REGULATION (Line & Load Combined)	$\pm(0.01\% + 1 \text{ MV})$
RIPPLE (RMS) AT 60 CPS	150 Microvolts
CURRENT REGULATION (Line & Load Combined)	$\pm 0.15\%$
RIPPLE CURRENT	10 Microamps.
RESPONSE TIME	50 Microseconds
CABINET SIZE	8 1/4" x 9" x 5 1/4"
RACK HEIGHT	5 1/4"

Unit is available for dual rack mounting



### WIDE RANGE TRANSISTORIZED DC SUPPLY

The QR150-1A is a completely self-protected, transistorized DC Power Supply. Output voltage range: 0 to 150 V DC at 0 to 1 Amp. output current. Combined line and load regulation is  $\pm(0.02\% + 4 \text{ MV})$ . Ripple is 1 MV RMS. *Circuit Design and protective features prevent damage to transistors under overload or short-circuit conditions.*

A UNIT OF RAYTHEON COMPANY

RICHARDS AVENUE • SOUTH NORWALK • CONNECTICUT



CIRCLE 19 ON READER SERVICE CARD

# Aeme Electric CUSTOM BUILT POWER SUPPLIES

These units are engineered to provide specified electrical characteristics in a practical physical design and to perform properly under a wide range of environmental conditions.

Our facilities can accommodate continuous production quantities as well as small lots.

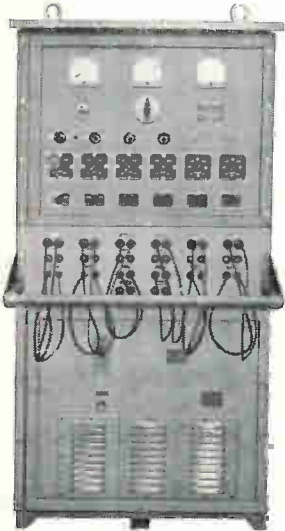

**ABOVE — 6 CIRCUIT  
POWER SUPPLY**  
Output: 4 circuits, 45 amp,  
65 volt DC  
2 circuits, 1-8 amp,  
65 volt DC  
Input: 460 volts, 3 phase,  
60 cycle

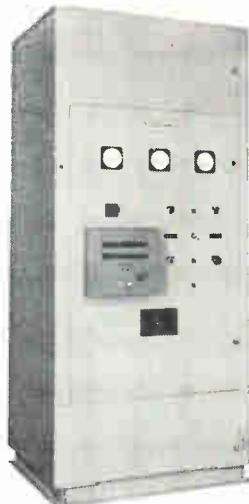

**ABOVE — STATIC POWER  
RECTIFIER**  
Output: 500 KW, 500 volts DC  
1000 amperes  
Input: 13,800 volts, 33 amp,  
3 phase, 60 cycle



**RIGHT — MODULE ANALYZER**  
Output: - 6.5 + 6.5 - 13  
+ 13 - 19.5 + 48  
- 48 volts DC  
Input: 115 volts, single  
phase, 60 cycle

Our vast store of engineering experience is available to assist you in developing a practical solution to your problem.

## ACME ELECTRIC CORPORATION

3112 Water St.

Cuba, N.Y.

In Canada: Acme Electric Corp. Ltd., 50 Northline Rd., Toronto, Ont.

# Aeme Electric

## New! MINIATURE AXIAL FANS

with  
up to 4 times  
greater cooling efficiency!



Characteristic	PAMOTOR Model 1000	Conventional Fan
Type of Motor	induction (capacitor-type squirrel cage)	shaded-pole
Housing	die cast warp-free Zymec	plastic
Output @ 60 cps (0 back pressure) (.25" back pressure) (.3" back pressure)	125 cfm 75 cfm 50 cfm	100 cfm 20 cfm 0
Output @ 50 cps (0 back pressure) (.25" back pressure)	100 cfm 62.5 cfm	75 cfm 5 cfm
Operating Temp. Range	-55°C to +85°C	-18°C to +44°C

The PAMOTOR Model 1000 Miniature Fan is completely interchangeable with conventional units now in use (4 1/8" center-to-center mounting holes). But the similarity ends there.

check this comparison chart!

The Model 1000 Fan meets MIL-T-5422E, Class 2 Environmental specifications. Inside-outside rotating motor design gives flywheel effect, resulting in constant, quiet fan speed. Large surface sleeve bearings mean minimum maintenance, maximum reliability.

For complete specifications and name of nearest stocking distributor, write to:

**PAMOTOR, Inc.**  
312 Seventh Street • San Francisco 3, Calif.

CIRCLE 200 ON READER SERVICE CARD



## INTELLECT GROWS ON A LOGIC TREE

MINIVAC makes possible a complete understanding of the exciting new world of computers. Logic trees make the programming of the most complex problem extremely simple. MINIVAC, a training digital computer, teaches the basic operations of even the largest commercial computers. Six comprehensive instruction manuals demonstrate to its operator how computers think, remember, calculate, make decisions and solve logical problems. MINIVAC is "the Christmas gift that makes sense" for hobbyists, businessmen, and students... anyone with an inquiring mind. **\$85.00**

## SCIENTIFIC DEVELOPMENT CORPORATION

372 MAIN STREET  
WATERTOWN, MASS.

Scientific Development Corporation  
Digital Computer Sales Division  
371 Main Street, Watertown, Mass.

Gentlemen:

Please send me  MINIVAC 601 Check or money order enclosed.  
 MINIVAC 601 C. O. D.  
 complete literature on MINIVAC 601.

Name \_\_\_\_\_  
Address \_\_\_\_\_  
City \_\_\_\_\_ Zone \_\_\_\_\_ State \_\_\_\_\_

CIRCLE 201 ON READER SERVICE CARD



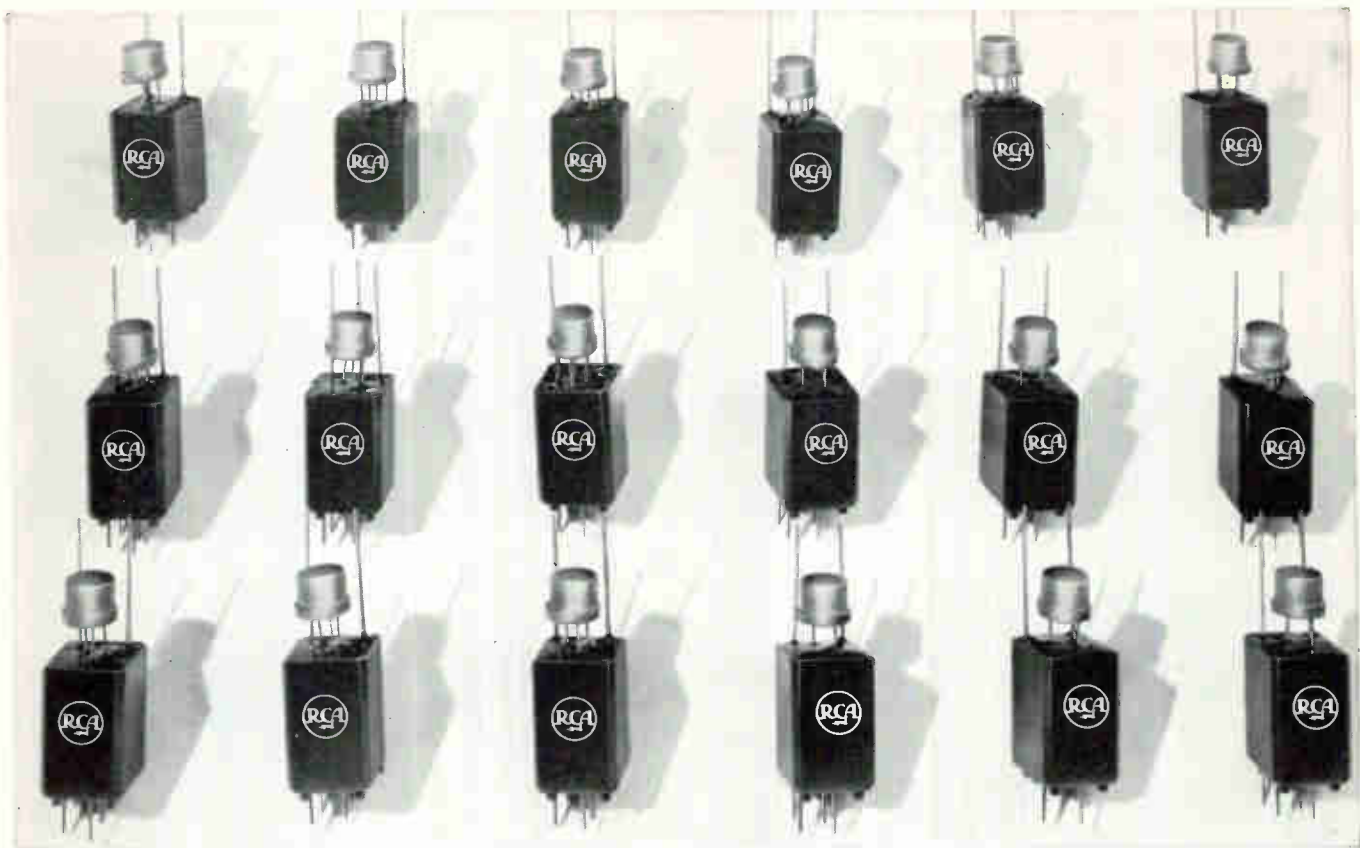

## Now you can buy RCA Packaged Circuits assembled and tested to your specifications

**RCA Minimodules – conventional components in high-density format – bring you today's economical answer to extra-dependable packaged transistor circuits.**

If your product calls for miniature packaged circuits... if your requirements include fast, high-volume availability... look into RCA Minimodules now.

- These high-density packaged circuit units bring you the reliability of conventional passive components, close-packed, interconnected, and encapsulated in fire-retardant epoxy-type resin to meet the mechanical and environmental requirements of MIL specifications. Standard, field-proved transistors offer you the exact characteristics your circuits need.

- RCA microelectronics specialists are ready to work with you to design your Minimodule circuit package. Typical of the 40 types now in production are four RCA Minimodules for digital-computer applications. These high-performance units, built with RCA's experience in manufacturing hundreds of thousands of digital Minimodules, are available now, ready for

mounting on standard printed-circuit boards. Order these RCA Minimodules now:

- RCA CP0917... Minimodule Inverter Circuit
- RCA CP0918... Minimodule Trigger Network
- RCA CP0919... Minimodule Power-Gate Input Circuit
- RCA CP0920... Minimodule Power-Gate Output Circuit

- Call your RCA representative for information on the comprehensive line of RCA transistor-circuit Minimodules and RCA Micromodules. Or write RCA Semiconductor and Materials Division, Commercial Engineering Section L-19-NM-3, Somerville, N. J.



**RCA Minimodules**—miniature packaged circuits, utilizing conventional components and transistors—can be supplied in high volume, in the format you need, with terminal arrangements to meet your assembly requirements. (Minimodule shown at left, before encapsulation, 1½ times actual size. Units below are typical of wide variation in configurations available through RCA.)



**For your extremely high-density applications** (several hundred thousand parts per cubic foot) specify RCA Micromodules, today's only microminiature packaged circuits backed by over 55,000,000 element-hours of testing. Your RCA Field Representative is ready now to quote low, production-quantity prices for RCA Micromodules. Call him today.

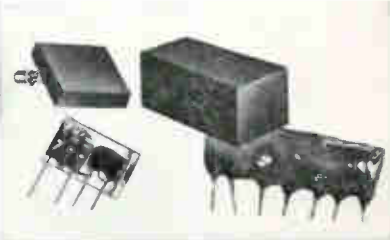

The Most Trusted Name in Electronics

**RCA SEMICONDUCTOR & MATERIALS DIVISION FIELD OFFICES...** EAST: Newark, N. J., 744 Broad St., HU 5-3900 • (Camden, N. J. area) Eriton, N. J., 605 Marlton Pike, HA 8-4802 • Syracuse, N. Y., 731 James St., Room 402, GR 4-5591 • Baltimore, Md., EN 9-1850 • **NORTHEAST:** Needham Heights 94, Mass., 64 "A" St., HI 4-7200 • **SOUTHEAST:** Orlando, Fla., 1520 Edgewater Drive, Suite 221, GA 4-4768 • **EAST CENTRAL:** Detroit 2, Mich., 714 New Center Bldg., TR 5-5600 • **CENTRAL:** Chicago, Ill., Suite 1154, Merchandise Mart Plaza, WH 4-2900 • Indianapolis 5, Ind., 2132 East 52nd St., CL 1-1405 • Minneapolis 16, Minn., 5805 Excelsior Blvd., WE 9-0676 • **WEST:** Los Angeles 22, Calif., 6801 E. Washington Blvd., RA 3-8361 • (San Francisco area) Burlingame, Calif., 1838 El Camino Real, OX 7-1620 • **SOUTHWEST:** Dallas 7, Texas, 7905 Carpenter, Freeway, ME 1-9720 • GOV'T: Dayton, Ohio, 224 N. Wilkinson St., BA 6-2366 • Washington, D. C., 1725 "K" St., N.W., FE 7-8500.







## Cost of one-dimensional criticality computations drops from an average of \$75.00 to \$7.50 per problem

Faster computing, less travel time are the reasons why General Nuclear Engineering Corporation has realized such cost savings since it installed an IBM 1620 Data Processing System at its Dunedin, Florida plant.

Since its main computing facilities are not located at Dunedin, General Nuclear has found that the new 1620 eliminates much of the travel time and expense involved in taking problems to off-site computers. In addition, the 1620 performs the simpler criticality computations 10 times faster than the computer previously used at one of General Nuclear's off-site data processing centers.

General Nuclear uses its new 1620 for other problems, too...heat transfer calculations, various transient codes, mathematical routines for the physics and engineering departments, multi-group calculations, and many other jobs you might expect only a much more expensive computer to be able to handle.

This isn't all. General Nuclear uses the 1620 to do statistical analyses and variance calculations on input data for programs run on off-site large-scale IBM computers.

For information on this highly versatile, low-cost data processing system, which rents for as little as \$1600 a month, contact your local IBM Representative.



Easy to program. FORTRAN, IBM's scientific computer language is available for the 1620. General Nuclear scientists use a special scientific interpretive program—FIDO—written by the Manager of their Computing Section.

**IBM**<sup>®</sup>  
DATA PROCESSING

# Arnold SOLID STATE POWER SUPPLIES

- small, lightweight, and regulated . . . designed to meet MIL-E-5272B
- 100% tested for reliability
- Sine wave, square wave or DC outputs
- Quick delivery on units below

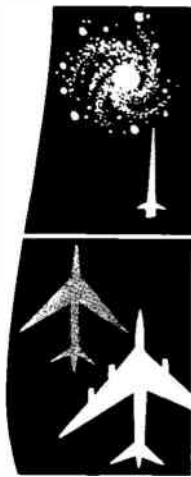

 **DC TO SINE WAVE Model KB** (Stock Item)



Input Voltage: . . . . . 24-30 VDC  
 Output Voltage: . . . . . 115 VRMS  
 Output Frequency: . . . . . 400 cps  
 (other frequencies available)  
 Output Power: . . . . . 50 volt-amps  
 Frequency Regulation: . . . . . 0.3% for 6 V  
 line variations  
 Harmonic Distortion (Total): . . . . . 2% at  
 specified load (4% max.)  
 Size and Weight: . . . . . 2 1/2" x 4" x 2 1/2"  
 high; 26 oz.

**DC TO DC Model 591HC**



Input Voltage . . . . . 24-30 VDC  
 Output Voltage Range . . . . . from 6 VDC  
 to 3500 VDC  
 Output Power . . . . . 60 watts (max.)  
 regulated  
 Regulation . . . . . -1.0% for 6 V line  
 variations;  
 -1.5% for 50% load  
 variations  
 Ripple . . . . . 0.3% RMS  
 Size and Weight . . . . . 3" OD x 3 1/8" high;  
 22 oz.

 **DC TO SQUARE WAVE Model 591ACB**



Input Voltage . . . . . 24-30 VDC  
 Output Voltage Range . . . . . 1.0 to 3500  
 VRMS, square wave, 400  
 cps (other frequencies  
 available)  
 Output Power . . . . . 50 V. A.  
 Regulation . . . . . Frequency and Voltage:  
 -1.0% for 6 V line  
 variations; +1.0% for  
 50% load variations  
 Size and Weight . . . . . 3" OD x 3" high;  
 19 oz.

Constant frequency, voltage and output as battery discharges. Units withstand short circuit, reversed polarity and input voltage transients of 60 volts. Load power factors as low as 0.2 (lead or lag) may be applied.

Literature with performance curves sent on request. Literature includes "easy to order" information—no need to write complicated specifications.



**ARNOLD MAGNETICS CORP.**  
 6050 W. Jefferson Blvd., Los Angeles 16, Calif.  
 VERmont 7-5313



## PRECISION VOLT & FREQUENCY METERS

Catalog available

If your operation demands accuracy to 1/10 of 1%, you need this AMF catalog, which includes specifications, sizes and weights of Frequency and Volt Meters for test research, industrial, military and government use.

AMF Meters are rugged. They compensate for practically any temperature and environment. They can be tailored to your requirements—or are available immediately from stock. Send today for your Catalog! Address Department S.



**American Machine & Foundry Company**  
 1101 North Royal Street, Alexandria, Va.

CIRCLE 202 ON READER SERVICE CARD

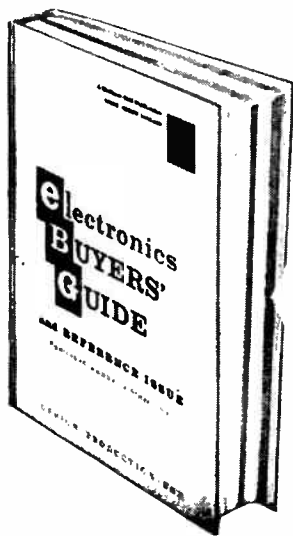

Seen  
the new

IDEA  
INDEX

IN EBG?

The INDEX to the editorial articles in electronics magazine, previously published annually in a December issue, now appears ONLY in the EBG. Another original EBG idea that saves time and trouble for users! Keep your EBG copy on your desk!

**EXTRA!**

Also in the EBG are condensed ABSTRACTS of all the editorial feature articles which have appeared to date in 1961. Another reason why EBG is used more by all four — men in research, design, production and management.



McGraw-Hill Publication,  
 330 West 42nd St., New York 36, N. Y.





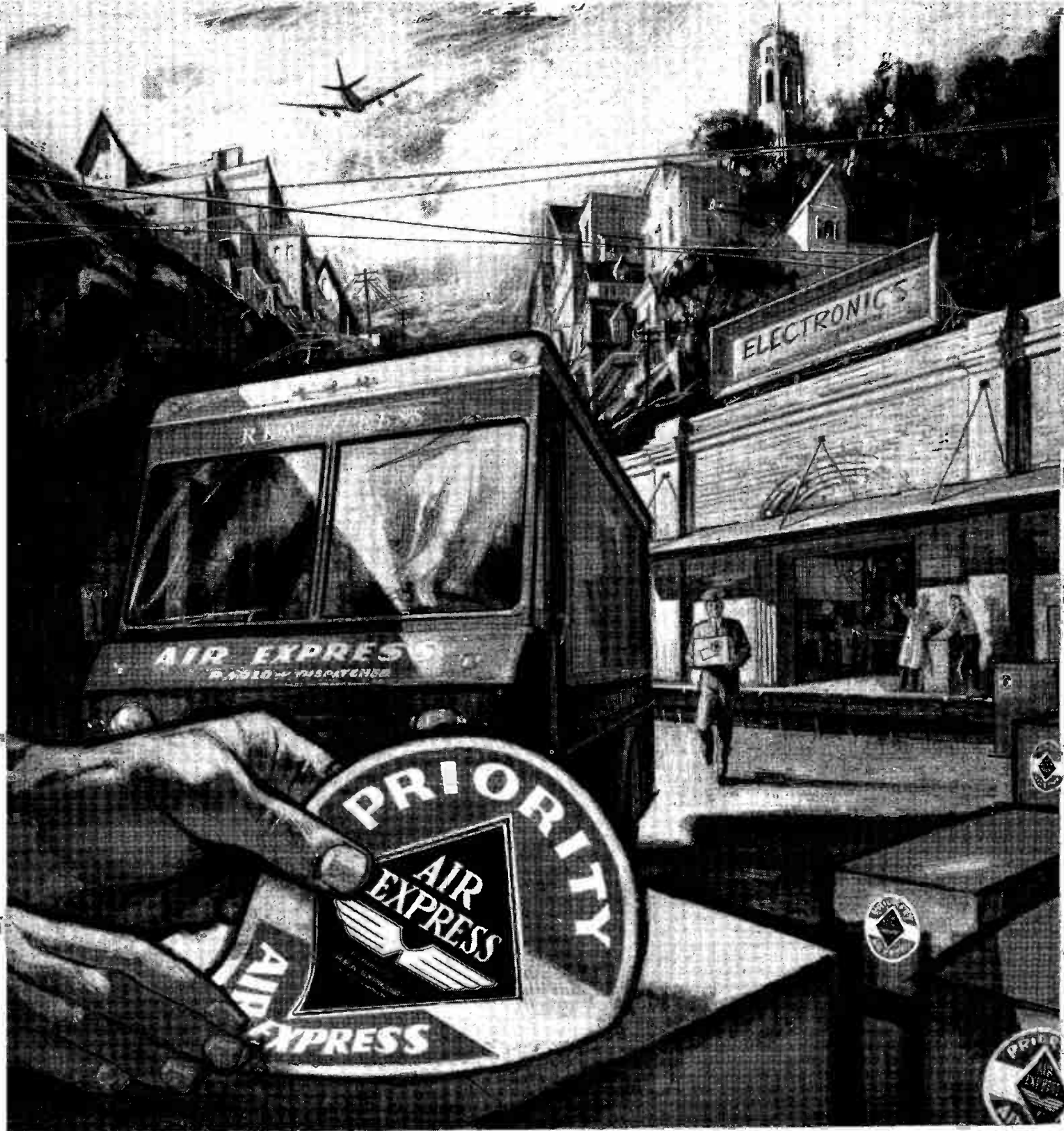

**AIR EXPRESS gets your shipment first on, first off, first there**

*AIR EXPRESS is more than America's fastest shipping service . . . it's the most impartial. Large shipments or small get identical, top priority treatment, plus those "extras" that make AIR EXPRESS first choice nationwide. A special fleet of 13,000 trucks, many radio-dispatched, pick up and deliver door-to-door. Your shipment is first on, first off, first there, via all 35 scheduled U. S. airlines, with kid-glove handling non-stop. And the cost for AIR EXPRESS service is amazingly low. Just one telephone call arranges everything, to 23,000 communities in the U. S. and Canada. It pays when you think fast . . . think AIR EXPRESS first!*

**AIR EXPRESS**



CALL YOUR LOCAL REA EXPRESS OFFICE FOR AIR EXPRESS SERVICE

ONE OF THE MOST VITAL equipment needs today and for the future is improved range instrumentation. More specifically: "The single most difficult task facing the range instrumentation engineer today is acquisition of high quality trajectory data during the boost and orbital phases."

This statement was made at the American Rocket Society meeting in New York in a paper by R. V. Godfrey of Pan American World Airways, Inc., which operates the Atlantic Missile Range for the Air Force, and C. L. Carroll of Aerospace Corp.

High quality data are needed to obtain real-time impact prediction for missiles, to establish orbital parameters for satellites and trajectories for manned and unmanned space probes, and—for the R&D engineer—to identify and isolate inertial guidance system errors.

Besides c-w interferometric tracking systems, such as Azusa I and II and the newer Mistram (ELECTRONICS, p 38, July 28, 1960; p 109 Nov. 17, 1961), pulse radar systems are moving forward at a healthy pace.

The C, L and X band radars Sperry is developing for the two

converted C-4 troop carrier ships are believed to have impressive range capabilities (ELECTRONICS, p 22, July 28, 1961). Advanced radar under development for later ships in USAF's Mobile Atlantic Range Stations (Mars) program will have even greater skin tracking capabilities. First Mars ship will be operational next fall. More ships will follow.

RCA is developing, in-house, a long-range tracking radar, a real-time tracking technique for off-the-launch-pad trajectory measurement, laser radar techniques and global-range integration techniques

## NEW PULSE TRACKERS Readied

BY SEPTEMBER, a new pulse radar will be operational at the Atlantic Missile Range. It will mark a significant jump beyond pulse trajectory measurement systems now in operation at U. S. missile ranges. Designated AN/FPQ-6, the new radar will be capable of nonambiguous range measurement of targets up to 32,000 nautical miles.

The AN/FPS-16 (now in use), out of which FPQ-6 was evolved, was built for nonambiguous range measurement of targets up to 500 n.mi. A digital range modification kit now in use at the Pacific Missile Range and ready for use at the Atlantic Missile Range (AMR), extends the nonambiguous range measurement capability to somewhat over 8,000 n.mi.

Both the FPS-16 and the FPQ-6 are capable of simultaneous presentation of returns from regular radar

echo (skin) targets and from beacon-carrying targets. Although the radars will track returns having negative signal-to-noise ratios, the usual practice is to quote ranges to the zero db signal-to-noise ratio condition to establish a reference point.

Using this reference, the FPS-16 will skin track targets having an effective radar cross section of one square meter to about 125 n.mi. The new FPQ-6 will extend this tracking range to 500 n.mi.

The range of either radar on beacon-carrying targets depends upon the characteristics of the beacon in the target and upon its antenna pattern. Beacon tracks are normally established to ranges many times beyond the skin tracking capability and could conceivably exceed the nonambiguous measurement capabilities of the

radars.

Later FPQ-6s may be beefed up in several ways. To quote a few possibilities: (1) parametric amplifiers would extend the one square meter range to 650 nautical miles; (2) use of one of the simpler versions of pulse compression techniques, 850 n.mi; (3) use of (1) and (2) together, 1,100 n.mi; and (4) a cryogenic version of (1) plus doubling the transmittal power of (2), 1,850 n.mi.

RCA's Missile and Surface Radar division built the FPS-16 and is now producing the FPQ-6 under contract to the Navy Bureau of Weapons. The first two FPQ-6s will be delivered to the Atlantic Missile Range and be checked out and operational by September. A transportable version, designated TPQ-18 that can be packed in nine shelters and transported in C-124 or C-133 cargo planes or by ship, will be delivered to AMR already checked out and ready to operate in August.

New features used in the FPQ-6, according to RCA, include: a revised console to provide the most useful acquisition features for the operators as well as automatic, semiautomatic and manual equipment to supplement the operators; improved built-in acquisition features in the ranging equipment; an auxiliary nonreferenced range system (Auxtrack) which permits

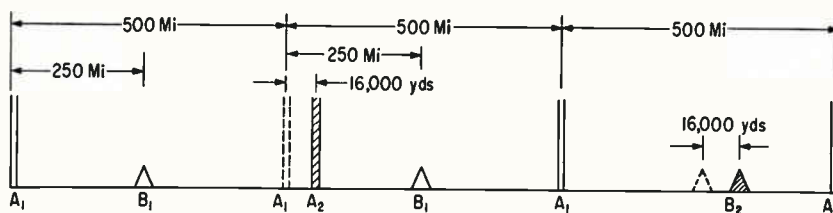

A<sub>1</sub> — REGULAR PULSE TRANSMISSION

B<sub>1</sub> — ECHO FROM A PREVIOUS A<sub>1</sub> PULSE TRANSMISSION

A<sub>2</sub> — DELAYED PULSE TRANSMISSION, 16,000 yd AFTER NORMAL TIME

B<sub>2</sub> — ECHO FROM THE FIRST A<sub>2</sub> PULSE TO BE TRANSMITTED, ONE ZONE BEHIND

FPQ-6 determines true range of target by placing it in a zone. In this example, target in second zone has apparent range of 250 n. mi, true range of 750 n. mi



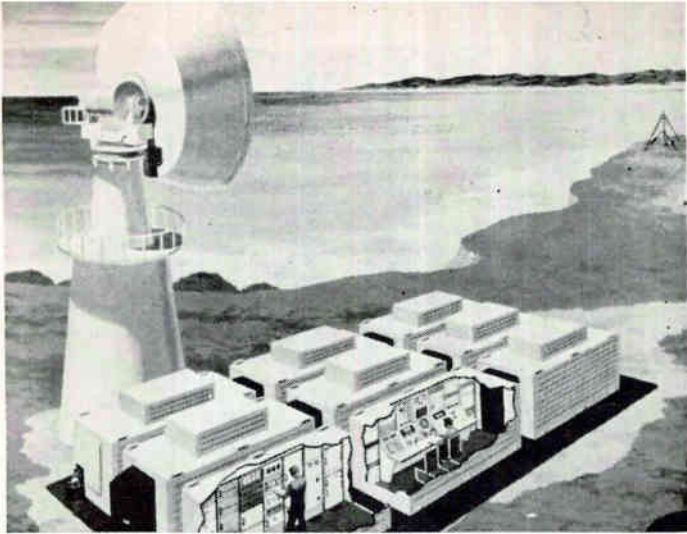

Modularized transportable version, AN/TPQ-18, can be moved by land carrier or cargo aircraft

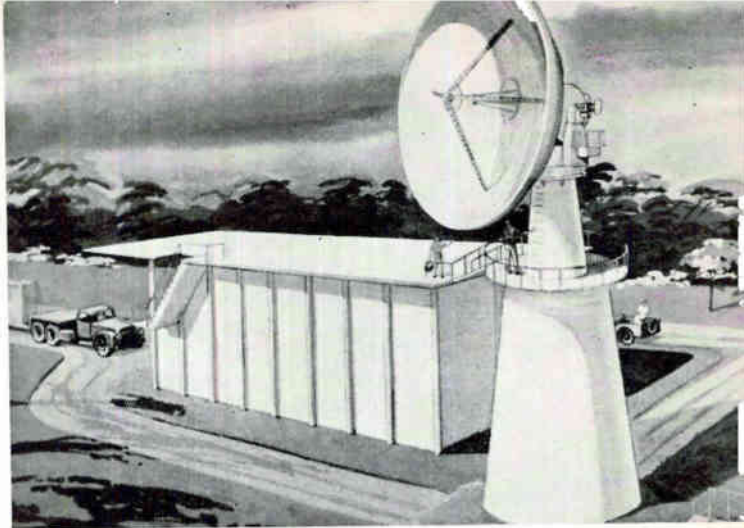

Permanent AN/FPQ-6 installation to meet tighter range requirements, nonambiguous tracking to 32,000 n. mi

## For Space Ranges

By JOHN F. MASON, Associate Editor

angle-only acquisition and tracking through operator selective gating of the tracking receivers; a C-scope with video integrator to enhance long range target acquisition; rapid slewing circuits (on the order of several hundred thousand yards per second) with added tracking features; and four A scopes displaying range increments.

The transmitter is a more stable version of the one developed several years ago for the Signal Corps and White Sands Missile Range. It is convertible to doppler measurement (target radial range rate), pulse compression, and other more elaborate coherent transmitter-receiver techniques. The transmitter frequency synthesizer and multiplier scheme may be used with minor variations to drive r-f output stages covering other r-f frequency bands, such as L, S or X band.

The digital range machine that has extended the nonambiguous tracking range to above 32,000 n.mi was originally developed as a modification kit for the FPS-16. As far as is known, RCA says, this is the only range tracker in the world with nonambiguous, multiple time around tracking capability to this range. The multiple time around feature permits the use of much higher repetition rates than could otherwise be utilized. It is all-electronic and prevents beacon-stealing. This feature is vital to multiple sta-

tion radar operation with overlapping radar coverage.

The trick to measuring nonambiguous range at such a distance is to be able to determine which transmitted pulse has created the echo that appears on the scope. For example, a pulse repetition frequency that allows a pulse to travel to a target 500 n.mi away and return before the next pulse is transmitted will present any target within this 500 mi range without ambiguity.

If, however, a target is 750 mi

from the transmitter, a second pulse will have been transmitted before the echo from the first pulse has returned. The 750-mi target will appear on the scope as 250 mi. To obtain its true range, it must be determined which zone the target is in. Its true range will be the 500 mi across zone 1 plus its apparent range of 250 mi, totaling 750 mi. A target at 1,250 mi true range—in zone 3—would still present an apparent range of 250 mi.

When a target is acquired with

### INSTRUMENTATION RADAR CHARACTERISTICS

System	FPS-16 (1955)	FPQ-6 (1961)
Frequency	5,400-5,900 Mc	C-band tunable 5,400-5,900 Mc
Peak power	1 Mw fixed; 250 Kw tunable	3 Mw
Pulse repetition frequency	various, between 142 & 1,707 pps	160 & 640 primary but others up to 1,707 pps
Pulse duration with pulse coding	0.25, 0.5 & 1 $\mu$ sec	0.25, 0.5, 1 & 2.4 $\mu$ sec
Antenna beam width	1.1 deg	0.1 deg
Receiver noise figure	10 db	8 db
Range measurement capability	500 n. mi; 8,000 with digital range modification	32,000 n. mi, nonambiguous
Range tracking granularity	1 yd	2 yd
Antenna size	12 ft; 4-horn monopulse	29 ft cassegrainian 5-horn monopulse feed
Antenna gain	44.5 db	51 db
Antenna polarization	vertical	vertical or circular
Antenna pedestal weight	12,000 lb	100,000 lb
Angle tracking rates	az 40 deg/sec; el 30 deg/sec	up to 28 deg/sec/in, both axes
Angle tracking precision	0.1 mil rms	0.05 mil rms
Range tracking rates	10,000 yd/sec	20,000 yd/sec

no previous reference some technique must be used to determine its zone. Here, in principle, is how the FPQ-6 does it automatically:

In the drawing, a target is acquired ( $B_1$ ) establishing an apparent range of 250 mi. On the next go-round, the transmitter pulse is delayed by 16,000 yards ( $A_2$ ). Two receiver tracking gates are generated simultaneously, the first to coincide with the regular pulse at the target's apparent range, and the second for the delayed pulse return.

A target echo appears again. If this echo appears from the delayed pulse, then the target is actually 250 miles away. In the example, however, the return appears from a normal transmission. This indicates that the target is at least more than one zone away.

On the next go-round, a delayed echo ( $B_2$ ) appears. This tells that the target is in zone 2. The true range is then 750 mi.

The zone number is thus obtained by counting the number of times the pairs of tracking gates are generated before a target return appears in the second gate. The true range is the number of zones minus one, plus the apparent range.

A problem arises from this zone identification technique. As the target moves from one zone into the next, tracking may be lost due to receiver saturation or ground clutter. The solution is to prevent the target signal's being returned in an interference region. This is done by alternately delaying groups of transmitter pulses and receiver tracking gates by 32,000 yds until the signal return is outside the interference region.

The antenna mount is probably the greatest single contributor to the successful performance of the radar, RCA says. Features included are precise data takeoffs; high and low servo response bandwidth capability with high gain across the variable range; high torques to counteract wind forces and to achieve high accelerations; hydrostatic bearing in azimuth and phased ball bearings in elevation to provide tracking smoothness at extremely low, as well as high, angular velocities; attention to maintaining the orthogonality of the azimuth and elevation mechanical axes; and minimization of changes in a stability due to thermal effects.

# Silver Price Jumps Nine Cents

WASHINGTON — Kennedy administration changes in silver policy, to reestablish a free market, has caused initial wide fluctuation in the world price. As predicted (ELECTRONICS p 14, Oct 20), world price almost immediately went over \$1 an ounce.

The Treasury stopped selling at 91 cents an ounce. This price, two cents under world price, had caused its free silver stock to dwindle from 210 million ounces in 1959 to 22 million.

Treasury estimates world demand at 300 million ounces and supply at 235 million. Demand will be lowered to 250 million ounces by having the Treasury draw on paper money reserves for its 50-million-ounce annual coinage requirements.

The administration wants Congress to repeal the mandatory buying price of 90.5 cents for new silver and to remove the 50 percent tax on silver transaction profits. Congress will probably go along, but senators from silver-producing states are expected to put up a fight.

Sen. Frank Church, of Idaho, a leader of the silver bloc, has predicted price will stabilize around \$1.10. He feels this price, plus

## SILVER IN ELECTRONICS

*Electronic industry is one of the principal users of the 100 million ounces of silver consumed annually in the U.S.*

*Silver Users Association estimates (based on a survey of California users) that some eight million ounces are used for printed circuits, silver cells batteries, waveguide plating and other electronic uses, except soldering, contacts and ceramics.*

*In the entire electrical industry, soldering and brazing consumes 24 to 27 million ounces, electrical contacts use 18 to 20 million ounces and ceramics take 1 to 13 million ounces*

restoration of a free market in the U. S., will stimulate production enough to close the gap between supply and demand.

Spokesmen for the Silver Users Association contend narrowing the gap and removing the profits tax will bring significantly larger amounts of silver—both new silver and hoarded—on the market. They estimate the world price may stabilize at only slightly higher than 91 or 92 cents an ounce.

## Electronic System Controls Freight Yard



*One of nine control towers in computer-controlled freight yard of Canadian National Railways at Montreal. Three miles long and 3,100 feet wide, yard has a capacity of 11,000 cars, can classify 7,000 cars a day. Closed circuit tv is used to read off car numbers. Radar measures car speed during hump-ing for train make-up. Car speed for optimum coupling is worked out by computer and braking is applied to cars automatically in a special track section*



# TEST, MAINTAIN MICROWAVE SYSTEMS?

*Do a more complete, better job  
faster and more economically  
with Dymec Microwave  
Test Sets—Signal Generators*

Dymec Microwave Test Sets and Signal Generators combine several basic instruments in one compact unit to give faster and more economical test and maintenance service for microwave systems.

Each test set includes signal generator, power meter, wavemeter and precision attenuator. They combine to meet a wide range of requirements:

DY-623B SHF Test Set, ideal for use with communications, control and video microwave systems; measures receiver sensitivity and selectivity, plus transmitter frequency and power level.

DY-624C X-Band Test Set, particularly useful for testing complete radar and fire control systems or radar beacon equipment.

DY-5003 X-Band Test Set, incorporates features of the DY-624C, has higher output power, more accurate attenuator, is protected against accidental application of high input signals.

DY-5381 High Power X-Band Signal Generator, provides minimum output of 250 milliwatts over its entire range, approximately 400 mw at band center; especially useful for testing radar systems through directional couplers. Also useful as parametric pump.

DY-5636 H-Band Test Set, covers the important microwave relay communications band, is particularly convenient for testing complete communications systems.

Brief specifications are presented here. Write your Dymec/Hewlett-Packard representative or contact us directly for complete information.

SPECIFICATIONS	DY-623B	DY-624C	DY-5003	DY-5381	DY-5636
Frequency Range	5925-7725 mc <sup>1</sup>	8500-10,000 mc	8500-10,000 mc	8500-10,000 mc	7125-8400 mc
Frequency Meter Range	5820-7780 mc	8500-10,000 mc	8500-10,000 mc	—	7125-8400 mc
Output Power	0 dbm (1 mw)	0 dbm (1 mw)	15 dbm (30 mw)	24 dbm (250 mw)	15 dbm (30 mw)
Output Attenuator Range	70 db	100 db	100 db	100 db	100 db
Internal Modulation	FM, 1 kc	Pulse, 35-3500 cps FM, power line frequency	Pulse, 35-3500 cps FM, power line frequency	Pulse, Square Wave, 35-3500 cps, FM, power line freq.	FM, 1 kc
External Modulation	FM, Pulse, Square Wave, 30 cps to 100 kc	FM, Pulse, Square Wave, 35-3500 cps	Pulse, FM, Square Wave, 35-3500 cps	Pulse, FM, Square Wave, 35-3500 cps	FM, Pulse, Square Wave, 30 cps to 100 kc
Power Measurement Range, CW	— 6 to + 3 dbm	— 6 to + 3 dbm	— 6 to + 3 dbm	—	— 6 to + 3 dbm
Price	\$1,900.00 (transit case)	\$2,265.00 (cabinet) \$2,250.00 (rack mtd.)	\$3,600.00 (rack mounted)	\$4,835.00 (rack mounted)	\$4,475.00 (transit case)

<sup>1</sup>3 Klystrons needed for full range.

Data subject to change without notice. Prices f.o.b. Palo Alto.



DY-624C X-Band Test Set (above)  
DY-5381 High Power X-Band  
Signal Generator (left)

## DYMEC

A Division of Hewlett-Packard Co.



Dept. E-12, 395 Page Mill Road, Palo Alto, California

Telephone: DAvenport 6-1755 TWX-117-U

## FILMISTOR<sup>®</sup>

METAL FILM RESISTORS  
OFFER 5 TEMP. COEFFICIENTS  
TO MEET ALL CIRCUIT  
REQUIREMENTS

RUGGED END-CAP  
CONSTRUCTION  
FOR LONG TERM  
STABILITY

EXCEPTIONAL  
RESISTANCE TO  
MOISTURE AND  
MECHANICAL DAMAGE

SURPASS MIL-R-10509  
PERFORMANCE  
REQUIREMENTS



Providing close accuracy, reliability and stability with low controlled temperature coefficients, these molded case metal-film resistors outperform precision wirewound and carbon film resistors. Prime characteristics include minimum inherent noise level, negligible voltage coefficient of resistance and excellent long-time stability under rated load as well as under severe conditions of humidity.

Close tracking of resistance values of 2 or more resistors over a wide temperature range is another key performance characteristic of molded-case Filmistor Metal Film Resistors. This is especially important where they are used to make highly accurate ratio dividers.

Filmistor Resistors, in 1/8, 1/4, 1/2 and 1 watt ratings, surpass stringent performance requirements of MIL-R-10509D, Characteristics C and E.

Write for Engineering Bulletin No. 7025 to: Technical Literature Section, Sprague Electric Co., 35 Marshall Street, North Adams, Mass.

For application engineering assistance, write: Resistor Div., Sprague Electric Co. Nashua, New Hampshire



<sup>®</sup> and <sup>®</sup> are registered trademarks of the Sprague Electric Co.

## Thin-Film Tunnel Devices Are Still in Research Stage

By MICHAEL F. WOLFF,  
Senior Associate Editor

HOW FAR have researchers gone in applying to practical devices the discovery of quantum-mechanical tunneling in supercooled thin-film devices?

A check made during the past few weeks finds the emphasis still on study of the tunneling phenomenon in prototype devices rather than on attempts to fabricate actual circuit elements.

When this type of tunneling was announced last year (*ELECTRONICS*, p 11, Nov. 25, 1960), there was considerable speculation on applications in cryogenic electronics. Researchers pointed out potential uses like computer switching and memory circuits, oscillators, triodes, resistors and capacitors.

A General Electric researcher points out that the thinness of the insulating film (about 20 angstroms) makes it difficult to control current. Current has been reproduced in the laboratory to within a factor of two. GE is experimenting with device prototypes and trying to further understand the electron tunneling before concentrating on current control.

Researchers at Arthur D. Little, Inc. explain that utilization of their tunneltron (*ELECTRONICS*, p 42, Dec. 9, 1960) depends to a great extent on thin-film technology. Their device uses aluminum oxide or barium stearate films whose thickness is limited to the range between roughly 15 and 25 angstroms over an area of 0.1 sq mm.

They are still optimistic about the basic device, however, pointing



ADL researcher uses vacuum evaporator to fabricate thin-film devices

out that its inherent noise temperature of a few degrees Kelvin and the ability to control the characteristic with a magnetic field make it potentially attractive for cryogenic computers.

Present plans at ADL are to see whether the tunneltron can be used in a practical circuit and also to use the tunneling effect as a tool for further study of superconductivity—as in measuring the width of the energy gap in superconducting metals.

Tunneltron oscillations have been measured in the r-f region. Further circuit studies will aim at making the device oscillate at a frequency predicted from a prior circuit analysis and then seeing how the oscillation parameters are affected by varying bias, temperature and magnetic field. Next step will be to test the tunneltron as an amplifier or rectifier.

Bell Labs is evaluating the potentialities of superconducting thin films for military and other applications, but they too are basically concerned with understanding properties of the materials rather than manufacturing devices.

A thin-film device of possibly more general utility is Philco's metal interface amplifier (*ELECTRONICS*, p 11, June 2, and p 89, Sept. 29, 1961). Consisting of a germanium substrate upon which



successive layers of aluminum, aluminum oxide and gold are deposited, this three-terminal device exhibits at room temperature amplification resembling that of an NPN transistor.

Interest remains strong in this device but there is disagreement as to the basic mechanism of operation. Philco researchers attribute the source of energetic electrons to tunnel emission through the thin insulating film. However, R. N. Hall questioned this, at GE Research Lab. He claims that when the aluminum film is evaporated on the germanium substrate, pin holes are formed through which the gold penetrates. Space-charge limited current flows from the gold into the space-charge region at the surface of the germanium and these electrons are collected by the n-type germanium as in a depletion-layer transistor.

Experiments at Raytheon discussed at NEREM by J. M. Lavine tend to support Hall's ideas. Lavine felt the majority of electrons collected by the germanium are coming through the pin holes, although a minority may well be energetic tunneling electrons. In the Raytheon research device, power gain of 20 db has been obtained at 1 Kc at room temperature. Beta as large as 200 has been exhibited.

Regardless of the mechanism, the metal interface amplifier is seen as eventually promising active thin-film devices. According to a Philco spokesman, a program of fabrication, testing and analysis has led to a new MIA configuration, including advances in fabrication techniques.

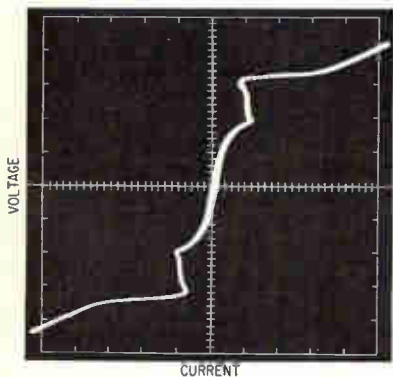

Tunneltron characteristic for lead-tin device at 3.3 degrees K. Vertical scale is 0.5 mv/large div, horizontal is 50  $\mu$ a/large div

## Magnetic Shift Registers Now Available At Sensible Prices

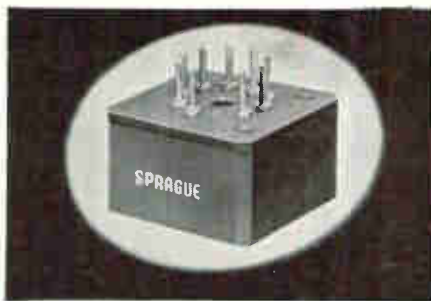

Sprague Electric Company's Special Products Division has scored another first by breaking the "\$5.00-per-bit" barrier. Magnetic Shift Registers for industrial control applications may now be obtained for less than the proverbial \$5.00 figure.

Inherently more reliable, more stable than costlier semiconductor alternates, these new encapsulated shift registers permit substantial savings in the design and production of your equipment without sacrificing quality or performance.

Sprague core-diode type shift registers employ high reliability components ruggedly assembled and epoxy encapsulated for long service. They are offered in a variety of package designs which have been developed to be compatible with all modern wiring techniques and equipment construction.

The cores used in Sprague magnetic shift register assemblies are all subjected to rigid switching tests which carefully control the basic parameters important to reliable operation in the final circuit application. Completed assemblies are 100% pulse-performance tested to insure strict adherence to engineering specifications.

Available in single-bit as well as multi-bit assemblies, with or without bit drivers, to meet your individual packaging requirements, Sprague Magnetic Shift Registers may well be the answer to some of your design problems.

For further information, or for application engineering assistance without obligation, write to Special Products Division, Sprague Electric Company, 35 Marshall Street, North Adams, Massachusetts.

CIRCLE 204 ON READER SERVICE CARD

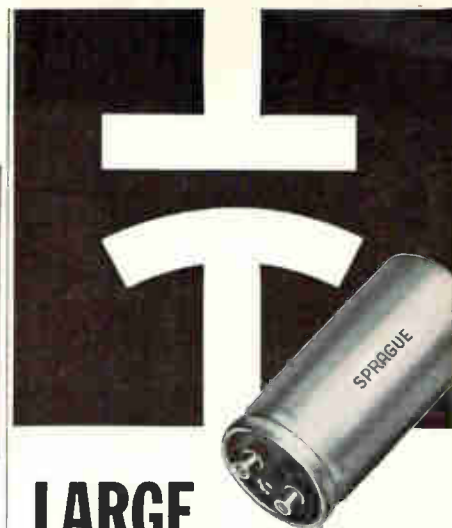

## LARGE VALUES OF CAPACITANCE

### IN SMALL PHYSICAL SIZE!

Sprague offers two series of "block-buster" electrolytic capacitors for use in digital power supplies and allied applications requiring extremely large values of capacitance.

Type 36D Powerlytic<sup>®</sup> Capacitors pack the highest capacitance values available in their case sizes. Intended for operation at temperatures to 65 C, maximum capacitance values range from 150,000  $\mu$ F at 3 volts to 1000  $\mu$ F at 450 volts.

Where 85 C operation is a factor, Sprague offers the Type 32D Computytic<sup>®</sup> Series, the ultimate in reliable long-life electrolytics for digital service. These remarkably trouble-free units have maximum capacitance values ranging from 130,000  $\mu$ F at 2.5 volts to 630  $\mu$ F at 450 volts.

Both 32D and 36D Capacitors have low equivalent series resistance and low leakage currents, as well as excellent shelf life and high ripple current capability.

If you'd like complete technical data on Type 36D units, write for Engineering Bulletin 3431. For the full story on the "blue ribbon" Type 32D Series, write for Engineering Bulletin 3441B to the Technical Literature Section, Sprague Electric Company, 35 Marshall Street, North Adams, Massachusetts.

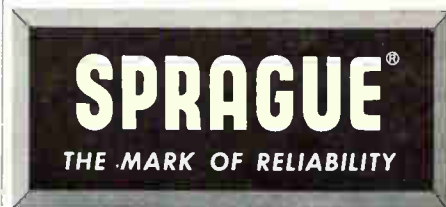

CIRCLE 31 ON READER SERVICE CARD



**THIS SEAL GUARANTEES YOU  
REAL LACING ECONOMY...  
increased production  
with fewer rejects!**

Always specify Gudebrod whether you use one spool of lacing tape or thousands because Gudebrod lacing tape is produced under strict quality control. Gudebrod checks and rechecks every lot of tape to insure that it meets the highest standards . . . higher standards than those required to meet MIL-T specifications.

Gudebrod helps increase your production because we carefully test, measure and maintain close tolerances on such characteristics as slip resistance, fray resistance, breaking strength, wax content, fungistatic effectiveness. These and other tests assure you that when Gudebrod lacing tape is used production increases. *Knots don't slip . . . harnesses stay tied . . . assemblies remain firm . . . there are fewer rejects!*

Whatever your lacing needs—Teflon\*, dacron†, glass, nylon, high temperatures, special finishes—Gudebrod makes it or will produce a tape to meet your special requirements. If you want a tape to meet 1500°F . . . Gudebrod Experimental Research Project 173 is the answer. If you want a tape that meets MIL-T-713A . . . Gudelace® (Style 18 Natural) is the answer.

**MAKE THE H-R TEST!** Write for samples of Gudelace or other Gudebrod lacing tapes and have them tested in your harness room. Compare a harness tied with a "Quality Controlled" Gudebrod tape and any other tape. This test will convince you that when you specify Gudebrod you specify *real* economy—increased production with fewer rejects.

Write for our free Technical Products Data Book. It explains Gudelace and other Gudebrod lacing tapes in detail.

\*Dupont's TFE fluorocarbon fiber.

†Dupont's polyester fiber.

## **GUDEBROD BROS. SILK CO., INC.**

Electronics Division  
225 West 34th Street  
New York 1, New York

Executive Offices  
12 South 12th Street  
Philadelphia 7, Pa.

## MEETINGS AHEAD

RELIABILITY AND QUALITY CONTROL, 8th National Symposium, PGRQC of IRE, AIEE, ASQC, EIA; Statler Hilton Hotel, Washington, D. C., Jan. 9-11, 1962.

OPTICAL CHARACTER RECOGNITION Symposium, National Bureau of Standards; Department of the Interior Aud., Washington, D.C., Jan. 15-17, 1962.

ELECTRICAL ENGINEERING Exposition for electrical-electronics industry, AIEE, New York Coliseum, N.Y.C., Jan. 29-Feb. 2, 1962.

REDUNDANCY TECHNIQUES FOR COMPUTING SYSTEMS, Information Systems Branch of Office of Naval Research; Department of Interior Aud., Washington, D. C., Feb. 6-7, 1962.

MISSILES & ROCKET TESTING Symposium, Armed Forces Communications and Electronics Association; Cocoa Beach, Fla., Feb. 6-8, 1962.

MILITARY ELECTRONICS, 3rd Winter Convention PGMIL of IRE (L.A. Section); Ambassador Hotel, Los Angeles, Calif., Feb. 7-9, 1962.

SOLID STATE CIRCUITS, International Conference, PGCT of IRE, AIEE; Sheraton Hotel and U. of Penn., Philadelphia, Pa., Feb. 14-16, 1962.

APPLICATION OF SWITCHING THEORY TO SPACE TECHNOLOGY Symposium, USAF, Lockheed Missiles and Space; at Lockheed, Sunnyvale, California, Feb. 27-Mar. 1962.

IRE INTERNATIONAL CONVENTION; Coliseum & Waldorf Astoria Hotel, New York City, Mar. 26-29, 1962.

SOUTHWEST IRE CONFERENCE AND SHOW; Rice Hotel, Houston, Texas, April 11-13, 1962.

JOINT COMPUTER CONFERENCE, PGEC of IRE, AIEE, ACM; Fairmount Hotel, San Francisco, Calif., May 1-3, 1962.

### **ADVANCE REPORT**

INTERNATIONAL CONGRESS ON HUMAN FACTORS, IRE Professional Group on Human Factors in Electronics; Lafayette Hotel, Long Beach, California, May 3-4, 1962. The program will be representative of the scope of the PGHFE as an interdisciplinary group of engineers and scientists. Papers that clearly deal with problems of human factors are solicited in the following areas: automatic control, biological science, communications, computers, cybernetics, electrical engineering information theory, mathematics, medicine, and psychology. Submitted papers should present new research findings, either experimental or theoretical with the experimental implications called out. Papers should illustrate the power and necessity of an interdisciplinary approach to the human factors area. Preferably papers should not exceed 30 minutes of presentation length. Abstracts of less than 300 words should be sent before January 1 to John W. Senders, Technical Program Committee Chairman, Minneapolis-Honeywell Regulator Company, 2600 Ridgewood Road, Minn. Final manuscripts of papers tentatively accepted on basis of abstracts should be submitted before February 15.



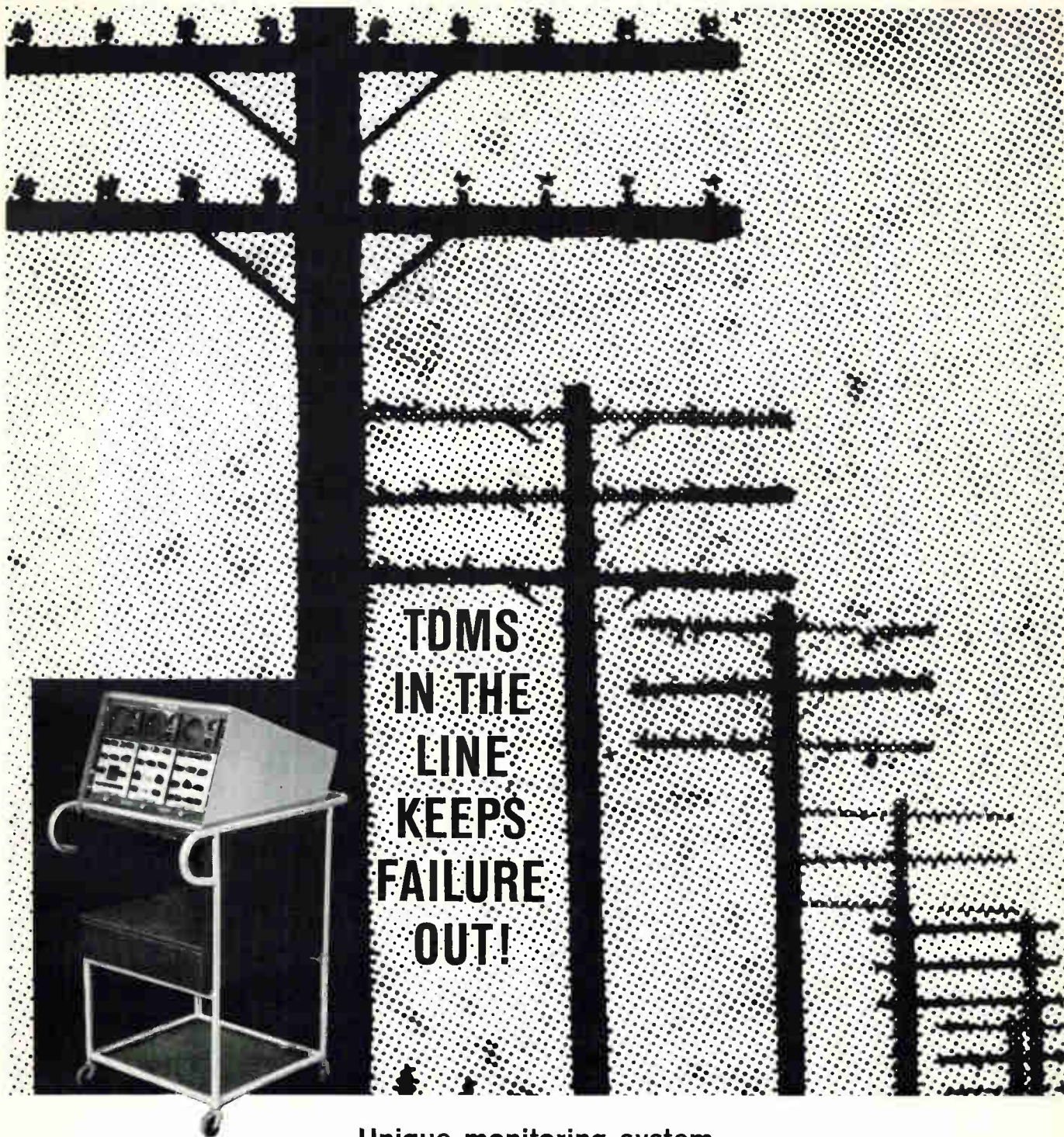

**TDMS  
IN THE  
LINE  
KEEPS  
FAILURE  
OUT!**

**Unique monitoring system  
anticipates trouble spots in communications networks**

Radiation's Telegraph Distortion Measurement System effectively reduces costly downtime in wire or radio telegraph and data links. A compact, self-contained unit, TDMS provides continuous on-line monitoring—and alerts even the non-technical operator when a circuit is deteriorating.

TDMS offers additional advantages which increase the efficiency of communication systems. It transmits perfect telegraph test signals, for example, permits adjustment of

telegraph relays during operation, and tests start-stop mechanisms. It can also replace most equipment needed for teleprinter terminal maintenance and monitoring.

TDMS (and other Radiation commercial equipment) owe their advantages to Radiation's unequalled experience in advanced aero/space communication systems. To find out how TDMS can service your network, write Dept. EL-121, Radiation at Orlando, 5800 McCoy Road, Orlando, Fla.



**RADIATION**  
*at Orlando*



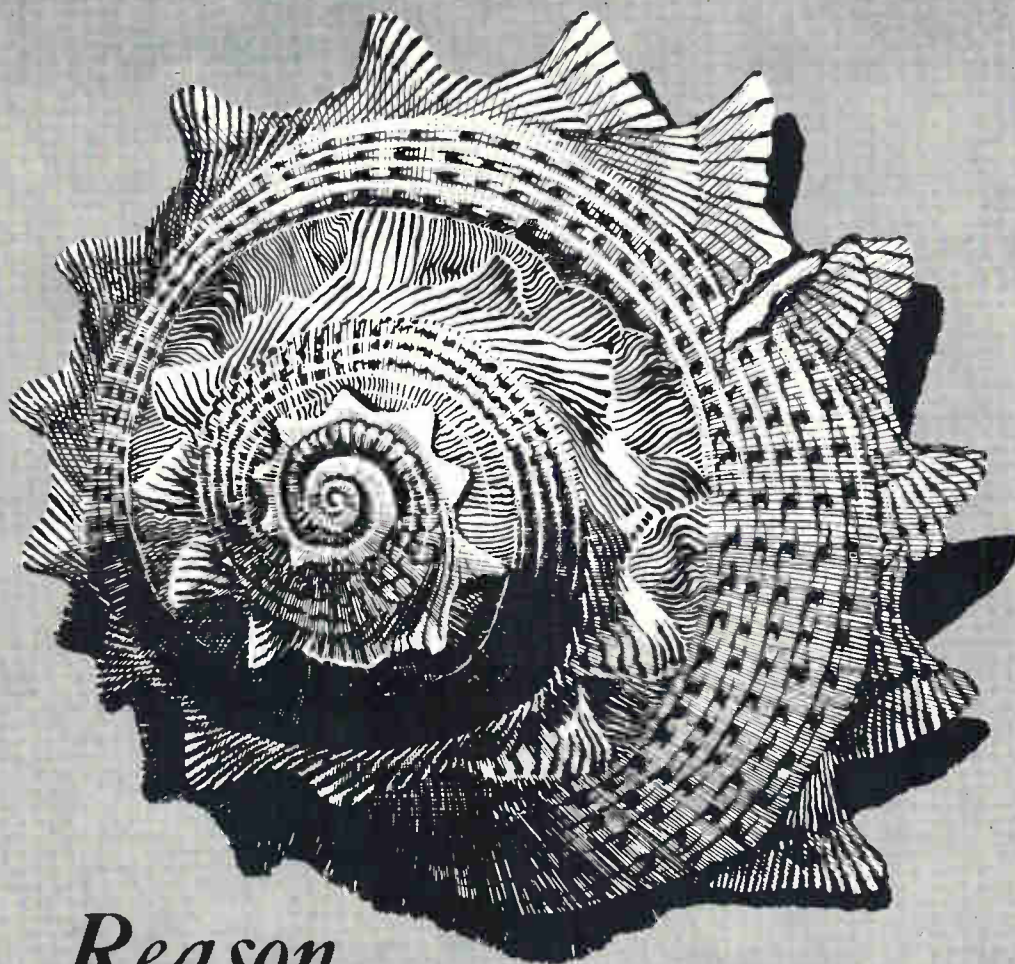

*Reason*

*Reason regulates all things . . . Epictetus*

Guided Missiles Range Division of Pan American World Airways, Inc., as prime contractor to the U. S. Air Force at Cape Canaveral, is increasing technical staffs in Planning, Engineering and Operations of the Atlantic Missile Range.

Technically respected people with leadership ability are needed to fill these new career positions.

Current requirements are for physicists, engineers and mathematicians with B.S., M.S., and Ph.D. degrees.

For a prompt reply, address your inquiry in confidence to: Professional Employment Manager, Guided Missiles Range Division, PAN AMERICAN WORLD AIRWAYS, INC., Dept. W-46, P. O. Box 4336, MU 113, Patrick Air Force Base, Florida.

All qualified applicants will be considered for employment without regard to race, creed, color or national origin.



GUIDED MISSILES RANGE DIVISION

PATRICK AIR FORCE BASE, FLORIDA

NOW...

**SINTERED  
MOLYBDENUM**

FOR THE

CHEMICAL  ELECTRONIC ELECTRICAL  GLASS METALWORKING INDUSTRIAL HEATING MISSILES  AIRCRAFT **INDUSTRIES****AVAILABLE FROM STOCK IN PRODUCT  
FORMS TO MEET YOUR NEEDS.**

Universal-Cyclops now adds sintered molybdenum mill products to its growing line of refractory metals. A leading producer of arc-cast molybdenum and its alloys, the company's Refractomet Division has adapted its years of experience and technical know-how in this area, to the production of sintered molybdenum.

The only integrated producer of molybdenum mill product forms, Universal-Cyclops now provides imme-

diately delivery of sintered product, as well as arc-cast, in all mill forms—for every application in the chemical, electronic, electrical, glass, metalworking, industrial heating, missiles, and aircraft industries.

For complete information, write Refractomet Division or call your nearest district sales office.

**UNIVERSAL  
CYCLOPS**STEEL CORPORATION  
EXECUTIVE OFFICES: BRIDGEVILLE, PA.COLUMBIUM • MOLYBDENUM • TANTALUM • TUNGSTEN  
HIGH TEMPERATURE METALS • TOOL STEELS • STAINLESS STEELS



**IMMEDIATELY  
AVAILABLE**

FROM



**CERAMIC-METAL  
HYDROGEN THYRATRONS**

Long-lasting, miniature thyratrons for compact modulator design in missile, airborne and ground-based applications. Ruggedly built . . . withstand severe shock, vibration and temperature extremes . . . functionally replace most glass-envelope tubes.



**CERAMIC-METAL  
HYDROGEN DIODES**

High-power, high-voltage, hydrogen-filled diodes for use as grid-controlled rectifiers, hold-off diodes, inverse clippers and back-swing clippers. Compact, light, rugged . . . withstand severe shock, vibration and temperature extremes.



**CERAMIC-METAL  
GLASS-METAL,  
TRIGGERED  
SPARK GAPS**

Compact, low-cost spark gaps designed for electronic crowbar and high energy switching operations. Low trigger energy requirement, fast follow-through after trigger pulse, unaffected by atmospheric conditions, zero filament power requirement. Ruggedly built to withstand severe shock, vibration and temperature extremes.



**TRANSFORMERS,  
POWER SUPPLIES**

EG&G is outstandingly well staffed and equipped to design and produce custom-built transformers, chokes, magnetic amplifiers, DC to DC converters, pulse transformers and power supplies for military or commercial use . . . and trigger transformers for all types of flash tubes.

*Full technical information on all products available on request.*



**Edgerton,  
Germeshausen  
& Grier, Inc.**

162 BROOKLINE AVENUE, BOSTON 15, MASS.

**ONE FLICK RESETS this  
HIGH SPEED *Electric* COUNTER**

Model "YE" by

**DURANT**

(Test count-life over 70 million)

Offered in TWO STYLES:

1. Quick PUSH-BUTTON RESET
2. Electric REMOTE RESET

First high-speed electrically actuated counters with added advantage of electric reset. Clean-cut, legible 3/16" figures, white on black. Ideal for all high-speed electric counting applications — accurate at high, low or intermediate speeds.

**DURANT MANUFACTURING CO.**  
1912 N. Buffum St. 12 Thurbers Ave.  
Milwaukee 1, Wis. Providence 5, R. I.  
Representatives in Principal Cities

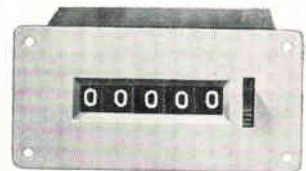

ALASKA GRAY  
AND SEAL BROWN

Compact, with great rigidity — entirely enclosed against dust and moisture. Base or panel mount. Speeds to 1500 C.P.M.

**DURANT**  
**COUNTING INSTRUMENTS**

CIRCLE 205 ON READER SERVICE CARD

**WHAT'S  
YOUR  
TRANSISTOR  
COOLING  
PROBLEM?**

Whatever it is, you can probably find the solution with a Birtcher Radiator. Available in sizes and designs to most efficiently cool all popularly used (and many special) transistors. Test reports show up to 27% more transistor efficiency!

AVAILABLE FROM AUTHORIZED BIRTCHER DISTRIBUTORS

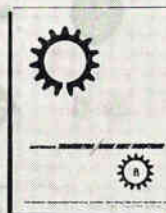

**NEW!**

**TRANSISTOR  
RADIATOR  
CATALOG 1-HR**

*Just off the press — write for it*

**B**

**THE BIRTCHER CORPORATION**

INDUSTRIAL DIVISION

745 S. MONTEREY PASS ROAD, MONTEREY PARK, CALIFORNIA



## For the man to see, go to EBG

One more reason electronics buyers' guide and Reference Issue is your most valuable reference book when you're buying:

For the first time, the 1961 EBG lists in the Green Section the actual name of the man to see in the company from which you want to buy . . . the man designated by the company who knows prices, delivery dates, specifications, etc. This valuable new feature is only one of many in this year's Manufacturers' Index. The same EBG section tells you the number of engineers, number of employees, dollar volume of business of each manufacturer, etc. And there's still more . . .

**Guide to military and government procurement** . . . Complete, most useful guide for the man who is doing business with the government. Lists the military and government agencies that buy electronic equipment and services, with phone numbers,

addresses, procurement officers' names, and what they buy.

**Specific product listing** . . . each listed under its specific heading, no matter how many products a company makes. More than 3,000 are cross-indexed.

**Registered trade-name index** . . . lets you find the manufacturer of a product when you know it only by its trade name.

**Local sales office listing** . . . gives you manufacturers' nearest sales offices, addresses and phone numbers.

These are only a few of the features that make electronics buyers' guide your "best buy" for both buying and selling in the electronics industry. Make the most of your '61 EBG. Use it every day.



**electronics buyers' guide** and reference issue *The Basic Buying Guide in Electronics since 1941*



A MCGRAW-HILL PUBLICATION 330 West 42nd St., New York 36, N. Y.



# The First Major Variable Resistor



In load life, freedom from resistance change under mechanical wear and aging, Stackpole Controls with new STABILITE\* Elements surpass any general purpose variable resistors produced since the early days of radio!

By achieving far greater variable resistor stability—at no increase in cost—the new Stackpole STABILITE elements provide greater circuit design freedom while assuring maximum dependability for the equipment in which they are used.

Available in all Stackpole Control



\*Trademark, Stackpole Carbon Co.,

electronics

# Advance in STABILITY in Years

types, STABILITE elements handle higher loads with an absolute minimum of derating. And they maintain their tolerance through years of hard use!

STABILITE elements result from entirely new techniques in applying carbon dispersions to a specially-developed base material. The accompanying data tells its own story of truly remarkable performance under pertinent conditions of normal use.

For complete details and engineering samples, call your local Stackpole sales engineer or write on company letterhead to: Electronic Components Division, Stackpole Carbon Company, St. Marys, Pennsylvania.

## STACKPOLE VARIABLE composition RESISTORS

Fixed Composition Resistors • Slide & Snap Switches • Ceramag®  
Ferrite Cores • Fixed Composition Capacitors • Ceramagnet®  
Ceramic Magnets • Electrical Contacts • Brushes for all Rotating  
Electrical Equipment • Graphite Bearings, Seal Rings, Anodes  
Hundreds of Related Carbon & Graphite Products



**Compare this performance  
with any controls you've  
ever used before!**

### PERFORMANCE TEST

LOAD LIFE @ 25°C, 1000 hours  
500 volts, dc. .... ¾ to 1 watt } depending  
750 volts, dc. .... ½ watt, Min. } on value.

LOAD LIFE @ 70°C, 1000 hours  
500 volts, dc. .... ½ to ¾ watt } depending  
750 volts, dc. .... ½ watt, Min. } on value.

SHELF LIFE ..... Unlimited

NOISE ..... 3 to 8 millivolts, values  
below 500,000 ohms.  
8 to 12 millivolts, values  
above 500,000 ohms.

### Average Percent Resistance Change

ZERO LOAD @ 100°C for 1000 hours  
±4%, values to 100k; ±2%, values above 100k.

VOLTAGE COEFFICIENT  
Less than ±0.01% per volt. (±0.005% per volt, avg.)

TEMPERATURE CHARACTERISTIC  
±3% from 20°C to 105°C

HUMIDITY: 95% RH @ 40°C for 240 hours  
±4% to ±5%, values to 250k; ±6% to ±9%, values  
above 250k.

MECHANICAL LIFE: 25,000 cycles... Less than ±4%

### Control "Mechanics" Have Been Improved Too!

- New rear bearings assure wobble-free shaft operation.
- 70% less backlash on "ordinary" tandem controls. Zero backlash on tandems for stereo.
- Close-tracking or matched element controls available for stereo.
- Full line of switches for most types—rotary, push-push, pull-push.
- Built-in solder flux guards on switches of miniature, ⅜" diameter types.



# HIGH PURITY METALS AND ELECTRONIC MATERIALS

## METALS AND ALLOYS

ALUMINUM	ANTIMONY
ARSENIC	BISMUTH
CAESIUM	GOLD
INDIUM	LEAD
SILVER	TIN
	ZINC

High purity alloys are made from these metals to customer specifications.

## STANDARD FORMS

INGOTS	SHEET
BARs	SHOT
RODS	POWDER
RIBBON	WIRE

## PREFORMS

Preforms are available in a range of sizes and shapes such as discs, dots, washers, squares and spheres. Enquiries are invited on our alloy preforms.

## COMPOUND SEMICONDUCTORS

INDIUM ANTIMONIDE

Available as crystals, wafers, circles, rings and other shapes made to precise tolerances.

## CHEMICALS

SALTS SOLUTIONS

# COMINCO PRODUCTS INC.

Electronic Materials Department  
933 West Third Avenue  
Spokane, Washington  
Ph. RI 7-7103 TWX: SP 311

Write for our catalogue



## Good parts work best!

Intermediate  
Frequency  
Transformer  
IFT



The high standards of MITSUMI electronic components are insured by a fully-automated assembly system, and double-checked by rigid quality controls. Mitsumi Electric Company is Japan's largest manufacturer of components for radio, television and communications equipment.

POLYVARICON  
Variable  
Capacitor



# MITSUMI PARTS

MITSUMI ELECTRIC CO., LTD.

Komae, Kitatama, Tokyo



CIRCLE 207 ON READER SERVICE CARD

## This Random-Access Crossbar Stores 200 6-Bit Instructions for Machine- Tool and Process Control. Access Time <12 Milliseconds.

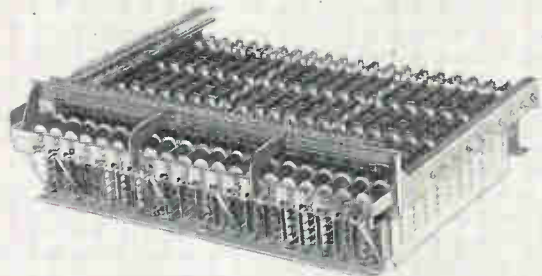

Minimize electronics, maximize reliability with this unique\* coordinately-actuated, high-speed electromechanical matrix—the ideal link between punched tape or cards and machine or process controls. 20 million operations/crosspoint rated, 100 million regularly achieved. Hundreds of modern automated devices are designed around the logic capabilities of Crossbar. Write. We'll tell you how and why.

\*Exclusivity protected by U.S. and Foreign Patents.

## Cunningham

ESTABLISHED 1838

SOPHISTICATED SWITCHING SYSTEMS  
BOX 516, ROCHESTER 2, NEW YORK

Plant & Offices:  
Honeoye Falls, N. Y.  
Phone: Honeoye Falls 485  
TWX RO 572-U



Sanborn® FIFO—fully transistorized, shown actual size

**SPECIFICATIONS: MODEL 860-4000 FIFO AMPLIFIER**

Isolated, floating, guarded input — 100 meg. impedance min. at DC

Isolated, floating output — impedance less than 35 ohms

Bandwidth DC to 3 db down at 10 KC

Max. Gain of 1000—10 mv in gives  $\pm 10$  volts out across 1000 ohms (floating). Optional Model 860-4000P with power output isolated from input can deliver  $\pm 5$  volts at  $\pm 100$  ma at ground potential

Linearity  $\pm 0.1\%$  of 10-volt floating output at DC

High Common Mode Rejection—160 db at DC, 120 db at 60 cps, 100 db at 400 cps, with 1000 ohms unbalance at source

Drift 2 uv, Noise 7 uv RMS

*Specifications subject to change without notice.*

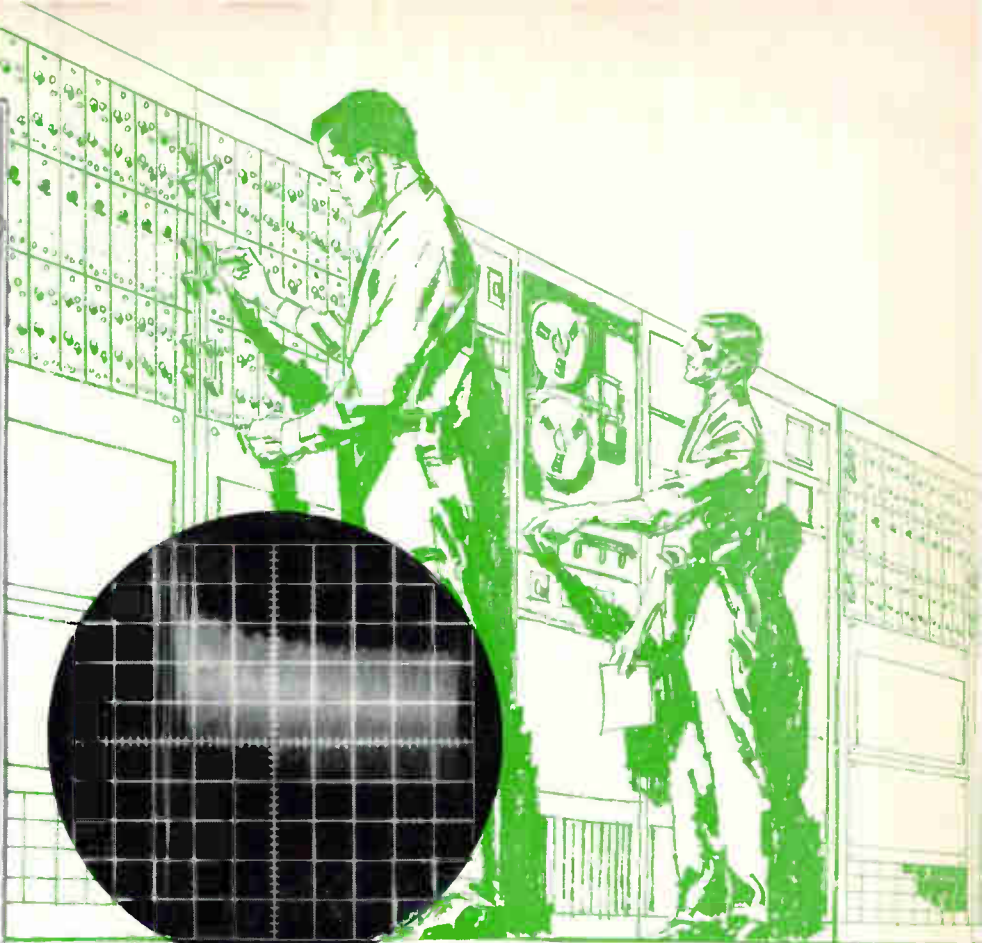

**1 MILLISECOND RECOVERY TIME** after a 14-volt overload.  
Time base,  $1/2$  ms/div; amplitude, 2% of full scale.  
A small AC signal was mixed with the overload to increase visibility of recovery trace.

## NEW 0-10 KC Floating Input-Floating Output DC AMPLIFIER

The new FIFO (floating input—floating output) is a fully transistorized amplifier designed especially for obtaining data from wide bandwidth transducers. A single FIFO used with an input scanner can amplify data from many transducers, or the outputs of any number of FIFO amplifiers may be sampled.

Model 860-4000, with gain of 1000, is particularly useful for extracting low level signals from a high noise level. Model 860-4000P (with grounded output isolated from input) can deliver  $\pm 5$  volts at  $\pm 100$  ma and is suitable for driving high frequency galvanometers. Both FIFO models have a high common mode rejection ratio and, as illustrated by the scope photo, exceptional overload recovery capability.

The FIFO amplifier is available in a portable case with individual power supply. Two channels with individual power supplies are available on a  $3\frac{1}{2}$ " x 19" panel for rack mounting, or you can mount eight amplifiers in 7" x 19" with a Sanborn Model 868-500F 8-channel power supply.

Contact the Sanborn Industrial Sales-Engineering representative nearest you or write the main office in Waltham for complete information and engineering assistance.

INDUSTRIAL DIVISION  
**SANBORN COMPANY**

175 Wyman Street, Waltham 54, Massachusetts  
A SUBSIDIARY OF HEWLETT-PACKARD COMPANY



For  
DC to 100 cps  
bandwidth

**DATA PREAMPLIFIER 860-1500S**

Has floating, guarded input and floating output; delivers  $\pm 5$  volts across 2000 ohms; linearity  $\pm 0.05\%$  of full scale (5 volts); bandwidth DC to 3 db down at 100 cps; rejection ratio 106:1 with 5000-ohm source unbalance at 60 cycles. Either fixed gain between 10 and 2000, or with attenuator to provide any selected gain within this range. Amplifier has less than 2 uv drift and less than 3 uv peak-to-peak noise.



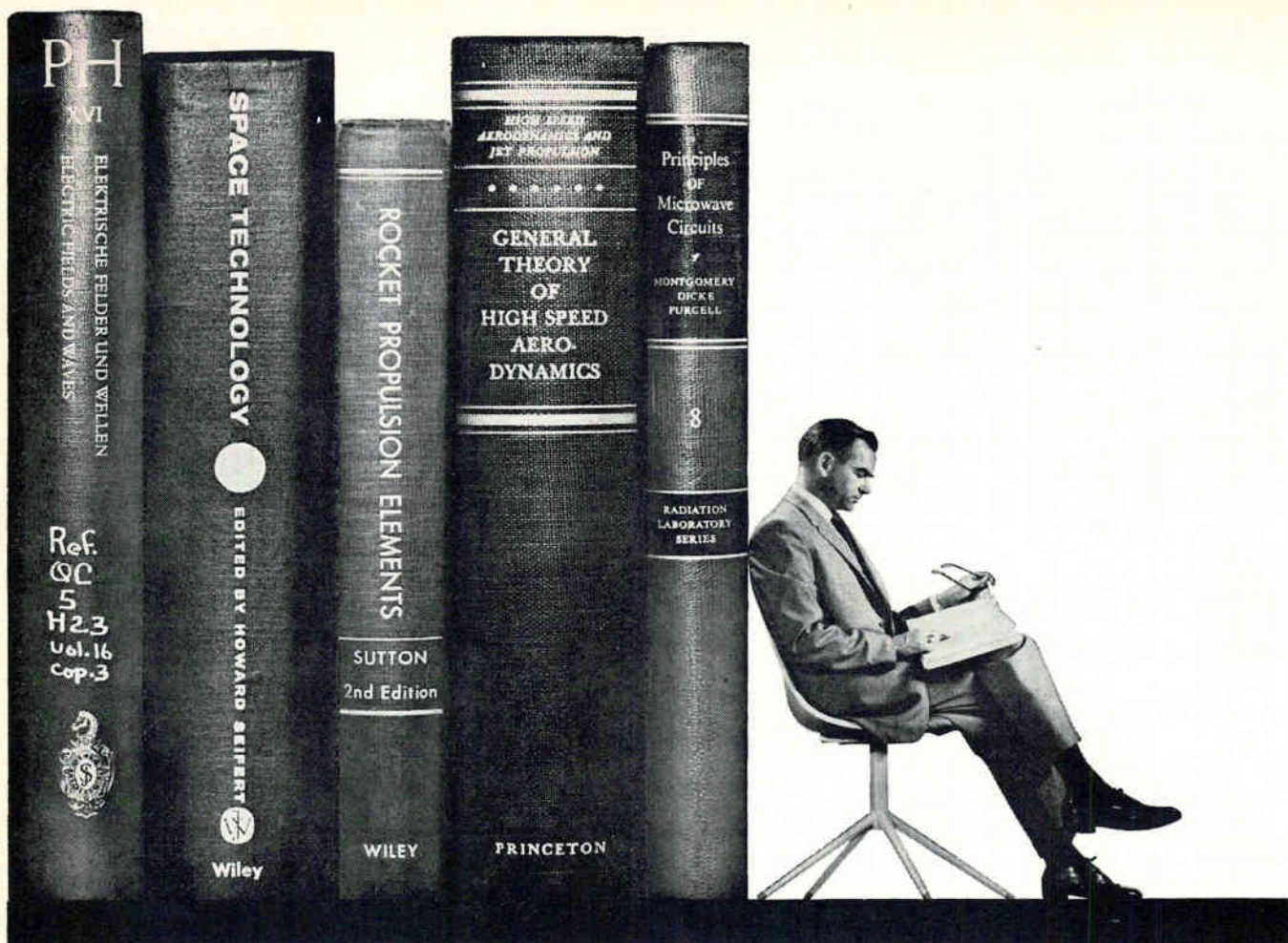

## *scientists and engineers in a unique role*

The frontiers of space science and technology are being expanded at Aerospace Corporation. The scientists and engineers of this organization are the critical civilian link uniting government and the scientific-industrial team developing space systems and advanced ballistic missiles. In this mission Aerospace Corporation provides advanced systems analysis and planning, theoretical and experimental research, initial systems engineering, initial technical direction and general technical supervision. Included in the latter are integration and review of the engineering, development and test operations of industry to the extent necessary to assure achievement of system concept and objectives in an economical and timely manner. These people are privileged to view both the state-of-the-art and system development in their totality. Immediate assignments exist for those individuals highly skilled in these specialties and who are knowledgeable in inter-disciplinary problem solving. Men with advanced degrees are urged to contact Aerospace Corporation, Room 110, P.O. Box 95081, Los Angeles 45, California.

*Organized in the public interest and dedicated to providing objective leadership in the advancement and application of space science and technology for the United States Government.*



### AEROSPACE CORPORATION

*All qualified applicants will receive consideration for employment without regard to race, creed, color or national origin.*

## NEW TAPES TAME DESTRUCTIVE HEAD-HEAT COMPLEX

SCOTCH® BRAND *Heavy Duty Instrumentation  
Tapes take new speed and friction tensions in stride!*



Today's trend to speed-up in the recording of instrumentation data—with tape speeds up to 120 inches per second—can mean "*Slow Down, Trouble Ahead!*" for tapes that can't cope. On the other hand, "SCOTCH" BRAND Heavy Duty Tapes love to live dangerously—are made for challenging environments where tape speeds are fast and getting faster, where instantaneous temperatures caused by friction between tape and head shoot up. Two new "SCOTCH" Tapes—Heavy Duty Tapes 498 and 499—are especially designed for applications where ordinary tapes soon wear out.

*They live 15 lives.* Actual field tests show that "SCOTCH" BRAND Heavy Duty Tapes last 15 times as long as standard tapes . . . stoutly resist high temperatures, both externally and internally generated. In instrumentation uses, where tensions caused by friction and heat make tape wear an important factor, these Heavy Duty Tapes preserve the integrity of the coating, minimize rub-off and particle redistribution that separate tape from head . . . and you from a signal.



*When the heat's on* for ordinary tape (above 150°F.), the binder softens and coating loosens from backing. Then the dropout count mounts. Not so with "SCOTCH" Heavy Duty Tapes! They coolly withstand the damaging effects of temperatures up to 250°F., without blocking or layer-to-layer adhesion. And excellent resolution is maintained at high and low frequencies.

*High conductivity* is another feature of "SCOTCH" Heavy Duty Tapes . . . nearly 1000 times that of conventional tapes! Static charges drain off without building up . . . you get a smooth, clean tape pass every time, with excellent resolution. This efficient static drain-off makes stray contaminants less likely to be attracted to the tape.

*At tape-killing paces*—in speeds, tensions, temperatures—we suggest you consider these heavy-duty champions of the tape world: No. 498 and (for extra recording time) No. 499. And for all your needs—in data acquisition, reduction, or control—there is a right "SCOTCH" BRAND tape for the job.

Call your 3M Representative in all major cities . . . he's a helpful guy, a convenient source of supply and information. Consult him for details or write: Magnetic Products Div., 3M Co., St. Paul, Minn.

© 1961 3M Co.

"SCOTCH" and the Plaid Design are registered trademarks of 3M Company, St. Paul 6, Minnesota. Export: 99 Park Avenue, New York, N.Y. In Canada: London, Ontario.



Magnetic Products Division **3M**  
COMPANY



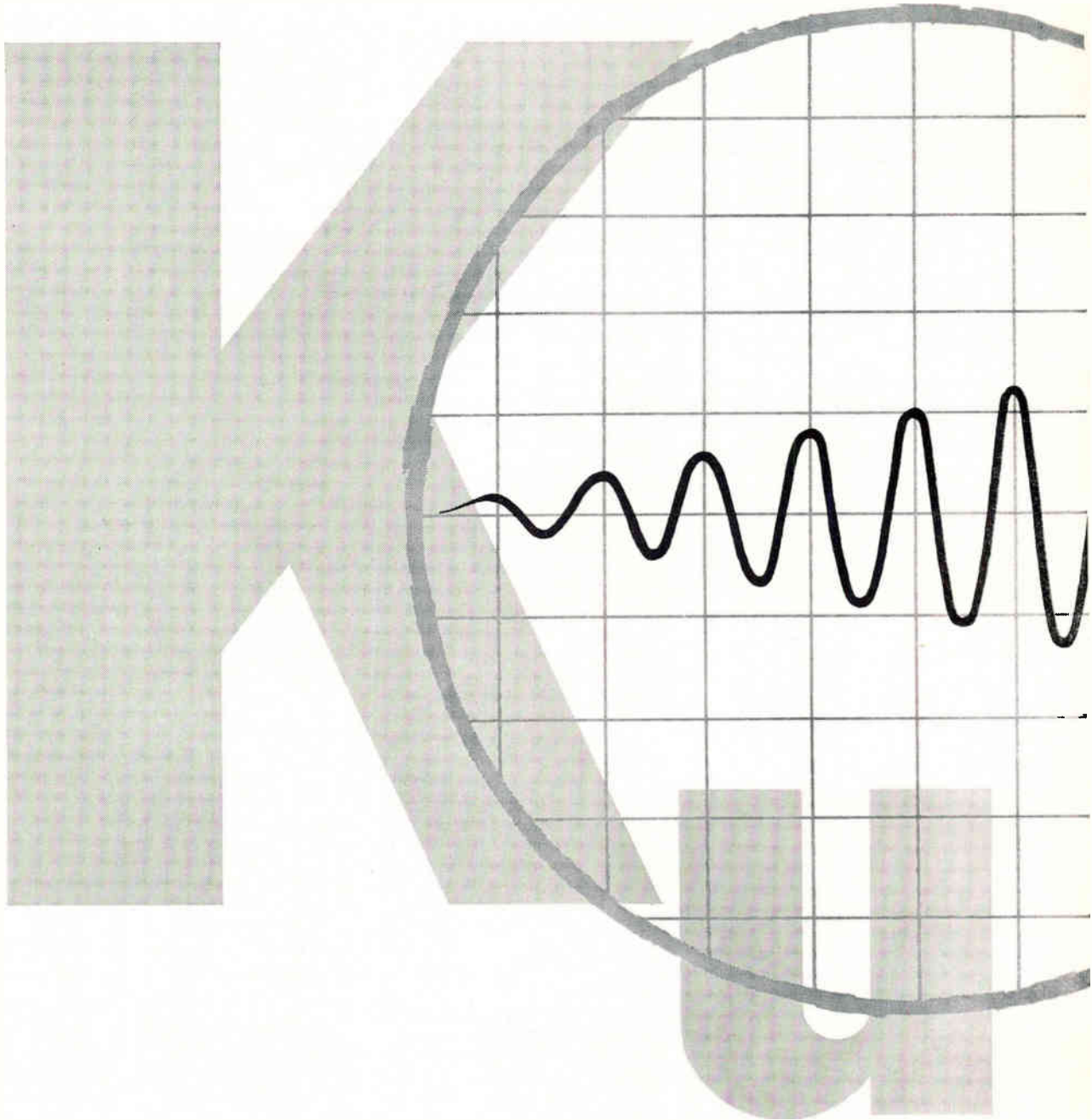

# 1 Kw 14-18 Kmc

## General Electric Announces Three $K_u$ Band TWT's With Power Up to 1 Kw



**Z-5183 (CW)**  
(without solenoid)

Saturation Gain . . . . . 30 decibels, min  
Power Output, CW . . . 10 w, nominal  
Length . . . . . 9 inches  
Weight (including solenoid) 34 pounds



**Z-5182 (CW)**  
(PPM)

Saturation Gain . . . . . 30 decibels, min  
Power Output, CW . . . 150 mw, min  
Length . . . . . 11.2 inches  
Weight . . . . . 3.0 pounds



**Z-5184 (Pulsed)**  
(without solenoid)

Saturation Gain . . . . . 25 decibels, min  
Power Output, peak . . 1 kw, nominal  
Duty Cycle . . . . . 0.01, nominal  
Length . . . . . 11 inches  
Weight (including solenoid) 20 pounds

A significant breakthrough in microwave technology now permits General Electric to offer highest available  $K_u$  Band power output.

Developed under an Air Force contract, the three new tubes can be operated singly or in cascade. The highest rated TWT, Z-5184, delivers 1 kw peak. The Z-5183 delivers 10 w CW, and the Z-5182, 150 mw CW.

With their broad bandwidth, high gain, and rugged metal-ceramic construction, General Electric TWT's offer optimum performance in critical applications, such as radar, CW amplification, ECM, microwave relay systems and radiometry. They are also particularly suitable for aircraft and space vehicle systems.

Sample tubes are available for customer evaluation. To obtain more information on these General Electric traveling-wave tubes, contact your nearest Power Tube Sales Office (telephone numbers listed below). Or write to Power Tube Department, G-E Company, Schenectady, N. Y., for bulletin PT-58.

265-12-9545-8481-44

POWER TUBE DEPARTMENT

**GENERAL  ELECTRIC**

**TELEPHONE TODAY**—Syracuse, OL 2-5102 . . . New York City, WI 7-4065 . . . Clifton, N. J., GR 3-6387 . . . Washington, D. C. EX 3-3600 . . . Chicago, SP 7-1600 . . . Dayton, BA 3-7151 . . . Orlando, Fla., GA 4-6280 . . . Los Angeles, GR 9-7765



# IN LESS THAN 4 SECONDS

FROM THIS

TO THIS

OR THIS

WITH THE REVOLUTIONARY  
PRODUCTION AID TOOL!

"PIG-TAILOR"<sup>®</sup>

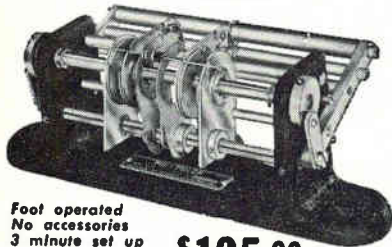

Foot operated  
No accessories  
3 minute set up

**\$125.00**

'PIG-TAILORING'

a revolutionary new mechanical process for higher production at lower costs. Fastest PREPARATION and ASSEMBLY of Resistors, Capacitors, Diodes and all other axial lead components for TERMINAL BOARDS, PRINTED CIRCUITS and MINIATURIZED ASSEMBLIES.

PIG-TAILORING eliminates: • Diagonal cutters • Long nose pliers • Operator judgment • 90% operator training time • Broken components • Broken leads • Short circuits from clippings • 65% chassis handling • Excessive lead tautness • Haphazard assembly methods.

PIG-TAILORING provides: • Uniform component position • Uniform marking exposure • Miniaturization spacing control • "S" leads for terminals • "U" leads for printed circuits • Individual cut and bend lengths • Better time/rate analysis • Closer cost control • Invaluable labor saving • Immediate cost recovery.

Pays for itself in 2 weeks

"SPIN-PIN"<sup>®</sup>

Close-up views of "SPIN-PIN" illustrate fast assembly of tailored-lead wire to terminal.

- No Training
- No Pliers
- No Clippings
- Uniform Crimps
- 22 Sizes

PAYS FOR ITSELF  
THE FIRST DAY!

**\$500**  
EACH

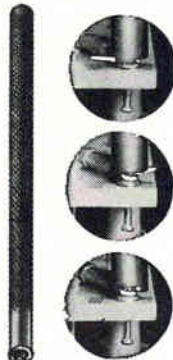

Write for illustrated book to Dept. E-12



**BRUNO-NEW YORK INDUSTRIES CORP.**

DESIGNERS & MANUFACTURERS OF ELECTRONIC EQUIPMENT

460 WEST 34th STREET • NEW YORK 1, N. Y.

now - tin oxide trimmers



"Infintrim"<sup>®</sup> by Intellux

Resolution is stepless, TC is better than 50ppm/°C and they are great for high ambient temperatures. Yet, Infintrims are interchangeable with ordinary trimming potentiometers.

Available in the popular 1/2" square shape as well as round, in values from 100 ohms to 10K.

Up date your circuits now . . . improve performance and reliability.

*intellux*

INCORPORATED

P.O. Box 929, Santa Barbara, Calif.

CIRCLE 209 ON READER SERVICE CARD

Write for complete  
"Infintrim Data"

# TEST FAST

AS-109-B



AS-101-B

AS-113-B



AS-112-14



AS-102-20



WITH EECO DUAL-CONTACT  
SOCKET ADAPTERS FOR RELAYS  
AND OTHER SOLDER  
TERMINAL COMPONENTS

Now you can halve the time for acceptance testing or breadboard checking, by using EECO socket adapters. End clip lead fumbling. Dual insulated contacts for each pin eliminate effect of contact resistance in measuring voltage drop. Highest specifications. AS Series adapters \$15 plus .50 per pin, substantial price breaks for quantity. Order from more than 50 configurations in catalog or send in your header and request quote at low standard price.

SEND FOR CATALOG AS-2



AUTOMATION DIVISION

**Electronic Engineering Company** of California

1601 E. Chestnut Ave. • Santa Ana, Calif. • KImberly 7-5501 • P. O. Box 58

Representative in Western Europe and Israel: Electronic Engineering S.A., C.P. 142, Fribourg, Switzerland EE 1-35

CIRCLE 210 ON READER SERVICE CARD

electronics

# TWA's superior experience is your assurance of superior cargo service



Fast, efficient service across the country or across the Atlantic. Detailed, meticulous service. When your business can profit by that kind of service, call TWA Air Freight. To serve you as no other airline can, TWA has:

**Exclusive nation-wide, world-wide routes.** Only TWA can give you one-carrier service to key cities within U. S. and major markets in Europe, Africa and Asia.

**Experienced personnel.** TWA's cargo experts are professionals like yourself. Abreast of the latest developments, they're ready to serve you with knowledge and skill.

**A fast growing fleet of modern planes.** Fast SuperJets and all-cargo Jetstream express flights move cargo of all descriptions over the world day and night.

**Unsurpassed maintenance for on-time performance.** Care that exceeds government standards keeps TWA planes in peak condition. Experience keeps them on time.

TWA has grown with the air freight industry. What's more, we've planned for its future. That's why in the busy years to come, TWA will continue to deliver your goods where the business is . . . *quickly, efficiently, dependably!*

Call your freight forwarder, cargo agent or nearest TWA Air Freight office for details of how TWA Air Freight can save you time and money.

\*TWA THE SUPERJET AIRLINE is a service mark owned exclusively by Trans World Airlines, Inc.

**TWA** THE  
SUPERJET  
AIRLINE®  
U.S.A. · EUROPE · AFRICA · ASIA



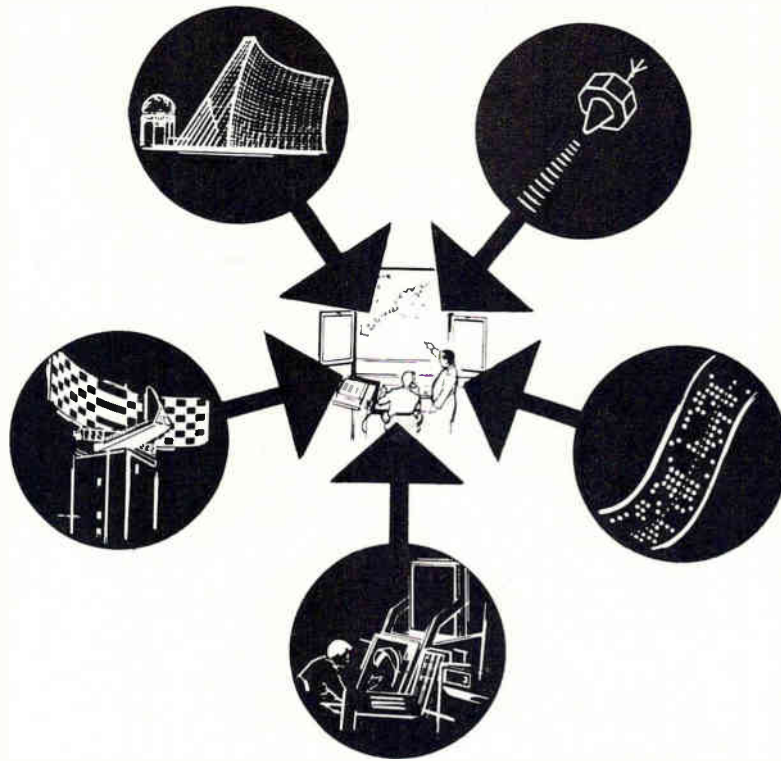

VITAL: command and control systems which collect, transmit, process and display information to military commanders responsible for compressed-time decisions.

THE  
**MITRE**  
 CORPORATION

is now engaged in designing and developing computer-based command and control systems which collect, sort, transmit, and display information vital to those who make command decisions. SAC's Command and Control System, SAGE, BMEWS, NORAD, MIDAS and other urgent military programs are all within the scope of MITRE's system integration work.

Formed in 1958, MITRE is an independent nonprofit corporation with a growing technical

staff engaged in systems planning, engineering and management for the Air Force Electronic Systems Division.

You are invited to join this scientific community and participate in important work which is performed in an atmosphere of objectivity and free inquiry.

Engineers and scientists interested in the vital field of command and control technology may inquire about openings in:

- Operations Research
- Communications
- Human Factors
- System Cost Analysis
- Econometrics
- Radar Systems and Techniques
- System Analysis
- Advanced System Design
- Computer Technology
- Mathematics
- Air Traffic Control System Development
- Antenna Design Microwave Components

Write in confidence to: VICE PRESIDENT — TECHNICAL OPERATIONS, THE MITRE CORPORATION,  
 Post Office Box 208, Dept. WN17, Bedford, Massachusetts

*An equal opportunity employer*

Different potting and encapsulating problems require different solutions. That's why General Electric offers a family of eight RTV and LTV silicones. LTV-602, for instance, is transparent, resilient and very easy to repair, curing in two hours. RTV liquid silicone rubber compounds offer good physical strength, resiliency and a selection of viscosities for impregnation, potting, conformal coatings or sealing.

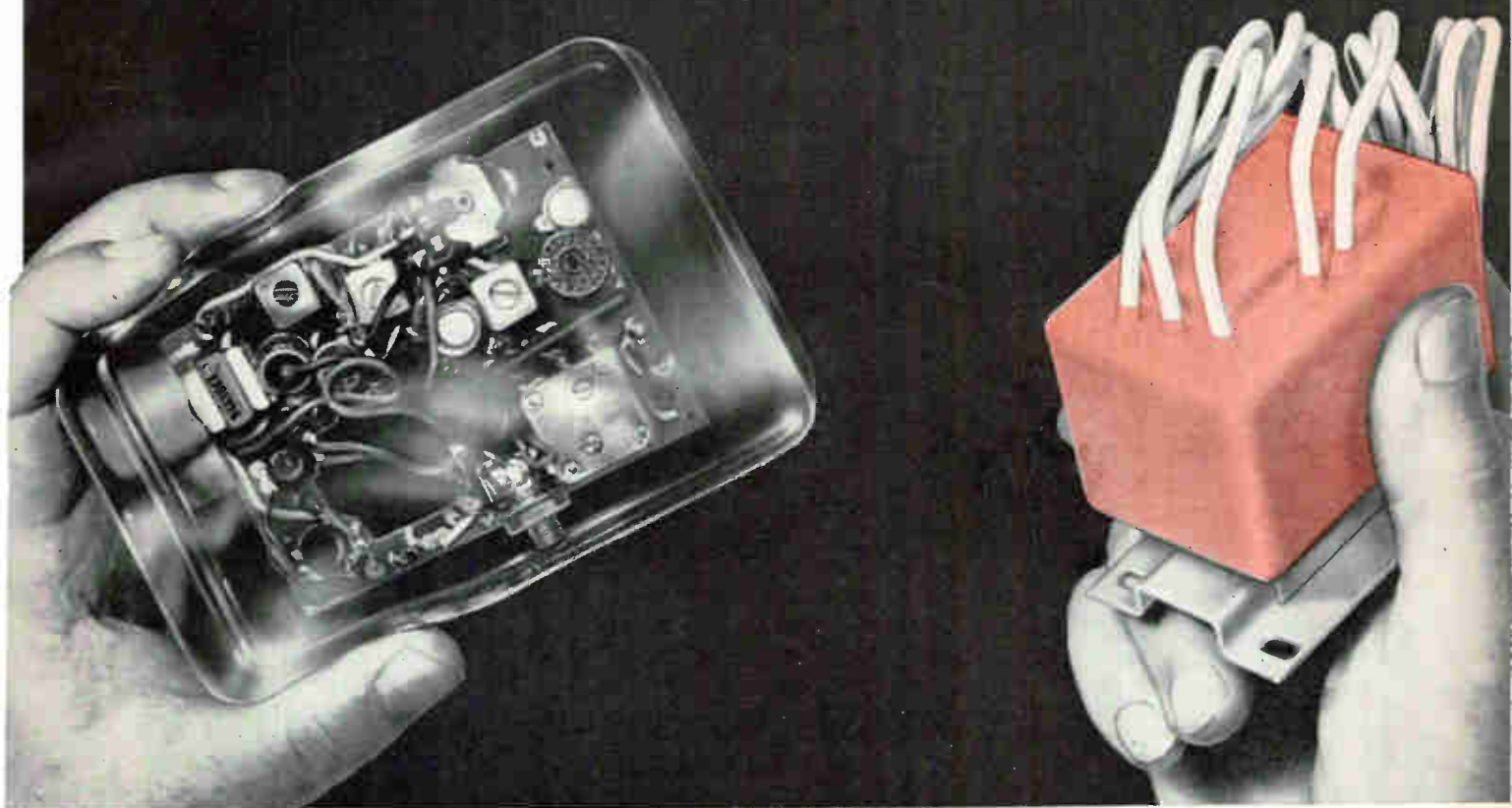

## 8 fast cures for potting and encapsulating problems

*General Electric Silicones protect against temperature, moisture, ozone, thermal and mechanical shock*



**Why are G-E silicones used?** To protect against temperature extremes from  $-65^{\circ}\text{F}$  to  $600^{\circ}\text{F}$  . . . to provide a resilient, shock-absorbing cushion for delicate parts . . . for outstanding electrical properties . . . for their very low (0.2%) shrinkage . . . for their resistance to moisture, ozone and thermal shock.



**How are G-E silicones used?** By dipping, pouring, spraying or buttering. Cure times can be varied from minutes to hours, depending on catalyst used and the heat applied (from room temperature to  $125^{\circ}\text{C}$ ). They bond easily to properly primed surfaces, are easily removed from unprimed surfaces.

	COLOR	VISCOSITY POISES	CONSISTENCY
LTV-602	Clear	15	Easily Pourable
RTV-11	White	120	Pourable
RTV-20	Pink	300	Pourable
RTV-40	White	450	
RTV-60	Red	550	
RTV-77	White	8,000	Spreadable Thixotropic Paste
RTV-88	Red	10,000	
RTV-90	Red	12,000	Stiff Paste

**Which is best for you?** G-E encapsulants vary in viscosity from a readily pourable liquid to a thick paste to fit special requirements. Applications range from deep impregnation of transformer coils to caulking of large equipment . . . from printed circuit encapsulation to making flexible molds.

Write for complete data. If you would like a free sample for evaluation, write on your business letterhead describing your proposed application. Section N1264, Silicone Products Dept., General Electric Co., Waterford, New York.

**GENERAL**  **ELECTRIC**

CIRCLE 49 ON READER SERVICE CARD





**WILLIAM C. DIMAN,**  
Hayes Furnace Division  
Manager, explains . . .

## WHY ELECTRONICS TURN TO HAYES

*Extremely Close Process Control* is vital in manufacturing semi-conductors and other electronic parts. Without this control, costs and scrap rates go up, product performance becomes unpredictable, and product life is drastically reduced. *The Trend Is To Hayes*—More and more electronic firms are looking to Hayes for consulting assistance and for equipment to solve complex and exacting heat treat jobs. Here are some "for instances" of the advanced equipment Hayes is offering:

**HAYES BA-19D DIFFUSION FURNACE** Highly precise unit assures even diffusion on silicon or germanium wafers. Extremely critical temp. control (reactor type). Uniform "flat" zone in depositing chamber totally free from temp. "ripples". Engineered atmospheres and distribution. Built-in program controller and instrument panel. Silicon carbide heating elements — temps. to 1350°C. Easy to maintain. Shipped complete, ready to operate. Type LA-19D furnace with nickel-chrome elements — temps. to 1000°C.



**HAYES LAC-55M ALLOYING FURNACE** Now used by many major electronics firms for alloying, metal bonding, soldering, other applications requiring close temp. control through 300°C to 1100°C. Unusual flexibility. 5-zone temp. control . . . maintain temps. within  $\pm 1/2^\circ\text{C}$ .



**HAYES MS-31R RECIRCULATING DRYER** Molecu-Dryer complete with gas/air recirculating unit, for "dry box" atmospheres for assembly of transistors, diodes, other electronic parts. Dew points to -100°F or lower. Economical — replaces expensive tank nitrogen. Simple controls. Easy maintenance. Standard units caps. to 16,000 CFH. Higher caps. on special order.



Hayes equipment covers every electronics requirement: zone refining, crystal growing, alloying, metal bonding, glass (or ceramic)-to-metal sealing, vacuum heat treating, high temp. outgassing, air/gas drying, atmosphere generation (hydrogen, nitrogen, dissociated ammonia, forming gas, endo and exo gases.) With theoretical development work in the lab backed-up by a double-check on actual production-scale equipment . . . Hayes can help you improve quality, cut costs, increase production. Write for Bulletin 5711C.

### C. I. HAYES, INC.

845 WELLINGTON AVE., CRANSTON 10, R.I.  
Established 1905



It pays to see Hayes for metallurgical guidance, lab. facilities, furnaces, atmosphere generators, gas and liquid dryers, Hayes-Master (TM) control units.

## REMOTE DATA RETRIEVERS, EVENT AND DATA RECORDERS

117.50  
121.00  
122.99  
127.99

## PRINT AND PLOT SIMULTANEOUSLY

**HOGAN FAXimile** recorders are available with up to 2000 individual styli for simultaneous recording. A wide range of stylus spacings is offered—up to 100 to the inch for high-speed facsimile, television and radar recorders and high resolution printers and plotters. Chart widths to 30" and feed rates to 50" per second.

Hogan specializes in electrolytic techniques for event, spectrum analysis, oscillograph and facsimile recording, frequency time analysis and special purpose binary and gray scale record applications. Hogan electrolytic recording papers provide a permanent high contrast black on white record which is reproducible on most conventional office duplicators.

Whatever your recording problem may be — contact **HOGAN FAXimile**, a subsidiary of **TELAutograph Corporation**, 635 Greenwich Street, New York 14, N. Y.

**HOGAN FAXimile Corporation • 635 Greenwich St., New York 14, N. Y.**  
A SUBSIDIARY OF TELAUTOGRAPH CORPORATION

CIRCLE 211 ON READER SERVICE CARD

thinking of magnets? think of

# PERMAG

- all sizes engineering
- all shapes precision grinding
- all grades precision cutting
- 24-hour delivery magnetizing

PERMAG CORP., 88-06 VAN WYCK EXPRESSWAY, JAMAICA 18, N. Y.  
PERMAG PACIFIC CORP., 2910 S. LA CIENEGA BLVD., CULVER CITY, CALIF.



CIRCLE 212 ON READER SERVICE CARD

# NEW IDEAS FOR SALE!

Words and pictures tell you about the top new product ideas each week in "On the Market". Who makes 'em and what they'll do for you. Easy way to keep in touch with the latest and best.

Another reason why it will pay you to subscribe to *electronics* (or renew your subscription) right now. Fill in the box on Reader Service Card. Easy to use. Postage free.

FIND WHAT  
YOU NEED IN . . .

# electronics

# VERSATILE

Multi-channel—telegraph A1 or telephone A3

# STABLE

High stability (.003%) under normal operating conditions

# RUGGED

Components conservatively rated. Completely tropicalized



FROM GROUND TO AIR OR POINT TO POINT

Here's the ideal general-purpose high frequency transmitter! Model 446, suitable for point-to-point or ground-to-air communication. Can be remotely located from operating position. Coaxial fittings to accept frequency shift signals.

This transmitter operates on 4 crystal-controlled frequencies (plus 2 closely spaced frequencies) in the band 2.5-24.0 Mcs (1.6-2.5 Mcs available). Operates on one frequency at a time; channeling time 2 seconds. Carrier power 350 watts, A1 or A3. Stability .003%. Nominal 220 volt, 50/60 cycle supply. Conservatively rated, sturdily constructed. Complete technical data on request.

Now! Complete-package, 192 channel, H.F., 75 lb. airborne communications equipment by Aer-O-Com! Write us today for details!

*Also available — Aerocom  
Model 1046 with 1 KW  
nominal carrier power and  
Model 100TFA—100 watts*

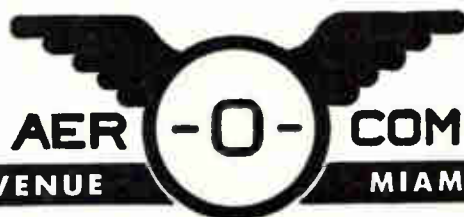

3090 S. W. 37th AVENUE

MIAMI 33, FLORIDA

A-131



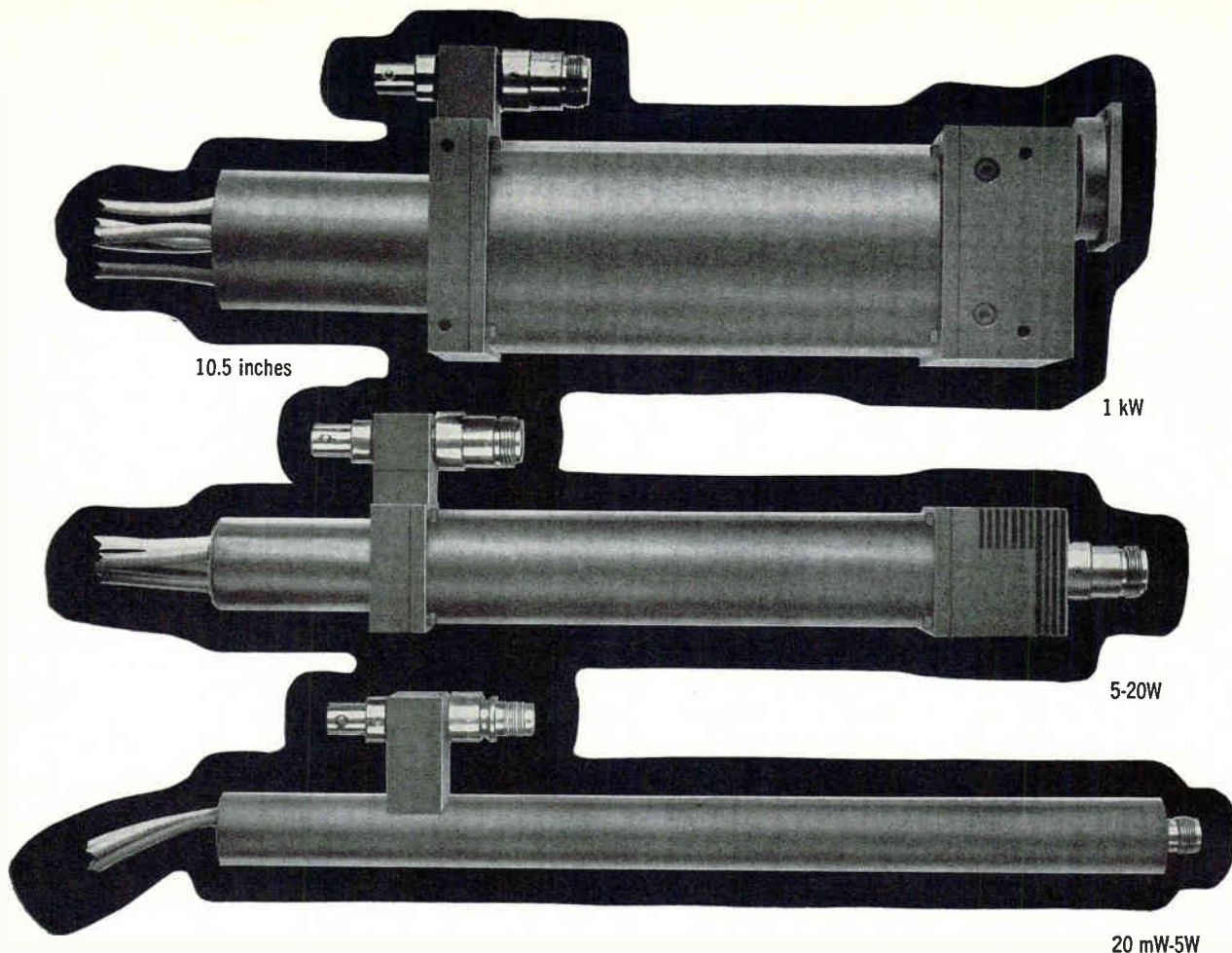

## NEW LITTON TRAVELING WAVE TUBES

**20 mW to 5.5 kW, 400 Mc to 11,000 Mc**

Want high performance, high CW power and wide bandwidth from a compact, lightweight TWT? You get just that with the Litton Industries underweight, undersized family of TWT's that are bigger and better in every other way. For instance, the L-3472 gives you 10 watts in a 12-inch, 2.5-pound package. The 2-watt L-3612 is only 11 inches long and weighs just 1.5 pounds.

Most of these tubes are PPM focused. Special helix design and fabrication techniques have raised the saturation gain to within three db of small signal gain. Can be supplied with small signal gains up to 60 db. Input and output circuits are coaxial, providing minimum frequency sensitivity. Bandwidth limited only by combined beam-circuit bandwidth. Optimum voltage for small signal operation same as for saturated operation. Helix isolated from tube body, permitting overload protection, helix modulation, and helix current monitoring.

Guaranteed to withstand Class II military environment. Applications include airborne ECM, power tube driver, radar target repeaters, and voice and data communications systems.

Contact us at San Carlos, California, for more information.

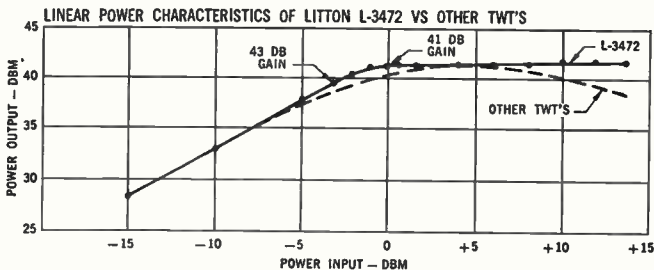

Tube Type Number	Frequency Range Megacycles	Power Output Minimum	Small Signal Gain Minimum	Duty Factor
L-3499	2000-4000	2 W	36 db	CW
L-3663	2000-4000	10 W	33 db	CW
L-3619	2000-4000	20 W	33 db	CW
L-3470	4000-8000	20 mW	36 db	CW
L-3711	4000-8000	1 W	36 db	CW
L-3471	4000-8000	2 W	36 db	CW
L-3657	4000-8000	10 W	33 db	CW
L-3658	4000-8000	20 W	33 db	CW
L-3611	7000-11000	20 mW	36 db	CW
L-3612	7000-11000	2 W	36 db	CW
L-3528	5000-11000	5 W	33 db	CW
L-3472	7000-11000	10 W	36 db	CW
L-3529	7000-11000	20 W	36 db	CW
L-3614	8000-11000	1 kW	36 db	.02
L-3497*	1240-1400	5.5 kW	40 db	.06
L-3674*	400- 450	5 kW	37 db	.06
L-3637*	5900-8400	200 mW	30 db	CW

\*In Development



**LITTON INDUSTRIES**  
**Electron Tube Division**

MICROWAVE TUBES AND DISPLAY DEVICES

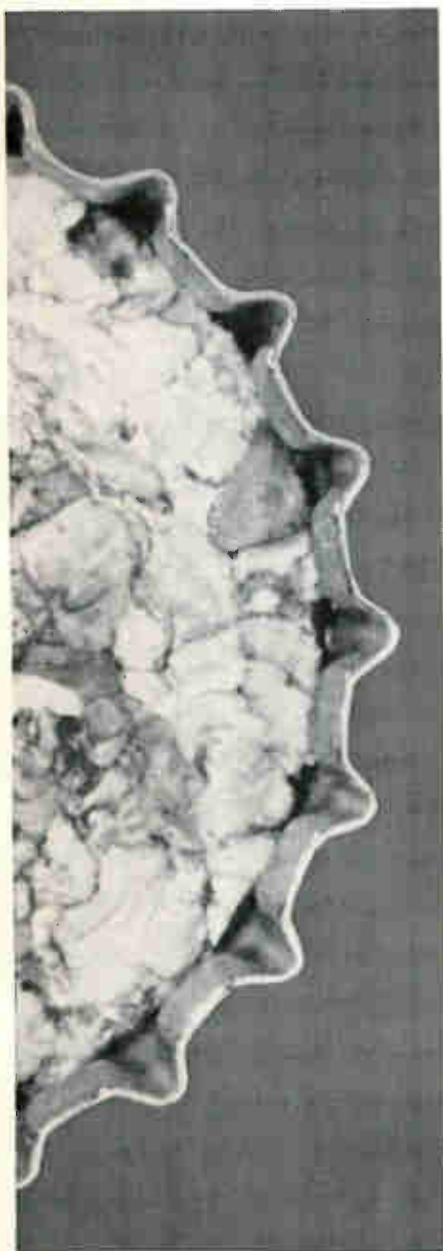

Counting bottle caps, pills or tiles . . . Veeder-Root electronic counters with photo-electric input record up to a surprising 300,000 units per minute.

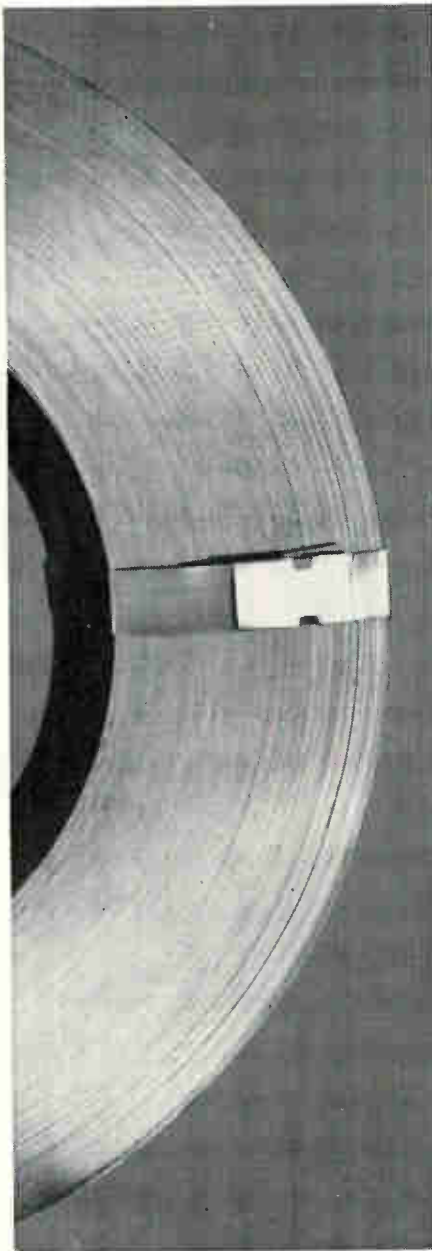

Operators in the remote control booth of high-speed strip mills get automatic readings of steel production on Veeder-Root electrical counters.

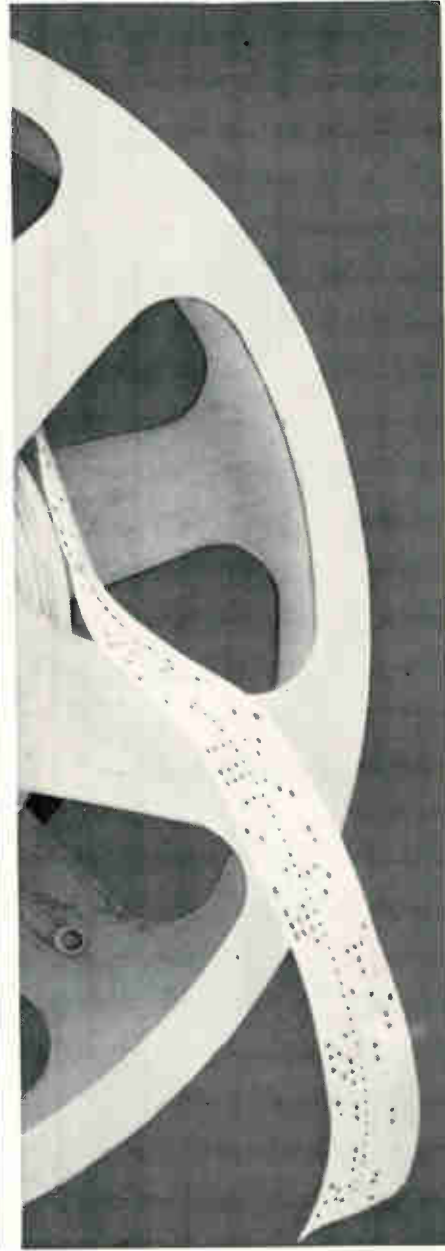

In industrial automation systems, Veeder-Root remote digital readout coordinates control, makes operating data instantly, constantly available.

**Indicate, coordinate, automate...with Veeder-Root counters!**  
Now get facts fast—facts you can use for stepping up your operation, for integrating parts of it, for activating other equipment, automatically. Veeder-Root makes facts like these surprisingly economical to come by. For details, write **Veeder-Root Inc., Hartford 2, Conn. count on...Veeder-Root**



# front end

# at the finish

# and...

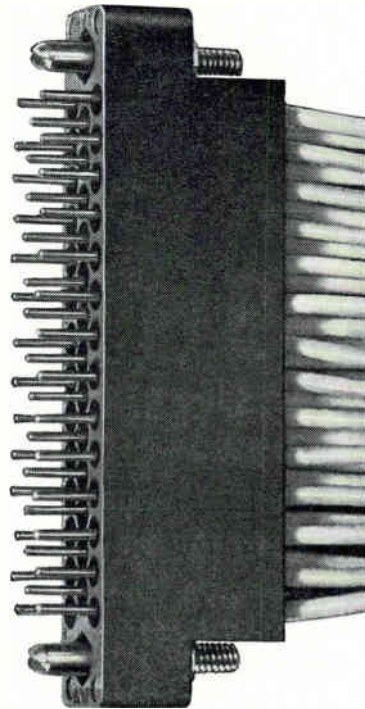
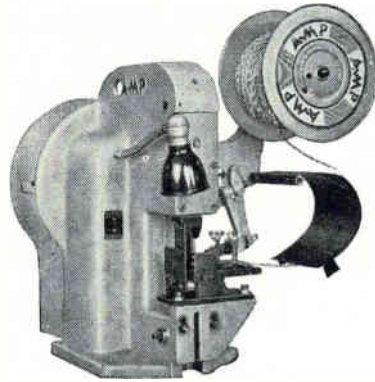
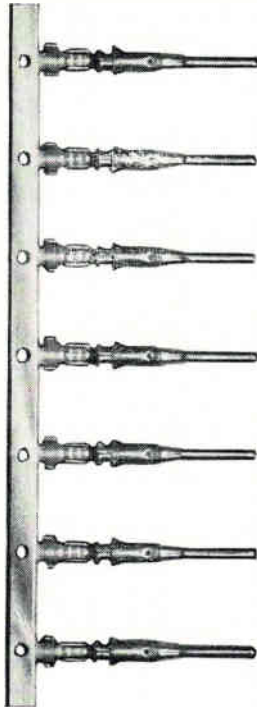

## AMPin-cert\* Pin And Socket Connectors Cost Less!

... and there are two good reasons why!

AMPin-cert Connectors give you the only stamped and formed pin and socket contacts in the industry.

Automatic application of the AMP\* solderless termination technique precision crimps contacts to leads at rates of 1,600 or more per hour with the use of minimum skill labor.

AMPin-cert Connectors cost less to buy and ... less to apply—give you connector performance of extreme reliability at the lowest installed cost in the industry.

Additional features include:

- Choice of 5 types of contacts
- Snap-in design contacts with cantilever beam construction for easy insertion and dependable retention forces
- Wide variety of configurations and sizes
- Complete line of matching hardware

For all the money-saving facts on AMPin-cert Pin and Socket Connectors write for complete information today!

\*Trademark of AMP Inc. \*

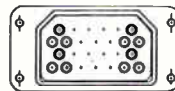
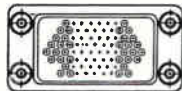
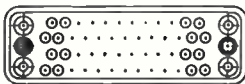

# AMP INCORPORATED

GENERAL OFFICES: HARRISBURG, PENNSYLVANIA

AMP products and engineering assistance are available through subsidiary companies in: Australia • Canada • England • France • Holland • Italy • Japan • Mexico • West Germany

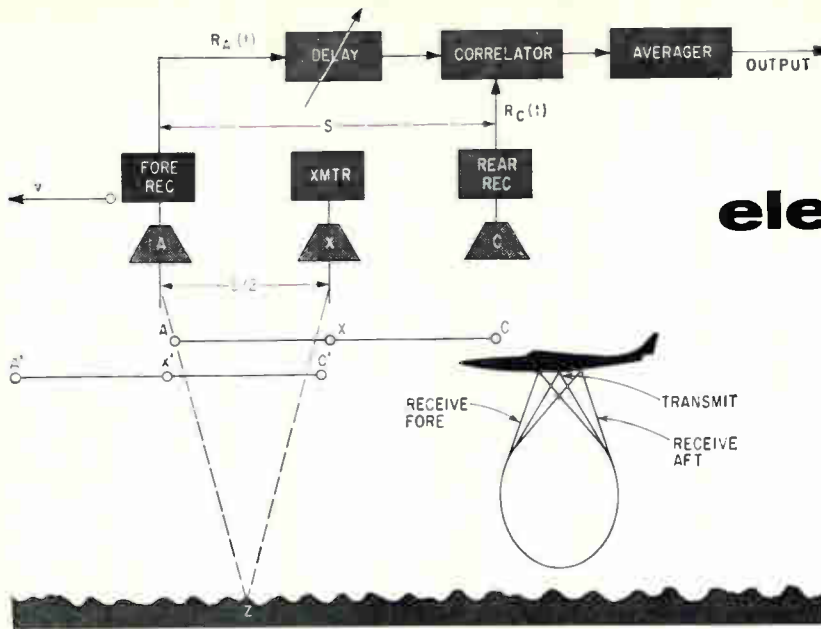

FIG. 1—Basic navigation system using correlation techniques. Inset of aircraft to right shows the transmit and receiver beam configuration

# Air and Space Navigation System

## USES CROSS-CORRELATION DETECTION TECHNIQUES

By RAYMOND J. MILLER, Advanced Guidance and Navigation Unit, Light Military Electronics Dept., Advanced Electronics Center, General Electric Co., Ithaca, N. Y.

*Time-domain measurement of reflected microwave beams determines surface velocity of aircraft or space vehicles. Time measurement is made by correlating echo signals received by several separated antennas*

THE CORRELATION NAVIGATOR is a self-contained surface speed and drift angle measuring system with capabilities for measuring altitude above terrain and vertical velocity.

This navigator is independent of the nature of the terrain and sea states encountered during operation. Unlike doppler systems, the system takes advantage of unique characteristics of radar signal returns from individual scatterers.

Self-contained velocity sensors using doppler frequency measurements of the echo power from one or more microwave beams have been developed. It is also possible to make a time-domain measurement of reflected microwave beams to determine surface velocity of a moving vehicle (see Ref.). This time measurement is made by cor-

relating the echo signals received by several separated antennas.

The inset in Fig. 1 shows transmit and receive beam configuration. One advantage over a doppler navigator is that a single wide beam of microwave energy is transmitted and the center of this beam is oriented perpendicular to the underlying reflecting surface. Ordinarily this reflecting surface would be the earth; however, the velocity sensing capability would be equally useful during approaches to the moon or other planets. Several receiving antennas are used and these also have vertically oriented broad-beam patterns. Because of the broad r-f beam patterns, small horn antennas are used throughout. This is not done as a technical trade-off: accuracy of the correlation technique is



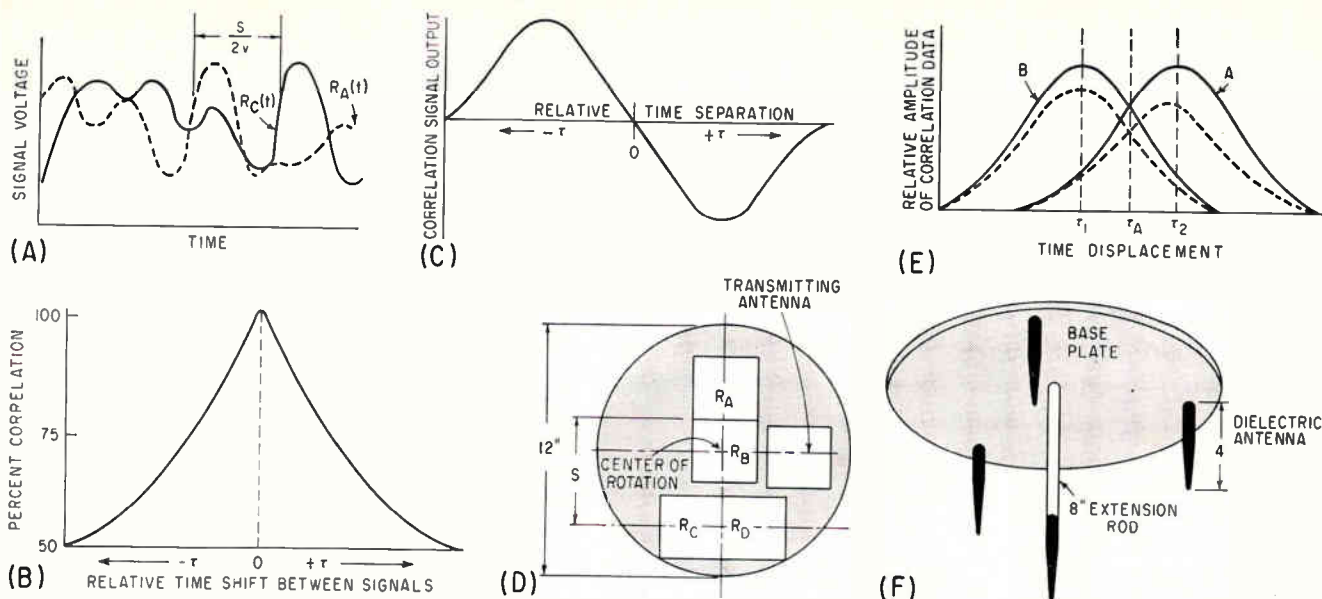

FIG. 2—Typical samples of  $R_A(t)$  and  $R_C(t)$  (A); autocorrelation curve for random function (B); differentiated correlation curve (C); antenna layout (D); data correlation curves (E); design of a receiving antenna that includes measurement of vertical velocity (F)

enhanced by use of small antennas and broad beamwidths.

The cross-correlation detection technique is based upon the principle that the echo return from a set of fixed scatterers at a point in space under identical conditions of transmission and reception is unique and reproducible at different times. This principle has been employed in airborne MTI systems to remove the ground clutter, and is a function of the aircraft velocity. The MTI technique accomplishes clutter removal by electrically phase-displacing the center of the receiving antenna so that during a pulse repetition interval, the antenna remains effectively stationary. The correlation navigator reverses this process by seeking out the amount of electrical phase shift required for maximum cancellation and then determining vehicle surface velocity from this information.

Figure 1 shows a simple correlation navigator including the relative positioning of the antennas and the method of signal processing. A single transmitter horn, X, and two receiving horns, A and C, are shown. Directly beneath the horns, two system positions in time are indicated. The two positions are separated by a distance,  $S/2$ , and in time by  $\tau$ .

Figure 1 shows that the path followed by transmitted energy to a scatterer, Z, and back to the receiving antenna, A, is identical to, but reversed in direction from, the path

followed by transmitted energy which is reflected  $\tau$  time later from scatterer Z back to receiving antenna C.

This example has only a single scatterer. However, the same argument holds for all other scatterers within the surface area intercepted and illuminated by the transmitted beam. Thus, the integrated received signals indicated by  $R_A(t)$  and  $R_C(t)$  in Fig. 1 are similar, but displaced in time by  $\tau$ .

From Fig. 1,  $\tau$  is inversely proportional to the indicated velocity,  $V$ , and is defined by:

$$\tau = \frac{\text{distance}}{\text{velocity}} = \frac{S/2}{V} = \frac{S}{2V} \text{ or } V = \frac{S}{2\tau} \quad (1)$$

The detected signals,  $R_A(t)$  and  $R_C(t)$ , are band-limited random noise signals, generally limited to the audio spectrum.

The upper frequency limit of the detected signals is directly proportional to the frequency of transmission twice the velocity of the vehicle and the sine of one-half the transmitted beam angle. Fig. 2A shows how typical samples of  $R_A(t)$  and  $R_C(t)$  would look.

In Eq. 1,  $S$  is known and can be measured as the mechanical spacing between the two receiving antennas. More properly,  $S$  is the spacing between the electrical centers of the two receiving antennas, and for high accuracy systems, the exact value of  $S$  must be ascertained during system operation over a calibrated course. Although  $S$  is a crit-

ical dimension in the measurement of  $V$ , the main criterion is that  $S$  remain fixed once the system has been calibrated. Original fabrication errors can be calibrated out of the system and through proper construction techniques,  $S$  can be held stable over the system operating environmental ranges.

Time  $\tau$  is a measurable function and is denoted as the time spacing between  $R_A(t)$  and  $R_C(t)$  in Fig. 2A. As indicated in Fig. 1,  $R_A(t)$  is passed through a variable delay line and the delayed  $R_A(t)$  is correlated against  $R_C(t)$  as the delay time is varied. When maximum correlation is achieved, the corresponding delay time is read out and substituted in Eq. 1 for  $\tau$  to establish the related value of  $V$ . This maximum correlation is achieved when the function  $R_A(t)$  of Fig. 2A is slid in time to the right until it is superimposed directly on function  $R_C(t)$ .

The position of the transmitting antenna midway between the receiving antennas (Fig. 1), is not essential in an operational system. The transmitting antenna may be at any convenient place on the vehicle, and can be the radar transmitter for another onboard system if it is at the same frequency and illuminates the desired surface area to provide a satisfactory backscattered signal.

Figure 2B shows a typical autocorrelation curve for a random function. The curve is symmetrical about the zero relative time shift

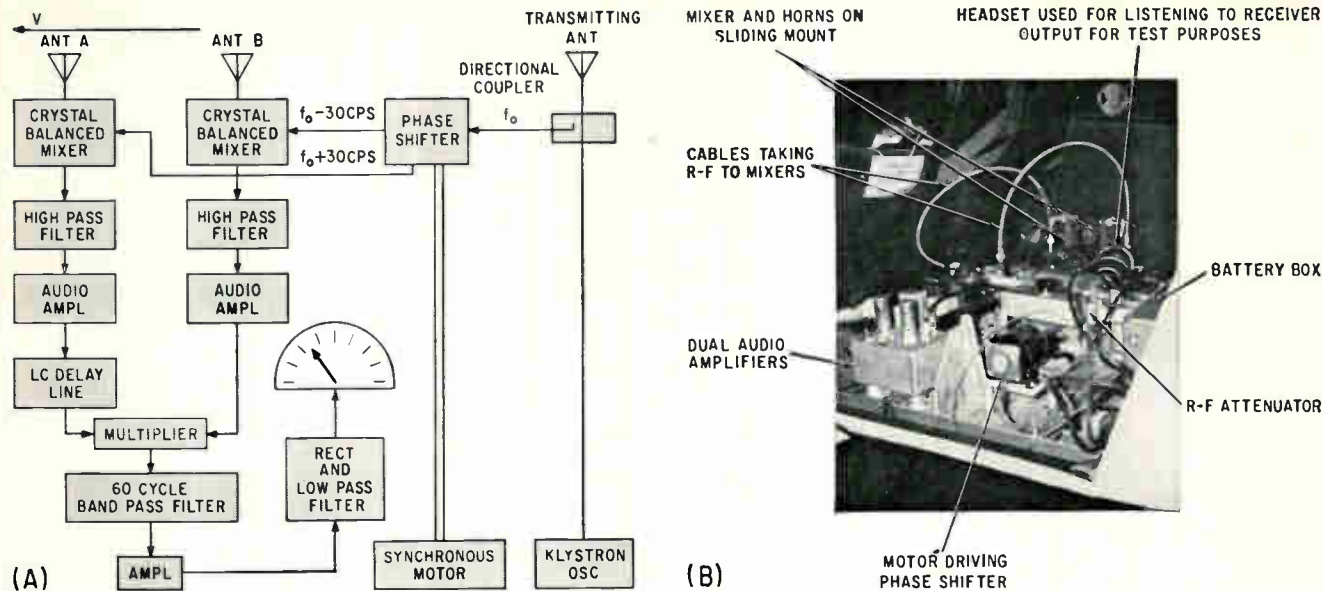

FIG. 3—Experimental correlation navigator radar that was flight tested (A); and navigator shown mounted in the test aircraft (B)

between the two signals. Since  $\tau$  must be measured accurately to determine  $V$ , it is desirable to operate on the correlation curve in a region where a small change in  $\tau$  results in a significant change in the correlation output signal. Therefore operation at the peak of the correlation curve is undesirable since the curve passes through zero slope in this region. One way to accomplish the desired effect is to differentiate one of the received signals prior to correlation with the other received signal. This is equivalent to differentiating the correlation curve, and results in a curve similar to Fig. 2C. This curve has maximum slope in the desired region of operation near  $\tau = 0$ .

However, this technique is not desirable: it requires a null detector operating about the zero signal level during lock-on; for operation over a sea surface and due to the decorrelation effects of a moving sea surface, the correlation curve itself becomes distorted so that it is no longer symmetrical and the zero crossover in Fig. 2B shifts. Although unrelated, this would produce a velocity measurement error somewhat equivalent to a sea bias error in a doppler system.

The foregoing discussion leads to the data processing technique used in the correlation navigator. Consider Fig. 2D which shows the actual antenna structure layout.

Four receiving horns and one transmitting horn are used. Actual

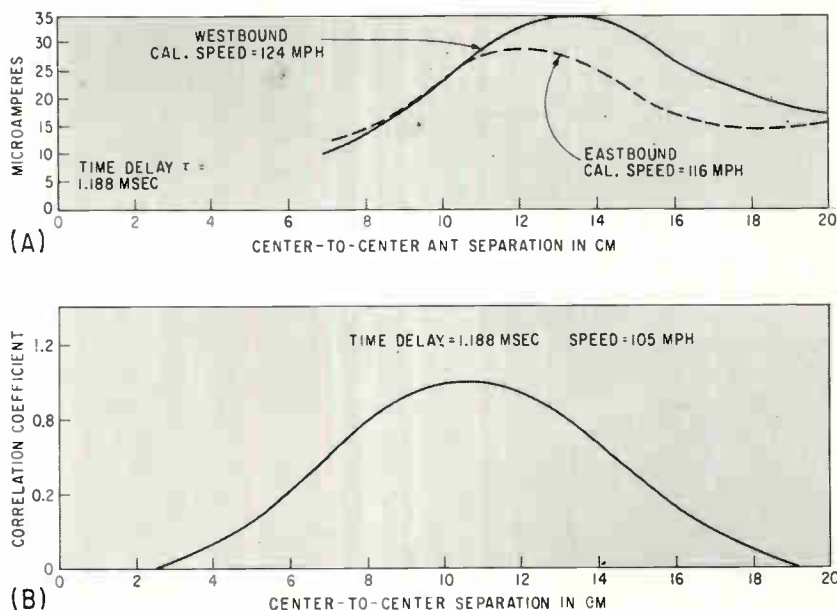

FIG. 4—Flight test data: (A) westbound peak position is 13.2, eastbound 12.3. Calculated speed (mph) =  $X/2\tau$  (where  $X$  is peak position in cm). Theoretical curve of cross correlation vs antenna separation (B)

antenna type and size will vary somewhat with the specific application, but in general each horn is approximately 3 inches square (assuming X-band transmission), resulting in an integral antenna structure of under 12 inches in diameter. With this antenna arrangement and with appropriate switching, the backscattered and received signals are processed to provide surface speed and drift angle information to a navigation computer.

In obtaining surface speed infor-

mation, the signal received by each of the forward horns is alternately correlated against the signals received by the rear pair. Since a different physical spacing is associated with these alternate correlations, two time spacings are associated with the two peak correlations (see Fig. 2E).

Curve A is the correlation curve between the data obtained at  $R_A$  and the data obtained at the rear horns. Curve B is the correlation curve between the data obtained at  $R_B$  and the data obtained at the



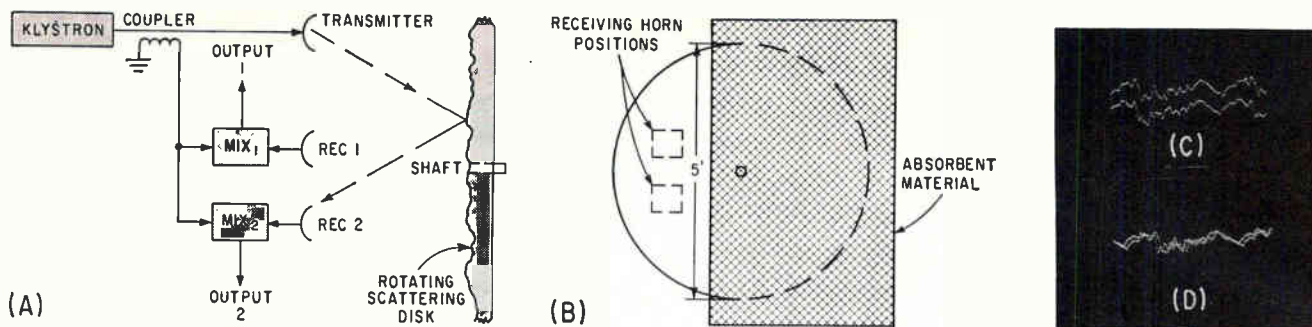

FIG. 5—Correlation navigator microwave test set-up (A) and front view of scattering disk (B); oscilloscope trace of the two independently detected backscattered signals (C and D)

rear horns. The value of  $\tau$  is determined by switching alternately between the two curves and detecting an error voltage signal. At a delay time of  $\tau_A$  where the separate correlation curves cross, the error signal goes to zero and the ground speed can be accurately measured as a function of  $\tau_A$ . Note, however, that the value of  $S$  to be used in Eq. 1 now becomes the equivalent  $S$  as indicated in Fig. 2D.

The constantly changing nature of the sea surface introduces a decorrelation function which is directly proportional to the relative delay time between the lead and the lag signals. This effect is shown in exaggerated form by the dotted curves in Fig. 2E. It can be readily seen that these modified curves are no longer symmetrical and, in fact, the peak correlation points have shifted to the left. In spite of this effect, the crossover point of the two curves remains the same, and the correct value of delay time,  $\tau_A$  is measured in determining the true surface speed.

In determining vehicle drift angle, the two juxtapositioned rear receiving horns are alternately switched at the same switching rate as the forward horns although 90 degrees out of phase. A second pair of correlation curves somewhat similar to those shown in Fig. 2E can be established by first comparing the data obtained at  $R_c$  with the data obtained at the forward receiving pair, and then comparing the data received at  $R_n$  with the data obtained at the forward pair. Again, an error detector is used to detect the difference or error signal voltage. This error signal is used in a servo loop to rotate mechanically the complete antenna assembly. When the antenna assembly axis is aligned with the surface

track of the vehicle, this error signal goes to zero, and the drift angle is read out as the angular position of the antenna assembly. Determination of drift angle completes the measurement of the true surface velocity of the vehicle.

Figure 1 also shows a variable delay element. The device used is a variable speed shift register; to use this device, several other techniques are employed within the data processor resulting in a digital data handling system.

First, the detected signals are amplified and clipped, preserving only the demodulated signal phase information. The lead signal is then sampled at a rate at least several times faster than the highest fundamental frequency contained in this noise signal, and the sampled information is transmitted through the register. At the output of the register, this signal is correlated on a bit-by-bit basis with the undelayed signals detected at the rear receivers. The output of the correlator goes to an integrator or data smoothing circuit which limits and averages the random fluctuations in the correlator output. These smoothed data are used to control an electronic servo loop which regulates the sampling or shifting frequency to the shift register.

The correlation navigator will always measure vehicle drift angle and surface speed accurately if the centerlines of the system receiver antenna patterns are normal to the underlying backscattering surface. However, normal flight maneuvers and vehicle trimming actions constantly cause the receiver antenna pattern centerlines to be nonperpendicular to the underlying surface, thus resulting in measured values of surface speed and drift

angle that differ from the true values. These errors in measurement are similar in nature to errors in an unstabilized doppler system and can be corrected by data stabilization for example. However, it has been found that even the uncorrected system would always have a measured error of less than 0.5 percent. An unstabilized, simple correlation navigation system with less-than-one-percent error appears feasible for many applications.

For soft lunar landings and Dynasoar recovery, the measurement of vertical velocity and altitude is important. The correlation navigator system can be implemented to provide these outputs in addition to the outputs of horizontal velocity and drift angle.

In general, a mechanically stabilized system is required to assure that the transmitted beam is vertically oriented. Through the use of pulsed transmission, altitude above terrain can be measured continuously as in other types of pulse altimeters. Ordinarily the altimeter will have a beam-limited return, and through threshold detection, a predicted accuracy of  $\pm 150$  meters at an altitude of 300 kilometers can be obtained in spite of an assumed moderately rough terrain. Over smoother terrain, accuracy would be proportionately better.

Vertical velocity could be obtained by a determination of altitude rate but studies show that a three-axis receiving antenna array can be used in determining all components of velocity directly through the correlation technique of data processing. One preliminary receiving antenna array for such an application (Fig. 2F) consists of a triangular array of three dielectric type receive antennas in the main antenna plane with a fourth dielec-

tric type receive antenna displaced vertically along the perpendicular to the centroid of the triangular array. By cross-correlating the signals received among the various pairs of antennas, the horizontal and vertical components of velocity can be separated out in much the same way as is done in present doppler systems, while retaining the simplicity of the correlation technique. Figure 2F does not show the single transmitting antenna since its positioning is not critical.

An experimental correlation Navigator radar was flight-tested in a small aircraft. Figure 3A diagrams the radar that was flight-tested. The transmitting horn was physically displaced an appreciable distance from the receiving horns, and one of the two receiving horns could be moved forward or backward or from side to side. Two receivers, consisting of synchronous detectors and audio amplifiers were used and their outputs were applied to a multiplier circuit. A rotary phase shifter caused correlation between the receiver outputs to be evidenced as a 60 cps voltage at the output of the multiplier rather than as a change in d-c level. Low audio frequency components, produced by the c-w transmitter leakage, were removed by 200-cps high-pass filters.

Space normally used for the rear seat was used for the correlation navigator equipment (see Fig. 3B).

The transmitter operated c-w at X-band with a power output of 100 milliwatts. Antennas were horns with 2½-inch by 3¼-inch openings. An L-C audio frequency delay line was used in the forward receiver, and correlation was measured as a function of antenna spacing while the aircraft maintained constant heading and airspeed. The correlation should have been a maximum when the centers of the two receiving horns were aligned in the direction of motion, and the spacing between the centers was equal to twice the distance that the aircraft traveled during the delay time, the delay being applied to the output of the leading antenna.

To check this relationship, a flight was made along a calibrated section of railway tracks and the data on output vs antenna spacing plotted in Fig. 4A was obtained. At the same time, the speed was

checked by noting the time of passing various structures at known distances along the track and plotting the result. Two runs were made: the first westbound, the second eastbound. The peaks of the curves agree quite well with theory.

A calculated curve of cross-correlation as a function of separation is shown (Fig. 4B) for comparison with the measured data. The time delay is 1.188 milliseconds, the value used in the tests. The speed assumed is 105 mph; at higher speeds, the entire curve is simply displaced to the right.

Later laboratory tests were made using the microwave system shown in Fig. 5A and 5B. For these experiments, a low power klystron transmitted a c-w signal toward a 5-foot diameter rotating wooden disk. The surface of the disk was dotted at random with different sized pieces of aluminum foil to provide a backscattering surface.

The backscattered energy was detected by the two receivers and synchronously detected directly to the doppler spectrum modulation. These two signals were then observed on a dual trace oscilloscope. Figures 5C and 5D shows a representative oscilloscope picture. Figure 5C shows the separate time synchronized traces of the two signals and Figure 5D is a later time synchronized presentation of the two independently detected signals superimposed upon one another. Figure 5D shows especially well the similarities between the two signals and the time displacement between them.

These experiments were carried out for various rotor speeds; in all cases the experimental data agreed with theoretical predictions within the limits of the test set-up.

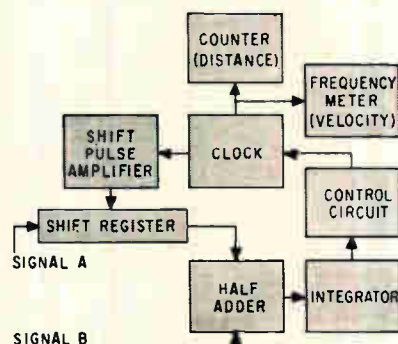

FIG. 6—Simplified velocity and distance data processor

Figure 6 shows a data processor for the correlation navigator. The demodulated and clipped lead signal, signal A, is sampled by a standard shift register and propagated through the register to one input of the half adder. The demodulated and clipped lag signal, signal B, goes to the other input of the half-adder. The half-adder is simply a binary device that gives an output signal if both input signals are of the same polarity, and no output signal if the two input signals are of unlike polarities.

The degree of coincidence or correlation between the two input signals can be measured as a function of the time-averaged output voltage from the half-adder circuit. If the input signals were a periodic function, the output from the correlator could be reduced to zero by shifting the phase of one input signal 180 degrees with respect to the other. However, this cannot be achieved for a random signal since the phase angle between the two signals is continuously changing (except when they are locked in phase) and the averaged voltage output from the correlator will approach  $e/2$  instead of zero volts.

The output of the integrator (Fig. 6) provides the driving signal for the control circuit which in turn varies the clock, or shift, frequency in a manner to maintain peak signal correlation.

The control circuit is critical to the system operation and both analog and digital techniques have been studied in this connection. The most accurate control circuit investigated employs digital techniques and two shift registers. In this circuit the error signal from the integrator is used to update a recirculating register, which in turn controls a second register. The overflow of the second register actually is the clock and provides the input signal directly to the shift pulse amplifier. Accuracy is limited only by the number of stages used in the two registers. The frequency of the clock is a measure of ground speed and the time integration of this frequency provides distance information.

#### REFERENCE

F. R. Dickey, Jr., The Correlation Aircraft Navigator, A Vertically-Beamed Doppler Radar, National Conf Proc, Aeronautical Electronics, Dayton, Ohio, 1958.



# Latest Developments in

*New tubes include ultralinear tubes using multiple rectangular cathodes, low screen-grid current tetrodes using collimated beams and high-gain video amplifiers*

By **LESLIE SOLOMON**,  
Associate Editor

SOME of the latest developments in circuits and electronic devices for the home-entertainment devices were given at the Radio Fall Meeting, sponsored by the EIA Engineering Department with participation by IRE professional groups, held in Syracuse, New York, be-

tween Oct. 30 and Nov. 1, 1961.

One problem often encountered in receivers is distortion of the signal by high-level undesired signals from other transmitters.

Within the receiver, interference from undesired signals is caused by curvature of the tube characteristics. To solve this interference problem, it becomes necessary to linearize the transfer characteristics of the input tubes (especially in sensitive receivers).

An ideal input tube should be capable of handling an undesired signal of at least 10 v peak-to-peak without generating serious interference, should be workable to at least 200 Mc and if possible to 400 Mc, the noise figure should be about 10 db for 200 Mc. Transconductance does not have to be high. Amplification should be just sufficient that the first stage can establish the overall noise figure (a little over one). However, the gain must not be so high as to overdrive the next stage with the undesired signal. The desired signal can then be amplified and the undesired signal attenuated in the following stages.

To suppress both cross modulation and intermodulation, the tube characteristics must approach a straight line. A quadratic characteristic will suppress cross modulation only. The variable pitch tubes com-

monly used can never completely suppress the interference. The transfer characteristics of such a tube consists of the sum of all the characteristics of the pitches, which are all three-halves power curves. Consequently, the sum of these curves can never be a straight line. One approach is to use only the top part of the transfer characteristic as it is more linear than the bottom.

A cathode construction, consisting of two or more rectangular cathodes mounted in a row next to each other and coated with carbonates only to the sides that face each other, can produce almost straight-line curves. At the moment, there is no explanation of the phenomena introduced by this cathode configuration. Figure 1A shows some characteristics of a diode developed at Westinghouse compared to a conventional diode. All tubes were aged and curves were made using 6.3 v (approximately 725 C cathode temperature) on the filaments. The conventional cathode shows a three-halves power curve while the new cathode configuration closely approaches a straight line. Where they are not straight, they follow a 1.25-power law.

Several experimental triodes and tetrodes were built using the new cathode. The tetrodes were made with three cathodes and lined-up

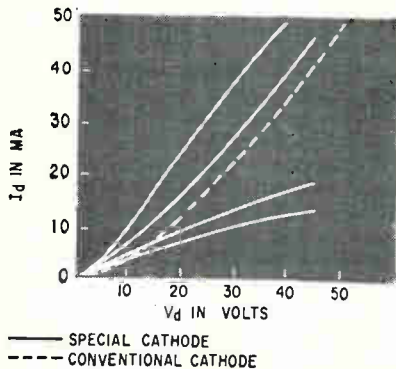

(A)

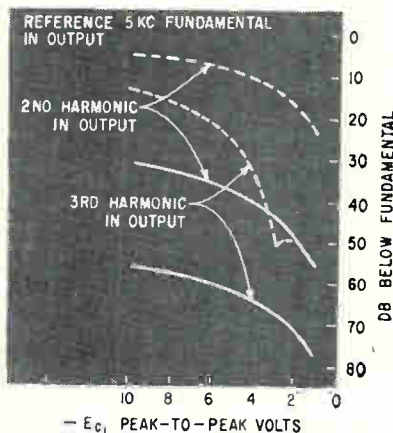

(B)

--- TUBE TYPE 6AB7  
 $E_f = 6.3V$ ,  $E = 200V$ ,  
 $E_{c2} = 200V + 100,000$  OHM RESISTOR  
 $E_{c1} = 0$ ,  $R_k = 220$  OHMS.  
— TETRODE WITH SPECIAL CATHODE CONSTRUCTION (3 CATHODES)  
 $E_f = 6.3V$ ,  $E_b = 200V$   
 $E_{c2} = 73.5V$ ,  $E_{c1} = 6V$

FIG. 1—Curves show special cathodes at different spacings compared with conventional cathode (A). Harmonic analysis shown at (B).

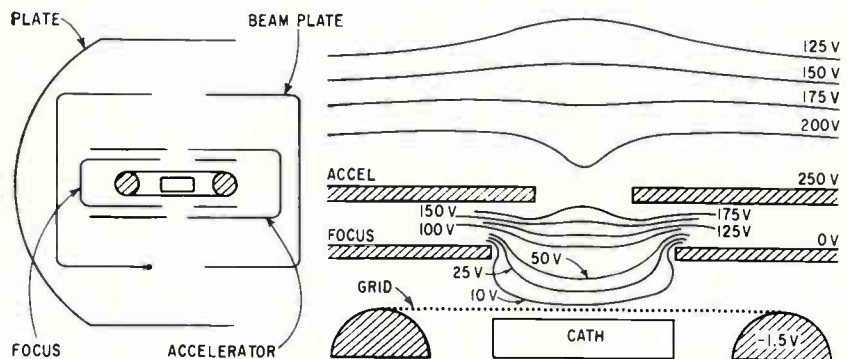

FIG. 2—Collimated beam tetrode and associated field plot

# Electron Devices

grids to reduce screen current. Figure 1B shows the result of harmonic measurements compared with a conventional 6AB7.

A tetrode was used in a communications receiver in place of the 6AB7 and a desired signal of 140  $\mu$ v of 4.1 Mc, 30-percent modulated with 1-Kc audio with an undesired signal of 10 v peak-to-peak, 3.95 Mc, 30-percent modulated with 1-Kc audio as composite input.

With the 6AB7 and the new tetrode, the level produced by the undesired signal was + 2 db the output produced by the undesired signal was - 0.6 db for the 6AB7 and - 28 db for the new tetrode. The effect of age, noise and other factors are still unknown.

The desire to obtain most of the characteristics of a tetrode or pentode without the useless and objectionable flow of screen-grid current has existed since the concept of those structures. Reducing the screen grid current results in a noise figure substantially that of a triode. Although focused electron beams with zero first accelerator currents have been used for some time in cathode-ray and special-purpose tubes, their use in the collimated beam tetrode, the DT-805H, results in near idealized pentode characteristics useful into the vhf spectrum.<sup>2</sup> This new design, originated by Tung-Sol Electric Inc, results in a plate family with sharp knees and low knee voltage around 50 v, a screen-to-plate ratio of 2 percent, noise figure compared to a cascode triode, transconductance of 10,000  $\mu$ mhos or more, gridplate capacitance of 0.02 pf and plate resistance of one-half megohm.

Figure 2 shows the construction of the tube. Adjacent to the cathode is a frame-type control grid. Between the control grid and anode are three separate slotted electrodes. There are the focus electrode, the accelerator (screen grid) and the suppressor beam plates. The beam focusing design eliminates lateral wire alignment between control and screen grids thus this design has only one wound grid. To obtain high

transconductance and low noise, a uniform accelerating field is presented to the cathode over a wide area. Figure 2 also shows a field plot of the structure and indicated the field configuration that maintains the low accelerator current essential for low noise figure.

The DT-805H compares in performance with a cascode-connected 6BQ7A and has a noise figure superior to r-f pentodes. The tube can handle an interfering signal level of over 350 mv at any bias while a recently introduced vhf frame grid triode (6ER5) can be used with no higher than about 100 mv interfering signal, both for 1-percent cross modulation.

Continuing efforts to simplify tv receiver design to obtain greater picture contrast has steadily increased the burden of the video amplifier. Reducing the number of i-f stages makes the tuner, remaining i-f stages and video amplifier make up the loss of gain. The introduction of strap frame grid i-f amplifier tubes such as the 6EJ7 and 6EH7 permits a substantial increase in gain per stage. However, this may not be sufficient to compensate for the elimination of one stage in a three i-f stage receiver. Some loss can be made up by narrowing the bandpass of the remaining i-f amplifiers or by operating the tubes near their maximum ratings. To improve the gain of a conventional video amplifier, the plate load can be increased to the point of losing the higher video frequencies, or a higher plate current tube with an increase in plate and screen supply voltages can be used.

To meet these objectives, Sylvania has developed a strap frame grid triode-pentode video amplifier that permits removal of one i-f stage, due to its high output with relatively low input.<sup>3</sup> The SR-2926, the new video amplifier, has a high  $\mu_{gm}$ /ma ratio and a low knee voltage that results in less voltage drop at peak signal. This permits higher output at lower plate and screen dissipations and the high efficiency in that less screen voltage is needed

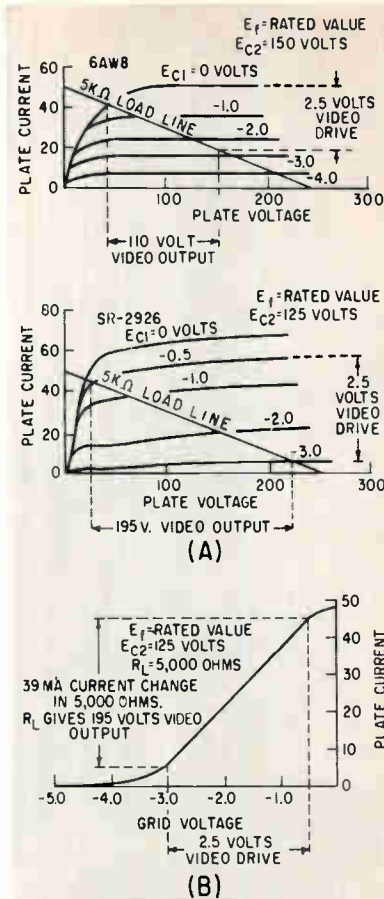

FIG. 3—Comparison of SR2926 with 6AW8 plate family curves. SR2926 transfer characteristic (B)

to produce a greater plate voltage swing.

The family of curves shown in Fig. 3A shows a typical video amplifier 6AW8 compared with the new SR-2926.

The transfer curve for this tube is shown in Fig. 3B. It combines a broad linear operating range with a sharp cutoff characteristic. This is important in video to prevent sync compression in the cutoff region. Saturation of the curve near maximum current is due to the plate load resistor. This can be corrected by decreasing the screen voltage, which would lower the zero bias plate current to where the plate load intercepts at the knee.

## REFERENCES

- All papers were given at the Radio Fall Meeting, Syracuse, New York, Oct 30 through Nov 1, 1961.  
 (1) A. Van der Jagt, An Ultra-Linear Transfer Characteristic.  
 (2) C. W. Buchler and R. E. George, A Low-Noise VHF Collimated Beam Tetrode.  
 (3) R. F. Bergdahl and A. J. Robinson, Progress in Video Amplifiers.



# Gas Tubes and a

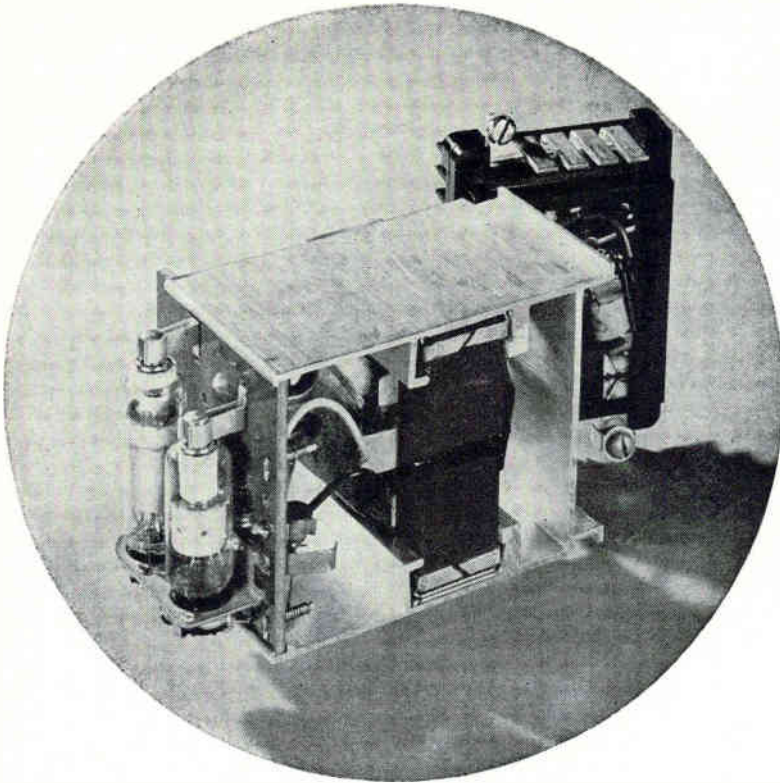

*Practical electronic ignition system has features which improve engine performance over conventional systems. Makes new high-speed engine design possible*

*Electronic components of the Tung-Sol EI-IV electronic ignition system consists of two separate units. Thyatron and cold cathode rectifier are mounted on the main unit; transistor and heat sink are separated to avoid effect of engine heat*

By HALSEY P. QUINN,

Chatham Electronics Div., Tung-Sol Electric, Inc., Livingston, N. J.

ELECTRONIC IGNITION systems should, ideally, be compatible with standard distributors, spark plugs, breaker points and battery supply. In addition, an electronic system must provide substantial operating advantages over conventional systems. For example, with a properly designed system, there should be no reason to change spark plugs, breaker points or adjust engine timing for the life of the vehicle. To meet these requirements, a practical electronic ignition system using a thyatron, cold-cathode rectifier and a transistor has been developed. It operates from a standard automotive battery without additional power supplies.

The system is characterized by three major differences over the

conventional ignition system: first, breaker points carry only a control current. This is so low, less than 10 percent of conventional breaker current, that burning, pitting and erosion appear to have been entirely eliminated. It is possible to use smaller gaps and to reduce the effect of contact bounce at high engine speeds. Second, a steep wave-front obtained from a capacitor discharge is supplied to the spark plug. Breakdown voltage is reached in 1 to 2  $\mu$ sec as compared to 70  $\mu$ sec in the conventional system. As a result, no matter how badly a plug may be fouled, the steep wave-front causes effective firing each time. This sharp rise prevents changes in timing that could reduce engine performance at high engine rpm.

Finally, the entire circuit incorporates short time constants so that there is negligible reduction in firing voltage at the maximum speed of existing spark-ignition engines.

In the circuit of the electronic system, Fig. 1, the high voltage lead to the distributor is at the right. When the cold-cathode thyatron  $V_2$  is fired, capacitor  $C_1$  discharges through the spark coil  $T_s$  to the plugs. Since this capacitor is normally charged to a value between 1.5 and 1.8 Kv, the turns ratio of the coil and hence the impedance of the discharge circuit as seen from the plug are quite low, thus permitting a 1 to 2 microsecond peak on the firing pulse. The thyatron is triggered to fire on the opening of the breaker points; this action also initiates the sequence that restores the charge on capacitor  $C_1$  for the next firing cycle.

The points close for the first time when the engine is cranked for starting. Since there is no charge on the firing capacitor initially, the first plug will not fire. However, this is the extent of the delay or warm-up required. This first closing does cause transistor  $Q_1$  to conduct and the control current flows through limiting resistor  $R_2$  to the base. The charging current, which

# Transistor for Electronic Ignition

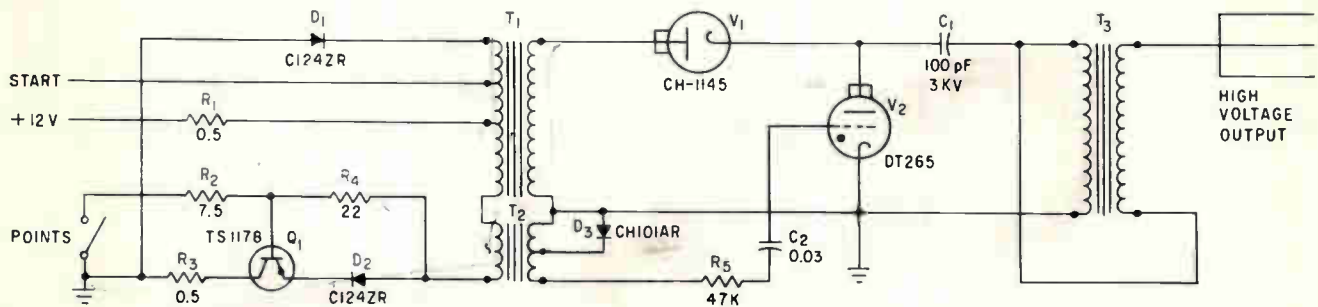

FIG. 1—Thyatron  $V_1$  discharges capacitor  $C_1$  through spark coil  $T_3$  to provide ignition spark

is roughly ten times the control current, then flows through  $R_1$  and  $R_3$ , as well as the primary of transformer  $T_1$ , and the transistor. This current builds up magnetic flux in the transformer and maintains that level until the next firing cycle.

After a dwell period equal to that in conventional ignition, the points open, the transistor becomes non-conducting, and the magnetic field of the transformer collapses. This raises the voltage on the transformer secondary and the anode of gas diode  $V_1$ , until the latter starts conducting, thereby charging firing capacitor  $C_1$ . The next closing of the points re-establishes the tran-

sistor current in the transformer primary.

When the points open again, the transistor stops conducting. Cessation of primary current causes the magnetic field to collapse, producing a high voltage spike on the secondary of both the main power transformer  $T_1$ , and the small trigger transformer  $T_2$ . The voltage on  $T_2$  causes thyatron  $V_2$  to fire and discharge capacitor  $C_1$  through the coil into the spark plug in about 3  $\mu$ sec. The resulting reduction of voltage on the cathode of rectifier  $V_1$ , causes this tube to conduct and charge the capacitor. The buildup of voltage on the capacitor is suffi-

ciently slow to permit the thyatron to deionize fully before the anode potential becomes positive. This cycle is repeated at each opening and closing of the breaker points.

The remaining components provide limiting and protective functions. Resistor  $R_2$  limits the control current. Resistors  $R_1$  and  $R_3$  together prevent an undesirable voltage distribution on the transistor and establish the proper charging current in the transformer primary. Diode  $D_1$  limits the surge voltage of the transformer after the points open, so as to protect the transistor. Diode  $D_3$  prevents the thyatron from conducting dur-

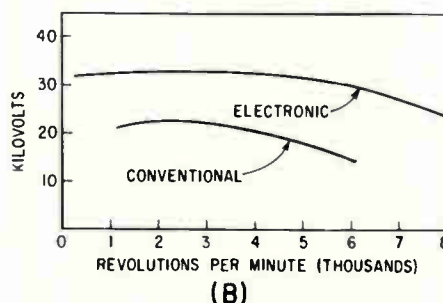
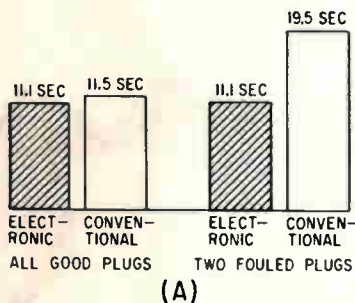

FIG. 2—Laboratory tests simulating running conditions of conventional and electronic systems show difference in acceleration time (A) and comparison of voltage fall-off at high engine speeds (B)

Electronic ignition systems have been talked about since 1945. But a really practical device could not be developed because vacuum tubes would not stand the environmental conditions to which this equipment is subject. Power transistors in high enough ratings were not available until a few years ago, so that even semiconductors did not permit development of a practical ignition system until recently. Tung-Sol's system will be available commercially in the spring of 1962



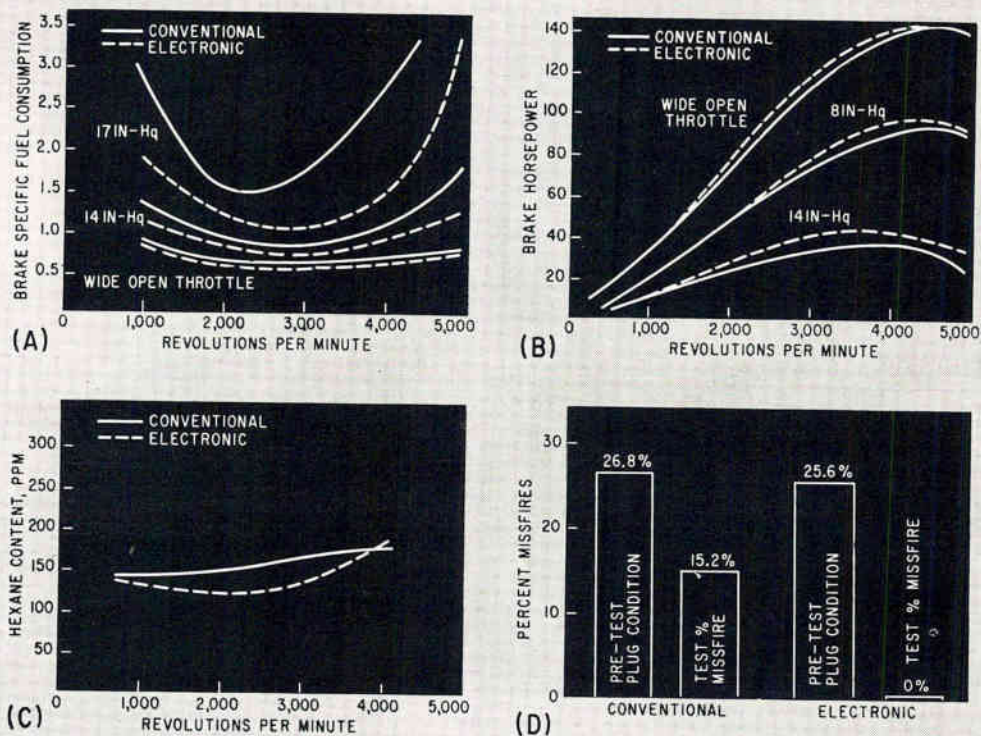

FIG. 3—Results of dynamometer tests of a conventional V8 engine equipped with both electronic and conventional ignition systems show the difference in gas consumption (A), horsepower (B), exhaust analysis (C) and misfires at full throttle (D)

ing the charging portion of the ignition cycle. Diode  $D_2$  provides emitter bias to the transistor to limit leakage current at high temperature. With this bias the transistor will provide satisfactory operation up to its maximum junction temperature rating of 212 F.

During cranking the battery is connected to the START terminal (Fig. 1) by means of the ignition switch or relay. This permits full firing voltage to be applied to the plugs even if battery voltage should drop to 6-v because of starter drain. As a result, the system has excellent cold weather starting characteristics because of the high voltage maintained by means of the starting tap. Also, the points carry only control current and do not "blue" as a result of long dwell time on cranking.

In laboratory tests an electronic ignition was operated through more

than 250,000 miles of equivalent driving without trouble. By comparison, a standard system showed a series of failures up to 165,000 miles, at which point it failed completely. Perhaps most significant is the comparison of operation under fouling conditions, shown by an acceleration test in Fig. 2A, and the fall-off in voltage with engine speed, shown in Fig. 2B.

Dynamometer tests with a standard V8 engine show fuel consumption vs engine speed, Fig. 3A, while Fig. 3B shows improvement in brake horsepower delivered to the dynamometer. The tests, indicate that electronic ignition can convert up to 6 percent more of the energy available in the fuel to mechanical energy. Consequently, there are less unburned hydrocarbons in the exhaust gases, Fig. 3C. It is reasonable to expect that up to 25 percent more brake horsepower can

be obtained from the electronic system with fouled plugs, for equivalent speed and fuel consumption conditions. Fig. 3D shows the percentage of misfires at full throttle for the two systems using fouled plugs. With new plugs, the electronic system had fewer misfires.

On one test run with two similar trucks, gasoline mileage increased more than 20 percent with the electronic system during 30,000 miles of operation.

When installed on a 2-cycle outboard motorboat engine that was particularly susceptible to trouble with fouled plugs, the electronic ignition system operated with plugs that could not be fired at all by conventional ignition.

Credit is due to W. Buchanan, E. Howland, J. Kuykendahl, R. Schellhorn and M. Yarmovsky for contributions to circuit and tube design.

# MEDICAL ELECTRONICS

## Part VI: Observing Life Processes

*Improvements in microscopic examination of living matter through use of closed-circuit television and electronic measuring, scanning, analyzing and computer techniques*

By WILLIAM E. BUSHOR  
Senior Associate Editor

MOST SIGNIFICANT contribution electronics is making to medicine may be in experimentation and research. This article will discuss the electronic laboratory tools and techniques being used to microscopically probe and study our biggest enigma—the life process itself.

*Optical-tv Microscopy*—Visualization of a biological specimen containing particles of microscopic proportions has required the development of image amplifying systems. The optical microscope together with an optical microprojection arrangement has long been used for this. However, the intense light required for illumination often heats the specimen too much. This problem is overcome using closed-circuit tv coupled to the microscope, and the added advantage is given of permitting an unlimited number of pathologists, biologists, researchers and the like to examine the enlarged view of the specimen simultaneously and at remote locations, if necessary. Also, it has been found particularly advantageous to use such systems in observing living organisms, especially with the phase contrast technique wherein objects that differ in optical path are made visible.

Practical examples are two integrated optical microscope-tv systems recently made available by Elgeet Optical Co. that can produce magnifications up to the lower limits of low-priced electron microscopes. The tv cameras used are

single, self-contained units whose video signals are routed to a tv monitor, usually with a 17-inch screen. One system, using Sylvania Electric Products' electronic units, gives magnifications up to  $2,500\times$  with 300-line resolution. The other, using Allen B. DuMont Labs' units, gives magnifications up to  $3,500\times$  with 600-line resolution.

Development of cathode-ray tubes with fiber-optic faceplates by a number of companies may eventually enhance characteristics of the tv monitors. When the electron beam excites the phosphor on the back of the faceplate, the resulting light is conducted to the front by millions of optical fibers that are made of some form of dielectric ma-

*Electron microscopes like this RCA unit give researchers a powerful tool for visualization of particles as small as  $1/20,000,000$  inch*

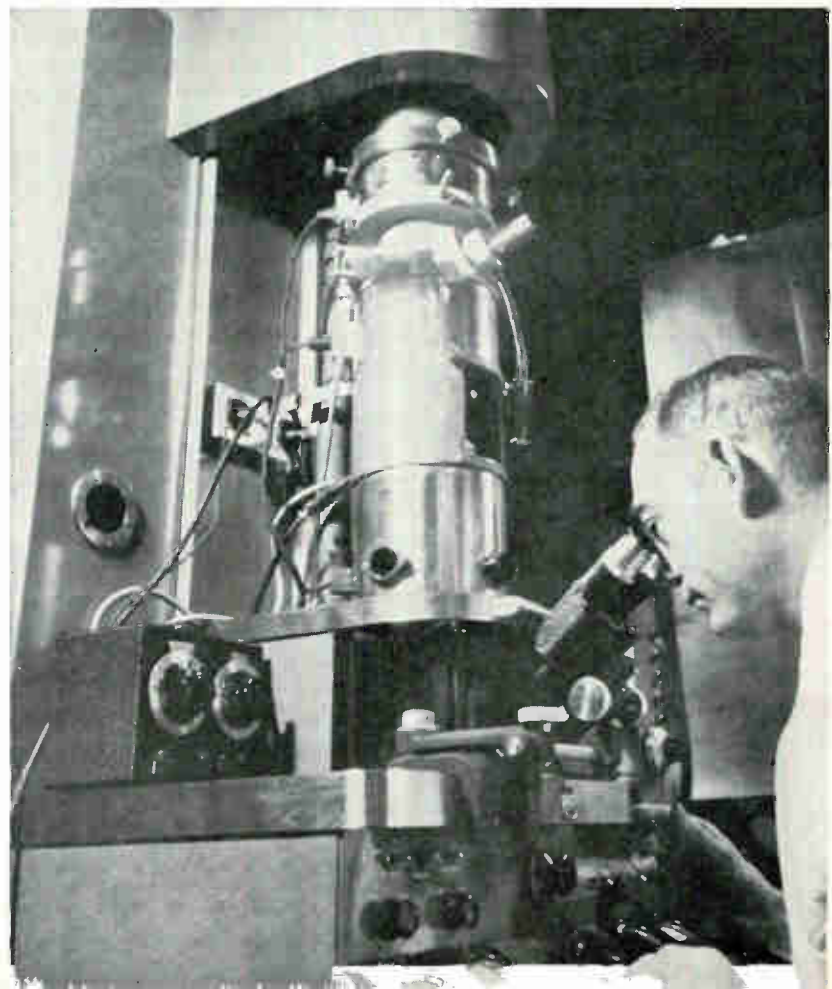



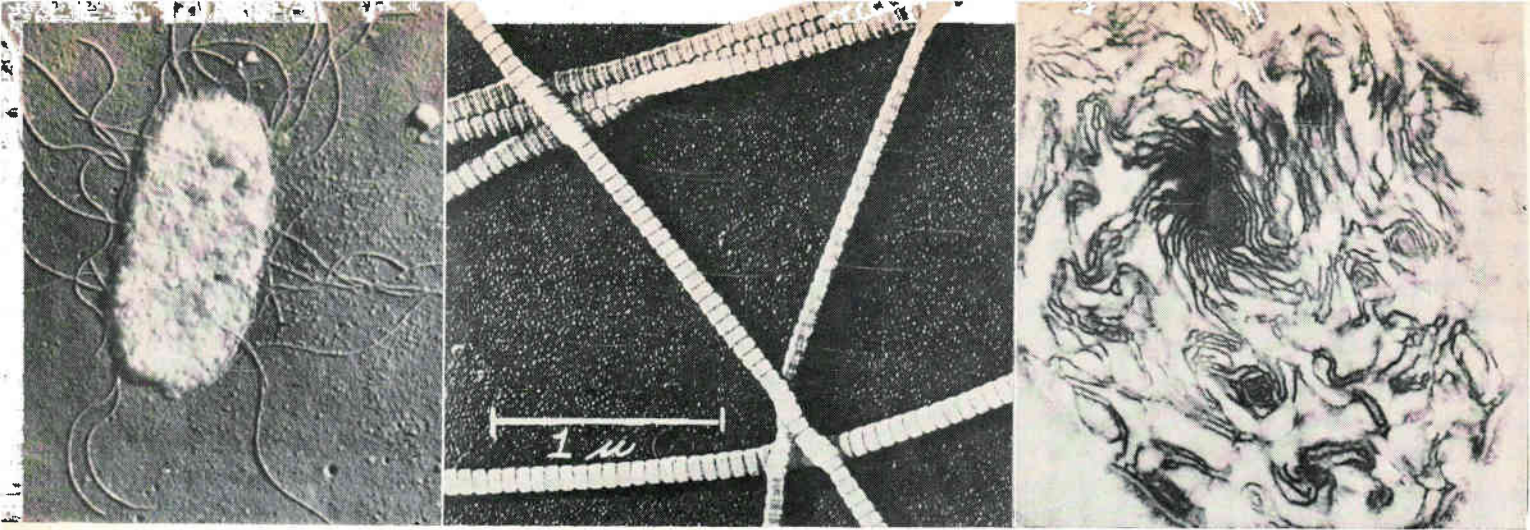

Micrographs made with RCA's electronic microscope. Left to right: bacteria, human collagen, snail sperm, tobacco

terial. Advantages of these tubes to the microscopist are that parallax is eliminated, light transmission efficiency is increased and brighter or more magnified images can be obtained by using tapered fibers. Cost is expected to inhibit their use in the immediate future.

**Electron Microscopy**—This technique provides 200 times the resolving power of compound light microscopes because the effective wavelength of the electron beam is only 1/100,000 that of visible light. This shorter wavelength permits objects such as viruses to be viewed in detail which are hidden by diffraction of light in optical instruments. Unfortunately, the full resolution theoretically possible with electron beams cannot be realized because electron lenses are much inferior to optical lenses. Theoretical and experimental resolution limit is still 8 to 10 Angstroms despite 0.05 Angstrom wavelength of an electron beam.<sup>1</sup>

There are two general types of electron microscopes: those requiring the viewed object to emit the electrons and those that generate the electron beam themselves. Since the former have little or no medical applications, only the latter types will be discussed here.

Illumination in electron microscopes is provided by an electron beam focused with an electron lens to irradiate a thinly sliced specimen. Since absorption of electrons is proportional to the density at any given point, the concentration pattern of electrons passing through forms a shadow-like image of the specimen's structure. After being

magnified thousands of times by another electron lens, the electron image impinges on a luminescent screen or photographic film, depending on whether immediate viewing or a permanent record is desired. Most electron microscopes use magnetic focusing lenses.

Although functionally an almost exact counterpart of optical microscopes, electron microscopes are physically dissimilar. They must operate in a vacuum and generate high accelerating potentials. Also, good electronic images can be obtained only if specimens have sufficient atomic density contrast. However, just as with optical systems, three-dimensional images can be obtained using stereoscopic viewing or metal-shadowing techniques. Electron microscopes require tissue preparation techniques different and more exacting than those used with optical instruments. New materials and section-cutting machines (microtomes) are required.

Research into the causes of rheumatism and arthritis has prompted the development of an electron microscope that can magnify an image 150,000 times. The instrument is being used at St. Thomas' Hospital Medical School in London. A cell measuring only one-thousandth of an inch can be blown up to a 15-inch diameter, thus permitting study of the structural detail of cartilage cells. Ordinary compound microscopes previously used had only a 1,000 magnification factor. Main problem the researchers are having is interpreting the image. This is because ordinary microscopes show hundreds of cells in the same field, while the electron mi-

croscope shows only a portion of a cell thereby leading to difficulty in identifying the cell itself.

Electron magnifications ranging from 2,000 × to 30,000 × have been obtained by Hitachi of Japan through use of a three-stage permanent-magnet lens system. Reportedly, resolving power extends down to 15 Angstroms. By using a permanent-magnet as the lens exciting source, no hysteresis effect is produced by opening and closing the 50-Kv power circuit as would be the case with electromagnetic lens exciters. Objective and projection lenses are single-gap devices while the condenser and intermediate lenses are double-gap devices.

A major disadvantage of electron microscopes is that the high vacuum required oxygen-starves and dehydrates the specimen. By the time the slide can be viewed, what was initially living matter has died and even changed its physical form.

Living bacteria have been photographed, however, at the National Center for Scientific Research in France using a 1.5-million-volt electron microscope to provide magnifications up to 25,000 ×. Biological specimen is held in a hollow container 0.1 cu mm in volume and exposed to normal atmosphere. The scanning beam, admitted through 0.1-micron thick windows, is boosted to nearly the speed of light by 750 to 1,000-Kv acceleration voltages. After exposure in the microscope, the bacteria in the cultures have reproduced.

Field ion microscopes, which have recently come into existence, produce ion beams with significantly



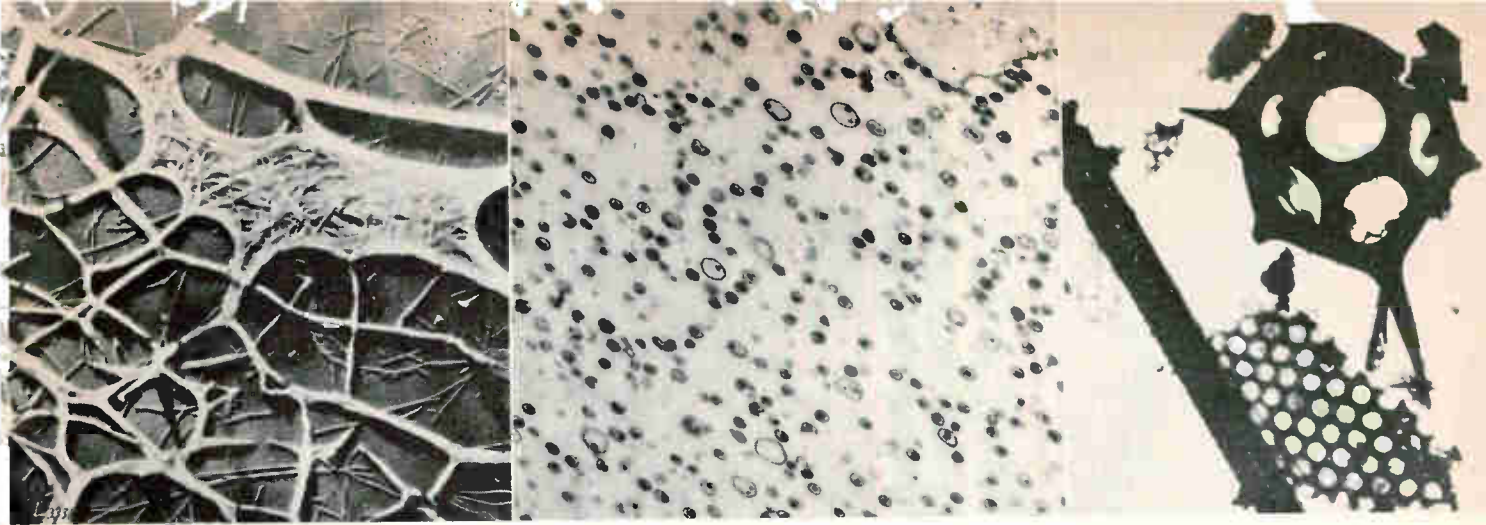

plant virus, mouse cancer virus and diatom (algae) fragments. Specimens were only 1/500,000 of an inch thick

shorter wavelengths than do the electron beams in the electron microscopes. The advantage in resolution thus obtained has been used to photograph an individual atom on a metallic surface. However, investigation revealed no applications of this instrument to medical or biological research.

**X-Ray Microscopy**—Through international agreement, techniques for enlarging images using x-rays have been called x-ray microscopy; these include contact microradiography projection microradiography and x-ray microscopy by total reflection. Although only the last is a truly microscope-type instrument, the others are of importance as research tools.

In contact microradiography (also called historadiography) the specimen is brought into contact with a fine-grained photographic film during exposure to x-rays. Because of this intimate pairing, the radiogram is the same size as the specimen, thus enlargement is necessary using a light microscope.<sup>2</sup> Optimum resolution obtainable with this technique is limited by the fineness of the photographic film. The geometrical blurring caused by short depth of focus can be controlled through use of thin emulsions and specimens.

A new kind of x-ray film developed by researchers at Stanford U. has enhanced microradiography by giving four times sharper images than previously obtainable. This facility should give scientists a look at the nucleus of a cell. Used with an electron microscope, magnifications of 40,000 diameters can be obtained

because the film resolves details to less than 600 Angstroms where best previous resolution was 2,000 Angstroms. The film is made by casting 1/250,000-inch thick layer of nitrocellulose mixed with a silver compound into a glass surface.

In projection microradiography (also called projection x-ray microscopy, geometric x-ray microscopy and x-ray shadow microscopy) the image is pre-enlarged by displacing the film with respect to the specimen. Thus, the divergent angle of the x-ray beam originating from a small focal point geometrically magnifies the specimen's shadow image. This approach is limited by geometrical blurring caused by the requirement for an ultrafine focal spot. With electron lenses (usually electromagnetic) to focus the x-ray beam, considerable reduction in focal spot size (and thus increased resolution) is obtained. Electrostatic lens systems are being experimented with but do not give high enough resolution. Although photographic enlargement is possible, the 10 to 100 times magnification obtained usually makes this unnecessary. Since depth of focus is larger, thicker specimens can be used than with contact microradiography.

A projection microradiograph for cancer tissue studies has been developed by the Central Organization for Applied Research in the Netherlands. This instrument provides binocular viewing either of the specimen or of its fluorescent image. Also, four types of target materials are used that can be interchanged during operation.

In x-ray microscopy by total reflection the image is formed as

with the light microscope. Because lens systems for x-rays are not practically feasible, the beam is bent by reflection from curved mirrors or by refraction from crystal surfaces. Resolving power depends on the wavelength of x-rays. Advantage of this instrument is that it can be used backwards to produce a narrow beam of high intensity for microdiffraction or microfluorometric studies. Unfortunately, the x-ray mirrors used in a laboratory model of a reflection system were found difficult to manufacture and adjust.<sup>3</sup> Lack of suitable refractive material has held back development of this system.

The Russians recently reported that their Machine Building Institute has constructed an x-ray microscope with a magnifying power of 2,000 diameters. No further details were available.

#### *Ultrasonic Absorption Microscope*

—An ultrasonic absorption microscope that produces high-resolution images for investigating the microstructure of biological systems has been evolved at the U. of Illinois.<sup>4</sup> Using light or electron microscopes, many structural components of biological materials may not be detected at all; however, if these substances have different acoustic absorption coefficients, ultrasonic microscopes will differentiate between them. Because some different types of protein molecules at equal concentrations absorb sound at different rates, this instrument should be useful in determining spatial distributions in and identifying types of protein in tissue.

Rectangular, 0.1-second pulses of



12-Mc sound generated by a piezoelectrical crystal are used to irradiate the specimen, which is imbedded in a liquid having the same acoustic impedance. This ultrasonic energy is partially absorbed by the specimen, the remainder passes through it exciting an iron-Constantin junction thermoelectric probe behind and adjacent to the region being investigated.

The electrical output of the probe is fed through a d-c amplifier to the vertical deflection plates of a crt. Thus, beam deflection magnitude is a measure of the relative amount of acoustic energy detected by the probe. Deflection changes resulting from moving the specimen toward and away from the sound source are recorded and then plotted to give a picture of the disturbance to the sound field distribution caused by the specimen.

*Ultraviolet Microscopy*—If an ultraviolet source is used for illumination, previously unsuspected differences in the chemical and optical properties of specimens are sometimes revealed. Photomicrographs made with ultraviolet light have greater contrast than those made with white light, resolution being greater because of shorter wave lengths involved. Also, use of uv eliminates the staining technique, which alter the specimen chemically and mechanically. This is often necessary with visible light microscopes to achieve sufficient contrast.

Living preparations, when observed against a dark field, reveal little scattering of light. Thus, uv microscopes inherently are subject to less error than light microscopes. Most important contribution of uv microscopy in this area has been the localization of nucleic acids.

Extensive use of uv microscopy has been hindered because: lenses are not apochromatic (that is, the image plane shifts with changes in wavelength), transmission through refractive elements is function of wavelength and uv light sources are not satisfactory for obtaining arc, flicker and like outputs. Furthermore, the uv image cannot be viewed directly with the eye; uv-sensitized photographic film, fluorescent phosphors, image converters and photocathode storage tubes are used as conversion mediums.<sup>5</sup>

Experimenters at the department of human anatomy of England's Oxford U. have used a uv microscope for directly observing the fundamental processes in living cells. The system uses a uv-sensitive vidicon tube, developed by EMI Electronics, which is fitted to the camera of a closed-circuit tv system. Various living cell preparations have been examined, including free swimming chromosomes and live sperms of mice and frogs.

A technique that has shown great promise for revealing microscopic structures in the living state is the uv color-translating tv microscope. This is a process that produces three separate visible images by successively illuminating the specimen with three different wavelengths. Color presentation indicates absorption differences not detectable on gray-scale black and white pictures except with a densitometer. When picked up on a tv camera, three sequential signals are generated, one for each uv wavelength. By synchronizing the sequenced signals with the color tv monitor and superimposing the images, a color display can be produced that corresponds to the uv absorption spectrum.<sup>6</sup>

This technique is being used in a uv color translating tv microscope built by the Rockefeller Institute for Medical Research from equipment donated by RCA.<sup>7</sup> It has been used to examine protoplasmic inclusions in streaming protoplasm (as in moving amoebae or cyclocis in plant cells), to localize colorless organic compounds like vitamin A and acriflavin which are otherwise difficult to observe, and to study uv radiation damage.

Another color translating system built by Avco's Research and Advanced Development division uses three grating monochromators, each with its own uv source, which can be set to a preselected wavelength over a range of 2,400 to 6,200 Angstroms.<sup>5</sup> A pair of rotating mirrors are used to sequentially illuminate the specimen at each of the three different wavelengths. The uv absorption images pass through the microscope optics and then are separated in space by a second pair of rotating mirrors. Three tv cameras receive the uv images. The uv vidicon tube in each camera is associated with a

primary color that is different than that assigned the other two. By presenting a composite picture on a 15-inch tricolor monitor, differences in spectrum transmission indicating differences in chemical composition of cellular components can be determined by observing variations in hue of the tv image.

*Infrared Microscopy*—Infrared radiation penetrates through some organic tissues better than visible light. Differences between cancer and normal cells in thick specimens, which cannot be distinguished with ordinary microscopes, can be observed with ir microscopes. Because no directly visible images are obtained, photomicrography must be used. This instrument is well suited for analysis of minute samples of drugs, perfumes, tissues, cells, blood and muscle fiber.

The instrument consists of an ir monochromator which concentrates ir energy through a slit and optical lenses onto the specimen. An optical system magnifies the image of the specimen up to 200 times and focuses it on a detector. To avoid chromatic aberration, reflective optics are used throughout.<sup>8</sup>

An infrared microscope capable of distinguishing between normal and cancerous cells and revealing internal structure of bone tissue and details of the eye's iris has been developed by Nippon Electric Co. in collaboration with the U. of Tokyo. The instrument is sensitive to radiation over a range of 4,000 to 13,000 Angstroms and will magnify an ir image 1,080 times.

The system consists of an optical microscope, an optical system that includes an image converter tube and a light source with an infrared filter, and a 16-Kv d-c power supply. Object to be viewed is illuminated with an ir beam from the source-filter combination. An objective lens focuses the magnified ir image on the photoelectric surface of the image tube. Electrons emitted are accelerated and focused by high-voltage electrodes to produce a visible image on a phosphorescent screen. The image can be photographed or coupled to a closed-circuit tv system for remote viewing. This instrument will probably be most useful in studies connected with dermatology, ophthalmology, cytology and pathology.

*Scanning Microscopy*—Tv-microscope systems use conventional scanning principles to convert the image on the target in the camera tube into electrical signals. The advantage of this approach is that invisible ir and uv images can be converted to a bright visible picture of practically any size if a camera pickup tube with appropriate sensitivity is used. Unfortunately, the object being viewed is continuously exposed to illumination, a situation that could have detrimental effects on the specimen (particularly living cultures).

There is a similarity between all scanning systems. The object area is systematically examined by an element of area that is small by comparison. Light flux is converted into an electrical signal whose amplitude is proportional to the light received and whose duration is proportional to size of the object. The size of the scanning element determines the working resolution.<sup>9</sup> A high degree of conservation of light energy required for examination of living material with minimum exposure is offered by the time-lapse and flying-spot scanning systems.

To study the progress of reactions in living cells, the National Institutes of Health and RCA have developed a uv time-lapse tv scanning system that measures the absorption products in the cell.<sup>10</sup> Since visualization and recording of absorption images can be done with 1/100-second exposures, cell injury from uv radiation is minimized.

A microscope with reflecting optics and illuminated by a xenon arc and quartz prism monochromator is used. A uv-sensitive vidicon is the image storing device. An automatic light shutter opens for 10 milliseconds exposing the target of a vidicon, whose electron beam has been blanked, to the uv light transmitted by the cell. When the shutter closes, the vidicon grid is unblanked and the stored image signal scanned and transmitted to a tv monitor, which displays one full frame in 33 milliseconds. It goes also to a line-selecting oscilloscope, which displays a single raster line derived from the vidicon scan signal and oriented vertically to traverse any portion of the uv-absorption image. A motion-picture camera photographs time-lapse sequences appearing on the monitor

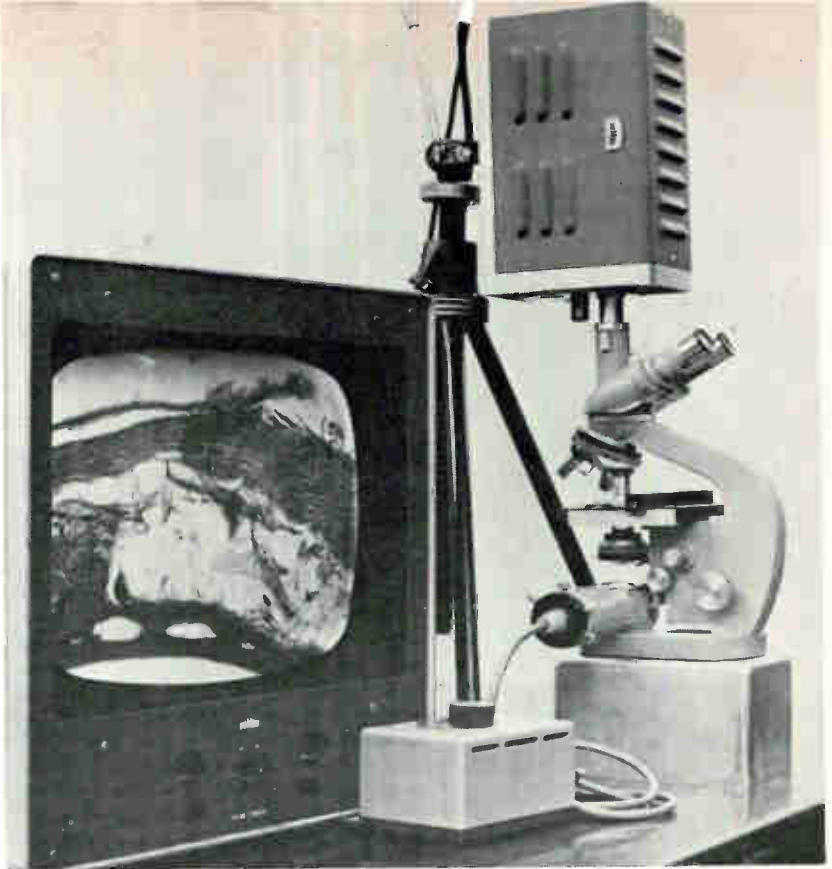

*Section of a frog's leg shown on a 17-inch monitor by combination of Elgeet's optical microscope and DuMont's closed-circuit tv*

*Direct observation of processes in living cells is possible with closed-circuit tv system using EMI Electronics' uv-sensitive vidicon camera tube*

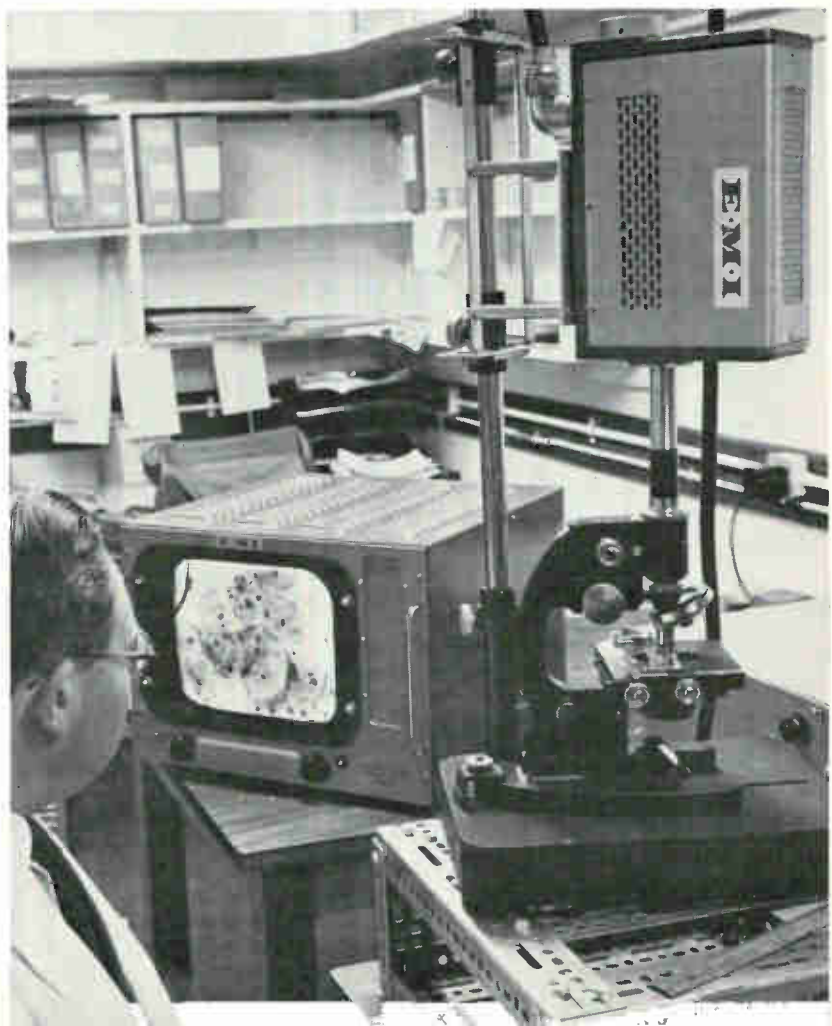



and oscilloscope screens. Special circuits synchronize the system with the tv vertical drive pulse.

Flying-spot uv scanning systems that spot-irradiate the specimen offer the highest efficiency of all uv microscopy approaches while requiring relatively simple circuits to obtain absorption measurements. The efficiency comes from the use of multiplier phototubes instead of photographic emulsions which need more dosage of the specimen to obtain a comparable image.

A flying-spot uv microscope has been developed at the U. of Texas Southwestern Medical School to study living cells.<sup>11, 12</sup> The light source is an uv-emitting flying-spot scanner having a 250-line raster that can be operated from a one-sweep-in-ten-second to one-sweep-in-1/20-second rate. By switching the raster on and off for any integral number of frames following any predetermined number of sweeps, intermittent irradiation studies can be made. Minification of the raster's image is achieved by sending it in reverse through the optical components of a reflecting microscope in which the specimen is mounted. Unabsorbed energy transmitted by the specimen strikes the photocathode surface of a uv-sensitive multiplier phototube. When amplified, the current generated by the multiplier phototube modulates a monitor tube synchronized with the uv flying-spot scanner. The black and white uv picture on the monitor represents primarily the nucleic acid absorption image of the living protoplasm. Through a beam splitter and a visible light scanner tube, the same area of the specimen can be viewed simultaneously in visible and uv light side-by-side on the monitor screen. Time-lapse motion-picture photography records the images.

Lack of wavelength control and spectral resolution are characteristic of uv scanning tubes. To overcome these disadvantages while retaining the merits of the flying-spot scanning technique, the Institute for Cancer Research in Philadelphia began working several years ago to develop a mechanical raster generator to be used with a conventional arc lamp and monochromator light source.<sup>13</sup> Late last month the project was completed. A d-c xenon arc is the light source

and a vibrating mirror moving on two axes simultaneously is the flying-spot scanner. Thus, the difficulties of electronic scanning—too wide a spectral bandwidth and too low a light intensity—have been eliminated. A small iris-like diaphragm in the single-prismed monochromator is the exit port for the uv beam that is focused on the specimen by achromatic optics and the sinusoidally deflecting mirror. A multiplier phototube detects the signals which are then amplified and sent to a tv monitor where an absorption image of the specimen is shown.

*Cell Counters*—Counting of red and white blood cells is commonly required for routine hospital admissions, diagnostic determinations and research studies. Electronics has made counting faster, easier and more accurate than manual methods. Also, the number of cells sampled is 50 or more times the amount used with manual count techniques, thus variations in count from random distribution of cells is markedly reduced. Inaccuracies caused by operator fatigue are eliminated and counts on a single specimen have been made practical.

By combining signal processing techniques with tv, quantitative measurements as well as counting

and measuring of particles can be accomplished. Automatic, instantaneous totalizing of particles can be done with a particle counter conceived by Bell Telephone Manufacturing Co. of Antwerp (an ITT associate). This instrument permits investigators to count bacterial colonies, and red and white blood cells and platelets.

The instrument uses a closed-circuit tv system (composed of a tv camera and control unit), a monitor, synchronizing generator, an optical microscope and an impulse counter. The image of the specimen slide appearing in the optical microscope is projected on the photocathode of the tv camera. This video signal is then fed to the monitor that displays the slide on its screen. By applying an additional slower raster signal to the monitor, a series of black lines appear on the screen. When any of these lines intersect a particle, an electrical pulse actuates the counter. The optical image from the microscope is enlarged until the diameter of the particle is equal to the distance between two successive lines.

Conversion equipment permits the use of uv light, but the loss in resolving power is about 1,000 to 1,500 Angstroms. Certain bacterial cultures which contain chlorophyll are spontaneously fluorescent when

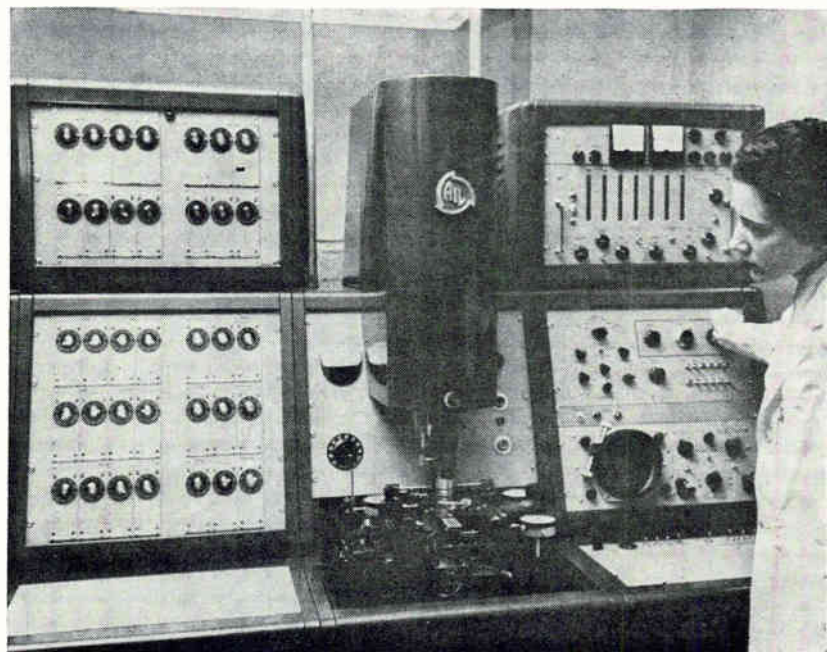

*AIL's Cytoanalyzer is a combination microscope and computer capable of sensing sizes and absorption of cell nuclei (Medical Tribune Photo—Esther Bubley)*

radiated with uv.

Sanborn Co. offers an optical-electronic white and red blood cell counter as a compact bench top unit.<sup>14</sup> The diluted sample is placed in a reservoir, the operating lever depressed and within six seconds (and for a 15-second period thereafter while sample flows through) the number of blood cells in a cubic millimeter of sample is continuously indicated on panel meter.

Use of a dark field optical system through which only the sampled solution moves insures that particles suspended are the only source from which electrical signals can be derived. Direct measurement of concentration is based on sensing flows through an inspection chamber. These are observed by a multiplier phototube. The dilution factor of the blood is such that cells are present in the inspection zone singly and only occasionally. An electrical signal is produced by the multiplier phototube for the exact duration of each cell's presence. Percent of time cells are present in the inspection volume is directly proportional to cell concentration. Thus, results are not affected by rate of flow, or cell type, size or morphology.

Blood cells can also be counted at high speeds and great accuracies for pathological purposes using the Evans Blood Cell Counter recently marketed by Racial Instrument of England. Principle of hydro blood cell propulsion permits count of white or red blood cells to be made. The quantity is read out on digital counters in millions of cells in a cubic centimeter.

*Cell Analyzers*—The Cytoanalyzer, developed by Airborne Instruments

Laboratory under the support of the American Cancer Society and NIH, uses computer techniques to automatically read microscope slides of smears prepared from cells of body secretions to determine presence or absence of abnormal cells among the large population of normal cells.<sup>15</sup> Thus, obviously normal specimens are eliminated leaving only the suspicious ones for the physician to examine further. This instrument is especially useful in automatically prescreening a mass of women for cancer of the cervix—the most prevalent form of cancer and one which can be controlled if detected at an early stage.

The smear image presented by an optical microscope is converted into an electrical signal by a Nipkow disk microscanner. As the entire nucleus of each particle is scanned, a series of video pulses is produced. The duration of each pulse is proportional to the length of the nucleus chord and the amplitude of the absorption. These quantities are measured and stored by analog circuits in a cell measurer that sorts the cells according to their area by summing all the chord measurements associated with the same nucleus. The absorption data are used to reject chords with high absorption values not characteristic of true cells. An association unit with a magnetic-core shift register informs the cell measurer which chords belong with a single nucleus by using the time coincidence between the stored and incoming chords. Selection circuits determine whether or not the particles satisfy established cytological rules for acceptance as cell nuclei. Accepted particles are classified into categories by a cell sorter according

to area and absorption values. Totalizers then count the number of particles falling into each category. The percentage of abnormal counts after 10,000 normal counts have been made is the criterion for labeling a smear normal or abnormal. Cancer cells from the vagina and cervix of a woman have larger and more deeply stained nuclei, and also a smaller cytoplasm/nuclear ratio.

Another cytological analyzer using computer techniques is the new automatic blood cell scanner, Cellscan, developed by Perkin-Elmer Co. and the U. of Rochester Medical School.<sup>16</sup> This instrument uses digital pattern recognition techniques to determine incidence of rare cell types thus aiding in identifying small exposures to ionizing radiation.

The system differentiates between classes of white cells by counting and sizing each cell's nucleus and granules. A tv microscanner produces a binary-coded video image—a digital ONE being generated when a white cell nucleus appears in the field of view, a ZERO for all other areas of view. These binary outputs are stored in a computer that makes several sequential passes through the image data until each group of ONE's is shrunk to an isolated ONE. The number of passes required to do this is proportional to the minimum chord of the original group. By counting the number of ONE's in the memory after each pass, an image histogram is completed. This information is then converted into a plot of the total number of groups of ONE's in the original image that fall into each of several maximum chord ranges.

## REFERENCES

- (1) R. C. Mellors, editor, "Analytical Cytology" (Ch 4 by C. C. Selby), McGraw-Hill Book Co., N. Y., 1959.
- (2) X-Ray Division and Kodak Research Laboratories, "Principles of Micro-radiography," Philips Electronics, Inc., Mount Vernon, N. Y., (no date).
- (3) R. C. Mellors, editor, "Analytical Cytology" (Ch 5 by A. Engstrom), McGraw-Hill Book Co., New York, N. Y., 1959.
- (4) F. Dunn and W. J. Fry, Ultrasonic Absorption Microscope, *Jnl Acoust Soc Am*, p 632-633, May 1959.
- (5) H. Phillip Hovnanian, Color-Translating Television Ultraviolet Microscopes, paper presented at *Microscopical Soc of Chi Symp*, June 10, 1958.
- (6) L. E. Flory, Scanning Microscopy in Medicine and Biology, *Proc IRE*, p 1889-1894, Nov 1959.
- (7) C. Berkley and M. A. Atamer, Observation with the Ultraviolet Color-Translating Television Microscope, *Fourth Int Conf on Med Elect*, July 1961.
- (8) H. L. Hackforth, "Infrared Radiation," McGraw-Hill Book Co., New York, N. Y., 1960.
- (9) W. E. Tolles and R. C. Bostrom, Some Theoretical and Practical Aspects of Microscanning, paper presented at *Western Electronics Show and Convention*, San Francisco, Calif, Aug. 25, 1955.
- (10) G. Z. Williams and G. X. Vurek, Measurements of Reaction Rates in Living Cells by Time-Lapse Ultraviolet Television Microscopy and Oscilloscopy, *Dig of Tech Papers*, 12th Ann Conf on *Elect Tech in Med and Bio*, Nov 1959.
- (11) P. O'B. Montgomery and W. A. Bonner, The Ultraviolet Flying Spot Television Microscope, *IRE Trans on Med Elect*, ME-6, p 143-146, Sept 1959.
- (12) L. L. Hundley, Flying-Spot Techniques in Microscopy, *Dig of Tech Papers*, 12th Ann Conf on *Elect Tech in Med and Bio*, Nov 1959.
- (13) J. J. Freed and J. L. Engle, Evaluation of Radiation Change in the Ultraviolet Microscopy of Living Cells, *Dig of Tech Papers*, 12th Ann Conf on *Elect Tech in Med and Bio*, Nov 1959.
- (14) P. L. Frommer, C. J. Brown, T. J. Hayes and J. F. Quinn, A Blood Cell "Counter" Utilizing the Direct Measurement of Particle Concentration, *Dig of Tech Papers*, 13th Ann Conf on *Elect Tech in Med and Bio*, Nov 1960.
- (15) R. C. Bostrom, H. S. Sawyer and W. E. Tolles, Instrumentation for Automatically Processing Cytological Smears, *Proc IRE*, p 1895-1900, Nov. 1959.
- (16) K. Preston, Jr., N. F. Izzo and M. Ingram, Machine Techniques for Automatic Identification of the Binucleate Lymphocyte, *Fourth Int Med Elect Conf*, July 1961.



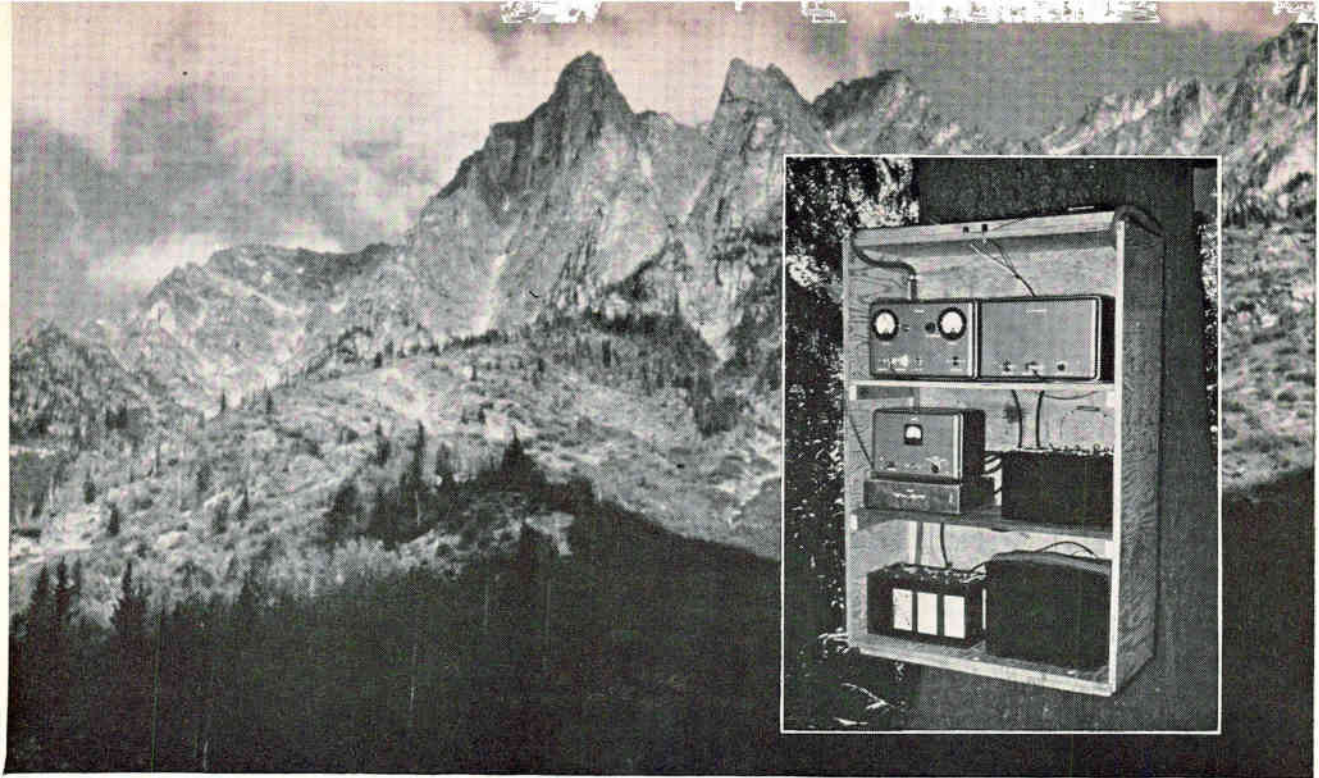

Warning system detects and reports on avalanches in areas like this one near Glacier, British Columbia, Canada

# Hybrid Telemeter Detects Avalanches

*System transmits tone-modulated signals to central station when wire is tripped.*

*Frequency of modulating tone identifies station transmitting alarm*

By G. NEAL  
S. A. STONE  
National Research Council,  
Ottawa, Canada

THIS WARNING SYSTEM detects the occurrence of an avalanche and transmits the information to a central location. The transmitted information is used to alert snow removal or rescue personnel.

An avalanche detecting unit is installed at a slide path in Glacier National Park, B. C. and two more provide service along the Trans-Canada Highway.

The system consists of a tone-modulated radio transmitter located safely to one side of the avalanche path, and a receiver and recording instrument at the road maintenance camp to decode and display the signal from the transmitter. A test

transmission, initiated by daylight falling on a sun switch, is sent each day to ensure that the equipment is ready.

Various types of sensors, including a light beam shining on a photocell and a pressure transducer mounted on the ground in the center of the avalanche path, were investigated.

These were rejected and the trip-wire was chosen. The trip wire consists of a pair of wires joined at the far end to form a closed circuit. An avalanche breaks the loop (Fig. 1A) to activate the transmitter.

Each transmitter is tone-modulated by a different frequency from 600 cps to 4,600 cps. Ten avalanche

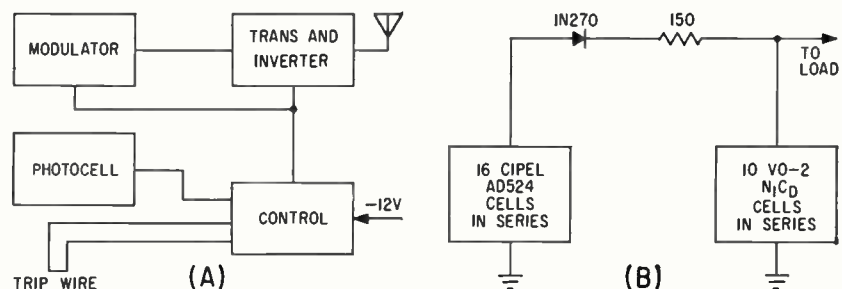

FIG. 1—Twelve-volt supply in transmitter (A) is from battery pack (B)

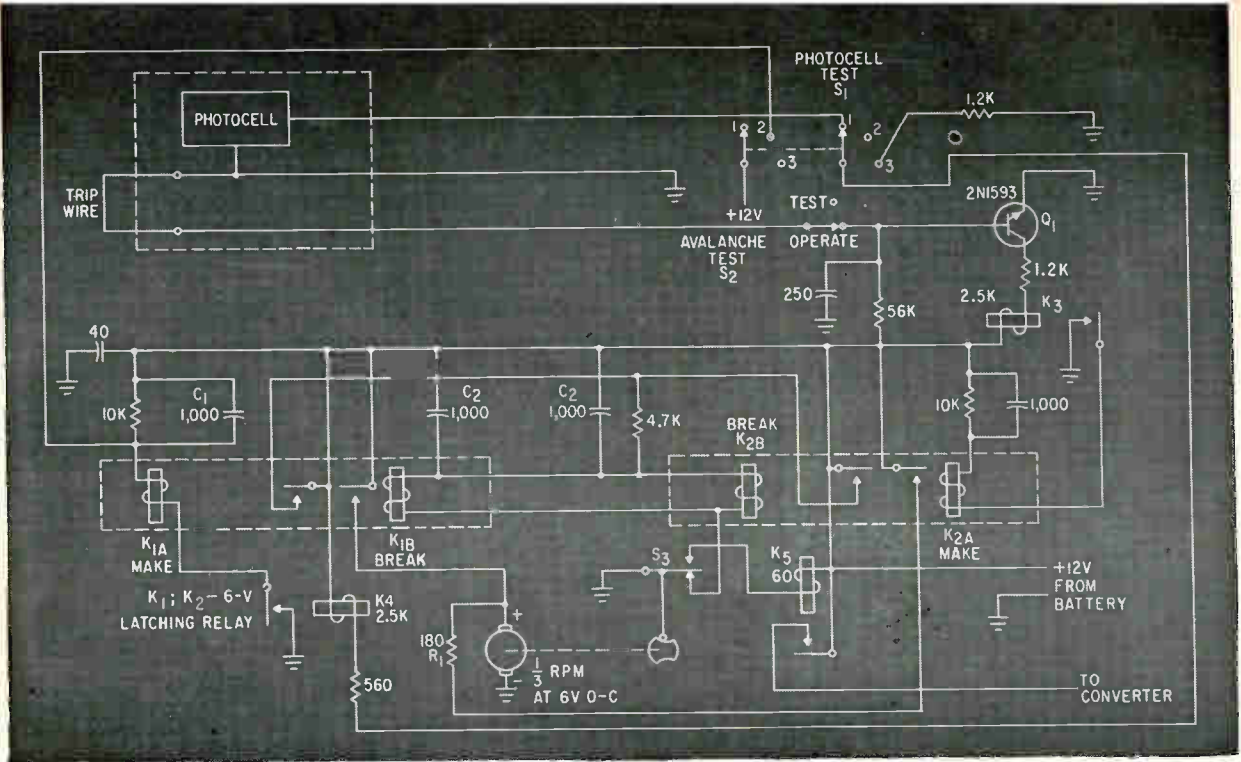

FIG. 2—Control circuit turns converter, transmitter and modulator off and on through relay contacts

paths can be monitored by each receiver.

The avalanche transmitter and modulator operates on 1,680 Kc and is all transistor, except for the final r-f stage, and delivers about 15 w into a  $\lambda/4$  bent-top antenna strung between trees.

Power for the final stage is supplied from a transistor converter that changes 12 v d-c into 410 v d-c, while the rest of the system works directly from the battery.

The battery (Fig. 1B) must deliver up to 8.5 amp for about 40 sec once a day for the test signal and the same current for about 1½ minutes in case of an avalanche. It must operate in a temperature range of  $\pm 30$  C and self discharging must be kept to a minimum.

The 4 amp-hr  $NiCd$  battery supplies low-duty-cycle high current and is trickle charged with primary cells. A single set of these batteries can provide up to seven months continuous operation.

The modulator uses a common-base feedback oscillator with a ferrite-core transformer. Two common-collector stages provide isolation and power gain. A 2N250 stage then drives a pair of 2N173's in push-pull to provide the plate-screen modulation of a 1625 tube in the final r-f stage.

Total current drawn by the modulator is metered. In addition, a portion of the oscillator output is rectified and metered to check performance.

The converter and the transmitter are built on a single chassis. A 2N274 crystal oscillator and 2N1046 buffer drive the 1625 tube. Metering of battery voltage, final current, final voltage and grid current provides for circuit adjustment at the avalanche site.

The receiving system consists of a crystal controlled fixed-tuned receiver, decoding and alarm chassis, and multipen recorder.

In the decoder, an audio tone from the receiver is passed through filters and converted to d-c. This voltage fires a thyratron in whose plate circuit is a relay that operates the pen.

The filter circuit permits identification of the avalanche transmitter from which the signals are received.

After the signal has been received for about 1 minute, a self-holding time-delay relay operates, turning on a warning light and ringing a bell. A pushbutton reset turns them off when the alarm has been sounded.

When, in the avalanche control unit (Fig. 2), daylight reduces the

resistance of the photocell to a sufficiently low value,  $K_1$  operates, and a pulse of current flows through  $C_1$  closing  $K_{1A}$ . This applies power to the d-c motor that closes  $S_2$ . Now, contactor  $K_3$  is energized through  $S_2$  and feeds 12 v to the converter, transmitter and modulator.

When  $S_2$  opens at the end of half a revolution of the cam,  $K_3$  removes power from the load and another pulse of current through  $C_2$  opens  $K_{1B}$ . Relay  $K_{1B}$  stays in this state until the following morning when light again will cause  $K_1$  to close and start the entire cycle.

Operation when an avalanche occurs is similar. If the closed loop forming the trip-wire is broken by an avalanche, the base of  $Q_1$ , which was held at ground by the low d-c resistance of the wire now is free to rise. Collector current then flows and  $K_3$  closes and a pulse of current turns on  $K_2$ . Power is applied to the motor through  $R_1$  and a contact on  $K_2$ . From there on, operation is exactly the same as for the daily test except that  $R_1$  slows the d-c motor giving a much longer trace on the recorder than for the test signal. This difference differentiates between a real avalanche and the daily test transmission.

With slight changes the system could provide flood warnings.



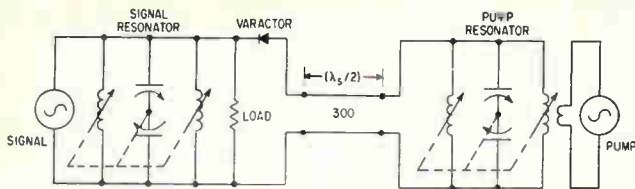

FIG. 1—Degenerate parametric amplifier using butterfly resonators

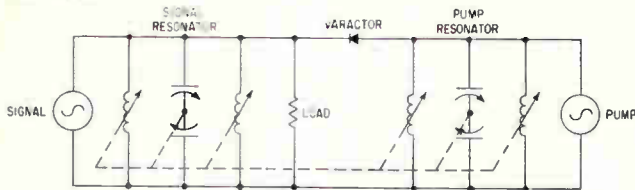

FIG. 3—Suggested circuit for single-knob tuning of a parametric amplifier

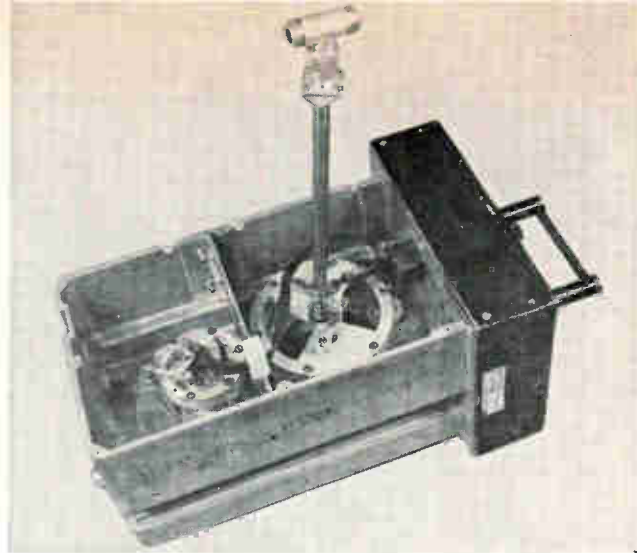

FIG. 2—Butterfly resonators are mounted in compartments. Signal resonator, right, has balun attached

# Degenerate Parametric Amplifier

## USES BUTTERFLY RESONATORS

*Design suggests the possibility of ultrahigh frequency parametric amplifiers using low-cost components and continuously tunable with a single control*

By RICHARD J. MAYER  
Electrophysics Group  
The Boeing Co., Renton, Wash.

PARAMETRIC AMPLIFIERS, while offering low-noise operation at ultrahigh frequencies, are relatively complex and usually difficult to tune. A design that shows promise of simplifying construction and tuning is built around two butterfly resonators. Other components in the circuit of this degenerate parametric amplifier (Fig. 1.) include an MA450E varactor diode and a half-wave (at signal frequency) section of 300-ohm twin-lead. A degenerate parametric amplifier is one in which the idler frequency is equal to the signal frequency.

Tuning range of the signal resonator is 135 to 485 Mc, and that of the pump resonator is 300 to 1,000 Mc. The varactor and the signal resonator are connected in series to one end of the twin lead, and the pump resonator to the other. The pump signal is loop-coupled to the

pump resonator, and the signal source and load are both direct-coupled to the signal resonator.

Operating at a signal frequency of 485 Mc and a pump frequency of approximately 970 Mc, the amplifier power gain is 18 db at a bandwidth of 10 Mc.

The amplifier is built into the tuning unit chassis shown in Fig. 2. At the left is the pump resonator with the coupling loop for the pump signal. The signal resonator and the varactor are on the right. A balun makes the transition from the unbalanced (coaxial) signal and load lines to the signal resonator.

Twin-lead was used because the resonators were fixed in the chassis and, therefore, both resonators could not be directly connected across the varactor. Because the twin-lead is one-half wavelength long at the signal frequency (and a full wavelength long at the pump frequency), it effectively couples the signal resonator directly across

the series combination of the varactor and the pump resonator. (Load impedance of a transmission line is repeated at half-wave intervals.)

Pump and signal circuits do not interact when the resonators are tuned to their respective resonant frequencies because the  $Q$  of butterfly resonators is high (typical values of  $Q$  range from 200 to 1000); the pump resonator is virtually a short-circuit at the signal frequency and, likewise, the signal resonator is a virtual short-circuit at the pump frequency.

If the resonators were removed from the chassis, it would be possible to eliminate the twin-lead. This suggests the use of gang-tuned resonators that are designed so that one maintains twice the resonant frequency of the other over a frequency band of interest; thus, a parametric amplifier that is tunable over a frequency band with a single control (Fig. 3) appears feasible.









**Now  
Reduce  
Your**

This semiconductor network data processor was developed by Texas Instruments Incorporated under the direction of Manufacturing and Electronic Technologies Laboratories, Aeronautical Systems Division, Dayton, Ohio.

# Microelectronic Design Time

with Series 51 **SOLID CIRCUIT**\* semiconductor networks

**HERE'S HOW:**

-  designed to fulfill logic functions of complete equipment assemblies—compatible with most of today's logic circuitry.
-  low power drain minimizes thermal problems and reduces power supply requirements.
-  advanced manufacturing techniques including diffused planar structures, deposited leads, oxide protection, and hermetically sealed package—offer you the potential for improved circuit reliability.
-  today's ultimate in microelectronics—with the highest function/size ratio for your digital circuits or equipments.
-  provide reduced microelectronic cost through TI's standard silicon wafer design.
-  meet military requirements:

Power Drain \_\_\_\_\_ 2-4 mw @ 3 volts  
 Fan-Out (TI SN 510, 512, 514, 515) \_\_\_\_\_ 4  
 Fan-Out (TI SN 511, 513) \_\_\_\_\_ 20  
 Propagation Delay \_\_\_\_\_ 75 to 450 nsec  
 Power Supply \_\_\_\_\_ 3 to 6 volts  
 Temperature Range \_\_\_\_\_ -55° to +125°C

UNIT	TI SN 510	TI SN 511	TI SN 512	TI SN 513	TI SN 514	TI SN 515
FUNCTION	Flip Flop, Counter	Flip Flop with emitter follower output	NOR/NAND Gate (6 input)	NOR/NAND Gate (6 input) with emitter follower output	Two NOR/NAND Gates (3 inputs each)	Exclusive OR
	Clock pulse is internally capacitive-coupled					

CONTACT YOUR NEARBY TI SALES ENGINEER TODAY FOR COMPLETE  SPECIFICATIONS AND CUSTOM DESIGN ASSISTANCE.

\*Trademark of Texas Instruments Incorporated

COMPONENTS DIVISION  
 CAPACITORS, DIODES,  
 RECTIFIERS, RESISTORS,  
 SEMICONDUCTOR NETWORKS,  
 SILICON CONTROLLED RECTIFIERS



**TEXAS INSTRUMENTS**  
 INCORPORATED  
 13500 N. CENTRAL EXPRESSWAY  
 P. O. BOX 5012 • DALLAS 22, TEXAS



# Pressure Data System Uses Digital Transducers

By E. L. KARLSON,  
 President  
 Precision Research Inc.,  
 Stamford, Conn.

DIGITAL data handling system has been designed around a transducer that reads pressure photoelectrically from binary encoded disks. No electrical analogs are involved, which eliminates the need for closely regulated power supplies to obtain highly accurate data. The same patented readout technique will also be used in temperature-monitoring transducers.

Flexibility is one of the basic advantages of a digital pressure data system using the transducers. The transducers can accommodate partial conversion of a plant to automatic operation. The system can later be made fully automatic without replacing the elements that have already been installed.

For example, existing gages can be replaced with the transducers shown in the photograph, which provide local readout of pressure. The same transducers can provide

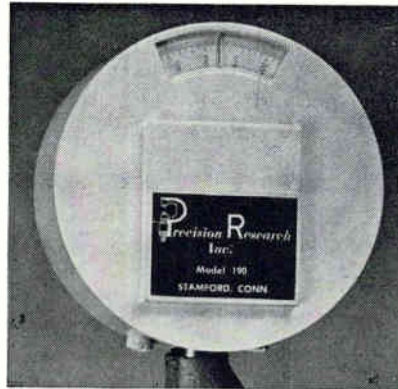

*Pressure transducer provides local indication as well as digital output for remote readout and control*

pressure information in either decimal or binary form for remote readout without the added cost and complexity of analog-to-digital conversion. Finally, the pressure data can be fed to a digital control computer for automatic operation.

Standard Bourdon tubes are used as the pressure-sensing elements, and they govern accuracy of the pressure data. Consequently, costly high-accuracy instrumentation is

unnecessary, which is particularly significant when other system parameters cannot be provided with comparable precision.

Pressure is read photoelectrically from high-tensile strength nickel disks attached to the pressure-sensing movement. The disks are encoded with gray binary code by precision electroforming. A window in the front face of the transducers permits pressure to be read locally.

A digital pressure data system can include a data control unit and a decimal converter display unit. The data control unit at A in the figure furnishes power for operating as many as six transducers.

Other system functions performed by the data control unit includes providing binary data continuously on indicator lamps for remote readout of the six transducers. The control unit also feeds the digital information to the decimal converter for display on counters, supplies interrogation pulses for independent binary or decimal readout of transducers and accepts external interrogation pulses from a computer to read out any one of the six transducers. The binary encoded outputs from the data control unit are provided in the form of positive or negative 10-volt pulses.

Information provided to the decimal converter readout display at rates from 1 to 10 bits per second is converted to decimal form and displayed by edge-lighted numerals from .000 to 999. The display can retain the most recent information until the converter is manually interrogated. Six converters fit on a 6 by 9 inch standard rack.

When the system includes a central computer as at B in the figure, any one of the six transducers can be interrogated, and the dated information is fed back sequentially to the computer. To interrogate a particular transducer, the computer feeds an encoded pulse that identifies the transducer to the local data control chassis over a two-wire line. The pulse is interpreted by the con-

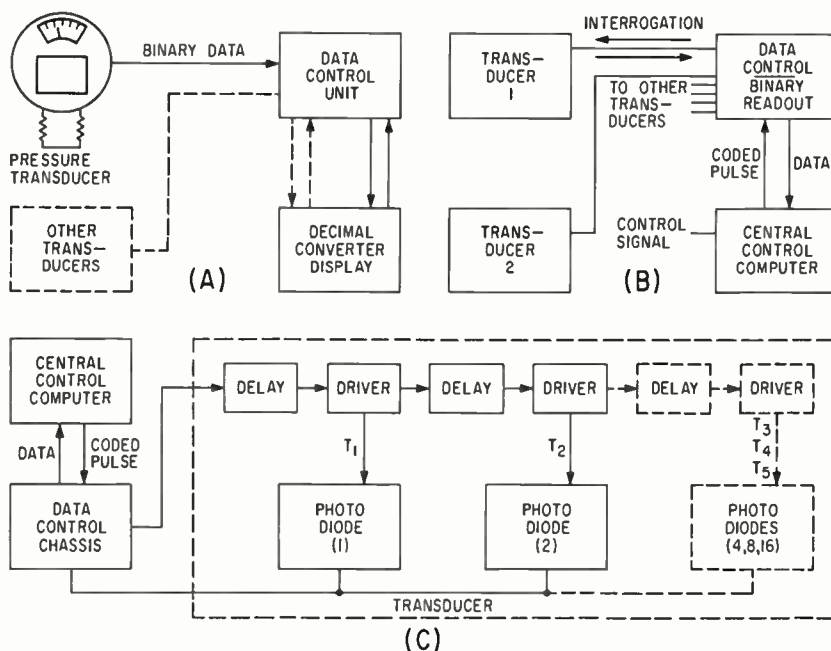

*Pressure is displayed in binary and decimal form (A), and transducers can be interrogated by computer (B). Driver pulses (C) each read one bit from the associated photo diode*

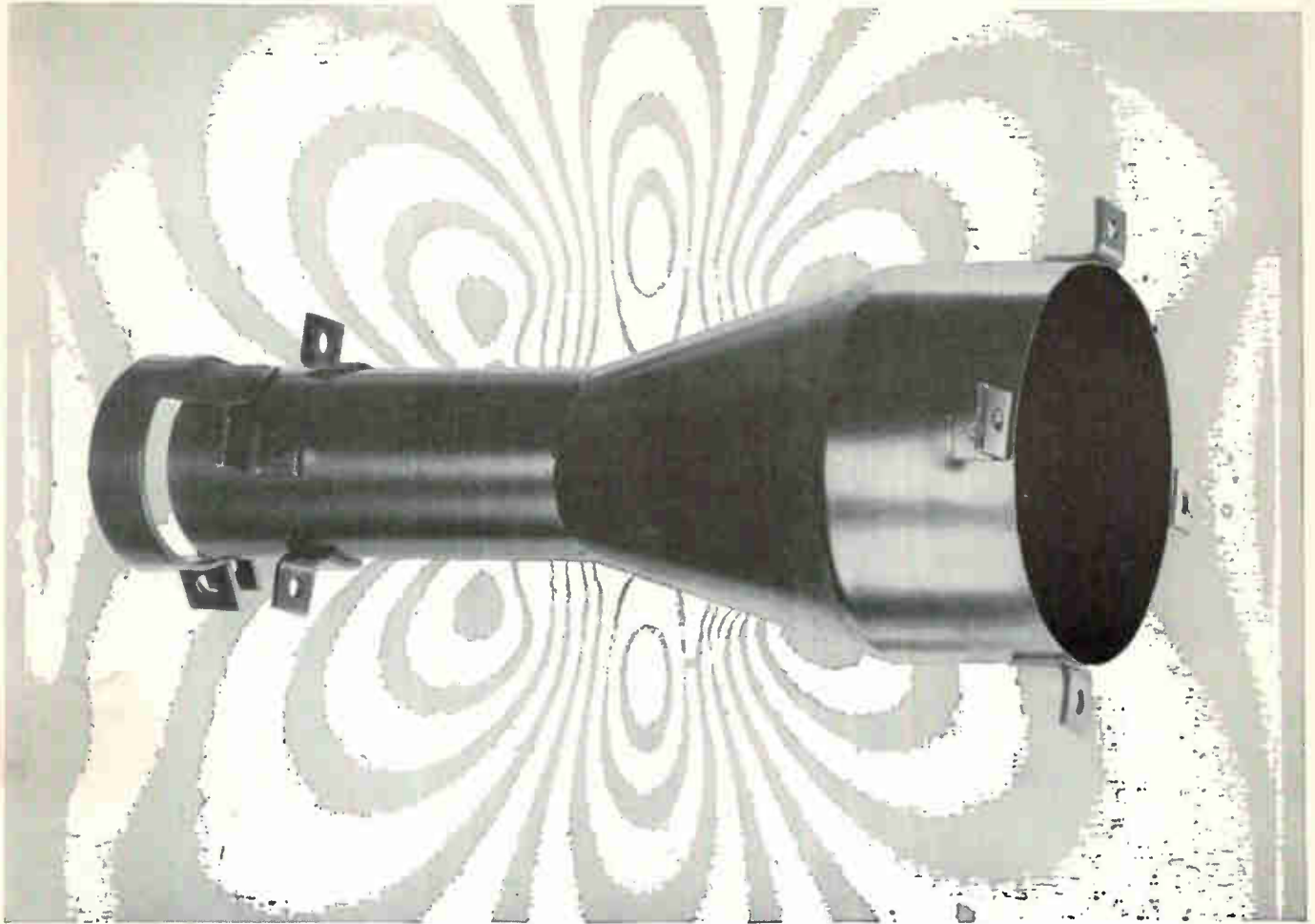

## keep your signals clean with engineered magnetic shielding

Keep stray magnetic fields out of your high gain input transformers and cathode ray tubes. Keep your signals free of noise, hum, cross-talk and distortion. You can do it only with *engineered* magnetic shielding.

These high-permeability shields are made from existing tools in a broad variety of single and multiple structures—cylinders, spheres, truncated cones—for applications ranging from dc into the audio range and higher. They can be used with almost all conventional transformer core and coil assemblies to provide any degree of magnetic, electrostatic or RF shielding against undesired signals of

all classes. Reduction of field strengths to 100 db and beyond is common.

With Magnetic Metals shielding, both the electrical and mechanical engineering is already done for you. Simply let us know your requirements . . . We'll engineer the exact type of shielding you need. In selection of raw material, design, fabrication, annealing, testing and gaging, Magnetic Metals has amassed a great backlog of shielding experience. For a better understanding of shielding and help in specifying it, write for our informative booklet, "Magnetic Shielding of Transformers and Tubes."

**M**MAGNETIC  
 **M**ETALS

### MAGNETIC METALS COMPANY

Hayes Avenue at 21st Street, Camden 1, N.J.

853 Production Place, Newport Beach, California

*transformer laminations • motor laminations • tape-wound cores  
powdered molybdenum permalloy cores • electromagnetic shields*





# Sperry adds high-power pulsed TWT's to list of tubes available in 30 days

In a move to simplify design problems in present and future radar systems, Sperry Electronic Tube Division of Sperry Rand Corporation has added two high-power pulsed traveling wave tubes to the list of advanced microwave tubes available in 30 days.

The two tubes covered by the announcement—the STL-114 and the STC-152—operate in L and C bands, respectively. They are typical of a line of pulsed TWT's ranging from P through V bands which Sperry offers on a firm delivery date basis.

### EASY RADAR APPLICATION

Sperry's pulsed TWT's are admirably suited to the demands of application in phased array radars, height finders, search, ECM, and other radar applications. Widely varied in-system experience has proved that their reliability, long life, high power, high gain, and extreme broadband operation make them ideal for radar use.

Design features of this tube family minimize the necessity for system adjustments in the field. Among these features are broadband response, constant voltage operation, and short circuit stability.

### VERIFIED RELIABILITY

These pulsed TWT's, produced at Sperry's Great Neck, N. Y., facility, have compiled an impressive record of in-system experience. Such experience has proved that their resistance to shock and vibration damage, their inherent indifference to ambient conditions, and their mounting flexibility make them ideal for ground or airborne application.

Place your order with your Cain & Company representative. His phone number appears in the adjacent column. Tubes are available within 30 days after receipt of order.

**FREE TECHNICAL INFORMATION** on the Sperry line of high-power pulsed traveling wave tubes may be obtained by writing to Sec. 102, Sperry Electronic Tube Division, Gainesville, Florida.

### V BAND CAPABILITY

Among Sperry's other interesting activities in pulsed TWT's is the extension of capability into the V Band—26.5 to 40.0 kMc. Although these efforts are largely classified, inquiries are invited from those who have the necessary clearance and need to know.



**FACTORY ALIGNMENT** of a Sperry TWT within its focusing solenoid greatly simplifies field maintenance. Once this operation has been performed by a skilled Sperry technician, the assembly is self-aligning.

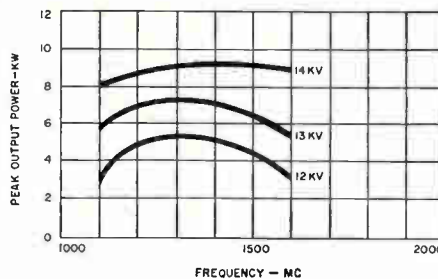

Typical saturated power output vs. frequency for a pulsed Sperry TWT.

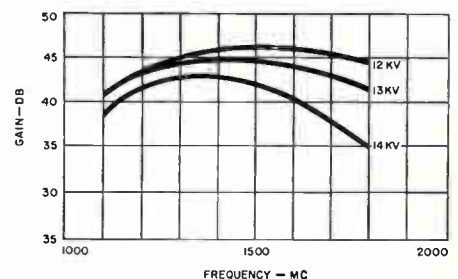

Typical small signal gain vs. frequency for a pulsed Sperry TWT.



**ELECTRONIC  
TUBE  
DIVISION**

GAINESVILLE, FLA. / GREAT NECK, N. Y.  
SPERRY RAND CORPORATION

# Inquire about Sperry Tubes from these convenient Cain & Company offices

## REGIONAL OFFICES

Burbank, California  
2615 W. Magnolia Blvd.  
VI 9-6781

Great Neck, Long Island,  
N. Y.  
260 Northern Boulevard  
HN 6-0600

Chicago 45, Illinois  
3508 Devon Avenue  
OR 6-9500

St. Petersburg, Florida  
410 — 150th Avenue  
Madeira Beach Prof. Bldg.  
391-0151

## DISTRICT OFFICES

Boston, Massachusetts  
Phone VO 2-5330

Philadelphia, Pennsylvania  
Phone VI 8-1700

Washington, D. C.  
Phone EX 3-7587

Dayton, Ohio  
Phone RO 7-8661

Dallas, Texas  
Phone BL 5-2050

Albuquerque, New Mexico  
Phone 268-5300

San Francisco, California  
Phone YO 8-0995

San Diego, California  
Phone HU 8-0665

Seattle, Washington  
Phone MA 3-3303



SPERRY RAND CORPORATION

CIRCLE 79 ON READER SERVICE CARD

December 15, 1961

trol unit, which then sends the appropriate interrogation pulse to the selected transducer.

The interrogation pulse passes through the magnetic-core timer at C. The timer, which is inside the transducer, is comprised of the magnetic cores, a series of transistor drivers for the cores and delay networks. Each of the successively more delayed driver pulses reads out one bit by interrogating the associated photo diode. The bits form the serial readout of pressure, which is fed back to the data control chassis. Finally the digital data is fed back to the computer over the same two-wire line.

Zeroing and calibration of the

transducers involves adjustment of only a single screw at the rear.

The digital pressure transducers can withstand adverse environmental conditions, such as corrosive atmospheres or outdoor use. No failures occurred in shock tests up to 5 g's, and the transducers can provide remote pressure readout operating over a temperature range from -40 to 250 F. The pressure instruments are being produced with pressure ranges from 10 inches of water full scale to 5,000 psi.

The temperature - monitoring transducers using this readout technique will cover temperature ranges up to 500 F.

## Magnetoresistance Voltage Regulator

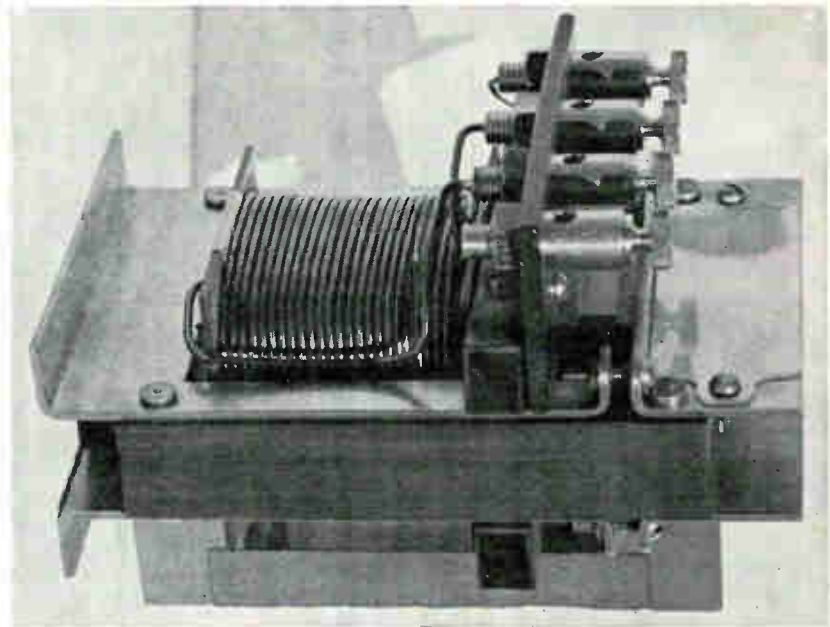

INDIUM antimonide semiconductor is used to maintain constant output voltage in a regulator designed specifically for tunnel diodes. The regulator is a practical application of the phenomenon of magnetoresistance, in which resistance of a semiconductor varies in proportion to the strength of an applied magnetic field. The magnetoresistance voltage regulator was developed by Battelle Memorial Institute in a research program sponsored by the Aeronautical Systems Center, Air Force Systems Command.

As input to the electromagnet shown in the photograph is increased, it produces a stronger mag-

netic field. The resistance of the indium antimonide semiconductor located in the field is therefore also increased. Similarly, a decrease in input to the magnet coil decreases magnetic field strength, thereby decreasing resistance.

The regulator can maintain an output voltage of 0.15 volt within  $\pm 5$  percent at 0.1 amp. This regulation is maintained with changes in load resistance of 50 percent and simultaneous changes of 10 percent in input voltage, normally 1.5 volts.

Much more precise regulation can be achieved with a magnetoresistance regulator when it is used with output voltages of one volt or more.



# Light-Triggered Device Switches High Power

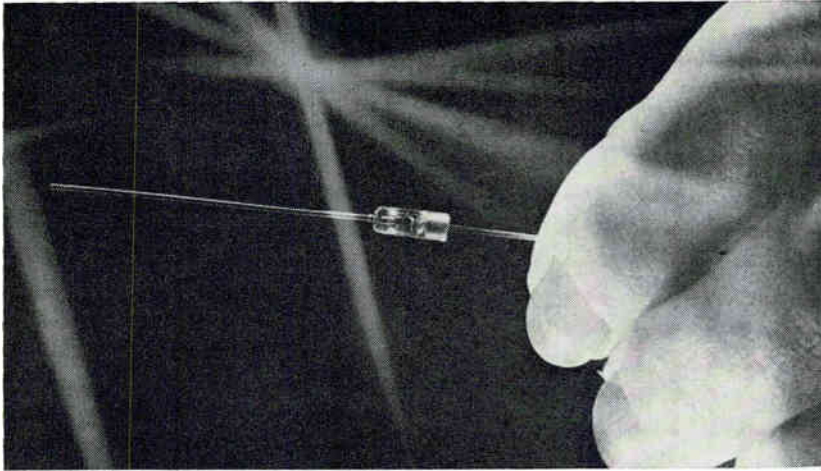

*Controlled rectifier with a light gate turn on handles 160 watts continuously, can eliminate several stages of circuit work*

SUBMINIATURE PNP SWITCHES, recently shown by GE's Rectifier Component Dept. to about 25 engineers in various electronic companies, made the engineers wonder why they hadn't thought of the idea themselves. Most intriguing was the device's high power handling ability—160 watts for continuous operation, two kilowatts for one cycle—which provide wide static switching applications.

Operating principle is based on triggering a *pnpn* junction by light, an effect long known to semiconductor researchers. This phenomenon completely isolates the input from the device, a highly desirable characteristic in a static switch. Also, the user can easily observe the status of the input signal.

Like other photovoltaic devices, this switch responds to light in the 0.4 to 1.1 millimicron region and peaks at approximately 0.8 millimicrons. This generally covers the range of human visibility and up to the near infra red area.

Turn-off turn-on time is being evaluated now, but switching speed is in the microsecond range, comparable to similar silicon controlled rectifiers. Reliability of light source should complement that offered by these semiconductor switches, which are inherently very high. Inexpensive miniature lamps of

both incandescent and neon types are available in both life and reliability categories to meet a wide variety of requirements.

Device will respond to light falling at angles perpendicular to the radial axis of the unit. Greatest sensitivity to light is for angles of approximately 45 deg. Optical performance can be enhanced by cylindrical or parabolic reflectors.

Peak reverse voltage and forward breakover voltage ratings vary from 50 volts to over 400 volts. Peak one cycle surge current rating is five amperes. At 35 C, the device is rated up to 400 milliamperes.

Preliminary application notes, supplied by GE, indicate interesting applications as relays, card and tape reading character recognition, photoelectric control and simple switching schemes.

Among computer men, the devices have aroused great interest in card and tape reading and character recognition. Fast, bistable operation presents very sharp wave fronts which simplify circuits and often enhance the operation of following computer circuits. The ZJ235 is a true *on-off* switch in comparison to photodiodes or other semiconductor devices. For character recognition a typical system would consist of an array of light activated switches, light admitted

through the cathode end.

One of the most difficult areas for the devices is in detection of objects interrupting a light beam, as great light sensitivity is needed for long light throws, and often circuits should be closed on the absence of light. These obstacles can be overcome by use of an inexpensive lens system, a stronger light source, or both. And to invert the action (closing when light is interrupted) an inexpensive relay can be added, or another silicon controlled rectifier can be included.

These light activated switches can be considered as silent, hermetically sealed relays that can operate as half wave static devices, full wave a-c load, or full wave d-c inductive load. When the light source is energized, the device latches into conduction. On a d-c circuit this latching action results in a simple, inexpensive memory. The device will remain *on* until intentionally turned *off* by methods used with conventional silicon controlled rectifiers, that is, mechanical interruption of the main load carrying circuit or commutation with capacitors.

In an a-c circuit, the device will turn *off* at the end of each positive half cycle. A full-wave bridge configuration is often the most practical circuit when the load demands full wave conduction.

In alarm circuits, light activated switches can accept different signals, a-c or d-c, of any voltage that can energize a lamp. This is usually difficult to accomplish with other types of alarm circuits. The load current limit of 400 ma for normal operation can be exceeded, as it would not be necessary to re-block forward voltage in a manually reset alarm system. The inherent memory of the device locks up the alarm signal, if this is desired.

By using two switches in a back-to-back configuration, efficient power reduction can be obtained in the form of a three-position switch. Power to the load can be reduced to half by illuminating just one of

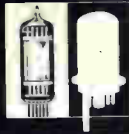

*Bendix Craftsmanship at work for you*

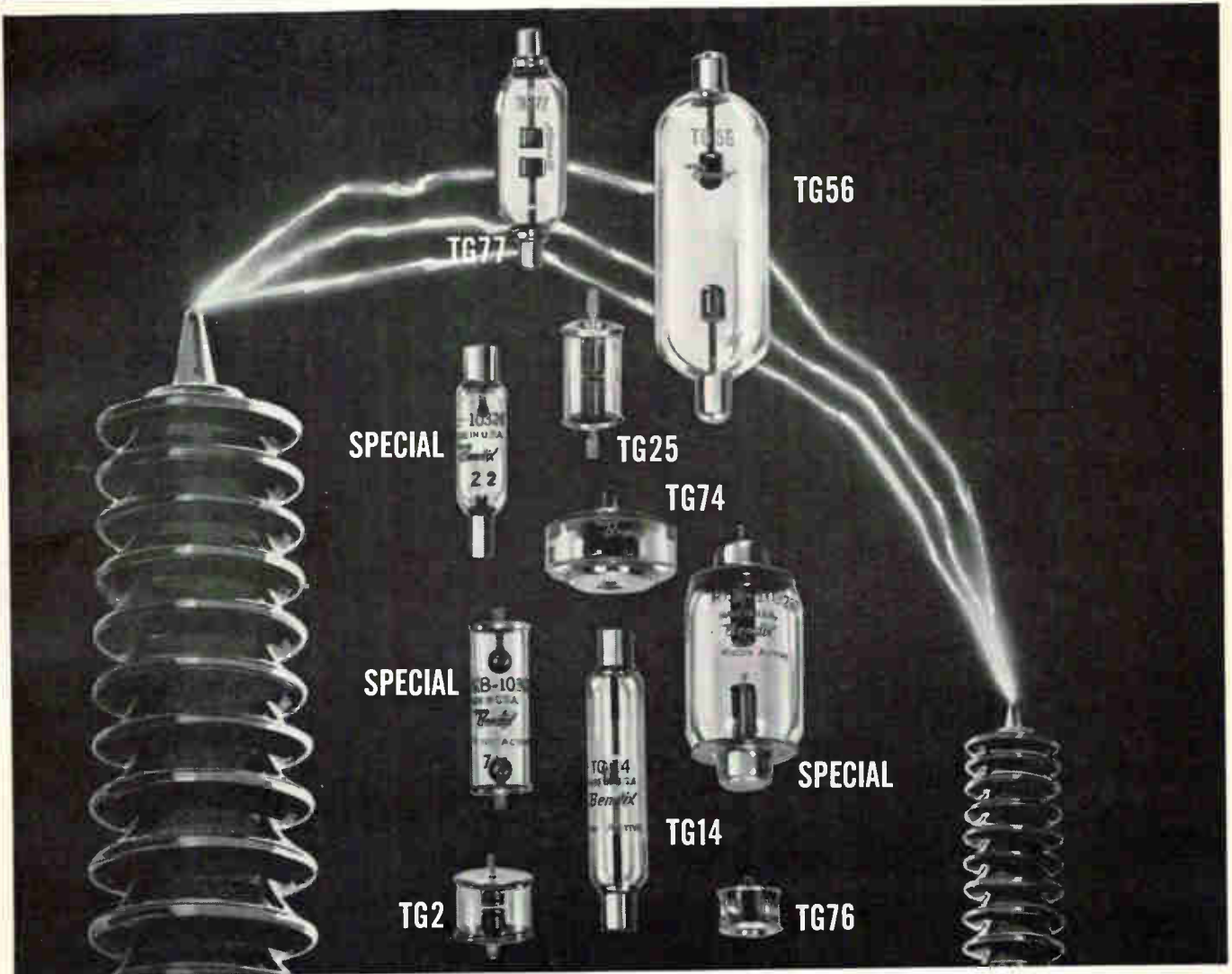

**BENDIX® SPARK GAP TUBES SPECIALLY DESIGNED TO PROTECT RADAR AND OTHER ELECTRONIC CIRCUITS** These versatile tubes do two major jobs in electronic circuits: first, protect radar and other electronic circuits against voltage overload, keeping high voltage surges from getting through to damage circuit components; second, act as a “triggering” switch in such applications as jet ignition systems. These tubes pass high currents with relatively low voltage drop, handle high voltages in small space. If this spark gap line—ranging from 750 V to 50 KV DC breakdown voltages—doesn’t meet your needs, we’ll design and produce special units for you. Write for details. Electron Tube Products, The Bendix Corporation, Eatontown, N. J. Export Sales: Bendix International, 205 E. 42nd St., New York 17, N.Y.

**Red Bank Division**





You can order

# TAS106M035POF

from your Mallory Distributor

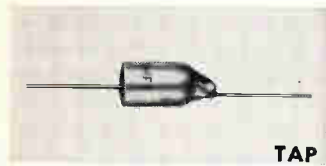

TAP

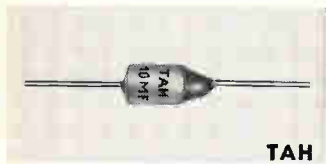

TAH



TAS



XTK



TAF



TAG



XTV



XTH



XTL

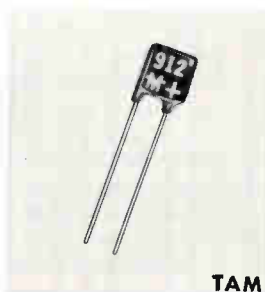

TAM



MTF



XTM

You don't need a paragraph of specs to order a Mallory Tantalum Capacitor. A simple 13-digit number tells the *complete* story. And you can choose from the industry's widest selection: Sintered Anode—Solid or Liquid Electrolyte, Foil—Polar or Non-polar, .25 mfd to 2200 mfd,  $-80^{\circ}\text{C}$  to  $+200^{\circ}\text{C}$ . Thirteen types, hundreds of ratings, a tantalum capacitor to fit your exact need.

To get the details, ask *your* Mallory Distributor for Catalog 9-169. It's loaded with information. Then specify Mallory and get *delivery from stock at regular factory prices.*

easiest to specify—easiest to buy

**Delivered from stock at factory prices by these distributors:**

- Arlington, Va. Rucker Electronic Products
- Baltimore, Md. Radio Electric Service
- Binghamton, N.Y. Federal Electronics
- Boston, Mass. DeMambro Radio Supply Co.
- Lafayette Radio
- Bridgeport, Conn. Westconn Electronics
- Buffalo, N.Y. Wehle Electronics
- Chicago, Ill. Allied Radio Corp.
- Newark Electronics Corp.
- Cincinnati, Ohio United Radio
- Cleveland, Ohio Pioneer Electronics
- Dallas, Texas Engineering Supply Co.
- Dayton, Ohio Allied Supply Co.
- Denver, Colo. Denver Electronics
- Houston, Texas Harrison Equipment Co., Inc.
- Lenert Company
- Indianapolis, Ind. Graham Electronics
- Los Angeles, Calif. California Electronics
- Kierulff Electronics, Inc.
- Radio Product Sales
- Minneapolis, Minn. Northwest Radio
- Monrovia, Calif. Lynch Electronics
- Montreal, Que. Canadian Electrical Supply Co.
- Mountainside, N.J. Federated Purchaser, Inc.
- Nashville, Tenn. Electra Dist. Co.
- Newton, Mass. Cramer Electronics, Inc.
- Newark, N.J. Lafayette Radio
- New York, N.Y. Harrison Radio Corp.
- Harvey Radio Co., Inc.
- Lafayette Radio
- Milo Electronics
- Terminal Hudson Electronics
- Oakland, Calif. Elmar Electronics, Inc.
- Orlando, Fla. East Coast Electronics
- Ottawa, Ont. Wackid Radio-TV Lab.
- Palo Alto, Calif. Zack Electronics
- Pasadena, Calif. Allied Radio of California
- Perth Amboy, N.J. Atlas Electronics
- Philadelphia, Pa. Herbach & Rademan
- Philadelphia Electronics
- Pittsburgh, Pa. Radio Parts Co.
- St. Louis, Mo. Olive Electronics
- Seattle, Wash. F. B. Connelly Co.
- Tampa, Florida Thuro Distributors, Inc.
- Toronto, Ont. Alpha Aracon Radio Co.
- Electro Sonic Supply
- Wholesale Radio & Electronics
- Tulsa, Okla. Engineering Supply Co.
- Union City, N.J. Nidisco—Union City
- Washington, D.C. Capitol Radio Wholsalers
- Electronic Industrial Sales
- White Plains, N.Y. Westchester Electronic Supply Co., Inc.
- Winston-Salem, N.C. Dalton-Hege Inc.

Distributor Division  
P. R. Mallory & Co. Inc.  
Indianapolis 6, Indiana



the switches, or full power can be obtained by illuminating both units. Simple power programming can be arranged by turning on one switch, with the other being turned on by a lamp in parallel with the load.

Another suggested application for the light activated switches is for small signal actuation by meter deflection. The light switch offers one of the simplest methods of closing a 400 volt 160 watt contact at the desired position of a meter pointer or disc.

Other suggested applications include simple computer logic, read-out from optical-electronic circuits, flame detection, squib firing, light flip-flops, light choppers, and tower light monitors.

To best understand the operation of a *mpn* switch, such as the ZJ235, Dennis Grapfam, applications engineer at GE, outlined the theory.

It is convenient to visualize the device as consisting of two independent silicon transistors, an *npn* and a *pnp* connected as shown:

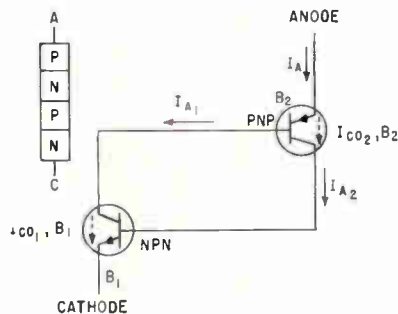

The collector of the lower *npn* transistor drives the base of the upper *pnp* transistor, while the *pnp*'s collector drives the *npn*'s base. This positive feedback loop has an overall gain of  $(B_1 \times B_2)$ , where  $B_1$  and  $B_2$  are the common-emitter current gains of the two transistors.

With no light applied, total anode current,  $I_A$ , may be expressed in terms of the two betas and the transistor leakage currents  $I_{C01}$ ,  $I_{C02}$  where,

$$I_{A1} = I_{C01}(1 + B_1) + B_1 I_{A2}$$

$$I_{A2} = I_{C02}(1 + B_2) + B_2 I_{A1}$$

$$I_A = (I_{A1} + I_{A2})$$

Solving these equations for  $I_A$  gives,

$$I_A = \frac{(I_{C01} + I_{C02})(1 + B_1)(1 + B_2)}{1 - B_1 B_2} \quad (1)$$

At junction temperatures below rated maximum, and with applied anode voltage less than the device's specified forward breakover voltage, the product  $(B_1 \times B_2)$  is less than unity. Since leakage current  $I_{C0}$  of a silicon transistor can be made very low, total device anode current  $I_A$  is also very low (equation 1), and the ZJ235 is said to be in its high impedance or off state.

To initiate the characteristic *mpn* switching action, i.e. the change-over from high to a low impedance or on state, this same loop gain  $(B_1 \times B_2)$  must be raised to unity. From equation 1,  $I_A$  goes to  $\infty$  when  $(B_1 \times B_2)$  goes to 1, and under these conditions both transistors are driven to saturation. Anode-cathode voltage falls, and device current is limited only by the external source impedance. Because the system is regenerative, the ZJ235 can only be returned to its high impedance state by interruption of the external anode supply.

In practice, the product  $(B_1 \times B_2)$  is raised to its initial value by utilizing the collector-current dependence of beta (in a transistor, beta increases with increasing collector current). By driving the ZJ235's anode current above its normal off-state leakage value,  $(B_1 \times B_2)$  is effectively raised to unity. This mechanism may be accomplished in any one, or a combination, of three ways:

By raising junction temperature—leakage current and hence beta increases rapidly with rising temperature.

By raising anode voltage—leakage current increases sharply as collector avalanche is approached.

By subjecting the device to incident light—high energy protons, or light particles, entering the silicon lattice releases considerable numbers of hole—electron pairs (compare effect of increasing temperature). These hole—electron pairs add to total anode current, the betas rise, and the light activated device switches. This mechanism is employed in practice.

With light applied to the device, equation 1 becomes modified as follows:

$$I_A = \frac{(I_{C01} + I_{C02} + I_L)(1 + B_1)(1 + B_2)}{1 - B_1 B_2}$$

where  $I_L$  is the current flow due to incident light.



# G-E LEXAN<sup>®</sup> POLYCARB



**STRENGTH** LEXAN slider for 4-pole switch is 20% glass-filled. The material withstands high impact forces and its flexural modulus is over 1 million psi. Used in rocket sled tests, the filled resin is relatively independent of heat, aging and most environments. It has high melt temperature and excellent electricals.  
(Atlas Chemical Industries)



**IMPROVED FABRICATION.** Formerly made of brass, blower couplings for radar unit are now inexpensively vacuum-formed of LEXAN resin, allowing considerable savings in machining costs. Couplings of polycarbonate resin are tough, flame-resistant, give smoother air flow than before. They withstand cycling from  $-54^{\circ}\text{C}$  to  $+54^{\circ}\text{C}$  under humid conditions. (General Electric)



**GOOD ELECTRICALS.** Microminiature connector contains up to 20% more contacts in the same space, thanks to dimensional stability and good electrical properties of LEXAN resin. Self-extinguishing, the material provides low loss, good insulation resistance and a dielectric constant and power factor which are virtually independent of temperature. (Amphenol-Borg Electronics Corp.)

## Learn more about your **BIGGEST CUSTOMER**

In 1961, military and space electronics exceeded, in dollar volume, the total of industrial electronics, consumer electronics, and the replacement components *put together* . . . just *one* fact from the "Summary of Electronics Markets" in your 1961 electronics Buyers' Guide and Reference Issue.

What's more, EBG follows up this interesting market fact with a statistical analysis of the military and space market, a military and government procurement guide, a list and descriptions of procuring agencies, and other information that helps you translate facts into profits for your business. You'll find daily use for EBG all year long.

**electronics BUYERS' GUIDE** and Reference Issue

The Basic Buying Guide in Electronics *since 1941*

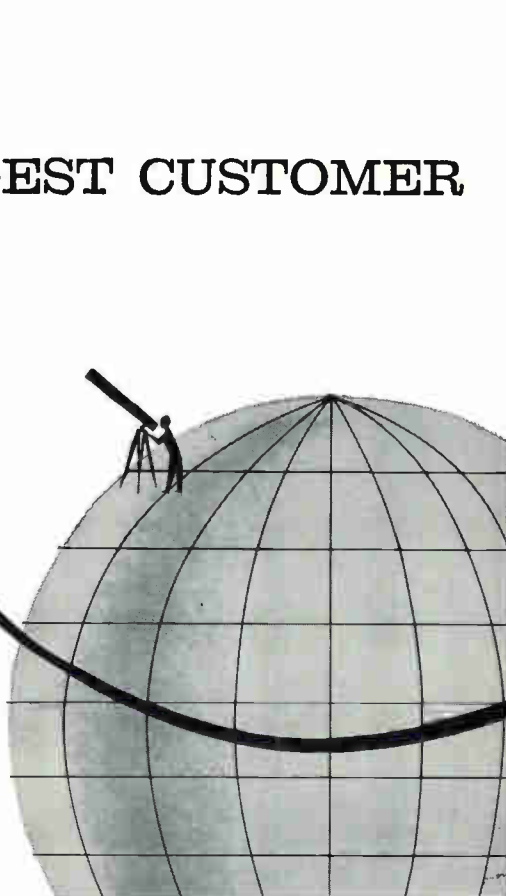

# ONATE RESIN THE MOST VERSATILE OF THE TOUGH THERMOPLASTICS

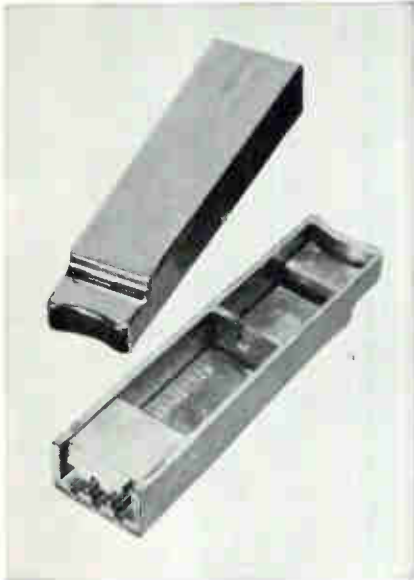

**HEAT RESISTANCE.** Because LEXAN resin can be painted with wear resistant high-temperature bake finishes, it was chosen to replace zinc die castings for auto radio pushbuttons. Base and top coats of these vacuum-metalized parts are baked at 265°F. Buttons are economically injection molded and light in weight . . . make a tight fit on the metal stake. (Motorola, Inc.)



**TRANSPARENCY.** Face-glass of this pressure gauge is molded of LEXAN 102 — a new, virtually water-white grade of resin. The instrument uses a gray LEXAN back-plate. Transparent LEXAN resin is shock- and heat-resistant . . . replaces glass. The opaque plastic replaces steel or brass. The two injection molded shells form a strong, good looking case. (United States Gauge)

## LOOKING FOR THAT EXTRA MARGIN OF DESIGN FREEDOM?

With LEXAN resin you can take down many of the old "proceed with caution" signs. Here is a material with outstanding impact strength! It is metal-like in mechanical properties: strong, hard, stiff, machineable — yet malleable (can be cold formed)! It is dimensionally stable, not only under impact or suddenly applied loads, but also at high temperatures and upon immersion in water. And LEXAN resin makes handsome products — smooth, transparent or opaque, colorful. A remarkable thermoplastic!

Don't overlook the design opportunities opened up by LEXAN resin. Send today for details on price, properties, applications and G-E's technical assistance program. Write to: General Electric, Chemical Materials Department, Section E-61, Pittsfield, Mass.

**LEXAN®**

Polycarbonate Resin

**GENERAL ELECTRIC**

CIRCLE 213 ON READER SERVICE CARD

# NEW!

**EXCLUSIVE! 2 FRAME GRID PENTODES**



**ONLY ONE OF ITS KIND ANYWHERE**

## FOUR SECTION-TUNED FM TUNER

Creates up to 30 times better image; Rejects all spurious signals

- ★ High thermal stability
- ★ Low oscillation radiation
- ★ Choice of 3 IF band widths

The first four section tuning system — plus two frame grid pentodes — results in revolutionary high rejection values for image, IF and spurious signals. Special features on the Model 311-0040 include an extremely linear dial calibration and selection of three different IF band widths to fit any FM application. AFC is accomplished through a special diffused silicon diode in a *patented* AFC circuitry. Easy to mount and connect via feed-through condensers and terminals located on top of tuner. For details, write about Model 311-0040.

Also — ask about the *complete Waller line* of transistor FM tuners and other tube types.

**THE WALLER CORPORATION**

Ridgefield, Crystal Lake, Illinois

CIRCLE 85 ON READER SERVICE CARD

85



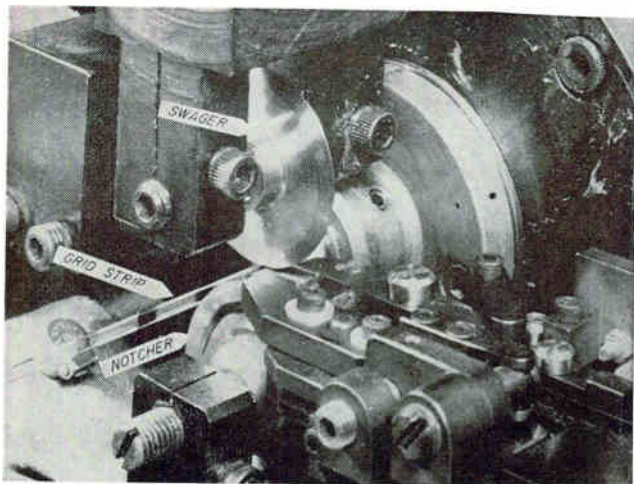

Grid wire is broken automatically at finish of each grid and is picked up at start of next

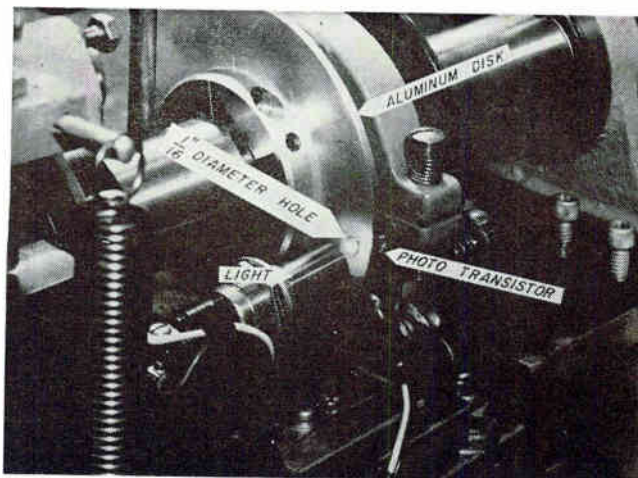

Control of the wire break mechanism is accomplished with photo transistor and disk on lathe cam shaft

## Wire Break Device Cuts Grid Winding Costs

By F. P. EHRHARDT  
Western Electric Co.  
Allentown, Pa.

TIME AND RAW MATERIAL can be saved in electron tube manufacture by adapting a wire breaking and pick-up mechanism to conventional grid winding machines. Improved grid quality results from reduced handling while operator efficiency is improved. Since the technique requires only a small investment, it can be used in limited quantity production as well as on fully automatic grid winding machines.

Conventional grids are made by attaching small diameter wire in a helix to two larger support wires; the support wires are notched, the grid wire is inserted and the notch is swaged over. The method requires no soldering or brazing and is accomplished with semi-automatic machines. The support wires themselves are pulled from supply spools through grooves in a rotating mandrel; the grid wire is pulled from another spool, as shown in one of the photographs. The swaging wheel peens metal from each side of the notch over the grid wire and locks it in place. Notching and swaging occurs twice for each revolution of the mandrel, since the grid must be attached to both support wires.

The support wires must extend beyond the helical grid at each end for assembly into the tube. In a conventional grid winding machine the notcher and swager wheels are moved out of position by cams when the last turn of one grid is reached and remain that way until the first turn of the next grid is reached. This leaves the lateral wire loose over the grid leg, which is about  $\frac{1}{4}$  of total grid length. After winding, grid strips are cut apart and the excess loose wire on each grid is removed manually and scrapped.

A wire break attachment makes it possible to interrupt the flow of lateral wire during winding so that only the turns required for each grid are wound. Strips of grids are wound as before but without loose turns. After the last turn of a grid is swaged in place, the lateral wire is broken and held until the support wire advances to the next winding position. When a notch is cut in the support wire for the first turn on the next grid in the strip, the wire being held is caught in the notch and swaged in place.

Two carbide jaws provided in the wire break mechanism serve as wire guides as well as a means of pinching the lateral wire being pulled onto the rotating mandrel. A light spring holds the jaws together

as wire slides through during winding. As soon as the last required turn of the grid is wound, a solenoid pushes the jaws together, clamping the lateral wire and causing it to break. Timing of the impulse to the solenoid is critical, as is the angular position of the winding mandrel at the time the wire is broken. With precise timing, the lateral wire will break at the last swaged notch and leave a lateral wire tail extending from the carbide jaws long enough to be picked up at the start of the next grid in the strip.

A light source and photo transistor on opposite sides of a disc on the lathe cam shaft allow accurate timing for the breaking mechanism. An important advantage of the attachment is that one operator can attend several machines at the same time, instead of just one.

### Vacuum Bakeout Improves Klystrons

THE BROAD BAND KLYSTRON tube on the cover of this issue is Sperry Electronic Tube Division's SAL 166, a high-power, high-energy-per-pulse tube for high power radars now in production at Gt. Neck, N. Y. Operating from 1,215 to 1,365 Mc,



# COLD CATHODE TUBES

- count
- readout
- store
- compute
- sort
- control
- time
- switch



GCA10G



GS10H



## TWO NEW TUBES

**GCA10G** — A recently developed tube for the direct coupling of a readout tube to a Dekatron without the need of any additional amplifiers.

**GS10H** — New, low cost, miniature selector with access to all cathodes. Seated height — 1 1/2".



**Dekatron Tubes** — Full line of twelve types for totalizing, sorting, programming or controlling. High speed (up to 20,000 cps). Reliable up to 100,000 hours — low current.



**Voltage Reference Tube** — Useful in high-level stages of DC amplifiers. No jump in characteristic. Constant internal resistance.



**Computer Trigger Tube** — Inexpensive subminiature tubes especially designed for computer application. Widely used for slow-speed storage applications.



**Tetrode Trigger Tube** — Designed for Dekatron coupling, readout circuits and bi-directional counting. Reliable in self-quench circuits. Drift-free operation.

**Baird-Atomic** has more different types of cold cathode counting tubes than anyone! All have been field proven ... all feature rugged construction, low power requirements and simple circuitry. And B/A tubes are backed by extensive applications engineering service and a network of distributors in the U. S. and Canada.

For more information on Baird-Atomic tubes and services, send today for **HANDBOOK OF COUNTING TUBES**. Price \$1.00.



**BAIRD-ATOMIC, INC.**

33 University Road · Cambridge 38, Mass.

Engineers and scientists: Investigate challenging opportunities with Baird-Atomic. Write Industrial Relations Director. All qualified applicants will receive consideration for employment without regard to race, creed, color or national origin.

ADVANCED OPTICS AND ELECTRONICS... SERVING SCIENCE



## ONE...

just set the part on the anvil (no masters or set gages needed)

## TWO...

turn the knob to lower spindle (stops automatically on contact)

## THREE...

read the measurement directly from the scale (and save up to 85% in gaging time!)

# MEASURE TO .0001"!



*... that's how quick and easy it is with the Bausch & Lomb DR-25B Optical Gage!*

Takes just seconds to get direct readings to .0001" . . . depth, thickness, height, diameter, taper. You read in "tenths" from 0" to 3" on a bright, magnified scale . . . with such extreme accuracy (0.000025") that masters or set gages are unnecessary. Specially calibrated to normal shop temperatures with easy conversion charts for any temperature fluctuation. Here's today's fastest, easiest way to get highest accuracy readings . . . with job-proved savings of as much as 85% in gaging time . . . for only \$875!

See it, compare it, in a free on-the-job demonstration.

**BAUSCH & LOMB**

SINCE  1853

Made in America,  
to the world's highest standards.

DISTRIBUTED IN U.S.A. THROUGH THE DOALL COMPANY

**BAUSCH & LOMB INCORPORATED**  
62324 Bausch St., Rochester 2, N. Y.

- I'd like an on-the-job demonstration of the DR-25B with no obligation on my part.  
 Please send Catalog D-285.

NAME ..... TITLE .....

COMPANY .....

ADDRESS .....

CITY ..... ZONE ..... STATE .....

the tube is believed to have the largest power rating for a 150 Mc bandwidth. Peak power is 12.5 Mw and average power is 60 Kw; gain is 38 db and duty cycle is 0.0061.

The high beam densities used in the tube place severe requirements on the materials used, and also require a hard vacuum during the life of the tube. Metals used in the structural parts of the tube are primarily oxygen-free copper and stainless steel; ceramic instead of glass is used for other parts since it allows bakeout at temperatures near 600 C, instead of the 450 C usual with glass.

The tube is built up from sub-assemblies, many of which are vacuum fired at 1,000 to 1,100 C before being assembled into the tube. High temperature vacuum firing is especially important for those internal tube structures that are near the cathode. To maintain high vacuum during service, the number of joints that must be vacuum tight



*Optical pyrometer is used to check temperature of subassembly during vacuum firing*

are reduced to a minimum by using one-piece hydroformed parts wherever possible. After the major sub-assemblies have been r-f brazed in hydrogen furnaces, they are heliarc welded together to form the seven foot high, 300 lb. tube.

The assembled tube is evacuated and an ion pump is attached to it to bring the pressure inside the tube down to  $10^{-6}$  or  $10^{-7}$  mm of mercury; the ion pump remains with the tube during the vacuum bakeout that follows and is removed only when the tube is ready for test.

Vacuum bakeout of the assembled



*Klystron is Heliarc welded on motor driven turntable*

and evacuated tube takes 48 hours. Six hours are required to bring the tube up to approximately 600 C, bakeout takes 30 hours, and 12 hours are required for cooling. Cathode conversion takes place during bakeout, with barium and strontium carbonates giving off CO and CO<sub>2</sub> to release the barium and strontium; the gases are removed by the ion pump, which is still attached to the tube. Although 16 to 20 hours are normally required for cathode conversion, the use of CerAlloy 400, manufactured by Ronson Metals Corp., Newark, New Jersey, cuts the time down to two hours.

Pressure in the final bakeout oven is about 10<sup>-3</sup> mm of mercury. Vacuum bakeout at this relatively low pressure has two important advantages. First, any leak that develops in a tube does not result in a large influx of gases into the tube to cause oxidation and, usually, tube destruction; no tube bodies have been lost because of leaky seals since the oven has been in use. Second, hydrogen and oxygen diffusion through tube structures (which increases with temperature) is less because the pressure differential across the walls is less. The oven itself is 14 feet high, eight feet of which are under ground.

When the tube is cooled, it is removed from the oven and voltage processed to burn off metal whiskers. After final outgassing to 5 × 10<sup>-9</sup> mm of mercury, the tube is pinched off and is ready for tests.

## BEHLMAN-INVAR

**IS TO ELECTRONIC POWER AS  
MERRILL IS TO LYNCH\***

\*IS TO PIERCE  
IS TO  
FENNER  
IS  
TO  
SMITH

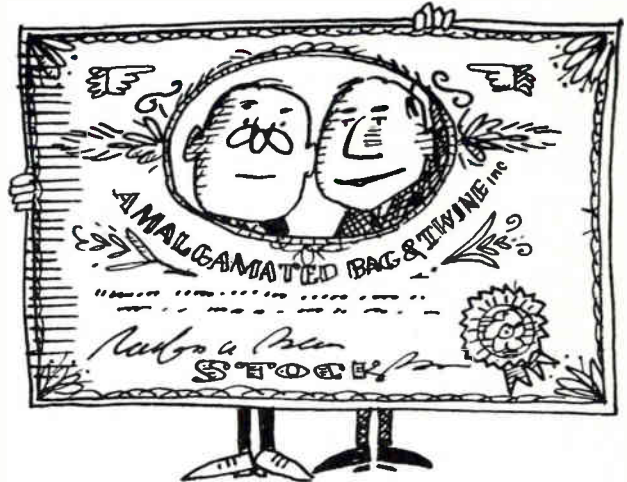

*And to determine what Behlman-Invar means to you, B/I has a complete catalog of AC and DC power supplies which is yours for the asking. Ask!*



**BEHLMAN-INVAR ELECTRONICS CORP.**

1723 Cloverfield Blvd., Santa Monica, California

CIRCLE 214 ON READER SERVICE CARD

### BUILD-YOUR-OWN ELECTRONIC ORGAN

STEP UP TO AN

*Artisan*

GREATEST  
NAME IN  
ORGAN KITS

20TH CENTURY  
SUCCESSOR  
TO THE  
PIPE ORGAN



PIPE-LIKE  
TONE AND  
APPEARANCE

DIRECT FACTORY  
TO OWNER  
SAVES 50%

WORLD'S LARGEST SELECTION OF ORGAN KITS,  
ACCESSORIES AND CUSTOM-BUILT ORGANS

Send for FREE literature

**DORSETT ELECTRONICS, INC.**

ELECTRONIC ORGAN DIVISION

4949X YORK BLVD., LOS ANGELES 42, CALIF.



PAY-AS-YOU  
BUILD

STEP-BY-STEP  
INSTRUCTIONS

HOME, CHURCH  
AND CONCERT  
MODELS

2-3-4 MANUALS  
FROM  
\$1,750 to \$12,500



## YOU ARE THERE!

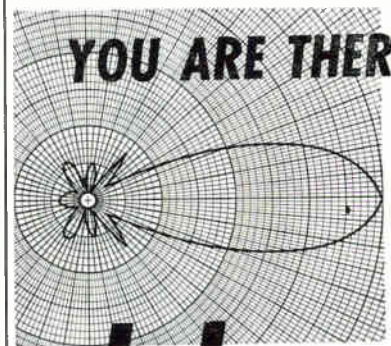

with **telrex**

### "BEAMED-POWER" ANTENNAS

NOW MAILING! PL88 — technical data, pricing bulletin describing Advanced-design commercial and citizen-band base-station antennas and accessories. Includes Tower, Rotator, "Baluns," Mastings and Transmission line data, plus nice-to-have-around "info." Request your copy, today; no obligation.

WORLD RENOWNED AND RESPECTED  
PERFORMANCE -6 to 1500 MC.

ANTENNAS  
SINCE 1921 **telrex**  
LABORATORIES

ASBURY PARK 25, NEW JERSEY, U.S.A.

CIRCLE 215 ON READER SERVICE CARD

CIRCLE 89 ON READER SERVICE CARD



# New On The Market

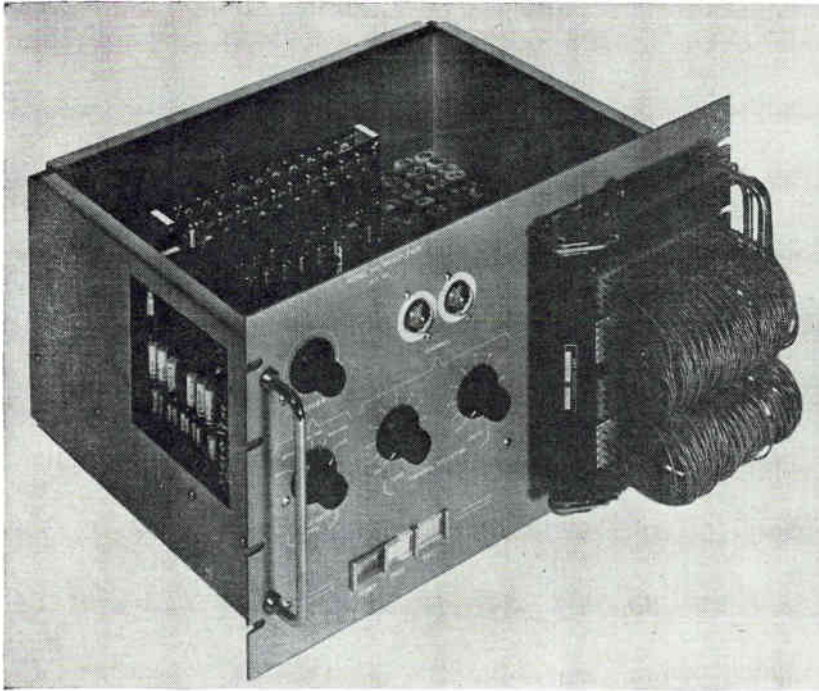

## Low & High-Level Multiplexer

FOR GROUND-BASED, GENERAL-PURPOSE USE

STELLARMETRICS, INC., 210 E. Ortega St., Santa Barbara, Calif. Model 100 Microplexer is an all-electronic sampling switch. It offers 100 separate input channels, sequentially switched to a common output bus, on each of the two poles which, in combination, apply the input information to a common output load. Full scale input signal

ranges as small as  $\pm 5$  mv may be sampled at any rate from 0 to 1,000 cps at 0.1 percent accuracy; and no drift (with time or temperature) can be measured. At the core of the unit is the Magristor which uses liquid as its enabling means, essentially eliminating noise.

CIRCLE 301 ON READER SERVICE CARD

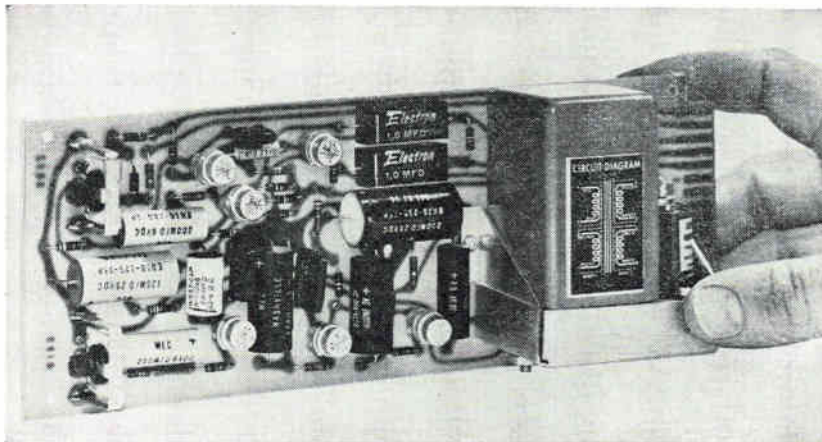

## Chopper Stabilizing Amplifier

SHIELDED AND ISOLATED INPUT

C.E.S. ELECTRONIC PRODUCTS, 5026 Newport Ave., San Diego 7, Calif.

Series 300 has a full wave transformer, a floating and shielded in-

put system and uses a 10,000-hr mechanical chopper in conjunction with solid-state circuitry to provide an amplifier of high performance. With an input impedance of 100,000 ohms, the amplifier noise is less than  $1 \mu\text{v}$  with a 1.6 cps filter on the output. Gain is 100 db and minimum output is  $\pm 5$  v.

CIRCLE 302 ON READER SERVICE CARD



## Variable Delay Line

HIGH RESOLUTION

COMPUTER DEVICES CORP., 6 W. 18th St., Huntington Station, N.Y. A delay range from 0 to 150  $\mu\text{sec}$  in precise steps of 0.1  $\mu\text{sec}$  is provided in the model V175. It utilizes an insertion switching technique that gives constant input and output load impedance regardless of the delay setting. Unit provides an output rise time which decreases with delay and at maximum delay is less than 4 percent. Attenuation is 6 db; distortion, less than 3 percent; accuracy at any delay setting, better than 2 percent; impedance, 500 ohms.

CIRCLE 303 ON READER SERVICE CARD

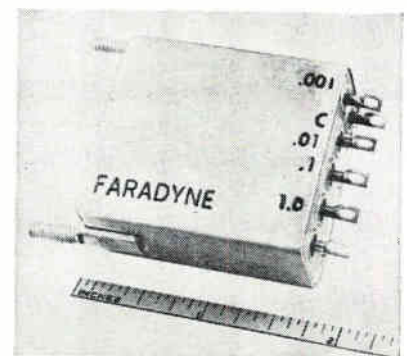

## Multiple Capacitor

HERMETICALLY SEALED

GULTON INDUSTRIES, INC., 212 Durham Ave., Metuchen, N.J. Hermetically sealed Faradyne Mylar capacitor has capacitance values of  $1 \mu\text{f}$ ,  $0.1 \mu\text{f}$ ,  $0.01 \mu\text{f}$  and  $0.001 \mu\text{f}$  within one single unit. Tolerance on these values within one unit is  $\pm 0.25$  percent. Use of the unit in oscillo-

# Now! For the first time...

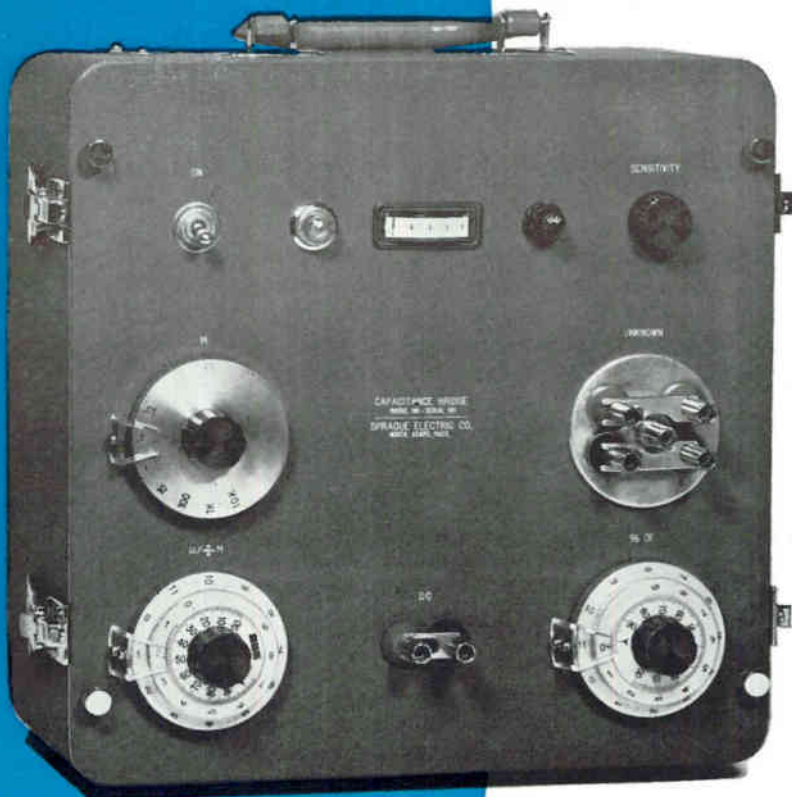

## TEST ELECTROLYTIC CAPACITORS

**Safely...  
Accurately...  
Simply!**

### SPECIFICATIONS

#### Capacitance

Range: 0 to 120,000 $\mu$ F at 120 cps  
Accuracy:  $\pm$ (1% of reading +10 $\mu$ F)  
Sensitivity:  $\pm$ (0.1% of reading +10 $\mu$ F)

#### Dissipation Factor

Range: 0 to 120% at 120 cps  
Accuracy:  $\pm$ (2% of reading +0.1% DF)  
Sensitivity:  $\pm$ (0.2% of reading +0.05% DF)

#### Maximum Voltage to Unknown

A-C: 0.5v RMS at 120 cps  
D-C: 0-600v (external)

#### Null Detection

Built-in Galvanometer to  
Indicate Bridge Balance

#### Power Input

105-125v, 60 cps, 15w

#### Case

Sturdy Aluminum Cabinet with  
Blue Textured Finish, Grey Panel

#### Dimensions

12" Wide x 12" High x 6" Deep

Note: Five other models, with variations in power inputs and test frequencies, are also available.

■ The Sprague Model 1W1 Capacitance Bridge introduces a new concept in bridge design. Built by capacitor engineers for capacitor users, it incorporates the best features of bridges used for many years in Sprague laboratories and production facilities.

■ The internal generator of the 1W1 Bridge is a line-driven frequency converter, and detection is obtained from an internal tuned transistor amplifier-null detector, whose sensitivity increases as the balance point is approached. It has provision for 2-terminal, 3-terminal, and 4-terminal measurements, which are essential for accurate measurement of capacitors with medium, low, and high capacitance values, respectively.

■ The Model 1W1 Capacitance Bridge will not cause degradation or failure in capacitors during test, as is the case in many conventional bridges and test circuits. The 120 cycle a-c voltage, applied to capacitors under test from a built-in source, never exceeds 0.5 volt! It is usually unnecessary to apply d-c polarizing voltage to electrolytic capacitors because of this safe, low voltage.

For complete technical data on this precision instrument, write for Engineering Bulletin 90,010 to Technical Literature Section, Sprague Electric Company, 35 Marshall Street, North Adams, Massachusetts.

### ELECTRONIC PRODUCTS by SPRAGUE

CAPACITORS  
RESISTORS  
MAGNETIC COMPONENTS  
TRANSISTORS

INTERFERENCE FILTERS  
PULSE TRANSFORMERS  
PIEZOELECTRIC CERAMICS  
PULSE-FORMING NETWORKS

HIGH TEMPERATURE MAGNET WIRE  
CERAMIC-BASE PRINTED NETWORKS  
PACKAGED COMPONENT ASSEMBLIES  
FUNCTIONAL DIGITAL CIRCUITS



'Sprague' and '®' are registered trademarks of the Sprague Electric Co.





## Circuit Designers!

Choose **CAMBION**<sup>®</sup> computer modules from the start

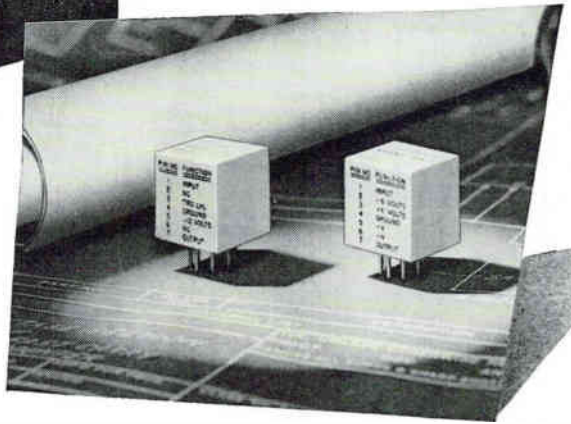

### ...FOR EASIEST PROTOTYPE DESIGN

CAMBION modules are built to make a designer's life easier by eliminating guess work. That's why they all have these physical characteristics that save you time and money in early design and prototype work — and in production!

- **Standard 7-pin miniature bases**—use them for plug-in or printed circuits.
- **Distinctive color-coding** — you can tell each module's function at a glance.
- **Compactness** — all modules require only 0.35 cu. in.
- **Uniform size** — easier arrangement in circuits without juggling.
- **Full range of types** — Flip-flops, And Gates, Or Gates, Inverters, Buffer Amplifiers, Level Triggers.
- **New Circuit Trial Case** specifically for CAMBION modules, lets you set up and check out any circuit ideas — change loads and connections with ease.

### ...AND BEST PERFORMANCE

CAMBION modules have a unique combination of dynamic characteristics, too. All units are compatible, and operate at up to 10 MC. They are built with MIL approved components, and surpass MIL environmental standards. Every CAMBION module is tested and monitored for 500 hours under dynamic conditions. That's your assurance of reliable performance — in any circuit! Contact CAMBION for full details or for application assistance. Write Cambridge Thermionic Corporation, 437 Concord Avenue, Cambridge 38, Mass.

CAMBRIDGE THERMIONIC CORPORATION  
**CAMBION**<sup>®</sup>  
 The guaranteed electronic components



scopes and other instruments can eliminate the need for employing potentiometers, which are usually required to adjust to the desired RC constant.

**CIRCLE 304 ON READER SERVICE CARD**

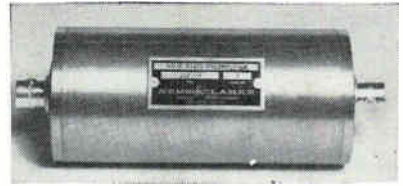

### Preamplifier

FOR TELEMETRY USE

VITRO ELECTRONICS, 919 Jesup-Blair Drive, Silver Spring, Md. The Nems-Clarke SSP101 is a low noise solid state preamplifier with a maximum noise figure of 4.5 db, a gain of 25 db minimum, and is flat across the band at 3 db. It is designed for the 225-260 Mc telemetry range. The SSP101 weighs 19 oz, can be used in any environment and is mounted at the antenna or directly at the coax cable.

**CIRCLE 305 ON READER SERVICE CARD**

### Crystal Switch

AMERICAN ELECTRONIC LABORATORIES, INC., Richardson Road, Colmar, Pa. Model SNB152A vhf/uhf crystal switch covers the frequency band from 20 Mc to 1,000 Mc with an insertion loss no higher than 3.5 db.

**CIRCLE 306 ON READER SERVICE CARD**

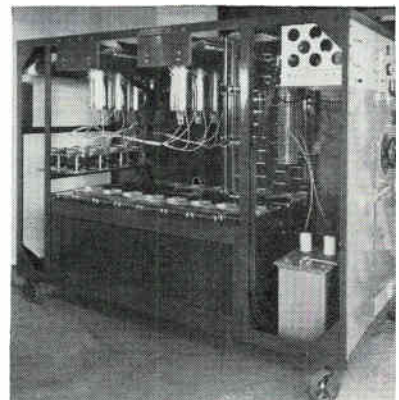

### Capacitor Banks

48,000 JOULES

PLASMANETICS CORP., 3086 Claremont Ave., Berkeley 5, Calif. Each bank consists of 16 capacitors which deliver a current of 2.5

**more usable  
sensitivity  
10 mc to  
44,000 mc  
IN ONE TUNING HEAD**

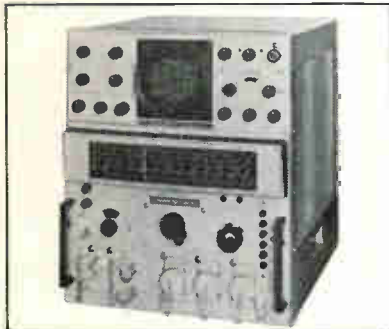

**PANORAMIC'S  
SPA-4a  
SPECTRUM  
ANALYZER**

Band	RF SENSITIVITY*
1. 10 - 420 MC	-100 to -110 dbm
2. 350 - 1000 MC	-95 to -105 dbm
3. 910 - 2200 MC	-100 to -110 dbm
4. 1980 - 4500 MC	-90 to -100 dbm
5. 4.5 - 10.88 KMC	-90 to -100 dbm
6. 10.88 - 18.0 KMC	-85 to -100 dbm
7. 18.0 - 26.4 KMC	-70 to -90 dbm
8. 26.4 - 44.0 KMC	-60 to -85 dbm

\*Measured when signal and noise equal 2X noise.

Using one tuning head which contains one triode and two Klystron oscillators, Model SPA-4a offers more exclusive advantages for applications demanding extreme sensitivity, stability, versatility, accuracy.

- Exceptionally low distortion. • Highly resolved & calibrated analysis. • Three precisely calibrated amplitude scales —40 db log, 20 db linear, 10 db power. • two independent frequency dispersion ranges—continuously adjustable 0—70 mc and 0—5 mc. Negligible internal frequency modulation permits narrow band analysis of FM problems • Variable I. F. bandwidth from 1 kc to 80 kc • Push-button frequency selector. • Synchroscope output with 40 db gain. • Accurate measurement of small frequency differences. A self-contained marker oscillator, modulated by a calibrated external generator, provides accurate differential marker pips as close as 10 kc. Tremendous flexibility and many unique advances of Panoramc's compact SPA-4a make it unsurpassed for visually analyzing FM, AM and pulsed signal systems; instabilities of oscillators; noise spectra; detection of parasites; studies of harmonic outputs; radar systems and other signal sources.

Write, wire or phone today for detailed SPA-4a bulletin.



Sec. 2900

**Panoramc  
electronics, inc.**

Formerly Panoramc Radio Products Inc.  
530 So. Fulton Ave., Mount Vernon, N.Y. • Owens 9-4600  
TWN; MTN-NY-5229  
Cable: Panoramc, Mt. Vernon, N.Y. State

CIRCLE 216 ON READER SERVICE CARD

December 15, 1961

Gertsch General Purpose RatioTran<sup>®</sup>

**NOW... A LOW-COST  
AC INDUCTIVE  
VOLTAGE DIVIDER  
—ACCURATE TO 0.001%**



In addition to the high accuracy, unit features high input impedance, low effective series impedance, and very low phase shift. You get characteristics comparable to those of more expensive instruments, in a Gertsch-quality unit.

5-decade transformer switching. Instrument is ideal for checking servos and resolvers... for voltmeter calibration, computer testing, and transformer turns ratio measurements.

Compact size—only 3½ inches high. Designed for bench mounting, and easily adapted to half-rack mounting with brackets furnished.

Send for literature on the RT-60 Series.

**Gertsch**

GERTSCH PRODUCTS, Inc.

3211 South La Cienega Boulevard, Los Angeles 16, California/UPTon 0-2761 - VERmont 9-2201

CIRCLE 93 ON READER SERVICE CARD

93





# ENVIRONMENT FOR ACHIEVEMENT



In GCA equipment, LFE can point to many developments, from the first portable precision approach radar to the advanced AN/TPN-12 now supplied to the U. S. Air Force. Like its predecessors, AN/TPN-12 is lightweight and portable by truck, ship or helicopter. It can be erected and operating in 2½ hours, and has proved reliable under the severest field conditions. With only normal maintenance, service life is over 2500 hours.

Like all LFE achievements, this tactical GCA system is the product of inventive minds encouraged by free inquiry, company-financed research, easy communications, and management that knows its technology.

If you feel your abilities would find fuller expression in this environment, please contact us now about new opportunities in:

## SYSTEMS, EQUIPMENT & COMPONENTS

Airborne Navigation <sup>for</sup> Automatic Controls  
Radar and Surveillance Ground Support  
Electronic Data Processing

Excellent opportunities are also available  
at our Monterey, California Laboratory

Write in complete confidence to:

C. E. Fitzgerald



**LABORATORY FOR ELECTRONICS**

1079 Commonwealth Avenue

Boston 15, Massachusetts

All qualified applicants will be considered for employment without regard to race, color, creed or national origin.

# data recorders expensive?



# not any more

now, Mnemotron gives you a complete, easy-to-use 4-channel analog tape record/reproduce system with **0.2% precision** for only **\$3,495**

Complete with 10½" reel tape transport, rack mounted.

Mnemotron offers a unique pulsed FM principle and fully transistorized, self-contained unit that records all analog data • data acquisition • storage, analysis and reduction • time scale contraction and expansion • programming • computer read IN and read OUT • dynamic simulation. With Mnemotron, you can do more with paper recorders . . . expanding frequency response and channel capacity, saving you from being deluged with data, permitting you to look at the same data at different time scales.

#### Model M204 features:

Any 2 adjacent speeds: 3¾, 7½, 15 ips. Added low speed available on special order.

#### Frequency Response:

- DC—800 cps @ 15 ips
- DC—400 cps @ 7½ ips
- DC—200 cps @ 3¾ ips

Linearity: 0.2% full scale.

Noise: less than —50 db full scale.

Crosstalk: below 70 db.

Extended range systems also available.

Write, wire, phone today for complete details.

**MNEM TRON**  
CORPORATION

precision analog data tape recorders and biological computers

37 South Main Street, Pearl River, N. Y.

• Phone: Pearl River 5-4015 (914)

• Cables: Mnemotron

CIRCLE 217 ON READER SERVICE CARD  
electronics

megamp at 20 Kv in 3  $\mu$ sec pulses. Charging time is less than 1 minute for each unit. As many as 60 separate banks can be connected in parallel, raising total energy output to  $3 \times 10^6$  joules. Amperage increases as the square root of the energy, so currents of  $2.4 \times 10^7$  amp are obtainable from these standard units.

**CIRCLE 307 ON READER SERVICE CARD**



### Tantalum Capacitor SOLID, POLARIZED

GOOD-ALL ELECTRIC MFG. CO., Ogalala, Neb. Type 901 solid polarized tantalum capacitor features high quality and long, reliable life. Ratings are from 0.0047 to 330  $\mu$ f and 6 to 35v d-c. Environmental characteristics meet MIL-C-26655A. They come in 4 subminiature case sizes and temperature range is  $-55$  C to  $+125$  C. Dissipation factor is 6 percent. Type 901 is suited for transistor, missile, communication, or similar circuitry.

**CIRCLE 308 ON READER SERVICE CARD**



### Voltage Reference 100 DB ISOLATION

CIRCUIT DYNE CORP., 480 Mermaid St., Laguna Beach, Calif. Isolation from line voltage changes in the order of 100 db is a feature of the type PR1 solid-state voltage reference supply. Unit is available in models to accept both 115 v and 6.3 v inputs, from 50 to 400 cps. Outputs may be specified at 5.9, 8.6, 11.0, 14.5, 17.2 and 22.0 v, nominally.

**CIRCLE 309 ON READER SERVICE CARD**

### Harmonic Generator

TELONIC INDUSTRIES, INC., Beach Grove, Ind. Wide-range harmonic generator can produce birdy mark-

**CIRCLE 95 ON READER SERVICE CARD** →



## REALLY STACKED

In more ways than one. Stacked reels, a 3-stacked recording head, and an economy of size which would enable you to stack more than forty of these miniature tape recorders into a cubic foot of space. ■ Using less than 1 watt of power, the Precision Model PS-303M records an hour of voice frequency data on a single reel of tape. It operates quietly, weighs just a few ounces, incorporates an 8-transistor, 2-diode electronics circuit. ■ The space-saving reel design is the same used in PI instrumentation magnetic tape recorders. It is one of the many advanced features which enable all PI instruments to offer full-size performance in a fraction of the space. Write for our new short-form catalog for details.



**PRECISION INSTRUMENT COMPANY**  
1011 Commercial Street • San Carlos • California  
Phone LYtell 1-4441 • TWX: SCAR BEL 30  
*Representatives in principal cities throughout the world*



*P.I. Invites inquiries from senior engineers seeking a challenging future.*



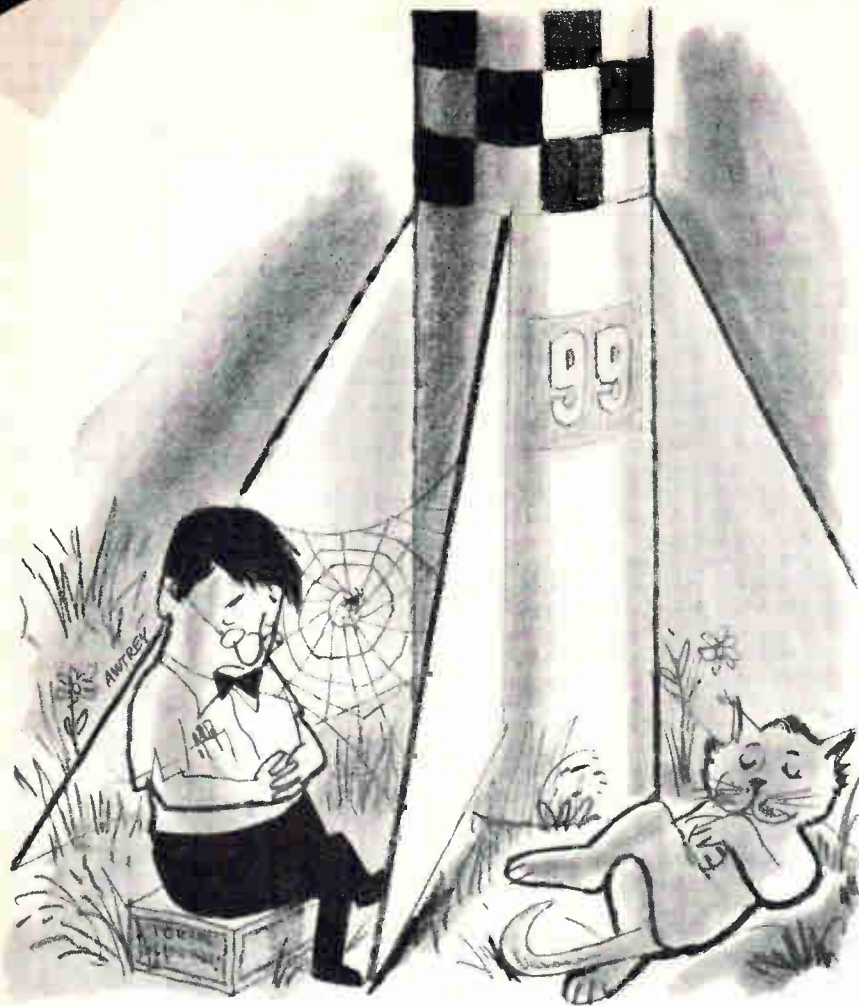

## still waiting for your pots?

Are your pot delivery schedules figured in weeks instead of days? If you're a member of the Pot Waiter's Club, read on:

At ACE, we fully inventory *all* parts for our complete standard line! And when a pot *has* to be made from scratch — we cut time there, too. All raw materials are warehoused, and a complete machine shop, including Swiss screw machines, is maintained. Our special prototyping department lops the time off special requirements.

Prepared engineering releases and part prints for standard pots await your incoming order. That's why, within hours after receipt, your order for standards is into manufacturing! So specify from Ace's comprehensive line of standards, in full resistance ranges, sizes, configurations and functions. Your "special spec" is probably among our standard line — and that means time and money saved for you!



*This 1-1/16" ACEPOT®*, typifying the entire standard line, is available on prompt delivery!

**ACE** ELECTRONICS ASSOCIATES, INC.  
 99 Dover Street, Somerville 44, Mass.  
 SOmerset 6-5130 TMX SMVL 181 West. Union WUX  
 Acepot® Acetrim\* Acesel® Aceohm® \*Reg. Appl. fo

CIRCLE 96 ON READER SERVICE CARD

ers up to several hundred times its fundamental oscillation.

CIRCLE 310 ON READER SERVICE CARD

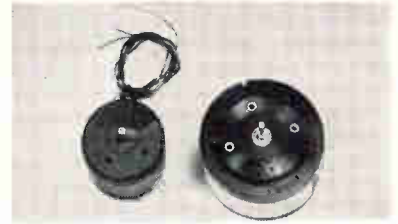

## Motors

### LIMITED ROTATION

POWER-TRONIC SYSTEMS INC., Pine Court, New Rochelle, N. Y. Series 90 limited rotation motors are high efficiency current to torque transducers which have no wiping contacts. The angular rotation limits can be varied  $\pm 5$  to  $\pm 25$  deg from a central position. Units are available in flange or front face type mounting for clamps or screws. Present units range from 0.1 in. oz for the size 15 motor to 2 in. oz for the size 23 motor. They are useful in ultra-low friction direct drive instrument and control applications.

CIRCLE 311 ON READER SERVICE CARD



## Radar Transponder

### SMALL AND LIGHT

AERO GEO ASTRO CORP., 1200 Duke St., Alexandria, Va. The AGA S/T-CV S-band (2,700 to 2,950 Mc) radar transponder is built to operate in typical missile environments. Features are its crystal video receiver and the fact that it is completely transistorized except for the ceramic triode transmitter tube. It measures  $3\frac{1}{2}$  by  $5\frac{1}{4}$  by  $6\frac{3}{4}$  in. and weighs 5.3 lb. It has a receiver sensitivity of  $-40$  dbm over the frequency range and a transmitter output of 3 w minimum.

CIRCLE 312 ON READER SERVICE CARD

## Variable Attenuator

INTERNATIONAL TELEPHONE AND TELEGRAPH CORP., Industrial Prod-

Proven  
performance  
in the most  
severe  
environments!

# H-H "Gray Line" RESISTORS



• Wide Range of Fixed Resistors



• Flat and Stack Mounting Power Resistors



• Axial-lead Types from 2 to 10 Watts



• Adjustable Resistors from 10 to 200 Watts

H-H "Gray Line" precision made resistors are available in a wide range of types . . . incorporate design and construction features that assure dependable performance in critical applications. Non-crazing and high temperature enamel, stronger core, welded wire connections, higher shock resistance and immunity to salt spray and humidity insure high reliability.

"Gray Line" fixed, ferule, axial and adjustable resistors comply with MIL-R-26 specifications.



## HARDWICK HINDLE • INC

40 Hermon St., Newark 5, N. J.



Sold thru Authorized  
Distributors Coast-to-Coast

CIRCLE 218 ON READER SERVICE CARD

December 15, 1961

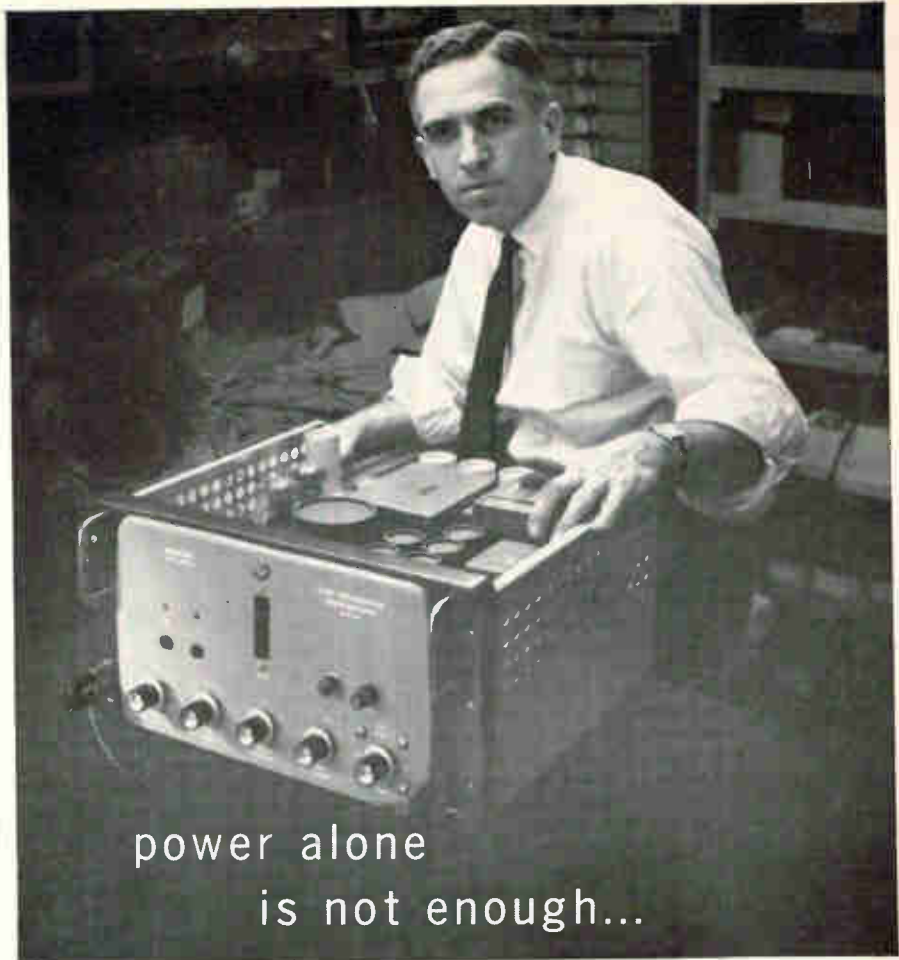

power alone  
is not enough...

it's the ultra low distortion — .005%  
in this audio amplifier  
that makes the big difference!

Here's a fifty-watt power amplifier with harmonic and intermodulation distortion of less than .005%. Distortion so low — you'd need special equipment to measure it!

That's why the UF-101A is a natural as a reference source, with a suitable oscillator, for low distortion measurement of power components, as well as a highly linear amplifier within the audio band.

The other characteristics of the UF-101A are equally outstanding. Phase distortion is negligible —  $\pm 2^\circ$  maximum deviation from linear phase shift. Total hum and noise level less than 10 microvolts input equivalent. Frequency range is from 20 cps to 20 kc. For convenience, the UF-101A has taps for matched load impedances from 1 to 225 ohms.

Some of the applications of this ultra-low distortion amplifier are: checking the residual distortion of distortion-measuring equipment, reproducing non-sinusoidal wave forms faithfully, and as an ultra-low distortion, high power source to supply test benches. Write for full information on the UF-101A.

Other Krohn-Hite amplifiers include the direct-coupled, wide band DCA-10 (10 watts), and DCA-50 (50 watts). Also, *Krohn-Hite Oscillators, Filters and Power Supplies.*



## KROHN-HITE CORPORATION

580 Massachusetts Avenue • Cambridge 39, Mass.

Pioneering in Quality Electronic Instruments

CIRCLE 99 ON READER SERVICE CARD



# NEW ERA'S TRANSFORMER SIMULATOR

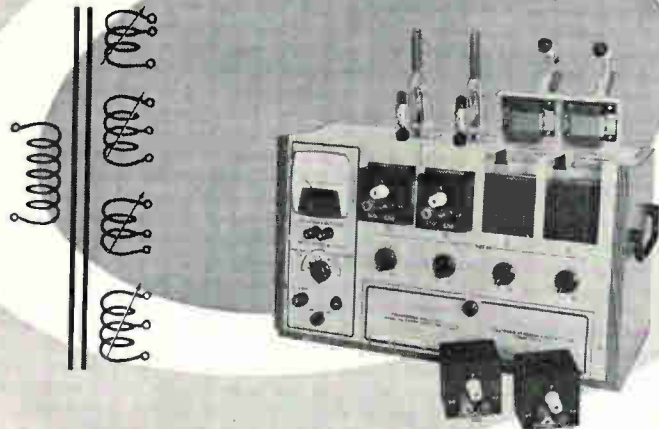

## SIMULATE ALL TYPES OF POWER AND CONTROL TRANSFORMERS ON THE LAB BENCH

The new TS-460 Transformer Simulator, designed for laboratory, industrial and test purposes, offers the engineer the convenience and flexibility of simulating all types of single or multi-output transformers on the laboratory bench. The equivalent of a wide variety of multi-winding transformers, the TS-460 provides four independent plug-in secondaries, each of which may be replaced or interchanged supplying individual outputs from 5 to 1500 VAC in 11 ranges. All secondaries are independently adjustable from zero to any value within the coil rating. They may also be interconnected in any desired series or parallel arrangement for voltages from zero up to 6000 VAC at up to 250 VA.

Four secondaries (values: 10, 100, 400, 1500 VAC) are provided with each instrument, and other values are available as accessories. Both primary and secondary AC voltages may be read with the built-in metering circuit. All coils are center-tapped, and maximum rating per coil is 60 VA. Transformer input is 50-1000 cps, and provision is also made for square-wave or non-sinusoidal primary inputs.

Price: (Complete with 4 secondaries) \$425.00 (F.O.B. plant)

### SPECIFICATIONS

Input: 115 VAC nominal, 50-1000 cps  
 Output Power: 60 VA per secondary, 250 VA total  
 Secondary Ranges: 11 total, 0-5 VAC to 0-1500 VAC  
 Regulation per Secondary: 10% for 10-100% load change  
 Metering: Primary and secondary AC voltages  
 Meter Range: 0-15 VAC x 1 x 10 x 100  
 Size: 10" x 17" x 8"  
 Secondaries may be used in parallel or series  
 Provision for square wave or non-sinusoidal inputs  
 Additional Coil Accessories—\$15.00 each

Write for Catalog #125

## ELECTRONIC RESEARCH ASSOCIATES, INC.

Laboratories and Factory: 67 Factory Place, Cedar Grove, New Jersey CEnter 9-3000

Subsidiaries: ERA Electric Co. • ERA Dynamics Corporation • Advanced Acoustics Co.

ucts Division, San Fernando, Calif. Type RT-1 variable attenuator has a range of 0 to 60 db to an accuracy of  $\pm 2$  db over the frequency range of 0 to 3,000 Mc.

CIRCLE 313 ON READER SERVICE CARD



### Shaft Position Encoder MINIATURE UNIT

DATA TECH, 238 Main St., Cambridge 42, Mass. The Vernisyn model VMI 15-216 digital shaft position encoder provides a 16 bit absolute readout of shaft position to an accuracy of  $\pm \frac{1}{2}$  bit in a single turn in a  $1\frac{1}{2}$  in. diameter by 2 in. package including electronics. This model provides an output in the form of fine and coarse pulse trains on separate lines such as to provide a complete angular position answer with respect to a reference radius every 10 millisecc.

CIRCLE 314 ON READER SERVICE CARD



### Decade Counting Unit SOLID STATE

COMPONENTS CORP., 106 Main St., Denville, N.J. The DCU-100 will count at speeds from d-c to over 200 Kc with a double pulse resolution of less than  $3 \mu\text{sec}$ . Four transistorized binaries with diode steering provide staircase output to drive directly an inexpensive D'Arsonval readout meter. An appropriate carry pulse output will drive another DCU-100 directly, so that a counting chain can easily be assembled. Each DCU-100 requires less than 10 ma at 6 v for operation.

CIRCLE 315 ON READER SERVICE CARD

## DEVELOPMENT & AEROSPACE SPECIALISTS

International Electric, Systems Managers in the design and development of a variety of advanced, large-scale, electronic systems, seeks specialists in two areas.

*Development Specialists*, with at least six years' association with large projects. They will evolve requirements for systems users in such areas as air traffic control, ASW, satellite control and command/control systems, and for work in information retrieval, man/machine communications and advanced computer utilization.

*Aerospace Specialists*, for integration of command/control systems with weapons systems.

Please send resume to Manager of Technical Staffing, Dept. EL

### INTERNATIONAL ELECTRIC CORPORATION

An Associate of International Telephone and Telegraph Corporation  
Rte. 17 & Garden State Parkway  
Paramus, N. J.

An equal opportunity employer.

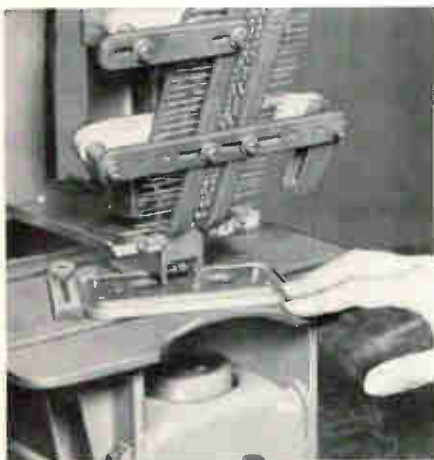

## INSERT COMPONENTS FASTER

With Dynasert you can insert components in PW boards up to 10 times faster than by hand. The Dynasert inserting machine feeds, cuts and bends leads, inserts and clinches all types of axial lead components. Practical even for sample runs. Find out more. Call or write Mr. D. R. Knight, Dynasert, United Shoe Machinery Corp., Boston 11, Mass. Area Code 617, Liberty 2-9100.

**United  
DYNASERT®**

CIRCLE 219 ON READER SERVICE CARD

December 15, 1961

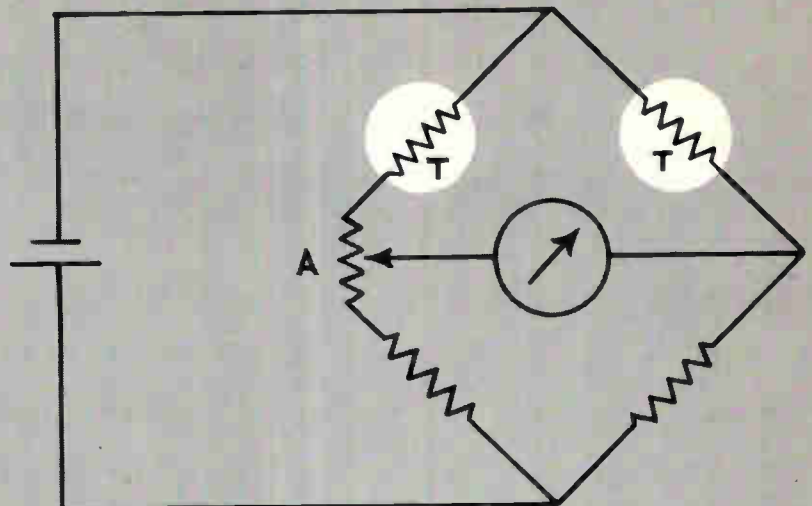

## A little thermistor makes a big difference in many thermal conductivity instruments

Place two small bead thermistors in a bridge circuit where enough current flows to heat them to 150° C, and you'll find you have an instrument for the measurement of many different physical phenomena. *For example:*

**GAS ANALYZER** — Place the thermistors in small cavities filled with identical gases, and balance the bridge by varying the setting of "A". A change in the gas in one of the cavities will either raise or lower the resistance of the thermistor because of a change in the thermal conductivity. This will unbalance the bridge and give a reading on a meter.

**FLOW METER** — Seal a thermistor in a cavity, and place the other thermistor in a pipe. Balance the bridge when there is no flow through the pipe. When the flow starts, the resistance of the thermistor changes, and the bridge becomes unbalanced.

**ANEMOMETER** — Design the instrument with a sensing thermistor held in free air, and it will be capable of measuring air velocity from the slightest breeze to a gale.

**VACUUM GAUGE** — Place one of the thermistors in an evacuated bulb and the other in a chamber connected to a vacuum pump. Pump the chamber down to a high vacuum, and balance the bridge. A reading can be obtained when the chamber is not a high vacuum because the presence of air will cool the thermistor and raise its resistance.

Thermistors can be used in many other circuits to great advantage. For details, application assistance and new Thermistor Catalog EMC 4, write:

*Fenwal Electronics' new, modern production facility and offices mean better service and better products for you.*

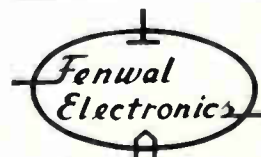

63 FOUNTAIN STREET  
FRAMINGHAM, MASS.

CIRCLE 101 ON READER SERVICE CARD

101



# MESUR-MATIC'S GO/NO-GO PRODUCTION LINE TEST EQUIPMENT

The unique Mesur-Matic line of GO/NO-GO test equipment makes it possible to establish inspection tolerances to extremely precise limits and yet utilize non-technical operator personnel. Errors of interpretation are completely eliminated by means of the flashing red and green lights which clearly indicate either a "GO" (within tolerance) or "NO-GO" (out of tolerance) condition. All models are available for either rack or bench mounting.

## TRANSFORMER TESTER

The Model TT-1-P56 is designed for precision evaluation of 50 and 60 cycle power transformers in the 1 to 1000 VAC range. Under actual operating conditions, each winding is tested against every other winding and the frame, to pre-established inspection tolerances. The voltage accuracy of each secondary and tap is individually indicated by means of the GO/NO-GO lights. Also available are testers for RF and audio transformers and 400, 800 and 1200 cycle power transformers.

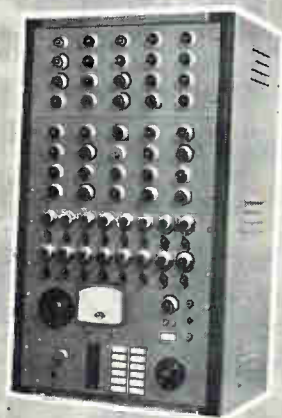

## DC COMPARATOR



The Mesur-Matic DC Comparator is designed for use as a "mid-line" comparison unit, making it possible to control test parameters to extremely precise limits without the need for complex, expensive equipment. The unit may be used to monitor flow rates, pressure, AC or DC voltage and current levels, frequency, temperature, humidity or any action which can be measured electrically through the use of transducers.

## IMPEDANCE COMPARATOR

The Model IC-1-LMN may be used not only for the precision testing of individual components but also for resistor-capacitor and resistor-inductor networks.



Mesur-Matic makes available still other equipment for a wide range of precision-test applications on the production line and in the lab. Circle the reader service card number below for complete data.

**MESUR-MATIC ELECTRONICS CORP.**  
BRADFORD, NEW HAMPSHIRE

## PRODUCT BRIEFS

**SERVO ACTUATOR** electro-hydraulic. Western Design & Electronics, Santa Barbara Airport, Goleta, Calif. (316)

**VERSATILE INK** for plated circuits. Naz-Dar Co., 461 Milwaukee, Chicago 10, Ill. (317)

**TRANSISTOR CIRCUIT-MOUNT** offers complete flexibility. Sanders Associates, Inc., 95 Canal St., Nashua, N. H. (318)

**PULSE TRANSFORMERS** subminiature. Valor Instruments, Inc., 13214 Crenshaw, Gardena, Calif. (319)

**SINGLE CRYSTALS** ammonium dihydrogen phosphate. Electro-Ceramics, Inc., 2645 South 2nd W., Salt Lake City 15, Utah. (320)

**DYNAMIC ANALYZER** analog recording. Digital Dynamics, Inc., 4201 Redwood Ave., Los Angeles 66, Calif. (321)

**SCREEN PRINTING CHASE** controlled stretch. Kay-Ess, Inc., 8 North St., Danbury, Conn. (322)

**D-C INTEGRATING SERVO** high stability. Kearfott Division, General Precision, Inc., 1150 McBride Ave., Little Falls, N.J. (323)

**INSTRUMENTATION CART** 16 in. wide, 32 in. high, 32 in. long. Atlantis Metal Products Division, P.O. Box 451, Garland, Texas. (324)

**INDICATOR TUBE** operates off transistors. Amperex Electronic Corp., 230 Duffy Ave., Hicksville, L.I., N.Y. (325)

**DIGITAL RECORDER** multichannel. Bytrex Corp., 50 Hunt St., Newton, Mass. (326)

**CRYSTAL DETECTOR** operates from 1 to 12.4 Gc. Alfred Electronics, 3176 Porter Dr., Palo Alto, Calif. (327)

**PHOTOMULTIPLIER** 3/4-inch. Westinghouse Electronic Tube Division, Elmira, N.Y. (328)

**UHF TV TRANSLATOR** 20-watt unit. Adler Electronics Inc., One LeFevre Lane, New Rochelle, N.Y. (329)

**MICROMINIATURE PGT** 0.03 oz. Miniature Electronic Components Corp., Holbrook, Mass. (330)





**ELECTROLYTIC  
AND  
PAPER TUBULAR  
CONDENSERS**

"35 YEARS OF PROVEN  
DEPENDABILITY"

**COSMIC CONDENSER CO.**

853 WHITTIER STREET, BRONX, N. Y.  
LUdlow 9-3360

CIRCLE 220 ON READER SERVICE CARD

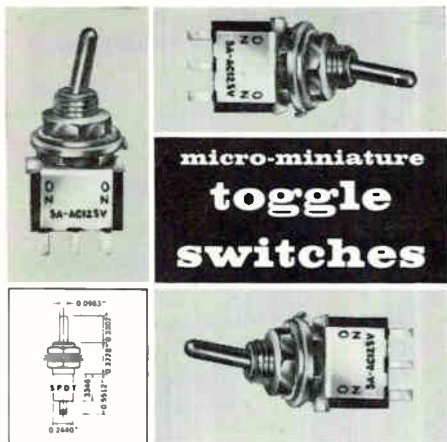

Shown actual size **DESIGNED FOR  
"LIMITED SPACE" PROBLEMS**

5 AMPS @ 115 VAC — and capable of  
carrying a 100% overload!

**SOLID SILVER** — contacts, terminals and  
moving parts! Not just plated!

**LONG LIFE RATINGS** — over 80,000  
operations for this tiny switch!

**MICRO-MINIATURE** — S.P.D.T. is sub-  
miniaturized to only 1/2" x 3/8" x 1/4"!

Quantity	S.P.D.T.	D.P.D.T.
1-24	\$1.65	\$2.15
25-90	1.12	1.43
100-499	.99	1.29
500 over	.83	1.08

**LARGER QUANTITY PRICES  
AVAILABLE ON REQUEST**

In use by over  
1000 manufacturers



**COMING  
SOON**

- Color-Coded Handle Inserts
- Weather-Proof Rubber Seals
- Momentary Toggle Switches
- Center-Off Toggle Switches

CIRCLE 221 ON READER SERVICE CARD

December 15, 1961



*The Lincoln Laboratory program for ballistic  
missile range measurements and penetration  
research includes:*

## EXPERIMENTAL RESEARCH

Measurements and analysis of ICBM flight phenomena for  
discrimination and for decoy design purposes, including optical,  
aerodynamic and RF effects.

## SYSTEM ANALYSIS

Studies to apply research findings to advance the technology  
of ICBM and AICBM systems.

## INSTRUMENTATION ENGINEERING

Designing radar, optical and telemetry equipment with which  
to measure ICBM flight effects under actual range conditions.

## RADAR SYSTEMS RESEARCH

Extending the theory and application of radar techniques to  
problems of discrimination, countermeasures and performance  
in a dense-target environment.

## HYPERSONIC AERODYNAMICS

Study of the flow-fields around re-entering bodies for various  
body designs and flight conditions. Excellent computer facilities  
available.

## RADAR PHYSICS

Theoretical and experimental studies in radar back-scattering.  
Interaction of RF radiation with plasmas.

- *A more complete description of the Laboratory's  
work will be sent to you upon request.*

All qualified applicants will receive consideration for employment without  
regard to race, creed, color or national origin.

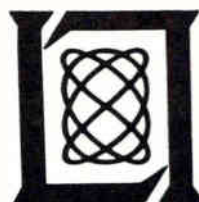

Research and Development

**LINCOLN LABORATORY**

Massachusetts Institute of Technology

**BOX 27**

**LEXINGTON 73, MASSACHUSETTS**



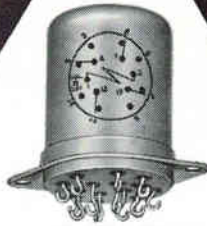

Type FC-4-250  
4P-DT  
(Military designation RY4LB3B3L01)

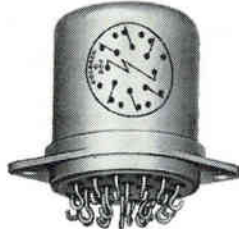

Type FC-6-250  
6P-DT  
(Military designation RY4LC3B3L01)

## RELAY RELIABILITY PIONEERS OF THE SPACE AGE

Redstone . . . Minuteman . . .  
Hawk . . . Bomarc . . . Polaris  
. . . and dozens of other ground and  
airborne equipment programs have bene-  
fitted from the time proven reliability of  
Struthers-Dunn FC-4 (4P-DT) and FC-6 (6P-DT)  
subminiature hermetically sealed can relays.  
Full quality control extends from incoming materials  
to finished units. They're made and assembled under  
spotlessly clean, rigidly controlled environmental con-  
ditions. Exacting performance to MIL-R-5757D specifications  
is doubly assured by constant checking in Dunco's quarter of  
a million dollar in-plant test laboratories. Greatly expanded  
facilities assure fast deliveries on both standard and special units.

Write for Data Bulletin FC.  
STRUTHERS-DUNN, Inc., Pitman, New Jersey

# STRUTHERS-DUNN

5,348 Relay Types

Sales Engineering offices in: Atlanta • Boston • Buffalo • Charlotte • Chicago • Cincinnati • Cleveland  
Dallas • Dayton • Denver • Detroit • High Point • Kansas City • Los Angeles • Montreal • New York  
Orlando • Pittsburgh • St. Louis • San Carlos • Seattle • Toronto • Export: Langguth-Olson Co., New York

## Literature of the Week

**POWER SUPPLY** Deltron Inc., 4th & Cambria Sts., Philadelphia 33, Pa. Bulletin DP 2026A gives a detailed description of the DIPAC dissipationless power amplitude control power supply. (331)

**R-F FILTERS** Genistron, Inc., 6320 W. Arizona Circle, Los Angeles 45, Calif., has released the 52-page catalog F-101 on a line of standard radio interference filters. (332)

**EPOXY CASTING RESIN** Emerson & Cuming, Inc., Canton, Mass. Preliminary technical bulletin covers Stycast 1264, a transparent high impact epoxy casting resin. (333)

**MICROWAVE FILTERS** Watkins-Johnson Co., 3333 Hillview Ave., Palo Alto, Calif. A technical bulletin illustrates and describes the WJ-501 electronically-tuned microwave filters. (334)

**COMPONENT END SEALING** Epoxy Products Division, Joseph Waldman & Sons, 137 Coit St., Irvington 11, N.J. An information bulletin tells how to end seal electronic components for environmental protection. (335)

**THERMOCOUPLE SELECTOR BOARD** Smith Thermotronics, Inc., Conshohocken, Pa. TSB-1, a wall mounting sample board, provides quick selection of thermocouples. (336)

**TRANSISTORIZED RELAY** General Electric Co., Schenectady 5, N. Y. Bulletin GPC-B49 describes the CR120F transistorized sensitive relay. (337)

**ASSEMBLIES & HARNESSSES** Microdot Inc., 220 Pasadena Ave., South Pasadena, Calif. Assemblies and harnesses for miniaturized coaxial circuitry are described in bulletin A&H-1. (338)

**NON-ENVIRONMENTAL CONNECTORS** Consolidated Electrodynamics Corp., 360 Sierra Madre Villa, Pasadena, Calif. Features of the series 610, 710, and 810 tiny non-environmental connectors are described in a 10-page bulletin. (339)

**AUDIO-VISUAL PRESENTATION** AVDOC, a division of Conductorlab, Inc., Groton, Mass., announces

a 4-page brochure on its capabilities and the availability of its service in the area of audio-visual presentation. (340)

**SUBMINIATURIZATION** Tri-Lab Electronics, Inc., 4319 Twain Ave., San Diego 20, Calif. A brochure on subminiaturization products and services is available. (341)

**H-V RECTIFIER ASSEMBLIES** Micro-Semiconductor Corp., 11250 Playa Court, Culver City, Calif. Bulletin 106 describes a line of high voltage rectifier assemblies. (342)

**INSTRUMENTATION** Empire Devices Inc., Amsterdam, N. Y. Catalog 614 presents the company's standard equipment including noise and field intensity meters, instruments for microwave systems & components, radar interference blankers. (343)

**ANALYZING INSTRUMENTS** Allison Laboratories, Inc., 11301 Ocean Ave., LaHabra, Calif. Catalog 860 illustrates and describes a line of analyzing instruments including model 201 variable filter. (344)

**H-V SOURCES** Smith-Florence Inc., 4228 Twenty-Third Ave., West, Seattle 99, Wash. A 4-page folder illustrates and describes a line of d-c regulated power sources from 0 to 20,000 v. (345)

**AUTOMATIC DIRECTION FINDER** Marconi's Wireless Telegraph Co. Ltd., Marconi House, Chelmsford, England. Bulletin TD271 deals with the model AD 360 fully transistorized automatic direction finder. (346)

**RELAY TESTER** Electronic Engineering Co. of California, 1601 E. Chestnut Ave., Santa Ana, Calif. Catalog sheet contains features and specifications of model RT-905 relay tester. (347)

**VHF PREAMPLIFIERS** Community Engineering Corp., State College, Pa. Bulletin covers a line of vhf ultra-low-noise preamplifiers. (348)

**SHIFT REGISTERS** Epsco-Components, 275 Massachusetts Ave., Cambridge 39, Mass., offers a 4-page brochure on a line of standard magnetic shift registers. (349)

**TANTALUM CAPACITORS** Ohmite Mfg. Co., 3695 Howard St., Skokie, Ill. Cross-reference lists, in alphabetical order, the wet-electrolytic slug and foil tantalum capacitors of other manufacturers along with Ohmite equivalents. (350)

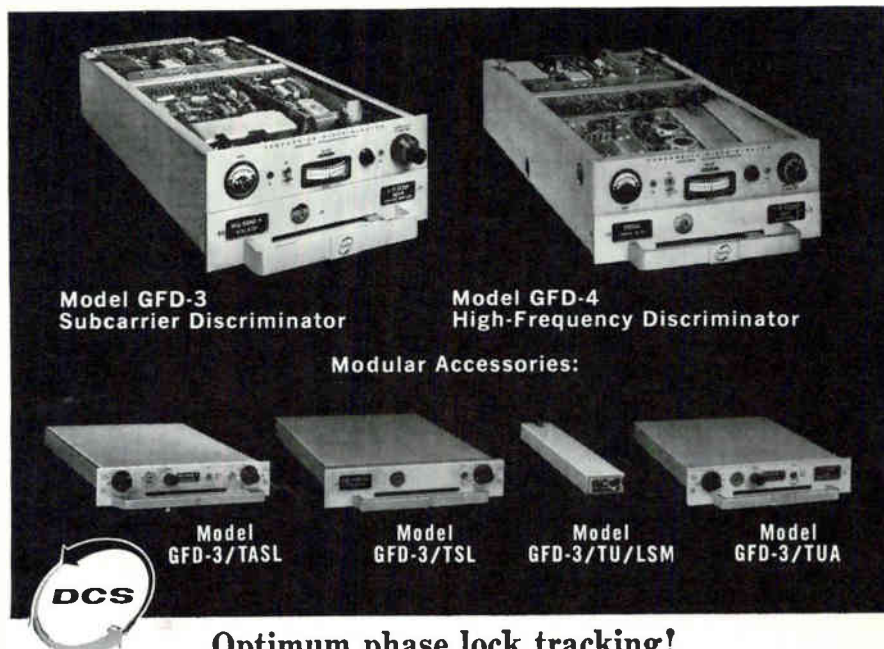

**Optimum phase lock tracking!**

— — *Just one reason*  
**you can't beat DCS Discriminators!**

**COMPARE THESE DCS FEATURES:**

- Super reliability — MTBF in excess of 5000 hours!
- Optimum phase-locked tracking — operator controlled.
- Widest frequency range — subcarriers to 1 mc.
- Maximum adaptability — widest variety of modular accessories.
- All solid-state — individual power supplies.
- YET — priced below many models with inferior performance!

Don't just take our word — ask our customers, who are actually using thousands of DCS Discriminators!

For example, consider reliability. Actual field data gathered by users has shown MTBF in excess of 5000 hours! What's more, we guarantee our MTBF data!

Also, DCS offers operator-controlled variable-loop tracking filters. Unlike inferior discriminators which are limited to a pre-set loop bandwidth and damping (claimed "optimum"), DCS Discriminators permit complete operator control in adapting characteristics of the phase-locked loop for *truly* optimum data reduction. A bench demonstration will quickly prove the superior performance possible with operator control. Numerous comparative customer evaluation reports attest to the superiority of the DCS operator-controlled phase-locked loop when signals are extremely weak.

The DCS family of discriminators offers the widest frequency ranges available. Discriminators to accommodate subcarriers in excess of 1 mc, intelligence frequencies in excess of 100 kc, constant-bandwidth, frequency translation, and predetection signals are standard, off-the-shelf products.

For complete information on the entire family of DCS Discriminators and accessories, call your nearest DCS Field Engineer or write: Dept. E-8.

**DATA-CONTROL SYSTEMS, INC.**  
*Instrumentation for Research*

Los Angeles • Santa Clara • Wash., D. C. • Cape Canaveral  
Home Office: E. Liberty St., Danbury, Conn. • Pioneer 3-9241

**DCS**





## Transco Building Larger Facilities

TRANSCO PRODUCTS, INC., manufacturer of microwave systems and components, fractional h-p motors, and aircraft communication-navigation equipment, will move into new quarters at 4241 Glencoe Ave., Venice, Calif., next April.

The new facility, currently under construction on a 4½ acre site, will have 51,200 sq ft of working area, all on ground level—over twice as much space as the present Transco plant in West Los Angeles. Facilities are designed for the manufac-

ture of high precision products.

The new plant will increase the engineering area three times, and provide an extensive microwave laboratory and new antenna pattern range. According to M. W. Sawyer, president, expansion (which follows by only one year complete modernization and enlargement of the present plant) was needed because of accelerated demand for company products and establishment of company in two new fields, motors and aircraft equipment.

low altitude navigation systems.

McCord was formerly production manager in the division's manufacturing department. In his new position he replaces Lee Strom who has joined TI's Components Division as technical advisor in the integrated circuits group.

### Diginamics Corp. Fills Two Posts

DIGINAMICS CORP. of Minneapolis has appointed two engineers to executive positions in charge of special project groups.

Keith J. Bulleyment was named principal systems engineer supervising the special digital systems group dealing with one-time digital systems. Edward G. Zoerb was appointed principal mechanical engineer in charge of the mechanical

engineering group.

Both formerly were associated with the Aeronautical Division of Minneapolis-Honeywell Regulator Co.

### Sanborn Establishes Transducer Division

SANBORN CO., Waltham, Mass., has established a transducer division with its own engineering staff and manufacturing facilities. The division will provide individual attention to the needs of military, industrial and medical equipment users.



### Dytronics Hires Glogowski

STEFAN W. GLOGOWSKI has been appointed chief engineer for Dytronics Inc., Rochester, Mich.

Dytronics, a subsidiary of Taylor Fibre Co., Norristown, Pa., makes die stamped circuits for electrical and electronic applications.

Prior to joining Dytronics, Glogowski was a project engineer in the Metal Fabricating Division of DeVilbiss Co., Toledo, O.



### Victor Fong Joins Clark Semiconductor

VICTOR FONG has been appointed manager of device fabrication for Clark Semiconductor Corp., Clark,



### McCord Assumes New Position

APPOINTMENT of A. Ray McCord as manager of the surveillance department in the Apparatus Division of Texas Instruments Inc., Dallas, Texas, has been announced. This department is primarily concerned with research, design and manufacturing of military surveillance and reconnaissance equipment, including infrared and radar systems and



## BF SERIES BATTERY HOLDER

Literally, BF Series Battery Holders are powerhouses . . . designed for use as highly stable, panel mounted cell sources of power. They will accommodate batteries and cells up to  $1\frac{3}{8}$ " diameter and lengths from  $1\frac{1}{4}$ " to  $7\frac{3}{8}$ ", enabling use of different battery combinations to obtain wide selection of voltages. Batteries are exchanged simply by unscrewing holder cap. Designed for mounting up to a  $1\frac{3}{8}$ " diameter hole and  $\frac{3}{8}$ " panel thickness.

Inquiries for special battery holder lengths are invited. Complete data available on request.



**300 SERIES:** • Designed to accommodate batteries up to  $\frac{1}{8}$ " diameter and lengths 1.300 to 5.850.

**400 SERIES:** • Accommodates batteries  $1"$  to  $1\frac{1}{8}"$  diameter and lengths from  $1\frac{1}{8}"$  to  $6\frac{3}{8}"$ .

**500 SERIES:** • Accommodates batteries ranging from  $1\frac{3}{8}"$  to  $1\frac{3}{8}"$  diameter and lengths from  $2\frac{3}{8}"$  to  $7\frac{3}{8}"$ .



**SECURITY  
DEVICES  
LABORATORY**

ELECTRONICS DIVISION OF  
SARGENT & GREENLEAF, INC.

ROCHESTER 21, NEW YORK

CIRCLE 222 ON READER SERVICE CARD  
December 15, 1961

**NOW**



## MICRO-MIDGET CHOPPERS FROM STOCK!

### RATINGS

Drive: 6.3 volts at 60 CPS or 400 CPS

Signal Level: 10 VDC at 2 MA max.

Size: World's Smallest

Contact Action: SPDT BBM

Temperature Range:  $-65^{\circ}\text{C}$  to  $+100^{\circ}\text{C}$

Life: 2,000 hours minimum

Shock: 100 G

*. . . plus a  
noise level down to  
0.6 microvolts!*



CAMBRIDGE DIVISION • CAMBRIDGE, MARYLAND

CIRCLE 107 ON READER SERVICE CARD 107



# NEW TRANSISTORIZED WIDEBAND AMPLIFIER OFFERS MORE PERFORM- ANCE THAN \$200 EVER BOUGHT BEFORE



The NEW transistorized **WB-100** wideband amplifier from Teltronics, Inc.

Here's more performance, less bulk than you might have thought possible at the cost:

- GAIN: . . . . . 20 db minimum
- FLATNESS: . . . . .  $\pm 1.0$  db maximum
- BANDWIDTH: . . . . . 1 to 100 mc minimum
- INPUT IMPEDANCE: . . Nominally, 50 ohms at 30 mc
- OUTPUT IMPEDANCE: . . Nominally, 50 ohms at 30 mc
- OUTPUT VOLTAGE: . . 70.5 mv peak into 50 ohm load
- POWER SUPPLY: . . +3.0 Vdc and -15 Vdc or 18 Vdc floating BNC connectors
- PACKAGE: . . . . . 6" l x 2" w x 1 1/8" h

## Problem in solid state electronics? TELL IT TO TELTRONICS!

Teltronics, Inc. offers an expanding line of precision amplifiers designed to meet your needs . . . plus first-class design and development brainpower in such varied areas as circuit design; custom test equipment and specials; and complete system design.



For complete information, please write or call:



23-27 Main Street, Nashua, New Hampshire — TUxedo 2-6264  
Export Division: EMEC, Inc. Plainview, L. I., N. Y.

N.J. He will be in charge of the production of the company's high frequency power transistors.

Before joining Clark, Fong was an engineer for RCA Semiconductor division, and did development work for Bell Telephone Laboratories.

## Cooper Accepts Cimron Post

EBERHARD COOPER, formerly an engineer at Cohu Electronics, Inc., has accepted the post of senior electronic engineer at Cimron Corp., San Diego, Calif.

At Cimron, Cooper will assume a major responsibility in the design of electronic instruments to augment the company's line of d-c and a-c digital voltmeters and volt-ratio meters.

## PEOPLE IN BRIEF

Roy A. Olerud, ex-ITT and Allen B. DuMont Laboratories, is named general mgr. of Custom Components, Inc., and all its wholly-owned subsidiaries. Republic Aviation promotes Everett S. Glines to general mgr. of its missile systems div. Norwood P. Cassidy, former Assistant Comptroller of the Navy, elected president of Servonics, Inc. Paul Garrison leaves I.T.E. Circuit Breaker Co. to become general mgr. of Technical Appliance Corp. John T. Whiteley, previously with British Columbia Telephone Co., has joined the engineering staff at Lynch Communication Systems Inc. Warner T. Smith and Robert M. Meadows move up at Superior Cable Corp. to v-p in charge of engineering and treasurer, respectively. N. R. Kornfield advances at Philco Corp. to mgr. of the special projects dept. in the Computer Div. Dunn Engineering Corp., ups Sydney Minault to v-p, manufacturing. Murray I. Disman, of Eitel-McCullough, Inc., appointed mgr. of microwave tube development. John M. Lambert, ex-General Electric Co., named mgr. of advanced systems in the Systems Div. of Avien, Inc. Samuel W. Daskam, formerly with RCA, is now applications mgr. at Clark Semiconductor Corp.

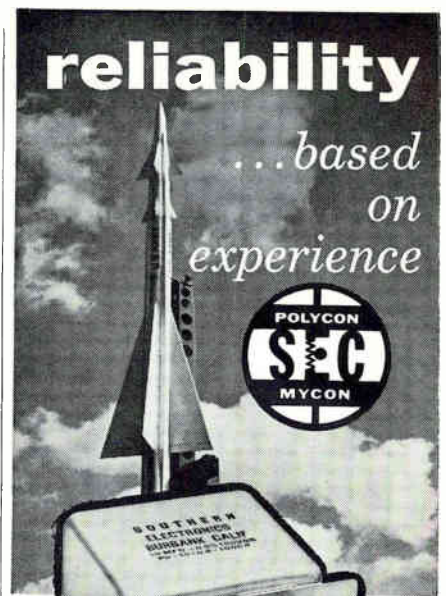

## ultra-high precision capacitors

Southern Electronics high-precision capacitors are demonstrating their proven reliability today in twelve different missiles, analog computers, and many radar and communications applications.

SEC high-precision capacitors utilize polystyrene, providing .01% tolerances, and mylar and teflon to meet .5% requirements. They show excellent stability characteristics over an extended temperature range, and tolerances are unaffected even at extreme high altitudes.

The unusual accuracy, stability and reliability of SEC capacitors are the result of engineering experience concentrated on the design and manufacture of precision capacitors only, plus rigid quality control standards subjecting each capacitor to seven inspections during manufacture, plus final inspection.

Our engineering experience enables us to meet your size requirements, while holding to exact capacitance and tolerance specifications.

SEC capacitors are manufactured in a wide range of capacitance to meet your needs from 100 mmfd. to any higher value, and meet or exceed the most rigid MIL-SPECS.

Write today for detailed technical data and general catalog.



**SOUTHERN  
ELECTRONICS**  
*Corporation*

150 WEST CYPRESS AVENUE  
BURBANK, CALIFORNIA

CIRCLE 223 ON READER SERVICE CARD  
electronics

Look how Lafayette Radio ENSURES

## OVERNIGHT DELIVERY

OF TI PRECISION CARBON FILM RESISTORS

★  
*Four locations . . . all stocked in depth with Texas Instruments complete line . . .*

★  
*High-speed order processing and shipment . . . makes TI resistors available within hours to meet your tightest delivery requirements.*

Call Lafayette today for immediate shipment at factory prices on:

### TI HARD GLASS HERMETIC

Hard glass encapsulation gives you unexcelled mechanical ruggedness, moisture resistance and extreme resistance to thermal shock.

### TI MIL-LINE

Packaged in tough TI-developed epoxy to provide the advantages of an insulated resistor at uninsulated resistor prices — use-proved by over seven years of service!

### TI MOLDED LINE

Tough-molded for complete mechanical protection during and after installation

AUTHORIZED



DISTRIBUTOR

**LAFAYETTE RADIO**  
INDUSTRIAL ELECTRONICS DIVISION

"ENTERPRISE" NUMBERS IN MAJOR CITIES

<b>JAMAICA</b> 165-08 Liberty Ave. Jamaica 33, N. Y. Area Code 212 OL 8-5050 TWX: NY 4-933	<b>NEW YORK</b> 100 Sixth Avenue New York 13, N. Y. Area Code 212 WO 6-5300 TWX: NY 1-648
---	--

<b>NEWARK</b> 24 Central Ave. Newark 2, N. J. Area Code 201 MI 3-6868	<b>BOSTON</b> 110 Federal St. Boston 10, Mass. Area Code 617 HU 2-0311 TWX: BS 447U
---	--

#18755

CIRCLE 225 ON READER SERVICE CARD

December 15, 1961

# BRISTOL'S LOW-NOISE CHOPPERS

open the way for new advances in  
low-level instrumentation

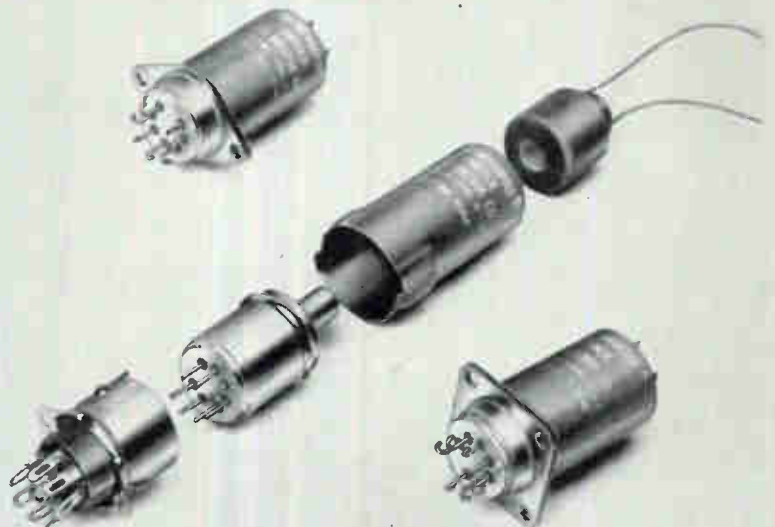

MINIATURE BRISTOL SYNCROVERTER CHOPPERS

Low-Noise Syncroverter\* choppers are used in the finest and most accurate d-c amplifiers, microvolt-am-meters and null-balance systems where only the best is required. Write for complete specifications: **ACCO**

**The Bristol Company, Aircraft Equipment Division, 150 Bristol Road, Waterbury 20, Conn.**

A Subsidiary of American Chain & Cable Company, Inc.



## BRISTOL

\*T.M. Reg. U. S. Pat. Off. 1.3

... engineers for precision, builds for reliability

CIRCLE 109 ON READER SERVICE CARD

109





Philco WDL has immediate and challenging engineering positions open in Discoverer, Midas and Advent programs in these categories:

Data systems engineering

Technical Staff — communications and data systems

Systems test planning

Systems reliability analysis

Design Engineering — surface and vehicle electronics

Human factors and operations analysis

Field tracking station activation

Tracking and control systems design

Logistics and station support

And others

*U S citizenship or current transferable Department of Defense clearance required.*

## *if your future is for growing...*

People at Philco's Western Development Laboratories are proud of their achievements, secure in the steady growth of their company, enthusiastic about their future.

In just four years, Philco WDL has expanded from a staff of 18 to more than 2,000. At the end of this year WDL will open a new 250,000-square-foot facility which will accommodate a continually expanding complement of engineers, scientists and supporting staff members.

Philco WDL, the space organization which designed and built the Courier satellite, conducts an ever-growing development program in tracking, satellite instrumentation, communications, data processing and command—moving hand in hand with the federal government in space exploration and space age defense.

Your growth with a growing company, ideal living on the Northern California Peninsula, professional and monetary advancement commensurate with your own ability—these are some of the advantages and satisfactions of working at Philco Western Development Laboratories.

If yours is one of the fields listed at the left, write today to Mr. W. E. Daly, in confidence, of course, Department E-12.

*This new 250,000-square-foot addition to Philco Western Development Labs is further indicative of your future there.*

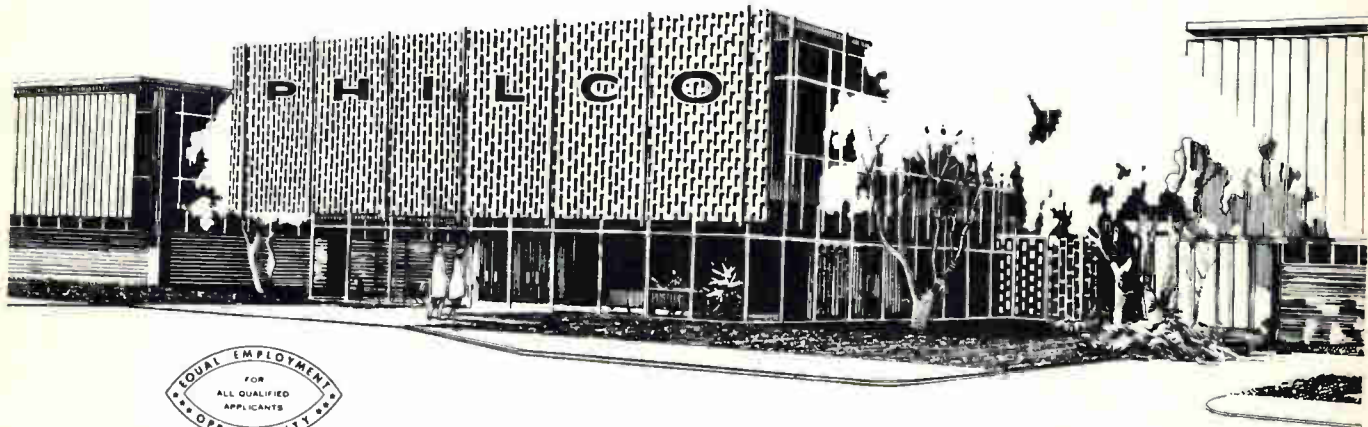

**PHILCO**  
Equal Opportunity  
*Famous for Quality the World Over*

**WESTERN DEVELOPMENT LABORATORIES**  
 3875 Fabian Way, Palo Alto, California



# EMPLOYMENT OPPORTUNITIES

(Continued from page 111)

## COMMUNICATIONS APPLICATION ENGINEER

Analysis of advanced electronic communication systems including radio, carrier, telephone, microwave.

Must have design and marketing experience with commercial and military users.

EE degree, 5 yrs. exp. min.

Send Resume to:

Microwave Services International Inc.

Consulting Engineers  
Route 46 Danville, N. J.

## DEPARTMENT MGR.—SYSTEMS ENGINEERING TO \$15,000 PER YEAR

To represent and to perform over-all supv. of I.E., operations research and computer operations groups within an organization which researches, plans and implements large automatic electromechanical systems. Client assumes all expenses.

ESQUIRE PERSONNEL SERVICE, INC.

202 SOUTH STATE ST. CHICAGO 4, ILLINOIS

## POSITION VACANT

Experienced Production man on solid Tantalum capacitors for Calif. firm. Practical man preferred. Give complete resume—absolutely confidential. P-7851, Electronics, Classified Adv. Div., 255 California St., San Francisco 11, Calif.

# electronics

## WEEKLY QUALIFICATIONS FORM FOR POSITIONS AVAILABLE

(Continued from page 110)

COMPANY	SEE PAGE	KEY #
MITRE CORPORATION Bedford, Massachusetts	48	15
PAN AMERICAN WORLD AIRWAYS INC. Guided Missiles Range Div. Patrick AFB, Florida	34	16
PHILCO WESTERN DEVELOPMENT LABORATORIES Palo Alto, California	111	17
SCIENTISTS, ENGINEERS & EXECUTIVES INC. Washington, D. C.	116*	18
P-7843	116*	19

\* These advertisements appeared in the 12/8 61 issue.

## FOR INFORMATION

### About Classified Advertising,

Contact The McGraw-Hill Office  
Nearest You.

ATLANTA, 9— 1375 Peachtree St. N.E. Trinity 5-0523 D. HICKS	HOUSTON, 25— Prudential Bldg. Room W-724 Holcombe Blvd. JA 6-1281
BOSTON, 16— Copley Square Congress 2-1160 M. SHOVLIN	LOS ANGELES, 17— 1125 W. 6th St. Huntley 2-5450
CHICAGO, 11— 645 No. Michigan Ave. Mohawk 4-5800 W. J. HIGGINS	NEW YORK, 36— 500 Fifth Ave. OXford 5-5959
CLEVELAND, 13— 1164 Illuminating Bldg. Superior 1-7000	H. T. BUCHANAN R. P. LAWLESS
DALLAS, 2— 1712 Commerce St. Vaughn Bldg. Riverside 7-9721 J. GRANT	T. W. BENDER - P. BOND PHILADELPHIA, 3— Six Penn Center Plaza LOCast 8-4330
DENVER, 2— 1700 Broadway— Tower Bldg. ALpine 5-2981 J. PATTEN	W. B. SULLIVAN PITTSBURGH, 22— 4 Gateway Center EXpress 1-1314
DETROIT, 26— 856 Penobscot Bldg. Woodward 2-1793 WM. H. GINDER, JR.	ST. LOUIS, 3— 7751 Carondelet Ave. PARKview 5-7285
	SAN FRANCISCO, 11— 255 California St. DUGlas 2-1600 J. A. HARTLEY

# JUST WHAT THE DOCTOR ORDERED

**LOW NOISE FIGURE**  
4.5 db max.

**12 MILLIAMPERE POWER DRAIN**  
less than your flashlight

**UNIFORM RESPONSE**  
within 3db over full range

**SMALL SIZE — LIGHT WEIGHT**  
2½" x 6½" — 19 ounces

## THE NEMS-CLARKE SOLID STATE TELEMETRY PREAMPLIFIER



Here's your baby for outstanding performance and economy in the 225-260 megacycle telemetry range — the Nems Clarke SSP-101 completely solid state preamplifier. Featuring extremely low noise, flat response, and a hefty 25db minimum gain, it's at home in any environment... installed either in the antenna mount or the coax cable. Its own external 12 volt power supply is available for rack mounting. Baby sitting? Forget it! The SSP-101 operates for thousands of trouble free hours at unattended locations.

Write for Data Sheet 999

**VITRO ELECTRONICS** A DIVISION OF VITRO CORPORATION OF AMERICA  
PRODUCERS OF **NEMS-CLARKE** EQUIPMENT  
919 JESUP-BLAIR DRIVE, SILVER SPRING, MARYLAND / 2301 PONTIUS AVENUE, LOS ANGELES 64, CALIFORNIA  
CIRCLE 224 ON READER SERVICE CARD  
electronics

# INDEX TO ADVERTISERS



## Audited Paid Circulation

• AMP Incorporated .....	54	• Hewlett-Packard Company	Inside front cover
Ace Electronics Associates, Inc.....	96	Hogan Faximile Corp.....	50
• Acme Electric Corp.....	20	Hughes Aircraft Co. ....	17
Aerocom .....	51		
Aerospace Corporation.....	42	IBM .....	22, 23
Air Express .....	25	Intellux Inc. ....	46
• Airpax Electronics, Inc.....	107	International Electric Corp.....	101
• Alco Electronic Products Inc.....	103		
American Machine & Foundry Co.....	24	• Kintel, A division of Colu Electronics	3rd cover
• Arnold Magnetics Corp.....	24	Inc. ....	
		Krohn-Hite Corp. ....	99
Baird-Atomic, Inc. ....	87	Laboratory for Electronics Inc.....	94
Barnstead Still & Sterilizer Co.....	14	• Lafayette Radio.....	109
Bausch & Lomb, Inc.....	88	Lincoln Laboratory .....	103
Behlman-Invar Electronics Corp.....	89	• Litton Industries,	
• Bendix Corporation		Electron Tube Division.....	52
Red Bank Division.....	81		
• Bircher Corporation, The.....	36	Magnetic Metals Company.....	77
Bristol Company, The.....	109	Mallory and Co., Inc., P. R....S, 9, 82,	83
Bruno-New York Industries Corp....	46	Mesur-Matic Electronics Corp.....	102
		Minnesota Mining & Mfg. Co.	
Cambridge Thermionic Corp.....	92	Magnetic Products Div.....	43
Cominco Products Inc. ....	40	Mitre Corp., The.....	48
• Cosmic Condenser Co.....	103	• Mitsumi Electric Co., Ltd.....	40
Cunningham .....	40	• Mnemotron Corp. ....	94
Data-Control Systems, Inc.....	105	Narda Microwave Corporation.....	13
• Dorsett Electronics, Inc.....	89		
• Durant Manufacturing Co.....	36	Oxalid, A Div. of General Aniline &	
Dymec, A Division of Hewlett Packard		Film Corp. ....	2
Co. ....	29		
Dynacor, Inc., A Sub. of Sprague		Pamotor, Inc. ....	20
Electric Co. ....	113	Pan American World Airways Inc....	34
		• Panoramic Electronics, Inc. ....	93
• Edgerton, Germeshausen & Grier, Inc..	36	• Permag Corp. ....	50
Electronic Engineering Co. of Calif..	46	Precision Instrument Co.....	95
Electronic Research Associates, Inc..	100		
		Radiation Inc. ....	33
• FXR, A Div. of Amphenol-Borg		• Radio Corporation of America.....	21
Electronics Corp. ....	3		4th cover
• Fenwal Electronics, Inc.....	101	• Raytheon Company.....	5
• General Ceramics, Div. of Indiana			
General .....	15	• Sanborn Company .....	41
• General Electric Co.		Sangamo Electric Co. ....	7
Chemical Materials Dept.....	84, 85	Scientific Development Corp.....	20
Silicone Prods. Dept.....	49		
Power Tube Dept.....	44, 45		
Gertsch Products, Inc.....	93		
• Gudebrod Bros, Silk Co., Inc.....	32		
• Hardwick-Hindle, Inc. ....	99		
• Hayes, Inc. C.I. ....	50		



## SQUARE-LOOP TAPE CORES TO MEET YOUR TOUGHEST SPECIFICATIONS

Speed your specs to Dynacor when you want square-loop tape cores to exact requirements—fast! Here you'll find a dependable combination of personnel, experience and facilities—the know-how to deliver parameters to your very tightest tolerance requirements for switching time, flux, and noise.

Dynacor Square-Loop Tape Cores are manufactured with the high permeability alloys—Grain-Oriented 50-50 Nickel Iron, 4-79 Molybdenum Permalloy, and Grain-Oriented 3% Silicon Iron . . . with fully guaranteed uniformity . . . under rigid standards of control and inspection.

Look to Dynacor for reliable production and swift delivery of your tape core requirements. For your convenience a full line of standard units are stocked for immediate off-the-shelf delivery—Send for bulletins DN 2000, DN 2001, DN 2002.



**DYNACOR, INC.**  
A SUBSIDIARY OF SPRAGUE ELECTRIC CO.  
35 Marshall St. • North Adams, Mass.



JULY 20, 1961

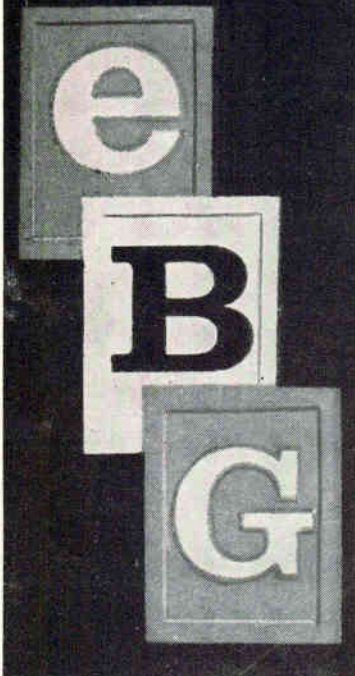

electronics  
BUYERS' GUIDE  
and  
Reference Issue

PRODUCTS, MATERIALS  
and SERVICES LISTINGS

Registered TRADENAMES

MANUFACTURERS'  
SALES OFFICES

ANNUAL electronics  
INDEX of ARTICLES

VOL. 34 28A

Security Devices Laboratory.....	107
• Sierra Electronic Corp.....	10
• Sorensen & Co.....	18, 19
• Southern Electronics Corp.....	108
Sperry Electronic Tube Div. Sperry Rand Corp. ....	78, 79
Sprague Electric Co. ....	30, 31, 91
Stackpole Carbon Co.....	38, 39
Struthers-Dunn .....	104
TWA Air Freight.....	47
Telrex Laboratories .....	89
Teltronics, Inc .....	108
Texas Instruments Incorporated Components Division .....	75
Thermal American Fused Quartz Co., Inc. ....	6
United Shoe Machinery Corp.....	101
Universal Cyclops Corp. ....	35
Veeder-Root, Inc. ....	53
• Vitro Electronics.....	112

Wallar Corp., The.....	85
Western Electric .....	16

CLASSIFIED ADVERTISING  
F. J. Eberle, Business Mgr.

EMPLOYMENT OPPORTUNITIES.111, 112

INDEX TO CLASSIFIED ADVERTISERS

Esquire Personnel .....	112
Microwave Services International Inc...	112
Philco Western Development Labs.....	111

• See Advertisement in the July 20, 1961 issue of Electronics Buyers' Guide for complete line of products or services.

This index and our Reader Service Numbers are published as a service. Every precaution is taken to make them accurate, but ELECTRONICS assumes no responsibilities for errors or omissions.

electronics



Audit Bureau  
of Circulations



Associated Business  
Publications

Audited Paid Circulation

JAMES T. HAUPTLI

Advertising Sales Manager

R. S. QUINT:  
Assistant Publisher Buyers' Guide and  
Business Manager  
FRED STEWART:  
Promotion Manager  
B. ANELLO:  
Marketing Service Manager

RICHARD J. TOMLINSON:  
Production Manager  
GEORGE E. POMEROY:  
Classified Manager  
HUGH J. QUINN:  
Circulation Manager

ADVERTISING REPRESENTATIVES

NEW YORK (36):  
Donald H. Miller, Henry M. Shaw, George  
F. Werner  
500 Fifth Avenue, Oxford 5-5959  
BOSTON (16):  
William S. Hodgkinson, Donald R. Furth  
McGraw-Hill Building, Copley Square,  
Congress 2-1160  
PITTSBURGH (22):  
David M. Watson  
Four Gateway Center, Express 1-1314  
PHILADELPHIA (3):  
Warren H. Gardner, William J. Boyle  
6 Penn Center Plaza, LOcust 8-4330  
CHICAGO (11):  
Harvey W. Wernecke, Robert M. Denmead  
645 North Michigan Avenue, Mohawk 4-5800  
CLEVELAND (13):  
Paul T. Fegley  
55 Public Square, Superior 1-7000  
SAN FRANCISCO (11):  
R. C. Alcorn  
255 California Street, Douglas 2-4600  
LOS ANGELES (17):  
Peter S. Carberry, Ashley P. Hartman  
1125 W. 6th St., Huntley 2-5450

DENVER (2):  
J. W. Patten  
Tower Bldg., 1700 Broadway, Alpine 5-2981  
ATLANTA (9):  
Michael H. Miller  
1375 Peachtree St. N.E., Trinity 5-0523  
HOUSTON (25):  
Joseph C. Page, Jr.  
Prudential Bldg., Holcomb Blvd.,  
Jackson 6-1281  
DALLAS (1):  
Frank Le Beau  
The Vaughn Bldg., 1712 Commerce St.  
Riverside 7-9721  
LONDON W1:  
Dennis McDonald  
34 Dover St.  
FRANKFURT/Main:  
Stanley R. Kimes  
85 Westendstrasse  
GENEVA:  
Michael R. Zeynel  
2 Place du Port

now!  
supply DC from  
0 to over  $\pm 1100$  volts in steps as small as  $1 \mu\text{v}$ !

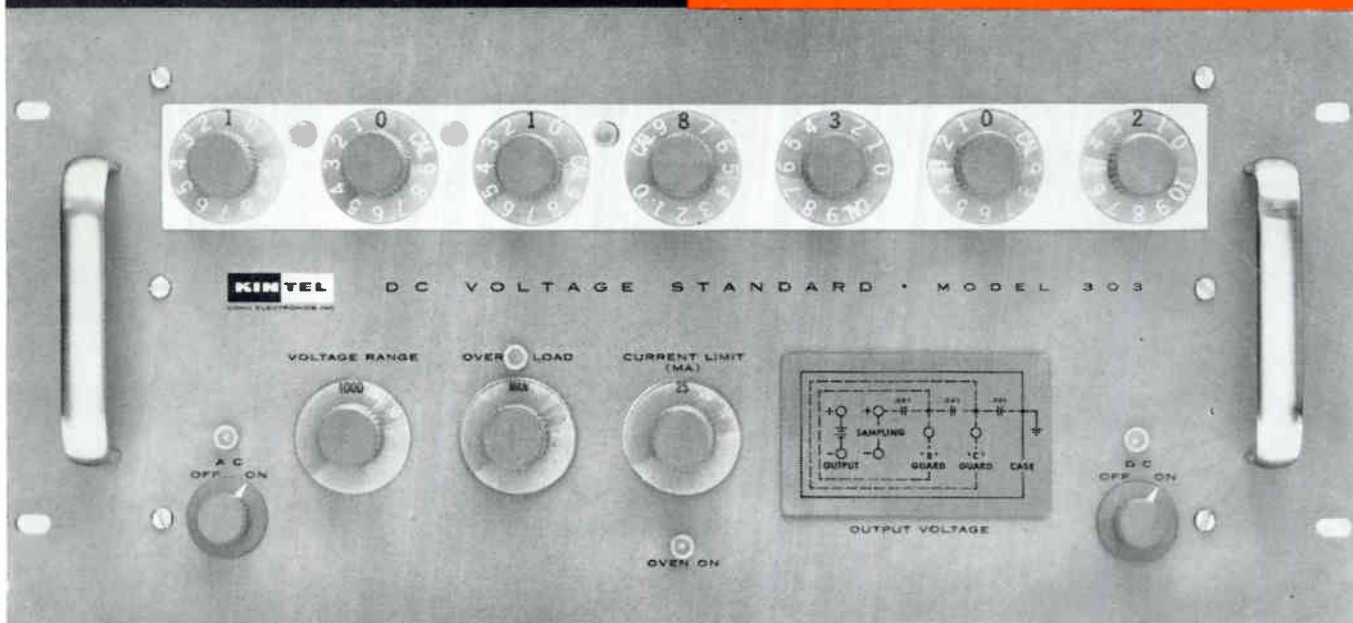

The seven 11-position readout-type dials on KIN TEL's new Model 303 DC Voltage Standard let you control the output from 0.000000 to over  $\pm 1100.0000$  volts in three ranges with a resolution of 0.1 part per million of full scale.

The voltage is held stable within 0.0025% of the dialed output for over eight hours, within 0.005% for over 30 days. Absolute accuracy is better than 0.01% of the setting.

The 303 has a four-terminal output—two to furnish current for the load, and two to sample the voltage across the load. By sampling at the load, no error is caused by current flowing through external leads, and the effective source impedance at the load is 0.001 ohm. Full accuracy is maintained with lead lengths on the order of 10 feet.

The output circuit is completely floating, shielded, and guarded— isolated from both chassis and power-line ground. Common-mode intermodulation products are rejected by 120 db at 60 cps.

Output current may be limited by a panel control to 5, 10, 15, or 25 milliamperes. An overload relay disconnects the output terminals if the selected current is exceeded or if the output voltage deviates from the setting.

These features make the 303 an ideal standard. Its wide range and high accuracy make it useful in many laboratory and industrial applications. And its exceptional resolution makes it especially valuable when small increments of voltage are needed. Price \$2800.

*Write today for detailed technical literature or demonstration.  
Representatives in all major cities.*

5725 Kearny Villa Road, San Diego 12, California. Phone: BRowning 7-6700





Nuclear interactions in a bubble chamber, courtesy of Brookhaven National Laboratory



**RCA** nuvistor

## For use in electronic equipment that must perform dependably in strong nuclear radiation fields

Among conventional active electronic circuit components, the RCA nuvistor electron tube is in the class of components *least susceptible to catastrophic failure from nuclear radiation*. In addition nuvistors are commercially available and offer extremely small size, light weight, and exceptionally low power drain.

These facts are of utmost importance to you if you are designing communications or navigational equipment which must provide dependable performance in an environment of strong nuclear radiation. In such an environment, even momentary failure of equipment can disastrously curtail our vital communications or navigation operations.

Recent tests have shown that the RCA-7586 nuvistor triode and the RCA-7587 nuvistor tetrode have given dependable performance after being subjected to a nuclear radiation pulse of extremely high intensity as specified in the Neutron Radiation Damage Test, Military Standard MIL-STD-446A, November 25, 1960.

In these critical equipment design areas, one cannot afford to risk component failure. Specify RCA nuvistor for airborne communications, airborne controls, missile avionic systems, radar networks, telemetering equipment, and ground support equipment.

For additional information, see the RCA Field Representative at our office nearest you.



The Most Trusted Name in Electronics

RCA ELECTRON TUBE DIVISION—FIELD OFFICES  
EAST: 744 Broad Street, Newark 2, New Jersey,  
HUMbaldt 5-3900 • MIDWEST: Suite 1154, Merchandise  
mart Plaza, Chicago 54, Illinois, WHItEhall 4-2900  
WEST: 6801 E. Washington Blvd., Los Angeles 22,  
Calif., RAYmond 3-8361 • 1838 El Camino Real, Bur-  
lingame, Calif., OXFord 7-1620