

electronics

Vapor deposition of single-crystal silicon layers on a silicon substrate can produce complete semiconductor circuits. Crystal below has 12 layers of alternating p- and n-type silicon. See p 55

A McGraw-Hill Publication 75 Cents

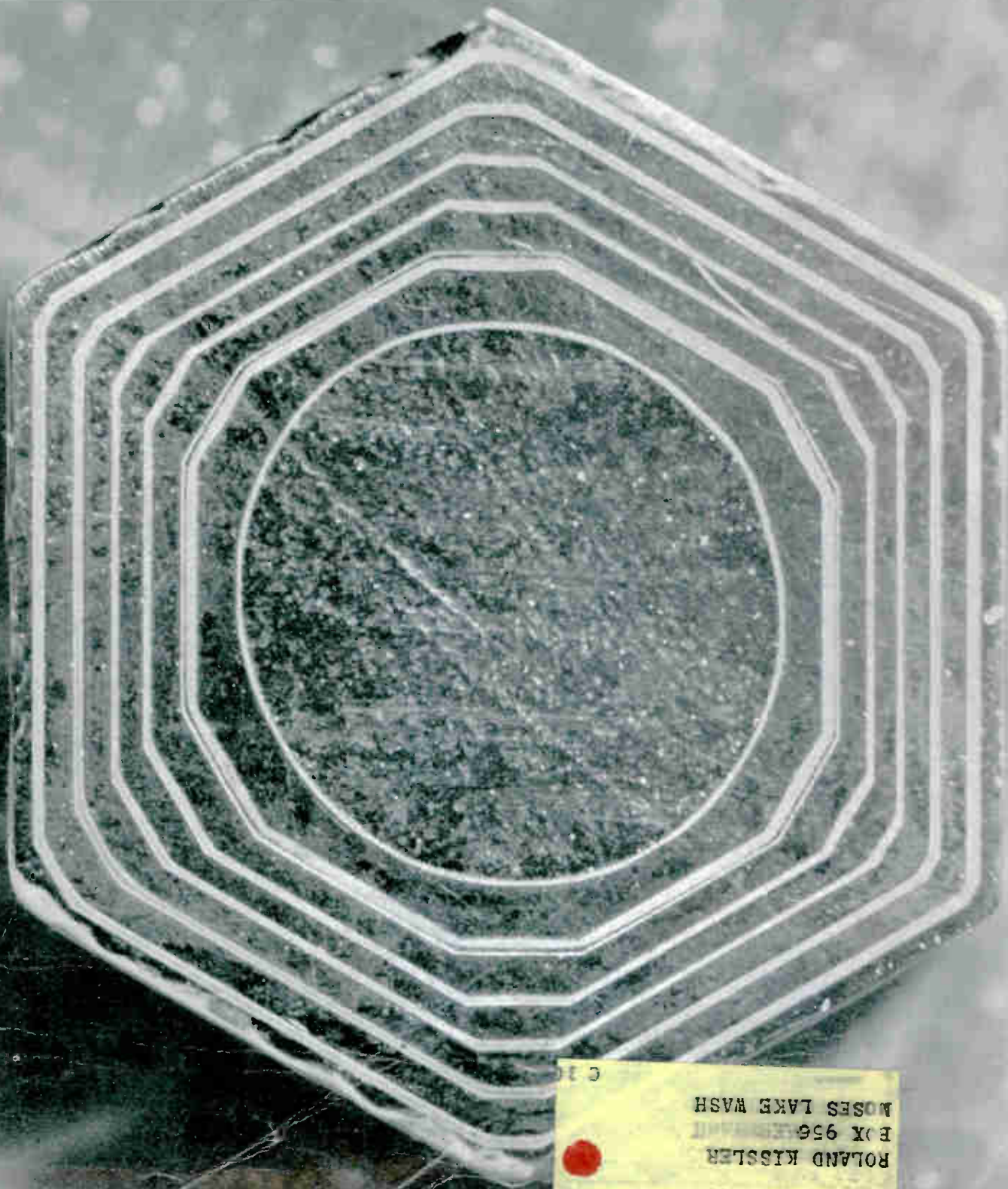

ROLAND KISSLER
BOX 956
MOSES LAKE WASH



PULSE TRANSFORMERS

FROM STOCK

MINIATURE STABLE WOUND CORE

HERMETIC MIL-T-27A TYPE TF5SX36ZZ

UTC miniature, wound core, pulse transformers are precision (individually adjusted under test conditions), high reliability units, hermetically sealed by vacuum molding and suited for service from -70°C . to $+130^{\circ}\text{C}$. Wound core structure provides excellent temperature stability (unlike ferrite). Designs are high inductance type to provide minimum of droop and assure true pulse width, as indicated on chart below. If used for coupling circuit where minimum rise time is important, use next lowest type number. Rise time will be that listed for this lower type number . . . droop will be that listed multiplied by ratio of actual pulse width to value listed for this type number. Blocking oscillator data listed is obtained in standard test circuits shown. Coupling data was obtained with H. P. 212A generator (correlated where necessary) and source/load impedance shown, 1:1:1 ratio.

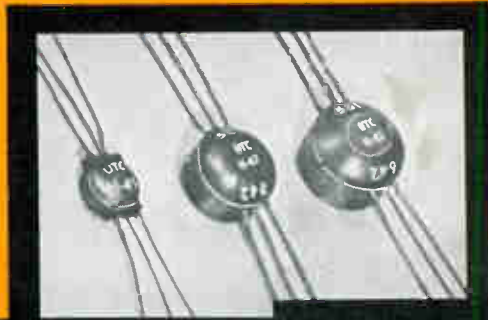

DEFINITIONS

Amplitude: Intersection of leading pulse edge with smooth curve approximating top of pulse.
Pulse width: Microseconds between 50% amplitude points on leading and trailing pulse edges.
Rise Time: Microseconds required to increase from 10% to 90% amplitude.
Overshoot: Percentage by which first excursion of pulse exceeds 100% amplitude.
Droop: Percentage reduction from 100% amplitude a specified time after 100% amplitude point.
Backswing: Negative swing after trailing edge as percentage of 100% amplitude.

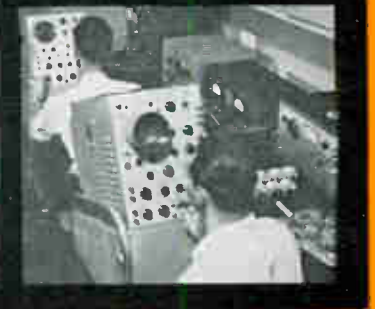

Type No.	APPROX. DCR, OHMS			BLOCKING OSCILLATOR PULSE				COUPLING CIRCUIT CHARACTERISTICS							
	1-2	3-4	5-6	Width μ Sec.	Rise Time	% Over Shoot	Droop %	% Back Swing	P Width μ Sec.	Volts Out	Rise Time	% Over Shoot	Droop %	% Back Swing	Imp. in.
H-45	3	3.5	4	.05	.022	0	20	10	.05	17	.01	20	0	35	250
H-46	5.5	6.5	7	.10	.024	0	25	10	.10	19	.01	30	10	50	250
H-47	3.7	4.0	4	.20	.026	0	25	8	.20	18	.01	30	15	65	500
H-48	5.5	5.8	6	.50	.03	0	20	5	.50	20	.01	30	20	65	500
H-49	8	8.5	9	1	.04	0	20	10	1	24	.02	15	15	65	500
H-50	20	21	22	2	.05	0	20	10	2	27	.05	10	15	35	500
H-51	28	31	33	3	.10	1	20	8	3	26	.07	10	10	35	500
H-52	36	41	44	5	.13	1	25	8	5	23	.15	10	10	45	1000
H-53	37	44	49	7	.28	0	25	8	7	24	.20	10	10	50	1000
H-54	50	58	67	10	.30	0	20	8	10	24	.25	10	10	50	1000
H-55	78	96	112	16	.75	0	20	10	16	23	.40	5	15	20	1000
H-56	93	116	138	20	1.25	0	25	10	20	23	.6	5	10	10	1000
H-57	104	135	165	25	2.0	0	30	10	25	24	1.5	5	10	10	1000
H-60	.124	.14	.05	.05	.016	0	0	30	.05	9.3	.012	0	0	20	50
H-61	.41	.48	.19	.1	.016	0	0	30	.1	8.2	.021	0	0	15	50
H-62	.78	.94	.33	.2	.022	0	0	18	.2	7.4	.034	0	5	12	100
H-63	1.86	2.26	.70	.5	.027	2	10	20	.5	7.5	.045	0	20	25	100
H-64	3.73	4.4	1.33	1	.033	0	12	25	1	7	.078	0	15	23	100
H-65	6.2	7.3	2.22	2	.066	0	15	25	2	6.6	.14	0	10	20	100
H-66	10.2	12	3.6	3	.087	0	18	30	3	6.8	.17	0	10	20	100
H-67	14.5	17.5	5.14	5	.097	0	23	28	5	7.9	.2	0	18	28	200
H-68	42.3	52.1	14.8	10	.14	0	15	28	10	6.5	.4	0	15	30	200

Vacuum Tube Type Ratio 1:1:1

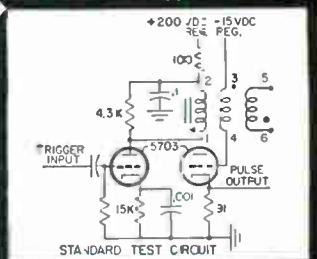

Transistor Type Ratio 4:4:1

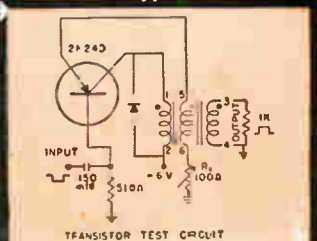

H-45, 46, 60 thru 68 are 3/8 cube, 1 gram H-47 thru 52, 9/16 cube 4 grams H-53 thru 57, 5/8 cube 6 grams

AND SPECIAL UNITS TO YOUR SPECS

While stock items cover special units to customers' low level uses only, most needs, ranging from low of UTC's production is on levels to 10 megawatts.

Write for Catalog for full details on these and 1000 other stock items

UNITED TRANSFORMER CORPORATION

150 Varick Street, New York 13, N. Y.

PACIFIC MFG. DIVISION: 4008 W. JEFFERSON BLVD., LOS ANGELES 16, CALIF.
 EXPORT DIVISION: 13 EAST 40th STREET, NEW YORK 16, N. Y. CABLES: "ARLAB"

electronics

A McGraw-Hill Publication 75 Cents



W. W. MacDONALD, Editor

J. M. CARROLL, Managing Editor
SENIOR ASSOCIATE EDITORS: Samuel Weber, Roland J. Charest. **ASSOCIATE EDITORS:** Frank Leary, Michael F. Tamaino, Sylvester P. Carter, William P. O'Brien, John F. Mason, William E. Bushor, Thomas Emma, Sy Vogel, Leslie Solomon, M. M. Perugini, George J. Flynn. **ASSISTANT EDITORS:** Michael F. Wolff, Nilo Lindgren, Stanley Fraud, Stephen B. Gray. **REGIONAL EDITORS:** Harold C. Hood (Pacific Coast, Los Angeles), Thomas Maguire (New England, Boston), Cletus M. Wiley (Midwest, Chicago). **MARKET RESEARCH EDITOR:** Edward DeJongh. **BUYERS' GUIDE EDITOR:** George Sideris. **ART DIRECTOR:** Harry Phillips; Howard R. Berry. **PRODUCTION EDITOR:** John C. Wright, Jr. **EDITORIAL ASSISTANTS:** Gloria J. Filippone, Arlene Rudd, Bernice Duffy, Lorraine Rossi, Virginia T. Bastian, Lynn Emery.

JAMES GIRDWOOD, Publisher

BUSINESS

Gen. Medaris Discusses Electronics Industry. Exclusive chat	32
Station Detects Underground Nuclear Blasts. Uses 21 seismometers	34
Air Force Tropo Ties England to Africa. New link hops 500 miles	37
Air Route Radars to Get More Range. 40 systems now operating	38
Soviet Journal Blasted for Errors. Russians criticizing each other	40
'No Limit to Ion Beam Focusing'. Schockley looks at future	42
Tv Techniques Speed Phone Calls. Stored program control is a key	45
Crosstalk	4
Comment	6
Electronics Newsletter	9
Electronics Abroad	12
Washington Outlook	14
Financial Roundup	18
25 Most Active Stocks	19
Marketing	22
Current Figures	23
Meetings Ahead	46

ENGINEERING

Vapor-deposited crystal was grown by alternating <i>p</i> - and <i>n</i> -type carriers during growth to form 12 deposited layers. See p 55	COVER
Laminar Junction Devices — New Concept in Microcircuits. Vapor deposition technique described. By J. E. Allegretti and D. J. Shombert	55
Radar Simulator Tests Moving-Target Indicators. Simulated signals received by airborne units. By H. Lobenstein and A. R. Dial	58
Testing and Evaluating Missile-Firing Interceptors. System determines vector paths. By W. J. Zable	61
Tuning-Fork Audio Filter Tunes Electrically. Adjustment of frequency is accurate to 50 parts per million. By J. J. O'Connor	66
Designing Shunt-Peaked Transistor Amplifiers. Maximally-flat-magnitude and pole-zero-cancellation. By R. S. Pepper and D. O. Pederson	68
Microwave Instrument Measures Dielectric Constants. Equipment features direct readout. By E. J. Luoma	71
Solid-State Pulser Drives Chemical Pump. Silicon controlled rectifiers replace thyratron circuit. By U. L. Upton	74

DEPARTMENTS

Research and Development. Cesium Cell Thermionic Converter	78
Components and Materials. Special Tubes for Nanosecond Display	82
Production Techniques. Wet Process Stacks Laminations Faster	86
New on the Market	90
Literature of the Week	100
New Books	104
People and Plants	108
Index to Advertisers	117

NEW YORK • WORLD CENTER FOR RADIO-ELECTRONICS • 1961

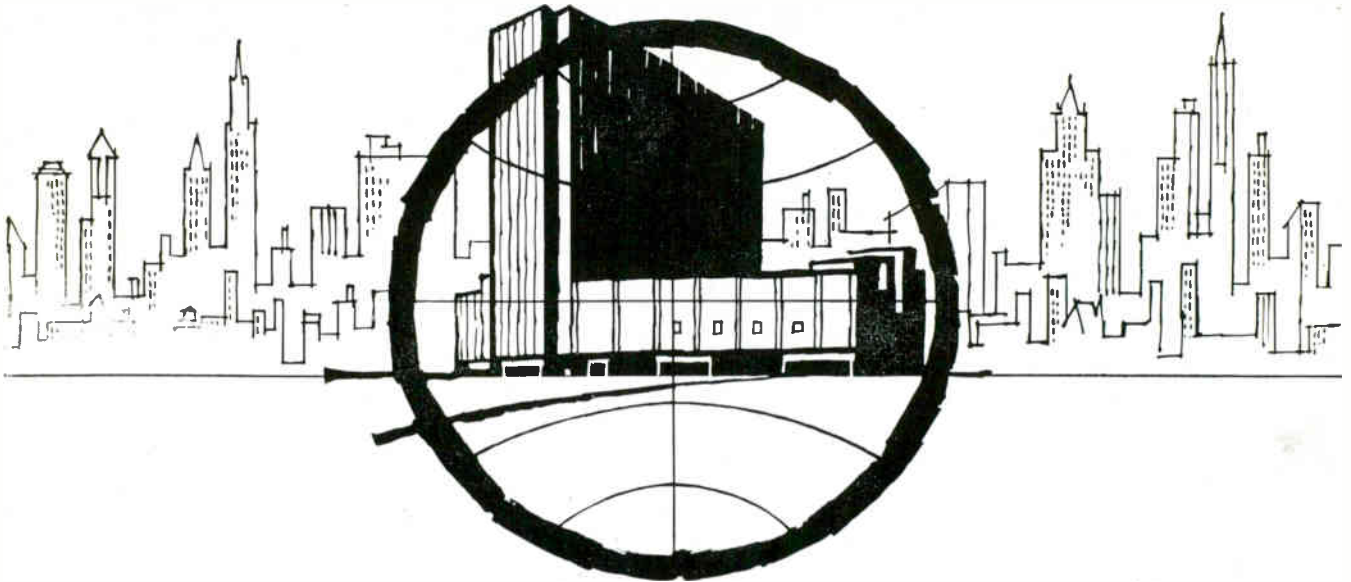

INTERNATIONAL CONVENTION AND **IRE** SHOW

MARCH 20-23



Visitors from all over the world will converge on the Coliseum, March 20-23, for IRE's big Show and International Convention. Join the more than 65,000 radio-electronics engineers who will attend!

On the Coliseum's **4** gigantic floors you'll see the latest production items, systems, instruments and components in radio-electronics; in radar; in complex air traffic control; in space communications — in any and every



field of radio-engineering you care to name. At the convention, you'll trade ideas with brilliant delegates from the world of radio-electronics, and choose from amongst scores of papers to be read by experts in their field. Like the IRE show, the convention is both a summing-up and a look into the future!



Registration: IRE members \$1.00—non-members \$3.00
No one under 18 years of age will be admitted.

Remember the occasion, the time, the place:

INTERNATIONAL CONVENTION and IRE SHOW • WALDORF-ASTORIA HOTEL • COLISEUM • NEW YORK CITY

MARCH 20-23 1961
The Institute of Radio Engineers
1 East 79th St., New York 21, N. Y.



IRE

GET A-HEAD

**think
small...**



At Burnell & Co., our engineers devote a big part of their thinking to shrinking—reducing the size (and cost) of components to the least common denominator consistent with high performance standards. From this staff have come such components as:

The Kernel ATE Adjustoroid®—This variable toroid contains an actual complete toroid with all the excellent characteristics of the non-adjustable type. Valuable in oscillators, discriminators, variable tuned circuits, etc.

MLP and MHP MICROID® Filters—Microminature counterparts of the popular Burnell TCL and TCH low pass and high pass filters, they range from 5 kc to 100 kc with a standard impedance of 10k ohms. Cascading the MLP with the MHP produces excellent re-

sponse band pass characteristics.

“Cheerio” Toroids — Subminiature high Q coils in a range of frequencies that make them ideal for transistorized equipment.

Crystal Filters—Advanced engineering techniques enable Burnell to offer at nominal cost, high selectivity, high attenuation crystal filters covering the extraordinary range of 1 kc to 30 mcs with considerable latitude in impedance.

Pulse networks, interference filters, active networks and magnetic amplifiers are among the newer additions to our product line.

Write for latest catalog.

Burnell & Co., Inc., has a number of positions available for engineers capable of thinking big and shrinking small. Inquiries are invited.

If you haven't already done so — send for your free membership in the Space Shrinkers Club.

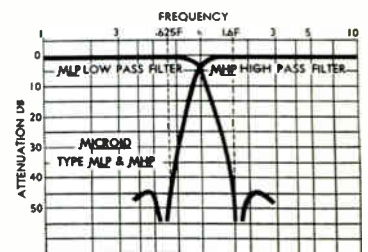
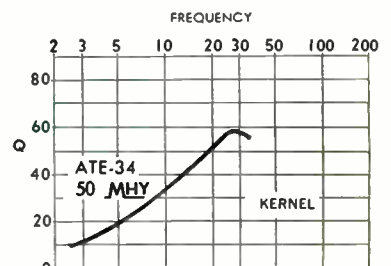

COPYRIGHT BURNELL & CO., INC. 1960

Burnell & Co., Inc.
PIONEERS IN microminaturization OF
TOROIDS, FILTERS AND RELATED NETWORKS

EASTERN DIVISION
DEPT 42
10 PELHAM PARKWAY
PELHAM, N. Y.
PELHAM 8-5000
TELETYPE PELHAM 3633



PACIFIC DIVISION
DEPT 42
720 MISSION ST.
SOUTH PASADENA, CALIF.
MURRAY 2-2841
TELETYPE PASACAL 7578

Mfd. in Canada by Edo (Canada) Ltd., Cornwall, Ont. • WELLINGTON 2-6774

CROSSTALK

TRANSLATIONS of articles in the Soviet press frequently cross our desk, giving us insights into the workings of the Soviet Union that our own meagre knowledge of the Russian tongue cannot provide. One such—discussed on p 40—tells of a drumfire of criticism to which the magazine *Radiotekhnika* is presently being subjected.

A couple of the journal's failings—if the accusations are true—are serious. Its editors have allegedly pocketed sums shaved off authors' fees, refereed each others' articles and shown less than scientific objectivity in selecting articles for publication. These things could happen anywhere; we cannot help feeling, however, that—human nature being the even mixture of the angelic and diabolic that it is—they're more likely to happen in a monolithic structure than in such a structure as we know in the U. S.

Here we have an honest respect for money as a medium of exchange, but we try to separate the handling of money from the making of editorial decisions; **ELECTRONICS'** editors buy articles, for example, but do not write the checks. Our readership holds us responsible for scientific objectivity to a degree that does not permit favoritism in selection of authors or material for publication. We either keep ahead of the industry on all fronts or our readers go away and seek elsewhere for the information they require. In the USSR, radio engineers have no other publication; it's *Radiotekhnika* or nothing, competition being a dirty word to Socialist planners.

The Russian editors are also being blasted for doctrinal errors. It seems that they would not take sides in an argument over whether or not the official view on noise-interference immunity was indeed the last word. The magazine held its silence on an article discussing an "obsoleted" method of evaluating noise immunity (by evaluation of signal-noise relationships). Readers wrote indignant letters pointing out that the official way was to figure out the receiver system's error probability. The editors said either method was feasible. Now they're the object of harsh criticism because they didn't properly lead.

A technical journal, or a magazine of industrial significance, has both historical and normative responsibilities; it must record facts of importance, and, by placing them in reasonable perspective, indicate and suggest the paths of progress. Our position in the editorship of **ELECTRONICS** is not an "official" one (as it would be in the Soviet Union), so we cannot legislate, we cannot throw material weight around, and we cannot be expected to observe any doctrine excepting that dictated by our own common sense and our understanding of truth as we see it.

We do not relish the plight of the editor of *Radiotekhnika*. If he is in the right, we wish him well. If his critics are in the right, we wish them well. Both are no doubt searching for truth as they see it; for anyone who seeks after truth, we have two wishes: "Good luck!" and "Good eyesight!"

Coming In Our December 9 Issue

MEMORY CELLS. Growing sophistication of the problems programmed on analog computers has given rise to a need for analog-computer memory cells. In our next issue, T. A. Bickart and R. P. Dooley of Johns Hopkins University Radiation Laboratory in Baltimore describe a simple circuit that holds negative- and positive-polarity signal levels. Circuit consists of an electronic switch, differentiator and operational amplifier.

IN ADDITION. A variety of interesting feature articles to appear next week includes: an image converter tube for high-speed photography by T. Nakamura and T. Kasai of Kobe Kogyo Corp.; a survey of infrared detectors by J. A. Jamieson of Aeronutronics; a high-precision sweep generator by E. W. Van Winkle of Bendix; and a technique for measuring delay times by H. T. McAleer of General Radio Co.

electronics

Dec. 2, 1960 Volume 33 Number 49

Published weekly, with *Electronics Buyers' Guide and Reference* annually, as part of the subscription, by McGraw-Hill Publishing Company, Inc. Founder: James H. McGraw (1860-1948).

Title registered U.S. Patent Office; Copyrighted 1960, McGraw-Hill Publishing Company, Inc. All rights reserved, including the right to reproduce the contents of this publication, in whole or in part.

Executive, editorial, circulation and advertising offices McGraw-Hill Building, 330 West 42nd Street, New York 36, N. Y. Telephone Longacre 4-3000. Teletype TWX N.Y. 1-1636. Cable McGrawhill, N.Y. Printed in Albany, N. Y.; second class postage paid.

Subscribers: Please address all correspondence, change of address notices, subscription orders or complaints to Fulfillment Manager, *Electronics*, at above address. Change of address notices should provide old as well as new address, including postal zone number if any. If possible, attach address label from recent issue. Allow one month for change to become effective.

For subscription information see last page of this issue.

Postmaster: Please send Form 3579.

CERAMICS FOR TRANSISTOR CIRCUITS

.1 μ F
actual size



HYPERCON[®] CAPACITORS



- Ultra-high capacitance
- Low voltage
- Miniature size
- Low Cost

Designed for use in semi-conductor and other low-voltage circuits, these new Hypercon Disc Ceramic Capacitors offer capacitance values formerly associated only with electrolytic capacitors. Yet they are only a fraction of the size of comparable electrolytics . . . and sold at only a fraction of the cost!

Hypercons have excellent stability, exhibiting no loss in capacitance when operating above room temperature. Their triple-purpose resin coating serves as insulation as well as protection against moisture and mechanical damage.

Hypercons are in mass production now, available for prompt delivery. For detailed specifications, write for Engineering Data Sheet 6141A to Technical Literature Section, Sprague Electric Company, 35 Marshall Street, North Adams, Massachusetts.

3 VDLTS D-C		12 VDLTS D-C	
μ F	Diameter in Inches	μ F	Diameter in Inches
.1	.225	.047	.275
.22	.275	.1	.400
.47	.400	.22	.595
1.0	.595	.47	.840
2.2	.840		

SPRAGUE[®]
THE MARK OF RELIABILITY

SPRAGUE COMPONENTS:

CAPACITORS • RESISTORS • MAGNETIC COMPONENTS • TRANSISTORS • INTERFERENCE FILTERS • PULSE-FORMING NETWORKS • PIEZOELECTRIC CERAMICS
HIGH TEMPERATURE MAGNET WIRE • CERAMIC-BASE PRINTED NETWORKS • PACKAGED COMPONENT ASSEMBLIES • FUNCTIONAL DIGITAL CIRCUITS

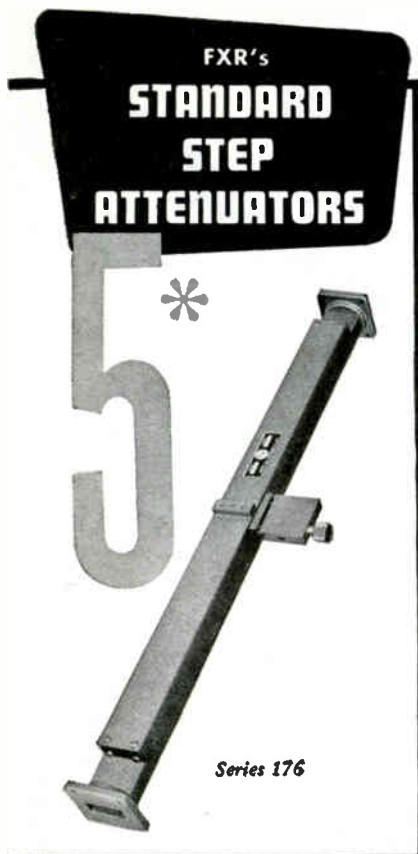

- OPERATION: Full waveguide bandwidth
- FREQUENCY RANGE:
7.05 KMc to 10 KMc
8.2 KMc to 12.4 KMc
- STEP LOSS: 40 db
- CALIBRATION & FREQUENCY SENSITIVITY: ± 0.4 db max
- VSWR: 1.1 max
- INSERTION LOSS: 0.5 db max



No. 5 of a series of FXR's new precision microwave components designed to meet the ever-growing needs of the microwave industry.

FXR's Standard Step Attenuator differs uniquely from other standard step attenuators in that the attenuation in a waveguide line can be changed without removing any component in the line. This convenient feature adds significantly to measurement accuracy. The attenuation is determined by the size of coupling holes and not by the resistivity of a loss-producing element. The attenuation value is, therefore, independent of time and ambient conditions and is relatively constant with frequency.

MODEL NO.	FREQUENCY RANGE KMc	WAVEGUIDE TYPE RG-()/U	PRICE
W176A	7.05-10.0	51	\$185.00
X176A	8.2-12.4	52	165.00

Write for Catalog Sheet No. 176



COMMENT

Diffusion

In your Aug. 26 issue (p 56), the article entitled "Transistor Operation Beyond Cutoff Frequency," by V. W. Vodicka and R. Zuleeg, has a very strange statement in the first paragraph. Mention is made of "Diffusion type transistors with graded base widths..." Would you be so kind as to tell me what is meant by this statement?

I have heard of transistors with graded base regions (drift transistors), and diffusion transistors (with homogeneous base regions). I have heard base width defined as the distance between emitter and collector. But I have never encountered the combination cited by Messrs. Vodicka and Zuleeg. A proper translation would be greatly appreciated.

SEYMOUR SAPOSNIK
SPRAGUE ELECTRIC
NORTH ADAMS, MASS.

Co-author Zuleeg replies:

In our original manuscript, the passage Mr. Saposnik is referring to read:

"Although modern diffusion techniques can produce graded base widths with theoretical frequency response in the kilomegacycle range..." In regard to semiconductor terminology, the sentence was misconstrued, and the phrase in the final publication is: "Diffusion type transistors with graded basewidths have theoretical frequency response in the gigacycle range..."

Here the term *diffusion* is improper because by definition a transistor with a graded base is a drift transistor and a transistor without a graded base or homogeneously doped base is called a diffusion transistor.

The change did refer to the original version of diffusion of impurities and confused it with the term *diffusion type transistor*, which refers to the transport of minority carriers in the base of a transistor by diffusion. In the case of homogeneous base-doping, e.g., for a transistor with graded base, the minority carrier transport is in contrast mainly by drift.

I am sorry this misconception of terminology arose. The sentence is

questionable and should have been corrected to read: "Transistors with a graded base, introduced by impurity diffusion techniques, have a theoretical frequency response in the gigacycle range..."

R. ZULEEG

HUGHES PRODUCTS
NEWPORT BEACH, CALIF.

Drift transistors are made by diffusion of impurities into the base region to produce a nonuniform field; a diffusion transistor cannot, in general, be made by diffusion processes, since they produce nonuniform fields in the base region. In this case, the modifier "diffused" and the noun "diffusion" do not have a common referent.

Solid-State Masers

In Fig. 2 of my article "Systems Applications of Solid-State Masers" (p 58, Nov. 4), Mr. L. R. Momo, one of the developers of the millimeter-wave maser he is shown holding, is incorrectly identified as the author. This robs Mr. Momo of appropriate identification with the device his ingenuity helped produce, and the credit that justifiably goes with it.

In the same caption, we said the active material was located at the end of a dielectric slab, which was instead a metal slab almost completely filling the cavity.

J. W. MEYER
MIT LINCOLN LABORATORY
LEXINGTON, MASS.

Credit where due; we regret mixing up Messrs. Momo and Meyer.

Army Electronics

Congratulations on your splendid article on Ft. Huachuca and the Army electronics program (p 38, Nov. 11).

One correction: the photo on p 38 shows Ford Instrument Co.'s surveillance aircraft flight control system AN/UPW-1; the photo was incorrectly captioned as to equipment type and manufacturer.

S. H. MCALONEY
FORD INSTRUMENT CO.
DIVISION OF SPERRY RAND CORP.
NEW YORK, NEW YORK

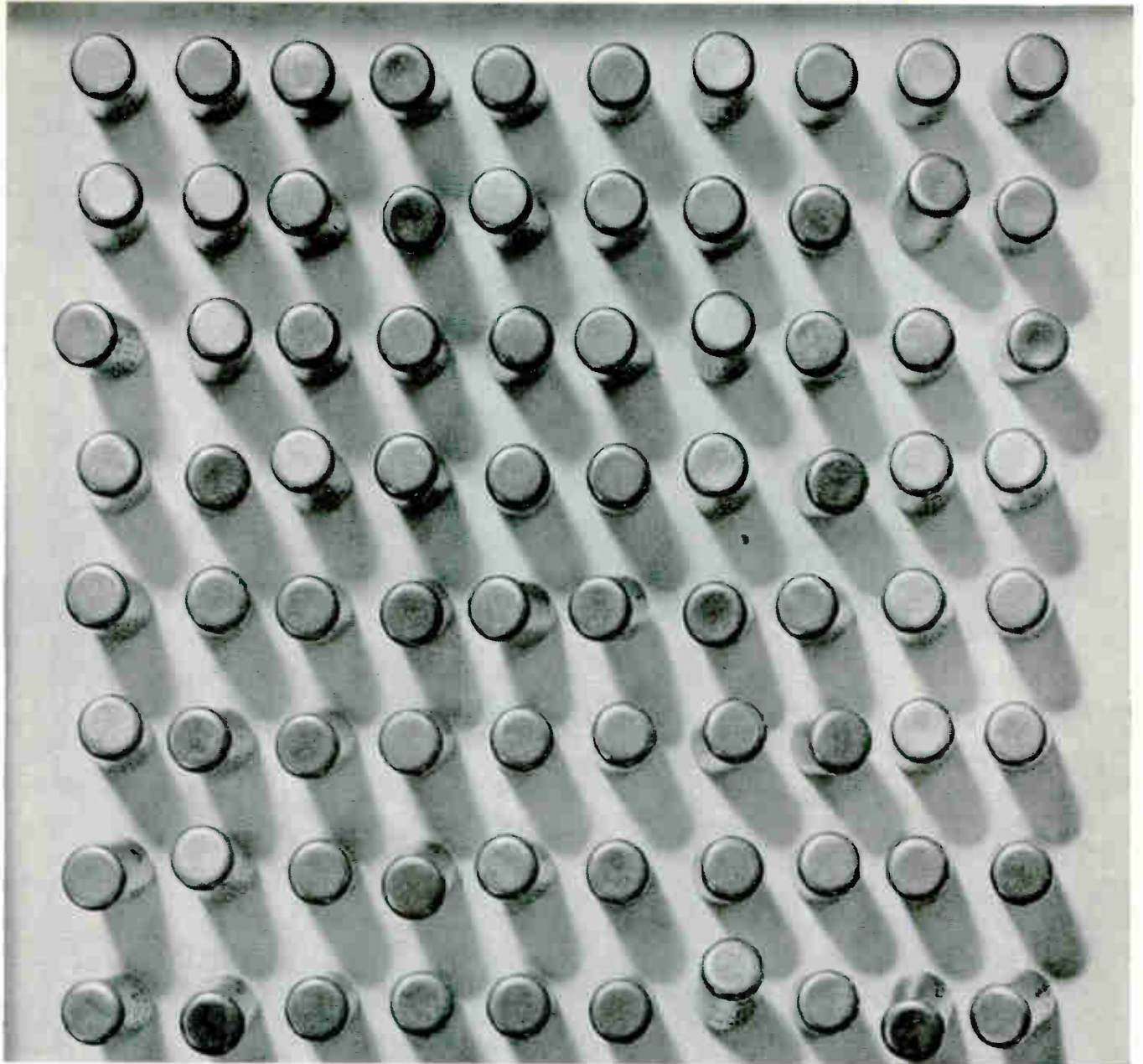

Germanium PNP Alloy Type **TRANSISTORS**

- 2S26 For Audio Frequency Power Amplification
- 2S45 For Intermediate Frequency Amplifier Service
- 2S52 For Converter Service
- 2SA49 For Intermediate Frequency Amplifier Service
- 2SA50 For Switching Purpose
- 2SA52 For Converter Service
- 2SA53 For Intermediate Frequency Amplifier Service
- 2SB26 For Audio Frequency Power Amplification
- 2SB47 Low Noise Factor with Audio Frequency Amplifier
- 2SB54 For Low Frequency Amplifier Service

- 2SB56 For Audio Frequency Power Amplifier Service
- 2SB189 For Medium Power Output Service

Germanium PNP Alloy Type **DRIFT TRANSISTORS**

- 2SA57 For High Frequency Amplifier Service
- 2SA58 For High Frequency Amplifier Service
- 2SA59 For High Frequency Amplifier Service
- 2SA60 For Converter Service
- 2SA92 For Local Oscillator Service
- 2SA93 For Mixer Services
- 2SA175 For High Frequency Amplifier Service

Toshiba

For complete information, write to
TOKYO SHIBAURA ELECTRIC CO., LTD.
 2, Ginza Nishi 5-chome, Chuo-ku, Tokyo, Japan

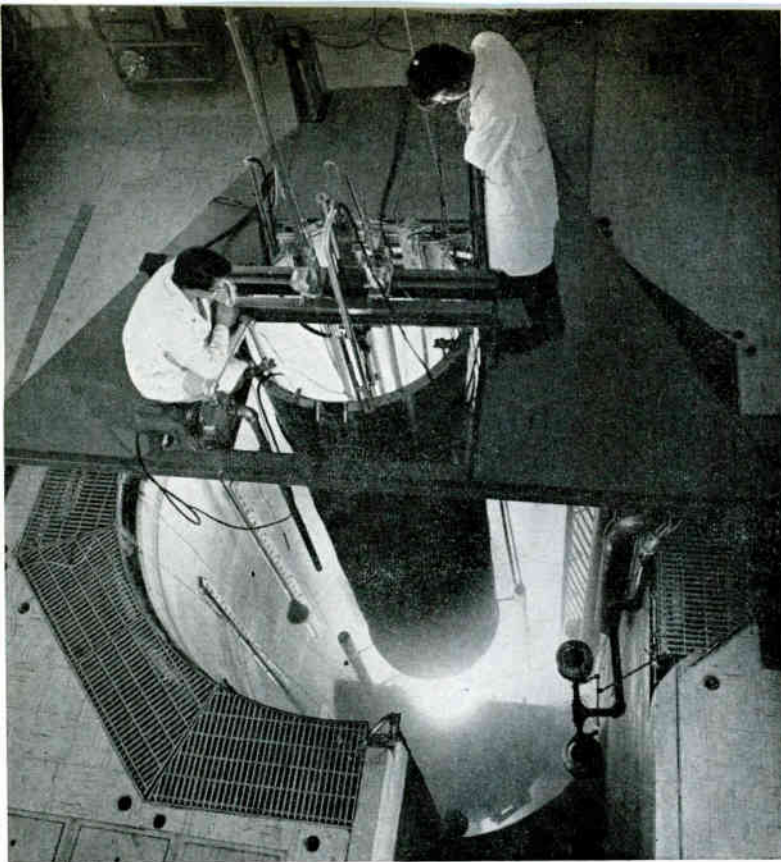

TRIGA Mark-F now in operation at General Atomic.

The TRIGA Mark-F Pulsing Reactor

General Atomic Division of General Dynamics Corporation is pleased to announce a new addition to its TRIGA family of reactors—the TRIGA Mark-F Pulsing Reactor.

The TRIGA Mark-F, developed by General Atomic, is especially designed to yield short reproducible pulses of neutrons and gamma rays for use in nuclear effects research and testing. It is capable of being pulsed repetitively to peak power levels of over 2,000,000 kilowatts with half-maximum pulse widths of 10 msec, owing to the inherent characteristics of the TRIGA reactor's unique uranium-zirconium hydride fuel elements. During pulsed operation, a maximum flux of 6×10^{16} neutrons/cm²-sec. can be achieved. The Mark-F design permits variation of neutron to gamma dose ratios by a factor of ten and provides for a large, easily accessible exposure window immediately adjacent to the core.

A prototype of the TRIGA Mark-F was placed in operation the summer of 1960, and construction of two such reactors will be completed in 1961 for the United States Government, including one for the U.S. Army's Diamond Ordnance Fuze Laboratories. Other versions of the TRIGA include the TRIGA Mark I and Mark II reactors—for training, research and isotope production—which are now in use, or soon will be, on five of the six continents.

For more information on the TRIGA Mark-F, write to:
TRIGA Applications Group, General Atomic,
P.O. Box 608, San Diego 12, California

Openings for electronic and electrical engineers.

Write: Manager of Personnel, General Atomic.

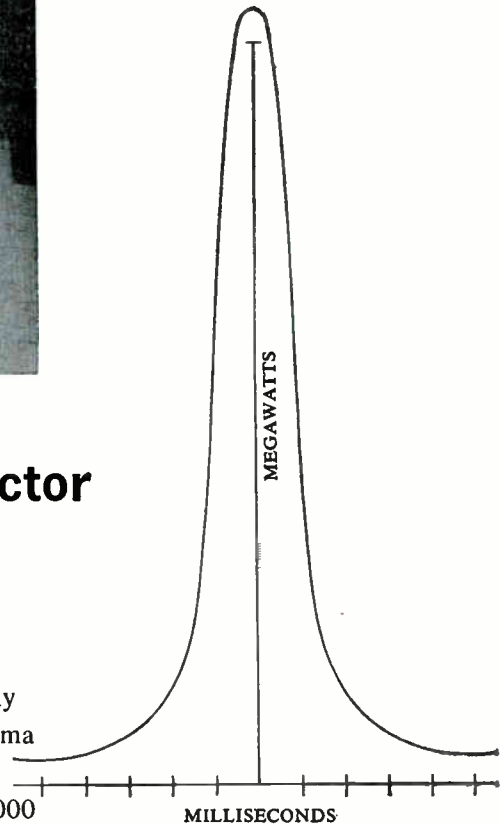

ELECTRONICS NEWSLETTER

Infrared and Tv Are "Eyes" of Tiros II

WEATHER SATELLITE Tiros II, put into orbit last week by the National Aeronautics & Space Administration, provides both photographic data from tv cameras and infrared measurements of earth's temperature and cloud cover.

The 280-lb cylindrical satellite is 42 inches in diameter and 19 inches deep. Equipment aboard includes: two tv cameras, $\frac{1}{2}$ -in. vidicon type; two tv magnetic tape recorders, capacity 32 pictures per orbit; one 5-channel infrared radiometer; one wide-field nonscanning ir sensor; one ir electronics package, including tape recorder, transmitter and power supply; two electronic clocks for control of systems operations; two 2-watt f-m transmitters for tv and ir data; two beacon transmitters for tracking and transmission of telemetry and vehicle attitude data.

Power supply consists of 9,200 solar cells, with outputs of 28 and 14 volts, and 63 nickel-cadmium storage batteries, rechargeable from solar-cell power supply.

Dynamic control system slowed the satellite from 126 rpm on release to its stabilizing spin of 9 rpm. Five pairs of rockets provide additional controls for spin-up if needed. Reference indicators are one ir horizon scanner, to generate a pulse for orientation information as the scanner crosses earth's horizon; nine sun-angle detectors mounted around the satellite perimeter to determine angle of sun at picture-taking.

Antennas are four transmitting antenna rods, mounted on bottom of satellite, forming crossed dipoles for all data transmission; and one receiving antenna rod, mounted on top center of satellite.

Hear Hum or Buzz In Microwave Fields

BEHAVIORAL EFFECTS of microwave and other r-f fields on human beings are being explored at GE's advanced electronics center in Ithaca, N. Y. One recent investigation may demonstrate that resonance effects

in the human body do occur under the proper circumstances.

Checking reports that people hear a humming or buzzing while in r-f fields from radar sets, the GE researchers discovered that a hum is heard by many people, but not those with nerve-block deafness, indicating that the effect is not taking place in the central nervous system. They also found that the effect, which may be caused by a harmonic of the prf, can be shielded out. Researchers feel that it may be either a resonance phenomenon or the Luxemburg effect—in which r-f induces sound in an ionized medium. Air trapped in the inner ear may be sufficiently ionized to evince the effect.

Phenomenon has been observed at levels as low as 0.4 milliwatt per square centimeter, equivalent to an energy level of 1.8 microjoules.

Balloon Tests Instruments For Future Tiros's

AS TIROS LOFTED last week, a giant balloon rose in South Dakota carrying equipment designed for future use in Tiros satellites.

Test package was made by researchers at University of Michigan, included advanced types of infrared sensors and other atmospheric sampling instruments. Package was dropped by parachute some twelve hours after launch.

Air Agency Postpones 50-Kc Deployment

FEDERAL AVIATION AGENCY last week announced a revision of its vhf deployment plan which will extend until Jan. 1, 1966, the date when the agency will have its channel assignments separated by only 50 kc. Both visual and instrument flight-rule communications will continue to use 100-Kc channel separation in the 118-127 Mc band until then. Vfr communications will continue thereafter with that separation "to the extent feasible." Plan provides for 50-Kc channeling in the 127-135 Mc band for users who have that tuning capability.

Beginning next Jan. 1, frequency assignments with 50-Kc separation

will be made below 127 Mc on a case-by-case basis. Until the end of 1965, however, the air agency figures that most 50-Kc channel assignments will be made in high-density traffic areas.

Hospital Installs Patient-Monitoring System

REMOTE ELECTRONIC system which displays and records condition of eight patients in a critical-care ward is now being evaluated by Roosevelt Hospital in New York City. System was developed by Epsco.

Transducers and electrodes attached to the patient provide data on continuous pulse rate, respiration rate and temperature, as well as input signals for electrocardiographs and electroencephalographs. These physiological processes can be checked by nurses viewing a central electronic observation panel.

Similar monitoring systems for operating and recovery rooms are also being developed by Epsco to provide anesthetists with additional data such as oxygen saturation and tension, direct blood pressure, and respiration carbon dioxide.

Weather System Moving on Schedule

SEMI-AUTOMATIC WEATHER forecasting and observing system being developed by United Aircraft and designated the 433L, system is progressing on schedule. A test facility will be in operation along the Atlantic coast by mid-1961, according to UA spokesman.

Test network of weather stations extending from Boston to Washington, D. C. is being readied for the start of the program. An interim data-processing center is in operation, and most subsystem designs are completed. Hermes Electronics is analyzing the data-handling problem and working out the data-flow design; Philco is developing display and presentation gear, besides supplying high-speed computer equipment; Tele-Dynamics division of American Bosch Arma is providing engineering support; Western Union is providing engineering assistance in high-speed digital data handling. Both Philco 2000 and IBM 704 computer systems will be used.

(Continued on page 10)

Plasma Fireballs May Be Future Weapon

SOVIET NUCLEAR PHYSICISTS and U. S. researchers are both working currently on a theory that artificial balls of lightning can be created by a powerful sustained r-f beam focused in a small volume of space.

Peter Kapitsa, Soviet physicist, theorizes that a natural lightning ball (St. Elmo's Fire) is a mass of highly ionized plasma fed continuously from resonance absorption of intense radio waves. Natural lightning is from 10 to 20 centimeters in diameter, indicating a feeding wavelength of about 35 to 70 cm. Plasma researchers in the U. S. think that a plasma fireball may be the fantastic future weapon Khrushchev boasted about recently.

U. S. techniques explored at Armour Research Foundation would use intersecting radar beams to create these fireballs; the radar beam would confine the fireball in space, permit moving it from place to place. Bendix is known to have created a fireball by means of a powerful radar and a reflector, which set up standing waves to ionize the air.

Nationwide Net May Link Data-Processing Systems

NATIONWIDE electronics net for transmitting business, industrial and scientific data could result from greater attention being given the data-processing business by communications companies. Collins Radio, for instance, has just announced a new communications and processing division which will concentrate on just such a project.

Success of pilot project, set up to perform computing services for company affiliates, would encourage Collins to undertake outside service contracts for a few selected subscribers within the next two years, according to president A. A. Collins. "Design of our systems communications and data-processing equipment anticipates the day when virtually all forms of intelligence will be conveyed automatically," he said.

Present center, to be housed in nearly-completed million-dollar

building, consists of automatic switching and control equipment providing intracompany voice, teletypewriter and data communications, by wire lines and both point-to-point and air-to-ground radio, between central data processor in Cedar Rapids, Ia., and subsidiary plant in Toronto. Additional links are being established with subscriber stations in Los Angeles, Dallas, Washington, D. C., and New York.

Air Defense Takes Over Space Surveillance

SPACE SURVEILLANCE detection network SPASUR, extending from San Diego to Georgia, and the National Space Surveillance Control Center (Spacetrack) have been transferred to Continental Air Defense Command. SPASUR was developed by the Navy to discover, identify and predict orbits for "dark" or non-radiating satellites. It and Spacetrack, to which SPASUR reported, were formerly under control of Advanced Research Projects Agency of the Defense Department.

Reshuffle gives CONAD direct control over space surveillance, separates even further the military and civilian aspects of space. Information on space projects previously handled by Spacetrack for civilian engineers will now be handled by National Aeronautics & Space Administration.

Instruments Speed Up Expressway Construction

ELECTRONIC AND NUCLEAR PROBES are important parts of crews working on the Milwaukee Expressway for Wisconsin State Highway Commission.

One portable nuclear probe uses radiation from cesium tablet to look into hills and locate rock formations in path of road cuts, look at stream bottoms to find rock or hardpan on which bridge piers could rest, and finally check thickness of the finished roadbed. Alternate probe substitutes radium-beryllium source of neutrons to measure soil moisture.

A third device measures resistivity of soil by beaming current between electrodes.

Geodimeter measures distances down to small fraction of an inch over several miles by beaming a light source to a reflector over downtown areas where buildings make measurement difficult. Computers are used to figure the amount of earth that must be excavated from hills, how much fill will be needed for valleys.

Radiometer Proposed to Detect Icebergs

RADIOMETER SYSTEM was proposed to the U. S. Coast Guard in Washington this week for use by International Ice Patrol in detecting icebergs.

Developed by AC Sparkplug division of General Motors, the passive system includes an airborne transmitter and receiver. Differences in thermal energy return from bergs and water surfaces are plotted on moving tape.

Researcher Probes Causes of Migraine

ELECTRONIC DETECTOR of wasted human energy is helping Nell Fahrion, psychology teacher at University of Colorado, find out whether diffused activity should be blamed for migraine headaches.

Recording instrument made to Miss Fahrion's specifications by a Denver engineering firm for her project includes a polygraph connected to small metal box fitted with two flat levers. The equipment is similar to a lie detector.

Right-handed person being tested places hands on levers, is then asked to respond to certain questions or stimuli by depressing the right-hand lever. Any activity by the supposedly motionless left hand is picked up, amplified and measured by electronic circuits.

Miss Fahrion is also looking for additional equipment to measure cranial blood pressure and volume changes.

A-L Silectron Steels

For Easier Magnetization

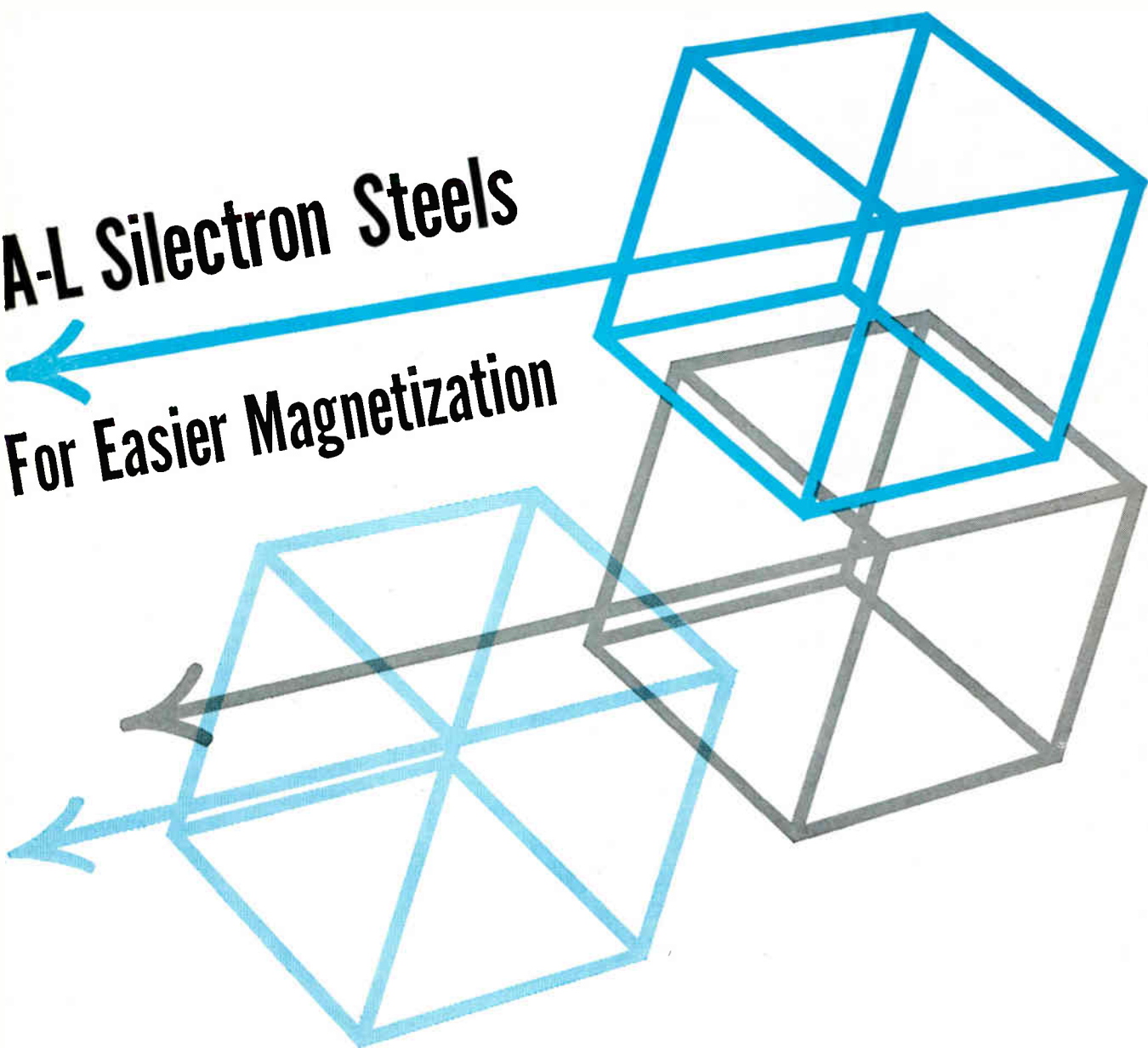

In A-L Silectron® (iron-silicon alloy) steels the grains are oriented so that magnetization is easiest in the direction of rolling. For example, the core loss of .014 inch thick Silectron, Grade 66 (AISI M-6), is only .659 watts per pound measured in the direction of rolling compared to 1.11 watts per pound of non-oriented transformer grade steel. (Both measurements made at 15 kilogausses and 60 cycles per second.)

While core designs should minimize the length of flux paths which are not parallel to the rolling direction, Allegheny Ludlum Silectron is so superior to all non-oriented grades that you can achieve better results with it even when 20 percent or more of the flux path is cross grain. Small scrapless EI Silectron laminations in which only the back of the E is cross grain are superior to the best conventional grades of silicon steels.

A-L Silectron is available in wide coils or in slit widths as narrow as ½ inch. For large power transformers use 14 mil Silectron. It's heat flattened to eliminate coil set and has very good (C-10) insulation. For wound cores unflattened 12 mil Silectron is a good choice. Its natural insulating coating, developed in a high temperature hydrogen anneal, is well suited for narrow widths. The 12 mil Silectron is also available with the same flattening and insulation as 14 mil.

Cores are more uniformly stacked and wound when you use Silectron because of its excellent gage uniformity. Magnetostriction is held to a minimum to prevent excessive noise levels.

Allegheny Ludlum Silectron is quality processed to give you consistently low core losses. For more technical information, contact your A-L salesman, or write: *Allegheny Ludlum Steel Corporation, Oliver Building, Pittsburgh 22, Pennsylvania. Dept. 00-00.*



ALLEGHENY LUDLUM

PIONEERING ON THE HORIZONS OF STEEL



ELECTRONICS ABROAD



Electronics Training UK Language Students

LONDON—Four-week courses in Indonesian are being given to Shell International employees headed east. Tape recording and intercom gear is being used. Equipment adapted for the training is based on U. S. systems of electronic education. It is made by General Electronic Labs., Cambridge, Mass. Students speak into tape recorders or directly to instructor (see photo), who monitors individual progress without disturbing the others. Shell officials say the new system cuts language training costs by one-tenth.

Dutch Prepared to Join Space Research Plans

AMSTERDAM—Netherlands officials are reportedly ready in principle to join in a cooperative plan to develop a space research rocket program within a European framework. The idea was sparked by British Air Minister Thornycroft, who is seeking a new use for the Bluestreak rocket. This rocket was originally intended for military use, but dropped by England as too expensive. The Dutch say that if the Thornycroft plan becomes operational they will join in the multi nation discussions.

Also from Amsterdam comes word of a new automated library system being readied for installation at Delft Technical University. Students will consult catalogs then dial code numbers of the books on

a telephone-type dial. This will light lamps inside the library stacks showing the location of the book selected by bookcase, shelf and position on the shelf. A conveyor belt will next move the book to the lending desk. The Delft library already includes telex links with other university and technical libraries in Holland among its operational equipment.

French Reactor Site To Get New Controls

PARIS—Transistorized control instrumentation for measuring logarithmic power increase and periodicity in ionization and fission chambers is being developed by the Grenoble Research Center of the Commissariat a L'Energie Atomique. First units will be installed in the Melusine swimming pool reactors at Grenoble and Fontenay-Aux-Roses. CEA has not said when installation will start.

Japanese Researchers Cite New Breakthroughs

TOKYO—Japanese scientists in government laboratories appear to be on the brink of several new breakthroughs in electronics. This week, Futoshi Onodera, a 32-year-old assistant at Tohoku University at Sendai, claims successful experimental manufacture of a new semiconductor film-type cryotron based on an American discovery.

Shigeru Takahashi, chief of the circuits section of the Ministry of International Trade and Industry laboratories, reports nearing completion of a tunnel-diode matrix for his Mark-VI computer. The section chief claims the new matrix will better transistor speeds 10 times at 0.2 microsecond. He and his assistants also have almost completed a Mark-IV computer based on research done at New York University but not previously incorporated in computers.

At Tokyo University, Prof. Eiichi Goto is completing research on a new parametron semiconductor (Japanese-invented) that is expected to compensate for the slow

characteristics of certain types.

Combined with current negotiations between U. S. and Japanese computer interests, observers feel these breakthroughs may give the Japanese widened horizons in the computer field.

Northern Ireland Gets Space Research Center

BELFAST—Agreement has been signed by the Chancellor of Queen's University and the U. S. Navy European Research Contracts office acting for the Advanced Projects Research Agency. The university will receive the largest financial backing ever made by the U. S. for space research work in western Europe. Funds include \$150,000 for a digital computer and money for additional research personnel. A special building will be made to house the computer and the university will establish a new lectureship in digital computing. About \$200,000 will be spent the first year and spending will probably continue at about \$56,000 annually.

More Electronics Firms Moving Into Italy

MILAN—One British and one American company are joining the growing roster of electronics companies moving into Italy. Pye, Ltd., major British tv, radio and electronics manufacturer, will start limited production of its lines this month in a newly-acquired plant near Milan that could be the future basis of all Pye export production. C. O. Stanley, company chairman, says the factory will be an inroad to the Common Market area. Initial products will be appliances, communications gear and specialized radio and telephone equipment.

New Milanese company, Marelli-Lenkurt, has been formed through General Telephone & Electronics' purchase of majority interest of Magnetti Marelli. The company will make microwave radio equipment, carrier apparatus and transmission equipment. Company officials say the European communications market is "a most promising area."

STEAM IT!

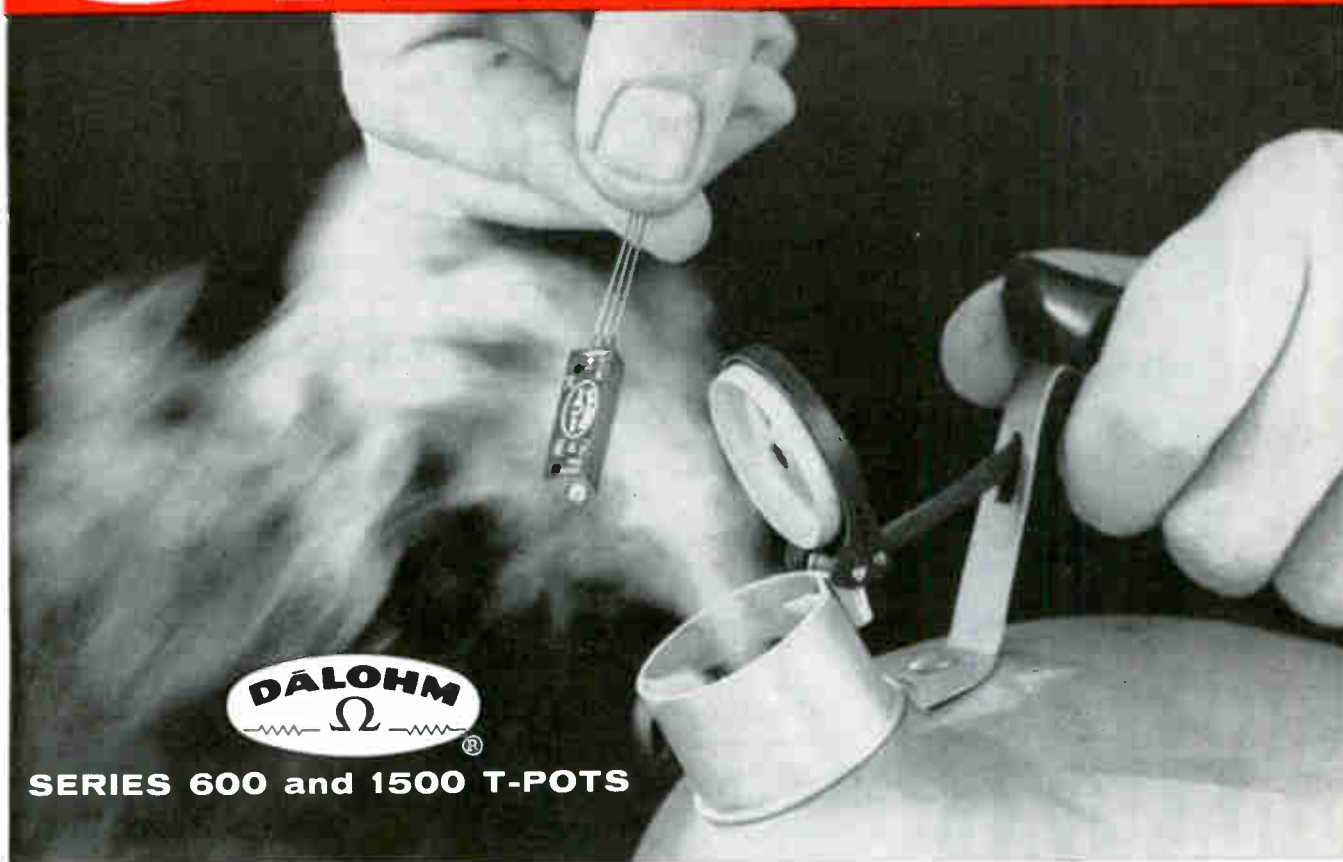

SERIES 600 and 1500 T-POTS

INHERENT STABILITY

Assured in a DALOHM Series 600 or 1500 Trimmer Potentiometer

The ability to perform reliably under extreme conditions of heat and humidity is only one mark of the inherent stability that is standard in Dalohm trimmer potentiometers.

Stored on the shelf for months... or placed under continuous load... operating in severe environmental, shock, vibration and humidity

conditions... Dalohm precision trimmer potentiometers retain their stability because it has been "firmly infixed" by Dalohm design and methods of manufacture.

For all applications demanding trimmer potentiometers that meet or surpass MIL specifications, you can depend on Dalohm.

WIRE WOUND • SEALED • HIGH POWER • DALOHM
SERIES 600 AND 1500 TRIMMER POTENTIOMETERS

Sub-miniature and miniature sizes with sealed cases. Four terminal configurations provide the solutions for demanding design problems.

	600	1500
Rated at ... watt	1	1
Resistance range	10 ohms to 30K ohms	10 ohms to 50K ohms
Standard tolerance	$\pm 5\%$	$\pm 5\%$
Size	.180" x .300" x 1.000"	.180" x .300" x 1.25"
Screw adjustment	15 ± 2 revolutions	25 ± 2 revolutions
Weight	2 grams	2.5 grams

Write for Bulletins R-41 and R-44, with handy cross-reference file cards.

SPECIAL PROBLEMS?

You can depend on DALOHM, too, for help in solving any special problem in the realm of development, engineering, design and production. Chances are you can find the answer in our standard line of precision resistors (wire wound, metal film and deposited carbon); trimmer potentiometers; resistor networks; collet-fitting knobs; and hysteresis motors. If not, just outline your specific situation.

- Completely sealed against moisture.
- Meet humidity requirements of MIL-STD-202A, Method 106A.
- End resistance is 1%, or 1 ohm.
- Nominal resolution of Series 600 is from 0.2% to 1.82%, depending on value; nominal resolution of Series 1500 is from 0.12% to 1.12%.
- Temperature coefficient is 50 PPM/ $^{\circ}$ C.
- Manufactured to meet the functional requirements of MIL-R-27208 and MIL-R-22097.

DALE ELECTRONICS, Inc.

FORMERLY DALE PRODUCTS Inc.
1300 28th Ave., Columbus, Nebr

A Subsidiary of

Hathaway
INSTRUMENTS, INC.

WASHINGTON OUTLOOK

EISENHOWER'S final defense budget, covering the fiscal year starting next July 1, will provide for an increase of at least \$1 billion in expenditures over the current \$41.5 billion level, and will request roughly the same appropriation of new funds (\$41.2 billion) voted by Congress this year.

Administration insiders call the new defense budget a tight one, and say the President has ordered the Pentagon to continue to hold down spending as firmly as possible. The President is determined to send his own kind of military program to Congress. His program is essentially a continuation of his past policies.

Eisenhower is making no changes because of the election. Indeed, says one official: "The budget will be tighter than if the Republicans had won. We don't have to accommodate to Nixon's views now." His point is this: Nixon had much to do with the rise to \$500 million in new contracting schedules since the July political conventions.

The proposed increases in outlays do not represent any important new program expansions beyond the ones already in the works, such as Polaris, Titan and Minuteman. Much of the increase in outlays will cover the extra costs of the recent contracting stepup. A large chunk will represent increased personnel and operating costs to maintain present force levels.

MOST WASHINGTON OBSERVERS regard Eisenhower's military budget preparations as so much paper-shuffling. The generals and admirals are expecting lots of additional money from Kennedy. They have already totaled up ambitious shopping lists to offer the president-designate, made up of items chopped out of the new budget by Eisenhower's economy policies.

Kennedy is expected to come up with a supplementary appropriation request for the current fiscal year within a month or two, then with a revised version of Eisenhower's budget for the next year. In all, these are expected to add at least \$2 billion in new contracts to the current rate of military spending.

Top priority items in Kennedy's plan: expansion of the Polaris and Minuteman missile programs, a continuous airborne B-52 alert and modernization of airlift and combat equipment for ground forces.

THE DEFENSE DEPT. has proposed a simplification—some officials call it a liberalization—of the technical-data provisions of the armed services procurement regulations. It scheduled a meeting with defense industry trade associations to discuss the proposed changes before making the new rules effective.

The Pentagon wants to get rid of the bothersome concept of proprietary data spelled out in contracts. Under this system, the military has had the responsibility for defining on a contract-by-contract basis before a contract was signed exactly what technical data it wanted rights to. The contractor has been faced with the overwhelming problem of isolating equipment designs and production techniques he wanted to protect. In practice, contractors have been forced to make proprietary secrets available to potential competitors working on related military projects.

The new policy would represent what officials describe as a new approach. It would offer companies contractual protection for technical data developed at their own expense.

The proposed change provides that data pertaining to items or components, which were developed and sold or offered for sale prior to the date of the contract, may be furnished on a limited rights basis. All other data shall be furnished on an unlimited rights basis. If at the time the contract is being negotiated, the contractor asserts the existence of other background data (that is other than data pertaining to components previously sold or offered for sale), which will necessarily be used in the contract, the government will acquire such data on an unlimited rights basis but may negotiate an equitable price for such rights to enable the government to reproduce items or processes developed in whole or in part at government expense.

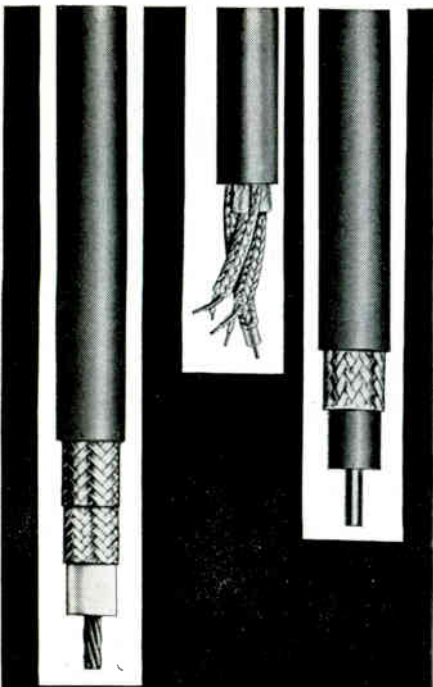

ROYAL COAXIAL CABLES

Royal has the skills and capacities to satisfy your coaxial or multi-conductor cable requirements . . . for electronic equipment, military applications, or community TV installations. Take a look at the Royal line . . . write for Bulletin 4C-3-L listing stock constructions. Or let us quote on your special requirements.



ROYAL ELECTRIC CORPORATION
301 Saratoga Avenue
PAWTUCKET • RHODE ISLAND

in Canada: Royal Electric Company (Quebec) Ltd.,
Pointe-Claire, Quebec

ROYAL
ELECTRIC
... an associate of

"the Best counter in decades"

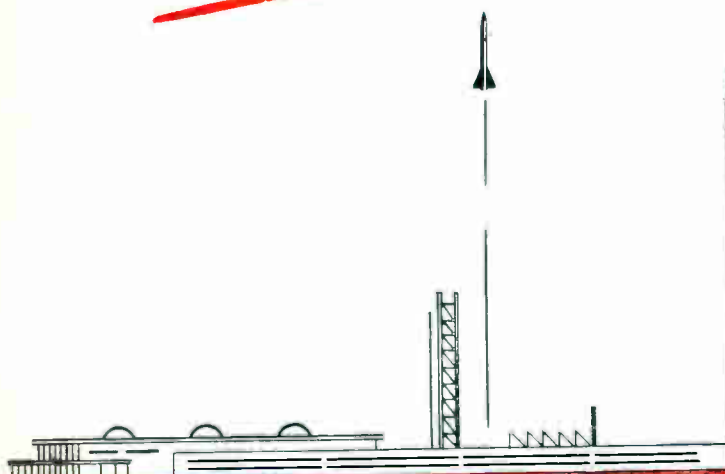
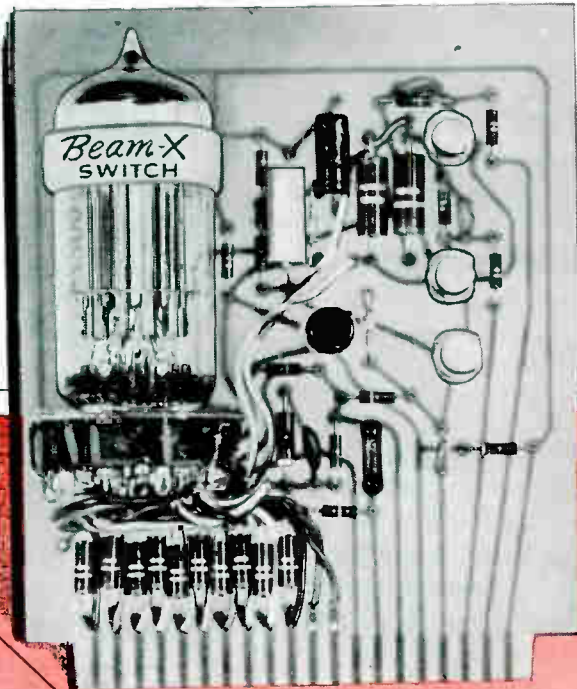

DC-101
10 Kc., commercial



DC-105
1 Mc., commercial

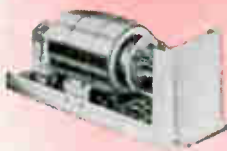

DC-106
100 Kc., commercial



DC-130
100 Kc., mil. spec.

NOW . . . THE *Beam-X** COUNTER

The new Burroughs BEAM-X Counter is the lowest cost transistorized decade counter available. The DC-111 Counter, newest product of the Electronic Tube Division, combines the Beam-X switch with transistors in a circuit capable of resolving pulses at 110 Kc. Electrical outputs are provided to operate remote Nixie® tubes, printers, and to perform other circuit functions. This latest addition to the Burroughs Counter line makes possible a number of advantages never before available:

- Use of new Beam-X switch—lowest cost, lightest weight, highest speed, smallest size 10 position electronic counting device.
- Total power consumption of only two watts.
- Elimination of as many as ninety components from counting circuits.
- Increased reliability due to component reduction and use of the ultra reliable Beam-X switch.

This counter is designed as a plug-in module for use in computers, electronic counters, machine control, automation and test equipment and military systems. The units may be directly cascaded. They can be driven by a twelve-volt signal, and are compatible with existing transistor logic circuits.

FOR DETAILED INFORMATION,
WRITE FOR BULLETIN 1002

ANOTHER ELECTRONIC CONTRIBUTION BY
Burroughs Corporation

ELECTRONIC TUBE DIVISION
Plainfield, New Jersey

* Trademark of Burroughs Corporation

Shallcross

precision
circuit
news

RESISTANCE NETWORKS

... the inside story
on quality

In reading ads for wirewound resistance networks, you sometimes find the superiority of one technical characteristic emphasized to a misleading degree. Desired accuracy, temperature coefficient, stability, and voltage division obtained in one type of network may be impossible to achieve in another.

Essentially, network quality is determined by the quality of its individual resistors. Beyond this, network performance improves or deteriorates depending on packaging and mounting techniques, AC layout and trimming methods, accuracy of measuring instruments, the manufacturer's production standards and his knowledge of the latest developments in network theory.

Shallcross offers a unique background of experience, reliability data, manufacturing and testing skills to minimize what few error factors remain in Shallcross precision wirewound resistors when the networks are sealed. For a sample of this ability, submit your next network requirement for evaluation by Shallcross engineers. Meanwhile, send for Bulletin A-2 for a practical discussion of proper network design.

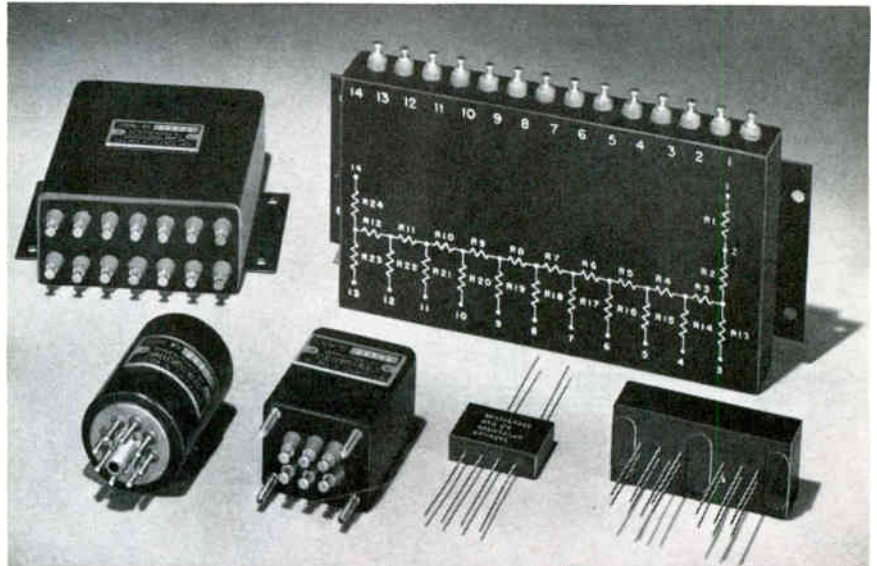

Temperature Stabilized COMPUTER NETWORKS

High reliability Shallcross P-Type precision wirewound resistors help these computer networks maintain close AC ratios over wide temperature ranges. To maintain these tolerances, Shallcross has refined resistor manufacturing techniques to provide TC tracking within ± 1 ppm in many cases. Individual resistor reliability is enhanced by stability "exercises" and by new tension relieving devices within each resistor. Beyond this, ex-

tremely accurate AC and DC measuring instruments help in final network design, trimming, packaging, and proof-of-performance testing.

From an extensive background of network engineering Shallcross offers analog to digital and digital to analog converters, voltage dividers, summing and integrator networks, and others to virtually any configuration.

WHY PACKAGE RESISTANCE NETWORKS?

Packaging does far more for resistor networks than provide convenient mounting and environmental protection. Some can also increase power dissipation, provide electrical shielding and increase network stability over extended temperature ranges. Principally however, enclosed networks maintain electrical performance by preventing "field introduced" errors brought about by improper mounting or damage to critical

AC layouts through improper resistor replacement during maintenance. Where unusually critical voltage division tolerances must be maintained, the design engineer should make provision for a packaged network in his application.

Shallcross regularly supplies networks in many hermetically sealed, encapsulated, and plug-in designs. For a discussion of when to use which style, write for Bulletin A-2.

Shallcross Manufacturing Co. Selma, North Carolina
Precision wirewound resistors, Switches, Instruments, Delay lines, Resistance networks, Audio attenuators.

Eight channels on a 7" high single chassis, provide economical, general purpose recording . . . choice of two amplifier types — low gain (0.01 to 500 volts); high gain 10 uv to 100mv.

8-channel direct writing "350" style recorder in a single 17½" high package . . . immediately visible inkless traces made by heated stylus on rectangular coordinate charts, at any of 9 electrically controlled chart speeds.

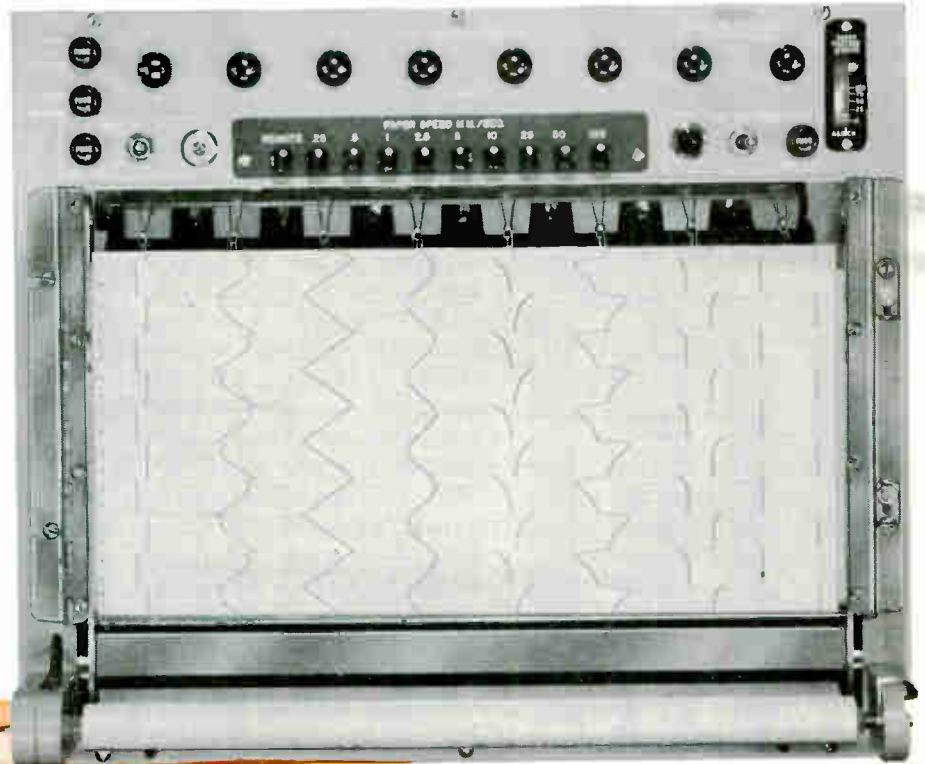

PRACTICAL ECONOMY and WIDE USEFULNESS
in a NEW SANBORN DIRECT WRITER

FOR MANY channels of accurate and economical microvolt to volt general purpose recording, investigate the performance and price of this new Sanborn "950" system. Choice of transistorized high or low gain amplifiers for stability, instantaneous operation and low power consumption.

Sensitivity Ranges	Input Resistance	Common Mode Voltage	Common Mode Rejection	Frequency Response	Zero Suppression	
10 uv to 2mv. div.	100,000 ohms all angles Roaring and guarded	± 500 volts max.	143 db min. DC 100 db min. at 60 cps with no unbalance 100 db min. at 60 cps with 500 ohms unbalance	0-150 cps with 3 db at 10 div. peak-to-peak	None	
With Model 958-25C0 Low Gain Amplifier (also 958-25CDA without zero suppression)	10 to 500 mV/div and 1 to 10 v/div	5 megohms each side balanced to ground	2.5 v max. on most sensitive range—creasing to ± 500 v on others	34 db on most sensitive range; 26 db on all other ranges	0-150 cps with 3 db at 10 div. peak-to-peak	For Model 958-2900 5X input, single ended or balance inputs

Specifications and prices subject to change without notice)

Get complete "950" information from any Sanborn Sales-Engineering Representative, located in principal cities throughout the United States, Canada and foreign countries.

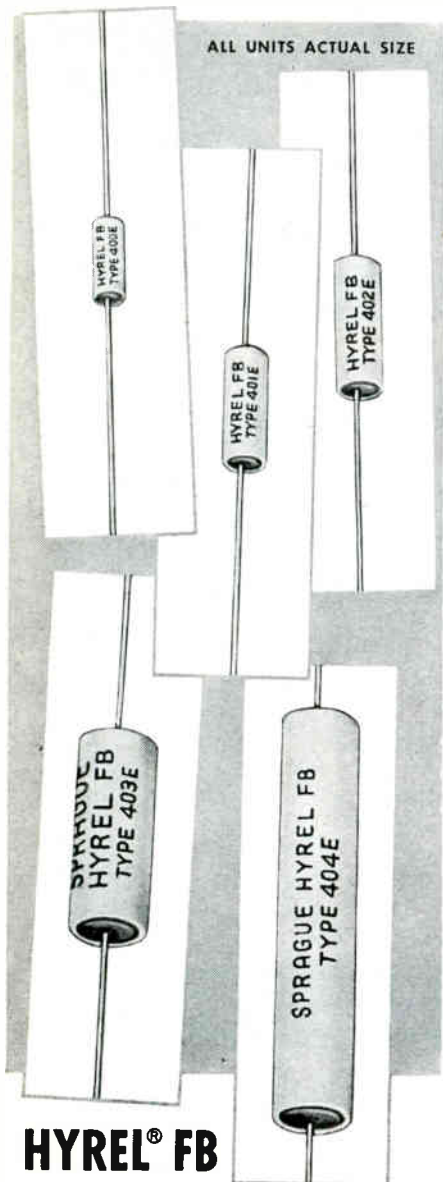

HYREL® FB

DEPOSITED CARBON RESISTORS

UNMATCHED FOR PERFORMANCE

... hermetically sealed in ceramic jackets against moisture and vapor... safely protected against mechanical abuse.

The Hyrel FB series is intended for applications in military, commercial and telephone equipment where long life under high humidity, small size, and stability of electrical characteristics are important.

WRITE FOR ENGINEERING BULLETIN 7010B

SPRAGUE ELECTRIC COMPANY

35 Marshall Street, North Adams, Mass.

Made to far exceed MIL-R-10509C Specifications



FINANCIAL ROUNDUP

ITT Discloses Cuban Losses

INTERNATIONAL TELEPHONE AND TELEGRAPH reports nine-month earnings of \$21,137,268 or \$1.36 per share for the first three-quarters of this year. In the same 1959 period, the corporation earned \$18,670,120, or \$1.22 per share on a smaller number of shares and before special nonrecurring charges of six cents a share. H. S. Geneen, ITT president disclosed that third-quarter net income is also up, to a level of \$6,882,795, or 44 cents per share as against last year's third quarter figure of \$6,207,191, or 40 cents per share before a special nonrecurring charge of 11 cents. Total sales this year for the nine-month period were \$580,058,955 as against \$533,006,508 for the same period in 1959. Geneen added that the 1960 figures excluded the Cuban subsidiary accounts, no longer consolidated because of seizure. "We are still pressing for tax or other relief for the loss of our approximate \$35 million in Cuban subsidiaries," he said. He added that any provision for such investment loss would be charged to earned surplus and would have no effect on the year's net income. Orders on hand as of Sept. 30 this year are approximately \$574 million as against \$549 million at the end of last year.

Transitron Electronics, Wakefield, Mass., announces it has entered into a formal agreement with Thermo King, Minneapolis, under which the New England firm would acquire all TK's assets. Under the agreement, one share of Transitron would be exchanged with one share of TK. In addition, options for 60,000 Thermo King shares would be converted into options for a similar number of Transitron shares. The final signing of the agreement is contingent on a two-thirds approval by TK stockholders and the carrying out of a secondary offering of 1½ million shares of Transitron common covered by a registration filed with Securities & Exchange Com-

mission. Transitron sales for the quarter ended Sept. 24 were \$11,767,511 as against \$10,155,534 in the same quarter a year ago.

Industro Transistor Corp., New York, reports net income of \$192,524 for the 1960 fiscal year. This is equivalent to 35 cents per share of common stock. In fiscal 1959, the firm sustained a net loss of \$34,330, or eight cents per common share. In 1958, the net loss per share was 20 cents. Sales this year more than doubled rising to \$1,282,116 from \$594,158 a year earlier.

Varian Associates, Palo Alto, Calif., and Eastern Industries, Hamden, Conn., announce that they have arrived at a preliminary basis for merger of Eastern into Varian on a three-to-one exchange of stock. Shareholder approval will be asked at a March meeting next year.

Canoga Electronics Corp., Van Nuys, Calif., announces sale of \$1½ million of convertible debentures and senior notes to Electronics Capital Corp. Canoga received \$1,200,000 through the sale of eight-percent convertible debentures and a \$300,000 long-term loan commitment. The debentures are convertible into 47 percent of the electronics company's total common stock. Canoga, organized in 1948, has current annual sales in excess of \$5 million. The company manufactures radar systems, space tracking systems, range instrumentation and related equipment.

United Industrial Corp., New York, reports third quarter sales for the period ended Sept. 30 amounted to \$10,131,365, a dip from the \$10,710,243 reported in this year's second quarter. Net income for the third quarter was \$78,844 in comparison to a deficit of \$65,957 for the six months ended June 30. Total sales for the nine-month period ending Sept., 1960 were

\$28,492,650. Net income after taxes, which included a special capital gain tax, was \$593,049, equivalent to 12 cents a share on common stock after provision for preferred dividends.

One-hundredth listing on the American Stock Exchange this year is an electronics company, **Terminal-Hudson Electronics**, an electronics distributor. Stock appeared on the ticker under the symbol "THE" at 6½. The company has 963,304 shares outstanding. The company operates both in the U.S. and abroad. It was formed through the recent merger of Terminal Electronics and Hudson Radio and TV.

Nuclear-Chicago, Des Plaines, Ill., and **Texas Nuclear**, Austin, Tex., have agreed on a basis for an exchange of shares. One share of N-C will be exchanged for each 3½ shares of Texas stock. The plan must meet with an 80 percent vote of Texas shareholders to be effective. Full exercise of the offer would require issuing 28,571 shares of N-C, which now has 743,006 shares out of the 1½ million shares authorized. Texas Nuclear has 100,000 shares outstanding.

25 MOST ACTIVE STOCKS

WEEK ENDING NOVEMBER 18, 1960

	SHARES (IN 100's)	HIGH	LOW	CLOSE
Ampex	1,153	237½	21½	23½
Gen Inst	918	39¾	35¼	37½
Sperry Rand	865	19¼	18½	18½
Gen Tel & Elec	823	27¾	26¾	26¾
Gen Controls	687	23¾	19¼	21¾
Standard Kollsman	683	23½	19½	23½
Gen Electric	641	79	77½	78½
Int'l Tel & Tel	637	41¼	40	41
Transitron	609	36¾	34½	35
RCA	599	55¾	53	54¼
Muter Co	532	8½	5¾	7¾
Westinghouse	530	51½	48½	49¼
Litton Ind	505	84¾	79¼	82¼
Martin Co	497	58¾	54	58½
Texas Inst	474	188	175¼	179½
Burroughs	451	28½	27¾	27¾
Elec & Mus Ind	447	6¼	6	6
Lockheed	427	27½	26¾	26¾
Avco Corp	420	14½	13½	13¾
Varian Assoc	374	48¼	45	46
Raytheon	354	35¾	32½	33¼
Univ Controls	333	15¾	14¾	14¾
Collins Radio	312	50¾	46½	48
Philco Corp	301	19½	18	18½
Beckman Inst	295	90½	84½	89

The above figures represent sales of electronics stocks on the New York and American Stock Exchanges. Listings are prepared exclusively for ELECTRONICS by Ira Haupt & Co., investment bankers.

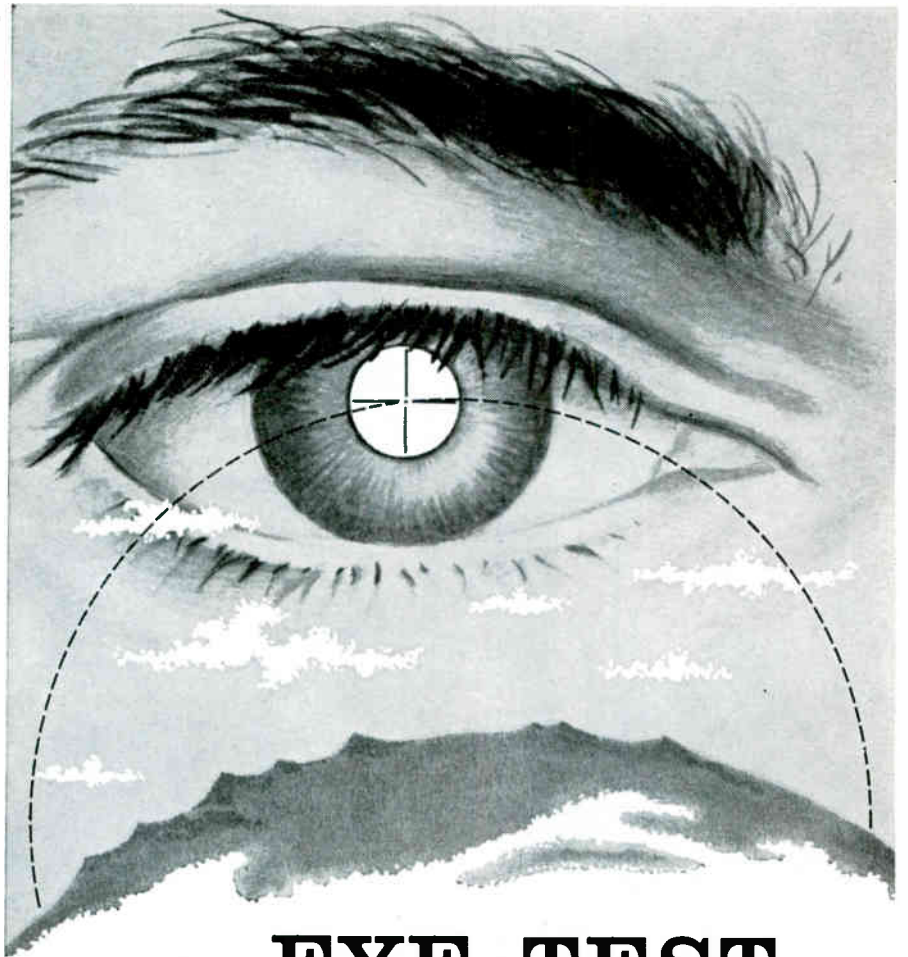

EYE TEST FOR RADAR

B&L optical-electronic-mechanical capabilities assure accuracy in missile tracking system

The strength of our missile defense program depends in part on extreme accuracy of radar tracking.

Bausch & Lomb has developed a camera lens for boresighting a radar antenna—in essence, this lens checks the performance of radar just as one's vision is checked in an eye examination.

Accuracy of this lens system easily meets the most extreme requirements.

The same skills that made possible this missile track radar camera lens are available to assist on your project. Write us for full details. Bausch & Lomb Incorporated, Military Products Division, 61411 Bausch St., Rochester 2, N. Y.



CIRCLE 119 ON READER SERVICE CARD
CIRCLE 20 ON READER SERVICE CARD →

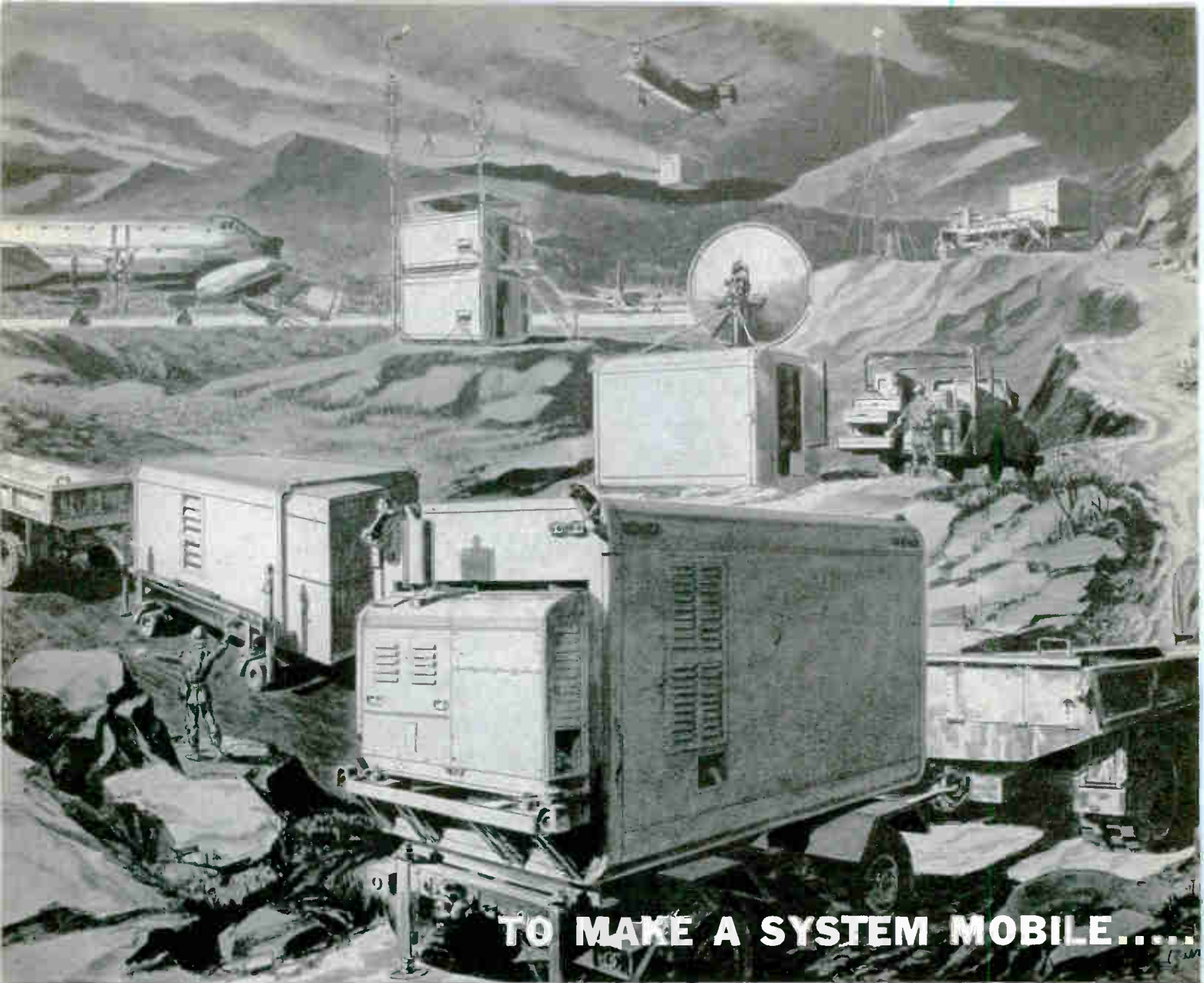

TO MAKE A SYSTEM MOBILE.....

Progress in Systems packaging... for the Missile Age

**CRAIG ENGINEERS
HEAD UP THE MOST
COMPLETE SYSTEMS
PACKAGING SERVICE
YOU'LL FIND...**

Dip into this versatile brainpower pool . . . and you'll come up with the answers to virtually any problem in systems packaging.

Example: a problem in housing mobile systems? Ask our production specialists. Their principal responsibility: development of light weight, high strength aluminum shelters, vans and trailers (like our famed Helicop-Hut, for instance) for mobile air transportable ground support electronic systems.

Example: a problem in components for mobile systems? Our men in this department specialize in such hardware as telescoping antenna masts, transit cases,

spare parts boxes, equipment racks or cabinets, or you name it.

Example: a problem in systems installation? The service: layout and installation of complete systems, through final check-out for maximum mobility and reliability, including all cabling, shock and vibration isolation, human engineering, environmental control and testing.

Example: a problem in systems reliability? Testing is a speciality at Craig. In addition to regular testing techniques and procedures, special tests are developed to insure equipment reliability, supported by complete and accurate test data of all kinds.

MASS PRODUCTION FACILITIES

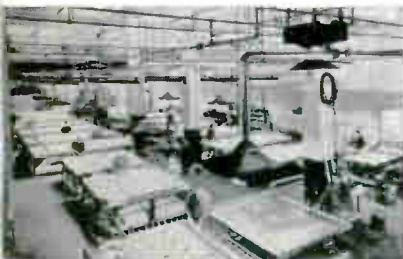

ENGINEERING AND RESEARCH SERVICES



TESTING: DEEP WATER FLOTATION



TESTING: THERMAL SHOCK CHAMBER





...TAKES A VERY SPECIAL KIND OF "WHEEL"

Example: a problem in fabrication ... or research? Craig's engineering design and development staff will work on it. Staff also provides a highly unique "fabrication research" service. Their work with aluminum, foamed plastic, and epoxy adhesives for lightest weight and highest strength may well prove helpful.

The Results: whatever your systems packaging problems, we can wrap them up for you, either in whole or in part, or as a supporting service to your plan of operations. Years of specialized knowledge in the field of systems engineering is an excellent reason to rely on Craig.



Craig's capabilities brochure will be sent on request. Write to Dept. A-3.

Craig

SYSTEMS, INC.

360 MERRIMACK ST., LAWRENCE, MASS. - TELEPHONE: MURdock 8-6961
Boston, Mass., CApital 7-7794

WASHINGTON, D. C.,
The LaSalle Suite 815
1028 Connecticut Ave., N. W.
District 7-1575

DALLAS, TEXAS
6300 North Central Expressway
EMerson 1-5522

LOS ANGELES 45,
CALIFORNIA
6214 W. Manchester Ave.
SPring 6-0025

Business systems and equipment are another Craig specialty through LeFebure Corporation, Cedar Rapids, Iowa — a Craig subsidiary

MOBILE GROUND SUPPORT EQUIPMENT



COMPLETE SYSTEMS PACKAGING



TELESCOPING MASTS AND CONTROL TOWERS



HELICOP-HUTS AWAITING DELIVERY



NOW! A COMBINATION PARABAM PULSE

50 μ sec. to 90 sec.

Plus WAVEFORM GENERATOR

Square, Triangular, Sine
0.01 cps to 2000 cps



Through unique design, the Parabam Model P-1 Pulse-Waveform Generator provides virtually transient free square, triangular and sine waves plus variable length pulses.

Has sufficient output to drive power transistors and relays, electrohydraulic valves and other units directly from the output terminals. *Applications* . . . test and development of servomechanisms, computers, input-output devices and geophysical equipment.

MODEL P-1 SPECIFICATIONS

- Waveforms: Sinusoidal, square and triangular.
- Frequency: continuously variable in 10 ranges . . . 0.01 cps to 2000 cps.
- Frequency stable within 1%.
- Pulse length continuously variable from 50 μ sec to 90 seconds.
- Pulse amplitude . . . 0 to 60 volts, 200 milliamps max. current.
- Rise/Fall time approx. 2 μ sec.
- Cabinet or rack mounted.

WRITE TODAY —

for Technical Bulletin No. 660-6 on the P-1 Pulse-Waveform Generator.

PARABAM, INC.

13000 YUKON AVENUE
HAWTHORNE • CALIFORNIA

MARKETING

Electrical Distributors Eye



Frank M. Viles, Jr.

"THIRTY PERCENT of all electronic products sold through distributors will be sold in 10 years through firms now electrical distributors," says Frank M. Viles, Jr., president of ITT's distributor products division.

Behind Viles' statement are intensive studies of the distribution trends which ITT made before setting up the division recently.

Biggest single factor in the drive of electrical distributors to get into the distribution of electronic products is the growing use of electronic equipment in the electrical machinery and electrical contracting industries.

Says Viles: "The electrical distributors are faced with the problem of either losing more and more of their business to electronics part distributors because they don't handle the electronics products wanted by their customers—or getting into electronics distribution themselves."

Number of electronic computer installations in use by state and local governments will double within the next two years, according to a survey of manufacturers of electronic computers, reports John Diebold Associates, computer consultants.

Survey found not only increased use of automation in "regular" business data processing but a variety of projects extending automation into new areas.

New era of product development and expansion in consumer electronics is foreseen by Edward R. Taylor, executive vice-president of Motorola and chairman of consumer products division of Electronic Industries Association. Many people have mistakenly assumed that consumer electronics have reached a plateau of economic opportunity, Taylor added.

Even without new products for home, automotive and other markets, consumer electronics sales will jump by 2 million units in television, 4.3 million in radio and 2.5 million in stereo in the next five years, predicted Taylor.

Headquarters for Motorola Military Electronics division, including market research, program planning, representation and administration functions, is being consolidated in Washington, D. C., reports Paul J. Sturm, division marketing director. "With the growing concentration of technical, military and other federal agencies in the nation's capital, it becomes necessary that defense suppliers reflect this trend in their own organization planning," Sturm said.

"We feel that basing our activities in Washington not only will improve our efficiency, but will also sharpen our response to fast-changing military needs," he added.

Joining Sturm in the new marketing headquarters are: John C. Parham, Washington region manager, Carl A. Nierzwicki, plans programming manager and three regional representatives.

MARKETING APPOINTMENTS: J. B. Holts assigned to newly-created job of marketing manager for new products of Centralab

Electronics

Electronics division of Globe-Union. . . . **William J. McClenahan** named marketing manager of Sperry Rand Corporation's Sperry Electronic Tube division located at Gainesville, Fla. . . . **Seymour S. Levine** appointed manager market planning of Westrex Corp., division of Litton Industries. Levine will help formulate marketing plans and be responsible for gathering information on short- and long-range marketing planning for commercial and government sales. . . . **Henry A. Head** promoted to position of manager of marketing planning in the Advanced Systems Development division, commercial group of International Business Machines Corp. . . . **Walter C. Byrne, Jr.**, appointed manager of microwave marketing, Communications and Controls division. Radio Corporation of America. . . . Board of Directors of Airpax Electronics elects **Rear Admiral Otto A. Scherini**, vice president of the corporation in charge of marketing. He will be in charge of sales of two divisions, in Florida and Maryland, as well as the nationwide sales organization.

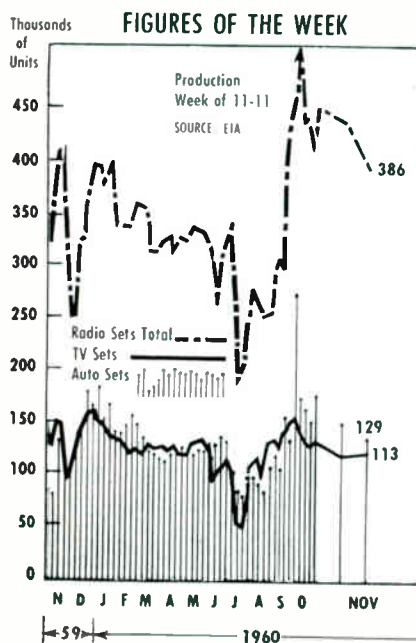

Engineering notes from the **SM/I** **REPORTER**

BY STANLEY M. INGERSOLL, Capabilities Engineer



Report No. 14

AME 604 Thermocouple Reference Junction Temperature Compensating System

The AME 604, the most advanced version of the SM/I Temperature Compensator, is a highly accurate device for electronically compensating for the cold junction in a thermocouple temperature measurement system for use where extreme environmental demands are made on airborne or ground equipment.

This 12-channel temperature measurement system is composed of 12 compensator modules and 12 power supply modules and operates from a 28 V.D.C. input. This unit is completely encapsulated to insure mechanical stability of the system. One power supply which incorporates solid state devices and one compensator module are required for each channel. Components in the compensator and power supply modules are assembled on a Melamine-Glass terminal board and following lead attachments are individually potted with a Urethane foam-type potting compound that provides maximum stability under extremes of temperature and humidity as well as protection against operational vibration. The system design is such that the number of channels may be changed to suit a customer's requirements.

Typical Performance Specifications

Electrical output	12 channels
Output impedance	875 ohms (each channel)
Accuracy	Better than $\pm 2^\circ\text{F}$. over a system operating temperature range of -32°F . to $+165^\circ\text{F}$. Better than straight line errors of $\pm 2^\circ\text{F}$. at 32°F . to $\pm 1^\circ\text{F}$. at 77°F . to $\pm 2^\circ\text{F}$. at 105°F . and 3°F . at 250°F .
Size	5" x 3 1/2" x 3"
Weight (less cables)	2.2 lbs.
Input power	28 V.D.C., 7.5 watts
Input signal	12 Chromel-Alumel grounded thermocouples

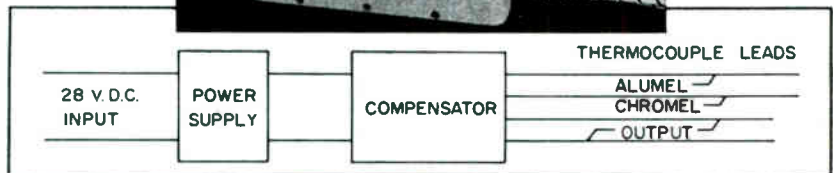
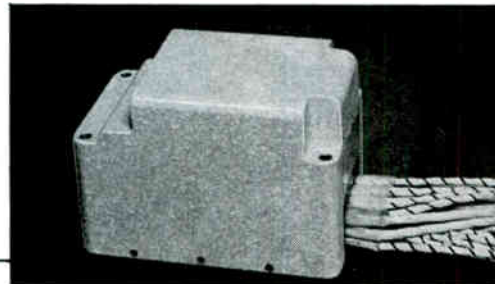

AME 604 Temperature Compensating System - System Diagram

For more information and complete operating specifications, write or wire SM/I today. Address your inquiry to Stanley M. Ingersoll, Capabilities Engineer.

SM/I

SERVOMECHANISMS/INC.

Los Angeles Division
1300 N. Aviation Boulevard
El Segundo, California

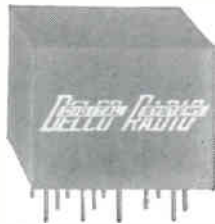
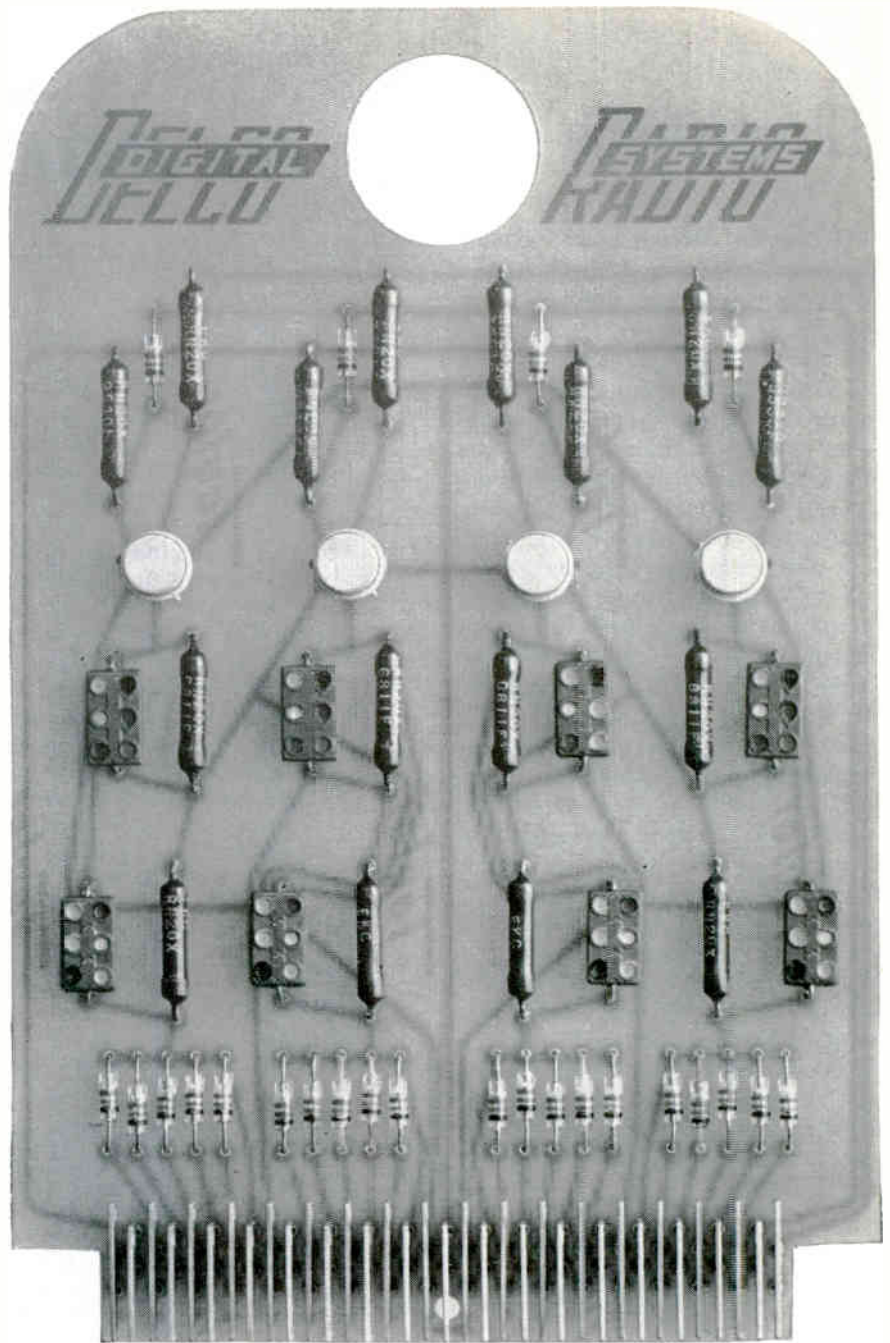

DIGITAL MODULES

... building block or plug-in card

Which package fits into your design? Packaged either way, Delco Radio Digital Modules meet or exceed all MIL-E-5272D (ASG) environmental requirements. Continuing life tests on these computer circuits now exceed four and one-half million transistor hours *without a failure*. The modules perform all the standard logic functions and come in many basic types and variations. Delco modules in the transistorized building block package are ideally suited for airborne guidance and control because of their extreme ruggedness, compactness and reliability. All miniature building block modules employ three dimensional welded wiring techniques and are vacuum encapsulated in epoxy resin. Delco Radio can offer you off-the-shelf digital circuits packaged as building blocks or plug-in cards, or can supply circuits to meet your specific needs. Our Sales Department will be happy to send you complete engineering data. Just write or call. ■ *Physicists and electronics engineers: Join Delco Radio's search for new and better products through Solid State Physics.*

PIONEERING ELECTRONIC PRODUCTS THROUGH SOLID STATE PHYSICS

Division of General Motors • Kokomo, Indiana



Distinctive SERVICE

... MINIMUM COST

You name it . . . we'll stamp it . . . exactly in accordance with the specs and degree of quality and finish you require. And we'll save you money on any quantity one to a million through the four Services described at the right.

It all adds up to a distinctive Service in Stampings. Special equipment, toolings and techniques, many unknown to ordinary stamping shops, have been perfected since 1913. The savings are passed on to you!

Want more details? Stampings Folder No. 4 contains helpful information for ordering most economically. Send for it.

Stampings DIVISION

THE LAMINATED SHIM COMPANY, INC.
4612 UNION STREET, GLENBROOK, CONNECTICUT

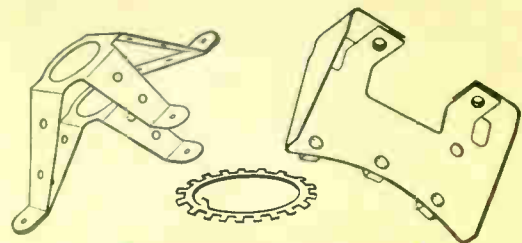

1 "ONE PLUS" METHOD

No tooling needed when you order just a few pieces. Economical for prototypes or experiment.

2 SHORT RUN METHOD

Perfect for "more than a few", but less than production quantities. Temporary tooling, simple dies and special presses keep costs down.

3 PRODUCTION RUN METHOD

Applies only when quantity, tolerance, size and contour factors justify our standard production method and/or nominal die charges.

4 "WATCH DOG" SERVICE

All repeat orders are screened and re-evaluated as to specs and quantity—then the Method best for you is used. A routine procedure—and the gain is yours.

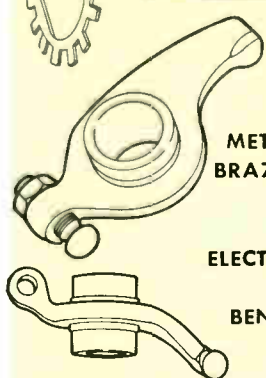
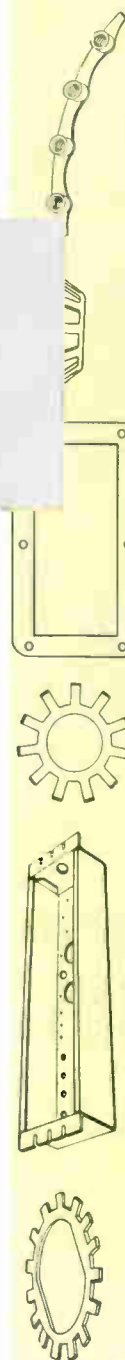

- SPACERS
- SIDE PLATES
- TAB WASHERS
- LOCK WASHERS
- METALLIC GASKETS
- BRAZED ASSEMBLIES
- SPECIAL REELS
- SHIMS
- ELECTRONIC CHASSIS
- MS CLAMPS
- BENCH ASSEMBLIES
- ROCKER ARMS
- CONVERSIONS



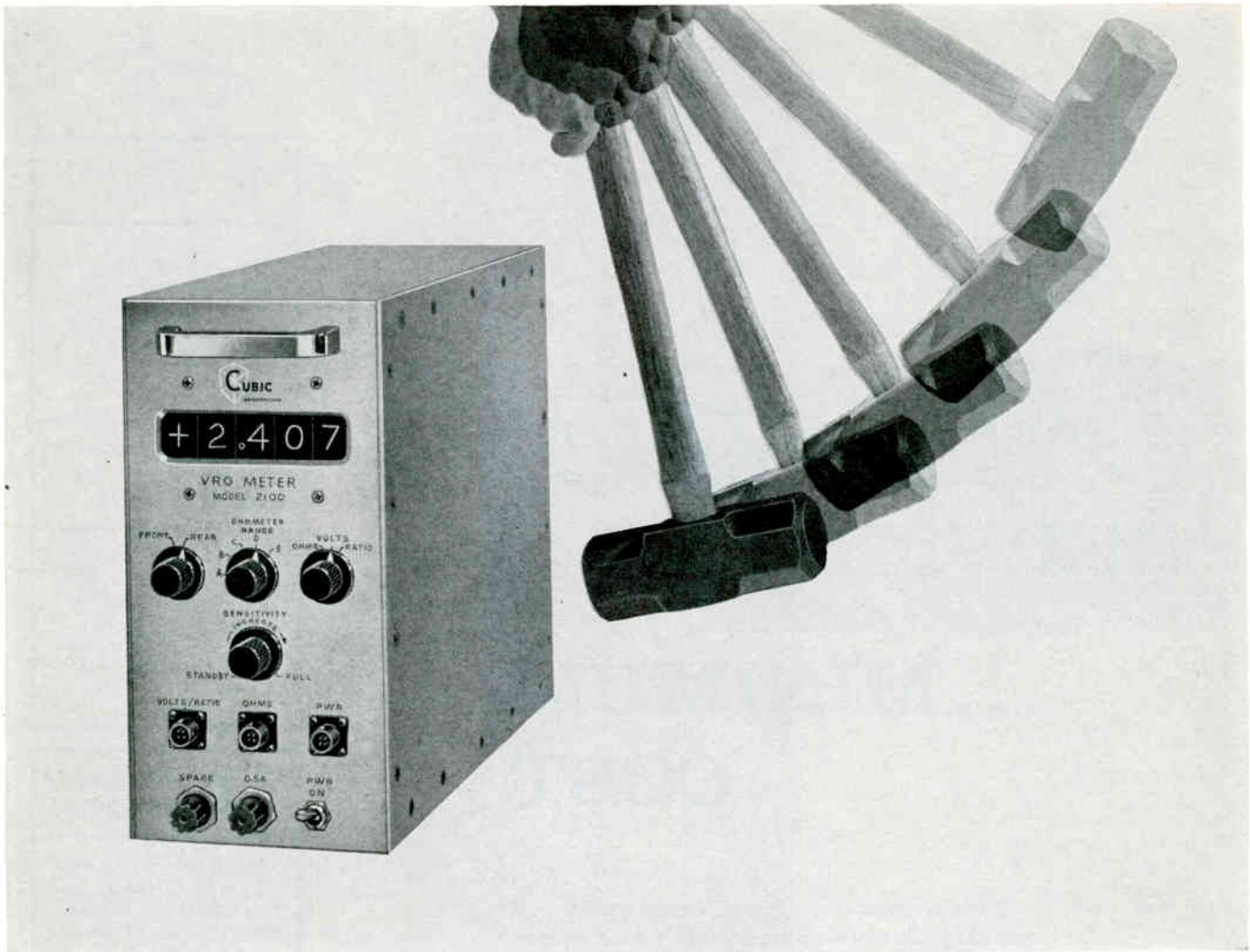

Cubic precision digital voltmeter withstands 50G shock

A new militarized version of the Cubic precision digital voltmeter is guaranteed to withstand shocks as high as a bone-crushing 50 G. The ability to shake off punishment that would wreck ordinary voltmeters, and to keep on performing perfectly for years and years under the hardest kind of use, is built into *every* Cubic digital voltmeter. These meters are "operator-proof" — they will not be damaged by any except the most flagrant misuse. Even voltages 100% over the top of the highest range will not harm them.

The advanced engineering of Cubic's transistor-driven stepping-switch design provides extraordinary reliability and accuracy. Cubic digital voltmeters achieve 99.997% repeatability, for precise accuracy again and again. Attenuator accuracy is 0.003% for wide-range precision. Bridge linearity of 0.003% is attained with carefully matched quality components. Noise rejection (60 cps) is 80 db.

Cubic's digital readout is simple, reliable and the easiest to read at a glance. Extra quality components throughout ensure minimum maintenance requirements. Before buying *any* digital instrument, investigate the best. Write for descriptive literature to Dept. E-4, Industrial Division, Cubic Corporation, San Diego 11, Calif.

BRIEF SPECIFICATIONS — MODEL 2100

ENVIRONMENTAL

shock test: will withstand 50G Navy shock test, and shipboard vibration

humidity: 100%

salt spray and fungus resistant

ELECTRICAL

volts: 0.01% accuracy from 1 millivolt to 1000 volts, automatic ranging and polarity

ohms: 0.1 ohm to 10 megohms, manual ranging

input power: 25 watts

ratiometer provision and switching

MECHANICAL

size: 5½" wide, 11¼" high, 14" deep

weight: 35 lb

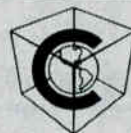

cubic
CORPORATION

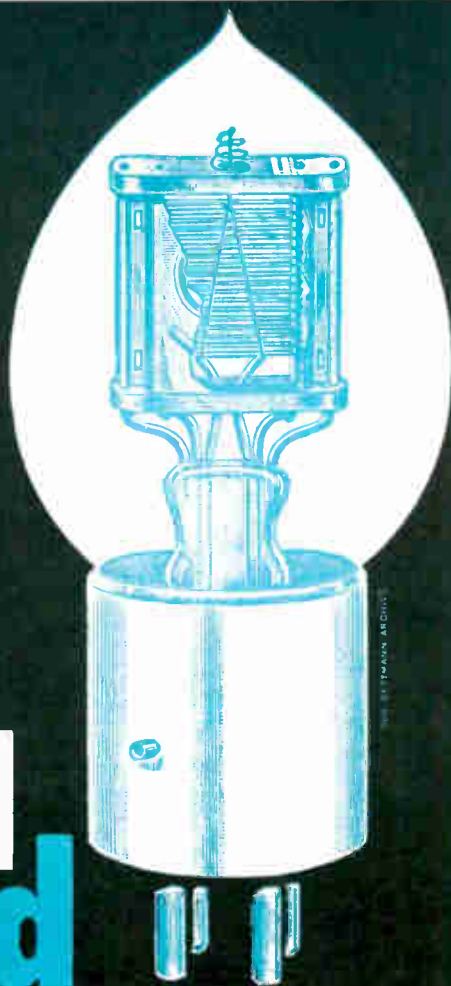

THEN
and

NOW

"Then," as it refers to the electronics industry, means . . . "just a very few years ago." The radically swift advances made in those few years have changed the whole concept of component design and performance.

Capacitor users will find the new capacitors which modern circuitry demands at Pyramid Electric Company, where miniaturization with highest reliability are among our proven engineering and production accomplishments. A few of the modern capacitor products are shown here.



type TAD . . . solid tantalum high reliability capacitors. They are available in a wide range of sizes and values, are hermetically sealed, and have a long shelf and operating life.

temperature range: -80°C to $+85^{\circ}\text{C}$
 $+125^{\circ}\text{C}$ (with derating)

Write for bulletin ET-7



type TAK-H . . . wet electrolyte tantalum capacitors with built-in rugged construction, seep and vibration proof, and made to meet specifications MIL-C-3965.

Write for bulletin ET-8



type MLE . . . true miniature electrolytic capacitors. They are metal clad of all-welded construction, made to last ten years or longer.

temperature range: -40°C to $+85^{\circ}\text{C}$

Write for bulletin EL-6



type 107 . . . Mylar* dielectric capacitors—the smallest film capacitors made. Non-hydroscopic polyester dielectric and wrapper with thermosetting resin end seals.

temperature range: -55°C to $+125^{\circ}\text{C}$

Write for bulletin MY-2

*Mylar—reg. duPont TM

For full details write or call: Sales Department S-100

PYRAMID ELECTRIC COMPANY

ORANGE STREET, DARLINGTON, SOUTH CAROLINA • In Canada: Wm. Cohen, Ltd., 8900 Tanguay Street, Montreal • Export: Morhan Exporting Company, 485 Broadway, New York 13, N. Y.



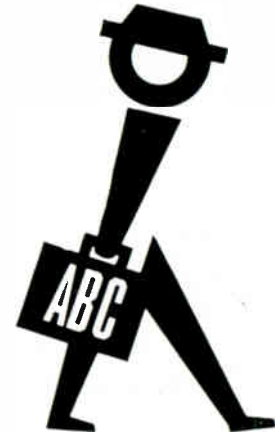

**here,
there . . .**

almost everywhere

Members of the specially trained, 70-man field auditing staff of the Audit Bureau of Circulations* make regular calls on 2,900 publications . . . ours included . . . located in almost as many places.

The ABC auditor's call might last a day, a week, or even several months . . . just as long as it takes him to make a complete audit of our circulation records and obtain the information about our circulation audience that ABC will later publish.

Actually, he is working for you — our readers and our advertisers. Knowing full well that we will stay in business only so long as our publication continues to serve the interests of our readers, this audit of our *paid* circulation provides us with a regular and objective review of how well you think we are doing.

Knowing full well that sales messages must reach a responsive audience in order to be effective, our advertisers are also interested in the ABC auditor's call. The hard, and sometimes cold, facts he reports about our circulation provide you with an informed basis for investing your advertising money.

Yes, the ABC auditor has been here . . . and he will be here again, calling to check on how well we are doing our job and to provide the facts to help us *and our advertisers* do even better.

electronics

A McGRAW-HILL PUBLICATION • 330 W. 42nd ST. • NEW YORK 36, N. Y. 

* This publication is a member of the Audit Bureau of Circulations, an association of nearly 4,000 publishers, advertisers, and advertising agencies. Our circulation is audited by experienced ABC field auditors. Our ABC report shows how much circulation we have, where it goes, how obtained, and other facts that tell you what you get for your advertising money when you use this publication.

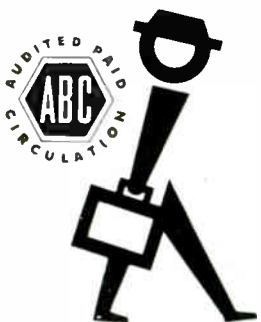

**NEW
HIGH-RELIABILITY
READOUT
DEVICES
NOW
AVAILABLE**

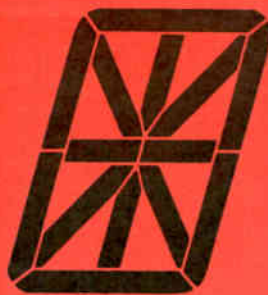

SYLVANIA TYPE AN-150 . . .
1½" ALPHA-NUMERIC . . . is
diagramed above in actual
size to show the 14 seg-
ments that produce the
complete English alphabet,
0-to-9 numerics, and selected
mathematical symbols.



SYLVANIA TYPE NU-150 . . .
1½" NUMERIC . . . is dia-
gramed above in actual size
to show the 9 segments that
produce a display of 0-to-9
numerics.

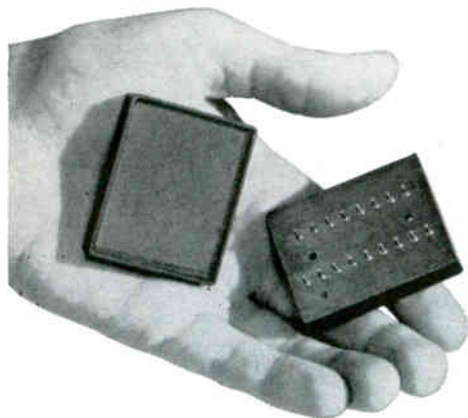

Sylvania Electroluminescent Panels provide new techniques for display of numeric and alpha-numeric information

Sylvania EL Readout Devices are composed of segments of electroluminescent lamps, insulated from each other and separately terminated. By selective excitation of the segments, symbols are produced for visual display.

The basic design and structural simplicity of *Sylvania EL Display Devices* offer the important benefits of minimal catastrophic failure, exceptional reliability, long life, simplified circuitry, negligible power requirements, compactness, flat construction for wide-angle viewing, high readability despite ambient light conditions, and plug-in design for instant interchangeability.

Want more details? Send today for the descriptive brochure "Sylvania Electroluminescent Display Devices." Write Electronic Tubes Division, Sylvania Electric Products Inc., Dept. EL, 1100 Main Street, Buffalo 9, N. Y. Want to discuss your specific requirements for readout devices? Contact your nearest Sylvania Sales Engineering office.

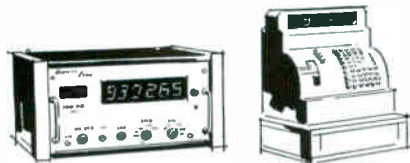

If you are designing . . . Digital Voltmeters, Cash Registers, Call Boards . . . investigate new SYLVANIA EL "READOUTS"!



If you are designing . . . Systems Displays, Tote Boards, Arrival Boards . . . investigate new SYLVANIA EL "READOUTS"!



If you are designing . . . Dispatch Boards for Police, Fire, Utilities, Commercial Carriers . . . investigate new SYLVANIA EL "READOUTS"!

SYLVANIA

Subsidiary of **GENERAL TELEPHONE & ELECTRONICS**





CHEMICALS

THE RAW MATERIALS OF PROGRESS

FLUORO-CHEMICALS FAMILY *provides new answers in electronics field*

3M specialty chemicals solve problems of miniaturization, corrosion protection, high-performance insulation, weight savings for electronics manufacturers

To cope with the increasingly complex design and production problems facing the electronics industry, a new and versatile family—3M Fluorochemicals—lends a powerful helping hand. An entirely new class of chemicals, they offer unique properties that allow designers and production men to surpass yesterday's accepted specification limits.

For today's designs, and for making tomorrow's possible . . . 3M Fluorochemicals offer new chemical, thermal and dimensional stability . . . add flexibility, long life and strength to many electronics parts and assemblies. And 3M research is still expanding the boundaries of this exciting new chemical frontier. Here at work are some outstanding members of this growing 3M family . . .

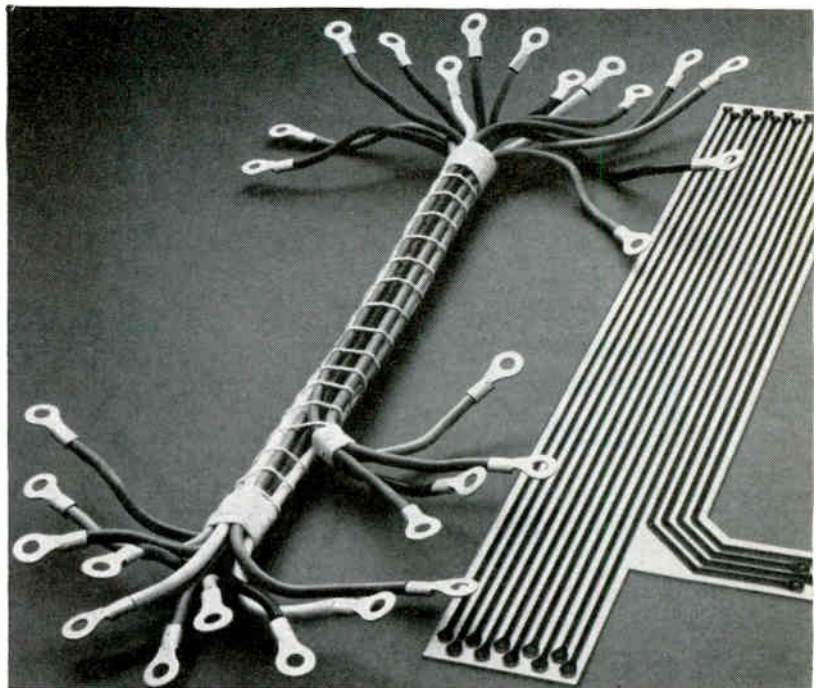

KEL-F® BRAND PLASTIC in film form, used in the laminated circuit, right, helped reduce weight from 14 to 2 ounces, compared with old circuit, left. For wire jackets and coatings, encapsulations, relay bobbins and other components, KEL-F Plastic overcomes such problems as rattling vibration, shattering cold, water immersion. Environmental temperatures can range from -420 to $+390^{\circ}$ F. for this non-flammable plastic with excellent dielectric and compressive strengths, zero moisture absorption. What production puzzles can KEL-F Plastic solve for you?

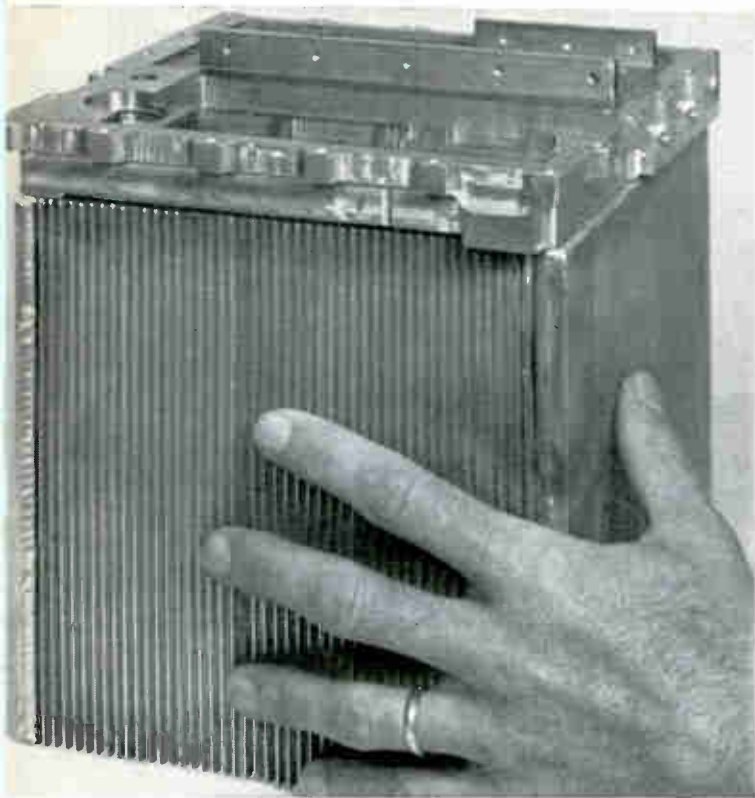

3M BRAND INERT LIQUIDS FC-75 AND FC-43 helped designers miniaturize this power unit by a "factor of six." Properties for these heat transfer fluids: high density, immiscibility and corrosion resistance . . . excellent dielectric strength, limited solubility, high thermal stability and low pour points. What can they cool off for you?

NEW FLUOREL® BRAND ELASTOMER 2141 provides an outstanding Mooney scorch curve—permits processors to make fast, economical cures . . . such as the O-ring of Fluorel Elastomer, right, which is free from defects of other elastomer O-ring shown. Fluorel Elastomer is non-combustible—provides excellent resistance to corrosives, fuels, solvents, ozone—has minimum compression set. Continuous service may be at 400° F., with reduced periods at 600° F. How can it take the heat off your electronics problems?

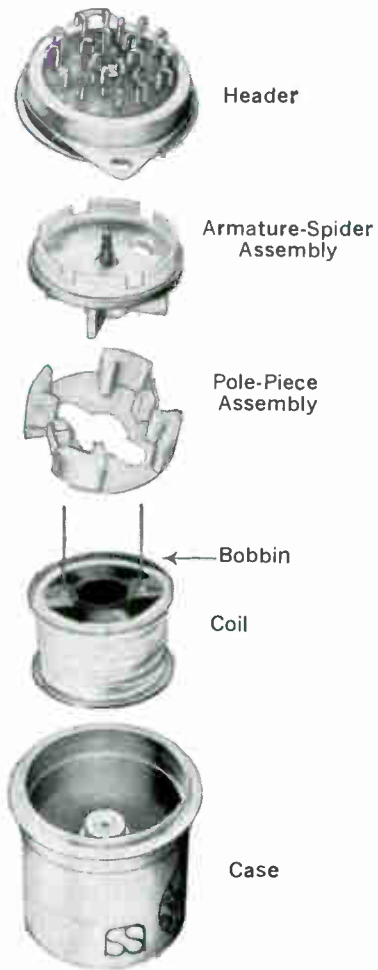

KEL-F BRAND PLASTIC is used for the bobbin in the above miniature relays used in missiles and ground support equipment. It was selected because it gave satisfactory performance consistently under all operating conditions. Its excellent electrical properties maintain high insulation resistance, especially at temperatures of 125° C. The tendency for electrical current to "creep" along the surface of the spool is almost negligible and it offers good mechanical strength as well. Can you put these electrical insulating properties to work for you?

Other members of the 3M family of specialty chemicals:

TURPOL® Brand Plasticizer for rubber compounding • 3M Brand Paint Primer Concentrate for high-strength, non-pigmented primers • KEL-F® Brand Elastomers • CARDOLITE® Brand Resin Flexibilizer for potting and encapsulation • CARDOLITE® Brand Friction Components for brake linings, clutch facings, other friction surfaces. For technical information and assistance about any of these products, write 3M Chemical Division, Dept. KAX-120, St. Paul 6, Minnesota.

"KEL-F", "FLUOREL", "TURPOL" and "CARDOLITE" are reg. TM's of 3M Co.

MINNESOTA MINING AND MANUFACTURING COMPANY

CHEMICAL DIVISION

... WHERE RESEARCH IS THE KEY TO TOMORROW



Gen. Medaris Discusses Electronics

Maj. Gen. John B. Medaris (USA, ret.) purchased equipment from our industry as the Army's top missile commander from 1955 to 1960. He is now in our industry, as president of Lionel Corp. The following exclusive interview was conducted by Senior Associate Editor Roland J. Charest



"Only real future for small firm is in specialization"

Q. General, renegotiation troubles a lot of companies. What are your views?

A. There are really two areas—redetermination and renegotiation.

The redetermination of prices on contracts is essential, if we are to move fast in the contracting field. The one sad thing that occurs is pure mechanics. A company that knows its price will probably be re-determined downward, dare not say so, nor create any fiscal reserve to pick up the slack. If they set up a fiscal reserve on their books, they have admitted to the negotiator that they expect to be negotiated downward. This is why it traps so many of them. They are unable to set up the reserves on their books and yet they get negotiated downward as they might have expected all the time.

Q. Should renegotiation be changed?

A. The big tragedy of renegotiation is the delay.

I think renegotiation is a cover plan to avoid or at least to minimize the effects of laxity in the administration of government contracts.

Q. Laxity on both sides?

A. No! Strictly on the government side. There should be a better way to recover overpayment and excess profits. If contracts are well and tightly written—and if they are well administered, you seldom get recoveries under renegotiation. The other thing we don't know is what's par for the course.

Q. Is industry guilty of concealing par for the course?

A. I don't think so. I think there is a basic difference of opinion between industry and the government as to what par should be.

Q. What advice would you give to

a small company trying to get military business?

A. Unless a small business specializes very highly in a very small field of electronics, it's going to run into an awful lot of trouble.

Q. How did you find the electronics industry to deal with, from a military viewpoint?

A. Rather difficult.

Q. Could you tell me why?

A. Yes. Because it is so difficult to define the most essential factor. That is what kind of dependence can you put on their work. It varies widely, not only between companies but, over a period of time, in the same company. This is one of the ills of the electronics industry—that people claim to do things they are unable to do.

Q. Is that because they're forced into it, General?

A. Sure. They feel they have to have business, so they are forced to attempt to do things which they are really unqualified or unable to carry through in first-class fashion.

Q. Is this getting worse now?

A. It isn't getting any better because competition is getting tighter.

Q. How does the electronics industry compare with others serving the military?

A. The electronics industry has become divided in a way that certain companies are almost entirely government, and other companies are almost entirely otherwise. And the ones that are completely directed towards the government field, are the ulcer-producers.

Q. Definition, please?

A. The backlog problem. In government business you never can see any further than over the next fence. So every day you're fighting

the problem of backlog: Have I got enough business on the books to carry me over that next fence? And this is ulcer-producing for anybody.

Q. Any suggestions?

A. The major step would be one that requires commercial courage. That is to appraise your capabilities correctly and conservatively, so that you don't offer to do something that you aren't pretty doggone sure you know how to do thoroughly and well. You should not buy the chance to do something and then try to hire the people to do it afterwards. This takes courage.

Q. If companies don't police themselves do you see the government policing?

A. The government has an indirect policing method. The government contracting officer has to make a selection, by an evaluation of the company's record. The company that has just fallen flat on its face doesn't get the next job.

Q. What'll happen to our industry when true peace comes?

A. I think we're into a period of protracted conflict, so that I think those terms of reference are highly unlikely.

Q. Would you cite any assets of our industry as you recall them?

A. The pure electronic industry has considerable momentum in new

Industry



"Some of the boys who gambled fell by the wayside—more will"



"I don't define my target until I'm ready to hit it"



"The engineering mind has inherently a good approach to business"

development. People who are thinking daily on an imaginative base have a tendency to continue.

Of greater significance is an understanding of what is taking place in the crossbreeding of technologies.

Q. Physics, for one?

A. Physics, for one; mechanics—precision mechanics; mechanics in miniature, with all of the techniques that go with it. It's difficult to find a real advance that doesn't combine more than one science.

Q. How about electronics industry management?

A. We have a general national problem in the management of technology. The real key is the question of whether management can understand what the engineers and scientists are trying to tell them.

Now if they can't, the only thing they can do is to bet blind on a man's reputation. Unfortunately, I'm afraid we have quite a number of companies where the gap is not bridged, but I do see an increasing tendency to put engineers in top management.

Q. In many areas that's here.

A. Yes, and where it is not, they have problems. We need an intensification of the education of an engineer, to be a businessman.

Q. How do you do this?

A. That's a good question. I

don't know. You either take time out to teach him, or he absorbs it by osmosis, through his skin. Fortunately, the engineering mind—I distinguish between that and the scientific mind—has inherently a good approach to business, because it goes in by the analytical route. The scientific mind, not so much so.

Q. Even in the laboratory?

A. Here is one of the great challenges of the time—the management of R&D activity. The people that you must depend upon for imaginative ideas must be given the technical freedom, and provided with the resources necessary to unlimber their imagination. Yet in the field of cold economics there has to be some limit. So the ability to challenge them within reasonable bounds and not inhibit their imagination rests on management. Somebody has to boss the laboratory as a laboratory. But somebody else has to boss it as a business mechanism.

Q. Do you have any suggestions?

A. We have to train 'em.

Q. What is the engineer's responsibility to management?

A. This depends on management. It doesn't depend on the researcher. You can draw the man out if you know how, and if you have an understanding of what he's probably thinking about; and if he can talk to you with a feeling that you un-

derstand him, he won't stay back.

Q. There's talk about central purchasing of components by the services. What are your views?

A. We just hope somebody around has enough judgment to know where to quit, with these things.

Getting back to management, it's important to motivate people to give you a little more than they know how to do.

Q. Even when they aren't aware they can give a little more?

A. Precisely. They do it if their opportunities are made proper to them and if they're put in a frame where doing what they want to do themselves is also doing what you want them to do.

Q. Proprietary rights have long been a bone of contention. How much should a company be able to keep of its secrets, and how much should the government keep?

A. I think this comes down to a basic principle in equity. What the government has paid for, the government should be able to keep; what the government has not paid for, the government has no right to. I do not believe there is any reason for the government to restrict the commercial application of a particular idea, but the one thing that I was opposed to in the service is the artificial creation of commercial competition by the government.

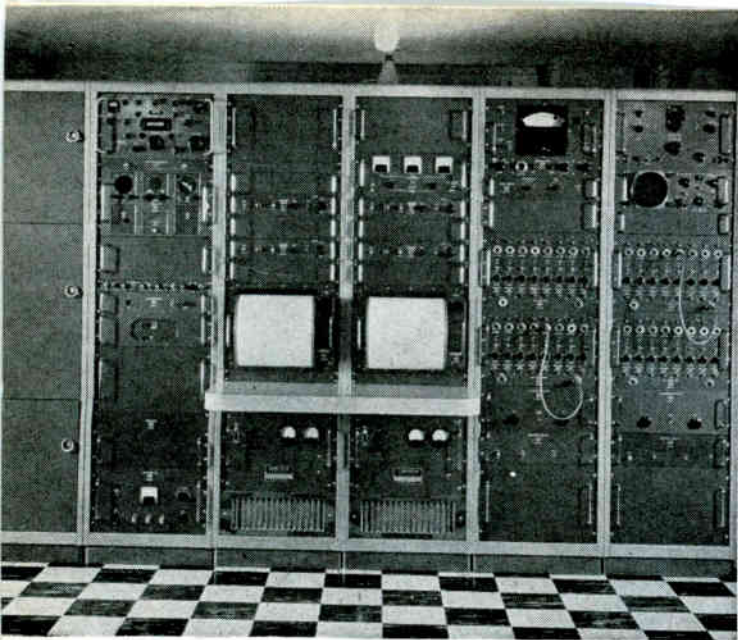

Control and recording console in central recording building of detection station

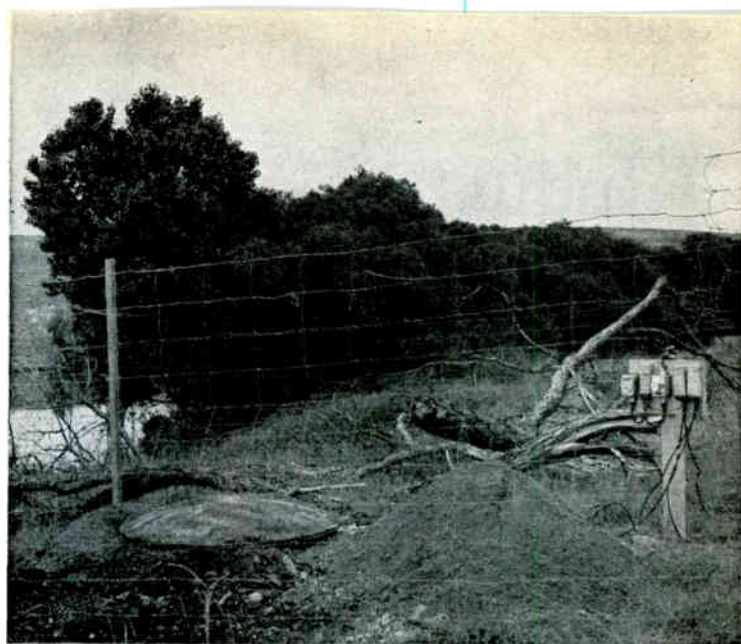

Top of underground vault with earth cover removed. Pole supports line terminations

Station Detects Underground Nuclear Blasts

Air Force station in southern Oklahoma may promote international agreement on stopping nuclear-weapons tests. It uses 21 seismometers, phototube amplifiers and processing equipment

TWENTY-ONE SEISMOMETERS (earth-motion detectors) are now being readied in the Wichita Mountains, Oklahoma for recording clandestine underground nuclear explosions. The instruments and support equipment are identical to those recommended by the conference of experts that met in Geneva in 1958 to study controlled cessation of nuclear-weapons testing. The detector station was engineered by the Geotechnical Corp. of Dallas under technical supervision of the Air Force Technical Applications Center. It is being operated by these two organizations. Overall direction is by Defense Dept's Advanced Research Projects Agency as part of its Project Vela.

Successful completion of detection-station tests are expected to influence efforts to achieve international agreement on controlled cessation of nuclear-weapons testing.

Selection of the Wichita Mountain site was made because microseismic noise (minute natural vibrations of the earth) is a minimum in this area. Man-made noise from large cities contributes to micro-

seismic noise; this rules-out some major university sites, which otherwise might have been ideal.

Electronic support equipment increases the sensitivity of the seismometers, which are set in underground vaults. The pattern of underground-vault arrangement and the distance between seismometers is such that the detector system has optimum directivity.

The seismometers detect motions within the earth in both vertical and horizontal directions. Resulting electric signals are amplified and recorded. Earth motion as small as 0.000001 inch occurring at a frequency of about one oscillation a second can be picked up. The vaults are water-and-pressure tight and are covered with one or two feet of earth to insulate the instruments from temperature changes.

Despite precautions to safeguard the instruments, basic physical phenomena may determine the system's success in differentiating between minor earthquakes and underground nuclear explosions. The originating force of all earthquakes, large or small, is generated beneath

the earth's crust. Man made nuclear explosions cannot occur at these depths. Thus, directivity not force is the prime factor in determining the existence and location of nuclear explosions, and differentiating them from earthquakes. Since passage of shock waves through the crust is more difficult than through the denser earth core, underground explosions may not be readily detected over long distances unless the detector is highly sensitive.

Four types of seismographs (seismometer plus amplifier and recorder) are used to distinguish between earthquakes and explosions. Long-period seismographs are best suited for the detection of long-period surface waves associated with explosions. Short-period seismographs best detect shorter-period body waves associated with quakes. Rejection of the shorter-period signals is made by the narrow-band seismographs that emphasize a period range of 1 to 3 seconds. For large disturbances, the broad-band seismograph responds equally well to several wave types issuing from

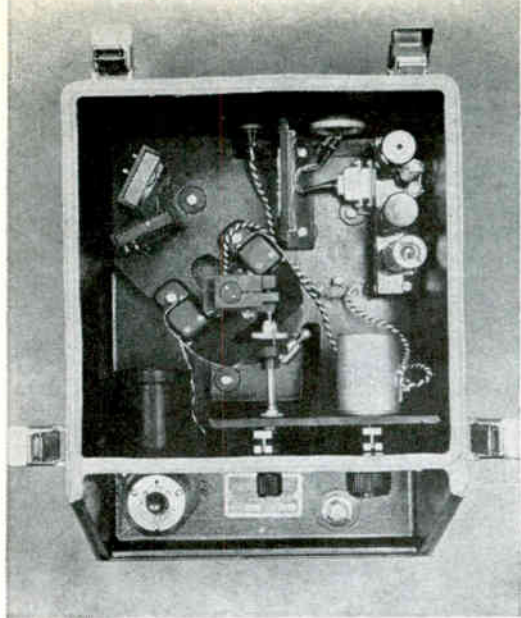

Phototube amplifier converts seismometer pickup to electrical signals

locations within the earth, although it is limited by microseismic noise. The combination of narrow and broad-band equipment may enable the detector system to gather complete data on all significant earth disturbances and to distinguish between explosions and quakes.

The phototube amplifiers, which amplify the electrical signals from the seismometers before sending them to the recording equipment, are also of two types: short-period and long-period. They are the same except for the type and period of the galvanometer used to obtain initial amplification. The light reflected from the galvanometer mirror falls on two photocells. As the galvanometer deflects in response to seismometer signals, the light varies in intensity but does not change its position on the photocells, thus improving linearity. The amplifiers' internal noise level is low enough to permit seeing the thermal-agitation noise (Johnson noise) of the seismometer coils. Amplifiers have a dynamic range of over 70 decibels.

Begun in 1959, the station was completed last October. Evaluation of the observatory's performance will be available to the scientific community and to the delegates of the United States, the U.S.S.R., and the United Kingdom who are now negotiating in Geneva to arrive at a treaty on the controlled cessation of nuclear weapons testing. The station records seismometer readings on both magnetic tape and film.

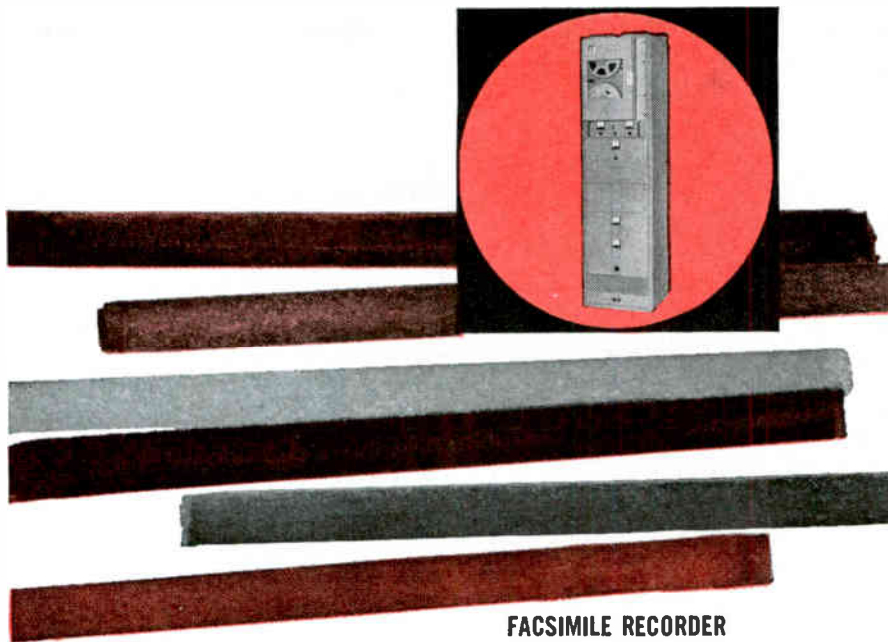

FACSIMILE RECORDER REPRODUCER...A TOTAL RECALL GRAPHIC MEMORY

The AIRCOM Modernization Program, Project Quick Fix, is aimed at improving the entire communications network which links United States military and weather installations throughout the world. An essential part of that program is the Crosby-Teletronics magnetic tape Facsimile Recorder Reproducer. It receives and stores all types of vital graphic information, retransmitting it, automatically or on command, when transmission conditions are more favorable or proper routes available.

If you have an application requiring reliable long-range transmission of maps, weather information or any other graphic material, this advance design, electronic "brain" may be your answer. Write for information on Model RR-290, Facsimile Recorder Reproducer (GXH-4). It is another example of Crosby-Teletronics Corporation leadership in test equipment, vacuum research and

communications



Crosby-Teletronics Corporation • 54 Kinkel Street • Westbury, Long Island, New York

Clevite's rectifiers find broad use as general purpose diodes in computers and as rectifiers in magnetic amplifiers, dc to dc converters and power supplies.

They are particularly useful in airborne applications where switching of equipment may generate high voltage transients in the line which would burn out ordinary diodes. Designed for maximum reliability, Clevite rectifiers provide high dissipation — 200 mw . . . high voltage — up to 600 v . . . high temperature — up to 150°C.

Where fast switching is not required, these rectifiers offer definite advantages in size, costs and superior overload protection. They are available in military types conforming to MIL-E-1143 (USAF).

Send for bulletin B217-3B

DIFFUSED SILICON RECTIFIERS

Diode Type	Maximum DC Inverse Operating Voltage (volts)	Maximum Average Forward Current @ 25°C (ma)	Maximum Forward Voltage Drop @ 25°C (volts @ ma)
1N645	225	400	1.0 @ 400
1N647	400	400	1.0 @ 400
1N649	600	400	1.0 @ 400
1N677	100	400	1.0 @ 400
1N681	300	200	1.0 @ 200
1N683	400	200	1.0 @ 200
1N685	500	200	1.0 @ 200
1N687	600	200	1.0 @ 200

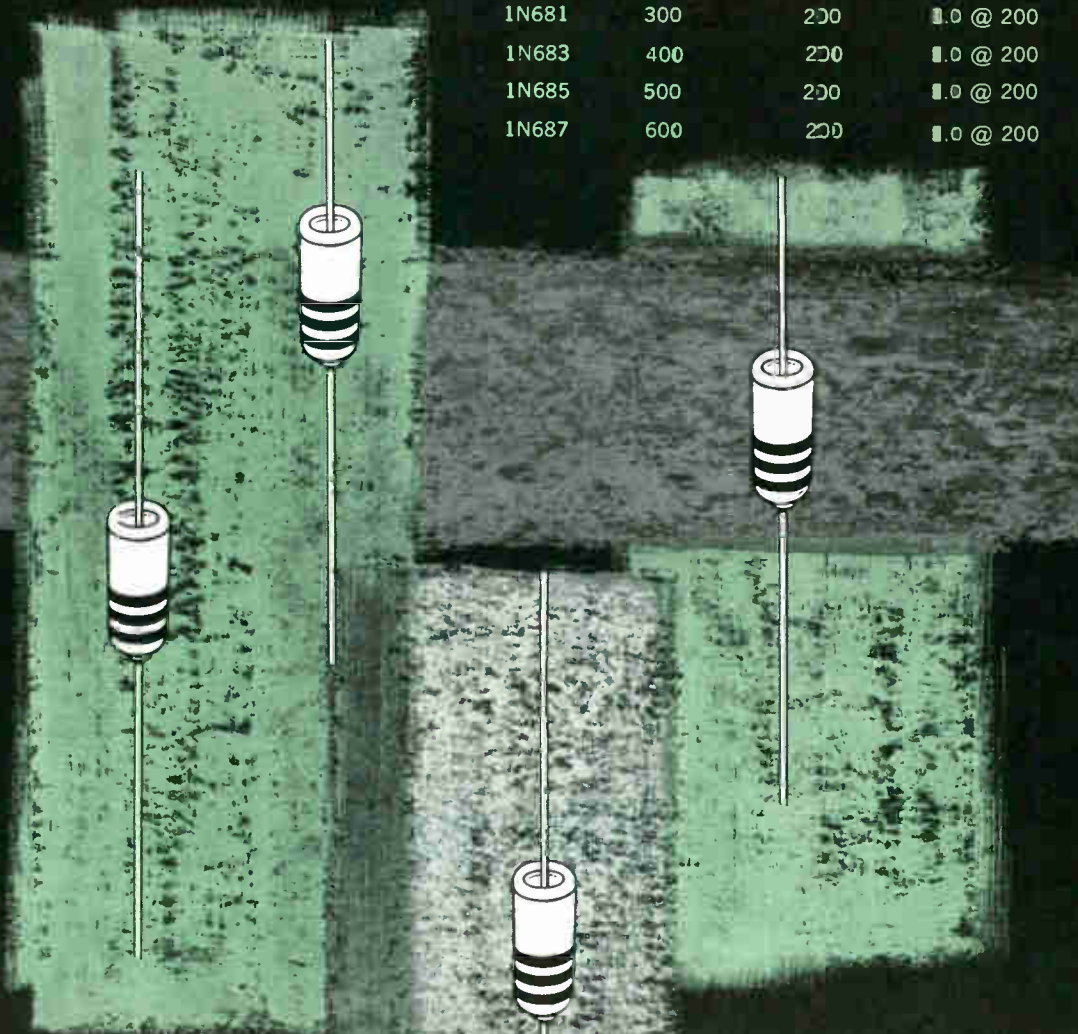

A DIVISION OF

CLEVITE
CORPORATION

Reliability In Volume

CLEVITE TRANSISTOR

200 Smith Street, Waltham 54, Mass.

Winbrook 4-7780



AIR FORCE TROPO TIES ENGLAND TO AFRICA

*Newest link hops 500 miles and features
high-power transmission gear run at 75 Kw*

THIS WEEK a multimillion-dollar troposcatter system for the U. S. Air Force is starting in Spain. The new three-hop network will join Morocco, Spain and England with high-quality voice circuits.

The project incorporates the earlier Senorita tropo circuit between Northern Africa and southern Spain that was completed in 1958 and upgraded last year to match the new network. In the new system, the first link from southern Spain goes northward approximately 250 miles; second link goes about 200 miles further to the Spanish border. The final hop stretches more than 500 miles to southern England.

Connections with a commercial telephone system will tie in air bases in England. Similarly in Spain, tie-in facilities will be provided at each repeater site.

Prime contractor, Page Communications Engineers, Inc., Washington, D. C., a subsidiary of Northrop Corp. is controlling operations from Madrid and working closely with U. S. Government agencies there. Basic engineering, in progress for over a year, is now practically complete. Equipment has been ordered from U. S. and overseas manufacturers. Deliveries beginning within the next few months with dovetail with building completions now slated for this month or early 1961.

Basic equipment in the system is the AN/FRC-39(V) tropospheric scatter radio terminal made by Radio Engineering Laboratories, New York. This transmitter-receiver gear, similar to that being procured for BMEWS, operates in the 755 to 985-Mc region. The Spain-UK system, will have 24 voice channels initially of its full 240-channel capacity. The equipment

uses parametric amplifiers in the front ends of the receivers and is designed for an intermodulation distortion figure between adjacent channels of 55 db. The FRC-39(V) contains its own exciters and quadruple diversity receivers as well as a 10-Kw power amplifier.

The FRC-39(V) will operate a 10-Kw power level on all links of the project except for the 500-mile path between England and Spain where more power is needed. A high-power amplifier made by Levinthal Electronics using a Varian klystron capable of providing 75 Kw is being used for the Spain to England hop.

Multiplexing equipment will be a frequency-division type designed and manufactured by Siemens & Halske, West Germany. The gear has been in military use in Germany and also on the Senorita circuit, where it was installed six months ago as a first step in the overall upgrading project.

Antennas for the new system will be 60-ft and 120-ft billboard types built to withstand 175-mph winds and six inches of ice while maintaining extremely close deflection tolerances. They are being made by Blaw-Knox in England and will be shipped to the site by the end of this year.

In addition to the problems of the 500-mile hop to England are natural geographic difficulties in Spain. The northern Spanish terminus is mostly rock swept by high winds and thunderstorms in summer, violent snow-storms in winter. It is fifty winding miles from the nearest town and over a hundred miles by twisting mountain roads to the nearest Air Force base.

The site in central Spain lies on a mesa near an ancient town that this year is getting its first run-

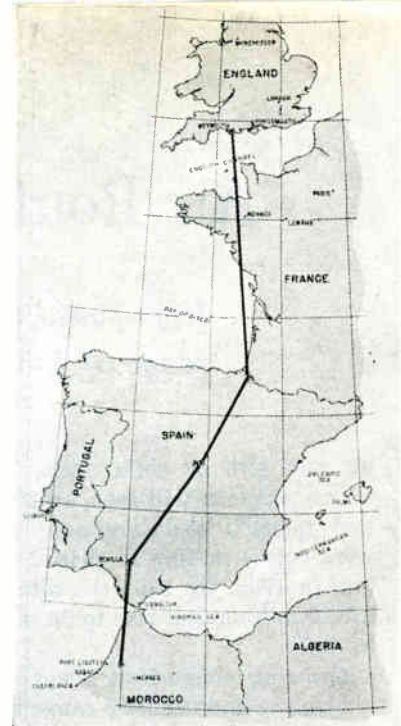

Route of UK-Spain troposcatter communication network

ning water. But this location provides ideal radio paths in three directions and will become a junction point with a future tropo system heading eastward across the Mediterranean. The main building, housing the electronic equipment will be large enough to accommodate three complete tropo terminals and an automatic telephone switching center.

The southernmost site in Spain near San Pablo is on a municipal air field close to the existing tropo site for the circuit to Northern Morocco, and also the USAF Communications Relay Center.

A feature of the new link system will be its automatic switching facilities slated for a channel control center to be installed at a site near Madrid. This will be the latest model crossbar 4-wire switching equipment manufactured by North Electric Co. It will be possible for a subscriber anywhere in the airbase complex being served to reach any other subscriber by dialing a set of code numbers. Signaling equipment of the CV-566 type, manufactured by Lynch Electric Corp. for the Signal Corps, will activate the automatic switching equipment.

Page, now operating Senorita will operate the entire new complex for a year after completion. The system is expected to be on the air by summer, 1961.

Air Route Radars to Get More Range

High-power transmitters, parametric preamplifiers will increase range of L-band units. The 40 now operating cost \$96 million

BY THE END OF THIS YEAR, U. S. major airports will rack up 22 million takeoffs and landings. There were only 4 million in 1946, 15 million in 1956. By 1965 the total will hit 30 million and rise to 35 million by 1970.

Growing congestion along U. S. airways is making long-range radar increasingly important in the Federal Aviation Agency's effort to keep control over air traffic. FAA has already committed \$96 million to building up a network of air route surveillance radars (ARSR), wants a system to keep all aircraft under continuous surveillance.

The L-band ARSRs are already spotted around the country. So far, 40 installations are complete or nearly finished. Of these, 29 are run by FAA, 11 by Air Defense Command.

The first of these stations began operating in 1957 when operations were still under control of Civil Aeronautics Administration. At that time, a \$9-million contract was awarded to Raytheon for 26 installations. Another contract for three installations went to General Electric.

Since then, contracts have been let for 18 more stations.

The last eight stations ordered contain design changes which increase range by stepping up transmitter power and through use of parametric preamplifiers for receivers, and special antennas. The new units are designed ARSR-2.

FAA has contracted separately for changeover of older stations to the new design.

Use of Raytheon's Amplitron tube boosts transmitter power output from 500 Kw peak to 4,000 Kw, giving a 68-percent range increase.

According to FAA deputy administrator J. T. Pyle, the ARSR-2 can detect a small jet aircraft like the T-33 at altitudes of more than 80,000 ft, 170 miles away. The new radar picks up large passenger planes

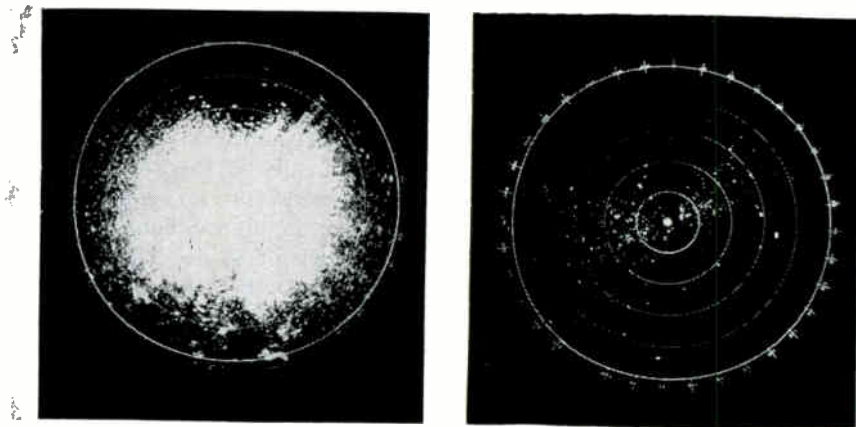

Display, left, shows conventional radar presentation obscured by ground clutter and storm return; display, right, is cleaned up by moving target indicator and circular radar polarization

at a range of more than 200 miles.

The new system also has a moving target indicator (MTI) with only one speed blind spot. (Previous MTIs for ARSR radar had several speed blind spots between zero and 600 knots.) The new system is blind only to aircraft flying towards the station at 560 knots, the speed of sound at 40,000 ft. This speed was chosen as the blind spot since most planes fly on either side of the sound barrier, seldom maintaining the speed of sound at that specific altitude.

New design allows selection of either linear or circular radar-signal polarization. This minimizes excessive clutter from atmospheric causes by giving the operator a chance to detect storm clouds, then eliminate them from the scope. Circular polarization cuts down return from spherical raindrops, passes echoes from other shapes. The circular polarizer is fitted into the waveguide beneath the antenna horn.

To help pinpoint targets, the operator can superimpose a ground-area map projection on the scope electronically. If the range setting of the radar is changed, the map changes accordingly.

The 16-in. ppi scope is said to be 300 times brighter than older scopes and give high definition (945-line resolution) while maintaining gray shades.

Scan-converter presentation includes normal video, MTI video, beacon or iff video, video mapping and combinations of these displays. Sweep ranges are 25, 50, 100 and 200 nautical miles. Each scan converter can supply data to a number of remote displays. Each display can present the total master display or a sector of it. The system also allows remote presentations by microwave relay in real time, or by relay over telephone lines with slight delays.

In addition to use by FAA, the ARSR radar equipment is also being used by Canada's Department of Transport, which maintains a network of 15 installations. Raytheon is currently installing two of the systems for Radio Suisse, one in Zurich and one in Geneva. Also in preparation is a system for the Lebanese government.

U. S. armed services are using ARSR equipment in air-defense installations, tying into FAA's overall traffic-control network where mutually convenient.

ALSiMAG[®] 243

... for LOW LOSS ... for HERMETIC SEALING

Parts Shown
Approximately
One Half Size

Impervious

**Thermal Expansion compatible
with glass-sealing alloys
(nickel-iron series)**

Unusually high Te Value

**Low Loss especially
at high frequencies**

Note These Advantageous Properties

PROPERTY	UNIT	ALSiMag 243	
Water Absorption	%	0 to .02 Impervious	
Specific Gravity	-----	2.8	
Density	Lbs. per cu. in.	.101	
Standard Body Colors ^d	-----	Buff	
Softening Temperature	°C. °F.	1 440 2 624	
Safe Temperature at Continuous Heat	°C. °F.	1 000 1 832	
Hardness	Mohs' Scale ^b	7.5	
Thermal Expansion Linear Coefficient	Per °C. 25-300°C. 25-700°C.	10.0 x 10 ⁻⁶ 11.2 x 10 ⁻⁶	
Tensile Strength	Lbs. per sq. in.	10 000	
Compressive Strength	Lbs. per sq. in.	85 000	
Flexural Strength	Lbs. per sq. in.	20 000	
Resistance to Impact (1/2" rod)	Inch-Lbs.	4.0	
Thermal Conductivity ^c (Approximate Values)	g. cal. x cm. thick cm ² x sec. x deg. C.	.008	
Dielectric Strength (step 60 cycles) Test discs 1/4" thick	Volts per mil	240	
Volume Resistivity at Various Temperatures	25°C. 100°C. 300°C. 500°C. 700°C. 900°C.	Ohms per centimeter cube	> 10 ¹¹ 5.0 x 10 ¹³ 7.0 x 10 ¹¹ 1.2 x 10 ¹⁰ 1.0 x 10 ⁹ 3.0 x 10 ⁸
Te Value ^d	°C. °F.	> 1 000 > 1 832	
Dielectric Constant ^e	60 Cycles 1 MC. 100 MC. 10,000 MC.	-----	6.3 6.2 6.1 5.8
Power Factor ^e	60 Cycles 1 MC. 100 MC. 10,000 MC.	-----	.0014 .0004 .0003 .0010
Loss Factor ^e	60 Cycles 1 MC. 100 MC. 10,000 MC.	-----	.009 .002 .002 .0058

The low loss, Te value and thermal expansion characteristics of Forsterite ceramics are not equalled by any other impervious ceramic. This is especially important when high frequencies or sealing to metals or glasses is involved.

These properties have created a steadily increasing demand for ALSiMag 243. In the past two years major improvements have been made on this material and its fabrication. We are now producing components formerly unattainable in this material and the number of applications is constantly increasing.

If your application requires the favorable characteristics of ALSiMag 243, why not send us your blue prints and outline your operating conditions? If it is possible that your requirements can be met, we will be glad to work with you at reasonable cost on prototypes for your practical tests. Test discs approximately 1/2" x 3/32" are available with our compliments.

A Subsidiary of
Minnesota Mining and
Manufacturing Company

AMERICAN LAVA
CORPORATION

CHATTANOOGA 5, TENN.
58TH YEAR OF CERAMIC LEADERSHIP

For service, contact American Lava representatives in Offices of Minnesota Mining & Manufacturing Co. in these cities (see your local telephone directory): Boston: Newton Center, Mass. • Chicago: Bedford Park, Ill. • Cleveland, O. • Dallas, Texas • Los Angeles, Cal. New York: Ridgefield, N. J. • Philadelphia, Pa. • St. Louis, Mo. • St. Paul, Minn. • So. San Francisco, Cal. • Seattle, Wash. All other export: Minnesota Mining & Manufacturing Co., International Division, 99 Park Ave., New York, N. Y.

VARIAN Potentiometer RECORDERS

Used by the thousands
because...

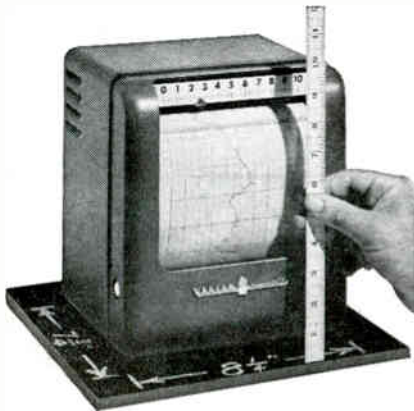

3. ANYWHERE USED, THEY **SAVE SPACE**

Equipment manufacturers praise the Varian G-11A because it fits neatly into instrument panels, occupying $\frac{1}{4}$ th the space of a conventional-sized recorder. Lab men appreciate Varian's portable versions because they add so little clutter to bench or table.

1% limit of error; 1 or $2\frac{1}{2}$ second full-scale balancing time; ranges from 0-9 millivolts to 0-100 volts; wide choice of speeds, accessories and charts; prices from \$385. For all the facts, write the Instrument Division.



VARIAN
associates
PALO ALTO 1, CALIFORNIA

Soviet Journal Blasted for Errors

JOURNAL of the Scientific-Technical Societies of the USSR recently blasted *Radiotekhnika*, one of the major electronics publications in the Soviet Union, for its "sterile scientific mannerism," for too much discussion and too few hard facts, and for errors—both factual and doctrinal.

Radiotekhnika is the organ of the Popov Society—the Scientific-Technical Society of Radio Engineering and Electrocommunications—which is roughly equivalent to the U. S. Institute of Radio Engineers. The magazine devotes itself to practical electronics.

The critical article in the journal of the parent group remarked that papers published by *Radiotekhnika* "should broadly illuminate practical problems, taking into account the needs of research, educational and planning institutes, and industry." Instead, the journal has "broken away from the radio-engineering public," publishes papers "overloaded with cumbersome, ill-conceived formulas," takes papers

"without adequate review . . . without any refereeing and on insufficient grounds," prints thesis works "to an unwarranted extent."

Other criticisms: "members of the editorial board have used their official position for pushing through their own papers and those of preferred authors." One member "even wrote a favorable decision on his own paper." Discussion papers have been inserted with "no kind of comment; if such comments are published, they contain serious errors."

More seriously still, the managing editor is accused of deducting sums from authors' fees, referees' payments and printers' costs; other editors have been, it is said, "moonlighting" and freelancing (illegal in the USSR).

In one specific instance, the editorship was blasted for refusing to follow the party line regarding noise immunity. Last year, *Radiotekhnika* published a paper which evaluated noise-interference immunity in terms of signal-to-noise ratio; official view is that noise im-

50-Million Watt Radar

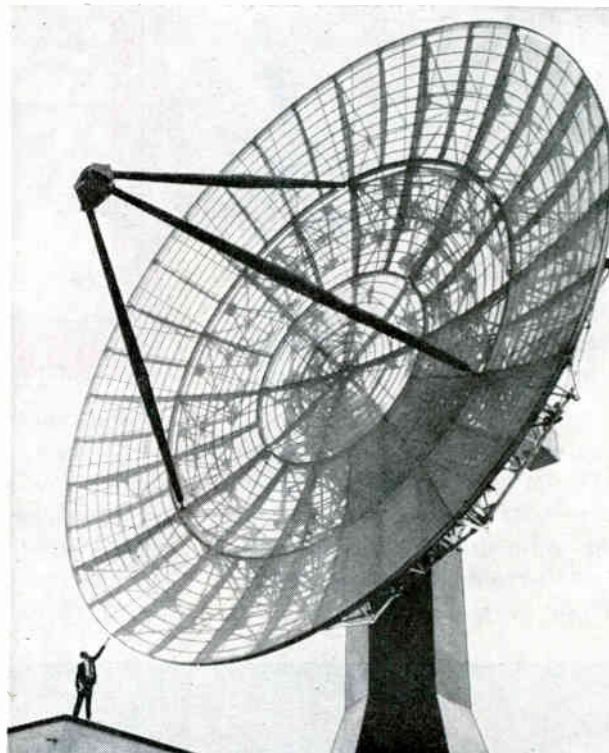

Experimental radar being built at Cornell Aeronautical Lab will be used to study ability of high-peak-power microwaves to penetrate ionosphere

munity can be evaluated only by figuring the probability of error in reception.

The magazine published the paper without comment; readers close to the party pulse wrote indignant letters; *Radiotekhnika* printed a conclusion to the effect that either method was reasonable.

Thermonuclear Reaction Controlled 1/1,000 Sec.

LIVERMORE, CALIF.—Scientists at the University of California Lawrence Radiation Lab here report the confinement of deuterium plasma at a temperature of 35 million degrees C for a period of 1/1000 sec. The experiment was significant because for the first time hot ions were involved, a situation necessary in achieving usable long-time thermonuclear reactions.

To achieve confinement, physicists used a "multistage magnetic compression mirror machine." The machine heats the plasma by confining it magnetically in several successive stages as it travels toward areas of higher magnetic field. Two stages of the machine were utilized; a three-stage test may be carried out next year.

Strength of magnetic field in the mirror machine increases from 600 gauss at point of injection of plasma to 20,000 gauss at a point 10 feet away. Pulsed magnetic fields drive the ions to regions of higher potential until, at the final stage, they are heated to 35 million degrees C and confined in an area roughly the size and shape of a football. Confinement is maintained by surrounding the ions with a region of higher magnetic force at either end.

Physicists were encouraged by finding that the plasma did not dissipate until the magnetic field was relaxed—in other words, the confinement time appears to be limited only by the period during which an exceptionally strong and stable magnetic field can be maintained.

The number of particles per cubic inch of plasma was estimated at one-millionth the number that would be in a cubic inch of air. This approaches the figure that in theory would be required in a mirror machine fusion reactor.

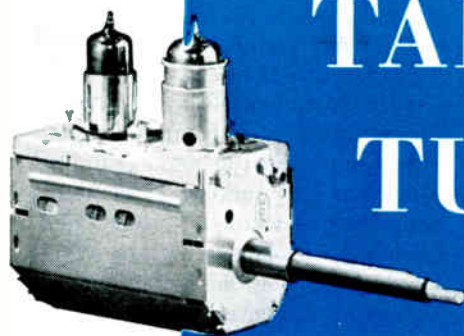

HOT ROD
(turret-type)



SILVER SEALED
(switch-type)



HI FI
(FM) Tuner

TARZIAN TUNERS

Noted for their
DEPENDABILITY
...HIGH QUALITY
and LOW COST

That's why the world's leading set manufacturers rely on the trouble-free TARZIAN TUNER for the excellent performance of their receivers.

Today TARZIAN TUNERS are backed up by more than 15 years of experience in the design . . . development . . . and production of more than 15 million TV Tuners.

And, Tarzian is the only commercial manufacturer offering both the HOT ROD (turret-type) and SILVER SEALED (switch-type) . . . as well as the newer Hi Fi FM Tuner.

All embody the high standards of QUALITY . . .

DEPENDABILITY . . . and PERFORMANCE that have made Tarzian a leader in the field.

For more information, write to: Sales Department
Tuner Division



SARKES TARZIAN INC

east hillside drive • bloomington, indiana

Manufacturers of Semiconductors, Air Trimmers and Broadcast Equipment

'No Limit to Ion Beam Focusing'

KANSAS CITY—Future breakthroughs in semiconductors will come from techniques we haven't thought of yet, said William Shockley, one of the inventors of the transistor, to 600 banquetees at Mid-American Electronics Conference here recently. He predicted methods for seeding a biaxial crystal and ion bombardment of fast-switching thin films for high-frequency applications. "There's no theoretical limit to fine focusing of an ion beam," said Shockley.

Semiconductors were featured in more than half of 38 papers. They ranged in complexity from a tutorial presentation of theory by Prof. John Warfield of Kansas University through description of a nanosecond-range bistable cryosar memory by Louis Fay, Bryant Computer Products, Walled Lake, Mich., to use of gallium arsenide tunnel diodes in amplifier, oscillator, switching and hybrid circuits, by James Shipley, Texas Instruments Incorporated, Dallas.

A transistorized magnetron-modulator, smaller and more efficient than an equivalent vacuum-tube circuit, was described by F. A. Gateka, Bell Telephone Labs., Laurel, Pa.

L. G. Larsen, University of Arizona, demonstrated design and low-noise characteristics of a coaxial-line parametric amplifier in the 72-Mc range. H. C. Hoyt, McDonnell Aircraft, St. Louis, described a 28-volt transistorized inverter power

supply that provides a regulated klystron beam potential.

Extreme complexity of tunnel-diode circuits is likely to limit their use to few-nanosecond high-speed access registers of computer memories, leaving 50-100 nanosecond applications to simpler, less costly thin films, concluded Arthur Pohm, associate professor, Iowa State University, Ames, following his survey of magnetic-film devices and their use in parametric amplifiers, parametrons and balanced modulators.

Electronic instrumentation is on threshold of tremendous boom, Robert Combs, U. of Nebraska, predicted in describing a biomedical engineering program at the school. Graduates have completed projects such as a feasibility system for wireless transmission of medical data, a low-frequency portable f-m transmitter and a prototype three-channel integrator.

Germany Markets 17-in. Portable Tv

SEVENTEEN-INCH portable television receiver recently put on the market by Korting Radiowerke GmbH of West Germany ignores the transistor trend, uses 16 tubes, sells for \$104 at export wholesale without a uhf tuner. Picture tube is a 17-in. 110-deg type. Receiver weighs 35 lb., consumes 170 w, has a silicon-diode rectifier.

Simulates Conditions 45 Miles Up

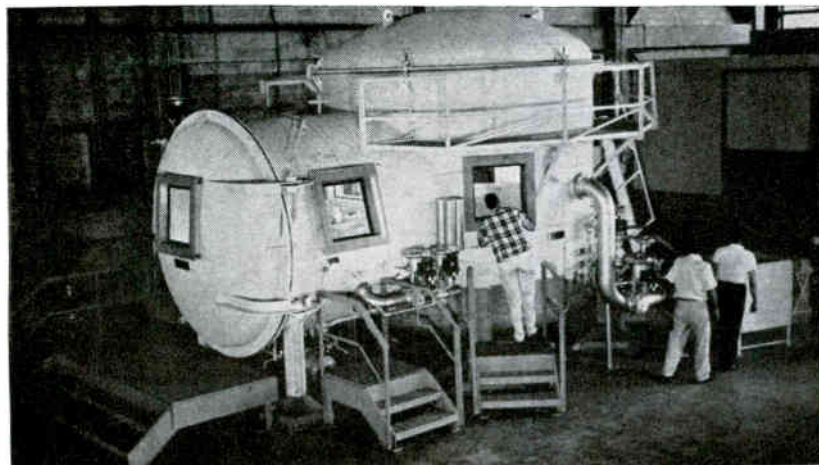

Capsule instrumentation and astronaut reaction to 45-mi altitude are telemetered from simulator (Tenney) by umbilical cord to readout



NEW RELIABILITY IN COMPUTER LOGIC CIRCUITRY

FAIRCHILD 2N706 SILICON LOGIC TRANSISTORS AND FD 100 ULTRA FAST SWITCHING DIODES ARE IMMEDIATELY AVAILABLE COAST-TO-COAST FROM THESE SOURCES.

FRANCHISED FAIRCHILD DISTRIBUTORS: Quantities 1 - 999

ALMAC ELECTRONICS CORPORATION
6301 Maynard Ave., Seattle 4, Washington
PArkway 3-7310

CRAMER ELECTRONICS INC.
811 Boylston St., Boston 16, Massachusetts
COpley 7-4700
WUX: FAX Boston, Massachusetts

DENNY-HAMILTON ELECTRONICS
1862 1/2 Bacon St., San Diego 7, California
ACademy 4-3451

HAMILTON ELECTRO SALES
12308 Wilshire Boulevard
Los Angeles 25, California
EXbrook 3-0441, BRadshaw 2-9154
TWX: W LA 6637

KIERULFF ELECTRONICS INC.
820 West Olympic Boulevard
Los Angeles 15, California
Richmond 8-2444, TWX: LA 46

PHILA. ELECTRONICS INC.
1225 Vine St., Philadelphia 7, Pennsylvania
LOcust 8-7444

SCHAD ELECTRONIC SUPPLY, INC.
499 South Market St., San Jose 13, California
CYpress 7-5858

SCHWEBER ELECTRONICS
60 Herricks Road
Mineola, Long Island, New York
Pioneer 6-6520, TWX: G CY NY 580-U

SCHWEBER ELECTRONICS, FLORIDA
P. O. Box 1491, Melbourne, Florida
PArkway 3-4461

SEMICONDUCTOR DISTRIBUTOR
SPECIALISTS, INC.
5706 West North Ave., Chicago 39, Illinois
NAtional 2-8860

VALLEY ELECTRONICS INC.
1735 East Joppa Road, Baltimore, Maryland
VAlley 5-7820, TWX: TOWS 564

VALLEY INDUSTRIAL
ELECTRONICS, INCORPORATED
1417 Oriskany Street W., Utica, New York
RANdolph 4-5168, WUX: FAX Utica, New York

WARD TERRY AND COMPANY
Electronics Parts Division
P. O. Box 869, Denver 1, Colorado
AMherst 6-3181

FAIRCHILD FIELD OFFICES Quantities of 1000 and up

LOS ANGELES, CALIFORNIA
8833 Sunset Boulevard
OLEander 5-6058, TWX: BV 7085

GARDEN CITY, L. I., NEW YORK
600 Old Country Road
Pioneer 1-4770, TWX: G CY NY 5391

OAK PARK, ILLINOIS
6957 West North Avenue
VIlage 8-5985, TWX: OAK PARK 2820

WASHINGTON 6, D. C.
1027 Cafritz Bldg., NAtional 8-7770

MARBLEHEAD, MASSACHUSETTS
19 Preston Beach Road, NEptune 1-4436

JENKINTOWN, PENNSYLVANIA
100 Old York Road
TUrner 6-6623, TWX: Jenkintown PA 1056

SYRACUSE, NEW YORK
731 James Street, Room 304
GRanite 2-3391, TWX: SS 94

ORLANDO, FLORIDA
4935 Susannah Blvd., CRestwood 7-5610



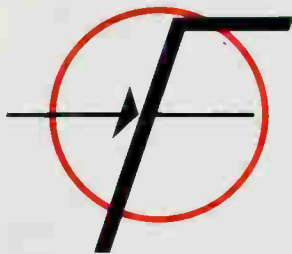

NEW RELIABILITY IN COMPUTER LOGIC CIRCUITRY

WITH FAIRCHILD CONTROLLED LIFETIME TRANSISTORS AND DIODES

These Fairchild transistors and diodes permit the design of simple, reliable computer logic circuitry through elimination of circuit clamps and speed-up capacitors. Also, transistor power dissipation is reduced. Even in this simple circuit, these Fairchild diodes and transistors — because of their controlled lifetime characteristics — permit switching speeds of 40 μ second delays per logic function. The transistors have low controlled storage time under severe overdrive conditions. The diodes have fast decay time at very low reverse current conditions. Stability over the full silicon temperature range of -55°C to $+125^{\circ}\text{C}$ provides high fan-out and very high fan-in capability.

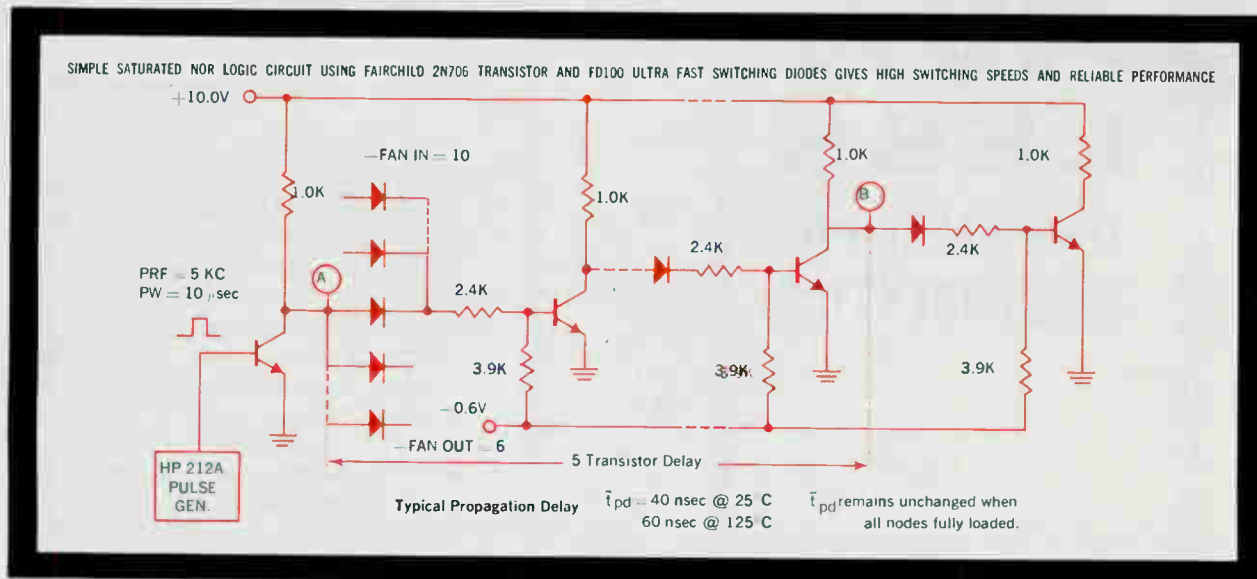

RATINGS AND CHARACTERISTICS (25°C) — 2N706 NPN DIFFUSED SILICON TRANSISTOR

SYMBOL	CHARACTERISTICS	RATING	MIN.	TYP.	MAX.	TEST CONDITIONS
V_{CB0}	Collector to base voltage	25 v				
V_{EB0}	Emitter to base voltage	3 v				
	Total dissipation, 100°C free air ambient	150 mw				
h_{FE}	D.C. pulse current gain	20				$I_C = 10 \text{ mA}$ $V_C = 10 \text{ v}$
$V_{BE(SAT)}$	Base saturation voltage			0.9		$I_C = 10 \text{ mA}$ $I_B = 1 \text{ mA}$
$V_{CE(SAT)}$	Collector saturation voltage		0.3	0.6		$I_C = 10 \text{ mA}$ $I_B = 1 \text{ mA}$
h_{fe}	Small signal current gain at $f = 100 \text{ mc}$	4				$I_C = 10 \text{ mA}$ $V_C = 10 \text{ v}$
C_{ob}	Collector capacitance (140kc)		3.5 pf	6 pf		$I_E = 0 \text{ mA}$ $V_C = 10 \text{ v}$

SPECIFICATIONS — FAIRCHILD F0100 — 25°C Except As Noted

SYMBOL	CHARACTERISTICS	MIN.	MAX.	CONDITIONS
BV	Breakdown Voltage	75 volts		@ $I_R = 5 \mu\text{A}$
I_R	Reverse Current		.100 μA	@ $V_R = 50 \text{ v}$, 25°C
V_F	Forward Voltage Drop		1 v	@ $I_F = 10 \text{ mA}$
C	Capacitance		2 μpf	@ $V_R = 0 \text{ v}$
t_{rr}	Reverse Recovery Time To $I_r = 1 \text{ ma}$		4 μs	@ $I_f = I_r = 10 \text{ ma}$
	Maximum Power Dissipation		250 mw.	
	Temp. Range Operating	-65°C to 175°C		
	Storage	-65°C to 200°C		

Write for full information on this circuit and complete specifications on the transistor and diode.

A wholly owned subsidiary
of Fairchild Camera and Instrument Corporation



545 WHISMAN RD. • MOUNTAIN VIEW, CALIF. • YORKSHIRE 8-8161

Centralab
 CERAMIC CAPACITORS
 FOR SEMI-CONDUCTOR
 CIRCUITS

COST
 UP TO
40%
LESS
 THAN PAPERS OR
 ELECTROLYTICS

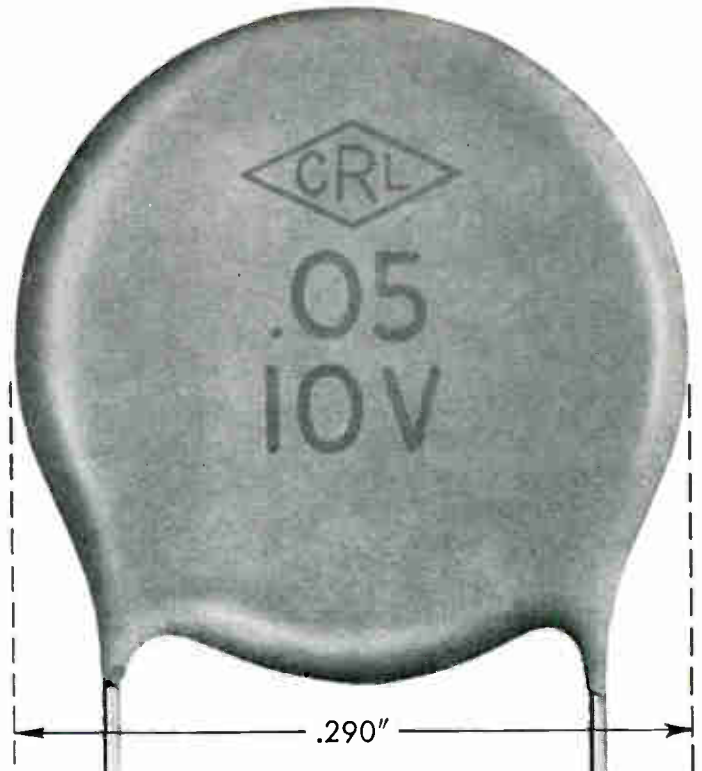

These are Ultra-Kaps*—
 ultra-miniature ceramic ca-
 pacitors for any low voltage
 use requiring extremely high
 capacities, low power factor
 and small size.

Ultra-Kaps have excellent
 stability from -55°C to
 $+85^{\circ}\text{C}$... and there has
never been a case of elec-
 trical failure among the mil-
 lions of them now in the
 field.

S P E C I F I C A T I O N S

10 VDCW Ultra-Kaps

Capacitance Range05 to .47 mfd.
 Sizes290" to .840" diam.
 Thickness156"
 Power Factor at 1 KC 10%

3 VDCW Ultra-Kaps

Capacitance Range02 to 2.2 mfd.
 Sizes125" to .840" diam.
 Thickness156"
 Power Factor at 1 KC 3%

For complete technical data write
 for Bulletins EP-594R and
 EP-746 or contact your
 CENTRALAB representative.

Centralab

The Electronics Div. of Globe-Union Inc.
 914M E. Keefe Ave. • Milwaukee 1, Wis.
 In Canada: P. O. Box 400, Ajax, Ontario

*Trademark

D-6015

Tv Techniques Speed Phone Calls

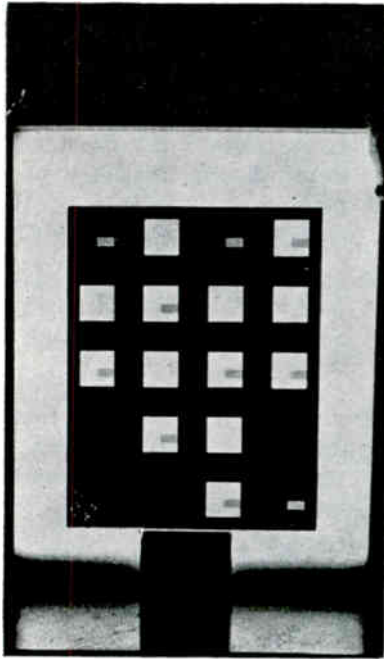

Photographic plate used in flying spot store memory. Each square has room for 33,000 information bits

STORED PROGRAM control is a key feature of Bell Lab's electronic telephone central-office system now being readied for production. The equipment solves problems in handling telephone calls a thousand times faster than does older central-office equipment. Modifications can easily be made when needed.

The system was customer-trial-tested in Morris, Illinois on November 17. Residents tried out such features as time-transfer of calls (calls automatically transferred to another phone until a specific time), use of home extension phones as intercoms, routing of incoming calls to another phone automatically when a line is busy and immediate connection made as soon as a line is no longer busy.

Dialed code inputs to a large, fast photographic memory called a flying-spot store, makes such operations possible. Information for directing switching operations is stored on four photographic plates.

In response to the dialing pulses, a cathode-ray tube reads information stored on the plates—each position of the cathode-ray beam enables it to read 67 different items. Altogether 2½ million items of information are stored and any item can be read in a few millionths of a second with all bits read in 1/9 second.

Barrier-grid tubes record dialed numbers before they are transferred to the flying-spot store. As soon as the numbers are sent to the memory, the barrier-grid tubes are erased. The barrier-grid tube is somewhat like a tv picture tube except that the target is not a phosphor screen but a piece of mica. An electron beam impinging on the target places a charge at that point. Charge or lack of charge represents information.

After receiving the dialed information, the flying spot store directs logic circuits in the closing of neon gas tube switches to route calls to their destinations.

Present dial systems have relay units that temporarily record numbers as they are dialed. Other relays perform the logic operations.

The electronic central-office system is so fast it can continually check its own circuits. When it discovers a fault, it locates and diagnoses the trouble, and in some cases, fixes it. If the fault can't be corrected by the system, the system makes a teletypewriter write out a trouble description giving also the month, day, hour and minute of malfunction.

Although the present system is only an experimental version that will probably point to many needed modifications, Bell Lab engineers are already at work on a production model suitable for volume manufacture by Western Electric Company. The overall system philosophy will remain the same. By mid 1965, the first production model is expected to be operational. From there on, the new systems will gradually replace outmoded central offices.



Vacuums approaching those of Outer Space

electronically!

From Ultek, only manufacturer devoted exclusively to the technology of fluidless vacuum pumping, the UlteVac electronic vacuum pump. UlteVac pumps produce exceptionally clean vacuums, to 10^{-9} mm Hg and below, with no moving parts, no contaminants, no hot filaments, no refrigeration; operate unattended for months.



**ELECTRONIC
HIGH-
VACUUM
PUMPS**

1 to 1000 Liters/Second



Series 110 Pump
1 Lite / Second

UlteVac pumps are rugged, easy-connecting, operable in any position. Hundreds in use in vacuum-tube processing, on super-power microwave tubes, mass spectrometers, electron microscopes, experimental applications. Immediate shipment of all sizes from stock. Ultek also offers exclusive line of high vacuum accessories including:

- SORPTION ROUGHING PUMPS
- METAL SEAL FITTINGS
- FULL CONDUCTANCE VALVES
- AMBIENT FORELINE TRAPS

Literature available (state application) from Ultek or its exclusive sales representative, Kinney Mfg. Div. of the New York Air Brake Co. Sales Offices in major U. S. cities.

U L T E K
CORP.

920-E Commercial St. • Palo Alto, Calif. • DA 1-4117

BIRD

"Termaline" 50 ohm Coaxial Line LOAD RESISTORS



**MODEL
888**

**1200
Watts**
Continuous
Duty
1500 Watts
Intermittent Duty
2 to 3 KW
Continuous Duty with
forced air cooling
Input connections are
available to terminate
most coaxial lines.

BIRD "Termaline" Load Resistors are designed to provide a constant impedance of 50 ohm from DC through the useful coaxial frequency range. Each Resistor is intended to simulate an infinite length of 50-ohm line, thus providing an almost reflectionless termination. Low VSWR and freedom from radiation makes the Bird Loads extremely useful during adjustment and testing. Measurements of power are also possible when these Resistors are used as terminations for the appropriate Bird "ThruLine" Directional Wattmeters. Accuracy in RF resistance, rugged ability to absorb power and absence of any need for adjustments has long characterized the Bird "Termaline" Load Resistors. For specifications on standard models see chart below. For other requirements please phone or write. Our long experience in this field may assist you in the solution of your problem.

Model	Max. Power	Freq. Range	Max. VSWR*	Input Connector
80-M	5 W	0-4 KMC	1.2	Type "N" male
80-F	5 W	0-4 KMC	1.2	Type "N" female
80-CM	5 W	0-4 KMC	1.2	Type "C" male
80-CF	5 W	0-4 KMC	1.2	Type "C" female
80-BNCM	5 W	0-4 KMC	1.2	Type BNC male
80-BNCF	5 W	0-4 KMC	1.2	Type BNC female
80-A	20 W	0-1000 MC	1.1	Type "N" female
81	50 W	0-4 KMC	1.2	Type "N" female
81-B	80 W	0-4 KMC	1.2	Type "N" female
82-A	500 W	0-3.3 KMC	1.2	Coplanar. Adapter to UG-21B/U supplied
82-AU	500 W	0-3.3 KMC	1.2	"LC" Jack mates with UG-154/U plug on RG-17/U cable
82-C	2500 W**	0-3.3 KMC	1.2	Coplanar. Fittings and cable assemblies for flexible and rigid coax lines available

*VSWR on all models is 1.1 max. from DC to 1000 MC.
**Water cooled

Other Bird Instruments



"ThruLine"
Directional
RF Wattmeters



"Termaline"
RF Absorption
Wattmeters



Coaxial
RF Filters



Coaxial
RF Switches



BIRD

ELECTRONIC CORP.

Churchill 8-1200
30303 Aurora Road, Cleveland 39, Ohio

Western Representative:
VAN GROOS COMPANY, Woodland Hills, Calif.

MEETINGS AHEAD

Dec. 1-2: Vehicular Communication, Annual Meeting, PGVC of IRE; Sheraton Hotel, Phila.

Dec. 5-7: Electronic Equipment Maintenance, EIA; Hilton Hotel, San Antonio, Tex.

Dec. 5-8: Electrical Insulation, National Conf., AIEE, NEMA; Conrad Hilton Hotel, Chicago.

Dec. 8: Man's Environment in Outer Space, Institute of Environmental Sciences; Henry Hudson Hotel, New York City.

Dec. 11-15: American Nuclear Society, Winter Meeting, ANS, AIF; Mark Hopkins Hotel, San Francisco.

Dec. 12-14: USA National Committee, URSI, Fall Meeting; National Bureau of Standards, Boulder, Colo.

Dec. 13-15: Eastern Joint Computer Conf., PGEC of IRE, AIEE, ACM; New Yorker Hotel, New York City.

Dec. 16-17: Combined Analog Digital Computer Systems Symposium, Simulation Councils, Inc., General Electric; Sheraton Hotel, Phila.

Jan. 8-12: Thermoelectric Energy Conversion, Dept. of Defense, Joint Technical Society; Statler-Hilton Hotel, Dallas, Tex.

Jan. 9-10: Plasma Dynamics; Southern Methodist Univ., Dept. of Mech. Engineering, Dallas, Tex.

Jan. 9-11: Reliability & Quality Control, ASQC, AIEE, EIA, PGRQC of IRE; Bellevue Stratford Hotel, Phila.

Jan. 12-13: Reliability of Semiconductor Devices, Working Group on Electron Tubes; Western Union Auditorium, New York City.

Jan. 17-19: Instrument Automation Conf., & Exhibit, ISA; Sheraton-Jefferson Hotel, Kiel Auditorium, St. Louis, Mo.

Feb. 1-3: Military Electronics, PGMIL of IRE; Biltmore Hotel, Los Angeles.

KEEP AHEAD WITH **HAVEG**

CUSTOM ENGINEERED FABRICATED SILICONE RUBBER

Today Haveg and only Haveg provides the high engineering qualities necessary to mold such difficult and complex parts . . . parts offering these important features.

1. High Temperatures—up to + 600°F.
2. Low Temperatures—down to - 150°F.
3. Excellent Electrical Properties at High Temperatures.
4. Low Compression Set Characteristics.
5. Long Life—unaffected by weather and ozone.
6. Wide Choice of Colors.

Many highly specialized procedures are essential to produce the superior quality so closely identified with Haveg. Expert tool design and construction, rigid process control and complete testing facilities are but a few of the vital operations in Haveg's quality assurance program.

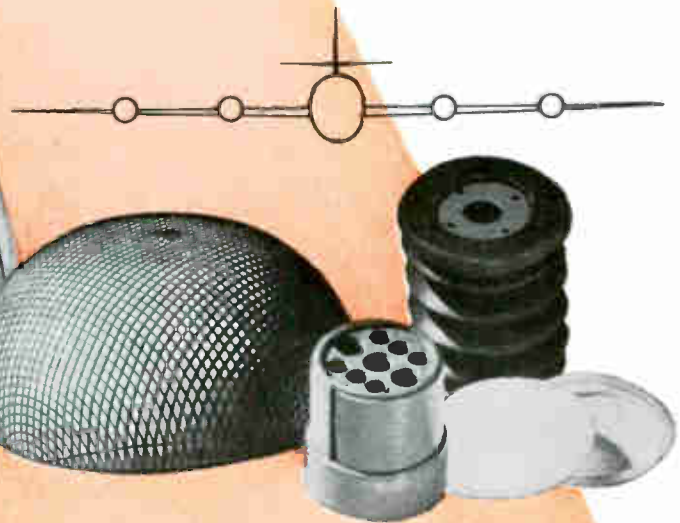

Haveg's versatile Reinforced Silicone Rubber Seals are being used with great success in aircraft, missile, electronic, appliance and other applications.

Haveg formulations maintain their physical and chemical characteristics under the most adverse conditions. By combining with use-proven reinforcing agents — Dacron[®], Teflon[®], fiber glass, Haveg can develop for the user a particular property, or a multiplicity of properties, such as strength, low coefficient of friction, maximum resistance to fuel, oil, chemicals and heat.

Haveg's Silicone Rubber can be precision molded into components of every description . . . with close tolerances to meet the most exacting specifications.

Haveg's Silicone Rubber can be extruded. Tubing, strippings, gasket material and similar products are manufactured by this method in an almost unlimited variety of sizes and configurations.

Strict adherence to the highest of standards of quality control permits Haveg to guarantee the quality of every shipment of Fabricated Silicone Rubber.

For further information, send for your copy of our new brochure giving important data on this very versatile Haveg product.

®Registered trade-mark of E. I. duPont deNemours & Co., (Inc.)



FIRST IN *Engineered* PLASTICS

TAUNTON DIVISION

HAVEG INDUSTRIES, INC.

336 Weir Street • Taunton, Massachusetts

Other Operating Divisions: American Super-Temperature Wires, Inc. — Burlington, Vermont • Blow Molding Division — Bridgeport, Connecticut • Chemical Materials Division — Wilmington, Delaware
Haveg Corporation — Wilmington, Delaware • Hemisphere Products Corporation — Rio Piedras, Puerto Rico • Reinhold Engineering & Plastics Co., Inc. — Norfolk, California

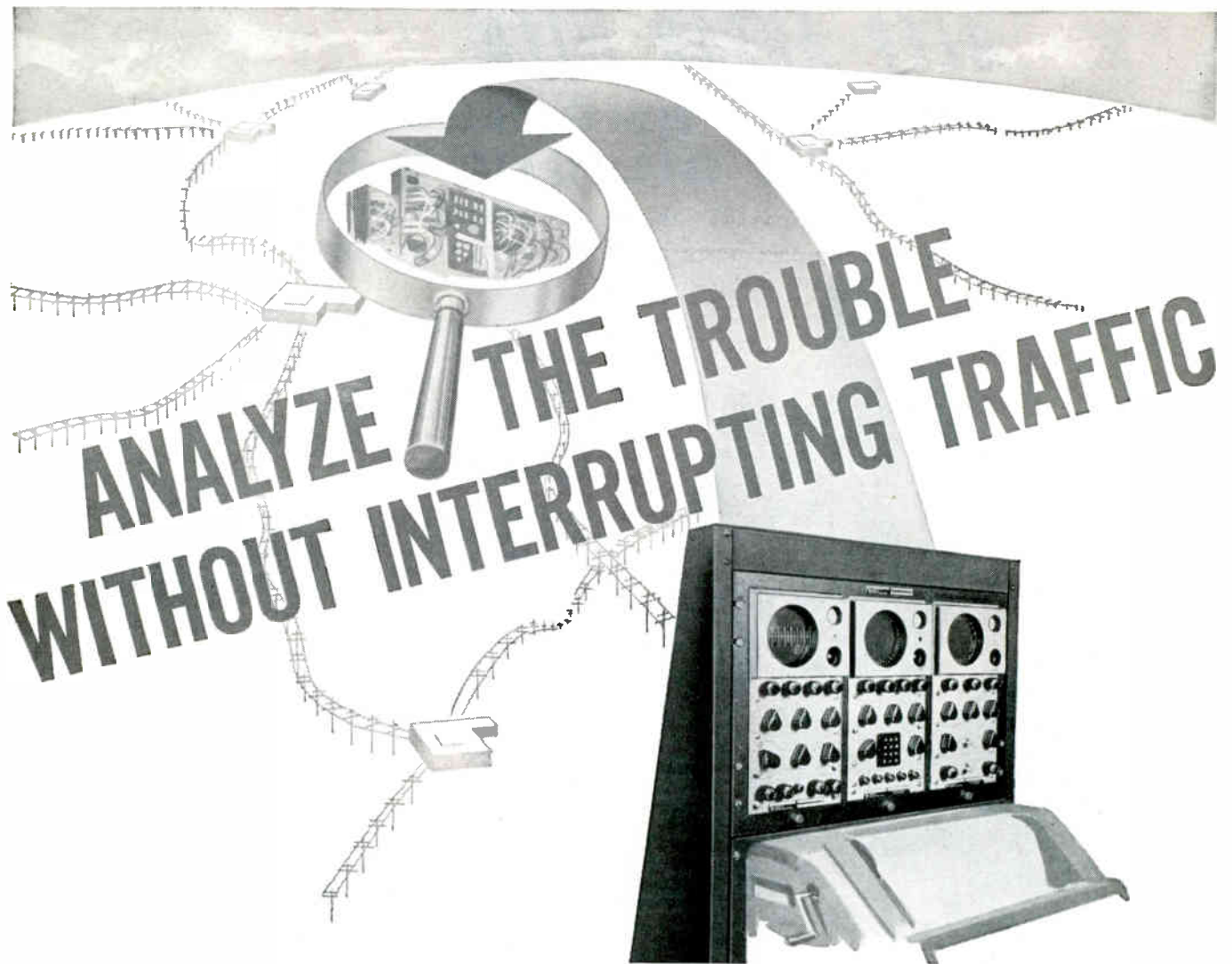

how to reduce down-time on telegraph and data transmission circuits

Radiation's new Telegraph Distortion Monitoring System (TDMS) provides in one compact assembly complete testing, monitoring and signal waveform analyses of telegraph circuits and data transmission lines. This versatile unit makes possible on-line quality control of communications links. It indicates malfunctions, analyzes their causes—without interrupting the flow of traffic.

The Radiation TDMS, with miniaturized components for space-saving compactness, can replace most test equipment now required for teletype maintenance and monitoring. Thus, in addition to reducing circuit outage, the TDMS permits reduction of test equipment costs and increases maintenance efficiency. Portability is achieved at the "push of a button".

For a detailed description of the operation and capabilities of the TDMS, write for Brochure RAD E-100B. Address Radiation Incorporated, Dept. EL-12, Melbourne, Fla.

THE ELECTRONICS FIELD ALSO RELIES ON RADIATION FOR . . .

RADIPLEX-50—channel low-level multiplexer with broad data processing applications. Features rugged solid-state circuitry, almost unlimited programming flexibility, unique modular construction for compactness and exceptional ease of operation and maintenance.

RADICORDER—Multistylus recorder provides high-speed instantaneous readout for wide range of data acquisition or processing systems. Eliminates necessity of electronically translating complete data, thereby reduces computer work loads.

TELEMETRY TRANSMITTER—Model 3115 is a ruggedized 215-260 MC unit with extremely linear FM output under the most severe environmental conditions. With its record of outstanding performance in many missile programs, Model 3115 is specified by leading missile manufacturers.

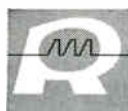

RADIATION
INCORPORATED

Available in production quantities...

2N327A | 2N328A | 2N329A Silicon PNP fused alloy transistors

Designed for switching and amplifying applications at low and medium current levels, these Hughes transistors offer you a number of advantages.

These devices, now available in production quantities, are housed in TO-5 packages. Engineered for reliability, they meet MIL-S-19500B specifications.



SILICON ALLOY JUNCTION TRANSISTORS
SPECIFICATIONS @ 25°C unless noted

TYPES 2N327A, 2N328A and 2N329A

	unit	2N327A			2N328A			2N329A		
		Min.	Typ.	Max.	Min.	Typ.	Max.	Min.	Typ.	Max.
Collector to Base Voltage (V_{CB0}) $I_{CB0} = -100 \mu\text{A dc}$	Vdc	-50	-65		-50	-65		-50	-65	
Emitter to Base Voltage (V_{EB0}) $I_{EB0} = -100 \mu\text{A dc}$	Vdc	-20	-50		-20	-50		-20	-50	
Collector to Emitter (V_{CE0}) $I_{CK0} = -100 \mu\text{A dc}$	Vdc	40	50		35	50		35	50	
DC Current Gain (h_{FE}) $I_B = 0.1 \text{ mA}$, $V_{CE} = -0.5 \text{ Vdc}$		9		22	18		44	36		88
DC Current Gain (h_{FE}) $I_B = -1.0 \text{ mA}$, $V_{CE} = -1.5 \text{ Vdc}$		6	11		9	18		14	26	
Transfer Ratio (h_{FE}) $V_{CE} = -5 \text{ Vdc}$, $I_C = -3 \text{ mA}$, $f = 1 \text{ kc}$		8	14		16	28		32	48	

Power Dissipation... 385mW (derate 3mW/°C above 25°C)
Operating and Storage Temperature Range... -65°C to +160°C

CREATING A NEW WORLD WITH ELECTRONICS

HUGHES

SEMICONDUCTOR DIVISION
HUGHES AIRCRAFT COMPANY

For further information, call the Hughes Semiconductor sales engineer or authorized distributor in your area.
Or write Hughes Semiconductor Division, Marketing Department, 500 Superior Avenue, Newport Beach, California.

CIRCLE 49 ON READER SERVICE CARD

CIRCLE 50 ON READER SERVICE CARD →



AN ACHIEVEMENT IN DEFENSE ELECTRONICS

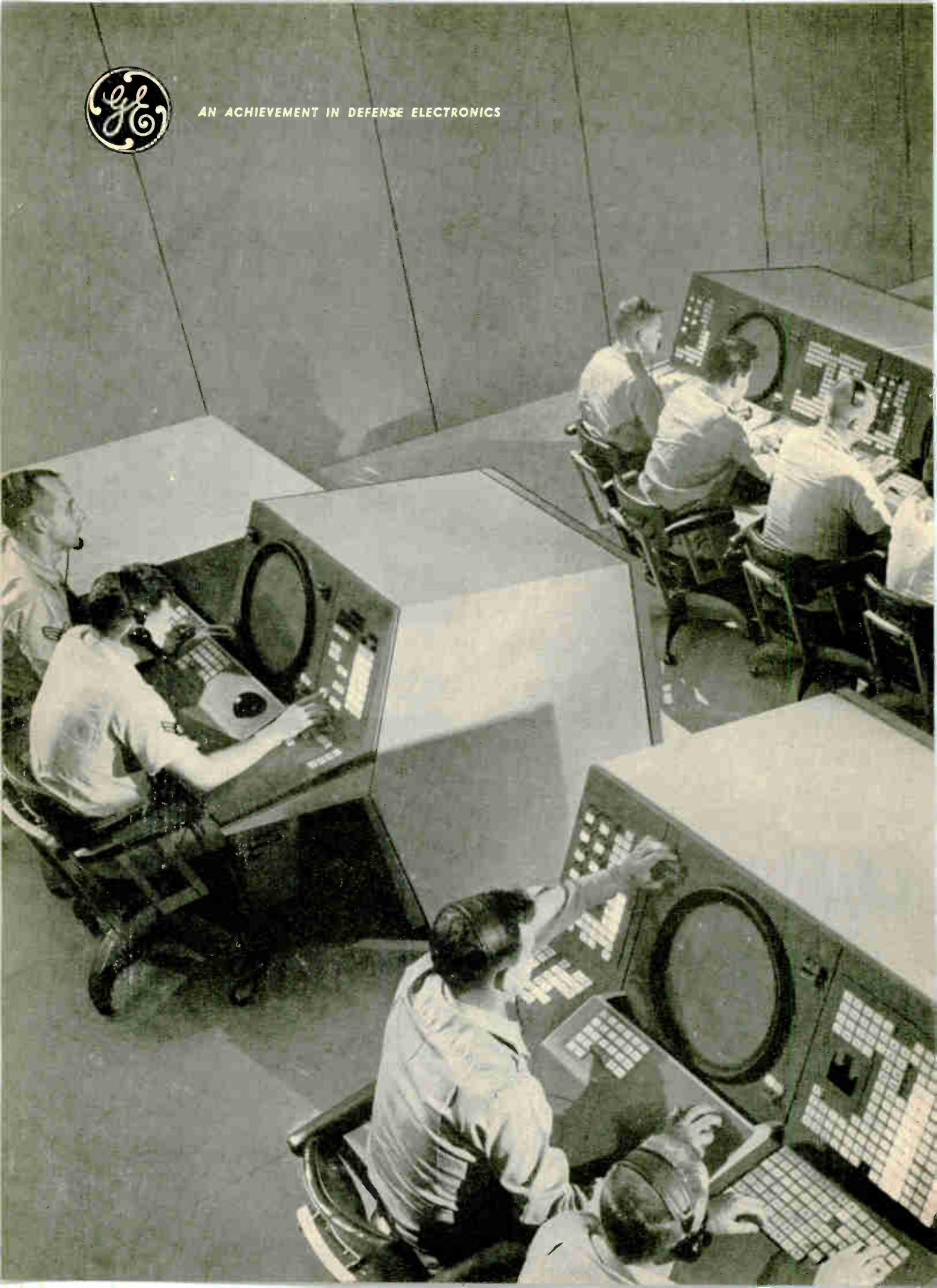

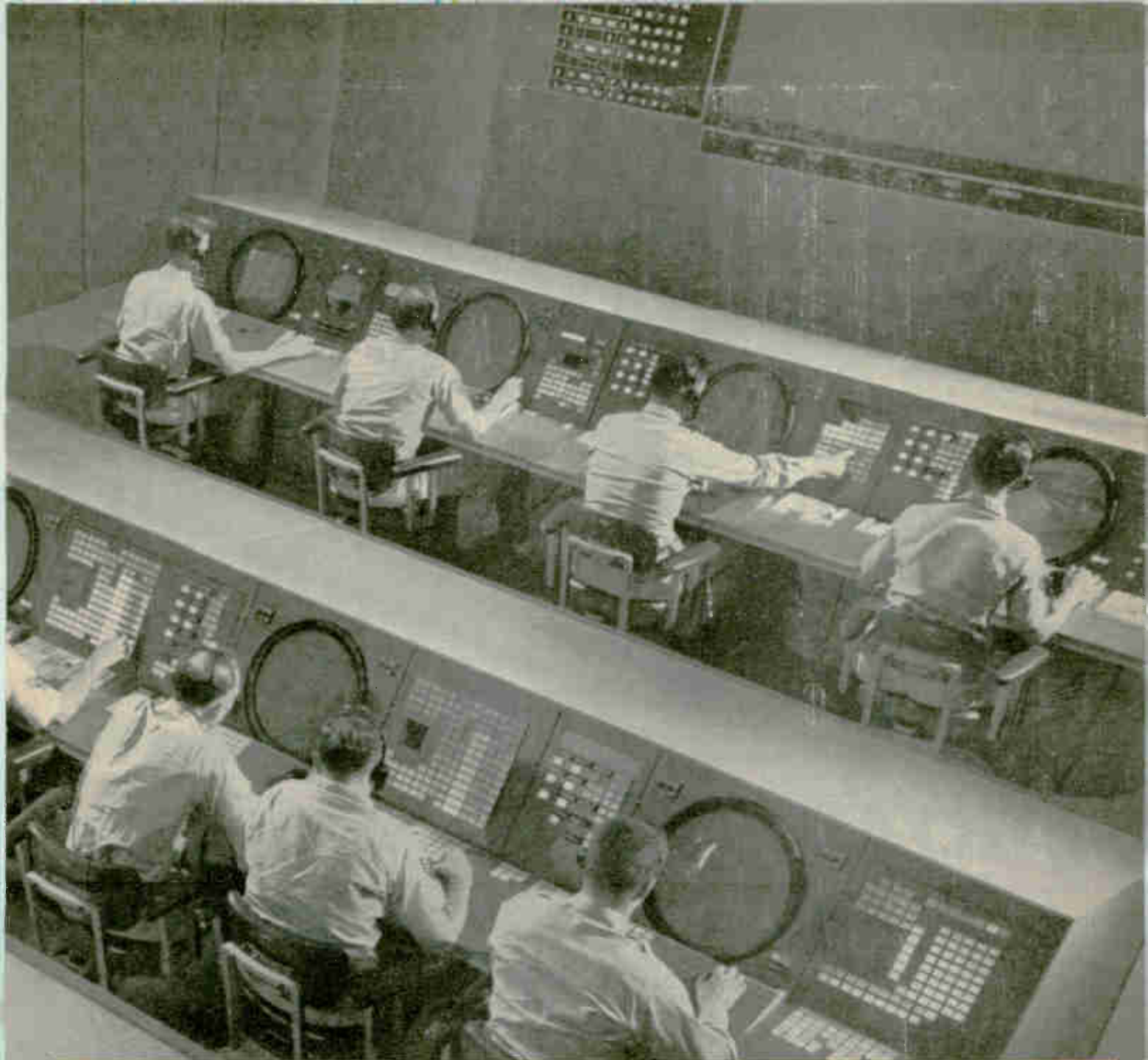

412L Strengthens Air Defense By Integrating Airspace Management

Rapid coordination of all phases of military airspace management is a major problem of air defense. This simulated operations room depicts the heart of the Air Force's 412L Air Weapons Control System—a single, semi-automatic electronic complex which coordinates radar stations, data processing and display centers and weapons bases into a unified network.

Within seconds, 412L will provide the vital detection and tracking data to human decision makers. Precious time will be gained since compu-

tations leading up to the final decisions will be done automatically. In addition, 412L is a highly flexible system designed for use throughout the Free World. It will operate in mobile as well as fixed environments.

Currently going into prototype production, 412L has already anticipated technological advances. And, importantly, new equipment can be integrated into this versatile Air Weapons Control System in the future, assuring a complex which will remain combat-ready for many years.

176-05

Progress Is Our Most Important Product

HEAVY MILITARY ELECTRONICS DEPARTMENT
DEFENSE ELECTRONICS DIVISION • SYRACUSE, NEW YORK

GENERAL  ELECTRIC

Stocked for Immediate Delivery NEW ALPHLEX® TEFLON* TUBING

Only Alpha gives you this delivery service because Alpha maintains a complete stock inventory of Teflon Tubing at all times... And Alphlex means quality: With wall thicknesses as thin as .009", this tubing retains all its properties in temperatures up to 250°C, and as low as -90°C. Thin wall — small size — unsurpassed flexibility — permit miniaturization and compactness of design not possible with conventional thermoplastic tubing.

Alphlex Tubing is available for immediate delivery through your local Alpha Wire Electronic Parts Distributors. Write for your free Catalog TS-2.

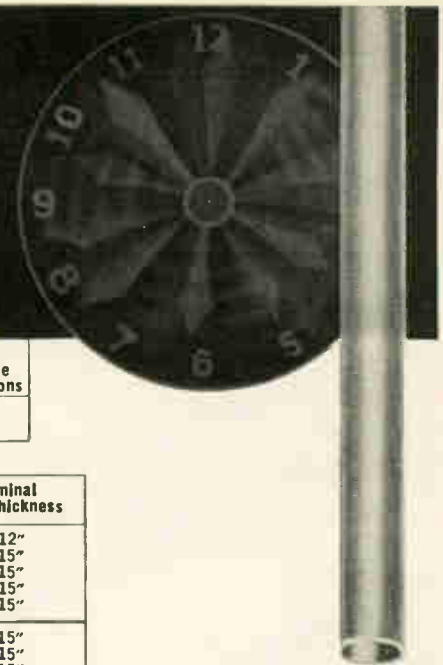

Dielectric Strength	Temp. Rating	Low Temp. Flexibility	Flammability	Tensile Strength	Ultimate Elongation	Fungi & Oil Resistance	Corrosion & Abrasion Resistance	Applicable Specifications
500-1000 V/MIL	250°C	-90°C	Non-Flammable	1500-3000 PSI	100-200%	Excellent	Excellent	ASTM

TABLE OF WALL THICKNESSES

Size	Nominal Inside Diameter	Nominal Wall Thickness	Size	Nominal Inside Diameter	Nominal Wall Thickness
30	.012"	.009"	10	.106"	.012"
28	.015"	.009"	9	.118"	.015"
26	.018"	.010"	8	.133"	.015"
24	.022"	.010"	7	.148"	.015"
22	.027"	.010"	6	.166"	.015"
20	.034"	.012"	5	.186"	.015"
19	.038"	.012"	4	.208"	.015"
18	.042"	.012"	3	.234"	.015"
17	.047"	.012"	2	.263"	.015"
16	.053"	.012"	1	.294"	.015"
15	.059"	.012"	0	.330"	.015"
14	.066"	.012"			
13	.076"	.012"			
12	.085"	.012"			
11	.095"	.012"			

ALPHA WIRE CORPORATION

200 Varick Street, New York 14, N. Y.

Pacific Division: 1871 So. Orange Dr., Los Angeles 19, Calif.

Subsidiary of LORAL Electronics Corporation



* T.M. DuPont

CIRCLE 200 ON READER SERVICE CARD

DELTASWITCH

PATENTED

A HIGH SPEED MERCURY COMMUTATING SWITCH

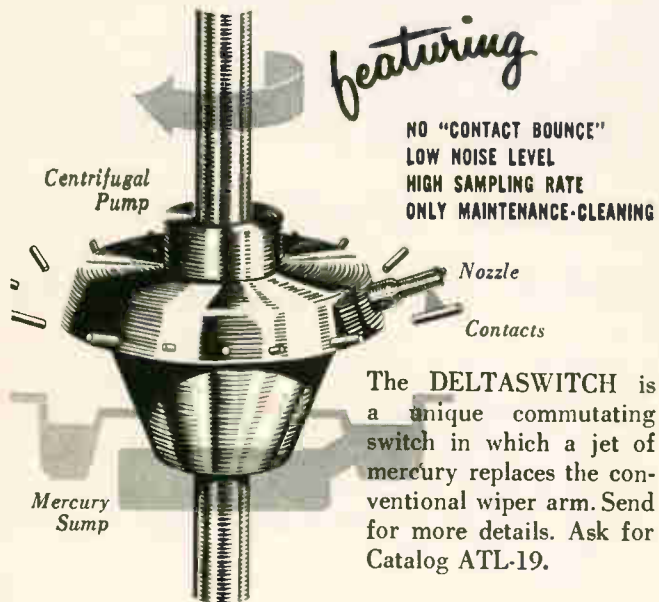

The DELTASWITCH is a unique commutating switch in which a jet of mercury replaces the conventional wiper arm. Send for more details. Ask for Catalog ATL-19.

ADVANCED *Technology* LABORATORIES
A DIVISION OF AMERICAN-Standard

DEPT. AEI 369 Whisman Road, Mountain View, California

52 CIRCLE 52 ON READER SERVICE CARD

ALL DIGITS CAN BE READ FROM ANY ANGLE

IN-LINE DIGITAL READOUT

featuring
ONE-PLANE PRESENTATION
Series 10000

Over 1000 firms throughout the world in just a few years prove unprecedented acceptance of IEE digital readouts.

The IEE digital readout puts the digit right up front, visible from any angle. Vision is unimpaired by stacked characters and sharp, clear-white digits provide high-contrast, error-proof reading. Use of words, color, and multiple projections offer utmost versatility.

PRICE \$1800 COMPLETE
QUANTITY PRICES ON REQUEST
WRITE TODAY FOR COMPLETE SPECIFICATIONS.

Binary-To-Decimal Decoders Available.
Representatives in Principal Cities

IEE INDUSTRIAL ELECTRONIC ENGINEERS, INC.
Engineers and Manufacturers of Fully Automatic Systems and Digital Readouts
5528 Vineland Avenue, North Hollywood, California

CIRCLE 201 ON READER SERVICE CARD

NOW ultra-accuracy possible in 2-speed servo systems with use of Ketay Vernier Resolvers

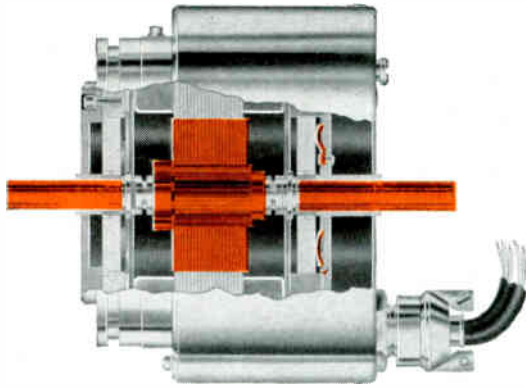

Ketay has developed a Vernier Resolver which permits the Systems Engineer to achieve utmost accuracy in his two-speed system. Replacing the fine speed transmitter and associated gearing on one end, and the fine speed receiver with coarse-to-fine gearing on the other end, it provides a basic system accuracy from input to output shaft of the order of 20 seconds of arc, maximum.

Operating on a variable reluctance principle, this resolver accomplishes its gear-up electrically . . . permitting coarse and fine speed units to be coupled directly. Thus, costly gearing with its contributing errors is eliminated. Also, as a variable reluctance device, it requires no windings on the rotor and therefore no sliprings or brushes. Errors due to brush contact resistance are eliminated, while greater reliability, extremely low breakaway torque and longer life are achieved.

The Vernier Resolver, in conjunction with a standard resolver, may also be used as a highly precise shaft angle encoder.

TYPICAL SPECIFICATIONS

These typical specifications are for a particular vernier resolver designed for a specific application and are included here to give a general idea of what parameters are available. Vernier resolvers can be supplied for a wide range of voltages, currents and frequencies. Electrical to mechanical ratios can be changed to suit specific needs.

Type #	SP 164
Electrical to Mechanical Ratio (Gear up)	64 : 1
Excitation	10 volts, 2.441 K.C.
Error Spread of Null Crossover points (Max.)	12 (seconds)
(3), (2) Error Spread over a Vernier interval (Max.)	4.5 (minutes)
Maximum over-lapping error between intervals—approx.:	21 (seconds)
Peak Output Voltage: (volts)	$2.3 \pm 10\%$
Peak Output Voltage on reference winding: (volts)	$2.5 \pm 4\%$
Open Circuit excitation current (untuned) (amps)	$0.64 \pm 4\%$
Open Circuit excitation current (tuned) (amps)	$0.065 \pm 10\%$
Open Circuit power (watts)	$0.65 \pm 10\%$
Max. Starting Torque (in-oz.)	0.1
Input impedance (ohms)	$15.6 \pm 4\%$ $\angle 84^\circ$
Null Voltage at Zero Points: (total rms)	7.5 mv.
Peak Third (3) harmonic voltage (mv.)	8.5
Phase Shift of output to input, approx.	3°
Ambient temperature (C)	-20° to $+70^\circ$
Weight—approximately	8 lbs. 13 oz.

- NOTES: 1. Configurations, size, weight, etc. can be modified to suit specific applications.
 2. Error spread can be trimmed down to value of over-lapping error or less.
 3. Error is for unit being used as 2 Phase Transducer.

Submit your problems to us and a qualified Ketay engineer will show you how a vernier resolver may solve them.

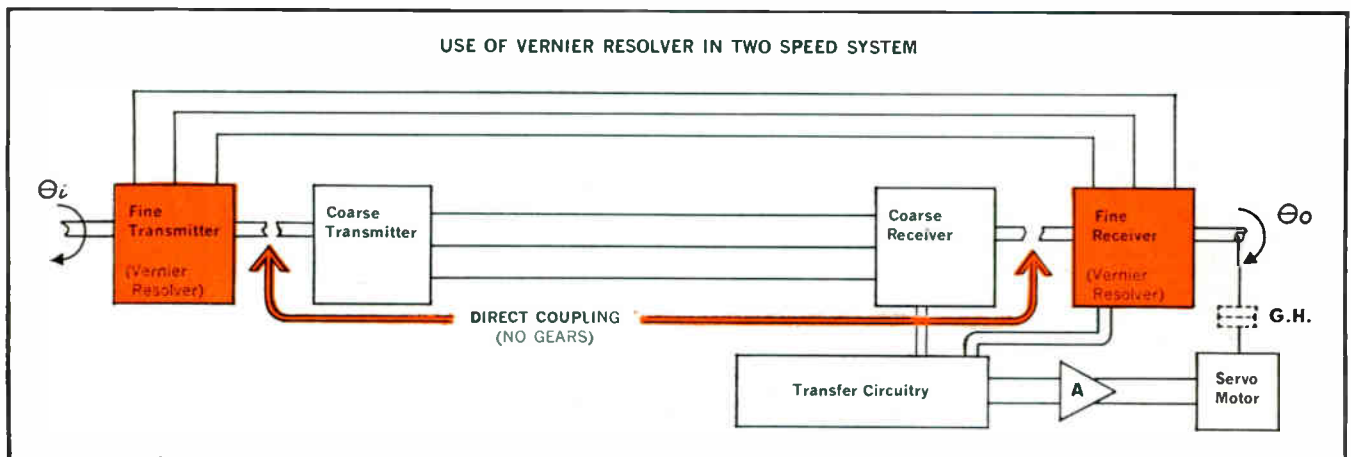

KETAY DEPARTMENT
NORDEN DIVISION
 UNITED AIRCRAFT CORPORATION
 COMMACK, LONG ISLAND, NEW YORK

PHILCO ANNOUNCES

NEW HIGH-SPEED
SWITCHING TRANSISTOR
IN TO-18 CASE...

MASS PRODUCED *with*
ABSOLUTE UNIFORMITY
to the **TIGHTEST SPECS**
IN THE INDUSTRY



This new Philco Germanium MADT is specifically designed for high-speed switching applications and is the ideal NOR logic transistor. The MADT Precision-Etch* process makes it possible to manufacture the 2N779 with the tightest control of parameters of any transistor in the entire industry. This extreme uniformity greatly simplifies the design of high performance, low cost switching circuits. For complete data and information, write Dept. E12260.

*Trademark Philco Corp.

MADT° 2N779					
ABSOLUTE MAXIMUM RATINGS					
Storage Temperature	-65°C to +100°C				
Collector Voltage, V_{CE}	-15 volts				
Total Device Dissipation at 25°C	60 mw				
ELECTRICAL CHARACTERISTICS (T=25°C)					
Static Characteristics		Min.	Typ.	Max.	
Collector Cutoff Current, I_{CBO} ($V_{CB} = -5v$)			1.0	3	μA
DC Current Amplification Factor, h_{FE} ($V_{CE} = -0.5v$, $I_C = -10$ ma)		50	90	200	
Base Voltage, V_{BE} ($I_C = -10$ ma, $I_B = -0.5$ ma)		0.29	0.33	0.36	volt
Collector Saturation Voltage, $V_{CE(SAT)}$ ($I_C = -10$ ma, $I_B = -0.5$ ma)		.09	0.12	0.16	volt
High Frequency Characteristics					
Output Capacitance, C_{ob} ($V_{CB} = -3v$, $I_E = 0$, $f = 4$ mc)			1.9	2.5	$\mu\mu f$
Input Capacitance, C_{ib} ($V_{EB} = -1v$, $I_C = 0$, $f = 4$ mc)			6.0	10	$\mu\mu f$
Gain Bandwidth Product, f_T ($V_{CE} = -5v$, $I_E = 7$ ma)		320	450		mc
Switching Characteristics					
Rise Time, t_r ($\beta_C = 10$)			13	18	$\mu\mu\text{sec}$
Hole Storage Factor, K'_s			39	50	$\mu\mu\text{sec}$
Fall Time, t_f ($\beta_{CO} = 10$)			10	18	$\mu\mu\text{sec}$

Immediately available
from your Philco
Industrial Semiconductor
Distributor.

PHILCO
Famous for Quality the World Over

LANSDALE DIVISION • LANSDALE, PENNSYLVANIA



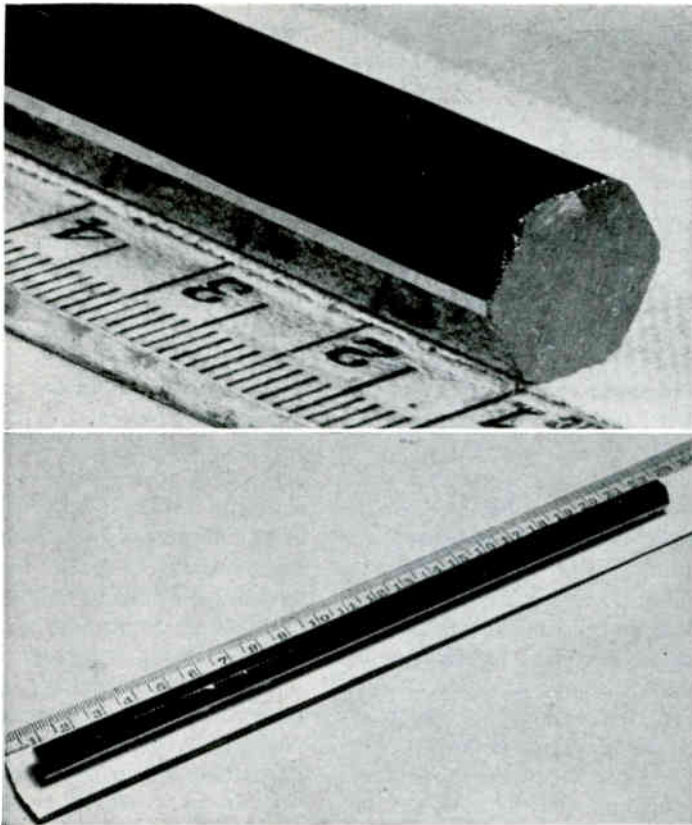

Typical single crystals formed by vapor phase deposition method

Silicon semiconductor devices can be formed by vapor deposition of single-crystal silicon layers on single-crystal silicon substrate. Technique is applicable to formation of complete circuits

LAMINAR JUNCTION LAYERS— New Concept in Microcircuits

By J. E. ALLEGRETTI, D. J. SHOMBERT,
Merck Sharp & Dohme Research Laboratories, Rahway, N. J.

CONTIGUOUS DEPOSITION of single-crystal silicon layers on a single-crystal silicon substrate by vapor-phase reduction of a volatile silicon derivative with hydrogen provides a new technology for forming complex solid-state configurations.

The laminar layers formed can be controlled in conductivity type, resistivity and thickness, to form a number of semiconductor device configurations during growth of the single crystal. These configurations can be deposited by a continuous growth process by changing the reactant gas composition to form lay-

ers in combinations; see Fig. 1.

Crystals formed by vapor deposition have been grown on cylindrical $\langle 111 \rangle$ oriented substrates. The growth direction is perpendicular to the axis of the substrate and proceeds outward from the substrate $\langle \bar{2}11 \rangle$ planes to form a crystal rod with a hexagonal cross section.

Typical vapor-deposited single crystals are shown in the photograph. The axis of the crystal is $\langle 111 \rangle$ oriented and the crystal faces on which deposition occurs are $\langle \bar{2}11 \rangle$ directed.

The crystal shown on the front

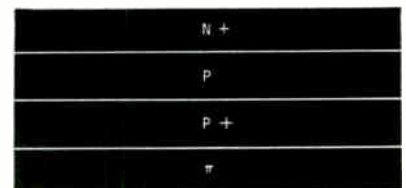

FIG. 1—Typical layered structure

cover was cut perpendicular to the $\langle 111 \rangle$ axis. It was grown by alternating p and n -type carriers during growth to form 12 deposited layers. This laminar layer structure was not intended to perform any electrical function, but was used to measure the rate of silicon

deposition as a function of surface area. The number of layers formed in this crystal shows that complex layered structures may be formed that could contain a number of electrically active elements at predetermined locations in the crystal. The number of layers formed in this crystal exceeds the number of layers that can be produced by more conventional junction-forming technologies.

The vapor deposition process has successfully produced many of the conventional device configurations, such as high-voltage *pin* rectifiers with peak-inverse voltages exceeding 2,000 volts, Zener diodes, *pnpn* switches, transistors and solar cells.

Relatively large areas can be formed by the deposition method. It is possible to think of areas of several square inches, since areas approaching these dimensions have been reproducibly prepared and measured.

A feature of forming layers by vapor-phase deposition is that control of doping agents during the growth process permits depositing layers with controlled resistivity gradients. As examples, step-type junctions similar to those obtained by alloying can be formed. Layers can be deposited with graded re-

sistivity profiles, as formed by solid-state diffusion, or with an inverse diffusion gradient.

Ability to control the resistivity gradient in each layer opens new approaches to the formation of devices. The *nipn* transistor recently announced by Bell Telephone Laboratories is an example of a structure made possible by vapor-phase deposition.

A number of advantages are indicated from the formation of junction layers by vapor-phase deposition. Relatively thick layers of silicon can be deposited, permitting electrical isolation between adjacent layers. As an example, a *pnp* configuration need not act as a transistor. If the *n* layer is heavily doped and relatively thick, there will be no electrical interaction between the three layers, and the *pnp* configuration will act as two back-to-back diodes. This, therefore, permits building a number of layers and retaining individuality of the devices within the structure.

Another property of the deposition method is that it is possible to put highly doped layers in the interior of a structure during the growth process. Thus a p^+ or n^+ layer could be buried five or six layers beneath the surface. This

would make possible a highly-conductive path or an isolation layer deep within the device. Positioning these heavily doped regions within a structure is now not possible by diffusion or alloying.

Deposition of lightly-doped regions of silicon on the surface or within the structure can be of advantage in many device designs. A number of alternating high-resistivity *n* and *p* layers, each relatively thin, may be deposited at the bottom of a device to provide an isolation region between deposited layers. This would reduce capacitive coupling between separate portions of the structure and also provide a high-resistivity path, since many back-biased diodes must be traversed to go from one region to another within a structure.

To form mesas on a finished structure for isolating certain device areas requires either etching or cutting down to a desired position in a structure to expose the proper layer. During deposition, certain layers could be made relatively thick solely to make the region easy to locate.

Another property of the deposition method is that each device structure within a crystal can be preceded and followed by a heavily

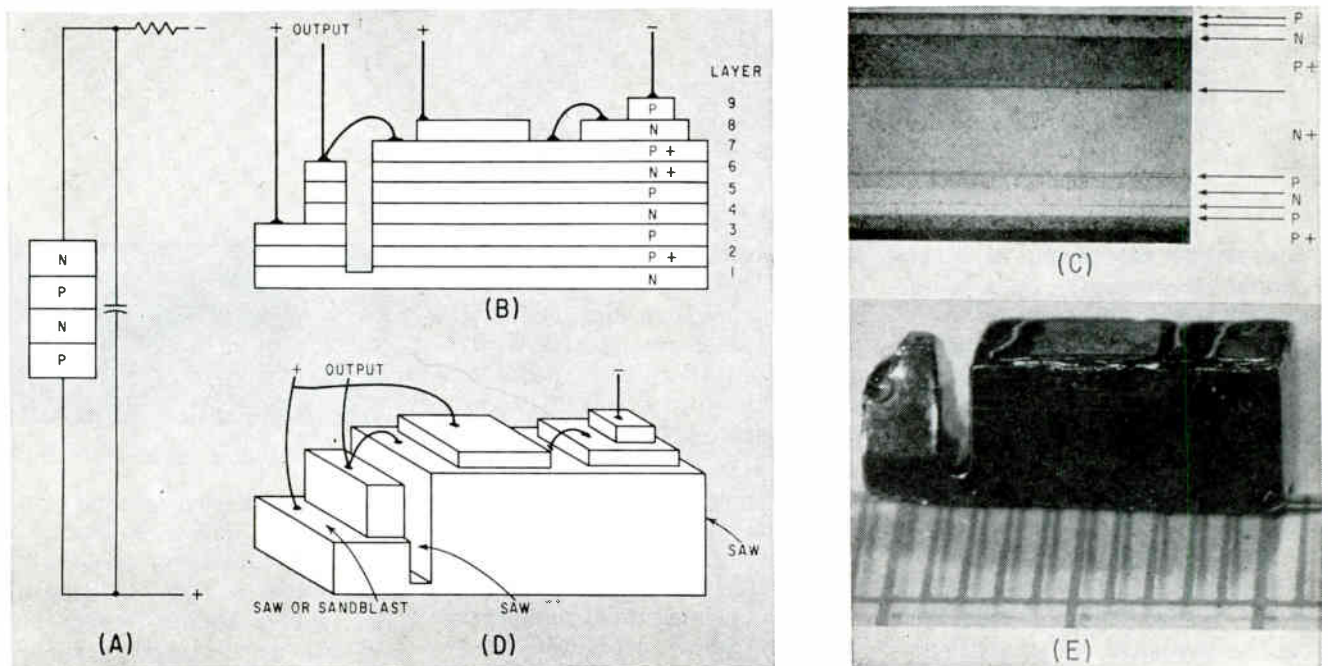

FIG. 2—Proposed relaxation oscillator circuit (A) is formed as shown in (B), resulting in structure (C); perspective view of completed structure is indicated in (D) and actual specimen is shown in (E)

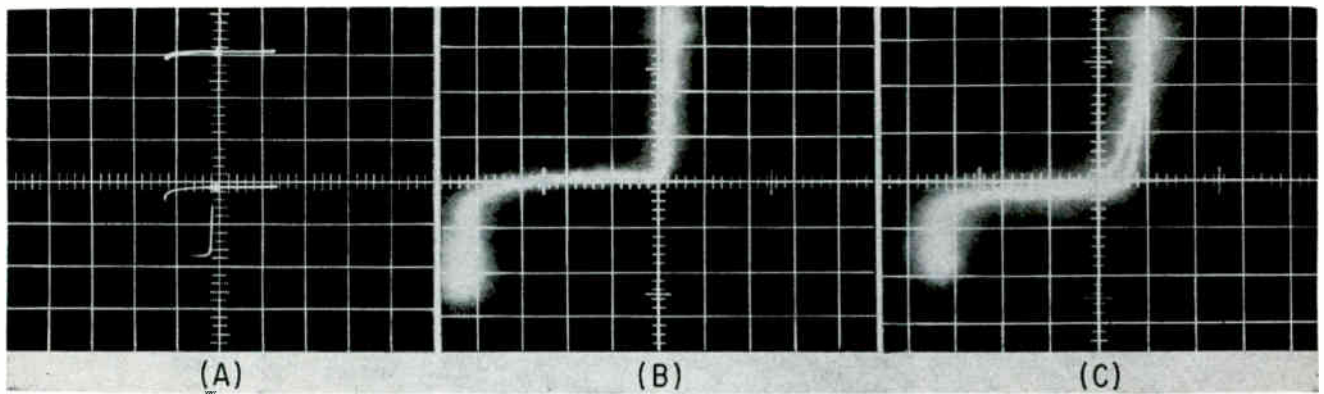

FIG. 3—PNPN-switch characteristic with 500 $\mu\text{a}/\text{cm}$ vertical scale and 20 v/cm horizontal scale (A); capacitor-diode layer characteristic with 5 ma/cm vertical scale and 10 v/cm horizontal scale (B); and outer $p\text{-}n$ junction characteristic with 1 ma/cm vertical scale and 20 v/cm horizontal scale (C)

doped layer. Thus if a pn junction is to be formed, an n^* could precede the n layer and a p^* layer could be deposited following the p deposition to form an n^*npp^* configuration. These heavily doped regions would facilitate contacting. Contacts could be made to the n^* and p^* areas by etching down into the degenerate regions and then making contact using thermo-compression bonding. Having these degenerate layers in the structure makes it unnecessary to evaporate and alloy metal contacts onto the n and p regions. Without the degenerate regions, some kind of metallic contact is essential. Presence of these degenerate regions at locations within the structure might enable many steps to be saved in constructing devices.

Present limitations of the deposition process are as follows. Ultra-thin layers of either type semiconductor cannot be buried deep within the structure because diffusion can destroy the individuality of these layers while the rest of the structure is being deposited. The fact that all layers are axially grown is a disadvantage. As may be seen from the front cover, locating and contacting a thin intermediate layer can be difficult. With masking during deposition to obtain partially grown layers, it should be possible to make contact with the isolated areas without subsequent etching and cutting. To demonstrate the usefulness of laminar junction layers in microcircuits, a relaxation oscillator was designed that would take a d-c signal and convert it to

a sawtooth wave at the output. The circuit is shown in Fig. 2A. The elements are a $pnpn$ switch, a back-biased diode to provide capacitance and a photodiode as a resistor.

Many structures can be visualized and designed to take advantage of the vapor-phase layer-deposition process. The design presented here is probably trivial to the microcircuit designer; the purpose is to demonstrate that a number of layers can be consecutively deposited to produce individual devices at predetermined locations within the crystal.

The laminar structure that was to be formed is shown in Fig. 2B. In this structure, layer 1 could serve as the device support and as an isolation layer. Layers 2, 3, 4, 5 and 6 could be deposited to form the $pnpn$ switch, and layers 7 and 8, and 8 and 9 as the capacitive and resistive diodes.

The layers of the structure were deposited on a substrate to form a crystal similar to that shown in the photograph. An initial n -type deposition was made to form a planar surface layer 12 mils thick on the substrate. Acceptor atoms were then introduced to produce a p^* layer having a resistivity of 0.01 ohm-cm until 60 mils on each crystal face had been deposited. A p region was then deposited for 1 mil followed by 2 mils of n and 2 mils of p -type silicon. Twelve mils of an n^* region was formed to facilitate locating the region for isolation of the $pnpn$ switch. A p^* layer was then deposited for 5 mils followed

by an n region for 2 mils and, finally, by 1 mil of p -type silicon.

The structure is shown in Fig. 2C where eight regions are shown by an HF-HNO₃ etch. Magnification factor is 100. The layer thicknesses deposited were within experimental accuracy of the desired values. The entire p^* and n regions below the p^* layer are not shown in this specimen. The next object was then to isolate the components to ascertain their electrical properties. By masking, etching and cutting the devices were isolated and measured.

Figure 2D shows schematically the method for isolating the junctions, and Fig. 2E shows a specimen that was used to measure device properties. The $pnpn$ characteristics are shown in Fig. 3A and the $p\text{-}n$ diodes of layers 7 and 8, and 8 and 9 are shown in Fig. 3B and 3C.

It is not intended here to present involved microcircuits. The circuit shown is simple in design and does not represent the complexity of structures possible by applying the vapor-deposition method. The intent is to demonstrate the fabrication of devices within a complex layered monocrystalline structure formed by vapor-phase deposition.

It is possible to combine this deposition technique with oxide masking, diffusion and alloying techniques, and to use these deposited configurations as building blocks for making microcircuit elements. This further increases the degrees of freedom for producing such elements.

RADAR-RETURN SIMULATOR TESTS

Moving-Target Indicators

Checking operation of an airborne moving-target indicator on the ground requires simulation of signals received in flight.

Among the conditions produced is clutter received by a rotating antenna on an aircraft hurtling along at 550 mph

By **HELMUT LOBENSTEIN & ALFRED R. DIAL**
Light Military Electronics Dept., General Electric Co., Utica, N. Y.

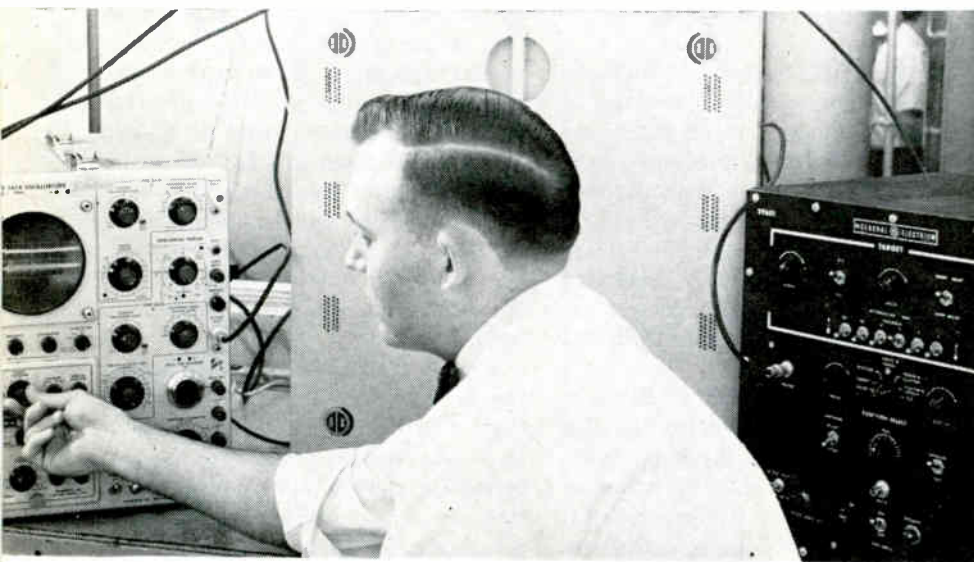

Typical setup for testing an Amti with the radar return simulator (black cabinet at right) and an oscilloscope

TESTING an airborne moving target indicator (amti) requires a signal input that is in all essentials similar to a normal radar signal return. A test set intended for this purpose must therefore generate targets, noise and clutter. To simulate platform motion the clutter must contain a doppler component that varies at the antenna scan rate, and to be useful in measuring mti performance both a fixed and moving target must be generated.

The radar return simulator has been used to check the cancellation ratio and own-ships-speed correcting network of a time-averaged-clutter - coherent - airborne - radar

(Taccar). This type of radar samples the clutter return, extracts from it the doppler shift due to platform movement, and after integration applies the resultant varying d-c level to a voltage-deviable oscillator. Oscillator frequency changes in a manner commensurate with the applied signal so as to make it appear that the radar is stationary. Therefore, fixed targets cancel after being processed by the mti circuitry. Moving targets have a phase component that is different from the clutter, or fixed targets, and are visible at the mti output.

The only means of checking a

comparator of this type without actually moving the unit and transmitting is by providing signal inputs such as are listed below. Available signal ranges encompass most existing radar systems. The following signals may be switch selected:

(1) Moving or stationary target pulse with range variable from 7 to 200 nautical miles, pulse width variable from 0.2 to 10 μ sec, and amplitude variable from 0 to 3.5 volts (peak);

(2) Johnson noise (0.3 to 3 volts, peak to peak);

(3) Frozen sea clutter/doppler-shifted or fixed with range/out to 70 nautical miles and amplitude variable from 0 to 6 volts, peak to peak.

The blocking oscillator shown in Fig. 1 is a trigger repeater that prevents loading the trigger source. The blocking oscillator can be switched so that its grid is returned to a positive source to provide an internal test trigger instead of the external trigger.

Moving-target simulation is accomplished by presenting a target on alternate sweeps. This is done by throwing switch S_1 to the 2-to-1 count-down mode. The input trigger now goes to a phantastron whose ON time is greater than the repetition-rate time, thereby making the trigger effective on alternate sweeps only. Since an mti is essentially a memory and comparison device, removing the target

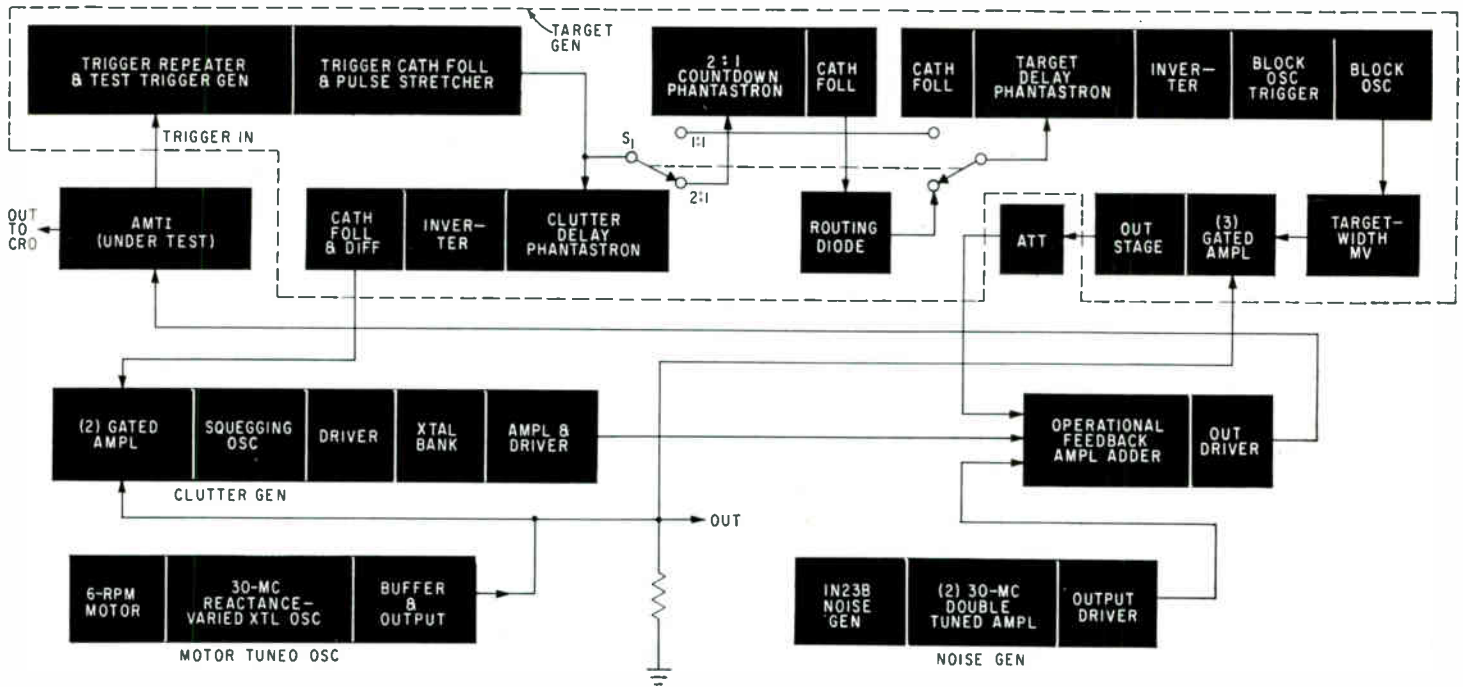

FIG. 1—Diagram of radar-return simulator shows an airborne moving-target indicator under test

every other sweep tells the comparator that a moving target is present.

A single phantastron with two overlapping switch-selected range-steps of 80 to 500 μ sec, or 440 to 2,680 μ sec produces wide target-delay ranges. The delay gate is differentiated, its leading-edge spike is clipped, and the pulse is amplified so that it can trigger the 0.2- μ sec blocking oscillator. Pulse width must be small to allow the target-width multivibrator to work between 0.2 and 10 μ sec. The target-width multivibrator output gates the 30-Mc output of the motor-tuned oscillator (mto) into the 3-stage i-f strip, thus producing a 30-Mc target pulse. In gating, switching transients are minimized, since they will be noncoherent and will appear as moving targets at the Amti output. Effort was made to obtain short rise times to achieve minimum pulse width. A gating waveform with 0.2- μ sec risetime throughout its width should be acceptable in testing most Amti's.

The multivibrator is cathode coupled to get linear width control and indifference to output loading. A pair of high-transconductance, narrow grid base, 6688 tubes are used to obtain switching at narrow pulse widths.

Several precautions were taken to reduce transients; these include clamping the amplifier suppressors to prevent their going positive,

biasing control grids at d-c ground and simultaneously gating the first-stage plate and suppressor grid. Thus switching transients were 25-db below output signal level.

In systems using own-speed correlative loops, r-f leakage during the target pulses is critical because the loop may lock to a c-w signal near its center frequency. To prevent this, the gated amplifiers are shielded to provide 70-db isolation.

The target should be available throughout the clutter region. Since the target range phantastron has a finite delay the clutter must be delayed by an identical amount if the target is to appear at the beginning of the clutter return. This can be done by choosing a minimum-target phantastron range, and delaying the clutter start accordingly. Therefore, minimum delay was established at 80 μ sec, the clutter delay phantastron being used to delay clutter to coincide with minimum target position. The clutter delay phantastron delay-time is adjustable from 86 to 115 μ sec to compensate for component variations.

The Johnson-noise source makes the radar return realistic. Noise is obtained by using a back-biased 1N23B silicon diode in the noise generator. The 1N23B has a maximum noise ratio of 2.7. Since impedance level of these diodes varies, a series potentiometer was used to set current level. Noise bandwidth

and amplitude are determined by the noise amplifiers. Three 6688A tubes, with a gain-bandwidth product of 130, deliver noise, amplified 60 db, into a 90-ohm resistive load.

Interstage coupling of the amplifiers is provided by double-tuned transformers. Output bandwidth of the noise generator is 13 Mc; bandwidth output of the adder circuit is 5 Mc. These parameters provide a wideband and narrowband noise source.

Antenna rotation, and the doppler shift to be expected at maximum platform speed, are simulated by pulling the frequency of a crystal oscillator in the mto at the antenna scan-rate. For this test set antenna rotation speed was established at 6 rpm; any other speed could have been chosen.

Determination of doppler shift, f_d , now follows:

$$f_d = KV, \text{ where } K = 2f/c$$

$$K = \frac{2(425) \times 10^6}{582 \times 10^6} = 1.46 \text{ cps/knot}$$

$$f_d = 1.46(480) = 700 \text{ cps}$$

Here f_d is the oscillator doppler shift, V is the assumed platform velocity of 480 knots, c is the velocity of light and f is the transmitted radar frequency.

Therefore, the oscillator should be pulled 1.4 Kc at an antenna rotation speed of 6 rpm. A cardioid-shaped capacitor across a feedback transformer in a grounded-grid

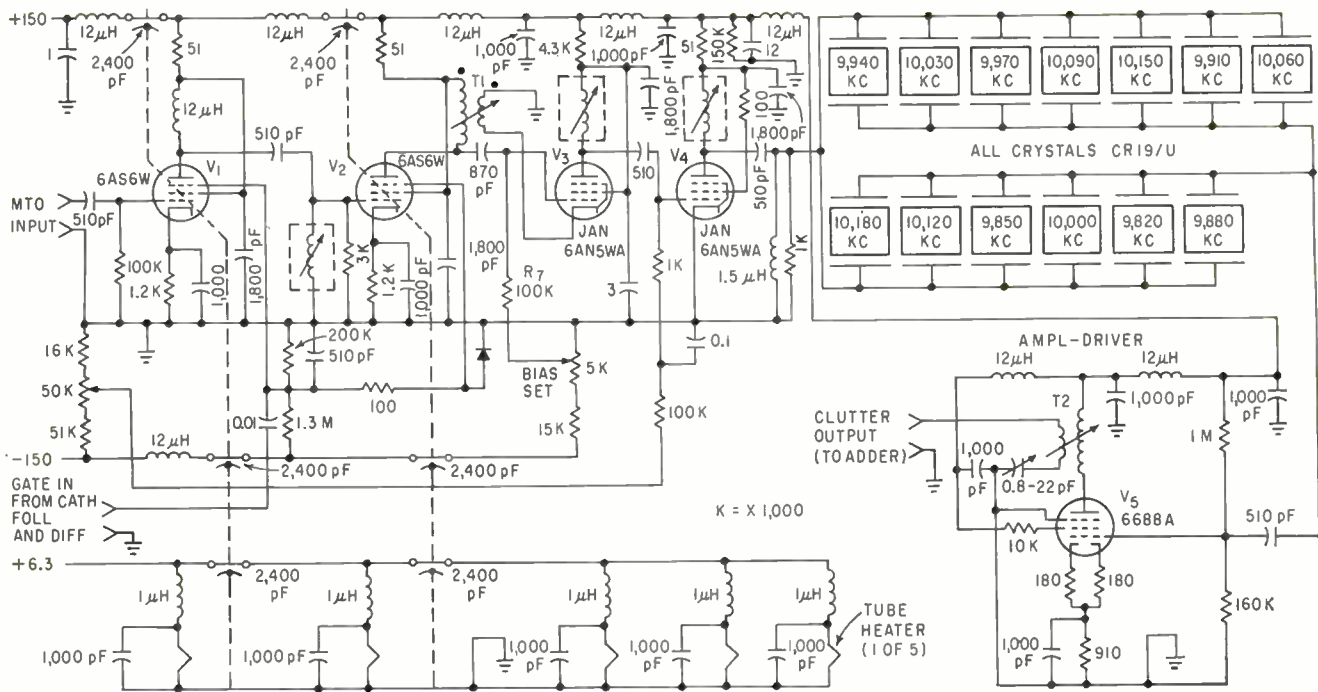

FIG. 2—The input from cathode follower and differentiator in the target generator gates the motor-tuned oscillator input into clutter generator

oscillator circuit achieves sinusoidal variation with shaft positioning. Frequency range is controlled by a trimmer in series with the tuning capacitor.

Clutter is produced by ringing a bank of closely spaced crystals and allowing the resultant frequencies to beat together to produce a jagged clutter return that decays with range. This technique was first used by MIT's Lincoln Laboratory. Since the target and clutter must

be in phase for Amti, the mto output goes through two amplifiers that are gated by the clutter-delay-phantastron output. The mto output then triggers a squegging oscillator (Fig. 1 and 2). The output of the squegging oscillator is amplified and drives the crystal bank. Fundamental-mode CR19U and third-overtone CR51U crystals were tried and the higher-Q fundamental-mode CR19U was found to ring for a longer period. Since loading re-

duces the otherwise substantial ringing period, the crystal bank is not loaded. The squegging-oscillator signal burst shapes the clutter rise by initially blocking the crystal-bank output amplifier.

The maximum pulling range of crystals is limited to approximately 0.3 percent of center frequency, and clutter bandwidth is determined by the crystal spread. A clutter BW of 1 Mc was used to limit the number of crystals. This is obtained by 13 crystals spaced 30-Kc apart in the 10-Mc region. The 30-Mc clutter is obtained by selecting the third harmonic of the crystal-bank output.

Output signals are combined in a feedback adder (Fig. 1) and signal levels are established for linear operation. This and an attenuator pad allow cancellation-ratio measurements to be easily made. Output signals can be selected by applying B+ to circuits with a panel-mounted switch.

Figure 3 shows cro patterns obtained while testing an Amti. The upper pattern of each of the three pairs of traces is the output of the simulator and the lower pattern is the output of the Amti. The clutter cancellation ratio is 44 db.

Figure 4 shows typical clutter output of the radar return simulator.

The authors thank W. E. Smith for his contributions to this article.

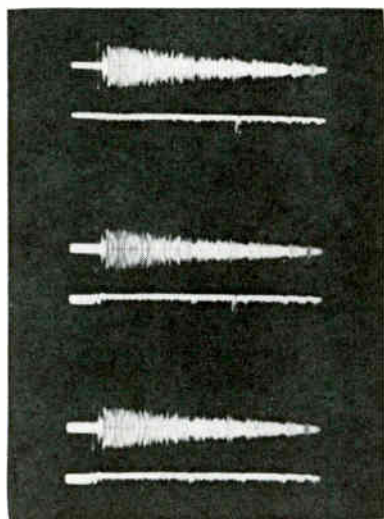

FIG. 3—In the three pairs of traces, clutter-cancellation ratio is 44 db; top pair shows moving target in clutter; center, moving target in clutter and noise; bottom, idle target in clutter and noise

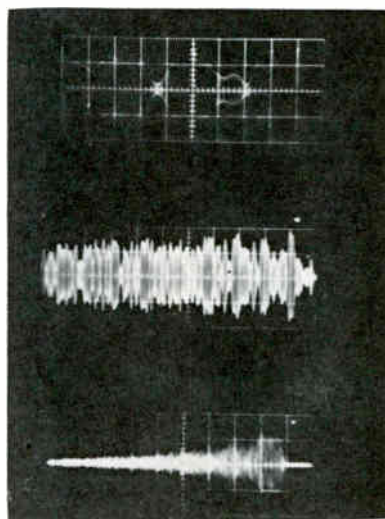

FIG. 4—Oscilloscope traces indicate typical clutter outputs. Top trace has a horizontal time scale of 100 sec/cm; center trace, 10 sec/cm, and the bottom trace, 1 sec/cm

Testing and Evaluating Missile-Firing Interceptors

System plots the trajectories of the interceptor aircraft, fired missile and drone aircraft.

Vector paths, rather than scalar distances, are determined for the three vehicles

By WALTER J. ZABLE, President, Cubic Corp., San Diego, California

EFFECTIVE EVALUATION of air-to-air weapon systems requires accurate information about the interceptor aircraft, target drone and missile trajectories, including the point of closest approach of missile to drone. For missiles with high-yield warheads, it is necessary also to provide interceptor data following missile launch to evaluate the escape maneuver. The recently developed multiple airborne target trajectory system (MATTS), in addition to providing scalar miss distances, computes trajectory and

vector miss-distance information for complete real time weapon-system evaluation.

MATTS is a three-target system installed on the Eglin Gulf Test Range, Florida, where its primary mission is evaluating the use of air-to-air rockets and missiles. Basically, MATTS is a ground-based c-w phase-comparison system. It tracks interceptor, missile and drone by receiving radio signals transmitted by small c-w transmitters in the airborne vehicles. The transmitted signals are received by

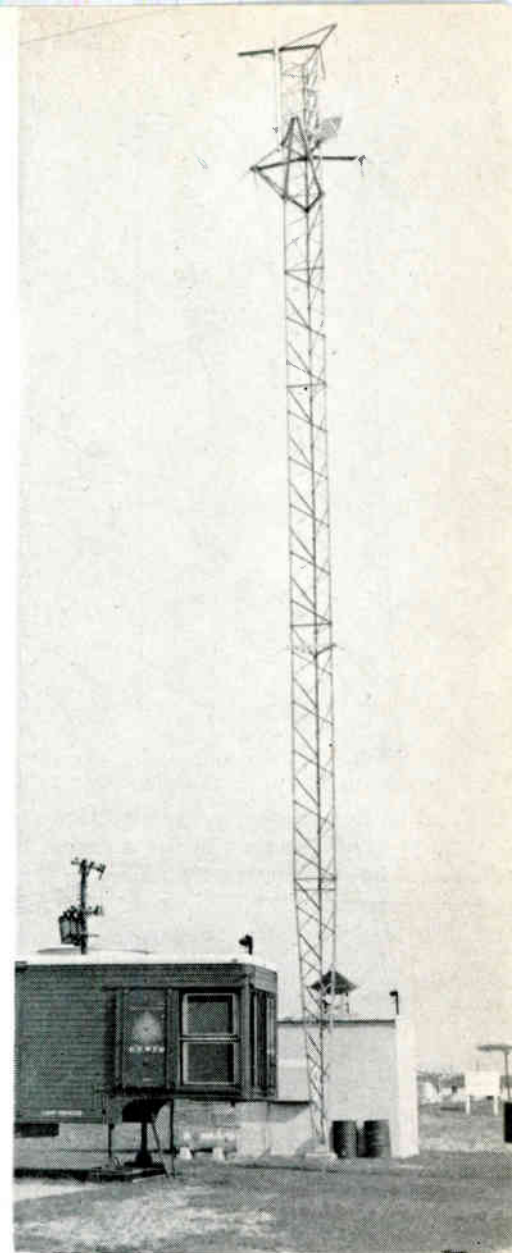

Van and antenna of MATTS installation at Eglin Gulf Test Range

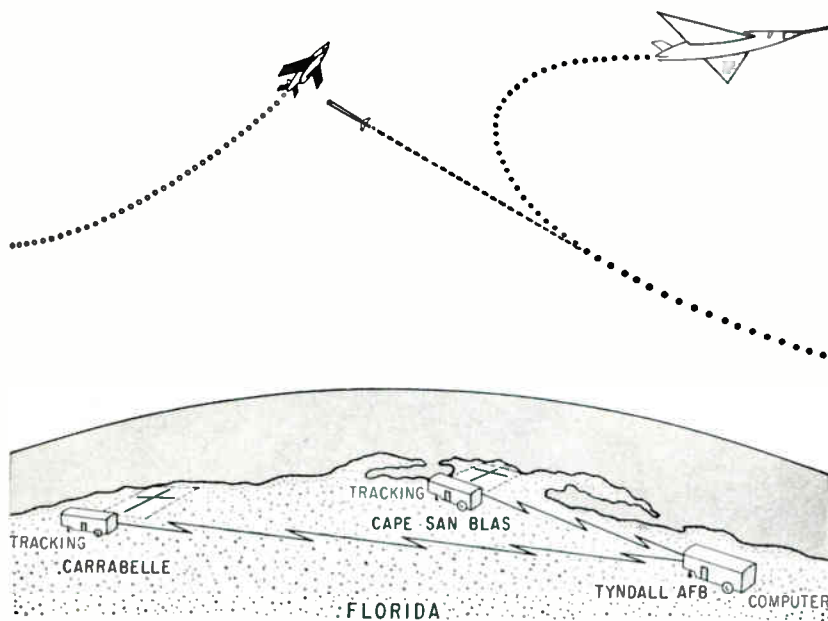

FIG. 1—Two tracking vans and one computer van house electronics

two separated ground stations; in the Eglin installation, these are located 42 miles apart, at Cape San Blas and Carrabelle (Fig. 1).

Each ground station determines a pair of direction cosines associated with the vector pointing at each target. This is done by using two angle-measuring equipments (AME) at each station. The AME's measure the phase difference between the signals received on two separate antennas on the AME baseline.

The measured phase angle between induced antenna currents is proportional to the difference in propagation time from an airborne-vehicle transmitter to the two antennas; thus, it is proportional also to the difference between the two transmission-path lengths. This path-length difference is directly

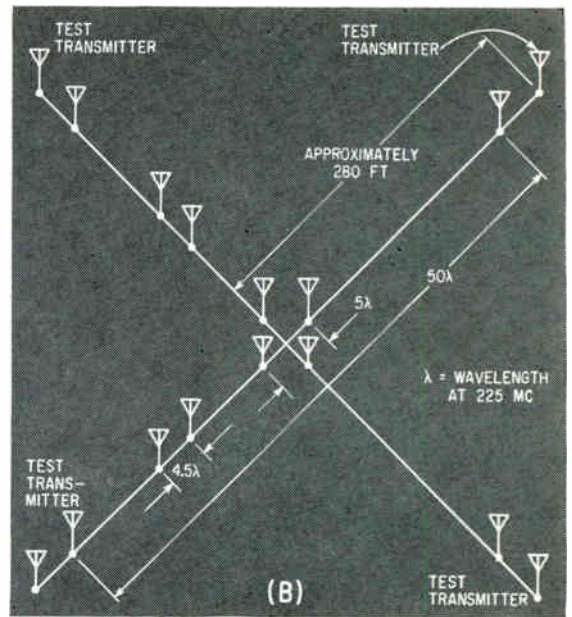
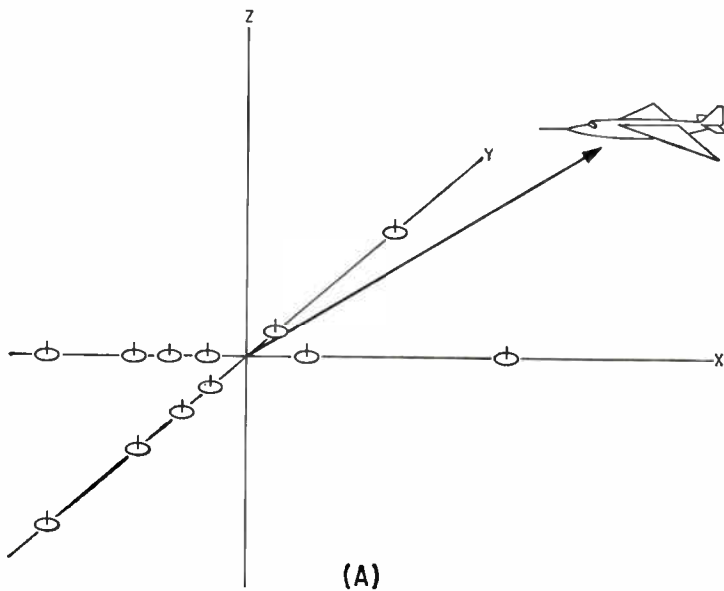

FIG. 2—Direction cosine of vector (A) is used in determining trajectory. Crossed baseline antenna field (B)

proportional to the direction cosine (with respect to the antenna baseline) of a vector pointing at the transmitter (Fig. 2A). The AME's continuously generate direction-cosine data, to six decimal places, in both visual and electrical form. Data are relayed to a central computer, where the trajectory of each target and the missile-drone and missile-interceptor separations at the time of simulated warhead

detonation are determined in real time.

The AME baseline is 50 wavelengths long. However, since such phase differences as n , $n + 2\pi$, $n + 4\pi$ yield identical indications, 50-wavelength antenna pair spacing provides, along with high angle resolution, a degree of ambiguity. The number of ambiguous angle indications (and also the accuracy) are reduced by decreasing the antenna

spacing until $\frac{1}{2}$ wavelength is reached. With $\frac{1}{2}$ -wavelength spacing, only a single direction cosine is measured corresponding to each measured phase difference. In the AME's used, ambiguities are eliminated, while accuracy is maintained, by using three antenna pairs on each baseline (Fig. 2B). One pair, at an equivalent half-wavelength spacing, is used for unambiguous coarse measurement. A

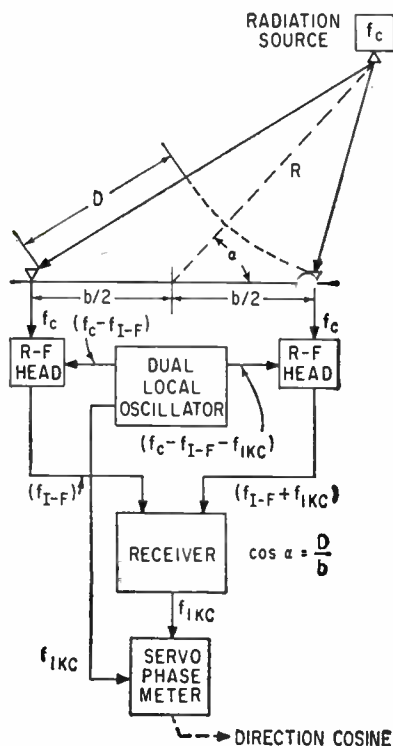

Fig. 3—Dual local oscillator of single-channel angle-measuring equipment has three outputs

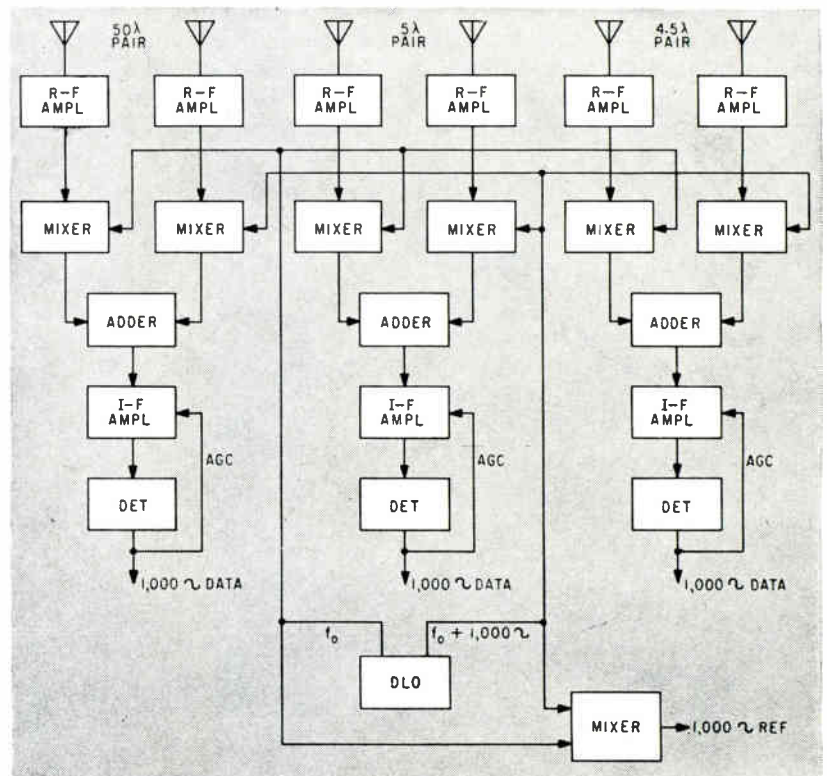

FIG. 4—Single-target, single-baseline system shows how i-f signals are obtained from each antenna pair

second (5-wavelength) pair, whose ambiguities have been resolved by the $\frac{1}{2}$ -wavelength pair, resolves the ambiguities of the 50-wavelength (fine) pair that provides the ultimate system accuracy. There are two phase-comparison receivers (one on each baseline) for each transmitter being tracked. A common time base is provided by a communications line between ground stations.

Each direction cosine measured by AME determines a conic surface on which the transmitter (the vehicle being tracked) lies. Such information is insufficient to determine actual direction in space. But with two AME's operating from mutually perpendicular and bisecting baselines, the transmitter's direction is uniquely determined by the straight line formed by the intersection of the two conic surfaces.

Unambiguous cosine information is developed by phasometers from the data received at the three pairs of antennas on each baseline. These phasometers consist of servo-control amplifiers coupled to precision gear trains. The amplifiers produce gear-train shaft rotations proportional to the phase differences between the data signals and internal reference signals. Digital encoders,

connected to the gear trains, digitize the direction-cosine data. Phase-measuring techniques have been developed for determining small phase differences with high accuracies. Measurements show standard deviations in cosine of about 15 ppm.

Since MATTS operates on phase-comparison principles, phase distortions within the system are minimized.

A simplified block diagram showing one channel of a basic angle-measuring equipment appears in Fig. 3. The signals received at the two antennas differ in phase by an amount dependent upon a direction cosine of the target position vector.

The dual local oscillator (dlo) produces three output signals of which two (1-Kc apart) are supplied to the two r-f heads, respectively, and the third is a 1-Kc reference signal for the servo phase-meter.

The r-f head with each antenna heterodynes the received and dlo signals. The two i-f signals are 1-Kc apart, and have the same phase relationship as did the r-f signals received at the antennas.

These two i-f signals are fed from the r-f heads to the receiver, consisting of a six-stage i-f am-

plifier and detector. The intermediate frequencies are added, amplified and detected. Output of the detector is a 1-Kc signal, called the data signal, which is directly related to the phase difference between the two received signals.

Each MATTS ground station has two r-f equipment packages performing these four functions:

(1) Receive simultaneously any three of four designated frequencies transmitted by three airborne signal sources.

(2) Produce 1-Kc outputs whose phases are proportional to the phase differences of the signals received at two antennas 50 wavelengths apart.

(3) Produce comparable 1-Kc outputs from the signals received at two antennas 5 wavelengths apart.

(4) Produce comparable 1-Kc outputs from the signals received at an equivalent half-wavelength pair of antennas.

A typical single-target, single-baseline AME r-f system is shown in Fig. 4. The signal received at one antenna of each pair is heterodyned with the local oscillator signal at f_0 , while the signal received at the opposite antenna of each pair is heterodyned with the local oscillator signal at the frequency ($f_0 + 1$ -Kc). The two i-f signals thus derived from each antenna pair are linearly added, amplified and detected to produce the 1-Kc data signal. The 1-Kc beat frequency produced by mixing the two dlo signals serves as a reference. Phase difference between the data signal and the reference signal equals the two phase difference between the two received signals (plus a fixed error which can be calibrated out).

Expanding the AME to a multiple-target system requires signal separation without loss of sensitivity of phase stability. This is done by filtering in the i-f amplifiers, after addition of the two i-f signals associated with each antenna pair.

As the phase stability of a tuned amplifier is directly proportional to its bandwidth, the r-f amplifiers are designed for maximum practical bandwidth and flat phase slopes to minimize phase dependence on temperature, voltage and other factors. However, if the two signals are passed through an amplifier whose bandwidth is much larger than

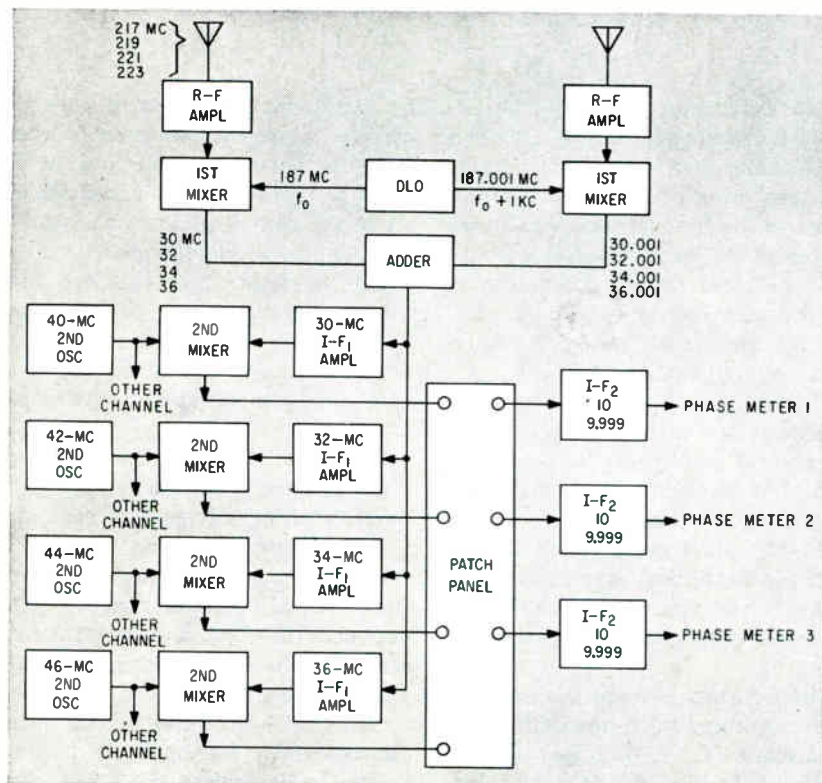

FIG. 5—Single-channel multiple-target receiver uses patch board for selecting target frequencies

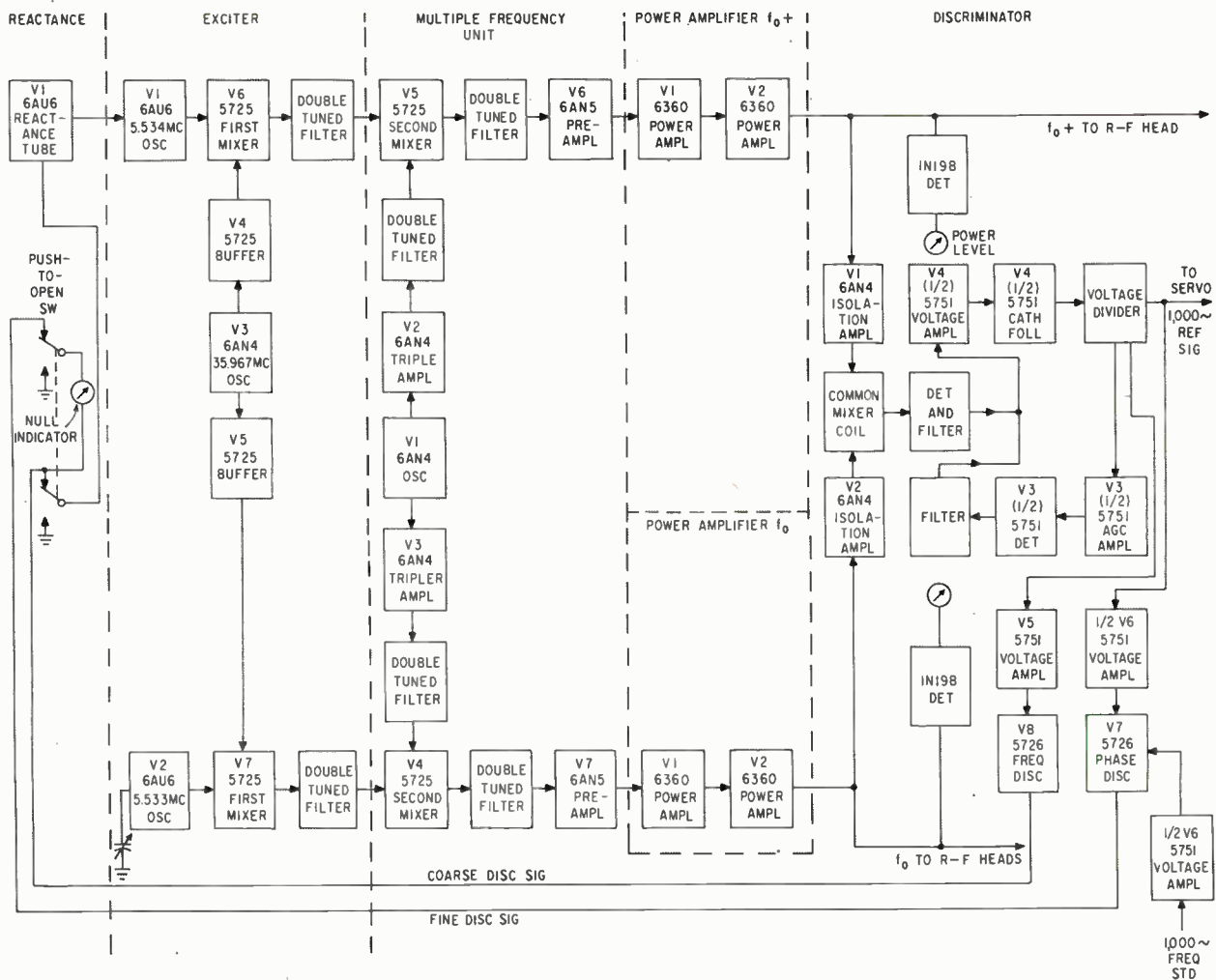

FIG. 6—Agc loop used in dual local oscillator has gain of approximately 30 db

their frequency difference, the phase variations of the detected beat frequency are much smaller than the total phase variations of the amplifier.

MATTS includes a three-channel system with each channel quickly tunable to one of four fixed frequencies.

An i-f amplifier with each phase-meter channel amplifies the proper signals and rejects unwanted signals. Selection of the channel for each target is made by connections at a patch panel between the second converters and the 10-Mc i-f amplifiers. The r-f amplifiers and the first converters are center-tuned to 220 Mc and have a bandwidth of 20 Mc, covering the whole spectrum of target frequencies. Figure 5 outlines a single-channel multiple-target receiver.

The r-f amplifiers (in the antenna field, one below each receiving antenna) amplify the antenna sig-

nal to overcome losses in the coaxial transmission lines between the antenna and the van. The signals are applied through coaxial cables to the first mixers, which are located in the vans. Each AME site contains 13 of these r-f amplifiers: one for each receiving antenna and one for the van-mounted antenna (for the calibration receiver).

The incoming antenna signal is coupled to the cathode of a grounded-grid r-f amplifier

The r-f amplifier has a net gain of 28 db and a band pass in excess of 15 Mc. The noise figure for all of these amplifiers averages 6 db with a sensitivity of 0.5 microvolts. Dynamic range is in excess of 60 db.

The r-f signals from the antenna field are mixed with one of the two dlo signals (f_0 ; $f_0 + 1$ Kc) so that the beat frequencies for the two signals corresponding to a given antenna pair are 1 Kc apart (Fig.

5). Bandwidth requirements are relatively stringent, because all frequencies between 30 Mc and 36 Mc must be passed with a phase stability of 0.1 degree under the expected environmental conditions.

The outputs from the two first mixers corresponding to each antenna pair are combined in an adder, which is extremely linear to keep intermodulation distortion minimum.

The first i-f amplifiers ($i-f_1$) amplify and aid in separating the four possible signals from different airborne vehicles. Each is tuned to a frequency corresponding to one of these signals and is also a buffer between the first and second mixers. Since only a single 1-Kc-apart pair of frequencies need be passed by each first i-f amplifier, its phase characteristic is important only in so far as it affects the single frequency pair. The bandwidth of the unit is made large compared to 1

Kc so that phase variations of the selected difference frequency are small compared to the amplifier's overall phase variation.

The second local oscillators provide signals for the second conversion, which lowers the frequencies generated by the first conversion so that their separation is large compared to a feasible second i-f bandwidth. Only one oscillator is required for each of the four received frequencies. It feeds the six mixers at each site through buffering that eliminates crosstalk.

The second mixer heterodynes the signal from the first i-f amplifier and the second local oscillator to produce a 10-Mc final i-f. There is a separate mixer for each of the four possible signals to be tracked and the individual mixers, local oscillator signals and first i-f signals are connected for complete separation of the data signals.

Much of the system i-f gain and most of the interchannel isolation are achieved in the second i-f amplifier *i-f*. Since four separate second local oscillators are used, all second i-f amplifiers operate at the same 10-Mc frequency. The i-f amplifiers are connected through a patch panel to the second mixers corresponding to the three selected target frequencies. The bandwidth must be large compared to the separation (1 Kc) of the two frequencies being amplified, and small compared to all other products of the second mixer feeding it (2 Mc is the separation of the closest unwanted product). After amplification, the signals are applied to a detector and cathode follower that beat the two i-f signals and extract the 1-Kc difference.

The 1-Kc output provides the servo phasemeter with a signal whose phase is related to the phase difference associated with the antenna pair feeding the amplifier. Automatic gain control is also provided to keep the amplitude of the 1-Kc output constant.

The dual local oscillator (dlo) uses multiplexing to eliminate the need for retuning or adjusting. It may be divided into seven parts: exciter section, reactance section, frequency-control unit, two power-amplifier sections, discriminator section and 1,000-cycle reference generator. Figure 6 is an overall block diagram of the dlo.

The discriminator maintains an exact 1-Kc separation between the two r-f signals, and supplies a voltage and frequency stabilized reference signal to the phasemeter. The circuits of this section are unconventional.

Signals from both channels are applied to a mixing coil that is a common plate load, and their difference frequency is detected by a detector-filter. The 1-Kc signal is applied to a voltage amplifier and then to a cathode follower. The cathode follower includes a resistance divider to provide predetermined amounts of the 1-Kc signal for the agc loop, the coarse discriminator, fine discriminator and reference input to the phasemeter. The agc loop contains an amplifier, detector, and r-f filter. Loop function is to maintain a constant level in the signals supplied to the phasemeter, fine discriminator and coarse discriminator.

One signal from the divider is applied to a voltage amplifier that has enough negative feedback to ensure linear operation. The amplifier output is coupled to a frequency discriminator by a transformer whose secondary has two windings. One winding is center-tapped, and is connected through an L-C combination to the other winding, to form a circuit resonant at 1 Kc. When the signal from the voltage amplifier is exactly 1 Kc, the discriminator output is zero. However, when the frequency of the input signal changes, the discriminator output also changes in amplitude and polarity (1-Kc positive, 1-Kc negative). The output of the frequency discriminator is applied to the reactance tube as a coarse control signal.

The voltage divider also provides an input signal to a voltage amplifier and a phase discriminator. The 1-Kc signal from the voltage divider is applied to the grid of one amplifier, while a 1-Kc signal from the reference generator is applied to the grid of another amplifier. The two plates are connected to the primaries of two interstage transformers; a dual diode is used in the secondary. The output polarity and magnitude are determined by the phase difference of the two input signals. The output of the phase discriminator is applied to the reactance tube as a fine control signal.

To make full use of the system's inherent tracking accuracy, MATTS output data is processed to a resolution of 5 ppm. Therefore, each direction cosine is derived as an 18-bit binary word. An additional bit is required for algebraic sign, since the direction-cosine value may be positive or negative.

An optical encoder provides a 13-bit fine data word for each direction cosine. A simple electro-mechanical encoder is coupled through a gear-down arrangement to each optical encoder and produces six bits of coarse data plus one bit for backlash correction.

The encoders are selectively interrogated 20 times, 10 times or once a second as commanded by MATTS internal timing. Each encoder generates a Gray-code number on interrogation, and separate Gray-to-binary conversions are made for the numbers in each encoder pair. Backlash effects are eliminated by combining each pair of coarse and fine encoder readings to form the final 19-bit word. Each sample is six words, corresponding to a pair of direction cosines for each of the three targets.

The MATTS data-handling equipment includes self-checking features. Known Gray-code numbers may be inserted at the input, and the final output format values checked against a stored, correct value. Any difference between the two is externally signaled to indicate equipment malfunction. Marginal checking is also provided, where the known Gray-code number is cyclically inserted into the input and certain voltages are increased and decreased in known sequence in parts of the equipment, with malfunctions again observed. Defective components may be located, since the voltage variations are confined to particular sections.

Intercept missions are plotted on X-Y and Y-Z boards. The plotted drone track continues to the point of burst, while the interceptor path is indicated up to the time of launch and following burst. The missile track is plotted from launch to burst.

Other applications of similar systems include range safety, drone guidance, missile evaluation, bomb scoring, air traffic control, simulated firings and formation-attack scoring.

Tuning-Fork Audio Filter Tunes

Tuning-fork frequency is adjusted to 50 parts per million by varying current in magnet coil; a highly selective audio filter results

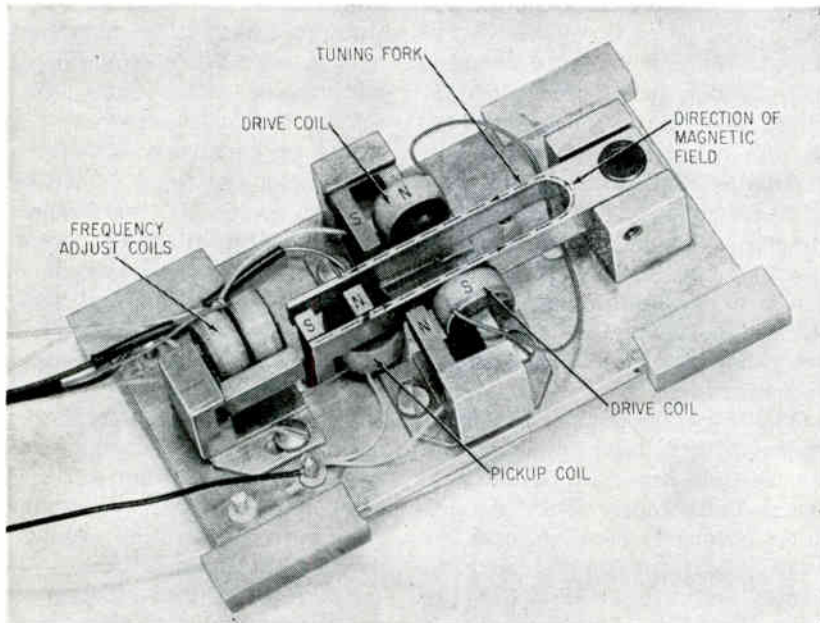

FIG. 1—Tuning-fork mechanical assembly shows arrangement and polarity of electromagnets

THE TUNING-FORK FILTER has high selectivity and stability in the audio-frequency region. However, this inherent stability makes it difficult to adjust its resonant frequency.

One way to vary the frequency of a tuning fork is to mechanically constrain the fork tines by weights or otherwise; this method has been used in acoustic and musical applications. When the tuning fork is used in an oscillator circuit as a frequency standard, the frequency can be adjusted by varying the phase shift at some point in the loop; also to some extent by changing the drive amplitude. The resonant frequency of a tuning fork depends somewhat on the air pressure surrounding it, and a frequency adjustment during manufacture can be obtained by varying pressure in the hermetically sealed container.

The frequency also depends on the strength of the magnetic fields applied to the tines, and a manufacturing adjustment can be obtained by using an extra magnet either inside or outside the fork container. However, an electrical adjustment can be made by generating the magnetic field with a current-carrying coil.

Figure 1 shows the mechanical arrangement of the tuning-fork filter. The two drive coils, mounted on permanent magnets, are shown on the outside of each fork tine. The adjacent portions of the fork tines act as magnetic shunts (with air gaps) between the faces of each magnet, and thus each tine is attracted to the nearest drive magnet. The input signal is applied to the drive coils in series, and the a-c current will generate a-c magnetic fields. This will tend to cause the fork to vibrate, but the magnetic forces are independent of the polarity of the signal current. Therefore, the magnetic bias supplied by

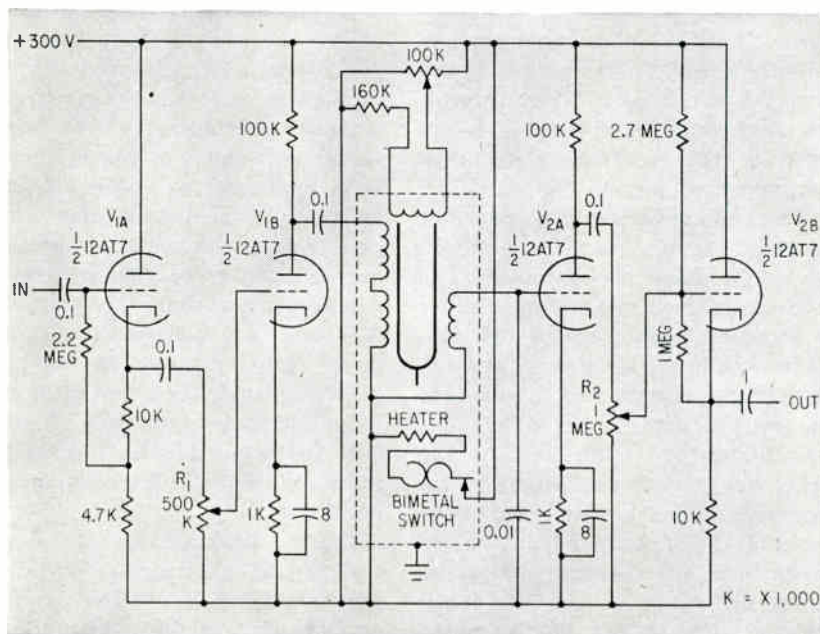

FIG. 2—Input and output cathode followers isolate filter from rest of circuit. Drive and pickup amplifiers cancel fork insertion loss

Electrically

By JOHN J. O'CONNOR,

Hathaway Instruments Inc., Denver, Colorado

the permanent magnets is necessary in the drive circuit to avoid frequency doubling effects and non-sinusoidal forcing functions.

When the frequency of the input signal is close to the fork frequency, the drive current will induce fork vibration. This will cause varying air-gap dimensions in the pickup circuit, and this variable reluctance is converted into an emf by the permanent magnet and coil of the pickup circuit. Thus, the movement of the fork tines couples energy from the drive coils to the pickup coil with frequency selectivity introduced by the natural resonance of the fork.

All coils for this 400 cps tuning fork filter were made of 13,000 turns of Awg 50 wire with a d-c resistance of 12,500 ohms. The Alnico II magnets had an air gap of 0.060 in. in the drive circuit and 0.050 in. in the pickup circuit.

As the fork vibrates, eddy currents are set up in the tines due to the motion of these conductors in the several magnetic fields. These eddy current losses increase with fork vibration amplitude to give more loss near resonance, and this causes a reduction in Q. By reducing the strength of the permanent magnets to ten percent of their saturated value, the basic Q of the filter was increased from 2,000 to 5,000. Other points of interest about the filter application of tuning forks, such as linearity, rejection ratio and transfer characteristics are described elsewhere².

The resonant frequency of a tuning fork depends on the ratio of its mechanical stiffness to its mass or inertia. When the fork is electrically driven with electromagnetic transducers, the magnets also affect the resonant frequency. The presence of a magnet near a tine will attract the tine away from its rest position toward the magnet, even when the fork is not vibrating. This steady-state or d-c attraction will be balanced by the attraction of other magnets or by a positional offset; in either case, there will be no first order effects on the reso-

nant frequency of the tuning fork.

When the tine is deflected toward the magnet during vibration, the decreased air gap causes an increase in the attractive force, tending to deflect the tine further. When the tine is deflected away from the magnet, the increased air gap causes a decrease in the attractive force, again allowing the tine to be deflected further. The net effect is to make the tines more limber, and this is true for magnets mounted either between or outside the tines. Therefore, a magnetic field generates spring forces that change the effective stiffness of the tuning fork, and consequently, its resonant frequency. This spring constant is negative; that is, an increase in magnetic field decreases frequency.

Magnetic stiffness has been used to adjust frequency in a resonant-reed audio filter³. A pair of current-carrying coils, similar to the drive and pickup coils and shown as the frequency adjust coils, was mounted on a soft iron yoke and aligned with the ends of the tines. The weak field generated by current in these coils follows the fork tines and interacts with the other fields. Along the top tine, the weak field will add to the fields of both the drive and the pickup circuits with its polarity as shown; it will subtract from both when its polarity is reversed. Along the bottom tine, either polarity of the weak field will give both addition and subtraction. Thus the net field acting on the top tine is increased or decreased while that of the bottom tine tends to be held constant. This unbalancing effect on the fork tines is responsible for the frequency adjustment. Since only a small frequency adjustment was required, there were no deleterious effects due to the unbalanced condition.

This theory was verified by blocked-tine tests in which one tine is clamped and the resonant frequency of the other is measured. The frequency of the top tine increased with one polarity of current in the frequency adjust coils and

decreased with the opposite polarity; the frequency of the bottom tine did not depend on the polarity of the weak field. The blocking of one tine changes the mechanical system and the numerical relationships between the several frequencies were not perfect. Additional corroboration of this theory is that the fork frequency did not change when the bias current was applied to the drive or pickup coils or both. The strength of these permanent magnets was not noticeably affected by a full bias current of either polarity.

An electrically tunable filter can lock on an incoming signal by feedback and thereby detect variations of signal frequency. It can scan a frequency band in search of a signal. It further can be used to set a precise frequency at a given temperature or to counteract any change of frequency due to aging. For this last reason the frequency adjustment was incorporated into a set of temperature-controlled tuning fork filters. The requirement was that all six filters be tunable to exactly the same frequency. It was determined that the 50 parts per million frequency adjustment obtained with one milliamp in the frequency adjust coils was adequate to compensate for manufacturing tolerances and aging.

Each tuning-fork filter was enclosed in a hermetically-sealed container and mounted on a printed circuit board. Figure 2 shows that the filter was isolated from the rest of the system by input and output cathode followers, V_{1A} and V_{2B} . The drive amplifier V_{1B} and the pickup amplifier V_{2A} cancel the 26-db insertion loss of the filter and supply an overall gain of unity through the two gain-adjustment potentiometers R_1 and R_2 .

REFERENCES

- (1) M. P. Johnson, Note to Appraise Some Possible Causes of the Pressure/Frequency Effect of the Tuning Fork, *J. Sci. Instr.*, 24, 10, p. 253, Oct. 1947.
- (2) J. J. O'Connor, A 400 Cps Tuning Fork Filter, Proceedings of the IRE, Nov. 1960.
- (3) G. Zelinger, Tunable Audio Filters, *ELECTRONICS*, p 173, Nov. 1954.

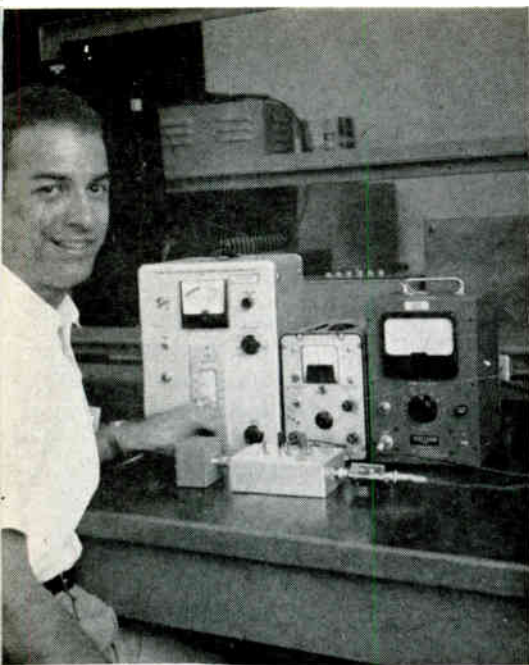

Designing Shunt-Peaked

Equations for maximally-flat-magnitude design and simpler polezero-cancellation design are presented. Examples and circuits clarify design steps

By R. S. PEPPER and D. O. PEDERSON,

Electronics Research Laboratory, University of California, Berkeley, Calif.

A METHOD of obtaining a cascaded, broad-band, video amplifier is to use shunt-peaked interstages. A typical amplifier with biasing and coupling is shown in Fig. 1A. The inductance improves the high-frequency response.

The common-emitter stage is represented by the approximate unilateral circuit model² shown in Fig. 1C. The range of validity for the circuit is $1/r_c C_c < \omega < \omega_T$. See Table I for definitions. The equivalent circuit of one stage of the amplifier is shown in Fig. 1D. In Fig. 1D, R_L is either the load at the output of the amplifier, or the low-frequency input resistance of the next stage. The current gain for the circuit in Fig. 1D is

$$T_I(p) = \frac{i_{out}}{i_{in}} = \frac{-\beta_0 \omega_\beta (p + R_I/L)}{D \{ p^2 + p[R_s/L + \omega_\beta/D] + \omega_\beta(R_s + R_I)/LD \}} \quad (1A)$$

Equation 1A has the form

$$\frac{A(p + z_1)}{(p + p_1)(p + p_2)} \quad (1B)$$

Two methods of design can be used to achieve useful response shapes. The first method is to cancel one of the poles of Eq. 1B with the zero, z_1 , giving a one-pole magnitude response: $T_I(p) = A/(p + p_1)$. The second method is to design for a maximally flat magnitude (MFM), two-pole, one-zero response. The first method is the simplest but the second gives a

larger gain-bandwidth product (GBW) for a flat magnitude response in the pass band. Curves of GBW product against bandwidth are shown in Fig. 2A for these two shunt-peaked design methods. The GBW curve is also shown for a simple resistive interstage.

In the pole-zero cancellation method the radial 3-db bandwidth (BW) is equal to the magnitude of the noncanceled pole.

$$BW = \omega_\beta/D + r'_b/L \quad (2)$$

The constraint that the zero cancel a pole, say p_2 , in Eq. 1B gives

$$BW \times D/\omega_T = |1/T_I(0)| = 1/G \quad (3)$$

The magnitude of the low frequency gain is

$$G = \beta_0 R_I / (R_I + R_s + r'_b) \quad (4)$$

Thus the GBW product is

$$G \times BW = \omega_T/D \quad (5)$$

Example 1, pole-zero cancellation: It is desired to build a one-stage amplifier having a 1-Mc bandwidth, driven by a current source, and having an $R_L = 146$ ohms. Transistor A, with operating point parameters given in Table II is used. From the expression given

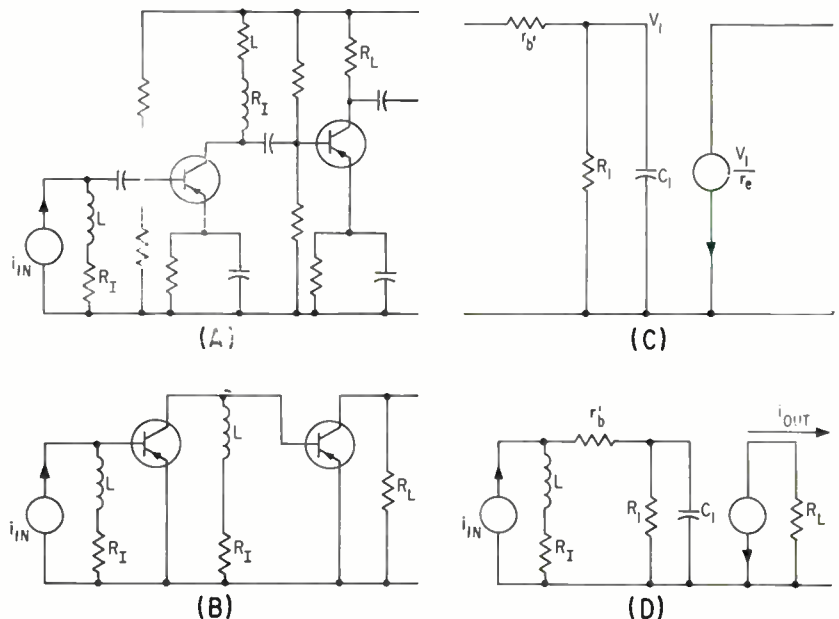

FIG. 1—Typical shunt-peaked amplifier (A) and effective high-frequency circuit (B). Approximate unilateral common-emitter circuit model (C) and high-frequency equivalent circuit of one-stage shunt-peaked amplifier (D)

Transistor Amplifiers

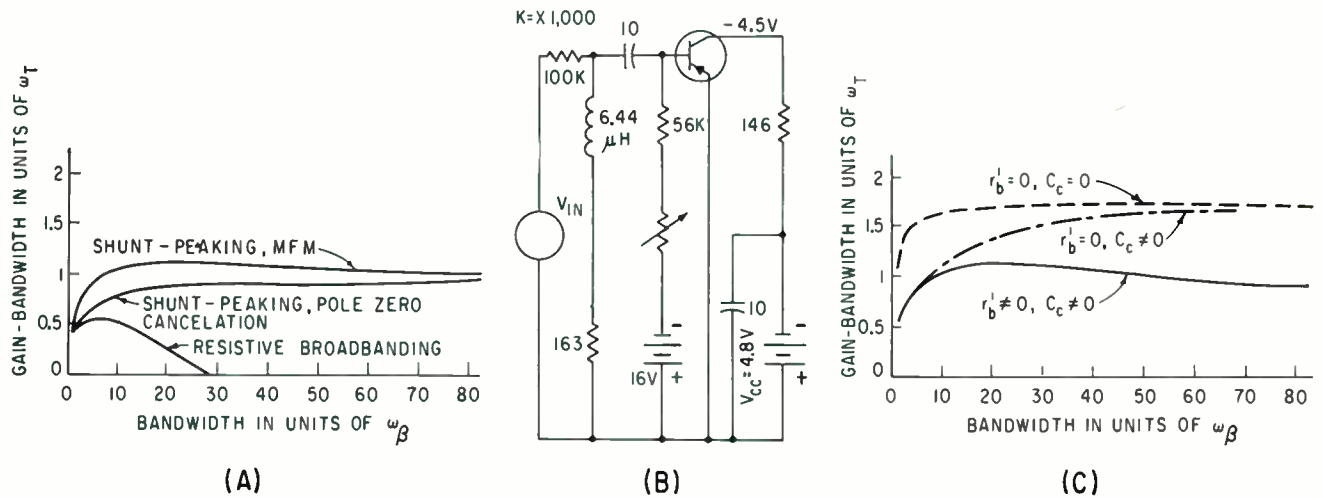

FIG. 2—Gain-bandwidth product as a function of bandwidth (A). Shunt-peaked circuit of Example 1, with pole-zero cancellation design (B). Gain-bandwidth product as a function of bandwidth for maximally-flat-magnitude design (C). Approximate transistor parameters for curves in (A) and (B) are $\omega_T = 108$, $\beta_0 = 50$, $C_c = 20$ pf, $r'_b = 50$, $r'_e = 30$; R_L for iterative stages is a function of input of following stages as discussed in Example 3

in Table I, D is found to be 1.16. Equation 2 is used to find $L = 6.41$ μ h. From Eq. 3 and 4 $R_l = 162$ ohms. Gain is found from Eq. 3 or 4: $G = |T_I(0)| = 10.9$.

The circuit diagram is shown in Fig. 2B. The agreement between calculated and experimental results was good.

	Calculated	Experimental
Gain	10.9	10.4
Bandwidth	1 Mc	1.05 Mc
GBW	10.9 Mc	10.9 Mc

For maximally flat magnitude (MFM) design the following equation must be satisfied.⁸

$$\frac{\mu^2(1 + \epsilon) + 2\mu(1 + \epsilon - 1/A_0) + 1 - 1/A_0^2}{2} = 0 \quad (6)$$

$$\text{where } \epsilon = r'_b/R_l \quad (7)$$

$$A_0 = |T_I(0)|/\beta_0 \quad (8)$$

$$\mu = (R_l/L) \times (D/\omega_\beta) \quad (9)$$

The 3-db bandwidth is

$$BW = \frac{\omega_\beta}{D} \frac{1}{A_0 \sqrt{2}} [1 + \sqrt{1 + 4\mu^2 A_0^2}]^{1/2} \quad (10)$$

The low frequency gain is given by Eq. 4.

Figure 2C shows GBW as a function of BW for various transistor parameters, including the ideal case where $r'_b = 0$ and $C_c = 0$. In Fig. 2C, r_c has been chosen to be a representative value. For $r'_b = 0$, note in Fig. 2C that as the band-

Table I—SYMBOLS AND DEFINITIONS

p = complex frequency variable	$R_l = \beta_0 r_e$
f = frequency in cps	R_L = load resistance presented to the collector
$\omega = 2\pi f = f$ in radians per second	C_c = collector depletion-layer capacitance
CE = common emitter	$D = 1 + \omega_T C_c (r_e + R_L)$
CB = common base	$C_1 = D/\omega_T r_e$
β = CE short-circuit current gain	BW = radian frequency where the magnitude of the gain = 0.707 of its low-frequency value
β_0 = low-frequency CE short-circuit current gain	$ T_I(0) = G = \text{magnitude of the low-frequency current gain}$
ω_β = radian frequency where the magnitude of the CE short-circuit current gain = 0.707 of its low-frequency value	$\mu = (R_l/L) \times (D/\omega_\beta)$
ω_β = radian frequency where β in the CE configuration = 1.	$\epsilon = r'_b/R_l$
$r_c \approx$ output impedance of the CB configuration, usually 1–2 megohms	$A_0 = T_I(0) /\beta_0 = G/\beta_0$
r'_b = ohmic base resistance	ω_α = radian frequency where the magnitude of the CB short-circuit current gain = 0.707 of its low-frequency value
$R_b = R_l + r'_b$	n = number of stages in a cascade amplifier
$r_e = kT/qI_e$, which is about 25 ohms at 1 ma at room temperature (that is, 0.025 volts/ I_e)	F = bandwidth shrinkage factor for cascade amplifiers = $(2^{1/n} - 1)^{1/2}$

n	1	2	3	4	5	6	7	8
F	1	0.64	0.51	0.44	0.39	0.35	0.32	0.30

width is increased, the stage becomes more efficient. The maximum GBW is $1.726 \omega_T/D$. The presence of r'_b , however, limits the maximum GBW product attainable.

By making r_c large, the maximum point on the GBW/BW plot can be shifted to larger bandwidths. A small r_c helps to reduce the effects of the D factor for small bandwidths.

Example 2, MFM design: In the

shunt-peaked interstage the three degrees of freedom are R_l , L , and r_e . If r_e is arbitrarily chosen and if the gain is specified, Eq. 4, 7, 8, 9, 6 and 10 can be used to compute R_l , ϵ , A_0 , R_l/L , and BW respectively. This same procedure also may be used if R_l is chosen. Solve for r_e , L , and BW .

It is possible to go from a bandwidth specification to an approximate gain specification. The GBW

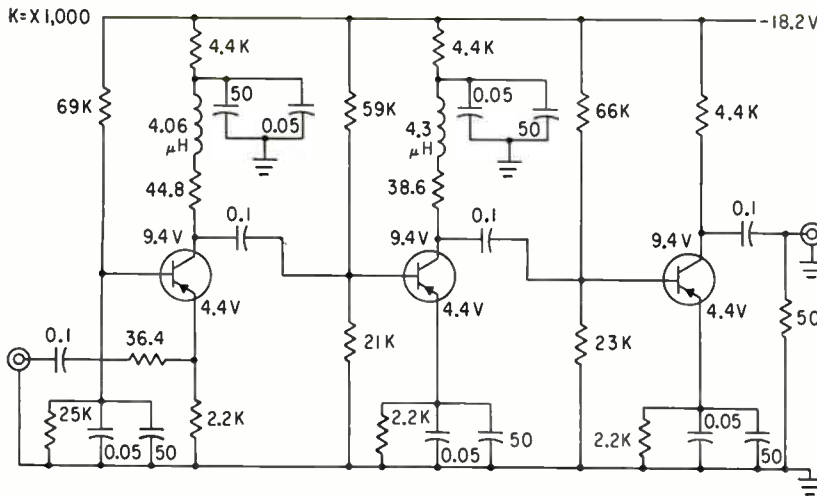

FIG. 3—Two-stage amplifier of Example 3 with common-base input

lies between ω_T/D and $1.726 \omega_T/D$. By assuming a value for the GBW a gain specification can be had from the bandwidth specification. It is now necessary to choose a value for R_i or r_e . This degree of freedom can be used to obtain the maximum possible GBW for the specified bandwidth. Because β_0 is a function of I_c , it is usually wise to choose I_c (hence r_e). The specification is for a bandwidth of 1.0 Mc and R_i is to be equal to the d-c input resistance (this stage is thus treated as an interior stage in an amplifier of identical stages). Alloy transistor B is used.

The GBW lies between ω_T/D and $1.726 \omega_T/D$. A good first estimate can be made by using the graph in Fig. 2C. A high estimate will be made to illustrate the iteration technique. Assume $GBW = 13$ Mc. Thus $G = 13$.

Using Eq. 4, 7 and 8, $R_i = 476$ ohms, $\epsilon = 0.168$, $A_0 = 0.157$.

From the expression given in Table I, D is 1.4. From Eq. 6 and 9, $\mu = 11.8$. Using Eq. 10 bandwidth = $BW = 5.34 \times 10^6$ and $f_{sub} = 0.87$ Mc. The GBW is 11.3 Mc.

Thus the assumed GBW is too high and the design is gone through again with GBW assumed to be 11.7 Mc. The results are: R_i

= 419 ohms, $\epsilon = 0.191$, $A_0 = 0.14$, $D = 1.349$, $\mu = 13.1$, $f_{sub} = 1.01$ Mc, $L = 55.7 \mu h$, $GBW = 11.8$ Mc.

An amplifier similar to Fig. 2C with changes in element values had the desired monotonically decreasing magnitude response. Agreement between calculated and experimental results for gain, bandwidth and GBW was within a few percent.

The design can be optimized by altering the value of r_e and going through the design again until the optimum value for r_e (and R_i) is found. For a large r_e , an external series emitter resistance can be added.

Cascading shunt-peaked stages is most easily done for the pole-zero cancellation method. For n identical one-pole stages bandwidth of the total cascaded amplifier is equal to the bandwidth of a single stage times a bandwidth shrinkage factor, F where $F = (2^{1/n} - 1)^{1/2}$. Values for F are given in Table I. For a 1-Mc amplifier with three identical stages, for example, bandwidth for each stage must be $1/F = 1/0.51 = 1.96$ Mc.

Example 3, Amplifier design: A two-stage amplifier is to be designed with a bandwidth of 2 Mc and an $R_L = 50$ ohms. Input im-

pedance of the amplifier is to be 50 ohms. An additional common-base input stage is used to obtain the 50 ohm input impedance.

Assume the common-base stage has a BW of ω_a and can be neglected in considering the BW shrinkage factor, F . Since the CE stages each have an identical one-pole response, the F factor is 0.64 and the BW per stage equals $(2 \text{ Mc} \times 2\pi)/0.64 = 19.6 \times 10^6$ rad/sec. The design is begun from the second CE stage, for which R_L is 50 ohms.

Alloy transistor C from Table II is used. Proceeding as in example 1, $D = 1.07$, $L = 4.3 \mu h$, $R_i = 38.6$ ohms, $G = |T_i(0)| = 2.74$.

Now the first CE stage is designed. Here $R_L = R_i(R_i + r'_e)/(R_i + R_i + r'_e)$, where R_i , R_i and r'_e refer to the values in the second CE stage just designed.

Transistor D from Table II is used, following the same procedure and obtaining $R_i = 50.6$ ohms, $D = 1.07$, $L = 4.06 \mu h$, $R_i = 44.8$ ohms, $G = 3.13$.

The common-base stage uses pnp alloy transistor E. Input impedance to the CB stages is $r_e + r'_e/\beta_0 \approx Z_{in}$. For this case, $Z_{in} \approx 3 + 63/112 \approx 13.6$ ohms. Thus, the external series resistor needed to provide an input impedance of 50 ohms = $50 - 13.6 = 36.4$ ohms.

The CB stage has a current gain of about 1 and therefore it does not enter into the over-all gain calculation. The over-all current gain is $2.74 \times 3.13 = 8.57$.

A transistor amplifier using the above design is shown in Fig. 3. Results are:

	Calculated	Experimental
Gain	8.57	8.5
Bandwidth	2 Mc	2.1 Mc
GBW	17.2 Mc	17.9 Mc

Research was supported in part by the Office of Naval Research under Contract Nonr-222(74).

REFERENCES

- (1) G. Bruun, Common-Emitter Transistor Video Amplifiers, *Proc IRE*, 44, p 1561, Nov. 1956.
- (2) D. O. Pederson, A Note on Simplified Transistor Equivalent Circuits, *Series No. 60, Issue No. 229, Report No. 81, Electronics Research Laboratory, University of California, Berkeley.*
- (3) D. O. Pederson and R. S. Pepper, An Evaluation of Transistor Lowpass Broadbanding Techniques, 1959 *IRE WESCON Convention Record, Part 2*, p 111, Aug. 1959 or R. S. Pepper, and D. O. Pederson, Shunt-Peaked Transistor amplifiers, *Series No. 60, Issue No. 234, Report No. 85, Electronics Research Laboratory, University of California, Berkeley.*

Table II—TRANSISTOR PARAMETERS AT THE OPERATING POINTS FOR THE EXAMPLES

Transistor	β_0	r_e (ohms)	f_β (Kc)	V_c	r'_e (ohms)	C_c (pf)	I_c (ma)	f_T (Mc)
A	105	13	120	4.5	36	14	2	12.6
B	83	30	123	4.5	80	14	0.9	10.2
C	105	13	87	5	82	19	2	9.15
D	95	13	110	5	77	21.5	2	10.4
E	112	13	127	5	63	19	2	14.2

Microwave Instrument Measures DIELECTRIC CONSTANTS

Direct-readout capability is unique feature, permits a 50-percent reduction in measurement time

By EINO J. LUOMA,
Corning Glass Works, Corning, New York

DIELECTRIC CONSTANT—or its square root, the index of refraction—can be determined by measuring either capacitance, velocity of propagation, Brewster's angle, refraction angle, or reflected power. Reflected power measurements eliminate the computation required by other techniques. This paper describes a method of using reflected power for direct reading of dielectric constant.

The power reflection coefficient from a flat sheet of dielectric material for the lossless case is

$$|R|^2 = \frac{4r^2 \sin^2 \phi}{(1-r^2)^2 + 4r^2 \sin^2 \phi} \quad (1)$$

where r is the interface reflection coefficient and ϕ is the electrical thickness and at normal incidence

$$r = (1 - \sqrt{\epsilon}) / (1 + \sqrt{\epsilon}) \quad (2)$$

where ϵ is the dielectric constant. When the sheet is an odd multiple of quarter waves in thickness, the $\sin^2 \phi$ in Eq. 1 reduces to unity and by substituting Eq. 2, Eq. 1 becomes

$$R = (\epsilon - 1) / (\epsilon + 1) \quad (3)$$

But
$$R = (\rho - 1) / (\rho + 1) \quad (4)$$

where ρ is the voltage standing wave ratio.

Therefore, from Eq. 3 and 4, $\epsilon = \rho$.

Since ρ can be read directly using a microwave ratiometer technique, it is possible to read dielectric constant directly. To do this,

it should be sufficient to read voltage standing wave ratio ρ at the frequency at which the thickness is any odd multiple of quarter waves. However, in applying this principle to practice, several complications arise.

One such complication is frequency ambiguity. For a sample of a given thickness, the quarter-wave thicknesses occur at discrete frequencies that are themselves dependent on the dielectric constant to be determined. This is shown in Fig. 1 and the table for $\frac{1}{4}$, $\frac{3}{4}$, and $\frac{5}{4}$ -in. wall thicknesses. Power-reflection-coefficient curves are shown for dielectric constants of 5 and 6.¹ This difficulty is overcome by using a microwave ratiometer technique that uses a sweep generator (Fig. 2). The X-Y recorder at the output of the ratiometer records the curves of Fig. 1 directly. Since the dielectric constant can be determined by measuring the height of one of the peaks of these curves, frequency ambiguity is

eliminated provided that the dielectric constant itself does not vary with frequency. Generally, for the dielectrics used in radomes, the dielectric constant does not change throughout the microwave region.

The output of the ratiometer varies with the power reflection coefficient, not with ρ , which was shown to be equal to dielectric constant at quarter-wave frequencies. On the other hand, over narrow ranges of ρ , say 5 to 6, the relationship between ρ and power reflection coefficient is nearly linear. Therefore, if two standards with different dielectric constant values are used, both being close to the unknown dielectric constants, a scale can be recorded with the X-Y recorder, and subsequently the unknown can be read directly from this linear scale. For routine quality control in producing the same dielectric materials, two standards are sufficient. If the instrument is used to measure a series of samples with widely varying dielectric con-

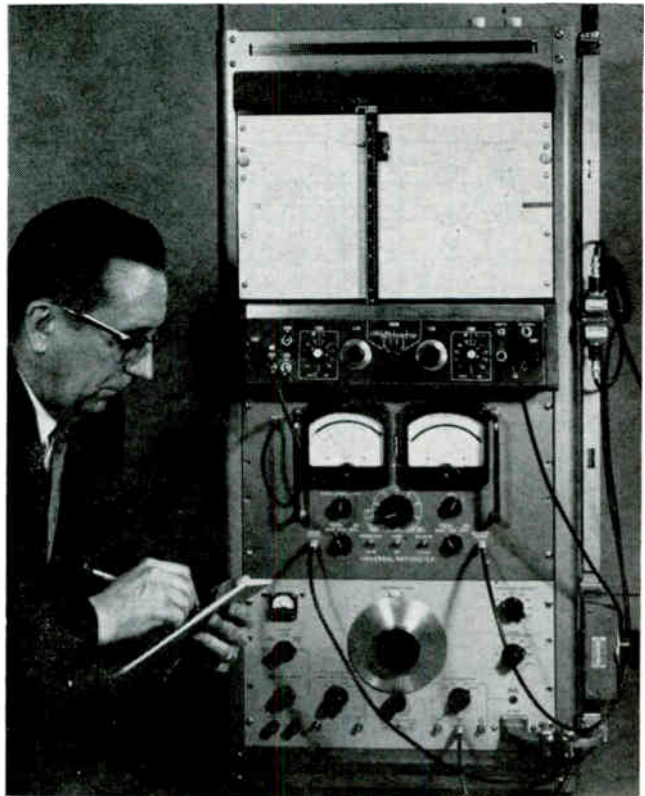

Author takes notes as microwave dielectrometer traces power reflection coefficient against frequency. Dielectric constant of test sample (middle curve) can be obtained to three significant figures

stants, a correspondingly larger number of standards is required.

The ideal sample is small and inexpensive. For correlation it is also desirable to measure the same samples as are used in a shorted-wave-guide type of dielectrometer. However, the measurement is based

on the assumption that the sample is an infinite-plane flat sheet. Therefore, a compromise is made. This compromise is determined experimentally. These experiments show that the one-inch circular disks in the shorted-waveguide dielectrometer, when placed over the open end

of a $1 \times \frac{1}{2}$ in. rectangular waveguide, give good reproducibility and correlation with the shorted-waveguide instrument. Samples should either be very small or very large (6 in. or more), intermediate sizes being the worst choice. Samples should have smooth surfaces and constant thickness.

When the sample is placed directly over the open end of the waveguide, the open end becomes an antenna, the sample being in the near field. Measurement was insensitive to reflecting objects placed as close as six inches from the antenna. The reason is that with samples of a dielectric constant of 5 or higher, a large percentage of the energy is reflected back into the waveguide, especially at the quarter-wave frequency and its odd multiples. Also, any undesired reflection from surrounding objects is reflected away at this frequency.

Figure 3A shows curves recorded with the direct-reading dielectrometer for four materials.

The peaks of the power-reflection-coefficient curves follow a scale (similar to a logarithmic scale) that is the relationship between power reflection coefficient and ρ . It would be impossible to read this scale to more than two significant figures. For quality control of dielectric constant, at least three significant figures are required; therefore, instrument sensitivity must be increased. When this is done the complete curve no longer fits the recorder. Therefore, the frequency scale is reduced to consider only the peak area. Figure 3B shows the result of this on three $\frac{1}{2}$ -in. specimens of Pyroceram 9606 with dielectric constants of 5.5, 5.6 and 5.7. This scale is now suitable for reading directly the dielectric constants of one-half inch specimens of Pyroceram 9606. The experimental curves are not as smooth as theoretical curves. When the sensitivity is increased the curves become even rougher. These imperfections are due to variations of antenna characteristics, directional-coupler characteristics and/or detector characteristics with frequency.

There are several remedies. One is, if a multiplicity of minor peaks occurs in the quarter-wave region as a modulation of the major peak, to use the highest peak as the reading. Since the dielectric constant

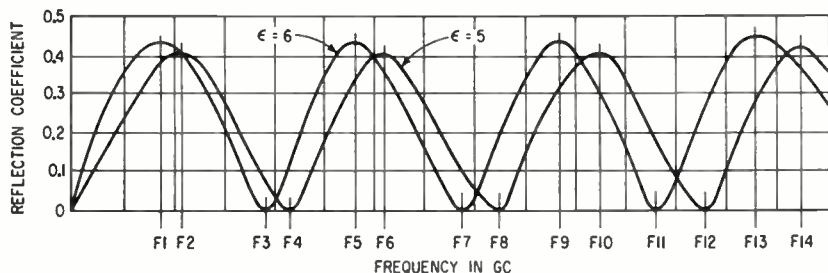

FIG. 1—Power reflection coefficient for a plain sheet at normal incidence

EFFECT OF DIELECTRIC THICKNESS ON FIG. 1'S CURVES

Thickness (in.)	ϵ	Frequency in Gc													
		f1	f2	f3	f4	f5	f6	f7	f8	f9	f10	f11	f12	f13	f14
0.125	6	9.64		19.28		28.93		38.57		48.21		57.86		67.50	
	5		10.56		21.28		31.69		42.25		52.82		63.38		73.94
0.250	6	4.82		9.64		14.46		19.28		24.10		28.93		33.75	
	5		5.82		10.56		15.84		21.12		26.41		31.69		36.97
0.375	6	3.21		6.42		9.64		12.85		16.07		19.28		22.50	
	5		3.52		7.04		10.56		14.08		17.60		21.12		24.65
0.500	6	2.41		4.82		7.23		9.64		12.05		14.46		16.87	
	5		2.64		5.28		7.92		10.56		13.20		15.84		18.47

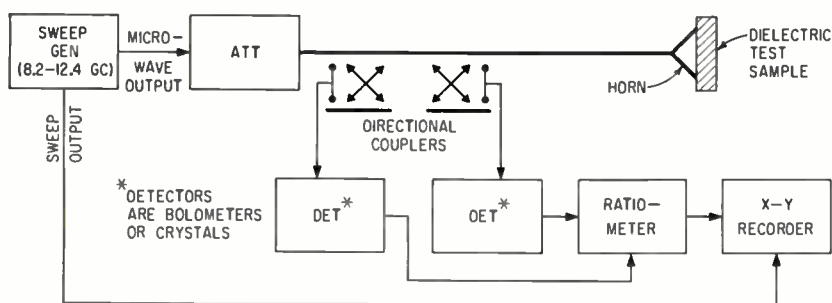

FIG. 2—Microwave instrumentation for dielectric-constant measurement

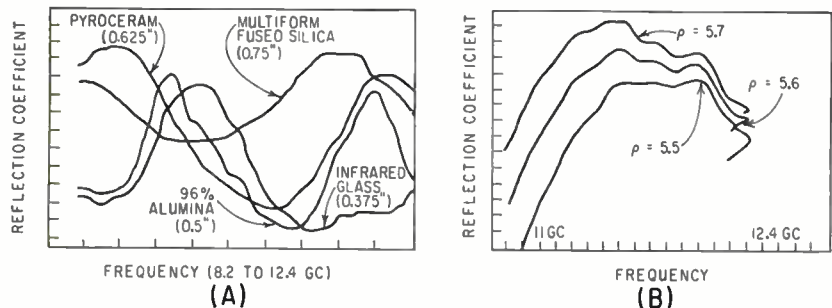

FIG. 3—Reflection-coefficient curves for four different materials (A). Increased-sensitivity measurement of Pyroceram (B)

changes slightly, the highest peak changes the most.

Another remedy is to design a better antenna. For one-inch disks, best results were achieved by sharpening the ends of the open waveguide Fig. 4A. This minimizes the ground-plane effect.

A third remedy is to increase the sweep speed and filter out the modulating peaks with a large capacitance across the ratiometer output. This results in a smoother curve, but accuracy is not as good.

A fourth remedy is to use well-matched directional couplers and detectors.

In applying reflectometer measurement directly to radomes, other complications arise. The spot covered by the waveguide horn excites a trapped wave in the radome wall that moves parallel to the electric field at the spot. This wave circulates around the radome wall and returns to the spot to affect the measurement; therefore, the thickness of the entire radome wall and variations of this thickness enter into the measurements. Thus, measurements must be made at that stage in radome production when the thickness is constant or nearly so. Unfortunately, at this stage the radome wall is likely to be a half-wave instead of odd multiple of quarter waves in the frequency band at which the radome is to be used. Consequently, it is necessary to make the measurement at frequency bands immediately below or above the band at which the radome is to be a half-wave. Due to lack of instrumentation, this is yet to be tried.

In radome measurements, the antenna horn can be placed into intimate contact with the radome wall or at a fixed distance from it. If placed in contact with the wall, it is important to have good coupling with the curved surface. This was obtained by using a horn with spring fingers as shown in Fig. 4B.

Loss tangent will affect the power reflection coefficient at the quarter-wave frequency. However, if it is low and relatively constant, as with ceramics, its effect can be neglected in the quality-control dielectric-constant measurements on the same material.

The microwave reflectometer can be adapted to read the loss tangent directly. This is done by

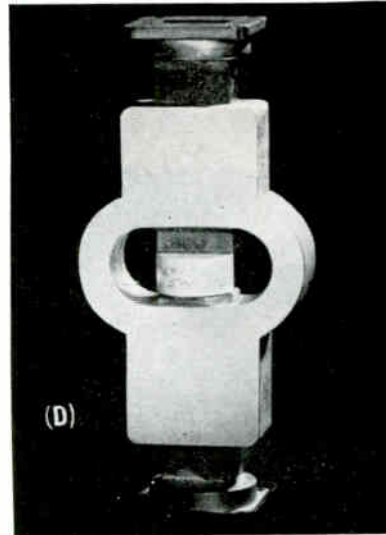
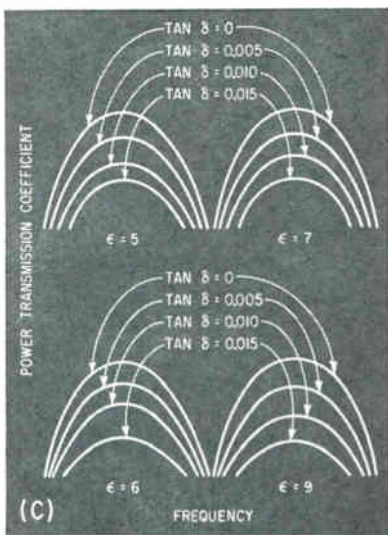
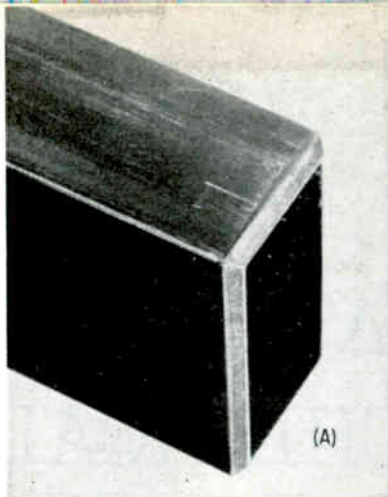

FIG. 4—Modified ends of waveguide (A). Horn with spring fingers (B). Quarter-wave peaks of power transmission coefficient (C). Adapter used for loss-tangent measurements (D)

working with the power transmission coefficient instead of the power reflection coefficient. As seen in Fig. 4C,¹ the peak of the power transmission curve at the half-wave frequency departs linearly from unity as a function of loss tangent. If loss-tangent standards are provided with two different loss tangents near the unknowns and with approximately the same dielectric constant, the loss tangent can be read directly. For manufacture of microwave absorbers, it is expected that this feature would be attractive. The adapting horns permitting this measurement with the reflectometer instrumentation are shown in Fig. 4D.

The correlation of dielectric-constant readings with the shorted waveguide dielectrometer readings is at the worst about ± 0.05 . This can be improved upon by providing samples that are mechanically perfect. Mechanical imperfections in the samples appear to have con-

siderably more effect on the shorted waveguide dielectrometer readings than on the reflectometer readings.

There is no difficulty in reading dielectric constant values to three significant figures for dielectric constants about six.

Measurement is rapid since the sample need not be inserted into a waveguide or cavity and the reading is direct, requiring no computation. There are improvements that would still further improve the usefulness of the instrument. A better antenna or means of coupling to a small sample could be designated to eliminate multiplicity of peaks. By cooling the end of the waveguide with a water jacket, the method has already been applied successfully to read dielectric constants at up to 1,000 C.

REFERENCE

- (1) J. A. diToro, Report No. NADC-EL-5313, Graphs of Transmission and Phase Data of Plane Dielectric Sheets for Radome Design, Bureau of Aeronautics.

SOLID-STATE PULSER DRIVES CHEMICAL PUMP

Silicon-controlled rectifiers in flip-flop circuit replace thyatron power supply in long-life, high-reliability apparatus application

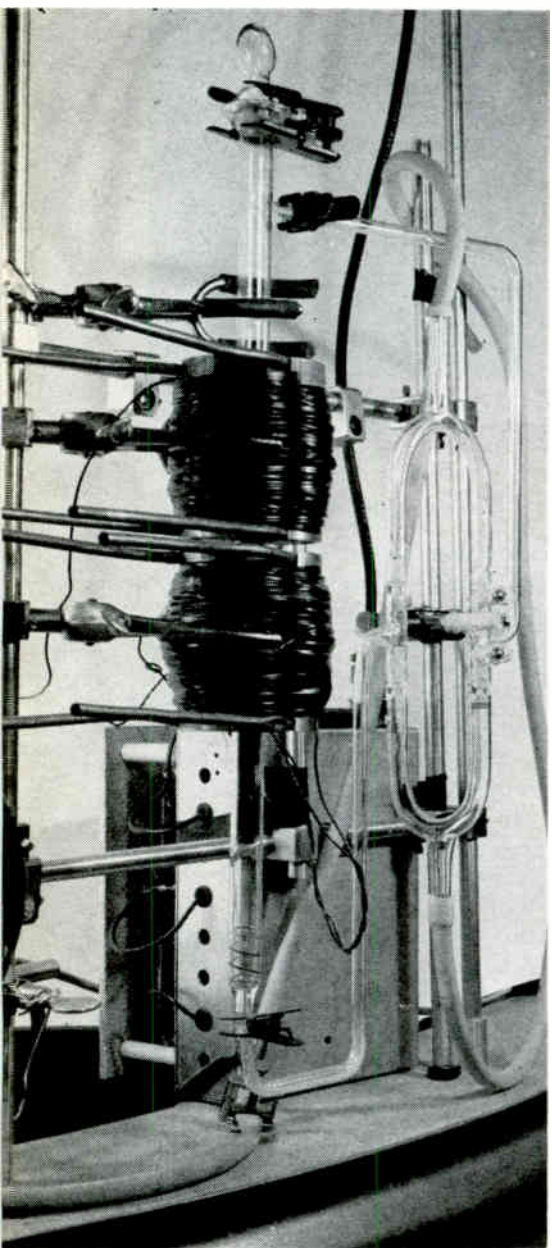

Gas pump consists of iron-cored piston in glass cylinder, driven alternately by two solenoids

By U. L. UPSON,
Hanford Laboratories, General Electric Co.,
Richland, Wash.

A PULSE GENERATOR was needed to drive a solenoid pump in a gas loop for long periods of unattended operation. The pump consists of two alternately energized solenoids driving a sealed-in-glass soft-iron piston in a glass cylinder. Pulses up to 5 amperes were needed at rates variable from $1\frac{1}{2}$ to 25 cps. Previous power sources used thyratrons, which required special time-delay circuits and were limited in current capacity¹. The solid-state, square-wave pulse generator has functioned without maintenance for nearly a year, operating continuously for up to three months.

The generator uses a modified parallel inverter², with a variable d-c power supply and load-compensating circuit. Two silicon-controlled rectifiers are coupled, through the compensated load and 4- μ fd capacitor, in a flip-flop circuit controlled by a variable-frequency relaxation oscillator, and conduct alternately to energize the two pump coils. This is shown in circuit diagram.

When the relay contacts close, a positive transient pulse fires Q_2 through C_1 and R_2 , establishing the conditions for self-commutating operation of the rectifiers, namely, one on, one off. Blocking diode 1N536 prevents simultaneous firing of Q_1 .

The unijunction relaxation oscillator Q_3 delivers 10 to 50 μ sec pulses from base one to the gates of the rectifiers, firing whichever is off.

On triggering the previously off unit, the rectifier's anode drops from B+ to nearly zero voltage, producing a negative spike across the commutating capacitor. This drives the anode of the previously conducting unit (already nearly zero) to a negative voltage, terminating conduction in that unit. The next oscillator pulse reverses the situation. The flip-flop action thus requires two trigger pulses a cycle, and the chemical pump frequency is half the oscillator frequency.

The pulse repetition frequency of the pulse generator is controlled by the unijunction transistor relaxation oscillator's time constant. Adjustment of frequency can be made by varying the resistance R_1 in the unijunction transistor emitter lead (fine adjust) and by switching the capacitances in the emitter to base 1 loop (coarse adjust).

For reliable operation of this circuit, the resistance should not exceed about two megohms; low frequency operation therefore requires increased capacitance in the base 1 loop. This capacitance, however, also determines the base 1 pulse width, which must be shorter than the commutating pulse width or the unijunction will re-fire the switched-off rectifier and stop the flip-flop action.

Commutating pulse amplitude is proportional to the impedance of each rectifier anode to B+, and for purely resistive loads it may be necessary to add inductance to the common B+ leg to develop an adequate pulse.

For a net inductive load no added

Readout Counter used in Tape Preparation for Machine Tool Control

A Veeder-Root Series 1538 Remote Data Readout Counter provides tape feed control for the motorized tape punching unit of the new Potter & Johnston Tape Control System. The tape punch is used to program machine functions on P & J Automatic Turret Lathes. The counter automatically controls the amount of tape feed required for each turret face involved, and stops the tape at preselected address points. When the correct address point is reached, a combination of holes representing the machine command is punched into the tape. Counter is automatically reset for each turret face.

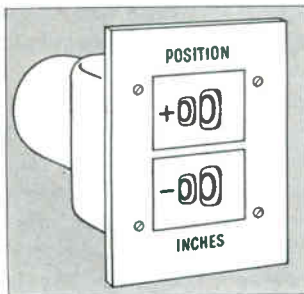
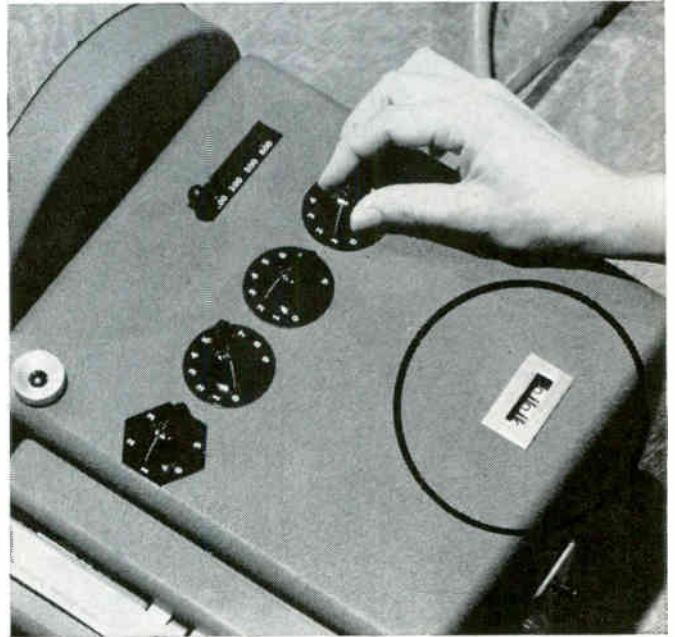

Servo Repeaters Drive Counters to Indicate Lineal Motion*

One of the ways to take advantage of digital readout for indicating and

recording information at remote points is through servo repeaters. Applications in aircraft, for altimeters, navigational displays and similar instrumentation, suggest many other opportunities to use counters for more positive indication and control. A typical "system" is shown here where a counter is used for indicating nuclear reactor rod position. The servo repeater and counter actually form one packaged unit, and the whole device can be potted for environmental protection. When used to drive counters, the servo gear ratio is best selected to provide full scale travel of the counter for one revolution of the control transformer shaft.

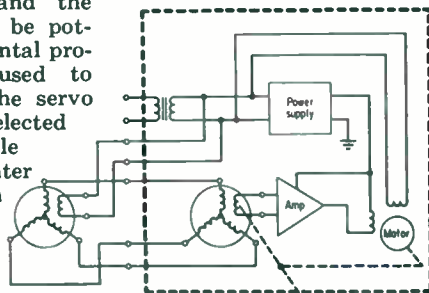

Typical servo repeater/counter device that converts synchro data to digital readout.

Output shaft to counter

Let Veeder-Root help you make Counters do more! Extensive design experience and precision production techniques make it possible for Veeder-Root to help you solve a wide variety of digital, readout, control and recording problems with counters — from the simplest ratchet to advanced readout and navigational devices. Send for information on specific applications or contact your local Veeder-Root Counting Engineer.

*Reprinted from CONTROL ENGINEERING June 1959. Copyright © 1959 by McGraw-Hill Pub. Co., Inc. All rights reserved.

Veeder-Root Readout Device

This is the basic series of Remote Data Readout Counters. Some are available for standard applications, or design variations will be submitted based on requirements. They function basically as analog to digital converters.

Series 1538/electrical reset/ electrically actuated. Speed 1000 cpm, 3 or 5 figure



Series 1538/electrically actuated/ manual reset. Speed 1000 cpm, 3 or 5 figure

Series 1606/mechanically actuated manual reset standard; bi-directional (non-reset) available. Speed 5000 cpm, up to 5 figures



Veeder-Root

HARTFORD 2, CONNECTICUT

"The Name that Counts"

New York • Chicago • Los Angeles • San Francisco • Seattle
St. Louis • Greenville, S. C. • Altoona, Pa. • Montreal
Offices and Agents in other principal cities



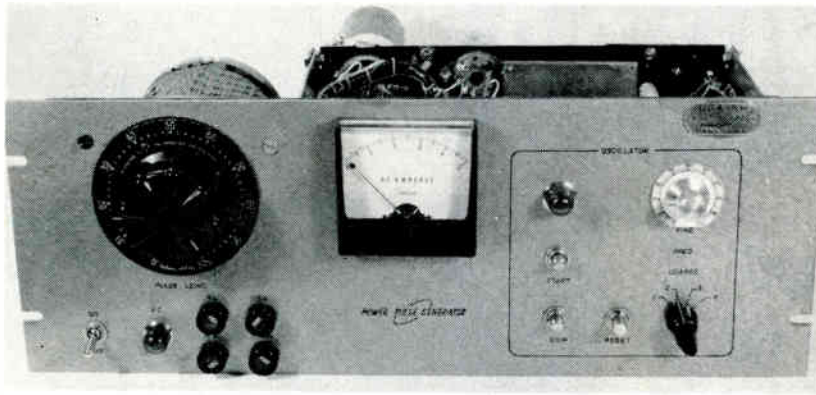

Power supply unit is compactly housed in standard 19-in. instrument rack. Controls at right adjust frequency, variable transformer is at left

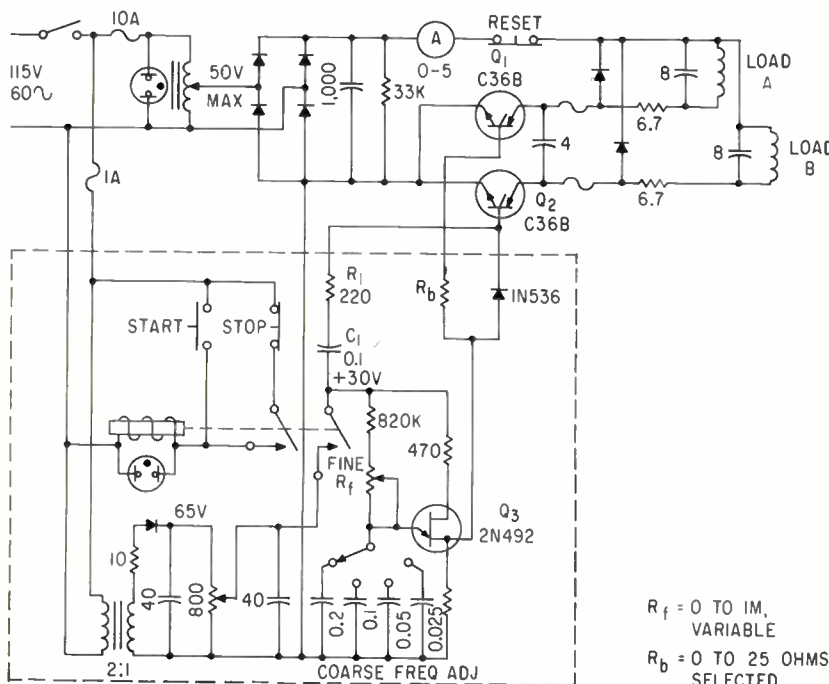

Schematic diagram shows silicon-controlled rectifiers in flip-flop arrangement triggered by unijunction transistor relaxation oscillator

inductance is required, but to protect the controlled rectifiers from inductive overvoltage, reverse-biased diodes are inserted across the loads. The width of the commutating pulse is determined by the value of the commutating capacitor and the resistance across it. Both load circuits are individually fused for safety.

For the variable inductance loads presented by coils with a moving armature it is necessary to bypass each load coil with a capacitor to prevent anode-triggering of the rectifiers by motion of the mechanical load. An $8\mu\text{fd}$ oil-filled capacitor

was found to provide adequate compensation for the system, giving a net inductive pulse-producing impedance to the fast switching transients from the rectifiers, but capacitive to the mechanically induced transients. Since these capacitors also shunt the loads with respect to the commutating source, resistances must be added to each of the load circuits to broaden the commutating pulse to over $50\mu\text{sec}$. These should be kept as low as possible to minimize I^2R losses. For the 6.7-ohm resistors (three 20-ohm 20-watt resistors in parallel), the power dissipation for each resistor

at 2.5 amperes (5-ampere peak square wave) is 42 watts, and the nominal time constant for this load and a $4\text{-}\mu\text{fd}$ commutating capacitor is $53\mu\text{sec}$.

In balancing the two rectifier gates to insure reliable operation, the gate impedance of each unit should be determined, and the blocking diode put in the higher-impedance output. The other gate can then be balanced, as well as isolated, by the resistance R_b , necessary to give current division to the two gates proportional to the required firing currents, as determined by test.

Momentary-contact start and stop switching with relay holding was used to insure zero-current startup on closing the main power switch, to protect the glass pump. A socket-head screw mechanical stop on the variable autotransformer dial plate limits input voltage to about 50 volts, and insures surge limiting to the power rectifiers on startup.

All components except the load coils and their compensating elements are mounted on a 7-in. by 19-in. relay-rack panel. The silicon-controlled rectifiers are capable of higher currents than demanded, but the present power level is more than adequate for the chemical pump application.

The current output is twice that of the thyatron circuit it supplants, and because the output is switched d-c rather than switched a-c, heating in the coils is greatly reduced, permitting the higher current capacity to be utilized. With slight modifications to obtain the desired frequencies and to compensate for load changes, the circuit can be adapted for other applications such as power vibrators, ratchet drive mechanisms, or any devices requiring a square-wave power input.

The author is grateful to Roy True, who fabricated this device, and who assisted substantially in determining correct operating parameters.

REFERENCES

- (1) N. S. Corney, H. B. F. Gow and R. B. Thomas, A Glass-Enclosed Gas Circulating Pump, *AERE c/m 364* (NSA 14-303).
- (2) Notes on the Application of the Silicon Controlled Rectifier, Bulletin No. ECG-371-1, Dec. 1958, General Electric Co., Syracuse, N. Y.



Down in Lubbock, Texas he hasn't missed a shot for over 12,800 hours!

Every time he pulls the trigger the sound is brought faithfully to KDUB-TV viewers by a pair of Eimac 4W20,000A tubes. According to KDUB's Chief Engineer Rudy Starnes, each tube has more than 12,800 hours in aural power output under its belt and is *still going strong!* At the same station, two other Eimac 4W20,000A's have each delivered over 8,000 hours in visual service and are *still going great guns!* Records to shoot for—but typical of what you can expect from Eimac . . . the most advanced name in negative grid tubes, microwave tubes, amplifier klystrons. Eitel-McCullough, Inc., San Carlos, California.



Typical Operation Eimac 4W20,000A. The water-cooled, ceramic and metal 4W20,000A has coaxial terminals and a long-life unipotential thoriated tungsten cathode heated by electron bombardment. Its maximum plate dissipation rating is 20kw. You'll also find it ideal for use in radar picket-ship duty delivering 750kw (¾ megawatt) pulse output.

Service	Frequency	Plate Voltage	Plate Current	Useful Power Output
FM Amplifier	220	7 kv	3.4 amps	13 kw
TV Amplifier	216	7 kv	6.0 amps*	25 kw*
Pulse RF Amp (Radar)	230	25 kv	60 amps	750 kw
Pulse Modulator		20 kv**	200 amps	3 Mw

*Peak Sync

**30kv in oil

negative grid tubes • microwave tubes • amplifier klystrons



Cesium Cell Thermionic Converter Tested

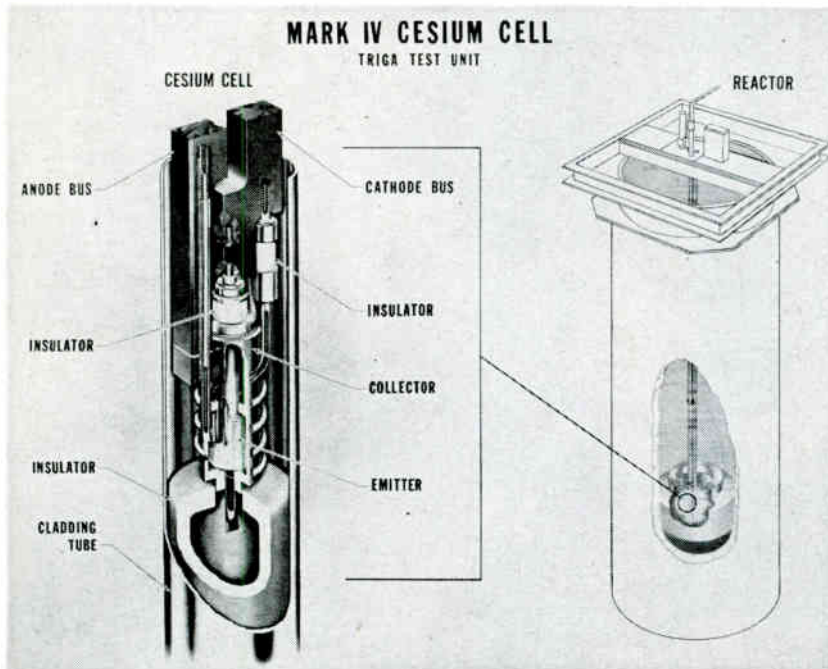

Cesium cell converter unit (left) and location of converter in reactor when positioned for power production (right)

tions, the electrons travel from the emitter to the collector without colliding with the cesium.

Output-characteristics measurements providing fundamental data necessary for the design of operational power conversion equipment have been made as a function of various cell parameters including among others cathode material, cathode temperature, inter-electrode spacing, cell geometry, and plasma density.

It has been observed that the output of cesium cells under certain operating conditions undergoes strong oscillations due to the cell generating a form of alternating current in addition to direct current. A pure direct current results under certain ranges of cell operation, but under other ranges of operation, a sizable alternating current signal having a frequency of 100 kilocycles is obtained.

Other General Atomic efforts in direct conversion research includes work with a new class of high-temperature semiconductor materials including thorium sulfide (a p-type semiconductor) and cerium sulfide (an n-type semiconductor). These materials are able to withstand much higher temperatures than conventional semiconductor materials such as germanium and silicon. Such materials when exposed to high heat show good thermoelectric

NINETY WATTS of electric power produced directly from the heat of nuclear fission. This was the result of a series of reactor operating tests using the TRIGA reactor at the General Atomic Division of General Dynamics Corporation, San Diego, California.

The tests centered about a cesium cell converter containing a nuclear fuel element made of uranium carbide and zirconium carbide. The nuclear fuel element is called the thermionic-emitter element, or simply the emitter. When the cesium cell is placed in the reactor, heat from the fissioning of the uranium causes electrons to be boiled out of the emitter. An electric current collector surrounding the emitter collects the electrons and passes them on to two heavy electrical conductors connected to an instrumented load at the top of the TRIGA reactor pool.

Over 12 test cycles totalling several hours of operation at temperatures ranging from room temperature to incandescence were conducted. No attempt was made to use the waste heat from the con-

verter to increase electrical output and efficiency.

Conversion of fission heat to electrical energy as measured at a bus bar outside the reactor showed overall efficiencies as high as 10 percent at an operating temperature of about 3500° F.

The 90 watts output was produced at a power density of 21 watts per square centimeter in the external load.

The uranium used in the thermionic emitter was fully enriched U-235. General Atomic constructed the emitter using a carbide fabrication technique.

A metal vapor, typically cesium, greatly enhances the direct conversion process in three ways: (1) the vapor steps up the rate at which the electrons boil out of the emitter, (2) it reduces the energy loss at the cold surface of the collector, and (3) most important of all, it becomes an ionized gas, or plasma, to cause the electron current to pass more readily through the region between the emitter and collector. Calculations show that in a large range of operating condi-

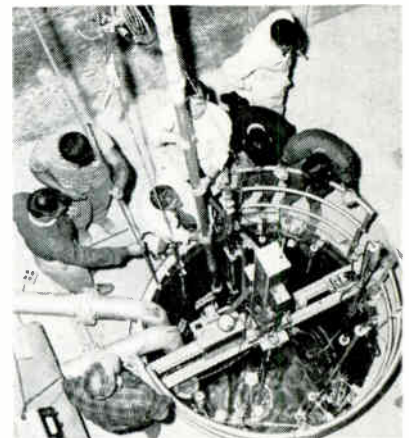

Twelve-foot aluminum tube holding cesium cell is lowered into reactor

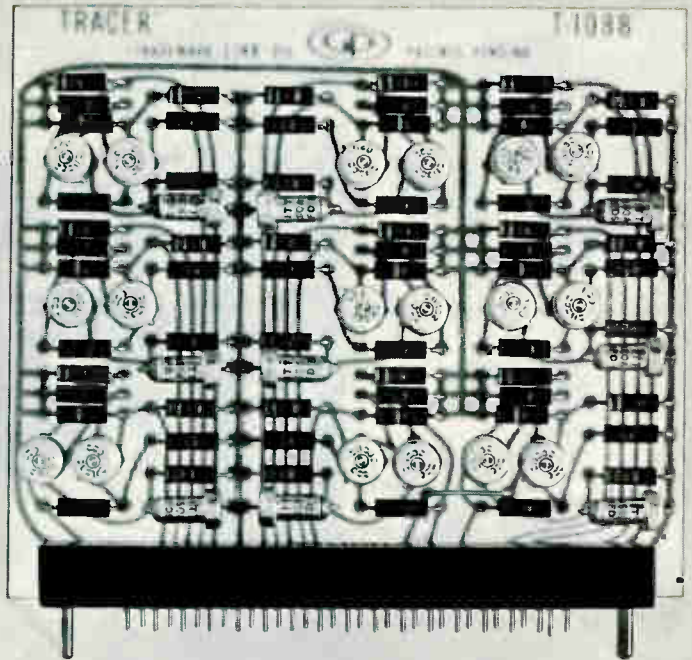
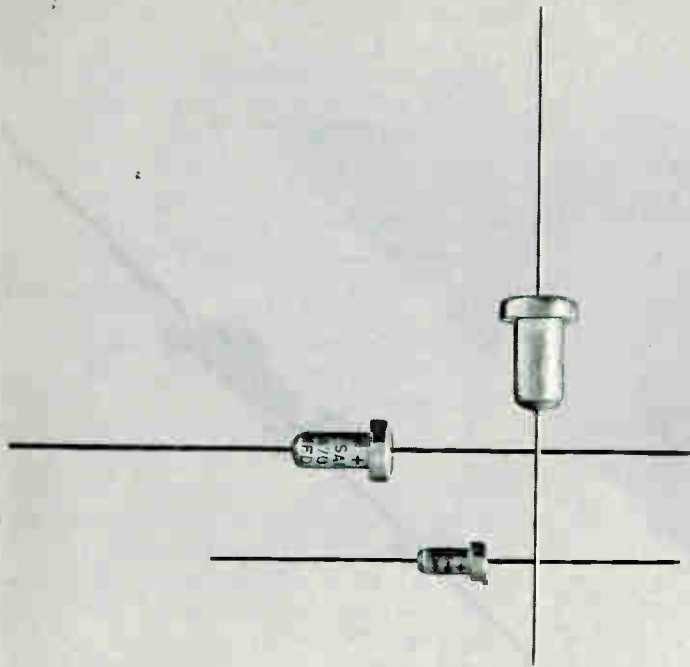

Link Division of General Precision, Inc. specified ITT capacitors for this vital portion of its Tracer Identification and Control System, which demands utmost reliability and long life expectancy from every component.

TOTAL PROCESS CONTROL AND DISCIPLINED PRODUCTION DELIVER

HIGH-RELIABILITY WET-ANODE TANTALUM CAPACITORS FROM ITT

ITT wet-anode tantalum capacitors meet MIL-C-3965B—a fact proved by independent laboratory qualifications tests on ITT capacitors. The reliability and long life expectancy of these competitively-priced capacitors are direct results of ITT's total process control and disciplined production procedures, above and beyond testing standards more stringent than normal industry practice—and backed by ITT's world-wide facilities and experience.



Phone these ITT-CD Capacitor Sales Offices:

Albuquerque AX 9-8013	Los Angeles HI 6-6325
Boston CA 7-2980	Miami MI 4-3311
Chicago SP 7-2250	Minneapolis WE 9-0457
Cleveland GR 5-3080	New York LO 5-1820
Dallas EM 1-1765	Philadelphia TR 8-3737
Dayton BA 8-5493	Phoenix WH 5-2471
Denver KE 4-5091	Rochester FI 2-1413
Detroit TO 8-3322	San Francisco LY 1-7321
Fort Wayne HA 0641	Seattle MA 2-5433
Kansas City JE 1-5236	St. Louis EV 2-3500

IN STOCK AT ITT DISTRIBUTORS:

- TWO TYPES—M-Type and P-Type, for applications from -55 to 85 and 125 C. respectively
- 29 VALUES—from 1.75 to 330 mfd's over a working voltage range to 125 VDC and maximum surge voltages to 140 VDC
- COMPACT AND RUGGED—sintered tantalum slug in fine-silver cases for 2000-hour life at maximum temperature and working voltage
- GUARANTEED—to 80,000 ft. and accelerations of 20 G's with a 0.1 in. excursion in 50-2000 cps range
- LONG STORAGE LIFE—tantalum-oxide dielectric is completely stable; assures trouble-free operation

COMPLETE SPECIFICATIONS ON ITT wet- and solid-anode tantalum capacitors are available on request. Write on your letterhead, please, to the address below.

ENGINEERS: Your ITT representative has a complete set of qualifications and quality control tests for your inspection.

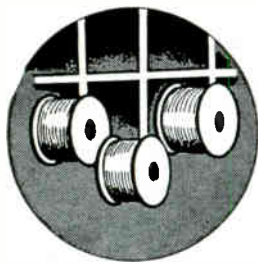

Measures Footage in Stock

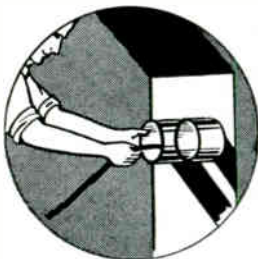

Measures Footage used



Measures Footage Needed



Foot-Marked
every
2 feet

**HICKORY
BRAND®**

Coaxial Cable

Sequential marking, available only on Hickory Brand Coaxial Cable, lets you accurately measure the footage you need, the footage you use and the footage you have left...and guarantees the footage you get! Saves time and cable!

Every two feet, numbers are permanently stamped in sequence on Hickory Brand Coaxial Cable... means better inventory control, eliminates waste in estimating installation requirements.

The conductor insulation and dielectric material used on Hickory Brand RF Cables is polyethylene, making these cables especially adaptable to applications requiring high, very high and ultra-high frequencies.

For economy and efficiency, order Hickory Brand!



*Write for complete information
on the full line of*

**HICKORY BRAND
Electronic Wires and Cables**

Manufactured by
SUPERIOR CABLE CORPORATION, Hickory, North Carolina

properties (conversion of heat to electricity). It may not be desirable to use thermoelectric materials within a reactor as is the case with a thermionic cell such as the cesium cell. However, design studies show that nuclear power may be coupled to thermoelectric generators by heat-transport fluids that can be flowed by natural convection or by electric-magnetic pumps. It is hoped that efficient, compact, and lightweight power plants can thereby be realized.

It may be possible to cascade—or couple in successive temperature ranges—two or more types of direct conversion devices. Thus, a cesium cell thermionic cell could be cascaded with semiconductor devices to increase the over-all efficiency of conversion.

The reactor tests are only the first step in a series of experiments aimed at obtaining a nuclear-thermionic reactor system for both space and land-based power applications. One significant indication of the tests is that the cesium cell converter appears to be capable of further increases in efficiency when its dimensions and temperatures are optimized—it has the capability for ultra-high temperature operation. The entire cell assembly was housed in an aluminum cladding tube identical to that normally housing a regular General Atomic TRIGA research reactor fuel element.

The tests were part of General Atomic's research and development program in direct conversion which is being supported by the Rocky Mountain-Pacific Nuclear Research Group composed of eight western utility companies and by the San Diego Gas & Electric Company.

Acoustical Data Analyzer

SONIC test data on a new jet engine were recently processed in seven hours, whereas previously it took more than one week. The time-saver is the Acoustical Data Analyzer developed by the Wichita (Kansas) Division of the Boeing Airplane Company.

Microphones were attached at 60 positions on the wings and fuselage. At various engine speeds, 720 readings were made and recorded on magnetic tape, which later was

cut into 15 loops. After receiving the 15 loops, the analyzer delivered data on approximately 900 punched cards for an IBM 709 computer to obtain a printed readout of data in 11 columns.

The analyzer uses frequency filters to divide sound from the tape recording into eight separate octave bands with a range of 20 to 20,000 cycles a second. Signals from the tape are changed into the decimal value of their effective voltage levels by comparison with a calibrated reference level artificially created by the analyzer. A card punch records the difference and gives channel number, computed sound intensity, octave number, and microphone attenuator correction.

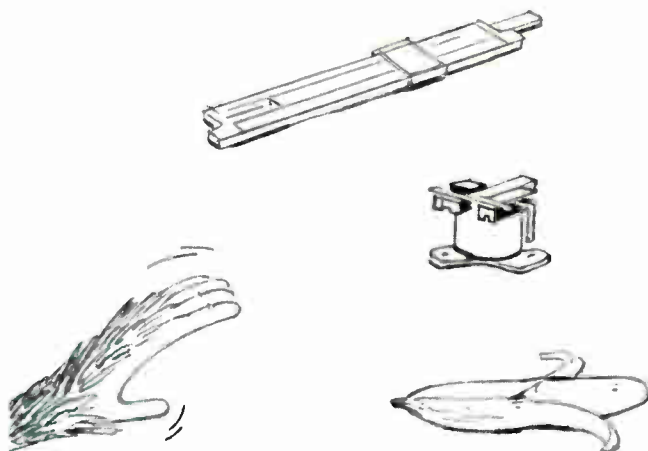

Will he make the right choice and find True Happiness?

Focusing Crystals FOR X-RAYS

DIFFRACTION focusing of x-rays may be done more efficiently and precisely because of new, simple die-forming techniques for obtaining focusing crystals.

Diffraction focusing is obtained from the atom planes of a single crystal deformed so as to form concentric atomic arrays. These arrays have a predetermined optical radii to suit the particular geometry of the diffraction apparatus. Additional forming of the crystal is necessary to obtain the bulk geometry needed for efficient and precise focusing needed for x-rays.

The Aeronautical Research Laboratory at Wright-Patterson Air Force Base, Ohio, has applied plastic deformation in two different ways to single crystals of thulium fluoride to obtain deformation arrays with the necessary radii. The thickness of the resulting crystals was sufficient to permit additional precision bulk shaping by grinding. One method involved room temperature plastic deformation of crystals 2.5 mm and under. This produced microscopic slip arrays that yield crystal-plane curvature with an incremental approximation of optical curvature. The second method uses high-temperature creep to die-form crystals of one centimeter thickness. Compound curvatures of planes by the mechanism of creep are a product of slip and the creation of a mosaic of microstructural elements.

With enough expertly "programmed" and ingeniously dispensed training by a machine, even monkeys can be taught all sorts of marvelous things. (There are those who say that for the rewards illustrated, even a monkey would know enough not to pick the Sigma relay. At times we too wonder if some of our customers wouldn't have been better off if they'd chosen a banana instead of one of our relays.) At any rate, we salute the hard-working souls who try to get other people to think; if their "teaching machines" lack human fervor and originality, as some say, perhaps the critics are confusing the methods with the accomplishments.

Continuing our discussion of Sigma relays vs. bananas (we've decided that *they're* our real competitive threat, not transistors), it is the Application that decides all. We can't hold a candle to their enclosure, and while heat improves them up to a point it's apt to make relays dry up and get lethargic instead of just squishy. What hurts the most, though, is that if a banana doesn't work in the application you had in mind, you can always eat it; in 20 years, we've never been able

to offer customers that consolation.

There's a ray of hope for relays, however, from one quarter where slide projectors, electric shocks, peanut butter and other assorted elements are being used in teaching machines. In one device relays and photocells "read" the student's answer to a slide-projected question, via selected light beams passing through holes in the edge of the slide. This particular programmer uses twelve Sigma Series 11 relays, noted for their compatibility with both monkeys and people. The machine can handle up to 4096 different questions ($12 \text{ relays} \times 2 \text{ positions} = 2^{12}$), and its output from the relays' contacts can run a congratulatory or reprimanding indicator, reward dispenser or some other electrically-actuated device. To the "student" using the machine, the fruits of his labors may be either literal or figurative, depending on what's connected to the machine. This, in turn, is usually determined by whether the student is a smart monkey or just a human being. Another good feature is that the inventor* is Sigma's Sales Manager's cousin's husband, which assures us a certain degree of customer sympathy and prompt payment of account.



This educationally-oriented advertisement is one in a series of public-spirited messages from Sigma, wholeheartedly devoted to fostering greater awareness among relay users. For those not yet ready to buy, Sigma once again offers a small remembrance gift. If you've got 26¢, send it to Sigma's Advertising Manager today, for your Big Application Boon of Oblige Noblesse (address "BABOON Branch"). Quantities limited by our patience; act now.

*Davis Scientific Instruments, 12137 Cantura St., Studio City, California

SIGMA INSTRUMENTS, INC.

62 Pearl Street, So. Braintree 85, Mass.

An Affiliate of The Fisher-Pierce Co. (since 1939)

Special Tubes for Nanosecond Display

By JOSEPH BURNS, Manager,
Cathode-Ray Tube Engineering,
Allen B. Du Mont Laboratories, Inc.,
Clifton, N. J.

SEVERAL SPECIAL PURPOSE tubes permit pulse height analysis where the pulse separation is in the order of μ secs. These tubes use one set of deflection plates for scanning an electron beam across a ladder of electron multipliers, and another set of plates for centering the beam on the ladder.

A tube of this type is the K 1159, a magnetic-focus, electrostatic-deflection, beam-deflection tube, shown in Fig 1. Here, the target contains a ladder of ten dynode-collector assemblies. The collectors are individually shielded to prevent inter-modulation of output signals. The capacitance between each collector and all other electrodes is nominally 1.5 pf. A collector current of approximately 300 μ a permits use of small load resistors feeding into cathode followers, resulting in a small-time constant for short rise and fall times. The voltage required for deflecting the beam across the entire ladder is 35 volts. The frequency response of the deflection structure permits analysis of megacycle information.

More recent tubes, like the K

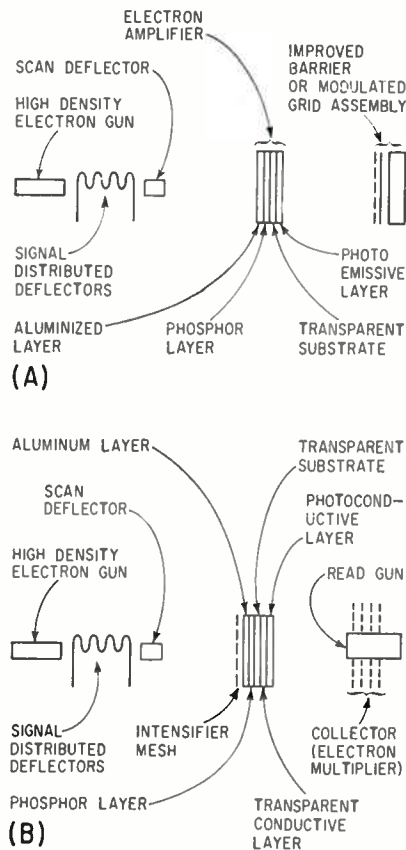

FIG. 2—Tube constructions proposed for storing nanosecond pulses for subsequent display at slow scan rates (A); and for double ended scan conversion (B)

1849, having a row of fine wires sealed along a scan direction, afford finer voltage height increments for pulse height analysis.

An improved design, for nanosecond display use, would include higher beam spot density, increased conductor area incident to the beam, secondary emission amplification, higher deflection sensibility, increased deflection system bandwidth, and reduction of plate capacitance and plate lead inductance to increase the plate ringing frequency.

These tubes can be designed with distributed deflectors to afford sufficient bandwidth to analyze pulse height information of nanosecond pulses.

The individual pulse can be sampled at standard increments, indi-

vidually stored or delayed, and displayed on a standard crt or storage tube a series of beam positions displaced on the vertical axis in accordance with pulse height information, while scanned in the horizontal direction at a rate proportional to the standard sampling increments. Single pulses, or succeeding increments in each of a train of repetitive pulses may be sampled by this technique.

A method of increasing the deflection system bandwidth, appropriate for pulse height analysis with single scan direction, would employ a single narrow pair of deflection plates for high-frequency response and electro-static or magnetic scan expansion to maintain deflection sensitivity. Several methods resulting in considerable scan expansion have resulted in spot elongation in the direction of scan. However, the extremes of scan including spot elongation, is proportional to the scanning voltage. Therefore the scan extremes can be used for pulse height analysis.

Various approaches available for increasing writing rates for faster pulse storage include use of denser electron beams, choice and processing of target materials, and use of optimum accelerating potential to increase the secondary emission ratio of target materials. To further increase writing speed, signal intensification methods including cascaded phosphor and photo-emissive layers or the use of thin-film dynodes can be employed. These devices, incorporated into the designs of experimental tubes, have yielded electron gains exceeding ten per stage. The loss in resolution is small through properly designed electron amplifiers.

A tube for storing nanosecond pulses for subsequent display at slow scan rates, may be seen in Fig. 2A.

A double ended scan conversion tube permitting simultaneous write and slow scan read, utilizing the same philosophy, may be seen in Fig. 2B.

An electron amplifier preceding

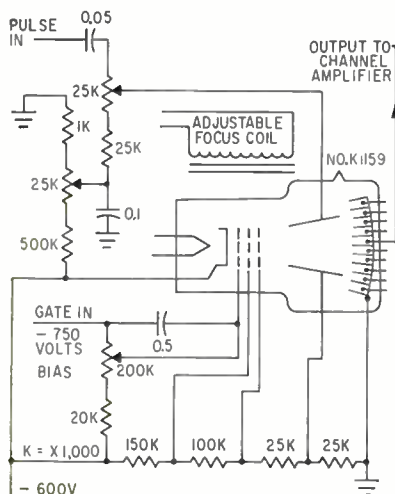
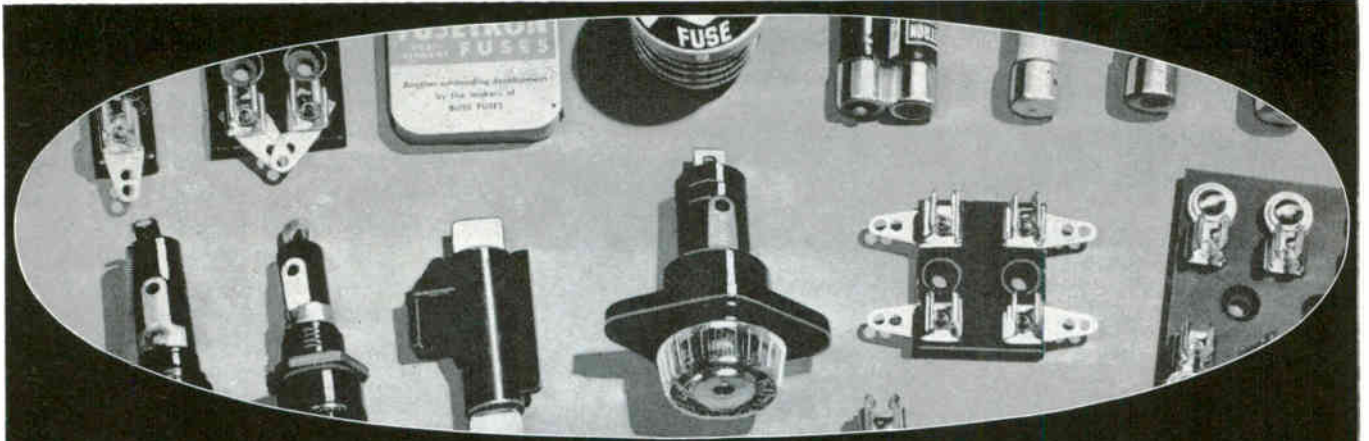
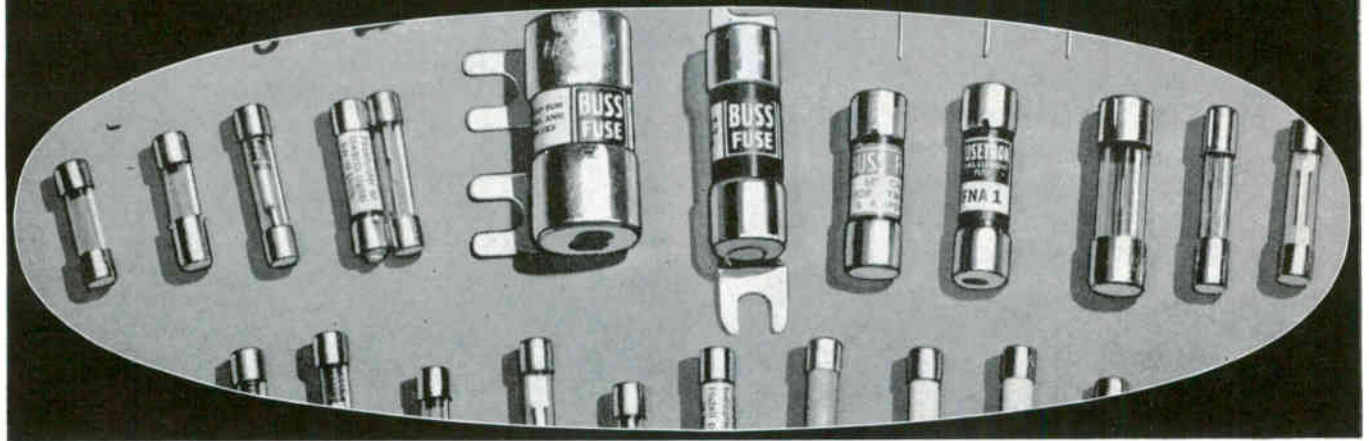

FIG. 1—Schematic of K 1159 beam deflection tube circuit



You'll save time, trouble..



*... by turning **FIRST** to **BUSS** for
fuses of unquestioned high quality*

By relying on BUSS as your source for fuses, you can quickly and easily find the type and size fuse you need. The complete BUSS line of fuses includes: dual-element "slow-blowing", single-element "quick-acting" and signal or visual indicating types . . . in sizes from 1/500 amp. up — plus a companion line of fuse clips, blocks and holders.

BUSS fuses are made to protect — not to blow needlessly

When you specify BUSS fuses — users of your equipment receive maximum protection against dam-

age due to electrical faults. And just as important, users are safeguarded against irritating, useless shutdowns caused by faulty fuses blowing needlessly.

A component part that operates as intended helps to maintain the reputation of your equipment for quality and service. That's why it pays to rely on dependable BUSS fuses.

If you should have a special problem in electrical protection . . . the world's largest fuse research

laboratory and its staff of engineers are at your service — backed by over 46 years of experience. Whenever possible, the fuse selected will be available in local wholesalers' stocks, so that your device can be easily serviced.

For more information on BUSS and Fusetron small dimension fuses and fuseholders . . . Write for bulletin SFB.

**BUSSMANN MFG. DIVISION,
McGraw-Edison Co.
University at Jefferson, St. Louis 7, Mo.**

1280

BUSS fuses are made to protect - not to blow, needlessly.

BUSS makes a complete line of fuses for home, farm, commercial, electronic, electrical, automotive and industrial use.



The future . . . from your point of view

A good day's growth for a hard
day's work.

A position to suit your talents,
experience and ambition.

Opportunity to exercise full
initiative in Research,
Radar, Doppler Naviga-
tional Systems, Magnetic
Memory Systems, Micro-
wave and Computers.

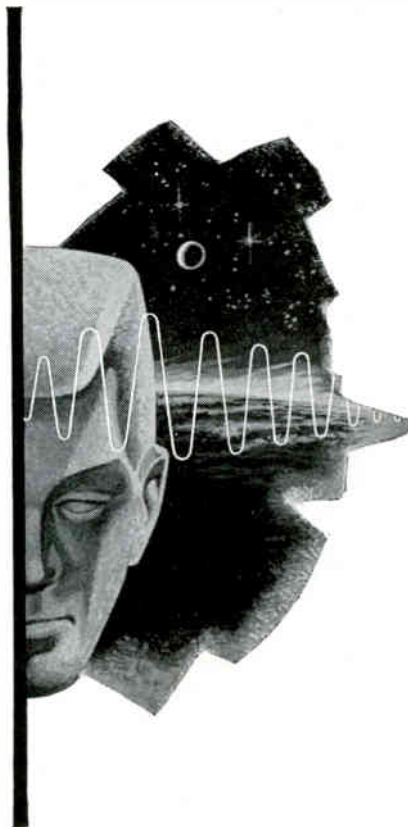

PLUS

Management awareness encouraging exploration beyond the
range of present knowledge.

APPOINTMENTS NOW AVAILABLE:

SENIOR ENGINEER

Air Traffic Control Systems

Experienced in problems involving the relation of overall
ground-air environment to such elements as Navigation,
Data Acquisition, Processing and Display.

SENIOR ENGINEER

Radar Systems & Techniques

Thoroughly grounded in existing systems, philosophies and
techniques. To study, design and plan advanced programs
for varied applications.

SENIOR ENGINEER

Airborne Electronic Weapon Systems

Experienced in existing systems and requirements. To plan
the optimum integration of such various subsystems as radar,
navigation, central data computers, communications, etc.

For a confidential discussion, please write: C. E. Fitzgerald

Laboratory For Electronics
1079 Commonwealth Avenue
Boston 15, Massachusetts



LABORATORY FOR ELECTRONICS

the photo-conductive target will increase the writing speed by a factor of ten. This will improve the ratio of output signal to noise since the electron multiplier in the collector output is ineffective in amplifying weak target signals obscured by noise in the read beam.

The output of this tube can be obtained across a load resistor in either the transparent conductive layer or collector circuit. Collector circuit output may be preferred for multiplier amplification. For simultaneous write and read, video cancellation of the write signal can be effected by uniting the outputs.

Cathode-ray tubes designed for displaying nanosecond transients must have a minimum of 3 KMc deflection system bandwidth for good fidelity, and writing speeds beyond 10 cm per nanosecond. The transit time through the signal deflection plates must be small compared with the rate of change of the signal phase to prevent distortion of the displayed signal. This required use of a single pair of short deflectors or distributed deflectors in which the signal keeps pace with the electron beam. Increased deflection sensitivity, without a reduction in deflection system bandwidth, is accomplished with distributed deflectors wherein repeated deflections are created by multiple plate sections, each equivalent in length to the single deflection plate pair. Two drawbacks of the distributed deflectors are reduction in scan and increased capacity. The latter is particularly objectionable at kilomegacycle frequencies.

To obtain high writing rates, assuming fixed phosphor efficiency and film speed, it is necessary that the electron beam current density and accelerating potential are high. To obtain a small, high current density spot size for high deflection sensibility, expressed in volts per trace width, the beam diameter leaving the electron gun must be large. These requirements are contrary to conditions necessary for achieving high deflection sensitivity and scan.

Several approaches are proposed for inclusion in a cathode-ray tube having extremely high bandwidth and writing speed:

Decrease in length of the distributed deflectors for feasibility

of construction and assembly, will reduce capacitance and increase scan. Short, straight plate leads fed directly out the tube neck will hold series inductance to a minimum.

One or more electron amplifier stages can be employed for higher writing current. The initial electron energies of exit electrons should be small to prevent degradation of line width.

Use of a post accelerator to permit high screen voltage for increased writing speed without loss of scan or deflection sensitivity will permit use of a lower accelerating potential on the electron gun for higher deflection sensitivity, without deflection distortion introduced by a high ratio of post-accelerator to accelerator voltages. The concept of a mesh post accelerator is not new to cathode-ray tubes, and is used extensively in direct view storage tubes.

Problems still associated with mesh post accelerators include ghosts due to secondary electrons. These can be collected by means of mesh closely spaced to the accelerator mesh, located at a point further from the screen and operated at a slightly higher potential than the post accelerator mesh.

Soviets Push Glass Insulators

VIENNA, AUSTRIA—MECHANIZATION and automation meet with difficulties in the manufacture of porcelain insulators. The Soviet Union has therefore devoted much attention to the development of a glass suitable for this purpose. Experimental work with low alkali glass insulators have been in progress since 1953, when the Soviet Glass Research Institute developed a suitable type of glass metal referred to as "13v". The composition is SiO₂, 63.5%; Al₂O₃, 15.5%; C₂O, 13%; Mg O, 4%; Fl, 2%; Na₂O, 2%.

Last year large-scale manufacture of low-alkali glass insulators was introduced in the Jarvakand Glass Works (Estonian SSR), and recently a flow line for this production has been designed. This will reduce manufacturing costs to such an extent that glass insulators will be far cheaper than porcelain ones.



CRT OF THE MONTH

New! ETC Type 31SBP — for transistorized scopes. Designed and produced by ETC to MIL-E-1D specifications, this 3 1/4" by 2 3/4" flat face tube combines very low deflection factors with excellent light output at modest voltages. Length is only 13 1/2". A linear post accelerator and geometry adjust electrode minimize pattern distortion.

Deflection Factors:

D1 & D2 25.0 to 30.0 v dc/in.

D3 & D4 12.5 to 15.5 v dc/in.

Post Accelerator Voltage: 3000 v dc.

pacing trends

IN CATHODE RAY TUBE DESIGN

...since 1937

Over 50 standard types . . . many specials . . . produced for oscilloscopes and critical display instrumentation. 1 to 10 guns; square, round, or rectangular faces; high resolution; spiral band for radar, fire control, counter-measures, guidance—where quality control counts most. Submit your application details for an engineering review.

electronic tube corporation
1200 E. MERMAID LANE, PHILADELPHIA 18, PENNA.

Wet Process Stacks Laminations Faster

By R. B. WOODWARD,
Chief Manufacturing Engineer,
Assembly Department,
Missile Systems Division,
Raytheon Co., N. Andover, Mass.

STACKING AND BONDING laminations by a mechanized wet stacking process has stepped up quality and production rates on motor rotors and stators for gyros and other small instruments used in missiles.

The new routine is straightforward, compared to the painstaking process formerly employed. A pre-

determined number of laminations for a complete stack is loaded onto a bullet-nosed mandrel. The mandrel is placed in a revolving turret, which dips the stack into bonding resin. After dipping, the mandrel is unloaded into a holding fixture and the stack compressed to its finished thickness. Surplus resin is washed off and the stack goes into a curing oven. The fixture is automatically released at the starting point.

The machine turns out more than

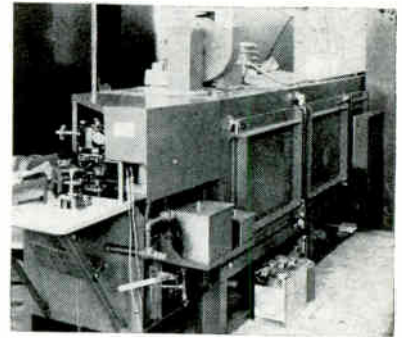

Fixtures pass through oven and return to operator's table for unloading

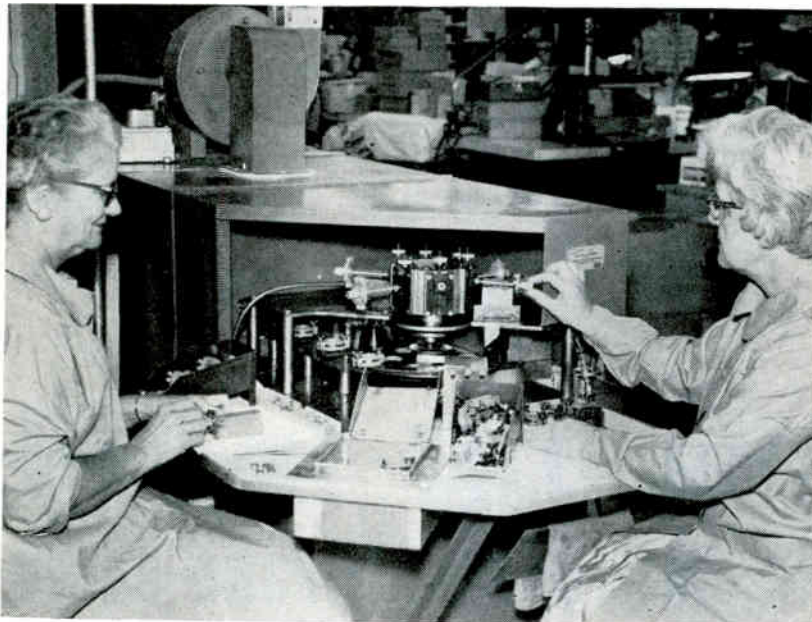

Operator at left inserts mandrel into laminations held in spacer block. At right, mandrel is removed from turret after laminations are coated

one complete stack a minute, raising monthly output to 5,800. It is saving 580 man-hours a month and has reduced working space by 200 feet. Details of the process follow.

The proper number of laminations are preloaded into a spacing block. The mandrel, carrying half of the fixture, is pushed through the center holes of the stack. The operation is like thrusting a pencil through a supply of washers. The operator then inserts the loaded mandrel into the machine's turret.

Slowly revolving, the stack is carried over an epoxy bath and is dipped. The mandrel, with the coated stack, is delivered to the second operator, who removes it from the turret and inserts it into the bottom half of the fixture. The laminations are now stacked between the fixture halves.

The mandrel is then stripped out and the two fixture halves are closed tightly with wing nuts until the stack is compressed to the desired height. The fixture is removed from the holder and placed on station in a chain. It passes under a high-pressure jet of solvent. The spray removes excess epoxy, which has been squeezed from between the laminations to the wire-carrying areas of the stack. An air jet then blows off any remaining epoxy and solvent. The fixture passes into the oven, where the resin is cured at 450 F for 36 minutes. An automatic ejector removes



Fixture containing cured stack drops from chain as mandrel is loaded in dipping turret

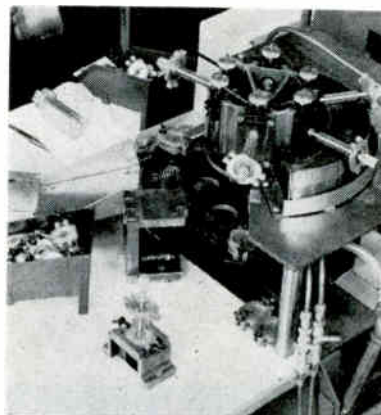

Overhead view of dipping turret, and holder used to join fixture halves and compress laminations

Precision
**FREQUENCY
 STANDARDS
 AND
 FORK OSCILLATOR
 UNITS**

OUR NEW HOME, DOUBLING OUR FORMER CAPACITY

Watch  *Master*
 ELECTRONICS

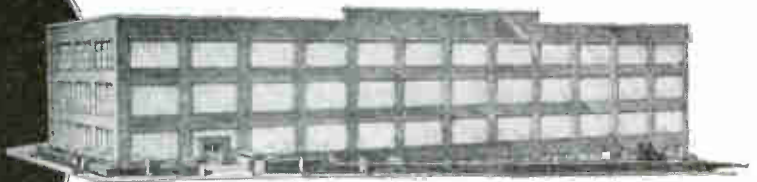

Our instruments, 40 to 30,000 cycles, are used extensively by industry and on government projects where enduring accuracy and maximum durability are required. Your inquiries on related products are invited.

PRECISION FORK OSCILLATOR UNITS

TYPE 2003



Size 1½" dia. x 4½" H. Wght. 8 oz.
 Frequencies: 200 to 4000 cycles
 Accuracies:—
 Type 2003 ($\pm .02\%$ at -65° to 85°C)
 Type R2003 ($\pm .002\%$ at 15° to 35°C)
 Type W2003 ($\pm .005\%$ at -65° to 85°C)
 Double triode and 5 pigtail parts required.
 Input, Tube heater voltage and B voltage
 Output, approx. 5V into 200,000 ohms

PRECISION FREQUENCY STANDARDS

TYPE 2005A

Size 8" x 8" x 7¼" High
Weight, 14 lbs.

Frequencies:
 50 to 400 cycles (Specify)
 Accuracy:
 $\pm .001\%$ from 20° to 30°C
 Output, 10 Watts at 115V
 Input, 115V. (50 to 400 cy.)



TYPE 2007-6



TRANSISTORIZED, Silicon Type
Size 1½" dia. x 3½" H. Wght. 7 ozs.
 Frequencies: 360 to 1000 cycles
 Accuracies:
 2007-6 ($\pm .02\%$ at -50° to $+85^{\circ}\text{C}$)
 R2007-6 ($\pm .002\%$ at $+15^{\circ}$ to $+35^{\circ}\text{C}$)
 W2007-6 ($\pm .005\%$ at -65° to $+85^{\circ}\text{C}$)
 Input: 10 to 30 Volts, D. C., at 6 ma.
 Output: Multitap, 75 to 100,000 ohms

TYPE 2121A

Size
8¾" x 19" panel
Weight, 25 lbs.

Output: 115V
 60 cycles, 10 Watt
 Accuracy:
 $\pm .001\%$ 20° to 30°C
 Input,
 115V (50 to 400 cy.)



TYPE 2001-2



Size 3¼" x 4½" x 6" H., Wght. 26 oz.
 Frequencies: 200 to 3000 cycles
 Accuracy: $\pm .001\%$ at 20° to 30°C
 Output: 5V. at 250,000 ohms
 Input: Heater voltage, 6.3-12-28
 B voltage, 100 to 300 V., at 5 to 10 ma.

TYPE 2111C

Size, with cover
10" x 17" x 9" H.
Panel model
10" x 19" x 8¾" H.
Weight, 25 lbs.

Frequencies: 50 to 1000 cy.
 Accuracy:
 $\pm .002\%$ at 15° to 35°C)
 Output: 115V, 75W.
 Input: 115V, 50 to 75 cy.



WHEN REQUESTING INFORMATION, PLEASE SPECIFY TYPE NUMBER

ACCESSORY UNITS FOR 2001-2



L—For low frequencies
 multi-vibrator type, 40-200 cy.
 D—For low frequencies
 counter type, 40-200 cy.
 H—For high freqs, up to 30 KC.
 M—Power Amplifier, 2W output.
 P—Power supply.



**American Time Products
 Inc.**
 61-20 Woodside Avenue
 Woodside 77, N. Y.

new GEN-PRO®

REPICON® REMOVABLE CONTACT CONNECTOR

New from Gen-Pro: Repicon high density removable contact connector in single or double insert types offers unlimited application in wiring installations. Available in 34, 42, 50, 81, 104 or 162 contacts.

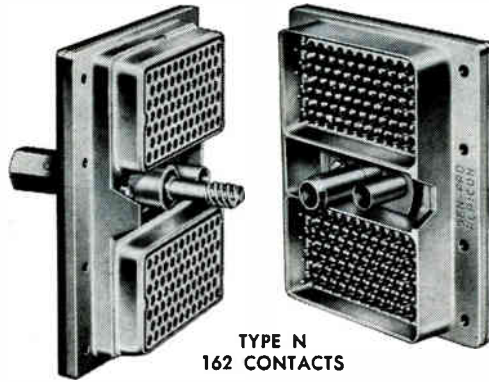
REPICON REMOVABLE CONTACTS in crimp or solder type afford higher contact retention ability, lower millivolt drop. Usable in various other existing connector body sizes and configurations. Contacts ordered separately.



TYPE N
162 CONTACTS

Write today for bulletin illustrating types in stock with specifications

GENERAL PRODUCTS CORPORATION
Over 25 Years of Quality Molding
UNION SPRINGS, NEW YORK TWX No. 169

CIRCLE 202 ON READER SERVICE CARD



...When there's NO SUBSTITUTE for PRECISION TIMING

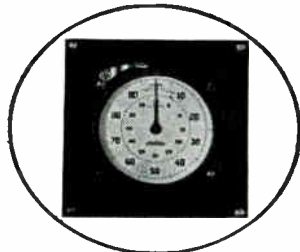

PANEL MOUNTED

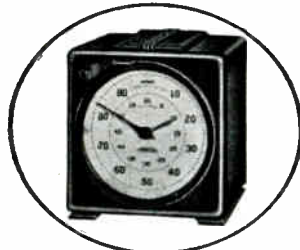

PORTABLE

When the emphasis is on accuracy in timing, the wise choice is STANDARD precision elapsed time indicators. Units are synchronous motor driven . . . electric clutch controlled by manual or automatic switch or output of electronic tubes . . . available with manual or electric zero reset, a-c or d-c clutch.

Model	Scale Divisions	Totalizes	Accuracy
S-100	1/5 sec.	6000 sec.	±.1 sec.
S-60	1/5 sec.	60 min.	±.1 sec.
SM-60	1/100 min.	60 min.	±.002 min.
S-10	1/10 sec.	1000 sec.	±.02 sec.
S-6	1/1000 min.	10 min.	±.0002 min.
S-1	1/100 sec.	60 sec.	±.01 sec.
MST	1/1000 sec.	.360 sec.	±.001 sec.
MST-500	1/1000 sec.	30 sec.	±.002 sec.

THE STANDARD ELECTRIC TIME COMPANY

89 LOGAN STREET, SPRINGFIELD, MASSACHUSETTS

Request Catalog No. 198

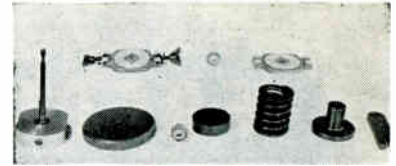

New fixture is cast aluminum, old is machined steel

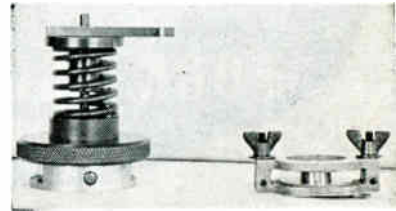

Old and new fixtures assembled. Gyro stator can be seen in new fixture

the fixture from the chain after bonding.

The old method required that individual laminations be laid out on a flat surface. They were sprayed with resin, dried under lamps, turned over and resprayed. Then they were picked up with tweezers and stacked by placing them one by one on posts in a fixture.

The top of the fixture was put in place, a spring added, the spring compressed by an arbor press and a key inserted to maintain spring pressure during bonding. Bringing the heavy steel fixture up to oven temperature required a longer bonding cycle. To quickly place the fixtures back into production, they had to be cooled in a dry ice bath.

The new fixtures lose heat so rapidly that cooling is unnecessary. They are investment cast of aluminum and cost only \$4, compared to \$100 or more for the old hardened and ground steel fixtures. The new equipment was designed and built by the Special Equipment Design Department at Raytheon-Andover.

Wiring Analyzer Tests 60 Circuits a Minute

AUTOMATIC WIRING analyzer that can check up to 6,000 circuit assemblies for current continuity and leakage has been developed by Hughes Aircraft Co., El Segundo, Calif. Tests are controlled by programmed IBM cards corresponding to the wiring diagram of circuits being checked. The machine processes 60 cards a minute.

After the unit under test is con-

nected to the analyzer, the cards are placed in a reader. As the cards complete their test cycle, they fall into "condition of circuit" bins which classify the type of failure and its location in the assembly.

Leakage failures are pinpointed by recycling trouble cards one at a time through the reader. Locator lights on a fault isolation panel indicate which wires in the circuit are faulty. The analyzer also contains a functional tester to check switches, relays, resistors and other components.

The analyzer can be adapted to any number of tests, in multiples of 1,200. Modifications in systems under test are accommodated by making new connector cables and preparing fresh test cards.

Solder Paste, Table Mechanize Soldering

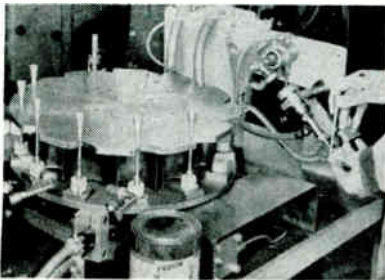

Paste is applied as parts are assembled

SOLDER JOINTS are made inside a thermostat housing in about 10 seconds with the indexing machine shown. The housing is fitted with an extension tube and a brass insert.

The part is placed under the nozzle of a solder paste applicator and receives a metered amount of solder. The operator puts the insert in the housing. More paste is applied as the extension tube is placed in the housing.

The assembly is loaded into a ceramic fixture and positioned in a spring-loaded slot. As the table indexes, the assembly passes pre-heat and final heat torches, air cools for two stations and is ejected onto a slide.

Paste used is a mixture of solder, flux and neutral binders made by Fusion Engineering, Cleveland, Ohio. The firm designed the setup for Continental Controls, Lakewood, Ohio.

the new look in "quick look" data handling

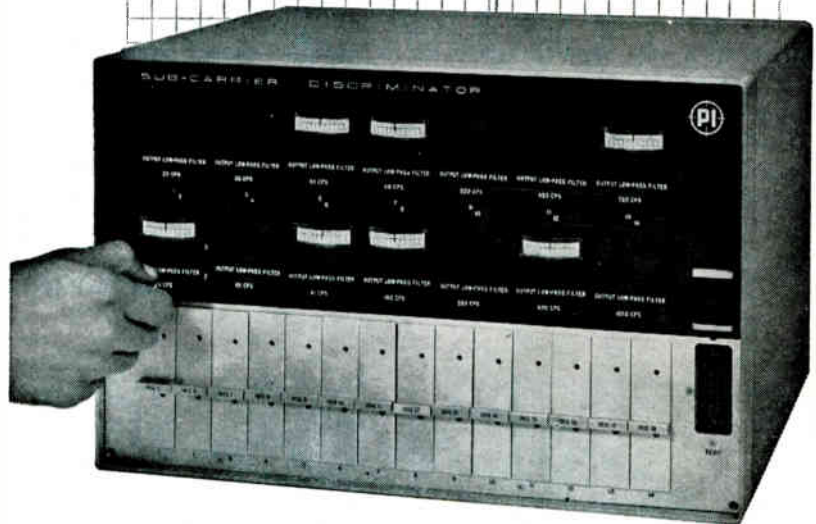

MINI-TEL all-solid-state telemetry sub-carrier discriminator

For "quick-look" analysis of FM telemetry data, the Precision MINI-TEL sub-carrier discriminator packs a surprising amount of usefulness into an exceptionally small space.

In its compact (less than 1 1/2 cubic feet) single-module package, occupying only 10 1/2 inches of rack space, the MINI-TEL provides up to 14 IRIG discriminator plug-in units, power supply, and output level monitor meters. Initial cost, maintenance, and power drain are exceptionally low.

Write for your copy of Bulletin 60 for details.



PRECISION INSTRUMENT COMPANY

1011 Commercial Street • San Carlos • California
Phone LYtell 1-4441 • TWX: SCAR BEL 30

REPRESENTATIVES IN PRINCIPAL CITIES THROUGHOUT THE WORLD

New On The Market

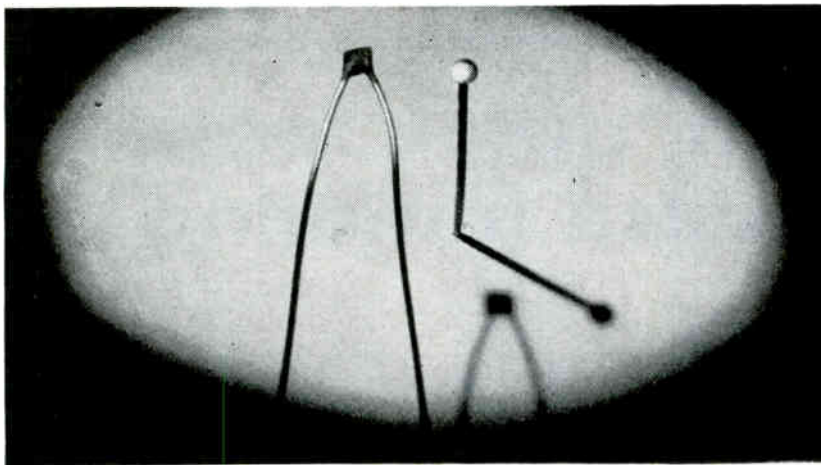

Ceramic Capacitor

10 to 220 pf—TO 30 WVDC

DEVELOPMENT of a new miniature ceramic capacitor has been announced by Gulton Industries, Inc., 212 Durham Ave., Metuchen, N. J.

Maximum size of the capacitor is 0.1 inch square by 0.05 inch thick, with a rating of 30 wvdc. Capacitance values are available in the range from 10 to 200 pf, with a

maximum capacitance change of ± 10 percent over the temperature range of -55 C to 85 C.

The capacitor meets or exceeds requirements of MIL-C-11015B, and is suitable for miniature computers, hearing aids, transceivers and modular packages.

CIRCLE 301 ON READER SERVICE CARD



Latching Relay

LIES FLAT ON PRINTED-CIRCUIT BOARD

DUAL-COIL, miniature latching relay is announced by Potter & Brumfield division of American Machine & Foundry Co., Princeton, Ind. The relay lies flat on a printed-circuit board, its height being 0.485 inch max; it requires an area of 1.100 by 0.925 in. on circuit boards.

Coils can be supplied with up to 10,000 ohms resistance per coil at 25 C. Gold-flashed, silver-magnesium-nickel contacts are rated 3 amp

at 30 v d-c or 2 amp at 115 v 60 cps, resistive. The relay will remain firmly latched in either armature position without coil power and will operate on a 3 ms pulse at nominal voltage at 25 C.

Designed to operate in severe environments, the FL relay meets applicable sections of MIL-R-25018, MIL-R-5757C, and ABMA-PD-R-187.

CIRCLE 302 ON READER SERVICE CARD

Miniature Indicator COLORED PLASTIC FACES

INDICATOR light is 1.6 inches long with a back-lighted rectangular head $\frac{3}{8}$ by $\frac{1}{8}$ inch. Two $\frac{1}{2}$ inch or three smaller digits or letters can be accommodated on the variously colored plastic faces. A midget flanged bulb for 6, 12 or 28 v supplies light.

Wherever fast identification is desired, such as on control panels for traffic systems or automated equipment, the lighting units can be used to provide identification at greater distances than non-illuminated or conventional front-lighted tabs.

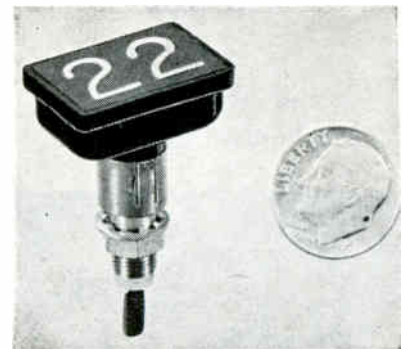

Cost of the lighting units ranges from \$1.10 to \$1.75 each depending on quantity. For full information contact Glar-Ban Corporation, 113 Glar-Ban Building, 3708 Harlem Road, Buffalo 15, New York.

CIRCLE 303 ON READER SERVICE CARD

Sliding Piston Trimmer FOR CAM DRIVE

VARIABLE trimmer capacitor with a sliding piston for use with cam driven mechanisms for fine-tuning action and long life is introduced by JFD Electronics Corp., 6101 Six-

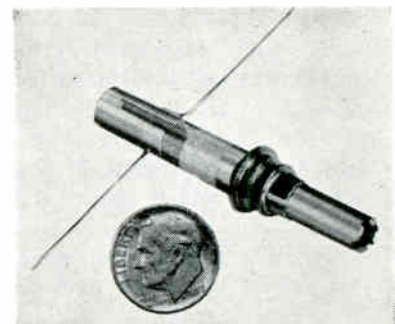

teenth Ave., Brooklyn 4, N. Y.

Spring fingers, rhodium plated

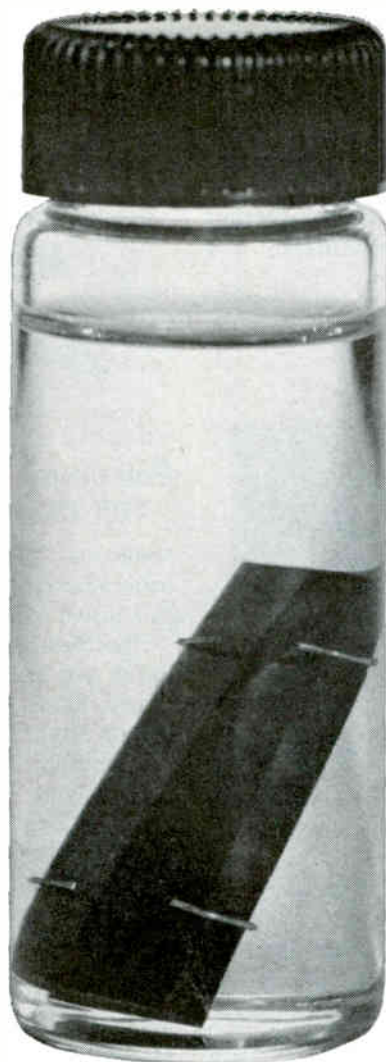

"FREON" SOLVENT left this acrylic resin and metal unharmed after prolonged exposure.



ORDINARY CHLORINATED SOLVENT under same conditions dissolves resin, damages metal.

How Freon[®] solvents help protect your investment in expensive, precision parts

"Freon" solvents provide *selective* solvent action. Result—fast, highly effective removal of oil, grease and dirt—yet complete safety to materials of critical components.

Will not damage metals, plastics or elastomers.

"Freon" solvents minimize swelling of plastics and elastomers . . . are non-corrosive to metals . . . won't soften paint, wire coating or insulation.

No residue. Because "Freon" solvents contain no inhibitors, no residue is left on dried parts. Solvent can be recovered readily and reused without need for

reinhibiting during recovery cycle.

Safe to personnel. Non-flammable and non-explosive, "Freon" solvents are also virtually non-toxic—will not cause headaches or nausea.

For you this means effective, remarkably safe cleaning of delicate mechanical and electronic equipment—greater protection for your investment. If you'd like more information about "Freon" solvents or technical assistance on solvent use and application, write: E. I. du Pont de Nemours & Co. (Inc.), "Freon" Products Division, Wilmington 98, Delaware.

FREON[®]
SOLVENTS



BETTER THINGS FOR BETTER LIVING . . . THROUGH CHEMISTRY

for long life and low contact resistance, achieve contact between the piston and the panel mount bushing. The trimmers are available in capacitance values from 0.6 to 90 pf in glass or quartz dielectric, and in standard, differential, split stator, with open or sealed construction.

Other specs include quartz and Invar construction for zero temperature coefficient, low loss and low inductance for high frequency

use, no derating up to 125 C for glass dielectric and 150 C for quartz, alloy plating for 50 hour salt spray resistance, gold plating over special alloy for r-f conductivity and freedom from silver migration, high Q dissipation factor. Price is from \$2 in production quantities with approximately a 4 week delivery.

CIRCLE 304 ON READER SERVICE CARD

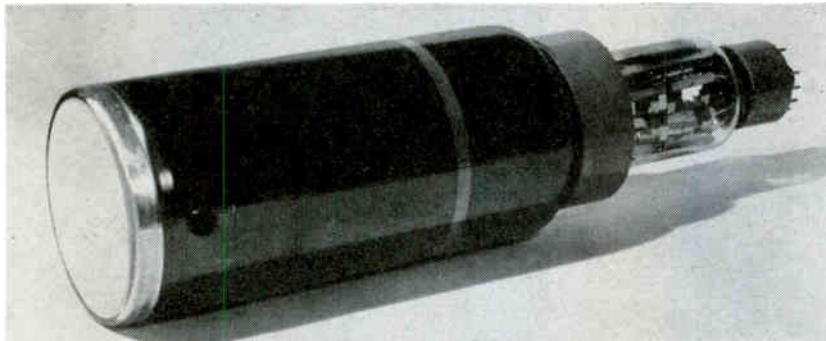

High Sensitivity CRT

DUAL BEAM, 5-INCH FACE

FIVE-INCH, dual beam cathode-ray tube, type 5CWP, features flat face plate, electrostatic deflection and focus, improved deflection sensitivity, accuracy, and low interaction between traces. High brightness is achieved through increased maximum ratings and screen aluminization.

Post acceleration and limited scan deflection electrodes improve deflection sensitivity. Deflection electrode and acceleration electrode, pattern adjustment electrode, and individual astigmatism adjustment elec-

trodes are brought out through the bulb wall to a ring base for ease of connection. Complete specifications can be obtained from Electronic Tube Sales Department, Allen B. Du Mont Laboratories, Divisions of Fairchild Camera and Instrument Corporation, Clifton, New Jersey.

Specifications include deflection factor uniformity of 2 percent max, pattern distortion of 3 percent max, and a tracking error of 0.060 inch max.

CIRCLE 305 ON READER SERVICE CARD

Output is in four ranges, 0 to 0.1, 1, 10, and 100 volts. Output on a-c is at line frequency but provisions are made in the unit to accommodate other frequencies. Accuracy is ± 0.25 percent of set voltage above 0.01 volt, and ± 0.2 percent of set voltage (+5 microvolts) below 0.01 volt. After a fifteen minute warm-up the output voltage remains within specifications for at least five minutes without readjusting the controls, adequate time for meter calibration.

The reference source is 12½ by 9½ by 8½ in. and weighs 20 lb. Cost is \$495 per unit, delivery in 2 to 3 weeks, from Commercial Products



Voltage Reference

A-C/D-C CALIBRATOR

MODEL 5890 portable voltage standard can be used for calibrating a-c and d-c voltmeters, as a source of accurate a-c or d-c voltage and power to 10 watts, and as a precision voltmeter from 0 to 100 v.

Div., Tensor Electric Development Co., Inc., 1873 Eastern Parkway, Brooklyn 33, N. Y.

CIRCLE 306 ON READER SERVICE CARD



Computer Delay Lines

FOR PRINTED CIRCUITS

MODULAR electromagnetic delay lines may be gaged for printed-circuit board applications.

Specified as Series DL-251, the units are constructed on non-nutrient, flame retarding plastic materials. Impedances range from approximately 300 to 600 ohms with delay times of 0.1 to 0.8 microsecond. The units are 0.625 inch wide and from 2 to 4 inches long.

Delay time to rise time ratios up to 10 to 1 are available, depending upon unit impedance and size. Operating temperature range is -55 C to 105 C. Approximately one week delivery on all units, from IMC Magnetics Corp., Gray & Kuhn Div., 570 Main St., Westbury, L. I., N. Y.

CIRCLE 307 ON READER SERVICE CARD

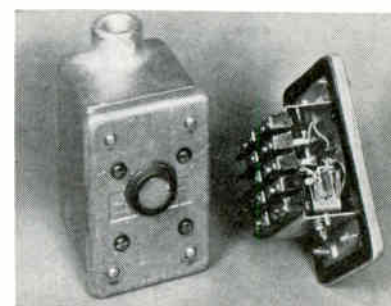

Modular Photorelay

WEATHER RESISTANT

BERKELEY/DYNAMICS, P. O. Box 1098, Burlingame, Calif. New rugged weather resistant photorelay Cyclops offers thousands of trouble free operations in industrial control applications. Two electronic components, a passive solid state cadmium sulfide photocell and a dependable dpdt relay are connected in series. As light intensity increases current flows through the

Did you know that your 1960 **electronics BUYERS' GUIDE** includes . . . Missiles in Production — p. R5, List of Military Procurement Locations and Personnel — p. R7, Characteristics of Plastics — p. R34, Characteristics of Laminates — p. R36, Wire, Tape and Foam Specifications — p. R38, Symbols Dictionary — p. R42, List of Industry Organizations, Services and Standards — p. R47, Military Standards — p. R50, Military Nomenclature — p. R53.

The only directory in the electronics industry with a Reference Section. It contains Market Data, Materials for Components, Specifications and Services, Design Data.

First choice of all 4!

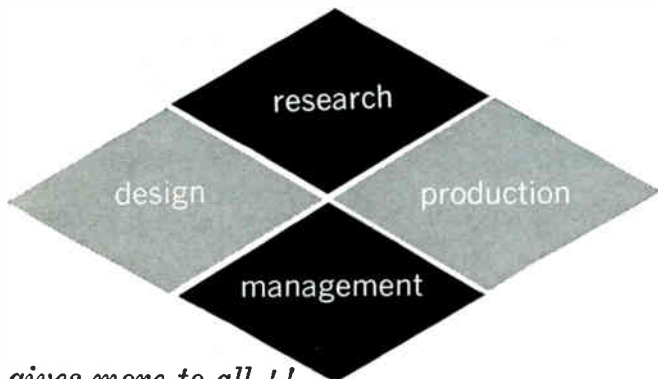

gives more to all 4!

electronics BUYERS' GUIDE
and REFERENCE ISSUE

NEW

1961

TRANSFORMERS

ENCAPSULATED

ULTRA MINIATURE

MOLDED

SUB MINIATURE

MIL-T-27A

MINIATURIZED MILITARY AND INDUSTRIAL TRANSFORMERS

MICROTRAN COMPANY INC.
145 EAST MINEOLA AVENUE
VALLEY STREAM, NEW YORK

YOURS FOR THE ASKING

catalog

MICROTRAN company inc.
145 East Mineola Avenue, Valley Stream, New York

CIRCLE 204 ON READER SERVICE CARD



**ONE
FOR
GOOD
MEASURE!**

You're always sure to be on the right track
when the job is done by

rustak MAC*
miniaturized — automatic
CHART RECORDER

Send today for complete specification sheet and prices.

DIMENSIONS:
3 3/8" w x 5 5/8" h
x 4 1/8" d



industrial co., inc.
130 SILVER STREET
MANCHESTER, N. H.

*Miniaturized Automatic Chart Recorder
ONLY \$79.50

Available from the following distributors:

- Allied Radio Corporation
Chicago 80, Illinois
- Arva, Inc.
Seattle, Washington
- Elder Electronics
Burlington, Ontario, Canada
- Electronic Parts Corporation
New Orleans 19, Louisiana
- Electro-Tech Equipment Company
New York 13, New York
- Fisher Switches, Inc.
San Francisco, California
- Harrison Equipment Company
Houston, Texas
- Hughes-Peters, Inc.
Columbus 11, Ohio
- Newark Electric Company
Inglewood, California
- Newark Electronics Corporation
Chicago 6, Illinois
- Oil Capitol Electronics Corporation
Tulsa, Oklahoma
- Pioneer Electronic Supply Company
Cleveland 15, Ohio
- Radio Parts, Inc.
Milwaukee 5, Wisconsin
- Radio Shack Corporation
Boston 17, Massachusetts
- R. V. Weatherford Company
Glendale, California

METALS for ELECTRONIC APPLICATION

rolled ULTRA THIN

by **OUR SPECIAL ROLLING TECHNIQUE**

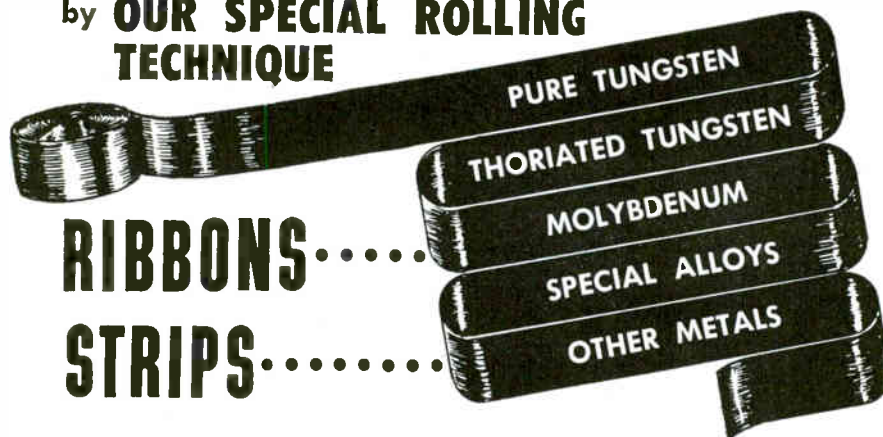

RIBBONS.....
STRIPS.....

TOLERANCES CLOSER THAN COMMERCIAL STANDARDS

Note: for highly engineered applications—strips of TUNGSTEN and some other metals can be supplied

rolled down to .0003 thickness

- Finish: Roll Finish—Black or Cleaned
- Ribbons may be supplied in Mg. weights if required

Developed and Manufactured by

H. CROSS CO. 3229 BERGENLINE AVE., UNION CITY, NEW JERSEY
Tele: Union City, N. J.: UN. 3-1134
N. Y. C., N. Y.: BR 9-4425

CIRCLE 205 ON READER SERVICE CARD

MICO Precision Apparatus

NEW HEAVY DUTY 2 & 3 DIMENSIONAL ENGRAVER



FOR Engraving Nameplates Fine Routing Work Profiling Small Objects Making Small Dies and Molds

UHF COAXIAL WAVEMETERS



2-75 Centimeter Range

Send for Illustrated Catalogs
MICO INSTRUMENT CO.

77 Trowbridge St. Cambridge 38, Mass.

94 CIRCLE 94 ON READER SERVICE CARD

How To Get Things Done Better And Faster

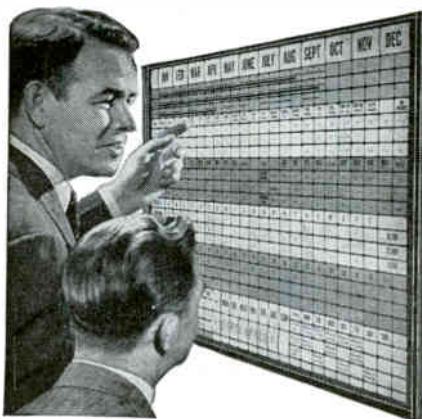

BOARDMASTER VISUAL CONTROL

- ☆ Gives Graphic Picture—Saves Time, Saves Money, Prevents Errors
- ☆ Simple to operate—Type or Write on Cards, Snap in Grooves
- ☆ Ideal for Production, Traffic, Inventory Scheduling, Sales, Etc.
- ☆ Made of Metal. Compact and Attractive. Over 500,000 in Use

Full price **\$4950** with cards

FREE

24-PAGE BOOKLET NO. C-30
Without Obligation

Write for Your Copy Today

GRAPHIC SYSTEMS
YANCEYVILLE, NORTH CAROLINA

CIRCLE 206 ON READER SERVICE CARD

photoresistor, energizing the relay. No warm up time required. Can be used for control, limit switch, counting, sorting, detection, go-no-go circuits, etc. Operating voltage 115 v a-c. Normally open or closed contacts available, rated 5 amperes at 115 v a-c. Screwdriver type terminal strips. Mounting: $\frac{1}{2}$ in. threaded hub. Modular construction allows speedy installation. Dimensions: length 4 in., width 3 in., and depth $3\frac{1}{2}$ in. Price is \$35.

CIRCLE 308 ON READER SERVICE CARD

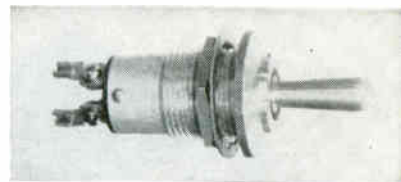

Toggle Switch CLOSES FROM ALL ANGLES

UNIVERSAL swivel type toggle switch can be actuated by applying a force on the toggle in any direction. Features of the switch include a toggle throw of 20 degrees in any direction, moisture proof construction, 25,000 operations minimum at rated load, anodized toggle and casing. The switch also has an adapter suitable for engraving.

Ratings of the T203 are 2-circuit at 10 amp resistive and 5 amp inductive or 3 amp lamp, 28 v d-c. The device is manufactured by Control Switch Div., Controls Company of America, Folcroft, Penn.

CIRCLE 309 ON READER SERVICE CARD



Pulse Generator SOLID STATE

MAGNETIC RESEARCH CORP., 3160 W. El Segundo Blvd., Hawthorne, Calif. New 9 Kw solid state pulse generators offer design engineers

a unit 50 to 70 percent smaller than tube-types, for use in low power radar altimeters, surveillance, target scoring and similar applications. Standard models operate from a 200 v d-c source and may be used with magnetrons or microwave triodes. The circuit includes a d-c charging line, self-contained trigger generator and pulse forming network. A bifilar pulse transformer is used in models intended for magnetron operation. Each of the six standard models features a pulse width of 0.25 μ sec with a rise time of 30 to 40 nsec (10 to 90 percent). Pulse frequencies of 10, 5 or 2 prf Kc are standard. Other pulse widths and repetition rates are available on special order.

CIRCLE 310 ON READER SERVICE CARD



Instrument Choppers LOW THERMAL NOISE

JAMES ELECTRONICS INC., 4050 N. Rockwell St., Chicago 18, Ill., has available a new line of low thermal noise instrument choppers for 60 and 400 cps. Reduction of thermal emf's to less than 0.5 μ v over normal operating temperature range of 0 C to +55 C is achieved by greatly improved switching circuit design and careful selection of materials. These choppers use a low loss hydroscopic Diallyl-Phthalate base. Models are available in dust sealed configurations for both dpdt and spdt circuit arrangements. Circuit measurement data on low thermal techniques, available. Units are

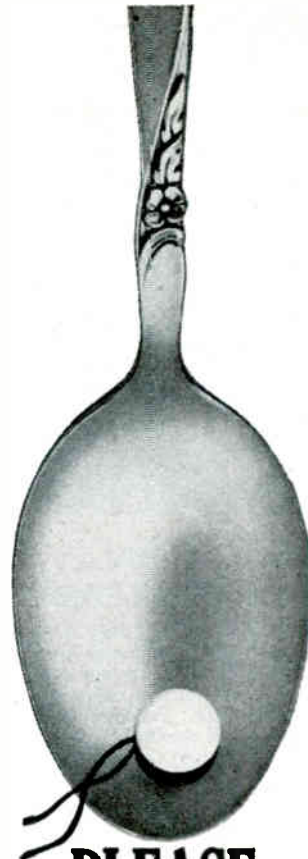

**PLEASE
DON'T
SWALLOW
OUR
MOTOR**

...IT'S HIDING BEHIND THE ASPIRIN. Actually, we set out to build an easy-to-read tiny timer...but we first had to build an aspirin-sized motor to drive it. This assignment might have been a headache for a sorcerer, but A. W. Haydon did it. And there is something magical about these micro-miniature elapsed time indicators and companion events counters. ■ This digital elapsed time indicator has many outstanding features: size is only $\frac{1}{2}$ " square x $1\frac{1}{6}$ " long...weight .75 ounce...

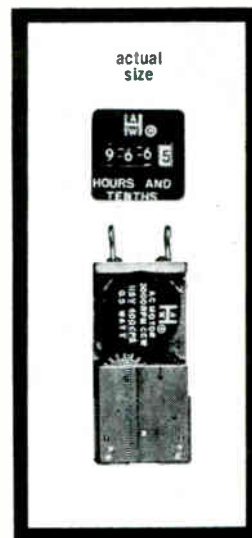

meets all mil specs... temp. range -54 to +125°C...vibration to 2000 cps at 20 G... choice of two ranges (hours to 9999, tenths to 999.9)... power input .5 watt, max. In fact, the complete data outweighs the equipment. Send for our heavyweight literature on the 19200 ETI right now. ■ Electrical or electronic, the A. W. Haydon Company works wonders in time. For electronic requirements call Culver City. For electro-mechanical devices call on our wizards in Waterbury.

THE AWHAYDON COMPANY
235 NORTH ELM STREET, WATERBURY 20, CONNECTICUT

SWITCHES

FOR AIRBORNE & MISSILE GROUND SUPPORT EQUIPMENT

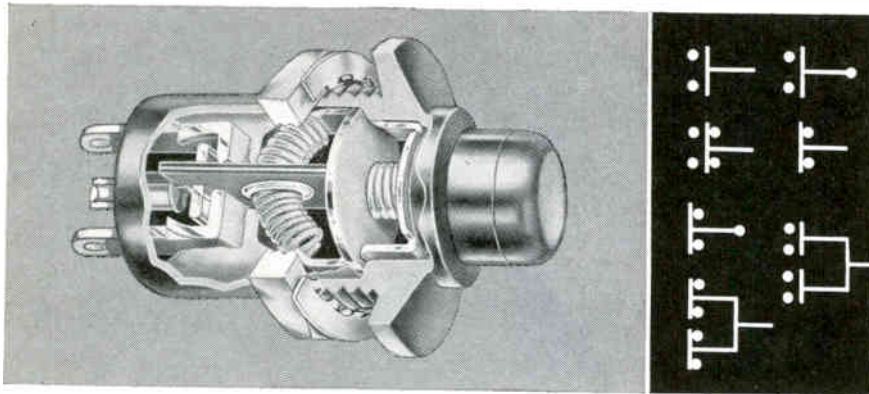

**FAST, POSITIVE ACTION
LONG SERVICE LIFE • MOISTURE-PROOF**



A broad line of sinusoidal toggle spring switches designed for compactness, light weight and high reliability in airborne and ground support missile control systems. Extremely fast, audible, double break action reduces arcing and contact wear to negligible minimum. Positive snap action mechanism cannot be teased on or off contact. All contacts made of heavy coin silver for long life and low contact resistance. Available with color coded buttons. These switches exceed military requirements for vibration, shock, humidity and corrosion resistance.

Western Distributor: *Western-Electromotive, Inc., Los Angeles.*

The UCINITE COMPANY

Division of United-Carr Fastener Corporation, Newtonville 60, Mass.

CIRCLE 207 ON READER SERVICE CARD

available from stock. Price range: \$25-\$40.

CIRCLE 311 ON READER SERVICE CARD

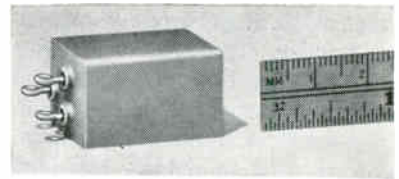

Resonant Circuit MINIATURIZED

CONTROL ELECTRONICS CO., INC., 10 Stepar Place, Huntington Station, L. I. N. Y., has developed a 45 Kc resonant circuit that has application in triggering and timing circuits. Unit measures less than 0.4 cu in. Model BF-128 will amplify by using resonance effect to increase voltage level of signal of the resonant frequency while rejecting other frequencies. It has a maximum 3 db bandwidth of 4,500 cps and source impedance of 3,000 ohms. Units are also available from 20 Kc to 100 Kc. Package dimensions are $\frac{3}{8}$ in. by $\frac{1}{8}$ in. by 1 in. and it is hermetically sealed and potted.

CIRCLE 312 ON READER SERVICE CARD

send for this

FREE

EICO Electronics Catalog

you save 50% on Top-Quality Test Instruments Hi-Fi • Ham Gear

KITS AND WIRED
for professional and home use

<p>TEST INSTRUMENTS battery eliminators battery testers bridges decade boxes electronic switch flyback tester oscilloscopes probes signal and sweep generators tube testers transistor tester vacuum tube voltmeters volt-ohm-milliammeters</p>	<p>HI-FI stereo and monaural tuners preamplifiers power amplifiers integrated amplifiers speaker systems</p>
<p>HAM GEAR cw transmitter modulator-driver grid dip meter</p>	
<p>OVER 2 MILLION EICO Instruments in use throughout the world.</p>	

LIFETIME service and calibration guarantee. IN STOCK at your neighborhood EICO dealer. Send now for FREE catalog E-12

EICO 33-00 N. Blvd., L. I. C. 1, N. Y. . . . praised by the experts as BEST BUYS IN ELECTRONICS

©1960 ELECTRONIC INSTR. CO., INC.

DYNASERT

COMPONENT INSERTING
for More Uniform PW Boards

You can't beat the quick, precise, feeding, trimming, bending of lead, inserting, and clinching operation in one single stroke of the Dynasert machine. Boards are neater, more dependable, easier to solder tightly. Damage to component body is eliminated. Handle all axial lead components up to 10 times faster. Simplifies operator training. Write for descriptive 12 page booklet.

United

UNITED SHOE MACHINERY CORPORATION
140 Federal Street, Boston, Mass.

CIRCLE 208 ON READER SERVICE CARD



Wire-Wound Pots INSULATED ROTORS

CONTINENTAL-WIRT ELECTRONICS CORP., 26 W. Queen Lane, Philadelphia 44, Pa. Series F-888 control is designed and priced for wide use in radio, tv, instrument, computer and test equipment. Resistance range from $\frac{1}{2}$ ohm to 25,000 ohms; ± 10 percent resistance tolerance; a 2-w power rating; and 3 percent linearity are standard. A wider range of resistance values, higher power dissipation characteristics, and closer linearity tolerances are available on special order. These con-

trols are compact, 1.125 in. diameter by 0.560 in. deep. They feature unique collector design, molded one-piece element insulator, shaft options, and taper choice.

CIRCLE 313 ON READER SERVICE CARD

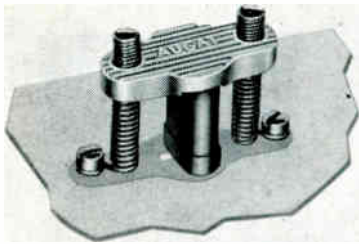

**Spring Hat Holder
FOR TRANSISTORS**

AUGAT BROS., INC., 33 Perry Ave., Attleboro, Mass. New universal spring hat holder will accommodate over 800 different transistors and diodes of many varying case sizes with either round or oval configurations. The holder is available with base insulator for complete electrical isolation to chassis. Featured is a knee action spring design which permits fast and easy replacement of component.

CIRCLE 314 ON READER SERVICE CARD



**Portable Scaler
TRANSISTORIZED**

TROXLER LABORATORIES, Box 5253, Raleigh, N. C. Completely transistorized portable glow-tube scaler includes regulated h-v supplies for detector probes. Sealed modular construction throughout. A 3½ in. built-in ratemeter, for rapid measurements and comparisons, also indicates high voltage in Kv. Jeweled-escapement timer maintains 1-minute counting interval within 0.1 percent, or scaler may be used to count continuously. Standard model operates from sealed silver-zinc battery, providing 30 hours operation per charge; external bat-

UNPRECEDENTED EFFICIENCIES IN HARMONIC GENERATION . . .

**11 kMc
input @
500 mw**

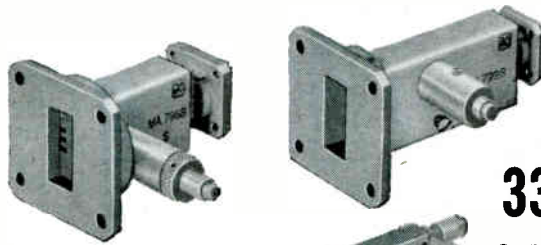

**33 kMc
output @
5 to 20 mw**

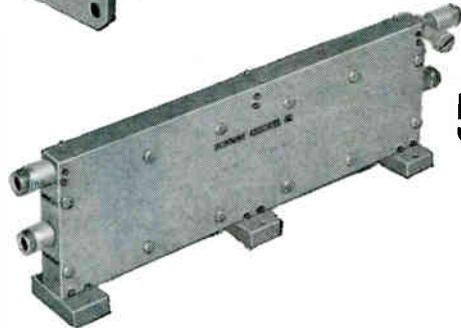

Nine new examples of Microwave Associates' capabilities in the design of harmonic generators are available now. These models feature exceptionally high output power with conversion losses well below existing devices.

New designs incorporating solid state elements can be used to eliminate costly klystrons, DC bias supplies and high voltage power supplies. All units feature broadband fixed-tuned operation, filters eliminating unwanted harmonics, and versatile coaxial, waveguide and

strip-line packaging.

These models are typical examples of our progress to date . . . presently we are working for even greater efficiencies and performance. Additional models in development converting 1 watt at 2000 Mc to 100 mw or more, at 4000 and 6000 Mc, to be announced soon.

Your specific application problems are of prime interest to us. Our Applications Engineers would welcome the opportunity to design harmonic generators to meet your specifications.

SPECIFICATIONS

INPUT

OUTPUT

Model	Connector Type UG-	Frequency Input kMc/s	Band	mw input	Connector Type UG-	Frequency Output kMc/s	Band	Conversion Loss (max.)	Output mw
MA796	23/U	0.26 — 0.28	P	20	23/U	1.30 — 1.43	L	13db	1
MA797	23/U	1.30 — 1.43	L	100	23/U	5.22 — 5.72	C	15db	3
MA798A	39/U	9.0±150Mc	X	500	596/U	18.0±300Mc	K	17db	10
MA798B	39/U	10.0±150Mc	X	500	596/U	20.0±300Mc	K	17db	10
MA798C	39/U	11.0±150Mc	X	500	596/U	22.0±300Mc	K	17db	10
MA798D	39/U	12.0±150Mc	X	500	596/U	24.0±300Mc	K	17db	10
MA799A	39/U	9.0±100Mc	X	500	600/U	27.0±300Mc	Ka	20db	5
MA799B	39/U	10.0±100Mc	X	500	600/U	30.0±300Mc	Ka	20db	5
MA799C	39/U	11.0±100Mc	X	500	600/U	33.0±300Mc	Ka	20db	5



Write or call:

MICROWAVE ASSOCIATES, INC.

BURLINGTON, MASSACHUSETTS

Western Union FAX-TWX: Burlington, Mass., 942 • BRowing 2-3000



THE
NEWEST ADDITION TO
THE
PREM-O-RAK[®]
MODULAR CONSOLE
SYSTEM
**SLOPED FRONT
CONSOLE
CABINET**

- Tops of front and rear are rounded.
- Designed for multiple installations.
- Made of No. 14 gauge steel and welded throughout.
- Sloped front is 19° from vertical.
- Panel mounting angles made of No. 12 gauge steel and tapped 10/32 on E.I.A. spacings; front and rear vertical angles adjustable to any position.
- Ball cornered end panels.

• Frame finished in gray hammertone. End panels in brown hammertone.



◀ Cat. No. FS-1001

Contact your local distributor or
SEND FOR
COMPLETE CATALOG
**PREMIER
METAL
PRODUCTS CO.**
337 MANIDA ST.,
NEW YORK 59, N. Y.

WESTERN
SALES OFFICE:
1667 Laurel Street, San Carlos, California
EXPORT DEPARTMENT: EMEC, 127 Grace St.,
Plainview, New York
IN CANADA: PREMIER METAL HOUSINGS, Ltd.,
5810 Smart Ave., Montreal

**RESISTANCE
THERMOMETERS**
by REC

-435 to +1800°F



Whether you are concerned with temperature measurements at -435° F or +1800° F there is a wide variety of REC temperature probes to fit your requirements. REC specializes in the design of high precision temperature probes, using highest purity platinum resistance elements.

Care and skill during manufacturing result in strain-free probes of highest stability.

Write for New Catalog No. 66030 for further information on REC's many Temperature Probes, Pressure Transducers, Pitot-Static Tubes.



**ROSEMOUNT
ENGINEERING
COMPANY**

4900 WEST 78TH ST. MINNEAPOLIS 24, MINNESOTA

CIRCLE 209 ON READER SERVICE CARD

**electronic
chemical**

new formula

EC-44

Economical! A little does a lot!



6 oz. \$3.50
spray can

with 5" Plastic
Extender
Push Button
Assembly
FREE

lubricates
conditions
cleans
all
**ELECTRICAL
CONTACTS**

Sold To Distributors Only

ELECTRONIC CHEMICAL CORP.
813 Communipaw Avenue Jersey City 4, N. J.

CIRCLE 210 ON READER SERVICE CARD

tery charger also allows 115 v a-c operation. Other models available for external 6 or 12 v d-c, 115 v a-c operation. Units may be used in any position. Price is \$1,700 to \$1,950, depending upon model.

CIRCLE 316 ON READER SERVICE CARD



Panel Meter
PLASTIC FRONT

THE HICKOK ELECTRICAL INSTRUMENT CO., 10514 Dupont Ave., Cleveland 8, O. Model 86H clear view meter features an acrylic plastic front. The acrylic plastic is claimed to be rugged and non-fading, allowing maximum light. The wide angle extended scale provides greater readability. The meter, available in all common milliammeter, ammeter and voltmeter ranges with an accuracy of 1 percent full scale, also features the Hickok taut band suspension which eliminates friction by eliminating pivots, jewels and hairsprings, the trouble spots on conventional meters.

CIRCLE 317 ON READER SERVICE CARD

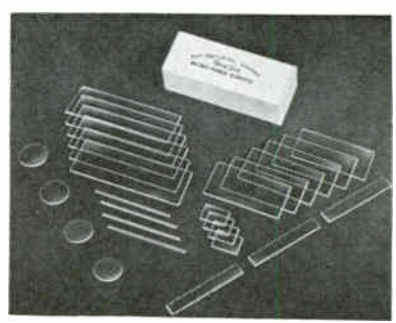

Thin-Plate Quartz
PRECISION-FABRICATED

DELL OPTICS CO., LTD., 327-55th St., West New York, N. J., has available Micro-Fused quartz in optical grades. This precision-fabricated quartz finds wide application for infrared, microwave and in numerous analytical applications. Micro-Fused quartz is available in very thin plates, optically ground and polished flat. Seven thicknesses are

supplied ranging from 0.003 in. to 0.021 in.; rounds, squares and rectangulars are supplied up to 4 in.

CIRCLE 318 ON READER SERVICE CARD

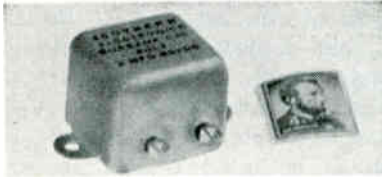

Tiny Capacitor HERMETICALLY SEALED

SOUTHERN ELECTRONICS CORP., 150 West Cypress Ave., Burbank, Calif., has developed a new sub-miniature capacitor for missile, computer and communications applications. Utilizing a polystyrene dielectric, and new winding techniques, a typical 2 μ f capacitor is contained in a one-inch cube. Other capacitors average 1½ in. by 1 in. by ½ in. Units are hermetically sealed and accuracy tolerances are held to within 0.1 percent. The capacitors are said to show excellent stability characteristics over an extended temperature range and tolerances are unaffected even at extreme high altitudes.

CIRCLE 319 ON READER SERVICE CARD

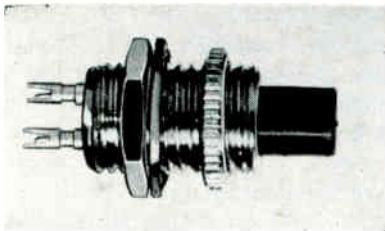

Panel Indicator Light LENSES IN FIVE COLORS

THE SLOAN CO., 7704 San Fernando Road, Sun Valley, Calif., announces the model 106S Color-Lite panel indicator light. This 2-terminal, fixed assembly utilizes the T-1 series bulb which has life of 100,000 hours at 5 v and 60,000 hours at 6.3 v. Lights may be installed either from the front or rear of panel in a ½ in. diameter hole. These lights are available with MS or commercial bulbs and lenses of red, white, blue, green or amber. All materials and processes used in their manufacture meet or exceed applicable MIL specs.

CIRCLE 320 ON READER SERVICE CARD

December 2, 1960



NEW Time Delay Relays

INSTANTANEOUS RESET... VOLTAGE-TEMPERATURE COMPENSATED

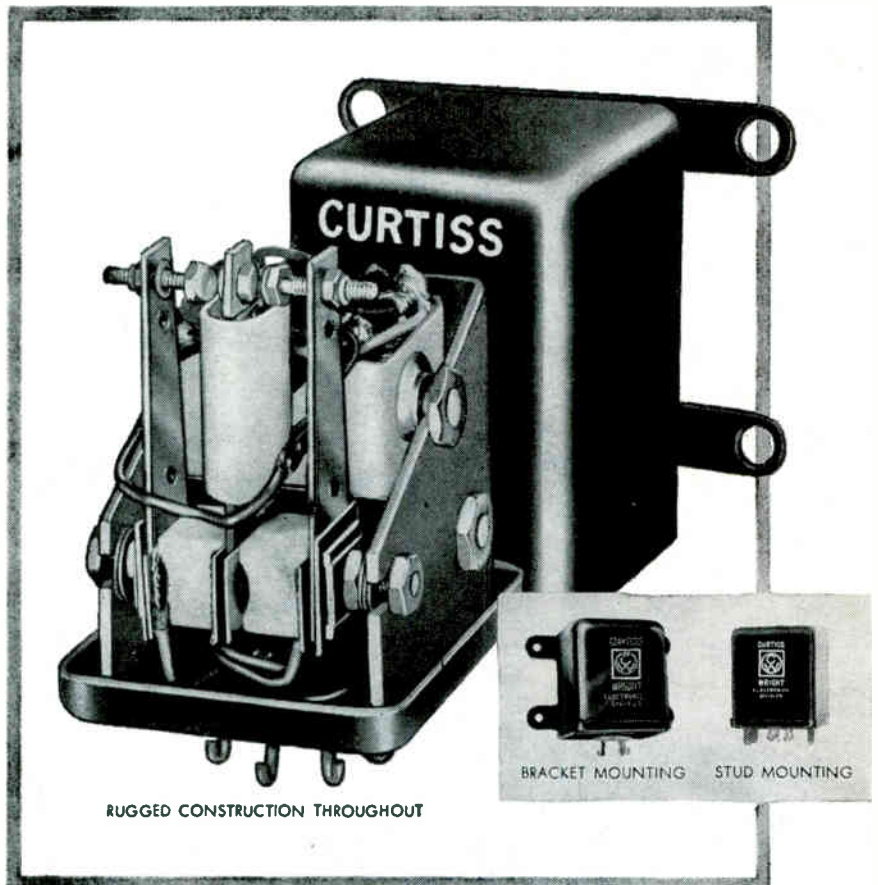

Designed with an instantaneous reset feature, these relays provide the same time delay for a series of cycles when temperature and voltage vary.

They are pre-set from 3 to 180 seconds, are chatter-free and will withstand severe shock and vibration. Because of this unique combination of features, these relays are now being used in such new circuit applications as:

- Sequential timing for missiles
- Automatic reset on digital readout equipment
- Oscillator stabilization
- Overload protection
- Computer sequencing



"DM" SERIES STEPPING MOTORS

Curtiss-Wright Stepping Motors convert digital pulses into mechanical work or motion. Units are bi-directional with high starting torque.

Write for complete Components Catalog 260 to help you select Curtiss-Wright electronic components for use where dependability is of prime importance.

COMPONENTS DEPARTMENT • ELECTRONICS DIVISION

CURTISS WRIGHT

CORPORATION • EAST PATERSON, N. J.

TIME DELAY RELAYS • DELAY LINES • ROTARY SOLENOIDS • DIGITAL MOTORS • TIMING DEVICES • DUAL RELAYS • SOLID STATE COMPONENTS

CIRCLE 99 ON READER SERVICE CARD 99

TELREX LABORATORIES

Designers and Manufacturers of

COMMERCIAL SERVICE "BEAMED-POWER" ARRAYS AND TWO-WAY SYSTEMS

Model illustrates a wide-spaced, 12 element circular polarized optimum-tuned skewed dipole "SPIRALRAY" antenna. Provides unusually high gain, even response, in all polarization planes, vertical, horizontal or oblique with unusually high signal-to-noise ratio.

NO OTHER CIRCULAR POLARIZED ARRAY known to the art today can provide the linear high gain and signal-to-noise ratio in all radiation planes.

The ideal antenna for missile tracking, telemetering and no-fade response to mobile (or moving) stations.

Models available to extend the practical range of 2-Way Communication Systems.

Model SY-12-104-11
\$265.00

Model MSY-104-110
\$390.00

(f.o.b. Asbury
Park, N. J.)

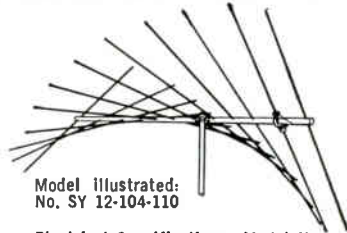

Model Illustrated:
No. SY 12-104-110

Electrical Specifications—Model No. SY-12-104-110: Polarization, circular, linear within 1/2 db. Gain 13 db. F/B-Ratio 30 db. V/S/W/R (50 ohm cable) 1.1/1. Beamwidth at half power points 33 degrees. Max. power input 300 w, with "Balun" supplied.

Mechanical Specifications: Boom diameter 2" O.D. x 25 ft. All aluminum boom and elements. Weight approx 25 lbs. Rated wind-load 90 mph. No ice load. Available for 120 mph wind load. (Model No. MSY-104-110).

- Telrex is equipped to design and supply to our specifications or yours, Broad-band or single frequency, fixed or rotary arrays for communications, FM, TV, scatter-propagation, etc.

- Consultants and suppliers to communication firms, universities, propagation laboratories and the Armed Forces.

ANTENNAS

Communication and TV Antennas

SINCE
1921

telrex LABORATORIES

ASBURY PARK 25, NEW JERSEY, U.S.A.

CIRCLE 211 ON READER SERVICE CARD

Literature of the Week

TRANSDUCATORS Control, a Division of Magnetics Inc., Butler, Pa., has published a new 38-page manual, T-11, which describes in detail the characteristics and functions of its static transducers, as well as outlining typical applications.

CIRCLE 321 ON READER SERVICE CARD

INDUCTION POTENTIOMETER TRANSDUCERS Servonic Instruments, Inc., 640 Terminal Way, Costa Mesa, Calif. Bulletin S-606 provides complete electrical, mechanical and dimension specifications for the UH-16 and UH-18 induction potentiometer transducers.

CIRCLE 322 ON READER SERVICE CARD

PRECISION SWITCHES Unimax Switch Division. The W. L. Maxson Corp., Ives Road, Wallingford, Conn. The new 32-page catalog No. 10-1 contains detailed information on the company's expanded line of snap-acting precision switches.

CIRCLE 323 ON READER SERVICE CARD

MICROWAVE EQUIPMENT DeMornay-Bonardi, 780 S. Arroyo Parkway, Pasadena, Calif. Twelve-page, 2-color booklet describes a complete line of millimeter wave components and instruments which generate, detect and measure microwave frequencies up to 140 Gc.

CIRCLE 324 ON READER SERVICE CARD

SILICON RECTIFIERS Standard Rectifier Corp., 620 East Dyer Road, Santa Ana, Calif. Complete with illustrations, specifications and drawings, a 16-page short form catalog covers a complete line of silicon power rectifiers.

CIRCLE 325 ON READER SERVICE CARD

ELECTRONIC CHOPPERS Solid State Electronics Co., 15321 Rayen St., Sepulveda, Calif., has published a data sheet describing models 50P, 60P and 70P transistorized plug-in electronic choppers.

CIRCLE 326 ON READER SERVICE CARD

PRESSURE TRANSDUCER Consolidated Electrodynamics Corp.,

electronics

By the process of electroplating it is often possible to combine the desirable properties of metals having widely different characteristics. For example, a Gold plated Tungsten wire combines the extremely high tensile strength of Tungsten with the solderability of Gold. Many other combinations are possible.

Write for list of products



SIGMUND COHN CORP.

121 SOUTH COLUMBUS AVE. MT. VERNON, N.Y.

SINCE 1901

360 Sierra Madre Villa, Pasadena, Calif., is offering an illustrated bulletin describing the type 4-326 strain gage pressure transducer.

CIRCLE 327 ON READER SERVICE CARD

VIDEO CRYSTAL RECEIVER
Weinschel Engineering, 10503 Metropolitan Ave., Kensington, Md., has released application note No. 5. "Microwave Antenna Pattern Measurements with the BA-7 Video Crystal Receiver."

CIRCLE 328 ON READER SERVICE CARD

CERAMIC-TO-METAL SEALING
Wilbur B. Driver Co., Newark 4, N. J. A six-page folder describes Ceramiseal, an iron, nickel, cobalt alloy specially designed and suited for ceramic-to-metal sealing.

CIRCLE 329 ON READER SERVICE CARD

COMMUTATOR-AMPLIFIER San Diego Scientific Corp., 3434 Midway Drive, San Diego 10, Calif., has published a brochure describing the Magne-Plexer, a solid state commutator-amplifier for millivolt inputs.

CIRCLE 330 ON READER SERVICE CARD

RELAY BULLETIN Babcock Relays, Inc., 1640 Babcock Ave., Costa Mesa, Calif. Technical bulletin BR-595 describes the new 4-pole, double throw, hermetically sealed BR-14 relay series.

CIRCLE 331 ON READER SERVICE CARD

VARIABLE RESISTORS Centralab, 900 East Keefe Ave., Milwaukee 1, Wisc., has available a new catalog sheet describing its line of stock model 7 linear motion variable resistors.

CIRCLE 332 ON READER SERVICE CARD

HIGH VACUUM EVAPORATOR
Vactronic Lab. Equipment, Inc., 21 Monmouth Court, East Northport, N. Y., has available a brochure illustrating and describing the model No. HVE-4000 portable high vacuum evaporator.

CIRCLE 333 ON READER SERVICE CARD

R-F FILTER Devco, Inc., East Longmeadow, Mass. A technical bulletin contains complete performance data, attenuation charts, specifications and applications for the L-Cap low cost broad-band r-f filter. Requests for copies should be made direct to the company.

JR. & SR. ENGINEERING WRITERS

NON-SUPERVISORY SALARIES TO \$11,500

Some of the most challenging and rewarding engineering writing assignments ever offered are now available at Hughes-Fullerton in Southern California.

These are important professional positions covering the entire spectrum of creative writing in the technical field.

Military Handbooks
Technical Proposals
Engineering Reports
Sales Engineering Brochures

Openings at all levels now provide unparalleled opportunities for junior as well as senior engineering writers on advanced projects such as:

Fixed-array Radar
Digital Computers
Digital Data Processing Systems
Unique Display Systems
Integrated Missile Defense Systems

BASIC REQUIREMENTS INCLUDE: an intense professional interest in communications in all media - from films to manuals; a demonstrated ability to convey technical information and ideas to a specific audience; above-average technical knowledge and interest; education and experience equal to the challenge (college degree, or equivalent in engineering writing experience).

Located in Southern California's Orange County (the nation's fastest-growing electronics center), Hughes-Fullerton offers you a stimulating, professional working environment and long-term stability.

call collect today!

For complete information on these challenging assignments, call us (collect, of course) right now! Ask for Mr. B. P. Ramstack at TROjan 1-4080, ext. 3741. Or, airmail resume to HUGHES-FULLERTON, P.O. Box 2097, Fullerton 3, California.

HUGHES

HUGHES AIRCRAFT COMPANY



SPRAGUE PIEZO- ELECTRIC CERAMIC ELEMENTS

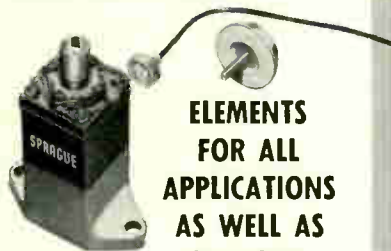

**ELEMENTS
FOR ALL
APPLICATIONS
AS WELL AS
COMPLETE**

**TRANSDUCER ASSEMBLIES
FOR MOST APPLICATIONS,
SUCH AS UNDERWATER
SOUND AND
VARIOUS ORDNANCE AND
MISSILE DEVICES.**



Sprague-developed mass production and quality-control techniques assure lowest possible cost consistent with utmost quality and reliability. Here too, complete fabrication facilities permit prompt production in a full, wide range of sizes and shapes.

Look to Sprague for today's most advanced ceramic elements—where continuing intensive research promises new material with many properties extended beyond present limits.



**YOUR INQUIRIES
ARE INVITED**

**WRITE FOR
LITERATURE**

SPRAGUE ELECTRIC COMPANY
35 Marshall Street, North Adams, Mass.

SPRAGUE®
THE MARK OF RELIABILITY

NEW BOOKS

Photochemistry in the Liquid and Solid States

Edited by L. J. HEIDT, R. S. LIVINGSTON, E. RABINOWITZ, and F. DANIELS

John Wiley and Sons, Inc., New York, N. Y., 1960, 174 p., \$6.

WITH the advent of space exploration, a great deal of attention has been given to various systems capable of storing energy. To date the vast, inexpensive source of energy—solar radiation—is still open for exploitation.

This collection of articles is based primarily on papers presented at the symposium in Dedham, Mass., in 1957, and also contains reprints from the *Journal of Physical Chemistry*. This work states the radiant flux density and spectral distribution of the sun's radiation incident on the earth, the criteria for suitable photochemical reactions and methods of absorbing solar radiation, storing this energy, and releasing the stored energy when needed. Intrinsic limitations with respect to known photochemical reactions are discussed. The topics comprise direct and sensitized photochemical reactions, luminescence phenomena, kinetic studies, excited states, photosynthesis and photoreactions in the solid state.

It is an excellent survey of current work in the field and should prove useful as supplementary reading in formal courses in photochemistry and solid state physics. It is not only useful to photochemists and solid state physicists, but is recommended to the biologist, chemist and engineer interested in the interaction of radiation with matter as well as practical applications of the former.—JOSEPH RENNERT, *Senior Scientist, Physics Dept., New York University, New York, N. Y.*

Merck Index of Chemicals & Drugs (Seventh Edition)

Merck & Co., Rahway, New Jersey, 1960, 1,641 p., \$12.

PREVIOUS editions of this widely used reference work are well known

to chemists, physicians and members of allied professions. However, in the world of electronics research where the development and evaluation of new and improved materials plays a significant role, this volume provides a useful and reliable source of information of over 10,000 descriptions of individual substances, more than 3,300 structural formulas, and about 30,000 names of chemicals and drugs alphabetically arranged and cross indexed.

Each main entry indicates the preferred chemical name, common or popular names, and generic and trade names. Trademark listing is as complete as possible and thoroughly cross indexed. Properties and sources of materials preceded by methods of preparation, with literature references, are given followed by an indication of uses. Hazards, toxicities and other safety factors are mentioned.

Indication is given of commercial availability and grades, such as U.S.P., N.F., and reagent. Empirical formulas are given for all chemicals having a definite structure. There is an up-to-date periodic table arranged in accordance with the latest concepts of nuclear science, a table of international atomic weights and close to 300 pages of appendices on such substances as chromatographic absorbents, radioactive isotopes, percentage solution tables, isotonic solutions, and atomic weights and their multiples and logs.

This is the latest edition of a reference work that is extending its audience and beginning to gear its materials data with information of interest to the electrochemist. The price is reasonable, since Merck makes this available at cost as a service to those dealing with materials and compounds.—M.F.T.

THUMBNAIL REVIEWS

Using and Understanding Probes. By R. C. Graf, Howard W. Sams & Co., Indianapolis, Indiana, 1960, 190 p., \$3.95. A comprehensive treatment of a subject usually dealt with only as an adjunct to instrument or measurement texts. Well written and illustrated, the book contains design and application in-

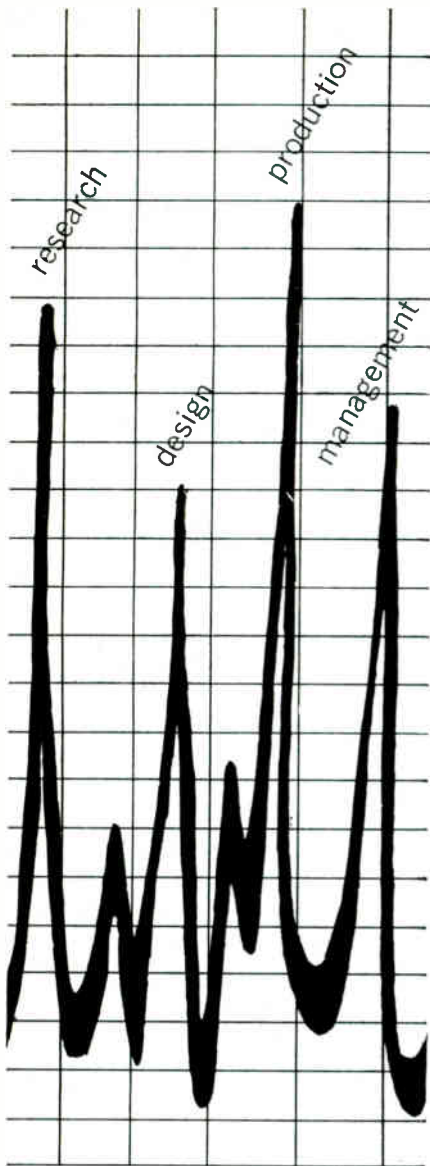

IT'S READ MORE BY ALL 4!

electronics magazine interprets electronics for electronics men every week. The latest components, economic trends, military applications. Technical data you'll want to file and keep. Get the facts first with a personal subscription (don't be low man on a routing slip). Mail the reader service card (postpaid) to **electronics**, the magazine that helps you to know and to grow! Rates: three years for \$12, one year for \$6; Canadian, one year for \$10; foreign, one year for \$20. Annual **electronics BUYERS' GUIDE** (single issue price \$3.00) included with every subscription.

subscribe today to
electronics

December 2, 1960

**CHECK THE LOW COST of these
new printed circuit test jacks**

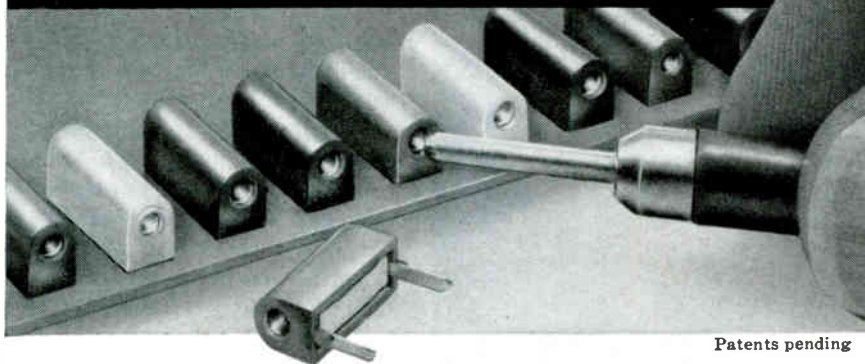

Patents pending

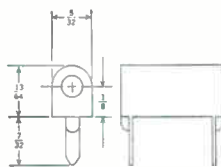

For .052 application holes
on .400 centers

Samples on request

Ucinite's new test jack is designed for permanent, soldered assembly to printed circuit boards. Gold-over-silver-plated beryllium copper contacts provide low-resistance contact for repeated insertions of standard .080" diameter test probes. Nylon bodies are available in eleven standard code colors. Uniquely simplified construction affords economical usage in all quantities. Immediate shipments from stock.

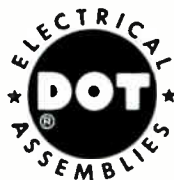

The UCINITE COMPANY

Division of UNITED-CARR Fastener Corporation
Newtonville 60, Massachusetts

CIRCLE 213 ON READER SERVICE CARD

Professional Opportunities Are Available For

Electrical Engineers

*with interest and experience
in the following fields:*

- Design and Development of:
Industrial Electronics and Power
Controls and Instrumentation
Electronics
- Operation & Maintenance of
Nuclear Devices

For information please write to:

Personnel Manager

**Brookhaven
National
Laboratory**

UPTON, LONG ISLAND, N. Y.

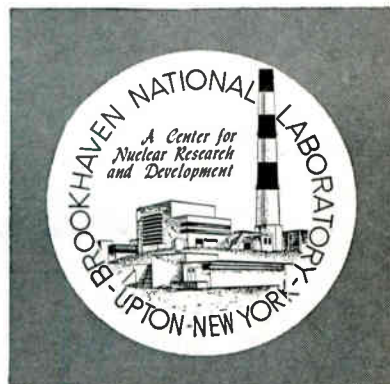

CIRCLE 377 ON READER SERVICE CARD

LOW-LOSS

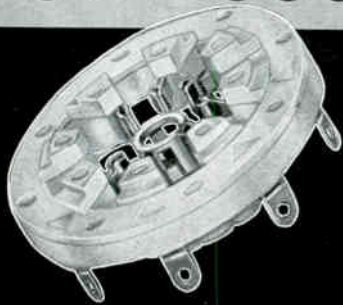

KEL-F SOCKETS

For high power transmitting tubes such as: 4X150A; 4X150D; 4X250B; 4CX250B; 7034; 7035; 4X250F

Molded of low dielectric loss-factor Kel-F plastic, these popular Johnson sockets are designed to handle a wide selection of high power transmitting tubes. Sockets are available in several designs—with or without screen grid by-pass capacitors. Control grid contact "guide" is machined for greater alignment accuracy—all contacts are low-resistance, silver-plated beryllium copper. Tube pin contacts are heat treated to provide positive contact pressure as well as extended life—annealed soldering tabs may be easily bent or formed. High quality, heat resistant, steatite chimney also available to direct air flow through tube cooling fins.

For complete specifications, write for Data Sheet 755 . . . or our newest components catalog, described below.



Basic socket with silver-plated brass mounting saddle.



Socket with mounting ring and screen grid by-pass capacitor.

New Catalog

Write today for our newest electronic components catalog—complete specifications, engineering prints and current prices on:

• Capacitors • Tube sockets • Connectors • Pilot lights • Insulators • Knobs, Dials • Inductors • Hardware



E. F. JOHNSON CO.

1809 2nd Ave. S.W. • Waseca, Minn.



electronics fills you in on every phase of the electronics industry each week featuring engineering and technical data every issue. Latest economic trends, technically interpreted, to help you make sound plans. Facts you'll want to file and keep. Subscribe now. Mail the reader service card (postpaid) to **electronics**, the magazine that helps you to know and to grow! Rates: three years for \$12, one year for \$6; Canadian, one year for \$10; foreign, one year for \$20. Annual **electronics BUYERS' GUIDE** (single issue price \$3.00) included with every subscription.

it's read
more by
all 4!

RESEARCH

DESIGN

PRODUCTION

MANAGEMENT

SUBSCRIBE TODAY TO
electronics!

formation of every type of probe likely to be encountered in any phase of electronics. Signal tracer and injector, demodulator, rectifier, low-capacitance, high-voltage, and direct and isolation probes are covered. Considerable space is also devoted to medical, radiation detector, industrial, and unusual and specialized probes. Effect of a probe on instrument operation and safety precautions to be observed are also discussed. Index is exceptionally complete for a paperback. A good buy for anyone using test equipment, especially technicians, and radio and tv servicemen.

Mathematical Methods for Digital Computers. Edited by A. Ralston and H. Wilf, John Wiley & Sons, Inc., New York, N. Y., 1960, 293 p. \$9. A comprehensive and up-to-date survey of numerical methods for use with digital computers. The chapter organization is excellent, presenting each method from derivation through flow chart. Time estimates and error analysis are included in most cases. The methods as presented are applicable to any general purpose computer and as such should be useful to anyone doing analysis.

Traité de Télévision. By P. Stroobants, Ateliers de Constructions Electriques de Charleroi, Charleroi, Belgium, 1960, 504 p (Volume 1 of two). A thorough, technical, often mathematical survey of television transmission principles and techniques. Well illustrated with photographs, graphs and circuit diagrams. International bibliography is included in each chapter. Interesting for comparison of European television practice against ours, but fundamentals covered apply to both. Volume 2 will cover television reception.

Thyratrons. By C. M. Swenne, The Macmillan Publishing Co., New York, N. Y., 1960, 73 p, \$3. A part of the Philips Technical Library, this volume is being published simultaneously in five languages. It is a basic, descriptive survey of thyratrons and their basic uses, including timer and inverter circuits. Well illustrated with photos and diagrams, but European circuit symbols are used.

A History of the Theories of Aether and Electricity. By Sir Edmund Whittaker, Harper & Brothers, New York, 1960—Vol. I, 428 p, \$1.95,—Vol. II, 307 p, \$1.85. This is

a detailed, critical account of the theories of electricity from Aristotle to Lorentz in Volume I and from Rutherford to wave mechanics in Volume II. It traces the ever-increasing complexity of man's idea of nature, paralleling his growth of practical knowledge and mathematical sophistication. Any work on this subject needs to be highly mathematical, but here the necessary mathematics is made clear at each stage, resulting in a clear and logical development. An excellent book for those with interest in mathematics or physics, or both.

Fluid Power Control. Edited by John F. Blackburn, G. Reethof and J. L. Shearer, published jointly by The Technology Press of M.I.T. and John Wiley and Sons, Inc., New York, 1960, 710 p, \$17.50. Eleven authors have written papers on various aspects of high pressure, fluid power components and systems. In high performance servos, fluid power actuators with operating pressures to 5,000 psi and higher have several advantages over electromechanical devices. The fluid operator is typically much faster, gives a stiffer system and may have a torque-to-inertia ratio several thousand times better. The book is primarily for those who are designing high pressure circuits and devices but it should also be useful to those in systems or servo work.

Practical Auto Radio Service and Installation. By Jack Greenfield, Gernsback Library, Inc., New York, 156 p, \$2.95. This book has been prepared for the practical serviceman and covers the various types of auto radios from conventional vacuum tube through hybrids to all transistor types. Installation, removal, trouble-shooting and repair, interference suppression and various types of power supplies are explained. Although emphasis is placed on the practical side of auto radios, theory is included as an aid to service and troubleshooting.

Nucleonics Fundamentals. By David B. Hoisington, McGraw-Hill Book Co., Inc., New York, 410 p, \$9.50. This is a survey of nuclear physics and engineering that is not highly mathematical. It should be useful to electronics engineers as an introduction to the subject or as a reference source. Topics discussed are particle accelerators, instrumentation, reactors, thermonuclear power and nuclear explosives. Sample problems (with answers are given.)

VITREOSIL[®]

PURE FUSED QUARTZ

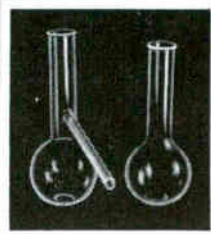

IDEAL FOR SEMI-CONDUCTOR METALS

Our unique process enables us to supply semi-conductor quality VITREOSIL to close tolerances in crucibles and special fabricated shapes. Write us about your requirements. See our ad in **Chemical Engineering Catalog**.

SPECTROSIL[®]

FOR HYPER-PURITY IN SEMI-CONDUCTOR WORK

PURITY—purest form of fused silica
TRANSPARENCY—unique optical properties
HOMOGENEITY—completely homogeneous and free from granularity
AVAILABILITY—block material for lenses, prisms, etc; rod, fiber, wool; hollow ware as tubing, crucibles, and special apparatus.

Write for complete, illustrated catalog.



THERMAL AMERICAN FUSED QUARTZ CO., INC.
 18-20 Salem St., Dover, N. J.

CIRCLE 215 ON READER SERVICE CARD

FIXED and VARIABLE

"224" SERIES

INDUCTORS

... for medium and high power RF equipment

A compact line—designed to offer higher current carrying capacity in less space!

Excellent for commercial and military transmitters, electronic heating or medical equipment—designed to occupy a minimum amount of space with the greatest possible current carrying capacity. All units in the line are extremely rugged, effectively insulated for low-loss. Fixed and variable types—wire-wound, edgewise-wound and tubing-wound for high or low power applications.

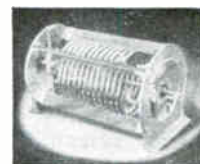

"224" SERIES—For high power RF applications. $\frac{3}{8}$ " and $\frac{1}{2}$ " copper tubing—units are especially designed to handle heavy current in continuous duty. Heavily silver-plated contact wheel. Cast aluminum end frames and glass bonded mica support bars.

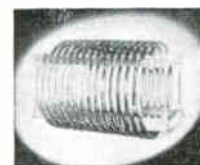

"202" SERIES FIXED COILS—Large surface area $\frac{1}{4}$ ", $\frac{3}{8}$ " and $\frac{1}{2}$ " copper tubing wound coils. Low loss—lower operating temperatures for continuous duty, high current applications. Simple, rugged "airwound" design with glass bonded mica support bars.

In addition to the inductors described above, Johnson designs and manufactures a wide range of special purpose inductors for industrial applications—from small wire-wound types to heavy tubing-wound coils with current carrying capacities up to 100 amperes. Johnson also manufactures a complete line of heavy duty RF components, such as: RF contactors; tower lighting filters; isolation filters; and phase sampling loops. Write to Broadcast Sales Dept. for full information.

New Catalog

Write today for our newest electronic components catalog—complete specifications, engineering prints and current prices on:

• Capacitors • Tube sockets • Connectors • Pilot lights • Insulators • Knobs, Dials • Inductors • Hardware



E. F. JOHNSON CO.

1912 2nd Ave. S.W. • Waseco, Minn.

CIRCLE 107 ON READER SERVICE CARD



R&D Paces Hewlett-Packard Expansion

COINCIDENT with the 20th anniversary of its founding, Hewlett-Packard Co. of Palo Alto, Calif., recently celebrated completion of its new \$4.5-million plant in Stanford Industrial Park. Situated on a 50-acre hilltop site, the four-building complex provides a total floor area of 387,500 sq ft and houses 2,300 of H-P's 3,000 employees.

One of the world's largest manufacturers of electronic measuring equipment, the company boasts sales of \$44,777,000 for the first nine months of the current fiscal year. Earnings totaled \$3,349,000, or 35 percent higher than the like period for '59. Product line includes some 400 precision instruments for measuring voltage, current, frequency, power, resistance, and other electrical quantities. Indicative of the evolutionary nature of H-P's business: 65 percent of last year's gross stemmed from products developed since 1954. Introduction of 20 new instruments per year is not unusual for this R&D-oriented firm.

Typical of extreme-accuracy instruments coming from H-P labs is its recently developed primary frequency and time standard, composed of three basic instruments. Designed to meet stringent requirements for accurately determining frequency and time, the standard will be used in such fields as space navigation, satellite tracking and missile guidance. Degree of accuracy is stated in parts per billion, or ten billion, rather than in fractions of a percent. The new device is stable within five parts in 10 billion per day, and can be adjusted in increments of one part in 10 billion,

the company says.

Headed by Bernard M. Oliver, H-P's aggressive R&D staff includes some 160 graduate engineers, half of whom hold advanced degrees. Last year's R&D expenditure topped \$3 million, 15 times that of 1950, and approximately 7 percent of gross sales.

Equally aggressive is the company's foreign effort. Today approximately 15 percent of total sales comes from abroad. "We've enjoyed good acceptance of our products overseas and are now selling in over 30 foreign countries," reports president David Packard. "Our European marketing activities are coordinated by a recently-established subsidiary. Hewlett-Packard, S. A., which is headquartered in Switzerland. Another subsidiary, Hewlett-Packard G.m.b.H., operates our manufacturing plant in Germany."

Hewlett-Packard subsidiaries within the U. S. include the Boonton Radio Corporation, Boonton, N. J.; F. L. Moseley Co.; Pasadena, Calif., and Palo Alto Engineering Company, Palo Alto. The company's Dymec division, designers and manufacturers of data processing and radar simulator systems, is also located in Palo Alto.

H-P stockholders recently voted a three-for-one stock split to form a wider base of stock ownership. The split was accomplished by a 200 percent stock dividend paid on September 15th.

"Our wider base of ownership helps qualify the company's stock for listing on the New York Stock Exchange," Packard said. "Deci-

sion to apply for listing, however, will be deferred until our Board of Directors has had an opportunity to review the fiscal year's operation which ended October 31."

While a large majority of the company's employees are now at the new Stanford plant, operation at the former facility on Page Mill Road in Palo Alto is continuing. Recently opened is a small manufacturing facility in Loveland, Colo., about 55 miles north of Denver.

Silicon Transistor Appoints Krasny

APPOINTMENT of Jerrold Krasny to the position of applications engineer has been announced by Robert L. Ashley, president of Silicon Transistor Corp., Carle Place, N.Y.

Krasny joined STC after five years with Sperry Gyroscope Co., marine division, Syosset, N.Y.



Shure Brothers Names Section Manager

APPOINTMENT of Otto Fried as manager of the electronic circuits section was recently announced by Shure Brothers, Inc., Evanston, Ill.

He was formerly chief engineer of Knight Electronics Corp., Chicago. He has also served in the engineering departments of Zenith Radio Corp. and Allied Radio Corp.

DI/AN Controls Sets Up West Coast Facility

ROBERT D. KODIS, president of DI/AN Controls, Inc., of Boston, Mass., has announced the establishment of DI/AN Controls of California, Inc. The new laboratory and

INERTIAL ENGINEERING INGENUITY

The Litton LN-3 Inertial Navigation System is a system in being. Production orders for this system to be used in the F-104 are, to the best of our knowledge, larger in number than those for any other inertial guidance system.

The LN-3, consisting of a two-gyro, four-gimbal platform, computer, adapter, and controls weighs less than 80 pounds installed. Even smaller systems, designed for orbital and sub-orbital guidance, are in development. These will weigh less than half as much as systems now in production.

Do you have experience applicable to the integration of developmental inertial guidance and computer sub-systems into functioning prototype systems? Can you evaluate performance in such systems with a view toward increasing system capabilities even further? If so, contact Mr. Donald A. Krause of our Research and Engineering Staff regarding your interests. You can share in generous employee benefits, including stock purchase and tuition-paid education plans. Relocation assistance is provided.



LITTON SYSTEMS, INC.
GUIDANCE & CONTROL SYSTEMS DIVISION
Beverly Hills, California

A servo amplifier plug-in module in the LN-3 Computer is discussed by Harold F. Erdley, left, Vice President, Litton Systems, Inc., and Director, Guidance Systems Laboratory and Nathan P. White, LN-3 Project Manager.

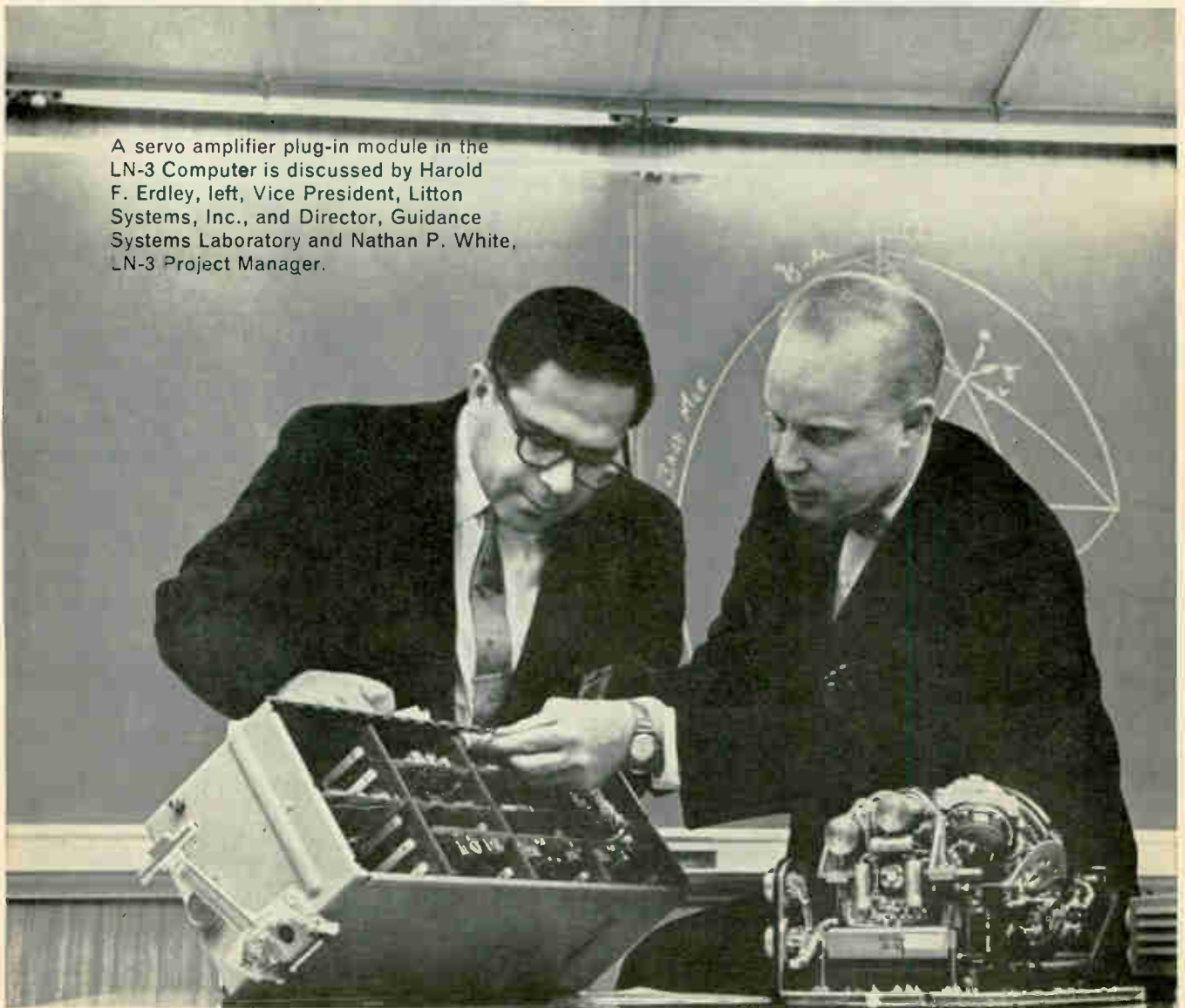

HOW FAST CAN YOU TEST Circuit Design Reliability?

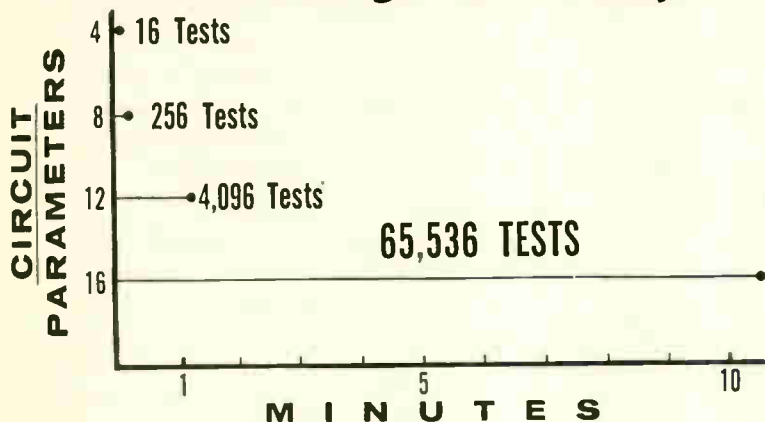

Yes, you can test all combinations of high and low values of as many as 16 circuit parameters in less than 11 minutes!
Write today for informative 8-page Brochure.



**AIRBORNE
INSTRUMENTS
LABORATORY**

DEER PARK, LONG ISLAND, NEW YORK
A DIVISION
OF CUTLER-HAMMER, INC.



TYPE
90
Circuit Design
Reliability Tester

PRICE:
\$3600.

CIRCLE 218 ON READER SERVICE CARD

This is not and is under no circumstances to be construed as an offer to sell, or as an offer to buy, or as a solicitation of an offer to buy, any of the securities herein mentioned. The offering is made only by the Prospectus

November 18, 1960

123,335 Shares
Metcom, Inc.
Common Stock

Price \$6.00 per share

Copies of the Prospectus may be obtained in any State only from such dealers participating in this issue, including the undersigned, as may legally offer these Securities under the securities laws of such State.

HAYDEN, STONE & CO.

manufacturing facility is situated in Mountain View, Calif.

This is the first out of state expansion for the 2½ year old Boston firm, which now shows a growth of 100 percent in 11 months of operation.

Henry L. Gorgas will head the new laboratory and engineering staff in the capacity of general manager. It is planned that the engineering staff of the new plant will reach 25 by the end of its first year of operation.

Mechtron Division Opens New Facility

A NEW FACILITY devoted exclusively to the production of cable, cable assemblies and harnesses, has been opened by the Mechtron Division of Tensolite Insulated Wire Co., Inc., Peekskill, N.Y. The new 7,500 sq ft facility is in addition to the other Mechtron plant in that city which is devoted to the production of Teflon and other specialty magnet wire constructions.



Whitbread Takes Over Newly Created Post

GEORGE P. WHITBREAD has been appointed to the newly created position of product manager, insulating materials, at Telecomputing Corporation's Narmco Industries Materials division, Costa Mesa, Calif. He was formerly chief chemist at Telecomputing's electronic components division.

Ross E. Hupp Enters Consulting Field

ROSS E. HUPP has resigned as general manager of the Erie Pacific division of Erie Resistor Corp. to



how to see high impedance ac signals

The Keithley Model 102B Amplifier combines a 400-megohm input with high gain and low noise. It sharply reduces circuit loading errors when measuring outputs from accelerometers and other piezo-electric devices. It also has many uses in studies on hearing aids, phonograph pick-ups, and microphones.

Features of the Model 102B are: decade gains from 0.1 to 1000, selectable bandwidths of 2 cps to 150 kc and 2 cps to 1.7 mc, and a 5-volt, 50-ohm output for scopes and recorders. Other features include:

- **input impedance** of 400 megohms, shunted by 3 μ f.
- **low noise level**, below 10 μ v from 10 cps to 150 kc at maximum gain.
- **gain accuracy** of 1% at midband for all gain settings.
- **rise time** of 0.3 μ sec at highest gain.
- **two accessory** low capacitance probes available.
- **Price** — \$325.00

Write today for Catalog B, containing detailed information on the Model 102B.



**KEITHLEY
INSTRUMENTS**

12415 EUCLID AVENUE
CLEVELAND 6, OHIO
CIRCLE 216 ON READER SERVICE CARD

establish an engineering consulting firm in the Los Angeles area.

He will devote a substantial portion of his time in a consulting capacity for both development and engineering service to Erie Pacific and its customers.



Stromberg-Carlson Appoints Orpin

L. H. ORPIN has been named general manager of Stromberg-Carlson, San Diego. S-C, which has headquarters in Rochester, N. Y., is a division of General Dynamics Corp.

Orpin rejoins the company after a separation of about a year, during which time he served as manager of planning for defense products for the Radio Corp. of America. He previously was director of plans and programs at Stromberg-Carlson, in Rochester, from 1957 to 1959.

Litton Fills European Executive Post

ROY E. WOENNE, who has been manufacturing director of the electron tube division of Litton Industries, San Carlos, Calif., has been named vice-president and technical director of Litton World Trade Corp., with headquarters in Zurich, Switzerland.

Marshall Industries Forms New Subsidiary

MARSHALL INDUSTRIES, INC. has announced the formation of a new subsidiary, Marshall Laboratories, in Torrance, Calif., to engage in the development and manufacture of electronic equipment for the missile and space vehicle industry.

President of the new firm is

ROHN COMMUNICATION TOWER

No. 60

for height up to
490 feet!

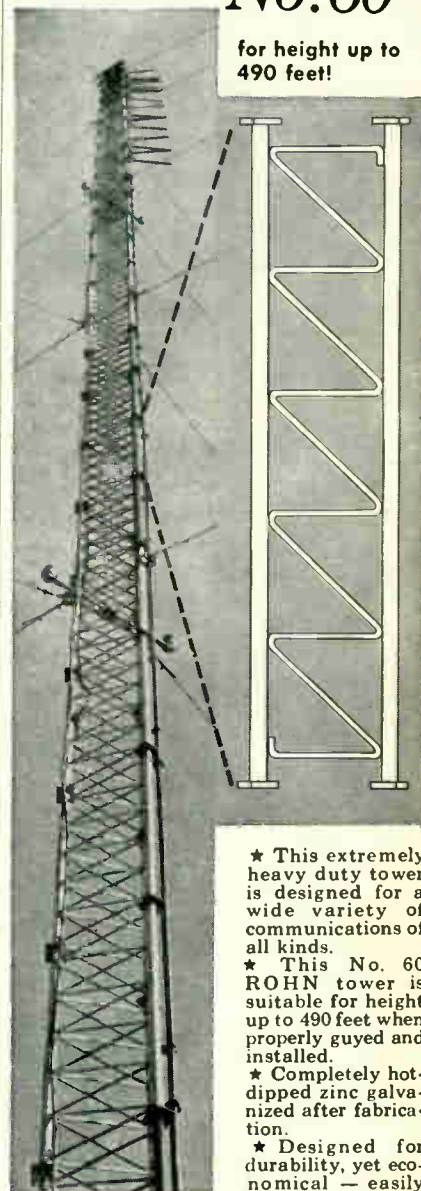

Shown above is a ROHN No. 60G tower used for FM broadcasting, installed to a height of 300 feet.

★ This extremely heavy duty tower is designed for a wide variety of communications of all kinds.

★ This No. 60 ROHN tower is suitable for height up to 490 feet when properly guyed and installed.

★ Completely hot-dipped zinc galvanized after fabrication.

★ Designed for durability, yet economical — easily erected and shipped. ROHN towers have excellent workmanship, construction and design. Each section is 10 feet in length.

FREE

Details and complete engineering specifications gladly sent on request. Also ROHN representatives are coast-to-coast to assist you.

Write-Phone-Wire Today!

ROHN Manufacturing Co.

6718 W. Plank Road,
Peoria, Illinois
Phone 7-8416

"Pioneer Manufacturers of
Towers of All Kinds"

Horizon Unlimited



for those who work at
Lockheed

Lockheed is constantly probing all sciences related to aircraft and space projects. Therefore, its program diversification is unusually broad, its opportunities for creative men exceptional.

Fields of endeavor cover the complete spectrum—from human engineering through celestial mechanics. Consider these interesting areas under investigation:

Design and development of data processing equipment; V/STOL design and development; electromagnetic research in corona and high-altitude breakdown studies, surface wave generation, antenna vehicle interaction, millimeter wave radiometry; electrical instrumentation; infrared and solid state physics; biophysics research (on radiation hazards coincident with space flight); solid state electronics; aerothermodynamics; dynamics; autocontrols; and servosystems.

Scientists and Engineers: If you qualify for work in any of these areas; if you want to grow with a company that is expanding on all fronts—write today to: Mr. E. W. Des Lauriers, Manager Professional Placement Staff, Dept. 1512, 2408 No. Hollywood Way, Burbank, California.

LOCKHEED

CALIFORNIA DIVISON



Stuart Baker, formerly associated with Space Technology Laboratories. Other members of the management group are: George M. Barr, marketing manager; George M. Takahashi, electronic development division manager; and Robert R. Morgan, production division manager.

Louis Pacent Rejoins Emerson Radio

LOUIS G. PACENT has rejoined Emerson Radio & Phonograph Corp., Jersey City, N.J., as vice president, manufacturing subsidiaries. He was vice president, engineering and manufacturing, prior to his leaving the company in 1958.

During his absence from Emerson, Pacent and his brother, Homer C. Pacent, devoted their efforts toward improving the operation of their privately owned enterprise, the Pacent Engineering Co., of which Louis was president.

Atlas Engineering Erecting New Plant

NORMAN SCOTCH, vice president of the Atlas Engineering Co., Inc., announces the construction of a new, ultra-modern plant in Roxbury, Mass. Completion date is scheduled for early February, 1961.

The new facilities will include 36,000 sq ft of manufacturing area—making Atlas Engineering one of the largest, independent, transformer manufacturing plants in the country, according to Scotch.



AIL Picks R. H. Close As Division Director

AIRBORNE INSTRUMENTS LABORATORY, Deer Park, N.Y., a division

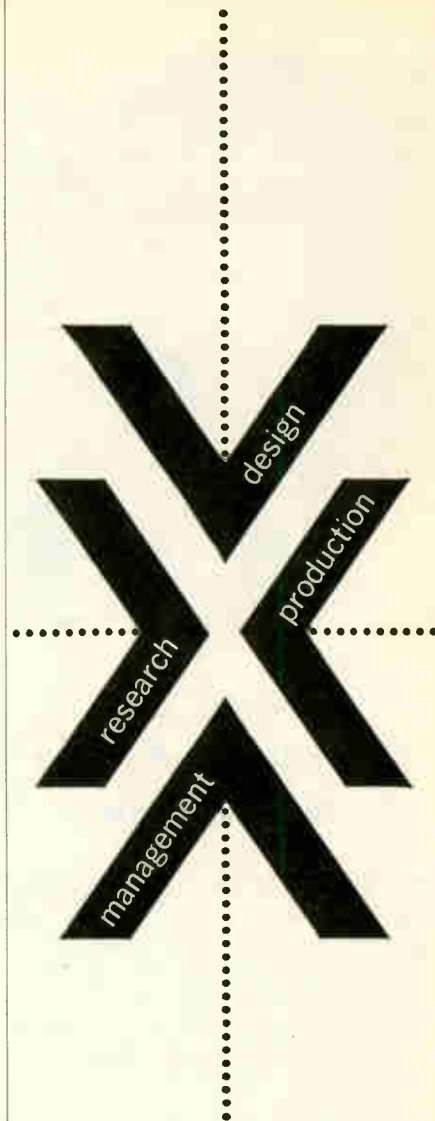

it's read
more
by all 4!

electronics magazine covers engineering and technically interpreted market trends every week. Government, military and economic developments, new applications, and technical data you'll want to file and keep. Subscribe now and read it first (don't be low man on a routing slip). Mail the reader service card (postpaid) to **electronics**, the magazine that helps you to know and to grow! Rates: three years for \$12; one year for \$6; Canadian, one year for \$10; foreign, one year for \$20. Annual **electronics BUYERS' GUIDE** (single issue price \$3.00) included with every subscription.

subscribe today to

electronics

of Cutler-Hammer, Inc., has appointed Richard N. Close to the position of director, apparatus division.

Prior to this appointment Close was the program director of AIL's multi-million dollar AN/USD-7 program.



General Atronics Names Executive V-P

GEORGE J. LAURENT has been named executive vice-president of General Atronics Corp., Bala-Cynwyd, Pa.

Laurent, who has served as vice-president and secretary-treasurer of the research and consulting firm since he figured in its founding five years ago, also is president of Atronic Products, Inc., a subsidiary of General Atronics Corp.



Meridian Metalcraft Elects Sterns V-P

WILLIAM G. STERNS, chief engineer of Meridian Metalcraft, Inc., Whittier, Calif., was recently elected vice president, engineering.

Sterns has been with Meridian Metalcraft, designers and manufacturers of microwave equipment, for approximately 3 years. He was appointed chief engineer early in 1959. As vice president, he will supervise the company's research, design and development activities.

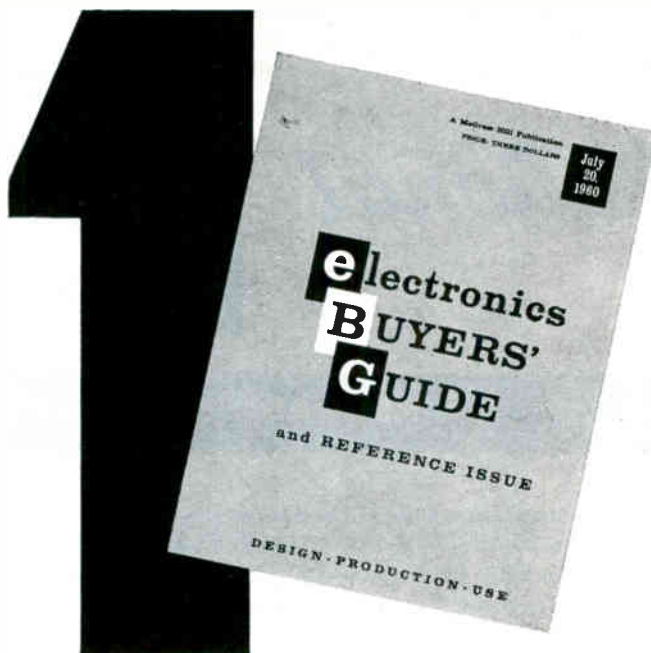

FIRST CHOICE OF ALL 4!

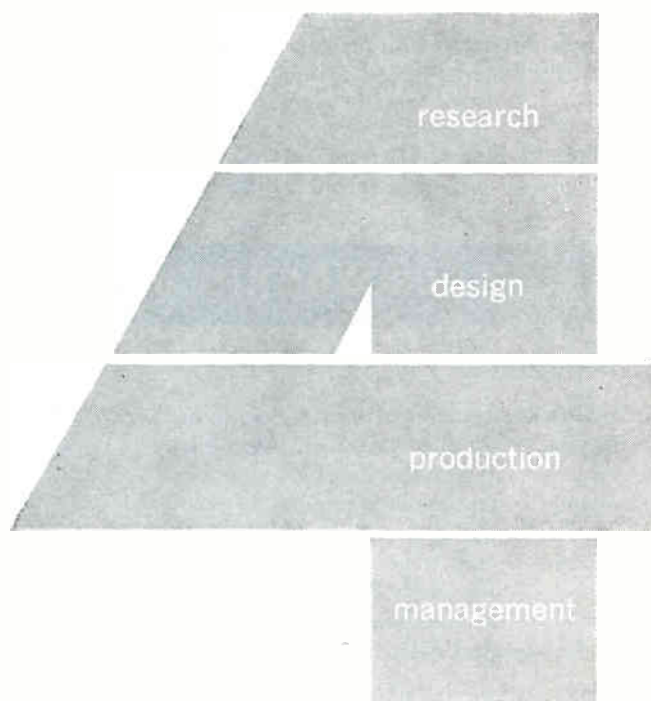

Edited and refined by the daily experience of users for 20 years. Unmatched for accuracy and completeness. Major corporations frequently order extra copies in addition to the hundreds of copies already received by employees who are regularly paying subscribers to **electronics**. The BUYERS' GUIDE is equally useful to men in research, design, production and management. Gives more information in less space.

gives more to all 4!

electronics BUYERS' GUIDE
and REFERENCE ISSUE

National *

Presents opportunities for personnel qualified for the following openings located at Dayton, Ohio

RESEARCH & DEVELOPMENT

DATA TRANSMISSION ENGINEER: For advanced planning in ON-LINE REAL TIME SYSTEMS. Applications would generally be focused on large-scale business and finance operations. Appropriate engineering degree and 6-10 years of experience necessary.

RESEARCH PHYSICIST: Ph.D. Physicist with 2-3 years minimum experience in semi-conductor R & D.

PHYSICAL CHEMIST: Ph.D. with interest in Materials R & D. Experience beyond doctoral work required.

MAGNETICS: Ph.D. Physicist with primary interest in magnetics research, experience beyond doctoral work required.

SYSTEMS ENGINEER: B.S. or M.S. in Electrical Engineering with interest in development of business

machine systems with 3-6 years of experience which should include some advanced circuit design preferably for Computer Development, but other may suffice.

DIGITAL COMMUNICATIONS PROJECT LEADER: 6-10 years, experience in military R & D projects related to Digital Communications. Background in circuits or systems desirable as well as some supervision.

OPERATIONS RESEARCH SPECIALIST: With interest or experience in Business Systems Research. Must have utilized advanced OR techniques, prefer Ph.D. or equivalent. Position entails research group guidance involving interrelated complex business functions.

ANALYST-PROGRAMMER: Experienced in conducting data processing feasibility studies for business systems applications.

ELECTRONIC DATA PROCESSING

PROGRAMMERS

DATA PROCESSING CENTER: Opportunities exist in our centers at Dayton, Ohio and New York City. Work involved is varied and challenging involving programming for our 304 large-scale computer. Advancement and growth potential for above-average personnel. Applicants should have at least two years' programming experience and a B.S. degree in Business Administration or Mathematics or equivalent. Tape systems background desired.

SALES SUPPORT: At least two years of programming experience plus B.S. or M.S. in Business Administration or Mathematics will qualify for challenging work with EDP sales organization. Opportunities are varied and include:

- Programming
- Manual Writing
- Systems Analysis
- Programming Research
- Programming Instruction

FOR THESE and other opportunities including:
 Senior Electronic Design Engineer
 Mathematician (Ph.D)
 Technical Writer
 Chemical Engineer (Development)
 Mechanical Engineer (M.S. applied mechanics)

WRITE NOW TO:

T. F. Wade
 Technical Placement F11-2
 The National Cash Register Company
 Main and K Street, Dayton 9, Ohio

THE NATIONAL CASH REGISTER COMPANY, DAYTON 9, OHIO

ONE OF THE WORLD'S MOST SUCCESSFUL CORPORATIONS

76 YEARS OF HELPING BUSINESS SAVE MONEY



MK-3 CTP vehicle on mount for antenna pattern measurement.

Unique electronic components successfully flight tested on ICBM re-entry vehicle control systems.



A Diversity of Current Projects

Continuing an outstanding record of achievements that includes the first recovery of a space vehicle from orbit, and the first flight demonstration of effective space vehicle stabilization control and navigation, MSVD electronics engineers are currently working in such areas as:

- Quick-launching Support Systems • Inertial Navigation Equipment • High Density Packaging • Stabilization Controls • Space-to-ground Communications Systems • Orbit Ejection Controls • Instrumentation for Nose Cones • Space Power Supplies • Satellite Telemetry Tracking & Command • Digital Computers • Circuit Design for Space Application • Electronic Navigation Techniques



Analytical Studies in satellite orbit control and space navigation.

ELECTRONICS ENGINEERS

**AT GENERAL ELECTRIC
YOU CAN APPLY YOUR COMMAND
OF ELECTRONICS TO
THE NATION'S MOST ADVANCED
SPACE PROBLEMS**

Today, engineers with TV and radio experience are working on missile and space vehicle payload problems at GE's Missile & Space Vehicle Department... others are applying their knowledge of radar to space communications... men with aircraft navigation experience are concentrating on advanced guidance and control systems for interplanetary space vehicles... In fact, engineers with experience in practically every area of electronics have transferred their technical knowledge directly to space problems.

Whether or not you've had specific experience in space electronics, you may be able to go right to work at MSVD on some of the most sophisticated and technologically exciting projects in the entire space field—from ICBM re-entry vehicles to operational space craft.

The work here is at the very edge of the state of the art, transforming the latest research discoveries into workable engineering solutions. You'll be concerned with new advances in plasma physics, thermo-electric phenomena, telemetry... with radical new requirements in micro-miniaturization, space to weight reductions, performance efficiency... with an entirely new order of reliability specifications to assure

systems' operation in space for a year or longer.

Excellent positions are currently open in four major areas at MSVD: Navigation and Control Engineering • Instrumentation and Communications Engineering • Ground Support Engineering • Advanced Systems Engineering

These positions will place you on the ground floor of the move of a large segment of the Department to the new Space Technology Center—located at Valley Forge Park, just 17 miles from Philadelphia.

Inquiries are invited from electronics engineers who are technically advanced in their own discipline, and are deeply interested in the related fields of space vehicle development. Write informally, or forward your resume to: D. G. Curley, Div. 69-WV.

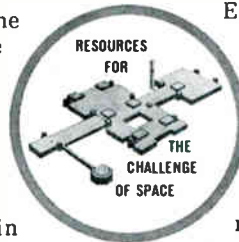

MISSILE & SPACE VEHICLE DEPARTMENT

GENERAL  ELECTRIC

3198 Chestnut Street, Philadelphia 4, Pennsylvania

ENGINEERS

**WHY SANDERS PROVIDES
REAL
OPPORTUNITY**

GROWTH

- From 11 men to 1400 in only 9 years — and still growing
- Gross sales increasing steadily — \$17 million in fiscal year 1960 — with 50% increase projected for 1961

This means new opportunities year by year for forward-looking, ambitious engineers

STABILITY

- Backlog of \$50 million at time of writing
- Most of the company's developmental work and specific products are in areas of the electronics industry where overall growth outlook is good — military systems, automatic assembly and microwaves' instrumentation and control

Long-term assignments assured on a diversity of contracts

REPUTATION

- PANAR® radar, FLEXPRINT® flexible printed circuits and TRI-PLATE® microwave products paved the way for new prime contracts — \$30 million worth, primarily for production of electronic systems that have emerged from the company's research and development programs.

Increase your own knowledge and professional stature by working with men who rely on new technical concepts rather than traditional approaches

INQUIRE NOW ABOUT POSITIONS IN:

CIRCUIT DESIGN — SENIOR LEVEL

Particular emphasis on transistor application to analog and digital techniques; data handling equipment; audio, video, RF circuitry and switching.

SYSTEMS

ECM, Radar and ASW. For theoretical studies and hardware implementation. Through Project Engineer level.

PACKAGING

For both airborne and ground based equipment. Experience in vibration, heat transfer, printed circuit techniques.

TRANSMITTER MODULATOR DESIGN

To contribute to the design of the Eagle Missile transmitter modulator. Experience with modulator or transmitter circuits and system design of oil immersed and dry designs on light weight units of ultra reliability. General experience with vacuum tubes and pulse circuits, high voltage design and magnetic circuits.

TEST EQUIPMENT

To design and develop test equipment for both manufacturing and research and development activities. Good knowledge of pulse and low frequency circuits, switch measurements, sweep circuits and the principles of pulse doppler radar.

RECEIVER DESIGN

VHF electronically scanned airborne receivers, filters, problems in spurious response reduction and multiplexing.

*Please address your inquiries to
Mr. Roland Hood, Employment Manager*



SANDERS ASSOCIATES, INC.

NASHUA, NEW HAMPSHIRE

©registered U.S. trademark

(less than 1 hour from downtown Boston)

ADDRESS BOX NO. REPLIES TO: Box No.
Classified Ad. Div. of this publication.
Send to office nearest you.
NEW YORK 36: P. O. Box 12
CHICAGO 11: 520 N. Michigan Ave.
SAN FRANCISCO 4: 68 Post St.

SELLING OPPORTUNITY AVAILABLE

Representatives desired by manufacturer of Industrial Electronic Instruments and Controls. P.O. Box 8216, Tulsa 15, Oklahoma.

SELLING OPPORTUNITY WANTED

Prominent Sales Engineering Agency, Interested representing Equipment Manufacturing to their O.E.M. and Airline Customers throughout Mid-west and Southwest. Facilities brochure available. RA-5705. Electronics.



**MANUFACTURERS'
REPRESENTATIVES**

IN THE ELECTRONIC INDUSTRY

SAMUEL K. MACDONALD, INC.

manufacturers representatives over 25 years
1531 SPRUCE STREET, PHILA. 2, PA.

Territory: Pennsylvania • New Jersey
Delaware • Maryland
Virginia • West Virginia
District of Columbia

Other Offices:
Pittsburgh
Baltimore
Washington, D.C.

CIRCLE 386 ON READER SERVICE CARD

FOR INFORMATION

About Classified Advertising

Contact The McGraw-Hill Office

Nearest You
ATLANTA, 9—1375 Peachtree St. N.E.
TRinity 5-0523

M. MILLER
BOSTON, 16—Copley Square
COngress 2-1160

M. J. HOSMER
CHICAGO, 11
520 No. Michigan Ave.
MOhawk 4-5800

W. J. HIGGINS
CLEVELAND, 13
1164 Illuminating Bldg.
SUperior 1-7000

W. B. SULLIVAN
DALLAS, 2—1712 Commerce St.,
Vaughn Bldg. RIverside 7-5117

J. GRANT
DENVER, 2
1700 Broadway—Tower Bldg.
ALpine 5-2981

J. PATTEN
DETROIT, 26—856 Penobscot Bldg.
WOodward 2-1793

P. HAMMOND
HOUSTON, 25
Prudential Bldg.,
Holcombe Blvd., Rm. W-724
JACKson 6-1281

GENE HOLLAND
LOS ANGELES, 17—1125 W. 6th St.
HUntley 2-5450

W. C. GRIES
NEW YORK, 36—500 Fifth Ave.
OXford 5-5959

H. T. BUCHANAN—R. P. LAWLESS
T. W. BENDER
PHILADELPHIA, 3
Six Penn Center Plaza
LOcust 8-4330

H. W. BOZARTH—P. PASCHALL
PITTSBURGH, 22—4 Gateway Center
EXpress 1-1314

P. PIERCE
ST. LOUIS, 8—3615 Olive St.
JEfferson 5-4867

ST. LOUIS, 8—3615 Olive St.
JEfferson 5-4867

SAN FRANCISCO, 4—68 Post St.
DOuglas 2-4600

R. KOCH

CIRCLE 385 ON READER SERVICE CARD

INDEX TO ADVERTISERS



Audited Paid Circulation

Advanced Technology Laboratories...	52	*General Electric Co., Heavy Military Electronics Department	50, 51
Airborne Instruments Laboratory...	110	General Products Corp.	88
Allegheny Ludlum Steel Corp.	11	Graphic Systems	94
Alpha Wire Corp.	52		
American Lava Corp.	39		
*American Time Products Inc.	87		
		Haveg Industries, Inc.	47
Bausch & Lomb Optical Co.	19	Hayden, Stone & Co.	110
*Bird Electronic Corp.	46	Haydon Co., A. W.	95
Brookhaven National Laboratory	105	*Hughes Aircraft Co.	49, 103
*Burnell & Co., Inc.	3		
Burroughs Corp., Electronics Tube Div.	15	*Industrial Electronic Engineers, Inc.	52
*Bussmann Mfg. Co., A Division of McGraw Edison	83	Institute of Radio Engineers	2
		*International Telephone and Telegraph Corp., Components Division	79
*Centralab, Electronics, Division of Globe-Union Inc.	44	Johnson Company, E. F.	106, 107
*Clevite Transistor, A Division of Clevite Corp.	36		
*Cohn Corp., Sigmund	100	Keithley Instruments	111
Craig Systems Inc.	20, 21		
*Crosby-Teletronics Corp.	35	Laboratory for Electronics	84
*Cross Co., H.	94	Laminated Shim Company, Inc., The	25
Cubic Corp.	26	Litton Industries	109
*Curtiss-Wright Corp.	99	Lockheed Electronics	112
*Dale Products, Inc.	13	*McGraw-Hill Book Co.	117
*Daven Company	3rd Cover	*Mico Instrument Co.	94
Delco Radio	24	*Microtran Co., Inc.	93
Du Pont De Nemours & Co. Freon Products Division	91	Microwave Associates, Inc.	97
		Minnesota Mining & Mfg. Co., Chemical Div.	30, 31
*Eitel-McCullough, Inc.	77		
Electronic Chemical Corp.	98	Parabam	22
*Electronic Instrument Co. Inc. (EICO)	96	*Philco Corp., Lansdale Div.	54
Electronic Tube Corporation	85	Precision Instrument Co.	89
		*Premier Metal Products Co.	98
*FXR Inc.	6	Pyramid Electric Co.	27
*Fairchild Semiconductor Corp.	42, 43		
General Dynamics Corp., General Atomic Division	8		

* See Advertisement in the July 20, 1960 issue of Electronics Buyers' Guide for complete line of products or services.

McGraw-Hill Book News



ELECTRICAL NOISE

Just Published. Here are the facts about electrical noise—how it originates in circuits—what terms describe it—how to measure it—how to design circuits to minimize its undesirable effects. The physical nature of the various sources of noise are described qualitatively as well as quantitatively, mathematical techniques are explained as needed, and a discussion of the relation of signal and noise in communication systems is included. By **W. R. Bennett**, Data Communications Consultant, Bell Telephone Laboratories, Inc. 270 pp., 105 illus., \$10.00

ELECTRONICS AND NUCLEONICS DICTIONARY

Just Published. Here are definitions of over 13,000 terms—accurately and clearly defined, ranging from television to avionics, from nuclear engineering to space electronics. The book labels synonyms, deprecated terms, and obsolete terms, and it covers spelling, hyphenation, and abbreviations. By **N. M. Cooke**, Cooke Engineering Co.; and **J. Markus**, Technical Director, Dictionary Department, McGraw-Hill Book Co. Over 13,000 terms, 452 illus. and diagrams, \$12.00

FIELD THEORY OF GUIDED WAVES

Just Published. Helps you effectively apply methods of analysis to a wide range of problems associated with the increasing use of guided waves in today's fields of communications. Provides a full account of waveguiding structures, as well as of waveguide antennas, and coupling apertures. Important mathematical techniques essential to the analysis of these devices are presented in detail and illustrated with worked-out solutions to scores of practical problems. By **R. E. Collin**, Case Institute of Technology. 603 pp., 220 illus., \$16.50

THE CRISIS WE FACE



The blunt truth about what automation is doing to our economic system and how it affects our military power. Two experts analyze the situation and discuss the needs and possibilities for change in our technical and organizational policies. A startling, thought-provoking book by G. Steele, and P. Kircher, \$4.95

Automation and the Cold War

10 DAYS' FREE EXAMINATION

McGraw-Hill Book Co., Inc., Dept. L-12-2
327 W. 41st St., N. Y. C. 36

Send me book(s) checked below for 10 days' examination on approval. In 10 days I will remit for book(s) I keep, plus few cents for delivery costs, and return unwanted book(s) postpaid. (We pay delivery costs if you remit with this coupon—same return privilege.)

- Bennett—Electrical Noise, \$10.00
 Cooke & Markus—Elec. & Nucleonics Dict., \$12.00
 Collin—Field Theory of Guided Waves, \$16.50
 Steele & Kircher—The Crisis We Face, \$4.95

(PRINT)

Name
 Address
 City Zone State
 Company
 Position

For price and terms outside U. S.
 Write McGraw-Hill Int'l., N. Y. C.

L-12-2

Resistance up to 100 Million (1 × 10⁸) MEGOHMS!



High Voltage Resistors

From a miniature ¼ watt resistor, rated at 250 volts, to the 100 watt resistor, rated up to 125 KV. Tapped resistors and matched pairs also available. Low temperature and voltage coefficients.

Few can match—and none can exceed—the stability and performance of rpc HIGH VOLTAGE RESISTORS! Ask anybody who uses them.

Tolerance—15% standard. 10%, 5% and 3% available. 2% in matched pairs.

Further information or engineering assistance gladly supplied.

RESISTANCE PRODUCTS COMPANY

914 S. 13th St., Harrisburg, Pa.

Radiation Inc.	48
*Radio Corporation of America... 4th Cover	
*Resistance Products Co.	118
*Rohn Mfg. Co.	111
Rosemount Engineering Co.	98
Royal Electric Corp.	14
Rust Industrial Co., Inc.	93

*Sanborn Company	17
Sarkes Tarzian, Inc.	41
Servomechanisms, Inc.	23
*Shallcross Mfg. Co.	16
*Sigma Instruments, Inc.	81
Sprague Electric Co.	5, 18, 104
Standard Electric Time Co., The... ..	88
Superior Cable Corp.	80
*Sylvania Electric Products, Inc., Electronic Tube Division	29

Telrex Laboratories	100
Thermal American Fused Quartz Co.	107
Tokyo Shibura Electric Co., Ltd.	7

*Ucinite Co., The, A Division of United Carr Fastener Corp.	96, 105
Ultex Corp.	45
United Aircraft Corp., Norden Div.	53
United Shoe Machinery Corp.	96
*United Transformer Corp.	2nd Cover

*Varian Associates	40
*Veeder-Root	75

MANUFACTURERS' REPRESENTATIVES	
MacDonald Inc., Samuel K.	116

CLASSIFIED ADVERTISING

F. J. Eberle, Business Mgr.

EMPLOYMENT OPPORTUNITIES. 114-116

ADVERTISERS INDEX

General Electric Co.	115
National Cash Register Co.	114
Sanders Associates Inc.	116

This index and our Reader Service Numbers are published as a service. Every precaution is taken to make them accurate, but ELECTRONICS assumes no responsibilities for errors or omissions.

electronics



Audited Paid Circulation

BRUCE A. WINNER,
Advertising Sales Manager

R. S. QUINT, Assistant Advertising Sales Manager and Buyers' Guide Manager; FRED STEWART, Promotion Manager; RICHARD J. TOMLINSON, Production Manager; GEORGE E. POMEROY, Classified Manager; HUGH J. QUINN, Circulation Manager.

ADVERTISING REPRESENTATIVES: NEW YORK Donald H. Miller, Henry M. Shaw, George F. Werner; BOSTON William S. Hodgkinson, Donald R. Furth; PITTSBURGH David M. Watson; PHILADELPHIA Warren H. Gardner, William J. Boyle; CHICAGO Harvey W. Wernecke, Martin J. Gallay; CLEVELAND P. T. Fegley; SAN FRANCISCO T. H. Carmody, R. C. Alcorn; LOS ANGELES Carl W. Dysinger, D. A. McMillan, Marshall Freeman; DENVER J. Patten; ATLANTA M. Miller; DALLAS Robert T. Wood; LONDON Edward E. Schirmer; FRANKFURT Stanley R. Kimes; GENEVA Michael R. Zeynel.

BRANCH OFFICES: National Press Bldg., Washington 4, D.C.; McGraw-Hill Bldg., Copley Square, Boston 16; Four Gateway Center, Pittsburgh 22; Six Penn Center Plaza, Philadelphia 3; 520 North Michigan Avenue, Chicago 11; 55 Public Square, Cleveland 13; 68 Post Street, San Francisco 4; 1125 West Sixth St., Los Angeles 17; 1740 Broadway, Denver 2; 1301 Rhodes-Haverty Bldg., Atlanta 3; 901 Vaughn Bldg., Dallas 1; McGraw-Hill House, London E.C.4; B5 Westendstrasse, Frankfurt/Main; 2 Place de Port, Geneva.

OFFICERS OF THE PUBLICATIONS DIVISION: Nelson L. Bond, President; Shelton Fisher, Wallace F. Traendly, Senior Vice Presidents; John R. Callahan, Vice President and Editorial Director; Joseph H. Allen, Vice President and Director of Advertising Sales; A. R. Venezian, Vice President and Circulation Coordinator.

OFFICERS OF THE CORPORATION: Donald C. McGraw, President; Joseph A. Gerardi, Hugh J. Kelly, Harry L. Waddell, Executive Vice Presidents; L. Keith Goodrich, Vice President and Treasurer; John J. Cooke, Secretary.

Subscriptions are solicited only from those actively engaged in the field of the publication and in a manner served by its contents. Position and company connection must be indicated on subscription orders. Subscription rates for individuals within the field of the Publication: United States and United States Possessions, \$6.00 one year; \$9.00 two years; \$12.00 three years. Canada, \$10.00 one year. All other countries \$20.00 one year. Single Copies, United States, United States Possessions and Canada 75¢; Buyers' Guide \$3.00; Single Copies all other countries \$1.50; Buyers' Guide \$10.00.

The Publisher, upon written request from any subscriber to our New York Office, agrees to refund that part of the subscription price applying to copies not yet mailed.

201 ROTARY SWITCH TYPES FOR IMMEDIATE OFF-THE-SHELF DELIVERY... FROM DAVEN!

Standard switches, adjustable stop switches, ceramic switches, subminiature Series G switches . . . available for immediate delivery from Daven or your local Daven Distributor.

This solves your problem of obtaining Daven precision rotary tap switches overnight . . . in breadboard, prototype or production quantities.

Write today for complete listings and technical data.



THE **DAVEN** COMPANY, Livingston, New Jersey

General
Mills

SWITCHES

TODAY, MORE THAN EVER, THE DAVEN © STANDS FOR DEPENDABILITY

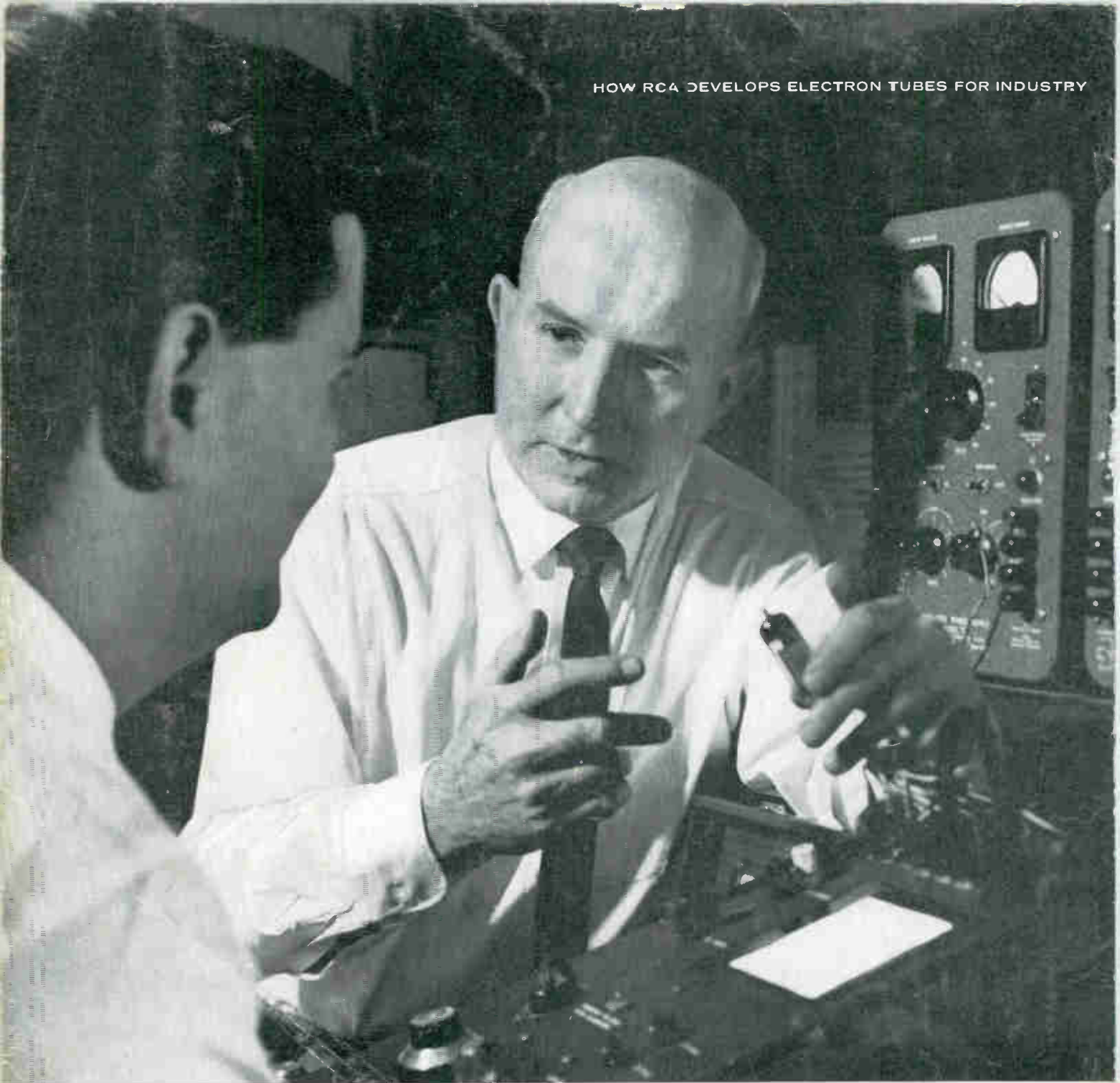

George Rose just won't sit still. As head of Receiving Tube Advanced Development, it is George Rose's job to direct the exciting activities of one of the most imaginative research teams at RCA. He is an able and dynamic chap: always on the move. So it's not surprising to find him not at his desk, but back in the lab pursuing his first love: the practice of shirtsleeve science.

George's multiple abilities guide the work of a group which fairly pops with new ideas. Recently he turned his staff loose on the problem of developing a modulator tube with exceptional isolation between inputs, good linearity, and high sensitivity. What emerged was an innovation in tube geometry: our new 7360 Beam Deflection Tube, one of the most significant contributions to single-sideband operation in many years. With the 7360, engineers can now design more efficient SSB circuits with fewer components.

The work of George's group, which has also been responsible for such electronic milestones as the nuvistor and the ceramic metal pencil tube, is another phase of RCA's broad continuing quest for finer, more reliable tube products for you.



RADIO CORPORATION OF AMERICA
Electron Tube Division
Harrison, N. J.

For Information Call—
 NEWARK 2, N.J.: 744 Broad Street • HUmboldt 5-3900
 DETROIT 2, MICH.: 714 New Center Building
 TRinity 5-5600
 CHICAGO 54, ILL.: Suite 1154
 Merchandise Mart Plaza • WHitehall 4-2900
 LOS ANGELES 22, CALIF.: 6355 E. Washington Blvd.
 RAYmond 3-8368