

September 23, 1960

electronics

Flight-deck crew on aircraft carrier can communicate despite 135-db ambient noise using radio helmet (below). Transmitter-receiver is transistorized, works at vhf frequencies. See p 57

A McGraw-Hill Publication 75 Cents



ROLAND KISSLER
BOX 658
NOSES TAKE BASE
C 1

Creative Microwave Technology

Published by MICROWAVE AND POWER TUBE DIVISION, RAYTHEON COMPANY, WALTHAM 54, MASS., Vol. 2, No. 4

RAYTHEON KLYSTRON CLOCKS 62,000 HOURS OF SERVICE

--tube retired after seven years of continuous operation

We don't send out 62,000-hour warranties; however, you can expect unusual performance from Raytheon klystrons. Take the tube cited above -- the QK-531 -- a 6,575-6,875 mc reflex klystron which we conservatively warrant for 7,500 hours. As the local oscillator in the Houstonia, Missouri, link of the Panhandle Eastern Pipeline Company's 400-mile microwave system, the tube performed a major function in relaying up to ten channels of information between the Odessa and Boonville stations.

How is this kind of performance built into a tube? Advanced manufacturing techniques and rigorous quality control is the answer.

If you need low-power coverage of government, studio link and common carrier frequency bands, look into the characteristics of Raytheon's complete line of klystrons.

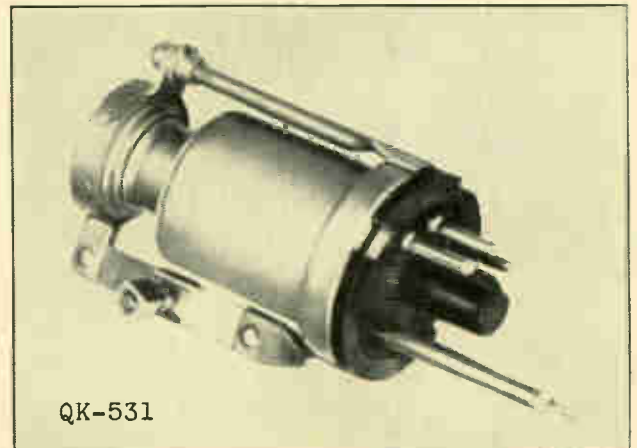

QK-531

The QK-531 is particularly suited for local oscillator service in microwave receivers. It is useful, also, as a local oscillator in microwave spectrum analyzers, as a pulse generator for testing circuit response and as a frequency modulated source in microwave relay links.



Homer Marrs of Motorola presents gold-plated klystron trophy to F. J. McElhatton, Panhandle Eastern Pipeline Co. J. A. Fowler, Supervisor of Communications for Panhandle, is at the left. Prized klystron, the Raytheon QK-531, performed for 62,000 hours.



Close control of product quality and costs at every state of production is responsible, in part, for Raytheon's success in meeting industry and government specifications. Every step of assembly is spot checked by inspectors, each with 10 years or more experience in microwave tube production.

Excellence in Electronics



You can obtain detailed application information and special development services by contacting: Microwave and Power Tube Division, Raytheon Company, Waltham 54, Massachusetts. In Canada: E. Waterloo, Ontario.

A LEADER IN CREATIVE MICROWAVE TECHNOLOGY

electronics

A McGraw-Hill Publication 75 Cents



W. W. MacDONALD, Editor

J. M. CARROLL, Managing Editor

SENIOR ASSOCIATE EDITORS: Samuel Weber, Roland J. Charest. ASSOCIATE EDITORS: Frank Leary, Michael F. Tomaino, Sylvester P. Carter, William P. O'Brien, John F. Mason, William E. Bushor, Thomas Emma, Sy Vogel, Leslie Solomon, M. M. Perugini, George J. Flynn. ASSISTANT EDITORS: Michael F. Wolff, Nilo Lindgren, Stanley Froud, Stephen B. Gray. REGIONAL EDITORS: Harold C. Hood (Pacific Coast, Los Angeles), Thomas Maguire (New England, Boston). MARKET RESEARCH EDITOR: Edward DeJongh. BUYERS' GUIDE EDITOR: George Sideris. ART DIRECTOR: Harry Phillips; Howard R. Berry. PRODUCTION EDITOR: John C. Wright, Jr. EDITORIAL ASSISTANTS: Glaria J. Filippone, Arlene Schlip, Bernice Duffy, Patricia Martine, Lorraine Rassi, Virginia T. Bastian, Ruth Ayres.

JAMES GIRDWOOD, Publisher

BUSINESS

\$134 Million for Space and Where it Went. A look at NASA's books	30
How Electronics Executives Make Out in Pay. Second only to one	32
More Work Needed on Tunnel Diode Materials	35
British Disclose Satellite Work. Airshow exhibitors take off wraps	36
Japan Plans More Computers. Tokyo sources report agreement	40
Urges More Spending for Radar Astronomy. 5% of space budget?	43
Crosstalk	4
Comment	6
Electronics Newsletter	11
Washington Outlook	14
Financial Roundup	23
25 Most Active Stocks	23
Marketing	26
Current Figures	26
Meetings Ahead	44

ENGINEERING

On extremely noisy aircraft carrier flight decks, communications can be impossible without special transmitter-receivers. See p 57	COVER
Helmet Transceiver for Flight Deck Communications. Receiver features noise-actuated avc. By D. C. Gibson	57
Mapping Caves Magnetically. Simple device gives underground position fix and provides communication link. By E. R. Roeschlein	61
Designing Transistorized Voltage Regulators. Techniques for series regulators. By E. Wilson	62
Using Ferrite Cores to Recognize Words. Coincidence detector compares code with fixed memory. By M. A. Merkel	66
New Look At Wave Analyzer Design. Transistors eliminate warm-up delays and reduce heat dissipation. By J. R. Petrak	68
Analyzing Magnetically Detented Stepper Motors. Output steps compared to input pulses. By H. J. Weber and M. Weiss	71
Extended Transmission-Line Charts. Permit plotting of impedance for negative-resistance components. By H. F. Mathis	76

DEPARTMENTS

Research and Development. Circular Array Scans at High Speed	80
Components and Materials. Contact Button From Knitted Wire	84
Production Techniques. Welder Seals 360 Crystals an Hour	88
New On the Market	92
People and Plants	104
Literature of the Week	102
Index to Advertisers	113

For ground based applications requiring fixed or steerable apertures up to 60 feet, these G/A parabolic reflector antennas offer a simple and lightweight method of achieving high gains over wide frequency bands. The offset-fed design (see figure 2) avoids aperture blocking and mismatched feeds. As a result, maximum gain is available, and the side lobes remain more than 17 db below the main lobe. Frequency bands as high as 10:1 can be covered with only two feeds. All components are air transportable and are designed for simple and fast field erection without special tools or heavy rigging. These low cost units are available right now with a variety of feed structures, and simple, rugged mounts for fixed or steerable applications. Also worth looking into: G/A's new line of low noise high gain preamplifiers and a group of other complementary system components for tunable radar, ECM and propagation experiments. Send for complete technical information; or inquire about openings with our growing technical staff.



Granger Associates / 974 Commercial Street
Palo Alto, California / Davenport 1-4175

Circle 2 on reader service card

Specifications: GA Models 703 and 704 Offset-fed Parabolic Reflector Antennas on Azimuth-elevation Mounts

Antenna apertures	Model 703—60 feet Model 704—30 feet
Gain	see figure 1 below
Upper frequency	Model 703 —750 Megacycles Model 704—1500 Megacycles
Mounting	steel tubing mast, tripod supported.
Rotation	Model 703—0.11 rpm Model 704—0.16 rpm
Azimuth	±360 degrees with stop-left and right controls. Synchronized azimuth indication.
Elevation	adjustable from 15 degrees above horizon to 3 degrees below horizon. Other degrees of travel and various driving mechanisms available at request.
Construction	expanded aluminum screen supported by lightweight aluminum truss.
Weight of reflectors	Model 703—2,000 pounds Model 704 —500 pounds
Weight, mountings	Model 703—16,000 pounds Model 704 —4,600 pounds

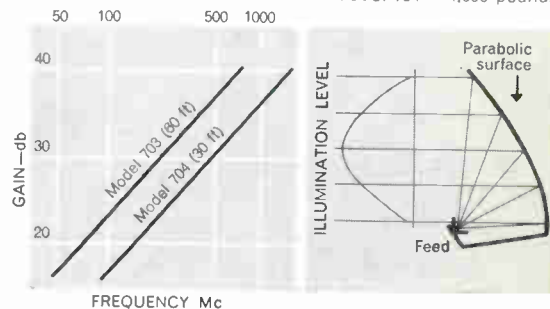

FIGURE 1

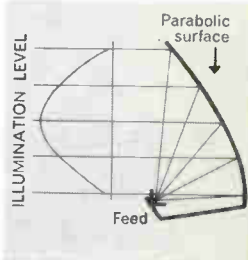
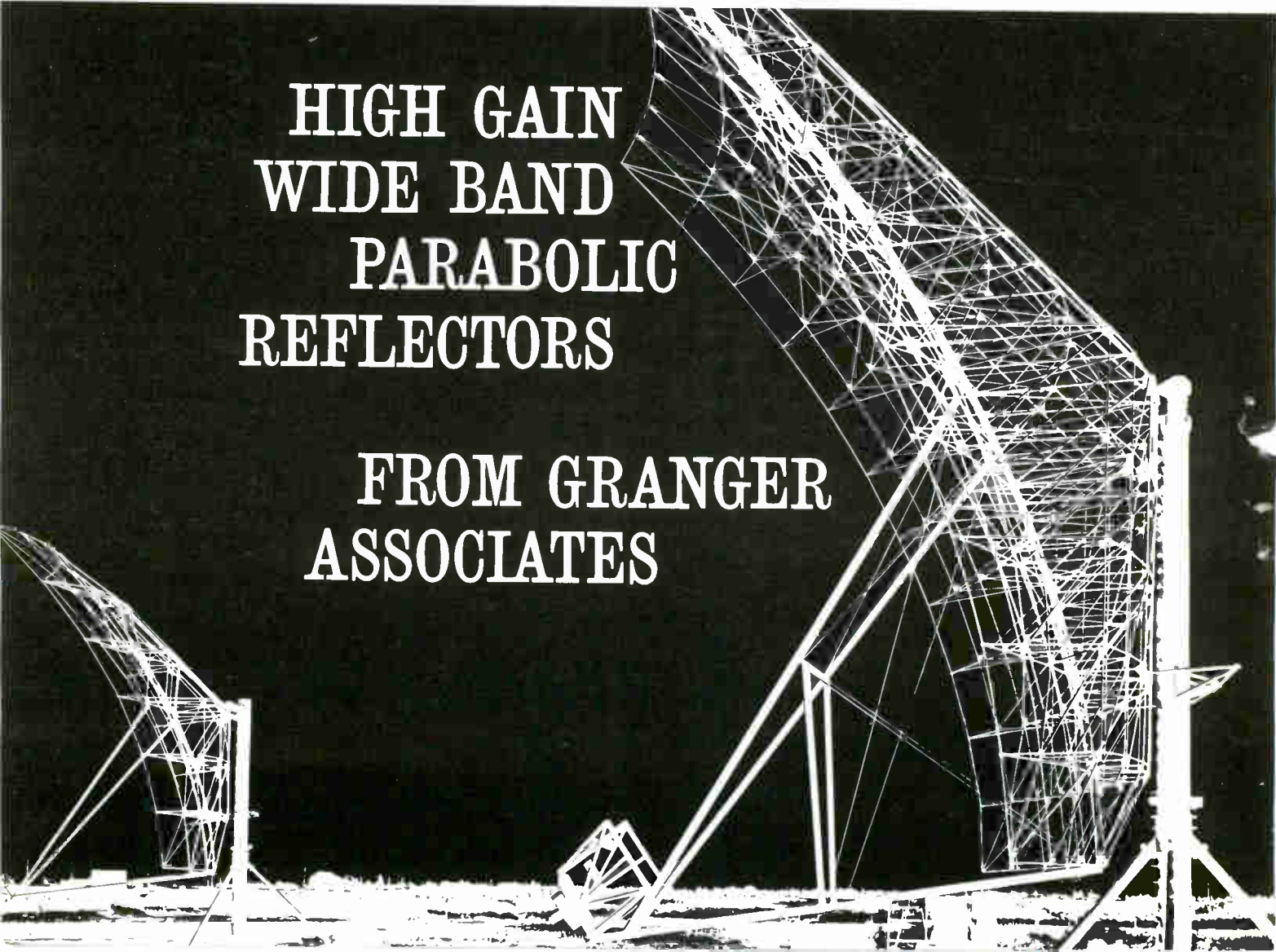

FIGURE 2

HIGH GAIN WIDE BAND PARABOLIC REFLECTORS

FROM GRANGER ASSOCIATES



CONVECTION COOLED GUARANTEED 5 YEARS

LAMBDA Transistorized Power Supplies

LA Series

5 and 10 AMP • 0-34 VDC



3 1/2" Panel Height on 5 AMP Models

LT Series

1 and 2 AMP • 0-32 VDC



Compact 3 1/2" Panel Height

CONDENSED DATA ON LA SERIES

LA 50-03AM (with meters)	0-34 VDC, 0-5A	\$425.
LA 100-03AM (with meters)	0-34 VDC, 0-10A	540.
LA 50-03A (without meters)	0-34 VDC, 0-5A	395.
LA 100-03A (without meters)	0-34 VDC, 0-10A	510.

MODEL	VOLTAGE STEPS
--------------	----------------------

LA 50-03A, LA 50-03AM-2, 4, 8, 16 and 0-4 volt vernier
LA100-03A, LA100-03AM-2, 4, 8, 16 and 0-4 volt vernier

Regulation: Line Better than 0.15 per cent or 20 millivolts (whichever is greater). For input variations from 100-130 VAC. Load Better than 0.15 per cent or 20 millivolts (whichever is greater). For load variations from 0 to full load.

AC Input: 100-130 VAC, 60 ± 0.3 cycle. This frequency band amply covers standard commercial power lines in the United States and Canada.

Ripple and Noise: Less than 1 millivolt rms.

Ambient Temperature: 50°C—continuous duty.

Remote DC Vernier: Provision for remote operation of DC Vernier.

Remote Sensing: Provision is made for remote sensing to minimize effect of power output leads on DC regulation, output impedance and transient response.

Size:

LA 50-03A	3 1/2" H x 19" W x 14 3/8" D
LA 100-03A	7" H x 19" W x 14 3/8" D

CONDENSED DATA ON LT SERIES

LT 1095M (with meters)	0-32 VDC, 0-1 AMP	\$315.
LT 2095M (with meters)	0-32 VDC, 0-2 AMP	395.
LT 1095 (without meters)	0-32 VDC, 0-1 AMP	285.
LT 2095 (without meters)	0-32 VDC, 0-2 AMP	365.

MODEL	VOLTAGE BANDS
--------------	----------------------

LT 1095, LT-1095M	0-8, 8-16, 16-24, 24-32
LT 2095, LT-2095M	0-8, 8-16, 16-24, 24-32

Regulation: Line Better than 0.15 per cent or 20 millivolts (whichever is greater). For input variations from 105-125 VAC. Load Better than 0.15 per cent or 20 millivolts (whichever is greater). For load variations from 0 to full load.

AC Input: 105-125 VAC, 50-400 CPS.

Ripple and Noise: Less than 1 millivolt rms.

Ambient Temperature: 50°C—continuous duty.

Remote DC Vernier: Provision for remote operation of DC Vernier.

Remote Sensing: Provision is made for remote sensing to minimize effect of power output leads on DC regulation, output impedance and transient response.

Size:

LT 1095	3 1/2" H x 19" W x 14 3/8" D
LT 2095	3 1/2" H x 19" W x 14 3/8" D

SEND TODAY FOR COMPLETE DATA.



LAMBDA ELECTRONICS CORP.

11-11 131 STREET • DEPT. 1 • COLLEGE POINT 56, N. Y. • INDEPENDENCE 1-8500

CIRCLE 3 ON READER SERVICE CARD

CROSSTALK



THIS LITTLE SYMBOL appears on the last page of each issue of **ELECTRONICS**, and indicates our membership in the Audit Bureau of Circulations.

You may not have noticed it. Normally, we don't either—it's just there, an important but passive element in our background of familiar things. But this month is ABC Month, and it set us to musing about this organization of which we are a member.

The Bureau is watchdog of the publishing industry. Your daily newspaper is probably a member. Most of the influential magazines are. It was formed in 1914 to provide a standard for measuring quality and quantity of circulation, and to put an end to a freewheeling era when, as one editor put it, a circulation figure was "any number that I may be told by my publisher" and a subscriber was "anyone who answers my advertisement."

ABC audits the circulation of only those publications for which subscribers pay. When a man pays for a magazine, he demonstrates in a truly meaningful way his interest in its contents. The magazine cannot take its readers' approval for granted; it must constantly win approval. Paid circulation figures alone tell ABC that a consumer publication is paying serious attention to the needs of its broad spectrum of readers. In the industrial field, the auditors also look to see that the circulation is focused on a carefully limited category of readers.

ELECTRONICS is sold only to those who are actively part of the electronics industry. We ourselves watch this very carefully, because it permits us, as editors, to select material of greatest significance to specialized professionals.

Each issue is like a popular referendum; so long as we continue to supply the material you need, your vote is favorable to us. ABC is the election board; they watch to make sure the tally is accurate. Their audit also assures you that this magazine continues to be sensitive to your requirements, and that your individual vote counts in the weekly referendum.

Coming In Our September 30 Issue

ELECTROMECHANICAL DEVICES AND SYSTEMS. Electromechanical components play an important role in many systems with which electronics engineers are concerned. Sometimes the electronics engineer needs only to be familiar with the overall operating characteristics of a particular electromechanical device; at other times he may have to choose between an electromechanical and an electronic component for a specific application.

Next week **ELECTRONICS** presents a Special Report on electromechanical devices and systems. Authored by Associate Editors Tomaino and Flynn, the report spotlights significant work under way in switching devices, rotating devices, actuators, timers and readout devices.

You'll learn, among other things, about latest trends in gyro design, microsecond control, and the influence of semiconductor technology in this area.

New concepts suggested by the application of exotic metals and ferrites to switching components are also explored.

electronics

Sept. 23, 1960 Volume 33 November 39

Published weekly, with **Electronics Buyers' Guide** and Reference annually, by McGraw-Hill Publishing Company, Inc. Founder: James H. McGraw (1860-1948).

Title registered U.S. Patent Office; Copyright 1960, McGraw-Hill Publishing Company, Inc. All rights reserved, including the right to reproduce the contents of this publication, in whole or in part.

Executive, editorial, circulation and advertising offices McGraw-Hill Building, 330 West 42nd Street, New York 36, N. Y. Telephone Longacre 4-3000. Teletype TWX N.Y. 1-1636. Cable McGraw-Hill, N.Y. Printed in Albany, N. Y.; second class postage paid.

Subscription price U. S. and possessions \$6 per year; single copies 75¢ **Buyers' Guide** \$3. Other countries, and longer periods, on request. Subscriptions solicited only from those actively engaged in the field of the publication and in a manner served by its contents; position and company should be indicated.

Subscribers: Please address all correspondence, change of address notices, subscription orders or complaints to Fulfillment Manager, **Electronics**, at above address. Change of address notices should provide old as well as new address, including postal zone number if any. If possible, attach address label from recent issue. Allow one month for change to become effective.

Postmaster: Please send Form 3579.

ALL UNITS ACTUAL SIZE

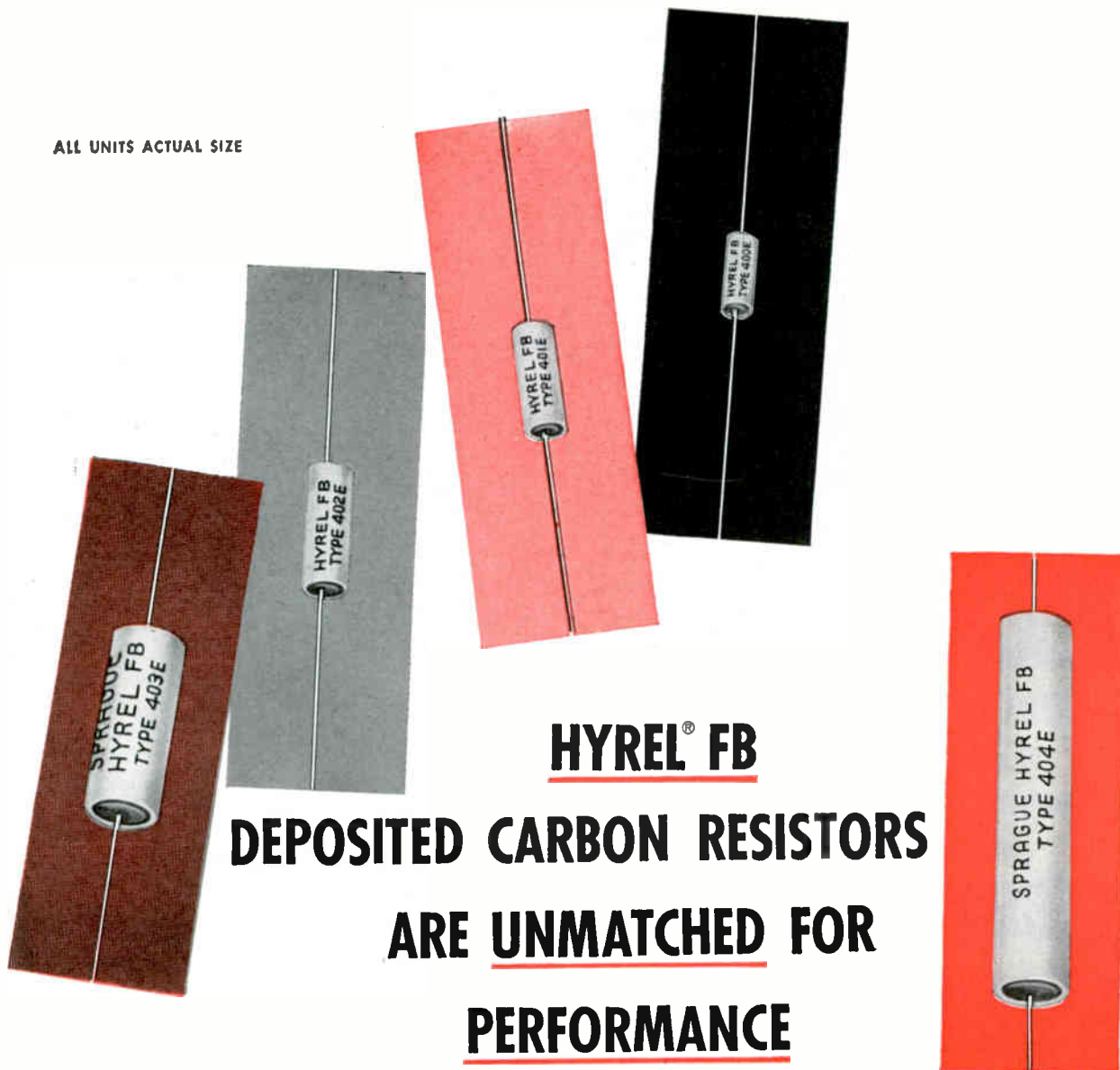

HYREL[®] FB
DEPOSITED CARBON RESISTORS
ARE UNMATCHED FOR
PERFORMANCE



HYREL[®] FB DEPOSITED CARBON RESISTORS
 are hermetically sealed in ceramic jackets against moisture
 and vapor ... **safely protected** against mechanical abuse.
 The Hyrel FB series is intended for applications in military, commercial
 and telephone equipment where **long life under high humidity,**
small size, and stability of electrical characteristics are important.

WRITE FOR ENGINEERING BULLETIN 7010B
SPRAGUE ELECTRIC COMPANY
 35 MARSHALL STREET • NORTH ADAMS, MASS.

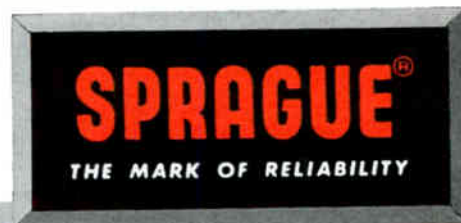

Made to far exceed MIL-R-10509C Specifications

SPRAGUE COMPONENTS:
 CAPACITORS • RESISTORS • MAGNETIC COMPONENTS • TRANSISTORS • INTERFERENCE FILTERS • PULSE NETWORKS
 HIGH TEMPERATURE MAGNET WIRE • CERAMIC-BASE PRINTED NETWORKS • PACKAGED COMPONENT ASSEMBLIES



a **spot** is a **spot**
is a high
resolution **spot**
with
CELCO YOKES

● **Celco YOKES**
keep spots **smallest**

● **Celco YOKES**
keep spots **roundest**

● **Celco YOKES**
keep spots **sharpest**

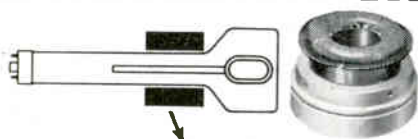

Use a **CELCO DEFLECTION YOKE** for
your high resolution applications.

In a **DISPLAY SPOT?** call **Celco!**

Celco
*Constantine Engineering
Laboratories Co.*

Main Plant: MAHWAH, N. J. Davis 7-1123

● Pacific Division - Cucamonga, Calif. - YUkon 2-2688

COMMENT

Electronics Probes Nature

Our thanks for . . . your special report "Electronics Probes Nature" (p 53, July 29). As a concise and timely coverage of very difficult fields, it was an excellent piece of work . . .

JOHN J. LISTER

U. S. NAVAL RESEARCH LABORATORY
WASHINGTON, D. C.

. . . We think the coverage is good, and that it is a rather well written article. We have learned quite a bit from reading it. It represents a good, workmanlike job of writing and reporting.

JOHN J. RAFFONE

BELL TELEPHONE LABORATORIES
NEW YORK.

L-F Antenna Design

With reference to the article "Antenna Design for Maximum L-F Radiation" by Monser and Sabin (p 84, June 3), it would be most interesting to know the details of the ground system used with the antennas, and the reference unattenuated field strength produced for 100-percent efficiency and one-kilowatt input.

PERRY W. ESTEN

RARET S. A.
LISBON, PORTUGAL

We referred the request to author Monser, who writes:

The ground system used for the 1/10 scale model tests consisted of a ground screen of 180 two-foot radials equally spaced about the antenna base and terminated in a copper-wire ring. Extending from this ring are sixty 118-ft radials of #16 solid copper wire, also equally spaced about the antenna base. The complete system was not buried. The ground system for the 150-ft antenna was similar to the system just described, except that the radial lengths were increased by a factor of 10, and the radials were buried approximately six inches in the earth.

The unattenuated field strength at one mile for 1 Kw of radiated power was taken as 186 mv per meter for the purpose of determin-

ing the radiation resistance of the antenna. The relationships used were

$$P_a = (E/186 \cdot d/5280)^2$$

and

$$R_a = P_a/I_a^2 \cdot 1,000$$

where E is the measured field strength in millivolts per meter, d is the distance in feet from the antenna where E was measured, P_a is the computed radiated power in kilowatts and I_a is antenna driving-point current in amperes rms. The aforementioned computations are not exact because of the slight shaping of the vertical pattern of the antenna resulting from the guy-wire top hat.

Probably a more appropriate constant would have been 195 for this loading condition. This constant is further suggested because the ground system used did not provide a perfectly reflecting ground. We were concerned with relative performance in our analysis, so that this refinement was not introduced.

Finally, some instrumentation error in measuring the r-f antenna input current probably existed. Also, when the measurements are made at high input power levels, rather than at the low levels required for our tests, antenna base capacitance affects the accuracy of the reading. Base capacitance values (after Hallen) may be on the order of 200 picofarads for broadcast towers.

GEORGE J. MONSER

AMERICAN ELECTRONIC
LABORATORIES
LANSDALE, PENNA.

Capacitor Bank

Thank you for the fine job you did on Dr. Buser's condenser-bank article ("Experimental 100,000 Joule Capacitor Bank for Plasma Research," p 58, Aug. 5). For the record, I'd like to call your attention to two small errors: the photo of the condenser bank was printed upside down, and the captions for *proper* and *improper* switch adjustments were reversed.

I. A. BALTON

U. S. ARMY SIGNAL RESEARCH &
DEVELOPMENT LABORATORY
FT. MONMOUTH, N. J.

HOW TO GENERATE 100-ma PULSES AT 10 mc

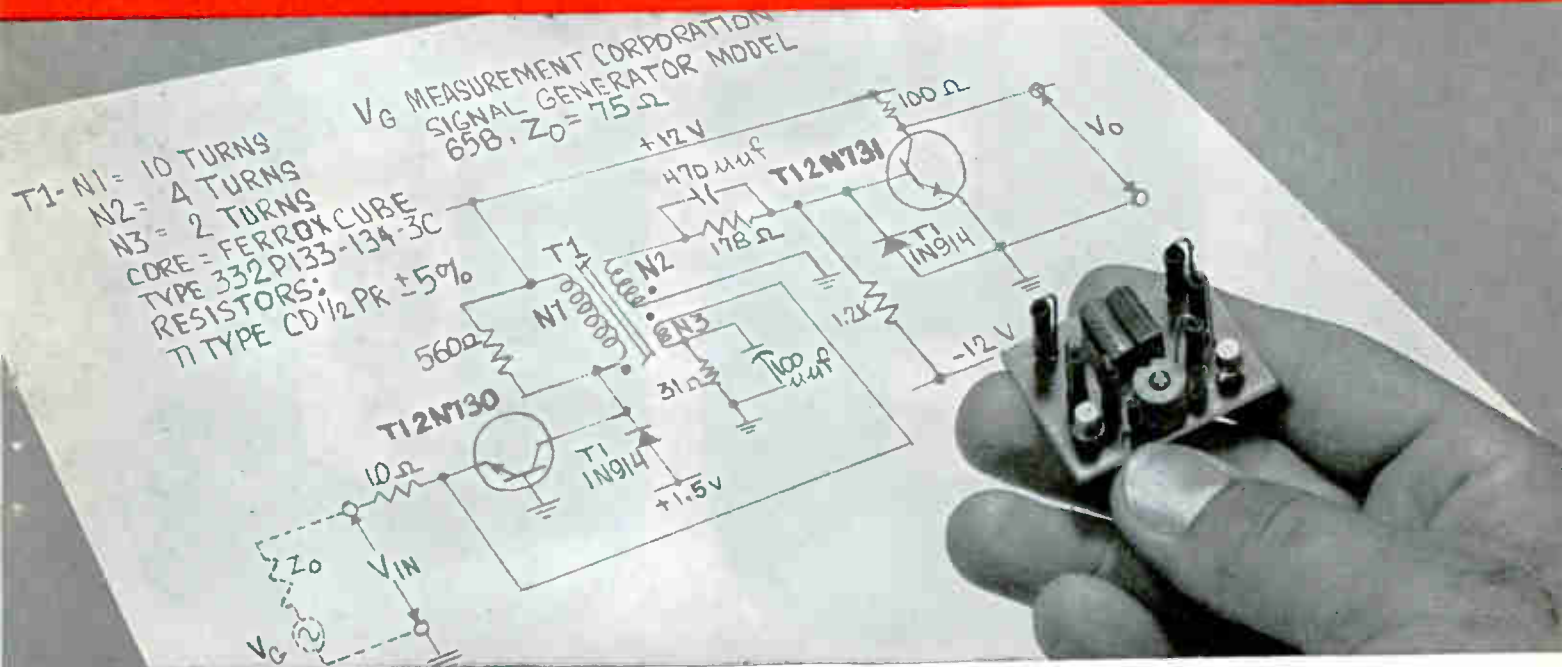

... WITH TI 2N730 and 2N731 SILICON MESA TRANSISTORS

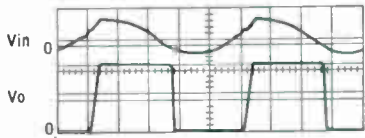

1 Megacycle
VERT.—5v/cm
HORIZ.—2 μsec/cm
T_A—25°C

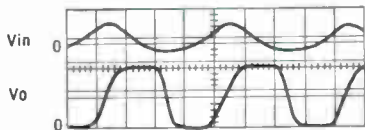

5 Megacycles
VERT.—5v/cm
HORIZ.—50 μsec/cm
T_A—25°C

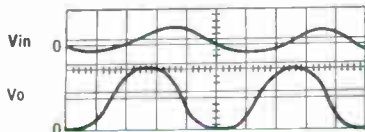

10 Megacycles
VERT.—5v/cm
HORIZ.—20 μsec/cm
T_A—25°C



See how these performance-proved characteristics apply to your high-current, high-speed switching circuits...

High-current loads — Switch 100 ma at 10-mc rates using TI 2N730 and 2N731 transistors (see applications circuit) • **Fast switching** — Note 20 millimicrosecond rise and fall times on

the waveforms illustrated • **Size and weight** — Save both size and weight with the subminiature TO-18 packaging of the TI 2N730 and 2N731 'mesas' • **Dissipation** — Get a full 500 mw (T_A=25°C) or 1.5w (T_C=25°C) with beta spreads of 20-60 (2N730) and 40-120 (2N731) • **Reliability** — TI Quality Assurance guarantees your performance to specifications • **Applications** — Use the TI 2N730 and 2N731 guaranteed performance in your digital computer clock pulse generators and similar high-load, high-speed, high-reliability circuits. Check these specifications:

electrical characteristics at 25°C ambient (unless otherwise noted)			2N730		2N731		unit		
PARAMETER	TEST CONDITIONS	min	max	min	max				
I _{CB0}	Collector Reverse Current	V _{CB} =30v	—	1.0	—	1.0	μa	Collector-Base Voltage	60v
I _{CB0}	Collector Reverse Current at 150°C	V _{CB} =30v	—	100	—	100	μa	Collector-Emitter Voltage	40v
BV _{CB0}	Collector-Base Breakdown Voltage	I _C =100μa	60	—	60	—	v	Emitter-Base Voltage	5v
BV _{CER}	Collector-Emitter Breakdown Voltage	I _{CER} =100ma R _{BE} =10 ohms	40	—	40	—	v	Total Device Dissipation	0.5w
BV _{EBO}	Emitter-Base Breakdown Voltage	I _E =100 μa	5	—	5	—	v	Total Device Dissipation at Case Temperature 25°C	1.5w
h _{FE}	DC Forward Current Transfer Ratio	I _C =150ma	20	60	40	120		Storage Temperature Range	-65°C to +175°C
V _{BE(sat)}	Base-Emitter Voltage	I _C =150ma	—	1.3	—	1.3	v		
V _{CE(sat)}	Collector-Emitter Saturation Voltage	I _C =150ma	—	1.5	—	1.5	v		
h _{fe}	AC Common Emitter Forward Current Transfer Ratio	I _C =50ma f=20mc	2.0	—	2.5	—			
C _{ob}	Common-Base Output Capacitance	I _E =0 f=1mc	—	35	—	35	μμf		

*Pulse conditions: Length = 300μs, duty cycle < 2%

CALL YOUR TI SALES OFFICE OR LOCAL AUTHORIZED TI DISTRIBUTOR FOR PRICE, DELIVERY AND COMPLETE TECHNICAL DATA.

 the **FIRST** silicon transistor manufacturer



INSTRUMENTS
INCORPORATED
SEMICONDUCTOR-COMPONENTS DIVISION
13500 N. CENTRAL EXPRESSWAY
POST OFFICE BOX 312 • DALLAS, TEXAS

CIRCLE 7 ON READER SERVICE CARD

hp 160B

Presented proudly

The **hp** 160B—a new 15 MC oscilloscope built to exacting MIL specifications; most versatile oscilloscope ever offered.

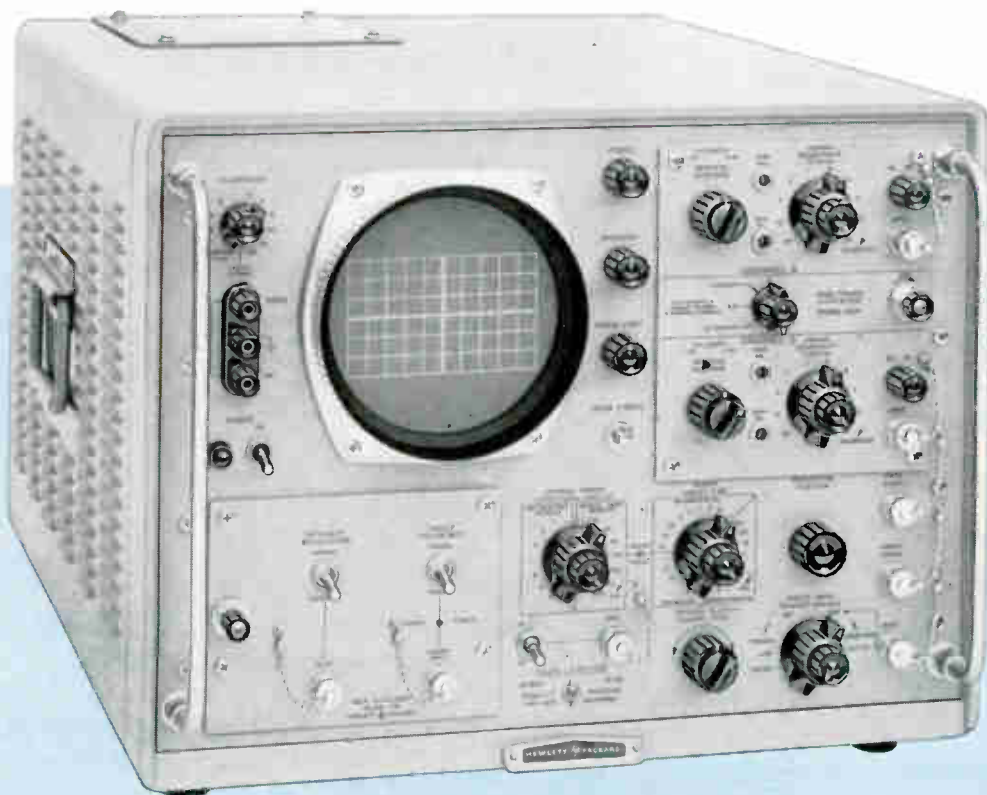

Here are some of the outstanding features:

New plug-in versatility **Horizontal plug-ins.** New 166 series horizontal (time axis) plug-ins add a whole new dimension of flexibility to the basic oscilloscope. First two of the series are: **Ⓢ 166C Display Scanner** making the 160B the world's first major scope with an *X-Y recorder output*. This output covers the full scope bandwidth and makes possible large, high resolution, permanent *X-Y records of repetitive waveforms*. **Ⓢ 166D Sweep Delay Generator** establishing new convenience for conventional sweep delay measurements. A unique mixed sweep feature permits detailed analysis of one pulse in a wavetrain while retaining a display (on a slower time scale) of the entire wave preceding the pulse of interest. Thus, you view the exact pulse or segment desired while still retaining presentation of the earlier display. Extremely high magnifications are possible with appropriate settings of sweep controls.

Vertical amplifier plug-ins. New 162 series plug-ins will include new amplifiers permitting scope operation under many different input conditions. Typical plug-in is **Ⓢ 162A Dual Trace Amplifier**, 20 mv/cm unit permitting simultaneous viewing of two phenomena or differential amplification of signals dc to 14 MC.

Military quality — Using premium components throughout, the 160B is designed to meet the highest standards of ruggedness, accuracy and dependability. It follows MIL-E-16400B for shock, vibration, humidity and temperature. Premium features include high stability tube-transistor circuits, regulated dc filament voltages, power transistors in efficient heat sinks, circuits on translucent epoxy-glass, simplified layout.

Easy to operate — Model 160B control array is traditional and logical. No special training is required to operate the 160B. Your set-up time and measurements are simplified with improved *preset triggering* and an *automatic beam-finder*. The first means that one preset adjustment insures optimum triggering for almost all conditions (even signals down to 2 mm deflection). The second means that with the press of one button the beam is instantly located and "held" until you center your trace.

SPECIFICATIONS

SWEEP GENERATOR:

Internal Sweep: 24 ranges, 0.1 $\mu\text{sec/cm}$ to 5 sec/cm ; vernier to 15 sec/cm

Magnification: 7 ranges, to 0.02 $\mu\text{sec/cm}$

Triggering: 2 mm minimum, internal, power line or vertical input signal. External 0.5 v peak to peak

Trigger Point: Pos. and Neg., -30 to +30 v

Sawtooth Output: -50 to +50 v

Gate Output: 50 v pulse

HORIZONTAL AMPLIFIER:

Bandwidth: dc to 1 MC

Sensitivity: 7 ranges, 0.1 v/cm to 10 v/cm; vernier to 25 v/cm

Input Impedance: 1 megohm, 30 pf shunt

CALIBRATOR:

Type: 1,000 cycle square wave, 1 μsec rise, decay time

Voltage: 9 ranges $\pm 3\%$, 0.2 mv to 100 v peak to peak

Current: 5 ma peak to peak, $\pm 3\%$

CATHODE RAY TUBE:

Type: 5AMP mono-accelerator, flat face, P1, P2, P7, P11 screen; 5,000 v accelerating potential

Deflection Sensitivity: 20 v approx.; intensity modulation 20 v pulse to blank

PRICE: **Ⓢ** 160B Oscilloscope, \$1,850.00

Ⓢ 162A PLUG-IN AMPLIFIER

Sensitivity Range: (Each channel) 0.02 v/cm to 50 v/cm, 10 ranges, 0.02 v/cm to 20 v/cm. Accuracy $\pm 5\%$

Pass Band: Dc coupled, dc to 14 MC, 0.025 μsec rise time
Ac coupled, 2 cps to 14 MC

Differential Input: Both attenuators may be switched to one channel and adjusted separately. Common Mode Rejection at least 40 db at max sens.; at least 30 db with attenuators

PRICE: **Ⓢ** 162A Plug-In Amplifier, \$350.00

Data subject to change without notice. Prices f.o.b. factory.



HEWLETT-PACKARD COMPANY

1019A Page Mill Road
Cable "HEWPACK"

Palo Alto, California, U.S.A.
DAvenport 6-7000

Field representatives in all principal areas

HEWLETT-PACKARD S.A., Rue du Vieux Billard No. 1,
Geneva, Switzerland

Cable "HEWPACKSA"

Tel. No. (022) 26. 43. 36



6038



THESE 50-Volt CAPACITORS

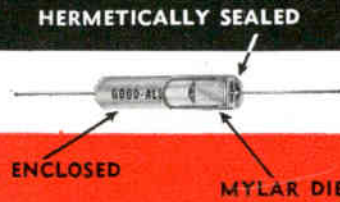

SOLVE SPACE PROBLEMS

TRANSISTOR COMPANIONS

Ideal transistor "companions" where hermetic sealing is required. Both types are smaller than comparable MIL-C-25A designs yet exceed all requirements of this specification. Their extremely miniature size saves space and weight with no sacrifice in reliability.

CAPACITY TOLERANCES TO $\pm 1\%$

Inherent stability of these designs leads to widespread use in tolerances of $\pm 5\%$, $\pm 2\%$ and $\pm 1\%$.

SUPERIOR STABILITY WITH LIFE

Exhibit excellent retrace following temperature cycling or accelerated life testing:

HIGH RELIABILITY CAPABILITY

These designs are capable of being produced to high reliability specifications comparable to MIL-C-14157 and MIL-C-26244 (USAF). Such customer applications are handled on a "project" basis, and the amount of premium cost varies depending on the level of performance required and on the lot acceptance testing specified.

50-VOLT DIMENSIONS

Capacitance in Mfds.	626C*		627C		628C*		629C		616C*†		617C†	
	D	L	D	L	D	L	D	L	D	L	D	L
.001	.173 x $\frac{3}{32}$.173 x $1\frac{13}{32}$.173 x $\frac{3}{32}$.173 x $\frac{3}{32}$.173 x $\frac{3}{32}$.173 x $\frac{3}{32}$.173 x $\frac{3}{32}$.173 x $\frac{3}{32}$.173 x $\frac{3}{32}$.173 x $\frac{3}{32}$.173 x $\frac{3}{32}$.173 x $\frac{3}{32}$
.0022	.173 x $\frac{3}{32}$.173 x $1\frac{13}{32}$.173 x $\frac{3}{32}$.173 x $\frac{3}{32}$.173 x $\frac{3}{32}$.173 x $\frac{3}{32}$.173 x $\frac{3}{32}$.173 x $\frac{3}{32}$.173 x $\frac{3}{32}$.173 x $\frac{3}{32}$.173 x $\frac{3}{32}$.173 x $\frac{3}{32}$
.0047	.173 x $\frac{3}{32}$.173 x $1\frac{13}{32}$.173 x $\frac{3}{32}$.173 x $\frac{3}{32}$.173 x $\frac{3}{32}$.173 x $\frac{3}{32}$.173 x $\frac{3}{32}$.173 x $\frac{3}{32}$.193 x $\frac{3}{32}$.193 x $\frac{3}{32}$.193 x $\frac{3}{32}$.193 x $\frac{3}{32}$
.01	.173 x $\frac{3}{32}$.173 x $1\frac{13}{32}$.173 x $\frac{3}{32}$.173 x $\frac{3}{32}$.173 x $\frac{3}{32}$.173 x $\frac{3}{32}$.173 x $\frac{3}{32}$.173 x $\frac{3}{32}$.193 x $\frac{3}{32}$.193 x $\frac{3}{32}$.193 x $\frac{3}{32}$.193 x $\frac{3}{32}$
.022	.233 x $\frac{3}{32}$.233 x $\frac{3}{32}$.233 x $\frac{3}{32}$.233 x $\frac{3}{32}$.233 x $\frac{3}{32}$.233 x $\frac{3}{32}$.233 x $\frac{3}{32}$.233 x $\frac{3}{32}$.233 x $\frac{3}{32}$.233 x $\frac{3}{32}$.233 x $\frac{3}{32}$.233 x $\frac{3}{32}$
.047	.312 x $\frac{3}{32}$.312 x $\frac{3}{32}$.312 x $\frac{3}{32}$.312 x $\frac{3}{32}$.312 x $\frac{3}{32}$.312 x $\frac{3}{32}$.312 x $\frac{3}{32}$.312 x $\frac{3}{32}$.312 x $\frac{3}{32}$.312 x $\frac{3}{32}$.312 x $\frac{3}{32}$.312 x $\frac{3}{32}$
.1	.400 x $1\frac{1}{16}$.400 x $1\frac{1}{16}$.400 x $1\frac{1}{16}$.400 x $1\frac{1}{16}$.400 x $1\frac{1}{16}$.400 x $1\frac{1}{16}$.400 x $1\frac{1}{16}$.400 x $1\frac{1}{16}$.500 x $1\frac{1}{16}$.500 x $1\frac{1}{16}$.500 x $1\frac{1}{16}$.500 x $1\frac{1}{16}$
.22	.500 x $1\frac{1}{16}$.500 x $1\frac{1}{16}$.500 x $1\frac{1}{16}$.500 x $1\frac{1}{16}$.500 x $1\frac{1}{16}$.500 x $1\frac{1}{16}$.500 x $1\frac{1}{16}$.500 x $1\frac{1}{16}$.562 x $1\frac{1}{16}$.562 x $1\frac{1}{16}$.562 x $1\frac{1}{16}$.562 x $1\frac{1}{16}$
.47	.560 x $1\frac{1}{16}$.560 x $1\frac{1}{16}$.560 x $1\frac{1}{16}$.560 x $1\frac{1}{16}$.560 x $1\frac{1}{16}$.560 x $1\frac{1}{16}$.560 x $1\frac{1}{16}$.560 x $1\frac{1}{16}$				
1.0												

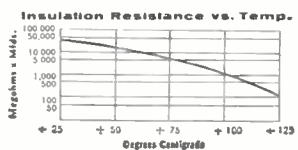
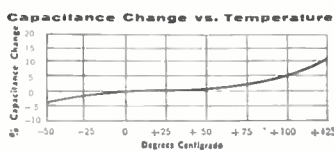

Full Rated to 85°C

Types **626G - 627G** (Extended foil)

Types **628G - 629G** (Inserted tab)

Temperature Range—Full rating at 85° C — to 125° C with 50% derating.

Life Test—500 hours at 85° C and 125% of rated voltage.

Capacity Tolerance—All tolerances to $\pm 1\%$.

Insulation Resistance—40,000 meg. x mfd. at 25° C but need not exceed 70,000 megohms.

Case Styles—Available in all case style variations in MIL-C-25A.

Full rated to 125°C

Type **616G** (Extended foil)

Type **617G** (Extended foil)

Temperature Range—Full rating to 125° C — to 150° C with 50% derating.

Life Test—500 hours at 125° C and 125% of rated voltage.

Capacity Tolerance—All tolerances to $\pm 1\%$.

Insulation Resistance—50,000 meg. x mfd. at 25° C but need not exceed 100,000 megohms.

Case Styles—Available in all case style variations in MIL-C-25A.

*These types have one lead grounded to the case. Others have both leads insulated. †Also available in 150V, 400V & 600V ranges.

AVAILABLE AT AUTHORIZED INDUSTRIAL DISTRIBUTORS

Write for detailed literature



GOOD-ALL ELECTRIC MFG. CO. • OGALLALA, NEBRASKA

A SUBSIDIARY OF THOMPSON RAMO WOOLDRIDGE INC.

ELECTRONICS NEWSLETTER

Bats Aid Researchers In Antijamming Project

NAVIGATION AND DATA-INTERPRETATION techniques of bats are being investigated by radar researchers at MIT's Lincoln Laboratory. Assisted by Harvard professor Donald R. Griffin, Lincoln scientists are studying how the furry creatures locate their own echoes from among peeps and squeals of other bats. Study's aim is to improve radar ranging and echo location, figure out better antijamming techniques.

Among electronic instruments developed in conjunction with the research project are an ultrasonic frequency meter for detecting bat peeps, photographic synchronization techniques, and lightweight portable ultrasonic microphones. Researchers are intrigued by the discovery that bats seem to do as well in discriminating among echoes as current theory would seem to allow.

USSR Expands Production Of Instruments, Controls

PRODUCTION of electronic level indicators has been started at a factory in the Kirghiz Republic, USSR. First shipment went to Red China. Soviets boast that Kirghizia is the first central Asian country to operate its own instrument industry. Factories there produce electrophoresis equipment and centrifuges in addition to the remote-control indicators. Exports go to Albania, Bulgaria, Poland, China, Iran and "other countries."

In the Ukraine, engineers have developed an automatic monitoring system that enables a dispatcher to control the operation of a natural-gas pipeline more than 1,800 miles long. According to Tass, transistorized instruments operate from a fixed program to take measurements, transmit data on gas pressure and flow and compressor operation to the central control point for monitoring and analysis. Kiev automatic-controls factory has begun making the systems for the Saratov-Moscow, Dashava-Kiev and Serpukhov-Leningrad pipelines.

An audible Braille system has been announced by Tass. The ma-

chine, developed as an aid for the blind, reads printed text with an optical system that throws the images of the various letters on a reading head of eight photoresistive elements. Resulting signal is translated into sound—apparently a unique sound for each character—and then passed through a speaker. The blind "reader" hears 300 to 400 signals a minute, is expected to interpret these as letters and form them into words.

Computermakers to Develop Logic, System Standards

OFFICE EQUIPMENT MANUFACTURERS INSTITUTE, a trade association of the multibillion-dollar office equipment industry, is hammering out a set of standards that should increase the interchangeability of equipment and programs. First standards may be ready by spring.

One program aims at setting up logical systems standards, including a common machine language. In developing these standards, OEMI is operating under sponsorship of the American Standards Association and the International Standards Organization (to which ASA is U.S. representative). The project is of special importance to organizations that use two or more types of computer; such users currently have to either prepare separate programs or go through elaborate translation procedures with a high error probability.

Program will reach a single standard for logical representation of characters and character format in the media used for interchange of instruction, data and control information between computers, will also provide for expansion and alternative choices. It includes in its scope standard terminology and definition of data-processing operations and functions.

J. W. Barker, former dean of Columbia's school of engineering and technical consultant to OEMI for the standardization projects, stresses the importance of allowing for technological progress while setting up guides so that the systems of different companies can be joined one to another. OEMI has selected six manufacturers, seven

user groups and seven general-interest groups to designate voting representatives on the data-processing standardization committee.

The other program relates to establishment of standard terminology and definitions, the format and symbology of output data, and other elements of interest to office-machine users.

Indian Firms to Produce Transistor Radios

SEVEN INDIAN RADIOMAKERS have recently entered into technical and financial collaboration with foreign firms to manufacture transistor radios for the huge subcontinent. Import of radios of any kind is banned by the New Delhi government, and requirements must be met by domestic production.

In four of the seven cases, a foreign parent is helping its Indian subsidiary set up production lines. These four are Philips of the Netherlands, British General Electric and two other British firms, Gramophone Co. and Murphy Radio Ltd.

The West German firm of SABA is collaborating with Hindustan General Electric for manufacture of SABA products in India. Bush Radio of England is working with Mulchandani Electrical & Radio Industries, and Britain's L. K. Cole has agreed to collaborate with National Ekco Radio & Engineering.

Stricter Regulations On Radiation Dosage

ATOMIC ENERGY COMMISSION has revised its regulations for protection of employees who work with radiation sources in industry. Amendments to current regulations embodying the changes take effect on Jan. 1.

Principal amendment limits the lifetime accumulated dose for radiation workers to about a third of the limit permitted under standing regulations. Total external radiation exposure that any worker may accumulate beyond the age of 18 is limited to five rems per year and not more than three rems in any one quarter. Present limits are 0.3 rems per week—about 15 rems per year—with no restrictions on accumulated dose.

READING AN INFERNO'S SECRETS...

Missile "silo" concept proved practical by Lockheed Electronics



The U.S. Air Force came to Lockheed Electronics with an extremely complex and urgent problem. Could the tremendous shock and heat of a missile blast-off be accurately measured in launchings from an underground silo?

Lockheed Electronics designed and built a special data-gathering system to analyze, through instrumentation, the searing heat and violent shock of more than 40 test firings. During each test more than 200 measurements were made simultaneously. Results have produced new understanding of missile stresses, acoustics, thermal radiation, shock and

vibration. This vital information is already being applied to the design of "hard" launching sites.

The capabilities of Lockheed Electronics, Information Technology Division extend to all phases of data handling—a fact well worth remembering when you encounter tough problems in this field.

CAPABILITIES—INFORMATION TECHNOLOGY DIVISION

Data processing

Data storage • Telemetry systems

Data reduction and display

Special-purpose computers

Traffic control systems • Systems research

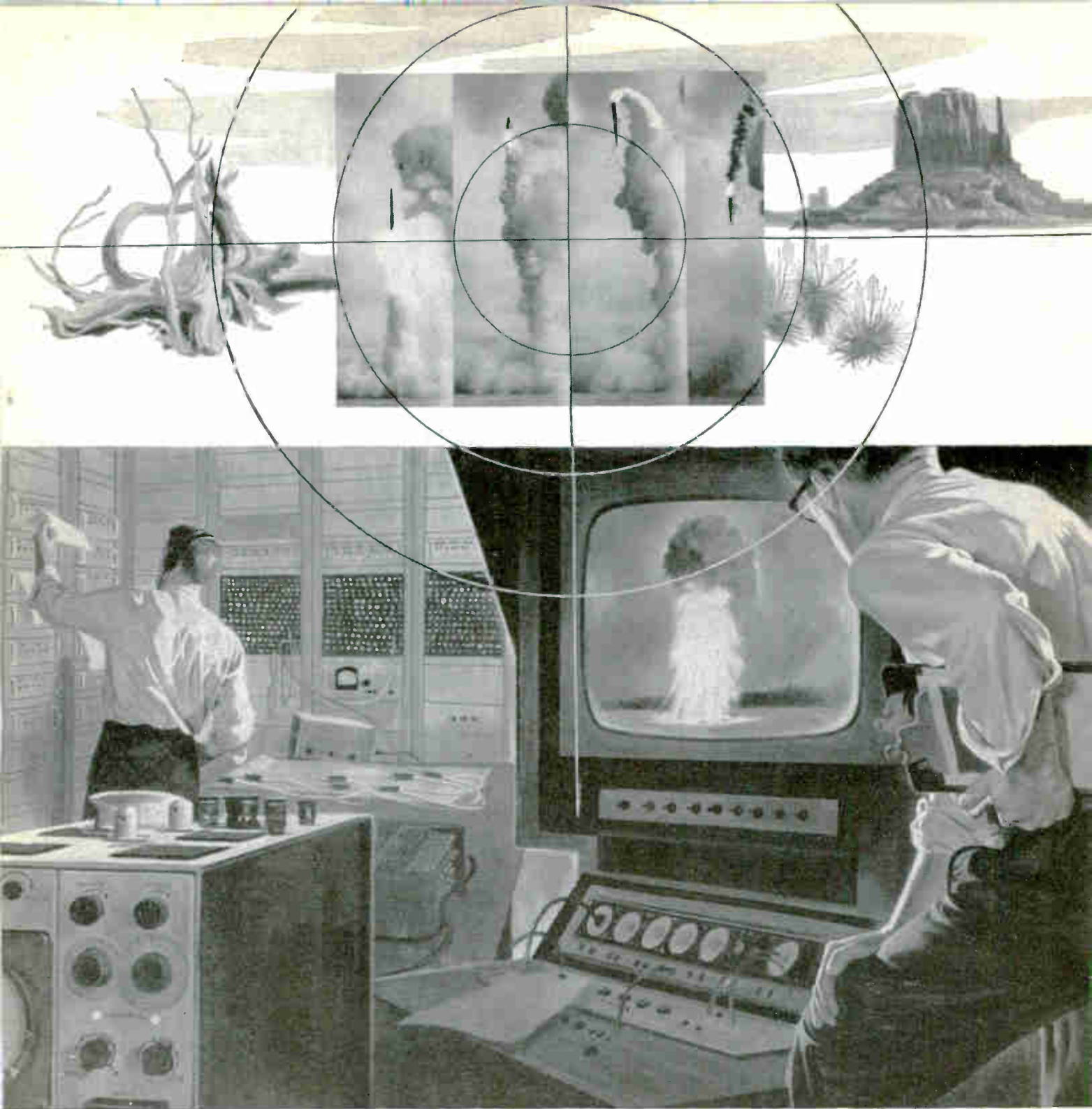

MINDING THE FUTURE

LOCKHEED ELECTRONICS

COMPANY

INFORMATION TECHNOLOGY DIVISION, METUCHEN, N. J.

OTHER LEC DIVISIONS: MILITARY SYSTEMS / STAVID ● ENGINEERING SERVICES ● AVIONICS AND INDUSTRIAL PRODUCTS

ENGINEERS AND SCIENTISTS: For unique position advancement opportunities,
please contact our Professional Placement Office in Plainfield, N. J.

CIRCLE 13 ON READER SERVICE CARD

WEINSCHEL ANTENNA PATTERN ANALYZER MODEL BA-7

Measure 45 db (r. f.) in one step using a maximum of 1 microwatt r. f. power*

*100% square wave modulated at 1000 cps \pm .1 cps. Observation time approximately 45 seconds for 45 db; only .2 seconds for 30 db.

Bandwidth variable from 2 to 15 cps with constant gain



MODEL BA-7

The BA-7 is the heart of a video detector system designed primarily for r. f. crystals. For greater versatility, a d. c. biasing circuit is included to permit use of conventional barretters, requiring a d. c. bias between 0 and 10 ma. The unit can be used to measure very high power ratios such as occur in making antenna pattern measurements, to determine the rejection coefficients of r. f. filters, and to calibrate attenuators. It has a wide dynamic linear range, a low noise level, and a wide r. f. frequency range where video crystal mounts are available.

For complete specifications, write for Bulletin No. 141.

Weinschel Fixed Coaxial Attenuators cover the frequency range of DC to 12.4 KMC. Write for complete catalog, specifying frequency range of interest.



Weinschel Engineering
KENSINGTON, MARYLAND

WASHINGTON OUTLOOK

EIGHTY-SEVENTH CONGRESS, when it convenes in January, will see a renewal of the fight to increase the amount of defense contracting thrown to small business. Some members of Congress want to give the Small Business Administration a direct role in defense procurement, interposing the agency between the Pentagon and its contractors.

(Question of military procurement problems of smaller businesses was also a major issue at the recent Electronics Industries Association conference at French Lick, Ind.)

Sen. William Proxmire (D., Wisc.) introduced a bill into the post-convention session of the 86th Congress to authorize the additional powers for SBA. The bill died with the adjournment, but it's a sure bet to be revived when the new Congress convenes. Proxmire's bill would station SBA representatives at major prime-contractor plants, as they are now stationed at key defense procurement points. Representatives would have access to the primes' production schedules, materiel requirements, and so forth, and would exert control over where the contractors buy assemblies and parts.

There is considerable opposition to Proxmire's proposal. Opposition centers in the armed services, large defense contractors and the Armed Services committee of Congress.

One top-level Pentagon official complains that while SBA would be given new authorities, "the military departments would not be relieved of the responsibility to ensure that the contract is successfully completed." He says it would be like "private industry trying to buy a fleet of trucks but insisting that the truck manufacturer buy and use whatever parts a third party directed."

But Proxmire and other small-business boosters argue that the Defense Department's present small-business program is inadequate. Under this program, large prime contractors are required to farm out work to small firms "to the maximum extent possible." The critics want "more teeth" in the Pentagon's policy, with hard and fast guidelines for subcontract awards, such as definite percentages set aside for small firms.

NATIONAL AERONAUTICS & SPACE ADMINISTRATION has received a green light to begin construction of a deep-space tracking station near Johannesburg, South Africa. Cost of the installation will run to \$5 million. Up to now, the agency has been vague about its plans for a South African station because of sticky diplomatic problems which have now been overcome.

The station will be used for tracking lunar and planetary space probes, will be capable of acquiring data from many millions of miles away. It will be similar to NASA's other deep-space tracking stations at Goldstone, Calif., and in Australia, and will be in the same performance class as the University of Manchester's Jodrell Bank station in England.

CONTRACTS FOR EQUIPMENT for NASA's Johannesburg station will not be placed for at least four months. Radio gear that had already been ordered was designed for the old 132-Mc band, rendered obsolete by the December 1959 agreement of the International Telecommunications Union which set aside 136-137 Mc for space communications.

Modification or replacement of existing equipment will cost NASA between \$3 million and \$5 million. The replacement program is now in full swing. Frequency changeover affects the 13 stations of the Minitrack network and the three deep-space tracking stations.

NASA officials stress that the frequency changeover will also afford the agency an opportunity to modernize their facilities with equipment reflecting state-of-the-art improvements.

There's a lot to like in TAN-O-MITE®

OHMITE TANTALUM SLUG CAPACITORS

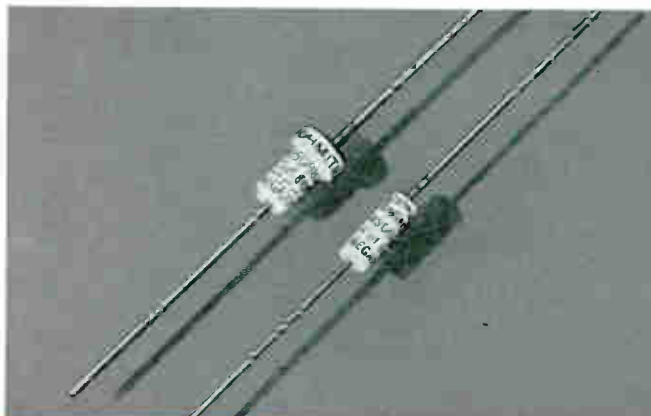

TWO CASE SHAPES—Regular "hatted" and spacesaving "straight side"



ALL THREE CASE SIZES of "hatted" capacitors—U, F, and G



MIL-C-3965B

ALL STANDARD MIL VALUES available in Ohmite Series TS capacitors



CONSISTENT QUALITY resulting from high standards of manufacture and inspection



FAST DELIVERY of MIL and stock values from factory and distributors

HAT-SHAPED TAN-O-MITE SERIES TS CAPACITORS							
CASE SIZE		MIN. MFD.	VOLTS		MAX. MFD.	VOLTS	
MIL	COMML.		85°C	125°C		85°C	125°C
T1*	U	1.7	125	85	30	6	4
T2*	F	9	125	85	140	6	4
T3*	G	25	125	85	330	6	4

*Styles CL44 Uninsulated and CL45 Insulated.

STRAIGHT-SIDE TAN-O-MITE SERIES TS CAPACITORS							
T1†	SUB	1.7	125	85	30	6	4
†Styles CL64 Uninsulated and CL65 Insulated.							

Rheostats
Power Resistors
Precision Resistors
Variable Transformers
Tantalum Capacitors

OHMITE

Tap Switches
Relays
R.F. Chokes
Germanium Diodes
Micromodules

OHMITE MANUFACTURING COMPANY 3610 Howard Street, Skokie, Illinois

Send for Bulletin 159

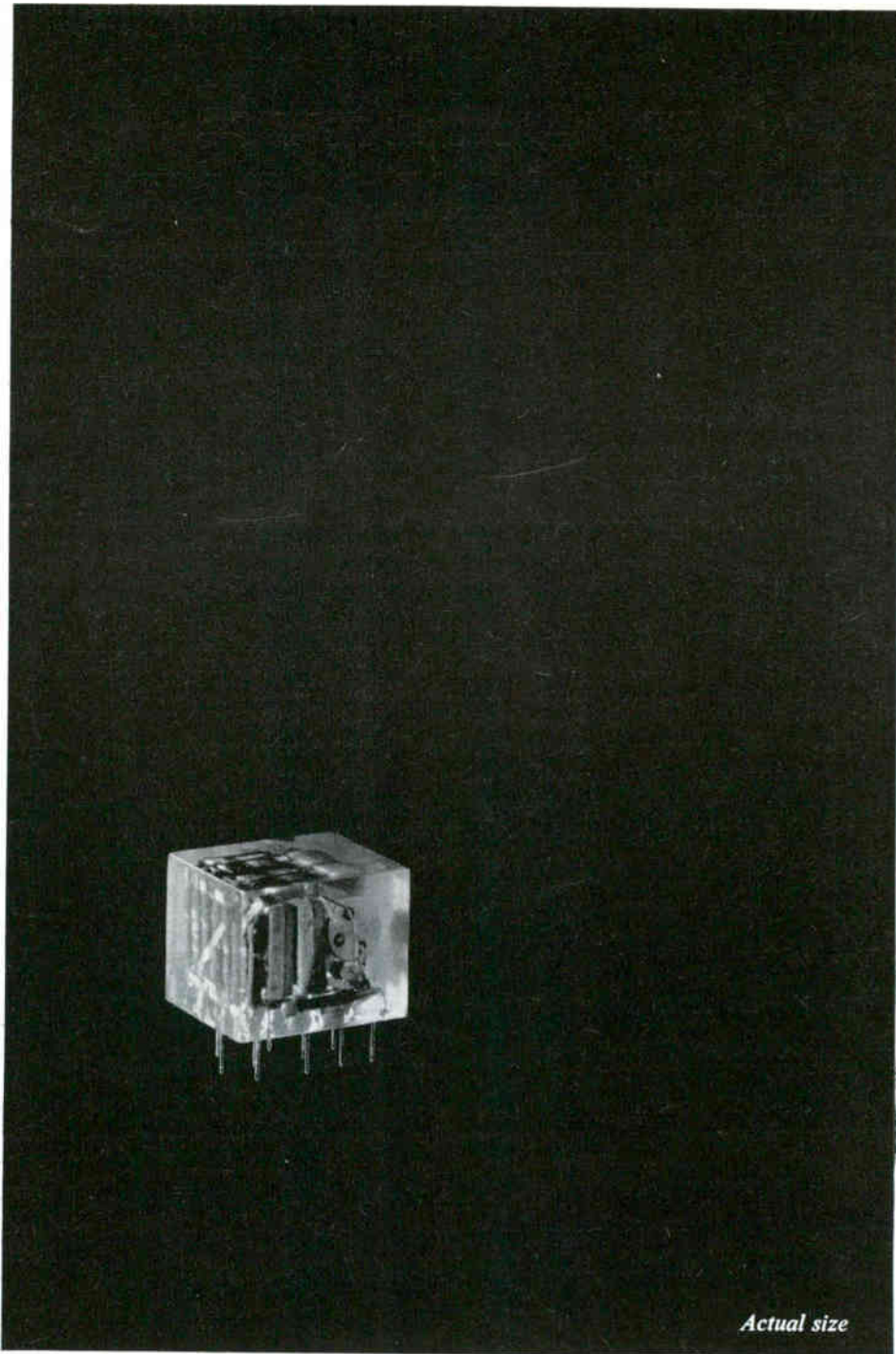

Actual size

FROM DELCO RADIO NEW IDEAS FOR DEFENSE

MINIATURE MODULES WITH STANDARD COMPONENTS

They are *building block modules*. They are a product of Delco Radio's newly developed, three-dimensional packaging technique. They are used to build light, compact, reliable airborne and special purpose digital computers for missile control. Each module, vacuum encapsulated with epoxy resin, contains up to 35 standard components per cubic inch—averaging more than 50,000 per cubic foot. The modules perform all the standard logic functions. They meet or exceed all MIL-E-5272D (ASG) environmental requirements and will operate over a temperature range of -55°C to $+71^{\circ}\text{C}$. They can be assembled in groups on printed circuit boards. There are 10 basic types and 15 variations of Delco Building Block Modules. With them, Delco Radio can quickly and easily build a compact, reliable computer for airborne guidance or any other military application. For complete details, write to our Sales Department. *Physicists and electronic engineers: Join Delco Radio's search for new and better products through Solid State Physics.*

PIONEERING PRECISION PRODUCTS THROUGH SOLID STATE PHYSICS

DELCO
DEPENDABILITY
RADIO

Division of General Motors • Kokomo, Indiana

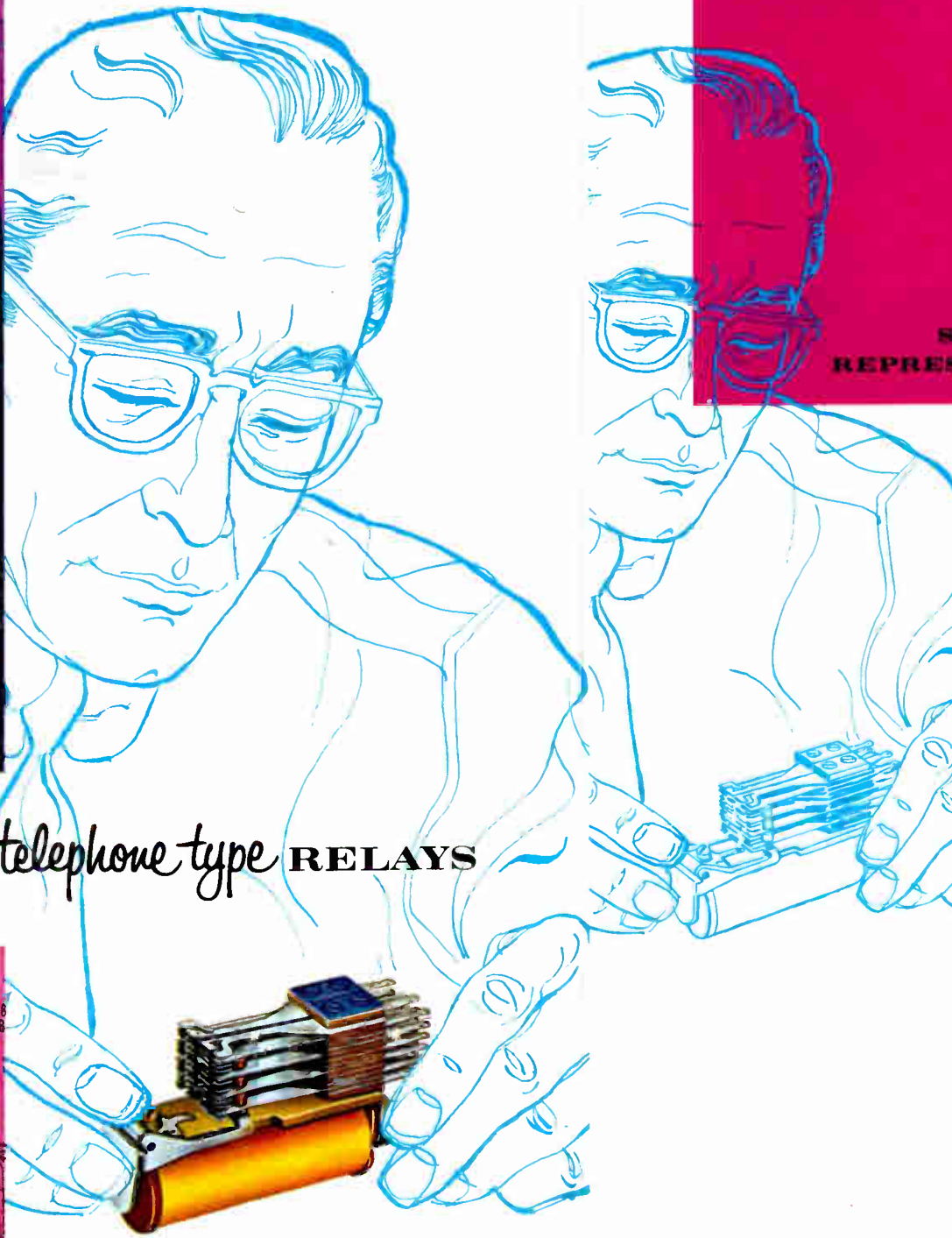

POTTER & BRUMFIELD
telephone type
RELAYS

SALES REPRESENTATIVES

POTTER & BRUMFIELD *telephone type* **RELAYS**

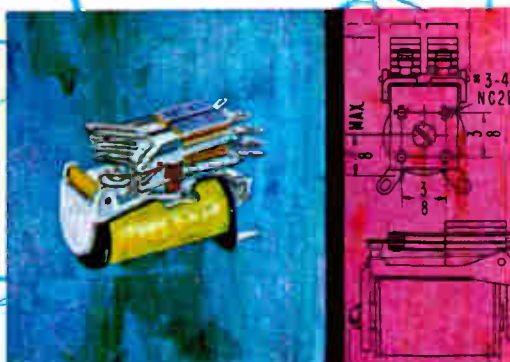

POTTER & BRUMFIELD
 DIVISION OF AMERICAN MACHINE & FOUNDRY COMPANY, PRINCETON, INDIANA
 IN CANADA: POTTER & BRUMFIELD CANADA LTD., GUELPH, ONTARIO

POTTER & BRUMFIELD

DIVISION OF AMERICAN MACHINE & FOUNDRY COMPANY • PRINCETON, INDIANA • TWX 73 • Phone: FULTON 5-5251

CANADA Manufacturing Facility • Potter & Brumfield Canada, Ltd. 135 Oxford Street, Guelph, Ontario • Phone: TAYLOR 2-0390

ILLINOIS, Chicago 35
 Bierhaus-Balhorn Sales, Inc.
 7185 W. Armitage Avenue
 Phone: Tuxedo 9-5011

ILLINOIS, Roselle
 D. L. Sisson Sales Company
 Box 226 (Distributor Sales)
 Phone: Lawrence 9-3131

INDIANA, Indianapolis
 R. O. Whitesell & Associates
 6620 East Washington Street
 Phone: Fleetwood 9-5374
 Fleetwood 9-5375

INDIANA, Princeton
 Potter & Brumfield
 Phone: Fulton 5-5251

KENTUCKY, Louisville
 John Bishop
 R. O. Whitesell & Associates
 400 North 38th Street
 Phone: Spring 6-2024

LOUISIANA, New Orleans 24
 Earl K. Moore Company
 5864 Louisville Street
 Phone: Audubon 2407

MASSACHUSETTS, Cambridge 42
 Glenn M. Hathaway
 Electronics, Inc.
 238 Main Street
 Phone: Kirkland 7-0380

MICHIGAN, Detroit 27
 Buryl Hill, Inc.
 15425 Schaefer Highway
 Phone: Vermont 8-3460

MICHIGAN, Grand Rapids 7
 Howard R. Davidson Company
 1200 Burton Street, S.E.
 Phone: Ch 5-1116

MINNESOTA, Minneapolis 17
 A. J. Warner Company
 5022 29th Avenue South
 Phone: Parkway 9-7371

MISSOURI, Kansas City 11
 E. B. Schwerin Company
 4210 Main Street
 Phone: Westport 1-7564

MISSOURI, St. Louis 35
 Joseph Giordano
 817 Gerald Avenue
 Phone: Jackson 1-8725

NEW MEXICO, Albuquerque
 Carl Carlberg
 Bowen & Carlberg
 2228-A San Mateo Blvd., N.E.
 P. O. Box 3177, Station D
 Phone: Alpine 5-4603

NORTH CAROLINA, Charlotte
 Jim Elam
 Cartwright & Bean
 625 Harwyn Drive
 Phone: Franklin 6-8648

NEW JERSEY, Camden 3
 Jack W. McCoy
 300 Broadway
 Phone: Woodlawn 6-1800
 Walnut 2-7333

NEW YORK, Albany 4
 Carse Electric Corporation
 P. O. Box 4127 Patroon Station
 Phone: Hobart 2-5364

NEW YORK, Buffalo 17
 The Robert F. Lamb Company
 3407 Delaware Avenue
 Phone: Bedford 3757

NEW YORK, De Witt
 C. L. Martin Sales Corporation
 103 Pickwick Road
 Phone: Syracuse, New York
 Gibson 6-2540

NEW YORK, Mamaroneck
 S. Wimpie Associates, Inc.
 P. O. Box 127
 510 West Boston Post Road
 Phone: Owens-8-7100

NEW YORK, New York 16
 American Machine & Foundry Co.
 International Group
 261 Madison Avenue
 Phone: Murray Hill 7-3100

OHIO, Cincinnati
 R. O. Whitesell & Associates
 2209 Losantville (Gf. M.)
 Phone: Melrose 1-9210

OHIO, Cleveland 15
 Scott & Steffen, Inc.
 1836 Euclid Avenue
 Phone: Tower 1-2626

OHIO, Dayton
 Robert Thinnies
 R. O. Whitesell & Associates
 2600 Far Hills Avenue
 Phone: AX 8-4261

OKLAHOMA, Oklahoma City
 John W. Elder Company
 1809 West Main Street
 Phone: Central 2-5365

OKLAHOMA, Tulsa 8
 John W. Elder Company
 P. O. Box 3395
 Phone: Diamond 3-9149

PENNSYLVANIA, Allentown
 Joseph Schmidt
 Beil & Whitaker
 1303 N. Troxell St.

PENNSYLVANIA, Bethlehem
 Beil & Whitaker, Inc.
 504 Hickory St.
 Phone: University 6-4424

PENNSYLVANIA, Pittsburgh 22
 Scott & Steffen, Inc.
 507 Liberty St. (Empire Bldg.)
 Phone: Grant 1-5233

PENNSYLVANIA, Reading
 Beil & Whitaker, Inc.
 3623 Jacksonwald Avenue
 Phone: Franklin 5-6837

TENNESSEE, Memphis
 James B. Cartwright
 Cartwright & Bean
 560 South Cooper Street
 Phone: Broadway 5-1914

TEXAS, Dallas 25
 John B. Guenther
 4533 N. Central Expressway
 Phone: LA 8-6286

UTAH, Salt Lake City 11
 R. G. Bowen Company, Inc.
 463 East 3rd South
 Phone: Empire 3-4528

VIRGINIA, Alexandria
 D. J. Fagge
 Potomac Electronics, Inc.
 1025 N. Royal Street
 Phone: Temple 6-8666

VIRGINIA, Alexandria
 Potter & Brumfield
 (Federal Agencies)
 D. J. Fagge
 1025 N. Royal Street
 Phone: Temple 6-8666

WASHINGTON, Seattle 2
 Fred H. Haight Company
 3212 Eastlake Avenue
 Phone: East 1818

WISCONSIN, Milwaukee 9
 E. A. Dickinson & Associates
 4117 N. Green Bay Avenue
 Phone: Concord 4-1080

CANADA, Guelph, Ontario
 Potter & Brumfield Canada,
 Limited
 135 Oxford Street
 Phone: Taylor 2-0390

CANADA, North Vancouver, B.C.
 Charles L. Thompson Limited
 3115 Lonsdale Avenue
 Phone: Yukon 7-9388

CANADA, Pointe Claire, Que.
 Aeromotive Engineering
 Products, Ltd.
 147 Hymus Blvd.
 Phone: Montreal—ME 1-4396
 OX 7-0810

CANADA, Toronto 9, Ontario
 A. T. R. Armstrong Limited
 P. O. Box 38, Station D
 Phone: Roger 2-7535

CANADA, Winnipeg 3, Manitoba
 Charles L. Thompson Limited
 1440 Erin Street
 Phone: Sunset 3-0848

New Random Access Memory Package...

uses only 18.75" IN STANDARD 19" RACK

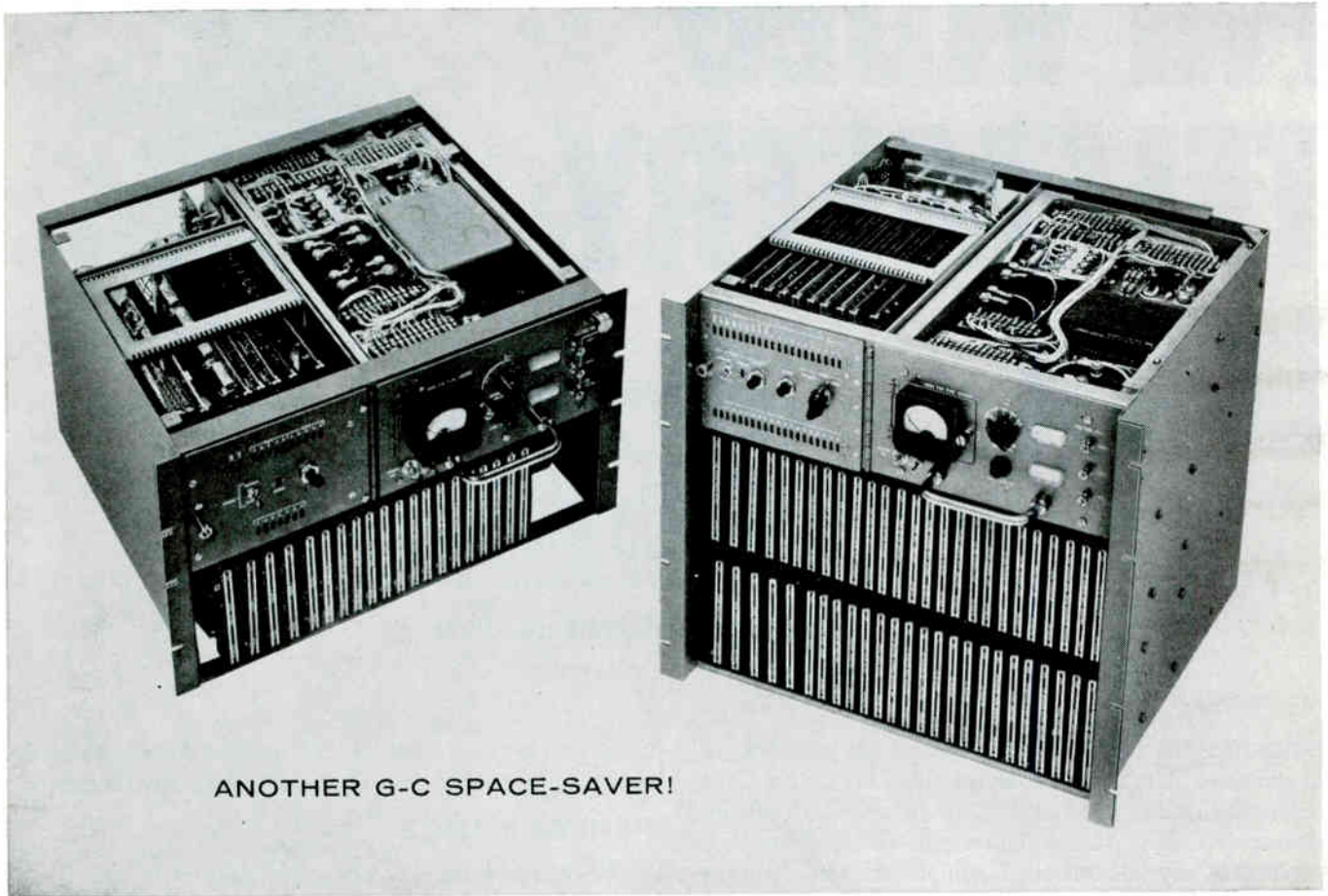

ANOTHER G-C SPACE-SAVER!

GENERAL CERAMICS, continuing its leadership in the memory packaging field, has made available double and triple bay random access memories with up to 4096 characters x 32 bits per character at cycle times up to 6 micro-seconds. Now you can get design economy since the basic G-C package requires only 18.75" of standard rack space—a reduc-

tion of up to 80% over typical units requiring a full six feet.

General Ceramics offers space-saving random access memory designs with varying number of characters, word lengths and logic.

Optional design features include parity checking, test cycles, indicator lights and power supply locations.

*Write on your company letterhead for additional information.
Please mention your requirements; address inquiries to Section E.*



APPLIED LOGIC DEPARTMENT
GENERAL CERAMICS
KEASBEY, NEW JERSEY, U.S.A.

TECHNICAL CERAMICS, FERRITE AND MEMORY PRODUCTS

TAPCO FM VIDEO TELEMETRY LINK

Airborne
Transmitter



Monitored TV picture tele-
metered from F-104 chase
plane by TAPCO system at
the Air Force William Tell
weapons meet.

Ground-based Receiver

TAPCO true FM video telemetry systems are built around an exclusive TAPCO circuit design. They utilize a unique system of signal synthesis which combines the advantages of wide-deviation FM modulation with the high-frequency stability of crystal-controlled equipment. The airborne transmitter is of compact modular design, allowing a wide choice of module components, and minimum problems of system integration.

APPLICATIONS

TAPCO video telemetry systems are ideal for applications requiring extremely stable picture transmission and reception. Operation over distances from one to 500 miles is not unusual. These systems are now ready for application to manned aircraft, drones, missiles, satellites, balloons,

space stations, and tanks, trucks, and bulldozers operated remotely in nuclear or other hazardous environments.

PERFORMANCE

Video Band Width: Up to 10 megacycles.

Frequency Stability: Transmitter—0.01%.
Receiver—0.001%.

Power Output: From 1 to 30 watts.

Output Frequency: 800-900 megacycles.

COMPLETE SYSTEMS

TRW can provide complete or partial telemetry systems, including transmitters, receivers, antennas, and the video camera and terminal equipment. Considerable system flexibility is allowed by the wide range of component choices.

TAPCO GROUP EXPORT REPRESENTATIVE
American Avitron Inc., Mamaroneck, New York

Advanced engineering projects at TAPCO offer excellent career opportunities for qualified engineers and scientists. Write Supervisor of Employment.

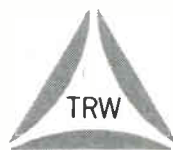

TAPCO GROUP
Thompson Ramo Wooldridge Inc.

DEPT. EL-960, CLEVELAND 17, OHIO

DESIGNERS AND MANUFACTURERS FOR THE AIRCRAFT, MISSILE AND SPACE, ORDNANCE, ELECTRONIC AND NUCLEAR INDUSTRIES

Collins Radio Calls Shares

DIRECTORS of Collins Radio Co., Cedar Rapids, Ia., announce that Oct. 17, 1960, has been set as the date for calling the 7,531 outstanding shares of the company's four-percent cumulative preferred stock. The redemption price is \$50.50 plus accrued dividends to the calling date. Also announced is a regular dividend of 50 cents payable Oct. 1 to stockholders of record on Sept. 15. The preferred stock, say directors, is convertible into common stock at a conversion price of \$28.95 per common share. The right of conversion will expire at the close of business Oct. 12.

Ferrodynamics Corp., Lodi, N. J., magnetic tape manufacturer, reports sales for the first half of 1960 were \$524,880, compared with \$380,778 in the first six months of 1959. Earnings for the period this year were \$29,857 or 10 cents per share of common stock, before provision for federal income tax. This compares with a loss of \$10,344 in the 1959 first half. After taxes, net income this year for the first six months amounted to \$19,533, or seven cents a share. Sales for this year are expected to reach \$1,250,000.

Midwest Technical Development Corp. Minneapolis announces investment of \$100,000 in debentures of the **San Diego Scientific Corp.**, San Diego, Calif. This is MTDC's Fourth West Coast investment. The San Diego company was founded about two years ago, became publicly owned last year. Traded over-the-counter, its stock has recently sold in the \$3-per-share range. The company manufactures high-speed magnetic amplifiers and solid-state switching devices.

Perkin-Elmer Corp., Norwalk, Conn., reports sales for the fiscal year ended July 31, 1960, of \$22.1 million, a 26-percent rise over the previous year's \$17.5-million volume. Net income was \$1,208,000, a 34-percent increase over last year's \$900,800. Earnings were equivalent to \$1.05 per share of

common stock compared with 80 cents per share the year before. At July 31, 1960, there were 1,147,136 shares outstanding, as against 1,130,920 the same date a year before. Company officials say net sales of foreign subsidiaries, which are not included in the company's financial statements, have also shown growth. West German and English manufacturing subsidiaries had combined sales of slightly more than \$3 million for their fiscal years just ended.

Barry Controls, Inc., Watertown, Mass., and **The Wright Line**, Worcester, Mass., jointly announce merger of the two firms. The new company will be called **Barry Wright Corp.**, with R. P. Collins, Wright president, as chairman of the board, and E. Pietz, Barry president, as president and chief executive of the new firm. Under terms of the merger, the approximately 1,600 stockholders of the two concerns will receive one share of stock in the new company for each share of stock they now hold.

25 MOST ACTIVE STOCKS

	WEEK ENDING SEPTEMBER 9, 1960			
	SHARES (IN 100's)	HIGH	LOW	CLOSE
Univ Control	1524	187/8	177/8	181/2
Ampex Corp	1422	303/8	271/2	281/8
Gen Tel & Elec	816	313/8	291/4	291/2
Collins Radio	676	611/2	55	571/2
Avco Corp	674	161/4	151/4	151/4
Telectro Ind	602	203/8	165/8	203/8
RCA	517	617/8	581/4	591/4
Texas Inst	502	2091/4	1901/4	1981/2
Elec & Musical Ind	491	73/8	7	71/4
Westinghouse Elec	460	531/4	511/8	521/2
Beckman Inst	444	103	943/4	983/4
Gen Elec	439	823/4	80	81
Gen Dynamics	409	421/2	405/8	407/8
Int'l Tel & Tel	406	413/8	395/8	401/2
Transitron	398	461/4	41	415/8
Gen Instrument	336	411/4	381/4	391/2
Avnet Elec	332	213/4	191/2	203/4
Amphenol Borg	321	475/8	455/8	475/8
Zenith Radio	310	1257/8	1193/4	1241/2
Victoreen	277	163/8	15	16
Standard Kollsman	270	255/8	233/8	243/8
Cubic Corp	269	613/4	57	601/4
Litton Indust	265	85	783/8	813/4
Sparton	260	87/8	73/4	85/8
Electronic Assistance	237	337/8	297/8	31

The above figures represent sales of electronics stocks on the New York and American Stock Exchanges. Listings are prepared exclusively for ELECTRONICS by Ira Haupt & Co., investment bankers.



VITREOUS-ENAMEL POWER RESISTORS

Sprague reliability is built-in these dependable Blue Jacket miniature axial lead resistors. New all-welded end-cup construction gives improved reliability under severe environmental conditions.

Blue Jackets are ideal for use in miniature electronic equipment with either conventional wiring or printed wiring boards.

Get complete data on these dependable minified resistors, write for *Engineering Bulletin 7410A*.

SPRAGUE ELECTRIC COMPANY
35 Marshall Street, North Adams, Mass.



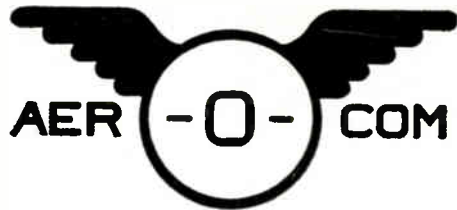

DEFINITELY DEPENDABLE!

Aerocom's Dual Automatic Radio Beacon

Reliability is built into every part of this dual 1000-watt aerophare unit. Ruggedly constructed and conservatively rated, it provides trouble-free unattended service, and at truly low operating and maintenance cost. It operates in the frequency range 200-415 kcs, using plug-in crystal for desired frequency.

Uses single phase power supply, nominal 220 volts, 50 or 60 cycles. Consists of two 1 kw transmitters with 2 keyers, automatic transfer unit and weatherproof antenna tuner. Each transmitter housed in separate fan ventilated rack cabinet, with controls in center rack cabinet.

Nominal carrier power is 1000 watts.

High level plate modulation of final amplifier is used, providing any desired level of modulation up to 100%. P-T switch interrupts tone, permitting voice operation. Operates in ambient temperatures from -35°C to 55°C , humidity up to 95%.

Standby transmitter is placed in operation when main transmitter suffers loss (or low level) of carrier power or modulation, or continuous (30 sec.) tone, or carrier frequency change of 5 kcs or more. Audible indication in monitoring receiver tells when standby transmitter is in operation.

Antenna may be either vertical tower or symmetrical T type.

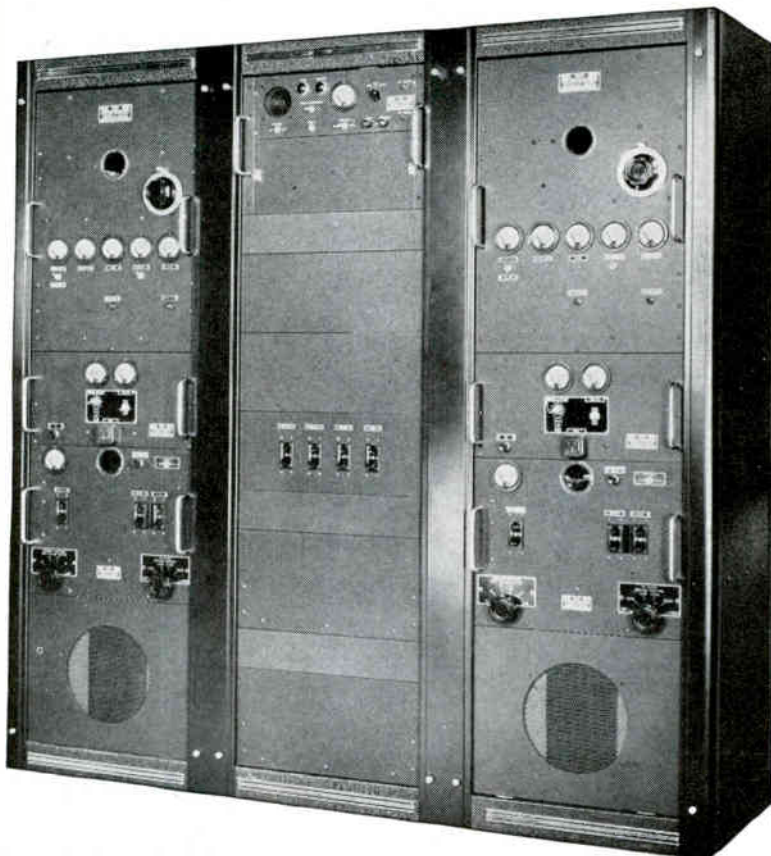

Also available in
50 WATT
100 WATT
400 WATT
and
4 KILOWATT
models

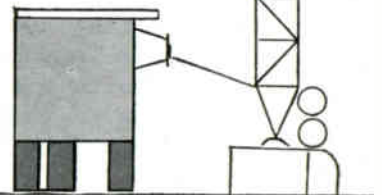

A-101

3090 S. W. 37th AVENUE • MIAMI, FLORIDA

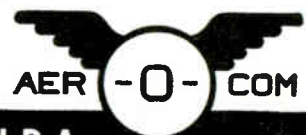



You
capture
the power
with RCA-7027-A... *the high-power-sensitivity
audio output beam power tube with extremely low distortion*

The tonal complexity of the trumpet is indicated in these power-frequency spectra, which show 12 perceptible overtones above a fundamental high-range note (698 cps), and 24 above a low-range note (175 cps). You capture the full dynamic range and tonal range with the RCA-7027-A in your audio output circuits.

Here is the top performer in audio power output tubes: RCA-7027-A! It's a high-perveance beam power tube with high power sensitivity and extremely low distortion, designed especially for top-quality audio systems. Two 7027-A's in Class AB₁ push-pull can deliver up to 76 watts power output with total harmonic distortion of only 2%!

Special design features help assure cool operation: new S-311 plate material, large grid-No. 1 radiating fins, and short stem leads. Double-base-pin connections for grids No. 1 and No. 2 provide flexibility of circuit arrangement, and assure cool operation of the grids to minimize reverse grid current.

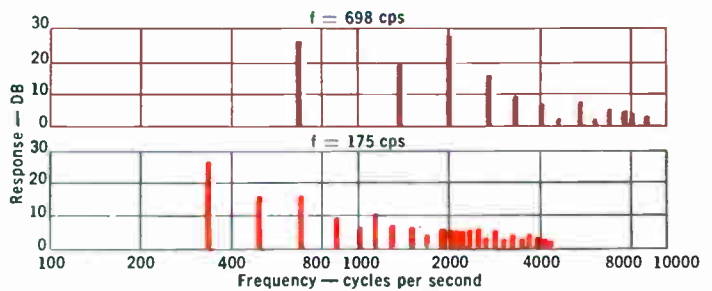

For audio power output that does credit to your best designs, specify RCA-7027-A. For information check with your RCA field representative, or write: Commercial Engineering, RCA Electron Tube Division, Harrison, N. J.

RCA Electron Tube Division—Field Offices

EAST: 744 Broad Street, Newark 2, New Jersey, HUmboldt 5-3900
 MIOWEST: Suite 1154, Merchandise Mart Plaza, Chicago 54, Ill., WHItetail 4-2900
 WEST: 6355 E. Washington Blvd., Los Angeles 22, California, RAYmond 3-8361



The Most Trusted Name in Electronics
 RADIO CORPORATION OF AMERICA



with a DI-ACRO ROL-FORM DIE

Workmarking from forming sheet materials in press brakes and punch presses is greatly reduced and in many metals completely eliminated when formed with the Di-Acro Rol-Form Die. Hardened and precision ground rolls pivot smoothly in the die block to fold material without strain. You save costs by discarding elaborate and time consuming preparation and work methods, reducing polishing time, eliminating scrap parts. You also cut costs in press brakes and punch presses by reducing the number of dies needed and the set-up time.

One Di-Acro Rol-Form Die with a 60° upper die forms any angle to 60° and any thickness of metal to 1/8" just by adjusting the ram or bed of the brake. Where ultra-high finish material is to be formed, nylon inserts can be used in the die block to further reduce the possibility of work marks.

The Rol-Form Die is offered in five styles and in lengths from 6 inches to 12 feet for use in all sizes and models of press brakes and punch presses.

For ordinary press brake forming ask about Di-Acro Standard Press Brake Dies.



Consult the yellow pages of your telephone book under Machinery-Machine Tools for the name of your nearest Di-Acro distributor or write us.

pronounced die-ack-ro



**O'NEIL-IRWIN
MFG. CO.**
321 Eighth Avenue
Lake City, Minnesota

MARKETING

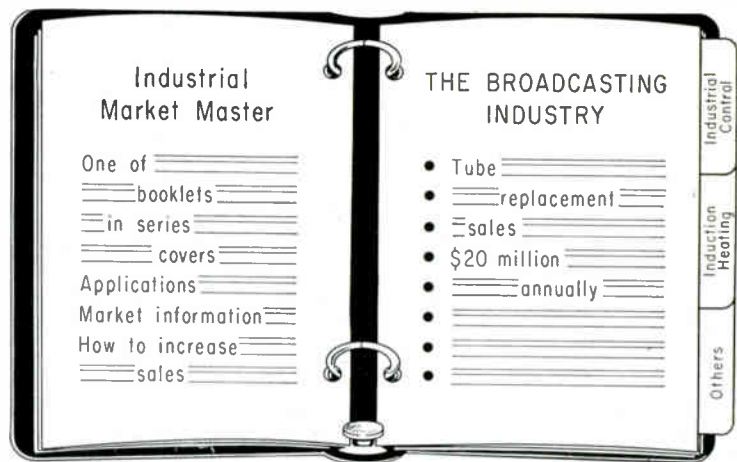

Above loose-leaf booklet of sales education material for distributors is producing sizable sales increases, reports Raytheon

'More Know Makes More Dough'

INVESTMENT last year by Raytheon's distributor products division of a few thousand dollars in equipping distributor salesmen with "know-how" to sell Raytheon's products is paying off in substantial sales increases, says John Ricketts, manager of the firm's Industrial Market Master program.

Sales for first half of 1960 are running 15 percent ahead of sales for the same period in 1959 and the increase is largely due to Market Master, Ricketts says.

Program strives to anticipate need of distributor salesmen for answers to such questions as:

- What does the product do?
- What are the applications?
- Who buys it?
- How big is the market today?
- Where is it headed?

Answers are contained in a loose-leaf booklet with individual analyses of markets, such as induction heating, dielectric heating, industrial controls, semiconductors, microwave communications, mobile and aviation communications.

Distributor salesmen, who have been using this material for about one year, were recently asked to give their reactions to its value to them.

Comment by one salesman: "More know has meant more dough." This is typical of the responses received.

It is not possible to list all information the program has supplied about industrial electronic markets. However, here is a sampling of estimates and comments:

Induction Heating: Market has more than trebled in three years.

Semiconductors: Estimated 1960 sales for all semiconductors total over \$500 million. Projected unit sales of transistors, diodes and rectifiers for 1964 amount to one billion units, up from 200 million units in 1959.

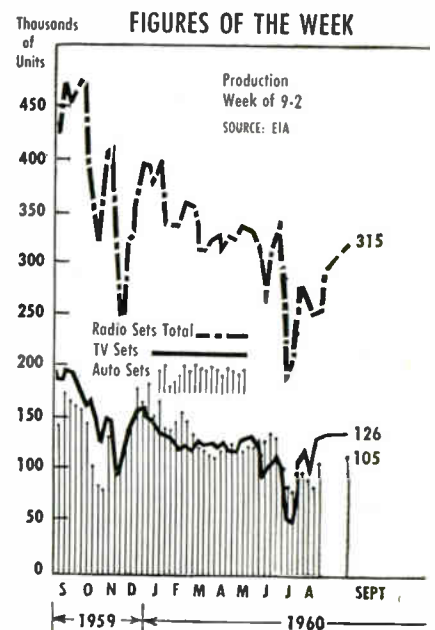

Mobile and Aviation Communications: Sales for 1960 are estimated at \$55 million for aviation portion and \$113 million for mobile radio.

Microwave Communications: Non-government sales of microwave relay and multiplex equipment are expected to total \$40-million-plus in 1960.

Exports to the U.S. from the United Kingdom dropped eight percent from last year during the first quarter of 1960, Business and Defense Services Administration, Electronics Division, reports.

U.K. shipments of electronic equipment and parts to this country are running at an annual rate of \$20.0 million, as against \$22.0 million for 1959. They totalled \$4.3 million in first quarter of this year.

Record-playing mechanisms dominate the list of items exported here—\$1,850,000 in the first quarter. Communications, navigation and radar equipment shipments were also substantial and growing—\$638,000 in the first quarter of 1960, up 45 percent from last year.

Other major exports on the list were: speakers and microphones, \$147,000; phonos, \$100,000; phono parts and accessories, \$203,000; tubes, \$391,000; other components and parts, \$370,000.

Relay sales will climb 35 percent in the next five years to over \$200 million, predicts Lloyd Aspinwall, president of Filtors, Inc. His forecast allows for inroads made by semiconductor devices.

The market for all types of electromechanical relays has doubled in the past five years, Aspinwall says, from \$78 million in 1955 to \$156 million in 1960. Expected rise is to \$210 million in 1965.

Big rise is partly due to the increase in the electronic portion of the total defense budget, he says. This amounted to 7 percent in 1955 and about 15 percent in 1960. In certain areas of weaponry, electronics accounts for nearly 50 percent of weapon costs. Electronics will account for about 20 percent of the total defense budget between 1965 and 1970, Aspinwall believes, and relay sales will rise accordingly.

The advertisement features a central graphic of several missiles in flight against a dark background. The missiles are labeled with their names: ATLAS, SNARK, POLARIS, MACE, THOR, MATADOR, REGULUS, and BOMARC. The text is arranged around the missiles, with 'magnetic controls company' at the top, 'has made' below it, '6147 GYRO TEMPERATURE CONTROLS' in large bold letters in the center, and 'for these missiles' at the bottom.

Missile manufacturers demand light, accurate, reliable gyro temperature controls—delivered on time. Magnetic Controls Company pioneered this field in 1952. Since then we have reduced the weight and size of these controls by 90% while *increasing* accuracy and reliability. This is why so many missile makers rely on Magnetic Controls Company. For experienced advice and detailed facts on specific applications, phone or write:

 **MAGNETIC CONTROLS COMPANY**
6411 CAMBRIDGE STREET • MINNEAPOLIS 26, MINN. • WE. 9-4691
Heat Control Systems • Static Inverters • Voltage Monitoring Systems

Exclusive Certified Test Data
Correlation Program from
Hughes Semiconductors

New Certi-Pak* gives you simple, easy device evaluation

Hughes' unique Certified Test Data Correlation Program gives you quick, easy assurance that the devices you specify from Hughes meet or exceed the parameters you require. This new service is provided absolutely free with quantity orders of Hughes Semiconductors.

Here's the way it works: when your order is readied for shipment, several units are selected *at random*—and carefully checked by the Hughes Quality Assurance Department for your specific requirements. The random sample is then tagged and the test results are entered on the Certified Test Data Correlation Form: actual *proof* that your units were thoroughly tested immediately before they were shipped to you.

When you receive your shipment, you'll find the Hughes CERTI-PAK containing the correlated test samples and the test data inside, appropriately marked. In the CERTI-PAK you'll also get a blank reporting form marked "Customer Results." After you complete your own tests, enter your data findings and correlate them with the Hughes original report.

The facilities of the Hughes field sales force and the plant at Newport Beach are readily available to you.

Hughes, of course, scrupulously tests every unit before it is approved for sale. But the unique Hughes Certified Test Data Correlation Program gives you benefits far beyond this. It saves time and money in lengthy tests and costly reshipments. It tells you at a glance that Hughes has tested your device to your specific requirements. And most of all, it gives you proven assurance that Hughes is making every effort to provide you with a product of quality.

For more information about this new service to you, contact Hughes Semiconductor Division, Marketing Department, 500 Superior Avenue, Newport Beach, California.

*HUGHES TRADEMARK



Creating a new world with ELECTRONICS

HUGHES

SEMICONDUCTOR DIVISION
HUGHES AIRCRAFT COMPANY

Amperex®

America's Largest Manufacturer of Frame Grid Tubes... Announces

2 NEW RUGGEDIZED AMPLIFRAME* TUBES... 7737 and 7308

**SPECIFICALLY
DEVELOPED...**

Several years ago, when AMPEREX announced the new 6922 and 6688 frame grid tubes for military and industrial applications, they were received with immediate and overwhelming acceptance. However, our applications work in these areas subsequently revealed that there was still room for improvement—as, for example, in the case of video amplifiers which must carry signals from DC to UHF... without microphonics, under extreme shock and vibration conditions. Today, with the new 7737 and 7308 AMPEREX Ampliframes (now in mass production in our Hicksville, Long Island plant), we believe that we have arrived at the ultimate in tube reliability.



***AMPLIFRAME** a new concept in electron tube construction, designed and mass produced exclusively by Amperex, incorporates the unique Frame Grid... the closest approach to the "ideal Physicists' grid"—electrical characteristics but no physical dimensions. Outstanding features of Amperex Frame Grid Tubes include:

- higher transconductance per milliampere
- tighter Gm and plate current tolerance
- low transit time
- low capacitances
- lower microphonics

SPECIFICATIONS

	7737	7308
Swept Frequency		
Vibration (50-2000 cps)	10 G	10 G
Noise & Microphonics		
Output	190 millivolts	10 millivolts
Plate Supply Voltage	190 volts	100 volts
Grid Supply Voltage	9 volts	9 volts
Cathode Bias Resistor	630 ohms	680 ohms
Plate Current	13 mA	15 mA
Transconductance	16,500 μ mhos	12,500 μ mhos
Amplification Factor	53	33

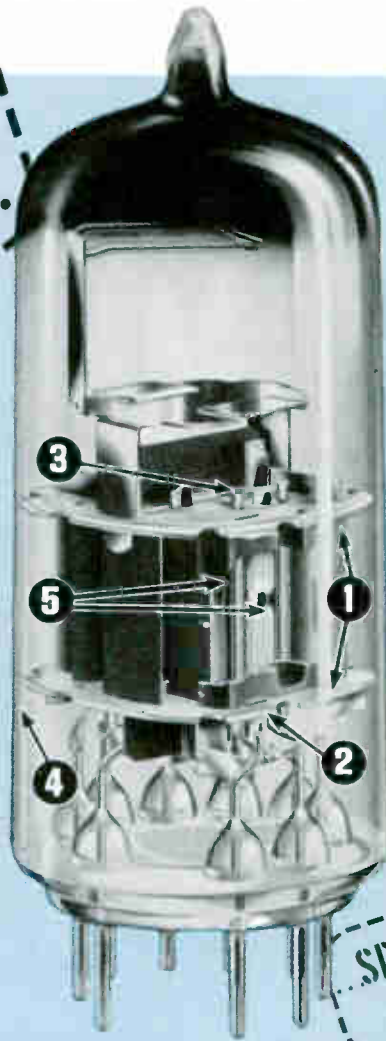

- 1 Heavy, square mica supports — eliminate mica chipping and flaking as well as loosening of mount when subjected to shock and vibration
- 2 Special mica holes anchor the anode firmly
- 3 Tongue mica dampens cathode movement allows normal expansion and contraction... prevents cathode bowing
- 4 Calibrated, tapered bulb rigidly holds mount... will not allow any movement
- 5 'Ampliframe' grid — rigid frame with fine grid wire under tension accurately maintains close grid-to-cathode spacing

**SPECIFICALLY
DEVELOPED**

for ultra-critical
military and industrial applications in
high shock and vibration environments

New

Amperex AMPLIFRAME 7737

Premium Quality

BROADBAND AMPLIFIER PENTODE

Extra-rugged, low-microphonic version of the 6688... for critical airborne applications, coaxial cable amplifiers, video and broadband IF amplifiers in communication links and TV equipment.

New

Amperex AMPLIFRAME 7308

Premium Quality

HIGH-GAIN TWIN TRIODE

Extra-rugged, low-microphonic version of the 6922... for use in radar, oscilloscopes, computers, broadband amplifiers and critical airborne applications.



ask Amperex

about Ampliframe tubes for ultra-critical military and industrial applications

AMPEREX ELECTRONIC CORPORATION
230 Duffy Ave., Hicksville, Long Island, N.Y.

In Canada: Rogers Electronic Tubes & Components, 116 Vanderhoof Ave., Toronto 17, Ont.

\$134 MILLION FOR SPACE

Details of NASA spending for first six months of 1960 give clue to who will get the billions yet to be spent. Contracts for final six months of this year will total \$300 million

THE NATIONAL AERONAUTICS and Space Administration plans to award contracts totaling close to \$300 million during the last six months of 1960.

Proposals for study contracts for Project Apollo, the manned spacecraft system, are due Oct. 10. Several contracts, expected to total \$1 million, will be awarded Nov. 14—and these will be just the beginning of new business amounting to many millions.

Research and development appropriations for fiscal year 1961 amount to \$621,450,000. Overall plans for

this 12-month period which began July 1, include five scientific satellites—two meteorological and one communications—two lunar and deep space probes; and continuation of project Mercury. (Plans for the next ten years in space are listed in *ELECTRONICS*, p 35, Aug. 19).

To give a detailed look at the contracts and who gets them, here is a complete listing of electronic and related equipment and studies NASA bought from Jan. 1 through June 30, 1960:

NASA HEADQUARTERS, WASHINGTON, D. C.—University of Michigan: \$50,000 for research on measurement of atmospheric pressure between earth and moon; \$117,500 for sounding rocket studies of the ionosphere in collaboration with the Ballistic Research Laboratories; \$270,000 for research involving high-altitude radiation measurements.

University of Chicago: \$38,525 for evaluation of telemetry records received from Explorer VI; \$102,737 for R&D on Atlas-Able V in lunar orbiter program.

Chance-Vought: \$29,791 for investigation of twin gyro reaction attitude controller.

Stanford Research Institute: \$33,030 for research in celestial mechanics and use of nonlinear differential equations.

Stanford University: \$122,600 for investigation of very low frequency radio propagation using satellite data.

Massachusetts Institute of Technology: \$75,000 for research preparatory to short-term measurement of satellite gravitational red-shift experiment; \$150,000 for research in long-distance communications by earth satellites and earth-to-space-probe communications; \$225,830 for development and manufacture of seven gamma-ray instrument packages including three for thermal and flight tests, two for balloon tests and two for satellite flights.

Thompson Ramo Wooldridge: \$47,414 for management and program control system.

Southwest Research Institute: \$40,000 for research to identify and determine rate of accumulation of trace toxicants in enclosed systems.

University of New Hampshire: \$31,280 to develop, construct and test four magnetometer instruments for use on satellite.

Grumman Aircraft: \$28,897 for research on improved particle-charging techniques.

Oklahoma State University of Agriculture and Applied Science: \$48,175 for designing, building and calibrating the instrumentation for two rocket experiments to determine polar conductivity.

ARINC Research: \$144,214 for reliability study of Project Saturn.

University of Rochester: \$46,800 for design, building and testing of a gamma-ray counter for S-16 satellite for the measurement of solar flares.

GODDARD SPACE FLIGHT CENTER, GREENBELT, MD. — Aerojet-General: \$992,734 for Aerobee sounding rockets and components.

Aerolab Development: \$207,600 for Argo D-8 sound rockets.

Airborne Instruments Labs, Div. of Cutler-Hammer: \$269,808 for airborne ground checkout equipment for ionosphere sounder system for scientific satellites.

University of Alaska: \$195,000 for Mini-track station at Fairbanks.

All Products: \$32,606 for antennas and spare parts for lunar and planetary exploration program.

Ampex: \$126,200 for FR-600 magnetic tape recorder; \$96,573 for magnetic tape recorders; \$40,200 for magnetic tape recorder.

Control Data: \$118,135 for data processor and magnetic tape units.

Cook Electric: \$228,212 for nine solar beam rocket instrumentation systems for sounding rocket program.

Electro-Mechanical Research: \$37,859 for telemetry ground station, Washington, D. C.; \$62,115 for digital decommutator and accessories for scientific satellites program.

Electronic Engineering Company of Calif.: \$63,451 for transistor computer format control buffer.

Radiation Inc.: \$52,846 for replacement cords for automatic reaction and reduction facility; \$87,981 for digital data recording system.

Varian Associates: \$30,000 for research to develop an alkali vapor spectral lamp for use in lunar and planetary exploration program; \$56,351 for development of rubidium vapor magnetometers, engineering services.

RCA: \$302,324 to design, develop, fabricate, acceptance test and deliver a laboratory model of an electrostatic tv satellite camera; \$55,806 for evaluation of TIROS I data.

Elgin National Watch: \$50,000 for matrix head system flight recorder; \$32,788 for drive mechanisms.

Geophysics Corp. of America: \$372,568 for instrumentation for determining composition of upper atmosphere.

Hewlett Packard: \$39,102 for electronic counter, installed digital recorder.

D. S. Kennedy: \$72,206 for automatic aiming telemetry antenna and pedestal for tracking satellites.

Minnesota Mining and Manufacturing: \$30,624 for high resolution tape, reels and instruments for meteorological satellite program.

New Mexico College of Agriculture and Mechanical Arts: \$725,787 for Mini-track field services and related support.

Plasmadyne: \$58,000 for study and design of ultraviolet air density meter.

Rand Corporation: \$114,441 for theoretical study of earth's magnetic field and the space environment near the earth.

Radiation Instruments Div. Laboratory: \$109,918 to devise multichannel pulse height analyzer for sounding rocket program.

Raymond Engineering Laboratory: \$66,999 for seven TIROS II magnetic tape recorders.

University of Texas: \$50,000 to procure and operate sound ranging system for meteorological satellite program.

Washington Technology Associates: \$97,652 for development of payload for Aerobee 100 rocket.

New York University: \$75,057 for transmission and reduction of time and material data study.

Consolidated Electrodynamics: \$29,447 for study directed toward the development of one megacycle flight recorder.

Tenney Engineering: \$35,052 for high-vacuum thermal chamber.

AND WHERE IT WENT

More than 2,000 companies contributed to McDonnell Aircraft's Mercury space capsule for NASA

Thompson Ramo Wooldrige: \$4,300,000 for development of Sunflower solar auxiliary power system.

Raymond Engineering Laboratory: \$25,000 for tape recorder.

Ohio Semi-Conductors: \$33,720 to develop two sensor vector component magnetometers.

General Electronic Laboratories: \$25,680 for telemeters.

Cooper Development: \$37,000 to develop and manufacture of telemetering systems.

Beckman Instruments: \$31,765 for spectroreflectometer.

LEWIS RESEARCH CENTER, CLEVELAND—MSA Research Corp: \$106,850 for two-phase sodium loop.

Diamond Power Specialty: \$34,873 for closed circuit tv system.

Jarrell-Ash Company: \$26,910 for spectrometer and associated equipment.

Hermes Electronics: \$33,500 for master time code generator.

Stauffer-Temescal: \$130,000 for electron bombardment unit.

Electro Instruments: \$119,068 for amplifiers for rocket research.

Webb Electric: \$44,003 for services, labor and material to install instrumentation and control equipment in the Rocket Combustion Laboratory.

Satham Instruments: \$40,600 for pressure measuring devices.

Tech Service: \$31,746 for instrumentation panels to measure stresses.

Del Electronics: \$34,010 for electrical power supplies for amplifiers.

Electronic Associates: \$38,550 for analog computer.

LANGLEY RESEARCH CENTER, HAMPTON, VA.—Tele-Dynamics: \$26,235 for amplifiers and oscillators.

G. T. Schjeidahl: \$29,764 for services and material to furnish spherical balloons for Project Echo.

Western Electric: \$33,058,690 for worldwide tracking system for Project Mercury.

Kaiser Fleetwings: \$37,812 for services and materials for six 100-ft inflatable satellite container assemblies for Project Echo.

Telecomputing Corp.: \$49,975 for services and material for basic systems of telereading equipment for Project Mercury.

Ampex: \$57,475 for magnetic recording-reproducing system.

Northern Radio: \$99,925 for services and materials for transmission system.

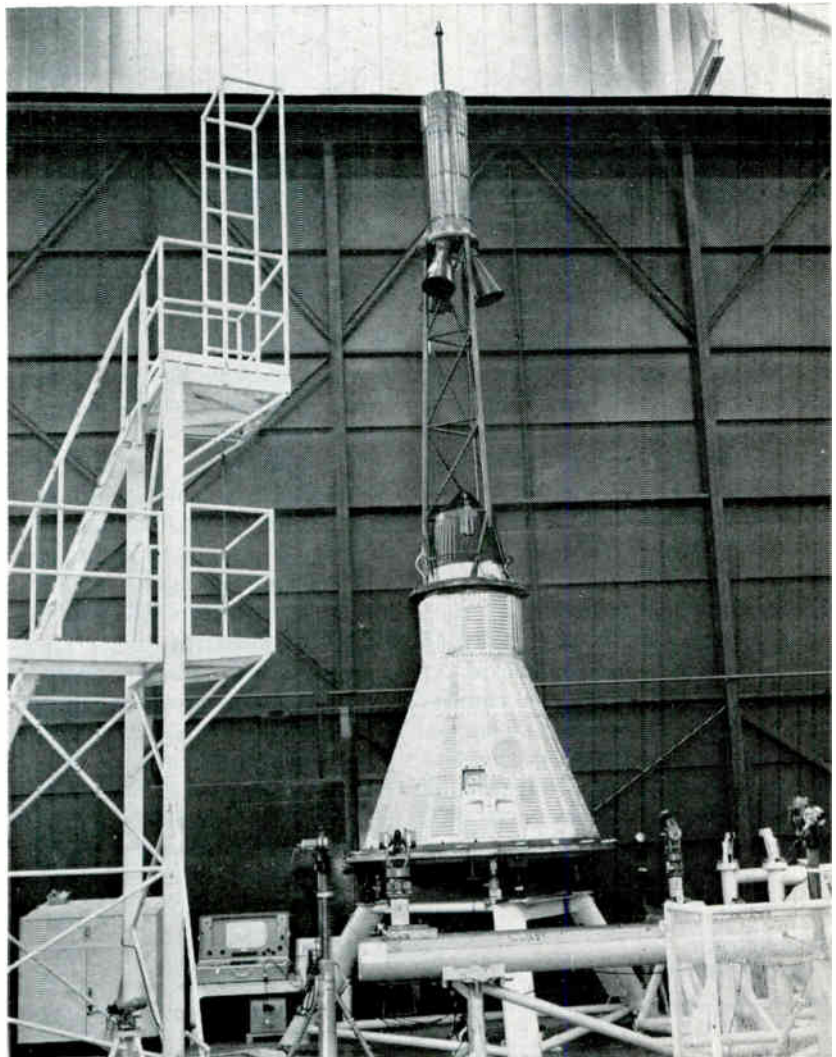

Hermes Electronics: \$303,821 for services and materials for range programming and timing system.

Consolidated Electro-Dynamics: \$12,000 for recorder, amplifier and systems: \$90,000 for galvanometers.

Beckman Instruments: \$39,564 for analog computing equipment.

RCA: \$181,650 for communication services for Project Mercury.

Simmonds Precision Products: \$149,921 for antennas and receivers.

R.C.A. Service Co.: \$36,000 for radar maintenance.

Dage Television: \$185,886 for closed-circuit tv.

Data Control Systems: \$30,720 for three switchable and nine subcarrier discriminators.

Electronic Associates: \$1,510,000 for analog computing equipment.

Bendix: \$43,859 for console, time-of-flight mass spectrometer analyzer and

vacuum system.

Radiation Dynamics: \$86,850 for communications systems for satellite applications.

WESTERN OPERATIONS OFFICE, SANTA MONICA, CALIF.—Douglas Aircraft: \$68,838,160 for services and materials for the design, development, fabrication and test of ten Saturn S-IV stage vehicles.

AMES RESEARCH CENTER, MOUNTAIN VIEW, CALIF.—Fischer Research Laboratory: \$48,000 for indicating millivolt potentiometers for general use in tunnel tests.

Precision Instrument Company: \$26,820 for 14-channel recorder-reproducer.

Applied Radiation: \$170,335 for ion accelerator for extension of energy range of existing accelerator.

GE: \$30,590 for tv system for sighting and control test for orbital astronomical observatory.

Electronic Associates: \$353,625 for analog computer system.

How Electronics Executives Make Out in Pay

Electronics runs second only to the automotive industry when it comes to pay for top executives, according to a recent study. Other pay is also up

INCOME FOR EXECUTIVES in the electronics industry last year rose 21 percent over 1958 levels. General industry increases were 8 percent.

This information was derived from a survey recently completed by McKinsey & Co., Inc., management consultants. With sales in the electronics industry up 11.6 percent in 1959 as compared with 1958 levels, according to the New York consulting firm, most chief executives in our industry got handsome salary boosts. The increments were surpassed only by those of executives of comparable level in the automotive industry. Here increases ran to 27 percent.

The survey comprises a study of general industry and was based on analysis of 605 American companies listed on the major stock exchanges. The survey shows that the weekly pay of hourly workers in industry as a whole has risen 24.8 percent since 1953, while the aver-

age U.S. chief corporation executive's compensation rose 16 percent since 1953. The 605 companies were grouped into 25 major industries, including the electrical equipment industry, and for the first time, a group of electronics companies.

Many companies heavily involved in electronics are included under industries such as business machines and consumer durables as well as under electronics.

The electronics group covers 35 companies with sales ranging from \$15 million to \$1.5 billion. Prime emphasis was placed on comparing year-to-year changes in executive pay in electronics with pay changes in other industries.

Within our industry, there were some wide variations among the 35 companies in executive compensation from year to year. In 1959 about 20 percent of the companies paid their chief executives less than in the previous year; 20 percent

paid the same amounts, and 60 percent paid them more. In most cases, where a decline or no increase in pay was registered, a decline in profits or a change in executive personnel occurred.

Derived from the survey is an indication that in all industry top executive compensation is closely tied to sales, and when charted runs roughly parallel. This is also true in the electronics industry. For example, a chief executive who wants to increase his total compensation from \$50,000 to \$100,000 a year would have to increase his company sales from \$10 million to just over \$100 million, according to the survey. Then, to increase his pay from \$100,000 to \$200,000, he would have to move to a company with sales of about \$1 billion.

Electronics company executives are paid slightly more than executives in industry as a whole.

For the purposes of the survey,

COMPENSATION
(in thousands of dollars)

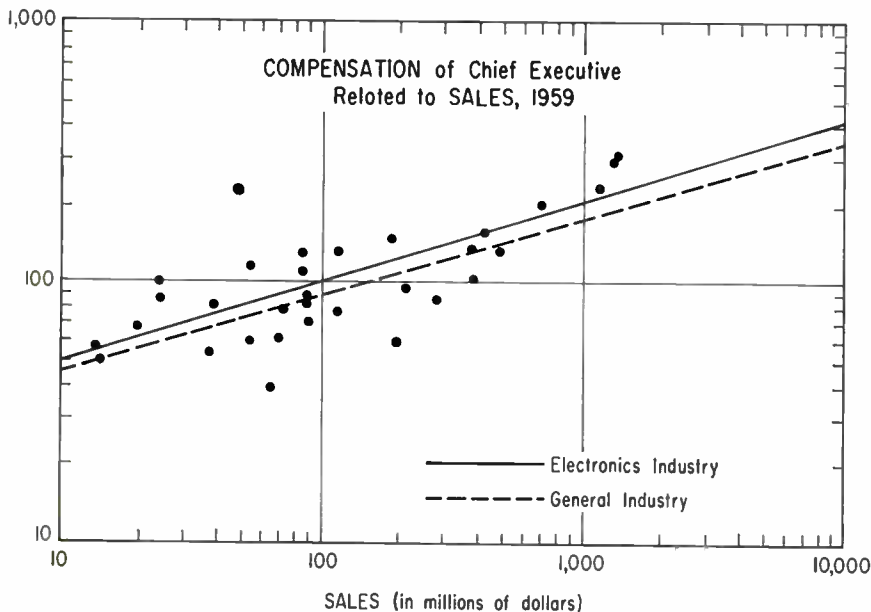

Graph shows steadily rising rate of pay for executives and indicates favorable position of electronics men. Growth closely parallels sales income

TYPICAL COMPENSATION OF OTHER SENIOR EXECUTIVES EXPRESSED AS PERCENTAGE OF CHIEF EXECUTIVE'S COMPENSATION

		1959		
		Typical Percentage of Chief Executive Officer		
Rank	Industry Group	2nd Highest Paid Executive	3rd Highest Paid Executive	4th Highest Paid Executive
1	Department stores	84%	73%	65%
2	Rubber	79	69	50
3	Soaps, cosmetics, pharmaceuticals	79	62	52
4	Tobacco	78	61	55
5	Paper	78	59	56
6	Electrical equipment	77	64	53
7	Textiles	76	64	69
8	Automotive	76	63	61
9	Petroleum	76	61	50
10	Consumer durables	74	62	55
11	Foods	73	58	51
12	Chemicals	72	63	60
13	ELECTRONICS	72	61	54
14	Nonferrous metals	72	60	55
15	Large diversified companies	71	61	52
16	Aircraft and missiles	71	61	50
17	Machinery (except elec.)	70	60	58
18	Industrial metal products	69	55	51
19	Public utilities	69	55	NA
20	Air transport	69	NA	NA
21	Building materials	66	53	42
22	Food and drug chains	64	57	NA
23	Steel	64	52	44
24	Business machines	64	52	39
25	Railroads	57	47	47

NA = Figures not available.

By JOHN G. McDONALD,
Management Consultant,
McKinsey & Co., Inc., N.Y.C.

researchers defined compensation as salary, bonuses and deferred accruals awarded to the top men. They did not include such items as company contributions to pension plans, stock option awards, or other fringe benefits in deriving compensation figures for any of the executive categories forming part of the survey.

Other high-level executives in electronics besides company presidents also fared well, according to the McKinsey survey. In 1959 the compensation of the second highest paid executive as a percentage of the pay of the chief officer in electronics followed the general industry pattern. The third and fourth highest paid men fared as well as their counterparts in general industry. The survey indicates wide swings from industry to industry, as shown on the table. The all-industry relationships are 72, 60 and 55 per cent for the number two, three, and four men.

Some idea of the exact rating of electronics executives' pay may be had from a detailed study forming part of the survey.

Of the 25 industries charted, the highest paid top men were executives in the soaps—cosmetics—pharmaceutical industry group. The 25th spot is held by air transport executives.

Electronics executives rank eighth in the list. Electronics firms with sales of \$50 million a year paid their executives \$80,000. Those with \$250 million annual sales paid \$130,000. Those with \$500 million sales paid \$160,000, according to the survey.

Looking at the number 1 spot for comparison, executive pay was \$84,000, \$170,000 and \$230,000 for the three sales categories mentioned above. On the other hand, the air transport men got \$50,000, \$75,000 and \$90,000, respectively.

reliability

in communications
or short wave
broadcasting

GATES HF-1M 1,000 watt 2-32 MC *High Frequency Transmitter*

Geography is simply a matter of place, not performance, with the Gates HF-1M High Frequency Transmitter. From the arctic to the tropics the dependability of this quality instrument is widely recognized . . . unflinchingly meeting the demands of commercial and government users. The combination of experienced engineering with quality materials has resulted in a transmitter that provides outstanding performance under the most critical conditions.

The HF-1M features a welcome *simplicity of rapid frequency change*. Any frequency from 3-32 Mc can be selected in seconds by adjusting three controls and selecting the proper crystal on the front panel. An easy method for even non-technical personnel. Other quality features of the HF-1M are:

- ★ Audio System for either broadcast or voice models.
- ★ Complete relay system for absolute protection.
High level Class B modulation with twin-drive audio for full reliability, low distortion and long tube life.
- ★ Complete accessibility and servicing ease.
- ★ 230 volt, 50 or 60 cycles, single phase operation.

Get more detailed information on quality high frequency transmitters by writing for our new catalog or our latest brochure. Write today!

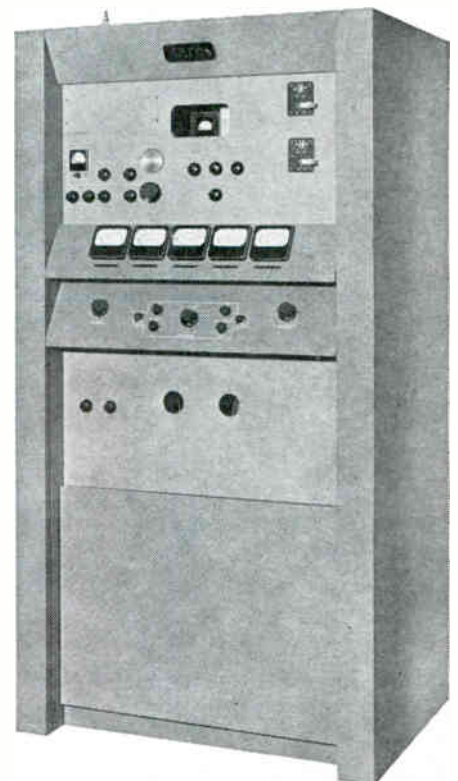

GATES

GATES RADIO COMPANY
Subsidiary of Harris-Intertype Corporation
QUINCY, ILLINOIS

**HARRIS
INTERTYPE
CORPORATION**

Offices in: HOUSTON, WASHINGTON, D.C. In Canada: CANADIAN MARCONI COMPANY
Export Sales: ROCKE INTERNATIONAL CO., 13 EAST 40th STREET, NEW YORK CITY

NEW WESTON PANEL METERS PROVIDE THREE IMPORTANT DESIGN ADVANTAGES...

- *Exclusive magnetic shielding*
- *Sustained accuracy—up to $\pm 0.5\%$*
- *Ranges tailored for special applications*

Long-term accuracy and reliability are special features of Weston's new line of panel instruments. Accuracy—in Model 1761—is up to $\pm 0.5\%$ of full scale deflection when supplied with knife edge pointer and mirror scale.

Exclusive CORMAG[®] self-shielded mechanisms are used in both Models 1751 and 1761. The meters may be mounted on magnetic or non-magnetic panels without special adjustments... are immune to the effects of stray fields and nearby instruments. Housed in dust and moisture-resistant Bakelite cases with glass windows, they are supplied in a wide variety of standard ranges.

Special range meters with conventional magnetic construction are available where higher current sensitivity, lower resistance, special ballistic characteristics and controlled scale distribution are required.

Call your Weston representative for details, or write for Catalogs 01-109 and 01-110—which contain technical information on this new line of precision panel meters. Weston Instruments Division, Daystrom, Inc., Newark 12, New Jersey. *International Sales Division, 100 Empire Street, Newark 12, New Jersey.*
In Canada: Daystrom Ltd., 840 Caledonia Rd., Toronto 19, Ontario.

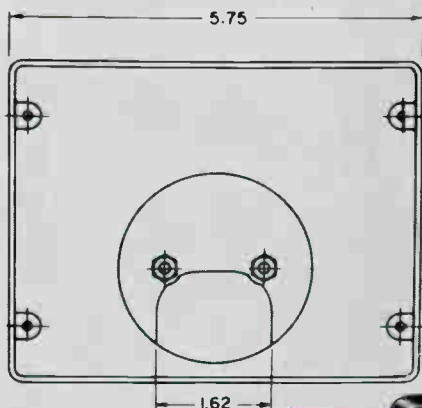
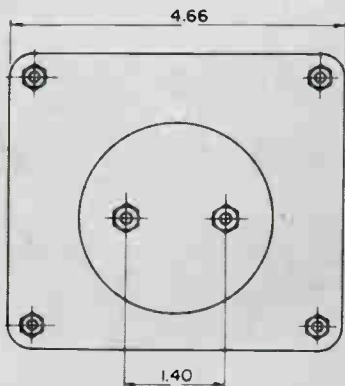
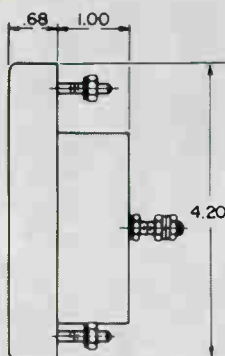

Standard instruments: Black Lance pointer, easy to read black markings on white dial, 100° arc. Model 1751—Size: Rectangular—4.66" x 4.20"; 4" long scale. Accuracy: $\pm 2\%$ full deflection as DC instrument. Model 1761—Size: Rectangular—5.75" x 4.62"; 4.5" long scale. Both models available as: DC ammeters, milliammeters, microammeters, voltmeters (1000 Ω /volt).

DAYSTROM, INCORPORATED
WESTON INSTRUMENTS DIVISION
Weston for Dependable Accuracy

EXPERIMENTAL FABRICATION
TECHNIQUES FOR TUNNEL DIODES

Process	Approximate Number of Diodes	I_{max} Range (10-mil dot)	I_{max}/I_{min}		Remarks
			Aver	Best	
Welding	100	0.1-50 ma	2.5	4	No post-etching
Capacitor discharge	10	—	—	—	
Local heating	100	0.1-20	2.5	4.5	"
Wire alloying	20	.05-20	3.5		"
Radiant strip heating	700	0.1-1,000	*	12	
Alloying furnace	600	0.1-150	*	11.5	
Resistive strip heating	5,000	0.1-1,000	*	12	"

* A large variety of materials and modifications to processes gives an average without significance

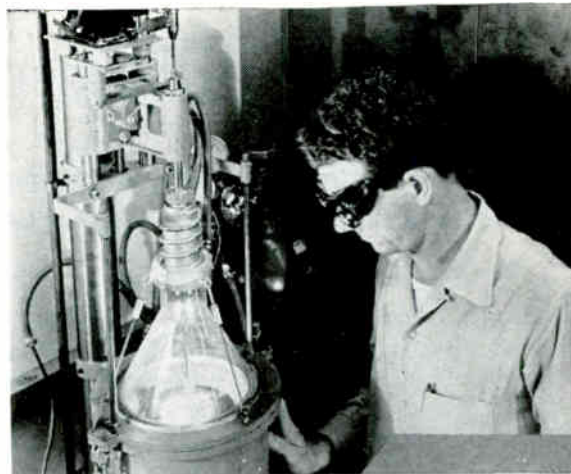

National Research Corp. crystal pulling furnace

More Work Needed on TUNNEL DIODE MATERIALS

Metallurgists say more basic study is required on use and control of semiconductors with many electrons in their conduction band

By THOMAS MAGUIRE
New England Editor

BOSTON — CRYSTAL GROWING and characterization techniques will have to give ten times the uniformity of techniques now used if the tunnel diode is to fulfill its commercial promise. That's what leading metallurgists said at a recent three-day conclave here.

For example, solubility limits for many impurities, particularly in the III-V compounds, are not known.

At the conference on Metallurgy of Elemental and Compound Semiconductors, nearly half the program was focused on the tunnel diode. The parley was sponsored by the Metallurgical Society of the American Institute of Mining, Metallurgical and Petroleum Engineers.

George C. Dacey of Bell Telephone Laboratories reminded the metallurgists that for the first time, the use and control of degenerate semiconductors (semiconductors with high number of electrons in conduction band) is necessary—and little is known about the metallurgy and physical properties of degenerate materials.

The tunnel diode has also introduced metallurgical fabrication problems. Since the tunnel diode forward characteristic has a nega-

tive resistance portion, it is necessary to produce *p-n* junctions with extremely steep impurity gradients between degenerate *n* and degenerate *p* material. This has thus far proved most feasible by the alloy process, Dacey said.

It has been necessary to use extremely short alloy heat cycles to prevent diffusion from destroying the steepness of the impurity gradient. It is possible that junction formation at lower temperatures, such as from ternary solutions, will be useful.

For high-frequency use, it is necessary also to produce diodes with extremely small transverse dimensions. Hopefully, new developments in alloying control will help to solve these problems.

In some cases, Dacey pointed out, even the problem has not yet been accurately outlined. The centers responsible for excess current in germanium or silicon tunnel diodes are not known. The effect, if any, of dislocations on the tunnel diode characteristic has not been established. As these and other device problems are clarified, additional materials requirements will emerge.

Among crystal-growing methods under investigation in research labs, dendritic growth is attracting interest. Dendrites were grown in

1953 at Associated Electric Industries in England. A Westinghouse program is studying preparation of tunnel diodes from dendritic material, with the hope of developing techniques for continuous production of single diodes and multiple junction modules on a dendritic strip. Advantage of dendritic strips would be ease of automated production.

Experimental fabrication techniques, summarized in the table, used *n*-type germanium exclusively as the base material. Indium-gallium and indium-gallium-zinc were used as alloying materials to form the *p*-region.

The base material was available in two forms: heavily doped arsenic dendrite grown directly from the melt; and lightly-doped dendrite from a continuous puller, into which arsenic was subsequently diffused from the vapor phase. According to T. P. Brody of the Westinghouse Research Laboratory, they proved equally suitable.

Prefabrication etching made no difference to current ratio of diodes made on doped-grown material, but appeared to improve somewhat those made on diffused material. Three post-etches were tried, with no significant difference in performance.

British Disclose Satellite Work

Airshow exhibitors reveal government and industry-sponsored space work, automatic landing system and other work on advanced electronic design

LONDON—REGULAR VISITORS to the annual British airshow held Sept. 5 to 11 at Farnborough, Hampshire, England found little new this year among the avionic exhibits. This show featured last year's models with increased reliability.

One manufacturer explained saying, "We are just between two aircraft generations: there is no more to develop on those currently flying and the new ones aren't flying yet. Missilewise the situation is the same. We are not in the space league so it's last year's equipment or nothing."

Other manufacturers are hoping that an announcement of a limited British space program will provide new development impetus.

Since the cancellation of Britain's only long range missile, Blue Streak, earlier this year, the British government has been deliberately noncommittal on space research policy despite heavy industry pressure.

Revelation that some government-sponsored space research was under way came at the Farnborough show when both Elliott-Automation Ltd. of London and Marconi's Wireless Telegraph Co. Ltd. of Chelmsford revealed they were working on a British space project. But no further details were disclosed.

While government-sponsored research is just emerging from security wraps, several firms have been developing, as private ventures, space instrumentation for the Anglo-American Scout satellite. They plan to exhibit the equipment next year.

Seen at Farnborough were the McMichael Radio Ltd. miniaturized binary counters with a 221,000 component per cu ft density. Operating as a two-transistor bistable circuit over a temperature range of zero to 60 C, McMichael packs 16 components into less than half a cu in. with a weight of $\frac{1}{4}$ oz. Other equip-

ment developed by Pye Ltd. for measuring electron density and temperature uses two $5\frac{1}{2}$ in. diameter circular cards forming a stack with a total power consumption of 60 mw.

Likely configuration for a British space satellite is a relay communications satellite. Preliminary feasibility studies by Hawker Siddeley Aviation Ltd. revealed at the show indicate that a 600 to 700-lb satellite on an elliptical 63-degree inclination orbit would provide 9.30 hours a day communication time between London and New York. The satellite would use a 3-ft diameter antenna, attitude stabilized by horizon sensors, for reception and transmission.

Solar cells would provide 500 watts to activate the 100-speech channels in the system. The satellite launching is proposed from a three-stage vehicle, the first two stages comprising the already existing British Blue Streak and Black Knight vehicles.

Another advance at the show was the British automatic landing system.

The system, ELECTRONICS learned, is now being fitted to the Royal Air Force V bomber deterrent force, and is to be installed on the 100-ton SC5 freighter Dove, to go into service in 1964 as an RAF transport aircraft.

Principle of the system is the extended use of the ILS approach, a radio altimeter for height and rate of descent measurements and a-c fed leader cables buried along the runway for azimuth direction.

Over 4,000 test landings at a government research unit here checked the system accuracy. Military installations will be for full automatic landing. Civil installations planned for the VC and DH 121 aircraft will only provide automatic flareout leaving the pilot to make the actual final touch down. At present intergovernment nego-

tiations are under way for a complete British automatic landing system to be flown to the States for FAA evaluation.

Already two of the specially designed 4,300 Mc f-m altimeters, developed by Standard Telephones and Cables Ltd. used in the system are under evaluation. Altimeter accuracy over the range 0 to 500 ft is quoted as better than ± 3 ft. With the system being installed both on military and civil aircraft, Britain wants the system to be adopted internationally.

Also announced at the show were details of Marconi's Wireless Telegraph Company's work on 50-cm coherent parametric amplifiers. In the Marconi system both the pump frequency and the signal frequency are locked in under crystal control. Both signal frequencies are now voltage additive while the noncoherent noise bands are only power additive. Noise factor claimed by Marconi for development tubes is 2 db at 600 Mc. Development is scheduled for completion by late 1961.

Turbojet Under Test

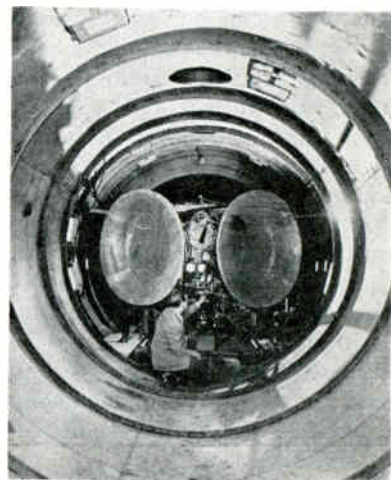

Performance of Navy aircraft engines in test chamber is monitored by Fischer and Porter data acquisition facility

Reliability in volume...



CLEVITE
TRANSISTOR
WALTHAM, MASSACHUSETTS



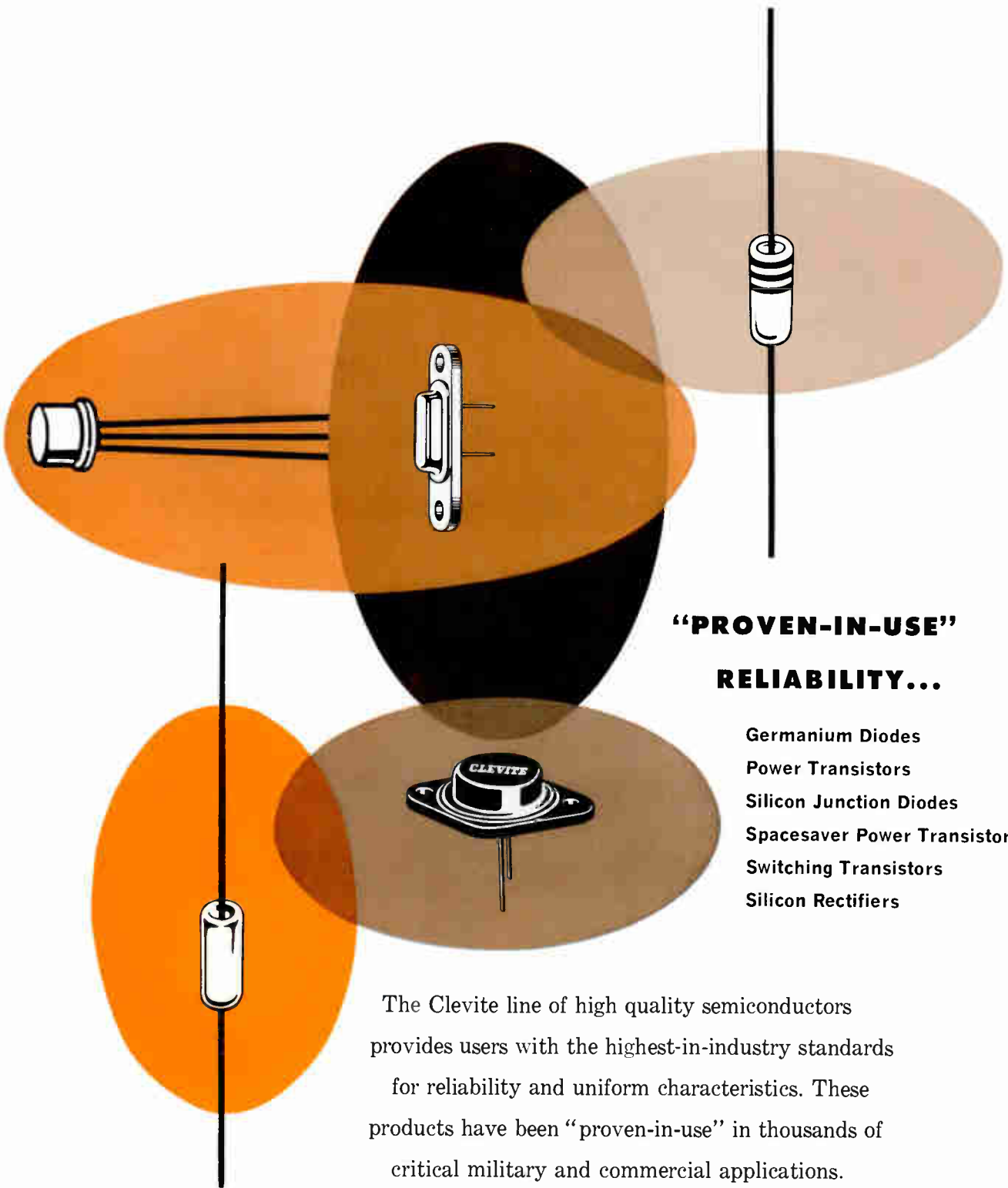

“PROVEN-IN-USE”

RELIABILITY...

- Germanium Diodes
- Power Transistors
- Silicon Junction Diodes
- Spacesaver Power Transistors
- Switching Transistors
- Silicon Rectifiers

The Clevite line of high quality semiconductors provides users with the highest-in-industry standards for reliability and uniform characteristics. These products have been “proven-in-use” in thousands of critical military and commercial applications.

Write now for complete data and detailed specifications.



Reliability In Volume . . .

CLEVITE TRANSISTOR

254 Crescent Street Waltham 54, Mass. Tel: TWinbrook 4-9330

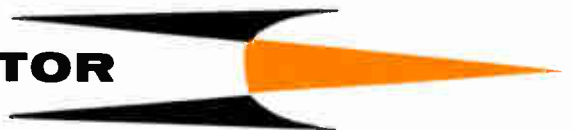

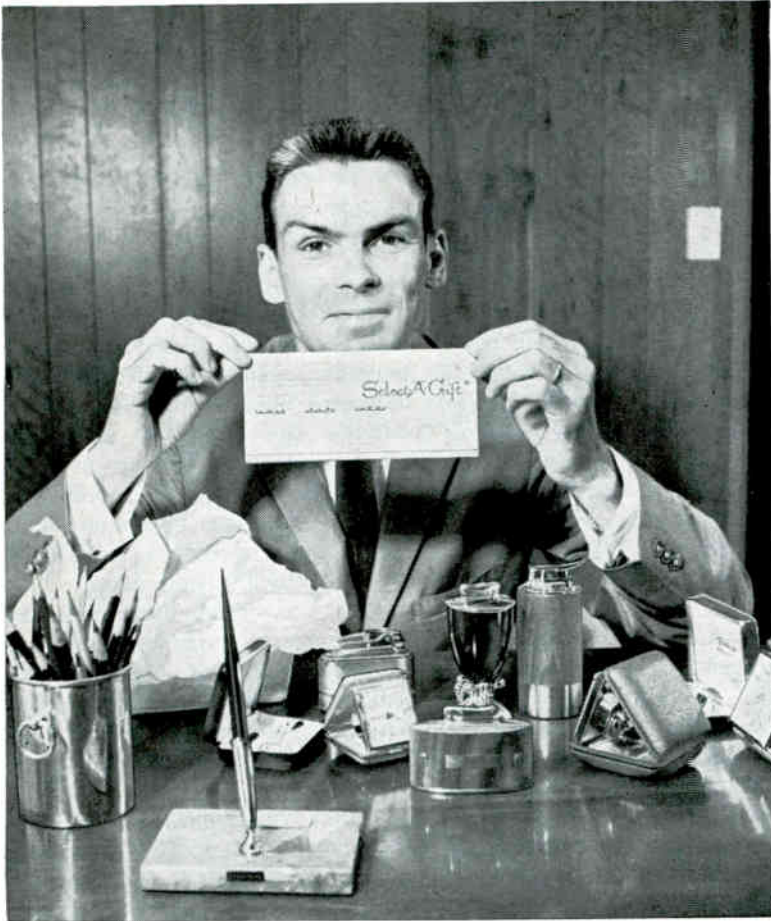

at last! . . . a gift he can really use!

Select-A-Gift is the one perfect answer for every gift-giving occasion. You *know* your gift will be wanted, needed, and appreciated because the recipient selects it himself from an extensive array of America's most wanted gift items. All you do is name the amount (\$2 to \$500). Select-A-Gift handles all details with utmost finesse and dignity—no prices mentioned—a real credit to your good taste and thoughtfulness.

For complete details about Select-A-Gift, the preferred prestige gift plan, mail the coupon today.

Select-A-Gift®

To: Select-A-Gift, Dept. 101, 1st Ave. N. at 13th St.,
Birmingham 3, Ala., FAirfax 3-6351

Please send me complete information on Select-A-Gift.

Name _____

Title _____

Firm name _____

Address _____

City _____ Zone _____ State _____

CIRCLE 215 ON READER SERVICE CARD



There's going to be a meeting

Who's going to get together and *what* are they going to talk about?

Electronics men are meeting all over the country to talk about everything from ultrasonics to quantum electronics.

electronics tells you where and when "Meetings Ahead" . . . gives you the highlights later on.

Another reason why it will pay you to subscribe to *electronics* (or renew your subscription) right now. Fill in the box on Reader Service Card. Easy to use. Postage free.

FIND WHAT YOU NEED IN...

electronics

← CIRCLE 38 ON READER SERVICE CARD

New Daven video distribution equipment

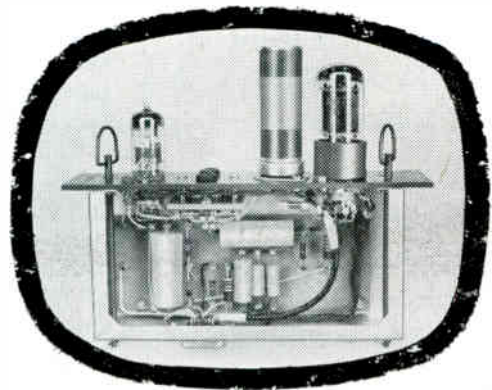

Greatest versatility for color or black-and-white!

- More outputs in less rack space
- Greatest selection to meet specific needs
- More flexibility for every possible application
- Very low differential phase and gain
- Extremely wide band width
- 7 plug-in video amplifier models; many also available as "bathtub" rack mounted chassis.

Write today for new 4-page technical bulletin!



THE **DAVEN** COMPANY

General
Mills

VIDEO EQUIPMENT
Livingston, New Jersey

TODAY, MORE THAN EVER, THE DAVEN © STANDS FOR DEPENDABILITY

CIRCLE 39 ON READER SERVICE CARD 39

new...

Malco

TABON TERMINALS and Insulating Sleeves

For Quick
Connect/Disconnect
Applications

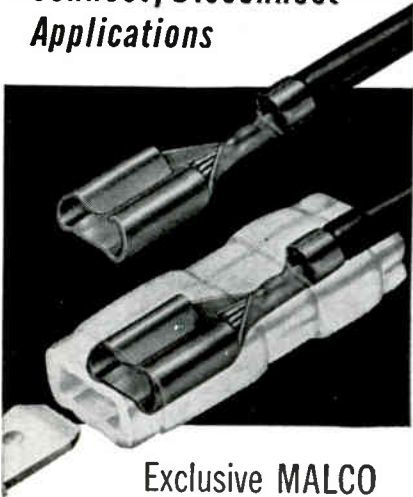

Exclusive MALCO
Design eliminates faulty
connections... assures
uniform crimping.

Specially contoured insulating sleeve accurately guides terminal into position on male tab. Entry of male tab (outside of terminal) within the insulating sleeve is positively prevented.

Malco Terminals are available in chain form for rapid machine crimping to wire. Insulating sleeves are also machine applied

REQUEST
BULLETIN
NO. 603



Malco MANUFACTURING CO.
4023 W. Lake St., Chicago 24, Ill.

Japan Plans More Computers

Tokyo sources report preliminary agreement with IBM to establish subsidiary there

TOKYO—Observers here report that International Business Machines has reached an agreement in principle with the Ministry of International Trade and Industry (MITI) on the validation under Japan's foreign investment law of IBM's decades-old manufacturing subsidiary. This agreement, when worked out in detail, will culminate four years of discussions and postponements.

Specifics must now be worked out and approved by the Japanese government's Foreign Investment Council. Those who have been watching this situation closely say they expect this phase to proceed without any hitches.

Negotiations were reportedly protracted by IBM's insistence on owning its subsidiary outright, in violation of Japan's traditional opposition to subsidiaries in which a foreign parent holds more than 50-percent equity.

Besides, the Japanese government has several times tried to form a consortium within the electronics industry to develop electronic computers. As part of the plan, Japan had wanted IBM to contribute technical knowhow.

The compromise agreement validates the subsidiary, leaving control very much in IBM's hands with one percent of the stock owned by nominee stockholders on the board of IBM Japan. It also sets up a cross-licensing agreement in which IBM extends some licenses to other Japanese manufacturers and becomes licensee under Japanese patents on the same terms.

The agreements were concluded at the end of last month, according to Tokyo sources, between J. W. Birkenstock of IBM and Shigeru Sabashi, director of MITI's Heavy Industries Bureau. MITI has forwarded the plan to its Foreign Investments Council which is expected to hand down a decision in the near future.

The agreement reportedly gives IBM a ten-percent royalty on sales

for a period of five years on the volume done by the Japanese subsidiary. It also gives IBM a five-percent royalty on sales made by Japanese builders of IBM systems outside the proposed subsidiary wherever IBM patents are involved. It also gives IBM a one-percent royalty for a five-year period on relays, diodes and transistors of IBM design used by Japanese firms.

Part of the planning calls for Japanese companies to operate as subcontractors of IBM Japan. Among these will probably be Hitachi, Fuji Communications, Oki Electric, Nippon Electric and others.

Tokyo commentators see the agreement between IBM and MITI as a breakthrough in the electronic computer field. Up to now, the computer business in Japan has been held back by certain lacks in technology, and by the inability of Japanese computermakers to work around foreign patent limitations.

Japanese industrialists and government men have long been convinced that the nation's low-cost labor and technical background makes computer manufacture a natural for Japan's industry, provided that suitable licensing agreements could be worked out with foreign companies.

The chairman of IBM Japan, Ko Mizushina, said the company plans to export IBM computer components to the U. S. Machines built by IBM Japan will contain some imported components but most of them will be manufactured domestically by Japanese subcontractors.

MITI sources say the new agreement will not set a precedent that will lead to the formation of other foreign subsidiaries in which a controlling interest is held by non-Japanese companies. They say that future developments in other companies and industries will very likely see a continued adherence by the Japanese government of not allowing more than 50-percent ownership by foreign companies.

Predicts 100 Billion Parts Per Cubic Foot

CEDAR RAPIDS, IA.—Outline of operation of a yet-to-be-invented device to duplicate the function of the brain neuron highlighted a conference on communications that attracted over 500 engineers here recently.

It was the fifth annual conference sponsored by the Cedar Rapids section of the Institute of Radio Engineers.

E. O. Johnson, chief engineer for RCA's semiconductor and materials division, discussed the artificial neuron that will help overcome the limitations of heat and maintainability in packing of sufficient density per cubic foot to match the brain's effective component density of 10^{11} . Optimum packing density of man-made devices now is about 10^6 .

Johnson listed gallium arsenide as one of the most important new semiconductor materials which, together with a general improvement in semiconductor technology, will lead to better device performance, reliability and lower cost. Gallium arsenide combines the frequency possibilities of germanium with a temperature capability that exceeds silicon.

The nation's need for improved communications was dramatized by a navy spokesman who declared, "Whether the U.S. is on the winning or losing side in any possible World War III will depend largely on how well we develop our communications systems."

Speaker was J. A. Krcek, assistant director of technical analysis for the deputy chief of naval operations. He said such present regular communication as from Honolulu to Washington by the moon must be expanded and he listed the economic aspects of space communications as the big battle.

S. J. Campanella, technical consultant to the chief engineer of Melpar Inc., sees more efficient use of the radio spectrum through speech bandwidth compression in voice communication. A significant compression potential exists since the information rate for transmission of the conventional speech signal is about 24,000 bits a second compared to 75 bits for equivalent transmission on teleprinter.

JENNINGS VACUUM CAPACITORS

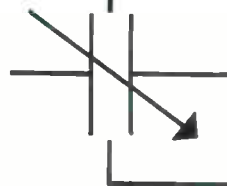
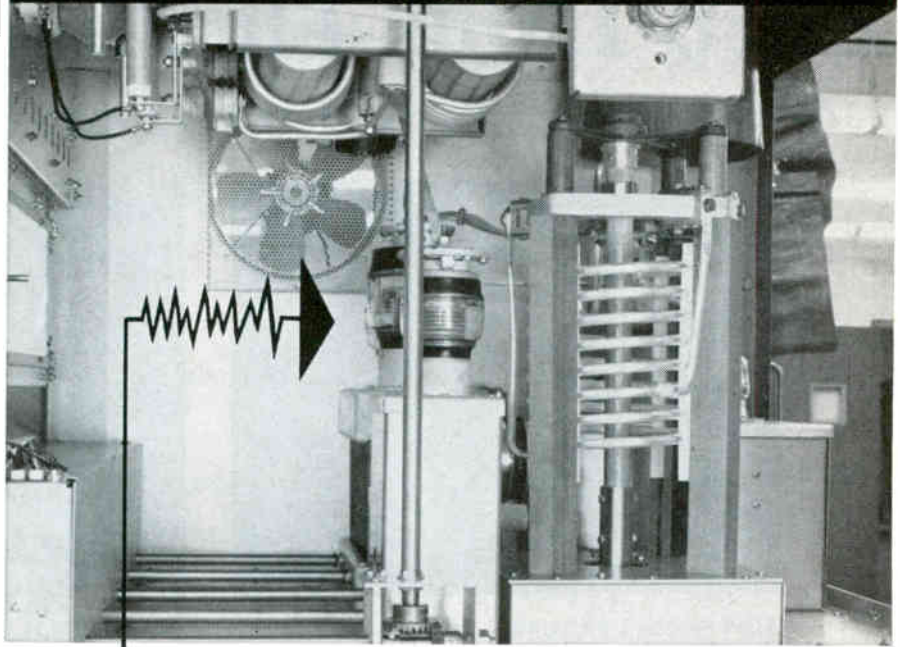

... speaking of capacitors—
**NOTICE HOW LITTLE SPACE
HIGH VOLTAGE VACUUM
CAPACITORS OCCUPY!**

Which is one of the reasons why Technical Materiel Corp. engineers are using 8 different types of vacuum capacitors in this new GPT-10K 10,000 watt SSB transmitter with complete band switching through its frequency range of 2 to 28 megacycles. Inductive losses are very low because the vacuum dielectric and concentric construction permits a maximum amount of capacitance at high voltage to be packed into an extremely small physical space. Vacuum capacitors also contribute to the superior performance of the transmitter through their extremely high ratio of capacitance change that makes possible a wide frequency range. Other advantages include all copper construction for high current ratings, and plates safely protected against contamination throughout their life by the vacuum seal.

Vacuum capacitors are useful in all sections of high powered transmitters, dielectric heating equipment, antenna phasing equipment and electronic equipment from cyclotrons to electron microscopes. Jennings manufactures over 300 types of vacuum capacitors with voltage ratings of 5 kv to 120 kv, and current ratings up to 500 amps rms. Further information on Jennings' complete line is available on request.

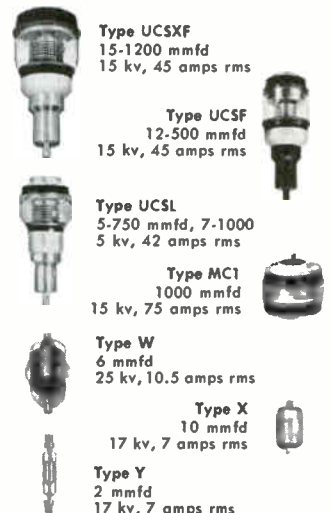

Reliability means Vacuum / Vacuum means **Jennings**

JENNINGS RADIO MFG. CORP., 970 McLAUGHLIN AVE., SAN JOSE 8, CALIF., PHONE CYpress 2-4025

Free from Thermal Fatigue

GENERAL ELECTRIC 6, 12 AND 25-AMP. SILICON RECTIFIERS

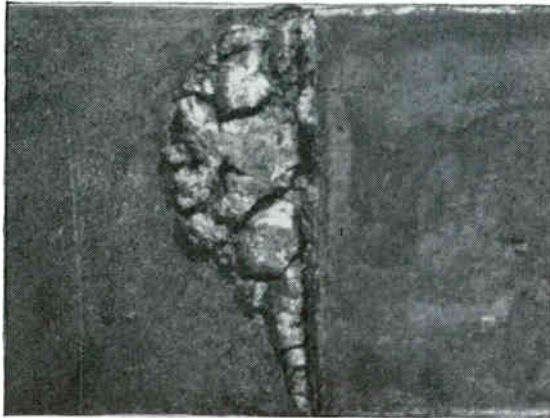

SOFT SOLDER FAILURE—As soft-solder joints are stressed by cyclical loads, solder begins to re-crystallize. (Photomicrograph above shows soft solder after 7000 cycles from 25°C to 160°C.) This causes heat dissipation path of rectifier to deteriorate until junction temperature reaches melting point or thermal runaway condition, and device fails.

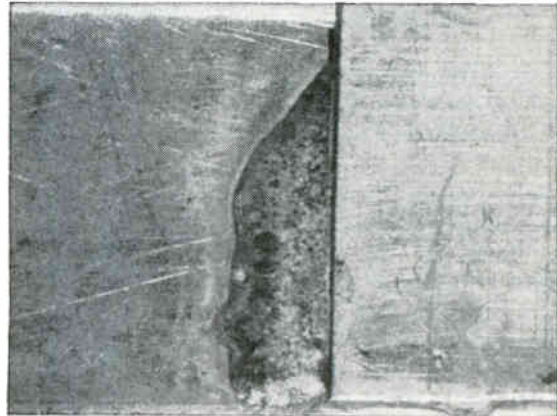

NO THERMAL FATIGUE — General Electric uses only hard solders in medium and high-current silicon rectifiers. (Note sound condition of G-E hard solder shown above.) Cycling tests on large samples of G.E.'s 1N2154 reveal no trace of thermal resistance deterioration after 70,000 temperature cycles from -35°C to 200°C.



A close look at the specs shows three more reasons why G-E medium currents are your best rectifier buy: (1) Lower leakage currents; (2) high surge current ratings for the new 1N1341A through 1N1206A and 1N2154 through 1N2160; (3) transient PRV ratings which let you buy only the continuous rating you need and still be fully protected for occasional transients. All units are available with negative polarity (at no extra cost) and come in a choice of hex sizes.

For the industry's fatigue-free medium-current silicon rectifiers, see your G-E Semiconductor District Sales Manager or Authorized Distributor. *In Canada:* Canadian General Electric Co., 189 Dufferin St., Toronto, Ontario. *Export:* International General Electric Co., 150 E. 42nd St., New York 17, N. Y.

Circuit designers: Make your job easier! Write for a free copy of "Characteristics of Common Rectifier Circuits." Contains basic constants you'll use every day on rectifier circuits and transformer design — all in handy, easy-reference form.

JEDEC or GE Type Number	Max Idc @ 145°C Stud Single Phase	Repetitive PRV	Transient PRV	Max. Peak 1 Cycle Surge
1N1341A	6A	50	100	150A
1N1342A	6A	100	200	150A
1N1343A	6A	150	300	150A
1N1344A	6A	200	350	150A
1N1345A	6A	300	450	150A
1N1346A	6A	400	600	150A
1N1347A	6A	500	700	150A
1N1348A	6A	600	800	150A
1N1199A	12A	50	100	240A
1N1200A	12A	100	200	240A
1N1201A	12A	150	300	240A
1N1202A	12A	200	350	240A
1N1203A	12A	300	450	240A
1N1204A	12A	400	600	240A
1N1205A	12A	500	700	240A
1N1206A	12A	600	800	240A
1N248	10A	50		200A
1N249	10A	100		200A
1N250	10A	200		200A
1N248A	20A	50		350A
1N249A	20A	100		350A
1N250A	20A	200		350A
1N2154	25A	50	100	400A
1N2155	25A	100	200	400A
1N2156	25A	200	350	400A
1N2157	25A	300	450	400A
1N2158	25A	400	600	400A
1N2159	25A	500	700	400A
1N2160	25A	600	800	400A

Progress Is Our Most Important Product

GENERAL  ELECTRIC

Section S2590, Semiconductor Products Dept., Electronics Park, Syracuse, N. Y.

Urges More Spending for Radar Astronomy

SEATTLE, WASH.—The first rocket probe to Mars should contain electronic equipment to detect any possible interference or destruction as a result of actions of intelligent beings, the third annual West Coast meeting of the American Astronautical Society was told recently.

The probe also should be capable of transmitting information back to Earth on the nature of the Martian canals and the two Martian moons, declared Wells A. Webb, research chemist for Hexcel Products, Inc., Berkeley, Calif., and James Harder, assistant professor of civil engineering at the University of California.

The two researchers pointed out there is enough evidence indicating the possibility of past or present intelligent life on Mars to make it worthwhile to instrument the first Mars probe so it will detect manifestations of such intelligence if it exists. They also believe it likely the Martians might be able to detect, destroy or capture rocket probes from Earth.

If the probe could carry some type of tv transmitting parabola, it could provide information on the Martian moons, declared the researchers.

Von R. Ashleman, associate professor of electrical engineering at Stanford University, called for allocation of at least five percent of the total expenditure for space exploration "for large scale development

of radar astronomy research facilities."

"Radar technology has advanced rapidly during the past few years, and systems now are being built which should push the range of detection out beyond Jupiter," said Ashleman. "However, more money is needed for continued improvement in radar capabilities, especially for the development of higher powered transmitters and larger antennas."

Possible answers to problems of re-entering the Earth's atmosphere in manned ballistic-type space vehicles were outlined by E. F. Styer of the Boeing Aero-Space division's structures technology department. Styer's work covered vehicle shape and size, re-entry angle, aerodynamic heating, radiation hazards, vehicle structure, maneuvering and entry methods, and landing.

Space vehicle systems will require "highly reliable automatic control systems with adequate provisions for in-route re-programming for emergency human decisions," emphasized Alfred M. Mayo, assistant director for bioengineering in the National Aeronautics and Space Administration's Office of Life Science Programs.

Display systems not only must give the operator immediate control requirement data but must answer the questions, "What am I doing?" "What should I be doing?" and "How am I doing?" Mayo declared.

Reusable Instrument Container

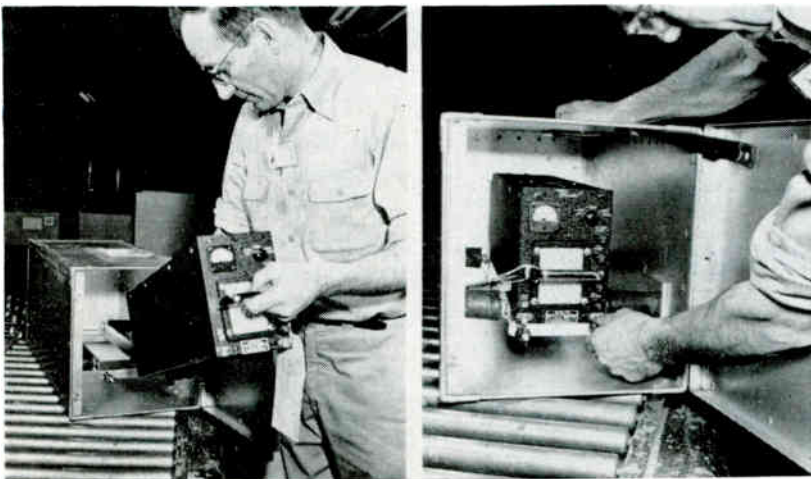

Universal reusable container by Bendix has an internal shock-absorbent rack to secure instrument firmly. Container will hold largest instrument in specified air transport rack (ATR) size, company says

*first
choice*
FOR
*critical
applications*



ADJUSTABLE PRECISION POLYSTYRENE CAPACITORS



**.01% accuracy
hermetically sealed**

SOUTHERN ELECTRONICS hermetically sealed precision adjustable capacitors are finding many applications in analog computers, network tuning circuits, differential analyzers and similar electronic circuitry that requires the utmost in accuracy and reliability.

SEC has pioneered in the design and manufacture of hermetically sealed adjustable capacitors, and this experience has resulted in a .01% accuracy standard, and a degree of in-circuit-reliability not previously available at any price. SEC adjustable capacitors incorporate features proven to be years ahead of any comparable product now available.

GENERAL SPECIFICATIONS

Available from .01 mfd. to 10 mfd.

Accuracy: .01%

Long Term Stability: 0.03%

Temperature Coefficient: -100 PPM per °C

Temperature Range: -40°F to +140°F

Write today for complete specifications and general catalog.



Fast delivery schedules. Phone or write for complete information.

**SOUTHERN
ELECTRONICS**
Corporation

150 WEST CYPRESS AVENUE
BURBANK, CALIFORNIA

-
- **Cosmic Ray Intensity**
-
- **Gravitational Force**
-
- **Atmospheric Density**
-
- **Outer Space Temperature**
-

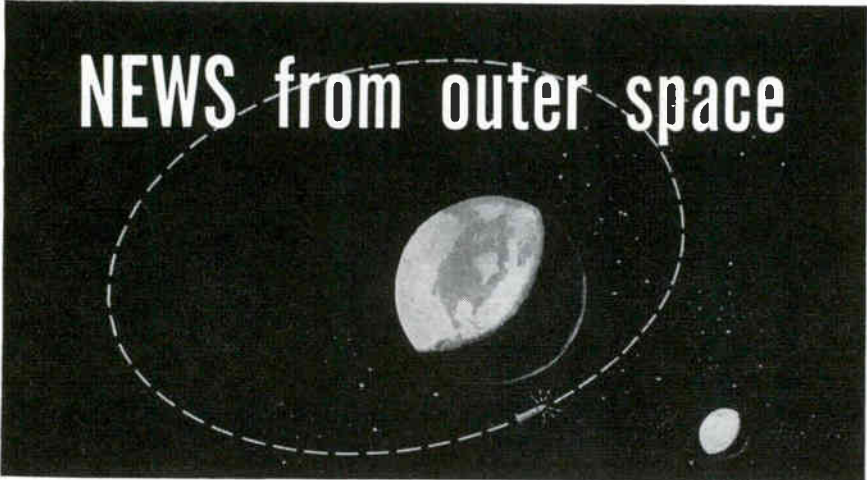

-
- **This important news** comes from outer
- space via telemetry receivers designed and
- produced by Nems-Clarke. More than 95%
- of the telemetry receivers at United States
- missile test stations and ranges were de-
- signed and built by Nems-Clarke. Among
- many installations now using this equip-
- ment are:

- **Patrick Air Force Base**
- **White Sands Missile Range**
- **Eglin Air Force Base**
- **Vandenberg Air Force Base**
- **Army Ballistic Missile Agency**

50 YEARS OF EXPERIENCE

NEMS • CLARKE CO.

A DIVISION OF VITRO CORPORATION OF AMERICA

919 JESUP-BLAIR DRIVE • SILVER SPRING, MARYLAND

MEETINGS AHEAD

- Sept. 23-24: Broadcasting Symposium, PGB of IRE, Willard Hotel, Washington, D. C.
- Sept. 23-25: Hi-Fi, Home Entertainment Show, Palmer House, Chicago.
- Sept. 26-30: Instrument-Automation Conf. and Exhibit of 1960, ISA Annual Meeting, Coliseum, New York City.
- Sept. 27-30: Space Power Systems Conf., ARS, Miramar Hotel, Santa Monica, Calif.
- Sept. 27-Oct. 1: Electrostatic Forces and Their Applications, Laboratoire D'Electrostatique et Physique du Metal, Institut Fourier, Place du Doyen-Gosse, Grenoble, France.
- Oct. 3-5: Communications Symposium, PGGs of IRE, Hotel Utica & Utica Memorial Auditorium, Utica, N. Y.
- Oct. 4-6: Radio Interference Reduction, PGRFI of IRE, Armour Research Foundation, Chicago.
- Oct. 4-7: Instrumentation Symposium, Nat. Inst. of Health, Bethesda, Md.
- Oct. 4-9: Data Processing Systems, Large Volume, Fall Meeting, AIEE, New York City.
- Oct. 5-6: Value Engineering, EIA, Disneyland Hotel, Anaheim, Calif.
- Oct. 10-12: National Electronics Conf., Hotel Sherman, Chicago.
- Oct. 11-14: Audio Engineering Soc., Annual Convention, Hotel New Yorker, New York City.
- Oct. 13-14: Engineering Writing & Speech, Annual Symposium, PGEWS of IRE, Bismark Hotel, Chicago.
- Oct. 14-15: Quality Control Conf., ASQC, Broadview Hotel, Wichita, Kan.
- Oct. 17-19: Adaptive Control Systems Symposium, IRE, Garden City Hotel, Garden City, N. Y.
- Oct. 18-20: Battery Symposium, Ministry of Aviation, S.R.D.E., The Pavilion, Bournemouth, England.

NOW AVAILABLE CBS MADT* HIGH-SPEED SWITCHING TRANSISTORS

20% Faster

25% More Efficient

MADT transistors offer you greater speed, efficiency, and performance per dollar than competitive high-speed devices in low-current switching circuits. They combine the advantages of the latest electrochemical, diffusion and micro-alloy techniques automated in mass production. Special CBS features include: cadmium junctions for increased dissipation ratings . . . hermetically sealed TO-1 package . . . over-all quality exceeding MIL-T-19500A. Check the 2N501 and 2N501A characteristics and their many advantages in the high-speed, efficient binary counter shown. Call or write for data and delivery information.

ADVANTAGES OFFERED BY 2N501 and 2N501A

1. Base resistance r_b , 50% lower
2. Collector capacitance C_c , 40% lower, more uniform
3. Lower hole storage delay time
4. Current gain more easily traded for speed
5. Saturation resistance 50% lower, more stable
6. Saturation voltage 50% lower, cooler operation
7. In-circuit device dissipation 66% lower
8. Higher temperature stability, efficient up to 65°C
9. Larger leads, more rugged and firmly attached
10. Adaptable to simple saturated circuits — lower current, voltage, power requirements
11. More high-speed, power-saving performance

CHECK THE CHARACTERISTICS

Characteristics	2N501	2N501A
Max. junction temperature, °C	85	100
Max. collector-base voltage, v	-15	-15
Max. dissipation, mw	25#	60†
Max. collector current, ma	-50	-50
Min. h_{FE} ($V_{CE} = -0.5v$, $I_C = -50$ ma)	20	20
Max. V_{CE} sat. ($I_C = -10$ ma, $I_B = 1$ ma), v	0.2	0.2
Max. V_{BE} "on" voltage, v	0.50	0.45
Typical gain-bandwidth product, mc	90	90
#At 45°C †At 25°C		

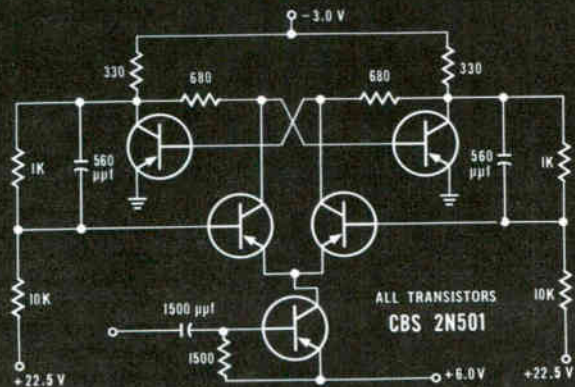

NEW HIGH-SPEED BASE-GATED BINARY COUNTER uses CBS MADT 2N501 transistors to achieve an input counting rate of 70 mc. The saturating transistor gate minimizes both turn-on and turn-off delay. Flip-flop transition is completed in less than 16 nsec.



semiconductors

More Reliable Products
Through Advanced Engineering

*Micro Alloy Diffused-base Transistor, trade-mark Philco Corp.

CBS ELECTRONICS, Semiconductor Operations, Lowell, Mass. • A Division of Columbia Broadcasting System, Inc.

Sales Offices: *Lowell, Mass.*, 900 Chelmsford St., GLENVIEW 2-8961 • *Newark, N. J.*, 231 Johnson Ave., TAlbot 4-2450 • *Melrose Park, Ill.*, 1990 N. Mannheim Rd., EStebrook 9-2100 • *Los Angeles, Calif.*, 2120 S. Gardfield Ave., RAYmond 3-9081 • *Atlanta, Ga.*, Cary Chapman & Co., 400 Trusco Way, S. W., PLaza 8-4500 • *Minneapolis, Minn.*, The Helmuth Co., 1711 Hawthorne Ave., FEderal 2-5457 • *Toronto, Ont.*, Canadian Electric Co., Ltd., LEExon 4-6311

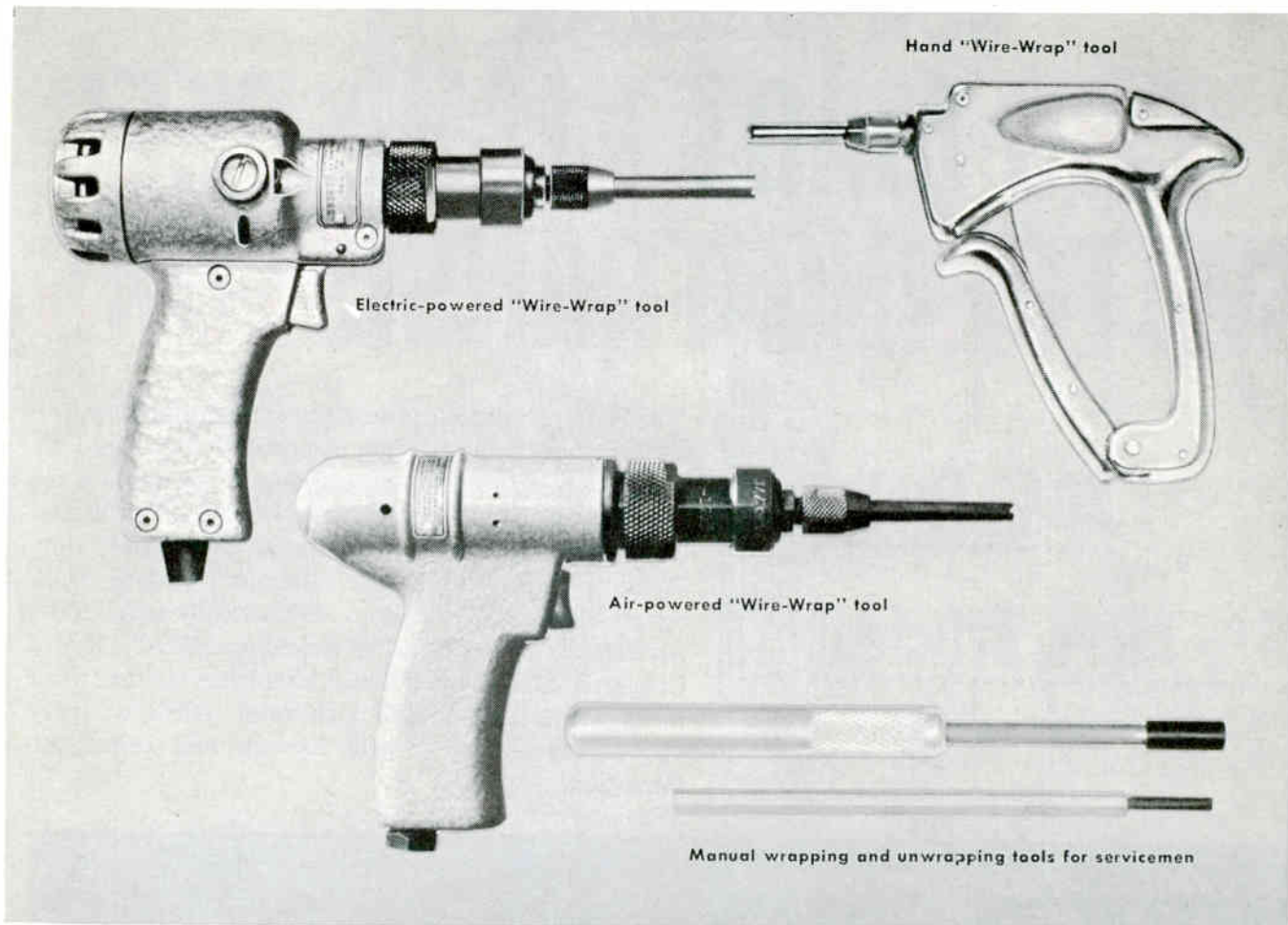

Gardner-Denver Wire-Wrap® roundup

Choose from Gardner-Denver's complete line of hand-held "Wire-Wrap" tools and put your electrical connections on a 3-second production schedule. That's all the time it takes to make a permanent electrical connection using the solderless wrapping method.

Proved superior by leaders in communications and electronics, these connections are lastingly secure, conquer vibration failure and corrosion. Only Gardner-Denver offers a complete line of equipment to make such connections, including . . .

automatic "Wire-Wrap" machines like the one at right. If you have a special problem in multiple operations of connecting wires, it'll pay you to see Gardner-Denver first. Want details? Write for bulletins.

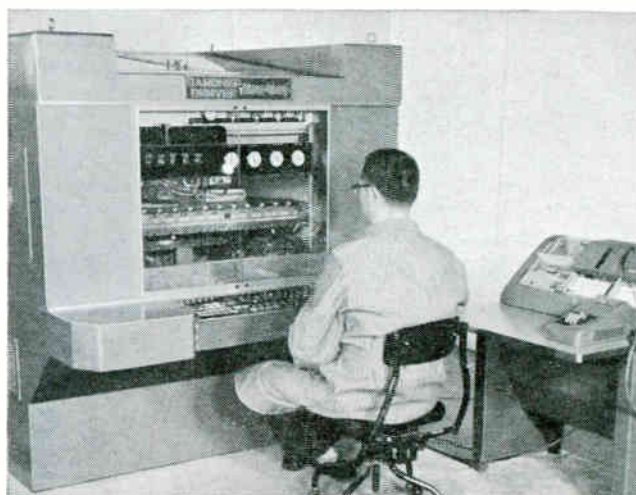

Operated manually or automatically by punched cards or tapes, machine can place 10,000 wires on a 20" x 20" modular terminal board. Wraps terminals in a 10" x 10" wrap area—puts as many as three connections on each terminal. Completes entire wrapping cycle to interconnect two terminals in six seconds.



EQUIPMENT TODAY FOR THE CHALLENGE OF TOMORROW

GARDNER - DENVER

Gardner-Denver Company, Quincy, Illinois

In Canada: Gardner-Denver Company (Canada), Ltd., 14 Curily Ave., Toronto 16, Ontario

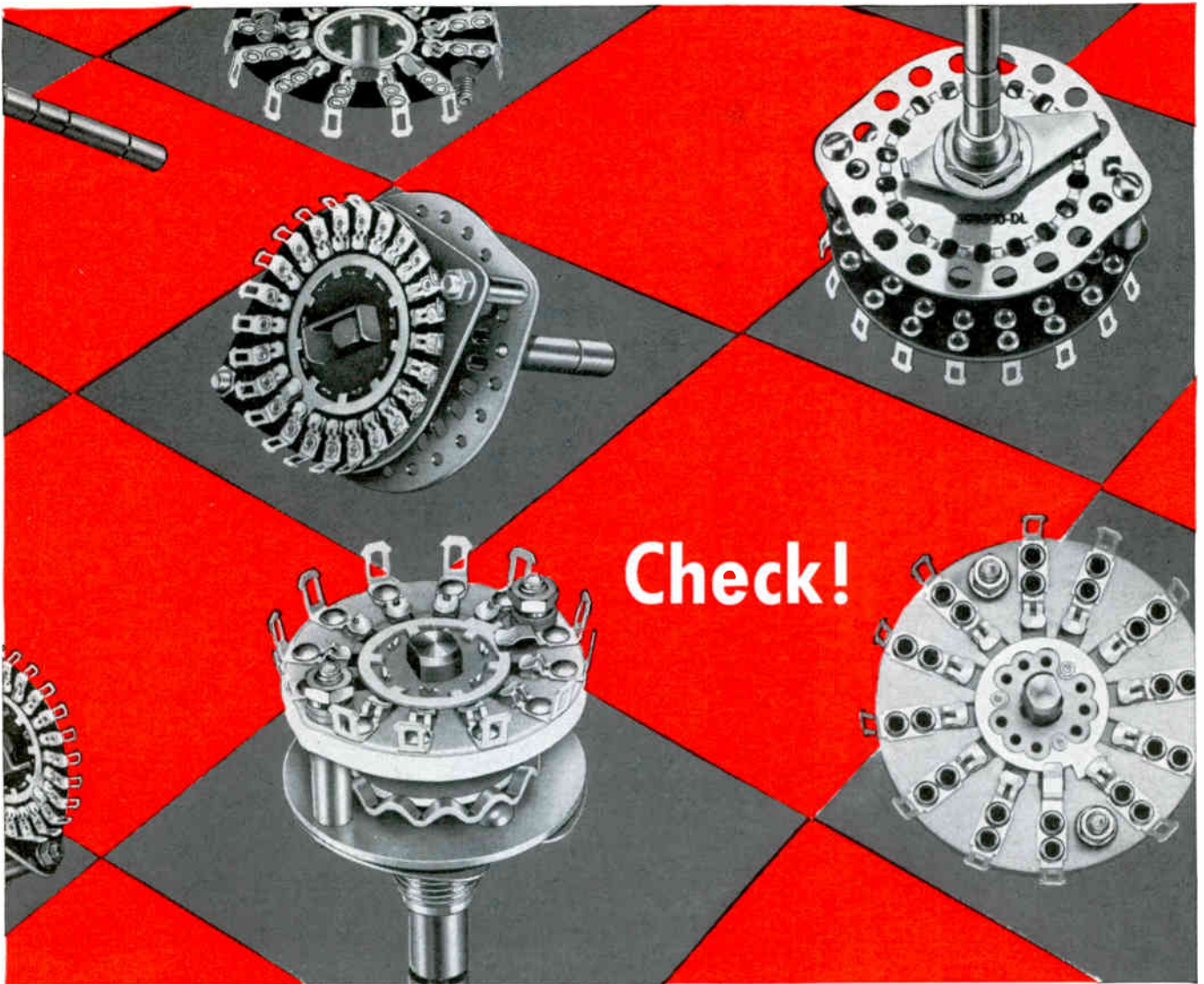

Check!

The move to **Oak Stock Switches** wins Design Time

One of our 124 different stock switches may be just what you need to put your prototype on the production line. The model you choose is available for 48-hour delivery, in quantities up to 249. What's more . . . most types and sizes are available from OAK only—fully assembled or as sub-assemblies.

And remember—if you can't find an OAK

Stock Switch to suit your needs, OAK's creative engineering staff will quickly modify an existing unit or develop a new one to meet your exact specifications.

Learn how OAK Stock Switches will save you time. Contact your nearest OAK representative or send for Catalog 399 showing complete stock line and prices.



Creative engineering • Quality components

OAK MANUFACTURING CO.

1260 CLYBOURN AVENUE, CHICAGO 10, ILLINOIS
phone MOhawk 4-2222

Switches • Rotary solenoids • Choppers • Vibrators • Tuners • Subassemblies



from milliwatts

to megawatts

EIMAC OFFERS RF POWER FOR ALL AIR-SPACE SYSTEMS

From miniature microwave devices to the highest power klystron, Eimac offers rf power for every type of air-space system. With tubes designed for airborne communication. For warning systems. For tracking and guidance. You can look to Eimac as the one source of all your rf power needs. ■ For still further progress, new tube types to meet new needs, Eimac continues to forge ahead with the most advanced research facilities available today for power tube development. And its manufacturing program is unmatched in ability to turn blueprint ideas into quantity production. No wonder Eimac tubes power nearly every major air-space system the world over: telemetry, troposcatter, navigational radar, high-power radar—including the recent BMEWS program. Eitel-McCullough, Inc., San Carlos, Calif.



Experience—the added alloy in A-L Electrical Steels

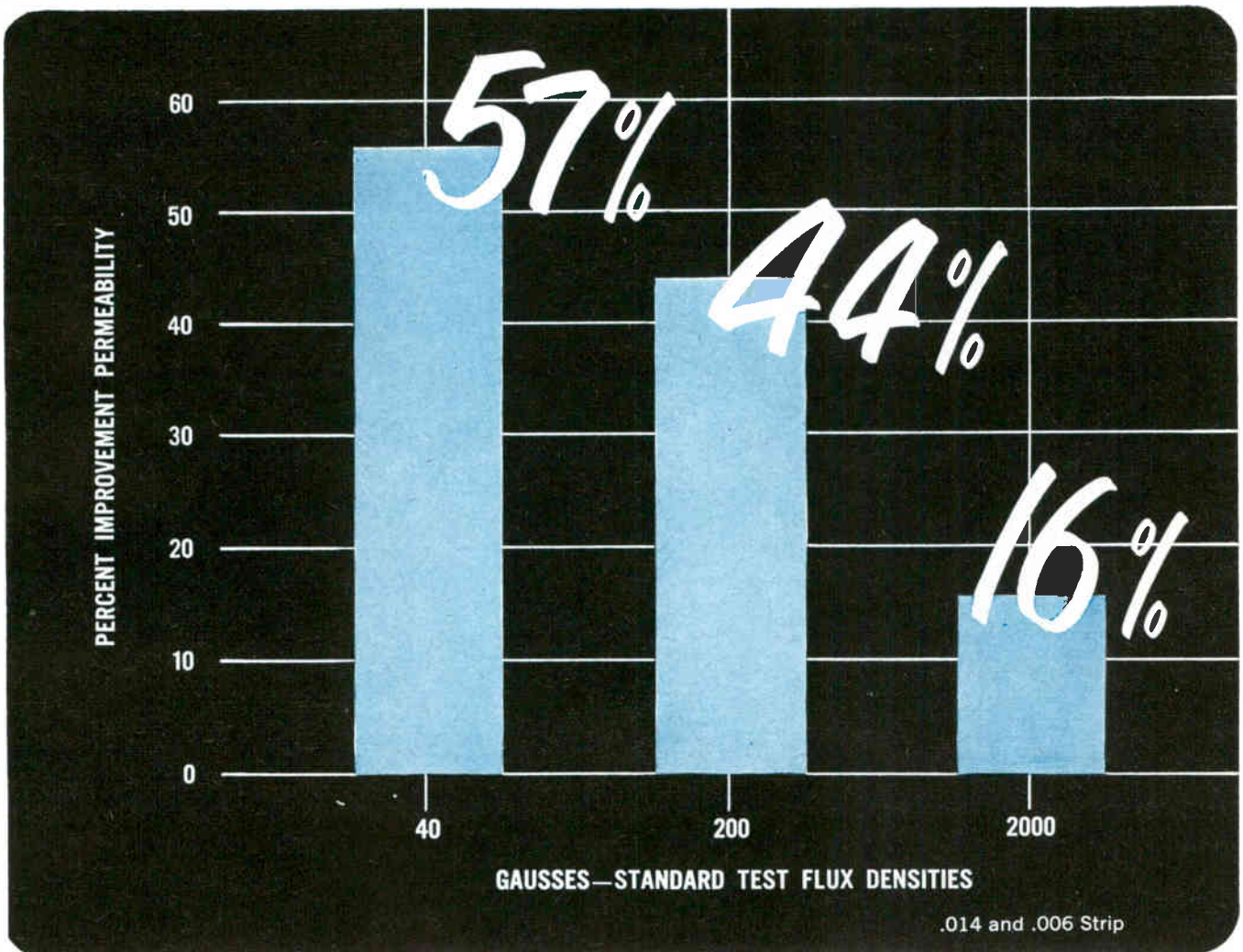

Greater permeability for Allegheny Ludlum's AL-4750...and it's *guaranteed*

promises more consistency, higher predictability for magnetic cores

AL-4750 nickel-iron strip now has higher *guaranteed* permeability values than ever before. For example, at 40 induction gaussses AL-4750 now has 57% higher permeability than in the past, using the standard flux density test.

This greater permeability means better consistency and predictability for magnetic core users . . . and allows careful, high performance design.

This improvement in AL-4750 is the result of Allegheny Ludlum's continuing research on electrical alloys and

nickel-bearing steels. Moly Permalloy has been similarly improved in permeability. A-L constantly researches silicon steels, including A-L's well-known grain-oriented silicon, Silectron, and other magnetic alloys.

Complete facilities for the fabrication and heat treatment of laminations are available at Allegheny Ludlum. And A-L's technical know-how guarantees you close gage tolerance, uniformity of gage throughout the coil and minimum spread of gage across the coil-width.

If you have a problem on electrical steels, laminations or magnetic material, call A-L for prompt technical assistance. Write for blue sheet EM-16 for complete data on AL-4750. *Allegheny Ludlum Steel Corporation, Oliver Building, Pittsburgh 22, Pa. Address Dept. E-9.*

WSW 7491

ALLEGHENY LUDLUM

STEELMAKERS TO THE ELECTRICAL INDUSTRY

Export distribution, Electrical Materials: AIRCO INTERNATIONAL INC., NYC 17

Export distribution, Laminations: AD. AURIEMA, NYC 4



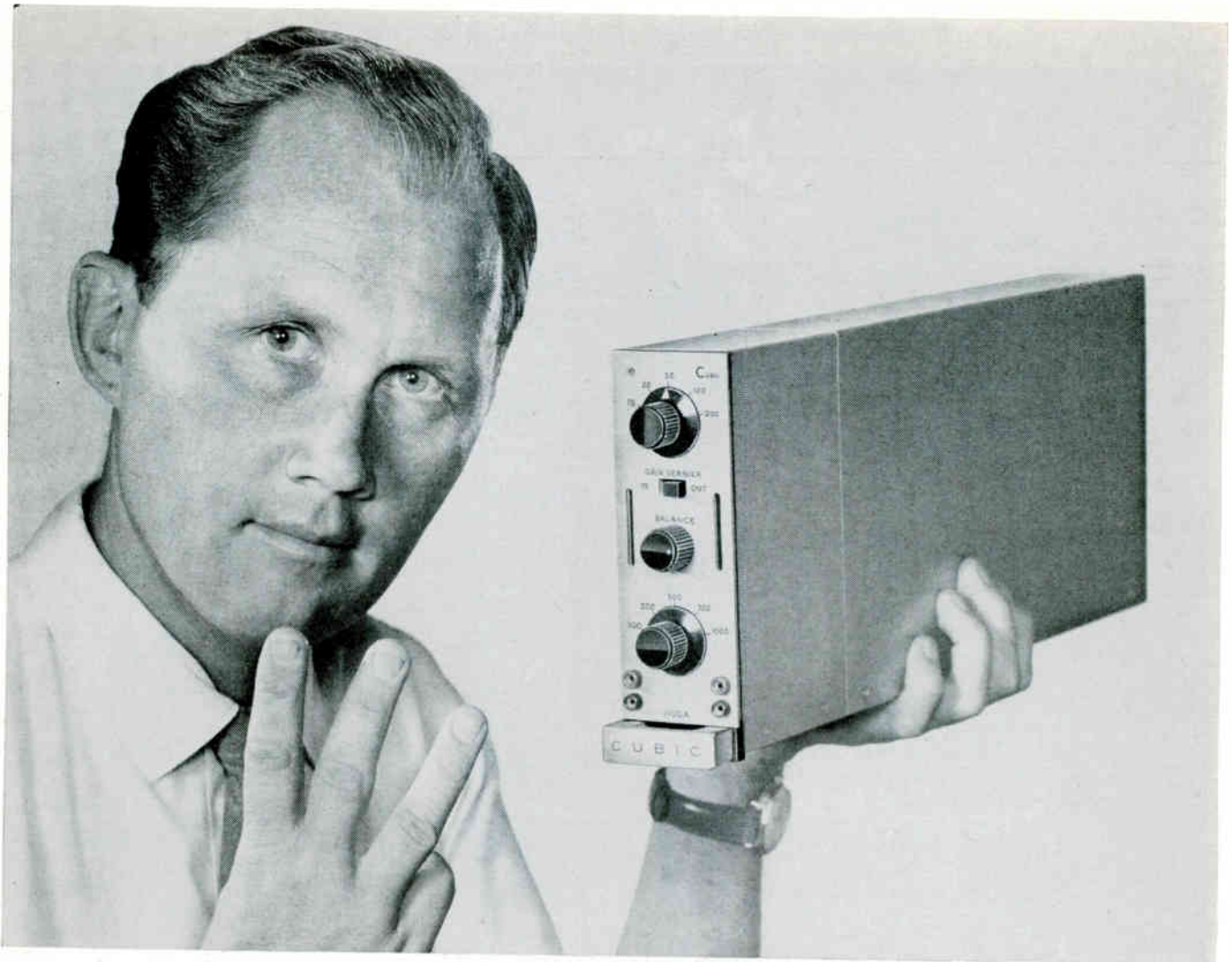

New Cubic 3-in-1 d-c amplifier has built-in strain-gauge power supply

Important savings in cost, space, and setup time are now possible for users of strain gauges with the Cubic Model 1100 d-c wideband amplifier. This newest addition to the Cubic line of instrumentation amplifiers is really three units in one. It is (1) a differential-input, wideband d-c amplifier, (2) a bridge balance circuit, and (3) a well regulated strain-gauge power supply.

For applications not requiring the self-contained power supply, modules which contain two d-c amplifiers can be supplied. You can mount 8 of these modules abreast (16 amplifiers) in a single standard rack.

Model 1100 amplifiers with built-in power supplies eliminate the hookup problems formerly encountered in multiple-strain-gauge operations. Even more important, they permit saving \$200-400 per channel since separate power supplies and bridge balance circuits are no longer needed.

ALSO THE 1000-SERIES

The Cubic line of d-c wideband amplifiers also includes the

Model 1000 series. These highly sophisticated solid-state instruments incorporate all the design improvements of 1960's state-of-the-art. Key to their versatility is the *Cubi-plug*, a module that plugs into the 1000-series amplifier chassis to provide any required gain, fixed or variable, and single-ended or differential input.

SPECIFICATIONS AVAILABLE

Write for complete specifications and ordering information on Cubic's complete line of instrumentation amplifiers. Dept. E-2, Industrial Division, Cubic Corporation, San Diego 11, California.



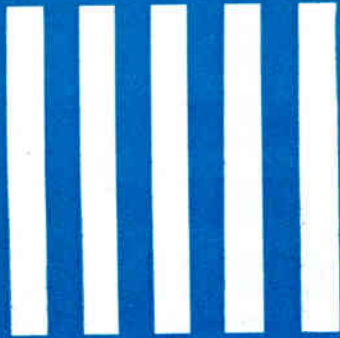

THE RIGHT LINE IN THE RIGHT PLACE AT THE RIGHT TIME...

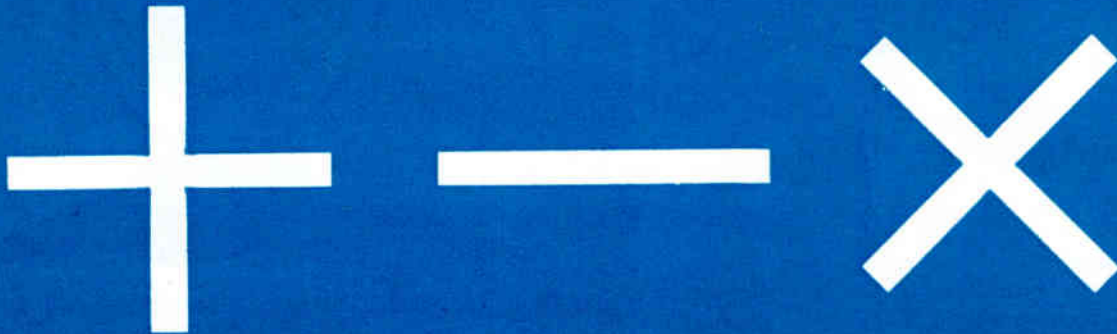

The Avnet System

creates a new Concept of Distribution

The Avnet System knows how to put the *right* line of electronic components in the *right* place at the *right* time. This little difference can make a big difference in your final result. If your requirements call for a certain type of component with, perhaps, highly individualized specifications, The Avnet System will put exactly what you need where you need it... at the time you designate.

This Concept of "right" in selecting a line of electronic components is one of the many advantages in The Avnet System. *Avnet maintains a network of Sales Engineers traveling the U.S. Each engineer has his counterpart in a Service Center Expediter. Tremendous stocking facilities are maintained strategically throughout the country. Avnet maintains and operates complete assembly facilities for Connector Prototype requirements.* For the right line of electronic components, contact your nearest Service Center in The Avnet System.

AVNET



THE AVNET SYSTEM
Men / Methods / Materials / Management
AVNET ELECTRONICS CORP.

Avnet Service Centers and Stocking Facilities are located in Los Angeles, Cal.; Sunnyvale, Cal.; Chicago, Ill.; Dayton, Ohio; Westbury, L. I.; Burlington, Mass.

Avnet distributes from its stocking facilities: BENDIX SCINTILLA CONNECTORS, SPERRY SEMICONDUCTORS, RHEEM SEMICONDUCTORS, ELECTROSNAP AND HETHERINGTON SWITCHES, GREMAR CONNECTORS, CLARE RELAYS, ROBERTSON SPLICE & CONNECTOR CASES, BABCOCK RELAYS, KING SUBMINIATURE HI-TEMP CERAMIC CAPACITORS, TIC PRECISION TRIMMERS, VIBREX FASTENERS by GENERAL TIRE & RUBBER CO., U. S. SEMCOR SEMICONDUCTORS, SANGAMO CAPACITORS, SPRAGUE CAPACITORS

IDEAS for cutting costs . . .

ELIMINATE THREADING OPERATION. Barrel of a small keycase flashlight required separate threading operation to accommodate cap. Fabricated Metal Goods Division engineers suggested three indentations to replace female thread so aluminum barrel could be completely fabricated on our multiple-plunger presses—cutting out cost of second operation.

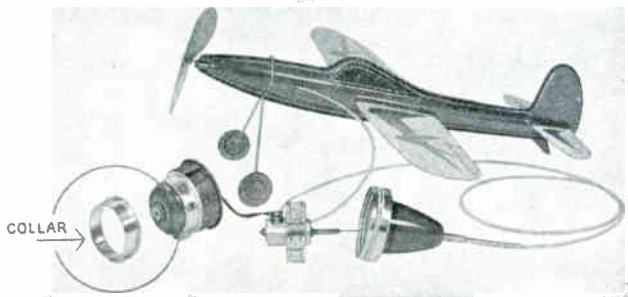
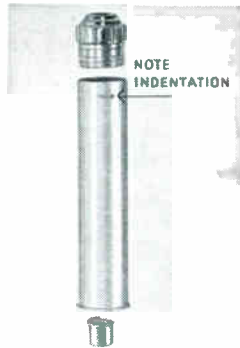

LOW-COST COLLAR. Toy maker needed a large flat-flange collar to act as stop and contact for switch and to conduct current from batteries to motor operating toy plane. Using experience in making eyelets, our engineers designed a precision aluminum part we could make on a multiple-plunger press. The part simplified assembly, served electrical and mechanical functions—had a very attractive price.

EYELET FOR OIL FEED. Motor manufacturer was making oil-feed tubes by cutting short lengths from seamless tube and flaring one end—and having some trouble in assembly with square-cut end. Our engineers designed a funnel-flange eyelet to the specified dimensions—with a radius on unflanged end to simplify assembly. Because we made the part on a multiple-plunger press, metal gage could be reduced. Total savings were very considerable.

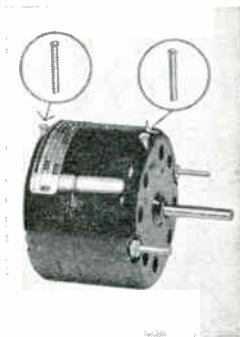

Maybe we can develop cost-cutting ideas for you, too. We offer a complete design-engineering service based on long experience and specialized production equipment. Write for Booklet BG-5. Better yet, send a sample, drawing, or description of a part you need to produce at low cost (any metal, any finish) for an eye-opening quotation. Address: Fabricated Metal Goods Division, The American Brass Company, Waterbury 20-A, Conn. 60178

ANACONDA®

MULTIPLE-PLUNGER PRESS PRODUCTS

Made by The American Brass Company

IT'S WHAT'S IN HERE THAT COUNTS

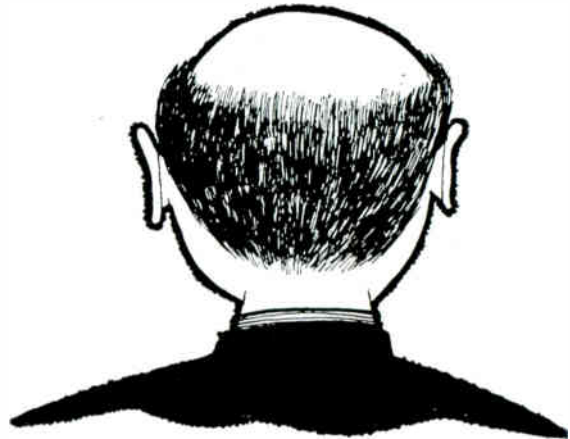

Do you know, for instance... which electronic stocks are hottest? Who's in the news and why? About "Three Approaches to Microminiaturization"? About the newest product ideas hitting the market? What's up in production? Opportunities overseas? What's going on in Washington?

It pays to know more than the next man! The questions above are just 6 reasons why you should subscribe to *electronics*.

IF YOU'RE ON THE TAG END OF A ROUTING SLIP, get your own subscription. Knowing what's going on is the first step to going up.

Fill in the coupon below right now...it will pay big dividends.

FIND WHAT YOU NEED IN... electronics

_____ Renew my subscription for 3 more years.

_____ Enter my new subscription.

U.S. Subscription Rates: _____ 3 years \$12. _____ 1 year \$6

Canadian rates \$10 for 1 year. Foreign rates \$20 for 1 year.

Name _____

Street _____

City _____ Zone _____ State _____

Company _____

Street _____

City _____ Zone _____ State _____

Your Title _____ Department _____

Product Manufactured or Service Performed _____

Mail reply to: electronics, 330 West 42nd Street, New York 36, N.Y.

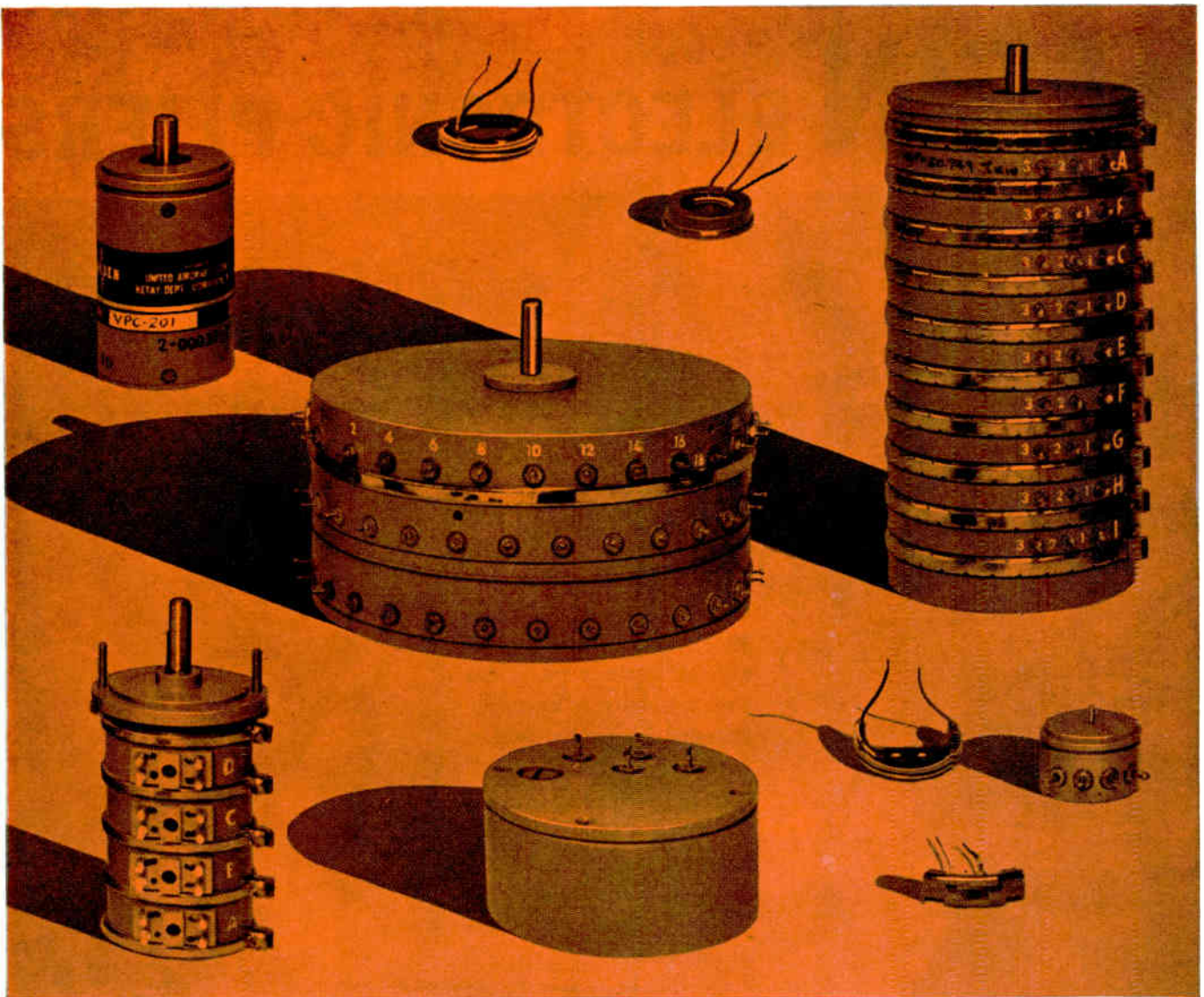

A collection of special Ketay potentiometers including single turn, multi-turn, ganged, sector, pendulum and pick-off types. Both linear and non-linear models are included.

Call on Ketay for your Precision Potentiometer Requirements

Ketay has capabilities for designing and manufacturing specialized as well as standard precision potentiometers. Ketay can fulfill a wide range of requirements with potentiometers offering these superior features:

PRECIOUS METAL or base metal windings meet temperature coefficients, low torque and low noise level requirements.

WELDED TAPS permit high resolution since there are no shorted turns in the tap region. Ketay-designed equipment enables wire to be welded $1/5$ the diameter of a hair.

OPTIMUM ACCURACY for all diameters—Ketay's exclusive servo-controlled winding machines assure constant tension and accurate spacing of turns. Conformity of 0.05% and better within a 3" diameter is an example of Ketay potentiometer accuracy.

HIGH TEMPERATURE (to 300°C) and nuclear resistance. Ketay can supply precision potentiometers to generate functions such as sine, cosine, tangent or exponential and empirically derived curves. Units can be designed for almost any environment. Detail your exact specifications and mail to us at



KETAY DEPARTMENT
NORDEN DIVISION
UNITED AIRCRAFT CORPORATION
COMMACK, LONG ISLAND, NEW YORK

SPEEDING UP ASSEMBLY LINE WITH KLEIN ELECTRONIC PLIERS

SHEAR CUTTING PLIERS

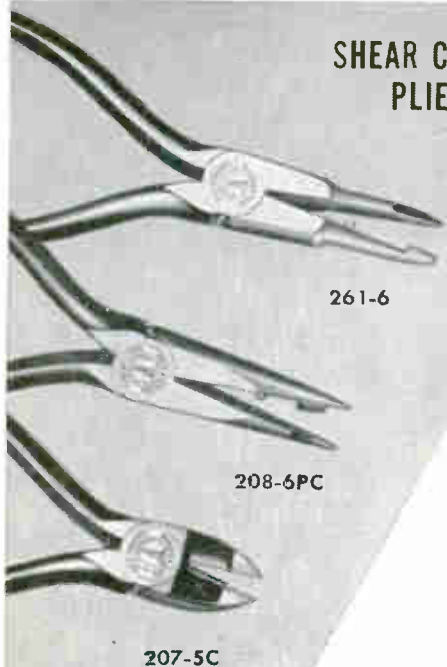

261-6

208-6PC

207-5C

LONG NOSE PLIERS

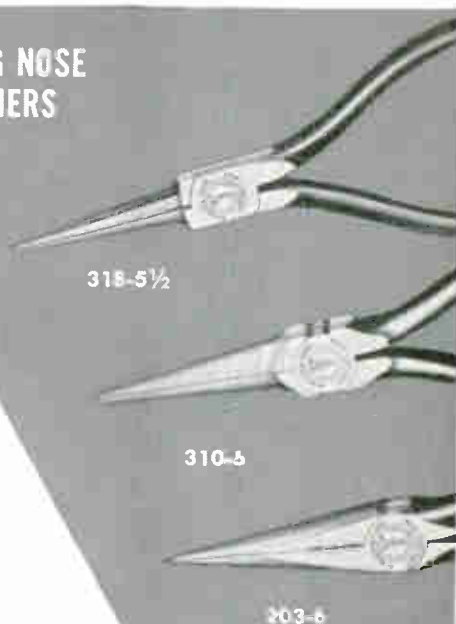

318-5½

310-5

303-6

In the rapidly growing field of electronics, there is an increasing need for highly specialized pliers. While you're using a plier designed to do a particular job, not only is assembly speeded up but better performance is assured.

Our own engineers, working with electronic manufacturers, have developed many pliers that serve the specialized needs of this field.

On this page are shown a few of the many pliers available in the complete Klein line.

WRITE FOR CATALOG

If you do not have a copy of the new Klein Catalog 103A illustrating and describing Klein Pliers, write for a copy. It will be sent without obligation.

ASK YOUR SUPPLIER

Foreign Distributor:
International Standard
Electric Corp., New York

MIDGET PLIERS

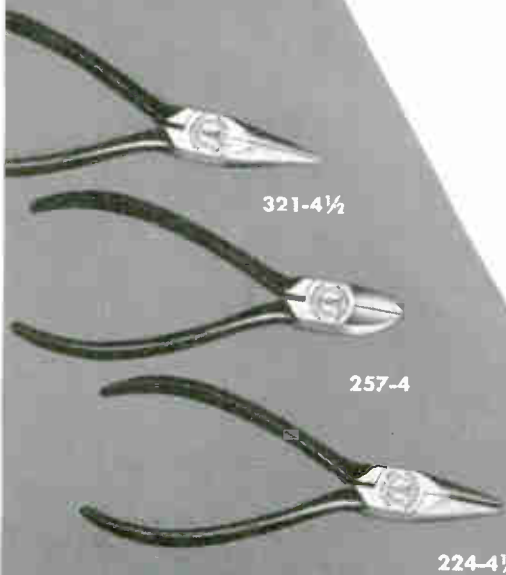

321-4½

257-4

224-4½

OBLIQUE CUTTERS

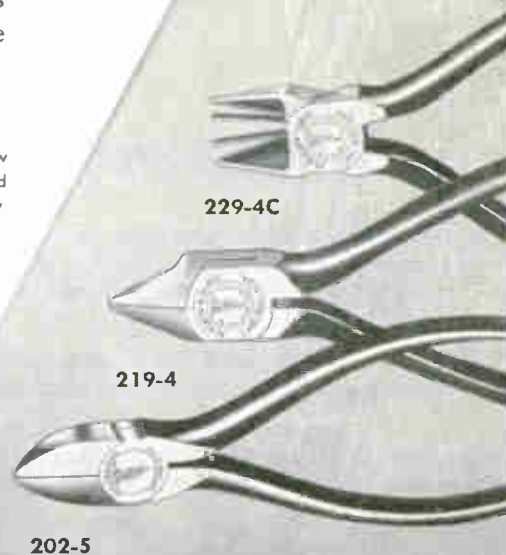

229-4C

219-4

202-5



Mathias KLEIN & Sons
Established 1857 Chicago, Ill., U.S.A.
7200 McCORMICK ROAD • CHICAGO 45, ILLINOIS

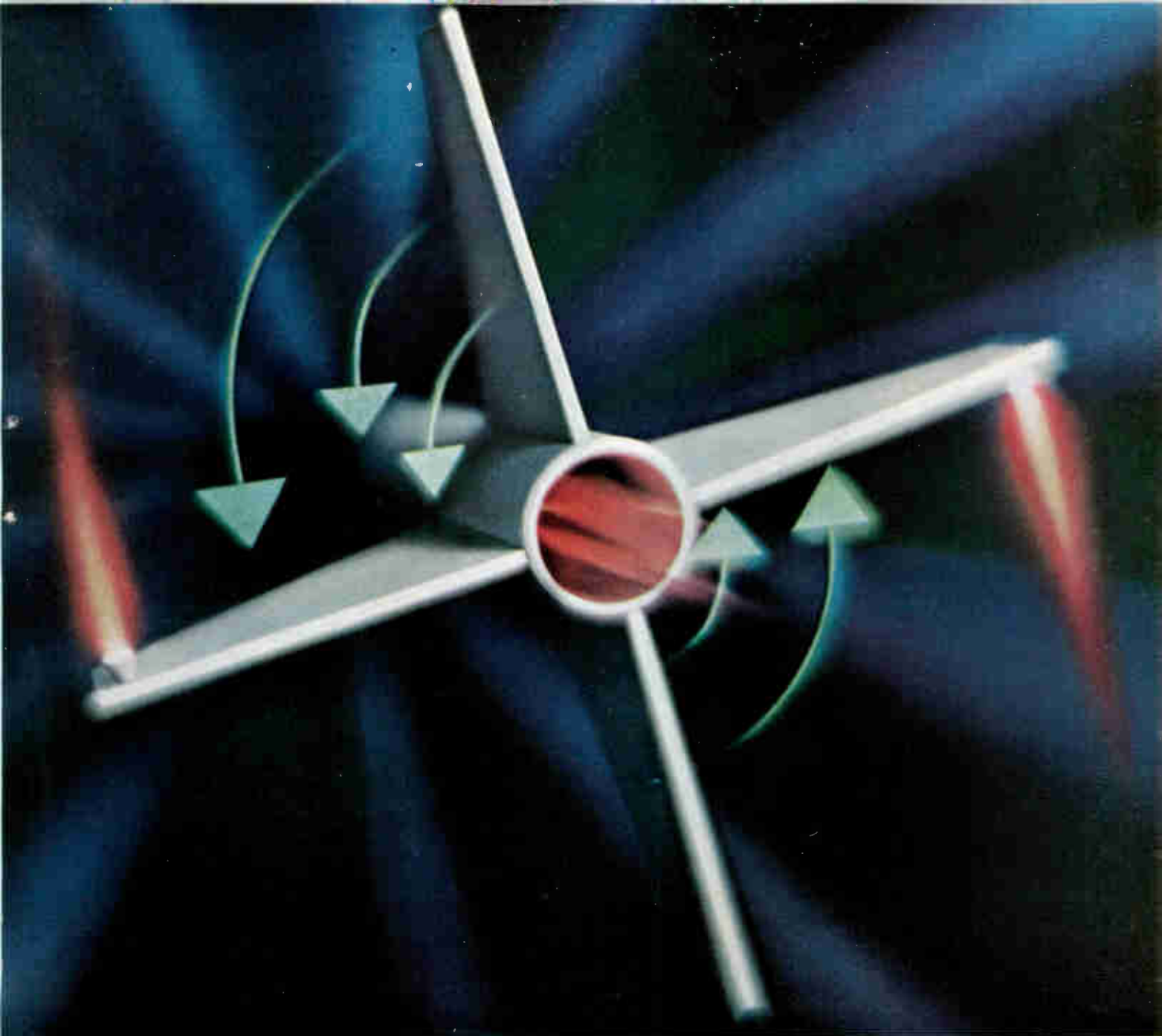

Reaction controls at work in space — symbolized.

STEERING GEAR FOR ASTRONAUTS

Conventional aircraft control surfaces will not guide space ships and capsules. Rudders, ailerons and elevators find no resistance and hence produce no reaction to their movements where there is no atmosphere. Even at altitudes only half way up, they are sluggishly ineffective.

The accepted answer to a dependable steering mechanism for astronauts is a system of jet reaction controls developed and produced by Bell Aerosystems Company. First used on Bell's own supersonic X-1B several years ago, the system has been greatly improved and adopted for the X-15, the Mercury man-in-space project and other space vehicles.

Through strategically located, low and high thrust (1 to

1500 pound) rocket engines, Bell's reaction controls not only position and guide the ship by controlling the roll, pitch and yaw, but they also provide for orbit changes and retro-thrust. Some of the jets are throttleable while others can be operated in combination to provide the astronaut positive and flexible control.

This revolutionary steering gear for space, available using monopropellants or high energy bipropellants, is just one of many advanced projects which are currently engaging the diversified talents of Bell Aerosystems Company in the fields of rocketry, avionics and space techniques. Engineers and scientists seeking challenging, long-range career opportunities can find them at Bell.



BELL AEROSYSTEMS COMPANY

BUFFALO 5, N. Y.

DIVISION OF BELL AEROSPACE CORPORATION

Successor to the Defense Group of Bell Aircraft Corporation

New, tri-dimensional packaging and interconnecting of modern electronic functions.

Here is simplicity from start to finish . . . the most complicated designs worked out on AMP-MECA's graph layout sheets in hours rather than days or weeks . . . finished modular construction that's "building-block" easy . . . extreme reliability and complete resistance to shock and vibration.

YOU GOT

IT MADE



WITH

MECA

Electronic functions are encapsulated for complete throw away or functions are assembled in open base cells for individual component replacement. Easily replaced, pluggable AMP-Cells work independently of or in harness with each other when programmed into AMP's 3-D circuit boards.

Available in 0.1" or 0.2" grid systems, AMP-MECA offers tri-dimensional flexibility—cells can be made larger or smaller—stacked, spread or lined-up in unlimited scope to accommodate your design needs. And production can be set up to fit your goals . . . by hand, or by programmed automation.

Learn how AMP-MECA can make it simple for you. Send for the full story on simplified interconnection of circuit functions and information on prototype assembly kits.

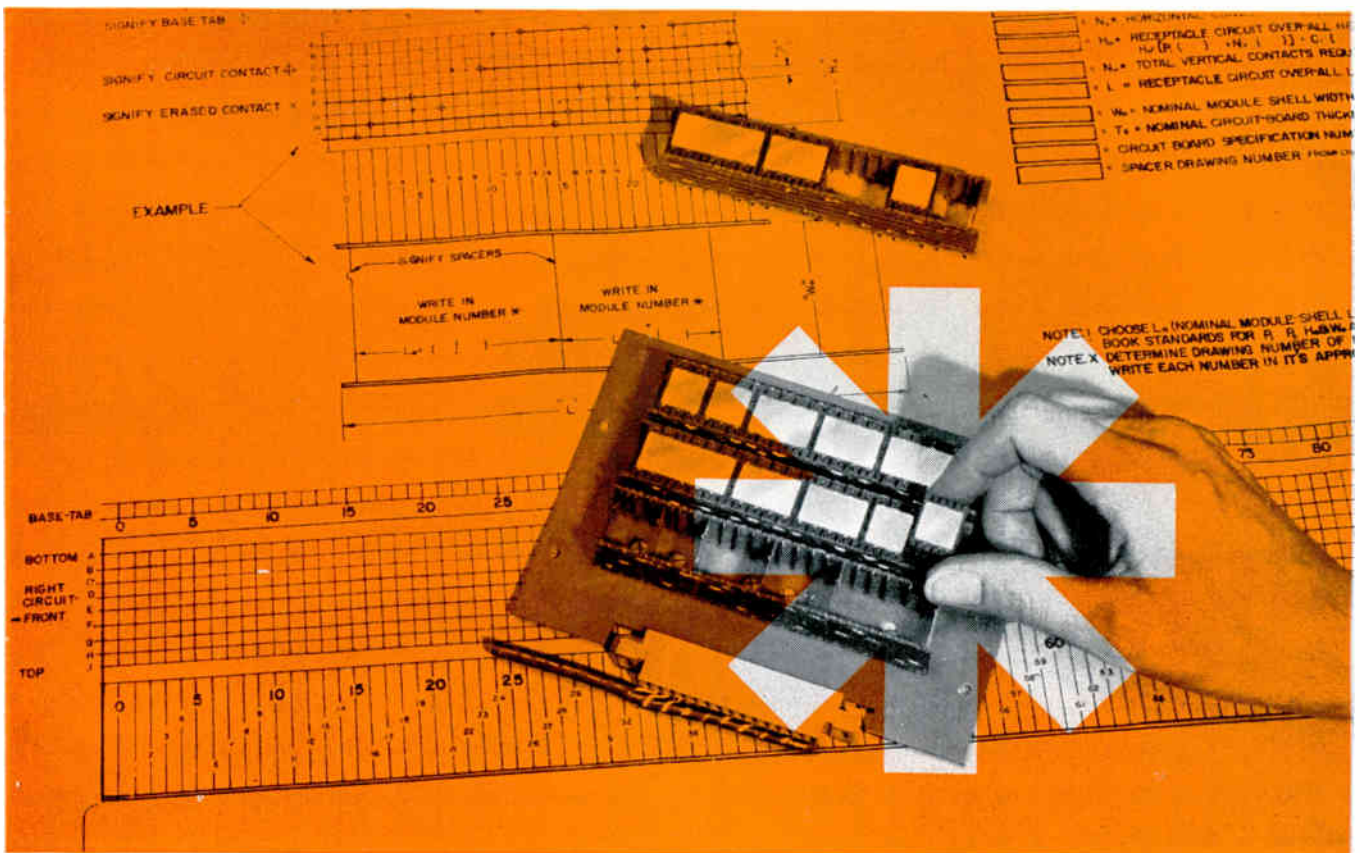

AMP INCORPORATED

GENERAL OFFICES: HARRISBURG, PENNSYLVANIA

AMP products and engineering assistance are available through subsidiary companies in: Australia • Canada • England • France • Holland • Italy • Japan • West Germany

electronics

September 23, 1960

Jet blasts and rough weather contribute to communications difficulties on carrier flight deck. Here, in catapult hookup, wind and fuel data must be provided by radio

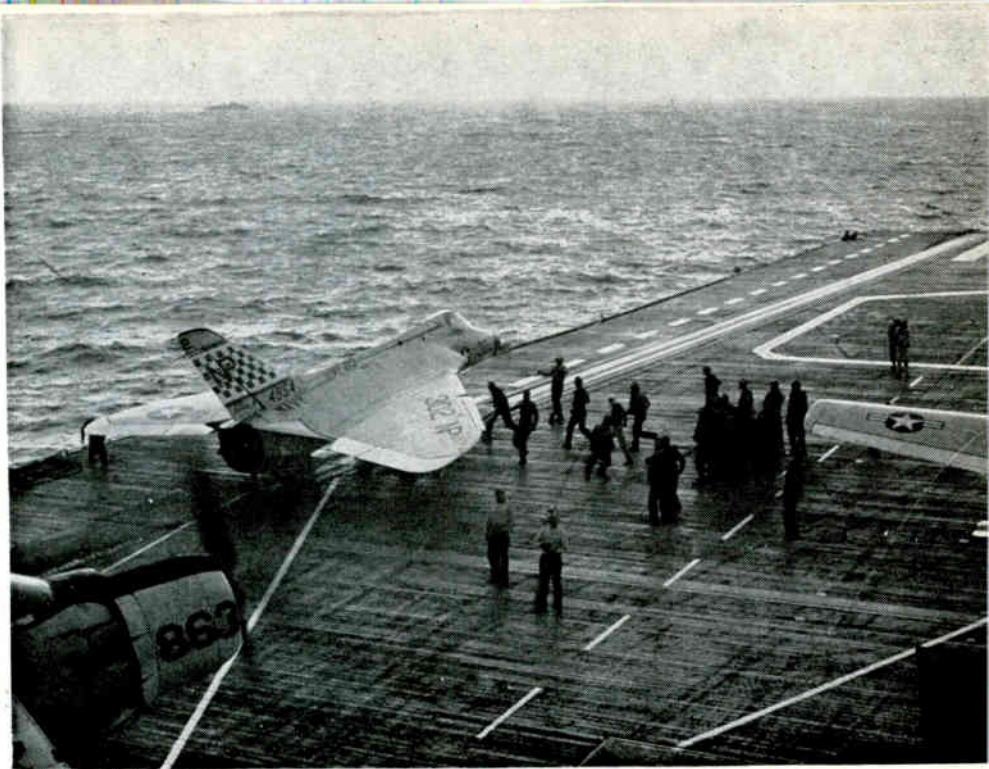

Helmet Transceiver for Flight Deck Communications

Transceiver mounted in a Roman-warrior type helmet is used on high-noise flight decks of aircraft carriers. Receiver audio output is automatically maintained at suitable level in fluctuating acoustic noise

By DALE C. GIBSON,

U. S. Naval Electronics Laboratory,
San Diego, Calif.

THERE HAVE been many attempts to lessen communication difficulties caused by noise from planes on the flight deck on an aircraft carrier. Jet-powered aircraft have made the situation intolerable, and intensified the need for an adequate communications system.

Once jet engines are started, noise pressure levels vary from approximately 110 db (re 0.0002 dyne per sq cm) to 135 db at manned locations. Sporadic noise peaks up to 150 db intensity exist at some deck locations when certain aircraft types are launched or when afterburners are used. Effective face-to-face voice communications (even shouting mouth-to-ear) is not possible, and hearing discomfort

and pain threshold levels are exceeded. Temporary and permanent hearing impairment dangers exist unless safety measures such as hearing defenders are employed. These rigorous acoustical conditions severely hamper the operations of fueling, arming, spotting, launching and recovering carrier aircraft.

Direct communication between key members of the Air Department, both on the decks and at interior control stations, is essential to any marked improvements in handling efficiency and personnel safety. Mental and physical stresses are such that a communications facility must be simple to operate and provide a positive information transfer. Fluctuating ambient jet noise and varying radio frequency signal strength must be automatically compensated for, without requiring special action and

distraction from the duties of the men concerned. The personal radio communications equipment must be physiologically acceptable, providing auxiliary functions such as hearing and vision protection, and yet must be self-contained and not encumber the wearer.

In the development of the flight deck communications system described here, the following specific requirements served as guides: (1) Completely reliable r-f coverage of the decks is essential, yet electromagnetic radiation beyond the ship must be minimized. (2) The radio link must be free of destructive multipath transmission effects, and it must be immune to interference both to and from other shipboard devices. (3) The wearable equipment must be rugged, miniaturized, lightweight, and preferably capable of universal fit. (4) The automatic features in each helmet must be

the minimum needed to keep the earphones quiet between transmissions, adjust the earphone volume with the ambient noise level fluctuations, and prevent overmodulation when shouting into the transmitter microphone. (5) Priority control must be provided for the fixed stations so that they can arouse instant and undivided attention by all listeners to emergency signals such as crash alarm and Air Officer-originated commands.

The radio system signal distribution diagram (Fig. 1A) depicts the basic flight deck communications system. It also indicates the automatic communications priority sequence. Essential units of the radio system include noise-attenuating two-way radio communications helmets, which are completely self-contained and incorporate special features to enable communications in high-level noise; auxiliary control equipment for signal control, distribution and processing; and control units, having a priority sequence, for interior flight control stations.

Developmental models of the communications helmet combine a transistorized vhf transmitter-receiver with hearing defenders containing receiving transducers and a noise shield containing a pressure gradient microphone. These items, and a hinged visor, are adjustably secured to a mounting frame which is physiologically designed to provide proper fit and comfort for the wearer. Total weight is under four pounds. Up to 25 percent weight and bulk reduction is possible through product engineering refinements. Transmitter speech level is compressed to prevent overmodulation distortion and peak-clipped to insure reasonably high-level modulation. Receiver audio output is automatically maintained at a suitable level as a function of ambient acoustic noise. Audio squelch is included to eliminate receiver output noise between reception of desired signals. Extensive r-f shielding and filtering are used to minimize the electromagnetic interference potential. Automatic gain control is provided to compensate for varying r-f signal strengths at different locations on deck. A two-frequency duplex radio link and relay control circuits are used at the fixed station to permit the preempt



In the battle against deck noise, helmeted aircraft crewmen resemble warriors of another epoch—or Martians

priority sequence, inherent crash alarm provisions, signal distribution at constant audio level regardless of source, and other features.

To provide a system adaptable to higher noise pressure levels, the concept of a relay talker functioning as an audio filter was adopted as an alternative operational mode. Because of the current state of the acoustics art, that is, speech processing techniques and characteristics of noise attenuators, shields, and canceling devices, it is not feasible to provide adequately intelligible speech communications directly between two helmet-equipped men both of whom may be in an ambient noise field much over 135 db. By the double advantage of a relay listener-talker located in relative quiet, however, it is possible to provide effective information transfer between the principals involved at the expense only of one talker and a slight time delay. The system contains provisions for either manual or automatic retransmission mode, selectable from the control unit at Flight Deck Control (see Fig. 1), although it has not yet been necessary to resort to the greater operational capability.

Because communications traffic on the radio system is intermittent with occasional periods of several minutes of inactivity, a recurrent beep tone is provided. Should the

fixed station radio relay or any control unit monitor or helmet receiver fail, those affected cease hearing the beep. Personnel become accustomed to hearing the beep so as to be unaware of its presence; however, if lacking, it is immediately missed and an operating spare unit may then be substituted.

A remote turn-on provision is included in the system. The auxiliary control equipment is automatically actuated whenever any of the three control units are turned on. This provision is a convenience, and reduces system operation to the simplest form. Once a control unit and communications helmet are switched on, the only action required by the operators is to actuate their microphone press-to-talk switches. Signal levels and distribution priorities are automatically controlled.

The helmet radio is a completely transistorized amplitude-modulated unit capable of sequential transmission and reception on any two frequencies over the range of 132 through 150.8 Mc. Duplex operation via a fixed station radio relay is used. For applications requiring only helmet-to-helmet communications, the transmitters and receivers of two helmets may be tuned to complementary frequencies; also, for two or more helmets, a common single frequency may be used on a party line basis. The audio pass bands for both transmitter and receiver extend from 300 cps to 6 Kc for improved speech intelligibility.

In the helmet transmitter-receiver (see Fig. 2) no attempt was made to use either true transceiver techniques or hybrid circuits; however, a common antenna and battery are employed.

The helmet transmitter consists of these three circuit modules:

- (1) Speech preamplifier and compressor-clipper: An RCA type M-55 /AIC lip-contacting, pressure gradient, dynamic microphone mounted in a rubber noise shield is used to prevent ambient jet noise from masking speech input. Compressor action maintains relatively constant modulation input at higher voice levels. Delayed compression is provided as a compromise between acceptable modulation variations (input speech ranges up to 15 db above normal voice level) and noise rushes between words which cause

decreased intelligibility of initial syllables. From 6 to 10 db of peak speech clipping follows the compression stage and clips those peaks which are too short for compression. No side tone is used since the tendency for a person to talk louder, to the extent of shouting as ambient acoustic noise increases, results in an improved signal-to-noise ratio at the microphone input and is desirable up to the point of voice overload. Also, the usual voice level, when a person is wearing hearing defenders, exceeds the otherwise normal voice level.

(2) Amplifier-modulator: Modulation varies from 15 percent at usual voice level (in low noise) to 50 percent at 15 db above normal voice level (in high noise) with no appreciable increase thereafter.

(3) Modulated oscillator: The helmet transmitter is an amplitude-modulated, crystal-controlled single transistor oscillator. Transmitter power input is 50 mw and circuit efficiency is approximately 10 percent. Crystal replacement and minor circuit changes are necessary to cover different operating frequencies within the vhf radio range.

The helmet receiver is a crystal-controlled, double-conversion superheterodyne and consists of these four modules: (1) radio frequency filter, first mixer, and first i-f filter; (2) first i-f, second mixer, second i-f, detector, agc amplifier, and audio squelch; (3) noise actuated gain and first audio; and (4) audio power output. Circuit breakdown in the block diagram does not correspond to the modular construction of the receiver.

The desired vhf signal is passed through a five-section r-f filter, mixed with the first local oscillator signal 5 Mc removed, and the difference signal is filtered and passed through the first i-f amplifier stage. (Crystal replacement and minor adjustments are required to change the receive frequency.)

Following the second conversion to 456 Kc, the signal is passed through two additional stages of i-f amplification. The bandwidth is ± 8 Kc at -3 db, -50 Kc and $+30$ Kc at -20 db, and -120 Kc and $+90$ Kc at -50 db, with all spurious responses at least 50 db below the main response.

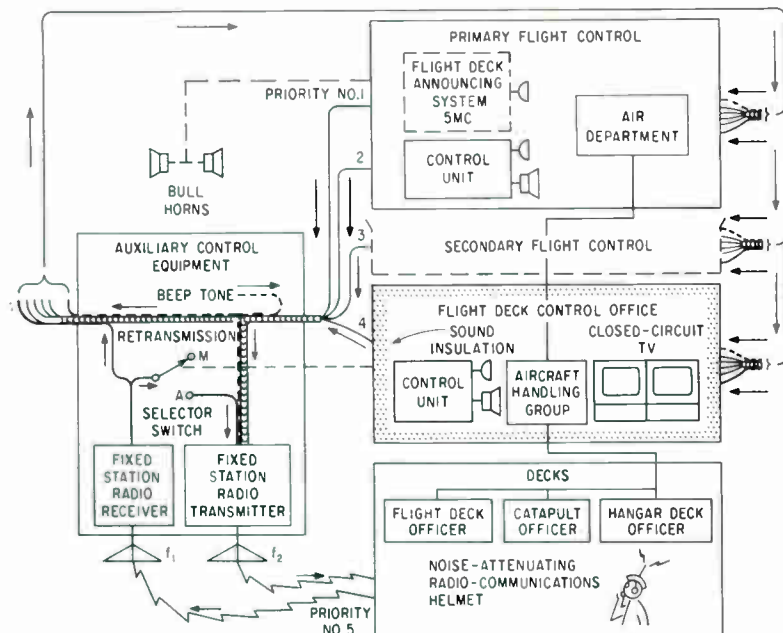

FIG. 1—Radio system signal distribution for flight deck operations indicate the automatic communications priority sequence

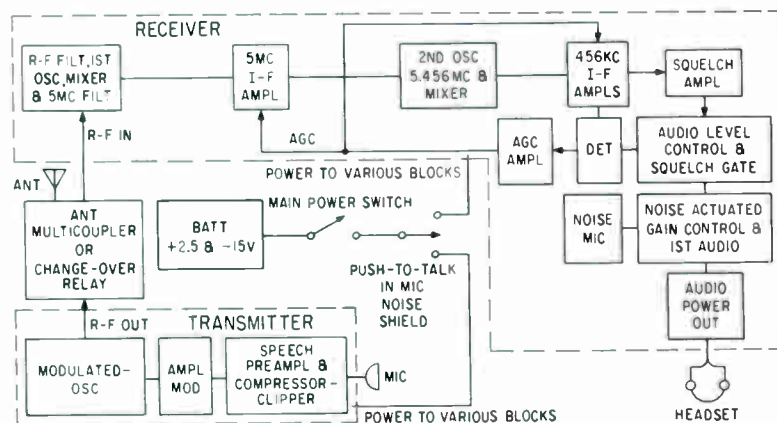

FIG. 2—Diagram of noise attenuating helmet transmitter-receiver shows basic components of system

The output of the second i-f amplifier is rectified and used for squelch control, which keeps the receiver output silent until a 15 microvolt signal appears on the antenna terminal of the multicoupler. When the squelch just opens, the receiver r-f signal-to-noise ratio is about 12 db. An automatic gain control stage limits the audio output increase to 9 db when a 30 percent modulated r-f input signal increases from 50 μ v. to 175 mv.

A noise-actuated gain (volume) control (see Fig. 3A) is combined with the first audio stage to maintain a satisfactory speech-signal-to-acoustic-noise ratio; it thus automatically offsets fluctuations of the ambient noise level. A Shure type MC-30 miniature microphone is

mounted within the radio enclosure as a noise pickup transducer; it provides a voltage which is amplified, rectified, and filtered and then used to control the gain of a transistorized speech amplifier. The signal output from the class-B audio power stage increases from below 2 mw when the ambient noise pressure level is below 110 db to 100 mw when the noise level reaches 140 db. The audio signal is reproduced in an RCA type H158/AIC earphone-hearing defender combination which contains type H143 transducers and attenuates the ambient jet noise in excess of 20 db across the audio spectrum. The acoustic-signal-to-attenuated-noise ratio at the listener's ear is maintained at a usable level and automatically in-

sures a high degree of speech intelligibility. Primary power for the complete receiver is 193 mw during standby and varies between 245 and 473 mw as signals are received in acoustic noise varying between quiet and 140 db.

The helmet antenna is a base-loaded monopole made of piano wire. Its pattern is essentially omnidirectional in the horizontal plane. Changes to the loading coil or antenna length are required to accommodate different sets of frequencies.

Since the one antenna is used for both transmitting and receiving, either a multicoupler or changeover relay is required. When the transmit and receive frequency separation is greater than 15 Mc, a passive multicoupler is satisfactory. Otherwise, a miniature antenna changeover relay (Elgin Watch Co. Neomite Type NMIC 1K) is used. The latter increases the battery drain by approximately 15 milliamperes during helmet transmissions. The helmet battery consists of 14 nickel-cadmium rechargeable cells (Gulton Industries type Voltablock 250 mamp-hr) series connected and tapped to provide rated nominal voltages of +2.5 and -15 volts. Under typical noise conditions and a duty cycle of 94 percent standby, 5 percent receive and 1 percent transmit, battery life is roughly 18 hours between needed recharges.

The main power switch on the helmet applies power to the receiver except when the push-to-talk switch is actuated and power is applied to the transmitter. Both the battery and the wiring require short-circuit fuse protection. All leads to acoustic components and the transmit-

receive control switch outside the helmet module enclosure are filtered by 0.01- μ f capacitors to eliminate electromagnetic interference pick-up.

Figure 3A, the noise actuated automatic volume control and power amplifier schematic, shows the helmet receiver audio circuits. The emitter current of a 2N43A low level audio amplifier stage, Q_1 , is regulated indirectly by the sound pressure level of ambient noise. The gain of controlled amplifier Q_2 (in db) is approximately a linear function of its emitter current. This current is passed through gain control stage Q_2 whose d-c resistance (pass characteristic) varies inversely with its base bias current. The bias for Q_2 is obtained from a noise microphone voltage that is amplified by transistor stage Q_3 , then rectified, filtered, and applied to the base of Q_2 . This transistor is bypassed with a 12- μ f capacitor C_1 to eliminate the degeneration that would otherwise be introduced into amplifier stage Q_2 .

During quiet acoustic noise conditions, the gain of the controlled amplifier is prevented from going to zero by the application of some quiescent conduction bias (through R_1) to gain-control stage Q_2 . To prevent quiescent bias from being applied at such times by the forward conduction of noise voltage rectifier D_1 , some reverse bias is provided by voltage divider R_2 and R_3 , which connects the negative and positive voltage supplies.

The audio circuit also contains the noise microphone, with its associated screw driver adjusted noise avc potentiometer R_4 , and the transformer coupled audio output stage.

The latter consists of a push-pull, class B power amplifier capable of delivering 100 milliwatts of audio to 8-ohm headphones. Two type 2N43A transistors, Q_4 and Q_5 , are employed in a conventional design using a thermistor in the bias circuit to improve temperature stabilization.

Figure 3B shows the noise automatic volume control characteristic curve. For comparison, an ideal characteristic is plotted on the same axes. The ideal curve is based upon the conclusion that the rate of headphone power increase should be 5 db per 10 db of increased sound pressure level (spl) reaching 100 mw at 140 db spl. Due to hearing impairment damage risk and overload distortion considerations, it was not advisable to exceed a headphone input power of 100 mw within the hearing defenders.

The developmental equipment of this flight deck communications system was submitted to service evaluation during air exercises aboard the *USS Lexington* during spring 1958. The practicability of personal two-way communications in high level acoustic noise and severe electromagnetic fields was proved. The integration of noise cancelling acoustic components with electronic circuits provided a highly intelligible and automatically compensating voice communications capability at all duty locations under all conditions of intense noise encountered during jet aircraft handling operations.

Production prototypes of the U. S. Navy Electronics Laboratory's system are currently being constructed by industry for the Bureau of Ships.

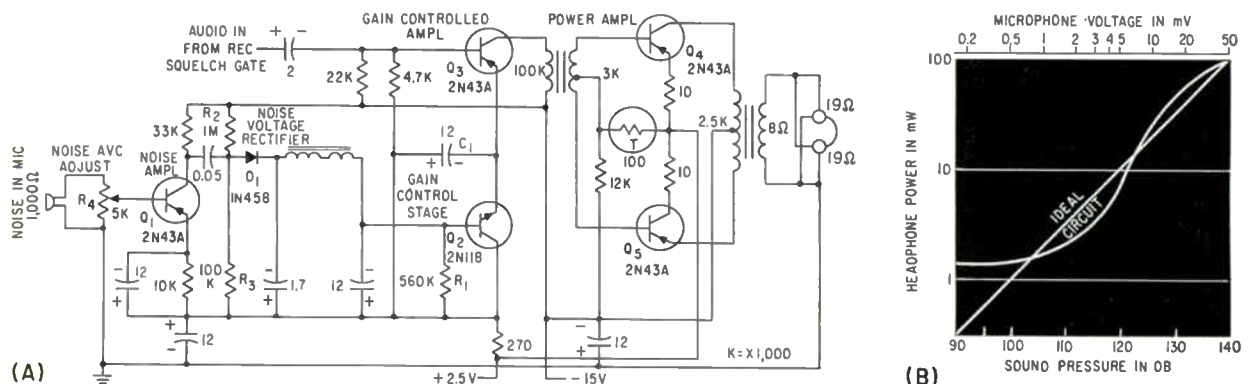
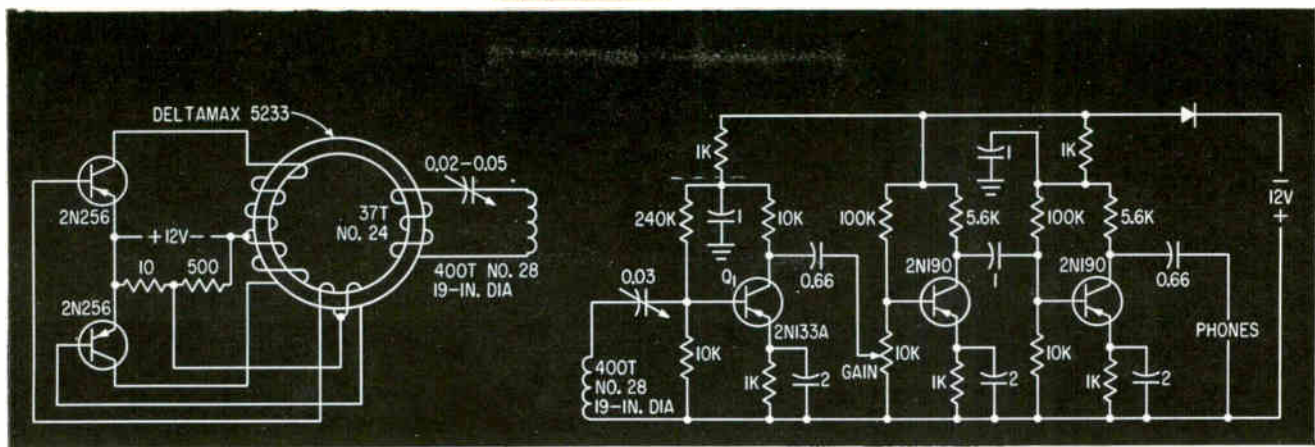

FIG. 3—Noise-actuated automatic volume control and power amplifier (A), and noise avc characteristic curve compared to ideal characteristic (B)



Transmitter (left) generates 2-Kc magnetic field picked up by transistorized receiver (right) located on surface

Mapping Caves Magnetically

Magnetic induction device helps map underground caves and also provides communication with the surface

By E. R. ROESCHLEIN

Sr. Electronic Engineer, U. S. Naval Avionics Facility, Indianapolis, Indiana

INVESTIGATION of underground caves and correlation with local surface topography is simplified by using this low-frequency magnetic induction field direction finder. The transistorized 5-watt 2,000 cps generator feeds a tuned loop and is located within the cave being mapped. The detector is located on the surface where mapping is easily accomplished.

The 2-Kc frequency was chosen since higher frequencies are severely attenuated by rock, soil and water. The mode of transmission is the magnetic induction field, which is attenuated as the inverse square of the distance. Since the distances involved are from 100 to 300 feet, the inverse square law is not too burdensome. The transmitter-receiver described has a range of approximately 400 ft and within this range has sufficient field strength for null determination and ease of communication.

The transmitter, shown in the figure, uses a pair of power transistors to drive a core to saturation in each direction. Base windings are connected to provide

feedback for oscillation. The bias network is adjusted so that twice operating current is drawn when the output is shorted (not oscillating). Link coupling is used between the transmitter and the transmitter loop antenna. Series tuning lowers the impedance and allows retuning when changes in frequency occur with battery aging. Initial frequency is determined by magnetic material, number of turns and battery voltage. The frequency decreases as the battery voltage reduces. Total current is 0.6 ampere at 12 v or about 7 w.

The receiver uses a pickup loop antenna similar to the transmitter and is also series tuned. Input transistor Q_1 , is a low-noise type and is followed by a two-stage audio amplifier. The stages have a common-emitter configuration with poor low-frequency response to minimize pickup from local power lines. Ample gain is afforded to take advantage of the low-noise properties of the first stage. The current drain is 3 ma.

In operation, the usual Morse code is used for communication

with long dashes being used for locating. The surface operator determines the local direction of magnetic flux by rotating his loop with the flux until a null occurs. This is a two-dimensional null and the direction of the flux both in azimuth and elevation can be determined. The transmitted magnetic flux is in the form of circles with the circumference of each circle passing through the transmitting coil. If the transmitter coil is horizontal, there will be one circle of infinitely-large radius that forms a vertical line through the transmitter coil. This line is the one that the surface operator looks for and can then locate the point directly over the cave operator.

Field strength varies as the inverse square of the distance, and since the low-frequency magnetic field is attenuated very slightly as it passes through the layers of rock, soil or water, the strength of the received signal can be measured. The system can be calibrated for distance on the surface and this calibration can be used for depth measurement.

Design technique for series voltage regulators

breaks the regulator into functional elements, then analyzes design criteria for each block. Test circuits are provided for verifying performance parameters

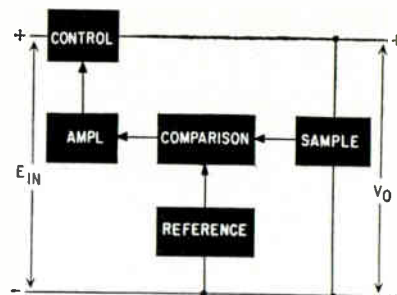

FIG. 1—Series d-c voltage regulator has five functional elements

Designing Transistorized

MOST SERIES VOLTAGE REGULATORS contain the five functional elements shown in Fig. 1; however, more than one of the functions may be performed by a single device or stage in simple regulators.

A d-c voltage regulator must maintain a constant voltage supply for specified load conditions. The regulator performs this function in a manner similar to a servo amplifier in that an error or difference voltage is used to control the output and minimize the error. The voltage difference between a reference and a sample of the regulated output is detected and amplified by the comparison element. A d-c amplifier can be used for further amplification. The control element senses the magnitude and phase of the amplified difference and regulates the load voltage in the direction to correct any voltage change.

The sampling element must be able to take a true sample of the output voltage to compare with a constant reference voltage. A resistance divider across the regulated output is usually adequate. The effects of changing temperature on the voltage sample can be reduced if wire-wound or other low-temperature-coefficient resistors are used in the divider. The temperature coefficients of the sampling resistors will be nearly the same and the sample voltage will not change with temperature if similar resistor material is used, since the resistors in the divider are subjected to the same conditions.

Silicon breakdown diodes are usually used as voltage references in transistor regulators. Their breakdown voltage is relatively constant over a wide range of reverse

current. The effects of temperature sensitivity, reverse current and dynamic resistance on breakdown voltage must be considered in selecting a reference diode.

Silicon diodes with breakdown voltages on the order of 5 volts or lower usually have a negative temperature coefficient. As the breakdown voltage increases, the temperature coefficient becomes increasingly positive.

Because of the characteristics shown in Fig. 2, a series combination of low-voltage diodes is preferred over one high-voltage diode if a high reference voltage is needed. It is important to maintain a near-constant temperature coefficient. Figure 3 is a reference element that shows why it is necessary also to keep the resistance as low as possible.

Assume $I_1 \gg I_2$ and ΔI_1 is small so the $\Delta R_R \cong 0$, then

$$\Delta I_1 R_1 + \Delta V_R = \Delta V_O \quad (1)$$

$$\Delta V_R \cong \Delta I_1 R_R \quad (2)$$

$$\Delta V_R R_1 / R_R + \Delta V_R \cong \Delta V_O \quad (3)$$

$$\Delta V_R / \Delta V_O \cong R_R / (R_1 + R_R) \quad (4)$$

Equation 4 shows that the change in reference voltage for a change in output voltage can be made small if the resistance of the breakdown diode is low and the reverse current is held constant. Ideally the reference voltage would not change for any normal output voltage change.

The comparison element can be a common-emitter stage or an emitter-coupled differential amplifier. The choice depends upon the degree of regulation and temperature stability required.

The potentiometer in Fig. 4A adjusts the output sample to match the reference voltage at a specified output voltage. The current from

the potentiometer wiper into the comparison element must be much smaller than that through the divider so that the sample voltage remains an accurate portion of the output. Current I_s , which is about equal to I_r , must be considerably larger than the emitter current change of Q_1 so that the reverse current in the diode can be kept constant.

The sample is applied to the base of Q_1 and the reference voltage is applied to the emitter. If the low output voltage tends to increase, the base-emitter voltage of Q_1 will increase and cause more collector current to flow. A drop in output voltage causes the collector current of Q_1 to decrease. The change in collector current and the change in the input current to the control element are out of phase because both are usually supplied from a common constant-current source. If the output voltage begins to rise, the amplified difference voltage will decrease the current into the control element and the output voltage will be corrected.

The reference element is usually positioned differently for high- and low-output voltages as shown in Fig. 4A. This is necessary to reduce the voltage requirements of Q_1 or to avoid using a series string of breakdown diodes for a high-voltage reference. The output phase is reversed.

For the low-voltage case of Fig. 4A, $A_1 V_O = V_R + V_{BE}$, where $A_1 = (R_2 + R_{p2}) / (R_1 + R_2 + R_{p1})$ the attenuation of the divider.

If the divider resistors are chosen so the sample voltage ratio of the output does not change

$$\Delta V_O = (\Delta V_R + \Delta V_{BE}) / A_1 \quad (5)$$

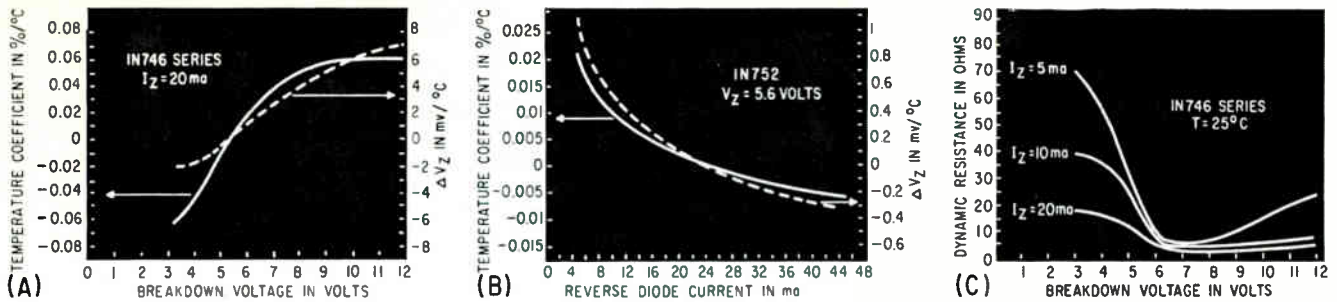

FIG. 2—Temperature coefficient and voltage change per degree change in temperature are plotted against breakdown voltage (A) and reverse diode current (B). Dynamic resistance is plotted against breakdown voltage in (C)

Voltage Regulators

By EARL WILSON, Semiconductor-Components Division, Texas Instruments Incorporated, Dallas, Texas

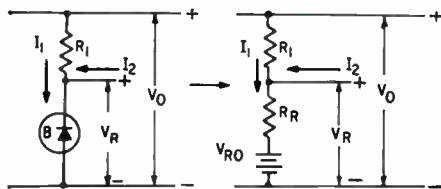

FIG. 3—Regulator reference element

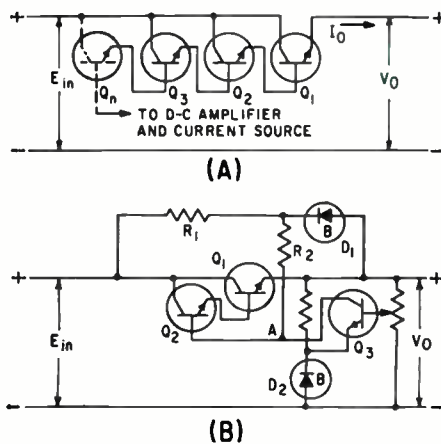

FIG. 5—Series regulator control element (A) and preregulator (B)

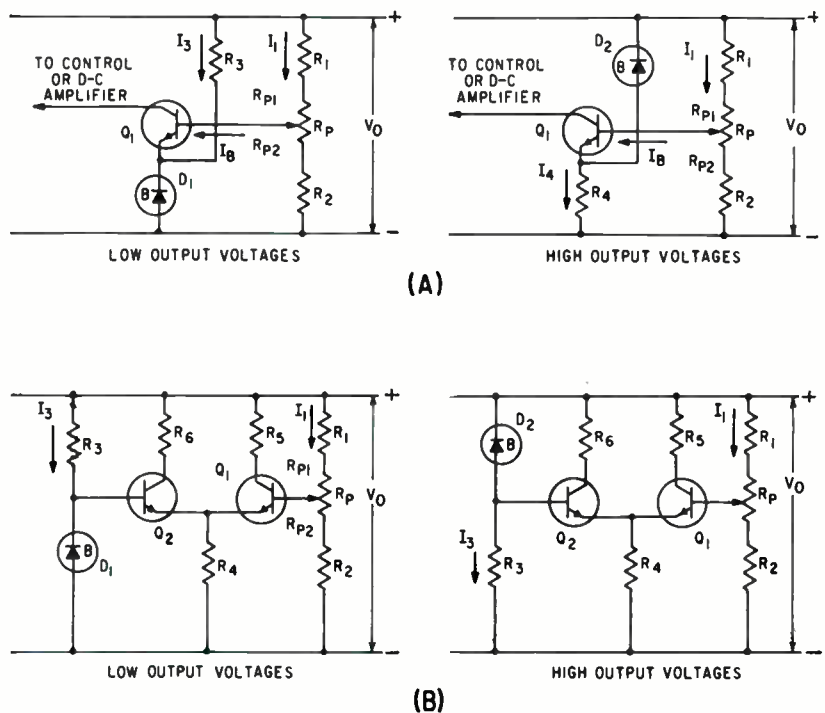

FIG. 4—Common-emitter comparison element (A) and differential amplifier comparison element (B) are shown along with sampling and reference elements for high and low output voltages

Equation (5) shows that temperature compensation can be realized if the reference element is a breakdown diode with a positive temperature coefficient that exactly cancels $\Delta V_{BE}/\Delta T$ of Q_1 .

The same approach shows that Eq. (6) applies for the high-voltage case

$$\Delta V_O = (\Delta V_R - \Delta V_{BE})/A_2 \quad (6)$$

where $A_2 = (R_1 + R_{P1})/(R_1 + R_2 + R_P)$

The breakdown diode must have a negative temperature coefficient equal to $\Delta V_{BE}/\Delta T$ of Q_1 .

An emitter-coupled differential amplifier, shown in Fig. 4B, is ideal as a comparison element if the

regulator is to perform over a wide temperature range or at high temperatures. The symmetrical arrangement of the differential amplifier makes it self-compensating for temperature effects. Self-compensation is improved if the transistors are well matched and mounted on a common heat sink.

The output of the differential amplifier is usually taken from only one side determined by the number of phase shifts between the comparison element and the control element. If the differential amplifier and the sampling element are assumed to be perfectly temperature compensated, the reference

diode must have a temperature coefficient of zero.

The d-c amplifier must raise the difference signal from the comparison element to a level sufficient to drive the control element. The only requirement in most cases is that gain be controlled so that it is large enough to provide current to the control element and small enough to retain circuit stability.

Often a single transistor or stage is both the comparison element and the d-c amplifier. Additional amplifier stages may be required for higher loop gain to improve the regulation and decrease the output resistance of the regulator. The

usual d-c amplifier element is similar to the common-emitter comparison element in Fig. 4A. A breakdown diode is used in the emitter circuit to improve the voltage gain.

Temperature compensation is not critical in this portion of the regulator, but the breakdown diode should have a temperature coefficient that will tend to cancel $\Delta V_{BE}/\Delta T$ of the amplifier transistor. The series control element Fig. 5A, must carry the entire load current, but during normal operation the collector voltage is much less than the output voltage. Some critical values that must be considered when selecting a control element are the maximum voltage, current and power ratings of the transistors. Some of the ratings that must be observed for Q_1 are $V_{CE(max)} \cong E_{in(max)} - V_{O(min)}$, $I_{C(max)} \cong I_{O(max)}$ and $P_{C(max)} \cong [E_{in(max)} - V_{O(min)}] I_{O(max)}$.

These conditions must be observed under all normal operating conditions and for all temperatures at which the regulator is to operate. Proper heat sinking is necessary to obtain maximum performance from the transistors used in the control element. If the voltage or current requirements exceed the maximum ratings of a control element transistor, series or parallel transistors can be used.

The control element drive current and the collector current of the d-c amplifier are supplied from a common shunted current source. The regulator should be designed so that the collector current of the d-c amplifier is equal to or greater than the maximum current needed for the base drive of the control element. This design consideration is needed to insure that the control element will have enough base drive current to maintain the output current. Because the current supplied to the base of the control element is usually small, a compound connection provides the current gain to maintain a load current.

The preregulator, Fig. 5B, should be included as a functional element if the regulator is to perform to its capabilities. If A in Fig. 5B is returned through a resistor directly to the positive terminal of the unregulated supply, ripple current caused by the unregulated voltage variations will be injected into the base of Q_2 . The ripple will

be amplified by the series control element and appear in the output. A preregulated d-c supply can be obtained from R_1 , R_2 and D_1 to eliminate the situation. The breakdown diode keeps a constant voltage across R_2 and a constant current to Q_2 and Q_3 . The breakdown voltage of D_1 can be any value less than $(E_{in} - V_o)$ that will supply sufficient current to Q_2 and Q_3 . If possible, the breakdown voltage of D_1 should be approximately four times the normal change in base-emitter voltage of the control element.

The preregulator reduces the output resistance of the regulator in addition to improving regulation. If the current supplying Q_2 and Q_3 were shunted through only a resistor, a load current increase would cause the output voltage to drop. The drop is caused by an increase in base-emitter voltage of the control element and by a higher voltage drop through the internal resistance of the unregulated supply. When this occurs the comparison element is forced to compensate for both changes, and the resistance of the unregulated supply as well as the emitter resistance of the control element will contribute to the output resistance of the regulator. Depending upon the source resistance, the output resistance can be reduced by as much as one order of magnitude if the preregulator is used.

The functional elements can be put together to form two typical voltage regulators. The voltage regulator in Fig. 6A has a single common-emitter stage that is both a comparison element and a d-c amplifier. This regulator performs well when load and temperature variations are reasonably small.

The regulator in Fig. 6B performs well over wide temperature ranges because of the self-compensating tendencies of the differential amplifier.

Regulator performance can be expressed in terms of R_o , F and K_T in the regulation equation $\Delta V_o = F \Delta E_{in} + R_o \Delta I_o + K_T \Delta T$ where output resistance

$$R_o = \Delta V_o / \Delta I_o \quad \left. \begin{array}{l} \Delta E_{in} = 0, \\ \Delta T = 0 \end{array} \right\} \text{regulation factor}$$

$$F = \Delta V_o / \Delta E_{in} \quad \left. \begin{array}{l} \Delta I_o = 0, \\ \Delta T = 0 \end{array} \right\} \text{and temperature coefficient}$$

$$K_T = \Delta V_o / \Delta T \quad \left. \begin{array}{l} \Delta I_o = 0, \\ \Delta E_{in} = 0 \end{array} \right\}$$

The output resistance and the regulation factor can be determined analytically by dividing the regulator into sections as shown in Fig. 7. A solution can be obtained for I_{c2} which is common to both sections. Then I_{c2} can be eliminated and an expression of V_o in terms of E_{in} and I_o obtained. From this equation the output resistance and the regulation factor can be determined

$$F = \frac{1}{h_{FE2}R_5(R_2R_3 - R_1R_R) + (R_1 + R_2)[h_{FE2}R_3R_R + h_{1E2}(R_R + R_3)]}$$

$$R_o = \frac{R_5 + h_{FE1}(R_Z + R_5)}{h_{FE1}h_{FE2}R_5(R_2R_3 - R_1R_R) + h_{FE1}(R_1 + R_2)[h_{FE2}R_3R_R + h_{1E2}(R_R + R_3)]}$$

The temperature coefficient is usually determined experimentally.

Verification of the performance parameters is usually necessary after the regulator has been designed. Figure 8A is a test circuit used to measure R_o , K_T and F . The methods used to determine R_o , F , and K_T are not complicated. The main concern is the choice of a voltmeter for measuring ΔV_o .

Figure 8B is a test circuit to determine ripple reduction. The a-c voltage providing the input ripple can be obtained by a filament transformer. The transformer can be connected to a variable voltage transformer to obtain a variable input ripple. The peak a-c input and output voltages can be measured with a calibrated scope, or the ratio of the two can be obtained by applying the output ripple to the horizontal deflection and the input ripple through an attenuator to the vertical deflection circuit of the scope. The attenuator can then be adjusted until the scope indicates equal ripple to each deflection. The attenuator will then indicate the reduction in ripple caused by the regulator.

Protection of the series control element is the major problem of overload protection in voltage regulators because it is directly in the current path of the load. Overload protection by current limiting offers some advantage in that it is instantaneous and the regulator will return to normal operation as soon as the overload is removed.

The compound connection of Q_1 and Q_2 is the current-limiting transistor as well as the series control

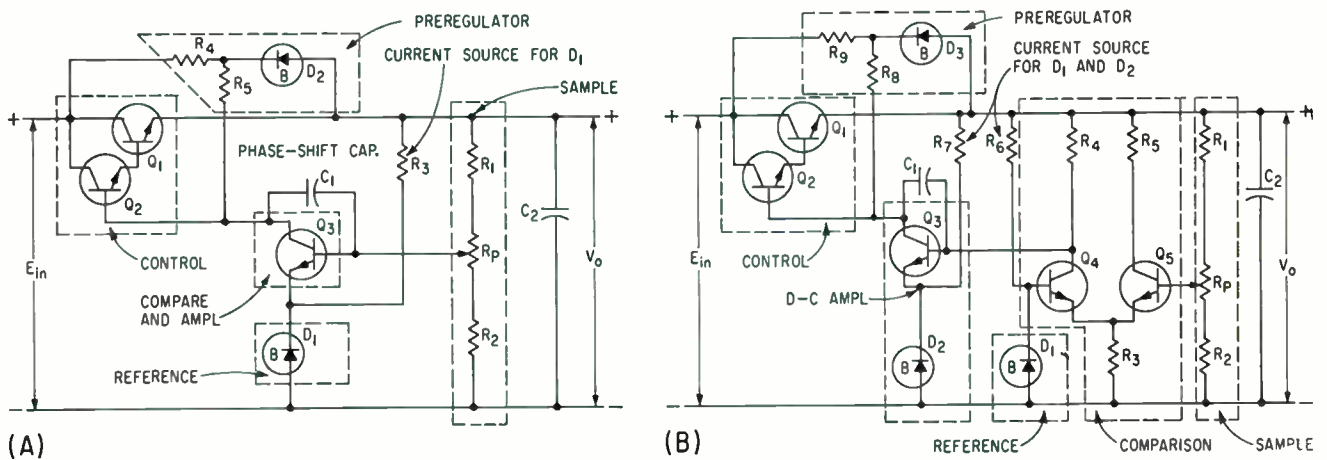

FIG. 6—Regulator with common-emitter comparison element (A) and differential amplifier comparison element (B)

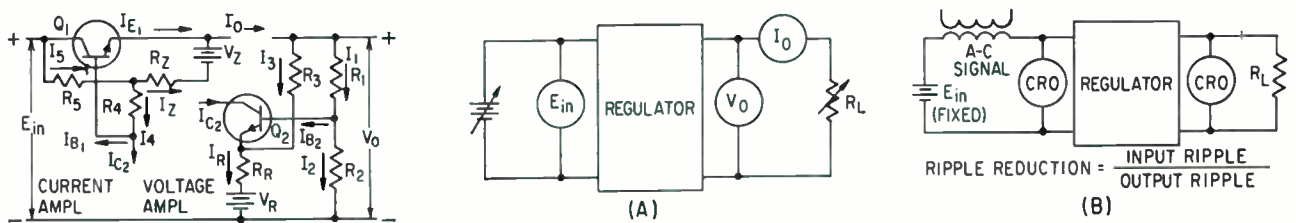

FIG. 7—Regulator is broken into current and voltage sections

element in Fig. 8C. The current limiting portion of the circuit consists of \$Q_1\$, \$Q_2\$, \$R_1\$ and \$D_1\$. Current limiting occurs when the base-emitter voltage of the control element plus the voltage drop across \$R_1\$ exceeds the breakdown voltage of \$D_1\$. The current level at which this occurs can be by \$R_1\$.

The response of this limiter to overloads is instantaneous. A disadvantage of overload protection using such a limiter is that \$Q_1\$ must withstand the maximum load current determined by \$R_1\$ and a voltage nearly equal to the unregulated input simultaneously as long as a short-circuit condition exists at the load. Thus the circuit is usually limited to low voltage and current regulators.

Load current interruption is usually the most dependable protection for regulator transistors if the overload can be detected and the load circuit interrupted before any damage is done to the regulator transistors.

The protective circuit in Fig. 8D was designed to be used with regulators of much higher current and voltage ratings than those obtainable using Fig. 8C. The controlled rectifier, \$Q_1\$, does not conduct during normal regulator oper-

ation and has no effect on the regulator performance. \$R_1\$ is the only portion of the protective circuit that is normally in the regulator circuit. A predetermined overload current causes the voltage drop across \$R_1\$ to increase until it exceeds the breakdown voltage of \$D_1\$. When \$D_1\$ breaks down, a gate current is supplied to \$Q_1\$ and the controlled rectifier goes into conduction. \$Q_1\$ then conducts a high current while the regulator current usually remains low. The high current through \$Q_1\$ will cause the fuse to open much faster than if a fuse were used alone for protection.

Rectifier \$Q_1\$ must have a breakdown voltage that is above the maximum output voltage delivered by the rectifier and filter network. This condition is necessary to prevent \$Q_1\$ from conducting without an applied gate current.

Resistor \$R_1\$ limits the surge current through \$Q_1\$. Resistor \$R_1\$ must

be as small as possible to assure that the controlled rectifier will shunt most of the fuse current around the regulator. $R_1 \cong E_{in(max)} / I_{surge}$, where \$E_{in(max)}\$ is the maximum output voltage of the rectifier and filter network, and \$I_{surge}\$ is the maximum allowable surge current through \$Q_1\$ (usually about 25 amps up to 8 msec). A fast-acting fuse is needed.

Resistors \$R_2\$ and \$R_3\$ are used to limit the gate current to \$Q_1\$. One hundred ohms is usually adequate for \$R_2\$, and \$R_3\$ should be on the order of 5 to 10 ohms. Diode \$D_1\$ must be a breakdown diode. The breakdown voltage is usually chosen to be small so that \$R_1\$ can be as small as possible ($R_1 = V_{z1} / I_{o(max)}$).

BIBLIOGRAPHY

- R. B. Hurley, "Junction Transistor Electronics" John Wiley and Sons, New York, p 208, 1958.
R. D. Middlebrook, Design of Transistor Regulated Power Supplies, *Proc IRE*, 45, p 1,502, Nov. 1957.

USING FERRITE CORES TO

By MILES A. MERKEL, Electronic Scientist, Department of Defense

THIS WORD SPOTTER recognizes ordered sequences of teletypewriter characters. The original idea came from a proposal by Lincoln Labs., Lexington, Mass. for a coincidence detector to recognize a 10-bit binary code. The word spotter, which is pictured in Fig. 1A, was designed for use with a five-baud teletypewriter; however, the logic of operation applies equally well to codes using more or less bauds per character. It occupies a volume of about four cubic feet, weighs 100 pounds, and consumes 15 watts of power. There are 12 stages, each of which is used to identify alphanumeric characters. This arrangement restricts recognition to words (groups of alphanumeric characters) containing no more than 12 characters.

Figure 2 is a block diagram of one of the 12 stages. The equipment consists of two memories, one moving and one fixed, that are coupled by a gate. The moving memory accepts words at one end and steps them along one character at a time, comparing them with words previously stored in the fixed memory. When a match occurs, the pulse detection circuit generates a voltage pulse that signals the presence of a desired word.

The moving memory, consisting of five parallel shift registers, will handle words at any speed up to 50,000 words a minute. This speed is dictated by the rate at which words are fed into the first stage. Voltage levels are fed to the enable inputs of the first stage flip-flop. A sync (or feed hole) pulse then sets the flip-flops to the corresponding state. This input can be from a perforated-paper-tape reader or a magnetic-tape reader. With a serial-to-parallel converter, sequential data from a magnetic tape recorder or teletypewriter land-line circuit can be used.

On receipt of the sync pulse, the characters stored in the shift regis-

ters are advanced one stage. During the interval between sync pulses, while the memory is static, complementary voltage levels from the five flip-flops associated with each stage are applied to ten gates. Five gates, determined by the states of the flip-flops associated with each character, will be open. An open gate will permit the interrogation pulse from the one-shot to trigger its associated pulse-transformer core-driver transistor. Interrogation is then performed on the gates of the remaining characters, one at a time, until all characters have been interrogated. An additional interrogation is performed on gates associated with unsaturating flip-flops in the pulse detection section. These flip-flops have been following the character-by-character interrogation of the stored vocabulary. If a match is detected in all characters by an unsaturating flip-flop, its gate is open and a pulse passes through, signaling the presence of a word. The flip-flops, one-shots, gates, and pulse-transformer core-drivers are conventional and will not be discussed.

The fixed memory, or vocabulary, consists of a one-turn secondary threaded in a logical arrangement through the pulse transformer cores, shown as doughnut shapes in Fig. 2. Physically these cores are ferrite U-cores with spring-loaded bars on top. The bars are all mounted on the hinged cover so they can be lifted for the insertion, or removal, of words in the vocabulary. Figure 1B is a photograph of one of these units. A total of 120 are used in the equipment.

The letter R was chosen to illustrate how a word is inserted in the vocabulary. The teletypewriter code for R is space-mark-space-mark-space. Note that the letter R has been threaded through the cores, which are pulsed in the complementary coding mark-space-mark-space-mark. The spotter is,

therefore, looking for the absence of pulses in all cores through which the one-turn secondary has been threaded. This approach is used because the digital task of detecting a no-pulse among pulses can be done more reliably than the analog task of detecting a discrete voltage among other discrete voltages.

Figures 1C and 1D are photographs of waveforms obtained from these cores. Figure 1C illustrates the condition of a match. This waveform should be a straight line; however, pulses of 0.2 volt are observed. These undesired transients are caused by interwiring pickup, and will be referred to as noise. Figure 1D illustrates non-match on one core. This pulse is of 1.2 volts, and will be referred to as signal. These waveforms illustrate the limiting condition in the operation of the equipment, which must be able to detect the difference between the noise pulses and the signal pulse from the minimum condition of nonmatch on one core only. The signal-to-noise ratio of the model is therefore five.

Manganese zinc ferrite cores were chosen for the word spotter in preference to the other core materials available^{1,2}.

A device that recognizes ordered sequences of coded alphanumeric characters has been described. One possible application would be in a teletypewriter distribution system where many messages destined for different addressees arrive on one signal line. The word spotter could be programmed to recognize the various addressees and channel their messages to print out on teletypewriter machines located with the addressee.

REFERENCES

- (1) C. D. Owens, A Survey of the Properties and Applications of Ferrites Below Microwave Frequencies, *Proc IRE*, 44, p 1,234, Oct. 1956.
- (2) Gelbard, Magnetic Properties of Ferrite Materials, *Tele-Tech*, 11, p 50, May 1952.

RECOGNIZE WORDS

Coincidence detector compares code with words set up in fixed memory, emits pulse when proper sequence appears. Spotter can recognize the addresses arriving on one line and direct messages to destinations

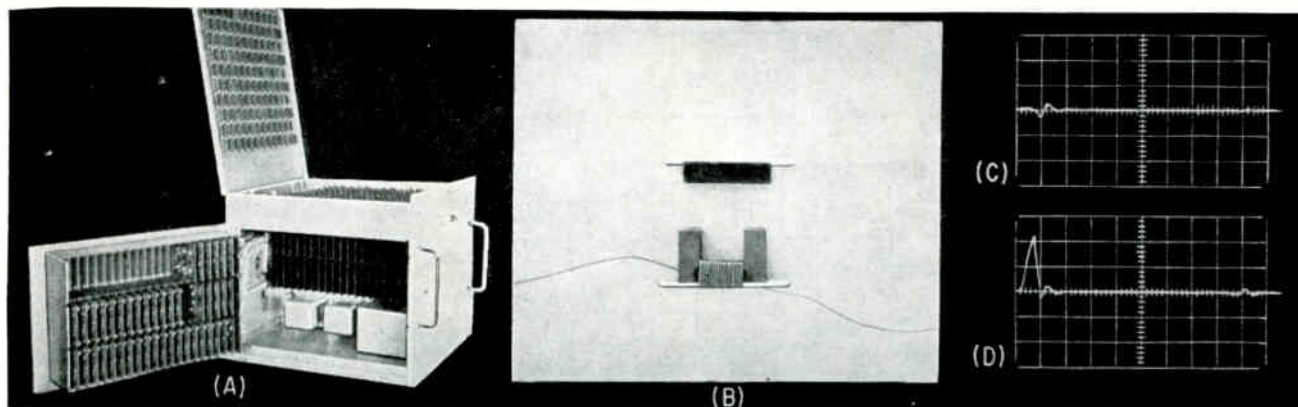

FIG. 1—Left view of word spotter (A) shows the top cover mounted with 120 bars (B top) that fit over the ferrite U-cores (B bottom) through which the one-turn secondary is threaded. Waveforms from the one-turn secondary show match (C) and nonmatch (D) on one core with a vertical scale of 0.5 v/cm and a horizontal scale of 1 μ sec/cm

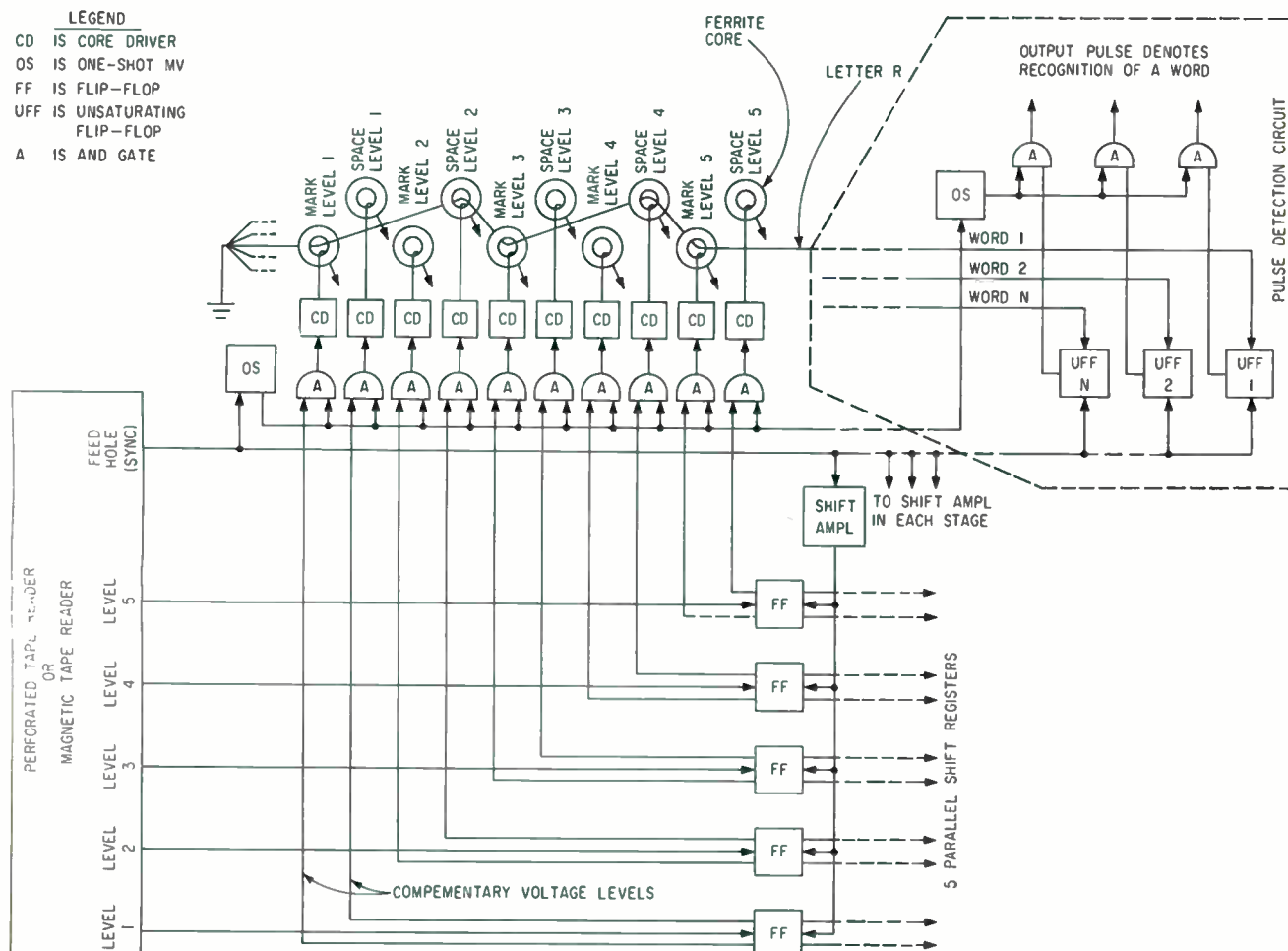
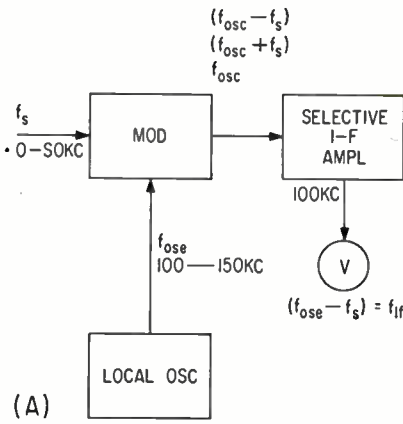
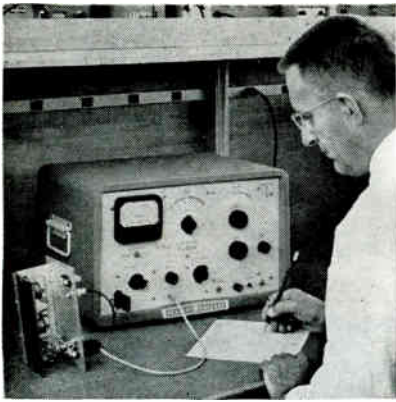

FIG. 2—Block diagram of one stage of word spotter shows ferrite U-cores and top bars as circular forms. The one-turn secondary is threaded through several stages to form a word. Several words may be set up, with the recognition of each word causing a separate output (top right)



New Look

By J. R. PETRAK,
Hewlett-Packard Co.,
Palo Alto, California

IT IS FREQUENTLY DESIRABLE to make voltage measurements of complex wave shapes in which magnitude and frequency of the wave's individual components must be determined. At times it is necessary also to determine the magnitude and frequency of a signal that occurs in the presence of another whose magnitude and frequency differ from the desired signal. The device that satisfies these requirements and is familiar to most engineers is the wave analyzer. Its principle of operation is usually likened to a stable superheterodyne receiver.

Figure 1A shows the operating principle of a wave analyzer of the heterodyne type. Frequency component, f_s , of the input signal under measurement is fed into the modulator, which is also driven from the local oscillator whose frequency is f_{osc} . The signal from the modulator consists of several frequency components; the principal ones are $(f_{osc} - f_s)$, $(f_{osc} + f_s)$ and f_{osc} . These components are fed through a selective i-f amplifier. Since the components may be close together (especially if f_s is a low audio frequency like 20 cycles), the selectivity of the i-f amplifier must be high to distinguish between the desired and the undesired components.

The output frequency from the selective i-f amplifier, which is $(f_{osc} - f_s)$ only, is rectified and metered. The linearity of the modulator must be such as to minimize frequency components not in the incoming signal. High selectivity and good modulator linearity—are important in wave analyzer design.

Figure 1B shows the parts of the transistorized wave analyzer. Although additional blocks have been added to those in Fig. 1A, the principle is the same but with the added features of an afc (automatic frequency control) system,

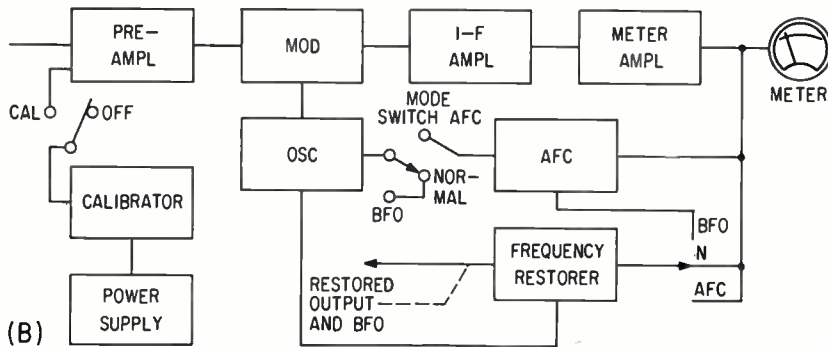

FIG. 1—Photo shows engineer using the bfo-feature to measure a filter characteristic (top left); block diagram of basic analyzer (A); final block diagram (B) of equipment described in this article

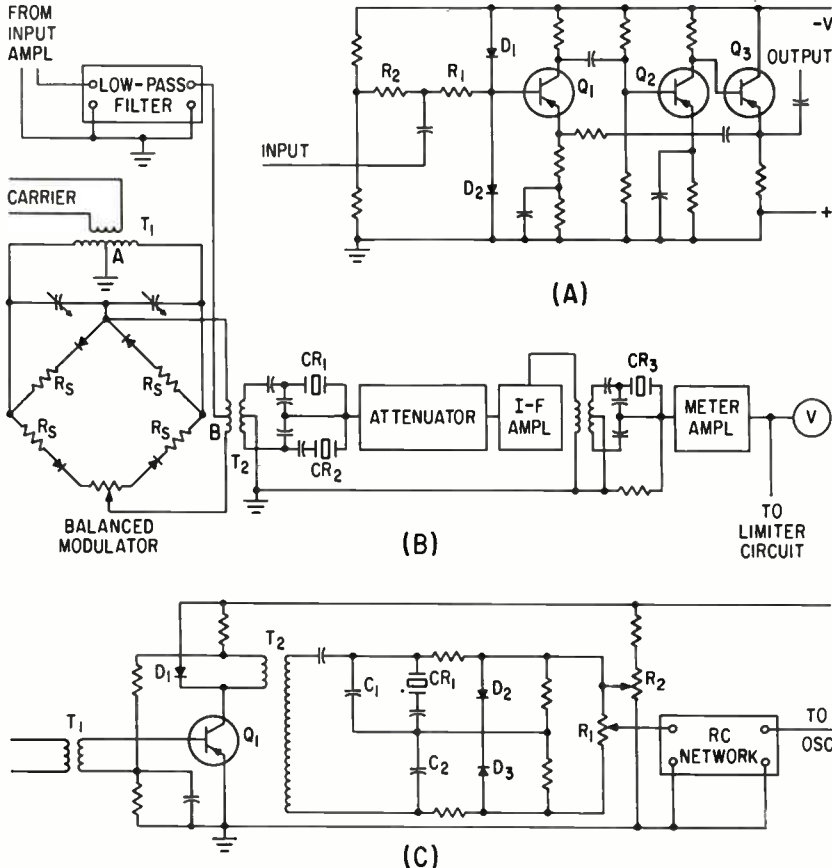

FIG. 2—Three stage amplifier with 40-db feedback has 17-db gain and runs at 200 millivolt signal level (A); balanced modulator is followed by i-f amplifier and meter drive circuits (B); limiter is followed by crystals for sharper frequency discrimination (C)

At Wave Analyzer Design

Transistor circuits confer greater temperature stability since their dissipation is less than vacuum tubes used earlier; moreover, size and weight are reduced and warm-up delays eliminated

frequency restorer circuit, bfo (beat frequency oscillator) and calibrator.

With the mode switch in the AFC position, the afc system is in operation and is similar to that used in radio receivers. A limiter drives a discriminator, whose d-c voltage output is proportional to frequency and is fed into the reactance circuit of the local oscillator, where it alters the local oscillator frequency to correct for detuning of the incoming signal.

In either the N (normal) or the AFC switch position, the frequency restorer circuit combines the local oscillator frequency, f_{osc} , with the signal from the i-f amplifier of frequency, f_{i-f} and feeds them through a low-pass filter. The difference frequency between the local oscillator and the i-f amplifier, $(f_{osc} - f_{i-f}) = f_s$, is extracted and amplified. This difference frequency provides an external signal which is present only when the analyzer is tuned to the frequency component of the input signal under measurement. The external signal may be applied to precision frequency measuring equipment for precise determination of the spectra.

With the mode switch in the BFO position, a crystal oscillator, whose frequency is the same as the i-f amplifier frequency, f_{i-f} , is switched in place of the i-f amplifier signal and fed into the modulator where it is combined with the local oscillator signal of frequency, f_{osc} . The difference frequency, $(f_{osc} - f_{i-f}) = f_s$, is recovered from the output of the low pass filter and amplified. Thus with no input signal applied to the instrument, an output signal is available for use with the wave analyzer. The combination may be envisioned as a transmission measuring set in which the oscillator section and the tuned voltmeter

section (wave analyzer) are both tuned to the identical dial frequency by a single control.

The input system consists of the input attenuator and preamplifier. The preamplifier, shown as one of the blocks in Fig. 1B should introduce little distortion into the system (85 to 90 db down), have a relatively high input impedance and provide overload protection.

To satisfy the first requirement, a three stage amplifier was constructed with *pn*p transistors as shown in Fig. 2A. Here the overall gain of the amplifier is 17 db with about 40 db of feedback. This, together with keeping the signal level low (that is, an output signal level of around 200 millivolts) resulted in an amplifier whose distortion figures are better than 90 db down.

The problem of obtaining high input impedance was solved by feedback, high base circuit impedance, and relatively high emitter resistance of the input transistor, Q_1 , for stabilization. The impedance is 100,000 ohms when looking into the input terminals of the amplifier.

Overload protection must be considered in transistor work. Protection was achieved by placing two silicon diodes, D_1 and D_2 in the base circuit of input transistor, Q_1 . Here D_2 is back-biased by the voltage between base and ground and D_1 is back-biased by the voltage between base and negative supply voltage.

Output from the amplifier is fed into a low-pass filter whose passband is 50,000 cycles and whose rejection region is in excess of 60 db at 100,000 cycles and higher. This filtering rejects input frequencies that are in the passband of the i-f amplifier and prevents erroneous readings.

The low-pass filter output feeds into the balanced modulator shown

in Fig. 2B. Good linearity is essential. The modulator is of the ring type used in telephone work. The local oscillator is used as the carrier or switching signal, (that is, the controlling signal that determines the path of the lower amplitude input signal) and is fed across the transformer T_1 . The low-pass filter input signal is fed into the center taps, A and B, of the transformers T_1 and T_2 . Output is taken from the terminals of T_2 and consists of both upper and lower side band frequencies, $(f_{osc} - f_s)$ and $(f_{osc} + f_s)$, as well as the carrier frequency f_{osc} . Balance is improved by series resistors, R_s , which swamp out effects of variations in the four diodes.

The i-f amplifier selectivity is achieved by quartz crystals that are placed in the circuit in Fig. 2B. The center frequency of the filter, which is composed of these quartz crystals, is 100 Kc and is made up of two sections separated by a section of amplification. Correct filter characteristics are achieved by tuning the crystals to prescribed frequencies with series and shunt capacitors. The pole and zero of each crystal configuration are altered by the shunt and series capacitances, respectively. The two crystals, CR_1 and CR_2 along with their capacitors, produce a double-humped response characteristic. The single crystal, CR_3 , and its capacitor is then tuned to fit between the double humps and produce a response curve that has a flat characteristic.

The limiter of the afc system is shown in Fig. 2C along with the discriminator. This is the circuit in the afc block in Fig. 1B. The limiter is driven through transformer T_1 from the output of the amplifier that feeds the rectifiers and meter. Limiting action is achieved by driving transistor, Q_1 ,

so that on positive input peaks the collector is driven to zero voltage and on negative input peaks the transistor is cut off, causing the collector to assume the d-c supply potential.

Figure 2C shows the discriminator circuit, which uses a quartz crystal², and associated capacitors for adjusting its center frequency to the center of the pass band of the i-f amplifier crystal filter. A quartz crystal in the discriminator permits a much sharper characteristic essential for proper performance.

The voltage developed across the series combination of C_1 and C_2 is rectified by the two diodes D_2 and D_3 and the difference between a portion of these two voltages appears across potentiometer, R_1 . Since the magnitude of this voltage is a function of frequency, it is fed through an $R-C$ network whose purpose is to stabilize the a-fc loop gain characteristics, to the reactance circuit of the oscillator.

Figure 3A is a circuit diagram of the block labeled osc in Fig. 1B. The output from the $R-C$ network is connected between the common connection of diodes D_1 and D_2 ,

and ground. These diodes are back-biased by the voltage obtained from R_2 in Fig. 2C and are operating as voltage-sensitive capacitor³ which, along with L_1 and C_1 determine the frequency of the oscillator. Thus a change in signal level at the output of the discriminator produces a change in capacitance in the frequency determining circuit of the oscillator, thereby altering the oscillator frequency.

The oscillator is of the bridge type in which the arms of the bridge are L_1 and C_1 , D_3 and D_4 and the reflected impedances across the winding of T_1 , which feeds the above elements. Figure 3B shows the equivalent bridge circuit. Here R_A and R_B are the reflected impedances of transformer T_1 and are low, R_{a-c} is the a-c resistance of the combination L_1 and C_1 at its resonant frequency, and R_d is the a-c resistance of the diode combination D_3 and D_4 . Silicon diodes are used as a forward-biased variable resistance limiting device.

Figure 3C shows a typical curve of the characteristics obtained when using diodes. As the magnitude of the direct current is increased, the value of the diodes' a-c

resistance decreases. The value of the bridge arm element R_d , and thus the bridge balance, is controlled by an external d-c source. The external d-c source, in addition to being of the proper magnitude, must be proportional to the output signal level of the oscillator. Assuming that the oscillator is oscillating, the bridge circuit is excited by the voltage developed across the transformer winding that feeds points A, A', of Fig. 3B. The unbalanced bridge signal is fed into the base of transistor Q_1 (Fig. 3A) and amplified. The collector circuit of Q_1 drives the basis of Q_2 and Q_3 , which form a class-B amplifier whose output drives the balanced modulator. As the emitter current of the class-B stage is one that varies proportionately to the amplifier signal level, it is a source of direct current with which to control the bridge arm element, R_d .

The oscillator is adjustable in frequency over a range of 100,000 cycles to 150,000 cycles; for dial calibration purposes this corresponds to an input signal range of 0 to 50,000 cycles. Because the wave analyzer has a fixed selectivity over its entire frequency range, a linear frequency dial calibration is used to permit constant resolution. This provides the same feel of tuning whether a 50-cycle or a 50,000-cycle signal is being tuned in. Actual linear-frequency versus dial-rotation is achieved by a special capacitor⁴. The drive mechanism for both the dial and the capacitor is such that an equivalent dial scale over 50 feet in length is achieved. With a scale of this length, the problem of finding signal frequencies close to each other, (that is, 60 cycle sideband frequencies on a signal at 10 Kc) is greatly simplified.

The author acknowledges the help of those instrumental in the development of the new wave analyzer, particularly B. M. Oliver, J. M. Cage, Brunton Bauer, and N. Kovalovski.

REFERENCES

- (1) R. F. Shea, *Transistor Circuit Engineering*, John Wiley and Sons Inc., New York, N. Y., 3, 1957.
- (2) D. I. Kosowsky, *High Frequency Crystal Filter Design Techniques and Applications*, *Proc IRE* 46, p 419, Feb. 1958.
- (3) L. J. Giaccolletto and John O'Connell, *A Variable-Capacitance Germanium Junction Diode for UHF*, *RCA Rev*, 17, p 68, March 1956.
- (4) B. M. Oliver, *Gamma-Derived Capacitors*, *Proc IRE* 47, p 1654, Sept. 1959.

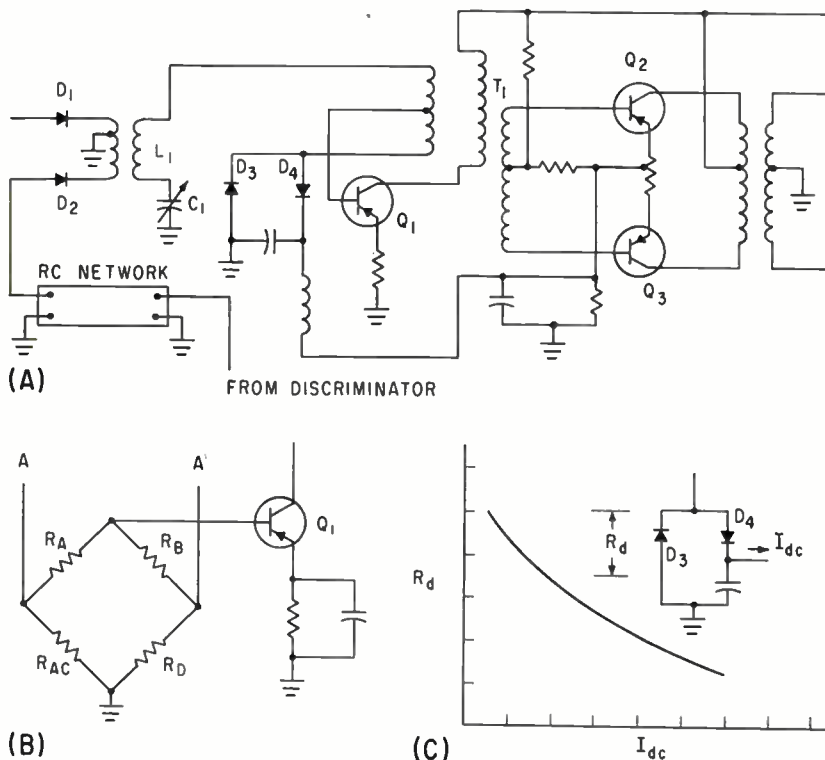

FIG. 3—Diodes in (A) act as voltage variable capacitors so that oscillator frequency is a function of discriminator input; equivalent circuit of the oscillator bridge is shown in (B) while diode a-c resistance characteristics are shown in (C)

Analyzing Magnetically-Detented Stepper Servo Motors

Digital test equipment evaluates motor performance in several modes.

Commercially available digital building blocks are used in logic and counter circuits

By H. J. WEBER and M. WEISS, Servomechanisms, Inc., Goleta, California

SINCE THE requirements for magnetically detented stepper motors are so varied, they are designed and produced to suit special applications. Because of this lack of standardization, an analyzer capable of providing a wide variety of test conditions and capable of fully evaluating the test results is needed to test these motors to prove performance. An analyzer that automatically checks motor response by comparing the number of applied voltage steps with the actual number of motor mechanical steps is shown in the photo. The motor can be stepped clockwise, or counterclockwise at will, while being tested under the several possible different modes of operation.

Essentially, a stepper-motor is a digital-to-analog converter in that it converts a pulse into a bi-directional scaled angular position. Thus the stepper motor could be used as a simple pulse-counter or, with a digital computing system, could be used in a digital servo to position indicators, transducers, or output elements to digital accuracy. The magnetically detented stepper motor consists of a two-pole permanent magnet rotor and a stator with two centertapped windings at right angles to each other. Applications of this motor are similar to those of older stepper motors that use mechanical escapements and latches to produce a fixed angular displacement for each input of voltage.

Although similar in application to

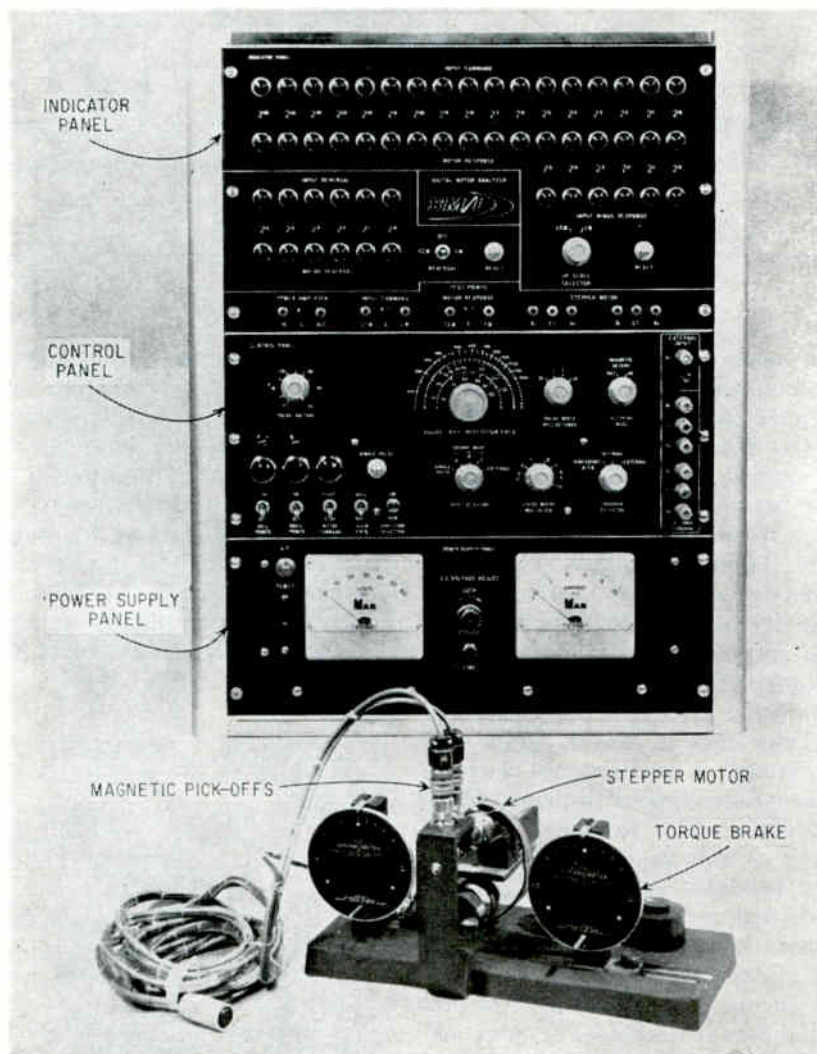

Tester uses modules mounted on slide-in boards which are easily accessible from rear of cabinet

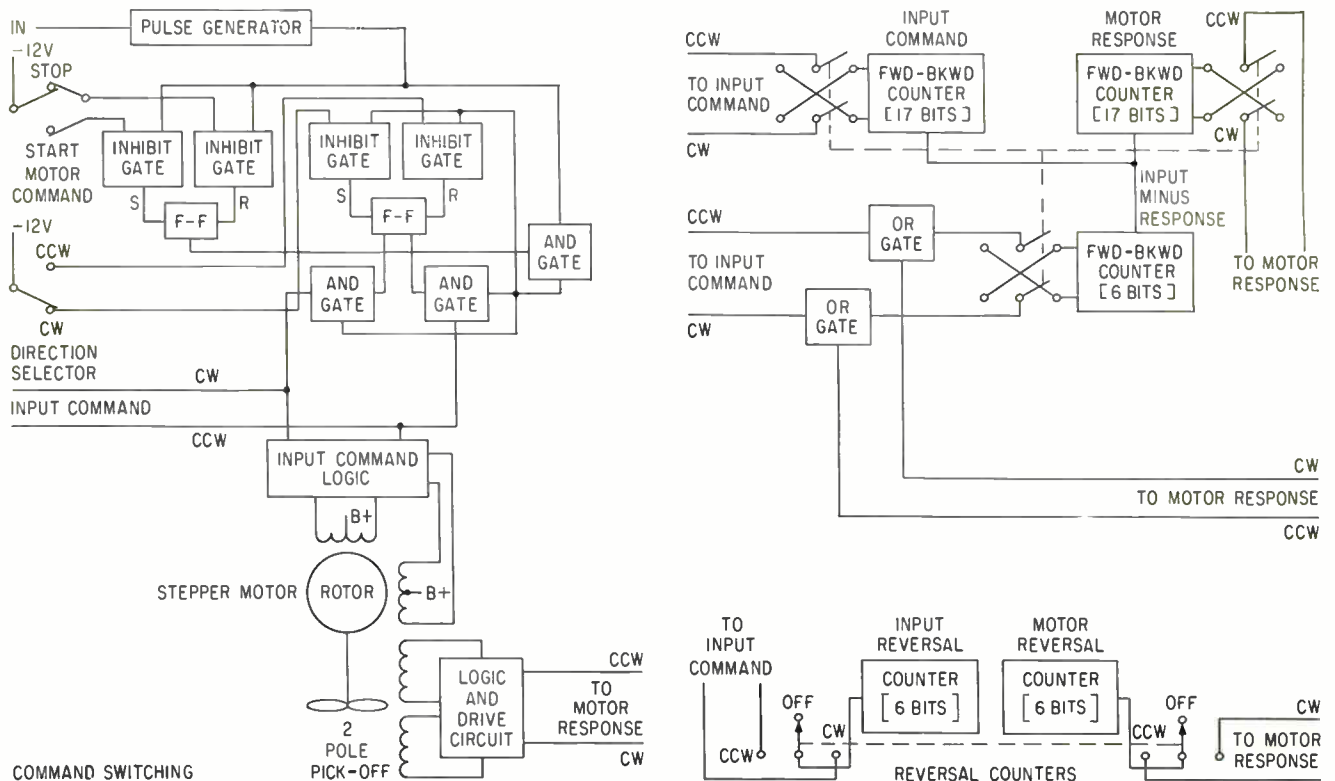

FIG. 1—Logic system of digital motor analyzer shows application of simple building blocks

the mechanically detented stepper motors, the magnetically detented stepper motor works on a simpler basis. When a d-c or pulse voltage is applied to the stator windings, the permanent magnet rotor will align itself with the stator magnetic field. When the voltage is switched from one winding to another, or the polarity of the voltage is reversed, the rotor realigns itself with the magnetic field in the new direction producing a step in rotor position.

This stepper motor offers improvement in performance over the conventional type with the mechanical detent. For example, stepping rates as high as 200 steps a second are feasible—an order of magnitude better than most conventional types. In addition, since there are no mechanical detents to wear out or go out of adjustment, life and reliability of the device is improved. This motor can be driven directly off the 400-cycle line as a split-phase induction motor when high-speed slew requirements must be met.

The fixture used to test these mo-

tors has a square-wave generator that can vary the frequency, pulse width and amplitude of the output waveform; a pickoff assembly that detects mechanical rotation of the motor; and counter circuits to tally and record motor input and output pulses. Logic for this analyzer was designed specifically to drive the stepper motor in 180-degree steps. This equipment can be adapted to

handle angular steps of other magnitudes.

Figure 1 is a block diagram of the logical operation of the system. The logic and counter circuits are well-tested digital building blocks. Figure 2 shows how the two basic types of internally generated pulses—single pulse and repetitive square waves—are generated. The input signal, regardless of its origin, is

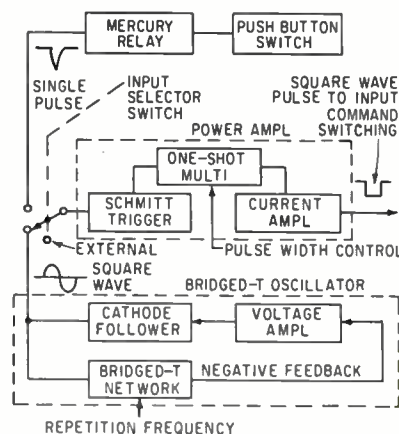
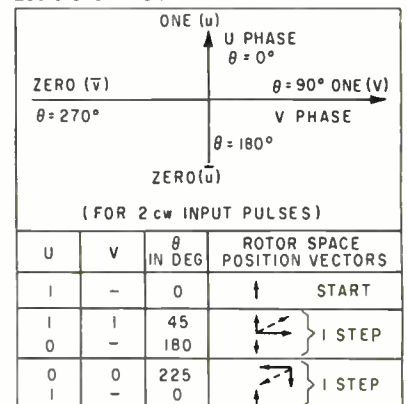

FIG. 2—Pulse generation circuit has three inputs

LOGIC OPERATION



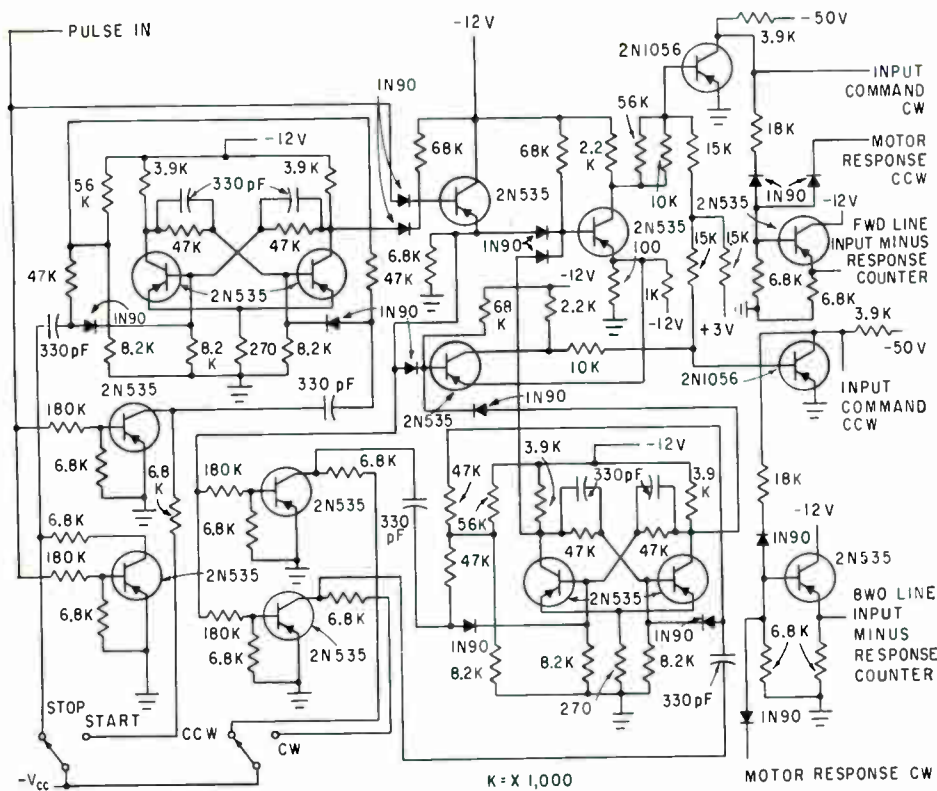

FIG. 3—Switching circuit provides inputs to counters and motor drive circuits

squared with a Schmitt trigger. Pulse width is established by the time constant of a monostable multivibrator. On square-wave input, repetition rate is determined by a bridged-T oscillator. Frequency of the oscillator is controlled by changing the resonant point or notch of the bridged network.

The mercury relay is used in the single-pulse generator eliminating

the contact bounce found in a mechanical switch. This assures that one and only one pulse will be generated for each operation of the single-pulse pushbutton. The equipment provides either single pulses or repetitive square waves over the range of 10-1,000 pps with a duty cycle varying from 10 to 90 percent of the period.

In Fig. 1 it can be seen that the

pulse train from the power amplifier is gated through logic circuits controlled by the MOTOR COMMAND and DIRECTION SELECTOR switches before reaching the input command bus. The schematic diagram of this section is shown in Figure 3. These circuits prevent switching from occurring in the middle of a pulse, keep the input pulse line closed even when switching motor direction and

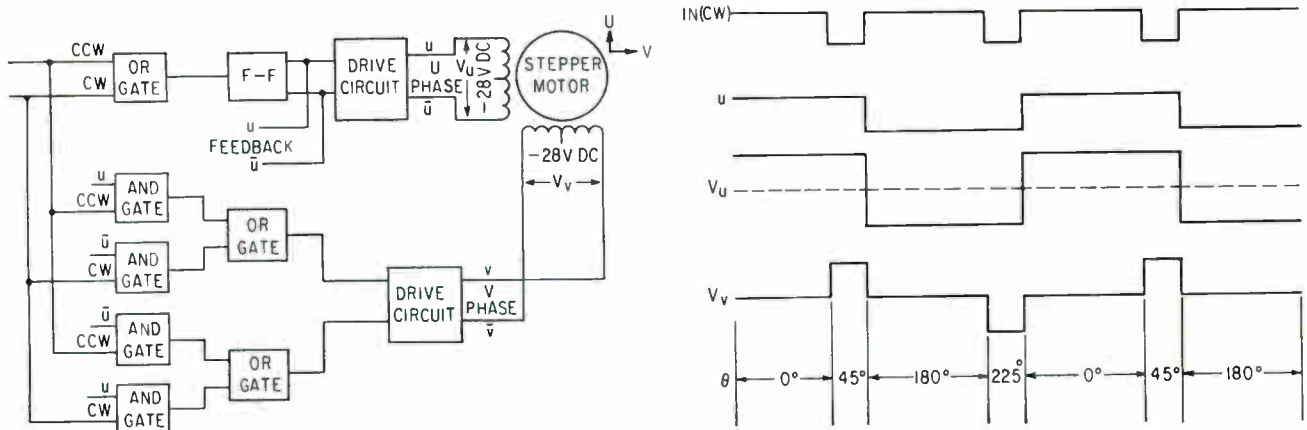

FIG. 4—Input command logic circuit drives the two phases of the motor

prevent, by using solid-state switching, the occurrence of spurious signals due to contact bounce.

The MOTOR COMMAND switch, when thrown to start position, sets a flip-flop, through inhibit circuits, that supplies d-c excitation to one side of an AND gate. This allows the input pulse train to pass through. The inhibit circuits prevent the flip-flop and hence the controlling AND gate from changing state in the middle of the pulse.

Similarly the DIRECTION SELECTOR switch sets a second flip-flop that supplies excitation to one of two AND gates, allowing the pulse train to pass through to either the cw or ccw line of the input command bus. Here again, the inhibit circuits prevent the controlling AND gates from changing state in the middle of a pulse. In addition, the flip-flop guarantees that one of the two command lines will always be closed even when the DIRECTION SELECTOR switch is momentarily opened as the direction is being reversed.

Figure 4 shows waveforms and the logical block diagram of the input command logic. The *U* phase is driven by a flip-flop producing the desired magnetic detent operation.

The *U* (or reference) phase when reversed provides the 180-degree step and determines the final position of the stepper motor. Without the *V* phase, however, the starting

torque is theoretically zero and the initial direction of rotation is indeterminate.

To illustrate how the logic works, let the *U* and *V* phases determine space axis whose positive directions are shown in the table. Using the convention that when the *U* flip-flop is ON or ONE, the *u* side of the winding is grounded and \bar{u} is at B+ (-28 v), and inversely when the *U* flip-flop is OFF or ZERO, the \bar{u} side is grounded and *u* is at B+ (-28v). For the *V* phase, both *v* and \bar{v} normally are open circuited, except that when a pulse is applied to the top of the drive circuit (ONE), *v* is grounded and \bar{v} is at B+, and conversely for a pulse applied to the bottom of the drive circuit (ZERO). For illustration, the table is given for the cw case, starting at zero degrees (*U* = ONE). When a voltage (pulse or d-c) is applied to one of the input lines of the drive circuit the end result is to apply B+ to one end of the motor winding and ground to the other end, sending current through the selected half of the winding.

Figure 5A shows the logic required to generate the motor response pulses as well as the waveforms occurring at several points for the example of cw rotation of the stepper motor. Both pick-offs produce the same waveform, so that the information as to direction

of rotation is supplied by which pick-off's signal came first. Each pick-off channel drives a monostable multivibrator, the output of which is anded with the signal from the other channel. Pulses appear only on the cw line. If the direction of rotation were reversed, pulses would have appeared only on the ccw line. The magnetic pick-offs and the motor response circuits are not sensitive to variations of the input repetition rate since the applied torque and hence speeds are nearly constant as long as the stepper motor is not driven beyond its capabilities. At low rep rates the motor is essentially sitting still for a major portion of the cycle, but when a pulse is applied, the torque, accelerations and speeds will be nearly constant at all rates. The schematic program of this section is shown in Fig. 5B.

A detailed analysis of the forward-backward counter used appeared in a previous article.¹

The digital modules used in the logic and counter circuits are mounted on 20 large slide-in boards. These slide-in boards are readily accessible from the rear of the test cabinet.

REFERENCE

- (1) H. J. Weber, Binary Circuits Count Backwards or Forwards, *ELECTRONICS*, p 82, Sept. 25, 1959.

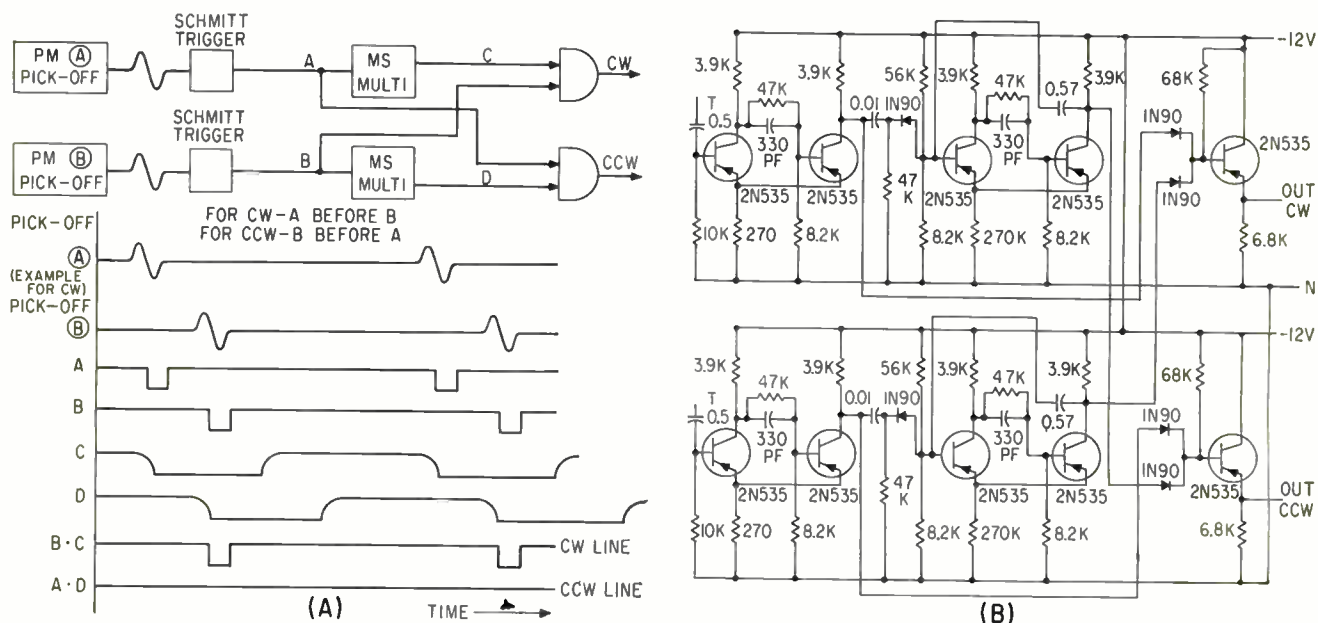

FIG 5—Motor response logic and waveforms (A) with circuit diagram (B)

NEW...
from
Cinch

SUB-MINIATURE SOCKETS

for NUVISTORS



for Mechanical Mounting

the 133-65-10-001 tube socket is fastened to the chassis by these two tabs rolled against the underneath side of the chassis.

- Impossible to Insert Tube Incorrectly or Damage the Contacts . . . The socket provides two slots of different widths. These mate with the two corresponding legs depending from the metal envelope of the tube to index the tube and socket contacts.

- Sub-Miniature Size Requires Minimum Space.

- Socket Body is Low Loss; Type MFE, Phenolic Insulation.

Saddle is of cold rolled steel, cadmium plated. Contacts are of copper alloy with cadmium plating.



or Solder Mounting

the tube 133-65-10-002 socket is furnished with solder washer which solders directly to the chassis at 430°F. Resists minimum pressure of 20 lbs.



Dimensions of Chassis Aperture

Here is shown the size of the Chassis hole for the sockets, either solder or mechanically fastened.

The thickness of the chassis may vary between .032 and .082 inches. The tube socket will resist a minimum pressure of 20 lbs. before dislodging.

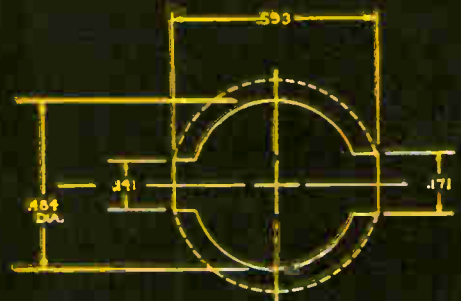

Cinch
ELECTRONIC
COMPONENTS

CINCH MANUFACTURING CORPORATION

1026 SOUTH HOMAN AVENUE, CHICAGO 24, ILLINOIS

Division of United Carr Fastener Corporation, Boston, Massachusetts

Centrally located plants at Chicago, Illinois; Shelbyville, Indiana; City of Industry, California, and St. Louis, Missouri



Available Now! Complete engineering data and detailed specifications on both of these Nuvistor sockets are yours for the asking. Phone NE. 2-2000 today or write/wire

Extended Transmission-Line Charts

*Charts permit plotting of impedance
for negative-resistance components*

By H. F. MATHIS, Goodyear Aircraft Corp., Akron, Ohio

IN SOME APPLICATIONS of circular transmission-line charts such as the Smith¹ or Carter² charts, it may be necessary or desirable to use impedances with negative-resistance components. For example; the normalized impedance of a very short stub antenna fed by a lossy transmission line may have a negative-

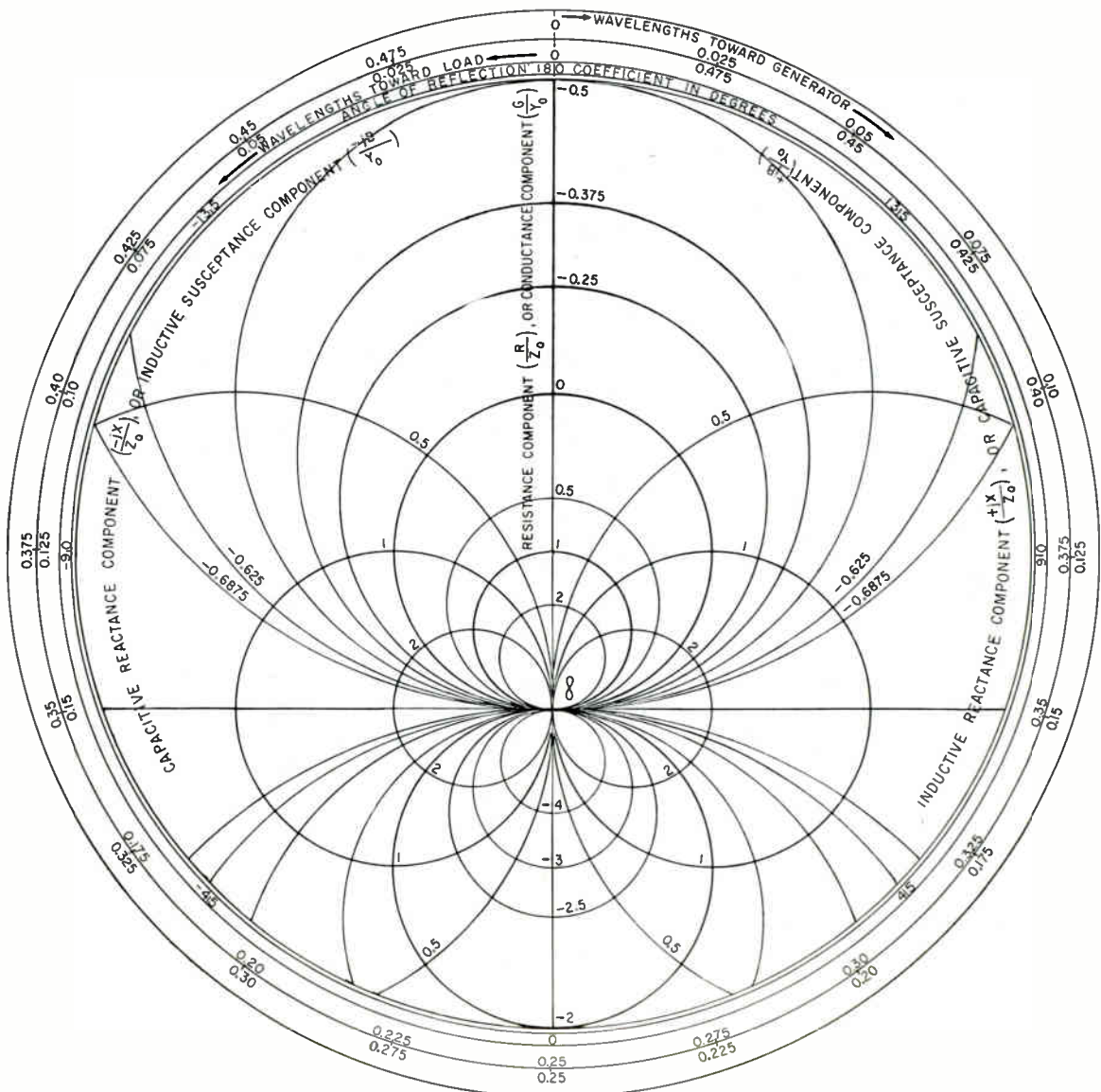
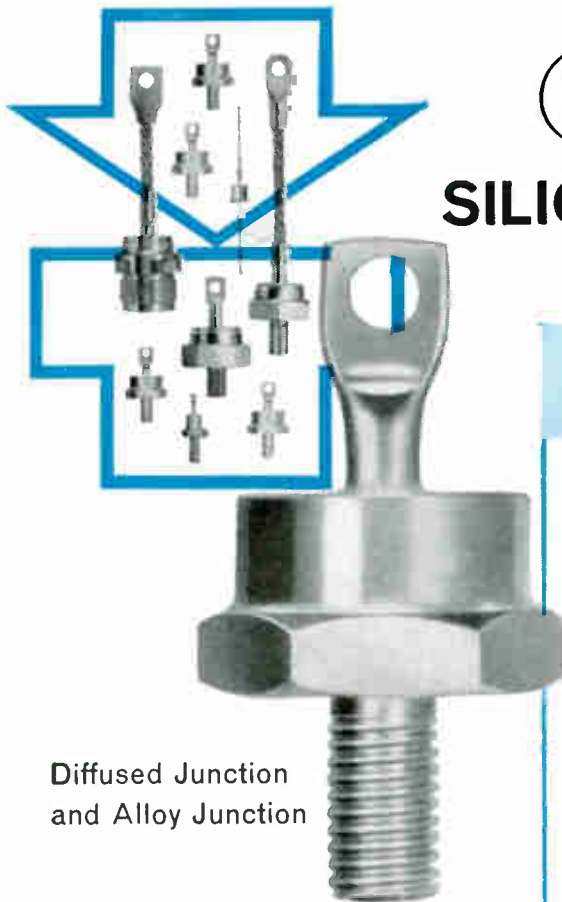

FIG. 1—Extended Smith chart. Intermediate circles omitted for clarity



Diffused Junction
and Alloy Junction

ts TUNG-SOL®

SILICON POWER RECTIFIERS

250 ma to 100 amps

This select line fits the broadest variety of applications. Each unit delivers across-the-board versatility and directly replaces many existing types.

Tung-Sol silicon rectifiers were designed to serve with unqualified dependability in the most exacting military and commercial applications. They're precision engineered to assure the utmost in top-performance uniformity and stability . . . and to function at maximum capacity even under the most severe environmental and electrical overload conditions. Write for the new Tung-Sol silicon rectifier interchangeability chart and complete technical information. Tung-Sol Electric Inc., Newark 4, New Jersey.

Standard JEDEC configurations and with Tung-Sol's unsurpassed Standard and reliability.

	Type	Peak Reverse Voltage (Volts)	Average Forward Current	Maximum Reverse Current *	Max. Full Load Voltage Drop (Volts)	Surge Current† (Amps)
250- mA Ambient Temperature	1N538	200	750 mA Dc @ 50°C	250 μA Dc	0.5	
	1N540	400	250 mA Dc @ 150°C	250 μA Dc	0.5	
	1N547	600	750 mA Dc @ 50°C 250 mA Dc @ 150°C	250 μA Dc	0.5	
1 Amp 150°C Case Temperature	1N253	100	1.0 A Dc	100 μA Dc	—	
	1N254	200	0.4 A Dc	100 μA Dc	1.0 ▲	
	1N255	400	0.4 A Dc	150 μA Dc	—	
	1N256	600	0.2 A Dc	250 μA Dc	—	
20 Amp 140°C Case Temperature	1N1191	50	20 A Dc	5 mA Dc	.55	Full cycle avg. 150°C case temp.
	1N1192	100	20 A Dc	5 mA Dc	.55	
	1N1193	150	20 A Dc	5 mA Dc	.55	
	1N1194	200	20 A Dc	5 mA Dc	.55	
	1N1195	300	20 A Dc	5 mA Dc	.55	
	1N1196	400	20 A Dc	5 mA Dc	.55	
	1N1197	500	20 A Dc	5 mA Dc	.55	
1N1198	600	20 A Dc	5 mA Dc	.55		
25 Amp 150°C Case Temperature	CS-120Z	50	25 A Dc	5 mA Dc	.55	Full cycle avg. 150°C case temp.
	CS-120A	100	25 A Dc	5 mA Dc	.55	
	CS-120B	200	25 A Dc	5 mA Dc	.55	
	CS-120C	300	25 A Dc	5 mA Dc	.55	
	CS-120D	400	25 A Dc	5 mA Dc	.55	
	CS-120E	500	25 A Dc	5 mA Dc	.55	
CS-120F	600	25 A Dc	5 mA Dc	.55		
35 Amp 140°C Case Temperature	1N1183	50	35 A Dc	10 mA Dc	0.6	full cycle avg. 140°C case temp.
	1N1184	100	35 A Dc	10 mA Dc	0.6	
	1N1185	150	35 A Dc	10 mA Dc	0.6	
	1N1186	200	35 A Dc	10 mA Dc	0.6	
	1N1187	300	35 A Dc	10 mA Dc	0.6	
	1N1188	400	35 A Dc	10 mA Dc	0.6	
	1N1189	500	35 A Dc	10 mA Dc	0.6	
1N1190	600	35 A Dc	10 mA Dc	0.6		

	Type	Peak Reverse Voltage (Volts)	Average Forward Current	Maximum Reverse Current*	Fwd. Voltage Drop** (Volts)	Surge Current† (Amps)
50 Amp 150°C Case Temperature	CH116Z	50	50 A Dc	20 mA Dc	1.1	500
	CH116A	100	50 A Dc	20 mA Dc	1.1	500
	CH116B	200	50 A Dc	20 mA Dc	1.1	500
	CH116D	400	50 A Dc	20 mA Dc	1.1	500
	CH116F	600	50 A Dc	20 mA Dc	1.1	500
70 Amp 150°C Case Temperature	1N1396	50	70 A Dc	15 mA Dc	1.3	1500
	1N1397	100	70 A Dc	15 mA Dc	1.3	1500
	1N1398	150	70 A Dc	15 mA Dc	1.3	1500
	1N1399	200	70 A Dc	15 mA Dc	1.3	1500
	1N1400	300	70 A Dc	15 mA Dc	1.3	1500
	1N1401	400	70 A Dc	15 mA Dc	1.3	1500
	1N1402	500	70 A Dc	15 mA Dc	1.3	1500
70 Amp 150°C Case Temperature	CH109Z	50	70 A Dc	30 mA Dc	1.3	1500
	CH109A	100	70 A Dc	30 mA Dc	1.3	1500
	CH109B	200	70 A Dc	30 mA Dc	1.3	1500
	CH109C	300	70 A Dc	30 mA Dc	1.3	1500
	CH109D	400	70 A Dc	30 mA Dc	1.3	1500
	CH109E	500	70 A Dc	30 mA Dc	1.3	1500
80 Amp 150°C Case Temperature	1N1291	50	80 A Dc	30 mA Dc	1.3	1500
	1N1292	100	80 A Dc	30 mA Dc	1.3	1500
	1N1293	200	80 A Dc	30 mA Dc	1.3	1500
	1N1294	400	80 A Dc	30 mA Dc	1.3	1500

▲ Max. fwd. voltage drop @ 0.5 amp., 25°C case temperature
 * Full cycle average for rectifier operating into inductive or resistive load at rated current and voltage
 ** 50 amp units @ 100 amps D.C. and 25°C;
 70 and 80 amp units @ 150 amps D.C. and 25°C
 † Max. half sine wave peak current for one cycle @ 60 cps
Storage temperature range for all types . . . -65° to 200°C

Technical assistance is available through the following sales offices: Atlanta, Ga.; Columbus, Ohio; Culver City, Calif.; Dallas, Texas; Denver, Colo.; Detroit, Mich.; Irvington, N. J.; Melrose Park, Ill.; Newark, N. J.; Philadelphia, Pa.; Seattle, Wash. Canada: Toronto, Ont.



resistance component. Such a component is equivalent to a reflection coefficient greater than 1. In this case, the charts can be extended by using negative resistance components in the basic equations for these charts.

Many of the techniques for the original charts can also be used on the extended charts. Although the extended charts are infinite in size, only the portions near the original sections are usually needed for practical problems.

Circular transmission-line charts are drawn by mapping the $R \geq 0$ half of the Z plane on

to the unit circle using the transformation $\Gamma = (Z - Z_0)/(Z + Z_0)$. It is customary to use normalized values of Z so that $\Gamma = (Z - 1)/(Z + 1)$.

An R -circle (or- G -circle) on the Smith chart has its center at $x = R/(R + 1)$, $y = 0$ and radius $r = 1/|R + 1|$. On this chart, an X circle (or B -circle) has its center at $x = 1$, $y = 1/X$ and radius $r = 1/|X|$. An extended Smith chart is shown in Fig. 1.

On the Carter chart, a Z -circle (or Y -circle) has its center at $x = (Z^2 + 1)/(Z^2 - 1)$, $y = 0$

and radius $r = 2|Z/(Z^2 - 1)|$. A θ -circle has its center at $x = 0$, $y = -\cot \theta$ and radius $r = |\csc \theta|$. The ambiguity due to $Z/\theta = -Z/\theta + 180^\circ$ may be removed by requiring that $Z \geq 0$. An extended Carter chart is shown in Fig. 2.

REFERENCES

- (1) P. H. Smith, Transmission-Line Calculator, ELECTRONICS, 12, p 29, Jan. 1939; and An Improved Transmission-Line Calculator, ELECTRONICS, 17, p 130, Jan. 1944.
- (2) P. S. Carter, Charts for Transmission Line Measurements and Computations, RCA Review, 3, p 355, Jan. 1939.

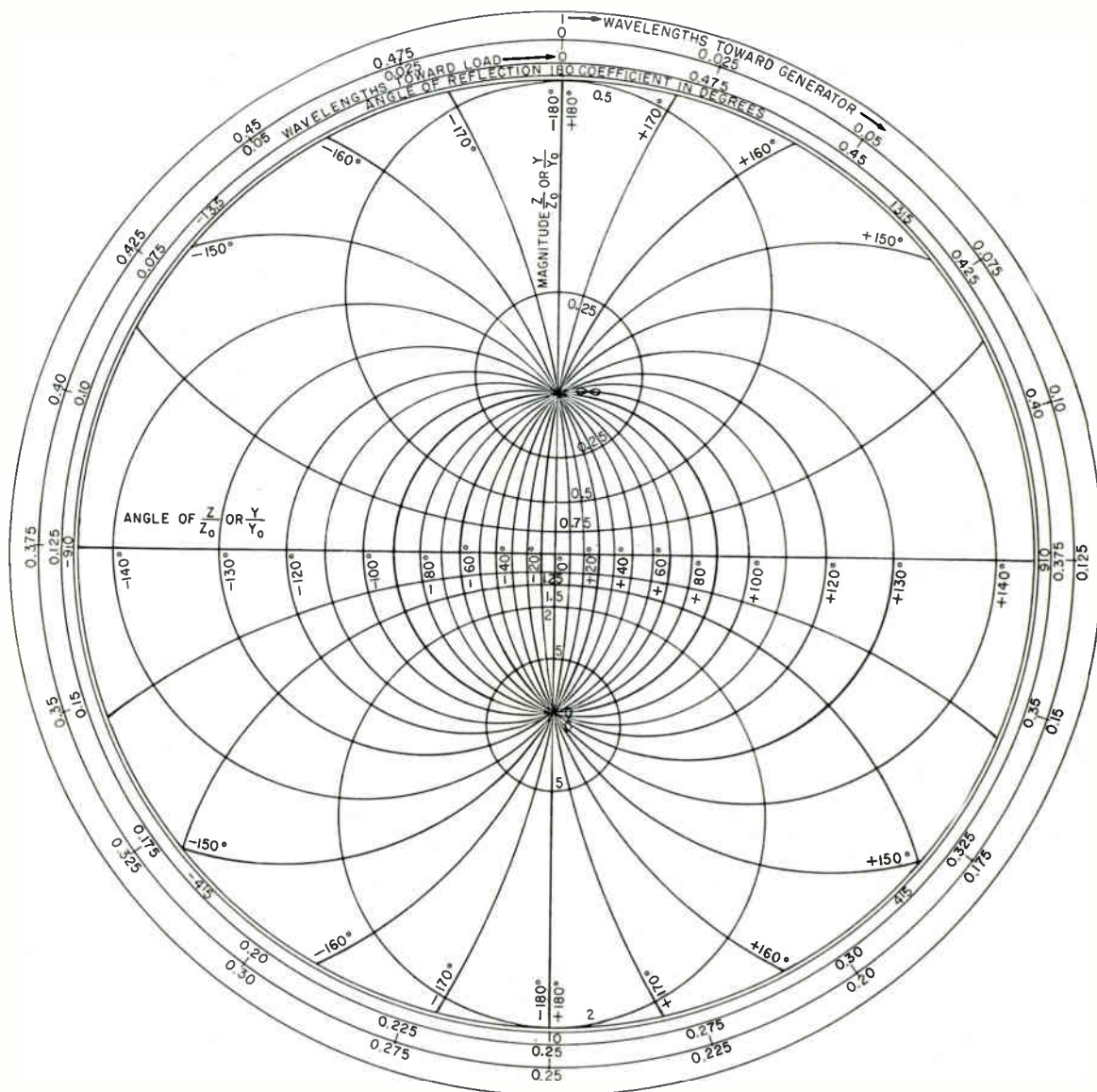

FIG. 2—Extended Carter chart. Intermediate circles omitted for clarity

HERE'S WHY CENTRICORES ARE PROBABLY THE MOST CONSISTENTLY UNIFORM CORES YOU CAN BUY:

The exceptional uniformity you get in tape-wound Centricores is not easy to come by. It's the result of painstaking precision at every stage of the manufacturing process—and, in fact, *before* manufacturing. Three principal factors help produce Centricore uniformity:

Careful classification of materials—Raw alloys are first “pedigreed”—meticulously selected, then tested for some 14 parameters, and classified by magnetic properties. We're the largest buyer of nickel alloy magnetic materials in the world... which permits us to choose material for Centricores from an unusually wide distribution of magnetic properties.

Special winding machines—We build our own machines, to die-making tolerances, for winding magnetic alloy tape into cores. We also build our own machines for applying insulating coating to the tape. These machines give us far greater uniformity in dimensions, insulation and ultimate performance of Centricores.

Closely-controlled annealing—Annealing—perhaps the most critical phase of the core-making process—is done under precisely regulated atmospheric and temperature stabilized conditions to hold Centricore magnetic performance to uniformly high levels.

Exceptional uniformity from core to core and lot to lot is further assured with Super Squaremu “79”, a new high-performance alloy we've developed. It has outstanding magnetic qualities and is remarkably uniform in squareness, thermal stability and gain. Super Squaremu “79” offers an effective solution to problems of variation in magnetic performance.

WRITE FOR BULLETIN C-3

SIZE	MATERIAL	THICKNESS
1	HIGH NICKEL Hymu 80 Squaremu 79 Super Squaremu 79	.001**
THRU	LOW NICKEL Squaremu 49 Carpenter 49	THRU
225	GRAIN-ORIENTED SILICON Crystalligned Microsil	.004*

*Special sizes, shapes and thicknesses quoted on request.

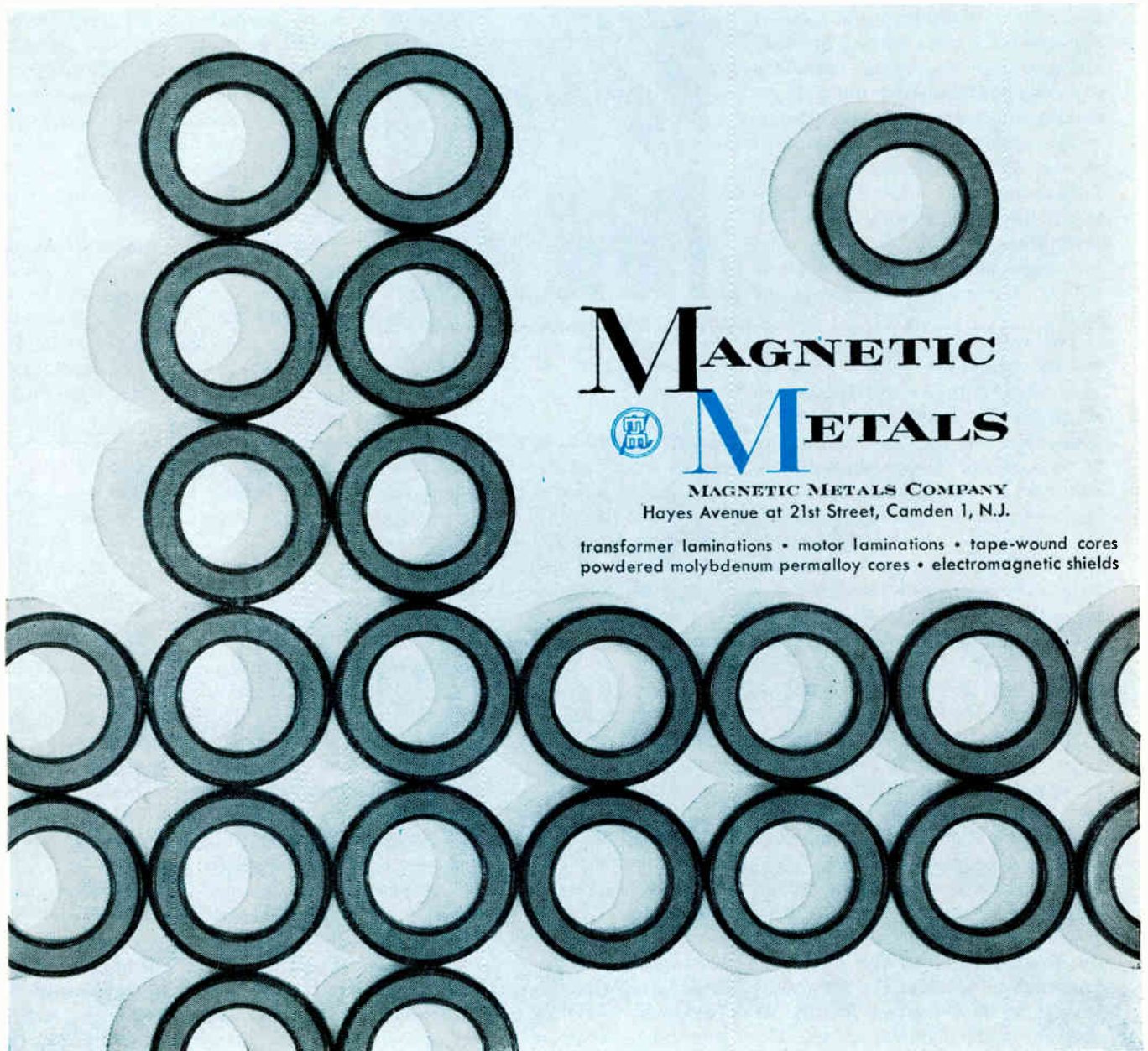

MAGNETIC METALS

 **METALS**

MAGNETIC METALS COMPANY
Hayes Avenue at 21st Street, Camden 1, N.J.

transformer laminations • motor laminations • tape-wound cores
powdered molybdenum permalloy cores • electromagnetic shields

Circular Array Scans at High Speed

EXPERIMENTAL circular antenna provides high-speed, narrow-beam scanning. Elements and reflector of broadband array are stationary, the only moving part being a relatively small rotor. Called Halo, the flexible antenna system can be mounted around existing structures without its scanning ability or radiation pattern being affected. It can also be mounted on a flat surface.

The circular array was developed by the Air Force primarily for tactical situations that require a transportable and easily erected array. However, its desirable electrical and mechanical characteristics make it suitable for a wide variety of other applications. Individual antennas can even be stacked for multiple receiving and transmitting functions.

The concept for Halo originated at the Electromagnetic Radiation Laboratory of the Air Force Electronic Research Directorate at Bedford, Mass. A 52-ft diameter model has been constructed by Andrew Alford Consulting Engineers of Boston.

The only moving part in the assembly is the rotor, which is a compact delay line with impedance controlled for matching and delay. The rotor can transfer more than 20 Kw of c-w power through 50-ohm coaxial line to any selected 90-degree segment of the antenna. The rotor provides the required delay in transferring energy to elements within the energized 90-degree section. Delay of a signal between the rotor and a center element is the equivalent of $7\frac{1}{2}$ electrical feet compared with that of an element at the end of a 90-degree segment.

With this unusual configuration, rotor speeds up to 180 rpm are possible, with equivalent azimuth scanning velocity. By incorporating a servo control system, an azimuth angle can be selected for the narrow beam with an accuracy within 3 seconds of arc.

The experimental model of the antenna operates in the uhf band from 225 to 400 Mc. Beamwidth of this array is 6 degrees at 225 Mc and about 3.5 degrees at 400 Mc.

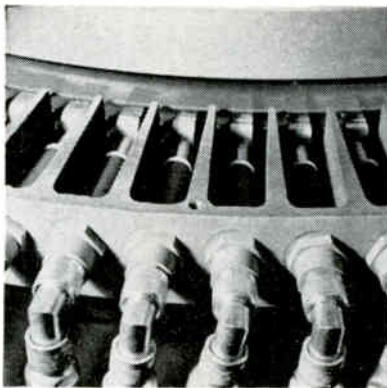

Elements of array at top are fed by rotor through coaxial connectors at bottom

Narrower azimuth beamwidth can be achieved by increasing the diameter of the circular antenna array. To reduce the width of the beam in elevation, additional circular arrays can be stacked vertically.

Performance characteristics such as rapid scanning, operation over at least a 2:1 frequency range and capability of handling high peak and average powers suggest many potential applications. However, mechanical simplicity and flexibility contribute greatly to the usefulness of the new antenna.

Each section of the circular array is identical and can be made of light but strong material. Sections of the antenna can be transported by motor vehicle and assembled quickly at a desired site. Smaller diameter antennas could be transported by helicopter, with rotor and electronic equipment matched to the antenna at the new location.

The antenna, mounted around a lighthouse, airport control tower or tall building, can be used for radar or communications. It can operate as a direction finder of transmissions from friendly or hostile sources. Navigational information can be transmitted to friendly ships or aircraft, and the antenna can be used with a search radar. Vertical stacking of the circular arrays permits more than one function.

The broadband characteristics permits switching of transmitting frequency to avoid natural or man-made interference. Coupling broadband operation with the power-handling capability also enables jamming of enemy transmissions. High azimuth resolution and scanning speed make the new array very suitable for monitoring enemy transmissions to determine their characteristics as well as the direction of their source.

Sectors of the antenna can be used in aircraft for side-looking radar mapping or for passive monitoring. The circular assembly, which is unaffected by the structure around which it is mounted, could be installed around the cylindrical body of a missile. With this arrangement, the antenna could be connected to a proximity device or could receive instructions from ground-based transmitters.

Large Cosmic Shower Supports New Theory

COSMIC RAYS may come from outside our galaxy. Records made by M.I.T. scientists of the largest cosmic ray shower they had ever observed support this conclusion. They believe that the source of the highest energy rays is beyond the Milky Way. This concept is a departure from the most current theories.

The unusually large shower was analyzed and results reported by J. Linsley and L. Scarsi. Bruno Rossi, also of M.I.T. and vacationing in Italy, cabled that the exceedingly large shower confirms the extragalactic acceleration mechanism for

America's modern way of doing business



AIR EXPRESS speeds newly created parts to assembly site in time for car to bow at international auto show

Air Express takes priority on all scheduled U. S. airlines

AIR EXPRESS is in the auto business, now! This crew is just finishing off the latest model. Hours from now, it will bow at a glamorous auto show. Many new parts were completed just in time, and flown to this assembly point with jet speed. All 35 scheduled U.S. airlines pampered them with priority treatment. AIR EXPRESS trucks (13,000... many radio-dispatched) rushed them door-to-door at both ends of their flights. As each part arrived, the shipper got a teletype receipt. That's service! AIR EXPRESS is in other businesses, too. It should be in yours. There's no finer partner and rates are low. One phone call is all it takes.

**AIR EXPRESS**



CALL AIR EXPRESS DIVISION OF RAILWAY EXPRESS AGENCY •

GETS THERE FIRST VIA U. S. SCHEDULED AIRLINES

Investigate today's most productive semi-automatic Coil Winder — the Leesona No. 108. Winds up to 30 coils simultaneously on short or long runs. Handles wire from No. 19 to No. 42 (B&S) and finer. Fingertip control . . . quick set-up . . . versatility. Leesona Corporation, P.O. Box 1605, Providence 1, Rhode Island.
(formerly Universal Winding Company)

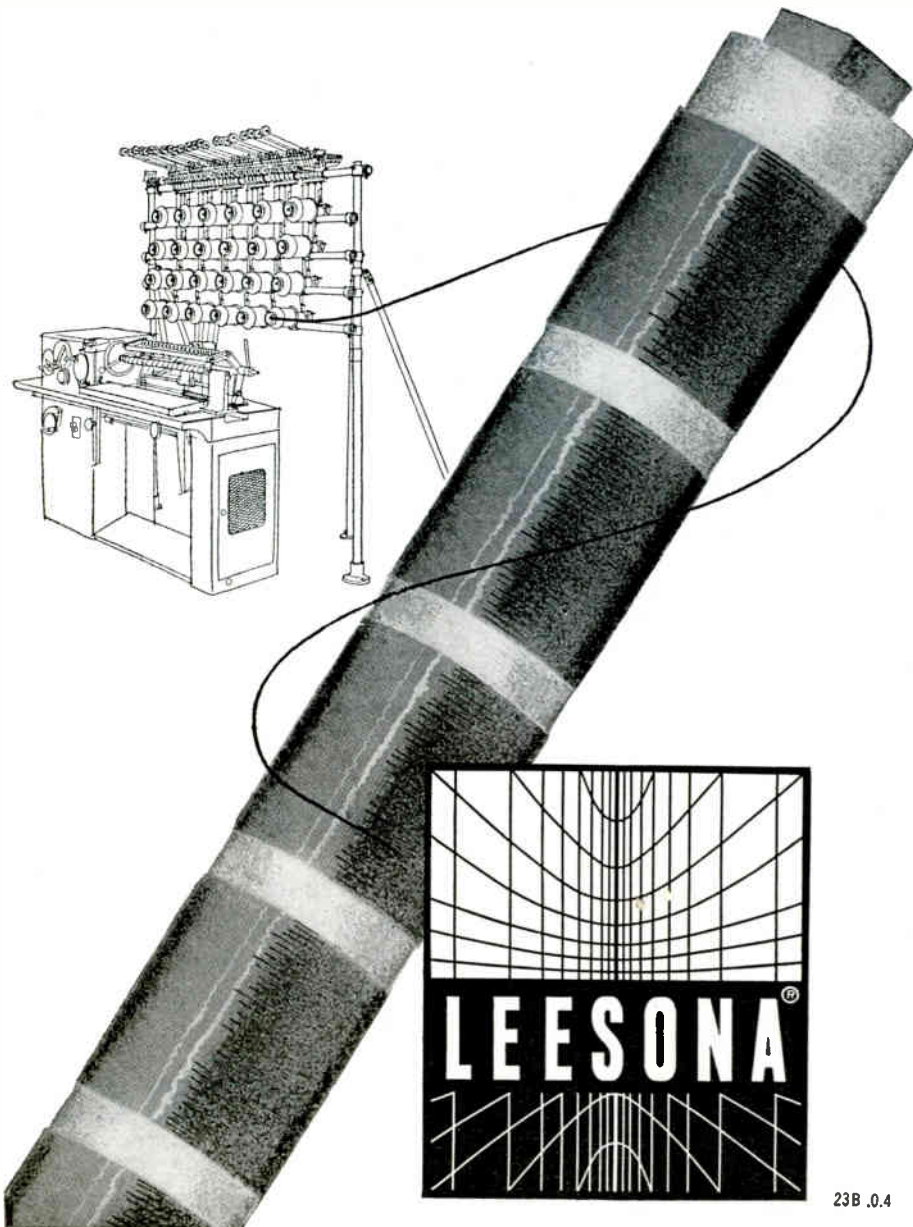

23B.0.4

cosmic rays. The opinion of the research group is supported by a series of recent observations of very high-energy showers.

The extremely large shower occurred at about midnight last December 3 near Albuquerque, but months were required to analyze data recorded during it. In only 10 microseconds, about 10 billion particles were detected. It is estimated that the cosmic ray that caused the shower must have had energy between 10^{18} to 20^{18} electron volts, at least 500 million times the maximum energy ever artificially imparted to a particle. Magnitude of the shower was more than three times that of the largest shower previously recorded by M.I.T. physicists, which took place at the Agassiz Astronomical Station at Harvard University in March 1957.

Cosmic ray particles entering the atmosphere at nearly the speed of light collide with atoms breaking up the atomic structure. The atomic particles in turn collide with other atoms, continuing the process of atomic disintegration.

To study cosmic rays, the shower of electrons striking the earth's surface as a result of this process are detected and counted. At the Volcano Ranch station near Albuquerque, an array of 20 large fluorescent plastic scintillation counters are used for this purpose. They are spread in a six-sided pattern over about 600 acres. Altitude at the site is 6,000 ft.

Detector outputs are amplified and displayed on an oscilloscope for photographic recording. Computer analyses of the data acquired in the extremely heavy shower of last December were made at Kirkland Air Force Base.

Following an original concept of Enrico Fermi, most current theories hold that cosmic ray particles gain energy while traveling through the magnetic fields of the galactic disk. However, about a year ago Rossi reported that his group found particles with energies higher than could be explained by any acceleration mechanism within the galaxy. He also stated that cosmic rays do not all come from the Milky Way.¹

Rossi suggested that scientists may have to revise their concept of our galaxy. The gas clouds and

magnetic fields of the Milky Way may extend much further. Ionized gases and magnetic fields outside our galaxy may cause the great acceleration and energies observed in the very heavy shower.

It has also been assumed that most of the primary rays are protons. However, it is also possible the ionized nuclei of heavier elements (like iron) are much more abundant than expected from the cosmic abundancies of elements.

REFERENCE

(1) Bruno Rossi, High-Energy Cosmic Rays, *Scientific American*, p 134, November, 1959.

Echo I Data Confirms Solar Pressure Theory

THEORETICAL predictions of the effects of solar radiation pressure have been demonstrated by Echo I. Observations of the balloon satellite have also provided the first accurate values of the extremely low air density at 1,000 miles altitude.

The theory concerning impact of solar pressure was advanced by H. M. Jones and I. I. Shapiro of M.I.T. Lincoln Laboratory and R. W. Parkinson of Thompson Ramo-Wooldridge. Measurements of the orbit of Echo I computed by P. Zadunaisky of the Smithsonian Observatory confirmed the theory. These measurements show that the lowest point of the orbit is being pushed towards the earth by the rays of the sun. The present rate of this movement is $1\frac{1}{2}$ miles each 24 hours. However, calculations indicate that this rate will soon decrease and then reverse.

Accurately predicting the effect of solar pressures on large, light-weight satellites with different orbits and launch times will aid in determining optimum orbit and launch time for accomplishing a specific mission. In certain orbits, a small variation in launch time can result in a great difference in satellite life because of solar pressure.

Accurate measurement of air density at very high altitudes furthers general knowledge of the dynamics of the atmosphere of the earth. However, this information also has immediate practical application in predicting behavior of space vehicles.

DIRECT DISPLAY OF RESPONSE UP TO 20 Mc

The Marconi 20-Mc Sweep Generator can be used in conjunction with any oscilloscope for direct display of video response characteristics up to 20 Mc. The instrument is designed for precise measurement. Frequency is indicated by crystal-controlled marker pips; and a special circuit provides for differential amplitude measurements, enabling relative response to be determined with a discrimination better than 0.01 dB.

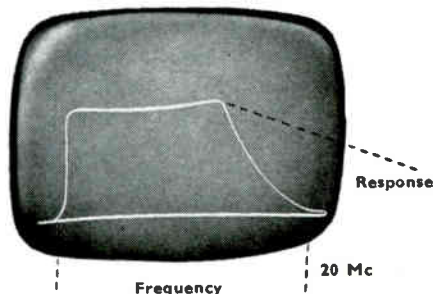

MARCONI 20-Mc SWEEP GENERATOR TYPE 1099

Abridged Specification

Frequency Swept Output: Frequency Range: Lower limit 100 kc, Upper limit 20 Mc. Output level: Continuously variable from 0.3 to 3 volts. Output Impedance: 75Ω. *Time Base:* Repetition Rate: 50 to 60 cps. Output for c.r.o. X deflection: 250 volts. *Frequency Markers:* At 1 Mc intervals; every fifth pip distinctive and crystal controlled. Tubes: 6AK5, 6BH6, 5763, 6BJ6, 6CD6G, 6BE6, 12AT7, 12AU7, 6C4, 5V4G, OA2, 5651.



Send for leaflet B124/A.

MARCONI INSTRUMENTS

111 CEDAR LANE
ENGLEWOOD
NEW JERSEY
Tel: LOWell 7-0607

Canada: Canadian Marconi Co • Marconi Building • 2442 Trenton Ave • Montreal 16
MARCONI INSTRUMENTS LTD • ST. ALBANS • HERTS • ENGLAND

Contact Button Made From Knitted Wire

AN UNUSUAL contact element, developed by Technical Wire Products Inc., of Springfield, N. J. has recently proved its usefulness in a large military computer. The material has acquired the name *fuzz button* because it resembles compacted metallic fuzz. The contact, made from knitted wire, has desirable properties as a contact element.

The diagram shows a section of knitted wire mesh. Note that there are several parallel circuits in direction A, but that the contact resistance at the loop crossovers are all in series in this direction. These contact resistances vary greatly. However, in direction B, the parallel circuits are continuous wires and variations in contact resistances at the loop crossover points will have little or no effect on the resistance in direction B. In the fuzz button, the mesh is always oriented in direction B.

This orientation is assured by the method of folding the knitted mesh

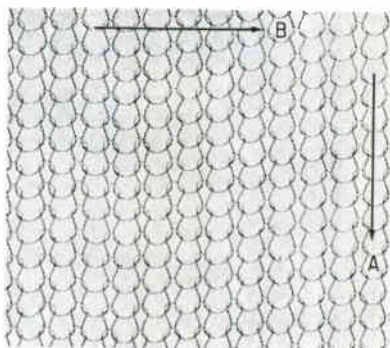

Orientation of wire mesh (left) in contact button. Present application of this contact is shown (right)

after it has been accurately cut to a specified weight. The folded mesh is then preformed into a slug of mesh approximately $\frac{1}{2}$ -in. diameter and $\frac{3}{4}$ -in. long. This preform is then cold pressed to a unit $\frac{1}{8}$ -in. long and $\frac{3}{8}$ -in. diameter, with the wires still running in the $\frac{1}{8}$ -in. direction.

The diagram shows that the loops inherent in knitting also give maximum resilient effect in direction B.

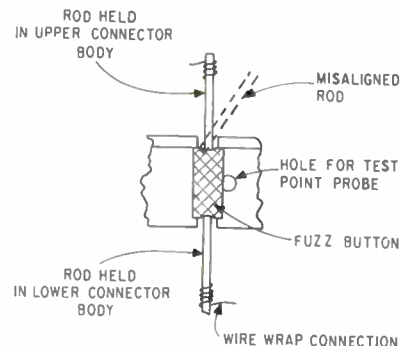

This resiliency remains in the final compressed form.

The present application of this new contact unit is shown in the diagram. The button is retained in the body of insulating material, with as many as 760 per connector. The mesh unit is contacted on both sides by a 0.045-in. x 0.045-in. rod to which wires are attached by wire-wrap techniques and which are held in connector bodies to match the location of the fuzz buttons. This arrangement has several advantages over usual male-female connectors.

The rods do not have to line up exactly on the center of the mating fuzz button; the rods can be misaligned (dotted lines in the diagram); there is no force required to separate the connector—the resiliency of knitted mesh in the button actually forces the rods apart when closing force is released. In addition, the many parallel wires in the button give reliable contact by both circuit and contact redundancy. The compressed mesh is approximately 15 percent wire by volume, so that many small specks of dust can fall harmlessly into the remaining 85 percent free volume.

In the present application, the units have proven 100 percent reliable. They have been tested through millions of cycles and have made contact each time. Even after lengthy storage periods, the buttons have made reliable contact.

Another useful feature of the contact button is shown. It is simple to provide a test point without

Beacon Antenna Takes 5,000 F

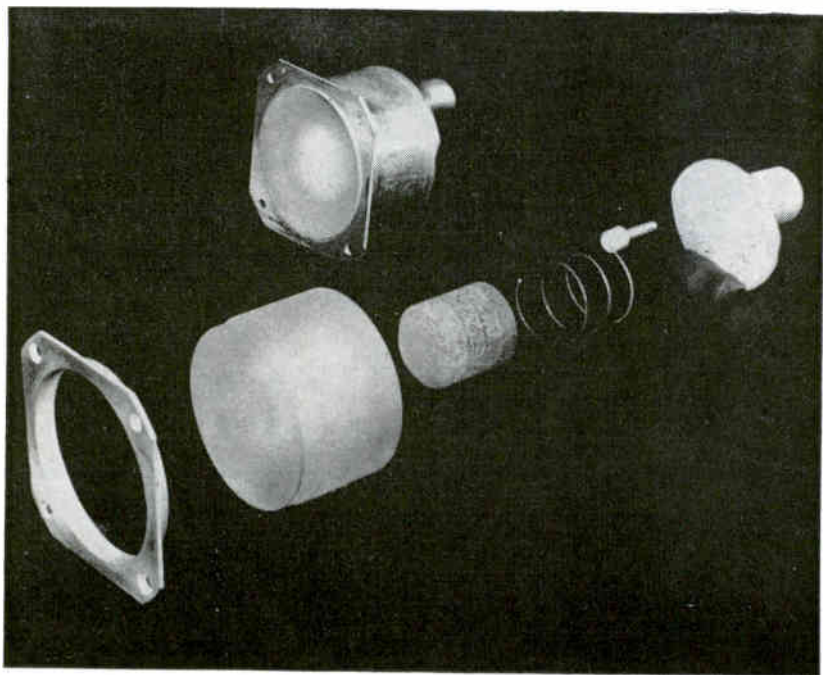

Flush-mounted s-band and c-band beacon antenna, developed by Melpar, Inc., for Project Mercury manned space capsule, uses materials such as fused quartz. The system provides circularly-polarized omnidirectional radiation coverage which is optimum for reliable lock-on of ground-based tracking antennas



SEALED IN A SECRET SILO

Somewhere in a wasteland, the Air Force Minuteman will keep its lonely vigil all through a thousand nights. Buried and untended, it must be ready to spring to life if the button is ever pushed.

Minuteman poses a real challenge to the New Reliability—reliability which must guarantee successful firing at any moment in the far future. Each of the missile's systems, each of its thousands of electronic components, must function perfectly at that given moment. For once the missile is lowered into its silo, no human hands again need touch it.

The Minuteman's critical guidance and control system has been entrusted to Autonetics. We are proud to be a member of this United States Air Force missile team.

Once again America's defense force reaps the harvest of Autonetics' pioneering. A decade of experience with major projects has given Autonetics a unique capability in systems management—and in meshing its work with that of other companies in building modern weapon systems.

Guidance Systems by Autonetics

DOWNEY, CALIFORNIA

A DIVISION OF NORTH AMERICAN AVIATION, INC. REGIONAL OFFICES: WASHINGTON, D.C. AND DAYTON, OHIO

INERTIAL NAVIGATION / ARMAMENT AND FLIGHT CONTROL / COMPUTERS AND DATA SYSTEMS



LAPP STAND-OFF INSULATORS FOR MODERATE OR HEAVY DUTY



For years, Lapp has been a major supplier of stand-off insulators to radio, television and electronics industries. Wide knowledge of electrical porcelain application, combined with excellent engineering and production facilities, makes possible design and manufacture of units to almost any performance specification. The insulators shown on this page are representative of catalog items—usually available from stock—and certain examples of special stand-offs. The ceramic used is the same porcelain and steatite of which larger Lapp radio and transmission insulators are made. Hardware is brass or bronze; brush nickel plating is standard.

Write for Bulletin 301 with complete description and specification data. Lapp Insulator Co., Inc., Radio Specialties Division, 171 Sumner St., Le Roy, N. Y.

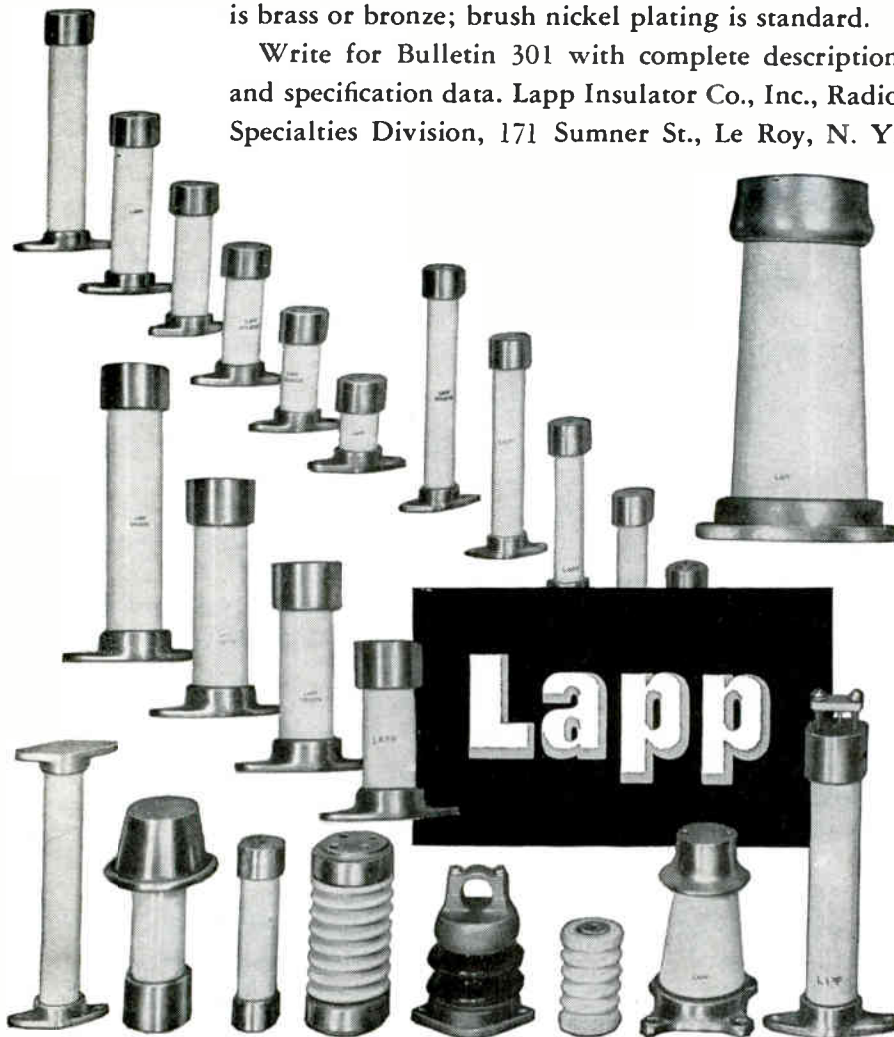

disturbing either contact. A small hole, large enough to take a test probe, is drilled so that it is about one-quarter of its diameter into the cavity holding the button. When the test probe is inserted in this hole, it compresses the button slightly from the side, making adequate contact for electrical tests.

Mechanical energy is absorbed by the button in internal friction. This property, plus the non-linearity of compression, means that the button will absorb shock and vibration efficiently, suggesting the elimination of vibration and shock isolation external of the contact system in relays and similar devices.

The important characteristics of the present button are: size, 0.156-in. diam and 0.438-in. long; weight, 0.009 oz.; deflection, compress 0.070 in. at 50 oz.; material, 3 percent silver and 97 percent copper alloy, gold-plated; contact resistance, 0.0055 to 0.008 ohms; current capacity, 2 amps for 10-deg. C rise.

Other sizes can be made, the minimum diameter being $\frac{3}{16}$ -in. or $\frac{1}{8}$ -in., depending on length. Other metals or alloys can be used, and one experimenter has passed as much as 60 amps through a fuzz button without causing any bad effects.

Superdense Ceramics

A NEW PRODUCTION process reducing voids or air pockets 80 percent over presently available ferroelectric ceramics and resulting in superdense pressure fired ceramics has been announced by Gulton Industries, Inc. of Metuchen, N. J. According to Leslie K. Gulton, president and chairman of the firm, the new pressure firing techniques mark an advance in the technology of manufacturing superdense ferroelectric and piezoelectric ceramics.

The elimination of voids by the new techniques is said to result in significantly higher piezoelectric sensitivity, higher dielectric constant, lower dielectric and acoustic loss, and a more rugged product with a 100 percent improvement in temperature stability.

In addition, this new processing technique results in a ceramic having highly uniform grain size with

corresponding improvement in the consistency of electromechanical properties. The technique also makes it possible to make larger one-piece ceramic units.

Through use of the new pressure fired process, densities greater than 8.0 have been attained in comparison to the 7.5 maximum densities previously reached by the industry in the production of lead zirconate-titanate.

The superdense ceramic, designated Glennite HT-8, is made by the application of extremely high pressure during firing from three axial directions to supply a net compacting force.

Oscillator-Transducer

AN ULTRA MINIATURE pressure-to-frequency converter, developed by Solid State Electronics Co., Sepulveda, California, promises a simplified approach to missile, space vehicle and industrial telemetering problems.

In this device, called an Osciducer, a temperature-stable silicon transistor oscillator has been wedged to a variable inductance diaphragm-type pressure transducer that provides a package for the measurement of pressure. Design consideration was given towards obtaining maximum stability of the oscillator as a function of temperature. Since transistors exhibit virtually no aging effect, long term stability is assured.

Commonly used interwiring between oscillator and transducer has been eliminated. For convenience, the units may be mounted separately. The Osciducer requires but three connections for operation: 28-v d-c at 2 milliamps, ground and the output. A silicon transistor emitter follower low-impedance output is provided to isolate the oscillator from external loading. The units can be supplied for all IRIG channels. Frequency deviation is nom. ± 7.5 percent of center frequency. Diaphragm and flush-type transducers are available from 5 to 5,000 psi differential, absolute or gage. The unit will operate with negligible effects in an environment of 2,000 g shock for a duration of 7 milliseconds; vibration, 60 g, 0-2,000 cps; acceleration, 3,000 g.

NEW EECO MAGNETIC CORE CIRCUITS

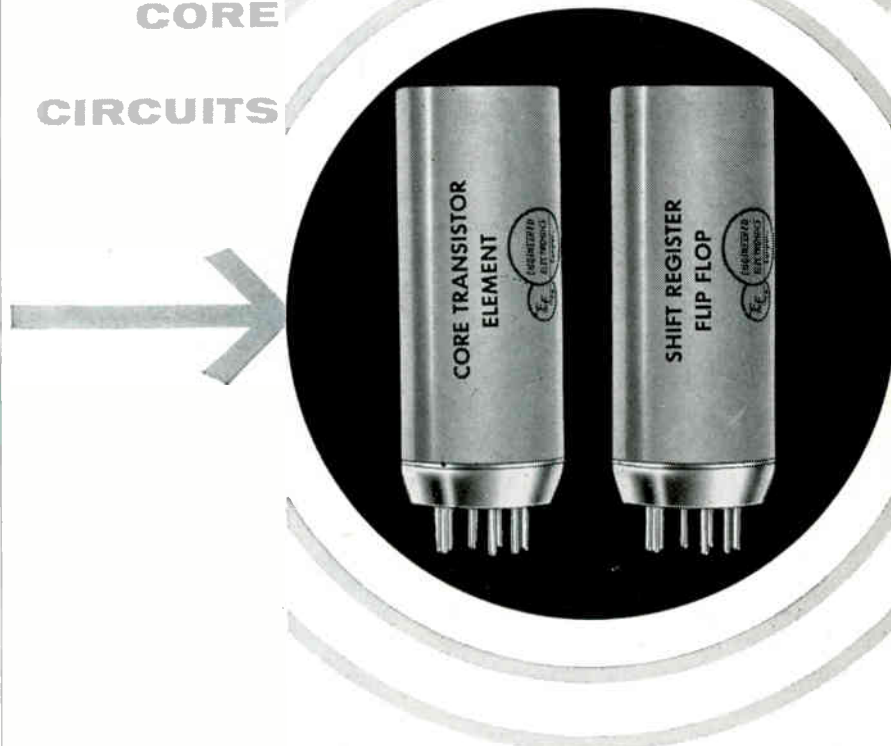

now you can choose

In designing digital systems and equipment employing EECO T-Series Transistor Circuits, you now have an extra choice—EECO Magnetic Core Circuits that are both physically and electrically compatible with the EECO T-Series. This new family of compatible magnetic core circuits for the frequency range 0 to 250 kcs includes a large selection of shift registers (in single or dual units), pulse gates, and core drivers.

ADVANTAGES

The ability of magnetic cores to maintain one of two discrete states makes them ideal for shift registers, or counters. A pulse sent through one set of windings will set the core to the "High-Level" state. A pulse sent through another set of windings will reset the core to the "Low-Level" state. Thus you get flip-flop action with a single core. In transistor circuits, on the other hand, it is normally necessary to use two transistors for each flip-flop.

Core circuits are used to good advantage in our line of shift registers. They offer versatility and space saving at a price lower than that of an equivalent transistor circuit.

COMPATIBILITY WITH T-SERIES

EECO Magnetic Core Circuits are electrically and physically compatible with EECO T-Series Transistor Circuits. They are packaged in T-Series containers, measuring $\frac{7}{8}$ " diameter x $2\frac{3}{4}$ " seated height, and they plug into the same miniature tube sockets as the T-Series.

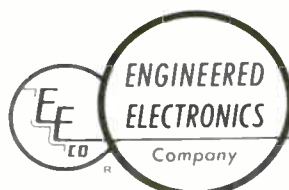

Write, wire, or 'phone today for detailed information on EECO Magnetic Core Circuits.

ENGINEERED ELECTRONICS COMPANY

1441 EAST CHESTNUT AVENUE • SANTA ANA, CALIFORNIA
Kimberly 7-5651

Welder Seals 360 Crystals an Hour

SEMI-AUTOMATIC HERMETIC SEALING machine for small, sensitive components has been developed under an Army contract. Component cans are sealed by projection welding in an inert atmosphere after assemblies are evacuated and flushed with gas.

U. S. Army Signal Supply Agency (USASSA), Philadelphia, Pa., reports that the machine is especially suited to quartz crystal units and relays which require seals with leak rates better than 10^{-8} cc per second. The machine was developed by Bulova Research and Development Laboratories, Woodside, N. Y.

Bulova has used the machine on pilot runs of quartz crystal units. Test results show that the method protects the crystals from excessive heat, which can produce frequency changes, and from flux, water vapor, dust and other contaminants.

The crystal holders were redesigned for projection welding. The bases are made with a V-projection which localizes current flow and heat, minimizing heat transfer to the crystal. A compression seal of glass and steel is used around the base pins. Units produced have passed military environmental tests. Holders are interchangeable with solder seal types.

A sealing speed of 360 units an hour can be maintained on the machine without operator fatigue. Including time spent in preparing the crystal assemblies for sealing, the production rate is 240 units an hour on crystals in HC-6/U and HC-13/U holders. The rate for crystals in HC-18/U holders is 120 an hour since they are small, have long leads and require more care. The evacuation and flushing cycle described below is independent of the sealing operation and can be carried out concurrently.

Pilot run results, holder design, construction and operation of the equipment are contained in Bulova's final engineering report (Contract No. DA-36-039-SC-72775) to USASSA.

Crystal assembly carrier fixtures of the type illustrated are loaded with the holder bases and covers.

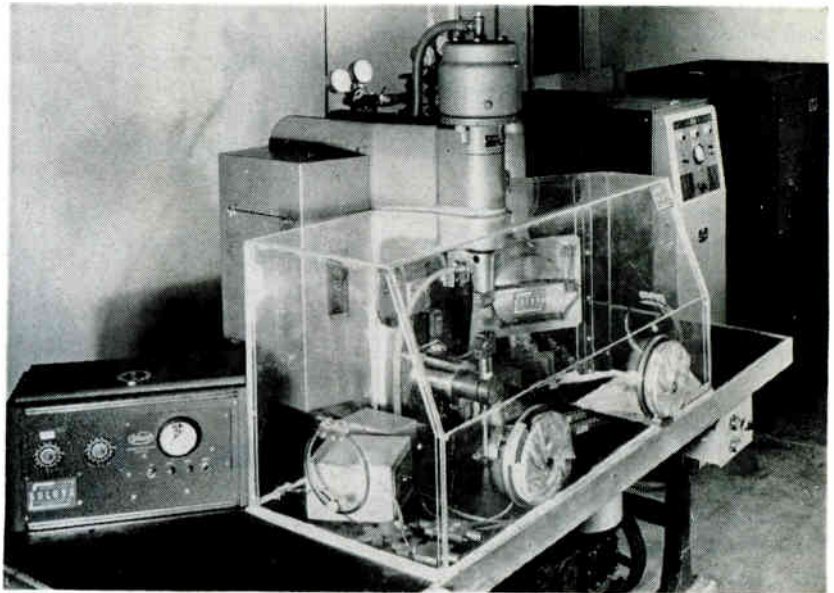

Crystal holders are sealed in inert gas chamber built around welder

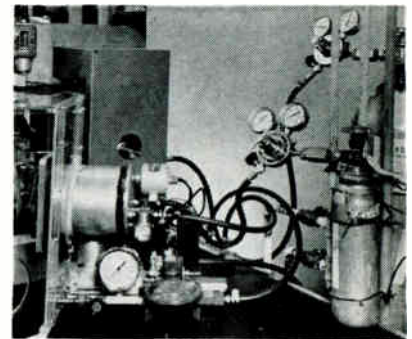
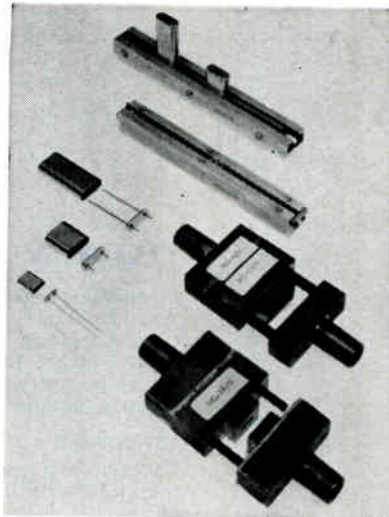

Valving permits any two flushing gases to be selected and blended

Crystal holders, carriers and welding electrodes

These hold the assembly ready for insertion into the welding electrodes.

The carriers are placed into an evacuation and flushing chamber. The chamber is equipped with controls enabling the selection of any vacuum between 5 and 500 microns, with alternate flushes of helium, nitrogen or blends of the two gases. Three evacuation-flush cycles are normally used, but one or two can be selected by the operator, who can also stop the cycle. Three cycles with vacuums of 10 microns take

1.5 minutes.

The operator next transfers the carriers from the evacuation chamber to an inert atmosphere chamber. This chamber contains the welding unit and operating controls. Arm ports and access doors are provided at convenient locations. Inert gas pressure is kept slightly above ambient pressure. The chamber is made of clear acrylic plastic.

The welding unit is a commercial model equipped with a sequence timer and a 100 psig air system producing electrode pressures of 480

ANOTHER QUALITY PRODUCT FROM **EFCON**

POLYSTYRENE

Excellent Retrace Performance Under Adverse Conditions - Time, Temperature, Environment

EFCON'S line of polystyrene dielectric capacitors provide greater dependability for precision circuit integration required in missiles, computers, industrial controls, etc. Reliability and Precision is ensured through carefully controlled processes in EFCON'S "clean room", where exacting conditions for humidity, temperature and airborne contaminants are maintained. Capacity remains through thermal cycling over the range of -65°c to $+85^{\circ}\text{c}$, without derating. Voltage ratings available -100, 200, 400, 600 volts and higher.



Write today

FOR TECHNICAL
BULLETINS ON

- Miniature Polystyrene, types PH, RH and PC
- Miniature Mylar
- High Temperature Teflon
- Solid Tantalum

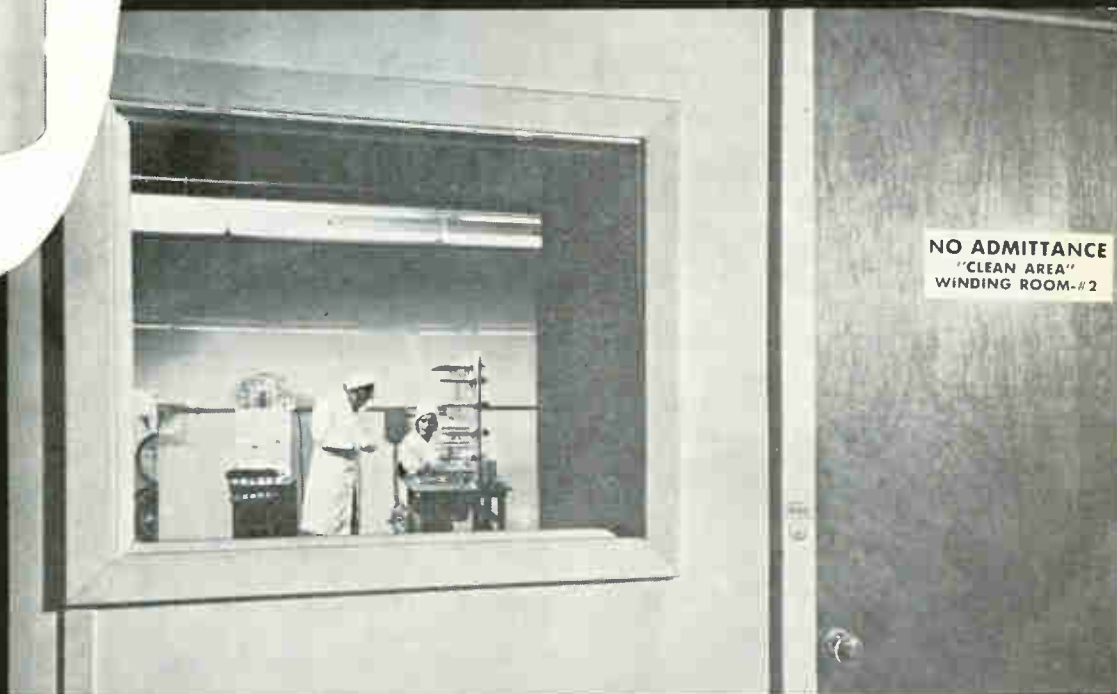

EFCON INCORPORATED

Patterson Place • Roosevelt Field • Garden City • L. I., New York

AMPLIFIER GAIN

The voltage amplification or gain of a d-c amplifier is the dimensionless ratio of the output voltage to the input voltage, assuming operation in the linear portion of the amplification characteristic, and at a specified frequency, usually 0 cps. The curve of amplifier gain vs. frequency of the input signal is termed "frequency response".

The gain factor is of little value to the user unless the minimum full scale input or the maximum linear full scale output is known. As part of a system, the desired amplifier output level is determined by the load characteristics. Typical amplifier loads are shown in Fig. 1.

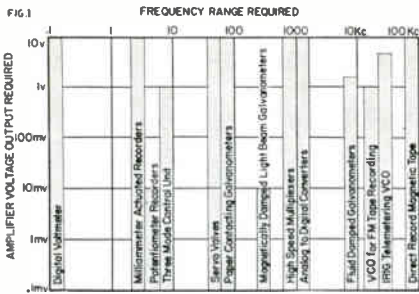

If the output requirement is known, the gain needed to amplify the input to give full scale output can be determined. However, power requirements must also be considered. If the load resistance is sufficiently low the maximum output current is reached before maximum voltage output, and the amplifier will saturate with further increases in input signal. The value of the voltage across the load with maximum rated current is then used to determine gain.

Gain Stability vs. Gain Accuracy

The errors in gain caused by external factors such as ambient temperature, line voltage, and component aging are termed gain instability. Gain accuracy is the allowable tolerance between gain settings and actual gain. Gain instability may be measured and recorded with a null

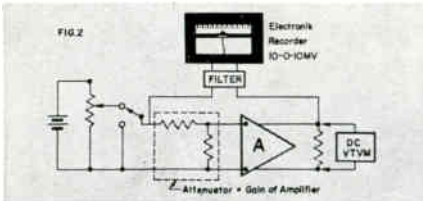

comparator circuit as shown in Fig. 2. The gain accuracy may be determined by substituting in this circuit

a precision attenuator. For information on gain stability measurement write for application notes BEAN 122.

AccuData III has Gain of 34,000

Full scale output of the new Honeywell AccuData III d-c amplifier is 10 volts, 25 milliamps up to 20 kc. Minimum full scale input is 0.3 mv single-ended, a voltage gain of 34,000. Its gain instability is $\pm 0.01\%$ for a $\pm 10^\circ$ F. temperature range. Gain setting accuracy with the fine gain control in the CCW position is $\pm 0.2\%$ for differential or single-ended connected gains up to 1000, and $\pm 0.5\%$ for



gains in the 3000 to 34,000 range. Eleven different gain positions including zero and an open loop position for operational amplifier connections are provided. Other features of this amplifier include high common-mode rejection, very low noise and drift, and unparalleled linearity. Write for Bulletin BS DISA-3 to Minneapolis-Honeywell, Boston Division, Dept. 7, 40 Life Street, Boston 35, Massachusetts.

Honeywell

First in Control
SINCE 1885

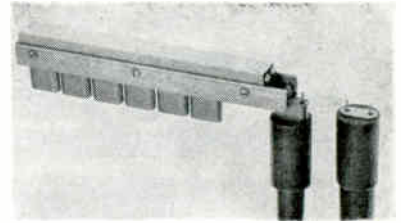

Loading crystal holder into welding electrode

to 2,400 pounds. A set of electrodes is provided for each crystal holder type. The bottom electrode is shaped to hold the crystal unit cover. Electrode sets can be changed in less than five minutes.

To load the electrodes, the assembly carrier is inverted and the cover placed in the electrode. The carriers hold the assembly together until cover and base are in welding position. The assembly can be slipped out of the carrier. After the holder is welded, the unit is ejected from the electrodes by a jet of nitrogen.

Electrode, Seal Are Fired Molly and Glass

METAL-LOADED QUARTZ is used as both conductor and seal in a Czechoslovakian technique for producing quartz discharge tubes, reports McGraw-Hill World News, Vienna. The electrode and sealing ring are made by sintering quartz glass powder with molybdenum powder.

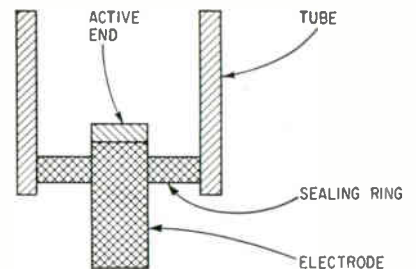

Cross section of electrode and seal

The quartz is chemically removed from the active end of the electrode and the porous molybdenum remaining is saturated with an emitter. The conductor thus made is sealed into the discharge tube. The molybdenum particles ensure low resistance, the glass ring makes a vacuum-tight seal and the sintered components of the electrode sufficiently eliminate internal stresses, according to the report.

Welding and Soldering Mumetal and 4750 Steel

SHIELDING and laminations of Mumetal and 4750 electrical steel can be welded or soldered without serious effects on their magnetic properties, according to Allegheny Ludlum Steel Corp., Pittsburgh. Data compiled during experimental work was recently published by the firm in its *Technical Horizons*.

Both alloys can be welded by tungsten inert gas shield techniques. Fusion welding or a filler material can be used, depending on thickness and other considerations. Fusion welds cause almost no deterioration of properties. The same alloy is recommended as filler material, but Types 308 and 310 stainless steel or SAE 1010 carbon steel may be used at some loss of properties. After annealing, 4750 can be soft-soldered without special preparation. Annealed Mumetal should be lightly abraded with emery cloth or treated with sulfuric acid, nitrite-hydrochloric acid, or a mixture of ferric chloride, hydrochloric acid, nitric acid and water. Tests were made on overlapped joints.

Bulb Heats Components To Testing Temperature

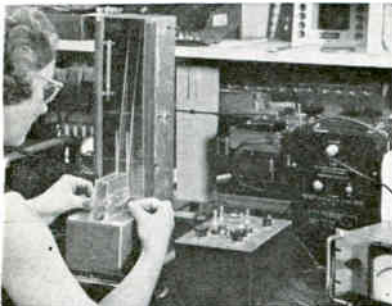

GERMANIUM DIODES are tested for reverse leakage at 45 C with this setup at Ballantine Laboratories, Inc., Boonton, N. J. The oven is a glass-faced box heated by a 40-watt lamp in the base of the box. A thermometer is mounted in the box. To maintain the desired temperature, the operator adjusts the voltage to the lamp with a Variac. The diodes are loaded into a gravity feed chute which runs to the bottom of the glass plate. Leads are pulled into spring clips connected to the instruments.

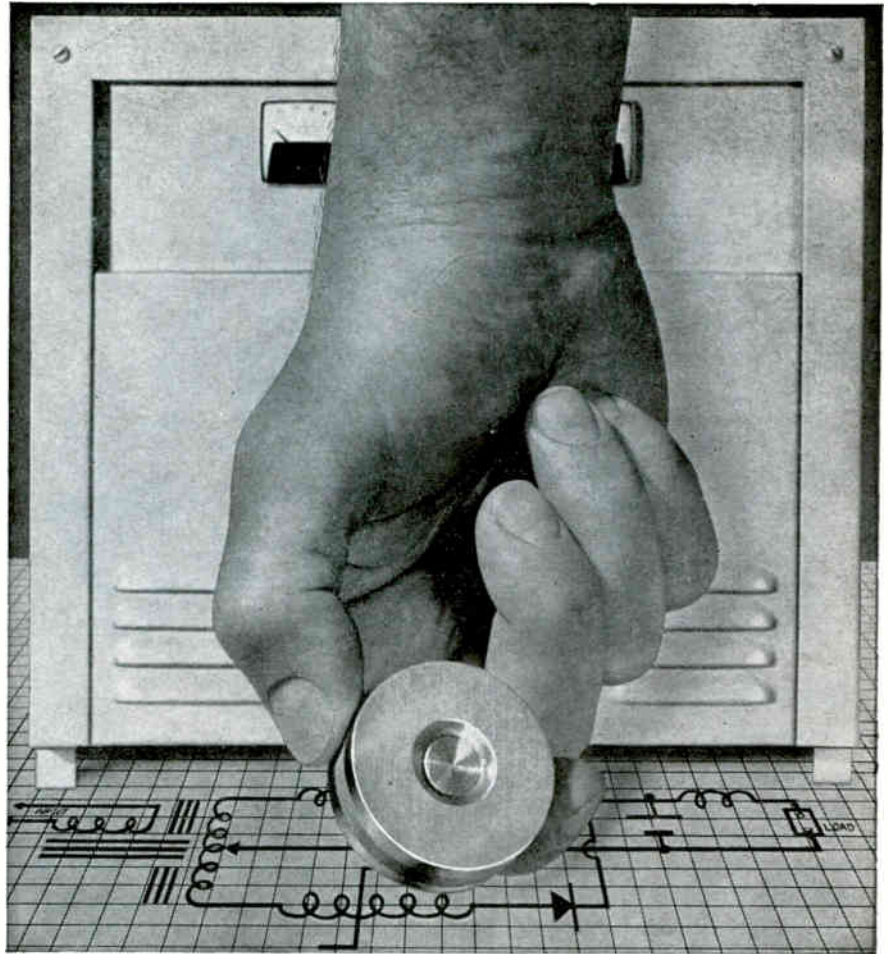

Can a silicon rectifier solve your problem?

It might, if you have a problem in DC power sources. For example, some time ago C & D needed a high efficiency, constant potential, current limiting DC power supply. Output had to be held within $\pm 1\%$ over an AC input variation of $\pm 15\%$. In addition, maintenance would have to be virtually nil.

The answer was found by using a silicon rectifier in combination with simplified components that became the heart of C & D's *AutoReg*® charger. *AutoReg* chargers provide continuous, automatic, unattended charging of industrial storage batteries. With the exception of a timing circuit there are no moving parts. There are no relays to adjust and practically no maintenance is required.

Now, C & D has expanded facilities of the *AutoReg* plant to provide industry with similar DC sources, which incorporate silicon rectifiers and automatic regulation. Final form of these units can supply power in a range from milliwatts to megawatts, depending upon your requirements.

Companies with a problem in DC power sources should write, giving a general outline of their requirements, to:
Vice President in Charge of Engineering

AutoReg® Power Sources



Manufacturers of Shyver-Clad® Industrial Batteries - PlastiCell® and PlastiCal® Batteries for Communications, Control, and Auxiliary Power - Producers of *AutoReg*® Silicon Chargers and *AutoCal*® Charger-Battery Combinations

New On The Market

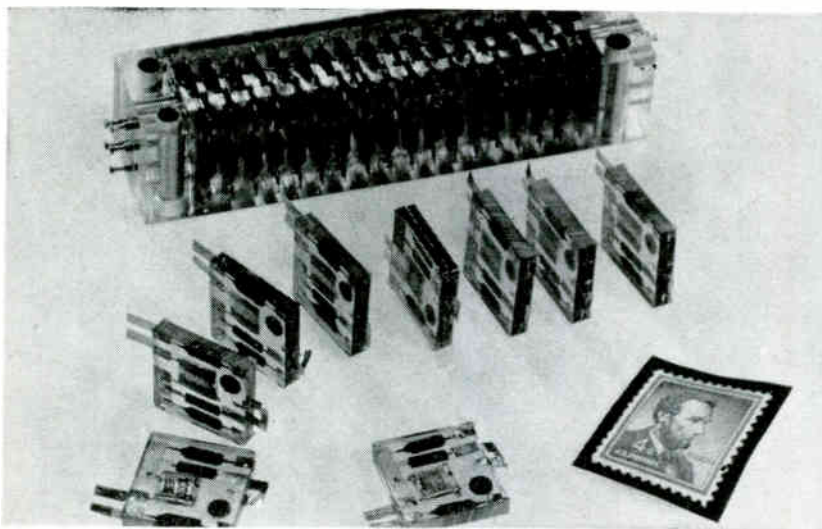

Magnetic Shift Register Elements FOR MILITARY ELECTRONICS

MAGNETIC shift register elements, capable of operating at low power, are available for military electronic design. Wafer construction permits rapid semi-automatic assembly and testing of shift registers of any desired length with up to ten elements per inch; each wafer stores a single binary bit.

The serial driven, gated transfer element permits operation at an information rate of 100 Kc at a peak shift pulse power of 0.1 watts. Similar shift register circuits are being designed for rates to 500 Kc.

Shifting is accomplished with a

single turn on each magnetic core, reducing the connections necessary within each element by 33 percent. Each element has a hole for a single drive or shift wire; when the elements are assembled into a shift register, this wire passes through the entire stack. Additional information and specific quotations can be obtained by writing to the Manager—Sales, Defense Industries Programs, General Electric Company, Heavy Military Electronics Department, Building #3, Court Street Plant, Syracuse, New York.

CIRCLE 301 ON READER SERVICE CARD

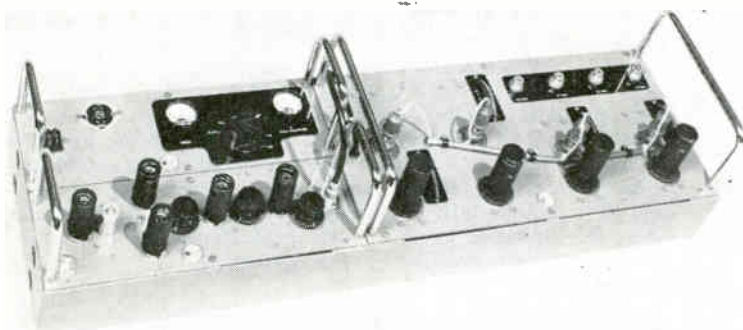

Parametric Amplifier FULLY COHERENT PUMP

MARCONI Wireless Telegraph Co. Ltd., Chelmsford, England, has developed a parametric amplifier for use with their range of 50 cm

radars. Of particular interest is that it incorporates a fully coherent pump frequency indicator. The system enables the inherent capabili-

ties of the amplifier to be exploited to the maximum.

The picture shows a development model of the pump frequency multiplier and amplifier.

CIRCLE 302 ON READER SERVICE CARD

For Temporary Connections BETWEEN CIRCUITS

A NEW device has been developed for establishing temporary connections between electronic or electrical circuits. Manufactured by Plastic Associates, 2900 S. Coast Blvd., Laguna Beach, Calif., the new units provide a quick, simple connecting operation.

The units consists of 20 rubber-core junction cells arranged in two parallel rows, with copper foil connecting each pair of cells. Wires can be inserted by pulling up the flexible rubber core at the center of each cell. When the core is re-

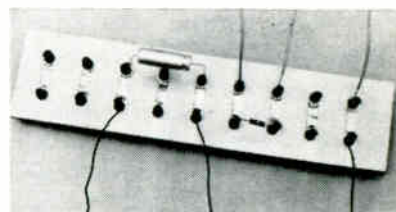

leased, the rubber expands, gripping the wire. Circuit elements such as resistors, capacitors, or diodes may be inserted between cell units.

The junction cells used in the Inter-Connek grip the wires between rubber and metal, automatically adjusting to various-sized wires. A large-diameter wire will not spring open the connection; thus, for example, it is possible to establish a firm contact between a fine-wire transistor and a heavy transformer lead.

CIRCLE 303 ON READER SERVICE CARD

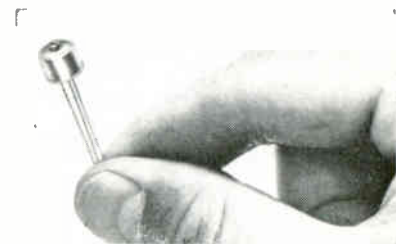

Miniature Trimmer SINGLE TURN

A SINGLE turn trimming potentiometer $\frac{1}{8}$ -inch in diameter and weigh-

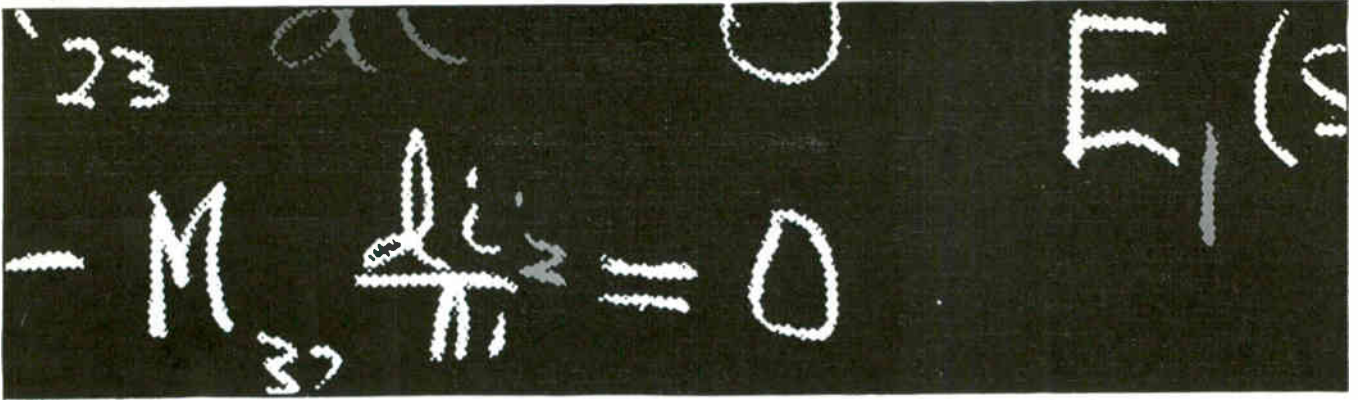

General Motors pledges

AC QUESTMANSHIP



AC Seeks and Solves the Significant—AC Design and Development is moving far ahead in new technology—the result of GM's commitment to make ever larger contributions to the defense establishment. AC plans to resolve problems even more advanced than AChiever inertial guidance for Titan / This is AC QUESTMANSHIP. It's a scientific quest for the development of significant new components and systems . . . to advance AC's many projects in guidance, navigation, control and detection / Dr. James H. Bell, AC's Director of Navigation and Guidance, sees this as a "creative challenge". His group takes new concepts and designs them into producible hardware having performance, reliability and long life. He strongly supports the fact that an AC future offers scientists and engineers "a great opportunity to progress with a successful and aggressive organization" / If you have a B.S., M.S., or Ph.D. in the electronics, scientific, electrical or mechanical fields, plus related experience, you may qualify for our specially selected staff. If you are a "Seeker and Solver", write the Director of Scientific and Professional Employment, Mr. Robert Allen, Oak Creek Plant, 7929 So. Howell Ave., Milwaukee, Wisconsin.

GUIDANCE/ NAVIGATION/ CONTROL/ DETECTION/ AC SPARK PLUG  The Electronics Division of General Motors

ing 1 gram has been developed by Spectrol Electronics Corp., 1704 S. Del Mar Ave., San Gabriel, Calif.

The single turn adjustment is from the top, rather than the side—more convenient for printed circuits. The unit is sealed to meet the severe requirements of MIL-STD-202A, Method 104, Condition A (hot water immersion), MIL-E-5272C, Procedure I (10 days humidity cycling) and MIL-STD-202A, Method 101A, Condition A (salt spray—96 hours); sealing allows the potentiometer to be encapsulated with other printed circuit components. Lead spacing is standard

for MIL printed circuit grid configuration and allows plugging into standard transistor socket for breadboarding.

Key specifications of the Model 80 are: diameter 0.345 in., height 0.28 in., resistance range 50 to 10,000 ohms; tolerance ± 5.0 percent; noise 100 ohms ENR per NAS-710; power rating 1 watt; shock 50 g; vibration 30 g to 2,000 cps; load-life 1,000 hours.

Price of 1 to 9 units is \$6.00; standard models will be stocked by distributors for off the shelf delivery.

CIRCLE 304 ON READER SERVICE CARD



Isolated Power Supply

SMALL CAPACITANCE TO GROUND

ZENER-DIODE regulated power supplies with outputs ranging from 6 to 24 volts d-c are offered in a hermetically sealed version by Elcor, Inc., Falls Church, Virginia. The d-c output of the supply is isolated to have a total distributed capacitance to ground of only 25 pf. Because of this feature it is adapted for use in transistor and vacuum-tube circuits that require a d-c power or voltage source that is capacitively as well as conductively isolated from ground. Conventional

type operation with either output terminal connected to ground or by-passed to ground is also possible. Leakage resistance between output and ground exceeds 50 kilomegohms, and breakdown voltage exceeds 1,000 volts. Power supplies in this series can be furnished for 6.3 or 117 volts a-c. Maximum d-c output current varies from 8 ma at 6 volts to 2 ma at 24 volts. Weight is 5½ oz.; size is 1½ by 1¼ by 2¼ inches.

CIRCLE 305 ON READER SERVICE CARD

Phase-Angle Voltmeter

FOR MILITARY SYSTEMS

AN ALL-TRANSISTOR phase-angle voltmeter designed specifically for military ground support, flight test and mobile field instrumentation systems, has been announced by North Atlantic Industries, Inc., Terminal Drive, Plainview, L. I., N. Y.

The Model VM-230 measuring instrument combines in one unit an a-c voltmeter, phase meter, phase sensitive null indicator, power factor meter and a meter that measures separately the inphase and quadrature components of a signal. A number of the units are already in use for pre-launch alignment of gyros and resolvers in missile fire control and guidance systems, as

well as other ground support and field instrumentation applications.

Measuring 8½ in. high by 7 in. wide, the meters use a rugged MIL-type, hermetically sealed movement, shielded inputs for signal, refer-

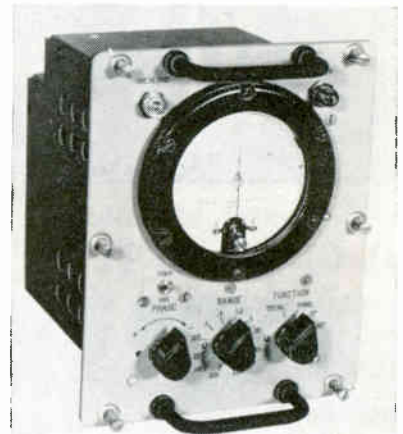

ence, power and chassis ground, and plug-in, all solid state amplifiers. Included on the front panel are on-off and overload lamps.

Standard production models are for 115 volts, 400 or 800 cps. All models provide 12 ranges of voltage measurement, covering 1 mv to 300 volts full scale, and use a calibrated center zero meter. Accuracy as a phase angle voltmeter is ± 3 percent of full scale and ± 2 percent of full scale as an a-c voltmeter. In the phase sensitive mode, null sensitivity is 2 microvolts and harmonic rejection is greater than 55 db.

Special or modified versions can be supplied for particular aircraft, shipboard or ground support equipment.

CIRCLE 306 ON READER SERVICE CARD

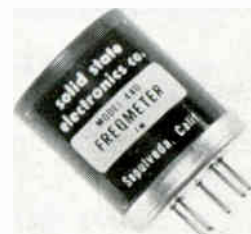

Frequency to D-C Converter

SINE WAVES AND PULSES

THE FREQMETER is a completely solid state unit which linearly converts frequency or repetition rate of signals to a proportional d-c voltage. This is accomplished with four standard models over an input fre-

work in Southern California on the



EAGLE

ADVANCED OPPORTUNITIES FOR SENIOR ENGINEERS

Bendix-Pacific Division, North Hollywood, California, as a member of the Bendix Corporation "EAGLE" Development Team, is a major contributor to the Navy's newest air-to-air Missile "EAGLE." This weapon system is a second generation air-to-air Fleet Defense System and offers challenging design opportunities to the creative engineer.

ADVANCED POSITIONS ARE OPEN TO MEN WITH BACHELOR, MASTER AND DOCTOR DEGREES IN ELECTRICAL AND MECHANICAL ENGINEERING WITH EXPERIENCE IN ELECTRONIC CIRCUIT DESIGN AND MECHANICAL PACKAGING. OTHER HIGH-LEVEL ELECTRONIC ENGINEERING POSITIONS AVAILABLE

Please send resume to
W. C. WALKER,
ENGINEERING EMPLOYMENT MANAGER

Bendix-Pacific Division
11602 SHERMAN WAY
NORTH HOLLYWOOD, CALIFORNIA



CIRCLE 377 ON READER SERVICE CARD

MODEL P-25

MODEL EW-16

MODEL FL-202

MODEL VO-38

MODEL TR-A

MODEL VR-2P

MODEL TR-B

MODEL TR-C

MODEL TK-70B

MODEL VTVM-500

KEW

Around the world it's **KEW**

KYORITSU ELECTRICAL INST. WORKS, LTD.
No. 120, Nakone-cho, Meguro-ku, Tokyo, Japan
Cable Address: "KYORITSUKEIKI TOKYO"
Tel: (717) 0131-5

CIRCLE 200 ON READER SERVICE CARD

September 23, 1960

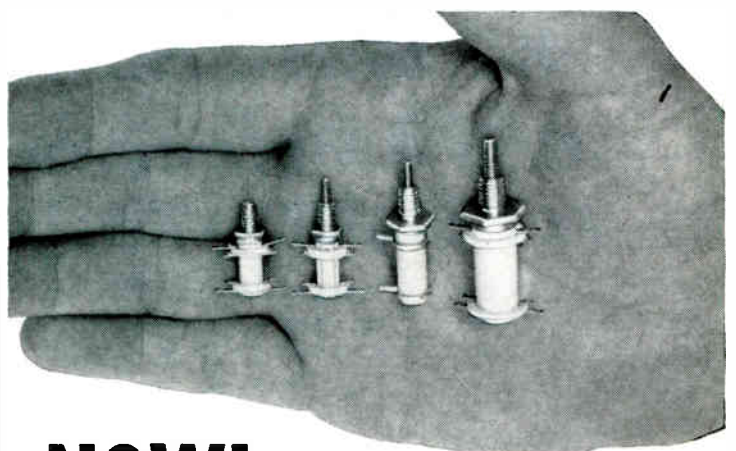

NOW! NEW LOWER PRICED COIL FORMS

Interchangeable with industry standards

Thermosetting epoxy cement permanently positions collars and lugs to withstand severe shock under high temperature (250°C). Available in any lug configuration. Completely rustproof and moisture resistant. Ceramic conforms to Grade L5 JAN-1-10 silicone impregnated. Lightweight aluminum bushing. Silicone fibre glass washers. Unique built-in dependable tension device guarantees vibration-proof, smooth tuning. Nickel-plated parts conform to MIL-P-5879 QQ-N-190. Diameters: .205, .260, .375, .500. Frequencies: .1-1.5 mc, .5-10 mc, 10-30 mc, 30-50 mc, 30-150 mc, 50-200 mc, and brass slugs. Write for quotes and bulletin CF-860.



ALSO AVAILABLE IN EXCLUSIVE RIBBED DESIGN

CIRCLE 95 ON READER SERVICE CARD

95

It helps
to have
a magnet
when looking for
a needle
in a haystack

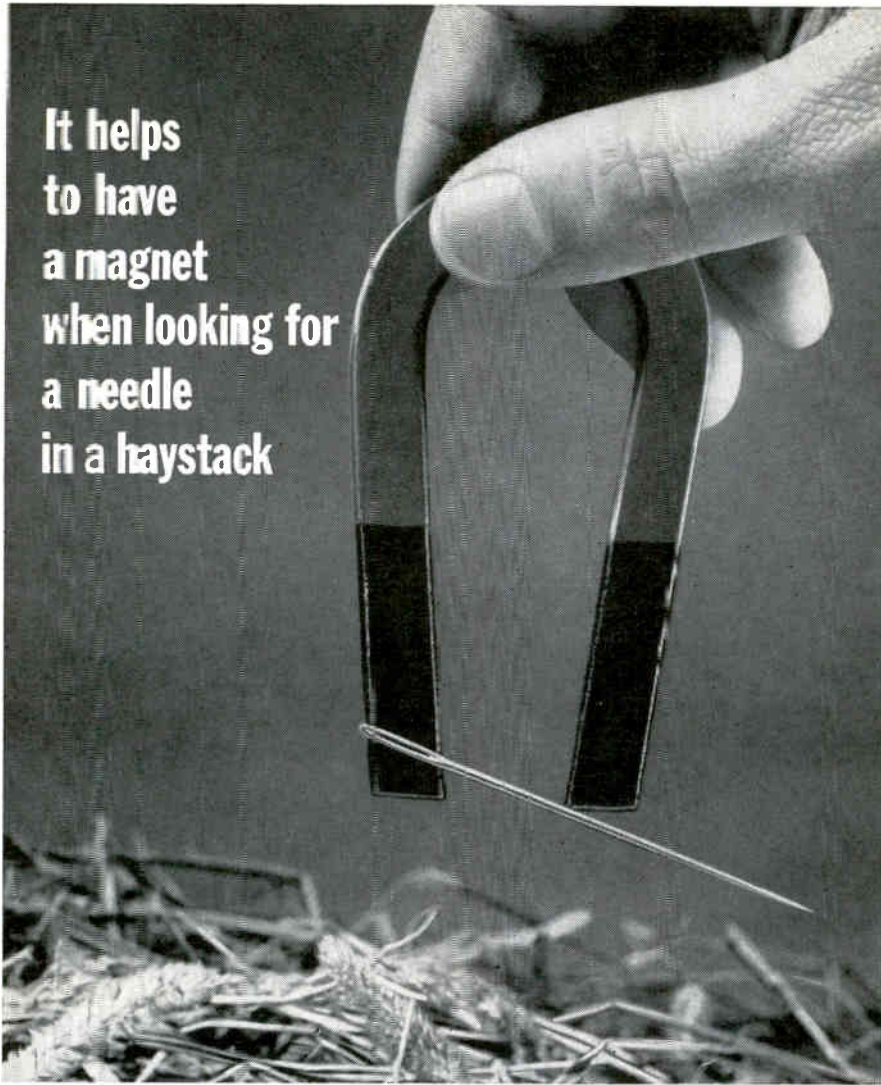

Let GPU *Site-Service* find the right plant location for you!

GPU *Site-Service* is complete and confidential. As the one central source of plant location information for nearly half of Pennsylvania and New Jersey, it has full details about any of 1279 communities, large and small.

Its files contain more than 600 listings of available sites and buildings, ready to be matched to your requirements.

Contacting GPU *Site-Service* can be your first step toward location in one of the nation's finest industrial areas.

Wire, write or phone today. Your inquiry will receive prompt, *confidential* attention.

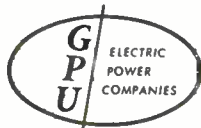

Metropolitan Edison Co.
Pennsylvania Electric Co.
New Jersey Power & Light Co.
Jersey Central Power & Light Co.

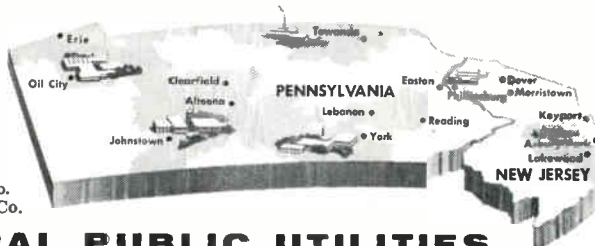

GENERAL PUBLIC UTILITIES CORPORATION

Att: Wm. J. Jamieson, Area Development Director, Dept. E-8
80 Pine St., New York 5, N. Y. Whitehall 3-5600

quency range extending from zero to 100 kc; model 410, zero to 100 cps; model 420, zero to 1 Kc; model 430, zero to 10 Kc; model 440, zero to 100 Kc.

Output of the converter is virtually insensitive to supply voltage, temperature, input amplitude or waveforms and will function properly when driven with sine, square and triangular waves, pulses, etc. The unit will also indicate the average frequency of random signals. The output may be used to drive meters, galvanometers, recorders, oscilloscopes, computers, digitizers or other indicating devices. No warmup time is required.

The unit has been designed for applications where stability, ruggedness, long life, efficiency and freedom from maintenance are necessary. Silicon semiconductors and reliable components are used. Applications include frequency measurements, frequency discrimination, vibration analysis, radiation monitoring, frequency control, harmonic analysis, speed control, telemetering, count rate measurements, f-m deviation detection, tachometry and flow rate measurements.

For additional information contact E. Y. Politi, Technical Director, Solid State Electronics Company, 15321 Rayen Street, Sepulveda, Calif.

CIRCLE 307 ON READER SERVICE CARD

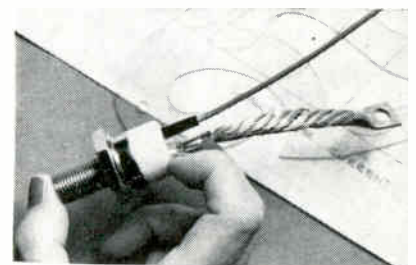

Silicon Power Transistors RATINGS TO 30 AMPS

A FAMILY of silicon transistors for use in high-current power supplies, regulators, amplifiers and high-power switching applications is available from the Westinghouse Electric Corporation, P.O. Box 2099, Pittsburgh, Pa. The transistors have maximum collector current ratings of 30 amperes, power dissipation of 250 watts and collector emitter voltages to 100, 150, or 200 volts.

The units are available in three

series, with collector current ratings of 10, 15, and 20 amperes respectively, at a current gain of 10. The devices have a low saturation resistance (r_{cs}). For example, the WX115 series of devices with collector current of 10 amperes has a maximum saturation resistance of only 0.15 ohm at 25 degrees C.

The junction operating and storage temperature range is -65 to 150 C. The double-ended case is ceramic and is hermetically sealed. The collector is electrically and thermally connected to a mounting stud that provides thermal contact with any external heat sink.

Some of the maximum ratings of these devices are as follows: emitter current 30 amp; collector current 30 amps; base current 10 amps; base to emitter voltage 15 volts; thermal impedance 0.45 degrees C per watt.

Typical OEM prices for 25 or more of the 10 ampere devices range from \$74 to \$137 each; for the 15 ampere devices, from \$98 to \$163 each; for the 20 ampere devices, \$123 to \$173 each.

CIRCLE 308 ON READER SERVICE CARD



Parametric Amplifier WIDE BANDWIDTH

A NEW parametric amplifier providing a wide instantaneous bandwidth of 35 to 40 Mc, low overall noise figure of 2.0 db and stable gain of 20 db is announced by Varian Associates, 611 Hansen Way, Palo Alto, Calif. It is available at customer specified center frequencies in the 500 to 1,000 Mc range.

The V-8350 uses two wideband variable reactance up-converters for simultaneous amplification and frequency conversion of a signal and its associated source of local oscillator power. By pumping both converters from the same source of X-band power, i-f frequency stability is maintained even with variations in pump frequency or phase.

The wide bandwidth provides

The Reproduction Machine That Goes Beyond The Call of Duty!

The Revolute Comet—finest in the Revolute line—not only gives you a fast mechanical speed, up to 125 fpm, but all the important *extras* that help convert speed to actual production of top quality prints! Its unique air knife-suction separator assures efficient separation even at highest speeds. Its perforated roller developer section—a Paragon-Revolute exclusive—provides positive one-pass development at any speed, cuts ammonia consumption ¼ to ½ over other designs. Add to these a powerful 7500 watt lamp, reducible by degrees to approximately 50%, precision machined cast aluminum framework, a host of operator conveniences, and you have a white-printer that goes far beyond the expected to give you the highest quality and quantity reproduction possible! The Comet comes in 42" or 54" printing width . . . choice of 100 or 150 watt/in mercury arc lamp. For proof of performance and economy beyond the call of duty, mail the coupon below.



Starting with the Comet's **Micro-Start Button**, the operator finds an array of conveniences right at the finger-tips.



Print Delivery Lever is within easy reach of operator's normal position, directs prints to front or rear delivery tray.



Lamp Intensity Control Knob reduces lamp intensity by degrees to 50%, provides wide flexibility for handling different reproduction materials.



Oak Feedboard (22½"x75") is slanted to just the right degree to aid operator's production, and to reduce fatigue.



Comet's Safety Device prevents the entering of foreign objects at feeding point by throwing Comet out of gear.



DIVISION OF CHARLES BRUNING CO., INC.

BRUNING

77 South Avenue, Rochester 4, N. Y.

YOURS

When You Attend a Demonstration of the Comet!



We would like to present you this professional Bruning pocket slide rule at the time you attend a demonstration of the Comet. This quality, all-plastic slide rule contains 9 basic slide rule scales, comes with genuine leather sheath.

Paragon-Revolute Advertising Department, Dept. P9-Z
1800 Central Rd., Mt. Prospect, Illinois

- Please send me more information about the Comet.
- Please arrange for your representative to contact me about a demonstration.

Name _____ Title _____

Company _____

Address _____

City _____ County _____ State _____

HOW TO RECORD RADAR ON MAGNETIC TAPE

For needed frequency response, use Ampex's new 4-megacycle tape recorders. Magnetic tape arrests radar giving you a second look or second try in reconnaissance, tracking, simulation, evaluation or training.

Want to know more? See our full page in the September 9th issue of Electronics. Or write us and we will send both the ad and descriptive literature.

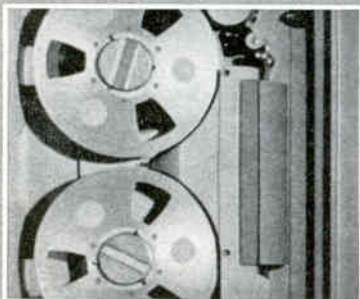

AMPEX

AMPEX DATA PRODUCTS COMPANY
Box 5000 Redwood City, California

large channel capacity of 40 Mc when used with a wideband i-f amplifier. With narrow-band i-f, low noise operation over the entire instantaneous bandwidth is achieved by tuning only the receiver local oscillator.

CIRCLE 309 ON READER SERVICE CARD

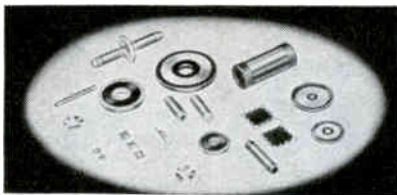

Film Resistors

METAL AND CARBON

FILM RESISTORS, INC., 242 Ridgedale Ave., Morristown, N. J., has available metal and carbon film resistors in special and custom designs. Specializing in microwave and precision miniature types, the line includes rod, disk, film card and wafer shape resistors on glass, ceramic and mica substrates produced economically to customer's exact specifications. The company provides complete cooperation on design and engineering problems with deliveries timed to customer's production line requirements.

CIRCLE 310 ON READER SERVICE CARD

Tunnel Diodes

HERMETICALLY SEALED

PHILCO CORP., Lansdale, Pa., announces a new series of hermetically sealed germanium tunnel diodes designed for low level switching and small signal applications such as in special counting circuitry. Peak point current is closely controlled providing a peak to valley ratio of 8 to 1. Typical performance shows peak voltage of 55 mv and a valley voltage of 320 mv. Units exhibit low series inductance of one nanohenry and low series resistance of one ohm. Measured frequency of oscillation is over 1,500 Mc. The new diodes are packaged in shortened, hermetically sealed transistor cases having thin bases and alloy contacts and featuring a specially designed outer tab of triangular configuration. They are available for immediate delivery at \$5 per unit in limited quantities.

CIRCLE 311 ON READER SERVICE CARD

SPECIFY RAPIDLY AND ACCURATELY WITH SPERRY'S SPECI-FILE



Now you can have Sperry's complete family of klystron and traveling wave tubes right at your fingertips for faster, more accurate tube selection. Attractively packaged and comprehensively indexed, the Sperry's Specifile gives you complete electronic and physical characteristics of every tube in the Sperry line.

TO GET YOUR FREE

Specifile, use this coupon:

Section C-104
SPERRY
ELECTRONIC TUBE DIVISION
Gainesville, Fla.

Please send me a FREE Sperry Specifile:

Name _____

Title _____

Company _____

Address _____

City _____

State _____



GAINESVILLE, FLORIDA

A Division of Sperry Rand Corporation

CIRCLE 201 ON READER SERVICE CARD
CIRCLE 101 ON READER SERVICE CARD →

WEIGHT of your system can be cut if you specify components capable of outstanding performance. Example: high output lets *one* Sperry traveling wave tube replace *two* ordinary tubes in Nike-Zeus. If weight reduction is a knotty problem for you, call Gainesville, Florida, FRanklin 2-0411 collect, for full information about Sperry capabilities.



Gainesville, Florida • A Division of Sperry Rand Corporation

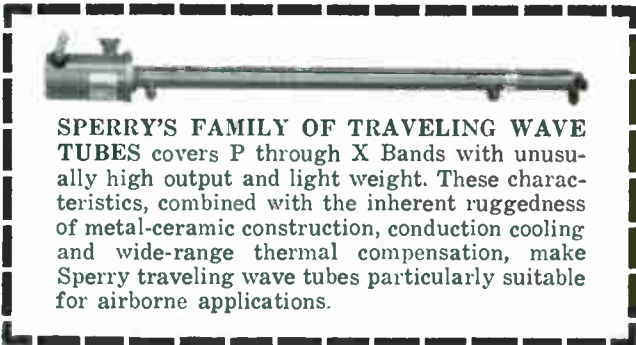

SPERRY'S FAMILY OF TRAVELING WAVE TUBES covers P through X Bands with unusually high output and light weight. These characteristics, combined with the inherent ruggedness of metal-ceramic construction, conduction cooling and wide-range thermal compensation, make Sperry traveling wave tubes particularly suitable for airborne applications.

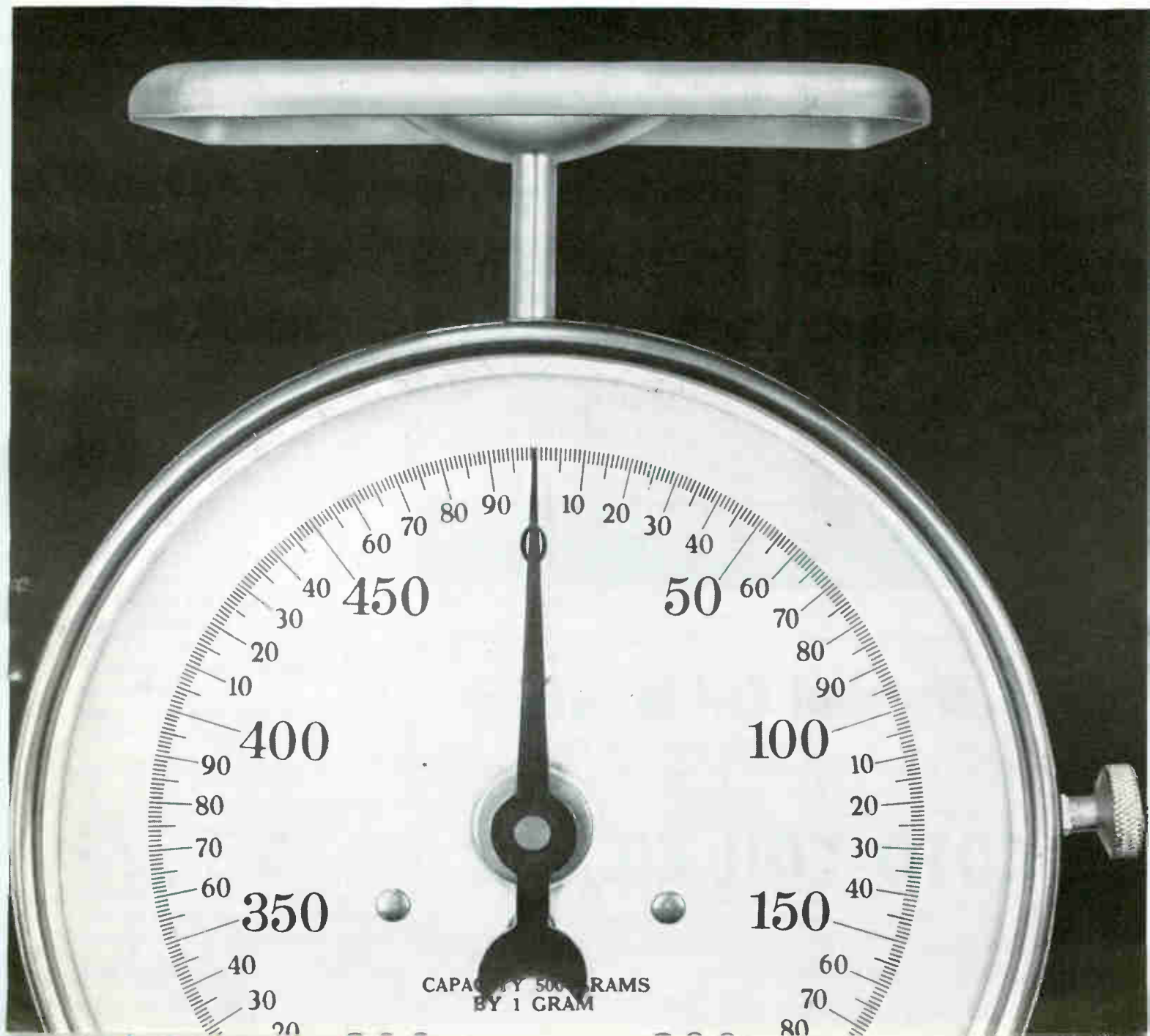

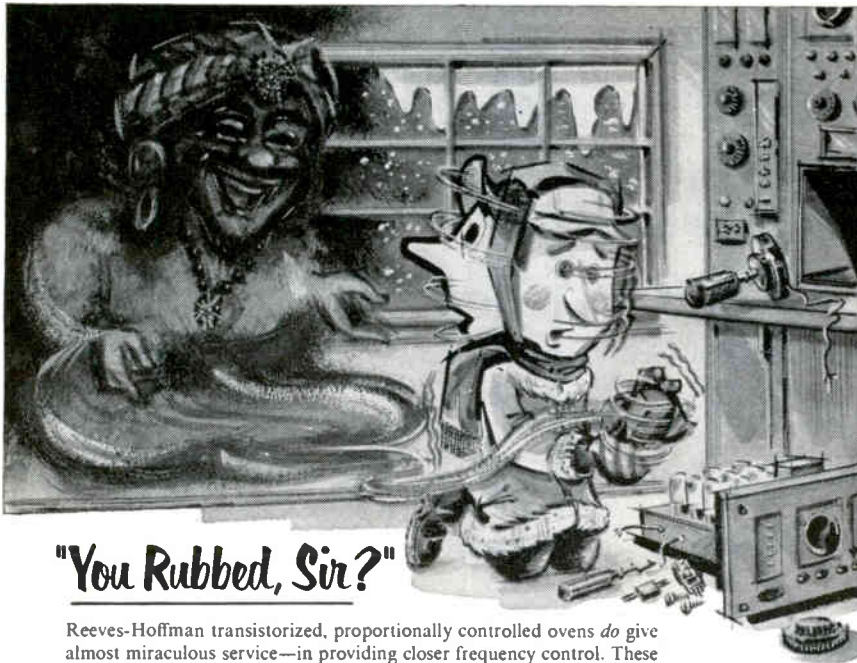

"You Rubbed, Sir?"

Reeves-Hoffman transistorized, proportionally controlled ovens *do* give almost miraculous service—in providing closer frequency control. These highly reliable ovens have no mechanical contacts. There are no spark-producing gaps. Radio interference is eliminated. Although it is difficult to measure temperature excursions beyond $\pm .01^\circ\text{C}$, it is reliably estimated that Reeves-Hoffman ovens provide control in the order of $\pm .001^\circ\text{C}$. If you have a problem involving reliable temperature control, contact Reeves-Hoffman for additional information.



WRITE FOR BULLETIN V1090.

DIVISION OF
DYNAMICS CORPORATION OF AMERICA
CARLISLE, PENNSYLVANIA

CIRCLE 202 ON READER SERVICE CARD

AVAILABLE IN RESEARCH AND PILOT PLANT QUANTITIES

IODINE SEMI-CONDUCTOR GRADE

Also available:

COBALTICYANIDES
CHROMICYANIDES

COBALTINITRITES
CHROMINITRITES

*Custom syntheses of special chemicals
for research and development*

GALLARD-SCHLESINGER CHEMICAL MFG. CORP.
GARDEN CITY, N. Y.

TEL: PIONEER 1-7990

Twx: NY 4-2699

CIRCLE 203 ON READER SERVICE CARD

... Electrical Coil Windings

... WIRE SIZES #6 TO #56

For 43 Years . . . specializing in all types of coils to customers' specifications. Design or engineering assistance available on request.

COTO-COIL CO., INC.

SINCE 1917

65 Pavilion Avenue Providence 5, Rhode Island

102 CIRCLE 102 ON READER SERVICE CARD

Literature of

TOPICS IN NOISE Airborne Instruments Laboratory, Deer Park, Long Island, N. Y. "Topics In Noise", a 52-page book containing a collection of 14 informative articles on noise, is now available.

CIRCLE 365 ON READER SERVICE CARD

MINIATURE PULSE TRANSFORMERS PCA Electronics, Inc., 16799 Schoenborn St., Sepulveda, Calif., has available the revised, updated, third edition of a comprehensive 20-page catalog on low-level pulse transformers, their history, differences compared to other transformer types, methods of measurement and theory of application.

CIRCLE 366 ON READER SERVICE CARD

MICROMINIATURE RELAYS Branson Corp., Whippany, N. J. A bulletin includes electrical and mechanical specifications, dimensional diagrams and engineering data for the type AR four-pole or two-pole microminiature relay and the MTRH time delay relays.

CIRCLE 367 ON READER SERVICE CARD

THERMOPLASTIC STRIP ADHESIVES Schjeldahl Co., Northfield, Minn., has published a folder describing Schjelbond strip thermoplastic adhesives which, because of their high dielectric strength, become excellent insulators between electrical parts and provide effective protection for printed circuits.

CIRCLE 368 ON READER SERVICE CARD

RANDOM SIGNAL INSTRUMENTS Flow Corp., 85 Mystic St., Arlington 74, Mass. Bulletin 50 illustrates and provides information about a line of aerodynamic and random signal instruments. Included are hot wire anemometer systems and probes, micromanometer, a static pressure probe, and a random signal voltmeter and correlator.

CIRCLE 369 ON READER SERVICE CARD

OSCILLOSCOPE CAMERAS Analab Instrument Corp., 30 Canfield Road, Cedar Grove, N. J. A catalog sheet illustrates and describes type 3000 series oscilloscope cameras which offer a great degree of flexibility through the use of a build-

the Week

ing-block design that permits the user to start with a basic camera and later alter its characteristics. The cameras described are designed for use on all existing oscilloscopes.

CIRCLE 370 ON READER SERVICE CARD

TERMINALS & CONNECTORS Electric Terminal Corp., Warwick Industrial Park, Post Road, Warwick, R. I., has published a new 28 page catalog No. 60 listing its standard line of terminals and connectors.

CIRCLE 371 ON READER SERVICE CARD

COAXIAL CONNECTORS Kings Electronics Co., Inc., 38 Marbledale Road, Tuckahoe, N. Y. Complete technical data on the Foamflex series of coaxial connectors are contained in a new 8-page catalog.

CIRCLE 372 ON READER SERVICE CARD

WIRING SERVICE AMP Inc., Harrisburg, Pa. "Creative Analysis" is a 10-page booklet telling the story of the company's service program created to help any manufacturer using electrical/electronic circuits in his products to improve his wiring reliability and production.

CIRCLE 373 ON READER SERVICE CARD

D-C POWER SUPPLIES General Electric Co., Schenectady 5, N. Y. Bulletin GEA-6690A, 12 pages, lists the features, operation and applications for a line of custom-built d-c power supplies for computers, aircraft, missiles, military and special applications.

CIRCLE 374 ON READER SERVICE CARD

TOGGLE SWITCHES McGill Manufacturing Co., Inc., Valparaiso, Ind. Literature describing the new 0111 series of 20 ampere, toggle switches is now available.

CIRCLE 375 ON READER SERVICE CARD

COMPUTER CONTROL SYSTEM Minneapolis - Honeywell Regulator Co., Industrial Division, Wayne and Windrim Aves., Philadelphia 44, Pa. A well-illustrated booklet describes a completely integrated industrial process control system, the heart of which is the 290 digital computer.

20 to 200 D.P.

Send your prints
for quotations

- SPURS
- HELICALS
- WORM AND WORM GEARS
- STRAIGHT BEVELS
- LEAD SCREWS
- RATCHETS
- CLUSTER GEARS
- RACKS
- INTERNALS
- ODD SHAPES

Production of fine-pitch gears of extreme accuracy for all kinds of instruments is a specialty of ours.

FOR
INSTRUMENTS

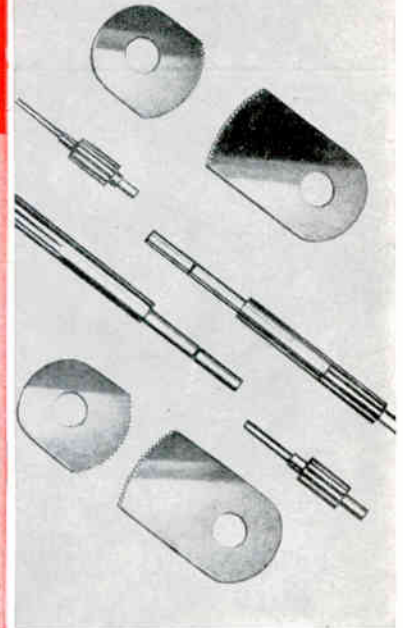

THE *Finest* IN GEARS

Beaver Gear Works Inc.
1021 PARMELE STREET, ROCKFORD, ILLINOIS



CIRCLE 204 ON READER SERVICE CARD

For the latest advances in data illumination, read:

PILOT
"LIGHTS"
that Enlighten
by **DIALCO**



The only Brochure devoted especially to visual indication by means of read-out lights, data display, placard lights, word and number discs, lenses-with-legends, etc. Applications: data processing, computers, automation, motor-controlled devices, automatic merchandising... Comprehensive, colorful. For a free copy, mail coupon now.

DIALIGHT CORP.
60 Stewart Ave., Brooklyn 37, N.Y.

E-9-23-60

Please send _____ copies of "Lights that Enlighten".

Name _____

Position _____ Dept. _____

Company _____

Address _____

City _____ Zone _____ State _____



Foremost Manufacturer of Pilot Lights

DIALIGHT
CORPORATION

60 STEWART AVE., BROOKLYN 37, N. Y.
HYACINTH 7-7600



Lockheed Adds to Georgia Complex

AN ULTRAMODERN \$155,000 aircraft electronics laboratory was recently dedicated at Lockheed's Marietta, Ga., plant. It is the latest addition to the plant's jet age aircraft engineering complex.

The laboratories are for R&D and testing of antennas, radomes, electronic transmission lines and components for high-speed and special mission aircraft.

This brings the total value of the advanced and comprehensive aircraft electronics testing facilities at Lockheed-Georgia to approximately \$500,000.

The completed portion of the concrete, steel and masonry test facility is a two-story structure with approximately 5,000 sq ft of floor space and three antenna

model ranges. Eventual plan is to add 3,500 sq ft of laboratory space. This will cost approximately \$60,000, making the total cost of the lab \$215,000. The new facility covers eight acres, including the antenna model ranges. Plastic towers for rotating large scale models are 22 ft high.

One of the lab's uses is determining the optimum location of antenna on jet and prop-jet aircraft. The configuration of radomes is another problem on which the engineers work. Equipment now installed is capable of testing radomes ranging in size from the small ones on the Lockheed Jet Star to huge radomes for the weather avoidance radar on the C-130B prop-jets.

guidance, has been appointed general operations manager of electronic systems operations for Ford Motor Company's Aeronutronic Division, Newport Beach, Calif. He succeeds Ernst H. Krause, who was named director of Aeronutronic's new technical staff.

Elms has been with the Crosley Division on Avco Corp. since April 1959, first as vice president, electronic systems, and then as executive vice president.

Electronic systems operations provides technical support for the national missile and satellite range programs.



Elms Takes Key Post At Aeronutronic

JAMES C. ELMS, physicist and specialist in flight control and missile

Raytheon Appoints Three Managers

APPOINTMENTS to three managerial posts in Raytheon Company's special microwave device operations have been announced.

Named were Eugene G. Slotta, manufacturing manager; Joseph J. Bolus, production engineering manager; and Charles Freed, head of the newly formed parametric devices department.

Slotta recently rejoined Raytheon after serving as plant manager for Precision Microwave Corp., Millis, Mass., for one year. Prior to that, he had been general superintendent of manufacturing for Raytheon's equipment division for three years.

Bolus joined Raytheon this year after serving since 1957 as assistant sales manager, chief engineer and a research and development engineer with Technicraft Division of the Electronic Specialty Co., Thomaston, Conn.

Freed was formerly with the high power klystron development group at Raytheon's Spencer Laboratory. His first assignment after joining Raytheon in 1958 was with the company's Research Division in work on parametric amplifiers.



Milgo Appoints Sales Manager

MILGO ELECTRONIC CORP., Miami, Florida, manufacturer of instrumentation systems for the missile industry, announces the appointment of John S. Ridley as sales manager.

Formerly of Aerojet-General, Ridley has recently devoted the major portion of his time to the range safety system at Vandenberg AFB. On this project, he was re-

**THESE BLOWERS ACTUALLY HAVE
the MOTIVATION ENERGY NECESSARY**

**...they
SUPPLY ACTUAL
RATED OUTPUT**

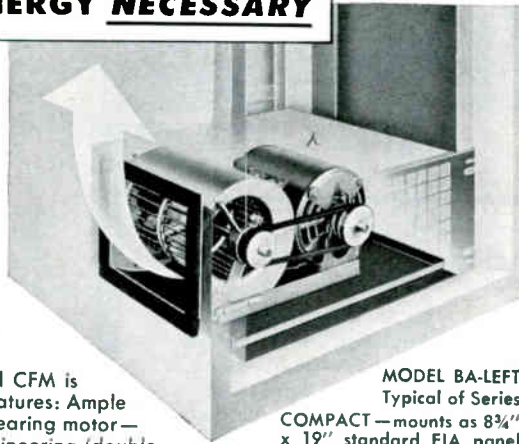

MODEL BA-LEFT
Typical of Series
COMPACT—mounts as 8 3/4" x 19" standard EIA panel
(7" and 5 1/4" models also available)

Ratings are based on tests outlined in 1955 NEMA publication FM1-7.02

Assurance of actual delivery of rated CFM is generated by two Western Devices features: Ample Power (standard: NEMA 1/4 HP ball bearing motor—1/2 HP for higher outputs); Superb Engineering (double width tight scroll blower assembly with dual rotor).

OTHER FEATURES:

- Large cooling capacity—to 1200 CFM
- MIL quality construction and finish (special finish available)
- Interference-free—meet MIL-1-16910A radio interference specs
- Quiet operation—cushion mounted—noise level only 51 db in 300-600 cps range, only 54 db in 4800 cps-infinity range (52 db isolated)

- Side, top, rear discharge areas; 8 standard models (plus variations, Twin Blowers, others 'to order')
- Easy maintenance without removing
- Cleanable filter—disposable available
- Motor—115 vac, 60 cps with thermal overload protection (MIL spec single- or 3-phase or 400-cycle also available)
- Sealed ball bearings support dual rotor's stainless steel shaft

Write or phone for complete data on BA Series above
... and our 6,000 and 12,000 BTU Refrigerated Blowers

ORegon 8-7827

ONE SOURCE . . .

for VENTILATED RELAY RACK CABINETS,
CONTROL CONSOLES, BLOWERS, CHASSIS,
CHASSIS-TRAK®, RELATED COMPONENTS

WESTERN DEVICES, INC.
600 W. FLORENCE AVE., INGLEWOOD 1, CALIF.
CIRCLE 206 ON READER SERVICE CARD

Best
solution
to
custom
design
potentiometer
problems...

Merely write to The Gamewell Company, stating your requirements.

Gamewell engineers will take it from there. They've been designing high precision potentiometers and rotary switches for a good many years. And a great many of them have been custom-designed.

Naturally, this experience pays off. Take selection of the best resistance material for a given application as just one example. Here, Gamewell makes full use of all available alloys. And, backed by extensive files of in-service data, assures the best design of the resistance element in conjunction with the most compatible wiper-contact material.

When necessary, of course, Gamewell's complete development and test facilities are put to use. Salt spray, humidity, extreme temperature, altitude, acceleration, vibration and many more test facilities are available to insure exact matching of pot to requirements.

In production, Gamewell facilities give custom-designed "pots" and rotary switches the benefits of today's most advanced methods and machines. Extensive metal working machinery, and refined dimensional checking devices assure production of every component to high precision tolerances. All "pots" are wound on precision machines, designed and built by Gamewell. And both winding and assembly are carried out in surroundings automatically kept spotlessly clean.

Thus it is that "pots" with even the most unusual electrical characteristics or mechanical features can be precisely produced in a minimum of time at Gamewell. Simplify your custom-designed potentiometer problems.

Write THE GAMEWELL COMPANY, 1380 Chestnut St., Newton Upper Falls 64, Massachusetts. A Subsidiary of E.W. Bliss Company.



PRECISION POTENTIOMETERS

"INTEGRALS OF
HIGH PERFORMANCE"

*This is not and is under no circumstances to be construed as an offer to sell, or as an offer to buy, or as a solicitation of an offer to buy, any of the securities herein mentioned.
The offering is made only by the Prospectus.*

September 8, 1960

50,000 Shares
Cubic Corporation
Capital Stock

Price \$54.50 per share

Copies of the Prospectus may be obtained in any state only from such dealers participating in this issue, including the undersigned, as may legally offer these Securities under the securities laws of such State.

HAYDEN, STONE & Co.

CIRCLE 205 ON READER SERVICE CARD

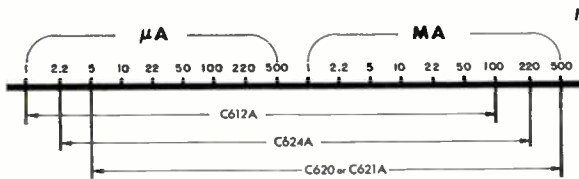

Regatron Programmable
**CONSTANT-CURRENT
POWER
SUPPLIES**

ASK FOR BULLETIN 3072A

Registered U.S. Pat. Off. Patents issued and pending.



**ELECTRONIC
MEASUREMENTS**
COMPANY, INCORPORATED
EATONTOWN • NEW JERSEY

Telephone: Liberty 2-0300

TWX: EAT 984

There's a lot that's special about Regatron Constant-Current Power Supplies . . . 0.1% regulation (above 2.2 ua) . . . a modulation input . . . zero to maximum-range vernier . . . wide range (see diagram above). And for use in automatic or semiautomatic applications, you'll have the advantage of the exclusive Regatron programming feature.

CIRCLE 207 ON READER SERVICE CARD

sponsible for the radar and data display systems. Also, in conjunction with the Avionics Division of Aerojet, he worked on special infrared devices for the USAF.



**Polarad Appoints
Sonnenschein**

APPOINTMENT of A. H. Sonnenschein as assistant to the president, has been announced by D. L. Jaffe, president of the Polarad Electronics Corp., Long Island City, N. Y. Formerly corporate director of planning, he will also retain the duties of the latter position.

Sonnenschein joined Polarad's technical staff in 1951 as a project engineer and subsequently held the positions of engineering group leader, director of engineering operations and chief systems engineer.

Polarad designs and manufactures microwave and electronic instrumentation. The company has divisions engaged in defense products, scientific instruments and microwave tubes. It also has several wholly owned domestic subsidiaries as well as a European affiliate, Polarad-France.

**Sigmund Cohn Corp.
Forms New Affiliate**

ADOLPH COHN, president of Sigmund Cohn Corp., Mt. Vernon, N. Y., has announced the organization of an affiliated company, to be known as Pyrofuze Corp. The activities of the new firm, taking place at the Mt. Vernon plant, involve the manufacture and marketing of specially processed Pyroforic products, which are now known as Pyrofuze.

Since 1901, Sigmund Cohn Corp. has operated as refiners, metallur-

Transistorized DC Power
for **TUNNEL
DIODE
APPLICATIONS**

\$199⁵⁰

Supplies regulated voltage output down to the millivolt region for tunnel diode biasing applications. Switchable to a constant current supply. Settable short circuit protection also makes it an ideal unit for general laboratory use.



T50-600	0-50VDC @ 0-600 ma 0.05% Regulation, 0.5 mv Ripple
T20-1	0-20VDC @ 0-1 amp. 0.05% Regulation, 0.5 mv Ripple

SEND FOR COMPLETE CATALOG



ELECTRONICS INC.
111 Pleasant Ave.,
Roosevelt, N. Y.



**WHO
DROPPED
THE BINOCULARS?**

With everybody watching each other along the DEW line and the Iron Curtain these days, electronics has replaced binoculars.

What's happening in the giant markets for missile controls, radar and communications equipment?

electronics tells how things are going, keeps you informed of developments as they occur. This is a good time to subscribe or renew your subscription. Just fill in box on Reader Service Card. Easy to use. Postage free.

**FIND WHAT
YOU NEED IN...
electronics**

Over 13,000 terms
in electronics
and nucleonics
 accurately, clearly defined
 to save you time and work

Save time with this single-volume source of definitions of virtually all the terms you work with—insure better results with the simple but strictly accurate and authoritative information throughout. Here are thousands of words and abbreviations covering practically every phase of these fields—from television to avionics, from nuclear engineering to space electronics. On questions of terminology likely to arise in your work, you will find here the concise information you need—clearly presented, authoritatively defined, and instantly accessible.

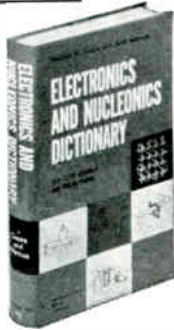

ELECTRONICS and NUCLEONICS DICTIONARY

By NELSON M. COOKE

President, Cooke Engineering Company and JOHN MARKUS

Technical Director, Dictionary Department McGraw-Hill Book Company

Over 13,000 terms, 452 illustrations and diagrams \$12.00

All definitions in the book are in accord with those authorized by official engineering organizations . . . synonyms, deprecated terms, and obsolete terms are specifically labeled as such . . . spelling and hyphenation of controversial words, compound terms, and abbreviations reflect best current usage. Over twelve years of intensive research and three years of active preparation of definitions have gone into this volume to give you instant, dependable reference to electronics and nucleonics terminology as it is used today.

Covers these and other areas . . .

radio • radar • television • avionics • cryogenics • computers • guided missiles • nuclear reactors • nuclear physics • telemetering • ultrasonics • electron optics • industrial electronics • high fidelity systems • magnetic tape systems • space technology • medical electronics • and more

10 DAYS' FREE EXAMINATION

McGraw-Hill Book Co., Inc., Dept. L-9-23
 327 W. 41st St., New York 36, N. Y.

Send me Cooke and Markus' ELECTRONICS AND NUCLEONICS DICTIONARY for 10 days' examination on approval. In 10 days I will remit \$12.00, plus few cents for delivery costs, or return book postpaid. (We pay delivery costs if you remit with this coupon; same return privilege.)

PRINT

Name

Address

City Zone... State.....

Company

Position

For price and terms outside U. S., write McGraw-Hill Int'l., NYC. L-9-23

CIRCLE 209 ON READER SERVICE CARD

September 23, 1960

WEST-CAP's

Sub-MINIATURES FOR PRINTED CIRCUITS AND CRITICAL SPACE APPLICATIONS

New "Red Head" CERAMIC CAPACITORS

SLIM AND TRIM

Extreme stability • Low dissipation factor • High insulation resistance • Operates under most rigid environmental conditions.

-55°C TO 150°C
200 VOLTS DC

EXCEEDING
 MIL-C-11015B /18 /19

SAN FERNANDO ELECTRIC MANUFACTURING CO.

SYMBOL OF QUALITY

Brochure upon request

1509-D FIRST ST. • SAN FERNANDO, CALIFORNIA • EMpire 1-8681

CIRCLE 210 ON READER SERVICE CARD

NEW FOAM PLANT



Here are the advantages you can expect when you specify MIDWEST FOAM —

- ALL TYPES OF Polyester or Polyester FOAMS
- Quality with economy
- Customized service
- Controlled cellular structure
- Uniform propensity and compression
- COMPLETE DESIGN SERVICE AVAILABLE

Here are the finest facilities available anywhere with the newest techniques in the production of polyurethane foam. A 600' production line customized to your specifications is at your command. We can guarantee your needs on your delivery date to eliminate your storage costs and to eliminate costly rejects and obsoletes. We have the automation, you push the button.

NO ORDER TOO SMALL OR TOO LARGE

Representatives—we still have some choice territories available. If you would like to represent the finest plastic foam producer in the United States, contact us immediately.

MIDWEST FOAM PRODUCTS COMPANY

1632 Chicago Avenue, Evanston, Illinois, Phone-Davis-8-6905,
 Factory—North Chicago, Illinois

CIRCLE 107 ON READER SERVICE CARD 107

**IN LESS THAN
4 SECONDS**

FROM THIS

TO THIS

OR THIS

**WITH THE REVOLUTIONARY
PRODUCTION AID TOOL!**

"PIG-TAILOR"[®]

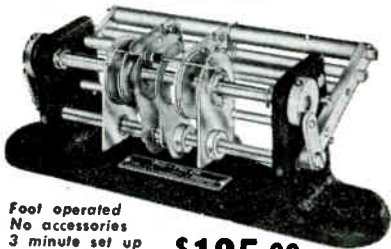

Fool operated
No accessories
3 minute set up

\$125.00

'PIG-TAILORING'

a revolutionary new mechanical process for higher production at lower costs. Fastest PREPARATION and ASSEMBLY of Resistors, Capacitors, Diodes and all other axial lead components for TERMINAL BOARDS, PRINTED CIRCUITS and MINIATURIZED ASSEMBLIES.

PIG-TAILORING eliminates: • Diagonal cutters • Long nose pliers • Operator judgment • 90% operator training time • Broken components • Broken leads • Short circuits from clippings • 65% chassis handling • Excessive lead tautness • Haphazard assembly methods.

PIG-TAILORING provides: • Uniform component position • Uniform marking exposure • Miniaturization spacing control • "S" leads for terminals • "U" leads for printed circuits • Individual cut and bend lengths • Better time/rate analysis • Closer cost control • Invaluable labor saving • Immediate cost recovery.

Pays for itself in 2 weeks

"SPIN-PIN"[®]

Close-up views of "SPIN-PIN" illustrate fast assembly of tailored-lead wire to terminal.

- No Training
- No Pliers
- No Clippings
- Uniform Crimps
- 22 Sizes

**PAYS FOR ITSELF
THE FIRST DAY!**

\$500
EACH

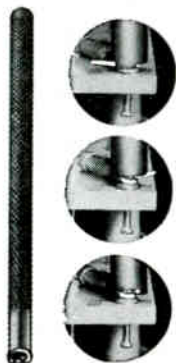

Write for illustrated book to Dept. E-10



BRUNO-NEW YORK INDUSTRIES CORP.

DESIGNERS & MANUFACTURERS OF ELECTRONIC EQUIPMENT
460 WEST 34th STREET • NEW YORK 1, N. Y.

gists and specialists in precious metal products. The corporation and its affiliated concerns employ approximately 150 people in their Mt. Vernon plant (50,000 sq ft). It is expected that additional personnel will be taken on as Pyrofuze Corp. expands its activities.



Kelly Takes Over Newly-Created Post

THOMAS J. KELLY has been promoted to the newly-created post of assistant director - international services for Raytheon Co., Waltham, Mass. For the past six years he has served in various management capacities in Raytheon's international operations.

The new position has been established as part of Raytheon's expanded world-wide activities. In addition to assisting international services director Donald A. Mitchell, Kelly will be responsible for the administration of a centralized export service.

Kelly joined Raytheon in 1941 as a field engineer and served subsequently as a marine products project engineer and as service manager for commercial equipment.

Loral Electronics Appoints Rutstein

IRVING RUTSTEIN was recently named engineering manager, countermeasures division of Loral Electronics Corp., New York, N. Y. He was formerly with the missile systems division of Republican Aviation Corp.

Loral supplies electronics systems and equipment to the Department of Defense. Through subsidiary firms it is a producer of electrical and electronic components for industrial and commercial uses.

VARIAN Potentiometer RECORDERS

*Something important
has been added . . .*

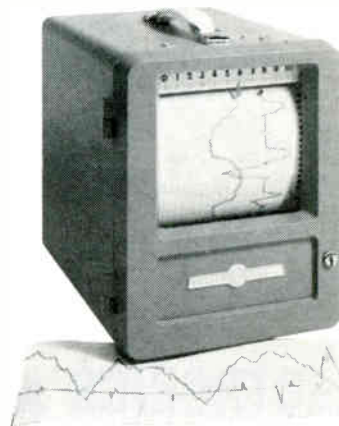

5. THE NEW G-22 IS

2 CHANNEL

Two channels mean more than just an added trace. They make the G-22 a correlator of simultaneous variables—any pair you choose. And among two-channel recorders, the G-22 is the most practical yet—lighter, more compact, more versatile and lower in cost than any other of its type.

Interchangeable plug-in input chassis; 1% limit of error and one second full-scale balancing time; adjustable range from 0-10 mv to 0-100 mv; dual chart speed standard; four speeds optional; portable or panel-mount versions; weight 35 pounds; price \$975. Full specifications available. Write the Instrument Division.

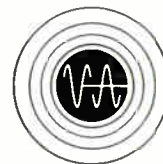

**VARIAN
associates**

PALO ALTO 1, CALIFORNIA

IT'S
WHAT'S
IN
HERE
THAT
COUNTS

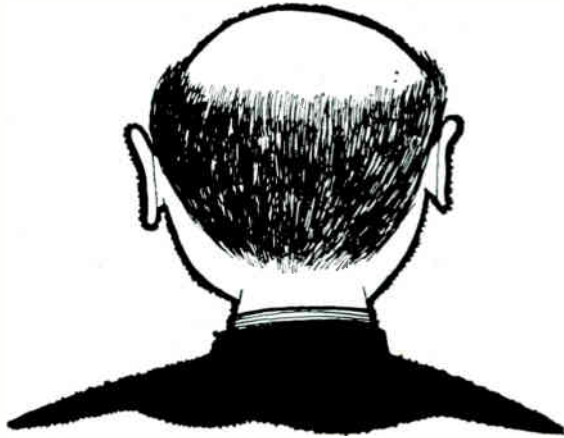

Do you know, for instance... which electronic stocks are hottest? Who's in the news and why? About "Three Approaches to Microminiaturization"? About the newest product ideas hitting the market? What's up in production? Opportunities overseas? What's going on in Washington?

It pays to know more than the next man! The questions above are just 6 reasons why you should subscribe to *electronics*.

IF YOU'RE ON THE TAG END OF A ROUTING SLIP, get your own subscription. Knowing what's going on is the first step to going up.

Fill in the coupon below right now... it will pay big dividends.

FIND WHAT YOU NEED IN... electronics

____ Renew my subscription for 3 more years.

____ Enter my new subscription.

U.S. Subscription Rates: ____ 3 years \$12. ____ 1 year \$6
Canadian rates \$10 for 1 year. Foreign rates \$20 for 1 year.

Name _____

Street _____

City _____ Zone _____ State _____

Company _____

Street _____

City _____ Zone _____ State _____

Your Title _____ Department _____

Product Manufactured or Service Performed _____

Mail reply to: **electronics**, 330 West 42nd Street, New York 36, N. Y.

September 23, 1960

NOW—Complete Line

dekatron®

Electronic Counting Tubes
(up to 20,000 counts/sec.)

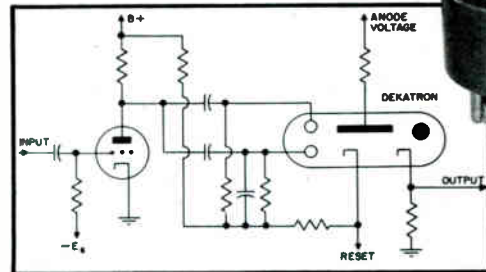

Typical Drive Circuit



Now available — only complete "Hand Book of Counting Tubes" in print. Tube specifications, applications, sample circuits, design criteria are included. Available at \$1.00 a copy through Dekatron Tube Section, Baird-Atomic, Inc.

No C. O. D. or purchase orders, please! Cash, check or money order accepted.

Baird-Atomic, Inc.

33 UNIVERSITY RD., CAMBRIDGE 38, MASS.



Instrumentation for Better Analysis
CIRCLE 213 ON READER SERVICE CARD

PLATINUM-CARBON EVAPORATION*

Specially developed
platinum cored
carbon rods

BRADLEY CARBON
ROD EVAPORATOR CORE OF
PLATINUM CARBON
SPECTROGRAPHICALLY
PURE GRAPHITE

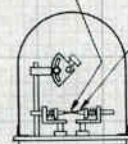

Designed for high resolution
shadow-casting

For use in the standard
carbon evaporation source
fitted to "Speedivac" 12E6
shadow-casting plant

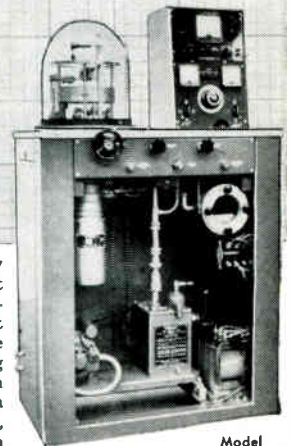

Model
12E6

The body of the rod is spectrographically pure graphite having at one end a short core containing a mixture of finely powdered graphite and platinum (by weight 85% platinum and 15% carbon). Suitable film compositions are obtained by using a platinum carbon rod in conjunction with a plain graphite rod. Where a higher percentage of platinum is required, they are used in pairs. These rods can be fitted to the standard carbon evaporation source supplied with "Speedivac" 12E6 vacuum coating unit which has been specially designed for electron microscopy.

*Based upon the technique developed by D. E. Bradley.

EDWARDS HIGH VACUUM INC.

1920 Buffalo Avenue, Niagara Falls, N. Y.

In Canada: Edwards High Vacuum (Canada) Ltd., Box 515, Burlington, Ont.

CIRCLE 109 ON READER SERVICE CARD

109

wanted:

engineers, physicists and mathematicians

FOR CAREERS WITH
**GUIDED MISSILES
RANGE DIVISION
PAN AM**

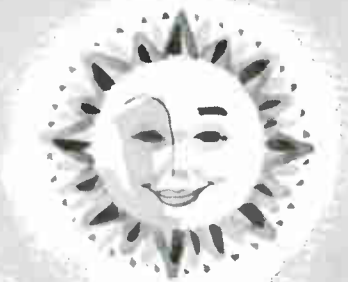

in **Florida**

There are now new, immediate, career positions at the Atlantic Missile Range for Electronic Engineers, Systems Engineers, Physicists and Mathematicians with B.S., M.S., and Ph.D. degrees with experience in one or more of the following fields:

- CW-RADAR*
- PULSE RADAR*
- COMMAND EQUIPMENT*
- ANALOG DISPLAY EQUIPMENT*
- RADIO COMMUNICATIONS*
- INFRA-RED EQUIPMENT*
- METRIC OPTICS*
- INSTRUMENTATION*
- PLANNING*
- OPTICAL DATA REDUCTION*
- ANALOG AND DIGITAL DATA HANDLING*

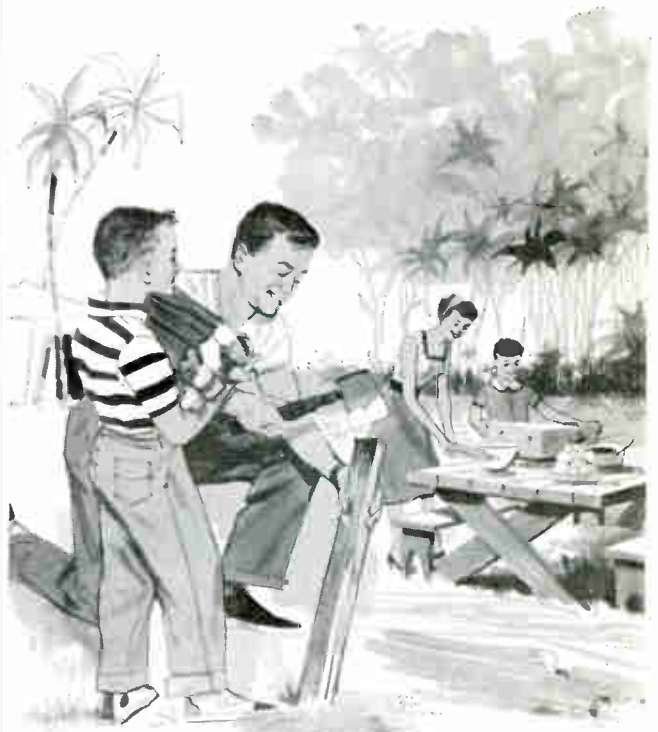

Pan Am's Guided Missiles Range Division (GMRD) is a technical organization with operations at Patrick Air Force Base, Cape Canaveral and stations along the 5,000-mile Atlantic Missile Range, the largest and most complex test range in the world.

If you seek a meaningful career in missiles and astronautics, investigate the opportunities with Pan Am. In addition to career advancement, Pan Am offers Florida living and the unique advantage of 90% world-wide air travel discounts.

Address your resume, including telephone number, in confidence to:

Dr. Gilbert S. Blevins
Dept. E-32, Guided Missiles Range Division
Pan American World Airways, Inc.
Patrick Air Force Base, Florida



GUIDED MISSILES RANGE DIVISION

PATRICK AIR FORCE BASE, FLORIDA

CIRCLE 380 ON READER SERVICE CARD

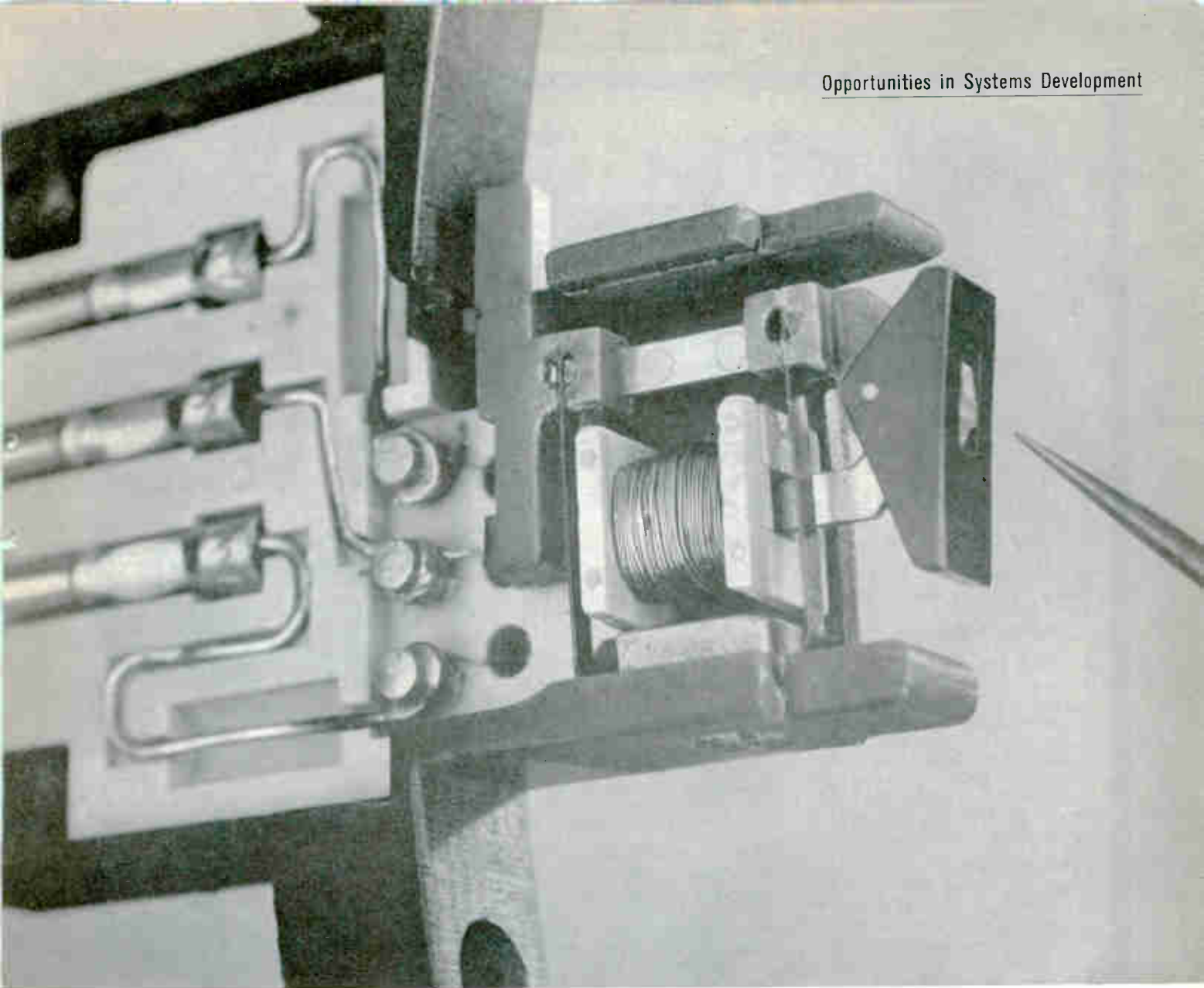

Approximately 5 times actual size, this new read-write head features an air bearing, mechanical lift, and integrated zener diodes.

Floating facts out of computer memory



This is a read-write head with an air-floated shoe. It was developed by IBM scientists and engineers for greater reliability of computer memories. It represents a significant improvement over present magnetic heads because it incorporates three unusual engineering achievements.

- An air bearing maintains the critical clearance between head and recording surface—even under severe thermal and vibrational environments.
- A newly developed mechanical lift separates the head from the rotating drum except during actual read or write operations. This eliminates start-and-stop wear.
- Zener diodes are packaged in the upper section of the head. This integration saves weight and space and enhances reliability.

Work on even more advanced read-write heads is now under way at IBM—aimed

at developing storage drums and discs with expanded memory capabilities. Interesting assignments are open. In addition, opportunities exist on projects involving, for example, cryogenics, microwaves, optics, semiconductors, inertial guidance, and human factors engineering.

If you have experience in any of these fields—plus a degree in engineering, mathematics, or one of the sciences, you may find the career you've been looking for in IBM systems development. For more information, write—outlining your background and interests—to:

Manager of Technical Employment
IBM Corporation, Dept. 554U4
590 Madison Avenue
New York 22, N. Y.

IBM®

SECURITY

CLIMATE

REWARDS

and CREATIVITY at

PHILCO Palo Alto

On the San Francisco Peninsula

You'll find exceptional opportunities and commensurate rewards with rapidly expanding Philco Western Development Laboratories, at the center of the San Francisco Bay Area's electronic industry. These are our immediate needs. Do they match your experience and interests?

SYSTEMS ENGINEERS

As an active participant in the formulation and design of microwave data telemetry and tracking systems, your responsibilities will include analysis of equipment design and performance, specification and technical direction of system test, analysis of flight test data, and preparation of system test report.

DESIGN ENGINEERS

Direct your ingenuity to the design of circuits forming integral parts of CW range measuring equipment and the integration of complex timing and coding circuitry for earth satellites. You will also establish and supervise test programs, direct the testing of setups, component parts, circuits and complete ranging systems, supervise and monitor electrical and environmental testing for qualification. Familiarity with transistor switching circuitry is required.

RANGE DESIGN ENGINEERS

Challenging assignments can be yours in the production of installation criteria, specifications, instructions and drawings required to implement advanced radar, telemetry, data processing, computing and communications systems.

RANGING AND TRACKING ENGINEERS

If your experience includes low-frequency phase measurements, tracking or radar, openings exist at PHILCO WDL for engineers to de-

sign, develop and insure fabrication of specialized test equipment.

RELIABILITY ASSURANCE

Your assignments will include evaluation of electronic components, preparation of specifications and drawings of components, analysis of failure of semi-conductors, tubes, or electromechanical devices.

QUALITY ASSURANCE

Qualified engineers are required immediately for in-process, final acceptance and testing of electronic and electromechanical equipment associated with missile and satellite tracking systems. Types of equipment include data processing, UHF and VHF transmitters and receivers, antenna systems.

Consider a career at Philco Western Development Laboratories, elite electronics center on the San Francisco Peninsula. For you . . . the encouragement of graduate study on a Tuition Refund basis at any of the excellent surrounding educational institutions, liberal employee benefits, and the facilities of Philco's new, modern R & D laboratories. For you and your family . . . the perfect climate, whether seasonal or cultural, in which to pursue all-year recreational activities. Only 45 minutes from cosmopolitan, dynamic San Francisco. We invite your inquiry in confidence as a first step toward expanding your skills at Philco, Palo Alto. Resumes may be sent to Mr. J. R. Miner.

Philco Corporation

WESTERN DEVELOPMENT LABORATORIES

3875 Fabian Way, Dept. E-923

Palo Alto, California

6559

CIRCLE 381 ON READER SERVICE CARD

ENCYCLOPEDIA EDITOR

excellent opportunity for man with academic or journalistic background in Physics-engineering who wishes career in publishing. We are looking for a permanent Encyclopedia Editor to rewrite articles and handle liaison with top men in the academic and industrial fields. Unusually attractive working environment in Charlottesville, Virginia, the perfect setting for gracious living in a University atmosphere. Liberal benefit program and relocation expense allowance.

Please send resume and salary requirements to:

McGraw-Hill Encyclopedia of Science & Technology
Box 3757 University Station
Charlottesville, Virginia

CIRCLE 382 ON READER SERVICE CARD



MANUFACTURERS' REPRESENTATIVES

IN THE ELECTRONIC INDUSTRY

SAMUEL K. MACDONALD, INC.

manufacturers representatives over 25 years
1531 SPRUCE STREET, PHILA. 2, PA.

Territory:
Pennsylvania • New Jersey
Delaware • Maryland
Virginia • West Virginia
District of Columbia

Other Offices:
Pittsburgh
Baltimore
Washington, D.C.

CIRCLE 384 ON READER SERVICE CARD

SEARCHLIGHT SECTION

(Classified Advertising)

BUSINESS OPPORTUNITIES
EQUIPMENT - USED or RESALE

Phone:

WALKER S-6000

Cables:

TELSERSUP

See pages 594, 595
of 1960 Electronics
Buyers' Guide for a
more complete listing

LIBERTY
ELECTRONICS
INC.

582 BROADWAY
New York 12, N. Y.

CIRCLE 460 ON READER SERVICE CARD

BERGER & CO.

816 Connecticut Avenue

Washington 6, D. C.

STerling 3-1184

INVESTMENTS

Specialized Negotiators for
the Purchase, Sale or Merger
of Companies in the Field of
Research and Development

CIRCLE 461 ON READER SERVICE CARD

INDEX TO ADVERTISERS



Audited Paid Circulation

AC Electronics	93	Oak Mfg. Co.	47
AMP Incorporated	56	Ohmite Mfg. Co.	15
Aeronautical Communications Equipment, Inc.	24	O'Neil-Irwin	26
Air Express	81	Paragon-Revolute, Division of Charles Bruning Co., Inc.	99
Allegheny Ludlum Steel Corp.	49	Potter & Brumfield, Division of American Machine & Foundry Co.	17, 18, 19, 20
American Machine & Foundry Co. Potter & Brumfield, Division	17, 18, 19, 20	Precision Instrument Co.	114
Amperex Electronic Corp.	29	Radio Corporation of America	4th Cover, 25
Ampex Data Products	100	Raytheon Company	2nd Cover
Anaconda American Brass	52	San Fernando Electric Co.	107
Avnet Electronics	51	Select-A-Gift	39
Baird-Atomic, Inc.	109	Southern Electronic Corp.	43
Beaver Gear Works, Inc.	103	Sperry Electronic Tube Division, A Division of Sperry Rand Corp.	100, 101
Bell Aerosystems Company	55	Sprague Electric Co.	5, 23
Bendix Corporation		Texas Instruments Incorporated Semiconductor-Components Divi- sion	7
Bendix-Pacific Division	95	Thompson-Ramo-Wooldridge, Inc.	22
Bruno-New York Industries Corporation	108	Tapco Group	22
C & D Batteries	91	Trygon Electronics Inc.	106
CBS Electronics	45	Tung-Sol Electric, Inc.	77
Celco-Constantine Engineering Laboratories	6	United Aircraft Corporation Norden Division	53
Cinch Mfg. Corporation Division of United-Carr Fastener Corporation	75	Varian Associates	108
Clevite Transistor Division		Waters Mfg. Inc.	95
Clevite Corp.	37, 38	Weinschel Engineering	14
Coto-Coil Co., Inc.	102	Western Devices, Inc.	105
Cubic Corp.	50	Weston Instruments Division	34
Daven Company	39		
Delco Radio	16		
Dialight Corporation	103		
Edwards High Vacuum Inc.	109		
Efeon Incorporated	89		
Eitel-McCullough, Inc.	48		
Electronic Measurements Co., Inc.	106		
Engineered Electronics Company	87		
Freed Transformer Co., Inc.	113		
Gallard-Schlesinger Chemical Mfg. Corp.	102		
Gamewell Co.	105		
Gardner-Denver Company	39		
Gates Radio Co.	33		
General Ceramics Corp.	21		
General Electric Co.			
Semiconductor Products	42		
General Public Utilities Corp.	96		
Good-All Electric Mfg. Co.	10		
Granger Associates	2		
Hayden, Stone & Co.	105		
Hewlett-Packard Co.	8, 9		
Hughes Aircraft Co.	28		
International Resistance Co.	3rd Cover		
Jennings Radio Manufacturing Corp.	41		
Klien & Sons, Mathias	54		
Kyoritsu Electrical Instruments Works, Ltd.	95		
Lambda Electronics Corp.	3		
Lapp Insulator Co., Inc.	86		
Leesona Corp.	82		
Lockheed Electronics Company	12, 13		
Magnetic Controls Co.	27		
Magnetic Metals Company	79		
Malco Tool & Mfg. Co.	40		
Marconi Instruments, Ltd.	83		
McGraw-Hill Book Company	107		
Midwest Foam Products Co.	107		
Minneapolis-Honeywell Regulator Co., Boston Division	90		
Nems-Clark Inc.	44		
North American Aviation, Inc.	85		

MANUFACTURERS' REPRESENTATIVES

MacDonald Inc. Samuel K. 112

CLASSIFIED ADVERTISING

F. J. Eberle, Business Mgr.

EMPLOYMENT OPPORTUNITIES 110-112

SPECIAL SERVICES 112

EQUIPMENT

(Used or Surplus New)
For Sale 112

ADVERTISERS INDEX

Berger & Co.	112
International Business Machines Corp.	111
Liberty Electronics, Inc.	112
McGraw-Hill Encyclopedia of Science & Technology	112
Morris Sales, S.	112
Pan American World Airways Inc.	112
Guided Missiles Range Div.	110
Philco Western Development Laboratories	112

* See Advertisement in the July 20, 1960 issue of Electronics Buyers' Guide for complete line of products or services.

This index and our Reader Service Numbers are published as a service. Every precaution is taken to make them accurate, but ELECTRONICS assumes no responsibilities for errors or omissions.

Give your Products

**MORE RELIABILITY and
BETTER PERFORMANCE with**

FREED QUALITY

In stock for immediate delivery

TOROIDAL INDUCTORS



- MIL Grade 4 — Metal Case
- MIL Grade 5 — Molded
- Uncased Units
- Highest Q
- Highest self resonant freq.
- Low temperature coefficient
- No hum pickup-astatic construction
- Can be supplied with center taps



FREQUENCY RANGE: 500CP TO 15KC

Type	Max Q	Inductance Range
TI-11	290	1MH to 50Hy
TI-12	255	1MH to 30Hy
TI-1A	250	1MH to 30Hy
TI-1	210	5MH to 20Hy
TI-4	195	5MH to 5Hy
TI-5	130	5MH to 2Hy
TI-16	72	1MH to 2Hy

FREQUENCY RANGE: 10KC TO 50KC

TI-13	303	1MH to 500MH
TI-2	285	1MH to 500MH
TI-6	279	1MH to 400MH
TI-7	200	.500MH to 200MH
TI-17	110	.100MH to 100MH

FREQUENCY RANGE: 30KC TO 200KC

TI-18	115	.1MH to 100MH
TI-8	140	.1MH to 100MH
TI-10	185	1MH to 200MH
TI-9	175	1MH to 500MH
TI-19	100	.1MH to 5MH
TI-3	260	.1MH to 10MH
TI-3A	310	10MH to 100MH

HIGH FREQUENCY TOROIDAL INDUCTORS

FREQUENCY RANGE: 20KC TO 10MC

TI-21	205	.010MH to .150MH
TI-22	250	.010MH to .700MH
TI-23	210	.010MH to .500MH
TI-20	305	.050MH to 5MH



Ruggedized, MIL STANDARD AUDIO TRANSFORMERS

Cor. No.	Imped. level—ohms	Appl.	MIL Std.	MIL Type
MGA 1	Pri. 10,000 C.T. Sec. 90,000 Split & C.T.	Interstage	90000	TF48X15AJ001
MGA 2	Pri. 600 Split Sec. 4, 8, 16	Matching	90001	TF48X16AJ002
MGA 3	Pri. 600 Split Sec. 135,000 C.T.	Input	90002	TF48X10AJ001
MGA 4	Pri. 600 Split Sec. 600 Split	Matching	90003	TF48X16AJ001
MGA 5	Pri. 7,600 Tap @ 4,800 Sec. 600 Split	Output	90004	TF48X13AJ001
MGA 6	Pri. 7,600 Tap @ 4,800 Sec. 4, 8, 16	Output	90005	TF48X13AJ002
MGA 7	Pri. 15,000 C.T. Sec. 600 Split	Output	90006	TF48X13AJ003
MGA 8	Pri. 24,000 C.T. Sec. 600 Split	Output	90007	TF48X13AJ004
MGA 9	Pri. 60,000 C.T. Sec. 600 Split	Output	90008	TF48X13AJ005

PARTIAL LISTING ONLY
WRITE FOR FURTHER INFORMATION ON THESE
UNITS OR SPECIAL DESIGNS
Send for NEW 48 page transformer catalog. Also ask
for complete laboratory test instrument catalog.

FREED-TRANSFORMER CO., INC.
1722 Weirfield St., Brooklyn (Ridgewood) 27, N.Y.

the new look

in "quick look" data handling

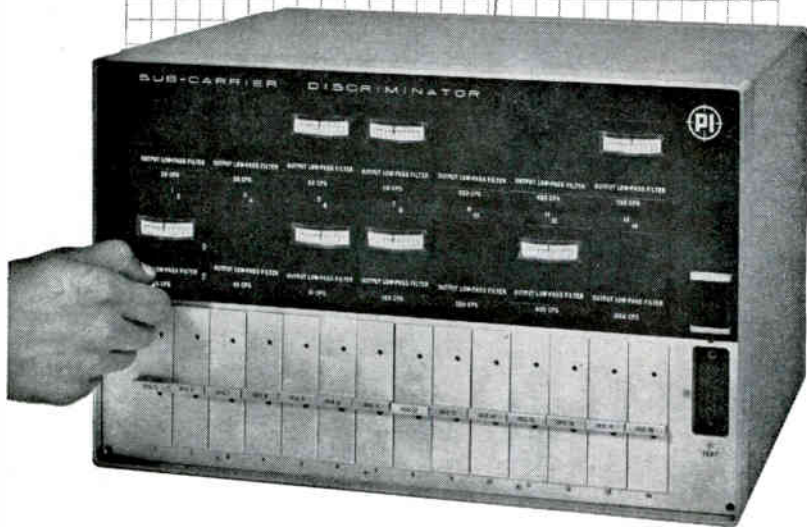

MINI-TEL

all-solid-state telemetry
sub-carrier discriminator

For "quick-look" analysis of FM telemetry data, the Precision MINI-TEL sub-carrier discriminator packs a surprising amount of usefulness into an exceptionally small space.

In its compact (less than 1 1/2 cubic feet) single-module package, occupying only 10 1/2 inches of rack space, the MINI-TEL provides up to 14 IRIG discriminator plug-in units, power supply, and output level monitor meters. Initial cost, maintenance, and power drain are exceptionally low.

Write for your copy of Bulletin 60 for details.



PRECISION INSTRUMENT COMPANY
1011 Commercial Street • San Carlos • California
Phone LYtell 1-4441 • TWX: SCAR BEL 30

REPRESENTATIVES IN PRINCIPAL CITIES THROUGHOUT THE WORLD

electronics



Audited Paid Circulation

BRUCE A. WINNER,
Advertising Sales Manager

R. S. QUINT, Assistant Advertising Sales Manager and Buyers' Guide Manager; FRED STEWART, Promotion Manager; RICHARD J. TOMLINSON, Production Manager; GEORGE E. POMEROY, Classified Manager; HUGH J. QUINN, Circulation Manager.

ADVERTISING REPRESENTATIVES: NEW YORK Donald H. Miller, Henry M. Shaw, George F. Werner; BOSTON William S. Hodgkinson, Donald R. Furth; PITTSBURGH David M. Watson; PHILADELPHIA Warren H. Gardner, William J. Boyle; CHICAGO Harvey W. Wernecke, Martin J. Gallay; CLEVELAND P. T. Fegley; SAN FRANCISCO T. H. Carmody, R. C. Alcorn; LOS ANGELES Carl W. Dysinger, D. A. McMillan, Marshall Freeman; DENVER J. Patten; ATLANTA M. Miller; DALLAS Robert T. Wood; LONDON Edward E. Schirmer; FRANKFURT Stanley R. Kimes; GENEVA Michael R. Zeynel.

BRANCH OFFICES: National Press Bldg., Washington 4, D.C.; 350 Park Square Bldg., Boston 16; Four Gateway Center, Pittsburgh 22; Six Penn Center Plaza, Philadelphia 3; 520 North Michigan Avenue, Chicago 11; 55 Public Square, Cleveland 13; 68 Post Street, San Francisco 4; 1125 West Sixth St., Los Angeles 17; 1740 Broadway, Denver 2; 1301 Rhodes-Haverty Bldg., Atlanta 3; 901 Vaughn Bldg., Dallas 1; McGraw-Hill House, London E.C.4; 85 Westendstrasse, Frankfurt/Main; 2 Place de Port, Geneva.

OFFICERS OF THE PUBLICATIONS DIVISION: Nelson L. Bond, President; Shelton Fisher, Wallace F. Traendly, Senior Vice Presidents; John R. Callahan, Vice President and Editorial Director; Joseph H. Allen, Vice President and Director of Advertising Sales; A. R. Venezian, Vice President and Circulation Coordinator.

OFFICERS OF THE CORPORATION: Donald C. McGraw, President; Joseph A. Gerardi, Hugh J. Kelly, Harry L. Waddell, Executive Vice Presidents; L. Keith Goodrich, Vice President and Treasurer; John J. Cooke, Secretary.

In **PRECISION FILM RESISTORS**

if it's news, expect it first from IRC

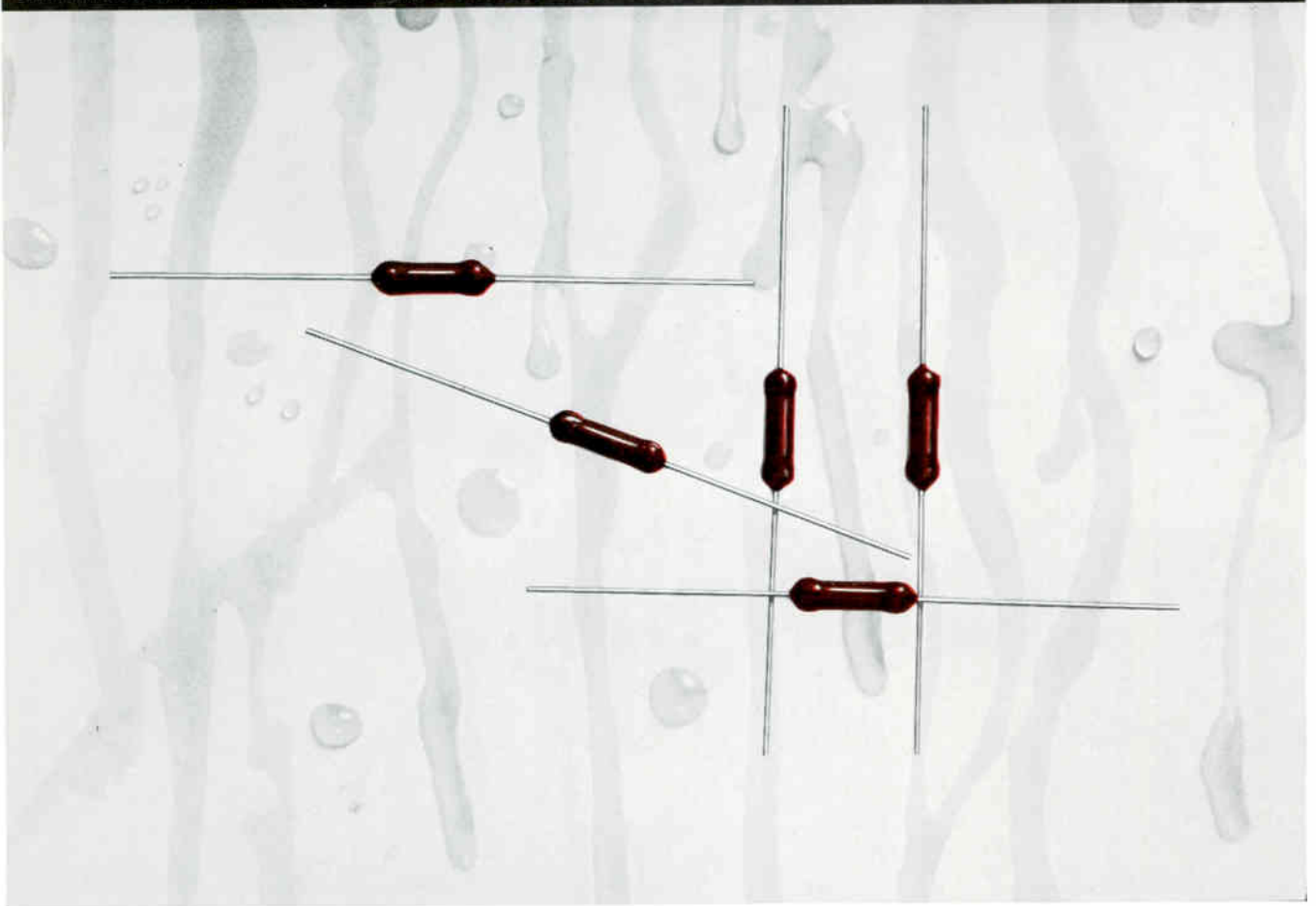

New **M***_{COAT} for resistors takes 30 cycles of MIL moisture

Moisture Resistant—Resistors with M Coat withstand 30 cycles of moisture, 300% of the MIL-R-10509C Characteristic B requirement, tested in accordance with MIL Standard 202. No other RN20X style film resistor on the market matches this performance.

Damage Resistant—M Coat adds greater protection for the resistance element, eliminates handling and assembly damage.

Superior Insulation—over 100 megohms after 30 cycles of moisture.

M Coat is currently available in the ½ watt size of IRC Precision Film Deposited Carbon Resistors, a type already noted for superior temperature characteristics, close tolerances, accuracy, and stability at high frequencies.

Rating: ½ watt at 70°C Ambient

Standard tolerance: ±1%

Range: 10 ohms to 2.49 megohms

Max. continuous working voltage: 350

Recommended Applications: Computer, amplifier, metering, and voltage divider circuits.

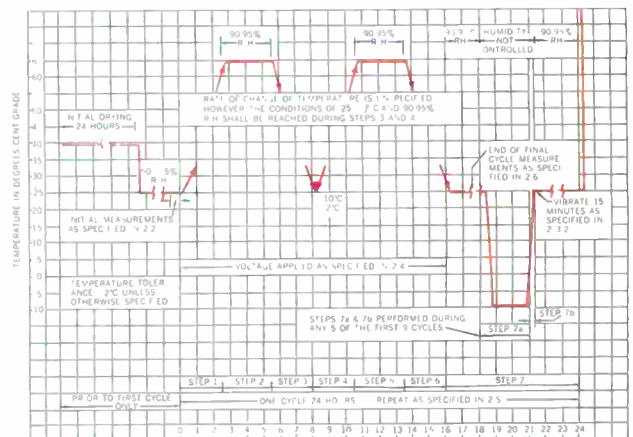

Write for Bulletin AE-15, International Resistance Co., 401 N. Broad St., Philadelphia 8, Pa.



*Trademark Exclusive IRC Moisture-proof Coating

Leading supplier to manufacturers of electronic equipment

FIRST
SILICON MESA
IN THE
TO-36 CASE
BROADENS
THE
COVERAGE
OF THIS
COORDINATED
SILICON LINE



Similar to
JEDEC
TO-3 Case

2N1487
2N1488
2N1489
2N1490



JEDEC
TO-8 Case

2N1483
2N1484
2N1485
2N1486



JEDEC
TO-5 Case

2N1479
2N1480
2N1481
2N1482



RCA 2N1511, 2N1512, 2N1513,
2N1514, in JEDEC TO-36 Case

RCA Announces Four New Silicon Mesa Power Transistors in the Popular TO-36 Case

Available immediately in quantity...four new NPN Diffused-Junction Types...
2N1511, 2N1512, 2N1513, 2N1514 • electrically equivalent to 2N1487, 1488, 1489, 1490
respectively • utilize the industry-preferred JEDEC TO-36 single ended stud package
with cold-weld seal • Designed for a wide variety of military and industrial applications

With RCA's new Silicon Mesa Power Transistors in the JEDEC TO-36 case, you gain all of these design advantages:

- ▶ More positive heat sink contact and excellent high-temperature performance up to 175°C plus the greater application flexibility of JEDEC TO-36 stud mounted case.
- ▶ Low saturation-resistance characteristics with high collector-current and voltage ratings.
- ▶ Wider application in military and industrial equipment—in power switching circuits, oscillator, regulator and pulse-amplifier circuits.
- ▶ The dependability of the cold-weld seal, proved by RCA through years of experience.
- ▶ Coordinated line of 16 RCA Silicon Power Transistors. These four new RCA transistors together with the 12 RCA Silicon Power Transistors shown in the accompanying table provide the designer of Industrial and Military equipment with a comprehensive selection of types to fit his specific needs.

ELECTRICAL CHARACTERISTICS								Max. Dissipation Watts	
Minimum and Maximum Values at Case Temperature = 25°C								25°C Case	100°C Case
RCA Type	Min V _{CEX} (volts)	Min V _{CEO} (volts)	Max I _C (amp)	Max I _{CEO} (μa)	Max. Saturation Resistance ohms	h _{FE}	h _{FE}	25°C Case	100°C Case
2N1514	100	55	6	25	0.67	25-75	25-75	60	30
2N1513	60	40	6	25	0.67	25-75	25-75	60	30
2N1512	100	55	6	25	2.00	10-50	10-50	60	30
2N1511	60	40	6	25	2.00	10-50	10-50	60	30
2N1490	100	55	6	25	0.67	25-75	25-75	60	30
2N1489	60	40	6	25	0.67	25-75	25-75	60	30
2N1488	100	55	6	25	2.00	10-50	10-50	60	30
2N1487	60	40	6	25	2.00	10-50	10-50	60	30
2N1486	100	55	3	15	1.00	35-100	35-100	15	7.5
2N1485	60	40	3	15	1.00	35-100	35-100	15	7.5
2N1484	100	55	3	15	2.67	15-75	15-75	15	7.5
2N1483	60	40	3	15	2.67	15-75	15-75	15	7.5
2N1482	100	55	1.5	10	7	35-100	35-100	4	2
2N1481	60	40	1.5	10	7	35-100	35-100	4	2
2N1480	100	55	1.5	10	7	15-75	15-75	4	2
2N1479	60	40	1.5	10	7	15-75	15-75	4	2

*sustaining volts

Call your RCA representative today for complete information. For additional technical data write to RCA Semiconductor and Materials Division, Commercial Engineering, Section 1-19-NN-2 Somerville, N. J.

RCA SEMICONDUCTOR & MATERIALS DIVISION FIELD OFFICES

NORTHEAST: 64 "A" Street, Needham Heights 94, Mass., HILcrest 4-7200. EAST: 744 Broad Street, Newark 2, N. J., HUmboldt 5-3900. EAST CENTRAL: 714 New Center Bldg., Detroit 2, Mich., TRinity 5-5600. CENTRAL: Suite 1154, Merchandise Mart Plaza, Chicago 54, Ill., WHitehall 4-2900. WEST: 6355 E. Washington Blvd., Los Angeles 22, Calif., RAymond 3-8361 • 1838 El Camino Real, Burlingame, Calif., OXFord 7-1620. SOUTHWEST: 7905 Empire Freeway, Dallas 7, Texas, FLeeewood 7-8167. GOV'T: 224 N. Wilkinson St., Dayton 2, Ohio, BALdwin 6-2366 • 1725 "K" Street, N.W., Washington 7, D. C., FEderal 7-8500.

Available
through your
RCA Distributor



The Most Trusted Name in Electronics
RADIO CORPORATION OF AMERICA