

August 19, 1960

electronics

*Master mask shown below controls illumination pattern
projected on a photoconductor matrix which forms logical
interconnections in a self-repairing computer. See p 56*

A McGraw-Hill Publication 75 Cents



ROLAND KISSLER
BOX 956
MOSES LAKE WASH

hp 456A AC CURRENT PROBE

Converts ac current to
ac voltage directly
(1 amp = 1 volt)
for reading on your
scope or voltmeter



Just clamp around
and read:

Tube circuits view current on your scope or measure it with a VTVM

Transistor circuits measure small signals dynamically, without clipping leads or circuit loading; study diodes at breakdown

Logic circuits measure ac current in presence of dc current

Impedance measuring . . with a dual-channel scope, measure current, voltage magnitude; phase angle

Power measuring with dual-channel scope read current, voltage directly, calculate power

Frequency counting use 456A with counter for clip-on frequency access

And, how about these? . . . phase comparisons of ac carrier waveforms; instrument fuse current ratings; cable identification, response of magnetic cores; magnetic field sensing; silicon rectifier peak currents

SPECIFICATIONS

- Sensitivity:** 1 mv/ma $\pm 1\%$ at 1 KC
 - Frequency Response:** $\pm 2\%$, 100 cps to 3 MC
 $\pm 5\%$, 60 cps to 4 MC
 ± 3 db, 20 cps to 15 MC
 - Maximum Input:** 1 amp rms; 1.5 amp peak
 - Maximum dc current:** Dc up to 0.5 amp has no appreciable effect
 - Input Impedance:** Probe adds to test circuit only approx. 0.05 ohms in series with 0.05 μ h
 - Output Noise:** Less than 50 μ a rms (100 μ a ac powered)
 - Power:** 10 radio mercury cells; approx. 400 hours service normally supplied. Ac supply available. Specify -hp- 456A-95A, \$32.00 extra. Factory installed, without batteries, \$20.00 extra.
 - Size:** 5" wide, 1 1/2" high, 6" deep, weight 3 lbs.
 - Price:** \$190.00 f.o.b. factory
- Data subject to change without notice

Just clamp the hp 456A probe around a wire under test and view or read ac current directly on an indicating device. Model 456A's 1 mv to 1 ma unity conversion permits direct readings up to 1 ampere rms. The instrument's wide bandwidth permits use with oscilloscopes to view complex current waveforms with rise times to 0.023 μ sec. No direct circuit connection is required; there is no loading, no appreciable impedance change in the circuit under test, and the impedance of the test circuit is immaterial.

HEWLETT-PACKARD COMPANY

1028K Page Mill Road, Palo Alto, California, U. S. A.
Cable "HEWPACK" • Davenport 5-4451

HEWLETT-PACKARD S. A.

Rue du Vieux Billard No. 1, Geneva, Switzerland
Cable "HEWPACKSA" • Tel. No. (022) 26. 43. 36



hp offers almost 400 precision test instruments

electronics

A McGraw-Hill Publication 75 Cents



W. W. MacDONALD, Editor

J. M. CARROLL, Managing Editor
 SENIOR ASSOCIATE EDITORS:
 Samuel Weber, Roland J. Charest.
 ASSOCIATE EDITORS: Frank Leary,
 Michael F. Tomaino, Sylvester P.
 Carter, William P. O'Brien, John
 F. Mason, William E. Bushor,
 Thomas Emma, Sy Vogel, Leslie
 Solomon, M. M. Perugini, George
 J. Flynn. ASSISTANT EDITORS:
 Michael F. Wolff, Nilo Lind-
 gren, Stanley Froud, Stephen B.
 Gray. REGIONAL EDITORS: Har-
 old C. Hood (Pacific Coast, Los
 Angeles), Thomas Maguire (New
 England, Boston). MARKET RE-
 SEARCH EDITOR: Edward DeJongh.
 BUYERS' GUIDE EDITOR: George
 Sideris. ART DIRECTOR: Harry
 Phillips; Howard R. Berry. PRO-
 DUCATION EDITOR: John C. Wright,
 Jr. EDITORIAL ASSISTANTS: Gloria
 J. Filippone, Arlene Schilp, Bernice
 Duffy, Patricia Martine, Lorraine
 Rossi, Virginia T. Bastian, Ruth
 Ayres, Mildred Scott.

JAMES GIRDWOOD, Publisher

BUSINESS

Air Force Letter Stirs Price Parley. May meet next month	30
Global Satellite Communications. Moon bounce points the way	31
Previewing Wescon Symposia. Chats with various chairmen	32
What's in U. S. 10-Year Space Timetable. NASA reveals aims	35
Uhf Secondary Voltage Standards Coming. Two new devices	36
ISA Conference Going to Coliseum. Moscow report on program	42
Green Light for Uhf-Tv Test. FCC to let contracts	44
Crosstalk	4
Comment	6
Electronics Newsletter	11
Washington Outlook	14
Financial Roundup	21
25 Most Active Stocks	22
Marketing	26
Current Figures	26
Meetings Ahead	46

ENGINEERING

Photoconductor matrix controlled by variable pattern is basis of all-purpose computer that can repair itself. See p 56	COVER
How a Closed-Circuit Pay Tv System Works. Design philosophy to functional operation By P. R. J. Court, C. A. S. Akrell, R. M. Reiter and G. S. Kimball	49
All-Purpose Computer Circuits. Automatically connected to solve specific problems By R. J. Domenico and R. A. Henle	56
Combining Transistors with Tunnel Diodes. Composite performance displays desirable features of both devices By C. D. Todd	59
Design of Mobile Receivers with Low-Plate-Potential Tubes. How to save space and power By C. Gonzalez and R. J. Nelson	62
Capacitance Change Indicates Liquid Levels. Accurate system calibrates turbine type flowmeters By T. L. Greenwood	66
Simplified Curve Tracer for Transistors and Diodes. Scope traces at six base-current values show characteristics By C. J. Candy	68

DEPARTMENTS

Research and Development. Optimizing Pulse-Forming Networks	72
Components and Materials. Capacitors Take 500 C	76
Production Techniques. Proportioners Mix Production Gases	80
New On the Market	84
Literature of the Week	100
People and Plants	102
Index to Advertisers	113

announcing . . .

New **WEST COAST** *Facilities*

**FOR
PRECIOUS METAL
CONTACTS**

Long a leader in development and production of miniature precious metal contacts and assemblies, General Findings & Supply Co. inaugurates nationwide facilities with the opening of a new West Coast plant.

**GENERAL FINDINGS &
SUPPLY COMPANY**

7327 LANKERSHIM BLVD,
NORTH HOLLYWOOD, CALIFORNIA

Thus General Findings & Supply Co. becomes the first major Eastern precious metal fabricator to offer invaluable, on-the-spot personalized research, development and fabrication facilities to the important West Coast Electronics Industry.

The new operation features an experienced staff of personnel from our main factory . . . equipped with the newest and most advanced machines and techniques and benefiting from high quality, delivery-controlled Leach & Garner Co. raw material produced at our Attleboro, Mass. plant. We are proud to offer this long awaited necessity to our Southern California customers and friends.



SLIP RINGS • MICRO BRUSHES • SPRINGS • RIVETS AND ASSEMBLIES
FOR POTENTIOMETERS • SYNCHROS • RELAYS • SWITCHES

Industrial Division

GENERAL FINDINGS & SUPPLY COMPANY

Sales Offices: New York • Chicago • Los Angeles • Attleboro

**MINIATURE
PRECIOUS METAL
CONTACTS**

For **MAXIMUM
PERFORMANCE**

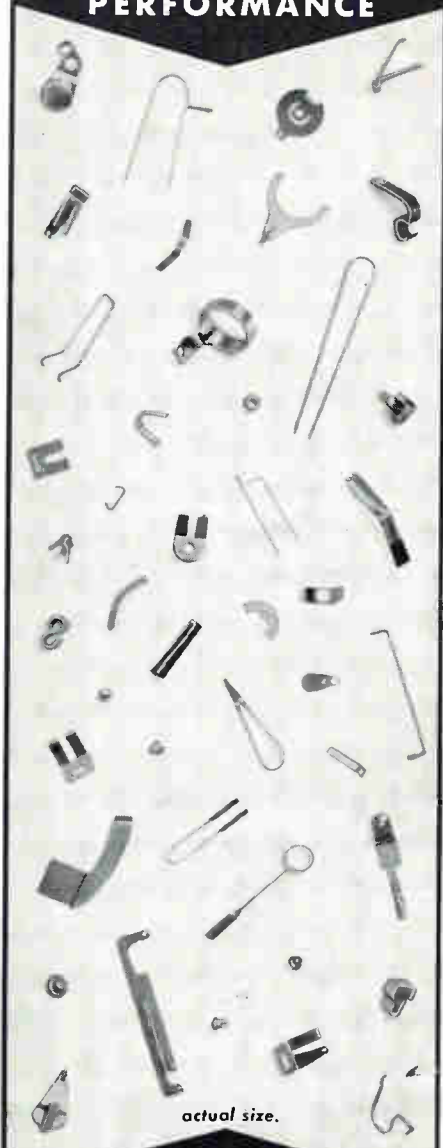

Slip Rings • Micro Brushes
Springs • Rivets
for
Potentiometers • Synchros
Relays • Switches

INDUSTRIAL DIVISION

**GENERAL FINDINGS
AND SUPPLY COMPANY**

Sales Offices: New York
Chicago • Los Angeles • Attleboro
Precision custom fabrications of all
precious metal contact alloys. Miniature
contacts using wire as fine as .005",
sheet as thin as .00075", and tubing as
small as .030" diameter. Precision base
metal fabrications also available.

For prompt quotations to your Print and Specifications, please write
52 Pearl Street • Attleboro, Mass.

NEW! 12,000 TO 30,000 VOLT SILICON RECTIFIER SERIES...

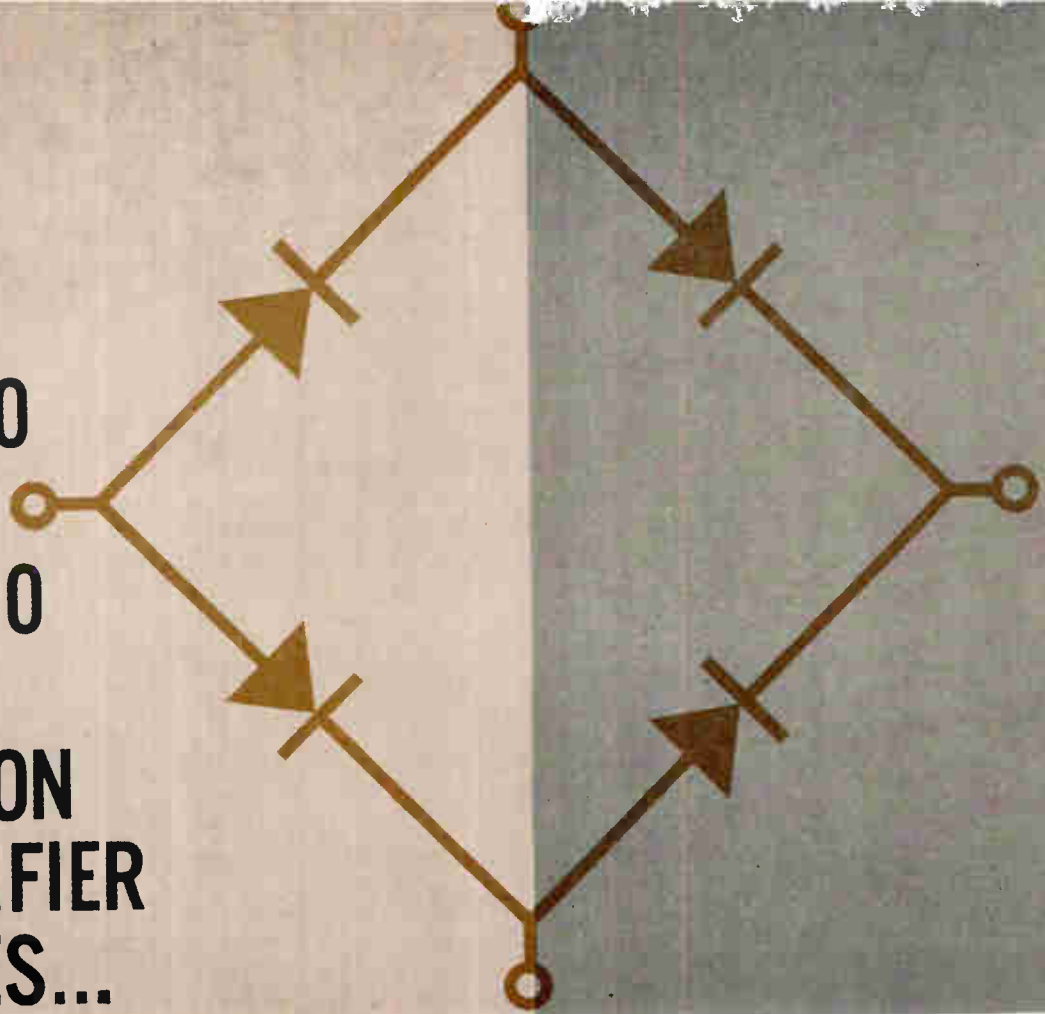

with no voltage derating over entire range -55°C to 175°C !

Ten new Very High Voltage silicon cartridge rectifiers rated from 12,000 to 30,000 volts are now available in production quantities from P S I.

Designated 1N3052 through 1N3061, the new units are added to the existing P S I line to provide 19 EIA types with voltages ranging from 1,000 to 30,000 volts.

NOTE THESE OTHER FEATURES:

- 1—Easy to mount, compact, light weight
- 2—Non-metallic electrically "cold" case
- 3—All welded construction
- 4—Meet all applicable MIL specs
- 5—*Lowest voltage drop—highest current ratings—best reverse leakage characteristics of any available types*

This new series is ideally suited to radar modulator and power supply applications.

Like the widely accepted 1N1730 series (1,000 to 5,000 volts) and the 1N2382 rectifier series (4,000 to 10,000 volts) the new types are of special significance where light weight, unusual ruggedness and high reliability are of prime importance.



Write or wire for detailed specifications, prices and delivery schedules.
NEW CONDENSED PSI CATALOG ALSO NOW AVAILABLE!

Pacific Semiconductors, Inc.

A SUBSIDIARY OF THOMPSON RAMO WOOLDRIDGE INC.
12955 CHADRON AVENUE, HAWTHORNE, CALIFORNIA

ELECTRICAL SPECIFICATIONS

TYPE NUMBER	PEAK AND CONTINUOUS INVERSE DC VOLTAGE -55°C to $+175^{\circ}\text{C}$ (Vdc)	EQUIVALENT RMS VOLTAGE (Vdc)	FORWARD DROP AT 100 mAdc AT 25°C (Vdc)	AVERAGE RECTIFIED CURRENT* (mAdc)	
				25°C	100°C
				1N3052	12,000
1N3053	14,000	9,900	75	100	50
1N3054	16,000	11,300	80	100	50
1N3055	18,000	12,700	85	100	50
1N3056	20,000	14,150	90	100	50
1N3057	22,000	15,500	95	100	50
1N3058	24,000	17,000	100	100	50
1N3059	26,000	18,350	105	100	50
1N3060	28,000	19,750	120	100	50
1N3061	30,000	21,150	125	100	50

*Half Sine Wave, Resistive or Inductive Load. For higher Ambient Temperature derate average rectified current linearly to zero at 175°C .

OTHER SPECIFICATIONS

1. Inverse Current at Rated Inverse Voltage: $10\ \mu\text{A}$ Max at 25°C and $100\ \mu\text{A}$ Max at 100°C .
2. Maximum Non-Recurrent Surge Current: .008 second, 2.5 Amps at 100°C .
3. Operating Temperature Range: -55°C to $+175^{\circ}\text{C}$.

CIRCLE 263 ON READER SERVICE CARD

Published weekly, including the ELECTRONICS BUYERS' GUIDE and REFERENCE Issue in mid-July as part of the subscription, by McGraw-Hill Publishing Company, Inc., James H. McGraw (1860-1948) Founder.

Executive, Editorial, Circulation and Advertising Offices: McGraw-Hill Building, 330 W. 42 St., New York, 36, N. Y. Longacre 4-3000. Publication Office: 99-129 North Broadway, Albany 1, N. Y. See panel below for directions regarding subscriptions or change of address.

OFFICERS OF THE PUBLICATIONS DIVISION: Nelson L. Bond, President; Shelton Fisher, Wallace F. Traendly, Senior Vice Presidents; John R. Callahan, Vice President and Editorial Director; Joseph H. Allen, Vice President and Director of Advertising Sales; A. R. Venezian, Vice President and Circulation Coordinator. **OFFICERS OF THE CORPORATION:** Donald C. McGraw, President; Joseph A. Gerardi, Hugh J. Kelly, Harry L. Waddell, Executive Vice Presidents; L. Keith Goodrich, Vice President and Treasurer; John J. Cooke, Secretary.

Subscriptions are solicited only from persons engaged in theory, research, design, production, management and use of electronic equipment. **POSITION and COMPANY CONNECTION** must be indicated on subscription orders. Subscription rates for individuals within the field of the Publication: United States and United States Possessions, \$6.00 one year; \$9.00 two years; \$12.00 three years. Canada, \$10.00 one year. All other countries \$20.00 one year. Single Copies, United States, United States Possessions and Canada 75¢; Buyers' Guide \$3.00; Single Copies all other countries \$1.50; Buyers' Guide \$10.00.

Our primary aim is to provide subscribers with a useful, valuable publication. Your comments and suggestions for improvement are encouraged and will be most welcome. The publisher, upon written request from any subscriber to our New York Office, agrees to refund the part of the subscription price applying to copies not yet mailed.

Second class postage paid at Albany, N. Y. Printed in U.S.A. Copyright 1960 by McGraw-Hill Publishing Co., Inc.—All Rights Reserved. Title registered in U. S. Patent Office.

BRANCH OFFICES: 520 North Michigan Avenue, Chicago 11; 68 Post Street, San Francisco 4; McGraw-Hill House, London E. C. 4; 85 Westendstrasse, Frankfurt/Main; National Press Bldg., Washington 4, D. C.; Six Penn Center Plaza, Philadelphia 3; Four Gateway Center, Pittsburgh 22; 55 Public Square, Cleveland 13; 856 Penobscot Bldg., Detroit 26; 3615 Olive St., St. Louis 8; 350 Park Square Bldg., Boston 16; 1301 Rhodes-Haverty Bldg., Atlanta 3; 1125 West Sixth St., Los Angeles 17; 1740 Broadway, Denver 2; 901 Vaughn Bldg., Dallas 1. **ELECTRONICS** is indexed semiannually, in July and December, and regularly in The Engineering Index.

Subscriptions: Send subscription correspondence and change of address to Fulfillment Manager, Electronics, 330 West 42nd Street, New York 36, N. Y. Subscribers should notify Fulfillment Manager promptly of any change of address, giving old as well as new address, and including postal zone number, if any. If possible, enclose an address label from a recent issue of the magazine. Since copies are addressed one to two issues in advance, please allow one month for change of address to become effective.

Postmaster: please send form 3579 to Electronics, 330 W. 42nd St., New York 36, N. Y.



Audited Paid Circulation

PAY TELEVISION. Many system approaches to pay tv are possible. In this week's lead article (see p 49) the engineers who developed the pay tv system inaugurated in Toronto, Canada, last February describe their company's system which has been designed to yield a home attachment at lowest cost. This article discusses the design philosophy of the system and the system itself in its four basic elements—the transmitting equipment, the distribution equipment, the telemeter equipment and the accounting equipment. This article has been specially prepared for **ELECTRONICS** by Patrick Court, director of research and development for the International Telemeter Company (a division of Paramount Pictures Corp.) and his three co-authors, engineers Carl Akrell, Abraham Reiter and Glenn Kimball.

ISA CONFERENCE. The Instrument Society of America, for the first time, will be using all four floors of the New York City Coliseum for its annual get-together this year. That's where the IRE meets, too, and the use of the same facilities may be symbolic. ISA officials this week predicted their annual conference "will soon be among the most important in the technical field—comparable to the IRE." Next month's ISA event runs from the 26th through the 30th. There will be more than 250 exhibits and 200 technical sessions. The program includes a "Report from Moscow," special workshops and panels. For an interesting preview, see Assistant Editor Lindgren's article on p 42.

Coming In Our August 26 Issue

MULTIBEAM CRT. Next week's cover will be carrying a picture of what looks to be a much-enlarged view of a member of the insect world. Inquisitive readers will discover that the bulbous thing is a cathode ray tube that displays a raster of thirty-nine traces originating from thirty-nine separate electron injectors. This uncommon breed of crt, although designed for shock-wave diagnostic work, will find application in any field where amplitudes can be presented as time duration—such as in simultaneous monitoring of temperatures, rates of flow, mechanical strains and complex wave functions. Author of this story is Lloyd Mancebo of the Lawrence Radiation Laboratory, University of California, Livermore, Calif.

TRANSISTOR FREQUENCY RANGE. After seeing a not fully detailed but nonetheless startling announcement in a company bulletin, one of our editors tracked down this significant story . . . a new circuit which, utilizing the principles of feedback amplification under oscillatory conditions, demonstrates a new mode of operation for transistors wherein the normal gain-bandwidth product can be extended considerably. Previously, most efforts toward improving the frequency range of transistors has been in the device fabrication line. Here is the circuit designer's approach. Authors V. W. Vodicka of the Lenkurt Electric Co., Inc., in San Carlos, Calif., and R. Zuleeg of the Hughes Semiconductor Laboratory in Newport Beach, Calif., tell how an ordinary transistor can be made to amplify in the kilomeg region.

FURTHERMORE. R. W. Frykman of Schjeldahl Co., Northfield, Minn., describes a radio command set and a lightweight command receiver for high-altitude balloons. Combination of resonant-reed relay and four-layer diode permits positive reception on crowded military radio channel.

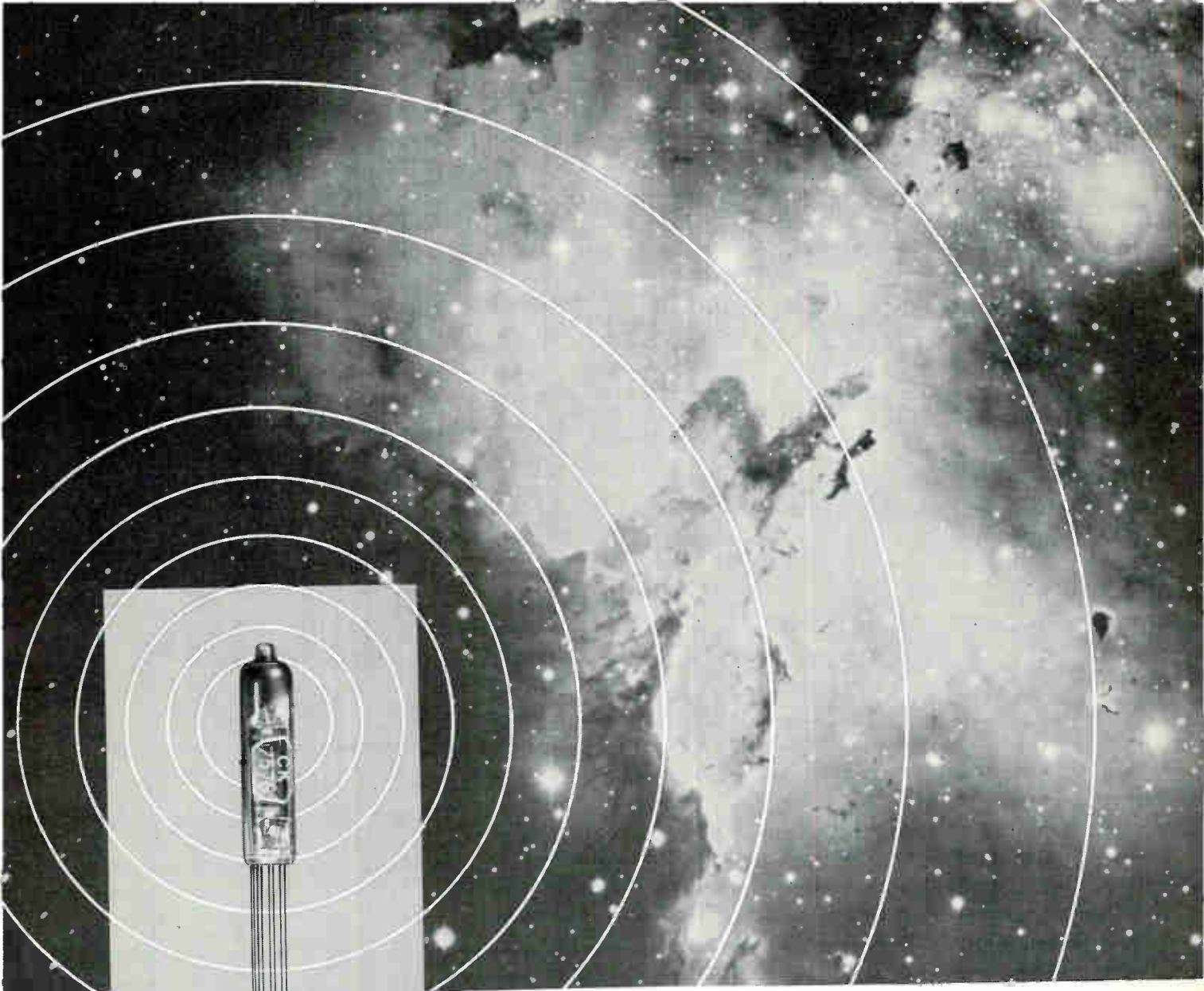

**CK7576 CHARACTERISTICS
AND TYPICAL OPERATION:
235Mc GROUNDED GRID
RF AMPLIFIER**

- Filament Voltage . . . 6.3 ± 5% volts
- Plate Voltage 200 volts
- Cathode Resistance . . . 150 ohms
- Peak RF Grid
to Cathode Voltage . . . 14 volts
- Grid Current 10 mA_{dc}
- Plate Current 37 mA_{dc}
- RF Driving Power
(Approx.) 0.5 watts
- Useful Power Output . . . 3.25 watts



Raytheon CK7576 Helps Keep Space Probes Sharp

Effective missile operation depends on compact, reliable telemetering made possible by components such as the CK7576.

The Raytheon CK7576 is a subminiature triode providing over 3 watts output at 235Mc in grounded grid RF power amplifier service. It offers designers of spaceborne telemetering equipment the advantages of excellent isolation between input and output circuits, high transconductance, high amplification factor, and impressive power-handling capabilities.

If your area of design interests includes airborne communication and navigation applications make it a point to investigate the CK7576 as well as the other versatile types in Raytheon's full line of subminiature tubes. For technical information, please write to: Raytheon, Industrial Components Division, 55 Chapel St., Newton 58, Massachusetts.

For Small Order or Prototype Requirements See Your Local Franchised Raytheon Distributor.

RAYTHEON COMPANY

INDUSTRIAL COMPONENTS DIVISION

TRANSISTORIZED

POWER SUPPLY



\$160 DELIVERED FROM STOCK

MODEL 3225

**A COMPLETELY TRANSISTORIZED
LABORATORY POWER SUPPLY
0-32 VOLTS, 0-250 MA**

Selectable Short Circuit Current 40, 100, 200, 350 MA
Protects Transistors Against Over-Voltage
Regulation 0.1% Ripple 1 MV
Size 7" x 5" x 4", Weight 5 Lbs.

MANY OTHER HIGHER CURRENT MODELS AVAILABLE

SALES REPRESENTATIVES

NEW YORK CITY: Marey Assoc., CI 5-3880
BUFFALO, N. Y.: L. Jacobson Co., DE 0442
ATLANTA, GA.: L. A. Walking Co., DR 3-8346
MIAMI, FLA.: L. A. Walking Co., CA 1-4297
FARMINGTON, CONN.: Keyco Assoc., DR 7-1771
HUNTSVILLE, ALA.: L. A. Walking Assoc., 534-3510
DALLAS, TEX.: So. Industrial Electronics, FL 2-3901
JACKSON, MICH.: W. Matteson & Assoc., ST 4-8920
SEATTLE, WASH.: D. H. Burcham Co., AT 4-7297
DAYTON, OHIO: Custom Engr. Corp., AX 8-5246
PORTLAND, ORE.: D. H. Burcham Co., CA 7-7333
PALO ALTO, CALIF.: Elmec Sales, Inc., DA 1-2430



Power Instruments Corp.

235 Oregon St., El Segundo, Calif.

SPring 2-2187 EAsgate 2-5690

COMMENT

Electronics Probes Nature

Wanted to extend my congratulations to you for the excellent report on probe techniques (Special Report "Electronics Probes Nature," p 53, July 29). I'm sure you've already had ample comment on it, but it occurs to me that we're frequently quick to throw brickbats when displeased and not always so quick with a compliment.

That issue is worth a compliment just for its news coverage. In the space of a very few pages, we have the Newsletter and Washington Outlook—both highly informative; then the Soviet electronics story and seven other stories all of great interest.

But the *chef d'oeuvre*—that special report! The thing I like so much is that, although I'm a stranger to many of the disciplines involved (I'm a computerman myself), I got almost as much information out of the report as your editors Bushor and Wolff put into it.

You certainly have an enviable assortment of talents available . . .

R. E. OLSON

MINNEAPOLIS

Reader Olson certainly makes up for many brickbats with his kind words, and we're glad he regards our assortment of talents (some people say "mixed bag" or "mixed grill") as enviable. Actually, we're pretty pleased with the spectrum of interests and capabilities represented by our staff and by our services. The Soviet story, for example, was mostly written by the chief of the McGraw-Hill World News bureau in Moscow, Ernest Conine. But it was pieced out with items from other correspondents in Zurich and Vienna and formed into a story by one of our New York editors.

The network of news-gathering offices which is McGraw-Hill World News is one of the assortment of talents that we value highly. And the work of cracker-jack interpretive editors like Bill Bushor and Mike Wolff, with their depth and breadth of technological understanding, is certainly an-

other most valuable publishing asset.

Procurement Practices

I was intrigued by the last item in Washington Outlook this week (p 14, Aug. 5), which says that Air Materiel Command's chief, General (S.E.) Anderson, is unhappy about industry adherence to "recently revised Air Force regulations on cost estimates and pricing techniques."

You didn't have much space to discuss it, and I feel it's important. Are you going to discuss it in greater detail?

GENE GOODMAN

PHILADELPHIA

Yup. See p 30, this issue.

On Liquefaction

I've been pleased recently with the increasingly higher literary level of my favorite magazine, and so I was wounded slightly by an error in your Aug. 5 Newsletter (p 11).

Your editors should know that *liquid* and *putrid* have one thing in common: the agent verb is spelled with an *e*, not an *i*.

Thus in the second Newsletter item "Microwave May Unlock Vast Oil Reserves," the microwave energy will liquefy, not liquify, the petroleum.

Tsk tsk.

J. D. CHAPLINE

PHILADELPHIA

Reader Chapline catches us with our i's crossed.

Twin-T Networks

I have just noticed an error on the labeling of the curves of "Graphical Solution for Twin-T Networks," June 17 (p 67).

The labels on Fig. 3 (p 68) for $\beta_1\Delta = 2.05$ and $\beta_2\Delta = 10.0$ were interchanged. This could cause considerable confusion in the use of the charts. You may wish to call the attention of your readers to this. . .

DONALD R. BOCAS

LOYOLA LABORATORIES
LOS ANGELES

For the
finest
combination
of vital
performance
factors...

Specify KETAY Servo Motors

Performance and reliability in the size 8 servo motor, for example, is underscored by:

- Unexcelled ratio of stall torque to power input at maximum rpm, as related in the chart below.
- High acceleration at stall.
- Efficient operation over the ambient temperature range of -55°C to $+125^{\circ}\text{C}$.
- Superior "white room" manufacturing, assembly and inspection techniques.

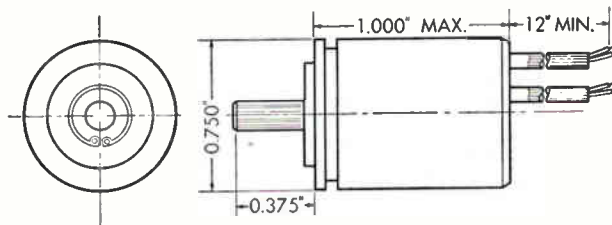
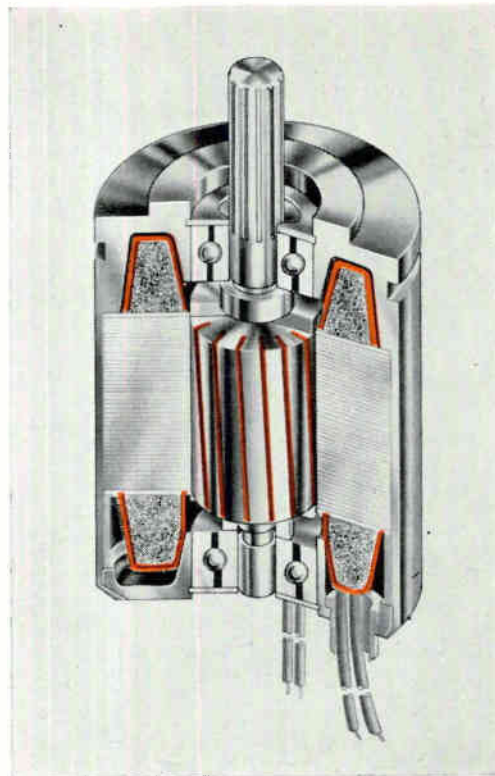

TYPICAL PERFORMANCE CHARACTERISTICS

Type Number	008E2A	008E2C	008E2D
Excitation Frequency (cps)	400	400	400
Rated Voltage:			
Fixed phase (volts)	26	26	26
Control phase (volts)	26	40/20	26
Input Power at Stall (watts)	1.75	1.75	2.50
Starting Voltage (volts)	0.68	1.0	0.68
Stall Torque (oz. -in.)	0.22	0.22	0.30
Ratio Stall Torque to Total Power Input	0.060	0.060	0.060
Rotor Inertia (gm. cm ²)	.414	.414	.414
Acceleration at Stall (rad./sec. ²)	36,000	36,000	53,000
No Load Speed (rpm)	6,500	6,500	6,500
Temperature Rise at Stall ($^{\circ}\text{C}$)	50	50	60
Operating Temperature Range ($^{\circ}\text{C}$)	-55 to $+125$	-55 to $+125$	-55 to $+125$

For more information on these or any other of the complete line of Ketay Servo Motors and/or motor generators from size 08 to size 23, 26 or 115 volt, 400 or 60 cycle excitation, please write.



KETAY DEPARTMENT
NORDEN DIVISION
UNITED AIRCRAFT CORPORATION
COMMACK, LONG ISLAND, NEW YORK

new
low
prices

**ON WESTINGHOUSE
SILICON POWER
TRANSISTORS**

**PRICES
REDUCED
UP TO 40%!**

AVAILABLE NOW IN ANY QUANTITY! Now you can have the proven quality and reliability of Westinghouse Silicon Power Transistors at the lowest cost yet. Types 2N1015 and 2N1016 are available in 30, 60, 100, 150 and 200 volt ratings in production quantities to meet your requirements at all times. Because these transistors have **True Voltage Ratings**, they can be operated continuously at full published voltage ratings without risk of failure.

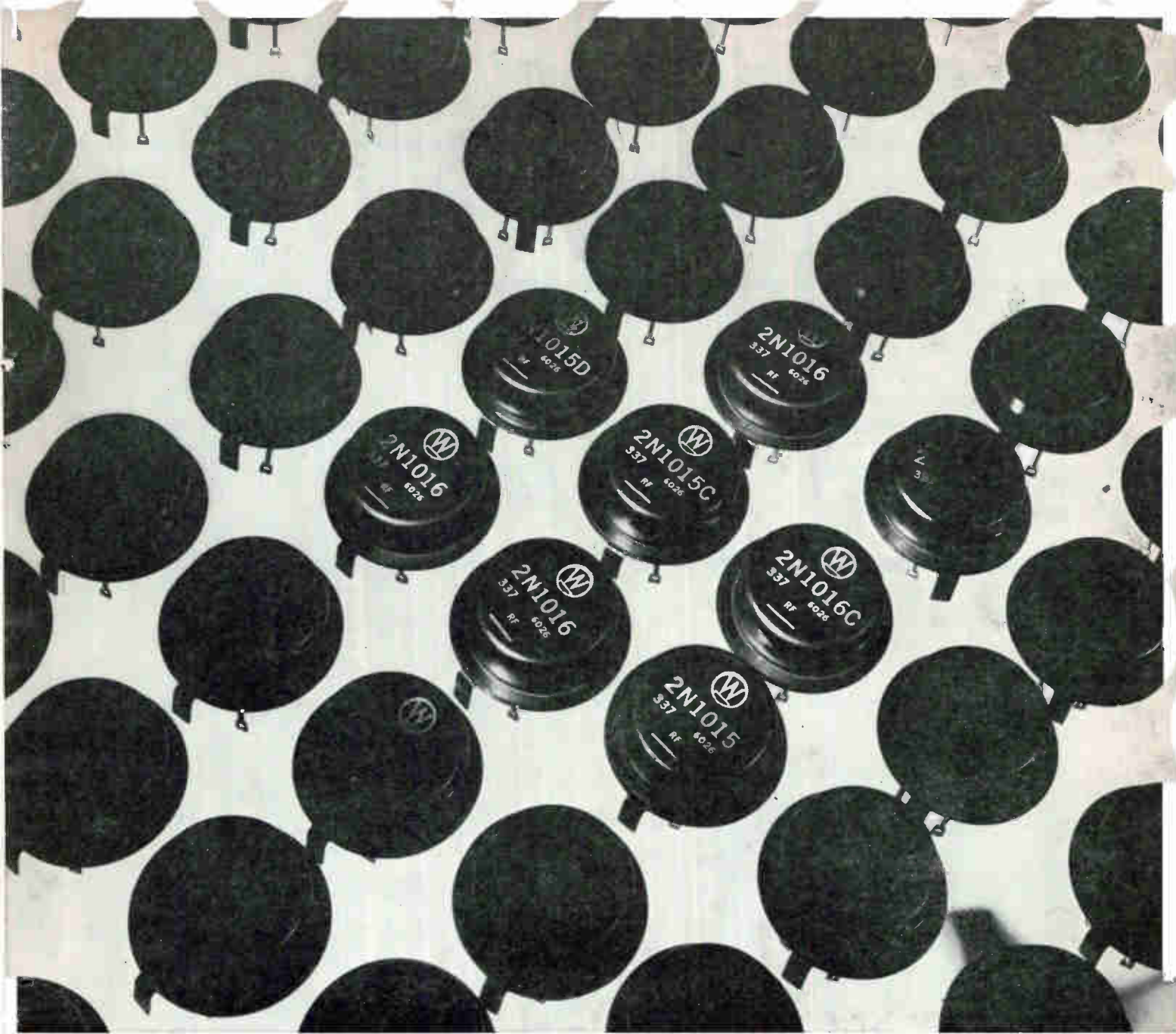

Other Westinghouse Transistor advantages include:

- High Power... up to 150 watts
- Collector current to 7.5 amperes
- Junction temperature to 150° C
- Designed to meet or exceed MIL specifications
- Extremely low saturation resistance

Present industrial and military applications include: Inverters • Regulators • Amplifiers • High Power Switching • Telemetry • Guidance • Power supplies.

For additional information, and quotation of new low prices, call your nearest Westinghouse representative or semiconductor distributor. Or write: Westinghouse Electric Corporation, Semiconductor Department, Youngwood, Penna. SC-1001

YOU CAN BE SURE... IF IT'S **Westinghouse**



Each Westinghouse Silicon Power Transistor is guaranteed by 100% power testing before shipment.

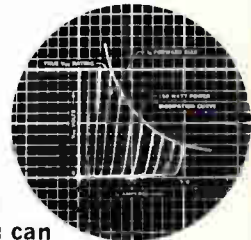

True Voltage Ratings—you can operate Westinghouse Silicon Power Transistors at full rating without risking transistor failure.

For immediate "off-the-shelf" delivery, order from these Westinghouse distributors:

EASTERN

- | | |
|--------------------------------|------------------------------|
| CAMERAIO | Pittsburgh, Pa./EX 1-4000 |
| CRAMER ELECTRONICS, INC. | Boston, Mass./CO 7-4700 |
| ELECTRONIC SUPPLY | Melbourne, Florida/PA 3-1441 |
| GENERAL RADIO SUPPLY CO., INC. | Camden, N.J./WO 4-8560 |
| KANN-ELLERT ELECTRONICS, INC. | Baltimore, Md./TU 9-4242 |
| MILGRAY ELECTRONICS | New York, N.Y./RE 2-4400 |
| RADIO & ELECTRONIC PARTS CORP. | Cleveland, Ohio/UT 1-6060 |
| SCHWEBER ELECTRONICS | Long Island, N.Y./PI 6-6520 |

MIDWESTERN

- | | |
|--|------------------------------|
| ELECTRONIC COMPONENTS FOR INDUSTRY CO. | St. Louis, Mo./WO 2-9917 |
| INTER-STATE RADIO & SUPPLY CO. | Denver 4, Colo./TA 5-8257 |
| LENERT CO. | Houston, Texas/CA 4-2663 |
| RADIO DISTRIBUTING CO. | Indianapolis, Ind./ME 5-8311 |
| SEMICONDUCTOR SPECIALISTS, INC. | Chicago, Ill./NA 2-8860 |
| UNITED RADIO, INC. | Cincinnati, Ohio/MA 1-6530 |

WESTERN

- | | |
|------------------------|-------------------------------|
| ELMAR ELECTRONICS | Oakland, Calif./TE 4-3311 |
| HAMILTON ELECTRO SALES | Los Angeles, Calif./BR 2-8453 |
| NEWARK ELECTRONICS CO. | Inglewood, Calif./OR 4-8440 |

Delivery from stock

NEW VHF-UHF POWER SOURCES

FULL-RANGE STABILITY

50 WATTS OUTPUT

25 to 1,000 MC!

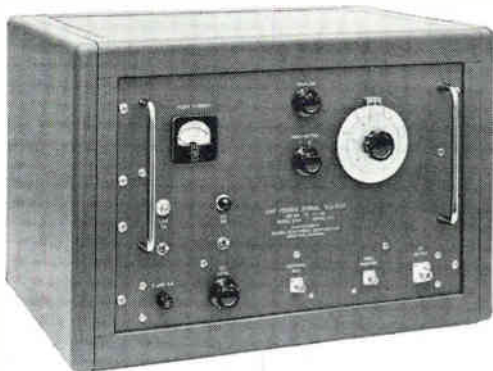

SPECIFICATIONS

Frequency range:	Model 215A-50, 25 to 50 MC Model 215A-150, 50 to 150 MC Model 215A-470, 150 to 470 MC Model 215A-1,000, 470 to 1,000
Power output:	50 watts \pm 1.5 db, into 50-ohm load, adjustable 20% to 100% of full power
Output stability:	\pm 5% after warmup
Frequency stability:	\pm 0.05% after warmup
Dial accuracy:	\pm 2% Models 215A-50/150 \pm 3% Models 215A-470/1,000
Resetability:	0.1%
Modulation:	External AM
Price:	\$3,300.00.

Data subject to change without notice. Price f.a.b. factory

Available in four off-the-shelf models covering the frequency range 25 to 1,000 MC, the new Sierra Electronic Corporation Model 215 Series VHF-UHF Power Sources provide extremely stable output to 50 watts. This unusual stability insures high repeatability for both routine check-out and precision laboratory work.

The instruments are continuously tunable over their respective ranges, offer high frequency stability and dependable operational stability under line voltage variation. Output power is adjustable 20% to 100% of rating. A plate current meter is provided for coupling adjustment, and a front-panel jack permits frequency monitoring with an external counter.

Sierra 215 Series Power Sources are easy to operate; completely self-contained and housed in sturdy bench cabinets. Rack mountable models also are available. They are ideal for accurate calibration of bi-directional power monitors and termination wattmeters, as well as for work in antenna design or other applications involving high attenuation of input signals.

For complete details, see your Sierra Representative or write direct.

Sierra

SIERRA ELECTRONIC CORPORATION

A Division of Philco Corporation

6755A BOHANNON DRIVE • Davenport 6-2060 • MENLO PARK, CALIF., U.S.A.

Sales representatives in all principal areas.

Canada: Atlas Instrument Corporation, Ltd., Montreal, Ottawa, Toronto, Vancouver.

Export: Frazar & Hansen, Ltd., San Francisco, Los Angeles

6755

ELECTRONICS NEWSLETTER

Ceramic Modules May Ease Gamma-Induced Problems

ONE ANSWER TO PROBLEM of sporadic malfunctions in electronic equipment under high peak dose-rates of gamma radiation was suggested last week by General Electric. The company's receiving-tube department says its ceramic circuit modules are not susceptible to malfunction in high gamma fluxes.

Problem has been much discussed at recent engineering conclaves, is a hot item on the agendas of the Pacific general meeting of American Institute of Electrical Engineers and Wescon (see also "Gamma Rays Cause Sporadic Mischief," *ELECTRONICS*, p 40, July 22). GE says its TIMMs (thermionic integrated micromodules, first discussed in *ELECTRONICS Components & Materials*, p 80, May 15 '59) have exhibited a tolerance to gamma-ray fluxes equivalent to those encountered within a mile of a one-megaton nuclear fireball.

TIMM circuits are built in ceramic and metal capsules about the diameter of a pencil, contain elements that perform functions normally handled by tubes, resistors and capacitors. The modules are evacuated and sealed under extremely high temperature.

Monitor to Guard Canal from Floods

ELECTRONIC TECHNIQUES will be used in a new system to monitor the Panama Canal and protect it from damage from flash floods, common there during the rainy season.

United Electrodynamics will design and install a rainfall and river-level monitoring and telemetering system to keep an unmanned watch on what's going on in surrounding rivers deep in the jungle. Remote stations will be interrogated from a central point by radio. Replies will be telemetered data on rainfall and river level.

Process is automatic, can measure from zero to 60 in. of rainfall to 0.1-in. precision, or keep up with river variations up to 35 ft to the nearest 0.01 ft, company engineers

say. Stations are meant to operate for two months at a time without maintenance.

Countermissiles Spark New R&D Contracts

DEFENSE AGAINST MISSILE ATTACK provides the impetus for several recent development contracts.

At Huntsville, Ala., Army missile agency awarded Western Electric \$18 million for work on the Nike-Zeus countermissile. The contract is for development of high-volume production techniques and tooling for Nike-Zeus components. Meanwhile engineers of Douglas Aircraft and Leach Corp. have developed an instrumentation system for the countermissile to record high-frequency wideband missile data for subsequent telemetering.

Sperry Gyroscope is developing a superpower klystron for Army Signal Corps that may substantially increase the range of the Zeus. Contract for \$1.3 million to push the development program will produce 20 developmental models of the new tube. Sperry rushed the initial design stages by using a computer to construct and test models of the tube before they were built.

Army Signal Supply Agency has awarded a \$4-million contract to Varian Associates for research and development of a high-powered radar for use against space weapons. Contract spreads over 3½ years, is aimed to produce a superpower microwave amplifier for Project Defender.

Servomechanisms Inc. has won a research contract from USAF's Wright Air Development Division to study use of molecular phenomena to achieve digital outputs from analog-type transducers. Price of the contract is not disclosed.

More Radar Beacons For Air-Traffic System

FEDERAL AVIATION AGENCY will beef up its radar beacon program with \$5.7-million worth of gear from Telecomputing Corp. Contract in-

cludes 36 complete systems and 31 partial systems.

Nine of the systems will go into air-route traffic-control centers, and the other 27 will be installed in airport control towers. FAA currently has 20 radar beacon systems in operation at 16 air-route centers.

The 31 partial systems—basically a decoder plus associated gear—will give beacon capabilities to some additional centers, which will use signals from existing military and FAA radars remoted over microwave transmission links.

France Liberalizes Import Restrictions

LATEST LIBERALIZATION of French import restrictions eases the problem of exporting many electronic items to the French market. Liberalization was announced at the end of June, raises the percentage of dollar-area commodities freed from quantitative import restrictions from 88.2 to 92.1 percent based on 1957 trade.

Included are such items as ferro-silico manganese and crude titanium. Among end-equipment items are ultrasonic machine tools, semi-automatic and automatic lathes, gearcutting and other machine tools, statistical and similar calculating machines, telephoto and communications equipment, low-frequency amplifiers, tv cameras, microscopes and electronic diffractory equipment, electronic measuring and control instruments, sound-recording equipment. Among components freed are relays, rheostats, potentiometers, receiving and amplifying tubes, parts for photoelectric cells.

U. S. Firm Imports Travelling-Wave Tubes

HIGH-FREQUENCY travelling-wave tubes for multichannel radio communications system are being bought by RCA from Mullard Ltd.

The British tubemaker won a \$2-million order for the special tubes against what is called "strong international competition," will make them at its microwave tube plant in Waddon, Surrey. Deliveries begin next May.

OZALID NEWSLETTER

NEW IDEAS TO HELP YOU WITH ENGINEERING REPRODUCTION AND DRAFTING

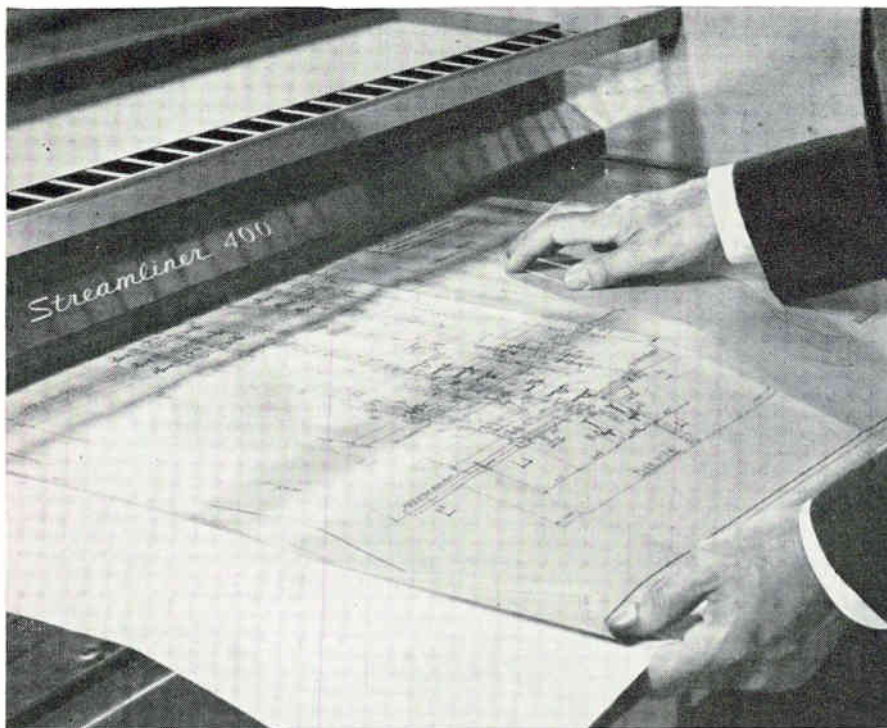

Get clean, sharp prints *fast* . . . with high-speed 200 SS paper.

Want more readable reproduction directly from poor originals . . . with super speed, too?

"Doing the difficult immediately" is one phrase that aptly describes Ozalid's Blue Line 200 SS paper. Want multiple copies of semi-opaque documents . . . in a hurry? 200 SS paper will do the job with less machine speed adjustment . . . less chance of error! Stuck with an old, yellowed or soiled original that must be reproduced clearly, or a machine with a low-light source (ultraviolet or fluorescent)? 200 SS paper is the answer! In fact, this super-speed diazo paper gives you improved quality and faster printing speeds for a host of tiresome copying chores: letters, bulletins, announcements, mimeograph and offset printed bond papers . . . not merely faster but cleaner and more legible as well.

Reading the rocks at rocket rate

One outstanding example of Ozalid

200 SS paper's super-speed usefulness is in the field of geology . . . where, in the exploration for oil and gas, it has had an enthusiastic reception.

Today, internationally known companies like the Schlumberger Oil Well Survey Company are employed to read every rock formation, every stratum of sand or substance beneath the surface that tells them first *where* to drill, and later, in the drilling operation, *when* to stop. In these operations, recording machines based on the Oscillograph principle record sound and light waves on photographic paper or film. Geologists can then read and interpret these records, known as "well-logs," with a good measure of accuracy.

Since drilling operations run as high as \$40,000 per day, speed of communication is understandably

important. That's where Ozalid 200 SS comes in. As the "well-logs" are taken from the recording devices, they are immediately processed and dried in field trucks. Duplicates are made in seconds right on the trucks on Ozalid 200 SS using Bambinos and/or Ozamatics®, and then sped to geologists for interpretation. Copies are simultaneously dispatched to drilling contractors and well owners. Thus 200 SS shortens the critical . . . and expensive . . . time interval between the recording of well pressures and the geologists' "make or break" decisions.

All this . . . and economy, too!

Naturally you'd expect that with all the outstanding benefits Ozalid 200 SS can give you, the cost would be a little higher. Not the case at all. It actually costs no more—and you save in *many* other ways as well. We'd like to quote from a truly unsolicited testimonial letter received from Mr. R. C. Purvayn, Purchasing Agent for Packaging Corporation of America: "We have found this paper to be of a nature that we can take letters, customer orders, etc., and run them on our Ozalid machine without the use of any type of masters. We have recently discontinued in a large measure the use of our (COMPETITIVE NAME DELETED) paper which costs us in the neighborhood of four and one-half cents per copy. Another added benefit with your 200 SS paper is that in filing we incur no wrinkling problem which has been a troublesome factor . . . we appreciate the savings which we have made with the use of your 200 SS paper . . ."

To sum it all up, Ozalid's Blue Line formula 200 SS paper facilitates higher printing speeds plus better image density for easiest reading . . . means time and money savings for you. If you'd like a convincing demonstration, may we suggest that you contact your Ozalid representative? He'll be happy to oblige . . . without obligation.

Ozalid, Johnson City, New York. A Division of General Aniline & Film Corp.

HOW TO GENERATE 100-ma PULSES AT 10 mc

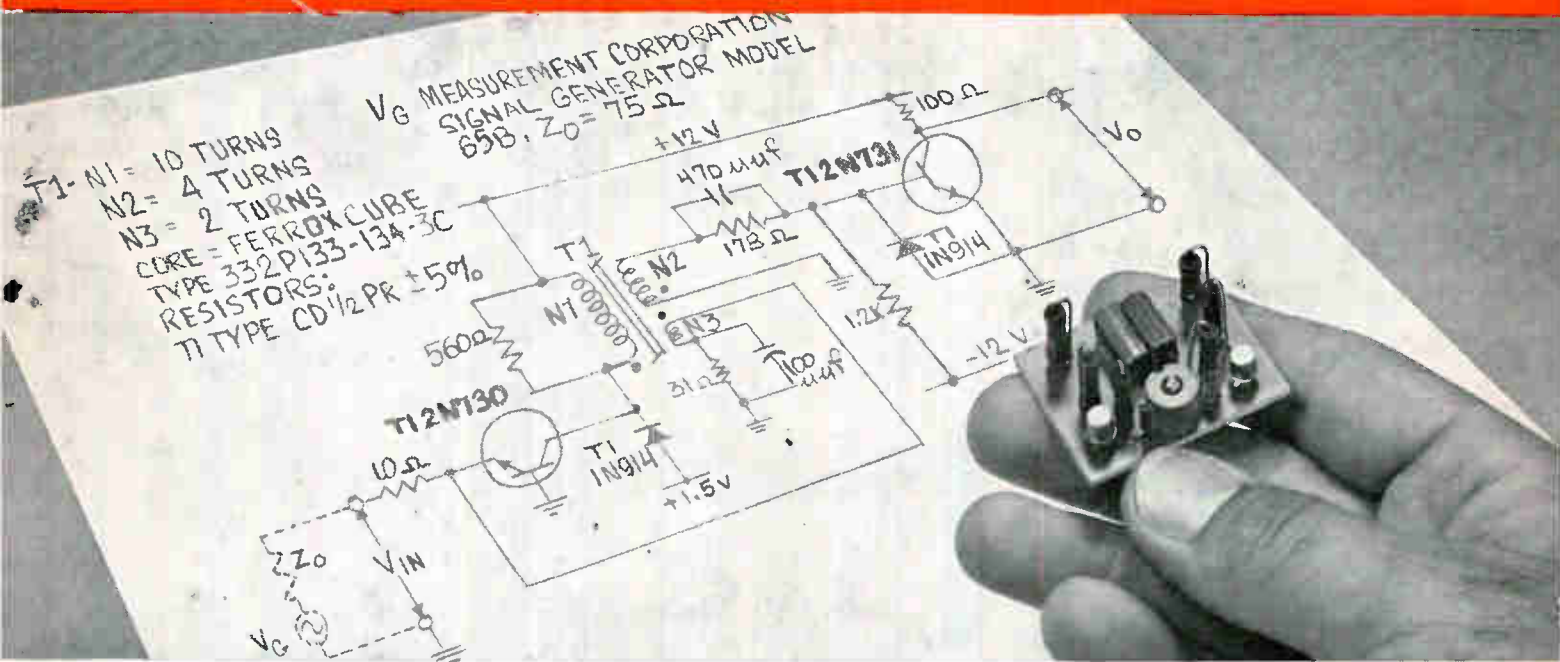

... WITH TI 2N730 and 2N731 SILICON MESA TRANSISTORS

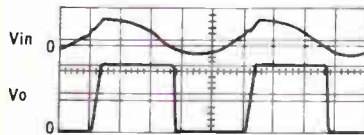

1 Megacycle
VERT.—5v/cm
HORIZ.—2 μ sec/cm
 $T_A=25^\circ\text{C}$

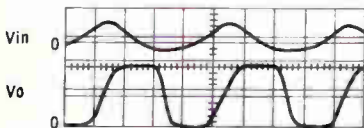

5 Megacycles
VERT.—5v/cm
HORIZ.—50 μ sec/cm
 $T_A=25^\circ\text{C}$

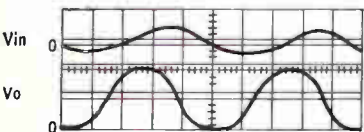

10 Megacycles
VERT.—5v/cm
HORIZ.—20 μ sec/cm
 $T_A=25^\circ\text{C}$



See how these performance-proved characteristics apply to your high-current, high-speed switching circuits...

High-current loads — Switch 100 ma at 10-mc rates using TI 2N730 and 2N731 transistors (see applications circuit) • *Fast switching* — Note 20 millimicrosecond rise and fall times on

the waveforms illustrated • *Size and weight* — Save both size and weight with the subminiature TO-18 packaging of the TI 2N730 and 2N731 'mesas' • *Dissipation* — Get a full 500 mw ($T_A=25^\circ\text{C}$) or 1.5w ($T_C=25^\circ\text{C}$) with beta spreads of 20-60 (2N730) and 40-120 (2N731) • *Reliability* — TI Quality Assurance guarantees you performance to specifications • *Applications* — Use the TI 2N730 and 2N731 guaranteed performance in your digital computer clock pulse generators and similar high-load, high-speed, high-reliability circuits. Check these specifications:

electrical characteristics at 25°C ambient (unless otherwise noted)			2N730		2N731		unit	
PARAMETER	TEST CONDITIONS	min	max	min	max			
I_{CBO}	Collector Reverse Current	$V_{CB}=30\text{v}$	—	1.0	—	1.0	μa	Collector-Base Voltage 60v
I_{CBO}	Collector Reverse Current at 150°C	$V_{CB}=30\text{v}$	—	100	—	100	μa	Collector-Emitter Voltage 40v
BV_{CBO}	Collector-Base Breakdown Voltage	$I_C=100\mu\text{a}$	60	—	60	—	v	Emitter-Base Voltage 5v
BV_{CER}	Collector-Emitter Breakdown Voltage	$I_{CER}=100\text{ma}$ $R_{BE}=10\text{ ohms}$	40	—	40	—	v	Total Device Dissipation 0.5w
BV_{EBO}	Emitter-Base Breakdown Voltage	$I_E=100\mu\text{a}$	5	—	5	—	v	Total Device Dissipation at Case Temperature 25°C 1.5w
hFE	DC Forward Current Transfer Ratio	$I_C=150\text{ma}$	20	60	40	120		Storage Temperature Range -65°C to +175°C
$V_{BE(sat)}$	Base-Emitter Voltage	$I_C=150\text{ma}$	—	1.3	—	1.3	v	
$V_{CE(sat)}$	Collector-Emitter Saturation Voltage	$I_C=150\text{ma}$	—	1.5	—	1.5	v	
h_{fe}	AC Common Emitter Forward Current Transfer Ratio	$I_C=50\text{ma}$ $f=20\text{mc}$	—	—	—	2.5		
C_{ob}	Common-Base Output Capacitance	$I_E=0$ $f=1\text{mc}$	—	35	—	35	$\mu\mu\text{f}$	

*Pulse conditions: Length = 300 μs , duty cycle < 2%

CALL YOUR TI SALES OFFICE OR LOCAL AUTHORIZED TI DISTRIBUTOR FOR PRICE, DELIVERY AND COMPLETE TECHNICAL DATA.

 the **FIRST** silicon transistor manufacturer

TEXAS



INSTRUMENTS
INCORPORATED
SEMICONDUCTOR COMPONENTS DIVISION
13500 N. CENTRAL EXPRESSWAY
POST OFFICE BOX 312 • DALLAS, TEXAS

DEMINERALIZED WATER AT 1200 G.P.H. WITH NEW BARNSTEAD CARTRIDGE DEMINERALIZER

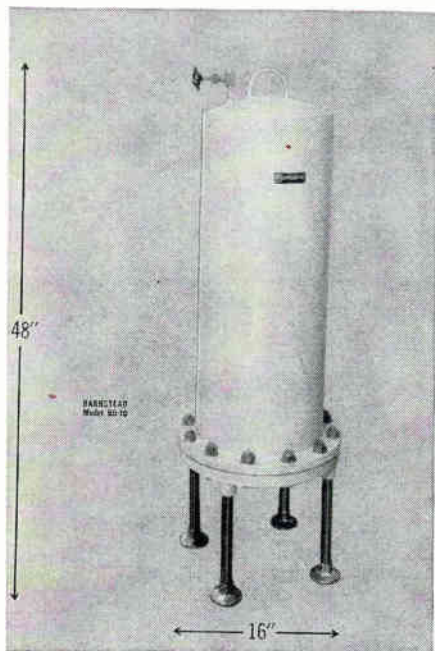

FOR

use as repurifying demineralizer in high purity rinsing in semi-conductor field

FOR

use in Cooling Loops of U.H.F. transmitting tubes.

FOR

purification and repurification systems.

FIVE

different cartridges: Standard, Mixed-Bed, Organic Removal, Oxygen, and Cation Supercartridges . . . all can be used interchangeably in the Barnstead BD-10.

NEW CATALOG #160

Describes Barnstead's complete line of Mixed-Bed, Two-Bed, and Four-Bed Demineralizers. Profusely illustrated with case histories, charts, diagrams and specifications. Write for your copy today!

Barnstead
STILL AND STERILIZER CO.

84 Lanesville Terrace, Boston 31, Mass.

**FIRST IN WATER
PURIFICATION SINCE 1878**

WASHINGTON OUTLOOK

PREPARATION of the fiscal 1962 budget is now being handled in such a way as to simplify any major revamping that the President-designate may want to make. The military services have been instructed to set their estimates for next years appropriations requests, contracting plans and actual outlays at four different levels, each assuming a different spending rate.

Basic level reflects the current rate of spending and contracting for each service, and represents President Eisenhower's defense policies. The services must squeeze their plans within these amounts, thus must include only top-priority projects. They then can assume three other levels, each progressively higher.

RATE OF MILITARY CONTRACT-LETTING is running ahead of last summer's. Rough Pentagon estimates show about \$6-billion-worth of new orders for the July-September quarter, some \$200 million over the rate for the comparable quarter last year.

The services have gotten a head start in awarding new orders because of a speedup in the Pentagon's reapportionment process. This is a joint Budget Bureau-Pentagon review of each service's major spending programs, made prior to allocation of funds newly appropriated by Congress.

POST OFFICE will begin testing facsimile mail transmission on Sept. 15 in a hookup between Washington, Chicago and Battle Creek, Mich. Only government mail will be transmitted during the test period, which runs through mid-December.

Letters will be prepared on special forms similar to wartime V-mail; then machines will open the letters and transmit them. At the receiving station they will be printed and sealed. At no time will the mail be read by operators.

ITT is the prime contractor on the project. A high-speed scanner developed by Stromberg-Carlson will read and transmit a typed or hand-written 8½-by-11-inch letter in four seconds. Xerographic printers made by Haloid receive the transmission and complete the operation.

The Post Office Department wants eventually to link every major city with such a system, says the cost will be low enough to attract general mail.

NATIONAL GLOBAL COMMUNICATIONS SYMPOSIUM held here two weeks ago (see "Highlighting Tomorrow's Communications," *ELECTRONICS*, p 31, Aug. 5) heard a report from Maj. Gen. James Dreyfus on the new Defense Communications Agency which will manage and supervise joint communications for the Department of Defense. Dreyfus, director of communications electronics for the Joint Chiefs of Staff, pointed out that the agency is scheduled to take control by March 1961, still faces many problems.

Among these problems, he mentioned that the capacity of the system must be increased manifold for new weapons systems; more computers will be required to reduce large quantities of data to essential intelligence; reliability must be improved; communications functions must be further combined to reduce cost and increase efficiency; and message handling and processing must be speeded up through automation.

Also at the Globecom meet, Space Technology Labs exec v-p Ruben Mettler said we will probably fall short of what is now predicted for the next three years in the satellite technology. Pattern of over- and underestimating, he added, appears to characterize such developments as electronics, nuclear science, automation, and so forth.

Short-term development is frequently limited by such factors as temporary engineering difficulties and shifts in public interest, Mettler said, whereas longer-term development more nearly reflects the onrush of general scientific and technological progress.



The Air Force Missile Family... Scions of Space Technology

Science and technology, especially as they relate to missile art, have advanced further in the last six years than in the preceding six centuries. Any review of the many milestones successfully attained since 1954 reveals an epic of hard work, inventiveness, accomplishment, and singleness of objective. This single objective—the achievement of operational weapon capability at the earliest possible date—is being realized.

The Air Force missile family including Atlas, Thor, Titan, and Minuteman, has achieved progress beyond expectation in a program unmatched for magnitude and complexity.

Space Technology Laboratories has had the responsibility since 1954 for the over-all systems engineering and technical direction of these programs. STL's scientific and technical management capabilities have not only helped to hasten the day of operational capability for Air Force ballistic missiles, but have also been applied in carrying out related space probe and satellite projects.

Scientists and engineers with outstanding qualifications find unusual opportunities for their skills and disciplines at STL. Positions on STL's technical staff are now available for those who wish to add a new dimension to their careers. Resumes and inquiries are invited.

SPACE TECHNOLOGY LABORATORIES, INC.

P. O. Box 95004, Los Angeles 45, California • STL
Florida offers immediate opportunities to outstanding



Project Engineers—Instrumentation. Write: Mr. George S. Cherniak, STL, P. O. Box 4277, Patrick Air Force Base, Florida

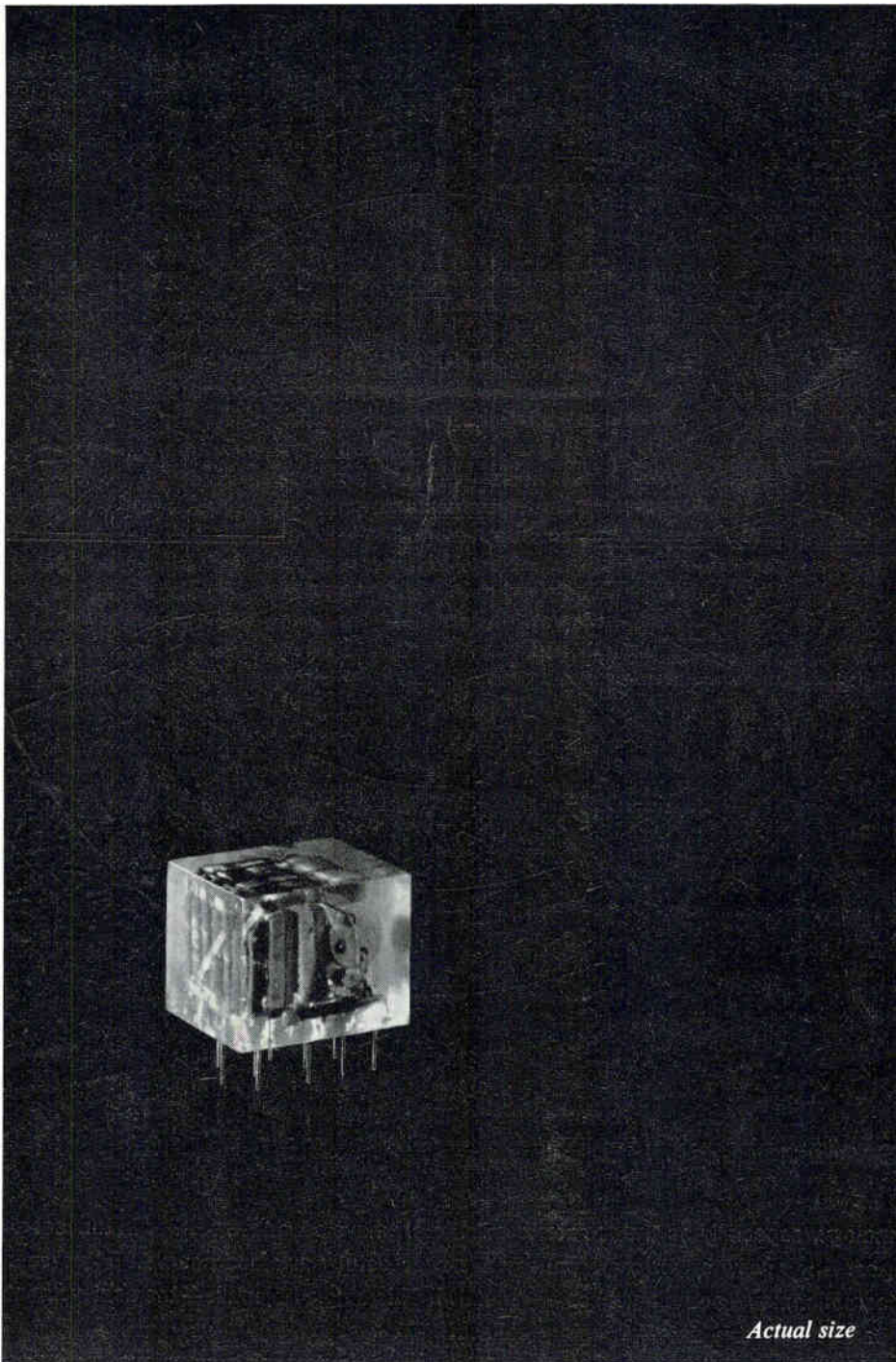

FROM DELCO RADIO NEW IDEAS FOR DEFENSE

MINIATURE MODULES WITH STANDARD COMPONENTS

They are *building block modules*. They are a product of Delco Radio's newly developed, three-dimensional packaging technique. They are used to build light, compact, reliable airborne and special purpose digital computers for missile control. Each module, vacuum encapsulated with epoxy resin, contains up to 35 standard components per cubic inch—averaging more than 50,000 per cubic foot. The modules perform all the standard logic functions. They meet or exceed all MIL-E-5272D (ASG) environmental requirements and will operate over a temperature range of -55°C to $+71^{\circ}\text{C}$. They can be assembled in groups on printed circuit boards. There are 10 basic types and 15 variations of Delco Building Block Modules. With them, Delco Radio can quickly and easily build a compact, reliable computer for airborne guidance or any other military application. For complete details, write to our Sales Department. *Physicists and electronic engineers: Join Delco Radio's search for new and better products through Solid State Physics.*

PIONEERING PRECISION PRODUCTS THROUGH SOLID STATE PHYSICS

DELCO
DEPENDABILITY
RADIO
& RELIABILITY

Division of General Motors • Kokomo, Indiana

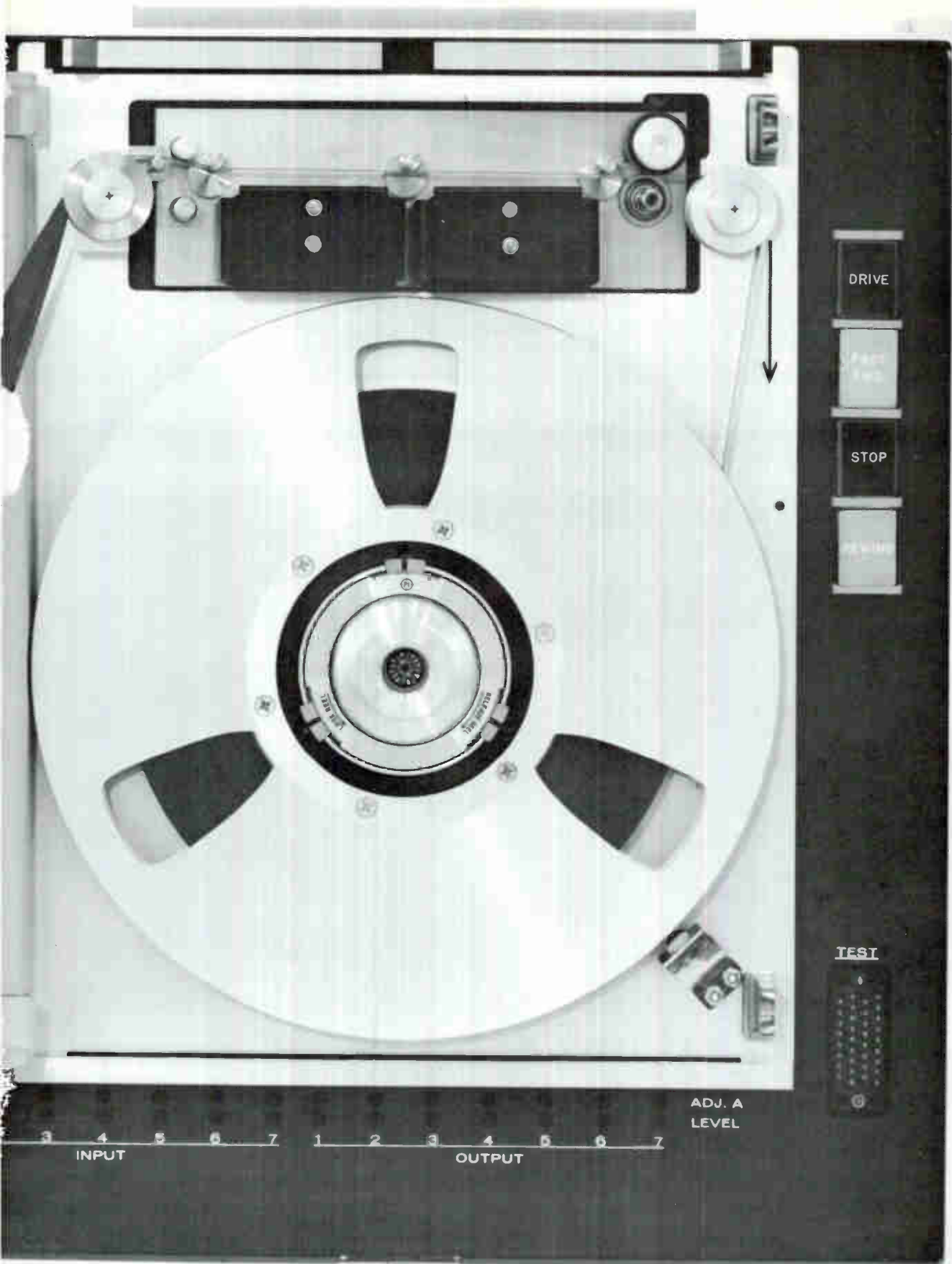

The **PRECISION**  **RECORDER** offers you literally *twice* the performance available in conventional instrumentation magnetic tape recorders... at significantly less cost... in a fraction of the space. Send for details today.



PRECISION INSTRUMENT COMPANY

REPRESENTATIVES IN PRINCIPAL CITIES THROUGHOUT THE WORLD



symbol of a new precision
in instrumentation

PRECISION opens the door to a new era in magnetic tape recording

with the ALL NEW PRECISION π RECORDER

- TWICE the frequency response previously obtainable with conventional recorders
- TWICE the recording time for a given length of tape — as much data on a 10½" reel as previously on a 14" reel
- HIGHER reliability, LOWER flutter, LESS need for maintenance, GREATER economy

The new Precision π Recorder offers performance levels previously achieved only under ideal conditions, in laboratory-type instruments many times as large and costing many times as much—performance levels literally TWICE those obtainable with ordinary recorders.

Based on the thoroughly tested and field-proven design of the first all-solid-state instrumentation tape recorder—the Precision PS-200 Series—the new π Recorder incorporates advanced mechanical and electronic concepts offering unparalleled economy of space and efficiency of function.



PRECISION INSTRUMENT COMPANY

1011 COMMERCIAL STREET • SAN CARLOS • CALIFORNIA
PHONE LYTELL 1-4441 TWX: SCAR BEL 30

After you've turned the page and opened the door to this new concept in instrumentation recording, the next step is to send for detailed specifications in new Bulletin No. 59. Send the postage-free reply card today.



Fairchild Buys 1/3 of Italian Company

FAIRCHILD SEMICONDUCTOR CORP. announces acquisition of a one-third interest in SGS, a Milan, Italy, semiconductor producer. The Italian firm will market and manufacture the Fairchild line of silicon semiconductors overseas. The Italian firm (*Societa Generale Semiconduttori*) was founded two and a half years ago by Olivetti and Telettra, and has been producing germanium alloy junction transistors, silicon diodes, gold bonded diodes and silicon rectifiers. Ownership of the Milan company will be held equally by Olivetti, a major business machine manufacturer; Telettra, one of Italy's biggest microwave communications equipment producers, and Fairchild. Financial details have not been disclosed.

Lionel Corp., New York City, announces plans to get more heavily into electronics by broadening its activities in research for television, radio and missiles, and establishing a new industrial electronics division. In line with these plans, the firm has signed an agreement to acquire the assets of Anton-Imco through an exchange of shares, subject to approval by shareholders of both companies. Lionel, which named Gen. John B. Medaris as its president early this month, reports sales of a sequential latching relay to major tv receiver manufacturers for remote control tuning.

Ironrite Corp., Mt. Clemens, Mich., reports sales of \$2,818,615 and a loss of \$175,956 for the six months ended June 30, 1960. For the comparable period of 1959 the company recorded sales of \$1,878,695 and a net profit of \$53,206. Reason for the decline is attributed in part to the firm's entry into a period of operational transition brought about by the acquisition of Dielectric Products Engineering Co. and the Warren Mfg. Co., both electronics firms. Company

president G. E. Horne says the diversification has provided management with a significant sales and earnings potential in electronics.

Hoffman Electronics, Los Angeles, reports net sales for the second quarter of this year were 34 percent greater than the preceding quarter, 26 percent higher than the comparable period of 1959. Sales for the three months ended June 30, 1960, totaled \$13,719,653. The comparable figure a year ago was \$10,912,712. In the first three months of 1960 sales were \$10,215,897. Net income this second quarter was \$120,524, compared with \$585,432 in the like 1959 quarter. This amounted to 8 cents a share this year in earnings, as compared with 38 cents a year ago.

Magnetics Inc., Butler, Pa., announces signing an agreement to purchase Kemco Corp., Sandy Lake, Pa., manufacturer of industrial control panels. Kemco will become a subsidiary of Magnetics, with no changes in personnel or policies. Anticipated Kemco sales for 1960 are about \$250,000.

Stockholders of Electrol, Inc., Kingston, N. Y., have approved acquisition of their company by Avien, Inc., Woodside, N. Y. Under the agreement Avien acquired the Kingston firm's assets in exchange for some 47,000 shares of class A capital stock valued at about \$647,000. Electrol manufactures hydraulic equipment, specializes in aircraft landing gear.

Raytheon Co., Waltham, Mass., reports sales for the first half of 1960 were \$277,564,000 and profits after taxes \$4,187,000. This is equal to \$1.08 per share on 3,723,008 shares of common stock, after provision for preferred dividends. In the comparable period a year ago, sales were \$235,164,000 and profits were \$5,112,000 or \$1.45 per share on 3,507,999 shares. In the

SPRAGUE PIEZO- ELECTRIC CERAMIC ELEMENTS



**ELEMENTS
FOR ALL
APPLICATIONS
AS WELL AS
COMPLETE**

**TRANSDUCER ASSEMBLIES
FOR MOST APPLICATIONS,
SUCH AS UNDERWATER
SOUND AND**

**VARIOUS ORDNANCE AND
MISSILE DEVICES.**



Sprague-developed mass production and quality-control techniques assure lowest possible cost consistent with utmost quality and reliability. Here too, complete fabrication facilities permit prompt production in a full, wide range of sizes and shapes.

Look to Sprague for today's most advanced ceramic elements—where continuing intensive research promises new material with many properties extended beyond present limits.



**WRITE FOR
LITERATURE**

SPRAGUE ELECTRIC COMPANY
35 Marshall Street, North Adams, Mass.

SPRAGUE®
THE MARK OF RELIABILITY

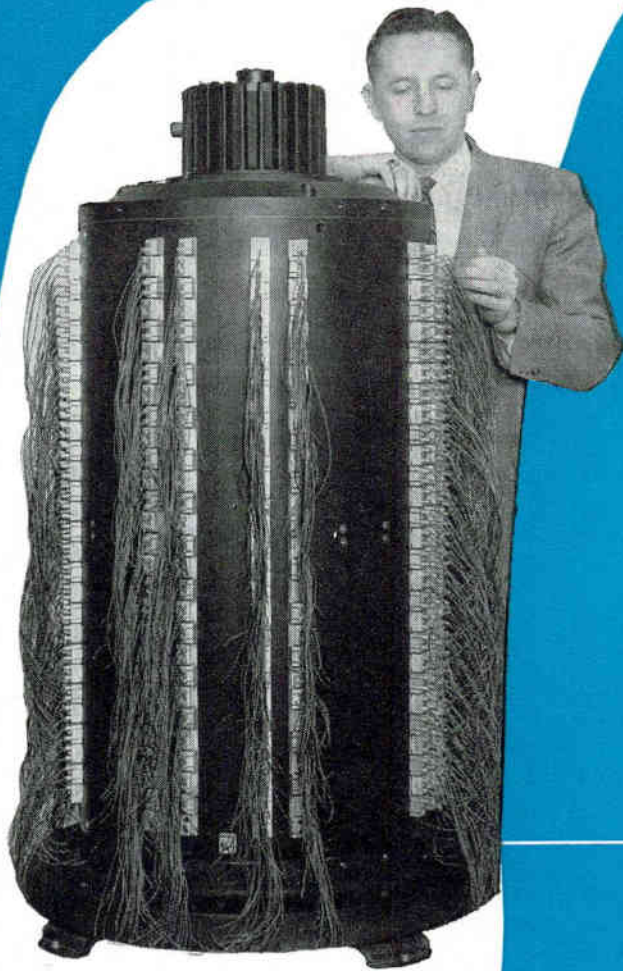

BRYANT offers...

**Storage at
less than
1/2¢ per bit!**



*— with the Bryant 18.5" diameter
Magnetic Storage Drum*

Standard operating parameters include:

- Bit repetition rate over 200 KC (RZ)
- Dynamic runout: less than .0002" T.I.R.
- Range: 600 RPM to 1800 RPM • Number of tracks: 825 • Bits per track: 7500
- Design life: over 3 years at 1800 RPM

Write today for data and specifications on this and other Bryant Standard Magnetic Storage Drums. BRYANT COMPUTER PRODUCTS, 1200 Oakman Boulevard, Detroit 32, Michigan. Division of EX-CELL-O Corporation.

second quarter of 1960, sales were \$142,812,000 and earnings were \$2,027,000 or \$.52 per share of common stock. In the comparable period of 1959, sales were \$121,862,000 and earnings were \$2,600,000 or \$.73 per common share. Funded backlog of government orders at end of the second quarter was in excess of \$330 million, compared with \$310 million at end of the first quarter.

Dynamics Corp. of America, for the six months ended June 30, 1960, announces a 58-percent increase in sales (now \$20.6 million) and a 64-percent increase in per-share earnings (now \$.87 million) over the comparable period a year ago.

25 MOST ACTIVE STOCKS

	WEEK ENDING AUGUST 5, 1960			
	SHARES (IN 100's)	HIGH	LOW	CLOSE
Avco Corp	5,278	16 ³ / ₈	14 ³ / ₈	16 ⁵ / ₈
Ampex	1,414	34 ³ / ₈	30	31 ³ / ₈
Gen Tel & Elec	1,188	30	27 ⁷ / ₈	28 ³ / ₈
Fairchild Eng	961	8 ¹ / ₄	6 ³ / ₄	8 ¹ / ₄
RCA	844	61 ¹ / ₂	58 ¹ / ₄	60 ³ / ₄
Gen Electric	737	85 ¹ / ₄	79 ¹ / ₄	81 ³ / ₈
Waltham Precision	708	2 ¹ / ₂	2	2 ³ / ₈
Sperry Rand	659	23	21	21 ³ / ₄
Gen Dynamics	636	47	43	47
Int'l Tel & Tel	616	41 ⁵ / ₈	39 ¹ / ₄	41 ¹ / ₄
Loral	542	94 ³ / ₈	85	92 ³ / ₄
Westinghouse	511	56 ¹ / ₄	52 ⁵ / ₈	56 ³ / ₈
Bulova	412	19 ⁵ / ₈	18 ⁵ / ₈	19 ¹ / ₄
Collins Radio	408	61 ⁵ / ₈	56 ⁷ / ₈	60 ¹ / ₂
Gen Instrument	374	42 ⁷ / ₈	39 ³ / ₈	41 ⁵ / ₈
Litton Ind	362	85 ¹ / ₄	80 ¹ / ₂	84 ¹ / ₂
Standard Kollsman	295	23 ³ / ₄	22 ¹ / ₈	22 ³ / ₄
Univ Controls	280	15 ³ / ₈	14 ¹ / ₄	14 ³ / ₄
Raytheon	272	39 ¹ / ₄	37 ¹ / ₂	39
Nat'l Video A	271	18 ³ / ₄	17	18
Lear Inc	268	19 ¹ / ₂	18 ¹ / ₈	19 ¹ / ₄
Zenith Radio	253	117 ⁷ / ₈	110 ¹ / ₂	116 ³ / ₄
Varian Assoc	237	58 ³ / ₄	54 ¹ / ₈	56
Philco Corp	231	26 ³ / ₈	24 ¹ / ₄	25 ¹ / ₈
Herold Radio	223	3 ⁵ / ₈	2 ⁵ / ₈	2 ⁷ / ₈

The above figures represent sales of electronics stocks on the New York and American Stock Exchanges. Listings are prepared exclusively for ELECTRONICS by Ira Haupt & Co., investment bankers.

NEW ISSUES PLANNED

	No. of Shares	Price per Share
Del Electronics	100,000	\$4.00
Hallcrafters Co.	100,000	°
Perkin-Elmer	100,000	°
Technical Measurement	120,000	5.00
Vitramon Inc.	103,512	°

°To be announced

DIVIDEND ANNOUNCEMENTS

	Amount per Share	Date Payable
Amer. Bosch Arma	1%	Oct. 14
AMP-Pamcor	\$.20	Sept. 1
Avnet Electronics	4%	Sept. 21
Magnavox	.25	Sept. 15
Rheem Mfg.	.15	Sept. 9
Transdyne	5%	Oct. 30
Sperry Rand	.20	Sept. 27
Sperry Rand pfd.	1.12 ¹ / ₂	Oct. 1

One of a series of advertisements
prepared by the ASSOCIATED
BUSINESS PUBLICATIONS

When you've got big plans for the future — you have good reasons for reading your businesspaper mightily carefully. This is where a man who means business gets facts, news, ideas . . . information he needs to do business. Issue after issue you find meaty stuff to keep your job and your business growing — in both the advertising and editorial pages of . . . your businesspaper.

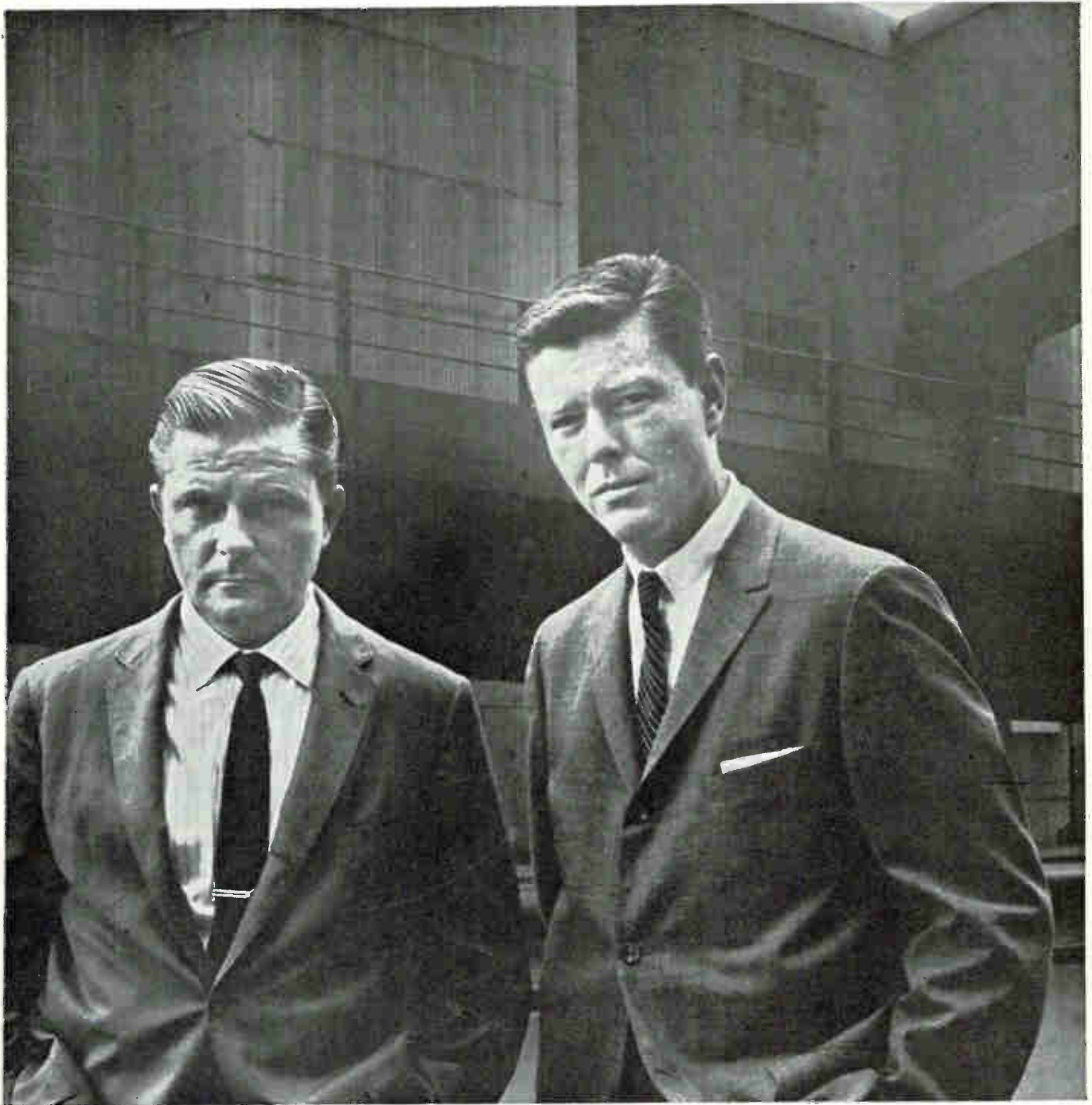

PHOTO ON LOCATION BY EHRENBERG

Where there's business action, there's a
businesspaper . . . where there's electronics business, there's

electronics

A McGRAW-HILL PUBLICATION • 330 WEST 42nd STREET, NEW YORK 36, N. Y.

August 19, 1960



Television

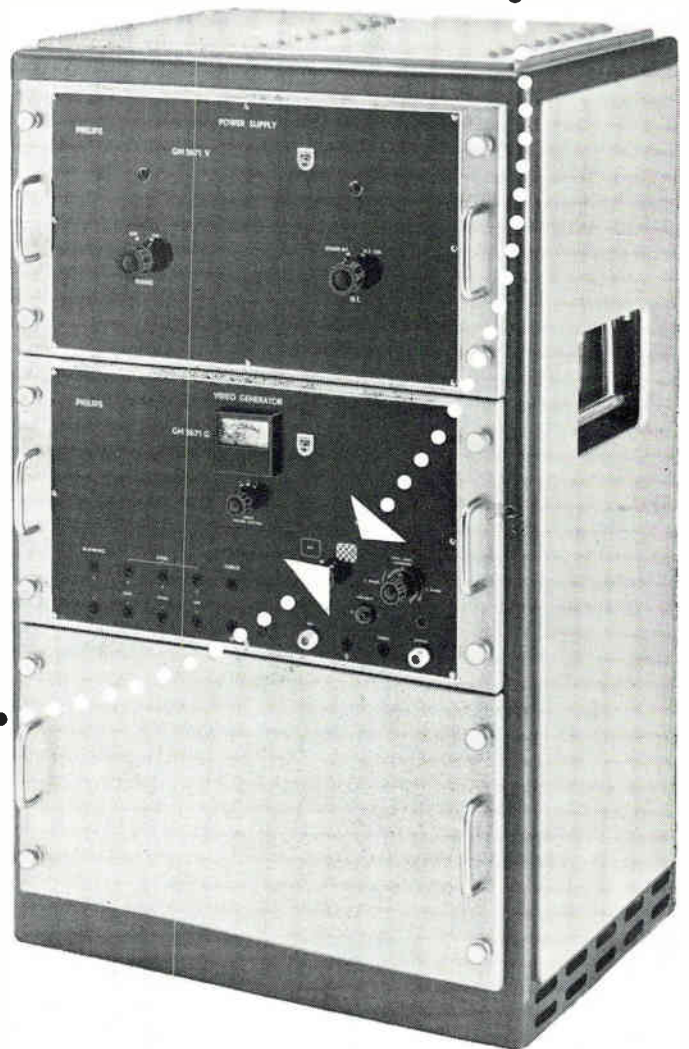
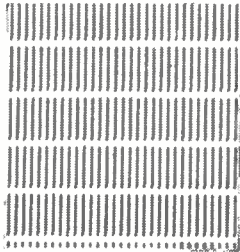
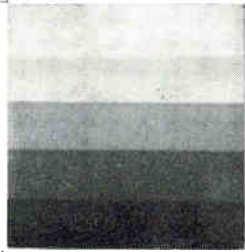
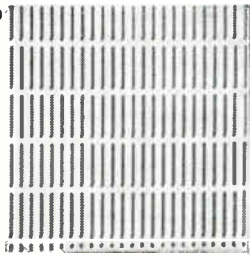

**T.V. Pattern Generator
type GM 2671**

PHILIPS *electronic measuring*

Sold and serviced by Philips Organizations all over the world

Further information will gladly be supplied by:

N.V. Philips' Gloeilampenfabrieken, EMA-Department, Eindhoven, the Netherlands

For Canada: Philips Electronics Ind. Ltd., Leaside, Toronto 17, Ont.

VHF Television Generator
type GM 2681

generators



GM 2671

- Valuable tool for T.V. setmakers, development laboratories, T.V. stations, relay-transmitters etc.
- Fully complies with the C.C.I.R. 625 lines, F.C.C. 525 lines and French 819 lines specifications.
- Composite video pattern enables fast checking of picture geometry, linearity, ringing, overshoot, frequency characteristics, gamma etc.
- High accuracy and stability of waveforms by using binary dividers and delay line.
- Checking of heater voltages and mains locking by means of a meter-instrument.
- Can also be supplied for 19" rack mounting.
- Suitable for all normal mains voltages (110 - 245 V).

TECHNICAL DATA

T.V. Systems CCIR 625 lines, 50 c/s
FCC 525 lines, 60 c/s
French 819 lines, 50 c/s

Master oscillator

Synchronisation by a crystal oscillator, mains comparison or external source.

Wave forms

The pulse timing, duration and rise times fully comply with the system specifications. The picture/sync ratio is adjustable around the standardized value.

Output

Video	Voltage	composite, 1 V _{p-p}
	Polarity	negative or positive (reversible)
	Impedance	75Ω

Auxiliary signals

total blanking	} Voltage 3 V _{p-p} Impedance 75Ω
total sync	
line sync	
frame sync	

External picture modulation

Voltage	1 V _{p-p}
Impedance	75Ω
Polarity	positive

GM 2681

- Suitable for the television bands I and III
- Can be used in connection with the Pattern Generator, type GM 2671 or separately
- Supplies picture and sound carriers separately or simultaneously, modulated or unmodulated
- Output voltages, modulation depth and sweep can be adjusted to standard specifications with the aid of the built-in voltmeter
- Suitable for all normal mains voltages (110-245 V)
- Available for incorporation in the GM 2671 (as below) in separate casing or mounting in 19" rack (as above).

TECHNICAL DATA

TV System

Video modulation: negative
Sound modulation: FM

Executions

CCIR 625 lines, 50 c/s,
FCC 525 lines, 60 c/s or
OIR 625 lines, 50 c/s system and special executions for Australia, Austria, Italy and New Zealand.

Output

Picture and sound carriers

Frequency	up to 12 channels in band I and III, crystal controlled, accuracy 0.02%
-----------	---

Voltage,

picture carrier	100 mV max.
sound carrier	30 mV max.

Attenuation

max. 80 dB, in steps of 4 and 20 dB

Accuracy

0.5 dB

Auxiliary oscillator

Frequency	equal to the picture-sound distance
-----------	-------------------------------------

Voltage

1 V_{rms}

Impedance

75Ω

Modulation

Video External

Voltage	1 V _{p-p}
---------	--------------------

Impedance

75Ω

Polarity

positive

Internal sound

1,000 c/s

External sound

30 - 16,000 c/s

Voltage

1 V_{rms}

Impedance

600Ω

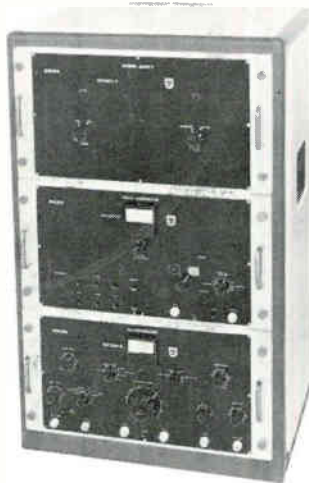

instruments: quality tools for industry and research



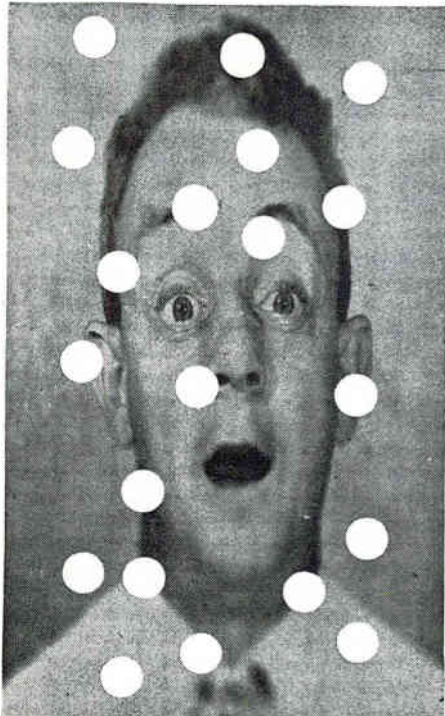

a **spot** is a **spot**
is a high
resolution **spot**
with

CELCO YOKES

- **Celco YOKES**
keep spots **smallest**
- **Celco YOKES**
keep spots **roundest**
- **Celco YOKES**
keep spots **sharpest**

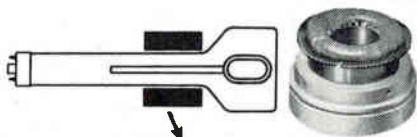

Use a **CELCO DEFLECTION YOKE** for
your high resolution applications.

In a **DISPLAY SPOT?** call **Celco!**

Celco

*Constantine Engineering
Laboratories Co.*

Main Plant: MAHWAH, N. J. DAvis 7-1123

• Pacific Division - Cucamonga, Calif. - YUkon 2-2688

MARKETING

PRINTED-CIRCUIT BOARD SHIPMENTS[↓]

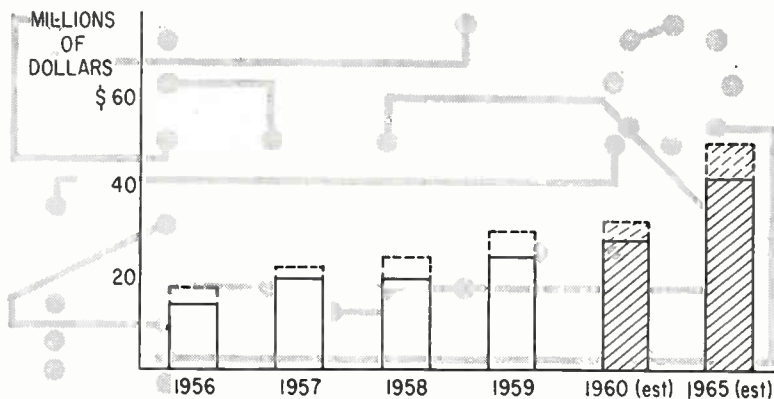

Source: ELECTRONICS ↓ Includes Captive Plant Shipments

P-C Board Business Due For 10% Rise

DEMAND for printed-circuit boards will pick up sharply in the second half of the year, manufacturers report. In the first six months, shipments held to about the same level as 1959 because of cutback in aircraft production and holdup in missile orders, but orders for missile business are now coming along fast.

Net result will be a 10-percent gain in printed-circuit board shipments in 1960. Increase last year was 20 percent, but 1959 gain really represented two years because normal growth was slowed almost to a halt in 1958.

Main factors behind the pattern of rising circuit board shipments are growth of the electronics industry and increasing acceptance of circuit boards as a reliable and practical way of producing electronic assemblies in volume, says Dick Zens, vice president of Electrolab Printed Circuits Corp.

Value of shipments this year should amount to somewhere between \$28 and \$33 million, up from \$25 to \$30 million in 1959. Continuation of a minimum average rate of increase of 10 percent for the next five years indicates a market of \$42 to \$50 million in 1965.

These estimates are somewhat lower than predictions for the market at this time last year. But, for the first time, marketing people have a factual guide for their estimates. Bureau of Census reports

printed-circuit board shipments in 1958 totalled \$15.7 million, but not all interplant or captive plant shipments are included.

At present, 35 percent of dollar value of shipments goes to the military, 40 percent to industry and 25 percent to consumers. But military users' share is headed for 40 to 50 percent, because of greater acceptance by military of circuit board reliability and military demand for higher price types.

Fast growing computer sales and industrial electronic sales (with many new applications) indicate industrial share will at least hold its own. Telephone market, which has hardly been dented, holds much promise for the future, says Bill McGinley, president of Method Manufacturing Co.

In the consumer market, sales of boards for use in radios have been hurt by Japanese imports. However, previous differences of opinion on use of circuit boards in tv sets has been largely resolved in favor of p-c board manufacturers, says R. E. Pritchard, executive secretary of the Institute of Printed Circuits. He adds: "P-c boards are now used by all tv makers except Zenith, which uses them in tuners."

What effect will micro-miniaturization developments have on the printed-circuit board market?

Manufacturers feel micro-miniaturization poses little threat to their

business. Says Bob Kingsbury, vice president of Photocircuits Corp.: "Costs of modular substitutes are appreciable and will have little effect on business until 1965."

McGinley points out that other growing markets—such as computers, telephones and appliances—will take up any slack that may result. Zens says modular circuits will have to be connected and may even bring additional business.

Average prices for the immediate future show little prospect of change, with several factors cancelling each other out. Material costs are rising. Use of more expensive glass epoxy boards is increasing. But manufacturers say there is a strong trend toward automated production, which is lowering production costs.

Trend toward automated production is putting considerable pressure on smaller firms, manufacturers say, because usually they cannot afford the required investment in capital equipment. As a result, large manufacturers are expected to get the biggest share of future sales increases.

Related development is that circuit boards manufactured by captive plants of end-equipment producers, usually large companies, are becoming of increasing importance. In 1959 captive producers accounted for 50 percent of total shipments as against 60 percent today.

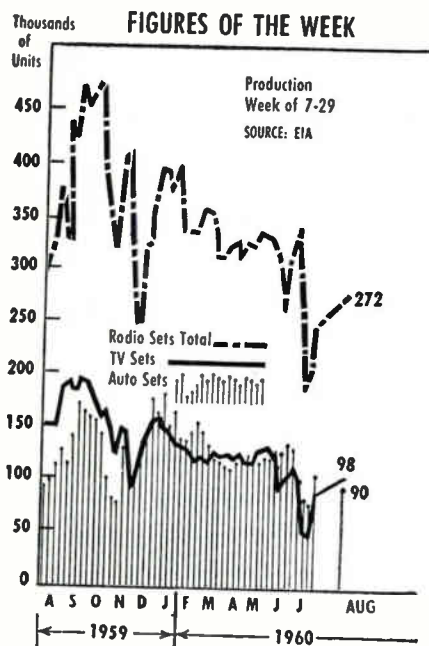

August 19, 1960

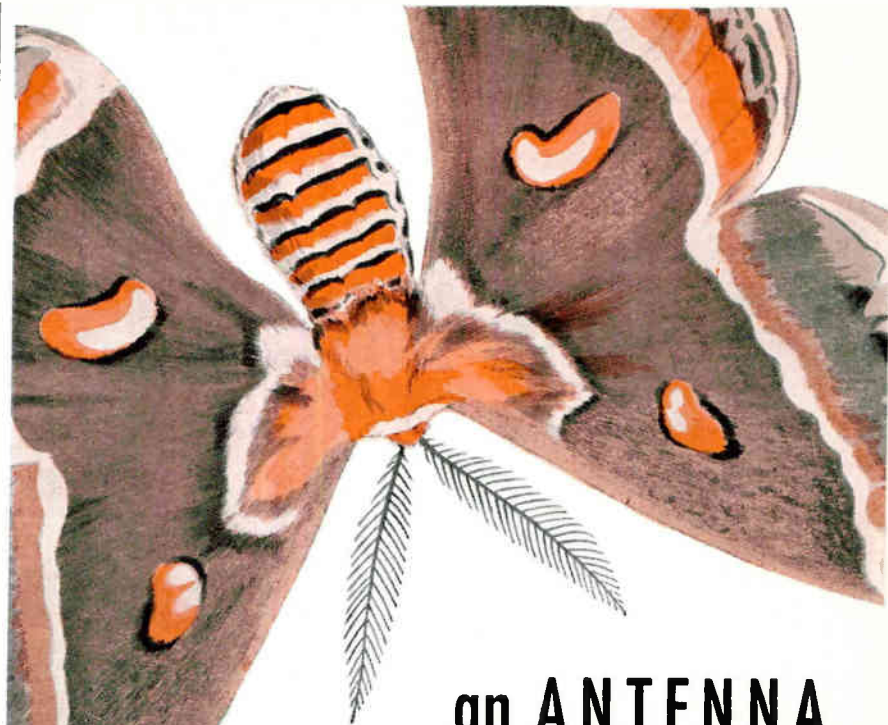

an ANTENNA we haven't worked on

Samia cecropia, one of the largest American moths. The bushy antennae are covered with organs of smell and enable the male to locate his mate by odor from as far away as three miles.

The cecropia moth's antennae are designed to perform a very unusual function. Modern aircraft and missiles also have unique requirements demanding specialized knowledge and capability.

In applying its special capabilities, Dorne & Margolin has never failed to provide practical solutions to its clients' RF systems problems.

So, when faced with an RF systems problem, think about D & M. An existing design or an easily adapted production model meeting your requirements may be available from us at low cost and great savings in time.

A comprehensive Antenna Catalog is yours on request.

Excellent positions in a growing organization affording opportunities for stock participation, as well as many other benefits, are offered to engineers. Contact R. E. Anderson, Chief Engineer.



DORNE & MARGOLIN, Inc.

WEST COAST:
1434 Westwood Boulevard
Los Angeles 24, California

EAST COAST:
29 New York Avenue
Westbury, L. I., N. Y.

CIRCLE 27 ON READER SERVICE CARD

27

**NOW...
AN
IMPROVED
2N697
IN
A
WELDED
MICRO-PACKAGE
THIS
SMALL!**

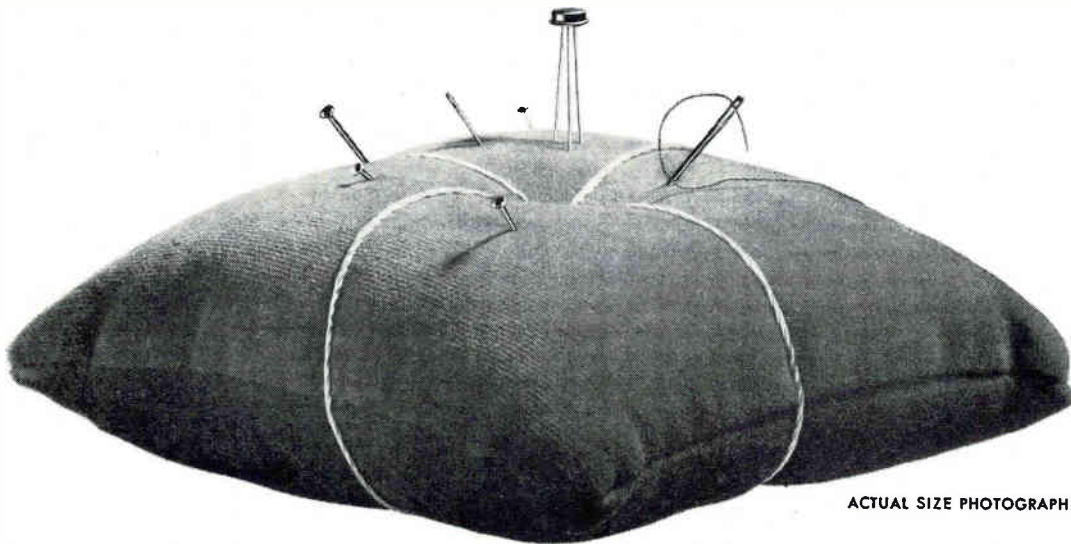

ACTUAL SIZE PHOTOGRAPH

MICROBLOC RT697M

... Rheem's new solid-design silicon mesa transistor!

WELDED HERMETIC SEAL



The MICROBLOC RT697M is the first micro-miniature silicon mesa transistor with a guaranteed welded hermetic seal. The glass sealing and welding techniques used in MICROBLOC production are the same techniques the industry has tested and perfected over the years, in the manufacture of millions of transistors. Each MICROBLOC is subjected to two hermetic seal

tests—a helium leak test and a Joy bomb test—to insure a vacuum-tight seal.

MICRO SIZE

The MICROBLOC RT697M is .063 inches flat, .211 inches in diameter, weighs only 1/4 gram, and occupies just 1/7th the volume of the standard 2N697.

IMPROVED ELECTRICAL CHARACTERISTICS

This new Rheem transistor has a three watt power dissipation—50% more than the standard 2N697. Result: cooler running junctions to assure wider safety margins and greater reliability. The MICROBLOC RT697M also has a 35 volt guaranteed minimum switchback voltage with base open, controlled small signal parameters and meets or exceeds every other specification of the 2N697.

SOLID DESIGN

As its name suggests, MICROBLOC is virtually a solid block—a silicon crystal embedded in an optimum

dimensioned, gas tight, hermetically sealed, welded block that is essentially all heat sink. There are no fragilely suspended internal leads or non-integrated elements, and the crystal is protected from welding flash. Thus, the MICROBLOC RT697M design is mechanically more stable, more resistant to shock and vibration than any previous transistor. It will withstand at least 1,500 G shock and 20,000 G acceleration, and is guaranteed to survive thermal shock and temperature cycling per MIL-S-19500B. (Additional data will be published as more stringent tests are completed.)

APPLICATION

The MICROBLOC RT697M is tailored for high-density applications, such as micro modules and miniaturized circuit boards. In addition, because of its cooler running junctions, it is an ideal improvement/replacement for standard size transistors in applications where wider safety margins and great reliability are required. (Rheem will also continue to offer its standard 2N697, TO-5 package, per MIL-S-19500/99A.)

OTHER MICROBLOC TYPES

Rheem is now producing a complete new series of MICROBLOC silicon mesa transistors. There is a MICROBLOC type for every electrical function that can be performed by transistors up to a 1 amp. current level. For full details, see your Rheem representative.

AVAILABLE IMMEDIATELY

PARAMETERS		TEST CONDITIONS	MIN.	TYP.	MAX.	UNIT
MAXIMUM RATINGS AT 25°C AMBIENT (unless otherwise noted)						
Collector--Base Voltage						60 V
Collector--Emitter Voltage (Base Open Circuit)						35 V
Emitter--Base Voltage						5 V
Total Device Dissipation at case temperature 25°C						3 W
Operating Temperature Range						-65°C to +175°C
All units are stabilized before testing at 300°C						
ELECTRICAL CHARACTERISTICS AT 25°C AMBIENT						
I_{CBO}	Collector Reverse Current	$V_{CB} = 30v$ $I_E = 0$	—	.005	1.0	μA
h_{FE}	D-C Forward Current Transfer Ratio	$I_C = 150ma$ $V_{CE} = 10v$	40	75	120	—
$V_{CE(sat)}$	Collector-Emitter Saturation Voltage	$I_C = 150ma$ $I_B = 15ma$	—	0.7	1.5	v
h_{fe}	A-C Common-Emitter Forward Current Transfer Ratio	$I_C = 50ma$ $V_{CE} = 10v$ $f = 20mc$	2.5	5	—	—
C_{ob}	Collector Capacitance	$I_E = 0$ $V_{CB} = 10v$ $f = 1mc$	—	20	35	$\mu\mu f$
SMALL SIGNAL PARAMETERS						
h_{fe}	Small Signal Forward Transfer Ratio	$I_C = 1mA$ $V_C = 5v$	30	70	—	—
h_{ib}	Common Base Input Impedance	$f = 1KC$	20	26	30	ohms
h_{rb}	Common Base Voltage Feedback Ratio		—	160×10^{-6}	250×10^{-6}	—
h_{ob}	Common Base Output Admittance			.2	1.0	$\mu mhos$



ENLARGED MICROBLOC OUTLINE
DIMENSIONS IN INCHES

RHEEM SEMICONDUCTOR CORPORATION

A SUBSIDIARY OF RHEEM MANUFACTURING COMPANY
Dept. G1, P.O. Box 1327, Mountain View, California • YORKSHIRE 8-9211

See Rheem at Wescon — booths 2844, 2845!



Air Force Letter Stirs Price Parley

Military-industry representatives may meet in Dayton next month to discuss contract pricing procedures now under sharp criticism by a top-ranking general

By THOMAS EMMA,
Associate Editor

AN AIR FORCE-industry committee formed to study contract pricing may meet in Dayton, O., next month—and in the background will be an Air Force general's letter sharply critical of seven prime contractors and subcontractors.

The letter was written by Gen. S. E. Anderson, of the Air Materiel Command, and sent to top trade organizations—Electronic Industries Association, the National Security Industrial Association and the Aerospace Industries Association of America.

Last October, AMC met with representatives of the three organizations, and top management of some 52 major contractors, to discuss the issue of contract pricing. At that time a steering committee made up of AMC, EIA, NSIA and AIA representatives was set up to study the problem and make recommendations.

The committee organized six subcommittees covering these specific areas:

Air Force surveillance of a prime's subcontracts; subcontractors' files and documentation of cost estimates; auditing; make-or-buy policies; "adequate competition" on subcontracts; and "acceptable pricing."

These subcommittees have been meeting regularly ever since and are still at work.

Pressure for this activity was brought about by reports from the General Accounting Office in Washington claiming that contractors inflate cost estimates, resulting in excessive profits. In one report, covering 14 companies, GAO claimed the Air Force was overcharged some \$30 million.

With this background, Gen. Anderson sent out a team of inspectors. They began their work last December, to see how contractors

were adhering to new contract pricing regulations set up at that time. The team inspected seven companies. In this letter sent by Gen. Anderson he said "much more remains to be accomplished."

Gen. Anderson's office this week declined to name the companies inspected.

The trade organizations, at press time, had not issued any comments on the letter or the unnamed firms involved.

The complaints listed in Anderson's letter, ELECTRONICS learns, include:

1. "At four of seven activities, pricing of provisioned items was on an after-the-fact basis. At only one location was there adequate action between the contractor and the Air Force so that priced exhibits would be submitted within the time period specified on contracts.

2. "At four of the seven activities the methods used to distribute certain overhead costs were so unrealistic as to be inequitable. The variation in methods of distributing costs was such as to have significant effect on the total charged to government contracts.

3. "Material pricing techniques used by three of the seven contractors generated unrealistic, inflated material estimates in cost proposals.

4. "When developing cost estimates, none of the contractors as a standard practice considered the cost reduction effect of similar work to be produced at the same time period. In fact, one contractor consistently submitted unrealistic, inflated estimates because of failure to consider this cost reduction effect.

5. "Three of the seven contractors did not have an established estimating system. Estimated procedures had not been developed. The cost estimating methods used were

not such that they could be relied upon by the Air Force to produce equitable results.

6. "Two of the seven contractors refused to provide cost breakdowns to support price quotations.

7. "Three of the seven contractors developed price estimates on the basis of past actual costs rather than projection of costs that could reasonably be anticipated during the period in which the items would be produced.

8. "Prime contractors had accepted unrealistic, inflated price quotations without question or review.

9. "Five of the seven contractors had no system for analyzing prices of high dollar value subcontracts.

10. "Six of the seven contractors had no effective system for consolidating requirements to obtain volume discounts on purchased items.

11. "In all of the contractors reviewed, there was a consistent pattern of sole source procurement and re-procurement without obtaining competition or otherwise insuring that prices were reasonable.

12. "Five of the seven contractors used unsupported factors and rates in developing price estimates.

13. "At five of the seven contractors' locations, many of the purchase orders submitted to the Air Force for review were submitted after-the-fact. This condition occurred principally because there were no established procedures for submitting purchase orders to ACO's for approval as required by the terms of the contracts."

Gen. Anderson concluded his letter by saying: "Basically, my objective in sending you this letter is to enlist and solicit your continued support and that of your association in this program of such vital importance to industry and to the Air Force."



Engineers (l.) at moon-bounce installation (r.) in Holmdel, N. J., speak to engineers in Goldstone, Calif.

SUCCESSFUL MOON BOUNCE POINTS TO Global Satellite Communications

HOLMDEL, N. J.—Successful tests here recently of an experimental moon-bounce microwave transmission system, developed by Bell Telephone Laboratories, demonstrated the feasibility of a future worldwide satellite-link communications network.

Reliable two-way conversation was held for several hours between Holmdel and Jet Propulsion Laboratories, Goldstone, Calif., using the moon as a passive microwave reflector. In these tests the moon served as a substitute for a proposed chain of active microwave relay satellites circling the earth at an altitude of 2,000-3,000 miles.

Transmission system at Holmdel includes a 10-kw microwave transmitter with a 4-stage water-cooled klystron, feeding a 60-ft parabolic dish antenna. One-half watt input signal drives the transmitter to full rated output.

A similar transmitter at Goldstone uses an 85-ft parabolic dish. Holmdel transmits on a frequency of 960 Mc, and Goldstone transmits at 2,390 Mc.

Holmdel receiving facility consists of a Bell-designed reflecting

horn antenna, a scaled up version of the ubiquitous model found in microwave relay installations. The receiver is equipped with a traveling wave ruby maser amplifier. The maser is kept at an operating temperature of 1½ K by a liquid helium refrigerating system. Total receiver noise temperature is about 20 K. A standby parametric amplifier prevents interruption in case of maser failure.

Goldstone station receives with an 85-ft parabolic dish and parametric amplifier receiver. Receiver noise temperature at Goldstone is 300 K.

Half-million mile transmitting distance, poor reflectance of the moon's surface, and atmospheric attenuation result in a power loss of 230 db. Received power is on an order of 10^{-10} watts.

Single-sideband modulation was selected for the moon-bounce because of higher transmitting efficiency. Company officials recommend the use of wideband f-m in satellite relay operations because of higher fidelity and voice clarity. Signal attenuation is greatly reduced in transmission to a relatively

close, active satellite.

Overall sound clarity is of the same quality as an early transatlantic radio-telephone transmission. Multiple reflections and varying transmission path lengths give the sound a warbling tone.

The moon must be visible from both stations for transmission to be possible. Consequently, total message handling time is limited to about 8 hours a day.

A servo system and computer at each station aim the transmitting and receiving antennas in tandem, compensating for the Earth's rotation, and keeping the antennas pointed at the moon. The moon is a relatively wide reflector, about ½ degree, and is a slow moving target, so constant correction is not necessary. Antenna shifts every 2 minutes are sufficient.

Fast moving earth satellites would require constant antenna repositioning. A network of 50 satellites is suggested so at least one would be visible from two different points at all times. In this mode of operation the antenna computer would be fed data corresponding to the predicted orbits of the satellites.

Previewing Wescon

Space age's complex interplay between man and machine



GERALD F. RABIDEAU



H. R. VAN SAUN



HENRY M. PARSONS



ARNOLD M. SMALL



BERNARD OLIVER



C. P. SONETT

COMPLEX INTERPLAY between man and machine, becoming more and more a fact of technological life as man moves into the space age, is getting rigorous attention in the special program of symposia at Wescon next week.

Four of the six symposia planned for the conference at the Los Angeles Sports Arena deal with this subject. In exclusive interviews with the chairmen of these shirt-sleeve sessions, *ELECTRONICS* learned this week some of the problems facing systems management men in developing equipment complexes relying on efficient functioning of both men and machines.

The four sessions dealing with the symbiosis of man and machine discuss the analysis, synthesis and design, operation and training and management of man-machine systems. G. F. Rabideau of Space Technology Labs chairs the first of these, H. R. Van Saun of Federal Aviation Agency will head the second, H. M. Parsons of System Development Corp. is chairman of the third, and Arnold Small of Hughes Aircraft leads the fourth.

In discussing the problems of analysis, Rabideau told *ELECTRONICS* that the stress lies in analyzing the interactions among the human and mechanical components of the system and the environment in which it operates. "There is probably no system output requirement for which a machine component cannot be designed," he said.

The special merit of the human component lies in his ability to function "in those major areas where the information necessary for making decisions is incomplete or ambiguous," Rabideau said, "as well as where the consequences of the decisions made are likely to affect human safety and welfare."

FAA's Van Saun pointed out that as machines get more complex, "the integration of the two-legged computer and the electronic computer

becomes increasingly important" if the designer is to capitalize on the capabilities of each. Declaring that this area is the one in which human-factors scientists can make their most significant contribution, Van Saun said "the purpose of this area of endeavor is not to analyze a system, but to determine how best to tie together the two elements for systems not yet actually in use."

The economics of systems are also critical, and rely on the careful apportionment of "which jobs can best be done by machines and which can best be done by men," he suggested, adding "this decision must be correctly made before the project gets to the stage of purchasing hardware."

Design and development of an efficiently interrelated system, says System Development's Parsons, "demands that the human-factors expert be more than just a practitioner of applied science involving the human mechanism." He suggests that the many operators and maintenance men to be found in an operating system require "representation from the beginning of systems design." The representative, Parsons says, must legislate for the operating people in a statesmanlike manner in order to resolve and integrate the conflicting interests of machine efficiency and human operability.

Chairman Small of the session on management of man-machine systems (actually the first of the four to occur) mentioned the evolutionary development of the symbiotic systems, discussed important contributions currently being made in decisionmaking theory and operational logistics for support of such complexes as Sage and the Air Defense Command. He also stressed the importance of asking "appropriate questions at the outset to give guidance to the many specialists who participate" in the design.

Other symposia discuss informa-

Symposia

gets special attention

tion theory and modulation methods and the Pioneer V experiment.

Bernard Oliver of Hewlett-Packard, who is chairman of the symposium on information theory, stressed in comments to *ELECTRONICS* that early theories in information are becoming modern practice. "There are currently so many means for transmitting information, or communicating from one point to another, that it now presents a problem for the prospective user as to which system he should use and why."

Oliver mentioned 15 or 20 different types of systems with rates from a few blips per second to hundreds of thousands per second. If a user is dealing with space communications, he said, "power and weight considerations become exceedingly important. On the other hand, if he is designing a system for transmitting information between banks, power and weight factors are subordinated to considerations of reliability and error rate."

The session on the Pioneer V experiment is chaired by C. P. Sonett of Space Technology Labs, who told *ELECTRONICS* that the speakers at the session will be using last-minute results of data reduction and interpretation from the experiments.

"A number of significant firsts were achieved," Sonett says, pointing out that the session will review results of particle radiation measurements in space and the associated magnetic field measurements.

"In addition to radiation and magnetic field instruments," he says, "the probe carried a coherent transponder which has enabled very accurate doppler measurements of velocities to be made.

"Using these data, a new and independent determination of the Astronomical Unit (the semi-major axis of the earth's orbit) has been made."

from Honeywell...  ANOTHER DIAMOND JUBILEE PRODUCT

NEW! WIDE-BAND D-C AMPLIFIER

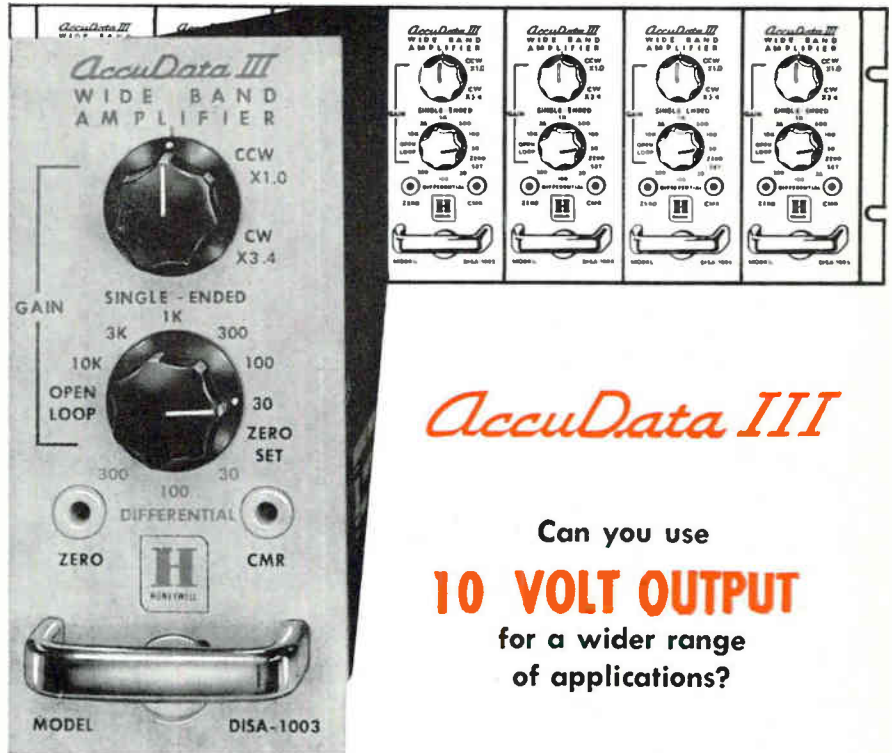

AccuData III

Can you use
10 VOLT OUTPUT
for a wider range
of applications?

In the new all-transistor AccuData III, low level signals from a wide variety of transducers can be amplified up to 10 volts with a high degree of accuracy. At 30 mv full scale input the noise error (0-10 cps) is less than 0.007%; common mode voltage transients are less than 0.008%; and zero drift is less than 0.007%. The total error, therefore, is only 0.022% . . . a new level of accuracy.

The Honeywell AccuData III Amplifier is particularly useful in high accuracy data handling systems where pick-up problems associated with long cable runs and ground loops must be completely eliminated.

The high 10 volt output allows direct connection between transducer and a wide selection of output devices including:

Analog/Digital Converters
High Speed Oscillographs
High Speed Printers

Servo Control Valves
High Speed Multiplexers
Telemeter Oscillator Controls

Either single ended or differential input ranges may be selected with a frequency range up to 20 kc. Input impedance is 20 megohms single-ended and 2 megohms differential. Seven amplifiers mounted in a 19 inch relay rack occupy a height of less than 5¼ inches. No cooling fans are required since the amplifier heat dissipation is only 8 watts.

Write for Bulletin BS DISA-3 to Minneapolis-Honeywell, Boston Division, Dept. 7, 40 Life Street, Boston 35, Massachusetts.

Honeywell

75th PI **YEAR**
CELEBRATING THE FUTURE



Industrial Products Group
SINCE 1885

YOU CAN SPECIFY savings in weight, improvements in performance, increases in reliability for your electronic systems from this box. This is Sperry's Speci-File—a complete electronic and physical biography of the traveling wave and klystron tubes offered by Sperry Gainesville. To speed your specifying, to make it more accurate, and to secure the benefits of outstanding microwave tube performance for your systems, order your free Sperry Speci-File today. Just fill in and mail the attached coupon.



Gainesville, Florida A Division of Sperry Rand Corporation

Section C-101
Sperry Electronic Tube Division
Gainesville, Florida

**Please send me a FREE Sperry
Speci-File:**

NAME _____

TITLE _____

COMPANY _____

ADDRESS _____

CITY _____

STATE _____

SPERRY SPECI-FILE

EXPERIMENTAL 10 WATTS NOM C BAND

STC 236 TRAVELING WAVE TUBE
A periodic permanent magnet focused communication traveling wave tube with waveguide input and output plus a tunable plunger for impedance match. (waveguide to heater)



PERFORMANCE DATA
Frequency range 3.9-8.2 kmc
Output power 10 watt nom, 5 watt linear max

X BAND 8.2 to 12.4 kmc
U BAND 12.4 to 18 kmc
P BAND 0.25 to 0.8 kmc



80 WATT PEAK Ku BAND

SOU-201 OSCILLATOR KLYSTRON
A two cavity, integral feedback, pulsed oscillator with waveguide output and non-intercepting control grid. Supplies up to approximately 80 watts peak at most mean average beam power of 175 watts. Suitable for use in general airborne applications.



PERFORMANCE DATA
Frequency range 12.4-18.0 kmc
Tuning range 78mc
Rated output power (peak) 80w peak—3200v
10w peak—1700v
175w max beam power (5 ms max) 20mc
Duty cycle 3%

SPERRY
ELECTRONIC
TUBE
DIVISION

*Send me one
for 1 watt*

What's In U. S. 10-Year Space Timetable

WASHINGTON—NATIONAL Aeronautics and Space Administration's 10-year program for space exploration will cost close to \$1.5 billion a year, much of which will be spent for electronic equipment.

Needs of this program were disclosed to 1,300 industry experts—including hundreds from top electronics suppliers—at a classified meeting recently in Washington.

Projects include numbers of meteorological earth satellites; a dozen passive communications satellites; active satellites to receive and retransmit messages; geophysical and astronomical laboratories weighing a ton or more. By 1967, the agency expects to be lofting payloads weighing 25 tons.

Right now, NASA is about ready to put up a passive reflector satellite. Before the end of the year, an astronaut should fly the first sub-orbital flight of the Mercury program, and first launchings of the Scout, Delta, and Atlas-Able rockets should be completed.

Next year the agency will attempt the first manned flight into space, will also try to hit the moon with an instrumented payload and launch the Centaur vehicle.

According to the plan, 1962 will see the first launchings of a two-stage Saturn. Eventually, the Saturn will be able to put 10-ton satellites into near-earth orbits.

During 1963 and 1964, the U. S. will attempt to launch an unmanned vehicle for controlled landings on the moon, and to put up an orbiting astronomical observatory. In 1964, NASA also plans to launch an unmanned vehicle to circumnavigate the moon and return to Earth, and try to send a reconnaissance flight to Mars or Venus.

In 1965, the plan calls for flight test of a nuclear second-stage vehicle. Contract negotiations started this week with Lockheed and Martin for studies on flight-testing a nuclear rocket engine.

In the 1965-1967 period, the agency plans its first launchings in a program that will lead to manned circumlunar flights and to near-earth space stations. By 1970, the space experts predict they will have manned flights landing on the moon.

FOR THESE PROJECTS NASA POSES THESE REQUIREMENTS

Earth satellites	Advanced instrumentation for measuring cloud cover and storm location, precipitation, temperature, wind direction, heat balance, water vapor and other constituents Advanced systems for on-board data analysis Infrared-sensitive tv tubes Data-storage systems High-resolution tv systems
Landing on the moon	Remote-control system for mobile vehicle Equipment for remote return of lunar surface samples
Exploration of the moon, planets, space	Radiation detectors covering all ranges of the energy spectrum, and capable of discriminating between particulate and wave radiation Micrometeoroid detectors Pressure, temperature and ionization gages Sound detectors and analyzers Mass spectrometers Tv systems for microscopic examination and telescopic scanning Special radars for mapping lunar surface Spectrometers for X-ray, fluorescent, gamma-ray and mass analysis Magnetometers Penetrometers Chemical analyzers Microbiological equipment Gravimeters High-power telemetry Low-noise receivers Improved power supplies of chemical, nuclear and solar varieties Space-transportable computers
Manned spaceflight	Environmental control systems Attitude controls Improved communications Guidance and control systems Pilot displays
All spaceflight missions	Tracking equipment for determining orbital data or position time histories Tracking equipment for command signals Tracking equipment for telemetry receivers Data acquisition and computing equipment Instruments stable enough to function under various pressures, temperatures, vibrations and accelerations Ion mass spectrometers Vacuum gages Radiation detectors and analyzers Ultraviolet and X-ray detectors and analyzers Directional magnetometers Plasma probes Telescope pointing controls Data preprocessing systems to edit data before transmission to monitoring station
Spacecraft	Guidance systems that can be corrected in flight Automatic controls for unmanned satellites Methods of controlling temperature
Rocket engines	Improved instrumentation for liquid-propellant flow, pressure and thrust Measuring devices to meet particular requirements of space-rocket testing Methods for shielding sensitive components from radiation of nuclear engines
Tracking systems	Automatic data-handling equipment Wideband communications Satellite beacons Improved programming Low-noise amplifiers Improved data-coding Increased information bandwidth Large ground antenna systems

Uhf Secondary Voltage Standards Coming

Two new instruments for voltmeter calibration feature stability, accuracy

DEMAND by electronics manufacturers for better voltage measurement accuracies has been growing stronger each year (ELECTRONICS, p 91, Sept. 11, 1959). A portion of the gap in reference standards for calibrating voltmeters over a range from d-c to 1,000 Mc will be filled by two new devices soon to be made commercially available—a micropotentiometer and an attenuation-thermocouple (A-T) voltmeter.

Manufactured by Ballantine Laboratories from a design developed at the National Bureau of Standards (NBS), the instruments will provide secondary standard accuracies for at least one year. Both instruments are simply constructed and use stable, passive circuit elements to provide long term reliability.

The Model 440 NBS Micropotentiometer (see photo) is designed to provide a precisely determined voltage in the range of 40 microvolt to 0.33 volt for input frequencies from d-c to 900-Mc. Input current flows through a uhf-type thermocouple

to a radial resistor of known constant value. Voltage developed across the resistor becomes the standard used to calibrate electronic voltmeters, signal generators and the like.

If the current provided by an external signal generator is maintained constant, the voltage drop across the radial resistor can be used as a precision low-impedance source of voltage whose output remains constant from d-c to beyond 500 Mc. After calibration corrections have been applied by NBS, accuracy will be better than ± 3 percent.

The micropotentiometer can be used as either a relative or an absolute voltage standard. As a relative standard, it is useful in calibrating the frequency response of equipment in terms of an arbitrary reference level. As an absolute standard, it is first necessary to calibrate the output at d-c or low-frequency a-c against an appropriate standard. It can then be used

to transfer this calibration accuracy to all frequencies within its range.

Nominal output voltage is a product of the heater current rating of the thermocouple and the resistance of the radial resistor. This voltage can be varied from one-third to full rated output by varying the thermocouple current over a three-to-one range. Additional voltage ranges are obtainable by removing the radial resistor and using it with another housing having a different thermocouple rating. Net price will be \$250.

The Model 389 NBS A-T Voltmeter is designed for calibration of voltmeters operating in the range of 10 Mc to 1,000 Mc from 0.5 to 300 volts. This instrument consists of an adjustable waveguide-below-cutoff attenuator feeding a special uhf vacuum-insulated thermocouple.

Output of the thermocouple (d-c) is read on an auxiliary millivoltmeter. The unknown signal is connected to the input electrode and the micrometer setting adjusted to produce a standard reading on the millivoltmeter. Voltage obtained from a calibration chart shows the input voltage for all settings of the micrometer at the frequency of measurement.

The movable electrode and thermocouple are mounted on a carriage that slides inside the attenuator barrel on six nylon pins and two sets of finger stocks. These stocks are driven by a two-inch micrometer calibrated in ten-thousandths of an inch. A spring and ball bearing assembly couples the micrometer to the carriage.

The A-T voltmeter will probably find its greatest use as a laboratory reference standard voltmeter to calibrate other voltmeters; however, it can also be used to measure voltage directly.

After calibration by NBS, the instrument will be accurate to within ± 1 percent for at least a year. Net price will be \$2,250.



Engineer makes use of micropotentiometer (arrow) to calibrate a new vtvm soon to be marketed by Ballantine Laboratories

the proven
solution
to complex
production
problems

APPLIED COMMUNICATION SYSTEMS

*A Division of
Science Research
Associates, Inc.*



ACS Production Systems A Unique Solution to Production Problems

To solve production problems in the manufacturing of complex products and systems, engineers at Applied Communication Systems (ACS) have created a unique audio-visual manufacturing system. This new production method can be applied to both limited and volume production operations.

The skill of the trained engineer or production specialist can be captured on synchronized color slides and tape recordings. Translated into step-by-step production assembly instructions, this know-how can be passed on to every production line worker through the use of ACS audio-visual equipment, mounted directly on each assembly work station.

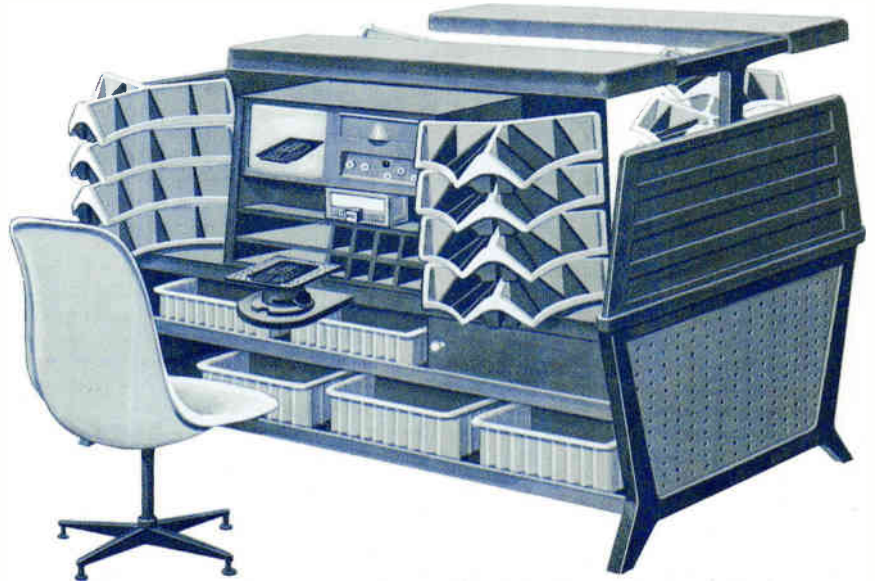

Proven Results

ACS systems have led to dramatic improvements in production, quality and standardization. Production costs have been reduced substantially through increased productivity per work station, and improved production planning. Defect rates and employee training time have been reduced sharply.

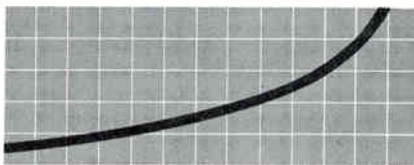

PRODUCTIVITY

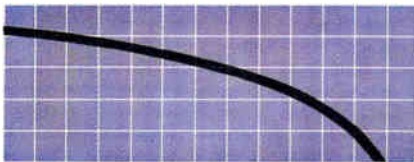

DEFECTS

Less than a year after a major electronics firm introduced audio-visual techniques, productivity increased approximately 40 per cent above the work standard. Defects were reduced from thirteen per unit to one-half per unit. In another industry where complex products are manufactured, productivity per worker increased from two to five units per day after the ACS audio-visual manufacturing system was installed.

Employee morale and motivation usually show considerable improvement because the ACS system increases the responsibility and interest of each production worker's job.

The costly effects of employee turnover and absenteeism on productivity and product quality can be minimized, since employees can be quickly taught through the use of the audio-visual programs.

ACS Production System

These major benefits result primarily from improvements in communications between engineering and production personnel. This improvement is brought about through the use of ACS audio-visual programs and equipment. Resembling a portable TV set, the ACS device contains both a 35 mm slide projector and a synchronized sound tape playback mechanism.

Designed to be mounted directly on each work station, the ACS device stays on the production line at all times. Simultaneously the production worker sees, on his own screen, each step of the assembly process, hears through a lightweight headset the synchronized assembly instructions, and carries out the assembly operation.

To reduce fatigue, carefully selected industrial background music is programmed into each ACS unit. This

music is automatically suppressed when instructions are heard.

The ACS audio-visual system allows complex technical information to be reduced to its simplest form and translated into step-by-step assembly instructions which are easily understood even by untrained production workers. The system eliminates the need for blueprints, assembly drawings, schematics, and other written instructions on the production line which require interpretation by the assembly worker. The simplicity of the audio-visual instructions enables the assembly worker to spend much less time interpreting instructions and much more time in actual product assembly. The results are major reductions in learning time for each operation and corresponding increases in proficiency and productivity.

The ACS system provides maximum flexibility. Engineering changes can be made on the production line quickly and easily. Tapes and slides can be stored indefinitely when a production run is interrupted, and the system can be expanded to accommodate changes and improvements in material control methods.

The time standard for each step of the assembly process is built into the sound tape, thus allowing adequate time for the production worker to complete the work element. As each worker's pro-



efficiency increases, the amount of instruction on the sound tape can be reduced.

The Total Work Environment

The success of ACS audio-visual techniques is due largely to the skilled planning of the sequential assembly instructions which are programmed into the ACS device. To be most effective these programs should combine technical information from industrial, and production engineering, quality control, and methods engineering.

The ACS system is a precision engineered combination of equipment, audio-visual programming, and methods planning which is designed to achieve maximum efficiency in manufacturing operations. Although it can be used separately, maximum results are obtained when the ACS audio-visual system is integrated with the ACS engineered work station. When combined these two elements provide a "total work environment" designed to make the operator as efficient as it is possible for him to be.

ACS Work Station

The ACS work station has been designed on the basis of careful micro-motion studies to organize the operator's work space in the most efficient manner. All work station fixtures such as part bins, tools, tool holders, and other equipment

are carefully located after a detailed analysis of the production operation has been made. Parts bins are designed to have a considerably greater capacity than that of work stations currently in use. All parts are assigned the simplest nomenclature and arranged in bins in the most logical order for assembly. In this way the ACS audio-visual system is integrated with the arrangement of the work station to insure maximum productivity.

Installing the ACS Production System

ACS production systems can be installed quickly and efficiently in your plant through the complete installation and training service provided by trained ACS engineers.

Because of its flexibility, the ACS production system can be installed during any phase of production.

An ACS engineer will survey your manufacturing facilities and select the production, inspection or testing stations where maximum benefits can be achieved most readily with ACS engineers. At the completion of the survey you may then proceed in either of two ways.

Usually the manufacturer selects two or three of his own technical personnel, typically from industrial and production engineering, to take an intensive

course of a few weeks duration in audio-visual production methods at the ACS Communications Development Center in Culver City, California, or Chicago, Illinois.

The newly trained company team works closely with the ACS engineering staff to organize the photographic and sound procedures which are required to install the ACS system on the production line. The ACS staff withdraws after the company team is fully trained, but professional assistance continues to be available whenever needed.

An alternative procedure involves having an ACS engineering team in residence at the manufacturer's site for approximately six weeks to install the ACS system and train personnel in the company.

In both cases ACS engineers work closely with the company personnel to select installation sites and determine optimum assembly methods, inspection and test procedures. Then the entire assembly sequence is photographed including the special tools and equipment and the specialized techniques of the engineer and experienced assembler. Step-by-step aural instructions are taped and synchronized with the slides. In this way the production know-how of the most skilled personnel is permanently recorded and made available for all work stations.

Applications of ACS Systems

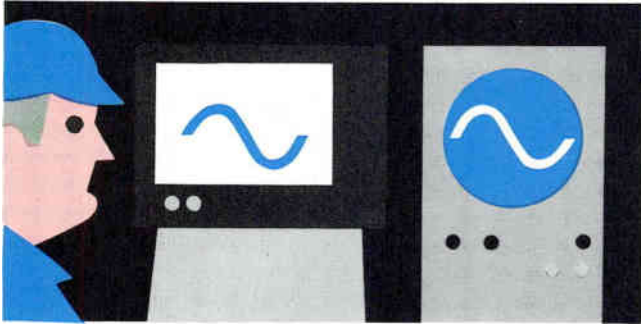

Testing, Inspection, Quality Control

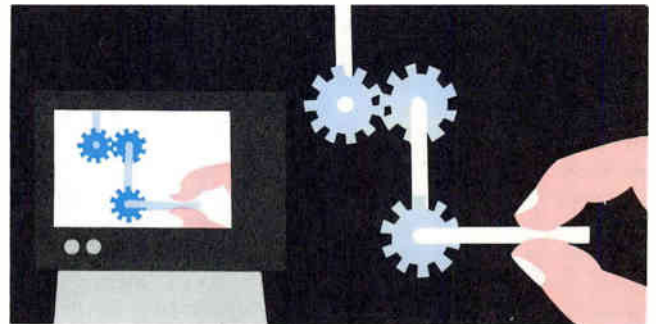

Assembly



Commercial Sales



Personnel Training



Duplication of Exact Procedures



Machine Tool Set-Up

ACS and Your Product

ACS production systems promise to open a new era in competitive manufacturing. Our industry survey team will be pleased to show you what an ACS audio-visual manufacturing system will do in increasing your profits, lowering your costs and improving your competitive position. Write or call: Department E

APPLIED COMMUNICATION SYSTEMS

A Division of Science Research Associates, Inc.

Culver City, California, 8535 Warner Dr., VERmont 7-7175
Chicago, Illinois, 259 East Erie Street, WHitehall 4-7552



*trademark

LAMINATED PLASTICS *What they are, where they can be used*

Taylor laminated plastics, also known as reinforced plastics, are thermosetting-type materials formed by impregnating paper, cotton cloth, asbestos, glass cloth, nylon or other base materials with synthetic resins and fusing them into sheets, rods, tubes and special shapes under heat and pressure. These materials exhibit a valuable combination of characteristics, including high electrical insulation resistance, structural strength, strength-to-weight ratio, and resistance to chemical reaction; also adaptability to fabricating operations.

Types of laminated plastics made by Taylor

There are four basic types of Taylor laminated plastics commonly specified and used throughout industry today. They are as follows:

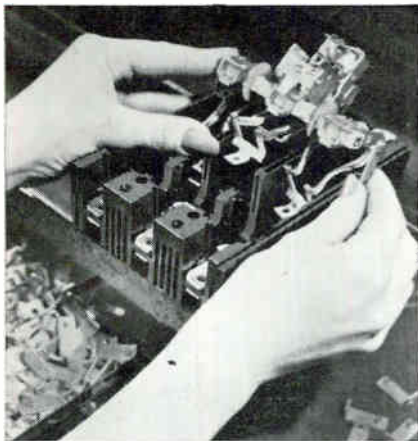

Phenolic Laminates. Paper, cotton fabric or mat, asbestos, glass cloth or nylon bases impregnated with phenol formaldehyde resins. These provide strength and rigidity, dimensional stability, resistance to heat, chemical resistance, and good dielectric characteristics. Some Taylor grades are excellent basic materials for gears, cams, pinions, bearings and other mechanical applications. Others are widely used in terminal boards, switchgear, circuit breakers, switches, electrical appliances and motors. Also in radios, television equipment and other electronic devices; and in missiles as nose cones, exhaust nozzles, and combustion chamber liners.

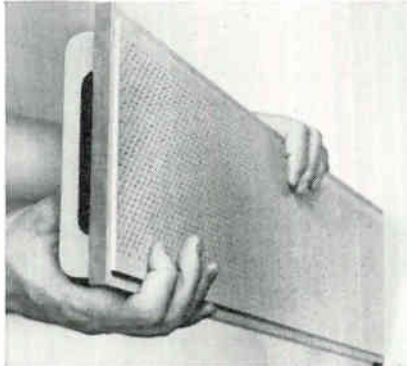

Melamine Laminates. Glass cloth or cotton fabric impregnated with melamine formaldehyde resin. Taylor melamine laminates have superior mechanical strength and are especially desirable for their arc-resistant qualities. Good flame and heat resistance, good resistance to the corrosive effects of alkalis and most other common solvents, besides other favorable characteristics. Typical applications include arc barriers, switchboard panels, and circuit-breaker parts in electrical installations.

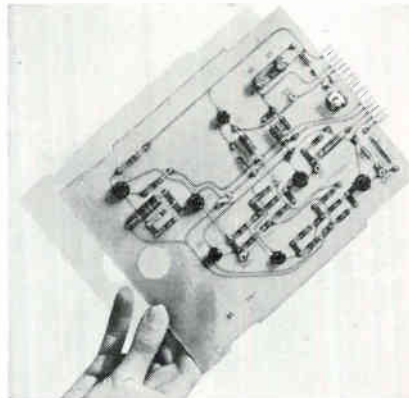

Silicone Laminates. Continuous-filament woven glass fabric impregnated with a silicone resin. These laminates combine high heat resistance (up to 500°F. continuous) with excellent electrical and mechanical properties. They are primarily used in high-temperature electrical applications and high-frequency radio equipment.

Epoxy Laminates. Continuous-filament woven glass fabric or paper impregnated with epoxy resin. Glass-fabric grades are designed for use in applications requiring high humidity-resistance, good chemical resistance,

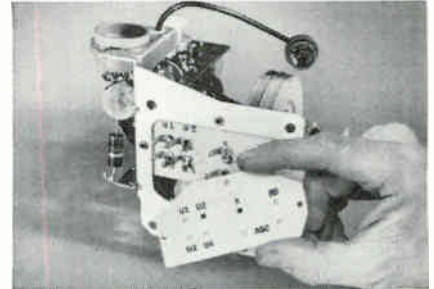

and strength retention at elevated temperatures. Paper grades are used under high-humidity conditions where resistance to acids and alkalis is required. Both grades are characterized by good dielectric strength, low dielectric losses, and high insulation resistance even following severe humidity conditions.

Recent technical advances in the bonding of various metallic and nonmetallic materials to laminated plastics have opened up new design opportunities. It is now possible to bond virtually any compatible material with a laminated plastic to form a composite which combines the advantages of both. One of the first composite materials was a copper-clad laminate used for printed circuits. More recent composite laminates, usually manufactured to customer specification, include the following: Taylorite[®] vulcanized fibre-clad, rubber-clad, asbestos-clad, aluminum-clad, beryllium-copper-clad, stainless-steel-clad, magnesium-clad, and silver-and gold-clad. Any one of these materials can be sandwiched between sheets of laminates, too, and can be molded to fit specific requirements.

Send for complete information about any or all of these Taylor laminates. And remember Taylor's new selection guide will simplify your problems in choosing the right laminate for your specific application. Taylor Fibre Co., Norristown 40, Pa.

Taylor
LAMINATED PLASTICS VULCANIZED FIBRE

**TWO OUTSTANDING
HIGH-TEMPERATURE
MAGNET WIRES**

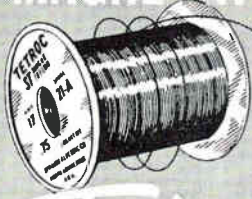

Tetroc

FOR CONTINUOUS OPERATION AT
HOTTEST SPOT TEMPERATURES
UP TO 200°C

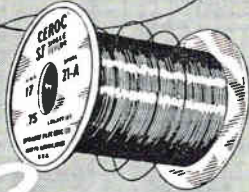

Ceroc

FOR CONTINUOUS OPERATION AT
HOTTEST SPOT TEMPERATURES
UP TO 250°C

For continuous operation at hottest spot temperatures up to 200°C (392°F) and up to 250°C (482°F) for short periods of time—depend upon TETROC—an all Teflon-insulated wire available in both single and heavy coatings.

CEROC is Sprague's recommendation for continuous operation at hottest spot temperatures up to 250°C (482°F) and up to 300°C (572°F) for short periods of time. Ceroc has a flexible ceramic base insulation with either single silicone or single or heavy Teflon overlays. The ceramic base stops "cut-through" sometimes found in windings of all-fluorocarbon wire. Both Tetroc and Ceroc magnet wires provide extremely high space factors.

Write for Engineering Bulletins 405 (Tetroc Wires) and 400A (Ceroc Wires).

SPRAGUE ELECTRIC COMPANY
35 Marshall Street, North Adams, Mass.

SPRAGUE®
THE MARK OF RELIABILITY

ISA Conference Going to Coliseum

Report from Moscow, 200 technical papers will highlight society's meeting Sept. 26-30

A "REPORT FROM MOSCOW," special workshops and panels and 200 technical papers will highlight the Instrument Society of America's 15th Annual Conference and Exhibit which will occupy all four floors next month in the New York City Coliseum.

ISA officials predict their yearly meetings "will soon be among the most important in the technical field—comparable to the IRE."

Up to 30,000 visitors are expected to view more than 250 exhibits. Convention dates: Sept. 26-30.

Theme for this year's meeting is "Progress Through Instrumentation" and keynote addresses on how instrumentation has affected growth in the petroleum and power industries and in the missile and space fields will be given by E. D. Reeves, vice president of the Humble Oil and Refining Co., O. W. Manz, executive vice president of Consolidated Edison of New York, and Lt. Gen. Bernard A. Schriever, USAF Air Research and Develop-

ment Command, Andrews AFB, Washington, D. C.

An indication of the penetration and influence that measurement and control engineers have achieved in industrial and scientific endeavors comes from the breadth of the Conference program.

It covers instrumentation for meteorology (including radiation meteorology), for research, for automotive work, for vibration and shock, for mass flow measurements, for process analysis, for nuclear, aeronautical and underwater work, and includes papers on integration of instrumentation and computers.

Though instrument men could never be accused of being blue-sky scientists, it is clear their work has produced and is producing much of the indispensable solid ground for scientific advances in many fields.

In addition to formal technical papers, there will be a number of special workshops and panels. Highlighting these panels will be one on automatic "soft" landings on earth and in space (five speak-

Poland Buys British Tv Gear



Warsaw's new Marconi Mark IV television camera (above) is compatible with USSR standards—625 lines, 50 fields, eight Mc/s channel

ers on this), and another which will report on the First Congress of the International Federation of Automatic Control, which was held in Moscow, this past June. These first-hand reports and evaluations of a prime international event, going under the heading "Report From Moscow," will be given Tuesday night, Sept. 27, starting at 7:30.

Another panel that should be highly important is on standards and measurements. The increasing demands for higher and higher accuracies in measurements have created special problems of developing and making easily available adequate standards, and in the past year, as a result of a survey made under the auspices of the Air Materiel Command (see *ELECTRONICS*, p 16, Aug. 21, 1959), organized efforts have been conducted into the standards question.

Instrumentation for underwater work is a relative newcomer, but systematic studies of ocean floors have recently received a large impetus. Scientists feel there is an urgent need to determine temperatures, pressures, sound-velocities, as well as speeds and directions of huge subsurface currents—as well as soundings and mappings.

Among these papers will be one on the instrumentation system used on the Bathyscaphe Trieste during its now-famous series of dives in the Marianas Trench off Guam in the winter of 1959-60, when it went seven miles down. Andreas B. Rechnitzer, scientist in charge of the Bathyscaphe Project, and one of the men making the record dive, is co-author with G. Farrell, Jr. (of Lockheed Aircraft) on this paper.

Displays of new equipment by manufacturers this year promise to be informative and exciting. Manufacturers have not released complete details on their exhibits, but ISA officials predict surprises—including a mysterious "spectacular" on opening day, Monday, September 26.

In addition to manufacturers' exhibits, this year the Department of Defense will be represented in a special section consisting of 26 departments of Army and Navy instrumentation. National Aeronautics and Space Administration, too, will be among the exhibitors.

New 'Wrap-and-endfill' Film Capacitors Based on Extensive Life Test Data

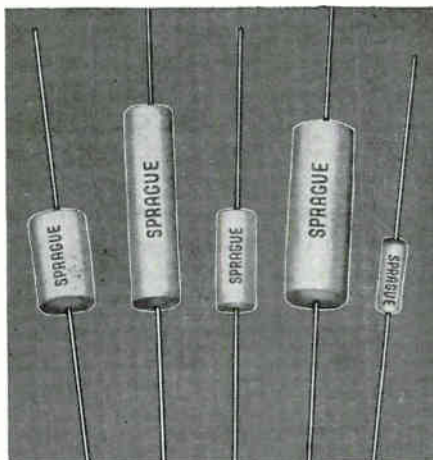

Sprague Electric Company has recently announced an improved version of its Yellow-Jacket Filmite "E" Capacitors for military and industrial applications. The most reliable "wrap-and-endfill" film capacitors made to date, Type 158P Yellow-Jackets are based on the most exhaustive life test studies ever made on polyester film capacitors. They will withstand a 250 hour accelerated life test of 150% of the 85 C rated voltage impressed, or the equivalent derated 125 C voltage. Company standards require that there be no more than 1 failure in every 25 samples tested.

Type 158P Yellow-Jacket Capacitors are ideal for applications in military electronics, computers, and industrial controls, being particularly well-suited for potting or encapsulating in electronic sub-assemblies, filters, etc.

For complete engineering data on Military-Grade Yellow-Jacket Film Capacitors (Type 158P) write for Engineering Bulletin 2301. Data on Sprague's Commercial and Entertainment Grade Yellow-Jacket Film Capacitors (Types 148P and 149P) is given in Bulletin 2063A. Both bulletins are available from Technical Literature Section, Sprague Electric Company, 35 Marshall St., North Adams, Mass.

CIRCLE 200 ON READER SERVICE CARD

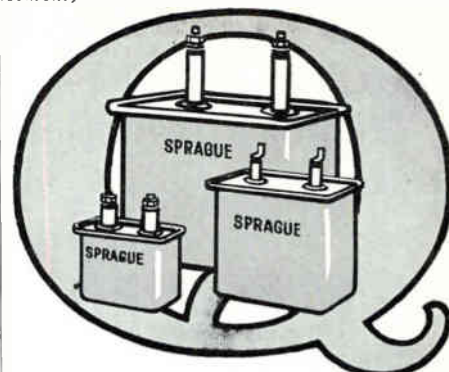

NEW DIFILM[®] VITAMIN Q[®] CAPACITORS

operate at +125 C
without derating . . .
save space and weight

Surpassing MIL-C-25A Type CP-70 requirements for performance, reliability, size, and temperature range without voltage derating, Sprague Type 272P DIFILM Vitamin Q[®] Capacitors are made to withstand the most severe operating conditions encountered in military and industrial electronic equipment.

The new dual dielectric used in these capacitors consists of both synthetic polyester film and the highest grade capacitor tissue . . . a combination which offers the best properties of both materials! The impregnant is Vitamin Q, a synthetic polymer which has been used exclusively by Sprague with outstanding success in paper capacitors for many years.

Seamless drawn rectangular capacitor cases provide virtually leak-proof containers with increased reliability over MIL-type units using fabricated cases.

Especially important to designers of electronic equipment is the saving in physical size and weight over conventional oil-paper capacitors. There is no need to use larger, bulkier, higher voltage capacitors because of the need to derate above 40 C. And there is no +85 C limitation to upper operating temperature so that ventilating and cooling devices for equipment enclosures often may be eliminated.

For complete engineering data on Drawn-Rectangular Case DIFILM Vitamin Q Capacitors, write for Bulletin 2340 to Technical Literature Section, Sprague Electric Company, 35 Marshall St., North Adams, Mass.



CIRCLE 43 ON READER SERVICE CARD

Time-Sharing Problem?

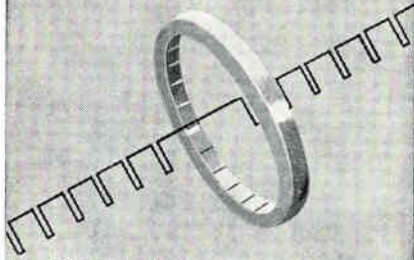

IDL MAY HAVE A SOLUTION -

Your data handling system, whether RF carrier or wire transmission line, may require time-sharing to increase its capacity and efficiency.

In the past, the advantages of motor driven switches used for multiplexing were outweighed by their disadvantages. They were smaller, lighter and simpler but, because of high contact resistance, bounce and short life, they contaminated data.

Then IDL introduced multi-fingered brushes traveling on the inner periphery of cylindrical sections to minimize resistance and bounce and extend trouble-free life to hundreds of hours. These concepts have been successfully applied to missiles in sampling 900 data points per second for more than 500 hours without signal contamination even in the milli-volt signal level ranges.

For example, Switch No. 500660 is a complete unit within a compact case, available at reasonable cost and capable of sampling up to 180 transducers. It combines 2 poles of 30 data channels with 2 poles of 60, data channels, each operating at 5 rps.



For further information, write for Technical Bulletin No. 500660; or let us propose a solution to your Time-Sharing Problem.

INSTRUMENT DEVELOPMENT LABORATORIES
INCORPORATED
Subsidiary of Royal McBee Corporation

51 MECHANIC STREET, ATTLEBORO, MASS.

Green Light for Uhf -Tv Test

FCC planners will be letting contracts under \$2-million budget for New York City project

THOSE PLANS for a uhf television test site atop the Empire State Building in New York City (ELECTRONICS, p 32, June 3) will start rolling this month, according to information from FCC.

At the Commission's request, Congress has put up \$2 million, a cut of \$250,000 from what was asked, to finance the tests. The studies will go on during fiscal years 1961 and 1962 in attempts to find out definitely whether or not uhf television will work in the New York City tv market area.

Heading up the project will be FCC's chief engineer, Edward W. Allen. According to commission spokesmen, the project will work on a contract basis and bids will be open to anyone who thinks his company can perform any phase of the work. A recent FCC bulletin invited bid proposals marked for attention of the chief engineer.

An advisory committee will check on all facets of the project and encourage active participation by tv industry groups.

Among those invited to pitch in are the National Association of Broadcasters, Electronic Industries Association, Association of Maximum Service Telecasters and Institute of Radio Engineers.

Also being asked to participate are: The Joint Council on Educa-

tional Television, Joint Technical Advisory Committee, Television Allocations Study Organization, Association of FCC Consulting Engineers and others.

Commission planners propose to place their antenna on the Empire State Building tower along with several vhf masts already there.

Another station will be set up about 15 miles away to broadcast on a separate uhf channel. By comparison, engineers will study any improvements which might be obtained by simultaneous broadcasts on two different frequencies.

Generally, transmissions with horizontal polarization will be used, but one station will be trying out part-time circular polarization for observation and measurement.

Also sought will be ways to improve uhf receivers. Favorable results will, if possible, be incorporated in test receivers used.

In the service area, measurements will be made inside buildings, on rooftops, at street level and other locations. Picture quality will be checked and compared at all sites.

New Image Tube Aids Astronomers

PHOTOELECTRIC image intensifiers aided astronomers here and abroad in recent galactic investigations by increasing the sensitivity of conventional telescopes up to 100 times.

The devices are similar in operation to conventional photomultiplier tubes. Incoming photons strike a photosensitive cathode, dislodging electrons which are accelerated in a strong electric field. The high speed electrons strike a phosphor screen, producing a burst of light which is photographed.

An intensifier built at the Paris Observatory by A. Lallemand and M. Duchesne replaces the phosphor screen with a photographic plate, resulting in direct indication of incoming photons.

U. S. research has been sponsored in part by the National Science Foundation.

Sorter Assembly Line

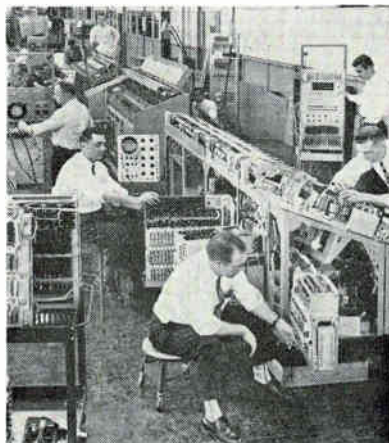

Engineers at Burroughs Corp. are working on magnetic ink character recognition sorters for 25 banks

PHASE EQUALIZATION

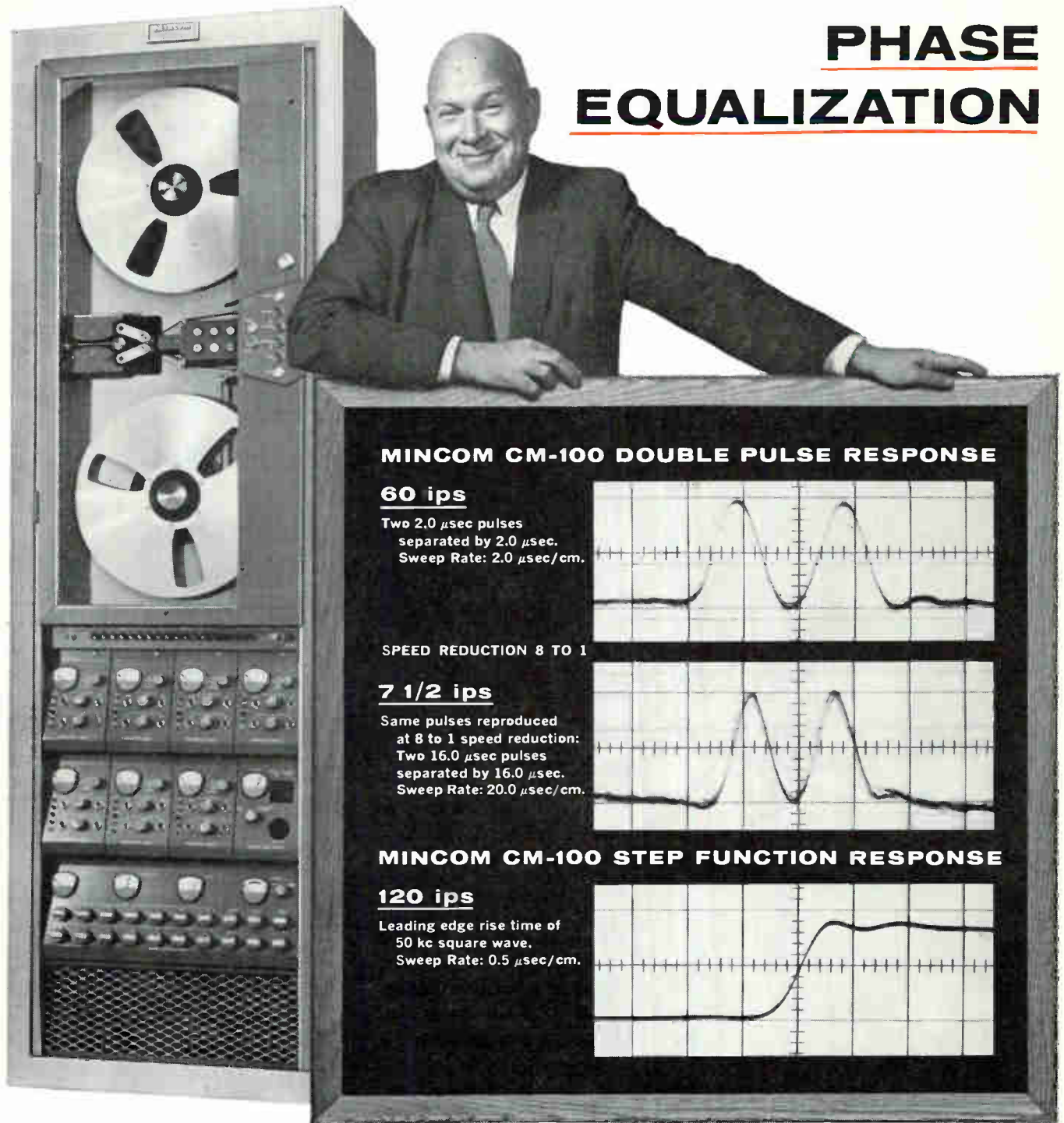

MINCOM CM-100 DOUBLE PULSE RESPONSE

60 ips
Two 2.0 μ sec pulses
separated by 2.0 μ sec.
Sweep Rate: 2.0 μ sec/cm.

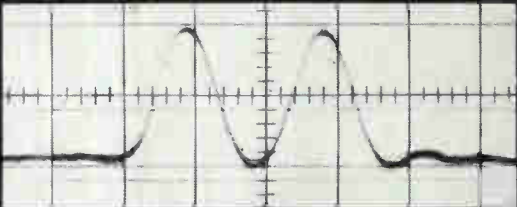

SPEED REDUCTION 8 TO 1

7 1/2 ips
Same pulses reproduced
at 8 to 1 speed reduction:
Two 16.0 μ sec pulses
separated by 16.0 μ sec.
Sweep Rate: 20.0 μ sec/cm.

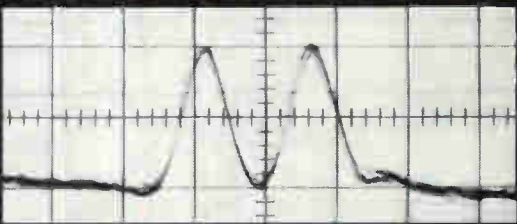

MINCOM CM-100 STEP FUNCTION RESPONSE

120 ips
Leading edge rise time of
50 kc square wave.
Sweep Rate: 0.5 μ sec/cm.

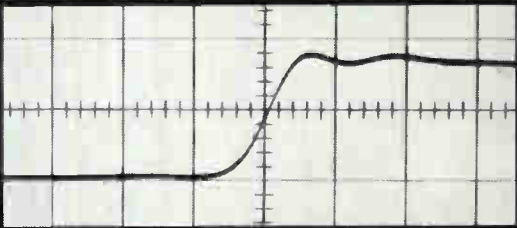

Constant phase equalization at all speeds—that's the story told in the picture above, and one big reason for the consistently good pulse response from the **Mincom Model CM-100 Magnetic Tape Instrumentation Recorder/Reproducer**. CM-100 also provides longer recording time because of higher tape packing density at all six speeds—from 3 hours and 12 minutes at 62.5 kc-7½ ips, to 12 minutes recording 1 mc-120 ips. Interested? Write today for brochure.



...WHERE RESEARCH IS THE KEY TO TOMORROW

MINCOM DIVISION **MINNESOTA MINING AND MANUFACTURING COMPANY**

2049 SOUTH BARRINGTON AVENUE, LOS ANGELES 25, CALIFORNIA • 425 13th STREET N.W., WASHINGTON 4, D. C.



20,000 Watt 4-22MC High Frequency Transmitters

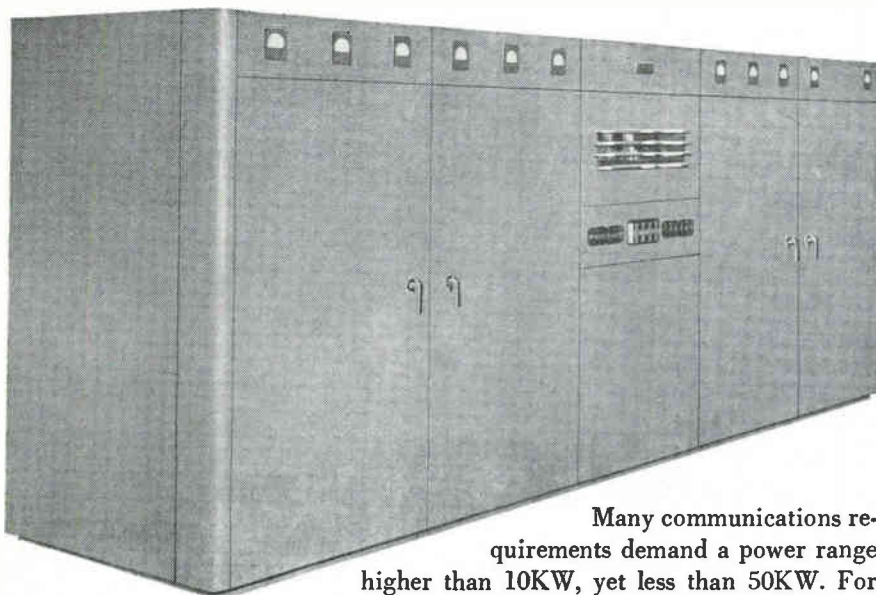

Many communications requirements demand a power range higher than 10KW, yet less than 50KW. For this service, the Gates HF-20 series for 20,000 watts offers several models for telegraph, telephone and short wave broadcasting, at 20KW power.

Telephone and broadcast models are high level modulated and match a wide variety of R.F. output impedances. Standard models cover all frequencies between 4 and 22 mc, and any frequency may be set up in two minutes or less. Models for specific frequencies are also available.

This famous series of Gates transmitters are built for 24-hour day commercial demands in arctic, moderate or equatorial environment and explains its world-wide use in private, industrial and government service. Even though substantial in size, most models are usually available from stock to fill emergency needs.

A new catalog is available, without cost where requested on your letterhead. Other models from 50 watts to 100,000 watts are also listed. Why not request your copy today?

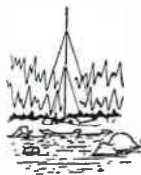

GATES RADIO COMPANY
 Subsidiary of Harris-Intertype Corporation
 QUINCY, ILLINOIS



Offices in: HOUSTON, WASHINGTON, D.C. In Canada: CANADIAN MARCONI COMPANY
 Export Sales: ROCKE INTERNATIONAL CO., 13 EAST 40th STREET, NEW YORK CITY

MEETINGS AHEAD

Aug. 22: Scientific Apparatus Makers Assoc., Market Managers, SAMA, Statler Hilton, Los Angeles.

Aug. 22-26: Thermonuclear Plasma Physics Symposium, Oak Ridge, U. S. Atomic Energy Comm., Gatlinburg, Tenn.

Aug. 23-26: Western Electronic Show and Convention, WESCON, Memorial Sports Arena, Los Angeles.

Aug. 23-26: Association for Computing Machinery, Nat. Conf., Marquette Univ., Milwaukee.

Aug. 29-31: Metallurgy of Elemental and Compound Semiconductors, AIME, Statler Hotel, Boston.

Sept. 7-8: Value Engineering, EIA, Disneyland Hotel, Anaheim, Calif.

Sept. 7-9: Automatic Control, Joint Conf., ASME, IRE, AIEE, ISA, MIT, Cambridge, Mass.

Sept. 8-9: Conference on Technical Communications, Society of Technical Writers and Editors, Univ. of Dayton, Dayton, O.

Sept. 9-10: Communications: Tomorrow's Techniques—A Survey, IRE, Roosevelt Hotel, Cedar Rapids, Ia.

Sept. 13-14: Bionics Symposium, Applying Biological Principles to Engr. Design, ARDC, Wright Air Devel. Div., Dayton Biltmore Hotel, Dayton, O.

Sept. 14-15: Industrial Electronic Test Equipment Symposium, Armour Research Foundation, Chicago.

Sept. 15-16: Engineering Management Conf., IRE, Morrison Hotel, Chicago.

Sept. 15-17: Upper Midwest Electronic Conf., Twin Cities Elec. Wholesalers, Civic Auditorium, Minneapolis.

Oct. 10-12: National Electronics Conf., Hotel Sherman, Chicago.

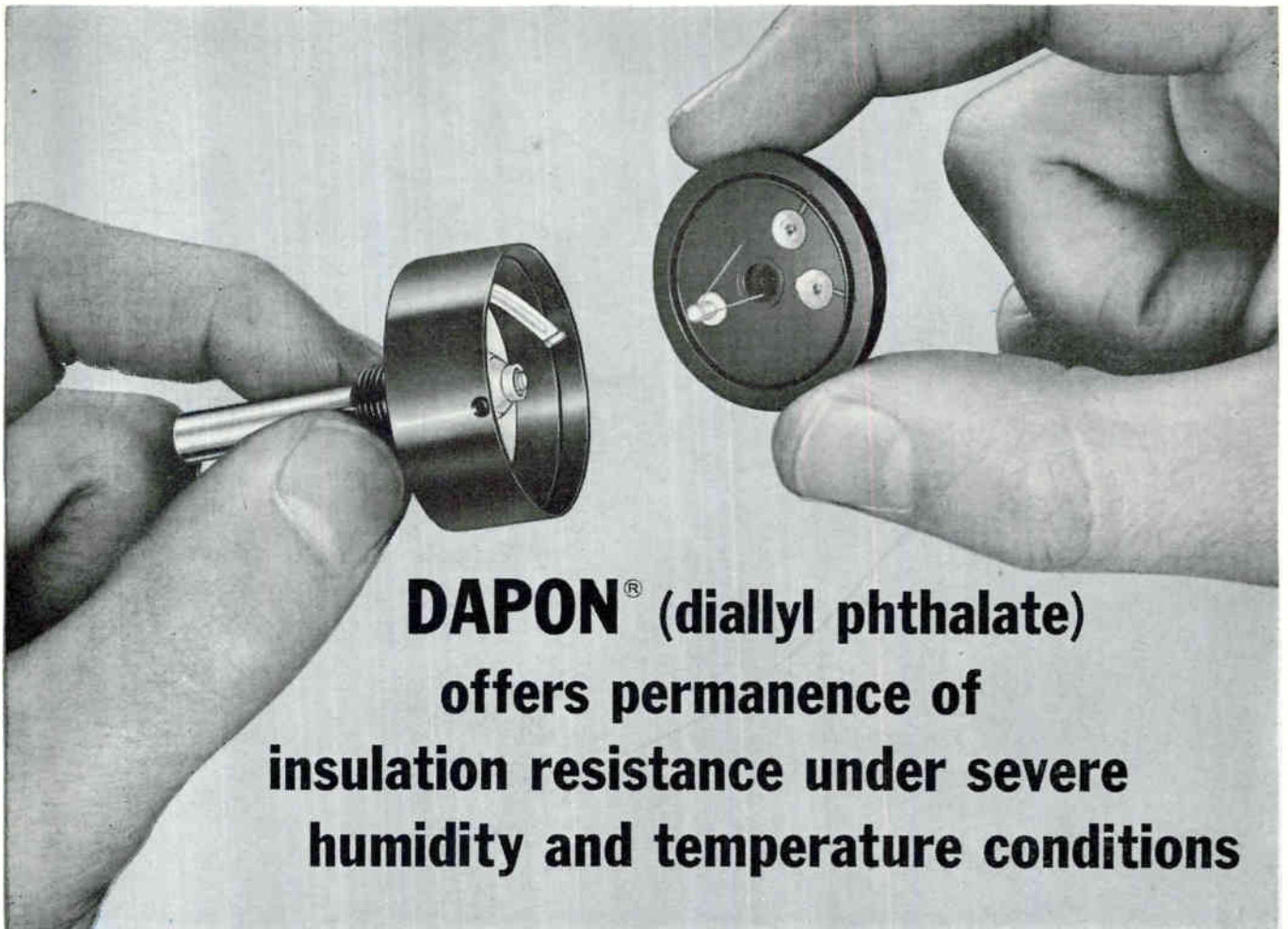

DAPON® (diallyl phthalate)
offers permanence of
insulation resistance under severe
humidity and temperature conditions

This plastic is ideal for applications where changes in humidity can affect electrical values. DAPON can prevent costly "in service" failures in electrical and electronic components.

A new molded plastic potentiometer produced by New England Instrument Company features exceptional resistance to humidity, high reliability and low noise. A raised conductive plastic ring is used in place of resistance wire in these miniature units. The new potentiometers are ideal for servo and instrumentation applications where long life and extreme accuracy are important factors.

The solid resistance element, insulating base and silver terminal leads are molded in one operation with DAPON (diallyl phthalate) Resin. Result: a single, almost indestructible precision unit.

New England Instrument chose DAPON because of its superior electrical and physical properties, and its low moisture absorption. DAPON also molds easily around metal inserts without cracking, and withstands extremes of temperature, vibration and shock.

Specify DAPON (diallyl phthalate) Resin when you need:

- Low dielectric loss
- High dielectric strength
- Superior dimensional stability
- Excellent arc resistance
- High volume and surface resistance after high humidity-high temperature conditioning

Write for FMC's data sheet containing technical information about DAPON, suggested uses for this resin, and the names of DAPON compounders.

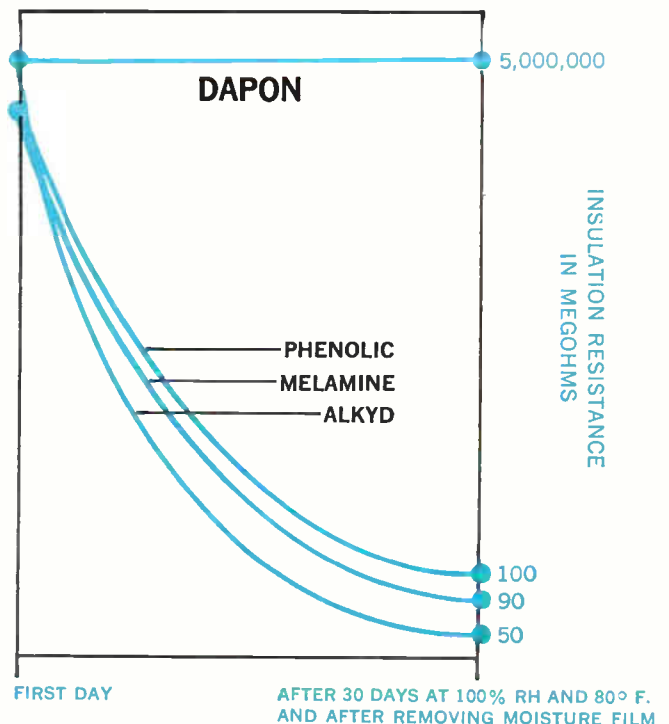

FOOD MACHINERY AND CHEMICAL CORPORATION

Dapon Department

161 East 42nd Street, New York 17, New York

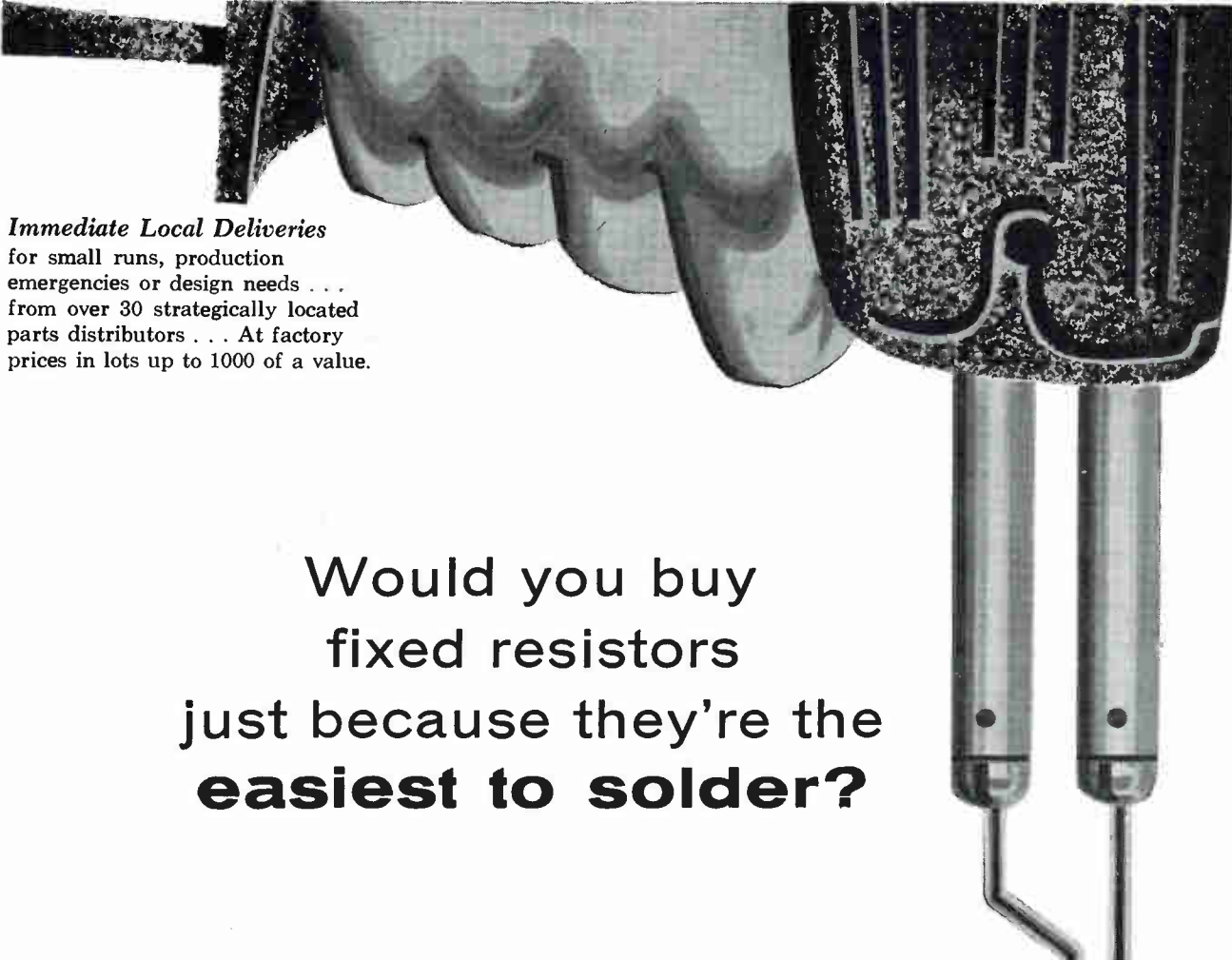

Immediate Local Deliveries
for small runs, production
emergencies or design needs . . .
from over 30 strategically located
parts distributors . . . At factory
prices in lots up to 1000 of a value.

Would you buy
fixed resistors
just because they're the
easiest to solder?

Of course you wouldn't!

But when you add the highest degree of "solderability" of any resistors on the market to top-notch reliability in other physical and electrical characteristics — well, that's something else. Like a lot of other cost-conscious producers, you'll then be using Stackpole Coldite 70+ Resistors!

Stackpole Coldite 70+ "solderability" saves time and money in your production. It assures perfect connections that eliminate a lot of possibilities for costly field service later on.

Coldite 70+ performance fully matches the "solderability" of the leads. They're designed to meet or excel MIL-R-11 in every respect. And they're tops in load life, humidity and moisture tests!

Electronic Components Div.—**STACKPOLE CARBON CO.**, St. Marys, Pa.



STACKPOLE
Coldite 70⁺
fixed composition resistors

CERAMAG® FERRITE CORES • VARIABLE COMPOSITION RESISTORS • SLIDE & SNAP SWITCHES • CERAMAGNET® CERAMIC MAGNETS • FIXED COMPOSITION CAPACITORS
BRUSHES FOR ALL ROTATING ELECTRICAL EQUIPMENT • ELECTRICAL CONTACTS
GRAPHITE BEARINGS, SEAL RINGS, ANODES • HUNDREDS OF RELATED CARBON & GRAPHITE PRODUCTS.

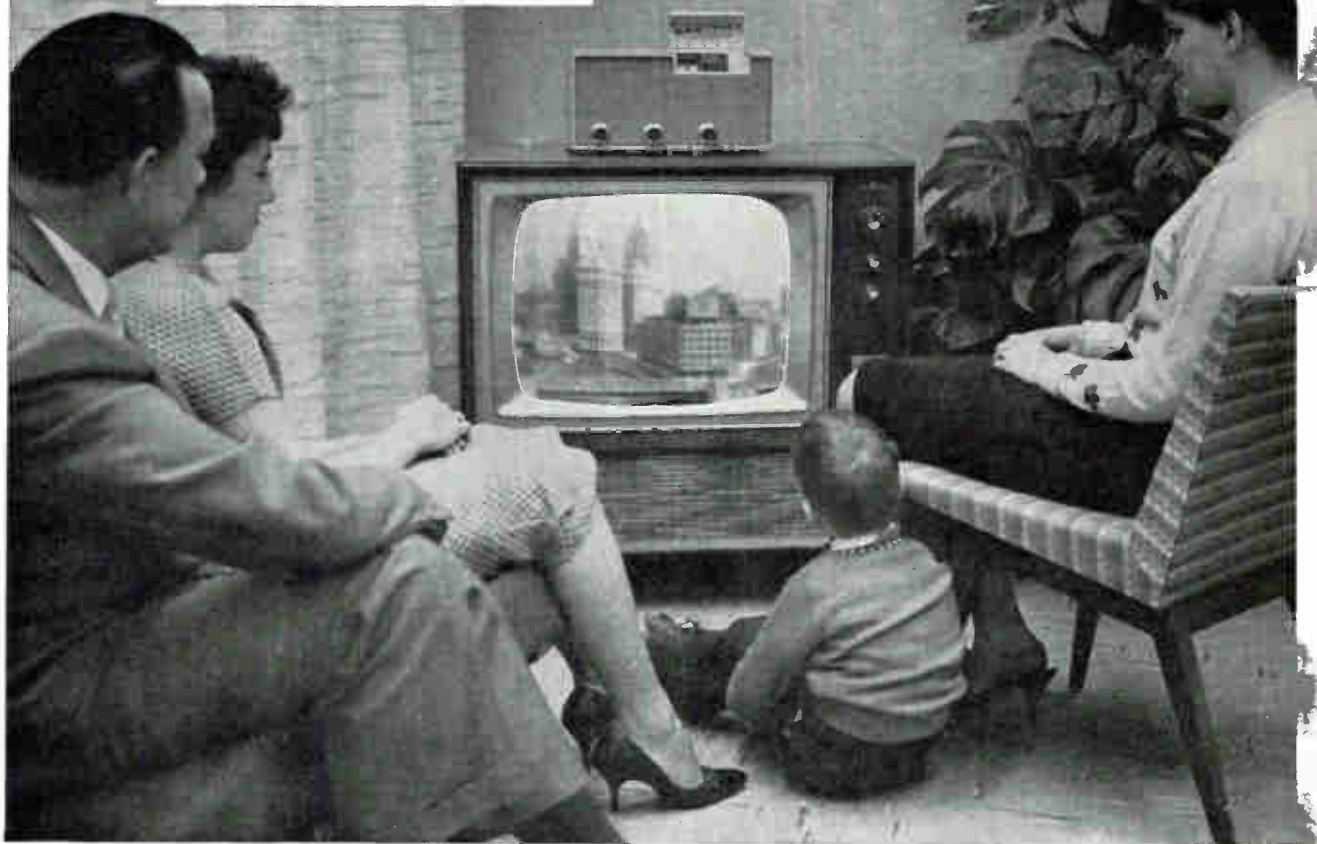

Contents of subscriber attachment (on top of tv set), including coaxial input plug, are completely inaccessible to all but collectors and repairmen

How a Closed-Circuit Pay Tv System Works

Program delivery transmitters, distribution equipment, coin-operated subscriber attachment and accounting machine are described on a functional level. Control logic circuit for subscriber attachment is discussed in detail

By PATRICK R. J. COURT, CARL A. S. AKRELL, ABRAHAM M. REITER and GLENN S. KIMBALL

International Telemeter Co.,
Los Angeles, Calif.

LAST FEBRUARY, the Trans-Canada Telemeter closed-circuit pay television system was inaugurated in Toronto (ELECTRONICS, p 52, Mar. 18). This article describes the de-

sign of the system and its four elements—transmitting equipment, distribution equipment, home attachment and accounting equipment.

Pay tv systems are likely to be installed in areas already served by broadcast tv. These systems will be required only to carry three Telemeter channels A, B and C; however, in areas not adequately served

by broadcast tv, the system might be a composite, offering vhf channels as a community antenna service in addition to the pay channels. This technique could also be used in apartment houses that use a built-in communal antenna. Thus Telemeter subscribers and nonsubscribers may be connected to the same cable network.

In the Telemeter system the pic-

ture and sound are hidden by transmitting them at nonstandard channel frequencies. This requires using a converter in the receiver attachment that can make the programs available at standard channel frequencies.

Need for multiple automatic pricing in five-cent increments leads to a digital price display. This suggests a price-control channel in which prices are transmitted as a sequence of pulses, each of five

cents value. Since individual price control is required for each channel, three control channels are needed.

Recording of each transaction made by the subscriber, including the identities of programs purchased, can be done in several ways. Magnetic tape recording is least complicated mechanically, hence this medium is preferred. Therefore, a binary code is used and the code information transmitted on a time-sharing basis along with the

price-control information.

The times at which subscribers may select a program are random, thus the price-control and identity code sequence must be continuously repeated during a program. The price control information must contain identifying characteristics to allow the logic, which controls the pricing mechanism, to recognize both the beginning and end of the sequence. The beginning is identified by a long, start-pricing pulse

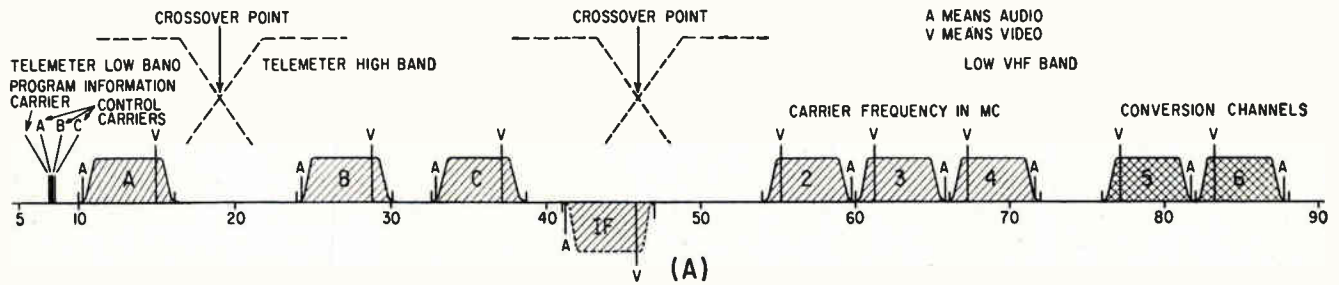
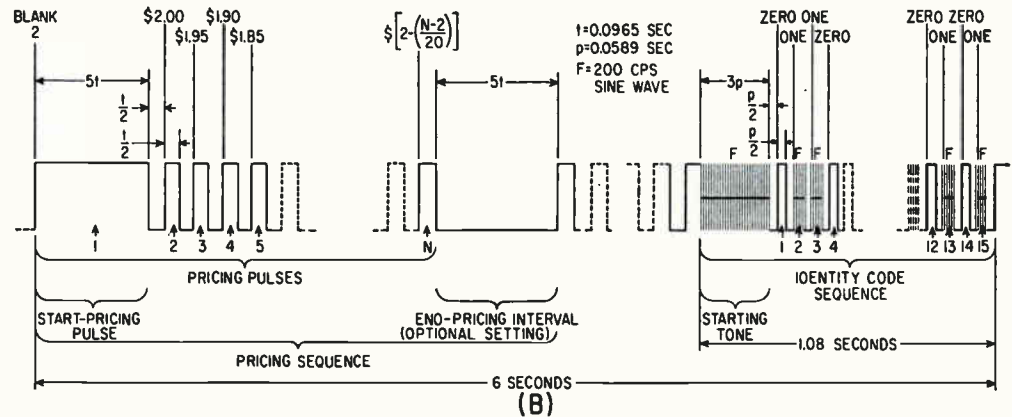

FIG. 1—General layout of channels used in International Telemeter pay tv system (A) and composite and waveform of control carrier modulation (B)



REQUIREMENTS FOR PAY TV SYSTEMS

Design of a pay tv system is based upon the requirements the system must satisfy. Security, recording of programs purchased and payment are basic requirements, while the remainder may be classified as highly desirable.

SECURITY—The picture and sound must be secure in that entertainment offered for sale is available only to customers willing to pay. Principal advantage of a closed-circuit pay tv system is its inherent security. All persons not actually connected to the cable may be disregarded, assuming that direct radiation from the cable is negligible. Additional security is directed only against subscribers to the system; this is done by a combination of technical, legal and accounting means.

With a cable system the problem of distributing pay tv programs is not unlike that of distributing electric power. Because the meter is the property of the system operator, there are legal penalties that deter tampering. Therefore, it is necessary to ensure that the subscriber cannot defeat the system without tampering with the meter.

While it is impracticable to make a home unit indestructible, it is possible to make the contents inac-

cessible to the subscriber. Access to the contents has to be provided for servicing, but the meter can be secured with a lock.

It is necessary that the picture and/or sound be hidden from the subscriber, both before he elects to purchase a program and at the end of the program. For multichannel systems, it must be made impossible for the subscriber to view programs on a channel other than that for which he has paid. A record made of each transaction can be helpful in detecting irregularities.

RECORDING OF PROGRAMS PURCHASED—Means must be provided for determining the number of subscribers that purchase each program. Since producers of entertainment sell their products for a percentage of the gross receipts, the gross for each program must be known. Thus, some kind of record must be made of each purchase by the subscriber, not only of the amount spent, but of the program that was bought. This record contributes to the system security and forms a basis for settling disputes between subscriber and system operator.

PAYMENT—There must be some way to collect money for the entertainment. There are two methods for this; cash payment or credit billing. A fixed monthly

whose relationship with the entire sequence is fixed, while the end is signified by a long end-pricing interval. The transmitted price is determined by the number of price pulses between these two signals, thus the position of the end-pricing interval is variable with respect to the entire sequence.

Since time constants are used in the attachment to recognize both the start and finish of the price-control sequence, these intervals are made ten times as long as the price pulses. Mechanical considerations in the attachment led to the choice of a price pulse repetition rate of approximately 10 per sec with a 50 percent duty cycle.

The identity code sequence must use a code that is easily recorded by simple circuits within the attachment, yet is decipherable by the data-processing equipment used at the accounting center. A code sequence of 15 binary bits is used in which ZEROES are transmitted as pulses, and ONES are transmitted as 200-cps tone bursts. This sequence is preceded by a long starting-tone burst of 200 cps, which is used by the data-processing equipment to recognize the start of the identity code sequence.

Both program price and identity number are encoded in the 15 bits which have a 50 percent duty cycle and occupy approximately one sixth of the total sequence of six seconds.

Figure 1B shows the composite waveform that is 100-percent amplitude modulated, in the negative sense, upon its control carrier.

Program information audio also has to be conveyed to the attachment. The high signal-to-noise ratio attainable in the distribution system, the need to achieve the simplest attachment and modest fidelity requirements, lead to choosing amplitude modulation of the program information carrier. One carrier serves all three channels; thus, in addition to the audio and video carriers of the channels themselves, it is necessary to transmit four carriers.

The distribution cable permits an apparently wide choice of frequencies for the system carriers. Economically, the spectrum below vhf channel 2 is preferred. Distribution efficiency of the system is greatest at the lowest frequencies, thus fewer distribution amplifiers are required. It is not necessary to transmit the program information audio or the control information within the channel spectra, nor is it necessary to relate the carrier to frequencies with respect to the channels.

Economic considerations led to grouping these four carriers at a low frequency to permit common, narrow-band amplification and separation by conventional superhet techniques within the attachment.

Locating three 6-Mc tv channels plus four narrow-band a-m channels in the 54 megacycles below vhf channel 2 is the first problem which must be dealt with. It is necessary to determine which standard channels should be the conversion channels. If only one is selected, there is no assurance that it will always be vacant as it must be if co-channel interference is to be avoided. The FCC allocation plan is helpful if two adjacent channels are selected; it is then certain that only one channel will be occupied by a local station.

In determining channel frequencies there are two doubtful regions: the two tv i-f channels, 21 to 27 Mc and 41 to 47 Mc. The former is obsolete, and may be neglected, while the latter is now almost universally used. Because of possible visible interference due to beats between the converted carriers and the local oscillators of both attachment and receiver, it is unwise to allow any Telemeter carrier to fall within the tv i-f. Thus the band from 41 to 47 Mc should be avoided.

In a composite system, carrying both Telemeter and vhf channels, it is necessary to provide room for filtering the Telemeter channels from the vhf channels; for example, by crossover networks. This requirement precludes the use of the spectrum above 47 Mc for Telemeter channels. Because of equalization

charge entitling the subscriber to all the entertainment offered does not satisfy the producers of the entertainment and is impracticable, even though it leads to the simplest kind of pay tv system.

Cash operation was chosen for the Telemeter system because entertainment is purchased that way. The purchase is impulsive and the customer is not discouraged by large monthly bills.

With cash operation, it is desirable that the pay tv device accept silver coins. To take care of overpayment owing to lack of correct change, it is also important to furnish a credit storage facility to register and hold the surplus against subsequent transactions.

MULTIPLE PRICING—*For the subscriber's convenience it is advantageous that the price demand for any given program be displayed automatically. Pricing capability should be flexible and controllable instantly from the studio. In the Telemeter system the price demand is controllable from \$2 to PAID in decrements of \$0.05.*

PROGRAM INFORMATION CHANNEL—*It is desirable to make available an audio program information channel. This channel would furnish the subscriber with information about the pay programs and can also be*

used as an entertainment channel.

NUMBER OF CHANNELS—*Use of a cable allows deciding how many pay channels the system should carry. The question is one of system flexibility versus economics; the decision to make available three channels in the Telemeter system resulted from consideration of these factors.*

MISCELLANEOUS—*There are other requirements such as complete compatibility with color, noninterference with broadcast programs, equipment reliability, convenience of operation by the subscriber, small size and pleasing appearance of the home unit, and simplicity of installation of the home unit. The home unit is an attachment to the subscriber's television receiver and installation is simplest if the only connections to the receiver are to its antenna terminals. Any schemes that involve making connections inside the customers' television receiver may receive unfavorable reaction from such organizations as the Underwriters' Laboratories and the Canadian Standards Association. These schemes may also prejudice relations between the subscribers and the operator of the system, since a failure in the receiver might be blamed on the attachment.*

problems within the distribution system, video information should not be transmitted below 10 Mc; thus the original 54 Mc of available spectrum has been whittled down to 31 Mc.

Conversion to an i-f that is higher than the incoming frequencies is contrary to normal superheterodyne practice and, if the Telemeter channel frequencies are improperly chosen, harmonics of the carriers will occur within one or both of the conversion channels. The converter mixer is nonlinear and substantial amounts of harmonics of the input frequencies appear at its output. The problem is serious because the low-frequency Telemeter channels span so many octaves, and harmonics even as high as the 10th order will create objectionable beat patterns in the reproduced picture. Even color sub-carrier frequencies cannot be neglected. The problem might be solved by more complex mixer circuit arrangements in the attachment. Cost consideration, however, rules out such a solution.

Because the Telemeter signals have to be amplified in the distribution system by distributed-line, wide-band amplifiers, first-order beat frequencies and harmonics must be considered. Since linearity of the amplifiers is not perfect, the carriers should be arranged so that the lowest frequency carrier is not less than one half of the upper band end frequency of the highest channel. This rule applies if harmonics of the low channels are to be avoided in the high channels.

These considerations, and the requirement of separation between the channels, lead to the conclusion that no single set of frequencies can satisfy all the requirements. The solution was to arrange the frequencies into two beat-free groups, spaced sufficiently far apart so that they are separable in the distribution system by crossover networks and thus amenable to separate amplification. It then became possible to avoid interfering harmonics within either of the conversion channels 5 and 6 provided that in a channel 6 system the frequencies used for Telemeter channels B and C are slightly different from those used in a channel 5 system.

The two groups of carriers were chosen to have approximately equal

energy content. If the control, program information and Telemeter channel audio carriers each have a voltage amplitude of one unit and the Telemeter channel video carrier has a voltage amplitude of two units, a beat-free group can be contrived consisting of the three control carriers, the program information carrier, channel A audio and channel A video with a combined peak voltage amplitude of seven units. The second beat-free group consists of channel B audio and video and channel C audio and video with a total voltage amplitude of six units. Figure 1A shows the layout of the Telemeter channels for channel 5 and channel 6 conversion; carrier frequencies are listed in the table.

Since the system transmitters deliver their outputs into a cable distribution system, there are no high power requirements; thus, the equipment can be compact. A block diagram of the transmitters is shown in Fig. 2.

The waveform in Fig. 1B is generated by a synchronously driven rotating disk, shown in Fig. 3. It is perforated near its edge in two tracks; the outer track generating the start-pricing pulse, the price pulses and the ZEROS of the program identity code and the inner track generating the starting-tone and the ONES of the identity sequence. A sliding arm closes five price holes to form the end-pricing interval, while fifteen adjustable tabs expose openings either in the outer or the inner track to create the binary identity code.

The disk is on a turntable in the price and code generator chassis so that its perforated edge extends into a gap in a "lighthouse" that con-

tains two semiconductor photodiodes with their illumination. The disk is rotated at 10 rpm and the photodiodes produce two separate pulsed outputs corresponding to the tracks. These pulses form inputs to the price control transmitter.

The two inputs are first shaped and d-c referenced by a multivibrator and then applied to two modulators that are driven directly from a common, crystal, controlled, carrier oscillator.

The waveform in Fig. 1B shows that the peak tone amplitude has the same level as the unmodulated carrier, thus two modulators are used. One supplies the portion of the carrier that is driven to zero by the pricing pulses and the ZEROS; the other is 100 percent modulated by tones and gated on by the ONES of the identity sequence. The two modulators have a common r-f plate circuit and are driven 180 degrees out of phase to cancel any leak-through and allow 100 percent modulation. The 200-cps tones are generated by a resonant reed-controlled oscillator for stability. Two outputs are produced; one is r-f at a level of approximately +40 dbmv, the other a detected waveform for monitoring.

The program information transmitter usually accepts audio from a continuous-loop tape transport. The tapes are pre-recorded with information about programs on the Telemeter channels. The transmitter is usually modulated at an average level of 40 percent and has a limiter to prevent peak modulation from exceeding 80 percent. This technique ensures proper functioning of the attachment which uses the program information carrier to derive age. The r-f output of the transmitter is approximately +40 dbmv.

All seven transmitter outputs are applied to the inputs of the carrier level equalizer. This device is a seven-section step-attenuator that allows ± 6 db adjustment of the carrier levels.

At the output of the carrier level equalizer, the three price control carriers and the program information carrier are all resistively matrixed in one section of the multiplexer. Then they are collectively filtered in an M-derived, low-pass filter to remove harmonics that might interfere with the video channels. Finally, this group of

Carrier Frequencies

Telemeter Carrier	Channel 5 Conversion (mc)	Channel 6 Conversion (mc)
Program information	8.39	8.39
Control channel A	8.475	8.475
Control channel B	8.525	8.525
Control channel C	8.575	8.575
Channel A audio	10.25	10.25
Channel A video	14.75	14.75
Channel B audio	24.35	25.5
Channel B video	28.85	30
Channel C audio	32.85	34
Channel C video	37.35	38.5

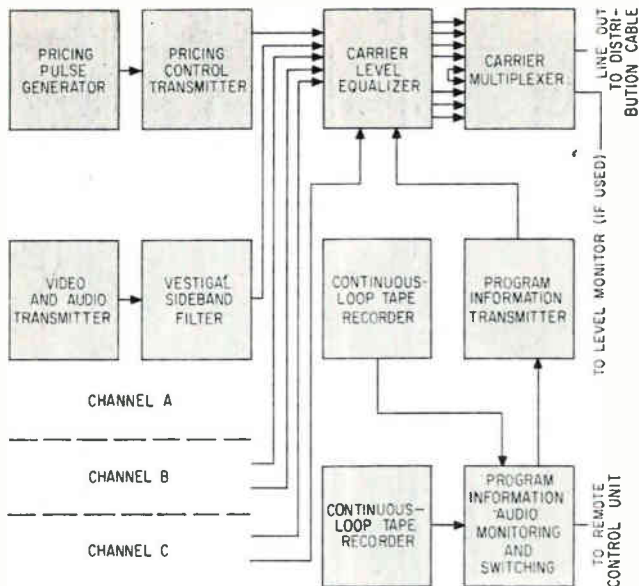

FIG. 2—Transmitting equipment delivers approximately +40 dbmv r-f output. A preset control permits relative adjustment of audio carrier level

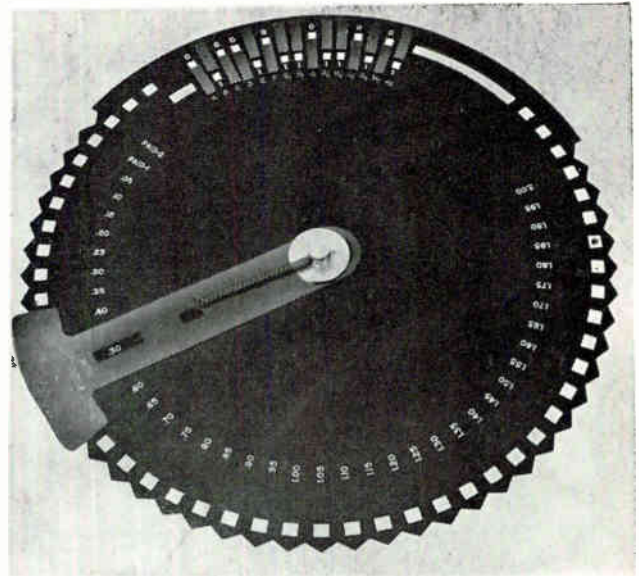

FIG. 3—Synchronously driven rotating disk used to generate price and code information. Unit is removable for easy adjustment of program price and identity code

four carriers is resistively combined with the other carriers of the system to produce two composite outputs at a nominal level of +12 dbmv, referred to any video carrier; all other carriers are at a nominal level of +6 dbmv. One output drives the first amplifier of the distribution system, while the other may be used for monitoring.

The distribution system is based upon a set of amplifiers and filters as shown in Fig. 4. The station is capable of developing 2-v rms across 75 ohms for each of the 3 video carriers, 1-v rms for each of the audio carriers, and 1-v rms for each of the control carriers. Each video carrier, and the program information carrier are independently age controlled.

The Telemeter band is first split into two bands, one above 19 Mc and the other below, and each band is amplified in a repeater amplifier. The output of each repeater is split; one output of each goes to a combining network for the line output and the other output of each is split further to provide the four inputs to the distribution amplifiers. The outputs of the distribution amplifiers are combined in a network to form a distribution point. The line output drives the next distribution station, but never serves subscribers.

Splitting of the input line into bands is achieved in the high-low filter equalizer. This unit comprises a crossover network centered at 19

Mc, an adjustable equalizer in series with the high-band output of the crossover, and an attenuator and adjustable equalizer in series with the low-band output. The cross-modulation between two carriers at +42 dbmv output is less than -7 db referred to 100 percent modulation of the carrier. Total input power is 90 watts an amplifier.

The splitter filter has two hybrid splitters, one for the low and one for the high band. One side of each splitter is connected to a crossover centered at 19 Mc whose output drives the next distribution station. The other side of the low-band splitter is connected to a crossover network centered at 9.3 Mc whose low and high outputs drive the control channel and channel A amplifiers, respectively. The other side of the high-band splitter is connected to a crossover centered between channel B video and channel C audio (the exact frequency depends on whether the channel 5 or channel 6 frequency schedule is used). The low and high outputs drive the channel B and channel C distribution amplifiers.

The distribution amplifiers are of the distributed-line type using constant-K lines. Total input power is 100 watts an amplifier.

The mixer filter combines the outputs of the four distribution amplifiers using three crossover networks. The control channels and channel A are first combined in a crossover centered at 9.37 Mc to

form the low band. Channels B and C are combined in a crossover centered between them to form the high band. The low and high bands are combined in a crossover centered at 19 Mc for delivery to the distribution network.

By splitting the input into two bands for the repeaters and channelizing the distribution amplifiers, the problem of picture deterioration from beats, harmonics and intermodulation is solved. In the repeaters, the carriers that are amplified in common (low band or high band) comprise a first-order beat-free set, that is, all second harmonic or sum and difference frequencies fall outside the band being amplified. Moreover the recombining crossover prevents these distortion products from reaching the line output. The third harmonic and second order beat problems are of little concern because the signal level is low. In the distribution amplifiers, channelizing the inputs eliminates all problems caused by harmonics and beats and the circuits in the mixer filter prevent distortion products from reaching the distribution output.

In any composite system, additional crossovers, centered at 46 Mc, will be used to separate and recombine the Telemeter and vhf channels, permitting them to be amplified separately and avoiding further problems of beats and harmonics. In such systems, crossovers can segregate subscribers

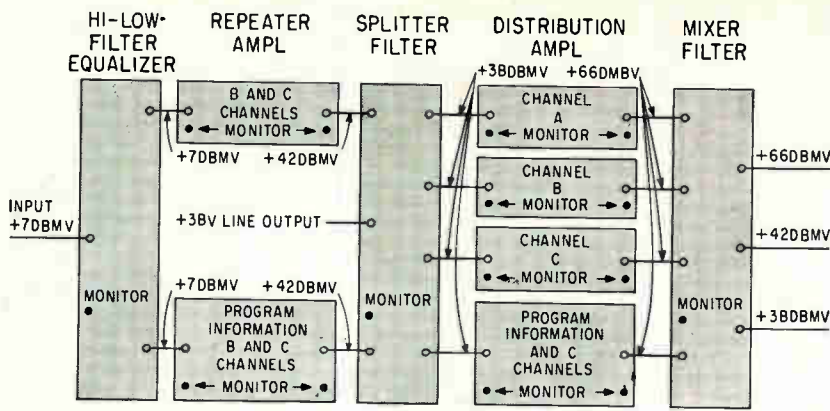

FIG. 4—All amplifiers in distribution equipment have self-contained power supplies using a plug-in bridge-type silicon rectifier

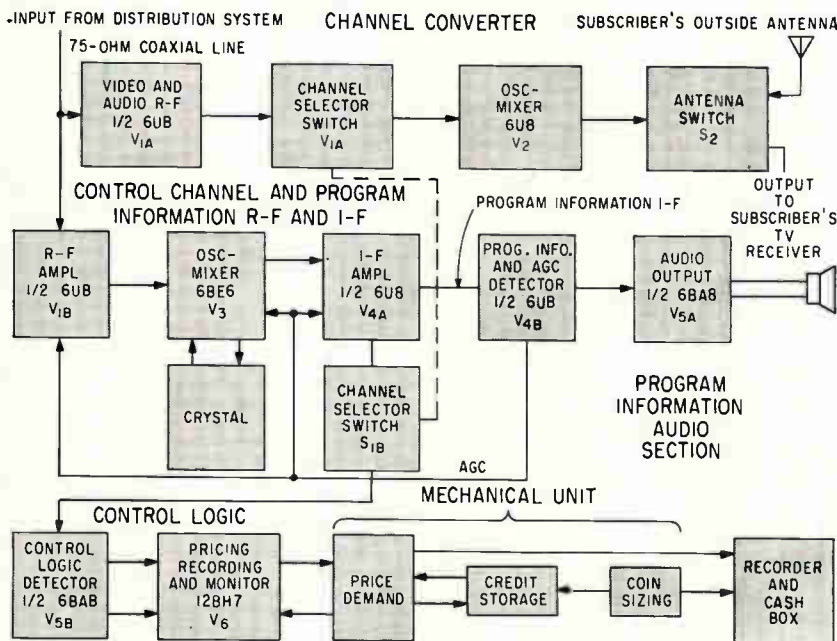

FIG. 5—Despite its many functions, the subscriber attachment contains a total of only six tubes and a rectifier

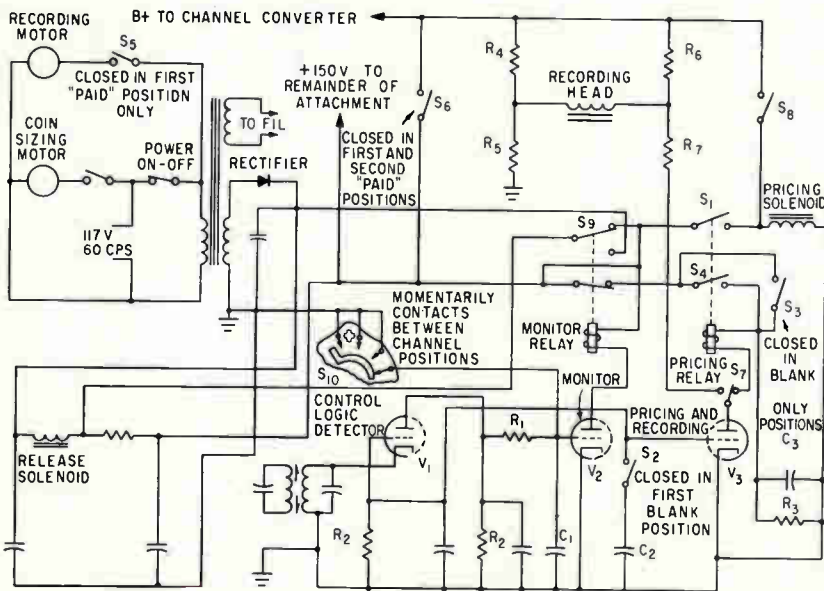

FIG. 6—Control logic circuit for the subscriber attachment provides price and code modulation signals, and monitor voltages

from nonsubscribers.

Although each distribution amplifier amplifies only a single channel, they are all broadband. This arrangement was decided upon after comparing tuned amplifiers and broadband amplifiers with filters. An important consideration is the arbitrary rule that every stage in the amplifiers shall have at least two tubes in parallel to increase reliability and to permit routine tube replacement without interrupting service. Another consideration is the relatively low ratio of center frequency to bandwidth, particularly on channel A. Both of these factors severely limit the impedance of a tuned amplifier making it less desirable than a broadband amplifier. Several other reasons for using broadband amplifiers are: the impedance match of a distributed amplifier is better than a tuned amplifier; distributed amplifiers require no alignment; the frequency response of a distributed amplifier is substantially independent of agc voltage and, moreover, is independent of tube characteristics, local heating and the like; and the four amplifiers are practically identical in construction. The vswr of all input and output terminals is 1.1 or better.

Signals to the subscriber attachment (Fig. 5) are received at the input to the attachment through a tapoff from the coaxial cable system. Video carriers are received at a nominal level of 1 mv (0 dbmv). All other carriers are at -6 db with respect to the video carriers. Permissible tolerance in level at the input is -6 db +12 db with respect to the nominal, a tolerance that is satisfied by the distribution system.

The input cable is terminated in 75 ohms by the input impedance of grounded-grid r-f amplifier V_{1A} seen through a wide-band transformer that accepts the spectrum from 8 to 40 Mc. Channel selector switch S_{1A} has four positions, OFF, A, B, and C, and selects the channels by switching incremental sections of a double-tuned bandpass filter that couples the plate of V_{1A} to the mixer grid of the V_2 . Enough r-f gain is obtained to ensure a reasonable noise performance from the con-

verter section; the overall noise figure is approximately 8 db.

Tube V_2 is a triode-pentode oscillator-mixer and the triode oscillator is tuned with preset trimmers to fixed frequencies by S_{1A} . The frequency stability is compensated to better than ± 100 Kc. The mixer plate load is a quadruple-tuned bandpass filter, providing excellent response and efficient rejection of all unwanted frequencies outside the converted channel 5 or 6. Output of the quadruple-tuned circuit is coupled to the subscriber's tv receiver through a resistive T-pad and a 75 to 300-ohm balanced transformer. The T-pad serves as an isolation network and is chosen to reduce the overall transfer power gain to a nominal 3 db. High-quality reproduction of both color and monochrome transmissions is assured by the 6-Mc overall bandwidth of the converter.

Antenna switch S_2 allows the subscriber to select either the output of the converter or the outside programs from his antenna as an input to his tv receiver.

Pentode r-f amplifier V_{1A} accepts and amplifies the program information carrier and control carriers A, B and C whose frequencies are 8.390, 8.475, 8.525 and 8.575 Mc. The plate circuit of this stage comprises a double-tuned r-f transformer tuned to 8.5 Mc with a bandwidth of 200 Kc, which couples to the input of a pentagrid mixer V_3 . The mixer stage has a crystal oscillator operating at 8.125 Mc and, after mixing, the resulting control i-f frequencies are 350, 400 and 450 Kc and the program information i-f frequency is 265 Kc. Mixer plate circuit is aperiodic so all these i-f carriers are presented to the grid of pentode i-f amplifier V_{1A} .

The plate load of V_{1A} consists of the primary windings of two i-f transformers in series. One transformer is tuned always to 265 Kc and delivers the program information i-f carrier to audio and agc detector V_{4A} . The other transformer is tuned by the channel selector switch S_{1A} to select either control i-f A, B or C. Switch S_{1A} connects preset trimmers in parallel with both primary and secondary for this function and the selected control carrier is demodulated by control logic detector V_{5B} . Both sets of detectors use triode tube sections

connected as dual diodes.

The program information carrier furnishes agc to all three stages and the delay is set to yield approximately 20 volts each of detected audio and control signals. The overall gain and agc characteristics are adjusted for correct operation of the attachment with input signal variations from 250 μ v to 2500 μ v.

Audio from detector V_{4A} drives audio output pentode V_{5A} directly through a volume control. The power output to the loudspeaker is 0.6 watt at 10 percent distortion.

Two signals are obtained from the control logic detector (Fig. 6). One output—the price and code modulation—is d-c connected to the grid of pricing and recording tube V_6 ; the pulses have sufficient amplitude to drive the tube from cutoff to full conduction. The other output is a negative d-c monitor voltage derived from the integrating time-constant C_1R_1 which controls monitor tube V_7 . Each price pulse causes V_6 to conduct, actuating the pricing relay and closing switch S_1 , which in turn energizes the pricing solenoid. This solenoid steps a pricing indicator wheel from rest position (first blank position), in increments of 5 cents, to the price asked. The price indicator is constrained from returning, under spring tension, to its blank position by the release solenoid. This solenoid is energized by the B+ current of the attachment, and is the B+ filter choke.

The beginning of the price sequence is recognized by a time-constant C_2R_2 . At the first blank position, the price indicator closes switch S_2 which introduces C_2 in parallel with the detector load R_2 . Only during the 0.5-second start-pricing pulse will the grid voltage of V_6 reach such a value that this tube will conduct and advance the price indicator from the first blank to the second blank position. Switch S_2 now opens and the subsequent short price pulses can be resolved by the detector. Tube V_6 is now turned on by every pulse and the price indicator steps in 5 cents increments to the price demand being transmitted.

The end of the price sequence is also recognized by a time-constant C_3R_3 and the logic uses switch S_3 which is opened by the price indicator in all positions except the

blank positions and S_4 , a second switch on the pricing relay.

Capacitor C_3 initially charged by S_3 in the bank positions of the price indicator, furnishes B+ current for V_6 . After S_3 has opened, the charge on C_3 is replenished by S_4 once during every short pulse. During the 0.5-second end-pricing interval however, the capacitor has time to discharge through R_3 and the pricing circuit becomes inoperative. Subsequent pulses at the grid of V_6 are ignored, as the tube has no plate voltage.

Assuming that the subscriber now purchases the program, the price indicator is advanced to the first paid position, closing switches S_5 and S_6 . Switch S_5 supplies B+ to the channel converter, permitting the subscriber to view the program. Switch S_6 furnishes a-c power to the motor which drives the tape recorder. The recording motor turns a cam which, after 4 seconds, moves switch S_7 over to the recording position; V_7 now drives the recording head with the composite waveform existing at its grid through bridge circuit R_4 , R_5 , R_6 and R_7 . After 8 seconds, enough time for at least one complete identity code sequence to be recorded, the cam momentarily closes switch S_8 energizing the pricing solenoid and advancing the price indicator to the second paid position. Switch S_7 returns to its original position, S_5 opens and the recording cycle is terminated. Switch S_6 is closed in both the first and second paid positions of the price indicator.

At the grid of monitor triode V_7 , the d-c signal level is about -10 volts, holding the tube at cutoff. At the end of the program, the control carrier is switched off at the transmitter and the monitor signal disappears. The monitor relay is energized, causing relay contacts S_9 to short circuit the release solenoid, which allows the price indicator to return to blank. The subscriber is dropped out. The price indicator also returns to blank if channel selector switch S_{10} is turned as a result of momentarily short-circuiting C_1 . The time-constant C_1R_1 is long enough to accommodate the mechanical time lag involved. If the unit is switched off, the price indicator returns to blank due to de-energization of the release solenoid.

ALL-PURPOSE COMPUTER

AUTOMATICALLY CONNECTED TO SOLVE SPECIFIC PROBLEMS

Photoconductor matrix is connected to form different logic combinations by changing the pattern of illumination. Concept can be extended to a logic system able to repair itself

By R. J. DOMENICO

R. A. HENLE,

IBM Product Development Laboratory,
Poughkeepsie, N. Y.

NEED FOR COMPUTERS to solve a restricted class of problems at maximum speed and minimum cost has become increasingly important in recent years. In process control, special computers have been designed and built only to analyze data obtained from terminal sets and feed back information to control a process. The military requires guidance, bombing and navigational computers. In the commercial area there are many data processing and scientific problems which require specialized equipment to minimize cost and processing time. The loss in flexibility of this equipment can be reconciled, since the problems for which the equipment is designed must be solved on a continual basis. A general-purpose machine that retains the advantages of the special-purpose machine with no loss of flexibility should attain wide

acceptance. A machine whose components can be connected to represent logically any computer would meet this requirement. With this ability, the system could be arranged to solve the special problem with maximum efficiency. A system that could be arranged under control of either the program or the operator would have this flexibility. This flexibility can be extended into concepts of self-repair.

Figure 1A is a generalized matrix. With proper matching of the amplifiers and the components used at the cross points, it is possible to connect the output of any one of the amplifiers to the input of any other amplifier through the matrix. The amplifier could be simple or complex logic blocks whose outputs would be a fixed logic function of the input. Some of these amplifiers could be arithmetic units, sections of registers, rings or combination logic. The components at the intersections could be resistors, diodes, capacitors, transformers and even direct connections, depending on the char-

acteristics of the amplifiers used. Figure 1B shows a transistor-resistor logic (TRL) block. The logic statement of the block is that of the OR inverter, also known as a NOR circuit. This is a building block from which can be constructed all the logic statements required in a computer system.

A logic 1 is defined when the output is at its most positive level or the transistor is off. For this condition all of the inputs must be at the logic 0 level or ground potential. Thus the logic statement is $\bar{A} \cdot \bar{B} \cdot \bar{C}$, or, using DeMorgan's theorem, $\overline{A + B + C}$. With this circuit the inversion takes place in the transistor and the OR operation in the resistors. If the input resistors are replaced by photoconductors and illuminated so as to reduce their resistance to the same value as the input resistors, the new circuit will operate exactly as does the original OR inverter block. The number of active inputs to an inverter is determined by the number of photocells illuminated, the limit being the same as in the case

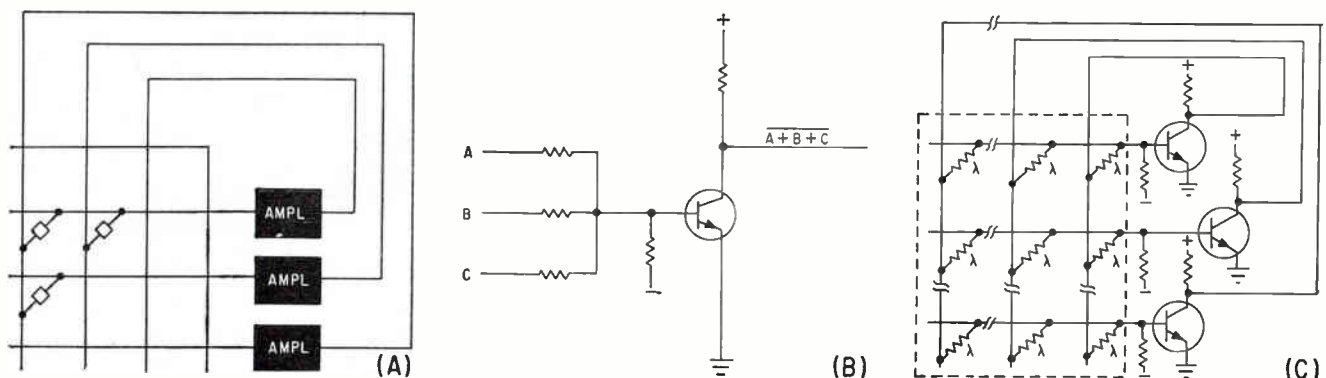

FIG. 1—Generalized matrix (A) can be connected in various ways; logic block (B) is OR inverter; photoconductor control matrix (C) is activated by light patterns

CIRCUITS

Checking resolution of magnified test pattern in small adaptive logic model

of resistors. However, by using photoconductors with a dark resistance greater than ten megohms, the total number of possible inputs, active and inactive, can be as high as 200, depending on d-c design tolerance limits.

Figure 1C shows an array of photoconductors with the horizontal lines connected to the inputs of the transistor amplifiers. The outputs of the transistor amplifiers are connected to the vertical inputs of the photoconductor matrix. By projecting a pattern of light on these photoconductors any combination of logical interconnections can be achieved. Extending this concept, a machine could be constructed from a number of small arrays or from one very large array.

There are several limitations that restrict the size of the system. The number of intersections is equal to the product of the number of input lines and the number of output lines to the amplifiers. For a thousand-transistor system with 100 percent flexibility of logic interconnections, one million photoconductors would be required. There are two limitations: size and illumination energy. Assuming an incandescent source, it has been determined that to illuminate a CdSe photoconductor matrix, dimensioned to allow 50 intersections a square inch and reduce the resistance to approximately 7,000 ohms, approximately 50 mw of source power per intersection is required. Therefore 50 kw of power would be required to control this matrix of one million photoconductors. Nevertheless, the number of photoconductors can be reduced to a reasonable number. First, the ma-

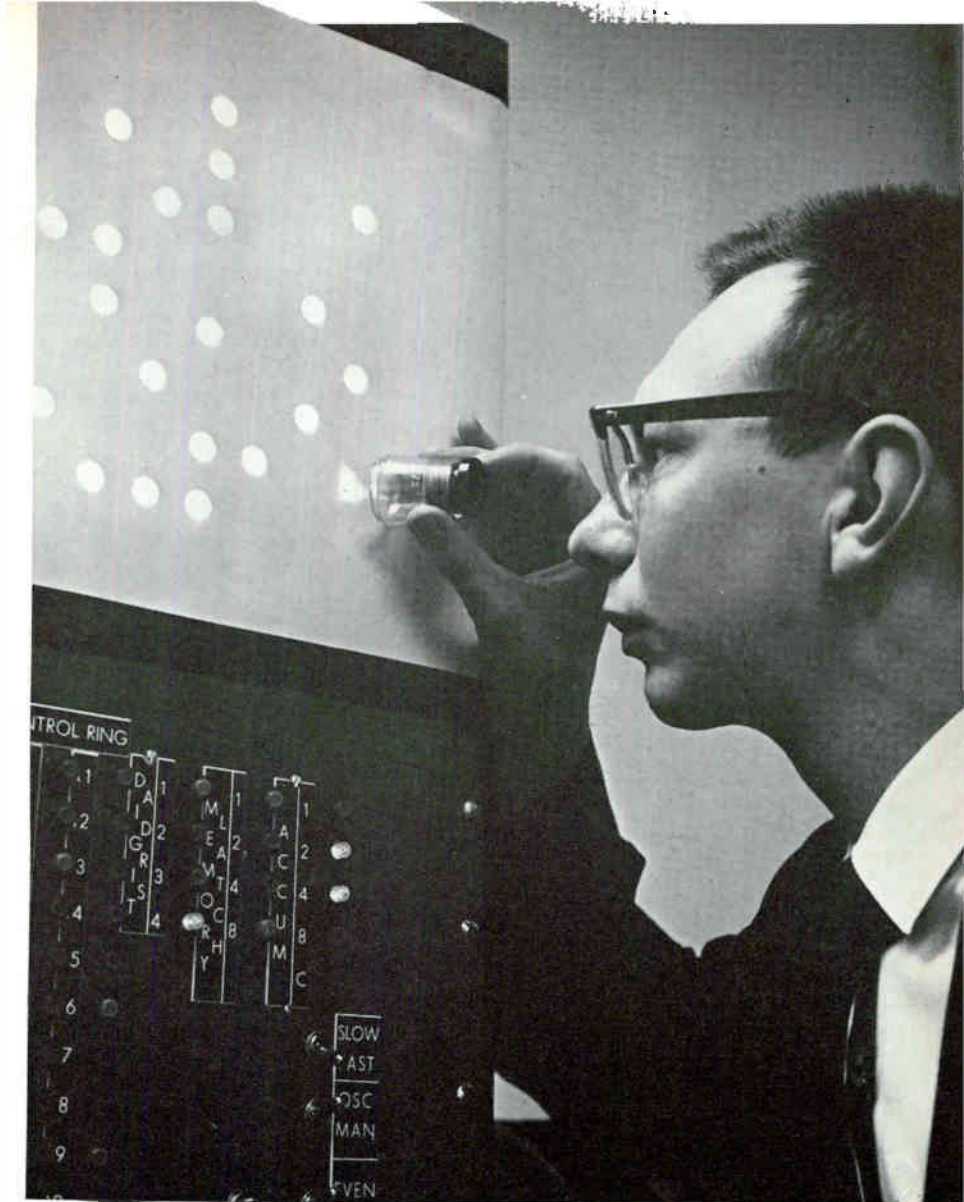

trix as shown has 100-percent flexibility; that is, the output of any block can be connected to the input of any other block. In general, this flexibility is not required. By choosing a section of the matrix about the main diagonal, flexibility is reduced; however, considerable freedom remains in the choice of interconnections. The percentage of flexibility is related directly to the number of photoconductors; that is, to have 10 percent flexibility, only 10 percent of the photoconductors are required. Another technique that reduces the number of photoconductors is to use complex logical statements in place of the simple blocks.

A photoconductor appears most satisfactory as the matrix element. It can be stimulated by light and therefore can be selected relatively inexpensively. It promises to be a low-cost, batch-fabricated device,

adaptable to low-cost logic and switchable at electronic speeds.

Figure 2 shows a block representation of an adaptive logic system in which the control matrix connects the logic circuits and brings the memory, input and output lines into the circuit under the control of a pattern generator. This pattern generator could be a light projector with an internally stored film library, a cathode-ray tube, or an electroluminescent matrix used with another memory to store the predetermined pattern. One system application would be a light pattern connecting the logic circuits to form the organization of a special-purpose computer. This organization would include all of the data-flow paths, control wiring and the input and output wiring. A second approach would be to use the control matrix to connect the logic circuits to do specific machine

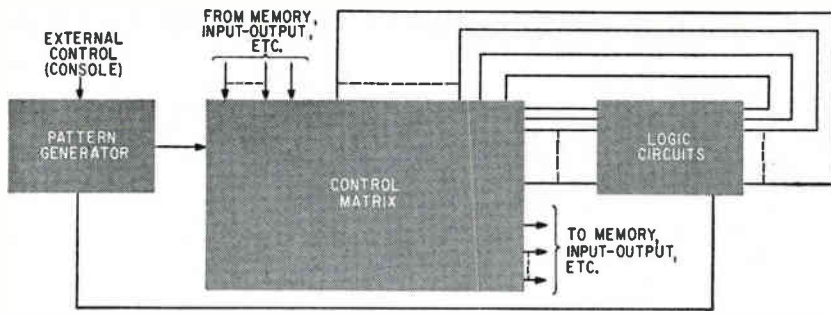

FIG. 2—Adaptive logic system shows logic circuits controlled by matrix

operations. This approach would allow maximum use of circuits. As an example, three preselected patterns could be designed. The first connects the logic circuits as an input computer, encoding input information and placing this information into the memory. The second pattern connects the logic circuits so that the machine becomes a processor, with no outside communication. The third pattern connects the logic circuits into an output computer, decoding the processed information and passing it to an output unit.

With the pattern generator under the control of the logic circuits, it is possible to achieve a logic system with self-repair capabilities. To locate a faulty component in a malfunctioning system, the field engineer will often use a block replacement system whereby a block known to be good is used to replace suspected blocks until the faulty

block is located. When the block that has failed has been replaced, the system resumes normal operation. The flexibility of the photoconductor matrix approach allows the same type of replacement procedure to be done systematically. By adjusting the light patterns it is possible to disconnect each of the logic blocks one at a time, continually monitoring the output to determine when the faulty component has been located.

Figure 3 shows one way a spare block, block No. 4, could be used to service a three-transistor TRL oscillator. Figure 3A shows the original circuit connection and photoconductor matrix pattern. In Figures 3B, 3C and 3D, block 4 has been used to replace blocks 1, 2 and 3. With this method of servicing the original circuit can be repaired and the faulty block isolated.

Figure 3E shows use of this re-

pair method on a matrix of circuits. The matrix interconnects three logic blocks plus the spare block, in the oscillator mode. In addition, a set of photoconductors selects an output and sends it through an error detector circuit to the pattern generator. When an error is detected, a signal is sent to the pattern generator to start a repair mode. The signal shifts the pattern one position along the diagonal so that the entire pattern moves down to remove one of the transistors. To remove one transistor, it is necessary to eliminate both the column and the row from the pattern. As the pattern shifts, the error-detecting circuit will continue to signal for new patterns until the circuit is functioning properly. The location at which the light spot stops in the output diagonal indicates which of the transistors was removed in repairing the circuit. To achieve this self-repairing feature it is necessary that each of the amplifiers controlled by the matrix be identical. However, each amplifier may be a complex logic statement in itself. In addition, a full matrix is used since full flexibility is required to eliminate a faulty component or circuit. The pattern generated on a film strip to allow self-repair is regular. Each of the light spots moves along its own diagonal and when all meaningful combinations have been exhausted, the pattern repeats.

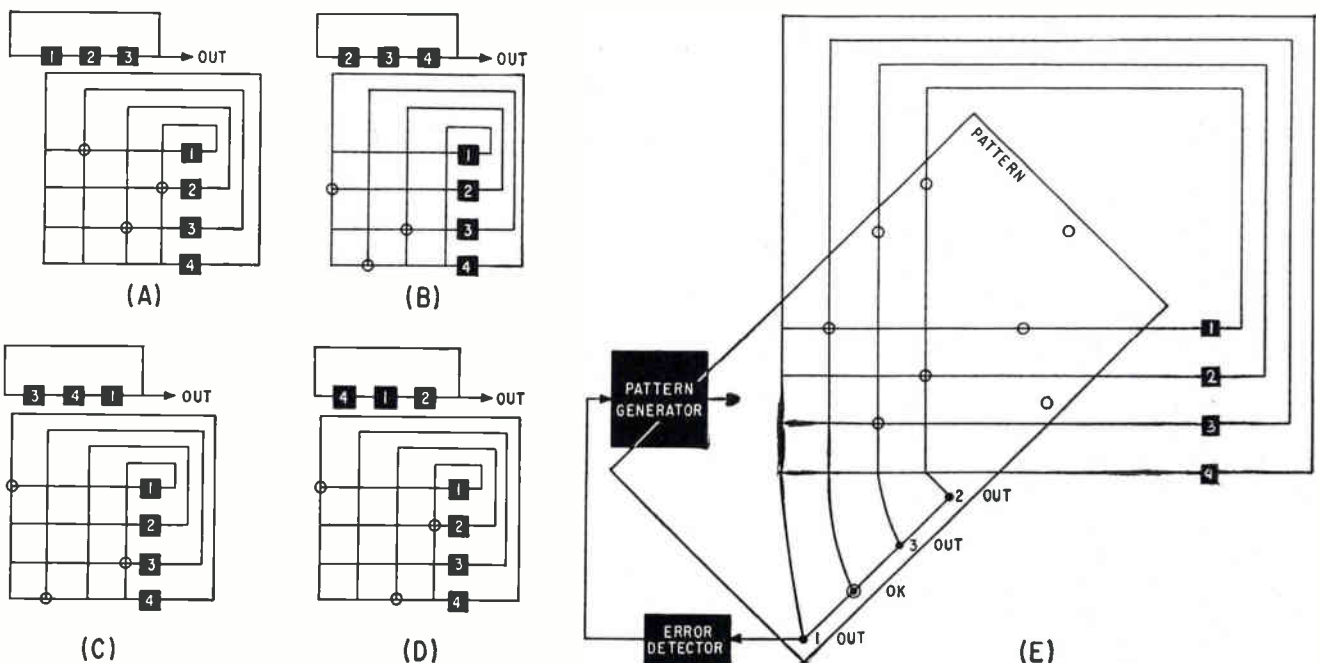

FIG. 3—Matrices for 3-block oscillator (A-D) show successive arrangements as pattern (E) is shifted along the diagonal

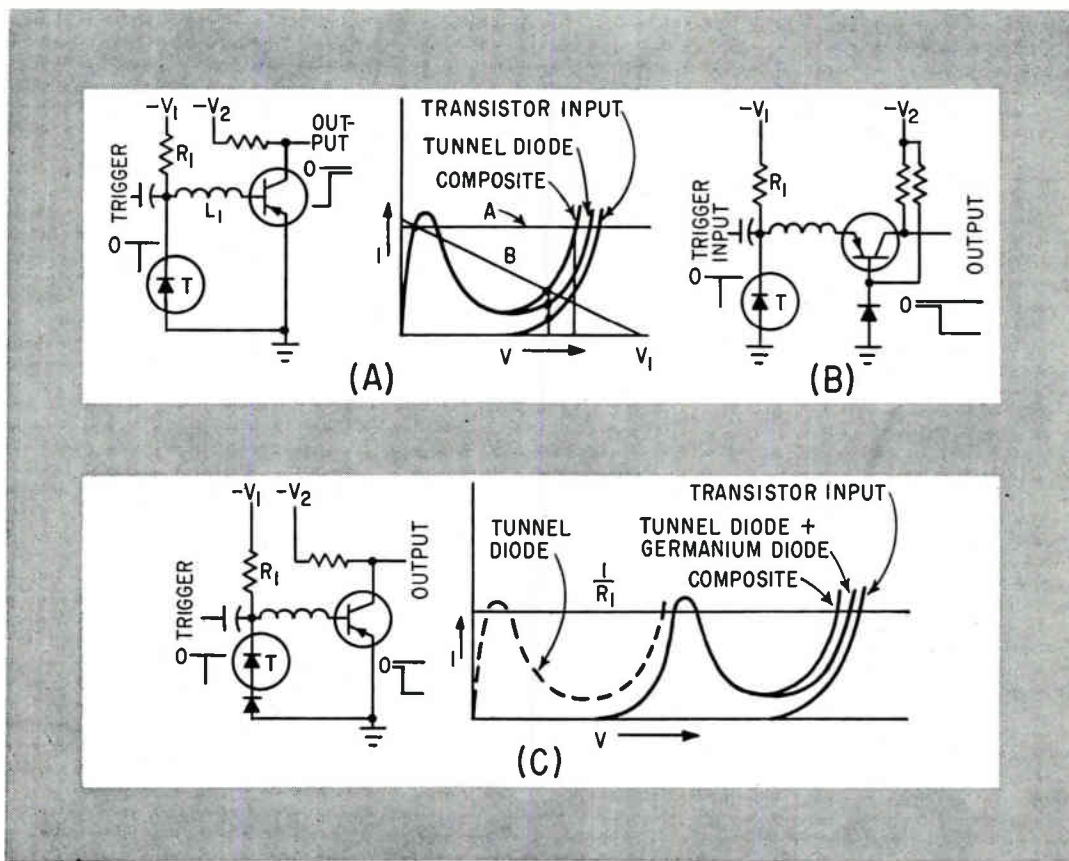

FIG. 1—Binary memory element (A) produces an inverter function; noninverting circuit is shown in (B). Silicon transistors can be used in the bistable memory element of (C)

Combining Transistors With Tunnel Diodes

Bistable memory elements and circuits with N-type characteristics can be obtained with transistor-tunnel diode combinations.

Here are some examples

By CARL DAVID TODD, Advanced Applications Section, Hughes Semiconductor Division, Newport Beach, California

BY COMBINING the tunnel diode with transistors, it is possible to take advantage of the favorable features of both devices. This article illustrates several methods of combining tunnel diodes and transistors. Circuits are shown for *pnp* transistors; however, they may be used with *npn* transistors if the diode and all power supplies are reversed.

Because of their high speed, tunnel diodes operated in a bistable mode will respond to short-duration trigger pulses. Because the output voltage level is low, the tunnel diode is difficult to use.

A transistor, on the other hand, operates at a much higher voltage level, though its ability to respond to short trigger pulses is not as great. Also, two transistors are normally required to achieve a bi-

stable condition. A combination of the tunnel diode and the transistor to take advantage of the desirable features of both devices could prove useful. Figure 1A shows one method of obtaining a binary memory element.

The supply voltage, V_1 , and load resistor, R_1 , are chosen such that the load line intersects the composite d-c characteristic curve at two stable points.

If it is desirable to have only high-speed—low-power triggering from one condition to the other, with resetting by some other means (such as supply disconnect or a high current reset pulse), then the load line might be A in Fig. 1A. Both V_1 and V_2 may be the same supply, and they can be any voltage that does not exceed the ratings of the transistor.

A requirement that the circuit be capable of resetting from a low-power trigger of the opposite polarity requires a load line similar to B in Fig. 1A. Here V_1 must be on the order of 500 millivolts, though it may be derived from the V_2 supply by a low-resistance voltage divider.

The small inductor, L_1 , between the tunnel diode and the base of the transistor isolates the shunt capacitance and resistance of the transistor input from the triggering source, thus allowing faster triggering. Ringing is possible but will normally be negligible.

The circuit of Fig. 1A removes the negative output voltage upon the appearance of a negative input pulse, thus producing inversion. Often this presents no problem and may even be desired.

Figure 1B shows how a noninverting circuit might look. The transistor is used in the common-base configuration and a germanium diode is used to bias the transistor ON, provided the tunnel diode is in the low-voltage state. A resistive divider could be used for the bias if the h_{FE} of the transistor is large, although the diode method gives some temperature drift compensation. A trigger switching the tunnel diode to the high-voltage state will cause the transistor to be turned off. The collector current level for a tunnel diode is lower for this circuit than the level for the circuit of Fig. 1A because of the

absence of the common-emitter current gain.

The limited voltage swing for germanium tunnel diodes is not adequate to allow a silicon transistor to be used in the circuit of Fig. 1A. A fixed bias in series with the base-emitter loop to aid the tunnel diode voltage will allow the circuit to operate. One approach is shown in Fig. 1C.

Some of the tunnel diodes using intermetallic compounds such as gallium arsenide have a much larger voltage swing and, thus, for some circuits, it may be possible to use them with silicon transistors without additional bias voltages.

One advantage of using a junction diode to develop the bias voltage is that the voltage change with temperature will be similar to that for the emitter-base diode.

Just as transistors may be used to modify the operating current level of breakdown diodes, they may also be used to increase or decrease the operating current level of tunnel diodes.

If the tunnel diode is placed in the emitter circuit as shown in Fig. 2A, the operating current will be decreased by $(h_{FE} + 1)$. A voltage offset will also occur as illustrated by the input characteristic curve of Fig. 2A. Replacing the shorting

jumper between C and D with a bias source will reduce this voltage offset. Point C should be made positive with respect to point D.

Using a silicon transistor such as the Hughes 2N1255 mesa transistor in this circuit will permit operation at 20 microamperes using a tunnel diode with a peak current of one milliamper.

An additional feature of the circuit shown in Fig. 2A is the availability of two output terminals. Point B is a low-voltage output terminal and is the algebraic sum of the voltage across the tunnel diode and the bias voltage between points C and D. Output terminal A can have a large voltage swing for switching.

Figure 2B illustrates how the operating current level of a tunnel diode may be increased by a factor approximately equal to the h_{FE} of the transistor.

The voltage offset illustrated in Fig. 2B is due to the base-emitter voltage drop of the transistor. A low-impedance bias source placed in series with the composite such that the emitter sees a positive voltage can largely correct for this voltage offset. A small bias source may be placed in series with the tunnel diode, with such polarity that the base of the transistor is

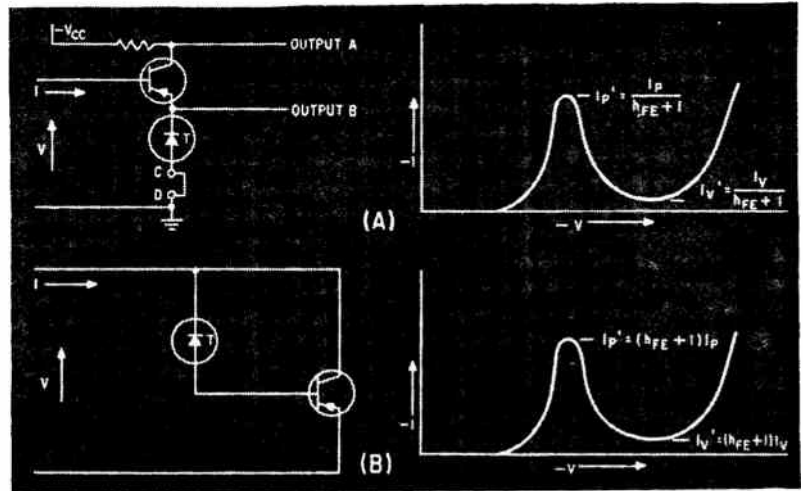

FIG. 2—Transistors may be used to decrease the operating current level of the tunnel diode (A) or to increase the current level (B)

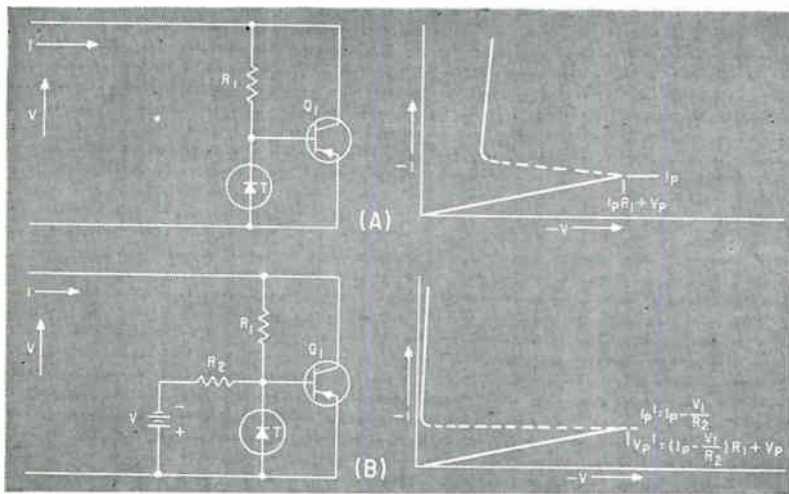

FIG. 3—Transistor-tunnel diode N-type circuit (A) is improved by adding a current bias source (B)

made slightly negative. Output resistance requirements for a bias supply used in the second way will be much less stringent than a supply in series with the composite unit.

Transistors may be used to modify the operating current levels of tunnel diodes. However, the composite unit will not possess the high-speed characteristics of the tunnel diode alone and stabilization of the composite device within the negative resistance region may be impossible. The main use of the circuits would be in low- to medium-speed switching or in medium-frequency relaxation oscillators below 1 megacycle.

Tunnel diodes are voltage stable, short-circuit stable, or more commonly referred to as belonging to the S type of negative resistance device. The voltage levels are relatively low for many applications and low-frequency relaxation oscillators using tunnel diodes require large inductances.

The circuit of Fig. 3A illustrates how to get an N-type characteristic with a transistor and tunnel diode. As the terminal voltage is increased from zero, transistor Q_1 is not conducting since the base-to-emitter voltage is too low. The equivalent circuit is thus only the tunnel diode

and resistor R_1 , until the current exceeds the diode peak current.

Then the voltage across the tunnel diode increases sharply, turning transistor Q_1 on. As long as the current through the diode is greater than the valley current, transistor Q_1 will conduct and a terminal voltage will yield a much higher current than before triggering. The slope of the characteristic in the ON region will be less than for the low-current OFF state. The a-c OFF resistance will be approximately equal to R_1 and the resistance for the ON condition will approach R_1 divided by the h_{FE} of the transistor.

The valley conditions for the circuit of Fig. 3A are a function of the gain of the transistor and the relative shapes of the tunnel diode and the transistor input characteristic curves. At best, the valley voltage will be approximately equal to the product of R_1 and the valley current of the tunnel diode.

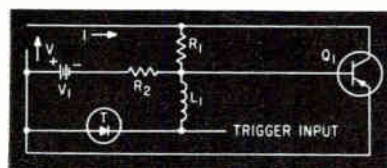

FIG. 4—Circuit with N-type characteristic is modified for high-speed triggering

The efficiency of the circuit as a switch is impaired by the voltage drop needed to maintain the valley current. The circuit of Fig. 3B uses a current bias source consisting of resistor R_2 and voltage source V_1 to decrease the valley current and, hence, the voltage drop in the ON state.

It is convenient to make the bias current slightly less than the valley current of the tunnel diode-transistor input composite characteristic. The sustaining current from the terminals is then a function of the difference between the valley current of the composite and the bias current and, hence, is considerably lower than for the previous circuit. An additional effect is the decrease in the triggering current for a given diode and firing voltage, and an increase of the OFF resistance.

As before, the valley conditions of the circuit of Fig. 3B will be a function of the transistor gain and the relative shapes of the tunnel diode and transistor input characteristic curves. By control of the bias current, this valley voltage may be made low.

The circuit of Fig. 3B may be modified one step further as shown in Fig. 4 to allow triggering of the tunnel diode directly, thus taking advantage of its ability to respond to a trigger of short duration. The small inductor, L_1 , isolates the circuit from the tunnel diode, thus allowing the greatest efficiency and speed of triggering. When the circuit is used with a current source and a capacitor to form a relaxation oscillator, this additional trigger input becomes the point at which to apply a synchronization signal.

BIBLIOGRAPHY

- I. A. Lesk, N. Holonyak, Jr. and U. S. Davidson, The Tunnel Diode—Circuits and Applications, *ELECTRONICS*, p 60, Nov. 27, 1959.
- W. F. Chow, Tunnel Diode Logic Circuits, *ELECTRONICS*, p 103, June 24, 1960.
- U. S. Davidson, Y. C. Hwang, G. B. Ober, Designing with Tunnel Diodes, *Electronic Design*, p 50, Feb. 3, 1960.
- W. W. Gartner, Esaki or Tunnel Diode, *Semiconductor Products*, 3, No. 5, p 31, May 1960 and 3, No. 6, p 36, June 1960.
- E. Goto, et al, Esaki Diode High-Speed Logical Circuits, *Trans IRE*, EC-9, No. 1, p 25, Mar. 1960.
- R. A. Pucel, Physical Principles of the Esaki Diode and some of its Properties as a Circuit Element, *Solid State Electronics*, 1, No. 1, p 22, Mar. 1960.
- T. P. Sylvan and Erich Gottlieb, Tunnel Diodes as Amplifiers and Switches, *Electronic Equipment Engineering*, p 64, May 1960.

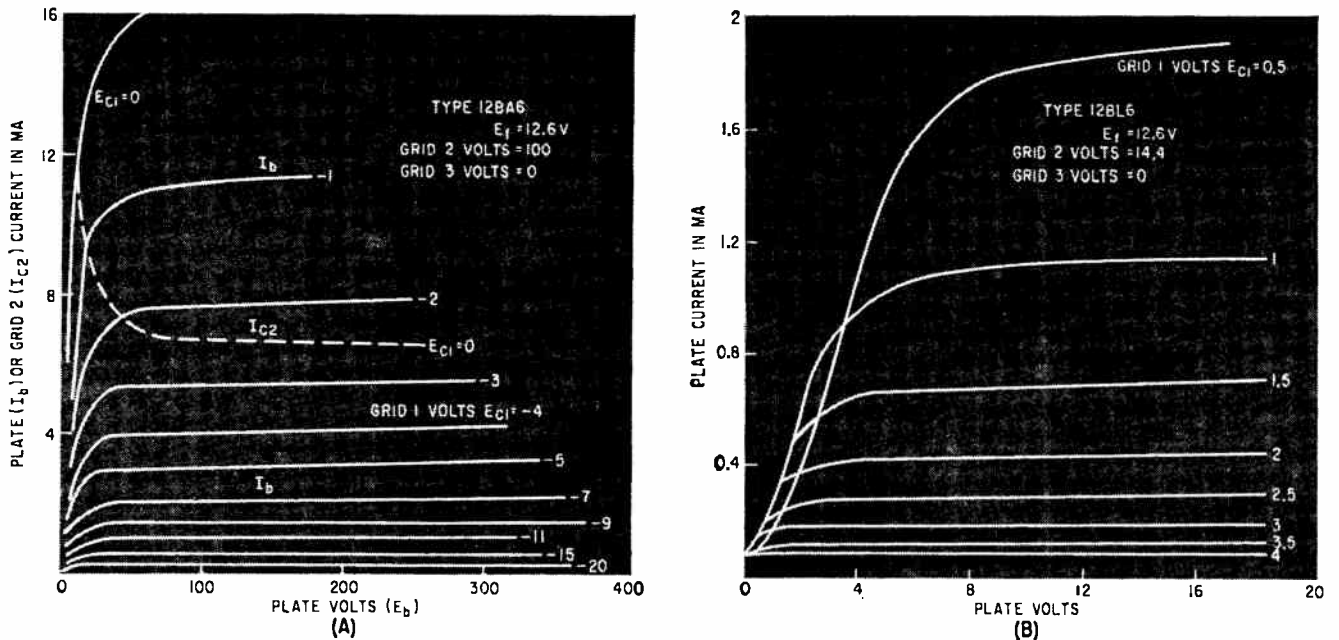

FIG. 1—Comparison of plate characteristics of r-f and i-f tubes: (A) 12BA6 high-voltage tube, (B) 12BL6 low-

Design of Mobile Receivers

By C. GONZALEZ

R. J. NELSON

Electron Tube Division,
RCA, Harrison, N. J.

TUBES WITH low plate and screen-grid potentials that operate directly from an automobile battery have shown advantages in automobile receivers at broadcast frequencies. Elimination of vibrator, power transformer and associated circuits has saved space. Also, overall power consumption and hum level have been reduced with a resultant increase in the efficiency and reliability. Many of the requirements of mobile communication receivers operating at higher frequencies are the same as those of mobile broadcast receivers.

This article presents performance data on several low-potential tubes at frequencies up to 200 Mc.

Vacuum tubes using low plate and screen-grid potentials have been widely used at frequencies up to 2 Mc in broadcast receivers, but have had little commercial use at frequencies above 10 Mc. At these higher frequencies, however, the

input resistance of an amplifier becomes low enough to have appreciable effect on the gain and selectivity of a preceding stage.

Because these effects might be more severe at low plate and screen-grid potentials, short-circuit input-impedance measurements were made over the range of 50 to 200 Mc. These measurements were made on the 12BL6 and 12EK6 tubes, which are widely used for r-f and i-f applications at low voltages. Figure 1A shows the plate family of the 12BA6 high-voltage r-f and i-f tube. Figures 1B and 1C show the characteristics for the 12BL6 and 12EK6 low-voltage tubes.

Figure 2A shows the input conductance of the 12EK6 as a function of transconductance for several frequencies. At 150 Mc, the 12EK6 has an input resistance of about 400 ohms, corresponding to an input conductance of 2,400 μ mhos. The input resistance increases to 3,700 ohms at 50 Mc, corresponding to an input conductance of 270 μ mhos. The 12BL6 input conductance curves are shown in Fig. 2B. This tube has an input

resistance of 800 ohms (1,250 μ mhos) at 150 Mc and 6,450 ohms (150 μ mhos) at 50 Mc. Both tubes were measured at conditions near the published typical values. The short-circuit output resistance of the 12EK6 (not shown) is 3,333 ohms at 150 Mc and 7,400 ohms at 50 Mc. These values are constant over the full range of transconductance.

A similar curve of input conductance as a function of transconductance for the 6CB6 is shown in Fig. 2C. For this tube the input resistance is 900 ohms at 150 Mc and 6,200 ohms at 50 Mc.

Performance requirements for mobile communication receivers have been defined from experience with high-voltage receivers. Consequently, established values of sensitivity, power output, bandwidth and stability must be maintained as criteria of operation for any receiver using low-potential tubes. The first column of Table I lists the basic performance requirements for this project. This table is based upon Electronic Industries Assn. minimum requirements, which are usually met or surpassed

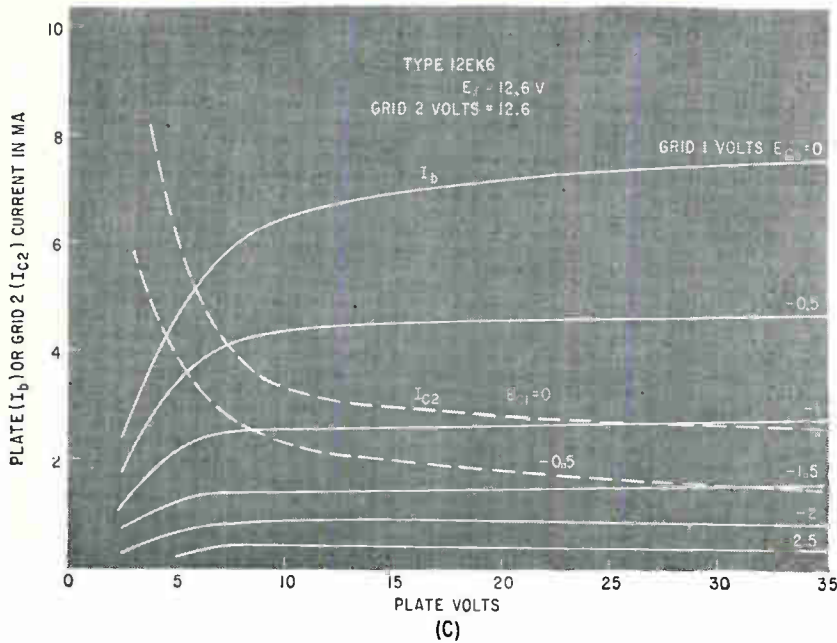

voltage tube and (C) 12EK6 low-voltage tube

Low-voltage tubes used with transistors in communications receiver save space and power, increase efficiency and reliability, by eliminating high-voltage components

With Low-Plate-Potential Tubes

by high-voltage equipment.

In the development of a hybrid or part-tube, part-transistor receiver for operation at mobile communications frequencies, it seemed best to use well-established circuits and techniques. Therefore a typical

high-voltage receiver was used as a guide to the design of a workable hybrid receiver. Figure 3 is the block diagram of the experimental hybrid receiver.

Conventional, readily available, low-voltage tubes are used through-

out. This was done because the use of conventional circuits and components would better show the feasibility of low-potential tube operation at these frequencies. Circuit modifications and the use of dual-purpose tubes could un-

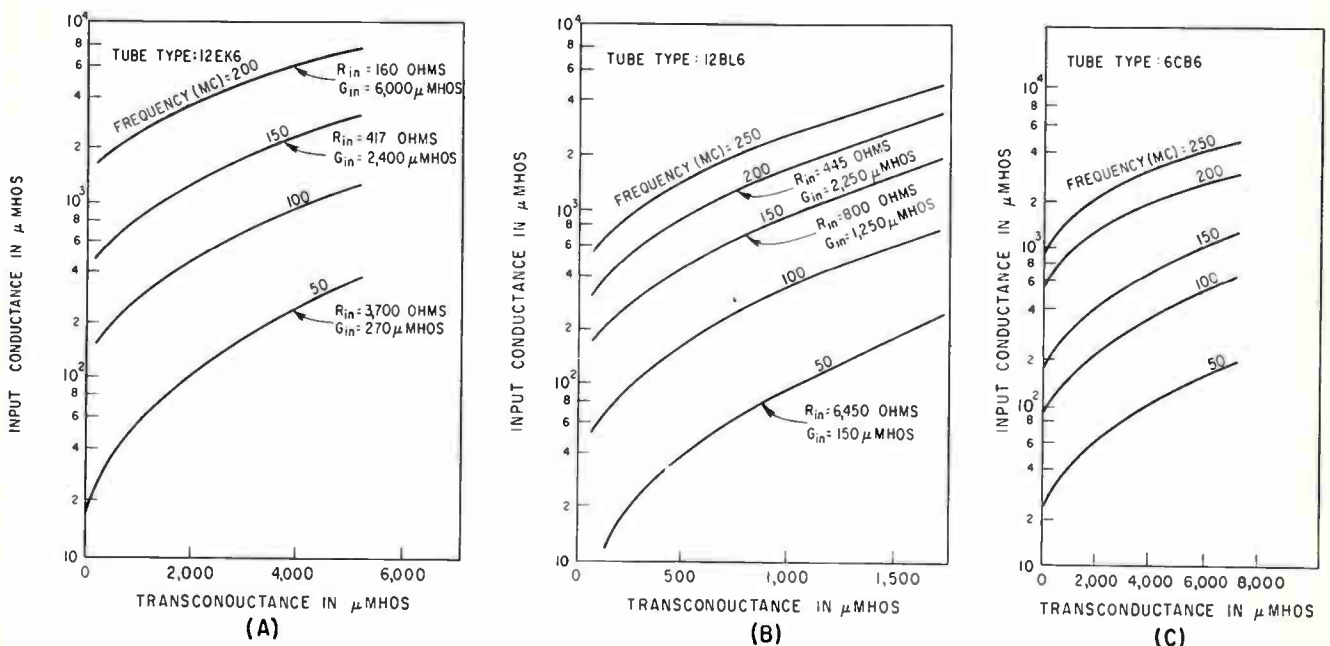

FIG. 2—Input conductance as a function of transconductance for several frequencies: (A) 12EK6 low-voltage tube, (B) 12BL6 low-voltage tube and (C) 6CB6 high-voltage tube

COMPARISON OF PROPOSED AND MEASURED RECEIVER SPECIFICATIONS

	Proposed	Measured
Frequency Range.....	150-175 Mc	175 Mc
Primary Power Source.....	<3.5 amp at 12.6 v	3.5 amp at 12.6 v d-c
Type of circuit.....	Double-conversion superheterodyne using separate crystals for 1st and 2nd oscillators	
Crystal Frequencies:		
1st oscillator.....	13.391-15.475 Mc	15.475 Mc
2nd oscillator.....	11.155 Mc	11.155 Mc
Crystal-Frequency Multiplication:		
1st oscillator.....	12	12
2nd oscillator.....	1	1
Intermediate Frequencies:		
High i-f.....	10.7 Mc	10.7 Mc
Low i-f.....	455 Mc	455 Mc
Selectivity (for adjacent channel)....	> 70 db	70 db
Sensitivity (for 20 db of quieting)....	<1.5 μ v (open circuit)	<1.2 μ v
Squelch.....	Threshold sensitivity 0.75 μ v (open circuit): variable	
Modulation acceptance.....	\pm 5 Kc min (for 30-Kc channel spacing)	\pm 13 Kc
Oscillator Stability.....	\pm 0.003%	\pm 0.003%
Audio Frequency Response.....	300-3,000 cps	300-3,000 cps
Audio Output.....	1 w at <15% distortion	1 w at 9% distortion Squawk=3.2 w at 17%
Image Rejection.....	> 85 db	60 db

doubtedly reduce the tube count and optimize the overall receiver design. The purpose of this project, however, was to evaluate the use of known low-potential tube types in a receiver for the range of 150 to 175 Mc.

The transistor driver and audio output stages and circuits are conventional. The overall gain in the audio section is about 40 db. A communications receiver of this type usually has a squelch circuit to reduce background noise and the resulting operator fatigue during no-signal periods. An approach toward such a circuit was made with a 12AD6 pentagrid tube as a first audio amplifier, as shown in Fig. 4A. The audio signal from the discriminator is applied to grid 3 (signal grid) of this tube. A negative d-c voltage produced by the amplification and rectification of noise voltages which appear at the discriminator output during no-transmission periods is applied to grid 1. This negative voltage cuts off the 12AD6 in the absence of carrier. The quieting effect produced when a signal is received allows the rectified noise voltage to drop to a value that permits the 12AD6 to conduct and amplify the audio signal approximately 5 times.

A double-action squelch results from using the negative voltage at the first limiter grid during signal periods to cut off the 12AD6 noise amplifier. Because there is no conduction in this tube, there will be

no negative rectified voltage to cut off the 12AD6 first audio tube, and it will conduct, allowing the audio signal to pass. Such a system is not critical for improper action of noise bandpass filters or regenerative effects that may be present in the i-f amplifier.

The limiter circuit consists of two stages in cascade, shown in Fig. 4B. The first stage uses a 12EK6, the second a 12B16. The time constants of both grid circuits are relatively short, minimizing the effects of the impulse noise in automobile ignition systems. Limiting begins with input signals of less than one microvolt at the r-f grid.

A Foster-Seely discriminator is used as shown in Fig. 4B. It is conventional in all respects and uses a 12AL5 and a 455-Kc discriminator transformer. No problems were met regarding linearity or inability to meet EIA standard mobile radio requirements for 30-Kc channel spacing.

The two low-frequency (455 Kc) i-f stages shown in Fig. 4C are conventional and use 12DZ6's. They provide a gain of more than 20 par stage with an average bandwidth of 12 Kc. Decoupling at the lower potential is important and may be obtained without a sacrifice in B+ voltage, by inductive-capacitive filter networks rather than the resistive-capacitive networks normally used. Conventional i-f transformers were used throughout.

The low-frequency oscillator cir-

cuit uses a version of a Colpitts crystal oscillator having a tuned plate circuit, as shown in Fig. 4D. More than adequate oscillator injection voltage is obtained from a 12EK6 operating at the crystal fundamental frequency of 11.155 Mc. The other 12EK6 stage shown in Fig. 4D uses no cathode bias and provides a conversion gain of approximately 10.

The two 12EK6's employed as 10.7-Mc (high-frequency) i-f amplifiers provide an overall gain of 400 with a bandwidth of 175 Kc. Commercially available transformers are also used in these stages.

A third-overtone crystal oscillator with two doubler stages is used for the high-frequency oscillator. Figure 4E shows this circuit. To achieve adequate drive for the 185-Mc doubler, it was necessary to insert a stage of straight-through amplification at 90 Mc. This oscillator develops 2 volts of injection at the mixer grid. Although this value is sufficient to provide mixer gain, the mixer gain is not optimized.

The 12EK6 used in the r-f stage, shown in Fig. 4F, receives input signals at 175 Mc. A pi network is used in the grid circuit to couple energy from the antenna, and a double-tuned capacitance-coupled transformer is used in the plate circuit. A gain of 20 is realized from the antenna to the grid of the first 10.7-Mc i-f amplifier.

The measured performance of the experimental receiver using low-potential tubes is compared with the original performance requirements in Table I. It may be seen that these low-potential tubes can perform most of the functions necessary to satisfy mobile receiver-circuit requirements. The disadvantages of the experimental receiver, particularly the excessive tube count in the high-frequency oscillator (which contributes to the overall current drain), the limited squelch operation and less-than-standard image rejection, are problems that can be solved with further development work. However, the requirement of using widely-accepted low-potential tube types reduces the overall design flexibility. The use of less widely accepted tubes for low-potential service would contribute in several instances to more effective circuits.

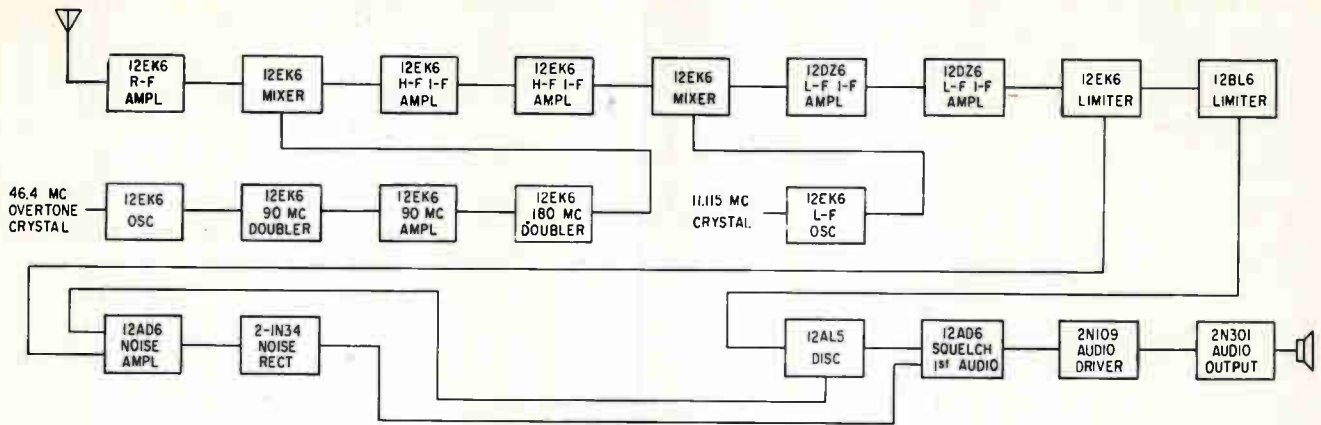

FIG. 3—Block diagram of experimental hybrid receiver for operation at mobile communications frequencies

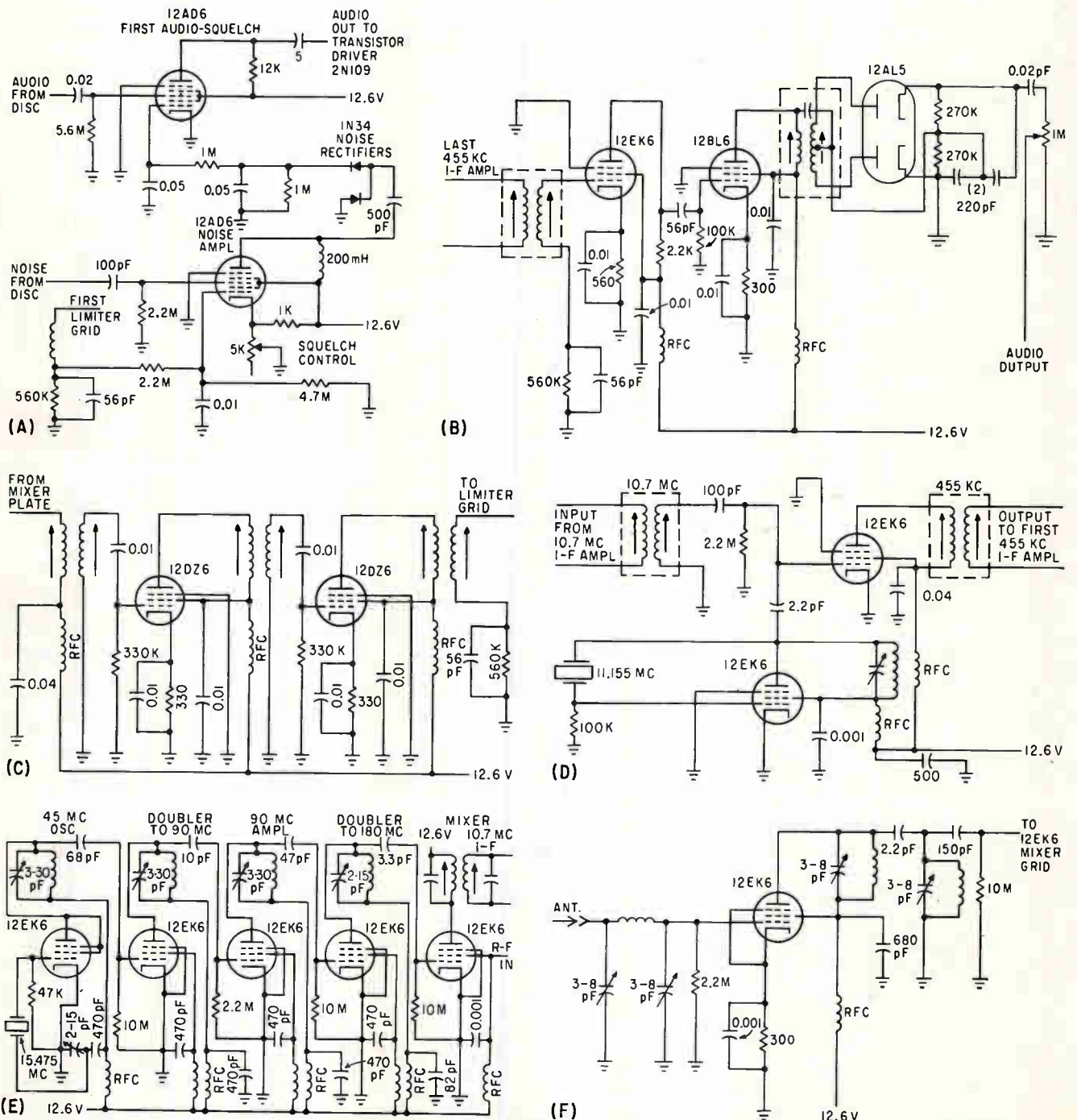
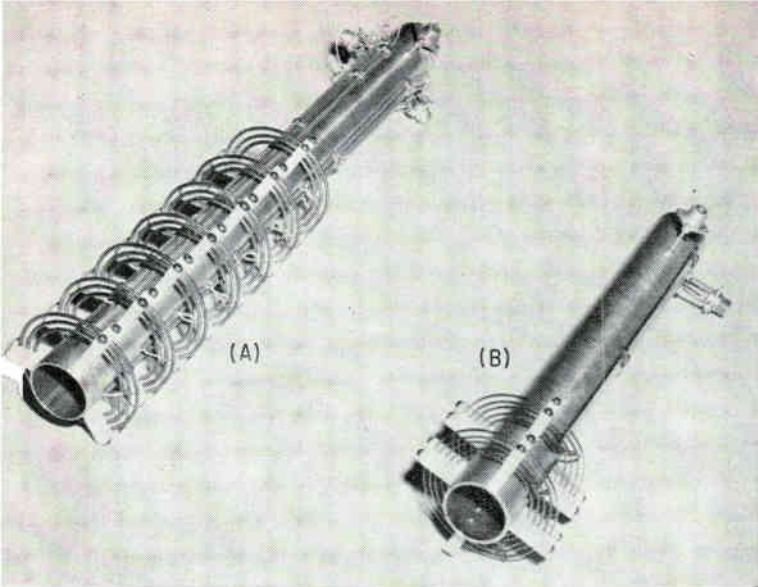

FIG. 4—Hybrid receiver stages: (A) squelch and first audio amplifier, (B) limiter and discriminator, (C) low-frequency i-f, (D) low-frequency oscillator and mixer, (E) high-frequency oscillator and mixer and (F) r-f amplifier



Ring detector for fuel (A) has seven levels; gage for liquid oxygen (B) uses two levels

Electrostatic capacitance of ring electrodes changes when in liquid. Amplified error signal from electrode bridge provides measurements accurate to 0.01 inch

CAPACITANCE CHANGE INDICATES LIQUID LEVELS

By THOMAS L. GREENWOOD,

Army Ballistic Missile Agency,
Redstone Arsenal, Huntsville, Ala.

MOST NONCONDUCTING liquids, including kerosene and liquid oxygen, have a characteristic electrostatic dielectric constant that is appreciably different from air or from the gaseous state of the liquid. This property is used in a liquid-level measuring system for calibrating turbine-type rate-of-flow meters. The electrostatic capacitance of electrodes is altered by the presence of a liquid.

Measuring the quantity of liquid through the rate-of-flow meter during a known number of output cycles gives the flow constant in gallons a cycle. Greatest accuracy is attained by draining known quantities of liquid from a tall, small-diameter tank through the meter and counting the number of meter output cycles occurring between the instants when the surface passes the accurately located detectors in the tank. It is not necessary that the flow rate be measured or be constant.

In Fig. 1A, the bridge circuit composed of capacitance *A* through *F* is excited by an audio generator. The cable-to-ground capacitances of the excitation leads, *A* and *B*, are common to all channels. Capacitances *C*, *D*, *E* and *F* are in the tank

and are subject to variation by the presence of liquid. These last four capacitances are equal.

When the liquid in the tank rises to *F*, the capacitance of *F* increases. This unbalances the bridge, producing a signal that is amplified and recorded as trace 1 on a graphic recorder. When the liquid rises to *E*, the bridge is balanced again and the recorded trace deflection returns to zero. When the liquid rises further to *D*, the bridge composed of *A*, *B*, *C* and *D* is unbalanced and the signal is amplified in another channel and recorded as trace 2. When the liquid rises to *C*, the bridge is balanced again and the trace deflection returns to zero. Thus each bridge and amplifier channel indicates the presence of liquids at two levels.

Figure 1B is the circuit of a single bridge showing only the components necessary for operation. The effect of residual capacitances, which are minimized by proper design, is not illustrated. The electrodes are concentric rings, grouped to compose a bridge circuit which is balanced when the tank is empty. If, due to manufacturing tolerances, the bridge circuit is not balanced, *C_p* provides adjustment of initial balance.

The photo shows the construction of the ring group. Teflon, which is

one of the few types of material approved for use in liquid oxygen, is used for insulating supports. The two level gage, (B) in the photo, has five concentric rings (four variable capacitances) at each level. It is for use in liquid oxygen. The second and fourth rings (from the center) are connected to one lead of the excitation source. The other rings are connected to the channel amplifier. This order of connection may be reversed. Connecting wires enclosed in metal tubing or coaxial cable keeps constant any capacitance that is not intended to be changed by the liquid. Capacitance between channel rings and excitation rings is 20 pf. With liquid between the rings the capacitance is increased to 30 pf.

The capacitances between excitation rings and ground, and between the channel rings and ground, are also changed by the presence of liquid. These residual capacitances must be minimized because they decrease the value of the unbalance signal whose magnitude is governed by the rate of capacitance changes in each branch of the bridge.

A 2.5-Kc generator supplies the bridge with about 10 volts excitation. A twin coaxial cable connects the gage with the generator. Low capacitance coaxial cables or other types of shielded cables, one for

each channel, carry the bridge unbalance signals to the amplifiers.

Figure 2 is a simplified schematic of the system. The dummy capacitor may be switched across either branch of the bridge by S_1 and S_2 to adjust the sensitivity of the amplifier. The dummy should be equal to the total capacitance change of the rings resulting from the presence of the liquid.

Preparation for use requires that the tank be empty. To provide a signal input to an amplifier for testing, the dummy capacitor is switched by S_1 and S_2 and the amplifier gain is adjusted for an output voltage of 30. Consecutive operation of the pushbuttons should produce output voltages agreeing within 2 or 3 volts.

The channel amplifier output voltages are linear with respect to input voltages and do not saturate until the output reaches 65 volts. The normal output is adjusted to 30 volts with maximum bridge unbalance, which exists when one level in a ring group is completely covered with liquid. The relay operating and release point is 15 volts, which occurs theoretically at the half-covered ring level.

Laboratory tests that simulate draining liquid from the tank show that this system gives results accurate within 0.01 inch.

The system is designed for calibration where the general liquid

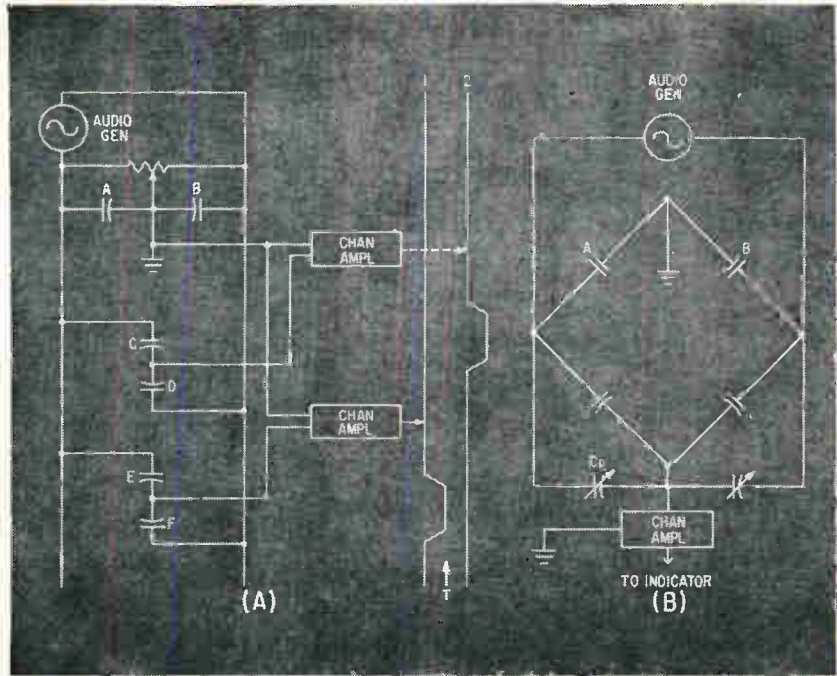

FIG. 1—Output signals of level-indicating system (A) can be used to give level indication at remote points. Basic bridge (B) is simple

level is known. The active regions on the gage may be overlapped to have the level indicated at all times. The output signals may be combined in a relay translator to give exact level indications at remote points. Such a system has been constructed and tested successfully.

Advantages of the system include: operation is not affected by low temperatures; cable length between tank and detectors can be 1,000 feet or more; detector loca-

tion may be varied; indication and recording may be done in many ways; several channel outputs may be combined to produce digital indications; ring detector groups have, due to their area, an inherent averaging effect that reduces fluctuations due to turbulent surfaces; there are no critical adjustments; and circuit operation may be easily and quickly checked.

This system was developed by government personnel.

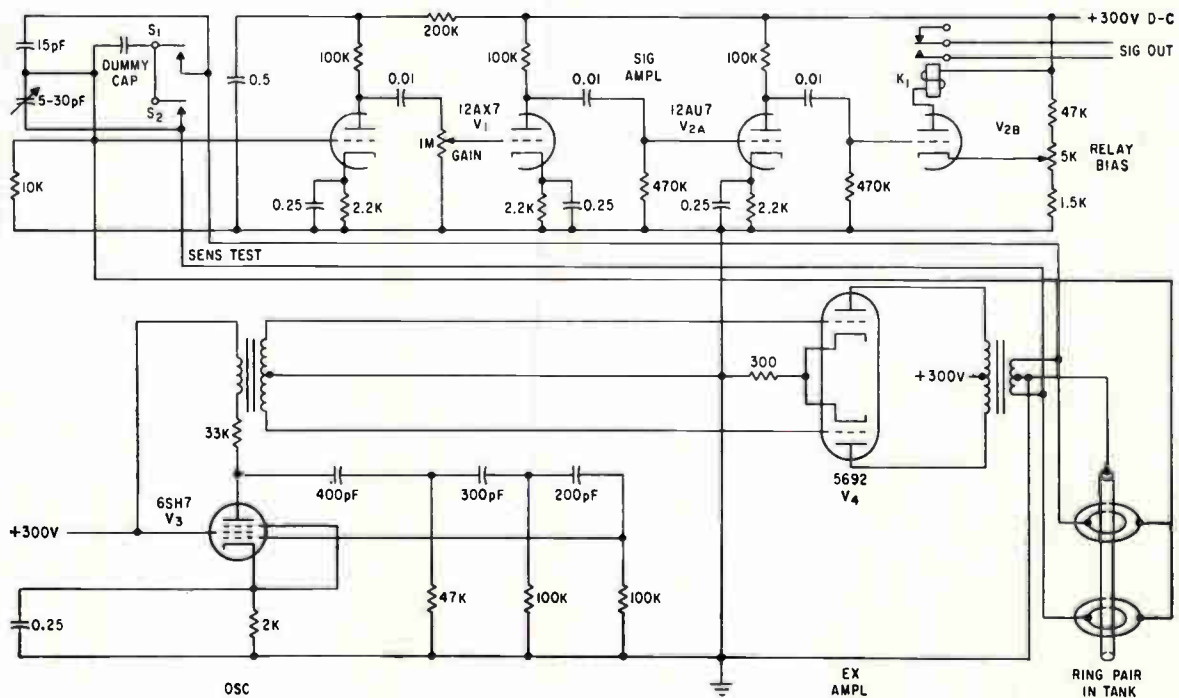

FIG. 2—Output of channel amplifier may operate recording galvanometer or indicator lamps

Simplified Curve Tracer

For Transistors and Diodes

Staircase waveform generator supplies test transistor with six values of base current during each cycle to develop family of curves. Range switches provide for a wide spread in test voltages and currents. Four-layer and tunnel diodes can also be checked

By C. J. CANDY*, U. K. Atomic Energy, Harwell, England

EXAMINATION of voltage-current characteristics with a curve tracer provides a fast method of verifying transistor and diode ratings. The characteristic curve can be used to detect aging or inferior components, determine approximate transistor gain and linearity, and to select avalanche transistors. While precise parameters are best obtained

with other means, a simple curve tracer can be used to determine characteristics with about 5-percent error.

The instrument has advantages such as wide range, low cost and small size. Transistors are the only active elements in the circuit and they have proven completely reliable during three years of use.

The test circuit, Fig. 1, illustrates how to obtain a set of collector current curves as a function of collec-

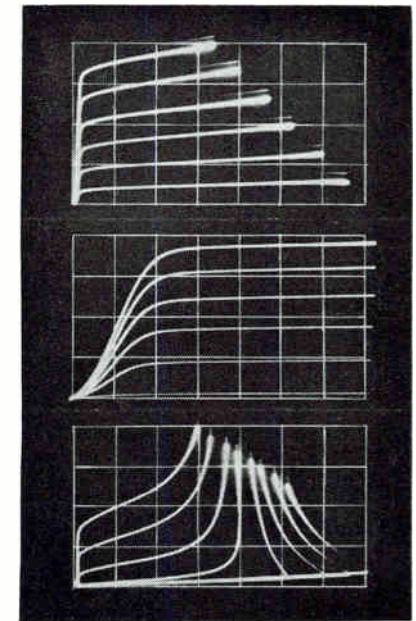

In the upper trace each horizontal division represents 2 volts. The middle trace is at 0.1 volt per division and the lower is for 10 volts per division

tor-to-emitter voltage. The transistor under test is supplied with a full-wave rectified 120-cps waveform derived from the 60-cps line. A reversing switch is included to accommodate *pnp* or *nnp* transistors. Since the system is grounded at the transistor emitter, the voltage across emitter resistor R_1 is proportional to collector current. This voltage is applied to the vertical or Y plates of an oscilloscope while the horizontal X plates are excited with collector voltage.

A family of curves is obtained by switching the transistor base current to a different value after each sweep. Six base current values are used sequentially to produce six curves as shown in the scope traces.

Potentiometer R_2 controls the amplitude of the sweep. Resistor R_3 limits collector current and defines the envelope of the display, which is a load line with the slope equal to total collector resistance. Resistors R_1 and R_3 are changed simultaneously to provide four current

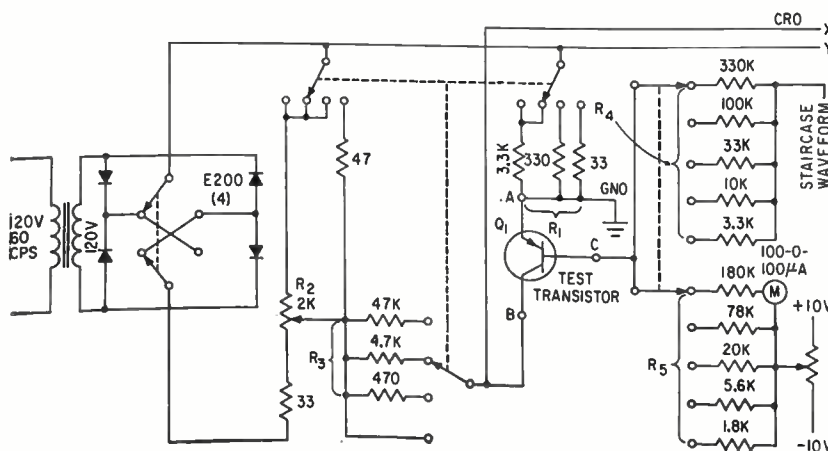
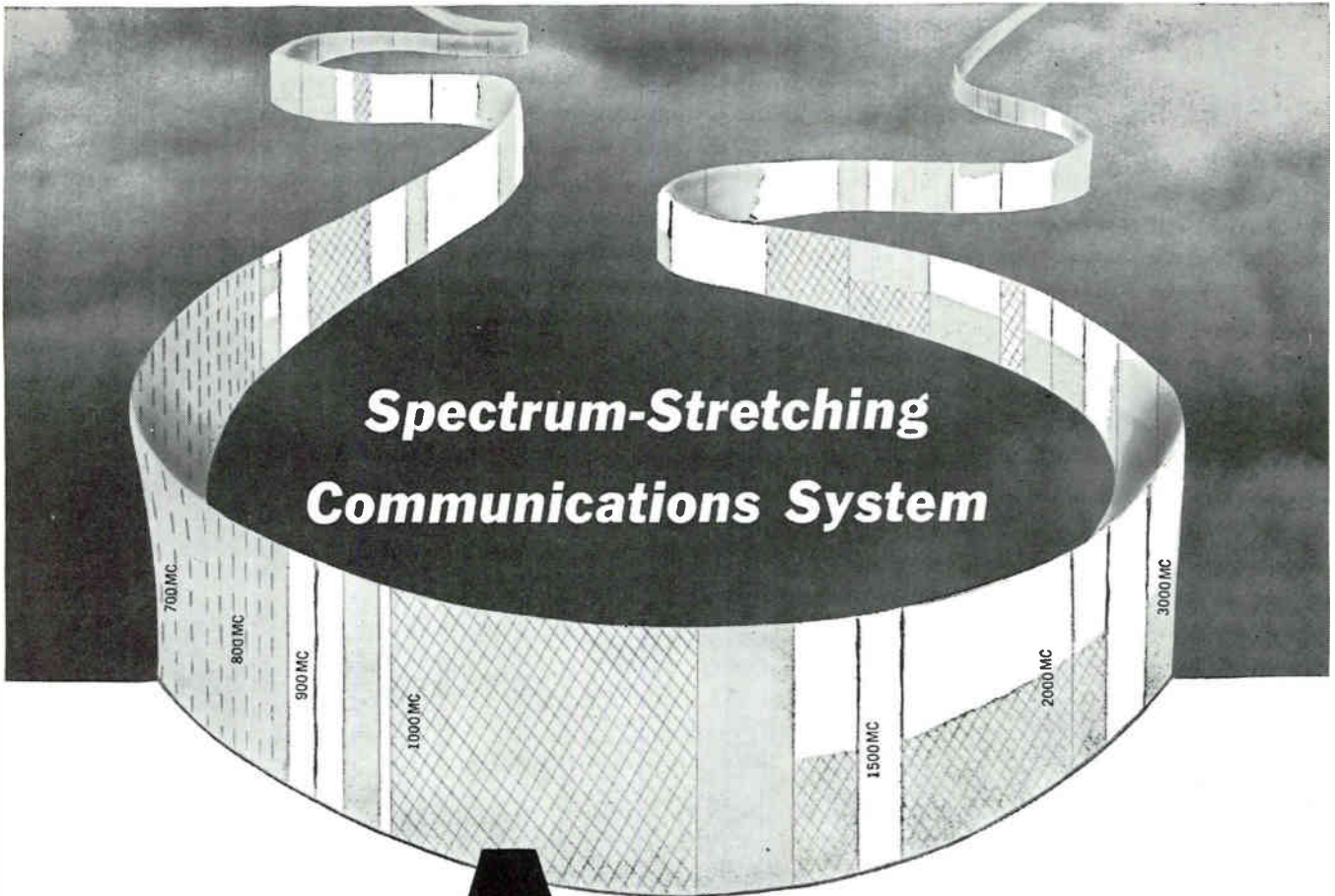

FIG. 1—Test transistor is driven by a six-level staircase signal. Polarity and range switches allow testing both *nnp* and *pnp* transistors as well as diodes, including 4-layer and tunnel diodes



THE BIG **A** LEADS THE WAY TO *INTEGRATED* COMMUNICATIONS SYSTEMS

ADLER heterodyne repeater techniques have opened a wide range of UHF channels for U. S. Army field communications, and prevented obsolescing of millions of dollars of VHF equipment. Developed and manufactured by ADLER, the "F-Head" converter permits the basic AN/TRC-24 VHF system to be used for UHF relaying in areas where VHF spectrum congestion is a problem. Designed for plug-in use, the compact "F-Head" heterodynes the VHF output of the AN/TRC-24 to the available UHF range. ADLER heterodyne techniques also are employed in advanced TV microwave and repeater systems, and multichannel communications.



SATELLITE RELAY SYSTEM — A reliable, worldwide network for telegraphy and teletype communications will be realized through PROJECT COURIER of the Advanced Research Projects Agency and U. S. Army Research & Development Laboratories. Each of the Courier's air-ground transportable stations duplex transmit and receive 15 million bits of stored information in the 4-minute contact with the satellite. As subcontractor to ITT Laboratories, ADLER is responsible for design, manufacture and equipment installation of the ground station trailers of this earth-satellite relay system.

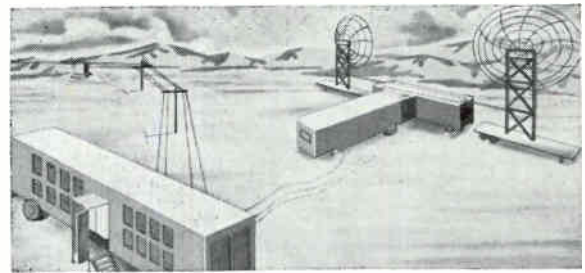

TRANSPORTABLE TROPOSPHERIC SCATTER SYSTEM— A new concept in continent-spanning tropospheric scatter communications soon will be available to the U. S. Air Force. For the first time, the full multichannel capability and reliability of a large, fixed installation will be provided in a compact, air-ground transportable package. The all-environment, 10kw, AN/MRC-85 is being designed and manufactured by ADLER under subcontract to Page Communications.

Write for all the facts on how ADLER experience can help solve your communications problems.

A ADLER

ADLER ELECTRONICS, INC. New Rochelle, N. Y.

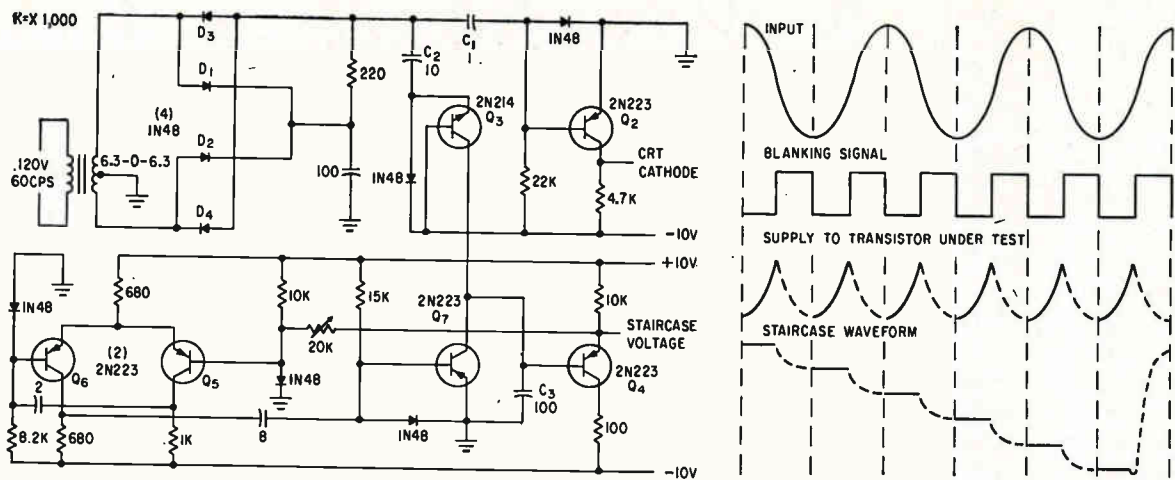

FIG. 2—Circuit generates a blanking signal at collector of Q_2 and a staircase waveform at the emitter of Q_4 . The staircase signal is generated by a charge transfer from C_2 to C_3 .

ranges. In the highest current position R_2 is changed from a voltage divider to a variable resistor in series with the 47-ohm collector load.

During each half cycle of line voltage the collector current rises and then returns to zero. Only the return half of the excursion is displayed on the oscilloscope because a positive blanking voltage is applied to the crt cathode on the first half. During the blanking time a staircase waveform is generated that sets the transistor base current for the next sweep.

The generating circuit and control waveforms are shown in Fig. 2. A low voltage sine wave from the transformer is rectified by diodes D_1 and D_2 , producing a positive voltage which charges capacitors C_1 and C_2 through the 220-ohm resistor. These capacitors are discharged every half cycle through diodes D_3 and D_4 . The discharge current in C_1 switches transistor Q_2 on, generating a positive pulse at its collector. This pulse is coupled to the crt cathode as the blanking voltage. When C_1 discharges, darkening the display, C_2 also discharges through the emitter of the npn transistor, Q_3 . Normal transistor action causes an almost equal charge to enter the collector of Q_3 , discharging the large capacitor C_3 by a fixed amount. The charge on C_2 is transferred to C_3 in each half cycle of line voltage. Apart from this charge transfer, little current is drawn from C_3 , therefore its voltage remains nearly constant

between transfers. The stepped voltage thus generated across C_3 is connected to emitter follower, Q_4 , whose output supplies base current to the transistor being tested.

Capacitor C_3 is periodically recharged to begin a new family of curves. This occurs when the voltage on C_3 becomes sufficiently negative to switch transistor Q_5 on and trigger the monostable circuit of Q_6 and Q_7 . Transistor Q_7 is then saturated, shorting C_3 to ground and a new cycle is ready when the trigger circuit releases Q_7 , eight milliseconds later.

The 20,000 ohm variable resistor in Fig. 2 is adjusted to reset the circuit after a six-step waveform has been generated. Thus a family of six transistor characteristics is displayed every 1/20 second, a speed sufficiently high to prevent flicker and still give adequate display.

Since the transistor under test requires a controlled base current, the staircase voltage is connected to the base of Q_1 (Fig. 1), through a large resistor. Because the base voltage of a conducting transistor changes little with current variation, the output of this resistor can be regarded as a current source.

The schematic of this base circuit is included in Fig. 1. The switched resistor, R_1 , determines the amplitude of the current steps applied to the base, while R_2 provides a monitored d-c bias current.

Originally the curve tracer incorporated a transistor driven crt but it is more economic to use one of the

miniature oscilloscopes now available commercially.

Minimum performance figures for the oscilloscope should be: frequency response from d-c to 10 Kc; the Y amplifier should have a gain of at least 0.5 volt/cm with an input impedance of at least 1 megohm; the X amplifier should have a gain of at least 0.1 volt/cm with an input impedance of at least 100,000 ohms; provision for applying an external blanking signal either to the crt cathode or grid.

The instrument will test transistors with collector currents ranging from 0.1 ma to 0.5 amp, and collector voltages from 0.1 to 100 volts. Only common emitter characteristics were considered in describing the circuit. Common base characteristics can be obtained by connecting the base to terminal A, the emitter to C, and the collector to B. Diodes can be checked by connecting them between terminals A and B. The instrument is useful for examining four-layer and tunnel diodes as well as composite transistor circuits.

The display is accurate to about 5 percent. Most of the error is caused by spurious 60-cycle voltages which could probably be reduced by a more careful component layout. A second source of error is capacitance between windings of the transformer; this capacitance shunts the transistor. This error can be minimized by choice of the order in which connections are made to the transformer windings.

BROADBAND COAX ISOLATORS FOR L&S BANDS



NEW COMPACT DEVICES PROVIDE MINIMUM ISOLATION OF 20 DB OVER EXTENDED BANDS

A single Raytheon L-band coaxial ferrite isolator now covers the full frequency range from 1,250 through 1,600 mc while its S-band sister covers the band from 2,000 to 4,000 mc.

The new units, designated 1cLM3 and 1cSM2, open new design possibilities in L and S band equipment. Where performance over narrow frequency ranges is specified, increased isolation is possible with either unit.

To learn more about this significant development or other important Raytheon advances in microwave ferrite devices, please write, stating your particular area of interest, to the address below.



THE MOST MODERN FACILITY devoted exclusively to microwave ferrite device and materials development, testing and production.

RAYTHEON COMPANY
SPECIAL MICROWAVE DEVICE OPERATIONS
WALTHAM INDUSTRIAL PARK
WALTHAM 54, MASSACHUSETTS

*In Canada, contact Raytheon Canada, Ltd.
P. O. Box 152, Waterloo, Ontario*

TYPICAL SPECIFICATIONS		
	1cLM3	1cSM2
Frequency range	1,250-1,600 mc	2,000-4,000 mc
Isolation		
Minimum	20 db	20 db
Maximum	40 db	31 db
Insertion loss		
Minimum	.8 db	1.3 db
Maximum	1.0 db	2.0 db*
Power		
Peak	10 kw	5 kw
Average	25 watts	5 watts
VSWR		
Minimum	1.10	1.02
Maximum	1.25	1.25
Weight (max.)	3.8 lbs.	2.25 lbs.
Max. dimension	12 in.	9.8 in.
Connectors	Type N	Type N

*1.0 db over narrow band.



EXCELLENCE IN ELECTRONICS

See our newest devices at WESCON—Booth 2052-3

CIRCLE 71 ON READER SERVICE CARD

Tap Setting on H-V Pulse-Forming Networks

By L. H. HOWE, Microwave Engineering Dept., Electronic Tube Div., Westinghouse Electric Corp., Elmira, N. Y.

SIGNIFICANT time savings can be realized using a dynamic method for positioning taps on high-voltage pulse-forming networks with reduced hazard to personnel. Immediate and continuous visual indication is provided, much soldering eliminated, and personnel qualified to use an oscilloscope can make the adjustments.

Operating a magnetron from a line-type pulser requires that taps on the E-type pulse-forming network be positioned for optimum wave shape. Although tap positions can be determined mathematically, final positioning is done experimentally with results determined empirically in the operating equipment.

Because of the high voltage, equipment is shut down and stored energy discharged before tap positions are changed. After unsoldering and resoldering taps, equipment is re-energized to observe results. The process is repeated until optimum wave shape is obtained, with each repetition increasing the probability of accidents.

Danger is reduced and considerable time saved by adding an intermediate step between computation and operational testing that closely duplicates performance in the actual equipment.

Input is provided by the pulse generator in Fig. 1A, which is matched to the network. Magnetron current-viewing resistor R_1 , comprising two disks with paralleled one- or two-watt resistors between them, provides sufficient voltage for a good oscilloscope presentation. Matching resistor R_2 is mounted near or preferably as an integral part of R_1 . Since network impedance is usually near 50 ohms, matching network and oscilloscope input cables are readily available. Pulses of variable amplitude and duration passed through a 50-ohm step attenuator from the generator are presented on an oscilloscope capable of displaying rise times of 0.01 μ sec.

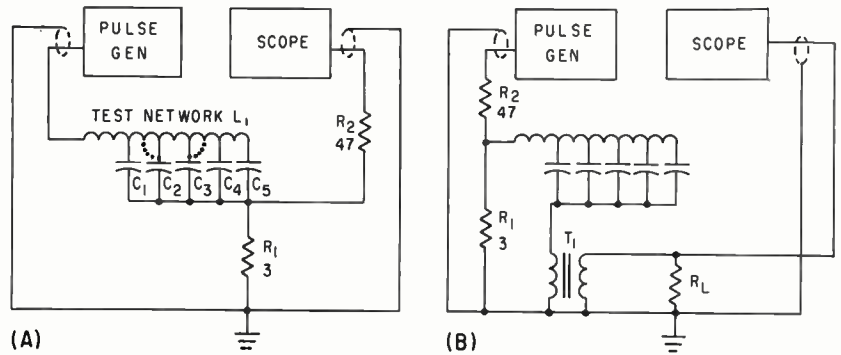

FIG. 1—Wave shape is continuously displayed using setup at (A) as pulse-forming network taps are set. Including pulse transformer at (B) closely duplicates equipment performance

Input pulse duration T_0 in Fig. 2 is considerably longer than computed network pulse width. Pulse t_p from matched and unmatched networks is also shown.

Coils of #16 bare copper wire in the units tested were 1 to 2 inches in diameter. Turn spacing on grooved solid micarta forms equalled wire diameter. Capacitors were connected to the coil under which they were mounted by short

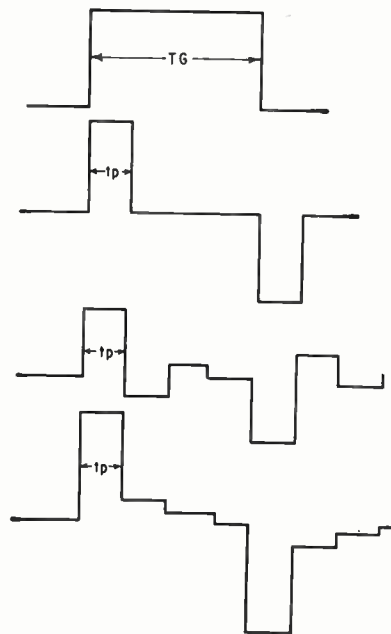

FIG. 2—Input T_0 produces wave shape immediately below it with correct matching, while bottom two wave shapes are examples of results of mismatches

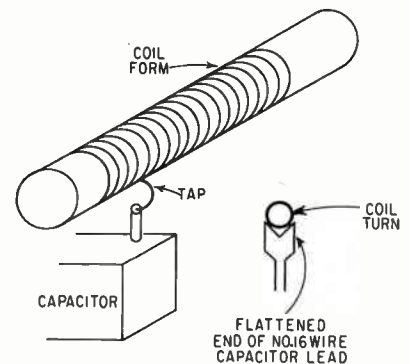

FIG. 3—Spring tension of wire maintains contact until optimum positions have been found

pieces of #16 wire with the ends flattened with pliers as in Fig. 3. A vee filed in the end permits movement of one wire without affecting others. Contact to turns relies on wire spring tension, with leads soldered only when correct positions have been found.

Greater separation between taps for C_2 and C_3 of Fig. 1A lowers the center of the pulse as shown in Fig. 4. Decreasing the number of turns before the tap for C_1 can increase rise time, but other taps must be repositioned for maximum flatness. When desired results have been obtained, usually moving a single tap one turn (less than 1 percent of total inductance) significantly affects wave shape.

Pulse width for a resistive load is $t_p = 2C_T Z_N = 2L_T/Z_N$, where C_T and L_T are total capacitance and

JONES & LAMSON OPTICAL COMPARATORS

the man who needs
a new machine tool is
already paying for it

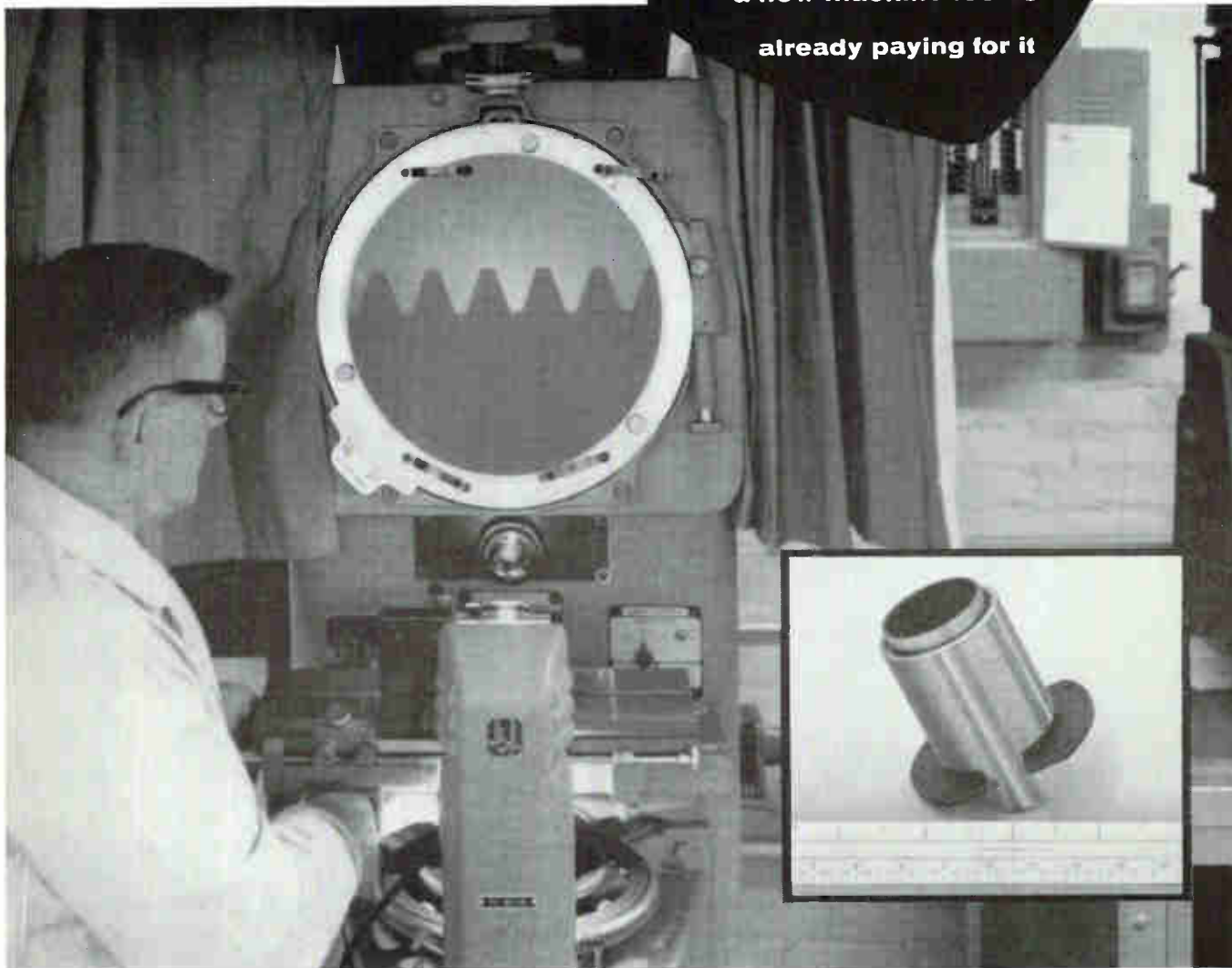

Unretouched photo (above) shows this cylindrical rack being inspected at 62.25X. Photo, courtesy of Baird-Atomic Inc., Cambridge, Mass.

4000% Increase in Inspection Efficiency through use of a J & L Optical Comparator

Baird-Atomic, Inc., Cambridge, Mass., manufacturer of scientific and research instruments needed a rapid and precise method for the quality control measurement and inspection of various components. After experimentation with various types of inspection equipment, a J & L FC-14 Optical Comparator was given a trial. It met all requirements perfectly.

The inspection of a cylindrical rack, heart of the Baird-Atomic Periscopic Sextant, used in advanced aircraft, gives an illustration of the J & L Comparator's efficiency.

The rigid quality control tolerances for this part include: tooth-to-tooth tolerance, .0002"; tooth-to-tooth error, .0003"; com-

posite error, .0003"; pitch dia. within .0005"; concentricity within .0005" TIR.

Adequate inspection and measurement by conventional methods proved laborious and time-consuming: inspection rate was little better than one rack per day. Now, using a J & L FC-14 Optical Comparator, average inspection rate is 42 per day, an increase of approximately 4000%!

Investigate the possibilities of J & L Comparators in *your* production set-up. Available in 12 different models, both floor and table types.

Write today for Comparator Catalog 5700. Jones & Lamson Machine Company, 539 Clinton Street, Springfield, Vermont.

NEW

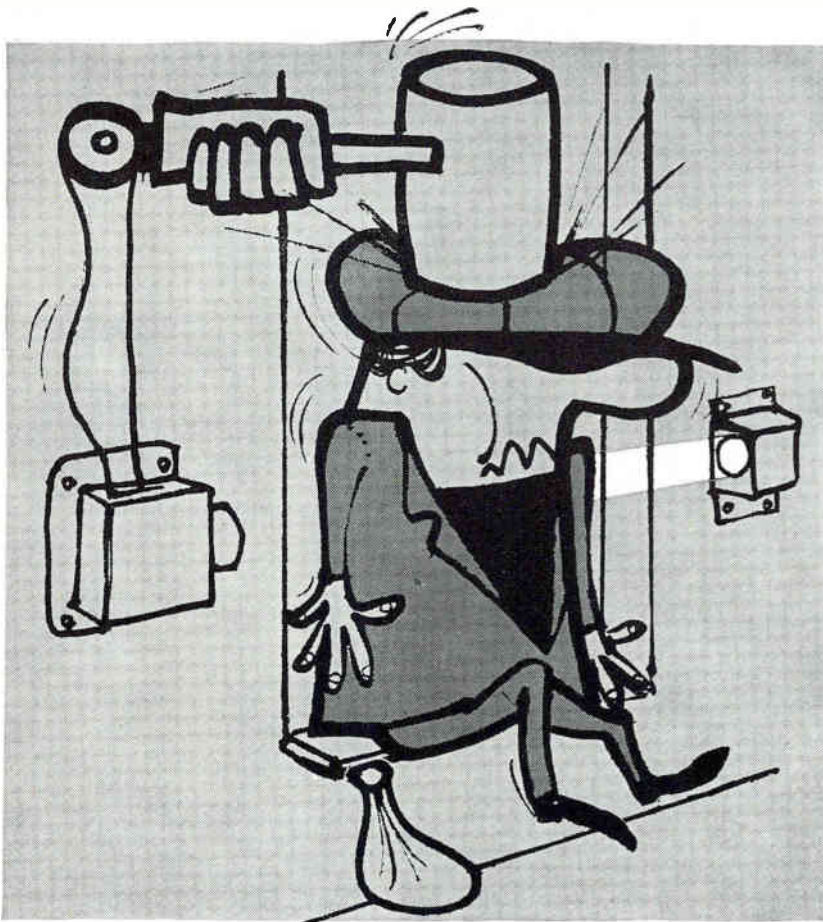

inductance, respectively, and network impedance $Z_N = (L_T/C_T)^{1/2}$. Magnetron current pulse width is usually less than that computed because of light initial current. Additional capacitance and inductance for a desired pulse width using a particular magnetron can be estimated with experience. After C_T and L_T have been established for correct pulse width and impedance, pulse shape is optimized by moving taps individually.

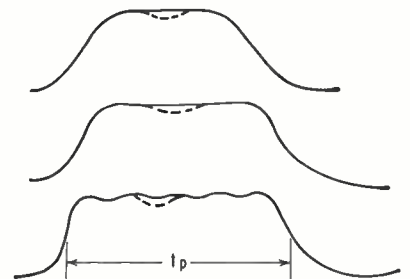

FIG. 4—Beginning with top wave shape, rise time increases as turns before first tap are decreased, while greater separation of second and third taps lowers center of pulse as indicated by dotted lines

When network and pulse transformer T_1 are both included as in Fig. 1B, R_i matches generator output and noninductive load R_i across the secondary of T_1 matches input to the oscilloscope probe. This arrangement duplicates equipment wave shape discontinuities on the bench for remedial adjustment. Simultaneous evaluation of network and transformer combinations approximate equipment performance quite closely. This setup also permits comparing variations of wave shapes from pulse transformers assumed to be identical.

Instruments Measure Solar Flare Radiation

INSTRUMENT package has been developed to measure solar flare radiation from high-altitude balloons. The instruments were specially designed by Air Force and Lockheed scientists to measure and record types and intensities of this type radiation, which could vitally affect manned space flight. A series of four launchings are planned that will lift the test packages above 99 percent of the earth's atmosphere.

PHOTOCHEMICALS FOR PHOTSENSITIVE DEVICES

General Electric makes luminescent grade cadmium sulfide and cadmium selenide for new and improved photosensitive devices. Broadest uses are expected to be in photoconductors, photoresistors and photovoltaic cells . . . and in combination with electroluminescent cells. And we're convinced these examples only scratch the surface. Give your own imagination free rein and see if you don't agree.

Doping and Sintering—Product applications requiring critical doping schedules for sintered layers—or single crystals—have a high degree of performance and dependability when using these high purity General Electric materials . . . uniform lot-to-lot. We'll provide you with pure cadmium (or zinc) selenide and sulfide, or if you prefer, doped and sintered materials to your particular specifications.

Free Data Sheet—Send for it Today: Yours for the asking—G-E Engineering Data Sheet on new photochemicals. Complete, concise, prepared as an aid to engineers and purchasing people alike. Send today . . . right now!

GENERAL ELECTRIC CO.
Lamp Metals and Components Dept., E-80
21800 Tungsten Road, Cleveland 17, Ohio

(In Canada, write: Canadian General Electric Co., Ltd., Component Sales,
221 Dufferin Street, Toronto 3, Ontario)

Please send me, without obligation, the new Engineering Data Sheet on Photochemicals.

Name _____

Company _____

Address _____

City _____ Zone _____ State _____

GENERAL  ELECTRIC

During these eruptions on the surface of the sun, radiation intensity is believed to reach levels that could be fatal in a few hours to a man in space not properly protected.

Radiation from solar flares is believed to equal or exceed normal radiation of the Van Allen belts. It permeates space outside the earth's magnetic field during these disturbances. The last peak in the eleven-year cycle of solar flare activity occurred in 1958. Measurements must be made soon before activity subsides to the lowest part of the cycle, which will be in 1963-64. Lockheed scientists think that manned space flights could be timed for the bottom of the cycle to limit the radiation hazard.

Some information on solar flare radiation has already been obtained from instruments on U. S. satellites, but the new instruments are expected to give a more detailed and accurate picture. The Thor-Able Star satellite is measuring some types of solar radiation but not the high-intensity radiation that occurs during solar flares. After the current series of measurements, similar instrumentation is planned for a satellite. However, the 135,000-ft altitude to which the balloon-borne instruments will be lifted makes the present measurements equally significant.

Instruments will be launched from Bemidji, Minn. This northern location was chosen because the earth's magnetic field causes radiation to be more intense nearer the earth's magnetic poles.

The instruments will identify neutrons, gamma rays and charged particles. Gamma ray and neutron measurements determine the quantity that results from interaction of solar flare radiation with the atmosphere. Charged particle measurements are to find the amount of solar radiation and to determine whether it includes high-energy electrons, alpha particles, neutrons, heavy nuclei and gamma rays. It is known to include protons.

The instruments used contain scintillation crystals that produce a light pulse when subjected to radiation. The pulses are sensed by light-sensitive tubes. Data is transmitted to the ground or to a monitoring aircraft.

NEW



P-4 PHOSPHORS FOR IMPROVED YIELDS AND BRIGHTNESS

General Electric's engineering developments and rigid process controls have come up with dramatically improved phosphors. New General Electric P-4 (Monochrome) Phosphors not only help improve your television picture tube production, but they pave the way for brighter, more uniform screens as well.

New G-E P-4 Phosphors meet all the requirements for a top-quality tube screen material. • Contamination resistance • Thermal stability • Screen adherence • Brightness and maintenance • Particle size control • Color uniformity • Freedom from foreign matter.

Technical Assistance by General Electric's highly qualified and experienced engineers is available when you use G-E Phosphors. Personal attention is given to your questions or problems concerning television, industrial or military tube applications.

Free Catalog—Send for it Today: Yours for the asking, all new G-E catalog that's jam-packed with engineering details and specifications on P-4, Industrial and Military Phosphors. Complete, concise, prepared as an aid to engineers and purchasing people alike. Send today . . . right now!

GENERAL ELECTRIC CO.
Lamp Metals and Components Dept. E-80
21800 Tungsten Road, Cleveland 17, Ohio

(In Canada, write: Canadian General Electric Co., Ltd., Component Sales,
221 Dufferin Street, Toronto 3, Ontario)

Please send me, without obligation, the new G-E catalog on Electronic Phosphors.

My interest is primarily in P-4 Phosphors

Industrial and Military Phosphors

Name _____

Company _____

Address _____

City _____ Zone _____ State _____

GENERAL  ELECTRIC

Aluminum Oxide Capacitors Take 500 C

CONSTRUCTION USES HIGH-OXIDE CERMET

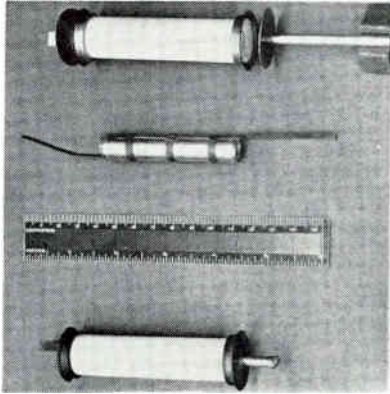

Ceramic case and metal end seal (top), capacitor roll (center) and assembled unit at bottom of photo show approximate size of 500 C oxide capacitor

ALUMINUM AND TANTALUM, the conventional electrolytic capacitor anode materials have serious limitations for use at high temperatures. However, work at General Electric shows that use of a new anode material permits operation of an anodically formed aluminum oxide dielectric in a stacked or wound foil construction at temperatures as high as 500 C.

Capacitance values up to 0.06 microfarad have been made, insulation resistance as high as 40 megohm microfarads at 500 C have been obtained.

The electrode material, designated M-257 by its producer, the Aluminum Company of America, came to the attention of the GE workers late in 1957. M-257 is one specific example of a number of materials variously referred to as alloys or cermets in that they are principally aluminum with an abnormally high oxide content. M-257 is made by forming a compact of fine aluminum powder having an oxide content of 6 to 8 percent Al_2O_3 . The compact may be extended or forged and further fabricated by rolling, drawing, etc. Early evaluation of this foil, by R. J. Stamets and R. A. West, of General Electric showed that after appropriate surface cleaning,

it anodized in a manner comparable to conventional electrolytic capacitor foil with the exception that terminal leakage currents during formation were rather high. This is consistent with the fact that the starting material is approximately 99 percent aluminum as compared with 99.99 percent purity in general use for anode foils.

The important characteristic of M-257 is its retention of physical properties such as tensile strength, yield strength, and percent elongation, as temperatures considerably above those at which pure aluminum alloys weaken.

It was this remarkable physical rigidity which led Stamets and West to the realization that failure to achieve significant results above 300 C with conventional foil might be due partially to the physical weakening of the dielectric support—the metal foil itself. Accompanying this thought was the postulation that an M-257 anodic oxide might serve as an excellent dielectric in the dry state despite its rather poor wet leakage characteristics.

A two-step anodization procedure was employed. First, the production of a so-called porous oxide by anodization of aluminum in electrolytes such as sulfuric acid, phosphoric acid, and oxalic acid. The second step involved anodization conventionally employed in the manufacture of electrolytic capacitors. The dense oxide of the second step was superimposed on the porous oxide, thus utilizing the dielectric properties of the dense type and the more rugged physical properties of the porous type. The porous oxide in an oxalic acid electrolyte was formed to a thickness of about 7.5 microns. The dense oxide was formed in a boric acid electrolyte to 1,000 volts.

Stacked and wound units were constructed. And a hermetically sealed ceramic case was designed by H. S. Moore that had a terminal to terminal resistance in excess of

7,000 megohms at 500 C. Life tests were conducted at 500 C with 100-v d-c applied for as long as 1,500 hours without significant change in characteristics. Indications are that these capacitors may be operated at 200 v or higher but insufficient data has been collected at higher voltage than 100 v.

Stacked or wound foil construction permitted operation in excess of 1,000 hours at 500 C with insulation resistance consistently in the range of 1 to 10 megohm microfarads and higher.

Another characteristic of the capacitors is their improvement in insulation resistance at high temperatures. This is probably the result of further liberation of chemisorbed water and/or sweeping out of ionic impurities.

Antenna Shields for Mercury Capsule

THE CONDITION and position of the first American in space will be flashed to Earth through thin, cylindrical

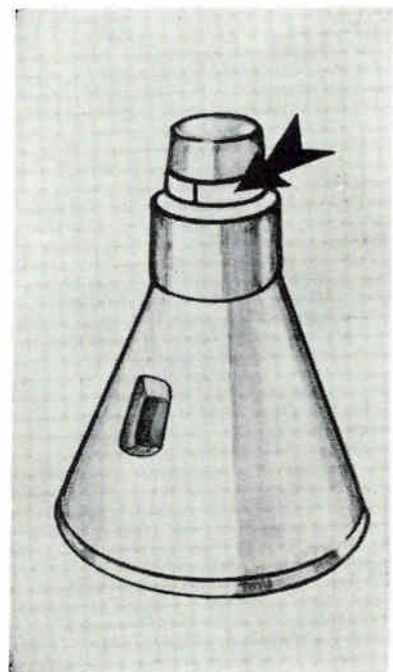

Arrow locates glass antenna shields on Project Mercury capsule

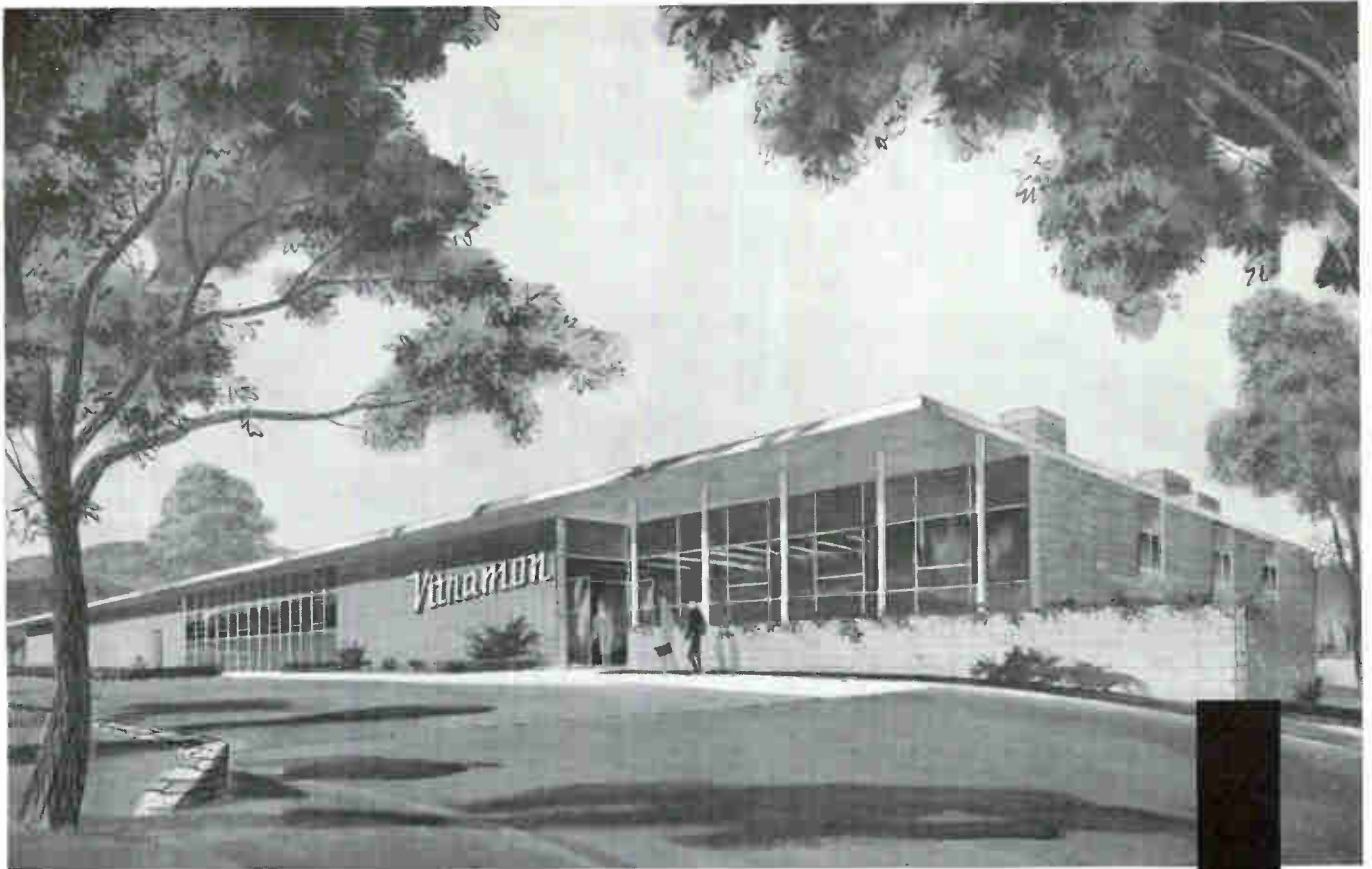

This modern, completely air-conditioned plant, located in Monroe, Connecticut, will also be headquarters for the Company's sales and executive offices.

NOW! EXPANDED PLANT FACILITIES ASSURE FASTER DELIVERY OF *VITRAMON*[®] CAPACITORS

We've expanded again! In fact, we're 4 times bigger and geared to the heaviest production schedule in our history!

But most important — our 50,000 square feet of new facilities mean more . . . better . . . faster deliveries of "VITRAMON" Capacitors.

Whether your application calls for the extraordinary electrical stability of our solid-state porcelain units or the miniaturized high capacity of our "VK" ceramic capacitors, you can now be sure of prompt delivery as well as RELIABLE PERFORMANCE!

For Free 18-Page "Facilities Brochure" circle Reader Service Card listed below.

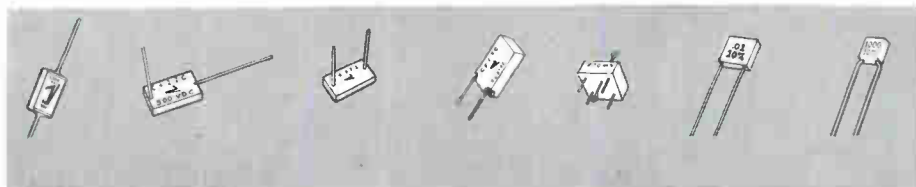

**Growth of
Physical Plant**

The dramatic growth of Vitramon, Incorporated during the past seven years reflects our industry's recognition of the critical importance of reliability in electronic components.

See us at WESCON, Booth No. 625

VITRAMON
INCORPORATED
BOX 544 • BRIDGEPORT 1, CONN.

7000 SHORT CIRCUITS WITHOUT A SINGLE FAILURE

**Wide Range Transistorized High Current
Power Supplies Set New High In Reliability**



Con Avionics proves extreme reliability of its zero to 50V rack mounted power supplies with a graphic demonstration at the 1960 I.R.E. Show.

Throughout the Show a new model Z50-15 Power Supply was short-circuited every 30 seconds, yielding a total of 7,000 short circuits without a single failure. Several thousands more shorts were applied during laboratory tests.

The company's new line of power supplies was designed under a "worst case analysis" program. The supplies are designed using standard non-selected components; performance is then mathematically and experimentally checked with the worst possible combination of component characteristics. This design technique is largely responsible for the new high set in reliability and insures long life and easy field maintenance.

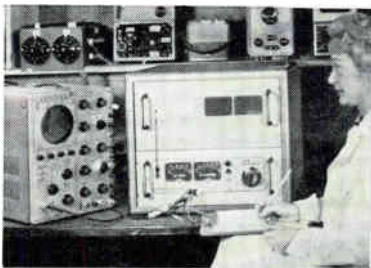

"Worst Case Analysis" Program Helps Set New High In Reliability

Wide Voltage Range, High Current Capacity, Among Electrical Features • The units are available in two series with 0.1% and 0.01% regulation. They have an unusually wide range of output voltage: 0 to 50 V.D.C., and an output current of 2, 5, 10 and 15 amperes.



"Flip Top Box" Permits Accessibility For Maintenance

Mechanical Features Highlight Flexibility

The new units are constructed with remote sensing to maintain regulation at the load and remote programming to permit output adjustment at remote control point. A floating output is also provided, through which either positive or negative terminals may be grounded. All the power supply units have a voltmeter and an ammeter. The front panel has a power switch, circuit breaker, coarse and fine voltage adjustment knobs, input fuse, pilot light and output terminals. Rear panels have an input line cord, output, remote sensing, and programming terminals.

Specifications

Input Power
Output Voltage
Output Current

Regulation

- a) for line variations
- b) for load variation
- no load to full load

Stability for 8 hours after 30 minute warm up

Ripple (rms)
Response time

Ambient temperature range

Temperature coefficient (% per °C)
Output Impedance at 10 KC (ohms)

Y Series

105 to 125 VAC, single phase, 48 to 62 cps.
0 to 50 VDC
2, 5, 10 and 15 amperes

Z Series

± 0.1%	± 0.01%
0.1% or 5 mv (whichever is greater)	0.01% or 1 mv (whichever is greater)
± 0.25%	± 0.05%
2 mv	1 mv
50 microseconds	
0 °C to + 50 °C	
0.02	0.01
0.003	0.0003

**CON
AVIONICS**

Consolidated Avionics Corporation
800 Shames Drive, Westbury, New York
EDgewood 4-8400

drical shields of glass.

The shields, transparent to radio signals, will protect transmitting and receiving antennas on Project Mercury capsules, especially during re-entry heat and shock.

Corning Glass Works is making the antenna shields for McDonnell Aircraft Corporation, prime Mercury capsule contractor for the National Aeronautics and Space Administration.

Corning's 96 percent silica glass was chosen because of its breakage resistance and stable electrical characteristics under sudden and extreme temperature changes. It is the type that goes into the company's Vycor brand industrial products. Even when plunged swiftly from high heat into icy water, the glass will not break.

Just a few months ago Corning announced it also was producing high temperature, optical quality glasses for Mercury capsule viewports.

Radio signals streaming back to Earth through the antenna shields will carry critical information about the astronaut's heart rate, blood pressure and body temperature. They also will keep track of the capsule's acceleration, assist in prediction of possible landing points, and monitor such capsule functions as oxygen pressurization.

Voice communications also will be transmitted and received by capsule antennas through the shields.

The glass is only 3/8-inch thick. Each section curves through approximately two feet. Height is just over 6 1/2 inches.

Corning said it is making three curved, translucent sections of shielding for each of 12 capsules. Three sections form a circle around antennas near the small end of the space vehicle.

The company said the glass will withstand a continuous operating temperature of 900 C and intermittent temperatures up to 1200 C.

The shields are formed by grinding blank pieces of glass to required thickness, sagging them under heat to the precise curve needed, cutting them to size, then bathing them in acid to impart high strength.

Viewports on the Mercury capsules will enable astronauts to see the earth's horizon and major land-

See us
at Wescon:
Booth 2255



marks and to sight on heavenly bodies. Early capsules will have round viewports, Corning said. Later models will have larger, rectangular windows—meeting astronauts' requirements for additional viewing area.

Price Reductions for Polycarbonate Resins

LOWER PRICE levels for Lexan polycarbonate resins, in advance of completion and start-up of General Electric Company's multi-million pound manufacturing facility at Mount Vernon, Indiana, which is scheduled for the third quarter of this year, have been announced by S. L. Brous, Marketing Manager of the Company's Chemical Materials Department, at Pittsfield, Massachusetts. New prices, reflecting reductions of about 35%, were effective in June.

Prices for natural color polycarbonates have been reduced to \$1.50 per pound in quantities of 10,000 pounds or more. Natural color prices range up to \$1.75 per pound in lots under 1,000 pounds, and are pegged at \$1.60 per pound at intermediate levels. Stock and custom color resins are now priced at \$1.75 per pound in quantities of 10,000 pounds or more. \$1.85 and \$1.95 per pound, respectively, are quoted in 1,000 to 10,000 pound units, and \$2.00 and \$2.50 per pound in smaller amounts.

These price reductions are applicable to current semi-works production quantities, and will enable fuller utilization of the premium properties of Lexan resin in applications where cost has previously been an obstacle.

When the commercial-scale plant is in operation, the Pittsfield, Massachusetts, semi-works plant will be devoted to continuing process studies, new resin development activities, and the potential manufacture of specialty polycarbonate resins.

More than 200 production applications are being served by this new class of plastics, whose development was pioneered in the United States by the General Electric Company.

STOP!

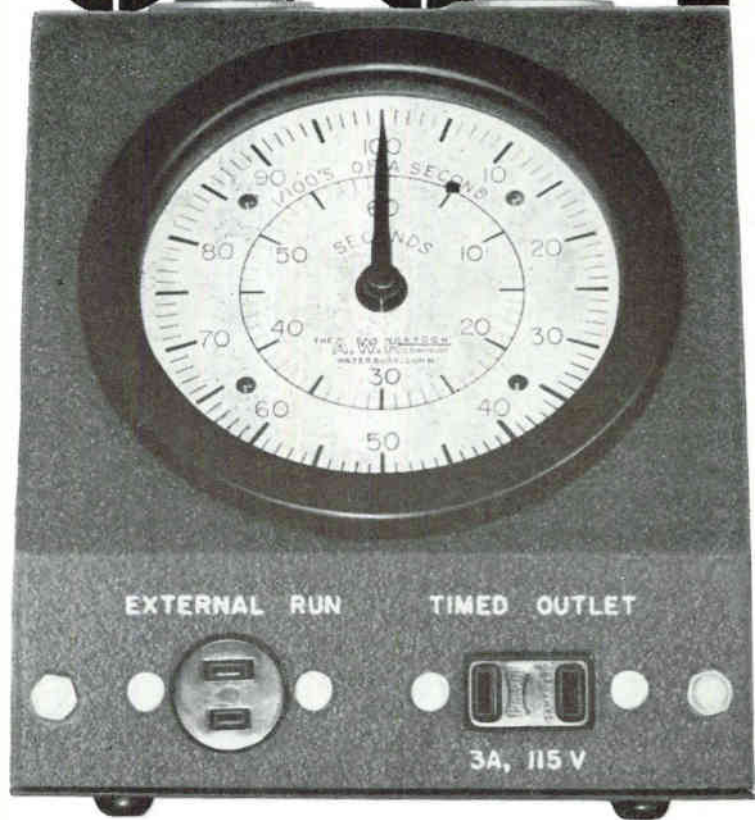

Look what happened when A. W. Haydon designed a new LABORATORY STOP CLOCK

You just won't find these features in any other stop clock. This versatile timer-of-all-work was designed by engineers who understand timers and timing...and who needed a precise time reference in their own work. **Timed outlet**—energized whenever clock runs, supplies 115V, 60 CPS, 3 amp to time and control external loads simultaneously...manually or automatically. **External Run Socket**—for remote running, using a control cable... manually or automatically (when wired into a system). **Clutchless timing mechanism**—needs no warm-up, make-ready or pre-start. Synchronous motor starts and drives instantly. No power consumed except during timing and reset. **Independent RUN and RESET** buttons for manual, local control. **Schematic diagram** and control circuitry silk-screened on bottom of housing for ready reference. ■ Bench type precision stop clocks are available with optional remote control for manual or automatic running and/or resetting. Clocks operate on commercial 115V, 60 CPS power; accuracy is ± 25 milliseconds.

Low power drain: only 2 watts, timing. Sweep second scale calibrated in 10 millisecond increments; totalizer scale calibrated in seconds, up to 1 min. Sturdy instrument case requires only 4¼" square bench space. For complete specifications, write for Bulletin ET-702. Ask also about panel-mounting versions.



AWH HAYDON
THE COMPANY
 235 North Elm Street, Waterbury 20, Connecticut

Proportioners Mix Production Gases

By A. J. MASELLA and R. T. MOULD,

Research and Development Dept., National Cylinder Gas Div. of Chemetron Corp., Chicago, Ill.

SPECIAL ATMOSPHERE requirements for such techniques as semiconductor crystal growing in a mixture of helium and argon are continually increasing. Special gas mixtures can be obtained, but at a premium to cover the additional cost to the supplier of mixing, handling and, if necessary, analyzing.

In many cases, on-site gas proportioning equipment pays for itself in reduced costs, particularly if very close control and certified analysis are required. It is also advantageous when different mixtures are needed for several processes or when mixtures must be tested to obtain the optimum ratio. Supply cylinder handling and warehousing is reduced, as well.

There are 3 basic types of proportioning equipment: manual, semiautomatic and automatic. Gas requirements should be examined closely for, while the system must be adequate, it is easy to buy equipment that is too elaborate.

Manual systems generally are used in shops and laboratories where gas demand is intermittent. Settings are required for each time the mixture is used. They can be mounted on a wheeled cart for portability. The gas lines of the manual proportioner in Fig. 1A are connected at a Y fitting just before a mixing device. The unit can be equipped with a 2-pen round-chart recorder and pilot lights to show when gas is flowing.

A semiautomatic system consists of the manual system with a pushbutton-activated solenoid valve placed in the line downstream from the mixer. Thus flowmeters do not have to be adjusted at each use. The system is most useful when the same flowrate and analysis is desired each time gas is used.

Automatic systems are used when flow demand varies and are the most accurate. In a surge system (Fig. 1B), the desired ratio is set in the flowmeters and valves and the surge

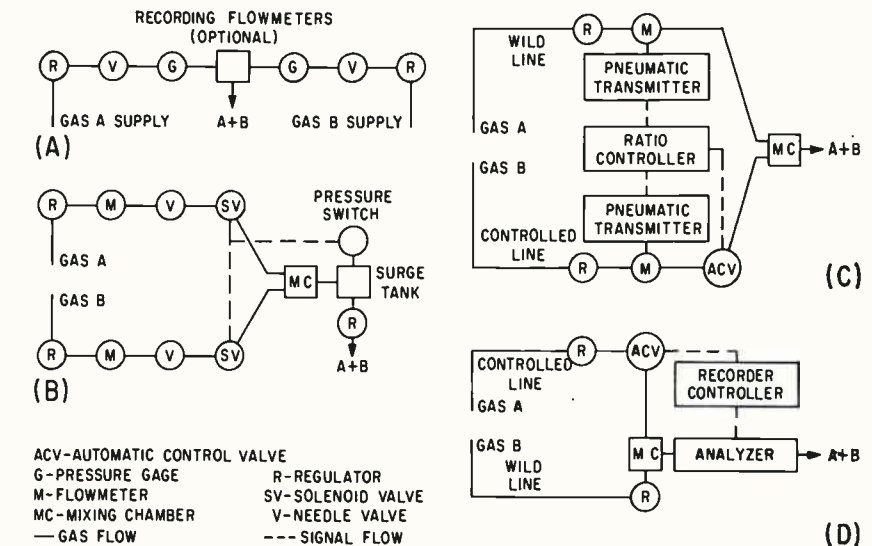

FIG. 1—Types of proportioning systems include manual (A), automatic surge tank (B), automatic transmitting flowmeter (C) and automatic analyzer (D)

tank is filled with the mixed gases. When a specified pressure is reached, the pressure switch closes the solenoid valves. When the pressure drops to a lower limit as the gas mixture is used, the pressure switch opens the solenoid valves to refill the tank. This is the least expensive automatic system. Mixture reproducibility is excellent provided valve and regulator settings are not changed. The chief limitations are tank volume and pressure. When the gas ratio is changed, the tank must be vented and purged with the new mixture.

Transmitting flowmeter system (Fig. 1C) maintains gas ratio by controlling flow. One gas line is "wild" since its flow depends only on downstream demand. The ratio controller receives signals from transmitting flowmeters in both lines and balances these signals. When the signal from the wild line varies, indicating changed demand, the controller activates the automatic control valve in the controlled line until the flowmeter signals balance.

An analytical system (Fig. 1D)

is the most expensive, but the most accurate. It is not affected by changes of pressure as is the flowmeter type. The analyzer continuously samples mixer output and signals a controller which operates the automatic valve. System capacity is changed by changing the automatic control valve size. If increased capacity is a strong possibility, this system could be least expensive in the long run.

Choice of instruments for a gas proportioner are many. Among the flow sensing devices are rotameters, orifice plates and venturis. Controllers may be indicating or recording. Flowmeters can indicate, record, integrate or combine functions. Thermal conductivity, specific gravity and chemical composition analyzers are available.

The photo shows a system installed by NCG at Texas Instruments, Inc., Semiconductor-Components Div. It combines transmitting flowmeter and analyzer systems. Pneumatic transmitter and flowmeter control one signal; combination transmitter-flowmeter, the other. The second gas has relatively

what
is the
frequency
standard
for the
U.S.A.?

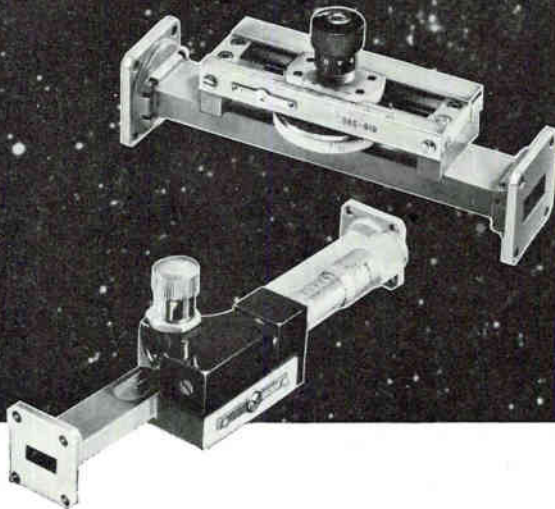

ANSWER: By act of Congress, the U.S. Bureau of Standards determines the primary standard, based on the revolution of the earth. All DeMornay-Bonardi microwave instruments are calibrated at frequencies which are verified by our secondary standard, which, in turn, is periodically calibrated, point for point, by the U.S. Bureau of Standards.

One way to properly match a microwave transmission line is by using a D-B Stub Tuner to reduce mismatch losses and utilize the total energy available.

D-B stub tuners in the 2.6 to 18 KMC range have a new scale and vernier that gives precise resettability in longitudinal travel. A new micrometer scale on the probe meas-

ures penetration with very high accuracy.

Probe wobble is eliminated, and no resonances can occur under any conditions. You can correct VSWR as high as 20:1 with amazing accuracy (1.02). You can tune with precision...reset to original settings with certainty that phase and magnitude have been duplicated.

Ditto for higher frequencies. D-B tuners in the 18 to 90 KMC range are not simply scaled-down units—they're engineered for ultramicrowave® use. All the above features are available, plus micrometer positioning which provides readability to .0001".

Write for data sheets—they detail all features, applications, dimensions, sizes. Bulletin DB-919.



780 SOUTH ARROYO PARKWAY • PASADENA, CALIFORNIA
See us at the WESCON SHOW Booths 2214-15



Power Transistor Test System

FLEXIBLE, ACCURATE COMPLETE LAB SYSTEM



MODEL PTT-1

**APPLICATIONS ENGINEERING
QUALITY CONTROL
RECEIVING INSPECTION**

For the first time, a complete power transistor test system is available in one "package." It provides complete DC characterization of transistors with output ranges up to 20 amperes and input current ranges from 10 micro-amperes to 2 amperes. The patch panel arrangement is such that any meter or power supply can be connected to the test transistor. Readout of breakdown voltage, emitter floating potential, saturation voltage, leakage current, input voltage and current plus output voltage and current are possible with this system. Individually designed systems for special requirements are also available.



SOLID STATE RELAYS—for microsecond switching application extremely resistant to high shock and vibration environments.

**WRITE FOR
INFORMATION
ON COMPLETE
SOLID STATE
RELAY LINE**

INTER MOUNTAIN INSTRUMENTS BRANCH • ELECTRONICS DIVISION

CURTISS  WRIGHT

CORPORATION • P. O. BOX 8324, ALBUQUERQUE, N. M.

**SOLID STATE RELAYS • TRANSISTOR TEST INSTRUMENTS AND
SYSTEMS • DIGITAL DATA ACQUISITION AND PROCESSING SYSTEMS**

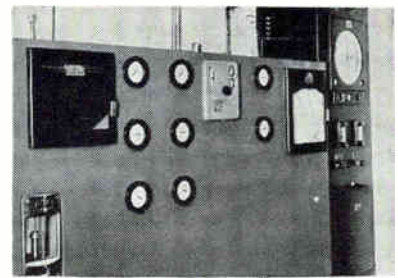

Panel of automatic combination system

small flowrate. The signals are balanced by a recording ratio controller. A thermal conductivity analyzer controls the set point of the ratio controller for additional accuracy.

Wire Stripper Now Strips Coaxial Cable

By JOHN L. CALVIN, Jr.
Beckman Instruments, Inc.,
Fullerton, Calif.

COAXIAL CABLE is automatically step-stripped and cut on a commercial wire stripper modified to obtain accurate cuts through the cable's outer jacket, copper shielding and polyethylene dielectric. A 2-foot cable is turned out each second, replacing hand cutting, 2 stripping operations, a coiling machine and 2 transports.

The cables are used in Beckman pH meter electrodes, which require cable with a dielectric resistance of 10^{12} ohms per foot. High-resistance cable terminations require a strip of nearly 2 inches on one end and 1 inch on the other end. Since the requirements were beyond the capabilities of the standard machine (Eubanks Engineering Co., Model 810), the following modifications were made:

Additional stripping blades were ground and honed to fit the cable layers. Stripping blade push power

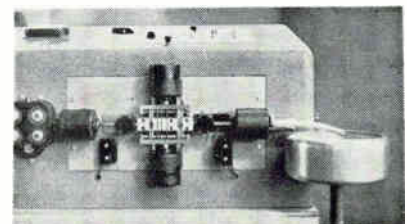

Top and bottom cylinders operate blades, other cylinders clamp and pull cable

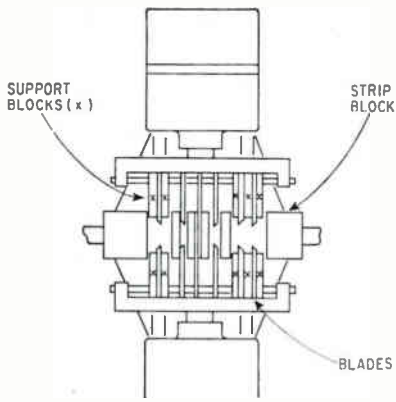

Arrangement of blades and support blocks in strip block

was doubled by adding an air cylinder in series with each of the 2 existing blade actuating cylinders.

Strip depth control was a problem. Each blade must cut through its layer without damaging the layer beneath. However, too shallow a cut through the shield would leave many uncut shielding strands and require hand trimming. Eubanks designed a chopping block type of support to be stacked beside each strip blade. When ganged together, this makes a stripping die to cradle and cut the cable. The blades and support blocks work in unison, the upper set biting down and the lower set biting up like a long set of jaws.

The nearly 3-inch combined strip length required a long, stationary strip block to hold constant the spacing of the support blocks and strip blades. The blades and blocks move through the spacing block, which also guides the cable past the blades.

Tubes through which the cable passes were bored out oversize to clear the diameter of RG-58 A/U cable. The machine's cycle was slowed slightly by increasing the air chamber volume of the delay valve.

Operation of the machine is similar to the standard model's operation. Cable is fed under a measuring unit which trips a switch. Compressed air halts the cable feed and operates the stripping mechanism. Air from a delay line operates clamp cylinders which pull the cable through the strip blades. Each moving clamp cylinder trips a switch which restores the system. Long cables are coiled for packaging by a rotating drum which accepts the stripped cable.

FIRST THINGS FIRST!

FOR IMPROVED THERMAL DESIGN, there is no substitute for effectively cooling, extending useful life and increasing tube reliability than with IERC Heat-dissipating Electron Tube Shields.

The right time to "plan in" IERC's Heat-dissipating Electron Tube Shield components in your thermal design and packaging is at the start—however, it's never too late to improve reliability, insure proper tube cooling and protection from shock and vibration with widely-used, MIL-approved IERC shields.



IERC Subminiature Heat-Dissipating Electron Tube Shields

New 1960 Subminiature Tube Shield Catalog gives you a complete showing of IERC's diversified line, thermal design and application tips, dimensional and specification data—available on request.

IERC  **DIVISION**

INTERNATIONAL ELECTRONIC RESEARCH CORPORATION
135 West Magnolia Boulevard, Burbank, California

New On The Market

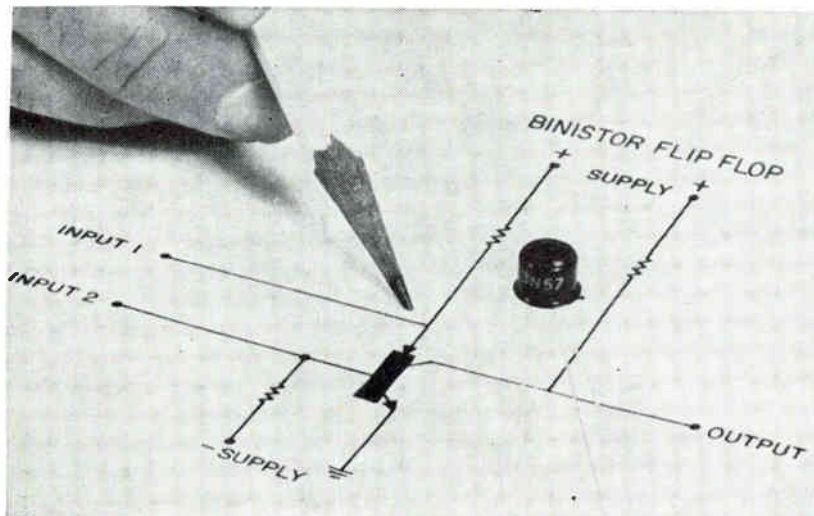

Binistor Switching Device

NEW SEMICONDUCTOR

A NEW BISTABLE switching device has been developed for use in switching and storage circuits. The binistor, which simplifies circuits for flip-flops, is announced by Transitron Electronic Corp., 168 Albion St., Wakefield, Mass.

The binistor employs a new mode of operation for bistable devices and offers a combination of reliability, economy, simplicity and uniformity that is claimed not to have been previously achieved. Relatively simple to use, it is compatible with present circuitry and does not require major system design changes.

Comparing the binistor with a typical flip-flop, the latter uses two transistors, seven resistors, two capacitors, two diodes and 28 solder connections. Many sophisticated flip-flops require considerably more components. A binistor stage reduces this total to only one binistor, three resistors and 10 solder connections.

In structure, the silicon *npn* tetra-layer binistor resembles a four-layer

switch. A major difference exists in the design and use of this structure, however. The output current is taken from an intermediate layer and the upper junction serves only as a latch—rather than as a lock—to hold the device ON when in the conducting state. The collector, emitter and base of the binistor are used in the same manner as a normal transistor.

In addition to flexibility in operation, the temperature range over which bistability is practical extends from -80 to $+250$ C; however, maximum temperature limits will be determined more by storage life degradation than by characteristics or parameters.

The speed of the first commercial binistor, while currently slower than high frequency transistors, is adequate for general purpose switching circuit needs. Now in development are models to meet varied requirements of speed, power, polarity and size.

CIRCLE 301 ON READER SERVICE CARD

Ionization Gage

ULTRAHIGH VACUUM

AN ULTRAHIGH vacuum, cold cathode ionization gage and transistorized gage control, available from NRC Equipment Corp., 160 Charlemont St., Newton, Mass., can indicate pressures down to the 10^{-11} mm Hg

range.

Designated as the Redhead magnetron gage, it will find application in ultrahigh vacuum research in solid-state physics, metallurgy, and thermo-nuclear power, and for in-

vestigations into the effect of extreme altitudes on materials and components. Special models are being developed for inclusion in satellites and space probes.

Besides measuring pressures between 1×10^{-4} and the 10^{-11} mm Hg range, the gage has a sensitivity about 50 times greater than the Bayard-Alpert type. Thus, it has much higher pumping speed, which is important when the gage is used as a pump to produce extremely low pressures in small ultrahigh vacuum systems. Combining cold cathode operation with this high pumping speed eliminates the need for a special means of outgassing the gage elements, thus simplifying gage operation.

Although the control incorporates sophisticated circuits to assure stable and accurate amplification of the very small ionization currents, it is simple to operate.

The model 552 Redhead magnetron ultrahigh vacuum ionization gage and the model 752 ultrahigh vacuum gage control are available from stock at \$245.00 and \$850.00.

CIRCLE 302 ON READER SERVICE CARD



Self-Activating Solvent

FAST EPOXY REMOVAL

EPOXY AND polyester resins can now be removed from potted components up to 10 times faster without damage to parts or materials with a new self-activating stripper. The solvent, called Tele-Solv, is available from Electronic Components division, Telecomputing Corp., 14706 Arminta St., Van Nuys, Calif.

The chemical will not corrode, discolor or otherwise affect copper, aluminum, ferrous metals or resin-

IN PRODUCTION AND IN USE

BELL AVIONICS

MINIATURE ACCELEROMETER



It's the **LIGHTEST** and **SMALLEST** with **HIGHEST PERFORMANCE** of any Accelerometer available in quantity today.

The BELL Model III B Accelerometer* is an electrically constrained, linear, inverted pendulum type with a D-C forcer and spring suspension. This precision instrument has been thoroughly tested and evaluated by government laboratories.

The superiority of Bell Accelerometers has been proved in many competitions. They have already been selected for such programs as:

SERGEANT — AGENA (including SAMOS and MIDAS) RANGER — SKY BOLT

* A new Model V A will shortly be available with the same performance but a substantial reduction in both weight and size.

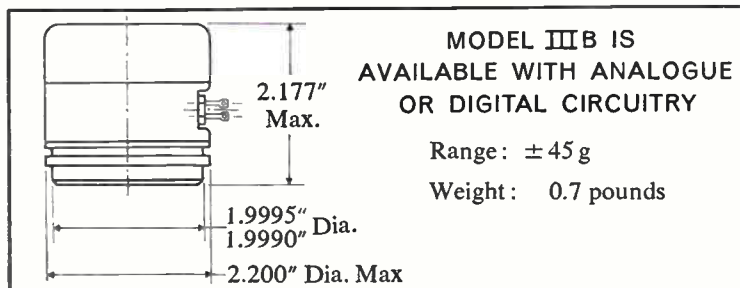

OTHER BELL AVIONICS PRODUCTS also designed and developed by Bell's Inertial Systems Laboratory under the direction of Dr. Helmut Schlitt include:

- Digital Velocity Meters
- Inertial Guidance Platforms
- Gyroscopes
- Gravity Gradient Meters

Direct inquiries to: Instrument Laboratory • 4515 Superior Ave. • Cleveland 3, Ohio



BELL AEROSYSTEMS COMPANY
FORMERLY: Bell Aircraft Corporation **BUFFALO 5, N. Y.**

based enamels. A controlled stripping agent, the process can be stopped at any time for removal of small parts when complete depotting is not required. No special

equipment or mixing is needed. The solvent is non-flammable and non-acidic; it is available in 1 gallon (\$7.95) and larger sizes.

CIRCLE 303 ON READER SERVICE CARD

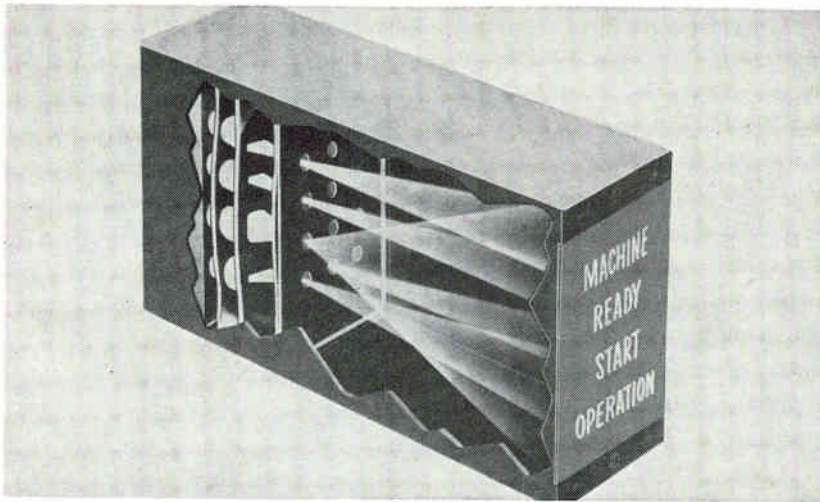

Digital Readout OF WORDS AND COLOR

A DIGITAL DISPLAY using words backlighted with color is available from Industrial Electronic Engineers, Inc., 5528 Vineland Ave., North Hollywood, Calif.

Words such as Machine, Ready, Start, Operation, or any other combination of words desired by the user, can be displayed. In addition red, orange, yellow, green, or blue colors may be displayed either by themselves or as background for the word messages.

The series 80,000 Digital Display is designed for visual communication and operations control with fully-automatic, semiautomatic, or manually operated equipment. Advantages include savings in time and labor, and increased efficiency of personnel and operations.

The display operates on a rear-projection principle. The unit contains a master condensing lens with twelve individual positions or lenses. On each lens is printed the desired word, message, or color. When one of the twelve lamps at the rear of the unit is lighted, the lamp projects the corresponding word or color onto the viewing screen at the front of the unit. The word message may be used by itself, or a colored background light may be projected simultaneously to indicate various condition or situation.

Priced at \$33.00, the display is available from stock in single units or in assemblies.

CIRCLE 304 ON READER SERVICE CARD

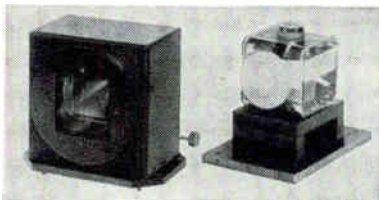

Kerr Cell Shutter

NANOSECOND OPERATION

A LINE OF hermetically sealed Kerr Cell electro-optical shutters that operate in nanoseconds (10^{-9}) has

been introduced by Electro-Optical Instruments, 2612 East Foothill Blvd., Pasadena, Calif. Resolution is better than 1 part in 10,000 or 20 minutes of arc—equivalent to 70 lines per mm with 6 inch focal length lens. The cell is hermetically sealed and has an integral plastic expansion bellows.

The Kerr cell is composed of two flat plates or electrodes immersed in a fluid which becomes birefringent upon the application of an electric field. When such a cell is

oriented between two polarizers crossed for minimum transmission the arrangement constitutes an optical shutter. With no voltage applied to the cell, light cannot be transmitted because of the crossed polarizers. When about 35 kilovolts are applied to the electrodes, the state of polarization is altered and transmission through the second polarizer is accomplished. Since no mechanical motion is involved, shutter speeds in the nanosecond time domain are feasible. Suitable pulse forming networks, modulator, and power supply are used with the Kerr Cell.

Applications include photo instrumentation of exploding wires, plasma studies, explosive analysis, hyperballistics, and magneto hydrodynamics. Additional applications are found in optical radar systems, optical communications, and other areas requiring extremely fast light modulation.

CIRCLE 305 ON READER SERVICE CARD

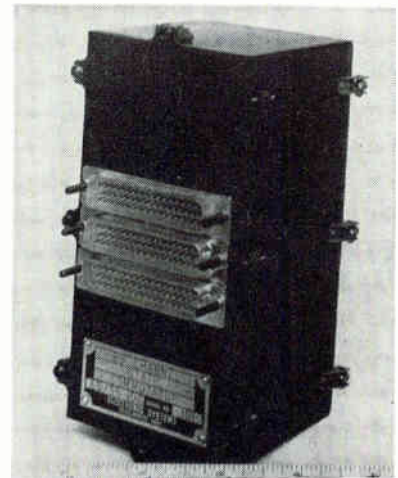

Solid-State Commutator

SCAN RATES TO 25 KC

SOLID STATE commutator samples data from multiple sources on a time sharing basis for use with recorders, indicating equipment or data transmitting equipment. Low noise levels and high resolution adapt the unit to critical applications.

The series ES/35 unit is supplied in standard scan rates of up to 25 Kc, and different models can accommodate from 2 to 100 channels. Input signal ranges of 0 to 10 mv and 0 to 5 volts are available, with crosstalk only 0.1 percent of input signal. Linearity is within ± 0.1

AUGAT

COMPLETE LINE OF SOCKET ASSEMBLIES FOR MICRO-MINIATURE RELAYS

Combining Holding Clip And
Built-In Socket For Unmatched
Reliability Under Severe Condi-
tions Of Shock And Vibration.



HORIZONTAL MOUNTING
(Solder Cup Contacts)

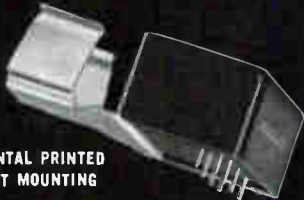

HORIZONTAL PRINTED
CIRCUIT MOUNTING



VERTICAL MOUNTING
(Solder Cup Contacts)

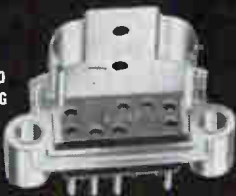

VERTICAL PRINTED
CIRCUIT MOUNTING



SOCKET ONLY WITH
MOUNTING SADDLE
(Solder Cup Contacts or
Printed Circuit Pins)

Patent Pending

These assemblies will accomodate
Micro-Miniature relays as manufac-
tured by G. E., Elgin, Sigma, Allied,
Potter & Brumfield, Clare, Iron Fire-
man, Babcock and many others.

For additional information
write for catalog RS-160

AUGAT BROS., INC.

31 Perry Avenue
Attleboro, Massachusetts

See us at the Wescon Show, Booth #2840

CIRCLE 201 ON READER SERVICE CARD
August 19, 1960

DON'T MISS THIS



New, Miniaturized 1-MC PRECISION CRYSTAL OSCILLATOR

with transistorized,
proportional-controlled oven

BULLETIN S-1159

contains typical specifications and
characteristics. Write for your copy.

REEVES-HOFFMAN

DIVISION OF DYNAMICS CORPORATION OF AMERICA

CARLISLE, PENNSYLVANIA

CIRCLE 202 ON READER SERVICE CARD

TELREX LABORATORIES

Designers and Manufacturers of

COMMUNICATION ARRAYS FOR THE ARMED FORCES and Commercial Service

"TRI-BAND®"
MODEL
XCYST
111420

Rotatable
52 ohm
Single-
Transmission-
Line Array

Power rating—
1.5 Kw., 100% A.M.

(Higher ratings
available)

Specifications:

Gain 11Mc.—8.0 db, F/B 24 db, E-Plane B-W 1/2 Power—66°
Gain 14Mc.—8.4 db, F/B 24 db, E-Plane B-W 1/2 Power—60°
Gain 20Mc.—8.6 db, F/B 24 db, E-Plane B-W 1/2 Power—56°
Wind surface—13.36 sq. ft. Load at 100 mph.—423 lbs.
Turning radius—23 ft. Container size—12"x12"x14"
Antenna weight—160 lbs. Shipping weight 200 lbs.
Antenna rated design with 1/2" radial ice—110 mph.

Calibrated for
easy assembly to
specifications and
center frequency
of your choice.
Custom Quality
construction
throughout. Sug-
gested rotator for
above — Telrex
Model 500-RIS.

Also available:
Over 172 off-the-
shelf fixed or ro-
tatable high-per-
formance arrays.
7Mc. to 600Mc.
Mono, Duo, Tri
and Multi-band
individually fed
or single line
feed, and med-
ium to extra
heavy duty ro-
tator-indicator
control systems, ro-
tated masts, and
towers.

- Telrex is equipped to design and supply to our specifications or yours, Broad-band or single frequency, fixed or rotary arrays for communications, FM, TV, scatter-propagation, etc.

- Consultants and suppliers to communication firms, universities, propagation laboratories and the Armed Forces.

For information or
to order, phone
PRospect 5-7252
or write
Department SC.

ANTENNAS

SINCE
1921

Communication and TV Antennas
telrex LABORATORIES

ASBURY PARK 25, NEW JERSEY, U.S.A.

CIRCLE 87 ON READER SERVICE CARD

87

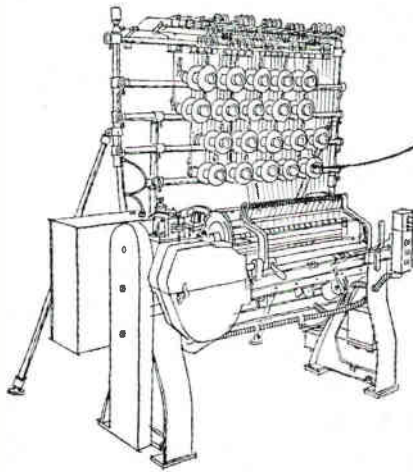

Investigate the super-precise fully automatic Leasona No. 107 Coil Winder for Paper Insulated Coils · Speeds up to 2500 rpm · Short Paper ($1\frac{3}{8}$ " insert) Attachment · Paper Miss Detector · Space Wind Attachment for High Voltage Coils · One operator for two or more machines! Leasona Corporation, P.O. Box 1605, Providence 1, Rhode Island. (formerly Universal Winding Company)

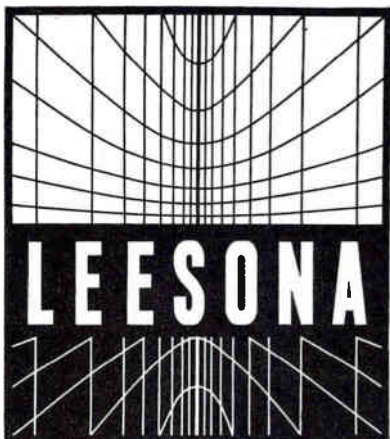

23B.0.1

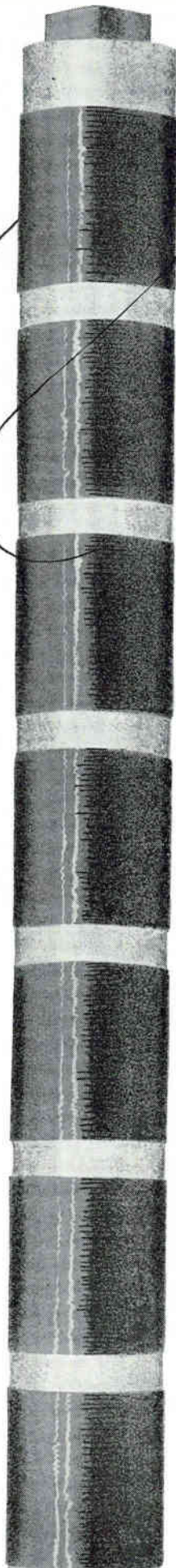

percent deviation from straight line; contact resistance is 25 ohms max.

Broad environmental compatibility includes: temperature range from -35 to $+125$ C; acceleration to 40 g; unlimited altitude; complete safety in ambient explosive atmosphere. Silicon semiconductor circuits provide reliability, simplicity and minimum size and weight.

The commutator functions not only as a direct replacement for mechanical rotary commutators but also as a means of high-speed, specialized synchronization. The latter capability permits commutation of signals at one point to be synchronized with decommutation at a remote point while utilizing only a single transmission channel. It also permits a recorded, commutated group of signals to be decommutated at any convenient subsequent time.

Complete specifications and operation characteristics are available from Electronic Systems Development Corp., 1484 E. Main Street, Ventura, Calif.

CIRCLE 306 ON READER SERVICE CARD

Coax Cable Connectors

NEW UG SERIES

THE NEW coaxial cable connectors are a new UG series designed to replace the standard BNC series on RG 58 C/U cable. The TPS is about $\frac{1}{3}$ smaller and lighter than the BNC series and features an exclusive three-pin lock which minimizes rocking of the mated pair and eliminates electrical discontinuity due to vibration and shock. Performance tests indicate the TPS comparable to the BNC in all respects. A full line of fittings is currently available from Dage Electric Company, Inc., 67 N. Second Street, Beech Grove, Ind.

CIRCLE 307 ON READER SERVICE CARD

Glass-Bonded Mica

SMOOTH FINISHES

A SPECIAL grade of glass-bonded mica, which can be finished to 10 to 18 microinch finishes for smooth potentiometer coil forms, has been perfected by Electronic Mechanics, Inc., Clifton, N. J.

The smooth finishes of this glass-bonded mica allows 0.0003 inch

wires to be wound smoothly and evenly, so that a brush riding across the winding will not bump or chatter. Since the coefficient of thermal expansion of Mykroy glass-bonded mica is the same as that of stainless steel, the dimensions of the mandrel when subjected to high operating temperatures change equally with those of the wire.

The material withstands operating temperatures to 1,000 F and has excellent electrical characteristics, including low loss factor.

Mykroy 1116 is available as centerless ground solid rods or short tubular forms with minimum wall thickness of 0.070 inch, and in tapered or saddle types of forms as custom-machined parts.

CIRCLE 308 ON READER SERVICE CARD

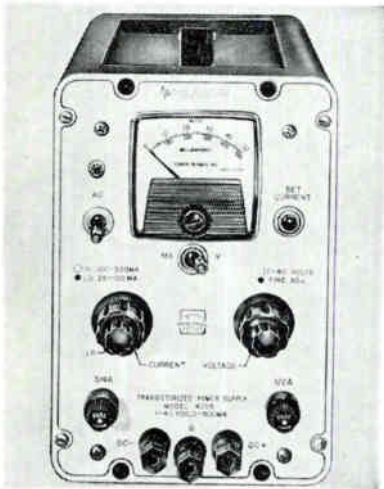

Power Supply

TRANSISTORIZED

POWER DESIGNS INC., 1700 Shames Drive, Westbury, L. I., N. Y. Model 4005 is a universal regulated d-c source which delivers constant voltage or constant current from the same output terminals. It may be operated as a constant voltage source, a constant current source, a constant voltage source with automatic current limiting or a constant current source with automatic voltage limiting. The Ambitrol dual regulator system permits continuous control of voltage or current with preadjustable, transient-free, electronic crossover to either mode of operation. Unit covers the range of 1-40 v d-c at 0-500 ma. Regulation for either mode of operation is better than 0.05 percent. Ripple content is less than 500 μ v as a

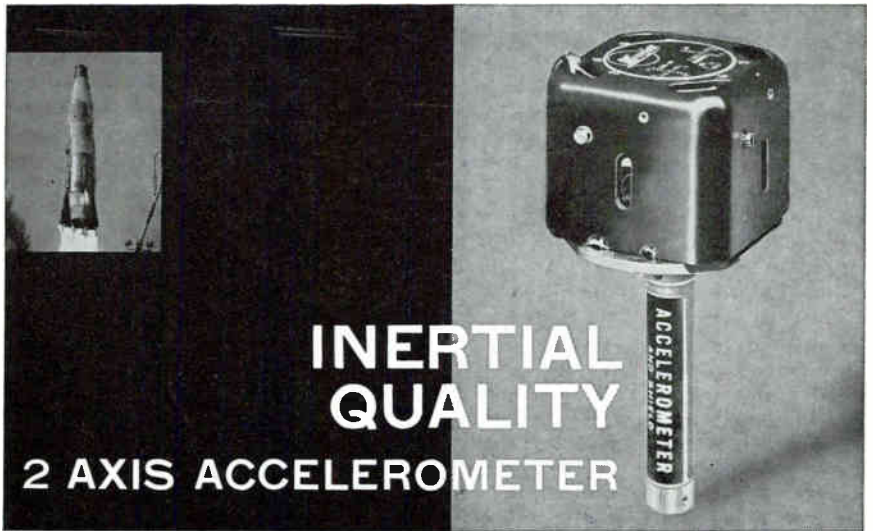

Highly precise and accurate, Kearfott two-axis accelerometers are pendulous devices which sense airframe acceleration forces acting on them.

An inverted pendulum utilizing a unique Hooke's joint suspension displaces as a function of acceleration in either of 2 axes. An AC pickoff signal is rectified and applied to voice coils restoring the pendulum to null. The DC required for restoration is proportional to acceleration. Typical characteristics for these units include range of ± 25 g's, scale factor of 5.0 ma/g, linearity of $\pm 0.005\%$ and threshold of 2×10^{-7} g's.

KEARFOTT DIVISION
Little Falls, New Jersey



GENERAL PRECISION, INC.
Other Divisions: GPL, Librascope, Link

CIRCLE 203 ON READER SERVICE CARD



This 100 kc plug-in package, Model CCO-7G, combines a high precision sealed-in-glass quartz crystal with integral temperature control and transistorized circuitry. Designed to deliver 100 kc output with stability of 2 parts in 10 million over ambient temperatures from 0°C. to 50°C. With fixed ambient conditions and voltage regulation, stability of one part in 10 million can be realized. The standard unit requires 27 volts dc, 12 ma for the oscillator and 27 volts, ac or dc, 10 watts for the crystal oven. Package size, excluding octal base, is 2" x 2" x 4 $\frac{1}{16}$ ".

BULLETIN NO. 520 AVAILABLE

**BLILEY ELECTRIC
COMPANY**

UNION STATION BUILDING • ERIE, PENNSYLVANIA



BLILEY
CCO-7G



MASSA

RECORDING SYSTEMS

ZERO BASED LINEARITY 1/4MM

(40mm FULL SCALE)

The lightweight, high-speed oscillograph Model OS-600 shown at the right is provided with INDIVIDUAL LINEARITY CONTROL ADJUSTMENTS for precisely setting the linearity at both extremes of deflections. This feature completely eliminates all errors due to inherent production variations in spring stiffness and magnetic field distribution near full scale amplitudes.

This rugged oscillograph, THE ONLY SOURCE FOR DIRECT RECTILINEAR INK WRITING, accurately records signals from DC to 120 cps. The electrodynamic drive system produces true rectilinear displacement of the pen tip. Electric writing can be effected by merely substituting an electric stylus for the ink pen.

PORTABLE AND MULTICHANNEL SYSTEMS

Available in 20 mm amplitude for rise time resolution of a few milliseconds, and 40 mm amplitudes. Individual transistorized driver amplifiers and power supplies for each channel designed to operate with frequency compensation either in or out.

LINEARITY CONTROL ADJUSTMENTS



PREAMPLIFIERS

A wide choice of plug-in preamplifiers is available to satisfy every recording requirement: low, medium, and high gain chopper DC, universal carrier and phase sensitive demodulator. Zero suppression is available on most models.

WESCON Booth No's. 557-558

OTHER MASSA PRODUCTS

ACCELEROMETERS MICROPHONES
TRANSDUCERS HYDROPHONES

AMPLIFIERS

COMPLETE LINE OF MULTI-CHANNEL AND PORTABLE RECORDING SYSTEMS

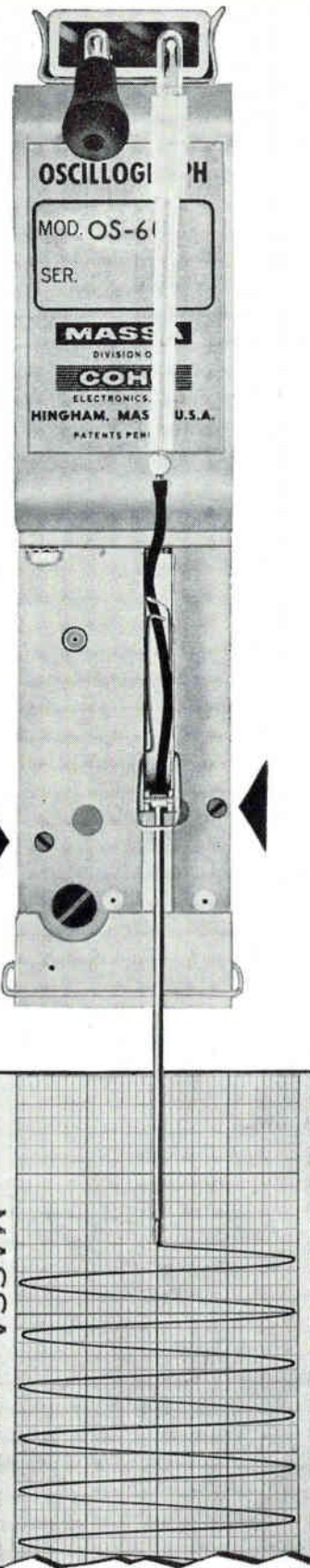

MASSA

A DIVISION OF

COHU

ELECTRONICS, INC.

6 FOTTLER RD.

HINGHAM, MASSACHUSETTS

voltage regulator and less than 25 μ a as a current regulator. Supply also features remote voltage programming, dual concentric controls for both coarse and fine adjustment of voltage or current and the Heatran circuit for electronic control of power transistor dissipation.

CIRCLE 315 ON READER SERVICE CARD

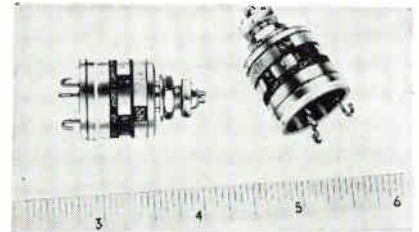

Potentiometer SINGLE TURN

MAUREY INSTRUMENT CORP., 7924 South Exchange Ave., Chicago 17, Ill. Model P/N 75-M72 wirewound, $\frac{3}{8}$ in. diameter, hermetically sealed trimmer dissipates 2 w at 80 C. Housing is electro-tinned brass, with glass header soldered in place. Shaft is sealed with Viton "A" O-ring. It is built to MIL specification, for use in extreme humidity environment.

CIRCLE 316 ON READER SERVICE CARD

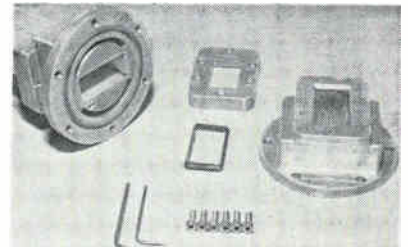

Waveguide Flanges EASILY ATTACHED

MICROTECH, INC., Milldale Road, Cheshire, Conn., has developed waveguide flanges which are attached to waveguide without soldering or brazing. They are said to have electrical characteristics equal to the equivalent brazed flange. Called "Easy-Tach", they can be attached to waveguide by inexperienced personnel using only Allen wrenches. In addition to being mechanical and electrical equivalents, the flange is also pressure tight. After assembly, the flange joint will stand greater than 230 lb straight

pull. They are ideal for field installations since assemblies can be fabricated on the spot. First models produced are ETP-137 plate and ETC-137 choke equivalent to UG-344/U and UG-343/U respectively. They are available in either aluminum or brass.

CIRCLE 317 ON READER SERVICE CARD

Adapter

LOW IMPEDANCE

WAYNE KERR CORP., 1633 Race St., Philadelphia 3, Pa. Type Z-601 adapter extends the versatility of the type B-601 r-f bridge to the measurement of impedances of less than 10 ohms. It enables the equivalent series components of small inductors, large-value capacitors, and a variety of semiconductors to be measured with an accuracy usually approaching that of the bridge itself. Circuit used is a T-network, the two ranges being provided by alternative series resistors; the unknown impedance is the shunt arm. The adapter extends the range to measure resistance 0.001 to 10 ohms; capacitance 0.001 to 5,000 μ f; and inductance 0.001 μ h to 300 μ h, all to an accuracy of 5 percent. Price is \$28.

CIRCLE 318 ON READER SERVICE CARD

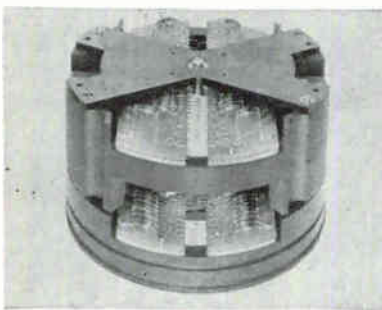

Shaft Position Encoder

1,000 COUNTS PER TURN

NORDEN DIVISION, United Aircraft Corp., Wiley St., Milford, Conn. The ADC-5-BSD (1000) shaft position encoder is capable of 100,000 counts in only 100 turns of the input shaft. It is basically a 1,000 count per turn device. It utilizes the Self-Selecting V-Brush technique, which provides a completely unambiguous output without the need for cumbersome and expensive external logic circuitry, as well as a new Split-bit technique, which

FLOATED RATE INTEGRATING GYROS

Specifically designed for missile applications, these Kearfott miniature gyros are available with short term drift rates of 0.01°/hr. Their outstanding accuracy and performance make them superior to any comparably-sized units on the market. Wide angle displacement gyros with high torquing rates for "strap-down" applications are also being produced. Performance characteristics that are even more precise can be provided within the same dimensions.



KEARFOTT DIVISION
Little Falls, New Jersey



GENERAL PRECISION, INC.
Other Divisions: GPL, Librascope, Link

CIRCLE 204 ON READER SERVICE CARD

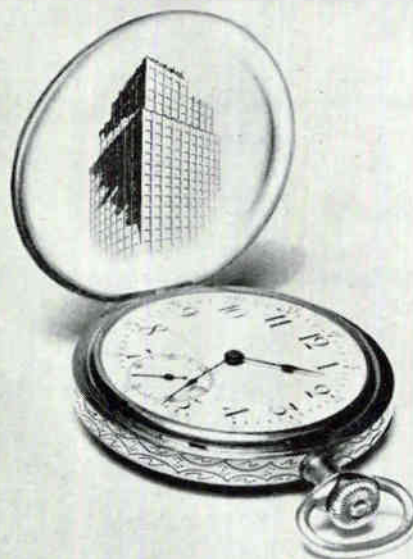

*Wisdom and
Assurance
are Endowed
with Age...*

established 1834

"BRUNO MEANS SECURITY"

AUTHORIZED INDUSTRIAL DISTRIBUTORS FOR: AEROVOX CORP. - ALPHA WIRE CORP. - AMERICAN TELEVISION & RADIO CO. - AMPERITE CO., INC. - AMPHENOL ELEC. CORP. - ARCO ELECTRONICS, INC. - ARROW-HART & HEGEMAN - BURGESS BATTERY CO. - CHICAGO STANDARD TRANSFORMER CORP. - CONTINENTAL CARBON, INC. - CORNELL-DUBILIER ELECTRIC CORP. - ERIE RESISTOR CORP. - EVEREADY BATTERIES - GENERAL CEMENT MFG. CO. - GUARDIAN ELECTRIC MFG. CO. - HAMMARLUND MFG. CO., INC. - I.T. & T. - E. F. JOHNSON CO. - KRAEUTER & CO., INC. - LITTELFUSE, INC. - P. R. MALLORY & CO. - MINNESOTA MINING & MFG. CO. - MUELLER ELECTRIC CO. - MULLARD TUBES - PRECISION APPARATUS CO., INC. - RADIO CORPORATION OF AMERICA - SIMPSON ELECTRIC CO. - H. H. SMITH, INC. - SPRAGUE PROD. CO. - SWITCHCRAFT, INC. - UNGAR ELECTRIC TOOLS CO., INC. - VACO PRODUCTS CO. - P. WALL MFG. CO. - WELLER ELECTRIC CORP. AND OTHER LEADING INDUSTRIAL LINES

BRUNO-NEW YORK, INC.
INDUSTRIAL ELECTRONIC DISTRIBUTOR



BRUNO BUILDING
460 WEST 34TH ST.,
NEW YORK 1, N. Y.
LONGACRE 4-8550



MICRO-MINIATURE RELAY STYLE 6A For Printed Circuits

Less Space

Lower Mounting Height

Terminals & Mounting
Conform to 0.2" Grid Spacing

For reliable switching of low-level as well as power loads. Style 6A will operate at coil power levels below most larger current-sensitive relays in its general class, yet easily switches load currents of 2 amps resistive and higher at 26.5 VDC or 115 VAC. Contact arrangement to DPDT.

Unique construction permits flexible wiring and a variety of schematics. Withstands 50 G shock and 20 G vibration to 2000 cycles.

Meets applicable portions of specifications MIL-R-5757C and MIL-R-25018 (USAF) Class B, Type II, Grade 3.

Call Or Write For Additional Information

PRICE ELECTRIC CORPORATION



306 Church Street • Frederick, Maryland
MOnument 3-5141 • TWX: Fred 565-U

permits incorporation of this high-resolution encoder into the smallest package possible. Applications include machine tool control, plotting tables, film readers and other data logging uses.

CIRCLE 319 ON READER SERVICE CARD

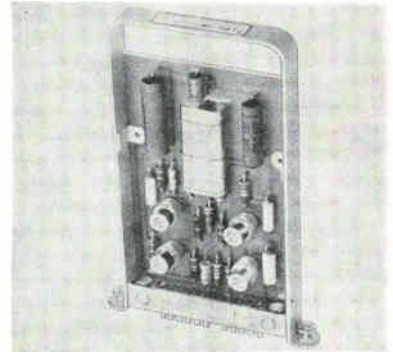

Crystal Oscillator PLUG-IN TYPE

PLUG-IN INSTRUMENTS, INC., 1416 Lebanon Road, Nashville 10, Tenn. Model S-50002-PA plug-in transistorized crystal oscillators have standard output frequencies of 5 Kc, 10 Kc, 20 Kc and 100 Kc. Other frequencies available on special order. The crystal oscillator has a sine wave output with an amplitude of approximately 7 v-pp when used with a load having an impedance of 1.5 K or higher. The output frequency and amplitude are very stable. Available in two mounting styles which permit these circuits to be individually or multiple mounted, they can be used with other plug-in circuits in assembly of many types of electronic equipment.

CIRCLE 320 ON READER SERVICE CARD

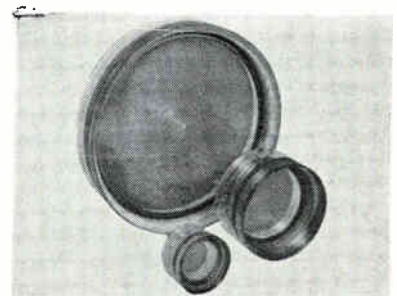

Photodiodes BI-PLANAR

ITT LABORATORIES, Fort Wayne, Ind. The FW series of photodiodes are a new approach to detection of gamma rays, cosmic rays, nuclear

particles, ultraviolet, and x-rays. Construction provides for close optical coupling of a flat scintillator disk, resulting in maximum use of the radiation. The series is bipolar and is linear from 10⁻⁹ amperes to 25 amperes. Use of appropriate scintillator phosphors makes the FW series suitable for providing qualitative as well as quantitative detection of most types of short burst radiation. Units measure from 1½ in. in diameter and 1½ in. in length to 7 in. in diameter and 3 in. in length. Although characteristics vary in the different types, in the 2½ in. unit, dark current output is about a billionth of an ampere with the anode at 2,500 v. Price: 2½ in., \$135 each; 1½ in., \$185; 5 in., \$250.

CIRCLE 321 ON READER SERVICE CARD



Delay Line HIGH-DENSITY

THE RALPH M. PARSONS CO., 151 South DeLancey Ave., Pasadena, Calif., announces a miniature lumped-constant delay line with a wide variety of general applications. Units are available in two standard configurations: cylindrical with a nine-pin header for standard tube socket mounting, and rectangular for use with printed circuitry. The cylindrical model is 1.0 in. in diameter by 2 in. long, and weighs 1.5 to 2.0 oz depending on required delay. Volume and weight of the rectangular models are comparable. Units having delay times of 0.5, 1.0, 2.0 and 3.0 μ sec are available off-the-shelf. The total delay is accurate to ± 3 percent. The rise-time to delay-time ratio is 5 percent with an attenuation of 1 db. Leakage resistance is more than 100 megohms between line

MAXIMUM ERROR 20 SECONDS ARC



Available in both conventional and gimbal mounted configurations, these synchros provide component accuracies of 20 seconds of arc or better. They permit RMS accuracy for 3 unit strings of better than 0.75 minutes. Specifically designed for precise data transmission in missile-borne applications, these components eliminate the need for 2 speed servos and complex electronics, provide increased reliability and marked improvement in over-all system performance.

KEARFOTT DIVISION
Little Falls, New Jersey



GENERAL PRECISION, INC.
Other Divisions: GPL, Librascope, Link

CIRCLE 205 ON READER SERVICE CARD

Install...

NATIONAL Molded Activated Carbon Getters

in your sealed electronic relay.

Here's why:

- **LARGE CAPACITY** — For contaminants which contribute to contact point failure.
- **STRONG** — Will not break down or dust even under severe mechanical operating conditions.
- **MOLDED** — Getter can be formed to fit your relay.

"National" and "Union Carbide" are registered trade-marks for products of

NATIONAL CARBON COMPANY

Division of Union Carbide Corporation

1300 Lakeside Avenue, Cleveland 14, Ohio



and ground at 500 v d-c. Input impedances available are 300, 500 and 1,000 ohms, ± 10 percent.

CIRCLE 322 ON READER SERVICE CARD

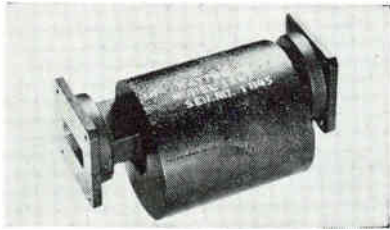

Isolator

FOR BROADBAND USE

RAYTHEON CO., 130 Second Ave., Waltham 54, Mass. Model 1XH7 isolator is 3.75 in. long, covers frequencies in the X-band region from 8,200 to 12,400 Mc. Designed to withstand the high temperatures usually associated with high average power and appreciable load mismatch, it can handle peak power of 25 Kw and average power of 150 w. Minimum isolation is 23 db. Maxi-

mum insertion loss is 0.8 db with a minimum of 0.5 db. Vswr is only 1.17 maximum and 1.04 minimum. It is equipped with RG-52/U waveguide and UG-39/U flanges and weighs 2.5 lb. Price is \$175.

CIRCLE 323 ON READER SERVICE CARD

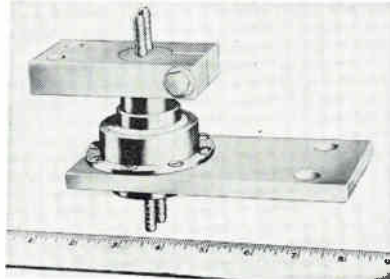

Powerful Rectifier

WATER COOLED

SARKES TARZIAN INC., 415 North College Ave., Bloomington, Ind. The ZB series of water cooled 1,000 ampere rectifiers covers a voltage range from 50-200 piv. Water cooling allows very small size and the total volume required for each de-

vice is less than 60 cu in. Three phase connection provides a current rating of 2,500 amperes, without paralleling units and 5,000 amperes with six phase connections.

CIRCLE 324 ON READER SERVICE CARD

H-V Supplies

TWO MODELS

RADIATION INSTRUMENT DEVELOPMENT LABORATORY, INC., 61 E. North Ave., Northlake, Ill. Models 40-6 and 40-7 feature long term stability, superior transient response and very low noise. They are based on the ORNL Q-2057 design and make use of 85A2 gas reference tubes for coarse control. For fine control the model 40-6 also uses Zener diodes. All switch positions are calibrated directly in volts. Each unit is only 3½ in. high and is suitable for rack mounting. Ruggedized chassis construction assures instrument stability. Both instruments have posi-

TOUGH NEW HIDE...

Another **SPECTROL** First



(Diallyl Iso-Phthalate)

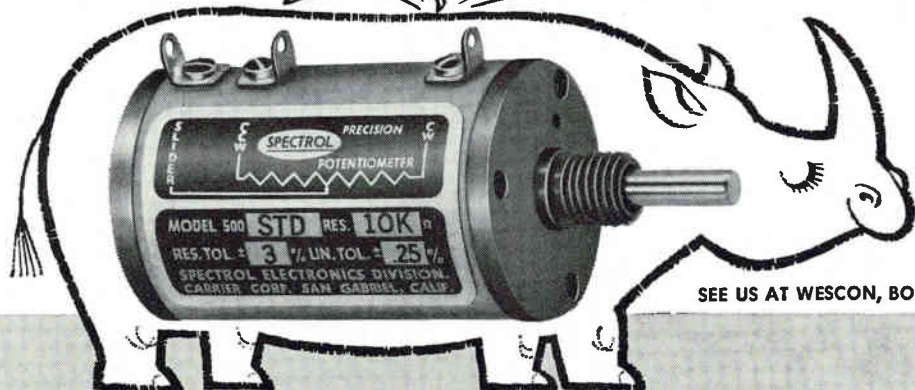

SEE US AT WESCON, BOOTH 1004

tive and negative output voltage connectors.

CIRCLE 325 ON READER SERVICE CARD



Counter-Timer

PROGRAMMABLE

SYSTRON CORP., 950 Galindo St., Concord, Calif. Programmable 1-Mc counter-timer is designed to MIL Spec and is completely ruggedized for the environment of field consoles of automatic checkout systems. Model 1036 measures frequency, period, time interval, frequency ratio and phase to accuracies of 1 part in 1 million. Additional Systron modules permit the

1036 to measure d-c voltages to 0.05 percent, a-c voltage (including true rms) to 0.1 percent and ohms to 0.15 percent.

CIRCLE 326 ON READER SERVICE CARD

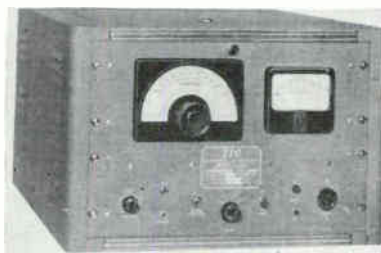

Frequency Converter

DELIVERS 250 VA

TEL-INSTRUMENT ELECTRONICS CORP., 728 Garden St., Carlstadt, N. J., announces a new, low cost, model 4025A frequency converter delivering 250 va. Unit features a wide selection of frequency ranges from 50 to 4,000 cps with fixed frequency accuracies up to 0.001 percent; capability of handling resistive or

reactive loads; nominal 1 percent harmonic distortion; zero output impedance and zero recovery time. The 4025A is designed for use with guided missile checkout systems, mag-amp testing, servo systems, aircraft instrumentation testing and other applications requiring power at fixed or variable frequencies.

CIRCLE 327 ON READER SERVICE CARD



UHF Diplexer

FOR MISSILE USE

HUGHES AIRCRAFT Co., Florence Ave. & Teale St., Culver City, Calif. Model U401 lightweight uhf di-

. for SPECTROL POTS

We haven't thought of a short, catchy name yet for Diallyl Iso-Phthalate, but maybe that's not too important. We'll be happy if you remember that this rugged new body for Spectrol pots is tougher than any other known plastic pot casing.

Essentially, Diallyl Iso-Phthalate consists of glass fibers suspended in plastic and molded under pressure. It has the following special characteristics:

Absorbs virtually no moisture.

Maintains dimensional stability under typical military environments.

Has high insulation resistance.

Withstands temperatures to 450°F.

This is a big improvement over previous plastic bodies. Accordingly, we have made Diallyl Iso-Phthalate casings available in many models in the broad Spectrol line. Your Spectrol rep has details, or just drop us a line at the factory.



NEW ENGINEERING AID

Have you received your pot selector chart? Suitable for wall mounting, this 24" x 30" chart contains complete and easily read specifications on 37 standard models of single and multi-turn precision potentiometers and three models of turns indicating dials (Multi-dials). For your free copy, contact your Spectrol engineering representative or write us direct. Please address Dept. 42.

SPECTROL

ELECTRONICS CORPORATION

- 1710 SOUTH DEL MAR AVENUE, SAN GABRIEL, CALIFORNIA
- 1250 SHAMES DRIVE, WESTBURY, L. I., NEW YORK

NEW PRECISION TAPES SOLVE ELECTRICAL INDUSTRY PROBLEMS

Solve insulating, bonding problems with SCHJELBOND THERMOPLASTIC TAPES

Schjelbond tapes combine an extremely strong bond with high dielectric strength. Manufactured to close dimensional tolerances, and with high electrical purity, they meet the most exacting standards.

SCHJELBOND 100 — .0025" thick Polyester dry strip adhesive without backing.

SCHJELBOND 300 — "Mylar"* backing, adhesive coated on one side.

SCHJELBOND 400 — "Mylar" backing, adhesive coated on both sides.

(Schjelbond 300 and 400 available with precise adhesive thicknesses from .0002-in. to .003-in., on .005-in. to .010-in. "Mylar".)

DIELECTRIC STRENGTH — "Mylar" rated at 4000 volts/mil.

BONDS — "Mylar", iron, steel, copper, glass, aluminum, wood, paper, cotton, silk, linen, nylon, wood fabrics, phenolics and ferrites.

SPECIAL LAMINATIONS, "Mylar" to "Mylar," are available.

SCHJELBOND ADHESIVE is also available with "Teslar" and other backing materials on special order.

*Du Pont trademark for its polyester film

"GIVE US A CHALLENGE..."

...and we will give you what you want. We at G. T. Schjeldahl Co. thrive on challenges. Our people specialize in making products to solve our customers' problems.

Our company is organized so we can move quickly to solve your problems. We have made many special laminations using Schjelbond for manufacturers of electric and electronic equipment. Our tape is suitable for many insulating jobs — from coil windings to flat cable.

If you have a problem in bonding, with a need for high dielectric strength, or if you need a special lamination, let us help. We can set up a complete production process for you. Send this coupon for further information."



Gilmore F. Schjeldahl

Please send me further detailed information about SCHJELBOND and special laminating.

Name _____ Title _____

Firm Name _____

Address _____

Town _____ State _____

PRODUCTS



SERVICES

G.T. Schjeldahl Co.

NORTHFIELD, MINNESOTA

Putting Tomorrow's Materials to Work Today

plexer permits a 100-w transmitter and sensitive receiver to be operated simultaneously with a single antenna in the 225-400 Mc band. With the transmitting frequency separated by less than 10 percent from the receiving frequency, isolation in excess of 100 db is provided in the receiving circuits. To conserve transmitter power, the insertion loss between transmitter and antenna is only 0.2 db with a vswr of 1.1. Design is such that no operational interaction between receiver and transmitter is experienced. Unit consists of a special combining circuit together with a bridged-T network and a pi-section filter on the receiving side. The assembly, which weighs less than 1 lb, has successfully withstood accelerations up to 150 g as well as other tests applicable to high-altitude rocket and missile environments.

CIRCLE 328 ON READER SERVICE CARD

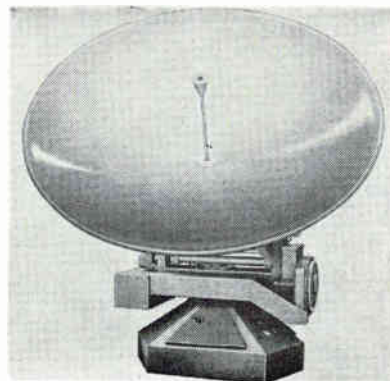

Helical Antenna BROADBAND

ANDREW CALIFORNIA CORP., 901 E. Marylind Ave., Claremont, Calif. Type 52055 (890-990) Helicone telemetry antenna system provides extremely reliable tracking operations by combining high gain with very low side and back lobes. The broadband Helicone feed, mounted in a parabolic reflector, has relatively constant impedance pattern over a very wide frequency band. This Helicone feed is adaptable to a variety of Andrew parabolic reflectors ranging in size from 6 ft to 28 ft and serving several frequency ranges. Mounted on a heavy duty two axis rotator the antenna system is designed for use under severe environmental conditions.

CIRCLE 329 ON READER SERVICE CARD



There's going to be a meeting

Who's going to get together and *what* are they going to talk about?

Electronics men are meeting all over the country to talk about everything from ultrasonics to quantum electronics.

electronics tells you where and when "Meetings Ahead"... gives you the highlights later on.

Another reason why it will pay you to subscribe to *electronics* (or renew your subscription) right now. Fill in the box on Reader Service Card. Easy to use. Postage free.

FIND WHAT YOU NEED IN...

electronics



SEALED ELAPSED TIME INDICATORS

SCHEDULE MAINTENANCE — STUDY PRODUCTIVITY

Glass-to-metal sealed ELAPSED TIME indicators. Compact, low cost, tamper-proof. Standard ASA/MIL dimensions, 2½" and 3½" sizes. Easy to read standard size counter registers 1/10 hour steps to 9999.9 or hour steps to 99999. Hermetically sealed. Shielded. Starts, operates continuously from - 55°C to +85°C. For 110-125 or 220-250 volts 60 cycle AC. Bulletin on request. Marion Instrument Division, Minneapolis-Honeywell Regulator Co., Manchester, N. H., U.S.A. In Canada, Honeywell Controls Limited, Toronto 17, Ontario.

VISIT BOOTH 2722 AT WESCON

Honeywell

75th YEAR
PI
YEAR

BEARING THE FUTURE



First in Control
SINCE 1887

CIRCLE 207 ON READER SERVICE CARD



ARE YOU PROPERLY GEARED FOR MINIATURIZATION?

SMALL DRILLS MUST BE HELD IN PRECISION COLLETS TO ASSURE ACCURACY

A super-sensitive drill press in which drills are held in precision collets to eliminate chucking errors.

Table is keyed to prevent any play. Feed is by raising table.

No quill to cause drag.

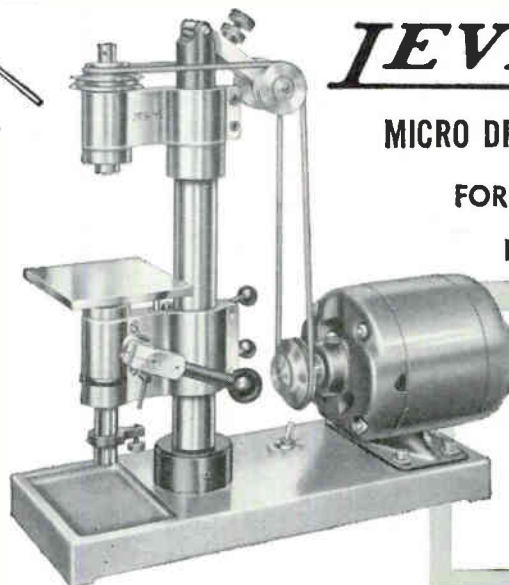

LEVIN®

MICRO DRILL PRESS

FOR VERY SMALL HOLES
DOWN TO .002"

For complete details of Micro-Drilling equipment send for catalog T.

Louis Levin & Son, Inc.
3610 So. Broadway
Los Angeles 7, Calif.

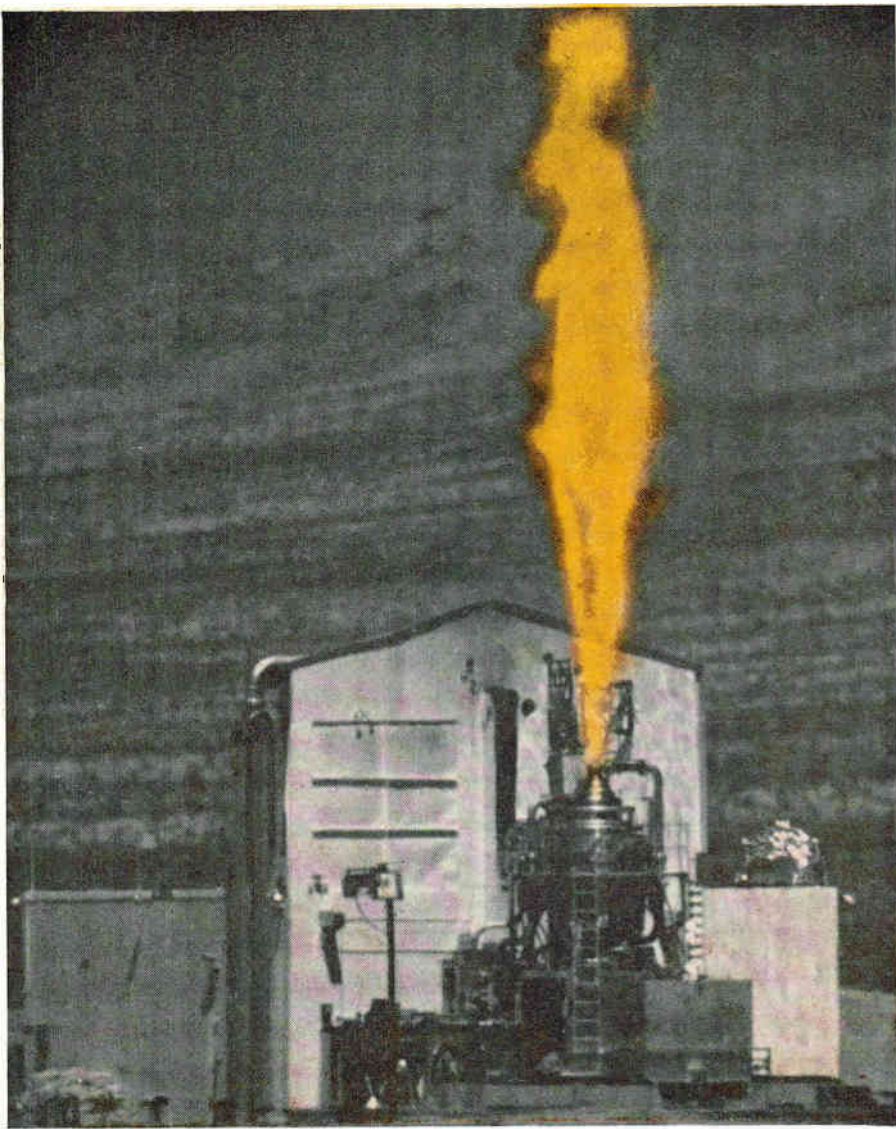

Space Propulsion for the future . . .

from the **KIWI** family of Nuclear Reactors

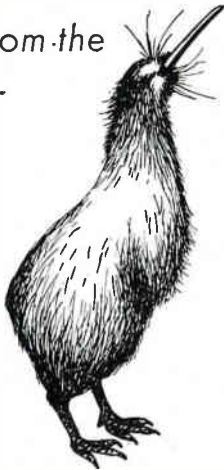

Los Alamos Scientific Laboratory has the major responsibility for research, development and testing in the AEC-NASA Rover program . . . another of the many investigations at Los Alamos into peacetime uses of nuclear energy.

PHOTO: First field test of a KIWI nuclear propulsion reactor.

For employment
information write:
Personnel Director
Division 60-93

los alamos
scientific laboratory
OF THE UNIVERSITY OF CALIFORNIA
LOS ALAMOS, NEW MEXICO

Literature of the Week

PLUG-IN CHOPPER Solid State Electronics Co., 15321 Rayen St., Sepulveda, Calif., has available literature covering the model 65 transistorized plug-in chopper with transformer coupled isolating drive capable of being driven from a 400 cycle power line or from a drive source that is common to the d-c voltage being chopped.

CIRCLE 333 ON READER SERVICE CARD

SILICON DIODES International Rectifier Corp., 1521 E. Grand Ave., El Segundo, Calif. Bulletin SR-213 covers two series of hermetically sealed silicon diodes that are manufactured expressly for industrial and military applications where high forward current and low leakage current are called for, over a wide range of temperature.

CIRCLE 334 ON READER SERVICE CARD

PRESSURE TRANSDUCER Consolidated Electrodynamics Corp., 360 Sierra Madre Villa, Pasadena, Calif. Details of a new type 4-382 pot pressure transducer designed for missile and operational aircraft applications in low pressure ranges are given in bulletin 4382.

CIRCLE 335 ON READER SERVICE CARD

VARIABLE RESISTOR Centralab, a division of Globe-Union, Inc., 900 E. Keefe Ave., Milwaukee 1, Wisc. Technical bulletin EP-891 contains complete data and specifications on the model 3W, a tiny 1½ watt wirewound variable resistor.

CIRCLE 336 ON READER SERVICE CARD

ISOLATORS Barry Controls Inc., 700 Pleasant St., Watertown 72, Mass., has available a catalog sheet on the series 6300-6550 isolators which protect lightweight equipment and components from vibration and shock.

CIRCLE 337 ON READER SERVICE CARD

SILVER-ZINC BATTERIES Yardney Electric Corp., 40-50 Leonard St., New York, N. Y. A 10-page illustrated brochure describes the physical, electrical and

NEW STROMBERG-CARLSON TELEPHONE HANDSET CRADLE



... for positive retention in all mobile applications

There's no jump, no sway—when a telephone handset is in the firm grip of this new handset cradle by Stromberg-Carlson.

Retaining clip spring assembly



assures positive retention in any mobile application on land or sea, or in the air. Even extremely severe jars,

jolts and vibrations fail to dislodge the handset.

The cradle is strong and resilient, fits any Stromberg-Carlson handset. Different models provide varying switch combinations with 2 or 4 Form C contacts. All models available with or without the clip assembly.

Specifications on request. In Atlanta call TRinity 5-7467; Chicago: STate 2-4235; Kansas City: HARrison 1-6618; Rochester: HUBbard 2-2200; San Francisco: OXFord 7-3630. Or write to Telecommunication Industrial Sales, 114 Carlson Road, Rochester 3, New York.

STROMBERG-CARLSON
A DIVISION OF
GENERAL DYNAMICS

CIRCLE 208 ON READER SERVICE CARD

August 19, 1960

typical application characteristics of a line of rechargeable silver-zinc batteries, which come in two types: high-rate for complete discharge in less than an hour and low-rate for discharge rates longer than an hour.

CIRCLE 338 ON READER SERVICE CARD

RADAR REFLECTIVITY Radiation Inc., Melbourne, Fla. Reflectivity studies and measurement facilities are discussed in a recently published six-page brochure.

CIRCLE 339 ON READER SERVICE CARD

UNITIZED ASSEMBLY CONTAINERS G. B. Lewis Co., Watertown, Wisc. A four-page folder illustrates and describes Plastibox unitized assembly containers and accessories for production line feed and storage of small parts.

CIRCLE 340 ON READER SERVICE CARD

R-F CONNECTORS Greomar Mfg. Co., Inc., 7 North Ave., Wakefield, Mass. A six-page, two-color illustrated brochure describes in detail the research, development and quality control as carried out at Greomar in the manufacture of r-f connectors.

CIRCLE 341 ON READER SERVICE CARD

GROUND SUPPORT EQUIPMENT Fruehauf Trailer Co., Detroit 32, Mich. The full scope of the company's ground support equipment program, including the design, research, development and production phases, is described and illustrated in a new 20-page, 3-color brochure.

CIRCLE 342 ON READER SERVICE CARD

SEMICONDUCTOR DEVICE Solid State Products, Inc., One Pingree St., Salem, Mass., has published a new applications bulletin illustrating how low-level logic operations and high-level output can be combined in a single circuit with the SSPI Tristor.

CIRCLE 343 ON READER SERVICE CARD

INDUSTRIAL TUBES Tung-Sol Electric Inc., One Summer Ave., Newark 4, N. J., has available a loose-leaf perforated, well-indexed folder containing illustrations and technical data on a wide line of industrial tubes.

CIRCLE 344 ON READER SERVICE CARD



BORIDES for modern industry

Leadership in high temperature technology, symbolized by the NORTON FIREBIRD, has made possible the production of the borides of chromium, titanium and zirconium in tonnage quantities.

In the METAL INDUSTRY, aluminum manufacturers utilize the low electrical resistivity and high resistance to attack by aluminum and cryolite that borides of titanium and zirconium provide. Borides are ideal boron sources for super alloys and nuclear steels . . . ROCKET ENGINE manufacturers take advantage of the superior resistance to erosion and corrosion at high temperatures that zirconium boride offers.

NORTON borides, because of their unusual properties, are being examined closely at Research and Development level as shapes and coatings for many applications.

In addition, borides of calcium, molybdenum, and vanadium are available on a limited basis for evaluation. If you have a specific requirement, let's hear about it.

Write NORTON COMPANY, Electro-Chemical Division, 687 New Bond St., Worcester 6, Mass.



Send for booklet on borides and other Norton Electro-Chemicals.

NORTON
ELECTRO-CHEMICALS

GIFTS OF THE FIREBIRD: compounds of silicon zirconium • boron • aluminum • magnesium titanium • chromium • including many borides carbides • nitrides • oxides

75 Years of...
Making better products...
to make your products better

CIRCLE 101 ON READER SERVICE CARD

101

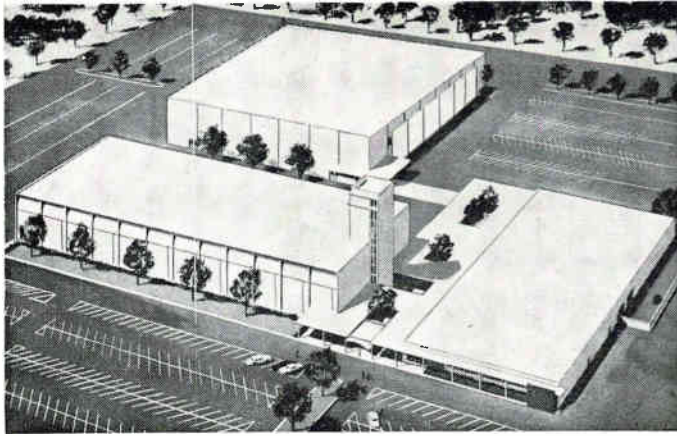

Autonetics Plans 3-Building Complex

PLANS for development of an 80-acre land parcel in Anaheim, Calif., into a large electronics complex were recently announced by John R. Moore, president, Autonetics, a division of North American Aviation, Inc.

Construction has already started on the first of three buildings totaling 400,00 sq ft for the division's armament and flight control operations.

By the end of 1961, employment at the new site is expected to reach 3,200 persons with an annual payroll exceeding \$20 million, Moore said.

"This facility when completed will allow Autonetics to consolidate related operations now carried on at various locations in the Los Angeles area", he explained.

Charles A. Wolf, vice president, armament and flight control product operations, will head the Anaheim-based Autonetics function, which will include administration, engineering, manufacturing, quality control, purchasing and marketing. At the facility, Autonetics will develop and produce multipurpose radars, armament control systems, autopilots, automatic landing systems, navigation bombing systems and controls for boost-glide weapon systems, interplanetary vehicles and satellites.

With headquarters in Downey, Calif., Autonetics employs 20,000 scientists, engineers, technicians, production and supporting personnel.

As an organization, Autonetics represents an activity that had its beginnings early in 1946 when North American Aviation undertook programs for high-performance weapon systems requiring autopilot and navigation equipment more advanced than any then available. The organization set up then to develop new electronics and control equipment for such weapon systems was the forerunner of today's Autonetics.

Present southern California facilities of Autonetics are situated in Downey, Compton, Whittier, Pico-Rivera, Paramount, Long Beach and Fullerton. Regional offices are in Washington, D. C., and Dayton, O. Autonetics' European office is in Geneva, Switzerland.



Budd Electronics Appoints V-P & G-M

JEROME L. STRAUSS has been appointed vice president and general manager of Budd Electronics, Inc.,

a subsidiary of The Budd Co. He will make his headquarters at the general offices in Long Island City, N. Y.

Strauss joined the Lewyt Manufacturing Corp., now Budd Electronics, in 1946 as sales manager. In 1950 he was appointed vice president for marketing.

This Budd subsidiary designs and produces data processing systems, communications equipment, electronic countermeasure systems, environmental controls for electronic instruments, and specialized test equipment.



Roy Herter Takes New Position

APPOINTMENT of Roy J. Herter as director of sales for the John E. Fast & Co., subsidiary of the Victoreen Instrument Co., Chicago, Ill., was recently announced.

Herter comes to this electronic capacitor manufacturer from the Cook Electric Co., where he was field sales manager. Previously, Herter had been assistant to vice president of marketing at Hoffman Electronics Corp., semiconductor division.

Announce Formation Of New Company

DAVID R. MILLER, president, has announced the formation of a new electronics firm, Computronics, Inc., in Denver, Colo.

The new company plans to pursue a program of development, manufacture and sales of components and systems for instrumentation, computers, controls, and data handling. Products already under

PROVEN, DEPENDABLE... REAR-PROJECTION TYPE

ON-LINE DIGITAL DISPLAYS

A Model and Size
For Your Every
Requirement

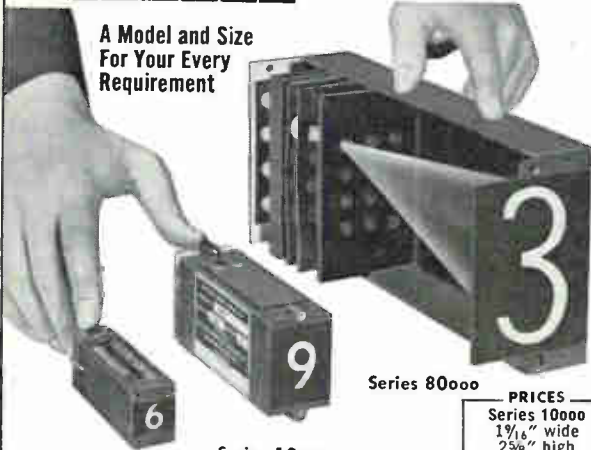

Series 120000

Series 10000

Series 80000

OUTSTANDING FEATURES

- All digits displayed on front viewing screen
- All digits uniform in size and intensity
- High-contrast viewing screen
- Digit style of your choice
- Colored digits of your choice
- Individual units may be group assembled for panel mounting

WRITE TODAY FOR COMPLETE DETAILED SPECIFICATIONS
Representatives in principal cities

PRICES	
Series 10000	1 1/16" wide 2 5/8" high 5 3/8" long \$18.00 each
Series 80000	3 1/4" wide 5 1/4" high 11 1/4" long \$33.00 each
Series 120000	1" wide 1 5/8" high 3 7/8" long \$35.00 each
Quantity Prices On Request	



INDUSTRIAL ELECTRONIC ENGINEERS, INC.

5528 Vineland Avenue, North Hollywood, California

CIRCLE 209 ON READER SERVICE CARD

CONANT

where stability
and miniaturization
are primary

**SEMICONDUCTORS
COPPER OXIDE
AND SELENIUM**

**INSTRUMENT RECTIFIERS
RING MODULATORS
HIGH-VOLTAGE RECTIFIERS
VOLTAGE REGULATORS
SWITCHED RECTIFIERS
CHOPPERS**

**SPECIAL PURPOSE UNITS
LIST PRICES FROM .42c**

5 COPPER OXIDE CELL STYLES FROM
.080" to .500" DIA. ACTIVE AREAS .0012 to
.125 SQ. IN.

SELENIUM CELL SIZES FROM .080" round
TO 2" SQUARE. .020" TO .045" THICK.

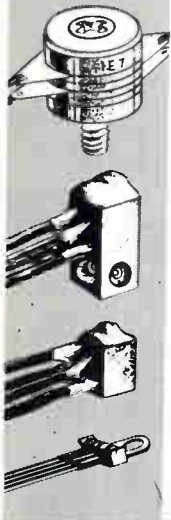

Write for
Free Bulletins
Dept. E

**CONANT LABORATORIES
LINCOLN, NEBRASKA**

CIRCLE 210 ON READER SERVICE CARD



get the shortest
etching time with

HUNT ETCHANTS



Wherever Hunt Etchants are used production rates jump.
HUNT R. C. E. (Rapid Circuit Etch) is a fast acting, specially balanced etchant for printed circuit board production.

HUNT S. C. E. (Solder Circuit Etch) is the only prepared product formulated to etch solder-plated boards at room temperature without attacking the solder.

Send for: **R. C. E. TECHNICAL BULLETIN 1 & 1A**
S. C. E. TECHNICAL BULLETIN 3

Hunt Etchants are now manufactured on the West Coast.

FOR SUPERIOR RESULTS AROUND THE CLOCK USE HUNT GRAPHIC ARTS CHEMICALS

PHILIP A. HUNT COMPANY

PALISADES PARK, N. J.

BRANCHES IN PRINCIPAL CITIES

In Canada: Philip A. Hunt Company (Canada) Ltd.
207 Queen's Quay West, Toronto



CIRCLE 103 ON READER SERVICE CARD

103

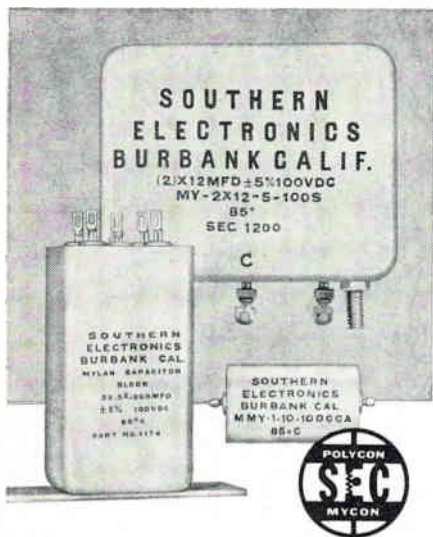

Capacitors for **NO COMPROMISE** Circuit Design

Unusual requirements in capacitance, tolerance, case size or configuration no longer need compromise your circuit designs. SOUTHERN ELECTRONICS' engineers are experienced in solving these problems to the extent that non-standard capacitors have become routine at SEC.

SEC has developed multiple block capacitors that are now saving space and weight in a production missile. Two 12mfd capacitors were designed to take less space than one, with improved electrical characteristics. In another application, SEC eliminated 6 tubular capacitors, utilizing a single can, 6 terminals and a common ground. Result: Room for additional components, easier wiring, and a less expensive component.

SEC, in addition to designing special capacitors to save weight and space, has developed dual-dielectrics to solve unusual temperature coefficient problems, and has introduced special dielectrics and oils for extreme high temperature and high voltage applications.

This engineering know-how has resulted in the use of SEC capacitors in twelve U.S. missiles, analog computers, and many radar and communications services.

SEC capacitors are manufactured in a wide range of capacitance to meet your needs from 100mmf to any higher value, with tolerances as low as 0.1%. They are made under unusually critical quality control standards, and meet or exceed the most rigid MIL-SPECS.

Write today for detailed technical data and general catalog.



Pioneers in custom precision capacitor engineering

SOUTHERN ELECTRONICS Corporation

150 WEST CYPRESS AVENUE
BURBANK, CALIFORNIA

manufacture include analog system controls, servo-set potentiometers, diode function generators, and a radio operated system of remote communication and indication. Future product planning will be directed toward development of digital-analog devices, analog system programming equipment, and digital instrumentation.



Appoint Luna to Fill Two Positions

Albert R. Luna has been named sales manager and chief applications engineer of Burmac Electronics Co., Inc., Rockville Center, N. Y., designers and manufacturers of equipment and components for the radar and microwave industry.

After eight years of radar engineering at Sperry Gyroscope Co., Luna was employed by AMP, Inc., as chief engineer of the Capatron division. He went subsequently to Filtron Co., Inc., where as chief engineer of the network division he was instrumental in launching that company in the pulse-forming network, power supply and pulse component field.

CSI Takes Over New Plant

OCCUPANCY of its new 30,000 sq ft plant by Computer Systems, Inc., in Monmouth Junction, N. J., is announced.

Expandable to 200,000 sq ft, the fully air conditioned facility will house laboratory, engineering, production and administration. Special power provisions will accommodate simultaneous operation of 18 full-sized MC-5900 analog computers composed of over 2,000 amplifiers.

A section of the plant will be de-

FOREMOST in MARINE LORAN

EDO CORPORATION
College Point, L.I., N.Y.
Since 1925

CIRCLE 214 ON READER SERVICE CARD

Heyco Nylon BUSHINGS

STRAIN RELIEFS
The insulating bushing that anchors a cord set to an electrically operated machine or appliance.

JUNCTION-TERMINAL BUSHINGS
Eliminate "pig-tails" — Miniature size. Snap-in assembly, color or number coded. Can be used as plug-in receptacle. Simple quick disconnect.

ACCORDIAN TYPE
Fit curved surfaces
Nylon bushing — brass tab

HEYCO NYLON Snap Bushings

10 Sizes for holes from $\frac{3}{8}$ " to $1\frac{3}{4}$ " dia. — various inside diameters. Snap locks into panels up to $\frac{3}{8}$ " thick.

FREE SAMPLES! BUSHINGS OF YOUR CHOICE

HEYMAN MANUFACTURING COMPANY
KENILWORTH 3, NEW JERSEY

CIRCUIT ENGINEERS

SALARY: TO \$15,000

Several immediate openings exist in Hughes-Fullerton's new Computer Laboratory for Circuit Engineers qualified in transistor circuitry design and semiconductor power supply design in connection with the design and development of large scale digital computers and digital systems.

These professional assignments involve such R & D areas as:

- Solid state digital circuitry involving millimicrosecond logic
- Microwave carrier digital circuits
- Sub-microsecond core memory
- Thin film storage techniques
- Functional circuit concepts
- Micro-miniaturization concepts
- Tunnel diodes ■ Microwave parametrons ■ Circuit organization for maximal-speed computing.

Located in Southern California's Orange County (the nation's fastest growing electronics center), Hughes-Fullerton offers you: a stimulating working environment; private or semi-private offices; long-term stability.

CALL COLLECT TODAY!

For complete information on these challenging assignments, call us collect today! Ask for:

Mr. B. P. RAMSTACK at:
TRojan 1-4080, ext. 3741.

Or, airmail resume to: HUGHES-FULLERTON R & D, P. O. Box 2097, Fullerton 1, California.

HUGHES

HUGHES AIRCRAFT COMPANY

voted to the production of the company's new ADRAAC system. This Automatic Digital Recording and Control system completely monitors, controls, and operates an analog computer from punched tape without human intervention.

By the end of 1960 engineering and production personnel will be doubled, according to the announcement.



Elect Rogoff Executive V-P

JULIAN ROGOFF, vice president and manager of the Omaton division of Burndy Corporation, has been elected executive vice president of the corporation.

He joined the company in 1930, was named assistant chief engineer in 1939, chief engineer in 1947, vice president in 1955, and has headed the Omaton division since 1956 when it was organized to serve the electronic and electrical manufacturing markets. He has been a member of the Burndy board of directors since 1947.

Sperry Division Expands Plant

A PLANT EXPANSION program adding 30,000 sq ft of floor space to its Gainesville, Fla., facility, has been completed by Sperry Electronic Tube division of Sperry Rand Corp.

Opening of the addition brings the division's total plant area to 160,000 sq ft. The division now employs more than 600 people at Gainesville.

Principal activities are the manufacture, testing and sales of a complete line of traveling wave and klystron microwave tubes. The division also carries on extensive research and development work.

*Here's a simple,
portable sound
analyzer*



THE ALLISON 532 OCTAVE BAND ANALYZER

The Allison 532 is a small, light weight instrument that is exceedingly easy to operate. It separates sound into frequency components for analysis. The 532 is suitable for use with sound level meters, tape recorders, microphone preamplifiers and similar equipment. For complete information, write for Technical Bulletin #532.

532 SPECIFICATIONS

- Five 10 db step attenuator
- Dynamic range of 66 db
- Eight bands with passive network
- Transistorized and battery operated
- Approximate shelf life for battery
- 33 db per octave attenuation rate with flat pass band
- Input level adjustable—nominally 1 volt
- Cutoff frequencies conform to ASA S-1.6-1960 Preferred Frequencies
- Meter circuit meets ASA Standard for S.L.M.S.
- Weight 6.5 lbs; 6³/₄" x 6³/₄" x 5¹/₂"
- Price \$425.00
F.O.B. factory

Write for new catalog of Allison Analyzing Instruments



*Proved
dependable
in years of service*

**Allison
Laboratories, Inc.**

11301 OCEAN AVENUE
LA HABRA, CALIFORNIA

WHAT HAPPENS WHEN A NATION SPENDS MORE ON GAMBLING THAN IT SPENDS FOR HIGHER EDUCATION ?

If you can find any Romans around, ask them. They lived pretty high on the hog in their day. That is, until some serious-minded neighbors from up North moved in. The rest is ancient history.

You'd think their fate would have taught us a lesson.

Yet today we Americans spend twenty billion dollars a year for legalized gambling, while we spend a niggardly four-and-a-half billion for higher education. Think of it! Over four times as much! We also spend six-and-a-half billion dollars a year for tobacco, nine billion dollars for alcoholic beverages, and billions more on other non-essentials.

Can't we read the handwriting on the wall?

Our very survival depends on the ability of our colleges and universities to continue to turn out thinking men and women. Yet today many of these fine institutions are hard put to make ends meet. Faculty salaries, generally, are so low that qualified teachers are leaving the campus in alarming numbers for better-paying jobs elsewhere.

In the face of this frightening trend, experts estimate that by 1970 college applications will have doubled.

If we are to keep our place among the leading nations of the world, we must do something about this grim situation before it is too late. The tuition usually paid by a college student covers less than half the actual cost of his education. The balance must somehow be made up by the institution. To meet this deficit even the most heavily endowed colleges and universities have to depend upon the generosity of alumni and public spirited citizens. In other words, they depend upon *you*.

For the sake of our country and our children, won't you do your part? Support the college of your choice *today*. Help it to prepare to meet the challenge of tomorrow. The rewards will be greater than you think.

It's important for you to know what the impending college crisis means to you. Write for a free booklet to HIGHER EDUCATION, Box 36, Times Square Station, New York 36, New York.



*Sponsored as a public service
in co-operation with The Council for Financial Aid to Education*



PROFESSIONAL SERVICES

ERCO RADIO LABORATORIES, INC.

Radio Communications Equipment
Engineering - Design - Development - Production
Our 30th Year in Air to Ground
Communication and Radio Beacons
Garden City • Long Island • New York

EUGENE MITTELMANN, E.E., Ph.D.

Consulting Engineer, Physicist
ELECTRONICS FOR INDUSTRY
Analysis, Research and Development
549 West Washington Boulevard
Chicago 6, Illinois
Central 6-2983

TELECHROME MFG. CORP.

Electronic Design Specialists
COLOR TELEVISION EQUIPMENT
Flying Spot Scanners, Color Synthesizers, Keyers,
Monitors, Oscilloscopes and Related Apparatus
Telemetering for Guided Missiles.
J. R. Popkin-Curman, Pres. & Dir. of Eng.
28 Ranick Dr. Amityville, L. I., N. Y.

THE CONSULTING ENGINEER

"By reason of special training, wide experience and tested ability, coupled with professional integrity the consulting engineer brings to his client detached engineering and economic advice that rises above local limitations and encompasses the availability of all modern developments in the fields where he practices as an expert. His services, which do not replace but supplement and broaden those of regularly employed personnel, are justified on the ground that he saves his client more than he costs him."

EMPLOYMENT OPPORTUNITIES



The Advertisements in this section include all employment opportunities—executive, management, technical, selling, office, skilled, manual, etc.

Positions Vacant	Civil Service Opportunities	Employment Agencies
Positions Wanted	Selling Opportunities Wanted	Employment Services
Part Time Work	Selling Opportunities Offered	Labor Bureaus

DISPLAYED

The advertising rate is \$34.33 per inch for all advertising appearing on other than a contract basis. Contract rates quoted on request.

An advertising inch is measured $\frac{1}{8}$ " vertically on a column—3 columns—30 inches to a page.
Subject to Agency Commission.

---RATES---

\$2.40 per line, minimum 3 lines. To figure advance payment count 5 average words as a line.

Box Numbers—counts as 1 line.

Discount of 10% if full payment is made in advance for 4 consecutive insertions.

Not subject to Agency Commission.

UNDISPLAYED

Send **NEW ADS** to **CLASSIFIED ADV. DIV. of ELECTRONICS**, P.O. Box 12, N. Y. 36, N. Y.

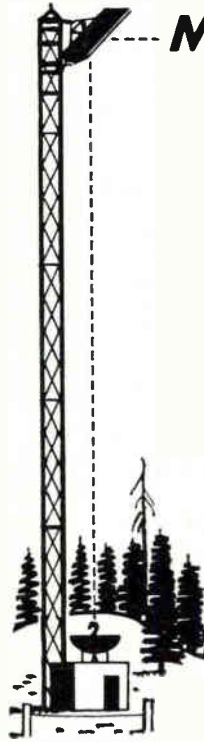

Microwave Engineers

Lenkurt Electric Co., a leading manufacturer of high performance carrier telephone, microwave and data transmission equipment, has immediate openings for senior microwave engineers in the development of microwave radio systems for multi-channel telephone service. Experience in video amplifier and broad band IF circuits, microwave test and design techniques and an understanding of semi-conductor applications in the microwave region is desirable. 5 - 10 years experience with a BS degree, or higher required. Top salary, liberal fringe benefits, including a stock purchase plan. Modern engineering labs located on the beautiful San Francisco peninsula.

Also other Communications Development Engineering positions available. For interested engineers, facilities in Vancouver, B.C., Canada, offer many opportunities.

Send resume or call collect LY 1-8461.

E. JACK SHANNAHAN
Employment Manager

Lenkurt

ELECTRIC CO., INC.

San Carlos, California

a subsidiary of General Telephone & Electronics



CIRCLE 379 ON READER SERVICE CARD

Your inquiry will have Special Value . . .

If you mention this magazine, when writing advertisers. Naturally, the publisher will appreciate it . . . but, more important, it will identify you as one of the men the advertiser wants to reach with this message . . . and help to make possible enlarged future service to you as a reader.

EMPLOYMENT OPPORTUNITIES

MILITARY SALES REPS**with Engineering Background**

Blue chip corporation, leading metropolitan New York, Military Electronic Equipment manufacturer and prime contractor with U. S. Gov't, seeks men with top-flight background in sales and engineering liaison with military purchasing units.

TERRITORIES:

- 1 Ft. Monmouth and Philadelphia signal procurement areas.
- 2 East Coast—To cover prime electronic and air frame manufacturers.
- 3 West Coast—To cover all air frame manufacturers including San Diego.
- 4 Ft. Huachuca, Arizona and the Southwest

No objection to multiple representation on non-conflicting product lines. These are permanent positions with exceptional growth potential. Send complete resume—confidentially handled.

RW-5080, Electronics, Class. Adv. Div., P. O. Box 12, N. Y. 36, N. Y.

CIRCLE 385 ON READER SERVICE CARD

SEARCHLIGHT SECTION

(Classified Advertising)

BUSINESS OPPORTUNITIES

EQUIPMENT - USED or RESALE

SENIOR ENGINEER

\$15,500

B.S.E.E. or physics degree required. 5 or more years experience to work in developing new and improving non-destructive testing techniques. This will involve fields of magnetics, acoustics and optics. Send resume in complete confidence. Company client assumes agency and relocation expenses.

ESQUIRE PERSONNEL

202 S. STATE STREET, CHICAGO 4, ILLINOIS

CIRCLE 387 ON READER SERVICE CARD

RESEARCH SCIENTIST

\$18,000

Five to ten years experience to join research technical staff. Broad background in physics, solid-state, microwave resonances, electromagnetic theory, etc. PhD in physics. Contact Law Musgrave.

MONARCH PERSONNEL

28 East Jackson Chicago 4, Illinois

CIRCLE 388 ON READER SERVICE CARD

ADDRESS BOX NO. REPLIES TO: Box No.

Classified Adv. Div. of this publication.

Send to office nearest you.

NEW YORK 36; P. O. Box 12

CHICAGO 11; 520 N. Michigan Ave.

SAN FRANCISCO 4; 68 Post St.

POSITION WANTED

Electrical Engineer (German) seeks connection with American firm with subsidiary in Germany or wishing to establish production facilities. Knowledge of American and German production methods, personnel procedures. Experienced in automatic machinery, communication circuits and electrical test equipment in U. S. and abroad. PW-4939, Electronics.

FOR SALE**38,000 SQUARE FEET SINGLE STORY BRICK INDUSTRIAL BUILDING & PLUS**

additional single story warehouse and office space totaling 10,000 square feet

Approximately 5 acres of land in city limits. Railroad siding, fully sprinklered with 50,000 gallon water tank, coal fired boiler and steam heat, paved street frontage, all utilities. Surplus of skilled female labor available, ideal for any assembly operation such as sewing, electronics, etc. 30 miles from Asheville in progressive Western North Carolina. Available 90 days after completion of sale. Contact:

PISGAH MILLS, INC.

P.O. Box 787

Brevard, N. C. Tel. No. Turner 2-2521

CIRCLE 460 ON READER SERVICE CARD

To EMPLOYERS Who Advertise for MEN:

Frequently, when there are many applicants for a position, only the most promising letters are acknowledged. The other applicants never know whether their letters reached a prospective employer or not. These men often become discouraged, will not respond to future advertisements and even question their bonafide character.

Every Advertisement Printed in the Employment Section Is Duly Authorized.

You can help keep our readers interested and get better returns to your advertising in this section if you acknowledge each reply—in plain envelopes, if you wish.

Classified Advertising Division

**McGraw-Hill
Publishing Co., Inc.**

"Put Yourself in his place."

FOR INFORMATION

About Classified Advertising,

Contact

*The McGraw-Hill
Office Nearest You.*

ATLANTA, 3

1301 Rhodes-Haverty Bldg.

JACKSON 3-6951

M. MILLER

BOSTON, 16

350 Park Square

HUBBARD 2-7160

M. J. HOSMER

CHICAGO, 11

520 No. Michigan Ave.

MOHAWK 4-5800

W. J. HIGGINS

CLEVELAND, 13

1164 Illuminating Bldg.

SUPERIOR 1-7000

W. B. SULLIVAN

DALLAS, 2

1712 Commerce St.,

Vaughn Bldg.

RIVERIDE 7-5117

J. GRANT

DENVER, 2

1700 Broadway—Tower Bldg.

ALPINE 5-2981

J. PATTEN

DETROIT, 26

856 Penobscot Bldg.

WOODWARD 2-1793

LOS ANGELES, 17

1125 W. 6th St.

HUNTLEY 2-5450

W. C. GRIES

NEW YORK, 36

500 Fifth Ave.

OXFORD 5-5959

H. T. BUCHANAN—R. P. LAWLESS

T. W. BENDER

PHILADELPHIA, 3

Six Penn Center Plaza

LOCUST 8-4330

H. W. BOZARTH - H. NICHOLSON

PITTSBURGH, 22

4 Gateway Center

EXPRESS 1-1314

P. PIERCE

ST. LOUIS, 8

3615 Olive St.

JEFFERSON 5-4867

SAN FRANCISCO, 4

68 Post St.

DOUGLAS 2-4600

S. HUBBARD

INDEX TO ADVERTISERS



Audited Paid Circulation

Adler Electronics, Inc.....	69	* Kearfott, Division of General Precision	89, 91, 93
Allison Laboratories, Inc.....	105	* Kintel, A Division of Cohu Electronics Inc.	3rd Cover
Applied Communications Systems	37, 38, 39, 40		
* Augat Bros., Inc.....	87		
		Leesona Corp.	88
* Barnstead Still & Sterilizer Co.....	14	Levin & Son, Inc., Louis.....	99
Bell Aerosystems, Co.....	85	Los Alamos Scientific Laboratories	100
* Bliley Electric Co.....	89		
Bruno-New York, Inc.....	91, 113	Marion Electrical Instrument Co., Division of Minneapolis-Honeywell Regulator Co.	99
* Bryant Computer Products.....	22	* Massa Division of Cohu Electronics, Inc.	90
		* Minneapolis-Honeywell Regulator Co. Boston Division	33
* Celco-Constantine Engineering Laboratories	26	Minnesota Mining & Mfg.—MinCom Division	45
Conant Laboratories	103		
Consolidated Avionics Corp.....	78	National Carbon Co.....	93
* Curtiss-Wright Corp.	82	Norton Company	101
Delco Radio	16	Ozalid, A Division of General Aniline & Film Corp.....	12
* DeMornay-Bonardi	81		
Dorne & Margolin, Inc.....	27	Pacific Semiconductors Inc.....	3
		Phillips Gloeilampfabriek, N. V.	24, 25
Edo Corporation	104	Power Instrument Corp.....	6
		Precision Instrument Co. 17, 18, 19,	20
Food Machinery and Chemical Corp. Chemicals & Plastics Division...	47	* Price Electric Corp.....	92
		* Radio Corporation of America... 4th Cover	
* Gates Radio Co.....	46	* Raytheon Company	5, 71
General Electric Co. Lamp Division	74, 75	* Reeves-Hoffman	87
* General Findings & Supply Company	2	* Resistance Products Co.....	114
		* Rheem Semiconductor Corp....28, 29	
Haydon Co., A. W.....	79		
* Hewlett Packard Co.....2nd Cover		Schjeldahl Co., G. T.....	96
* Heyman Manufacturing Co.....	104	* Sierra Electronic Corporation.....	10
* Hughes Aircraft Co.....	105	* Southern Electronics Corp.....	104
Hunt Company, Phillip A.....	103	Space Technology Laboratories, Inc.	15
		Spectrol Electronics Corp.....94,	95
* Industrial Development Laboratories, Inc.	44	* Sperry Electronic Tube Division, Sperry Rand Corp.....	34
* Industrial Electronic Engineers, Inc.	103		
International Electronic Research Corp.	83		
Jones & Lamson Machine Co.....	73		

*See Advertisement in the July 20, 1960 issue of Electronics Buyers' Guide for complete line of products or services.

IN LESS THAN 4 SECONDS

FROM THIS

TO THIS

OR THIS

WITH THE REVOLUTIONARY PRODUCTION AID TOOL!

"PIG-TAILOR"[®]



Foot operated
No accessories
3 minute set up

\$125.00

"PIG-TAILORING"

a revolutionary new mechanical process for higher production at lower costs. Fastest PREPARATION and ASSEMBLY of Resistors, Capacitors, Diodes and all other axial lead components for TERMINAL BOARDS, PRINTED CIRCUITS and MINIATURIZED ASSEMBLIES.

PIG-TAILORING eliminates: • Diagonal cutters • Long nose pliers • Operator judgment • 90% operator training time • Broken components • Broken leads • Short circuits from clippings • 65% chassis handling • Excessive lead tautness • Haphazard assembly methods.

PIG-TAILORING provides: • Uniform component position • Uniform marking exposure • Miniaturization spacing control • "S" leads for terminals • "U" leads for printed circuits • Individual cut and bend lengths • Better time/rate analysis • Closer cost control • Invaluable labor saving • Immediate cost recovery.

Pays for itself in 2 weeks

"SPIN-PIN"[®]

Close-up views of "SPIN-PIN" illustrate fast assembly of tailored-lead wire to terminal.

- No Training
- No Pliers
- No Clippings
- Uniform Crimps
- 22 Sizes

PAYS FOR ITSELF THE FIRST DAY!

\$500 EACH

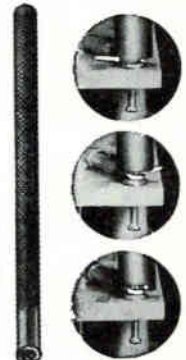

Write for illustrated book to Dept. E-9



BRUNO-NEW YORK INDUSTRIES CORP.
DESIGNERS & MANUFACTURERS OF ELECTRONIC EQUIPMENT
460 WEST 34th STREET • NEW YORK 1, N. Y.

Resistance

up to

100 Million

(1 × 10¹¹)

MEGOHMS!



High Voltage Resistors

From a miniature ¼ watt resistor, rated at 250 volts, to the 100 watt resistor, rated up to 125 KV.

Tapped resistors and matched pairs also available. Low temperature and voltage coefficients.

Few can match—and none can exceed—the stability and performance of rpc HIGH VOLTAGE RESISTORS! Ask anybody who uses them.

Tolerance—15% standard. 10%, 5% and 3% available. 2% in matched pairs.

Further information or engineering assistance gladly supplied.

RESISTANCE PRODUCTS COMPANY

914 S. 13th St., Harrisburg, Pa.

Sprague Electric Co. 21, 42, 43
Stackpole Carbon Co. 48
Stromberg-Carlson 101

Taylor Fibre Co. 41
Telrex Laboratories 87
* Texas Instruments, Incorporated
Semiconductor-Components Division 13

United Aircraft Corp.
Nordson Div. 7

* Vitramon, Inc. 77

* Westinghouse Electric
Corporation 8, 9

* See Advertisement in the July 20, 1960 issue of Electronics Buyers' Guide for complete line of products or services.

CLASSIFIED ADVERTISING

F. J. Eberle, Business Mgr.

PROFESSIONAL SERVICES 107

EMPLOYMENT OPPORTUNITIES. 107-112

ADVERTISERS INDEX

ACF 108
Boeing Airplane Co. 111
Esquire Personnel 112
I.B.M. 108
Lenkurt Electric Co., Inc. 107
Minneapolis Honeywell Ordnance Div. 110
Monarch Personnel 112
Philco Western Development Laboratories 110
Pisgah Mills, Inc. 112
Texas Instruments Incorporated. 109

This index and our Reader Service Numbers are published as a service. Every precaution is taken to make them accurate, but ELECTRONICS assumes no responsibilities for errors or omissions.

BRUCE A. WINNER, Advertising Sales Manager, R. S. QUINT, Assistant Advertising Sales Manager and Buyers' Guide Manager. FRED STEWART, Promotion Manager. RICHARD J. TOMLINSON, Production Manager. GEORGE E. POMEROY, Classified Manager. HUGH J. QUINN, Circulation Manager.

ADVERTISING REPRESENTATIVES

NEW YORK: Donald H. Miller, Henry M. Shaw, George F. Werner.
BOSTON: William S. Hodgkinson, Donald R. Furth.
PITTSBURGH: David M. Watson.
PHILADELPHIA: Warren H. Gardner, William J. Boyle.
CHICAGO: Harvey W. Wernecke, Martin J. Gallay.
CLEVELAND: P. T. Fegley.
SAN FRANCISCO: T. H. Carmody, R. C. Alcorn.
LOS ANGELES: Carl W. Dysinger, D. A. McMillan, Marshall Freeman.
DENVER: J. Patten.
ATLANTA: M. Miller.
DALLAS: Robert T. Wood.
LONDON: Edward E. Schirmer.
FRANKFURT: Stanley R. Kimes.
GENEVA: Michael R. Zeynel.

DIGGING FOR IDEAS?



If you're buying electronic equipment and components the best place to look is where the selection is the largest. Maybe there's a product or service you don't know about that will solve your problem.

The BUYERS' GUIDE is packed with ideas and facts that give you a better basis of buying judgment.

From accurate, up-to-date facts on current designs, materials and markets to detailed catalog information on new product types—the GUIDE puts you in a strong position to make the best buying choice for yourself and your company.

And there are the names and addresses of 4,000 manufacturers and their local offices so you can make your move most easily.

O.S.A.

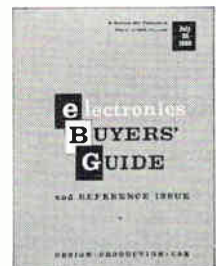

FIND
WHAT
YOU
NEED

IN
THE **electronics**
BUYERS' GUIDE

HERE'S WHY CALCULATING ENGINEERS USE KIN TEL DIGITAL VOLTMETERS

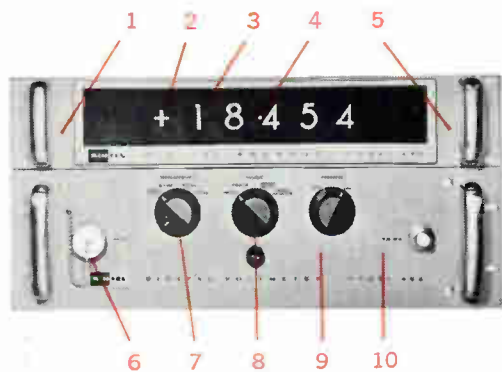

MODEL 501
DC DIGITAL VOLTMETER

1. Single-Plane Readout... no superimposed outlines of "off" digits... readout lamps have ten times longer life.
2. Automatic Polarity Indication... no lead switching.
3. Ten Times Greater Resolution at decade voltage points than other 4-digit voltmeters. A unique extra fifth digit in the left decade indicates "0" or "1" to provide 100% over-ranging.
4. Automatic Ranging... decimal point is automatically positioned for maximum resolution and accuracy.
5. Remote Readout Mounting... no electronic circuitry in readout allows easy remote mounting.
6. Floating Input... input may be floated above or below chassis ground... 10 megohms input impedance... input connectors on front and rear.
7. Adjustable Sensitivity... control permits decreasing sensitivity to allow reading of noisy signals... greatly increases instrument usefulness.
8. Built-in Printer Drive for parallel input printers... control permits either automatic operation when voltmeter reaches null, or remote operation by external contact closure.
9. Reliability... transistor drive circuits provide "cushioned" DC drive for stepping switches for long, trouble-free operation.
10. Accuracy... measures DC from ± 0.0001 to ± 1000.0 volts... continuous, automatic calibration against internal standard cell provides $0.01\% \pm 1$ digit (of reading) DC accuracy.

Price: \$2995

*These let you measure AC,
increase sensitivity,
measure ratios,
scan multiple inputs*

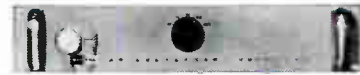

AC CONVERTER Price: \$850

The Model 452 AC converter can be added to the basic 501 DC digital voltmeter to permit 4-digit measurement of 0.001 to 999.9 volts AC, RMS, 30 to 10,000 cps. Accuracy is 0.2% of full scale and ranging is manual (auto-ranging models are available).



DC PREAMPLIFIER Price: \$1475

The Model 459 differential DC preamplifier has a gain of -100 which extends the DC sensitivity of KIN TEL digital voltmeters to 1 microvolt. Overall system accuracy when the 459 is used with a digital voltmeter is $0.15\% \pm 5$ microvolts. Input resistance is greater than 5 megohms, and input and output circuits are completely floating and isolated from each other and chassis ground. Common mode rejection is 180 db for DC and 130 db for 60 cps with up to 1000 ohms input unbalance. Input can be floated up to ± 250 volts.

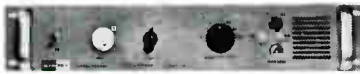

AC-DC PREAMPLIFIER Price: \$1225

The Model 458A is a single-ended preamplifier with a gain of -100 which extends the sensitivity of KIN TEL digital voltmeters to 1 microvolt DC, and 10 microvolts AC from 30 to 2000 cps. An additional $+1$ DC gain position provides $>10,000$ megohms input impedance and 0.001% gain accuracy.



DVM & RATIOMETER Price: \$3835

The Model 507B measures both DC voltages from ± 0.0001 to ± 1000.0 volts and DC/DC ratios from .0001:1 to 999.9:1. Ranging is automatic and accuracy is $0.01\% \pm 1$ digit both for ratios and voltage. Any external reference between 1 and 100 volts may be used for ratio measurements.

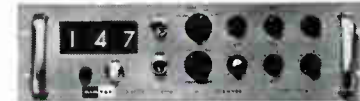

INPUT SCANNER Price: \$2500

The Model 453M master scanner automatically or manually scans up to 400 1-wire, 200 2-wire, or 100 4-wire inputs. Addition of a slave scanner (453S) permits scanning up to 1000 data points.

5725 Kearny Villa Road,
San Diego 11, Calif.

Phone: BRowning 7-6700
Representatives in all major cities

KIN TEL
A DIVISION OF
COHU
ELECTRONICS, INC.

New **RCA-7735 VIDICON** gives you all three...

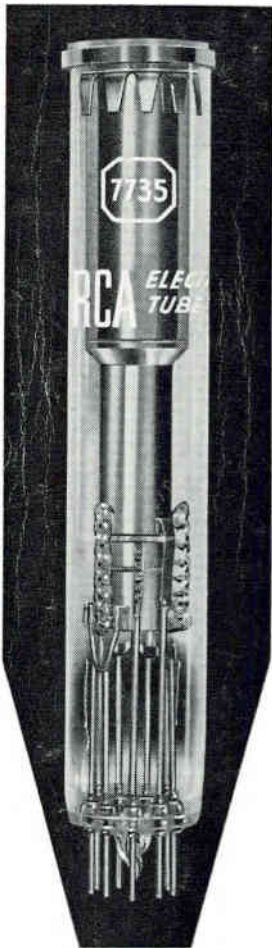

INCREASED
SENSITIVITY



HIGH
UNIFORMITY



LOW
LAG

For superior pictures under industrial lighting conditions....RCA-7735 is specifically tailored to industrial TV requirements. It can produce a good picture with as little as $\frac{1}{2}$ -foot-candle of illumination on the faceplate. The use of a photoconductor having high sensitivity, exceptional uniformity and low lag, makes this tube ideal for use in low-light level industrial applications.

A short, low-heater-power version—RCA-7262-A—is also available. Both tubes have a resolution capability of 600 lines and a spectral response covering the entire visible spectrum. Both use a glass-beaded gun structure. And tight manufacturing controls pay off in excellent tube-to-tube uniformity.

For complete information about either RCA-7735 or RCA-7262-A get in touch with the RCA Field Office nearest you, or write RCA Electron Tube Division, Commercial Engineering, Section H-19-Q-3, Harrison, N. J.

Visit the R.C.A. Exhibit at the WESCON Show



The Most Trusted Name in Electronics
® RADIO CORPORATION OF AMERICA